



**HAL**  
open science

# Directed homotopy and homology theories for geometric models of true concurrency

Jérémy Dubut

► **To cite this version:**

Jérémy Dubut. Directed homotopy and homology theories for geometric models of true concurrency. General Mathematics [math.GM]. Université Paris Saclay (COMUE), 2017. English. NNT : 2017SACLN032 . tel-01590515

**HAL Id: tel-01590515**

**<https://theses.hal.science/tel-01590515v1>**

Submitted on 19 Sep 2017

**HAL** is a multi-disciplinary open access archive for the deposit and dissemination of scientific research documents, whether they are published or not. The documents may come from teaching and research institutions in France or abroad, or from public or private research centers.

L'archive ouverte pluridisciplinaire **HAL**, est destinée au dépôt et à la diffusion de documents scientifiques de niveau recherche, publiés ou non, émanant des établissements d'enseignement et de recherche français ou étrangers, des laboratoires publics ou privés.

NNT : 2017SACLN032

THÈSE DE DOCTORAT  
DE  
L'UNIVERSITÉ PARIS-SACLAY  
PRÉPARÉE À  
L'ÉCOLE NORMALE SUPÉRIEURE DE CACHAN  
(ÉCOLE NORMALE SUPÉRIEURE PARIS-SACLAY)

ECOLE DOCTORALE N° 580  
Sciences et technologies de l'information et de la communication

Spécialité de doctorat : mathématiques et informatique

Par

**M. Jérémy Dubut**

Directed homotopy and homology theories  
for geometric models of true concurrency

**Thèse présentée et soutenue à Cachan, le 11/09/17 :**

**Composition du Jury :**

M. Eric Goubault	Professeur Ecole Polytechnique	Co-directeur de thèse
M. Jean Goubault-Larrecq	Professeur ENS Paris-Saclay	Directeur de thèse
Mme. Kathryn Hess	Professeure EPFL	Présidente
M. Steve Oudot	Chargé de Recherche INRIA	Examineur
M. Timothy Porter	Emeritus Professor Ex University of Bangor	Rapporteur
M. Martin Raussen	Professor Aalborg Universitet	Examineur
M. Robert J. van Glabbeek	Chief Research Scientist CSIRO	Rapporteur



# Remerciements

Je tiens tout d'abord à remercier les membres de mon jury: Tim pour sa relecture approfondie, ainsi que pour les corrections de mes nombreuses fautes d'anglais et contresens historiques que j'ai pu débiter ces dernières années et les quelques discussions qu'on a pu avoir à Palaiseau ; Rob aussi pour sa relecture approfondie, pour ses commentaires et pour nous faire l'honneur de faire ce long chemin depuis l'Australie ; Martin pour avoir accepté de faire partie de mon jury malgré le mauvais timing. J'aimerais aussi le remercier, avec Lisbeth, pour les nombreuses discussions, pour m'avoir accueilli à plusieurs reprises à Aalborg, pour m'avoir soutenu et donné à de nombreuses reprises la possibilité de présenter mes travaux lors de divers événements ACAT ; Kathryn pour avoir accepté de faire partie de mon jury, mais aussi pour m'avoir donné la possibilité de faire un stage en 2012 à l'EPFL et pour m'avoir soutenu ; Steve pour avoir accepté de faire partie de mon jury et pour les nombreuses discussions sur l'homologie persistante.

J'aimerais tout particulièrement remercier Jean et Eric, pour ces trois ans et demi (en réalité, cinq et demi) et leur inestimable travail d'encadrement. Je tiens surtout à les remercier de m'avoir donné la liberté d'apprendre et de comprendre ce que bon me semblait, mais aussi d'avoir su être exigeant quand il le fallait, quitte à être durs, notamment lorsqu'il a fallu écrire des articles ou préparer des exposés. Outre les nombreuses connaissances engrangées, je garderai de ces années sous leur direction les nombreuses et longues discussions (scientifiques ou non) au LSV avec Jean, les nombreux tableaux noircis à essayer de comprendre des théories obscures, et les margaritas avec Eric à Columbus.

J'aimerais aussi remercier tous mes collègues du LSV: tous les thésards, et notamment Marie (un peu notre grande sœur à tous), Simon (et Emilie ! pour les nombreux voyages Cachan-Chilly, et autres, cf. Nadine), Samy (pour les discussions en tout genre à la machine à café, et cf. Nadine), Patrick (pour les débats parfois un peu trollesques qui ont animé la vie de notre bureau pendant trois ans), Nathan (pour les discussions et le soutien mutuel sur les divers aspects pénibles, surtout administratifs, de la vie de doctorant), ... ; Catherine, Francis, Hugues, Imane, Thida et Virginie pour avoir rendu ma vie au LSV bien plus facile ; Anthony, Claudine, David, Etienne, Frédéric, Gilles, Hubert, Lucca et Sylvain avec qui j'ai apprécié enseigner ; tous les autres, pour avoir rendu la vie du LSV si agréable. Je tiens aussi à m'excuser auprès d'eux, et notamment mes co-bureaux (Benoit, Patrick, Pierre, Marie), pour mes discussions parfois un peu bruyantes avec Jean.

J'aimerais aussi remercier mes collègues de l'équipe cosynus au LIX (Sam, Manu, Sylvie, Uli, Eric, Nicolas, Jérémy, Bibek) pour les discussions à l'X et aux divers événements ACAT, mais aussi Evelyne pour l'aide administrative.

J'aimerais remercier les différents chercheurs avec qui j'ai apprécié discuter et collaborer au cours de ces trois années: Paul-André Melliès (pour m'avoir introduit au monde des catégories et de la topologie algébrique, et pour avoir accepté de faire parti de mon jury de mi-parcours) ; Sanjeevi Krishnan (pour nous avoir accueilli avec Eric à Columbus) ; Philippe Malbos (pour ses quelques visites sur Paris) ; Ichiro Hasuo, Shin-ya Katsumata et tout le MMSD group (pour m'avoir accueilli à Tokyo) ; l'équipe logique du LIPN et notamment Flavien Breuvert (pour m'avoir invité à leur séminaire).

J'aimerais remercier un certain nombre de personnes qui ont su me guider au cours de ma vie: Steeve et Cali, qui ont été comme des grands frères à une époque où je passais plus de temps à jouer au foot qu'autre chose ; l'instituteur remplaçant de CM2, qui m'a appris à raisonner de manière logique et à pratiquer l'origami ; Mme Rannou, professeure de mathématiques en Première et Terminale, qui

m'a redonné goût aux mathématiques ; M. Lafforgue, professeur de mathématiques en MPSI, qui m'a appris que bien souvent un dessin valait bien plus que des mots.

D'un point de vue plus personnel, je n'aurais pu tenir ces trois années (voire plus) sans les bouffées d'oxygène que m'ont procuré des personnes - des amis - extraordinaires. J'aimerais tous les remercier maintenant. Tout d'abord, la Nadine's family (Président, Présidente, Samy, Sarah, Seya, Joris, Romain, Davy, et j'en passe), qui, malgré le fait que je ne sois qu'une pièce rapportée, a égayé ces trois-quatre dernières années, à grands renforts de sushis (et autres plats typiques du régime alimentaire du cachanais) et de soirées jeux. Ensuite, j'aimerais remercier un peu pêle-mêle: Zubair, Thomas et Maxime, mes amis de prépa, mes compagnons de galère (a.k.a., colles) ; Hadrien et Luc, des camarades de promo, et des compagnons d'une autre galère (a.k.a., la prépa agreg) ; Julien (Shadoko), un autre camarade de promo, et son éternelle et communicative bonne humeur ; la famille Hilger, pour m'avoir recueilli à plusieurs reprises chez eux ; Makiko-sensei, pour m'avoir donné la motivation d'apprendre le japonais ; Yūko-san, pour m'avoir encouragé et m'avoir donné des nouvelles d'Osaka.

J'aimerais remercier Terry Pratchett et Nintendo pour avoir rendu les voyages en train ou en avion beaucoup moins longs, Scandal pour m'avoir donné la motivation d'écrire le présent mémoire, ADUM pour m'avoir rendu résilient et Aki pour m'avoir fait prendre quelques kilos.

Je ne pourrais terminer ces remerciements sans parler de ma famille. Je tiens à remercier: la famille Charvet, et tout particulièrement Mauricette, qui a toujours été prévenante avec moi, malgré ma faible présence aux événements familiaux ; mon beau-frère Patrick, pour m'avoir tout de suite considéré comme sa famille ; ma nièce Chloé, qui, malgré ses caprices, est toujours aussi attachante ; ma grande sœur Claire, qui a toujours su m'écouter et s'occuper de moi quand j'en avais besoin. Enfin, je ne saurais trop remercier mes parents, Alain et Catherine. Sans eux, je ne serais vraisemblablement jamais arrivé où j'en suis.

Au moment d'écrire ces dernières lignes de remerciements, je ne peux m'empêcher d'avoir une pensée pour Julien et Maurice, avec qui j'aurais aimé partager ces moments.

Le 15/08/17, à Chilly-Mazarin

# Contents

<b>Remerciements</b>	<b>i</b>
<b>Introduction</b>	<b>1</b>
<b>I Modeling Concurrency</b>	<b>7</b>
<b>1 Abstract models for true concurrency</b>	<b>9</b>
1.1 Transition systems and variants . . . . .	9
1.1.1 Traditional systems . . . . .	9
1.1.2 Asynchronous transition systems . . . . .	11
1.1.3 Transition system with independence . . . . .	14
1.2 Bisimulation behaviors . . . . .	16
1.2.1 Bisimulation of transition systems . . . . .	16
1.2.2 Game theoretical view . . . . .	17
1.2.3 Logical view . . . . .	17
1.2.4 Fibrational view . . . . .	17
1.2.5 Coalgebraic view . . . . .	19
1.3 Semantic for true concurrency . . . . .	20
1.3.1 Unfolding of transition systems . . . . .	20
1.3.2 Event structures and unfolding of TSI . . . . .	20
1.3.3 Bisimulations of event structures . . . . .	21
1.3.4 Action refinement . . . . .	21
1.4 Higher Dimensional Automata (HDA) . . . . .	22
1.4.1 The formalism . . . . .	22
1.4.2 Paths, homotopy and unfolding . . . . .	23
1.4.3 Bisimilarities . . . . .	25
1.5 SU and PV-programs . . . . .	25
1.5.1 SU-programs . . . . .	26
1.5.2 PV-programs . . . . .	27
<b>2 Modeling true concurrency geometrically</b>	<b>29</b>
2.1 Geometric realizations . . . . .	29
2.2 Several ways of modeling directedness . . . . .	31
2.2.1 PO-spaces . . . . .	32
2.2.2 Local PO-spaces . . . . .	33
2.2.3 Streams . . . . .	34
2.2.4 Dspaces . . . . .	36
2.2.5 Comparison . . . . .	39
2.3 Geometric view of true concurrency . . . . .	40
2.4 Trace spaces . . . . .	45

<b>3</b>	<b>General theory of bisimulations and unfoldings in accessible categories</b>	<b>47</b>
3.1	Categorical models and bisimilarities . . . . .	47
3.1.1	Category of models, subcategory of paths . . . . .	48
3.1.2	A relational bisimilarity of models: path-bisimilarity . . . . .	48
3.1.3	A fibrational bisimilarity of models: $\mathcal{P}$ -bisimilarity . . . . .	49
3.2	Accessible models and equivalence of bisimilarities . . . . .	49
3.3	Presheaf models . . . . .	51
3.4	Relationships with coreflections . . . . .	53
3.5	Unfoldings in accessible models . . . . .	54
3.5.1	$\mathcal{P}$ -unfolding and bisimilarity . . . . .	54
3.5.2	Unfolding is a right adjoint . . . . .	55
3.6	Unfoldings and universal coverings . . . . .	58
3.6.1	Coverings of groupoids . . . . .	58
3.6.2	Unfoldings and unique path lifting property . . . . .	58
<b>II</b>	<b>Dihomotopy Theories</b>	<b>63</b>
<b>4</b>	<b>Dihomotopy equivalences and the fundamental category</b>	<b>65</b>
4.1	Existing frameworks . . . . .	66
4.1.1	Non directed case . . . . .	66
4.1.2	Several extensions . . . . .	67
4.1.3	Examples of $I$ -dihomotopy equivalences . . . . .	68
4.2	Relation with the fundamental category . . . . .	69
4.2.1	Classical case and direct extension . . . . .	69
4.2.2	Localization of a category . . . . .	70
4.2.3	Groupoidification . . . . .	73
4.3	Inessential morphisms and the category of components . . . . .	74
4.3.1	Yoneda morphisms, inessential morphisms . . . . .	74
4.3.2	Calculus of fractions and localizations . . . . .	77
4.3.3	The category of components . . . . .	78
4.3.4	Equivalence with a quotient . . . . .	79
4.3.5	Hierarchy of equivalences between fundamental categories . . . . .	82
<b>5</b>	<b>Directed deformation retracts and the dihomotopy hypothesis</b>	<b>85</b>
5.1	The homotopy hypothesis . . . . .	85
5.1.1	Model structures . . . . .	85
5.1.2	Quillen-Serre model structure . . . . .	88
5.1.3	A modern formulation of the homotopy hypothesis . . . . .	89
5.2	Model structures for $(\infty, 1)$ -categories and first attempt . . . . .	91
5.2.1	Bergner model structure . . . . .	92
5.2.2	The trace and path categories . . . . .	94
5.2.3	Partially enriched categories . . . . .	96
5.3	Directed deformation retracts . . . . .	98
5.3.1	Inessential dipaths . . . . .	98
5.3.2	Deformation retracts: non-directed and reversible cases . . . . .	100
5.3.3	Inessential dipaths and deformations retracts . . . . .	101

<b>III</b>	<b>Directed Homology Theories via Diagrams and Open Maps</b>	<b>107</b>
<b>6</b>	<b>Directed homologies</b>	<b>109</b>
6.1	Classical homology and a few properties . . . . .	111
6.1.1	Definitions . . . . .	111
6.1.2	Homotopy invariance . . . . .	112
6.1.3	Hurewicz and Whitehead theorems . . . . .	112
6.1.4	Eilenberg-Steenrod axioms . . . . .	113
6.1.5	Computability . . . . .	114
6.2	Existing directed homologies . . . . .	115
6.3	Trace spaces and evolution . . . . .	115
6.4	Natural homotopy and homology . . . . .	117
6.5	Homology of diagrams . . . . .	120
6.5.1	Category of diagrams and functoriality . . . . .	120
6.5.2	(Co)completeness and additivity axiom . . . . .	121
6.5.3	Null objects and dimension axioms . . . . .	122
6.5.4	Semi-exact categories and exact sequences . . . . .	123
6.5.5	Homological categories and homology of diagrams . . . . .	125
6.5.6	About modularity and the exactness axiom . . . . .	127
6.5.7	About relative homology and short exact sequences . . . . .	128
<b>7</b>	<b>Bisimulations of diagrams</b>	<b>131</b>
7.1	Fibrational bisimilarity for diagrams . . . . .	131
7.2	Relational definition . . . . .	133
7.3	Diagrammatic Hennessy-Milner logic . . . . .	135
7.4	Unfolding and po-diagrams . . . . .	139
7.5	Grothendieck construction of a po-diagram . . . . .	141
7.5.1	Grothendieck construction of a po-diagram in modules . . . . .	141
7.5.2	Extending equivalence of categories to partially enriched categories . . . . .	142
7.5.3	Relating bisimulation and equivalence of Grothendieck construction . . . . .	145
7.6	Decidability . . . . .	146
7.6.1	The existential theory of some rings . . . . .	146
7.6.2	Theory of matrices . . . . .	146
7.6.3	Decidability in $\mathbb{R}$ . . . . .	147
7.6.4	The rational case . . . . .	147
7.6.5	Further discussions on integers . . . . .	148
7.6.6	Finitary diagrams and formulae . . . . .	148
7.6.7	Decidability of bisimilarity . . . . .	149
7.6.8	Decidability of the model checking . . . . .	151
<b>8</b>	<b>Homology and bisimulations</b>	<b>153</b>
8.1	First easy consequences of using bisimulations . . . . .	153
8.1.1	Equivalence of bimodules and natural systems . . . . .	153
8.1.2	Directed Hurewicz theorem . . . . .	154
8.1.3	A first homotopy axiom . . . . .	154
8.2	Cubical complexes . . . . .	155
8.3	Discrete homology of a cubical complex . . . . .	156



---

8.3.1	Discrete traces and homologies . . . . .	156
8.3.2	Construction of the functorial part . . . . .	157
8.3.3	Construction of the natural isomorphism part . . . . .	159
8.3.4	Consequences . . . . .	162
8.4	Relation with inessential equivalences, second homotopy axiom . . . . .	164
8.4.1	Traces vs dipaths, again . . . . .	164
8.4.2	Second homotopy axioms . . . . .	165
	<b>General conclusion</b>	<b>167</b>
	<b>Bibliography</b>	<b>171</b>
	<b>A Résumé en français</b>	<b>179</b>

# Introduction

Concurrent systems are a particular framework where different agents or processes evolve in the same environment. They must cohabit by managing the resources, avoiding conflicts. Verifying such programs is a difficult task: it is necessary to ensure that the system never goes wrong, regardless of its behaviors. One could apply classical methods from sequential systems, by checking every possible execution of the system, that is what is used in *interleaving* semantics for concurrency. However, the number of such executions grows exponentially with the size of the system, which make this method unpractical.

The idea of *true concurrency* is that several executions may have exactly the same behaviors because, for each agent, they correspond to the same execution, differing only by the way they are scheduled one from each other. This suggests that one should study not every possible execution, but every possible execution modulo an equivalence relation, relating executions that are only differing by permuting independent actions, which decreases greatly the number of execution to consider.

Surprisingly, the models for true concurrency are very geometric by nature: they have algebraic structure which can be interpreted topologically. Roughly speaking, such a system is a topological space of states, where executions are interpreted as “monotonous” (more precisely, *directed*) paths in this space, following the execution flow of the system. The equivalence relation on executions is then interpreted continuously: two executions, seen as directed paths, are equivalent if one can be continuously deformed into the other while preserving the direction of times, the execution flow.

This brings the idea that those models for true concurrency must be studied geometrically using tools from mathematics. Moreover, studying spaces, paths and continuous deformations of paths is one of the main ideas of a well known field in mathematics: algebraic topology. Intuitively, its goal is to study spaces up to continuous deformations using algebraic structures (categories, groups, modules, ...) that reflect the geometry of the space: paths, continuous deformations of paths, continuous deformations of continuous deformations, and so on.

The only difference with our study of truly concurrent system is the crucial role of the direction from execution flow. Everything should be compatible with this structure: paths must be directed, deformations must be in some way directed, and so on. This opens a new field of research: *directed algebraic topology*, where the main focus is to construct similar algebraic invariants for spaces with direction, defining suitable notions of deformations that are compatible with direction, and so on.

## True concurrency

The models for true concurrency were designed by extending the classical models of transition systems for interleaving semantics. The idea is to specify somehow that some actions are independent and can be done in any order, and in particular, *simultaneously*. A typical example is two agents  $A$  and  $B$ , making some computations and updating the value of some variables. For example, assume that there are two different variables  $X$  and  $Y$  and that  $A$  wants to update the value of  $X$  to 0, noted  $X := 0$ ;  $B$  wants to update the value of  $Y$  to 1, noted  $Y := 1$ . With a classical transition system, this concurrent system would be modeled as follow:

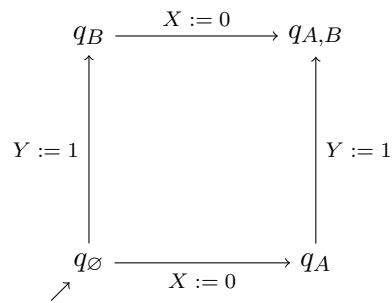

With this model, the different possible behavior are first  $A$  does its action then  $B$  or first  $B$  does its action then  $A$ , and those two behaviors are considered independently. However, with the idea from true concurrency, since  $A$  and  $B$  are updating different variables, there is no conflict or concurrence on the resources (here the variables). So, those two actions can be considered independent, meaning that doing first one then the other or in the other way makes no difference. Furthermore, those two actions can be made simultaneously.

There are several way to specify that actions are independent:

- the first basic idea is to define a relation directly on transitions depicting the fact that they are independent. This leads to the notion of *transition system with independence* [Nielsen 1994].
- the second idea is to regroup transitions that represent the same event. In the previous example, the two transitions labelled  $X := 0$  represent the same event “ $A$  update the value of  $X$  to 0”. One can then define an independence relation on those events, this leads to the notion of *asynchronous systems* [Shields 1985, Bednarczyk 1987].
- the last is to specify squares of transitions of the form:

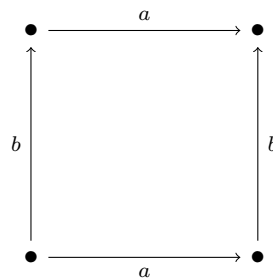

where  $a$  and  $b$  are independent actions and to add a formal square in the specification, depicted as follow:

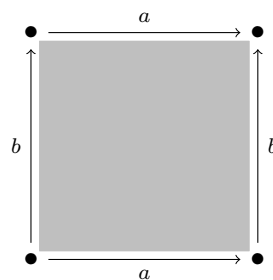

This idea can be extended to higher dimensional behaviors: one can specify  $n$ -dimensional cubes of transitions where parallel transitions are labelled by the same action, and all actions are independent to each other and add a formal  $n$ -dimensional cube in the specification. This leads to the notion of higher dimensional automata [Pratt 1991], (HDA for short).

All those models come with a way to compare them, defined with bisimulations, extending the work from classical transition systems.

## Modeling true concurrency with geometry

HDA are very geometrical by nature. They are specified as formal elements of any dimension representing independent behaviors of actions. Those formal objects must satisfy some boundary conditions: if you consider a subset of  $n - 1$  actions among  $n$  independent actions, then they must be independent. This allows one to interpret formal objects of dimension  $n$  as a geometrical cube of dimension  $n$  and the equations satisfied represent glueing conditions on those cubes. To summarize, from an HDA, it is possible to construct a topological space by glueing cubes together. This space represents the space of states of the HDA, and is called the *geometric realization*. For example, the square depicted above can be geometrically interpreted as a real square  $[0, 1] \times [0, 1]$ .

From this geometric interpretation, one can see executions as paths, that is, continuous functions from the segment  $[0, 1]$  to the geometric realization. The only problem is the directedness: an execution in HDA is directed by nature. It has a source and a target, and the transition can only go from the source to the target. Geometrically, a transition is modeled as a copy of the segment  $[0, 1]$  inside the geometric realization, the source being mapped on 0, the target on 1. The problem is that paths in  $[0, 1]$  are not directed (here, in the sense they are not monotonic), and so one can define a path from 1 to 0. Those paths cannot be interpreted as executions in the underlying HDA. So one must specify somehow some directedness on the geometric realization: the cubes  $[0, 1]^n$  used to construct the geometric realization are naturally directed. One can define a partial order on them as the product ordering. This local ordering on each cube can be extended to a directed structure on the whole geometric realization:

- either by following the idea from manifolds, that local orders which globally behave well. That leads to *local po-spaces* [Fajstrup 2003] and *streams* [Krishnan 2009],
- or by specifying a collection of paths that are locally monotonic. This leads to *d-spaces* [Grandis 2001].

Either way, this directed structure allows one to define *directed paths*, which are paths that are compatible with the directed structure, and that will model executions.

Following the idea from true concurrency, executions of HDA can be related using an equivalence relation interpreting that executions equal up to permutation of independent actions. It is called *homotopy* in [van Glabbeek 2005]. Geometrically, this can be modeled using the notion of *dihomotopy*, extending to a directed framework the notion of homotopy in topological spaces. Homotopy is the equivalence between paths of a space, relating paths that can continuously be deformed one from the other. Similarly, dihomotopy is the relation that relates two directed paths that can continuously be deformed one from the other, in such a way that the deformation must be somehow compatible with directedness.

## Directed algebraic topology

Spaces, paths, homotopies are studied in the so called field of *algebraic topology*. In algebraic topology, one studies spaces modulo continuous deformations, called *homotopy equivalences*. One can then construct algebraic invariants of homotopy equivalence: for example, paths modulo homotopy can be seen as the morphisms of a category, called the *fundamental category*, which is an invariant modulo equivalence of categories. More generally, higher order deformations (much as, continuous deformations between homotopies) provides group structures, called *homotopy groups*, which are invariants of homotopy equivalence. The problem with these algebraic invariants is that they are not easily computable. Other algebraic invariants were defined, extending the work on Euler characteristic: homology groups are Abelian groups that compute the number of “holes” of any dimension of a space. Those homology groups are computable. Although not complete, they are sufficiently precise in many cases.

The goal of *directed algebraic topology* is to extend this work on directed spaces, defining directed analogue of homotopy equivalence, homotopy groups and homology groups, and so on. The most notable work is the one from Grandis, compiled in the textbook [Grandis 2009] where all those constructions were done for a specific notion of directed homotopy equivalence. This work, however, fails to describe some behaviors that we would be interested for our study of truly concurrent systems.

Another thread can be found in [Fajstrup 2016], compiling 20 years of work of the authors. Notably, their work on trace spaces (a nice abstraction of the notion of execution in this context) and on directed components (extending the work on the fundamental category and path-connected components in a directed setting), was a solid basis for this thesis.

Another aspect is the work on model structures. Model structures are an abstract model for thinking about objects up to homotopies. The most known result on this subject [nLab 2017] is that the algebraic structure of topological spaces (with paths, homotopies, higher homotopies) can be reflected exactly by  $\infty$ -groupoids, that is, higher categories with objects, morphisms between objects, morphisms between morphisms and so on, where everything is invertible. This result is called the *homotopy hypothesis*. Porter made some development on the same ideas in the directed case, in [Porter 2008, Porter 2015], looking for a model structure for d-spaces through the theory of  $(\infty, 1)$ -categories.

## Outline

This thesis will focus mainly on the last aspect: constructing a coherent theory of homotopy equivalences and algebraic structures modeling homotopy and homology in the context of directed algebraic topology. The thesis will be structured in three parts.

- 1) In a first part, we will recall the models of true concurrency, either abstractly, or geometrically. In Chapter 1, we will investigate the abstract models extending transition systems: asynchronous transition systems, transition systems with independence and higher dimensional automata. We will study their bisimulations, namely, the ways to compare the behaviors of those systems. In Chapter 2, we will look at the geometric models. We will define the geometric realization and see an overview of the different way to add directedness on it. We will then see how states, executions, equivalence of executions modulo permutation of independent actions can be modeled geometrically. Finally, in Chapter 3, we will investigate the general notion of bisimilarity seen in Chapter 1, defined using lifting properties. This chapter will be independent of the rest of the thesis, and no particular focus on true concurrency and geometry

will be made. For this bisimilarity, we will study a general class of models for which several equivalent characterizations hold. We will also see that a general notion of unfolding can be defined in this context.

- II) In the second part, we will focus on the homotopy theory of directed spaces. In Chapter 4, we will see two notions of directed homotopy equivalences proposed in [Grandis 2009], the reversible and the directed one. We will see how they fail to capture some behaviors that we may want. We will also see what are their actions on the fundamental category and in what way this category is an invariant in terms of localizations. Finally, we will see a construction similar to the category of components from [Goubault 2007], which is in between the fundamental category and its groupoidification and which is much more convenient for our study. In Chapter 5, we will investigate the homotopy hypothesis and its possible extension to the directed case. We will see that the idea from [Porter 2015] to compare homotopy theory of directed spaces to  $(\infty, 1)$ -category is convenient when considering reversible equivalence, not more. We will then see how this can be slightly modified to take into account what reversible equivalence lacks, in particular using the category of components. Finally, we will design a notion of directed homotopy equivalence, the *inessential equivalence* based on the idea of deformation retracts and of inessentiality from [Goubault 2007]. This inessential equivalence will have all the properties we expected: the category of components will be an invariant, it will be in between reversible and directed equivalences, and they allow a directed homotopy hypothesis.
- III) In the third part, we will focus on homology theories of d-spaces. In Chapter 6, we will look at the classical theory of homology in topological spaces and overview its particular interesting properties, in particular, the Eilenberg-Steenrod axioms [Eilenberg 1945]. We will then define our directed homologies, bimodule and natural homologies, following the idea that it must look at trace spaces and their evolution with time. Finally, we investigate the Eilenberg-Steenrod axioms for this homology. In Chapter 7, we define a notion of bisimilarity of diagrams, following the theory of [Joyal 1996]. We prove a few equivalent characterizations following the ones in classical bisimulations and we prove the decidability of the existence of such a bisimulation in a particular case. Finally, in Chapter 8, we use this notion of bisimulation to compare diagrams of homology and homotopy defined in Chapter 6, allowing us to prove homotopy axioms, computability in a particular case and invariance by some action refinements.

## Publications

The materials for this thesis are based on four scientific publications:

- [Dubut 2015] is a conference paper at ICALP'15. It is the basis for the definition of our directed homology in Chapter 6, the definition of bisimulation of diagrams in Chapter 7 and the equivalence with a discrete definition of homology in Chapter 8.
- [Dubut 2016b] is a longer journal version of the previous paper, published in APCS. It develops the discussion about Eilenberg-Steenrod axioms of Chapter 6. These two papers received the first prize for “STIC Doctoral School Best Scientific Contribution” in 2016.
- [Dubut 2016c] is a conference paper at CSL'16. It is the basis of the new materials of Chapter 4 and 5, evoke the link between bisimulations and the Grothendieck construction of Chapter 7 and the second homotopy axiom of Chapter 8.

- [Dubut 2016a] is a conference paper at CONCUR'16. It is the materials of Chapter 3.

Part I

# Modeling Concurrency





# Abstract models for true concurrency

---

In this chapter, we look at classical models of true concurrency. Starting in Section 1.1.1 with classical transition systems and their interleaving semantics, we look at different ways to add true concurrency in the picture, especially by specifying that transitions, actions or events are independent (asynchronous systems 1.1.2, transition systems with independence 1.1.3). In Section 1.2, we look at bisimulations for transition systems: they are a classical way to say that two systems have the same computational behavior. We make an overview of the different equivalent formulations of this equivalence relation (game theoretic, logical, ...). After that, in Section 1.3 we look at extensions of bisimulations for true concurrency, in the case of transition systems with independence, by unfolding such systems to event structures. We also look at action refinements, an important feature of true concurrency in Section 1.3.4: if two systems are equivalent, they are equivalent whatever is the granularity of actions. In Section 1.4, we start our tour to geometry: higher dimensional automata are a powerful model for true concurrency which is geometric. Concurrent behaviors are modeled by higher-dimensional cells that can be interpreted geometrically as we will see in the next chapter. Finally, in Section 1.5, we describe two concrete languages, PV and SU-programs, and their translation in abstract models.

## 1.1 Transition systems and variants

In this section, we start by recalling a few transition systems for modeling concurrency, along with their executions and simulations.

### 1.1.1 Traditional systems

Transition systems are the simplest models of computations. They consist of a transition graph, that is, objects which represent the states of the system and transitions which model the change of state of the system due to particular events.

Fix a set  $\Sigma$ , called the **alphabet**. A  $(\Sigma)$ -**transition system** is a tuple  $T = (Q, i, \Delta)$  where:

- $Q$  is a set (of **states**),
- $i$  is a element of  $Q$  (called the **initial state**),
- $\Delta$  is a subset of  $Q \times \Sigma \times Q$  (**transitions**).

A **morphism  $f$  of transition systems** from  $T = (Q, i, \Delta)$  to  $S = (Q', i', \Delta')$  is a function

$$f : Q \longrightarrow Q'$$

such that:

- $f(i) = i'$ ,
- for every transition  $(q, a, q') \in \Delta$ ,  $(f(q), a, f(q')) \in \Delta'$ .

$\Sigma$ -transition systems, together with morphisms of transition systems form a category, noted  $\mathbf{Tr}(\Sigma)$ .

Morphisms act like particular simulations, in the sense that if  $f : T \rightarrow S$  is a morphism of transition systems, then  $S$  contains (at least) the computational behavior of  $T$ . First, executions of  $T$  can be simulated in  $S$ . To be more precise, an **execution** of  $T = (Q, i, \Delta)$  is a finite sequence:

$$q_0 \xrightarrow{a_1} q_1 \xrightarrow{a_2} \dots \xrightarrow{a_n} q_n$$

where  $q_0 = i$  is the initial state of  $T$  and for every  $j \in \{1, \dots, n\}$ ,  $(q_{j-1}, a_j, q_j) \in \Delta$ . Executions can be seen as particular morphisms. A **branch** is a transition system of the form  $B = (\mathbf{[n]}, 0, \Lambda)$  where:

- $\mathbf{[n]} = \{0, 1, \dots, n\}$ ,
- for every  $j \in \{1, \dots, n\}$ , there is a unique transition of the form  $(j-1, a_j, j)$  in  $\Lambda$ , for some  $a_1, \dots, a_n \in \Sigma$ .

Then an execution of  $T$  is exactly a morphism from a branch to  $T$ . So if  $p : B \rightarrow T$  is an execution of  $T$  and  $f : T \rightarrow S$  is a morphism of transition systems, then  $f \circ p$  is an execution of  $S$ . Actually, this statement can be made even more precise, by using the notion of **simulation**. A simulation from  $T = (Q, i, \Delta)$  to  $S = (Q', i', \Delta')$  is a relation  $R \subseteq Q \times Q'$  such that:

- $(i, i') \in R$ ,
- for every  $(q, q') \in R$ , and every transition  $(q, a, p)$  in  $T$ , there is a transition  $(q', a, p')$  in  $S$  such that  $(p, p') \in R$ .

When such a simulation exists, we say that  $T$  is **simulated by**  $S$ .

A morphism  $f : T \rightarrow S$  induces a simulation  $R = \{(q, f(q)) \mid q \in Q\}$ . When  $T$  is simulated by  $S$  then the executions of  $T$  are contained in the executions of  $S$ , but the converse is false. Consider for example, the following two transition systems:

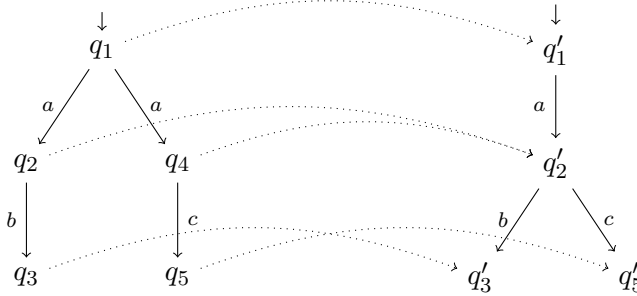

Figure 1.1: Two transition systems  $T$  (on the left) and  $S$  (on the right), and a morphism from  $T$  to  $S$

There is a morphism from  $T$  to  $S$  which maps  $q_2$  and  $q_4$  to  $q'_2$ , they have the same executions, namely  $0 \xrightarrow{a} 1 \xrightarrow{b} 2$  and  $0 \xrightarrow{a} 1 \xrightarrow{c} 2$ , but there is no simulation from  $S$  to  $T$ . Indeed, if there were some, say  $R$ , we must have  $(q'_1, q_1) \in R$ . Then since  $(q'_1, a, q'_2)$  is a transition of  $S$  there must be  $q$  state of  $T$  and a transition  $(q_1, a, q)$  in  $T$  with  $(q'_2, q) \in R$ . So  $q$  can only be  $q_2$  or  $q_4$ . If it is  $q_2$ , since  $(q'_2, c, q'_5)$  is a transition of  $S$ , there must be a transition  $(q_2, c, q')$  in  $T$  for some  $q'$ , which is not the case. Similarly if it is  $q_4$ .

Transition systems can model interleaving behaviors of concurrency. Let us illustrate this on an example. Assume that we have two processes  $A$  and  $B$  executing in parallel.  $A$  wants to change

the value of a variable  $X$  to 0 and  $B$  wants to change the value of  $Y$  to 1. The behavior of those processes can be modeled by the following transition system:

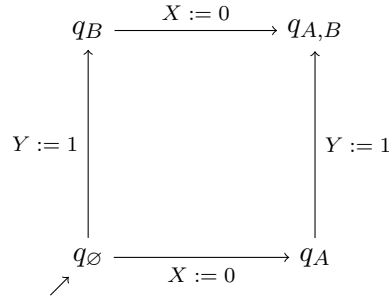

Figure 1.2: A transition system modeling two processes executing an action in parallel

Intuitively,  $q_\emptyset$  corresponds to the state where neither  $A$  nor  $B$  have done their action,  $q_A$  (resp.  $q_B$ ) to the state where  $A$  (resp.  $B$ ) has done its action but not  $B$  (resp.  $A$ ), and  $q_{A,B}$  to the state where both  $A$  and  $B$  have done their action. So the different behaviors modeled by this transition system are that  $A$  can do its action before  $B$  or vice versa, that is, executions of this system are interleaving of executions of  $A$  and  $B$ . There is no way to model that  $A$  and  $B$  execute *simultaneously*.

### 1.1.2 Asynchronous transition systems

To solve this problem, one extends the notion of executions to take into account that two actions can be made simultaneously. But one must be careful because not just any actions can be executed simultaneously. Indeed, in the first example, if  $X$  and  $Y$  are the same variable, executing  $X := 0$  and  $Y := 1$  may lead to unexpected results. So one must declare beforehand which are the actions that can be done simultaneously.

A  $(\Sigma)$ -**asynchronous transition system** [Shields 1985, Bednarczyk 1987]  $(Q, i, \Delta, \lambda, I)$  is the following data:

- a function  $\lambda : E \rightarrow \Sigma$ .  $E$  is called the set of **events** and  $\lambda$  associates an event with the action it induces.
- a  $E$ -transition system  $(Q, i, \Delta \subseteq Q \times E \times Q)$ ,
- an irreflexive and symmetric relation  $I \subseteq E^2$  (**independence relation**),

such that:

- i) for every  $e \in E$ , there are states  $q, q' \in Q$  with  $(q, e, q') \in \Delta$ ,
- ii) for every pair  $(q, e, q')$  and  $(q, e, q'')$  of transitions,  $q' = q''$ ,
- iii) for every pair  $(q, e, q')$  and  $(q, e', q'')$  of transitions with  $(e, e') \in I$ , there is a pair of transitions  $(q', e', p)$  and  $(q'', e, p)$  for some state  $p$ ,

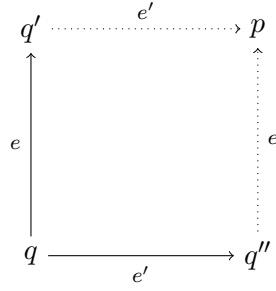

- iv) for every pair  $(q, e, q')$  and  $(q', e', q'')$  of transitions with  $(e, e') \in I$ , there is a pair of transitions  $(q, e', p)$  and  $(p, e, q'')$  for some state  $p$ .

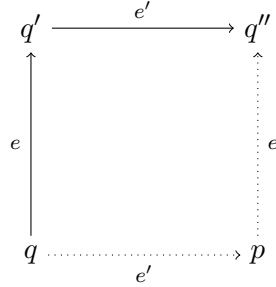

An asynchronous transition system is then a transition system which is deterministic with respect to events and for which one can declare that two events can occur simultaneously. Indeed, if two events are independent, the axioms *iii*) and *iv*) provide that those events can occur in any order, in particular simultaneously.

A **morphism**  $(f, g)$  of asynchronous transition systems from  $(Q, i, \Delta, \lambda : E \rightarrow \Sigma, I)$  to  $(Q', i', \Delta', \lambda' : E' \rightarrow \Sigma, I')$  is a pair of functions  $f : Q \rightarrow Q'$  and  $g : E \rightarrow E'$  such that:

- $\lambda' \circ g = \lambda$ ,
- $f(i) = i'$ ,
- for every transition  $(q, e, q') \in \Delta$ ,  $(f(q), g(e), f(q')) \in \Delta'$ .

We note  $\mathbf{ATr}(\Sigma)$  the category of asynchronous transition systems and morphisms of transition systems.

We can now update the example of the introduction of this section. In this case, events are actions. We need to declare an independence relation on the set of events  $\{X := 0, Y := 1\}$ . If  $X$  and  $Y$  are distinct variables, we can execute both events simultaneously and we can define  $I = \{(X := 0, Y := 1), (Y := 1, X := 0)\}$ .

The interest of events over actions is that we can model the following behavior:

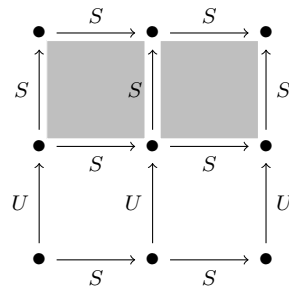

You may think it as two processes executing actions in parallel, which are of two kinds  $S$  and  $U$  (see later for their actual meaning), such that  $U$  and  $S$  cannot be executed simultaneously, but  $U$  and  $U$  (resp.  $S$  and  $S$ ) can. So we will be able to model it with this asynchronous transition system:

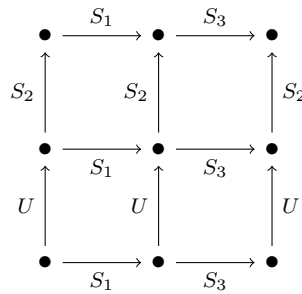

with  $S_1$ ,  $S_2$  and  $S_3$  pairwise independent. Intuitively, the event  $S_1$  (resp.  $S_3$ ) means that the first process executes its first (resp. second)  $S$  action, while  $S_2$  means that the second process executes its  $S$  action. So for example, every  $S_1$ -transition models the same event whose induced action is an  $S$ -action. They only differ on where the second process is in its own execution.

We can now extend the notion of executions to handle simultaneous behaviors. A **trace** on  $\Sigma$  is a word on  $\text{Mul}(\Sigma)$  the set of finite multisets of  $\Sigma$ . A **trace language**  $M$  is a set of traces on  $\Sigma$  such that:

- if  $u.S \in M$ , with  $S \in \text{Mul}(\Sigma)$  and  $u$  a trace, then  $u \in M$  (closure under prefix).
- if  $u.(S_1 + S_2).v \in M$ , with  $S_1, S_2 \in \text{Mul}(\Sigma)$  and  $u, v$  traces, then  $u.S_1.S_2.v \in M$ .

An asynchronous transition system induces a trace language as follow. Define a **cube** as an asynchronous transition system of the form:

- its states are  $\{0, 1\}^n$  for some  $n$ ,
- its initial state is  $(0, \dots, 0)$ ,
- its set of events is  $\{1, \dots, n\}$ ,
- its transitions are of the form  $(v, i, v + e_i)$  where  $e_i$  is the vector with 0 everywhere except the  $i$ th coordinate which is 1,
- $I$  is  $\{(i, j) \mid i \neq j\}$ ,
- $\lambda$  is anything you want.

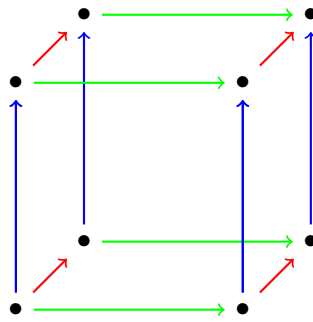

Figure 1.3: A cube for  $n = 3$  ; each color corresponds to an event.

An **asynchronous branch** is then the concatenation of cubes (identifying the upper corner of one cube with the lower corner of the following). For example, this is an asynchronous branch:

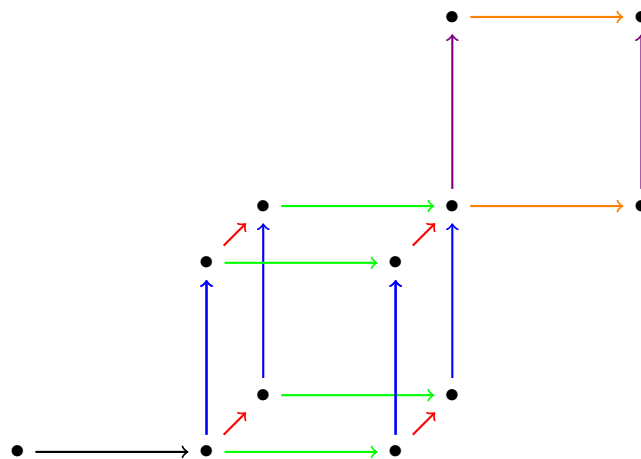

Figure 1.4: An asynchronous branch.

The trace induced by an asynchronous branch  $c_1, \dots, c_n$  is defined as  $S_1 \dots S_n$  where  $S_i$  is the image of the  $\lambda$  function in the cube  $c_i$ . An asynchronous execution of an asynchronous transition system  $T$  is a morphism from an asynchronous branch to  $T$ . The trace language induced by  $T$  is then the set of traces induced by its asynchronous executions (it is easy to check that it is actually a trace language). When there is a morphism from  $T$  to  $S$  then the trace language of  $T$  is included in  $S$ .

The idea is similar to Mazurkiewicz traces [Mazurkiewicz 1989], although the definition is a bit different.

### 1.1.3 Transition system with independence

In asynchronous transition systems, we specify simultaneity by refining the notion of actions by, intuitively, regrouping transitions which represent the same event, possibly in a different context. Those events were explicit and independence was defined on those events. In this subsection, we present an extension of transition systems from [Nielsen 1994] in which one can define independence directly on transitions and where events are implicit and can be defined afterwards.

A **transition system with independence**  $(Q, i, \Delta, I)$  is:

- a  $\Sigma$ -transition system  $(Q, i, \Delta)$ ,
- an irreflexive symmetric relation  $I \subseteq \Delta^2$  (**independence relation**).

Define  $\prec \subseteq \Delta \times \Delta$  as:

$$(q, a, q') \prec (p, a, p') \text{ iff } \exists b. ((q, a, q'), (q, b, p)), ((q, a, q'), (q', b, p')), ((q, b, p), (p, a, p')) \in I$$

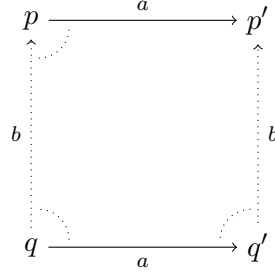

and let  $\sim$  be the least equivalence relation which contains  $\prec$ . We call **events** the equivalence classes of  $\sim$ . Those data must satisfy the following properties:

- if  $(q, a, q') \sim (q, a, q'')$ , then  $q' = q''$ ,
- if  $((q, a, q'), (q', b, q'')) \in I$ , then there exists a state  $p$  such that  $((q, a, q'), (q, b, p)) \in I$  and  $((q, b, p), (p, a, q'')) \in I$ ,

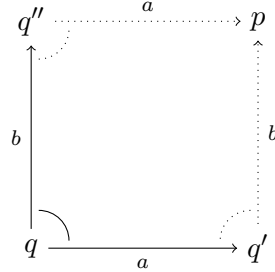

- if  $(q, a, q') \prec (p, a, p')$  and  $((p, a, p'), (s, b, s')) \in I$ , then  $((q, a, q'), (s, b, s')) \in I$ ,
- if  $(q, a, q') \prec (p, a, p')$  and  $((q, a, q'), (s, b, s')) \in I$ , then  $((p, a, p'), (s, b, s')) \in I$ .

The small arcs in the two previous pictures denote that the transitions linked by it are independent. Axiom *i*) means that those systems are deterministic with respect to events. Axiom *ii*) is the property we expect of independence, that is, if two transitions are independent, they can be done in any order we want. Axioms *iii*) and *iv*) mean that independence can be defined on events, that is, is compatible with  $\sim$ . With those events and this extended independence relation, one defines an asynchronous transition system. The diamonds given by axiom *ii*) give rise to a relation on executions, namely, the smallest equivalence relation  $\simeq$  on executions which relates execution of the form:

$$\begin{aligned} q_0 \xrightarrow{a_1} q_1 \longrightarrow \dots q_i \xrightarrow{a_{i+1}} q_{i+1} \xrightarrow{a_{i+2}} q_{i+2} \longrightarrow \dots \xrightarrow{a_n} q_n \\ q_0 \xrightarrow{a_1} q_1 \longrightarrow \dots q_i \xrightarrow{a_{i+2}} q'_{i+1} \xrightarrow{a_{i+1}} q_{i+2} \longrightarrow \dots \xrightarrow{a_n} q_n \end{aligned}$$



with the following diamond:

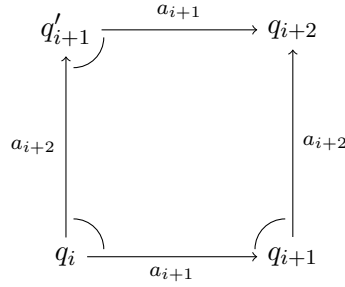

## 1.2 Bisimulation behaviors

Until now, we have seen how to describe that a system has more behaviors than another, either by comparing their set of executions, or by using simulations. One can define that two systems are equivalent by symmetrizing simulations or inclusions. But we actually do not get some behaviors. For example, take those two transition systems:

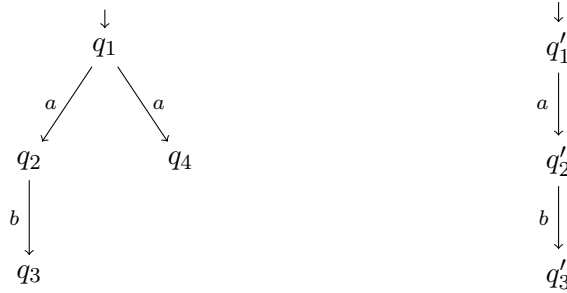

Those two simulate each other (their are actually morphisms in both directions). But in the left one, one can do an  $a$  and then be in a state where nothing can be done, in particular no  $b$ . This cannot occur in the right one. The reason why simulations cannot detect this behavior is because one first chooses a system and then tries to simulate its behavior in the other, while we would like to start in one, try to simulate it and then possibly change the system. This will distinguish those two systems. Indeed, start from the left one, do an  $a$  action and go to the state  $q_4$ . You must simulate this action by doing the only  $a$  action in the right one. Then switch to the right one and do a  $b$  action. You cannot simulate this action in the left one. We will be able to do this by using the notion of bisimulation. In this section, we make an overview of different possible equivalent view of bisimilarity.

### 1.2.1 Bisimulation of transition systems

A **bisimulation** [Park 1981] between  $T = (Q, i, \Delta)$  and  $S = (Q', i', \Delta')$  is a relation  $R \subseteq Q \times Q'$  such that:

- $(i, i') \in R$ ,
- for every  $(q, q') \in R$ , and every transition  $(q, a, p)$  in  $T$ , there is a transition  $(q', a, p')$  in  $S$  such that  $(p, p') \in R$ ,

- for every  $(q, q') \in R$ , and every transition  $(q', a, p')$  in  $S$ , there is a transition  $(q, a, p)$  in  $T$  such that  $(p, p') \in R$ .

When such a bisimulation exists, we say that  $T$  and  $S$  are **bisimilar**. For example, the two previous systems are not bisimilar.

### 1.2.2 Game theoretical view

First, a game theoretical view from [Stirling 1996] formalizes the intuition we gave in the previous subsection. Given two transition systems  $T = (Q, i, \Delta)$  and  $S = (Q', i', \Delta')$ , we consider the following game with two players **Attacker** and **Defender**:

- Start with  $(p, q) := (i, i')$ , and repeat the following steps.
- **Attacker** chooses  $T$  or  $S$ . Assume that he chooses  $T$ , the other case is symmetric.
- **Attacker** chooses a transition from  $p$  in  $T$ , say  $(p, a, p')$ .
- **Defender** chooses a transition from  $q$  in  $S$  of the form  $(q, a, q')$ . If he cannot, he loses.
- Pose  $(p, q) := (p', q')$ .

Then  $T$  and  $S$  are bisimilar if and only if **Defender** has a strategy to never lose.

### 1.2.3 Logical view

We consider the logic, called Hennessy-Milner logics [Hennessy 1980], whose formulae are those generated by the following grammar:

$$\phi ::= \langle a \rangle \phi \mid \neg \phi \mid \bigwedge_{i \in I} \phi_i \quad a \in \Sigma, I \text{ a set}$$

Let  $T = (Q, i, \Delta)$  be a transition system. We define that a state  $p$  satisfies a formula  $\phi$  and note  $p \models \phi$  by induction on  $\phi$ :

- $p \models \langle a \rangle \phi$  iff there is a transition  $(p, a, p') \in \Delta$  such that  $p' \models \phi$ ,
- $p \models \neg \phi$  iff  $p \not\models \phi$ ,
- $p \models \bigwedge_{i \in I} \phi_i$  iff for all  $i \in I$ ,  $p \models \phi_i$ .

We say that  $T$  satisfies  $\phi$  and note  $T \models \phi$  iff  $i \models \phi$ .

It characterizes bisimulations in the following sense:  $T$  and  $S$  are bisimilar iff for every formula  $\phi$ ,  $(T \models \phi \text{ iff } S \models \phi)$ .

### 1.2.4 Fibrational view

We have already defined branches in Section 1.1.1. Note  $\mathbf{Br}(\Sigma)$  the full subcategory of  $\mathbf{Tr}(\Sigma)$  whose objects are branches. As observed previously, morphisms of transition systems are particular simulations. Do we have a similar result for bisimulations? The answer is yes, in the condition that a morphism lift executions.

For example, come back to the case of those two non-bisimilar transition systems:

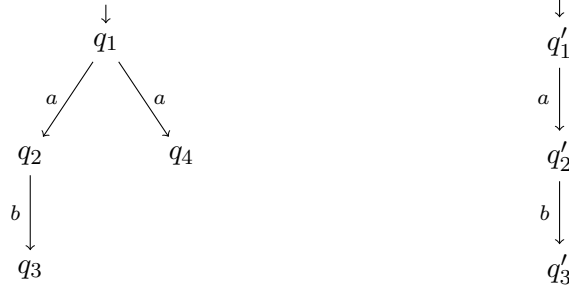

We have said that there are morphisms in both direction. From right to left, we have the inclusion into the left branch. This morphism does not lift the right  $a$  transition, i.e., there is no  $a$  transition of the system on the right that is mapped on the right  $a$  transition of the left system. From left to right, this is the only possible “projection”. This morphism maps the right  $a$  transition of the left system to the only  $a$  transition of the right system. The latter can be extended by a  $b$  transition, while the first cannot. This says that the  $a - b$  execution of the right system cannot be lifted by this morphism on a  $a - b$  execution of the right one, starting with the right  $a$  transition.

This idea is formalized using the notion of open morphism. We say that a morphism  $f : T \rightarrow S$  is **open** if for every diagram of the form:

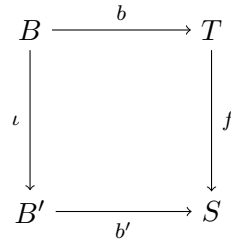

with  $B$  and  $B'$  branches, there is an execution  $\theta : B' \rightarrow T$  such that:

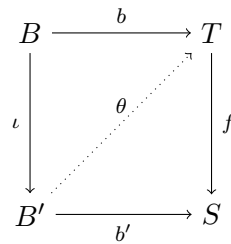

When there is an open morphism  $f : T \rightarrow S$ , then  $T$  and  $S$  are bisimilar. Indeed, the relation  $R = \{(p, f(p)) \mid p \text{ is accessible}\}$ , where we say that  $p$  is accessible iff there is an execution  $b : B \rightarrow T$  of size  $n$  with  $b(n) = p$ , is a bisimulation.

This result can be strengthened as follow: two systems  $T$  and  $S$  are bisimilar iff there is a span of open maps between them, i.e., there are a system  $U$  and open maps  $f : U \rightarrow T$  and  $g : U \rightarrow S$ . We have already seen that open morphisms induce bisimulations so if there is a span of open maps between two systems, they are bisimilar. Reciprocally, if  $R$  is a bisimulation between  $T$  and  $S$ , define  $U = (R, (i, i'), \Delta'')$  where  $\Delta'' = \{(p, q, a, (p', q')) \mid (p, a, p') \in \Delta \wedge (q, a, q') \in \Delta'\}$ , and  $f$  (resp.  $g$ ) being the first (resp. second) projection. It is easy to check that  $f$  and  $g$  are open.

This view was developed in [Joyal 1996] and was applied in other models than transition systems. We will see other occurrences of this theory later on.

### 1.2.5 Coalgebraic view

This starts with the following observation [Jacobs 2016]: a transition system is a set  $Q$  of states together with two functions

- $i : * \rightarrow Q$ , where  $*$  is a singleton (initial state),
- $\Delta : Q \rightarrow \mathcal{P}(\Sigma \times Q)$ , where  $\mathcal{P}(X)$  is the set of subsets of  $X$  (transitions).

So a transition system consists of a bialgebra  $* \rightarrow Q \rightarrow \mathcal{P}(\Sigma \times Q)$ , more precisely, a set  $Q$ , an  $F$ -algebra on  $Q$  with

$$F : \mathbf{Set} \rightarrow \mathbf{Set} \quad X \mapsto *$$

and a  $G$ -coalgebra on  $Q$  with

$$G : \mathbf{Set} \rightarrow \mathbf{Set} \quad X \mapsto \mathcal{P}(\Sigma \times X)$$

Given two endofunctors on the same category  $\mathcal{C}$ ,  $F, G$ -bialgebras form a category whose morphisms from  $F(X) \xrightarrow{f_1} X \xrightarrow{f_2} G(X)$  to  $F(Y) \xrightarrow{g_1} Y \xrightarrow{g_2} G(Y)$  are morphisms  $h$  of  $\mathcal{C}$  from  $X$  to  $Y$  such that:

$$\begin{array}{ccccc} F(X) & \xrightarrow{f_1} & X & \xrightarrow{f_2} & G(X) \\ \downarrow F(h) & & \downarrow h & & \downarrow G(h) \\ F(Y) & \xrightarrow{g_1} & Y & \xrightarrow{g_2} & G(Y) \end{array}$$

In the case of transition systems seen as  $F, G$ -bialgebras, a morphism  $f$  of  $F, G$ -bialgebra from  $T$  to  $S$  is a morphism of transition systems with the extra property that for every transition of the form  $(f(p), a, q')$  in  $S$ , there is a transition  $(p, a, p')$  in  $T$  with  $f(p') = q'$ . In this case, morphisms of  $F, G$ -bialgebra do not coincide with open morphisms. They will when every state of  $T$  is accessible. So a similar result holds: two transition systems are bisimilar iff there is a span of  $F, G$ -bialgebras morphisms between them.

$$\begin{array}{ccccc} F(X) & \xrightarrow{f_1} & X & \xrightarrow{f_2} & G(X) \\ \uparrow F(h_1) & & \uparrow h_1 & & \uparrow G(h_1) \\ F(R) & \xrightarrow{k_1} & R & \xrightarrow{k_2} & G(R) \\ \downarrow F(h_2) & & \downarrow h_2 & & \downarrow G(h_2) \\ F(Y) & \xrightarrow{g_1} & Y & \xrightarrow{g_2} & G(Y) \end{array}$$

### 1.3 Semantic for true concurrency

In this section, we see how bisimilarity can be defined in true concurrency: this will involve unfolding and event structures. We end the section with a discussion of the notion of actions and its refinements.

#### 1.3.1 Unfolding of transition systems

The unfolding of a transition system is an equivalent system without loops, obtained by “unfolding” the loops. More precisely, it is a synchronisation tree which is bisimilar to the transition system. Given a transition system  $T = (Q, i, \Delta)$ , the unfolding  $\text{Unfold}(T)$  of  $T$  is the transition system  $(P, j, \Gamma)$  where:

- $P = \{(q_0, a_1, q_1, \dots, a_n, q_n) \mid q_i \in Q, a_i \in \Sigma, (q_i, a_{i+1}, q_{i+1}) \in \Delta \wedge q_0 = i\}$
- $j = (i)$
- $\Gamma = \{((q_0, a_1, q_1, \dots, a_n, q_n), b, (q_0, a_1, q_1, \dots, a_n, q_n, b, q)) \mid (q_n, b, q) \in \Delta\}$

It is easy to check that  $\{(q_n, (q_0, a_1, q_1, \dots, a_n, q_n)) \mid (q_0, a_1, q_1, \dots, a_n, q_n) \in P \wedge q_0 = i\}$  is a bisimulation between  $T$  and  $\text{Unfold}(T)$ .

Equivalently, the unfolding of  $T$  can be defined as a glueing of all branches of  $T$ , i.e., in terms of colimits. We will look at a generalization to other categories of systems in Chapter 3. Unfolding is then the right adjoint of the inclusion of trees in these systems.

#### 1.3.2 Event structures and unfolding of TSI

This will be similar in transition systems with independence: unfolding is the right adjoint of some inclusion. Event structures will play the role of trees in this case. A ( $\Sigma$ -labelled) **event structure** is a tuple  $S = (E, \leq, \text{Cons}, \lambda)$  where:

- a set  $E$  of **events**,
- a partial order  $\leq$  on  $E$ , called the **causal dependency order**,
- a set  $\text{Cons}$  of finite subsets of  $E$ , called the **consistency relation**,
- a function  $\lambda : E \rightarrow \Sigma$ , the **labelling**.

which satisfies that:

- for every event  $e$ , the set  $\{e' \mid e' \leq e\}$  is finite (finite cause),
- for every event  $e$ ,  $\{e\} \in \text{Cons}$ ,
- if  $Y \subseteq X$  and  $X \in \text{Cons}$ , then  $Y \in \text{Cons}$ ,
- if  $X \in \text{Cons}$ , for every pair of events  $e \leq e'$  with  $e' \in X$ ,  $X \cup \{e\} \in \text{Cons}$ .

An event structure induces a transition system with independence as follow:

- its states are the **configurations**, that is finite downward-closed sets  $C$  of events in  $\text{Cons}$ ,
- transitions are triples  $(C, a, C')$  such that  $C' = C \sqcup \{e\}$  with  $\lambda(e) = a$ ,
- its initial state is the empty set,

- the independence relation is the set of pairs  $((C, a, C'), (D, b, D'))$  such that if  $C' = C \sqcup \{e\}$  and  $D' = D \sqcup \{e'\}$ ,  $e$  and  $e'$  are **concurrent** meaning that  $e \not\leq e'$ ,  $e' \not\leq e$  and  $\{e, e'\} \in \text{Cons}$ .

This construction extends to a coreflexion from a category of event structures to a category of transition systems with independence [Nielsen 1994]. Its right adjoint is what is called the **unfolding**. Intuitively, it is constructed as a system whose states are executions modulo  $\simeq$ .

### 1.3.3 Bisimulations of event structures

Bisimulations of event structures thus induce bisimulations on transition systems with independence through this unfolding. A **history-preserving bisimulation** [Rabinovitch 1988] between two event structures  $S$  and  $T$  consists of a set  $R$  of triples  $(C, f, C')$  with  $C$  a configuration of  $S$ ,  $C'$  a configuration of  $T$  and  $f : C \rightarrow C'$  an isomorphism of posets, such that:

- $(\emptyset, \emptyset, \emptyset) \in R$ ,
- for every  $(C, f, C') \in R$ , for every event  $e$  such that  $C \sqcup \{e\}$  is a configuration with  $\lambda(e) = a$ , there is an event  $e'$  such that  $C' \sqcup \{e'\}$  is a configuration with  $\lambda(e') = a$ , and there is an isomorphism of posets  $f' : C \cup \{e\} \rightarrow C' \cup \{e'\}$  that extends  $f$  and such that  $(C \cup \{e\}, f', C' \cup \{e'\}) \in R$ ,
- symmetrically.

We say that  $R$  is **strong** if furthermore:

- if  $(C, f, C') \in R$ ,  $D \subseteq C$  and if  $f' : D \rightarrow D'$  is the restriction of  $f$  on  $D$ , then  $(D, f', D') \in R$ ,
- symmetrically.

We then say that two event structures are **(strong) hp bisimilar** if there is a (strong) history-preserving bisimulation between them. By extension, we say that two transition systems with independence are **(strong) hp bisimilar** if their unfoldings are. Equivalent definitions of hp bisimilarity and strong hp bisimilarity were investigated in [Joyal 1996], in particular a logical view, a more classical definition using relations directly on the system, not on the unfolding, and a fibrational view.

### 1.3.4 Action refinement

Until now, we have seen bisimulations as equivalence relations of systems with specified actions. But the notion of actions depends on the degree of abstractions. For example, summing two integers can be seen as an action on its own or as a sequence of smaller operations on digits. So a system can be modeled in different ways, depending on how fine-grained the actions are considered. An important property for systems and their bisimulations is that if two systems are bisimilar, then they must be bisimilar whatever is the granularity of actions.

Let us look at an easy example. Let  $T = (Q, i, \Delta)$  be a  $\Sigma$ -transition system and  $a \in \Sigma$ . Suppose that the action  $a$  can be decomposed into a finite sequence of smaller actions  $a_1, \dots, a_n$ . We can transform  $T$  into another transition system  $T'$  by replacing every transition  $(q, a, q') \in \Delta$  by a sequence of transitions  $(q, a_1, q_1), \dots, (q_i, a_{i+1}, q_{i+1}), \dots, (q_{n-1}, a_n, q')$ , where  $q_1, \dots, q_{n-1}$  are fresh new states. It is then easy to prove that if two transition systems  $T$  and  $S$  are bisimilar, then  $T'$  and  $S'$  obtained by replacing  $a$  by  $a_1, \dots, a_n$  are bisimilar.

This example is simple, because we only replace some actions by a linear sequence of actions, but we may imagine replacing actions by any transition system (with a final state).

This idea of replacing actions by more complicated objects have been formalized for event structures in [van Glabbeek 2001]. A **refinement function**  $\text{ref}$  is a function from  $\Sigma$  to particular event structures (namely **prime** event structures). One can then refine an event structure by modifying events in such a way that action  $a$  of  $\Sigma$  is decomposed into actions of  $\text{ref}(a)$ . One of the main result from [van Glabbeek 2001] is that if two event structures are (strong) bisimilar then their refinements by any refinement function are (strong) hp bisimilar. We say that (strong) hp bisimilarity is invariant under action refinement.

## 1.4 Higher Dimensional Automata (HDA)

In Sections 1.1.2 and 1.1.3, we have seen extensions of transition systems in which we specify transitions or events that are independent. This independence allows us to specify that two actions are done simultaneously, and can be depicted by squares of the form:

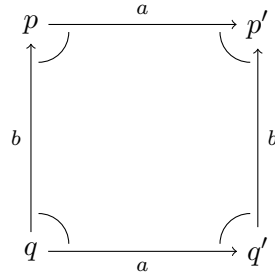

The idea of higher dimensional automata (HDA for short) [Pratt 1991], is to specify those squares (and more generally, cubes of any dimension) explicitly. In this section, we present those HDA, their unfolding and bisimulations.

### 1.4.1 The formalism

A **precubical set** is a sequence  $(Q_n)_{n \in \mathbb{N}}$  of sets together with functions:

$$\partial_i^\alpha : Q_n \longrightarrow Q_{n-1}$$

for  $n \in \mathbb{N}$ ,  $1 \leq i \leq n$  and  $\alpha \in \{0, 1\}$ , satisfying for every  $1 \leq i < j \leq n$  and  $\alpha, \beta \in \{0, 1\}$ :

$$\partial_i^\alpha \circ \partial_j^\beta = \partial_{j-1}^\beta \circ \partial_i^\alpha.$$

A **higher dimensional automata** is a tuple  $(Q, \partial, i, \lambda)$  with:

- $(Q, \partial)$  a precubical set,
- $i \in Q_0$  (**initial state**),
- $\lambda : Q_1 \longrightarrow \Sigma$  (**labelling**), such that for every  $c \in Q_2$  and  $i \in \{1, 2\}$ :

$$\lambda(\partial_i^0(c)) = \lambda(\partial_i^1(c)).$$

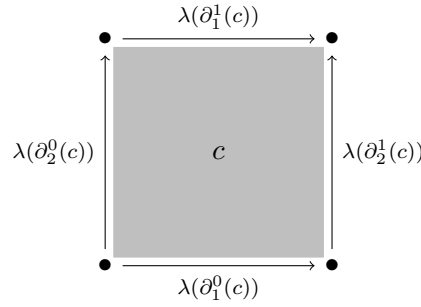

HDA are the most powerful models for concurrency. [van Glabbeek 2005] translated many models for concurrency into HDA in a way that preserves behaviors. Those constructions were improved in [Goubault 2012] to make them adjunctions, extending the work from [Nielsen 1995].

### 1.4.2 Paths, homotopy and unfolding

Paths are similar to branches seen previously, and represent executions of the system: they will be sequences of actions, some potentially simultaneous, except that an action is not required to terminate before another can start. For example, an action  $a$  may be started, then an action  $b$  is started, then the action  $b$  is terminated, then the action  $a$  is terminated. More precisely [van Glabbeek 2005], a **path**  $\pi$  in an HDA  $(Q, \partial, i, \lambda)$  is a sequence  $(t_1, c_1), \dots, (t_n, c_n)$ , depicted as

$$i = c_0 \xrightarrow{t_1} c_1 \xrightarrow{t_2} \dots \xrightarrow{t_n} c_n$$

where:

- $c_k \in Q$ ,
- $t_k$  is of the form  $\partial_{j_k}^{\alpha_k}$ ,
- if  $\alpha_k = 0$ , then  $t_k(c_{k-1}) = c_k$ , with  $t_k(c_k) = c_{k-1}$  otherwise.

For example, if we consider the following HDA:

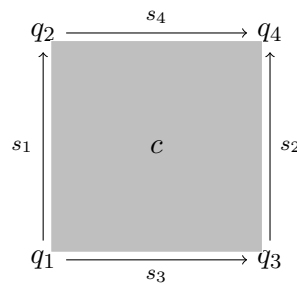

with  $i = q_1$ ,  $\lambda(s_1) = \lambda(s_2) = a$  and  $\lambda(s_3) = \lambda(s_4) = b$ , and if we want to formalize the previous execution, that is, starting  $a$ , starting  $b$ , ending  $b$ , ending  $a$ , we will consider the path:

$$(\partial_1^0, s_1), (\partial_2^0, c), (\partial_2^1, s_2), (\partial_1^1, q_4)$$

which geometrically can be depicted as follow (in red):



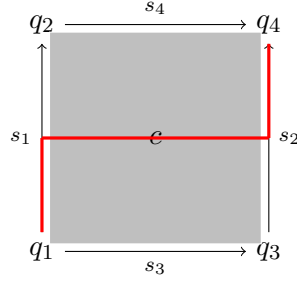

Homotopy is a way to express that two paths represent the same execution modulo permutations of independent actions. It is similar to the relation  $\simeq$  defined for executions of transition systems with independence. It will be defined by saying that two paths are equivalent if one can deform one into the other by doing elementary modifications, which consist essentially in permuting two independent elements of a path. A path  $\pi = i \xrightarrow{t_1} c_1 \xrightarrow{t_2} \dots \xrightarrow{t_n} c_n$  is elementary homotopic to  $\pi' = i \xrightarrow{t'_1} c'_1 \xrightarrow{t'_2} \dots \xrightarrow{t'_n} c'_n$  if there are  $1 \leq j \leq n-1$  and  $k < l$  such that for every  $p \neq j$   $c_p = c'_p$ , for every  $r \notin \{j, j+1\}$   $t_r = t'_r$  and one of the following occurs:

- $t_j = \partial_k^0$ ,  $t_{j+1} = \partial_l^0$ ,  $t'_j = \partial_{l-1}^0$  and  $t'_{j+1} = \partial_k^0$ ,
- $t_j = \partial_k^1$ ,  $t_{j+1} = \partial_l^1$ ,  $t'_j = \partial_{l-1}^1$  and  $t'_{j+1} = \partial_k^1$ ,
- $t_j = \partial_k^0$ ,  $t_{j+1} = \partial_l^1$ ,  $t'_j = \partial_{l-1}^1$  and  $t'_{j+1} = \partial_k^0$ ,
- $t_j = \partial_l^0$ ,  $t_{j+1} = \partial_k^1$ ,  $t'_j = \partial_k^1$  and  $t'_{j+1} = \partial_{l-1}^0$ .

We call **homotopy** the reflexive, symmetric, transitive closure of elementary homotopy. In this case, we say that the paths are **homotopic** [van Glabbeek 2005].

Geometrically, in the 2-dimensional case, elementary homotopy can be depicted as follow:

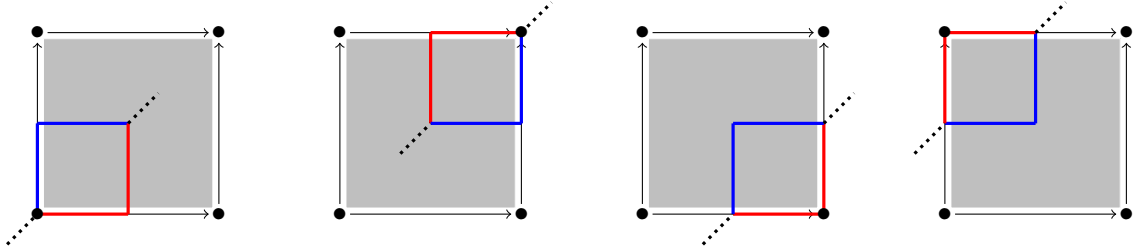

where the four conditions consist in replacing the blue part by the red part.

Unfolding is also similar to the one from transition systems. It is defined as an HDA of paths modulo homotopy [van Glabbeek 1991]. The **unfolding** of an HDA  $(Q, \partial, i, \lambda)$  is the HDA  $(Q', \partial', i', \lambda')$  where:

- $Q'_n$  is the set of homotopy class of paths  $i \xrightarrow{t_1} c_1 \xrightarrow{t_2} \dots \xrightarrow{t_k} c_k$  with  $c_k \in Q_n$ ,
- $i'$  is the homotopy class of the constant path (which corresponds to the empty sequence),
- $\lambda([i \xrightarrow{t_1} c_1 \xrightarrow{t_2} \dots \xrightarrow{t_k} c_k]) = \lambda(c_k)$ ,
- $\partial_i^1([i \xrightarrow{t_1} c_1 \xrightarrow{t_2} \dots \xrightarrow{t_k} c_k]) = [i \xrightarrow{t_1} c_1 \xrightarrow{t_2} \dots \xrightarrow{t_k} c_k \xrightarrow{\partial_i^1} \partial_i^1(c_k)]$ ,

- $\partial_i^0([i \xrightarrow{t_1} c_1 \xrightarrow{t_2} \dots \xrightarrow{t_k} c_k]) = [\pi]$  where  $\pi$  is a path such that  $\pi \xrightarrow{\partial_i^0} c_k$  is homotopic to  $i \xrightarrow{t_1} c_1 \xrightarrow{t_2} \dots \xrightarrow{t_k} c_k$ .

### 1.4.3 Bisimilarities

There are several definitions of bisimilarity of HDA [van Glabbeek 2005], which use the same pool of axioms. They are based on a particular observation of a path. First, the **split-trace** of a path, is the sequence of labellings of actions started and terminated along the path. For example, the split-trace of the path from the previous example would be  $a_+.b_+.b_-.a_-$ , meaning that an  $a$  action is started, then a  $b$  action is started, then a  $b$  action is terminated and finally an  $a$  action is terminated. But this observation is partial since if several  $a$  actions are started, when an  $a$  action is terminated, denoted by  $a_-$ , we do not know which one is terminated. The **ST-trace** is an improvement of the split-trace in which the  $a_-$  are replaced by  $a_k$  where  $k$  denotes which action is terminated. For example, a path of the form “a first  $a$  action is started ; a second  $a$  action is started ; the second  $a$  action is terminated ; the first  $a$  action is terminated” would have a ST-trace of the form  $a_+.a_+.a_2.a_1$ . A **bisimulation** between two HDA is a relation  $R$  between paths which satisfies some of those axioms:

1. the empty paths are related,
2. if two paths are related then their ST-traces are the same,
3. if  $(\pi, \pi') \in R$  and  $\rho$  is homotopic to  $\pi$ , then there is  $\rho'$  homotopic to  $\pi'$  such that  $(\rho, \rho') \in R$ ,
4. symmetrically,
5. if  $(\pi, \pi') \in R$  and  $\pi$  is a prefix of  $\rho$ , then  $\pi'$  is a prefix of some  $\rho'$  such that  $(\rho, \rho') \in R$ ,
6. symmetrically,
7. if  $(\pi, \pi') \in R$  and  $\rho$  is a prefix of  $\pi$ , then there is a prefix  $\rho'$  of  $\pi'$  such that  $(\rho, \rho') \in R$ ,
8. symmetrically.

When  $R$  satisfies:

- 1 – 8, we say that the HDA are **hereditary history-preserving bisimilar** (hhp-bisimilar for short),
- 1 – 6, we say that the HDA are **history-preserving bisimilar** (hp-bisimilar for short),
- 1 – 2 and 5 – 8, we say that the HDA are **ST-bisimilar**. In this case, 7 – 8 are consequences of the other axioms.

Easily, hhp implies hp which implies ST and the other implications do not hold.

There is another notion of bisimulation from [Fahrenberg 2013] which is based on the fibrational view from Section 1.2.4.

## 1.5 SU and PV-programs

In the following, we describe two languages which concretely talk about true concurrency: the SU-programs [Afek 1990] and the PV-programs [Dijkstra 1965]. For both, we also describe how they can be translated in HDA or TSI.

### 1.5.1 SU-programs

Assume that we have  $n$  processes,  $A_1, \dots, A_n$  running in parallel and that those processes have access to a global memory. Each possesses its own part of the memory and those parts form a partition of the global memory.

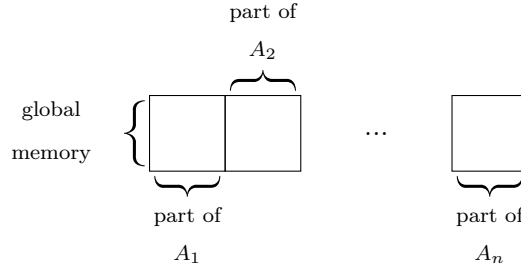

Each process can do two types of actions on the memory:

- **S-actions**, which consist in **scanning** the whole global memory,
- **U-actions**, which consist in **updating** their own part of the memory.

The processes can also globally synchronize, in the sense that they all wait until every process has finished its execution until a certain point of the program. So a SU-program with  $n$  processes  $P$  will be a term generated by the following grammar:

$$P ::= Q_1 \parallel \dots \parallel Q_n \mid P \bullet P$$

$$Q_1, \dots, Q_n, Q ::= S.Q \mid U.Q \mid \varepsilon$$

For example,  $(S.S \parallel U.S) \bullet (U \parallel S.U)$  stands for a SU-program with 2 processes. The first one does 2 S-actions while the second does a U-action then an S-action. At this point, they synchronize, that is, they wait until the other has finished this part of the program. Then, the first does a U-action while the other does an S-action followed by a U-action.

There is a translation from SU-programs to transition systems with independence (and so to HDA). Start with a program of the form  $Q_1 \parallel \dots \parallel Q_m$ . Let  $k_i$  be the size of  $Q_i$ , that is, the number of  $S$  and  $U$  in it and denote  $Q_i[j]$  the  $j$ -th letter of  $Q_i$ . The states of this program are  $\{0, \dots, k_1\} \times \dots \times \{0, \dots, k_m\}$ . There is exactly one transition from  $(j_1, \dots, j_i, \dots, j_m)$  to  $(j_1, \dots, j_i + 1, \dots, j_m)$  and it is labelled by  $Q_i[j_i + 1]$ . Two transitions are independent if and only if either they are both labelled by  $S$ , or both by  $U$ . The intuition is the following: if two processes are doing an action simultaneously, there are three possible cases:

- they are both S-actions: in this case, since the memory is not changed, there is no problem,
- they are both U-actions: in this case, since disjoint parts of the memory are changed, there is no problem,
- one is an S-action and the other is a U-action: in this case, one process is scanning the memory while the other is changing its part, which makes the value of the memory scanned unpredictable. There is a problem.

Now, if we have a program of the form  $P_1 \bullet P_2 \bullet \dots \bullet P_m$ , with  $P_i$  containing no  $\bullet$ , the transition system associated with this program is obtained by considering the transition systems for every  $P_i$  as defined above and then identifying the state  $(k_1, \dots, k_m)$  of  $P_i$  with the state  $(0, \dots, 0)$  of  $P_{i+1}$ .

For example, using the geometric picture from HDA, the SU-program  $(S.S \parallel U.S) \bullet (U \parallel S.U)$  can be seen as:

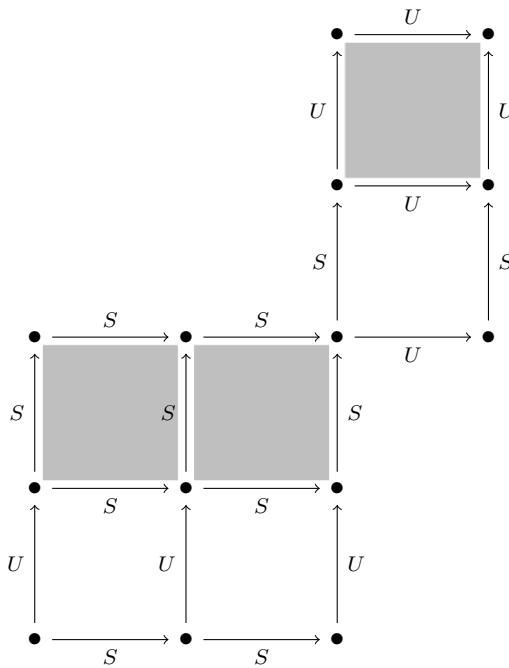

### 1.5.2 PV-programs

In this language, we assume that we have  $n$  processes  $A_1, \dots, A_n$  running in parallel and that, this time, those processes can concurrently access  $m$  resources  $R_1, \dots, R_m$ . Each resource has a capacity  $\nu_i$ , which is an integer in  $\{1, \dots, n-1\}$  which represents the maximal number of processes that can have access to this resource simultaneously.

A process can do two types of actions:

- $P_i$ -actions, which consist in asking for access to the resource  $R_i$ ,
- or
- $V_i$ -actions, which consist in freeing access to the resource  $R_i$ .

Between those actions, the processes can do local actions that are independent of each other and are seen as silent actions. The processes can also globally synchronize, in the same sense as SU-programs. So a PV-program with  $n$  processes  $P$  will be a term generated by the following grammar:

$$P ::= Q_1 \parallel \dots \parallel Q_n \mid P \bullet P$$

$$Q_1, \dots, Q_n, Q ::= P_i.Q \mid V_i.Q \mid \varepsilon$$

Much as SU-programs, PV-programs can be translated into transition systems with independence. For an explicit construction, see [Fajstrup 2016]. Let us illustrate this on an example.

Consider the program  $P_1.P_2.V_2.V_1 \parallel P_2.P_1.V_1.V_2$  with  $\nu_1 = \nu_2 = 1$ . The two processes cannot have simultaneous access to the resources. This program is modeled by the following transition system with independence. Start by constructing the following grid:

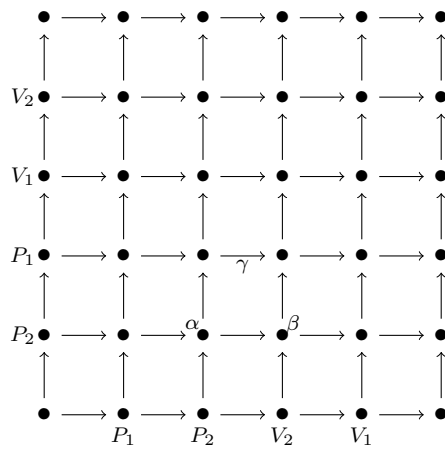

For example, the state  $\alpha$  corresponds to a state where horizontal process has the access to the first resource, and both processes ask for the access to the second resource but do not get it yet; the state  $\beta$  corresponds to a state where the horizontal process has access to the first resource, had the access to the second resource but has released it, and the vertical process still waiting for the access to the second resource; and so on. Every state corresponds to a valid configuration of the program, meaning that there is no state where both processes have access to the same resource. However, there are transitions that are not possible. For example, the transition  $\gamma$  corresponds to a sequence of configurations where the horizontal process starts by waiting for the access to the second resource, gains it and finishes by releasing it, while the vertical process has the access to the second resource. So the only possible transitions are:

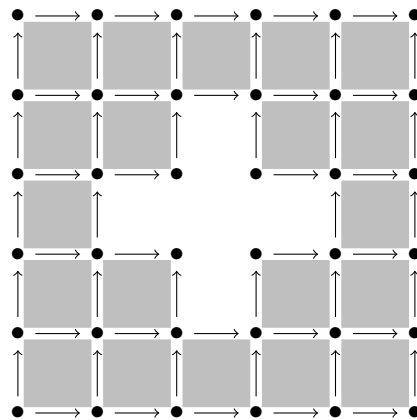

and since we assume that the operations other than P and V are all independent, all squares are independent meaning that in the HDA we have 2-dimensional squares as depicted above.

# Modeling true concurrency geometrically

---

We have seen in the previous chapter several abstract formalisms to talk about true concurrency, that is, concurrent systems in which processes can do actions simultaneously. In particular, we have seen higher dimensional automata, which are on top of the hierarchy of expressiveness. HDA are, by nature, very geometric. The underlying precubical set can be thought as a collection of cubes of any dimensions which represent the truly concurrent behaviors of the system: an  $n$ -cube models  $n$  actions that can be done simultaneously. In this chapter, we formalize this geometric idea. We associate a precubical set with different geometric objects, defined by glueing together (real) cubes. We start, in Section 2.1, by doing it in topological spaces. This allows us to relate intuitions from HDA and from topology. The only problem is directedness: transitions of HDA are directed while topological spaces are not. So the Section 2.2 is dedicated to looking at different ways to add directedness. We will mainly see two ways and compare them: firstly with the idea of defining an order locally and assuring global consistency, this leads to streams [Krishnan 2009]; and then by specifying particular paths that we consider directed, this leads to  $d$ -spaces [Grandis 2009]. We will then see, in Section 2.3, how to geometrically study concurrent programs, defining directed homotopies and fundamental categories. Finally, in Section 2.4, we look at another important construction which somehow formalizes a “space of executions” in directed spaces, the trace space from [Fahrenberg 2007].

## 2.1 Geometric realizations

The general idea is to **realize** precubical sets in topological spaces. In the following, we denote by **Top** the category of topological spaces and continuous functions. The **standard topological cube of dimension  $n$** , denoted  $\square_n$ , is the product space  $[0, 1]^n$ . A **face map** is a continuous function of the form  $d_i^\alpha : \square_{n-1} \rightarrow \square_n$  with  $1 \leq i \leq n$  and  $\alpha \in \{0, 1\}$  such that

$$d_i^\alpha(t_1, \dots, t_{n-1}) = (t_1, \dots, t_{i-1}, \alpha, t_i, \dots, t_{n-1}).$$

The **geometric realization** of a precubical set  $(X, \partial)$ , denoted  $\text{Geom}(X)$ , is the disjoint union  $\bigsqcup_{n \in \mathbb{N}} X_n \times \square_n$  quotiented by the smallest equivalence relation  $\sim$  such that for every  $n \in \mathbb{N}^*$ , every  $1 \leq i \leq n$ , every  $\alpha \in \{0, 1\}$ , every  $x \in X_n$  and every  $\mathbf{t} \in \square_{n-1}$ ,

$$(\partial_i^\alpha(x), \mathbf{t}) \sim (x, d_i^\alpha(\mathbf{t})).$$

For example, the geometric pictures of HDA in the previous chapter are geometric realizations. Actually, those examples were really non-degenerated. More complicated phenomena can occur: for example, a cube may have different faces which are identified. For example, with  $X_2 = \{c\}$ ,  $X_1 = \{s_1, s_2, s_3\}$ ,  $X_0 = \{p_1, p_2\}$ , we can construct a hollow cylinder:

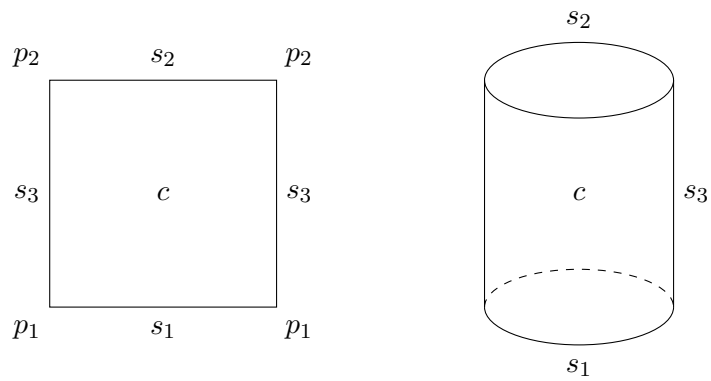

with  $\partial_1^0(c) = s_1$ ,  $\partial_1^1(c) = s_2$ ,  $\partial_2^0(c) = \partial_2^1(c) = s_3$ , and one can construct more twisted spaces like the Möbius strip:

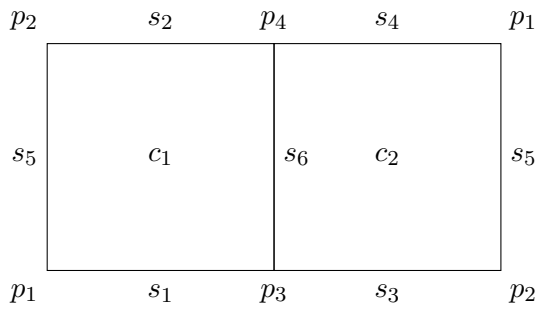

- a state is just a point,
- an execution is a path, i.e. a continuous function from the segment  $[0, 1]$  to  $\text{Geom}(X)$ ,
- homotopy seen for HDA can be defined continuously: given two paths  $\gamma, \rho$  such that  $\gamma(0) = \rho(0) = a$  and  $\gamma(1) = \rho(1) = b$  (we say that  $\gamma, \rho$  go from  $a$  to  $b$  and note  $\gamma, \rho : a \rightsquigarrow b$ ), a homotopy  $H$  between  $\gamma$  and  $\rho$  is a continuous function

$$H : [0, 1] \times [0, 1] \longrightarrow \text{Geom}(X)$$

such that:

- $H(t, 0) = a$  and  $H(t, 1) = b$  for all  $t \in [0, 1]$ ,
- $H(0, t) = \gamma(t)$  and  $H(1, t) = \rho(t)$  for all  $t \in [0, 1]$ .

More generally, given a topological space  $X$ , a **path in  $X$**  is a continuous function from  $[0, 1]$  to  $X$ . We note  $P(X)$  the set of paths in  $X$ . It can be equipped with a topology, the compact-open topology, whose open sets are generated by the

$$[K, U] = \{\gamma \mid \gamma(K) \subseteq U\}$$

with  $K$  compact of  $[0, 1]$  and  $U$ , an open set of  $X$ . For  $a, b \in X$ , we denote by  $P(X)(a, b)$  the subspace of paths from  $a$  to  $b$ . A **homotopy** between  $\gamma$  and  $\rho \in P(X)(a, b)$  is then a path in  $P(X)(a, b)$  from  $\gamma$  to  $\rho$ . In this case, we say that  $\gamma$  and  $\rho$  are homotopic, and we note  $[\gamma]$  the equivalence class of  $\gamma$ .

There is still a flaw in this geometric view of concurrency: non-directedness. The problem is that transitions, for example in a HDA, are directed: there is a source and a target. Those transitions are geometrically modeled as a segment  $[0, 1]$  with the source mapped on 0 and the target on 1. This segment is not directed in the sense that one can define a path from 1 to 0, meaning that one can follow transitions backwardly, which is not possible in a HDA. So paths are not the good way to model executions but directed paths are. The goal of the following chapter (and of directed algebraic topology in general) will be to add this directedness into the definition of topological spaces to define nice notions of directed spaces.

## 2.2 Several ways of modeling directedness

The general idea will be to add some extra structures to the topological spaces being used. We will see different ways to do so in the following. We will define cocomplete categories of “directed spaces”  $\mathcal{D}$ , which have a natural “forgetful functor”  $\mathcal{U}$  to topological spaces. A crucial property of this forgetful functor would be that it preserves colimits. Indeed, in this case, if one can provide a functor  $G' : \square \longrightarrow \mathcal{D}$ , such that  $\mathcal{U} \circ G' = G$  as defined in the previous subsection, then the unique functor  $\widehat{G'}$  will satisfy that  $\mathcal{U} \circ \widehat{G'} = \text{Geom}$  and will be a candidate of a realization of precubical sets in directed spaces. A way to assure that it preserves colimits is to assure that it has a right adjoint, or even better, that it is a topological functor [Adámek 2004]. The idea of a topological functor  $F$  is that every antecedent of an object corresponds to a way of adding some structure on this object. Moreover, those ways should naturally be ordered by the quantity of structures added in such a way that we can talk about the “coarsest structure such that ...”. A typical example is the forgetful functor from topological spaces to sets. A topological functor always has a right adjoint (given by the finest structure) and a left adjoint (given by the coarsest structure). More precisely, given a functor  $F : \mathcal{C} \longrightarrow \mathcal{D}$ , the **fiber over  $d$** , is the class of objects of  $\mathcal{C}$  such that  $F(c) = d$ . This



fiber over  $d$  is ordered by  $c \leq c'$  if and only if there is a morphism from  $f : c \rightarrow c'$  with  $F(f) = \text{id}_d$ . We say that  $F$  is **topological** if:

- it is faithful,
- for every fiber over an object of  $\mathcal{D}$ ,  $\leq$  is a partial order,
- for every object  $d$  of  $\mathcal{D}$ , and every collection of morphisms  $(g_i : d \rightarrow F(c_i))_{i \in I}$  there is an object  $c$  of  $\mathcal{C}$  such that  $F(c) = d$  and a collection of morphisms  $(f_i : c \rightarrow c_i)_{i \in I}$  with  $F(f_i) = g_i$  such that for every morphism  $h : F(c') \rightarrow F(c)$ , if for every  $i \in I$ , there is a morphism  $h_i : c' \rightarrow c_i$  with  $F(h_i) = g_i \circ h$ , then there is  $h' : c' \rightarrow c$  with  $F(h') = h$ .

For example, the forgetful functor  $\mathcal{U} : \mathbf{Top} \rightarrow \mathbf{Set}$  is topological. Given a set  $X$  and two topologies  $O_1$  and  $O_2$  on  $X$ ,  $X, O_1 \leq X, O_2$  if and only if the identity function is continuous, considering  $O_1$  as the topology on the domain, and  $O_2$  on the image. This means that elements of  $O_2$  (which are open sets for this topology) are also elements of  $O_1$ . This means that  $X, O_1 \leq X, O_2$  if and only if  $O_2 \subseteq O_1$  and so  $\leq$  is a partial order. Given a collection of functions  $(g_i : X \rightarrow Y_i)_{i \in I}$  where  $Y_i$  are topological space, there is a coarsest topology on  $X$  that makes the  $g_i$  continuous: this is the topology generated by the  $g_i^{-1}(U)$  with  $U$  open set of  $Y_i$ . This coarsest topology is the object  $c$  required in the third point of the definition of a topological functor.

### 2.2.1 PO-spaces

Let us start with a simple idea:

**Definition 1.** A **partially ordered space** (po-space for short) is a topological space  $X$  with a partial order  $\leq$  on it. A **dimap** between po-spaces is a continuous monotone function between them. We note **POTop** the category of po-spaces and dimaps.

Usually, one says ‘po-space’ for a topological space with a closed partial order on it [Nachbin 1965], but as this closure property is not useful in our study, we will omit it from our definition.

$\square_n$  can be equipped with a partial order, namely the product (or component-wise) order. The face maps  $d_i^\alpha$  are then dimaps, and so this defines a functor  $G' : \square \rightarrow \mathbf{POTop}$ . By a **directed path in  $X$**  (or **dipath** for short) we mean a dimap from  $[0, 1]$ , with its usual ordering, to  $X$ . The dipaths of  $\square_n$  are then component-wise increasing paths.

There is a forgetful functor from **POTop** to **Top** which forgets the partial order. It satisfies the first two conditions of a topological functor, since the ordering  $\leq$  denotes the inverse inclusion of the partial orders. **POTop** is cocomplete and the colimits are computed as follow: let  $D : \mathcal{D} \rightarrow \mathbf{POTop}$  be a small diagram. Forgetting the partial order, this diagram has a colimit in **Top**, let us note it  $X$ , which is the space

$$\bigsqcup_{d \in \text{Ob}(\mathcal{D})} D(d) / \sim$$

where  $\sim$  is the smallest equivalence relation such that for every  $f : d \rightarrow d'$  morphism of  $\mathcal{D}$ , for every  $x \in D(d)$ ,  $x \sim D(f)(x)$ , equipped with the quotient topology. We note  $p_d : D(d) \rightarrow X$  the quotient maps.  $X$  can be equipped with a preorder  $\sqsubseteq$ , with  $\alpha \sqsubseteq \beta$  if and only if there is a sequence  $\alpha = \gamma_1, \dots, \gamma_n = \beta$  such that for every  $i \in \{1, \dots, n-1\}$ , there  $x_i$  and  $y_i$  in some  $D(d_i)$  with  $x_i \leq y_i$  in  $D(d_i)$ ,  $p_{d_i}(x_i) = \gamma_i$  and  $p_{d_i}(y_i) = \gamma_{i+1}$ . The preorder  $\sqsubseteq$  may not be a partial order. For example, with this diagram:

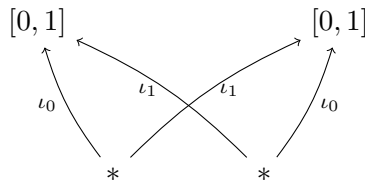

where  $*$  is a point space and  $\iota_\alpha$  is the function that maps  $*$  to  $\alpha$ ,  $X$  is homeomorphic to a circle:

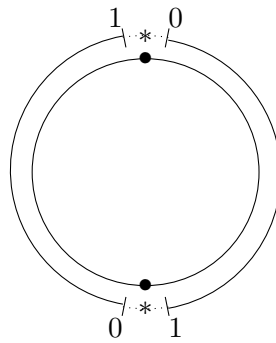

and  $\sqsubseteq = X \times X$ .

Denote by  $\equiv$  the relation such that  $\alpha \equiv \beta$  if and only if  $\alpha \sqsubseteq \beta$  and  $\beta \sqsubseteq \alpha$ , and  $Y = X / \equiv$ , equipped with the quotient topology and the quotient order (which is a partial order this time). Then  $Y$  is the colimit of  $D$  in **POTop**.

Remark that, from this computation, the forgetful functor does not preserve colimits. Indeed, considering the previous example, its colimit in **Top** is a circle, while its colimit in **POTop** is a point. We could have avoided this problem by considering preorder instead of partial order. The problem is still here: we would expect that the glueing of two directed segments as in this example would give us somehow a “directed circle”, i.e., a circle on which one can only turn in one direction, but the colimit is a circle on which every path is directed.

### 2.2.2 Local PO-spaces

We have seen that the main problem of po-spaces is that we must define an order globally, which does not allow us to consider directed looping behaviors. The next idea is the same as in manifolds: we define our structure locally and we assure that it is globally coherent. This will be done through the notion of charts and atlases (see for example [Fajstrup 2003]):

**Definition 2.** Fix a topological space  $X$ . A **chart** on  $X$  is a pair  $(U, \leq_U)$  where  $U$  is an open set of  $X$  and  $\leq_U$  is a partial order on  $U$ . An **atlas** on  $X$  is a collection  $\mathcal{U}(X)$  of charts on  $X$  which forms a covering of  $X$  and such that for every  $x \in X$ , there is an open neighborhood  $W_x$  of  $x$  and a partial order  $\leq_x$  on  $W_x$  such that for every  $(U, \leq_U) \in \mathcal{U}(X)$ , for every  $y, z \in U \cap W_x$ ,  $y \leq_U z$  if and only if  $y \leq_x z$ . We call such  $W_x$  a **po-neighborhood** of  $x$  with respect to  $\mathcal{U}(X)$ . We say that two atlases  $\mathcal{U}(X)$  and  $\mathcal{U}'(X)$  are **equivalent** if their union is an atlas.

The condition of an atlas means that all the local partial order that we define must coincide at least on a neighborhood of any point.

**Definition 3.** A **locally partially ordered space** will be a topological space  $X$  equipped with an equivalence class of atlases. A **dimap**  $f : X, \mathcal{U} \rightarrow Y, \mathcal{V}$  between locally partially ordered spaces is a continuous function such that for every  $x \in X$ , there are po-neighborhoods  $W_x$  of  $x$  with respect to some atlas of  $\mathcal{U}$  and  $W_{f(x)}$  of  $f(x)$  with respect to some atlas of  $\mathcal{V}$  such that for every  $y, z \in f^{-1}(W_{f(x)}) \cap W_x$ ,

$$\text{if } y \leq_x z \text{ then } f(y) \leq_{f(x)} f(z).$$

We note **LocPOTop** the category of locally partially ordered spaces and dimaps.

In this category, it is possible to model a directed circle. Define  $S^1$  as the subspace of  $\mathbb{R}^2$  of points of the form  $\{e^{i\theta} \mid \theta \in \mathbb{R}\}$ . We consider the following two charts:

- $U_1 = \{e^{i\theta} \mid -\frac{3\pi}{4} < \theta < \frac{3\pi}{4}\}$ , with for every  $\theta, \theta' \in ]-\frac{3\pi}{4}, \frac{3\pi}{4}[$ ,  $e^{i\theta} \leq_{U_1} e^{i\theta'}$  if and only if  $\theta \leq \theta'$  (in red in the figure),
- $U_2 = \{e^{i\theta} \mid \frac{\pi}{4} < \theta < \frac{7\pi}{4}\}$ , with a similar order (in blue in the figure).

Those two charts form an atlas.

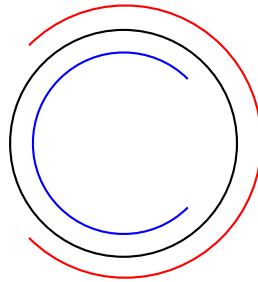

A po-space  $(X, \leq)$  is a locally partially ordered space with the atlas  $\{(X, \leq)\}$ . So one can define a directed path in a locally partially ordered space  $X$  as a dimap from the po-space  $[0, 1]$  (with the usual order) to  $X$ . Intuitively, a directed path is a path which is locally increasing. For example, in the case of the directed circle, its directed paths are exactly the paths that turn anti-clockwise.

This category seems nicer to models looping behaviors. The counterpart is that computing colimits is hard. It is an open problem to know whether **LocPOTop** is cocomplete. In any case, the same kind of problems happen: when computing the colimit, it may be necessary to quotient more than in topological spaces and so the forgetful functor does not preserve colimits, see for example [Fajstrup 2016].

### 2.2.3 Streams

We have seen that colimits are a problem in our search for a nice notion of directed spaces. We would like to continue this idea of defining an order locally, but this time assuring cocompleteness. The idea here is similar to free cocompletion: the “smallest cocomplete category containing a certain category” is its category of presheaves. We will follow the same idea with the notion of prestream [Krishnan 2009]:

**Definition 4.** A **prestream** is a topological space  $X$  with a **precirculation**, i.e., a collection  $(\sqsubseteq_U)_{U \in \mathcal{O}(X)}$  where  $\sqsubseteq_U$  is a preorder on the open set  $U$ , satisfying that for every pair of open sets,

$U \subseteq V$ , we have  $\sqsubseteq_U \subseteq \sqsubseteq_V$ . A **morphism of prestreams**  $f : (X, (\sqsubseteq_U)_{U \in \mathcal{O}(X)}) \longrightarrow (Y, (\preceq_V)_{V \in \mathcal{O}(Y)})$  is a continuous function  $f : X \longrightarrow Y$  such that for open set  $V$  of  $Y$ , for all  $x, y \in f^{-1}(V)$ , if  $x \sqsubseteq_{f^{-1}(V)} y$  then  $f(x) \preceq_V f(y)$ . We note **PreStr** the category of prestreams and morphisms of prestreams.

Every po-space may be seen as a prestream: take as precirculation  $\sqsubseteq_U$  the restriction of the partial order on  $U$ . But we will see later that this precirculation is not necessary a good one to consider. For the case of the segment,  $[0, 1]$ , we have another precirculation from [Haucourt 2012]: define  $x \sqsubseteq_U y$  if and only if the whole segment  $[x, y]$  is included in  $U$ . We denote this prestream by  $\overrightarrow{[0, 1]}$ . It is this structure on the segment that we will use to define directed paths in a prestream: a **directed path** in  $X$  is a prestream morphism from  $\overrightarrow{[0, 1]}$  to  $X$

In this category, things are much more simpler with respect to colimits:

**Proposition 1.** *The forgetful functor  $\mathcal{F}$  from **PreStr** to **Top** is topological. In particular, **PreStr** is cocomplete and  $\mathcal{F}$  preserves colimits.*

*Proof.* Let us check the three conditions:

- $\mathcal{F}$  is faithful trivially.
- The order  $\leq$  on the fiber corresponds to the inclusion of the precirculations and so is a partial order.
- Given a collection  $(g_i : X \longrightarrow \mathcal{F}(Y_i, \sqsubseteq^i))_{i \in I}$  of morphisms in **Top**, we want to construct the “smallest” precirculation that makes the  $g_i$  morphisms of prestreams. It is defined as  $x \sqsubseteq_U y$  if and only if for every  $i \in I$ , for every open set  $V_i$  of  $Y_i$  such that  $U \subseteq g_i^{-1}(V_i)$ ,  $g_i(x) \sqsubseteq_{V_i}^i g_i(y)$ .

.QED.

We can make the computation of the colimits more explicit. The coproduct of a family  $(X_i, \sqsubseteq_i)_{i \in I}$  of prestreams is the prestream  $(\bigsqcup_{i \in I} X_i, \bigsqcup_{i \in I} \sqsubseteq_i)$ . Given an equivalence relation  $\equiv$  on a prestream  $(X, \sqsubseteq)$ , the quotient  $X/\equiv$  can be equipped with a precirculation  $\preceq$  such that  $\alpha \preceq_V \beta$  if and only if there is a sequence  $y_1, x_2, y_2, \dots, y_{n-1}, x_n$  of elements of  $q^{-1}(V) \subseteq X$ , where  $q : X \longrightarrow X/\equiv$  is the quotient map, such that  $q(y_1) = \alpha$ ,  $q(x_n) = \beta$  and for all  $i$ ,  $y_i \sqsubseteq_{q^{-1}(V)} x_{i+1}$  and  $x_{i+1} \equiv y_{i+1}$ . Then the colimit of a small diagram  $D : \mathcal{D} \longrightarrow \mathbf{PreStr}$  is obtained by quotienting the coproduct of  $(D(d))_{d \in \text{Ob}(\mathcal{D})}$  by the smallest equivalence relation such that  $(d, x) \equiv (d', D(f)(x))$  for every morphisms  $f : d \longrightarrow d'$  of  $\mathcal{D}$  and every  $x \in F(d)$ .

There are several possible way to construct a circle in **PreStr**. The idea is to quotient the real line  $\mathbb{R}$  (or the segment  $[0, 1]$ ) by the equivalence relation  $t \equiv t'$  if and only if  $t - t'$  is an integer. Depending on the prestream structure on  $\mathbb{R}$ , this will give different structures on the circle. Much as the segment  $[0, 1]$ , there are (at least) two prestream structures on  $\mathbb{R}$ . First, the one coming from the po-space  $(\mathbb{R}, \leq)$ , the other defined as  $x \sqsubseteq_U y$  if and only if  $[x, y] \subseteq U$ . With the first structure,  $(\mathbb{R}, \leq)/\equiv$  has a trivial precirculation: with the notation of the previous paragraph,  $\alpha \preceq_V \beta$  for every  $\alpha$  and  $\beta \in V$ . Indeed,  $\alpha$  is of the form  $q(t)$  for some  $t \in [0, 1[$  and  $\beta = q(t')$  for some  $t' \in [0, 1[$ . Assume that  $t \leq t'$ . Then  $\alpha \preceq_V \beta$ . But  $t' \leq t + 1 \equiv t$  and so  $\beta \preceq_V \alpha$ . On the other side, the second structure is more interesting. In this one,  $\alpha \preceq_U \beta$  if and only if the arc segment between  $\alpha$  and  $\beta$ , turning anti-clockwise is included in  $U$ . This implies that the directed paths are exactly the paths that turn anti-clockwise.

With prestreams, we define a category of “directed spaces” which behaves well with respects to colimits in **Top**. The problem is that this category is too large: if we have the idea that the directed

structure is defined locally, we lose the coherence of this structure, that is, the fact that if two local definitions intersect on some open neighborhood of a point, then they must coincide. To continue the parallel with free cocompletion, we consider presheaves when we would like sheaves. Following this idea, we define streams [Krishnan 2009]:

**Definition 5.** A precirculation is a **circulation** if for every family of open sets  $(U_i)_{i \in I}$ ,  $x \sqsubseteq_{\bigcup_{i \in I} U_i} y$  if and only if there are a sequence  $x = z_1, z_2, \dots, z_n = y$  of points and a sequence  $U_{i_1}, \dots, U_{i_{n-1}}$  such that for every  $k$ ,  $z_k \sqsubseteq_{U_{i_k}} z_{k+1}$ . We note **Str** the full subcategory of **PreStr** consisting of **streams**, that is prestreams whose precirculation is a circulation.

This means, in particular, that if  $x \sqsubseteq_U y$  then there is a chain of inequalities inside smaller open sets, as small as you want. The first structure on  $\mathbb{R}$  (the one from po-space) fails this condition. Indeed, take two disjoint open segments of  $\mathbb{R}$ , say  $U_1 = ]0, 1[$  and  $U_2 = ]2, 3[$ . Since  $\frac{1}{2} \leq \frac{5}{2}$ ,  $\frac{1}{2} \sqsubseteq_{U_1 \cup U_2} \frac{5}{2}$  in this structure. But there is no sequences as in the definition of a stream, because the two are disjoint. On the contrary, one can prove that the second structure is a stream.

In streams, colimits initially look much harder to compute, but, in fact, not really:

**Proposition 2.** *The forgetful functor from **Str** to **Top** is topological. Moreover, the limits in **Str** are computed as in **PreStr**.*

The proof is much harder than in prestreams. See [Goubault-Larrecq 2014] for example for a complete proof.

## 2.2.4 Dspaces

In this subsection, we will see another point of view of “directed spaces”. Previously, we have seen a local definition of “directedness” with streams and locally partially ordered spaces and then directed paths were defined by specifying a particular structure on the segment. Here, we will do things in the other way: we will specify a particular subset of paths that we will consider as “directed”, and it is this specification that will define “directedness”. That is the main idea of d-spaces [Grandis 2001, Grandis 2009]:

**Definition 6.** A **d-space** is a topological space  $X$  together with a subset  $\vec{P}(X)$  of  $P(X)$ , called the **directed paths** (or **dipaths** for short) satisfying the following:

- the constant paths are directed, i.e., for every  $x \in X$ , the path  $c_x : t \mapsto x$  is in  $\vec{P}(X)$ ,
- dipaths are closed under concatenation, i.e., for every  $\gamma_1, \gamma_2 \in \vec{P}(X)$  with  $\gamma_1(1) = \gamma_2(0)$ , the path  $\gamma_1 \star \gamma_2$  defined as:

$$\begin{aligned} \gamma_1 \star \gamma_2(t) &= \gamma_1(2t) && \text{if } t \leq \frac{1}{2} \\ &= \gamma_2(2t - 1) && \text{if } t \geq \frac{1}{2} \end{aligned}$$

is also in  $\vec{P}(X)$ ,

- dipaths are closed under non-decreasing reparametrizations, i.e., for every  $\gamma \in \vec{P}(X)$  and every continuous and monotone function  $r : [0, 1] \rightarrow [0, 1]$ ,  $\gamma \circ r \in \vec{P}(X)$ .

A **dimap** between d-spaces is a continuous function  $f : X \rightarrow Y$  such that for every  $\gamma \in \vec{P}(X)$ ,  $f \circ \gamma \in \vec{P}(Y)$ . We denote the category of d-spaces and dimaps by **dTop**.

It is very easy to add d-space structures on topological spaces. For example, on the segment  $[0, 1]$ , one can define  $\overrightarrow{P}([0, 1])$  as the set of non-decreasing paths, that is, continuous monotone functions. Let us note  $\overrightarrow{[0, 1]}$  this d-space. Then for any d-space  $X$ ,  $\overrightarrow{P}(X)$  is exactly the set of dimaps from  $\overrightarrow{[0, 1]}$  to  $X$ . To define a directed circle, just define

$$\overrightarrow{P}(S^1) = \{t \mapsto e^{i\theta(t)} \mid \theta : [0, 1] \longrightarrow \mathbb{R} \text{ non-decreasing}\}.$$

Given a set of paths  $Q \subseteq P(X)$ , there is always a smallest (for inclusion) set of paths satisfying the conditions of dipaths and containing  $Q$ , since  $P(X)$  satisfies them and that for every collection of such sets, their intersection satisfies those axioms too. Let us note this set by  $\langle Q \rangle$ . It can be computed as follow:

**Proposition 3.** For  $\gamma_1, \dots, \gamma_n$  paths with  $\gamma_i(1) = \gamma_{i+1}(0)$ , denote by  $\gamma_1 \star \dots \star \gamma_n$  the path defined as:

$$\gamma_1 \star \dots \star \gamma_n(t) = \gamma_{i+1}(nt - i) \quad \text{if } \frac{i}{n} \leq t \leq \frac{i+1}{n}$$

$\langle Q \rangle$  is exactly the set of paths of the form:

$$(\gamma_1 \star \dots \star \gamma_n) \circ r$$

with  $\gamma_i \in \{\gamma \circ q \mid \gamma \in Q, q \text{ non-decreasing reparametrization}\} \cup \{c_x \mid x \in X\}$  and  $r$  a surjective non-decreasing reparametrization.

But let us first prove the following lemma:

**Lemma 1.** If  $Q'$  is closed under non-decreasing reparametrization, then any path  $\gamma$  of the form  $(\gamma_1 \star \dots \star \gamma_n) \circ r$  with  $\gamma_i \in Q'$  and  $r$  a non-decreasing reparametrization can also be decomposed as  $(\gamma'_1 \star \dots \star \gamma'_p) \circ r'$  with  $\gamma'_i \in Q'$  and  $r'$  **surjective** a non-decreasing reparametrization.

*Proof of the lemma.* If  $r$  is constant, let  $i$  be an integer such that  $\frac{i-1}{n} \leq r(0) \leq \frac{i}{n}$ . Then  $\gamma_i \circ (t \mapsto nr(0) - i + 1) \in K$  since  $K$  is closed under non-decreasing reparametrization and  $(\gamma_i \circ (t \mapsto nr(0) - i + 1)) \circ id = (\gamma_1 \star \dots \star \gamma_n) \circ r$ . Now let assume that  $r$  is not constant. Let

$$I_0 = \{i \mid \frac{i-1}{n} \leq r(0) \leq \frac{i}{n}\}$$

$I_0$  has one or two elements (if  $r(0) = \frac{i}{n}$  or not). Let  $i_0$  be the maximum of  $I_0$ . Since  $r$  is not constant then  $r(0) \neq \frac{i_0}{n}$  (a problem may have occurred if  $r(0) = 1$ ). Similarly, define  $i_1$  as the minimum of  $\{i \mid \frac{i-1}{n} \leq r(1) \leq \frac{i}{n}\}$ . In this case,  $r(1) \neq \frac{i_1-1}{n}$ . Note  $p = i_1 - i_0 + 1$  and  $\gamma'_i = \gamma_{i_0+i-1}$ , for  $i \in \{2, \dots, p-1\}$ ,  $\gamma'_1 = \gamma_{i_0} \circ (t \mapsto (i_0 - nr(0))t + nr(0) + 1 - i_0)$  and  $\gamma'_p = \gamma_{i_1} \circ (t \mapsto (nr(1) + 1 - i_1)t)$  (the construction is similar if  $p = 1$ ).  $\gamma'_1$  and  $\gamma'_p$  belongs to  $K$  since it is closed under non-decreasing reparametrization. Note  $t_i = \min\{t \mid r(t) = \frac{i+i_0-1}{n}\}$  for all  $i \in \{1, \dots, p-1\}$ . We note  $r'$  the following function:

- for  $t \in [0, t_1]$ ,  $r'(t) = \frac{n}{p(i_0 - nr(0))}(r(t) - r(0))$ . Remark that  $r'(0) = 0$  and  $r'(t_1) = \frac{1}{p}$ .
- for  $t \in [t_{p-1}, 1]$ ,  $r'(t) = 1 - \frac{n}{p(nr(1) - i_1 - 1)}(r(1) - r(t))$ . Remark that  $r'(t_{p-1}) = \frac{p-1}{p}$  and  $r'(1) = 1$ .
- for  $t \in [t_i, t_{i+1}]$  for  $i \in \{1, \dots, p-2\}$ ,  $r'(t) = \frac{n}{p}r(t) + \frac{1-i_0}{p}$ . Remark that  $r'(t_i) = \frac{i}{p}$  and  $r'(t_{i+1}) = \frac{i+1}{p}$ .

It is easy to check that  $r'$  is a well-defined, continuous, non-decreasing and surjective. It remains to prove that  $(\gamma_1 \star \dots \star \gamma_n) \circ r = (\gamma'_1 \star \dots \star \gamma'_p) \circ r'$  :

- for  $t \in [0, t_1]$ ,

$$(\gamma_1 \star \dots \star \gamma_n) \circ r(t) = \gamma_{i_0}(nr(t) + 1 - i_0)$$

and

$$\begin{aligned} (\gamma'_1 \star \dots \star \gamma'_p) \circ r'(t) &= \gamma'_1(pr'(t)) \\ &= \gamma'_1\left(\frac{n}{i_0 - nr(0)}(r(t) - r(0))\right) \\ &= \gamma_{i_0}(n(r(t) - r(0)) + nr(0) + 1 - i_0) \\ &= \gamma_{i_0}(nr(t) + 1 - i_0) \end{aligned}$$

- for  $t \in [t_{p-1}, 1]$ ,

$$(\gamma_1 \star \dots \star \gamma_n) \circ r(t) = \gamma_{i_1}(nr(t) + 1 - i_1)$$

and

$$\begin{aligned} (\gamma'_1 \star \dots \star \gamma'_p) \circ r'(t) &= \gamma'_p(pr'(t) + 1 - p) \\ &= \gamma'_p\left(1 - \frac{n}{nr(1) - i_1 - 1}(r(1) - r(t))\right) \\ &= \gamma_{i_1}(nr(1) + 1 - i_1 - n(r(1) - r(t))) \\ &= \gamma_{i_1}(nr(t) + 1 - i_1) \end{aligned}$$

- for  $t \in [t_i, t_{i+1}]$ ,

$$(\gamma_1 \star \dots \star \gamma_n) \circ r(t) = \gamma_{i_0+i}(nr(t) - i_0 - i + 1)$$

and

$$\begin{aligned} (\gamma'_1 \star \dots \star \gamma'_p) \circ r'(t) &= \gamma'_{i+1}(pr'(t) - i) \\ &= \gamma_{i_0+i}(nr(t) + 1 - i_0 - i) \end{aligned}$$

.QED.

*Proof of the proposition.* Note  $K$  this set of paths. Let us first prove that  $K$  contains  $Q$  and satisfies the axioms. Let note  $Q' = \{\gamma \circ q \mid \gamma \in Q, q \text{ non-decreasing reparametrization}\} \cup \{c_x \mid x \in X\}$ . Since non-decreasing reparametrizations are closed under composition,  $Q'$  is closed under non-decreasing reparametrization.

- $K$  contains  $Q$  (case  $n = 1, q = id$ ),
- $K$  contains constant paths (case  $n = 1$ ),
- $K$  is closed under non-decreasing reparametrization by the previous lemma,
- Let  $\gamma = (\gamma_1 \star \dots \star \gamma_n) \circ r$  and  $\gamma' = (\gamma'_1 \star \dots \star \gamma'_m) \circ r'$  be two elements of  $K$ , such that  $\gamma(1) = \gamma'(0)$ . Since  $r$  and  $r'$  are surjective:

$$\gamma \star \gamma' = (\gamma_1 \star \dots \star \gamma_n \star \gamma'_1 \star \dots \star \gamma'_m) \circ (r \star r')$$

with  $r \star r'$  surjective. Consequently,  $\gamma \star \gamma' \in K$ .

Now let us prove that this is the smallest one, that is, given such a set  $K'$ , then  $K \subseteq K'$ . Let  $\gamma = (\gamma_1 \star \dots \star \gamma_n) \circ r \in K$ . We want to prove that  $\gamma \in K'$ . Since  $K'$  is closed under non-decreasing reparametrization, it is enough to prove that  $\gamma_1 \star \dots \star \gamma_n \in K'$ .  $\gamma_1 \star \dots \star \gamma_n$  is equal up to non-decreasing reparametrization to  $(\gamma_1 \star (\gamma_2 \star (\dots \star (\gamma_{n-1} \star \gamma_n) \dots)))$  and since  $K'$  is closed under non-decreasing reparametrization and concatenation, it is enough to prove that  $\gamma_i \in K'$ , which is true since  $K'$  contains constant paths,  $Q$  and is closed under non-decreasing reparametrizations. *.QED.*

**Proposition 4.**  *$d\mathbf{Top}$  is cocomplete.*

Indeed, given a small diagram  $D : \mathcal{D} \rightarrow \mathbf{dTop}$ , the colimit of  $D$  is computed as follow. Form first the colimit in  $\mathbf{Top}$ , that is, the space:

$$X = \bigsqcup_{d \in \text{Ob}(\mathcal{D})} D(d) / \sim$$

where  $\sim$  is the smallest equivalence relation such that  $(d, x) \sim (d', D(f)(x))$  for every morphism  $f : d \rightarrow d'$ . Denote the quotient map by  $p_d : D(d) \rightarrow X$ . Define  $\vec{P}(X)$  as  $\langle Q \rangle$  where:

$$Q = \{p_d \circ \gamma \mid d \in \text{Ob}(\mathcal{D}), \gamma \in \vec{P}(D(d))\}.$$

In particular, we observe that the forgetful functor from  $\mathbf{dTop}$  to  $\mathbf{Top}$  preserves colimits. Actually, we have better:

**Proposition 5.** *This forgetful functor is topological.*

*Proof.* Let us prove the three axioms:

- Faithfulness is trivial.
- The order on each fiber corresponds to the inclusion of sets of dipaths, and so is a partial order.
- Assume given a collection of morphisms  $(g_i : X \rightarrow F(Y_i))_{i \in I}$ . Define  $\vec{P}(X)$  as the set:

$$\{\gamma \in P(X) \mid \forall i, g_i \circ \gamma \in \vec{P}(Y_i)\}.$$

*.QED.*

### 2.2.5 Comparison

For every stream  $(X, \sqsubseteq)$ , the directed paths, that is, the morphisms of prestreams from  $\overrightarrow{[0, 1]}$  to  $X$  satisfies the conditions of dipaths of a d-space. This extends to a functor  $S : \mathbf{Str} \rightarrow \mathbf{dTop}$ . Reciprocally, from a d-space  $X$ , one can define a circulation  $\sqsubseteq$  such that  $x \sqsubseteq_U y$  if and only if there is a dipath  $\gamma \in \vec{P}(X)$  with  $\gamma(0) = x$ ,  $\gamma(1) = y$  and the image of  $\gamma$  is included in  $U$ . This extends to a functor  $D : \mathbf{dTop} \rightarrow \mathbf{Str}$ .

As observed in [Haucourt 2012],  $S$  is left adjoint to  $D$ ,  $D \circ S \circ D = D$  and  $S \circ D \circ S = S$ . This implies in particular that if  $\mathbf{HStr}$  denotes the full subcategory of  $\mathbf{Str}$  of streams which are in the image of  $D$  and  $\mathbf{CdTop}$  denote the full subcategory of  $\mathbf{dTop}$  of d-spaces which are in the image of  $S$ , then  $S$  and  $D$  restrict to functors  $\bar{S} : \mathbf{CdTop} \rightarrow \mathbf{HStr}$  and  $\bar{D} : \mathbf{HStr} \rightarrow \mathbf{dTop}$  which form an equivalence of categories.

In the literature, those streams (resp. d-spaces) have been considered. First, streams in  $\mathbf{HStr}$  are called **Haucourt streams** in [Goubault-Larrecq 2014]. They can be characterized by the following:



a Haucourt stream is a stream  $(X, \sqsubseteq)$  whose circulation satisfies that for every open set  $U$  and  $x, y \in U$ ,  $x \sqsubseteq_U y$  if and only if there is a directed paths (that is a prestream morphism from  $\overrightarrow{[0, 1]}$  to  $X$ ) with  $\gamma(0) = x$ ,  $\gamma(1) = y$  and the image of  $\gamma$  is included in  $U$ . Let us prove this statement.

We first prove that streams in the image of  $D$  are Haucourt. Let  $X$  be a d-space.  $D(X)$  is of the form  $(X, \sqsubseteq)$ . Let  $x \sqsubseteq_U y$ , i.e., there is a dipath  $\gamma \in \overrightarrow{P}(X)$  from  $x$  to  $y$  with image included in  $U$ . We prove that this  $\gamma$  is a directed path in  $(X, \sqsubseteq)$ , that is, a prestream morphism from  $\overrightarrow{[0, 1]}$  to  $(X, \sqsubseteq)$ . So let  $V$  be a open set of  $X$  and  $[t, t'] \subseteq \gamma^{-1}(V)$ . We must prove that  $\gamma(t) \sqsubseteq_V \gamma(t')$ , that is, there is a dipath  $\gamma'$  from  $\gamma(t)$  to  $\gamma(t')$  with image included in  $V$ . Define the non-decreasing reparametrization  $r(u) = (t' - t) \cdot u + t$ . Then  $\gamma' = \gamma \circ r$  is such a dipath. Reciprocally, let us assume there is a prestream morphism  $\gamma : \overrightarrow{[0, 1]} \rightarrow (X, \sqsubseteq)$  from  $x$  to  $y$  with image included in  $U$ . We must construct a dipath  $\gamma'$  (which will not necessarily be  $\gamma$ ) from  $x$  to  $y$  with image included in  $U$ . Since the image of  $\gamma$  is included in  $U$ ,  $[0, 1] \subseteq \gamma^{-1}(U)$ . So since  $\gamma$  is a prestream morphism  $x = \gamma(0) \sqsubseteq_U \gamma(1) = y$ , which provides the desired dipath.

We prove now that every Haucourt stream is in the image of  $D$ , more precisely, that for every Haucourt stream  $(X, \sqsubseteq)$ ,  $D \circ S(X, \sqsubseteq) = (X, \sqsubseteq)$ . Since  $S$  and  $D$  do not change the underlying space, we must prove that if  $\preceq$  is the circulation of  $D \circ S(X, \sqsubseteq)$  then  $\preceq = \sqsubseteq$ .  $\preceq$  is defined as follow:  $x \preceq_U y$  if and only if there is a directed path in  $(X, \sqsubseteq)$  from  $x$  to  $y$  with image included in  $U$ , which is equivalent to  $x \sqsubseteq_U y$  because  $(X, \sqsubseteq)$  is Haucourt.

Secondly, d-spaces in **CdTop** are called **complete d-spaces** in [Ziemiański 2012]. They are defined as follow. We call **weak dipaths of a d-space**  $X$  a path  $\gamma$  of  $X$  such that for every open set  $V$ , for every  $t \leq t'$  such that  $[t, t'] \subseteq \gamma^{-1}(V)$ , there is a dipath  $\gamma' \in \overrightarrow{P}(X)$  from  $\gamma(t)$  to  $\gamma(t')$  with image included in  $V$ . Weak dipaths satisfy the axioms of dipaths in d-spaces and we denote the d-space whose dipaths are weak dipaths by  $\bar{X}$ . Another way to formulate this is that  $\bar{X} = S \circ D(X)$ . We say that a d-space is **complete** if and only if  $X = \bar{X}$  or, equivalently, if and only if every weak dipath is a dipath. Since  $\bar{X} = S \circ D(X)$ , then a complete d-space is in the image of  $S$ . Reciprocally, let  $(X, \sqsubseteq)$  be a stream. Let us prove that  $S(X)$  is complete, that is, every weak dipath  $\gamma$  is a directed path. Let  $V$  be an open set of  $X$  and  $t \leq t'$  with  $[t, t'] \subseteq \gamma^{-1}(V)$ . Since  $\gamma$  is a weak dipath, there is a directed path  $\gamma'$  from  $\gamma(t)$  to  $\gamma(t')$  with image included in  $V$ . The latter says that  $[0, 1] \subseteq \gamma'^{-1}(V)$  and since  $\gamma'$  is stream morphism this implies that  $\gamma'(0) \sqsubseteq_V \gamma'(1)$ , that is,  $\gamma(t) \sqsubseteq_V \gamma(t')$ .

## 2.3 Geometric view of true concurrency

Now that we have seen an overview of the possible way of expressing directedness, we choose to use d-spaces from now. Fix such a d-space  $X$  with dipaths  $\overrightarrow{P}(X)$ . We denote by  $\overrightarrow{P}(X)(x, y)$  the set of dipaths from  $x$  to  $y$ .  $\overrightarrow{P}(X)$  and  $\overrightarrow{P}(X)(x, y)$  can be equipped with the subspace topology from  $P(X)$ , that is why we will call them **dipath spaces**.

Recall that we have defined homotopy as a path in the space of paths. We can do the same here: we call **dihomotopy** [Fajstrup 2016] between two dipaths  $\gamma, \gamma'$  from  $x$  to  $y$  a continuous function

$$H : [0, 1] \rightarrow \overrightarrow{P}(X)(x, y)$$

such that  $H(0) = \gamma$  and  $H(1) = \gamma'$ . In this case, we say that  $\gamma$  and  $\gamma'$  are **dihomotopic**, and we denote by  $[\gamma]$  the equivalence class of  $\gamma$ .

The idea is, intuitively, that two dipaths are dihomotopic if we can continuously deform one into the other while staying a dipath during the deformation. Let illustrate this on a example. Consider the following d-space.

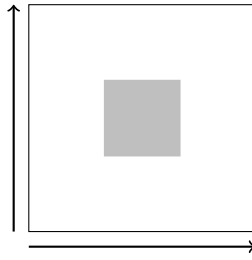

It consists of a square  $[0, 1]^2$  (in white) from which we have carved out a smaller square  $[\frac{1}{3}, \frac{2}{3}]^2$  (in gray), equipped with the subspace topology from  $\mathbb{R}^2$ . Observe that it is the geometric realization of the program  $P_1.V_1 \parallel P_1.V_1$ , or of the program  $U \parallel S$ . The dipaths are the paths that are monotone component-wise. If we consider the following two dipaths, on the left:

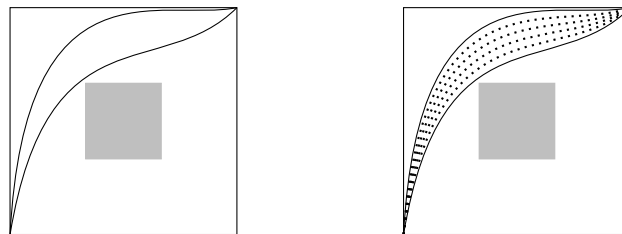

Figure 2.1: (Di)homotopic dipaths

whose images are depicted on the space, these two dipaths are dihomotopic since we can continuously deform one into the other while staying a dipath as depicted on the right. On the other hand, if we consider the following two dipaths, on the left:

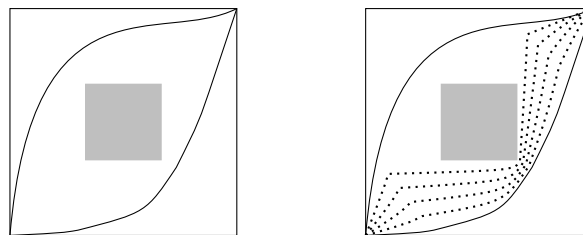

Figure 2.2: Non-(di)homotopic dipaths

those two dipaths are not dihomotopic because if we want to continuously deform one into the other, we would be blocked by the hole.

At the beginning of the section, we have seen two ways of defining homotopy: either as a function  $H : [0, 1] \times [0, 1] \rightarrow X$ , or as a function  $H : [0, 1] \rightarrow P(X)(x, y)$ . We choose to extend the second definition to d-spaces but we could have done the same with the first. The main point comes from the possible directed structures with which one can equip the segment. We have seen the directed

segment  $\overrightarrow{[0, 1]}$  whose dipath are monotone paths. Symmetrically,  $\overleftarrow{[0, 1]}$  is the d-space whose dipaths are antitonic paths. Since the set of d-space structures on a topological space is a complete lattice, there is a smallest d-space structure that contains  $\overrightarrow{[0, 1]}$  and  $\overleftarrow{[0, 1]}$ , that we denote by  $\widetilde{[0, 1]}$ . to be more explicit, the dipaths of  $\widetilde{[0, 1]}$  are the paths that only have a finite number of changes of monotonicity, or equivalently, that are finite concatenations of monotonic and antitonic paths. But there are two others structures on the segment coming from the adjunctions of the forgetful functor from d-spaces to topological spaces. Given a topological space  $X$ , one can always define two directed structures on it:

- $\overline{X}$  whose dipaths are constant paths. This is the smallest (for inclusion) possible structure on a topological space.
- $\overleftarrow{X}$  whose dipaths are all the paths. This is the largest possible structure on a topological space.

It has to be noticed that  $\widetilde{[0, 1]}$  and  $\overleftarrow{[0, 1]}$  do not coincide, since there are paths that have an infinite number of changes of monotonicity (for example,  $t \mapsto t \sin(\frac{1}{t})$ ). In the following, we will consider topological spaces as d-spaces by implicitly using the structure  $\overleftarrow{X}$ . The other structure also has its own interest: a dihomotopy defined as a continuous function  $H : [0, 1] \rightarrow \overrightarrow{P}(X)(x, y)$  is the same as a dimap  $H : \overrightarrow{[0, 1]} \times \overrightarrow{[0, 1]} \rightarrow X$  with some boundary conditions. One could argue: why this choice ? The point is that we are interested in continuous deformation of dipaths (executions) such that during the deformation we always have a dipath (execution), but we do not care about directedness of the deformation. Some authors (see [Grandis 2009], for example) chose to use  $\overrightarrow{[0, 1]}$  instead of  $\widetilde{[0, 1]}$ . Using the definition as a map from  $[0, 1]$  to  $\overrightarrow{P}(X)(x, y)$ , using  $\overrightarrow{[0, 1]}$  means that we consider dihomotopies as dipaths in the (suitable) d-space of dipaths. It does make a difference in general, in particular, if one has in mind that topological spaces are  $\infty$ -groupoids, considering  $\overrightarrow{P}(X)$  as a topological space means that, intuitively (we will come to this more precisely later),  $X$  can be seen as an  $(\infty, 1)$ -category, while seeing  $\overrightarrow{P}(X)$  as a d-space means that  $X$  can be seen as an  $(\infty, \infty)$ -category.

A dipath being also a path, one may be wondering how homotopy between dipaths and dihomotopy can be compared. In the previous example, these two equivalence relations on dipaths coincide: the fact that, during the deformation, one must stay a dipath is not important. It is a general behavior for simple spaces (see [Goubault 2016], in the case of non-positively curved spaces). But there are space for which homotopy and dihomotopy are different, and this is important !

Let us illustrate this on the following example, called the **matchbox**, from [Fahrenberg 2003]:

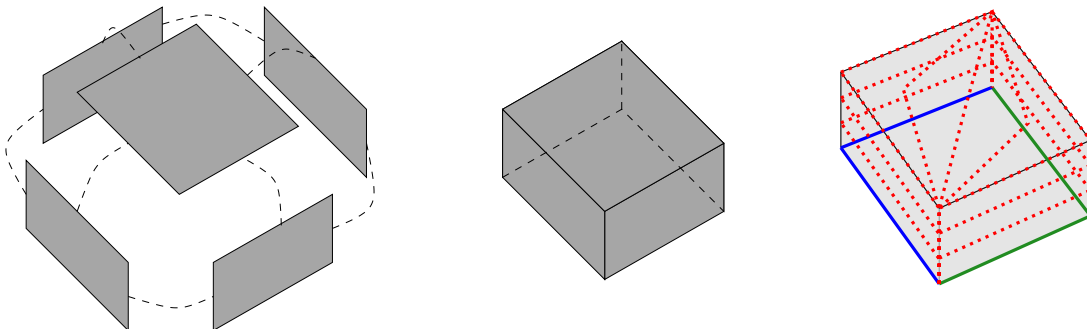
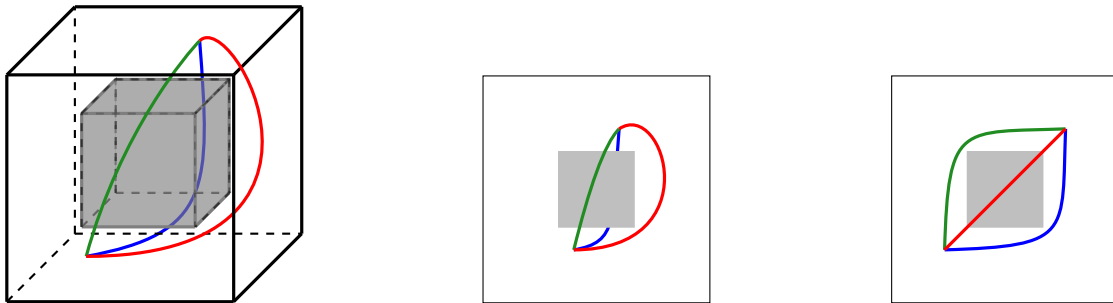

Figure 2.3: The matchbox and some homotopic behavior

This d-space is constructed as follow. Consider the topological cube  $\square_3$ , i.e., the set of triples  $(t_1, t_2, t_3)$  such that  $t_i \in [0, 1]$ . The matchbox  $\mathbb{M}_{\square}$  is then the sub-space of  $\square_3$  whose points are triples  $(t_1, t_2, t_3)$  with  $t_1 \in \{0, 1\}$  or  $t_2 \in \{0, 1\}$  or  $t_3 = 1$ . Geometrically,  $\mathbb{M}_{\square}$  is a hollow cube whose lower face has been cut.  $\square_3$  can be equipped with a structure of po-space by the product ordering, and so of a d-space structure whose dipaths are monotonic paths.  $\mathbb{M}_{\square}$  has two particular dipaths depicted in blue and green on the above right picture. These two dipaths are homotopic, a homotopy is drawn of the right. But during this deformation, one must cross the upper face and at this point, the path must go down and so is not monotone. Consequently, this homotopy is not a dihomotopy. More generally, any homotopy must intersect the upper face and so cannot be a dihomotopy. Those dipaths are then not dihomotopic.

We choose to present this example because it is a very simple space to describe, but the problem also occur for geometric realizations of concurrent programs. Consider for example the program  $P_1.V_1 \parallel P_1.V_1 \parallel P_1.V_1$  with  $\nu_1 = 2$ . Its geometric realization is the following, on the left, a face view is depicted in the middle, and a side view on the right:



More precisely, it is the space  $[0, 1] \times [0, 1] \times [0, 1] \setminus [\frac{1}{3}, \frac{2}{3}] \times [\frac{1}{3}, \frac{2}{3}] \times [\frac{1}{3}, \frac{2}{3}]$ . Consider as dipaths the monotone paths. The blue and green paths are homotopic just turn around the hole. But they are not dihomotopic since a homotopy must go through a path similar to the red one depicted above, which cannot be a dipath.

Actually, the things are even trickier. If you extend the blue and green dipaths in the matchbox with the red dipaths as follow:

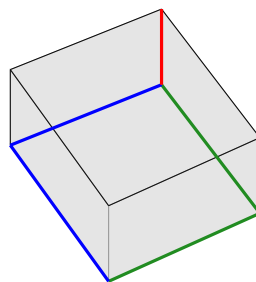

Figure 2.4: Non-cancellative behavior in the matchbox

the extended dipaths are dihomotopic. This means that dihomotopies may have non-cancellative behaviors: non-dihomotopic dipaths may become dihomotopic after concatenation. This kind of behavior cannot occur with homotopy in topological spaces. Indeed, a path is always invertible up to homotopy: given a path  $\gamma : [0, 1] \rightarrow X$ , the path  $\gamma^{-1}$  which maps  $t$  to  $\gamma(1-t)$  satisfy that  $\gamma \star \gamma^{-1}$  and  $\gamma^{-1} \star \gamma$  are homotopic to constant paths. So, since homotopy is preserved by concatenation, if

$\tau \star \gamma$  and  $\rho \star \gamma$  are homotopic then  $\tau$  is homotopic to  $\tau \star \gamma \star \gamma^{-1}$ , which is homotopic to  $\rho \star \gamma \star \gamma^{-1}$ , itself homotopic to  $\rho$ .

All those data can be summarized in one structure, the **fundamental category** [Brown 2006]. Given a topological space  $X$ , the fundamental category  $\pi_1(X)$  is the category whose:

- objects are points of  $X$ ,
- morphisms from  $x$  to  $y$  are paths from  $x$  to  $y$  modulo homotopy,
- composition  $[\gamma] \circ [\rho]$  is given by  $[\rho \star \gamma]$ ,
- identities are equivalence classes of constant paths  $[c_x]$ .

This category is well defined:

- the composition does not depend on the representative elements used: if  $H$  is a homotopy between  $\gamma$  and  $\gamma'$ , and  $H'$  between  $\rho$  and  $\rho'$  then  $H \star H'$  defined as  $t \mapsto H(t) \star H'(t)$  is a homotopy between  $\gamma \star \rho$  and  $\gamma' \star \rho'$ .
- the composition is associative: concatenation is not associative but  $(\gamma_1 \star \gamma_2) \star \gamma_3$  is homotopic to  $\gamma_1 \star (\gamma_2 \star \gamma_3)$ . Actually, there is a reparametrization  $r$  such that  $(\gamma_1 \star (\gamma_2 \star \gamma_3)) \circ r = (\gamma_1 \star \gamma_2) \star \gamma_3$ .

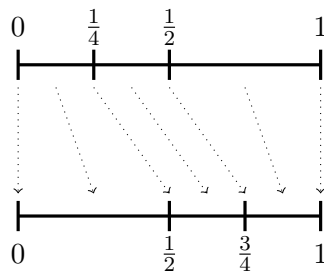

- the constant paths are neutral elements for concatenation modulo dihomotopy:  $c_x \star \gamma$  and  $\gamma \star c_y$  are both homotopic to  $\gamma$ . Actually, there are reparametrizations as previously.

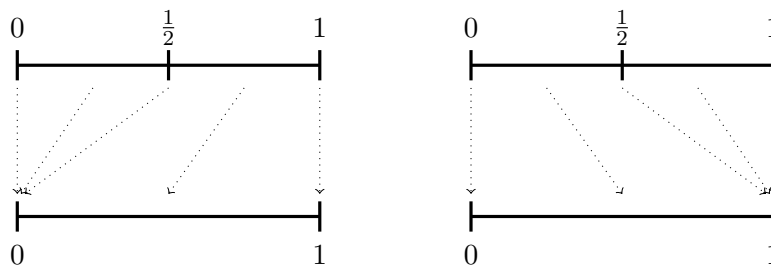

The existence of an inverse path modulo homotopy implies that this category is always a groupoid, that is, a category such that every morphism is an isomorphism. That is why we talk about the **fundamental groupoid** of  $X$ . A groupoid is in particular left and right cancellative, that is, if  $f \circ g = f \circ h$  then  $g = h$ , and symmetrically, as observed earlier on paths modulo homotopy.

This construction extends to a functor  $\pi_1 : \mathbf{Top} \rightarrow \mathbf{Grpd}$ , where  $\mathbf{Grpd}$  is the category of small groupoids and functors. For a continuous map  $f : X \rightarrow Y$ ,  $\pi_1(f)$  is defined as the functor which

maps any point  $x$  of  $X$  to  $f(x)$ , and any homotopy class  $[\gamma]$  to the homotopy class  $[f \circ \gamma]$ . It is well defined since for every homotopy  $H : [0, 1] \rightarrow P(X)(x, y)$  between  $\gamma$  and  $\gamma'$ , the homotopy  $H' : [0, 1] \rightarrow P(Y)(f(x), f(y))$  which maps  $t$  to the path  $f \circ H(t)$  is a homotopy between  $f \circ \gamma$  and  $f \circ \gamma'$ .

The **fundamental category**  $\overrightarrow{\pi}_1(X)$  of a d-space is defined similarly [Grandis 2009, Fajstrup 2016], considering dipaths modulo dihomotopy instead. The well-definedness is similar: the main point is that everything works modulo non-decreasing reparametrizations as observed above, and so, since dipaths are closed under those reparametrizations, everything works as well in dipaths. In contrast to topological spaces, the fundamental category of a d-space is not a groupoid, not even cancellative (see what we observed on  $\mathbb{M}_{\square}$ ). This is a crucial point in directed algebraic topology: essentially nothing is invertible, that is what makes things much more complex. Similarly to the topological case,  $\overrightarrow{\pi}_1$  extends to a functor from **dTop** to **Cat**, the category of small categories and functors.

## 2.4 Trace spaces

Finally, we present another way of abstracting executions geometrically. We have seen that dipaths with dihomotopy are a nice abstraction of executions with homotopy. Dipaths encode continuously the succession of actions done by the processes, but also the time they need to do so. This time information is not necessarily needed, and another way to abstract an execution would be to forget about this, by quotienting dipaths modulo reparametrizations, which leads to the notion of **traces** [Fahrenberg 2007].

We say that a dipath  $\gamma$  from  $a$  to  $b$  reparametrizes to a dipath  $\gamma'$  from  $a$  to  $b$  if there is a monotone, surjective and continuous function  $r : [0, 1] \rightarrow [0, 1]$  such that  $\gamma' = \gamma \circ r$ . Denote by  $\sim_{rep}$  the smallest equivalence relation such that  $\gamma \sim_{rep} \gamma'$  with  $\gamma$  reparametrizes to  $\gamma'$ , and denote by  $\langle \gamma \rangle$  the equivalence class of  $\gamma$  modulo  $\sim_{rep}$ . This class is called the **trace of  $\gamma$** .

The set of traces (resp. of traces from  $a$  to  $b$ ) is naturally equipped with a topology by considering the quotient space  $\overrightarrow{P}(X) / \sim_{rep}$  (resp.  $\overrightarrow{P}(X)(a, b) / \sim_{rep}$ ). This space is denoted by  $\overrightarrow{T}(X)$  (resp.  $\overrightarrow{T}(X)(a, b)$ ) and is called the **trace space**.

Trace spaces have good theoretical properties (see for instance [Raussen 2009]). In particular, they are homotopically equivalent (to be defined soon) to path spaces in some cases (typically, in the case of geometric realizations of PV/SU programs). They also have nice computational properties (see [Raussen 2010, Raussen 2012a, Raussen 2012b]): it is possible to compute a finite representation of trace spaces, which allows one to compute algebraic invariants, e.g., homology groups. They were applied in [Fajstrup 2012] to static analysis of concurrent programs.

What makes them a bit more convenient than dipaths is the fact that concatenation  $\star$  can be defined on traces by  $\langle \gamma \rangle \star \langle \gamma' \rangle = \langle \gamma \star \gamma' \rangle$  and is an associative operation on traces (which was not the case on dipaths). In particular, this implies that concatenation is associative modulo dihomotopy on dipaths. The counterpart is that paths in trace spaces do not in general come from paths in spaces of dipaths, meaning that one cannot recover dihomotopies as paths in the space of traces in general. But, it is the case for some spaces like geometric realizations of programs.

Let us look at two simple examples. We look at the trace space of these two d-spaces, that we have already seen earlier. We will write  $X_1$  for the left one and  $X_2$  for the right one.

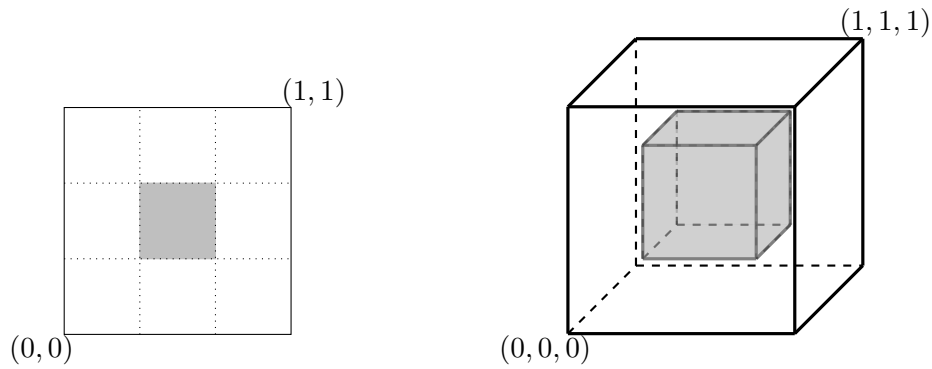

As shown in [Raussen 2010],  $\vec{T}(X_1)((0,0), (1,1))$  is a topological space with two connected components, one is composed of the traces which have dihomotopy type of the path going up to the left of, then above the hole, the other component is composed of the traces which have the dihomotopy type of the path going along the bottom of the hole then up on its right. Moreover, the two connected components of  $\vec{T}(X_1)((0,0), (1,1))$  are contractible ; it is thus homotopy equivalent to two points.

As shown again in [Raussen 2010],  $\vec{T}(X_2)((0,0,0), (1,1,1))$  is homotopy equivalent to the circle  $S^1$ : there is a unique dipath up to dihomotopy, hence the trace space  $\vec{T}(X_2)((0,0,0), (1,1,1))$  is connected, but there is a finer structure of dihomotopies which accounts for the non simple-connectness character of  $\vec{T}(X_2)((0,0,0), (1,1,1))$ . For example, a homotopy equivalence (to be defined soon) from  $\vec{T}(X_2)((0,0,0), (1,1,1))$  to the boundary of a triangle is depicted here:

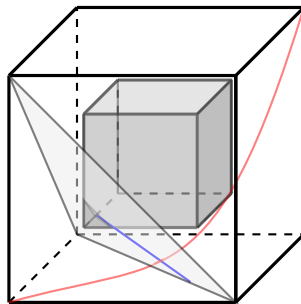

# General theory of bisimulations and unfoldings in accessible categories

---

In this chapter, I would like to come back to the general theory of bisimulations from [Joyal 1996], presented in Chapter 1 in the case of transition systems. This chapter is not directly related to the rest of this thesis. No particular focus on true concurrency or geometry will be made (although we will talk about the universal covering of a groupoid), and this chapter may be skipped for a first reading.

In Chapter 1, we have seen that the general idea was to provide conditions on morphisms of systems for them to act like bisimulations. We saw that the main point was that such morphisms must lift executions. In the original paper [Joyal 1996], this general idea was formalized: as long as you provide a category of models and a sub-category of “path shapes” (for example, branches in the case of transition systems), it is possible to describe a notion of bisimilarity as the existence of a span of morphisms that lifts executions. A number of occurrences of this theory can be observed: transition systems with bisimulations, transition systems with independence and (strong) history-preserving bisimulations, ... can be describe as such. Also in this paper, another general theory of bisimulations, more classic, was described: two systems are bisimilar if there is a relation between their executions. Those two theories were proved to coincide with classical theory of bisimulations, but there were no general results stating that both theories coincide generally.

Independently, we have seen that unfoldings are important for computational systems. They allow one to consider systems which are simpler since they do not have any looping behaviors. Theoretically, the unfolding process is in general a right adjoint of some inclusion of “simple systems” into the full category of systems, for example, inclusion of synchronization trees into transition systems, or event structures into transition systems with independence.

In this chapter, we describe a general class of systems, called **accessible categorical models**, with specified path shapes that satisfies some conditions, intuitively, that we can form trees from path shapes. In this general theory, both theories of bisimulations from [Joyal 1996] coincide and a nice notion of unfolding can be described. In Section 1, we recall the general theory from [Joyal 1996] and in Section 2, we describe accessible categorical models by explaining why in this case both theories of bisimulations coincide. We then prove that presheaf models from [Joyal 1996] are accessible (Section 3) and that accessibility is preserved by coreflections (Section 4). In Section 5, we describe the general definition of unfoldings and show that this produces a bisimilar system and that unfolding is the right adjoint of some inclusion. Finally, in Section 6, following intuitions from universal coverings from algebraic topology, we prove that unfolding is universal, and that the universal covering of a pointed connected groupoid is a particular case of unfolding.

## 3.1 Categorical models and bisimilarities

We first recall, from [Joyal 1996], two notions of bisimilarities in a category with a specified subcategory of path shapes.



### 3.1.1 Category of models, subcategory of paths

We consider a category  $\mathcal{M}$  (of **models**) together with a small subcategory (of **path-shapes**)  $\mathcal{P}$ . We assume that  $\mathcal{M}$  and  $\mathcal{P}$  have a common initial object  $I$ , i.e., an object  $I \in \mathcal{P}$  such that for every object  $A$  of  $\mathcal{P}$  (resp. of  $\mathcal{M}$ ), there is a unique morphism in  $\mathcal{P}$  (resp. in  $\mathcal{M}$ ) from  $I$  to  $A$ . We denote this morphism by  $\iota_A$  this unique morphism. One typical example is the category of transition systems  $\mathbf{Tr}(\Sigma)$  together with the subcategory of branches  $\mathbf{Br}(\Sigma)$ . A common initial object of  $\mathbf{Tr}(\Sigma)$  and  $\mathbf{Br}(\Sigma)$  is then the branch of length 0 ( $[0], 0, \emptyset$ ).

### 3.1.2 A relational bisimilarity of models: path-bisimilarity

Equivalence of transition systems is defined through the notion of **bisimulation**. Classically, a bisimulation is defined as presented in Section 1.2.1, as relation on states.

A bisimulation  $R$  between  $T_1$  and  $T_2$  induces a relation  $R'_n$  between executions of length  $n$  of  $T_1$  and  $T_2$  by:

$$R'_n = \{(f_1 : B_1 \longrightarrow T_1, f_2 : B_2 \longrightarrow T_2) \mid \forall i \in [n], (f_1(i), f_2(i)) \in R\}$$

These relations satisfy that:

- $(\iota_{T_1}, \iota_{T_2}) \in R'_0$  by the first condition of a bisimulation;
- by the second condition, if  $(f_1, f_2) \in R'_n$  and if  $(f_1(n), a, q_1) \in \Delta_1$  then there is  $q_2 \in Q_2$  such that  $(f_2(n), a, q_2) \in \Delta_2$  and  $(f'_1, f'_2) \in R'_{n+1}$  where  $f'_i(j) = f_i(j)$  if  $j \leq n$ ,  $q_i$  otherwise;
- symmetrically with the third;
- if  $(f_1, f_2) \in R'_{n+1}$  then  $(f'_1, f'_2) \in R'_n$  where  $f'_i$  is the restriction of  $f_i$  to  $[n]$ .

In fact, bisimilarity of transition systems is equivalent to the existence of such relations on executions. This leads us to the general notion of strong path-bisimulation [Joyal 1996].

A **strong path-bisimulation**  $R$  between  $X$  and  $Y$ , objects of  $\mathcal{M}$  is a set of elements of the form  $X \xleftarrow{f} P \xrightarrow{g} Y$  with  $P$  an object of  $\mathcal{P}$  such that:

- (a)  $X \xleftarrow{i_X} I \xrightarrow{i_Y} Y$  belongs to  $R$ ;
- (b) if  $X \xleftarrow{f} P \xrightarrow{g} Y$  belongs to  $R$  then for every **path extension** of  $X$ , i.e, every morphism  $p$  in  $\mathcal{P}$  such that:

$$\begin{array}{ccc} P & \xrightarrow{f} & X \\ p \downarrow & \nearrow f' & \\ Q & & \end{array}$$

commutes then there exists a path extension of  $Y$

$$\begin{array}{ccc} P & \xrightarrow{g} & Y \\ p \downarrow & \nearrow g' & \\ Q & & \end{array}$$

such that  $X \xleftarrow{f'} Q \xrightarrow{g'} Y$  belongs to  $R$ ;

(c) symmetrically;

(d) if  $X \xleftarrow{f} P \xrightarrow{g} Y$  belongs to  $R$  and if we have a morphism  $p : Q \rightarrow P \in \mathcal{P}$  then  $X \xleftarrow{f \circ p} Q \xrightarrow{g \circ p} Y$  belongs to  $R$ ;

We say that  $X$  and  $Y$  are **strong path bisimilar** iff there exists a strong path bisimulation between them.

### 3.1.3 A fibrational bisimilarity of models: $\mathcal{P}$ -bisimilarity

We have seen that in the case of transition systems, bisimilarity is equivalent to the existence of morphisms having lifting properties with respect to executions. This can be extended to any category of models with a specified sub-category of path-shapes.

We say that a morphism  $f : X \rightarrow Y$  of  $\mathcal{M}$  is **( $\mathcal{P}$ -)open** iff for every commutative diagram:

$$\begin{array}{ccc} P & \xrightarrow{x} & X \\ p \downarrow & & \downarrow f \\ Q & \xrightarrow{y} & Y \end{array}$$

with  $p : P \rightarrow Q \in \mathcal{P}$ , there exists a morphism  $\theta : Q \rightarrow X$  such that the following diagram commutes:

$$\begin{array}{ccc} P & \xrightarrow{x} & X \\ p \downarrow & \nearrow \theta & \downarrow f \\ Q & \xrightarrow{y} & Y \end{array}$$

We then say that two objects  $X$  and  $Y$  of  $\mathcal{M}$  are  **$\mathcal{P}$ -bisimilar** iff there exists a span  $f : Z \rightarrow X$  and  $g : Z \rightarrow Y$  where  $f$  and  $g$  are  $\mathcal{P}$ -opens.

It is known that if  $X$  and  $Y$  are  $\mathcal{P}$ -bisimilar then they are strong path bisimilar [Joyal 1996], but the converse does not seem to hold in general. It will hold in the case of transition systems (both  $\mathcal{P}$  and path bisimilarities coincide with the classical bisimilarity), but there is no general result for the converse. The purpose of the next section is to investigate a general framework in which those two notions of bisimilarities coincide.

## 3.2 Accessible models and equivalence of bisimilarities

For the converse, we must build a span of open maps from a strong path-bisimulation. It requires in particular that we construct an object of  $\mathcal{M}$ , which will be the tip of the span. One way of doing so is to glue the elements of the bisimulation in order to obtain an "object of bisimilar paths". Categorically, a glueing is a colimit, so a natural hypothesis should be the existence of some colimits in  $\mathcal{M}$ .

Concretely, a  **$\mathcal{P}$ -tree** in  $\mathcal{M}$  is a colimit in  $\mathcal{M}$  of a small diagram with values in  $\mathcal{P}$ , i.e., of a functor  $D : \mathcal{D} \rightarrow \mathcal{P}$  where  $\mathcal{D}$  is a small category. We say that **all  $\mathcal{P}$ -trees exist in  $\mathcal{M}$**  if every

small diagram with values in  $\mathcal{P}$  has a colimit in  $\mathcal{M}$ . In the category of transition systems,  $\mathbf{Br}(\Sigma)$ -trees are exactly synchronization trees. In particular, all  $\mathbf{Br}(\Sigma)$ -trees exists in  $\mathbf{Tr}(\Sigma)$ . We denote by  $\mathbf{Tree}(\mathcal{M}, \mathcal{P})$  for the full subcategory of  $\mathcal{M}$  of  $\mathcal{P}$ -trees.

Let  $R$  be a strong path bisimulation between  $X$  and  $Y$  and assume that all  $\mathcal{P}$ -trees exist. Let us construct a span of maps between  $X$  and  $Y$ . First, we construct the tip of the span as the colimit of a particular diagram with values in  $\mathcal{P}$ , defined from  $R$ . Let  $\mathcal{C}$  be the following category:

- objects of  $\mathcal{C}$  are elements of  $R$ ;
- morphisms from  $X \xleftarrow{x} P \xrightarrow{y} Y$  to  $X \xleftarrow{x'} Q \xrightarrow{y'} Y$  are morphisms  $p : P \rightarrow Q$  of  $\mathcal{P}$  such that the following diagram commutes:

$$\begin{array}{ccccc} & & P & & \\ & x \swarrow & & \searrow y & \\ X & & & & Y \\ & \nwarrow x' & \downarrow p & \nearrow y' & \\ & & Q & & \end{array}$$

Then define the diagram  $F : \mathcal{C} \rightarrow \mathcal{P}$  which maps every  $X \xleftarrow{x} P \xrightarrow{y} Y \in R$  to  $P$  and every  $p$  to itself. Since  $\mathcal{P}$ -trees exist ( $F$  is small because  $R$  is a set), let  $(Z, ([\alpha]_{\alpha \in R}))$  be the colimit of  $F$ , where the  $[X \xleftarrow{x} P \xrightarrow{y} Y] : P = F(X \xleftarrow{x} P \xrightarrow{y} Y) \rightarrow Z$  are the maps from the colimit.

$Z$  will be the tip of our span. Now we need to construct maps  $\Phi : Z \rightarrow X$  and  $\Psi : Z \rightarrow Y$ . Let us do it for  $\Phi$ : since  $(X, (F(X \xleftarrow{x} P \xrightarrow{y} Y) \xrightarrow{x} X))$  is a cocone of  $F$ , there exists a unique morphism  $\Phi : Z \rightarrow X$  such that for every  $X \xleftarrow{x} P \xrightarrow{y} Y \in R$  the following diagram commutes:

$$\begin{array}{ccc} P & \xrightarrow{[X \xleftarrow{x} P \xrightarrow{y} Y]} & Z \\ x \downarrow & \searrow \Phi & \\ X & & \end{array}$$

To prove that strong path-bisimilarity implies  $\mathcal{P}$ -bisimilarity, we just need to prove that  $\Phi$  is open, but this does not hold in general. We will need that we do not create more paths in a tree than the ones we used in the glueing. In the case of transition systems, this says that every path in a tree seen as the colimit of a certain diagram  $D$  with values in  $\mathbf{Br}(\Sigma)$  is a subbranch of some  $D(i)$ . More generally, we will say that  $\mathcal{M}$  is  $\mathcal{P}$ -**accessible** if:

- all  $\mathcal{P}$ -trees exist;
- every morphism  $f : P \rightarrow Z$  where  $P \in \mathcal{P}$  and  $(Z, (\eta_d)_{d \in \mathcal{D}})$  is the colimit of a non-empty small diagram  $D : \mathcal{D} \rightarrow \mathcal{P}$  factorizes as  $f = \eta_d \circ p$  for some  $d \in \mathcal{D}$  with  $p : P \rightarrow D(d) \in \mathcal{P}$ .

In particular,  $\mathbf{Tr}(\Sigma)$  is  $\mathbf{Br}(\Sigma)$ -accessible.

The name “accessible” is a reference to  $\kappa$ -accessible categories [Makkai 1989] where  $\kappa$  is a cardinal, which is a very similar property of a category, requiring the existence of some colimits (in this case, filtered colimits) and the same kind of factorizations for morphisms whose codomain is such a colimit.

Assuming that  $\mathcal{M}$  is  $\mathcal{P}$ -accessible, we can now prove that  $\Phi$  is open. Consider a commutative diagram of the form:

$$\begin{array}{ccc} P & \xrightarrow{z} & Z \\ p \downarrow & & \downarrow \Phi \\ Q & \xrightarrow{x} & X \end{array}$$

with  $p$  in  $\mathcal{P}$ . As  $Z$  is a colimit of a non-empty (because  $R$  is non-empty) small diagram, then by  $\mathcal{P}$ -accessibility,  $z : P \rightarrow Z$  factorizes as  $[X \xleftarrow{x'} P' \xrightarrow{y'} Y] \circ p'$  for some  $X \xleftarrow{x'} P' \xrightarrow{y'} Y \in R$  and  $p' : P \rightarrow P' \in \mathcal{P}$ . Then, by condition (d) of a strong path bisimulation,  $X \xleftarrow{x' \circ p'} P \xrightarrow{y' \circ p'} Y$  belongs to  $R$ . Moreover, the following diagram commutes:

$$\begin{array}{ccc} & P & \\ x' \circ p' \swarrow & & \searrow y' \circ p' \\ X & & Y \\ & p' \downarrow & \\ & P' & \\ x' \swarrow & & \searrow y' \end{array}$$

Then,  $z = [X \xleftarrow{x'} P' \xrightarrow{y'} Y] \circ p' = [X \xleftarrow{x' \circ p'} P \xrightarrow{y' \circ p'} Y]$ .

So,  $x \circ p = \Phi \circ z = \Phi \circ [X \xleftarrow{x' \circ p'} P \xrightarrow{y' \circ p'} Y] = x' \circ p'$  by definition of  $\Phi$ . This means that we have the following commutative diagram:

$$\begin{array}{ccc} P & \xrightarrow{x' \circ p'} & X \\ p \downarrow & \nearrow x & \\ Q & & \end{array}$$

Then, by condition (b) of a strong path bisimulation, there is a path extension of  $Y$ :

$$\begin{array}{ccc} P & \xrightarrow{y' \circ p'} & Y \\ p \downarrow & \nearrow y & \\ Q & & \end{array}$$

such that  $X \xleftarrow{x} Q \xrightarrow{y} Y$  belongs to  $R$ .

Then the morphism  $\theta = [X \xleftarrow{x} Q \xrightarrow{y} Y] : Q \rightarrow Z$  is the lifting we were looking for:

$$\begin{array}{ccc} P & \xrightarrow{z} & Z \\ p \downarrow & \nearrow \theta & \downarrow \Phi \\ Q & \xrightarrow{x} & X \end{array}$$

So we deduce:

**Theorem 1.** *If  $\mathcal{M}$  is  $\mathcal{P}$ -accessible and if  $X$  and  $Y$  are strong path bisimilar then they are  $\mathcal{P}$ -bisimilar.*

### 3.3 Presheaf models

Presheaf models were introduced in [Joyal 1996], motivated by the work on pretopoi in [Joyal 1994]. We prove in this section that presheaf models are a particular case of accessible models.

Assume given a small category  $\Delta$  with an initial object  $J$ . A **rooted presheaf on  $\Delta$**  is a functor  $F$  from  $\Delta^{op}$  to  $\mathbf{Set}$  such that  $F(J)$  is a singleton. Let  $[\Delta^{op}, \mathbf{Set}]_*$  be the category of rooted presheaves on  $\Delta$  and natural transformations. We have a functor (called the **Yoneda embedding**)  $\mathfrak{Y} : \Delta \rightarrow [\Delta^{op}, \mathbf{Set}]_*$ :

- we associate an object  $P$  of  $\Delta$  with the rooted presheaf  $\mathfrak{Y}(P)$  which maps:

- every object  $Q$  of  $\Delta$  to  $\Delta(Q, P)$ ,
- every morphism  $p : Q \rightarrow Q'$  of  $\Delta$  to the function  $\mathfrak{Y}(P)(p) : \Delta(Q', P) \rightarrow \Delta(Q, P) \quad f \mapsto f \circ p$ .
- we associate a morphism  $p : P \rightarrow P'$  with the natural transformation  $\mathfrak{Y}(p) : \mathfrak{Y}(P) \rightarrow \mathfrak{Y}(P')$  defined by

$$\mathfrak{Y}(p)_Q : \Delta(Q, P) \rightarrow \Delta(Q, P') \quad f \mapsto p \circ f$$

**Theorem 2.** *Let  $\mathcal{P}$  be the image of  $\mathfrak{Y}$  and  $\mathcal{M} = [\Delta^{op}, Set]_*$ . Then  $\mathcal{M}$  is  $\mathcal{P}$ -accessible.*

*Proof.*

- ★  **$\mathcal{P}$  is a full embedding of  $\mathcal{M}$ :** by the Yoneda lemma.
- ★ **computation of colimits in  $\mathcal{M}$ :** consider a small diagram  $D : U \rightarrow \mathcal{M}$ . The colimit in  $[\Delta^{op}, Set]_*$  of  $D$  is the colimit in  $[\Delta^{op}, Set]$  (which is cocomplete [Borceux 1994b]) of the small (non-empty) diagram  $D_\perp : U_\perp \rightarrow \mathcal{M}$  where:
  - $U_\perp$  is the category obtained by adding an object  $\perp$  to  $U$  with a unique morphism from  $\perp$  to any object of  $U$  or  $\perp$  and no morphism from an object of  $U$  to  $\perp$ ,
  - $D_\perp$  maps  $\perp$  to  $\mathfrak{Y}(J)$  (which is the initial object of  $\mathcal{M}$  and  $\mathcal{P}$  by the Yoneda lemma), any object  $u$  of  $U$  to  $D(u)$ , the morphism from  $\perp$  to  $u$  object of  $U_\perp$  to the unique natural transformation from  $\mathfrak{Y}(J)$  to  $D_\perp(u)$  and any morphism  $\nu$  of  $U$  to  $D(\nu)$ .
- ★ **all trees exist:** consequence of the previous point.
- ★  **$\mathcal{P}$ -accessibility:** let  $D : U \rightarrow \mathcal{P}$  be a non-empty small diagram and  $f : \mathfrak{Y}(P) \rightarrow colim D$  a morphism of  $\mathcal{M}$  with  $P$  in  $\Delta$  and  $colim D$  the colimit of  $D$  in  $\mathcal{M}$ .  $(colim D)(P)$  is computed as the quotient:

$$\left( \bigsqcup_{u \in U} D(u)(P) \sqcup \Delta(P, J) \right) / \sim$$

where  $\sim$  is the equivalence relation on  $\bigsqcup_{u \in U} D(u)(P) \sqcup \Delta(P, J)$  generated by:

- for every  $\nu : u \rightarrow u'$  of  $U$ , for every  $x \in D(u)(P)$ ,  $x \sim D(\nu)_P(x)$ ,
- for every  $x \in \Delta(P, J)$  and every  $u$  in  $U$ ,  $x \sim \eta_u(x)$ .

Since  $U$  is non-empty, every  $x$  in  $\Delta(P, J)$  is equivalent to some element of  $\bigsqcup_{u \in U} D(u)(P)$ . So, every element of  $(colim D)(P)$  is the image of one of the projections of an element of some  $D(u)(P)$ . Let  $v$  be an object of  $U$  and  $x \in D(v)(P)$  such that  $f_P(id_P) \in (colim D)(P)$  is the image of  $x$  by the projection from  $D(v)(P)$  to  $(colim D)(P)$ . By the Yoneda lemma, there exists a unique natural transformation  $\theta : \mathfrak{Y}(P) \rightarrow D(v)$  such that  $\theta_P(id_P) = x$ .  $\theta$  belongs to  $\mathcal{P}$  because  $\mathcal{P}$  is a full embedding of  $\mathcal{M}$ . If  $\pi_v : D(v) \rightarrow colim D$  is the morphism from the universal cocone, then by the Yoneda lemma,  $f = \pi_v \circ \theta$ .

.QED.

### 3.4 Relationships with coreflections

We have seen in Chapter 1 that coreflections are a nice categorical way to express the fact that a computational model can be simulated by another one. This view was initiated in [Winskel 1984], where it was shown in particular that event structures can be simulated by occurrence nets and so by 1-safe Petri nets. Note that the right adjoints of those coreflections give interesting constructions: in the case of occurrence nets in Petri nets, the right adjoint gives what is called the unfolding of a 1-safe Petri net. In this section, we prove that accessibility is preserved by coreflections.

In fact we can prove the even more general following theorem:

**Theorem 3.** *Let  $\mathcal{P}$  (resp.  $\mathcal{P}'$ ) be a subcategory of  $\mathcal{M}$  (resp.  $\mathcal{M}'$ ). Assume that:*

- $\mathcal{M}$  is  $\mathcal{P}$ -accessible,
- there is a functor  $F : \mathcal{M} \rightarrow \mathcal{M}'$  such that:
  - $F$  preserves trees, i.e., for every small diagram  $D : U \rightarrow \mathcal{P}$ ,  $F(\text{colim } D)$  is a colimit of  $F \circ D$  in  $\mathcal{M}'$ ,
  - $F$  induces a functor from  $\mathcal{P}$  to  $\mathcal{P}'$ ,
  - there is a functor  $G : \mathcal{P}' \rightarrow \mathcal{P}$  and a natural isomorphism  $\nu : F \circ G \rightarrow \text{id}_{\mathcal{P}'}$ .

Then  $\mathcal{M}'$  is  $\mathcal{P}'$ -accessible.

The preservation of trees holds for example when  $F$  is a left adjoint. The other two conditions hold for example when  $F$  induces an equivalence between  $\mathcal{P}$  and  $\mathcal{P}'$ . So, we deduce:

**Corollary 1.** *If  $F : \mathcal{M} \rightarrow \mathcal{M}'$  is a coreflection, if  $\mathcal{P}'$  is the image of  $\mathcal{P}$  by  $F$  and if  $\mathcal{M}$  is  $\mathcal{P}$ -accessible then  $\mathcal{M}'$  is  $\mathcal{P}'$ -accessible.*

*Proof of Theorem 3.* Let  $G : \mathcal{P}' \rightarrow \mathcal{P}$  and  $\nu : F \circ G \rightarrow \text{id}_{\mathcal{P}'}$  a natural isomorphism.

- ★ **existence of trees:** let  $D : U \rightarrow \mathcal{P}'$  be a small diagram. By preservation of trees and existence of trees in  $\mathcal{M}$ ,  $F(\text{colim } G \circ D)$  is a colimit of  $F \circ G \circ D$  in  $\mathcal{M}'$ . But  $\nu$  induces a natural isomorphism between  $D$  and  $F \circ G \circ D$ . Then the colimit of  $D$  in  $\mathcal{M}'$  exists.
- ★  **$\mathcal{P}'$ -accessibility:** Let  $z : P' \rightarrow Z$  morphism of  $\mathcal{M}'$  with  $P' \in \mathcal{P}'$  and  $(Z, (\eta_u)_{u \in U})$  is the colimit of a non-empty small diagram  $D : U \rightarrow \mathcal{P}'$ .

By naturality of  $\nu$ , the following diagram commutes:

$$\begin{array}{ccc}
 F \circ G(P') & \xrightarrow{F \circ G(z)} & F \circ G(Z) \\
 \nu_{P'}^{-1} \uparrow & & \downarrow \nu_Z \\
 P' & \xrightarrow{z} & Z
 \end{array}$$

By  $\mathcal{P}$ -accessibility,  $G(z) : G(P') \rightarrow G(\text{colim } D) = \text{colim } (G \circ D)$  factorizes as  $G(z) = \eta_u \circ p$  with  $p : G(P') \rightarrow G \circ D(u)$  morphism of  $\mathcal{P}$  and  $\eta_u : G \circ D(u) \rightarrow \text{colim}(G \circ D)$  is from the universal cocone. Then the following diagram commutes:

$$\begin{array}{ccc}
 & F \circ G \circ D(u) & \\
 F(p) \nearrow & & \searrow F(\eta_u) \\
 F \circ G(P') & \xrightarrow{F \circ G(z)} & F \circ G(\text{colim } D) \\
 \nu_{P'}^{-1} \uparrow & & \downarrow \nu_{\text{colim } D} \\
 P' & \xrightarrow{z} & \text{colim } D
 \end{array}$$

Then  $z$  factorizes as  $\eta'_u \circ (\nu_{D(u)} \circ F(p) \circ \nu_{P'}^{-1})$  with  $\eta'_u : D(u) \rightarrow \text{colim } D$  coming from the universal cocone and  $\nu_{D(u)} \circ F(p) \circ \nu_{P'}^{-1} : P' \rightarrow D(u)$  morphism of  $\mathcal{P}'$ .

.QED.

### 3.5 Unfoldings in accessible models

#### 3.5.1 $\mathcal{P}$ -unfolding and bisimilarity

Remember that the unfolding of a transition system is an equivalent system without loops, obtained by “unfolding” the loops. More precisely, it is a tree which is bisimilar to the transition system. Concretely, the unfolding is defined as a transition system whose states are executions of the initial system, that is, it is defined as a glueing of all executions of this system. This is the way we will define more generally the unfolding in a categorical model.

Let  $\mathcal{M}$  a category where all trees exist and  $X$  an object of  $\mathcal{M}$ . Let  $\mathcal{C}_X$  be the small category whose:

- objects are morphisms  $x : P \rightarrow X$  of  $\mathcal{M}$  with  $P$  in  $\mathcal{P}$ ,
- morphisms from  $x : P \rightarrow X$  to  $x' : Q \rightarrow X$  are morphisms  $p : P \rightarrow Q$  of  $\mathcal{P}$  such that the following diagram commutes:

$$\begin{array}{ccc}
 & P & \\
 x \swarrow & & \downarrow p \\
 X & & Q \\
 x' \swarrow & & \\
 & & 
 \end{array}$$

We then define the small diagram  $F_X : \mathcal{C}_X \rightarrow \mathcal{P}$  which maps every  $x : P \rightarrow X$  to  $P$  and every  $p$  to itself. Let  $\text{Unfold}(X)$  be the colimit of  $F_X$  in  $\mathcal{M}$ . We call it the ( $\mathcal{P}$ -) **unfolding of  $X$** . Since  $(X, (x : P \rightarrow X)_x)$  is a cocone of  $F_X$ , there is a unique morphism  $\text{unf}_X : \text{Unfold}(X) \rightarrow X$  such that for every  $x : P \rightarrow X$  with  $P \in \mathcal{P}$ , the following diagram commutes:

$$\begin{array}{ccc}
 & F_X(x : P \rightarrow X) = P & \\
 x \swarrow & & \downarrow [x : P \rightarrow X] \\
 X & & \text{Unfold}(X) \\
 \text{unf}_X \swarrow & & 
 \end{array}$$

where  $[x : P \rightarrow X]$  is the morphism coming from the colimit.

Using a similar argument to that in Theorem 1, we have the following:

**Theorem 4.** *When  $\mathcal{M}$  is  $\mathcal{P}$ -accessible,  $\text{unf}_X$  is  $\mathcal{P}$ -open and so  $X$  and  $\text{Unfold}(X)$  are  $\mathcal{P}$ -bisimilar (strong path bisimilar).*

*Proof.* Let a commutative diagram of the form :

$$\begin{array}{ccc} P & \xrightarrow{z} & \text{Unfold}(X) \\ p \downarrow & & \downarrow \text{unf}_X \\ Q & \xrightarrow{x} & X \end{array}$$

with  $p \in \mathcal{P}$ . As  $\text{Unfold}(X)$  is the colimit of a non-empty diagram (because there is a morphism from  $I$  to  $X$ ) in  $\mathcal{P}$ , then by  $\mathcal{P}$ -accessibility, there exist a morphism  $x' : P' \rightarrow X$  with  $P'$  in  $\mathcal{P}$  and a morphism  $p' : P \rightarrow P'$  in  $\mathcal{P}$  such that  $z = \nu_{x'} \circ p'$  where  $\nu_{x'} : F_X(x') = P' \rightarrow \text{Unfold}(X)$  is the morphism from the colimit. But, as  $\text{Unfold}(X)$  together with the  $\nu_x$  is a cocone of  $F_X$ , then  $z = \nu_{x'} \circ p' = \nu_{x' \circ p'}$ , and so by definition of  $\text{unf}_X$ ,  $x \circ p = \text{unf}_X \circ z = x' \circ p'$ . Now consider  $\nu_x : F_X(x) = Q \rightarrow \text{Unfold}(X)$ . Then :

- $\text{unf}_X \circ \nu_x = x$  by definition of  $\text{unf}_X$
- $\nu_x \circ p = \nu_{x \circ p} = \nu_{x' \circ p'} = z$

i.e., the following diagram commutes :

$$\begin{array}{ccc} P & \xrightarrow{z} & \text{Unfold}(X) \\ p \downarrow & \nearrow \nu_x & \downarrow \text{unf}_X \\ Q & \xrightarrow{x} & X \end{array}$$

.QED.

### 3.5.2 Unfolding is a right adjoint

The following lemma implies that the unfolding of a tree (and so of an unfolding) is isomorphic to the tree itself:

#### Lemma 2.

- (i) When all trees exist in  $\mathcal{M}$ ,  $\text{Unfold}$  extends to a functor  $\text{Unfold} : \mathcal{M} \rightarrow \text{Tree}(\mathcal{M}, \mathcal{P})$ .
- (ii) When  $\mathcal{M}$  is  $\mathcal{P}$ -accessible,  $\mathcal{P}$  is dense in  $\text{Tree}(\mathcal{M}, \mathcal{P})$ , i.e., for every  $X \in \text{Tree}(\mathcal{M}, \mathcal{P})$ ,  $(X, (x)_{x:P \rightarrow X})$  is a colimit of  $F_X$ .

*Proof.*

- (i) **★ definition of Unfold on morphisms:** let  $f : X \rightarrow Y$  be a morphism of  $\mathcal{M}$ . Then  $(\text{Unfold}(Y), ([f \circ x : P \rightarrow Y])_{x:P \rightarrow X})$  is a cocone of  $F_X$ . So there is a unique morphism  $\text{Unfold}(f) : \text{Unfold}(X) \rightarrow \text{Unfold}(Y)$  such that for every path  $x : P \rightarrow X$  of  $X$ , the following diagram commutes:

$$\begin{array}{ccc} & P & \\ [x : P \rightarrow X] \swarrow & & \downarrow [f \circ x : P \rightarrow Y] \\ \text{Unfold}(X) & & \text{Unfold}(Y) \\ \searrow \text{Unfold}(f) & & \end{array}$$



- ★ **identities:** we know that  $id_{\mathbf{Unfold}(X)} \circ \nu_x = \nu_x$  so by unicity,  $\mathbf{Unfold}(id_X) = id_{\mathbf{Unfold}(X)}$ .
- ★ **compositions:** let  $f : X \rightarrow Y$  and  $g : Y \rightarrow Z$ . By definition of  $\mathbf{Unfold}$ , the following diagram commutes :

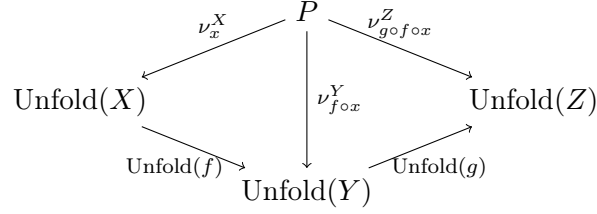

So by unicity,  $\mathbf{Unfold}(g \circ f) = \mathbf{Unfold}(g) \circ \mathbf{Unfold}(f)$ .

- (ii) ★  $(X, (x)_{x:P \rightarrow X})$  is a **cocone** : because the following diagram commutes :

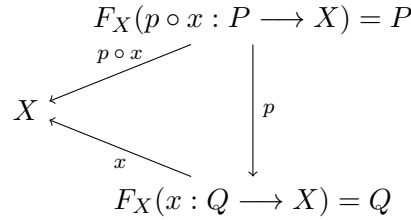

- ★ **colimit** : Give another cocone  $(Z, (\kappa_x : P \rightarrow Z)_{x:P \rightarrow X})$  of  $F_X$ .

- **construction of a morphism  $\Phi : X \rightarrow Z$**  : as  $X$  is in  $\mathbf{Tree}(\mathcal{M}, \mathcal{P})$ , there is a small non-empty diagram  $G : U \rightarrow \mathcal{P}$  such that  $(X, (\mu_u)_{u \in U})$  is a colimit of  $G$  for some  $\mu_u$ . So, for every  $u$ ,  $\mu_u : D(u) \rightarrow X$  is an object of  $\mathcal{C}_X$ . Let us prove that  $(Z, (\kappa_{\mu_u} : D(u) \rightarrow Z)_{u \in U})$  is a cocone of  $D$ , i.e., given a morphism  $\tau : u \rightarrow v$  in  $U$ , the following diagram commutes :

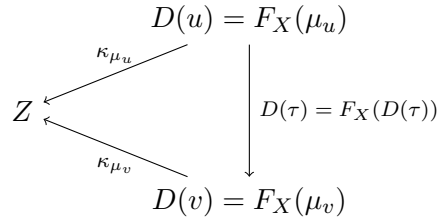

which is true because  $(Z, (\kappa_x : P \rightarrow Z)_{x:P \rightarrow X})$  is a cocone of  $F_X$ . Then, there is a unique morphism  $\Phi : X \rightarrow Z$  such that for every  $u \in U$ , the following diagram commutes :

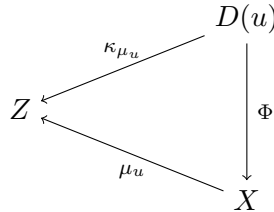

- $\Phi$  is a **morphism of cocones from  $(X, (x)_{x:P \rightarrow X})$  to  $(Z, (\kappa_x : P \rightarrow Z)_{x:P \rightarrow X})$**  : i.e., for every  $x : P \rightarrow X$ ,  $\Phi \circ x = \kappa_x$ . As  $X$  is the colimit of  $D$  which is non-empty, then by  $\mathcal{P}$ -accessibility, there is an object  $u$  of  $U$  and a morphism  $p : P \rightarrow D(u)$  in  $\mathcal{P}$  such that  $x = \mu_u \circ p$ . But, by the previous point,  $\Phi \circ \mu_u = \kappa_{\mu_u}$  and as  $(Z, (\kappa_x : P \rightarrow Z)_{x:P \rightarrow X})$  is a cocone of  $F_X$ ,  $\kappa_{\mu_u} \circ p = \kappa_{\mu_u \circ p} = \kappa_x$ . So,  $\kappa_x = \Phi \circ \mu_u \circ p = \Phi \circ x$ .

- **unicity of  $\Phi$**  : any morphism of cocones from  $(X, (x)_{x:P \rightarrow X})$  to  $(Z, (\kappa_x : P \rightarrow Z)_{x:P \rightarrow X})$  is also a morphism of cocones from  $(X, (\mu_u)_{u \in U})$  to  $(Z, (\kappa_{\mu_u} : D(u) \rightarrow Z)_{u \in U})$  and so is equal to  $\Phi$  by unicity.

.QED.

From this sort of density property, we deduce that the unfolding is a right adjoint of the inclusion of trees in  $\mathcal{M}$ . This result is similar to the one from [Winskel 1984] stating that the unfolding is the right adjoint of the inclusion of occurrence nets in 1-safe Petri nets.

**Theorem 5.** *When  $\mathcal{M}$  is  $\mathcal{P}$ -accessible,  $\text{Unfold}$  is a right adjoint of  $\text{inj} : \mathbf{Tree}(\mathcal{M}, \mathcal{P}) \rightarrow \mathcal{M}$ , the embedding of  $\mathbf{Tree}(\mathcal{M}, \mathcal{P})$  in  $\mathcal{M}$ . In particular, the injection of  $\mathbf{Tree}(\mathcal{M}, \mathcal{P})$  in  $\mathcal{M}$  is a coreflection.*

*Proof.*

★ **definition of the counit  $\varepsilon$**  :  $\text{inj} \circ \text{Unfold} \rightarrow \text{id}_{\mathcal{M}}$  :  $\varepsilon_X = \text{unf}_X$

★ **naturality of  $\varepsilon$**  : let  $f : X \rightarrow Y$  be a morphism of  $\mathcal{M}$ . We want to prove that  $\text{unf}_Y \circ \text{Unfold}(f) = f \circ \text{unf}_X$ . It is sufficient to prove that for every  $x : P \rightarrow X$ ,  $\text{unf}_Y \circ \text{Unfold}(f) \circ \nu_x = f \circ \text{unf}_X \circ \nu_x^X$  :

$$\begin{aligned} f \circ \text{unf}_X \circ \nu_x &= f \circ x \\ &= \text{unf}_Y \circ \nu_{f \circ x} \\ &= \text{unf}_Y \circ \text{Unfold}(f) \circ \nu_x \end{aligned}$$

★ **definition of the unit  $\eta$**  :  $\text{id}_{\mathbf{Tree}(\mathcal{M}, \mathcal{P})} \rightarrow \text{Unfold} \circ \text{inj}$  : by density of  $\mathcal{P}$  in  $\mathbf{Tree}(\mathcal{M}, \mathcal{P})$ , for every  $X \in \mathbf{Tree}(\mathcal{M}, \mathcal{P})$  there is a unique (iso)morphism  $\eta_X : X \rightarrow \text{Unfold}(X)$  such that for every  $x : P \rightarrow X$ ,  $\eta_X \circ x = \nu_x$ .

★ **naturality of  $\eta$**  : let  $f : X \rightarrow Y$  be a morphism of  $\mathbf{Tree}(\mathcal{M}, \mathcal{P})$ . We want to prove that  $\text{Unfold}(f) \circ \eta_X = \eta_Y \circ f$ . It is sufficient to prove that for every  $x : P \rightarrow X$ ,  $\text{Unfold}(f) \circ \eta_X \circ x = \eta_Y \circ f \circ x$  :

$$\begin{aligned} \text{Unfold}(f) \circ \eta_X \circ x &= \text{Unfold}(f) \circ \nu_x \\ &= \nu_{f \circ x} \\ &= \eta_Y \circ (f \circ x) \end{aligned}$$

★ **first equation of adjointness** : we want to prove that for every  $X \in \mathbf{Tree}(\mathcal{M}, \mathcal{P})$ ,  $\text{unf}_X \circ \eta_X = \text{id}_X$ . By density, it is sufficient to prove that for every  $x : P \rightarrow X$ ,  $\text{unf}_X \circ \eta_X \circ x = x$ . This is true because  $\text{unf}_X \circ \eta_X \circ x = \text{unf}_X \circ \nu_x = x$ .

★ **second equation of adjointness** : we want to prove that for every  $X \in \mathcal{M}$ ,  $\text{Unfold}(\text{unf}_X) \circ \eta_{\text{Unfold}(X)} = \text{id}_{\text{Unfold}(X)}$ . It is sufficient to prove that for every  $x : P \rightarrow X$ ,  $\text{Unfold}(\text{unf}_X) \circ \eta_{\text{Unfold}(X)} \circ \nu_x = \nu_x$ . This is true because  $\text{Unfold}(\text{unf}_X) \circ \eta_{\text{Unfold}(X)} \circ \nu_x = \text{Unfold}(\text{unf}_X) \circ \nu_{\nu_x} = \nu_{\text{unf}_X \circ \nu_x} = \nu_x$ .

.QED.

### 3.6 Unfoldings and universal coverings

Unfoldings and coverings of spaces [May 1999] are very similar in the sense that they both “unfold” loops (or “kill” the first homotopy group). But it seems that there were no general formal links in the literature between those two structures. We present here a view toward this.

#### 3.6.1 Coverings of groupoids

Coverings of groupoids are more natural than coverings of spaces as they are defined by lifting properties and their existence does not assume any hypothesis on the groupoid. They are very close to coverings of spaces since a covering of a space induces a covering of its fundamental groupoid and lots of properties of coverings of spaces can be expressed on the induced coverings of groupoids [May 1999].

A **small pointed connected groupoid** (spc groupoids for short) is a pair  $(\mathcal{C}, c)$  of a small connected groupoid  $\mathcal{C}$  and an object  $c$  of  $\mathcal{C}$ . A **pointed functor** is a functor  $F : (\mathcal{C}, c) \rightarrow (\mathcal{D}, d)$  between spc groupoids such that  $F(c) = d$ . We denote by  $\mathbf{Grpd}_*$  the category of spc groupoids and pointed functors.

A **covering of a spc groupoids**  $(\mathcal{C}, c)$  is a pointed functor  $F : (\tilde{\mathcal{C}}, \tilde{c}) \rightarrow (\mathcal{C}, c)$  such that for every morphism  $f : c \rightarrow c'$  of  $\mathcal{C}$  there exist a unique object  $\tilde{c}'$  of  $\tilde{\mathcal{C}}$  and an unique morphism  $\tilde{f} : \tilde{c} \rightarrow \tilde{c}'$  such that  $F(\tilde{f}) = f$ . We say that a covering is **universal** if  $\tilde{\mathcal{C}}(\tilde{c}, \tilde{c}) = \{id_{\tilde{c}}\}$ .

Covering are similar to open maps since they satisfy a lifting property. In fact, they are open maps when we consider the following subcategory of paths. Let  $\mathcal{I}$  be the full subcategory of  $\mathbf{Grpd}_*$  whose objects are the following two spc groupoids:

- **0**, the spc groupoid with one object and only the identity as morphism,
- **1**, the spc groupoid with two objects:



pointed on 0.

It is easy to check that  $\mathbf{Grpd}_*$  is  $\mathcal{I}$ -accessible.

Coverings are exactly the open maps whose lifts are unique. Universal coverings are universal in the category of coverings in the following sense [May 1999]: given a universal covering  $F : (\tilde{\mathcal{C}}, \tilde{c}) \rightarrow (\mathcal{C}, c)$  and a covering  $G : (\mathcal{D}, d) \rightarrow (\mathcal{C}, c)$ , then there is a unique pointed functor  $H : (\tilde{\mathcal{C}}, \tilde{c}) \rightarrow (\mathcal{D}, d)$  such that  $G \circ H = F$ . Moreover,  $H$  is a covering. This means that universal covering is initial in the category of coverings. In particular, universal coverings are unique up to isomorphism. Contrary to universal coverings of spaces, universal coverings of groupoids always exist [May 1999].

#### 3.6.2 Unfoldings and unique path lifting property

We have just seen that (universal) coverings are defined by unique lifting property. Now let us see the link between unfoldings and unique liftings.

We say that a morphism  $f : X \rightarrow Y$  is a ( $\mathcal{P}$ -) **covering** if it has the **unique path lifting property**, i.e., if for every commutative diagram:

$$\begin{array}{ccc} P & \xrightarrow{x} & X \\ p \downarrow & & \downarrow f \\ Q & \xrightarrow{y} & Y \end{array}$$

with  $p : P \rightarrow Q \in \mathcal{P}$ , there exists a unique morphism  $\theta : Q \rightarrow X$  such that the following diagram commutes:

$$\begin{array}{ccc} P & \xrightarrow{x} & X \\ p \downarrow & \nearrow \theta & \downarrow f \\ Q & \xrightarrow{y} & Y \end{array}$$

This is the same as  $\mathcal{P}$ -open but with the unicity of the lift.

The following result states that unfolding is a covering and that moreover it is initial among coverings.

**Theorem 6.** *When  $\mathcal{M}$  is  $\mathcal{P}$ -accessible:*

- i)  $\text{unf}_X$  has the unique path lifting property
- ii) for every morphism  $f : Y \rightarrow X$  which has the unique lifting property, there is a unique morphism  $\tilde{f} : \text{Unfold}(X) \rightarrow Y$  such that  $f \circ \tilde{f} = \text{unf}_X$ . Moreover,  $\tilde{f}$  has the unique path lifting property.

*Proof.*

- i) This is a consequence of ii) because  $\text{id}_X$  has the unique path lifting property and  $\text{id}_X \circ \text{unf}_X = \text{unf}_X$  and so  $\text{unf}_X = \widetilde{\text{id}_X}$ .
- ii) **★ construction of  $\tilde{f}$ :** for every  $x : P \rightarrow X$  path of  $X$ , by the unique path lifting property, there is a unique  $\tilde{x} : P \rightarrow Y$  such that:

$$\begin{array}{ccc} I & \xrightarrow{!} & Y \\ ! \downarrow & \nearrow \tilde{x} & \downarrow f \\ P & \xrightarrow{x} & X \end{array}$$

i.e., a unique  $\tilde{x}$  such that  $f \circ \tilde{x} = x$ . Let us prove that  $(Y, (\tilde{x})_{x:P \rightarrow X})$  is a cocone of  $F_X$ , i.e., if  $p : P \rightarrow Q \in \mathcal{P}$  and  $x : Q \rightarrow X$ , we have to prove that  $\widetilde{x \circ p} = \tilde{x} \circ p$ . But,  $f \circ \widetilde{x \circ p} = x \circ p = (f \circ \tilde{x}) \circ p = f \circ (\tilde{x} \circ p)$ . So, by unicity,  $\widetilde{x \circ p} = \tilde{x} \circ p$ . Now, as  $(\text{Unfold}(X), (\nu_x)_x)$  is a colimit of  $F_X$ , there is a unique  $\tilde{f} : \text{Unfold}(X) \rightarrow Y$  such that for every  $x : P \rightarrow X$ ,  $\tilde{f} \circ \nu_x = \tilde{x}$  and so,  $f \circ \tilde{f} \circ \nu_x = f \circ \tilde{x} = x = \text{unf}_X \circ \nu_x$  and by unicity,  $f \circ \tilde{f} = \text{unf}_X$ .

**★ unicity of  $\tilde{f}$ :** let  $g : \text{Unfold}(X) \rightarrow Y$  such that  $f \circ g = \text{unf}_X$ . Then, for every  $x : P \rightarrow X$ ,  $f \circ g \circ \nu_x = \text{unf}_X \circ \nu_x = x$ . Then, by unicity of  $\tilde{x}$ ,  $g \circ \nu_x = \tilde{x}$  and unicity of the definition of  $\tilde{f}$ ,  $g = \tilde{f}$ .

**★ existence of the lift:** Let a diagram of the form :

$$\begin{array}{ccc}
 P & \xrightarrow{z} & \text{Unfold}(X) \\
 p \downarrow & & \downarrow \tilde{f} \\
 Q & \xrightarrow{y} & Y
 \end{array}$$

with  $p \in \mathcal{P}$ . Then, we have the following commutative diagram :

$$\begin{array}{ccc}
 P & \xrightarrow{z} & \text{Unfold}(X) \\
 p \downarrow & & \downarrow \text{unf}_X \\
 Q & \xrightarrow{f \circ y} & X
 \end{array}$$

As  $\text{unf}_X$  is  $\mathcal{P}$ -open, there is  $\theta : Q \rightarrow \text{Unfold}(X)$  such that:

$$\begin{array}{ccc}
 P & \xrightarrow{z} & \text{Unfold}(X) \\
 p \downarrow & \nearrow \theta & \downarrow \text{unf}_X \\
 Q & \xrightarrow{f \circ y} & X
 \end{array}$$

Now,  $f \circ \tilde{f} \circ \theta = \text{unf}_X \circ \theta = f \circ y$  and so  $\tilde{f} \circ \theta = \widetilde{\text{unf}_X \circ \theta} = y$  and so

$$\begin{array}{ccc}
 P & \xrightarrow{z} & \text{Unfold}(X) \\
 p \downarrow & \nearrow \theta & \downarrow \tilde{f} \\
 Q & \xrightarrow{y} & Y
 \end{array}$$

★ **unicity of the lift:** assume that we have two lifts:

$$\begin{array}{ccc}
 P & \xrightarrow{z} & \text{Unfold}(X) \\
 p \downarrow & \nearrow \theta_1, \theta_2 & \downarrow \tilde{f} \\
 Q & \xrightarrow{y} & Y
 \end{array}$$

By  $\mathcal{P}$ -accessibility, we know that every path of  $\text{Unfold}(X)$  is of the form  $\nu_{x_i} : P \rightarrow \text{Unfold}(X)$ , for some  $x_i$ . Then, the previous diagram is of the form :

$$\begin{array}{ccc}
 P & \xrightarrow{z} & \text{Unfold}(X) \\
 p \downarrow & \nearrow \nu_{x_1}, \nu_{x_2} & \downarrow \tilde{f} \\
 Q & \xrightarrow{y} & Y
 \end{array}$$

with  $x_1 = f \circ \tilde{x}_1 = f \circ \tilde{f} \circ \nu_{x_1} = f \circ y = f \circ \tilde{f} \circ \nu_{x_2} = f \circ \tilde{x}_2 = x_2$

.QED.

In the case of  $\mathbf{Grpd}_*$  and  $\mathcal{I}$ , this implies that the unfolding is a covering and is initial in the category of coverings. So we deduce:

**Corollary 2.** *The universal covering of a spc groupoid coincides with its  $\mathcal{I}$ -unfolding.*

## Conclusion

In this chapter, we have describe a general class of models for which bisimilarity of Joyal et al. is equivalent to the existence of a relation on executions, paths of the systems. These models are those from which we have a nice subcategory of trees constructed as colimits of path shapes or executions forms. In those models, we have also proved that we have a nice notion of unfolding, which is right adjoint to the inclusion of trees and that it is a universal covering, that is, initial among coverings, morphisms having the unique lifting property. In particular, we have describe an explicit relation between universal covering of a groupoid in algebraic topology and a unfolding.



## Part II

# Dihomotopy Theories





# Dihomotopy equivalences and the fundamental category

---

With this chapter, we start our study of directed spaces using tools from algebraic topology. We first investigate dihomotopy equivalences. In classical algebraic topology, homotopy equivalences are a way to describe that two topological spaces can be continuously deformed into each other. For directed spaces, an analogue would be that two d-spaces can be continuously deformed into each other, using transformations that preserve somehow directedness. We will see that there are several possible way to express the preservation of directedness.

Classically, homotopy equivalences are defined as continuous functions that are invertible up to homotopy. Much as homotopy of paths, homotopy of functions can be defined either with classical homotopy, that is, function from  $X \times [0, 1]$  to  $Y$ , or as a function from  $X$  to the space of paths  $P(Y)$ . There is an analogue of this idea for directed algebraic topology: one can defined several notions of dihomotopies of dimaps by either as dimaps  $X \times I$  to  $Y$ , with  $I$  being a directed structure of  $[0, 1]$ , or as a particular function from  $X$  to a sub-space of the space of dipaths of  $Y$ . There will be a correspondence between structures of the segments as seen in Chapter 2 and known classes of dipaths. We will see this in Section 4.1

In Section 2.3, we have seen the fundamental category of a d-space, which is a summary of the dihomotopy structure of dipaths of this d-space. We would like it to be an invariant of dihomotopy equivalence. In the classical case, the fundamental groupoid of a space is an invariant modulo homotopy equivalence, meaning that a homotopy equivalence induces an equivalence of categories between fundamental groupoids. As observed in [Grandis 2009], in the directed case, this is strictly true only for reversible equivalences, that is, dihomotopy equivalences defined with  $\overleftarrow{[0, 1]}$  as directed structure on the segment, not for directed equivalences, that is, dihomotopy equivalences defined with  $\widetilde{[0, 1]}$  as directed structure. We will see this in Section 4.2.1. The crucial observation is that it fails only because too few morphisms in the fundamental category are isomorphisms. The idea is then to invert some morphisms to make the fundamental category an invariant of other types of dihomotopy equivalences. This process of inverting morphisms of a category is called localization. We will then see in Section 4.2.3, that a directed equivalence induces an equivalence of categories between groupoidifications of the fundamental categories, that is, the categories obtained by inverting every morphism in the fundamental category.

However, the groupoidification is a bit disappointing: the functor from a category to its groupoidification is not faithful, meaning that we lose information from the category. In particular, even when the category is not cancellative, groupoidification is still a groupoid and so cancellative. Consequently, groupoidification loses cancellative behaviors. Following ideas from [Goubault 2007] on the category of components, we will look in Section 4.3 at a better localization of the fundamental category: we will localize at morphisms that behave like isomorphisms, meaning that they must induces isomorphisms of Hom-sets by composition, and a condition similar to closure under pullbacks and pushouts, the Ore conditions, which makes our framework different from that of Goubault et al. They will be called inessential morphisms. We will see that this set of morphisms has many nice

properties: it has the 2-out-of-6 property (Section 4.3.1), it has a calculus of right and left fractions, it is saturated (Section 4.3.2). In particular, a calculus of right and left fractions allows us to localize a category at those inessential morphisms nicely, forming the category of components, following the terminology from [Goubault 2007]. Finally, we prove in Section 4.3.4 that the category of components is equivalent to a quotient (which allows one in some cases to do computations) for a larger class of categories than in [Goubault 2007], namely for categories whose subcategory of inessential morphisms has a selection.

## 4.1 Existing frameworks

### 4.1.1 Non directed case

We have seen the notion of homotopies between paths, defined as a path in the space of paths. This can be extended to general functions. A **homotopy** between continuous functions  $f, g : X \rightarrow Y$  is continuous function  $H : X \rightarrow P(Y)$  such that  $x \mapsto H(x)(0)$  is equal to  $f$  and  $x \mapsto H(x)(1)$  is equal to  $g$ . As argued in the previous chapter, there is another way (which is the usual way that you can find in textbooks, such as [Hatcher 2002]) to define homotopy between functions. Let us call a **classical homotopy** between  $f, g : X \rightarrow Y$ , a continuous function  $K : X \times [0, 1] \rightarrow Y$  such that  $x \mapsto K(x, 0)$  is equal to  $f$  and  $x \mapsto K(x, 1)$  is equal to  $g$ . Using one or the other is the same:

**Proposition 6.** *There is a homotopy between two functions if and only if there is a classical homotopy between them.*

*Proof.* Let us first assume that there is a homotopy  $H : X \rightarrow P(Y)$ . We construct the classical homotopy  $K : X \times [0, 1] \rightarrow Y$  which maps  $(x, t)$  to  $H(x)(t)$ . The only thing to prove is that it is continuous. Let  $V$  be an open set of  $Y$ . Let us prove that  $K^{-1}(V)$  is open in  $X \times [0, 1]$ . Let  $(x, t) \in K^{-1}(V)$ . This means that  $H(x)(t) \in V$ , that is,  $t \in H(x)^{-1}(V)$ . Since  $H(x)$  is continuous,  $H(x)^{-1}(V)$  is an open set of  $[0, 1]$  which contains  $t$ . Since  $[0, 1]$  is compact and so locally compact, there are an open set  $W$  and a compact  $K$  of  $[0, 1]$  such that  $t \in W \subseteq K \subseteq H(x)^{-1}(V)$ . We consider then the open set  $[K, V] = \{\gamma \mid \gamma(K) \subseteq V\}$  of  $P(Y)$ . By construction of  $K$ ,  $x \in H^{-1}([K, V])$  and since  $H$  is continuous,  $H^{-1}([K, V])$  is open in  $X$ . Then  $H^{-1}([K, V]) \times W$  is an open set of  $X \times [0, 1]$ , which contains  $(x, t)$  and which is contained in  $K^{-1}(V)$ .

Reciprocally, let us assume that there is a classical homotopy  $K : X \times [0, 1] \rightarrow Y$ . We construct the homotopy  $H : X \rightarrow P(Y)$  which maps  $x$  to  $t \mapsto K(x, t)$ . Given an open set  $[K, V]$  of  $P(Y)$ , let  $x \in H^{-1}([K, V])$ . Since  $V$  is open in  $Y$  and  $K$  is continuous,  $K^{-1}(V)$  is open in  $X \times [0, 1]$ . For every  $t \in K$ , since  $(x, t) \in K^{-1}(V)$ , there is  $U_t$  open set of  $X$  and  $W_t$  open set of  $[0, 1]$  such that  $(x, t) \in U_t \times W_t \subseteq K^{-1}(V)$ . Since  $K$  is compact and  $(W_t)_{t \in K}$  forms a covering of  $K$  with open sets, there is a finite subcovering  $(W_t)_{t \in Q}$  of  $K$ . Define  $U = \bigcap_{t \in Q} U_t$ . This is an open set of  $X$  which contains  $x$  and such that  $U \times K \subseteq K^{-1}(V)$ , that is  $U \subseteq H^{-1}([K, V])$ . .QED.

In either case, we say that  $f$  and  $g$  are **homotopic** if there is a (classical) homotopy between them. The idea is that two homotopic maps are equal up to continuous deformations. In algebraic topology, we are interested in equivalences of spaces up to continuous deformations. This will be defined using **homotopy equivalences**: we say that a continuous function  $f : X \rightarrow Y$  is a homotopy equivalence if there is a continuous function  $g : Y \rightarrow X$  such that  $f \circ g$  and  $g \circ f$  are homotopic to identities. This means essentially that  $f$  is a homeomorphism up to continuous deformations. We say that two spaces are **homotopically equivalent** if there is a homotopy equivalence between them.

Let us illustrate this on examples.

1. Consider two discrete spaces  $X$  and  $Y$ , that is, whose open sets are all subsets.  $X$  and  $Y$  are homotopically equivalent if and only if they are in bijection.
2. Every two cubes  $\square_n$  and  $\square_p$  are homotopically equivalent. Since homotopy equivalences are closed under composition, it is sufficient to prove that  $\square_n$  is equivalent to  $\square_0$ , that is, a point space. The constant continuous function from  $\square_n$  to  $\{(0, \dots, 0)\}$  is inverse of the inclusion modulo homotopy. When a space is homotopically equivalent to a point space, we say that it is **contractible**. Contractible spaces are, in some way, the simplest spaces that we may consider.
3. The circle is not contractible: the intuition is that “holes” must be conserved by homotopy equivalences. That is one of the main idea in algebraic topology, “holes” give algebraic information of the space which are invariant of homotopy equivalences, and are “obstructions” to contractibility.
4. The circle, the boundary of a square and the annulus are all homotopically equivalent.

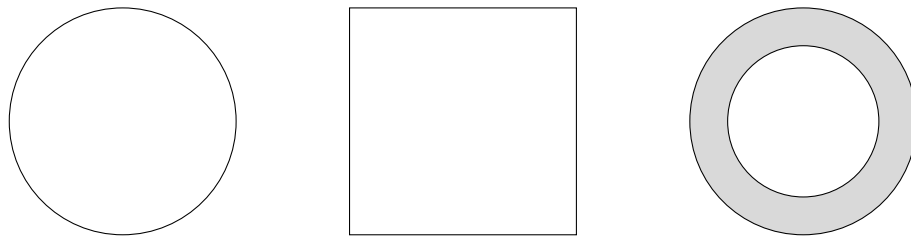

Since homotopies are closed under compositions, that is, if  $f_1$  is homotopic to  $f_2$  and  $g_1$  is homotopic to  $g_2$ , then  $g_1 \circ f_1$  is homotopic to  $g_2 \circ f_2$ , one can quotient **Top** by homotopy. We call **homotopy category of Top**, the category **HoTop** whose objects are topological spaces and whose morphisms are homotopy classes of continuous functions. Isomorphisms in **HoTop** are precisely the homotopy classes of homotopy equivalences.

#### 4.1.2 Several extensions

As we have seen, there are several possible directed structures on the segment  $[0, 1]$ , each of which defining a notion of classical dihomotopy: for  $I \in \{\overline{[0, 1]}, \widehat{[0, 1]}, \overleftarrow{[0, 1]}, \overrightarrow{[0, 1]}, \overleftarrow{\overrightarrow{[0, 1]}}\}$ , a  **$I$ -dihomotopy** is a dimap  $K : X \times I \longrightarrow Y$ . The existence of a  $I$ -dihomotopy between two dimaps is an equivalence relation for  $I \in \{\overline{[0, 1]}, \widehat{[0, 1]}, \overleftarrow{[0, 1]}\}$  but not for  $I \in \{\overrightarrow{[0, 1]}, \overleftarrow{\overrightarrow{[0, 1]}}\}$ . We then say that two dimaps are  **$I$ -dihomotopic** if there is a zig-zag of  $I$ -dihomotopies between them, that is, there are dimaps  $f_0 = f, f_1, \dots, f_n, f_{n+1} = g$ , and  $I$ -dihomotopies  $K_1, \dots, K_{n+1}$  with for every  $i, x \mapsto K_i(x, 0)$  equal to  $f_{i-1}$  and  $x \mapsto K_i(x, 1)$  equal to  $f_i$ , or vice versa. We say that a dimap is a  **$I$ -dihomotopy equivalence** if it is invertible up to  $I$ -dihomotopy and we say that two d-spaces are  **$I$ -dihomotopically equivalent** if there is a  $I$ -dihomotopy equivalence between them.

Among those five notions of dihomotopy/dihomotopy equivalence, three of them are of particular interest because they are equivalent to the existence of a continuous function  $H$  from  $X$  to a subspace of  $P(Y)$  such that for every  $t \in [0, 1], x \mapsto H(x)(t)$  is a dimap. Only the subspace involved changes:

- if  $I = \overline{[0, 1]}$ , we consider the whole space of paths  $P(X)$ . This seems not to be considered in the literature, mainly because it does not sufficiently use directedness. We may call them **undirected dihomotopies/equivalences**.

- if  $I = \overrightarrow{[0, 1]}$ , we consider the space of dipaths  $\overrightarrow{P}(X)$ . It is the main notion used in [Grandis 2009]. It is called dihomotopy equivalence there. The main idea is that everything is defined using only  $\overrightarrow{[0, 1]}$  as structure on the segment. We will call it **directed dihomotopies/equivalences**.
- if  $I = \widetilde{[0, 1]}$ , we consider the space of reversible dipaths  $\widetilde{P}(X)$ , that is, dipaths  $\gamma$  such that  $\gamma^{-1}$  is also a dipath. Being equivalent in this case is really strong since in general there are not many reversible dipaths. For example, in po-spaces seen as d-spaces, the only reversible dipaths are constant paths, and being equivalent then means being dihomeomorphic (that is, isomorphic in the category **dTop**). This equivalence is called **reversible dihomotopies/equivalences** [Grandis 2009].

### 4.1.3 Examples of $I$ -dihomotopy equivalences

1. Let us first look at the different directed structures of the segment and when they are equivalent to a point space. Note  $<$  the order on the set  $S = \{\overrightarrow{[0, 1]}, \overleftarrow{[0, 1]}, \widetilde{[0, 1]}\}$  such that:

$$\overleftarrow{[0, 1]} < \overrightarrow{[0, 1]} < \widetilde{[0, 1]}.$$

**Proposition 7.** *For every  $I, J \in S$ ,  $I$  is  $J$ -dihomotopically equivalent to a point space if and only if  $J \leq I$ .*

The “if” part comes from the fact that the constant map from  $I$  to  $\{0\}$  is inverse modulo  $J$ -dihomotopy to the inclusion from  $\{0\}$  to  $I$ . The “only if” part comes from the fact that if  $J > I$ , then there is no dimap  $\gamma$  from  $J$  to  $I$  such that  $\gamma(0) = 0$  and  $\gamma(1) = 1$ . For example, in the case where  $I = \overrightarrow{[0, 1]}$  and  $J = \widetilde{[0, 1]}$ , this means that there is no dipath from 1 to 0 in  $\overrightarrow{[0, 1]}$ .

More generally, the cube  $I^k$  is  $J$ -dihomotopically equivalent to a point if and only if  $J \leq I$  by the same arguments.

2. Let us look now at the following two d-spaces:

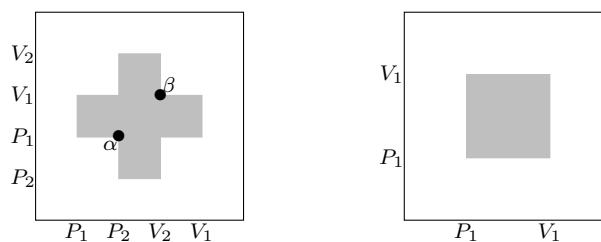

They are geometric realization of PV-programs. They are subspaces of  $[0, 1]^2$  (in white) in which we have carved small rectangles (in grey). Their dipaths are component-wise monotonous paths. The left one is called the **Swiss flag** (SF) and the right one the **squared annulus** (SA). First, those two d-spaces are not reversibly equivalent since they are po-spaces and they are not isomorphic because of the local maximum  $\alpha$  (resp. local minimum  $\beta$ ). From a computer science point of view  $\alpha$  (resp.  $\beta$ ) corresponds to a deadlock (resp. an inaccessible state). On the other hand, they are directedly equivalent (and so undirectedly equivalent). There are a dimap from SF to SA (whose image is depicted in light grey on the left below) and a dimap from SA to SF (whose image is depicted in light grey on the right below), which are inverse to each other up to directed dihomotopies.

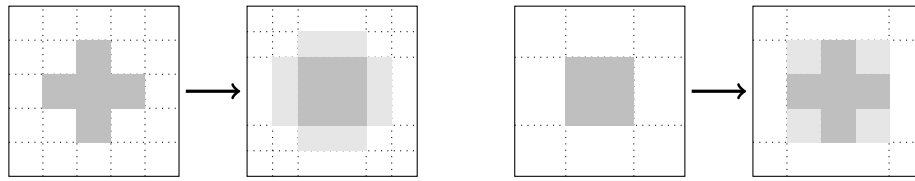

3. We will see later that the matchbox  $\mathbb{M}_{\square}$  is not reversibly equivalent to a point. The argument will use the fundamental category. We prove now that it is directedly equivalent to a point. Since we have seen that the square  $[0, 1]^2$  is directedly equivalent to a point, it is enough to prove that  $\mathbb{M}_{\square}$  is equivalent to its upper face. It is easy to prove that the injection  $\iota$  of the upper face into the matchbox is inverse modulo directed dihomotopy to the projection  $p$  of the matchbox on its upper face. In one direction,  $p \circ \iota$  is equal to identity, in the other direction a dihomotopy from identity to  $\iota \circ p$  is given by this picture:

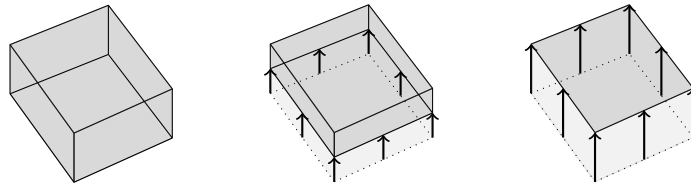

Observe that this is a directed dihomotopy but not a reversible dihomotopy since the dipaths followed by this dihomotopy (depicted by the arrows) are not reversible.

## 4.2 Relation with the fundamental category

### 4.2.1 Classical case and direct extension

In classical algebraic topology, the fundamental groupoid of a topological space is an invariant of this space, in the following sense:

**Theorem 7** ([Brown 2006]). *A homotopy equivalence  $f : X \rightarrow Y$  induces an equivalence of categories  $\pi_1(f) : \pi_1(X) \rightarrow \pi_1(Y)$ .*

*Proof.* We prove the following first: a homotopy  $H$  between  $f, g : X \rightarrow Y$  induces a natural transformation  $\sigma : \pi_1(f) \rightarrow \pi_1(g)$ . Indeed, let  $x$  be a point of  $X$ .  $\sigma_x$  should be a homotopy class of paths from  $f(x)$  to  $g(x)$ . We pose  $\sigma_x = [H(x)]$ . Let us prove that it is natural, that is, for every path  $\gamma : x \rightsquigarrow y$ , the two paths  $(f \circ \gamma) \star H(y)$  and  $H(x) \star (g \circ \gamma)$  from  $f(x)$  to  $g(y)$  are homotopic. Consider the homotopy  $H' : [0, 1] \rightarrow P(Y)(f(x), g(y))$  which maps  $t \in [0, 1]$  to the following path:

$$s \mapsto \begin{cases} H(x)(2s) & \text{if } s \leq \frac{1-t}{2} \\ H(\gamma(2s+t-1))(1-t) & \text{if } \frac{1-t}{2} \leq s \leq 1 - \frac{t}{2} \\ H(y)(2s-1) & \text{if } 1 - \frac{t}{2} \leq s \end{cases}$$

It is easy to check that  $H'(0) = H(x) \star (g \circ \gamma)$  and  $H'(1) = (f \circ \gamma) \star H(y)$ .

Moreover, since the fundamental groupoid is a groupoid, any such natural transformation is automatically a natural isomorphism. Now, since  $f \circ g$  and  $g \circ f$  are both homotopic to identities then by the previous result, there are natural isomorphisms between  $\pi_1(f) \circ \pi_1(g)$  and  $\text{id}_{\pi_1(Y)}$ , and between  $\pi_1(g) \circ \pi_1(f)$  and  $\text{id}_{\pi_1(X)}$ . *.QED.*

Let us try to do the same in **dTop**. First:

**Lemma 3** ([Grandis 2009]). *Let  $I \in \{\overrightarrow{[0, 1]}, \widetilde{[0, 1]}\}$ . Then a  $I$ -dihomotopy between  $f$  and  $g$  induces a natural transformation from  $\overrightarrow{\pi_1}(f)$  to  $\overrightarrow{\pi_1}(g)$ . If  $I = [0, 1]$ , then this natural transformation is an isomorphism.*

*Proof.* We do exactly the same proof. Observe that  $\sigma_x$  is an isomorphism if  $H(x)$  is a reversible dipath. The only thing to verify is that  $H'$  is actually a dihomotopy, that is, it is with values in dipaths. Since dipaths are closed under concatenation and non-decreasing reparametrization, it is enough to prove that each piece is a dipath:

- the first part is a non-decreasing reparametrization of  $H(x)$  which is a dipath if  $I \in \{\overrightarrow{[0, 1]}, \widetilde{[0, 1]}\}$ ,
- idem for the third part,
- the second part is a non-decreasing reparametrization of  $s \mapsto H(\gamma(s))(1-t)$  with  $t$  fixed. Since  $x \mapsto H(x)(1-t)$  is a dimap and  $\gamma$  is a dipath, then  $s \mapsto H(\gamma(s))(1-t)$  is a dipath.

*.QED.*

**Corollary 3** ([Grandis 2009]). *If  $f$  is a reversible equivalence, then  $\overrightarrow{\pi_1}(f)$  is a equivalence of categories. This result is false for undirected and directed equivalences.*

A counter-example for the other cases is the directed segment: we have seen that it is (un)directedly equivalent to a point. Since, the fundamental category of  $\overrightarrow{[0, 1]}$  is isomorphic to the poset  $([0, 1], \leq)$  (and so is not a groupoid), it cannot be equivalent to the fundamental category of a point (which is a groupoid). This result implies in particular that the matchbox cannot be reversibly equivalent to a point since its fundamental category is not a groupoid.

### 4.2.2 Localization of a category

In the previous subsection, we have seen that in the case of directed equivalences, the only problem is that there are too few isomorphisms in the fundamental category. So to turn the fundamental category into an invariant of directed equivalence, one should invert some of its morphisms. There is a general process of inverting morphisms in a category, which is called **localization** [Gabriel 1967].

We start with a category  $\mathcal{C}$  and a subclass  $W$  of morphisms of  $\mathcal{C}$ . A **localization of  $\mathcal{C}$  at  $W$**  is a category  $\mathcal{C}[W^{-1}]$  together with a functor  $Q_{\mathcal{C}, W} : \mathcal{C} \rightarrow \mathcal{C}[W^{-1}]$  such that:

- for every  $w \in W$ ,  $Q_{\mathcal{C}, W}(w)$  is an isomorphism,
- for every functor  $F : \mathcal{C} \rightarrow \mathcal{D}$  such that for every  $w \in W$ ,  $F(w)$  is a isomorphism, there is a unique functor  $\tilde{F} : \mathcal{C}[W^{-1}] \rightarrow \mathcal{D}$  such that  $F = \tilde{F} \circ Q_{\mathcal{C}, W}$ .

As usual, the localization is unique up to isomorphism, when it exists. For the existence, there is a general construction for localizations. We need first some usual constructions from category theory.

Given a class  $\mathcal{O}$  and for every pair  $c, c' \in \mathcal{O}$ , a set  $M_{c, c'}$ , the **free category  $(\mathcal{O}, M)^*$  generated by  $\mathcal{O}, M$**  is the (possibly large) category whose:

- objects are the elements of  $\mathcal{O}$ ,
- the morphisms from  $c$  to  $c'$  are finite non-empty sequences  $(c; f_1, \dots, f_n; c')$  such that there are  $c_0, c_1, \dots, c_n$  with  $c_0 = c$ ,  $c_n = c'$ , and for every  $i$ ,  $f_i \in M_{c_{i-1}, c_i}$ ,

- the composition is the concatenation,

$$(c'; g_1, \dots, g_p; c'') \circ (c; f_1, \dots, f_n; c') = (c; f_1, \dots, f_n, g_1, \dots, g_p; c''),$$

- identity of  $c$  is  $(c; ; c)$ .

A **congruence**  $R$  on a (possibly large) category  $\mathcal{C}$  is a collection  $(R_{c,c'})_{c,c' \in \text{Ob}(\mathcal{C})}$ , where  $R_{c,c'}$  is an equivalence relation on  $\mathcal{C}(c, c')$  such that:

- for every  $f, f' : c \rightarrow c'$ , for every  $g : c'' \rightarrow c$ , if  $(f, f') \in R_{c,c'}$  then  $(f \circ g, f' \circ g) \in R_{c'',c'}$ ,
- for every  $f, f' : c \rightarrow c'$ , for every  $g : c' \rightarrow c''$ , if  $(f, f') \in R_{c,c'}$  then  $(g \circ f, g \circ f') \in R_{c,c''}$ .

Given a collection of relations  $\sim = (\sim_{c,c'})$ , there always is a smallest congruence (for inclusion) such that for every  $c, c'$ ,  $\sim_{c,c'} \subseteq R_{c,c'}$ . It is called the **congruence generated by**  $\sim$ . The **quotient** of a (possibly large) category  $\mathcal{C}$  by a congruence  $R$ , is the (possibly large) category  $\mathcal{C}/R$  whose:

- objects are objects of  $\mathcal{C}$ ,
- morphisms from  $c$  to  $c'$  are elements of  $\mathcal{C}(c, c')/R_{c,c'}$ , those elements are written  $[f]_R$ ,
- identity of  $c$  is  $[id_c]_R$ ,
- composition is given by  $[f]_R \circ [g]_R = [f \circ g]_R$  (which is well defined by definition of a congruence).

Let us come back to the localization of  $\mathcal{C}$  at  $W$ . We consider  $O = \text{Ob}(\mathcal{C})$  and  $M_{c,c'} = \mathcal{C}(c, c') \sqcup \{\bar{f} \mid f : c' \rightarrow c \in W\}$ . Let  $R$  be the congruence on  $(O, M)^*$  generated by the following relations:

- $(c; id_c; c) \sim (c; ; c)$ ,
- $(c; f, g; c') \sim (c; g \circ f; c')$ ,
- $(c; f, \bar{f}; c) \sim (c; ; c)$ ,
- $(c; \bar{f}, f; c) \sim (c; ; c)$ .

**Theorem 8** ([Gabriel 1967]). *When  $(O, M)^*/R$  is a category (i.e., not large), then it is the localization of  $\mathcal{C}$  at  $W$ . In particular, when  $\mathcal{C}$  is small, then  $\mathcal{C}[W^{-1}]$  exists and is small.*

*Proof.* There is a functor  $Q : \mathcal{C} \rightarrow (O, M)^*/R$  which maps:

- every object  $c$  to  $c$ ,
- every morphism  $f : c \rightarrow c'$  to  $[(c; f; c')]_R$ .

$$Q(id_c) = [(c; id_c; c)]_R = [(c; ; c)]_R = [id_c]_R = id_c$$

$$Q(g \circ f) = [(c; g \circ f; c'')]_R = [(c; f, g; c'')]_R = [(c'; g; c'') \circ (c; f; c')]_R = [(c'; g; c'')]_R \circ [(c; f; c')]_R = Q(g) \circ Q(f)$$

Given a morphism  $w \in W$ ,  $Q(w) = [(c; w; c')]_R$ . Let us prove that  $[(c'; \bar{w}; c)]_R$  is an inverse of  $Q(w)$ :

$$Q(w) \circ [(c'; \bar{w}; c)]_R = [(c; w; c')]_R \circ [(c'; \bar{w}; c)]_R = [(c; w; c') \circ (c'; \bar{w}; c)]_R = [(c'; \bar{w}, w; c')]_R = [(c'; ; c')]_R = id_{c'}$$

Given another such functor  $F : \mathcal{C} \rightarrow \mathcal{D}$ . Define  $\tilde{F} : (O, M)^*/R \rightarrow \mathcal{D}$  to be the functor which maps:

- every object  $c$  to  $F(c)$ ,



- every morphism  $[(c; h_1, \dots, h_n; c')]_R$  to  $h'_n \circ \dots \circ h'_1$  where  $h'_i$  is equal to  $F(h_i)$  if  $h_i$  is a morphism of  $\mathcal{C}$ , otherwise  $h_i = \bar{f}_i$  and  $h'_i$  is equal  $F(f_i)^{-1}$ .

It is well-defined:

$$\begin{aligned}\tilde{F}([(c; id_c; c)]_R) &= id_{F(c)} = \tilde{F}([(c; ; c)]_R) \\ \tilde{F}([(c; f, g; c')]_R) &= F(g) \circ F(f) = F(g \circ f) = \tilde{F}([(c; g \circ f; c')]_R) \\ \tilde{F}([(c; f, \bar{f}; c)]_R) &= F(f)^{-1} \circ F(f) = id_{F(c)} = \tilde{F}([(c; ; c)]_R)\end{aligned}$$

It is easy to check that it is a functor, that  $F = \tilde{F} \circ Q$  and it is the only such functor. *.QED.*

Let us note  $\mathbf{Cat}_2$  be the category whose objects are pairs  $(\mathcal{C}, W)$  of a small category  $\mathcal{C}$  and of a subset  $W$  of morphisms of  $\mathcal{C}$  and whose morphisms from  $(\mathcal{C}, W)$  to  $(\mathcal{C}', W')$  are functors  $F : \mathcal{C} \rightarrow \mathcal{C}'$  such that for every  $f \in W$ ,  $F(f) \in W'$ . The localization extends to a functor  $\Lambda : \mathbf{Cat}_2 \rightarrow \mathbf{Cat}$ : for a morphism  $F : (\mathcal{C}, W) \rightarrow (\mathcal{C}', W')$ , the functor  $Q_{\mathcal{C}', W'} \circ F$  from  $\mathcal{C}$  to  $\mathcal{C}'[W'^{-1}]$  maps every elements of  $W$  to an isomorphism. So there is a unique functor  $\Lambda(F) : \mathcal{C}[W^{-1}] \rightarrow \mathcal{C}'[W'^{-1}]$  such that  $\Lambda(F) \circ Q_{\mathcal{C}, W} = Q_{\mathcal{C}', W'} \circ F$ . Actually, it even extends to a strict 2-functor:

**Proposition 8.** *Let  $F, G : (\mathcal{C}, W) \rightarrow (\mathcal{C}', W')$  be functors in  $\mathbf{Cat}_2$ . If there is a natural transformation  $\sigma : F \rightarrow G$  then there is natural transformation  $\Lambda(\sigma) : \Lambda(F) \rightarrow \Lambda(G)$ .*

*Proof.* We define  $\Lambda(\sigma)_c$  as  $[(F(c); \sigma_c; G(c))]$ . To prove the naturality it is enough to prove the following two commutativity conditions:

- given a morphism  $f : c \rightarrow c'$  of  $\mathcal{C}$ :

$$\begin{array}{ccc} F(c) & \xrightarrow{[(F(c); \sigma_c; G(c))]} & G(c) \\ \downarrow [(F(c); F(f); F(c')))] & & \downarrow [(G(c); G(f); G(c')))] \\ F(c') & \xrightarrow{[(F(c'); \sigma_{c'}; G(c'))]} & G(c') \end{array}$$

which is true since:

$$\begin{aligned} [(G(c); G(f); G(c'))] \circ [(F(c); \sigma_c; G(c))] &= [(F(c); G(f) \circ \sigma_c; G(c'))] \\ &= [(F(c); \sigma_{c'} \circ F(f); G(c'))] \\ &= [(F(c'); \sigma_{c'}; G(c'))] \circ [(F(c); F(f); F(c'))] \end{aligned}$$

- given a morphism  $f : c \rightarrow c' \in W$ :

$$\begin{array}{ccc} F(c) & \xrightarrow{[(F(c); \sigma_c; G(c))]} & G(c) \\ \uparrow [(F(c); F(f); F(c'))]^{-1} = \Lambda(F)([(c'; \bar{f}; c)]) & & \uparrow \Lambda(G)([(c'; \bar{f}; c)]) = [(G(c); G(f); G(c'))]^{-1} \\ F(c') & \xrightarrow{[(F(c'); \sigma_{c'}; G(c'))]} & G(c') \end{array}$$

which is true since  $\Lambda(F)([c'; \bar{f}; c]) = [(F(c); F(f); F(c'))^{-1}]$ , idem for  $G$  and since  $\sigma$  is natural  $\sigma_{c'} \circ F(f) = G(f) \circ \sigma_c$ , so  $[(F(c); \sigma_{c'} \circ F(f); G(c'))] = [(F(c); G(f) \circ \sigma_c; G(c'))]$ , that is,  $[(G(c); G(f); G(c'))]^{-1} \circ [(F(c'); \sigma_{c'}; G(c'))] = [(F(c); \sigma_c; G(c))] \circ [(F(c); F(f); F(c'))]^{-1}$ .

.QED.

### 4.2.3 Groupoidification

We have seen that directed equivalences do not induce equivalences of fundamental categories. The main problem was that there were too few isomorphisms. Here, we tackle this problem by inverting morphisms of the fundamental category using localization. But since we have no information on which morphisms are needed to be inverted, we will invert all the morphisms. This process is called **groupoidification**.

There is a functor  $\kappa : \mathbf{Cat} \rightarrow \mathbf{Cat}_2$  which maps every category  $\mathcal{C}$  to the pair  $(\mathcal{C}, \text{Mor}(\mathcal{C}))$ . The groupoidification functor is the composition  $\Lambda \circ \kappa : \mathbf{Cat} \rightarrow \mathbf{Cat}$ . Let us denote by  $Gp$  this functor. Actually,  $Gp$  is with values in groupoids, and even more, this groupoid is universal in the following sense:

**Proposition 9.** *For every small category  $\mathcal{C}$ ,  $Gp(\mathcal{C})$  is a small groupoid such that for every functor  $F : \mathcal{C} \rightarrow \mathcal{D}$  where  $\mathcal{D}$  is a groupoid, then there is a unique functor  $\tilde{F} : Gp(\mathcal{C}) \rightarrow \mathcal{D}$  such that  $F = \tilde{F} \circ Q_{\mathcal{C}, \text{Mor}(\mathcal{C})}$ .*

*Proof.* It is a groupoid since every morphism of  $Gp(\mathcal{C})$  is of the form  $[(c; f_1, \dots, f_n; c')]$  with either  $f_i$  a morphism of  $\mathcal{C}$ , either  $f_i = \bar{g}_i$  for some morphism  $g_i$  of  $\mathcal{C}$  and so the inverse of such a morphism is  $[(c'; h_n, \dots, h_1; c)]$  with  $h_i = \bar{f}_i$  if  $f_i$  is a morphism of  $\mathcal{C}$ ,  $h_i = g_i$  if  $f_i = \bar{g}_i$ .

The universal property is a particular case of the universal property of a localization. .QED.

From this study, we can prove what we were looking for:

**Theorem 9.** *If  $f : X \rightarrow Y$  is a directed equivalence, then  $Gp(\overrightarrow{\pi}_1(f)) : Gp(\overrightarrow{\pi}_1(X)) \rightarrow Gp(\overrightarrow{\pi}_1(Y))$  is an equivalence of categories.*

*Proof.* We have seen in Lemma 3 that a directed homotopy between  $f$  and  $g$  induces a natural transformation from  $\overrightarrow{\pi}_1(f)$  to  $\overrightarrow{\pi}_1(g)$ . Then from Proposition 8, a directed homotopy induces a natural transformation from  $Gp(\overrightarrow{\pi}_1(f))$  to  $Gp(\overrightarrow{\pi}_1(g))$ . Since the groupoidification is a groupoid, this natural transformation is automatically a natural isomorphism. .QED.

Moreover, inducing an equivalence between groupoidifications is weaker than inducing an equivalence:

**Proposition 10.** *Let  $F : (\mathcal{C}, W) \rightarrow (\mathcal{C}', W')$  and  $G : (\mathcal{C}', W') \rightarrow (\mathcal{C}, W)$  be such that  $F$  and  $G$  form an equivalence of categories. Then  $\tilde{F}$  and  $\tilde{G}$  form an equivalence between  $\mathcal{C}[W^{-1}]$  and  $\mathcal{C}'[W'^{-1}]$ .*

In particular, since a functor  $F : \mathcal{C} \rightarrow \mathcal{C}'$  is automatically a morphism  $F : (\mathcal{C}, \text{Mor}(\mathcal{C})) \rightarrow (\mathcal{C}', \text{Mor}(\mathcal{C}'))$ , an equivalence of categories induces an equivalence between the groupoidifications.

*Proof.* First notice that given two functors  $F, G : (\mathcal{C}, W) \rightarrow (\mathcal{C}', W')$  and a natural transformation  $\sigma : F \rightarrow G$  then  $\tilde{\sigma} : \tilde{F} \rightarrow \tilde{G}$  defined as  $\tilde{\sigma}_c = [(F(c); \sigma_c; G(c))]$  is also natural. Consequently, if  $\sigma$  is a natural isomorphism, i.e.,  $\sigma_c$  is an isomorphism for all  $c$ , then  $\tilde{\sigma}_c$  is also an isomorphism for all  $c$ . .QED.

### 4.3 Inessential morphisms and the category of components

#### 4.3.1 Yoneda morphisms, inessential morphisms

One problem of the groupoidification is that we completely lose non-cancellative behaviors, since a groupoid is left and right cancellative. This implies for example that the functor  $Q_{\mathcal{C},W}$  is not faithful when  $\mathcal{C}$  is not cancellative, which is the case for the fundamental category of the matchbox. The real problem comes from the fact that, in the groupoidification, we invert everything, in particular things that do not behave like isomorphisms. For example, for the non-cancellative behaviors, we have morphisms such that  $h \circ f = h \circ g$  and  $f \neq g$ , and so  $h$  is far from being an isomorphism.

The idea from [Goubault 2007] is to localize at some set of morphisms that behave like isomorphisms. We do the same here, except that the axioms defining those morphisms are slightly different.

We say that a morphism  $f : c \rightarrow c'$  is a **Yoneda morphism** if:

- **right cancellation:** for every object  $c''$  such that  $\mathcal{C}(c', c'') \neq \emptyset$ , the function

$$c'' \circ f : \mathcal{C}(c', c'') \rightarrow \mathcal{C}(c, c'') \quad g \mapsto g \circ f$$

is a bijection.

- **left cancellation:** for every object  $c''$  such that  $\mathcal{C}(c'', c) \neq \emptyset$ , the function

$$f \circ c'' : \mathcal{C}(c'', c) \rightarrow \mathcal{C}(c'', c') \quad g \mapsto f \circ g$$

is a bijection.

For example, the morphism  $h$  from non-cancellation is not a Yoneda morphism. In particular, the dihomotopy class of the red dipath in the matchbox from picture 2.4 is not a Yoneda morphism in  $\overrightarrow{\pi}_1(\mathbb{M}_{\square})$ .

Another convenient property of the class of isomorphisms is the following. We say that a subclass  $W$  of morphisms has:

- **right Ore condition:** for every  $f : c \rightarrow c' \in W$ , for every  $g : c'' \rightarrow c'$ , there are  $f' : d \rightarrow c'' \in W$  and  $g' : d \rightarrow c \in \mathcal{C}$  for some  $d$  such that  $f \circ g' = g \circ f'$

$$\begin{array}{ccc} d & \xrightarrow{g' \in \mathcal{C}} & c \\ f' \in W \downarrow & & \downarrow f \in W \\ c'' & \xrightarrow{g \in \mathcal{C}} & c' \end{array}$$

- **left Ore condition:** for every  $f : c \rightarrow c' \in W$  and every  $g : c \rightarrow c'' \in \mathcal{C}$  there are  $f' : c'' \rightarrow d \in W$  and  $g' : c' \rightarrow d \in \mathcal{C}$  for some  $d$  such that  $f' \circ g = g' \circ f$ .

$$\begin{array}{ccc} c & \xrightarrow{g \in \mathcal{C}} & c'' \\ f \in W \downarrow & & \downarrow f' \in W \\ c' & \xrightarrow{g' \in \mathcal{C}} & d \end{array}$$

Those axioms are strengthened in [Goubault 2007] where they require closure under pullbacks and pushouts instead. Those properties are important in our study for the following reason. Let us come back to the Swiss flag d-space from Section 4.1.3. Consider the dipath whose image is depicted in red below:

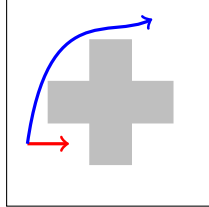

It is easy to check that the dihomotopy class of this dipath is a Yoneda morphism in  $\vec{\pi}_1(SF)$ . However, this dipath leads to an unsecured region, that is, a set of states that can only lead to a deadlock. Inverting this morphism is no good, since it will identify unsecured states with secured states. That is why the right Ore condition is interesting: this dipath fails this condition with the dipath depicted in blue, there is no way to complete the square with dipaths. Symmetrically, the left Ore condition avoids the identification of inaccessible states with accessible ones.

**Definition 7.** Given a small category  $\mathcal{C}$ , we define a **Yoneda system**  $\Theta$  of morphisms of  $\mathcal{C}$  as a subset of morphisms of  $\mathcal{C}$  such that:

- every element of  $\Theta$  is left and right cancellative,
- $\Theta$  has left and right Ore conditions.

**Lemma 4.** *The set of Yoneda systems of morphisms of  $\mathcal{C}$  is a non-empty complete lattice for inclusion.*

*Proof.* The set of Yoneda systems is non-empty since the set of isomorphisms is a Yoneda system. The sup is given by the union. *.QED.*

**Definition 8.** We denote by  $\mathfrak{I}(\mathcal{C})$  the maximal Yoneda system of morphisms of  $\mathcal{C}$ . We call its elements **inessential morphisms of  $\mathcal{C}$** .

For example, for the d-space SF, the inessential morphisms of  $\vec{\pi}_1(SF)$  are the dihomotopy classes of dipaths that are included in the zones delimited by dotted lines (modulo boundary conditions) here:

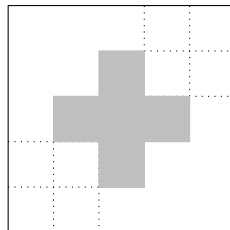

**Lemma 5.**  *$\mathfrak{I}(\mathcal{C})$  makes  $\mathcal{C}$  into a category with weak equivalences, i.e.,  $\mathfrak{I}(\mathcal{C})$  is a subcategory of  $\mathcal{C}$  which contains the isomorphisms and which has the 2-out-of-3 property. Moreover,  $\mathfrak{I}(\mathcal{C})$  has the 2-out-of-6 property.*

*Proof.*

- **contains isomorphisms:** the set of isomorphisms is a Yoneda system.

- $\mathfrak{J}(\mathcal{C})$  is closed under composition: let  $\Theta$  be a Yoneda system. Let  $\langle \Theta \rangle$  be the set

$$\{f_1 \circ \dots \circ f_n \mid n \geq 1, f_i \in \Theta\}.$$

$\langle \Theta \rangle$  is closed under composition. It is enough to prove that  $\langle \Theta \rangle$  is a Yoneda system:

- **left, right cancellation:** left and right cancellative morphisms are closed under composition,
- **left, right Ore condition:** by induction on  $n$ :

$$\begin{array}{ccccccc}
 c_0 & \xrightarrow{f_1 \in W_1} & c_1 & \xrightarrow{f_2 \in W_2} & c_2 & \xrightarrow{f_3 \in W_3} & \dots & \xrightarrow{f_n \in W_n} & c_n \\
 \downarrow g \in \mathcal{C} & \text{right Ore} & \downarrow g_1 \in \mathcal{C} & \text{right Ore} & \downarrow g_2 \in \mathcal{C} & \text{right Ore} & & \text{right Ore} & \downarrow g_n \in \mathcal{C} \\
 & \text{in } W_1 & & \text{in } W_2 & & \text{in } W_3 & & \text{in } W_n & \\
 d_0 & \xrightarrow{f'_1 \in W_1} & d_1 & \xrightarrow{f'_2 \in W_2} & d_2 & \xrightarrow{f'_3 \in W_3} & \dots & \xrightarrow{f'_n \in W_n} & d_n
 \end{array}$$

- **2-out-of-3 property:** let  $\Theta$  be a Yoneda system. Let  $[\Theta]$  be the set

$$\{f \mid \exists g, h \in \Theta, g = f \circ h\} \cup \{f \mid \exists g, h \in \Theta, g = h \circ f\} \cup \Theta.$$

We prove that  $[\Theta]$  is a Yoneda system:

- **left, right cancellation:** let  $f : a \rightarrow b$  be such that there exist  $g : b \rightarrow c \in \Theta$  and  $h : a \rightarrow c \in \Theta$  such that  $h = g \circ f$ , the other case is symmetric. The left cancellation is easy, since if  $\mathcal{C}(d, a) \neq \emptyset$ , the function  $f \circ d$  is equal to  $(g \circ d)^{-1} \circ (h \circ d)$  which is a bijection. For the right cancellation, let  $d$  with  $\mathcal{C}(b, d) \neq \emptyset$ . By the left Ore condition, there is a morphism  $k : d \rightarrow e \in \Theta$  with  $\mathcal{C}(c, e) \neq \emptyset$ . Let us prove that  $d \circ f$  is injective and surjective.
  - \* **injective:** let  $\alpha_1, \alpha_2 : b \rightarrow d$  be such that  $\alpha_1 \circ f = \alpha_2 \circ f$ . So  $k \circ \alpha_1 \circ f = k \circ \alpha_2 \circ f$ . Since  $e \circ g$  is a bijection, there are  $\beta_1, \beta_2 : c \rightarrow e$  such that  $k \circ \alpha_i = \beta_i \circ g$ . So  $\beta_i \circ h = \beta_i \circ g \circ f = k \circ \alpha_i \circ f$  and since  $e \circ h$  is a bijection,  $\beta_1 = \beta_2$ , thus  $k \circ \alpha_1 = k \circ \alpha_2$ . Since  $k \circ b$  is a bijection,  $\alpha_1 = \alpha_2$ .
  - \* **surjective:** let  $\alpha : a \rightarrow d$ , so  $k \circ \alpha : a \rightarrow e$ . Since  $e \circ h$  is a bijection, there is  $\beta : c \rightarrow e$  such that  $k \circ \alpha = \beta \circ h = \beta \circ g \circ f$ . Since  $k \circ b$  is a bijection, there is  $\gamma : b \rightarrow d$  such that  $k \circ \gamma = \beta \circ g$ . Since  $k \circ \alpha = k \circ \gamma \circ f$  and  $k \circ a$  is a bijection,  $\alpha = \gamma \circ f$ .
- **left, right Ore condition:** let  $f : a \rightarrow b$  be such that there exist  $g : b \rightarrow c \in \Theta$  and  $h : a \rightarrow c \in \Theta$  such that  $h = g \circ f$ , the other case is symmetric.
  - \* **right:** let  $\alpha : d \rightarrow b$ . By the right Ore condition on  $h$  and  $g \circ \alpha$ , there  $\beta : e \rightarrow d \in \Theta$  and  $\gamma : e \rightarrow a \in \mathcal{C}$  such that  $g \circ \alpha \circ \beta = h \circ \gamma = g \circ f \circ \gamma$ . Since  $g \circ e$  is a bijection,  $\alpha \circ \beta = f \circ \gamma$ .
  - \* **left:** let  $\alpha : a \rightarrow d$ . By the left Ore condition on  $h$  and  $\alpha$ , there are  $\beta : d \rightarrow e \in \Theta$  and  $\gamma : c \rightarrow e \in \mathcal{C}$  such that  $\beta \circ \alpha = \gamma \circ h = (\gamma \circ g) \circ f$ .

Now define  $X_0 = \Theta$ ,  $X_{2i+1} = \langle X_{2i} \rangle$  and  $X_{2i+2} = [X_{2i+1}]$ . Let  $X_\infty = \bigcup_{i \in \mathbb{N}} X_i$ . By what we just proved, for every  $i$ ,  $X_i$  is a Yoneda system which contains  $\Theta$ , so  $X_\infty$  is a Yoneda system which contains  $\Theta$ . Moreover,  $X_\infty$  has the 2-out-of-3 property.

- **2-out-of-6 property:** Let  $\Theta$  be a Yoneda system. Let  $u : a \rightarrow b$ ,  $v : b \rightarrow c$  and  $w : c \rightarrow d$  be such that  $v \circ u$  and  $w \circ v \in \Theta$ . It is enough to prove that  $\Theta \cup \{v\}$  is a Yoneda. Indeed, if  $\Theta = \mathfrak{I}(\mathcal{C})$ , then this prove that  $v \in \mathfrak{I}(\mathcal{C})$  by maximality. Since  $\mathfrak{I}(\mathcal{C})$  has the 2-out-of-3 property, this prove that  $u$  and  $w$  are also in  $\mathfrak{I}(\mathcal{C})$ . Since  $\mathfrak{I}(\mathcal{C})$  is closed under composition, this prove that  $w \circ v \circ u \in \mathfrak{I}(\mathcal{C})$ .
  - **left, right cancellation:** let us do the right cancellation, the left is symmetric. Let  $e$  such that  $\mathcal{C}(c, e) \neq \emptyset$ . Let us prove that  $e \circ v : \mathcal{C}(c, e) \rightarrow \mathcal{C}(b, e)$  is injective and bijective.
    - \* **injective:** let  $\alpha_1, \alpha_2 : c \rightarrow e$  be such that  $\alpha_1 \circ v = \alpha_2 \circ v$ . So  $\alpha_1 \circ v \circ u = \alpha_2 \circ v \circ u$  and since  $e \circ (v \circ u)$  is a bijection,  $\alpha_1 = \alpha_2$ .
    - \* **surjective:** let  $\alpha : b \rightarrow e$ . Since  $e \circ (v \circ u)$  is a bijection, there is  $\beta : c \rightarrow e$  such that  $\alpha \circ u = \beta \circ v \circ u$ . To prove surjectivity, it is then enough to prove that  $e \circ u$  is injective.
    - \*  **$e \circ u$  is injective:** let  $\alpha_1, \alpha_2 : b \rightarrow e$  be such that  $\alpha_1 \circ u = \alpha_2 \circ u$ . Since  $\mathcal{C}(b, e) \neq \emptyset$ , then by the left Ore condition on  $w \circ v \in \Theta$ , there is  $\beta : e \rightarrow f \in \Theta$  such that  $\mathcal{C}(d, f) \neq \emptyset$ . So  $\beta \circ \alpha_1 \circ u = \beta \circ \alpha_2 \circ u$ . Since  $f \circ (w \circ v)$  is a bijection, there is  $\gamma_1, \gamma_2 : d \rightarrow f$  such that  $\gamma_i \circ w \circ v = \beta \circ \alpha_i$ . Thus  $\gamma_1 \circ w \circ v \circ u = \gamma_2 \circ w \circ v \circ u$ . Since  $f \circ (v \circ u)$  is a bijection,  $\gamma_1 \circ w = \gamma_2 \circ w$  and thus  $\beta \circ \alpha_1 = \beta \circ \alpha_2$ . Since  $\beta \circ b$  is a bijection,  $\alpha_1 = \alpha_2$ .
  - **left, right Ore condition:** let us prove the right Ore condition, the other is symmetric. Let  $\alpha : e \rightarrow c$ . By the right condition on  $u \circ v \in \Theta$  and  $\alpha$ , there are  $\beta : f \rightarrow e \in \Theta$  and  $\gamma : f \rightarrow a \in \mathcal{C}$  such that  $v \circ (u \circ \gamma) = \alpha \circ \beta$ .

.QED.

**Corollary 4.**  $\mathfrak{I}(\mathfrak{I}(\mathcal{C})) = \mathfrak{I}(\mathcal{C})$

*Proof.* It is enough to prove that  $\mathfrak{I}(\mathcal{C})$  is a Yoneda system of  $\mathfrak{I}(\mathcal{C})$ :

- **left, right cancellation:** we prove left cancellation. Let  $w : a \rightarrow b \in \mathfrak{I}(\mathcal{C})$  and let  $c$  be such that  $\mathfrak{I}(\mathcal{C})(b, c) \neq \emptyset$ . In particular,  $\mathcal{C}(b, c) \neq \emptyset$  and  $c \circ w : \mathcal{C}(b, c) \rightarrow \mathcal{C}(a, c)$  is a bijection. It is enough to prove that:
  - $c \circ w$  sends inessential morphisms to inessential morphisms: by closure under composition,
  - $(c \circ w)^{-1}$  sends inessential morphisms to inessential morphisms: by the 2-out-of-3 property.
- **left, right Ore condition:** we prove the left Ore condition. Let  $w : a \rightarrow b$  and  $w' : a \rightarrow c$  be inessential morphisms. By the left Ore condition in  $\mathcal{C}$ , there are a morphism  $\alpha : b \rightarrow d \in \mathcal{C}$  and an inessential morphism  $\beta : c \rightarrow d$  such that  $\alpha \circ w = \beta \circ w'$ . Then by the 2-out-of-3 property,  $\alpha$  is also inessential.

.QED.

### 4.3.2 Calculus of fractions and localizations

The axioms of Yoneda systems are close to the axioms for having a **calculus of fractions** [Gabriel 1967]. These axioms are general conditions for the existence of the localization, regardless of the problems from set-theory. They also allow us to simplify the construction from section 4.2.2.

More concretely, given a category  $\mathcal{C}$  and a subclass  $W$  of morphisms, we say  $W$  has a **calculus of right fractions** if:

- $W$  is a subcategory of  $\mathcal{C}$ ,
- $W$  has the right Ore condition,
- for every morphisms  $f, g : a \rightarrow b \in \mathcal{C}$  and  $h : b \rightarrow c \in W$  with  $h \circ f = h \circ g$ , then there is a morphism  $h' : d \rightarrow a \in W$  such that  $f \circ h' = g \circ h$ .

Dually, one can define what it means to say that  $W$  has a calculus of left fractions.  $\mathfrak{J}(\mathcal{C})$  has then a calculus of right and left fractions since the last condition is implied by cancellation.

The main interest of a right calculus of fractions is that the construction of the localization  $\mathcal{C}[W^{-1}]$  from Section 4.2.2 can be simplified. Remember that morphisms were equivalence classes of sequences  $f_1, \dots, f_n$  where  $f_i$  is either a morphism of  $\mathcal{C}$ , or a formal inverse of a morphism of  $W$ , i.e., those sequences are zig-zags of morphisms. By the right Ore condition and the closure under composition, those zig-zags are always equivalent to a span with one branch in  $W$ , and one branch in  $\mathcal{C}$ . More precisely, its objects are still those of  $\mathcal{C}$ , but this time, its morphisms from  $a$  to  $c$  are equivalence classes of spans  $a \xleftarrow{w} b \xrightarrow{f} c$  of morphisms of  $\mathcal{C}$  with  $w : a \rightarrow b \in W$ . We say that two spans  $a \xleftarrow{w} b \xrightarrow{f} c$  and  $a' \xleftarrow{w'} b' \xrightarrow{f'} c'$  are equivalent if there are morphisms  $s : d \rightarrow b$  and  $t : d \rightarrow b'$  such that  $s \circ w = t \circ w' \in W$  and  $s \circ f = t \circ f'$ . In particular, when  $W$  has the 2-out-of-3 property,  $s$  and  $t$  are in  $W$ . We denote this equivalence class by  $[a \xleftarrow{w} b \xrightarrow{f} c]$ . The composition  $[a \xleftarrow{w} b \xrightarrow{f} c] \circ [c \xleftarrow{w'} d \xrightarrow{f'} e]$  is defined as follow: by the right Ore condition on  $f$  and  $w$ , there are morphisms  $w'' \in W$  and  $f'' \in \mathcal{C}$  such that  $f \circ w'' = w \circ f''$ . The composition is then defined by  $[a \xleftarrow{w \circ w''} d \xrightarrow{f \circ f''} e]$ . The dual construction can be made when  $W$  has a calculus of left fractions. When  $W$  has both calculus of left and right fractions, those two constructions coincide (up to isomorphism).

One other interest is that one can characterize when  $W$  is **saturated**, i.e., when  $W$  is exactly the set of morphisms which become isomorphisms through localization. More precisely, let  $W' = \{f \mid Q_{\mathcal{C}, W}(f) \text{ is an iso}\}$ . We say that  $W$  is saturated when  $W' = W$ . In the case where  $W$  has a calculus of fractions (either right or left), it is known [Borceux 1994a] that  $W$  is saturated if and only if  $W$  has the 2-out-of-6 property. In particular,  $\mathfrak{J}(\mathcal{C})$  is saturated.

### 4.3.3 The category of components

Our goal now is to construct a localization of the fundamental category, mid-way between it and its groupoidification. We have seen that  $\mathfrak{J}(\overrightarrow{\pi}_1(X))$  has a calculus of right and left fractions and so its localization  $\overrightarrow{\pi}_1(X)[\mathfrak{J}(\overrightarrow{\pi}_1(X))^{-1}]$  is easy to compute. We denote this localization by  $\overrightarrow{\pi}_0(X)$  and call it the **category of components**, following the denomination from [Goubault 2007]. More generally, given a small category  $\mathcal{C}$ , we denote by  $\overrightarrow{\pi}_0(\mathcal{C})$ , the localization  $\mathcal{C}[\mathfrak{J}(\mathcal{C})^{-1}]$ .

One should notice that this does not extend to a functor: indeed a dimap  $f : X \rightarrow Y$  induces a functor between category of components if it sends an element of  $\mathfrak{J}(\overrightarrow{\pi}_1(X))$  to an element of  $\mathfrak{J}(\overrightarrow{\pi}_1(Y))$ , which is not the case in general.

For example, since every isomorphism is inessential, the category of components of a groupoid is the groupoid itself. Another example is the fundamental category of the directed segment  $[0, 1]$ . This category is isomorphic to the poset  $([0, 1], \leq)$  and so every morphism is inessential. So its category of components is its groupoidification. Let us denote by  $\overrightarrow{S^1}$ , the d-space whose underlying space is  $S^1$ , the circle, and whose dipaths are paths that turn anti-clockwise, that is, paths of the form  $t \mapsto e^{i\Phi(t)}$  for some non-decreasing function  $\Phi : [0, 1] \rightarrow \mathbb{R}$ . In this case, the only Yoneda morphisms of  $\overrightarrow{S^1}$  are the identities, i.e., dihomotopy class of constant paths. Indeed, they are the only ones that induces

bijections between Hom-sets by composition: if you take any non-constant dipath  $\gamma$ , say from  $e^{i\theta}$  to  $e^{i\theta'}$  then  $[\gamma] \circ \_ : \vec{\pi}_1(\vec{S}^1)(e^{i\theta'}, e^{i\theta}) \rightarrow \vec{\pi}_1(\vec{S}^1)(e^{i\theta}, e^{i\theta})$  is not surjective since it never reaches the class of the constant path. Hence  $\vec{\pi}_0(\vec{S}^1) = \vec{\pi}_1(\vec{S}^1)$ .

This time the functor  $R_{\mathcal{C}} = Q_{\mathcal{C}, \mathcal{J}(\mathcal{C})} : \mathcal{C} \rightarrow \vec{\pi}_0(\mathcal{C})$  is faithful, and so we do not lose the non-cancellative behaviors. Indeed, let  $f, g : c \rightarrow d$  be such that  $R_{\mathcal{C}}(f) = R_{\mathcal{C}}(g)$ .  $R_{\mathcal{C}}(f)$  is the equivalence class of the span  $c \xleftarrow{\text{id}_c} c \xrightarrow{f} d$  and this equality means that there are two morphisms  $s, t : e \rightarrow c \in \mathcal{J}(\mathcal{C})$  such that  $s = t$  and  $f \circ s = g \circ t$ . Since  $d \circ s$  is a bijection,  $f = g$ .

### 4.3.4 Equivalence with a quotient

Another good property of this category of components is that, in concrete cases, it is equivalent to a generalized quotient of the fundamental category (which is not true in general for a localization). In [Goubault 2007], the theory was introduced for loop-free categories, i.e., for categories whose endomorphisms and isomorphisms are identities (which is the case for the fundamental category of pospaces, or for geometric realization of SU/PV-programs). In the latter case, this allows one to compute a finite category which is equivalent to the category of components. See the tool ALCOOL [Haucourt ].

For example, it is possible to prove that the category of components of the Swiss flag is equivalent to the category generated by the following directed graph:

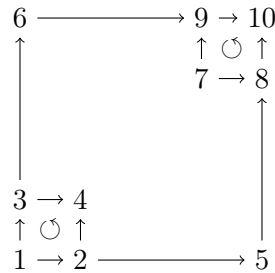

where  $\circlearrowleft$  denotes a relation. Similarly, the category of components of the squared annulus is equivalent to the category generated by the following directed graph:

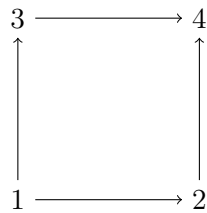

In particular, these categories are not equivalent.

Actually, this phenomenon is more general, but the quotient used is trickier. Let us start by recalling the construction of a generalized quotient from [Bednarczyk 1999]. A **generalized congruence** on a small category  $\mathcal{C}$  is the following data:

- an equivalence relation  $\simeq_o$  on objects of  $\mathcal{C}$ ,
- a partial equivalence relation (i.e., symmetric and transitive relation)  $\simeq_m$  on  $Mor_+(\mathcal{C})$  (i.e., the set of non-empty finite sequences of morphisms of  $\mathcal{C}$ ). We call the set  $\{\gamma \in Mor_+(\mathcal{C}) \mid \gamma \simeq \gamma\}$  the **support of  $\simeq_m$** .



These data must satisfy:

- if  $(\beta_m, \dots, \beta_0, \alpha_n, \dots, \alpha_0)$  is in the support of  $\simeq_m$ , then source of  $\beta_0 \simeq_o$  target of  $\alpha_n$ ,
- if  $(\beta_m, \dots, \beta_0) \simeq_m (\alpha_n, \dots, \alpha_0)$ , then target of  $\beta_m \simeq_o$  target of  $\alpha_n$ ,
- if  $c \simeq_o d$ , then  $(id_c) \simeq_m (id_d)$ ,
- if  $(\beta_m, \dots, \beta_0) \simeq_m (\alpha_n, \dots, \alpha_0)$ ,  $(\gamma_p, \dots, \gamma_0) \simeq_m (\delta_q, \dots, \delta_0)$  and source of  $\beta_0 \simeq_o$  target of  $\alpha_n$ , then

$$(\beta_m, \dots, \beta_0, \alpha_n, \dots, \alpha_0) \simeq_m (\gamma_p, \dots, \gamma_0, \delta_q, \dots, \delta_0),$$

- if  $\alpha$  and  $\beta$  are composable (i.e., source of  $\beta =$  target of  $\alpha$ ), then  $(\beta, \alpha) \simeq_m (\beta \circ \alpha)$ .

Given a relation  $R_0$  on objects of  $\mathcal{C}$  and a relation  $R_m$  on  $Mor_+(\mathcal{C})$ , there is a smallest (for inclusion) generalized congruence that contains  $(R_0, R_m)$  [Bednarczyk 1999].

Given a generalized congruence  $(\simeq_o, \simeq_m)$  on  $\mathcal{C}$ , we define the **generalized quotient**  $\mathcal{C}/(\simeq_o, \simeq_m)$  as the category whose:

- objects are equivalence classes  $[x]_0$  of objects of  $\mathcal{C}$  modulo  $\simeq_o$ ,
- morphisms from  $[x]_0$  to  $[y]_0$  are equivalence classes

$$[(\alpha_n, \dots, \alpha_0)]_m$$

of elements of the domain of  $\simeq_m$  modulo  $\simeq_m$  such that the target of  $\alpha_n \simeq_o y$  and the source of  $\alpha_0 \simeq_o x$ ,

- composition is  $[(\beta_m, \dots, \beta_0)]_m \circ [(\alpha_n, \dots, \alpha_0)]_m = [(\beta_m, \dots, \beta_0, \alpha_n, \dots, \alpha_0)]_m$ ,
- identity on  $[x]_0$  is  $[(id_x)]_m$ .

[Goubault 2007] considers the generalized congruence  $\simeq$  generated by the relation  $(f) \simeq_m (id_x)$  for every  $f \in \mathfrak{I}(\mathcal{C})$  and  $x$  being either the source or the target of  $f$ . When the category  $\mathcal{C}$  is without loops,  $\overrightarrow{\pi}_0(\mathcal{C})$  is equivalent to the generalized quotient  $\mathcal{C}/\simeq$ . This statement is not true in general: in quotienting  $\mathcal{C}$  by  $\simeq$ , every inessential morphism is identified to an identity. So when a category has loops, they might be a hom-set  $\mathcal{C}(c, d)$  such that there are two different inessential morphisms in it. For example, if  $\mathcal{C}$  is a groupoid, every morphism being an isomorphism and so inessential, this case often occurs. In this case, when quotienting, those two morphisms are identified, and so we lose faithfulness and thus the equivalence. The idea is that one should not quotient all the inessential morphisms, but only one by hom-set. But the choice of the inverted morphism should be compatible with the structure of the category. By a **selection** of a category  $\mathcal{C}$ , we will mean a subcategory  $\Sigma$  of  $\mathcal{C}$ , which is a poset (i.e., every homset has at most one morphism) such that for every pair  $(c, d)$  of objects,  $\mathcal{C}(c, d) = \emptyset$  if and only if  $\Sigma(c, d) = \emptyset$ .

There are categories which do not have selections. For example, consider the free category generated by  $O = \{a, b, c, d\}$ ,  $M_{a,b} = \{f\}$ ,  $M_{b,d} = \{g\}$ ,  $M_{a,c} = \{h\}$  and  $M_{c,d} = \{k\}$ . A selection of  $(O, M)^*$  must contain  $\{f, g, h, k\}$  and so by composition, must contain  $g \circ f$  and  $k \circ h$  which are different. Here we are interested in selections of  $\mathfrak{I}(\mathcal{C})$ . It is not clear to me whether  $\mathfrak{I}(\mathcal{C})$  always has a selection or not, but my conjecture would be it does. For example, the above example is not the set of inessential morphisms of a category  $\mathcal{C}$  since  $\mathfrak{I}(\mathfrak{I}(\mathcal{C})) = \mathfrak{I}(\mathcal{C})$  and  $f, g, h, k$  are not Yoneda morphisms. On the contrary, here are three examples of cases where  $\mathfrak{I}(\mathcal{C})$  has a selection:

1. when  $\mathcal{C}$  is without loop, in particular when  $\mathcal{C}$  is the fundamental category of a pospace. In this case,  $\mathfrak{I}(\mathcal{C})$  is itself a poset and so a selection.
2. when  $\mathcal{C}$  is the fundamental category of the directed circle. In this case,  $\mathfrak{I}(\mathcal{C})$  is the set of identities, which is itself a selection.
3. when  $\mathcal{C}$  is a groupoid, in particular when  $\mathcal{C}$  is the fundamental category of a topological space. In this case, every morphism is an isomorphism and so inessential. We construct a selection as follow. Let us assume that it is connected. Choose one object  $c$  of  $\mathcal{C}$ . For every other object  $d$  of  $\mathcal{C}$ , just choose a morphism  $\sigma_d$  from  $c$  to  $d$ , and choose its inverse from  $d$  to  $c$ . Now, if for every pair  $(d, d')$ , we chose  $\sigma_{d'} \circ \sigma_d^{-1}$  from  $d$  to  $d'$ . This forms a selection of  $\mathcal{C} = \mathfrak{I}(\mathcal{C})$ .

When  $\Sigma$  is a selection of  $\mathfrak{I}(\mathcal{C})$ , we denote by  $\mathcal{C}/\Sigma$  the generalized quotient of  $\mathcal{C}$  by the generalized congruence generated by the relation  $(f) \simeq_m (id_x)$  for every  $f \in \Sigma$  and  $x$  being either the source or the target of  $f$ .

**Theorem 10.** *If  $\Sigma$  is a selection of  $\mathfrak{I}(\mathcal{C})$ ,  $\overrightarrow{\pi}_0(\mathcal{C})$  is equivalent to  $\mathcal{C}/\Sigma$ .*

*Proof.* We denote by  $\sigma_{x,y}$  the unique morphism of  $\Sigma$  from  $x$  to  $y$  when it exists.

We start by defining a functor  $Q : \overrightarrow{\pi}_0(\mathcal{C}) \rightarrow \mathcal{C}/\Sigma$ . It maps every object  $x$  to the class  $[x]_0$  modulo  $\sim_0$  and every class of span  $[x \xleftarrow{f} y \xrightarrow{g} z]$  in the localization with  $f \in \mathfrak{I}(\mathcal{C})$  to  $[g \circ \tilde{f}^{-1}]_m$  the class of  $g \circ \tilde{f}$  modulo  $\sim_m$  where  $\tilde{f}$  is the unique morphism from  $y$  to  $y$  such that  $\sigma_{y,x} \circ \tilde{f} = f$ .  $\tilde{f}$  is an isomorphism because it is an endomorphism which belongs to  $\mathfrak{I}(\mathcal{C})$  by 2-out-of-3 property.

This is well defined: indeed, it does not depend on the span representing  $[x \xleftarrow{f} y \xrightarrow{g} z]$ . If we take another span representing it  $x \xleftarrow{f'} y' \xrightarrow{g'} z$ , there exists a span  $y \xleftarrow{u} w \xrightarrow{v} y'$  such that  $f \circ u = f' \circ v$ ,  $g \circ u = g' \circ v$  and  $g \circ u = g' \circ v$  belongs to  $\mathfrak{I}(\mathcal{C})$ . By the 2-out-of-3 property,  $u$  and  $v$  belongs to  $\mathfrak{I}(\mathcal{C})$ . Since  $(u, f) \sim_m (v, f') \sim_m (u, \tilde{f}) \sim_m (v, \tilde{f}')$ . Moreover  $(u, \tilde{f}, \tilde{f}^{-1}, g) \sim_m (u, g) \sim_m (v, g') \sim_m (v, \tilde{f}', \tilde{f}'^{-1}, g')$ . But, since  $\tilde{f} \circ u \in \mathfrak{I}(\mathcal{C})$ , there is a  $h$  such that  $\tilde{f} \circ u \circ h = \sigma_{w,y}$  and so  $(\tilde{f}^{-1}, g) \sim_m (\tilde{f}'^{-1}, g')$ . It is a functor because  $Q([x \xleftarrow{id_x} x \xrightarrow{id_x} x]) = [id_x \circ id_x]_m = [id_x \circ id_x]_m = [id_x]_m$  and if  $x \xleftarrow{f} y \xrightarrow{g} z \xleftarrow{h} y' \xrightarrow{k} x'$ , let  $y \xleftarrow{h'} w \xrightarrow{g'} y'$  coming from the right Ore condition on  $h$  and  $g$  with  $h' \in \mathfrak{I}(\mathcal{C})$ . Then  $Q([z \xleftarrow{h} y' \xrightarrow{k} x'] \circ [x \xleftarrow{f} y \xrightarrow{g} z]) = Q([x \xleftarrow{f \circ h'} w \xrightarrow{k \circ g'} x']) = [f \circ h'^{-1}, k \circ g']_m$  and  $Q([z \xleftarrow{h} y' \xrightarrow{k} x']) \circ Q([x \xleftarrow{f} y \xrightarrow{g} z]) = [\tilde{f}^{-1}, g, \tilde{h}^{-1}, k]_m$ . Since  $g \circ h' = g' \circ h$ ,  $(g) \sim_m (\tilde{h}^{-1}, h', g) \sim_m (\tilde{h}^{-1}, g', h)$ . So  $(\tilde{f}^{-1}, g, \tilde{h}^{-1}, k) \sim_m (\tilde{f}^{-1}, \tilde{h}'^{-1}, g', k)$ . But  $(f \circ h'^{-1}, f \circ h') \sim_m (id) \sim_m (\tilde{f}^{-1}, \tilde{h}'^{-1}, f \circ h')$ . Since  $f \circ h' \in \mathfrak{I}(\mathcal{C})$ ,  $(f \circ h'^{-1}) \sim_m (\tilde{f}^{-1}, \tilde{h}'^{-1})$  and  $(\tilde{f}^{-1}, g, \tilde{h}^{-1}, k) \sim_m (f \circ h'^{-1}, f \circ h')$ .

Now, we define a functor  $R : \mathcal{C}/\Sigma \rightarrow \overrightarrow{\pi}_0(\mathcal{C})$ . For every class  $\alpha$  modulo  $\sim_0$ , make a choice  $R(\alpha) \in \alpha$ . Note that by the Ore conditions, if  $c \sim_0 d$ , then there is a span  $c \xleftarrow{f} e \xrightarrow{g} d$  of morphisms of  $\mathfrak{I}(\mathcal{C})$  and so of  $\Sigma$ . Every  $[f_1, \dots, f_n]_m$  with  $f_i : d_i \rightarrow c_i$ ,  $c_{i-1} \sim_0 d_i$  and with  $c_0 = R([d_1]_0)$  and  $d_{n+1} = R([c_n]_0)$  will be mapped to  $[c_n \xleftarrow{\sigma_{e_n, c_n}} e_n \xrightarrow{\sigma_{e_n, d_{n+1}}} d_{n+1}] \circ [c_{n-1} \xleftarrow{\sigma_{e_{n-1}, c_{n-1}}} e_{n-1} \xrightarrow{f_n \circ \sigma_{e_{n-1}, d_n}} c_n] \circ \dots \circ [c_0 \xleftarrow{\sigma_{e_0, c_0}} e_0 \xrightarrow{f_1 \circ \sigma_{e_0, d_1}} c_1]$ . We can prove that this does not depend on the choices of the  $e_i$  and of the element representing  $[f_1, \dots, f_n]_m$  and that defines a functor.

We now prove that  $Q \circ R = id$ . But first, let us prove by induction on  $n$  that for every  $(f_1, \dots, f_n)$  with  $f_i : d_i \rightarrow c_i$  and  $c_i \sim_0 d_{i+1}$  and for every  $x \sim_0 d_1$  and  $y \sim_0 c_n$ , there is a morphism  $h : z \rightarrow y$  such that there is a morphism in  $\mathfrak{I}(\mathcal{C})$  from  $z$  to  $x$  and  $(f_1, \dots, f_n) \sim_m (h)$ :

- **if  $n = 1$ :** we have  $f : c \rightarrow d$ ,  $x \sim_0 c$  and  $y \sim_0 d$ . We have then  $e$  such that there are morphisms in  $\mathfrak{J}(\mathcal{C})$  from  $e$  to  $d$  and from  $e$  to  $y$ . By the right Ore condition on  $\sigma_{e,d} \in \mathfrak{J}(\mathcal{C})$  and  $f$  there are  $g : w \rightarrow e$  and  $\gamma : w \rightarrow c \in \mathfrak{J}(\mathcal{C})$  with  $f \circ \gamma = \sigma_{e,d} \circ g$ . So  $\sigma_{w,c}$  exists and  $\mathcal{C}(w, e)$  is non-empty. Since,  $\sigma_{e,d} \circ w : \mathcal{C}(w, e) \rightarrow \mathcal{C}(w, d)$  is a bijection, there is  $h : w \rightarrow e$  such that  $\sigma_{e,d} \circ h = f \circ \sigma_{w,c}$ . Since  $x \sim_0 c \sim_0 w$ , there is  $u$  such that there are morphisms in  $\mathfrak{J}(\mathcal{C})$  from  $u$  to  $x$  and from  $u$  to  $w$ . Then  $\sigma_{e,y} \circ h \circ \sigma_{u,x}$  and  $u$  are what we were looking for.
- **inductive case:** by the induction hypothesis on  $(f_2, \dots, f_n)$ ,  $c_1$  and  $y$ , there is a morphism  $f : w \rightarrow y$  such that  $(f_2, \dots, f_n) \sim_m (f)$  and there is a morphism in  $\mathfrak{J}(\mathcal{C})$  from  $w$  to  $c_1$ . By the right Ore condition on  $\sigma_{w,c_1} \in \mathfrak{J}(\mathcal{C})$  and  $f_1$  there are  $g : u \rightarrow w$  and  $\gamma : u \rightarrow d_1 \mathfrak{J}(\mathcal{C})$  such that  $f \circ \gamma = \sigma_{w,c_1} \circ g$ . As previously, we can assume that  $\gamma = \sigma_{u,c_1}$ . Then, the rest is similar to the previous case.

Now, it is clear that for every class  $\alpha$  modulo  $\sim_0$ ,  $Q(R(\alpha)) = [R(\alpha)]_0 = \alpha$ . Then for every class  $\gamma$  modulo  $\sim_m$ , by what we just proved, there is  $f : x \rightarrow y$  with  $R([y]) = y$  and there is a morphism in  $\mathfrak{J}(\mathcal{C})$  from  $x$  to  $R([x])$  and  $\gamma = [f]_m$ . So  $R(\gamma) = [R([x]) \xleftarrow{\sigma_{x,R([x])}} x \xrightarrow{f} y]$  and  $Q(R(\gamma)) = [f]_m = \gamma$ .

It remains to define a natural isomorphism  $\tau : id \rightarrow R \circ Q$  which will be defined by  $\tau_c : c \rightarrow R([c])$  is equal to  $[c \xleftarrow{\sigma_{\alpha,c}} \alpha \xrightarrow{\sigma_{\alpha,R([c])}} R([c])]$  (such an  $\alpha$  exists since  $x \sim_0 R([c])$ ). This does not depend on the choice of  $\alpha$  and is an isomorphism with inverse  $[R([c]) \xleftarrow{\sigma_{\alpha,R([c])}} \alpha \xrightarrow{\sigma_{\alpha,c}} c]$ . *.QED.*

### 4.3.5 Hierarchy of equivalences between fundamental categories

We proved that an equivalence of categories induces an equivalence of categories between groupoidifications. In this section, we want to add category of components in this comparison. We will prove the following:

**Proposition 11.** *An equivalence of categories induces an equivalence of categories between categories of components. A functor which induces an equivalence of categories between categories of components induces an equivalence of categories between groupoidifications.*

For the first part, by lemma 10, it is enough to prove that an equivalence of categories  $F : \mathcal{C} \rightarrow \mathcal{D}$  maps elements of  $\mathfrak{J}(\mathcal{C})$  to elements of  $\mathfrak{J}(\mathcal{D})$ . It is enough to prove that  $\langle \{F(w) \mid w \in \mathfrak{J}(\mathcal{C})\} \cup \mathfrak{J}(\mathcal{D}) \rangle$  is a Yoneda system. We denote by  $\sigma : id_{\mathcal{D}} \rightarrow F \circ G$  the natural isomorphism.

- **left, right cancellation:** let us prove the left one. It is enough to prove that for every  $w : a \rightarrow b \in \mathfrak{J}(\mathcal{C})$ ,  $F(w)$  is left cancellative. Let  $c$  be such that  $\mathcal{D}(F(b), c) \neq \emptyset$ . Since  $\sigma_c : c \rightarrow F(G(c))$ ,  $\mathcal{D}(F(b), F(G(c))) \neq \emptyset$ . The fact that  $F$  is fully faithful implies that  $\mathcal{C}(b, G(c)) \neq \emptyset$ , and so  $G(c) \circ w$  is a bijection. Note  $F_{x,y}$  the function from  $\mathcal{C}(x, y)$  to  $\mathcal{D}(F(x), F(y))$  induced by  $F$ . Since  $F$  is fully faithful, those  $F_{x,y}$  are bijections. Then:

$$c \circ F(w) = (\sigma_c^{-1} \circ F(a)) \circ F_{a,G(c)} \circ (G(c) \circ w) \circ F_{b,G(c)}^{-1} \circ (\sigma_c \circ F(b))$$

is a bijection.

- **left, right Ore condition:** let us prove the left one. Let  $w : a \rightarrow b \in \mathfrak{J}(\mathcal{C})$  and  $f : F(a) \rightarrow c \in \mathcal{D}$ . Then  $\sigma_c \circ f : F(a) \rightarrow F(G(c))$ , and since  $F$  is fully faithful, there is  $g : a \rightarrow G(c)$  with  $F(g) = \sigma_c \circ f$ . By the left Ore condition on  $w \in \mathfrak{J}(\mathcal{C})$  and  $g$ , there are  $\alpha : G(c) \rightarrow d \in \mathfrak{J}(\mathcal{C})$  and  $\beta : b \rightarrow d$  with  $\beta \circ w = \alpha \circ g$ . Then  $F(\beta) \circ F(w) = (F(\alpha) \circ \sigma_c) \circ f$  and  $F(\alpha) \circ \sigma_c$  is in  $\langle \{F(w) \mid w \in \mathfrak{J}(\mathcal{C})\} \cup \mathfrak{J}(\mathcal{D}) \rangle$ .

For the second part, let us note the following:

**Lemma 6.** *Let  $\mathcal{C}$  be a small category and  $W' \subseteq W$  be two sets of morphisms. Then  $\mathcal{C}[W'^{-1}]$  is isomorphic to  $(\mathcal{C}[W^{-1}])[W''^{-1}]$  where  $W'' = \{Q_{\mathcal{C},W}(w') \mid w' \in W'\}$ .*

Then the second part of the proposition follows from this and the lemma 10.

*Proof.* Note  $R_{\mathcal{C},W,W'} = Q_{\mathcal{C}[W^{-1}],W''} \circ Q_{\mathcal{C},W} : \mathcal{C} \rightarrow (\mathcal{C}[W^{-1}])[W''^{-1}]$ . It is enough to prove that  $R_{\mathcal{C},W,W'}$  satisfies the universal property of  $Q_{\mathcal{C},W'}$ . First,  $R_{\mathcal{C},W,W'}$  maps elements of  $W'$  to isomorphisms since  $Q_{\mathcal{C}[W^{-1}],W''}$  maps elements of the form  $Q_{\mathcal{C},W}(w')$  with  $w' \in W'$  to isomorphisms.

Now let  $F : \mathcal{C} \rightarrow \mathcal{D}$  be such that  $F$  maps elements of  $W'$  to isomorphisms. In particular, it maps elements of  $W$  to isomorphisms. So there is a unique functor  $F_1 : \mathcal{C}[W^{-1}] \rightarrow \mathcal{D}$  such that  $F_1 \circ Q_{\mathcal{C},W} = F$ . Then for every  $w' \in W'$ ,  $F_1(Q_{\mathcal{C},W}(w')) = F(w')$  is an isomorphism. So there is a unique functor  $F_2 : (\mathcal{C}[W^{-1}])[W''^{-1}] \rightarrow \mathcal{D}$  such that  $F_2 \circ Q_{\mathcal{C}[W^{-1}],W''} = F_1$  and  $F_2 \circ R_{\mathcal{C},W,W'} = F$ . For every  $F_3$  such that  $F_3 \circ R_{\mathcal{C},W,W'} = F$ , by unicity of  $F_1$ ,  $F_1 = F_3 \circ Q_{\mathcal{C},W}$ , and by unicity of  $F_2$ ,  $F_3 = F_2$ . .QED.

## Conclusion and discussion

In this chapter, we have investigated two existing notions of dihomotopy equivalences: the reversible equivalence and the directed equivalence. We looked at what their actions are on the fundamental category. Much as in classical algebraic topology, where homotopy equivalences induce equivalences of categories between fundamental groupoids, reversible equivalences induce equivalences of categories between fundamental categories. The case of directed equivalences is more complicated. The main problem is that directed homotopies induces natural transformations between induced functors on the fundamental categories, but those natural transformations are almost never isomorphisms. The idea was then to invert morphisms in the fundamental category using localizations. This reformulates as: a directed equivalence induces an equivalence of categories between the groupoidifications of the fundamental categories, where groupoidification is the process of inverting every morphism of a category. We then investigated a second process of inversion: localization at inessential morphisms. This process produces a category, the category of components which is in-between the category and its groupoidification. Much as in the work of [Goubault 2007], we prove that this category of components is in many cases equivalent to a quotient.

Now that we have this category of components, we would be interested in a notion of dihomotopy equivalence for which its action on the fundamental category is precisely this category of components. We will define in the next chapter such a notion.



# Directed deformation retracts and the dihomotopy hypothesis

---

## 5.1 The homotopy hypothesis

The homotopy hypothesis is a test to apply to any potential model for  $\infty$ -groupoids: any reasonable interpretation of what  $\infty$ -groupoids are should reflect exactly the algebraic structure of a topological space [Grothendieck 1983]. Intuitively, a (small)  $\infty$ -category is a set of objects (of dimension 0), between every pair of objects a set of morphisms (objects of dimension 1), between every pair of morphisms between two objects a set of 2-morphisms (objects of dimension 2), and so on. An  $\infty$ -groupoid is then an  $\infty$ -category where all those data are invertible up to higher-dimensional data.

A topological space intuitively naturally gives rise to a structure of  $\infty$ -category. Its 0-dimensional objects are points, its 1-dimensional are paths, its 2-dimensional objects are homotopies (i.e., paths in the space of paths), and so on. All those data are invertible, that is, form a  $\infty$ -groupoid: for example, we have seen that paths have an inverse modulo homotopy.

The homotopy hypothesis states that to study the geometry of a topological space, up to continuous deformations, it should be enough to study this  $\infty$ -groupoid, whatever the reasonable interpretation chosen for the latter.

A modern formulation of the homotopy hypothesis uses the language of model categories, introduced in [Quillen 1967]. Model structures are a convenient framework to design theories of certain objects modulo weak-equivalences, namely morphisms that are not necessarily isomorphisms but, in a way, act as such. They give nice conditions for the localization to be defined and computable in some way. They also allow one to compare those structures by comparing their localizations. In this section, we start by recalling definitions in model structures: lifting property, weak factorization system, homotopy, Quillen-equivalence (Section 5.1.1). In parallel, we will follow the example of the Strøm model structure: a model structure on topological spaces whose weak-equivalences are homotopy equivalences.

After that, in Section 5.1.2, we will see another model structure in topological spaces, the Quillen-Serre model structure, whose weak-equivalences are weak homotopy equivalences, namely continuous functions that induce isomorphisms between homotopy groups. That is precisely this model structure that will be reflected by  $\infty$ -groupoids. In the language of model structures, this means that we will present a model structure, the Kan-Quillen model structure, which models  $\infty$ -groupoids and that will be Quillen-equivalent to the Quillen-Serre model structure. It will be based on simplicial sets (Section 5.1.3.1) and its fibrant and cofibrant objects, the Kan complexes (Section 5.1.3.3) are precisely the objects that model  $\infty$ -groupoids.

### 5.1.1 Model structures

A model structure on a category is given by three classes of morphisms: the weak-equivalences, that almost act like isomorphisms, typically like isomorphisms up to homotopy ; fibrations that act like

nice surjections lifting things, typically lifting homotopies ; cofibrations that act like nice injections extending things, typically extending homotopies. Those three classes of morphisms will satisfies some properties that will allow the computation of the localization at the weak-equivalence: it will be equivalent to a category of homotopy types and morphisms up to homotopy. This localization is precisely what we mean by modeling something: for example, a model for  $\infty$ -groupoids will be a such a localization such that its objects act like  $\infty$ -groupoids. It will also be possible to compare model structures with the notion of Quillen-equivalences, forcing model structures to have the same localization.

### 5.1.1.1 Lifting property

The conditions on those data will be based on fibrational properties, meaning that they will use morphisms having lifting properties with respect to others. We say that a morphism  $f : a \rightarrow b$  has the **left lifting property** with respect to  $g : c \rightarrow d$  (or equivalently, that  $g$  has the **right lifting property** with respect to  $f$ ) if for every commutative diagram of the form:

$$\begin{array}{ccc} a & \xrightarrow{u} & c \\ f \downarrow & & \downarrow g \\ b & \xrightarrow{v} & d \end{array}$$

there is a morphism  $\theta : b \rightarrow c$  which makes the following diagram commutes:

$$\begin{array}{ccc} a & \xrightarrow{u} & c \\ f \downarrow & \nearrow \theta & \downarrow g \\ b & \xrightarrow{v} & d \end{array}$$

A crucial example in topological space is the **homotopy lifting property**. We say that a continuous function  $f : X \rightarrow Y$  has the homotopy lifting property with respect to  $Z$  if and only if for every continuous function  $g : Z \rightarrow X$  and every classical homotopy  $H : Z \times [0, 1] \rightarrow Y$  such that  $H(z, 0) = f \circ g(z)$ , then there is a classical homotopy  $K : Z \times [0, 1] \rightarrow X$  such that  $K(z, 0) = g(z)$  and  $H = f \circ K$ . Equivalently,  $f$  has the homotopy lifting property with respect to  $Z$  if and only if it has the right lifting property with respect to  $\iota_0 : Z \rightarrow Z \times [0, 1]$ , which maps  $z$  to  $(z, 0)$ . We call **Hurewicz fibration** (resp. **Serre fibration**) any function which has the homotopy lifting property with respect to every space (resp. with respect to every cube  $\square_n$ ).

Dually, we say that a continuous function  $f : X \rightarrow Y$  has the **homotopy extension property** with respect to  $Z$  if and only if for every function  $g : Y \rightarrow Z$  and every homotopy  $H : X \rightarrow P(Z)$  such that  $H(x)(0) = g \circ f(x)$ , then there is a homotopy  $K : Y \rightarrow P(Z)$  such that  $K(y)(0) = g(y)$  and  $K \circ f = H$ . Equivalently,  $f$  has the homotopy extension property with respect to  $Z$  if and only if it has the left lifting property with respect to  $\sigma_0 : P(Z) \rightarrow Z$  which maps every path  $\gamma$  to  $\gamma(0)$ . We call **Hurewicz cofibration** any function which has the homotopy extension property with respect to every space.

### 5.1.1.2 Model categories

By a **weak factorization system** on  $\mathcal{C}$ , we will mean a pair  $(L, R)$  of classes of morphisms such that:

- every morphisms  $f : a \rightarrow b$  of  $\mathcal{C}$  can be factorized as:

$$a \xrightarrow{\in L} c \xrightarrow{\in R} b,$$

- $L$  is precisely the class of morphisms of  $\mathcal{C}$  which have the left lifting property with respect to every element of  $R$ ,
- $R$  is precisely the class of morphisms of  $\mathcal{C}$  which have the right lifting property with respect to every element of  $L$ .

A **model category** is a complete and cocomplete category  $\mathcal{C}$  together with three classes of morphisms:

- $W$  called **weak equivalences**,
- $\text{Fib}$  called **fibrations**,
- $\text{Cof}$  called **cofibrations**,

satisfying that:

- $W$  makes  $\mathcal{C}$  into a category with weak equivalences. Recall that this means that every isomorphism of  $\mathcal{C}$  is in  $W$  and  $W$  has the 2-out-of-3 property.
- $(\text{Cof}, \text{Fib} \cap W)$  and  $(\text{Cof} \cap W, \text{Fib})$  are weak factorization systems on  $\mathcal{C}$ .

For example, **Top** with homotopy equivalences as weak equivalences, Hurewicz fibrations as fibrations, and closed Hurewicz cofibrations, i.e., Hurewicz cofibrations  $f : X \rightarrow Y$  such that  $f(X)$  is closed in  $Y$ , as cofibrations form a model category called the **Strøm model category** [Strøm 1972].

We say that an object  $c$  is **fibrant** if the unique morphism from  $c$  to the final object of  $\mathcal{C}$  is a fibration. Dually, we say that it is **cofibrant** if the unique morphism from the initial object to  $c$  is a cofibration. The fibrant cofibrant objects are of particular interest: since every  $c$  is weakly equivalent to a fibrant cofibrant object, those objects can be thought as “homotopy types” of objects. In the case of the Strøm model structure, every space is fibrant and cofibrant, but this a very particular property from this model category.

### 5.1.1.3 Homotopy and homotopy category

In a model category, there always is a notion of homotopy, using a cylinder object (that you can think as the product by a segment, for example  $X \times [0, 1]$  is a cylinder object). A **cylinder object** of an object  $X$  in a model category is an object  $\text{Cyl}(X)$  such that the codiagonal map  $\Delta_X : X \sqcup X \rightarrow X$  factorizes as:

$$X \sqcup X \xrightarrow{\iota} \text{Cyl}(X) \xrightarrow{p} X$$

where  $p$  is a weak equivalence. A **left homotopy** from  $f$  to  $g$ , where  $f, g : X \rightarrow Y$  is a map  $H$  from any cylinder object  $\text{Cyl}(X)$  to  $Y$  such that  $H \circ \iota = f \sqcup g$ .



In a model category, this notion of homotopy is an equivalence relation. It coincide with a dual notion of **right homotopy** using **path objects** instead (for example, the space of paths). In the case of Strøm model structure, left and right homotopies coincide with (classical) homotopy. The interest of this is that, between cofibrant and fibrant objects, weak equivalences coincide with homotopy equivalences, that is, maps that are invertible up to left homotopy. This implies in particular that the localization  $\mathcal{C}[W^{-1}]$  is equivalent to the category whose objects are fibrant and cofibrant objects and whose morphisms are morphisms of  $\mathcal{C}$  modulo left homotopy. This category, noted  $\mathbf{Ho}(\mathcal{C})$ , is called the **homotopy category** of  $\mathcal{C}$ . Coherently, the homotopy category  $\mathbf{HoTop}$  is the homotopy category of the Strøm model category.

The language of model categories provides also a way to compare those models, by giving some condition for the homotopy categories to be equivalent. A **Quillen adjunction**  $F \dashv G$  from a model category  $\mathcal{C}$  to  $\mathcal{C}'$  is an adjunction such that  $F$  maps cofibrations of  $\mathcal{C}$  to cofibrations of  $\mathcal{C}'$  and  $G$  maps fibrations of  $\mathcal{C}'$  to fibrations of  $\mathcal{C}$ . A **Quillen equivalence** is a Quillen adjunction such that for every cofibrant object  $c$  of  $\mathcal{C}$  and every fibrant object  $c'$  of  $\mathcal{C}'$ , a maps from  $c$  to  $G(c')$  is a weak equivalence of  $\mathcal{C}$  if and only if the adjoint morphism from  $F(c)$  to  $c'$  is a weak equivalence of  $\mathcal{C}'$ . The interest is that a Quillen equivalence induces an equivalence of categories between the homotopy categories  $\mathbf{Ho}(\mathcal{C})$  and  $\mathbf{Ho}(\mathcal{C}')$ .

### 5.1.2 Quillen-Serre model structure

Actually, the Strøm model category is folklore and was not the first one considered by Quillen. It has no particular interest except to make things coherent. The first model category was a model category on  $\mathbf{Top}$  whose weak equivalences are **weak homotopy equivalences**. Those are continuous functions that induces isomorphisms between **homotopy groups**. We have seen that a homotopy equivalence induces an equivalence of categories between fundamental groupoids. Given a topological space  $X$ , and a point  $x$  of  $X$ , the homset  $\pi_1(X)(x, x)$ , denoted  $\pi_1(X, x)$ , is then a group and is called the **first homotopy group of  $X$** . A homotopy equivalence  $f : X \rightarrow Y$  induces an isomorphism of groups  $\pi_1(f) : \pi_1(X, x) \rightarrow \pi_1(Y, f(x))$ . This homotopy group can be expressed directly. Denote by  $\mathbf{Top}_2$  the category whose objects are pairs  $(X, A)$  of topological spaces with  $A \subseteq X$ , and whose morphisms from  $(X, A)$  to  $(Y, B)$  are continuous functions  $f : X \rightarrow Y$  with  $f(A) \subseteq B$ . Given two maps  $f, g : (X, A) \rightarrow (Y, B)$ , a **homotopy relative to  $A$**  is a map  $H : (X \times [0, 1], A \times [0, 1]) \rightarrow (Y, B)$  such that  $H(x, 0) = f(x)$  and  $H(x, 1) = g(x)$ . A **relative homotopy class** of a map  $f$  in  $\mathbf{Top}_2$  will be the class of maps that are homotopic to  $f$ .  $\pi_1(X, x)$  is then the set of homotopy classes of maps from  $(\square_1 = [0, 1], \partial\square_1 = \{0, 1\})$  to  $(X, x)$ , with concatenation as group operation. This can be generalized to any dimension: denote by  $\pi_n(X, x)$  the set of homotopy classes of maps from  $(\square_n, \partial\square_n)$ , where  $\partial\square_n$  is the subspace of  $\square_n$  whose points are  $(t_1, \dots, t_n)$  such that there is  $i \in \{1, \dots, n\}$  with  $t_i \in \{0, 1\}$ , to  $(X, x)$ . There are several ways to define a group operation on  $\pi_n(X, x)$ : fix  $i \in \{1, \dots, n\}$  and  $f, g : (\square_n, \partial\square_n) \rightarrow (X, x)$ . Define  $f \star_i g : (\square_n, \partial\square_n) \rightarrow (X, x)$  as

$$\begin{aligned} f \star_i g(t_1, \dots, t_n) &= f(t_1, \dots, t_{i-1}, 2t_i, t_{i+1}, \dots, t_n) && \text{if } t_i \leq \frac{1}{2} \\ &= g(t_1, \dots, t_{i-1}, 2t_i - 1, t_{i+1}, \dots, t_n) && \text{if } t_i \geq \frac{1}{2} \end{aligned}$$

By an Eckmann-Hilton argument, those operations coincide and are commutative which makes  $\pi_n(X, x)$  Abelian groups for  $n \geq 2$ . Finally, denote by  $\pi_0(X)$  the set of path-connected components of  $X$ . All those data are functorial, that is, a continuous function  $f : X \rightarrow Y$  induces a group morphism (resp. a function) from  $\pi_n(X, x)$  to  $\pi_n(Y, f(x))$  for  $n \geq 1$  (resp. from  $\pi_0(X)$  to

$\pi_0(Y)$ ). We say that  $f$  is a **weak homotopy equivalence** if those morphisms are isomorphisms. In particular, a homotopy equivalence is a weak homotopy equivalence.

There is a model category on **Top** whose weak equivalences are weak homotopy equivalences, called the Quillen-Serre model structure. See [Quillen 1967] for a description and proofs. In this model category, the fibrations are Serre fibrations and the fibrant and cofibrant objects are the so-called **CW-complexes**. The identity functor on **Top** forms a Quillen-adjunction from Strøm model structure to Quillen-Serre model structure.

### 5.1.3 A modern formulation of the homotopy hypothesis

#### 5.1.3.1 Simplicial sets

In this section, we present a model for  $\infty$ -groupoids, which, in retrospect, can be seen to be inherent in work even before the formulation by Grothendieck of the homotopy hypothesis in 1983; see for instance in Quillen's lecture notes [Quillen 1967]. They are defined as particular **simplicial sets**. Simplicial sets are similar to precubical sets, in the sense that they are particular presheaves. Define the category  $\Delta$  whose objects are integers and whose morphisms from  $n$  to  $m$  are monotonous functions  $f : \{0, \dots, n\} \rightarrow \{0, \dots, m\}$ . Among those maps, there are two particular types of functions of particular interest:

- for  $n \in \mathbb{N}$  and  $i \in \{0, \dots, n+1\}$ ,  $\delta_i : n \rightarrow n+1$  which maps  $j < i$  to  $j$  and  $j \geq i$  to  $j+1$ . They are called **face maps**.
- for  $n \in \mathbb{N}$  and  $i \in \{0, \dots, n\}$ ,  $\sigma_i : n+1 \rightarrow n$  which maps  $j \leq i$  to  $j$  and  $j > i$  to  $j-1$ . They are called **degeneracy maps**.

A **simplicial set** is a functor from  $\Delta^{op}$  to **Set**, i.e., a presheaf on  $\Delta$ . Since face and degeneracy maps generate the category  $\Delta$ , there is a more practical definition of simplicial sets. A simplicial set is a collection  $(X_n)_{n \in \mathbb{N}}$  of sets together with functions:

- for every  $n \in \mathbb{N}$ , for every  $i \in \{0, \dots, n+1\}$ ,  $d_i : X_{n+1} \rightarrow X_n$ , also called **face maps**.
- for every  $n \in \mathbb{N}$ , for every  $i \in \{0, \dots, n\}$ ,  $s_i : X_n \rightarrow X_{n+1}$ , also called **degeneracy maps**.

satisfying the following equations, called the **simplicial relations**:

$$\begin{array}{ll}
 d_i \circ d_j = d_{j-1} \circ d_i & \text{if } i < j \\
 s_i \circ s_j = s_{j+1} \circ s_i & \text{if } i \leq j \\
 d_i \circ s_j = \text{id} & \text{if } i \in \{j, j+1\} \\
 d_i \circ s_j = s_j \circ d_{i-1} & \text{if } i > j+1 \\
 d_i \circ s_j = s_{j-1} \circ d_i & \text{if } i < j
 \end{array}$$

A morphism of simplicial sets from  $X$  to  $X'$  is a natural transformation from  $X$  to  $X'$ , seen as functors. More practically, it is a collection of morphisms  $(f_n : X_n \rightarrow X'_n)_{n \in \mathbb{N}}$  such that:

$$f_n \circ d_i = d'_i \circ f_{n+1}$$

$$f_{n+1} \circ s_i = s'_i \circ f_n$$

We denote by **SSet** the category of simplicial sets and morphisms of simplicial sets.

5.1.3.2 Geom-Sing adjunction

Much as in precubical sets, a functor  $F : \Delta \rightarrow \mathcal{C}$  with  $\mathcal{C}$  cocomplete induces a functor  $\tilde{F} : \mathbf{SSet} \rightarrow \mathcal{C}$  which has automatically a right adjoint. This allows one to nicely construct a geometric realization of a simplicial set. For  $n \in \mathbb{N}$ , let  $\Delta_n$  be the subspace of  $\mathbb{R}^{n+1}$  whose points are the  $(t_0, \dots, t_n)$  such that  $t_i \in [0, 1]$  and  $\sum_{i=0}^n t_i = 1$ . Those spaces are called **standard geometric simplices**.

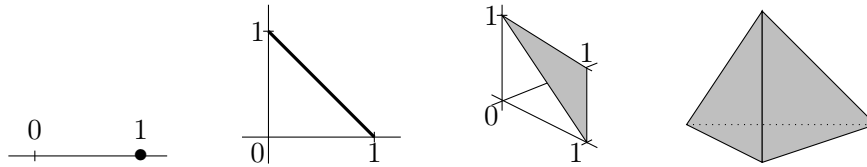

Figure 5.1: Standard geometric simplex  $\Delta_0, \Delta_1, \Delta_2, \Delta_3$

For  $n \in \mathbb{N}$  and  $i \in \{0, \dots, n+1\}$ , let  $\partial_i : \Delta_n \rightarrow \Delta_{n+1}$  which maps  $(t_0, \dots, t_n)$  to  $(t_0, \dots, t_{i-1}, 0, t_i, \dots, t_n)$ . For  $n \in \mathbb{N}$  and  $i \in \{0, \dots, n\}$ , let  $\xi_i : \Delta_{n+1} \rightarrow \Delta_n$  which maps  $(t_0, \dots, t_{n+2})$  to  $(t_0, \dots, t_{i-1}, t_i + t_{i+1}, t_{i+2}, \dots, t_{n+2})$ . This defines a functor  $G : \Delta \rightarrow \mathbf{Top}$  and so a functor  $Geom : \mathbf{SSet} \rightarrow \mathbf{Top}$  called the **geometric realization**. It is always a CW-complex.

The right adjoint of  $Geom$ , is called the **singular complex functor**, noted  $Sing$ , and is defined as follow. Given a topological space  $X$ , define  $Sing(X)_n$  as the set of continuous functions from  $\Delta_n$  to  $X$ . The face and degeneracy maps are:

- for  $\alpha : \Delta_{n+1} \rightarrow X$ ,  $d_i(\alpha) = \alpha \circ \partial_i$ ,
- for  $\alpha : \Delta_n \rightarrow X$ ,  $s_i(\alpha) = \alpha \circ \xi_i$ .

5.1.3.3 Kan complexes

$Sing(X)$  always has a particular property: it is a **Kan complex**. Let us make precise this statement. Define the **standard simplex**  $St^n$  to be the simplicial set  $(St_m^n)_{m \in \mathbb{N}}$  with  $St_m^n = \Delta(m, n)$ , that is, the monotonous functions from  $\{0, \dots, m\}$  to  $\{0, \dots, n\}$ . Its geometric realization is the standard geometric simplex. For  $0 \leq i \leq n$ , define the  $(n, i)$ -**horn**  $\Lambda^{n,i}$  to be the sub-simplicial set of  $St^n$  such that  $\Lambda_m^{n,i}$  is the set of monotonous function  $f : \{0, \dots, m\} \rightarrow \{0, \dots, n\}$  such that  $i$  is not in the image of  $f$ . Let  $\iota_i : \Lambda^{n,i} \rightarrow St^n$  denote the inclusion.

For example, in the case  $n = 2$ , the geometric realizations of the standard simplex and of the horns are the following:



Figure 5.2: Geometric realizations of  $St^2, \Lambda^{2,0}, \Lambda^{2,1}, \Lambda^{2,2}$

A **Kan complex** is a simplicial set  $X$  such that for every morphism  $f : \Lambda^{n,i} \rightarrow X$ , there is a morphism  $\tilde{f} : St_n \rightarrow X$  which extends  $f$ , meaning that  $\tilde{f} \circ \iota_i = f$ .

The singular complex of a topological space is always a Kan complex. This comes from the fact that there is a retraction  $r : Geom(St_n) = \Delta_n \rightarrow Geom(\Lambda^{n,i})$ . Indeed,  $Geom(\Lambda^{n,i})$  is the subspace

of  $\Delta_n$  of points  $(t_0, \dots, t_n)$  such that there is a  $j \neq i$  with  $t_j = 0$ . The retraction maps  $(t_0, \dots, t_n)$  to  $(t_0 - s, \dots, t_{i-1} - s, t_i + ns, t_{i+1} - s, \dots, t_n - s)$  where  $s = \min\{t_j \mid j \neq i\}$ .

Kan complexes can model the expected behavior of  $\infty$ -groupoids: objects of dimension 0 are element of  $X_0$ , morphisms are element of  $X_1, \dots$ . The existence of the inverse of a morphism  $f \in X_1$  can be encoded by the Horn-filling condition. Start with the following horn:

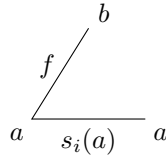

It can be extended to a 2-simplex:

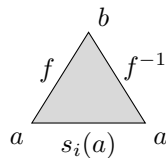

Similarly, in the other way, which gives one an inverse modulo objects of dimension 2, and this can be generalized to any dimension.

### 5.1.3.4 Kan-Quillen model structure and homotopy hypothesis

With this as an interpretation of  $\infty$ -groupoids, the homotopy hypothesis becomes a theorem:

**Theorem 11** ([Quillen 1967]). *There is a model structure on  $\mathbf{SSet}$ , called the **Kan-Quillen model structure** such that the adjunction  $\mathit{Geom} \dashv \mathit{Sing}$  is a Quillen equivalence between the Quillen-Serre model structure on  $\mathbf{Top}$  and this model category.*

The weak-equivalences of this model category are the morphisms  $f$  of simplicial sets such that  $\mathit{Geom}(f)$  is a weak homotopy equivalence. The fibrant and cofibrant objects are exactly the Kan complexes. This explains why the homotopy types of spaces are the same as Kan complexes, that is,  $\infty$ -groupoids.

## 5.2 Model structures for $(\infty, 1)$ -categories and first attempt

We have seen in the previous section that topological spaces can be studied as  $\infty$ -groupoids. Almost the same should hold for d-spaces: d-spaces give rise to a natural structure of  $\infty$ -category. Objects of dimension 0 are points, objects of dimension 1 are dipaths, objects of dimension 2 are dihomotopies, and so on. The only difference is that everything is not invertible: we have already seen that dipaths do not have an inverse modulo dihomotopy in general. But since we consider a dihomotopy as being a path in a topological space of paths, the  $\infty$ -groupoidal structure of those spaces transfers to the  $\infty$ -categorical structure of the d-space. More practically, dipaths are not invertible, but all the data of higher dimensions are invertible. To summarize, a d-space gives rise to a natural structure of an  $(\infty, 1)$ -category, that is 1-dimensional data is not reversible but higher dimensional data is.

### 5.2.1 Bergner model structure

As we have seen, the intuition is that an  $(\infty, 1)$ -category is an  $\infty$ -category whose 1-skeleton is a category with no particular property (at least, not a groupoid), and whose higher dimensional data between two objects of dimension 0 has an  $\infty$ -groupoid structure. That is why, it is natural to model  $(\infty, 1)$ -categories as “categories enriched in  $\infty$ -groupoids”.

Let us recall a few definitions from enriched categories. Let  $\mathcal{V}$  be a monoidal category. We note  $\otimes$  its tensor product,  $I$  its unit element,  $\alpha_{a,b,c} : (a \otimes b) \otimes c \rightarrow a \otimes (b \otimes c)$  its associativity morphism,  $\lambda_a : a \otimes a \rightarrow a$  its left unit and  $\rho_a : a \otimes a \rightarrow a$  its right unit. In the following, we will use mainly categories (**Set**, **SSet**, **Ab**, **Top**, **HoTop**) with their cartesian structures.

A (small) **enriched category**  $\mathcal{C}$  in  $\mathcal{V}$  is the following data:

- a set  $\text{Ob}(\mathcal{C})$  (of **objects**),
- for every pair  $(a, b)$  of objects, an object  $\mathcal{C}(a, b)$  in  $\mathcal{V}$ ,
- for every triple  $(a, b, c)$  of objects, a morphism

$$\circ_{a,b,c} : \mathcal{C}(a, b) \otimes \mathcal{C}(b, c) \rightarrow \mathcal{C}(a, c)$$

of  $\mathcal{V}$ , called the **composition**,

- for every object  $a$ , a morphism

$$u_a : I \rightarrow \mathcal{C}(a, a)$$

of  $\mathcal{V}$ , called the **unit**.

satisfying that:

- (**associativity axiom**): for every tuple  $(a, b, c, d)$  of objects, the following diagram commutes:

$$\begin{array}{ccc}
 (\mathcal{C}(a, b) \otimes \mathcal{C}(b, c)) \otimes \mathcal{C}(c, d) & \xrightarrow{\circ_{a,b,c} \otimes \text{id}} & \mathcal{C}(a, c) \otimes \mathcal{C}(c, d) \\
 \downarrow \alpha_{\mathcal{C}(a,b), \mathcal{C}(b,c), \mathcal{C}(c,d)} & & \downarrow \circ_{a,c,d} \\
 \mathcal{C}(a, b) \otimes (\mathcal{C}(b, c) \otimes \mathcal{C}(c, d)) & & \\
 \downarrow \text{id} \otimes \circ_{b,c,d} & & \downarrow \\
 \mathcal{C}(a, b) \otimes \mathcal{C}(b, d) & \xrightarrow{\circ_{a,b,d}} & \mathcal{C}(a, d)
 \end{array}$$

- (**unit axiom**): for every pair  $(a, b)$  of objects, the following diagram commutes:

$$\begin{array}{ccccc}
 I \otimes \mathcal{C}(a, b) & \xrightarrow{\lambda_{\mathcal{C}(a,b)}} & \mathcal{C}(a, b) & \xleftarrow{\rho_{\mathcal{C}(a,b)}} & \mathcal{C}(a, b) \otimes I \\
 \downarrow u_a \otimes \text{id} & & \downarrow \text{id} & & \downarrow \text{id} \otimes u_b \\
 \mathcal{C}(a, a) \otimes \mathcal{C}(a, b) & \xrightarrow{\circ_{a,a,b}} & \mathcal{C}(a, b) & \xleftarrow{\circ_{a,b,b}} & \mathcal{C}(a, b) \otimes \mathcal{C}(b, b)
 \end{array}$$

An **enriched functor**  $F$  on  $\mathcal{V}$  from  $\mathcal{C}$  to  $\mathcal{D}$  is the following data:

- a function  $F : \text{Ob}(\mathcal{C}) \rightarrow \text{Ob}(\mathcal{D})$ ,
- for every pair  $(a, b)$  of objects of  $\mathcal{C}$ , a morphism  $F_{a,b} : \mathcal{C}(a, b) \rightarrow \mathcal{D}(F(a), F(b))$  of  $\mathcal{V}$ ,

satisfying that:

- for every triples  $(a, b, c)$  of objects, the following diagram commutes:

$$\begin{array}{ccc}
 \mathcal{C}(a, b) \otimes \mathcal{C}(b, c) & \xrightarrow{\circ_{a,b,c}} & \mathcal{C}(a, c) \\
 \downarrow F_{a,b} \otimes F_{b,c} & & \downarrow F_{a,c} \\
 \mathcal{D}(F(a), F(b)) \otimes \mathcal{D}(F(b), F(c)) & \xrightarrow{\circ_{F(a), F(b), F(c)}} & \mathcal{D}(F(a), F(c))
 \end{array}$$

- for every object  $a$  of  $\mathcal{C}$ , the following diagram commutes:

$$\begin{array}{ccc}
 I & \xrightarrow{u_a} & \mathcal{C}(a, a) \\
 & \searrow u_{F(a)} & \downarrow F_{a,a} \\
 & & \mathcal{D}(F(a), F(a))
 \end{array}$$

We note  $\mathbf{Cat}(\mathcal{V})$  the category of enriched categories on  $\mathcal{V}$  and enriched functors.

For the rest of the subsection, let  $\mathcal{V} = \mathbf{SSet}$  with its cartesian structure. In this case, enriched categories are called **simplicial categories**. Given a simplicial category  $\mathcal{C}$ , one can define its 1-skeleton  $\tau_1(\mathcal{C})$  as follow. First, given a simplicial set  $X$ , let  $\pi_0(X)$  be the set  $X_0 / \sim$  where  $\sim$  is the smallest equivalence relation such that for every  $c \in X_1$ ,  $d_0(c) \sim d_1(c)$ .  $\pi_0$  extends to a functor from  $\mathbf{SSet}$  to  $\mathbf{Set}$ , which preserves finite products. Define then  $\tau_1(\mathcal{C})$  the category whose:

- objects are objects of  $\mathcal{C}$ ,
- morphisms from  $a$  to  $b$  are  $\pi_0(\mathcal{C}(a, b))$ ,
- composition is given by

$$\pi_0(\circ_{a,b,c}) : \pi_0(\mathcal{C}(a, b)) \times \pi_0(\mathcal{C}(b, c)) = \pi_0(\mathcal{C}(a, b) \times \mathcal{C}(b, c)) \longrightarrow \pi_0(\mathcal{C}(a, c)),$$

- the identity at  $a$  is the equivalence class of the unique element of dimension 0 in the image of  $u_a$ .

Intuitively, if we think  $\mathcal{C}$  as a d-space,  $\tau_1(\mathcal{C})$  corresponds to its fundamental category.  $\tau_1$  extends to a functor from  $\mathbf{Cat}(\mathbf{SSet})$  to  $\mathbf{Cat}$ .

There is then a model structure on  $\mathbf{Cat}(\mathbf{SSet})$ , called the **Bergner model structure**, whose weak equivalences, called Dwyer-Kan weak equivalences in this context, are enriched functors  $F : \mathcal{C} \rightarrow \mathcal{D}$  such that:

- for every pair  $(a, b)$  of objects of  $\mathcal{C}$ ,  $F_{a,b} : \mathcal{C}(a, b) \rightarrow \mathcal{D}(F(a), F(b))$  is a weak equivalence in the Kan-Quillen model structure,
- $\tau_1(F)$  is an equivalence of categories.

See [Bergner 2004] for a complete description of this model category and proofs. As expected, the fibrant and cofibrant objects are simplicial categories whose hom-simplicial sets are Kan complexes, that is,  $(\infty, 1)$ -categories.

There are other model categories which are Quillen equivalent to Bergner's model structure. See, for example, the Joyal model structure on simplicial sets [Joyal 2008a], very close to the Kan-Quillen model structure.

### 5.2.2 The trace and path categories

The idea for constructing a  $(\infty, 1)$ -category from a d-space was to consider the category whose morphisms are dipaths. More precisely, the category whose:

- objects are points,
- morphisms from  $a$  to  $b$  are dipaths from  $a$  to  $b$ , that is  $\vec{\mathbb{P}}(X)(a, b)$ ,
- the identities are the constant dipath,
- composition is concatenation.

The problem is that this is not a category since concatenation on dipaths is not associative. The idea from [Porter 2015] was to use traces instead. This category is called the **trace category** and denoted by  $\vec{T}(X)$ . Since traces from  $a$  to  $b$  can be equipped with a topology which makes the concatenation continuous, this makes  $\vec{T}(X)$  a category enriched in **Top** with its cartesian structure. By applying the *Sing* functor, this leads to a simplicial category, denoted by  $\vec{\mathbb{T}}(X)$ . The idea from [Porter 2008, Porter 2015] was then to use tools from model categories to study d-spaces.

The first problem comes from the use of trace spaces instead of dipaths. We would expect that  $\tau_1(\vec{\mathbb{T}}(X))$  to be (at least equivalent to) the fundamental category of  $X$ , which is not the case. The other problem is that comparing those simplicial categories up to Dwyer-Kan weak equivalences is an invariant of reversible equivalence by nature.

The first problem will be overcome by using dipaths instead of traces. Indeed, the concatenation is not associative, but it is modulo homotopy in the sense that the map  $(\gamma_1, \gamma_2, \gamma_3) \mapsto \gamma_1 \star (\gamma_2 \star \gamma_3)$  is homotopic to the map  $(\gamma_1, \gamma_2, \gamma_3) \mapsto (\gamma_1 \star \gamma_2) \star \gamma_3$ . To make this category of dipaths a category, we will consider it enriched in **HoTop**. We note  $\vec{\mathbb{P}}(X)$  the category enriched in **HoTop** defined above, with the exception that all continuous functions are taken modulo homotopy, that is:

- composition is concatenation modulo homotopy,
- the identity at  $a$  is the homotopy class of the morphism from  $*$ , a one point space to  $\vec{\mathbb{P}}(X)(a, a)$  which maps  $*$  to the constant dipath.

Dwyer-Kan weak equivalences can be modified in this context. First, the 1-skeleton  $\tau_1(\mathcal{C})$  of an enriched category  $\mathcal{C}$  in **HoTop** is defined as follow:

- its objects are objects of  $\mathcal{C}$ ,
- its morphisms from  $a$  to  $b$  are the path-connected components of  $\mathcal{C}(a, b)$ ,
- composition is the function induced on path-connected components by the composition in  $\mathcal{C}$ .

Since the path-connected components of  $\vec{P}(X)(a, b)$  are exactly the dihomotopy classes of dipaths,  $\tau_1(\vec{P}(X))$  is precisely the fundamental category  $\vec{\pi}_1(X)$ . We say **topological Dwyer-Kan weak equivalences** for the enriched functors  $F : \mathcal{C} \rightarrow \mathcal{D}$  between categories enriched in **HoTop** such that:

- $F$  induces an equivalence of categories between the 1-skeletons  $\tau_1(\mathcal{C})$  and  $\tau_1(\mathcal{D})$ ,
- for every pair  $(a, b)$  of objects of  $\mathcal{C}$ , the map  $F_{a,b} : \mathcal{C}(a, b) \rightarrow \mathcal{D}(F(a), F(b))$  is an isomorphism of **HoTop**, that is, the homotopy class of a homotopy equivalence.

For a dimap  $f : X \rightarrow Y$ ,  $\vec{P}(f)$  is such a weak equivalence if and only if  $f$  induces an equivalence of categories between fundamental categories and if for every pair  $(a, b)$  of points of  $\mathcal{C}$ , the function  $f_{a,b}$  from  $\vec{P}(X)(a, b)$  to  $\vec{P}(Y)(f(a), f(b))$  which maps  $\gamma$  to  $f \circ \gamma$  is a homotopy equivalence.

**Theorem 12.** *If a dimap  $f : X \rightarrow Y$  is a reversible equivalence then  $\vec{P}(f)$  is a topological Dwyer-Kan equivalence.*

*Proof.* The part for fundamental categories has already been proved in Corollary 3.

For the second part, fix  $a$  and  $b$  two points of  $X$ . We prove that  $f_{a,b}$  is a homotopy equivalence. First note that if  $\gamma$  is a reversible dipath from  $a'$  to  $a$  for some  $a'$ , the map  $\gamma \star b$  from  $\vec{P}(X)(a, b)$  to  $\vec{P}(X)(a', b)$  is a homotopy equivalence with inverse modulo homotopy  $\gamma^{-1} \star b$ . Idem for  $\gamma$  from  $b$  to  $b'$  for some  $b'$ . Now let  $g : Y \rightarrow X$  and  $H : X \rightarrow \vec{P}(X)$  a reversible homotopy with  $H(x)(0) = x$  and  $H(x)(1) = g \circ f(x)$ . Then the following diagram is commutative modulo homotopy:

$$\begin{array}{ccc}
 \vec{P}(X)(a, b) & \xrightarrow{f_{a,b}} & \vec{P}(Y)(f(a), f(b)) \\
 \downarrow a \star H(b) & & \downarrow g_{f(a), f(b)} \\
 \vec{P}(X)(a, g(f(b))) & \xleftarrow{H(a) \star g(f(b))} & \vec{P}(X)(g(f(a)), g(f(b)))
 \end{array}$$

the homotopy being the same as the one constructed in 4.2.1.

Since  $H(a)$  and  $H(b)$  are reversible dipaths, and since homotopy equivalences have the 2-out-of-3 property, then  $g_{f(a), f(b)} \circ f_{a,b}$  is a homotopy equivalence. Symmetrically,  $f_{g(f(a)), g(f(b))} \circ g_{f(a), f(b)}$  is a homotopy equivalence. Consequently,  $g_{f(a), f(b)}$  is a homotopy equivalence and so is  $f_{a,b}$ . *QED.*

Dipaths categories are then invariants of reversible equivalences modulo topological Dwyer-Kan equivalences, but not of other kind of “dihomotopy equivalences”. We would be interested in the same kind of invariants for weaker equivalences. For example, as explained in the previous chapter, we would be interested in considering the category of components and not the fundamental category.



Another problem to overcome is also the other condition of Dwyer-Kan equivalences. Indeed, requiring that for every pair of points  $f_{a,b}$  is a homotopy equivalence between path spaces is also very strong. Consider a point space. Its dipath category has only one object and the dipath space is a point space. For a d-space, to have a Dwyer-Kan equivalence between its dipath category and the one of the point space requires in particular there is a dipath between every pair of points. In particular, essentially no pospace can fulfill this condition. The spaces which are equivalent to a point are the most simplest spaces one may consider, and one may expect that the basic bricks of the theory (for example, the  $\square_n$ ) to be equivalent to a point, which is not the case. In the next subsections, we will tackle this problem. One solution might have been to add the kind of equivalences we want using Bousfield localization on the Dwyer-Kan model category, but we will use another solution.

### 5.2.3 Partially enriched categories

We have seen that the problem comes from the mishandling of empty dipath spaces. We overcome this problem by explicitly handling them in the definition of an enriched category, leading to the notion of partially enriched categories. Those were invented (as far as I know) in [Dubut 2016c] in the case of Abelian groups to have an explicit “empty group” to define an analogue of the Grothendieck construction for diagrams with values in **Ab**. We will see this later. A (small) **partially enriched category  $\mathcal{C}$  in  $\mathcal{V}$**  is the following data:

- a set  $\text{Ob}(\mathcal{C})$  (of **objects**),
- a preorder  $\leq$  on  $\text{Ob}(\mathcal{C})$ , called the **domain**,
- for every pair  $a \leq b$  of objects, an object  $\mathcal{C}(a, b)$  in  $\mathcal{V}$ ,
- for every triple  $a \leq b \leq c$  of objects, a morphism

$$\circ_{a,b,c} : \mathcal{C}(a, b) \otimes \mathcal{C}(b, c) \longrightarrow \mathcal{C}(a, c)$$

of  $\mathcal{V}$ , called the **composition**,

- for every object  $a$ , a morphism

$$u_a : I \longrightarrow \mathcal{C}(a, a)$$

of  $\mathcal{V}$ , called the **unit**.

satisfying that:

- (**associativity axiom**): for every tuple  $a \leq b \leq c \leq d$  of objects, the following diagram commutes:

$$\begin{array}{ccc}
 (\mathcal{C}(a, b) \otimes \mathcal{C}(b, c)) \otimes \mathcal{C}(c, d) & \xrightarrow{\circ_{a,b,c} \otimes \text{id}} & \mathcal{C}(a, c) \otimes \mathcal{C}(c, d) \\
 \downarrow \alpha_{\mathcal{C}(a,b), \mathcal{C}(b,c), \mathcal{C}(c,d)} & & \downarrow \circ_{a,c,d} \\
 \mathcal{C}(a, b) \otimes (\mathcal{C}(b, c) \otimes \mathcal{C}(c, d)) & & \\
 \downarrow \text{id} \otimes \circ_{b,c,d} & & \downarrow \\
 \mathcal{C}(a, b) \otimes \mathcal{C}(b, d) & \xrightarrow{\circ_{a,b,d}} & \mathcal{C}(a, d)
 \end{array}$$

- **(unit axiom)**: for every pair  $a \leq b$  of objects, the following diagram commutes:

$$\begin{array}{ccccc}
 I \otimes \mathcal{C}(a, b) & \xrightarrow{\lambda_{\mathcal{C}(a,b)}} & \mathcal{C}(a, b) & \xleftarrow{\rho_{\mathcal{C}(a,b)}} & \mathcal{C}(a, b) \otimes I \\
 \downarrow u_a \otimes \text{id} & & \downarrow \text{id} & & \downarrow \text{id} \otimes u_b \\
 \mathcal{C}(a, a) \otimes \mathcal{C}(a, b) & \xrightarrow{\circ_{a,a,b}} & \mathcal{C}(a, b) & \xleftarrow{\circ_{a,b,b}} & \mathcal{C}(a, b) \otimes \mathcal{C}(b, b)
 \end{array}$$

The axioms are the same as for enriched categories, except for the fundamental role played by the domain  $\leq$  in every clause. Trivially, an enriched category is a partially enriched category whose domain is  $\text{Ob}(\mathcal{C}) \times \text{Ob}(\mathcal{C})$ . One should note that partially enriched categories in **Top**, in **HoTop** and in **SSet** are still very close to  $(\infty, 1)$ -categories but also to Gaucher's flows [Gaucher 2003], which were introduced for similar motivations. The dipath category is naturally a partially enriched category in **HoTop** with the domain  $\preceq$ , called the **accessibility preordering**, defined as  $a \preceq b$  if and only if there is a dipath from  $a$  to  $b$ . A **partially enriched functor**  $F$  on  $\mathcal{V}$  from  $\mathcal{C}$  to  $\mathcal{D}$  is the following data:

- a monotonous function  $F : \text{Ob}(\mathcal{C}) \rightarrow \text{Ob}(\mathcal{D})$ ,
- for every pair  $a \leq b$  of objects of  $\mathcal{C}$ , a morphism  $F_{a,b} : \mathcal{C}(a, b) \rightarrow \mathcal{D}(F(a), F(b))$  of  $\mathcal{V}$ ,

satisfying that:

- for every triple  $a \leq b \leq c$  of objects, the following diagram commutes:

$$\begin{array}{ccc}
 \mathcal{C}(a, b) \otimes \mathcal{C}(b, c) & \xrightarrow{\circ_{a,b,c}} & \mathcal{C}(a, c) \\
 \downarrow F_{a,b} \otimes F_{b,c} & & \downarrow F_{a,c} \\
 \mathcal{D}(F(a), F(b)) \otimes \mathcal{D}(F(b), F(c)) & \xrightarrow{\circ_{F(a),F(b),F(c)}} & \mathcal{D}(F(a), F(c))
 \end{array}$$

- for every object  $a$  of  $\mathcal{C}$ , the following diagram commutes:

$$\begin{array}{ccc}
 I & \xrightarrow{u_a} & \mathcal{C}(a, a) \\
 & \searrow u_{F(a)} & \downarrow F_{a,a} \\
 & & \mathcal{D}(F(a), F(a))
 \end{array}$$

We denote by  $\mathbf{PeCat}(\mathcal{V})$  the category of partially enriched categories on  $\mathcal{V}$  and partially enriched functors.  $\vec{P}$  is then a functor from  $\mathbf{dTop}$  to  $\mathbf{PeCat}(\mathbf{HoTop})$ . The 1-skeleton functor extends to  $\mathbf{PeCat}(\mathbf{HoTop})$ : the only modification is that for every pair  $a \not\leq b$  of objects of  $\mathcal{C}$ , the set of morphisms from  $a$  to  $b$  is the empty set. This leads to the category of components of a partially enriched category in  $\mathbf{HoTop}$ , defined as  $\vec{\pi}_0(\mathcal{C}) = \vec{\pi}_0(\tau_1\mathcal{C})$ . Note that the category of components of a d-space  $X$ , as defined in Section 4.3.3, is exactly  $\vec{\pi}_0(\vec{P}(X))$ . Note also that as previously,  $\vec{\pi}_0$  is not a functor.

We now can change the definition of weak-equivalences as desired. We say **inessential equivalence** for a partially enriched functor  $F : \mathcal{C} \rightarrow \mathcal{D}$  in  $\mathbf{HoTop}$  such that:

- $F$  induces an equivalence of categories between  $\vec{\pi}_0(X)$  and  $\vec{\pi}_0(Y)$ ,
- for every pair  $a \leq b$  of objects of  $\mathcal{C}$ ,  $F_{a,b}$  is an isomorphism.

For a dimap  $f : X \rightarrow Y$ ,  $\vec{P}(f)$  is such an equivalence if and only if  $f$  induces an equivalence of categories between component categories and if for every pair  $a \leq b$  of points of  $X$ , the function  $f_{a,b}$  from  $\vec{P}(X)(a,b)$  to  $\vec{P}(Y)(f(a),f(b))$  which maps  $\gamma$  to  $f \circ \gamma$  is a homotopy equivalence.

### 5.3 Directed deformation retracts

We can summarize what we have seen until now in the following array:

type of equivalence	type of dipaths	localization of the fundamental category	weak equivalences
reversible	reversible	fundamental category/localizing isos	Dwyer-Kan
directed	all	groupoidification/localizing everything	none
??	??	component/localizing inessentials	inessential

We would like now to complete this array by defining nice dipaths and equivalences that correspond to inessential equivalences. We will first define the type of dipaths we will use. The definition is very similar to the definition of inessential morphisms of a category. We will define the equivalence, but contrary to what we have seen with reversible and directed equivalences, we will not define them as inverse modulo the corresponding notion of dihomotopies, but using deformation retracts. Deformation retracts are a more intuitive way to define deformations of spaces and are enough to characterize homotopy equivalence.

#### 5.3.1 Inessential dipaths

The class of dipaths we will consider are defined similarly to inessential morphisms of a category. First, we say that a dipath  $\gamma$  from  $a$  to  $b$  is a **Yoneda dipath** if:

- **right cancellation:** for every point  $c$  such that  $\vec{P}(X)(b,c) \neq \emptyset$ , the continuous function

$$\gamma \star c : \vec{P}(X)(b,c) \rightarrow \vec{P}(X)(a,c) \quad \rho \mapsto \gamma \star \rho$$

is a homotopy equivalence.

- **left cancellation:** for every point  $c$  such that  $\vec{P}(X)(c,a) \neq \emptyset$ , the continuous function

$$c \star \gamma : \vec{P}(X)(c,a) \rightarrow \vec{P}(X)(c,b) \quad \rho \mapsto \rho \star \gamma$$

is a homotopy equivalence.

We have seen that reversible dipaths are Yoneda and that was used to prove Theorem 12. On the other hand, the red dipath seen in the matchbox is not Yoneda. The Ore conditions become the following. We say that a set  $W$  of dipaths has:

- **right Ore condition:** for every  $\gamma : a \rightsquigarrow b \in W$ , for every dipath  $\rho : c \rightsquigarrow b$ , there are  $\gamma' : d \rightsquigarrow c \in W$  and a dipath  $\rho' : d \rightsquigarrow a$  for some  $d$  such that  $\rho' \star \gamma$  is dihomotopic to  $\gamma' \star \rho$

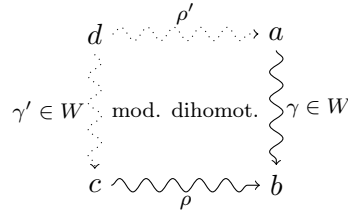

- **left Ore condition:** for every  $\gamma : a \rightsquigarrow b \in W$  and every dipath  $\rho : a \rightsquigarrow c$  there are  $\gamma' : c \rightsquigarrow d \in W$  and a dipath  $\rho' : b \rightsquigarrow d$  for some  $d$  such that  $\gamma \star \rho'$  is dihomotopic to  $\rho \star \gamma'$ .

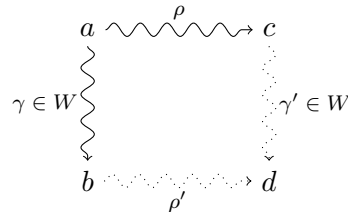

**Definition 9.** Given a d-space  $X$ , we define a **Yoneda system**  $\Theta$  of dipaths of  $X$  as a subset of dipaths of  $X$  such that:

- every element of  $\Theta$  is left and right cancellative,
- $\Theta$  has left and right Ore conditions.

Similarly to Yoneda systems of morphisms, the set of Yoneda systems of dipaths is a complete lattice for inclusion (with sup as union). We denote by  $\mathfrak{J}(X)$  the maximal Yoneda system of dipaths of  $X$  and call its elements **inessential dipaths**.

**Lemma 7.**  $\mathfrak{J}(X)$  contains the reversible dipaths, is closed under concatenation and dihomotopy. Furthermore,  $\{[\gamma] \mid \gamma \in \mathfrak{J}(X)\}$ , the set of dihomotopy classes of elements of  $\mathfrak{J}(X)$ , is included in  $\mathfrak{J}(\pi_1^\rightarrow(X))$ .

*Proof.*

- $\mathfrak{J}(X)$  contains the reversible dipaths:  $\tilde{\mathfrak{P}}(X)$  is a Yoneda system.
- $\mathfrak{J}(X)$  is closed under concatenation: same proof as the closure under composition for  $\mathfrak{J}(\mathcal{C})$ .
- $\mathfrak{J}(X)$  is closed under dihomotopy: since Yoneda dipaths are closed under dihomotopy and Ore conditions are modulo dihomotopy.
- $\{[\gamma] \mid \gamma \in \mathfrak{J}(X)\} \subseteq \mathfrak{J}(\pi_1^\rightarrow(X))$ : We prove that  $\{[\gamma] \mid \gamma \in \mathfrak{J}(X)\}$  is a Yoneda system of morphisms of  $\mathfrak{J}(\pi_1^\rightarrow(X))$ .

- **cancellation:** the map induced on path-connected components by  $c \star \gamma$  is exactly  $[\gamma] \circ c$ . We have seen that a homotopy equivalence induces a bijection between path-connected components.
- **Ore condition:** easy.

.QED.

### 5.3.2 Deformation retracts: non-directed and reversible cases

A deformation retract of a topological space is intuitively a subspace for which one can continuously deform the big space on the smaller space. Precisely, a pair  $(X, A)$  of spaces with  $A \subseteq X$  is a **deformation retract** if there is a homotopy  $H : X \rightarrow P(X)$  such that:

- $H(x)(0) = x$  for all  $x \in X$ ,
- $H(x)(1) \in A$  for all  $x \in X$ ,
- $H(a)(t) = a$  for all  $a \in A$ .

One recovers homotopy equivalence as follow:

**Theorem 13** ([Hatcher 2002]). *Two spaces  $X$  and  $Y$  are homotopically equivalent if and only if there are a space  $Z$  and two deformation retracts  $(Z, \tilde{X})$  and  $(Z, \tilde{Y})$  with  $X$  (resp.  $Y$ ) homeomorphic to  $\tilde{X}$  (resp.  $\tilde{Y}$ ).*

The if part is easy since the map  $x \mapsto H(x)(1)$  in the definition of a deformation retract is a homotopy equivalence with inverse the inclusion of  $A$  in  $X$ . The converse uses the so-called **mapping cylinder**. Given a continuous function  $f : X \rightarrow Y$ , define the space  $M_f$  as the quotient  $X \times [0, 1] \sqcup Y$  by the relation such that for all  $x \in X$ ,  $(x, 0)$  is equivalent to  $f(x)$ . Let  $\tilde{X} = X \times \{1\}$  and  $\tilde{Y} = Y$ . Without any condition on  $f$ , it is easy to prove that  $(M_f, \tilde{Y})$  is always a deformation retract. When furthermore  $f$  is a homotopy equivalence, then  $(M_f, \tilde{X})$  is also a deformation retract. See [Aguado 2012] for a complete (technical) description of the homotopy.

Actually, the very same construction works for reversible equivalence, as long as we equip the mapping cylinder with the suitable d-space structure. Given a dimap  $f : X \rightarrow Y$ , define its **reversible mapping cylinder**, noted  $\widetilde{M}_f$  as the quotient  $X \times \widetilde{[0, 1]} \sqcup Y$  by the same relation. Equivalently, it is defined as the d-space whose underlying space is  $M_f$  and whose dipaths are generated by the dipaths of  $Y$  and the paths  $(\gamma, \gamma')$  of  $X \times [0, 1]$  where  $\gamma$  is a dipath of  $X$  and  $\gamma'$  is any path.

Then a **reversible deformation retract** is a pair  $(X, A)$  of d-spaces, where  $A$  is a subd-space of  $X$  (meaning that it is a subspace and the dipaths of  $A$  are the dipaths of  $X$  included in  $A$ ), if there is a homotopy  $H : X \rightarrow \tilde{P}(X)$  such that:

- $H(x)(0) = x$  for all  $x \in X$ ,
- $H(x)(1) \in A$  for all  $x \in X$ ,
- $H(a)(t) = a$  for all  $a \in A$ ,  $t \in [0, 1]$ ,
- $x \mapsto H(x)(t)$  is a dimap for all  $t \in [0, 1]$ .

Then  $(\widetilde{M}_f, \tilde{Y})$  is always a reversible deformation retract and when  $f$  is a reversible equivalence,  $(\widetilde{M}_f, \tilde{X})$  is also a reversible deformation retract. Consequently:

**Theorem 14.** *Two d-spaces  $X$  and  $Y$  are reversibly equivalent if and only if there are a d-space  $Z$  and two reversible deformation retracts  $(Z, \tilde{X})$  and  $(Z, \tilde{Y})$  where  $X$  (resp.  $Y$ ) is dihhomeomorphic to  $\tilde{X}$  (resp.  $\tilde{Y}$ ).*

The same argument does not work for directed equivalence, since the homotopy constructed in [Aguado 2012] uses the fact that one can reverse the time, which can be done in reversible dipaths, not in general.

### 5.3.3 Inessential dipaths and deformations retracts

For the inessential case, we have a choice. Either use the homotopy equivalence framework, or use the deformation retract one, which a priori do not coincide. We choose to use the latter. Since inessential dipaths are not reversible in general, this leads to two notions of deformation retracts, depending on the direction of the deformation.

We say that a pair  $(X, A)$  of d-spaces is a **future inessential deformation retract** (FIDR for short) if there is a continuous function  $H : X \rightarrow \mathfrak{J}(X)$  ( $\mathfrak{J}(X)$  is equipped with the subspace topology of  $\overrightarrow{P}(X)$ ) such that:

- for every  $x \in X$ ,  $H(x)(0) = x$ ,
- for every  $a \in A$  and  $t \in [0, 1]$ ,  $H(a)(t) = a$ ,
- for every  $x \in X$ ,  $H(x)(1) \in A$ ,
- for every  $t \in [0, 1]$ , the map  $H_t : X \rightarrow X$ ,  $x \mapsto H(x)(t)$  is a dimap,
- for every dipath  $\delta$  of  $A$  from  $z$  to  $H_1(x)$  there is a dipath  $\gamma$  of  $X$  from  $y$  to  $x$  with  $H_1(y) = z$  and  $H_1 \circ \gamma$  and  $\delta$  are dihomotopic.

We stress here the fact that  $H$  must take values in the inessential dipaths  $\mathfrak{J}(X)$ . Similarly, we define **past inessential deformation retracts** (PIDR for short) by switching the role of 1 and 0 in the previous definition. We then say that two d-spaces are **inessentially equivalent** if there is a zigzag of FIDR and PIDR between them.

#### Example 1.

- 1) Observe that PIDR (resp. FIDR) between topological spaces (i.e. d-spaces whose set of dipaths contains all paths) coincide with non-directed deformation retracts. In particular, if two topological spaces are homotopically equivalent then they are inessentially equivalent. The converse also holds.
- 2)  $\{1\}$  is a future deformation retract of  $\overrightarrow{[0, 1]}$ . Indeed, the function  $H : \overrightarrow{[0, 1]} \rightarrow \mathfrak{J}(\overrightarrow{[0, 1]})$ ,  $s \mapsto (t \mapsto (1-t)s + t)$  satisfies the conditions above. Similarly,  $\{0\}$  is a past deformation retract of  $\overrightarrow{[0, 1]}$ . More generally, every past face  $\overrightarrow{[0, 1]^k} \times \{0\} \times \overrightarrow{[0, 1]^l}$  (resp. future face  $\overrightarrow{[0, 1]^k} \times \{1\} \times \overrightarrow{[0, 1]^l}$ ) is a past (resp. future) deformation retract of the directed cube  $\overrightarrow{[0, 1]^{k+l+1}}$ .
- 3) Is the deformation depicted in Section 4.1.3 a future deformation retract from  $M_{\square}$  to its upper face? The answer is no because the dipaths followed by the homotopy are not all inessential. In particular, we have seen that the path on the back here:

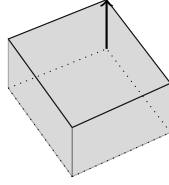

is not inessential.

- 4) We will see later that the category of components is an invariant of inessential equivalence, in the sense that if two d-spaces are inessentially equivalent, then they have equivalent categories of components. In particular, this implies that the matchbox  $\mathbb{M}_{\square}$  is not inessentially equivalent to a point space, and that the Swiss flag SF is not inessentially equivalent to the squared annulus SA.

**Proposition 12.** *If two d-spaces are reversibly equivalent, then they are inessentially equivalent. If two d-spaces are inessentially equivalent, then they are directedly equivalent.*

*Proof.* We use Theorem 14 for the first part. A reversible deformation retract is a FIDR (and modulo inversion of time, a PIDR). Indeed, the reversible dipaths are inessential and the last condition of a FIDR is automatic since  $\gamma = \delta \star H(x)^{-1}$  works.

For the second part, if  $(X, A)$  is a FIDR (or a PIDR), the inclusion of  $A$  in  $X$  is a directed equivalence with  $H_1$  as inverse modulo directed homotopy. *.QED.*

Finally, we can complete our array with the following:

**Theorem 15.** *A PIDR (resp. a FIDR) induces a inessential equivalence between dipath categories. Consequently, if two d-spaces are inessentially equivalent then their dipaths categories are inessentially equivalent.*

*Proof.* Let us prove the case of a FIDR. Note  $H$  the homotopy and  $H_t$  the d-map which maps  $x$  to  $H(x)(t)$ . Let  $\iota : A \rightarrow X$  denote the inclusion. We will prove the following statements:

1. for every pair  $(a, b)$  of points of  $A$  such that  $\vec{P}(A)(a, b) \neq \emptyset$ , the function  $\iota_{a,b} : \vec{P}(A)(a, b) \rightarrow \vec{P}(X)(a, b)$  which maps  $\gamma$  to  $\gamma$  is a homotopy equivalence. And for every pair  $(a, b)$  of points of  $X$  such that  $\vec{P}(X)(a, b) \neq \emptyset$ , the function  $H_{1,a,b} : \vec{P}(X)(a, b) \rightarrow \vec{P}(A)(H_1(a), H_1(b))$  which maps  $\gamma$  to  $H_1 \circ \gamma$  is a homotopy equivalence.
2.  $H_1$  induces a functor  $\vec{\pi}_0(H_1)$  from  $\vec{\pi}_0(X)$  to  $\vec{\pi}_0(A)$ , i.e., if  $\gamma \in \mathcal{J}(\vec{\pi}_1(X))$ , then  $H_1 \circ \gamma \in \mathcal{J}(\vec{\pi}_1(A))$ .
3. the  $\iota$  induces a functor  $\vec{\pi}_0(\iota)$  from  $\vec{\pi}_0(A)$  to  $\vec{\pi}_0(X)$ , i.e.,  $\mathcal{J}(\vec{\pi}_1(A)) \subseteq \mathcal{J}(\vec{\pi}_1(X))$ .
4.  $\vec{\pi}_0(H_1)$  and  $\vec{\pi}_0(\iota)$  form an equivalence of categories.

This implies that  $\vec{P}(\iota)$  and  $\vec{P}(H_1)$  are inessential equivalences.

Before starting, let us note the following about dihomotopies in  $A$  and  $X$ :

- two dipaths included in  $A$  are dihomotopic in  $A$  iff they are dihomotopic in  $X$ : the only if is trivial because a dihomotopy in  $A$  is also a dihomotopy in  $X$ . The converse holds because a dihomotopy  $K$  in  $X$  between two dipaths  $\gamma, \gamma'$  in  $X$  induces a dihomotopy  $H_1 \circ K$  in  $A$  between  $H_1 \circ \gamma = \gamma$  and  $H_1 \circ \gamma' = \gamma'$ .

- for any pair  $(a, b)$  of points of  $A$ ,  $\overrightarrow{\pi}_1(A)(a, b)$  is equal to  $\overrightarrow{\pi}_1(X)(a, b)$ : by the previous point,  $\overrightarrow{\pi}_1(A)(a, b)$  embeds in  $\overrightarrow{\pi}_1(X)(a, b)$ . This injection is also surjective because any dipath  $\gamma$  in  $X$  between  $a$  and  $b$  is dihomotopic to  $H_1 \circ \gamma$ .
1. The proof is exactly the same as in theorem 4.2.1, the only property of the reversible dipaths used was the cancellation, which is also satisfied by inessential dipaths.
  2. We prove that  $W = \{[H_1 \circ \gamma] \mid [\gamma] \in \mathfrak{J}(\overrightarrow{\pi}_1(X))\}$  is a Yoneda system of morphisms of  $\overrightarrow{\pi}_1(A)$ .

- **right cancellation:** let  $\gamma$  be a dipath from  $a$  to  $b$  such that  $[\gamma] \in \mathfrak{J}(\overrightarrow{\pi}_1(X))$  and let  $c \in A$  such that  $\overrightarrow{\pi}_1(A)(H_1(b), c) \neq \emptyset$ . We must prove that

$$(H_1 \circ \gamma) \star c : \overrightarrow{\pi}_1(X)(H_1(b), c) \longrightarrow \overrightarrow{\pi}_1(X)(H_1(a), c) \quad [\delta] \longmapsto [(H_1 \circ \gamma) \star \delta]$$

is a bijection. The following diagram is commutative:

$$\begin{array}{ccc} \overrightarrow{\pi}_1(X)(H_1(a), c) & \xrightarrow{H(x) \star c} & \overrightarrow{\pi}_1(X)(a, c) \\ (H_1 \circ \gamma) \star c \uparrow & & \uparrow \gamma \star c \\ \overrightarrow{\pi}_1(X)(H_1(b), c) & \xrightarrow{H(y) \star c} & \overrightarrow{\pi}_1(X)(b, c) \end{array}$$

because  $\gamma \star H(y)$  and  $H(x) \star (H_1 \circ \gamma)$  are dihomotopic.  $H(x) \star c$  and  $H(y) \star c$  are bijections because  $H(x)$  and  $H(y)$  belong to  $\mathfrak{J}(X)$  and  $\gamma \star c$  is a bijection because  $[\gamma] \in \mathfrak{J}(\overrightarrow{\pi}_1(X))$ .  $(H_1 \circ \gamma) \star c$  is then a bijection.

- **left cancellation:** let  $\gamma$  be a dipath from  $a$  to  $b$  such that  $[\gamma] \in \mathfrak{J}(\overrightarrow{\pi}_1(X))$  and let  $c \in A$  such that  $\overrightarrow{\pi}_1(A)(c, H_1(a)) \neq \emptyset$ . We must prove that

$$c \star (H_1 \circ \gamma) : \overrightarrow{\pi}_1(X)(c, H_1(a)) \longrightarrow \overrightarrow{\pi}_1(X)(c, H_1(b)) \quad [\delta] \longmapsto [\delta \star (H_1 \circ \gamma)]$$

is a bijection. Since  $H(x) \in \mathfrak{J}(X)$ , by the left Ore condition, there is dipath  $\alpha$  from  $d$  to  $c$  for some  $d$  such that  $[\alpha] \in \mathfrak{J}(\overrightarrow{\pi}_1(X))$  and  $\overrightarrow{\pi}_1(X)(d, a) \neq \emptyset$ . Consequently, the following diagram commutes:

$$\begin{array}{ccccc} \overrightarrow{\pi}_1(X)(c, H_1(a)) & \xrightarrow{\alpha \star H_1(a)} & \overrightarrow{\pi}_1(X)(d, H_1(a)) & \xleftarrow{d \star H(a)} & \overrightarrow{\pi}_1(X)(d, a) \\ c \star (H_1 \circ \gamma) \downarrow & & \downarrow d \star (H_1 \circ \gamma) & & \downarrow d \star \gamma \\ \overrightarrow{\pi}_1(X)(c, H_1(b)) & \xrightarrow{\alpha \star H_1(b)} & \overrightarrow{\pi}_1(X)(d, H_1(b)) & \xleftarrow{d \star H(b)} & \overrightarrow{\pi}_1(X)(d, b) \end{array}$$

$d \star \gamma$  is a bijection since  $[\gamma] \in \mathfrak{J}(\overrightarrow{\pi}_1(X))$  and  $\overrightarrow{\pi}_1(X)(d, a) \neq \emptyset$ . Similarly,  $d \star H(a)$  and  $d \star H(b)$  are bijections, so  $d \star (H_1 \circ \gamma)$  is a bijection.  $\alpha \star H_1(a)$  and  $\alpha \star H_1(b)$  are bijections because  $\alpha \in \mathfrak{J}(\overrightarrow{\pi}_1(X))$ . Consequently,  $c \star (H_1 \circ \gamma)$  is a bijection.

- **right Ore condition:** let  $[\gamma] \in \mathfrak{J}(\overrightarrow{\pi}_1(X))$  with  $\gamma$  a dipath from  $a$  to  $b$  and let  $\delta$  be a dipath in  $A$  from  $c$  to  $H_1(b)$ . Since  $H(b) \in \mathfrak{J}(X)$ ,  $[\gamma \star H(b)] \in \mathfrak{J}(\overrightarrow{\pi}_1(X))$ . By the right Ore condition in  $\overrightarrow{\pi}_1(X)$  on  $[\gamma \star H(b)]$  and  $[\delta]$  there are a dipath  $\eta$  in  $X$  from  $d$  to  $a$  and a dipath  $\mu$  in  $X$  from  $d$  to  $c$  such that  $[\mu] \in \mathfrak{J}(\overrightarrow{\pi}_1(X))$  and  $\mu \star \delta$  is dihomotopic to  $\eta \star \gamma \star H(b)$  and so to  $\eta \star H(a) \star (H_1 \circ \gamma)$ .  $\eta \star H(a)$  is dihomotopic to  $H(d) \star (H_1 \circ \eta)$  and since  $c \in A$ ,  $\mu$  is dihomotopic to  $H(d) \star (H_1 \circ \mu)$ .  $H(d) \star (H_1 \circ \mu) \star \delta$  is dihomotopic to  $H(d) \star (H_1 \circ \eta) \star (H_1 \circ \gamma)$ . Since  $H(d) \in \mathfrak{J}(X)$ ,  $(H_1 \circ \mu) \star \delta$  is dihomotopic to  $(H_1 \circ \eta) \star (H_1 \circ \gamma)$  within  $A$  and  $[H_1 \circ \mu] \in W$ .



- **left Ore condition:** similar.

3. We start by proving that  $W' = \{[\gamma] \mid [H_1 \circ \gamma] \in \mathfrak{J}(\overrightarrow{\pi}_1(A))\} \subseteq \mathfrak{J}(\overrightarrow{\pi}_1(X))$ . To this end, we prove that  $W'' = \langle W' \cup \mathfrak{J}(\overrightarrow{\pi}_1(X)) \rangle$  is a Yoneda system (remember that  $\langle W \rangle$  is the category generated by  $W$ ).

- **right cancellation:** let  $[\gamma] \in W'$ , from  $a$  to  $b$  and let  $c$  such that  $\overrightarrow{\pi}_1(X)(b, c) \neq \emptyset$ . Then, the following diagram commutes:

$$\begin{array}{ccc} \overrightarrow{\pi}_1(X)(b, c) & \xrightarrow{\gamma \star c} & \overrightarrow{\pi}_1(X)(a, c) \\ H_{1,b,c} \downarrow & & \downarrow H_{1,a,c} \\ \overrightarrow{\pi}_1(A)(H_1(b), H_1(c)) & \xrightarrow{(H_1 \circ \gamma) \star H_1(c)} & \overrightarrow{\pi}_1(A)(H_1(a), H_1(c)) \end{array}$$

We have already proved that  $H_{1,b,c}$  and  $H_{1,a,c}$  are homotopy equivalences and so induce bijections.  $(H_1 \circ \gamma) \star H_1(c)$  is a bijection since  $H_1 \circ \gamma \in \mathfrak{J}(\overrightarrow{\pi}_1(A))$ . Consequently,  $\gamma \star c$  is a bijection.

- **left cancellation:** similar.

- **right Ore condition:** let  $[\gamma] \in W'$  be a dipath from  $a$  to  $b$  and let  $\delta$  be a dipath from  $c$  to  $b$ . By the right Ore condition in  $\overrightarrow{\pi}_1(A)$  between  $H_1 \circ \gamma$  and  $H_1 \circ \delta$ , there are a dipath  $\eta$  from  $d$  to  $H_1(a)$  and a dipath  $\mu$  from  $d$  to  $H_1(c)$  such that  $[\mu] \in \mathfrak{J}(\overrightarrow{\pi}_1(A))$  and  $\mu \star (H_1 \circ \delta)$  is dihomotopic to  $\eta \star (H_1 \circ \gamma)$ . Then, by the last condition of a FIDR, there is a dipath  $\mu'$  from  $e$  to  $c$  such that  $H_1 \circ \mu'$  is dihomotopic to  $\mu$  (and so  $H_1(e) = d$ ). Since  $H(a) \in \mathfrak{J}(X)$  then by the right Ore condition in  $\overrightarrow{\pi}_1(X)$  between  $H(a)$  and  $H(e) \star \eta$ , there are a dipath  $\varepsilon$  from  $f$  to  $e$  with  $[\varepsilon] \in \mathfrak{J}(\overrightarrow{\pi}_1(X))$  and a dipath  $\kappa$  from  $f$  to  $a$  such that  $\varepsilon \star H(e) \star \eta$  is dihomotopic to  $\kappa \star H(a)$ . Then  $\kappa \star \gamma$  is dihomotopic to  $\varepsilon \star \mu' \star \delta$  with  $[\varepsilon \star \mu'] \in W''$ .

- **left Ore condition:** let  $[\gamma] \in W'$  be a dipath from  $a$  to  $b$  and let  $\delta$  be a dipath from  $a$  to  $c$ . By the left Ore condition in  $\overrightarrow{\pi}_1(A)$  between  $H_1 \circ \gamma$  and  $H_1 \circ \delta$ , there are a dipath  $\eta$  from  $H_1(b)$  to  $d$  and a dipath  $\mu$  from  $H_1(c)$  to  $d$  such that  $[\mu] \in \mathfrak{J}(\overrightarrow{\pi}_1(A))$  and  $(H_1 \circ \delta) \star \mu$  is dihomotopic to  $(H_1 \circ \gamma) \star \eta$ . Then  $\gamma \star (H(b) \star \eta)$  is dihomotopic to  $\delta \star (H(c) \star \mu)$  with  $[H(c) \star \mu] \in W''$ .

We now prove that  $\mathfrak{J}(\overrightarrow{\pi}_1(A)) \subseteq \mathfrak{J}(\overrightarrow{\pi}_1(X))$ . To this end, we prove that  $W''' = \langle \mathfrak{J}(\overrightarrow{\pi}_1(A)) \cup \mathfrak{J}(\overrightarrow{\pi}_1(X)) \rangle$  is a Yoneda system.

- **right cancellation:** let  $[\gamma] \in \mathfrak{J}(\overrightarrow{\pi}_1(A))$ , from  $a$  to  $b$  and let  $c$  such that  $\overrightarrow{\pi}_1(X)(b, c) \neq \emptyset$ . Then, the following diagram commutes:

$$\begin{array}{ccc} \overrightarrow{\pi}_1(X)(b, c) & \xrightarrow{b \star H(c)} & \overrightarrow{\pi}_1(X)(b, H_1(c)) \\ \gamma \star c \downarrow & & \downarrow \gamma \star H_1(c) \\ \overrightarrow{\pi}_1(X)(a, c) & \xrightarrow{a \star H(c)} & \overrightarrow{\pi}_1(X)(a, H_1(c)) \end{array}$$

$b \star H(c)$  and  $a \star H(c)$  are bijection since  $H(c) \in \mathfrak{J}(X)$  and  $\gamma \star H_1(c)$  is a bijection since  $\gamma \in \mathfrak{J}(\overrightarrow{\pi}_1(A))$ ,  $\overrightarrow{\pi}_1(X)(b, H_1(c)) = \overrightarrow{\pi}_1(A)(b, H_1(c))$  ( $b \in A$ ) and  $\overrightarrow{\pi}_1(X)(a, H_1(c)) = \overrightarrow{\pi}_1(A)(a, H_1(c))$  ( $a \in A$ ). Consequently,  $\gamma \star c$  is a bijection.

- **left cancellation:** similar.

- **right Ore condition:** let  $[\gamma] \in \mathcal{J}(\vec{\pi}_1(A))$  with  $\gamma$  a dipath in  $A$  from  $a$  to  $b$ . Let  $\delta$  be a dipath in  $X$  from  $c$  to  $b$ . Then  $\delta$  is dihomotopic to  $H(c) \star (H_1 \circ \delta)$ , since  $b \in A$ . Since  $H_1 \circ \delta$  is a dipath in  $A$  from  $H_1(c)$  to  $b$ , then by the right Ore condition in  $\vec{\pi}_1(A)$ , there are a dipath  $\eta$  from  $d$  to  $a$  and  $\mu$  a dipath in  $A$  from  $d$  to  $H_1(c)$  with  $[\mu] \in \mathcal{J}(\vec{\pi}_1(A))$  and  $\eta \star \gamma$  is dihomotopic to  $\mu \star (H_1 \circ \delta)$ . By the last condition of a FIDR, there is a dipath  $\mu'$  in  $X$  from  $e$  to  $c$  with  $H_1 \circ \mu'$  is dihomotopic to  $\mu$  (and so  $H_1(e) = d$ ).  $[\mu']$  belongs to  $W' \subseteq \mathcal{J}(\vec{\pi}_1(X))$  and  $\mu' \star \delta$  is dihomotopic to  $\mu' \star H(c) \star (H_1 \circ \delta)$  which is dihomotopic to  $H(e) \star \mu \star (H_1 \circ \delta)$  which is dihomotopic to  $H(e) \star \eta \star \gamma$ .
  - **left Ore condition:** similar.
4. We have two functors  $\vec{\pi}_0(H_1) : \vec{\pi}_0(X) \rightarrow \vec{\pi}_0(A)$  and  $\vec{\pi}_0(\iota) : \vec{\pi}_0(A) \rightarrow \vec{\pi}_0(X)$ . Let us prove that they form an equivalence of categories. First,  $\vec{\pi}_0(H_1) \circ \vec{\pi}_0(\iota) = id_{\vec{\pi}_0(A)}$ . Secondly, we have a natural transformation  $\nu : id_{\vec{\pi}_0(X)} \rightarrow \vec{\pi}_0(\iota) \circ \vec{\pi}_0(H_1)$  defined by  $\nu_x : x \rightarrow H_1(x) = [H(x)] \in \mathcal{J}(\vec{\pi}_1(X))$  and so is an isomorphism in  $\vec{\pi}_0(X)$ .

.QED.

## Conclusion

To summarize, we have the following array:

type of equivalence	type of dipaths	localization of the fundamental category	weak equivalences
reversible	reversible	fundamental category/localizing isos	Dwyer-Kan
directed	all	groupoidification/localizing everything	none
FIDR/PIDR	inessential	component/localizing inessentials	inessential

In particular, we have described a new notion of dihomotopy equivalence using directed deformation retracts and inessential dipaths, that is, dipaths that have some properties of reversible ones. We prove that the action of inessential equivalence on fundamental categories corresponds to comparing categories of components up to equivalence. Furthermore, if reversible equivalence induces Dwyer-Kan weak equivalence on the dipath category, inessential equivalence induces something similar, up to two exceptions:

- as said earlier, fundamental category is replaced by category of components,
- enriched categories are replaced by partially enriched categories allowing us to handle more carefully emptiness.



## Part III

# Directed Homology Theories via Diagrams and Open Maps



# Directed homologies

The problem with homotopy groups is that they are hardly computable. Even given a finite presentation of a space, typically using pre-cubical or pre-simplicial sets, there is no nice way to compute their homotopy groups. For example, we would expect that the  $n$ th homotopy group to only depend on cells of small dimensions, typically lower than  $n$  or  $n + 1$ . But it is not the case: the 2-sphere

$$S^2 = \{(t_0, t_1, t_2) \in \mathbb{R}^3 \mid 0 \leq t_i \leq 1 \wedge \sum t_i^2 = 1\}$$

can be presented (for example in pre-simplicial sets) using only cells of dimension lower than 2. It can be proved that  $S^2$  has infinitely many non-trivial homotopy groups. Consequently, homotopy groups do not depend on the “cellular structure” of a space.

Following an idea derived from the Euler characteristic, homology avoids this problem: homology can be defined directly on the cellular structure, for example, directly on a finite presentation, and was made to count things, typically, holes of a space. Let us illustrate this on an example from [Hatcher 2002]. Start with the following graph:

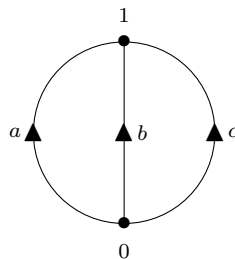

Its geometric realization is three copies  $a, b, c$  of the segment  $[0, 1]$  whose 0 points (resp. 1 points) are identified. Its fundamental group on 0 is computed as follows. The path that follows  $a$  forwardly and  $b$  backwardly is not homotopic to the constant path. It is a generator of the fundamental group and let us note it  $ab^{-1}$ . Another generator is given by  $cb^{-1}$  and those two are the only generators and there is no relation between them. Consequently, the fundamental group is the free group with two generators. Those generators represent the smallest cycles that cannot be squeezed to a point. If now we had a 2-dimensional cell as follows:

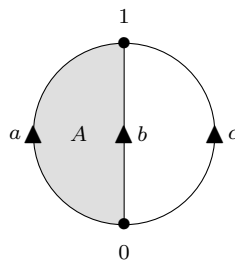

then the generator  $ab^{-1}$  is killed since the path is now homotopic to the constant path and the fundamental group is then isomorphic to  $\mathbb{Z}$ . In those examples, the higher homotopy groups are all trivial. Assume now that we add another 2-dimensional cell  $B$  as follow:

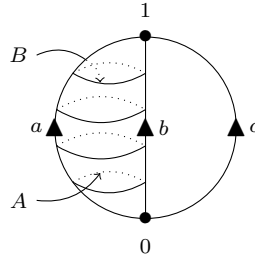

The fundamental group is still  $\mathbb{Z}$  but now, higher generators are created: there is a continuous function from  $\square_2$  which “covers”  $A$  and  $B$  and which cannot be deformed to a constant function. This gives a generator of  $\pi_2$ . As said previously on the 2-sphere, this also creates generators for infinitely many other homotopy groups.

Now imagine that we want to compute holes directly on the cellular structure. We will do this using abelian groups. Start with the first graph. With abelian notation, the generators are  $a - b$  and  $c - b$ . Actually, the elements generated by those two are the combinations  $n.a + m.b + p.c$  with  $n, m, p$  integers and  $n + p + m = 0$ . Equivalently, if  $\mathbb{Z}[a, b, c]$  (resp.  $\mathbb{Z}[0, 1]$ ) denotes the free abelian group generated by  $a, b$  and  $c$  (resp.  $0$  and  $1$ ) and  $\partial_1$  denotes the morphism from  $\mathbb{Z}[a, b, c]$  to  $\mathbb{Z}[0, 1]$  which maps  $a, b$  and  $c$  to  $1 - 0$ , then those elements are precisely the kernel of  $\partial_1$ .  $\partial_1$  is a boundary map and the generated elements are those without boundary. Let us call them cycles. Now add the 2-cell  $A$  as previously. We are interested in holes, that we may think as cycles that cannot be filled. This can also be expressed as boundary maps: the boundary of the cell  $A$  is precisely  $a - b$  (modulo orientation). This means that the generator  $a - b$  can be filled with the cell  $A$ . More precisely, there is a map  $\partial_2$  from  $\mathbb{Z}[A]$  to  $\mathbb{Z}[a, b, c]$  which maps  $A$  to  $a - b$ . The cycles that can be filled are precisely the image of  $\partial_2$ . Actually, notice that  $\text{Im}\partial_2 \subseteq \text{Ker}\partial_1$ . We can then form the group  $\text{Ker}\partial_1/\text{Im}\partial_2$  which will have one generator  $c - b$ , which stands for a 1-dimensional hole. This will be the definition of the first homology group. Similarly, if we add the second 2-cell  $B$ ,  $\partial_2$  will be from  $\mathbb{Z}[A, B]$  and will map  $B$  to  $a - b$ .  $\text{Ker}\partial_1/\text{Im}\partial_2$  still have one generator but now  $\partial_2$  has a non-trivial kernel ( $A - B$  is a generator) which creates a generator for a second homology group, which stands for a 2-dimensional hole. And if we add higher dimensional cells we can continue this process to define a sequence of groups as quotients  $\text{Ker}\partial_n/\text{Im}\partial_{n+1}$  of boundary maps.

In this chapter, we will recall the definition of singular homology of a topological space (Section 6.1.1) and see some of its properties: it is an invariant of homotopy (Section 6.1.2), it is complete in some cases (Section 6.1.3), it is modular (Section 6.1.4) and it is computable (Section 6.1.5). We would then define a similar theory for directed spaces. We start, in Section 6.2, by presenting a few candidates proposed in the literature and explain why we are not happy with them. We then describe our own candidates: starting with the idea that what matter are the dipath/trace spaces and how they evolve with time (Section 6.3), we construct several diagrams, namely functors from any small category to a specified category (typically, a category of modules), which represent the homology of the trace spaces of a d-space and how they evolve when extending traces, called natural and bimodule homologies (Section 6.4). Finally, in Section 6.5, we look at first nice properties of this homology theory: first invariance under dihomotopy and several Eilenberg-Steenrod axioms, in particular, we will see what can be said about modularity using the theory of exactness in non-Abelian theories

from [Grandis 1991a].

## 6.1 Classical homology and a few properties

The goal of this section is to briefly present the theory of homology in classical algebraic topology. For a general study, see for example [Hatcher 2002].

### 6.1.1 Definitions

Homology is a general technique to measure default of exactness in a sequence of morphisms. We start here by looking at the case of  $\mathcal{R}$ -modules for a certain ring  $\mathcal{R}$  (we will see a more general framework soon). We note  $\mathbf{Mod}(\mathcal{R})$  the categories of  $\mathcal{R}$ -modules and linear maps. The notion of exact sequence is important in algebra since many properties can be expressed using it. Precisely:

**Definition 10.** Let  $f : A \rightarrow B$  and  $g : B \rightarrow C$  be linear maps. We say that the following sequence:

$$A \xrightarrow{f} B \xrightarrow{g} C$$

is **exact** if  $Im(f) = Ker(g)$ . We say that it is **short exact** if, furthermore,  $f$  is injective and  $g$  is surjective. We say that the following sequence

$$\cdots \xrightarrow{f_{n+1}} A_n \xrightarrow{f_n} \cdots \xrightarrow{f_2} A_1 \xrightarrow{f_1} A_0$$

is **long exact** if for every  $n \in \mathbb{N}$ , the sequence:

$$A_{n+2} \xrightarrow{f_{n+2}} A_{n+1} \xrightarrow{f_{n+1}} A_n$$

is exact.

As announced, we want to look at default of exactness of sequences of linear maps. We call **chain complex** a sequence  $C = (\partial_{n+1} : C_{n+1} \rightarrow C_n)_{n \in \mathbb{N}}$  of linear maps such that for every  $n \in \mathbb{N}$ ,  $\partial_n \circ \partial_{n+1} = 0$ . In particular, this implies that  $Im(\partial_{n+1}) \subseteq Ker(\partial_n)$ . So a chain complex is exact precisely when all the quotients  $Ker(\partial_n)/Im(\partial_{n+1})$  are trivial. We then use those quotients to measure the default of exactness: we call  **$n$ th module of homology** and denote by  $H_n(C)$  the quotient  $Ker(\partial_n)/Im(\partial_{n+1})$  (by convention  $H_0(C) = C_0/Im(\partial_1)$ ).

A morphism of chain complexes

$$(f_n)_{n \in \mathbb{N}} : (\partial_{n+1} : C_{n+1} \rightarrow C_n)_{n \in \mathbb{N}} \rightarrow (\partial'_{n+1} : C'_{n+1} \rightarrow C'_n)_{n \in \mathbb{N}}$$

is a sequence of linear maps  $(f_n : C_n \rightarrow C'_n)_{n \in \mathbb{N}}$  such that for every  $n \in \mathbb{N}$ ,

$$f_n \circ \partial_{n+1} = \partial'_{n+1} \circ f_{n+1}.$$

We denote by  $\mathbf{C}_\bullet(\mathbf{Mod}(\mathcal{R}))$  the category of chain complexes of  $\mathcal{R}$ -modules and morphisms of chain complexes.

$H_n$  extends to a functor from  $\mathbf{C}_\bullet(\mathbf{Mod}(\mathcal{R}))$  to  $\mathbf{Mod}(\mathcal{R})$  by defining  $H_n((f_k)_{k \in \mathbb{N}}) : H_n(C) \rightarrow H_n(C')$  as the linear map  $[x] \mapsto [f_n(x)]$  (where  $[x]$  is the class of  $x \in Ker \partial_{n-1}$  in  $H_n(C)$ ).



In algebraic topology, we study the geometry of a space using a particular chain complex, called the **singular chain complex**. Recall the Sing functor from Section 5.1.3. It is a functor from **Top** to **SSet** which maps a topological space  $X$  to a simplicial set such that  $\text{Sing}(X)_n$  is the set of continuous functions from  $\Delta_n$  to  $X$ . Recall also the face maps  $d_i : \text{Sing}(X)_{n+1} \rightarrow \text{Sing}(X)_n$  are defined as  $d_i(\alpha) = \alpha \circ \partial_i$ , where  $\partial_i : \Delta_n \rightarrow \Delta_{n+1}$  is the corresponding geometric face map, that is the inclusion of the  $i$ -th face into the  $n$ -th standard geometric simplex. The singular chain complex  $C(X)$  is then defined as follow:

- for  $n \in \mathbb{N}$ ,  $C_n(X)$  is the free module generated by  $\text{Sing}(X)_n$ ,
- $\partial_{n+1} : C_{n+1}(X) \rightarrow C_n(X)$  is the linear map such that for every  $\alpha \in C_{n+1}(X)$ ,

$$\partial(\alpha) = \sum_{i=0}^{n+1} (-1)^i d_i(\alpha).$$

The  $n$ th module of singular homology of  $X$ , denoted by  $H_n(X)$ , is defined as  $H_n(C(X))$ .  $C$  and  $H_n$  extends to functors from **Top** to respectively  $\mathbf{C}_\bullet(\mathbf{Mod}(\mathcal{R}))$  and  $\mathbf{Mod}(\mathcal{R})$ .

Intuitively, the homology of a space computes the number of holes of any dimension of this space. For example, a space has a hole of dimension 1, if the image of the boundary of a triangle by a continuous function cannot be extended in a continuous function from the whole triangle. For example,  $\mathbb{R}^2 \setminus \{0\}$  has a hole of dimension 2. Similarly,  $n$ -spheres have a hole of dimension  $n$ . From the homology point of view, this means that their  $n$ th homology module is isomorphic to  $\mathcal{R}$ .

Given a pair  $(X, A)$  in  $\mathbf{Top}_2$ , there is an injection from  $C(A)$  into  $C(X)$  and one can form the quotient  $C(X)/C(A)$  which defines a chain complex called the **chain complex of  $X$  relative to  $A$** . We note  $H_n(X, A) = H_n(C(X)/C(A))$  and called it the  **$n$ th module of homology of  $X$  relative to  $A$** . Intuitively, it computes the algebraic informations of  $X$  modulo  $A$  and is useful to know more precisely where the various bits of information on  $X$  are located.  $H_n$  extends to a functor from  $\mathbf{Top}_2$  to  $\mathbf{Mod}(\mathcal{R})$ . Remark that in particular,  $H_n(X) = H_n(X, \emptyset)$ .

For every  $i \geq 1$ , there is a natural linear map  $\delta_i : H_i(X, A) \rightarrow H_{i-1}(A)$  defined as follow. The kernel of  $\partial_i : C_i(X)/C_i(A) \rightarrow C_{i-1}(X)/C_{i-1}(A)$  is precisely the class of elements  $\alpha$  of  $C_i(X)$  such that  $\partial_i(\alpha)$  is included in  $A$ . Since  $C(A)$  is a chain complex,  $\partial_i(\alpha)$  belongs to  $\text{Ker} \partial_{i-1}$ . This process behaves well modulo  $\text{Im} \partial_i$  and so defines a linear map from  $H_i(X, A)$  to  $H_{i-1}(A)$ .

### 6.1.2 Homotopy invariance

The theorem of homotopy invariance of the homology is a correction result:

**Theorem 16** ([Hatcher 2002]). *If two continuous maps from  $X$  to  $Y$  are homotopic then the linear maps induced on homology coincide. In particular, if  $X$  and  $Y$  are homotopically equivalent then homology are isomorphic.*

### 6.1.3 Hurewicz and Whitehead theorems

Reciprocally, in the case  $\mathcal{R} = \mathbb{Z}$ , the homology is not that far from homotopy:

**Theorem 17** (Hurewicz [Hatcher 2002]). *Let  $X$  be a topological space. Then:*

- $H_0(X)$  is isomorphic to the free Abelian group generated by  $\pi_0(X)$ , that is, to  $\bigoplus_{\pi_0(X)} \mathbb{Z}$ ,

- if  $X$  is  $(n-1)$ -connected, i.e., for every  $1 \leq i \leq n-1$  and every  $x \in X$ ,  $\pi_i(X, x)$  is trivial and  $\pi_0(X)$  is a singleton then:
  - if  $n = 1$ ,  $H_1(X)$  is isomorphic to the abelianization of  $\pi_1(X)$ ,
  - otherwise,  $H_n(X)$  and  $\pi_n(X)$  are isomorphic.

Moreover, those isomorphisms are natural in  $X$ .

**Theorem 18** (Whitehead [Spanier 1966]). *Let  $X$  and  $Y$  be two simply-connected (i.e., 1-connected) CW-complexes. If a continuous function  $f : X \rightarrow Y$  induces an isomorphism in homology, i.e., for every  $n \in \mathbb{N}$ ,  $H_n(f) : H_n(X) \rightarrow H_n(Y)$  is an isomorphism, then  $X$  and  $Y$  are homotopically equivalent.*

### 6.1.4 Eilenberg-Steenrod axioms

Eilenberg and Steenrod isolated in [Eilenberg 1945] a few common properties of the different homology theories that can be defined on topological spaces and which are enough to prove main results about those theories. Those properties were stated for theories with values in Abelian groups (or  $\mathbb{Z}$ -modules), but can actually be stated more generally in Abelian categories ( $\mathbf{Mod}(\mathcal{R})$  is such a category) or even in more general frameworks as we will see later. We will stick here to categories of modules.

A **homology theory** is a family  $(H_n)_{n \in \mathbb{N}}$  of functors from  $\mathbf{Top}_2$  to  $\mathbf{Mod}(\mathcal{R})$ , together with a family of natural transformations  $\partial_n$  from  $H_n$  to the functor  $(X, A) \mapsto H_{n-1}(A, \emptyset)$ . We say that a homology theory satisfies the **Eilenberg-Steenrod axioms** if it satisfies the following:

- **homotopy axiom:** if two maps  $f, g : (X, A) \rightarrow (Y, B)$  are homotopic then  $H_n(f) = H_n(g)$  for every  $n$ . In particular, homotopy equivalences induce isomorphisms between homology modules.
- **excision axiom:** for every pair  $(X, A)$  and every open subset  $U$  of  $X$  such that the closure of  $U$  is included in the interior of  $A$  and if  $\iota$  denotes the inclusion from  $(X \setminus U, A \setminus U)$  to  $(X, A)$  then  $H_n(\iota)$  is an isomorphism for every  $n$ ,
- **dimension axiom:**  $H_n(*, \emptyset)$  is a trivial module for every  $n \neq 0$ ,
- **additivity axiom:** for every  $n$ , the functor  $H_n : \mathbf{Top} \rightarrow \mathbf{Mod}(\mathcal{R})$  which maps  $X$  to  $H_n(X, \emptyset)$  preserves coproducts,
- **exactness axiom:** for every pair  $(X, A)$ , the following sequence:

$$\cdots \longrightarrow H_n(A, \emptyset) \xrightarrow{H_n(i)} H_n(X, \emptyset) \xrightarrow{H_n(j)} H_n(X, A) \xrightarrow{\partial_n} H_{n-1}(A, \emptyset) \longrightarrow \cdots$$

is long exact, where  $i$  is the inclusion from  $(A, \emptyset)$  to  $(X, \emptyset)$  and  $j$  is the inclusion from  $(X, \emptyset)$  to  $(X, A)$ .

Singular homology is a homology theory that satisfies the Eilenberg-Steenrod axioms. Actually, the exactness axiom can be extended in the following way. Let us say that a sequence of morphisms of chain complexes of the form:

$$A \xrightarrow{(f_n)_{n \in \mathbb{N}}} B \xrightarrow{(g_n)_{n \in \mathbb{N}}} C$$

is **(short) exact** if for every  $n$ , the sequence:

$$A_n \xrightarrow{f_n} B_n \xrightarrow{g_n} C_n$$

is (short) exact. One can observe that the sequence:

$$C(A) \xrightarrow{i} C(X) \xrightarrow{q} C(X)/C(A)$$

where  $i$  is the injection and  $q$  the quotient map, is short exact. The fact that this particular short exact sequence of chain complexes induces a long exact sequence of homology is more general:

**Theorem 19** ([Hatcher 2002]). *If*

$$A \xrightarrow{f} B \xrightarrow{g} C$$

*is a short exact sequence of chain complexes then there is a long exact sequence of the form:*

$$\dots \longrightarrow H_n(B) \xrightarrow{H_n(g)} H_n(C) \longrightarrow H_{n-1}(A) \xrightarrow{H_{n-1}(f)} H_{n-1}(B) \longrightarrow \dots$$

One of the important theorem that can be proved from the Eilenberg-Steenrod axioms is the following:

**Theorem 20** (Mayer-Vietoris [Hatcher 2002]). *Let  $A, B \subseteq X$  be spaces such that the union of the interiors of  $A$  and  $B$  covers  $X$ . Then, there is a long exact sequence of the form:*

$$\dots \longrightarrow H_n(A \cap B) \longrightarrow H_n(A) \oplus H_n(B) \longrightarrow H_n(X) \longrightarrow H_{n-1}(A \cap B) \longrightarrow \dots$$

### 6.1.5 Computability

The main interest of homology is that it is computable when the space is finitely presented, typically by a finite presimplicial set. The main ingredient is that, when  $\mathcal{R}$  is a principal ideal domain, the finitely generated modules are isomorphic to a module of the form  $\mathcal{R}/(\alpha_1) \times \dots \times \mathcal{R}/(\alpha_k)$  where  $(\alpha)$  is the ideal generated by  $\alpha$  and with  $(\alpha_1) \subseteq \dots \subseteq (\alpha_k)$ , and this form is unique. So when the space is presented by a finite presimplicial set, its homology is isomorphic to a finitely generated module computed from the presimplicial structure, and from this structure it is possible to compute those  $\alpha_1$  when  $\mathcal{R} \in \{\mathbb{R}, \mathbb{Q}, \mathbb{Z}\}$ . When  $\mathcal{R} \in \{\mathbb{R}, \mathbb{Q}\}$  those module are in fact vector spaces of finite dimension and so isomorphic to  $\mathbb{R}^p$  (resp.  $\mathbb{Q}^p$ ) for some  $p$ . We call those integers the **Betti numbers**. When  $\mathcal{R} = \mathbb{Z}$ , it is isomorphic to an Abelian group of the form  $\mathbb{Z}^\beta \times \mathbb{Z}/\alpha_1\mathbb{Z} \times \dots \times \mathbb{Z}/\alpha_k\mathbb{Z}$  with  $2 \leq \alpha_1 | \dots | \alpha_k$ . The  $\alpha_i$  are called **torsion coefficients**. It is possible to compute those integers computing Smith normal form, see [Munkres 1930].

Another tool to compute homology is the Mayer-Vietoris theorem. This theorem means that homology is modular: in some cases, it is possible to express the homology of some spaces using simpler spaces. It is, for example, possible to compute homology of spheres using this theorem. Indeed, a  $n$ -sphere is the union of two contractible spaces (the 2 hemispheres) whose intersection is (up to homotopy equivalence) a  $n - 1$ -sphere, and by the Mayer-Vietoris, it is possible to compute by induction those homology modules:  $H_n(S^n) \simeq \mathbb{Z}$  and for  $k \neq n$ ,  $H_k(S^n) \simeq 0$ .

## 6.2 Existing directed homologies

Since [Goubault 1995], different definition of directed homologies were proposed for various frameworks. From a theoretical point of view, we would like to construct a homology theory which satisfies as many good properties (for example, those presented earlier for classical homology) as possible. Among those, here are a few:

- directed homology must be an invariant of directed homotopy. Here it does depend on the dihomotopy theory considered. In our case, it would be the inessential theory.
- directed homology should detect default of dihomotopy and not be too far from homotopy. Typically, we would like that spaces much as the matchbox (which is not inessentially equivalent to a point) not to have a trivial directed homology.
- directed homology should be modular or at least be with values in a category where the theory of exact sequences should be nice.
- directed homology should be, somehow, computable in some cases.

Among the proposition, we could mention:

- the branching, confluent and total homologies from [Goubault 1995]. They were made for studying geometric properties of HDA. They are computable but they lack of directedness, since they are essentially invariant by undirected equivalence.
- the directed homology from [Grandis 2004]. It is constructed by equipping homology groups with an order. If you have in mind that the generators of those groups are holes, the order represents how those holes are located from one to the other. It is invariant by directed equivalence (it was made for this). For example, the matchbox has a trivial directed homology in this case since it is classically contractible, so its singular homology is trivial, and only trivial structures can be equipped on trivial groups.
- the directed homology [Fahrenberg 2003], using  $\omega$ -categories. Fahrenberg observed that the homology of the matchbox was trivial.
- the homology graph from [Kahl 2014]. The idea is similar to [Grandis 2004], except that groups are equipped with more general relations. Kahl proved that it is invariant by an analogue of homeomorphisms for pre-cubical sets. The matchbox has a trivial homology graph for the same reason as Grandis' proposal.
- the homology with values in cancellative monoids from [Patchkoria 2006]. Since cancellative monoids only catch cancellative behaviors, it is not satisfactory for our purpose.
- directed (co)homology from [Ghrist 2016]. It was made for a completely different purpose (solve pursuit-evasions problem) and does not seem to relate to our goal.

## 6.3 Trace spaces and evolution

We have seen that trace spaces are good abstractions for a space of “executions” of a truly concurrent system. They give interesting information about the space. However, limiting ourself to only one

trace space is not sufficient to classify spaces. Let us look at those two d-spaces, which are geometric realizations of  $SU$ -programs:

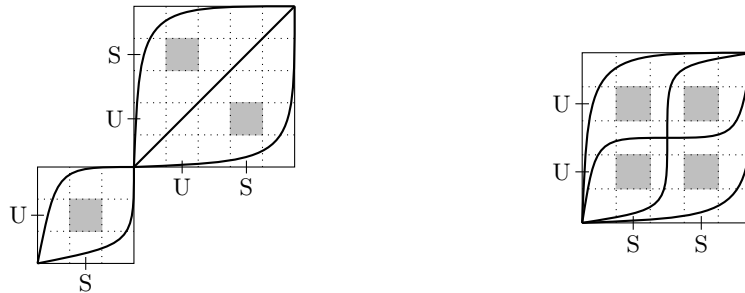

Both d-spaces have a trace space between their extremal points homotopically equivalent to a six point space. From a computer science point of view, this means that they have six maximal non-equivalent executions, depicted in both pictures. So if we were to only consider those trace spaces, we would not be able to distinguish those two spaces/programs, while they should be. From a computer science point of view, the observations from those two programs are different. From a mathematical point of view, those spaces are not even homotopically equivalent since they do not have the same number of holes.

In the following, much as [Rausssen 2007], we will study a structure which will allow us to look at all the trace spaces between two points and how their geometries evolve when varying their end points. More precisely, we will:

- organize traces following the extension relation. This will be done by considering the category of factorizations or the enveloping category of the trace category from section 5.2.2,
- associate each trace or each pair of points (depending on which structure we use) with the trace space between its end points. This will define a functor from the structure from the first point to the category of topological spaces.
- apply homotopy group or homology module functors.

These ideas will be developed in the next section, but let us look at the previous example and show how these ideas will solve our problem. Being able to observe all the trace spaces between two points allow us to distinguish the two previous d-spaces. Indeed, if we look at the trace space between  $\alpha$  and  $\beta$  in the left example:

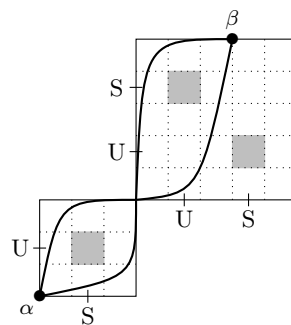

This trace space is homotopically equivalent to a four point space. However, there is no pair of points in the right space between which the trace space has this homotopy type. This means that the evolution of executions is not the same in those two programs and so they cannot be equivalent.

## 6.4 Natural homotopy and homology

We define now precisely the structures mentioned previously. Let us start by recalling the category of traces from section 5.2.2. The **category of traces of  $X$**   $\overrightarrow{T}(X)$  is the category whose:

- objects are points of  $X$ ,
- morphisms are traces,
- the identity of  $a$  is the trace  $\langle c_a \rangle$  of the constant path at  $a$ ,
- composition is concatenation.

The idea of our directed homology will be to describe the evolution of those traces by extending them. Given any category  $\mathcal{C}$ , we call an **extension** of  $\mathcal{C}$  every pair  $(f : a' \rightarrow a, g : b \rightarrow b')$  of morphisms such that  $\mathcal{C}(a, b) \neq \emptyset$ . In particular, since traces are morphisms of the category of traces, we call the extensions of  $\overrightarrow{T}(X)$ , **extensions of traces**,

We will use two ways for describing the evolution. First, by using the **enveloping category** of  $\overrightarrow{T}(X)$ : the enveloping category of a category  $\mathcal{C}$ , noted  $\mathcal{E}(\mathcal{C})$ , is the category whose:

- objects are pairs  $(a, b)$  of objects of  $\mathcal{C}$  such that  $\mathcal{C}(a, b) \neq \emptyset$ ,
- morphisms from  $(a, b)$  to  $(a', b')$  are extensions  $(f : a' \rightarrow a, g : b \rightarrow b')$ ,
- the identity of  $(a, b)$  is  $(\text{id}_a, \text{id}_b)$ ,
- composition is  $(f', g') \circ (f, g) = (f' \circ f, g' \circ g)$ .

The enveloping category is used in [Mitchell 1972] to describe systems of coefficients to compute homology of small categories and functors from  $\mathcal{E}(\mathcal{C})$  to  $\mathbf{Ab}$  are called bimodules. We will use this terminology more generally for any functor from  $\mathcal{E}(\mathcal{C})$  to some category  $\mathcal{M}$ .

We then have a functor  $\overrightarrow{BT}(X) : \mathcal{E}(\overrightarrow{T}(X)) \rightarrow \mathbf{Top}$  which maps:

- a pair  $(a, b)$  to  $\overrightarrow{T}(X)(a, b)$ ,
- an extension  $(\alpha : a' \rightarrow a, \beta : b \rightarrow b')$  to the continuous function from  $\overrightarrow{T}(X)(a, b)$  to  $\overrightarrow{T}(X)(a', b')$  which maps  $\gamma$  to  $\alpha \star \gamma \star \beta$ .

We call it the **bimodule of traces of  $X$** .

The other way will use the **category of factorizations**, noted  $\mathcal{F}(\mathcal{C})$ , whose:

- objects are morphisms of  $\mathcal{C}$ ,
- morphisms from  $f : a \rightarrow b$  to  $g : a' \rightarrow b'$  are extensions  $(\alpha : a' \rightarrow a, \beta : b \rightarrow b')$  such that  $\beta \circ f \circ \alpha = g$ .
- composition and identities are the same as  $\mathcal{E}(\mathcal{C})$ .

The category of factorizations is used in [Baues 1985] for the same reasons as the enveloping category. Functors from  $\mathcal{F}(\mathcal{C})$  to  $\mathbf{Ab}$  are called natural systems, and we will also use this terminology.

We then have a functor  $\overrightarrow{NT}(X) : \mathcal{F}(\overrightarrow{T}(X)) \rightarrow \mathbf{Top}_*$ , where  $\mathbf{Top}_*$  is the full subcategory of  $\mathbf{Top}_2$  whose objects are pairs  $(X, x)$  where  $x$  is a point of  $X$ , which maps:

- every trace  $\pi$  from  $a$  to  $b$  to  $(\overrightarrow{T}(X)(a, b), \pi)$ ,
- every extension  $(\alpha : a' \rightarrow a, \beta : b \rightarrow b')$  to the continuous function from  $\overrightarrow{T}(X)(a, b)$  to  $\overrightarrow{T}(X)(a', b')$  which maps  $\gamma$  to  $\alpha \star \gamma \star \beta$ .

We call it the **natural system of traces of  $X$** . By abuse of notation, we will also write  $\overrightarrow{NT}(X)$  the functor with values in  $\mathbf{Top}$  which forgets about the trace itself.

There is a functor  $\kappa_{\mathcal{C}} : \mathcal{F}(\mathcal{C}) \rightarrow \mathcal{E}(\mathcal{C})$  which maps every morphism to its pair of end objects. In particular,

$$\overrightarrow{NT}(X) \circ \kappa_{\overrightarrow{T}(X)} = \overrightarrow{BT}(X).$$

We will see later that this functor has particular properties that will imply that  $\overrightarrow{NT}(X)$  and  $\overrightarrow{BT}(X)$  are equivalent in some sense, and so we could use either structure for defining our directed homology.

From those functors, one can apply homotopy group and homology module functors. Let us start with homotopy:

**Definition 11 (Natural homotopy).** We define for  $n \geq 1$ ,  $\overrightarrow{\Pi}_n(X) : \mathcal{F}(\overrightarrow{T}(X)) \rightarrow \mathcal{M}$  (where  $\mathcal{M}$  is either  $\mathbf{Set}$ ,  $\mathbf{Gr}$  or  $\mathbf{Mod}(\mathcal{R})$ ) composing  $\overrightarrow{NT}(X)$  with the  $(n - 1)^{th}$  homotopy group (set if  $n = 1$ ) functor  $\pi_{n-1}$ . We call it the  **$n$ th natural system of homotopy**.

You may have noticed that there is a shift of indexes. This comes from the fact that we want  $\overrightarrow{\Pi}_1(X)$  to be similar to  $\overrightarrow{\pi}_1(X)$ .

**Definition 12 (Natural homology).** We define for  $n \geq 1$ ,  $\overrightarrow{NH}_n(X) : \mathcal{F}(\overrightarrow{T}(X)) \rightarrow \mathbf{Mod}(\mathcal{R})$  composing  $\overrightarrow{NT}(X)$  with the  $(n - 1)^{th}$  homology module functor  $H_{n-1}$ . We call it the  **$n$ th natural system of homology**. We define for  $n \geq 1$ ,  $\overrightarrow{BH}_n(X) : \mathcal{E}(\overrightarrow{T}(X)) \rightarrow \mathbf{Mod}(\mathcal{R})$  composing  $\overrightarrow{BT}(X)$  with the  $(n - 1)^{th}$  homology module functor  $H_{n-1}$ . We call it the  **$n$ th bimodule of homology**.

Let us consider the following pospace, denoted  $a + b$ , which is made up of two directed segments  $a$  and  $b$  where their initial points are identified, and their final points are identified too. In the following picture, we distinguish two particular points  $x$  and  $y$  on  $a$ , with  $x < y$  (respectively  $x'$  and  $y'$  on  $b$ , with  $x' < y'$ ), which we will use to describe the category of factorization  $\mathcal{F}(\overrightarrow{T}(a + b))$  as well as the natural homology  $\overrightarrow{NH}_n(a + b)$ .

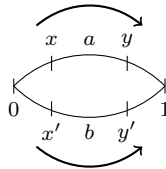

The description of  $\mathcal{F}(\overrightarrow{T}(a + b))$  is now as follow. Objects of  $\mathcal{F}(\overrightarrow{T}(a + b))$  are traces, which can be either:

- constant traces,  $0, x, y, x', y', 1$ , for all points  $x, y, x', y'$  that we chose to distinguish in the picture of  $a + b$ .

- non constant and non maximal traces of the form  $[0, x]$ ,  $[x, y]$ ,  $[y, 1]$  etc.
- maximal traces  $a$  and  $b$ .

We chose below to draw a picture of a subcategory of  $\mathcal{F}(\vec{T}(a+b))$ , where  $x, y, x'$  and  $y'$  are any distinguished points of  $a$  and  $b$  as discussed before. The extension morphisms in  $\mathcal{F}(\vec{T}(a+b))$  are pictured below as arrows ; for instance, there is an extension morphism from the trace  $[x, y]$  to  $[0, y]$  and to  $[x, 1]$ , among other extension morphisms:

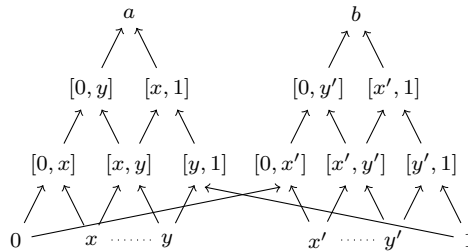

The only difference between  $\mathcal{F}(\vec{T}(a+b))$  and  $\mathcal{E}(\vec{T}(a+b))$  is that  $\mathcal{E}(\vec{T}(a+b))$  only has one top object, which corresponds to the pair  $(0, 1)$ . That is, it is of the following form:

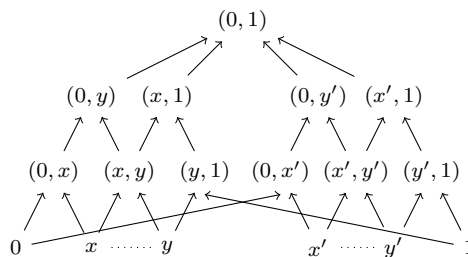

Now, we can picture  $\overline{NH}_1(a+b)$ , by applying the homology functor on the trace spaces from the starting point to the end point of the traces. For instance, the trace space  $\vec{T}(a+b)(x, y)$  (respectively  $\vec{T}(a+b)(0, y)$ ) corresponding to the trace  $[x, y]$  (respectively  $[0, y]$ ) in the diagram above, is just a point, hence has zeroth homology group equals to  $\mathcal{R}$  (respectively  $\mathcal{R}$ ). All other zeroth homology groups are also  $\mathcal{R}$  with the exception of the ones corresponding to the two maximal traces  $a$  and  $b$ , going from 0 to 1. In that case,  $\vec{T}(a+b)(0, 1)$  is composed of two points, that we can identify with  $a$  and  $b$  themselves, and has  $\mathcal{R}^2$  (or  $\mathcal{R}[a, b]$  with the identification we just made) as zeroth homology group. Now the extension morphism from  $[0, y]$  to  $a$  induces a map in homology which maps the only generator of  $H_0(\vec{T}(a+b)(0, y))$  to generator  $a$  in  $\mathcal{R}[a, b]$  as indicated in the picture below:

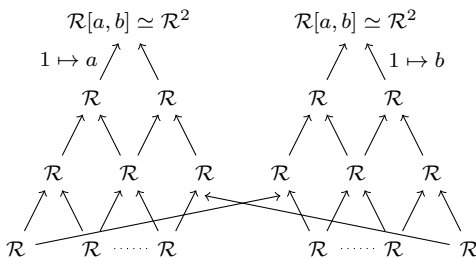



Similarly, the first bimodule of homology  $\overrightarrow{BH}_1(a + b)$  is of the following form:

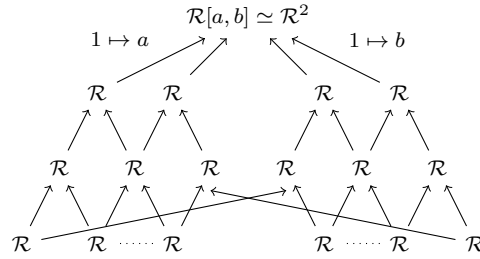

## 6.5 Homology of diagrams

### 6.5.1 Category of diagrams and functoriality

The first requirement of a homology theory is that it should be functorial. Natural systems and bimodules are both particular case of diagrams with values in a specified category  $\mathcal{M}$  (in our case,  $\mathcal{M}$  is **Set**, **Gr**, **Mod**( $\mathcal{R}$ ), **Top** or **Top**<sub>\*</sub>), i.e., a functor from any small category to  $\mathcal{M}$ . That will be the category where our directed homotopy and homology functor will live.

We define **Diag**( $\mathcal{M}$ ) the category whose:

- objects are **diagrams**, i.e., functors from any small category  $\mathcal{C}$  to  $\mathcal{M}$ ,
- morphisms from  $F : \mathcal{C} \rightarrow \mathcal{M}$  to  $G : \mathcal{D} \rightarrow \mathcal{M}$  are pairs  $(\Phi, \sigma)$  where
  - $\Phi$  is a functor from  $\mathcal{C}$  to  $\mathcal{D}$ ,
  - $\sigma$  is a natural transformation from  $F$  to  $G \circ \Phi$ .
- the identity on  $F : \mathcal{C} \rightarrow \mathcal{M}$  is  $id_F = (id_{\mathcal{C}}, 1_F)$  where
  - $id_{\mathcal{C}}$  is the identity functor on  $\mathcal{C}$ ,
  - $1_F$  is the identity natural transformation on  $F$ .
- the composition is defined as follow:  $(\Psi, \tau) \circ (\Phi, \sigma)$ , where  $(\Phi, \sigma) : (F : \mathcal{C} \rightarrow \mathcal{M}) \rightarrow (G : \mathcal{D} \rightarrow \mathcal{M})$  and  $(\Psi, \tau) : (G : \mathcal{D} \rightarrow \mathcal{M}) \rightarrow (H : \mathcal{E} \rightarrow \mathcal{M})$ , is  $(\Psi \circ \Phi, (\tau_{\Phi(c)} \circ \sigma_c)_{c \in \text{Ob}(\mathcal{M})})$ .

**Proposition 13.**  $\overrightarrow{BT}$  (resp.  $\overrightarrow{NT}$ ) extends to a functor from **dTop** to **Diag**(**Top**) (resp. **Diag**(**Top**<sub>\*</sub>)).

*Proof.* Let us do it for  $\overrightarrow{NT}$ . If  $f : X \rightarrow Y$  is a dimap, we define  $\overrightarrow{NT}(f) = (\Phi, \sigma) : \overrightarrow{NT}(X) \rightarrow \overrightarrow{NT}(Y)$  as follow:

- $\Phi : \mathcal{F}(\overrightarrow{T}(X)) \rightarrow \mathcal{F}(\overrightarrow{T}(Y))$  such that  $\Phi(\langle \gamma \rangle) = \langle f \circ \gamma \rangle$  and  $\Phi(\langle \alpha \rangle, \langle \beta \rangle) = (\langle f \circ \alpha \rangle, \langle f \circ \beta \rangle)$
- if  $\gamma$  is a dipath from  $x$  to  $y$ ,  $\sigma_{\langle \gamma \rangle} : \overrightarrow{T}(X)(x, y) \rightarrow \overrightarrow{T}(Y)(f(x), f(y))$   $\langle \rho \rangle \mapsto \langle f \circ \rho \rangle$ .  $\sigma_{\langle \gamma \rangle}$  does not depend on  $\gamma$  but only on its end points.

It is easy to check this defines a functor.

.QED.

**Corollary 5.** The following extend to functors:

- $\overrightarrow{\Pi}_1$  with values in **Diag**(**Set**),

- $\overrightarrow{\Pi}_2$  with values in  $\mathbf{Diag}(\mathbf{Gr})$ ,
- $\overrightarrow{\Pi}_n$  for  $n \geq 2$  with values in  $\mathbf{Diag}(\mathbf{Ab})$ ,
- $\overrightarrow{NH}_n$  and  $\overrightarrow{BH}_n$  for every  $n$ , with values in  $\mathbf{Diag}(\mathbf{Mod}(\mathcal{R}))$ .

### 6.5.2 (Co)completeness and additivity axiom

Let us look at the limits and the colimits of  $\mathbf{Diag}(\mathcal{M})$ . First, as it is well known [Mac Lane 1978],  $\mathbf{Cat}$  is complete. If  $\mathcal{C}$  is a small category and  $F : \mathcal{C} \rightarrow \mathbf{Cat}$  a diagram in  $\mathbf{Cat}$ , the limit of  $F$  is the category  $\mathbf{Lim}(F)$  whose:

- objects are the families  $(x_c)_{c \in \mathbf{Ob}(\mathcal{C})}$  where  $x_c \in \mathbf{Ob}(F(c))$  and for every morphism  $f : c \rightarrow c'$  of  $\mathcal{C}$ ,  $F(f)(x_c) = x_{c'}$ ,
- morphisms from  $(x_c)_{c \in \mathbf{Ob}(\mathcal{C})}$  to  $(y_c)_{c \in \mathbf{Ob}(\mathcal{C})}$  are the families  $(g_c)_{c \in \mathbf{Ob}(\mathcal{C})}$  where  $g_c : x_c \rightarrow y_c$  and for every morphism  $f : c \rightarrow c'$  of  $\mathcal{C}$ ,  $F(f)(g_c) = g_{c'}$ ,
- composition  $(h_c)_{c \in \mathbf{Ob}(\mathcal{C})} \circ (g_c)_{c \in \mathbf{Ob}(\mathcal{C})}$  is  $(h_c \circ g_c)_{c \in \mathbf{Ob}(\mathcal{C})}$ ,
- the identity of  $(x_c)_{c \in \mathbf{Ob}(\mathcal{C})}$  is  $(\text{id}_{x_c})_{c \in \mathbf{Ob}(\mathcal{C})}$ .

together with the projection functors.

A functor from  $\mathcal{C}$  to  $\mathcal{M}$  will be called a  $\mathcal{C}$ -**diagram** of  $\mathcal{M}$ . We say that a category  $\mathcal{M}$  has  $\mathcal{C}$ -**limits** if every  $\mathcal{C}$ -diagram of  $\mathcal{M}$  has a limit.

**Proposition 14.** *Let  $\mathcal{C}$  be a small category. If  $\mathcal{M}$  has  $\mathcal{C}$ -limits then  $\mathbf{Diag}(\mathcal{M})$  has  $\mathcal{C}$ -limits.*

*Proof.* Suppose that  $\mathcal{M}$  has  $\mathcal{C}$ -limits. Let  $F : \mathcal{C} \rightarrow \mathbf{Diag}(\mathcal{M})$ .  $F$  induces a  $\mathcal{C}$ -diagram in  $\mathbf{Cat}$   $G_F : \mathcal{C} \rightarrow \mathbf{Cat}$  as follow:

- $G_F(c)$  is the domain of  $F(c)$ ,
- $G_F(f)$  is the first component of  $F(f)$ .

As  $\mathbf{Cat}$  is complete,  $G_F$  has a limit  $(\mathbf{Lim}(G_F), \pi_c : \mathbf{Lim}(G_F) \rightarrow G(c))$ . Now, the limit of  $F$  is the functor  $\mathbf{Lim}(F) : \mathbf{Lim}(G_F) \rightarrow \mathcal{M}$  such that:

- $\mathbf{Lim}(F)((x_c)_{c \in \mathbf{Ob}(\mathcal{C})})$  is the limit of the functor which maps
  - \* every  $c \in \mathbf{Ob}(\mathcal{C})$  to  $F(c)(x_c)$ ,
  - \* every  $f : c \rightarrow c'$  of  $\mathcal{C}$  to the component of  $x_c$  in the second component of  $F(f)$  (which is a natural transformation).

Such a limit exists because  $\mathcal{M}$  has  $\mathcal{C}$ -limits.

- $\mathbf{Lim}(F)((g_c)_{c \in \mathbf{Ob}(\mathcal{C})})$  (where  $g_c : x_c \rightarrow y_c$ ) is the unique morphism of  $\mathcal{M}$  defined below. As  $\mathbf{Lim}(F)((y_c)_{c \in \mathbf{Ob}(\mathcal{C})})$  is a limit in  $\mathcal{M}$ , it makes every such diagram:

$$\begin{array}{ccc}
 \mathbf{Lim}(F)((x_d)_d) & \overset{\exists!}{\dashrightarrow} & \mathbf{Lim}(F)((y_d)_d) \\
 \downarrow & & \downarrow \\
 F(c)(x_c) & \xrightarrow{F(c)(g_c)} & F(c)(y_c)
 \end{array}$$

commutative, together with the projection maps

$$(\pi_c, (\sigma_{c,(x_d)_d})_{(x_d)_d \in \text{Ob}(\text{Lim}(G_F))}) : \text{Lim}(F) \longrightarrow F(c)$$

where  $\sigma_{c,(x_d)_d} : \text{Lim}(F)((x_d)_d) \longrightarrow F(c)(x_c)$  is the projection map coming from the fact that  $\text{Lim}(F)((x_d)_d)$  is a limit.

.QED.

**Corollary 6.** *If  $\mathcal{M}$  is complete then  $\mathbf{Diag}(\mathcal{M})$  is complete.*

We have a similar result for colimits.

**Proposition 15.** *If  $\mathcal{M}$  is cocomplete then  $\mathbf{Diag}(\mathcal{M})$  is cocomplete.*

The colimits are very technical but follow the same ideas as for the limits: compute the colimit in  $\mathbf{Cat}$  and then construct a diagram on this colimit using colimits in  $\mathcal{M}$ . The main difference is that the latter colimits are not colimits of  $\mathcal{C}$ -diagrams much as in limits and are much more complicated. We will not prove this result, our only interest here are coproducts for the additivity axiom. Those are really simple:

**Proposition 16.**  *$\mathbf{Diag}(\mathcal{M})$  always has coproducts.*

Those coproducts are computed as follow. Given a family  $(F_i : \mathcal{C}_i \longrightarrow \mathcal{M})_{i \in I}$  of diagrams, its coproduct is the diagram whose:

- domain is the category which is the disjoint union of the  $\mathcal{C}_i$ ,
- the value of the functor of the  $i$ th component of the disjoint union is the value of  $F_i$ .

Recall now that the coproduct in  $\mathbf{dTop}$  is also the disjoint union. So if  $X = \sqcup X_i$  is a disjoint union of d-spaces, then  $\overrightarrow{T}(X)(a, b)$  is:

- $\emptyset$  if  $a$  and  $b$  are not in the same  $X_i$ ,
- $\overrightarrow{T}(X_i)(a, b)$  if  $a, b \in X_i$ .

Put another way, the trace category  $\overrightarrow{T}(X)$  is the disjoint union of the  $\overrightarrow{T}(X_i)$ . Consequently:

**Proposition 17 (Additivity axiom).**  $\overrightarrow{NT}, \overrightarrow{BT}, \overrightarrow{NH}_n$  and  $\overrightarrow{BH}_n$  preserve coproducts.

### 6.5.3 Null objects and dimension axioms

One reason why homology works so well is that it is with values in Abelian categories.  $\mathbf{Diag}(\mathcal{M})$  is (essentially) never Abelian: for example, an Abelian category is required to have a zero object, that is, an object which is both initial and final (for example, any trivial group in  $\mathbf{Ab}$ ). In  $\mathbf{Diag}(\mathcal{M})$ , the initial object is always the empty diagram. When  $\mathcal{M}$  has a initial object, the initial object of  $\mathbf{Diag}(\mathcal{M})$  is the diagram from  $\mathbf{1}$ , the category with one object and one morphism, to  $\mathcal{M}$ , which maps the only object of  $\mathbf{1}$  to the initial object of  $\mathcal{M}$ . Consequently, in this case, the initial and the final objects cannot coincide and  $\mathbf{Diag}(\mathcal{M})$  is not Abelian.

Nevertheless, when  $\mathcal{M}$  is Abelian (for example, if  $\mathcal{M} = \mathbf{Mod}(\mathcal{R})$ ), there are particular diagrams that looks like zero objects: the diagrams  $F : \mathcal{C} \longrightarrow \mathcal{M}$  such that for every object  $c$ ,  $F(c)$  is a zero object of  $\mathcal{M}$ . We will see later that they play the same role as a zero object in this case. We will call them **null diagrams**. In particular, the initial and the final objects of  $\mathbf{Diag}(\mathcal{M})$  are null. Consequently:

**Proposition 18 (Dimension axiom).** *For every  $n \neq 1$ ,  $\overrightarrow{NH}_n(*)$  and  $\overrightarrow{BH}_n(*)$  are final and so, null.*

### 6.5.4 Semi-exact categories and exact sequences

Among Eilenberg-Steenrod axioms, the exactness axiom, or more precisely, the more general statement that claims that homology must transform short exact sequences of chain complexes into long exact sequences is a purely algebraic statement, no topology is involved. For singular homology, this works because homology is defined as the homology of a chain complex in modules and that the category  $\mathbf{Mod}(\mathcal{R})$  is Abelian. Actually, it seems unavoidable to be in an Abelian category to even be able to talk about chain complexes, kernels, images, exact sequences, and so on. Since categories of diagrams are not Abelian in general, we should turn to non-Abelian theories. In the next few subsections, we will study the theory from [Grandis 1991a, Grandis 1991b] which turns out to be the framework that will allow us to look at the theory of exact sequences in diagrams.

Let  $\mathcal{A}$  be a category. An **ideal** of  $\mathcal{A}$  is a class of morphisms closed under left and right compositions by any morphism of  $\mathcal{A}$ . Let  $N$  be an ideal of  $\mathcal{A}$ . We call the morphisms in  $N$ , the **null morphisms**. A **null object** is an object of  $\mathcal{A}$  whose identity is null. We say that  $N$  is **closed** if every null morphism factorizes through a null object, i.e., for every  $f : a \rightarrow b \in N$ , there exists a null object  $c$  and two morphisms  $g : a \rightarrow c$  and  $h : c \rightarrow b$  such that  $f = h \circ g$ .

The class of linear maps which maps every element to zero is an ideal of  $\mathbf{Mod}(\mathcal{R})$ . In this case, the null objects are precisely the trivial modules. More generally, the class of morphisms which factorizes through a zero object of an Abelian category  $\mathcal{A}$  (those morphisms are called zero morphisms) is an ideal of  $\mathcal{A}$ . By definition, this ideal is closed. Given a category  $\mathcal{M}$  and an ideal  $N$  of  $\mathcal{M}$ , the class  $L_N$  of morphisms of diagrams  $(\Phi, \sigma) : F : \mathcal{C} \rightarrow \mathcal{M} \rightarrow G : \mathcal{D} \rightarrow \mathcal{M}$  such that for every  $c$  object of  $\mathcal{C}$ ,  $\sigma_c \in N$  is an ideal of  $\mathbf{Diag}(\mathcal{M})$ . The null objects are precisely the diagrams  $F : \mathcal{C} \rightarrow \mathcal{M}$  such that for every object  $c$ ,  $F(c)$  is a null object. In the case of  $\mathbf{Mod}(\mathcal{R})$  and the ideal of zero morphisms, those null objects are what we called null diagrams previously. Also in this case,  $L_N$  is closed since every null morphism from  $F : \mathcal{C} \rightarrow \mathbf{Mod}(\mathcal{R})$  to  $G : \mathcal{D} \rightarrow \mathbf{Mod}(\mathcal{R})$  factorizes through the diagram  $0_{\mathcal{D}} : \mathcal{D} \rightarrow \mathbf{Mod}(\mathcal{R})$  which maps every object of  $\mathcal{D}$  to the trivial module.

The **kernel** (with respect to  $N$ ) of a morphism  $f : a \rightarrow b$  of  $\mathcal{A}$  is (when it exists) the unique (up to isomorphism) morphism  $\ker f : \text{Ker } f \rightarrow a$  such that:

- $f \circ \ker f \in N$ ,
- for every  $g : c \rightarrow a$  such that  $f \circ g \in N$ , there exists a unique  $h : c \rightarrow \text{Ker } f$  such that  $g = \ker f \circ h$

We define dually, the **cokernel**  $\text{cok } f : b \rightarrow \text{Cok } f$ .

In the case of an Abelian category with its ideal of zero morphisms, kernels and cokernels exist and are given by the kernels and cokernels of the Abelian structure. They then are a special case of the following:

**Definition 13** ([Grandis 1991a]). A **semiexact category** is a pair  $(\mathcal{A}, N)$  where  $N$  is a closed ideal of the category  $\mathcal{A}$  such that every morphism of  $\mathcal{A}$  has a kernel and a cokernel with respect to  $N$ .

**Lemma 8.** *If  $(\mathcal{M}, N)$  is semi-exact then  $L_N$  is a closed ideal of  $\mathbf{Diag}(\mathcal{M})$  and  $\mathbf{Diag}(\mathcal{M})$  has kernels with respect to  $L_N$ .*

*Proof.*

- $L_N$  **is an ideal:** because  $N$  is.
- $L_N$  **closed:** we know by 3.7 of [Grandis 1991a] that in  $\mathcal{M}$ ,  $f : a \rightarrow b$  is null if and only if  $f$  factorizes through  $\ker \text{id}_b : \text{Ker } \text{id}_b \rightarrow b$  and we know that  $\text{Ker } \text{id}_b$  is a null object. So

if  $(\Phi, \sigma) : (F : \mathcal{C} \rightarrow \mathcal{M}) \rightarrow (G : \mathcal{D} \rightarrow \mathcal{M})$  is null then it factorizes through  $0_G$  where  $0_G : \mathcal{D} \rightarrow \mathcal{M}$  with  $0_G(d) = \text{Ker id}_{G(d)}$  and  $0_G(f) : 0_G(d) \rightarrow 0_G(d')$  the unique morphism which makes this square commutative:

$$\begin{array}{ccc} \text{Ker id}_{G(d)} & \xrightarrow{\text{ker id}_{G(d)}} & G(d) \\ 0_G(f) \downarrow & & \downarrow G(f) \\ \text{Ker id}_{G(d')} & \xrightarrow{\text{ker id}_{G(d')}} & G(d') \end{array}$$

coming from the universal property of  $\text{ker id}_{G(d')}$ . You may note that this construction coincides with  $0_{\mathcal{D}}$  defined in the case where  $\mathcal{M}$  is Abelian.

- **kernels:** if  $(\Phi, \sigma) : (F : \mathcal{C} \rightarrow \mathcal{M}) \rightarrow (G : \mathcal{D} \rightarrow \mathcal{M})$ , we construct its kernel:

$$(\Phi_{\text{ker}}, \sigma_{\text{ker}}) : (F_{\text{ker}} : \mathcal{C}_{\text{ker}} \rightarrow \mathcal{M}) \rightarrow (F : \mathcal{C} \rightarrow \mathcal{M})$$

as follow.

- $\mathcal{C}_{\text{ker}} = \mathcal{C}$ ,
- $\Phi_{\text{ker}} = \text{id}_{\mathcal{C}}$ ,
- $F_{\text{ker}} : \mathcal{C} \rightarrow \mathcal{M}$  with  $F_{\text{ker}}(c) = \text{Ker } \sigma_c$  and  $F_{\text{ker}}(f)$  the unique morphism which makes the left square commutative:

$$\begin{array}{ccccc} \text{Ker } \sigma_c & \xrightarrow{\text{ker } \sigma_c} & F(c) & \xrightarrow{\sigma_c} & G(\Phi(c)) \\ F_{\text{ker}}(f) \downarrow & & \downarrow F(f) & & \downarrow G(\Phi(f)) \\ \text{Ker } \sigma_{c'} & \xrightarrow{\text{ker } \sigma_{c'}} & F(c') & \xrightarrow{\sigma_{c'}} & G(\Phi(c')) \end{array}$$

coming from the universal property of  $\text{ker } \sigma_{c'}$ ,

- $(\sigma_{\text{ker}})_c = \text{ker } \sigma_c$ .

.QED.

One may be wondering why nothing was said about the cokernels: the thing is that they are much more complicated. Remember that kernels in  $\mathbf{Mod}(\mathcal{R})$  are actually equalizers and since the limits in  $\mathbf{Diag}(\mathbf{Mod}(\mathcal{R}))$  are computed levelwise, it is natural that kernels are computed levelwise, i.e., the kernel in diagrams is a diagram of kernels. Dually, cokernels in  $\mathbf{Mod}(\mathcal{R})$  are coequalizers, and remember that colimits are complicated in  $\mathbf{Diag}(\mathcal{M})$ , so it is expected that cokernels in  $\mathbf{Diag}(\mathcal{M})$  are complicated too.

**Lemma 9.** *Diag(Mod( $\mathcal{R}$ )) has cokernels with respect to  $L_N$ .*

*Proof.* If  $(\Phi, \sigma) : (F : \mathcal{C} \rightarrow \mathbf{Mod}(\mathcal{R})) \rightarrow (G : \mathcal{D} \rightarrow \mathbf{Mod}(\mathcal{R}))$ , we construct its cokernel:

$$(\Phi_{\text{cok}}, \sigma_{\text{cok}}) : (G : \mathcal{D} \rightarrow \mathbf{Mod}(\mathcal{R})) \rightarrow (G_{\text{cok}} : \mathcal{D}_{\text{cok}} \rightarrow \mathbf{Mod}(\mathcal{R}))$$

as follow:

- $\mathcal{D}_{\text{cok}} = \mathcal{D}$
- $\Phi_{\text{cok}} = \text{id}_{\mathcal{D}}$
- Let  $\Gamma = \{(R_d)_{d \in \text{Ob}(\mathcal{D})} \mid R_d \text{ submodule of } G(d) \text{ containing all the elements of } \text{Im } \sigma_c \text{ with } \Phi(c) = d \text{ and such that if } f : d \rightarrow d' \text{ then } G(f)(R_d) \subseteq R_{d'}\}$ .  $\Gamma$  contains  $(G(d))_{d \in \text{Ob}(\mathcal{D})}$  and is closed under intersection. Define then  $(H_d)_{d \in \text{Ob}(\mathcal{D})}$  as the intersection of all the elements of  $\Gamma$ . Then  $(H_d)_{d \in \text{Ob}(\mathcal{D})} \in \Gamma$ .  
We also define  $G_{\text{cok}} : \mathcal{D} \rightarrow \mathbf{Mod}(\mathcal{R})$  with  $G_{\text{cok}}(d) = G(d)/H_d$  and  $G_{\text{cok}}(f)([x]) = [G(f)(x)]$ . This is well defined because  $(H_d)_{d \in \text{Ob}(\mathcal{D})} \in \Gamma$ .
- $(\sigma_{\text{cok}})_d(x) = [x]$

Actually, this construction is the coequalizer of  $(\Phi, \sigma)$  and  $(\Phi, (0 : F(c) \rightarrow G(\Phi(c)))_{c \in \text{Ob}(\mathcal{C})})$ .  
*.QED.*

**Proposition 19.** *(Diag(Mod( $\mathcal{R}$ )),  $L_N$ ) is semi-exact.*

Being able to talk about null morphisms and (co)kernels, allows us to define exactness. The **image** of a morphism  $f$  is given by  $\text{im } f = \ker \text{cok } f$  (or  $\text{Im } f = \text{Ker } \text{cok } f$  for the corresponding object) and the **coimage** by  $\text{coim } f = \text{cok } \ker f$  (or  $\text{Coim } f = \text{Cok } \ker f$ ). The sequence

$$A \xrightarrow{f} B \xrightarrow{g} C$$

is said to be:

- **of order two** if  $g \circ f$  is a null morphism,
- **short exact** if  $f = \ker g$  and  $g = \text{cok } f$
- **exact** if  $\text{im } f = \ker g$ .

**Chain complexes** in a semi-exact category  $\mathcal{M}$  are defined the same way as in abelian groups requiring that the sequence of morphisms  $C_{n+1} \xrightarrow{\partial_{n+1}} C_n \xrightarrow{\partial_n} C_{n-1}$  be of order two for each  $n$  [Grandis 1991b]. A morphism of chain complexes  $(f_n)_n : (C_n, \partial_n) \rightarrow (C'_n, \partial'_n)$  is given by morphisms  $f_n : C_n \rightarrow C'_n$  such that  $\partial'_n \circ f_{n+1} = f_n \circ \partial_n$ . We denote this category by  $C_\bullet(\mathcal{M})$ . This category is also semi-exact (the null morphisms being families of null morphisms in  $\mathcal{M}$ ).

### 6.5.5 Homological categories and homology of diagrams

Now, to define homology of a chain complex in a certain category, we must be able to talk about sub-quotients as in the case of modules, i.e., if  $K \subseteq H \subseteq G$  are modules, we can define  $H/K$ . This is not the case in general, for example in groups even if  $H$  and  $K$  are normal sub-groups of  $G$ ,  $H/K$  may not define a group...

A morphism which is the kernel (resp. the cokernel) of a morphism will be called **anormal mono** (resp. **normal epi**). In Abelian category, normal monos (resp. normal epis) are all the monos (resp. all the epis). In the case of modules, monos are injections and epis are surjections.

**Proposition 20.** *Normal monos in (Diag( $\mathcal{M}$ ),  $L_N$ ) are the  $(\Phi, \sigma)$  where  $\Phi$  is an isofunctor (that is, a bijective-on-objects fully faithful functor, or an isomorphism in the category of small categories and functors) and every  $\sigma_c$  is a normal mono in  $(\mathcal{M}, N)$ . Normal epis in (Diag(Mod( $\mathcal{R}$ )),  $L_N$ ) are  $(\Phi, \sigma)$  where  $\Phi$  is an isofunctor and every  $\sigma_c$  is surjective.*

*Proof.* Consequence of the computation of kernels and cokernels.

.QED.

**Definition 14** ([Grandis 1991a]). We say that a morphism is **exact** if it factorizes as  $n \circ q$  with  $q$ , a normal epi and  $n$ , a normal mono. Given two monos  $m$  and  $n$ , we write  $m \geq n$  if there is a morphism  $k$  (that will be unique and monic) such that  $n = m \circ k$ .

A semi-exact category  $(\mathcal{A}, N)$  is said to be **homological** if:

- normal monos and normal epis are closed under composition,
- if  $m : b \rightarrow a$  is a normal mono and  $q : a \rightarrow c$  is a normal epi such that  $m \geq \ker q$  then  $q \circ m$  is exact.

In this case, if  $m : b \rightarrow a$  and  $n : c \rightarrow a$  are two normal monos with  $m \geq n$ , and if we write  $q$  for the unique normal epi (up to isomorphism) such that  $n = \ker q$ , the objects  $\text{Coim } q \circ m$  and  $\text{Im } q \circ m$  are isomorphic. We call this object the **sub-quotient** of  $a$  induced by  $m \geq n$ , and we denote it by  $b/c$ .

In an Abelian category, by the epi-mono factorization, every morphism is exact. So, every Abelian category is homological. In the case of modules, normal monos are exactly sub-modules and  $\geq$  is just the inclusion. So, the subquotient is really the quotient  $b/c$  of submodules of  $a$ .

**Proposition 21.** *Diag(Mod( $\mathcal{R}$ )) is homological.*

*Proof.*

- the normal monos (resp. epis) are closed under composition because those of  $\mathbf{Mod}(\mathcal{R})$  are.
- let  $(\Phi, \sigma) : (F : \mathcal{C} \rightarrow \mathbf{Mod}(\mathcal{R})) \rightarrow (G : \mathcal{D} \rightarrow \mathbf{Mod}(\mathcal{R}))$  be a normal mono. Thus  $\Phi$  is an isofunctor. As normal monos and normal epis are stable under composition with an isomorphism, we can suppose, without loss of generality, that  $\Phi = id_{\mathcal{C}}$  and  $\mathcal{D} = \mathcal{C}$ . The same way we can take  $(\Psi, \tau) : (G : \mathcal{C} \rightarrow \mathbf{Mod}(\mathcal{R})) \rightarrow (H : \mathcal{E} \rightarrow \mathbf{Mod}(\mathcal{R}))$  a normal epi with  $\Psi = id_{\mathcal{C}}$  and  $\mathcal{C} = \mathcal{E}$  and so,  $(\Psi, \tau) \circ (\Phi, \sigma) = (id_{\mathcal{C}}, (\tau_c \circ \sigma_c)_{c \in \text{Ob}(\mathcal{C})})$ .

In  $\mathbf{Mod}(\mathcal{R})$ ,  $\tau_c \circ \sigma_c = \iota_c \circ \eta_c$  where  $\eta_c = \tau_c \circ \sigma_c : F(c) \rightarrow \text{Im } \tau_c \circ \sigma_c$  which is surjective and  $\iota_c : \text{Im } \tau_c \circ \sigma_c \rightarrow H(c)$  the inclusion, which is injective. Since  $(\eta_c)_{c \in \text{Ob}(\mathcal{C})}$  and  $(\iota_c)_{c \in \text{Ob}(\mathcal{C})}$  are natural and so  $(id_{\mathcal{C}}, \eta)$  is a normal epi,  $(id_{\mathcal{C}}, \iota)$  is a normal mono and  $(\Psi, \tau) \circ (\Phi, \sigma) = (id_{\mathcal{C}}, \iota) \circ (id_{\mathcal{C}}, \eta)$ .

.QED.

Consequently, in  $\mathbf{Diag}(\mathbf{Mod}(\mathcal{R}))$ , normal monos are (up to isomorphisms) diagrams of submodules,  $\geq$  is just the inclusion of submodules levelwise, and subquotient is just levelwise subquotient.

With the subquotients, the kernels and the images, it is possible to define homology in a homological category:

**Definition 15** ([Grandis 1991b]). For a chain complex  $C = (C_n, \partial_n)$ :

- $Z_n(C) = \text{Ker } \partial_{n-1}$
- $B_n(C) = \text{Im } \partial_n$
- $H_n(C) = Z_n(C)/B_n(C)$

and those constructions are functorial.

As we have seen, homology modules of a space are defined as the homology modules of the singular chain complex. We can do the same with our directed homology. Define  $\overrightarrow{BC} : \mathbf{dTop} \rightarrow \mathbf{Diag}(C_\bullet(\mathbf{Mod}(\mathcal{R})))$  composing  $\overrightarrow{BT}$  with the functor  $C$  which associate every space with its singular chain complex. Similarly, we can define  $\overrightarrow{NC} : \mathbf{dTop} \rightarrow \mathbf{Diag}(C_\bullet(\mathbf{Mod}(\mathcal{R})))$ , using  $\overrightarrow{NT}$  instead. Diagrams in chain complexes can be seen as chain complexes in diagrams, so we can assume that  $\overrightarrow{BC}$  and  $\overrightarrow{NC}$  take values in  $C_\bullet(\mathbf{Diag}(\mathbf{Mod}(\mathcal{R})))$ . We can then apply  $H_n$  functors:

**Proposition 22.** *For every  $n \leq 0$ ,  $H_n \circ \overrightarrow{BC} = \overrightarrow{BH}_{n+1}$  and  $H_n \circ \overrightarrow{NC} = \overrightarrow{NH}_{n+1}$ .*

### 6.5.6 About modularity and the exactness axiom

The result in Abelian category on transformations of short exact sequences in chain complexes into long sequences on homology can be extended in homological categories:

**Theorem 21** ([Grandis 1991b]). *Let  $\mathcal{M}$  be a homological category. For every short exact sequence in  $C_\bullet(\mathcal{M})$ :*

$$U \xrightarrow{m} V \xrightarrow{p} W$$

there exists a sequence of order two in  $\mathcal{M}$ :

$$\dots \longrightarrow H_n(V) \xrightarrow{H_n(p)} H_n(W) \xrightarrow{\partial_n} H_{n-1}(U) \xrightarrow{H_{n-1}(m)} H_{n-1}(V) \longrightarrow \dots$$

which is natural in the short exact sequence.

Moreover, [Grandis 1991b] gives some conditions for this sequence to be exact. In particular, those conditions are always satisfied iff  $\mathcal{M}$  is **modular**.

Let us explain what modularity means in the case of diagrams. A **normal subobject** of  $F : \mathcal{C} \rightarrow \mathbf{Mod}(\mathcal{R})$  is a morphism of the form  $(id_{\mathcal{C}}, \sigma)$  where every  $\sigma_c$  is an inclusion into  $F(c)$ . The set of all normal subobjects of  $F$  is a lattice whose order is inclusion, meet is intersection, join is union,  $\perp$  is  $\sigma_c = 0$  and  $\top$  is  $id_{F(c)}$ . Moreover, it is a modular lattice, in the sense that if  $X \leq B$  then  $X \vee (A \wedge B) = (X \vee A) \wedge B$ . We denote this lattice by  $Nsb(F)$ . If  $f : F \rightarrow G$  is a morphism in  $\mathbf{Diag}(\mathbf{Mod}(\mathcal{R}))$ , we can define a Galois connection  $(f_*, f^*)$  where:

- $f_* : Nsb(F) \rightarrow Nsb(G)$  with  $f_*(m) = \text{Im } f \circ m$ .
- $f^* : Nsb(G) \rightarrow Nsb(F)$  with  $f^*(n) = \text{Ker } ((\text{cok } n) \circ f)$ .

The condition of modularity can be expressed as every morphism  $f : F \rightarrow G$  satisfies:

- 1) for every  $x \in Nsb(F)$ ,  $f^* \circ f_*(x) = x \vee f^*(\perp)$ .
- 2) for every  $y \in Nsb(G)$ ,  $f_* \circ f^*(y) = y \wedge f_*(\top)$ .

**Proposition 23.** *In  $\mathbf{Diag}(\mathbf{Mod}(\mathcal{R}))$ , 1) and 2) fail and so  $\mathbf{Diag}(\mathbf{Mod}(\mathcal{M}))$  is not modular, meaning there some long sequences in homology that are not exact.*

*Proof.*

- 1) Let:



- $F$  the functor from the discrete category  $\mathbf{2}$  with two objects to  $\mathbf{Mod}(\mathcal{R})$  which sends every object to  $\mathcal{R}$ ,
- $G$  the functor from the discrete category  $\mathbf{1}$  with one object to  $\mathbf{Mod}(\mathcal{R})$  which sends this object to  $\mathcal{R}$ ,
- $f : F \rightarrow G$  the morphism  $(\Phi, \sigma)$  where  $\Phi$  sends every object of  $\mathbf{2}$  to the unique object of  $\mathbf{1}$  and  $\sigma$  is the natural transformation from  $F$  to  $G \circ \Phi$  which is only composed of identities,
- $x$  the normal subobject of  $F$  which is the functor from  $\mathbf{2}$  to  $\mathbf{Mod}(\mathcal{R})$  which sends one object to 0 and the other to  $\mathcal{R}$ .

In this case,

$$x \vee f^*(\perp) = x \neq F = f^* \circ f_*(x).$$

2) Let:

- $F$  the functor from  $\mathbf{1}$  to  $\mathbf{Mod}(\mathcal{R})$  which this object to  $\mathcal{R}$ ,
- $G$  the functor from the category  $\mathbf{2}'$  with two objects  $\{a, b\}$  and one non-identity morphism which goes from  $a$  to  $b$ , to  $\mathbf{Mod}(\mathcal{R})$  which sends each object to  $\mathcal{R}$  and the morphism to identity,
- $f : F \rightarrow G$  the morphism  $(\Phi, \sigma)$  where  $\Phi$  sends the unique object of  $\mathbf{1}$  to  $a$  and  $\sigma$  is the natural transformation from  $F$  to  $G \circ \Phi$  which is only composed of identities,
- $y$  the normal subobject of  $G$  which is the functor from  $\mathbf{2}'$  to  $\mathbf{Mod}(\mathcal{R})$  which sends  $a$  to 0,  $b$  to  $\mathcal{R}$  and the morphism to 0.

In this case,

$$y \wedge f_*(\top) = y \neq 0_G = f_* \circ f^*(y).$$

where  $0_G : \mathbf{2}' \rightarrow \mathbf{Mod}(\mathcal{R})$  which maps each object to 0 and the morphism to 0.

*.QED.*

### 6.5.7 About relative homology and short exact sequences

Finally, let us talk about relative homology now. We have seen that relative homology is defined as the homology of the quotient  $C(X)/C(A)$ , that is, as the cokernel of the inclusion  $C(A) \hookrightarrow C(X)$ . Since, in modules, normal monos are precisely injections, the sequence  $C(A) \rightarrow C(X) \rightarrow C(X)/C(A)$  is short exact and so produces a long exact sequence in homology. In the case of d-spaces and diagrams, the inclusion  $\iota : \overrightarrow{BC}(A) \rightarrow \overrightarrow{BC}(X)$  is not a normal mono. So one can still look at the cokernel of  $\iota$  and define  $\overrightarrow{BC}(X)/\overrightarrow{BC}(A) = \text{Cok } \iota$ , but the sequence

$$\overrightarrow{BC}(A) \xrightarrow{\iota} \overrightarrow{BC}(X) \xrightarrow{\text{cok } \iota} \overrightarrow{BC}(X)/\overrightarrow{BC}(A)$$

is not short exact. The reason is that the cokernel in diagrams is defined as a quotient, but we quotient possibly more than what is given by the injection of  $\iota$ . Intuitively, we expect that for object  $(a, b)$  of  $\mathcal{E}(\overrightarrow{T}(X))$ , the value of the functor  $\overrightarrow{BC}(X)/\overrightarrow{BC}(A)$  on  $(a, b)$  to be somehow  $C(\overrightarrow{T}(X)(a, b))/C(\overrightarrow{T}(A)(a, b))$ . This is not the case and what we obtain is  $C(\overrightarrow{T}(X)(a, b))/M_{a,b}$  where  $M_{a,b,n}$  is the free module generated by the triples  $(\langle \alpha \rangle, \sigma, \langle \beta \rangle)$  where  $\alpha$  is a dipath in  $X$  from  $a$  to  $a'$ ,  $\beta$  is a dipath in  $X$  from  $b'$  to  $b$  and  $\sigma \in C(\overrightarrow{T}(A)(a', b'))_n$ . The idea is that we do not quotient by singular simplexes of traces inside  $A$  but by singular simplexes of traces that goes through  $A$  at

some point. So, if we define  $\overrightarrow{BC}(A \subseteq X)$  as  $\text{Ker cok } \iota$ , that is the chain complex in  $\mathbf{Diag}(\mathbf{Mod}(\mathcal{R}))$  such that  $\overrightarrow{BC}(A \subseteq X)_n$  from  $\mathcal{E}(\overrightarrow{T}(X))$  to  $\mathbf{Diag}(C_\bullet(\mathbf{Mod}(\mathcal{R})))$  whose value on  $(a, b)$  is  $M_{a,b}$  defined above, then the following sequence:

$$\overrightarrow{BC}(A \subseteq X) \xrightarrow{\text{ker cok } \iota} \overrightarrow{BC}(X) \xrightarrow{\text{cok } \iota} \overrightarrow{BC}(X)/\overrightarrow{BC}(A)$$

is short exact.

## Conclusion and discussion

In this chapter, we have described two homology theories for d-spaces. They both follow the same idea: we look at trace spaces and how they evolve by extending traces. The only difference is the description of the evolution, which leads to either a natural system when evolution is describe by traces and the category of factorizations, or a bimodule when evolution is describe by pairs of points and the enveloping category. We thus have a homology theory with values in diagrams in modules. This category of diagrams is not abelian, and we thus cannot use the work on exact sequences directly. However, we have seen that this category is homological in Grandis' sense, and so we can develop a non-abelian theory of exact sequences, although not as nice as in the abelian case.

A natural question now is what about the homotopy axiom. The first kind we could think about follows this idea: in classical algebraic topology, we have seen that a homotopy equivalence induces isomorphisms in homology. Actually, this result can be strengthened [Hatcher 2002]: a weak homotopy equivalence (continuous function that induces isomorphisms in homotopy groups) induces isomorphisms in homology. A direct extension of this result in our case would be: if for a  $\text{dimap } f : X \rightarrow Y$ ,  $\overrightarrow{\Pi}_n(f) : \overrightarrow{\Pi}_n(X) \rightarrow \overrightarrow{\Pi}_n(Y)$  is an isomorphism for every  $n$ , then  $\overrightarrow{NH}_n(f) : \overrightarrow{NH}_n(X) \rightarrow \overrightarrow{NH}_n(Y)$  is an isomorphism for every  $n$ . The problem with this statement is that the hypothesis is very strong. Since the category  $\overrightarrow{T}(X)$  keeps lots of information about  $X$ , an  $f$  such that  $\overrightarrow{\Pi}_n(f)$  is an isomorphism is not that far from dihomeomorphism. The thing is that we did not explain yet how we will compare diagrams. What we just said means that isomorphism in  $\mathbf{Diag}(\mathcal{M})$  is not a nice way to compare diagrams of homology. Remember that we are interested in how the trace spaces evolve with time, and so we must design an equivalence that compares those diagrams following this idea.



# Bisimulations of diagrams

---

We have seen in the previous chapter that small diagrams with values in  $\mathcal{R}$ -modules are of particular interest. Nevertheless, comparing them up to isomorphisms, i.e., morphisms  $(\phi, \sigma)$  where  $\phi$  is an isofunctor and  $\sigma$  is a natural isomorphism, is too strong for our study of directed spaces. Indeed, the category of factorizations of the trace category contains too much information about the space. The idea would be that we want to compare homology (or homotopy) diagrams in such a way that two d-spaces have equivalent natural homology if the evolution of those diagrams with time are similar. This idea is similar to bisimulation in transition systems: systems are equivalent if they have similar evolutions of executions. We will formalize this idea using a particular instance of the fibrational views of bisimilarity evoked in section 1.2.4. We will derive several equivalent characterizations of this bisimilarity, following the different view evoked in this same section: relational definition (Section 1.2.1) and logical definition (Section 1.2.3). We will also see another characterization using an extension of the Grothendieck's construction which will have no particular interest, except to relate diagrams up to bisimulations and the partially enriched categories seen in Chapter 5. Finally, in Section 7.6, we will look at decidability questions of this bisimilarity and of the diagrammatic logic. This will use an existential theory of matrices in the reals or in the rationals both of which can be reduced to the existential theory of the reals.

## 7.1 Fibrational bisimilarity for diagrams

We recall first that, in the general formalism from [Joyal 1996], one must start with a category  $\mathcal{M}$  (of **models**) together with a subcategory  $\mathcal{P}$  (of **execution forms**). In our case, we will start with the category  $\mathbf{IsoDiag}(\mathcal{A})$  of small diagrams in a category  $\mathcal{A}$  and whose morphisms are pairs  $(\Phi, \sigma)$  where  $\Phi$  is a functor and  $\sigma$  is a natural isomorphism. The difference with  $\mathbf{Diag}(\mathcal{A})$  from the previous chapter is the fact that the natural transformation must be an isomorphism. For every  $n \in \mathbb{N}$ , let  $[n] = \{0, 1, \dots, n-1\}$ , and let  $i_{mn} : [m] \rightarrow [n]$  be the inclusion map, for  $m \leq n$ . As a poset,  $[n]$  is a category, and  $i_{mn}$  is then a functor. Consider the subcategory  $\mathcal{P} \subseteq \mathbf{IsoDiag}(\mathcal{A})$  whose objects are functors  $F : [n] \rightarrow \mathcal{A}$  and whose morphisms from  $H : [m] \rightarrow \mathcal{A}$  to  $F : [n] \rightarrow \mathcal{A}$  are of the form  $(i_{mn}, id)$ .  $\mathbf{IsoDiag}(\mathcal{A})$  and  $\mathcal{P}$  have a common initial object: the empty diagram. We can actually simplify the definition of open morphisms in this case:

**Lemma 10.** *A morphism  $(\Phi, \sigma) : (F : \mathcal{C} \rightarrow \mathcal{A}) \rightarrow (G : \mathcal{D} \rightarrow \mathcal{A}) \in \mathbf{IsoDiag}(\mathcal{A})$  is open iff it has the right lifting property with respect to  $(i_{n,n+1}, id)$  for all  $n \in \mathbb{N}$ .*

*Proof.*

$\Rightarrow$  by definition of open maps.

$\Leftarrow$  we show that it has the right lifting property with respect to  $i_{n,m}$ , using the fact that

$$i_{n,m} = i_{m-1,m} \circ \dots \circ i_{n,n+1}.$$

.QED.

**Proposition 24.** *A morphism  $(\Phi, \sigma) : (F : \mathcal{C} \rightarrow \mathcal{A}) \rightarrow (G : \mathcal{D} \rightarrow \mathcal{A}) \in \text{IsoDiag}(\mathcal{A})$  is open iff it has the right lifting property with respect to  $(i_{0,1}, id)$  and  $(i_{1,2}, id)$ , i.e., iff:*

- $\Phi$  is surjective on objects,
- for every morphism  $j : d \rightarrow d'$  of  $\mathcal{D}$  and every  $c$  of  $\mathcal{C}$  such that  $\Phi(c) = d$  there exists  $i : c \rightarrow c'$  such that  $\Phi(i) = j$ .

*Proof.*

$\Rightarrow$  by definition of open maps

$\Leftarrow$  Let us show that  $(\Phi, \sigma)$  has the right lifting property with respect to  $i_{n,n+1}$ . The case 0 is by hypothesis. Assume  $n \geq 1$  and given a commutative diagram:

$$\begin{array}{ccccc} P : [n] & \rightarrow & \mathcal{A} & \xrightarrow{(p, \rho)} & F : \mathcal{C} \rightarrow \mathcal{A} \\ (i_{n,n+1}, id) \downarrow & & & & \downarrow (\Phi, \sigma) \\ Q : [n+1] & \rightarrow & \mathcal{A} & \xrightarrow{(q, \eta)} & G : \mathcal{D} \rightarrow \mathcal{A} \end{array}$$

We want  $(r, \theta)$  such that:

$$\begin{array}{ccccc} P : [n] & \rightarrow & \mathcal{A} & \xrightarrow{(p, \rho)} & F : \mathcal{C} \rightarrow \mathcal{A} \\ (i_{n,n+1}, id) \downarrow & & & \nearrow (r, \theta) & \downarrow (\Phi, \sigma) \\ Q : [n+1] & \rightarrow & \mathcal{A} & \xrightarrow{(q, \eta)} & G : \mathcal{D} \rightarrow \mathcal{A} \end{array}$$

$r : [n+1] \rightarrow \mathcal{C}$  is constructed as follow:

- for  $0 \leq i \leq n-1$ ,  $r(i) = p(i)$  and for all  $j \leq i$ ,  $r(j \leq i) = p(j \leq i)$ ,
- it remains to construct  $r(n-1 \leq n)$  (which will determine  $r(n)$ ). We know that  $q(n-1 \leq n) : q(n-1) \rightarrow q(n)$  and that  $q(n-1) = \Phi(p(n-1))$ . Thus by the second property of  $\Phi$ , there exists a morphism  $i : p(n-1) = r(n-1) \rightarrow c$  of  $\mathcal{C}$  such that  $\Phi(i) = q(n-1 \leq n)$ . We pose  $r(n-1 \leq n) = i$ .

By construction  $p = r \circ i_{n,n+1}$  and  $\Phi \circ r = q$ .

$\theta = (\theta_i)_{0 \leq i \leq n} : Q \rightarrow F \circ r$  is defined as  $\sigma^{-1} \circ \eta$ . Consequently, it is natural isomorphism and  $\sigma \circ \theta = \eta$ . It remains to prove that  $\theta \circ id = \rho$ , i.e., for every  $0 \leq i \leq n-1$ ,  $\theta_i = \rho_i$ , which is true since they are both equal to  $\sigma_{q(i)}^{-1} \circ \eta_i$ .

.QED.

Let us look at some examples. First, as we will prove later, the morphism  $(\kappa_{\mathcal{C}}, id)$  from  $\overrightarrow{NH}_n(X)$  to  $\overrightarrow{BH}_n(X)$  defined in Section 6.4 is always an open map, which explains why they can be used equivalently. Now, recall the first natural system of homology of  $a+b$  in figure 7.1 left. As we will prove later, there is a always a finite diagram that is bisimilar to  $\overrightarrow{NH}_n(X)$  when  $X$  is nice enough.

Such a diagram is given in figure 7.1 right, and a open map from  $\overrightarrow{NH}_1(a+b)$  to this finite diagram is depicted by the color on this same figure 7.1.

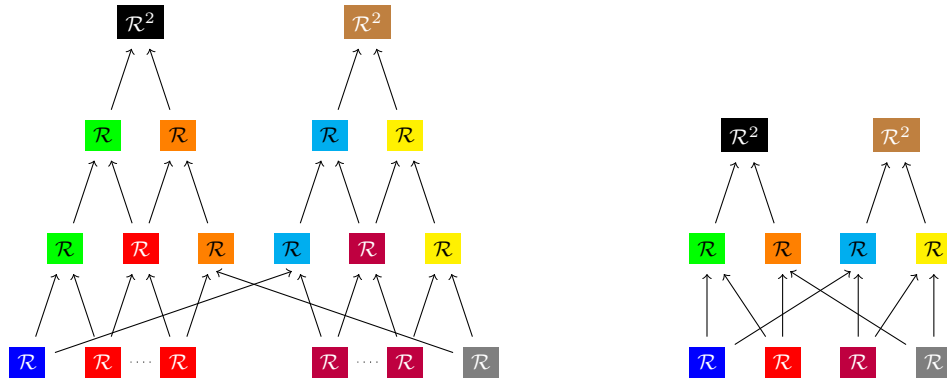

Figure 7.1: Example of an open map for the first natural system of homology of  $a + b$

## 7.2 Relational definition

We now turn to a more classical characterization of bisimulation for our diagrams, that relates to theoretical computer science and concurrency theory :

**Definition 16.** A bisimulation  $R$  between two diagrams  $F : \mathcal{C} \rightarrow \mathcal{A}$  and  $G : \mathcal{D} \rightarrow \mathcal{A}$  is a set of triples  $(c, f, d)$  where  $c$  is an object of  $\mathcal{C}$ ,  $d$  is an object of  $\mathcal{D}$  and  $f : F(c) \rightarrow G(d)$  is an isomorphism of  $\mathcal{A}$  such that for all  $(c, f, d)$  in  $R$ :

- if there exists  $i : c \rightarrow c' \in \mathcal{C}$  then there exists  $j : d \rightarrow d' \in \mathcal{D}$  and  $g : F(c') \rightarrow G(d') \in \mathcal{A}$  such that  $g \circ F(i) = G(j) \circ f$  and  $(c', g, d') \in R$ ,

$$\begin{array}{ccccc}
 c & F(c) & \xrightarrow{f} & G(d) & d \\
 i \downarrow & F(i) \downarrow & & G(j) \downarrow & j \downarrow \\
 c' & F(c') & \xrightarrow{g} & G(d') & d'
 \end{array}$$

- if there exists  $j : d \rightarrow d' \in \mathcal{D}$  then there exists  $i : c \rightarrow c' \in \mathcal{C}$  and  $g : F(c') \rightarrow G(d') \in \mathcal{A}$  such that  $g \circ F(i) = G(j) \circ f$  and  $(c', g, d') \in R$ ,

$$\begin{array}{ccccc}
 c & F(c) & \xrightarrow{f} & G(d) & d \\
 i \downarrow & F(i) \downarrow & & G(j) \downarrow & j \downarrow \\
 c' & F(c') & \xrightarrow{g} & G(d') & d'
 \end{array}$$

and such that:

- for all  $c \in \mathcal{C}$ , there exists  $d$  and  $f$  such that  $(c, f, d) \in R$ ,
- for all  $d \in \mathcal{D}$ , there exists  $c$  and  $f$  such that  $(c, f, s) \in R$ .

**Proposition 25.** *Two functors  $F : \mathcal{C} \rightarrow \mathcal{M}$  and  $G : \mathcal{D} \rightarrow \mathcal{M}$  are bisimilar iff there exists a bisimulation between them.*

*Proof.*

$\Rightarrow$  Assume that there is a span:

$$\begin{array}{ccc} & H : \mathcal{E} \longrightarrow \mathcal{A} & \\ & \begin{array}{c} \swarrow (\Phi, \sigma) \quad \searrow (\Psi, \tau) \\ \end{array} & \\ F : \mathcal{C} \longrightarrow \mathcal{A} & & G : \mathcal{D} \longrightarrow \mathcal{A} \end{array}$$

of open maps. We define  $R = \{(\Phi(e), \tau_e \circ \sigma_{\Phi(e)}^{-1}, \Psi_e) \mid e \in \mathcal{E}\}$  and show that this is a bisimulation. First, it is well defined because  $\tau$  and  $\sigma$  are isomorphisms. The third condition of a bisimulation comes from the surjectivity of  $\Phi$ . Idem for the fourth and the surjectivity of  $\Psi$ . The first condition comes from the second condition on  $\Phi$  of an open map: let  $(\Phi(e), \tau_e \circ \sigma_{\Phi(e)}^{-1}, \Psi_e)$  in  $R$  and  $i : \Phi(e) \rightarrow c' \in \mathcal{C}$ . By the condition on  $\Phi$  there exists  $k : e \rightarrow e'$  in  $\mathcal{E}$  such that  $\Phi(k) = i$ . Then define  $j = \Psi(k)$ ,  $d' = \Psi(e')$  and  $g = \tau_{e'} \circ \sigma_{\Phi(e')}^{-1}$ .  $(\Phi(e'), g, d')$  belongs to  $R$  by construction and  $g \circ F(i) = G(j) \circ \tau_e \circ \sigma_{\Phi(e)}^{-1}$  by naturality of  $\sigma$  and  $\tau$ . Idem for the second condition of a bisimulation.

$\Leftarrow$  Assume now that there is a bisimulation  $R$  between  $F$  and  $G$ . We will construct a span of open maps. Let  $\mathcal{E}$  be the small category whose objects are elements of  $R$ , and whose morphisms from  $(c, f, d)$  to  $(c', f', d')$  are pairs  $(i, j)$  of a morphism  $i : c \rightarrow c'$  in  $\mathcal{C}$  and of a morphism  $j : d \rightarrow d'$  in  $\mathcal{D}$ , such that the following diagram commutes:

$$\begin{array}{ccc} F(c) & \xrightarrow{f} & G(d) \\ F(i) \downarrow & & \downarrow G(j) \\ F(c') & \xrightarrow{f'} & G(d') \end{array}$$

Define the tip  $H$  of the span between  $F$  and  $G$  as the functor  $H : \mathcal{E} \rightarrow \mathcal{A}$  that maps every object  $(c, f, d) \in R$  to  $F(c)$ , and every morphism  $(i, j) : (c, f, d) \rightarrow (c', f', d')$  to  $F(i) : F(c) \rightarrow F(c')$ .

We now build a morphism  $(\Phi, \sigma)$  from  $H$  to  $F$ . We start by building  $\Phi : \mathcal{E} \rightarrow \mathcal{C}$ . We define  $\Phi$  as the functor that maps every object  $(c, f, d)$  to  $c$  and every morphism  $(i, j) : (c, f, d) \rightarrow (c', f', d')$  to  $i : c \rightarrow c'$ . We verify that  $\Phi$  satisfies the condition of the previous proposition:

1.  $\Phi$  is surjective on objects: this is third condition of the definition of  $R$  as a bisimulation.
2. Let  $i : \Phi(e) \rightarrow c'$  be a morphism of  $X$ . The object  $e$  must be a triple  $(c, f, d) \in R$ , and  $i$  is a morphism from  $c$  to  $c'$  in  $\mathcal{C}$ . By the first condition of the definition of  $R$  as a bisimulation, there is a triple  $(c', f', d') \in R$  and a morphism  $j : d \rightarrow d'$  of  $\mathcal{D}$  such that the following diagram commutes:

$$\begin{array}{ccc}
F(c) & \xrightarrow{f} & G(d) \\
F(i) \downarrow & & \downarrow G(j) \\
F(c') & \xrightarrow{f'} & G(d')
\end{array}$$

In particular,  $(i, j)$  is a morphism of  $E$ , from  $(c, f, d)$  to  $(c', f', d')$ . Moreover,  $H(i, j) = i$ .

For every  $(c, f, d) \in R$ , let  $\sigma_{(c,f,d)} = id_{F(c)} : H(c, f, d) = F(c) \longrightarrow F \circ \Phi(c, f, d) = F(c)$ . Those are isomorphisms, and define a natural transformation  $\sigma : H \longrightarrow F \circ \Phi$ . It follows that  $(\Phi, \sigma)$  is an open map from  $H$  to  $F$ .

We define the open map  $(\Psi, \tau)$  from  $H$  to  $G$  similarly.

.QED.

### 7.3 Diagrammatic Hennessy-Milner logic

In this section, we prove a logical characterization using a logic similar to Hennessy-Milner logic from section 1.2.3.

**Definition 17** (Syntax).

**Object formulae:**  $S ::= [x]P \quad x \in Ob(\mathcal{A})$

**Morphism formulae:**  $P ::= \langle f \rangle P \mid ?S \mid \neg P \mid \bigwedge_{i \in I} P_i \quad f \in Mor(\mathcal{A})$  and  $I$  a set

In the following, we will denote by  $\top$  the empty conjunction, i.e.,  $\top = \bigwedge_{i \in \emptyset} P_i$ .

**Definition 18** (Semantics). For a diagram  $F : \mathcal{C} \longrightarrow \mathcal{A}$ , for every object  $c$  of  $\mathcal{C}$  and for every isomorphism  $f$  of  $\mathcal{A}$  of the form  $f : F(d) \longrightarrow x$  for some  $d$  and  $x$ , we define  $F, c \models S$  for an object formula  $S$  and  $F, f, d \models P$  for a morphism formula  $P$  by induction on  $S$  (resp.  $P$ ) as follow:

- $F, c \models [x]P$  iff there exists an isomorphism  $f : F(c) \longrightarrow x$  of  $\mathcal{A}$  such that  $F, f, c \models P$ ,
- $F, f, c \models \langle g \rangle P$  iff  $g : x \longrightarrow x'$  and there exists  $i : c \longrightarrow c'$  in  $\mathcal{C}$  and an isomorphism  $h : F(c') \longrightarrow x'$  such that  $h \circ F(i) = g \circ f$  and  $F, h, c' \models P$ ,

$$\begin{array}{ccc}
F(c) & \xrightarrow{F(i)} & F(c') \\
f \downarrow & & \downarrow h \\
x & \xrightarrow{g} & x'
\end{array}$$

- $F, f, c \models ?S$  iff  $F, c \models S$ ,
- $F, f, c \models \neg P$  iff  $F, f, c \not\models P$ ,
- $F, f, c \models \bigwedge_{i \in I} P_i$  iff for all  $i \in I$ ,  $F, f, c \models P_i$ .



We say that a diagram  $F : \mathcal{C} \rightarrow \mathcal{A}$  is **logically simulated** by another diagram  $G : \mathcal{D} \rightarrow \mathcal{A}$  if for every object  $c$  of  $\mathcal{C}$ , there exists an object  $d$  of  $\mathcal{D}$  such that for all object formulae  $S$ ,  $(F, c \models S \text{ iff } G, d \models S)$ . Two diagrams  $F$  and  $G$  are **logically equivalent** if  $F$  is logically simulated by  $G$  and  $G$  is logically simulated by  $F$ .

We note that logical equivalence is an equivalence relation between diagrams.

**Theorem 22.** *Two diagrams are bisimilar iff they are logically equivalent.*

*Proof.*

$\Rightarrow$  First, let us suppose that  $F$  and  $G$  are bisimilar. We can restrict to the case where there exists an open map  $(\Phi, \sigma) : F \rightarrow G$ , the general case ensuing.

We prove that:

1.  $(F, c \models S \Leftrightarrow G, \Phi(c) \models S)$  for all object formulae  $S$  and for all objects  $c$  of  $\mathcal{C}$ ,
2.  $(F, f, d \models P \Leftrightarrow G, f \circ \sigma_d^{-1}, \Phi(d) \models P)$  for all morphism formulae  $P$  and for all isomorphisms  $f : F(d) \rightarrow x$  of  $\mathcal{A}$ ,

by induction on  $S$  (resp.  $P$ ).

- ★ If  $F, c \models [x]P$  then there exists an isomorphism  $f : F(c) \rightarrow x$  of  $\mathcal{A}$  such that  $F, f, c \models P$ . By induction hypothesis,  $G, f \circ \sigma_c^{-1}, \Phi(c) \models P$  and so  $G, \Phi(c) \models [x]P$ . Conversely, if  $G, \Phi(c) \models [x]P$  then there exists an isomorphism  $f : G(\Phi(c)) \rightarrow x$  of  $\mathcal{A}$  such that  $G, f, \Phi(c) \models P$ . By induction hypothesis,  $F, f \circ \sigma_c, c \models P$  and so  $F, c \models [x]P$ .
- ★ If  $F, f, c \models \langle g \rangle P$  then there exists  $i : c \rightarrow c'$  in  $\mathcal{C}$  and an isomorphism  $h : F(c') \rightarrow x'$  such that  $h \circ F(i) = g \circ f$  and  $F, h, c' \models P$ .

$$\begin{array}{ccc}
 F(c) & \xrightarrow{\quad F(i) \quad} & F(c') \\
 f \downarrow & & \downarrow h \\
 x & \xrightarrow{\quad g \quad} & x'
 \end{array}$$

By induction hypothesis,  $G, h \circ \sigma_{c'}^{-1}, \Phi(c') \models P$ . By naturality of  $\sigma$  :

$$\begin{array}{ccc}
 G(\Phi(c)) & \xrightarrow{\quad G(\Phi(i)) \quad} & G(\Phi(c')) \\
 \sigma_c^{-1} \downarrow & & \downarrow \sigma_{c'}^{-1} \\
 F(c) & \xrightarrow{\quad F(i) \quad} & F(c') \\
 f \downarrow & & \downarrow h \\
 x & \xrightarrow{\quad g \quad} & x'
 \end{array}$$

So  $G, f \circ \sigma_c^{-1}, \Phi(c) \models \langle g \rangle P$ .

Conversely, if  $G, f \circ \sigma_c^{-1}, \Phi(c) \models \langle g \rangle P$  then there exists  $j : \Phi(c) \rightarrow d'$  in  $\mathcal{D}$  and an isomorphism  $h : G(d') \rightarrow x'$  such that  $h \circ G(j) = g \circ f \circ \sigma_c^{-1}$  and  $G, h, d' \models P$ .

$$\begin{array}{ccc}
G(\Phi(c)) & \xrightarrow{\quad G(j) \quad} & G(d') \\
\sigma_c^{-1} \downarrow & & \downarrow h \\
F(c) & & \\
f \downarrow & & \\
x & \xrightarrow{\quad g \quad} & x'
\end{array}$$

As  $(\Phi, \sigma)$  is open, there exists  $i : c \rightarrow c'$  in  $\mathcal{C}$  such that  $\Phi(i) = j$  and  $\Phi(c') = d'$ . So  $G, h, \Phi(c') \models P$  and by induction hypothesis,  $F, h \circ \sigma_{c'}, c' \models P$ . Moreover, by naturality of  $\sigma$  :

$$\begin{array}{ccc}
G(\Phi(c)) & \xrightarrow{\quad G(\Phi(i)) \quad} & G(\Phi(c')) \\
\sigma_c^{-1} \downarrow & & \downarrow \sigma_{c'}^{-1} \\
F(c) & \xrightarrow{\quad F(i) \quad} & F(c') \\
f \downarrow & & \downarrow h \circ \sigma_{c'} \\
x & \xrightarrow{\quad g \quad} & x'
\end{array}$$

So,  $F, f, c \models \langle g \rangle P$ .

- ★  $F, f, c \models ?S$  iff  $F, c \models S$  iff  $G, \Phi(c) \models S$  iff  $G, f \circ \sigma_c^{-1}, \Phi(c) \models ?S$
- ★  $F, f, c \models \neg P$  iff  $F, f, c \not\models P$  iff  $G, f \circ \sigma_c^{-1}, \Phi(c) \not\models P$  iff  $G, f \circ \sigma_c^{-1}, \Phi(c) \models \neg P$
- ★  $F, f, c \models \bigwedge_{i \in I} P_i$  iff for all  $i \in I$ ,  $F, f, c \models P_i$  iff for all  $i \in I$ ,  $G, f \circ \sigma_c^{-1}, \Phi(c) \models P_i$  iff  $G, f \circ \sigma_c^{-1}, \Phi(c) \models \bigwedge_{i \in I} P_i$

From this and the surjectivity of  $\Phi$ , we deduce the result.

⇐ Conversely, suppose that  $F$  and  $G$  are logically equivalent. Define the relation:

$$\begin{aligned}
R = \{ & (c, f, d) \mid \forall S, (F, c \models S \Leftrightarrow G, d \models S), f : F(c) \rightarrow G(d) \text{ iso s.t.} \\
& f = h_2^{-1} \circ h_1 \text{ with } h_1, h_2 \text{ isos and } \forall P, (F, h_1, c \models P \Leftrightarrow G, h_2, d \models P) \}
\end{aligned}$$

We prove that  $R$  is a bisimulation:

- ★ Let  $c$  be an object of  $\mathcal{C}$ . We exhibit an object  $d$  of  $\mathcal{D}$  and an isomorphism  $f : F(c) \rightarrow G(d)$  such that  $(c, f, d) \in R$ . Let  $d$  such that for all object formulae  $S$ ,  $F, c \models S \Leftrightarrow G, d \models S$  (there exists at least one such a  $d$  by the hypothesis). Let :

$$Z = \{h \mid h : G(d) \rightarrow F(c) \text{ iso}\}$$

$Z$  is non empty :  $F, c \models [F(c)]\top$  because  $id_{F(c)} : F(c) \rightarrow F(c)$  is an iso. So,  $G, d \models [F(c)]\top$  and there exists an isomorphism  $h : G(d) \rightarrow F(c)$ .

Now, assume that there is no  $h \in Z$  such that for all path formulae  $F, id_{F(c)}, c \models P$  iff  $G, h, d \models P$ . Then for all  $h \in Z$ , let  $P_h$  be a formula such that  $F, id_{F(c)}, c \models P_h$  and  $G, h, d \not\models P_h$  (we can always assume that we are in this case because we have negation).

Then  $F, c \models [F(c)] \bigwedge_{h \in Z} P_h$  and  $G, d \not\models [F(c)] \bigwedge_{h \in Z} P_h$  which is absurd. So there is an isomorphism  $h : G(d) \rightarrow F(c)$  such that for all morphism formulae  $P$ ,  $F, id_{F(c)}, c \models P$  iff  $G, h, d \models P$ . Then  $(c, h^{-1}, d) \in R$ .

★ Assume that we have :

$$\begin{array}{ccccc}
 c' & & F(c') & & \\
 \uparrow & & \uparrow & & \\
 i & & F(i) & & \\
 \uparrow & & \uparrow & & \\
 c & & F(c) & \xrightarrow{h_1} & x & \xleftarrow{h_2} & G(d) & & d
 \end{array}$$

with  $h_1, h_2$  isos and for all morphism formulae  $P$ ,  $F, h_1, c \models P$  iff  $G, h_2, d \models P$  (that is  $(c, h_2^{-1} \circ h_1, d) \in R$ ). First, this diagram is commutative :

$$\begin{array}{ccc}
 F(c') & \xrightarrow{id} & F(c') \\
 \uparrow F(i) & & \uparrow F(i) \circ h_1^{-1} \\
 F(c) & \xrightarrow{h_1} & x
 \end{array}$$

so  $F, h_1, c \models \langle F(i) \circ h_1^{-1} \rangle \top$  and then  $G, h_2, d \models \langle F(i) \circ h_1^{-1} \rangle \top$ . So, the set :

$$Z = \{(h, j) \mid j : d \rightarrow d', h : G(d') \rightarrow F(c') \text{ iso such that } F(i) \circ h_1^{-1} \circ h_2 = h \circ G(j)\}$$

is non empty. Assume that there is no  $(h, j) \in Z$  such that for all morphism formulae  $P$ ,  $F, id_{F(c')}, c' \models P$  iff  $G, h, d' \models P$ . Then, for all  $(h, j) \in Z$ , let  $P_{(h,j)}$  be a path formula such that  $F, id_{F(c')}, c' \models P_{(h,j)}$  and  $G, h, d' \not\models P_{(h,j)}$ . Then,  $F, h_1, c \models \langle F(i) \circ h_1^{-1} \rangle \bigwedge_{(h,j) \in Z} P_{(h,j)}$

and  $G, h_2, d \not\models \langle F(i) \circ h_1^{-1} \rangle \bigwedge_{(h,j) \in Z} P_{(h,j)}$  which is absurd. So there are  $h$  and  $j$  such that :

$$\begin{array}{ccccccc}
 c' & & F(c') & \xrightarrow{id_{F(c')}} & F(c') & \xleftarrow{h} & G(d') & & d' \\
 \uparrow & & \uparrow & & \uparrow & & \uparrow & & \uparrow \\
 i & & F(i) & & F(i) \circ h_1^{-1} & & G(j) & & j \\
 \uparrow & & \uparrow & & \uparrow & & \uparrow & & \uparrow \\
 c & & F(c) & \xrightarrow{h_1} & x & \xleftarrow{h_2} & G(d) & & d
 \end{array}$$

and for all morphism formulae  $P$ ,  $F, id_{F(c')}, c' \models P$  iff  $G, h, d' \models P$ . In particular, for all object formulae  $S$ ,  $F, id_{F(c')}, c' \models ?S$  iff  $G, h, d' \models ?S$  i.e.  $F, c' \models S$  iff  $G, d' \models S$  and so  $(c', h^{-1}, d') \in R$ .

★ the other two conditions are symmetric.

.QED.

## 7.4 Unfolding and po-diagrams

In the previous chapter, we have seen that diagrams whose underlying category is a pre-order (the  $\overrightarrow{NH}_n(X)$  for example) were of particular interest. In this section, we prove that up to an operation of unfolding, everything can be made in those diagrams.

More precisely, by a **po-diagram** we will mean a diagram  $F : \mathcal{C} \longrightarrow \mathcal{A}$  such that  $\mathcal{C}$  is a preorder, i.e., a category whose Hom-sets are either empty, or a singleton. We denote by **PoDiag**( $\mathcal{A}$ ) the full subcategory of **IsoDiag**( $\mathcal{A}$ ) consisting of po-diagrams.

We will first prove that a diagram is always bisimilar to a po-diagram, namely its **unfolding**. Given a diagram  $F : \mathcal{C} \longrightarrow \mathcal{A}$ , define its **unfolding** as the diagram  $\text{Unf}(F) : \text{Unf}(\mathcal{C}) \longrightarrow \mathcal{A}$  such that:

- the objects of  $\text{Unf}(\mathcal{C})$  are non-empty finite sequences  $(f_1, \dots, f_n)$  of composable morphisms of  $\mathcal{C}$ , i.e., domain of  $f_i = \text{codomain of } f_{i-1}$ ,
- the set of morphisms of  $\text{Unf}(\mathcal{C})$  from  $(f_1, \dots, f_n)$  to  $(g_1, \dots, g_p)$  is  $\{(g_{n+1}, \dots, g_p)\}$  if  $n \leq p$  and for all  $i \leq n$ ,  $f_i = g_i$ , and is empty otherwise,
- composition of  $\text{Unf}(\mathcal{C})$  is concatenation,
- identities of  $\text{Unf}(\mathcal{C})$  are empty sequences,
- $\text{Unf}(F)(f_1, \dots, f_n) = F(c)$  where  $c$  is the codomain of  $f_n$ ,
- $\text{Unf}(F)(g_{n+1}, \dots, g_p) = F(g_p \circ \dots \circ g_{n+1})$ .

From a more abstract viewpoint, the unfolding can be seen as follow: recall that  $\mathcal{P}$  is the subcategory of **IsoDiag**( $\mathcal{A}$ ) consisting of diagrams of the form  $B : [n] \longrightarrow \mathcal{A}$ . Consider the category  $\mathcal{P} \downarrow F$ , i.e.:

- whose objects are morphisms of the form  $(\Phi, id) : (B : [n] \longrightarrow \mathcal{A}) \longrightarrow F$  for some  $B : [n] \longrightarrow \mathcal{A} \in \mathcal{P}$ ,
- morphisms from  $(\Phi, \sigma) : (B : [n] \longrightarrow \mathcal{A}) \longrightarrow F$  to  $(\Phi', \sigma') : (B' : [n'] \longrightarrow \mathcal{A}) \longrightarrow F$  are morphisms  $i_{n,m} : (B : [n] \longrightarrow \mathcal{A}) \longrightarrow (B' : [n'] \longrightarrow \mathcal{A})$  such that  $(\Phi', \sigma') \circ i_{n,m} = (\Phi, \sigma)$ .

Formally,  $\mathcal{P} \downarrow F$  is not a comma category since we only consider morphisms  $(\Phi, id)$ , i.e., whose second component is a natural transformation consisting of identities. There is a functor  $\mathcal{U} : \mathcal{P} \downarrow F \longrightarrow \mathbf{IsoDiag}(\mathcal{A})$  which maps  $(\Phi, \sigma) : (B : [n] \longrightarrow \mathcal{A}) \longrightarrow F$  to  $B : [n] \longrightarrow \mathcal{A}$ . Then  $\text{Unf}(F)$  is the colimit of  $\mathcal{U}$ . The idea is similar to Chapter 3.  $\mathcal{P} \downarrow F$  can be seen as the category of finite sequences  $(f_1, \dots, f_n)$  of composable morphisms of  $\mathcal{C}$  and the unfolding is just a glueing of all those data.

**Lemma 11.**

- i) For all  $F$ ,  $\text{Unf}(F)$  is well defined and is a po-diagram.
- ii)  $\text{Unf}(F)$  extends to a functor  $\text{Unf} : \mathbf{IsoDiag}(\mathcal{A}) \longrightarrow \mathbf{PoDiag}(\mathcal{A})$ .
- iii)  $\text{Unf}$  preserves open maps, i.e., if  $(\Phi, \sigma)$  is an open map then so is  $\text{Unf}(\Phi, \sigma)$ .

*Proof.*

- i) Easy.

ii) Given a morphism of diagrams  $(\Phi, \sigma)$  from  $F : \mathcal{C} \rightarrow \mathcal{A}$  to  $G : \mathcal{D} \rightarrow \mathcal{A}$ , we define  $\text{Unf}(\Phi, \sigma) = (\text{Unf}(\Phi), \text{Unf}(\sigma))$  with:

- $\text{Unf}(\Phi)(f_1, \dots, f_n) = (\Phi(f_1), \dots, \Phi(f_n))$ ,
- $\text{Unf}(\sigma)_{(f_1, \dots, f_n)} = \sigma_{\text{codom}(f_n)} : F(\text{codom}(f_n)) \rightarrow G \circ \Phi(\text{codom}(f_n))$ .

It is easy to check that  $\text{Unf}(\Phi)$  is a functor. Naturality of  $\text{Unf}(\sigma)$  comes from the naturality of  $\sigma$ .

iii) Now assume that  $(\Phi, \sigma)$  is open.

- **surjectivity on objects:** Let  $(g_1, \dots, g_n)$  be a non-empty finite sequence of composable morphisms of  $\mathcal{D}$ . By surjectivity on objects of  $\Phi$ , there is an object  $c_0$ , of  $\mathcal{C}$  such that  $\Phi(c_0) = \text{dom}(g_1)$ . Then by the lifting property of  $\Phi$ , there is a morphism  $f_1 : c_0 \rightarrow c_1$  of  $\mathcal{C}$  such that  $\Phi(f_1) = g_1$ . We have  $\text{dom}(g_2) = \text{codom}(g_1) = c_1$  so by the lifting property of  $\Phi$  there is a morphism  $f_2$  such that... By induction, we construct a non-empty finite sequence of composable morphisms of  $\mathcal{C}$  such that for all  $i$ ,  $g_i = \Phi(f_i)$  and so  $\text{Unf}(\Phi)(f_1, \dots, f_n) = (g_1, \dots, g_n)$ .
- **lifting property:** the proof is the same as the previous point.
- **$\text{Unf}(\sigma)$  is a natural isomorphism:** because  $\sigma$  is.

.QED.

**Proposition 26.** *If we denote the injection by  $\iota : \mathbf{PoDiag}(\mathcal{A}) \rightarrow \mathbf{IsoDiag}(\mathcal{A})$ , there is a natural transformation  $\mu : \iota \circ \text{Unf} \rightarrow \text{id}_{\mathbf{IsoDiag}(\mathcal{A})}$  such that for all  $F$ ,  $\mu_F$  is an open map. In particular,  $F$  and  $\text{Unf}(\iota)F$  are bisimilar.*

One should remark that, nevertheless,  $\text{Unf}$  is not a right adjoint of  $\iota$ .

*Proof.* Let  $F : \mathcal{C} \rightarrow \mathcal{A}$  be a diagram. We construct  $\mu_F = (\Phi_F, \text{id}) : \text{Unf}(F) \rightarrow F$  as follow:

- $\Phi_F(f_1, \dots, f_n) = \text{codom}(f_n)$
- $\Phi_F(g_{n+1}, \dots, g_p) = g_p \circ \dots \circ g_{n+1}$

So,  $\text{Unf}(\iota)F = F \circ \Phi_F$ . Then:

- **surjectivity on objects:**  $\Phi_F(\text{id}_c) = c$ ,
- **lifting property:** if we have a morphism  $f : \text{codom}(f_n) \rightarrow c$  then  $(f)$  is a morphism from  $(f_1, \dots, f_n)$  to  $(f_1, \dots, f_n, f)$  such that  $\Phi_F(f) = f$ ,
- **$\text{id}$  is a natural isomorphism:** OK.

Naturality of  $\mu$  is easy.

.QED.

**Corollary 7.** *Two diagrams  $F$  and  $G$  are bisimilar iff there are a po-diagram  $H$  and a span of open maps  $F \leftarrow H \rightarrow G$ .*

*Proof.* If there is a span of open maps  $F \xleftarrow{(\Phi, \sigma)} H \xrightarrow{(\Psi, \tau)} G$ , then  $F \xleftarrow{(\Phi, \sigma) \circ \mu_H} \text{Unf}(H) \xrightarrow{(\Psi, \tau) \circ \mu_H} G$  is also a span of open maps since  $\mu_H$  is open and open maps are closed under composition. Moreover  $\text{Unf}(H)$  is a po-diagram. .QED.

## 7.5 Grothendieck construction of a po-diagram

From now on, we will consider that  $\mathcal{A}$  is a category of  $\mathcal{R}$ -modules for some ring  $\mathcal{R}$ .

### 7.5.1 Grothendieck construction of a po-diagram in modules

The Grothendieck construction (see for example [Johnstone 2002]) is a formal construction which maps any functor  $F : \mathcal{C} \rightarrow \mathbf{Cat}$  from any small category  $\mathcal{C}$  to the category of small categories to a category  $\int F$ , which is intuitively its category of elements. More precisely,  $\int F$  is the category whose:

- objects are couples  $(c, x)$  with  $c$  an object of  $\mathcal{C}$  and  $x$  an object of  $F(c)$ ,
- morphisms from  $(c, x)$  to  $(d, y)$  are couples  $(f, g)$  with  $f : c \rightarrow d$  a morphism of  $\mathcal{C}$  and  $g : F(f)(x) \rightarrow y$  morphism of  $F(d)$ ,
- the identity of  $(c, x)$  is  $(id_c, id_x)$ ,
- composition is defined by  $(f, g) \circ (f', g') = (f \circ f', g \circ F(f)(g'))$ .

When  $F : \mathcal{C} \rightarrow \mathcal{A}$ ,  $F$  can be seen as a functor  $F : \mathcal{C} \rightarrow \mathbf{Cat}$ : a module being an abelian group for the additive structure, it can be seen as a category with one object. So we can apply the Grothendieck construction on such a functor. When  $\mathcal{C}$  is a poset the definition simplifies greatly as follow.  $\int F$  is the category whose:

- objects are the objects of  $\mathcal{C}$ ,
- morphisms from  $c$  to  $d$ , with  $c \leq d$ , are the elements of  $F(d)$ ,
- the identity of  $c$  is  $0_{F(c)}$ ,
- composition is defined by: for every  $g' \in F(d)$  and  $g \in F(e)$  with  $c \leq d \leq e$ ,  $g \circ g' = g + F(d \leq e)(g')$ .

By construction, Hom-sets have a structure of  $\mathcal{R}$ -modules. A stronger statement is the following:

**Proposition 27.** *When  $F : \mathcal{C} \rightarrow \mathcal{A}$  is a po-diagram,  $\int F$  has the structure of a partially enriched category in  $\mathcal{A}$ .*

*Proof.* First, we must prove that the composition is bilinear:

$$\begin{aligned} (\alpha.g_1 + \beta.g_2) \circ (\alpha.g'_1 + \beta.g'_2) &= \alpha.g_1 + \beta.g_2 + F(d \leq e)(\alpha.g'_1 + \beta.g'_2) \\ &= \alpha.(g_1 + F(d \leq e)(g'_1)) + \beta.(g_2 + F(d \leq e)(g'_2)) = \alpha.(g_1 \circ g'_1) + \beta.(g_2 \circ g'_2) \end{aligned}$$

Next, we must prove the axioms of a partially enriched category from section 5.2.3:

– (unit) can be expressed as: for all  $g \in F(d)$ ,

$$g + F(c \leq d)(0) = g = F(d \leq d)(g) + 0$$

which is true because  $F(d \leq d) = id$  since  $F$  is a functor and  $F(c \leq d)(0) = 0$  since  $F(c \leq d)$  is a morphism of groups.

– (associativity) can be expressed as for all  $g \in F(d)$ ,  $g' \in F(e)$  and  $g'' \in F(f)$ :

$$\begin{aligned} F(e \leq f)(F(d \leq e)(g) + g') + g'' &= \\ F(e \leq f)(F(d \leq e)(g)) + F(e \leq f)(g') + g'' &= \\ F(d \leq f)(g) + F(e \leq f)(g') + g'' & \end{aligned}$$

.QED.

**Lemma 12.**  $\int$  extends to a functor  $\int : \mathbf{PoDiag}(\mathcal{A}) \longrightarrow \mathbf{PeCat}(\mathcal{A})$ .

*Proof.* If  $(\Phi, \sigma)$  is a morphism of po-diagrams from  $F : \mathcal{C} \longrightarrow \mathcal{A}$  to  $G : \mathcal{D} \longrightarrow \mathcal{A}$ , we define a partially enriched functor  $\int(\Phi, \sigma)$  from  $\int F$  to  $\int G$  as follow:

- the monotonous function part is  $\Phi$ ,
- for  $c \leq c'$ ,  $\int(\Phi, \sigma)_{c,c'} : F(c) \longrightarrow G(\Phi(c'))$  is  $\sigma_{c'}$ .

The first axiom of partially enriched functor comes from the naturality of  $\sigma$  and the second is trivial. .QED.

### 7.5.2 Extending equivalence of categories to partially enriched categories

We have seen in section 5.2.3 a notion of weak equivalences of partially enriched categories coming from the theory of model structures. Partially enriched categories being extensions of enriched categories and so of categories, there is another natural way to define that two partially enriched categories are equivalent by extending the notion of equivalence of categories. Usually, we say that two categories  $\mathcal{C}$  and  $\mathcal{D}$  are **equivalent** if there are two functors  $F : \mathcal{C} \longrightarrow \mathcal{D}$  and  $G : \mathcal{D} \longrightarrow \mathcal{C}$  and two natural isomorphisms  $\sigma : F \circ G \longrightarrow id_{\mathcal{D}}$  and  $\tau : G \circ F \longrightarrow id_{\mathcal{C}}$ . This definition is equivalent (modulo the axiom of choice) to the fact that there is a functor  $F : \mathcal{C} \longrightarrow \mathcal{D}$  which is:

- **fully faithful:** for every objects  $c, c'$  of  $\mathcal{C}$ , the fonction  $F_{c,c'} : \mathcal{C}(c, c') \longrightarrow \mathcal{D}(F(c), F(c'))$  is a bijection,
- **essentially surjective:** for every object  $d$  of  $\mathcal{D}$ , there are an object  $c$  of  $\mathcal{C}$  and an isomorphism from  $F(c)$  to  $d$ .

Equivalence of categories is extended to the enriched case by enriching either of the above equivalent characterization. In our case of partial enrichment, generalizing those definitions goes wrong for two reasons. First, because of partiality, natural transformations have no nice extensions. Secondly, already in the enriched case, this definition has a weird behavior in some cases. For example, when enriching in modules, essential surjectivity (or the existence of natural isomorphisms) becomes trivial, since neutral elements of the Hom-objects are always isomorphisms. For these reasons, we will not consider those characterizations but the following one:

**Proposition 28.** *Two categories  $\mathcal{C}$  and  $\mathcal{D}$  are equivalent iff there is a span  $\mathcal{C} \xleftarrow{F} \mathcal{E} \xrightarrow{G} \mathcal{D}$  of functors which are:*

- *fully faithful,*
- *surjective on objects.*

The main point is that we do not talk about isomorphisms of  $\mathcal{C}$  and  $\mathcal{D}$  anymore.

*Proof.*

$\Leftarrow$  Obvious because surjectivity implies essential surjectivity.

$\Rightarrow$  Suppose that there is a fully faithful and essentially surjective functor  $F : \mathcal{C} \rightarrow \mathcal{D}$ . Let  $\mathcal{E}$  be the category whose:

- ★ objects are tuples  $(c, \theta, \eta, d)$  which satisfies the requirement of essential surjectivity, i.e.,  $\theta : F(c) \rightarrow d$  is inverse of  $\eta : d \rightarrow F(c)$ ,
- ★ the Hom-set  $\mathcal{E}((c, \theta, \eta, d), (c', \theta', \eta', d'))$  is  $\mathcal{C}(c, c')$ ,
- ★ compositions and identities are those of  $\mathcal{C}$ .

Let  $F_{\mathcal{C}} : \mathcal{E} \rightarrow \mathcal{C}$  be the functor such that:

- ★  $F_{\mathcal{C}}(c, \theta, \eta, d) = c$ ,
- ★  $F_{\mathcal{C}}((c, \theta, \eta, d), (c', \theta', \eta', d')) : \mathcal{E}((c, \theta, \eta, d), (c', \theta', \eta', d')) \rightarrow \mathcal{C}(c, c')$  is  $id_{\mathcal{C}(c, c')}$ .

It is fully faithful (obvious) and surjective because  $(c, id_{F(c)}, id_{F(c)}, F(c))$  is an object of  $\mathcal{E}$ .

Let  $F_{\mathcal{D}} : \mathcal{E} \rightarrow \mathcal{D}$  be the functor such that:

- ★  $F_{\mathcal{D}}(c, \theta, \eta, d) = d$ ,
- ★  $F_{\mathcal{D}}((c, \theta, \eta, d), (c', \theta', \eta', d')) : \mathcal{E}((c, \theta, \eta, d), (c', \theta', \eta', d')) \rightarrow \mathcal{D}(d, d')$  is the function

$$f \mapsto \theta' \circ F_{c, c'}(f) \circ \eta$$

which is a bijection with inverse  $g \mapsto F_{c, c'}^{-1}(\eta' \circ g \circ \theta)$ .

It is fully faithful because  $F$  is and surjective because  $F$  is essentially surjective.

.QED.

**Definition 19.** We say that a partially enriched functor  $F : \mathcal{E} \rightarrow \mathcal{C}$  is:

- **fully-faithful** if for every pair  $e \leq e'$  in  $\mathcal{E}$ ,  $F_{e, e'} : \mathcal{E}(e, e') \rightarrow \mathcal{C}(F(e), F(e'))$  is an isomorphism,
- **surjective** if  $F : \text{Ob}(\mathcal{E}) \rightarrow \text{Ob}(\mathcal{C})$  is surjective,
- **fibrational** if for every  $e \in \text{Ob}(\mathcal{E})$  and  $c \in \text{Ob}(\mathcal{C})$  such that  $F(e) \leq c$  there is  $e'$  such that  $e \leq e'$  and  $F(e') = c$ .

We call **strong equivalence** any partially enriched functor which is fully-faithful, surjective and fibrational. We say that two partially enriched categories are **equivalent** if there is a span of strong equivalences between them.

The last condition may seem a bit weird, but it is very important. Without the fibrational condition, this equivalence would be a bit trivial: taking a suitable  $\mathcal{E}$  whose domain is equality would make equivalent two partially enriched categories which have the same endomorphisms. Moreover, the strong equivalences between two enriched categories (seen as partially enriched categories) are exactly the fully-faithful surjective enriched functors between them.

The following result was easy in the non-enriched case because of the several equivalent formulations, but now it must be proved:



**Proposition 29.** *Equivalence of partially enriched categories is an equivalence relation.*

*Proof.* Reflexivity and symmetry are obvious. The only interesting part is transitivity, i.e., assume that we have four strong equivalences as follow:

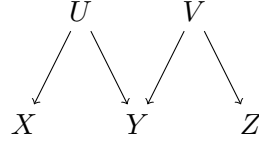

then we must construct two strong equivalences as follow:

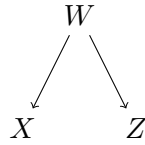

As strong equivalences are closed by composition, it is enough to prove the following. Assume that we have two strong equivalences as follow:

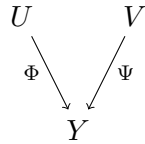

then we must construct two other strong equivalences as follow:

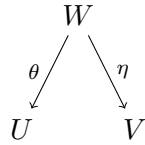

Construct the partially enriched category  $W$  whose:

- objects are pairs of  $(u, v)$  with  $u$  object of  $U$  and  $v$  object of  $V$  such that  $\Phi(u) = \Psi(v)$ ,
- its domain is  $(u, v) \leq (u', v')$  iff  $u \leq u'$  and  $v \leq v'$ ,
- Hom-object  $W((u, v), (u', v')) = Y(\Phi(u), \Phi(u')) = Y(\Psi(v), \Psi(v'))$  (well defined for  $u \leq u'$  and  $v \leq v'$ );
- compositions and identities are those of  $Y$ .

Define the partially enriched functor  $\theta : W \rightarrow U$  such that:

- $\theta(u, v) = u$ ,
- $\theta_{(u,v),(u',v')} : Y(\Phi(u), \Phi(u')) \rightarrow U(u, u') = \Phi_{u,u'}^{-1}$ .

It is a strong equivalence:

- **fully-faithful** obvious,
- **surjective**  $\theta$  is surjective because  $\Psi$  is,

- **fibrational** given  $u \leq u'$  and  $v$  such that  $\Phi(u) = \Psi(v)$ , then  $\Psi(v) = \Phi(u) \leq \Phi(u')$  and as  $\Psi$  is fibrational, there is  $v'$  such that  $v \leq v'$  and  $\Psi(v') = \Phi(u')$  that is  $(u', v')$  is an object of  $W$ ,  $\theta(u', v') = u'$  and  $(u, v) \leq (u', v')$ .

We construct a strong equivalence  $\eta : W \rightarrow V$  the same way.

.QED.

### 7.5.3 Relating bisimulation and equivalence of Grothendieck construction

First, we prove that the Grothendieck construction sends open morphism to equivalences:

**Proposition 30.** *If  $(\Phi, \sigma)$  is an open morphism between po-diagrams, then  $\int(\Phi, \sigma)$  is a strong equivalence. Consequently, if two po-diagrams are bisimilar, then their Grothendieck constructions are equivalent.*

*Proof.* Assume that  $(\Phi, \sigma)$  is open between po-diagrams. Let us prove that  $\int(\Phi, \sigma)$  is a strong equivalence:

- **surjectivity:** comes from the surjectivity on  $\Phi$ .
- **fibrationality:** comes from the lifting property of  $\Phi$ .
- **fully-faithful:** comes from the fact that  $\sigma$  is a natural isomorphism.

If two po-diagrams are bisimilar, then there is span of open morphisms whose tip is also a po-diagram. Then we deduce the result by applying the functor  $\int$ . .QED.

Reciprocally, we would like to prove that if the Grothendieck constructions of two po-diagram are equivalent, then they are bisimilar. It is done as follow: assume that  $F : \mathcal{C} \rightarrow \mathcal{A}$  and  $G : \mathcal{D} \rightarrow \mathcal{A}$  are two po-diagrams and that there is a span of strong equivalences  $\int F \xleftarrow{K} \mathcal{M} \xrightarrow{L} \int G$ , where  $\mathcal{M}$  is partially enriched category on  $\mathcal{A}$ . Let us start by constructing a diagram  $H : \mathcal{E} \rightarrow \mathcal{A}$  from  $\mathcal{M}$  as follow:

- $\mathcal{E}$  is the set  $\{(e, e') \mid e, e' \in \text{Ob}(\mathcal{M}) \wedge e \leq e'\}$  equipped with the preorder  $(e, e') \sqsubseteq (e'', e''')$  iff  $e = e''$  and  $e' \leq e'''$ ,
- $H(e, e') = \mathcal{M}(e, e')$ ,
- $H((e, e') \sqsubseteq (e, e'')) : \mathcal{M}(e, e') \rightarrow \mathcal{M}(e, e'')$  is the morphism of groups that maps  $g \in \mathcal{M}(e, e')$  to  $\circ_{e, e', e''}(g, 0_{\mathcal{M}(e', e'')})$ .

Let us prove that this is a functor:

- $H((e, e') \leq (e, e'))(g) = \circ_{e, e', e'}(g, 0_{\mathcal{M}(e', e')})$   
 $= \circ_{e, e', e'}(g, u_{e'}(0)) = g$  by (unit).
- $H((e, e'') \leq (e, e''')) \circ H((e, e') \leq (e, e''))(g)$   
 $= H((e, e'') \leq (e, e'''))(\circ_{e, e', e''}(g, 0_{\mathcal{M}(e', e'')}))$   
 $= \circ_{e', e'', e'''}(\circ_{e, e', e''}(g, 0_{\mathcal{M}(e', e'')}), 0_{\mathcal{M}(e'', e''')})$   
 $= \circ_{e, e', e'''}(g, \circ_{e', e'', e'''}(0_{\mathcal{M}(e', e'')}, 0_{\mathcal{M}(e'', e''')}))$  by (associativity)  
 $= \circ_{e, e', e'''}(g, 0_{\mathcal{M}(e', e''')})$  because  $\circ_{e', e'', e'''}$  is a morphism of groups  
 $= H((e, e') \leq (e, e'''))(g)$ .

Let us define an open map  $(\Phi, \sigma)$  from  $H$  to  $F$  as follow:

- $\Phi(e, e') = K(e')$  (which is monotonous),
- for every  $e \leq e'$ ,  $\sigma_{(e, e')} : \mathcal{M}(e, e') \longrightarrow F(K(e')) = \int F(K(e), K(e'))$  is  $K_{e, e'}$

Let us prove that this is a well defined open map:

- **naturality of  $\sigma$** : it can be reformulated as for every  $e \leq e' \leq e''$ , for every  $g \in \mathcal{M}(e, e')$ ,  
 $K_{e, e'}(H((e, e') \leq (e, e''))(g)) = K_{e, e''}(\circ_{e, e', e''}(g, 0))$   
 $= \circ_{K(e), K(e'), K(e'')}(K_{e, e'}(g), K_{e, e''}(0))$  because  $K$  is a partially enriched functor  
 $= \circ_{K(e), K(e'), K(e'')}(K_{e, e'}(g), 0)$  because  $K_{e, e''}$  is a morphism of groups  
 $= F(e' \leq e'')(K_{e, e'}(g))$  by definition of the composition in  $\int F$ .
- **surjectivity**: comes from the surjectivity of  $K$ .
- **lifting property**: comes from the fibrational condition of  $K$ .
- **$\sigma$  natural isomorphism**: comes from the fully-faithfulness of  $K$ .

The same way, one can construct an open map from  $H$  to  $G$ . Consequently:

**Theorem 23.** *Two po-diagrams are bisimilar iff their Grothendieck constructions are equivalent. Two diagrams are bisimilar iff the Grothendieck construction of their unfoldings are equivalent.*

## 7.6 Decidability

The end of this chapter is dedicated to proving some decidability results on bisimilarity and diagrammatic logic in the case of modules, more particularly, in real and rational vector spaces. The main idea of those results will be to reduce our problems to the existence of some invertible matrices satisfying linear conditions. In the present section, we focus on an existential theory of matrices. We first recall the case of the existential theory of the reals, known to be decidable. We then introduce the existential theory of invertible matrices in  $\mathbb{R}$  and  $\mathbb{Q}$  and we prove the decidability of their satisfiability problems.

### 7.6.1 The existential theory of some rings

Designing algorithms for finding solutions of equations is a old problem in mathematics. The famous Hilbert's tenth problem posed the problem for polynomial equations in integers, but the question can be asked for other rings. Tarski in [Tarski 1951] solved this question for the reals: the first-order logic of real closed fields is decidable, although the solution being of non-elementary complexity. Improvement had been done: it was proved to be in EXPSPACE in [Ben-Or 1986] and that the existential theory of the reals is in PSPACE in [Canny 1988]. On the other hand, Matiyasevich's negative answer of the tenth problem, means that the existential theory of the integers is undecidable. In particular, since it is possible to express that a rational is an integer (using possibly universal quantifiers), the full first-order logic of the rationals is undecidable. However, it is still an open question whether its existential fragment is decidable or not.

### 7.6.2 Theory of matrices

In this section, we will consider a logic of matrices that will be expressible in the existential theory of the reals. It will be the main ingredient to decide some problems in diagrams with values in vector

spaces. Namely, we consider formulae of the form:

$$\exists_{n_1} X_1 \dots \exists_{n_k} X_k \cdot \bigwedge_{j=1}^m P_j(X_1, \dots, X_k)$$

where:

- $n_i \geq 0$ , is an integer,
- $P_j$  is a predicate of the form  $A.X_i = X_j.B$  for some  $i, j$  and matrices  $A, B$  with coefficients in rationals,  $A$  of size  $n_j \times n_i$ , and  $B$  of size  $n_i \times n_j$ .

We call it the **existential theory of invertible matrices**.

We will consider the following decision problem: given such a formula, is it satisfiable, that is, are there matrices  $M_1, \dots, M_k$ , with  $M_i$  of size  $n_i \times n_i$ , invertible such that for every  $j$ ,  $P_j(M_1, \dots, M_k)$  is true ?

We may ask this question for matrices  $M_i$  in the reals or the rationals. We will prove that the two problems actually coincide and are decidable in PSPACE.

### 7.6.3 Decidability in $\mathbb{R}$

We stick here to the case of the reals. We prove that we have a reduction to the existential theory of the reals. Given a formula

$$\Phi = \exists_{n_1} X_1 \dots \exists_{n_k} X_k \cdot \bigwedge_{j=1}^m P_j(X_1, \dots, X_k)$$

we will construct a formula  $\Psi$  in the existential theory of the reals which is satisfiable if and only if  $\Phi$  is.

First, for every quantifier  $\exists_{n_i} X_i$ , we fix  $2.n_i^2$  fresh first-order variables  $x_i^{r,s}$  and  $y_i^{r,s}$  for  $r, s \in \{1, \dots, n_i\}$ . Let  $X_i$  be the matrix of size  $n_i \times n_i$  whose coefficients are  $x_i^{r,s}$ , and  $Y_i$  whose coefficients are  $y_i^{r,s}$ . Developing  $A.X_i = X_j.B$  leads to  $n_j n_i$  linear equations on the variables  $x_i^{r,s}$  and  $x_j^{r,s}$ . So every predicate  $P_j$  induces a set  $L_j$  of linear equations. It remains to express that  $X_i$  is invertible in first-order logic. The idea is to express that  $Y_i$  is its inverse. Developing  $X_i.Y_i = \text{Id}$  and  $Y_i.X_i = \text{Id}$ , leads to  $2.n_i^2$  polynomial equations on the variables  $x_i^{r,s}$  and  $y_i^{r,s}$ . Let  $S_i$  be this set. We note  $\Psi$  the formula:

$$\exists x_1^{1,1} \dots \exists x_k^{n_k, n_k} \cdot \bigwedge_{i=1}^k S_i \wedge \bigwedge_{j=1}^m L_j$$

$\Psi$  is of polynomial size on the size of  $\Phi$ .

**Proposition 31.**  *$\Psi$  is satisfiable in the existential theory of the reals iff  $\Phi$  is satisfiable in the existential theory of invertible matrices in the reals. Consequently, the existential theory of invertible matrices in the reals is decidable in PSPACE.*

### 7.6.4 The rational case

As we have seen previously, first-order theories of rationals are harder in general. But there are some algebraic problems that are known to coincide when considering the reals and the rationals.

Given a linear system with coefficients in rationals, gaussian elimination works independently of the coefficient field. Consequently, the real subspace  $F_{\mathbb{R}}$  of solutions of this system has the same

dimension as the rational subspace  $F_{\mathbb{Q}}$  of solutions of the system. Actually,  $F_{\mathbb{R}} \cap \mathbb{Q}^n = F_{\mathbb{Q}}$  and they have a common basis whose vectors are in the rationals.

Similarly, the problem of equivalence of matrices coincides in the reals and the rationals. Given two matrices  $A$  and  $B$  with coefficients in the rationals,  $A$  and  $B$  are equivalent if there are two invertible matrices  $X$  and  $Y$  such that  $A.X = Y.B$ . This problem is also solvable using gaussian elimination by computing the rank of  $A$  and  $B$ , which is independent of the coefficient field.

Our problem is a generalization of the equivalence problem and the same kind of results hold here:

**Proposition 32.** *A formula  $\Phi$  is satisfiable in the existential theory of invertible matrices in the reals if and only if it is satisfiable in the rationals.*

*Proof.* Let  $\Phi$  be a formula which is satisfiable in the reals. It is enough to prove that the formula  $\Psi$  constructed in the previous subsection has a model in the rationals. We have seen that the satisfiability problem reduces to solving a linear system  $\bigwedge_{j=1}^m L_j$  in  $\mathbb{R}^{n_1^2 + \dots + n_k^2}$ , with the constraints

that some matrices are invertible. Since  $\Psi$  is satisfiable, the linear system  $\bigwedge_{j=1}^m L_j$  has a non trivial subspace  $F$  of solution in the reals. Let  $p$  be its dimension and  $t_1, \dots, t_p$  a basis (which is in the rationals, since the system is with coefficients in the rationals). There is then an isomorphism

$\kappa : F \longrightarrow \mathbb{R}^p$ . The set of solution of  $\bigwedge_{i=1}^k S_i \wedge \bigwedge_{j=1}^m L_j$  in the reals is a subset  $S$  of  $F$ . It is enough to prove that  $S$  is a non-empty open set of  $F$  (with any topology coming from a norm). Indeed, in this case, the image  $\kappa(S)$  is then a non-empty open set of  $\mathbb{R}^p$ . Since,  $\mathbb{Q}^p$  is dense in  $\mathbb{R}^p$ ,  $\kappa(S)$  intersects  $\mathbb{Q}^p$  and there is  $(s_1, \dots, s_p) \in \kappa(S) \cap \mathbb{Q}^p$ . Then,  $s_1.t_1 + \dots + s_p.t_p$  is a vector of rationals which is solution of  $\bigwedge_{i=1}^k S_i \wedge \bigwedge_{j=1}^m L_j$ .

It remains to prove that  $S$  is open in  $F$ . So it is enough to prove that the set of solutions  $T_i$  of  $S_i$  is an open set of  $\mathbb{R}^{n_1^2 + \dots + n_k^2}$ .  $T_i$  is of the form  $\mathbb{R}^{n_1^2 + \dots + n_{i-1}^2} \times \text{Inv}_{n_i} \times \mathbb{R}^{n_{i+1}^2 + \dots + n_p^2}$ , where  $\text{Inv}_{n_i}$  is the set of invertible matrices in the reals of size  $n_i \times n_i$ .  $\text{Inv}_{n_i}$  is the inverse image of  $\mathbb{R} \setminus \{0\}$  by the determinant function, which is continuous. Consequently,  $\text{Inv}_{n_i}$  is open, and  $T_i$  is open. *.QED.*

### 7.6.5 Further discussions on integers

A natural question would be: what about integers ? We know that their existential theory is undecidable, so the line of proof in the case of the reals cannot apply here. The result on the rationals tends to imply that we do not use the full power of the existential fragment. Nevertheless, contrary to the rationals, the theory of matrices in integers is more complicated. For example, the equivalence of matrices is not solved by the rank, but by invariant factors, computed by an extension of the gaussian elimination, the Smith normal form. So it is an open question whether the existential theory of invertible matrices in integers is decidable or not.

### 7.6.6 Finitary diagrams and formulae

Finally, we prove a few decidability results for bisimilarity of diagrams and diagrammatic logic using the existential theory of invertible matrices. In this section, we consider diagrams with values in real vector spaces (or rational, but as we have seen in the previous section, the two theories will coincide). We first describe the diagrams and the formulae used, the finitary diagrams and formulae. We then prove the decidability of two following problems:

- **bisimilarity:** given two finitary diagrams, are they bisimilar ?
- **diagram model-checking:** given a finitary diagram  $F$ , an object  $c$  of its domain and a positive finitary state formula  $S$ ,  $F, c \models S$  ?

In our work on directed algebraic topology, the finite diagrams produced in [Dubut 2015] are of a particular form: their domain is a poset and they are with values in finite dimensional real (or rational) vector spaces. Consequently, we are particularly interested in deciding whether two such diagrams are bisimilar. We then call **finitary diagram**  $F$  the following data:

- a finite poset  $\mathcal{C}, \leq$ , which will be called the **domain**,
- for every element  $c$  of  $\mathcal{C}$ , an integer  $F(c)$  (which stands for the real vector space  $\mathbb{R}^{F(c)}$ ),
- for every pair  $c \leq c'$  of  $\mathcal{C}$ , a matrix  $F(c \leq c')$  of size  $F(c) \times F(c')$ , with coefficient in the rationals,

such that:

- $F(c \leq c)$  is the identity matrix,
- for every triple  $c \leq c' \leq c''$ ,  $F(c \leq c'') = F(c' \leq c'').F(c \leq c')$ .

Similarly, we are interested in model-checking of such diagrams because it may be simpler to just provide a formula from diagrammatic logic as a witness that two diagrams are not bisimilar. We will consider the formulae generated by the following grammar, called **finitary formulae**:

$$\text{Object formulae: } S ::= [n]P \quad n \in \mathbb{N}$$

$$\text{Morphism formulae: } P ::= \langle M \rangle P \mid ?S \mid \neg P \mid \top \mid P_1 \wedge P_2 \quad M \text{ matrix in the rationals}$$

Here,  $[n]P$  stands for  $[\mathbb{R}^n]P$  which makes finitary formulae diagrammatic formulae in real vector spaces. This time, since we only have finitely branching diagrams, we only consider finite conjunctions. We will more particularly consider **positive** formulae, i.e., formulae that do not use negation.

For both problem, the main idea will be to construct non-deterministically a formula of the existential theory of invertible matrices and to check it using the previous section.

### 7.6.7 Decidability of bisimilarity

We start with the bisimilarity problem. Given two finitary diagrams  $F$  and  $G$ , with domain  $\mathcal{C}, \leq$  and  $\mathcal{D}, \preceq$  respectively. The idea is to construct non-deterministically a bisimulation  $R$ , that is, a set of triples  $(c, M, d)$  where  $M$  is a matrix in the reals (or the rationals) satisfying the properties of a bisimulation from Section 2, except that we will not construct explicitly the matrices  $M$ , but a formula in the existential theory of invertible matrices that encodes that there exist some matrices  $M$  such that the bisimulation constructed satisfies those properties.

Consider the algorithm 1 written in pseudo-code. It maintains the bisimulation  $R$  and two sets  $var$ , encoding the variables of the formula we are constructing and  $lin$ , encoding its predicates.

The algorithm always terminates. First, the inner while loop terminates since after every loop an element  $(c, X, d)$  is marked and only elements of the form  $(c', X', d')$  with either  $c < c'$  and  $d \preceq d'$  or  $c \leq c'$  and  $d \prec d'$  are added. The outer loop terminates since after every loop at least one element of  $S$  is removed.

**Algorithm 1** Bisimilarity of finitary diagrams

**Require:** Two finitary diagrams  $F : \mathcal{C} \longrightarrow \mathcal{A}$  and  $G : \mathcal{D} \longrightarrow \mathcal{A}$ .

**Ensure:** Answer **Yes** iff  $F$  and  $G$  are bisimilar.

```

1:  $S := \mathcal{C} \sqcup \mathcal{D}$ ;
2:  $R := \emptyset$ ;
3:  $lin := \emptyset$ ;
4:  $var := \emptyset$ ;
5: while  $S$  is non empty do
6:   Pick some  $c \in S$ . Let us assume that  $c \in \mathcal{C}$ , the other case is symmetric.
7:   Non-deterministically choose  $d \in \mathcal{D}$  with  $F(c) = G(d) = n$ .
8:   if  $d$  does not exist then
9:     FAIL
10:  end if
11:   $S := S \setminus \{c, d\}$ ;
12:  Create a fresh variable  $X$  and add the pair  $(X, n)$  to  $var$ ;
13:  Add  $(c, X, d)$  to  $R$  and do not mark it;
14:  while there is a non-marked element in  $R$  do
15:    Pick a non-marked element  $(c, X, d) \in R$ , with  $F(c) = G(d) = n$ ;
16:    Mark  $(c, X, d)$ ;
17:    for all  $c' > c$  do
18:      Non-deterministically choose  $d' \succeq d$  with  $F(c') = G(d') = m$ .
19:      if  $d'$  does not exist then
20:        FAIL
21:      end if
22:       $S := S \setminus \{c', d'\}$ ;
23:      Create a fresh variable  $X'$  and add the pair  $(X', m)$ ;
24:      Add  $(c', X', d')$  to  $R$  and do not mark it;
25:      Add the equation  $G(d \leq d').X = X'.F(c \leq c')$  to  $lin$ ;
26:    end for
27:    for all  $d \prec d'$  do
28:      Symmetrically
29:    end for
30:  end while
31: end while
32: Let  $\Phi$  be the formula of the existential theory of invertible matrices existentially quantified by
    $\exists_n X$  for every  $(X, n) \in var$  and whose predicate are the linear equations from  $lin$ .
33: return Yes if  $\Phi$  is valid, No otherwise.

```

Assume that there is an execution of the algorithm that answers **Yes**. Let  $R$  and  $\Phi$  constructed during this execution. Since the algorithm answers **Yes**, the formula  $\Phi$  is satisfiable, that is, for every  $(X, n) \in var$ , there is an invertible matrix  $M_X$  of size  $n \times n$  such that for every equation  $A.X = X'.B$  in  $lin$ ,  $A.M_X = M_{X'}.B$  holds. Let  $R'$  be the set

$$\{(c, M_X, d) \mid (c, X, d) \in R\}$$

Then by construction of  $R$  and  $\Phi$ ,  $R'$  is a bisimulation between  $F$  and  $G$ .

Assume that there is a bisimulation  $R'$  between  $F$  and  $G$ . We show that there are non-

deterministic choices that lead to the answer **Yes**. The idea is to assure that every  $(c, X, d)$  that belongs to  $R$  at some point corresponds to an element  $(c, f, d)$  of  $R'$ . To assure this, we must:

1. when choosing  $d$  in line 7, choose it such that there is  $(c, f, d) \in R'$ . It exists by definition of a bisimulation.
2. when choosing  $d'$  in line 18, choose it in such a way that there is  $(c', f', d')$  in  $R'$  and that the element  $(c, f, d) \in R'$  corresponding to  $(c, X, d)$  satisfies that  $G(d \leq d') \circ f = f' \circ F(c \leq c')$ . Such a  $d'$  always exist since  $R'$  is a bisimulation.

With this, the algorithm does not **FAIL** and the formula  $\Phi$  is valid: the assignment that maps  $X$  to the corresponding  $f$  satisfies  $\Phi$ . Consequently, the algorithm answers **Yes**.

Finally, this algorithm non-deterministically constructs in exponential space a formula of exponential size in the size of the data. By Theorem 5, this algorithm is in NEXPSPACE. Consequently, since  $\text{NEXPSPACE} = \text{EXPSPACE}$ :

**Theorem 24.** *Knowing if two finitary diagrams are bisimilar in the reals or in the rationals is decidable in EXPSPACE. Furthermore, they are bisimilar in the reals if and only if they are bisimilar in the rationals.*

## 7.6.8 Decidability of the model checking

### 7.6.8.1 Positive case

We start with the positive fragment. So starting with a finitary diagram  $F$ , an element  $c$  of its domain, and a positive finitary object formula  $S$ , we inductively construct two lists, initially empty:

- *var* of pairs  $(X, n)$  where  $X$  is a variable and  $n$  an integer. This will stand for  $\exists_n X$ ,
- *lin* of equations  $A.X = Y.B$  where  $X$  and  $Y$  are variables and  $A$  and  $B$  are matrices,

as previously.

The formula  $S$  is of the form  $[n]P$ . We first check if  $n = F(c)$ . If it is not the case then we fail. Otherwise, let  $X$  be a fresh variable. Add the pair  $(X, n)$  to *var*. Continue with  $F$ ,  $c$ ,  $X$  and  $P$ .

Now, assume that we consider the following data: a finitary diagram  $F$ , an element of its domain  $c$ , a variable  $X$  in *var* and a positive finitary morphism formula  $P$ . Several case:

- if  $P = ?S'$ , continue with  $F$ ,  $c$  and  $S'$ ,
- if  $P = \top$ , stop,
- if  $P = P_1 \wedge P_2$ , first continue with  $F$ ,  $c$ ,  $X$  and  $P_1$ . When this part terminates, continue with  $F$ ,  $c$ ,  $X$  and  $P_2$ ,
- if  $P = \langle M \rangle P'$ , with  $M$  of size  $n_1 \times n_2$ . If  $n_1 \neq F(c)$ , then we fail. Otherwise, non-deterministically choose an element  $c' \geq c$ , with  $F(c') = n_2$ . If such a  $c'$  does not exist, then we fail. Finally, create a fresh variable  $X'$ , add  $(X', n_2)$  to *var* and  $M.X = X'.F(c \leq c')$  to *lin*.

If the algorithm does not fail, construct a formula  $\Phi$  from *var* and *lin* as previously and check if it is satisfiable using the existential theory of invertible matrices. The formula  $\Phi$  is non-deterministically constructed in polynomial time and so is of polynomial size. So, this algorithm is in NPSPACE and since  $\text{NPSPACE} = \text{PSPACE}$ :

**Theorem 25.** *Knowing if a finitary diagram satisfies a positive finitary formula (either in the reals or in the rationals) is decidable in PSPACE.*



### 7.6.8.2 Full case

The full case is also decidable for the reals. The idea is similar, except that, because of the negation, it is not possible to encode our problem in the existential fragment. However, using the same ideas, it is still possible to encode it in the full first-order theory of real closed fields. There are two counter-parts:

- first, since the full first-order theory is decidable in EXPSPACE, the full model-checking in the reals is in EXPSPACE,
- secondly, theorem 6 does not hold anymore and nothing can be said about the rational case.

# Homology and bisimulations

---

Now we have all the ingredients for our directed homology theory: we have defined natural systems and bimodules of homology in Chapter 6, and we have specified how to compare those diagrams with bisimulations in Chapter 7. In the present chapter we will focus on the properties induced by comparing diagrams of homology with bisimilarity. First, as evoked several times earlier, we prove that natural systems and bimodules of homology are bisimilar in Section 8.1.1. We then investigate the relation between natural systems of homotopy and diagrams of homology by proving an analogue of Hurewicz theorem (Section 8.1.2) and a first version of homotopy invariance (Section 8.1.3).

From this point, we will restrict to a particular case, namely d-spaces that are geometric realization of cubical complexes, that is, spaces that are a finite union of some cubes in  $\mathbb{R}^n$ . From this presentation of such a d-space, it will be possible to compute finite diagrams in modules by restricting natural systems of homology to some particular traces, obtained by concatenation of segments that join centers of cubes (Section 8.3.1). We will prove in Sections 8.3.2 and 8.3.3 that this finite diagram is bisimilar to the natural system of homology and from the work on the previous chapter, it will be decidable if two d-spaces which are geometric realizations of cubical complexes have bisimilar natural systems of homology. Finally, we relate this directed homology theory to the dihomotopy theory from Part II by proving in Section 8.4 that two d-spaces which are the geometric realizations of cubical complexes and which are inessentially equivalent have bisimilar natural systems of homology.

## 8.1 First easy consequences of using bisimulations

### 8.1.1 Equivalence of bimodules and natural systems

First, we have defined two directed homologies: one using bimodules  $\overrightarrow{BH}_n(X)$ , one using natural systems  $\overrightarrow{NH}_n(X)$ . We have also seen that there is a functor  $\kappa_{\mathcal{C}} : \mathcal{F}(\mathcal{C}) \rightarrow \mathcal{E}(\mathcal{C})$  such that for every  $n$ ,

$$\overrightarrow{NH}_n(X) \circ \kappa_{\overrightarrow{\mathcal{T}}(X)} = \overrightarrow{BH}_n(X).$$

**Proposition 33.**  $(\kappa_{\overrightarrow{\mathcal{T}}(X)}, id)$  is an open map from  $\overrightarrow{NH}_n(X)$  to  $\overrightarrow{BH}_n(X)$ . In particular,  $\overrightarrow{BH}_n(X)$  and  $\overrightarrow{NH}_n(X)$  are bisimilar for all  $n$ .

*Proof.* Three properties to prove:

- $id$  is a natural isomorphism.
- $\kappa_{\mathcal{C}}$  is surjective on objects: let  $(a, b)$  be an object of  $\mathcal{E}(\mathcal{C})$ . This means that  $a$  and  $b$  are objects of  $\mathcal{C}$  such that there is a morphism  $f$  from  $a$  to  $b$ . Then  $f$  is an object of  $\mathcal{F}(\mathcal{C})$  with  $\kappa_{\mathcal{C}}(f) = (a, b)$ .
- let  $(\alpha, \beta)$  be a morphism from  $(a, b)$  to  $(a', b')$  in  $\mathcal{E}(\mathcal{C})$ . This means that  $\alpha$  is a morphism from  $a'$  to  $a$  and  $\beta$  is a morphism from  $b$  to  $b'$  in  $\mathcal{C}$ . Let  $f$  be such that  $\kappa_{\mathcal{C}}(f) = (a, b)$ . This means that  $f$  is a morphism from  $a$  to  $b$  in  $\mathcal{C}$ . Consequently,  $(\alpha, \beta)$  is a morphism from  $f$  to  $\beta \circ f \circ \alpha$  in  $\mathcal{F}(\mathcal{C})$  and  $\kappa_{\mathcal{C}}(\alpha, \beta) = (\alpha, \beta)$ .

.QED.

**Proposition 34.** *For every dimap  $f : X \rightarrow Y$ , if  $\overrightarrow{NH}_n(f)$  is an open map, then  $\overrightarrow{BH}_n(f)$  is an open map.*

*Proof.* The natural morphism parts are the same, so if one is an isomorphism, the other is too.

For the functorial part, we prove the following more general statement. If  $F : \mathcal{C} \rightarrow \mathcal{D}$  is a functor, then if  $\mathcal{F}(F)$  satisfies the properties of an open map, that is, surjective on objects and the fibrational property, then  $\mathcal{E}(F)$  satisfies them too. First, let us prove that  $\mathcal{E}(F)$  is surjective on objects. Let  $(c, d)$  be an object of  $\mathcal{E}(\mathcal{D})$ . Then there is a morphism  $f$  from  $c$  to  $d$ . By surjectivity on objects of  $\mathcal{F}(F)$ , there is a morphism  $g$  from  $a$  to  $b$  with  $\mathcal{F}(F)(g) = F(g) = f$ . In particular,  $F(a) = c$  and  $F(b) = d$ , that is,  $F(a, b) = (c, d)$ . Next, let  $(\alpha, \beta)$  be a morphism from  $(c, d)$  to  $(c', d')$  in  $\mathcal{E}(\mathcal{D})$  and let  $a, b$  such that  $F(a) = c$ ,  $F(b) = d$  and  $(a, b)$  being an object of  $\mathcal{E}(\mathcal{C})$ . So there is a morphism  $f$  from  $a$  to  $b$  in  $\mathcal{C}$  and  $(\alpha, \beta)$  is a morphism from  $F(f)$  to  $\beta \circ F(f) \circ \alpha$ . By the fibrational property of  $\mathcal{F}(F)$ , there is a morphism  $(\alpha', \beta')$  in  $\mathcal{F}(\mathcal{C})$  such that  $F(\alpha') = \alpha$  and  $F(\beta') = \beta$ .  $(\alpha', \beta')$  is also a morphism of  $\mathcal{E}(\mathcal{C})$ .

We conclude by using this result on  $\overrightarrow{T}(f)$ . .QED.

### 8.1.2 Directed Hurewicz theorem

Remember that Hurewicz theorem in classical algebraic topology states that homology in  $\mathbb{Z}$ -modules (i.e., Abelian groups) are deeply related to homotopy groups. We have the same here. In this subsection, we stick to directed homology in **Diag(Ab)**.

We say that a  $d$ -space  $X$  is 1-connected if  $\overrightarrow{\Pi}_1(X)$  is a diagram such that for every trace  $\langle \gamma \rangle$ ,  $\overrightarrow{\Pi}_1(X)(\langle \gamma \rangle)$  is a singleton, meaning that if  $\gamma$  is a dipath from  $a$  to  $b$ ,  $\overrightarrow{T}(X)(a, b)$  has one connected components. For  $n \geq 2$ , we say that  $X$  is  $n$ -connected if it is  $n - 1$  connected and if  $\overrightarrow{\Pi}_n(X)$  is a null diagram.

**Theorem 26** (Directed Hurewicz theorem). *Let  $X$  be a  $d$ -space. Then:*

- $\overrightarrow{NH}_1(X)$  is isomorphic to  $\text{Free} \circ \overrightarrow{\Pi}_1(X)$ , where  $\text{Free} : \mathbf{Set} \rightarrow \mathbf{Ab}$  is the functor that gives the free Abelian group generated by a set.  $\overrightarrow{BH}_1(X)$  is bisimilar to  $\text{Free} \circ \overrightarrow{\Pi}_1(X)$ .
- if  $X$  is  $(n - 1)$ -connected, then:
  - if  $n = 2$ ,  $\overrightarrow{NH}_2(X)$  is isomorphic to  $\text{Abel} \circ \overrightarrow{\Pi}_2(X)$ , where  $\text{Abel} : \mathbf{Gr} \rightarrow \mathbf{Ab}$  is the functor that gives the abelianization of a group.  $\overrightarrow{BH}_2(X)$  is bisimilar to  $\text{Abel} \circ \overrightarrow{\Pi}_2(X)$ .
  - else,  $\overrightarrow{NH}_n(X)$  is isomorphic to  $\overrightarrow{\Pi}_n(X)$  and  $\overrightarrow{BH}_n(X)$  is bisimilar to  $\overrightarrow{\Pi}_n(X)$ .

*Proof.* This a consequence of the naturality of the classical Hurewicz theorem .QED.

### 8.1.3 A first homotopy axiom

We have seen at the end of the Chapter 5 that we could state a homotopy axiom as follow: if a dimap induces isomorphisms between diagrams of homotopy then it induces isomorphisms between natural systems of homology. We then argued that isomorphisms are too strong and we develop the idea of bisimulations. The question now is: can we state a homotopy axiom using bisimulation ? Here is the answer:

**Theorem 27** (First homotopy axiom). *Let  $f : X \rightarrow Y$  be a dimap. If for every  $n$ ,  $\overrightarrow{\Pi}_n(f) : \overrightarrow{\Pi}_n(X) \rightarrow \overrightarrow{\Pi}_n(Y)$  is an open map, then for every  $n$ ,  $\overrightarrow{NH}_n(f) : \overrightarrow{NH}_n(X) \rightarrow \overrightarrow{NH}_n(Y)$  and  $\overrightarrow{BH}_n(f) : \overrightarrow{BH}_n(X) \rightarrow \overrightarrow{BH}_n(Y)$  are open maps.*

*Proof.* It is enough to prove it for natural systems by Proposition 34.

The functorial parts of  $\overrightarrow{\Pi}_n(f)$  are the same as those of  $\overrightarrow{NH}_n(f)$ . So if the parts of  $\overrightarrow{\Pi}_n(f)$  are surjective on objects and have the fibrational property, then those of  $\overrightarrow{NH}_n(f)$  too.

If the natural morphism part of  $\overrightarrow{\Pi}_n(f)$  is a isomorphism for every  $n$ , this means that for every pair  $(a, b)$  such that there is a dipath from  $a$  to  $b$ , the continuous function

$$\overrightarrow{T}(f)(a, b) : \overrightarrow{T}(X)(a, b) \rightarrow \overrightarrow{T}(Y)(f(a), f(b))$$

which maps the trace  $\langle \gamma \rangle$  to the trace  $\langle f \circ \gamma \rangle$  induces a isomorphisms between homotopy groups for every  $n$ . So it induces isomorphisms between homology modules for every  $n$ , that is, the natural morphism part of  $\overrightarrow{NH}_n(f)$  is an isomorphism. *QED.*

## 8.2 Cubical complexes

Much as precubical sets, cubical complexes are finite unions of certain cubes of side-length 1 parallel to the axes in  $\mathbb{R}^d$ , whose vertices have integer coordinates [Kaczynskil 2003]. Formally, let us define a ( $d$ -dimensional) **cubical complex**  $K$  as a finite set of **cubes**  $(D, \vec{x})$ , where  $D \subseteq \{1, 2, \dots, d\}$  and  $\vec{x} \in \mathbb{Z}^d$ , which is closed under taking past and future faces (to be defined shortly). The cardinality  $|D|$  of  $D$  is the **dimension** of the cube  $(D, \vec{x})$ . Let  $\vec{1}_k$  be the  $d$ -tuple whose  $k$ th component is 1, all others being 0. Each cube  $(D, \vec{x})$  is **realized** as the geometric cube  $\rho(D, \vec{x}) = I_1 \times I_2 \times \dots \times I_d$  where  $I_k = [x_k, x_k + 1]$  if  $k \in D$ ,  $I_k = [x_k, x_k]$  otherwise, matching the definition of [Kaczynskil 2003].

When  $|D| = n$ , we write  $D[i]$  for the  $i$ th element of  $D$ . For example, if  $D = \{3, 4, 7\}$ , then  $D[1] = 3$ ,  $D[2] = 4$ ,  $D[3] = 7$ . We also write  $\partial_i D$  for  $D$  minus  $D[i]$ . Every  $n$ -dimensional cube  $(D, \vec{x})$  has  $n$  **past faces**  $\partial_i^0(D, \vec{x})$ , defined as  $(\partial_i D, x)$ , and  $n$  **future faces**  $\partial_i^1(D, \vec{x})$ , defined as  $(\partial_i D, x + \vec{1}_{D[i]})$ ,  $1 \leq i \leq n$ .

Together with these face operators,  $K$  exhibits the structure of a precubical set. Cubical complexes are very particular precubical sets. Notably, they are non-looping in the sense of [Fajstrup 2005]. They are however enough for most purposes, including the definition of geometric semantics of finite SU/PV-programs.

The **geometric realization**  $\overrightarrow{Geom}(K)$  of a precubical set  $K$  is obtained using the study from Chapter 2. It is the geometric realization using the functor from the category  $\square$  to the category **dTop** which maps  $n$  to  $\square_n$  with the component-wise non-decreasing paths as dipaths (actually, everything could be done in any other category of directed spaces).

For example, the matchbox is really obtained by drawing a finite precubical set (a cubical complex, really) with 2-dimensional cubes  $A, B, C, D$ , and  $E$ , defined so that  $\partial_1^0 A = \partial_1^0 B$  (the lower dashed connection in the exploded view),  $\partial_2^0 A = a$ ,  $\partial_2^0 B = b$ ,  $\partial_1^0 a = \partial_1^0 b = s$ , and so on.

Let us make this construction explicit here. Let  $\overrightarrow{\square}_n$  be the standard oriented cube  $[0, 1]^n$ , with dipaths the pointwise non-decreasing paths. Form the coproduct  $A = \sum_{e \in K} \overrightarrow{\square}_{n_e}$  where  $n_e$  is the dimension of  $e$ , i.e., the disjoint union of as many copies of  $\overrightarrow{\square}_n$  as there are  $n$ -dimensional cubes  $e$ , for  $n \in \mathbb{N}$ ; the elements of  $A$  are pairs  $(e, \vec{a})$  where  $e$  is an  $n$ -dimensional cube in  $K$  and  $\vec{a} \in [0, 1]^n$ , for some  $n$ . For convenience, for  $\vec{a} = (a_1, a_2, \dots, a_n)$ , we write  $\delta_i^\alpha \vec{a}$  for  $(a_1, a_2, \dots, a_{i-1}, \alpha, a_i, \dots, a_n)$ . Finally, we glue all these cubes together, by defining  $\overrightarrow{Geom}(K)$  as  $A/\equiv$ , where  $\equiv$  is the smallest equivalence relation such that  $(\partial_i^\alpha e, \vec{a}) \equiv (e, \delta_i^\alpha \vec{a})$ . We shall write  $[e, \vec{a}]$  for the point obtained as the equivalence class of  $(e, \vec{a})$ .

For a cubical complex  $K$ , the element  $[(D, \vec{x}), \vec{a}]$  (with  $D \subseteq \{1, 2, \dots, d\}$ ,  $|D| = n$ ,  $\vec{x} \in \mathbb{Z}^d$ ,  $\vec{a} \in [0, 1]^n$ ) of  $\overrightarrow{Geom}(K)$  defines a point  $\varepsilon([(D, \vec{x}), \vec{a}]) = \vec{x} + \sum_{i=1}^n a_i \vec{1}_{D[i]}$ . One checks easily that  $\varepsilon$  is a dihomoeporphism of  $\overrightarrow{Geom}(K)$  onto the union of the cubes  $\rho(D, \vec{x})$ ,  $(D, \vec{x}) \in K$ .

The main interest of cubical complexes in our study is that from [Raussen 2012a], the trace space of the geometric realization of a cubical complex is computable, in the sense that it is possible to compute a finite structure (namely a prod-simplicial complex) from which it is possible to compute homology modules. This will be a corner stone of computability of our directed homology.

### 8.3 Discrete homology of a cubical complex

#### 8.3.1 Discrete traces and homologies

Paralleling the notion of trace in a d-space, for example as in [Fajstrup 2005], there is a notion of **discrete trace** in a precubical set  $K$ . Given  $a, b \in K$ , say that  $a$  is a **past boundary** of  $b$  if and only if  $a = \partial_{i_0}^0 \partial_{i_1}^0 \dots \partial_{i_k}^0 b$  for some  $k \geq 0$ ,  $i_0, i_1, \dots, i_k$ . **Future boundaries** are defined similarly, using the superscript 1 instead of 0. We write  $a \preceq b$  if and only if  $a$  is a past boundary of  $b$  or  $b$  is a future boundary of  $a$ . (Beware that this is not a transitive relation; we write  $\preceq^*$  for its reflexive transitive closure.) A **discrete trace** from  $a$  to  $b$  in  $K$  is then a sequence  $c_0 = a \preceq c_1 \preceq c_2 \preceq \dots \preceq c_n = b$ ,  $n \in \mathbb{N}$ .

Abusing the  $\overrightarrow{T}(X)$  notation we used earlier for d-spaces, let  $\overrightarrow{T}(K)$  be the small category whose objects are elements of  $K$  and whose morphisms are discrete traces. Applying the enveloping category or factorization category constructions, gives us categories  $\mathcal{E}(\overrightarrow{T}(K))$  and  $\mathcal{F}(\overrightarrow{T}(K))$ . The objects of the first are pairs  $(a, b)$  with  $a \preceq^* b$ , and the objects of the second are discrete traces. Their morphisms from a discrete trace from  $a$  to  $b$  to a discrete trace from  $a'$  to  $b'$  (or from  $a \preceq^* b$  to  $a' \preceq^* b'$ ) are the **discrete extensions**, namely pairs of discrete traces  $\alpha$  from  $a'$  to  $a$  and  $\beta$  from  $b$  to  $b'$ .

Note that we are not restricting  $a, b$  to be points, namely, of dimension 0; however, it is helpful to imagine, geometrically, that a full cube  $a$  stands for the point at its center. The construction is again due to Fajstrup [Fajstrup 2005]. Formally, for  $a = (D, \vec{x})$ ,  $n = |D|$ , let  $\hat{a}$  be the point  $[a, \bullet]$  in  $\overrightarrow{Geom}(K)$ , where  $\bullet = (\frac{1}{2}, \frac{1}{2}, \dots, \frac{1}{2})$  is the center of the standard cube  $\square_n$ . Through the  $\varepsilon$  isomorphism,  $\hat{a}$  is the point  $\vec{x} + \sum_{i=1}^n \frac{1}{2} \vec{1}_{D[i]}$  in  $\mathbb{R}^d$ , the center of the cube  $\rho(D, \vec{x})$ .

Every discrete trace  $\alpha$  from  $a$  to  $b$ , say of the form  $c_0 = a \preceq c_1 \preceq c_2 \preceq \dots \preceq c_n = b$ , defines a trace  $\hat{\alpha}$  from  $\hat{a}$  to  $\hat{b}$ , obtained by concatenating the  $n$  straight lines  $\widehat{c_0 c_1}, \widehat{c_1 c_2}, \dots, \widehat{c_{n-1} c_n}$ . For a simple example, consider the cubical complex whose geometric realization is shown on Figure 8.1, left. There is a discrete trace  $\alpha$  equal to  $b \preceq A \preceq t'$ , since  $b = \partial_1^0 A$  is a past boundary of  $A$  and  $t' = \partial_2^1 \partial_1^1 A$  is a future boundary of  $A$ . The corresponding trace  $\hat{\alpha}$  is shown on the same figure, middle. Formally, if  $c_{i-1}$  is a past boundary  $\partial_{i_1}^0 \partial_{i_2}^0 \dots \partial_{i_k}^0 c_i$  of  $c_i$ , then  $\hat{c}_{i-1} = [\partial_{i_1}^0 \partial_{i_2}^0 \dots \partial_{i_k}^0 c_i, \bullet] = [c_i, \vec{a}]$  where  $\vec{a} = \delta_{i_k}^0 \dots \delta_{i_2}^0 \delta_{i_1}^0 \bullet$ ; define the dipath  $\pi$  by  $\pi(t) = [c_i, (1-t)\vec{a} + t\bullet]$  for  $t \in [0, 1]$ , and the trace  $\widehat{c_{i-1} c_i}$  as  $\langle \pi \rangle$ . Similarly for future boundaries.

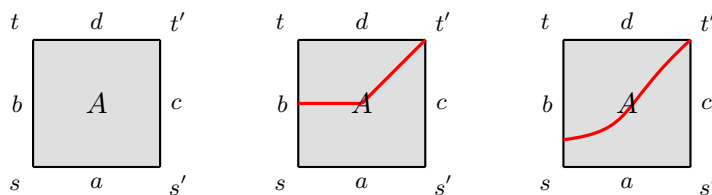

Figure 8.1: From discrete traces to traces and vice versa

$\hat{\cdot}$  then defines a functor from  $\vec{T}(K)$  to  $\vec{T}(\overrightarrow{Geom}(K))$ . We can define the  *$n$ th discrete bimodule of homology of  $K$*  as the functor

$$\overrightarrow{DBH}_n(K) : \mathcal{E}(\vec{T}(K)) \longrightarrow \mathbf{Mod}(\mathcal{R}) = \overrightarrow{DBH}_n \circ \mathcal{E}(\hat{\cdot}).$$

Similarly, one can define the  *$n$ th discrete natural system of homology of  $K$*  as the functor

$$\overrightarrow{DNH}_n(K) : \mathcal{F}(\vec{T}(K)) \longrightarrow \mathbf{Mod}(\mathcal{R}) = \overrightarrow{DBH}_n \circ \mathcal{F}(\hat{\cdot}).$$

As in the case of d-spaces, there is an open map from  $\overrightarrow{DNH}_n(K)$  to  $\overrightarrow{DBH}_n(K)$ , and so, the two constructions are bisimilar.

Discrete homologies are constructed by considering only a finite number of homology modules of trace spaces, while homologies of the geometric realization are (in general) not even countable. That does make a difference up to isomorphisms, not up to bisimulation:

**Theorem 28** (Discrete Homology  $\equiv$  Geometric Homology). *For every cubical complex  $K$ , there is an open map from  $\overrightarrow{NH}_n(\overrightarrow{Geom}(K))$  to  $\overrightarrow{DNH}_n(K)$ . In particular,  $\overrightarrow{NH}_n(\overrightarrow{Geom}(K))$ ,  $\overrightarrow{BH}_n(\overrightarrow{Geom}(K))$ ,  $\overrightarrow{DNH}_n(K)$  and  $\overrightarrow{DBH}_n(K)$  are all bisimilar.*

The next subsections are dedicated to the construction of the open map  $(\text{Car}, \sigma)$  from  $\overrightarrow{NH}_n(\overrightarrow{Geom}(K))$  to  $\overrightarrow{DNH}_n(K)$ .

### 8.3.2 Construction of the functorial part

In this Section, we assume that  $K$  is a cubical complex, and  $X$  is its geometric realization  $\overrightarrow{Geom}(K)$ .

The functor  $\text{Car}$  is based on the notion of **carrier sequence** due to Fajstrup [Fajstrup 2005]. For a point  $s$  in  $X$ , there is a unique cube  $e \in K$  of minimal dimension  $m$  such that  $s$  can be written as  $[e, \vec{a}]$ ,  $\vec{a} \in \vec{\square}_m$ . Write  $\text{Car}(s)$  for this cube  $e$ , and call it the **carrier** of  $s$ . Every trace  $\langle \gamma \rangle$  in  $X$  gives rise to an ordered sequence of cubes  $\text{Car}(\langle \gamma \rangle)$  obtained as the carriers of  $\gamma(t)$ ,  $t \in [0, 1]$ , and removing consecutive duplicates. More precisely, given a dipath  $\gamma$  of  $X$ , there is a unique sequence  $c_0, c_1, \dots, c_k$  of elements of  $K$  and a unique sequence of real numbers  $0 = t_0 \leq t_1 \leq \dots \leq t_k \leq t_{k+1} = 1$  (call them the **times of change**) such that:

- for every  $1 \leq i \leq k$ ,  $c_{i-1} \neq c_i$ ,
- for every  $0 \leq i \leq k$ , for every  $t \in [t_i, t_{i+1}]$ ,  $\gamma(t)$  is a point of the form  $[c, \vec{a}]$  with  $c = c_i$ ,
- for every  $0 \leq i \leq k$ , for every  $t \in (t_i, t_{i+1})$ ,  $\text{Car}(\gamma(t)) = c_i$ ,
- $\text{Car}(\gamma(0)) = c_0$  and  $\text{Car}(\gamma(1)) = c_k$ ,
- for every  $1 \leq i \leq k$ ,  $\text{Car}(\gamma(t_i)) \in \{c_{i-1}, c_i\}$  and if furthermore  $t_i = t_{i+1}$  then  $\text{Car}(\gamma(t_i)) = c_i$ .

The sequence  $c_0, c_1, \dots, c_k$  is called the **carrier sequence of  $\gamma$** . Two dipaths that are equivalent modulo reparametrization have the same carrier sequence, so it is legitimate to call carrier sequence,  $\text{Car}(\gamma)$  of  $\gamma$  the carrier sequence of the trace,  $\langle \gamma \rangle$ , of  $\gamma$ . By a compactness argument  $\text{Car}(\langle \gamma \rangle)$  is a finite sequence, in fact a discrete trace. For example, the carrier sequence of the trace on the right of Figure 8.1 is  $b \preceq A \preceq t'$ .

We use this to define our functor  $\text{Car}$ , on objects by letting  $\text{Car}(\langle \gamma \rangle)$  be defined as above, and on morphisms by letting  $\text{Car}(\langle \alpha \rangle, \langle \beta \rangle) = (\text{Car}(\langle \alpha \rangle), \text{Car}(\langle \beta \rangle))$  for every extension  $(\langle \alpha \rangle, \langle \beta \rangle)$ . This is surjective on objects since  $\text{Car}(\hat{\gamma}) = \gamma$  for every discrete trace  $\gamma$ . We now claim that  $\text{Car}$  is the

functorial part of an open map, and this amounts to show that: given any trace  $\langle \gamma \rangle$  of  $\overrightarrow{Geom}(K)$ , with carrier sequence  $c_0 \preceq \dots \preceq c_k$ , if the latter extends to a discrete trace  $c_{-p} \preceq \dots \preceq c_{-1} \preceq c_0 \preceq \dots \preceq c_k \preceq c_{k+1} \preceq \dots \preceq c_{k+q}$  in  $K$ , then  $\langle \gamma \rangle$  extends to some trace  $\langle \alpha \star \gamma \star \beta \rangle$  such that  $\text{Car}(\langle \alpha \star \gamma \star \beta \rangle) = c_{-p} \preceq \dots \preceq c_{-1} \preceq c_0 \preceq \dots \preceq c_k \preceq c_{k+1} \preceq \dots \preceq c_{k+q}$ . By induction, the cases  $(p, q) = (1, 0)$  and  $(p, q) = (0, 1)$  suffice to establish the property. Some care has to be taken: the extension paths are *not* concatenations of simple straight lines joining the extra points  $\hat{c}_j$ ,  $j \geq k$  or  $j \leq 0$ . As the following shows (for  $(p, q) = (0, 2)$ ),

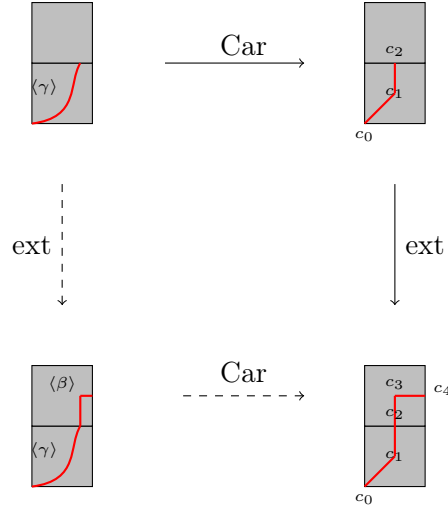

the dipath  $\beta$  does not—and cannot—go through  $\hat{c}_3$ . Details of the construction are given by the following lemma:

**Lemma 13.** *Let  $\langle \gamma \rangle$  be a trace in  $X (= \overrightarrow{Geom}(K))$  with carrier sequence  $c_0 \preceq c_1 \preceq \dots \preceq c_k$ .*

- *For every cube  $c_{-1} \preceq c_0$ , there is a dipath  $\alpha$  in  $X$  such that  $\text{Car}(\langle \alpha \star \gamma \rangle) = c_{-1} \preceq c_0 \preceq c_1 \preceq \dots \preceq c_k$ .*
- *For every cube  $c_{k+1}$  such that  $c_k \preceq c_{k+1}$ , there is a dipath  $\beta$  in  $X$  such that  $\text{Car}(\langle \gamma \star \beta \rangle) = c_0 \preceq c_1 \preceq \dots \preceq c_k \preceq c_{k+1}$ .*

*Proof.* We examine the second case only: the other case is symmetric. Since  $c_k \preceq c_{k+1}$ ,  $c_k$  can be a past boundary of  $c_{k+1}$ , or  $c_{k+1}$  can be a future boundary of  $c_k$ . We examine both cases:

- If  $c_k$  is a past boundary of  $c_{k+1}$ , say  $c_k = \partial_{i_p}^0 \dots \partial_{i_0}^0 c_{k+1}$ , then by using the precubical equations we may require  $i_0 > \dots > i_p$ . Writing  $\gamma(1)$  as  $[c_k, \vec{a}]$ , we also have  $\gamma(1) = [c_{k+1}, \delta_{i_0}^0 \dots \delta_{i_p}^0 \vec{a}]$  by the definition of the geometric realization. Since  $\text{Car}(\gamma(1)) = c_k$ , no component  $a_i$  of  $\vec{a}$  is equal to 0 or 1. Let  $\vec{b} = \delta_{i_0}^0 \dots \delta_{i_p}^0 \vec{a}$ : it follows that the components  $b_i$  of  $\vec{b}$  that are equal to 0 are exactly those such that  $i \in \{i_0, \dots, i_p\}$ . Let  $\vec{a}'$  be the tuple whose  $i$ th component  $a'_i$  is  $1/2$  if  $b_i = 0$ , and  $b_i$  otherwise. We define the dipath  $\beta$  by  $\beta(t) = [c_{k+1}, (1-t)\vec{b} + t\vec{a}']$ ,  $t \in [0, 1]$ . Note that  $\beta$  is indeed monotonic, because  $b_i \leq a'_i$  for every  $i$ . One easily checks that  $\beta(0) = \pi(1)$ , and that the carrier sequence of  $\langle \beta \rangle$  is  $c_k \preceq c_{k+1}$ : for  $t = 0$ ,  $\text{Car}(\beta(0)) = \text{Car}(\gamma(1)) = c_k$ , and, for  $t \neq 0$ ,  $\beta(t) = [c_{k+1}, (1-t)\vec{b} + t\vec{a}']$  where no component of  $(1-t)\vec{b} + t\vec{a}'$  is equal to 0 or 1, so its carrier  $\text{Car}(\beta(t))$  is  $c_{k+1}$ . It follows that  $\text{Car}(\langle \gamma \star \beta \rangle) = c_0 \preceq c_1 \preceq \dots \preceq c_k \preceq c_{k+1}$ .
- If  $c_{k+1}$  is a future boundary of  $c_k$ , then  $c_{k+1}$  is of the form  $\partial_{i_0}^1 \dots \partial_{i_p}^1 c_k$  with  $i_0 > \dots > i_p$ , and  $\gamma(1) = [c_k, \vec{a}]$  for some tuple  $\vec{a}$  whose components  $a_i$  are all different from 0 or 1 (because

$\text{Car}(\gamma(1)) = c_k$ ). Let  $\vec{b}$  be the tuple obtained from  $\vec{a}$  by changing the  $i$ th component into 1 if and only if  $i \in \{i_0, \dots, i_p\}$ . In other words, let  $b_i = 1$  if  $i \in \{i_0, \dots, i_p\}$ ,  $b_i = a_i$  otherwise. One can therefore write  $\vec{b}$  as  $\delta_{i_0}^1 \cdots \delta_{i_p}^1 \vec{b}'$ , where  $\vec{b}'$  is the tuple obtained from  $\vec{b}$  by removing its components of indices  $i_0, \dots, i_p$ . Define the dipath  $\beta$  by  $\beta(t) = [c_k, (1-t)\vec{a} + t\vec{b}]$ . This is monotonic because  $a_i \leq b_i$  for every  $i$ . For  $t \neq 1$ , no component of  $(1-t)\vec{a} + t\vec{b}$  is equal to 0 or 1, so  $\text{Car}(\beta(t)) = c_k$ , and for  $t = 1$ ,  $\beta(1) = [c_k, \vec{b}] = [c_{k+1}, \vec{b}']$ , which shows that  $\text{Car}(\beta(1)) = c_{k+1}$  since no component of  $\vec{b}'$  is equal to 0 or 1. Again, it follows that  $\text{Car}(\langle \gamma \star \beta \rangle) = c_0 \preceq c_1 \preceq \cdots \preceq c_k \preceq c_{k+1}$ .

.QED.

### 8.3.3 Construction of the natural isomorphism part

We now need to build a natural isomorphism  $\sigma : \overline{NH}_n \rightarrow \overline{DNH}_n \circ \text{Car}$ . In other words, we need to build isomorphisms of modules  $\sigma_{\langle \gamma \rangle} : H_n(\vec{T}(X)(a, b)) \rightarrow H_n(\vec{T}(X)(\widehat{\text{Car}}(a), \widehat{\text{Car}}(b)))$  for  $\gamma$  a dipath from  $a$  to  $b$ , that are natural, in the sense that, for every extension  $(\langle \alpha \rangle, \langle \beta \rangle)$  of  $\langle \gamma \rangle$ , with  $\alpha$  a dipath from  $a'$  to  $a$  and  $\beta$  a dipath from  $b$  to  $b'$ , the following square commutes:

$$\begin{array}{ccc}
 H_n(\vec{T}(X)(a, b)) & \xrightarrow{\sigma_{\langle \gamma \rangle}} & H_n(\vec{T}(X)(\widehat{\text{Car}}(a), \widehat{\text{Car}}(b))) \\
 \downarrow H_n(\langle \alpha \star \_ \star \beta \rangle) & & \downarrow H_n(\langle \widehat{\text{Car}}(\alpha) \star \_ \star \widehat{\text{Car}}(\beta) \rangle) \\
 H_n(\vec{T}(X)(a', b')) & \xrightarrow{\sigma_{\langle \alpha \star \gamma \star \beta \rangle}} & H_n(\vec{T}(X)(\widehat{\text{Car}}(a'), \widehat{\text{Car}}(b')))
 \end{array}$$

where  $\langle \alpha \star \_ \star \beta \rangle$  is the continuous function which maps the trace  $\langle \rho \rangle$  to the trace  $\langle \alpha \star \rho \star \beta \rangle$ .

Let  $\gamma$  be from  $s$  to  $t$ . Every cube  $\square_k$  has a lattice structure whose meet  $\wedge$  is pointwise min and whose join  $\vee$  is pointwise max. Write  $s$  as  $[\text{Car}(s), \vec{a}]$ , and let  $s_- = [\text{Car}(s), \vec{a} \wedge \bullet]$ . Recall that  $\bullet = (\frac{1}{2}, \dots, \frac{1}{2})$ , and that  $\widehat{\text{Car}}(s) = [\text{Car}(s), \bullet]$ . Similarly, let  $\widehat{\text{Car}}(t) = [\text{Car}(t), \bullet]$ , and we define  $t_+ = [\text{Car}(t), \vec{b} \vee \bullet]$ , where  $t = [\text{Car}(t), \vec{b}]$ . The situation is illustrated here:

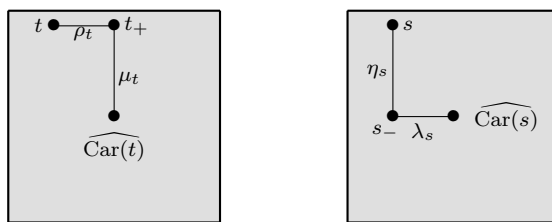

There are obvious dipaths  $\eta_s, \lambda_s, \mu_t, \rho_t$  as displayed there, too. For example,  $\eta_s(t) = [\text{Car}(s), (1-t)(\vec{a} \wedge \bullet) + t\vec{a}]$ . Those induce continuous maps between trace spaces by concatenation. For example, there is a continuous map  $\eta_s^* : \vec{T}(X)(s, t) \rightarrow \vec{T}(X)(s_-, t)$  that sends each trace  $\langle \pi \rangle$  to  $\langle \eta_s \star \pi \rangle$ . Similarly,  $\lambda_s^*(\langle \pi \rangle) = \langle \lambda_s \star \pi \rangle$ , and symmetrically,  ${}^* \mu_t(\langle \pi \rangle) = \langle \pi \star \mu_t \rangle$ ,  ${}^* \rho_t(\langle \pi \rangle) = \langle \pi \star \rho_t \rangle$ . We prove now that all those continuous functions are homotopy equivalences. The proof will use the following technical lemma:

**Lemma 14.** Let  $F, G : \vec{P}(X)(s, t) \rightarrow \vec{P}(X)(s', t')$  such that:

- for every pair of dipaths  $\gamma, \rho$  that are equivalent modulo reparametrization,  $F(\gamma)$  and  $F(\rho)$  are equivalent modulo reparametrization—so  $F$  induces  $\tilde{F} : \vec{T}(X)(s, t) \rightarrow \vec{T}(X)(s', t')$ , and similarly for  $G$ .



- for every  $\gamma$ ,  $F(\gamma)$  and  $G(\gamma)$  have the same carrier sequence.

Then  $\tilde{F}$  and  $\tilde{G}$  are homotopic.

*Proof.* Let  $C(X)(s', t')$  be the subspace of  $\vec{P}(X)(s', t') \times \vec{P}(X)(s', t')$  that consists of pairs of dipaths that have the same carrier sequence. The key ingredient consists in constructing a continuous map  $\Gamma : [0, 1] \times C(X)(s', t') \rightarrow \vec{P}(X)(s', t')$  in such a way that  $\Gamma(0, (p, q)) = p$  and  $\Gamma(1, (p, q)) = q$ . Let  $c_0, c_1, \dots, c_k$  be the common carrier sequence to  $p$  and  $q$ , let  $t_0 \leq t_1 \leq \dots \leq t_{k+1}$  be the times of change for  $p$ , and  $s_0 \leq s_1 \leq \dots \leq s_{k+1}$  be the times of change for  $q$ . Define  $u_i(t) = ts_i + (1-t)t_i$  for  $t \in [0, 1]$ ,  $0 \leq i \leq k+1$ . For every  $u \in [u_i(t), u_{i+1}(t)]$ , define  $v$  as  $\frac{u-u_i(t)}{u_{i+1}(t)-u_i(t)}$ . (This is defined provided  $u_i(t) \neq u_{i+1}(t)$ ; if this is not the case, let  $v = 0$ .) Then  $p(v(t_{i+1} - t_i) + t_i)$  is of the form  $[c_i, (a_1^u, \dots, a_m^u)]$  and  $q(v(s_{i+1} - s_i) + s_i)$  is of the form  $[c_i, (b_1^u, \dots, b_m^u)]$ . We then define  $\Gamma(t, p, q)(u) = [c_i, (1-t)a_j^u + tb_j^u]$ .

We have to define a homotopy  $H : [0, 1] \times \vec{T}(X)(s, t) \rightarrow \vec{T}(X)(s', t')$ . It will be defined as the composition of:

- $\text{id} \times \kappa : [0, 1] \times \vec{T}(X)(s, t) \rightarrow [0, 1] \times \vec{P}(X)(s, t)$ , where  $\kappa$  is a continuous map from  $\vec{T}(X)(s, t)$  to  $\vec{P}(X)(s, t)$ , defined in such a way that  $\langle \kappa(\langle \pi \rangle) \rangle = \langle \pi \rangle$  for every trace  $\langle \pi \rangle$ , therefore defining a canonical dipath representing a given trace. The existence of such a map is shown by Raussen in [Raussen 2009], as the composition norm  $\circ \vec{s}$  of two more elementary maps.
- $\text{id} \times (F, G) : [0, 1] \times \vec{P}(X)(s, t) \rightarrow [0, 1] \times C(X)(s', t')$ , where  $(F, G)$  maps  $\pi$  to  $(F(\pi), G(\pi))$ .
- $\Gamma : [0, 1] \times C(X)(s', t') \rightarrow \vec{P}(X)(s', t')$ , as defined above.
- and  $\langle \_ \rangle : \vec{P}(X)(s', t') \rightarrow \vec{T}(X)(s', t')$ , which maps each dipath to its trace.

We compute:  $H(0, \langle \pi \rangle) = \langle \Gamma(0, (F(\kappa(\langle \pi \rangle)), G(\kappa(\langle \pi \rangle))) \rangle = \langle F(\kappa(\langle \pi \rangle)) \rangle = \tilde{F}(\langle \pi \rangle)$ . Similarly,  $H(1, \_ ) = \tilde{G}$  and therefore  $H$  is a homotopy from  $\tilde{F}$  to  $\tilde{G}$ . .QED.

**Lemma 15.** *The maps  $\eta_s^*$ ,  $\lambda_s^*$ ,  ${}^*\mu_t$  and  ${}^*\rho_t$  are homotopy equivalences.*

*Proof.* We prove it for  $\eta_s^*$ , the other three being similar. By abuse of language, write  $\eta_s^*(\pi)$  for the dipath  $\eta_s \star \pi$  as well—we reason on spaces of dipaths first, then take a reparametrization quotient.

Observe that  $\eta_s^*$  maps  $\vec{P}(X)(s, t)$  to  $\vec{P}(X)(s_-, t)$ . We need to build a map  $\nu : \vec{P}(X)(s_-, t) \rightarrow \vec{P}(X)(s, t)$  such that  $\eta_s^* \circ \tilde{\nu}$  and  $\tilde{\nu} \circ \eta_s^*$  are homotopic to the identity using the previous lemma.

For every dipath  $\pi$  from  $s$  to  $t$ , the carrier sequence  $c_0, c_1, \dots, c_k$  of  $\eta_s^*(\pi)$  is equal to that of  $\pi$ . In the other direction, we shall define  $\nu$  so that it also preserves the carrier sequence. This will turn out to be the crucial property that will allow us to conclude by the previous lemma.

For every dipath  $\pi$  from  $s_-$  to  $t$ , with carrier sequence  $c_0, c_1, \dots, c_k$ , and with times of change  $0 = t_0 \leq t_1 \leq \dots \leq t_k \leq t_{k+1} = 1$ , we define  $\nu(\pi)$  as follow. We abuse the notation  $\vee$ , and write  $[c, \vec{a}] \vee_c [c, \vec{b}]$  for  $[c, \vec{a} \vee \vec{b}]$ . The three occurrences of  $c$  must be the same for this notation to make sense, but our intuition is best served by ignoring the  $c$  subscript to  $\vee$ , and to understand this as taking maxes, componentwise, in a local cube  $c$ . We then define  $\nu(\pi)(u)$  for increasing values of  $u$ , inductively, as  $s \vee_{c_0} \pi(u)$  for  $u \in [t_0, t_1]$ , as  $\nu(\pi)(t_1) \vee_{c_1} \pi(u)$  for  $u \in [t_1, t_2]$ ,  $\dots$ , and finally as  $\nu(\pi)(t_k) \vee_{c_k} \pi(u)$  for  $u \in [t_k, t_{k+1}]$ .

On  $[t_0, t_1]$ ,  $\nu(\pi)$  is a continuous monotonic map, with value  $\nu(\pi)(0) = s \vee_{c_0} s_- = s$  at  $u = t_0 = 0$ , and with value  $\nu(\pi)(t_1) = s \vee_{c_0} \pi(t_1)$  at  $u = t_1$ .

Let us show by induction on  $j$  that for every  $u$  with  $0 \leq u \leq t_j$ ,  $\text{Car}(\nu(\pi)(u)) = \text{Car}(\pi(u))$ . For  $j = 0$ , this says that  $\text{Car}(s) = \text{Car}(s_-)$ , which is by construction of  $s_-$ . Otherwise, by induction

hypothesis, for every  $u$  with  $0 \leq u \leq t_j$ ,  $\text{Car}(\nu(\pi)(u)) = \text{Car}(\pi(u))$ . Let  $t_j < u \leq t_{j+1}$ . We can write  $\pi(t_j)$  as  $[c_j, (b_1, \dots, b_m)]$  and  $\pi(u)$  as  $[c_j, (a_1, \dots, a_m)]$ , where  $b_i \leq a_i$  for every  $i$ .

- If  $u < t_{j+1}$ , by the properties of the carrier sequence,  $\text{Car}(\pi(u)) = c_j$ , so with  $0 < a_i < 1$  for every  $i$ . Since  $b_i \leq a_i$ ,  $b_i < 1$  for every  $i$ . Let us write  $\nu(\pi)(t_j)$  as  $[c_j, (b'_1, \dots, b'_m)]$ . Since  $\text{Car}(\nu(\pi)(t_j)) = \text{Car}(\pi(t_j))$ ,  $b_i = 1$  iff  $b'_i = 1$ . It follows that  $b'_i < 1$  for every  $i$ . Therefore  $0 < \max(a_i, b'_i) < 1$ , so  $\text{Car}(\nu(\pi)(u)) = c_k$ .
- If  $u = t_{j+1}$ , we observe that  $\max(a_i, b'_i)$  is equal to 1, resp. to 0, resp. in  $(0, 1)$ , if and only if  $a_i$  is. This observation is enough to conclude that  $\text{Car}(\nu(\pi)(t_{j+1})) = \text{Car}(\pi(t_{j+1}))$ , and is proved as follows. If  $a_i = 1$ , then  $\max(a_i, b'_i) = 1$ . If  $a_i = 0$  then  $b_i = 0$ ; moreover, since  $\text{Car}(\nu(\pi)(t_j)) = \text{Car}(\pi(t_j))$ ,  $b_i = 0$  iff  $b'_i = 0$ , so  $b'_i = 0$ , from which we obtain  $\max(a_i, b'_i) = 0$ . Finally, if  $0 < a_i < 1$  then  $b_i < 1$ , and  $b'_i < 1$  (since  $\text{Car}(\nu(\pi)(t_j)) = \text{Car}(\pi(t_j))$ ,  $b_i = 1$  iff  $b'_i = 1$ ), so  $0 < \max(a_i, b'_i) < 1$ .

This finishes our argument that  $c_0, \dots, c_k$  is the carrier sequence of  $\nu(\pi)$ , with times of change  $0 = t_0 \leq \dots \leq t_{k+1} = 1$ .

It remains to show that  $\nu(\pi)(1) = t$ . This is the only place where we need the  $\varepsilon$  mapping. The above argument works in general precubical sets, not just cubical complexes. On the contrary, we need the specific features of cubical complexes to show that  $\nu(\pi)(1) = t$ . We discuss this in a remark at the end of the section.

We know that  $\text{Car}(t) = \text{Car}(\nu(\pi)(1)) = c_k$ . Moreover,  $t$  is below  $\nu(\pi)(1)$  in the ordering  $\leq$  of the pospace  $X = \overrightarrow{\text{Geom}}(K)$ , because  $\nu(\pi)(1) = \nu(\pi)(t_k) \vee_{c_k} \pi(1) = \nu(\pi)(t_k) \vee_{c_k} t$ . Suppose that  $\nu(\pi)(1) \not\leq t$ . Because  $K$  is a cubical complex, we can make use of the  $\varepsilon$  isomorphism. From  $\nu(\pi)(1) \not\leq t$ , we obtain  $\varepsilon(\nu(\pi)(1)) \not\leq \varepsilon(t)$ . Let us write  $\varepsilon(\nu(\pi)(t_j))$  as  $(x_1^j, \dots, x_d^j)$  and  $\varepsilon(\pi(t_j))$  as  $(y_1^j, \dots, y_d^j)$ . We show that  $\varepsilon(\nu(\pi)(t_j)) \not\leq \varepsilon(t)$  by decreasing induction on  $j$ . The case  $j = k + 1$  is by assumption. Suppose  $\varepsilon(\nu(\pi)(t_{j+1})) \not\leq \varepsilon(t)$ . There must be an index  $m \in \{1, 2, \dots, d\}$  such that  $x_m^{j+1} > y_m^{k+1}$ . It is easy to see that the identity  $\varepsilon([c, \vec{a}] \vee_c [c, \vec{b}]) = \varepsilon([c, \vec{a}]) \vee \varepsilon([c, \vec{b}])$  holds, where the right-hand  $\vee$  is componentwise max in  $\mathbb{R}^d$  (a property that is not usually implied by the mere fact that  $\varepsilon$  is an isomorphism). From that and  $\nu(\pi)(t_{j+1}) = \nu(\pi)(t_j) \vee_{c_j} \pi(t_{j+1})$ , we infer that  $x_m^{j+1} = \max(x_m^j, y_m^{j+1})$ , hence  $y_m^{j+1} \leq x_m^{j+1}$ . But  $\pi$  restricts to a dipath from  $t_j$  to  $t$ , so  $\varepsilon(\pi(t_j)) \leq \varepsilon(t)$ , and therefore  $y_m^{j+1} \leq y_m^{k+1} < x_m^{j+1}$ . From  $y_m^{j+1} < x_m^{j+1}$  and  $x_m^{j+1} = \max(x_m^j, y_m^{j+1})$ , we obtain  $x_m^{j+1} = x_m^j$ , whence  $x_m^j > y_m^{k+1}$ . In particular,  $\varepsilon(\nu(\pi)(t_j)) \not\leq \varepsilon(t)$ .

Taking  $j = 0$ , this implies that  $\varepsilon(s) \not\leq \varepsilon(t)$ . This is impossible, since  $\pi$  is a dipath from  $s$  to  $t$ .

We have constructed a map  $\nu$  such that  $\pi$  and  $\nu(\pi)$  have the same carrier sequence. By the previous lemma,  $\tilde{\nu}$  is an inverse modulo homotopy of  $\eta_s^*$ . *.QED.*

Define  $\tau_{\langle \gamma \rangle}$  as the composition  $(\ast \mu_t)^{-1} \circ \ast \rho_t \circ (\lambda_s^\ast)^{-1} \circ \eta_s^\ast$  of four homotopy equivalences (here  $(\ast \mu_t)^{-1}$  and  $(\lambda_s^\ast)^{-1}$  denote inverse modulo homotopy of  $\ast \mu_t$  and  $\lambda_s^\ast$ ), so  $\tau_{\langle \gamma \rangle}$  is a homotopy equivalence. It only remains to prove that the construction is natural in **HoTop**, meaning that the following diagram:

$$\begin{array}{ccc}
 \overrightarrow{T}(X)(s, t) & \xrightarrow{\tau_{\langle \gamma \rangle}} & \overrightarrow{T}(X)(\widehat{\text{Car}}(s), \widehat{\text{Car}}(t)) \\
 \downarrow \langle \alpha \star \_ \star \beta \rangle & & \downarrow (\widehat{\text{Car}}(\alpha) \star \_ \star \widehat{\text{Car}}(\beta)) \\
 \overrightarrow{T}(X)(s', t') & \xrightarrow{\tau_{\langle \alpha \star \gamma \star \beta \rangle}} & \overrightarrow{T}(X)(\widehat{\text{Car}}(s'), \widehat{\text{Car}}(t'))
 \end{array}$$

is commutative modulo homotopy, which is true by lemma 14. Finally, define  $\sigma_{\langle \gamma \rangle} = H_n(\tau_{\langle \gamma \rangle})$ .  $\sigma$  is a natural isomorphism because  $\tau$  is a natural isomorphism in **HoTop**.

Lemma 15 is false in general in a non-looping precubical set. Our result states that if there is a dipath from  $s$  to  $t$ ,  $s_-$  has the same carrier as  $s$  and there is a dipath from  $s_-$  to  $s$  then the trace spaces  $\vec{T}(X)(s, t)$  and  $\vec{T}(X)(s', t)$  are homotopically equivalent—in particular, they have the same number of connected components. But let us consider the following non-looping precubical set:

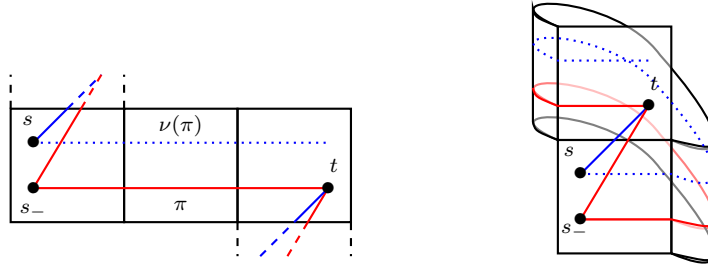

It has three squares (look at the view on the left), and the bottom face of the rightmost square is glued to the top face of the leftmost one. The glueing is displayed on the right. Consider now  $s$ ,  $s_-$  and  $t$  as in the figure.  $\vec{T}(X)(s, t)$  has one connected component (one of its element is drawn in plain blue) while  $\vec{T}(X)(s', t)$  has two (an element of each is drawn in plain red). Hence Lemma 15 would fail if we allowed  $K$  to be a general non-looping precubical set, not just a cubical complex.

The argument we use to prove Lemma 15 works perfectly well in general non-looping precubical sets, except for one thing: it may be that  $\nu(\pi)(1)$  does not coincide with  $t$ , and is strictly above. See the dotted blue line in the figure above to contemplate what  $\nu(\pi)$  looks like in this example.

### 8.3.4 Consequences

#### 8.3.4.1 Computability

This result has for consequence that our directed homology is computable in the sense that the following problem is decidable:

**data:** Two cubical complexes  $K$  and  $K'$  and an integer  $n \geq 1$ .

**question:** Are  $\vec{NH}_n(\vec{Geom}(K))$  and  $\vec{NH}_n(\vec{Geom}(K'))$  bisimilar when homology is with values in  $\mathbb{R}$ -modules ?

For this, it is enough to compute  $\vec{NH}_n(K)$  and  $\vec{NH}_n(K')$  in the reals and use the algorithm from the last chapter. Given a cubical complex, computing  $\vec{NH}_n(K)$  can be done in two steps:

1. compute a diagram with values in finite pre-simplicial sets (similar to precubical sets, or simplicial sets without degeneracies) from which the application of the simplicial homology functor produces a diagram in real vector spaces isomorphic to  $\vec{NH}_n(K)$ ,
2. compute this homology.

The second step is implemented in several classic tools for computing homology. For example:

- Sage module CHomP [Palmieri ],
- RedHom library [Brendel ].

For the first step, there are two possibilities:

- use the work from [Rausssen 2010]. This produces a diagram in prod-simplicial complexes, kind of a mix between pre-cubical and pre-simplicial sets. From those prod-simplicial complexes, it is possible to produce pre-simplicial sets as required. We will not present the full construction from [Rausssen 2010], but at least develop an example. Consider the following d-space:

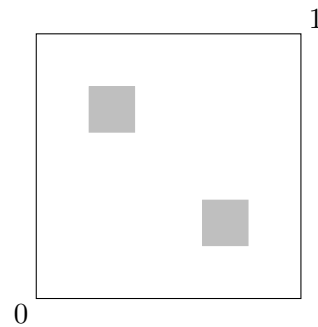

It is the geometric realization of some cubical complex. To compute the prod-simplicial complex for the trace space between 0 and 1, we “extend” every holes in at least one direction and check which induced spaces have a non-empty trace space. For example, by extending each hole in one direction we obtain four cases:

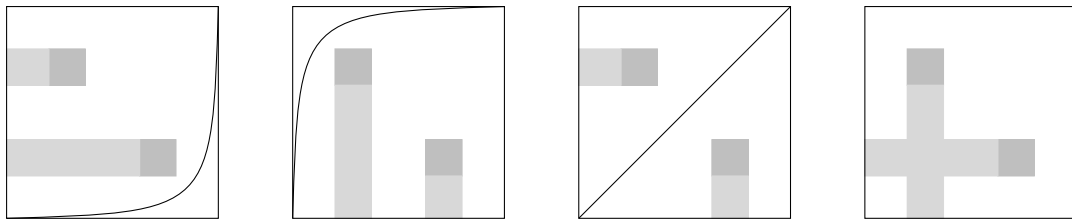

Only three of them have non-empty trace spaces which produces three cells in the prod-simplicial complex. Those cells are all of dimension 0 meaning that the trace space is equivalent to a 3 point space.

- the second possibility is to use the recent work from [Ziemiański 2017]. This produces a diagram in finite posets from which it is possible to construct the required diagram in presimplicial sets by applying the nerve functor. Those posets are produced by constructing the set of **cube chains**, which are very similar to our discrete traces. They are sequences of cubes such that the upper corner of a cube coincide with the lower corner of the next cube. They can essentially be ordered by inclusion, which produce the poset.

One should observe that classical methods from persistent homology cannot apply in our case, even multidimensional persistency [Zomorodian 2005]. The problem is that the quiver that we use (the categories  $\overrightarrow{NT}(X)$  and  $\overrightarrow{BT}(X)$ ) are not even tamed which makes the theory of persistency much harder.

### 8.3.4.2 Invariance under some action refinements

We have seen in Section 1.3.4 the particular importance of action refinement. Let us restrict here to the case of refining actions only by finite sequences of actions. Geometrically speaking, those refinements are modeled by **subdivision**. Given a cubical complex  $K$ , its subdivision  $\text{Sub}(K)$  is the cubical complex whose cubes are

$$\{(D, 2x + \sum_{j \in D'} \vec{1}_j) \mid (D, x) \in K, D' \subseteq D\}.$$

It is clear that  $\overrightarrow{\text{Geom}}(\text{Sub}(K))$  is dihhomeomorphic to  $\overrightarrow{\text{Geom}}(K)$ . Consequently,  $\overrightarrow{NH}_n(\overrightarrow{\text{Geom}}(K))$  is isomorphic to  $\overrightarrow{NH}_n(\overrightarrow{\text{Geom}}(\text{Sub}(K)))$ . Hence:

**Corollary 8** (Invariance under sequential refinement).  $\overrightarrow{DNH}_n(K)$  is bisimilar to  $\overrightarrow{DNH}_n(\text{Sub}(K))$ .

## 8.4 Relation with inessential equivalences, second homotopy axiom

### 8.4.1 Traces vs dipaths, again

We argued in Section 5.2.2 the difference between traces and dipaths. We used dipaths to define equivalences because they are purer, in the sense that path-connected components of spaces of dipaths are exactly equivalence classes of dipaths modulo dihomotopy, which is not the case for trace spaces. On the contrary, trace spaces are better for computation: concatenation is associative which allows one to define nice structures like the category of traces, they are computable in easy case [Raussen 2010]. That is why we used traces instead of dipaths in the definition of our directed homologies. But we could have defined them using only dipaths and dihomotopies.

First, since the dipaths category is not strictly a category because concatenation is only associative modulo dihomotopy, we cannot use it instead of the trace category. But we can use the fundamental category  $\overrightarrow{\pi}_1(X)$ . We can then apply the enveloping category  $\mathcal{E}$  and the category of factorizations  $\mathcal{F}$  on it. Similarly to  $\overrightarrow{BT}(X)$ , we can define a functor  $\overrightarrow{BP}(X) : \mathcal{E}(\overrightarrow{\pi}_1(X)) \rightarrow \mathbf{HoTop}$  which maps every pair of points  $(a, b)$  to the space of dipaths  $\overrightarrow{P}(X)(a, b)$  and every extensions  $(\langle \alpha \rangle, \langle \beta \rangle)$  to the homotopy class of the continuous function from  $\overrightarrow{P}(X)(a, b)$  to  $\overrightarrow{P}(X)(a', b')$  which maps a dipath  $\gamma$  to  $\alpha \star \gamma \star \beta$ . Remember that, since concatenation is not associative, we must define everything modulo homotopy. Since homology is invariant under homotopy, meaning that the functor  $H_n$  is actually a functor from  $\mathbf{HoTop}$  to  $\mathbf{Mod}(\mathcal{R})$ , one can define directed homology by applying this functor to  $\overrightarrow{BP}(X)$ . We denote the functor  $H_{n-1} \circ \overrightarrow{BP}(X)$  by  $\overrightarrow{DBH}_n(X)$ .

Everything that we have done with traces can be done with this definition with the following two exceptions: it is not possible to define diagrams of homotopy since we must point the dipath spaces and that we do not have a canonical dipath, but a dihomotopy class of dipaths ; the theory of homology of diagrams does not work well with this definition since  $\overrightarrow{DBH}_n(X)$  cannot be defined as the homology of a chain complex of diagrams of modules (we should somehow have something modulo homotopy). The other annoying property is that, in general,  $\overrightarrow{DBH}_n(X)$  is not bisimilar to  $\overrightarrow{BH}_n(X)$ , since dipath spaces and trace spaces do not have the same homology. But, this is the case in cubical complexes:

**Proposition 35.** For every cubical complexes  $K$ ,  $\overrightarrow{BH}_n(\overrightarrow{\text{Geom}}(K))$  is bisimilar to  $\overrightarrow{DBH}_n(\overrightarrow{\text{Geom}}(K))$ .

*Proof.* Let  $X = \overrightarrow{\text{Geom}}(K)$ . We construct an open map  $(\Phi, \sigma) : \overrightarrow{BH}_n(X) \rightarrow \overrightarrow{DBH}_n(X)$  as follow:

- the natural isomorphism is given by [Raussen 2009],

- $\Phi$  from  $\mathcal{E}(\overrightarrow{T}(X))$  to  $\mathcal{E}(\overrightarrow{\pi}_1(X))$  which maps  $(a, b)$  to  $(a, b)$  and every extension  $(\langle\alpha\rangle, \langle\beta\rangle)$  to  $([\alpha], [\beta])$ . It is trivially surjective on objects, and given an extension  $([\alpha], [\beta])$  from  $(a, b)$  to  $(a', b')$ ,  $(\langle\alpha\rangle, \langle\beta\rangle)$  is an extension from  $(a, b)$  to  $(a', b')$ .

.QED.

### 8.4.2 Second homotopy axioms

Our goal is to prove the following:

**Theorem 29** (Second homotopy axiom). *For every two cubical complexes  $K$  and  $K'$ , if  $\overrightarrow{Geom}(K)$  and  $\overrightarrow{Geom}(K')$  are inessentially equivalent, then their homology  $\overrightarrow{BH}_n(\overrightarrow{Geom}(K))$  and  $\overrightarrow{BH}_n(\overrightarrow{Geom}(K'))$  are bisimilar.*

This means that our directed homology is an invariant of inessential equivalences at least on spaces where we can do computations. By the previous proposition, it is enough to prove that  $\overrightarrow{DBH}_n(\overrightarrow{Geom}(K))$  and  $\overrightarrow{DBH}_n(\overrightarrow{Geom}(K'))$  are bisimilar. We can conclude using the following:

**Lemma 16.** *If  $(X, A)$  is a FIDR, and if  $H : X \rightarrow \mathcal{J}(X)$  is the corresponding dihomotopy, then  $H_1$  induces an open map from  $\overrightarrow{DBH}_n(X)$  to  $\overrightarrow{DBH}_n(A)$ . Similarly, for PIDR.*

*Proof.* First, the induced functor is defined  $\Phi_{H_1} : \mathcal{F}(\overrightarrow{\pi}_1(X)) \rightarrow \mathcal{F}(\overrightarrow{\pi}_1(A))$  by sending every class  $[\gamma]$  to  $[H_1 \circ \gamma]$ . This functor is surjective since  $H_1$  is the identity on  $A$ . It satisfies the fibrational property: given a class  $[H_1 \circ \gamma]$  of dipaths modulo dihomotopy in  $A$  with  $\gamma$  from  $x$  to  $y$  and let  $([\alpha], [\beta])$  be an extension in  $A$ , i.e.,  $\alpha$  and  $\beta$  are dipaths in  $A$  with  $\alpha$  from  $x'$  to  $H_1(x)$  and  $\beta$  from  $H_1(y)$  to  $y'$ .

By the last condition of a future deformation retract, there is a dipath  $\alpha'$  in  $X$  from  $w$  to  $x$  such that  $H_1 \circ \alpha'$  and  $\alpha$  are dihomotopic.

$\overrightarrow{P}(X)(y, y')$  is non-empty since it contains  $H(y) \star \beta$ . Since  $H_1 \circ \_ : \overrightarrow{P}(X)(y, y') \rightarrow \overrightarrow{P}(A)(H_1(y), y')$ ,  $\delta \mapsto H_1 \circ \delta$  is a homotopy equivalence,  $H_1 \circ \_ : \overrightarrow{\pi}_1(X)(y, y') \rightarrow \overrightarrow{\pi}_1(A)(H_1(y), y')$ ,  $[\delta] \mapsto [H_1 \circ \delta]$  is a bijection. There is, thus, a dipath  $\beta'$  from  $y$  to  $y'$  such that  $H_1 \circ \beta'$  is dihomotopic to  $\beta$ . Then  $([\alpha'], [\beta'])$  is the lifting we were looking for.

Now,  $H_1$  induces a natural transformation,  $\sigma_{H_1} : \overrightarrow{P}(X) \rightarrow \overrightarrow{P}(A) \circ \Phi_{H_1}$  by  $\sigma_{H_1, [\gamma]} : \overrightarrow{P}(X)(x, y) \rightarrow \overrightarrow{P}(A)(H_1(x), H_1(y))$ ,  $\delta \mapsto H_1 \circ \delta$  which is a homotopy equivalence. Consequently, by applying the homology functor, this forms a natural isomorphism from  $\overrightarrow{DBH}_n(X)$  to  $\overrightarrow{DBH}_n(A) \circ \Phi_{H_1}$ . .QED.

## Conclusion

In this last chapter, we come full circle. Using bisimilarity to compare diagrams of homology makes all our theory coherent: the two definitions using natural systems and bimodules are equivalent; homotopy axioms works up to bisimilarity; for cubical complexes, diagrams of homology are computable up to bisimilarity; and finally, for cubical complexes, our homology is an invariant of inessential equivalence.



# General conclusion

## Conclusion

When I started my thesis, my primary goal was to design a homology theory for directed spaces. There were many existing theories that do not satisfy us: they all somehow fail to detect sufficiently precisely default of dihomotopy (typically in examples like the matchbox). If the idea of looking at traces or dipaths spaces is not new, our use of bisimulations to compare diagrams of homology is a new and elegant idea: if the category of factorizations of the trace category is rigid, bisimilarity will smooth things out. The systematic use of bisimulations in our theory allows us to prove many important results: computability, homotopy axioms, directed Hurewicz theorem. In parallel, we also developed the theory of bisimulations of Joyal et al.: the case of bisimilarity of diagrams that was of particular usefulness in our theory was developed by proving many equivalent characterizations, in particular by relating diagram in modules to partially enriched categories through the Grothendieck construction; we investigated a general class of models for which this bisimilarity theory has many good properties, in particular with respect to unfoldings (existence, adjointness, universality).

Next, the question of which dihomotopy theory do we capture arose. At that time, I heard about Porter's ideas on the directed homotopy hypothesis. The fact that directed spaces should somehow look alike  $(\infty, 1)$ -categories seemed clear to me, but the direct application of Bergner's model structure on the trace category did not convince me, since it seems to capture reversible equivalence, which is much more rigid than we wanted. Following intuitions I got with bisimilarity, and more particularly the relation with partially enriched categories, and Goubault et al.'s work on categories of components, I designed a proposal of a directed homotopy hypothesis:  $d$ -spaces up to inessential equivalences are related to partially enriched categories up to equivalences close to Dwyer-Kan equivalences, and so, still close to  $(\infty, 1)$ -categories. It turned out that this makes all our theory coherent: inessential equivalence is in-between reversible and directed equivalence and classify many spaces as we wanted; its action on the fundamental category uses the category of components; the theory is still close to  $(\infty, 1)$ -categories; diagrams of homology are an invariant of it, at least for spaces for which we can make some computations.

## Future work

### Model structures for directed spaces

We have seen with the directed homotopy hypothesis that there is a close relation between  $d$ -spaces and model structures for  $(\infty, 1)$ -categories. Designing model structures for directed spaces is a hard problem that is actively studied, without succeeding for now (although Krishnan's recent unpublished work on this topic seems promising). Two natural questions arise from my thesis: is there a model structure (or similar categorical objects) for  $d$ -spaces and inessential equivalences? Do we have a formulation of our directed homotopy hypothesis similar to Quillen's for topological spaces? We do not have the answer of those questions yet, but we may have ideas for the first one. If the first question means: do we have a model structure whose weak-equivalences are FIDR or PIDR, the answer is no: the 2-out-of-3 property fails. However, there is hope that we might be able to construct a category of fibrant objects (an alternative to model structures) for which a path object can be the space of inessential dipaths.



**Fundamental categories and d-spaces, again**

In classical algebraic topology, given a groupoid, there is always a topological space whose fundamental groupoid is equivalent to the initial groupoid. This space can be constructed, similarly to classifying spaces, as the geometric realization of the nerve of the groupoid. Although intuitive, this result is not easy to prove and uses results from Quillen model structures (see for example, [Joyal 2008b]). Can we prove a similar result for d-spaces and fundamental categories? That is, is there a geometric realization in d-spaces such that this realization of the nerve of a category produces a d-space whose fundamental category is equivalent to this category? Typically, we would like a geometric realization similar to those seen in Chapter 2 for precubical sets. This should define a directed structure on geometric standard simplex  $\Delta_n$ , let us note  $\vec{\Delta}_n$  this hypothetic structure, and one property should be that  $\vec{\pi}_1(\vec{\Delta}_n)$  is equivalent to the poset  $\{0, \dots, n\}$  with the usual ordering. We have such a structure: if  $\Delta_n = \{(t_0, t_1, \dots, t_n) \in [0, 1]^{n+1} \mid \sum_i t_i = 1\}$ , for  $i \in \{0, \dots, n\}$ , define

$$D_i = \{(t_0, \dots, t_n) \in \Delta_n \mid \forall j < i, t_j < t_i \wedge \forall j > i, t_j \leq t_i\}.$$

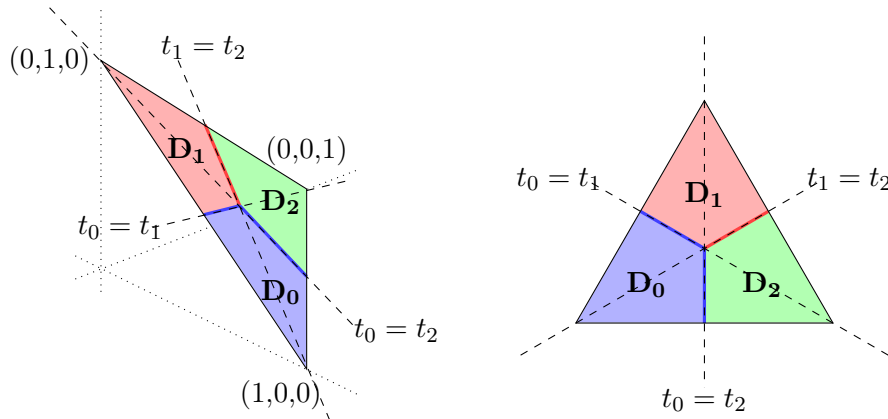

Figure 8.2: 2-dimensional structure  $\vec{\Delta}_2$

We will say that a continuous map  $\gamma : I \rightarrow \Delta_n$  is a dipath of  $\Delta_n$  if it is such that there exist  $k \geq 1, 0 \leq i_1 < \dots < i_k \leq n$  integers and  $0 < t_1 < \dots < t_{k-1} < t_k = 1$  real numbers with :

- $\forall t \in [0, t_1], \gamma(t) \in D_{i_1}$  ;
- $\forall j \in \{2, \dots, k\}, \forall t \in ]t_{j-1}, t_j], \gamma(t) \in D_{i_j}$ .

Is it possible to prove that the induced geometric realization produces a d-space as wanted ?

**Relation to persistency**

We have seen in Chapter 8 that even if intuitions from persistent homology seems similar to our computation of diagrams of homology, we cannot use directly techniques from persistency. Nevertheless, it would be interesting to look at what kind of informations persistency can give us on cubical complexes. For example, consider this cubical complex:

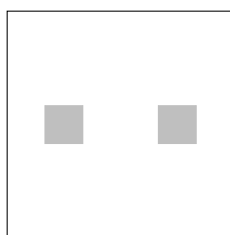

Persistency will be able to describe the evolution of the trace space between 0 and  $(t_1, t_2)$  by letting  $t_1$  and  $t_2$  evolve.

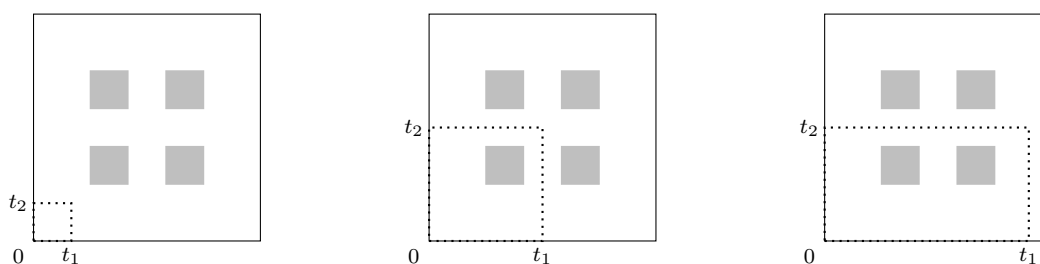

This uses 2-dimensional persistency theory, but this essentially only look at how holes appear. We may be more interested by looking at trace spaces between  $(t_1, t_2)$  and  $(t_3, t_4)$  and see how it evolves when letting  $t_1, t_2, t_3$  and  $t_4$  evolve, using 4-dimensional persistency.

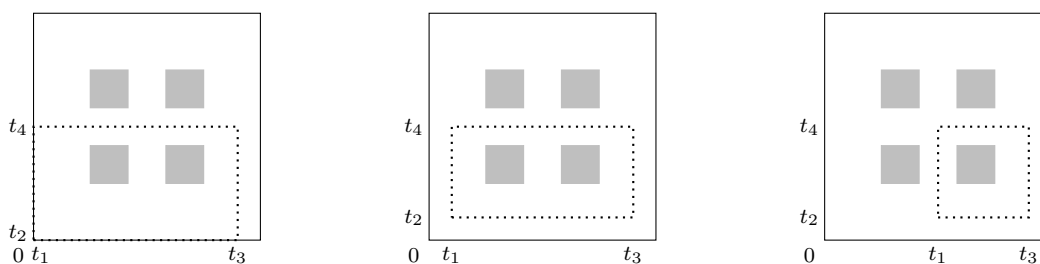



# Bibliography

- [Adámek 2004] Jiří Adámek, Horst Herrlich and George E. Strecker. *Abstract and Concrete Categories: The Joy of Cats*. Dover Publication, 2004. (Cited on page 31.)
- [Afek 1990] Yehuda Afek, Hagit Attiya, Danny Dolev, Eli Gafni, Michael Merritt and Nir Shavit. *Atomic Snapshots of Shared Memory*. In Proceedings of the 9th annual ACM symposium on Principles of distributed computing PODC, Journal of the ACM, volume 40, pages 873–890. ACM New York, January 1990. (Cited on page 25.)
- [Aguado 2012] Alex Aguado. A short note on mapping cylinders. arXiv:1206.1277v2, July 2012. (Cited on pages 100 and 101.)
- [Baues 1985] Hans-Joachim Baues and Günther Wirsching. *Cohomology of small categories*. Journal of Pure and Applied Algebra, vol. 38, no. 2-3, pages 187–211, November 1985. (Cited on page 118.)
- [Bednarczyk 1987] Marek A. Bednarczyk. *Categories of asynchronous systems*. Phd thesis, University of Sussex, 1987. (Cited on pages 2, 11 and 180.)
- [Bednarczyk 1999] Marek A. Bednarczyk, Andrzej M. Borzyszkowski and Wieslaw Pawlowski. *Generalized Congruences - Epimorphisms in Cat*. Theory and Applications of Categories, vol. 5, no. 11, pages 266–280, December 1999. (Cited on pages 79 and 80.)
- [Ben-Or 1986] Michael Ben-Or, Dexter Kozen and John Reif. *The Complexity of Elementary Algebra and Geometry*. Journal of Computer and System Sciences, vol. 32, pages 251–264, 1986. (Cited on page 146.)
- [Bergner 2004] Julia E. Bergner. *A model category structure on the category of simplicial categories*. Transactions of the American Mathematical Society, 2004. (Cited on pages 94 and 185.)
- [Borceux 1994a] Francis Borceux. *Handbook of Categorical Algebra 1: Basic Category Theory*. Cambridge University Press, 1994. (Cited on page 78.)
- [Borceux 1994b] Francis Borceux. *Handbook of categorical algebra 2: Categories and structures*. Cambridge University Press, 1994. (Cited on page 52.)
- [Brendel ] Piotr Brendel, Paweł Dłotko, Grzegorz Jabłoński, Mateusz Juda, Andrzej Krajniak, Marian Mrozek, Hubert Wagner, Przemysław Witek and Natalia Zelazna. *RedHom*. <http://capd.sourceforge.net/capdRedHom/people.php>. (Cited on page 162.)
- [Brown 2006] Ronald Brown. *Topology and Groupoids*. Booksurge LLC, S.Carolina, 2006. (Cited on pages 44 and 69.)
- [Canny 1988] John Canny. *Some algebraic and geometric computations in PSPACE*. In Proceedings of the twentieth annual ACM symposium on Theory of computing (STOC), pages 460–467, 1988. (Cited on page 146.)
- [Dijkstra 1965] Edsger W. Dijkstra. *Cooperating sequential processes, Technical Report EWD-123*. Technical report, University of Texas, 1965. (Cited on page 25.)

- [Dubut 2015] Jérémy Dubut, Eric Goubault and Jean Goubault-Larrecq. *Natural Homology*. In Proceedings of the 42nd International Colloquium on Automata, Languages and Programming (ICALP'15) – Part II, volume 9135 of *Lecture Notes in Computer Science*, pages 171–183. Springer, July 2015. (Cited on pages 5 and 149.)
- [Dubut 2016a] Jérémy Dubut, Eric Goubault and Jean Goubault-Larrecq. *Bisimulations and Unfolding in P-Accessible Categorical Models*. In Proceedings of the 27th International Conference on Concurrency Theory (CONCUR 2016), volume 59 of *Leibniz International Proceedings in Informatics (LIPIcs)*, pages 1–14. Schloss Dagstuhl–Leibniz-Zentrum fuer Informatik, 2016. (Cited on page 6.)
- [Dubut 2016b] Jérémy Dubut, Eric Goubault and Jean Goubault-Larrecq. *Directed homology theories and Eilenberg-Steenrod axioms*. Applied Categorical Structures, pages 1–33, 2016. (Cited on page 5.)
- [Dubut 2016c] Jérémy Dubut, Eric Goubault and Jean Goubault-Larrecq. *The Directed Homotopy Hypothesis*. In Proceedings of the 25th Annual EACSL Conference on Computer Science Logic (CSL'16), volume 62 of *Leibniz International Proceedings in Informatics*, pages 1–16. Leibniz-Zentrum für Informatik, September 2016. (Cited on pages 5 and 96.)
- [Eilenberg 1945] Samuel Eilenberg and Norman E. Steenrod. *Axiomatic Approach to Homology Theory*. Proceedings of the National Academy of Science of the United States of America, vol. 31, no. 4, pages 117–120, April 1945. (Cited on pages 5 and 113.)
- [Fahrenberg 2003] Ulrich Fahrenberg. *Directed Homology*. In Proceedings of the 5th Workshop on Geometric and Topological Methods in Concurrency (GETCO), Marseilles, France, September 2003. (Cited on pages 42 and 115.)
- [Fahrenberg 2007] Ulrich Fahrenberg and Martin Raussen. *Reparametrizations of continuous paths*. Journal of Homotopy and Related structures, vol. 2, no. 2, pages 93–117, 2007. (Cited on pages 29 and 45.)
- [Fahrenberg 2013] Ulrich Fahrenberg and Axel Legay. *History-Preserving Bisimilarity for Higher-Dimensional Automata via Open Maps*. In Proceedings of the 29th Conference on the Mathematical Foundations of Programming Semantics, MFPS XXIX, volume 298 of *Electronic Notes in Theoretical Computer Science*, pages 165–178, 2013. (Cited on page 25.)
- [Fajstrup 2003] Lisbeth Fajstrup. *Discovering Spaces*. Homology, Homotopy and Applications, vol. 5, no. 2, pages 1–17, 2003. (Cited on pages 3, 33 and 182.)
- [Fajstrup 2005] Lisbeth Fajstrup. *Dipaths and dihomotopies in a cubical complex*. Advances in Applied Mathematics, vol. 35, no. 2, pages 188–206, August 2005. (Cited on pages 155, 156 and 157.)
- [Fajstrup 2012] Lisbeth Fajstrup, Eric Goubault, Emmanuel Haucourt, Samuel Mimram and Martin Raussen. *Trace Spaces: An Efficient New Technique for State-Space Reduction*. In Proceedings of the 21st European Symposium on Programming (ESOP), volume 7211 of *Lecture Notes in Computer Science*, pages 274–294, Tallinn, Estonia, March 2012. Springer. (Cited on page 45.)
- [Fajstrup 2016] Lisbeth Fajstrup, Eric Goubault, Emmanuel Haucourt, Samuel Mimram and Martin Raussen. *Directed Algebraic Topology and Concurrency*. Springer, 2016. (Cited on pages 4, 27, 34, 40, 45 and 182.)

- [Gabriel 1967] Peter Gabriel and Michel Zisman. *Calculus of Fractions and Homotopy Theory*, volume 35 of *Ergebnisse der Mathematik und ihrer Grenzgebiete*. Springer, 1967. (Cited on pages 70, 71 and 77.)
- [Gaucher 2003] Philippe Gaucher. *A model category for the homotopy theory of concurrency*. *Homology, Homotopy and Applications*, vol. 5, no. 1, pages 549–599, 2003. (Cited on page 97.)
- [Ghrist 2016] Robert Ghrist and Sanjeevi Krishnan. *Positive Alexander Duality for Pursuit and Evasion*. arXiv:1507.04741, May 2016. (Cited on page 115.)
- [Goubault-Larrecq 2014] Jean Goubault-Larrecq. *Exponentiable streams and prestreams*. *Applied Categorical Structures*, vol. 22, no. 3, pages 515–549, June 2014. (Cited on pages 36 and 39.)
- [Goubault 1995] Eric Goubault. *Géométrie du parallélisme*. Phd thesis, Ecole Polytechnique, 1995. (Cited on page 115.)
- [Goubault 2007] Eric Goubault and Emmanuel Haucourt. *Components of the Fundamental Category II*. *Applied Categorical Structures*, vol. 15, no. 4, pages 387–414, August 2007. (Cited on pages 5, 65, 66, 74, 75, 78, 79, 80, 83, 184 and 185.)
- [Goubault 2012] Eric Goubault and Samuel Mimram. *Formal Relationships Between Geometrical and Classical Models for Concurrency*. In *Proceedings of the workshop on Geometric and Topological Methods in Computer Science (GETCO)*, volume 283, pages 77–109. *Electronic Notes in Theoretical Computer Science*, 2012. (Cited on page 23.)
- [Goubault 2016] Eric Goubault and Samuel Mimram. *Directed Homotopy in Non-Positively Curved Spaces*. Submitted, 2016. (Cited on page 42.)
- [Grandis 1991a] Marco Grandis. *General homological algebra, I. Semiexact and homological categories*. Preprint 186, Dipartimento di Matematica Università degli Studi di Genova, 1991. (Cited on pages 111, 123, 126 and 188.)
- [Grandis 1991b] Marco Grandis. *General homological algebra, II. Homology and satellites*. Preprint 187, Dipartimento di Matematica Università degli Studi di Genova, 1991. (Cited on pages 123, 125, 126, 127 and 188.)
- [Grandis 2001] Marco Grandis. *Directed homotopy theory, I. the fundamental category*. arXiv:math/0111048v2, November 2001. (Cited on pages 3, 36 and 182.)
- [Grandis 2004] Marco Grandis. *Inequillogical spaces, directed homology and noncommutative geometry*. *Homology, Homotopy and Applications*, vol. 6, no. 1, pages 413–437, 2004. (Cited on page 115.)
- [Grandis 2009] Marco Grandis. *Directed Algebraic Topology: Models of Non-Reversible Worlds*, volume 13 of *New Mathematical Monographs*. Cambridge University Press, 2009. (Cited on pages 4, 5, 29, 36, 42, 45, 65, 68, 70, 182, 183 and 186.)
- [Grothendieck 1983] Alexander Grothendieck. *Pursuing Stacks*. Manuscript, 1983. (Cited on page 85.)
- [Hatcher 2002] Allen Hatcher. *Algebraic topology*. Cambridge University Press, February 2002. (Cited on pages 66, 100, 109, 111, 112, 114 and 129.)

- [Haucourt ] Emmanuel Haucourt. *ALCOOL*. <http://www.lix.polytechnique.fr/Labo/Emmanuel.Haucourt/programmation.html>. (Cited on page 79.)
- [Haucourt 2012] Emmanuel Haucourt. *Streams, d-Spaces and Their Fundamental Categories*. Electronic Notes in Theoretical Computer Science, vol. 283, pages 111–151, June 2012. (Cited on pages 35 and 39.)
- [Hennessy 1980] Matthew Hennessy and Robin Milner. *On Observing Nondeterminism and Concurrency*. In Proceedings of the 7th Colloquium on Automata, Languages and Programming, pages 299–309. Springer Berlin Heidelberg, 1980. (Cited on pages 17 and 189.)
- [Jacobs 2016] Bart Jacobs. Introduction to Coalgebra: Towards Mathematics of States and Observation. Cambridge Tracts in Theoretical Computer Science. Cambridge University Press, October 2016. (Cited on page 19.)
- [Johnstone 2002] Peter T. Johnstone. Sketches of an elephant: A topos theory compendium, volume 1. Oxford University Press, 2002. (Cited on page 141.)
- [Joyal 1994] André Joyal and Ieke Moerdijk. *A completeness theorem for open maps*. Annals of Pure and Applied Logic, vol. 70, no. 1, pages 51–86, November 1994. (Cited on page 51.)
- [Joyal 1996] André Joyal, Mogens Nielsen and Glynn Winskel. *Bisimulation from open maps*. Information and Computation, vol. 127, no. 2, pages 164–185, June 1996. (Cited on pages 5, 19, 21, 47, 48, 49, 51, 131 and 189.)
- [Joyal 2008a] André Joyal. The Theory of Quasi-Categories and its Applications. Lecture notes, 2008. (Cited on page 94.)
- [Joyal 2008b] André Joyal and Myles Tierney. Notes on simplicial homotopy theory. Lecture notes, 2008. (Cited on page 168.)
- [Kaczynskil 2003] Tomasz Kaczynskil, Konstantin Mischaikow and Marian Mrozek. *Computing homology*. Homology, Homotopy and Applications, vol. 5, no. 2, pages 233–256, 2003. (Cited on page 155.)
- [Kahl 2014] Thomas Kahl. *The homology graph of a precubical set*. Homology, Homotopy and Applications, vol. 16, no. 1, pages 119–138, 2014. (Cited on pages 115 and 186.)
- [Krishnan 2009] Sanjeevi Krishnan. *A Convenient Category of Locally Preordered Spaces*. Applied Categorical Structures, vol. 17, no. 5, pages 445–466, October 2009. (Cited on pages 3, 29, 34, 36 and 182.)
- [Mac Lane 1978] Saunders Mac Lane. Categories for the Working Mathematician, volume 5 of *Graduate Texts in Mathematics*. Springer, 1978. (Cited on page 121.)
- [Makkai 1989] Michael Makkai and Robert Paré. Accessible categories: The foundations of categorical model theory, volume 104 of *Contemporary Mathematics*. American Mathematical Society, 1989. (Cited on page 50.)
- [May 1999] J. P. May. A Concise Course in Algebraic Topology. Chicago Lectures in Mathematics. University of Chicago Press, 1999. (Cited on page 58.)

- [Mazurkiewicz 1989] Antoni Mazurkiewicz. *Basic notions of trace theory*. In Linear Time, Branching Time and Partial Order in Logics and Models for Concurrency. REX 1988. Lecture Notes in Computer Science, volume 354, pages 285–363. Springer, Berlin, Heidelberg, 1989. (Cited on page 14.)
- [Mitchell 1972] Barry Mitchell. *Rings with several objects*. Advances in Mathematics, vol. 8, no. 1, pages 1–161, February 1972. (Cited on page 117.)
- [Munkres 1930] James R. Munkres. Elements of Algebraic Topology. Addison-Wesley Publishing Company, 1930. (Cited on page 114.)
- [Nachbin 1965] Leopoldo Nachbin. Topology and order, volume 4 of *Van Nostrand mathematical studies*. Robert E. Krieger Publishing Company, 1965. (Cited on page 32.)
- [Nielsen 1994] Mogens Nielsen, Valdimiro Sassone and Glynn Winskel. *Relationships Between Models of Concurrency*. In A Decade of Concurrency Reflections and Perspectives: REX School/Symposium Noordwijkerhout, The Netherlands June 1–4, 1993 Proceedings, pages 425–476. Springer Berlin Heidelberg, 1994. (Cited on pages 2, 14, 21 and 180.)
- [Nielsen 1995] Mogens Nielsen and Glynn Winskel. Models for concurrency, volume 4 of *Handbook of logic in computer science*. Oxford University Press, 1995. (Cited on page 23.)
- [nLab 2017] nLab. *homotopy hypothesis*. <https://ncatlab.org/nlab/show/homotopy+hypothesis>, 2017. (Cited on page 4.)
- [Palmieri ] John H. Palmieri. *CHomP*. <http://doc.sagemath.org/html/en/reference/homology/sage/interfaces/chomp.html>. (Cited on page 162.)
- [Park 1981] Daniel Park. *Concurrency and Automata on Infinite Sequences*. Lecture Notes in Computer Science, vol. 154, pages 167–183, 1981. (Cited on page 16.)
- [Patchkoria 2006] Alex Patchkoria. *On exactness of long exact sequences of homology semimodules*. Journal of Homotopy and Related structures, vol. 1, no. 1, pages 229–243, October 2006. (Cited on page 115.)
- [Porter 2008] Timothy Porter. *Enriched categories and models for spaces of evolving states*. Theoretical Computer Science, vol. 405, no. 1-2, pages 88–100, October 2008. (Cited on pages 4, 94 and 185.)
- [Porter 2015] Timothy Porter. Steps towards a ‘directed homotopy hypothesis’.  $(\infty, 1)$ -categories, directed spaces and perhaps rewriting. Presented at Homotopy in Concurrency and Rewriting, available from [www.lix.polytechnique.fr/Labo/Samuel.Mimram/docs/hcr/porter.pdf](http://www.lix.polytechnique.fr/Labo/Samuel.Mimram/docs/hcr/porter.pdf), June 2015. (Cited on pages 4, 5, 94 and 185.)
- [Pratt 1991] Vaughn Pratt. *Modeling concurrency with geometry*. In Proceedings of the 18th ACM SIGPLAN-SIGACT symposium on Principles of programming languages (POPL), pages 311–322, January 1991. (Cited on pages 3, 22 and 181.)
- [Quillen 1967] Daniel G. Quillen. Homotopical Algebra, volume 43 of *Lecture Notes in Mathematics*. Springer Berlin Heidelberg, 1967. (Cited on pages 85, 89 and 91.)



- [Rabinovitch 1988] Alexander Rabinovitch and Boris Trakhtenbrot. *Behavior structures and nets*. Fundamenta Informaticae, vol. 11, no. 4, pages 357–403, December 1988. (Cited on pages 21 and 189.)
- [Raussen 2007] Martin Raussen. *Invariants of Directed Spaces*. Applied Categorical Structures, vol. 15, no. 4, pages 355–386, August 2007. (Cited on page 116.)
- [Raussen 2009] Martin Raussen. *Trace spaces in a pre-cubical complex*. Topology and its Applications, vol. 156, no. 9, pages 1718–1728, May 2009. (Cited on pages 45, 160 and 164.)
- [Raussen 2010] Martin Raussen. *Simplicial models of trace spaces*. Algebraic & Geometric Topology, vol. 10, no. 3, pages 1683–1714, August 2010. (Cited on pages 45, 46, 163 and 164.)
- [Raussen 2012a] Martin Raussen. *Execution spaces for simple higher dimensional automata*. Applicable Algebra in Engineering, Communication and Computing, vol. 23, no. 1, pages 59–84, April 2012. (Cited on pages 45 and 156.)
- [Raussen 2012b] Martin Raussen. *Simplicial models for trace spaces II: Genral higher dimensional automata*. Algebraic & Geometric Topology, vol. 12, no. 3, pages 1745–1765, 2012. (Cited on page 45.)
- [Shields 1985] Michael W. Shields. *Concurrent Machines*. Computer Journal, vol. 28, no. 5, pages 449–465, January 1985. (Cited on pages 2, 11 and 180.)
- [Spanier 1966] Edwin H. Spanier. Algebraic topology. Springer, 1966. (Cited on page 113.)
- [Stirling 1996] Colin Stirling. *Modal and temporal logics for processes*. In Logics for Concurrency. Lecture Notes in Computer Science., volume 1043, pages 149–237. Springer Berlin Heidelberg, 1996. (Cited on page 17.)
- [Strøm 1972] Arne Strøm. *The homotopy category is a homotopy category*. Archiv der Mathematik, vol. 23, 1972. (Cited on page 87.)
- [Tarski 1951] Alfred Tarski. A decision method for elementary algebra and geometry. University of California Press, 1951. (Cited on page 146.)
- [van Glabbeek 1991] Robert J. van Glabbeek. Bisimulations for higher dimensional automata. Email message, <http://theory.stanford.edu/~rvg/hda>, June 1991. (Cited on page 24.)
- [van Glabbeek 2001] Robert J. van Glabbeek and Ursula Goltz. *Refinement of actions and equivalence notions for concurrent systems*. Acta Informatica, vol. 37, pages 229–327, 2001. (Cited on page 22.)
- [van Glabbeek 2005] Robert J. van Glabbeek. *On the Expressiveness of Higher Dimensional Automata: (Extended Abstract)*. Electronic Notes in Theoretical Computer Science, vol. 128, no. 2, pages 5–34, April 2005. (Cited on pages 3, 23, 24, 25 and 182.)
- [Winskel 1984] G. Winskel. *A New Definition of Morphism on Petri Nets*. In STACS 84, Symposium of Theoretical Aspects of Computer Science, Paris, France, 11-13 April, 1984, Proceedings, pages 140–150, 1984. (Cited on pages 53 and 57.)
- [Ziemiański 2012] Krzysztof Ziemiański. *A cubical model for path spaces in d-simplicial complexes*. Topology and its Applications, vol. 159, no. 8, pages 2127–2145, May 2012. (Cited on page 40.)

- 
- [Ziemiański 2017] Krzysztof Ziemiański. *Spaces of directed paths on pre-cubical sets*. *Applicable Algebra in Engineering, Communication and Computing*, 2017. (Cited on page 163.)
- [Zomorodian 2005] Afra Zomorodian and Gunnar Carlsson. *Computing Persistent Homology*. *Discrete and Computational Geometry*, vol. 33, no. 2, pages 249–274, February 2005. (Cited on page 163.)



# Résumé en français

---

## Introduction

Les systèmes concurrents sont un modèle particulier où différents agents, ou processus, évoluent dans le même environnement. Ils doivent cohabiter en gérant les ressources disponibles et en évitant les conflits. Vérifier de tels systèmes est une tâche difficile: il est nécessaire de s'assurer que le système ne fasse jamais rien de mauvais, quelque soit son comportement. Il est possible d'appliquer des méthodes classiques venant des systèmes séquentiels, en vérifiant toutes les exécutions possibles du système, c'est-à-dire, ce qui est utilisé dans les sémantiques par *entrelacements* de la concurrence. Cependant, le nombre de telles exécutions croît exponentiellement avec la taille du système, ce qui rend ces méthodes inapplicables.

L'idée de la *vraie concurrence* est que de nombreuses exécutions peuvent avoir exactement le même comportement, puisque, pour chaque agent, les exécutions sont les mêmes, et qu'elles diffèrent seulement par la façon dont les actions de chaque agent sont planifiées les unes par rapport aux autres. Cela suggère qu'il faudrait étudier non pas toutes les exécutions possibles, mais toutes les exécutions modulo une relation d'équivalence reliant des exécutions qui diffèrent seulement par permutation d'actions indépendantes, ce qui décroît grandement le nombre d'objets à considérer.

De manière surprenante, les modèles de la vraie concurrence sont très géométriques par nature: ils possèdent une structure algébrique qui peut être interprétée topologiquement. Grossièrement, un tel système est un espace topologique d'états, où les exécutions sont interprétées comme des chemins monotones (ou de manière plus précise, *dirigés*) dans cet espace, suivant le flot d'exécution du système. La relation d'équivalence sur les exécutions est alors elle-même interprétée continûment: deux exécutions, vues comme des chemins dirigés, sont équivalents s'il est possible de déformer continûment l'une en l'autre, tout en préservant la direction du temps, le flot d'exécution.

Cela amène à l'idée que ces systèmes de vraie concurrence doivent être étudiés géométriquement, en utilisant des outils mathématiques. De plus, étudier des espaces, leurs chemins, les déformations continues entre leurs chemins est l'une des idées principales d'un domaine bien connu des mathématiques: la topologie algébrique. Intuitivement, son but est d'étudier des espaces à déformations continues près, en utilisant des structures algébriques (catégories, groupes, modules, ...) qui reflètent la géométrie de l'espace: les chemins, les déformations continues entre chemins, les déformations continues entre déformations continues, etc.

La seule différence avec notre étude des systèmes de vraie concurrence est le rôle crucial de la direction du flot d'exécution. Tout doit être compatible avec celle-ci: les chemins doivent être dirigés, les déformations doivent être dirigées d'une façon ou d'une autre, etc. Cela ouvre un nouveau champ de recherche: la *topologie algébrique dirigée*, où le but principal est de construire des invariants algébriques similaires à la topologie algébrique classique, de définir des notions convenables de déformations qui préserve la direction, etc.

## Modéliser la vraie concurrence

Les modèles de la vraie concurrence ont été conçus en étendant les modèles classiques, comme les systèmes de transition et leur sémantique par entrelacement. L'idée est de pouvoir spécifier que des actions peuvent être indépendantes et peuvent ainsi être exécutées dans n'importe quel ordre, mais aussi (et surtout), *simultanément*. Un exemple typique est le cas de deux agents  $A$  et  $B$ , effectuant des calculs et mettant à jour la valeur de variables. Par exemple, supposons qu'il y a deux variables différentes  $X$  et  $Y$  et que  $A$  veut modifier la valeur de  $X$  à 0, ce que l'on notera  $X := 0$ ;  $B$  veut changer la valeur de  $Y$  à 1, noté  $Y := 1$ , tout cela en parallèle. Dans les systèmes de transition, ce système concurrent serait modélisé comme suit:

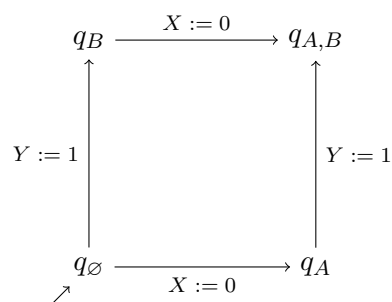

Avec ce modèle, les différents comportements possibles sont soit  $A$  effectue son action en premier puis  $B$  fait son action, soit  $B$  effectue son action en premier puis  $A$  fait son action, et ces deux comportements sont considérés de manière indépendante. Cependant, avec l'idée de la vraie concurrence, comme  $A$  et  $B$  mettent à jour des variables différentes, il n'y a aucun conflit ou réelle concurrence sur les ressources (ici, les variables). Ces actions peuvent donc être considérées indépendantes, ce qui signifie que faire l'une avant l'autre est équivalent à faire l'autre avant l'une, et que ces actions peuvent, en réalité, être effectuées simultanément.

Il y a plusieurs façon de spécifier que des actions sont indépendantes:

- la première idée est de définir une relation directement sur les actions qui représente le fait qu'elles soient indépendantes. Cela amène à la notion de *systèmes de transition avec indépendance* [Nielsen 1994].
- la deuxième idée est de regrouper les transitions qui représentent le même événement. Dans l'exemple précédent, les deux transitions étiquetées par  $X := 0$  représentent le même événement, à savoir " $A$  met à jour la valeur de  $X$  à 0". Il est alors possible de définir une relation d'équivalence sur ces événements, ce qui amène à la notion de *systèmes asynchrones* [Shields 1985, Bednarczyk 1987].
- la dernière idée est de spécifier les carrés de transitions de la forme:

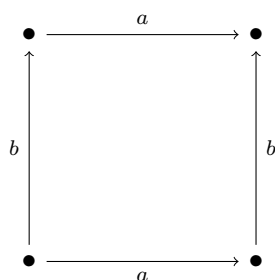

où  $a$  et  $b$  sont indépendantes et d'ajouter un carré formel dans la spécification, représenté comme suit:

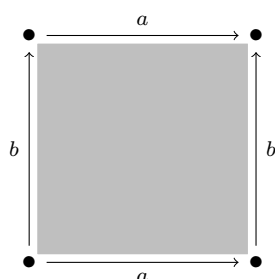

Cette idée peut être étendue aux dimensions supérieures: il est possible de spécifier des cubes de transitions de dimension  $n$ , où les transitions parallèles sont étiquetées par la même action, et où toutes les actions sont indépendantes les unes par rapport aux autres et enfin ajouter un cube de dimension  $n$  dans la spécification. Cela amène à la notion d'automates de dimension supérieure [Pratt 1991] (raccourci en HDA).

Tous ces modèles sont accompagnés d'une façon de les comparer, définie à l'aide de bisimulations, étendant le travail sur les systèmes de transition classiques.

Les HDA sont très géométriques par nature. Ils sont définis comme des collections d'éléments de diverses dimensions représentant les comportements indépendants des actions du système. Ces objets formels satisfont certaines conditions de "bord": grossièrement, tout sous-ensemble parmi un ensemble de  $n$  actions indépendantes est un ensemble d'actions indépendantes. Cela permet d'interpréter les objets de dimension  $n$  comme un cube géométrique de dimension  $n$ , et les équations satisfaites représentent des conditions de recollements de ces cubes. Pour résumer, à partir d'un HDA, il est possible de construire un espace topologique en recollant les cubes suivant les équations. Cet espace représente l'espace des états de l'HDA, et est appelé sa *réalisation géométrique*. Par exemple, le carré représenté au dessus peut être représenté géométriquement par un carré réel  $[0, 1] \times [0, 1]$ .

A partir de cette interprétation géométrique, il est possible de voir les exécutions comme des chemins, c'est-à-dire, des fonctions continues du segment  $[0, 1]$  dans la réalisation géométrique. Le seul problème est que le caractère dirigé n'est pas pris en compte: une exécution dans un HDA est dirigée par nature. Elle a une source et un but, et il n'est possible d'aller que de la source vers le but. Géométriquement, une exécution modélisée comme une copie du segment  $[0, 1]$  dans la réalisation géométrique, la source étant envoyée sur 0 et le but sur 1. Le problème est que les chemins définis de cette façon ne sont pas dirigés (ici, comprendre monotone), et ainsi il est possible de définir un chemin du but vers la source. Ces chemins ne peuvent pas être interprétés comme des exécutions du

HDA. Il est donc nécessaire de spécifier d'une façon ou d'une autre que la réalisation géométrique est dirigée: les cubes  $[0, 1]^n$  utilisés pour construire la réalisation géométrique sont naturellement dirigés. Il est possible de les équiper d'un ordre partiel, à savoir l'ordre produit. Cet ordre local à chaque cube peut être étendu en une structure dirigée sur la réalisation géométrique toute entière:

- soit en suivant l'idée des variétés, en considérant comme structure dirigée une collection d'ordre locaux qui interagissent bien globalement. Cela amène aux *espaces localement partiellement ordonnés* [Fajstrup 2003] et aux *streams* [Krishnan 2009],
- soit en spécifiant une collection de chemins qui sont localement monotones. Cela amène aux *d-espaces* [Grandis 2001].

Dans tous les cas, la structure dirigée permet de définir des *chemins dirigés*, qui sont des chemins compatibles avec la structure, et qui modéliseront les exécutions.

En suivant l'idée de la vraie concurrence, les exécutions d'un HDA peuvent être reliées par une relation d'équivalence interprétant que les exécutions sont égales à permutation des actions indépendantes près. Cette relation d'équivalence est appelée *homotopie* dans [van Glabbeek 2005], et fait écho à l'homotopie bien connue de la topologie algébrique. Géométriquement, l'homotopie dans les HDA peut être interprétée comme une notion d'homotopie dirigée ou *dihomotopie*, intuitivement, une relation similaire à l'homotopie classique dans les espaces topologiques, satisfaisant en plus une certaine compatibilité avec la structure dirigée. De manière un peu plus concrète, l'homotopie classique est une relation d'équivalence qui relie des chemins qui peuvent continûment être déformés l'un en l'autre. De manière similaire, la dihomotopie est une relation d'équivalence qui relie des chemins dirigés qui peuvent continûment être déformés l'un en l'autre, de façon à ce que la déformation soit compatible avec la structure dirigée.

Il est donc possible d'interpréter l'essence calculatoire d'un HDA géométriquement: l'espace dirigé représente les états, la structure dirigée en elle-même représente le flot d'exécution, les chemins dirigés représentent les exécutions, les dihomotopies représentent la relation d'équivalence modulo permutation d'actions indépendantes. L'étude systématique des espaces, de leurs chemins, des déformations continues entre chemins, ..., est le corps principal du domaine de la topologie algébrique. Dans ce domaine, on étudie les espaces modulo déformations continues, appelées *homotopies équivalences*, en construisant des invariants algébriques. Par exemple, les chemins modulo homotopies forment les morphismes d'une catégories, appelée la *catégorie fondamentale* de l'espace, et en est un invariant modulo homotopie équivalence. D'autres invariants algébriques ont été considérés: groupes d'homotopies, modules d'homologies, de cohomologie, ... Le but de la *topologie algébrique dirigée* est d'étendre ce travail à un cadre dirigé, en définissant des analogues dirigés aux équivalences d'homotopies, ainsi qu'aux invariants algébriques. Des travaux notoires ont été effectués dans ce sens:

- les travaux de Marco Grandis, compilés dans [Grandis 2009], forme une jolie théorie de la topologie algébrique dirigée, pour une notion spécifique d'équivalence d'homotopie. Ces travaux échouent néanmoins à décrire certains comportements qui nous intéressent ici.
- les travaux de [Fajstrup 2016]. Notamment, leurs travaux sur les espaces de traces (une autre façon d'interpréter les exécutions géométriquement) et les composantes dirigées (analogues dirigés des composantes connexes par arcs) furent une base solide pour la présente thèse.

Le but de celle-ci est de continuer sur cette voie en étudiant des théories homotopiques et homologiques pour ces espaces dirigés.

## Théories homotopiques pour les d-espaces

Revenons un peu sur les invariants algébriques en topologie algébrique classique, notamment la catégorie fondamentale  $\pi_1(X)$ , catégorie des points et chemins modulo homotopies, est un invariant de l'espace  $X$  modulo équivalence d'homotopie. Que cela signifie-t-il ? Tout d'abord, une équivalence d'homotopie est définie comme une fonction continue qui est un homéomorphisme à déformations continues près. De manière plus précise, c'est une fonction  $f : X \rightarrow Y$  telle qu'il existe une fonction continue  $g : Y \rightarrow X$  telle que  $g \circ f$  et  $f \circ g$  sont, à déformations continues près, égales à des identités. Cette dernière propriété se traduit par l'existence d'une fonction continue  $H : X \rightarrow P(X)$ , aussi appelée homotopie, où  $P(X)$  est l'espace des chemins de  $X$ , telle que  $H(x)(0) = x$  et  $H(x)(1) = g \circ f$  (idem pour  $f \circ g$ ). Maintenant, la construction de la catégorie fondamentale étant fonctorielle, une fonction continue  $f : X \rightarrow Y$  induit un foncteur  $\pi_1(f) : \pi_1(X) \rightarrow \pi_1(Y)$ . De plus, une homotopie entre deux fonctions continues induit un isomorphisme naturel entre les foncteurs induits (il est facile de voir que c'est isomorphisme car la catégorie fondamentale d'un espace est toujours un groupoïde, tout chemin ayant un inverse modulo homotopie). Par conséquent, une équivalence d'homotopie induit une équivalence de catégories entre les catégories fondamentales. C'est en ce sens que la catégorie fondamentale est un invariant.

Maintenant, que pouvons-nous faire dans le cas dirigé ? La catégorie fondamentale, cette fois notée  $\vec{\pi}_1(X)$ , fait toujours sens: c'est la catégorie des points et des chemins dirigés modulo dihomotopies. En quoi, pouvons-nous dire que c'est un invariant ? Pour quelle relation d'équivalence sur les d-espaces ? Il y a plusieurs façons naturelles d'étendre la notion d'équivalence d'homotopie à un cadre dirigé (cf. [Grandis 2009] par exemple). Par exemple, il suffit d'étendre la notion d'homotopie entre dimaps (fonctions continues qui préservent la structure dirigée): une dihomotopie est une fonction continue  $H : X \rightarrow K$ , où  $K$  est un sous-espace de l'espace des chemins  $P(Y)$ , et telle que pour tout  $t \in [0, 1]$ ,  $x \mapsto H(x)(t)$  est une dimap. Suivant le choix de  $K$ , on obtient différentes notions de dihomotopie et donc d'équivalence de dihomotopie:

- Le plus naturel serait de prendre  $K = \vec{P}(Y)$ , l'ensemble des chemins dirigés. Dans ce cas, une équivalence de dihomotopie n'induit pas une équivalence de catégories entre les catégories fondamentale, mais entre leurs groupoidifications. De plus, cette équivalence échoue à détecter certains défauts de dihomotopie. Un exemple typique est la boîte d'allumettes:

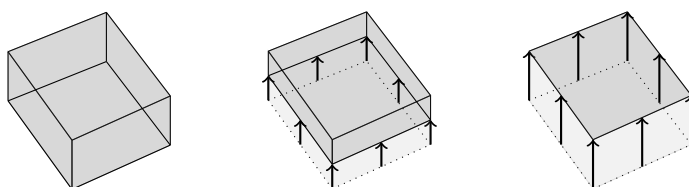

Ce d-espace est une cube d'intérieur vide duquel on a enlevé la face du dessous. Les chemins dirigés sont les chemins qui vont du haut vers le bas et du premier plan vers le fond. Dans cet espace, les chemins dirigés qui longent les bords de la face du dessous (soit vers la gauche, soit vers la droite) ne sont pas dihomotopes. Pourtant, la boîte d'allumettes est équivalente à un point selon cette définition, ce qui implique que cette définition n'est pas assez précise pour détecter ce genre de défauts de dihomotopie. Cela est attendu: l'action de cette équivalence sur la catégorie fondamentale étant la groupoidification, elle gomme tout comportement non-cancellatif de la dihomotopie, comme c'est le cas dans la boîte.

- une autre possibilité est de prendre  $K = P(Y)$ . Cette définition n'a aucune bonne propriété (une dihomotopie n'induit même pas une transformation naturelle entre les foncteurs induits).



- Une dernière possibilité est de prendre  $K = \widetilde{P}(Y)$ , à savoir l'ensemble des chemins réversibles, c'est-à-dire les chemins dirigés  $\gamma$  tels que  $\gamma^{-1} : t \mapsto \gamma(1 - t)$  soit aussi dirigé. Dans ce cas, une équivalence de dihomotopie induit une équivalence de catégories entre les catégories fondamentales. Le problème est que cette définition est beaucoup trop forte: il est très difficile pour des espaces d'être équivalents. Par exemple, pour des po-espaces (des espaces munis d'un ordre partiels, les chemins dirigés étant les chemins monotones), cette équivalence correspond aux dihoméomorphismes.

Il faudrait donc chercher une autre définition d'équivalence de dihomotopie et de comprendre quelle action celle-ci pourrait avoir sur la catégorie fondamentale. Il s'avère que cette catégorie fondamentale en elle-même (i.e., modulo équivalence de catégories) est un invariant très fort et que comme dans le cas de la première définition ci-dessus, il pourrait être préférable de la voir modulo une étape de localisation (i.e. d'inversion de certains morphismes). La groupoidification est en effet une localisation: elle est obtenue en inversant formellement tous les morphismes de la catégorie, ce qui est beaucoup trop, puisque certains morphismes n'agissent vraiment pas comme des isomorphismes (comme c'est le cas dans les phénomènes non-cancellatifs). C'est le point de vue considéré dans [Goubault 2007], pour la construction des composantes connexes par arcs dirigées. L'idée est d'inverser seulement certains morphismes, appelés morphismes de Yoneda, qui induisent des bijections par composition à gauche et à droite. Les phénomènes non-cancellatifs sont des exemples typiques de morphismes qui ne sont pas de Yoneda. De plus, pour que la localisation ait de bonnes propriétés (typiquement, pour que l'on soit en présence de calculs de fractions à gauche et à droite), l'ensemble de morphismes à inverser est défini comme le plus grand ensemble de morphismes de Yoneda ayant des propriétés de pushouts/pullbacks. Ce sont les morphismes *inésentiels*.

C'est en suivant cette idée que nous avons défini notre notion d'équivalence de dihomotopie: la classe de chemins à considérer doit être une classe de chemins qui agissent comme des chemins réversibles, de la même façon que les morphismes inésentiels dans les composantes agissent comme les isomorphismes. Nous avons alors construit une classe de chemins dirigés, les *chemins inésentiels*, comme le plus grand ensemble de chemins dirigés qui induisent des équivalences d'homotopie par concaténations à gauche et à droite, et qui satisfont des propriétés de Ore à gauche et à droite, modulo dihomotopie. De manière plus précise, on dit qu'un chemin dirigé  $\gamma$  de  $a$  vers  $b$  est de Yoneda si:

- **cancellation à droite:** pour tout point  $c$  tel que  $\vec{P}(X)(b, c) \neq \emptyset$ , la fonction continue:

$$\gamma \star c : \vec{P}(X)(b, c) \rightarrow \vec{P}(X)(a, c) \quad \rho \mapsto \gamma \star \rho$$

est une équivalence d'homotopie.

- **cancellation à gauche:** symétriquement avec la concaténation à gauche.

L'ensemble de chemins inésentiels  $\mathcal{I}(X)$  est le plus grand ensemble de chemins de Yoneda tel que:

- **condition de Ore à droite:** pour tout dichemin  $\gamma$  de  $a$  vers  $b$  dans  $\mathcal{I}(X)$ , pour tout dichemin  $\rho$  de  $c$  vers  $b$ , il y a un dichemin  $\gamma'$  de  $d$  vers  $c$  dans  $W$  et un dichemin  $\rho'$  de  $d$  vers  $a$  pour un certain  $d$  tels que  $\rho' \star \gamma$  est dihomotope à  $\gamma' \star \rho$

$$\begin{array}{ccc}
 d & \xrightarrow{\rho'} & a \\
 \gamma' \in W \downarrow & \text{mod. dihomot.} & \downarrow \gamma \in W \\
 c & \xrightarrow{\rho} & b
 \end{array}$$

- **condition de Ore à gauche:** symétriquement.

La deuxième étape est de ne pas définir l'équivalence de dihomotopie en suivant l'idée d'étendre la notion d'homotopie, mais étendant celle de rétracts par déformations. Dans le cas classiques, ces retracts formalisent plus fidèlement ce que l'on appelle déformations continues et caractérisent complètement l'équivalence d'homotopie: deux espaces sont homotopiquement équivalents si et seulement si il existe un span de retracts par déformations entre eux.

En mélangeant ces deux ingrédients, il est possible de définir une notion d'équivalence de dihomotopie, l'*équivalence inéssentielle*, qui a de bonnes propriétés: elle interagit bien avec les phénomènes de non-cancellation, son action sur la catégorie fondamentale correspond à une légère modification de la catégorie de composantes de [Goubault 2007], elle est beaucoup moins rigide que l'équivalence utilisant les chemins réversibles. De manière plus précise, on dit qu'une paire  $(X, A)$  de d-espace est un **FIDR** s'il existe une fonction continues  $H : X \rightarrow \mathcal{J}(X)$  telle que:

- pour tout  $x \in X$ ,  $H(x)(0) = x$ ,
- pour tout  $a \in A$  et  $t \in [0, 1]$ ,  $H(a)(t) = a$ ,
- pour tout  $x \in X$ ,  $H(x)(1) \in A$ ,
- pour tout  $t \in [0, 1]$ , la fonction  $H_t : X \rightarrow X$ ,  $x \mapsto H(x)(t)$  est une dimap,
- pour tout dichemin  $\delta$  de  $A$  de  $z$  vers  $H_1(x)$  il existe un dichemin  $\gamma$  de  $X$  de  $y$  vers  $x$  avec  $H_1(y) = z$ , et  $H_1 \circ \gamma$  et  $\delta$  dihomotopes.

Symétriquement, on peut définir un *PIDR* en inversant les rôles de 0 et 1 dans la définition de FIDR. On dit que deux d-espaces sont inéssentiellement équivalent s'il existe un zig-zag de FIDR et de PIDR entre eux.

Un autre aspect à considérer quand on construit une théorie homotopique est le théorie des structures de modèle. Les structures de modèles est un modèle pour raisonner sur des objets modulo homotopies. L'un des résultats les plus importants dans cette théorie est ce qu'on appelle l'*hypothèse d'homotopie*: la structure algébrique d'un espace topologique (avec ses chemins, homotopies, déformations d'ordre supérieur), peut être reflétée par les  $\infty$ -groupoïdes, c'est-à-dire, des catégories d'ordre supérieur avec des objets, des morphismes entre objets, des morphismes entre morphismes, etc, telle que toutes ces données soient inversibles. Dans le langage des structures de modèle, ceci peut être reformulé comme le fait qu'il existe une structure de modèle sur les espaces topologiques qui soit équivalente à une structure de modèle des  $\infty$ -groupoïdes. Ces  $\infty$ -groupoïdes sont modélisés par des ensembles simpliciaux un peu spéciaux, appelés complexes de Kan, qui satisfont des conditions de remplissage, qui modélisent le caractère inversible des données de la catégorie d'ordre supérieur.

Porter développa une théorie similaire dans le cas dirigé en ce basant cette fois-ci sur les  $(\infty, 1)$ -catégories [Porter 2008, Porter 2015]. L'idée est que contrairement aux espaces topologiques où les données de dimension 1, à savoir, les chemins sont inversibles (modulo homotopie), ce n'est pas le cas des d-espaces. Il est donc plus naturel de les comparer aux  $(\infty, 1)$ -catégories, catégories d'ordre supérieur où seules les données de dimension  $\geq 2$  sont inversibles.

Il existe différentes structures de modèle pour les  $(\infty, 1)$ -catégories, mais celle qui semble la plus facile à relier aux d-espaces est la structure de Bergner [Bergner 2004], où les  $(\infty, 1)$ -catégories sont modélisées par des catégories simplicialement enrichies. Si cette théorie est jolie, elle ne peut être reliée qu'aux équivalence de dihomotopie qui utilise les chemins réversibles (par exemple, elle doit impliquer que les catégories fondamentales soient équivalentes). En réalité, on peut modifier un peu les constructions pour voir un lien avec les équivalences inéssentielles.

La catégorie enrichie à considérer est ce qu'on appelle la catégorie des dichemins: ces objets sont les points, les morphismes sont les dichemins et la composition est la concaténation. On peut la voir comme une catégorie enrichie dans les espaces topologiques, excepté que la concaténation n'est pas associative... mais elle l'est modulo homotopie. C'est donc naturellement une catégorie enrichie dans la catégorie homotopique des espaces topologiques. Une équivalence de dihomotopie (version chemins réversibles) induit alors une (sorte d')équivalence de Dwyer-Kan entre les catégories de dichemins, ce qui n'est pas le cas des autres types d'équivalence. L'idée est donc de changer un peu les équivalences sur les catégories enrichies pour relier cette théorie à d'autres types d'équivalences de dihomotopie.

Tout d'abord, au lieu de demander à ce que les catégories fondamentales soient équivalentes, on peut demander à ce que les catégories de composantes le soient. Mais cela ne suffit pas. Une équivalence de Dwyer-Kan demande à ce que les fonctions qui, à un dichemin  $\gamma$ , associe  $f \circ \gamma$  soient toutes des équivalence d'homotopie, ce qui est beaucoup trop fort ! En effet, pour être équivalent à un point, cela demande en particulier que tous les espaces de chemins soient non vides, ce qui n'arrive jamais dans les po-espaces. Il s'agit donc de gérer un peu mieux les ensembles vides de dichemins. C'est pourquoi, il ne faut pas voir la catégorie de dichemins comme une catégorie enrichie, mais comme une catégorie partiellement enrichie, i.e., dans laquelle les ensembles vides de morphismes sont gérés à part.

Avec ces deux nouvelles idées, il est donc possible de définir une notion d'*équivalence inéssentielle* entre catégorie partiellement enrichie et de montrer qu'une équivalence inéssentielle entre d-espaces induit une équivalence inéssentielle entre les catégories (partiellement enrichie) de dichemins.

## Théories homologiques pour les d-espaces

Un autre invariant intéressant en topologie algébrique est l'homologie. Intuitivement, c'est une collection de modules (typiquement, des groupes abéliens ou des espaces vectoriels), qui comptent le nombre de trous de l'espace. Même si cet invariant n'est pas complet, au sens où il existe des espaces qui ont la même homologie mais qui ne sont pas homotopiquement équivalents, l'homologie a néanmoins de très bonnes propriétés. Tout d'abord, elle est complète dans certains cas, ou tout du moins, elle donne suffisamment d'informations sur l'espace dans de nombreux cas. Ensuite, elle est calculable: lorsque l'espace est finiment présenté, typiquement à l'aide d'ensembles simpliciaux, il est possible de calculer une présentation finie de l'homologie et de tester que des espaces ont la même homologie à partir de ces présentations. Ceci n'est pas possible avec les théories homotopiques. Une autre propriété intéressante est que ce calcul peut souvent se faire de manière modulaire: il est parfois possible de décrire l'homologie d'un espace à partir d'homologies d'espaces plus simples. Cette dernière propriété peut se décrire d'un point de vue purement algébrique: l'homologie est un processus algébrique général de calcul de défauts d'exactitude, et la modularité est juste un cas particulier d'exactitude. C'est le genre de propriétés décrites dans les axiomes d'Eilenberg-Steenrod.

Définir une théorie homologique pour les d-espaces est un challenge ardu. De nombreuses tentatives ont été faites ces vingt dernières années. Certaines d'entre elles fonctionnent de la façon suivante. L'idée est de séparer la topologie de l'ordre: on commence par regarder le d-espace comme un espace topologique, on en prend son homologie classique, puis on ajoute une structure dessus provenant de la structure dirigée (typiquement, un ordre partiel, ou une relation plus générale, cf. [Grandis 2009, Kahl 2014]). L'inconvénient de cette méthode est qu'elle n'est pas assez précise. Reprenons l'exemple de la boîte d'allumettes. On a vu précédemment que celle-ci avait un défaut de dihomotopie puisque des dichemins étaient non dihomotopes. Par contre, comme espace topologique, la boîte est triviale, contractile: il est possible de la déformer continûment en un point (cf. la figure

plus haut). D'un point de vue homologique, cela entraîne que son homologie classique est triviale, et que donc ces propositions d'homologies dirigées sont aussi triviales. C'est en fait un challenge d'observer d'un point de vue purement algébrique ce genre de défauts de dihomotopie. Dans cette thèse, nous proposons une (en réalité, des, mais qui seront toutes équivalentes) théories homologies pour les d-espaces.

L'idée de base de notre homologie est simple: il s'agit de regarder les espaces de dichemins (ou de traces) d'un point de vue de la topologie algébrique classique et de voir comment ceux-ci évoluent avec le temps, c'est-à-dire par extensions. Par exemple, pour distinguer deux espaces de cette forme:

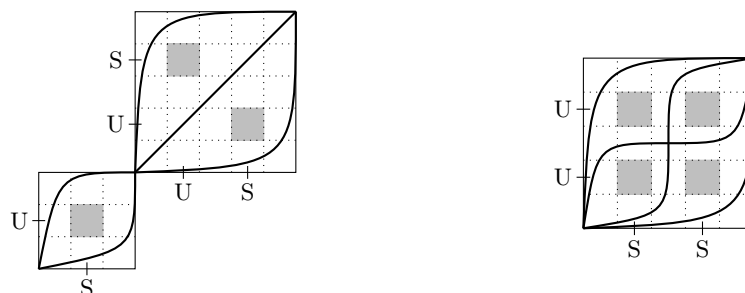

espaces provenant de réalisations géométriques de systèmes de vraie concurrence, il est nécessaire de regarder tous les espaces de traces. En particulier, si on ne regarde que les espaces de traces maximales, on observe que ceux-ci sont homotopiquement équivalents (grossièrement, ils sont équivalents à un espace discret à six points, c'est-à-dire, il y a six classes d'équivalences d'exécutions maximales modulo la relation d'équivalence qui permute les actions indépendantes). Par contre, si par exemple l'espace de traces dans l'espace de gauche:

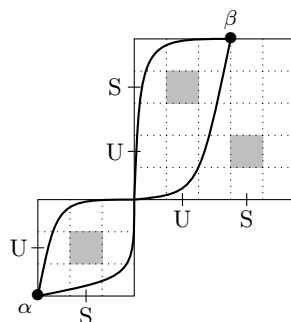

on observe que celui-ci est équivalent à un espace à quatre points lorsque aucun espace de trace de l'espace de droite a ce type d'homotopie.

D'un point de vue un peu plus formel, notre homologie est définie comme une collection de diagramme à valeurs dans les modules, c'est-à-dire de foncteurs à valeurs dans les modules, mais dont le domaine n'est pas fixe. Etant donné un d-espace  $X$ , le domaine (commun)  $\mathcal{F}(X)$  de ces foncteurs sera la catégorie dont les objets sont les traces et dont les morphismes sont les *extensions*, à savoir les paires de traces qui "étendent" une trace donnée. Le  $n$ -ième système naturel d'homologie de  $X$  est alors le foncteur  $\overline{NH}_n(X) : \mathcal{F}(X) \rightarrow \mathbf{Mod}(\mathcal{R})$  qui associe à chaque trace de  $a$  vers  $b$ , le  $n - 1$  module d'homologie de l'espace des traces entre  $a$  et  $b$ .

Par exemple, considérant le d-espace suivant:

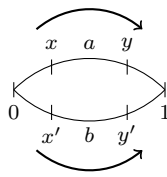

qui est le recollement de deux segments dirigés, le domaine des diagrammes d'homologie à cette forme:

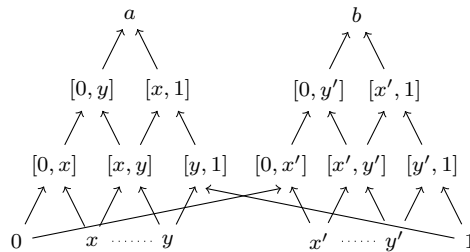

et l'image du premier diagramme d'homologie a cette forme:

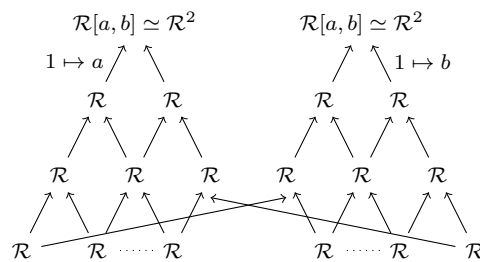

L'homologie définie de cette façon a de très bonnes propriétés: elle est fonctorielle, elle peut être reliée à une notion de diagrammes d'homotopie (défini exactement de la même façon, en remplaçant les modules d'homologie par les groupes d'homotopie) à l'aide d'un théorème à la Hurewicz, l'homologie d'un point est nulle (axiome de la dimension), l'homologie préserve les coproduits (axiome de l'additivité). En ce qui concerne les propriétés d'exactitude (et donc de modularité), les choses sont plus compliquées. La catégorie des diagrammes à valeurs dans les modules n'est pas abélienne, et donc la théorie générale des suites exactes ne s'applique ici. Il faut donc se tourner vers des théories non-abéliennes, comme par exemple la théorie des catégories homologiques et modulaires de [Grandis 1991a, Grandis 1991b]. Il s'avère que la théorie des diagrammes à valeurs dans les modules est semi-exacte (i.e., qu'on peut parler d'objets et morphismes nuls, de noyaux, de conoyaux, d'images et de suites exactes, c'est-à-dire, tout ce dont on a besoin pour parler d'homologie !) et homologique (c'est-à-dire que la théorie homologique définie purement algébriquement à partir des complexes de chaînes fait sens). Dans une telle catégorie, les théorèmes d'exactitude du type "une suite exacte courte en complexes de chaînes induit une suite exacte longue en homologie" tiennent presque. Ils deviennent "une suite exacte courte induit une suite longue d'ordre 2, qui est exacte à certains endroits, et partout ailleurs modulo des conditions". Les dites conditions sont toujours satisfaites si et seulement si la catégorie est modulaire, ce qui n'est pas le cas ici. Il est néanmoins possible de construire certaines suites exactes longues en homologie, ce qui est déjà suffisant pour

espérer des théorèmes de modularité.

Une dernière propriété reste: la calculabilité. Strictement parlant, l'homologie naturelle n'est pas calculable: le domaine des foncteurs n'est quasiment jamais dénombrable et il n'y a aucun espoir de le décrire à isomorphisme près. Cependant, rien ne dit qu'il faille regarder les diagrammes à isomorphismes près ! C'est l'une des idées nouvelles décrites dans cette thèse: ce qui nous intéresse est l'évolution de l'espace des traces au court du temps, ce qui est beaucoup plus faible que l'isomorphisme des diagrammes. L'idée est très similaire aux bisimulations dans les systèmes concurrents. Ce n'est pas l'isomorphisme des systèmes qui nous intéresse mais le fait que les systèmes évoluent de la même façon. Il est donc naturel que des équivalences de type bisimulations apparaissent dans cette théorie homologique. La notion de bisimilarité que nous introduisons ici peut se voir de nombreuses façons. Initialement, elle est décrite à l'aide de la théorie générale de la bisimilarité en termes de morphismes ouverts de [Joyal 1996]. Ces morphismes ouverts répondent à la question suivante: comment peut-on assurer qu'un morphisme implique l'existence d'une bisimulation entre des systèmes ? La réponse générale est "lorsque ce morphisme relève les exécutions". Il est alors possible de voir les choses dans l'autre sens: définir une classe de morphismes ayant des propriétés de relèvements par rapport à ce que l'on considère comme des exécutions et définir la bisimilarité comme l'existence d'un zig-zag (très souvent, un span suffit) de tels morphismes. C'est de cette façon que la bisimilarité dans les diagrammes est définie: comme l'existence d'un span de morphismes de diagrammes qui ont des propriétés de relèvements par rapport aux diagrammes finis linéaires. Cette définition est naturelle dans l'étude homologique et en particulier pour la calculabilité. Etant donné un complexe cubique euclidien fini (typiquement, le genre de d-espaces finiment présentés obtenus comme réalisation géométrique de systèmes de la vraie concurrence), il est possible de définir un diagramme fini. Ce diagramme est une sorte de discrétisation de l'homologie naturelle et il est possible de construire un morphisme de l'homologie naturelle vers cette discrétisation. Ce morphisme est un exemple typique de morphisme ouvert dans ce contexte. Un autre exemple de morphisme ouvert est un morphisme d'oubli d'informations non nécessaire: le domaine de l'homologie naturelle est une catégorie des traces et extensions alors que la construction du diagramme n'utilise que les points extrémaux des traces et les extensions. Il est donc possible de construire une théorie homologique en définissant les diagrammes sur cette catégorie des paires de points et extensions (ce qui donne des bimodules), et il y a un morphisme ouvert naturel d'oubli de l'homologie naturelle vers l'homologie de bimodules.

Pour résumer, en utilisant cette théorie de la bisimilarité dans les diagrammes, il est possible de construire des diagrammes finis (sous condition que le d-espace soit finiment présenté) bisimilaires à l'homologie naturelle. Pour la calculabilité, il reste à savoir si la bisimilarité est elle-même décidable. La définition en termes de morphismes ouverts n'est pas très pratique en ce sens. Cependant, il est possible de donner des caractérisations plus praticables. La première utilise des relations proches des bisimulations de structures d'évènements [Rabinovitch 1988]. Dans le cas où l'homologie est calculée dans les réels, on se retrouve à comparer des diagrammes dont le domaine est un poset fini et est à valeurs dans les espaces vectoriels de dimension finie. Décider la bisimilarité devient alors un problème d'existence de matrices inversibles, ce qui peut s'encoder dans la théorie existentielle de réelle, le tout en EXSPACE.

La bisimilarité peut aussi être décrite logiquement, à la manière de [Hennessy 1980]. Deux diagrammes sont bisimilaires si et seulement si ils vérifient les mêmes formules d'une logique qui décrit intuitivement les évolutions possibles d'un diagramme. Une formule dans cette logique peut alors servir de certificat que deux diagrammes ne sont pas bisimilaires. Dans le même cas que précédemment, savoir si une formule positive (sans négation) est satisfaite par un diagramme est décidable en PSPACE.

Au total, il est possible de décider si deux d-espaces finiment présentés ont la même homologie (modulo bisimilarité).

Pour terminer, il reste à faire le lien avec la théorie homotopique. On montre que dans le cas finiment présenté, si deux d-espaces sont inéssentiellement équivalents, alors leurs homologies sont bisimilaires. L'homologie naturelle est donc, au moins pour les espaces sur lesquels on peut faire des calculs, un invariant de l'équivalence inéssentielle.





**Titre :** Théories homotopiques et homologiques dirigées pour des modèles géométriques de la vraie concurrence

**Mots clés :** topologie algébrique dirigée, vraie concurrence, homologie, homotopie

**Résumé :** Le but principal de la topologie algébrique dirigée est d'étudier des systèmes qui évoluent avec le temps à travers leur géométrie. Ce sujet émergea en informatique, plus particulièrement en vraie concurrence, où Pratt introduisit les automates de dimension supérieure (HDA) en 1991 (en réalité, l'idée de la géométrie de la concurrence peut être retracée jusque Dijkstra en 1965). Ces automates sont géométrique par nature: chaque ensemble de  $n$  processus exécutant des actions indépendantes en parallèle peuvent être modéliser par un cube de dimension  $n$ , et un tel automate donne naissance à un espace topologique, obtenu en recollant ces cubes. Cet espace a naturellement une direction du temps provenant du flot d'exécution. Il semble alors totalement naturel d'utiliser des outils provenant de la topologie algébrique pour étudier ces espaces: les chemins modélisent les exécutions et les homotopies de chemins, c'est-à-dire les déformations continues de chemins, modélisent l'équivalence entre exécutions modulo ordonnancement d'actions indépendantes, mais ces notions géométriques doivent préserver la direction du temps, d'une façon ou d'une autre. Ce caractère dirigé apporte des complications et la théorie doit être refaite, essentiellement depuis le début.

Dans cette thèse, j'ai développé des théories de l'homotopie et de l'homologie pour ces espaces dirigés. Premièrement, ma théorie de l'homotopie dirigée est basée sur la notion de rétracts par déformations, c'est-à-dire de déformations continues d'un gros espaces sur un espace plus petit, suivant des chemins inessentiels, c'est-à-dire qui ne changent pas le type d'homotopie des « espaces d'exécutions ». Cette théorie est reliée aux catégories de composantes et catégories de dimension supérieures. Deuxièmement, ma théorie de l'homologie dirigée suit l'idée que l'on doit regarder les « espaces d'exécutions » et comment ceux-ci évoluent avec le temps. Cette évolution temporelle est traitée en définissant cette homologie comme un diagramme des « espaces d'exécutions » et en comparant de tels diagrammes en utilisant un notion de bisimulation. Cette théorie homologique a de très bonnes propriétés: elle est calculable sur des espaces simples, elle est un invariant de notre théorie homotopique, elle est invariante par des raffinements d'actions simples et elle une théorie des suites exactes.

**Title :** Directed homotopy and homology theories for geometric models of true concurrency

**Keywords :** directed algebraic topology, true concurrency, homology, homotopy

**Abstract :** Studying a system that evolves with time through its geometry is the main purpose of directed algebraic topology. This topic emerged in computer science, more particularly in true concurrency, where Pratt introduced the higher dimensional automata (HDA) in 1991 (actually, the idea of geometry of concurrency can be tracked down Dijkstra in 1965). Those automata are geometric by nature: every set of  $n$  processes executing independent actions can be modeled by a  $n$ -cube, and such an automaton then gives rise to a topological space, obtained by glueing such cubes together. This space naturally has a specific direction of time coming from the execution flow. It then seems natural to use tools from algebraic topology to study those spaces: paths model executions, homotopies of paths, that is continuous deformations of paths, model equivalence of executions modulo scheduling of independent actions, and so on, but all those notions must preserve the direction. This brings many complications and the theory must be done again.

In this thesis, we develop homotopy and homology theories for those spaces with a direction. First, my directed homotopy theory is based on deformation retracts, that is continuous deformation of a big space on a smaller space, following directed paths that are inessential, meaning that they do not change the homotopy type of spaces of executions. This theory is related to categories of components and higher categories. Secondly, my directed homology theory follows the idea that we must look at the spaces of executions and those evolves with time. This evolution of time is handled by defining such homology as a diagram of spaces of executions and comparing such diagrams using a notion of bisimulation. This homology theory has many nice properties: it is computable on simple spaces, it is an invariant of our homotopy theory, it is invariant under simple action refinements and it has a theory of exactness.