



HAL
open science

Trans-translation in the human bacterial pathogen *Legionella pneumophila*

Romain Brunel

► **To cite this version:**

Romain Brunel. Trans-translation in the human bacterial pathogen *Legionella pneumophila*. Microbiology and Parasitology. Université de Lyon, 2016. English. NNT : 2016LYSE1219 . tel-01592258v1

HAL Id: tel-01592258

<https://theses.hal.science/tel-01592258v1>

Submitted on 23 Sep 2017 (v1), last revised 25 Sep 2017 (v2)

HAL is a multi-disciplinary open access archive for the deposit and dissemination of scientific research documents, whether they are published or not. The documents may come from teaching and research institutions in France or abroad, or from public or private research centers.

L'archive ouverte pluridisciplinaire **HAL**, est destinée au dépôt et à la diffusion de documents scientifiques de niveau recherche, publiés ou non, émanant des établissements d'enseignement et de recherche français ou étrangers, des laboratoires publics ou privés.



N°d'ordre NNT : 2016LYSE1219

THESE de DOCTORAT DE L'UNIVERSITE DE LYON

opérée au sein de
l'Université Claude Bernard Lyon 1

Ecole Doctorale N° 341
Evolution Ecosystèmes Microbiologie Modélisation (E2M2)

Spécialité de doctorat : Microbiologie

Soutenue publiquement le 22/11/2016, par :
M. Romain Baptiste BRUNEL

Trans-traduction chez la bactérie pathogène de l'homme *Legionella pneumophila*

Devant le jury composé de :

Mme Hilde DE REUSE, Présidente du jury, Rapportrice
Chef de Laboratoire, Institut Pasteur, Paris

Mme Ina ATTREE, Rapportrice
Directrice de Recherche au CNRS, CEA de Grenoble

M. Hubert HILBI, Rapporteur
Directeur de Recherche, Université de Zurich

M. Michael MOUREZ, Examineur
Directeur de Recherche, Sanofi-Aventis

Mme Patricia DOUBLET, Examinatrice, Présidente du Jury
Professeure des Universités, Université Claude Bernard Lyon 1

M. Xavier CHARPENTIER, Directeur de thèse
Chargé de Recherche Inserm, HDR

UNIVERSITE CLAUDE BERNARD - LYON 1

Président de l'Université

Président du Conseil Académique

Vice-président du Conseil d'Administration

Vice-président du Conseil Formation et Vie Universitaire

Vice-président de la Commission Recherche

Directrice Générale des Services

M. le Professeur Frédéric FLEURY

M. le Professeur Hamda BEN HADID

M. le Professeur Didier REVEL

M. le Professeur Philippe CHEVALIER

M. Fabrice VALLÉE

Mme Dominique MARCHAND

COMPOSANTES SANTE

Faculté de Médecine Lyon Est – Claude Bernard

Directeur : M. le Professeur G.RODE

Faculté de Médecine et de Maïeutique Lyon Sud – Charles Mérieux

Directeur : Mme la Professeure C. BURILLON

Faculté d'Odontologie

Directeur : M. le Professeur D. BOURGEOIS

Institut des Sciences Pharmaceutiques et Biologiques

Directeur : Mme la Professeure C. VINCIGUERRA

Institut des Sciences et Techniques de la Réadaptation

Directeur : M. X. PERROT

Département de formation et Centre de Recherche en Biologie Humaine

Directeur : Mme la Professeure A-M. SCHOTT

COMPOSANTES ET DEPARTEMENTS DE SCIENCES ET TECHNOLOGIE

Faculté des Sciences et Technologies

Directeur : M. F. DE MARCHI

Département Biologie

Directeur : M. le Professeur F. THEVENARD

Département Chimie Biochimie

Directeur : Mme C. FELIX

Département GEP

Directeur : M. Hassan HAMMOURI

Département Informatique

Directeur : M. le Professeur S. AKKOUICHE

Département Mathématiques

Directeur : M. le Professeur G. TOMANOV

Département Mécanique

Directeur : M. le Professeur H. BEN HADID

Département Physique

Directeur : M. le Professeur J-C PLENET

UFR Sciences et Techniques des Activités Physiques et Sportives

Directeur : M. Y.VANPOULLE

Observatoire des Sciences de l'Univers de Lyon

Directeur : M. B. GUIDERDONI

Polytech Lyon

Directeur : M. le Professeur E.PERRIN

Ecole Supérieure de Chimie Physique Electronique

Directeur : M. G. PIGNAULT

Institut Universitaire de Technologie de Lyon 1

Directeur : M. le Professeur C. VITON

Ecole Supérieure du Professorat et de l'Education

Directeur : M. le Professeur A. MOUGNIOTTE

Institut de Science Financière et d'Assurances

Directeur : M. N. LEBOISNE

Remerciements

Je tiens d'abord et surtout à remercier Xavier. Xavier qui montait son équipe et qui m'a montré les murs en trains d'être peints, le sol du P2 en train d'être monté, l'ancien sol plein d'amiante en train d'être démonté, les PSM qui débarquaient (et qui se faisaient péter en deux dès le premier jour par le technicien qui les amenaient), les achats de pipettes, de paillasses, de Técan, d'incubateurs qui coûtent un an de salaire de thésard, de cytomètres en flux qui se bouchent... Hé oui, parce que quand Xavier achète un nouvel équipement, c'est comme un enfant qui ouvre un cadeau de Noël. La preuve, c'est que c'est tellement un geek qu'il m'a parlé de Linux avant de me parler de science, et que quand il a acheté un vélo pour monter sur sa colline, il en a pris un qui se pouvait être hacké. Je pense qu'il n'y a eu aucune transition entre le gosse au lunettes cul-de-bouteilles que j'ai vu sur le poster de la retraite du CIRI et le papa barbu qu'il est aujourd'hui pour ses enfants sages à la maison et pour nous, ses gosses attardés du labo. Heureusement, il a décidé de ne garder que les bons côtés de l'enfant : l'humour et la joie de vivre et la curiosité qui font de lui un excellent chercheur et un encore meilleur mentor. Parce que s'il se promenait avec une tétine, ça ne ferait quand même pas sérieux. En tout cas, merci de m'avoir fait confiance pour rejoindre ton « équipe » (on peut parler d'équipe quand il n'y a qu'une personne ?) à l'époque. Et merci pour les quatre ans qui ont suivi, du début tu m'as d'abord montré comment rater un Northern jusqu'à la fin où tu m'as laissé écrire le papier, en passant par des conseils très sérieux sur le moyen de reconnaître des bactéries pathogènes des poumons en respirant leur odeur. Merci de m'avoir laissé la possibilité d'orienter le projet vers des trucs qui marchaient un peu mieux que ce qu'on a vendu au concours de l'école doctorale ; et merci de m'avoir accompagné pour faire des travaux qui m'ont appris à aimer encore plus la bactériologie. Merci aussi pour le congrès à Copenhague où j'ai pu parler *in english* dans le texte au milieu de gens vachement plus doués que moi et où j'ai pu rencontrer mon idôle (Didiiiiiiiiieerrr !). Merci enfin pour les vacanc... Heu, « l'école thématique » à Marseille. Enfin, merci d'avoir accepté mes horaires non-matinaux sans rien me dire... J'espère que je suis devenu un bon scientifique, et si le jury décide que c'est le cas, ce sera grâce à toi. Et s'ils trouvent eux aussi que la thèse est trop longue, ce sera aussi à cause de toi. C'est toi qui a attisé ma passion scientifique et qui a fait de moi le chercheur que je suis aujourd'hui.

Merci aussi au reste de l'équipe (parce qu'on n'est pas restés deux très longtemps heureusement). A mon P-A d'abord, mon Pierre-Alexandrie-Alexandra, mon canard. Je pense qu'on n'entendra plus avant longtemps résonner au R+3 de tels hymnes à la joie et à l'amour que sont « Bohemian Rhapsody », « Magnolias forever », et bien sûr « Week-end à Rome » du grand poète moderne Etienne Daho. Ces repiquages du vendredi en musique ont illuminé ma thèse et m'ont permis de tenir face à l'adversité des clonages qui marchent pas et des électroporations qui finissent aussi bien qu'un changement d'ampoule dans une baignoire. Ça me manque tes remarques sur le fait que ta barbe soit aussi fournie que la mèche de Nicolas Sirkis alors que la mienne est aussi poilue que le crâne du Dalai-lama. En tout cas je n'oublierai jamais ce séjour magique que l'on a passé tous les deux à Copenhague, et où pendant que tu dormais profondément j'essayais d'expliquer au ministère de l'intérieur Danois qu'il ne fallait pas se préoccuper du tremblement de terre de 7.9 dont l'épicentre était dans notre chambre ; c'était juste toi qui ronfle.

Merci à Laetitia ensuite, avec qui j'ai adoré me chambrer et m'engueuler pour de faux (parce que des fois on est d'accord mais on a juste envie de râler). Merci de m'avoir appris plein de « trucs de labo » qui ne sont bien sûrs marqués nulle part mais qu'on est censés savoir de façon innée et magique. Merci de m'avoir si gentiment rappelé de ranger ma paillasse (au doux cri de « tu manipes comme un porrrrc »), même si la tienne était systématiquement 10 fois plus dégueulasse au même moment. Merci de m'avoir montré qu'on peut être une excellente chercheuse et jurer comme un charretier, parce que j'avais peur de devoir un jour lever le pied sur les jurons en tant que forme de ponctuation.

Merci à Maria qui nous a rejoint après quelques années, pour être venue remplir le rôle difficile d'être la voix de la raison dans cette équipe de fous.

Merci à l'équipe Legio, avec qui on partage tout, des gâteaux aux PSM (mais pas les pipettes parce que les vôtres sont pourries et que nous on a des pipettes 5 étoiles).

Merci d'abord à Anne, ma « maman du labo ». Merci d'avoir recommandé à Xavier pour je-ne-sais quelle raison ce petit benêt qui venait à tes cours de bactério et filait à l'anglaise dès que ta collègue arrivait avec ses cours de champignons sous le bras. Merci pour les débats à deux balles à la cantine sur tout et rien et pour les fous rires. Merci pour les « non mais Romain... » assorti d'un

hochement de tête négatif à chaque fois que je sortais une ânerie plus grosse que moi. Et rappelle-toi que : Zumba, hé ! Zumba, ho !

A Céline, qui était là le matin quand j'arrivais et souvent encore là quand je partais, qui m'a soutenu et appris que rater un Western c'était pas la fin du monde puisqu'au moins il n'y avait pas d'apparition surnaturelle dans les miens. Merci d'avoir été là pour agrémenter les « nuits au labos » (comprendre : après 18h en hiver quand il fait noir et qu'il n'y a déjà plus personne parce qu'ils ont tous des gosses). A Julie et Fabien, ceux du début, qui formaient avec Céline le trio original des Legio Team, merci de m'avoir accueilli au labo et intégré rapidement dans le clan des « ceux qui n'ont pas de gosses et qui veulent parler d'autre chose que des couches-culottes à la cantine ». Merci à Valérie, qui bien qu'elle ne fût là qu'à mi-temps, était toujours partante pour une pause thé bienvenue.

Merci à Anne-Lise de m'avoir appris la danse de « dans ta face ». J'espère que ça me servira si je me fais braquer en Colombie. Ils penseront que je suis un fou dangereux. Merci à Nat' de m'avoir appris plein de techniques et pour avoir pris soin de mes petits macrocros, et pour être un lien indéfectible entre les « vieux » et les « djeun's » de l'étage.

Merci à Patricia, Christophe, et Elisabeth pour avoir toujours été là quand j'avais besoin de savoir quelque chose. En particulier merci aux profs de l'étage pour me rappeler chaque jour toutes les raisons pour lesquelles je ne passerai probablement jamais un concours de maître de conf' en France. Et merci aux parents de l'étage pour avoir rempli ma longue liste de raisons de ne pas faire d'enfants tout en laissant systématiquement la colonne « avantage » vierge.

Après le labo, passons à la vie en dehors du bâtiment Lwoff. Même si celle-ci s'est réduite à peau de chagrin après avoir commencé mon boulot ici, quelques irréductibles ont résisté encore et toujours à l'invasion des Légios dans l'empire de Romain.

D'abord, merci à Etienne. Merci à toi, ô libanormand velu, de m'avoir appris à prendre confiance en moi, de m'avoir appris à mettre des chemises, et de m'avoir répété sans cesse depuis 8 ans que je n'ai pas de poils. Courage à toi jeune padawan, toi aussi tu l'écriras ta thèse.

Merci à Julio, mon chauve roux, pour m'avoir toujours rappelé par ta simple présence qu'on pouvait être un geek alcoolique et amateur d'humour noir bien serré, et quand même réussir sa

thèse. Merci pour tes réflexions toujours soit extrêmement intelligentes soit extrêmement stupides, et pour la réflexion que tu offres généreusement quand on se voit dans ton crâne luisant.

Merci à Jem, mon anglais. Merci d'avoir partagé avec moi ton amour de l'honnêteté crue et de la rigolade. Merci de m'avoir rappelé qu'on peut être un fan absolu de Star Wars sans être un ado attardé. Ou plutôt si, on est des ados attardés, mais qu'en fait on s'en fout. Merci d'avoir choisi de rester en France malgré le Brexit. Vérifie quand même si t'as ton visa.

Merci à Julien, pour avoir toujours gardé le contact malgré ton départ à Paris. Merci pour tes coups de fils à 19h, quand je suis au pic de ma journée de travail au labo. Merci d'avoir été le premier à te marier et d'avoir foutu la pression sur tous tes potes qui sont en couple.

Merci à Axel et Erica, mes collègues, mes partenaires de paillasses et mes binômes, pour m'avoir accompagné jusqu'à la fin du Master. Même si on s'est moins vu depuis, ça ne change rien, on sera toujours le trio de choc qui a déchiré le Master GBC.

Merci à ma famille, et spécialement à ma mère. On a toujours manqué de tout sauf d'amour et d'ambition. Merci de m'avoir toujours encouragé à poursuivre ce que j'aimais. Merci de m'avoir fait crouler sous les livres sur les dinosaures, l'univers et le corps humain pour assouvir ma curiosité dans cette ère maudite où l'internet n'était qu'une promesse lointaine.

Enfin, merci à Maria, ma chérie, ma *Mamita*. Merci d'avoir été là tous les soirs où ça n'allait pas, tous les jours où ça allait, et toutes les fois où on se demandait qu'est-ce qui allait se passer plus tard. Merci de m'avoir accueilli avec des petits plats les soirs où je finissais tard. Merci de m'avoir rappelé tous les jours où je doutais que j'avais de la chance d'être là. Je n'aurais pas pu finir l'écriture de ce pavé sans toi. Maintenant on va écrire un autre pavé de notre vie, al otro lado del mundo.

Et merci à Gato pour tous les poils sur mes vêtements.

Résumé du travail de thèse

Ce travail de thèse a été mené au sein de l'équipe de Xavier Charpentier. Notre équipe était, au début de ma thèse, hébergée au sein de l'Unité Mixte de Recherche 5240 « Microbiologie, Pathogénie, Adaptation » (CNRS, Insa de Lyon, UCB Lyon 1). Nous avons ensuite rejoint le Centre International de Recherche en Infectiologie (Inserm U1111, CNRS, ENS de Lyon, UCB Lyon 1). Les travaux présentés ici sont le fruit de trois années de recherche passés sous la direction de Xavier Charpentier, chargé de recherche à l'Inserm et directeur de l'équipe « Transfert de gene horizontal chez les bactéries pathogènes (HoriGene) ».

L'objectif global de ma thèse a été d'étudier un mécanisme cellulaire qui intervient dans la traduction des protéines : la trans-traduction. Nous avons étudié le rôle de ce mécanisme chez notre modèle d'étude, la bactérie pathogène de l'homme *Legionella pneumophila*. Ce travail a été réalisé sous forme de deux axes majeurs : d'abord, la démonstration de l'essentialité de ce mécanisme pour la viabilité de cette bactérie ; puis l'évaluation de l'efficacité d'un nouvel antibiotique décrit comme étant un inhibiteur de ce mécanisme, pour le traitement de la Légionellose, l'infection pulmonaire causée par *L. pneumophila*. Ces deux axes ont été complétés par un troisième axe qui a permis l'ouverture de mes travaux à la recherche d'autres mécanismes essentiels dont nous ignorons le potentiel comme cible antibiotique.

Ce manuscrit de thèse s'ouvre par une introduction qui rappelle des notions et découvertes récentes et nécessaires pour replacer mes recherches dans leur contexte bibliographique. Cette introduction débute par un rappel historique des débuts de la bactériologie et de l'infectiologie modernes, et met en parallèle de ces notions historiques des découvertes récentes qui ont été réalisées dans chacun de ces domaines. Après cette ouverture, l'introduction rappelle des notions de bases de la recherche sur les antibiotiques, de leurs mécanismes d'action et de résistance, et une revue complète des classes existantes de ces molécules. Cette partie est suivie d'une explication détaillée de l'état des connaissances sur le mécanisme de trans-traduction, qui fait l'objet des deux

premiers axes de mes travaux. Enfin, la technique de Tn-seq qui fait l'objet du troisième axe, est présentée en détail.

Dans le premier axe, nous avons étudié le mécanisme de trans-traduction et son essentialité dans la bactérie pathogène de l'homme *Legionella pneumophila*. Ce mécanisme a été très bien étudié chez d'autres espèces de bactéries comme *Escherichia coli*. Il permet de venir au secours des ribosomes qui se trouvent bloqués lors de la traduction. Ces événements de blocages sont consécutifs à la lecture d'ARN messagers tronqués et dépourvus de codons stop, ou à un événement de changement de cadre de lecture qui cause l'omission d'un codon stop. La fréquence de ces blocages est extrêmement élevée, atteignant 2 à 4% des événements de traductions en phase exponentielle de croissance. Sans codon stop, les ribosomes sont incapables de se libérer d'eux-mêmes du complexe qu'ils forment avec l'ARN messager et la protéine en cours de synthèse.

Sans système de sauvetage, vu la fréquence des blocages, tous les ribosomes d'une cellule bactérienne seraient bloqués en moins d'un cycle cellulaire. Pourtant, paradoxalement, le mécanisme de trans-traduction est dispensable chez la plupart des espèces bactériennes. Cela a été récemment expliqué par la présence de mécanismes alternatifs à la trans-traduction, qui remplissent une fonction similaire et assistent ce mécanisme principal. Chez une poignée de bactéries pathogènes, ces mécanismes alternatifs sont absents, et la trans-traduction est essentielle. Cela suggère que ce mécanisme puisse être une cible antibiotique intéressante et pour le moment inusitée, pour lutter contre ces micro-organismes, dont certains sont des pathogènes d'importance majeure en santé publique (*Mycobacterium tuberculosis*, en particulier).

Nous avons étudié le mécanisme de trans-traduction chez *L. pneumophila*, où nous n'avons pas découvert de traces des mécanismes alternatifs décrits chez d'autres espèces bactériennes. Nous n'avons pas non plus réussi à réaliser une délétion du gène codant pour le composant principal du mécanisme, appelé tmRNA. Cela suggérerait que chez cette espèce, le mécanisme pouvait être essentiel pour la viabilité. Nous avons remplacé le promoteur du gène du tmRNA dans le génome par une version inductible à volonté, par l'ajout dans le milieu de culture d'un inducteur chimique. Nous avons pu montrer grâce à cette souche mutée que la croissance de *L. pneumophila* en milieu

artificiel dépend d'un haut niveau d'expression de ce gène. Nous avons également montré que la réduction des niveaux de tmRNA réduisait la capacité d'infection de cellules eucaryotes, notamment dans l'hôte environnemental *Acanthamoeba castellanii*, ainsi que dans les macrophages humains. Ces résultats démontrent que la trans-traduction est un mécanisme essentiel pour la croissance de la bactérie *Legionella pneumophila*.

Nous avons tenté d'analyser plus en détail les raisons sous-jacentes à l'arrêt de croissance que nous avons observé. Nous avons noté qu'une déplétion en tmRNA inhibait la division cellulaire, comme mis en évidence par l'absence de septums visibles en microscopie électronique. En revanche, les bactéries continuent visiblement à synthétiser leur paroi puisque celles-ci prennent un aspect filamenteux. De plus, la perte de croissance observée semble mener à une perte de viabilité limitée. En revanche, de façon intéressante, une diminution même limitée des niveaux de tmRNA a permis de renforcer considérablement l'efficacité d'antibiotiques visant le ribosome, y compris les macrolides qui sont utilisés pour le traitement de la légionellose. Ces résultats confirment non seulement l'intérêt de ce mécanisme comme cible antibiotique, mais révèlent également le potentiel de molécules inhibitrices de la trans-traduction comme adjuvants d'antibiotiques déjà existants.

Ce premier axe a fait l'objet de la rédaction d'un article dont je suis le premier auteur et qui est soumis dans la revue Scientific Reports et en attente d'évaluation par les pairs.

Dans le second axe, nous avons testé l'efficacité d'une nouvelle famille d'inhibiteurs de la trans-traduction contre les agents causatifs de la Légionellose, et notamment *Legionella pneumophila*. Ces inhibiteurs ont été récemment découverts et présentent une activité antibiotique contre plusieurs bactéries pathogènes d'intérêt majeur, notamment *Bacillus anthracis* (anthrax) et *Shigella flexneri* (shigelloses). Elles présentent également une activité antibiotique contre *Escherichia coli*, à condition d'inactiver chez cette espèce un système d'efflux de petites molécules. De façon surprenante et intéressante, ces inhibiteurs semblent donc avoir un effet même sur les espèces pour lesquelles la trans-traduction n'est pas un mécanisme essentiel. Pourtant, et bien que la cible exacte de ces molécules soit inconnue, l'activité antibiotique de ces composés semble bien liée à l'inhibition de

la trans-traduction puisque l'expression de systèmes alternatifs de sauvetage du ribosome réduit leur efficacité.

Nous avons naturellement cherché à savoir si cette nouvelle famille d'antibiotique pouvait avoir un effet sur *L. pneumophila*, où nous venions de démontrer l'importance du mécanisme de trans-traduction. Nous avons testé l'effet du KKL-35, un membre de cette nouvelle famille d'antibiotiques. Le KKL-35 inhibe la croissance des quatre espèces testées (*Legionella pneumophila*, *dumoffii*, *longbeachae*, *micdadei*) à des concentrations très basses. Dans le cas de *L. pneumophila*, toutes les souches cliniques testées étaient sensibles à partir d'une concentration de 0.4 mg/mL (0.12 μ M). De plus, pour toutes les souches et espèces testées, le KKL-35 possède une activité bactéricide à la concentration minimale inhibitrice ou à deux fois cette concentration.

De façon surprenante, nos résultats suggèrent que l'inhibition de la trans-traduction n'est pas responsable de l'activité antibiotique du KKL-35 chez *L. pneumophila*. Diminuer l'expression d'un composant du mécanisme de trans-traduction n'a pas eu d'effet sur la concentration minimale inhibitrice, pas plus que l'expression d'un mécanisme alternatif à la trans-traduction. Nous avons tenté d'identifier la cible de cet antibiotique, mais nous n'avons pas pu isoler de mutant résistant à cette molécule. De façon intéressante, cela suggère que l'apparition de résistances à un traitement antibiotique basé sur le KKL-35 pourrait être très lent.

Ce second axe a fait également l'objet de la rédaction d'un article dont je suis le premier auteur et qui sera soumis prochainement pour publication.

Dans notre troisième axe, nous avons souhaité ouvrir notre recherche par la mise en place d'une approche nouvelle appelée Tn-seq. Cette technique consiste à réaliser une mutagénèse systématique par l'introduction aléatoire d'un transposon dans le génome, puis à identifier de façon globale la position et le nombre d'insertions dans la banque de mutants obtenue par séquençage à haut débit des régions flanquantes des transposons. Cela permet d'obtenir de façon systématique une liste de gènes essentiels pour la viabilité, comme c'était le cas du tmRNA et de la trans-traduction dans le

premier axe ; mais également de mettre en évidence les gènes essentiels pour la viabilité dans certaines conditions particulières, comme l'infection d'un hôte ou un la survie à un stress.

Nous avons développé des outils et mis en place des techniques qui nous ont permis d'introduire cette technique au laboratoire, et de réaliser la mutagenèse de deux modèles : *L. pneumophila*, et l'archée hyperthermophile *Pyrococcus thermophilus*, pour qui nous avons rapporté la réalisation de la première mutagenèse systématique dans un article en cours de publication. Bien que de nombreuses limitations techniques ont émaillé ce troisième axe de recherche, ces travaux nous ont apporté de nouvelles connaissances qui nous rapprochent de la réalisation de banques de mutants de taille plus importantes.

Ce troisième axe a fait l'objet d'une publication dont je suis second auteur et qui fait l'objet de révisions mineures sous la suggestion des pairs qui l'ont évaluée.

Cette thèse est présentée en anglais, pour des raisons de compréhension par un membre du jury d'évaluation venant de l'étranger, et pour des raisons de diffusion à l'international.

Summary

Remerciements.....	3
Résumé du travail de thèse.....	7
Summary.....	12
List of figures.....	17
List of tables.....	22
Introduction.....	23
1. A commented history of bacteriology and infectiology: building from the past.....	23
1.1. The discovery of micro-organisms.....	23
1.1.1. Historical context.....	23
1.1.2 Recent discoveries in bacteriology and new challenges.....	27
1.2. A link between disease and bacteria.....	43
1.2.1. Invention of epidemiology and infectiology.....	43
1.2.2. Recent advances in bacterial infectiology.....	46
2. The antibiotic era.....	54
2.1. Historical context.....	54
2.1.1. Invention of chemotherapy: the first synthetic antibiotics.....	54
2.1.2. Rise of the natural antibiotics.....	56
2.1.3 The Golden Age of antibiotics.....	60
2.1.4 The age of resistance: towards a post-antibiotic era?.....	65
2.2. Approaches for antibiotic discovery, modes of action, resistance.....	70
2.2.1. Antibiotic discovery and drug development.....	70
2.2.2. Modes of action.....	77
2.2.3. Modes of resistance.....	78

2.3. Antibiotic classes.....	80
2.2.1. Cell wall disruptors and synthesis inhibitors	80
2.2.2. Inhibitors of nucleic acids synthesis	84
2.2.3. Protein synthesis inhibitors.....	89
3. Trans-translation, a new antibiotic target	98
3.1. Normal translation mechanism in Prokaryotes	98
3.2. Conditions inducing ribosomal stalling	99
3.3. Discovery of trans-translation: what is that band on the gel?.....	101
3.4. Components involved in trans-translation	105
3.5. Mechanism of trans-translation	121
3.6. Ribosome rescue in absence of trans-translation.....	125
3.7. What's to come in trans-translation research?	132
3.8. Interest of trans-translation as an antibiotic target.....	139
4. Legionella pneumophila, the accidental human pathogen	150
4.1. Description and epidemiology	150
4.2. Legionnaire's disease, or Legionellosis.....	155
4.3. From natural transformation to trans-translation in <i>L. pneumophila</i>	159
5. Identification of essential genes: the Tn-seq technique	162
5.1. Principle.....	162
5.2. Application and discoveries.....	165
Objectives of the thesis.....	167
Objective 1: Trans-translation in <i>Legionella pneumophila</i>.....	168
Trans-translation is essential in the human pathogen <i>Legionella pneumophila</i>	169
Abstract.....	170
Introduction.....	171
Results	173

Construction of an inducible allele of <i>ssrA</i> in <i>L. pneumophila</i>	173
<i>tmRNA</i> is essential for axenic growth in <i>L. pneumophila</i>	173
<i>tmRNA</i> -depleted <i>L. pneumophila</i> can be rescued by other ribosome release systems	174
Loss of <i>tmRNA</i> results in growth arrest and filamentation.....	175
<i>tmRNA</i> -depleted <i>L. pneumophila</i> are impaired for multiplication within eukaryotic hosts .	176
Trans-translation promotes resistance to ribosome-targeting antibiotics.....	177
Discussion	178
Materials and Methods	182
Chemical, growth conditions and culture media.....	182
Strains and plasmids construction.....	182
RNA extraction and quantification.....	183
Northern-blot analysis.....	184
Real-time quantitative PCR analysis	184
Infection of eukaryotic hosts.....	185
Light and epifluorescence microscopy.....	186
References	186
Acknowledgments	192
Author contributions	192
Competing financial interesting	192
Figures	193
Additional results and discussion	199
Is there really no alternative ribosome rescue factor in <i>Legionella</i> ?	199
Trans-translation inhibition does not cause in competence development.....	201
<i>tmRNA</i> -depleted <i>L. pneumophila</i> fails to infect an insect model (<i>Galleria mellonella</i>)	203
Does <i>tmRNA</i> depletion induce cell death? Or is it bacteriostasis?	204
Attempts to explore the link between the divisome and trans-translation.....	205

Prospects of this research	207
Objective 2: Activity of KKL-35 against the etiologic agents of Legionnaire’s disease	209
KKL-35 exhibits bactericidal activity against Legionella species in vitro and during infection of human macrophages	210
Abstract	210
Introduction	211
Methods	213
Strains, Growth Media and antibiotics used	213
Determination of Minimal Inhibitory Concentrations (MIC) and Minimal Bactericidal Concentrations (MBC).....	214
Time-Kill assay.....	214
Evaluation of synergetic activity.....	215
Intracellular activity determination.....	215
Intracellular growth monitoring.....	216
Selection of resistant mutants by serial passages	216
Results	217
KKL-35 inhibits Legionella growth in vitro.....	217
KKL-35 has activity on intracellularly multiplying Legionella pneumophila.....	217
Inhibition of trans-translation does not impact efficacy of KKL-35	218
Legionella pneumophila does not acquire resistance to KKL-35 rapidly.....	218
Discussion	218
Figures	221
Additional result and discussion	226
Testing KKL-35 in solid medium.....	226
Objective 3: Tn-Seq approach for discovery of essential genes and the study of gene function	
229	

Mutagenesis by in vitro transposition followed by natural transformation.....	230
Purification of the Mariner transposase.....	230
In vitro transposition with the Mariner transposase	231
In vivo transposition with a plasmid containing the Mariner transposase and a cognate transposon	238
In vivo transposition by conjugation.....	238
In vivo transposition by electroporation.....	241
Strains used in this study	248
Conclusions and future prospects.....	249
References	250

List of figures

Fig. 1 Marcus Terencius Varro (left) and Antoni van Leeuwenhoek (right).....	24
Fig. 2 From left to right, Louis Pasteur, Julius von Liebig, Maria Manasseina, Robert Koch.....	25
Fig. 3 Microbial diversity in acidic hot springs in the Andes (pH 2.7) assessed through three different metagenomics approaches.....	29
Fig. 4 Differences in gut microbiota composition in rural African children from Burkina Faso (A) and urban European children from Italy (B).....	29
Fig. 5 An updated tree of life. Red dots signal a phylum with no isolated representative.	32
Fig. 6 Principle of the diffusion chamber (left) and iChip, an improved version for high-throughput isolation (right).....	35
Fig. 7 Type I and II toxin/antitoxin systems.....	37
Fig. 8 Interplay of bacteriostatic TA systems and bacteriolytic programmed cell death.....	38
Fig. 9 Most of the genes of giant viruses have no matches in databases.....	40
Fig. 10 Diversity of giant viruses.....	40
Fig. 11 The forest of life.	42
Fig. 12 John Snow and his map of the cases of Cholera in Broad Street, London.....	43
Fig. 13 From left to right, Benjamin Jesty, Edward Jenner, and Louis Pasteur.....	45
Fig. 14 Vaccination coverage worldwide, 1980-2012.....	47
Fig. 15 Number of deaths per year associated with each type of infectious disease.....	53
Fig. 16 Correlation between economic development and prevalence of infectious diseases.....	53
Fig. 17 Genesis of the synthetic antibiotics.	55
Fig. 18 Ernest Duchesne and the first page of his thesis.	57
Fig. 19 The fathers of Penicillin.....	60
Fig. 20 Selman Waksman in his lab, in 1953.....	61
Fig. 21 Principle of the Waksman pipeline for antibiotic discovery.....	63
Fig. 22 The antibiotic discovery timeline.....	64
Fig. 23 Timeline of the inevitable apparition of antibiotic resistance.....	66
Fig. 24 Mechanisms of Horizontal Gene Transfer in bacteria.	67

Fig. 25 Main classes of antibiotics and their cellular targets.....	78
Fig. 26 Mechanisms of antibiotic resistance and tolerance.	79
Fig. 27 Cell wall synthesis and its known inhibitors.....	80
Fig. 28 Examples of β -lactam antibiotics.....	81
Fig. 29 Structure of the glycopeptide Vancomycin.....	82
Fig. 30 The small-molecule inhibitor of MurA, Fosfomycin	83
Fig. 31 Lipopeptides representatives.....	83
Fig. 32 Mycolic acid synthesis inhibitors.....	84
Fig. 33 Trimethoprim (left) and Sulfamethoxazole (right), often used together in a 1:5 ratio....	86
Fig. 34 On the left, the quinolone Nalidixic acid. On the right, the fluoroquinolone Ciprofloxacin.	87
Fig. 35 Rifampicin, the most common representative of the Rifamycin family.	87
Fig. 36 Metronidazole, the most common representative of the nitroimidazole class.....	88
Fig. 37 Nitrofurantoin, a common nitrofurantoin antibiotic.....	89
Fig. 38 Bacterial translation and ribosome-targeting antibiotics. (Wilson, 2013)	89
Fig. 39 Macrolide representatives.....	90
Fig. 40 Lincosamides	91
Fig. 41 Streptogramins representatives.....	92
Fig. 42 Amphenicols representatives	93
Fig. 43 The original natural compound Pleuromutilin (left) and the hemisynthetic Retapamulin, approved for human use (right).	94
Fig. 44 Aminoglycoside representatives.....	95
Fig. 45 Tetracyclines representatives	96
Fig. 46 Oxazolidinone representatives.....	96
Fig. 47 The prodrug Pyrazinamide	97
Fig. 48 Translation in prokaryotes.	99
Fig. 49 Conditions triggering ribosome stalling and the need for ribosome rescue mechanisms	101
Fig. 50 The first model for 10Sa RNA/tmRNA tagging activity, in response to translation of damaged mRNAs.	104

Fig. 51 Alignment of <i>ssrA</i> gene sequences show highly conserved sequences amongst different bacterial phyla	106
Fig. 52 Refined structure of tmRNA from <i>E. coli</i> , obtained from a biochemical approach.....	106
Fig. 53 Consensus secondary structure of <i>E. coli</i> tmRNA.	108
Fig. 54 <i>Thermus thermophilus</i> tmRNA predicted secondary structure	109
Fig. 55 Consensus sequence for the resume codon and the two preceding codons (upper left), relative abundance of aminoacid residues encoded in the tmRNA ORF (upper right), and consensus protein sequence of the beginning and the end of the tmRNA-encoded tag (bottom).	109
Fig. 56 tmRNA sequences available on the tmRNA website as of 2014, ordered by phylogeny	110
Fig. 57 <i>ssrA</i> -anchored genomic island in <i>Legionella pneumophila</i> str. Paris	111
Fig. 58 Integrative elements anchored to <i>ssrA</i> in enterobacteria	111
Fig. 59 <i>smpB</i> gene neighborhood in a set of bacterial species.....	113
Fig. 60 Position of <i>smpB</i> and <i>ssrA</i> in <i>Legionella pneumophila</i> str. Paris genome.	113
Fig. 61 Comparison of the structure of a tRNA (left) and the structure of the complex formed by SmpB and the tRNA-like domain of tmRNA obtained by cryo-EM studies.	114
Fig. 62 Structures of SmpB in solution (left) and of the complex formed by SmpB and the TLD of tmRNA (right)	114
Fig. 63 Accommodation of a tRNA (left) and of tmRNA-SmpB (right) in the ribosome.....	115
Fig. 64 The complex formed by EF-Tu, SmpB and tmRNA and the same complex loaded into the A site of the ribosome.....	117
Fig. 65 Regulation of RNase R by acetylation and interaction with tmRNA-SmpB.....	118
Fig. 66 <i>sspB</i> , a small adaptor of ClpX that directly binds <i>ssrA</i> tags and directs them for degradation	120
Fig. 67 Summary of the mechanism of trans-translation (Giudice et al. 2014).....	122
Fig. 68 Conservation of <i>arfA</i> amongst various bacterial taxa.	126
Fig. 69 Predicted hairpins within the ORFs of <i>arfA</i> mRNAs in <i>E. coli</i> , <i>D. dadantii</i> and <i>S. typhimurium</i>	128
Fig. 70 Model of ArfA post-transcriptional regulation by trans-translation in proteobacteria ..	128
Fig. 71 Structure of ArfB bound to the ribosome.....	129

Fig. 72 Alignments of <i>arfB</i> genes in several bacterial species.....	130
Fig. 73 Repartition of <i>arfB</i> amongst bacterial genomes	131
Fig. 74 <i>ArfA</i> and <i>ArfB</i> , alternatives mechanisms to trans-translation.....	132
Fig. 75 Loss of tmRNA and <i>SmpB</i> central loop in <i>Mycoplasma suis</i>	133
Fig. 76 Repartition of <i>arfA</i> and <i>arfB</i> sequence and current knowledge on their ability to complement loss of trans-translation.....	134
Fig. 77 Jakobids and Oomycetes are the only eukaryotes whose mitochondria have retained tmRNA.	135
Fig. 78 Comparison of ICT1 structure to bacterial RF1 and RF2.....	136
Fig. 79 Proposed roles for mtRF1 as a ribosome rescue factor and mtRF1a as a release factor.	136
Fig. 80 Alignment of RF2 from <i>T. thermophilus</i> and human mtRF1a, C12orf65 and ICT1.....	137
Fig. 81 Alignment of <i>E. coli</i> and <i>C. crescentus</i> <i>arfB</i> and human ICT1 sequences.	138
Fig. 82 The regulation of the Lac operon relies on trans-translation.....	142
Fig. 83 High-throughput assay for the discovery of trans-translation inhibitors.	144
Fig. 84 Determination of the trans-translation step inhibited by the identified compounds....	145
Fig. 85 Compounds inhibiting trans-translation identified by the high-throughput screen....	146
Fig. 86 Cryo-EM-density map of tmRNA– <i>SmpB</i>	148
Fig. 87 The Bellevue-Stratford Hotel in Philadelphia, where the first recognized outbreak of Legionnaire’s disease occurred in 1979	150
Fig. 88 Repartition of species and serotypes of <i>Legionella</i> found among 508 cases of Legionellosis	152
Fig. 89 Genomes of 38 <i>Legionella</i> species have been sequenced and a phylogenetic tree has been built using a set of orthologous genes.....	154
Fig. 90 Characteristics of the genomes of sequenced <i>L. pneumophila</i> strains	155
Fig. 91 Intracellular multiplication of <i>Legionella pneumophila</i>	157
Fig. 92 <i>Legionella pneumophila</i> promotes through T4SS effectors the formation of a replicative LCV in the host where it thrives and multiplies.....	158
Fig. 93 Phylogenetic trees of two <i>L. pneumophila</i> str. Paris proteins with eukaryotic-like domains.	159
Fig. 94 Principle of the Tn-Seq approach.....	164

Fig. 95 Different approaches for Tn-Seq DNA analysis	165
Fig. 96 Neighbour-joining tree of ArfB sequences from various bacterial species with the putative "ArfB/ICT1" of <i>Legionella pneumophila</i> and <i>longbeachae</i> and ICT1 from <i>Acanthamoeba castellanii</i>	200
Fig. 97 A reduction in trans-translation activity does not trigger competence development.....	202
Fig. 98 Survival curves of <i>Galleria mellonella</i> larvae infected with different strains of <i>L. pneumophila</i>	203
Fig. 99 CFU counting after growth with or without IPTG and adjustment of the samples at OD=1.	204
Fig. 100 Determination of KKL-35 MIC by the agar dilution method in GYE medium.....	227
Fig. 101 Gellan gum as an alternative to agar/charcoal for preparation of <i>L. pneumophila</i> solid medium.....	227
Fig. 102 Tn-Seq approach by in vitro mutagenesis.	230
Fig. 103 Plasmids built for in vitro transposition.	232
Fig. 104 Determination of efficient transposase concentration for in vitro transposition.....	233
Fig. 105 Ideal transposition conditions at 50µg/mL transposase.	235
Fig. 106 Reparation is essential after transposition in vitro and before natural transformation with transposed gDNA.....	236
Fig. 107 pSAM-Ec, a suicide plasmid used for transient delivery of the Mariner transposase and its cognate transposon	239
Fig. 108 Validation of the transposition mutants obtained by electroporation of pSAM-Ec....	242
Fig. 109 Southern-blot against the <i>kan^R</i> gene in gDNA of isolated mutants.	243
Fig. 110 Mutant 3 exhibits an impaired fitness at 30°C (A) and morphological defects (B)....	246

List of tables

Table 1 Publicly advertised new antibiotics in clinical trials or recently approved, as of 2013....	76
Table 2 Main classes of antibiotics and their cellular targets.....	77
Table 3 Exhaustive list of pathogenic species in which essentiality of trans-translation has been assessed, as of 2016.....	140
Table 4 Identification of the location of transposon insertion in Mutants 1 to 12. All 16- or 17-bp sequences were unique in the genome. One insertion (mutant 8) was in the pLPP resident plasmid of <i>L. pneumophila</i> Paris.....	245
Table 5 Strains used for the Tn-seq approach.	248

Introduction

*Germes were a novelty then. The great Pasteur had just invented them.
My mother thought they were little tigers, ready to gobble us up from inside.*

Marcel Pagnol, *My Father's Glory*

1. A commented history of bacteriology and infectiology: building from the past

In this introductory part, I will present new concepts, notions and discoveries that recently emerged in bacteriology and infectiology, and that I found either relevant to my work or relevant to the future of these fields. These discoveries, by their intrinsic cutting-edge nature, often answer questions while raising new ones. To understand their scope, it is thus important to know the historical context of both fields of bacteriology and infectiology. That's why for each field, historical considerations will be presented in parallel to the recent findings I chose to highlight.

1.1. The discovery of micro-organisms

1.1.1. Historical context

The discovery of the “minute creatures” around us

The first mention of invisible organisms surrounding us can be traced as far as the Roman Republic, in the writings of a scholar named Marcus Terentius Varro. In a treaty about rural life and agriculture, he warned against building farms near swamps, affirming that in such places “*there are bred certain minute creatures which cannot be seen by the eyes, but which float in the air and enter the body through the mouth and nose and cause serious diseases*” (Varro, _160 BCE). This hypothesis is remarkable, as it predates the first observations of micro-organisms and the discovery of their link to disease by no less than 18 centuries. Unfortunately, the astute vision of Varro was more of a conjecture than a scientific hypothesis, as he did not try to provide any evidence to support his assertions. Thus, his remark was mostly ignored and lost for centuries, as were most of the remarkable advances of the Roman civilization in terms of hygiene and public health.

The history of microbiology really started during the Renaissance, in the early 17th century, with the invention of the microscope. Historical sources are unclear on who was the first inventor

of the microscope, Galileo and Zacharias Janssen being two strong contenders for this title (Ball, 1966). The magnification on these first microscopes was weak but allowed to observe in detail small animals, such as fleas, and large cells, such as plant cells. Rapid advances in lens manufacturing techniques allowed to increase their capabilities, and from 1674 to 1676 the Dutch naturalist Van Leeuwenhoek described the discovery of pluri- and unicellular micro-organisms in environmental samples, including protozoa, algae, and even bacteria, in his own dental plaque (see below). His findings were confirmed and reinforced by the works of Robert Hooke, who was mandated by the English Royal Society to verify his claims.

I saw with as great wonderment as ever before an unconceivably great number of little animalcules. These animalcules, or most of them, moved so nimbly among one another that the whole stuff seemed alive and moving...there are more animals living in the scum on the teeth in a man's mouth than there are men in a whole kingdom.

Antoni van Leeuwenhoek, Letter to the Royal Society of London, 17 September, 1683



Fig. 1 Marcus Terentius Varro (left) and Antoni van Leeuwenhoek (right).

A long-brewing dispute about spontaneous generation

The immense diversity of morphologies observed by Van Leeuwenhoek revealed an unsuspected world of invisible organisms. While their existence was rapidly accepted by the scientific establishment, their link to disease was not established at first. Instead of wondering if they could find their way into the human body, a heated debate arose between scientists to define

whether these micro-organisms could spontaneously appear from the inert organic matter, or if they were merely multiplying from already existing units of life. The “spontaneous generation” theory had strong supporters during two centuries, including Buffon, John Needham, Felix Pouchet and even the Roman Catholic Church (in a superb exercise of intellectual gymnastics, they argued that the mystical creation had no reason to not be a continuous miracle). Charles Darwin was in favor of spontaneous generation as a hypothesis but noted, with reason, that evidence was lacking at his time.

Several scientists attacked the theory and tried to disprove it, namely Lazzaro Spallanzani, Pier Antonio Micheli and Joseph Priestley. The theory had already fell in disgrace in most of the scientific world when Charles Cagniard de la Tour and Theodor Schwann discovered simultaneously that yeast, this wonderful element that had brought nourishment in the form of bread and joy in the form of beer for the past three millenniums, seemed to be composed of living beings that were necessary for fermentation. This sparked a strong debate in the middle of the 19th century between two leading authorities of their time, Louis Pasteur and Justus von Liebig. This dispute was mostly about whether yeast was a living organism or a chemical catalyzer of fermentation. The argument could have had only limited implications for both biology and amateurs of lager; however, like often in French-German relationships of that time, things rapidly escalated out of proportions. It sparked a burning public debate between the two. Liebig’s disdainful ignorance of Pasteur’s theories encouraged the French scientist to use his recent discoveries about sterilization techniques and his invention of swan-necked bottles to prove that yeast inoculation was indeed needed for fermentation, and that it was a living organism (Pasteur, 1860). Incidentally, using these inventions definitively closed the debate about spontaneous

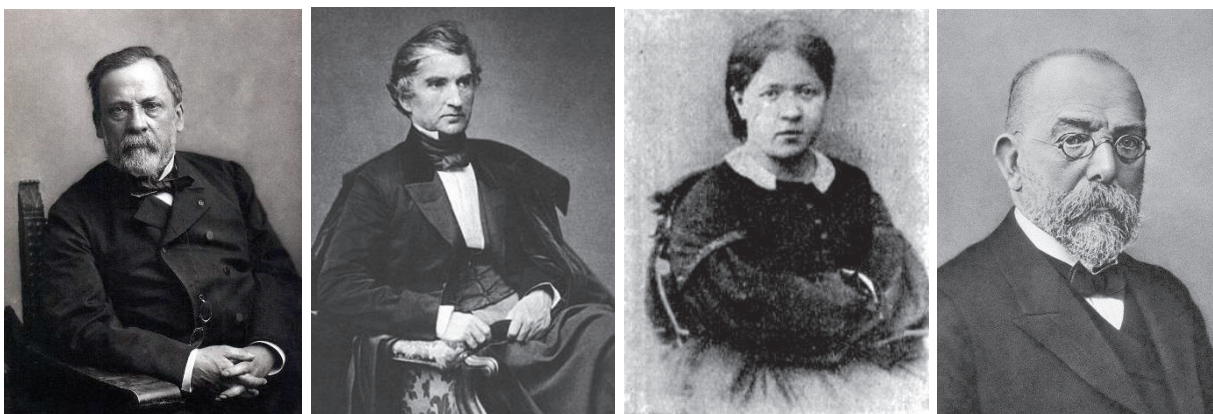

Fig. 2 From left to right, Louis Pasteur, Julius von Liebig, Maria Manasseina, Robert Koch.

generation still defended by Pouchet, by showing that heating broth and preventing its exposition to air prevented growth. Contamination or inoculation, not spontaneous generation, was therefore neces (Pasteur, 1862).

Pasteur once again played a great role in proving the role of certain micro-organisms in human and veterinary diseases, a point that will be further discussed later (cf. p. 43). Less known is the fact that a few years later, Maria Manasseina proved that a cell-free extract of yeast (obtained by crushing and not heating, and therefore containing unadulterated zymase enzymes) could perform the fermentation process in absence of yeast cells, proving that the truth was somewhere in between Liebig's and Pasteur's theories (von Manassein, 1897). Unfortunately, her work was ignored; the microbiologist Eduard Buchner dismissed her results, suggesting fiendishly that her broths were probably contaminated (Creese, 2015). He then repeated her work 20 years later without citing her, on purpose, and was awarded a Nobel prize for it.

Around the same time as the infamous Pasteur-Liebig dispute, Robert Koch invented the solid growth medium, a point that proved decisive for the isolation of new micro-organisms from the environment and their study as pure cultures. Starting from exotic supports such as sterile potato slices, he rapidly switched to organic polymers, gelatin first, then agar, which is still used in most microbiological solid media. The idea of using agar was given to Koch by Fanny Hesse, an unpaid worker of his lab; he never credited her for that contribution. The development of culture-based identification allowed the isolation of thousands of microbial species in the following years. A major flaw of culture-based techniques is the discrepancy between the number of micro-organisms visible in a microscopic observation of an environmental sample and the number of said microbes able to be cultivated on solid media (~0.05-1%). This inconsistency was named "the great plate count anomaly" and remained unexplained for more than a century (Staley and Konopka, 1985). Hypotheses about this divergence just started to be verified in the last few years, a point that will be discussed below.

A century after the works of Koch, the development of the Polymerase Chain Reaction (PCR) and the subsequent explosion in biomolecular techniques, notably massive parallel sequencing, unveiled that this hidden, uncultured bacterial diversity was in reality much more colossal than

imagined. Not only this opens opportunities for scientific discovery and exploration, but it also challenges most of the paradigms about evolution, and perhaps our definition of life itself.

1.1.2 Recent discoveries in bacteriology and new challenges

According to its modern definition, a micro-organism or microbe is a living being, invisible to the naked eye, whose size range is in the order of a micrometer. Micro-organisms comprise members of all the domains of life: Bacteria, Eukaryota, and Archaea. They can be uni- or pluricellular, with a wide diversity of morphology, size, division method, and ideal growth conditions. Most of the discussions in this manuscript will focus on bacteria, which make up the majority of the known phyla of micro-organisms. The recently uncovered massive diversity of bacterial species is a challenge for bacteriologists, as the advent of new sequencing techniques forces us to face massive amounts of data and information that changed our vision of the bacterial world and question several well-established paradigms.

Uncovering the diversity of the bacterial world through metagenomics

While cultivation of most micro-organisms from environment samples still proves difficult, the emergence of biomolecular techniques allowed us to peek into the genetic diversity of the microbial world. Invention of the PCR (Mullis and Faloona, 1987) and all its derived genetic tools, in particular DNA sequencing, allowed the development of environmental microbiology and genomics. Coupled together, these two domains form the “metagenomics” approaches, that allowed to recently uncover that microbial ecosystems have a very complicated organization, with puzzling and fluctuating dynamics in the relative abundance of species and genera (Riesenfeld *et al.*, 2004). The most common approach in metagenomics consists in extracting the whole DNA from an environmental sample containing millions of micro-organisms, then amplifying a highly conserved gene (usually 16S rDNA) with universal primers, and using new-generation massive parallel sequencing to assess the diversity of the sequence of that gene to deduce the number of different species in the sample (Keller and Zengler, 2004; Armougom and Raoult, 2009). The most striking contribution of metagenomics was the realization that the microbial diversity was much larger than anything we expected, and that very diverse microbial ecosystems could thrive in extreme environments, such as the bottom of the ocean, Earth's crust, salt mines, oil wells or acidic springs (Fig. 3).

Using these new tools for the study of microbial ecosystems in the environment is crucial to identify new species for various applications such as bioremediation or drug discovery (Lorenz and Eck, 2005; Li and Vederas, 2009). It is equally important to understand how these ecosystems interact with macroscopic species, at the level of their own ecosystem, or at the single animal level. In this regard, the most important recent studies about bacterial ecosystems were the publications that led to the discovery of the prominent role played by the microbiota in health. The microbiota is the community of all microorganisms that live in or upon the body of an animal. In the case of humans, it is composed of at least ten times as many cells as the human body itself, most of them residing in the intestinal tract (Gill *et al.*, 2006). The diversity of the microbiota seems to be heavily variable among humans, depending on diet, antibiotic intake, country, and ethnicity (Fig. 4), possibly making it impossible to exactly define what is a “healthy” microbiota.

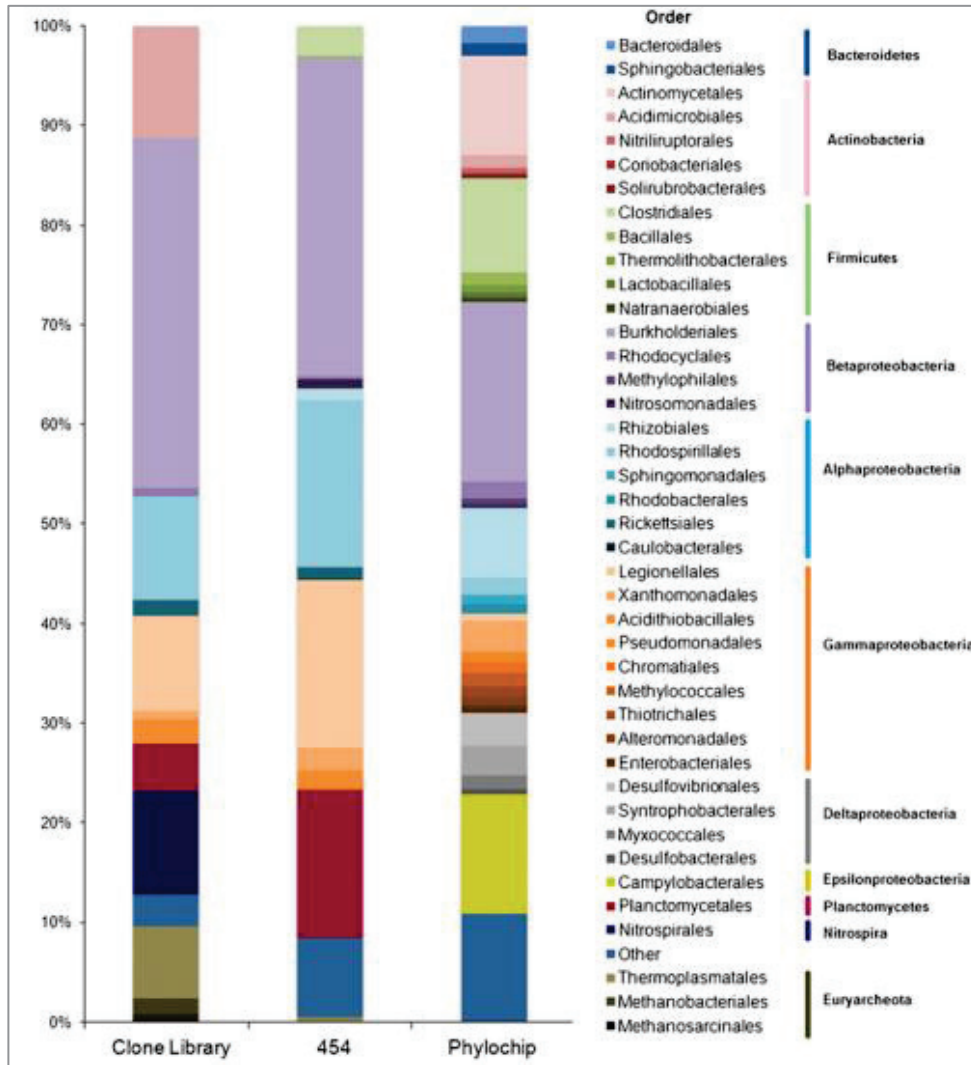

Fig. 3 Microbial diversity in acidic hot springs in the Andes (pH 2.7) assessed through three different metagenomics approaches. <http://link.springer.com/article/10.1007/s00248-011-9943-3>

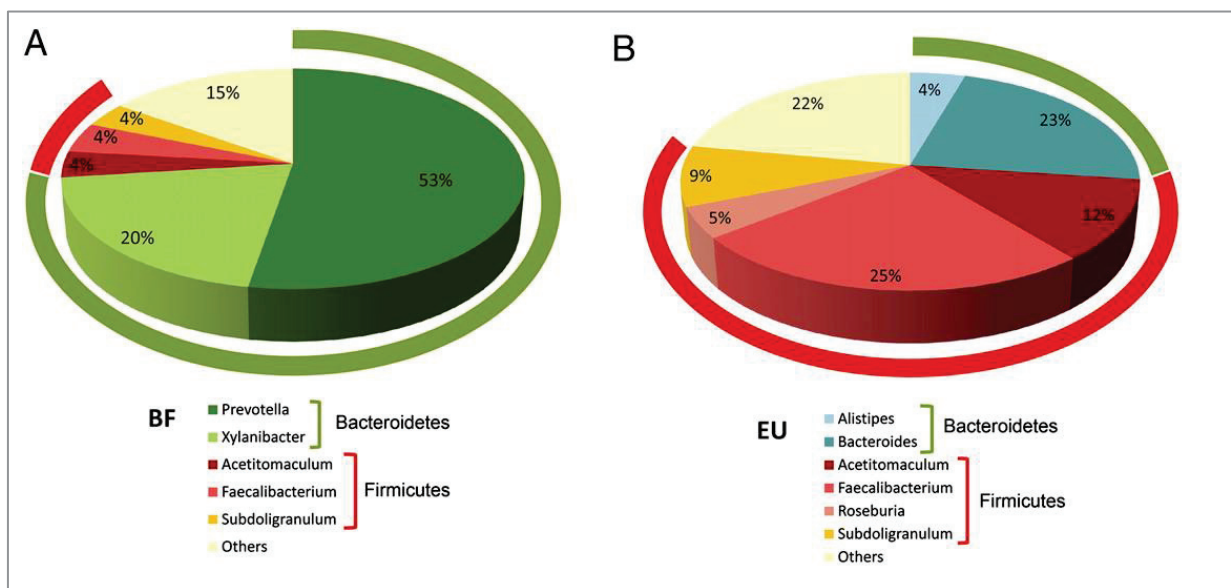

Fig. 4 Differences in gut microbiota composition in rural African children from Burkina Faso (A) and urban European children from Italy (B). <http://www.pnas.org/content/107/33/14691.full>

The role of the microbiota in regard to animal and human health seems to have been heavily underestimated until the last decade (McFall-Ngai *et al.*, 2013). Metagenomic data suggests a role of the composition of the digestive microbiota in obesity, certain forms of autism, diabetes, and auto-immune diseases (Vrieze *et al.*, 2010). The vaginal microbiota could also play a role during birth, in the development of the immune system of the newborns, a fact that could explain the puzzling higher prevalence in auto-immune diseases and allergies in children delivered by Caesarean sections (Pistiner *et al.*, 2008; Dominguez-Bello *et al.*, 2010). A sudden imbalance in the composition of the microbiota allows opportunists such as *Clostridium difficile* or *Candida albicans* to invade and overrun the mucous membranes, causing infection associated with the use of antibiotics and antiseptics (Bartlett *et al.*, 1978). Incidentally, restoring a diverse microbiota has proven efficient in eliminating invasions caused by opportunist pathogens (Gough *et al.*, 2011).

Studying the organization of bacterial communities, even with new techniques brought to us by the -omics revolution, is difficult because of the massive amounts of data to analyze. This data reveals complex interactions, dependencies and competition between thousands of different species. But the benefits of studying such relations will be paramount in the future to reshape our understanding of bacterial-animal relationships, and the role of bacterial communities in health (McFall-Ngai *et al.*, 2013).

“Uncultivable species” or “uncultivated species”?

The accumulation of massive amounts of recent genomic and phylogenetic data allowed to establish an updated tree of life (Fig. 5), which reveals that an overwhelming majority of the known genera of living organisms are bacteria, and that most of them have no cultivated representatives (Hug *et al.*, 2016). This discrepancy, already mentioned earlier as “the great plate count anomaly” is one of the oldest and most perplexing mysteries of the bacteriology field. For decades, bacteriologists have simply ignored and dismissed that fact with simplistic, unverified theories such as the possibility that common culture media were not adapted to the cultivation of most species, that they grew too slowly, or that the majority of cells from environmental samples visible under the microscope were simply dead.

Out of convenience, bacteriologists then resolved to using as model organisms a handful of fast-growing, easily cultivable and isolable bacterial species, while ignoring most of the immense

diversity later uncovered by metagenomics. Of course, these models allowed to easily study the fundamental mechanisms of life and their contribution to biology was formidable. But new evidence point at the fact that these fast-growing bacterial “weeds” are probably poor representatives of the majority of the uncultivated bacterial world (Cray *et al.*, 2013; Epstein, 2013). Indeed, when new pathogens emerge and need to be isolated for evident and pressing public health reasons, even if their isolation proves problematic at first, most of the time specific conditions allowing their cultivation end up being discovered (see for example the discovery of *Legionella pneumophila*, p.150). These “fastidious” bacteria often grow at a slower pace than most bacterial models and require environmental conditions or exotic nutrients not found in basic growth media (Singh, Eldin, *et al.*, 2013; Singh, Kowalczywska, *et al.*, 2013), but their “uncultivable” status can often be overturned by discovering the right conditions with a good dose of patience, logic and chance (Lagier *et al.*, 2015). Among the most common bacterial human pathogens, only members of the *Chlamydiae* and *Rickettsiae* genera still resist cultivation (Singh, Eldin, *et al.*, 2013). Being intracellular pathogens, their multiplication is probably conditioned to regulation systems that requires to be exposed to very precise concentrations of specific nutrients that would mimic their natural cellular host environment. These conditions have been found for other intracellular pathogens such as *Legionella pneumophila* (Feeley *et al.*, 1979), *Tropheryma whipplei* (Renesto *et al.*, 2003) or recently *Coxiella burnettii* (Singh, Kowalczywska, *et al.*, 2013).

What we call “fastidious” bacteria in a clinical setting, could therefore be representatives of the normal, “uncultivable” bacterial world; by opposition to the fast-growing weeds readily isolable in rich media that form an oligarchic, ruling minority in our labs. The fact that the conditions of growth of “uncultivable” bacteria can be identified with enough perseverance opens gigantic perspectives for the future exploration of the still-ignored majority of the bacterial world.

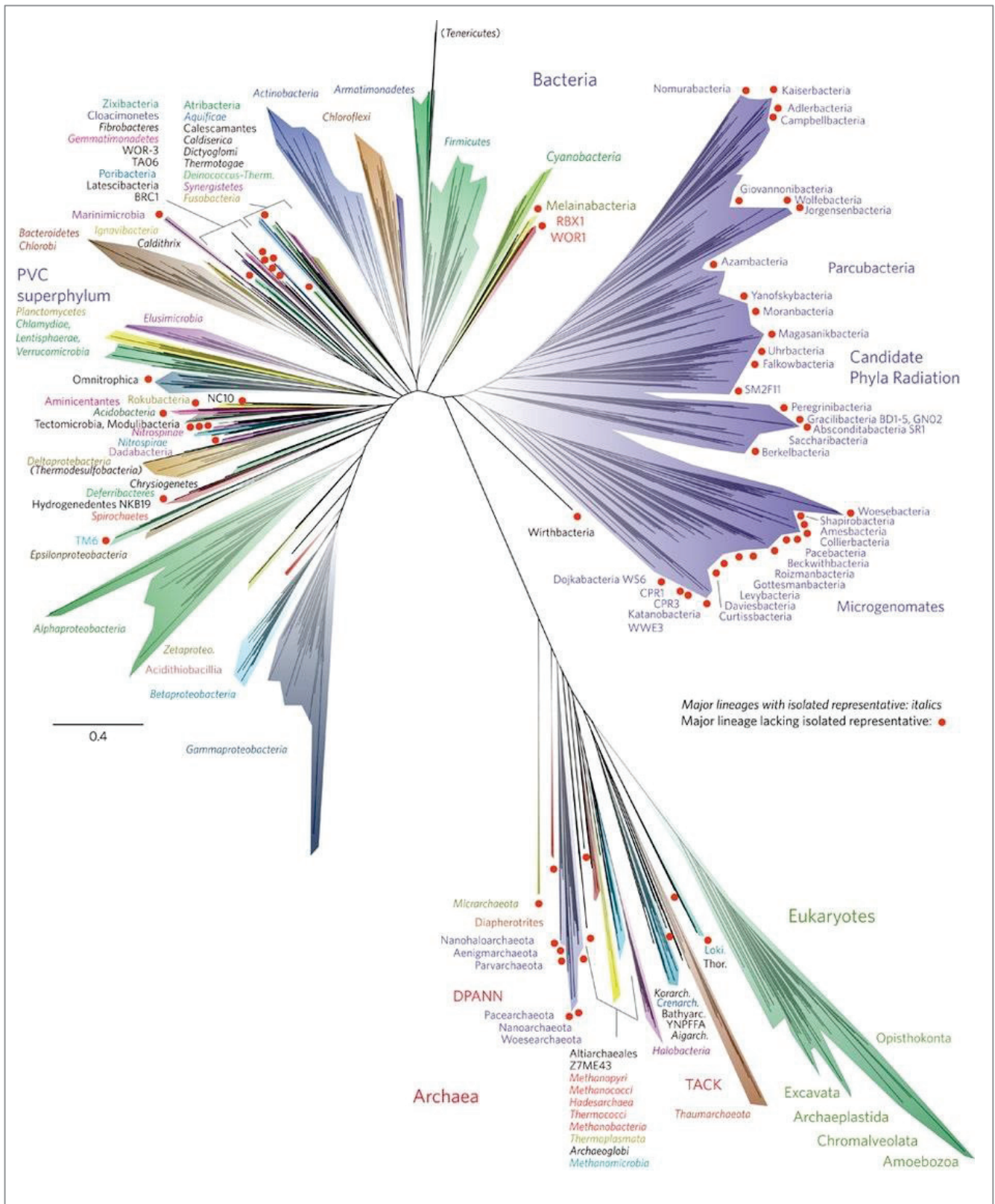

Fig. 5 An updated tree of life. Red dots signal a phylum with no isolated representative. (Hug et al. 2016)

Recent discoveries and new methods have started to uncover the reasons why most environmental bacteria are so refractive to form colonies on rich media, despite being provided with all the necessary nutrients.

- Agar, which is used as a supposedly inert support in the vast majority of solid growth media for isolation, has the property of producing reactive oxygen species when it is autoclaved in presence of other media components, resulting in the killing of most bacterial species that cannot produce enough peroxidase to counteract ROS (Tanaka *et al.*, 2014). The discovery of this “hidden pitfall” in solid media preparation was made only two years ago, while agar has been used since the invention of the solid medium by Koch in 1882. Autoclaving agar alone or using other jellifying agents did not induce a similar bacterial mortality and allowed to isolate a larger bacterial diversity from environmental samples.
- Type of nutrients, pH, temperature, and oxygen levels in culture all have an impact on the possibility to isolate new bacterial species. Using two hundred different conditions on a single fecal sample, a single team impressively reported the isolation of 340 bacterial species, including 174 species never described in the gut by metagenomics and 31 new species never identified by neither metagenomics or culture (Lagier *et al.*, 2012). Interestingly, the overlap between the species identified by massive parallel sequencing and those isolated was really low, revealing a very high bias in 16S rDNA-based metagenomic approaches, that failed to detect a large part of the microbial diversity. The global microbial diversity of the planet could therefore be much larger than what was previously uncovered by metagenomics.
- An interesting and fundamental observation to explain the global uncultivability of environmental bacteria was made through a very simple experiment: plating an environmental sample, followed by incubation for a few months. After a random number of days, bacteria from the sample would form colonies in a very short time and become readily cultivable (Buerger *et al.*, 2012a). The number of days needed to emerge as a colony did not depend from the genus or the species of the bacteria. This led to the conclusion that most environmental bacteria might be in a state of dormancy that is only reversed in a

stochastic way, allowing the bacteria to test if the environment has become fit for multiplication: the “bacterial scout hypothesis”(Buerger *et al.*, 2012b).

- Some bacteria seem to rely on growth-promoting factors produced by other bacteria to grow, such as siderophores or metabolic byproducts. In this case, co-culture or identification and purification of the growth factors are necessary for cultivation (D’Onofrio *et al.*, 2010). On the contrary, there can be cases in which a species producing growth inhibitors arises early on the plate and prevents the growth of the other bacteria. Moreover, it seems that most environmental bacteria are oligotrophic, preferring a low-nutrient environment similar to their natural conditions, to a rich medium (Vartoukian *et al.*, 2010). To account for this, “extinction cultures” were invented, consisting of diluting samples until in average less than 1 bacterium is present in each culture (Watve *et al.*, 2000). This method allowed to isolate *Pelagibacter ubique*; it is probably the most abundant organism on Earth but hadn’t been cultivated until that point (Rappé *et al.*, 2002).

From all these observations, a revolutionary system based on incubation chambers was developed, that allows to pre-incubate a single bacterial cell in contact with its environment before being plated on rich media (Kaeberlein *et al.*, 2002). The chamber is delimited by a porous membrane that prevents bacteria from entering or exiting the chamber but allows the exchange of growth factors, small molecules and ions with the environment and other bacteria (Fig. 6, left). Doing so leaves time for bacteria to exit dormancy, divide, and multiply as micro-colonies of pure cultures without worrying about finding the ideal growth conditions, as bacteria are cultivated in their natural environment.

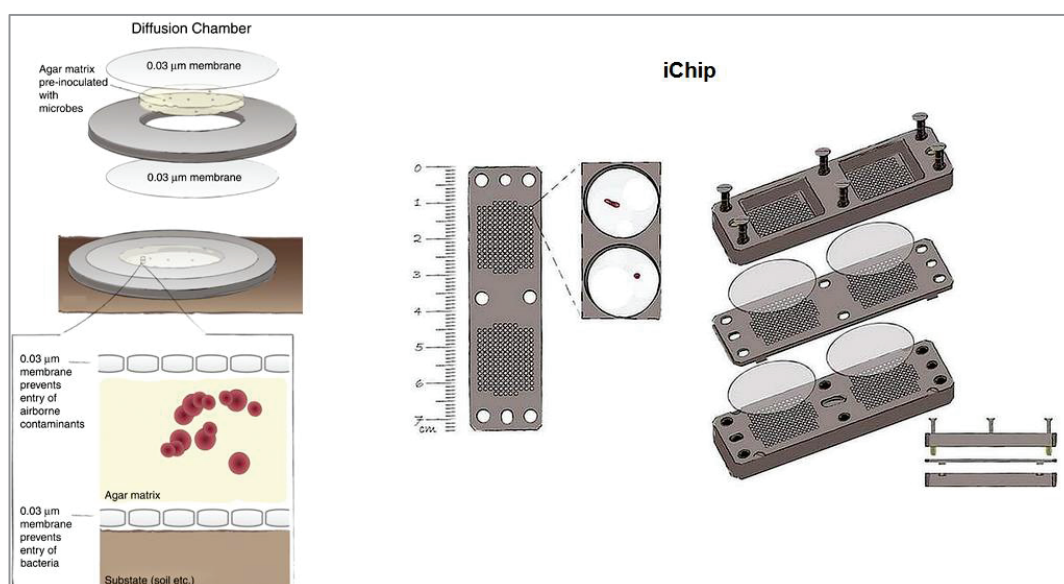

Fig. 6 Principle of the diffusion chamber (left) and iChip, an improved version for high-throughput isolation (right) (Nichols *et al.*, 2010)

Interestingly, using these microcolonies as inoculum instead of an environmental sample increases the efficacy of plating on usual growth media. Indeed, within the microcolony that serves as an inoculum, not all bacteria are dormant at the time of plating; using this pre-purified culture as inoculum also prevents competition from “weeds” and inhibitor-producing species. The pre-incubation in growth chambers increases the cultivability of environmental bacteria on usual growth media from 0.05-1% (when an environmental sample is directly plated) to 40-90%, depending on the environment sampled (Bollmann *et al.*, 2007; Epstein *et al.*, 2013). The bacteria still uncultivable after pre-incubation may need co-culturing or more exotic growth factors in the medium (Nichols *et al.*, 2008). Using iChip (Nichols *et al.*, 2010), an optimized version of these chambers (Fig. 6, right), *Eleftheria terrae*, a previously uncultivated bacterium, was isolated. It produces Teixobactin, an antibiotic from a novel family with a new mode of action, proving the interest of tapping into this unexplored part of the microbial world (Ling *et al.*, 2015).

Isolating, cultivating and domesticating the immense diversity of bacteria unveiled by metagenomics is one of the greatest challenges of modern bacteriology. The approaches consisting of combining improved growth conditions with new cultivation methods to isolate new species, renamed “Culturomics” (Greub, 2012), will complement efficiently metagenomics and help us face this challenge.

When are bacteria really dead?

The seemingly prevalent state of dormancy amongst environmental bacteria is, to say the least, puzzling. Even the ability to overturn the cultivability of a bacterial sample questions the relevance of a commonly accepted test of bacterial viability, primordial for clinical bacteriology. Indeed, for decades, cultivating bacteria has been the gold standard for asserting the bacterial viability in a culture (Fournier *et al.*, 2013). The ability to grow and form colonies in artificial media is still the method of reference to determine the bactericidal effect of an antibiotic (CSLI Guidelines, 1999). But what is the relevance of such methods if bacteria may be dormant and not dead?

The long-held view that non-growing bacteria are dead is challenged by the discovery that most bacteria can enter a state in which they are metabolically active, with an intact membrane, but unable, or unwilling to divide and therefore to form colonies. This physiological state is often referred to as “VBNC” (Viable But Non Cultivable) (Oliver, 2005). It poses challenges for asserting the efficacy of antibacterial compounds and disinfection regimens. Indeed, for *Legionella pneumophila* contaminated water, heat or chlorine treatment can induce the entry into the VBNC state, in which bacteria are unable to grow on media, but in that state they are still pathogenic and able to infect their hosts (Steinert *et al.*, 1997; García *et al.*, 2007; Alleron *et al.*, 2008). *Vibrio cholerae* switches from a VBNC to a cultivable state in the human gut, a change associated with virulence development (Colwell *et al.*, 1996). In tuberculosis, the entry into the VBNC state may explain the sudden recurrence of the disease years after apparent curing (Gengenbacher and Kaufmann, 2012).

Another striking recent discovery is the fact that in a bacterial culture, a subpopulation of cells seems to be able to survive exposure to a high antibiotic concentration that kills all the rest of the population, and to resume growth when antibiotic concentration decreases (Lewis, 2007; Lewis, 2010). These “persister” cells are not resistant to antibiotics in the usual sense, as they are genetically identical to the rest of the population, do not possess specific resistance genes, and they don't grow as long as the antibiotic is present (Keren *et al.*, 2004). This observation has massive implications for the treatment of patients using antibiotics, as persisters could explain the failure of treatments even in absence of resistance and relapses after treatment (Lewis, 2007).

As the VBNC state, the dormancy of environmental bacteria, and the formation of persisters all seem to be controlled, reversible and possibly related phenomena, the mechanisms underlying these states are being heavily researched at the moment. One of the most notable discovery is the link existing between persister cells and toxin/antitoxin systems. This link was discovered when populations of mutant bacteria with higher rates of persister cells were found to have mutations in these TA systems (Moyed and Bertrand, 1983).

TA systems are encoded by two genes, generally organized in operon, that encode a toxin and an antitoxin. Several regulations of the toxin activity exist, the most common being type I and II (Fig. 7). The antitoxin mRNA can bind the toxin mRNA and prevent its expression (Type I) or the antitoxin is a labile protein that bind a stable toxin and inhibits it (Type II). If a stress occurs and prevents the expression of the operon, the toxin is unleashed, leading to mRNA degradation, gyrase inhibition, or inhibition of the division machinery (Wen *et al.*, 2014).

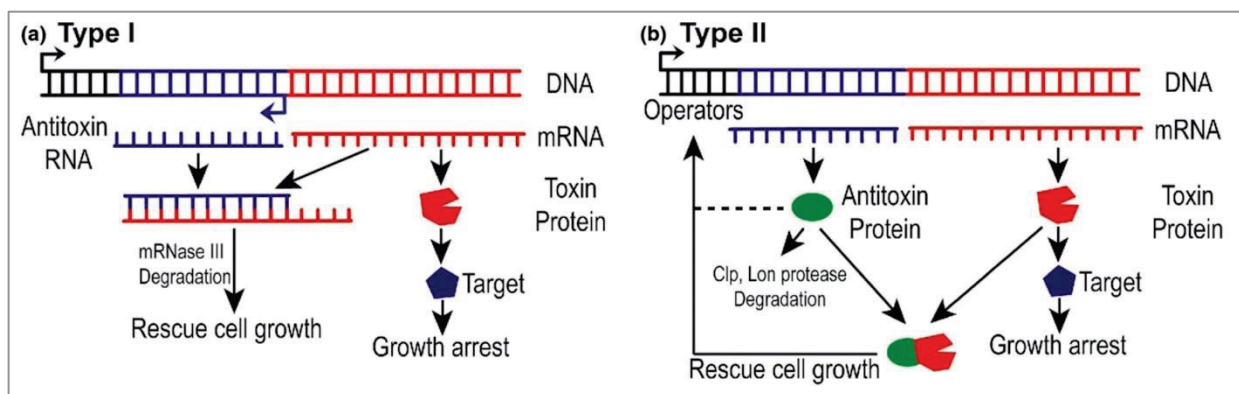

Fig. 7 Type I and II toxin/antitoxin systems. (Wen *et al.*, 2014)

These mechanisms had been first described as a protection system for plasmids, as bacteria that would lose the plasmid bearing the TA genes during segregation would stop expressing the antitoxin and enter dormancy because of the remaining stable toxin proteins (Hayes, 2003). It might well be probable that TA systems are selfish genes that promote their own conservation and replication by making themselves essential, while providing advantages such as segregation-dependent killing for plasmids or the possibility for bacteria to enter a persister state to resist stresses (Van Melderen and Saavedra De Bast, 2009). When they were discovered, TA systems were hastily named a “programmed cell death” or “a bacterial apoptosis” and described as an admirable feat of altruism and multicellular behavior in populations of bacteria. But this hypothesis has been heavily criticized since; indeed, in most TA systems, the effect of the toxin is bacteriostatic and rapidly reversible

(Prozorov and Danilenko, 2010). It seemed then more plausible that TA systems are used to quickly stop the metabolism of bacteria in the event of a stress. However, real cell death pathways that induce bacteriolysis have been discovered and seem to be triggered in some cases in response to prolonged toxin-induced dormancy (Bayles, 2014).

TA systems could be selfish genes that emerged as plasmid protectors; they were acquired by bacteria by horizontal gene transfer and integrated in their chromosomes; here, they acquired a role in rapid metabolic regulation; in the event of a prolonged stress, they serve as triggers of altruistic cell death (Fig. 8) (Bayles, 2014). In this hypothesis, persisters would be bacteria appearing stochastically within populations where the loss or non-expression of programmed cell death components induce survival even after long periods of dormancy (Lewis, 2000).

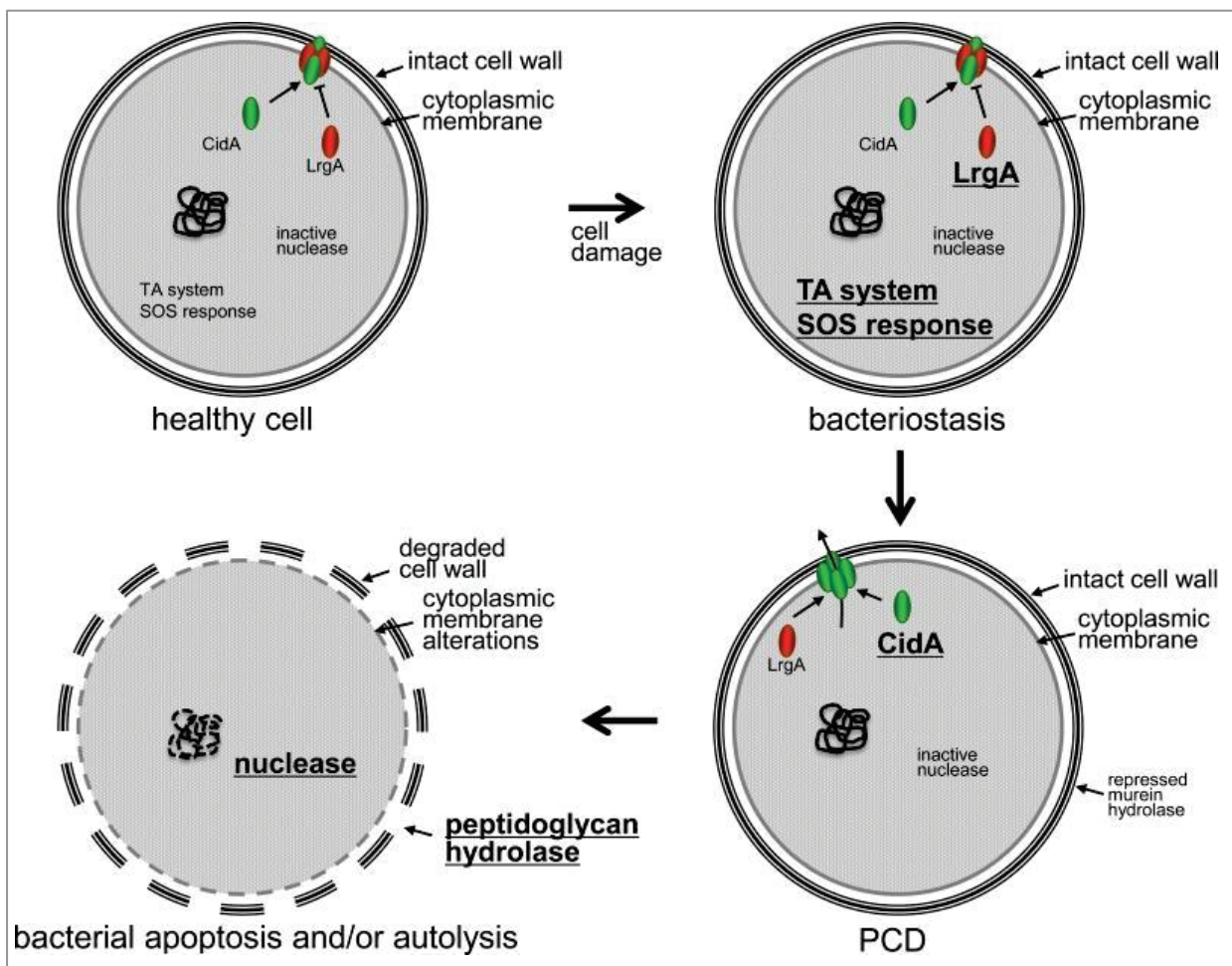

Fig. 8 Interplay of bacteriostatic TA systems and bacteriolytic programmed cell death (Bayles, 2014)

It is surprising that the false assumption that uncultivability of bacteria meant that the cell was dead lasted for decades, and was only challenged in the last decade. Defining the physiological implications of VBNC and persister cells, as well as deciphering the mechanisms underlying the

regulation of these physiological states, will continue to prove to be an interesting challenge in the coming years.

What is “alive” in the microbial world?

While most environmental bacteria might be in dormancy, and while fungi and protists tend to form inactive spores and cysts, they are still considered to be “living” organisms even when they stay in a metabolically inactive state. However, similarly inactive viruses are not considered to be alive and they are therefore excluded from the micro-organisms. The basis of that exclusion relies on their impossibility to self-replicate, and to provide their own metabolism. Instead, they rely on parasiting living organisms, their cellular mechanisms and their metabolism to replicate. Viruses are therefore considered to be an elaborate form of “selfish genetic elements”, a category of genes that only code for their self-preservation and that parasite living organisms. In this aspect, viruses are no more alive than any other parasitic genetic elements such as transposons, homing endonucleases, plasmids, or the previously described toxin/antitoxin systems.

But the recent discovery of giant viruses the size of a bacteria, containing hundreds of genes of unknown function and complicated structures, has led to the suggestion that these viruses were once living, free micro-organisms that underwent simplification when their lifestyle became parasitic (La Scola *et al.*, 2003; Philippe *et al.*, 2013; Legendre *et al.*, 2015). Indeed, loss of unused functions and redundant genes is systematic in the genome of pathogenic organisms, compared to their free-living relatives (Moran, 2002). For example, the 12 deadliest human pathogens that cause an epidemic risk all have a significantly smaller genome than their closest non-pathogenic species (Georgiades and Raoult, 2010). The various steps of simplification of micro-organisms which underwent a change in lifestyle towards parasitism or symbiosis are observable in contemporary environments. Some bacteria such as *Shigella flexneri* have recently lost functions by switching from commensalism to pathogenicity (Jin *et al.*, 2002), while other bacteria such as *Coxiella burnettii* are only able to grow by infecting eukaryotic hosts (Hackstadt and Williams, 1981). Self-replicating endosymbionts (mitochondria, plastids) and insect symbionts are closely related to bacteria and in all probability, they emerged from intracellular parasitic bacteria that turned their relation with the host into symbiosis (Ball *et al.*, 2016).

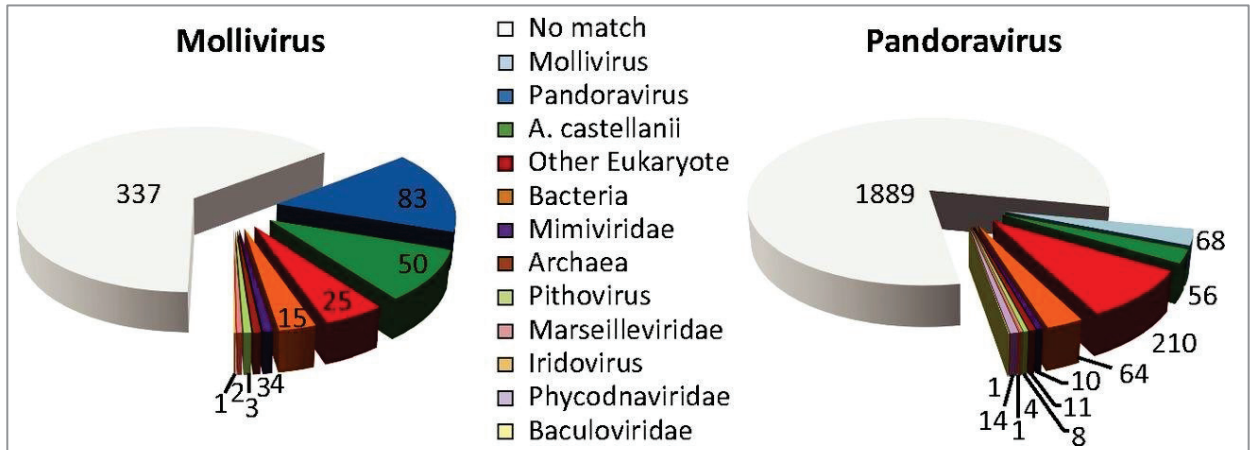

Fig. 9 Most of the genes of giant viruses have no matches in databases. Among those who have homologs, they can be found in the three domains of life and in other viruses. Legendre et al., 2015

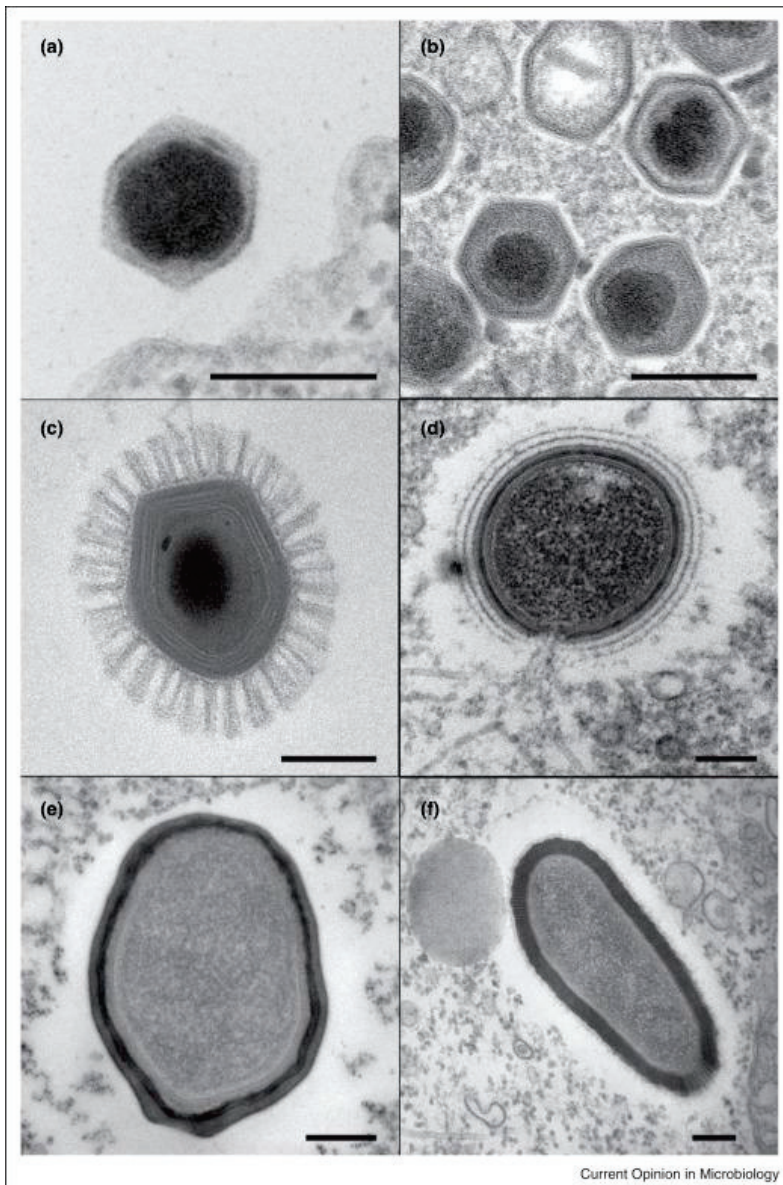

Fig. 10 Diversity of giant viruses.
(Fischer, 2016)
(a) Port-Micu virus
(b) Unclassified faustovirus
(c) 'Megavirus chilensis'
(d) Mollivirus sibericum
(e) Pandoravirus salinus
(f) Pithovirus sibericum

Giant viruses have the size of a bacteria (Fig. 10) (Fischer, 2016) and are able to infect the same hosts as some intracellular bacteria, and despite being deprived of ribosomes and unable to translate proteins by themselves, some of them still encode some translation factors and transfer RNAs (Philippe *et al.*, 2013). Their lifestyle change could have occurred around the age of LUCA, as their genome is comprised of eukaryotic, archaeal and bacterial-like genes, and it's hard to identify exactly where they belong in the phylogeny, to the point that it has been proposed that giant viruses should be named the fourth domain of life (Fischer, 2016).

It must be noted that the origin story of a “LUCA contemporary turned virus” is pushed forward by the discoverers of the giant viruses. Although it is well-argued and tempting, it has been heavily commented and criticized (Moreira and López-García, 2009; Yutin and Koonin, 2013; Yutin *et al.*, 2014). Indeed, extensive transfers of genes between giant viruses, their hosts, and other parasites has been evidenced by the analysis of their genomes. So many transfers events seem to have occurred in giant viruses, with successive genome expansions and reductions (“accordion evolution”), that it is hard to define where their origin lies, when they emerged, and how to define them exactly (Filée, 2013). Of course, these concerns have been countered by the proponents of the fourth domain hypothesis, in the form of a hilariously vitriolic response (Claverie and Ogata, 2009).

These recent discoveries blur the frontier between what is a living organism and what is a selfish, non-living genetic element. Where should we draw the line? Is it the ability to produce proteins? Then what if we discover a giant virus with ribosomes but without tRNAs, thus still unable to replicate without a host? Is it the ability to self-replicate? What about obligate intracellular bacterial parasites that lost this ability outside their niche? Is it the ability to perform some form of metabolism and protein synthesis? What about bacterial cells deprived of a chromosome, resulting from a division error, which are eventually doomed but possess ribosomes and are still able to produce proteins for a while? In the coming years, the question of redefining what exactly is a living being will probably stir a heated debate in biology. The utmost question might not be “where is the line?”, but rather “should we draw a line?”

Beyond their own special case, the puzzle that is giant virus phylogeny uncovers a bigger, and more important problem for bacteriology: defining the limits of the species.

What is a species in the microbial world?

The rise of genomics has uncovered another fundamental aspect of micro-organisms: horizontal gene transfers between species, genera, and even reigns of life are ubiquitous (de la Cruz and Davies, 2000; Ochman *et al.*, 2000). Most micro-organisms are chimeric entities. The composition of their genome was shaped as much by vertical transmission and random mutations, as by inter-species gene transfer. As such, the tree of life presented in Fig. 5, established by studying only the 16S ribosomal DNA, is less a “tree of life” than the “tree of evolution of the 16S ribosomal DNA”. If additional conserved genes are also considered to build a phylogenetic tree, the real “tree of life” resembles more a “web” or a “forest” of life (Fig. 11) (Puigbò *et al.*, 2013).

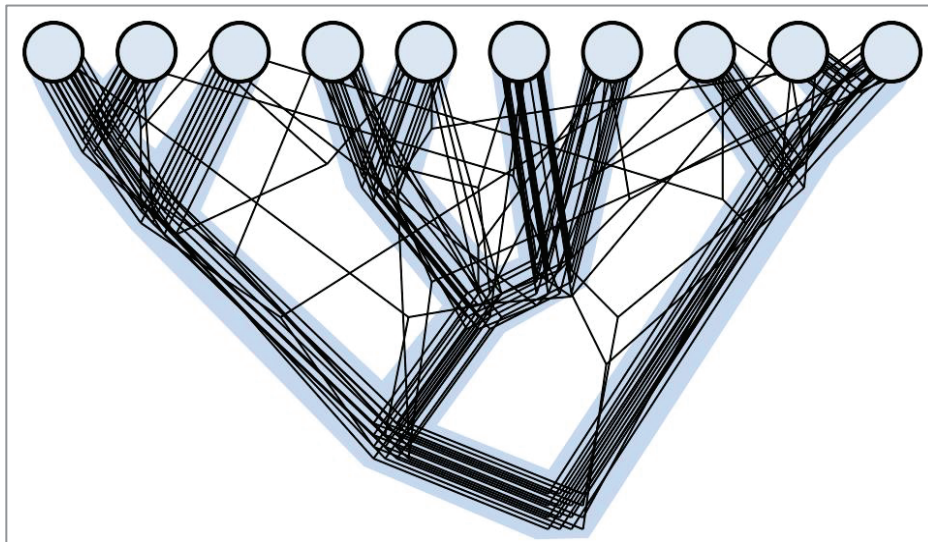

Fig. 11 The forest of life.

The black lines represent phylogenetic trees constructed using different conserved genes as a reference, and the blue thick lines represent a consensus tree. (Puigbò *et al.*, 2013)

As such, the definition of species had to be refined. Common methods for defining if two closely related strains (according to their 16s DNA sequence) belong to the same species are MALDI-TOF analysis, DNA typing with methods such as PFGE (Pulse-Field Gel Electrophoresis), sequencing of housekeeping genes or of the full genome, %G+C, and phenotypic observations; the majority of these observations must point to the fact that the strain studied is indeed a new species (Stackebrandt *et al.*, 2002). Recently, advances in bioinformatic analysis have allowed to reconstruct full genomes from metagenomic data, and thus without the need to cultivate the bacteria from the samples (Albertsen *et al.*, 2013). Developing better methods to obtain highly resolved trees, and to share this knowledge in accessible and updated databases will be crucial for modern bacteriology.

1.2. A link between disease and bacteria

1.2.1. Invention of epidemiology and infectiology

The germ theory

1854. A cholera epidemic is ravaging London, and a physician named John Snow is trying to identify the source of the infection to stop it. He has doubts about the miasma theory that affirms then that “bad air” causes infections. Unfortunately, John Snow knows nothing about bacteriology, and the link between bacteria and infections has not been established yet. Despite this, he successfully identifies that most cases are linked to a single water well, using maps and pinpointing the location of the cases (Fig. 12). John Snow’s investigation was the first historical example of using epidemiological data to solve a public health crisis (Snow, 1855). But the link between the cholera epidemic and *Vibrio cholerae*, that were teeming in the water well, had yet to be established.

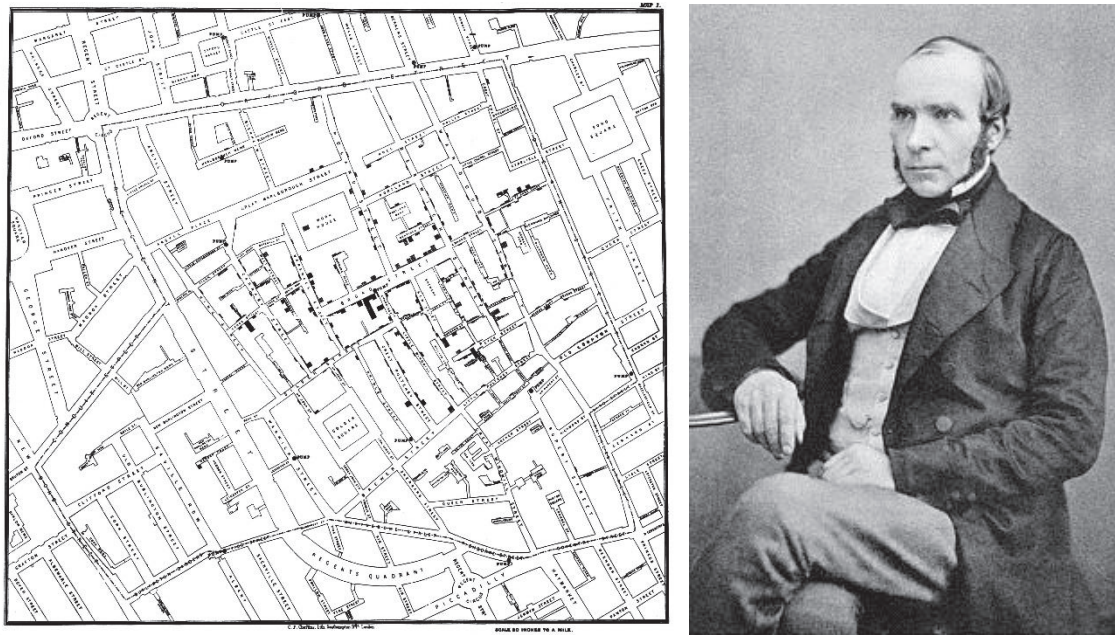

Fig. 12 John Snow and his map of the cases of Cholera in Broad Street, London

A few years later, invention of solid media and improvements in sterilization techniques by Koch and Pasteur allowed the discovery of many new bacterial species. Koch confirmed previous observations that affirmed that bacilli are observable in the blood of sheep infected by anthrax. He named the bacteria *Bacillus anthracis* and observed that it is able to form spores that are highly resistant to heat and disinfection. While previous observations of the bacteria had already been made in sick animals, he is the first to affirm that it is the agent responsible for the disease. He proved it by isolating the bacteria, cultivating it, and injecting it in animals that then developed the

disease. This discovery formed the proof of concept necessary to prove his germ theory of disease, that replaced the erroneous miasma theory (Brock, 1999).

Koch's method was used to establish four postulates for the identification of pathogens:

- *The microorganism must be found in abundance in all organisms suffering from the disease, but should not be found in healthy organisms.*
- *The microorganism must be isolated from a diseased organism and grown in pure culture.*
- *The cultured microorganism should cause disease when introduced into a healthy organism.*
- *The microorganism must be reisolated from the inoculated, diseased experimental host and identified as being identical to the original specific causative agent.*

Koch's postulates allowed to rapidly identify pathogens responsible for cholera, typhoid fever, tuberculosis, and leprosis, among others. However, the agents responsible for several diseases such as influenza remained elusive, as they were caused by viral pathogens and could not be cultivated nor observed with an optical microscope. Koch's postulates fell short in the identification of these pathogens by assuming that all infectious diseases were caused by living micro-organisms visible in an optical microscope.

Development of hygiene

The most important advance from germ theory was the invention of hygiene practices. Before this, the relationship between western human societies and hygiene was a fluctuating hate/love relationship. In ancient Greece and Rome, public baths were popular, and systems for transporting potable spring water into streets and houses throughout the cities of the Empire were an impressive achievement of Roman culture. Such baths stayed popular until the 14th century, when the Catholic Church suddenly banned them for being indecent. Private baths appeared but remained reserved to elites, while the Church was promoting ablutions using "holy water". Things went from bad to worse at the Renaissance, when the new fad was believing that washing with water opened skin pores and allowed the entry of diseases through miasmas. That led to an incredibly dubious fashion of appearing in public in dirty clothing, to cover the skin with layers upon layers of makeup, and to use massive amounts of perfumes to hide an unavoidable foul stench.

Fortunately, the discovery of the link between microbial pathogens and disease led to the development of hygiene practices at the end of the 19th century that still persist today (at least in the majority of the population). Washing hands to prevent post-partum infections led to a spectacular drop in maternal mortality, an observation already made and published decades earlier by a doctor named Ignaz Semmelweis, and grossly ignored by the scientific community because it did not fit the miasma theory. Disinfection of surgical instruments, invented by Joseph Lister, allowed a dramatic decrease in post-surgical infections. Pasteurization of drinks and food reduced the number of diseases from parasites and bacteria infesting aliments, as well as conserving them longer, preventing famines.

Vaccination

Edward Jenner invented and popularized the concept of vaccination by repeating a previous experiment by Benjamin Jesty, a rural aristocrat that observed that farmers that had contracted cowpox were protected from the often deadly human smallpox, and was the first to inoculate farmers on purpose with cowpox (*vaccinus* means *from the cow* in Latin). The popularization and standardization of that method by Jenner allowed to vaccinate more than 100,000 Englishmen in his lifetime, and was even conveyed in Spain and the Spanish colonies.



Fig. 13 From left to right, Benjamin Jesty, Edward Jenner, and Louis Pasteur holding a desiccated rabbit spine used to produce the rabies vaccine.

Standardization was pursued further by extracting contaminated lymph and conserving it in glycerin for long-term storage. It is unclear what strain of cowpox Jenner used, nor to which extent the successive passages in human modified and attenuated the virus; but it was not until the works of Pasteur that the first voluntarily attenuated and killed vaccines were developed. The successive

cultures of *Pasteurella multocida* and *Bacillus anthracis* led to the apparition of strains with attenuated virulence that could be used as vaccines without side effects. Pasteur also developed an attenuated vaccine against rabies that is one of his most famous achievements, but his methods have been since criticized: no tests were performed to ensure that the dog who had bitten Josef Meister (the young shepherd that was the first patient for the vaccine) effectively had rabies; moreover, after vaccinating him with the attenuated strain, Pasteur did a “positive control” that consisted in injecting Meister with a non-attenuated rabies strain. Pasteur’s attenuation was also far from being as efficient as a later vaccine based on phenol-inactivated virus, and he appeared to have lied to the public about the efficiency of his methods of attenuation. Nevertheless, the heavy communication surrounding the case, the success of arm-to-arm cowpox vaccination, and the success of a cholera vaccination campaign in Spain at the same time allowed the acceptance of vaccination by the general public.

1.2.2. Recent advances in bacterial infectiology

Hygiene in the modern world

Basic principles of hygiene invented at the end of the 19th century are still applied today. The development of new antiseptics such as quaternary ammonium compounds, chlorhexidine, or triclosan improved the efficiency of disinfection, especially on resistant forms such as spores and non-enveloped viruses (Jumaa, 2005). New methods of sterilization have been developed, such as flash pasteurization, gas-based disinfection with hydrogen peroxide or azote, and use of ionizing radiation such as gamma rays. New approaches such as the use of auto-disinfecting surfaces by oligo-dynamic effect (copper or aluminum) are tested in hospital settings (Casey *et al.*, 2010).

The use of hygiene practices has reduced the number of infectious-related deaths and probably heavily contributed to the increase in human lifespan and the demographic explosion in the 19th and 20th centuries. But during the same time, an increase in autoimmune diseases such as allergies and type 1 diabetes has been observed. This led to the popularization of the hygiene hypothesis, that states that reduced exposure to pathogens increases the risk of autoimmune reaction (Yazdanbakhsh *et al.*, 2002). This theory has been considerably discussed and criticized since (Okada *et al.*, 2010). Recent advances in the knowledge of the interaction between the microbiota and the immune system tend to prove that disequilibrium in microbiota diversity is indeed

associated with immune defects (Frei *et al.*, 2012). Future works about this subject will probably prove fascinating.

Vaccination

Vaccinating is a very efficient way of protecting a population. Mandatory vaccination campaigns have been launched in all countries in the world during the 20th century and have been extremely successful (Fig. 14) (Dye, 2014). In the specific case of human-specific diseases with no animal reservoir, global and coordinated vaccination efforts have been able to eradicate pathogens. Indeed, the most impressive success of vaccination was the eradication of smallpox that was achieved in 1977, through a worldwide coordinated campaign led by the WHO (Henderson, 1976). Eradication of poliomyelitis is also underway and has been achieved in most countries (Grassly, 2013). For the first time in since the invention of vaccination, a vaccine protecting against a form of human cancer is available, with the Human Papillomavirus vaccine (Garland *et al.*, 2016). Vaccination of cattle also has become systematic almost anywhere in the world and allowed to reduce zoonosis and epidemics (Normile, 2010) while increasing the yield of livestock farming, helping to reduce poverty and famine.

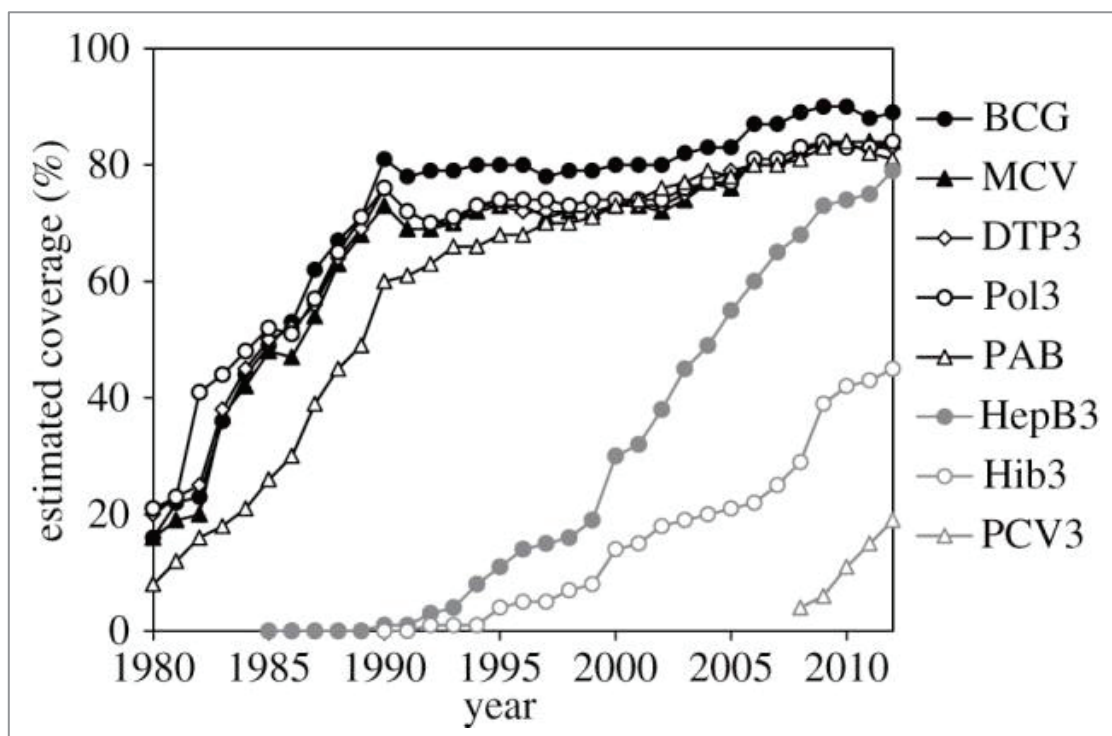

Fig. 14 Vaccination coverage worldwide, 1980-2012.

BCG, Bacille Calmette Guérin vaccine for TB; DTP3, third dose of diphtheria toxoid, tetanus toxoid and pertussis vaccine; HepB3, third dose of hepatitis B vaccine; Hib3, third dose of *Haemophilus influenzae* type B vaccine; MCV, measles-containing vaccine; PAB, protection at birth from tetanus; PCV3, third dose of pneumococcal conjugate vaccine; Pol3, third dose of polio vaccine.

Vaccination is powerful as a prophylactic tool, to prevent epidemics and reduce the prevalence of a pathogen. But vaccination is associated with risks that are often not worth taking, given the prevalence of the disease. For example, vaccines against meningitis or seasonal influenza are recommended only to exposed or fragile populations. Moreover, as soon as early in the 20th century, vaccine producers realized that developing vaccines against certain pathogens proved difficult. Some pathogens are able to change their epitopes and to evade recognition by the immune system, either by rapid evolution (influenza), by crippling the immune system (HIV), or by modifying/hiding their surface (bacterial phase variation, biofilms). Others are poorly immunogenic and cannot induce a strong response despite improvement in adjuvant technology. For example, a vaccine against dengue has recently been approved (Dengvaxia) but has a limited protective effect that reflects the poor immunogenic nature of the dengue virus (Capeding *et al.*, 2014). Vaccines against HIV and malaria are being developed but their efficacy is disappointing. Vaccination may never be an efficient strategy against these diseases.

Moreover, in the case of diseases with animal reservoirs, systematic vaccination of the human population is not sufficient to ensure the eradication of the pathogens. Efforts to vaccinate populations of wild animals have been successful in the case of rabies in Europe but were costly and difficult (Brochier *et al.*, 1991). Insect-borne diseases (Yellow fever, malaria, dengue, borreliosis, trypanosomiasis...) are by far the most important category of zoonoses: 17% of infectious cases, 1 billion cases and 1 million deaths by year according to WHO. In the case of insect-borne diseases, eradication of the vector would be necessary. The use of the sterile insect technique was successful in eradicating other insects such as the screw-worm fly in North and Central America (Knipling, 1960) but efforts against mosquitoes have proven more difficult, as eradicating mosquitoes from a zone tends to promote rapid invasion by mosquitoes from neighboring zones. A new idea emerged with the discovery of the insect bacterial symbiont *Wolbachia*. Introducing different strains of *Wolbachia* isolated from other insect families into mosquitoes prevents them from infection by most viruses; releasing millions of *Wolbachia*-bearing mosquitoes to replace the current population would “vaccinate” mosquitoes and prevent the formation of an empty ecological niche (Bian *et al.*, 2010). Unfortunately, *Wolbachia* reduces the fitness of mosquitoes and their lifespan (Hoffmann *et al.*, 2011). Efforts to reduce these drawbacks are underway.

Identification of bacterial pathogens

Since the discovery of bacterial pathogens in the 19th century, advances in the infectiology field included the discovery of viruses as pathological agents, of prions as new pathogens, of uncultivable bacterial pathogens, and the discovery of opportunistic pathogens in which virulence is modulated by growth conditions. Koch's postulates were therefore outdated and had to be revised by an updated version based on recent biomolecular discoveries (Fredricks and Relman, 1996):

- *A nucleic acid sequence belonging to a putative pathogen should be present in most cases of an infectious disease. Microbial nucleic acids should be found preferentially in these organs or gross anatomic sites known to be diseased (i.e., with anatomic, histologic, chemical, or clinical evidence of pathology) and not in these organs that lack pathology.*
- *Fewer, or no, copy numbers of pathogen-associated nucleic acid sequences should occur in hosts or tissues without disease.*
- *With resolution of disease (for example, with clinically effective treatment), the copy number of pathogen-associated nucleic acid sequences should decrease or become undetectable. With clinical relapse, the opposite should occur.*
- *When sequence detection predates disease, or sequence copy number correlates with severity of disease or pathology, the sequence-disease association is more likely to be a causal relationship.*
- *The nature of the microorganism inferred from the available sequence should be consistent with the known biological characteristics of that group of organisms. When phenotypes (e.g., pathology, microbial morphology, and clinical features) are predicted by sequence-based phylogenetic relationships, the meaningfulness of the sequence is enhanced.*
- *Tissue-sequence correlates should be sought at the cellular level: efforts should be made to demonstrate specific in situ hybridization of microbial sequence to areas of tissue pathology and to visible microorganisms or to areas where microorganisms are presumed to be located.*
- *These sequence-based forms of evidence for microbial causation should be reproducible.*

New bacterial pathogens have been identified in the last decades. Some of them are causing the emergence of new diseases, mostly zoonoses and tick-borne diseases such as the Q fever (caused by *Coxiella burnetii*), Rickettsiae, or Lyme disease (*Borrelia burgdorferi*) (Parola and Raoult, 2001). They can also be emerging because of human intervention, such as *Legionella pneumophila* epidemics that started to occur because of the invention of air conditioning units and hot water systems, that efficiently house and spread the pathogen (Wadowsky *et al.*, 1982; Witherell *et al.*, 1986). Some of the “emerging” pathogens did not actually appear recently but were rather previously ignored, such as *Helicobacter pylori* in peptic ulcer and stomach cancer (Marshall *et al.*, 1985), or had already been prevalent but were hard to identify because of their unculturability, such as *Rickettsiae*. A sizable number of Alzheimer’s disease cases could be associated with borreliosis, that could be a trigger or a cause for the disease (Miklossy *et al.*, 2004).

Emerging viral diseases are also numerous, and include AIDS, hemorrhagic and lethal fevers (Ebola, Marburg, Lassa, Crimean-Congo, West Nile, Rift Valley), pneumonia (SARS), and arboviruses (Zika, Chikungunya). While the updated Koch postulates are an important improvement to standardize the identification of new pathogens, and have the advantage of accommodating both bacterial and viral pathogens, they still fall short in some cases, such as protein-based diseases (prions) (Walker *et al.*, 2006).

Revolutionary advances in the field of diagnostics also occurred since Koch. While cultivation of the pathogen, isolation on solid media, and identification by microscopic observations and culture on selective media are still considered the “gold standard” in clinical bacteriology, new techniques allow for quicker diagnosis and higher sensitivities:

- The use of mass spectrometry on isolated bacterial colonies (MALDI-TOF) allows to obtain a spectrum specific to a given bacterial species, and is much quicker and less work-intensive than the use of selective media or microscopic observations (Croxatto *et al.*, 2012). While its sensitivity is very high, and its speed makes it a valuable new tool in clinical microbiology, it requires the use of a comprehensive database and the prior cultivation of the bacterial pathogen.

- Nucleic-acid based approaches are becoming a new standard for pathogen identification in a clinical setting. They are mostly based on PCR amplification of highly conserved genes (16S rDNA, *rpoS*) and their sequencing (Woo *et al.*, 2008), or real-time quantitative PCR amplification of

specific genes (Espy *et al.*, 2006). While they have the advantage of being performable either on cultivated bacteria or directly on patient samples, their sensitivity and specificity are variable, and authorities have been cautious in their approval of such methods.

- Chemical-based tests (mostly urine test strips) are available for some pathogens and diseases, such as urinary tract infections, *S. pneumoniae* infections, or Legionnaire's disease (Murdoch *et al.*, 2001; Murdoch *et al.*, 2001; Eidelman *et al.*, 2002). They have the advantage of being very quick and easy to perform, but their range of application is very limited and their sensitivity and specificity are variable.

Fighting infectious disease in the 21st century: a common goal

Of course, the most important advancement since the germ theory is the colossal reduction in infectious-disease related mortality. Until the 20th century, infectious diseases were by far the most important cause of human mortality. Lung infections (Tuberculosis, pneumonia and influenza) were the leading causes of death until the 1920s and infectious diseases taken together were by far the most frequent causes of death (Center for Disease Control, 1998). Epidemics in Europe almost wiped out the population of the continent, with the bubonic plague killing 35 million, a third of the population of Europe and a fourth of the world population (Biraben, 1980); the Spanish flu of 1918 killed 50 million, with 1 billion contracting the virus (Johnson and Mueller, 2002). Meanwhile, on the other side of the Atlantic, the Columbian Exchange successfully wiped out the indigenous populations of the Americas and their civilizations (killing 80-100 million, 90-95% of the population), mostly through smallpox (Cook, 1998).

Even besides epidemics, death in childbirth due to poor hygiene conditions were as high as 2.5% in the 17th century (Dobbie, 1982). Life expectancy was as low as 35 years from the 16th to the 18th century (Galor and Moav, 2005), a figure heavily biased by very high infant mortality, as someone who survived until 21 years old had a total life expectancy closer to 70 years (Lancaster, 1990). Today the tables have turned, as life expectancy reaches 80 years or more in industrialized countries, and the most common cause of death worldwide has become non-communicable diseases (68% of deaths) (WHO, 2012).

Infectious diseases are still a massive concern, as they are the second cause of death worldwide, with 23% of total deaths. More importantly, they are the most common cause of deaths for children

(68%). The burden of infectious diseases is especially heavy in developing countries (Fig. 16), where it hinders economic development and induces a vicious circle by preventing these countries from affording the expensive prophylactic actions and infrastructure needed to reduce their infection rates. It is interesting to note that almost all countries situated in the tropics are poor, an observation that is easily correlated with the heaviest burden of infectious disease in tropical settings, in particular malaria (Fig. 16B). The only two notable exceptions amongst tropical countries are Hong-Kong and Singapore that enjoy a special status as independent city-states ideally situated in commercial hubs.

The most common causes of death from infectious diseases are respiratory and diarrheal infections, followed by AIDS, Tuberculosis, and Malaria (Fig. 15). Only a handful of pathogens cause the vast majority of deaths and should be the focus of research in infectious disease, if the attribution of resources was dependent on the lethality of each disease and not their potential return on investment. But research alone cannot face the challenge of infectious diseases. Most of these deaths should already be preventable, either by vaccination, proper healthcare access or enforcement of basic prophylactic and hygienic principles. Preventing these deaths were the focus of no less than three out of the eight United Nation's millennium development goals for 2015: "Reduce child mortality", "Improve maternal health", and "Combat "HIV/AIDS, malaria and other diseases". Bringing new ideas to the table to reduce the number of preventable illnesses as low as possible should prove a formidable challenge for the 21st century.

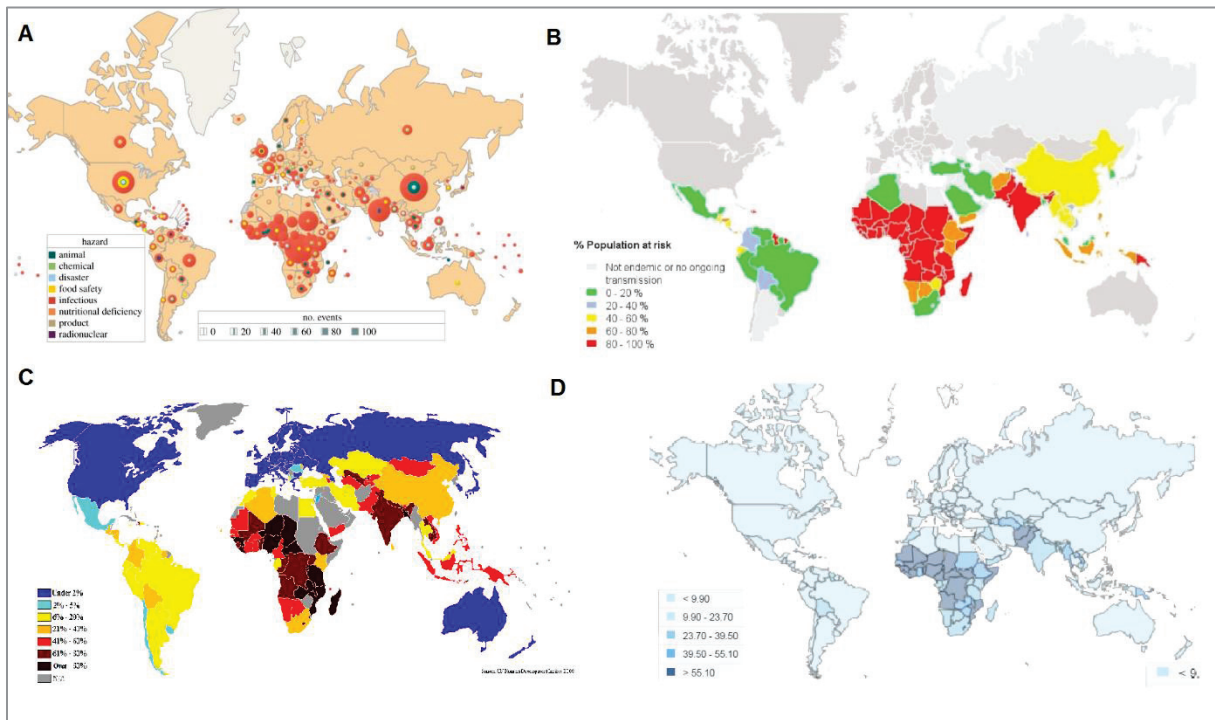

Fig. 16 Correlation between economic development and prevalence of infectious diseases.
 (A) Map of international health hazards. In red are infectious diseases outbreaks (84% of hazards) (Dye, 2014)
 (B) Percentage of population exposed to malaria. Map from the CDC Malaria Map application.
 (C) Poverty, expressed as percentage of the population living with <US \$2/day. Data from the World Bank.
 (D) Mortality rate of infants. Data from the UN Inter-agency Group for Child Mortality.

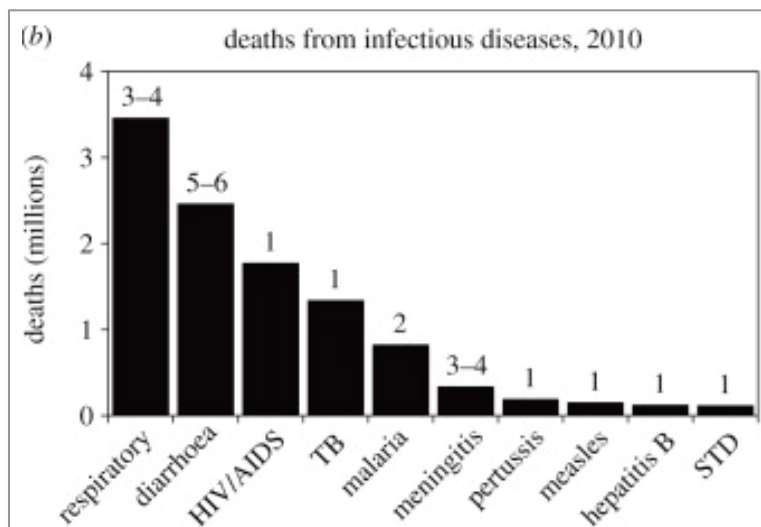

Fig. 15 Number of deaths per year associated with each type of infectious disease. The number of pathogen species involved in the majority of cases for each type of death is indicated above bars. (Dye, 2014)

The works of Jenner, Pasteur and Koch therefore allowed the development of hygiene practices, clinical microbiology and vaccination, which were responsible for most of the decline in infection-related death, by reducing the spreading of epidemics and improving infant survival. But it was another discovery that allowed to not only prevent, but also cure bacterial infectious diseases: antibiotics.

2. The antibiotic era

2.1. Historical context

2.1.1. Invention of chemotherapy: the first synthetic antibiotics

Aniline, from the dye to the patient

Until the beginning of the 20th century, treatment of life-threatening infections was often based on toxic inorganic compounds such as mercury or arsenic. For example, a common treatment of syphilis and malaria was Fowler's solution, a potassium arsenic solution (Jolliffe, 1993). Of course, while somewhat efficient for life-threatening infections, this treatment was toxic, carcinogen, with heavy side effects at short and long term for the patients (Franklin *et al.*, 1950; Regelson *et al.*, 1968). At the same time, the chemical industry was focused on obtaining synthetic blue dyes from readily available coal tar, as indigo blue was at the time obtained from tropical plants and was costly to produce and import. This led to the discovery of the compound aniline, from which several dyes could be made, e.g. safranine, mauveine and fuschine (Drews, 2000). Antoine Béchamp developed a method for mass production of aniline that started the industrial production of such dyes (Riethmiller, 2005). Aniline also incidentally had interesting properties as an analgesic, which prompted to study the effects of these new dyes on several medical conditions. Aniline derivatives were developed, and Béchamp found that when it reacted with arsenic, the obtained product retained the antiparasitic value of arsenic but with a reduced toxicity for humans. Named Atoxyl (aminophenyl arsenic acid), the compound was used extensively in a veterinary setting, and proved so efficient to protect cattle against tropical parasites that it was suggested by the German Association of Tropical Diseases in 1922 to sell the formula to the British government in exchange for the German colonies lost in the first World War (Pope, 1924).

Atoxyl still had a non-negligible toxicity in humans, with 2% of treated patients losing their eyesight due to damages caused to the optic nerves. In 1906, Paul Ehrlich was trying to prove that it was possible to identify compounds that kills microbes without harming superior organisms, a concept that he named the "magic bullet" and that was later renamed chemotherapy. He developed Arspenamine (sold under the name Salvarsan), an Atoxyl derivative that had lost its antiparasitic properties, but incidentally had also lost most of its toxicity and gained activity against syphilis



*Fig. 17 Genesis of the synthetic antibiotics.
From left to right, commercial forms of Fowler's solution, Atoxyl, Salvaran, Prontosil,
and battlefield kits of Sulfanilamide powder and tablets from WW2.*

(Drews, 2000; Riethmiller, 2005). At the time, the syphilis epidemics had already been lasting for four centuries and was extremely prevalent; the only existing treatment was based on extremely toxic mercury injections. Ehrlich used Salvarsan as evidence that chemotherapy was the most viable way of treating infections, paving the way for the research of even less toxic compounds, not based on heavy metals.

In 1932, researchers at Bayer were searching for new drugs amongst the thousands of new derivatives obtained from aniline. They discovered that Sulfonamidochrysoïdine, an aniline derivative without any heavy metal atoms, had an antibacterial effect against Gram-negative bacteria. Sold under the name Prontosil, it was the first broadly available, non-toxic antibiotic, and would bring Gerhard Domagk, its discoverer, the Nobel of medicine (although he had to wait for the end of the war as the Nazi government would not let him receive it). Unfortunately for Bayer that funded the work, researchers at Pasteur Institute discovered that Prontosil was in fact a prodrug and that its active form was Sulfanilamide, a simpler, stable compound that was not patentable and was already widely available from the dye industry (Otten, 1986). Sulfanilamide, in powdered and tablet forms, was extensively used on the battlefield by Allied forces during World War II and contributed to their victory by reducing drastically the mortality rate of their soldiers (Fig. 17). Incidentally, in 1937 a severe incident with contaminated sulfanilamide killed a hundred patients and forced the publication of a law making mandatory the pre-market review of the safety of all drugs by a governmental agency, the FDA; a model of regulation that was followed worldwide and

still subsists today. Sulfanilamide and its family of derivatives, Sulfonamides, were the first class of synthetic antibiotics, and they are still in use today.

New synthetic antibiotics

Other classes of antibiotics from synthetic origin have been identified later. Before WW2, the Quaker Oats company, specialized in cereals, was looking for ways to valorize the waste that was cereal bran (the outer part of the seed). They discovered furfural, a small molecule that provided an interesting backbone for chemistry, and started to provide large amount of it to the chemical industry (Brownlee and Miner, 1929). Among the derivatives obtained from furfural, nitrofurans were identified as antibiotic molecules and their usage started around the Normandy invasion, for infested wounds where sulfonamides were inefficient.

In 1962, nalidixic acid was accidentally discovered as an impurity during the production of the anti-malarial drug chloroquine. Contrary to most antibiotic classes, the conditions of the discovery of nalidixic acid occurred in undisclosed conditions, probably because the authors of the original patent had actually no right to claim priority on the discovery (Bisacchi, 2015). Derivatives of Nalidixic acid compose the Quinolone and Fluoroquinolone antibiotic classes, who are amongst the most widely used antibiotics worldwide.

More recently, Linezolid was the first approved antibiotic of the Oxazolidinone class. This class had been discovered earlier in the 1950s with a good in vitro activity of the simple 2-Oxazolidone molecule; but non-toxic, efficient forms were discovered much lately (Ford *et al.*, 2001).

Sulfonamides, quinolones, oxazolidinones and nitrofurans are the only known synthetic antibiotic classes. All the other classes of antibiotics, and therefore the large majority of such drugs, have not been invented, but discovered.

2.1.2. Rise of the natural antibiotics

Hinting at vital competition in the microbial world

Among the works of Pasteur on *Bacillus anthracis*, an interesting remark emerged when he observed in 1877 that co-infection between anthrax and other bacterial species sometimes prevented the emergence of the disease (Sams *et al.*, 2014). Pasteur rightly recognized that a competition occurred but wrongly attributed the results to limited oxygen availability for both

species at the same time. Jean Paul Vuillemin coined the term “antibiosis” to describe an antagonism between two micro-organisms, and suggested that this antagonism may rise from substances that they produce, that he named “antibiotics” (Waksman, 1947). Over a few years, results similar to Pasteur’s were observed with *Streptococcus* species, and the then-named *Bacillus pyocyaneus* (now known as *Pseudomonas aeruginosa*). For this last example, it was clear that a product was secreted by the bacteria, as it exhibited a bright blue color visible in infected wounds and culture supernatants. In 1889, Rudolf Emmerich and Oscar Löw purified this substance and found that it was enough alone to prevent the development of anthrax. As they believed the substance to be an enzyme, they named it pyocyanase (Emmerich and Löw, 1899). It was later discovered to actually be pyocyanine (Hassan and Fridovich, 1980), a quinolone derivative secreted by *P. aeruginosa* as toxins, used against concurrent bacteria and to modulate the host’s immune response. Pyocyanine was very toxic to mammals and was not really considered as a viable treatment for infections.

Duchesne, unaware discoverer of natural antibiotics

In 1897, in the charming French city of Lyon, an intern at the Military Health School defended his doctoral thesis for the title of doctor in medicine. Titled “*Contribution to the study of vital competition in micro-organisms: antagonism between molds and microbes*” (Fig. 18), the work of Ernest Duchesne explored the competitive relationship between bacteria and mold, when they are both placed in the same broth (Duckett, 1999). While in the vast majority of his observations, bacteria could overcome molds because of their highly superior division rate and because they actively destroyed mold spores, a different result was obtained with molds of the genus *Penicillium*. Maybe because he was a connoisseur of fine French cheese, he chose to use *Penicillium glaucum*,

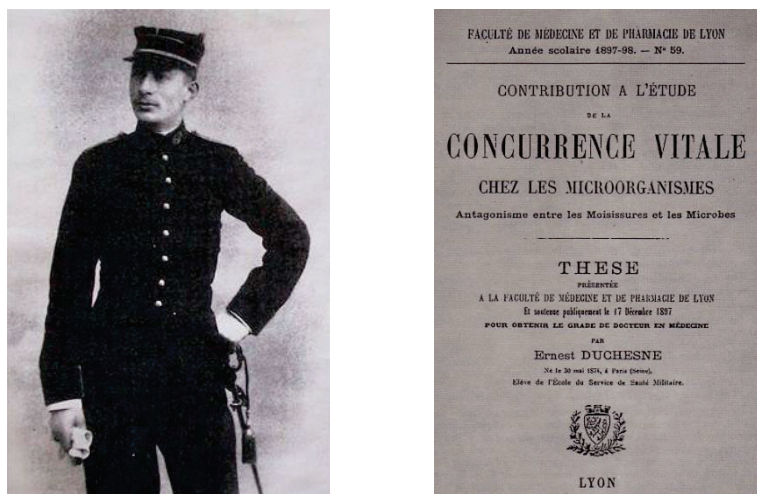

Fig. 18 Ernest Duchesne and the first page of his thesis.

used for the production of the *Bleu de Gex*. When placed in competition with different species of bacteria, *Penicillium glaucum* could stop their multiplication and therefore win the race, not by superseding their speed but by crippling the growth of the competition. Surprised by this result, Duchesne used crude supernatant from broth cultures of *Penicillium*, that he injected into guinea pigs infected by *Salmonella typhimurium*. This injection protected the animals from the infection. Duchesne could not identify the compound responsible for the bacterial growth inhibition (patulin, a mycotoxin) but suggested that it could be used to treat other bacterial diseases, including in humans, hinting at the future discovery of penicillin.

His thesis ended by an enlightened sentiment: “*We hope that the pursuit of these studies on the vital competition for life between fungi and microbes that we have only begun here, and for which we do not pretend to have made more than a small contribution, may result in the discovery of other facts useful and applicable to prophylactic hygiene and therapy*”. The work of Duchesne was highly appreciated by the jury and he graduated *cum laude* and with the highest possible grade. Unfortunately, and despite the possible implications of his work for the treatment of bacterial infections, his advisor did not pursue this project and his thesis was forgotten for decades.

Fleming *et al.*: Penicillin, from bench to bedside

In 1928, Alexander Fleming, unaware of the previous works of Duchesne, rediscovered by accident the bactericidal properties of certain *Penicillium* cultures (Ligon, 2004). Already famous for discovering lysozyme, a peptidoglycan-degrading enzyme produced by animals as a part of their immune system, Fleming had left his lab for summer holidays in the countryside. He had forgotten Petri dishes containing staphylococci cultures on his bench, clearly not preoccupied by all the obvious rules of basic hygiene and biosafety. At his return, he remarked that fungi had grown in his plates, as is often the cases with petri dishes left incubating for a few weeks. In one of these, the bacterial colonies had disappeared around the fungi, a fact that he noted with a famously disappointing historical quote: “*That's funny.*” Fleming’s accidental discovery probably helped perpetuating the cliché of the absentminded but brilliant scientist. But fortunately for him, he had more vision than Duchesne’s mentor and, well-counseled by a lab assistant that reminded him “*it’s how you discovered lysozyme*”, noted like Duchesne before him that the discovery of this competition had potential as a treatment. He tested culture supernatants (which he poetically dubbed “*mould*

juice") on several bacterial pathogens and tried to isolate the active ingredient. He noted that it was active on gram-positive but not gram-negative bacteria. He renamed the "mould juice" Penicillin, but abandoned its study after failing to isolate and produce the active compound, wondering if it could really be of any clinical interest.

His works were immediately picked up in 1940 by Oxford researchers, Ernst Boris Chain and Edward Abraham. In a few years, they achieved the isolation, identification, molecular description and small-scale production of penicillin. They quickly realized the potential of the molecule for the war effort, in a country that was involved on several fronts of the war and under constant bombing. In particular, Chain was a German-born Jew who escaped his country in 1933 and as a refugee, was particularly eager to participate in the team's effort to make Penicillin a viable treatment for the Allied Forces. A junior member of the team, Norman Heatley, had a critical role in achieving the mass production of penicillin by suggesting new conditions to extract it. He was also involved in the first tests of purified penicillin *in vivo*, writing in his lab notes:

"After supper with some friends, I returned to the lab and met the professor to give a final dose of penicillin to two of the mice. The 'controls' were looking very sick, but the two treated mice seemed very well. I stayed at the lab until 3.45am, by which time all four control animals were dead. It really looks as if penicillin may be of practical importance." - (Wright, 2004)

Thereby, Heatley did not only establish a long-lasting tradition of junior lab members staying in the lab late at night; he also pushed for human trials, which proved successful. He also played a role in developing a collaboration with the laboratory of Howard Florey, a previous Oxford fellow, in the US, where resources were less scarce. Together, they achieved mass-scale production of penicillin. Their collective work was recognized by a Nobel Prize in medicine, awarded in 1945 to Fleming, Chain and Florey.



*Fig. 19 The fathers of Penicillin.
From left to right, Alexander Fleming, Boris Chain, Howard Florey, and Norman Heatley.*

The discovery of Penicillin, a natural compound that was stable and potent *in vivo* to fight bacterial infections, opened the gates for the discovery of other classes of natural antibiotics. What was missing were drugs for intrinsically resistant bacteria, in particular for the White Death, Tuberculosis. All that was needed was a pipeline for antibiotic discovery.

2.1.3 The Golden Age of antibiotics

The Waksman pipeline

In the post-war years, the revolution brought forth by Penicillin and Sulfonamides, both in treatment of the prevalent community-acquired infectious diseases and the treatment of wounded soldiers, pushed towards the research of new classes of antibiotic compounds. Penicillin and Sulfonamides indeed have a spectrum of action limited to some gram-positive bacteria. Of course, more efficient versions of these drugs were found as natural compounds (e.g. cephalosporin) or were refined by chemical modification (e.g. ampicillin from penicillin; sulfamethoxazole from sulfanilamide), widening their spectrum, decreasing their toxicity and improving their chemical properties and *in vivo* stability. But they still remained inefficient on a lot of pathogens, and in particular on mycobacteria.

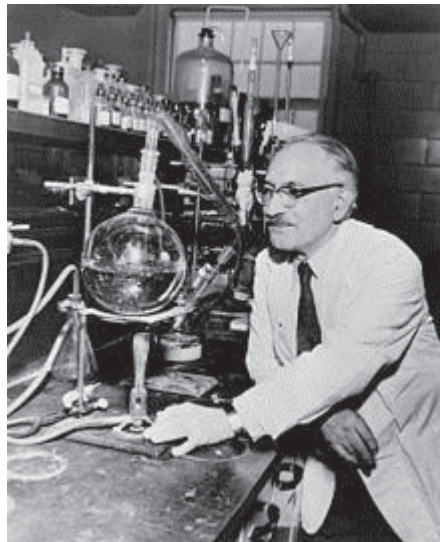

Fig. 20 Selman Waksman in his lab, in 1953.

Selman Waksman had been working for a few years on actinomycetes (an order of actinobacteria), and especially the *Streptomyces* genus, soil-dwelling, sporulating, filamentous bacteria able to produce a large range of complex compounds. Waksman refined a protocol for the recovery of *Streptomyces* spores from soil samples, by heating, filtrating and drying the samples to eliminate vegetative bacteria, keeping only spores of bacteria and fungi, that he then grew on rich media (Waksman and Woodruff, 1940). He observed that between 20 and 50% of the recovered actinomycetes were able to inhibit the growth of certain other bacterial species in co-cultures, and, knowing that they produce complex compounds as well as fungi, linked that observation to the previous discovery of penicillin. He quickly discovered Streptothricin, an antibacterial compound produced by almost 10% of *Streptomyces* species and active against gram-negative bacteria ((Waksman and Woodruff, 1942)). Unfortunately, this compound was toxic and could not be used for human treatment.

Encouraged by this discovery, Waksman developed a simple but revolutionary pipeline (Fig. 21) to rapidly identify new antibiotics produced by *Streptomyces*. Using this platform for high-throughput screening, Waksman discovered Neomycin (Waksman and Lechevalier, 1949), and his post-graduate student, Albert Schatz, discovered Streptomycin (Schatz *et al.*, 1944), the first representatives of the aminoglycoside class of antibiotics. Both molecules had the interesting property of being active on gram-negative bacteria and Penicillin-resistant pathogens such as *Salmonella typhimurium*, *Pseudomonas aeruginosa* and *Escherichia coli*. But the most important observation was that both molecules were efficient against *Mycobacterium tuberculosis*. The first

efficient treatments against the White Plague, which was until then untreatable and probably was the most important cause of death in the human history, had been discovered.

Waksman formalized the use of the name “antibiotic”, citing the earlier invention of the term by Vuillemin. He defined it as such:

“An antibiotic is a chemical substance, produced by micro-organisms, which has the capacity to inhibit the growth of and even to destroy bacteria and other micro-organisms. The action of an antibiotic against micro-organisms is selective in nature, some organisms being affected and others not at all or only to a limited degree; each antibiotic is thus characterized by a specific antimicrobial spectrum. The selective action of an antibiotic is also manifested against microbial vs. host cells. Antibiotics vary greatly in their physical and chemical properties and in their toxicity to animals. Because of these characteristics, some antibiotics have remarkable chemotherapeutic potentialities and can be used for the control of various microbial infections in man and in animals.” (Waksman, 1947)

Per Waksman’s definition, antibiotics are therefore natural products, and as such synthetic molecules such as Sulfonamides are excluded. The modern usage of the word includes such molecules as well. Some references consider that antibiotics only include molecules with limited toxicity in animals, while the term antimicrobial is often used in place of antibiotics but can also refer to antiviral and antiparasitic drugs.

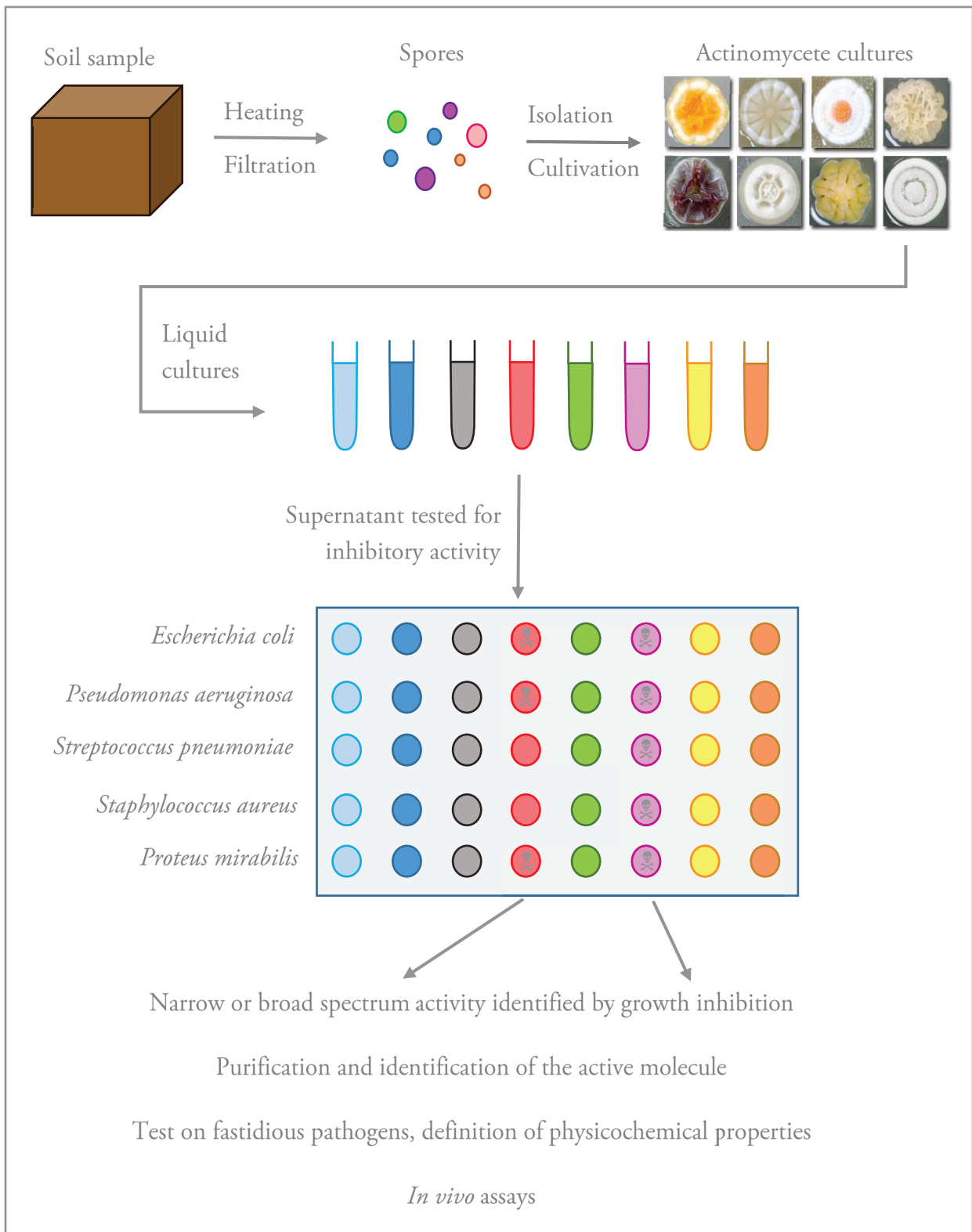

Fig. 21 Principle of the Waksman pipeline for antibiotic discovery.

Acceleration of the discoveries and abandonment of the Waksman pipeline

In the following years, the Waksman pipeline was used to isolate more Actinomycetes and isolate active compounds among them. From the 1940s to 1960s, on average, a new class of antibiotic was discovered every two years (Fig. 22), a period often referred to as the “golden age of antibiotic discovery” (Lewis, 2012).

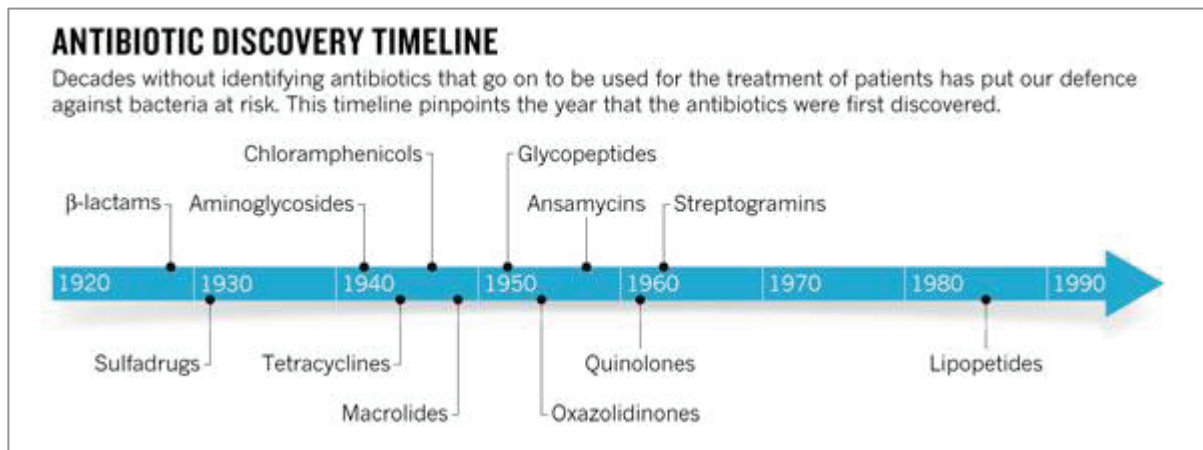

Fig. 22 The antibiotic discovery timeline.

As previously said, only Sulfonamides, Oxazolidinones and Quinolones are of synthetic origin. Beta-lactams (such as penicillins) and Pleuromutilins (discovered in 1950 and missing on this timeline presented in Fig. 22) are produced by fungi. All the other classes that have been discovered are natural products from Actinomycetes, often of the genus *Streptomyces*.

The cumulative discovery of these different classes, and the dozens of different molecules derived from them by hemisynthesis, allowed a massive use in antibiotic usage throughout the world. It caused a drastic reduction in mortality and prevalence of bacterial infectious diseases and, in the case of human-to-human transmissible infections, a steep decrease in global epidemics. But rapidly, near the end of the 1960s, the pipeline went dry (Fig. 22).

Some antibiotics such as Streptothricin and Streptomycin are extremely common amongst *Streptomyces* species, as they are produced by respectively 10 and 1% of all known species of this genus. Others are extremely rare molecules, due to their complexity, such as glycopeptides which contain amino acid chains, produced by a successive and complicated set of enzymes (nonribosomal protein synthases). Therefore, it is not surprising that the order in which each antibiotic class has been discovered is correlated with its abundance and complexity in the microbial world. But this

rapid and inevitable decrease paved the way for the current situation, in which new antibiotics are lacking.

2.1.4 The age of resistance: towards a post-antibiotic era?

Discovery of antibiotic resistance

Since the first years of the antibiotic era, it was immediately evident that some bacteria were inherently resistant to sulfonamides and penicillins, and that inside these classes, each molecule could have different spectra. Nevertheless, as the mechanism of action of antibiotics was unknown, the reasons behind that diversity of sensitivities were puzzling. It was also quickly noted that for some antibiotics, resistance could appear during treatment, as remarked by Chain and Abraham in 1940 with successive cultures of sensitive strains in presence of penicillin (Abraham and Chain, 1940), by early tests of streptomycin in treatment of TB (Hinshaw *et al.*, 1947), or during an outbreak of Penicillin-resistant *Staphylococcus aureus* in the UK as early as 1942 (Rammelkamp and Maxon, 1942).

As soon as Penicillin usage was being tested in humans in 1940, it was evident that some bacteria were resistant to it because they could degrade the molecule. Chain and Abraham observed in 1940 that an extract of *E. coli* was sufficient to degrade Penicillin and identified an enzyme that they named Penicillase as responsible (Abraham and Chain, 1940). But, a few months later, it was observed that *S. aureus* could become resistant by successive cultures in presence of penicillin, and could not extract a similar enzyme from the extract of the resistant strain (Abraham *et al.*, 1941).

This observation was linked to a previous observation about bacteriophages, to which bacteria could become resistant when genetic mutations were induced in said bacteria by UV or X-ray radiations. Milislav Demerec, a specialist of that field and a pioneer of genetics, justly made the assumption that antibiotic resistance could occur as a result of mutation, a hypothesis that he based on the rate of apparition of streptomycin-resistant bacteria in culture (Demerec, 1945; Demerec, 1948). This rate being low (10^{-7}), he wrongly assumed that the rate of apparition of bacteria also resistant to a second antibiotic would always be 10^{-14} ; he also believed that Penicillin resistance only occurred as well as a result of mutations. He blamed non-compliant patients for letting their infection reach the numbers of bacteria statistically sufficient for the apparition of resistance and

recommended the use of two different antibiotics at the same time, expecting it would be enough to avoid the worry of resistance for a few centuries (Demerec, 1948).

While the use of two antibiotics with different and synergetic activities is considered today a fundamental basis of antibiotic stewardship, the rate of dissemination of resistance in the following years occurred faster than anything Demerec ever imagined. In the following decades of the golden age of antibiotic discovery, for each discovery of a new antibiotic class, resistant strains appeared in clinical settings a few years later and became widespread at an alarming rate (Fig. 23) (Gauwerky *et al.*, 2009).

Dissemination of antibiotic resistance

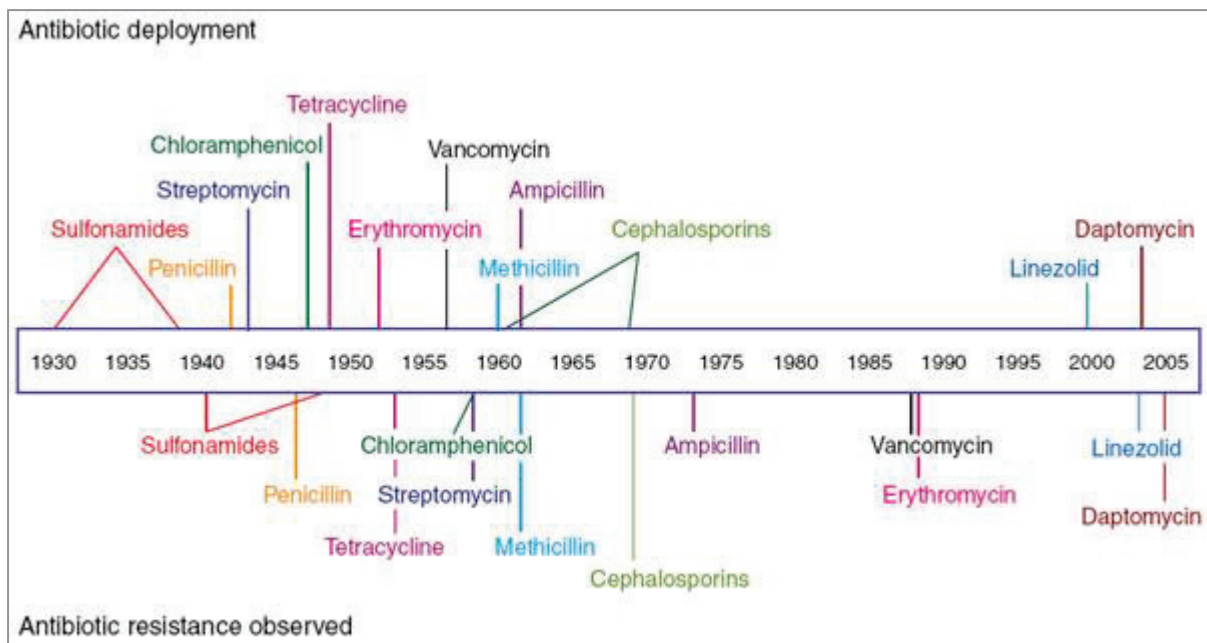

Fig. 23 Timeline of the inevitable apparition of antibiotic resistance. On top, the date at which each antibiotic became available, and on the bottom, the year at which antibiotic resistance was first observed in a clinical setting.

The rate of apparition of mutations could not explain alone the explosion in the number of resistant strains. Other mechanisms of resistance based on enzymes, similarly as penicillinase, were being discovered, *e.g.* other beta-lactamases against cephalosporins and penicillin derivatives resistant to penicillinase, chloramphenicol-acetyl transferase, erythromycin methylases... As such, it became evident that these genes could not have emerged by simple mutation, independently in every resistant strain, and that they were either prevalent in an ignored subpopulation or acquired one way or another.

In 1928, Frederick Griffith identified that a “transforming principle” existed in bacteria and was transmissible among them, changing their phenotype (Griffith, 1928). Re-adapted and pushed further by Avery, MacLeod and McCarty in 1944 (Avery *et al.*, 1944), this experiment proved that the “transforming principle” is DNA, and not proteins as some believed at the time. Moreover, this discovery not only proved that DNA was the carrier of genetic information, but also that bacteria were able to share this information between each other. Ironically, the mechanism that allowed to transform bacteria, later named “natural transformation”, is relatively rare in the bacterial world, and Griffith was lucky enough to use a naturally transformable species, *Streptococcus pneumoniae*, in his experiments.

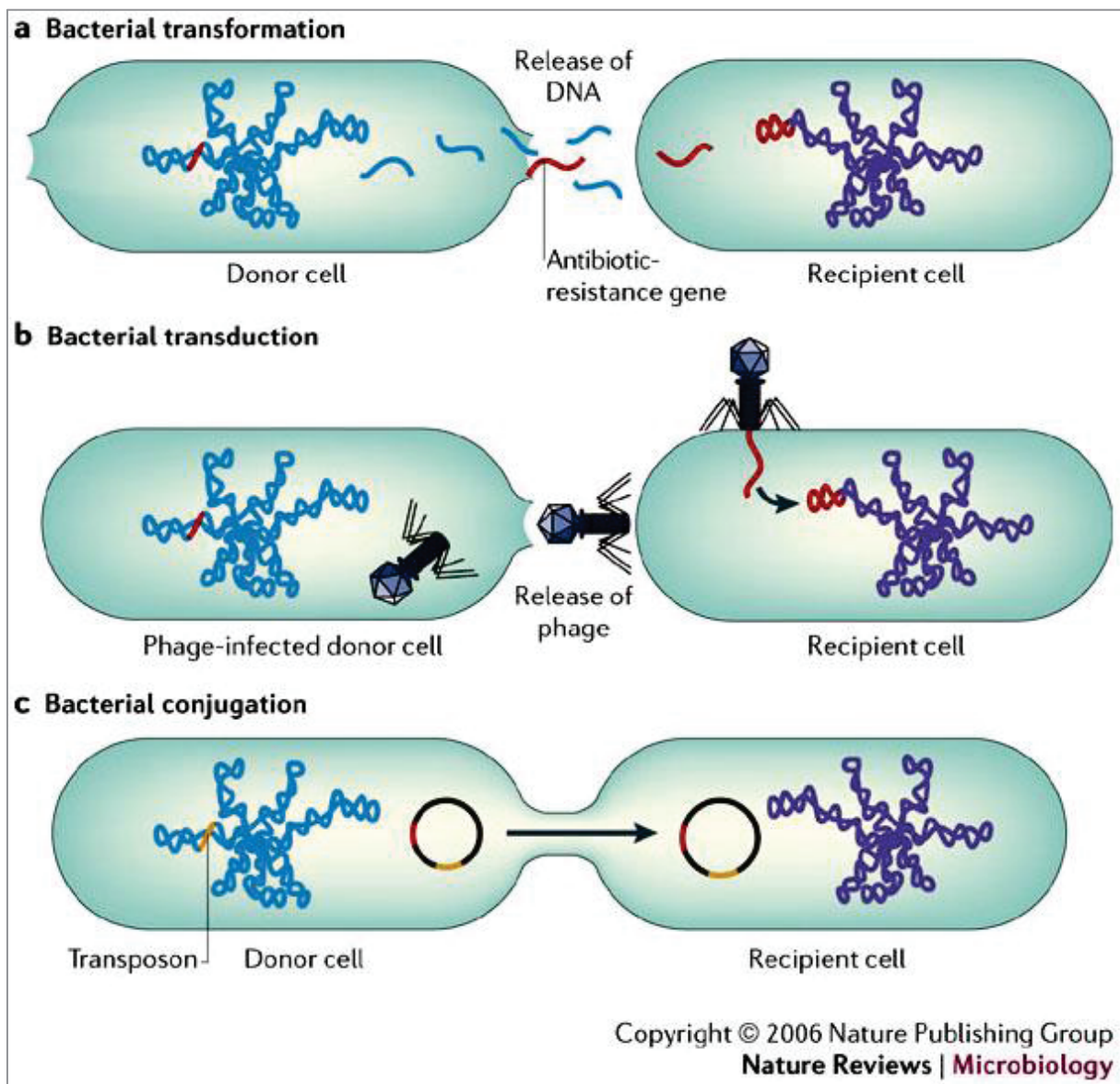

Fig. 24 Mechanisms of Horizontal Gene Transfer in bacteria.

In 1947, Joshua Lederberg discovered that an exchange of genetic information occurs between living *E. coli* cells; it is the first observation of the mechanism of conjugation, that allows the transfer of plasmids from one cell to another. He coined the term “plasmid” in 1953, unifying a previously disparate nomenclature. He also discovers with his wife Esther that bacterial viruses (bacteriophages) transmit genetic information from one cell to another, a new mechanism that he named transduction.

Together, transformation, conjugation and transduction are the three known mechanisms of bacterial horizontal gene transfer (Fig. 24) (Furuya and Lowy, 2006). The responsibility of HGT in emergence of bacterial resistance was quickly established, as plasmids are more often than not bearing resistance genes in the nature, as naturally transformable bacteria can quickly acquire resistance genes, and as transduction of resistance genes was obtained *in vitro* as early as the 1950s.

Antibacterial resistance in the 21st century

The later emergence of genetics, then genomics, allowed to take a broader view of the mechanisms of transfer of antimicrobial resistance. It is now generally accepted that horizontal gene transfer of pre-existing genes plays a greater role in emergence of resistance than mutation and clonal expansion of resistant strains (Ochman *et al.*, 2000; Martínez, 2008). Most resistance gene homologues have been found in environmental bacteria communities containing the original organisms from which the antibiotic has been isolated. This indicates that human use of antibiotics only promoted the transfer of such genes from the environments towards pathogens, rather than their apparition. Genetic analyses have uncovered how resistance genes are transferred, grouped together and complement each other to form transferable multi-drug resistance genomic islands (Davies, 1994).

The over-prescription, frequent non-compliance, and misuse of antibiotics (especially in the farming industry) are being pointed at as responsible for the selective pressure that promotes such a dissemination. It has been indeed shown recently that subinhibitory concentrations of antibiotics, such as found in the soil around farms and hospitals, were enough to pressure bacteria into conserving their resistance genes (Gullberg *et al.*, 2011). Moreover, contrary to a long-lasting paradigm (Andersson and Levin, 1999), recent studies have shown that not all resistance genes are being a burden for the fitness of bacteria (Skurnik *et al.*, 2013). Even in absence of antibiotics, loss

of the resistance genes occurs at a rate extraordinarily slower than the rate of acquisition of resistance (Andersson and Levin, 1999; Roux *et al.*, 2015).

The earlier works on the mechanisms of antibacterial resistance pointed at mutations and enzymes able to render inefficient the molecule. Since then, indirect and less specific mechanisms were discovered. Biofilm formation allows bacteria to evade the immune system, antiseptics and antibiotics, by forming a protective and impermeable coating made with polysaccharides and DNA (Mah and O'Toole, 2001). Biofilms play a role in the failure of treatments against *e.g.* *P. aeruginosa*, *S. aureus*, and *E. coli* infections. Worse, exposition to some antibiotics triggers the formation of biofilms (Hoffman *et al.*, 2005). In addition to biofilms, mechanisms of efflux have become widespread. Efflux pumps-encoding genes are often found in resistance genomic islands along with drug-modifying enzymes (Webber and Piddock, 2003). Often having a wide spectrum of action against small or large molecules, they form the first line of defense for bacteria against antibiotic exposure.

Since the drought in antibiotic discovery and the rise of resistance, deaths from antibiotic-resistant bacterial infections have been rapidly rising. The alarm was triggered by Margaret Chan, head of WHO, in a 2012 speech:

The antimicrobial threat is easy to describe. It has an irrefutable logic. Antimicrobial resistance is on the rise in Europe, and elsewhere in the world. We are losing our first-line antimicrobials. Replacement treatments are more costly, more toxic, need much longer durations of treatment, and may require treatment in intensive care units. For patients infected with some drug-resistant pathogens, mortality has been shown to increase by around 50%. Let me give an example of what this means for a disease of global significance. Among the world's 12 million cases of tuberculosis in 2010, WHO estimates that 650,000 involved multidrug-resistant TB strains. Treatment of MDR-TB is extremely complicated, typically requiring two years of medication with toxic and expensive medicines, some of which are in constant short supply. Even with the best of care, only slightly more than 50% of these patients will be cured. Many other pathogens are developing resistance to multiple drugs, some to nearly all. Hospitals have become hotbeds for highly-resistant pathogens, like MRSA, ESBL, and CPE, increasing the risk that hospitalization kills instead of cures. These are end-of-the-road pathogens that are resistant to last-line antimicrobials. If current trends continue unabated, the future is easy to predict. Some experts say we are

moving back to the pre-antibiotic era. No. This will be a post-antibiotic era. In terms of new replacement antibiotics, the pipeline is virtually dry, especially for gram-negative bacteria. The cupboard is nearly bare. Prospects for turning this situation around look dim. The pharmaceutical industry lacks incentives to bring new antimicrobials to market for many reasons, some of which fall on the shoulders of the medical and public health professions. Namely, our inability to combat the gross misuse of these medicines. From an industry perspective, why invest considerable sums of money to develop a new antimicrobial when irrational use will accelerate its ineffectiveness before the R&D investment can be recouped? A post-antibiotic era means, in effect, an end to modern medicine as we know it. Things as common as strep throat or a child's scratched knee could once again kill. Some sophisticated interventions, like hip replacements, organ transplants, cancer chemotherapy, and care of preterm infants, would become far more difficult or even too dangerous to undertake. At a time of multiple calamities in the world, we cannot allow the loss of essential antimicrobials, essential cures for many millions of people, to become the next global crisis.

Margaret Chan, 2012 speech in Copenhagen (Chan, 2012)

Currently, the U.S. and European Centers for Disease Control estimate that antibiotic resistance causes 50000 deaths annually, in the US and EU alone (Center for Disease Control, 2013; ECDC/EMA Joint Working Group, 2015). The direct cost associated with resistance is estimated at \$20 billion annually in the US alone, to which can be added \$35 billion in lost productivity. Fighting antimicrobial resistance and discovering new antibiotics will be a formidable challenge for the 21st century.

2.2. Approaches for antibiotic discovery, modes of action, resistance.

2.2.1. Antibiotic discovery and drug development

Identification of natural products

Identification of potent antibacterial compounds of natural origin has been by far the most effective method for antibiotic discovery. Many micro-organisms of the soil (fungi and bacteria) have developed means to control the growth of their competitors as an evolutionary strategy. These antibiotics are often identified by the Waksman pipeline (cf. Fig. 21, p.63) or a variation of it. Once the producer has been identified, the product is chemically defined, as well as the genes

coding for its synthesis. Mass production of the compound can then be attempted, either by directly cultivating the species in a fermenter, by cloning the cluster of producing genes into a more efficient producer, or by total chemical synthesis.

Harnessing these compounds for use against pathogens has advantages. First, natural antibiotic compounds have been designed and refined by thousands of years of co-evolution between the producer and the targets. Therefore, they often have a great efficiency, stability and penetration through the cell wall, even before any improvement by hemisynthesis. Second, they are readily produced by the species identified and can be purified as a fermentation product rather than synthesized, allowing to scale up their production rapidly even if chemical synthesis is inefficient. Third, some of them are large molecules that are not obtainable by simple chemistry. Some antibiotics are such complex molecules that total synthesis is impossible, and they could never have been found by screening of compounds libraries.

Of course, this method also has disadvantages. Some antibiotic producers grow poorly in artificial media, or only produce the antibiotic in some specific, hard to define conditions. A serious problem of redundancy also exists, with almost 10% of *Streptomyces* species producing Streptothricin and 1% of them producing Streptomycin (Lewis, 2013). The discovery pipeline rapidly reached its limits, as discovery of new classes rapidly decreased in the 1960s, then stalled (cf. Fig. 22, p.64). The time and date at which each class of antibiotics was discovered often reflected its relative prevalence in natural environments, and suggests that maybe only a few rare natural compounds could be identified yet (Baltz, 2006). Finally, resistance to natural compounds almost always exist in the nature, in competitors of the antibiotic producers. The constant struggle caused by antibiotic secretion in the environment creates a selection pressure that facilitates the emergence of resistance genes, and their transfer onto mobile genetic elements rapidly moving across phyla. This is of course one of the main concerns when using natural antibiotics, since the emergence of resistant pathogens has been obviously facilitated by the existence of these mobile genetic elements carrying resistance genes.

New approaches are being developed to revive the Waksman pipeline. Some researchers are cultivating previously uncultivated species to find new antibiotic producers (cf. Fig. 6 p.35), or co-cultivating species from the same environment to find antibiotic producers that rely on metabolic

products from another species to grow or synthesize the antibiotic. Recent efforts also have been undertaken to discover antibiotic producers in unexplored environments, such as marine trenches (Fenical and Jensen, 2006) and microbiota of saltwater sponges (Haber and Ilan, 2014).

Rational drug design and discovery

Rational drug design and discovery are based on the hypothesis that disrupting a target identified as essential for viability would result in a therapeutically interesting growth inhibition, and that identification of specific inhibitors of this target would provide lead compounds with antibiotic activity (Mandal *et al.*, 2009). It is therefore also known as reverse pharmacology, by opposition to the classical forward pharmacology where compounds are tested for their inhibitory effect, as with the Waksman pipeline.

Rational drug discovery starts with the identification of an interesting biomolecule target, for example a protein that is essential for viability, virulence, or biofilm development. Inhibitors of this target are often identified by high-throughput screening of libraries of small compounds against a purified form of the target, with a reporter system that indicates binding or inhibition of function. Alternatively, and more recently, compounds can also be designed from scratch with computer-assisted drug design, using structural data to model an inhibitor that interacts with an essential subdomain of the target (structure-based drug design). Lead compounds that have been identified or designed are then tested against the whole pathogen for their ability to inhibit growth or virulence.

This method has advantages. Poorly soluble compounds and known hazardous substructures (such as mutagenic alkylating groups) can be avoided deliberately. Compounds identified by screening of libraries are often small molecules, and they are obviously readily available and synthesizable. Compounds designed with computers and software are often small molecules as well, by choice. They are therefore likely to have certain good pharmaceutical qualities, such as good solubility, low production cost and ability to passively diffuse through the cell wall. As the structure of the obtained lead compounds is already known, the identification step that is necessary with natural drugs can be avoided.

Rational, target-based drug design also has downsides. The interesting compounds are evaluated by scoring their different properties, including their binding to the target, to identify the best

candidates; but this scoring may not reflect a good efficiency against the whole pathogen. Molecules identified often fail to achieve sufficient penetration through the cell wall (especially in gram-negative bacteria), because the scoring methods and guidelines have been defined for human drugs and the majority of antibiotics have very different properties than molecules that target human cells (Lewis, 2013). They also can be effectively excluded by efflux, or be broken down by enzymes, both difficulties being unpredictable before testing the compound against the pathogen itself rather than just the purified target. Target-based design and discovery also does not predict the likelihood of off-target interactions. The compound may bind other, non-essential components in the pathogen, increasing the minimal inhibitory concentration necessary to inhibit the essential target. Worse, their specificity may not be limited to the pathogen, and they can exhibit toxic side effects in eukaryotes.

In non-infective human health, this method has borne fruits and led to major advances in drug discovery. It has also yielded interesting lead compounds for antibiotherapy, yet among them, only oxazolidinones have been approved for now (Ford *et al.*, 2001).

Drug development and improvement (pre-clinical testing)

“Hit compounds” are molecules showing activity, that have been identified in natural extracts or by rational drug design or discovery. As these compounds often lack ideal pharmaceutical properties, they can be improved during drug development by chemical modification. The first step is to identify the moiety or functional group (the substructure in the molecule that causes the pharmaceutical effect). Analogs of the hit compounds containing the functional group are produced and tested for their affinity to the target. Derivatives which display an increased affinity are named “lead compounds”. They are tested for stability, solubility in water and lipids, toxicity in animals and cell cultures, potency, pharmacokinetics and metabolism. They are further derived to improve these properties in a process called “lead optimization”. The best derivative obtained in the pre-clinical process is then synthesized in large quantities and formulated for clinical testing.

Antibiotic compounds have a few features that distinguish them from patient-targeting drugs. Drugs that target human proteins should have certain properties that makes them good candidates. These properties are summarized in Lipinski's “rule of five” that has been widely adopted by the industry (Lipinski *et al.*, 2001):

- *Its molecular weight is less than 500.*
- *The compound's lipophilicity, expressed as a quantity known as logP (the logarithm of the partition coefficient between water and 1-octanol), is less than 5.*
- *The number of groups in the molecule that can donate hydrogen atoms to hydrogen bonds (usually the sum of hydroxyl and amine groups in a drug molecule) is less than 5.*
- *The number of groups that can accept hydrogen atoms to form hydrogen bonds (estimated by the sum of oxygen and nitrogen atoms) is less than 10.*

While these properties seem to be good predictors of the “druglikeness” of a compound targeting human proteins, the penetration through the cell wall of bacteria is a different business, and it is likely that blindly following these rules may have hurt antibiotic discovery in the past 20 years (Lewis, 2013). Rules defining the properties most likely able to improve penetration and avoid exclusion by efflux systems are lacking and should be investigated.

Clinical testing

Clinical testing of a new drug is a long and costly process that is paid for by the manufacturer, performed by specialized companies or the manufacturer, evaluated by national drug safety agencies, and subdivided in several phases numerated from 0 to III. Results and data in each phase are thoroughly evaluated, and determine whether the next phase should be undertaken, meaning that the number of drugs reaching each phase rapidly declines from phase 0 to phase III. At each clinical phase, the cost of testing is progressively growing. For anti-infective drugs such as antibiotics, average cost of phase I to III trials are \$4.2, \$13.9 and \$22.8 million, respectively (Sertkaya *et al.*, 2016).

Clinical testing often begins with phase 0 (first-in-human) testing to determine toxicity and metabolism of the drug in a small cohort of healthy humans. Initial drug dosing is derived from toxicity data obtained in animals. Phase I trials consist in testing doses in a larger group of healthy humans, by increasing the dosage progressively until side effects are encountered, to determine the most efficient dose with a good risk/benefits ratio. Phase II trials are performed in large cohorts of patients affected by the targeted disease. In phase III trials, the new drug is either tested against a

placebo, or against the usual treatment if the disease is life-threatening. More rarely, if no previous treatment is available and the disease is life-threatening, phase III trials may not include such controls, and results are instead compared to average mortality rates available in epidemiological data. Trials are performed in double-blind, meaning that neither patients nor physicians know what gets administered: either the placebo, the standard treatment, or the new drug. Some national drug safety agencies such as the FDA may require “phase IV” clinical trials, that are post-approval data gathering on patients administered with the drug.

Only a handful of new antibiotics have reached phase III testing or FDA approval in the last decade (Bassetti *et al.*, 2013). Some of them, e.g. Linezolid, have already been used for a few years in clinical settings for non-approved uses, as their administration has been authorized in cases of emergency when usual treatments have failed. All of the antibiotics recently approved belong to previously commercialized antibiotic classes.

Drug	Antibiotic class	Spectrum of microbiological activity	Main clinical indication	Development phase
ME 1036	Carbapenem	Gram-positive, including MRSA and VRE, and Gram-negatives such ESBL-strains but not <i>P. aeruginosa</i>	CAP	Preclinical development
BAL30072	Monocyclic β -lactam	MDR <i>P. aeruginosa</i> Acinetobacter including metallo- β -lactamases and enterobacteriaceae	NK	I
CB-182,804	Polimyxin	MDR Gram-negative	NK	I
ME1071	Betalactamase inhibitor	Gram-negative		I
BC-3781	Pleuromutilin	Gram-positive, including MRSA	cSSSIs	II
Biapenem	Cerbpenem	Gram-negative and Gram-positive	RTI, UTI	II
Delafloxacin	Quinolone	Broad-spectrum including fluoroquinolone-resistant MRSA	cSSTI	II
Eravacycline	Tetracycline	Gram-negative but not <i>Pseudomonas</i>	cIAI	II
JNJ-Q2	Quinolone	Enhanced Gram-positive activity including fluoroquinolone-resistance-resistant MRSA	cSSSIs	II
MK-7655	Betalactamase inhibitor	Gram-negative	cIAI, cUTIs	II
Plazomicin	Aminoglycoside	MDR enterobacteriaceae and <i>S. aureus</i> , including aminoglycoside-resistant	cUTI, cIAI	II

		and metallo- β -lactamase producers		
Radezolid	Oxazolidinone	Gram-positive	CAP, SSTI	II
Razupenem	Carbapenem	Gram-negative and Gram-positive	cSSSIs	II
Tebipenem/pivoxil	Carbapenem	Gram-positive and Gram-negative	otolaryngological/RTI	II
Tomopenem	Carbapenem	Gram-positive, including MRSA and Gram-negatives including ESBL-producing Enterobacteriaceae	cSSSIs, HAP	II
Ceftazidime/Avibactam	Cephalosporin + beta-lactamase inhibitor	MDR <i>P. aeruginosa</i> & enterobacteriaceae, excluding metallo- β -lactamases	cUTI, cSSTI, VAP	III
Ceftobiprolemecaril	Cephalosporin	Gram-positive	cSSTI, hospitalized CAP	III
Ceftolozane/tazobactam	Cephalosporin + beta-lactamase inhibitor	Gram-negative	cIAI, cUTIs, HAP, VAP	III
Cethromycin	Ketolide	Gram-positive and Gram-negative	CAP	III
Dalbavancin	Glycopeptide	Gram-positive	cSSTI	III
Nemonoxacin	Quinolone	Gram-positive and Gram-negative	CAP	III
Omadacycline	Tetracycline	Gram-positive and Gram-negative	cSSSIs, CAP	III
Oritavancin	Glycopeptide	Gram-positive, including MRSA, VRSA, VRE	cSSSIs	III
Panipenem	Carbapenem	Gram-negative and positive	cUTIs, RTI, obstetrical and gynaecological infections	III
Solithromycin		Gram-positive	CAP	III
Tedizolidphosphate	Oxazolidinone	Gram-positive, including MRSA	cSSSIs	III
Besifloxacin	Quinolone	Gram-positive and Gram-negative	Ophthalmic infection	Approved by FDA
Ceftarolinefosamil	Cephalosporin	Gram-positive	cSSSIs, CAP	Approved by FDA and EMA
Doripenem	Carbapenem	Gram-negative	cUTIs, cIAIs, HAP, VAP	Approved by FDA and EMA
Telavancin	Glycopeptide	Gram-positive	cSSTI, HAP, VAP	Approved by FDA and EMA

Table 1 Publicly advertised new antibiotics in clinical trials or recently approved, as of 2013. Abbreviations: NK not known, RTI respiratory tract infections, cSSTI complicated skin and soft tissue infections, cIAI complicated intra-abdominal infections, CAP community acquired pneumonia. (Bassetti et al., 2013)

2.2.2. Modes of action

Antibiotics target one or two essential cellular mechanisms to induce growth arrest, and sometimes cell death. To avoid toxicity in mammals, this target has to be structurally different to its eukaryotic homologue, or to be specific to prokaryotes. Identifying this target is useful to design new derivatives and escape bacterial resistance, and also to reduce unwanted cross-reaction with eukaryotic mechanisms. The different classes of antibiotics can be grouped according to their target (Table 2), and a visual summary of the main classes is presented in Fig. 25. The next subsection (2.3. Antibiotic classes) will include description of each class, including their mode of action, target, source, and associated modes of resistance.

Target	Class
Cell wall synthesis (Penicillin-binding proteins)	Beta-lactams
Cell wall synthesis (nascent peptidoglycan chains)	Glycopeptides
Cell wall synthesis (peptidoglycan precursor)	Fosfomycin
Cellular envelope disruption	Lipopeptides
Nucleic acids synthesis (Folate, precursor of nucleotides)	Sulfonamides
Nucleic acids synthesis (Gyrase)	Quinolones
Nucleic acids synthesis (RNA polymerase)	Rifamycins
Nucleic acids synthesis (damages to DNA)	Nitro-imidazoles
Nucleic acids synthesis (damages to DNA)	Nitrofurans
Protein synthesis (50S, peptidyl-tRNA dissociation)	Macrolides
Protein synthesis (50S, peptidyl-tRNA dissociation)	Lincosamides
Protein synthesis (50S, peptidyl-tRNA dissociation)	Streptogramins
Protein synthesis (50S, peptidyltransferase activity)	Amphenicols
Protein synthesis (50S, peptidyltransferase activity)	Pleuromutilins
Protein synthesis (30S, proofreading)	Aminoglycosides
Protein synthesis (30S, Amino-acyl tRNA charging)	Tetracyclines
Protein synthesis (50S, P site binding)	Oxazolidinones
Protein synthesis (Trans-translation)	Pyrazinamide

Table 2 Main classes of antibiotics and their cellular targets.

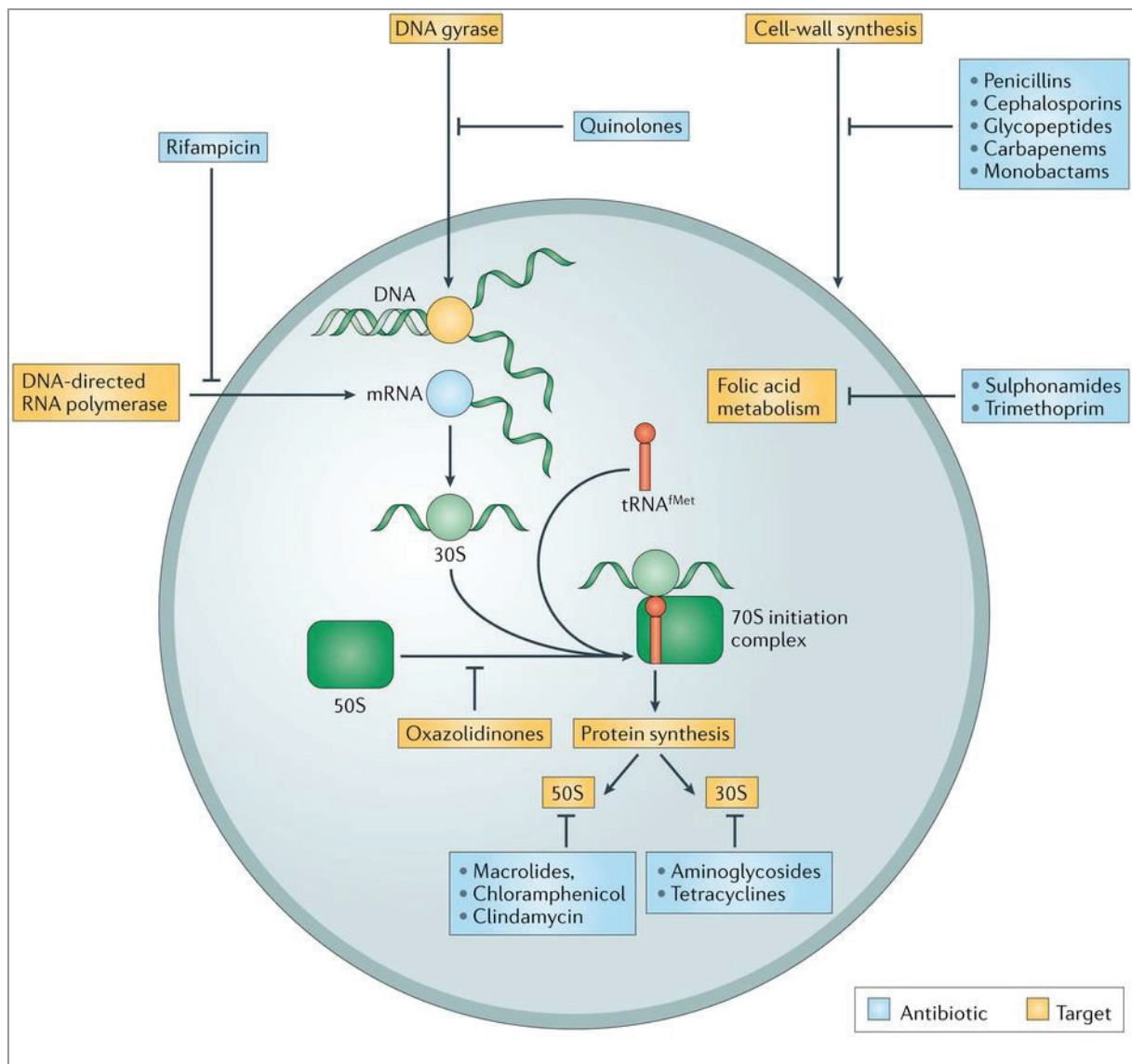

Fig. 25 Main classes of antibiotics and their cellular targets (Lewis, 2013)

2.2.3. Modes of resistance

An antibiotic effectively inhibits bacterial growth only if the molecule is able to cross the cell wall, recognize its target, and reach an intracellular concentration sufficient to block the essential mechanism targeted. Bacteria can be intrinsically tolerant to antibiotics, for example because the target is not recognized, because the molecule cannot cross an external membrane, or because the mechanism is redundant in this species. Bacteria can also become resistant, by acquiring passive or active mechanisms specifically aimed at reducing the efficacy of the drug. For example, resistance can occur by degradation or efflux of the drug, chemical modification of the drug or of the target, or overexpression of the target. Most common resistance and tolerance mechanisms to antibiotics

are resumed in Fig. 26. These mechanisms are genetically encoded and controlled and can be either spread by clonal expansion (vertical transfer) or by horizontal gene transfer (*cf.* Fig. 24, p.67).

Recent evidence showed that most of these mechanisms were probably already present in the environment in bacterial species neighboring natural antibiotic producers. Human use of antibiotics promoted the transfer and the spreading of such genes in human pathogens. Recently, evidence hinted at the fact that even subinhibitory concentrations of antibiotics, at levels similar to these found in the soil, are sufficient for maintaining a selective pressure that prevents the loss of these resistance mechanisms.

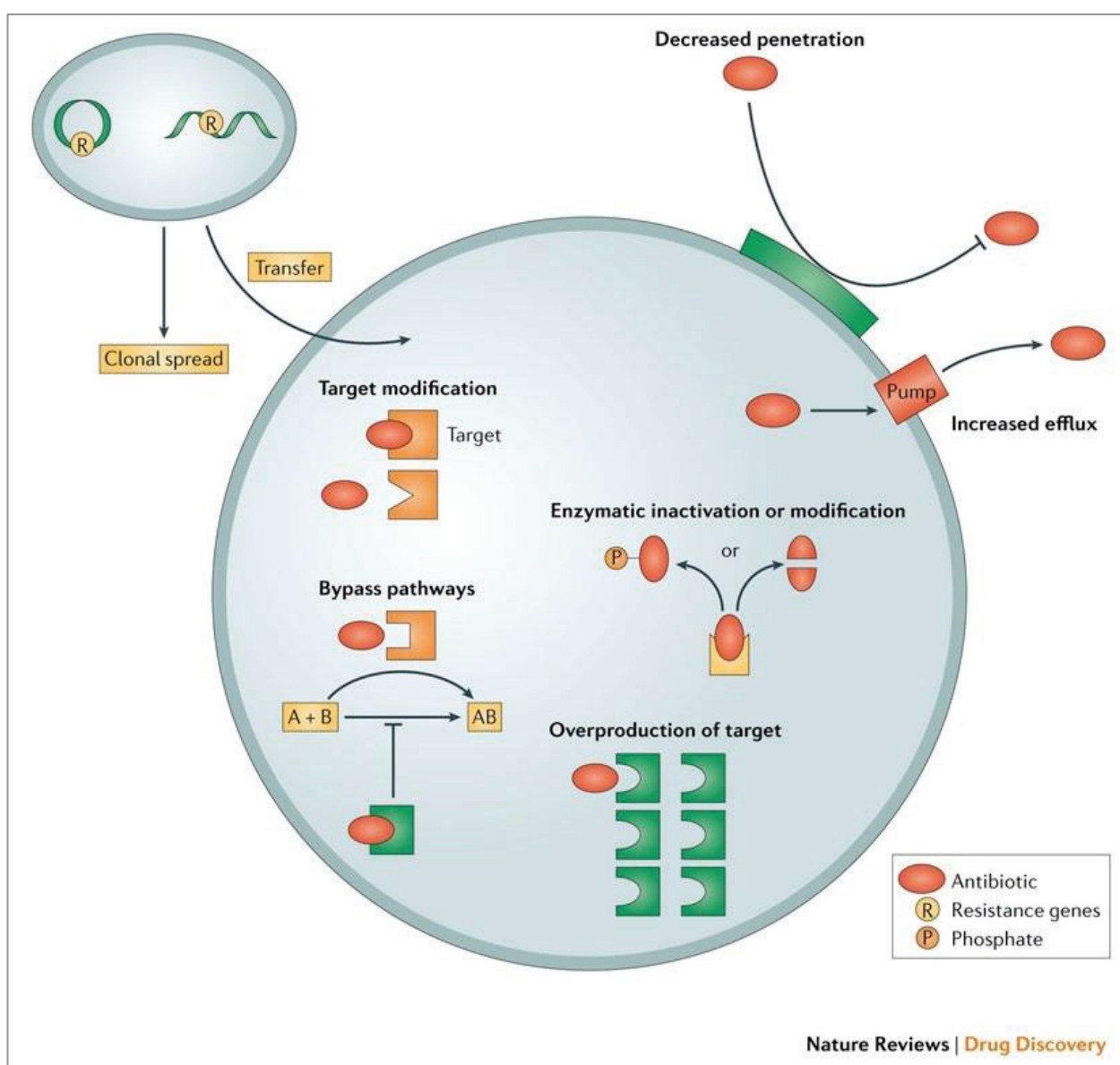

Fig. 26 Mechanisms of antibiotic resistance and tolerance. (Lewis, 2013)

2.3. Antibiotic classes

2.2.1. Cell wall disruptors and synthesis inhibitors

Cell wall synthesis inhibitors prevent the correct synthesis of peptidoglycan chains (Fig. 27) (Silver, 2003), and cell wall disruptors undermine the integrity of the envelope. Therefore, they both induce morphological defects and growth arrest, and often cellular death.

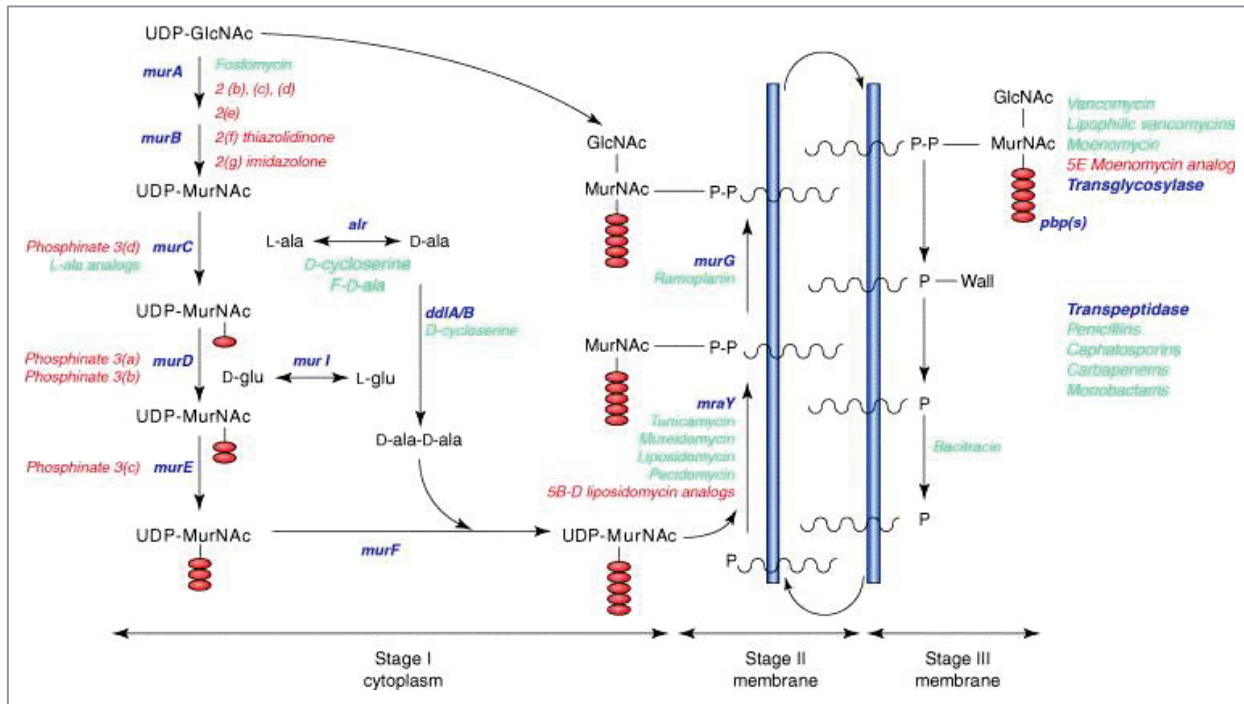

Fig. 27 Cell wall synthesis and its known inhibitors. The most common are transglycosylase inhibitors (glycopeptides) and transpeptidase inhibitors (beta-lactams). (Silver, 2003)

Beta-lactams

Beta-lactams were the first class of antibiotics of natural origin identified, with the discovery of Penicillin (cf. p. 56). Subclasses of β -lactams include penicillins, monolactams, cephalosporins, monolactams and carbapenems. All antibiotics in this class share the presence of a β -lactam ring (Fig. 28) that give them their specificity for the target, Penicillin-Binding Proteins (PBP). PBP are responsible for the synthesis of peptidoglycan, an essential component of the cell wall in both gram-positive and gram-negative bacteria. Beta-lactams bind PBP and prevent them from catalyzing the last steps of peptidoglycan synthesis (transpeptidation), resulting in impaired cell wall synthesis. This leads either to growth arrest or formation of cell wall-deprived spheroplasts, cell morphology distortion and lysis, depending on the species, sensitivity and drug concentration. Beta-lactams can therefore either be bacteriostatic or bactericidal drugs.

Resistance to Beta-lactam antibiotics often occurs by enzymatic degradation of the β -lactam ring. Such enzymes are named β -lactamases and are almost ubiquitous in the bacterial world, and are often found in mobile genetic islands. In response to the emerging problem of β -lactamases, antibiotics resistant to their activity have either been designed by hemisynthesis or discovered as natural compounds. Other modes of resistance have been identified with such compounds, such as mutation of the PBP targets for decreased affinity, or mutation of β -lactamases to increase their range of action.

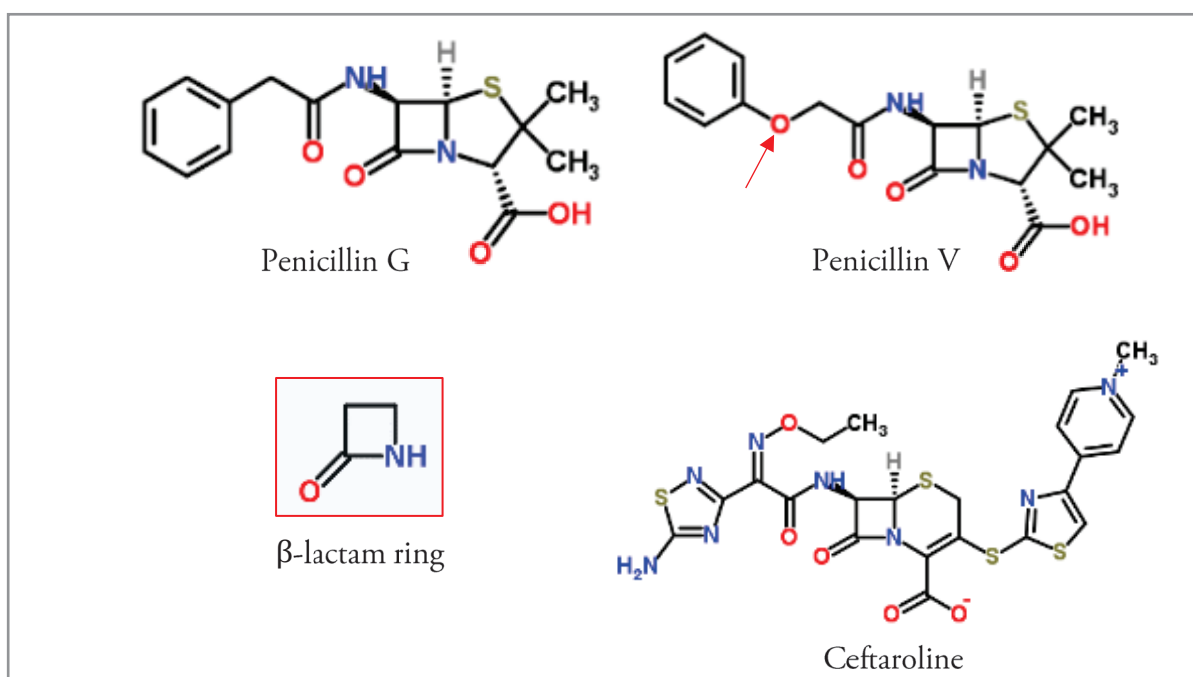

Fig. 28 Examples of β -lactam antibiotics. The β -lactam ring is represented in the lower left. Penicillin G (higher left) was the molecule identified by Fleming. Penicillin V (Phenoxymethylpenicillin, higher right) has been modified to allow its use through the oral route. The modification is indicated by the red arrow and increases its resistance to acidic conditions. Ceftaroline (lower right) is one of the last-generation cephalosporins. Extensive modifications have been brought from the original cephalosporin molecule but the β -lactam ring is still present.

Newly discovered broad spectrum- and metallo- β -lactamases are able to degrade the last generations of carbapenems and cephalosporins, that are considered to be last-line drugs. A new approach to counter resistance is the use of inhibitors of β -lactamases in conjunction with older β -lactams, to restore their activity. One such drug is clavulanic acid, combined with amoxicillin.

Glycopeptides

Glycopeptides are glycosylated non-ribosomal peptides. Glycopeptides include the widely-used Vancomycin (Fig. 29), as well as Telavancin, Teicoplanin, or the newly-discovered Teixobactin. They interact with peptidoglycan and prevent its synthesis by steric hindrance. As they are very large molecules, they are inefficient to cross the external membrane of gram-negative bacteria, and their spectrum of action is therefore limited to gram-positive bacteria. Glycopeptides are used in treatments of highly-resistant infections by gram-positive species such as *Clostridium difficile* or *Staphylococcus aureus*. Glycopeptides are natural compounds obtained from *Actinobacteria*. Some of them have been modified by hemisynthesis, such as Teicoplanin. Resistance to Glycopeptides occurs through mutations allowing the formation of peptidoglycan with a modified amino-acid composition, reducing or suppressing the specificity of the drugs.

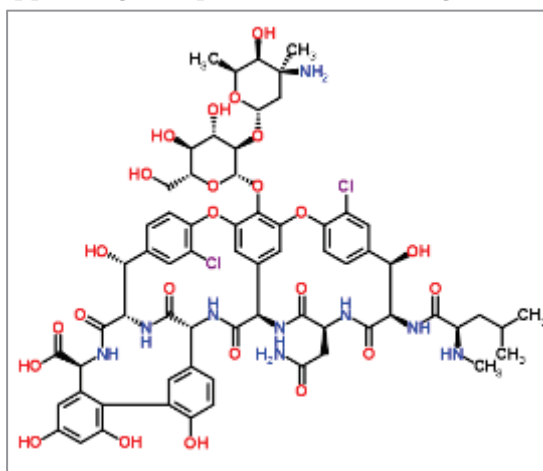

Fig. 29 Structure of the glycopeptide Vancomycin. The molecule contains two sugars visible at the top and an heptapeptide.

Fosfomycin

Fosfomycin is a unique antibiotic that inhibits the MurA enzyme, responsible for an essential step in peptidoglycan synthesis. This enzyme links a pyruvate derivative to the sugar portion of peptidoglycan. This pyruvate itself is necessary to link the sugar with the peptide portion of peptidoglycan. MurA has a free cysteine in its enzymatic core necessary to its activity; fosfomycin gets covalently bound to this cysteine, irreversibly inhibiting the enzyme. Fosfomycin is naturally produced by some *Streptomyces* species but can be now totally synthesized, as it is a small and simple molecule (Fig. 30). It is active against both gram-positive and gram-negative bacteria, and is a replacement of choice for beta-lactam resistant infections. Resistance occurs through enzymes that modify the molecule to render it inactive.

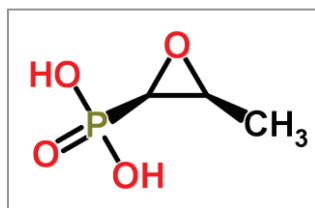

Fig. 30 The small-molecule inhibitor of MurA, Fosfomicin

Lipopeptides

Lipopeptides are natural antibiotic compounds that possess both a lipidic and a circular peptidic structure. Examples of lipopeptides include polymyxins (*e.g.* polymyxin E/colistin, produced by *Paenibacillus polymyxa* and polymyxin B, produced by *Bacillus polymyxa*), daptomycin (*Streptomyces roseosporus*), and surfactin (*Bacillus subtilis*). Lipopeptides are amphiphile molecules, having both lipophilic and hydrophilic affinity. Like detergents, they can dissolve the lipids of the plasmic membrane, targeting mainly the lipid A of the LPS. They modify the potential of the membrane, induce a disequilibrium in ion concentration and/or cause leaks of cellular contents. This disruption of the integrity of the bacterial envelope leads to cellular death, and therefore lipopeptides are bactericidal. Resistance to lipopeptides occurs through modification of the membrane composition or charge. For example, resistance to colistin occurs through modification of the lipid A by phosphoethanolamine addition by an enzyme (*mcr-1* plasmids). Despite being often toxic for patients, a renewed interest in lipopeptides has emerged since the emergence of multiresistant strains.

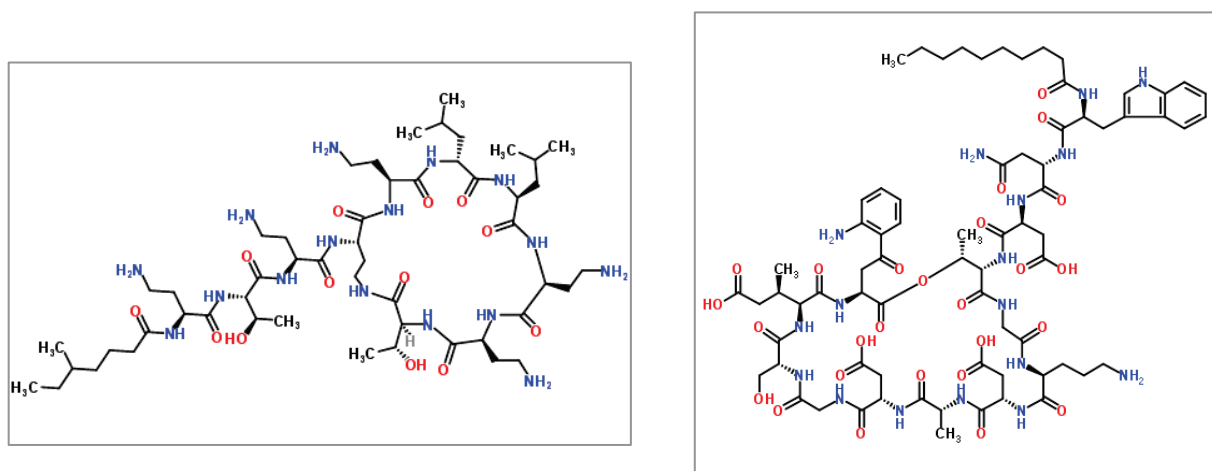

Fig. 31 Lipopeptides representatives: colistin (left) and daptomycin (right).

Mycolic acid synthesis inhibitors

The envelope of mycobacterial cells is relatively different from these of gram-positive and gram-negative bacteria. In particular, they contain very long fatty acids known as mycolic acid. Disrupting the synthesis of these molecules destabilizes the cellular envelope and leads to cell death. Mycolic acid synthesis inhibitors have been identified in the 1950s by screening of synthetic compounds exhibiting anti-TB activity, and two of them have been used in human medicine: isoniazid and ethionamide. Both compounds are prodrugs that enter the cell and are transformed into active forms by enzymes, the catalase KatG (isoniazid) and the mono-oxygenase EthA (ethionamide). They form reactive species that covalently bind the NAD coenzyme, that is needed for synthesis of mycolic acid. Their bactericidal action even occurs on intracellular and dormant mycobacteria, making them essential to cure TB and prevent relapse. Resistance to both compounds usually occurs through loss or mutation of the enzymes necessary for prodrug activation.

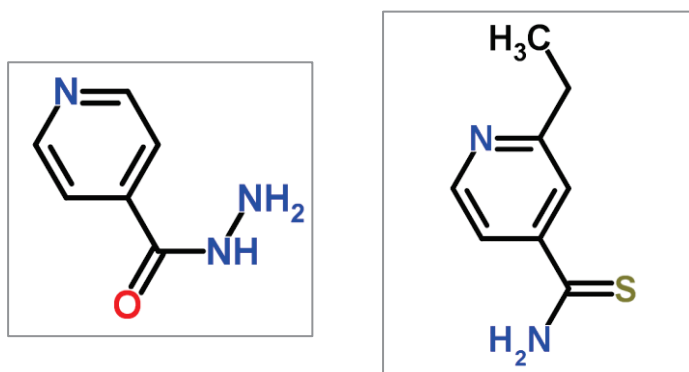

Fig. 32 Mycolic acid synthesis inhibitors: Isoniazide (left) and ethionamide (right).

2.2.2. Inhibitors of nucleic acids synthesis

Nucleic acids synthesis is a good target for antibiotics. Global inhibition of DNA or RNA synthesis leads to stasis, and cell death can be induced by damages to the genetic material.

Sulfonamides and Diaminopyrimidines

Sulfonamides have been previously mentioned as the first widely available antibiotic class (see p.54), and also the first of synthetic origin. Discovered during a chemistry boom triggered by the mass-production of aniline dyes, sulfonamides share a common functional group comprising a sulfonyl joined to an amine. Examples of Sulfonamides include the pioneer drug Sulfanilamide and

the widely-used Sulfamethoxazole (Fig. 33, left). Their range of action is broad-spectrum, being efficient against both gram-positive and negative bacteria.

Diaminopyrimidines include Trimethoprim (Fig. 34, right) and its derivatives (e.g. brodimoprim, iclaprim). They have been discovered through rational drug design of purine derivatives and screening against pathogens. This approach also led to the discovery of antiparasitic, antitumoral and immunosuppressant purine derivatives. The range of action of trimethoprim is broad-spectrum.

Sulfonamides share a structural similarity with para-aminobenzoic acid (PABA), and diaminopyrimidines share a structural similarity with dihydrofolate. Both PABA and dihydrofolate are precursors of folate (vitamin B9), which is itself a precursor for the synthesis of the purine and thymidine nucleotides. These similarities allow the inhibition of two enzymes of the folate synthesis pathway, dihydropteroate synthetase (sulfonamides) and dihydrofolate reductase (diaminopyrimidines). As folate is not readily available in tissues of the host, pathogens cannot compensate the loss of that synthesis pathway and DNA replication is stopped by a lack of available nucleotides. Mammals also lack the folate synthesis pathway, getting their supply of folate through feeding; while dihydrofolate reductase is present in mammals, trimethoprim makes folate synthesis an excellent specific target for antibiotics.

Used together, trimethoprim and sulfamethoxazole exhibit a synergetic activity by blocking the synthesis of folate at two different steps of the pathway. Moreover, as sulfonamides had been used for three decades when Trimethoprim was discovered, resistance to sulfonamides was already widespread at that time. Combining Trimethoprim with sulfonamides renewed the clinical interest of that class; the two molecules are almost always prescribed together. Co-administration of both drugs also contributes to limiting the rate of apparition of resistance. Nevertheless, wide usage, including long-period prescription for prophylaxis in immunosuppressed patients, has allowed resistance genes to emerge. Resistance to trimethoprim/sulfamethoxazole occurs through efflux, mutation of the targeted enzymes, and often expression of plasmid-borne genes coding for mutated enzymes (*sul* genes for sulfonamides and *dfr* genes for trimethoprim).

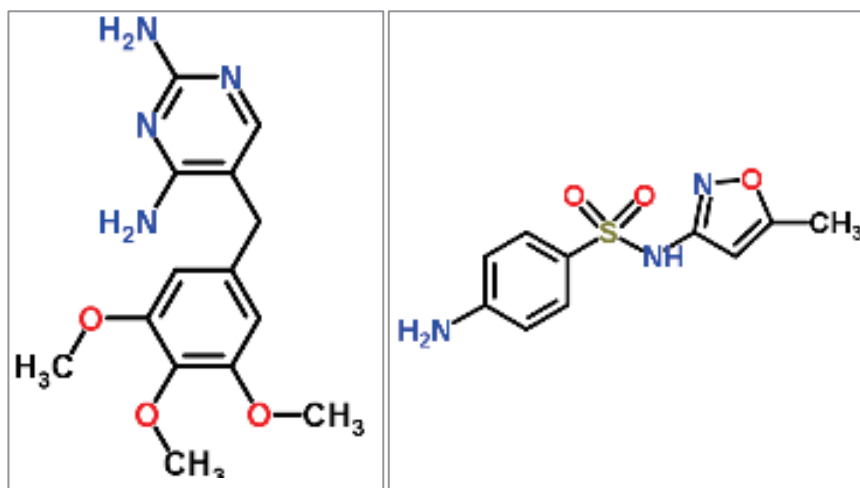

Fig. 33 Trimethoprim (left) and Sulfamethoxazole (right), often used together in a 1:5 ratio.

Quinolones/Fluoroquinolones

Quinolones are synthetic antibiotics discovered by accident as byproducts of quinine production, and they all share a similar core based on nalidixic acid. Examples of quinolones include nalidixic acid (Fig. 34, left) and cinoxacin, both discontinued. Indeed, most quinolones are no longer used since the invention of the more potent fluoroquinolones. Fluoroquinolones are derivatives of quinolones whose action is increased by the presence of a fluorine atom that increases potency and penetration, in particular in gram-positive bacteria. Fluoroquinolones include the widely-used ofloxacin, levofloxacin and ciprofloxacin (Fig. 34, right). The range of action of fluoroquinolones is broad-spectrum.

Quinolones and Fluoroquinolones act by inhibiting the bacterial topoisomerases (gyrase, topoisomerase IV), both enzymes responsible for coiling and relaxing the strands of DNA. Inhibition of topoisomerases blocks the replication fork, preventing DNA replication and eventually leading to double-strand breaks at the site of inhibition and cell death. Hence, most fluoroquinolones exhibit a bactericidal effect at high concentrations. Fluoroquinolones are widely used but are slightly toxic and sometimes present a sudden and impressive side effect, rupture of Achille's tendon. Resistance to fluoroquinolones often occurs by mutation of the *gyrA* and *parC* genes coding for the gyrase and the topoisomerase IV, respectively.

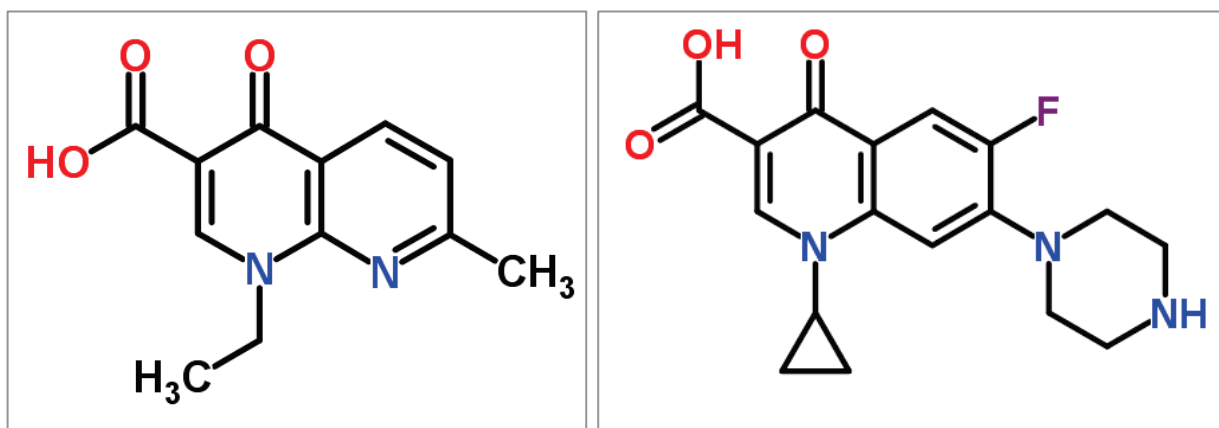

Fig. 34 On the left, the quinolone Nalidixic acid. On the right, the fluoroquinolone Ciprofloxacin.

Rifamycins

Rifamycins are natural compounds produced by *Streptomyces mediterranei*. They are large, complex and cyclic molecules. The original natural compound Rifamycin was poorly active, and its derivative were at first only usable by intravenous injection. Rifamycin was improved by hemisynthesis into the orally-stable, widely-used Rifampicin (Fig. 35). Rifamycins interact with the bacterial RNA polymerase, inducing the abortion of transcription after the addition of a few nucleotides, and therefore globally inhibiting transcription. Rifampicin exhibit bactericidal activity, through a mechanism poorly understood. Rifampicin has broad-spectrum activity, being active on most gram-positive bacteria, uncommon gram-negative pathogens such as *Legionella pneumophila* and *Listeria monocytogenes*, and also against *Mycobacterium tuberculosis* (Rifampicin is a cornerstone of the anti-TB drug regimen). However, it is inefficient against most *Enterobacteriaceae*. Resistance to Rifamycin often occurs through mutation of the *rpoB* gene coding for the β subunit of the RNA polymerase.

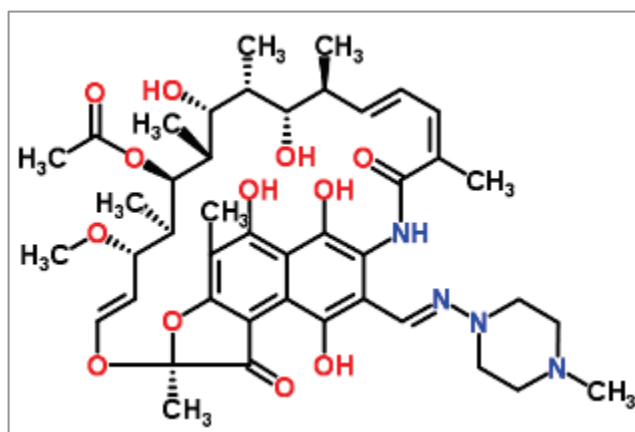

Fig. 35 Rifampicin, the most common representative of the Rifamycin family.

Nitro-imidazoles

Nitro-imidazoles are antibiotic and antiparasitic compounds. The first member of that class, 2-nitroimidazole (azinomycin) was discovered as a natural compound produced by *Streptomyces eurocidicus*. Later, a more potent derivative, 5-nitroimidazole, was synthetically produced, and then itself derived into the drugs metronidazole and tinidazole. Nitro-imidazoles have a reduced spectrum of action limited to some microaerophilic bacteria such as *Helicobacter pylori* and most anaerobic bacteria. They have to be transformed into their active form by reduction in the cell, a reaction that only occurs in anaerobic conditions. Nitro-imidazoles act by inducing DNA damage by direct interaction with the strands of DNA, and they are therefore bactericidal. Resistance usually occurs by reduction of the redox activity, decrease uptake, and mutations in the *rdxA* gene encoding a nitroreductase that turns the drugs into their active form.

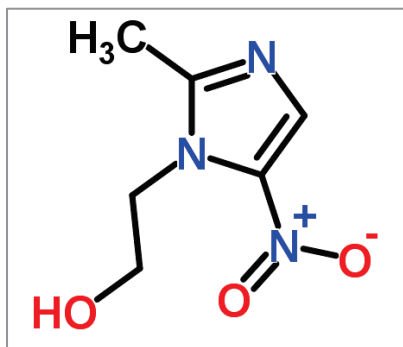

Fig. 36 Metronidazole, the most common representative of the nitroimidazole class.

Nitrofurans

Nitrofurans are antibiotic and antiparasitic compounds. The initial discovery of their action was made in the wake of World War 2, when derivatives of furfural, a massively available by-product of cereal grain husks, were found to be bacteriostatic. The first compound available, Furacin (5-nitro-2-furaldehyde semicarbazone), was used in the form of topical creams for wounds in the last part of the war. Later, more potent derivatives such as nitrofurantoin (Fig. 37) were invented. The mode of action of Nitrofurans is unclear, as they seem to have an effect on several important cellular mechanisms. Evidence suggests that they are prodrugs, reduced in the cell into more potent chemicals that interact with ribosomal components and induce DNA breaks, that explains their bactericidal activity. Nitrofurans are efficient against some gram-positive (*S. aureus*, *E. faecalis*) and some gram-negative bacteria (*N. gonorrhoeae*, *S. enterica*, *E. coli*). Interest in nitrofurans has increased recently for the treatment of urinary tract infections where resistance to

more common antibiotics has risen sharply. Resistance is rare, probably because targets are multiple in the cell. It often occurs by loss of the reductase enzymes responsible for the reduction of the prodrugs into their more potent metabolites.

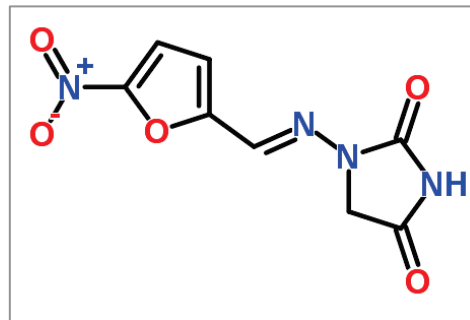

Fig. 37 Nitrofurantoin, a common nitrofuran antibiotic.

2.2.3. Protein synthesis inhibitors

Protein synthesis is by far the most common target for antibiotics (Fig. 25, p.78). Ribosome-targeting antibiotics either target the 50S or the 30S ribosomal subunit, and mostly interfere with the elongation cycle (Fig. 38) (Wilson, 2013), even if antibiotics that inhibit translation initiation and termination also exist.

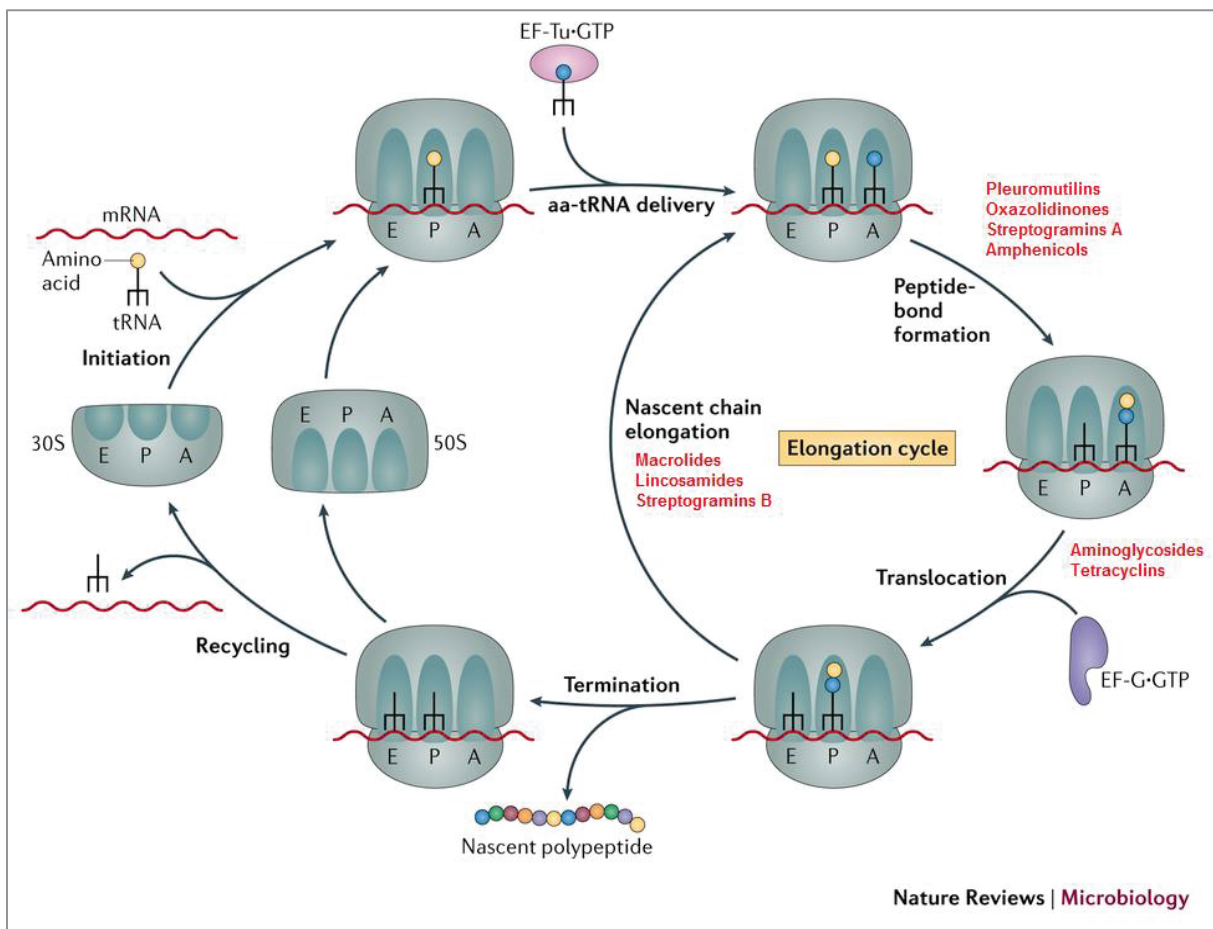

Fig. 38 Bacterial translation and ribosome-targeting antibiotics. (Wilson, 2013)

Inhibiting ribosomal activity leads to a reduction in protein turnover that induce growth inhibition. For this reason, most protein synthesis inhibitors are bacteriostatic. The exceptions to that rule are antibiotics that induce misreading, which leads to accumulation of toxic, misfolded proteins. A debate on the cause of bactericidal activity of such ribosome-targeting antibiotics was launched recently, with some groups arguing that the misfolding of iron-sulfur cluster-containing proteins led to an increase in reactive-oxygen species (ROS) and oxidation of cellular components (Kohanski *et al.*, 2007; Dwyer *et al.*, 2009). That theory was highly controversial and led to more serious rebuttals (Keren *et al.*, 2013; Liu and Imlay, 2013). Other theories explain the bactericidal activity through accumulation of malformed membrane protein that leads to osmotic shock and loss of cellular content (Kohanski *et al.*, 2008); iron-sulfur components seem indeed involved in bactericidal activity, but this is because their mistranslation increases antibiotic uptake, and not because of ROS formation (Ezraty *et al.*, 2013).

Macrolides

Macrolides are large cyclic lactone rings (usually 14-16 carbon atoms) glycosylated with at least one sugar. Macrolides include the widely-used Erythromycin, Azithromycin and Clarithromycin (Fig. 39). They interact with the 50S ribosomal subunit, and in particular the 23S rRNA. They induce the dissociation of the growing peptidyl-tRNA from the ribosome. Their action is bacteriostatic. Macrolides are efficient on gram-negative and gram-positive bacteria and have a broader spectrum of action than beta-lactams, being efficient on intracellular bacteria such as *L. pneumophila*, *Rickettsiae*, *Mycoplasma* and some *Mycobacteria*. Macrolides are natural compounds produced by *Actinobacteria* (e.g. Erythromycin). Improved derivatives obtained by hemisynthesis have either a better resistance to acidity (Clarithromycin) or a slowed metabolic degradation

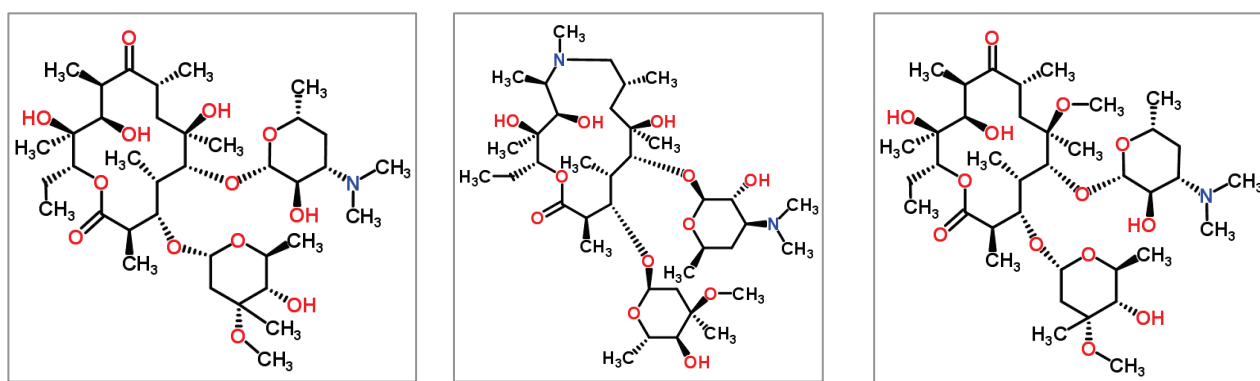

Fig. 39 Macrolide representatives, from left to right: Erythromycin, Clarithromycin and Azithromycin.

(Azithromycin). Resistance to macrolides usually occurs by efflux or by modification of the target, notably by methylation of the 23S rRNA.

Lincosamides

Lincosamides are molecules smaller than macrolides, that contain an amino-acid (proline derivative) and a sugar. Only a few Lincosamides are approved for human use, including the natural product Lincomycin (produced by a *Streptomyces*) and its hemisynthetic derivative Clindamycin, much more used because of its more potent activity (Fig. 40). Lincosamides, like macrolides, inhibit the ribosome by interacting with the 50S at the level of the 23S rRNA, triggering the early release of the peptidyl-tRNA. Lincosamides are also bacteriostatic, although their spectrum of action is reduced to gram-positives only. As with Macrolides, resistance occurs often by methylation of the 23S rRNA.

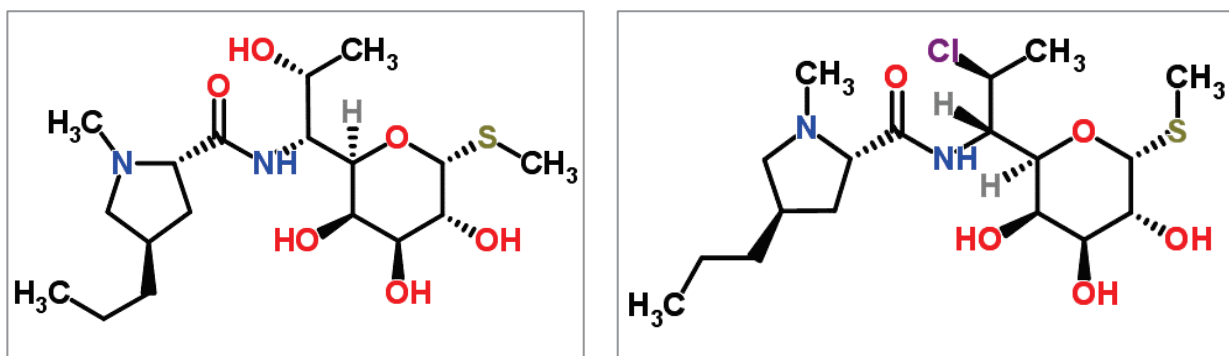

Fig. 40 Lincosamides: left, the natural product Lincomycin and right, the more potent hemisynthetic derivative Clindamycin.

Streptogramins

Streptogramins are antibiotic combinations produced by *Streptomyces* species. They're composed of a mixture of a type A and a type B Streptogramin.

- Type B are depsipeptides (*i.e.* amino-acid chains with one or more ester chains instead of the usual amide peptide bonds), produced non-ribosomally. Type B streptogramins have the same target and mode of action as Macrolides and Lincosamides. Macrolides, Lincosamides and Type B Streptogramins are therefore antagonists of each other. Examples of Type B Streptogramins include Pristinamycin IA and its hemisynthetic, less hydrophobic derivative Quinupristin.
- Type A are complex macromolecules (23-carbon unsaturated chains with lactone and peptide bonds) synthesized by a cluster of enzymes. Type A Streptogramins, like type B,

also target the 23S rRNA; the sites of interaction of Streptogramins A and B on the 23S partly overlap. Streptogramin A inhibit the peptidyltransferase activity. Examples of Type A Streptogramins include Pristinamycin IIA and its hemisynthetic derivative Dalfopristin.

Separately, Streptogramins A and B have a bacteriostatic effect. Used together, their action becomes synergetic and bactericidal. Indeed, Streptogramin A, by interacting with the ribosome, changes its conformation and increases its affinity for Streptogramin B. Together, they are able to prevent the loading of new tRNAs and they induce the release of the peptidyl-tRNA. Resistance to Streptogramins occurs often through target and antibiotic enzyme-based modifications. Some resistance genes such as *erm*, encoding a 23S rRNA methylase, can provide cross-resistance to Macrolides, Lincosamides and Streptogramins.

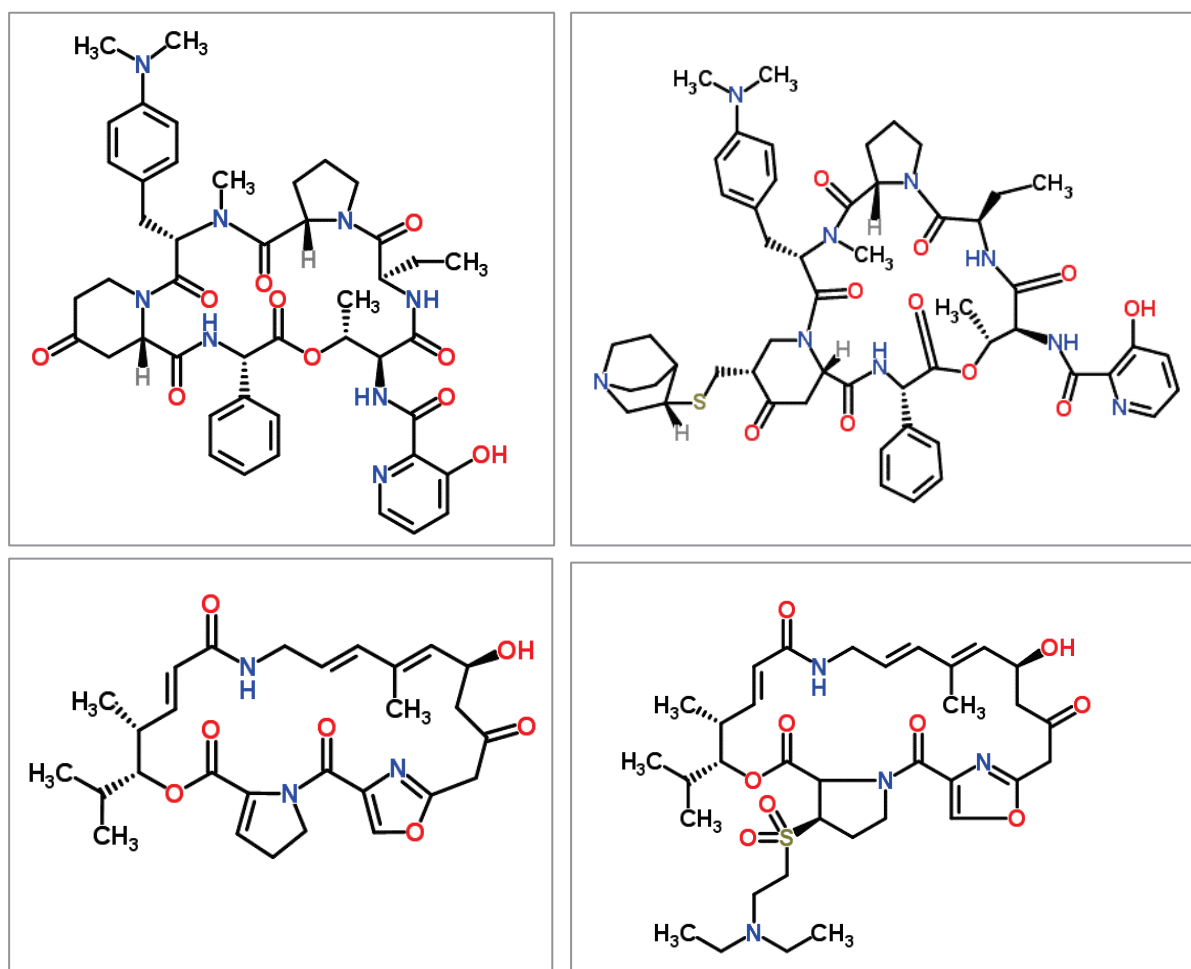

Fig. 41 Streptogramins representatives. On the left, Pristinamycin IA (up) and IIA (down).
On the right, their derivatives Quinupristin (up) and Dalfopristin (down).

Amphenicols

Amphenicols are an antibiotic class containing a typical benzene ring linked to two chlorine atoms. Amphenicols are mostly composed of Chloramphenicol and its derivatives, such as Thiamphenicol and Florfenicol. Amphenicols target the peptidyltransferase activity of the 50S subunit of the ribosome, preventing the transfer of a new amino-acid and therefore the elongation of the nascent polypeptide. They are bacteriostatic and their spectrum of action is wide, being efficient against gram-negative and gram-positive, aero- and anaerobic bacteria. Resistance to Amphenicols is mediated by modifying enzymes such as the chloramphenicol-acetyltransferase (*cat*).

Chloramphenicol induces dose-independent, irreversible medullar aplasia (destruction of the bone marrow hematopoietic stem cells) in a significant proportion of patients that seem genetically predisposed to this adverse effect. It also leads to dose-dependent bone marrow suppression. This led to the progressive abandonment of Chloramphenicol for human use, except for a few local applications such as eyedrops. Derivatives such as Thiamphenicol or Florfenicol lack the p-nitro group that is responsible the dose-independent aplasia (Fig. 42) and are therefore sometimes still used in a human and veterinary context.

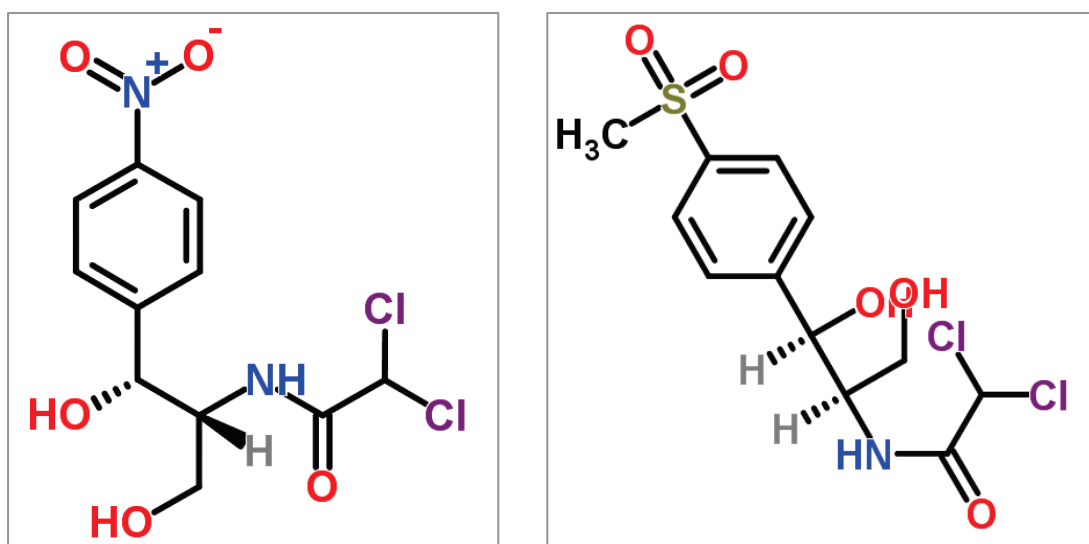

Fig. 42 Amphenicols representatives. On the left, Chloramphenicol. On the right, the derivative Thiamphenicol in which the p-nitro group responsible for medullar aplasia has been replaced by a sulfomethyl group.

Pleuromutilins

Pleuromutilins are diterpene antibiotics, comprising a cyclooctane ring and a variable side chain. The first representative, Pleuromutilin, was discovered in the 1950s as a natural product secreted by the fungus *Clitopilus passeckerianus*. Semi-synthetic derivatives such as Valnemulin and Tiamulin had been approved for animal use since the 1970s, but human use only started with the approval of Retapamulin for topical use, in 2007. They are mainly used to fight gram-positive cocci responsible for surface infections, such as *S. aureus* and *S. pyogenes*. Pleuromutilins interact with the 23S rRNA and ribosomal proteins at the level of the peptidyltransferase center, where they inhibit peptide bond formation and therefore protein elongation. Resistance to Pleuromutilins is not widespread yet, but is especially encountered in veterinary settings, since they have been in use longer in cattle. Resistance usually occurs from mutations in *rplC* (ribosomal protein L3) or the 23S rRNA, or by plasmid-borne genes encoding efflux pumps. Pleuromutilins have recently attracted attention since one of their representatives has been approved for topical use in humans. They have very few cross-resistance with other antibiotics and could be useful against multi-resistant strains. New derivatives are being developed and tested for uses that would not be limited to topical applications.

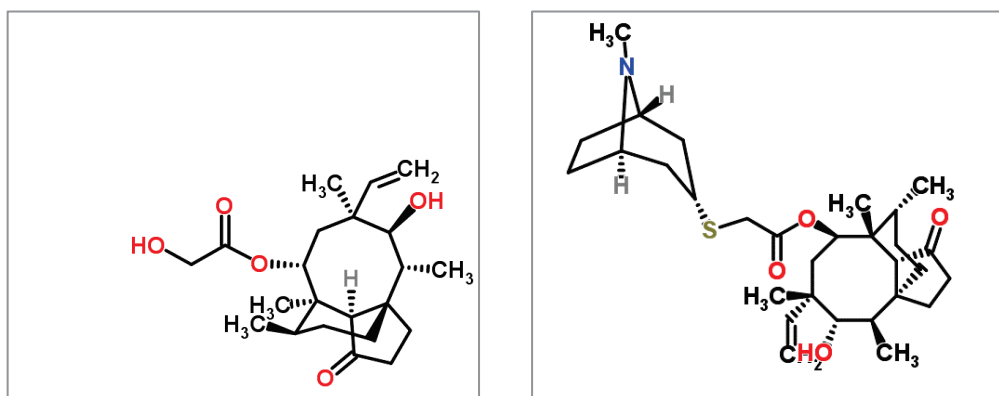

Fig. 43 The original natural compound Pleuromutilin (left) and the hemisynthetic Retapamulin, approved for human use (right).

Aminoglycosides

Aminoglycosides are antibiotic compounds containing aminosugars, usually to the number of three. They were identified as natural compounds synthesized by *Streptomyces* (compounds then generally bear the suffix -mycin) and *Micromonospora* (-micin) species. The first compound identified were Streptothricin and Streptomycin (see p. 60), and other natural compounds of that class were discovered afterwards (Kanamycin, Gentamicin, Neomycin) or derived by hemisynthesis

(Tobramycin). Aminoglycosides are mainly used against gram-negative aerobic bacteria, with some having activity against some gram-positive bacteria as well. Aminoglycosides interact with the 16S ribosomal RNA at the level of the A-site, where they inhibit ribosome activity and assembly of the 30S subunit, and misreading. Aminoglycosides exhibit bactericidal activity. Uptake of aminoglycosides induces misreading and misfolding of membrane proteins; this leads to disruption of the membrane integrity, increased uptake of aminoglycosides, and eventually cell death. Resistance to aminoglycosides usually occurs through reduced uptake, modification of the drug, or modification of the 16S rRNA by methylation. Because of their bactericidal activity, and because they exhibit synergetic activity with cell wall synthesis inhibitors, aminoglycosides have a major role in infectious disease management.

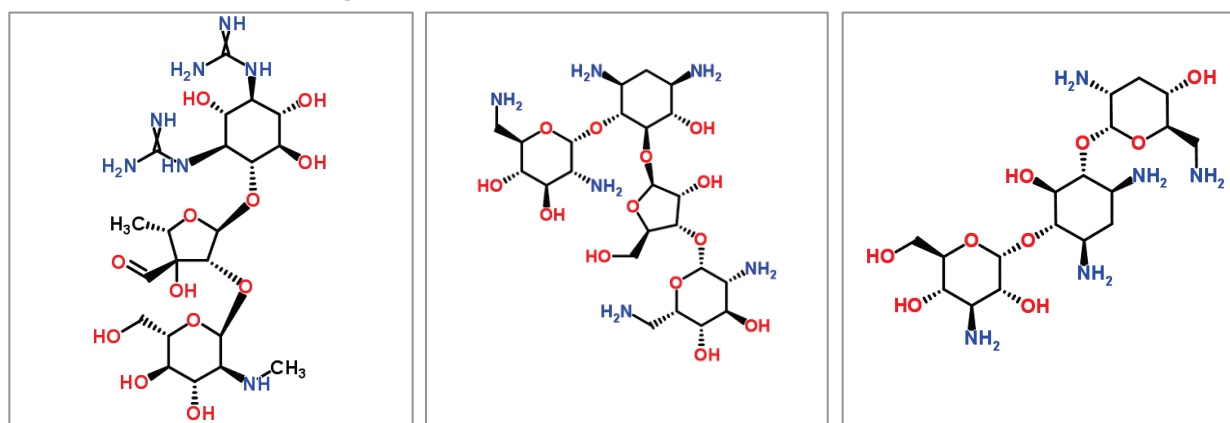

Fig. 44 Aminoglycoside representatives. From left to right, the natural compounds Streptomycin and Neomycin B, and the hemisynthetic Tobramycin.

Tetracyclines

Tetracyclines are compounds defined by a 4-ring carbocyclic functional group, discovered as natural compounds produced by *Streptomyces* species in the late 1940s. Thousands of derivatives have been discovered or produced by hemisynthesis but only a handful have been widely used in human and veterinary settings, including chlortetracycline, oxytetracycline and the more recent tigecycline, developed to overcome the widespread resistance to this class by addition of lateral groups on the first cycle. Tetracyclines were the first broad-spectrum antibiotics, having activity against a large number of gram-positive and gram-negative pathogens. Tetracyclines target the decoding center on the 30S subunit of the ribosome, preventing interaction between the aminoacyl-tRNA and the mRNA at the level of the A site. This prevents protein elongation and leads to bacteriostasis. Resistance to tetracyclines is widespread and results almost always from expression

of a specific efflux pump (*tetA*), modification of the 30S ribosomal subunit by an elongation-like factor protein (*tetO*) or, more rarely, degradation by oxygen-using enzymes (*tetX*).

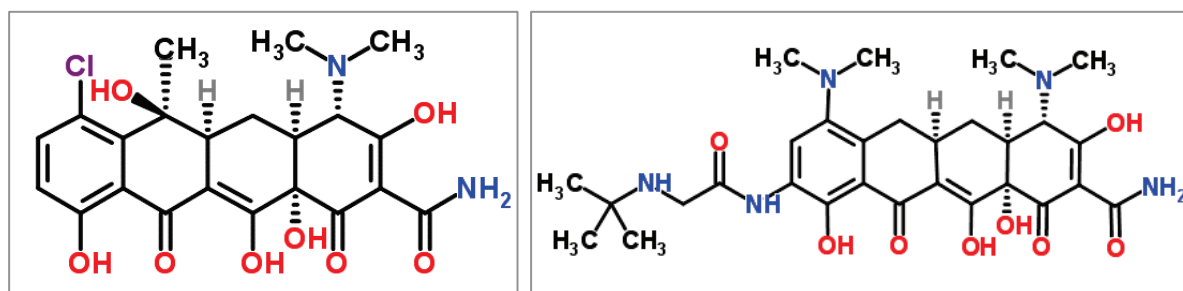

Fig. 45 Tetracyclines representatives: left, the original natural compound chlortetracycline.
Right, the recent hemisynthetic tigecycline

Oxazolidinones

Oxazolidinones are a family of synthetic antibiotic compounds discovered and reported by the American company DuPont in the late 1980s, although their activity may have been noted earlier, in the 1940s. Lead compounds had been discovered by screening and had limited activity at first, but as they were a totally novel class of antibacterial compounds, they were further studied by a company named Pharmacia in the 1990s and derived to obtain more potent agents. Linezolid (Fig. 46, left) was the first Oxazolidinone approved for human use in 2000, and has a remarkable efficiency against gram-positive bacteria, especially multidrug-resistant enterococci and staphylococci. New oxazolidinones are being developed, including the promising Tedizolid (Fig. 46, right) that has been approved in 2014 for skin infections. Oxazolidinones inhibit the very first steps of translation, binding the peptidyl-transferase center and perturbing the position of the Met-tRNA initiator in the P-site. Despite being recent and synthetic antibiotics, resistance to oxazolidinones has already emerged in clinical settings. It often occurs by modification of the 23S rRNA through methylation or mutation.

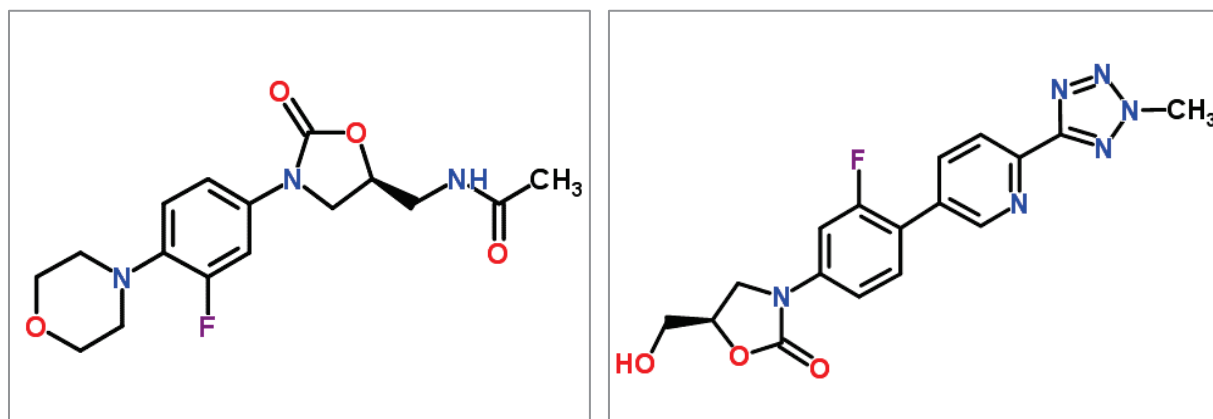

Fig. 46 Oxazolidinone representatives: left, linezolid; right, tedizolid.

Pyrazinamide

Pyrazinamide is a prodrug yielding an antibiotic efficient only against *Mycobacterium africanum* and *tuberculosis*. It was discovered in the 1950s by screening of synthetic compounds showing activity against the agent of TB, along with Isoniazid and Ethionamide. Like these two other anti-tuberculous drugs, pyrazinamide crosses the mycobacterial cell envelope and is modified by the enzyme pyrazinamidase into the active form, pyrazinoic acid. Pyrazinamidase is a nicotinamidase and pyrazinamide is a nicotinic acid derivative. Only *M. tuberculosis* and *M. africanum* recognize pyrazinamide as a substrate; *M. bovis* pyrazinamidase has a single-amino acid substitution that prevents its recognition and other bacterial pyrazinamidases don't recognize it as a substrate either. The target of pyrazinamide was elusive for a long time, in part because mutations yielding appear principally in the pyrazinamidase gene and not the target itself (Hirano *et al.*, 1997). The target had been falsely assumed at first to be the mycobacterial membrane (Zhang *et al.*, 2003). In fact, the active form targets the ribosomal protein RpsA and inhibits trans-translation, a mechanism that rescues stalled ribosomes that encountered a problem during translation (Shi *et al.*, 2011; Yang *et al.*, 2015). Pyrazinamide exhibits mostly bacteriostatic activity, but also bactericidal activity against dormant *M. tuberculosis*, a property essential for curing TB and avoiding relapses ((Hu *et al.*, 2006)). Resistance appears often by mutation in the gene coding for the pyrazinamidase, but also more rarely in the *rpsA* gene.

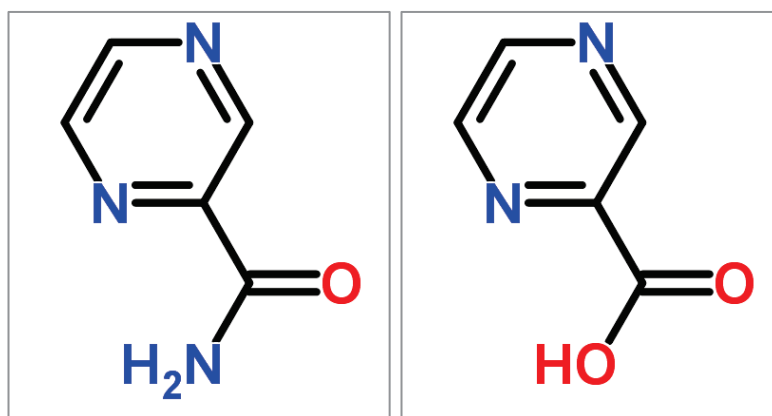

Fig. 47 The prodrug Pyrazinamide (left) and the active form pyrazoic acid (right)

The usefulness of pyrazinamide as an anti-TB drug is interesting, but is limited by the impossibility to use it against other bacterial species. The surprising discovery of trans-translation as the target of pyrazinamide shed light on this mechanism as a possibly ignored and interesting antibiotic target.

3. Trans-translation, a new antibiotic target

3.1. Normal translation mechanism in Prokaryotes

Before engaging in the details of how ribosomes often fail to properly perform translation and are rescued, it could be useful to quickly review our knowledge of the mechanism of translation in a normal translation reaction. In prokaryotes, translation is operated by a 70S ribosome, comprising a small (30S) and a large (50S) subunit. Transcription and translation occur concurrently in the cytoplasm; translation starts as soon as the 5' of the mRNA exits the RNA polymerase. Translation starts at a start codon and normally ends at a stop codon, both forming the limits of an open-reading frame. Several ribosomes are usually loaded onto a single transcript, forming polysomes. The mechanism of translation in prokaryotes is represented in Fig. 48 (Keiler, 2015).

Ribosomes recognize a signal in the 5' UTR (Untranslated Region) called the Shine-Dalgarno sequence, that differentiates the methionine start codons from non-start methionine inside gene sequences; this is particularly important for the correct translation of multicistronic mRNAs produced from operons. The recognition of the Shine-Dalgarno sequence by the 30S subunit and the recognition of the start codon by the initiator methionine-tRNA triggers the formation of a pre-initiation complex, operated by initiation factors IF1, 2 and 3. The initiation of translation starts with the binding of the 50S subunit to the pre-initiation complex and the release of the initiation factors. The ribosome possesses three empty sites that can receive tRNAs: A (for Aminoacyl-tRNA), P (for Peptidyl-tRNA), and E (Exit). The recognition of sense codons by their cognate tRNAs charged with the corresponding aminoacid occurs at the A site of the ribosome. The tRNA is pre-bound by EF-Tu, an elongation factor, that also binds a GTP molecule, forming the “ternary complex”. EF-Tu hydrolyses its GTP if the interaction between the A site codon of the transcript and the anticodon of the tRNA is correct. This induces a conformational change in EF-Tu that places its bound amino-acyl tRNA closer to the tRNA of the P-site and allows the ribosome to perform transpeptidation, i.e. the synthesis of a peptide bond between the nascent peptide chain and the amino-acyl-tRNA of the A site. After transpeptidation, the elongation factor EF-g, also a GTPase, induces the translocation of the tRNA into the P-site, shifting its previous occupant into the E site. This elongation continues until a stop codon is encountered.

When a stop codon enters the A site, release factors possessing a tripeptide with anticodon activity recognize the stop signal and induce the release of the newly synthesized protein. RF1 recognizes the termination codons UAA and UAG, while RF2 recognizes UAA and UGA. The release of the ribosomal subunits, of the mRNA, and of the tRNAs still bound to the E and P sites involves RF3, EF-g, and the Ribosome Release Factor (RRF). The ribosomal subunits are recycled for a new round of translation and the uncharged tRNAs receive new amino acids from their cognate aminoacyl tRNA synthetases. The ending of translation and the release of the ribosome therefore is an active mechanism.

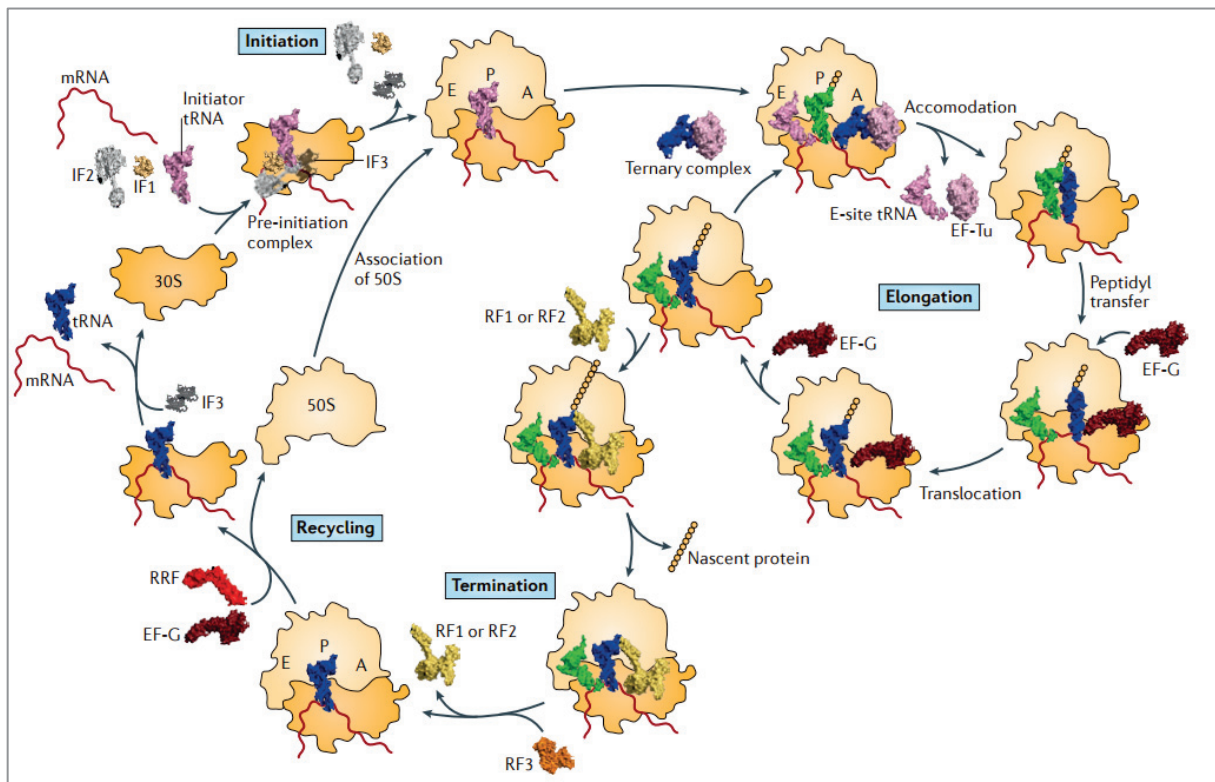

Fig. 48 Translation in prokaryotes. (Keiler, 2015)

3.2. Conditions inducing ribosomal stalling

As the ending of translation is an active mechanism that needs signals and correctly functioning mechanisms to be performed, a number of errors can occur and prevent the normal termination of the translation mechanism (Giudice and Gillet, 2013; Keiler, 2015). Ribosomes that are unable to further continue their round of translation and have to be rescued are called “stalled” ribosomes. Stalling is different from the common phenomenon of ribosome pausing, where resuming translation is possible. A stalled ribosome cannot escape its fate by itself and has to be rescued by external mechanisms.

First and foremost, a problem with the transcript can induce ribosome stalling. As transcription starts with the synthesis of the 5' end of the mRNA, and as both transcription and translation occur in the same cellular compartment, prokaryotic translation often starts before the end of the synthesis of the transcript. Therefore, there are no proofreading mechanisms to verify the integrity of the mRNAs before translation initiates. Transcription can be abruptly aborted, resulting in transcripts lacking a stop codon, or non-stop mRNA. Incorrect transcription of the stop codon can also occur, either by a transcription error, a mutation in the gene, or a frameshifting present in the coding sequence or induced during transcription. Despite not being shortened or aborted, in these situations, the “non-stop mRNA” induces stalling when its end is reached. Even if the transcript is correctly synthesized, it can be degraded by endo- and exonucleases during or before its translation, removing the stop codon. Among these nucleases are toxins from toxin/endotoxin systems such as RelE that specifically cleave mRNAs that are being translated (Pedersen *et al.*, 2003).

Some genes also encode stretches of amino acids (in particular polyproline stretches) that induce ribosome stalling. In this particular case, ribosome rescue occurs thanks to a newly discovered mechanism based on elongation factor P (EF-P) and not on the classical ribosome rescue factors described below (Ude *et al.*, 2013).

Interestingly, ribosome pausing can also induce stalling. Pausing is frequent in bacterial translation, the rate of synthesis of proteins varying wildly in function of the codon composition of the ORF. For example, stretches of rare codons provoke long pauses because their cognate tRNAs are too rare in the local pool of tRNAs (Li *et al.*, 2006). Moreover, some peptides, as soon as they start exiting the ribosomal tunnel, adopt a structure that blocks their own elongation; others interact with the ribosomal tunnel to induce such blocking (Tenson and Ehrenberg, 2002). The synthesis of these “regulatory nascent peptides” often requires other factors that interact with them to relax the interaction with the ribosome, and therefore regulates their expression. In their absence, the pause becomes a stalling event (Sunohara *et al.*, 2004).

Pauses of several seconds during normal translation events are not infrequent as translation does not occur at a steady rate because of the relative rarity of some tRNAs and the need to unfold secondary structures in mRNA (Li, 2015). It was recently discovered that extensive pauses, even on mRNAs with stop codons, can induce the cleavage of the mRNA immediately in 3' of the A site of

the ribosome, forming non-stop complexes and inducing stalling. Toxins such as RelE, were proposed as obviously responsible for this phenomenon (Christensen and Gerdes, 2003), until it was shown that cleavage still occurred in cells lacking any of those systems (Hayes and Sauer, 2003). Endonucleases and 3'-5' exonucleases normally can't reach the ribosomal A site and perform a cleavage at this position. It has been proposed that ribosome itself might have an endonucleolytic activity, but no evidence of it has been discovered yet.

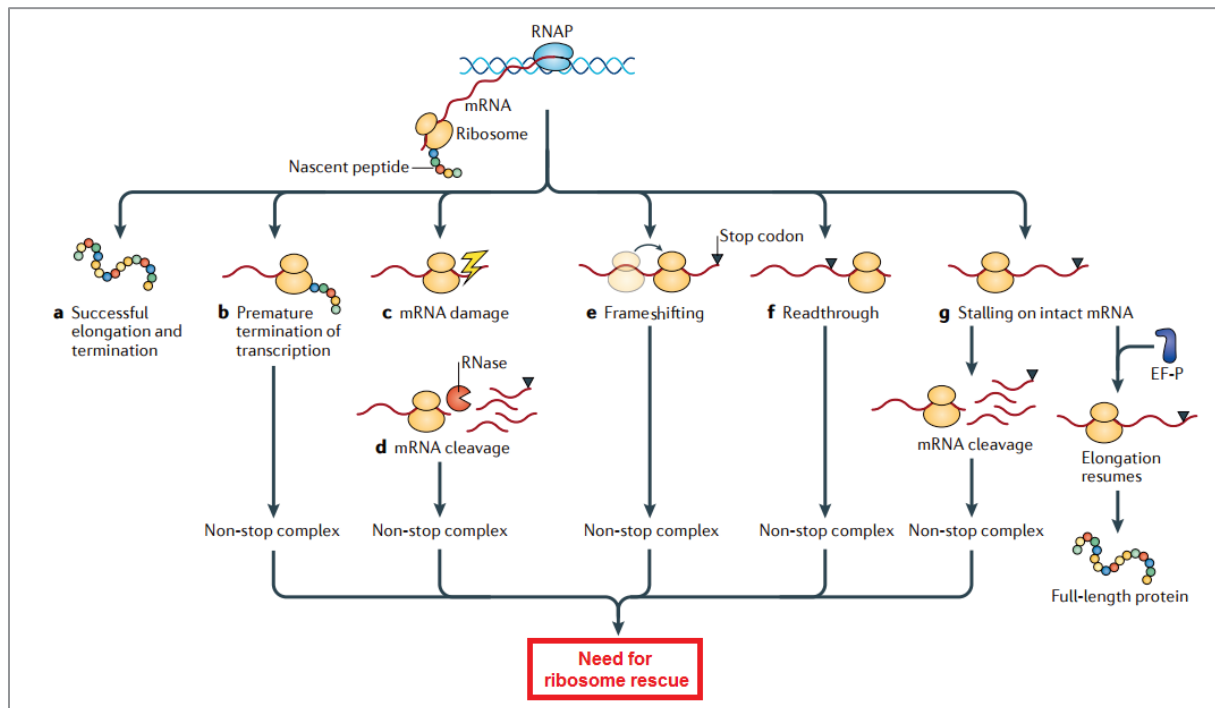

Fig. 49 Conditions triggering ribosome stalling and the need for ribosome rescue mechanisms. Adapted from Keiler, 2015.

Ribosome stalling is problematic for bacteria because even if a single ribosome encounters an error and stalls, it prevents all the other following ribosomes loaded onto the same polysome from reaching the stop codon, and thus it induces a traffic jam. If such errors accumulate at a faster rate than the cell can resolve them, the global translation rate will decrease until it finally stops, inducing bacteriostasis in a similar way as the translation inhibiting antibiotics previously described. Bacteria have evolved means to resolve ribosome stalling, the most common and efficient being trans-translation.

3.3. Discovery of trans-translation: what is that band on the gel?

10Sa RNA, a bifunctional transfer- and messenger RNA

In 1978 it was found that *E. coli* produced a number of small stable RNAs of unknown function, in addition to the already-known transfer and ribosomal RNAs (Lee *et al.*, 1978). One

of them had a Svedberg sedimentation coefficient of 10 and was therefore named 10S RNA (Ray and Apirion, 1979). Soon later, this 10S band was found to actually contain two structurally different small RNAs, that were renamed 10Sa and 10Sb RNAs (Jain *et al.*, 1982). 10Sb RNA was identified as the RNA component of a ribozyme complex with ribonuclease activity, RNase P. 10Sa RNA, synthesized at roughly 10% of ribosomal RNA levels was expected to play an important role in the physiology of the cell. Yet, its function remained elusive.

In 1989, a unique locus coding for 10Sa RNA was identified and cloned in plasmids, showing that a 457-nt precursor RNA was synthesized by that gene and processed into a shorter, 363-nt molecule (Subbarao and Apirion, 1989). The gene was sequenced (Chauhan and Apirion, 1989) and found to be monocistronic and to possess a fragmentary open-reading frame deprived of a start codon and potentially encoding a 10-aminoacid peptide of sequence ANDENYALAA. The position of the gene in the genome of *E. coli* was also identified (Oh *et al.*, 1990). The gene was named *ssrA*, for small stable RNA. The possibility that the gene was really encoding the peptide was not considered at that time because of the lack of start codon and because the RNA was not associated with ribosomes in normal conditions. Deletion of the gene was possible and led to mild phenotypes such as a slightly slower growth and disruption of the regulation of lytic phages (Oh and Apirion, 1991). However, the function of 10Sa RNA was still unknown.

A few years later, two essential discoveries were made that hinted at the role of 10Sa RNA. First, it was found to contain a tRNA-like structure, that could be aminoacylated with an Alanine (Komine *et al.*, 1994). Second, it was fortuitously observed that when the eukaryotic gene coding for murine interleukine-6 was cloned and overexpressed in *E. coli*, a small population of proteins were truncated and exhibited at their C-terminal end the decapeptide encoded in the 10Sa RNA pseudo-ORF (Tu *et al.*, 1995). In an *ssrA* deletion mutant, truncated proteins were still produced but they were deprived from such modifications, confirming that this gene was at the origin of this C-terminal tag. No chimeric IL6-10Sa-tag transcripts were observable, so this phenomenon was probably not due to a genetic recombination or transcripts splicing. However, as previous observations had shown no interaction between the ribosome and the 10Sa RNA (Ray and Apirion, 1979), the authors concluded that it probably could not act as a mRNA template by itself and that chimeric IL6-10Sa-tag mRNA could exist but not be detectable. This conclusion turned out to be

wrong. Indeed, a few years later, maybe encouraged by their intriguing results, interaction between ribosomes and 10Sa RNA was reassessed and proven (Komine *et al.*, 1996; Tadaki *et al.*, 1996).

In 1996, in Bob Sauer's lab, Kenneth Keiler, who had been working on hydrophobic tags that mark proteins for degradation (1729701), noticed that the C-terminal extremity of this mysterious 10Sa decapeptide exhibited similar hydrophobic properties to the tags he had been studying. He stitched together the previous observations on 10Sa RNA and suggested that it may act as a new mRNA template that adds a degradation tag to the end of proteins whose RNA templates lack stop codons. His paper established the first model of the mechanism (Keiler *et al.*, 1996). They first showed that adding the coding sequence for the tag to the end of a gene led to a reduced half-life for its cognate protein, which was not the case with a modified, less hydrophobic tag. He then postulated that the subpopulation of tagged proteins observed in overexpression conditions had been tagged because they were incomplete, which could happen if their template had been degraded and lacked a stop codon. While he did not observe whether the proteins translated from non-stop mRNA were tagged, they verified that the expression of genes lacking a stop codon led to their degradation in an *ssrA*-dependent manner.

Based on these results, and the previous observations that 10Sa RNA was a tRNA-like molecule that could be alanine-charged and that encoded a tag peptide, they proposed a model for an *ssrA*-based peptide tagging system used for the quality control and degradation of proteins synthesized from damaged, stop-codon lacking messenger RNAs (Fig. 50). In this model, 10Sa RNA recognizes a ribosome blocked on a non-stop mRNA and gets loaded into it at the A site because of its alanine-tRNA-like structure; the ribosome translates the open-reading frame of 10Sa RNA, which codes for the decapeptide tag; this tag is added to the end of the unfinished protein; translation ends on 10Sa RNA stop codon; the released polypeptide is then degraded by proteases that recognize this tag.

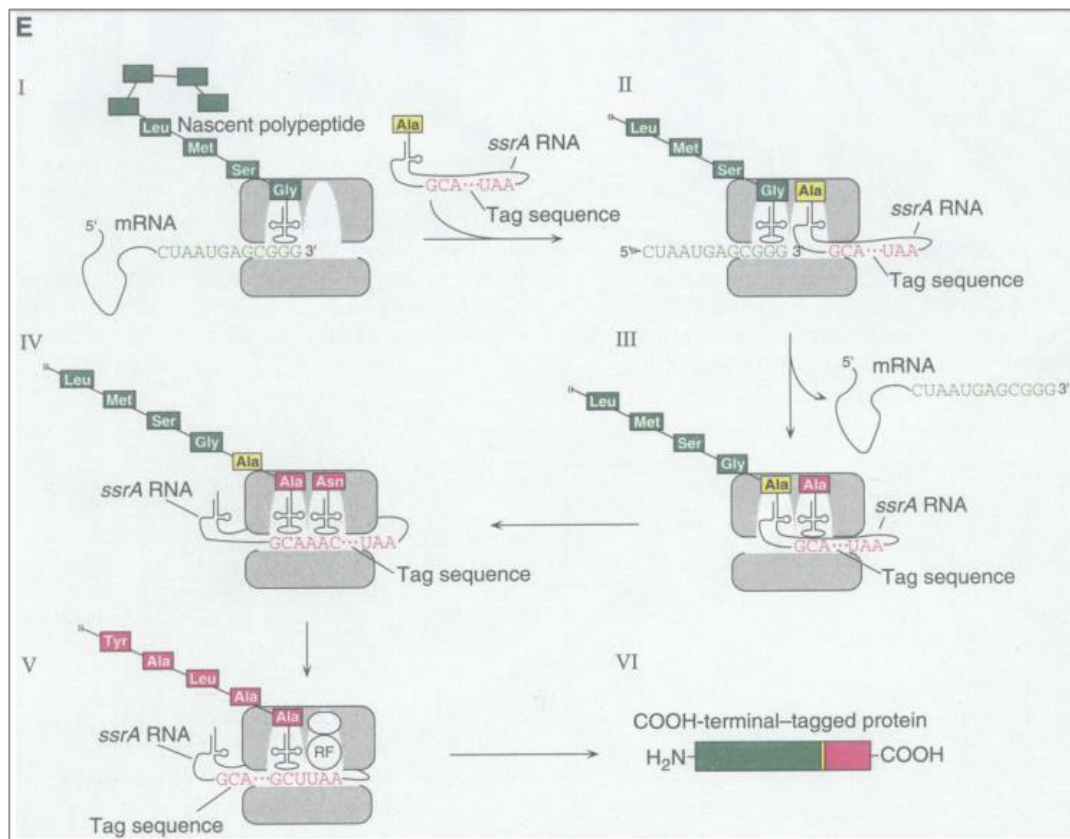

Fig. 50 The first model for 10Sa RNA/tmRNA tagging activity, in response to translation of damaged mRNAs. (Keiler *et al.* 1996)

In a comment on Keiler's paper (Atkins and Gesteland, 1996), John Atkins and Raymond Gesteland, two specialists of recoding (events in which the linear readout of the genetic code is not respected), suggested to rename 10Sa RNA to tmRNA, for transfer- and messenger-RNA. In this publication, they also proposed to name the mechanism "trans-translation", to describe the fact that the template used by the ribosome switches from mRNA to tmRNA and that translation resumes in *trans*, on the tmRNA ORF. Keiler's results and hypothesis were strengthened by a paper the same year (Muto *et al.*, 1996) that showed a direct observation of the tagging of proteins translated from non-stop mRNAs.

SmpB, tmRNA's helpful neighbor

In 1991, the genetic environment of the *ssrA* gene in *E. coli* had been found to contain two small ORFs coding for proteins of unknown functions that were named *smpA* and *smpB* (for small protein A and B) (Miczak *et al.*, 1991). SmpA was later found to be involved in the outer membrane protein assembly complex and not trans-translation, and renamed BamE. However, the *smpB* gene was found to be neighboring *ssrA* in *M. tuberculosis* as well (Dong *et al.*, 2002), a hint that the two genes may be involved in the same process. Once the function of tmRNA was discovered, the

possible role of SmpB in trans-translation was explored. The 1991 paper (Miczak *et al.*, 1991) hypothesized that SmpB could be a nucleic acid-binding protein as its small size was similar to other proteins of such function. This was verified in a paper published by Bob Sauer's lab that showed that SmpB did not only bind tmRNA with a high affinity and specificity, but it was also essential for trans-translation activity (Karzai *et al.*, 1999). It was shown to not be involved in tmRNA Alanine acetylation, but essential for the first steps of the reaction that lead to transpeptidation of the nascent peptidic chain onto the Ala-tmRNA. SmpB therefore was correctly assumed to be part of a nucleoproteic complex along with tmRNA, and to have critical activity for its recognition and loading onto blocked ribosomes.

These initial discoveries shaped our basic knowledge of trans-translation. More recent work has unearthed the characteristics of the components involved in this mechanism and refined our knowledge of its inner workings.

3.4. Components involved in trans-translation

tmRNA, the transfer- and messenger-RNA

Most of the knowledge on trans-translation has been developed by studying the mechanism in the *E. coli* model organism. In particular, structure and function of tmRNA has been decrypted in this species, and the secondary structures for other species have been deduced from the structure discovered for *E. coli* tmRNA. This structure has been explored at first by comparing the sequence of the *ssrA* gene in several species (Williams and Bartel, 1996) that suggested that tmRNA is a highly structured circular molecule with pseudoknots and helix regions that are highly conserved amongst bacteria (Fig. 51).

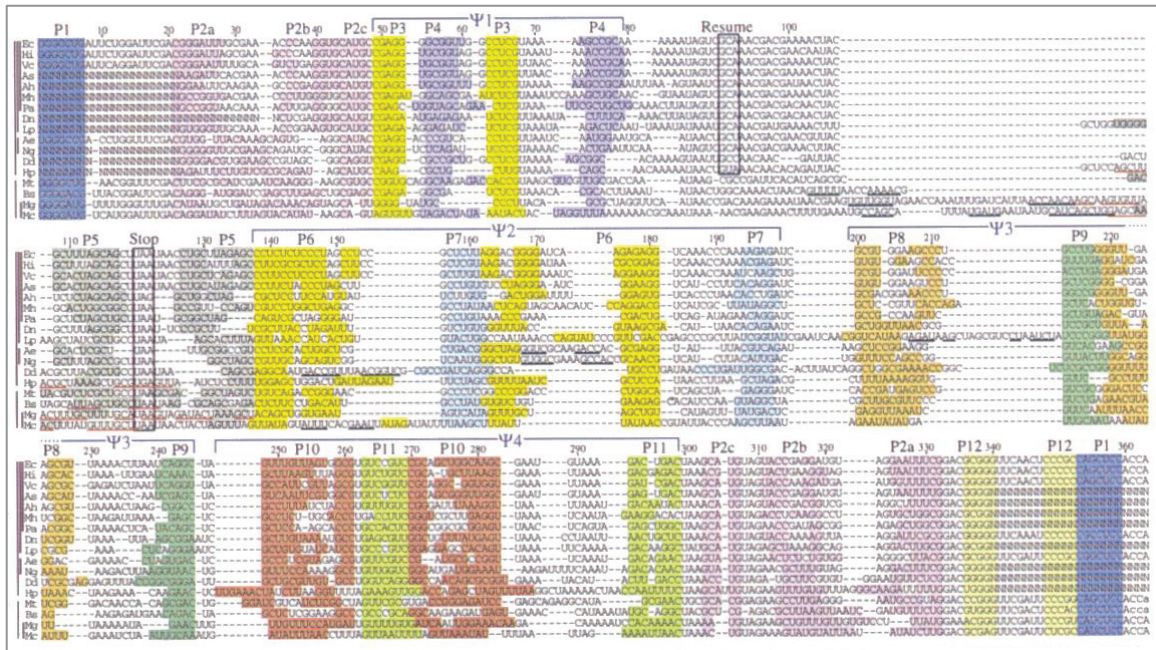

Fig. 51 Alignment of *ssaA* gene sequences show highly conserved sequences amongst different bacterial phyla. From top to bottom: *Ec* Escherichia coli; *Hi* Haemophilus influenzae; *Vc*, Vibrio cholerae; *As*, Aeromonas salmonicida; *Ab*, Alteromonas haloplanktis; *Mh*, Marinobacter hydrocarbonoclasticus; *Pa*, Pseudomonas aeruginosa; *Dn*, Dichelobacter nodosus; *Lp*, Legionella pneumophila; *Ae* Alcaligenes eutrophus; *Ng*, Neisseria gonorrhoeae; *Dd*, Desulfotribrio desulfuricans; *Hp*, Helicobacter pylori; *Mt*, Mycobacterium tuberculosis; *Bs*, Bacillus subtilis; *Mg*, Mycoplasma genitalium; *Mc*, Mycoplasma capricolum. (Williams and Bartel, 1996)

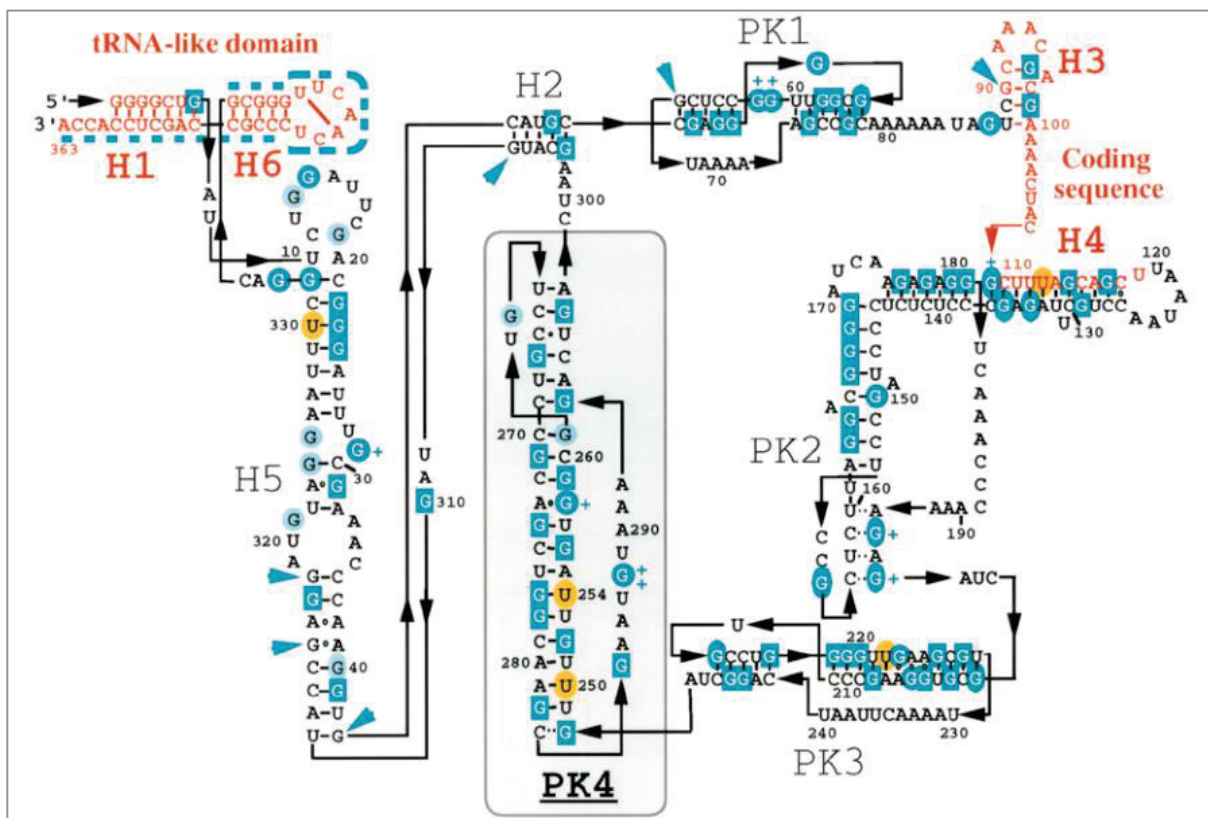

Fig. 52 Refined structure of *tmRNA* from *E. coli*, obtained from a biochemical approach. H1 to H4 : helices. PK1 to PK4: pseudoknots. In blue and yellow, guanine and uridine residues that interacted with the probe used in the study (a nickel-containing macrocycle). (Hickerson et al., 1998)

With the help of these predictions, the structure was then resolved through biochemical approaches, by nuclease and chemical probing in *E. coli* (Felden *et al.*, 1996). This allowed to grasp a better and tangible understanding of the complex organization of the tmRNA molecule. Some minor differences were found between the two approaches and suggest that the tmRNA molecule probably possesses different folded states, and varies from one to another to accommodate its insertion and movement inside the ribosome (Felden *et al.*, 1997). Later, new probing techniques helped to refine the structure, that is presented in Fig. 52 (Hickerson *et al.*, 1998), Fig. 53 (Withey and Friedman, 2003) and Fig. 54 (Giudice *et al.*, 2014) . The secondary structure includes 4 pseudoknots (noted PK1 to 4), 6 helices (noted H1 to 6) and a tRNA-like domain containing an alanine acceptor arm and a TΨC arm. The open-reading frame, or coding sequence, starts with a resume codon and ends with a stop codon. A G-U base pair in the tRNA-like domain is essential for amino-acetylation. An alanine residue upstream of the ORF is essential for trans-translation activity and is highly conserved.

As previously said, *ssrA* encodes a 457-nt precursor ((Subbarao and Apirion, 1989)). This precursor has to be processed into the mature 363-nt tmRNA molecule by various exonucleases and endonucleases, including RNase R (Cairrão *et al.*, 2003), RNase E (Subbarao and Apirion, 1989), RNases T and PH (Li *et al.*, 1998) and RNase III (Srivastava *et al.*, 1990). Moreover, modifications of the nucleotides of the TΨC arm are necessary for the alanine-aminoacetylation of tmRNA. These modifications are identical to these in found in tRNAs: 5-methyluridine and pseudouridine (Felden *et al.*, 1998). Acetylation is operated by the same alanyl tRNA synthetase as the Alanine-tRNA. In large part due to this secondary structure, the final molecule is very stable, with a half-life of 89 minutes in WT *E. coli* cells in log phase (Keiler and Shapiro, 2003b).

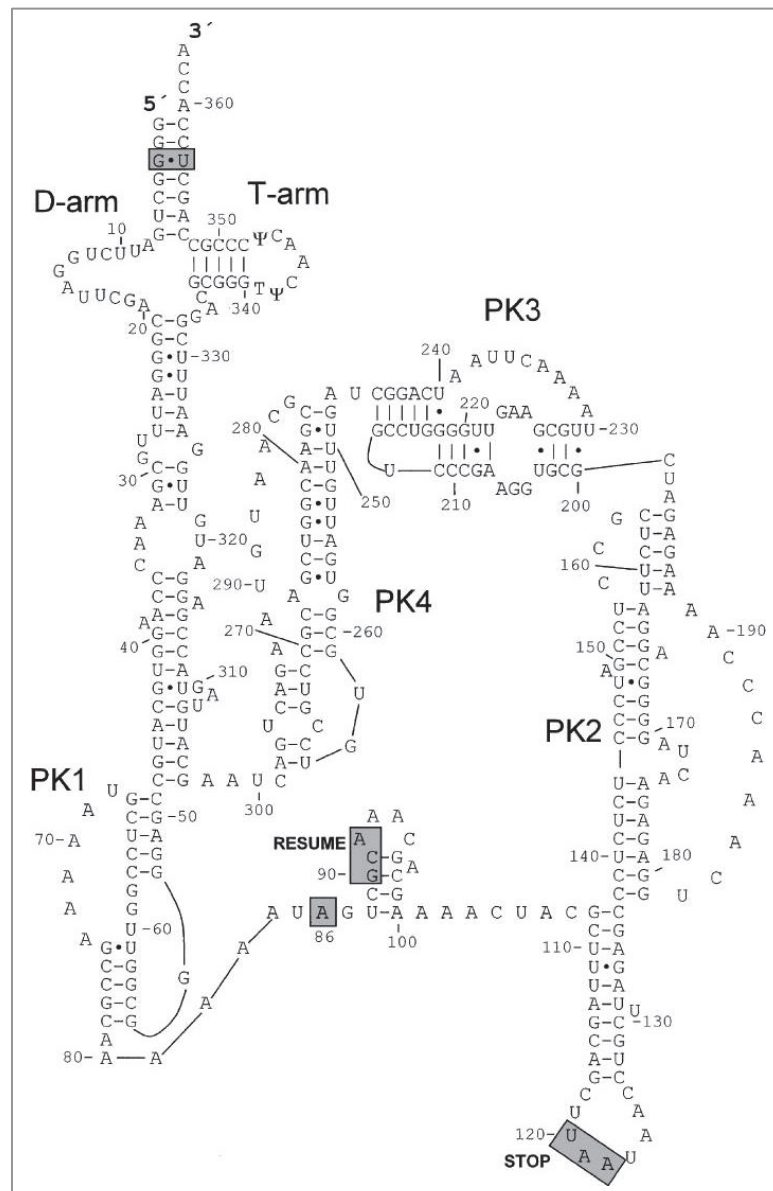
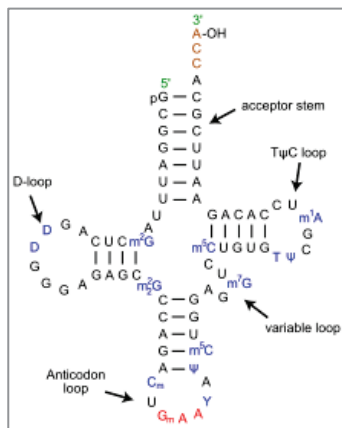

Fig. 53 Consensus secondary structure of *E. coli* tmRNA. “The structure consists of a tRNA-like domain, which encompasses nt 1–27 and 326–363 and contains the D- and T-arms, a helical spacer, which encompasses nt 28–48 and 303–325, and a domain containing the mRNA-like sequence of tmRNA, which encompasses nt 49–302 that includes four pseudoknots (PK1–4). The sequence encoding the tag peptide is from nt 90 to nt 122. Some of the important features of the sequence are boxed in gray. These include the resume (nt 90–92) and stop (nt 120–122) codons in the mRNA-like sequence, nt 86, which is universally conserved and essential for trans-translation, and G3-U357, the base pair required for aminoacylation”. (Withey and Friedman, 2003)
 In the upper left corner a tRNA molecule is represented for comparison.

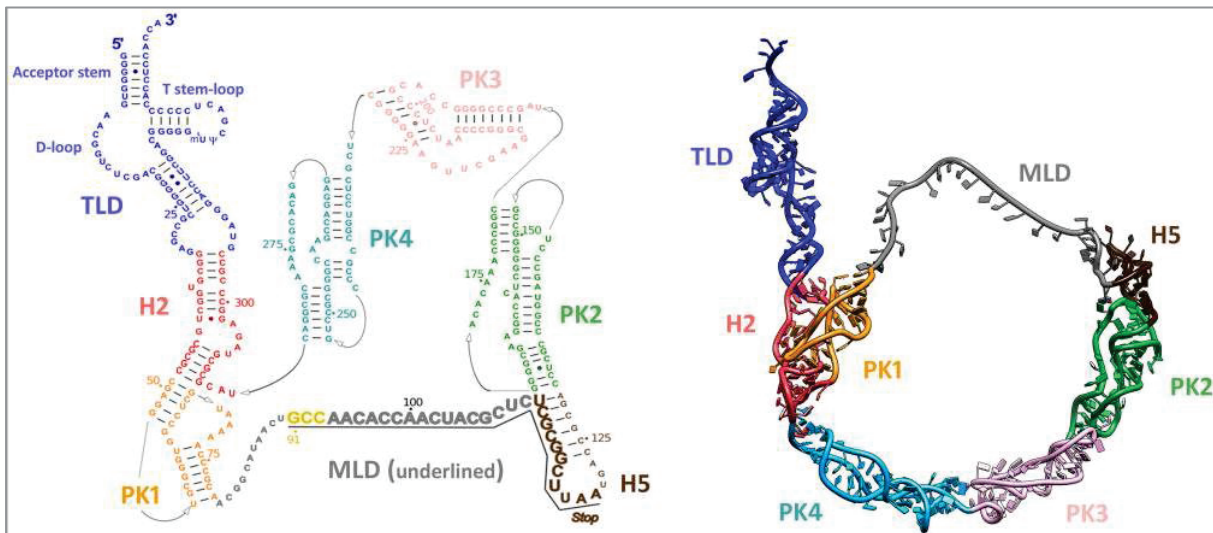

Fig. 54 *Thermus thermophilus tmRNA* predicted secondary structure (left) and 3D molecular model based on the prediction and on cryo-EM data (right). Giudice et al., 2014

Conservation of the *ssrA* gene among the bacterial world is extremely high (Fig. 51). This suggests that the structure of tmRNA is highly important for its function and that the mechanism of trans-translation already existed in the common ancestor of bacteria. Residues that contribute to the secondary structure are particularly conserved and important for function and interaction with the partners of tmRNA, SmpB and the ribosome. On the other hand, the sequence that encodes the degradation tag, in particular in its central part, is less conserved (Fig. 55) (Moore and Sauer, 2007). As the set of proteases that digest tagged proteins is not very conserved in different bacterial species either, the tag-encoding ORF may have evolved in each species to accommodate the loss, acquisition and changes in specificity of this set of enzymes. The length of the tag ranges from 8 to 35 aa, with an average of 10 aa. The amino acid composition of the tag is also extremely skewed towards small residues such as Asn or Ala (Fig. 55). Concurrently, complex and oxidation-sensitive residues such as Trp and Cys are rarely found, probably to preserve a high tagging efficiency in starvation and stressful conditions that could increase the need for trans-translation activity.

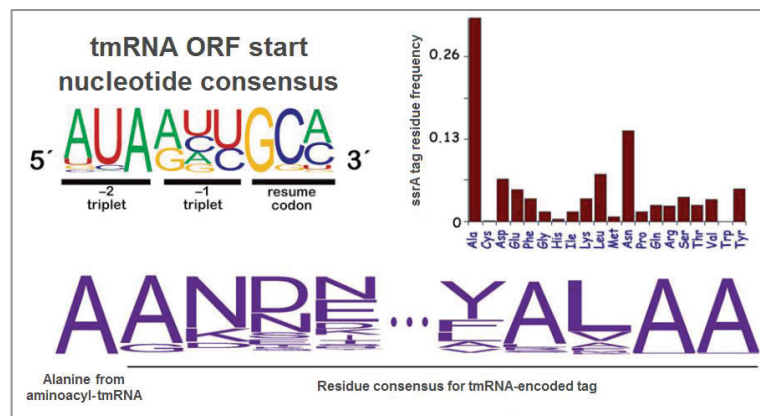

Fig. 55 Consensus sequence for the resume codon and the two preceding codons (upper left), relative abundance of amino acid residues encoded in the *tmRNA* ORF (upper right), and consensus protein sequence of the beginning and the end of the *tmRNA*-encoded tag (bottom). 17291191

The *ssrA* gene is ubiquitous in prokaryotes. It has been found in all but one sequenced genomes of Eubacteria, and in a significant number of plastids (chloroplasts, chromoplasts) and insect endosymbionts ((Hudson *et al.*, 2014)). It is not found in the genome of mitochondria except in a few jakobids and oomycetes, and has therefore been probably lost shortly after the symbiogenesis event that led to the emergence of Eukaryota. A program named ARAGORN has been developed to search for tmRNA sequences in sequenced genomes of prokaryotes, and a dedicated website that indexes all known tmRNA sequences is available and has been regularly updated since 2000 (hosted at the Sandia National Laboratories as of 2016 - <http://bioinformatics.sandia.gov/tmrna/>) (Fig. 56) (Williams, 2000; Gueneau de Novoa and Williams, 2004; Hudson *et al.*, 2014; Hudson and Williams, 2015).

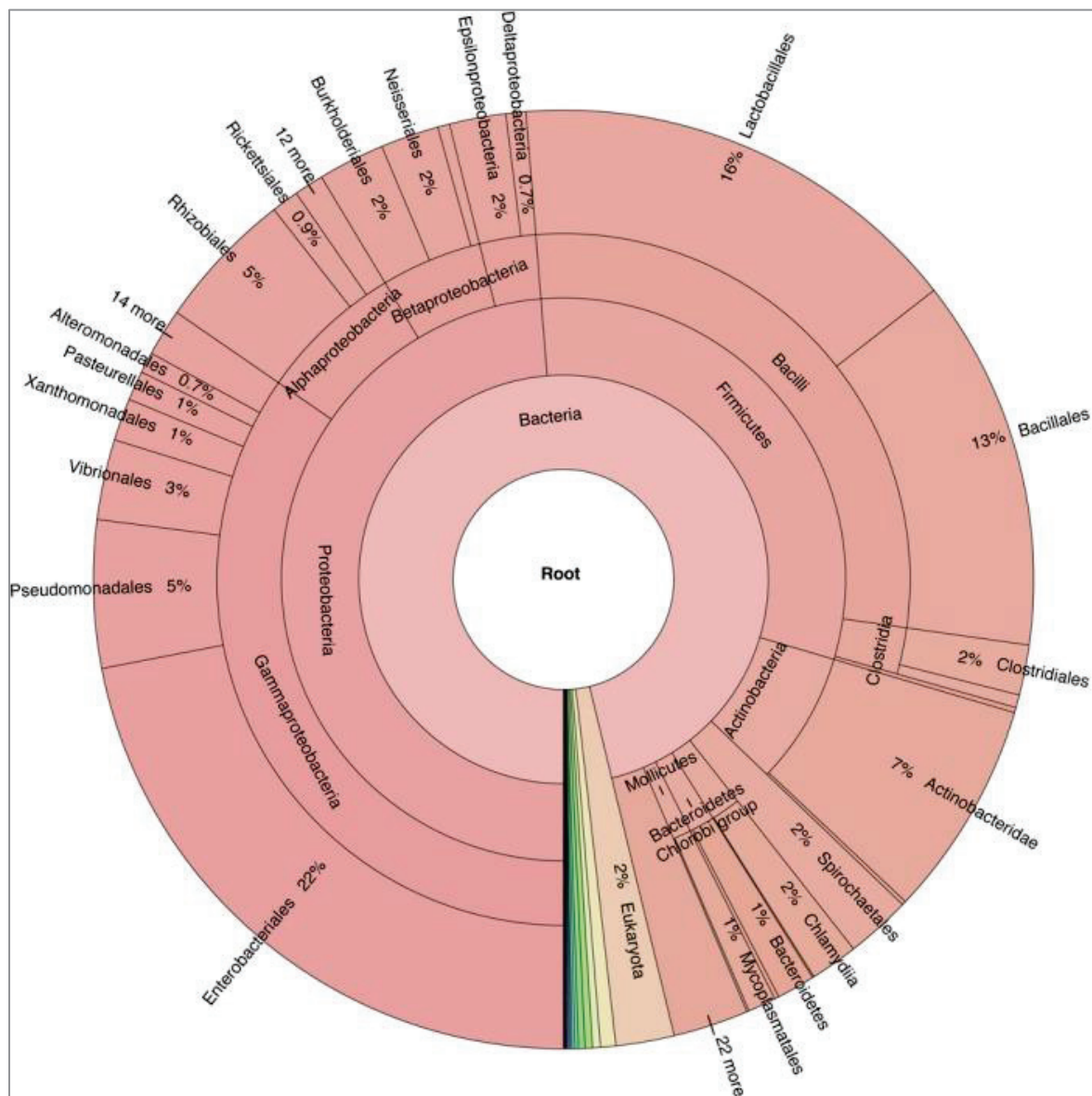

Fig. 56 tmRNA sequences available on the tmRNA website as of 2014, ordered by phylogeny. (Hudson *et al.* 2014)

SmpB, the wingman of tmRNA

SmpB is a protein essential to trans-translation activity. Deletion of *smpB* led to the same phenotype as an *ssrA* deletion in *E. coli* (Karzai *et al.*, 1999), *Caulobacter crescentus* (Keiler and Shapiro, 2003a) and *B. subtilis* (Wiegert and Schumann, 2001). This deletion also prevents binding of tmRNA to 70S ribosomes (Karzai *et al.*, 1999). SmpB presence does not influence tmRNA stability in vitro, but it prevents its degradation by nucleases in vivo (Hanawa-Suetsugu *et al.*, 2002; Hallier *et al.*, 2004). SmpB also improves the alanine charging of tmRNA and seems to be essential in particular to help tmRNA to bind the A site of the ribosome (Shimizu and Ueda, 2002).

As previously said, the role of *smpB* in trans-translation had been discovered because of the observation that it neighbored *ssrA* in both of the non-related species *E. coli* and *M. tuberculosis*. This suggests that this genetic organization, and the SmpB-tmRNA complex itself are probably ancestral in bacteria. However, even when they are neighbors, *ssrA* and *smpB* can either be transcribed as an operon or independently (Shin and Price, 2007) and this close disposition is not retrieved in all bacterial species (Fig. 59). For example, in *Legionella pneumophila*, *ssrA* and *smpB* are located far apart (distance: 375kb, on a 3.5Mb genome). Indeed, they are positioned at a relatively similar distance to the origin of replication of the chromosome, but in opposite directions (distance to origin: *ssrA* +182kb and *smpB* -193kb, cf. Fig. 60). The distance of a gene to the origin influences its level of expression because of a dose effect due to the partial meridioidy induced by replication in exponentially-growing bacteria. As tmRNA-SmpB form a 1:1 complex, an organization where the two genes are at the same distance to the origin is not surprising. rDNA and tDNA genes are also often found near the origin, as this induces a needed increase in their expression levels during exponential growth.

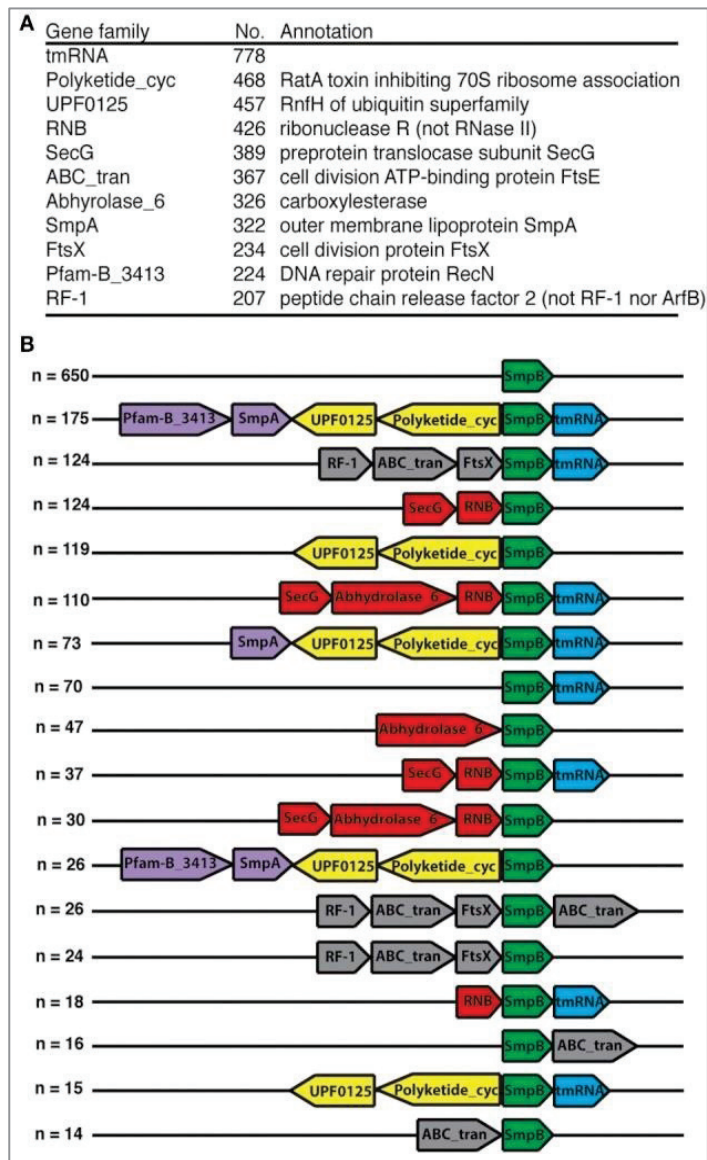

Fig. 59 *smpB* gene neighborhood in a set of bacterial species ($n=2012$).
 (A) Most frequent neighbouring genes. (B) Most frequent clusters of neighboring genes.

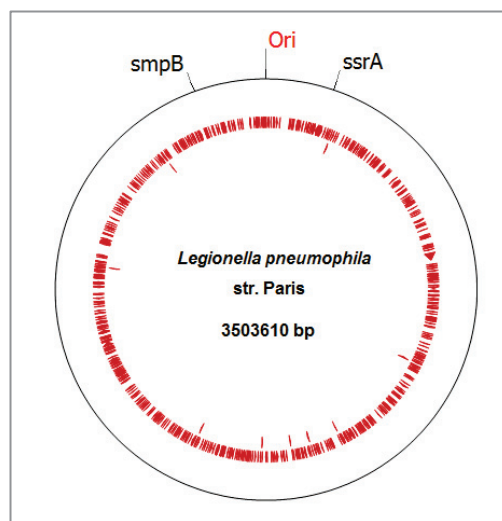

Fig. 60 Position of *smpB* and *ssrA* in *Legionella pneumophila* str. Paris genome. This organization is similar in other *Legionella pneumophila* strains as well as close species such as *Legionella longbeachae*.

SmpB, as its nomenclature indicates, is a small protein (160 aa in *E. coli*, 156 aa in *B. subtilis*, both 18 kDa). SmpB binds tmRNA after its amino acetylation and forms a nucleoprotein complex before being loaded on the ribosome. The protein has three identified binding sites located at the tRNA-like domain and several SmpB molecules can bind a single tmRNA (Wower *et al.*, 2002). However, it has been demonstrated that it has a single preferential binding site at the D-arm (see Fig. 53), and that only a single SmpB was present in the complex at several steps of trans-translation, forming a 1:1:1 stoichiometry with ribosomes and tmRNA (Bugaeva *et al.*, 2008). As such, it has been speculated that SmpB filled the role of the D-loop (anticodon arm) that is missing in the tRNA-like domain tmRNA, compared to the normal structure of a tRNA. This was corroborated by structural data of the tmRNA-SmpB complex obtained by crystallography (Dong *et al.*, 2002; Gutmann *et al.*, 2003) and cryo-EM (Giudice *et al.*, 2014) (Fig. 62 and Fig. 61).

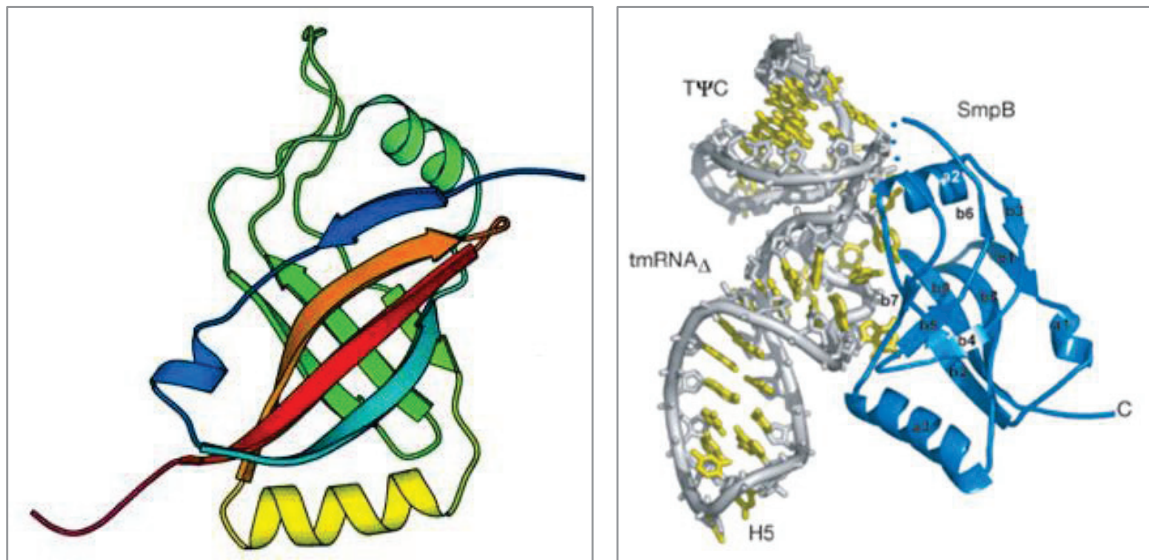

Fig. 62 Structures of SmpB in solution (left) and of the complex formed by SmpB and the TLD of tmRNA (right), both obtained by crystallography. (Dong *et al.*, 2002; Gutmann *et al.*, 2003)

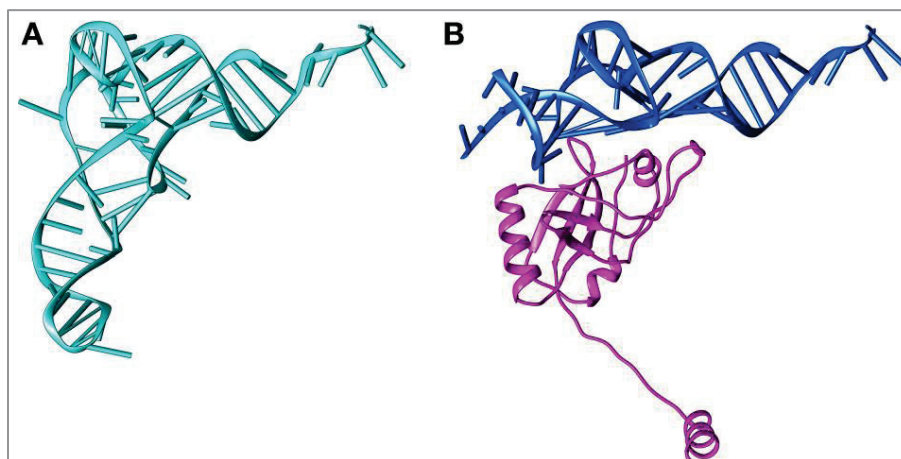

Fig. 61 Comparison of the structure of a tRNA (left) and the structure of the complex formed by SmpB and the tRNA-like domain of tmRNA obtained by cryo-EM studies. (Giudice *et al.*, 2014)

The structure of SmpB contains a main body, made of an oligonucleotide-binding fold comprising a central beta-barrel flanked by three alpha helices, and a long C-terminal tail (Fig. 62). The interaction between SmpB and tmRNA involves the D-arm of tmRNA and a small bulge flanking the T-arm (GAC, nt 333-335 in *E. coli*, cf. Fig. 53), and highly conserved amino acids at the surface of the main body of SmpB including Glu-31, Leu-91, and Lys-124 (Dulebohn *et al.*, 2006). The long (~20 aa) and protruding C-terminal tail of SmpB had been proved to be essential for trans-translation activity (Jacob *et al.*, 2005), but its exact function escaped understanding when the first structural data were obtained. The tail does not interact with tmRNA and was totally unfolded in structures obtained by crystallography, either alone or in complex with the tmRNA-like domain (Fig. 62). A mutant with truncated C-tail can still bind tmRNA and the ribosome but lacks tagging activity (Jacob *et al.*, 2005). Cryo-EM and crystallography of the trans-translation complex inside the ribosome later showed that the extremity of the tail folds into a helix only when tmRNA-SmpB binds the ribosome (see Fig. 61 and Fig. 63). This tail recognizes and fits into the empty mRNA conduit left open in ribosomes translating truncated non-stop mRNAs (Fig. 63). Unlike tmRNA that cannot recognize and bind ribosomes in absence of SmpB, the protein can bind ribosomes alone if they both exhibit an empty A site and a mRNA conduit empty in 3' of the P site (15069072). This allows a specific recognition of stalled ribosomes in need of ribosome rescue and a correct accommodation of tmRNA near the decoding center for translation of its ORF (PMC3895274). It is the recognition of such stalled ribosomes by SmpB that triggers trans-translation (15069072).

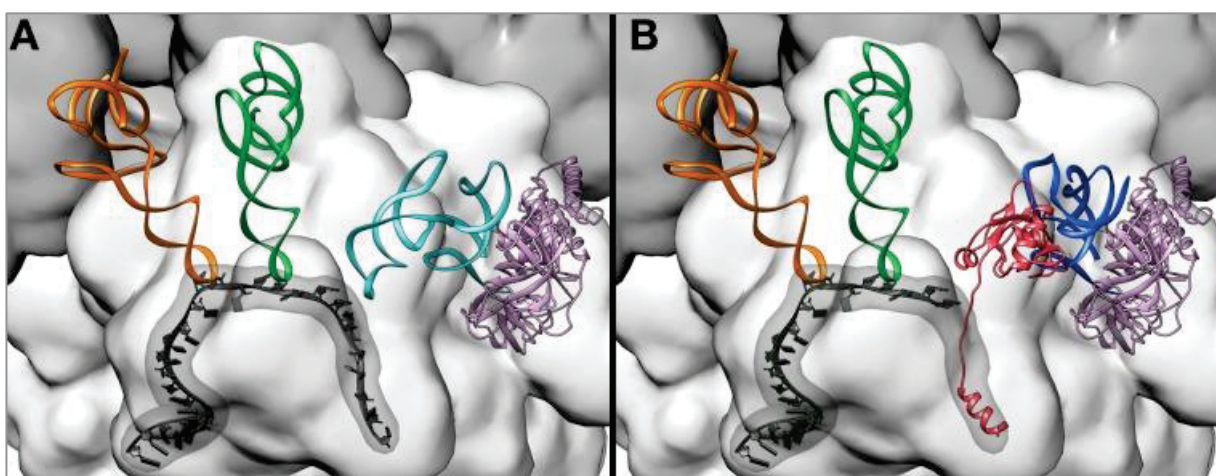

Fig. 63 Accommodation of a tRNA (left) and of tmRNA-SmpB (right) in the ribosome. In orange and green are tRNA in the E and P sites, respectively. In cyan is a tRNA in the A site (left only). In red is SmpB with its C-tail in the mRNA conduit, and in blue is tmRNA (right only). The purple protein is the elongation factor EF-Tu whose role is described below. (Giudice *et al.*, 2014)

If the ribosome is pausing on an intact mRNA with a length >15nt after the P site, tmRNA-SmpB can be loaded into the A site, but interaction is weak because the C-tail cannot enter the conduit and the complex gets rejected before transpeptidation, in a similar way as near-cognate tRNAs (25246654). Interestingly, trans-translation can be triggered on a ribosome with a non-empty mRNA conduit, with an efficiency that decreases with the length of the strand downstream of the P site (15050821). If the ribosome is stalled, but the mRNA conduit is occupied by an mRNA sequence that is less than 15nt long downstream from the P site, the C-tail of SmpB can dislodge this short strand and trans-translation can still occur (16204455). This 15nt length corresponds to the size of the mRNA path between the P site and the outside of the ribosome. This means that trans-translation can occur on any stalled ribosome with a mRNA strand not protruding from the ribosome, as can be formed when endonucleases and toxins degrade the 3' part of the mRNA not protected by the ribosome (*cf.* Fig. 49, p.101).

EF-Tu, Elongation Factor Tu

As previously mentioned, EF-Tu is a GTPase that binds charged tRNAs and that favors transpeptidation when the codon-anticodon binding is correct. EF-Tu was found to also interact with the acceptor arm of Alanine-charged tmRNA (Rudinger-Thirion *et al.*, 1999; Barends *et al.*, 2001), with a binding affinity similar to tRNAs (Barends *et al.*, 2000; Shimizu and Ueda, 2006). Together with SmpB, they form a complex that gets loaded onto the A site of stalled ribosomes (Fig. 63 and Fig. 64) (Valle *et al.*, 2003; Neubauer *et al.*, 2012). It performs the same action on tmRNA than on tRNAs, pushing it near the transpeptidase center and allowing the formation of a peptide bond between the alanine of tmRNA and the stalled peptide. With tRNAs, the activity of EF-Tu is triggered by the stability induced by the recognition of the stop codon. In the case of SmpB, this stabilization is caused by the recognition of stalling by the C-tail of SmpB (Shimizu and Ueda, 2006).

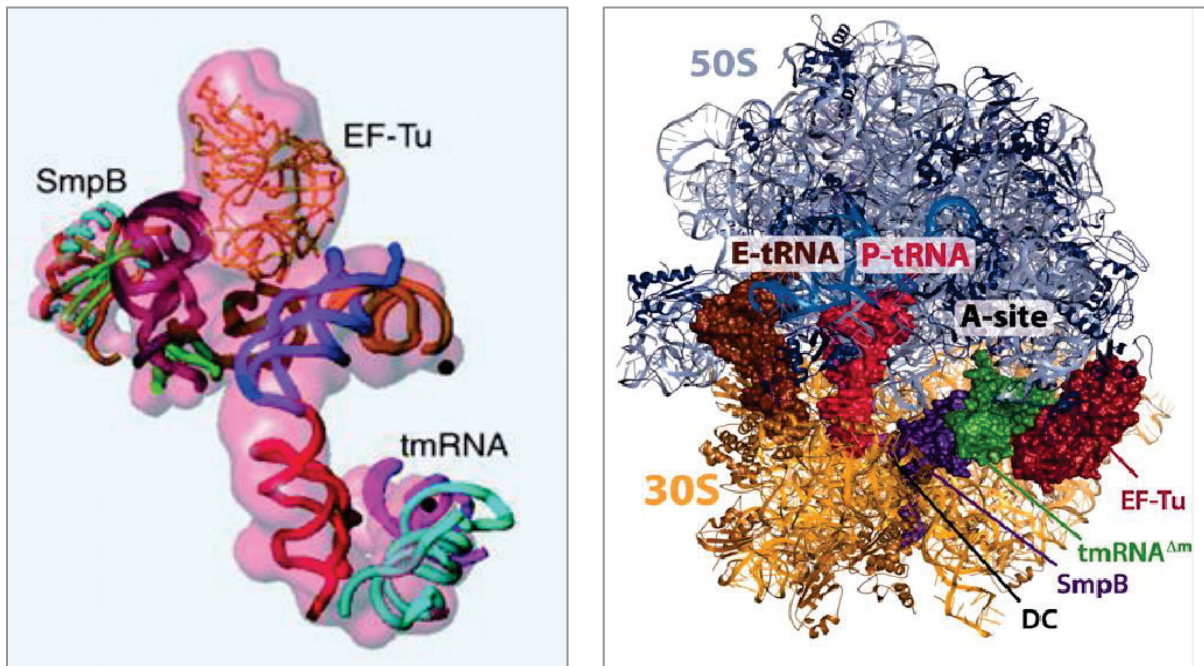

Fig. 64 The complex formed by EF-Tu, SmpB and tmRNA and the same complex loaded into the A site of the ribosome, both images obtained by crystallography (Valle *et al.*, 2003; Neubauer *et al.*, 2012)

Ribosomal protein S1

S1 is the largest and longest ribosomal protein. It is encoded by the *rpsA* gene and interacts with the 30S subunit. It is essential for the translation of most mRNAs (Sørensen *et al.*, 1998), where its function is to unwind the secondary structures for proper decoding of the transcript.

S1 had been found along with tmRNA, SmpB, EF-Tu, and RNase R in early co-immunoprecipitation studies (Karzai and Sauer, 2001). It binds tmRNA with an impressive 600-fold superior affinity compared to alanine-tRNAs, and can even form complexes with free tmRNA and facilitate its binding to ribosomes (Wower *et al.*, 2000). Unlike all these other components that interact with the tRNA-like domain of tmRNA, ribosomal protein S1 interacts with its pseudoknot ring, in particular PK2, inducing notable changes in conformation of the mRNA-like domain (Bordeau and Felden, 2002). The proposed role of S1 is to unwind the complex structure of that domain to facilitate the switch to the new template. It seems to not be essential for the early steps of trans-translation such as charging and tRNA-like function (Takada *et al.*, 2007) but to be essential for the tagging activity of tmRNA *in vivo* (Saguy *et al.*, 2007); nevertheless, contradictory results obtained in an *in vitro* cell-free model suggest that S1 could be completely dispensable for trans-translation, including tagging (Qi *et al.*, 2007). The role for S1 in *E. coli* trans-translation is still up for debate; in any case, it plays a minor role compared to SmpB and EF-Tu. However, in

M. tuberculosis it was found that pyrazinamide inhibits trans-translation (cf. p.97) by binding ribosomal protein S1, and that pyrazinamide-resistant mutants could arise by spontaneous mutations of *rpsA* (Yang *et al.*, 2015). Ribosomal protein S1 is thus by all accounts essential for trans-translation in this pathogen.

RNase R, the cleanup worker

RNase R is a 3'-5' exoribonuclease that participates in the maturation of tmRNA from its precursor (Cairrão *et al.*, 2003). It exhibits helicase activity and can degrade structured RNAs. RNase R was also found early to co-precipitate with the tmRNA/SmpB/EF-Tu complex, suggesting that it directly interacts with the trans-translation complex (Karzai and Sauer, 2001). It was found that the C-terminal portion of RNase R indeed interacts with tmRNA-SmpB, and that this interaction plays an important role both in trans-translation and RNase R stability (Liang and Deutscher, 2012).

RNase R levels are highly fluctuating, with a low concentration in log phase due to a high instability of the protein, and a stabilization associated with an increase in concentration in stationary phase. This change in stability is regulated in an unusual manner by the acetylation of the protein (Liang and Deutscher, 2012). It was also found that under stress conditions such as cold shock or starvation, stabilization of RNase R occurs by acetylation too (Chen and Deutscher, 2005). Acetylation also prevents the protein from binding tmRNA-SmpB. When RNase R is deacetylated and bound to tmRNA-SmpB, two fates are possible for the protein: either the complex is free, in which case tmRNA-SmpB promotes its degradation by proteases (Fig. 65); or the complex is bound to ribosomes to perform trans-translation, in which case RNase R escapes degradation. tmRNA-SmpB is therefore directly involved in RNase R regulation in log phase (Deutscher, 2015).

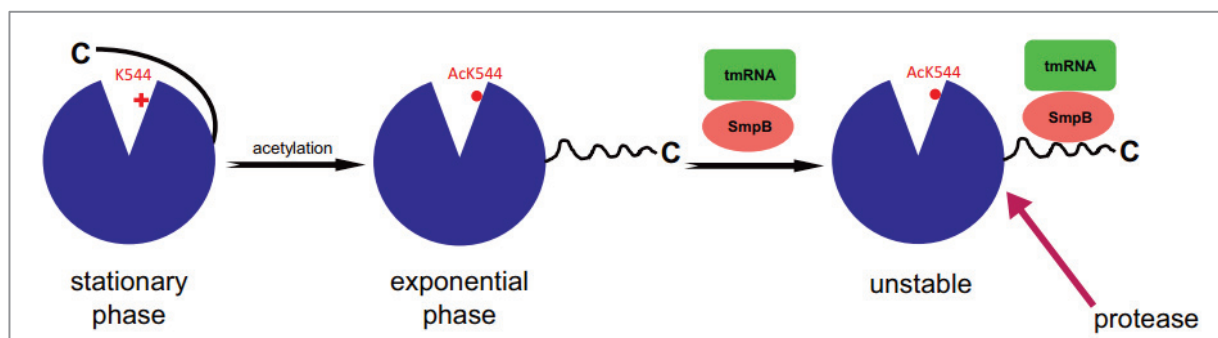

Fig. 65 Regulation of RNase R by acetylation and interaction with tmRNA-SmpB (Deutscher, 2015)

It was shown that RNase R plays an important role in trans-translation, by specifically degrading the mRNA that caused stalling and onto which the ribosome that endures trans-translation is loaded (Yamamoto *et al.*, 2003; Richards *et al.*, 2006). This non-stop mRNA decay prevents the consecutive loading of new ribosomes onto the problematic transcript, as these ribosomes would in turn also need rescuing. The recruitment of RNase R is selective for non-stop mRNAs, requires both tmRNA and SmpB, occurs only at the ribosome and involves the C-terminal tail of the nuclease (Ge *et al.*, 2010). It was also shown that the recruitment of RNase R to stalled ribosomes occurred only after the correct establishment of tmRNA as the new template for translation (Venkataraman *et al.*, 2014). As soon as tmRNA becomes the new template for translation, the faulty mRNA is released from the ribosome and is degraded by RNase R.

It can seem paradoxical that the trans-translation apparatus directly downregulates RNase R levels outside of the ribosome, yet actively recruits it at the ribosome during trans-translation. In fact, in exponential phase, most RNase R enzymes are bound to ribosomes and involved in degradation of trans-translation-inducing transcripts; in this position, they are not degraded (Liang and Deutscher, 2013). Only the free form of the enzyme, which can be hazardous to cells because of its ability to degrade indistinctly transcripts and stable RNAs, is kept at low levels by this targeted degradation mechanism (Deutscher, 2015). It is also notable that the *mnr* gene encoding RNase R is non-essential for trans-translation or viability in *E. coli*, suggesting that non-stop mRNA decay is more of a perk of the mechanism rather than a central element of trans-translation.

***ssrA*-tag-targeting proteases**

The observation that the *ssrA*-encoded tag was a hydrophobic tag similar to degradation tags recognized by proteases was essential in the discovery of the role of tmRNA (*cf.* p.101). In the original paper, Tsp (tail-specific protease, *prc* gene) was described as responsible for the degradation of the substrates tagged by tmRNA. This enzyme is periplasmic and indeed involved in the degradation of substrates with several different C-terminal hydrophobic tails (Silber *et al.*, 1992), allowing notably the maturation of the cell wall-synthesizing PBP3. Rapidly, it was found that other proteases were involved in degradation of these tagged substrates: Lon protease (Choy *et al.*, 2007), ClpXP and ClpAP (ClpP is a proteolytic subunit; ClpA, ClpX are unfolding components) (Gottesman *et al.*, 1998), FtsH (Herman *et al.*, 1998).

In particular, the role of ClpP is primordial for the degradation of *ssrA*-tagged substrates in *E. coli*. Both the ClpAP and the ClpXP protease complexes have adaptors that specifically recognize *ssrA* tags, respectively named ClpS (Dougan *et al.*, 2003) and SspB (Wah *et al.*, 2002; Dougan *et al.*, 2003). Surprisingly, ClpAP alone recognizes and degrades *ssrA*-tagged substrates but when it is in complex with ClpS, the adaptor inhibits their degradation (Dougan *et al.*, 2002). On the other hand, degradation by ClpXP plays a major role in trans-translation as it accounts for more than 90% of *ssrA*-directed proteolysis in *E. coli* (Farrell *et al.*, 2005). SspB is not essential for the recognition of these substrates but increases the affinity of *ssrA*-tagged proteins for ClpXP (Fig. 66).

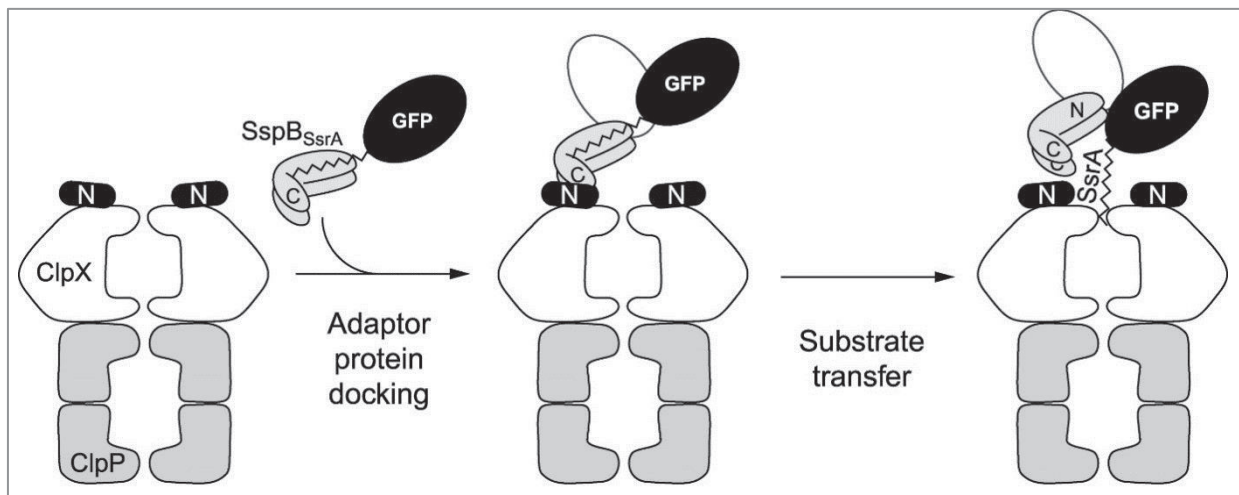

Fig. 66 *sspB*, a small adaptor of ClpX that directly binds *ssrA* tags and directs them for degradation (Dougan *et al.*, 2003)

The degradation of tagged, unfinished proteins released after trans-translation is important to prevent their accumulation. The buildup of these aborted polypeptides is harmful, as evidenced by the toxic activity of puromycin, a molecule that resembles an aminoacyl-tRNA and induces spontaneous translation abortion (Nathans, 1964). Unfinished proteins can exhibit misfolding, in particular if only a single cysteine from a disulfide bond is present. Misfolded proteins expose hydrophobic residues, leading to aggregation and formation of inclusion bodies; they expose cross-reactive residues, in particular the oxidisable cysteine and methionine, leading to covalent binding to non-specific targets; and they also expose protein-protein interaction domains which can react aspecifically (Wickner *et al.*, 1999). More importantly, aborted and misfolded membrane-included proteins are highly toxic because they destabilize the membrane, a well-known pitfall in the ectopic expression and overproduction of such proteins (Miroux and Walker, 1996). Tagging by tmRNA and degradation by the set of proteases that recognize the *ssrA* tag prevents the accumulation of this potentially harmful waste.

3.5. Mechanism of trans-translation

The number of copies of tmRNA is estimated at 500-1000 copies per cell, or one for 10 to 20 ribosomes (Lee *et al.*, 1978; Moore and Sauer, 2005). SmpB is expressed at relatively similar levels (Sundermeier and Karzai, 2007). By measuring the abundance of tagged protein in a multiple protease knockout background, it was first estimated that 1 out of 250 translation reactions is rescued by trans-translation (Moore and Sauer, 2005). This was actually an underestimation, as apparently at least 1/50 and up to 1/25 translation initiations are futile and have to be rescued (Ito *et al.*, 2011). Therefore, in a single generation, statistically, all ribosomes endure trans-translation. Moreover, the number of ClpXP complexes is sufficient to degrade 100,000 *ssrA*-tagged proteins per generation (Farrell *et al.*, 2005). These figures highlight the crucial role of trans-translation in maintaining the constant neosynthesis of proteins and therefore the homeostasis of the cell.

The increasing of knowledge on the properties of the trans-translation components and new approaches for structural visualization of the ribosome have allowed to decipher most of the proceedings of this mechanism. A complete summary of the mechanism is presented in Fig. 67 (Giudice *et al.*, 2014).

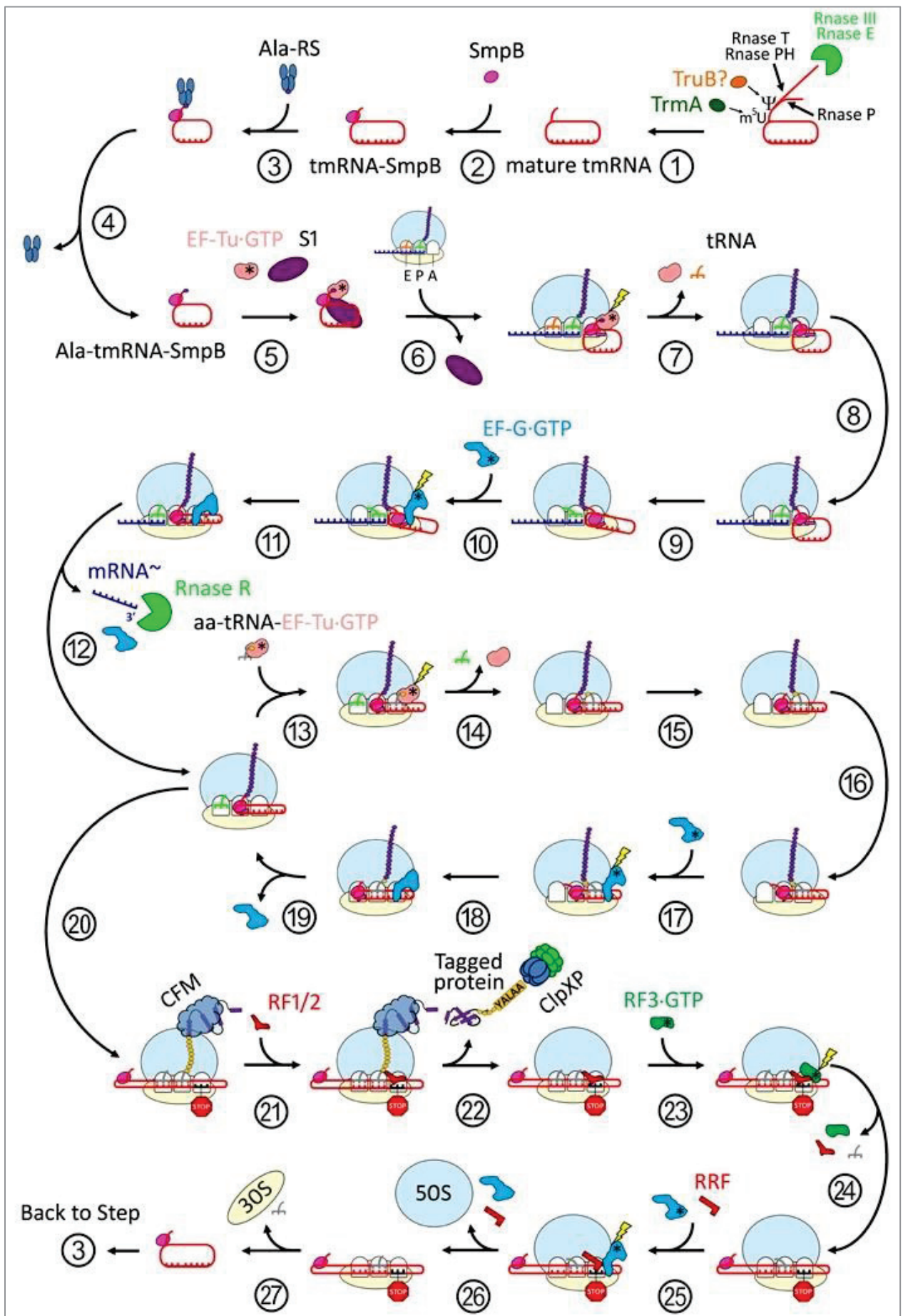

Fig. 67 Summary of the mechanism of trans-translation (Giudice et al. 2014)

Maturation (steps 1-5, Fig. 67)

The components of trans-translation need to be synthesized, matured and assembled as a scaffold in order for the ribosomal rescue to be performed. tmRNA is matured by processing enzymes as described previously (cf. p.105) that cleave the precursor and modify nucleotides in the tRNA-like domain. Mature tmRNA can bind SmpB, forming a nucleoproteic complex. Some contradicting results suggests that at this step, two different SmpB molecules might bind a single tmRNA, with SmpB-1 remaining bound to a high-affinity region of tmRNA for the remainder of the trans-translation event and SmpB-2 binding a lower-affinity structure and probably accompanying it only during the first steps of the mechanism (Kaur *et al.*, 2006; Gillet *et al.*, 2007). In other observations, sometimes obtained within the same laboratory, the stoichiometry of the complex seems to be limited to 1:1 (Valle *et al.*, 2003; Sundermeier and Karzai, 2007). In the following steps of trans-translation, only one SmpB is present (Bugaeva *et al.*, 2008). In the visual representation of the mechanism in Fig. 67, only a single SmpB is represented in association with tmRNA, as the role and timing of the potential SmpB-2 remains relatively unknown yet. The acceptor arm of tmRNA is then recognized and acetylated by an alanine-aminotransferase (AlaRS, gene *alaS*). The complex formed by aminoacetylated tmRNA bound to SmpB is recognized and bound by EF-Tu, and probably by ribosomal protein S1 too, forming a complex that is ready to perform trans-translation.

Recognition and loading onto a stalled ribosome (steps 6-10, Fig. 67)

SmpB plays a primordial role in recognizing stalled ribosome, by adopting the conformation of an anticodon arm in the D-loop of the tRNA-like domain of tmRNA, allowing the recognition and loading of the complex in ribosomes with an empty A site. Its C-terminal tail also allows to recognize specifically 70S ribosomes that exhibit both an empty A site and either no mRNA in 3' of the P site or a very short mRNA (<15nt) that does not reach the end of the mRNA canal. If both conditions are fulfilled, the EF-Tu elongation factor hydrolyzes GTP to allow the correct placement of the complex in the A site and the transpeptidation by the ribosome of the nascent protein onto the Alanine of the tRNA-like domain. If the A site is occupied but the ribosome is nevertheless stalling (e.g. with antibiotic exposure or when the nascent peptide blocks its own exit from the ribosomal exit tunnel), removal of the tRNA at the A site is operated by the peptidyl-tRNA

hydrolase Pth (Vivanco-Domínguez *et al.*, 2012). If the A site is empty but the mRNA is intact, the ribosome is encountering a pause, not a stalling event. In this case, the trans-translation complex cannot establish a strong enough interaction, and translation may resume normally as soon as the reason for the pause is resolved. If pausing continues for too long, degradation of the mRNA occurs by cleavage at the A site or at the edge of the mRNA conduit as previously described (cf. p.99), leaving the ribosome in position to be rescued by trans-translation.

Template switching and elongation (steps 10-19, Fig. 67)

Once tmRNA-SmpB is correctly placed into the A site and transpeptidation has occurred, the elongation factor EF-G displaces the complex into the P site. This allows the expulsion of the tRNA that was in the E site, but also of the mRNA that was the template until that point. The mRNA is degraded by RNase R, which is recruited to the ribosome by the trans-translation machinery. The mRNA-like domain of tmRNA accommodates itself in order to become the new template for translation. Translation of the ORF begins with the resume codon that is recognized by its cognate tRNA, adding the correct amino acid (usually an Alanine) by transpeptidation onto the Alanine that was added by the tRNA-like domain. Translation of the tmRNA ORF and elongation of the unfinished protein continues as any usual translation reaction, with EF-Tu and EF-G catalyzing the action of the cognate tRNAs and the addition of their amino acids to the peptidic chain.

Termination and recycling (steps 20-27, Fig. 67)

The tmRNA ORF ends with a stop codon, allowing the normal termination of translation. The stop codon is recognized either by the release factor RF1 or RF2, depending on the nucleotide sequence of the stop codon. The tagged protein is then released from the ribosome. The tag is recognized by proteases that degrade the unfinished polypeptide. If the polypeptide is long enough to have adopted a stable secondary structure (usually with the help of the co-translational folding machinery, CFM), unwinding of the structure is required for degradation. ClpXP, that degrades >90% of the *ssrA*-tagged substrates in *E. coli*, contains both an ATP-binding subunit that unfolds substrates (ClpX) and a proteolytic subunit (ClpP). RF3 and RRF then catalyze the release of the remaining tRNAs, of the ribosomal subunits, and of tmRNA-SmpB. tmRNA can then be re-aminoacylated to start a new cycle of trans-translation.

3.6. Ribosome rescue in absence of trans-translation

Hinting at trans-translation alternatives

Trans-translation plays a seemingly crucial role by resolving the extremely common and hazardous ribosome stalling phenomenon. In a single generation each ribosome could encounter a stalling event. One could assume that the mechanism would be essential for growth. However, paradoxically, the deletion of *ssrA* or *smpB* has rather mild effects on viability and growth of model organisms such as *E. coli*. It is not the case in a number of pathogenic species in which the mechanism is essential for viability even in non-stressful conditions such as growth in a rich medium (discussed below, cf. p.139). The discrepancy was perplexing and unresolved as late as 2010.

It had been observed that even in absence of tmRNA, stalled ribosomes were being released in an unknown way (Szaflarski *et al.*, 2008; Kuroha *et al.*, 2009; Janssen and Hayes, 2009). Interestingly, in *E. coli*, most of the phenotypes observed with $\Delta ssrA$ were complemented by the introduction of an *ssrA^{DD}* allele that allows the release of ribosomes but not the tagging of proteins, proving that the most important role of trans-translation is the release of stalled ribosomes (Keiler *et al.*, 1996). Similarly, in *N. gonorrhoeae*, the *ssrA^{DD}* allele was sufficient to compensate the lethality of an *ssrA* deletion (Huang *et al.*, 2000). It was therefore plausible, given all these clues, that another mechanism could exist and perform the release of stalled ribosomes in absence of trans-translation, or when the mechanism is overwhelmed.

ArfA (Alternative Ribosome Factor A)

A screen for *E. coli* random point mutants in which *ssrA* would become essential was performed, and allowed to identify a previously undescribed gene called *yhdL* (Chadani *et al.*, 2010). A single substitution in that gene caused *ssrA* to become essential in *E. coli* (Fig. 68). A double *ssrA yhdL* deletion mutant could only be constructed if complemented by a plasmid bearing *ssrA* or *ssrA^{DD}*, confirming the loss of ribosome release ability. Concurrently, subinhibitory doses of puromycin, a drug that induce spontaneous abortion of translation and can therefore “rescue” stalled ribosomes, relieved the double deletion lethality. Further *in vitro* analysis proved that *yhdL* alone could resolve non-stop ribosomal stalling. However, contrary to trans-translation, no tagging for protein degradation or mRNA decay mechanisms were found in the YhdL-mediated ribosome rescue. *yhdL*

was renamed *arfA* for alternative ribosome-rescue factor A. Homologues of *arfA* have been discovered in other γ - and β -proteobacteria (Fig. 68).

Escherichia coli K12	1	MSRYQHTKGQIKDNAIEALLHDPLFRQRVEKNKKGKGSYMRKKGHGNRGNWEASGKKVNHFFTTGLLLSGAC	72
ArfA-A18T	1T.....	72
Shigella boydii Sb227	1R.....	72
Citrobacter koseri ATCC BAA-895	1L.....	72
Salmonella enterica serovar Typhimurium str. LT2	1K.....	68
Salmonella enterica serovar Typi str. E00-7866	1K.....	68
Enterobacter cloacae subsp. cloacae ATCC 13047	1H.....	66
Klebsiella pneumoniae NTUH-K2044	1Q.....	69
Providencia stuartii ATCC 25827	1KR.....	59
Serratia proteamaculans 568	1	TK.R.....Q.....I.....T.....R.....D.....AKG.....	56
Erwinia pyrifoliae Epl/96	1	TV...K.V.R.....KP...V.Q.....R...E...KK.C.....CASSL..P....	68
Yersinia pestis KIM 10	1	TT.R...K...L.....I.....S.....Q...E.YAKGS.....Q	57
Pectobacterium atrosepticum SCRI1043	1	TT.R.KR.K.QN.....I.V.E.....R.D.MKK.S.....QS.DYLPALF.FS	69
Dickeya dadantii Ech703	1	N.G.K..A.....L.A.....R.....R.VQKE.....	58
Xenorhabdus nematophila ATCC 19061	1	TT.N.K..V.....L.....S.E.R.KNSS...NN---N..KLL..	64
Erwinia amylovora CFBP1430	1	TV...K..I.R.....R...KP.L.V.Q.....R...E...EKKTG.....LTISV..S.FP.LL.EA	73
Haemophilus influenzae Rd KW20	15	.L..R.V....VM...G.K.....KR.....Q..A..	56
Actinobacillus succinogenes 130Z	24	R.QC.T.R...LQ.....KL.....Q..P.	64
Vibrio fischeri ES114	16	E.GR.....LK.VVTSQ...T.IV.A.....S...RG.	57
Neisseria gonorrhoeae SK-92-679	6	N..K.R...LK..VKSD...HK..RKR.....N.Q	43
Vibrio parahaemolyticus 16	35	R.E.....LK.VVTSE..KV...A.....FS..M..	72
Vibrio Harveyi ATCC BAA-1116	21	R.E.....LK.VVTSQ...T..V.A.....FN..A..	58
Shewanella baltica OS223	13	HESGR.T.T...LK..VTS...T.T..A.....D..AQN	54

Fig. 68 Conservation of *arfA* amongst various bacterial taxa. (Chadani et al. 2010)
The grey box indicates a highly conserved residue, its mutation rendered ArfA inefficient and *ssrA* essential in *E. coli*.

The mechanism by which ArfA recognizes and frees ribosomes stalled on non-stop mRNAs has been deciphered by genetic, biochemical and structural approaches. First, it was found that ArfA interacts with RF2 and recruits it at the level of the free A site of the stalled ribosome (Chadani *et al.*, 2012; Shimizu, 2012). RF2 is responsible for the hydrolysis of the peptidyl-tRNA at the P site, that induces its release from the ribosome and starts the recycling of the translation machinery in a similar way as the end of the translation cycle. As ArfA is not responsible for the enzymatic activity and as RF2 normally is recruited to the ribosome by the recognition of a stop codon, it was supposed that the role of ArfA is to recognize stalled ribosomes. Indeed, it was found that ArfA can recognize stalled ribosomes in a similar way as SmpB does, with its N-terminal end being loaded near the peptidyl-transferase center and the C-terminal tail being inserted in the empty mRNA channel (Kurita *et al.*, 2014). As with SmpB, the affinity of ArfA for ribosomes decreases with the length of the mRNA strand upstream of the P site (26554029). When ArfA binds stably to a stalled ribosome, it recruits RF2 to the A site. It then induces a conformational change in RF2 that is necessary for a GGQ conserved motif to access to and perform the hydrolysis of the peptidyl-tRNA; this conformational change is similar to the one that occurs upon recognition of the cognate stop codon by RF2 alone (Zeng and Jin, 2016). As of today, no resolved structure of ArfA bound to RF2 and the ribosome have been published.

An intriguing discovery was made when the regulation of ArfA was studied. The expression of the gene is constitutive at relatively high levels, but the protein levels of ArfA are low in normal

growth conditions. The transcript produced from *arfA* forms a 3' hairpin that is recognized by RNAse III and is cleaved, removing the stop codon from the transcript (Fig. 69). The non-stop message induces ribosome stalling and degradation of ArfA by trans-translation tagging (Garza-Sánchez *et al.*, 2011). It is speculated that this regulation allows the more efficient and complete trans-translation mechanism to rule over non-stop complex rescue in normal conditions. However, if trans-translation becomes overwhelmed by a sudden increase in ribosome stalling, ArfA could then take over the responsibility of rescuing stalled ribosomes. ArfA does not induce degradation of proteins from stalled complexes and could therefore promote an increase in its own translation by releasing non-stop complexes on *arfA* mRNAs. This would establish rapidly ArfA as a backup emergency mechanism (Abo and Chadani, 2014) (Fig. 70). The downregulation allows trans-translation to remain the major mechanism for ribosome rescue in non-stressful conditions, which is probably advantageous for the cell as it also operates mRNA and protein decay, that ArfA does not address. ArfA and its downregulation mechanism appears conserved at least amongst γ and β -proteobacteria (Schaub *et al.*, 2012) (Fig. 69).

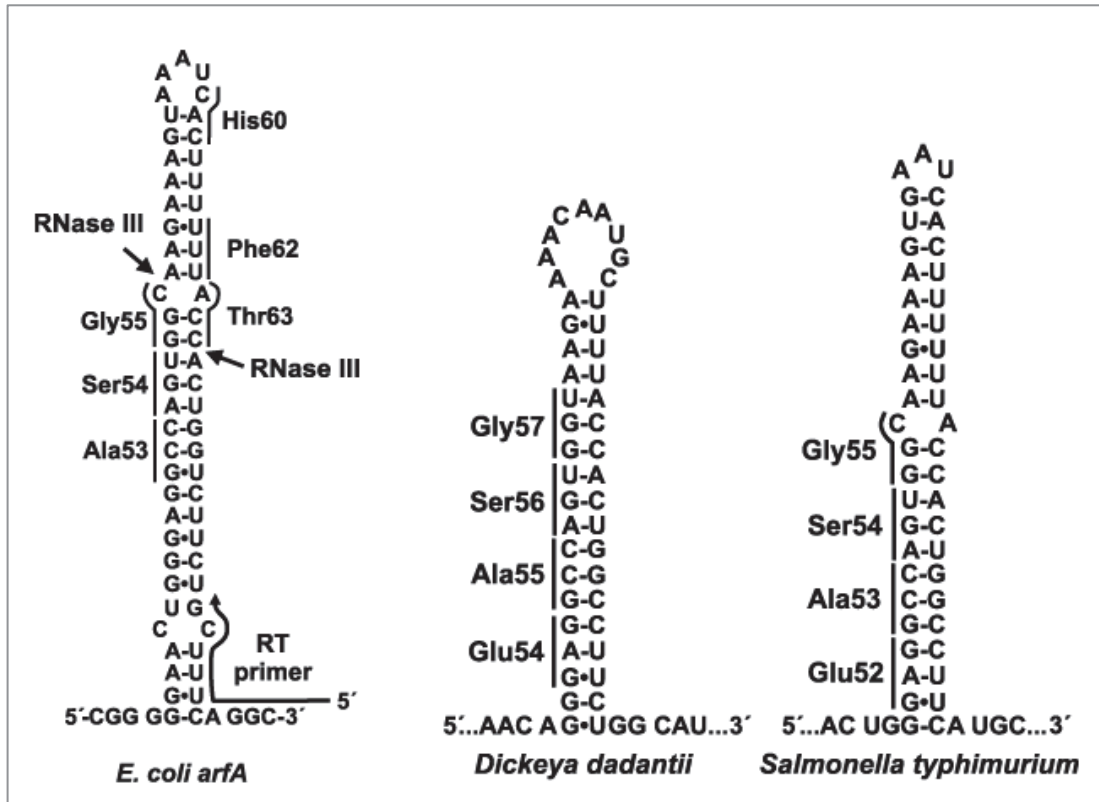

Fig. 69 Predicted hairpins within the ORFs of *arfA* mRNAs in *E. coli*, *D. dadantii* and *S. typhimurium*. RNase III cleavage sites are indicated for *E. coli arfA* mRNA. (Schaub et al., 2012)

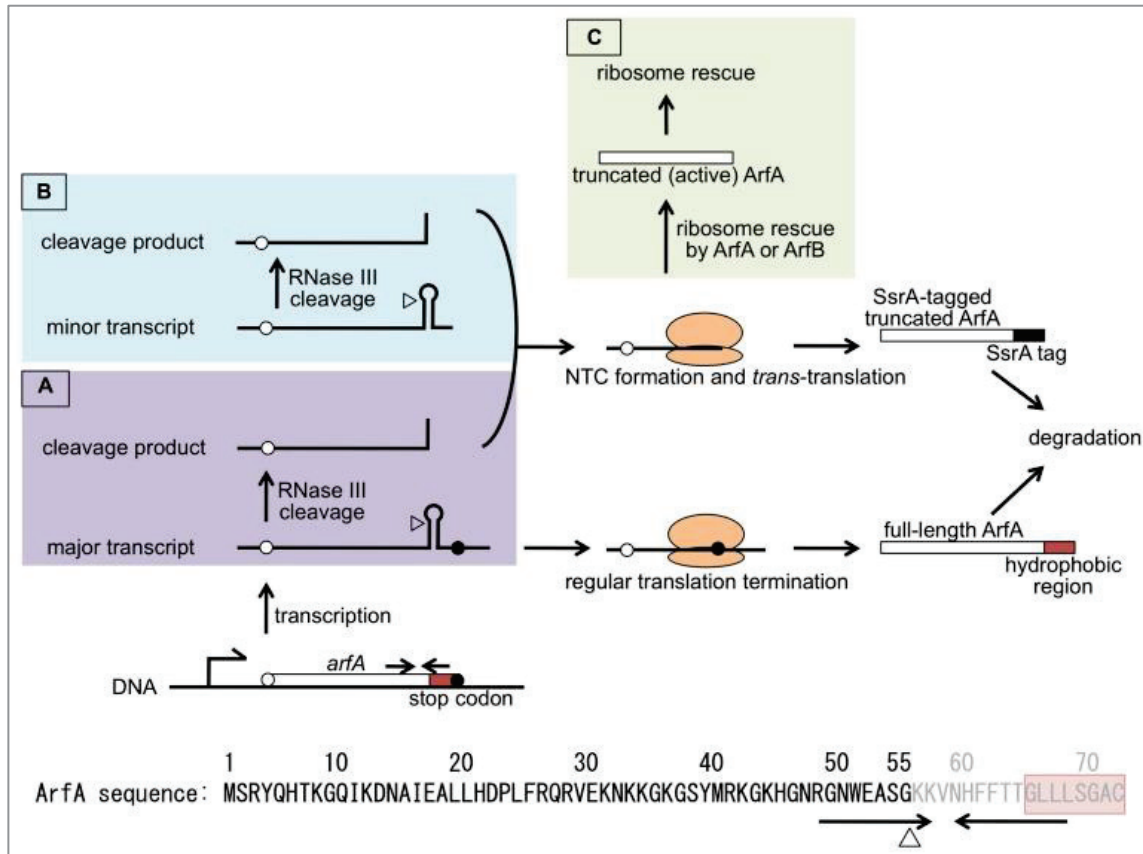

Fig. 70 Model of *ArfA* post-transcriptional regulation by trans-translation in proteobacteria (Schaub et al., 2012)

ArfB (Alternative Ribosome Factor B)

Only two months after the first publication on *arfA*, a second group published the discovery of a closely related gene named *yaeJ* (Handa *et al.*, 2011). The product of this gene was known to be non-essential, but was suspected to have a peptidyl-hydrolase activity, as it is a distant homolog of RF1 and RF2, and contains their highly-conserved GGQ motif important for peptidyl-tRNA hydrolysis, but not the domain that recognizes stop codons. It was found that YaeJ is indeed recruited to stalled ribosomes, where it hydrolyzes peptidyl-tRNA on non-stop mRNA (Chadani *et al.*, 2011; Handa *et al.*, 2011). The GGQ motif and the C-terminal tail of YaeJ are essential for its activity. It was then deduced from these results that YaeJ was able to recognize stalled ribosomes similarly as SmpB and ArfA, by inserting its C-terminal tail in the empty mRNA channel. Contrary to SmpB and ArfA that recognize stalled ribosomes but let tmRNA and RF2 (respectively) perform the ribosome release, YaeJ also operates the peptidyl-hydrolase activity. Based on these results, *yaeJ* was renamed *arfB* to reflect the name change of *yhdL/arfA*. Structural data has been obtained for ArfB bound to a stalled ribosome (Gagnon *et al.*, 2012). The structure shows how the GGQ motif accommodates itself at the peptidyl-transferase center in the same fashion as release factors. It also shows how the C-terminal tail forms a helix that fits in the mRNA channel, similarly as the C-tail of SmpB (Fig. 71).

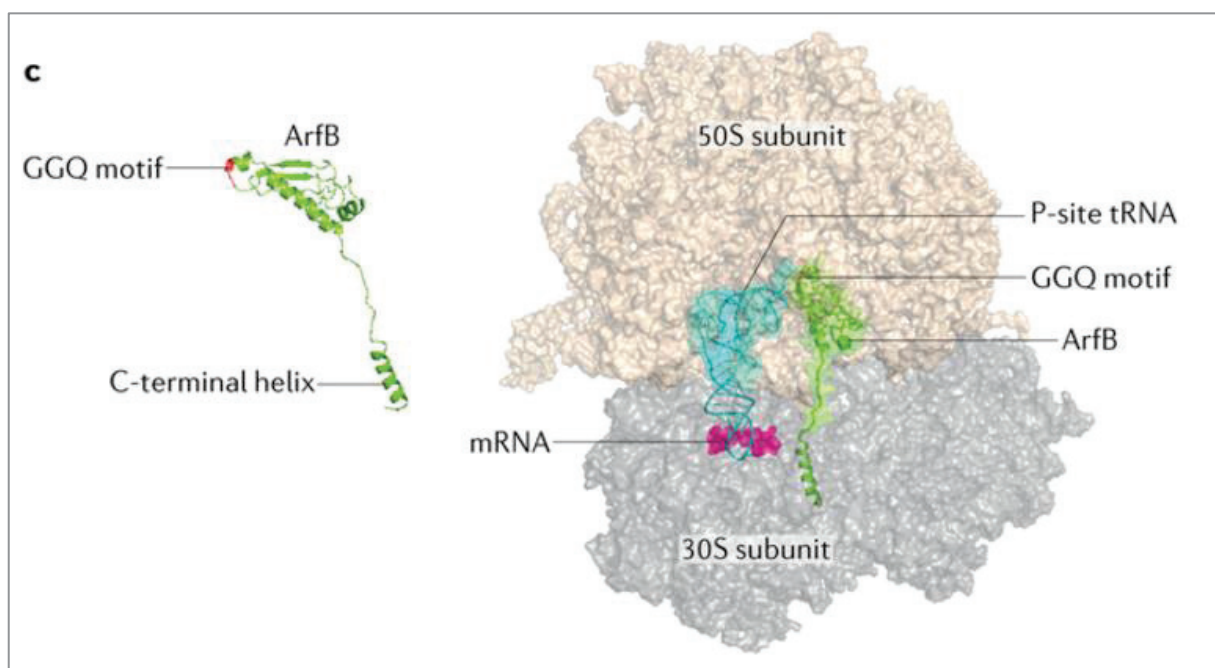

Fig. 71 Structure of ArfB bound to the ribosome (Keiler 2015, from data obtained in Gagnon *et al.*, 2012)

Based on the sequence of *E. coli arfB*, homologues had been discovered in a few bacterial species. The discovery of *C. crescentus arfB*, whose sequence is closer to a consensus among eubacterial *arfB* sequences, allowed to reveal the true distribution of this alternative mechanism among a large number of bacteria (Feaga *et al.*, 2014b) (Fig. 72 and Fig. 73).

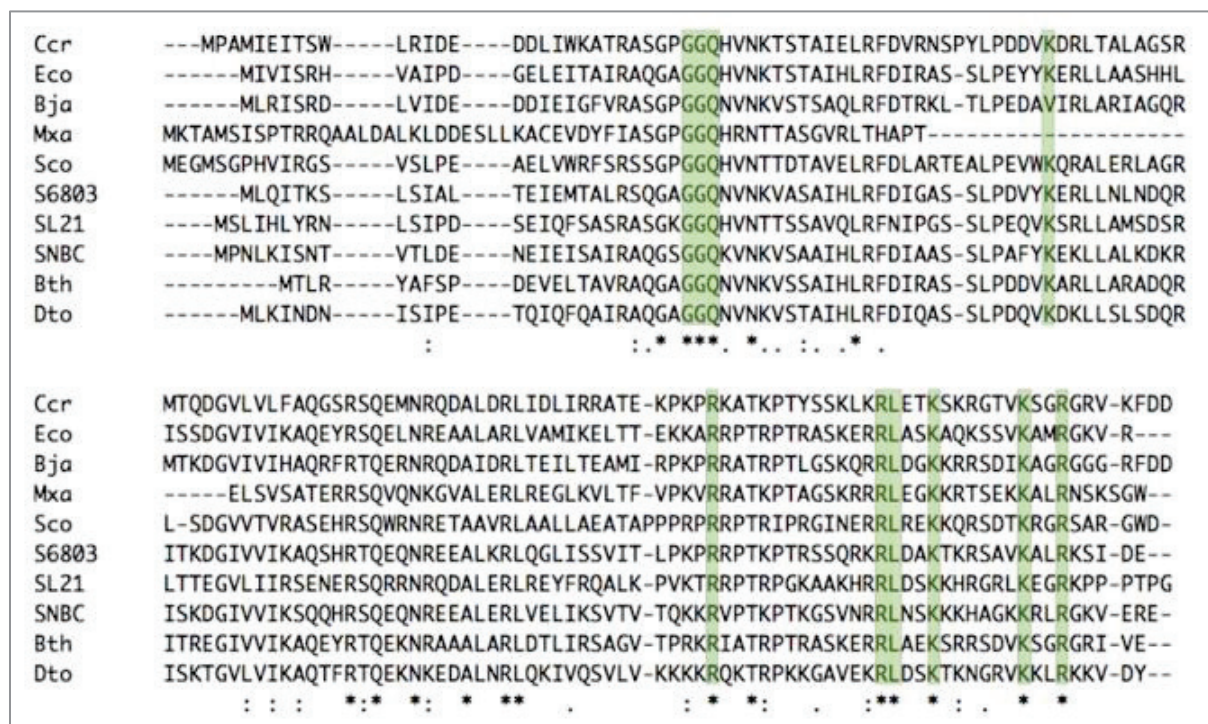

Fig. 72 Alignments of *arfB* genes in several bacterial species.

Ccr, *Caulobacter crescentus*; *Eco*, *Escherichia coli*; *Bja*, *Bradyrhizobium japonicum*; *Mxa*, *Myxococcus xanthus*; *Sco*, *Streptomyces coelicolor*; *S6803*, *Synechocystis sp. strain PCC6803*; *SL21*, *Spirochaeta sp. strain L21-RPul-D2*; *SNBC*, *Sulfurovum sp. strain NBC37-1*; *Bth*, *Burkholderia thailandensis*; and *Dto*, *Desulfobacula toluolica strain Tol2*. (Feaga *et al.* 2014)

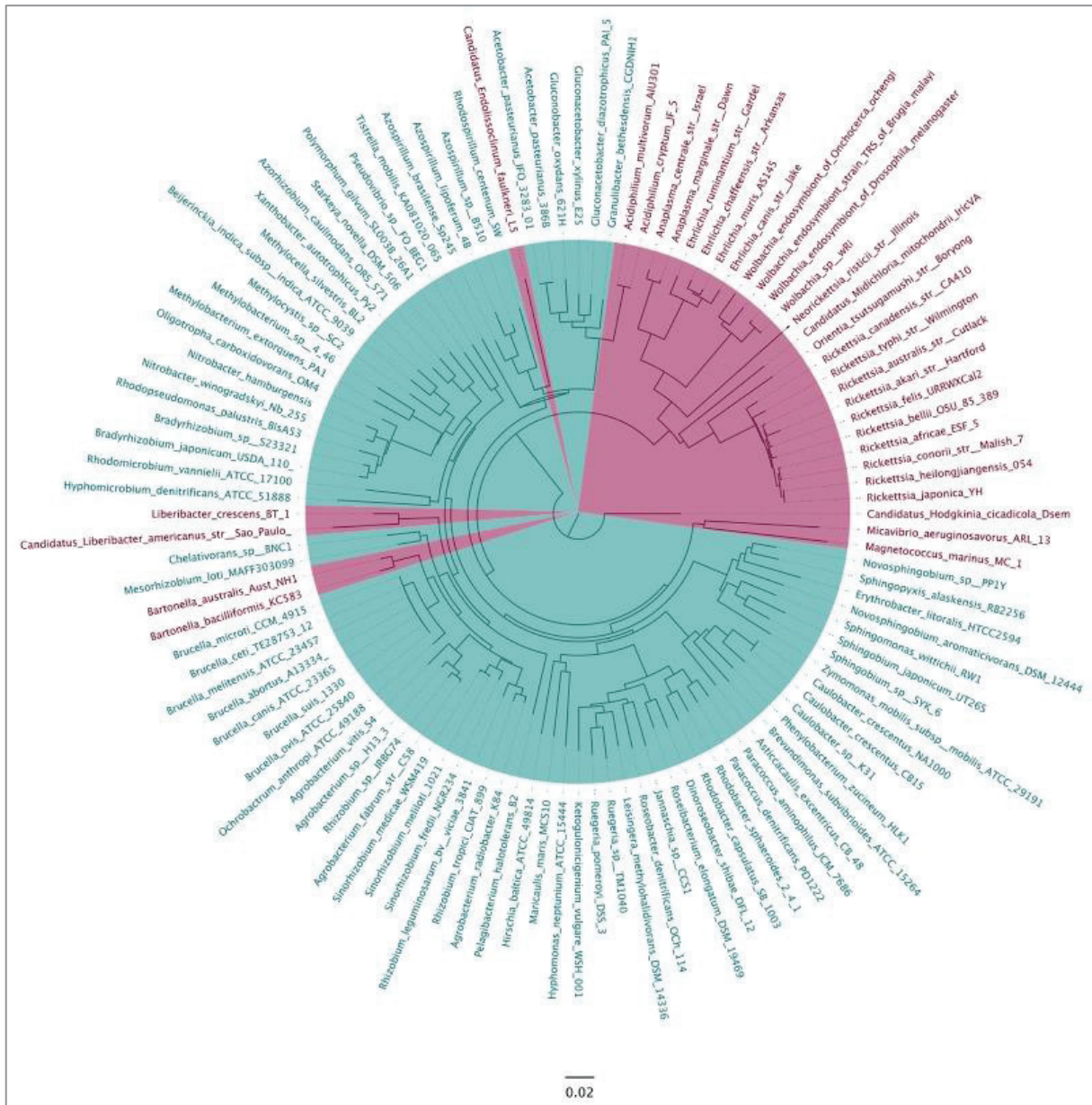

Fig. 73 Repartition of *arfB* amongst bacterial genomes. The phylogenetic tree has been built based on 16S rDNA sequences. In blue, *arfB* homologues have been found, in magenta species in which no homolog was found. (Feaga et al. 2014)

Unlike ArfA, the alternative factor ArfB cannot support viability of *E. coli* in absence of other factors, as evidenced by the lethality of the double $\Delta srrA \Delta arfA$ mutant (Chadani *et al.*, 2010), unless it is overexpressed from a multicopy plasmid (Chadani *et al.*, 2011). However, in *Caulobacter crescentus*, *arfA* is absent and *arfB* alone can compensate for the loss of trans-translation ((Feaga *et al.*, 2014b)). Both ArfA and ArfB are therefore alternative ribosome rescue mechanisms of varying importance that complement and assist trans-translation (Fig. 74).

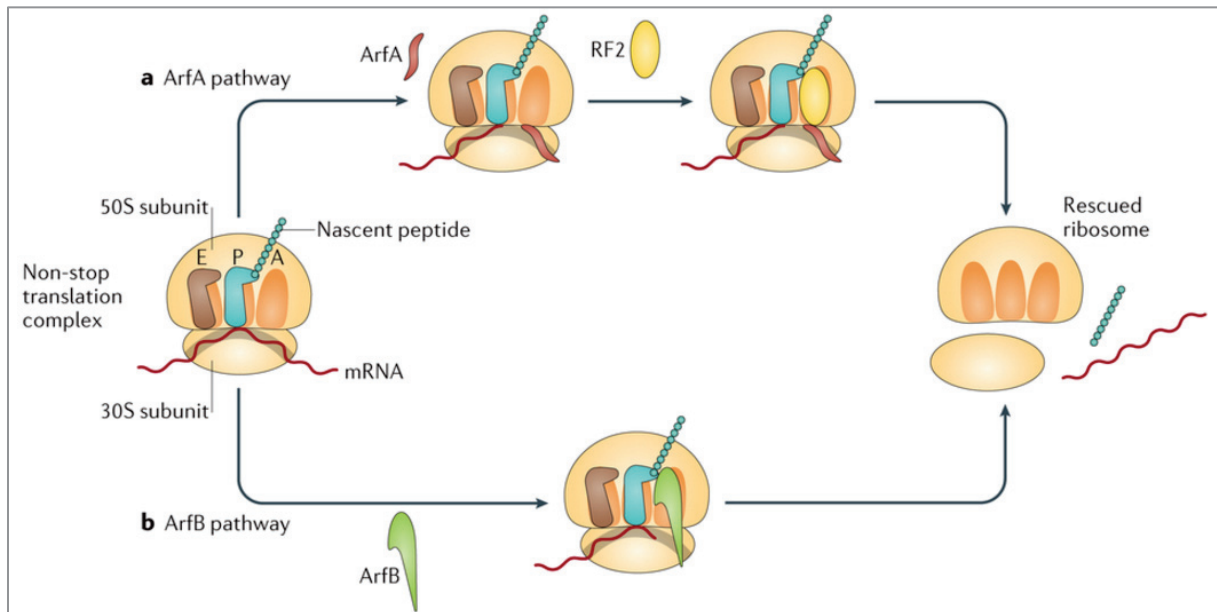

Fig. 74 ArfA and ArfB, alternatives mechanisms to trans-translation (Keiler, 2015)

3.7. What's to come in trans-translation research?

New alternative ribosome rescue systems?

Both *arfA* and *arfB* homologues have been found in a number of bacterial taxa, but as their sequence is less conserved than *srrA* or *smpB*, it is considerably harder to identify such homologues through bioinformatics approaches. For example, *Caulobacter crescentus arfB* was not found using a simple BLAST analysis from *E. coli arfB* and had to be identified by screening a large library of transposition mutants in an *srrA* deletion background (Tn-seq method, described in an upcoming chapter, cf. p.162) (Feaga *et al.*, 2014b). Based on *arfB* sequences from both *E. coli* and *C. crescentus*, *arfB* putative homologs have been found in almost all bacterial taxa, whereas *arfA* homologs were only found in proteobacteria. It is difficult to affirm if *arfA* homologues are really absent in other taxa if such homologs have different sequences that prevent to identify them.

Evidence points at the existence of other alternative ribosome rescue factors, or at the fact that *arfA* or *arfB* sequences are present but have not been found by bioinformatics. Indeed, a general consensus seems to emerge on the essentiality for all bacteria to possess at least one ribosome rescue system (Keiler and Feaga, 2014). The universality of trans-translation, the presence of backup systems, and the extremely high rate of futile translation initiation all point towards an express and constant need for ribosome rescue. In the majority of cases, the essentiality of trans-translation is explained by the fact that the species lack alternative ribosome rescue systems, or the fact that these systems are not efficient enough to compensate for the loss of trans-translation (Fig. 76). However, in some cases no alternative rescue systems have been found, but trans-translation can be inactivated nevertheless. It is the case for example with *B. subtilis* and *F. tularensis* (Keiler and Feaga, 2014).

Moreover, some rare but notable examples of bacteria with reduced genomes seem to have lost trans-translation components (Hudson *et al.*, 2014). In the extremely small (157–174 kbp) and odd (14–18% G+C) genome of the insect endosymbiont *Carsonella ruddii* strain PC, in the other insect endosymbiont *Hodgkinia cicadicola* (134–144 kbp), and in the four sequenced strains of the intracellular erythrocyte pathogen *Mycoplasma suis* (740 kbp), SmpB has lost its central loop, essential for trans-translation in *E. coli*. Moreover, *ssrA* was apparently lost in *M. suis* (Fig. 75) and in *C. ruddii* strain PC. No *arfA* or *arfB* genes were encountered in this last strain. All these clues suggest that new, alternative ribosome rescue systems are still to be discovered.

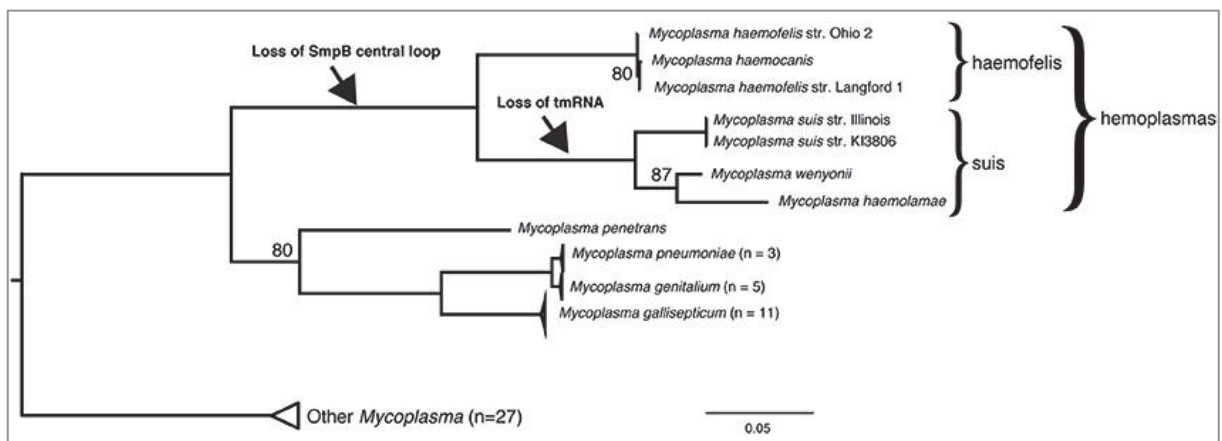

Fig. 75 Loss of *tmRNA* and *SmpB* central loop in *Mycoplasma suis* (Hudson, 2014)

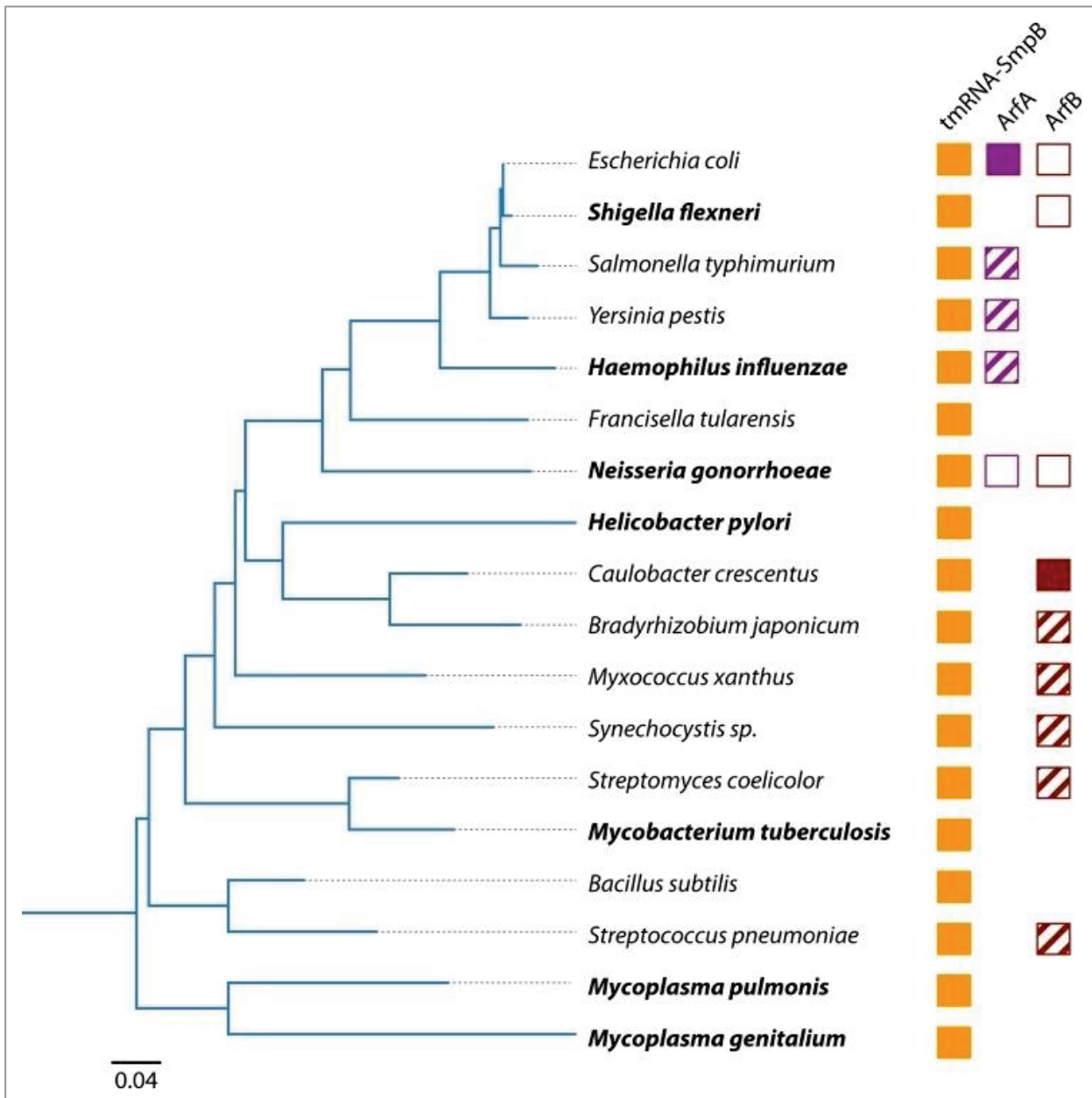

Fig. 76 Repartition of *arfA* and *arfB* sequence and current knowledge on their ability to complement loss of trans-translation. The yellow square indicates the presence of both *ssrA* and *smpB* in the genome. The purple squares indicate the presence of *arfA*, and the red squares the presence of *arfB*. A full square indicates that loss of trans-translation can be compensated by the alternative rescue factor. An empty square indicates that the alternative rescue factor cannot compensate the loss of trans-translation. A hashed square indicates that the ability of the system to maintain viability in absence of trans-translation is unknown. (Keiler and Feaga, 2014)

Mitochondria have ribosome rescue systems, but not trans-translation

Previous evidence had shown that neither tmRNA nor SmpB were conserved in most eukaryotes, nor in their mitochondria. Some *smpB* and *ssrA* sequences have been found in eukaryotic genome sequencing projects, but they either originated from contaminations, endosymbionts, or plastids (Hudson *et al.*, 2014). The only two exceptions are the mitochondria of some jakobids (Jacob *et al.*, 2004) and oomycetes (Hafez *et al.*, 2013), unicellular eukaryotes

phylogenetically distant from animals. Their mitochondria seem to have conserved tmRNAs but without the mRNA-like domain (Fig. 77).

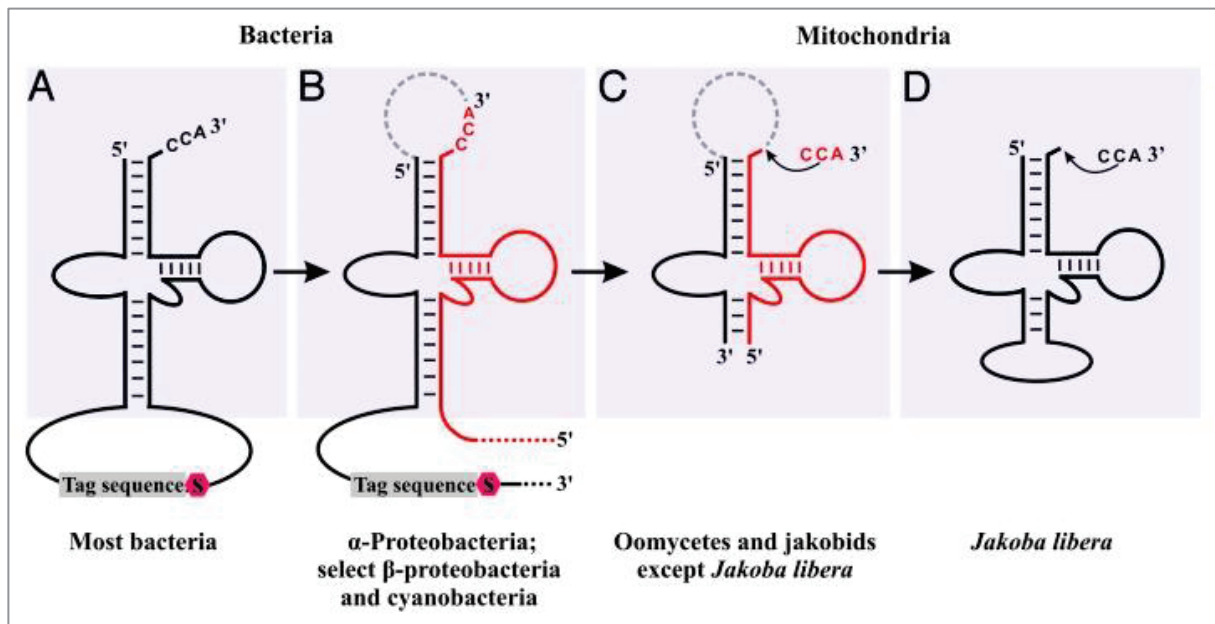

Fig. 77 Jakobids and Oomycetes are the only eukaryotes whose mitochondria have retained tmRNA. (Hafez *et al.*, 2013)

Mammalian mitoribosomes perform the translation of 13 proteins that are essential for the respiratory chain (Christian and Spremulli, 2012). However, the inner workings of their translation machinery is still largely misunderstood. Until 2010, no ribosome rescue mechanism had been identified in animal mitochondria. Two putative release factors, mtRF1a and mtRF1, had been identified previously (Zhang and Spremulli, 1998; Soleimanpour-Lichaei *et al.*, 2007); both are distant homologs of bacterial RF1. mtRF1a decodes stop codons UAA and UAG, while the usual stop codon UGA is decoded into a tryptophan in mitochondria (Soleimanpour-Lichaei *et al.*, 2007). Two other stop codons seem to exist in mitochondria, the reassigned AGA and AGG codons that lack corresponding tRNAs (Young *et al.*, 2010). mtRF1 was thought to recognize all four stop codons (Young *et al.*, 2010), but biochemical in vitro assays and structural data tend to contradict this hypothesis (Huynen *et al.*, 2012; Lind *et al.*, 2013); mtRF1 activity is not yet clearly understood, but it seems that it recognizes mitoribosomes with an empty A site and no mRNA after the P site, and performs ribosome rescue in these conditions, similarly to bacterial ribosome rescue factors (Fig. 79) (Huynen *et al.*, 2012).

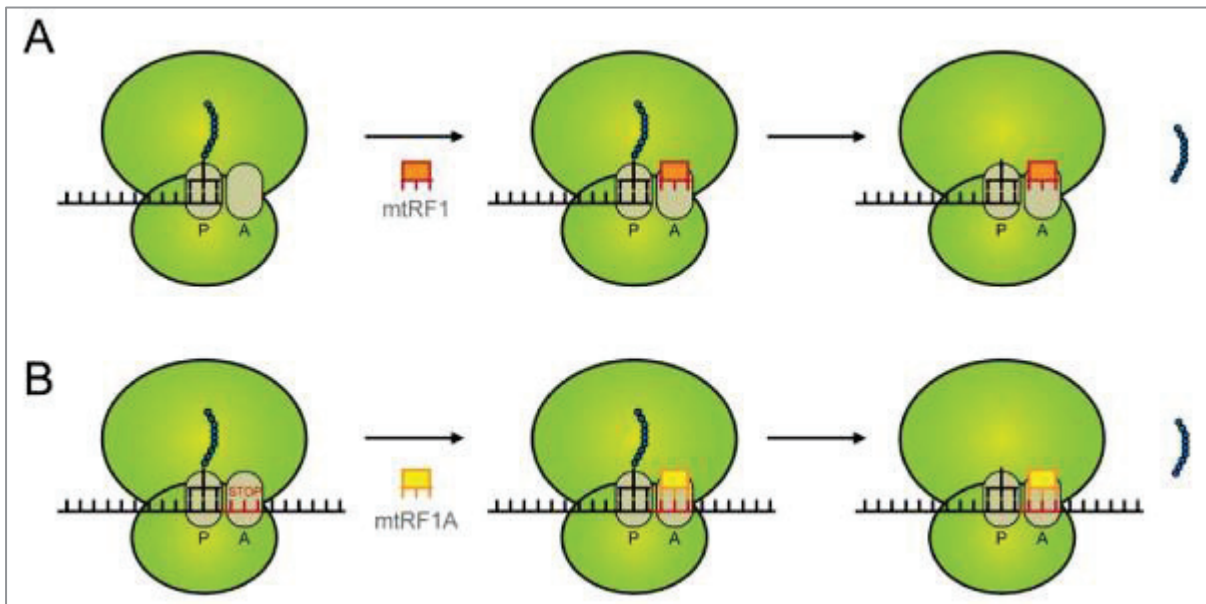

Fig. 79 Proposed roles for mtRF1 as a ribosome rescue factor and mtRF1a as a release factor (Huynen *et al.*, 2012).

Interestingly, as some other mitochondrial essential proteins (Adams and Palmer, 2003), the *MTRF1* and *MTRF1A* genes are encoded in the nucleus of the eukaryotic cell (in humans, on the chromosome 13 and the chromosome 6, respectively). This prompted the search for other potential release factors, probably encoded in the nucleus as well and possibly related to bacterial RF2. Two of them were identified: C12orf65, that could either be a potential third release factor or a new ribosome rescue factor, but remains to be studied in more detail (Richter *et al.*, 2010; Kogure *et al.*, 2012); and ICT1, that is either only a mitochondrial ribosome rescue factor (Richter *et al.*, 2010) or both a rescue and a release factor for the unusual AGA/G stop codons (Akabane *et al.*, 2014), according to divergent results (Chrzanowska-Lightowlers and Lightowlers, 2015).

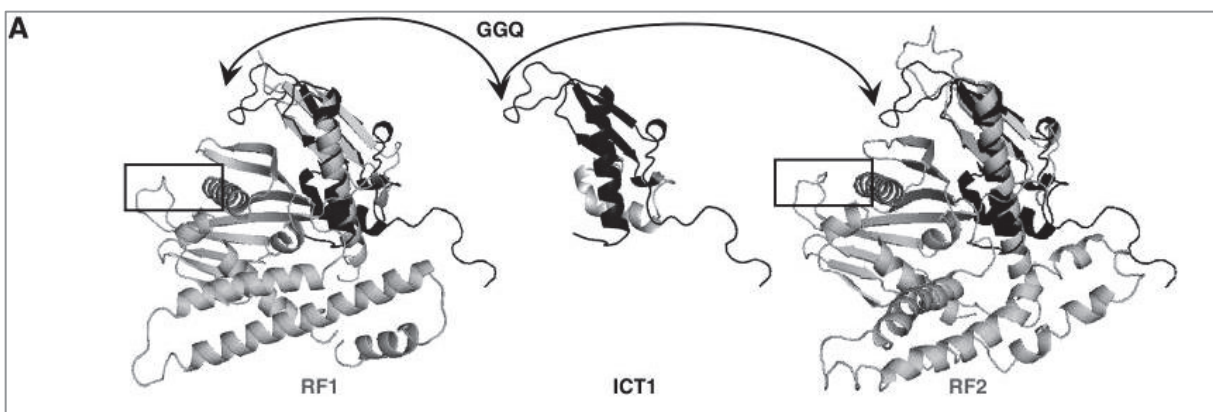

Fig. 78 Comparison of ICT1 structure to bacterial RF1 and RF2. Arrows indicate the GGQ conserved peptidylhydrolase motif, boxes indicate the stop codon recognition domain (Richter *et al.*, 2010)

ICT1 (immature carcinoma transcript 1) had been previously found co-immunoprecipitated with the mitoribosome (Rorbach *et al.*, 2008) and its expression is known to be modified in some cancer cell lines (van Belzen *et al.*, 1998). ICT1 is closely related to bacterial release factors but lack their stop codon recognition domain (Fig. 78). It was found, like mtRF1, mtRF1a and C12orf65 to possess a GGQ peptidylhydrolase motif (Fig. 80). It is also not a free protein, but instead an integral component of the mitoribosome (Richter *et al.*, 2010). ICT1 is also strictly required for the viability of human cells (Handa *et al.*, 2010).

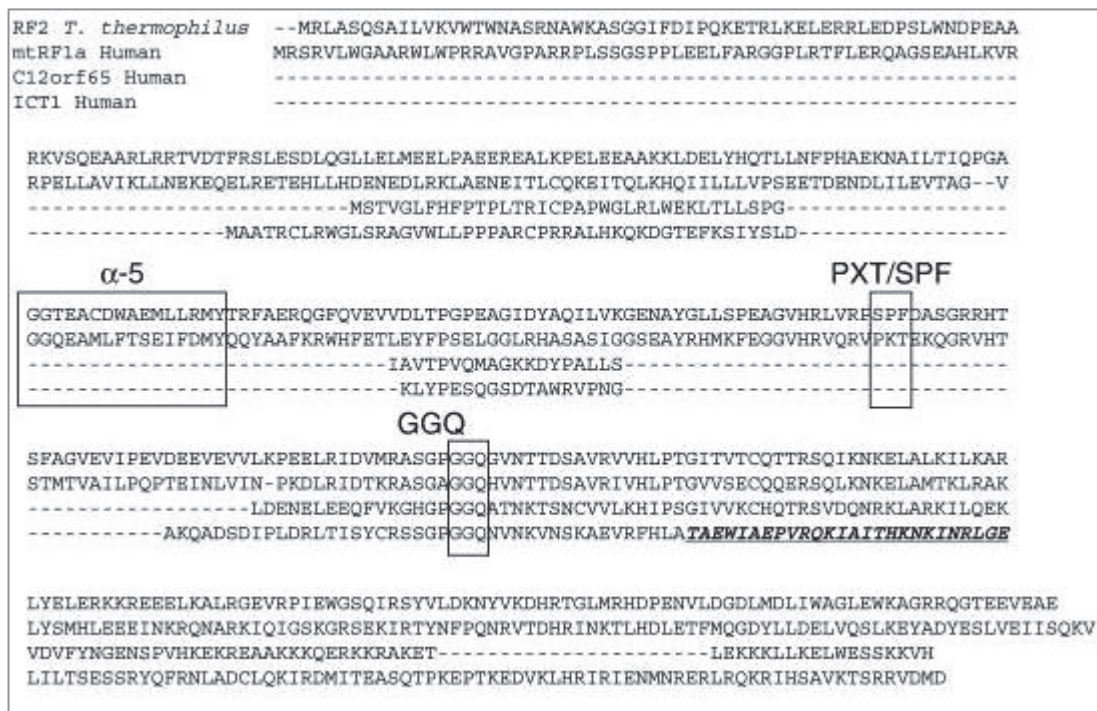

Fig. 80 Alignment of RF2 from *T. thermophilus* and human mtRF1a, C12orf65 and ICT1. GGQ: conserved peptidylhydrolase motif. PXT/SPF: tripeptide motifs involved in the recognition of stop codons in bacterial RF1 and RF2, respectively. α -5: helix that recognizes the first U of stop codons in bacterial RF1 and RF2.

A discussion is opened on the exact role of ICT1 (Wesolowska *et al.*, 2014; Chrzanowska-Lightowlers and Lightowlers, 2015). A team defends the hypothesis that it is a rescue factor permanently bound to the mitoribosome and indifferent to the codon present in the A site ((Richter *et al.*, 2010)). They also argue that a frameshift seems to occur upon the absence of cognate tRNAs for AGA/G, and that this frameshift allows the apparition of a UAG stop codon by recoding in the two mitochondrial ORFs that contain these “unusual stop codons”; UAG would then be recognized by mtRF1a, which would be the only release factor (Temperley *et al.*, 2010). Another team observed *in vitro* that ICT1 could not perform the rescue activity when it was bound to the ribosome, but only when it was free, acting then both as a rescue factor for stalled ribosomes and incidentally as a release factor on AGA/G codons, that were in their opinion stalling codons

(Akabane *et al.*, 2014). They also found that ICT1 activity was indifferent from the length of the mRNA in 3' of the A site, which seemed coherent with structural data that described an absence of insertion of the C-terminal tail of ICT1 in the mRNA channel (Lind *et al.*, 2013). But the first team retorted that the *in vitro* model could not perform the frameshift observed *in vivo* and that the observed ICT1 activity on AGA/G codons was therefore artificial, because they induced a stalling that did not occur in mitochondria (Chrzanowska-Lightowlers and Lightowlers, 2015).

Amongst the disputes of these eukaryotists, Kenneth Keiler's team decided to chime in and to pile even more controversy (Feaga *et al.*, 2016). They found that, contrary to previous results, ICT1 activity on stalled ribosomes reduced dramatically with the size of the mRNA in the entry channel of the ribosome, as with bacterial rescue mechanisms. They also showed that ICT1 was in fact a homolog of ArfB and not RF2 (Fig. 81). ICT1 ectopic expression can complement the loss of both *ssrA* and *arfB* in *C. crescentus*; concurrently, the loss of ICT1 could be complemented in human cells by *C. crescentus arfB*. The viability of ICT1-expressing *C. crescentus* with no other ribosome rescue factors debunks the possibility that ICT1 is a release factor for AGA and AGG, since these codons encode arginine in bacteria, and ICT1 would then induce the premature termination of translation in most bacterial ORFs.

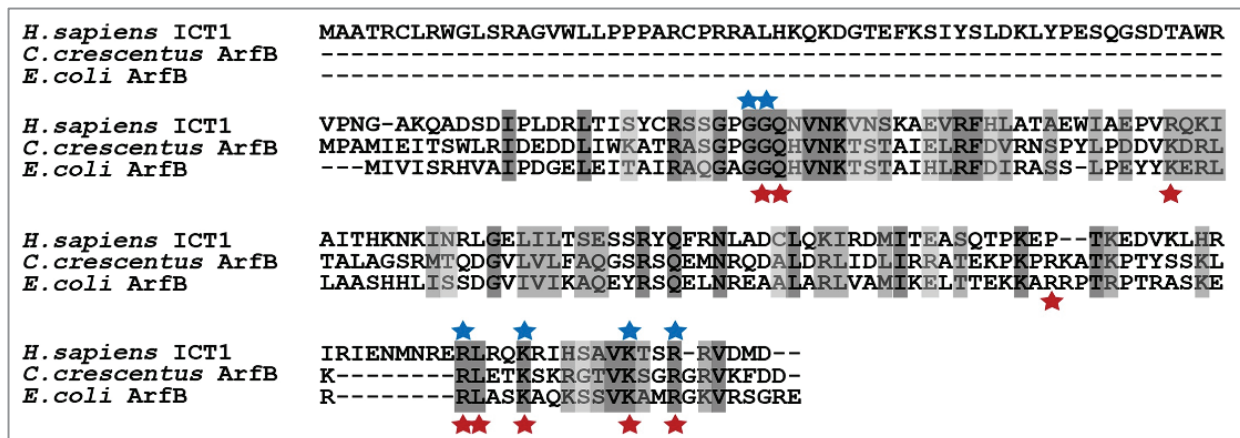

Fig. 81 Alignment of *E. coli* and *C. crescentus arfB* and human ICT1 sequences. (Feaga *et al.*, 2016)

More work will be necessary to explain the role of ICT1, mtRF1, mtRF1a and C12orf65 in mitochondrial translation and ribosome rescue. But it seems that as for bacteria, the role of ribosome rescue in mitochondria is paramount. The role of these genes in several forms of cancer implies that inhibitors of these mechanisms may be a clue for new treatments of those illnesses.

Uses of trans-translation in the biotech and diagnosis industries

Being a universal and highly conserved gene encoding an abundant RNA, *ssrA* and tmRNA are interesting alternatives to 16S rDNA and rRNA for the diagnosis and identification of bacterial samples. Several patents using tmRNA sequencing as an identification tools have been deposited: for group B *Streptococcus* (Barry *et al.*, 2009), for *S. aureus* (Smith *et al.*, n.d.), or for microbiota composition analyses (Forney, 2011).

The *ssrA*-tagged directed protein degradation has also been of interest for industrial applications, in particular for the overexpression of proteins and their purification. A patent describes the use of both the *ssrA* tag and a secretion sequence to prevent the accumulation of the potentially toxic overexpressed protein in the cytoplasm if the secretion system gets overwhelmed, preserving the producing bacteria from the formation of inclusion bodies (Georgiou and DeLisa, 2003).

Not disregarding these specific applications, the most exciting and recent application of trans-translation research is certainly the discovery that this mechanism could be a new antibiotic target.

3.8. Interest of trans-translation as an antibiotic target

Trans-translation is an essential mechanism in a number of human pathogens

The idea that trans-translation could be an interesting antibiotic target was not evident at first, since most of the research on the mechanism had been done on *E. coli*, where it is not essential. In non-pathogenic *E. coli*, deleting either *ssrA* or *smpB* induces a mild pleiotropic phenotype and has a barely detectable effect on fitness (Oh and Apirion, 1991). However, it was progressively discovered that the mechanism was essential in a certain number of pathogenic species, either for their viability or for their virulence. A list of pathogens in which the essentiality of trans-translation has been assessed is presented in Table 3. To the best of my knowledge, this list is exhaustive.

Species	Essentiality	Reference
<i>Shigella flexneri</i>	Essential for viability	(Nitya S. Ramadoss <i>et al.</i> , 2013)
<i>Neisseria gonorrhoeae</i>	Essential for viability	(Huang <i>et al.</i> , 2000)
<i>Helicobacter pylori</i>	Essential for viability	(Thibonnier <i>et al.</i> , 2008)
<i>Haemophilus influenzae</i>	Essential for viability	(Akerley <i>et al.</i> , 2002)
<i>Mycoplasma genitalium</i>	Essential for viability	(Hutchison <i>et al.</i> , 1999)
<i>Mycoplasma pneumoniae</i>	Essential for viability	(Hutchison <i>et al.</i> , 1999)
<i>Enterococcus faecalis</i>	Essential for viability	(Michaux <i>et al.</i> , 2014)
<i>Mycobacterium tuberculosis</i>	<i>ssrA</i> essential for viability; <i>smpB</i> can be deleted	(Personne and Parish, 2014)
<i>Staphylococcus aureus</i>	Essential for viability? One paper reports the construction of a viable Δ <i>ssrA</i> strain with upregulated virulence	(Liu <i>et al.</i> , 2010; Fey <i>et al.</i> , 2013)
<i>Escherichia coli</i>	Non-essential for viability Essential for virulence of avian ExPEC (Extra-intestinal pathogenic <i>E. coli</i>)	(Oh and Apirion, 1991; Mu <i>et al.</i> , 2013)
<i>Francisella tularensis</i>	Non-essential for viability. Essential for virulence	(Svetlanov <i>et al.</i> , 2012)
<i>Yersinia pseudotuberculosis</i>	Non-essential for viability. Essential for virulence	(Okan <i>et al.</i> , 2006)
<i>Yersinia pestis</i>	Non-essential for viability. Essential for virulence	(Okan <i>et al.</i> , 2010)
<i>Salmonella enterica</i>	Non-essential for viability. Essential for virulence	(Julio <i>et al.</i> , 2000)
<i>Streptococcus pneumoniae</i>	Non-essential for viability. Essential for virulence	(Mann <i>et al.</i> , 2012)

Table 3 Exhaustive list of pathogenic species in which essentiality of trans-translation has been assessed, as of 2016.

The fact that trans-translation can be essential for viability is explained by the previously discussed, absolute necessity for bacteria to resolve ribosome stalling to ensure their survival (Keiler and Feaga, 2014). In all the pathogens where trans-translation was found to be essential for viability, none of the known alternative ribosome rescue factors were identified (Fig. 76, p.134). As these species are all strict pathogens, most of which lost a number of redundant mechanisms to reduce their genome and accommodate the acquisition of virulence genes, it is possible that the loss of alternatives to trans-translation is a common phenomenon during the switch to a pathogenic way of life. It is nevertheless important to notice that this observation could be biased by the higher number of research projects conducted on bacterial pathogens rather than on non-pathogenic species.

The fact that trans-translation is essential for the virulence of a number of pathogens is explained by the more global observation that in all species, trans-translation plays an important role in the regulation of the expression of a number of important mechanisms.

Trans-translation is essential for the regulation of several bacterial mechanisms and for survival to stress, including antibiotics

It has been previously mentioned that in *E. coli*, deletion of either *ssrA* or *smpB* had a mild but pleiotropic phenotype. First, it had been observed that several phages lost their cycle regulation, for example the T4 and the Mu bacteriophage (Ranquet *et al.*, 2001; Slavcev and Hayes, 2003). In both cases, the expression of the protein controlling the lytic cycle of the phages are targeted and regulated by trans-translation. *E. coli ssrA*-deleted strains also exhibit the hallmarks of a constitutive heat shock response, which was found to be induced by the accumulation of stalled ribosomes, and not because of the accumulation of misfolded or unfinished peptides (Munavar *et al.*, 2005). Concurrently, growth at high temperatures is slowed down (Komine *et al.*, 1994). Metabolism is also somewhat impacted in *E. coli*, as *ssrA* mutants recover more slowly from carbon starvation (Oh and Apirion, 1991) and from exposure to the toxins of their TA systems (Christensen and Gerdes, 2003).

Moreover, the regulation of LacI, the inhibitor of the Lac operon, is completely dependent on trans-translation (Abo *et al.*, 2000). The end of the *lacI* gene is overlapped by a lac operator that is bound by LacI itself in the absence of lactose, resulting in the early termination of transcription of

lacI before the stop codon and the production of a non-stop *lacI* mRNA. The product of that transcript is targeted by trans-translation and degraded, greatly limiting the number of LacI proteins in the cytoplasm. In the advent of an increase in lactose availability in the medium, the LacI repressor binds lactose and concurrently loses its ability to bind DNA. As the number of LacI proteins has been maintained low until that point by *ssrA*-orientated degradation, the repression of the *lac* operon can be quickly lifted to immediately profit from this carbon source. The own expression of *lacI* is then increased, because its transcript is now also produced full-length. The higher number of copies of the LacI repressor in presence of lactose allows a quick restoration of the repression, as soon as the lactose concentration start to decrease.

In other bacterial species where it is not essential for viability, trans-translation also plays a role in various cellular mechanisms. In *B. subtilis*, it is necessary for sporulation because the expression of σK , the transcription factor of sporulation, is regulated by trans-translation (Abe *et al.*, 2008). As in *E. coli*, fitness of an *ssrA* deletion strain was decreased at high temperatures, but also in toxic environments such as exposure to ethanol or heavy metals (Muto *et al.*, 2000). In *Caulobacter crescentus*, a bacterium with a well-regulated cell cycle where asymmetric division leads to two structurally different daughter cells, trans-translation is essential for the correct timing of DNA replication (Keiler and Shapiro, 2003a); the degradation of tmRNA occurs at the beginning of DNA replication and is necessary for this step of the division cycle ((Keiler and Shapiro, 2003b)). In the nitrogen-fixing rhizobial symbiont *Bradyrhizobium japonicum*, deletion of *ssrA* prevents the establishment of symbiosis with plants (Ebeling *et al.*, 1991). Thus, trans-translation is involved in stress resistance and regulation in a broad number of species.

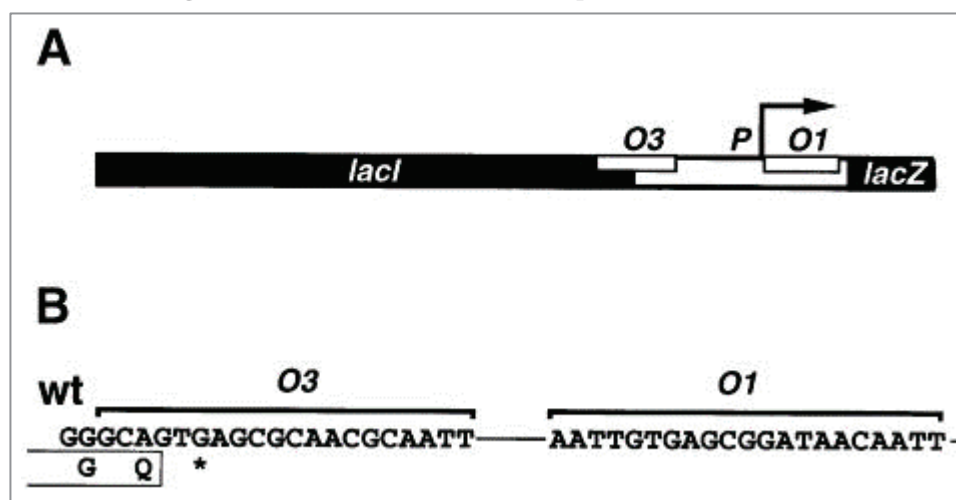

Fig. 82 The regulation of the Lac operon relies on trans-translation. The O3 lac operator overlaps the TGA stop codon. (10899129)

In pathogenic species where trans-translation is essential for virulence, the exact role of the mechanism in pathogeny has not always been established. In *Yersinia pseudotuberculosis*, *ssrA* disruption induces a sensitivity to carbon starvation and a slight fitness impairment. The loss of virulence seems related to a defect in expression of VirF, a transcription factor regulating the expression of the Type III Secretion System of that species (Okan *et al.*, 2006). It was speculated that a repressor of *virF* could be targeted by trans-translation and degraded, but such a repressor has not been identified yet. In *Salmonella enterica* serovar *typhimurium*, a number of genes involved in virulence are not correctly expressed in an *ssrA* deletion strain (Julio *et al.*, 2000). As for other pathogenic species in which trans-translation is essential for virulence, the reason for this necessity is less clear. It is nevertheless obvious that infection of a human host is a stressful undertaking, with restricted availability of nutrients and exposure to immunological hazards; The importance of a system as efficient as trans-translation for the correct and timely expression of virulence proteins is therefore not surprising. For *Francisella tularensis* and *Yersinia pestis*, the loss of virulence of *ssrA* mutants could provide interesting strains for the development of vaccines (Okan *et al.*, 2010; Svetlanov *et al.*, 2012).

Interestingly, one of the consequence of the loss of trans-translation is a lower resistance to ribosome-targeting antibiotics. This observation was realized in both *E. coli* (Luidalepp *et al.*, 2005) and in the cyanobacterium *Synechocystis* sp. (de la Cruz and Vioque, 2001), where an *ssrA* deletion increases the efficiency of chloramphenicol, erythromycin, kanamycin... Concurrently, in mycobacteria, exposure to ribosome-targeting antibiotics induce an overexpression of *ssrA* (Andini and Nash, 2011). Antibiotics that induce miscoding, like aminoglycosides, induce read-through of stop codons and stalling (Abo *et al.*, 2002). The prolonged pauses caused by other ribosome-blocking antibiotics probably induce mRNA decay which induces stalling even after the removal of the antibiotic; in both cases the trans-translation mechanism is undoubtedly required to counteract the action of these drugs.

The fact that a number of pathogenic species responsible for severe human diseases need trans-translation suggests that targeting this mechanism with a specific inhibitor would cause bacteriostasis, loss of virulence, and an increased sensitivity to ribosome-targeting antibiotics.

Trans-translation inhibitors have antibiotic activity

The potential of trans-translation inhibitors as antibiotics was confirmed by the discovery that pyrazinoic acid, the active metabolite produced from pyrazinamide inhibited trans-translation in *M. tuberculosis* (cf. p.97). Pyrazinoic acid interacts with RpsA (ribosomal protein S1) and prevents trans-translation activity, without inhibiting normal translation. The prodrug has to be reduced into its active form by pyrazinamidase, an enzyme that normally metabolizes the closely related molecule nicotinamide; only *M. tuberculosis* and *M. africanum* pyrazinamidases can recognize the prodrug and metabolize it (Shi *et al.*, 2011; Yang *et al.*, 2015). Pyrazinoic acid itself is electrically charged and cannot cross bacterial membranes. Pyrazinamide and pyrazinoic acid are therefore useless against other pathogens.

New inhibitors of trans-translation were sought out and discovered in Kenneth Keiler's lab (Nitya S Ramadoss *et al.*, 2013). As the target of interest had been identified and validated, a rational and orientated drug discovery approach was designed (cf. p.72). A high-throughput assay based on luciferase activity was designed to look for inhibitors of trans-translation-mediated tagging and degradation (Fig. 83A). The gene coding for luciferase, a luminescence-producing enzyme, was modified to encode a strong terminator upstream of its stop codon. In this system, the luciferase enzyme is expressed from a non-stop mRNA, systematically targeted by trans-translation, tagged by tmRNA and degraded. Thus, cells in which this system is introduced do not exhibit any luminescence in normal growth conditions. If one of the tested compounds inhibits either tagging by tmRNA or degradation of tagged compounds by proteases, the luciferase will stop being degraded and luminescence will increase. A hit rate of 0.2% was obtained (178 compounds), and 46 compounds readily available were further tested with a new screening assay.

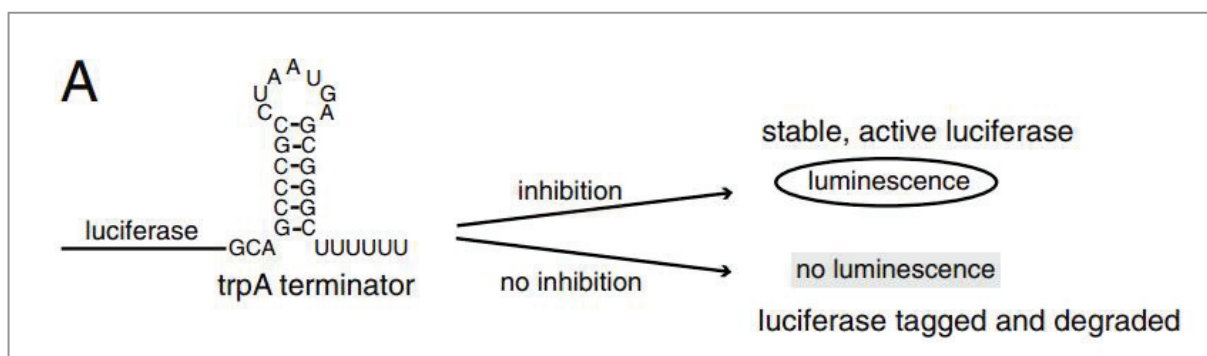

Fig. 83 High-throughput assay for the discovery of trans-translation inhibitors. (A) A luciferase gene modified to be targeted by trans-translation was used as the selection for the discovery of hit compounds. (B) Five compounds identified as trans-translation inhibitors.

The second screening was designed to discern whether tagging or proteolysis was the target of the compounds identified (Fig. 84). The green fluorescent protein (GFP) or the mCherry protein were either expressed from a gene with an early terminator as previously, or fused to the *ssrA* decapeptide degradation tag. In the first case, inhibition of either tagging or proteolysis both prevent the degradation of GFP and allow fluorescence to emerge. In the second case, as the protein is already tagged for degradation, whether trans-translation is active or not, only inhibition of proteolysis can allow fluorescence. This approach allows to determine whether proteolysis is targeted; unfortunately, it cannot determine whether a compound that inhibits tagging also targets proteolysis.

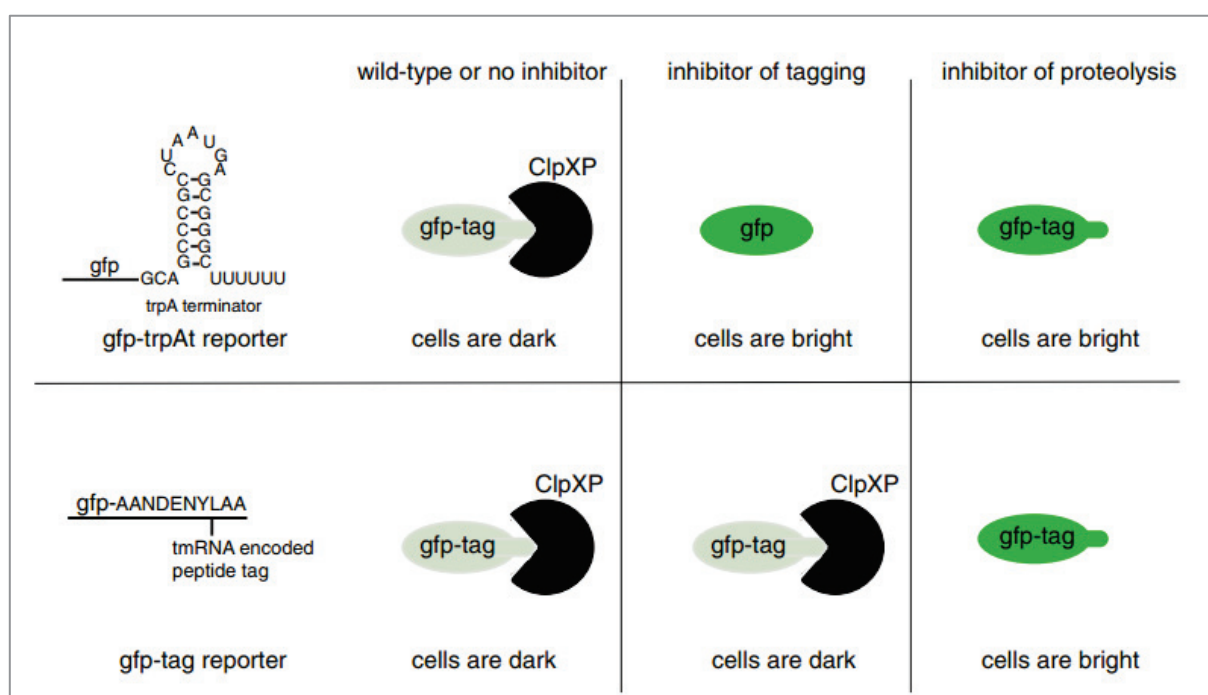

Fig. 84 Determination of the trans-translation step inhibited by the identified compounds.

From these approaches, a family of structurally close compounds with high activity were identified (Fig. 85). These lead compounds were further analyzed and it was found that KKL-35 and KKL-10 inhibit trans-translation before tagging, while KKL-52 and KKL-22 inhibit proteolysis; KKL-55 apparently inhibits both steps.

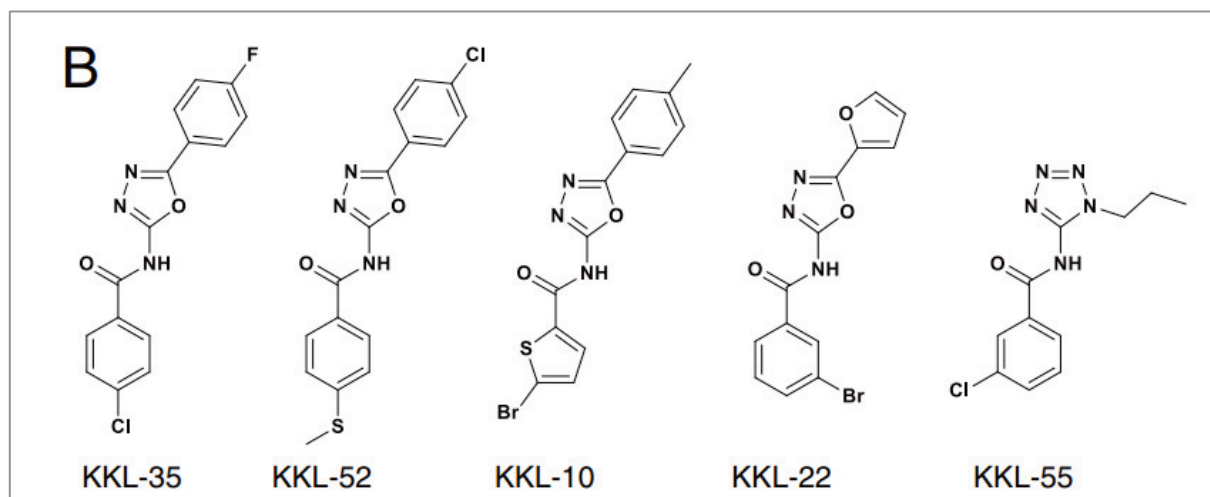

Fig. 85 Compounds inhibiting trans-translation identified by the high-throughput screen.

The compounds had been tested until that point either *in vitro* or against *E. coli* where trans-translation is not essential. No antibiotic effect was detected at first against that species with any of these five compounds, which was not surprising as trans-translation is not essential in *E. coli*. KKL-35, which exhibited a specific activity against tagging at a very low concentration ($IC_{50}=0.9\mu M$), was further tested for antibiotic activity. Its activity was assessed against *Shigella flexneri*, a close pathogenic relative of *E. coli* in which alternative ribosome factors have been lost and in which trans-translation is essential (Nitya S. Ramadoss *et al.*, 2013). The compound inhibited *S. flexneri* growth at a low MIC of $6\mu M$ (1.9 mg/L), and was bacteriostatic. To verify that trans-translation was indeed targeted *in vitro*, *arfA* from *E. coli* was cloned in a plasmid and expressed in *S. flexneri* before exposure to KKL-35; it prevented the growth inhibition. Concurrently, subinhibitory concentrations of puromycin, a drug that induce spontaneous abortion of translation and can therefore “rescue” stalled ribosomes, had an antagonist effect on KKL-35. Both results show that trans-translation is indeed the target of KKL-35 in *S. flexneri*.

To verify whether KKL-35 could have an effect on *E. coli* at high concentrations, it was tested on a $\Delta tolC$ strain deficient for the export of small molecules. Surprisingly, KKL-35 could inhibit the growth of this strain at a very low concentration ($MIC = 0.3\mu M$ or 0.1 mg/L). This could be explained by the fact that, as previously mentioned, expression of ArfA in *E. coli* is inhibited by trans-translation in normal conditions. The sudden influx of highly-concentrated inhibiting compound that blocks trans-translation probably overwhelms the ribosomes before ArfA production can resume at sufficient levels to replace trans-translation. This was verified by the pre-expression of non-regulated *arfA* from a plasmid that prevented the activity of KKL-35. These

results show that trans-translation-inhibiting compounds can hinder growth of strains in which the mechanism is not essential, at both conditions that alternative ribosome factors are downregulated beforehand and that the compound can reach an efficient concentration quickly enough to prevent the lifting of that downregulation. As for now, the regulation of *arfA* and *arfB* homologs in other species than *E. coli* has not been widely studied because of the difficulty to identify their homologues in distant taxa. However, it seems that *arfA* downregulation by trans-translation is widespread in β and γ -proteobacteria (Schaub *et al.*, 2012).

KKL-35 was also tested against a highly virulent pathogenic species in which trans-translation essentiality had not been determined, *Bacillus anthracis*, and also in *Mycobacterium smegmatis*, a close relative of pathogenic mycobacteria. The compound could inhibit their growth at MICs of 3 and 1.3 μ M, respectively. In *M. smegmatis*, it was also determined to be bactericidal at the same concentration as the MIC. This shows that trans-translation inhibitors have broad-spectrum activity and that KKL-35 and its derivatives are good candidates for a new antibiotic family.

KKL-35 has since been tested on other pathogens, with success. KKL-35 was shown to inhibit the growth of *M. tuberculosis* (Keiler *et al.*, unpublished results), and *S. aureus* (Keiler and Alumasa, 2013). tmRNA is essential in *M. tuberculosis* but conflicting reports exist for *S. aureus* where a Δ *ssrA* strain was reported (Liu *et al.*, 2010) but where a global mutagenesis screen did not report any transposon insertion in either *ssrA* nor *smpB* (Fey *et al.*, 2013). KKL-35 is also efficient against *Francisella tularensis* (where trans-translation is not essential for viability but is essential for virulence) in broth at a MIC = 0.3 μ M (Goralski *et al.*, 2016). Because of its low solubility, the closely related compounds KKL-10 and KKL-40 were also tested in that strain and had similar MICs in broth. When tested during the intracellular infection of mammalian cells, both compounds stopped the infection and provided protection from lysis. These results confirm the broad-spectrum activity of these trans-translation inhibiting compounds against a number of important human pathogens.

Are trans-translation inhibitors a new class of antibiotics? First, the basic moiety of KKL-35, 52, 10 and 22 is similar in all these compounds: a 2-amido-1,3,4-oxadiazole; KKL-55 is a closely related 2-amido-tetrazole (Fig. 85). This suggests that this moiety is the active part of these molecules and that they probably all share a common mechanism. The mechanism of action of this

family of inhibitors is being investigated by click chemistry (Alumasa and Keiler, 2015) at the time of the redaction of this thesis work. Preliminary results suggest that trans-translation components are not directly targeted and that they bind the base of helix 89 in 23S rRNA, a novel target that is not bound by any other antibiotic (Keiler, 2016). This structure is involved in the function of the peptidyltransferase center (Burakovsky *et al.*, 2011) and is known to interact with the tRNA-like domain of tmRNA during its accommodation and translocation to the P site (Weis *et al.*, 2010) (Fig. 86).

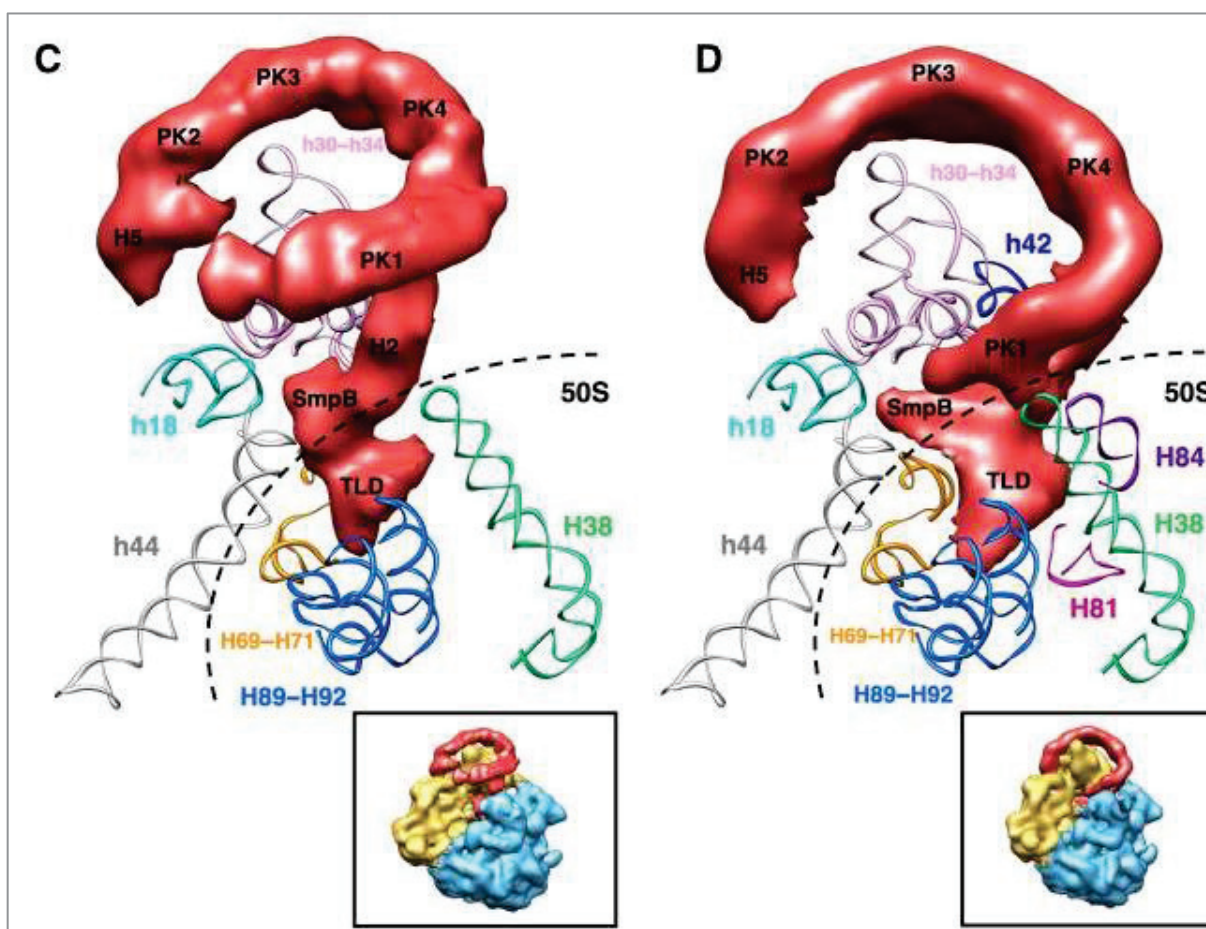

Fig. 86 Cryo-EM-density map of tmRNA-SmpB (in red) with its neighbouring RNA helices of tmRNA-SmpB in the accommodated (C) and translocated (D) states.

Another important point for the definition of a new antibiotic class is the relative safety of the molecules towards animals. As trans-translation is absent in mitochondria and eukaryotic ribosomes, it's an ideal target for specific drugs. Blocking the ribosome directly has been a long-standing and well-proven efficient strategy for antibiotic development (cf. p. 89). The structures of the bacterial and eukaryotic ribosomes are different enough that cross-reaction with ribosome-targeting antibiotics is very rare. Indeed, the first results on cytotoxicity of these compounds show

no toxicity at concentration sufficient to eliminate intracellular *F. tularensis*. This new family of compounds with a previously unseen mechanism are excellent candidates to become a new class of antibiotics.

4. Legionella pneumophila, the accidental human pathogen

4.1. Description and epidemiology

Discovery of *L. pneumophila* in a Legionnaire's disease outbreak

In 1979, in Philadelphia, a group of veterans from the American Expeditionary Forces named the American Legion were reunited in the Bellevue-Stratford Hotel (Fig. 87) for a convention. The luxurious hotel had richly decorated interiors and air conditioning. More than 2,000 veterans and their family attended the convention. As soon as the second day of the convention, and for 7 days after it ended, convention visitors fell ill with cough and pneumonia. Hotel workers and passersby that lived near or visited the hotel also were afflicted as long as 23 days after the end of the conference. As most convention visitors had left the 3-day conference by the time that they developed symptoms, the CDC launched an unprecedented investigation at the hotel to estimate the scope of the outbreak. In total, 182 cases of what became known as Legionnaire's disease (or Legionellosis) were declared during the outbreak; 147 had to be hospitalized and 29 died (16%) (Fraser *et al.*, 1977). The investigation excluded swine flu and common community-acquired pneumonia.



Fig. 87 The Bellevue-Stratford Hotel in Philadelphia, where the first recognized outbreak of Legionnaire's disease occurred in 1979

The investigation continued and, following Koch's postulates (*cf.* p.43), investigators found a new bacterium in the lung of autopsied patients (Chandler *et al.*, 1977) and confirmed that it

caused pulmonary infections in guinea pigs (McDade *et al.*, 1977). The bacterium was named *Legionella pneumophila* (lung-loving, in Latin).

In retrospective, it was discovered that *L. pneumophila* had already causes unexplained outbreaks of pneumonia. The oldest was a 1957 outbreak in a meat processing facility (Osterholm *et al.*, 1983); employees that declared the disease were sought out almost 30 years later and found to have high titers of *L. pneumophila*-specific antibodies. In 1968, an epidemic of acute febrile illness of undetermined origin was declared in a facility of the health department of Pontiac, Michigan. Retrospectively, it was found to also have been an epidemic caused by *L. pneumophila* (Glick *et al.*, 1978).

Characterization of *Legionella pneumophila*

L. pneumophila is a Gram-negative bacillus with pleomorphic appearance (Chandler *et al.*, 1977). It was not related to any other bacteria genera known at the time (Brenner *et al.*, 1979). It was found to multiply intracellularly in human cells (Horwitz and Silverstein, 1983) and in amoebae from freshwater environments and soil (Rowbotham, 1980). Rapidly, *L. pneumophila* was discovered in aquatic environments that were determined to be its natural habitat (Fliermans *et al.*, 1979). It was also discovered that although *L. pneumophila* is ubiquitous in such natural environments, it escaped attention until then because it was mostly causing disease when it invaded artificial water systems (Dondero *et al.*, 1980), causing lung infections at the alveolar level after being inhaled in the form of aerosols produced by shower heads, humidifiers, air conditioning and cooling towers (Dennis *et al.*, 1982; Bollin *et al.*, 1985; Woo *et al.*, 1986).

Growth of the bacterium in artificial media is slow (3-5 days) and fastidious. After fumbling for a while with a crude medium containing starch and beef extract (Feeley *et al.*, 1978), a medium for isolation and culture was designed and is still used today. It is based on charcoal and yeast extract, supplemented with iron and cysteine and buffered at pH 6.9 with ACES (N-(2-Acetamido)-2-aminoethanesulfonic acid) (Feeley *et al.*, 1979). The activated charcoal allows growth by reducing the formation of reactive oxygen species produced when autoclaving the components, to which *L. pneumophila* is very sensitive (Hoffman *et al.*, 1983). A liquid medium with similar composition except without charcoal was designed and is filter-sterilized rather than autoclaved (Ristroph *et al.*, 1980).

L. pneumophila has a monopolar flagellum. It is flagellated only when the bacterium is virulent, which corresponds to the detection of a lack of nutrients (in culture, early stationary phase) (Heuner and Steinert, 2003). The cross-section of the bacterium is 0.7-1 μ M, and its length is very variable, ranging from coccoid forms to filamentous forms containing several adherent bacteria (Katz *et al.*, 1984). These morphological variations are related to complex networks of regulation that control the different lifestyles of the bacterium. Indeed, *L. pneumophila* switches between three very different lifestyles, which require highly regulated modifications of gene expression: coccoid planktonic cells, virulent and flagellated; in biofilm, with other bacterial species; and intracellular, which is thought to be the only environment in which *L. pneumophila* multiplies (Robertson *et al.*, 2014).

Legionella species and strains, and their repartition

Since the 1976 outbreak, other *Legionella* species have been discovered. The most important is *Legionella longbeachae*, another Legionnaire's disease etiologic agent found in soils rather than freshwater, and which is prevalent in Australia (McKinney *et al.*, 1981; Steele *et al.*, 1990). More than 50 other species have been discovered. Other Legionellosis-causes species, in order of

<i>Legionella</i> species, serogroup	Species	Serogroup
<i>L. pneumophila</i>	91.5 (465)	
1		84.2 (428)
6		1.7 (9)
5		1.3 (7)
4		1.0 (5)
3		1.0 (5)
7		0.6 (3)
2		0.4 (2)
8		0.4 (2)
13		0.4 (2)
Unknown ^a		0.6 (3)
<i>L. longbeachae</i>	3.9 (20)	
Unknown		2.6 (13)
1		1.2 (6)
2		0.1 (1)
<i>L. bozemanii</i>	2.4 (12)	
Unknown		2.0 (10)
1		0.2 (1)
2		0.2 (1)
<i>L. micdadei</i>	0.6 (3)	
<i>L. dumoffii</i>	0.6 (3)	
<i>L. feeleii</i>	0.4 (2)	
<i>L. wadsworthii</i>	0.2 (1)	
<i>L. anisa</i>	0.2 (1)	
Unknown species	0.2 (1)	
Total	100 (508)	

NOTE. Data are percentage (no.) of isolates.
^a Serogroup unknown but not serogroup 1.

Fig. 88 Repartition of species and serotypes of *Legionella* found among 508 cases of Legionellosis from the United States (72.2%), Italy (12.6%), Switzerland (6.1%), Australia (4.7%), and New Zealand (4.3%). (Yu *et al.*, 2002)

prevalence, are *L. bozemanii*, *L. micdadei*, *L. dumoffii*, *L. feeleii*, *L. wadsworthii* and *L. anisa* (Yu *et al.*, 2002) (Fig. 88).

L. pneumophila is by far the most represented species in human infections. It represents 90% of cases in both the 2002 international report represented in Fig. 88 and in a 2009 European survey covering 1166 culture-confirmed cases (Beauté *et al.*, 2013). At least 16 different serogroups of *L. pneumophila* exist (Tronel and Hartemann, 2009). Serogroup 1 is by far the most represented, with 85% of all cases of Legionellosis in both cited reports (Yu *et al.*, 2002; Beauté *et al.*, 2013).

Genome sequences are available for a growing number of Legionella species that show a large diversity in genome size and of genes encoding virulence-associated proteins (Fig. 89) (Burstein *et al.*, 2016). This diversity is probably associated with a difference in host specificity in natural environments and also explains why, even if many species can cause Legionellosis, the number of human cases is heavily biased towards *L. pneumophila* and *L. longbeachae*; these species in particular are probably better armed to infect human cells. The emergence of a related intracellular pathogen, *Coxiella burnetii*, the etiologic agent of a zoonosis called the Q fever, has broadened the Legionellales order to another genus than *Legionella* (Weisburg *et al.*, 1989). Even more recently, *Berkiella*, a genus of intra-nuclear amoebal parasites has joined the Legionellales order (Mehari *et al.*, 2015). The Legionellales order is very isolated in the bacterial phylogeny (Wu *et al.*, 2009), which can be explained by an evolution driven by their particular ecological niche and by the difficulty of isolating the majority of Legionellales even with the medium defined for *L. pneumophila* (Adeleke *et al.*, 1996). It could well be possible to identify new orders of Legionellales in the near future with new cultivation techniques (cf. p. 30).

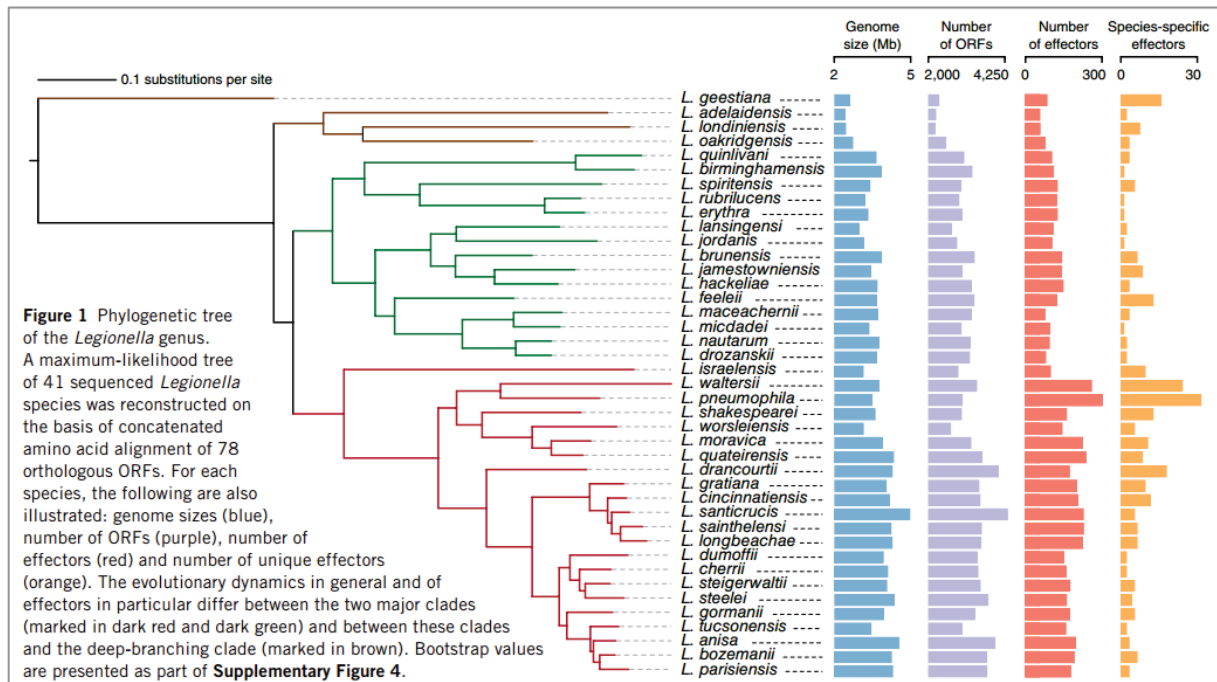

Fig. 89 Genomes of 38 *Legionella* species have been sequenced and a phylogenetic tree has been built using a set of orthologous genes. (Burstein *et al.*, 2016)

Legionella pneumophila strains are named after the location of an outbreak from which they have been isolated, or by the name of the location where they are endemic. For example, in France, the endemic clonal strains Paris and Lorraine have been identified in the capital and in the east of the country, respectively (Lawrence *et al.*, 1999; Ginevra *et al.*, 2008); the Lens strain resulted from an outbreak in Northern France (Nguyen *et al.*, 2006). The Alcoy strain is endemic in Spain where it regularly causes outbreaks (Fernández *et al.*, 2002), and the Corby strain was isolated in the UK (4020112). In the US, the Philadelphia strain is the one that had been isolated in the original 1976 outbreak; another strain named Wadsworth (or 130b, or AA100 depending on the publication) was isolated in a medical center of the town of the same name. The genome of all these *L. pneumophila* strains have been sequenced and revealed an intra-species divergence, with 10% of all sequenced genomes being strain-specific (Fig. 90) (Gomez-Valero and Buchrieser, 2013).

With the diminishing cost of whole-genome sequencing, a growing number of genomes of environmental and clinical strains have been sequenced and published in the last five years (Qin *et al.*, 2012; Okamoto *et al.*, 2014; Pagnier *et al.*, 2014; Morrison *et al.*, 2015; Watanabe *et al.*, 2015; Maita *et al.*, 2016; Morrison *et al.*, 2016). They provide new insight in the complex genomic specialization of this genera of bacteria that co-evolve with their eukaryotic hosts.

	Paris	Lens	Philadelphia	Corby	Alcoy	130b	Lorraine
Chromosome size (Mb)	3.5	3.3	3.4	3.6	3.5	3.5	3.5
G + C content (%)	38	38	38	38	38	38	38
Number of genes	3178	3034	3083	3290	3197	3293	3170
Number of protein-coding genes	3079	2921	2999	3193	3191	3288	3080
Pseudogenes	45	59	32	44	?	?	37
tRNA	43	43	43	44	?	42	44
Coding density (%)	87	87	88	87	86		87
Plasmids	1	1	0	0	0	0	1

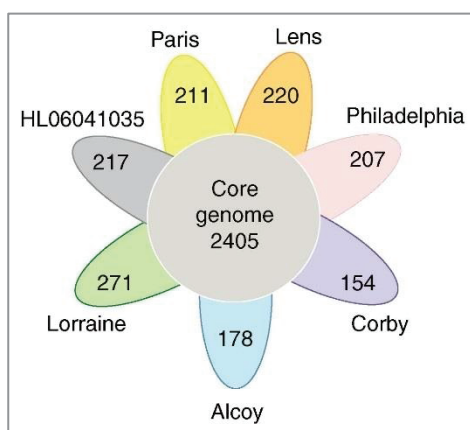

Fig. 90 Characteristics of the genomes of sequenced *L. pneumophila* strains (up) and representation of the relative abundance of strain-specific genes compared to the core genome (left) (Gomez-Valero and Buchrieser, 2013)

4.2. Legionnaire's disease, or Legionellosis

Etiology of Legionellosis and treatment

In natural environments, *Legionella* spp. are thought to multiply primarily or exclusively within unicellular eukaryotic hosts, in particular phagocytic amoebae (Abu Kwaik *et al.*, 1998). When aerosols of contaminated water are accidentally inhaled, they infect primarily alveolar macrophages and neutrophils, causing a severe pneumonia (Legionellosis/Legionnaire's disease). Probably more frequent but less often diagnosed, they can also cause a severe fever that lasts a few days (Pontiac fever). They can also fail to cause any symptoms at all despite prolonged exposure, as evidenced by

the continuous exposure of the Philadelphia hotel employees who had high antibody titers but no signs of illness (Fraser *et al.*, 1977). Legionellosis primarily affects old, immunocompromised, smoking, and chronic lung diseases-suffering patients; it is therefore a classic example of opportunist pathogen. It also affects men thrice as much as women, for reasons unclear (Campese *et al.*, 2011).

Treatment of Legionellosis involves prolonged and adequate antibiotic treatment. Although rapid urinary tests exist for diagnosis, unless an outbreak has been detected, Legionnaire's disease is often overlooked. Symptoms are these of a community-acquired pneumonia, which are often treated with beta-lactams, inefficient on *L. pneumophila* because of both beta-lactamase activity (Fu and Neu, 1979) and poor activity on its PBP_s (Weisholtz and Tomasz, 1985). A prolonged delay before adequate treatment massively increases mortality (Heath *et al.*, 1996).

Adequate antibiotic regimen for the treatment of Legionellosis have been empirically determined (Edelstein, 1995) to be macrolides (erythromycin, clarithromycin, azithromycin, cf. p.90) or fluoroquinolones (norfloxacin, levofloxacin, ciprofloxacin cf. p.86). They are sometimes used in association with ryfamincins (rifampicin, cf. p.87). Cyclines (tetracycline, cf. p. 95) are also effective but not recommended because of their side effects. Macrolides and fluoroquinolones have the same efficiency on the outcome of the disease, with a slight advantage in the reduction of clinical symptoms with fluoroquinolones (Blázquez Garrido *et al.*, 2005).

Failure of antibiotic treatment is unfortunately frequent (>10% of cases) (Campese *et al.*, 2011). However, no antibiotic resistance has been observed in isolated clinical strains, at the exception of beta-lactamase activity and a few recent and very sporadic cases of resistance (Bruin *et al.*, 2014). Various reasons could explain this high rate of failure. Intracellularly-grown *L. pneumophila* are more resistant to antibiotic killing (Barker *et al.*, 1995). Antibiotics have to penetrate through the alveolus, the macrophage, the LCV and then the bacterial envelope. The empiric observation of the efficiency of macrolides and quinolones might be explained by their high ability to cross membranes and to reach elevated concentrations in lung macrophages (Honeybourne, 1997). Furthermore, while no resistance is observed in clinical isolates, the procedure of isolation is often performed at the beginning of the hospitalization, and a recent study has evidenced that fluoroquinolone resistance could emerge in a few days in response to the treatment (Shadoud *et al.*,

2015). New antibiotics with good penetration and synergic activity with either macrolides or fluoroquinolones would probably increase the success of treatment of Legionellosis.

Host-pathogen relationships

The cycle and mode of infection of *L. pneumophila* is similar in both amoebal and human hosts (Swanson and Hammer, 2000) (Fig. 91). Phagocytosis is promoted by a number of virulence factors, including a collagen-like protein (Vandersmissen *et al.*, 2010), a very large toxin (>800 kDa!) secreted by a type I secretion system (Fuche *et al.*, 2015), and the injection of “effector” proteins through a type IV secretion system (detailed below) that begins as soon as contact occurs (Bruckert *et al.*, 2014). Phagocytosis occurs rapidly through actin-mediated phagocytosis, pinocytosis, or a special mechanism of coil phagocytosis induced by the bacterium (King *et al.*, 1991).

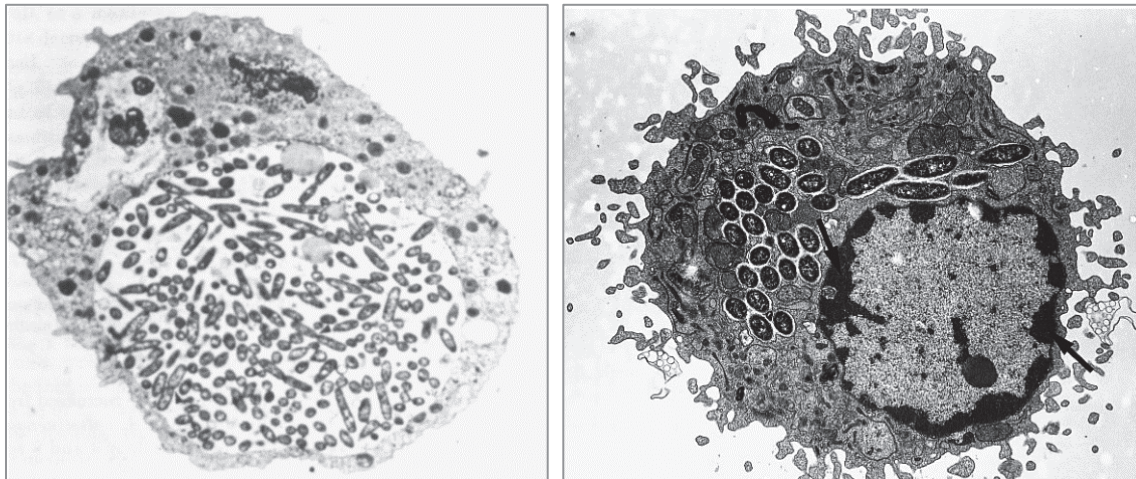

Fig. 91 Intracellular multiplication of *Legionella pneumophila* within: left, an environmental amoeba (*Acanthamoeba palestinensis*); right, a human monocyte (9851034)

L. pneumophila has developed a well-studied, specialized and extensive set of genes exclusively dedicated to infecting and taking over its hosts. The genes encoding these so-called “effectors” proteins represent on average an impressive 10% of the genome (Fig. 90). For example, there are 275 effector identified in the Philadelphia strain. Identifying their mechanism of action is complicated by their redundancy; single mutants often lack a distinct phenotype (Allombert *et al.*, 2014). The effector proteins are secreted from the phagosome into the cytoplasm of the host cell *via* one or two type IV secretion systems: the Dot/Icm system, assisted in some strains by the *lvh* system (Segal *et al.*, 1999; Zink *et al.*, 2002).

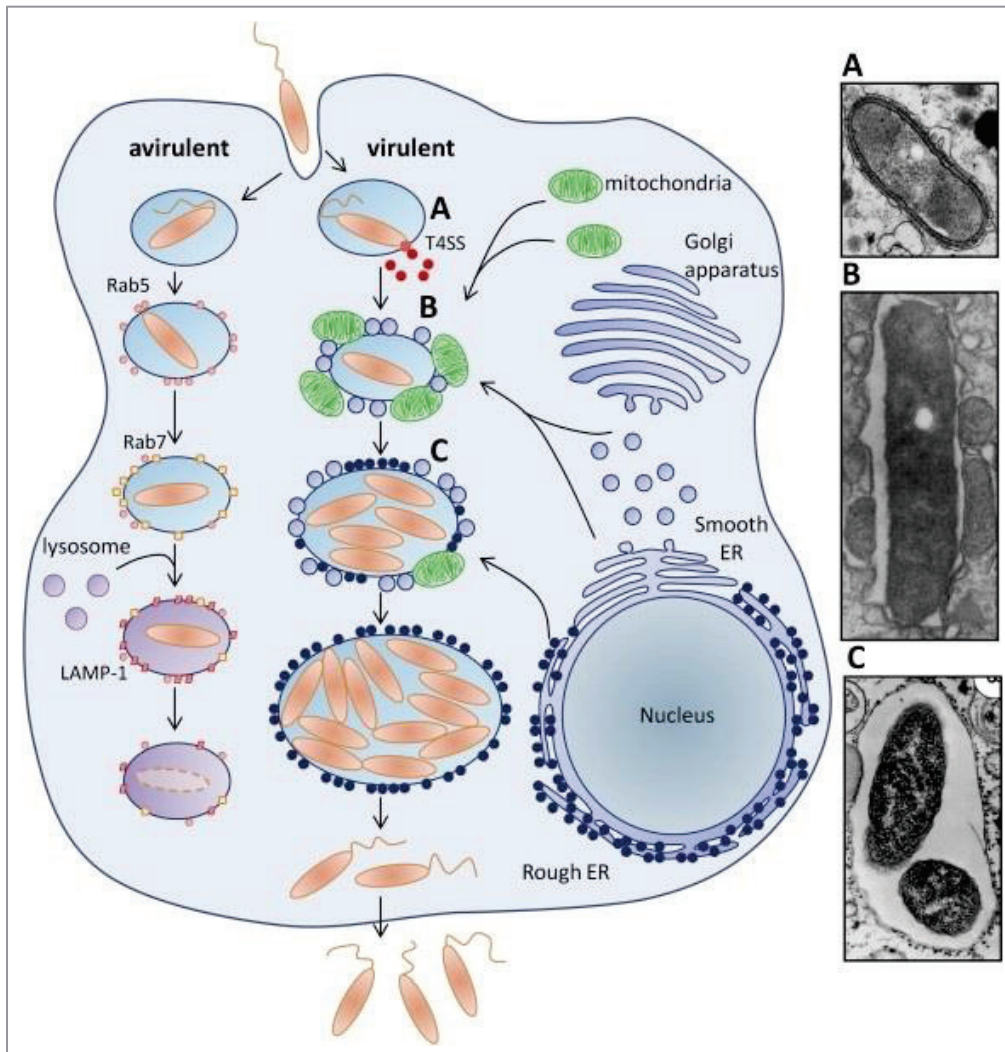

Fig. 92 *Legionella pneumophila* promotes through T4SS effectors the formation of a replicative LCV in the host where it thrives and multiplies. (Allombert *et al.*, 2014)

The Dot/Icm T4SS is essential for the infection of human and amoebal hosts and is found in all *Legionellales*, including *Coxiella burnetii* (Segal *et al.*, 2005). The effectors of the T4SS system completely remodel the vesicular trafficking of the host, preventing the phagosome-lysosome fusion, then establishing a replication niche called the Legionella-Containing Vacuole (LCV). This vacuole gets progressively decorated with rough endoplasmic reticulum, mitochondria, and ubiquitinated proteins that provide the nutrients necessary for the rapid multiplication of the bacteria (Hubber and Roy, 2010). Once nutrients start lacking, *L. pneumophila* switches to a flagellated, short-rod phenotype (Molofsky and Swanson, 2004). It then escapes the host, either by nonlytic release in amoeba (Chen *et al.*, 2004) or by apoptotic lysis in macrophages (Zink *et al.*, 2002).

Intriguingly, among T4SS effectors are found a high number of genes that contain eukaryotic-like domains. Such effectors are abundant amongst all sequenced *Legionella strains and species* ((Burstein *et al.*, 2016)). Some of them are conserved and others are strain-specific (D’Auria *et al.*, 2010; Gomez-Valero *et al.*, 2011). These genes have probably been acquired by inter-domain horizontal gene transfer, as their closest orthologues are found in amoebal genomes (Gomez-Valero and Buchrieser, 2013) (Fig. 93). Effectors with eukaryotic-like domains often play a role similar to their orthologues in the eukaryotic cell, but to the benefit of the bacteria.

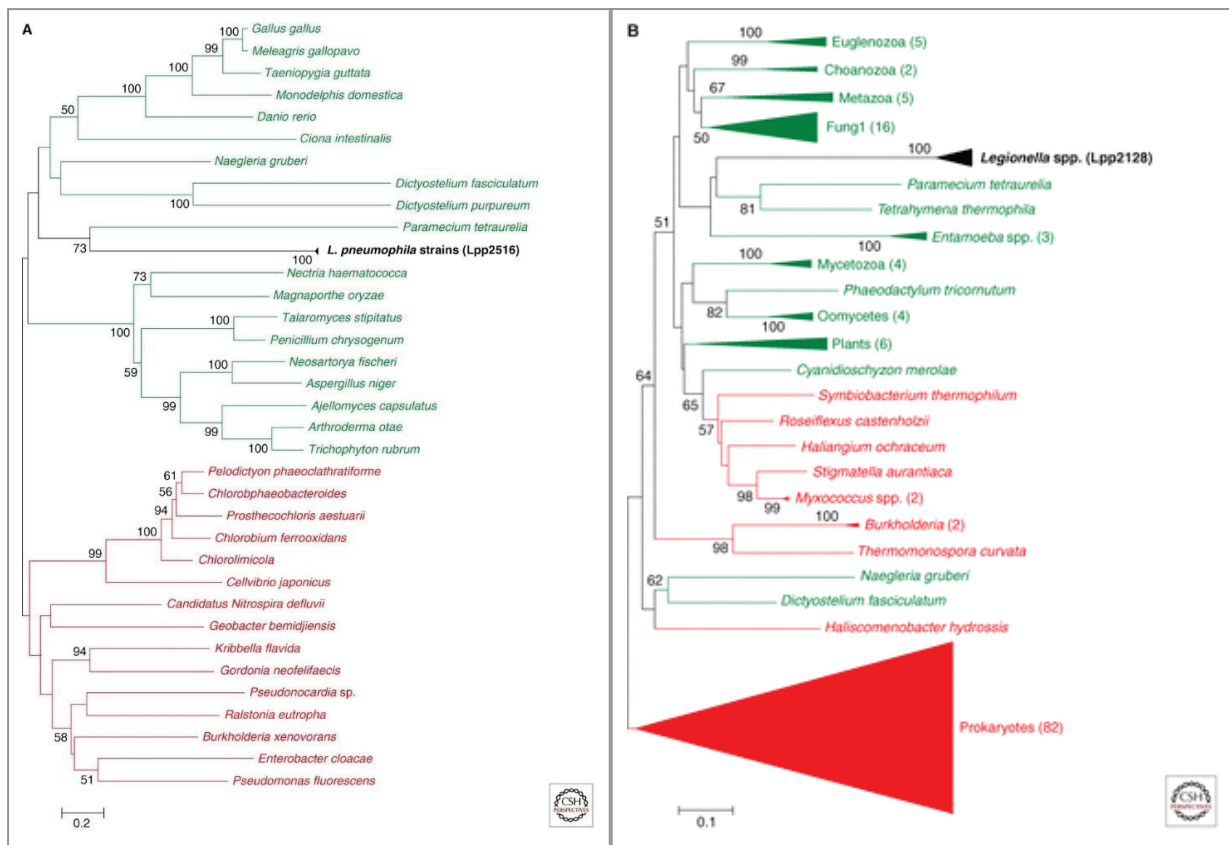

Fig. 93 Phylogenetic trees of two *L. pneumophila* str. Paris proteins with eukaryotic-like domains. Closest orthologues of both effectors are found in eukaryota (in green) rather than prokaryota (in red). (Gomez-Valero and Buchrieser, 2013)
(A) Lpp2516 is a arylamine N-acetyltransferase (B) sphingosine-1-phosphate lyase

4.3. From natural transformation to trans-translation in *L. pneumophila*

Competence and natural transformation in *L. pneumophila*

The acquisition of eukaryotic-like genes occurred in all probability by inter-domain horizontal gene transfer between *L. pneumophila* and its hosts. Amongst the three known mechanisms of HGT (cf. Fig. 24 p.67), natural transformation seems the obvious way from which amoebal DNA could

have been assimilated, as it is the only mechanism that allows the acquisition of free DNA and is not vector-based.

In some bacteria, natural transformation is a constitutively active phenomenon (Sparling, 1966). In most, expression of the genes involved in the mechanism is repressed at a transcriptional level, except in some specific conditions that include: exposure to antibiotics (Charpentier *et al.*, 2012), growth phase (Bott and Wilson, 1967), detection of an adequate substrate (Meibom *et al.*, 2005) and quorum sensing (Pestova *et al.*, 1996). In *L. pneumophila*, our laboratory has recently uncovered that competence for natural transformation is not controlled by transcriptional repression, but by post-transcriptional degradation of transcripts produced from constitutively-expressed genes (Attaiech *et al.*, 2016). This regulation is operated by a RNA chaperone and its cognate small RNA, that recognize the 5' untranslated region of competence transcripts, forming a kissing complex, preventing their translation and inducing their degradation.

A few growth conditions and mutants that induced competence for natural transformation were known before this work was completed. Competence is induced by growth in low-temperature and microaerophilic conditions (Sexton and Vogel, 2004), DNA damage induced by UV light or DNA gyrase inhibitors such as fluoroquinolones (cf. p. 86) (Charpentier *et al.*, 2011), and during a short window of the late exponential phase of growth (Attaiech *et al.*, 2016). Competence is constitutive in mutants of the RNA chaperone and its small silencing RNA; but also in mutants of *comR*, a gene of unknown function (Sexton and Vogel, 2004; Attaiech *et al.*, 2016). Another gene whose deletion causes competence deregulation is *rnr*, that encodes RNase R, involved in RNA decay during translation (cf. p.118) (Charpentier *et al.*, 2008). Competence is also constitutive in the Lp02 strain, a derivative of the Philadelphia-1 isolate, when grown at 30°C. The underlying mechanism is unknown (Sexton and Vogel, 2004).

A link between transformation and trans-translation?

At the time of the beginning of my thesis, our laboratory had a very limited understanding of the mechanism of regulation controlled by the RNA chaperone. It was also found that in the *rnr* hypercompetent mutant, tmRNA was not processed correctly at low temperatures, leading to accumulation of precursor tmRNA that correlates with competence development (Charpentier *et al.*, 2008).

Moreover, hints at a role of trans-translation exist in both *B. subtilis*, where the ClpP protease is essential for competence development (Msadek *et al.*, 1998). In *H. pylori*, tagging by tmRNA is essential for natural transformation (Thibonnier *et al.*, 2008). In *S. pneumoniae*, competence development is regulated by the rate of errors during translation (Stevens *et al.*, 2011) Naturally, we wondered whether this error in processing tmRNA and a reduction in trans-translation activity was involved in competence development. This led us to study trans-translation in *L. pneumophila*, the main focus of the work presented here.

Tn-seq for the study of natural transformation

Even though our lab uncovered a part of the regulation behind the development of competence for natural transformation in *L. pneumophila*, this mechanism is still relatively unknown in this species. In *S. pneumoniae*, which is the best described model for natural transformation, a new approach named Tn-seq allowed to confirm the role of all the genes previously found to be involved in this mechanism over three decades of work, and to provide new insights into its regulation (van Opijnen and Camilli, 2012). We were naturally interested in implementing this high-throughput and powerful method in our laboratory.

5. Identification of essential genes: the Tn-seq technique

5.1. Principle

The emergence of high-throughput sequencing (HTS) has allowed the development of new techniques for the study of gene function, regulation, and target discovery for rational drug design (cf. p.72). For example, RNA-Seq consists in extraction of total RNA, retro-transcription, and HTS that allows to study quantitatively the transcriptome at a given timepoint or in different conditions ((Wang *et al.*, 2009)). Tn-seq is a new technique that combines systematic transposition with high-throughput sequencing.

Genome-wide mutagenesis by transposition before genomics

Transposition systems such as Tn5, Tn10 or Mariner have been used for a long time in bacteria to perform systematic mutagenesis or random mutagenesis followed by selection of the mutants of genes of interest (Kleckner *et al.*, 1977). Such transposases recognize inverted repeated sequences (IR) that normally flank the transposase-encoding gene; the transposase cuts its own DNA sequence at both IRs and randomly pastes it elsewhere in the genome. Interestingly, the transposase only recognizes these IRs and not its own coding sequence in-between. This sequence can therefore be replaced by another gene that will be cut and pasted randomly as well, as long as the transposase is expressed *in trans*. For example, adding IRs around an antibiotic resistance marker, cloning it in a suicide vector containing the transposase gene, and transferring that vector in bacteria allows to create a pool of random mutants in the genome that are easily selectable.

For a long time, this random mutagenesis was then coupled with low-throughput solutions to analyze and identify mutants with interesting phenotypes. Typically, mutants with interesting phenotypes were selected through a screen and isolated. Their DNA was extracted, then either digested or sonicated. It could be then directly cloned into plasmids, transformed into *E. coli*, selected using the marker of the transposon, and sequenced by Sanger. The identification of the region flanking the transposon indicated the gene that had been inactivated in the mutant of interest. This is the method that was used to identify the hypercompetent *proQ* and *comR* mutants in *L. pneumophila* (Sexton and Vogel, 2004).

A method for systemic identification of essential genes within a pool of random transposition mutants was also developed (Akerley *et al.*, 2002). It consisted in systematic mutagenesis by transposition, coupled with identification of genes essential for viability under certain conditions, *e.g.* growth in rich or minimal media, infection of animal models, antibiotic exposure. Indeed, mutants with insertions in genes essential for survival in the tested condition would die off and be missing from the pool; analysis of the remaining mutants allowed to identify them by differential analysis. A variant using different transposons tagged for the identification of each mutant of the pool was used to identify some genes essential for infection of a guinea pig model by *L. pneumophila* (Edelstein *et al.*, 1999). An improved method called TraSH (transposon site hybridization) was also used to identify essential genes for growth in vitro and in different cellular hosts of *L. pneumophila* str. Philadelphia (O'Connor *et al.*, 2011). However, these techniques were both work-intensive and low-throughput.

High-throughput sequencing applied to systematic transposon mutagenesis

The advent of the genomic era solved this problem by allowing massive parallel sequencing of the regions flanking the transposons in all the library of mutants; while also providing quantitative data for comparative analyses between different conditions of growth (van Opijnen and Camilli, 2013; Chao *et al.*, 2016). The reliable transposition method was coupled to new high-throughput sequencing machines to yield a series of different techniques called InSeq, TraDIS, HITS and Tn-Seq (Fig. 95). The last name, Tn-Seq, while only used at first for a specific technique, is becoming increasingly used to define all methods that couple systematic transposition to high-throughput sequencing.

All methods share a common goal: creating a large library of mutants by random insertions of transposons; extracting DNA from the libraries of mutants, before and after growth in selected conditions; massively sequence the flanking regions of the transposons; quantitatively mapping the insertions; identify genes in which the number of insertions is null or changed between different conditions as important for growth in such settings.

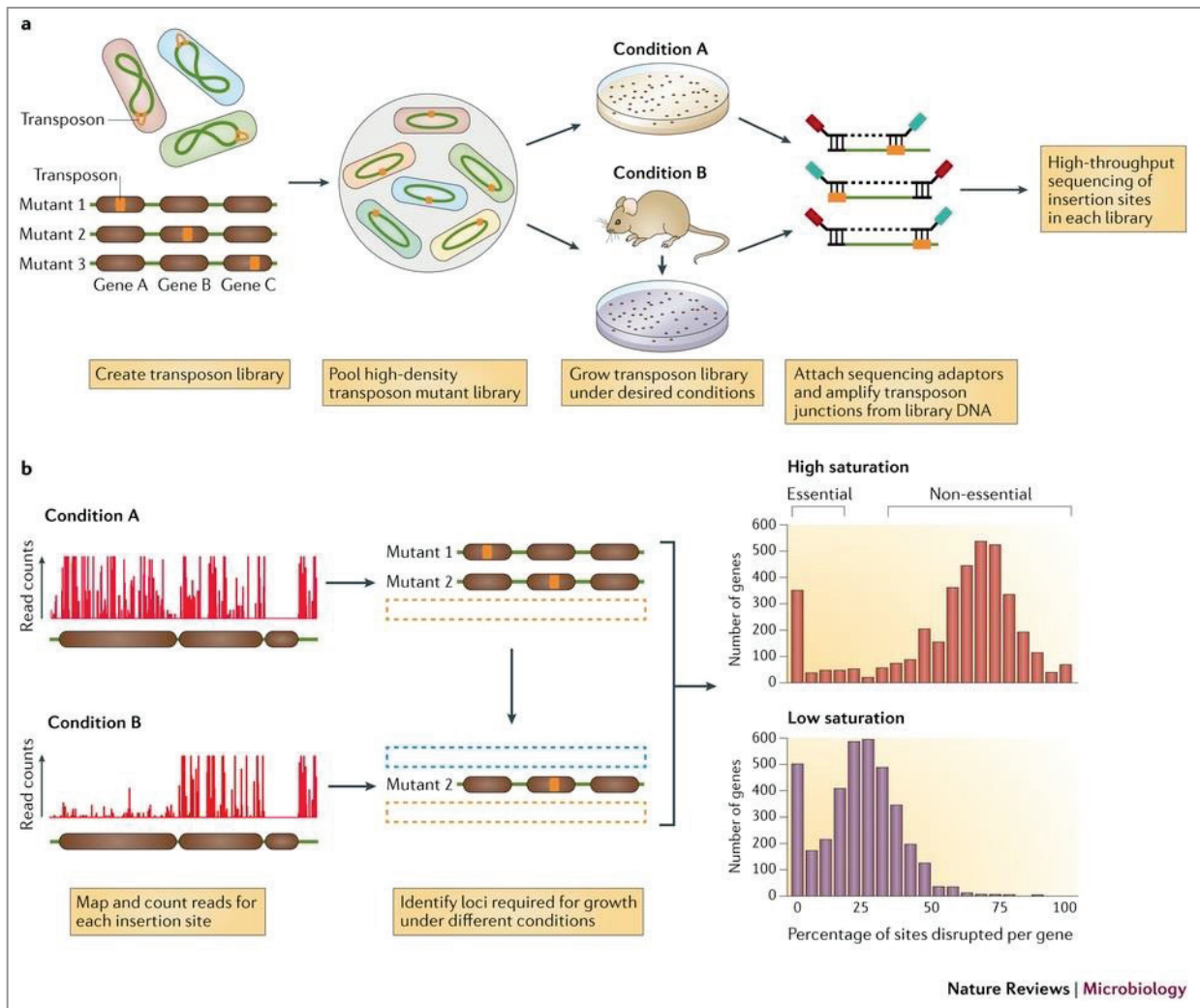

Fig. 94 Principle of the Tn-Seq approach. (Chao et al. 2016)

The methods for the preparation of libraries of DNA from the samples for massive parallel sequencing is what differentiates the different methods presented in Fig. 95.

- HITS and TraDIS are relatively similar. They both rely on random DNA shearing, which can be performed by sonication or digestion by a restriction enzyme that does not cut in the transposon. This is followed by end repair, ligation of an adaptor of known sequence, and amplification by PCR of the flanking region between the transposon and the adaptor. With HITS, one of the primer is biotinylated, allowing a purification by affinity of the PCR products amongst the sheared DNA from the sample.
- Similarly, Tn-Seq and INSeq are almost similar except for a purification step. DNA from the samples is not sheared randomly in this case. Both methods rely on the Mariner transposase, whose IR sequences can be mutated at a single nucleotide (without loss of efficiency) to introduce a MmeI restriction site. MmeI is a unique restriction enzyme that

does not cut at its restriction site but 20 bases downstream. Even when accounting for the first 4 bp downstream that still belong to the IR, 16 bases from the flanking regions can be identified, which is sufficient to effectively map the insertion.

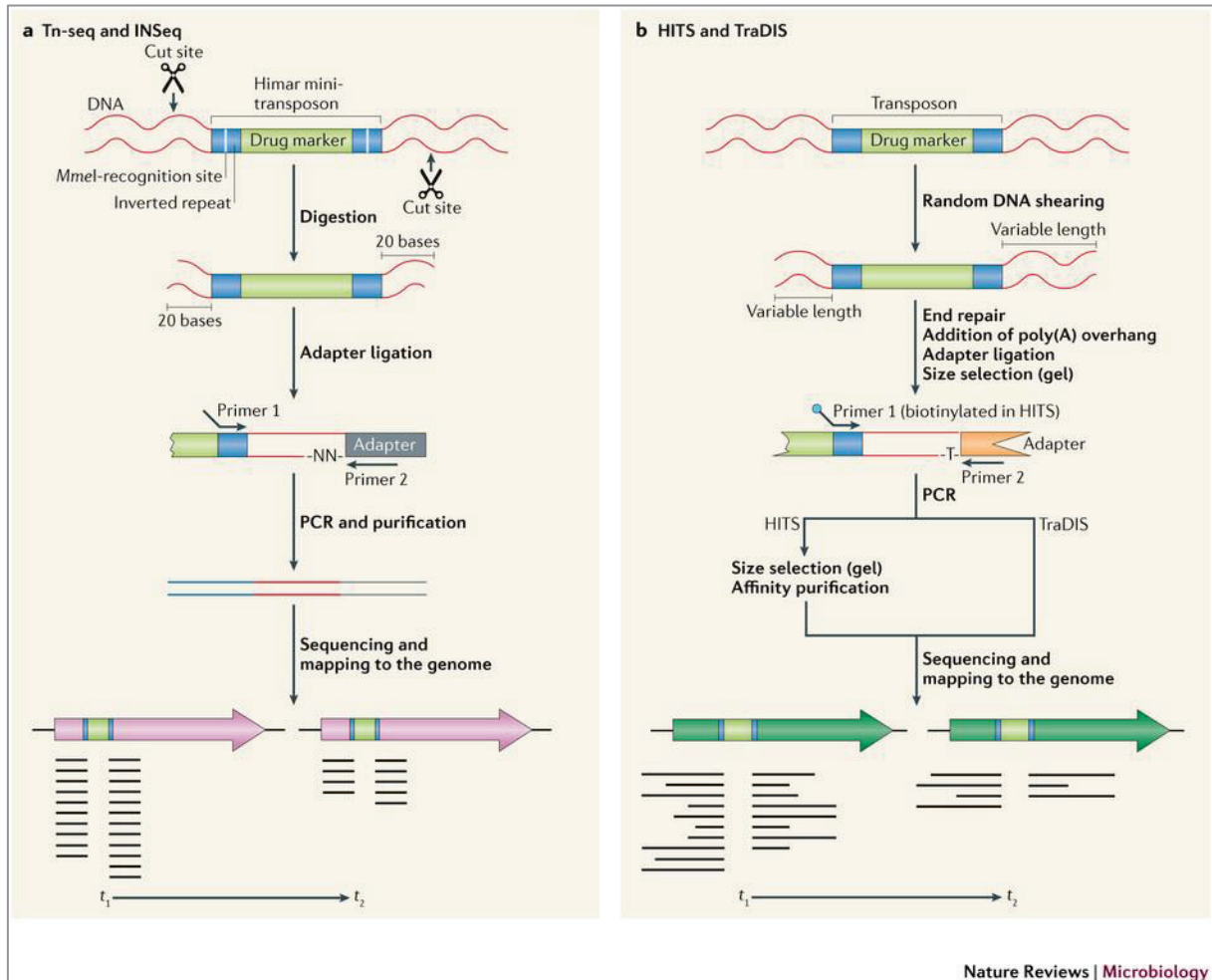

Fig. 95 Different approaches for Tn-Seq DNA analysis (van Opijnen and Camili, 2013).

The analysis of the sequencing data obtained from Tn-Seq analyses has been facilitated by the publication of several software packages that allow visualization of the mapping of insertions, and analysis of the contribution of each gene in the different tested conditions. Among others, we can recommend the software packages ESSENTIALS (Zomer *et al.*, 2012), ARTIST (Pritchard *et al.*, 2014) and Tn-Seq Explorer (Solaimanpour *et al.*, 2015).

5.2. Application and discoveries

Tn-seq approaches, although recent, have already been used in a number of bacterial species and provided us with new insights into important cellular mechanisms.

The first and most obvious application of Tn-seq is the massive discovery of all genes essential for growth in artificial media. Discovering such genes provides new targets for rational drug design (cf. p.72) that could have been overlooked until now. This was applied for example in the pneumonia-causing human pathogen *Streptococcus pneumoniae* (van Opijnen *et al.*, 2009). Interestingly, within an already small *Mycoplasma* genome, systematic mutagenesis and discovery of all essential genes has shown that almost a third of them are of unknown function (Hutchison *et al.*, 2016).

Another application of Tn-seq is the determination of genes not essential for basal metabolism but for virulence and survival within a host in particular. This was used to study the genes important for intestinal colonization by *Vibrio cholerae* (Dong *et al.*, 2013; Fu *et al.*, 2013), multiplication of *Yersinia pestis* in tissues (Palace *et al.*, 2014), resistance to bile by *Salmonella typhi* (Langridge *et al.*, 2009), and virulence of both *Burkholderia pseudomallei* (Gutierrez *et al.*, 2015) and *Haemophilus influenzae* (Gawronski *et al.*, 2009) in the lung.

An interesting use of Tn-seq is the discovery of genes implicated in a specific function. This was applied to find the genes implicated in immunity to the type VI secretion system of *Vibrio cholerae* (Dong *et al.*, 2013), alternative metabolism pathways in the bioremediation agent *Shewanella oneidensis* (Brutinel and Gralnick, 2012), the alternative ribosome rescue factor *arfB* that was elusive in *C. crescentus* (Feaga *et al.*, 2014a) (cf. p.129), and formation of persisters in *E. coli* (Molina-Quiroz *et al.*, 2016).

A mechanism particularly adapted to Tn-seq analysis is natural transformation. Indeed, this mechanism exhibits different modes and circuits of regulation in different species, and it is not essential for cell viability.

Objectives of the thesis

Objective 1: Determination of the role of trans-translation in *L. pneumophila*

- Is trans-translation essential in *L. pneumophila*?
- Is trans-translation involved in competence development and natural transformation in that species?
- What are the phenotypes associated with the loss of trans-translation in *L. pneumophila*?
- Is trans-translation involved in the high rate of antibiotic failure in the treatment of Legionnaire's disease?

Objective 2: Assess the efficiency of the new family of oxadiazole trans-translation inhibitors against the etiologic agents of Legionnaire's disease

- Is KKL-35 efficient against *Legionella* spp.?
- Is it bactericidal or bacteriostatic?
- Does it inhibit intracellular growth in human macrophages?
- What is the target of that new antibiotic in *L. pneumophila*?
- Is resistance readily acquirable by mutation?

Objective 3: Develop tools to establish a systematic mutagenesis approach for the study of natural transformation by Tn-seq

- Define the best strategy for the construction of a library of transposed mutants
- Verify the randomness of the insertion
- Validate the approach by mapping the insertions in isolated mutants
- Apply the tools in different microbial models, including *L. pneumophila* and the thermophilic archaea *Pyrococcus furiosus*, to create libraries of mutants.

Objective 1:

Trans-translation in *Legionella pneumophila*

As explained in the introduction of this thesis, trans-translation has been determined to be essential for viability or virulence in a limited but growing number of bacterial pathogens (cf. p.139). Trans-translation had not yet been studied in *L. pneumophila*, for which the literature only indicates that the *ssrA* gene is used in some strains as a docking platform for an episome bearing the alternative T4SS *lwh* (cf. p.111 and p. 157). A genome-wide mutagenesis by transposition (TraSH) had been performed and published in the Philadelphia strain (cf. p. 162) that showed a stark decrease in fitness associated with insertions in SmpB but does not report the results for *ssrA*, maybe because annotations on their reference genome only contained protein-coding ORFs.

Our primary goal was to establish whether or not a link between trans-translation and competence development existed in our model, *L. pneumophila*, as explained p.160. The problem was that my mentor had found earlier that deleting *ssrA* proved impossible, as no mutants appeared when trying to replace the gene by an antibiotic resistance cassette. We circumvented the problem by an approach inspired by precedent works (19043582, 10947848) in which *ssrA* was turned into an inducible gene. This allowed to study the phenotypes associated with the loss of trans-translation, which are presented in the following paper, pending review in Scientific Reports.

Trans-translation is essential in the human pathogen *Legionella pneumophila*

Short title: trans-translation in *Legionella pneumophila*

Romain Brunel^{1,2} and Xavier Charpentier^{1,2*}

¹ Univ Lyon, Université Claude Bernard Lyon 1, INSA-Lyon, CNRS, UMR5240, Microbiologie, Adaptation et Pathogénie, 10 rue Raphaël Dubois, F-69622, Villeurbanne, France

²CIRI, Team “Horizontal gene transfer in bacterial pathogens”, Inserm, U1111, Université Claude Bernard Lyon 1, CNRS, UMR5308, École Normale Supérieure de Lyon, Univ Lyon, 69100, Villeurbanne, France

* Corresponding author

E-mail: xavier.charpentier@univ-lyon1.fr

Abstract

Trans-translation is a ubiquitous bacterial mechanism for ribosome rescue in the event of translation stalling. Although trans-translation is not essential in several bacterial species, it has been found essential for viability or virulence in a wide range of pathogens. We describe here that trans-translation is essential in the human pathogen *Legionella pneumophila*, the etiologic agent of Legionnaire's disease (LD), a severe form of nosocomial and community-acquired pneumonia. The *ssrA* gene coding for tmRNA, the key component of trans-translation, could not be deleted in *L. pneumophila*. To circumvent this and analyse the consequences of impaired trans-translation, we placed *ssrA* under the control of a chemical inducer. Phenotypes associated with the inhibition of *ssrA* expression include growth arrest in rich medium, hampered cell division, and hindered ability to infect eukaryotic cells (amoebae and human macrophages). LD is often associated with failure of antibiotic treatment and death (>10% of clinical cases). Decreasing tmRNA levels in the cell led to significantly higher sensitivity to ribosome-targeting antibiotics, including erythromycin and rifampicin, recommended treatments for LD. Interfering with trans-translation may thus not only halt the progression of infection, but could also potentiate the currently recommended therapeutic treatment of LD.

Introduction

Translation of new proteins from messenger RNAs (mRNAs) is essential to maintain homeostasis of the cell and the ribosome is a proven target for antibiotics, as full and generalised arrest of translation generally leads to bacteriostasis and ultimately death^{1,2}. Transient translation arrest occurs naturally but without consequences on the cell viability. It has been shown that ribosome pausing for a few seconds occurs naturally during translation³ and that total ribosome blocking (called “stalling”) occurs naturally at a very high rate in bacteria⁴. Common causes of ribosome stalling include translation of specific peptides that interact with the ribosome exit tunnel⁵, stretches of repeated or rare codons that exhaust the local pool of corresponding tRNAs^{6,7}, and amino acid starvation that reduces the global pool of available charged tRNAs⁸. Besides, a frequent cause of ribosome stalling is the translation of mRNAs lacking a stop codon, as recognition of the stop signal by termination factors is necessary for the release of the translation complex⁹. Such non-stop mRNAs may arise by abortion of transcription and the absence of a quality check between the coupled transcription and translation steps. Non-stop mRNAs are also generated during ribosome pausing by mRNA cleavage near the ribosomal A site¹⁰ or by ribonucleolytic toxins^{11–13}. While most causes of ribosomal pausing are temporary, ribosomes stalled on non-stop mRNAs have to be actively rescued and this process is considered essential for viability in bacteria¹⁴.

Trans-translation is a ubiquitous bacterial mechanism that resolves ribosome stalling caused by non-stop mRNAs^{15,16}. It is operated by a nucleoprotein complex composed of SmpB (Small protein B)^{17,18} and tmRNA (transfer- and messenger-RNA), a highly structured RNA encoded by the *srrA* gene¹⁹. Both components are highly conserved in bacteria and can be found in almost all sequenced bacterial genomes, except for a handful of eubacterial species and some insect endosymbionts²⁰. The SmpB-tmRNA complex recognizes stalled ribosomes with a free A site into which the complex is loaded, thanks to the Alanine-tRNA-like structure of tmRNA, assisted by SmpB^{21–23}. The unfinished polypeptide is then transferred onto tmRNA by transpeptidation, displacing tmRNA into the P site. The non-stop mRNA is released and degraded by RNase R, an exoribonuclease that interacts with the trans-translation complex^{24,25}. Translation resumes using tmRNA as a new template. The messenger section of tmRNA bears a short open reading frame that encodes a degradation tag recognized by different proteases^{26–28}, and also ends with a stop codon, allowing normal termination of translation. Trans-translation therefore not only resolves ribosome

stalling, but also triggers the degradation of both the source of the problem (the faulty mRNA) and its consequences (aborted translation products, stalled ribosome subunits).

Trans-translation is highly mobilized in metabolically active bacteria, even in non-stressful conditions where at least one trans-translation event occurs per ribosome and per cell cycle in exponentially growing *Escherichia coli*⁴. Further highlighting the essential nature of ribosome rescue for the cell, alternate ribosome rescuing systems are widely found in the phylogeny and can compensate the loss of ribosome rescue by trans-translation^{14,29}. Two have been identified so far: ArfA³⁰ and ArfB³¹ (Alternative rescue factors A and B). Both are only able to recognize stalled ribosomes and promote their dissociation, while lacking mRNA and protein degradation signals. In a small number of bacterial species where none of these alternatives have been found, trans-translation is essential and neither *ssrA* nor *smpB* genes can be deleted^{32–37}. Interestingly, all these species are pathogens, suggesting that the loss of these redundant, less efficient ribosome rescue factors makes trans-translation a target for antibiotics that could spare the normal microbiota. Trans-translation has indeed been retrospectively identified as the target of pyrazinamide, a first-line tuberculosis drug active against *Mycobacterium tuberculosis*³⁸, even in its dormant form. Thus, trans-translation appears as a prime target for this intracellular pathogen that target the human alveolar macrophage.

Legionella pneumophila is another pathogen that infects the human alveolar macrophage. It is a gram-negative bacterium responsible for epidemic pneumonia outbreaks. It is ubiquitous in freshwater environments where it infects and multiplies within eukaryotic hosts such as amoebas³⁹. *L. pneumophila* can also infect humans by accident when contaminated water is aerosolized by man-made equipment (such as cooling towers, spas, showers or humidifiers) and inhaled. *L. pneumophila* infects alveolar macrophages in the same way it infects amoebas⁴⁰, leading to a severe pneumonia called Legionnaire's disease. Trans-translation had not yet been studied in *L. pneumophila* but analysis of available sequenced genomes indicates that all *Legionella* species lack the alternative rescue factor ArfA, and that except for a few species rarely found in a clinical setting (*L. drancourtii*, *L. quateirensis*, *L. tunisiensis* and *L. feeleii*), the majority also lacks ArfB. Several attempts to disrupt the *ssrA* or *smpB* genes in *L. pneumophila* have failed, suggesting that trans-translation might be essential in that pathogen^{41,42}.

We here used an innovative approach to confirm this result and study the physiological

consequences of the loss of trans-translation activity in *L. pneumophila*. We report the phenotypes associated with the loss of trans-translation in *L. pneumophila*, namely in terms of multiplication in rich medium, infection of amoebas and human macrophages, antibiotic sensitivity and cell morphology. Our results support the potential of targeting trans-translation for therapeutic use against *L. pneumophila*.

Results

Construction of an inducible allele of *ssrA* in *L. pneumophila*

Repeated attempts to generate a deletion mutant of the *ssrA* gene by allelic exchange with a kanamycin resistance marker failed to generate kanamycin-resistant transformants. We thus constructed a conditional mutant allele of *ssrA* by placing its expression under the control of the LacI repressor. We assembled a synthetic construct in which we inserted a first lac operator (*lacO*) repressor site between the putative -10 and -35 box of the *ssrA* promoter and a second *lacO* site between the -10 box and the *ssrA* transcription start site (Fig. 1A). Upstream of this modified promoter we also inserted a marker conferring gentamicin resistance for selection and a constitutively expressed *lacIq* gene. We introduced this synthetic construct in *L. pneumophila* by natural transformation and, in the presence of IPTG, we could isolate colonies in which the wild-type *ssrA* allele was effectively replaced by the inducible allele of *ssrA*, termed *ssrA^{ind}* (Fig. 1B). Despite the high stability of tmRNA, removal of IPTG leads to decreasing tmRNA levels over time (Fig. 1C) indicating that in the absence of IPTG, *ssrA^{ind}* expression is effectively under repression by LacIq.

tmRNA is essential for axenic growth in *L. pneumophila*

Growth of the *ssrA^{ind}* mutant was assessed in the presence of varying concentrations of IPTG in standard *L. pneumophila* liquid medium AYE and on solid CYE medium. Ten-fold serial dilutions of an *ssrA^{ind}* mutant were spotted on CYE plates containing two-fold decreasing concentrations of IPTG (Fig. 2A). At concentration of IPTG from 500 μ M and down to 32 μ M the *ssrA^{ind}* mutant could grow and produce colonies identical to these produced by the wild-type strain (Fig. 2B). Analysis of tmRNA expression by Northern-blot and quantification par real-time quantitative PCR

(qPCR) revealed that at 32 μM expression of tmRNA is slightly lower than in the wild-type strain (expression of 0.65 ± 0.11 relative to 1 in the wild-type strain). Increasing IPTG levels to 500 μM did not increase tmRNA levels (0.65 ± 0.02), indicating that at 32 μM expression is already fully derepressed and that introduction of the LacO sites weakened the tmRNA promoter (Fig. 2C). At concentrations below 16 μM the *ssrA^{ind}* mutant could no longer produce colonies. In the absence of IPTG, no growth was observed and only revertants that escaped LacI repression were obtained at a frequency of $\sim 1 \cdot 10^{-6}$. Exactly as on solid media, concentrations of IPTG below 32 μM could not support normal growth in liquid medium (Fig. 2B). tmRNA is known to be expressed at high levels, sometimes even detectable by ethidium bromide staining of total RNA analysed on polyacrylamide gels. Indeed, RNAseq analysis of total RNA had found *ssrA* as the most expressed non-rRNA gene in *L. pneumophila*⁴³. Interestingly, the qPCR data also revealed that reducing the amount of tmRNA only by a two-fold factor already has dramatic consequences on the growth and viability (Fig. 2C). Thus, high expression levels of tmRNA are required for normal growth in *L. pneumophila*. We conclude that trans-translation is essential in this human pathogen.

tmRNA-depleted *L. pneumophila* can be rescued by other ribosome release systems

Trans-translation can release stalled ribosomes and also promotes the degradation of both the potentially hazardous faulty mRNAs and the aborted translation products. In order to determine the contribution of these activities to the normal of growth of *L. pneumophila* we determine whether other ribosome rescue systems could promote grow of the trans-translation deficient *ssrA^{ind}* mutant. The gene encoding the alternate ribosome rescue factor ArfA³⁰ was cloned from *E. coli* into a plasmid to form pArfA and introduced in *L. pneumophila*. Ectopic expression of *E. coli arfA* had no effect on fitness, either in the wild type or in the *ssrA^{ind}* strain cultivated in presence of IPTG. In absence of IPTG, expression of ArfA could restore growth of the *ssrA^{ind}* mutant to a level close to that of the wild-type strain or the *ssrA^{ind}* mutant with 500 μM IPTG (Fig. 3A). Likewise, growth of the *ssrA^{ind}* mutant expressing ArfA was possible on solid media without IPTG but yielded smaller colonies than the wild-type strain or the *ssrA^{ind}* mutant with 500 μM IPTG (Fig. 3B). Northern-blot analysis and qPCR confirmed that tmRNA was not expressed in the *ssrA^{ind}/pArfA* strain and that growth was not due to reversion of the repression (Fig. 3C). Therefore, ectopic expression of

E. coli arfA can partially complement the loss of trans-translation in *L. pneumophila*. Puromycin is an antibiotic mimicking the structure of an aminoacyl-tRNA and induces spontaneous translation abortion, causing growth arrest at concentrations equal or higher than its MIC. At lower doses, the abortion of translation induced by puromycin can also rescue stalled ribosomes⁴⁴, paradoxically allowing the growth of bacteria that have lost the functionality of their ribosome rescue mechanisms³⁰. Indeed, growth of tmRNA-depleted *L. pneumophila* was possible in presence of a subinhibitory concentration of puromycin, albeit at a slower rate than the wild-type (Fig. 3D). Altogether the data indicate that the inability of the *ssrA^{ind}* mutant to grow in rich medium is primarily linked to loss of the ribosome rescue activity of trans-translation.

Loss of tmRNA results in growth arrest and filamentation

In the absence of IPTG the *ssrA^{ind}* mutant could not produce colonies or grow normally in liquid medium, yet we observed a slight and variable increase in absorbance in liquid cultures suggesting that some growth could still occur in tmRNA-depleted cells (Fig. 2B, 3A and 3B). Light microscopy revealed that under tmRNA depletion, the cells exhibited a striking filamentation phenotype (Fig. 4A). Absorbance increase in absence of IPTG is likely the result of that extensive cell elongation, which continued up to 48h of culture, leading to filaments of a length up to several hundred micrometres long. Interestingly, DNA staining using the Hoescht dye was visible along the whole length of filaments, suggesting that DNA replication still occurs and results in multi-chromosomal cells. Propidium iodide (PI) staining was used to assess membrane integrity and is a widely used marker of cellular death⁴⁵. A high proportion of tmRNA-depleted cells were stained by PI after 24 hours of culture, indicating that a large part of the filamentous tmRNA-depleted bacteria has a compromised membrane integrity and are probably dead. Interestingly, a significant number of filaments were still not stained by PI which suggests that their membrane is not compromised and that they could therefore still be alive even long after tmRNA depletion. This result was confirmed by regrowth assays in liquid medium where tmRNA-depleted cells could restart growth at a slower rate when IPTG was added 24 or 48 hours following removal of IPTG (Fig. S1A). The filamentous cells are thus likely able to resume division to some extent. Electron microscopy observations showed that no septa were visible in horizontal slices of filamentous cells (Fig. 4B) indicating that

loss of trans-translation hampered establishment of the divisome. Ribosomes are visible as dark dots in electron micrographs and a higher ribosomal concentration was observed in the cytoplasm of the *ssrA^{ind}* mutant compared to the wild-type strain suggesting that tmRNA-depleted cells compensate the accumulation of stalled polysomes with synthesis of new ribosomes (Fig. 4B). This data indicates that the major consequence of loss of trans-translation is the inhibition of the cell division machinery. This may be due to a direct requirement of trans-translation to express components of the divisome at sufficient levels. *L. pneumophila* is also known to filament under nutrient scarcity in late stationary phase or under nutrient-limiting growth conditions⁴⁶. The filamentation phenotype may thus also reflect the inability of the *ssrA^{ind}* mutant to use the nutrients provided by laboratory medium.

tmRNA-depleted *L. pneumophila* are impaired for multiplication within eukaryotic hosts

While trans-translation is evidently required for the growth of *L. pneumophila* in rich medium, it is insufficient to conclude on its essentiality in the natural environment of the bacteria. The natural ecological niche of *L. pneumophila* is the intracellular replication vacuole that the bacterium establishes within its eukaryotic host, where it uses nutrients different than those found in the laboratory medium⁴⁷. Evidence has shown that some stresses (heat, nutrient starving, sodium, chlorine) can hinder the culturability of the bacterium *in vitro*, but they nevertheless retain their ability to infect amoebas⁴⁸⁻⁵¹. We thus tested the ability of the *ssrA^{ind}* mutant to infect, survive and replicate within amoebas and human macrophages. Wild-type, *ssrA^{ind}* and *ssrA^{ind}/pArfA* strains were used to infect eukaryotic hosts at a low multiplicity of infection (MOI=0.01), and sampling was performed daily to estimate the rate of bacterial multiplication. The avirulent *dotA* mutant, unable to replicate within cells was used as a negative control. In the amoeba *Acanthamoeba castellanii*, high-level expression of *ssrA^{ind}* allowed infection of the host and replication at a normal rate. In contrast, infection in absence of IPTG did not allow *L. pneumophila* to establish an infection cycle and led to a swift decline in bacterial charge, similar as in the *dotA* avirulent strain (Fig. 5A). Ectopic expression of *arfA* restored almost completely the virulence of the *ssrA^{ind}* strain in absence of IPTG (Fig. 5A). In monocyte-derived U937 human macrophages, high-level expression of *ssrA^{ind}* or *arfA*

gave similar results, and in absence of IPTG, *ssrA^{ind}* was also impaired for multiplication within macrophages, albeit less affected than in amoeba *Acanthamoeba castellanii* (Fig. 5B). The *ssrA^{ind}* suffered a sharp decrease in bacterial count at 24 h, similar to that avirulent *dotA* mutant. Yet, following this the *ssrA^{ind}* mutant was able to grow but the infection yielded two orders of magnitude fewer cfu than that of the wild-type strain or of the *ssrA^{ind}* mutant in the presence of IPTG. Analysis of tmRNA expression by qRT-PCR showed that LacIq repression was not very effective in this condition of infection, with tmRNA only three times less expressed in the absence of IPTG compared to with 500 μ M of IPTG. This probably explains the significantly less strong phenotype of the *ssrA^{ind}* mutant compared to the infection of the amoeba host. Overall, the collected data show that trans-translation is not only required for growth in artificial rich medium but also for infection and replication within its natural and accidental hosts.

Trans-translation promotes resistance to ribosome-targeting antibiotics

Trans-translation has recently been shown to mediate tolerance to a number of ribosome-targeting antibiotics^{52,53}, although such data only exists for *E. coli* and not for any species in which the mechanism is essential. Thanks to our approach, we could also study the effect of a decreased expression of *ssrA* on antibiotic tolerance in *L. pneumophila*. The role of trans-translation was assessed by comparing the efficiency of different classes of antibiotics against the *ssrA^{ind}* mutant, in presence of excess IPTG (500 μ M) or with an IPTG concentration (4 μ M) that allows *L. pneumophila* to grow at 50% of its normal growth rate. Under such conditions, the levels of tmRNA are limiting and represent the closest possible situation to the absence of trans-translation. IC50, the concentrations at which half the growth was obtained compared to the condition without antibiotic, was used to estimate if there was a significant difference in antibiotic sensitivity when trans-translation activity was reduced. IC50 of ribosome-targeting antibiotics were significantly decreased (Mann-Wilcoxon U test, one-tailed, n=6, p<0.01) but not IC50 of Norfloxacin (p=0.93), which targets the DNA gyrase involved in replication. The data are consistent with the situation in other species and confirmed that trans-translation is required to overcome the stress caused by translation-inhibiting antibiotics. Interestingly, when trans-translation activity is limiting, *L. pneumophila* also appears to be slightly more susceptible to rifampicin, an antibiotic that targets the

RNA polymerase (Mann-Wilcoxon U test, one-tailed, n=6, p<0.01).

Discussion

Despite being an efficient mechanism for ribosome rescue, trans-translation is not essential in model bacterial species. In *E. coli* or *Bacillus subtilis*, the deletion of *ssrA* or *smpB* is tolerated and compensated by alternative rescue factors like ArfA and/or ArfB^{8,53-56}. In contrast, trans-translation was proven essential in a number of bacterial pathogens of high clinical importance that lack either one or both of the two known alternative rescue factors. (*Mycoplasma pneumoniae*³², *Mycoplasma genitalium*³², *Neisseria gonorrhoeae*³³, *Haemophilus influenzae*³⁴, *Helicobacter pylori*³⁵, *Shigella flexneri*³⁶, *M. tuberculosis*³⁷). Our study was motivated by the fact that all sequenced *L. pneumophila* strains (and most *Legionella* spp.) were found to lack both known ribosome rescue factors alternative to trans-translation, suggesting that trans-translation might be essential and a potential therapeutic target. We developed here a conditional inactivation strategy with a chromosomal inducible allele replacement to verify this prediction. The constitutive *lacI^q* repressor is inserted upstream and in opposite orientation of the *ssrA* gene. The original promoter of the targeted *ssrA* gene is conserved but with lacO sites inserted between regulatory sequences (Fig. 1A). This leaves the gene itself untouched, allowing normal expression levels in absence of repression by LacI. A more conventional approach is to delete the targeted gene while providing the same gene on a temperature-sensitive multicopy plasmid⁵⁷. Our approach has the advantage of keeping the original genetic context of the targeted gene and its copy number. In the conditional *ssrA^{ind}* mutant, normal growth was obtained in presence of a soluble, readily available chemical inducer (IPTG), allowing us to grow cultures and then depleting them of tmRNA at will. This approach suffered from a few flaws, in particular the emergence of unrepressed mutants in cultures at a frequency of 1.10⁻⁶ (Fig. 2A), which required us to systematically check for revertants. Repression in the absence of IPTG was not complete, and probably caused by the extremely high basal transcription of the near-consensus promoter of *ssrA*, a fact confirmed by variability in repression strength depending on growth conditions, as seen during infection of human macrophages and discussed below. Yet, using this inducer-dependent expression system we show that high-level expression of tmRNA is essential for axenic growth of *L. pneumophila*, as evidenced by the inducer-dose-dependent growth in liquid or solid medium (Fig. 2). tmRNA, and by extension trans-translation, is therefore essential for growth of *L. pneumophila*

in rich medium. Expression levels of tmRNA necessary to support normal growth appear slightly lower than wild-type levels (Fig. 2), suggesting that tmRNA is produced in excess in wild-type cells in normal growth conditions. This indicates that expression of tmRNA is high enough to not be limiting in case of exposure to less favourable conditions (e.g. starvation when exiting the host, exposure to harmful environmental settings or antibiotics).

Ectopic expression of the alternative ribosome rescue system ArfA, cloned from *E. coli*, restored the ability of tmRNA-depleted cells to grow normally and to infect eukaryotic hosts, albeit with a fitness cost. This proves that as in other species^{33,36}, the release of the stalled ribosomal subunits is critical for survival and growth but not protein tagging and mRNA decay. We attempted to delete *ssrA* and *smpB* by allelic exchange in an ArfA-expressing strain but failed to obtain any mutants. In addition to the tmRNA level measurements that showed some residual amounts of transcript in depleted cells even in absence of IPTG, this result suggests that a low residual trans-translation activity probably is still present, and that *E. coli* ArfA by itself could not be sufficient to sustain *L. pneumophila* viability.

The inducer-dependent conditional expression system allowed us to analyse the consequences of loss trans-translation. The striking, homogenous filamentation phenotype observed in tmRNA-depleted cells had never been reported and indicates that bacterial elongation can continue despite accumulation of stalled ribosomes, while cell division itself is quickly impaired (Fig. 4). Subpopulation of filamentous cells can be routinely observed in *L. pneumophila* cultures grown on solid medium⁵⁸ or exposed to stressful conditions (antibiotics, UV light)⁵⁹. In such cases the population exhibits widely varying lengths and the underlying mechanisms are poorly understood⁶⁰. The filamentation induced by loss of trans-translation appears distinct as it is a more homogenous phenotype that increases overtime, with filaments several hundred micrometers long after 48 h of culture (Fig. S1B). A similar, systematic filamentous phenotype was previously observed when the activation of the stringent response was impaired in *L. pneumophila*. Indeed, deletion of *relA* and *spoT* (which both synthesise the stringent response alarmone ppGpp) induced filamentation in the post-exponential (PE) growth phase^{61,62}. The stringent response is induced by RelA recognition of uncharged tRNAs loaded onto the A site of ribosome during starvation, and expression of *spoT* under inorganic phosphate starvation. Since tmRNA depletion should increase the number of stalled ribosomes with free A sites and slow global translation rates, it is possible that

the pool of charged tRNAs stays high in tmRNA-depleted cells and that virtually no ribosome gets loaded with an uncharged tRNA. Meanwhile, the growth arrest may prevent phosphate levels from becoming limited in the medium. Both effects could lead to extremely low ppGpp levels and therefore mirror the filamentations phenotype of a *relA/spoT* mutant or a *crrA* overexpression mutant. An alternate hypothesis is that generalised ribosome stalling greatly reduces protein synthesis, preventing the production of the components of the cell division apparatus, whose levels have to be exactly regulated for normal division⁶³. Additionally, levels of FtsZ, an essential component of the early division ring, are tightly regulated by direct recognition and degradation by the ClpXP protease^{64,65}. In *E. coli*, reducing the level of expression of the *ftsZ* gene led to a very similar filamentation phenotype⁵⁷. In *L. pneumophila*, deleting *clpP* also led to division issues⁶⁶. ClpXP is one of the main operators for the degradation of SsrA-tagged unfinished polypeptides through the specific recognition of this tag by the adaptor SspB²⁸. A sharp decrease in the number of SsrA-tagged substrates caused by tmRNA depletion could increase the availability of the protease and increase the degradation of FtsZ. We could not directly test this hypothesis, as specific antibodies against *L. pneumophila* FtsZ are not available. Translational fusions of FtsZ with an antibody-specific epitope tag (1X-, 2X- and 3X-Flag) induced an unwanted, systematic filamentation even in a wild-type background. Surprisingly, some of these filamentous bacteria were viable, able to form colonies and grow in liquid medium, showing that filamentation is not always associated with mortality in *L. pneumophila* and cannot explain alone the growth arrest observed during tmRNA depletion.

When placed in contact with a permissive amoeba host, the *ssrA^{ind}* mutant deprived of IPTG inducer failed to establish an infection cycle and the bacterial charge quickly dropped over time similarly to the avirulent *dotA* mutant. In monocyte-derived human macrophages, the phenotype was surprisingly milder, with a sharp increase in the usual, initial drop in bacterial charge (representing the subpopulation of bacteria from the inoculum who failed to establish a successful infection cycle) followed by successful intracellular multiplication. The multiplication was not due to the emergence of unrepressed revertants, as *ssrA^{ind}* bacteria sampled during intracellular multiplication remained unable to grow on solid medium without IPTG. We confirmed by RT-qPCR analysis that the growth observed was in fact due to a decreased repression of *ssrA* expression by LacIq during infection of macrophages. The lower but non-null tmRNA levels explain the slower

but successful infection of human macrophages by *ssrA^{ind}* in absence of IPTG, but the reason for the relaxed repression remains unexplained, as the RPMI infection medium supposedly does not contain any potential inducer (lactose). Despite this technical hindrance, infection profiles obtained here suggest that total or partial depletion of tmRNA and therefore inactivation of trans-translation indeed impairs the ability of *L. pneumophila* to multiply within its eukaryotic hosts.

No previous study had been conducted on the consequences of a reduction in trans-translation activity on stress sensitivity in species in which the mechanism is essential. Our system allowed to artificially reduce tmRNA levels, in order to assess its effect on sensitivity to replication, transcription and ribosome-targeting antibiotics. We induced a reduction in tmRNA levels that are limiting for growth and corresponding to a ~50% decrease in growth rate. We observed that for all tested ribosome-targeting antibiotics, but not for the gyrase-targeting norfloxacin, the decrease in trans-translation activity led to an increased antibiotic sensitivity. The strongest difference was observed with the macrolide erythromycin. Macrolides are the recommended treatment for Legionnaire's disease in Europe and the US. A lower but significant difference was also observed with rifampicin, which targets the RNA polymerase and blocks transcription. Rifampicin activity probably increases the number of stalled ribosomes: first, by blocking unfinished transcription complexes, in which the stop codon has not been transcribed yet; and second, by reducing the availability of new transcripts for ribosomal subunits, which have an increasing chance over time to load onto an older, degraded, non-stop mRNA. Although there is a debate on the clinical efficiency of using a double antibiotic regimen for Legionnaire's disease, some evidence of an increased efficiency has led to the frequent administration of rifampicin in association with a macrolide (erythromycin or azithromycin). Therefore, our results show that blocking trans-translation not only strongly impairs fitness and virulence of *L. pneumophila*, but it also increases the efficiency of two antibiotic drugs already used to treat Legionnaire's disease.

In conclusion, trans-translation represents an interesting target for development of new antibiotic molecules targeting *L. pneumophila* and this species may be susceptible to recently discovered small molecule inhibitors of trans-translation⁶⁷.

Materials and Methods

Chemical, growth conditions and culture media

L. pneumophila strains were grown either in AYE liquid media (ACES [N-(2-acetamido)-2-aminoethanesulfonic acid]-buffered yeast extract) or CYE solid media (ACES-buffered charcoal yeast extract). When necessary, IPTG (isopropyl β -D-1-thiogalactopyranoside) was used at concentrations ranging from 500 μ M to 2 μ M in either medium. When appropriate, gentamicin (7 μ g/mL) or chloramphenicol (5 μ g/mL) were added to the medium. Strains were stored in AYE supplemented with 15% glycerol at -80°C, and were cultivated weekly by incubation on solid plates for three days at 37°C. Fresh cultures used for all experiments were obtained by patching an inoculum on a new plate and incubating it for 24 h. tmRNA depletion was induced by resuspending fresh patches from a solid culture into liquid medium without IPTG. Growth in liquid medium was performed in 13 mL capped tubes containing 2-3 mL of medium at 37°C with shaking (200 rpm). Alternatively, growth in 96-well plates, 100 μ L/well, was monitored by measuring absorbance in a Tecan Infinite M200Pro temperature-controlled plate reader. Every ten minutes, the plate was agitated for 60 s with orbital shaking and 60 s with lateral shaking (5 mm amplitude each) and absorbance was measured at 600 nm. *E. coli* was grown on GL medium (Lysogeny broth with agar). Chloramphenicol (25 μ g/mL), ampicilline (100 μ g/mL) and X-gal (20 μ g/mL) were added when needed.

Strains and plasmids construction

All strains used in this study are derived from the *L. pneumophila* Paris clinical isolate CIP107629. Oligonucleotides used are listed in Supplementary Table 1, and plasmid sequences are available upon request. The conditional *ssrA*^{And} mutant was constructed as follows. First, a 2 kb-long 5' region flanking *ssrA* was amplified by PCR (Phusion DNA Polymerase, Thermo Scientific) using primers complementary to a gentamicin resistance cassette. Overlapping PCR was used to assemble this fragment with a PCR product containing an *aac1* gentamicin-resistance cassette obtained from pXDC18. Second, a 2kb-long region encoding *ssrA* (without its promoter) and its 3' flanking region was amplified using primers containing a sequence complementary to *lacI*⁰ and a modified *ssrA*

promoter with two high-binding lacO sites between the putative -35 and -10 transcription sites, and between the -10 and the +1 transcription sites. That modified promoter associated with *ssrA* form the *ssrA^{ind}* allele. Overlapping PCR was used to assemble a DNA fragment consisting of the *lacI^q* gene and the *ssrA^{ind}+5'* region product. Each assembled PCR products were cloned into pGEM-T Easy (Promega). The two resulting plasmids were then digested with AatII and XmnI restriction enzymes (New England Biolabs) and products of interest were separated by agarose gel electrophoresis and purified using a Qiaquick gel extraction kit. A 2562nt fragment (XmnI-3' region-*gentR*-AatII) and a 5083nt fragment (AatII-*lacI^q*-*ssrA^{ind}*-3' region-pGEM-T Easy backbone-XmnI) were ligated using T4 DNA ligase (NEB), transformed into *E. coli*. The pGEM-T-*ssrA^{ind}* plasmid obtained was used to transform a hypercompetent *L. pneumophila* Paris *comR* mutant⁶⁸ on a CYE plate containing 500 μM IPTG. Gentamicin-resistant *L. pneumophila* Paris *ssrA^{ind} comR* transformants were obtained and clones were reisolated on CYE plate containing gentamicin and 500 μM IPTG. Genomic DNA was extracted using the Wizard Genomic DNA purification kit (Promega) and used to transform a wild-type *L. pneumophila* Paris strain as previously described. *L. pneumophila* Paris *ssrA^{ind}* mutants were obtained by natural transformation and purified on CYE plate containing 500 μM IPTG.

The pArfA plasmid was constructed as follows. The alternative ribosome rescue factor gene *arfA* was cloned from *E. coli* K-12 (strain DH5-α λpir) into pX5, a pMMB207C derivative, under the control of a constitutive promoter, to form the plasmid pArfA. pArfA was introduced by electroporation into *L. pneumophila* str. Paris WT and *ssrA^{ind}* and chloramphenicol-resistant transformants were selected.

RNA extraction and quantification

Bacteria were grown for 3 days on CYE containing different concentrations of IPTG. Alternatively, bacteria were obtained by sampling supernatants from macrophage infections (performed as described below). At various time points, cells were centrifuged and resuspended in 100μL TEL (Tris 10 mM, EDTA 1 mM, Lysozyme from chicken eggs 10 mg/mL, pH 7) on ice. Cell suspension was mixed with 1mL commercial tri-reagent solution (acid guanidinium thiocyanate-phenol-chloroform) and lysed by repeated pipetting. Lysis was pursued by 15 min of incubation at 65°C,

then the samples were centrifuged (3' at 5000 g). RNA extraction was continued by mixing the supernatant with an equal volume of chloroform and centrifuging (3' at 5000 g). The supernatant was collected and precipitated by isopropyl alcohol. The pellets were washed by 80% ethanol, dried, then resuspended in RNase-free water. RNA sample purity and concentration were determined by spectrophotometric analysis on a NanoDrop 2000 UV-Vis Spectrophotometer (Thermo Scientific).

Northern-blot analysis

Northern-blot analysis was performed as previously described⁴³. One microgram of total RNA in TBE (Tris, Borate, EDTA)-Urea denaturing buffer (Thermo Fischer) was loaded per lane and run on denaturing urea 6% acrylamide gel in TBE buffer. Total RNAs were visualized by ethidium bromide staining to check for equal loading of the lanes. RNAs were transferred to a charged nylon membrane (Amersham Hybond-N+, GE Healthcare Science) by electrophoretic transfer (30 min, 300 mA) and then cross-linked to the membrane by UV irradiation. Membrane were hybridised at 42 °C with 5'-biotinylated oligonucleotide probes (5 nM) for tmRNA in ULTRAhyb Ultrasensitive Hybridization Buffer (Ambion). Following overnight hybridisation, the membranes were washed twice in 2X SSC buffer containing 0.1% SDS at 65 °C according to the ULTRAhyb manufacturer instructions. Probed membranes were revealed using horseradish peroxidase-conjugated streptavidin and enhanced luminol substrate (Chemiluminescent Nucleic Acid Detection Module, Pierce). Luminescence signals were acquired using an imaging workstation equipped with a charge-coupled device camera (Thermo Scientific).

Real-time quantitative PCR analysis

RNA were extracted as described above and traces of genomic DNA were removed by a DNase I treatment. RNA were purified on silica-based column (Zymo Research). RNA (2µg) were reverse transcribed with RevertAid H Minus First Strand cDNA Synthesis Kit (Thermo Scientific) and used as template for real-time PCR with Premix Ex Taq™ (Tli* RNase H Plus) (TaKaRa) on LC480 instruments (Roche). Data were analyzed with the Δ Ct method using 16S rRNA as a reference.

Amounts of tmRNA were expressed relatively to the wild-type strain.

Infection of eukaryotic hosts

A. castellanii cells were routinely cultivated in PYG medium (Peptone-Yeast Extract-Glucose) at 30°C. Four hours before infection, cells were incubated for 10 min on ice to allow detachment from the flask, then collected, centrifuged, and resuspended in A.c. buffer⁶⁹. *A. castellanii* cells were plated in 24-well plates at a concentration of 10⁶ cells/well (three wells per tested strain and per condition). *L. pneumophila* strains were resuspended in A.c. buffer with or without IPTG (starting tmRNA depletion at that point) 4 hours before infection and incubated at 30°C. At T0 of infection, bacteria were added at a concentration of 10³ cells/well (multiplicity of infection 0.001), 500 µM IPTG was added to designated wells, and infection was started by centrifuging the plates for 10 min at 1000 rpm. Bacterial concentration of the inoculum, as well as possible presence of revertants was verified by plating 10-fold serial dilutions on both CYE and CYE containing 500 µM IPTG. Similarly, at each time point, an aliquot of the supernatant was sampled and 10-fold serial dilutions were plated on CYE and CYE containing 500 µM IPTG to measure bacterial concentrations. U937 human monocytes were cultivated routinely in RPMI-1640 Glutamax medium (Thermo Fischer) at 37°C, 5% CO₂. Three days before infection, cells were resuspended in fresh medium with 100 ng/mL PMA (Phorbol 12-myristate 13-acetate, Sigma-Aldrich), in order to trigger their differentiation into macrophages, and plated into 24-well plates (one well per tested strain and per time point, with technical triplicates). Four hours before infection, PMA was washed off by replacing the medium thrice, and *L. pneumophila* strains were resuspended in RPMI with or without 500 µM IPTG (starting tmRNA depletion at that point) and incubated at 37°C. Bacteria were added to the wells at a MOI of 0.001, 500µM IPTG was added when indicated, and infection was started by centrifuging the plates at 1000rpm for 10min. Inoculum concentration was verified by spotting 10-fold dilutions onto CYE and CYE containing 500 µM IPTG. Subsequently, at each time point and for each condition, the whole supernatant of a well was collected into a 1.5mL tube, and the cells were incubated into 200 µL sterile ultrapure water + Triton X-100 0,1% for 5 minutes. The cells were detached by pipetting and promptly combined to the supernatants, and centrifuged 5 min at 6000g. The supernatant was removed and replaced by 100µL sterile ultrapure water, and

10-fold dilutions of that suspension of bacteria and lysed cells were spotted onto CYE and CYE containing 500 μM IPTG. This method allowed to determine bacterial multiplication while accounting for intracellular bacteria, with a very low detection limit of 20 bacteria/well, but was not applicable to amoebae which proved more resistant to lysis.

Light and epifluorescence microscopy

Bacteria were cultivated in AYE with or without 500 μM IPTG and sampled at 0, 24 and 48 h. As a control for cell death, wild-type cells were heat-killed (3 min at 70°C). Live bacteria were resuspended in room-temperature phosphate-buffer saline and stained for 10 min with Hoescht 33258 (500 $\mu\text{g}/\text{mL}$) to stain DNA in all cells and Propidium Iodide (20 $\mu\text{g}/\text{mL}$) to stain RNA and DNA only in dead cells or living cells with impaired membrane integrity. Bacteria were then washed twice with PBS and spotted onto PBS-agar 2% pads on glass slides, covered by a coverslip and immediately observed with a Zeiss Axioplan 2 epifluorescence microscope. All pictures were taken with the same exposition (10 ms for phase contrast and 500 ms for both fluorescent stains) and large fields with numerous bacteria are presented to accurately display the phenotype of the population observed in each condition. Pictures were coloured, contrast-adjusted (excepted for the Propidium Iodide images) and assembled using the ImageJ software.

References

1. Poehlsgaard, J. & Douthwaite, S. The bacterial ribosome as a target for antibiotics. *Nat. Rev. Microbiol.* **3**, 870–881 (2005).
2. Tenson, T. & Mankin, A. Antibiotics and the ribosome. *Mol. Microbiol.* **59**, 1664–1677 (2006).
3. Wen, J.-D. *et al.* Following translation by single ribosomes one codon at a time. *Nature* **452**, 598–603 (2008).
4. Moore, S. D. & Sauer, R. T. Ribosome rescue: tmRNA tagging activity and capacity in *Escherichia coli*. *Mol. Microbiol.* **58**, 456–466 (2005).

5. Tenson, T. & Ehrenberg, M. Regulatory Nascent Peptides in the Ribosomal Tunnel. *Cell* **108**, 591–594 (2002).
6. Roche, E. D. & Sauer, R. T. SsrA-mediated peptide tagging caused by rare codons and tRNA scarcity. *EMBO J.* **18**, 4579–4589 (1999).
7. Ude, S. *et al.* Translation Elongation Factor EF-P Alleviates Ribosome Stalling at Polyproline Stretches. *Science* **339**, 82–85 (2013).
8. Li, X., Yagi, M., Morita, T. & Aiba, H. Cleavage of mRNAs and role of tmRNA system under amino acid starvation in *Escherichia coli*. *Mol. Microbiol.* **68**, 462–473 (2008).
9. Capecchi, M. R. Polypeptide chain termination in vitro: isolation of a release factor. *Proc. Natl. Acad. Sci. U. S. A.* **58**, 1144–1151 (1967).
10. Hayes, C. S. & Sauer, R. T. Cleavage of the A Site mRNA Codon during Ribosome Pausing Provides a Mechanism for Translational Quality Control. *Mol. Cell* **12**, 903–911 (2003).
11. Zhang, Y. *et al.* MazF Cleaves Cellular mRNAs Specifically at ACA to Block Protein Synthesis in *Escherichia coli*. *Mol. Cell* **12**, 913–923 (2003).
12. Christensen, S. K. & Gerdes, K. RelE toxins from Bacteria and Archaea cleave mRNAs on translating ribosomes, which are rescued by tmRNA. *Mol. Microbiol.* **48**, 1389–1400 (2003).
13. Christensen, S. K., Pedersen, K., Hansen, F. G. & Gerdes, K. Toxin–antitoxin Loci as Stress-response-elements: ChpAK/MazF and ChpBK Cleave Translated RNAs and are Counteracted by tmRNA. *J. Mol. Biol.* **332**, 809–819 (2003).
14. Keiler, K. C. & Feaga, H. A. Resolving Nonstop Translation Complexes Is a Matter of Life or Death. *J. Bacteriol.* **196**, 2123–2130 (2014).
15. Keiler, K. C., Waller, P. R. H. & Sauer, R. T. Role of a Peptide Tagging System in Degradation of Proteins Synthesized from Damaged Messenger RNA. *Science* **271**, 990–993 (1996).
16. Keiler, K. C. Biology of trans-Translation. *Annu. Rev. Microbiol.* **62**, 133–151 (2008).
17. Karzai, A. W., Susskind, M. M. & Sauer, R. T. SmpB, a unique RNA-binding protein essential for the peptide-tagging activity of SsrA (tmRNA). *EMBO J.* **18**, 3793–3799 (1999).
18. Felden, B. & Gillet, R. SmpB as the handyman of tmRNA during trans-translation. *RNA Biol.* **8**, 440–449 (2011).

19. Felden, B. *et al.* Probing the structure of the Escherichia coli 10Sa RNA (tmRNA). *RNA* **3**, 89–103 (1997).
20. Hudson, C. M., Lau, B. Y. & Williams, K. P. Ends of the line for tmRNA-SmpB. *Front. Microbiol.* **5**, (2014).
21. Hanawa-Suetsugu, K., Takagi, M., Inokuchi, H., Himeno, H. & Muto, A. SmpB functions in various steps of trans-translation. *Nucleic Acids Res.* **30**, 1620–1629 (2002).
22. Sundermeier, T. R., Dulebohn, D. P., Cho, H. J. & Karzai, A. W. A previously uncharacterized role for small protein B (SmpB) in transfer messenger RNA-mediated trans-translation. *Proc. Natl. Acad. Sci. U. S. A.* **102**, 2316–2321 (2005).
23. Valle, M. *et al.* Visualizing tmRNA Entry into a Stalled Ribosome. *Science* **300**, 127–130 (2003).
24. Karzai, A. W. & Sauer, R. T. Protein factors associated with the SsrA·SmpB tagging and ribosome rescue complex. *Proc. Natl. Acad. Sci.* **98**, 3040–3044 (2001).
25. Richards, J., Mehta, P. & Karzai, A. W. RNase R degrades non-stop mRNAs selectively in an SmpB-tmRNA-dependent manner. *Mol. Microbiol.* **62**, 1700–1712 (2006).
26. Herman, C., Thévenet, D., Bouloc, P., Walker, G. C. & D'Ari, R. Degradation of carboxy-terminal-tagged cytoplasmic proteins by the Escherichia coli protease HflB (FtsH). *Genes Dev.* **12**, 1348–1355 (1998).
27. Gottesman, S., Roche, E., Zhou, Y. & Sauer, R. T. The ClpXP and ClpAP proteases degrade proteins with carboxy-terminal peptide tails added by the SsrA-tagging system. *Genes Dev.* **12**, 1338–1347 (1998).
28. Dougan, D. A., Weber-Ban, E. & Bukau, B. Targeted Delivery of an ssrA-Tagged Substrate by the Adaptor Protein SspB to Its Cognate AAA+ Protein ClpX. *Mol. Cell* **12**, 373–380 (2003).
29. Keiler, K. C. Mechanisms of ribosome rescue in bacteria. *Nat. Rev. Microbiol.* **13**, 285–297 (2015).
30. Chadani, Y. *et al.* Ribosome rescue by Escherichia coli ArfA (YhdL) in the absence of trans-translation system. *Mol. Microbiol.* **78**, 796–808 (2010).
31. Chadani, Y., Ono, K., Kutsukake, K. & Abo, T. Escherichia coli YaeJ protein mediates a

- novel ribosome-rescue pathway distinct from SsrA- and ArfA-mediated pathways. *Mol. Microbiol.* **80**, 772–785 (2011).
32. Hutchison, C. A. *et al.* Global Transposon Mutagenesis and a Minimal Mycoplasma Genome. *Science* **286**, 2165–2169 (1999).
33. Huang, C., Wolfgang, M. C., Withey, J., Koomey, M. & Friedman, D. I. Charged tmRNA but not tmRNA-mediated proteolysis is essential for *Neisseria gonorrhoeae* viability. *EMBO J.* **19**, 1098–1107 (2000).
34. Akerley, B. J. *et al.* A genome-scale analysis for identification of genes required for growth or survival of *Haemophilus influenzae*. *Proc. Natl. Acad. Sci.* **99**, 966–971 (2002).
35. Thibonnier, M., Thiberge, J.-M. & De Reuse, H. Trans-Translation in *Helicobacter pylori*: Essentiality of Ribosome Rescue and Requirement of Protein Tagging for Stress Resistance and Competence. *PLoS ONE* **3**, e3810 (2008).
36. Ramadoss, N. S., Zhou, X. & Keiler, K. C. tmRNA Is Essential in *Shigella flexneri*. *PLoS ONE* **8**, e57537 (2013).
37. Personne, Y. & Parish, T. Mycobacterium tuberculosis possesses an unusual tmRNA rescue system. *Tuberculosis* **94**, 34–42 (2014).
38. Shi, W. *et al.* Pyrazinamide Inhibits Trans-Translation in Mycobacterium tuberculosis. *Science* **333**, 1630–1632 (2011).
39. Rowbotham, T. J. Preliminary report on the pathogenicity of *Legionella pneumophila* for freshwater and soil amoebae. *J. Clin. Pathol.* **33**, 1179–1183 (1980).
40. Swanson, M. S. & Hammer, and B. K. *Legionella Pneumophila* Pathogenesis: A Fateful Journey from Amoebae to Macrophages. *Annu. Rev. Microbiol.* **54**, 567–613 (2000).
41. O'Connor, T. J., Adepoju, Y., Boyd, D. & Isberg, R. R. Minimization of the *Legionella pneumophila* genome reveals chromosomal regions involved in host range expansion. *Proc. Natl. Acad. Sci. U. S. A.* **108**, 14733–14740 (2011).
42. Charpentier, X., Faucher, S. P., Kalachikov, S. & Shuman, H. A. Loss of RNase R Induces Competence Development in *Legionella pneumophila*. *J. Bacteriol.* **190**, 8126–8136 (2008).
43. Attaiech, L. *et al.* Silencing of natural transformation by an RNA chaperone and a multitarget small RNA. *Proc. Natl. Acad. Sci.* 201601626 (2016). doi:10.1073/pnas.1601626113

44. Ivanova, N., Pavlov, M. Y. & Ehrenberg, M. tmRNA-induced Release of Messenger RNA from Stalled Ribosomes. *J. Mol. Biol.* **350**, 897–905 (2005).
45. Williams, S. C. *et al.* Distinguishing between living and nonliving bacteria: Evaluation of the vital stain propidium iodide and its combined use with molecular probes in aquatic samples. *J. Microbiol. Methods* **32**, 225–236 (1998).
46. Warren, W. J. & Miller, R. D. Growth of Legionnaires disease bacterium (*Legionella pneumophila*) in chemically defined medium. *J. Clin. Microbiol.* **10**, 50–55 (1979).
47. Fonseca, M. V. & Swanson, M. S. Nutrient salvaging and metabolism by the intracellular pathogen *Legionella pneumophila*. *Front. Cell. Infect. Microbiol.* **4**, 12 (2014).
48. Steinert, M., Emödy, L., Amann, R. & Hacker, J. Resuscitation of viable but nonculturable *Legionella pneumophila* Philadelphia JR32 by *Acanthamoeba castellanii*. *Appl. Environ. Microbiol.* **63**, 2047–2053 (1997).
49. García, M. T., Jones, S., Pelaz, C., Millar, R. D. & Abu Kwaik, Y. *Acanthamoeba polyphaga* resuscitates viable non-culturable *Legionella pneumophila* after disinfection. *Environ. Microbiol.* **9**, 1267–1277 (2007).
50. Alleron, L., Merlet, N., Lacombe, C. & Frère, J. Long-Term Survival of *Legionella pneumophila* in the Viable But Nonculturable State After Monochloramine Treatment. *Curr. Microbiol.* **57**, 497–502 (2008).
51. Epalle, T. *et al.* Viable but Not Culturable Forms of *Legionella pneumophila* Generated After Heat Shock Treatment Are Infectious for Macrophage-Like and Alveolar Epithelial Cells After Resuscitation on *Acanthamoeba polyphaga*. *Microb. Ecol.* **69**, 215–224 (2014).
52. Luidalepp, H., Hallier, M., Felden, B. & Tenson, T. tmRNA decreases the bactericidal activity of aminoglycosides and the susceptibility to inhibitors of cell wall synthesis. *RNA Biol.* **2**, 70–74 (2005).
53. Li, J., Ji, L., Shi, W., Xie, J. & Zhang, Y. Trans-translation mediates tolerance to multiple antibiotics and stresses in *Escherichia coli*. *J. Antimicrob. Chemother.* **68**, 2477–2481 (2013).
54. Oh, B.-K. & Apirion, D. 10Sa RNA, a small stable RNA of *Escherichia coli*, is functional. *Mol. Gen. Genet. MGG* **229**, 52–56 (1991).
55. Komine, Y., Kitabatake, M., Yokogawa, T., Nishikawa, K. & Inokuchi, H. A tRNA-like

- structure is present in 10Sa RNA, a small stable RNA from *Escherichia coli*. *Proc. Natl. Acad. Sci. U. S. A.* **91**, 9223–9227 (1994).
56. Shin, J.-H. & Price, C. W. The SsrA-SmpB Ribosome Rescue System Is Important for Growth of *Bacillus subtilis* at Low and High Temperatures. *J. Bacteriol.* **189**, 3729–3737 (2007).
57. Dai, K. & Lutkenhaus, J. *ftsZ* is an essential cell division gene in *Escherichia coli*. *J. Bacteriol.* **173**, 3500–3506 (1991).
58. McDade, J. E. *et al.* Legionnaires' disease: isolation of a bacterium and demonstration of its role in other respiratory disease. *N. Engl. J. Med.* **297**, 1197–203 (1977).
59. Charpentier, X., Kay, E., Schneider, D. & Shuman, H. A. Antibiotics and UV Radiation Induce Competence for Natural Transformation in *Legionella pneumophila*. *J. Bacteriol.* **193**, 1114–1121 (2011).
60. Robertson, P., Abdelhady, H. & Garduño, R. A. The many forms of a pleomorphic bacterial pathogen—the developmental network of *Legionella pneumophila*. *Front. Microbiol.* **5**, 670 (2014).
61. Molofsky, A. B. & Swanson, M. S. *Legionella pneumophila* CsrA is a pivotal repressor of transmission traits and activator of replication. *Mol. Microbiol.* **50**, 445–461 (2003).
62. Dalebroux, Z. D., Edwards, R. L. & Swanson, M. S. SpoT governs *Legionella pneumophila* differentiation in host macrophages. *Mol. Microbiol.* **71**, 640–658 (2009).
63. Romberg, L. & Levin, P. A. Assembly Dynamics of the Bacterial Cell Division Protein FtsZ: Poised at the Edge of Stability. *Annu. Rev. Microbiol.* **57**, 125–154 (2003).
64. Camberg, J. L., Hoskins, J. R. & Wickner, S. ClpXP protease degrades the cytoskeletal protein, FtsZ, and modulates FtsZ polymer dynamics. *Proc. Natl. Acad. Sci.* **106**, 10614–10619 (2009).
65. Camberg, J. L., Hoskins, J. R. & Wickner, S. The interplay of ClpXP with the cell division machinery in *Escherichia coli*. *J. Bacteriol.* **193**, 1911–1918 (2011).
66. Li, X. *et al.* The ClpP protease homologue is required for the transmission traits and cell division of the pathogen *Legionella pneumophila*. *BMC Microbiol.* **10**, 54 (2010).
67. Ramadoss, N. S. *et al.* Small molecule inhibitors of trans-translation have broad-spectrum

- antibiotic activity. *Proc. Natl. Acad. Sci. U. S. A.* (2013). doi:10.1073/pnas.1302816110
68. Juan, P.-A., Attaiech, L. & Charpentier, X. Natural transformation occurs independently of the essential actin-like MreB cytoskeleton in *Legionella pneumophila*. *Sci. Rep.* **5**, 16033 (2015).
69. Moffat, J. F. & Tompkins, L. S. A quantitative model of intracellular growth of *Legionella pneumophila* in *Acanthamoeba castellanii*. *Infect. Immun.* **60**, 296–301 (1992)

Acknowledgments

RB is the recipient of a doctoral fellowship from the French Ministry of Higher Education and Research. This work was supported by a CNRS-Inserm ATIP-Avenir grant awarded to XC. This study has been funded by a Research Grant 2015 by the European Society of Clinical Microbiology and Infectious Diseases (ESCMID) to XC.

Author contributions

RB and XC designed, performed, analysed experiments and wrote the manuscript.

Competing financial interesting

RB and XC declare no potential conflict of interest.

Figures

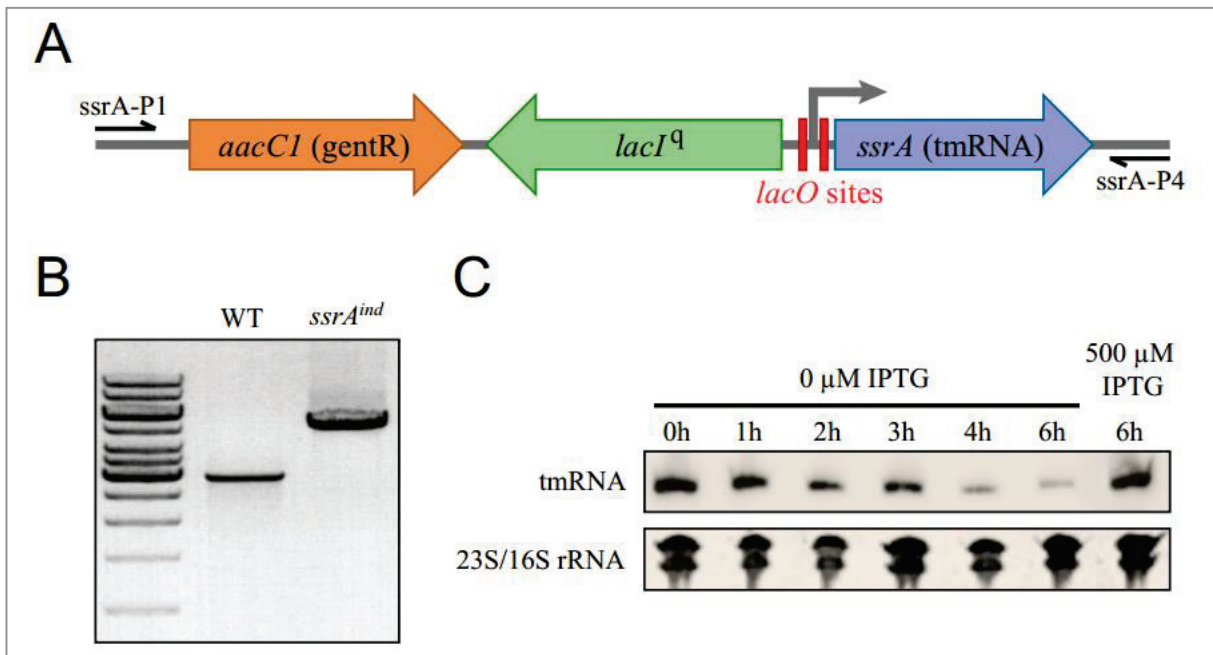

Figure 1. Construction of *ssrA^{ind}*, an *L. pneumophila* mutant in which *ssrA* is under repression by the LacI repressor (A) Schematic diagram of the IPTG-inducible allele *ssrA^{ind}*. A gentamicin resistance gene *aacC1*, the *lacI_q* gene and a modified *ssrA* promoter with two LacO sites (red boxes) were inserted upstream of the predicted *ssrA* transcription start site. (B) PCR verification of the construction using primers *ssrA*-P1 and *ssrA*-P4. (C) Northern-blot analysis of tmRNA expression in the wild-type strain and the *ssrA^{ind}* mutant. Bacteria were cultivated with IPTG in solid medium then cultivated for the indicated duration in IPTG-free liquid medium or with 500 μ M IPTG. Ethidium-bromide stained ribosomal RNA were used as loading controls.

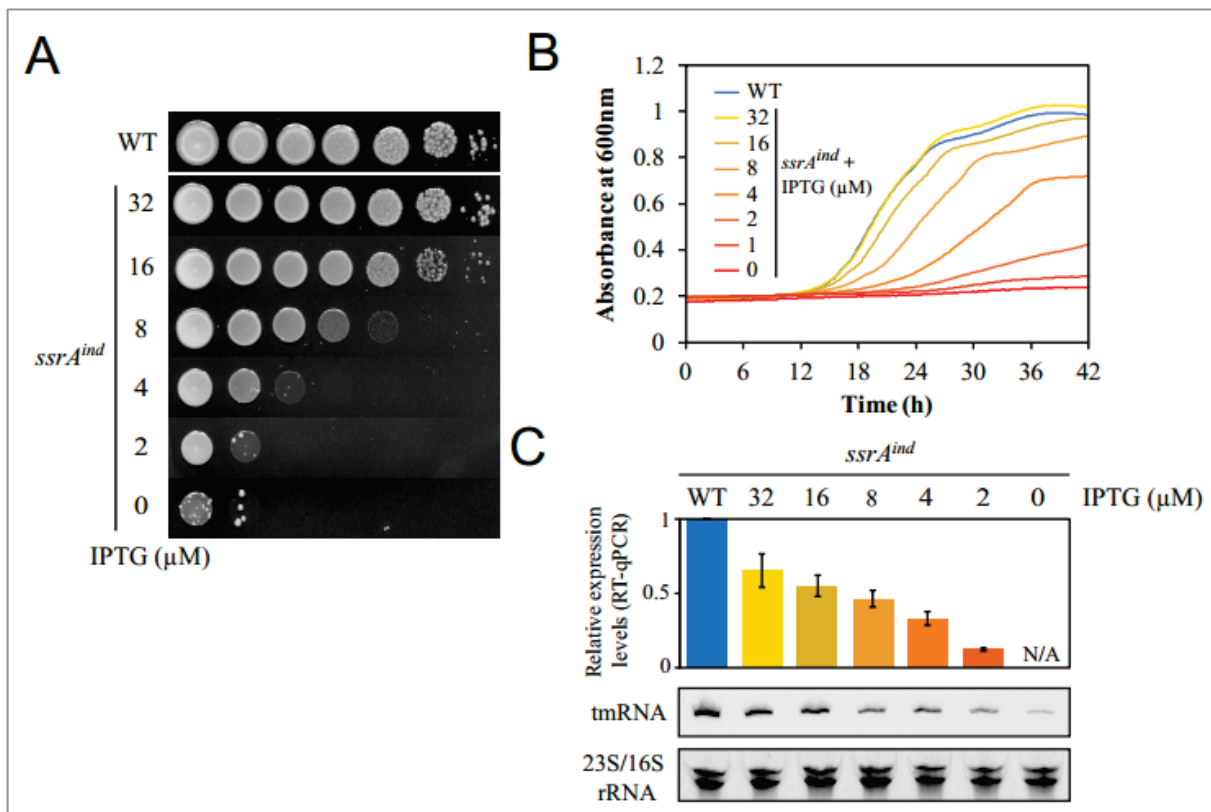

Figure 2. tmRNA is essential for growth of *L. pneumophila* in rich medium. (A) Serial, ten-fold dilutions of suspensions of the wild-type and the *ssrA^{ind}* mutant grown with IPTG were spotted on CYE solid medium containing various concentrations of IPTG. (B) Growth curve of the wild-type and the *ssrA^{ind}* mutant in AYE liquid medium containing various concentrations of IPTG. (C) Northern-blot and RT-qPCR analysis of the relative abundance of tmRNA after growth on solid medium. Ethidium-bromide stained ribosomal RNA were used as loading controls. RT-qPCR expression data are average (+/- standard deviation) from three quantifications.

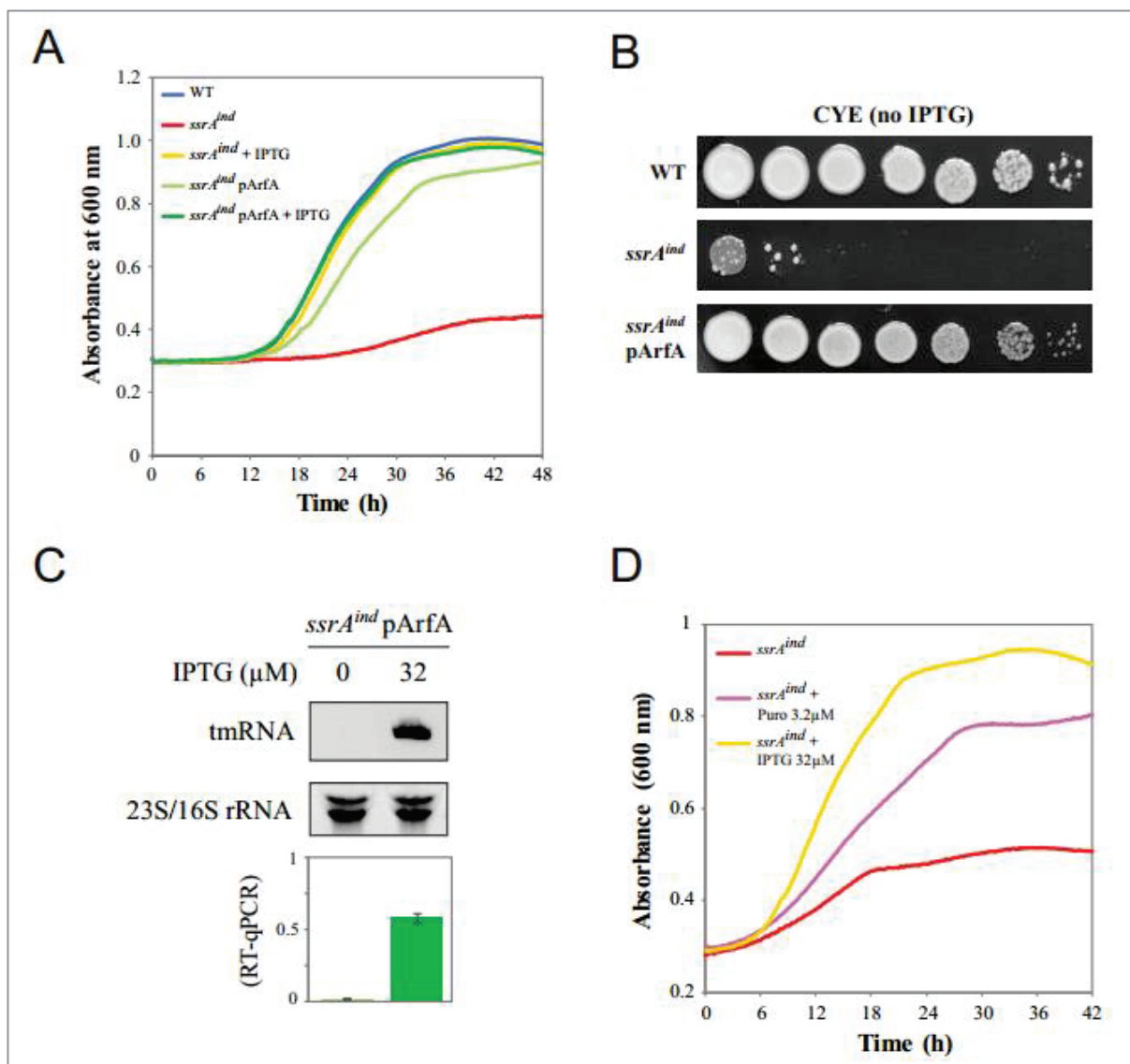

Figure 3. Ribosome release systems can compensate for the loss of tmRNA. Growth of the *ssrA^{ind}* mutant expressing the *E. coli arfA* gene in liquid AYE medium (A) and on solid CYE medium (B). (C) Northern-blot and RT-qPCR analysis of the relative abundance of tmRNA in the *ssrA^{ind}* mutant expressing the *E. coli arfA*. (D) Growth of the *ssrA^{ind}* mutant in the presence of subinhibitory concentrations of puromycin and in the absence of IPTG.

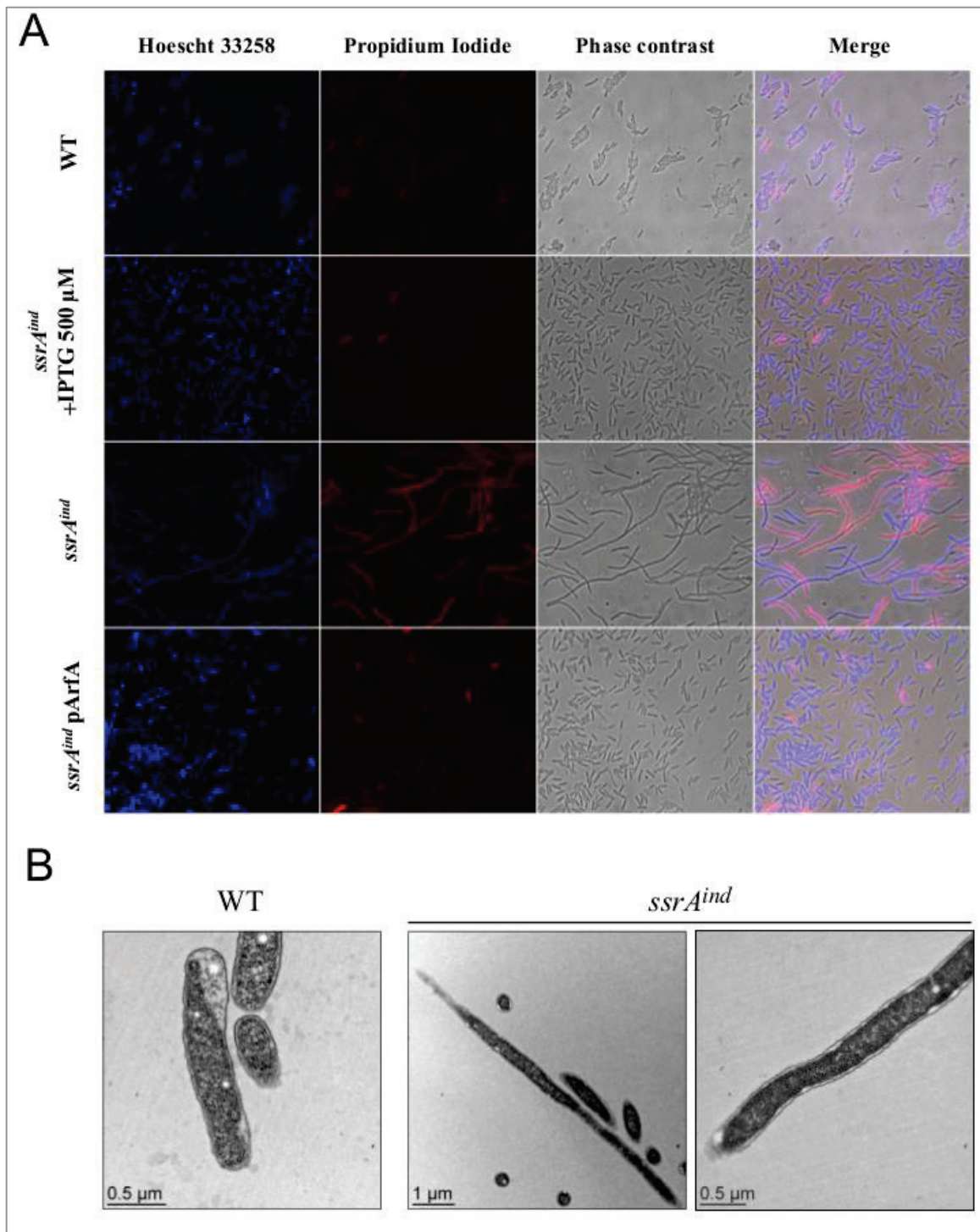

Figure 4. tmRNA-depleted *L. pneumophila* exhibit filamentation and impaired membrane integrity. (A) Fluorescence microscopy of the wild-type strain, *ssrA^{ind}* mutant and *ssrA^{ind}/pArfA* grown for 24 hours (h) in AYE medium and stained with Hoescht 33258 and Propidium Iodide. (B) Electron micrographs of the wild-type strain and *ssrA^{ind}* mutant grown for 24 hours in AYE in the absence of IPTG.

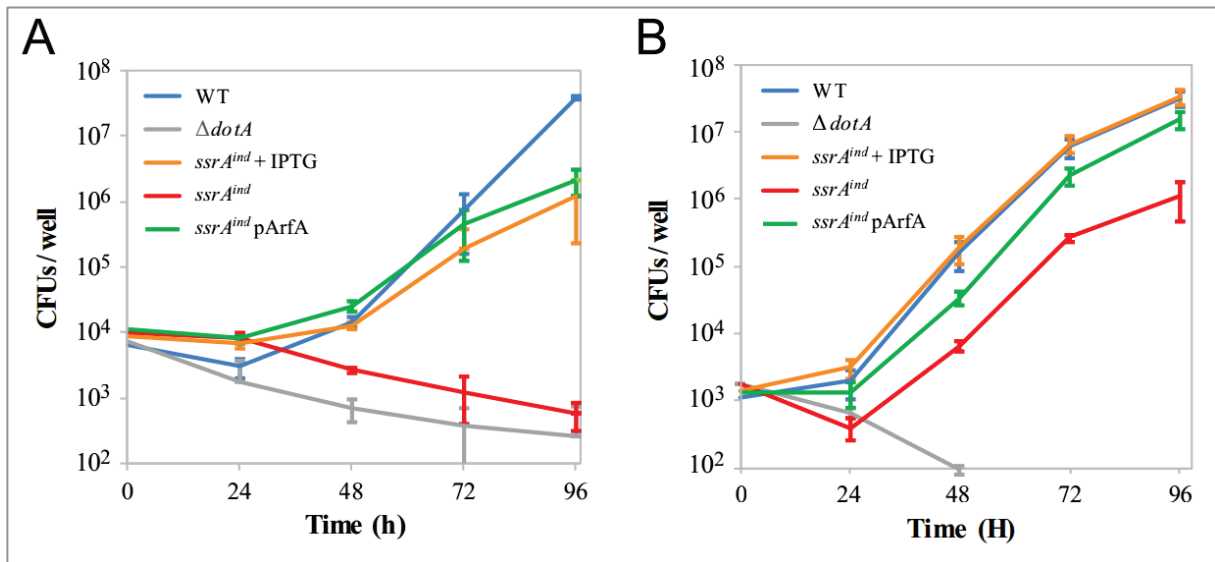

Figure 5. Growth of tmRNA-depleted *Legionella pneumophila* is impaired in eukaryotic hosts. Intracellular multiplication in *A. castellanii* (A) and U937 monocyte-derived human macrophages (B) was followed by plating samples on CYE plates containing IPTG and counting colony-forming units. Both charts represent the average of technical triplicates and are representative of three independent experiments. Error bars indicate standard deviation between the triplicates. (C) RT-qPCR analysis of tmRNA-depleted *ssrA^{ind}* grown in U937 cells. Expression data are average (+/- standard deviation) from three quantifications.

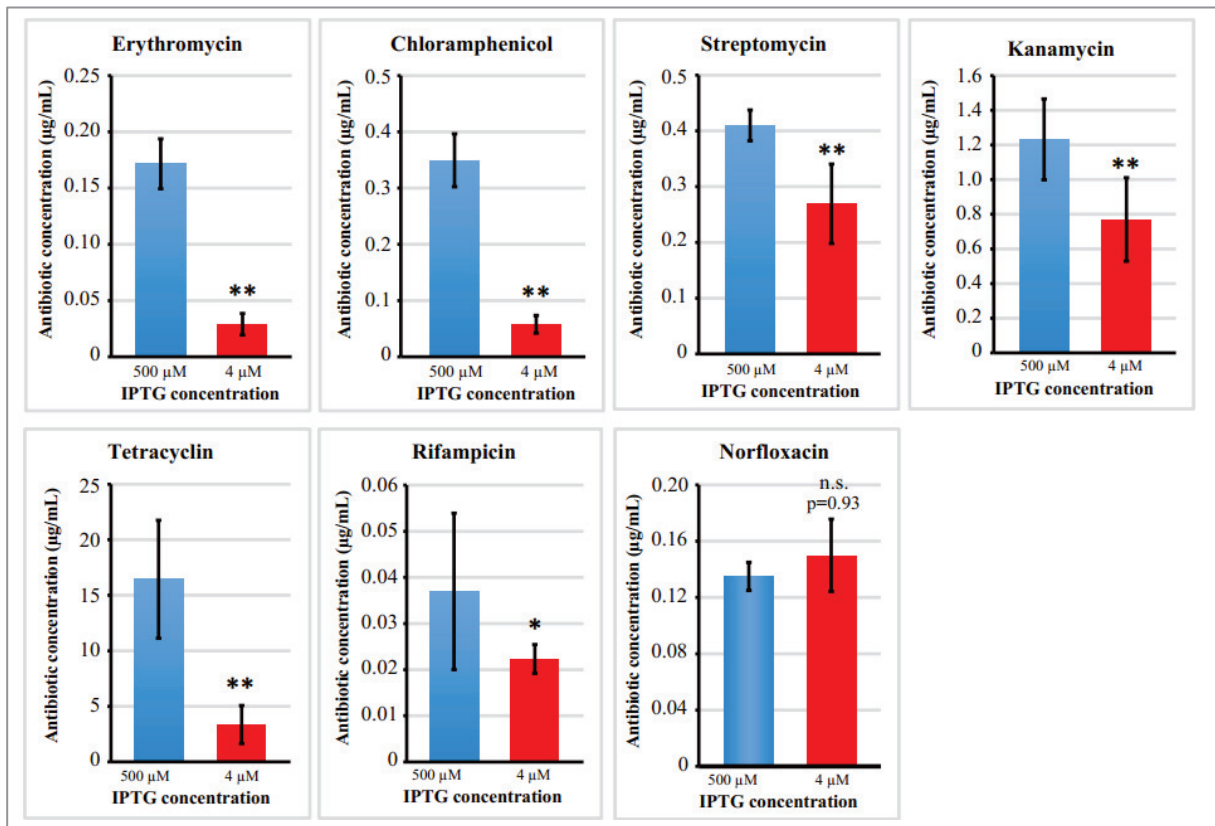

Figure 6. Antibiotic sensitivity of *L. pneumophila* with limited *ssrA* expression. The *ssrA^{ind}* strain was grown in AYE with either 500 or 4 µM IPTG and antibiotic sensitivity was assayed as described in Materials and Methods. The chart represents the average IC₅₀ obtained in six independent experiments, and error bars indicate standard deviation between experiments. (**) = $p < 0.005$, (*) = $p < 0.01$, (n.s.) = non significant, Mann-Wilcoxon U test, one-tailed.

Additional results and discussion

Here are presented additional results from this project that were not cited in the paper.

Is there really no alternative ribosome rescue factor in *Legionella*?

As explained in the paper, when using the BLAST algorithm to look for ArfA homologues using the ArfA protein sequence from *E. coli*, no hits are found in Legionellales. This is not surprising, as it is found only in a limited number of species, mainly enterobacteriaceae (cf. p.126). We had no more success with the more widely conserved ArfB (cf. p.131). When blasting ArfB from *E. coli*, no hits are found in Legionellales; when blasting ArfB from *Caulobacter crescentus*, the only hits are in the *Legionella* species *quateirensis*, *drancourtii*, *tunisiensis* and *feleii*, as well as the Legionellales *Coxiella burnettii* and *Berkellia aquae*. Blasting any of these Legionellales ArfB sequences against *Legionella pneumophila* or *longbeachae* does not give significant hits.

However, it is interesting to note that in *L. pneumophila* and *L. longbeachae*, a gene containing a GGQ conserved motif is present and well-conserved among the different sequenced strains. Its length is similar to ArfB, and it apparently lacks the stop-codon recognition domain of a release factor. Depending on the strain, it is annotated “peptidyl-tRNA hydrolase” (a frequent annotation for ArfB), “Peptide chain release factor”, “RF-1” (e.g. in *L. longbeachae* that already has another, much more probable RF-1-encoding gene), or a vague “similar to proteins of unknown function”. Blasting this protein sequence against non-Legionellales bacteria does not yield anything results else than very distant RF-1 sequences.

Intriguingly, when the product of this unknown gene is blasted not against bacterial genomes, but eukaryotic ones, an excellent hit emerges: a gene from *Acanthamoeba castellanii*, annotated ICT1. *A. castellanii* is an environmental amoeba, host of *Legionella pneumophila* in freshwater settings. In fact, when aligning and constructing a neighbor-joining tree with these sequences, it becomes evident that the mysterious gene found in *L. pneumophila* and *L. longbeachae* has a common ancestor with ICT1 from *A. castellanii*; whereas the ArfB genes found in some *Legionella* and other Legionellales have a bacterial origin (Fig. 96). However, the alignment suggests that C-terminal and N-terminal parts of ICT1 have been lost during its acquisition from the host.

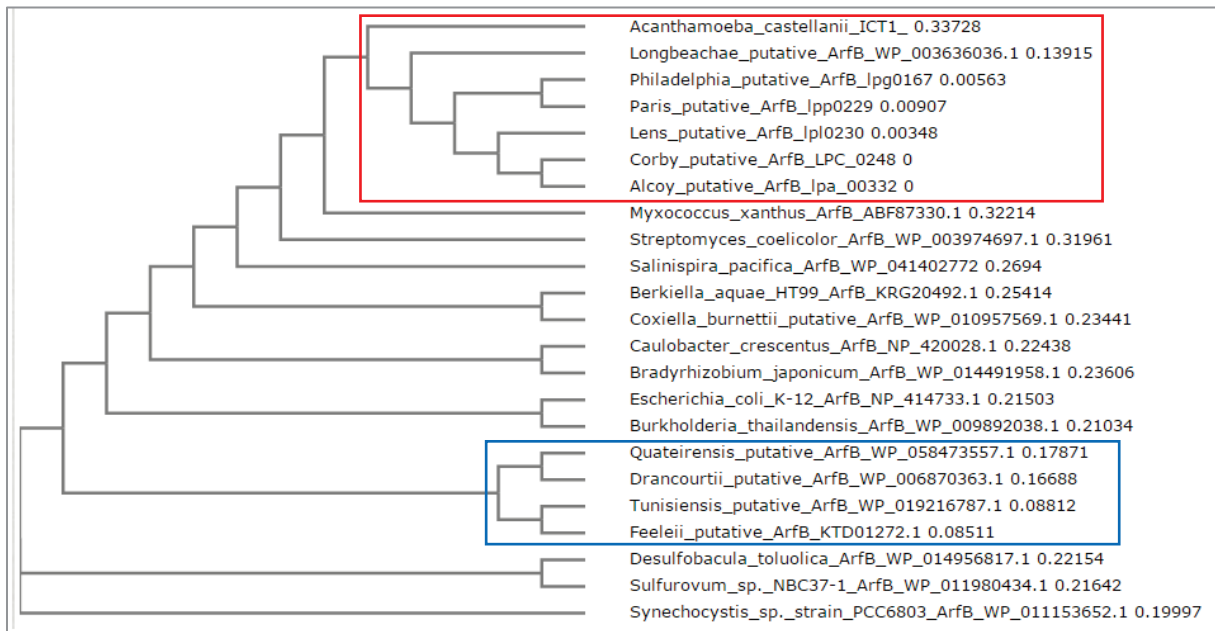

Fig. 96 Neighbour-joining tree of ArfB sequences from various bacterial species with the putative "ArfB/ICT1" of *Legionella pneumophila* and *longbeachae* and ICT1 from *Acanthamoeba castellanii*.
Tree realized following an alignment with Clustal Omega.

Two hypotheses are plausible to explain the presence of that ICT1-like gene in *Legionella*. The first is that the common ancestor of *L. pneumophila* and *longbeachae* had acquired ICT1 from their host, by inter-domain horizontal gene transfer, as with eukaryotic-like effector proteins (cf. p.157), and both lost the bacterial *arfB* found in some Legionellales and other bacteria. The gene was then reduced by progressive simplification. The second hypothesis is that, because of the sequence homology between ArfB and ICT1, they recombined together after horizontal gene transfer to form a hybrid eukaryotic/bacterial gene.

Another mystery is the absence of homologues of "*A. castellanii* ICT1" in other amoebae. In fact, when blasting that protein sequence against *Amoebozoae*, no hits are found. When it is done against all Eukaryota, we can find good hits in the conserved domain of the C12orf65 mitochondrial rescue factor gene of a large number... of birds (e.g. parrots, pelicans).

Obviously, the results presented in the paper show that this gene, whatever its function might be, is not sufficient to compensate for the loss of trans-translation in *L. pneumophila*. However, it also underlines both the ability of *L. pneumophila* to coevolve with its host (cf. p.157) and the possibility to discover overlooked alternative mechanisms of ribosome rescue in species in which none have been found yet (cf. p.132). The absence of homologues of the gene in other amoeba and

the probable transfer that gave rise to it in both *L. pneumophila* and its host are puzzling and would deserve a deeper exploration.

Trans-translation inhibition does not cause in competence development

As previously explained (cf. p.160), in an Rnase R deficient mutant, an hypercompetence phenotype was correlated with a reduction in the processing and maturation of precursor tmRNA. We tried to use our *ssrA^{ind}* mutant to assess whether trans-translation activity was indeed involved in competence regulation.

Reliably evaluating the rate of transformation of tmRNA-depleted cells was not possible, because of the reduction in viability and cultivability associated with depletion. We reduced the tmRNA levels in an *ssrA^{ind}* mutant that was also transformed with a fluorescent reporter plasmid, pXDC91 (Charpentier *et al.*, 2011). This reporter contains a transcriptional fusion between the *comEA* gene (essential for natural transformation and upregulated during competence), and a *gfp* gene.

What we observed was that a reduction in trans-translation activity was not associated with an increase in expression of *comEA* (Fig. 97). To the contrary, the peak of *comEA* expression that is usually observed at mid-exponential phase was progressively reduced in a dose-dependent manner in tmRNA-depleted cells. To give an order of comparison, a strong induction of competence by subinhibitory concentrations of Norfloxacin in the same conditions induced a peak at 14000 RFUs, more than twice the value of the natural peak observed here at 500 μ M IPTG. In conclusion, trans-translation is not involved in the regulation of competence development; quite the opposite, it seems that a correct functioning of ribosome rescue is necessary for the correct expression of the genes of the competence regulon.

Since then, our lab has uncovered that competence development in *L. pneumophila* is controlled by RocC (formerly ProQ) and its cognate small silencing RNA RocR that target the 5' UTR region of the transcripts of the competence regulon (27432973). Targeted transcripts have their RBS sequence covered by the silencing RNA, and therefore they are not translated and stay exposed to RNAses rather than protected by ribosomes. This confirms that trans-translation has no reason to be involved in competence regulation. Moreover, as RNase R is the only 3'-5' exoribonuclease in

L. pneumophila, it is not surprising that its deletion decreases the rate at which silenced transcripts are degraded, allowing hypercompetence.

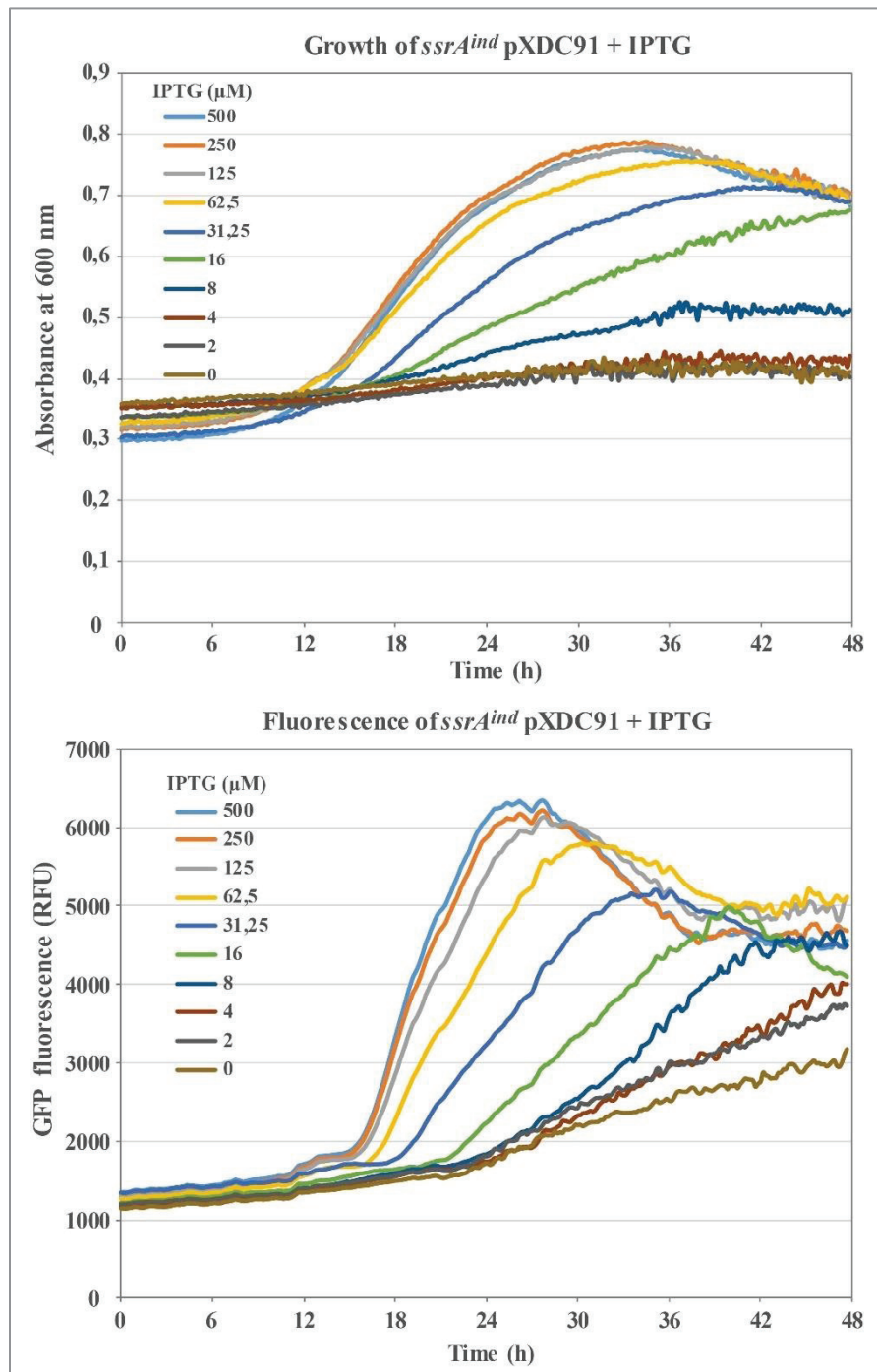

Fig. 97 A reduction in trans-translation activity does not trigger competence development. *L. pneumophila* str. Paris *ssrA*^{ind} pXDC91 was grown in AYE with a decreasing range of concentration of IPTG. GFP fluorescence (480/520nm) was monitored in a Tecan M200pro.

tmRNA-depleted *L. pneumophila* fails to infect an insect model (*Galleria mellonella*)

An infection model based on the larvae of the honeycomb moth was recently developed and tested with *L. pneumophila* (Harding *et al.*, 2012), method illustrated in (Harding *et al.*, 2013). In this model, bacteria propagate intracellularly in hemocytes, phagocytic cells of the insect immune system. The infection and takeover of hemocytes by *L. pneumophila* occurs similarly as in macrophages and amoebae, and is Dot/Icm-dependent. This model has tremendous advantages compared to the guinea pig model: it does not require an ethic committee review, larvae can be ordered promptly all year long (they are used as fishing lures), they are cheap (~\$10 for 50 larvae), they do not require a specific housing facility and can be manipulated in a L2 laboratory and under a laminar flow hood, and infection is realized with an injection rather than with aerosol exposure, that is riskier for the lab workers.

We assessed the ability of our different mutant strains to infect and kill *G. mellonella* larvae. They were challenged as previously described (Harding *et al.*, 2013), by an injection of 10^6 bacteria in 10 μ L of phosphate-buffer saline in the first right proleg of the larvae. The graph presented in Fig. 98 is representative of the survival of the larvae after 24 and 48h (n=15 for each tested strain).

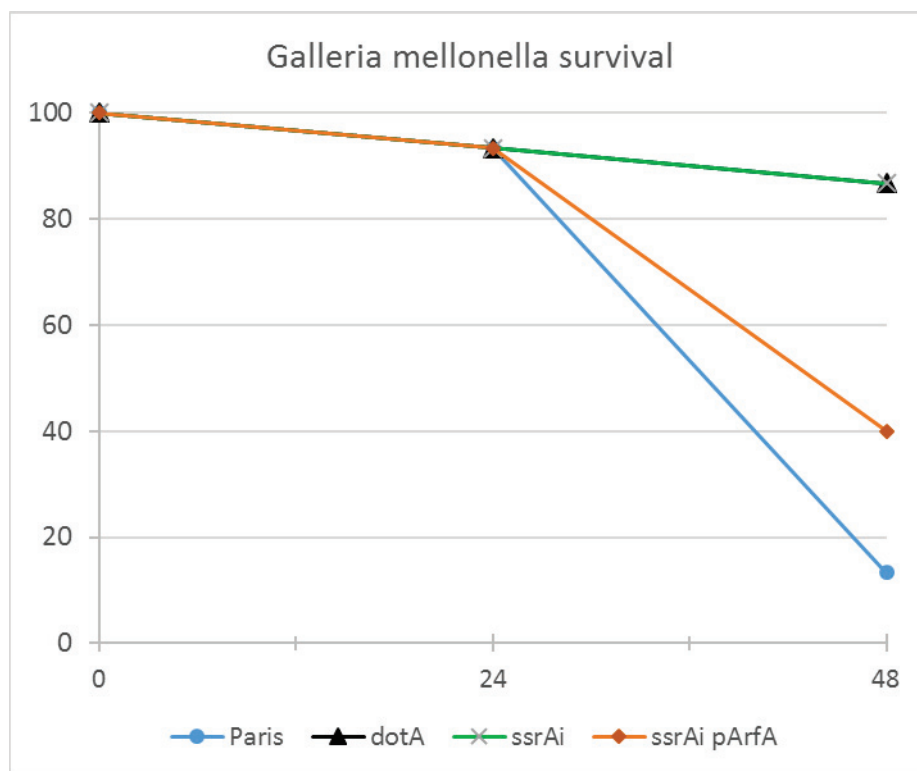

Fig. 98 Survival curves of *Galleria mellonella* larvae infected with different strains of *L. pneumophila*.

The wild-type Paris strain resulted in death of almost all larvae at 48H. The $\Delta dotA$ strain was not able to infect the larvae; neither was the *ssrA^{ind}* strain. In both conditions 2 larvae died out of 15, probably as a result of the injection; similar results were obtained in other experiments with injection of PBS alone (not shown). Loss of virulence of the *ssrA* strain was complemented by the pArfA plasmid, although with a cost in fitness. These results are similar as these observed in amoebal infections.

Does tmRNA depletion induce cell death? Or is it bacteriostasis?

As explained in the paper, determining the fate of tmRNA-depleted cells was a technical challenge. We resolved to using a marker of membrane integrity to determine that only about half of the population was seemingly dead at 24 and 48h of culture without IPTG. Counting filamentous cells before plating was obviously not possible with the conventional approach of using optical density as a reference. We could have counted them under a microscope; the problem is that filamentous cells tended to aggregate together and form something close to a plate full of spaghetti, absolutely impossible to enumerate.

We tried anyway to get an idea of the number of CFUs in a culture of tmRNA-depleted *L. pneumophila*. We cultivated both the wild-type strain and the *ssrA^{ind}* strain in AYE with 500 μ M IPTG or without, for 24 and 48H. At each time point, we sampled each culture and diluted or concentrated samples to reach an OD₆₀₀=1. These samples were then serial diluted 10-fold and plated on CYE. Results are presented in Fig. 99.

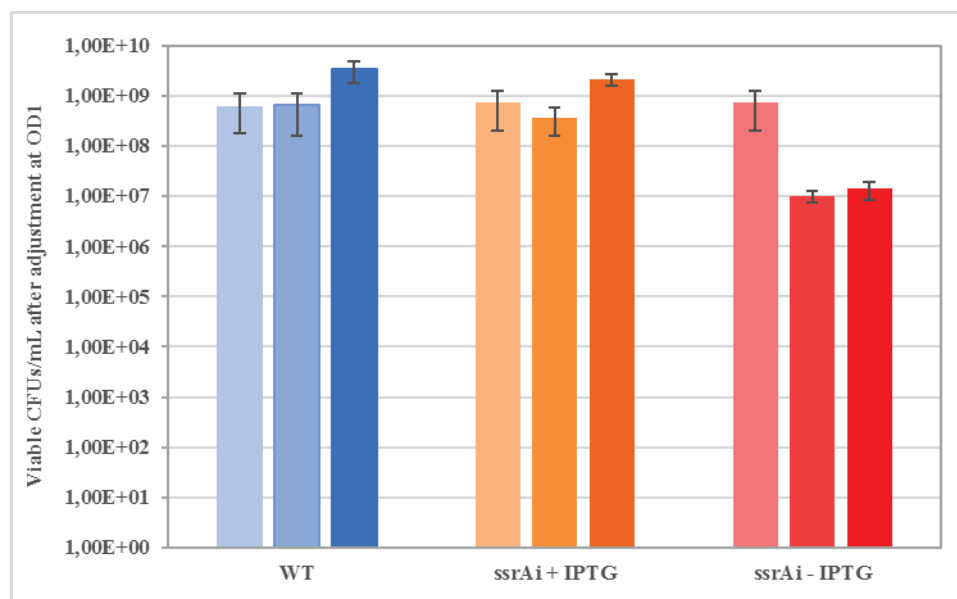

Fig. 99 CFU counting after growth with or without IPTG and adjustment of the samples at OD=1.

We observed a rise in the number of CFU/mL in controls, easily explained by the reduction in cell size of *L. pneumophila* in stationary phase (cf. p.151). tmRNA-depleted cells formed 2 logs less CFUs than the controls. This is coherent with the microscopy observations that showed that only about half of the filaments were stained by PI and then probably dead; and given that said filaments reached lengths of more than a hundred micrometers, for an identical OD of 1, there must be about 100 times less filaments in this conditions than 1- μ m long coccoid cells in the controls. If tmRNA depletion induced lethality systematically, we would have observed a much more important log reduction in this experiment. We can conclude that despite being essential for growth, tmRNA depletion obviously does not induce a dramatic cell death and that about half of the filaments in the culture should be able to resume growth.

To confirm these results, we performed regrowth assays in which IPTG was added to the culture at T=0, 24 and 48h (Fig. S1 in the paper). We observed a rapid regrowth after addition of the inducer at 24h, and a slower regrowth at 48h. Unfortunately, we couldn't perform longer experiments because of media oxidation and evaporation at longer time points. But this confirms that the growth inhibition induced by tmRNA depletion is not massively lethal for *L. pneumophila*, and is mostly bacteriostatic.

Attempts to explore the link between the divisome and trans-translation

The most surprising and intriguing result of this project is certainly the fact that tmRNA-depleted cells are filamentous. To our knowledge, such a phenotype has never been reported in studies of trans-translation, either in species where the mechanism is essential or in these where it is dispensable. Hypotheses on that phenotype are discussed in the paper and in the next paragraph.

One of our hypotheses was that in trans-translation depleted cells, the divisome apparatus was not able to assemble correctly. Indeed, our electron microscopy observations showed that no septa were visible in any of the filamentous cells, however they obviously had no problem to continue growing and therefore synthesizing new cell envelope and performing a certain level of metabolism. Such a filamentous phenotype was also reminiscent of publications in *E. coli* where under- or over-expressing the major divisome component FtsZ led to filamentation (1400163). It was also found in *E. coli* that ClpXP, the major protease complex involved in the degradation of trans-translation-tagged protein substrates (cf. p.119), was responsible for the regulation of FtsZ levels in the cell by

direct recognition and degradation (19541655). Therefore, it was possible that a drastic reduction in trans-translation activity and tagging induced by tmRNA depletion could make ClpXP more available to degrade FtsZ, preventing the early steps of the divisome assembly.

To try to follow FtsZ levels and observe septa with epifluorescence microscopy, we tried to build several strains that contained tag sequences recognized by antibodies or the fluorescent protein Gfp. To our knowledge, no such approaches had been performed in *L. pneumophila* yet. Depending on papers and species, the N-ter or C-ter parts of the proteins could be tagged; but both are important for the function and assembly of FtsZ polymers. We tried to create N-terminal fusions, as *ftsZ* is the last gene of an operon in *L. pneumophila* str. Paris and we wanted to replace the gene by natural transformation and recombination, with a resistance marker in the opposite direction for selection of mutants. We tried to create FtsZ-Gfp, FtsZ-Strep (WSHPQFEK tag), FtsZ-Flag (DYKDDDDK), FtsZ-2XFlag (DYKDHD-G-DYKDHD) and FtsZ-3XFlag (DYKDHD-G-DYKDHD-I-DYKDDDDK) mutants. The fusion with the *gfp* gene proved lethal, as no mutants were obtained with that construction. FtsZ-Strep and -Flag were viable and exhibited a normal appearance at exponential phase but seemed longer at stationary phase than controls. FtsZ-2XFlag and -3XFlag were viable but formed longer cells and were not used further. The FtsZ-Strep and -Flag construction were introduced in both wild-type and *ssrA^{ind}* backgrounds.

Fluorescent microscopy at the cytoplasmic level proved extremely difficult to perform in *L. pneumophila*. Only one paper reports the use of immunofluorescence against a cytoplasmic protein in that species ((Vincent *et al.*, 2012)), but was unable to yield results when we tried to apply it in our case. The critical point was to sufficiently open the cell wall and membranes while retaining the ultrastructure of the bacteria. *L. pneumophila* has a particular cell wall composition that makes it very tight and highly resistant to lysozyme (Amano and Williams, 1983), in all probability because amoeba produce it as part of their digestion process. A large number of combinations of fixation techniques (including methanol, formaldehyde and glutaraldehyde) and lysozyme concentrations were assayed but yielded poor results, either no staining or cell lysis. No reliable immunofluorescent staining procedure has been discovered from these experiences.

We also used the FtsZ-Flag mutant to perform a Western-blot analysis to assess the levels of FtsZ over tmRNA depletion. Cultures of *ssrA^{ind}* with or without IPTG were cultivated and

heroically sampled for one day and one night until the control reached a maximum OD600 of 6, (around 5 a.m). At this point, filamentation was already noticeable, with cells of a length of more than 10 μm . After Western-blot with an anti-Flag antibody, it was found that in both conditions the global levels of FtsZ compared to total proteins was relatively stable. Therefore, contrary to our hypothesis, trans-translation depletion does not seem to induce noticeable decreases of FtsZ levels.

Prospects of this research

To further this project, several points would need to be explored.

First, the filamentation phenotype is still enigmatic. Hypotheses for this filamentous phenotype are discussed in the paper. The most probable explanation is that, despite the fact that translation probably still occurs at some levels (because filamentous cells still lengthen and are full of ribosomes that must have been neo-synthesized during filamentation, Fig. 4 in the paper), generalized ribosome blocking probably prevents the sufficient expression of proteins essential to the division machinery. We can dismiss the idea that trans-translation downregulates an inhibitor of division in a similar way as with LacI and ArfA expression, by *srrA*-tagging, because tmRNA-depleted cells complemented by ArfA are not filamentous. The regulation of *L. pneumophila* cell size has been explored and results from different and complicated regulatory pathways (reviewed in 25566200). The divisome assembly requires a precise regulation of the concentration of its components to trigger the formation of the Z-ring. Furthermore, toxin/antitoxin systems could play a role in the growth arrest and membrane permeabilization observed, if the antitoxins are not expressed at sufficient levels. These three hypotheses should be investigated further to understand the intriguing filamentation phenotype that we observed.

We lacked time to explore the specific role of protein tagging in the pathogen. In *Helicobacter pylori*, for example, ribosome rescue is essential but protein tagging is not (Thibonnier *et al.*, 2008). This is coherent with the more global observation that ribosome rescue is the most important mechanism of trans-translation, which explains why alternative ribosome rescue factors deprived of tagging activity almost always complement loss of trans-translation ((Keiler and Feaga, 2014)). Studying a tagging-deficient mutant of tmRNA in *L. pneumophila* and compare it to the results obtained with the *srrA*^{ind} pArfA mutant could allow to discover which mechanisms of that pathogen

are regulated by trans-translation tagging, and to assess whether the reduced fitness and virulence of the *ssrA*^{ind} pArfA mutant is due to incomplete ribosome rescue or a need for tagging activity.

Finally, as we demonstrated essentiality of trans-translation in *L. pneumophila*, it should be assessed as well in other Legionellales, including other strains of *L. pneumophila*, in *L. longbeachae*, and in *Coxiella burnetii*. Moreover, the activity and phylogeny of the putative alternative ribosome rescue factor that may have been acquired from eukaryotes (cf. p.199) should be investigated.

Objective 2: Activity of KKL-35 against the etiologic agents of Legionnaire's disease

KKL-35 is a new antibiotic that inhibits trans-translation activity in *E. coli* and exhibits antibiotic activity in a wide range of pathogens (cf. p.144). The paper that revealed the discovery of that new oxadiazole family was published early after the beginning of my thesis, when our preliminary results already showed that trans-translation was essential in *L. pneumophila*. We then decided to get the new drug synthesized and to test it against our pathogen and its close relatives.

The following paper presents this work, mostly conducted in parallel to the experiments of Objective 1. The paper, not yet in its final state, is expected to be submitted soon, either to *Antimicrobial Agents and Chemotherapy* or *Clinical Microbiology and Infections*, as “KKL-35 inhibits growth of *Legionella pneumophila* in vitro and multiplication within human macrophages”, by Romain Brunel, Ghislaine Descours, and Xavier Charpentier. G. Descours performed the MIC determinations on Erythromycin-resistant strains in a BSL3 lab.

KKL-35 exhibits bactericidal activity against *Legionella* species *in vitro* and during infection of human macrophages

Romain Brunel^{1,2}, Ghislaine Descours³ and Xavier Charpentier^{1,2*}

¹ Univ Lyon, Université Claude Bernard Lyon 1, INSA-Lyon, CNRS, UMR5240, Microbiologie, Adaptation et Pathogénie, 10 rue Raphaël Dubois, F-69622, Villeurbanne, France

² CIRI, Team “Horizontal gene transfer in bacterial pathogens”, Inserm, U1111, Université Claude Bernard Lyon 1, CNRS, UMR5308, École Normale Supérieure de Lyon, Univ Lyon, 69100, Villeurbanne, France

³ CIRI, Team “Pathogenesis of *Legionella*”, Inserm, U1111, Université Claude Bernard Lyon 1, CNRS, UMR5308, École Normale Supérieure de Lyon, Univ Lyon, 69008, Lyon, France

Abstract

We recently reported that trans-translation is essential in the human pathogen *L. pneumophila*. A new family of oxadiazole compounds that inhibit trans-translation have been reported to have broad-spectrum antibiotic activity. We tested a compound of this family, KKL-35, and found it to inhibit growth of all tested strains of *L. pneumophila* at sub-micromolar MICs (<0.125µM). KKL-35 also displays significant activity against other Legionnaire’s disease-causing *Legionella* species. KKL-35 exhibits bactericidal activity at or near the MIC on all tested strains. It also inhibits multiplication of *Legionella pneumophila* in human macrophages at several stages of infection. No resistant mutant could be obtained in evolution experiments, suggesting that resistance is not easily acquirable. However, several results suggest that the antibiotic effect is not solely related to inhibition of trans-translation activity in *L. pneumophila*. The mechanism of action of KKL-35 in this species remains unclear and we suggest that KKL-35 has more than one target.

Introduction

Legionella pneumophila is a gram-negative pathogenic bacteria ubiquitous in freshwater environments. When contaminated droplets of water are aerosolized and inhaled by humans, they can infect alveolar macrophages, causing a severe pneumonia called Legionnaire's disease or Legionellosis. Despite adapted and timely treatments (a monotherapy of macrolides or fluoroquinolones, sometimes associated with rifampicin), the possibility to quickly diagnose the disease by rapid urinary antigen tests, and no apparent *in vitro* resistance of the isolated strains to such antibiotics, Legionnaire's disease has a high mortality rate (in average 10% of cases). Although some predispositions are associated with a bad prognosis such as age, smoking, or immunodeficiency, there is currently no consensus on why the treatment failure rate is so high.

Among suspected causes for those failures, it has been suggested that antibiotics may have difficulties to reach sufficiently high concentrations inside *L. pneumophila*'s replicative niche, the phagocytic vacuole of lung macrophages (Havlicek *et al.*, 1987). *Legionella* spp. are gram-negative intracellular bacteria; therefore, these molecules have to cross a high number of biological membranes to reach their molecular target. It has also been shown that the inhibition of replication of *Legionella pneumophila* in macrophages by drugs such as erythromycin and rifampicin is reversible and that multiplication resumes as soon as the antibiotic concentration decreases (Horwitz and Silverstein, 1983). Recently, evidence emerged showing that during the few days of a course of fluoroquinolone therapy, *Legionella pneumophila* can quickly acquire high levels of resistance by mutation (Shadoud *et al.*, 2015). Therefore, new antibiotics exhibiting a strong activity against *Legionella pneumophila*, a good ability to cross biological membranes, and whose target cannot become easily resistant by mutation, are needed to decrease the mortality of the disease.

We recently demonstrated that trans-translation, a universal bacterial rescue mechanism for ribosomes stalled during translation, was essential for *Legionella pneumophila* growth and infection of its cellular host. Essentiality of trans-translation in this species is probably due to the apparent absence in the majority of the *Legionellaceae* genus of the alternative ribosome rescue systems that have been found in a wide range of bacterial species in which trans-translation is not essential. Those systems are able to complement to a certain extent the loss of trans-translation activity, and it has thus been hypothesized that at least one active ribosome rescue system is needed to face the

very high natural occurrence of ribosome stalling(Keiler and Feaga, 2014). Indeed, it was measured that as much as 2-4% of translation events are aberrant and require rescue in *E. coli*; in absence of rescue systems, all ribosomes would be stalled in less than a cell cycle(Ito *et al.*, 2011). Ribosome rescue seems to play a key role in the regulation of the cell division septum assembly in *Legionella pneumophila*, as inhibiting the expression of its major component hinders normal cell division. Trans-translation had previously been widely ignored as a target for antibiotherapy until it was found to be essential in a number of pathogenic species, either for virulence (*Salmonella enterica*, *Salmonella typhimurium*, *Yersinia pestis*, *Francisella tularensis*, *Streptococcus pneumonia*) or growth *in vitro* (*Haemophilus influenza*, *Shigella flexneri*, *Mycoplasma* spp., *Helicobacter pylori*, *Mycobacterium tuberculosis*). Since then, it has been hypothesized that trans-translation could be a valid, yet-unexplored target for antibiotherapy against those species.

A molecular screen recently identified a family of small compounds with an oxadiazole moiety able to inhibit trans-translation in an *in vitro* model, at micromolar concentrations(Nitya S Ramadoss *et al.*, 2013). One compound of this family, KKL-35, was found to exhibit a particularly potent antibiotic activity against *S. flexneri*, in which trans-translation was known to be essential. It also exhibited activity on species in which essentiality of trans-translation is unknown, and even in *E. coli*, even though alternative ribosome rescue factors exist in this species. In *E. coli*, the main alternative rescue mechanism is repressed by trans-translation in normal conditions, and it is speculated that inhibition of trans-translation KKL-35 overwhelms the global pool of bacterial ribosomes before alternative systems can be expressed to complement the loss of the main rescue mechanism.

In the original study, KKL-35 had not been tested against an intracellular pathogen during infection of its host. It was recently realized with *Francisella tularensis*, where compounds of the same family were found to inhibit intracellular replication(Goralski *et al.*, 2016). The present study assessed KKL-35 *in vitro* activity against a set of *Legionella* species and strains, allowing the determination of MIC and MBC values for those strains. We report here that KKL-35 exhibits bactericidal activity against *Legionella pneumophila in vitro* at very low concentrations and is able to stop bacterial multiplication in a model of infection of human macrophages.

Methods

Strains, Growth Media and antibiotics used

Strains used in this study included clinical isolates of *L. pneumophila* of strains Paris, Lens, Philadelphia-1, Lorraine and 130b, as well as clinical isolates of *L. longbeachae*, *L. dumoffii*, *L. micdadei*. Fifteen strains of *L. pneumophila* str. Paris derivatives, obtained by serial passages in increasing concentrations of Erythromycin, were obtained from a previous unpublished work by G.D. *Legionella pneumophila* Paris was transformed with the plasmid pX5, a pMMB207C derivative harboring the *gfp+* gene under a constitutive Ptac promoter. The strain obtained was used for direct monitoring of macrophage infections by fluorescence reading. The previously described *ssrA^{ind}* and *ssrA^{ind}* pArfA strains were also used.

Acer-Yeast Extract broth medium (AYE) was prepared with 10 g/L ACES (*N*-(2-acetamido)-2-aminoethanesulfonic acid, Carl Roth), 12 g/L yeast extract (BD Difco), 0.3 g/L iron III pyrophosphate (Sigma-Aldrich) and 0.5 g/L L-cysteine (Carl Roth). pH was adjusted at 6.9 with KOH and the solution was filter-sterilized and kept away from light, at 4°C.

ACES-buffered charcoal yeast extract plates (CYE) were prepared with 10 g/L ACES (Carl Roth) and 10 g/L yeast extract (Merck) autoclaved together, 30 g/L agar and 4 g/L charcoal autoclaved together, and complemented with 0.25 g/L filtered iron III nitrate (Sigma-Aldrich) and 0.4 g/L L-cysteine (Carl Roth). Unless indicated otherwise, cultures in CYE plates were incubated for 72h at 37°C in air, then patched onto CYE again for 24h to obtain fresh cultures before experiments were performed.

KKL-35 was synthesized (Ambinter), and correct molecular composition and purity was verified by mass spectrometry and nuclear magnetic resonance. When KKL-35 became available from common providers (Sigma-Aldrich), it was purchased and tested. KKL-35 from both sources exhibited the same *in vitro* activity (data not shown) but the color of the powder was slightly different. Results presented in this study were obtained from the Ambinter-sourced compound only. A stock solution of KKL-35 was prepared at 10mM (3.2 g/L) in dimethylsulfoxide (DMSO) and kept at -20°C, where it retained the same activity for more than a year. At all tested KKL-35

concentrations, similar concentrations of DMSO alone had no effect on growth of *Legionella* nor any cytotoxicity on human macrophages.

Determination of Minimal Inhibitory Concentrations (MIC) and Minimal Bactericidal Concentrations (MBC)

No CSLI guidelines have yet been published for testing sensitivity of *Legionella* strains to antibiotics; EUCAST recently released a guideline suggesting the gradient strip method to assess MIC but no such strips are commercially available for KKL-35. Broth microdilution in AYE medium has been the most commonly used method [BALTCH ET AL. 1995] in the literature and was our method of choice for evaluation of antibiotic activity on cultures in artificial media. Tested strains were plated from glycerol stocks at -80°C onto CYE plates and incubated at 37°C in air for 72h. They were then plated again as patches onto new CYE plates for 24h to obtain fresh cultures. Each strain was resuspended in AYE medium and placed into the wells of a 96-well polystyrene plate and a range of twofold dilutions of KKL-35 was added to the cultures. The starting concentration of the cultures was 10^6 CFU/mL and was verified by plating and counting of serial dilutions of the cultures at the beginning of the experiment. The 96-well plate was sealed with a Breathe-Easy membrane (Sigma-Aldrich) to prevent evaporation and was incubated for 48h at 37°C in air with no agitation. At 48H MICs were determined visually as the lowest concentrations at which no growth was visible. Cultures from all wells with concentration higher or equal the MIC were collected, serial diluted and plated onto CYE agar for counting. MBC was defined at the minimal concentration at which 99.9% of bacteria were killed.

Time-Kill assay

Legionella pneumophila str. Paris was plated from a glycerol stock at -80°C onto CYE and incubated at 37°C in air for 72h, then plated again as patches onto new CYE plates for 24h to obtain a fresh culture. Bacteria were resuspended in AYE medium at $\text{OD}_{600}=1$, then 5 microliters of this suspension were added to polypropylene tubes containing 2mL of AYE medium (final concentration $3 \cdot 10^6$ CFU/mL) and a range of twofold dilutions of KKL-35. Tubes were then incubated at 37°C in air, with shaking. At each time point, 10 microliters of each culture was collected, serial diluted, plated on CYE agar and CFUs were counted.

Evaluation of synergetic activity

The checkerboard broth microdilution method was used to evaluate a possible synergic activity between KKL-35 and other antibiotics. *Legionella pneumophila* str. Paris was plated from a glycerol stock at -80°C onto CYE and incubated at 37°C in air for 72h, then plated again as patches onto new CYE plates for 24h to obtain a fresh culture. Bacteria were resuspended in AYE medium, then added to a final $\text{OD}_{600}=0.1$ ($\sim 1.5 \cdot 10^7$ CFU/mL) to a 96-well polystyrene plate containing a twofold range of concentration of KKL-35 in columns, crossing a range of another antibiotic in rows. The plate was then incubated for 48h in a Tecan Infinite M200Pro Reader at 37°C , with both agitation and absorbance reading at 600nm every 10 minutes. The highest absorbance reading for each well was kept as value. Compared to the classic evaluation of growth by visual observation, this method allowed to obtain a quantitative measure of growth in wells with intermediate growth, as well as the possibility to observe potential transient growth arrests followed by growth resume. Growth inhibition was defined as a maximal absorbance value $<10\%$ the value of the negative control. Fractional Inhibitory Concentrations (FICs) were defined as previously described.

Intracellular activity determination

U937 cells grown in RPMI 1640 containing 10% fetal calf serum (FCS) were differentiated into human macrophages by addition of phorbol 12-myristate 13-acetate (PMA) at 100 ng/mL, then seeded into 96-well polystyrene plates (10^6 cells/well). Differentiation was conducted over 3 days, then 4 hours before infection the medium was replaced by fresh medium + 10% FCS. *Legionella pneumophila* str. Paris was plated from a glycerol stock at -80°C onto CYE and incubated at 37°C in air for 72h, then plated again as patches onto new CYE plates for 24h to obtain a fresh culture. 4 hours before infection, bacteria were resuspended in RPMI 1640. Infection of macrophages was performed by replacing their medium by RPMI 1640 + 2% FCS containing *Legionella pneumophila* at a multiplicity of infection of 10. KKL-35 or DMSO was added at T+1H. Plates were centrifuged 10min at 1000g then incubated at 37°C with 5% CO_2 for 72H. Microscopy photography was then performed with an inverted microscope (Nikon Eclipse TS100) equipped with a color camera (Olympus D20). Intra- and extracellular bacteria were harvested by removing the supernatant, replacing it with deionized water, mechanically shearing the macrophages by

repeated pipetting and mixing the original supernatant with the macrophage lysate. This lysate was serially diluted, plated on CYE and bacterial colonies were counted after 72H of growth.

Intracellular growth monitoring

Infection of U937 macrophages was performed as described above, except that the GFP-producing *Legionella pneumophila* str. Paris pX5 was used, and that the infection was performed in CO₂-independent medium after differentiation, and was monitored by a Tecan Infinite M200Pro plate reader. The plate was incubated in the reader at 37°C and GFP fluorescence levels were automatically monitored every hour for 72h at an excitation wavelength of 470nm, and emission wavelength of 520nm.

Selection of resistant mutants by serial passages

Two different lineages were founded from *Legionella pneumophila* str. Paris and propagated by serial passages in presence of KKL-35 or Norfloxacin, as previously described. Briefly, a suspension of *Legionella pneumophila* str. Paris in AYE was added to a concentration of 10⁸ CFU/mL in a 24-well polystyrene plate with twofold KKL-35 or Norfloxacin concentrations ranging from 0.5 times to 8 times the MIC that was determined for the parental strain (Norfloxacin: 0.25 mg/L, KKL-35: 0.04 mg/L). A Breath-Easy membrane (Sigma-Aldrich) was used to reduce evaporation. Plates were then incubated for four days at 37°C in air without agitation, after which the minimum inhibitory concentration was noted for each antibiotic. Bacteria from the well with the highest antibiotic concentration in which growth was observable were transferred using a 1:40 dilution to a new plate containing twofold antibiotic concentrations ranging from 0.5 to 8 times the MIC of the previous cycle. Serial passages were repeated 10 times, and the experiment was performed twice independently.

Results

KKL-35 inhibits *Legionella* growth in vitro

Efficacy of KKL-35 was first assessed *in vitro* on several strains of *Legionella* spp. Minimum Inhibitory Concentrations (MIC) and Minimum Bactericidal Concentrations (MBC) were assessed by the microdilution method as described above. Results are presented in **Table 1**. On different *Legionella* species and strains, MIC ranged from 10.24 g/L to 0.04 g/L. KKL-35 was remarkably potent on the most common etiologic agent of Legionellosis, the species *Legionella pneumophila*, with all tested strains exhibiting a MIC around 0.04 g/L. MBC ranged from one to two times the MIC for all tested strains and species, indicating a bactericidal activity of KKL-35. Several mutations in ribosomal components that allow resistance to erythromycin had no effect on KKL-35 activity (**Table 2**).

A time-kill assay was also performed on *Legionella pneumophila* str. Paris (**Fig. 1**) and showed a decrease in cell viability (assessed by the ability to form colonies) as soon as 24h after addition of KKL-35 at concentrations equal or higher than MIC. Exposure to half the MIC led to transient bacteriostatic activity, followed by regrowth to a normal maximum bacterial concentration after 48h. Lower concentrations had no effect on growth.

KKL-35 has activity on intracellularly multiplying *Legionella pneumophila*

KKL-35 activity was tested on *Legionella pneumophila* str. Paris during infection of U937 monocyte-derived human macrophages. Infection by *Legionella pneumophila* was hampered by KKL-35 in a dose-dependent manner, with a MIC of 2mg/L (**Fig. 2**). Addition of KKL-35 1h after infection, when bacteria are intracellular but not yet multiplying, stopped the infection and protected macrophages from lysis (**Fig. 2A**). Addition of KKL-35 at later time points (18 or 24h) stopped bacterial multiplication as well. Interestingly, the MIC was lower when KKL-35 was added to actively multiplying intracellular bacteria (**Fig. 2B**). KKL-35 toxicity was also tested by the Alamar Blue assay and was found not to be toxic for macrophages at tested concentrations (up to 10 times the MIC) (not shown).

Inhibition of trans-translation does not impact efficacy of KKL-35

MIC of KKL-35 was assessed in different genetic backgrounds to verify whether trans-translation inhibition was directly responsible for the antibiotic effect in *L. pneumophila*. Activity was assessed when expression of *ssrA* (tmRNA) was reduced or when expression of *ssrA* was inhibited and complemented by expression of the alternative rescue factor *arfA*. No difference in KKL-35 MIC was observed in these cases (Fig. 3).

Moreover, inhibition of the expression of the major trans-translation component made *L. pneumophila* particularly susceptible to ribosome-targeting antibiotics, in particular macrolides. However, no synergy with KKL-35 was found with the other antibiotics tested, including puromycin that induces abortion of translation and counteracts KKL-35 activity in other species (Table 3).

Altogether the data suggests that the antibiotic activity of KKL-35 is not primarily linked to inhibition of trans-translation.

Legionella pneumophila does not acquire resistance to KKL-35 rapidly

Rates of emergence of KKL-35 resistant isolates within a population was compared to the rate of appearance of resistance to a fluoroquinolone, Norfloxacin. Over 10 passages (roughly 60 generations), fluoroquinolone sensitivity peaked from a normal MIC of 1 mg/L to a maximum of 128 or 256 mg/L, while KKL-35 sensitivity never exceeded 2 times the normal MIC of 0.04 mg/L (Fig. 4). The results indicate that resistance cannot be obtained in an experimental evolution system under chronic exposure to the drug. Although this experimental setup allowed the emergence of resistance to fluoroquinolone, no resistance was detected for KKL-35. The data suggest that no viable mutation can confer resistance or that resistance requires mutation of multiple targets.

Discussion

We investigated the effect of KKL-35 *in vitro* on clinical isolates of several *Legionella* species, and found it to be bactericidal on all tested strains. KKL-35 was especially efficient on the different tested strains of *Legionella pneumophila*, the species responsible for more than 90% of Legionellosis cases, with a MIC of 0.04 mg/L (0.125 μ M). The bactericidal effect of KKL-35 on *Legionella*

pneumophila was achieved at one or two times the MIC and led to a progressive decline in cell viability over time.

Related oxadiazoles KKL-10 and KKL-40 were recently found to be able to stop intracellular multiplication of *F. tularensis* (Goralski *et al.*, 2016). KKL-35 was reportedly not tested on intracellular bacteria during infection of human cells because of its lower solubility at efficient concentrations; in our case we did not encounter solubility problems at the tested concentrations and up to 10 times the *in vivo* MIC. We tested KKL-35 on *Legionella pneumophila* str. Paris over the course of infection of monocyte-derived human macrophages (U937) and found it to be able to stop bacterial multiplication when added to the medium at T+1h, 18 or 24h after the beginning of the infection. Interestingly, KKL-35 was more potent on actively-multiplying *Legionella* at later stages of infection. This proves that KKL-35 is able to successfully cross the biological membranes of the macrophage to reach intracellular *Legionella pneumophila*. We also assessed the viability of macrophages exposed to KKL-35 for 72h and found it to not be toxic in the tested range (up to 10 times the *in vivo* MIC).

As trans-translation activity has been described to be involved in bacterial resistance to ribosome-targeting antibiotics, we tested KKL-35 in combination with other antibiotics to assess their possible synergy. Contrary to what was expected, no synergy was found with ribosome-targeting antibiotics, whereas we previously found that a reduction in tmRNA levels led to an increased sensitivity of *Legionella pneumophila* to such antibiotics. However, KKL-35 was found to retain a normal activity on different tested strains of Erythromycin-resistant *Legionella pneumophila*. There is apparently no cross-resistance between macrolides and KKL-35.

Identification of the target of an antibacterial compound is usually performed by isolation of mutants exhibiting a higher resistance to the compound, followed by sequencing and identification of single-point mutations. Sequential passages in a range of concentration of the compound did not yield such mutants over the course of ten passages in two independent experiments, whereas doing so with a fluoroquinolone (Norfloxacin) yielded a population resistant to 128 times the normal MIC in only 6 passages, in both independent experiments. This result suggests that mutations of the gene encoding the target of KKL-35 may be highly detrimental for the bacteria, and/or that several cellular components are targeted.

KKL-35 was first identified in a high-throughput screen that aimed to identify molecules able to inhibit trans-translation activity *in vitro*. Its antibacterial activity was discovered subsequently and is assumed to result from the inhibition of that pathway. However, we found evidence suggesting that trans-translation may not be the target of KKL-35 in *Legionella pneumophila*, or at least not its only target. Indeed, MICs were identical when tested on a wild-type strain of *Legionella pneumophila*, on an inducible mutant of the tmRNA-encoding gene exhibiting different levels of expression of that gene, or when the inhibition of tmRNA expression was complemented by an alternative ribosome rescue system (ArfA from *Escherichia coli*). Addition of Puromycin, a drug able to abort protein elongation and therefore to resolve ribosome stalling, also failed to modify the MIC of KKL-35, contrary to results obtained in *Shigella flexneri* and to the observation that puromycin rescued trans-translation depletion in *L. pneumophila*. Also, as discussed above, KKL-35 has no synergic activity with Erythromycin, while a reduction in tmRNA levels greatly enhances activity of this antibiotic in *Legionella pneumophila*.

The molecular target of KKL-35 is being investigated and may lie in the helix 89 of the 23S rRNA. This helix plays an important role in the peptidyltransferase center of the ribosome, known to interact with tmRNA during trans-translation. It is possible that in *L. pneumophila*, this target is less prone to support viable mutations. Normal translation may also be inhibited by KKL-35 in *L. pneumophila*, explaining why trans-translation does not seem involved. Alternatively, it could be that other important cellular mechanisms are inhibited in addition or instead of trans-translation. Other oxadiazoles of the same class seem to inhibit the degradation of unfinished proteins released from ribosomes rescued by trans-translation. KKL-35 does not inhibit this activity in *E. coli*, but it could be different in *L. pneumophila*. Further studies will be needed to better understand the mechanism of action of KKL-35 on *Legionella* species.

Figures

Strain	Average MIC (mg/L)	Average MBC (mg/L)
<i>L. pneumophila</i> str. Paris	0,04 (±0)	0,04 (±0)
<i>L. pneumophila</i> str. Lens	0,04 (±0)	0,08 (±0)
<i>L. pneumophila</i> str. Lorraine	0,04 (±0)	0,04 (±0)
<i>L. pneumophila</i> str. Philadelphia	0,067 (±0,062)	0,067 (±0,023)
<i>L. pneumophila</i> str. 130b	0,04 (±0)	0,04 (±0)
<i>Legionella longbeachae</i>	0,32 (±0)	0,533 (±0,185)
<i>Legionella micdadei</i>	5,12 (±0)	10,24 (±0)
<i>Legionella dumoffii</i>	2,56 (±0)	5,12 (±0)

Table 1: Activity of KKL-35 against several *Legionella* species *in vitro* (average and standard deviation from three independent experiments).

Strain	Ribosomal mutations			Erythromycin MIC (g/L)	KKL-35 MIC (mg/L)
	23SrRNA a (no. of mutated copies)	L4 protein	L22 protein		
Paris WT (ancestral)	-	-	-	0.25	0.04
Ery 1	G2057A (3/3) + A2059C (3/3)	G66D	-	1024	
Ery 2	C2611G (3/3)	Q62R + G64E	-	1024	0.04
Ery 3	C2611T (3/3)	G66A	-	1024	0.04
Ery 4	A2058T (2/3)	G66A	K90M	1024	0.04
Ery 5	G2057A (3/3) + A2058C (2/3) + A2059G (1/3)	G66A	-	1024	0.04
Ery 6	C2611T (3/3)	G66D	-	1024	0.04
Azi 1	C2611T (3/3)	T65K + G66R	G91D	1024	0.04
Azi 2	A2058G (3/3)	-	-	1024	0.04
Azi 3	C2611T (3/3)	T65K + G66C	-	2048	0.04
Azi 4	C2611G (3/3)	del63KG64	-	2048	0.04

Azi 5	A2058G (3/3)	T65K	P87L + G91D	1024	0.04
Azi6	A2058G (3/3)	-	-	2048	0.04

Table 2: Activity of KKL-35 against several *Legionella pneumophila* str. Paris-derived Erythromycin-resistant strains

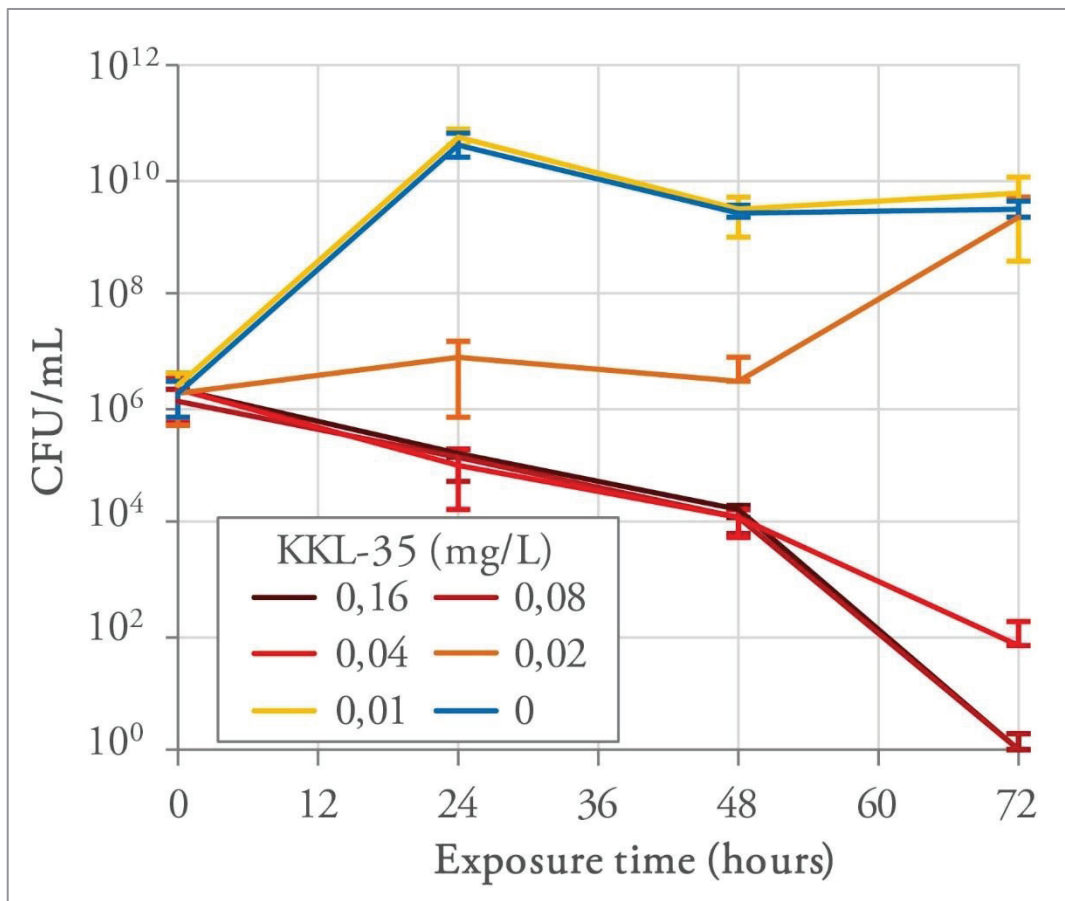

Fig. 1: Time-kill assay, KKL-35 on *Legionella pneumophila* str. Paris

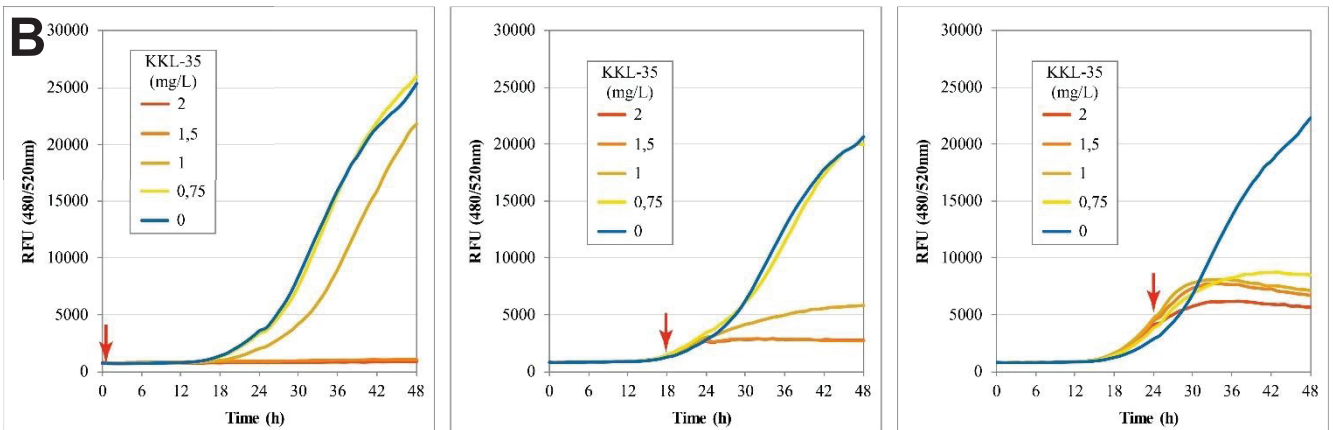
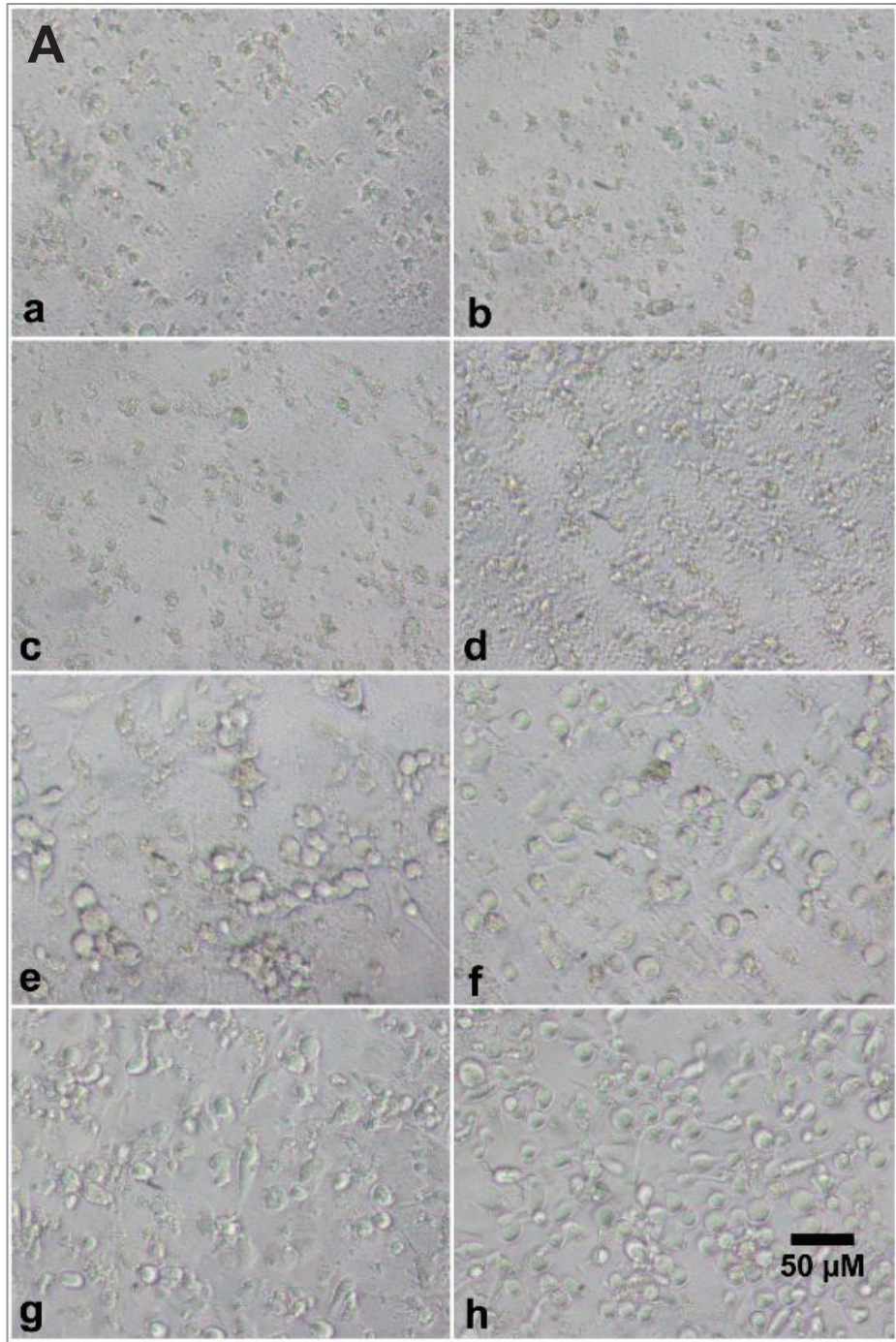

Fig. 2 Effect of KKL-35 on intracellular *Legionella pneumophila*. **(A)** Light microscopy observation of U937 macrophages infected at an MOI of 10 then treated with KKL-35 as described above. KKL-35 concentrations are 0 (a), 0.32 (b), 0.64 (c), 1.28 (d), 2.56 (e), 5.12 (f) and 10.24 g/L respectively, while (h) represents a non-infected control. MIC is reached at (e) 2.56 g/L. **(B)** Intracellular multiplication of *L. pneumophila* Paris pX5 is halted by KKL-35 addition at various time points.

	Erythromycin	Norfloxacin	Rifampicin	Chloramphenicol
MIC alone (mg/L)	0.125	0.25	0.012	1
MIC in combination (mg/L)	0.125	0.25	0.012	1
Σ FIC	2	2	2	2
Synergy	No	No	No	No

Table 3: Assessment of interaction between KKL-35 and other antibiotics by the checkerboard method. Σ FIC is the sum of fractional inhibitory concentrations. A Σ FIC between 1 and 4 denotes indifference between the two tested compounds.

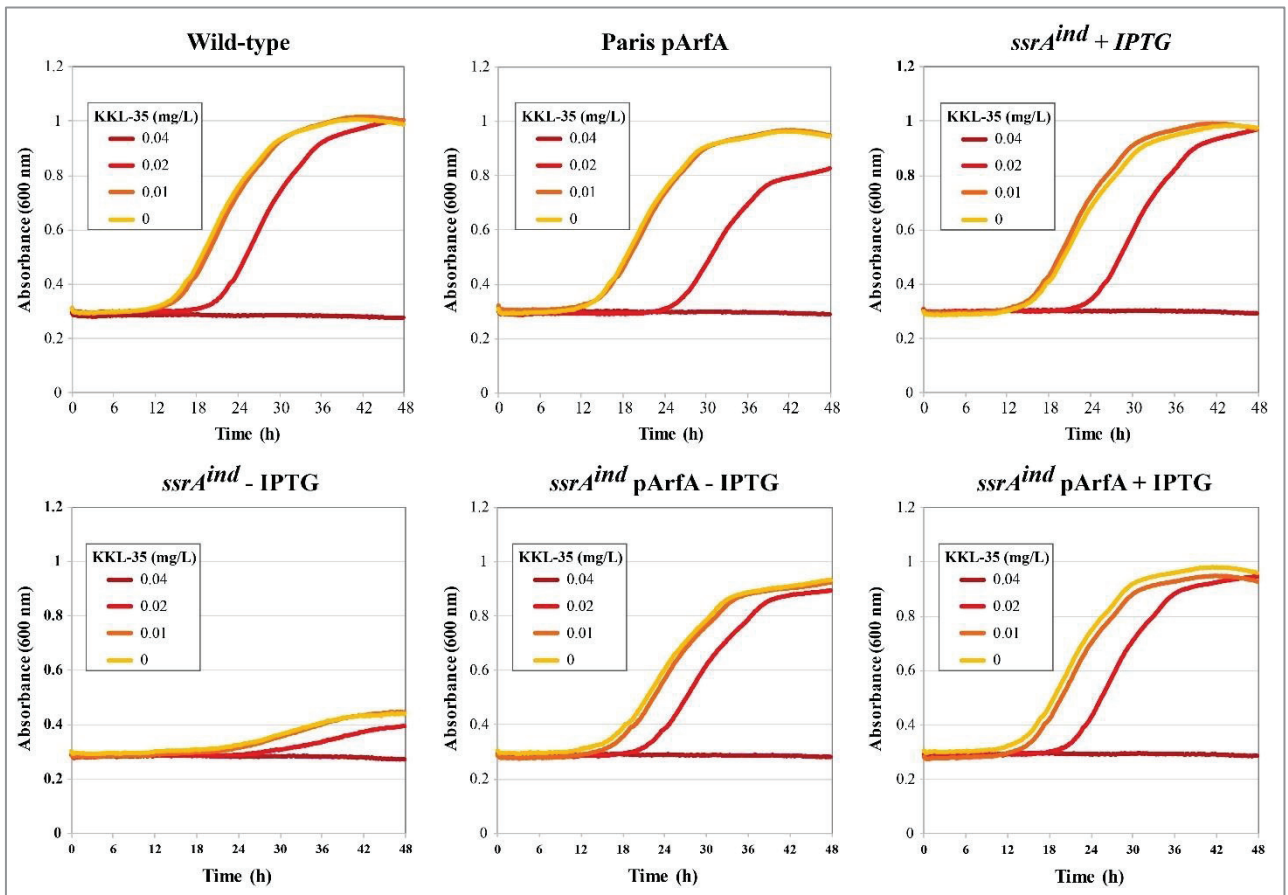

Fig. 3: KKL-35 MIC is not affected by tmRNA depletion nor by relying on alternative ribosome rescue factors. (+IPTG) indicates addition of 500 μ M IPTG.

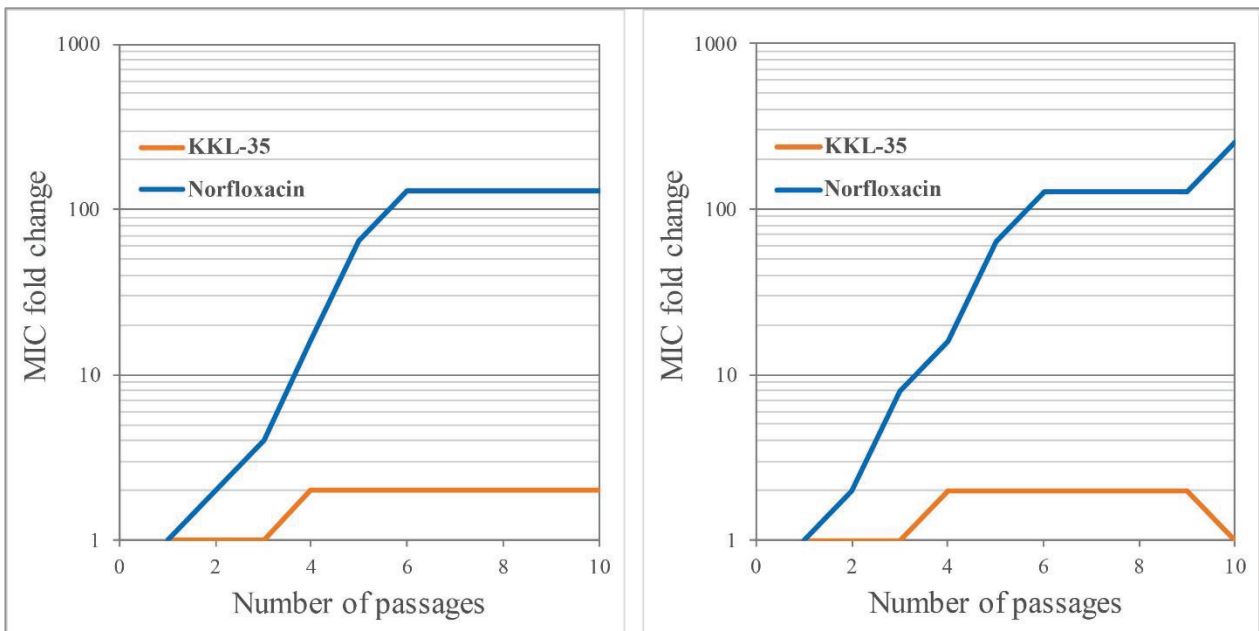

Fig. 4: Evolution of resistance to KKL-35 and Norfloxacin. Each chart represents an independent experiment.

Additional result and discussion

Testing KKL-35 in solid medium

As said in the paper, no guidelines to assess *L. pneumophila*'s resistance to antibiotics existed as far as September 2016. EUCAST recently recommended strip gradient testing as a convenient method in clinical labs but recognized that it was poorly replicable. No KKL-35 gradient strips are commercially available. The methods recommended by EUCAST (European Committee on Antimicrobial Susceptibility Testing) for MIC determination in other species are disk diffusion or agar dilution. Both methods rely on growth on solid media; however, for *L. pneumophila*, the activated charcoal often inactivates antibiotics or reduce their activity.

We tested KKL-35 in disk assays on CYE plates, and obtained very small inhibition zones (1-2mm from the disk) that contrasted with the excellent efficiency observed in broth. We decided to try to remove charcoal from the medium to assess its effect on KKL-35. Activated charcoal is necessary for growth because of the reactive oxygen species formed by autoclaving the components of the medium, namely agar (cf. p.21) and carbon sources that react together through the Maillard reaction (cf. p. 151). The medium also requires addition of reactive components that are prone to oxidation, namely cysteine and ferric ions.

Therefore, we replaced agar by gellan gum, that was diluted in water and autoclaved alone, then mixed with AYE filter-sterilized broth. Gellan gum normally requires addition of ions to polymerize, and polymerization speed is related to the valence of such ions; no additional ions was added in our case because of the presence of trivalent ferric ions in the medium. We found 0.4-0.5% gellan gum to be a good compromise between solidity and malleability, even if the medium formed seems noticeably harder than 1-2% agar-based media.

Growth on this medium was possible in 3 days similarly to growth in CYE medium and colonies formed normally. This medium had the visual advantage of being highly clear, contrary to CYE and even agar-based media in general. We replaced AYE broth by autoclaved yeast extract-ACES plus filter-sterilized iron and cysteine for commodity reasons, and found no difference in growth.

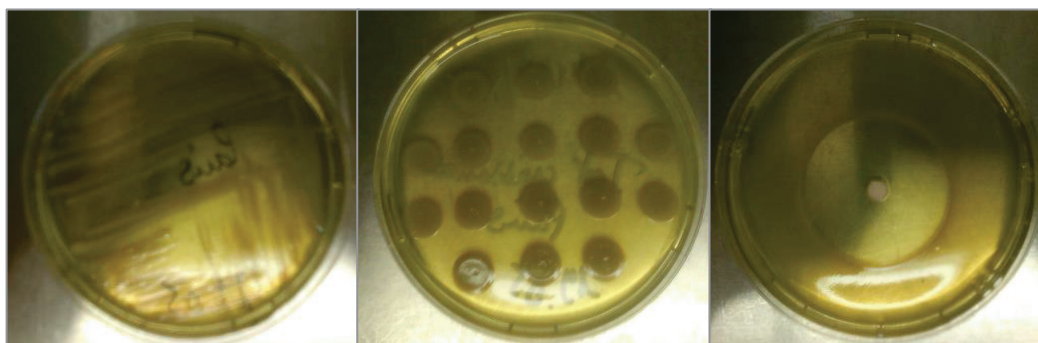

Fig. 101 Gellan gum as an alternative to agar/charcoal for preparation of *L. pneumophila* solid medium.
 Left: normal growth of *L. pneumophila* Paris from a glycerol stock after 3 days at 37°C.
 Middle: growth of 10µL spots of an inoculum at 10⁴ CFU/mL for agar dilution method.
 Right: Inhibition zone obtained with a disk containing 10µL of KKL-35 at 10mM concentration.
 The same assay on CYE yields a 1-2mm inhibition zone.

The inhibition zones obtained with the disk assay were significantly larger than in CYE medium. However, they were still seemingly small compared to the potency of KKL-35 in broth. The paper that reported the discovery of KKL-35 also noticed poor diffusion in solid media.

KKL-35 (µM)	0	0.031	0.062	0.125	0.25	0.5
KKL-35 (mg/L)	0	0.01	0.02	0.04	0.08	0.16
Croissance	+	+/-	-	-	-	-

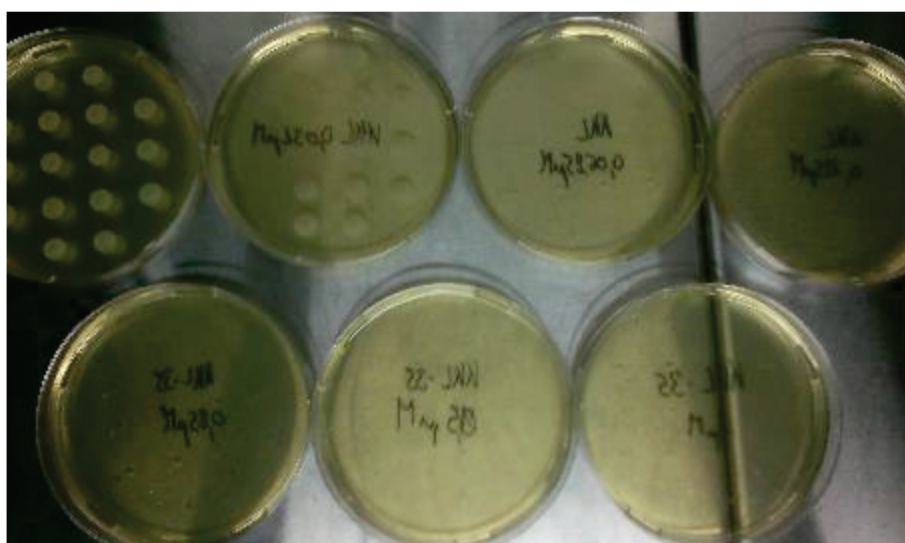

Fig. 100 Determination of KKL-35 MIC by the agar dilution method in GYE medium.

We then decided to switch to the agar dilution method, that relies on preparing different plates with increasing concentrations of antibiotic mixed in the medium before pouring and assessing growth in those different plates. We prepared KKL-35 plates with concentrations centered around the MIC obtained in broth. Spots of 10µL of an inoculum at 10⁴ bacteria were dropped to form a grid on the plate. The MIC obtained by this method is determined as the first concentration at

which no spot grows. We obtained a MIC of 0.02mg/mL, which is only one dilution more than the MIC obtained in broth.

This result confirms the possibility of using gellan-gum based medium to perform the agar dilution method with *L. pneumophila* and confirm MIC results obtained by broth microdilution.

Objective 3: Tn-Seq approach for discovery of essential genes and the study of gene function

The results presented previously uncover a need for a better pipeline for the discovery of essential genes that would be potential targets for new antibiotics. Indeed, the discovery that tmRNA is essential in *Legionella pneumophila* was incidental to research on natural transformation, as explained p.201. Tn-seq, which pairs systematic transposon mutagenesis with high-throughput sequencing, is a new and powerful method for both discovering essential genes and studying the function of non-essential genes (cf. p.162).

We were very interested in developing the Tn-seq approach in our *L. pneumophila* model, as well as in a new model, the extremophile archaea *Pyrococcus furiosus*. That new model was being developed by a post-doctoral fellow, Natalia Guchinskaya, in collaboration with the team of Phillippe Oger. As some bacteria, *Pyrococcus furiosus* is able to acquire exogenous free DNA and recombine it in its genome, generating recombinants with a very high frequency. This mechanism was recently uncovered but its mechanism is still unknown. Indeed, archaea lack genes coding for the DNA uptake system of naturally transformable bacteria. We then undertook the project of implementing Tn-seq in both *L. pneumophila* and *P. furiosus*, to identify new genes essential for growth *in vitro* and for mechanisms such as natural transformation.

Some results of this work are presented in a paper under revision in Scientific Reports, named “Random mutagenesis of the hyperthermophilic archaeon *Pyrococcus furiosus* using *in vitro* mariner transposition and natural transformation”, by Natalia Guschinskaya, Romain Brunel, Maxime Tourte, Gina Lipscomb, Michael Adams, Philippe Oger and Xavier Charpentier.

Mutagenesis by *in vitro* transposition followed by natural transformation

As both our models are able to perform natural transformation, we aimed to reproduce a method developed in *Streptococcus pneumoniae*, wherein transposition is performed *in vitro* by a purified Mariner transposase (Lampe *et al.*, 1996; van Opijnen *et al.*, 2009; van Opijnen *et al.*, 2014). A transposon containing a resistance marker is supplied by a plasmid and transposed onto purified genomic DNA of the target strain. This transposed gDNA is used to transform a culture. After selection, a library of mutants bearing random insertions is obtained. This library is then directly analyzed to get a quantitative assessment of the number of mutants containing a transposon at each possible site of insertion; the library can also be submitted to a stress to identify the genes necessary to survive in that condition. The methods available to analyze those libraries are presented in Fig. 95, p.165.

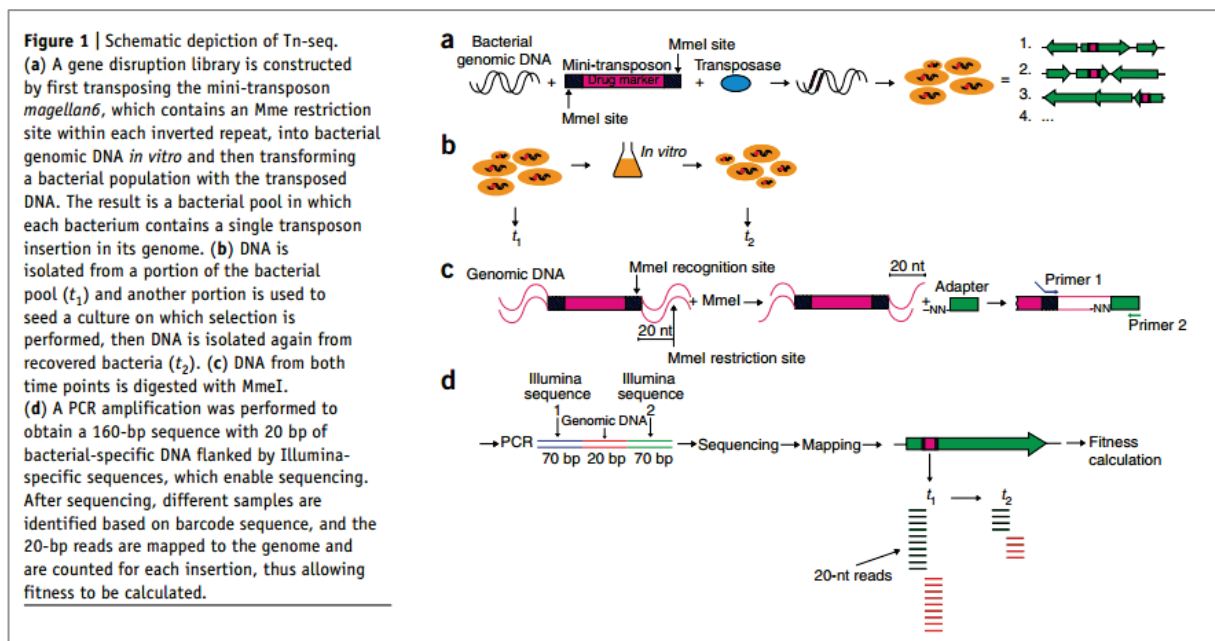

Fig. 102 Tn-Seq approach by *in vitro* mutagenesis.

Purification of the Mariner transposase

We chose as transposase a hyperactive form of Mariner called MarC9 (Lampe *et al.*, 1999). This transposase inserts its cognate transposon in any random TA dinucleotide in the target DNA. We chose MarC9 over other transposase because the randomness of insertion has been well documented for this enzyme, in contrast to others like Tn5 where insertion bias has been reported.

The Mariner transposase was obtained from a pMAL-C9 plasmid created by Tim van Opijnen and was gifted to us by Jan-Willem Veening. The plasmid contains a translational fusion between a hyperactive form of the Mariner transposase (MarC9) and the Maltose-Binding Protein (MBP) that allows the purification of the chimeric protein by binding to an amylose resin. MBP-MarC9 was purified following a published protocol by Opijnen *et al.* (van Opijnen *et al.*, 2014). Briefly, MBP-MarC9 is overexpressed in *E. coli* during exponential phase, cells are lysed by sonication, DNA and RNA are digested by enzymes, and the lysate is flowed through an amylose resin that gets bound by MBP. After several washes, the bound MBP-MarC9 is eluted from the resin by competition, by the addition of maltose for which MBP has a higher affinity. We obtained excellent results with this method, which yielded about 100 μ g of highly pure MBP-MarC9 at a concentration of 500 μ g/mL.

In vitro transposition with the Mariner transposase

Donor plasmids bearing transposons

For *L. pneumophila*, we used a resistance gene for kanamycin as a marker for transposition, as this resistance has a negligible rate of spontaneous apparition in a population. *P. furiosus* is both an archaea and a thermophile growing at >90°C, so it is much more complicated to identify compounds that are both inhibitory against this species and stable at this temperature; it is even harder to identify resistance genes to those compounds. We tried using simvastatin, an inhibitor of cholesterol synthesis, and a modified gene allowing the overexpression of its target as a marker of resistance (Waege *et al.*, 2010). However, this strategy gave poor results, probably because the designed resistance marker did not confer high levels of resistance. We then used instead a strain auxotrophic for uracil and a transposon bearing the *pyrF* gene that restores uracil prototrophy (Farkas *et al.*, 2012).

We constructed two plasmids, pLLA13-Kan and pJET-pyrF, that both contain a transposon comprising the marker flanked by two inverted repeated regions. Those IRs contain each an MmI restriction site (Fig. 103).

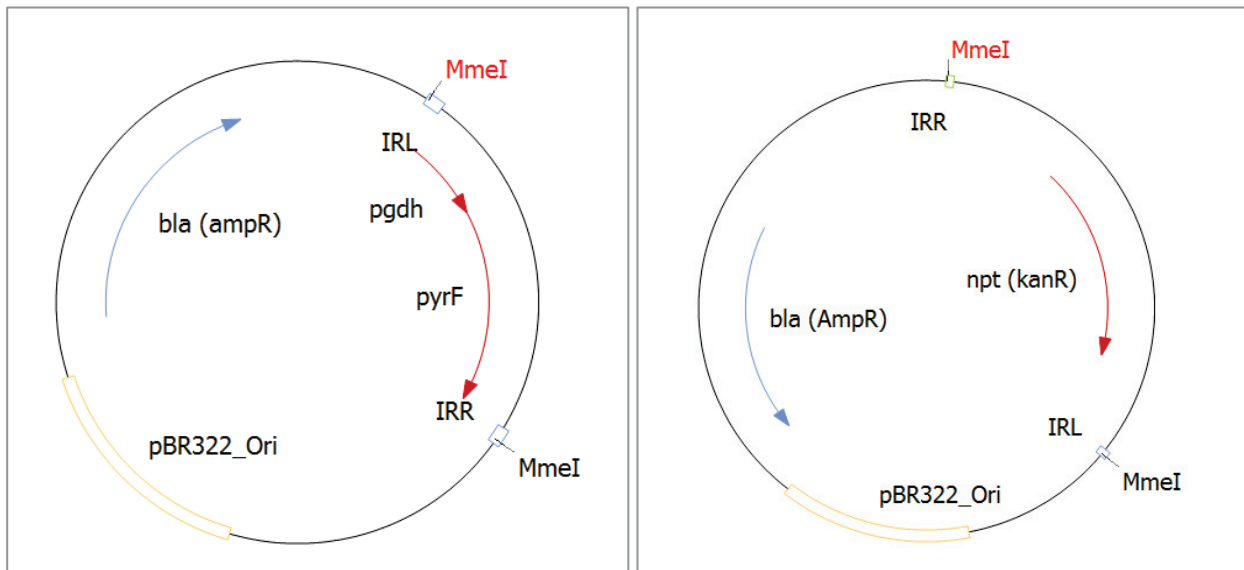

Fig. 103 Plasmids built for *in vitro* transposition.
 Left: pJET-pyrF. *pgdh* is a strong promoter from the glutamate deshydrogenase gene. Right: pLLA13-Kan.

Conditions allowing an efficient *in vitro* transposition.

The reaction mix was prepared as previously described. It contains, among other components, Mg^{2+} ions necessary for the transposition reaction.

The donor plasmid needed to be freshly prepared and to be mainly present in its supercoiled form for a good transposition efficiency. Indeed, transposition requires dimerisation of two transposase enzymes, each recognizing and binding one of the inverted repeated sequence. This dimerisation is facilitated in supercoiled plasmids by the physical proximity of the two IRs, due to the topology of the DNA in that state. We prepared routinely plasmid DNA the same day as the transposition reaction, as nicks tend to accumulate in plasmid preparations kept at 4 or $-20^{\circ}C$. We found the Qiagen miniprep kits to be poorly adapted to these needs, as almost half of the plasmid preparations obtained was nicked. This was first solved by cooling all reagents of the kit (except Solution II that contains SDS) and performing the minipreps in a cold room; then by switching to the E.Z.N.A. Plasmid Mini Kit II from OmegaBiotek which yielded mainly supercoiled DNA. We also found that doubling the volumes of solution I, II and III for lysis and neutralization yielded cleaner preparations.

P. furiosus gDNA was prepared by phenol/chloroform extraction. *L. pneumophila* gDNA was prepared with a kit that relies on alkaline lysis (Promega Wizard Genomic DNA), as we were

concerned with the possibility of losing the resident pLPP plasmid present in the Paris strain that we use as a model when using the phenol/chloroform method.

We transposed an equal weight of genomic DNA and plasmid DNA to be in excess of transposons. gDNA concentrations were visually assessed by gel electrophoresis as we noted that 260/280nm measurements gave erroneous readings with high-quality gDNA with long fragment sizes.

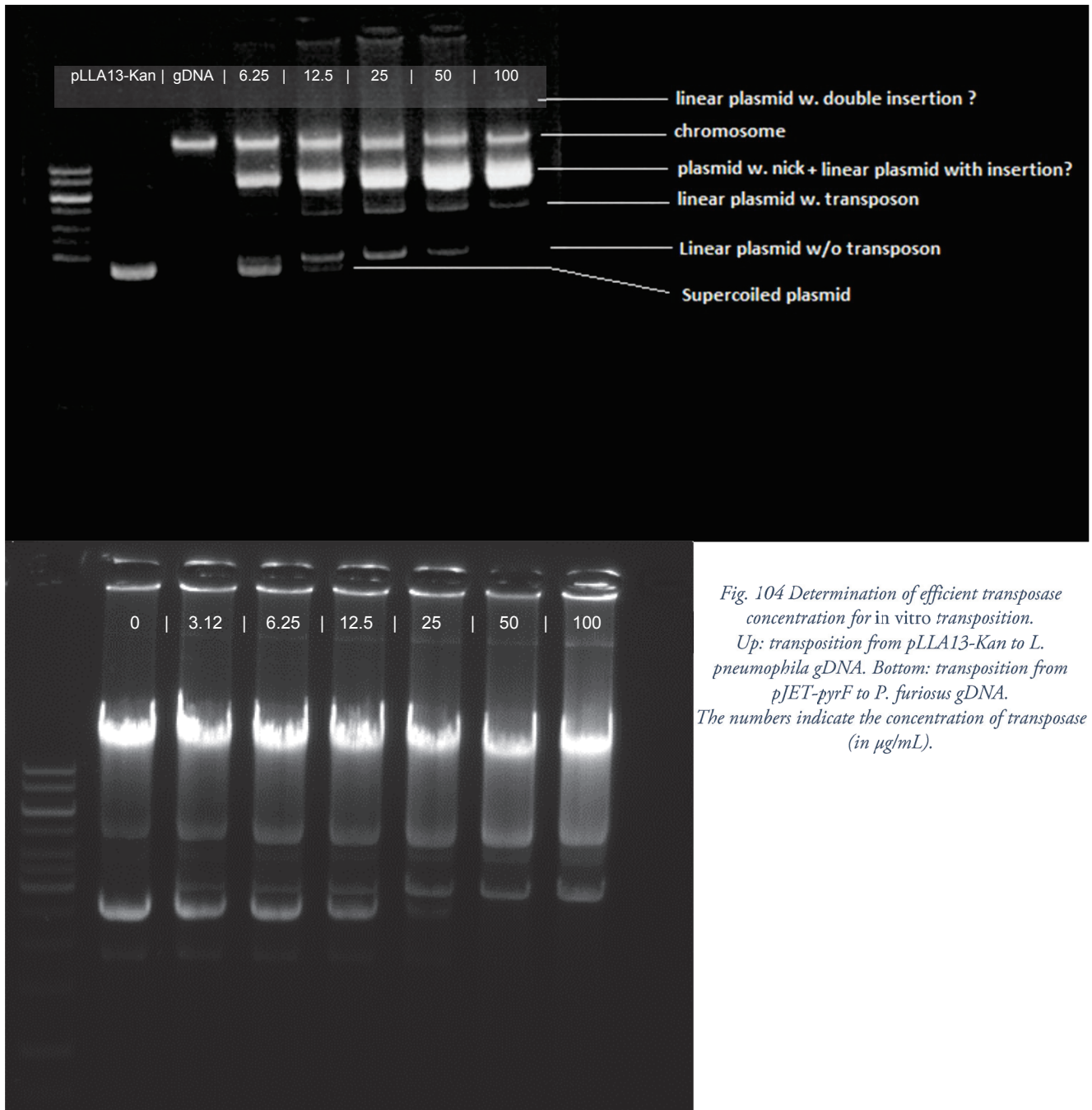

Fig. 104 Determination of efficient transposase concentration for in vitro transposition. Up: transposition from pLLA13-Kan to *L. pneumophila* gDNA. Bottom: transposition from pJET-pyrF to *P. furiosus* gDNA. The numbers indicate the concentration of transposase (in µg/mL).

We found the minimum concentration of transposase enzyme necessary to perform total transposition from 1 µg of plasmid DNA in 1h to be 50 µg/mL. This was defined by the ability of transforming all supercoiled plasmid into other forms, described below. Transposition was performed for 1h at 30°C, with longer incubation time not increasing transposition efficiency.

The supercoiled plasmid is transformed into other forms (Fig. 104) whose relative abundance can be used to assess transposition efficiency.

- The form that migrates the farthest on the gel is the supercoiled plasmid. This form must be the most abundant before transposition and disappear after transposition.
- A form with a slightly larger apparent size corresponds to the plasmid in a linear form with the transposon totally removed. This is the desirable outcome of *in vitro* transposition.
- A form which corresponds to linearized plasmid with its transposon still present is also visible. It results from double-strand breaks during plasmid preparation; but its relative abundance does not change during transposition, confirming that only supercoiled plasmids are transposon donors. The abundance of this form must be almost negligible in plasmid preparations.
- Finally, a form whose abundance increases during transposition is visible at the top. It corresponds to both the size of a nicked, relaxed plasmid that could occur by the transposase nicking the plasmid at a single IR; and to a plasmid that would have received a second transposon by transposition. It is known that transposition also occurs in the donor and not only in the target gDNA. The abundance of these undesirable products was not reduced by increasing gDNA target concentration (see Fig. 104, up vs. bottom). Adding too much transposase favored the formation of these forms rather than the desirable “cut transposon” form (see Fig. 104, up). The 50µg/mL concentration is a good compromise for efficient transposition (see Fig. 105).

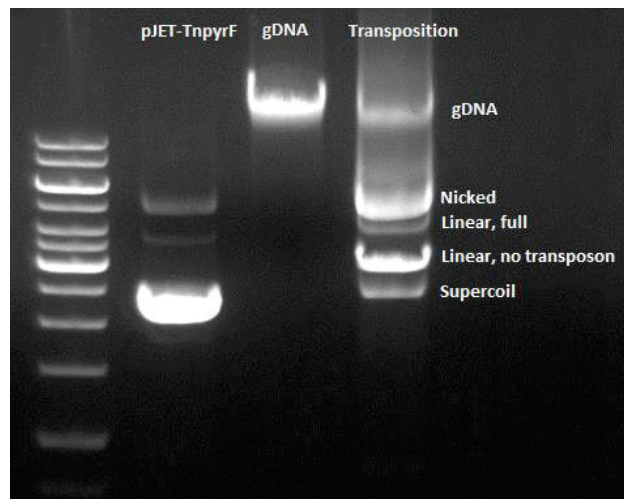

Fig. 105 Ideal transposition conditions at 50 μ g/mL transposase. Some supercoil plasmid is left but the abundance of the desirable linear form without transposon is very high.

In the literature, some authors used the original, non-MBP version of the MarC9 transposase that they purified from inclusion bodies after overexpression in *E. coli*. They reported contamination with nucleases that induced DNA degradation at concentrations slightly superior to the efficient concentration for transposition. We did not observe such a problem with MBP-MarC9, confirming the superiority of this purification technique. We nevertheless observed the formation of smears of gDNA with *P. furiosus* gDNA, but not *L. pneumophila* gDNA. Such smears only formed when gDNA was mixed with both transposase and donor plasmid, and not transposase alone. The signification of this observation is unclear.

DNA purification and reparation

Mariner transposase tend to stay bound to IRs even after insertion of the transposon in the target DNA. Opijnen *et al.* recommend to heat inactivate the enzyme and alcohol-precipitate the DNA to concentrate it before further processing. We found this method to be inefficient as protein precipitates tended to form and prevent DNA resuspension. We therefore added a step of phenol-chloroform extraction and alcohol precipitation after transposition.

Once the DNA is cleaned and resuspended, transposition junction have to be repaired. Indeed, insertion of the transposon into the target DNA leaves staggered ends at the level of the junction (Skipper *et al.*, 2013). Leaving those ends unrepaired would prevent natural transformation with the transposed DNA (Fig. 106).

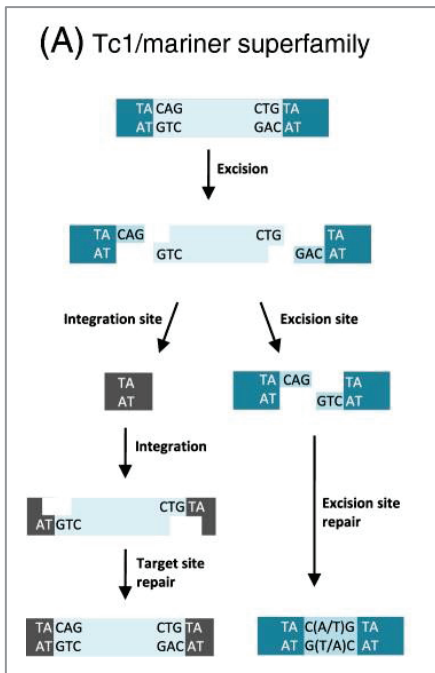
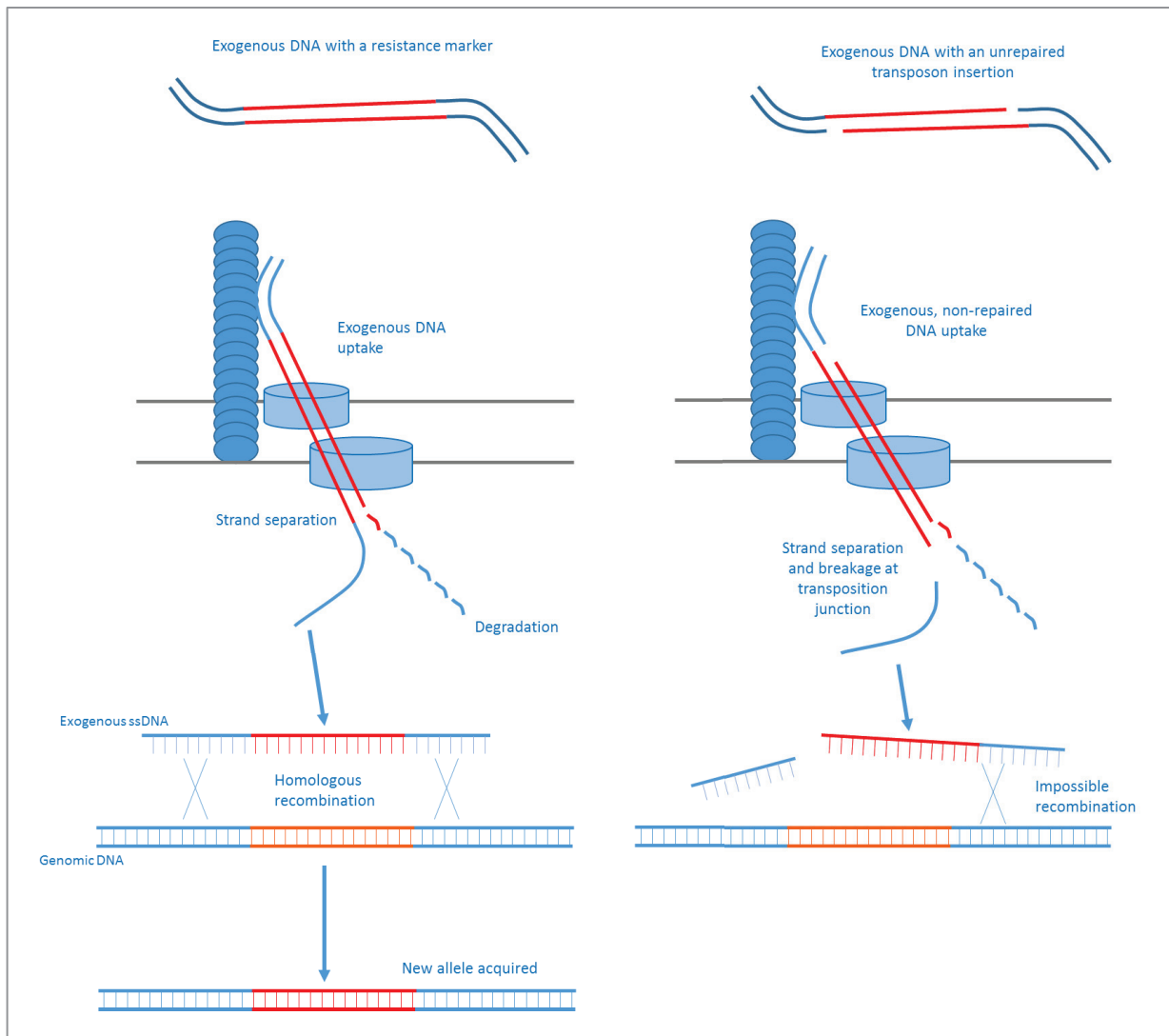

Fig. 106 Repair is essential after transposition *in vitro* and before natural transformation with transposed gDNA. (A) Mariner family transposases leave a single-strand gap at transposition junctions (B) Acquisition of a new allele by natural transformation requires intact flanking regions with homology for homologous recombination. The gaps left by transposition prevent recombination because of the loss of the flanking region in the single-strand DNA obtained after uptake.



Repairing transposition junction was performed as described before (van Opijnen *et al.*, 2014). First with T4 DNA polymerase, at low temperature to perform gap filling while reducing its exonuclease activity. This was followed by heat inactivation, then by overnight *E. coli* DNA ligase treatment for nick repair. Despite having a similar nick repair activity according to the supplier, *E. coli* ligase could not be replaced by T7 DNA ligase as no transformants were obtained when this enzyme was used for reparation. Repaired DNA was then dosed; usually half or more of the DNA was lost during the steps of cleaning preceding repair. It was then used for natural transformation.

Natural transformation with transposed gDNA

Natural transformation was performed with transposed gDNA by routine techniques used for creation of mutants with PCR products or gDNA bearing a marker. For *P. furiosus*, transformation was performed by N. Guschinskaya as previously described (Lipscomb *et al.*, 2011), by mixing a mid-log phase liquid culture with DNA then immediately plating on minimal medium without uracil, followed by anaerobic incubation for 64h at 80°C. For *L. pneumophila*, we used a technique published by our lab (Buchrieser and Charpentier, 2013) in which the bacteria are grown until OD₆₀₀=1 then 1mL of culture is mixed with DNA, followed by overnight incubation in microaerophilic conditions, then plating on kanamycin-containing plates and incubation for 3 days at 37°C. Transformation rates were assessed by comparing the cellular concentration before plating (measured by plating serial dilutions on non-selective plates) and the number of transformants.

With *P. furiosus*, we obtained rates of transformation of 10⁻⁴ to 10⁻⁵, compared to a rate of 10⁻² with a similar quantity of gDNA containing a marker at a single locus. For *L. pneumophila* we obtained a rate inferior to 10⁻⁹, compared to a normal rate of 10⁻⁷-10⁻⁸ with a similar quantity of gDNA containing a marker at a single locus. How can we explain this low rate of transformation? First, it should be noted that half the DNA measured by dosing after transposition are the remaining forms of donor plasmid that are useless for mutagenesis. Second, we observed that transposition seems to occur mostly in the donor plasmid itself rather than in the target gDNA. Third, it is possible that reparation is not very efficient.

This transformation rate decrease is problematic, as with *L. pneumophila* we could only obtain in the best cases a few colonies, and in most experiments, none. Consequently, we abandoned this approach for mutagenesis of *L. pneumophila*. For *P. furiosus*, we could assemble a library of 4000

mutants, which is to our knowledge the first systematic mutagenesis library obtained in this species. More repetitions will however be necessary to obtain a large genome coverage for Tn-seq. It is generally accepted that ten unique insertions per gene on average are necessary to assure with a good confidence that the genes lacking insertions are essential. These first results are already encouraging, especially considering the difficulties in manipulating that thermophilic anaerobic micro-organism, and considering that most of the genome of this species is composed of genes of unknown function. Indeed, among a few dozen mutants that were isolated for identification of the position of the insertions, one of them was already found to exhibit a deficit in transformation efficiency, a result that is being further investigated.

As mentioned earlier, these results are submitted in Scientific Reports in a paper authored by Natalia Guschinskaya.

In vivo transposition with a plasmid containing the Mariner transposase and a cognate transposon

As the previously described strategy yielded poor results with *L. pneumophila*, we tried alternative approaches to introduce the transposon and build a library of mutants in this species. In bacteria for which conditions inducing competence for natural transformation are unknown, transposition is performed *in vivo*. A plasmid containing both the gene for the Mariner transposase and the transposon containing the selection marker is introduced into the target strain, either by conjugation or by electroporation. This plasmid has to be a suicide vector, in order to select only transformants in which the resistance marker has been introduced in the genome by transposition.

In vivo transposition by conjugation

Donor strains and plasmids

We first tried to introduce a transposition suicide vector by conjugation. The most common and robust suicide delivery vectors in the literature are R6K plasmids. Their replication is initiated by a protein called Π (*pir* gene) that recognizes their R6K γ origin of replication. In R6K suicide vectors, the *pir* gene has been removed from the plasmid. It is expressed *in trans* from the chromosome in strains created for the purpose of maintaining these vectors, for example the *E. coli* strains SM10 λ *pir*, S17-1 λ *pir*, DH5- α λ *pir*, or MFD*pir*. It was found recently that SM10 λ *pir* and

S17-1 λ pir, routinely and extensively used in the literature for the conjugative delivery of R6K suicide vectors for transposition, also delivered the Mu bacteriophage that inserts itself randomly by transposition (Ferrières *et al.*, 2010). These strains therefore introduce a serious bias by creating mutants with two insertions, in which a phenotype can be wrongly attributed to the transposon rather than Mu. We used the MFDpir (Mu-Free Donor) strain that had been created to circumvent this problem, and that is able to perform conjugation of plasmids with RP4 transfer origins.

We tried building a R6K donor plasmid by introducing our Kan^R-Mariner transposon into the pMAL-C9 plasmid and switching its origin of replication for a R6K γ origin, but manipulating this plasmid proved difficult. We were gifted by Erwan Gueguen a R6K plasmid with RP4 oriT that was created by Wiles *et al.* (Wiles *et al.*, 2013). This plasmid, pSAM-Ec, contains a Kan^R-Mariner transposon with MmeI sites and an unadulterated gene coding for MarC9 (without MBP), under a pTac promoter (Fig. 107). Unlike the plasmid that we tried to build earlier, the *lacI* repressor is not present on pSAM-Ec. Repression of the expression of MarC9 should therefore not require IPTG after transfer in *L. pneumophila* where *lacI* is not present in the genome; concurrently, repression in the *E. coli* MFDpir strain used as donor has a low efficiency and often led after culture to the apparition of a population in which the plasmid received a second transposon. We limited this problem by reducing the concentration of Kanamycin in the medium (to maintain a selective pressure for the plasmid, while avoiding to give a fitness advantage to strains in which a second

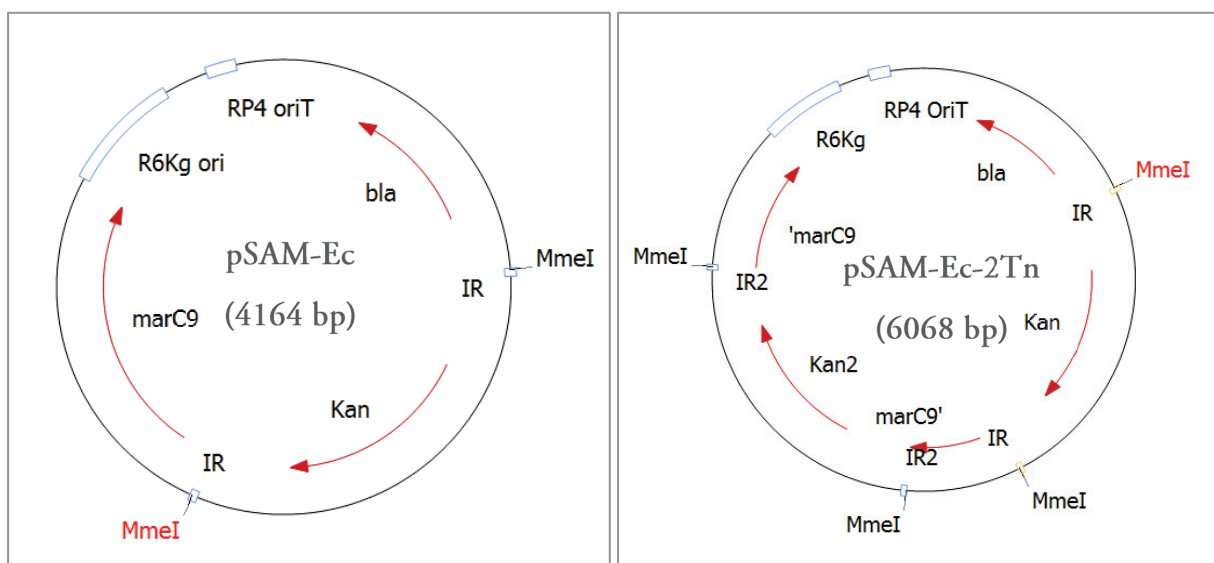

Fig. 107 pSAM-Ec, a suicide plasmid used for transient delivery of the Mariner transposase and its cognate transposon (left). On several occasions, cultivating the MFDpir pSAM-Ec strain led to the emergence of a population containing plasmids with two transposons. In this case, the plasmid had an insertion in the *marC9* gene, making the plasmid inefficient for transposition (right)

Kan^R transposon inserted itself in the plasmid), and adding glucose for increased expression of the *lacI* gene.

In addition to these problems with jugulating the transposition in the donor strain, we met another problem when trying to perform conjugations between *E. coli* and *L. pneumophila*. Indeed, the MFDpir strain is auxotrophic for diaminopimelic acid (DAP), an essential component of the cell wall. During construction of the strain, the *pir116* gene (a mutated *pir* gene that increases the copy number of R6K plasmids) was inserted in *dapA*. This insertion was deliberate as it both allows to maintain R6Kγ plasmids and to counter-select the donor strain without any antibiotic after conjugation, simply by plating on a medium without DAP. The problem is that *L. pneumophila* is sensitive to salts and does not support *E. coli* media; while *E. coli* MFDpir does not survive in *L. pneumophila* media with added DAP. Indeed, the transporter for DAP and cystine is the same in *E. coli* (Berger and Heppel, 1972), and as cystine is present in large excess in *L. pneumophila* media (resulting from the oxidation of the added cysteine by ferric ions), it competes with DAP.

We tried performing matings on a CYE medium without cysteine and iron supplement (iron supplementation is needed because the excess cysteine reacts with the iron in the medium). No transformants were obtained with any of the mating experiments performed. It is unclear if the use of the non-supplemented medium is the only cause, or if mating of the plasmid itself failed.

Prospects to improve this approach

The use of the MFDpir strain was necessary, considering the potential bias introduced by Mu bacteriophage transposition with other donor strains. Mu transposition has indeed been reported in *L. pneumophila* (Mintz and Shuman, 1987). However, this strain could be modified to get rid of its problematic DAP auxotrophy; a wild-type copy of *dapA* could be reintroduced somewhere in the genome. Counter-selection could be easily performed by the use of a *L. pneumophila* receiver strain resistant to an antibiotic to which the MFDpir is sensible, e.g. Streptomycin. *L. pneumophila* is also naturally resistant to beta-lactams, and it should be assessed whether counter-selection on Ampicillin is possible; we did not find in the literature whether *L. pneumophila* beta-lactamase is secreted and would allow the concurrent growth of the donor strain.

In vivo transposition by electroporation

This part of the work was performed in collaboration with Gaëlle Gueton, a student in first year of Master's degree who I mentored, and who performed the experiments.

Electroporation conditions

To circumvent the problems that were encountered with conjugation, we tried to directly introduce the pSAM-Ec plasmid by electroporation in *L. pneumophila*. The plasmid was introduced into DH5- α λ pir and purified using the EZNA miniprep kit, with the protocol for low-copy plasmids. We also built a DH5- α λ pir *dapA::pir116* strain by transferring the *dapA::pir116* construction from MFDpir, as this mutation is supposed to change the copy number of R6K plasmids from 5-10 to >100, but this only doubled the yield of the plasmid preparation.

Ideal conditions allowing the electroporation of *L. pneumophila* have been assessed by Chen et al. (Chen *et al.*, 2006). These conditions are: 1mm-gap electroporation cuvettes, 25 μ F, 2.4kV/cm, 100 Ω , >10¹⁰ CFU/cuvette. We repeated their experiments and found those conditions to be indeed ideal; however, the transformation rates allegedly obtained by the authors of that paper are unrealistic, compared to the results we obtained and to results that were reported by colleagues that we inquired. We obtained low transformation rates, around 10⁻⁸ in the Paris strain, either with pSAM-Ec or a control plasmid with the same Kan^R resistance marker (pX1K). However, the success of electroporation wildly fluctuated and we could not reliably obtain any mutants in most experiments.

We obtained nevertheless small libraries in both the *L. pneumophila* Paris wild-type and *proQ* strains (respectively 3000 and 4500 mutants). A dozen colonies were isolated from each library before they were pooled, to verify the randomness of the insertions and to identify their position.

Verification of mutants

We developed a validation approach based on the different steps performed in Tn-seq; except, in our case, we performed it on isolated mutants rather than a library, and we did not sequence the flanking region by high-throughput sequencing but rather by cloning and sanger sequencing.

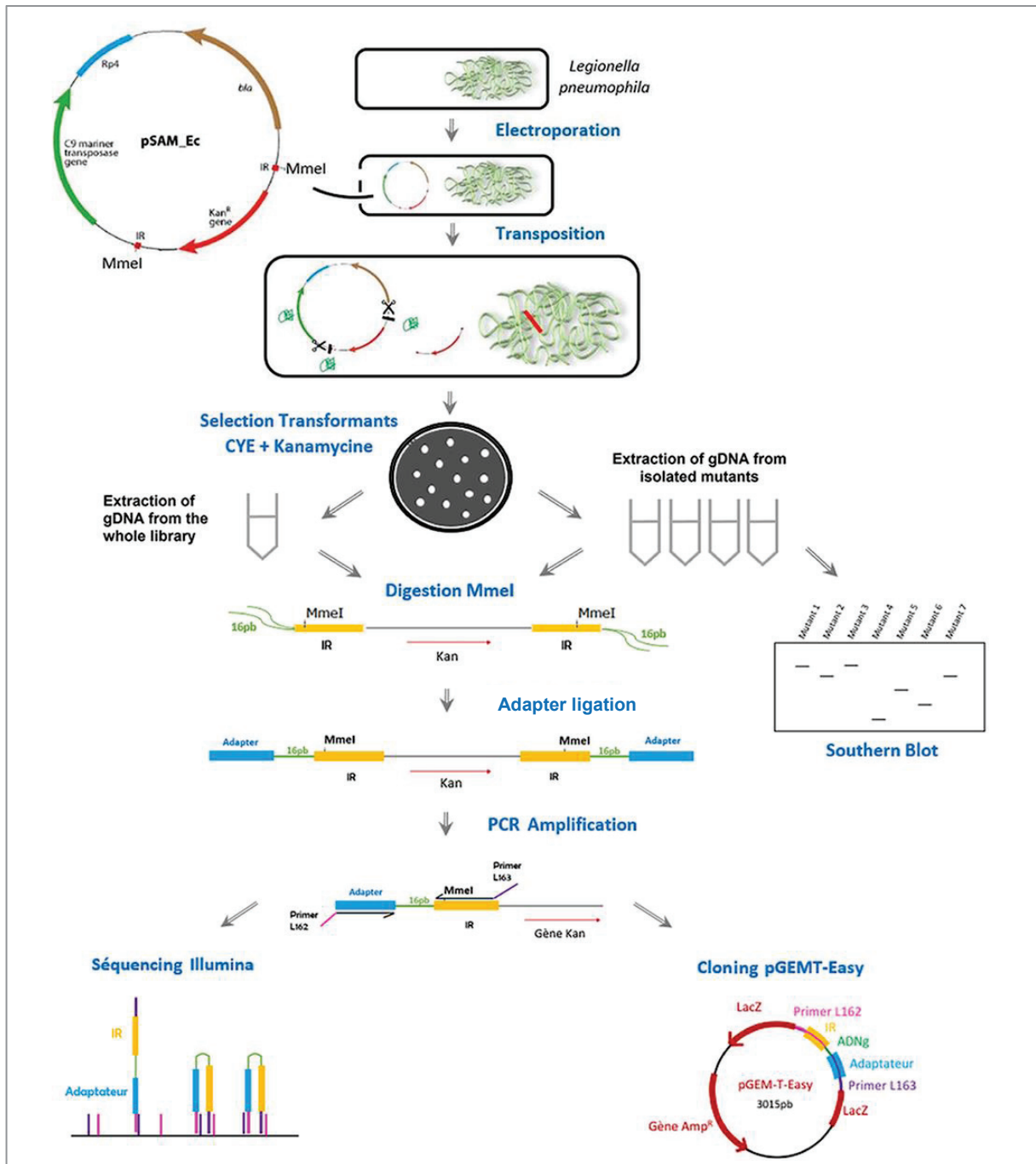
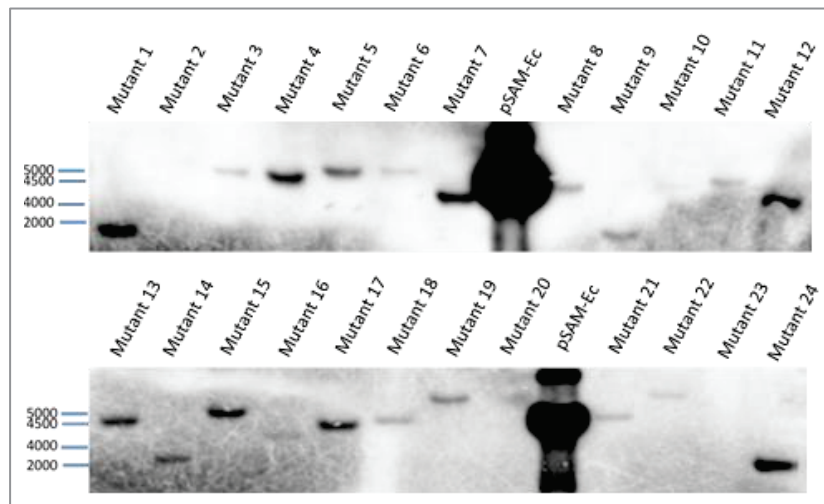

Fig. 108 Validation of the transposition mutants obtained by electroporation of pSAM-Ec. On the left is presented the normal Tn-seq approach, on the right is our validation approach performed on isolated mutants.

First, we verified that insertions in each isolated mutant were unique and random; Southern blot was performed against the *kan^R* gene and showed that mutants indeed exhibited single insertions at random positions (Fig. 109).



*Fig. 109 Southern-blot against the *kan^R* gene in gDNA of isolated mutants. Mutants 1 to 12 are in the wild-type background while mutants 13 to 24 are in the *proQ* background. Control is a linearized preparation of *pSAM-Ec*. Two bands are visible in the control as plasmids that received a second transposon were present in the prep.*

We then extracted gDNA from mutants 1 to 12 for identification of insertions. *MmeI* digestion was performed, and was found to require very pure DNA. We found phenol/chloroform gDNA extraction to be superior to the Promega kit based on alkaline lysis, with which protein contamination was important. After digestion, we performed gel purification at the expected size for the transposon cut *MmeI* + 2*16 bp flanking regions, using a *MmeI* digestion of the *pSAM-Ec* plasmid as guide. This step is optional but allows to concentrate the fragments of interest and remove a large part of the gDNA that does not contain transposons, before processing with adapter ligation.

After purification, the fragments are ligated to adapters with T4 DNA ligase. These adapters are composed of two PCR primers of complementary sequence, mixed together to form dsDNA. The simplest possibility at this step is to use adapters in which one primer ends with a random 2-nt stagger, that allows cohesive binding and ligation to the random 2-nt stagger formed by the *MmeI* digestion at each side of the transposon. This solution can however result in unwanted ligation reactions, for example between gDNA fragments with complementary staggers, or between adapters with staggers complementary to each other. Another solution is to dephosphorylate the gDNA fragments, then to use adapters containing a phosphate at the staggered end; this way, only

adapter-gDNA fragment ligations are possible. Although theoretically better, we found this solution to be less efficient and to cause problems downstream, for unclear reasons. Therefore, we proceeded with the first approach, without dephosphorylation step.

Once the adapters have been ligated, we proceeded to PCR amplification of the [Adapter-Flanking region-IR] fragments with primers binding at the IR and on the adapters. At this step, Illumina adapters and barcodes for multiplexing are added by the primers used for PCR amplification. We chose to use such primers even though we did not proceed with high-throughput Illumina sequencing downstream. Indeed, they had the interesting property of increasing the size of the [Adapter-Flanking region-IR] PCR fragment of interest, that is barely longer than the primers themselves and would otherwise have been difficult to distinguish after gel electrophoresis. The conditions for the PCR reaction proved also difficult to tune, and we found the Q5 polymerase from NEB to perform better than other polymerases for this very short amplification.

The PCR fragments obtained were then gel purified (on 2% TAE-agarose) and cloned into the pGEM-T Easy vector (Promega). Blue/White selection was performed, plasmid was purified and Sanger sequenced. We found 10 out of 12 mutants to have correct PCR fragments, in which the 16-bp sequence corresponding to the gDNA region flanking the transposon was clearly identifiable and corresponded to a single possible TA site on the genome of *L. pneumophila* Paris. In two out of these ten mutants, the flanking region was 17-bp long instead of the expected 16-bp, an observation that was confirmed by the literature where authors have shown that MmeI sometimes cuts one nucleotide farther than the expected site (Callahan *et al.*, 2016). However, in two cases the identification failed. In the first case, the clone isolated was bearing a mix of the two possible plasmids that can be obtained from cloning either the left or right regions flanking the transposon; this is a minor problem that would not have been encountered in the normal high-throughput sequencing Tn-seq workflow. However, in the second case, the sequence obtained was different from what was expected and could have emerged from non-specific binding of the primers used for PCR amplification to a gDNA fragment that we were unable to identify. This possible aspecific amplification should be investigated further before proceeding to the high-throughput approach. Nevertheless, our results show that the mutants were indeed obtained by transposition and contained a unique insertion that was identifiable through sequencing of the regions flanking the transposon.

Mutant	IR	Adapter	Flanking region size (bp)	Flanking region sequence	Position in <i>L. pneumophila</i> genome	Gene	Fonction
1	OK	OK	16	TATGTTAAACGAAGCA	895763.895778	5' of <i>lpp0801</i>	Superfamily II DNA/RNA helicase, SNF2 family
2	OK	OK	16	TAGTTTTTAAATGTAC	942894.942909	5' of <i>lpp0841</i>	lag-1 (oacétyltransferase)
3	OK	OK	16	TAGATATAAAACCAGC	1415301.1415316	<i>lpp1275</i>	<i>lspD</i> type II secretion system
4	OK	OK	17	TACTTCCCAGAGCTGGT	830263.830279	<i>lpp0747</i>	putative peptide transport fused subunits of ABC superfamily: ATP-binding components
5	OK	OK	17	TACTACTGTCTGTAGGC	3315619.3315635	<i>lpp2903</i>	conserved protein of unknown function with serine runs (158 serines / 342 aa !!)
6	OK	OK	16	TACTTTGCAAGTTTGC	493821.493836	<i>lpp0445</i>	glutamate-cysteine ligase, GCS2
7	OK	OK	16	TAATGCATGGATTGCC	312069.312084	<i>lpp0280</i>	Conserved protein, unknown function (DUF2309) - nucleoside-diphosphate-sugar pyrophosphorylase in <i>Haloarcula vallismortis</i>
8	OK	OK	16	TAAAGCTGCATGCCTA	pLPP 53883.53898	<i>plpp0053</i>	Unknown function. Predicted orthologue of <i>E. coli</i> gene <i>yhcG</i> (restriction endonuclease-assisting exonuclease)
9	OK	OK	16	TAAAGCTCGGATGTGA	3395769.3395784	<i>lpp2979</i>	Tyramine oxidase
10	-	-	-	n.a. (mix of the two possible plasmids)	?		
11	Shortened	Modified	22	CAGGCGACACGCATCTGCATC	?		
12	OK	OK	16	TATAATAAATTGAGAA	2841926.2841941	<i>lpp2489</i>	Conserved protein of unknown function (<i>Legionella</i> specific protein with part of an AroA domain)

Table 4 Identification of the location of transposon insertion in Mutants 1 to 12. All 16- or 17-bp sequences were unique in the genome. One insertion (mutant 8) was in the pLPP resident plasmid of *L. pneumophila* Paris.

Interestingly, we noticed that one of the mutants (#3) we obtained grew slowly in AYE liquid media, a phenotype that was aggravated at low temperatures. Mutant 3 also formed small filamentous cells and did not exhibit the diauxy normally observed in early log phase (Fig. 110). We found that the insertion in this mutant was located in the *lspD* gene that encodes an essential component of the type II secretion system, that is important for the secretion of proteases. A similar phenotype was described for a deletion mutant of *lspD* (Söderberg *et al.*, 2004). Additionally, these authors described the essentiality of the T2SS for intracellular growth and survival in tapwater (Söderberg *et al.*, 2008). This result confirms the interest in using genome-wide transposon mutagenesis to study gene fitness in different conditions in this species.

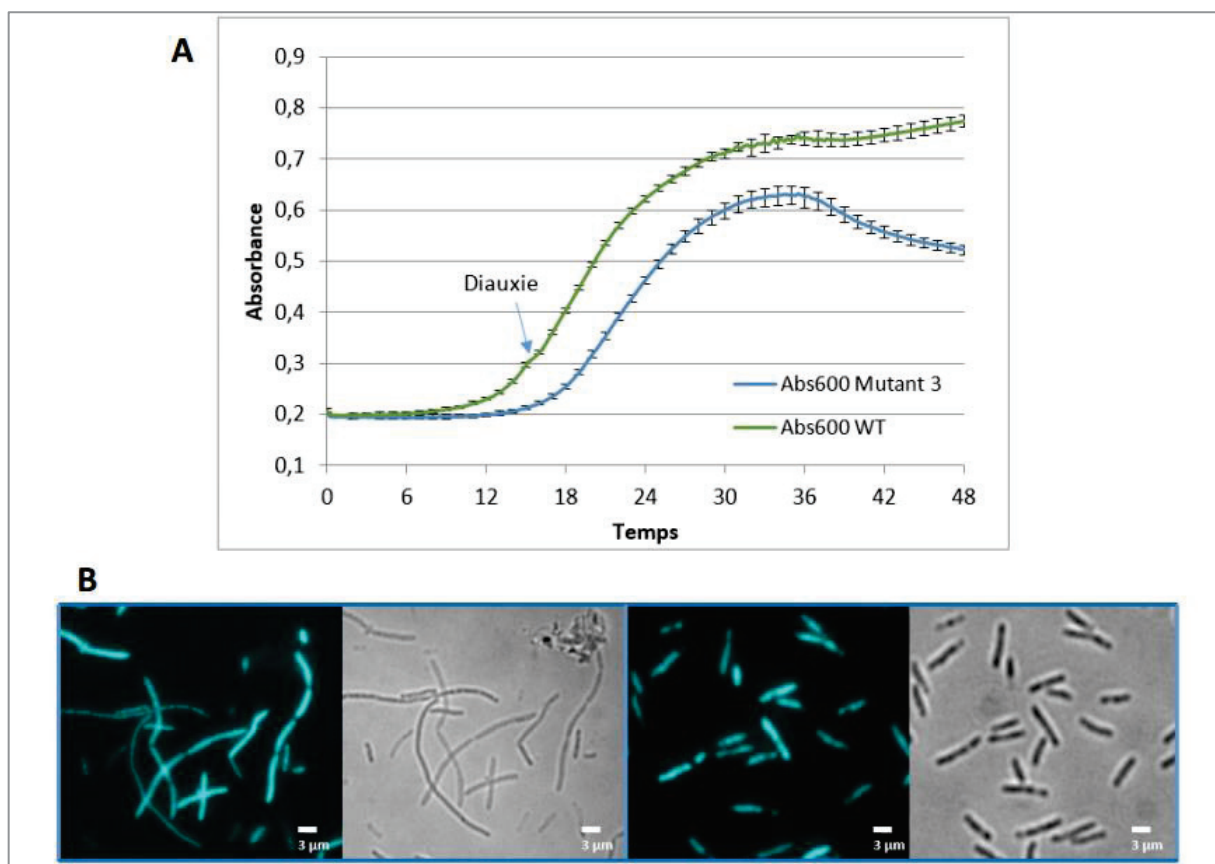

Fig. 110 Mutant 3 exhibits an impaired fitness at 30°C (A) and morphological defects (B)

Prospects to improve this approach

Efforts to improve the transformation rates with the pSAM-Ec plasmid should be undertaken. The most obvious explanation for the low transformation rates obtained is that *L. pneumophila* has restriction/modification systems that degrade the plasmid after electroporation. Indeed, better transformation rates (+3 logs) were obtained with the control pX1K plasmid in a JR32 strain artificially derived from the Philadelphia strain but deprived of restriction/modification systems.

We tried heat-shocking the Paris strain before or after electroporation to inactivate those systems, as described for other species refractive to xenogenic plasmids (van der Rest *et al.*, 1999), but the heat-shock decreased considerably the viability. An alternative solution would be to create a *pir* or *pir116*-expressing strain of *Legionella pneumophila*, where the pSAM-Ec plasmid would be introduced and purified from. Moreover, the pSAM-Ec plasmid should be modified by cloning a lacI^q gene, to prevent the expression of the transposase in the donor strain.

Strains used in this study

Strain	Plasmid	Phenotype	Description	Reference
DH5- α λ pir			Used for plasmid preparations (mutated endonucleases and <i>recA</i>), including R6K	(Taylor <i>et al.</i> , 1993)
DH5- α λ pir	pMAL-C9	Amp ^R	Used for purification of pMAL-C9	(van Opijnen <i>et al.</i> , 2014)
DH5- α λ pir	pJET-pyrF	Amp ^R	Used for in vitro transposition of <i>P. furiosus</i> p _{GDH} - <i>pyrF</i>	N. Guschinskaya
DH5- α λ pir	pLLA13-Kan	Amp ^R Kan ^R	Used for in vitro transposition of the Kan ^R Mariner transposon.	This work
DH5- α λ pir	pSAM-Ec	Amp ^R Kan ^R	Used for miniprep of pSAM-Ec for electroporation	This work
DH5- α λ pir	pX1K	Kan ^R	Used as a control for electroporation	X. Charpentier
DH5- α λ pir	pKD46	Amp ^R	Used for λ Red-based chromosomal recombination	(Datsenko and Wanner, 2000)
DH5- α λ pir <i>dapA::pir116</i>		Δ <i>dapA</i> Erm ^R	Created from DH5- α λ pir pKD46 and a <i>dapA::erm-pir116</i> PCR fragment from MFDpir. pKD46 is heat-sensitive and was deliberately lost. DAP auxotrophy.	This work
DH5- α λ pir <i>pir116</i>	pSAM-Ec	Δ <i>dapA</i> Erm ^R Amp ^R Kan ^R	Doubles the yield of pSAM-Ec preps.	This work
MFDpir		Δ <i>dapA</i> Erm ^R Zeo ^R	DAP auxotrophy.	(Ferrières <i>et al.</i> , 2010)
MFDpir	pSAM-Ec	Δ <i>dapA</i> Erm ^R Zeo ^R Amp ^R Kan ^R	Used for conjugation of pSAM-Ec. Poor yields and quality of plasmid preps, not to use for electroporations.	This work
<i>Legionella pneumophila</i> Paris			Clinical isolate CIP107629	National Reference Center
<i>Legionella pneumophila</i> JR32		Strep ^R	Laboratory derivative from the Philadelphia strain. Deficient in Restriction/modification systems	(Marra and Shuman, 1989)

Table 5 Strains used for the *Tn*-seq approach.

Conclusions and future prospects

The three axes of the work presented here have a common goal: uncovering the Achilles' heel of a dangerous bacterial pathogen, *L. pneumophila*.

We first showed trans-translation to be essential in *Legionella pneumophila*, and that this mechanism has the interesting properties of playing a role in resistance to ribosome-targeting antibiotics and in regulation of cell division. This last point will necessitate more work to be clearly understood. These results make trans-translation an excellent and unused target for antibiotherapy of Legionnaire's disease.

We then tested an antibiotic compound from a new class that targets this mechanism, and found it to be exceptionally efficient against *L. pneumophila* and other etiologic agents of Legionnaire's disease. This provides further interest in developing this new class into a human drug. We also found trans-translation to not be the target, or not the only target, of this drug. More investigation will be needed to establish what is the target of trans-translation in this species, as well as in others.

Finally, we developed tools to perform the Tn-seq approach in two different models of our laboratory, *P. furiosus* and *L. pneumophila*. The results we obtained already bore fruits with *P. furiosus*, but will need more development to increase the size of the libraries in both cases. Implementing this technique will allow us to discover new essential genes for rational drug development, uncover new functions in the mostly non-annotated genome of the archaea, and reveal the implication of new genes in particular mechanisms of interest, such as natural transformation.

References

- Abe, T., Sakaki, K., Fujihara, A., Ujiie, H., Ushida, C., Himeno, H., *et al.* (2008) tmRNA-dependent trans-translation is required for sporulation in *Bacillus subtilis*. *Mol Microbiol* **69**: 1491–1498.
- Abo, T., and Chadani, Y. (2014) The fail-safe system to rescue the stalled ribosomes in *Escherichia coli*. *Front Microbiol* **5**: 156.
- Abo, T., Inada, T., Ogawa, K., and Aiba, H. (2000) SsrA-mediated tagging and proteolysis of LacI and its role in the regulation of lac operon. *EMBO J* **19**: 3762–3769.
- Abo, T., Ueda, K., Sunohara, T., Ogawa, K., and Aiba, H. (2002) SsrA-mediated protein tagging in the presence of miscoding drugs and its physiological role in *Escherichia coli*. *Genes Cells* **7**: 629–638.
- Abraham, E.P., and Chain, E. (1940) An enzyme from bacteria able to destroy penicillin. *Rev Infect Dis* **10**: 677–678.
- Abraham, E.P., Chain, E., Fletcher, C.M., Florey, H.W., Gardner, A.D., Heatley, N.G., and Jennings, M.A. (1941) Further observations on penicillin. *Eur J Clin Pharmacol* **42**: 3–9.
- Abu Kwaik, Y., Gao, L.Y., Stone, B.J., Venkataraman, C., and Harb, O.S. (1998) Invasion of protozoa by *Legionella pneumophila* and its role in bacterial ecology and pathogenesis. *Appl Environ Microbiol* **64**: 3127–3133.
- Adams, K.L., and Palmer, J.D. (2003) Evolution of mitochondrial gene content: gene loss and transfer to the nucleus. *Mol Phylogenet Evol* **29**: 380–395.
- Adeleke, A., Pruckler, J., Benson, R., Rowbotham, T., Halablab, M., and Fields, B. (1996) *Legionella*-like amebal pathogens--phylogenetic status and possible role in respiratory disease. *Emerg Infect Dis* **2**: 225–230.
- Akabane, S., Ueda, T., Nierhaus, K.H., and Takeuchi, N. (2014) Ribosome Rescue and Translation Termination at Non-Standard Stop Codons by ICT1 in Mammalian Mitochondria. *PLOS Genet* **10**: e1004616.
- Akerley, B.J., Rubin, E.J., Novick, V.L., Amaya, K., Judson, N., and Mekalanos, J.J. (2002) A genome-scale analysis for identification of genes required for growth or survival of *Haemophilus influenzae*. *Proc Natl Acad Sci* **99**: 966–971.
- Albertsen, M., Hugenholtz, P., Skarshewski, A., Nielsen, K.L., Tyson, G.W., and Nielsen, P.H. (2013) Genome sequences of rare, uncultured bacteria obtained by differential coverage binning of multiple metagenomes. *Nat Biotechnol* **31**: 533–538.

- Alleron, L., Merlet, N., Lacombe, C., and Frère, J. (2008) Long-term survival of *Legionella pneumophila* in the viable but nonculturable state after monochloramine treatment. *Curr Microbiol* **57**: 497–502.
- Allombert, J., Lazzaroni, J.-C., Baïlo, N., Gilbert, C., Charpentier, X., Doublet, P., and Vianney, A. (2014) Three antagonistic cyclic di-GMP-catabolizing enzymes promote differential Dot/Icm effector delivery and intracellular survival at the early steps of *Legionella pneumophila* infection. *Infect Immun* **82**: 1222–1233.
- Alumasa, J.N., and Keiler, K.C. (2015) Clicking on trans-translation drug targets. *Front Microbiol* **6**: 498.
- Amano, K., and Williams, J.C. (1983) Peptidoglycan of *Legionella pneumophila*: apparent resistance to lysozyme hydrolysis correlates with a high degree of peptide cross-linking. *J Bacteriol* **153**: 520–526.
- Andersson, D.I., and Levin, B.R. (1999) The biological cost of antibiotic resistance. *Curr Opin Microbiol* **2**: 489–493.
- Andini, N., and Nash, K.A. (2011) Expression of tmRNA in mycobacteria is increased by antimicrobial agents that target the ribosome. *FEMS Microbiol Lett* **322**: 172–179.
- Armougom, F., and Raoult, D. (2009) Exploring Microbial Diversity Using 16S rRNA High-Throughput Methods. *J Comput Sci Syst Biol* **2** <http://www.omicsonline.org/exploring-microbial-diversity-using-s-rrna-highthroughput-methods-jcsb.1000074.php?aid=1230>. Accessed September 20, 2016.
- Atkins, J.F., and Gesteland, R.F. (1996) A case for trans translation. *Nature* **379**: 769–771.
- Attaiech, L., Boughammoura, A., Brochier-Armanet, C., Allatif, O., Peillard-Fiorente, F., Edwards, R.A., *et al.* (2016) Silencing of natural transformation by an RNA chaperone and a multitarget small RNA. *Proc Natl Acad Sci U S A* **113**: 8813–8818.
- Avery, O.T., Macleod, C.M., and McCarty, M. (1944) Studies on the chemical nature of the substance inducing transformation by a Desoxyribonucleic acid fraction isolated from *Pneumococcus* type III. *J Exp Med* **79**: 137–158.
- Ball, C.S. (1966) The Early History of the Compound Microscope. *Bios* **37**: 51–60.
- Ball, S.G., Bhattacharya, D., and Weber, A.P.M. (2016) Pathogen to powerhouse. *Science* **351**: 659–660.
- Baltz, R.H. (2006) Marcel Faber Roundtable: is our antibiotic pipeline unproductive because of starvation, constipation or lack of inspiration? *J Ind Microbiol Biotechnol* **33**: 507–513.
- Barends, S., Karzai, A.W., Sauer, R.T., Wower, J., and Kraal, B. (2001) Simultaneous and functional binding of SmpB and EF-Tu-TP to the alanyl acceptor arm of tmRNA. *J Mol Biol* **314**: 9–21.

- Barends, S., Wower, J., and Kraal, B. (2000) Kinetic parameters for tmRNA binding to alanyl-tRNA synthetase and elongation factor Tu from *Escherichia coli*. *Biochemistry (Mosc)* **39**: 2652–2658.
- Barker, J., Scaife, H., and Brown, M.R. (1995) Intraphagocytic growth induces an antibiotic-resistant phenotype of *Legionella pneumophila*. *Antimicrob Agents Chemother* **39**: 2684–2688.
- Barry, T.G., Maher, M.M., and Smith, T.J. (2009) Method for the detection of group B *Streptococcus* (GBS) (*Streptococcus agalactiae*) in mammals. <http://www.google.com/patents/US20090246764>. Accessed September 21, 2016.
- Bartlett, J.G., Moon, N., Chang, T.W., Taylor, N., and Onderdonk, A.B. (1978) Role of *Clostridium difficile* in antibiotic-associated pseudomembranous colitis. *Gastroenterology* **75**: 778–782.
- Bassetti, M., Merelli, M., Temperoni, C., and Astilean, A. (2013) New antibiotics for bad bugs: where are we? *Ann Clin Microbiol Antimicrob* **12**: 22.
- Bayles, K.W. (2014) Bacterial programmed cell death: making sense of a paradox. *Nat Rev Microbiol* **12**: 63–69.
- Beauté, J., Zucs, P., Jong, B. de, and European Legionnaires' Disease Surveillance Network (2013) Legionnaires disease in Europe, 2009-2010. *Euro Surveill Bull Eur Sur Mal Transm Eur Commun Dis Bull* **18**: 20417.
- Belzen, N. van, Dinjens, W.N., Eussen, B.H., and Bosman, F.T. (1998) Expression of differentiation-related genes in colorectal cancer: possible implications for prognosis. *Histol Histopathol* **13**: 1233–1242.
- Berger, E.A., and Heppel, L.A. (1972) A binding protein involved in the transport of cystine and diaminopimelic acid in *Escherichia coli*. *J Biol Chem* **247**: 7684–7694.
- Bian, G., Xu, Y., Lu, P., Xie, Y., and Xi, Z. (2010) The endosymbiotic bacterium *Wolbachia* induces resistance to dengue virus in *Aedes aegypti*. *PLoS Pathog* **6**: e1000833.
- Biraben, J.N. (1980) An essay concerning mankind's demographic evolution. *J Hum Evol* **9**: 655–663.
- Bisacchi, G.S. (2015) Origins of the Quinolone Class of Antibacterials: An Expanded “Discovery Story.” *J Med Chem* **58**: 4874–4882.
- Blázquez Garrido, R.M., Espinosa Parra, F.J., Alemany Francés, L., Ramos Guevara, R.M., Sánchez-Nieto, J.M., Segovia Hernández, M., *et al.* (2005) Antimicrobial chemotherapy for Legionnaires disease: levofloxacin versus macrolides. *Clin Infect Dis Off Publ Infect Dis Soc Am* **40**: 800–806.

- Bollin, G.E., Plouffe, J.F., Para, M.F., and Hackman, B. (1985) Aerosols containing *Legionella pneumophila* generated by shower heads and hot-water faucets. *Appl Environ Microbiol* **50**: 1128–1131.
- Bollmann, A., Lewis, K., and Epstein, S.S. (2007) Incubation of environmental samples in a diffusion chamber increases the diversity of recovered isolates. *Appl Environ Microbiol* **73**: 6386–6390.
- Bordeau, V., and Felden, B. (2002) Ribosomal protein S1 induces a conformational change of tmRNA; more than one protein S1 per molecule of tmRNA. *Biochimie* **84**: 723–729.
- Bott, K.F., and Wilson, G.A. (1967) Development of competence in the *Bacillus subtilis* transformation system. *J Bacteriol* **94**: 562–570.
- Brenner, D.J., Steigerwalt, A.G., and McDade, J.E. (1979) Classification of the Legionnaires' disease bacterium: *Legionella pneumophila*, genus novum, species nova, of the family Legionellaceae, familia nova. *Ann Intern Med* **90**: 656–658.
- Brochier, B., Kieny, M.P., Costy, F., Coppens, P., Bauduin, B., Lecocq, J.P., *et al.* (1991) Large-scale eradication of rabies using recombinant vaccinia-rabies vaccine. *Nature* **354**: 520–522.
- Brock, T.D. (1999) *Robert Koch*. American Society of Microbiology, . <http://www.asmscience.org/content/book/10.1128/9781555818272>. Accessed September 20, 2016.
- Brownlee, H.J., and Miner, C.S. (1929) Process of manufacturing furfural. <http://www.google.com/patents/US1735084>. Accessed September 21, 2016.
- Bruckert, W.M., Price, C.T., and Abu Kwaik, Y. (2014) Rapid nutritional remodeling of the host cell upon attachment of *Legionella pneumophila*. *Infect Immun* **82**: 72–82.
- Bruin, J.P., Koshkolda, T., IJzerman, E.P.F., Lück, C., Diederens, B.M.W., Den Boer, J.W., and Mouton, J.W. (2014) Isolation of ciprofloxacin-resistant *Legionella pneumophila* in a patient with severe pneumonia. *J Antimicrob Chemother* **69**: 2869–2871.
- Brutinel, E.D., and Galnick, J.A. (2012) Anomalies of the anaerobic tricarboxylic acid cycle in *Shewanella oneidensis* revealed by Tn-seq. *Mol Microbiol* **86**: 273–283.
- Buchrieser, C., and Charpentier, X. (2013) Induction of competence for natural transformation in *Legionella pneumophila* and exploitation for mutant construction. *Methods Mol Biol Clifton NJ* **954**: 183–195.
- Buerger, S., Spoering, A., Gavrish, E., Leslin, C., Ling, L., and Epstein, S.S. (2012a) Microbial Scout Hypothesis and Microbial Discovery. *Appl Environ Microbiol* **78**: 3229–3233.
- Buerger, S., Spoering, A., Gavrish, E., Leslin, C., Ling, L., and Epstein, S.S. (2012b) Microbial Scout Hypothesis, Stochastic Exit from Dormancy, and the Nature of Slow Growers. *Appl Environ Microbiol* **78**: 3221–3228.

- Bugaeva, E.Y., Shpanchenko, O.V., Felden, B., Isaksson, L.A., and Dontsova, O.A. (2008) One SmpB molecule accompanies tmRNA during its passage through the ribosomes. *FEBS Lett* **582**: 1532–1536.
- Burakovsky, D.E., Sergiev, P.V., Steblyanko, M.A., Konevega, A.L., Bogdanov, A.A., and Dontsova, O.A. (2011) The structure of helix 89 of 23S rRNA is important for peptidyl transferase function of Escherichia coli ribosome. *FEBS Lett* **585**: 3073–3078.
- Burstein, D., Amaro, F., Zusman, T., Lifshitz, Z., Cohen, O., Gilbert, J.A., *et al.* (2016) Genomic analysis of 38 Legionella species identifies large and diverse effector repertoires. *Nat Genet* **48**: 167–175.
- Cairrão, F., Cruz, A., Mori, H., and Arraiano, C.M. (2003) Cold shock induction of RNase R and its role in the maturation of the quality control mediator SsrA/tmRNA. *Mol Microbiol* **50**: 1349–1360.
- Callahan, S.J., Luyten, Y.A., Gupta, Y.K., Wilson, G.G., Roberts, R.J., Morgan, R.D., and Aggarwal, A.K. (2016) Structure of Type IIL Restriction-Modification Enzyme MmeI in Complex with DNA Has Implications for Engineering New Specificities. *PLoS Biol* **14**: e1002442.
- Campese, C., Bitar, D., Jarraud, S., Maine, C., Forey, F., Etienne, J., *et al.* (2011) Progress in the surveillance and control of Legionella infection in France, 1998–2008. *Int J Infect Dis* **15**: e30–e37.
- Capeding, M.R., Tran, N.H., Hadinegoro, S.R.S., Ismail, H.I.H.J.M., Chotpitayasunondh, T., Chua, M.N., *et al.* (2014) Clinical efficacy and safety of a novel tetravalent dengue vaccine in healthy children in Asia: a phase 3, randomised, observer-masked, placebo-controlled trial. *Lancet Lond Engl* **384**: 1358–1365.
- Casey, A.L., Adams, D., Karpanen, T.J., Lambert, P.A., Cookson, B.D., Nightingale, P., *et al.* (2010) Role of copper in reducing hospital environment contamination. *J Hosp Infect* **74**: 72–77.
- Center for Disease Control (1998) National Vital Statistics System - Mortality - Historical Data 1900-1998. http://www.cdc.gov/nchs/nvss/mortality_historical_data.htm. Accessed September 21, 2016.
- Center for Disease Control (2013) Untreatable: Report by CDC details today's drug-resistant health threats. <https://www.cdc.gov/media/releases/2013/p0916-untreatable.html>. Accessed September 21, 2016.
- Chadani, Y., Ito, K., Kutsukake, K., and Abo, T. (2012) ArfA recruits release factor 2 to rescue stalled ribosomes by peptidyl-tRNA hydrolysis in Escherichia coli. *Mol Microbiol* **86**: 37–50.
- Chadani, Y., Ono, K., Kutsukake, K., and Abo, T. (2011) Escherichia coli YaeJ protein mediates a novel ribosome-rescue pathway distinct from SsrA- and ArfA-mediated pathways. *Mol Microbiol* **80**: 772–785.

- Chadani, Y., Ono, K., Ozawa, S., Takahashi, Y., Takai, K., Nanamiya, H., *et al.* (2010) Ribosome rescue by *Escherichia coli* ArfA (YhdL) in the absence of trans-translation system. *Mol Microbiol* **78**: 796–808.
- Chan, M. (2012) WHO | Antimicrobial resistance in the European Union and the world. *WHO* http://www.who.int/dg/speeches/2012/amr_20120314/en/. Accessed September 21, 2016.
- Chandler, F.W., Hicklin, M.D., and Blackmon, J.A. (1977) Demonstration of the agent of Legionnaires' disease in tissue. *N Engl J Med* **297**: 1218–1220.
- Chao, M.C., Abel, S., Davis, B.M., and Waldor, M.K. (2016) The design and analysis of transposon insertion sequencing experiments. *Nat Rev Microbiol* **14**: 119–128.
- Charpentier, X., Faucher, S.P., Kalachikov, S., and Shuman, H.A. (2008) Loss of RNase R Induces Competence Development in *Legionella pneumophila*. *J Bacteriol* **190**: 8126–8136.
- Charpentier, X., Kay, E., Schneider, D., and Shuman, H.A. (2011) Antibiotics and UV Radiation Induce Competence for Natural Transformation in *Legionella pneumophila*. *J Bacteriol* **193**: 1114–1121.
- Charpentier, X., Polard, P., and Claverys, J.-P. (2012) Induction of competence for genetic transformation by antibiotics: convergent evolution of stress responses in distant bacterial species lacking SOS? *Curr Opin Microbiol* **15**: 570–576.
- Chauhan, A.K., and Apirion, D. (1989) The gene for a small stable RNA (10Sa RNA) of *Escherichia coli*. *Mol Microbiol* **3**: 1481–1485.
- Chen, C., and Deutscher, M.P. (2005) Elevation of RNase R in response to multiple stress conditions. *J Biol Chem* **280**: 34393–34396.
- Chen, D.-Q., Huang, S.-S., and Lu, Y.-J. (2006) Efficient transformation of *Legionella pneumophila* by high-voltage electroporation. *Microbiol Res* **161**: 246–251.
- Chen, J., Felipe, K.S. de, Clarke, M., Lu, H., Anderson, O.R., Segal, G., and Shuman, H.A. (2004) *Legionella* effectors that promote nonlytic release from protozoa. *Science* **303**: 1358–1361.
- Choy, J.S., Aung, L.L., and Karzai, A.W. (2007) Lon protease degrades transfer-messenger RNA-tagged proteins. *J Bacteriol* **189**: 6564–6571.
- Christensen, S.K., and Gerdes, K. (2003) RelE toxins from Bacteria and Archaea cleave mRNAs on translating ribosomes, which are rescued by tmRNA. *Mol Microbiol* **48**: 1389–1400.
- Christian, B.E., and Spremulli, L.L. (2012) Mechanism of protein biosynthesis in mammalian mitochondria. *Biochim Biophys Acta* **1819**: 1035–1054.
- Chrzanowska-Lightowlers, Z.M., and Lightowlers, R.N. (2015) Response to “Ribosome Rescue and Translation Termination at Non-standard Stop Codons by ICT1 in Mammalian Mitochondria.” *PLoS Genet* **11**: e1005227.

- Claverie, J.-M., and Ogata, H. (2009) Ten good reasons not to exclude giruses from the evolutionary picture. *Nat Rev Microbiol* **7**: 615; author reply 615.
- Colwell, R.R., Brayton, P., Herrington, D., Tall, B., Huq, A., and Levine, M.M. (1996) Viable but non-culturable *Vibrio cholerae* O1 revert to a cultivable state in the human intestine. *World J Microbiol Biotechnol* **12**: 28–31.
- Cook, N.D. (1998) *Born to Die: Disease and New World Conquest, 1492-1650*. Cambridge University Press, .
- Cray, J.A., Bell, A.N.W., Bhaganna, P., Mswaka, A.Y., Timson, D.J., and Hallsworth, J.E. (2013) The biology of habitat dominance; can microbes behave as weeds? *Microb Biotechnol* **6**: 453–492.
- Creese, M.R.S. (2015) *Ladies in the Laboratory IV: Imperial Russia's Women in Science, 1800-1900: A Survey of Their Contributions to Research*. Rowman & Littlefield, .
- Croxatto, A., Prod'hom, G., and Greub, G. (2012) Applications of MALDI-TOF mass spectrometry in clinical diagnostic microbiology. *FEMS Microbiol Rev* **36**: 380–407.
- Cruz, F. de la, and Davies, J. (2000) Horizontal gene transfer and the origin of species: lessons from bacteria. *Trends Microbiol* **8**: 128–133.
- Cruz, J. de la, and Vioque, A. (2001) Increased sensitivity to protein synthesis inhibitors in cells lacking tmRNA. *RNA NYN* **7**: 1708–1716.
- CSLI Guidelines (1999) M26-A: Bactericidal Activity Antimicrobial Agents. <http://shop.clsi.org/microbiology-documents/M26.html>. Accessed September 20, 2016.
- Datsenko, K.A., and Wanner, B.L. (2000) One-step inactivation of chromosomal genes in *Escherichia coli* K-12 using PCR products. *Proc Natl Acad Sci U S A* **97**: 6640–6645.
- D'Auria, G., Jiménez-Hernández, N., Peris-Bondia, F., Moya, A., and Latorre, A. (2010) *Legionella pneumophila* pangenome reveals strain-specific virulence factors. *BMC Genomics* **11**: 181.
- Davies, J. (1994) Inactivation of antibiotics and the dissemination of resistance genes. *Science* **264**: 375–382.
- Demerec, M. (1945) Production of *Staphylococcus* Strains Resistant to Various Concentrations of Penicillin. *Proc Natl Acad Sci U S A* **31**: 16–24.
- Demerec, M. (1948) Origin of Bacterial Resistance to Antibiotics. *J Bacteriol* **56**: 63–74.
- Dennis, P.J., Taylor, J.A., Fitzgeorge, R.B., Bartlett, C.L., and Barrow, G.I. (1982) *Legionella pneumophila* in water plumbing systems. *Lancet Lond Engl* **1**: 949–951.
- Deutscher, M.P. (2015) How bacterial cells keep ribonucleases under control. *FEMS Microbiol Rev* **39**: 350–361.

- Dobbie, B.M. (1982) An attempt to estimate the true rate of maternal mortality, sixteenth to eighteenth centuries. *Med Hist* **26**: 79–90.
- Doléans-Jordheim, A., Akermi, M., Ginevra, C., Cazalet, C., Kay, E., Schneider, D., *et al.* (2006) Growth-phase-dependent mobility of the lvh-encoding region in *Legionella pneumophila* strain Paris. *Microbiol Read Engl* **152**: 3561–3568.
- Dominguez-Bello, M.G., Costello, E.K., Contreras, M., Magris, M., Hidalgo, G., Fierer, N., and Knight, R. (2010) Delivery mode shapes the acquisition and structure of the initial microbiota across multiple body habitats in newborns. *Proc Natl Acad Sci U S A* **107**: 11971–11975.
- Dondero, T.J., Rendtorff, R.C., Mallison, G.F., Weeks, R.M., Levy, J.S., Wong, E.W., and Schaffner, W. (1980) An outbreak of Legionnaires' disease associated with a contaminated air-conditioning cooling tower. *N Engl J Med* **302**: 365–370.
- Dong, G., Nowakowski, J., and Hoffman, D.W. (2002) Structure of small protein B: the protein component of the tmRNA–SmpB system for ribosome rescue. *EMBO J* **21**: 1845–1854.
- Dong, T.G., Ho, B.T., Yoder-Himes, D.R., and Mekalanos, J.J. (2013) Identification of T6SS-dependent effector and immunity proteins by Tn-seq in *Vibrio cholerae*. *Proc Natl Acad Sci* **110**: 2623–2628.
- D'Onofrio, A., Crawford, J.M., Stewart, E.J., Witt, K., Gavrish, E., Epstein, S., *et al.* (2010) Siderophores from neighboring organisms promote the growth of uncultured bacteria. *Chem Biol* **17**: 254–264.
- Dougan, D.A., Reid, B.G., Horwich, A.L., and Bukau, B. (2002) ClpS, a substrate modulator of the ClpAP machine. *Mol Cell* **9**: 673–683.
- Dougan, D.A., Weber-Ban, E., and Bukau, B. (2003) Targeted Delivery of an *ssrA*-Tagged Substrate by the Adaptor Protein SspB to Its Cognate AAA+ Protein ClpX. *Mol Cell* **12**: 373–380.
- Drews, J. (2000) Drug discovery: a historical perspective. *Science* **287**: 1960–1964.
- Duckett, S. (1999) Ernest Duchesne and the concept of fungal antibiotic therapy. *Lancet Lond Engl* **354**: 2068–2071.
- Dulebohn, D.P., Cho, H.J., and Karzai, A.W. (2006) Role of conserved surface amino acids in binding of SmpB protein to SsrA RNA. *J Biol Chem* **281**: 28536–28545.
- Dwyer, D.J., Kohanski, M.A., and Collins, J.J. (2009) Role of reactive oxygen species in antibiotic action and resistance. *Curr Opin Microbiol* **12**: 482–489.
- Dye, C. (2014) After 2015: infectious diseases in a new era of health and development. *Philos Trans R Soc Lond B Biol Sci* **369**: 20130426.
- Ebeling, S., Kündig, C., and Hennecke, H. (1991) Discovery of a rhizobial RNA that is essential for symbiotic root nodule development. *J Bacteriol* **173**: 6373–6382.

- ECDC/EMEA Joint Working Group (2015) Data and reports: Antimicrobial resistance and consumption. <http://ecdc.europa.eu/en/eaad/antibiotics-get-informed/antibiotics-resistance-consumption/pages/data-reports.aspx>. Accessed September 21, 2016.
- Edelstein, P.H. (1995) Antimicrobial Chemotherapy for Legionnaires' Disease: A Review. *Clin Infect Dis* **21**: S265–S276.
- Edelstein, P.H., Edelstein, M.A., Higa, F., and Falkow, S. (1999) Discovery of virulence genes of *Legionella pneumophila* by using signature tagged mutagenesis in a guinea pig pneumonia model. *Proc Natl Acad Sci U S A* **96**: 8190–8195.
- Eidelman, Y., Raveh, D., Yinnon, A.M., Ballin, J., Rudensky, B., and Gottehrer, N.P. (2002) Reagent strip diagnosis of UTI in a high-risk population. *Am J Emerg Med* **20**: 112–113.
- Emmerich, R., and Löw, O. (1899) Bakteriolytische Enzyme als Ursache der erworbenen Immunität und die Heilung von Infektionskrankheiten durch dieselben. *Z Für Hyg Infect* **31**: 1–65.
- Epstein, S. (2013) The phenomenon of microbial uncultivability. *Curr Opin Microbiol* **16**: 636–642.
- Epstein, S.S., Sizova, M., and Hazen, A. (2013) New Approaches to Cultivation of Human Microbiota. In *The Human Microbiota*. Fredricks, D.N. (ed.). John Wiley & Sons, Inc., pp. 303–314 <http://onlinelibrary.wiley.com/doi/10.1002/9781118409855.ch13/summary>. Accessed September 20, 2016.
- Espy, M.J., Uhl, J.R., Sloan, L.M., Buckwalter, S.P., Jones, M.F., Vetter, E.A., *et al.* (2006) Real-time PCR in clinical microbiology: applications for routine laboratory testing. *Clin Microbiol Rev* **19**: 165–256.
- Ezraty, B., Vergnes, A., Banzhaf, M., Duverger, Y., Huguenot, A., Brochado, A.R., *et al.* (2013) Fe-S Cluster Biosynthesis Controls Uptake of Aminoglycosides in a ROS-Less Death Pathway. *Science* **340**: 1583–1587.
- Farkas, J., Stirrett, K., Lipscomb, G.L., Nixon, W., Scott, R.A., Adams, M.W.W., and Westpheling, J. (2012) Recombinogenic Properties of *Pyrococcus furiosus* Strain COM1 Enable Rapid Selection of Targeted Mutants. *Appl Environ Microbiol* **78**: 4669–4676.
- Farrell, C.M., Grossman, A.D., and Sauer, R.T. (2005) Cytoplasmic degradation of *ssrA*-tagged proteins. *Mol Microbiol* **57**: 1750–1761.
- Feaga, H.A., Quickel, M.D., Hankey-Giblin, P.A., and Keiler, K.C. (2016) Human Cells Require Non-stop Ribosome Rescue Activity in Mitochondria. *PLoS Genet* **12**: e1005964.
- Feaga, H.A., Viollier, P.H., and Keiler, K.C. (2014a) Release of nonstop ribosomes is essential. *mBio* **5**: e01916.

- Feaga, H.A., Viollier, P.H., and Keiler, K.C. (2014b) Release of Nonstop Ribosomes Is Essential. *mBio* **5**: e01916-14.
- Feeley, J.C., Gibson, R.J., Gorman, G.W., Langford, N.C., Rasheed, J.K., Mackel, D.C., and Baine, W.B. (1979) Charcoal-yeast extract agar: primary isolation medium for *Legionella pneumophila*. *J Clin Microbiol* **10**: 437–441.
- Feeley, J.C., Gorman, G.W., Weaver, R.E., Mackel, D.C., and Smith, H.W. (1978) Primary isolation media for Legionnaires disease bacterium. *J Clin Microbiol* **8**: 320–325.
- Felden, B., Hanawa, K., Atkins, J.F., Himeno, H., Muto, A., Gesteland, R.F., *et al.* (1998) Presence and location of modified nucleotides in *Escherichia coli* tmRNA: structural mimicry with tRNA acceptor branches. *EMBO J* **17**: 3188–3196.
- Felden, B., Himeno, H., Muto, A., Atkins, J.F., and Gesteland, R.F. (1996) Structural organization of *Escherichia coli* tmRNA. *Biochimie* **78**: 979–983.
- Felden, B., Himeno, H., Muto, A., McCutcheon, J.P., Atkins, J.F., and Gesteland, R.F. (1997) Probing the structure of the *Escherichia coli* 10Sa RNA (tmRNA). *RNA* **3**: 89–103.
- Fenical, W., and Jensen, P.R. (2006) Developing a new resource for drug discovery: marine actinomycete bacteria. *Nat Chem Biol* **2**: 666–673.
- Fernández, J.A., López, P., Orozco, D., and Merino, J. (2002) Clinical study of an outbreak of Legionnaire's disease in Alcoy, Southeastern Spain. *Eur J Clin Microbiol Infect Dis Off Publ Eur Soc Clin Microbiol* **21**: 729–735.
- Ferrières, L., Hémerly, G., Nham, T., Guérout, A.-M., Mazel, D., Beloin, C., and Ghigo, J.-M. (2010) Silent mischief: bacteriophage Mu insertions contaminate products of *Escherichia coli* random mutagenesis performed using suicidal transposon delivery plasmids mobilized by broad-host-range RP4 conjugative machinery. *J Bacteriol* **192**: 6418–6427.
- Fey, P.D., Endres, J.L., Yajjala, V.K., Widhelm, T.J., Boissy, R.J., Bose, J.L., and Bayles, K.W. (2013) A genetic resource for rapid and comprehensive phenotype screening of nonessential *Staphylococcus aureus* genes. *mBio* **4**: e00537-512.
- Filée, J. (2013) Route of NCLDV evolution: the genomic accordion. *Curr Opin Virol* **3**: 595–599.
- Fischer, M.G. (2016) Giant viruses come of age. *Curr Opin Microbiol* **31**: 50–57.
- Fliermans, C.B., Cherry, W.B., Orrison, L.H., and Thacker, L. (1979) Isolation of *Legionella pneumophila* from nonepidemic-related aquatic habitats. *Appl Environ Microbiol* **37**: 1239–1242.
- Ford, C.W., Zurenko, G.E., and Barbachyn, M.R. (2001) The discovery of linezolid, the first oxazolidinone antibacterial agent. *Curr Drug Targets Infect Disord* **1**: 181–199.
- Forney, L.J. (2011) Categorization of microbial communities. <http://www.google.com/patents/US20110053802>. Accessed September 21, 2016.

- Fournier, P.-E., Drancourt, M., Colson, P., Rolain, J.-M., La Scola, B., and Raoult, D. (2013) Modern clinical microbiology: new challenges and solutions. *Nat Rev Microbiol* **11**: 574–585.
- Franklin, M., Bean, W.B., and Hardin, R.C. (1950) Fowler's solution as an etiologic agent in cirrhosis. *Am J Med Sci* **219**: 589–596.
- Fraser, D.W., Tsai, T.R., Orenstein, W., Parkin, W.E., Beecham, H.J., Sharrar, R.G., *et al.* (1977) Legionnaires' disease: description of an epidemic of pneumonia. *N Engl J Med* **297**: 1189–1197.
- Fredricks, D.N., and Relman, D.A. (1996) Sequence-based identification of microbial pathogens: a reconsideration of Koch's postulates. *Clin Microbiol Rev* **9**: 18–33.
- Frei, R., Lauener, R.P., Cramer, R., and O'Mahony, L. (2012) Microbiota and dietary interactions: an update to the hygiene hypothesis? *Allergy* **67**: 451–461.
- Fu, K.P., and Neu, H.C. (1979) Inactivation of beta-lactam antibiotics by *Legionella pneumophila*. *Antimicrob Agents Chemother* **16**: 561–564.
- Fu, Y., Waldor, M.K., and Mekalanos, J.J. (2013) Tn-Seq analysis of *Vibrio cholerae* intestinal colonization reveals a role for T6SS-mediated antibacterial activity in the host. *Cell Host Microbe* **14**: 652–663.
- Fuche, F., Vianney, A., Andrea, C., Doublet, P., and Gilbert, C. (2015) Functional type 1 secretion system involved in *Legionella pneumophila* virulence. *J Bacteriol* **197**: 563–571.
- Furuya, E.Y., and Lowy, F.D. (2006) Antimicrobial-resistant bacteria in the community setting. *Nat Rev Microbiol* **4**: 36–45.
- Galor, O., and Moav, O. (2005) Natural Selection and the Evolution of Life Expectancy. Social Science Research Network, Rochester, NY. <http://papers.ssrn.com/abstract=885956>. Accessed September 21, 2016.
- García, M.T., Jones, S., Pelaz, C., Millar, R.D., and Abu Kwaik, Y. (2007) *Acanthamoeba polyphaga* resuscitates viable non-culturable *Legionella pneumophila* after disinfection. *Environ Microbiol* **9**: 1267–1277.
- Garland, S.M., Kjaer, S.K., Muñoz, N., Block, S.L., Brown, D.R., DiNubile, M.J., *et al.* (2016) Impact and Effectiveness of the Quadrivalent Human Papillomavirus Vaccine: A Systematic Review of 10 Years of Real-world Experience. *Clin Infect Dis Off Publ Infect Dis Soc Am* **63**: 519–527.
- Garza-Sánchez, F., Schaub, R.E., Janssen, B.D., and Hayes, C.S. (2011) tmRNA regulates synthesis of the ArfA ribosome rescue factor. *Mol Microbiol* **80**: 1204–1219.
- Gauwerky, K., Borelli, C., and Korting, H.C. (2009) Targeting virulence: a new paradigm for antifungals. *Drug Discov Today* **14**: 214–222.

- Gawronski, J.D., Wong, S.M.S., Giannoukos, G., Ward, D.V., and Akerley, B.J. (2009) Tracking insertion mutants within libraries by deep sequencing and a genome-wide screen for *Haemophilus* genes required in the lung. *Proc Natl Acad Sci U S A* **106**: 16422–16427.
- Ge, Z., Mehta, P., Richards, J., and Karzai, A.W. (2010) Non-stop mRNA decay initiates at the ribosome. *Mol Microbiol* **78**: 1159–1170.
- Gengenbacher, M., and Kaufmann, S.H.E. (2012) Mycobacterium tuberculosis: success through dormancy. *FEMS Microbiol Rev* **36**: 514–532.
- Georgiades, K., and Raoult, D. (2010) Defining pathogenic bacterial species in the genomic era. *Front Microbiol* **1**: 151.
- Georgiou, G., and DeLisa, M. (2003) Engineering of leader peptides for the secretion of recombinant proteins in bacteria. <https://patents.google.com/patent/US20030180937A1>. Accessed September 21, 2016.
- Gill, S.R., Pop, M., Deboy, R.T., Eckburg, P.B., Turnbaugh, P.J., Samuel, B.S., *et al.* (2006) Metagenomic analysis of the human distal gut microbiome. *Science* **312**: 1355–1359.
- Gillet, R., Kaur, S., Li, W., Hallier, M., Felden, B., and Frank, J. (2007) Scaffolding as an organizing principle in trans-translation. The roles of small protein B and ribosomal protein S1. *J Biol Chem* **282**: 6356–6363.
- Ginevra, C., Forey, F., Campèse, C., Reyrolle, M., Che, D., Etienne, J., and Jarraud, S. (2008) Lorraine strain of *Legionella pneumophila* serogroup 1, France. *Emerg Infect Dis* **14**: 673–675.
- Giudice, E., and Gillet, R. (2013) The task force that rescues stalled ribosomes in bacteria. *Trends Biochem Sci* **38**: 403–411.
- Giudice, E., Macé, K., and Gillet, R. (2014) Trans-translation exposed: understanding the structures and functions of tmRNA-SmpB. *Front Microbiol* **5**: 113.
- Glick, T.H., Gregg, M.B., Berman, B., Mallison, G., Rhodes, W.W., and Kassanoff, I. (1978) Pontiac fever. An epidemic of unknown etiology in a health department: I. Clinical and epidemiologic aspects. *Am J Epidemiol* **107**: 149–160.
- Gomez-Valero, L., and Buchrieser, C. (2013) Genome dynamics in *Legionella*: the basis of versatility and adaptation to intracellular replication. *Cold Spring Harb Perspect Med* **3**.
- Gomez-Valero, L., Rusniok, C., Jarraud, S., Vacherie, B., Rouy, Z., Barbe, V., *et al.* (2011) Extensive recombination events and horizontal gene transfer shaped the *Legionella pneumophila* genomes. *BMC Genomics* **12**: 536.
- Goralski, T.D.P., Dewan, K.K., Alumasa, J.N., Avanzato, V., Place, D.E., Markley, R.L., *et al.* (2016) Inhibitors of Ribosome Rescue Arrest Growth of *Francisella tularensis* at All Stages of Intracellular Replication. *Antimicrob Agents Chemother* **60**: 3276–3282.

- Gottesman, S., Roche, E., Zhou, Y., and Sauer, R.T. (1998) The ClpXP and ClpAP proteases degrade proteins with carboxy-terminal peptide tails added by the SsrA-tagging system. *Genes Dev* **12**: 1338–1347.
- Gough, E., Shaikh, H., and Manges, A.R. (2011) Systematic review of intestinal microbiota transplantation (fecal bacteriotherapy) for recurrent *Clostridium difficile* infection. *Clin Infect Dis* **53**: 994–1002.
- Grassly, N.C. (2013) The final stages of the global eradication of poliomyelitis. *Philos Trans R Soc Lond B Biol Sci* **368**: 20120140.
- Greub, G. (2012) Culturomics: a new approach to study the human microbiome. *Clin Infect Dis* **18**: 1157–1159.
- Griffith, F. (1928) The Significance of Pneumococcal Types. *J Hyg (Lond)* **27**: 113–159.
- Gueneau de Novoa, P., and Williams, K.P. (2004) The tmRNA website: reductive evolution of tmRNA in plastids and other endosymbionts. *Nucleic Acids Res* **32**: D104–108.
- Gullberg, E., Cao, S., Berg, O.G., Ilbäck, C., Sandegren, L., Hughes, D., and Andersson, D.I. (2011) Selection of resistant bacteria at very low antibiotic concentrations. *PLoS Pathog* **7**: e1002158.
- Gutierrez, M.G., Yoder-Himes, D.R., and Warawa, J.M. (2015) Comprehensive identification of virulence factors required for respiratory melioidosis using Tn-seq mutagenesis. *Front Cell Infect Microbiol* **5**: 78.
- Gutmann, S., Haebel, P.W., Metzinger, L., Sutter, M., Felden, B., and Ban, N. (2003) Crystal structure of the transfer-RNA domain of transfer-messenger RNA in complex with SmpB. *Nature* **424**: 699–703.
- Haber, M., and Ilan, M. (2014) Diversity and antibacterial activity of bacteria cultured from Mediterranean *Axinella* spp. sponges. *J Appl Microbiol* **116**: 519–532.
- Hackstadt, T., and Williams, J.C. (1981) Biochemical stratagem for obligate parasitism of eukaryotic cells by *Coxiella burnetii*. *Proc Natl Acad Sci U S A* **78**: 3240–3244.
- Hafez, M., Burger, G., Steinberg, S.V., and Lang, B.F. (2013) A second eukaryotic group with mitochondrion-encoded tmRNA: in silico identification and experimental confirmation. *RNA Biol* **10**: 1117–1124.
- Hallier, M., Ivanova, N., Rametti, A., Pavlov, M., Ehrenberg, M., and Felden, B. (2004) Pre-binding of small protein B to a stalled ribosome triggers trans-translation. *J Biol Chem* **279**: 25978–25985.
- Hanawa-Suetsugu, K., Takagi, M., Inokuchi, H., Himeno, H., and Muto, A. (2002) SmpB functions in various steps of trans-translation. *Nucleic Acids Res* **30**: 1620–1629.

- Handa, Y., Hikawa, Y., Tochio, N., Kogure, H., Inoue, M., Koshihara, S., *et al.* (2010) Solution structure of the catalytic domain of the mitochondrial protein ICT1 that is essential for cell vitality. *J Mol Biol* **404**: 260–273.
- Handa, Y., Inaho, N., and Nameki, N. (2011) YaeJ is a novel ribosome-associated protein in *Escherichia coli* that can hydrolyze peptidyl-tRNA on stalled ribosomes. *Nucleic Acids Res* **39**: 1739–1748.
- Harding, C.R., Schroeder, G.N., Collins, J.W., and Frankel, G. (2013) Use of *Galleria mellonella* as a model organism to study *Legionella pneumophila* infection. *J Vis Exp JoVE* e50964.
- Harding, C.R., Schroeder, G.N., Reynolds, S., Kosta, A., Collins, J.W., Mousnier, A., and Frankel, G. (2012) *Legionella pneumophila* pathogenesis in the *Galleria mellonella* infection model. *Infect Immun* **80**: 2780–2790.
- Hassan, H.M., and Fridovich, I. (1980) Mechanism of the antibiotic action pyocyanine. *J Bacteriol* **141**: 156–163.
- Havlichek, D., Saravolatz, L., and Pohlod, D. (1987) Effect of quinolones and other antimicrobial agents on cell-associated *Legionella pneumophila*. *Antimicrob Agents Chemother* **31**: 1529–1534.
- Hayes, C.S., and Sauer, R.T. (2003) Cleavage of the A Site mRNA Codon during Ribosome Pausing Provides a Mechanism for Translational Quality Control. *Mol Cell* **12**: 903–911.
- Hayes, F. (2003) Toxins-antitoxins: plasmid maintenance, programmed cell death, and cell cycle arrest. *Science* **301**: 1496–1499.
- Heath, C.H., Grove, D.I., and Looke, D.F. (1996) Delay in appropriate therapy of *Legionella pneumonia* associated with increased mortality. *Eur J Clin Microbiol Infect Dis Off Publ Eur Soc Clin Microbiol* **15**: 286–290.
- Henderson, D.A. (1976) The eradication of smallpox. *Sci Am* **235**: 25–33.
- Herman, C., Thévenet, D., Bouloc, P., Walker, G.C., and D'Ari, R. (1998) Degradation of carboxy-terminal-tagged cytoplasmic proteins by the *Escherichia coli* protease HflB (FtsH). *Genes Dev* **12**: 1348–1355.
- Heuner, K., and Steinert, M. (2003) The flagellum of *Legionella pneumophila* and its link to the expression of the virulent phenotype. *Int J Med Microbiol IJMM* **293**: 133–143.
- Hickerson, R.P., Watkins-Sims, C.D., Burrows, C.J., Atkins, J.F., Gesteland, R.F., and Felden, B. (1998) A nickel complex cleaves uridine in folded RNA structures: application to *E. coli* tmRNA and related engineered molecules. *J Mol Biol* **279**: 577–587.
- Hinshaw, H.C., Pyle, M.M., and Feldman, W.H. (1947) Streptomycin in tuberculosis. *Am J Med* **2**: 429–435.

- Hirano, K., Takahashi, M., Kazumi, Y., Fukasawa, Y., and Abe, C. (1997) Mutation in *pncA* is a major mechanism of pyrazinamide resistance in *Mycobacterium tuberculosis*. *Tuber Lung Dis Off J Int Union Tuberc Lung Dis* **78**: 117–122.
- Hoffman, L.R., D’Argenio, D.A., MacCoss, M.J., Zhang, Z., Jones, R.A., and Miller, S.I. (2005) Aminoglycoside antibiotics induce bacterial biofilm formation. *Nature* **436**: 1171–1175.
- Hoffman, P.S., Pine, L., and Bell, S. (1983) Production of superoxide and hydrogen peroxide in medium used to culture *Legionella pneumophila*: catalytic decomposition by charcoal. *Appl Environ Microbiol* **45**: 784–791.
- Hoffmann, A.A., Montgomery, B.L., Popovici, J., Iturbe-Ormaetxe, I., Johnson, P.H., Muzzi, F., *et al.* (2011) Successful establishment of *Wolbachia* in *Aedes* populations to suppress dengue transmission. *Nature* **476**: 454–457.
- Honeybourne, D. (1997) Antibiotic penetration in the respiratory tract and implications for the selection of antimicrobial therapy. *Curr Opin Pulm Med* **3**: 170–174.
- Horwitz, M.A., and Silverstein, S.C. (1983) Intracellular multiplication of Legionnaires’ disease bacteria (*Legionella pneumophila*) in human monocytes is reversibly inhibited by erythromycin and rifampin. *J Clin Invest* **71**: 15–26.
- Hu, Y., Coates, A.R., and Mitchison, D.A. (2006) Sterilising action of pyrazinamide in models of dormant and rifampicin-tolerant *Mycobacterium tuberculosis*. *Int J Tuberc Lung Dis Off J Int Union Tuberc Lung Dis* **10**: 317–322.
- Huang, C., Wolfgang, M.C., Withey, J., Koomey, M., and Friedman, D.I. (2000) Charged tmRNA but not tmRNA-mediated proteolysis is essential for *Neisseria gonorrhoeae* viability. *EMBO J* **19**: 1098–1107.
- Hubber, A., and Roy, C.R. (2010) Modulation of host cell function by *Legionella pneumophila* type IV effectors. *Annu Rev Cell Dev Biol* **26**: 261–283.
- Hudson, C.M., Lau, B.Y., and Williams, K.P. (2014) Ends of the line for tmRNA-SmpB. *Front Microbiol* **5**: 421.
- Hudson, C.M., and Williams, K.P. (2015) The tmRNA website. *Nucleic Acids Res* **43**: D138–140.
- Hug, L.A., Baker, B.J., Anantharaman, K., Brown, C.T., Probst, A.J., Castelle, C.J., *et al.* (2016) A new view of the tree of life. *Nat Microbiol* **1**: 16048.
- Hutchison, C.A., Chuang, R.-Y., Noskov, V.N., Assad-Garcia, N., Deerinck, T.J., Ellisman, M.H., *et al.* (2016) Design and synthesis of a minimal bacterial genome. *Science* **351**: aad6253.
- Hutchison, C.A., Peterson, S.N., Gill, S.R., Cline, R.T., White, O., Fraser, C.M., *et al.* (1999) Global Transposon Mutagenesis and a Minimal *Mycoplasma* Genome. *Science* **286**: 2165–2169.

- Huynen, M.A., Duarte, I., Chrzanowska-Lightowlers, Z.M.A., and Nabuurs, S.B. (2012) Structure based hypothesis of a mitochondrial ribosome rescue mechanism. *Biol Direct* **7**: 14.
- Ito, K., Chadani, Y., Nakamori, K., Chiba, S., Akiyama, Y., and Abo, T. (2011) Nascentome Analysis Uncovers Futile Protein Synthesis in Escherichia coli. *PLoS ONE* **6**: e28413.
- Jacob, Y., Seif, E., Paquet, P.-O., and Lang, B.F. (2004) Loss of the mRNA-like region in mitochondrial tmRNAs of jakobids. *RNA N Y N* **10**: 605–614.
- Jacob, Y., Sharkady, S.M., Bhardwaj, K., Sanda, A., and Williams, K.P. (2005) Function of the SmpB tail in transfer-messenger RNA translation revealed by a nucleus-encoded form. *J Biol Chem* **280**: 5503–5509.
- Jain, S.K., Gurevitz, M., and Apirion, D. (1982) A small RNA that complements mutants in the RNA processing enzyme ribonuclease P. *J Mol Biol* **162**: 515–533.
- Janssen, B.D., and Hayes, C.S. (2009) Kinetics of paused ribosome recycling in Escherichia coli. *J Mol Biol* **394**: 251–267.
- Jin, Q., Yuan, Z., Xu, J., Wang, Y., Shen, Y., Lu, W., *et al.* (2002) Genome sequence of Shigella flexneri 2a: insights into pathogenicity through comparison with genomes of Escherichia coli K12 and O157. *Nucleic Acids Res* **30**: 4432–4441.
- Johnson, N.P.A.S., and Mueller, J. (2002) Updating the accounts: global mortality of the 1918–1920 “Spanish” influenza pandemic. *Bull Hist Med* **76**: 105–115.
- Jolliffe, D.M. (1993) A history of the use of arsenicals in man. *J R Soc Med* **86**: 287–289.
- Julio, S.M., Heithoff, D.M., and Mahan, M.J. (2000) ssrA (tmRNA) Plays a Role in Salmonella enterica Serovar Typhimurium Pathogenesis. *J Bacteriol* **182**: 1558.
- Jumaa, P.A. (2005) Hand hygiene: simple and complex. *Int J Infect Dis IJID Off Publ Int Soc Infect Dis* **9**: 3–14.
- Kaeberlein, T., Lewis, K., and Epstein, S.S. (2002) Isolating “Uncultivable” Microorganisms in Pure Culture in a Simulated Natural Environment. *Science* **296**: 1127–1129.
- Karzai, A.W., and Sauer, R.T. (2001) Protein factors associated with the SsrA·SmpB tagging and ribosome rescue complex. *Proc Natl Acad Sci* **98**: 3040–3044.
- Karzai, A.W., Susskind, M.M., and Sauer, R.T. (1999) SmpB, a unique RNA-binding protein essential for the peptide-tagging activity of SsrA (tmRNA). *EMBO J* **18**: 3793–3799.
- Katz, S.M., Hashemi, S., Brown, K.R., Habib, W.A., and Hammel, J.M. (1984) Pleomorphism of Legionella pneumophila. *Ultrastruct Pathol* **6**: 117–129.
- Kaur, S., Gillet, R., Li, W., Gursky, R., and Frank, J. (2006) Cryo-EM visualization of transfer messenger RNA with two SmpBs in a stalled ribosome. *Proc Natl Acad Sci U S A* **103**: 16484–16489.

- Keiler, K. (2016) Trans-Translation As A Target For Novel Antibiotics. *FASEB J* **30**: 242.1-242.1.
- Keiler, K.C. (2015) Mechanisms of ribosome rescue in bacteria. *Nat Rev Microbiol* **13**: 285–297.
- Keiler, K.C., and Alumasa, J.N. (2013) The potential of trans-translation inhibitors as antibiotics. *Future Microbiol* **8**: 1235–1237.
- Keiler, K.C., and Feaga, H.A. (2014) Resolving Nonstop Translation Complexes Is a Matter of Life or Death. *J Bacteriol* **196**: 2123–2130.
- Keiler, K.C., and Shapiro, L. (2003a) tmRNA Is Required for Correct Timing of DNA Replication in *Caulobacter crescentus*. *J Bacteriol* **185**: 573–580.
- Keiler, K.C., and Shapiro, L. (2003b) tmRNA in *Caulobacter crescentus* is cell cycle regulated by temporally controlled transcription and RNA degradation. *J Bacteriol* **185**: 1825–1830.
- Keiler, K.C., Waller, P.R.H., and Sauer, R.T. (1996) Role of a Peptide Tagging System in Degradation of Proteins Synthesized from Damaged Messenger RNA. *Science* **271**: 990–993.
- Keller, M., and Zengler, K. (2004) Tapping into microbial diversity. *Nat Rev Microbiol* **2**: 141–150.
- Keren, I., Kaldalu, N., Spoering, A., Wang, Y., and Lewis, K. (2004) Persister cells and tolerance to antimicrobials. *FEMS Microbiol Lett* **230**: 13–18.
- Keren, I., Wu, Y., Inocencio, J., Mulcahy, L.R., and Lewis, K. (2013) Killing by Bactericidal Antibiotics Does Not Depend on Reactive Oxygen Species. *Science* **339**: 1213–1216.
- King, C.H., Fields, B.S., Shotts, E.B., and White, E.H. (1991) Effects of cytochalasin D and methylamine on intracellular growth of *Legionella pneumophila* in amoebae and human monocyte-like cells. *Infect Immun* **59**: 758–763.
- Kleckner, N., Roth, J., and Botstein, D. (1977) Genetic engineering in vivo using translocatable drug-resistance elements. New methods in bacterial genetics. *J Mol Biol* **116**: 125–159.
- Knipling, E.F. (1960) The eradication of the screw-worm fly. *Sci Am* **203**: 54–61.
- Kogure, H., Hikawa, Y., Hagihara, M., Tochio, N., Koshiba, S., Inoue, Y., *et al.* (2012) Solution structure and siRNA-mediated knockdown analysis of the mitochondrial disease-related protein C12orf65. *Proteins* **80**: 2629–2642.
- Kohanski, M.A., Dwyer, D.J., Hayete, B., Lawrence, C.A., and Collins, J.J. (2007) A Common Mechanism of Cellular Death Induced by Bactericidal Antibiotics. *Cell* **130**: 797–810.
- Kohanski, M.A., Dwyer, D.J., Wierzbowski, J., Cottarel, G., and Collins, J.J. (2008) Mistranslation of Membrane Proteins and Two-Component System Activation Trigger Antibiotic-Mediated Cell Death. *Cell* **135**: 679–690.

- Komine, Y., Kitabatake, M., and Inokuchi, H. (1996) 10Sa RNA is associated with 70S ribosome particles in *Escherichia coli*. *J Biochem (Tokyo)* **119**: 463–467.
- Komine, Y., Kitabatake, M., Yokogawa, T., Nishikawa, K., and Inokuchi, H. (1994) A tRNA-like structure is present in 10Sa RNA, a small stable RNA from *Escherichia coli*. *Proc Natl Acad Sci U S A* **91**: 9223–9227.
- Kurita, D., Chadani, Y., Muto, A., Abo, T., and Himeno, H. (2014) ArfA recognizes the lack of mRNA in the mRNA channel after RF2 binding for ribosome rescue. *Nucleic Acids Res* **42**: 13339–13352.
- Kuroha, K., Horiguchi, N., Aiba, H., and Inada, T. (2009) Analysis of nonstop mRNA translation in the absence of tmRNA in *Escherichia coli*. *Genes Cells Devoted Mol Cell Mech* **14**: 739–749.
- La Scola, B., Audic, S., Robert, C., Jungang, L., Lamballerie, X. de, Drancourt, M., *et al.* (2003) A giant virus in amoebae. *Science* **299**: 2033.
- Lagier, J.-C., Armougom, F., Million, M., Hugon, P., Pagnier, I., Robert, C., *et al.* (2012) Microbial culturomics: paradigm shift in the human gut microbiome study. *Clin Microbiol Infect* **18**: 1185–1193.
- Lagier, J.-C., Edouard, S., Pagnier, I., Mediannikov, O., Drancourt, M., and Raoult, D. (2015) Current and past strategies for bacterial culture in clinical microbiology. *Clin Microbiol Rev* **28**: 208–236.
- Lampe, D.J., Akerley, B.J., Rubin, E.J., Mekalanos, J.J., and Robertson, H.M. (1999) Hyperactive transposase mutants of the Himar1 mariner transposon. *Proc Natl Acad Sci U S A* **96**: 11428–11433.
- Lampe, D.J., Churchill, M.E., and Robertson, H.M. (1996) A purified mariner transposase is sufficient to mediate transposition in vitro. *EMBO J* **15**: 5470–5479.
- Lancaster, H.O. (1990) *Expectations of Life: A Study in the Demography, Statistics, and History of World Mortality*. Springer Science & Business Media, .
- Langridge, G.C., Phan, M.-D., Turner, D.J., Perkins, T.T., Parts, L., Haase, J., *et al.* (2009) Simultaneous assay of every *Salmonella Typhi* gene using one million transposon mutants. *Genome Res* **19**: 2308–2316.
- Lawrence, C., Reyrolle, M., Dubrou, S., Forey, F., Decludt, B., Goulvestre, C., *et al.* (1999) Single Clonal Origin of a High Proportion of *Legionella pneumophila* Serogroup 1 Isolates from Patients and the Environment in the Area of Paris, France, over a 10-Year Period. *J Clin Microbiol* **37**: 2652–2655.
- Lee, S.Y., Bailey, S.C., and Apirion, D. (1978) Small stable RNAs from *Escherichia coli*: evidence for the existence of new molecules and for a new ribonucleoprotein particle containing 6S RNA. *J Bacteriol* **133**: 1015–1023.

- Legendre, M., Lartigue, A., Bertaux, L., Jeudy, S., Bartoli, J., Lescot, M., *et al.* (2015) In-depth study of Mollivirus sibericum, a new 30,000-y-old giant virus infecting Acanthamoeba. *Proc Natl Acad Sci U S A* **112**: E5327-5335.
- Lewis, K. (2000) Programmed death in bacteria. *Microbiol Mol Biol Rev MMBR* **64**: 503–514.
- Lewis, K. (2007) Persister cells, dormancy and infectious disease. *Nat Rev Microbiol* **5**: 48–56.
- Lewis, K. (2010) Persister cells. *Annu Rev Microbiol* **64**: 357–372.
- Lewis, K. (2012) Antibiotics: Recover the lost art of drug discovery. *Nature* **485**: 439–440.
- Lewis, K. (2013) Platforms for antibiotic discovery. *Nat Rev Drug Discov* **12**: 371–387.
- Li, G.-W. (2015) How do bacteria tune translation efficiency? *Curr Opin Microbiol* **24**: 66–71.
- Li, J.W.-H., and Vederas, J.C. (2009) Drug Discovery and Natural Products: End of an Era or an Endless Frontier? *Science* **325**: 161–165.
- Li, X., Hirano, R., Tagami, H., and Aiba, H. (2006) Protein tagging at rare codons is caused by tmRNA action at the 3' end of nonstop mRNA generated in response to ribosome stalling. *RNA* **12**: 248–255.
- Li, Z., Pandit, S., and Deutscher, M.P. (1998) 3' Exoribonucleolytic trimming is a common feature of the maturation of small, stable RNAs in Escherichia coli. *Proc Natl Acad Sci U S A* **95**: 2856–2861.
- Liang, W., and Deutscher, M.P. (2012) Transfer-messenger RNA-SmpB protein regulates ribonuclease R turnover by promoting binding of HslUV and Lon proteases. *J Biol Chem* **287**: 33472–33479.
- Liang, W., and Deutscher, M.P. (2013) Ribosomes regulate the stability and action of the exoribonuclease RNase R. *J Biol Chem* **288**: 34791–34798.
- Ligon, B.L. (2004) Penicillin: its discovery and early development. *Semin Pediatr Infect Dis* **15**: 52–57.
- Lind, C., Sund, J., and Aqvist, J. (2013) Codon-reading specificities of mitochondrial release factors and translation termination at non-standard stop codons. *Nat Commun* **4**: 2940.
- Ling, L.L., Schneider, T., Peoples, A.J., Spoering, A.L., Engels, I., Conlon, B.P., *et al.* (2015) A new antibiotic kills pathogens without detectable resistance. *Nature* **517**: 455–459.
- Lipinski, C.A., Lombardo, F., Dominy, B.W., and Feeney, P.J. (2001) Experimental and computational approaches to estimate solubility and permeability in drug discovery and development settings. *Adv Drug Deliv Rev* **46**: 3–26.
- Lipscomb, G.L., Stirrett, K., Schut, G.J., Yang, F., Jenney, F.E., Scott, R.A., *et al.* (2011) Natural competence in the hyperthermophilic archaeon Pyrococcus furiosus facilitates genetic

manipulation: construction of markerless deletions of genes encoding the two cytoplasmic hydrogenases. *Appl Environ Microbiol* **77**: 2232–2238.

Liu, Y., and Imlay, J.A. (2013) Cell Death from Antibiotics Without the Involvement of Reactive Oxygen Species. *Science* **339**: 1210–1213.

Liu, Y., Wu, N., Dong, J., Gao, Y., Zhang, X., Shao, N., and Yang, G. (2010) SsrA (tmRNA) acts as an antisense RNA to regulate *Staphylococcus aureus* pigment synthesis by base pairing with crtMN mRNA. *FEBS Lett* **584**: 4325–4329.

Lorenz, P., and Eck, J. (2005) Metagenomics and industrial applications. *Nat Rev Microbiol* **3**: 510–516.

Luidalepp, H., Hallier, M., Felden, B., and Tenson, T. (2005) tmRNA Decreases the Bactericidal Activity of Aminoglycosides and the Susceptibility to Inhibitors of Cell Wall Synthesis. *RNA Biol* **2**: 70–74.

Mah, T.F., and O'Toole, G.A. (2001) Mechanisms of biofilm resistance to antimicrobial agents. *Trends Microbiol* **9**: 34–39.

Maita, C., Matushita, M., Okubo, T., Matsuo, J., Miyake, M., Nagai, H., and Yamaguchi, H. (2016) Draft Genome Sequences of *Legionella pneumophila* JR32 and Lp01 Laboratory Strains Domesticated in Japan. *Genome Announc* **4**.

Manassein, M. von (1897) Zur Frage von der alkoholischen Gahrung ohne lebende Hefezellen. *Berichte Dtsch Chem Ges* **30**: 3061–3062.

Mandal, S., Moudgil, M. 'nal, and Mandal, S.K. (2009) Rational drug design. *Eur J Pharmacol* **625**: 90–100.

Mann, B., Opijnen, T. van, Wang, J., Obert, C., Wang, Y.-D., Carter, R., *et al.* (2012) Control of virulence by small RNAs in *Streptococcus pneumoniae*. *PLoS Pathog* **8**: e1002788.

Marra, A., and Shuman, H.A. (1989) Isolation of a *Legionella pneumophila* restriction mutant with increased ability to act as a recipient in heterospecific matings. *J Bacteriol* **171**: 2238–2240.

Marshall, B.J., Armstrong, J.A., McGeachie, D.B., and Glancy, R.J. (1985) Attempt to fulfil Koch's postulates for pyloric *Campylobacter*. *Med J Aust* **142**: 436–439.

Martinez, J.L. (2008) Antibiotics and antibiotic resistance genes in natural environments. *Science* **321**: 365–367.

McDade, J.E., Shepard, C.C., Fraser, D.W., Tsai, T.R., Redus, M.A., and Dowdle, W.R. (1977) Legionnaires' disease: isolation of a bacterium and demonstration of its role in other respiratory disease. *N Engl J Med* **297**: 1197–1203.

- McFall-Ngai, M., Hadfield, M.G., Bosch, T.C.G., Carey, H.V., Domazet-Lošo, T., Douglas, A.E., *et al.* (2013) Animals in a bacterial world, a new imperative for the life sciences. *Proc Natl Acad Sci U S A* **110**: 3229–3236.
- McKinney, R.M., Porschen, R.K., Edelstein, P.H., Bissett, M.L., Harris, P.P., Bondell, S.P., *et al.* (1981) *Legionella longbeachae* species nova, another etiologic agent of human pneumonia. *Ann Intern Med* **94**: 739–743.
- Mehari, Y.T., Hayes, B.J., Redding, K.S., Mariappan, P.V.G., Gunderson, J.H., Farone, A.L., and Farone, M.B. (2015) Description of “*Candidatus Berkiella aquae*” and “*Candidatus Berkiella cookevillensis*”, two intranuclear bacteria of freshwater amoebae. *Int J Syst Evol Microbiol* .
- Meibom, K.L., Blokesch, M., Dolganov, N.A., Wu, C.-Y., and Schoolnik, G.K. (2005) Chitin induces natural competence in *Vibrio cholerae*. *Science* **310**: 1824–1827.
- Michaux, C., Hartke, A., Martini, C., Reiss, S., Albrecht, D., Budin-Verneuil, A., *et al.* (2014) Involvement of *Enterococcus faecalis* small RNAs in stress response and virulence. *Infect Immun* **82**: 3599–3611.
- Miczak, A., Chauhan, A.K., and Apirion, D. (1991) Two new genes located between 2758 and 2761 kilobase pairs on the *Escherichia coli* genome. *J Bacteriol* **173**: 3271–3272.
- Miklossy, J., Khalili, K., Gern, L., Ericson, R.L., Darekar, P., Bolle, L., *et al.* (2004) *Borrelia burgdorferi* persists in the brain in chronic lyme neuroborreliosis and may be associated with Alzheimer disease. *J Alzheimers Dis JAD* **6**: 639-649-681.
- Mintz, C.S., and Shuman, H.A. (1987) Transposition of bacteriophage Mu in the Legionnaires disease bacterium. *Proc Natl Acad Sci U S A* **84**: 4645–4649.
- Miroux, B., and Walker, J.E. (1996) Over-production of proteins in *Escherichia coli*: mutant hosts that allow synthesis of some membrane proteins and globular proteins at high levels. *J Mol Biol* **260**: 289–298.
- Molina-Quiroz, R.C., Lazinski, D.W., Camilli, A., and Levy, S.B. (2016) Transposon-sequencing analysis unveils novel genes involved in the generation of persister cells in uropathogenic *Escherichia coli*. *Antimicrob Agents Chemother* .
- Molofsky, A.B., and Swanson, M.S. (2004) Differentiate to thrive: lessons from the *Legionella pneumophila* life cycle. *Mol Microbiol* **53**: 29–40.
- Moore, S.D., and Sauer, R.T. (2005) Ribosome rescue: tmRNA tagging activity and capacity in *Escherichia coli*. *Mol Microbiol* **58**: 456–466.
- Moore, S.D., and Sauer, R.T. (2007) The tmRNA system for translational surveillance and ribosome rescue. *Annu Rev Biochem* **76**: 101–124.
- Moran, N.A. (2002) Microbial minimalism: genome reduction in bacterial pathogens. *Cell* **108**: 583–586.

- Moreira, D., and López-García, P. (2009) Ten reasons to exclude viruses from the tree of life. *Nat Rev Microbiol* **7**: 306–311.
- Morrison, S.S., Desai, H.P., Mercante, J.W., Lapierre, P., Raphael, B.H., Musser, K., and Winchell, J.M. (2016) Complete Genome Sequences of Three Outbreak-Associated *Legionella pneumophila* Isolates. *Genome Announc* **4**.
- Morrison, S.S., Kozak-Muiznieks, N.A., Sammons, S., Rowe, L.A., Frace, M., and Winchell, J.M. (2015) Draft Genome Sequence of *Legionella pneumophila* D-5864, a Serogroup 6 Strain. *Genome Announc* **3**.
- Moyed, H.S., and Bertrand, K.P. (1983) *hipA*, a newly recognized gene of *Escherichia coli* K-12 that affects frequency of persistence after inhibition of murein synthesis. *J Bacteriol* **155**: 768–775.
- Msadek, T., Dartois, V., Kunst, F., Herbaud, M.-L., Denizot, F., and Rapoport, G. (1998) ClpP of *Bacillus subtilis* is required for competence development, motility, degradative enzyme synthesis, growth at high temperature and sporulation. *Mol Microbiol* **27**: 899–914.
- Mu, X., Huan, H., Xu, H., Gao, Q., Xiong, L., Gao, R., *et al.* (2013) The transfer-messenger RNA-small protein B system plays a role in avian pathogenic *Escherichia coli* pathogenicity. *J Bacteriol* **195**: 5064–5071.
- Mullis, K.B., and Faloona, F.A. (1987) Specific synthesis of DNA in vitro via a polymerase-catalyzed chain reaction. *Methods Enzymol* **155**: 335–350.
- Munavar, H., Zhou, Y., and Gottesman, S. (2005) Analysis of the *Escherichia coli* Alp phenotype: heat shock induction in *ssrA* mutants. *J Bacteriol* **187**: 4739–4751.
- Murdoch, D.R., Laing, R.T., Mills, G.D., Karalus, N.C., Town, G.I., Mirrett, S., and Reller, L.B. (2001) Evaluation of a rapid immunochromatographic test for detection of *Streptococcus pneumoniae* antigen in urine samples from adults with community-acquired pneumonia. *J Clin Microbiol* **39**: 3495–3498.
- Muto, A., Fujihara, A., Ito, K.I., Matsuno, J., Ushida, C., and Himeno, H. (2000) Requirement of transfer-messenger RNA for the growth of *Bacillus subtilis* under stresses. *Genes Cells Devoted Mol Cell Mech* **5**: 627–635.
- Muto, A., Sato, M., Tadaki, T., Fukushima, M., Ushida, C., and Himeno, H. (1996) Structure and function of 10Sa RNA: trans-translation system. *Biochimie* **78**: 985–991.
- Nathans, D. (1964) Puromycin inhibition of protein synthesis: incorporation of puromycin into peptide chains. *Proc Natl Acad Sci U S A* **51**: 585–592.
- Neubauer, C., Gillet, R., Kelley, A.C., and Ramakrishnan, V. (2012) Decoding in the absence of a codon by tmRNA and SmpB in the ribosome. *Science* **335**: 1366–1369.

- Nguyen, T.M.N., Ilef, D., Jarraud, S., Rouil, L., Campese, C., Che, D., *et al.* (2006) A community-wide outbreak of legionnaires disease linked to industrial cooling towers--how far can contaminated aerosols spread? *J Infect Dis* **193**: 102–111.
- Nichols, D., Cahoon, N., Trakhtenberg, E.M., Pham, L., Mehta, A., Belanger, A., *et al.* (2010) Use of ichip for high-throughput in situ cultivation of “uncultivable” microbial species. *Appl Environ Microbiol* **76**: 2445–2450.
- Nichols, D., Lewis, K., Orjala, J., Mo, S., Ortenberg, R., O’Connor, P., *et al.* (2008) Short peptide induces an “uncultivable” microorganism to grow in vitro. *Appl Environ Microbiol* **74**: 4889–4897.
- Normile, D. (2010) Rinderpest, deadly for cattle, joins smallpox as a vanquished disease. *Science* **330**: 435.
- Ochman, H., Lawrence, J.G., and Groisman, E.A. (2000) Lateral gene transfer and the nature of bacterial innovation. *Nature* **405**: 299–304.
- O’Connor, T.J., Adepoju, Y., Boyd, D., and Isberg, R.R. (2011) Minimization of the Legionella pneumophila genome reveals chromosomal regions involved in host range expansion. *Proc Natl Acad Sci* **108**: 14733–14740.
- Oh, B.-K., and Apirion, D. (1991) 10Sa RNA, a small stable RNA of Escherichia coli, is functional. *Mol Gen Genet MGG* **229**: 52–56.
- Oh, B.K., Chauhan, A.K., Isono, K., and Apirion, D. (1990) Location of a gene (ssrA) for a small, stable RNA (10Sa RNA) in the Escherichia coli chromosome. *J Bacteriol* **172**: 4708–4709.
- Okada, H., Kuhn, C., Feillet, H., and Bach, J.-F. (2010) The “hygiene hypothesis” for autoimmune and allergic diseases: an update. *Clin Exp Immunol* **160**: 1–9.
- Okamoto, A., Lee, H., Yabutani, M., Yamada, K., and Ohta, M. (2014) Draft Genome Sequence of a Legionella pneumophila Serogroup 4 Strain Causing Legionellosis. *Genome Announc* **2**.
- Okan, N.A., Bliska, J.B., and Karzai, A.W. (2006) A Role for the SmpB-SsrA system in Yersinia pseudotuberculosis pathogenesis. *PLoS Pathog* **2**: e6.
- Okan, N.A., Mena, P., Benach, J.L., Bliska, J.B., and Karzai, A.W. (2010) The smpB-ssrA Mutant of Yersinia pestis Functions as a Live Attenuated Vaccine To Protect Mice against Pulmonary Plague Infection. *Infect Immun* **78**: 1284–1293.
- Oliver, J.D. (2005) The viable but nonculturable state in bacteria. *J Microbiol* **43 Spec No**: 93–100.
- Opijnen, T. van, Bodi, K.L., and Camilli, A. (2009) Tn-seq: high-throughput parallel sequencing for fitness and genetic interaction studies in microorganisms. *Nat Methods* **6**: 767–772.
- Opijnen, T. van, and Camilli, A. (2012) A fine scale phenotype-genotype virulence map of a bacterial pathogen. *Genome Res* **22**: 2541–2551.

- Opijnen, T. van, and Camilli, A. (2013) Transposon insertion sequencing: a new tool for systems-level analysis of microorganisms. *Nat Rev Microbiol* 11: 435–442.
- Opijnen, T. van, Lazinski, D.W., and Camilli, A. (2014) Genome-Wide Fitness and Genetic Interactions Determined by Tn-seq, a High-Throughput Massively Parallel Sequencing Method for Microorganisms. In *Current Protocols in Molecular Biology*. John Wiley & Sons, Inc., <http://onlinelibrary.wiley.com.gate1.inist.fr/doi/10.1002/0471142727.mb0716s106/abstract>. Accessed September 22, 2016.
- Osterholm, M.T., Chin, T.D., Osborne, D.O., Dull, H.B., Dean, A.G., Fraser, D.W., *et al.* (1983) A 1957 outbreak of Legionnaires' disease associated with a meat packing plant. *Am J Epidemiol* 117: 60–67.
- Otten, H. (1986) Domagk and the development of the sulphonamides. *J Antimicrob Chemother* 17: 689–696.
- Pagnier, I., Croce, O., Robert, C., Raoult, D., and La Scola, B. (2014) Genome Sequence of *Legionella massiliensis*, Isolated from a Cooling Tower Water Sample. *Genome Announc* 2.
- Palace, S.G., Proulx, M.K., Lu, S., Baker, R.E., and Goguen, J.D. (2014) Genome-wide mutant fitness profiling identifies nutritional requirements for optimal growth of *Yersinia pestis* in deep tissue. *mBio* 5.
- Parola, P., and Raoult, D. (2001) Tick-borne bacterial diseases emerging in Europe. *Clin Microbiol Infect Off Publ Eur Soc Clin Microbiol Infect Dis* 7: 80–83.
- Pasteur, L. (1860) *Mémoire sur la fermentation alcoolique*. Mallet-Bachelier, .
- Pasteur, L. (1862) *Mémoire sur les corpuscules organisés qui existent dans l'atmosphère: examen de la doctrine des générations spontanées*. Mallet-Bachelier, .
- Pedersen, K., Zavialov, A.V., Pavlov, M.Y., Elf, J., Gerdes, K., and Ehrenberg, M. (2003) The Bacterial Toxin RelE Displays Codon-Specific Cleavage of mRNAs in the Ribosomal A Site. *Cell* 112: 131–140.
- Personne, Y., and Parish, T. (2014) *Mycobacterium tuberculosis* possesses an unusual tmRNA rescue system. *Tuberculosis* 94: 34–42.
- Pestova, E.V., Håvarstein, L.S., and Morrison, D.A. (1996) Regulation of competence for genetic transformation in *Streptococcus pneumoniae* by an auto-induced peptide pheromone and a two-component regulatory system. *Mol Microbiol* 21: 853–862.
- Philippe, N., Legendre, M., Doutre, G., Couté, Y., Poirot, O., Lescot, M., *et al.* (2013) Pandoraviruses: amoeba viruses with genomes up to 2.5 Mb reaching that of parasitic eukaryotes. *Science* 341: 281–286.

- Pistiner, M., Gold, D.R., Abdulkerim, H., Hoffman, E., and Celedón, J.C. (2008) Birth by cesarean section, allergic rhinitis, and allergic sensitization among children with a parental history of atopy. *J Allergy Clin Immunol* **122**: 274–279.
- Pope, W.J. (1924) Synthetic therapeutic agents. *Br Med J* **1**: 413–414.
- Pritchard, J.R., Chao, M.C., Abel, S., Davis, B.M., Baranowski, C., Zhang, Y.J., *et al.* (2014) ARTIST: High-Resolution Genome-Wide Assessment of Fitness Using Transposon-Insertion Sequencing. *PLoS Genet* **10**: e1004782.
- Prozorov, A.A., and Danilenko, V.N. (2010) Toxin-antitoxin systems in bacteria: Apoptotic tools or metabolic regulators? *Microbiology* **79**: 129–140.
- Puigbò, P., Wolf, Y.I., and Koonin, E.V. (2013) Seeing the Tree of Life behind the phylogenetic forest. *BMC Biol* **11**: 46.
- Qi, H., Shimizu, Y., and Ueda, T. (2007) Ribosomal protein S1 is not essential for the translation machinery. *J Mol Biol* **368**: 845–852.
- Qin, T., Cui, Y., Cen, Z., Liang, T., Ren, H., Yang, X., *et al.* (2012) Draft genome sequences of two *Legionella dumoffii* strains, TEX-KL and NY-23. *J Bacteriol* **194**: 1251–1252.
- Ramadoss, N.S., Alumasa, J.N., Cheng, L., Wang, Y., Li, S., Chambers, B.S., *et al.* (2013) Small molecule inhibitors of trans-translation have broad-spectrum antibiotic activity. *Proc Natl Acad Sci U S A*.
- Ramadoss, N.S., Zhou, X., and Keiler, K.C. (2013) tmRNA Is Essential in *Shigella flexneri*. *PLoS ONE* **8**: e57537.
- Rammelkamp, C.H., and Maxon, T. (1942) Resistance of *Staphylococcus aureus* to the Action of Penicillin. *Exp Biol Med* **51**: 386–389.
- Ranquet, C., Geiselmann, J., and Toussaint, A. (2001) The tRNA function of SsrA contributes to controlling repression of bacteriophage Mu prophage. *Proc Natl Acad Sci U S A* **98**: 10220–10225.
- Rappé, M.S., Connon, S.A., Vergin, K.L., and Giovannoni, S.J. (2002) Cultivation of the ubiquitous SAR11 marine bacterioplankton clade. *Nature* **418**: 630–633.
- Ray, B.K., and Apirion, D. (1979) Characterization of 10S RNA: a new stable rna molecule from *Escherichia coli*. *Mol Gen Genet MGG* **174**: 25–32.
- Regelson, W., Kim, U., Ospina, J., and Holland, J.F. (1968) Hemangioendothelial sarcoma of liver from chronic arsenic intoxication by Fowler's solution. *Cancer* **21**: 514–522.
- Renesto, P., Crapoulet, N., Ogata, H., La Scola, B., Vestris, G., Claverie, J.-M., and Raoult, D. (2003) Genome-based design of a cell-free culture medium for *Tropheryma whippiei*. *Lancet Lond Engl* **362**: 447–449.

- Rest, M.E. van der, Lange, C., and Molenaar, D. (1999) A heat shock following electroporation induces highly efficient transformation of *Corynebacterium glutamicum* with xenogeneic plasmid DNA. *Appl Microbiol Biotechnol* **52**: 541–545.
- Richards, J., Mehta, P., and Karzai, A.W. (2006) RNase R degrades non-stop mRNAs selectively in an SmpB-tmRNA-dependent manner. *Mol Microbiol* **62**: 1700–1712.
- Richter, R., Rorbach, J., Pajak, A., Smith, P.M., Wessels, H.J., Huynen, M.A., *et al.* (2010) A functional peptidyl-tRNA hydrolase, ICT1, has been recruited into the human mitochondrial ribosome. *EMBO J* **29**: 1116–1125.
- Riesenfeld, C.S., Schloss, P.D., and Handelsman, J. (2004) Metagenomics: genomic analysis of microbial communities. *Annu Rev Genet* **38**: 525–552.
- Riethmiller, S. (2005) From Atoxyl to Salvarsan: searching for the magic bullet. *Chemotherapy* **51**: 234–242.
- Ristroph, J.D., Hedlund, K.W., and Allen, R.G. (1980) Liquid medium for growth of *Legionella pneumophila*. *J Clin Microbiol* **11**: 19–21.
- Robertson, P., Abdelhady, H., and Garduño, R.A. (2014) The many forms of a pleomorphic bacterial pathogen—the developmental network of *Legionella pneumophila*. *Front Microbiol* **5**: 670.
- Rorbach, J., Richter, R., Wessels, H.J., Wydro, M., Pekalski, M., Farhoud, M., *et al.* (2008) The human mitochondrial ribosome recycling factor is essential for cell viability. *Nucleic Acids Res* **36**: 5787–5799.
- Roux, D., Danilchanka, O., Guillard, T., Cattoir, V., Aschard, H., Fu, Y., *et al.* (2015) Fitness cost of antibiotic susceptibility during bacterial infection. *Sci Transl Med* **7**: 297ra114.
- Rowbotham, T.J. (1980) Preliminary report on the pathogenicity of *Legionella pneumophila* for freshwater and soil amoebae. *J Clin Pathol* **33**: 1179–1183.
- Rudinger-Thirion, J., Giegé, R., and Felden, B. (1999) Aminoacylated tmRNA from *Escherichia coli* interacts with prokaryotic elongation factor Tu. *RNA N Y N* **5**: 989–992.
- Saguy, M., Gillet, R., Skorski, P., Hermann-Le Denmat, S., and Felden, B. (2007) Ribosomal protein S1 influences trans-translation in vitro and in vivo. *Nucleic Acids Res* **35**: 2368–2376.
- Sams, E.R., Whiteley, M., and Turner, K.H. (2014) “The battle for life”: Pasteur, anthrax, and the first probiotics. *J Med Microbiol* **63**: 1573–1574.
- Schatz, A., Bugle, E., and Waksman, S.A. (1944) Streptomycin, a Substance Exhibiting Antibiotic Activity Against Gram-Positive and Gram-Negative Bacteria.*†. *Exp Biol Med* **55**: 66–69.
- Schaub, R.E., Poole, S.J., Garza-Sánchez, F., Benbow, S., and Hayes, C.S. (2012) Proteobacterial ArfA peptides are synthesized from non-stop messenger RNAs. *J Biol Chem* **287**: 29765–29775.

- Segal, G., Feldman, M., and Zusman, T. (2005) The Icm/Dot type-IV secretion systems of *Legionella pneumophila* and *Coxiella burnetii*. *FEMS Microbiol Rev* **29**: 65–81.
- Segal, G., Russo, J.J., and Shuman, H.A. (1999) Relationships between a new type IV secretion system and the icm/dot virulence system of *Legionella pneumophila*. *Mol Microbiol* **34**: 799–809.
- Sertkaya, A., Wong, H.-H., Jessup, A., and Beleche, T. (2016) Key cost drivers of pharmaceutical clinical trials in the United States. *Clin Trials Lond Engl* **13**: 117–126.
- Sexton, J.A., and Vogel, J.P. (2004) Regulation of Hypercompetence in *Legionella pneumophila*. *J Bacteriol* **186**: 3814–3825.
- Shadoud, L., Almahmoud, I., Jarraud, S., Etienne, J., Larrat, S., Schwebel, C., *et al.* (2015) Hidden Selection of Bacterial Resistance to Fluoroquinolones In Vivo: The Case of *Legionella pneumophila* and Humans. *EBioMedicine* **2**: 1179–1185.
- Shi, W., Zhang, X., Jiang, X., Yuan, H., Lee, J.S., Barry, C.E., *et al.* (2011) Pyrazinamide Inhibits Trans-Translation in *Mycobacterium tuberculosis*. *Science* **333**: 1630–1632.
- Shimizu, Y. (2012) ArfA recruits RF2 into stalled ribosomes. *J Mol Biol* **423**: 624–631.
- Shimizu, Y., and Ueda, T. (2002) The role of SmpB protein in trans-translation. *FEBS Lett* **514**: 74–77.
- Shimizu, Y., and Ueda, T. (2006) SmpB triggers GTP hydrolysis of elongation factor Tu on ribosomes by compensating for the lack of codon-anticodon interaction during trans-translation initiation. *J Biol Chem* **281**: 15987–15996.
- Shin, J.-H., and Price, C.W. (2007) The SsrA-SmpB Ribosome Rescue System Is Important for Growth of *Bacillus subtilis* at Low and High Temperatures. *J Bacteriol* **189**: 3729–3737.
- Silber, K.R., Keiler, K.C., and Sauer, R.T. (1992) Tsp: a tail-specific protease that selectively degrades proteins with nonpolar C termini. *Proc Natl Acad Sci U S A* **89**: 295–299.
- Silver, L.L. (2003) Novel inhibitors of bacterial cell wall synthesis. *Curr Opin Microbiol* **6**: 431–438.
- Singh, S., Eldin, C., Kowalczywska, M., and Raoult, D. (2013) Axenic culture of fastidious and intracellular bacteria. *Trends Microbiol* **21**: 92–99.
- Singh, S., Kowalczywska, M., Edouard, S., Eldin, C., Perreal, C., Weber, P., *et al.* (2013) Cell extract-containing medium for culture of intracellular fastidious bacteria. *J Clin Microbiol* **51**: 2599–2607.
- Skipper, K.A., Andersen, P.R., Sharma, N., and Mikkelsen, J.G. (2013) DNA transposon-based gene vehicles - scenes from an evolutionary drive. *J Biomed Sci* **20**: 92.

- Skurnik, D., Roux, D., Cattoir, V., Danilchanka, O., Lu, X., Yoder-Himes, D.R., *et al.* (2013) Enhanced in vivo fitness of carbapenem-resistant oprD mutants of *Pseudomonas aeruginosa* revealed through high-throughput sequencing. *Proc Natl Acad Sci U S A* **110**: 20747–20752.
- Slavcev, R.A., and Hayes, S. (2003) Blocking the T4 lysis inhibition phenotype. *Gene* **321**: 163–171.
- Smith, T.J., Maher, M.M., O’Grady, J., and Barry, T. Nucleic acid sequences based on the bacterial ssra gene and its tmrna transcript for the molecular detection of s.aureus. <http://google.com/patents/WO2010115912A2>. Accessed September 21, 2016.
- Snow, J. (1855) *On the Mode of Communication of Cholera*. John Churchill, .
- Söderberg, M.A., Dao, J., Starkenburg, S.R., and Cianciotto, N.P. (2008) Importance of type II secretion for survival of *Legionella pneumophila* in tap water and in amoebae at low temperatures. *Appl Environ Microbiol* **74**: 5583–5588.
- Söderberg, M.A., Rossier, O., and Cianciotto, N.P. (2004) The type II protein secretion system of *Legionella pneumophila* promotes growth at low temperatures. *J Bacteriol* **186**: 3712–3720.
- Solaimanpour, S., Sarmiento, F., and Mrázek, J. (2015) Tn-seq explorer: a tool for analysis of high-throughput sequencing data of transposon mutant libraries. *PLoS One* **10**: e0126070.
- Soleimanpour-Lichaei, H.R., Kühn, I., Gaisne, M., Passos, J.F., Wydro, M., Rorbach, J., *et al.* (2007) mtRF1a is a human mitochondrial translation release factor decoding the major termination codons UAA and UAG. *Mol Cell* **27**: 745–757.
- Sørensen, M.A., Fricke, J., and Pedersen, S. (1998) Ribosomal protein S1 is required for translation of most, if not all, natural mRNAs in *Escherichia coli* in vivo. *J Mol Biol* **280**: 561–569.
- Sparling, P.F. (1966) Genetic transformation of *Neisseria gonorrhoeae* to streptomycin resistance. *J Bacteriol* **92**: 1364–1371.
- Srivastava, R.K., Miczak, A., and Apirion, D. (1990) Maturation of precursor 10Sa RNA in *Escherichia coli* is a two-step process: the first reaction is catalyzed by RNase III in presence of Mn²⁺. *Biochimie* **72**: 791–802.
- Stackebrandt, E., Frederiksen, W., Garrity, G.M., Grimont, P.A.D., Kämpfer, P., Maiden, M.C.J., *et al.* (2002) Report of the ad hoc committee for the re-evaluation of the species definition in bacteriology. *Int J Syst Evol Microbiol* **52**: 1043–1047.
- Staley, and Konopka (1985) Measurement of in situ activities of nonphotosynthetic microorganisms in aquatic and terrestrial habitats. *Annu Rev Microbiol* **39**: 321–346.
- Steele, T.W., Moore, C.V., and Sangster, N. (1990) Distribution of *Legionella longbeachae* serogroup 1 and other legionellae in potting soils in Australia. *Appl Environ Microbiol* **56**: 2984–2988.

- Steinert, M., Emödy, L., Amann, R., and Hacker, J. (1997) Resuscitation of viable but nonculturable *Legionella pneumophila* Philadelphia JR32 by *Acanthamoeba castellanii*. *Appl Environ Microbiol* **63**: 2047–2053.
- Stevens, K.E., Chang, D., Zwack, E.E., and Sebert, M.E. (2011) Competence in *Streptococcus pneumoniae* is regulated by the rate of ribosomal decoding errors. *mBio* **2**.
- Subbarao, M.N., and Apirion, D. (1989) A precursor for a small stable RNA (10Sa RNA) of *Escherichia coli*. *Mol Gen Genet MGG* **217**: 499–504.
- Sundermeier, T.R., and Karzai, A.W. (2007) Functional SmpB-ribosome interactions require tmRNA. *J Biol Chem* **282**: 34779–34786.
- Sunohara, T., Jojima, K., Yamamoto, Y., Inada, T., and Aiba, H. (2004) Nascent-peptide-mediated ribosome stalling at a stop codon induces mRNA cleavage resulting in nonstop mRNA that is recognized by tmRNA. *RNA N Y N* **10**: 378–386.
- Svetlanov, A., Puri, N., Mena, P., Koller, A., and Karzai, A.W. (2012) *Francisella tularensis* tmRNA system mutants are vulnerable to stress, avirulent in mice, and provide effective immune protection. *Mol Microbiol* **85**: 122–141.
- Swanson, M.S., and Hammer, B.K. (2000) *Legionella Pneumophila* Pathogenesis: A Fateful Journey from Amoebae to Macrophages. *Annu Rev Microbiol* **54**: 567–613.
- Szaflarski, W., Vesper, O., Teraoka, Y., Plitta, B., Wilson, D.N., and Nierhaus, K.H. (2008) New features of the ribosome and ribosomal inhibitors: non-enzymatic recycling, misreading and back-translocation. *J Mol Biol* **380**: 193–205.
- Tadaki, T., Fukushima, M., Ushida, C., Himeno, H., and Muto, A. (1996) Interaction of 10Sa RNA with ribosomes in *Escherichia coli*. *FEBS Lett* **399**: 223–226.
- Takada, K., Takemoto, C., Kawazoe, M., Konno, T., Hanawa-Suetsugu, K., Lee, S., *et al.* (2007) In vitro trans-translation of *Thermus thermophilus*: ribosomal protein S1 is not required for the early stage of trans-translation. *RNA N Y N* **13**: 503–510.
- Tanaka, T., Kawasaki, K., Daimon, S., Kitagawa, W., Yamamoto, K., Tamaki, H., *et al.* (2014) A Hidden Pitfall in the Preparation of Agar Media Undermines Microorganism Cultivability. *Appl Environ Microbiol* **80**: 7659–7666.
- Taylor, R.G., Walker, D.C., and McInnes, R.R. (1993) *E. coli* host strains significantly affect the quality of small scale plasmid DNA preparations used for sequencing. *Nucleic Acids Res* **21**: 1677–1678.
- Temperley, R., Richter, R., Dennerlein, S., Lightowers, R.N., and Chrzanowska-Lightowers, Z.M. (2010) Hungry codons promote frameshifting in human mitochondrial ribosomes. *Science* **327**: 301.

- Tenson, T., and Ehrenberg, M. (2002) Regulatory Nascent Peptides in the Ribosomal Tunnel. *Cell* **108**: 591–594.
- Thibonnier, M., Thiberge, J.-M., and De Reuse, H. (2008) Trans-Translation in *Helicobacter pylori*: Essentiality of Ribosome Rescue and Requirement of Protein Tagging for Stress Resistance and Competence. *PLoS ONE* **3**: e3810.
- Tronel, H., and Hartemann, P. (2009) Overview of diagnostic and detection methods for legionellosis and *Legionella* spp. *Lett Appl Microbiol* **48**: 653–656.
- Tu, G.-F., Reid, G.E., Zhang, J.-G., Moritz, R.L., and Simpson, R.J. (1995) C-terminal Extension of Truncated Recombinant Proteins in *Escherichia coli* with a 10Sa RNA Decapeptide. *J Biol Chem* **270**: 9322–9326.
- Ude, S., Lassak, J., Starosta, A.L., Kraxenberger, T., Wilson, D.N., and Jung, K. (2013) Translation Elongation Factor EF-P Alleviates Ribosome Stalling at Polyproline Stretches. *Science* **339**: 82–85.
- Valle, M., Gillet, R., Kaur, S., Henne, A., Ramakrishnan, V., and Frank, J. (2003) Visualizing tmRNA Entry into a Stalled Ribosome. *Science* **300**: 127–130.
- Van Melderen, L., and Saavedra De Bast, M. (2009) Bacterial toxin-antitoxin systems: more than selfish entities? *PLoS Genet* **5**: e1000437.
- Vandersmissen, L., De Buck, E., Saels, V., Coil, D.A., and Anné, J. (2010) A *Legionella pneumophila* collagen-like protein encoded by a gene with a variable number of tandem repeats is involved in the adherence and invasion of host cells. *FEMS Microbiol Lett* **306**: 168–176.
- Varro, M.T. (~160 BCE) *De Re Rustica*. p. 12:2.
- Vartoukian, S.R., Palmer, R.M., and Wade, W.G. (2010) Strategies for culture of “unculturable” bacteria. *FEMS Microbiol Lett* **309**: 1–7.
- Venkataraman, K., Zafar, H., and Karzai, A.W. (2014) Distinct tmRNA sequence elements facilitate RNase R engagement on rescued ribosomes for selective nonstop mRNA decay. *Nucleic Acids Res* **42**: 11192–11202.
- Vincent, C.D., Friedman, J.R., Jeong, K.C., Sutherland, M.C., and Vogel, J.P. (2012) Identification of the DotL coupling protein subcomplex of the *Legionella* Dot/Icm type IV secretion system. *Mol Microbiol* **85**: 378–391.
- Vivanco-Domínguez, S., Bueno-Martínez, J., León-Avila, G., Iwakura, N., Kaji, A., Kaji, H., and Guarneros, G. (2012) Protein synthesis factors (RF1, RF2, RF3, RRF, and tmRNA) and peptidyl-tRNA hydrolase rescue stalled ribosomes at sense codons. *J Mol Biol* **417**: 425–439.
- Vrieze, A., Holleman, F., Zoetendal, E.G., Vos, W.M. de, Hoekstra, J.B.L., and Nieuwdorp, M. (2010) The environment within: how gut microbiota may influence metabolism and body composition. *Diabetologia* **53**: 606–613.

- Wadowsky, R.M., Yee, R.B., Mezmar, L., Wing, E.J., and Dowling, J.N. (1982) Hot water systems as sources of *Legionella pneumophila* in hospital and nonhospital plumbing fixtures. *Appl Environ Microbiol* **43**: 1104–1110.
- Waage, I., Schmid, G., Thumann, S., Thomm, M., and Hausner, W. (2010) Shuttle Vector-Based Transformation System for *Pyrococcus furiosus*. *Appl Environ Microbiol* **76**: 3308–3313.
- Wah, D.A., Levchenko, I., Baker, T.A., and Sauer, R.T. (2002) Characterization of a specificity factor for an AAA+ ATPase: assembly of SspB dimers with ssaA-tagged proteins and the ClpX hexamer. *Chem Biol* **9**: 1237–1245.
- Waksman, S.A. (1947) What is an antibiotic or an antibiotic substance? *Mycologia* **39**: 565–569.
- Waksman, S.A., and Lechevalier, H.A. (1949) Neomycin, a New Antibiotic Active against Streptomycin-Resistant Bacteria, including Tuberculosis Organisms. *Science* **109**: 305–307.
- Waksman, S.A., and Woodruff, H.B. (1940) The Soil as a Source of Microorganisms Antagonistic to Disease-Producing Bacteria. *J Bacteriol* **40**: 581–600.
- Waksman, S.A., and Woodruff, H.B. (1942) Streptothricin, a New Selective Bacteriostatic and Bactericidal Agent, Particularly Active Against Gram-Negative Bacteria. *Exp Biol Med* **49**: 207–210.
- Walker, L., Levine, H., and Jucker, M. (2006) Koch's postulates and infectious proteins. *Acta Neuropathol (Berl)* **112**: 1–4.
- Wang, Z., Gerstein, M., and Snyder, M. (2009) RNA-Seq: a revolutionary tool for transcriptomics. *Nat Rev Genet* **10**: 57–63.
- Watanabe, K., Suzuki, H., Nakao, R., Shimizu, T., and Watarai, M. (2015) Draft Genome Sequences of Five *Legionella pneumophila* Strains Isolated from Environmental Water Samples. *Genome Announc* **3**.
- Watve, M., Shejval, V., Sonawane, C., Rahalkar, M., Matapurkar†, A., Shouche†, Y., *et al.* (2000) The “K” selected oligophilic bacteria: A key to uncultured diversity? *ResearchGate* **78**: 1535–1542.
- Webber, M.A., and Piddock, L.J.V. (2003) The importance of efflux pumps in bacterial antibiotic resistance. *J Antimicrob Chemother* **51**: 9–11.
- Weis, F., Bron, P., Giudice, E., Rolland, J.-P., Thomas, D., Felden, B., and Gillet, R. (2010) tmRNA-SmpB: a journey to the centre of the bacterial ribosome. *EMBO J* **29**: 3810–3818.
- Weisburg, W.G., Dobson, M.E., Samuel, J.E., Dasch, G.A., Mallavia, L.P., Baca, O., *et al.* (1989) Phylogenetic diversity of the Rickettsiae. *J Bacteriol* **171**: 4202–4206.
- Weisholtz, S., and Tomasz, A. (1985) Response of *Legionella pneumophila* to beta-lactam antibiotics. *Antimicrob Agents Chemother* **27**: 695–700.

- Wen, Y., Behiels, E., and Devreese, B. (2014) Toxin-Antitoxin systems: their role in persistence, biofilm formation, and pathogenicity. *Pathog Dis* **70**: 240–249.
- Wesolowska, M.T., Richter-Dennerlein, R., Lightowlers, R.N., and Chrzanowska-Lightowlers, Z.M.A. (2014) Overcoming stalled translation in human mitochondria. *Front Microbiol* **5** <http://journal.frontiersin.org/article/10.3389/fmicb.2014.00374/abstract>. Accessed September 21, 2016.
- WHO (2012) Non-communicable diseases mortality and morbidity. *WHO* http://www.who.int/gho/ncd/mortality_morbidity/en/. Accessed September 21, 2016.
- Wickner, S., Maurizi, M.R., and Gottesman, S. (1999) Posttranslational quality control: folding, refolding, and degrading proteins. *Science* **286**: 1888–1893.
- Wiegert, T., and Schumann, W. (2001) SsrA-mediated tagging in *Bacillus subtilis*. *J Bacteriol* **183**: 3885–3889.
- Wiles, T.J., Norton, J.P., Russell, C.W., Dalley, B.K., Fischer, K.F., and Mulvey, M.A. (2013) Combining quantitative genetic footprinting and trait enrichment analysis to identify fitness determinants of a bacterial pathogen. *PLoS Genet* **9**: e1003716.
- Williams, K.P. (2000) The tmRNA Website. *Nucleic Acids Res* **28**: 168.
- Williams, K.P. (2002) Integration sites for genetic elements in prokaryotic tRNA and tmRNA genes: sublocation preference of integrase subfamilies. *Nucleic Acids Res* **30**: 866–875.
- Williams, K.P. (2003) Traffic at the tmRNA gene. *J Bacteriol* **185**: 1059–1070.
- Williams, K.P., and Bartel, D.P. (1996) Phylogenetic analysis of tmRNA secondary structure. *RNA* **2**: 1306–1310.
- Wilson, D.N. (2013) Ribosome-targeting antibiotics and mechanisms of bacterial resistance. *Nat Rev Microbiol* **12**: 35–48.
- Witherell, L.E., Novick, L.F., Stone, K.M., Duncan, R.W., Orciari, L.A., Kappel, S.J., and Jillson, D.A. (1986) Legionella in cooling towers. *J Environ Health* **49**: 134–139.
- Withey, J.H., and Friedman, D.I. (2003) A salvage pathway for protein structures: tmRNA and trans-translation. *Annu Rev Microbiol* **57**: 101–123.
- Woo, A.H., Yu, V.L., and Goetz, A. (1986) Potential in-hospital modes of transmission of Legionella pneumophila. Demonstration experiments for dissemination by showers, humidifiers, and rinsing of ventilation bag apparatus. *Am J Med* **80**: 567–573.
- Woo, P.C.Y., Lau, S.K.P., Teng, J.L.L., Tse, H., and Yuen, K.-Y. (2008) Then and now: use of 16S rDNA gene sequencing for bacterial identification and discovery of novel bacteria in clinical microbiology laboratories. *Clin Microbiol Infect Off Publ Eur Soc Clin Microbiol Infect Dis* **14**: 908–934.

- Wower, I.K., Zwieb, C.W., Guven, S.A., and Wower, J. (2000) Binding and cross-linking of tmRNA to ribosomal protein S1, on and off the Escherichia coli ribosome. *EMBO J* **19**: 6612–6621.
- Wower, J., Zwieb, C.W., Hoffman, D.W., and Wower, I.K. (2002) SmpB: a protein that binds to double-stranded segments in tmRNA and tRNA. *Biochemistry (Mosc)* **41**: 8826–8836.
- Wright, P. (2004) Norman George Heatley. *The Lancet* **363**: 495.
- Wu, D., Hugenholtz, P., Mavromatis, K., Pukall, R., Dalin, E., Ivanova, N.N., *et al.* (2009) A phylogeny-driven genomic encyclopaedia of Bacteria and Archaea. *Nature* **462**: 1056–1060.
- Yamamoto, Y., Sunohara, T., Jojima, K., Inada, T., and Aiba, H. (2003) SsrA-mediated trans-translation plays a role in mRNA quality control by facilitating degradation of truncated mRNAs. *RNA N Y N* **9**: 408–418.
- Yang, J., Liu, Y., Bi, J., Cai, Q., Liao, X., Li, W., *et al.* (2015) Structural basis for targeting the ribosomal protein S1 of Mycobacterium tuberculosis by pyrazinamide. *Mol Microbiol* **95**: 791–803.
- Yazdanbakhsh, M., Kremsner, P.G., and Ree, R. van (2002) Allergy, parasites, and the hygiene hypothesis. *Science* **296**: 490–494.
- Young, D.J., Edgar, C.D., Murphy, J., Fredebohm, J., Poole, E.S., and Tate, W.P. (2010) Bioinformatic, structural, and functional analyses support release factor-like MTRF1 as a protein able to decode nonstandard stop codons beginning with adenine in vertebrate mitochondria. *RNA N Y N* **16**: 1146–1155.
- Yu, V.L., Plouffe, J.F., Pastoris, M.C., Stout, J.E., Schousboe, M., Widmer, A., *et al.* (2002) Distribution of Legionella Species and Serogroups Isolated by Culture in Patients with Sporadic Community-Acquired Legionellosis: An International Collaborative Survey. *J Infect Dis* **186**: 127–128.
- Yutin, N., and Koonin, E.V. (2013) Pandoraviruses are highly derived phycodnaviruses. *Biol Direct* **8**: 25.
- Yutin, N., Wolf, Y.I., and Koonin, E.V. (2014) Origin of giant viruses from smaller DNA viruses not from a fourth domain of cellular life. *Virology* **466–467**: 38–52.
- Zeng, F., and Jin, H. (2016) Peptide release promoted by methylated RF2 and ArfA in nonstop translation is achieved by an induced-fit mechanism. *RNA N Y N* **22**: 49–60.
- Zhang, Y., and Spremulli, L.L. (1998) Identification and cloning of human mitochondrial translational release factor 1 and the ribosome recycling factor. *Biochim Biophys Acta* **1443**: 245–250.

Zhang, Y., Wade, M.M., Scorpio, A., Zhang, H., and Sun, Z. (2003) Mode of action of pyrazinamide: disruption of Mycobacterium tuberculosis membrane transport and energetics by pyrazinoic acid. *J Antimicrob Chemother* **52**: 790–795.

Zink, S.D., Pedersen, L., Cianciotto, N.P., and Abu-Kwaik, Y. (2002) The Dot/Icm type IV secretion system of Legionella pneumophila is essential for the induction of apoptosis in human macrophages. *Infect Immun* **70**: 1657–1663.

Zomer, A., Burghout, P., Bootsma, H.J., Hermans, P.W.M., and Hijum, S.A.F.T. van (2012) ESSENTIALS: Software for Rapid Analysis of High Throughput Transposon Insertion Sequencing Data. *PLoS ONE* **7** <http://www.ncbi.nlm.nih.gov/pmc/articles/PMC3416827/>. Accessed November 13, 2014.