



HAL
open science

Management of electric vehicle systems with self-interested actors

Wenjing Shuai

► **To cite this version:**

Wenjing Shuai. Management of electric vehicle systems with self-interested actors. Networking and Internet Architecture [cs.NI]. Ecole Nationale Supérieure des Télécommunications de Bretagne - EN-STB, 2016. English. NNT : 2016TELB0408 . tel-01593254v1

HAL Id: tel-01593254

<https://theses.hal.science/tel-01593254v1>

Submitted on 26 Sep 2017 (v1), last revised 26 Sep 2017 (v2)

HAL is a multi-disciplinary open access archive for the deposit and dissemination of scientific research documents, whether they are published or not. The documents may come from teaching and research institutions in France or abroad, or from public or private research centers.

L'archive ouverte pluridisciplinaire **HAL**, est destinée au dépôt et à la diffusion de documents scientifiques de niveau recherche, publiés ou non, émanant des établissements d'enseignement et de recherche français ou étrangers, des laboratoires publics ou privés.

UNIVERSITE BRETAGNE LOIRE

THÈSE / Télécom Bretagne
sous le sceau de l'Université Bretagne Loire
pour obtenir le grade de Docteur de Télécom Bretagne

En accréditation conjointe avec l'Ecole Doctorale Matisse
Mention : Informatique

présentée par
Wenjing Shuai

préparée dans le département Réseaux, Sécurité et Multimédia (RSM)
Laboratoire Irisa

Management of electric vehicle systems with self-interested actors

Thèse soutenue le 13 septembre 2016
Devant le jury composé de :

Bruno Tuffin
Directeur de recherche, Inria-Rennes / président

Aline Carneiro Viana
Chargée de recherche (HDR), Inria-Saclay / rapporteur

Maurice Gagnaire
Professeur, Télécom ParisTech / rapporteur

Dominique Barth
Professeur, Université de Versailles Saint-Quentin / examinateur

Alexander Pelov
Maître de conférences, Télécom Bretagne / examinateur

Patrick Maillé
Maître de conférences, Télécom Bretagne / directeur de thèse

Sous le sceau de l'Université Bretagne Loire

Télécom Bretagne

En accréditation conjointe avec l'Ecole Doctorale Matisse

Ecole Doctorale – MATISSE

Management of electric vehicle systems with self-interested actors

Thèse de Doctorat

Mention : Informatique

Présentée par **WENJING SHUAI**

Département : RSM

Laboratoire : OCIF

Directeur de thèse : **PATRICK MAILLÉ**

Soutenue le 13 Septembre 2016.

Jury :

Mme. Aline CARNEIRO VIANA, Chargée de recherche (HDR), Inria-Saclay (Rapporteur)
M. Maurice GAGNAIRE, Professeur, Télécom ParisTech (Rapporteur)
M. Patrick MAILLÉ, Maître de Conférences, Télécom Bretagne (Directeur de thèse)
M. Dominique BARTH, Professeur, Université de Versailles Saint-Quentin (Examineur)
M. Bruno TUFFIN, Directeur de recherche, Inria-Rennes (Examineur)
M. Alexander PELOV, CEO, Acklio (Encadrant de thèse)

Acknowledgements

I would like to thank the jury member: Prof. CARNEIRO VIANA, Prof. GAGNAIRE, Prof. BARTH and Prof. TUFFIN for accepting to evaluate my manuscript, which is yet one more responsibility at a busy time.

I would like to express my deep gratitude to my supervisor Prof. MAILLÉ and my advisor CEO Alexander PELOV, for being very helpful throughout the 3 years and a half. I appreciate their patience, their optimism and sense of humor but most importantly, their professionalism and the exchange of ideas we have had.

I would like to thank my colleagues in the department of RSM, their kindness and encouragement delights every single day of mine. I'll miss the joyful hours spent with other PhD students.

Above all, I am grateful for the unconditional love and support from my parents and my boyfriend.

Abstract

Electric Vehicles (EVs), as their penetration increases, are not only challenging the sustainability of the power grid, but also stimulating and promoting its upgrading. Indeed, EVs can actively reinforce the development of the Smart Grid if their charging processes are properly coordinated through two-way communications, possibly benefiting all types of actors. Because grid systems involve a large number of actors with nonaligned objectives, we focus on the economic and incentive aspects, where each actor behaves in its own interest. We indeed believe that the market structure will directly impact the actors' behaviors, and as a result the total benefits that the presence of EVs can earn the society, hence the need for a careful design.

The thesis first provides an overview of economic models considering unidirectional energy flows, but also bidirectional energy flows, i.e., with EVs temporarily providing energy to the grid. We describe and compare the main approaches, summarize the requirements on the supporting communication systems, and propose a classification to highlight the most important results and lacks.

We propose to use the recharging processes of EVs to provide regulation to the grid by varying the instantaneous recharging power. We provide an economic analysis of the incentives at play, including the EV owners point of view (longer recharging durations and impact on battery lifetime versus cheaper energy) and the aggregator point of view (revenues from recharging versus regulation gains). In particular, we analyze the range of regulation rewards such that offering a regulation-oriented recharging benefits both EV owners and the aggregator. After that, we split the monopolistic aggregator into two competing entities. We model a non-cooperative game between them and examine the outcomes at the Nash equilibrium, in terms of user welfare, station revenue and electricity prices. As expected, competing stations offer users with lower prices than the monopolistic revenue-maximizing aggregator do. Furthermore, the amount of regulation service increases significantly than that in the monopolistic case.

Considering the possibility of discharging, we propose an approach close to Vehicle-to-Grid, where EVs can give back some energy from their batteries during peak times. But we also use EVs as energy transporters, by taking their energy where it is consumed. A typical

example is a shopping mall with energy needs, benefiting from customers coming and going to alleviate its grid-based consumption, while EV owners make profits by reselling energy bought at off-peak periods. Based on a simple model for EV mobility, energy storage, and electricity pricing, we quantify the reduction in energy costs for the EV-supported system, and investigate the conditions for this scenario to be viable.

Résumé en français

L'arrivée sur le marché des véhicules électriques (VE), et leur pénétration de plus en plus conséquente, ont un impact non négligeable sur le réseau électrique. De par la grande quantité d'énergie demandée pour recharger ces véhicules, la stabilité même des différents maillons du réseau (production, transport, distribution) est susceptible d'être menacée. Cependant, dans l'optique de la transition du réseau électrique vers davantage d'adaptabilité et d'intelligence supportée par les technologies de l'information et de la communication—le Smart Grid—, les véhicules électriques peuvent aussi être vus comme offrant de nouvelles opportunités. En effet, la demande en énergie des VE étant relativement flexible (rechargement pendant la nuit, notamment) et contrôlable à distance (véhicules connectés), leur présence sur le réseau électrique ouvre la voie à des optimisations via le processus de recharge (lissage de la demande, aide à la régulation offre-demande) ou même par l'utilisation de cette nouvelle capacité de stockage d'énergie, distribuée géographiquement.

Néanmoins, l'écosystème associé aux véhicules électriques implique un grand nombre d'acteurs divers, aux objectifs rarement alignés: les conducteurs souhaitent recharger rapidement et à moindre coût, les producteurs d'énergie souhaitent une demande flexible, les intermédiaires comme les gestionnaires de stations de recharge cherchent à maximiser leurs revenus, qui peuvent venir aussi bien des utilisateurs (paiement de la recharge) que des gestionnaires du réseau électrique (rémunération pour la flexibilité de la demande).

Dans cette thèse, nous nous intéressons aux aspects économiques liés à la recharge de véhicules électrique, en prenant en compte le fait que chaque acteur peut prendre des décisions stratégiques. Ainsi, les mécanismes de marché choisis devraient directement influencer sur les comportement des acteurs, et par conséquent sur les gains apportés par les VE à chacun de ces acteurs et à la société en général. D'où le besoin de précautions lors de la définition des règles pour ces marchés.

Je présente tout d'abord un état de l'art structuré des différents modèles de la littérature introduits pour ces problèmes. Beaucoup se limitent à des flux d'énergie unidirectionnels (du réseau électrique vers le véhicule), mais certains considèrent également la possibilité de transferts temporaires d'énergie dans le sens opposé. Nous décrivons et comparons les

principales approches, en mettant en évidence les besoins en communication des mécanismes correspondants, et les principales propriétés économiques afin de souligner les résultats les plus significatifs ainsi que les éventuels manques. Nous faisons ensuite une première proposition, consistant à utiliser le processus de recharge des VEs pour fournir un service de régulation au réseau électrique, en adaptant la puissance instantanée de charge. Nous conduisons une analyse économique des incitations en jeu, en incluant le point de vue des conducteurs (compromis entre prix et durée de la recharge, comptant également l'impact sur la durée de vie de la batterie), celui des agrégateurs/stations de recharge (revenus venant des utilisateurs et/ou du réseau via les récompenses liées à la régulation). En particulier, nous analysons les valeurs des incitations à la régulation qui sont suffisantes pour qu'une offre de recharge-régulation soit bénéfique à la fois pour l'agrégateur et les conducteurs. Cette étude étant initialement conduite dans le cas d'un monopole qui peut offrir une recharge normale ou une recharge-régulation, nous regardons ensuite l'impact de la compétition. Pour cela, nous étudions à l'aide de la théorie des jeux, la compétition entre un agrégateur n'offrant que des recharges à puissance fixe, et un autre n'offrant que de la recharge-régulation. La compétition semble préférable pour les utilisateurs et pour la société, puisque les prix sont alors plus bas qu'avec le monopole, et que la participation aux services de régulation est bien plus élevée.

Enfin, nous proposons d'utiliser une autre propriété des véhicules électriques, à savoir leur capacité de stockage d'énergie. En effet, les VEs peuvent se charger pendant les heures de faible demande, donc à des prix réduits, et éventuellement revendre une partie de l'énergie accumulée pendant les pics de demande. Nous définissons un scénario où on utilise même la mobilité des VEs, en consommant l'énergie apportée par des VEs, par exemple dans un centre commercial où certains clients revendent une partie de leur électricité pendant leur durée de visite. Nous utilisons un modèle markovien de mobilité des véhicules, afin de mener une étude économique des gains et coûts d'une telle approche. En particulier, des compromis apparaissent dans le choix des puissances de décharge (pertes versus décharge insuffisante si le temps de séjour des véhicules est court), et dans le choix du nombre de stations de décharge à installer (probabilité de blocage versus coûts de maintenance). A partir de valeurs réalistes des marchés de l'électricité, nous déterminons numériquement les conditions pour qu'un tel scénario soit viable, et quantifions les économies qu'il peut apporter.

Cette dissertation se conclut par une prise de recul sur les contributions et sur les extensions qui pourraient y être apportées. Je décris également quelques directions de recherche que je n'ai pas eu le temps de développer au cours de ma thèse, mais qui me semblent intéressantes comme travaux futurs.

Table of contents

Résumé en français	vii
List of figures	xiii
List of tables	xvii
1 Introduction	1
1.1 Thesis context	1
1.2 Thesis contributions and organization	3
2 Charging Electric Vehicles in the Smart City: A Survey of Economy-driven Approaches	7
2.1 Techno-economic environment of EVs	7
2.1.1 Facilities for Electric Vehicle Charging	7
2.1.2 EVs – An enabler of the Smart Grid and a participant in Electricity markets	10
2.1.3 Dealing with self-interested actors	12
2.2 Unidirectional charging mechanisms	15
2.2.1 Static unidirectional recharging	15
2.2.2 Dynamic models	22
2.3 Bidirectional energy trading	29
2.3.1 Individual arbitrage	29
2.3.2 V2G for regulation services	30
2.3.3 V2G as storage for renewable energy	33
2.4 Communication aspects	35
2.4.1 Information exchanges	35
2.4.2 Time granularity	39
2.5 Classification of approaches and research challenges	39
2.6 Summary	42

3	Charging station’s behavior study while using flexible EV recharging to perform frequency regulation	45
3.1	Regulation recharging	46
3.1.1	The opportunity of EV providing regulation	46
3.1.2	Regulation mechanism	47
3.1.3	Monetary incentives	49
3.1.4	User preferences	50
3.1.5	Recap	51
3.2	Monopolistic aggregator scenario	53
3.2.1	Aggregator strategic decisions	53
3.2.2	Aggregator revenue	54
3.2.3	Maximizing the aggregator revenue	55
3.2.4	When will the aggregator offer an “ <i>R-charging</i> ” option?	60
3.2.5	Application in a real world market	62
3.2.6	Recap	63
3.3	Competition Between Regulation-Providing and Fixed-Power Charging Stations for EVs	63
3.3.1	Game definition	65
3.3.2	Best-response prices	66
3.3.3	Nash equilibrium	71
3.3.4	Recap	74
3.4	Comparison between the Nash equilibrium and the Monopolistic case	75
3.4.1	Average user utility	75
3.4.2	Application in a real world market	77
3.5	Summary	79
4	Reducing grid dependency in transit areas	81
4.1	Related work	81
4.2	Model description	83
4.2.1	Time-of-use electricity pricing	83
4.2.2	Electricity demand of the facility	84
4.2.3	Potential supply from EVs	84
4.2.4	EV mobility	84
4.2.5	Costs faced by the facility	84
4.2.6	Management options	85
4.3	Analysis—Small k	86
4.3.1	Stochastic analysis	87

4.3.2	Cost function of the facility	89
4.3.3	Optimal discharging power	90
4.4	Extension to larger k	92
4.4.1	Setting the discharging power	92
4.4.2	Optimal number of dischargers to install	92
4.5	Numerical results	94
4.5.1	Optimal number of dischargers	94
4.5.2	The difference between rush hour and vacant hour	96
4.5.3	Effect of the surplus energy in EVs	96
4.6	Summary	97
5	Conclusion and future work	99
5.1	Summary of the thesis	100
5.2	Perspectives and work plan	101
	Publications	103
	References	105
	Appendix A Gestion du système des véhicules électriques avec des acteurs rationnels	113
A.1	Introduction	113
A.2	Charger des véhicules électriques dans la ville intelligente: une enquête	114
A.2.1	Environnement techno-économique de VE	114
A.2.2	Mécanismes de charge unidirectionnels	114
A.2.3	Commerce d'énergie bidirectionnel	115
A.3	Étude du comportement des stations lors d'utiliser la recharge VE pour la régulation	116
A.3.1	Mécanisme de régulation	116
A.3.2	Agent de recharge monopolistique	118
A.3.3	Compétition entre <i>R-charging</i> station et <i>S-charging</i> station	118
A.3.4	Comparaison entre l'équilibre de Nash et le modèle monopolistique	119
A.4	Réduire la dépendance du réseau dans les zones de transit	119
A.4.1	Description du modèle	119
A.4.2	Analyse	121
A.5	Récap	122

List of figures

1.1	Actors and energy flows in the Smart Grid	2
2.1	Classification of the charging facilities for EVs	9
2.2	Smart Grid Actors related to EV charging.	11
2.3	Capacity constraints: a simple tree topology.	18
2.4	Ontario Electricity Time-of-use Price periods.	30
2.5	A virtual power plant, with energy flows.	34
2.6	Dynamic problem setting	40
3.1	Power and cumulated energy an EV obtained with and without regulation (simulation with $C_B = 50\text{kWh}$, $P_d = 20\text{kW}$, $P_n = 16\text{kW}$, $\Delta = 0.1\text{hour}$, $\rho_u =$ $\rho_d = 0.45$)	48
3.2	User utility for the three charging options ($C_B = 50$, $P_d = 20$, $P_A = 8$, $T_s =$ 0.15 , $T_r = 0.04$): the best choice depends on the user sensitivity θ	52
3.3	Aggregator revenue as a function of T_s ($t = 0.03$, $C_B = 50\text{kWh}$, $\bar{\theta} = 0.3$).	55
3.4	Aggregator revenue as a function of T_r and T_s ($t = 0.03$, $r_d = 0.6$, $r_u = 2.0$, $C_B = 50\text{kWh}$, $\rho_d = 0.48$, $\rho_u = 0.48$, $\gamma = 0.05$, $\bar{\theta} = 0.3$, $x = 0.8$).	56
3.5	Aggregator revenue as a function of T_r and T_s ($t = 0.03$, $r_d = 0.6$, $r_u = 2.0$, $C_B = 50\text{kWh}$, $\rho_d = 0.48$, $\rho_u = 0.48$, $\gamma = 0.05$, $\bar{\theta} = 0.3$, $x = 0.2$).	57
3.6	Aggregator Revenue with multiple combinations of r_d and r_u	60
3.7	User welfare with multiple combinations of r_d and r_u	62
3.8	Observed regulation prices, and thresholds for <i>R-charging</i> to be beneficial for the aggregator	64
3.9	<i>S-charging</i> station revenue as a function of T_r and T_s ($t = 0.03$, $\bar{\theta} = 0.3$, $C_B = 50\text{kWh}$, $x = 0.8$). The red, yellow and blue areas are separated by $T_r = (t + (P_d - P_A) \frac{\bar{\theta}}{C_B}) \frac{P_A}{P_d}$ and $T_r = (t + P_d \frac{\bar{\theta}}{C_B}) \frac{P_A}{P_d}$, referring to (3.32).	68

3.10	<i>R</i> -charging Station revenue as a function of T_r and T_s ($t = 0.03$, $r_d = 0.7$, $r_u = 2.1$, $C_B = 50kWh$, $\rho_d = 0.48$, $\rho_u = 0.48$, $\gamma = 0.05$, $\bar{\theta} = 0.3$, $x = 0.8$). The red region corresponds to non-negative revenues, i.e., $\frac{T_r}{P_A} < \frac{T_s}{P_d}$	71
3.11	Nash equilibria in case of small r_d and r_u	73
3.12	Nash equilibria in case of large r_d and r_u	74
3.13	Comparison between Monopoly (left-hand side) and Nash equilibrium (right-hand side), in terms of station revenue and user utility, with $t = 0.03$, $\bar{\theta} = 0.3$, $C_B = 50$, $\rho_d = \rho_u = 0.48$, $\gamma = 0.05$, $r_d = 0.4$, $r_u = 1.6$ (r_d and r_u are the daily average of 20/07/2015).	75
3.14	Comparison between Monopoly (left-hand side) and Nash equilibrium (right-hand side), in terms of user participation, with $t = 0.03$, $\bar{\theta} = 0.3$, $C_B = 50$, $\rho_d = \rho_u = 0.48$, $\gamma = 0.05$, $r_d = 0.4$, $r_u = 1.6$ (r_d and r_u are the daily average of 20/07/2015).	76
3.15	Comparison between Monopoly (left-hand side) and Nash equilibrium (right-hand side), in terms of electricity prices, with $t = 0.03$, $\bar{\theta} = 0.3$, $C_B = 50$, $\rho_d = \rho_u = 0.48$, $\gamma = 0.05$, $r_d = 0.4$, $r_u = 1.6$ (r_d and r_u are the daily average of 20/07/2015).	76
3.16	Comparison of feasible regions on $r_d \times r_u$ plane and the optimal x , $t = 0.03$, $C_B = 50$, $\rho_d = \rho_u = 0.48$, $\bar{\theta} = 0.3$, $\gamma = 0.05$ for the first row, $\bar{\theta} = 0.1$, $\gamma = 0.05$ for the second, and $\bar{\theta} = 0.1$, $\gamma = 0.5$ for the third.	78
4.1	System implementation: EVs can sell their surplus energy (bought off-peak) to make profit and reduce the facility grid dependency during peaks.	83
4.2	Continuous-Time Markov Chains describing the evolution of the number of plugged EVs m_t (<i>top</i>) and of $(n_t, m_t) = (\text{nb_discharging_EVs}, \text{nb_plugged_EVs})$ (<i>bottom</i>). Both are for Scheme 1	88
4.3	Transition diagram for the number of discharging EVs in the unplugging scheme (Scheme 2)	89
4.4	Cost variation with different discharging powers ($\theta = 0.1$, $\lambda = 20$, $k_1 = k_2 = 7$).	91
4.5	Cost variation with different number of dischargers.	93
4.6	Optimal number of dischargers according to EV arrival rate λ	94
4.7	Optimal number of dischargers versus average surplus energy $1/\theta$	95
4.8	Variation of saving according to the EV arrival rate λ	95
4.9	Variation of saving versus average EV surplus energy $1/\theta$	96

A.1	Puissance et énergie accumulée un EV obtenu avec et sans ajustement (simulation avec $C_B = 50\text{kWh}$, $P_d = 20\text{kW}$, $P_n = 16\text{kW}$, $\Delta = 0.1\text{hour}$, $\rho_u = \rho_d = 0.45$)	117
A.2	Illustrations des modèle des sections A.3 et A.4	118
A.3	Variation de coût avec différentes puissances de décharge (ligne pleine) et nombre variable de décharge (ligne en pointillés) lorsque $\theta = 0.1$, $\lambda = 20$. .	121

List of tables

2.1	Charging powers and corresponding charging duration T under the SAE J1772 standard	8
2.2	Main questions related to the EV charging problem, and desirable properties	14
2.3	Comparing mechanisms proposed for static scenarios on a toy example . . .	19
2.4	Economic approaches for static unidirectional recharging	23
2.5	A dynamic problem setting	24
2.6	Information exchanges for charging schemes with two types of actors (EV and energy sellers)	36
2.7	Information exchanges for charging schemes with a 3-layer system (the sequentiality of the exchanges differ among schemes)	36
2.8	Information exchanges for charging schemes with a 3-layer system (the sequentiality of the exchanges differ among schemes)	38
2.9	Time scale at which charging management operates	38
2.10	A classification of economic schemes for EV charging. A diamond mark indicates papers considering PHEVs (which can use fossile fuel) rather than BEVs (which can only use the electric energy stored in their battery).	41
3.1	Model notations	52
3.2	Solution of $\frac{\partial R_r}{\partial T_r} = 0$ in different circumstances	69
4.1	Model variables	86
A.1	Variables des modèle	121

Chapter 1

Introduction

1.1 Thesis context

Diminishing oil supply and increasing environmental concerns strongly motivate research efforts toward the electrification of transportation, and technological advances have fostered a rapid arrival of Electric Vehicles (EVs) in the market. However, the charging of EVs has a tremendous impact on the stakeholders in both the electricity and transportation domains, such as electricity producers, power grid operators, policy makers, retailers, and customers [23]. The EV load can drive electricity prices up [8], and alter the producers' generation portfolios, resulting in an increase of CO₂ emission [30]. Additionally, high penetration with uncontrolled charging threatens the sustainability of distribution networks [43, 86]. For example, for an EV penetration of 25%, almost 30% of network facilities would need to be upgraded, while this ratio drops to 5% if the charging load can be shifted to less crowded time periods [24]. These research works reach a consensus that EV charging should be controlled to avoid distribution congestion and higher peak-to-average ratios (i.e., demand sporadicity).

At the same time, the Power Grid is witnessing one of its major evolutions since its conception at the beginning of the past century. The classical structure of electricity being produced in a small number of big, centralized, power plants, and flowing through the transmission and distribution networks to be consumed by end users is being challenged by the increasing penetration of renewable energy sources. The possibility to communicate bidirectionally with all elements of the grid—and as a consequence to achieve unprecedented levels of monitoring and control—serves as a major technological enabler of the new Smart Grid, allowing to accommodate new types of demand and production sources as illustrated in Figure 1.1.

In this context, EVs impose new burdens due to the extra demands they constitute, but also open opportunities thanks to the fact that their demands are relatively flexible, and

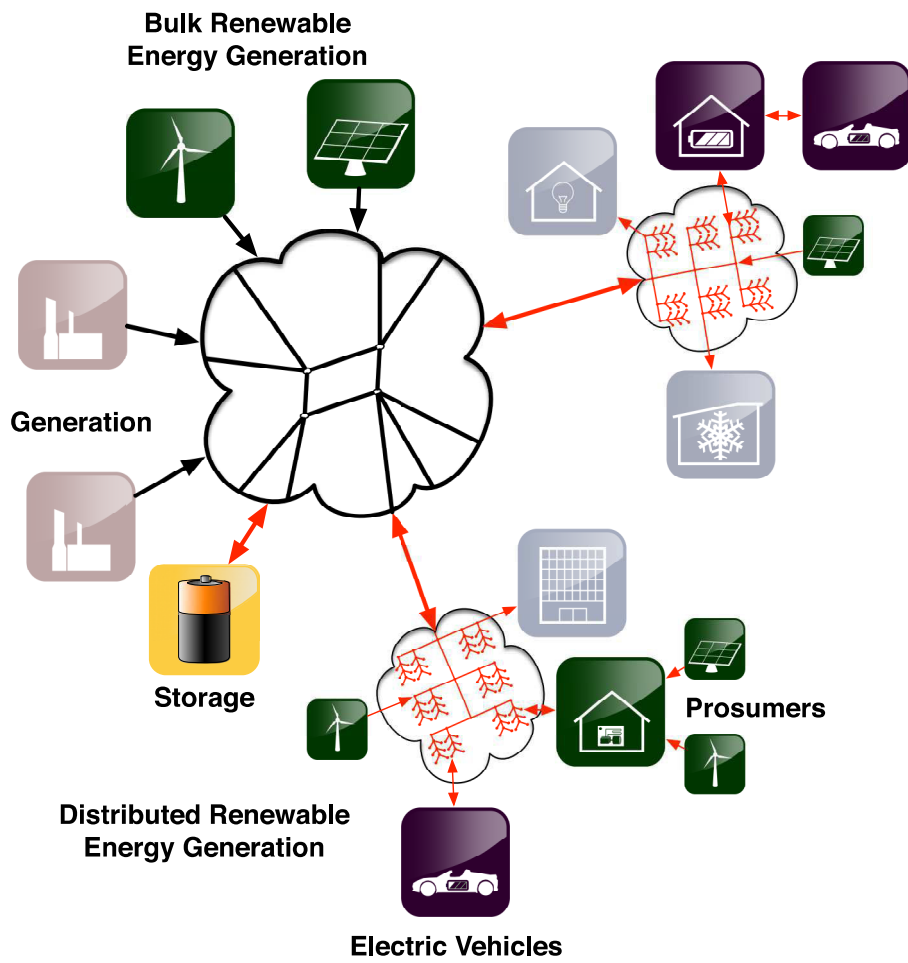

Fig. 1.1 Actors and energy flows in the Smart Grid

that their batteries can be temporarily used to support the power grid: EVs can be active contributors in the smart grid instead of passive consumers.

The important aspect stressed in this thesis is that EVs cannot be assumed to be directly coordinated by a central entity controlling all charging processes. Indeed, EVs belong to individuals with specific preferences and constraints, who would not relinquish control of the charging process without being properly compensated. Instead, it is reasonable to assume that they react selfishly to management schemes: only when sufficient incentives are offered may EV owners coordinate their charging time and power, i.e., reschedule (directly or by giving some control to an external entity) the charging processes rather than recharging their batteries within the shortest delay, which is convenient for them but problematic in the grid operator perspective. Those incentives can take several forms, from fixed rewards for letting the grid control the charging, to auctions for energy, or through time-varying prices set by grid operators.

Therefore, we think EV charging must be managed using market mechanisms, where participants are assumed to have different objectives. Hence an appropriate framework to study the EV management schemes is that of economy, and more precisely game theory [33, 79] which provides specific tools to model and analyze the interactions among self-interested actors.

1.2 Thesis contributions and organization

The contributions of the thesis consist of a survey of the current literature on this topic plus two specific proposals dealing with EV charging management

The survey presented in Chapter 2 reviews the economy-driven schemes for EV charging management proposed in the literature. While the research on that topic is quite flourishing in the last years, there is to our knowledge no work presenting a comprehensive overview of the different approaches considered. We classify the existing models, highlight their main assumptions and results, in order to compare them and identify the most promising types of mechanisms together with the directions that deserve further research.

EV charging management requires the support of a corresponding communication structure. In some algorithms, information is broadcasted from grid operators to EVs; bidirectional unicast is sometimes needed to coordinate the charging behaviors of specific EVs; finally EVs multicasting to charging stations (with or without station relaying) and stations responding (by unicast, multicast or broadcast) are necessary in reservation-based systems. The importance of Information and Communication Technologies on the implementation of Smart Grid can never be overemphasized [28, 102], and specially designed communication

systems for vehicles [5] are also relevant for better scheduling the charging of EVs. Hence charging algorithms and the corresponding communication systems should be considered simultaneously to make the best of their economical and environmental potentials. Existing works in the literature provide general overviews of the requirements and challenges; the survey investigates the economic properties of the charging algorithms, but keep track of their prerequisites on communication systems in terms of the volume and the frequency of information exchanges.

Our first proposal described in Chapter 3 provides economical incentives to EV owners who consent to be recharged at a lower average power (real time recharging power could change over the charging period). This of course prolongs their recharging time, so is better suited for users not facing imminent departures. For those impatient ones, we keep the high-power recharging option available at a higher price. This price discrimination benefits the EV owners who can accept longer recharging durations, meanwhile provides an extra revenue for the charging stations, who can use the flexible recharging processes of those EVs to offer services to the grid operators and earn remunerations in return. These remunerations reflect the balance between supply and demand of the market thus vary significantly. High remunerations favor the station, whereas lower ones would make it unworthy for the station to offer both recharging options—when high-power recharging is offered only, some of the patient clients would switch to this option while the rest can still decline and leave the system. Note that entitling one single entity to provide both types of charging services perhaps results in the low-power recharging option offered less often, because when the remuneration is inferior to a certain threshold, the station would turn to the mode where only high-power charging is offered. This jeopardizes user and grid operator in a way that one of them loses a source of cheap energy and the other service. To avoid this, we break the monopolistic charging station into two, each one being in charge of one service. Their relationship forms a non-cooperative game. We examine the Nash equilibria of this game. By doing this, the inexpensive low-power recharging option can endure lower remunerations while being offered more often than in the monopolistic case, because here the station that does this has no other revenue source to turn to. To the best of our knowledge, this model is innovative in terms of giving the closed form revenue-maximizing electricity prices, as well as offering some insight into whether providing regulation while recharging EVs consists a profitable option for the aggregator.

Our second proposal is detailed in Chapter 4 and reverses the role of EV owners—they are no longer customers but energy sellers, who discharge the surplus electricity stored in their batteries to a facility, while the vehicles are parked in the facility's parking lot. The attractiveness for EV owners comes from the profits they acquire, through recharging more

than sufficient energy in the batteries during off-peak periods of time and selling the excess part to the facility. From the viewpoint of the facility, instead of buying electricity at on-peak prices from the utility companies to cover its un-shiftable demand during peak time, it can first purchase from the available EVs at a relatively lower price and only turn to the grid to compensate the insufficient part. This proposal is suitable for the areas where the price margin between on-peak and off-peak is large, and selling surplus energy to the grid is either inconvenient or restricted for the EV owners. It turns out that price margins in different countries and areas vary quite a lot. Scandinavian countries have the reputation of being aggressive in adopting renewable energy and have taken a leading position in Smart Grid applications. Price variations there appear to be wider than in most other countries. Although some independent system operators allow to take electricity from individuals generated from their on roof solar panels, this is not yet a wide spread policy. Even so, considering the price they offer and the accessibility of the discharging equipments, we think giving energy directly to the facility who is in need will still be an interesting choice. The originality of this model lies in an analytical cost-minimizing discharging power, which provides a tradeoff between buying electricity from local utility companies at peak price, and paying relatively less to available EVs owners for purchasing surplus energy stored in their onboard batteries.

Finally, Chapter 5 concludes the thesis, by taking a step back on what we have done, describing what extensions can be investigated for future work, and what other research directions on the topic I think are worth investigating, although I did not have the opportunity to develop them further within the limited time span of my PhD.

Chapter 2

Charging Electric Vehicles in the Smart City: A Survey of Economy-driven Approaches

This chapter reviews the state-of-the-art models. Following a discussion of the technical environment of the charging problem, an introduction of the economic vocabulary and the desirable properties of an EV management scheme, we present and classify the charging schemes proposed in the literature to exploit the benefits and avoid undesirable outcomes from EVs entering the grid ecosystem. This review covers both *unidirectional charging* (energy only goes from the grid to the EV batteries) as well as *bidirectional energy trading* (the grid can also take energy from the on-board EV batteries). Finally, we summarize the communication aspects of the schemes (type of exchanges, volume and frequency), while providing a general classification of all models and approaches, stressing their limitations to highlight the need for further research in specific directions.

2.1 Techno-economic environment of EVs

2.1.1 Facilities for Electric Vehicle Charging

The term "Electric Vehicle" can refer to a broad range of technologies. Generally speaking, the extension of this concept covers all vehicles using electric motor(s) for propulsion, including road and rail vehicles, surface and underwater vessels, even electric aircrafts. Since this chapter concerns the charging management schemes and their impacts on the grid as well as on their owners from an economic perspective, we narrow the use of "Electric Vehicle" to mention a passenger car with a battery that needs refills of electricity from external sources.

8 Charging Electric Vehicles in the Smart City: A Survey of Economy-driven Approaches

Table 2.1 Charging powers and corresponding charging duration T under the SAE J1772 standard

	Level 1	Level 2	
AC	$\sim 1.9\text{kW}$	$\sim 19.2\text{kW}$	
	$T = 17\text{h}$	$T = 1.2\text{h}$	
	Level 1	Level 2	Level 3
DC	$\sim 36\text{kW}$	$\sim 90\text{kW}$	$\sim 240\text{kW}$
	$T < 1\text{h}$	$T < 20\text{min}$	$T < 10\text{min}$

Battery Electric Vehicles (BEV) and Plug-in Hybrid Electric Vehicles (PHEV) are two types of Plug-in Electric Vehicles (PEV); PHEVs differ from BEVs in that the former have a gasoline or diesel engine coexisting with an electric motor.

The economic mechanisms evoked in this chapter mainly differ in the way prices are defined, in the mobility models (if any) of EVs, in the time scale considered, and in the directions for power flows (from the grid to EVs, or both ways). The specificities of EVs—being BEVs or PHEVs—do not play a major role with regard to the economic aspects, and often schemes are proposed that can be indifferently applicable to each type of EV. Hence in this survey we present mechanisms without always specifying the EV type; we do it when it has an influence on the performance or applicability of the scheme.

Note that charging can be performed in diverse ways: EVs can use an on-board or off-board charger [104, 105], or use inductive charging while parked, thanks to Inductive Power Transmission (IPT) technology [100, 59]. The ultimate experience of IPT is charging while in motion, of which a prototype named On-Line Electric Vehicle (*OLEV*) has been designed in the Korea Advanced Institute of Science & Technology [88]. Those cases being rare, we can consider in this chapter that the charging is done via a physical connection.

To insure safe electricity delivery to an EV from the source, some particular EV Supply Equipment (EVSE) is needed, which puts tight constraints on how EVs can be recharged (or discharged if possible). The charging rate limit, battery capacity and AC/DC conversion efficiency vary among the different charging facilities and patterns. Two levels for AC charging and three levels for DC charging are approved by the SAE J1772 standard¹, as shown in Table 2.1, giving the estimated time T needed to fully recharge a battery with 25kWh usable pack size, starting from an initial State Of Charge (SOC) of 20%.

Note the the recharge duration is not simply the energy injected divided by the recharging power level, since roughly 70% of energy is injected at a Constant-Current, whereas the rest

¹<http://www.sae.org/smartgrid/chargingspeeds.pdf>

is obtained at a Constant-Voltage with the current diminishing to near zero. So the overall charging process is not accomplished at a constant power.

There are other charging standard proposals, which roughly correspond to the categories in Table 2.1. For example CHAdeMO² falls into DC Level 2, and Tesla Supercharger overlaps with DC Level 3.

EV battery is recharged through its inlet, which has a fixed shape thus needs a compatible connector (also known as coupler) to feed energy in. At the other end of the cable stretching out from the connector is a plug that only a matching socket can secure it. With regard to the connector/inlet pair and plug/socket pair, there are several world standards including but not limited to: SAE J1772 (known colloquially as the Yazaki connector) in Northern America; VDE-AR-E 2623-2-2 (known colloquially as the Mennekes connector) in Europe; EV Plug Alliance proposal (colloquially known as the Scame connector) in Italy and JEVS G105-1993 (known as the trade name CHAdeMO) in Japan. Albeit charging facility types are numerous, the International Electrotechnical Commission has managed to propose a worldwide charging mode standard. Four modes (1-4) are incorporated, specifying different levels of power and safety protocols between an EV and its charging station.

Figure 2.1 summarizes the main categories in which we can divide the charging stations. *Individual stations* capable of charging a single EV refer to those located in individual

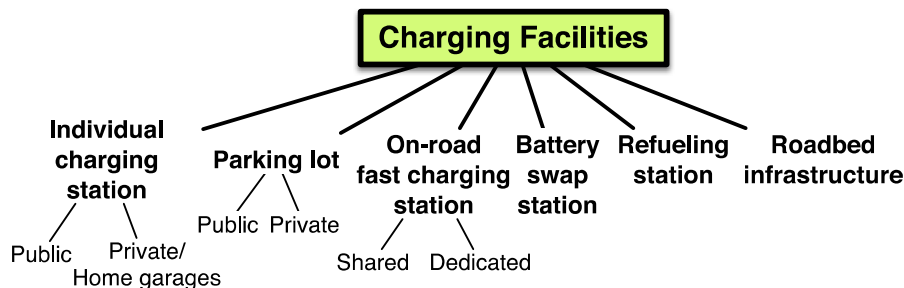

Fig. 2.1 Classification of the charging facilities for EVs

homes. *Parking lots* for EVs are yet to be developed to their full potential: they contain many individual EVSEs in physical proximity, belonging to the same entity. Public EV parkings are open to any EV, while private EV parkings provide access only to a specific fleet of EVs, e.g., owned by a single company. *On-road stations* are relays for EVs on long journeys, they can generally charge EVs at the highest possible rate to minimize the delay.

Roadbed infrastructures for EVs are based on IPT technology [69]. We already witness roadbed infrastructures that charge EVs at traffic intersections [73] or even without stop-

²<http://www.chademo.com>

ping [63]. As some EVs can use other types of energy sources, they can be replenished in *refueling station*, e.g. classical petrol stations, compressed air stations, or *battery-swapping stations*. Those charging solutions are out of the scope of this chapter due to the fact that they are either to some extent overlapping with refuelling problems for conventional cars, or still in experimental stage.

2.1.2 EVs – An enabler of the Smart Grid and a participant in Electricity markets

The Smart Grid is an evolution of the Power Grid which is expected to lead to a more efficient use of the grid resources, for example with a reduced Peak-to-Average power consumption ratio, faster repairs, self-healing and self-optimizing possibilities, and full integration of renewable energy sources.

Demand Response (DR) is the possibility for the power grid to alter the consumption patterns of end users; it can be implemented through various mechanisms. DR was initially used primarily toward large electricity consumers, but the transition to the Smart Grid provides a paradigm shift, where every load, no matter how small, can participate in a DR program. Energy Storage is a key technology for the integration of Renewable Energy Sources to the grid. Pumped-storage hydroelectricity (PSH) accounts for 99% of the world bulk storage capacity³, but there are physical limitations to the quantity of energy that these types of storage can hold.

EVs can both participate in DR and serve as Energy Storage facilities. They can respond to DR signals, such as price variations or direct control messages by modulating their power consumption, thus providing necessary flexibility to the grid operator. In some cases, EVs can also inject electricity back to the grid, thus serving as distributed energy sources. These can be leveraged by the network operators to improve renewable energy integration, to help self-healing or to provide ancillary services, so as to reduce the dependency on specialized equipments like diesel generators.

Figure 2.2 shows the major entities related to EV charging. A Transmission System Operator [27] (TSO, in Europe)—or in some contexts (in North America) an Independent System Operator [29] (ISO)—is responsible for operating, ensuring the maintenance of and, if necessary, developing the transmission system in a given area. Consumers equipped with energy sources that can deliver electricity to the distribution network are called prosumers.

In a classical electricity market, end-users have contracts with an electricity *retailer*, who buys the electricity produced by *generators*. The transaction can be brokered via a

³<http://www.economist.com/node/21548495>

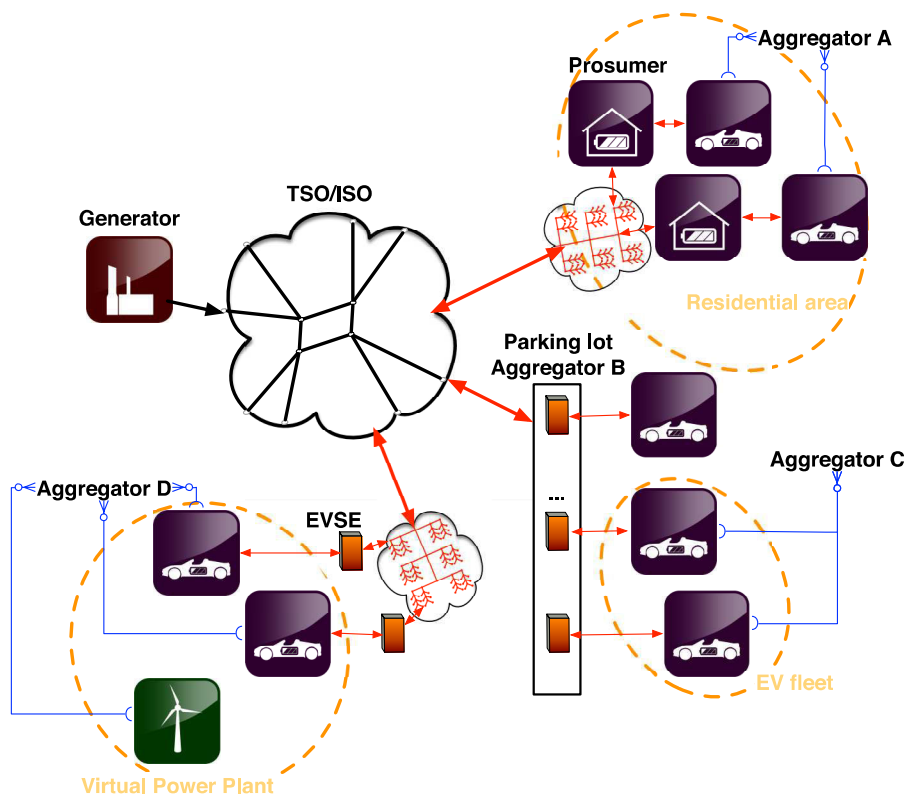

Fig. 2.2 Smart Grid Actors related to EV charging.

bilateral agreement or on a wholesale market. As the aggregated energy consumption of a big region can be known with satisfactory precision well in advance, contracts for buying the bulk of the necessary electricity can be done a year or a month ahead on the *futures market*. However, electricity consumption is heavily dependent on the weather, thus requires a significant amount of energy to be traded 24 hours in advance on the *day-ahead market*. Finally, fine adjustments can be made up to an hour ahead, which are traded on the *intra-day market*.

To match supply and demand for electricity instantaneously, ISO/TSOs operate ancillary services markets (generally using auctions) where they purchase ancillary services from generators and/or consumers who have the ability to vary their generation or consumption powers. ISO/TSOs also keep a close watch on the efficiency and effectiveness of those markets.

2.1.3 Dealing with self-interested actors

As elaborated before, EV charging involves many Smart Grid actors, whose objectives are not necessarily aligned: EV owners want to store enough energy as quickly as possible, and at the lowest cost, whatever the impact on other EVs or on generation costs; electricity producers and retailers are mainly driven by net benefits; while ISOs generally aim to ensure the most efficient use of resources and to maintain the supply-demand balance.

Therefore, when designing mechanisms to decide allocations and prices paid, one has to anticipate that the actors may try to play the system at their advantage. For example, if decisions are made based on signals from users such as their willingness-to-pay, the rules should ensure that reporting untruthful values does not bring any gain to the corresponding actors: such a property is called *incentive compatibility*.

More generally, an appropriate framework to study the interactions among several decision-makers is that of game theory [33]. A key notion is the Nash equilibrium, that is an outcome (a decision made by each actor) such that no actor can improve his individual payoff (utility) through an unilateral move. As stable situations, Nash equilibria are often considered to be the expected outcomes from interactions. Hence many of the mechanisms described in this chapter rely on that notion.

Nash equilibria can be attained when all actors have perfect knowledge of their opponents, their decision sets, and their preferences. But those strong (and often unrealistic) conditions are not necessary: in several cases the Nash equilibria can be reached or approached via some limited information exchanges among actors, or even without such exchanges but just by trying out decisions and *learning* the best ones [32].

To summarize the EV charging problem setting, we recall the relevant actors and set up the vocabulary as below:

- **EV:** A physical electric vehicle or its owner who will generally be assumed to have a *utility function* (or benefit), that represents his preferences. We will mostly use the classical *quasi-linear utility* model [72]: for a given price and energy allocation, the EV owner utility will be the difference between the owner's *willingness-to-pay* (or *valuation*, i.e., the value of energy for him, expressed in monetary units) and the price actually paid.
- **Aggregator:** An entity acting as an intermediary between the demand (retailers/users) and supply (generators, ISO/TSO or charging stations in some scenarios) sides of the electricity market [40]. When an aggregator is designed to be a representative of a group of EV owners, its utility will be the aggregated user utility. Otherwise, when it acts in its own interest as an intermediate energy supplier, the measure of utility will similarly be the difference between *revenues* (the monetary gains from their clients) and *costs*. That difference is often called *benefit*. The function of an aggregator sometimes overlaps with that of a widely acknowledged market player called Electro-mobility service provider. We adopt the former because the terms of Electro-mobility service provider encompasses also the provision of EVs—their manufacturing, financing and maintenance—which cannot be more important for the EV-ecosystem whereas the topic is beyond the scope of this thesis. We tend to use aggregator to lead more attention towards the side of smart grid and EVs' interaction with it.
- **EV charging station:** The owner and/or operator of one or several EVSEs in physical proximity, who allows EV recharging and/or discharging with the aim of maximizing revenue, but always under some physical constraints such as local transformer capacity and standard recharging power level.
- **ISO (or TSO):** An entity in charge of operating and maintaining the transmission system in a given area. It sets a constraint for the aggregated EV load according to the transformer capacity, and purchases ancillary services when necessary, in order to maintain the supply-demand balance.

The aggregated utility of all users (here, EVs) is called *user welfare*, and the aggregated utility of all suppliers (EV charging stations or aggregator) is the *supplier welfare*. *Social welfare* (=user welfare+supplier welfare) quantifies the global value of the system for the society, and is computed as the sum of all users' valuations minus all costs (production,

Table 2.2 Main questions related to the EV charging problem, and desirable properties

Question	Criteria	ExamplesIn this chapter
How to settle the conflict between EV demand and grid capacity?	A desirable management scheme achieves higher EV satisfaction and/or station revenue, meanwhile lowers the grid burden.	[34, 35, 84, 94, 71, 7, 82, 45, 68, 49, 48, 31] Section 2.2.1, 2.2.2
How to coordinate the time-flexible EV demand scattered in individual EVs to perform load shedding, peak shaving, and to smooth renewable energy output?	A well designed pricing policy can incentivize participants to shift their demands in a distributed manner, without intrusively taking full control over their charging processes.	[10, 74, 70, 36, 89, 13, 65, 95, 101, 14] Section 2.2.1, 2.2.2, 2.3.3
How could an EV owner reduce his/her electricity expenses by paying the time-of-use electricity price?	A satisfying charging program is flexible in order to respect EV owners' travel plans, and is robust to price uncertainty.	[20, 50, 66, 46, 67, 103] Section 2.3.1
How to dispatch ancillary service tasks as well as the associated revenue among EVs providing such services?	A good allocation satisfies some fairness properties in terms of actor utilities.	[83, 51, 52, 25, 91, 92, 99, 98, 37] Section 2.3.2
How to organize EV charging market between self-interested EV owners and revenue-pursuing charging stations?	A good mechanism should be incentive compatible and achieve high (near-optimal) user/supplier/social welfare.	[38, 39, 82, 45, 68, 26] Section 2.2.2

transportation, if any). Note that money exchanges do not appear in that measure, since they stay within the society.

To provide a guideline for future proposals, we list in Table 2.2 the main questions raised by EV charging, and summarize from our point of view, the criteria that make a good charging management scheme. Also, we indicate in which sections of this chapter those points are addressed.

2.2 Unidirectional charging mechanisms

In this section, we assume that energy can only go from the grid to EV batteries. Electricity is expensive to store and supply over the grid must match demand at all instants: hence it is not possible for the grid to simply produce in anticipation the power needed to satisfy the charging requests that will occur from possibly many EVs over some periods of time. Standby generation units can be swathed on, but incur high costs, hence this is not a satisfying solution either. Remark that the generation part is not the only limiting factor: transmission networks and transformer station limits constitute other bottlenecks. We therefore consider here the scenario where several EVs are plugged-in for recharging, but the available energy is not sufficient to feed them all (or producing extra energy incurs high costs), so the aggregator is responsible for allocating the scarce resource among the clients.

This section reviews the main economic approaches to manage the (unidirectional) charging of EVs. We first describe *static* approaches for energy sharing (where the objective and decisions are based on a snapshot of the system regardless of possible impacts of future variations), then extend the sharing problem to *dynamic* scenarios (where the uncertainty of future events is taken into account); we also consider the mobility aspects of EVs (involving the choice of locations to charge, and price/distance tradeoffs) and finally point out mechanisms based on *frequency regulation*.

2.2.1 Static unidirectional recharging

Sharing energy efficiently among users

This subsection is devoted to the energy allocation problem within one indivisible time slot, i.e., only the current demands are considered and there is no uncertainty considered about future events (variations in supply and/or demand). We start with topology-free models, where each EV's consumption is constrained by its charger and battery, then together with other EVs, jointly curbed by the supply (typically, from their common aggregator). Then we move on to topology based models, where the throughput of the transformers further narrows the feasible choices.

Sharing without topology-based constraints Consider a charging station with several plugged-in EVs demanding electricity. How should the station dispatch the scarce available energy among them? We suppose here that there is no discrimination among EVs caused by the topology of the (sub-)grid they are connected to. Energy supply is considered as a constant for models in [34, 35], and as a variable in [84, 94].

Galus and Andersson [34] consider a large amount of PHEVs connected to an energy hub which converts gas and electricity to cover a commercial area's heat and electricity needs. Hence the total energy available to PHEVs is the transferring limit of the hub, minus the commercial area's un-shiftable demand. Each PHEV is assumed to report truthfully to the aggregator an individual (utility) parameter describing its willingness-to-pay for one unit of energy, at every time instant. This value depends on the gap between the current SOC and its target, as well as the time left before its departure. The aggregator then dispatches the available power, based on those parameters collected from all plugged EVs, to maximize the total (declared) value of energy for PHEVs, generally feeding first the EVs with lower SOC and imminent departure. A strong assumption made here is that EV owners do not try to play the system by falsely declaring their utility parameters to obtain higher utilities. The authors extend their work by adding a network operator, in charge of a higher-level dispatch of electricity and gas over all the aggregators [35], thus the supply limit is simultaneously restricted to the capability of the hub and the electricity and gas fed-in to an aggregator by that network operator.

In contrast to [34] where energy supply is given as a constraint, Samadi *et al.* [84] let the aggregator decide the amount of electricity to sell in order to maximize social welfare, that is the aggregated benefit of all the self-interested users minus the generation cost. They propose a distributed iterative algorithm where the aggregator updates the unit energy price and each user responds by updating his load (to the utility-maximizing one under the present price) until convergence, at which point energy allocations become effective. Here again, no strategic behavior from users is assumed: they react myopically without integrating the fact that their utilities depend only on the converged outcome.

In Tushar *et al.*'s model [94], users are not only informed of the price, but also of the total consumption limit. Each user aims to maximize his utility function, while knowing that if total demand exceeds the consumption limit, then none will be allocated any electricity. This scenario is modeled as a Stackelberg game [79] (also known as leader-follower game), with the aggregator as the leader, setting prices so as to maximize revenue; and EVs as the followers—price-takers competing for resource through their demands. The leader sets the price first, then the followers send their demand to an intermediary manager, until the unique EV equilibrium for that price is reached. The total consumption is then sent to the leader, who updates the price to achieve a higher revenue; that process being repeated until the revenue is maximized.

Sharing with topology-based constraints The following models share the assumption that EVs are connected at the leaves of a tree-like distributed network. The objective of an allocation can be efficiency [71] or fairness [7].

Maillé and Tuffin [71] propose a solution to share resource among self-interested users over a tree structure, through an auction and with the objective of maximizing social welfare. The mechanism was initially defined for bandwidth sharing in telecommunication access networks, but is also applicable to energy: an EV can send several bids to the auctioneer, each with the form of a (unit_price, quantity) pair; the auctioneer then computes energy allocations and prices based on the bids submitted by all EVs. The number of pairs one EV can submit is chosen as a trade-off between efficiency and (communication and computational) complexity. The mechanism in [71] follows the principle of Vickrey-Clarke-Groves mechanisms [96, 19, 44]; it incentivizes truthful bidding for the users and guarantees efficient allocation—in the sense of user welfare maximizing, since no costs are assumed here.

Rosenberg and Keshav [7] aim at finding a proportionally fair [54] sharing of a fixed amount of energy among users. The algorithm consists in each link computing its congestion or *shadow price* [55], and transmitting downwards the total congestion price from the root of the tree (wherefrom energy is available) to users plugged at leaves; the latter then demand their utility-maximizing amount after receiving the price (assuming logarithmic utility functions). Such a method converges to the proportionally fair allocations. Note that users here are not aware of the links capacity limits, so their initial demands might exceed them before reaching convergence, an outcome not occurring in [94] where users sharing a link know its capacity and act to avoid outstripping it.

Example Now we illustrate some of those approaches via a simple example.

Consider an aggregator having to allocate energy to two users A and B with (non-decreasing) concave quadratic valuation functions θ (indicating their willingness-to-pay for energy) as expressed below:

$$\theta(x) = \begin{cases} -ax^2 + bx & x \leq \frac{b}{2a} \\ \frac{b^2}{4a} & x > \frac{b}{2a}, \end{cases} \quad (2.1)$$

where x is the allocated energy and a, b are user-specific parameters. Note that $\frac{b}{2a}$ is the maximum amount of energy that the user wants, i.e., giving him more than this value won't increase his valuation. Users A and B differ in their preferences: set $a_A = 0.5, a_B = 1$ (the respective values of parameter a for player A and B) and $b_A = b_B = 2$. The utility of each

player is therefore the difference between his valuation function, and the price he is charged (typically, px with p denoting the unit price).

The aggregator acts as a representative of the EVs in [34, 71], trying to maximize the aggregated user utility. Similarly, in [7] the aggregator has also a user-based objective, namely proportional fairness. In contrast, in [94, 84] he plays “against” EV users, trying to maximize his revenue by setting the unit price p . The supply constraint is a tight bound of C in [94], while in [84] it is part of the decision variables, the authors assume a cost of αC^2 and consider C to be optimized by the aggregator.

Table 2.3 shows the outcomes of those approaches for our example. Remark that welfare-oriented approaches [34] (and [71] if $C_2 \geq C_1$ for example) lead to the same allocations as the revenue-oriented ones [94, 84]. Those allocations correspond to demands at the *market price* (the unit price as which demand equals supply); indeed such allocations are efficient, but also allow the aggregator to extract the maximum surplus from users. Note however that the prices paid are different: with VCG-based schemes, users are charged below the market price, which can be interpreted as the cost for having them reveal truthfully their valuation (while this information-revealing aspect is not considered in [94, 84]).

For the models in [7, 71], that consider tree-like network topologies, we take in our example the simple topology of Figure 2.3, where C_1 and C_2 are capacity limits.

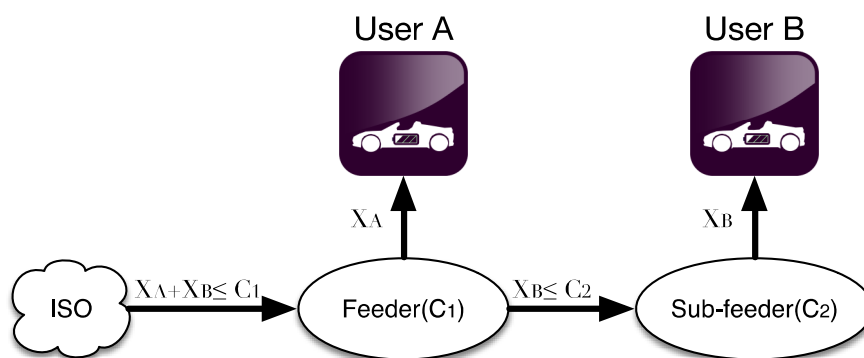

Fig. 2.3 Capacity constraints: a simple tree topology.

The objective in [7] is to achieve proportional fairness in this setting, or equivalently, to maximize $\log x_A + \log x_B$ under the capacity constraints. Hence energy is shared equally if the constraints allow it, as shown in Table 2.3.

Table 2.3 Comparing mechanisms proposed for static scenarios on a toy example

	Aggregator objective	Constraints	Allocation x_A	Allocation x_B
[34]	$\max_{x_A, x_B} \theta_A(x_A) + \theta_B(x_B)$	$x_A + x_B \leq C$	$\min\{1, \frac{2C}{3}\}$	$\min\{\frac{1}{2}, \frac{C}{3}\}$
[94]	$\max_p p(x_A + x_B)$	$x_A + x_B \leq C$	$\min\{1, \frac{2C}{3}\}$	$\min\{\frac{1}{2}, \frac{C}{3}\}$
[84]	$\max_{p, C} p(x_A + x_B) - \alpha C^2$	$x_A + x_B \leq C$	$\frac{2}{3}C = \frac{2}{2+3\alpha}$	$\frac{1}{3}C = \frac{1}{2+3\alpha}$
[71]	$\max_{x_A, x_B} \theta_A(x_A) + \theta_B(x_B)$	$x_A + x_B \leq C_1$ $x_B \leq C_2$	$\min\{1, \max\{\frac{2C_1}{3}, C_1 - \min\{\frac{1}{2}, C_2\}\}\}$	$\min\{\frac{1}{2}, \frac{C_1}{3}, C_2\}$
[7]	$\max_{x_A, x_B} \log x_A + \log x_B$	$x_A + x_B \leq C_1$ $x_B \leq C_2$	$C_1 - \min\{\frac{C_1}{2}, C_2\}$	$\min\{\frac{C_1}{2}, C_2\}$

Electricity sharing over several time slots

This subsection adds the dimension of time when scheduling EV charging. A given time interval is divided into multiple time slots. Unlike the previous subsection which treats as decision variables the amount of electricity to be allocated among EVs, in this subsection those variables now expand on time, becoming vectors, to exploit the time flexibility of allocation. Therefore the problem is to reshape the aggregated charging *load curve* under constraints on the total energy transferred. We start with models aiming at forming a flat load curve, then turn to those that can shape the load into an arbitrary curve.

Flat charging curves Time is discretized so a charging plan for an EV is a vector over slots, with the magnitudes representing the charging rates. This rate takes discrete values in [10, 14] and continuous values in [74].

Beaude, Lasaulce and Hennebel [10] slice one time period (typically one day) into several slots (e.g., of length 30 minutes), and users choose when to start recharging their EVs at a constant power level without interruption until reaching their target SOCs. In other words, the charging demand is a shiftable rectangle covering several slots. For the aggregator, a supply increase causes a cost increase, and the cost function is assumed to be continuously differentiable and strictly convex. This cost is directly transferred through prices to users, who are aware of this mechanism and want to choose the best charge starting slot(s) to minimize their individual costs.

Let us illustrate the scheme through a simple example. Suppose EV A (resp., B) needs a one-time-slot recharging at the power of c . They can choose between slot 1 and slot 2. Denote the consumption profile for A (resp., B) in time slots 1 and 2 with the vector $[x_A^1 \ x_A^2]$ (resp., $[x_B^1 \ x_B^2]$). For a specific time slot, the aggregated load can be $2c$, c , or zero depending on user

decisions, with respective costs to the aggregator $\text{Cost}(2c) > \text{Cost}(c) > \text{Cost}(0)$. This cost is handed down to the users in the form of unit prices $p(\text{Cost}(2c)) > p(\text{Cost}(c)) > p(\text{Cost}(0))$.

The game played among users is proved to be a potential game [76], hence having pure Nash equilibria. Not all those equilibria yield identical cost, but the authors prove that for an infinite number of cars the equilibrium is unique and optimal.

In the same vein, Mohsenian-Rad *et al.* [74] use this consumption-dependent electricity price to elicit users to voluntarily minimize the cost to the aggregator, and meanwhile reduce the peak-to-average ratio of the load curve. The aggregator sets a unit price linearly increasing in the consumption level, so that the price paid is quadratic in the consumption. Users have multiple independent appliances to manage, and the constraint of non-stopping recharging in [10] is relaxed, so higher flexibility is offered: the charging rate is variable as long as the total energy injected to one appliance meets the client's demand. When a day starts, each user first starts from a random hourly consumption schedule and broadcasts it to the rest of the community. Then, sequentially, users choose their cost-minimizing schedules based on those received from the others and their own daily needs. The authors prove that the process converges, to a unique equilibrium where the total charging cost is minimized. A desirable byproduct of minimizing the cost is that the peak-to-average ratio of the load curve is also significantly reduced: although the solutions of these two problems are not identical, data analyses suggest that they are close, since the lowest achievable peak-to-average is only 0.05% lower than that achieved by the cost-minimizing solution.

The convergence requires rounds of bi-directional communication between an EV and the aggregator. To accelerate the procedure and achieve real-time responds, Binetti *et al.* [14] propose to schedule one EV at a time, once it connects to the grid. First the aggregator anticipates its load curve for the following 24 hours, and lets the first arriving EV know about this profile upon arrival; then the EV owner, after a simple computation, decides when to start recharging its EV at a constant yet self-defined power level, without interruption. The computation complexity is low and can be easily adapted to the circumstance where EVs arrive in a batch. In [14] EV owners arrange their recharging with the aim of minimizing the objective function of the aggregator, which is a linear combination of the variance and peak of the aggregated load profile, thus users are assumed altruistic; but a more realistic approach should cover EV owner selfishness, hence an incentive problem: how to define prices so that selfish users behave in the best interest of the aggregator? We expect load-dependent prices to lead to situations where the aggregator cost is (at least approximately) minimized, as is done under other assumptions in [10, 74].

Following an arbitrary curve Merely flattening the aggregated charging consumption of EVs is not always desirable or sufficient, especially when EVs share the supply system with other consumers. To flatten the overall demand curve, the EV consumption should be adjusted according to the external un-shiftable loads. Following are examples of guiding EVs through the electricity price, so that their aggregated load follows a predefined curve.

Ma, Callaway and Hiskens [70] model the behavior of self-interested users as a noncooperative game, the objective of the charging control being *valley filling*, i.e., shifting EV demand to the valley hours of the non-EV load. A consumption-dependent electricity price (a linear function of the ratio of the real-time consumption to the generation capacity) elicits users to defer their charging processes toward the valley periods, where prices hit the bottom. To avoid oscillations in user behavior and ensure convergence, an extra fee is added to the electricity price as a penalty on deviation from the population average, so that users selfishly minimizing their costs converge to a Nash equilibrium, which happens to be the socially optimum outcome if all EVs have an identical charging deadline. By adopting a different form of penalty, Gan, Topcu and Low [36] prove the convergence to the optimum for EVs with different deadlines. Moreover, they extend the algorithm so that the aggregate load can follow any given profile, hence its application goes beyond valley filling.

When real-time electricity prices can reflect the congestion status, an EV would be contributing to valley-filling by simply following a cost-minimizing charging program. Franco, Rider and Romero [31] seek a daily charging dispatch that achieves cost minimization under hourly electricity prices. They consider a specific distribution network where each node brings a constraint about the consumption it can support. The aggregator solves the problem in a centralized manner, i.e., tries to postpone the shiftable EV loads to the time slots with lower prices, while respecting the constraints and satisfying EV demand. Similarly, Hu *et al.* [49] propose a centralized cost-minimizing control mechanism based on predicted hourly electricity prices, where the aggregator directly controls the charging of each plugged EV, whose daily travel plan and corresponding energy demand can be estimated day-ahead. The aggregators sharing a distribution grid respond to hourly congestion prices set by the ISO, by updating their previously optimized EV recharging schedules. After convergence, the ISO re-sets the price depending on its supply capacity, until the overall energy consumption scheduled of all the aggregators falls below this capacity. The authors recently extended this work in [48], to the case of a tree-like distribution network where EVs are plugged on the leaves.

Summary of Static unidirectional recharging

Table 2.4 summarizes the static approaches, differentiating them according to the type of economic model considered, the controller's objective, and the main model constraints. The first group ([34, 84, 94]) uses Stackelberg game models, with the aggregator being the leader and EVs the followers. The leader plays with the electricity price and followers adapt their consumption. This method can be used to achieve different objectives, such as user welfare and social welfare, in an iterative manner. When topology-based constraints are considered ([71, 7]), EVs might not be aware of the whole topology and/or constraints of each segment, but congestion information at each node is handed down in the form of electricity prices. This method can achieve proportional fairness among homogeneous cooperative users [7]. For heterogeneous self-interested users, each with a private utility function, the central controller can organize an auction and dispatch energy efficiently among bidders, respecting topology constraints [71].

All those charging schemes consider imposing consumption-dependent electricity prices to cost-sensitive users. While user demands are assumed elastic in schemes studying a single time slot, they are considered fixed for those designed for several time slots, the flexibility stemming from the repartition of consumption over time to meet demand constraints. That fixed-demand assumption is mathematically convenient (in particular, the optimal load curve is unique and computable), but it ignores the fact that EVs may benefit from alternative energy sources and therefore have flexible demand for grid power. So we encourage future research to consider demand flexibility in both time and volume. This complicates the analysis of the aggregator's task (to choose a load curve) and of the EV choices (among the different sources), but we believe it is worth studying.

One inherent difficulty in distributed systems is convergence. Although it is mathematically convenient to assume arbitrarily variable charging rates between slots, batteries actually prefer stable charging rates. This hinders the convergence to global optimum in atomic charging games, and results in optimality being only achievable for an infinite number of EVs [10]. Convergence can be guaranteed by modifying user choices (e.g., through penalties as in [36]), but this must translate into economic incentives by affecting utilities, hence comes with a cost.

2.2.2 Dynamic models

Dealing with uncertainties about future events

All the models described so far are *static*, in the sense that they consider a time interval (be it one time slot or several) where all the information needed to find the optimal power

Table 2.4 Economic approaches for static unidirectional recharging

Paper	Model	Aggregator objective	Constraints
[34]	Stackelberg game	User welfare	Fixed produced energy
[94]	Stackelberg game	Revenue	Fixed produced energy
[84]	Stackelberg game	Revenue minus costs	Quadratic production cost
[7]	Cooperation	Proportional fairness	Fixed produced energy Fixed transmission capacity
[71]	Auction	User welfare	Fixed produced energy Fixed transmission capacity
[10]	Potential game	Generation cost	Fixed charging rate per EV Non-Interruptible charging
[74]	Potential game	Peak-to-Average ratio	Fixed appliance consumption
[70]	Non-cooperative game	Energy cost	Fixed non-EV demand
[36]	Cooperation	Vally filling	Fixed non-EV demand

allocation is already available (prices, users, constraints, etc.). But this is not the case when actors have to commit for some future slots before all relevant input information is available. For example a user can optimize his current consumption based on the present price (e.g., [35]), while knowing future price variations would have enabled him to get an even better payoff; similarly, an EV owner informed of the future electricity price but unable to precisely predict its departure time can do no better than minimizing its *expected* electricity cost [75]. A robust optimization approach dealing with unknown future prices is taken by Conejo, Morales and Baringo in [20], the objective being to minimize the daily energy cost [11]. Other types of unknown information are brought by the clients yet to come, e.g., the quantity and elasticity of their demands. *Dynamically adapting algorithms* (also called online algorithms) anticipating and adapting to new inputs must hence be defined for such cross-slot optimization. We now turn our attention to such approaches developed in the literature.

A simple version of a dynamic algorithm consists in repeatedly applying static algorithms, namely the ones in previous subsections, each time some new information is available. This leads to allocations that are optimal if time slots are independent; but in the general case, things are more complicated, and make specifically designed dynamic algorithms necessary. Let us borrow an example from Gerding *et al.* [38] to illustrate that.

Example 1. Consider two EV clients: Carol's EV is going to stay plugged-in for 2 time slots, while David leaves at the end of the first time slot. Their marginal valuations of one unit of energy are claimed to be [\$10, \$4] for Carol, and [\$5] for David, as shown in Table 2.5. These values stand for the maximum amount a user is willing to pay for each unit of energy: Carol

Table 2.5 A dynamic problem setting

	Carol	David
Plug-in time slots	$T_C = \{1, 2\}$	$T_D = \{1\}$
Marginal willingness-to-pay	$v_C = [10, 4]$	$v_D = [5]$

would like to pay \$10 or less to buy the first unit and \$4 or less for the second, and one unit for \$5 or less is sufficient for David. Suppose we have one unit of energy available at each time slot, and that our goal is to maximize social welfare (i.e., the total user valuation for the allocated energy). If users only report their current willingness-to-pay but not their intended plug-in duration, treating the problem as static leads to allocating the current unit to the user who values it most. For our example, Carol would obtain the first time slot (having the highest valuation), and would have no competitor for the second time slot, hence obtaining it again, for a total user benefit of $\$10 + \$4 = \$14$. But this greedy allocation per slot is not optimal: from Table 2.5 we remark that allocating the first unit to David and the second to Carol yields a higher total benefit of $\$15 = \$5 + \$10$. To quantify the loss of value due to limited information, a common measure is the ratio of the objective value reached with the algorithm considered, over the optimum value that could have been reached, had all information been available. In our example, this efficiency measure equals $14/15$.

As evoked before, a possibility when facing new information is to relaunch the decision search (in a myopic way, in the sense that there is no attempt to account for future incoming information). Going back to Example 1, this method would achieve an efficiency of 1 if Carol and David truthfully report their plug-in duration and willingness-to-pay, i.e., reveal all the information in Table 2.5. But if a third user Edith, with marginal willingness-to-pay \$6, enters the system at the second time slot and leaves immediately after, that information would trigger an allocation update, giving the first-slot unit to Carol (if there is still a chance to do so) and the second one to Edith. This allocation will again need to be adjusted if more information arrives, e.g., saying that there will be two units of energy for sale at the second time slot. Such a method should yield higher welfare than repeating static algorithms per-slot without adjusting according to newly revealed information, but still does not guarantee to provide the best decisions from the available information (that includes, e.g., probability distributions for the expected future events).

We will henceforth call *dynamic settings*, situations where decisions must be made over time, and not all future information is available: clients dynamically enter and leave the system, there is uncertainty about the set of feasible decisions in the future [78], etc.

Finding efficient solutions for dynamic problems is already complicated, but things can be worse when facing self-interested actors who may be reluctant to reveal information or could strategically report it, as pointed out before. For the dynamic energy allocation problem, Gerding *et al.* [39] design a two-sided auction mechanism in which truthful reports (from the selling and buying parties) can be guaranteed by the mechanism in two specific cases (where sellers are myopic, or each buyer is interested in only one time slot). Otherwise, relaxing the requirement of truthfulness may lead to higher efficiency, by allowing the actors to strategize [39].

Note that very different models for user preferences are considered in the aforementioned references. We therefore believe there is a strong need to survey the current users' economic interests, as well as the potential users' expectations, to build reasonable models and validate them.

Mobility-based charging management models

Let us not forget that the primary function of EVs is transportation; this characteristic makes mobility an unavoidable aspect to consider for charging arrangement schemes; be it by simply considering parking periods, or by covering complex mobility plans of EV owners as is done here. First, we take the EV owner point of view when selecting a charging station, then the charging stations point of view through competition to attract users.

Charging reservation For EVs facing several options to get energy, guided reservation can reduce the charging delay [82, 45], and charging cost [68, 103].

Qin and Zhang [82] design a mechanism to recommend charging stations to EVs traveling in a transportation network, in order to minimize their overall queueing time before getting recharged. For each on-road EV, only the stations on the shortest path connecting its current location to its destination can be candidates, so none of them will cause any detour. Each on-road EV periodically sends a reservation request to all reachable stations on the remaining part of its journey; those stations estimate the waiting time for this EV, and the one with the shortest waiting time estimation is reserved. This reservation can be adjusted (through cancellation and re-scheduling) at the next round, to dynamically follow the optimal schedule. The authors prove a lower-bound of the waiting time, and simulations show that the proposed distributed algorithm achieves a performance close to that bound.

Unlike [82] where the personal information (location and destination) of each EV is revealed to all the potential stations, Guo *et al.* [45] allow the users to keep these information; even estimating the total time for charging at a specific station (the sum of driving time, waiting time and charging time) is performed by each EV. The estimation is based on the

situation of the EV itself and the information received from the power system control center, the intelligent transportation system center, and each charging station.

For an EV owner who is more sensitive to the energy cost than to the time consumed, time-dependent electricity pricing provides an opportunity to trade longer traveling and waiting times for cost saving. Liu, Wu and Long [68] schedule the charging jointly with the routing in that context. An algorithm is designed to find the path as well as the charging quantity at each station on it, so that the total electricity cost of the journey is minimized. Particularly for a taxi driver, Yang *et al.* [103] study the optimal charging problem for EV taxis with time-varying service incomes and charging costs. They aim at maximizing the long-term average profit of a driver under the constraint of the SOC (state-of-charge) dynamics of the EV battery. It is assumed that the expected revenue from one service time slot and the expected electricity price vary periodically. Those average values and their variation cycles can be learnt by the taxi driver from past experience. At each idle time slot (no passenger onboard), the taxi driver can decide whether to service or to recharge. The authors provide an algorithm and give a closed-form proof of its viability.

Station competition Charging stations compete for customers through prices [26], and may also try to learn the pattern of customers in order to achieve higher revenues [39].

Garzas and Granados [26] assume that all users (informed with the locations of the stations) first send charging requests to all reachable stations, who then broadcast their prices to the users. Finally, each user chooses the cheapest station among all accessible ones. Competition among stations is an oligopoly game [53] on prices, where revenues are proportional to prices and to market shares (the latter decreasing as price increases). The cost for producing energy is assumed to follow a convex function. Simulation results show that this pricing mechanism provides stations with higher utility than the equilibrium price of the Bertrand oligopoly game. Users benefit from the price information, saving maximumly 11.5% with respect to choosing the nearest station. Note that the energy prepared by a station may be below the demand from the actually arrived customers, but the authors claim that the probability of this occurring is very low since users sent requests to many stations *before* choosing where to recharge, so that stations are likely to over-provision energy. Stations can then use the possibly extra energy to serve customers coming without reservation.

The scheme in [39] described in Section 2.2.2 performs a dispatching of clients to separate stations, more specifically, each client is routed to a station where he is entitled with a unit of energy at a time slot convenient to him (a $\langle station, slot \rangle$ pair), through a two-sided auction organized by a central controller. EVs can make a reservation by reporting their willingness-to-pay matrix over all possible $\langle station, slot \rangle$ pairs to the controller, while each

station reports the costs of the units of energy it can provide. Upon receiving the reports from both sides, the central controller finds a $\langle station, slot \rangle$ pair maximizing the difference (if positive) between the user's willingness-to-pay of this pair and its cost claimed by the station.

Admitting that predicting EV mobility is hard, historical travel surveys can give statistical insights. Since the results on gasoline cars can be safely transplanted to EVs, data sets can be easily found in [3, 41]. Information on user mobility helps the charging stations to better price their energy and organize reservations. Our literature survey shows a very limited number of analytical results for economic models for EV charging encompassing mobility due to the complexity of the models, but the (numerical) results obtained so far suggest this direction has the potential to yield significant improvements.

The special case of (unidirectional) regulation service and wind-balancing

Load variation, in the sense of supply-demand balancing, has an effect which is equivalent to generation variation. So maneuverable EV charging can offer regulation, in the same way as generation units in conventional power grids. More precisely, when oversupply (resp., supply shortage) occurs, regulation down (resp., up) can be realized by raising up (resp., reducing) the recharging power of EVs. Of course, this implies that the penetration rate of EVs is sufficiently large for such scenarios to make sense: too few EVs would not provide much service, since their batteries would quickly be filled and/or the demand reduction they could offer would be insufficient. Note that with respect to the aforementioned scenarios, the purpose is no longer to play with the tradeoff between EVs' valuation for energy and generators' production costs, but to complete the task of opposing frequency deviation and maintaining a satisfactory frequency level. In this case, the commercial reward from providing frequency regulation (the most expensive ancillary service [60]) is potentially very attractive for EV owners. We devote a separate subsection to unidirectional regulation here, and address bidirectional regulation in Section 2.3.2.

Sortomme and El-Sharkawi [89] consider an aggregator using EVs to provide regulation services while recharging their batteries. Every time slot (typically, an hour), the aggregator chooses a preferred charging rate for each EV, the actual charging rate being subject to fluctuations around this value due to regulation. The aggregator revenues stem from EV owners (paying for charging their cars) and from the grid (paying for carrying out regulation services). The aggregator's purpose can be to maximize its profit or to reduce the average unit electricity price of users. For both purposes, the authors highlight the need for efficient optimization for the system to benefit both EVs and the aggregator, since simple heuristics lead to significantly poor performance.

Bessa *et al.* [13] also consider an aggregator recharging EVs while providing regulation services, and compare the revenue of providing only downward regulation with that of providing both downward and upward regulation. The conclusion is that two-sided regulation is economically more attractive when capacity payment (paid for keeping a certain regulation capacity plugged, i.e., standing by for being occasionally called upon) is offered, otherwise the uncertainty of the parameters—day-ahead wholesale prices, regulation price, vehicle mobility—plays greater roles, hence the importance of accurate prediction.

Conceptually, regulation is just another type of allocation problem, where the commodity is not electricity but a share of regulation. So algorithms in Section 2.2.1 should also work by replacing energy amounts with power increment or decrement amounts. However:

1. The regulation service asks for an immediate response (within seconds) and each cycle lasts for a short duration (a few minutes), which requires the algorithms to converge fast enough.
2. Costs for EVs need to be better understood. EVs are supposed to be energy-centric and price-sensitive—their main purpose is to reach a desirable SOC at minimum cost—, but providing regulation imposes extra costs due to the negative effects that rapid power changes have on batteries. Those effects are not directly reflected in EVs' energy valuation functions. Therefore, to dispatch regulation in the same manner as energy, power fluctuations need to be included into utility functions, together with the price and resulting SOC. We did not find representative models in this category for uni-directional regulation, which leaves room for research.
3. In practice, regulation payment is settled on an hourly basis (much larger than the operating cycle, which is a few minutes), and it is a prerequisite for the regulation provider to set aside a sufficiently large regulation capacity (e.g., 0.1MW) and maintain its reliable connection to the grid for at least one hour. Hence, if EVs cannot commit to stay plugged-in that long, their marginal contributions can not be readily obtained, and payment sharing becomes complicated. The Shapley value [87] can be applied in that case; we encourage further propositions based on revenue-sharing tools rather than resource allocation for the specific context of regulation.

Due to the unpredictability of the regulation signal, the models in Section 2.2.1 cannot be directly applied either, since they consist in partitioning a flexible load to track a given known profile. These features of the regulation service, and its high profitability, make it a specific allocation problem worth specific research effort.

By varying the charging rate, EVs can also help cope with the intermittency of wind generation, as shown by Leterme *et al.* [65]: wind farms can declare their next-day production

in the day-ahead market, based on predictions for generation and EV availability. Then at every time slot (e.g., of duration 15 minutes) of the next day, it is a stochastic optimization problem to decide the charging rate of the EVs, to minimize the current production mismatch plus the expected mismatch for the rest of the day.

2.3 Bidirectional energy trading

Bidirectional energy trading refers to the cases where EVs can not only buy electricity from the grid, but also sell it back thanks to the Vehicle-to-Grid (V2G) technology. This provides the grid operator with an economical way to balance demand and supply, relying on EV batteries as storage facilities or energy buffers. As evoked previously with unidirectional energy flows, here too the EV penetration must be sufficient, so that the contribution of EV batteries to the storage service be significant at the grid scale. In order to make the storage providing option attractive to self-interested EV owners, a reasonable portion of the benefit should be shared with them. One possibility of doing so is through bidirectional real-time pricing, i.e., setting prices for both energy directions. If user reactions to price signals follow some predictable patterns, then carefully designed price schemes can help leverage the great storage capacity scattered in individual EV batteries.

This section reviews the control mechanisms for bidirectional energy trading. The first subsection introduces models characterizing behaviors of individual users facing time-varying bidirectional electricity prices; then we turn our attention to schemes where EVs are treated as batteries (intermittently) available to support the grid.

2.3.1 Individual arbitrage

Bidirectional electricity pricing (i.e., one price for buying energy from the grid and another price for selling it back) offers EVs the opportunity to arbitrage, i.e., to buy electricity when prices are low and then wait for the grid to repurchase it back at higher prices. Note that the energy transmission and/or AC/DC conversion losses should then be considered. In order for an EV to get a higher arbitrage revenue, the bidirectional electricity prices play critical roles, together with the mobility of the EV. The literature provides two ways of analysis of this setting.

Hutson, Venayagamoorthy and Corzine [50] propose an algorithm to carry out energy trading between an EV and the grid, based on hourly market clearing price data from California ISO (CAISO)⁴. The algorithm uses Binary Particle Swarm Optimization to find

⁴<http://www.caiso.com/Pages/default.aspx>

most profitable buying and selling times throughout a day from the EV owner point of view, while guaranteeing a State-of-Charge (SOC) above requirements. The model assumes that the market clearing price is known in advance, a very strong assumption.

In the same vein, Liang *et al.* [66] consider a household using a PHEV for daily commute; the householder wants to minimize his energy cost by exchanging electricity with the grid throughout the day, knowing that the electricity price is the Time Of Use (TOU) price in Ontario⁵ as shown in Figure 2.4. The difficulty lies in the (hardly foreseeable) mobility of



Fig. 2.4 Ontario Electricity Time-of-use Price periods.

the user. Numerical results indicate that with an estimation of the statistics of the PHEV mobility and energy demand, the proposed scheme performs closely to a scheme with perfect knowledge of the PHEV mobility and energy demand information (efficiency is close to 1). This scheme can then be adjusted when congestion occurs among a group of households, e.g., their aggregated charging (discharging) rate exceeds the upper bound of the power system. This high-level adjustment will cause a deviation from the PHEVs' optimal plans, and a cost increase, so the authors further design an adjustment policy such that the power system constraints are satisfied and the incremental cost for PHEVs is minimized [67].

2.3.2 V2G for regulation services

Kempton and Letendre [56] proposed the first description of the key concepts of Vehicle to Grid (V2G). Their analysis shows that the passenger (combustion) vehicle fleet has ten times the mechanical power of all current American's electrical generation equipment combined, and is idle most of the time. So even with moderate penetration, EVs have the potential to participate in the power market and it is also attractive for the grid operators to let them do so. The authors then examine the possibility and profitability of selling EV energy to the

⁵<http://www.ontarioenergyboard.ca/OEB/Consumers/Electricity/Electricity+Prices>

grid. According to their estimations, the benefit to the grid exceeds the cost to the vehicle owners. But this is assuming EVs work as peak power plants, which is not only difficult for them due to their on-board storage limitations [57], but also not very financially attractive according to White and Zhang's analysis [97] or even not profitable at all when payment do not compensate the battery degradation [106]. So Kempton and Tomić [57] suggest *regulation* services as a more profitable power market, which better exploits the strengths of EVs: quick response time, low standby costs, and low capital cost per kW. A case study of fleets of EVs participating in ancillary services in four US regional regulation markets is provided in [93], suggesting that with a few exceptions when the annual market value of regulation was low, V2G power for regulation services is profitable.

In the European market, a simulation based on real data, done by Andersson *et al.* in [6], shows that the current German regulating power market would yield significantly higher profits to the PHEVs than the Swedish market. They provide a SWOT (Strength, Weaknesses, Opportunities and Threats) analysis of PHEVs as regulating power providers, based on which they portray an ideal regulating power market suited for PHEVs, featured by some key parameters. An ideal regulation market for EVs should provide high capacity payment, allow bidding regulation up and regulation down separately, and have a relatively small bulk bidding size (i.e., 1MW).

Considering how scattered and individually owned EVs can participate in the regulation market, Quinn, Zimmerle, and Bradley [83] stress the need for an aggregator, by comparing a centralized architecture (direct communication between EVs and the ISO) with an aggregative (tree-like) architecture—a 3-layer structure involving the ISO, aggregator(s) and EVs. The first reason is the relatively low reliability of an individual EV, i.e., the probability of staying plugged-in for a given duration: from 83.6% to 91.7% for a time duration of 1 hour, which is incomparable with conventional regulation providers such as natural gas turbines, which have a reliability of 98.89% [83]. Therefore an aggregator is needed to collect a fleet of EVs so that their reliability be compatible with the current regulation services system requirements. Beside reliability, capacity requirements also call for aggregators: the minimum contractible capacity set by the ISO (from 0.1MW to 10MW in current electricity markets) are indeed way too high for a single EV, due to the battery sizes and the limits of recharging/discharging equipments. The aggregator can submit bids to the ISO in the regulation service market, depending on the number (and state) of the EVs it manages. During regulation periods, each aggregator then receives a request from the ISO for a certain amount of power (positive or negative) below the contracted regulation capacity.

Admitting that aggregators are necessary for EVs to be accepted in power markets, the questions arise of how much regulation capacity an aggregator should bid for (normally a

bid consists of a capacity and a corresponding price, but we consider only capacity here) to the ISO depending on the number of EVs available and their expected departure times, and how to dispatch the allocated regulation burden among those EVs. Based on simulations, Kamboj, Decker and Kempton [51] recommend to dispatch regulation up (down) to EVs whose SOC are above (below) the average level of all. The suggested bidding is proportional to the available energy capacity (up and down, in kWh), divided by the regulation duration. A scaling parameter quantifying the aggregator degree of conservativeness, is used in the bidding strategy to account for the tradeoff between the revenue and the penalty for not meeting the requested power. The authors evaluate this strategy based on real price signal from PJM (Pennsylvania-New Jersey-Maryland Interconnection), the largest transmission operator in the world [52], and suggest to share the revenue among EVs according to the Shapley value [87], a policy with good incentive and fairness properties but computationally difficult to implement. The data shows that by providing regulation services for 15 hours a day, an EV can expect to yield one hundred dollars a month of revenues, given the current Regulation Market Clearing Prices.

Focusing on regulation dispatch among EVs, Escudero-Garzas, Garcia-Armada and Seco-Granados [25] compare several allocation schemes, assuming that the aggregator manages a (sufficiently large) group of EVs available for a known time period (i.e., no mobility is considered). Their first scheme maximizes social welfare, that is the total user payoff minus the cost (due to battery degradation), but this may result in a high dispersion among SOC after regulation. The mechanism is then improved by considering penalties for SOC approaching the boundaries of some acceptable zones. Maximizing this modified social welfare results in maintaining the variance level among EV SOC to the one of their arrival time. Additionally, the authors suggest a water-filling method (originally used in information theory to maximize the throughput over parallel channels with different channel capacity [21]): the variance among SOC keeps decreasing, reaching zero, but on the other hand the variance among user payoffs is larger than that after the social welfare maximizing scheme is applied. Another aggregator allocation scheme maximizing social welfare is designed by Sun, Dong, and Liang [91, 92]. They adopt a general Lyapunov optimization framework and develop a dynamic algorithm to maximize the expected user welfare over an infinite time horizon, which is proven to be asymptotically optimal and performs substantially better than a greedy algorithm optimizing the per-slot system performance.

But EVs are not solely regulation providers, they have individual travel plans. Specifically, consider an EV who wants to charge itself to a target SOC before a predetermined departure time, at minimum cost. Han, Han and Sezaki [46] suppose that this user has two choices for each plugged-in hour: recharging, or regulating. For the latter, he will be payed a price known

in advance for allowing the aggregator to charge or discharge his battery: the uncertainty for the user lies in the direction and amount of the regulation service, out of his control but affecting his outcome. The proposed solution consists in the user first making a utility-maximizing plan for the whole plugged-in time—assuming null regulation—where utility is the revenue from regulation service minus the charging cost and a punishment based on the discrepancy between the actual SOC on departure and the EV owner’s desire. Then, since the regulation causes unpredictable (bounded) fluctuations of the SOC, the user relaunches this algorithm again based on the current SOC (hence a static solution to a dynamic problem, as we pointed out in Subsection 2.2.2). This method is based on the empirical observation that the time average of regulation requests is almost zero [64], hence the adjustments from the initial plan remain small.

On the other hand, the aggregator between the ISO and EVs can be a retailer of regulation services, who first contracts with ISO, then outsources the service to EVs, by setting prices to sell/buy energy to/from EVs to carry out the service; EVs, based on their status and the prices offered by the aggregator, decide whether or not to participate and how much energy to provide or absorb. Wu, Mohsenian-Rad, and Huang model the relation between the aggregator and EVs as Stackelberg game when providing frequency regulation [99] and wind power compensation [98]. They design a pricing mechanism to elicit EVs to voluntarily carry out the services. Among the limitations, let us remark that users in [99, 98] are assumed homogenous, i.e., they have identical preferences. For heterogenous users, a pricing design is provided by Gao *et al.* [37]: heterogeneity lies in a willingness-to-pay parameter, indicating the users’ possibly negative unit value (in monetary unit per kWh) for (re)(dis)charging the battery. This parameter, compared to the price provided by the aggregator, determines the decision of each EV: upon receiving the regulation power request from the ISO, the aggregator calculates the price so that just enough power from the group of EVs is chosen, taking into account that users are self-interested and rational. The authors prove the existence of such an optimal price when the distribution of the user parameters follows a regular distribution [77]. If the aggregator knows this distribution, it can easily calculate the optimal price and broadcast it to users. Simulations show that the scheme leads to lower prices than [99], hence benefiting the aggregator. When the willingness-to-pay parameter distribution is unknown, the aggregator can implement a learning algorithm to fix the optimal price, using interactions with EVs.

2.3.3 V2G as storage for renewable energy

Wind farm and solar generation are vagary. This plays as a barrier for renewable energy to be widely and efficiently used. Indeed, the day-ahead market requires reliable production,

and mismatches between submitted bid and real-time injection are sanctioned. EVs, with their on-board batteries, can provide storage services through V2G technology, i.e., absorb the surplus and release it when necessary, to maintain a stable output level, or more specifically, to minimize the discrepancy between the real-time output and the day-ahead bidding. This can greatly help the development of wind energy according to Kempton and Tomić's calculations [58], suggesting that V2G could stabilize large-scale (one-half of US electricity) wind power with 3% of the fleet dedicated to regulation for wind, plus 8-38% of the fleet providing operating reserves or storage for wind. In terms of expenses, Budischak *et al.* [17] estimate that the electricity system can be powered 90% to 99.9% of the time entirely on renewable electricity, at costs comparable to today's, if we optimize the mix of generation and storage technologies including EV fleets.

To optimize generation and storage, one difficulty lies in providing incentives to attract enough EVs to temperately donate their batteries, and in designing schedules to make the best of them. Vasirani *et al.* [95] model a Virtual Power Plant (VPP) with EVs providing storage services, as shown in Figure 2.5, where the reward to individual EVs is not monetary, but consists in free electricity, proportional to the storage it provides to the VPP. The VPP

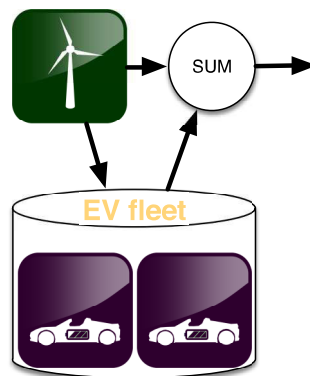

Fig. 2.5 A virtual power plant, with energy flows.

bids in the day-ahead market on how much energy it is going to inject every hour for the next day. These amounts are based on generation predictions, and take into account the storage system. During the next day, the VPP repeatedly searches for the optimal amount of energy to store in (or to withdraw from) EV batteries every hour, as the prediction gets more accurate over time. The feasibility of this approach is confirmed through a realistic case-study, using real wind power generation data, corresponding electricity market prices and EVs' characteristics.

Xie *et al.* [101] use a similar model to minimize the impact of wind farm production variations. They compare two settings: in the first one EVs cooperate with the wind farm

by allowing it to use their batteries as a buffer; in the second they just use their batteries to provide frequency regulation to the grid and make revenues, leaving the wind farm undergo the penalties inherent to production variations. Numerical results show that the penalty decrease imposed on the wind farm exceeds the decrease of regulation revenue received by the EVs, leaving a negotiation margin to benefit both sides.

2.4 Communication aspects

Before summarizing the economic properties of the mechanisms proposed in the literature, we first stress the importance of communication systems on their implementation. Information enables decision making and optimization, this section focuses on the content of information exchanges and their frequency.

2.4.1 Information exchanges

For models that involve two types of actors (i.e., where aggregators and stations are not distinguished and can be referred to as energy vendors), Table 2.6 presents the main information exchanges that are necessary to implement the schemes described before.

Table 2.6 Information exchanges for charging schemes with two types of actors (EV and energy sellers)

Ref.	EVs to Energy vendor	Energy vendor to EVs
[45]		Station availability, traffic, charging rate and location
[34]	Willingness-to-pay parameter	Energy allocation
[26]†	Charging request (multicast)	Price offers (multicast)
[71]	Bids (set of pairs <i>unit price, quantity</i>)	Energy allocation and price
[38, 39]	Willingness-to-pay vector/matrix	Energy allocation or reservation
[82, 68]	Travel plan: speed, consumption, route	Charging plan (energy, time and location)
[84, 94, 7]	*Energy demand	*Price
[10, 74, 70, 36]	*Energy demand vector over discretized time	*Pricing rule, exogenous load or aggregated load of competitors (this forms a penalty while EVs iterate)
[46]	Willingness to offer regulation (binary decision)	Capacity and energy prices
[37, 99]	Regulation amount (energy willing to buy/sell)	Regulation electricity price
[89, 13]	Energy demand, charging rate limits, flexibility	Direct control (for regulation)

Table 2.7 Information exchanges for charging schemes with a 3-layer system (the sequentiality of the exchanges differ among schemes)

Ref.	EVs to Aggregator	Aggregator to ISO (station‡)	ISO (station‡) to Aggregator	Aggregator to EVs
[35]	Willingness-to-pay	Total demand	Load reduction signal	Energy allocation
[39]‡	Willingness-to-pay	User dispatch	Cost matrix	Energy allocation
[65]	SOC	Nothing	Wind generation forecast	Charging power allocation
[25]	SOC, acceptable SOC inter-val, battery cost function	Regulation capacity	Regulation amount and prices	Regulation allocation
[91, 92]	Utility and cost functions, SOC and accumulated costs	Nothing	Regulation amount	Regulation allocation
[95, 101]	SOC, cost function	Nothing	generation information, electricity price and/or penalty price	Regulation allocation

Note that in [26] marked with a dagger, the energy vendors are charging stations competing on price to attract EVs; all other models consider a single aggregator as energy vendor, thus research on competition among energy sellers is not abundant. We also highlight that some mechanisms (marked with a star) involve a convergence phase, hence the need for repeated exchanges (with low latency to converge rapidly) before decisions can be made. Grayed cells indicate that regulation services are provided during the charging. References are ranked from the lightest communication burden to the heaviest one.

Some algorithms consider 3 “layers” of actors, i.e., EV-Aggregator-ISO or EV-Aggregator-Stations (shown with a double dagger), with the information exchanged shown in Table 2.8. The table does not include hardware-related information such as energy transfer efficiency or battery capacity, because they are not crucial for the economic performance of the schemes and often do not need frequent updating, hence have little impact on the communication system. Remark also that there can be a tradeoff between communicating and storing: for example in [92], the users’ accumulating costs can be either sent at every time slot, or recorded with a corresponding user ID. Finally, note that not only information transmission requires communication: so does information retrieval, such as environmental information (wind speed, temperature) that affect energy generation and its forecasting, and user travel record that helps predicting their mobility.

Table 2.8 Information exchanges for charging schemes with a 3-layer system (the sequentiality of the exchanges differ among schemes)

Ref.	EVs to Aggregator	Aggregator to ISO (station‡)	ISO (station‡) to Aggregator	Aggregator to EVs
[35]	Willingness-to-pay parameter	Total energy consumption	Load reduction signal if necessary	Energy allocation
[39]‡	Willingness-to-pay vector or matrix	User dispatch	Cost matrix	Energy allocation (reservation of a time slot at a station)
[65]	SOC	Nothing	Wind generation, and forecasting error probability distribution	Charging power allocation
[25]	SOC, acceptable SOC interval, battery cost function	Regulation capacity	Regulation signal (amount and prices)	Regulation allocation
[91, 92]	Utility and cost functions, SOC and accumulated costs	Nothing	Regulation signal (amount)	Regulation allocation
[95, 101]	SOC cost function	Nothing	generation information, electricity price and/or penalty price	Regulation allocation

Table 2.9 Time scale at which charging management operates

Seconds	Minutes	An hour	Day-ahead
[92, 99, 37] (Frequency regulation signal)	[45] (Supply's variation) [25, 91] (Regulation settlement every 5 min) [34, 35, 84, 39, 94, 71, 7, 26](The arrival of supply or EV)	[82] (Charging reservation updating) [38] (Willingness-to-pay of newly arrived EVs) [46, 89, 25] (Hourly settlement of frequency regulation) [65, 95] (Dynamic forecast of wind generation)	[74, 10, 70, 36, 68, 13] (A whole-day plan is made on priori knowledge of price and/or consumption)

2.4.2 Time granularity

Table 2.9 proposes a classification of the approaches presented before, according to the time scale at which they operate. Algorithms that update every few seconds are designed for immediate regulation allocation. Regulation requests are sent frequently thus allocations should be computed rapidly. On the other hand, systems reacting to events occurring over time such as supply variations or EV requests can be expected to run less frequently, say, once every few minutes on average. Algorithms running roughly every hour are evoked by the periodic revelation of new environment information such as renewable energy generation or regulation bidding. Long term planning such as day-ahead schedule is made upon precise forecast.

Note that decision updates are driven by new information, so the table also shows the frequency of information exchanges in those algorithms.

2.5 Classification of approaches and research challenges

We summarize in Table 2.10 the economic approaches described in Section A.2.2 and Section A.2.3. Firstly the models are classified into two categories, namely *static* and *dynamic* ones, defined in Subsection 2.2.2. Static models deal with an isolated time interval in which the performance is determined by actions taken during this time, and optimal actions can be found based on current state information. Contrarily, in a dynamic model where system information varies over time, actions should be updated based on state perturbations caused by such sequential revelations, leading to dynamic optimization methods [12, 81] as illustrated in Figure 2.6. As such, the static setting could be seen as a special case where the state is constant (but still depends on the action taken).

We then distinguish the ways decision-makers interact: *optimization-based approaches* correspond to the cases where one central controller imposes his decisions about allocations and/or prices, and is not influenced by any other actor's actions. Ideally, such a central controller has access to all the information needed, thus the management problem reduces to a classical optimization problem: the room for research is therefore

- for static models, in improving the optimization methods in terms of computational efficiency and/or approximation of the optimum;
- for dynamic models, in increasing the prediction accuracy and designing algorithms that are robust to unpredictable residuals.

In contrast, *game-theoretic approaches* refer to the cases where interactions among several rational actors are considered: even if resources are still dispatched by a central

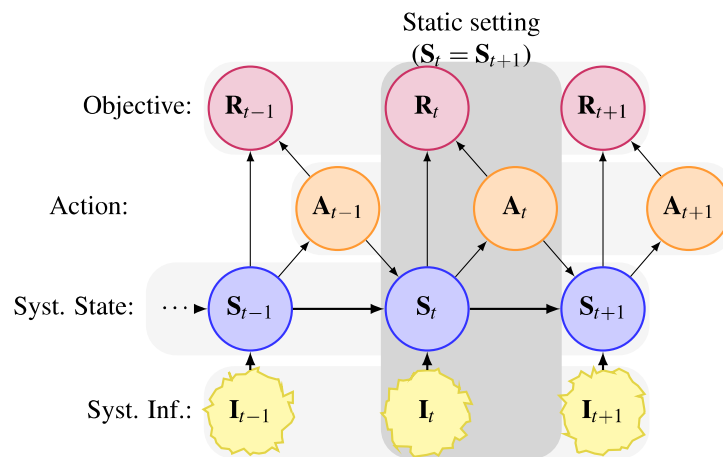

Fig. 2.6 Dynamic problem setting

controller, the allocations are affected by other actors' selfish behaviors (e.g., bids sent by EVs). Here, static problems already lead to complex models, and even for those approaches, analytical proofs of incentive-compatibility are only valid for some very specific utility functions. While the need seems to be for incentive compatible mechanisms in dynamic settings, designing such schemes is still an open research question in many cases. The difficulty often lies in the evolution of knowledge and beliefs (and thus actions) of actors over time, since the actions taken partly reveal one's private information; analyzing the equilibria of such games is extremely complex.

The last main criterion is related to the implementation type of the schemes: *revelation schemes* imply that actors have to exchange information (such as the willingness-to-pay), and can choose strategically what to reveal, hence the importance of properties such as incentive compatibility. On the opposite, *tâtonnement schemes* involve a convergence of allocations (and often prices) through iterative methods.

A key aspect in several tâtonnement-based mechanisms is the convergence of the method: here the limits we found are in the convergence speed (especially in dynamic settings: do prices and allocations have time to converge before the setting changes, say, before another EV arrives?). This is barely addressed in the literature, where in addition convergence is only established for some specific types of utility functions, which need validation.

The classification highlights the need for game-theoretic models in dynamic settings. While it is extremely difficult to design incentive-compatible schemes in dynamic settings, it seems capital to us to develop game-theoretic approaches, even if based on tâtonnement schemes.

Table 2.10 A classification of economic schemes for EV charging. A diamond mark indicates papers considering PHEVs (which can use fossil fuel) rather than BEVs (which can only use the electric energy stored in their battery).

	Optimization-based approaches		Game-theoretic approaches
Static	[35] [◇] Heuristic demand curtailment per slot	Revelation schemes	[34] [◇] Auction based on willingness-to-pay, incentive compatibility assumed
	[13, 31][50] [◇] [103] [◇] Optimization made on prediction of unknown future parameters	Tâtonnement schemes	[71] Auction based on willingness-to-pay, incentive compatibility proved
	[25] Fair allocation of regulation per slot		[36, 7, 84, 94, 74, 10, 49, 48], [70] [◇] Stackelberg game between aggregator and EVs, leader is not omniscient (i.e., unaware of user utility function)
Dynamic	[66] [◇] , [67] [◇] EV mobility is modeled as a Markov chain	Revelation schemes	[26] Oligopoly game among charging stations
	[89, 95, 101], [65] [◇] Forecast accuracies increase as time approaching	Tâtonnement schemes	[38] Incentive compatible for dynamically arriving clients.
	[82, 46, 14] Dynamically relaunch a static algorithm		[45] Dynamically relaunch a static algorithm
			[39, 37] Sellers learn users' willingness-to-pay dynamically

2.6 Summary

EVs, in addition to the prospect of being wholly driven by renewable energy, are not only energy-efficient but also cost-efficient [23], and emit less greenhouse gas than fossil-fuel based transportation. The main risk they incur comes from the negative impacts they may have on the grid, mostly caused by uncontrolled recharging superimposing on other loads, which exacerbates the grid aging. Coordinating recharging and/or discharging not only alleviates those negative effects, but can also help improve the grid by participating to services such as frequency regulation and energy storage for (intermittent) renewable energy generation. These opportunities can be realized in the Smart Grid realm, so EVs and Smart Grid are mutually reinforcing. From the EV owner's point of view, organized recharging and discharging offer the possibility to reduce energy costs or even generate profits.

This chapter surveys the charging managements schemes of the literature, with a focus on economy-driven mechanisms. The proposed models, often based on optimization and/or game-theory tools, range from the simple sharing of a given energy amount among several customers (a classical problem) to more complex settings covering aspects such as uncertainty about future events, user mobility constraints, charging station positions, and new grid services like regulation. While some interesting mechanisms have been proposed, and perform well on simulation scenarios, we observed a quite limited amount of analytical results due to the increasing complexity of the settings (large number of actors, specific constraints of distribution networks and EV batteries) and the economic constraints (nonalignment of actors' objectives). Hence we think that further research is needed to better understand the key principles to apply when designing charging management schemes.

The present survey highlights the potential of V2G technology to benefit both EV owners and the grid operator, but also the difficulty of distributing those gains to EV owners to incentivize them to cooperate with the grid operator. From the literature review, we witness that management of EV charging processes in smart grids has attracted researchers from diverse domains, and we envision more effort will be devoted to this topic. Several research perspectives are promising from our point of view. Firstly, we consider the trend is pointing at Microgrids [90], which are systems with multiple distributed generators and consumers that can switch between Island mode and connected mode: the presence of EVs is likely to increase the autonomy of such systems. Another research perspective regards the charging management of fleets of EVs, from a fleet owner perspective. For example, with the technology of driverless cars getting matured, driverless taxi fleet may emerge, offering new possibilities for charging (and service providing) management.

EV technology is an extremely fast-developing field. Technology innovations can reform charging management schemes, for example the roadbed infrastructure would enable charging

in motion, which would greatly reduce the reliance on battery capacity and change the understanding (and modeling) of “plug-in” time. Economic models for such scenarios are still to be defined.

Chapter 3

Charging station's behavior study while using flexible EV recharging to perform frequency regulation

Despite that EV recharging represents a considerable extra load on the grid, they, at the same time, offer new opportunities in terms of consumption flexibility. In this chapter, we use the recharging processes of EVs to provide regulation to the grid by varying the instantaneous recharging power. We provide an economic analysis of the incentives at play, including the EV owners point of view (longer recharging durations and impact on battery lifetime versus cheaper energy) and the station point of view (recharging revenues tradeoff with regulation gains).

In particular, Section 3.2 considers the scenario where a monopolistic recharging station (an aggregator, as we name it) is maximizing its average revenue, which partly comes from EV owners for recharging their batteries and the rest from grid operator for providing regulation. We analyze the range of regulation rewards (defined by the grid operator) such that offering a regulation-oriented recharging benefits both EV owners and the aggregator. Interestingly, we observe that under current market conditions in France, such a aggregator could offer 50% cheaper electricity to those regulation-friendly EV owners, and still be better off than offering only conventional constant-power recharging.

Section 3.3 models a non-cooperative game between two EV charging stations. One is a fixed-power charging station purchasing electricity from the grid at wholesale price and reselling the energy to EV owners at a higher retail price; the other is regulation-providing and varies the recharging power level of its clients to provide regulation services to the grid, so its profit comes from both EV owners (who buy energy) and the grid (which pays for regulation services). We analyze the competition among those charging providers, and

examine the performance at the equilibrium in terms of user welfare, station revenue and electricity prices. As expected, competing stations provide users with lower charging prices than a monopolistic provider would. Moreover, while competition benefits users, it also benefits the grid in that the amount of regulation services increases significantly with respect to the monopolistic case.

3.1 The features of EV-provided frequency regulation

In this section, we are going to address the question of why we turn to EVs when regulation is demanded, and how those recharging EVs are supposed to carry out such services.

3.1.1 The opportunity of EV providing regulation

Among the main difficulties of the penetration of EVs in the smart city is the associated energy equation: how can the power grid accommodate the corresponding demand [2]? And the question of economic incentives to elicit the most efficient use of resources needs also to be considered (refer to the state-of-the-art in Chapter 2 and references therein).

A key point to tackle these problems is to not merely consider EV recharging as conflicting with existing load and a threat to the sustainability of the power grid, but also as an enabler in the transition of the power grid to the so-called Smart Grid. This includes the provision of services such as: distributed energy sources, demand-response units, and regulation service providers, which is the concern of this chapter.

Previous work addressing this issue focuses on fairness issues among users in terms of final state-of-charge [25]; on the resulting long term user welfare [91, 92], or on incentivizing EV owners to contribute to regulation [99, 98]. Among the limitations, let us remark that users in [99, 98] are assumed homogenous, i.e., they have identical preferences. For heterogenous users, a pricing design is provided by Gao, Chen, Wang and Liu [37]: heterogeneity lies in a willingness-to-pay parameter for (re)(dis)charging the battery.

The aforementioned schemes all depend on the application of Vehicle to Grid (V2G) technology, which allows EV batteries to discharge energy not only to the car engines but also to all kinds of other electricity appliances. Among the concerns about this approach, one can ask whether users will be willing to trade their surplus energy for money, since the less energy left in the battery, the more range anxiety the driver would have. The energy delivery efficiency and its impact on battery sustainability are also of significant importance. A conservative means lies in offering regulation by modulating the power level during EV recharging. More precisely, when oversupply (resp., supply shortage) occurs, regulation

down (resp., up) can be realized by raising up (resp., reducing) the recharging power of EVs. This principle is adopted by Sortomme and El-Sharkawi [89] for maximizing revenue from EV owners (paying for recharging their cars) and from the grid (paying for carrying out regulation services). In the same vein, Leterme, Ruelens, Claessens, and Belmans [65] design an algorithm that manages a large EV fleet assisting a wind farm to maintain a stable output.

We take the option of recharging-based rather than V2G-based regulation, but unlike [89, 65], we entitle EV owners the freedom to decide whether to take part in regulating while recharging, after being informed of the stochasticity in the recharging power, or to recharge at a constant power level.

This leads to EV owners' concern over recharging time after giving their consent to provide regulation while recharging. Fortunately, according to a national household travel survey of the United States [61, 85], a passenger vehicle spends on average 75 minutes a day on journey, hence is parked most of the time. We assume this to remain true for EVs, i.e., the time they are available for recharging largely exceeds that the recharging process would actually take. So some EV drivers are willing to take advantage of the idle time by accepting longer recharging durations in return for cheaper energy.

In this section, the entity who is in charge of providing recharging services to EV users is called an aggregator, and manages both types of recharging.

3.1.2 Regulation mechanism

The aim of frequency control is to reduce the effect of frequency disturbance caused by imbalance between load and supply. Frequency control occurs over a variety of time scales which can be divided into three types, namely primary, secondary and tertiary control, with time granularity ranging from seconds, minutes to more than half an hour respectively [1]. We consider discretized time, and refer to the time frame of one regulation session as Δ (in hours). Typically we expect to have Δ within 0.1 (6 minutes) and 0.25 (15 minutes).

Periodically, the grid operator, buyer of the regulation service, sends a regulation request (assumed independent from one slot to the next) to the aggregator specifying its demand, which can be regulation-up, -down or -null. Upon receiving the signal, the aggregator sets the EV recharging power to be 0 kW¹, P_d kW, or P_n kW respectively: P_d is the maximum acceptable power level allowed by the EV supply equipment in the station, and P_n is the default recharging power ($0 \leq P_n \leq P_d$) defined by the aggregator itself, when no regulation is needed, namely regulation null. Note that this mechanism increases (decreases) the EV

¹We do not allow here EVs to deliver energy to the grid (the so-called vehicle-to-grid transfer).

consumption responding to regulation-down (-up). This counter-intuitive naming stems from conventional regulation services, where providers are *generation units* whereas the task is given to *consumers* here. For later convenience we will use the notation $x := \frac{P_n}{P_d}$, so that $x \in [0, 1]$.

Figure 3.1 compares the power profiles between recharging at full power P_d and recharging while reacting to regulation requests, as well as the energy accumulated in an EV battery. We denote by C_B the total energy requested by the EV, and by ρ_u (resp., ρ_d) the probability of occurrence of regulation up (resp., down).

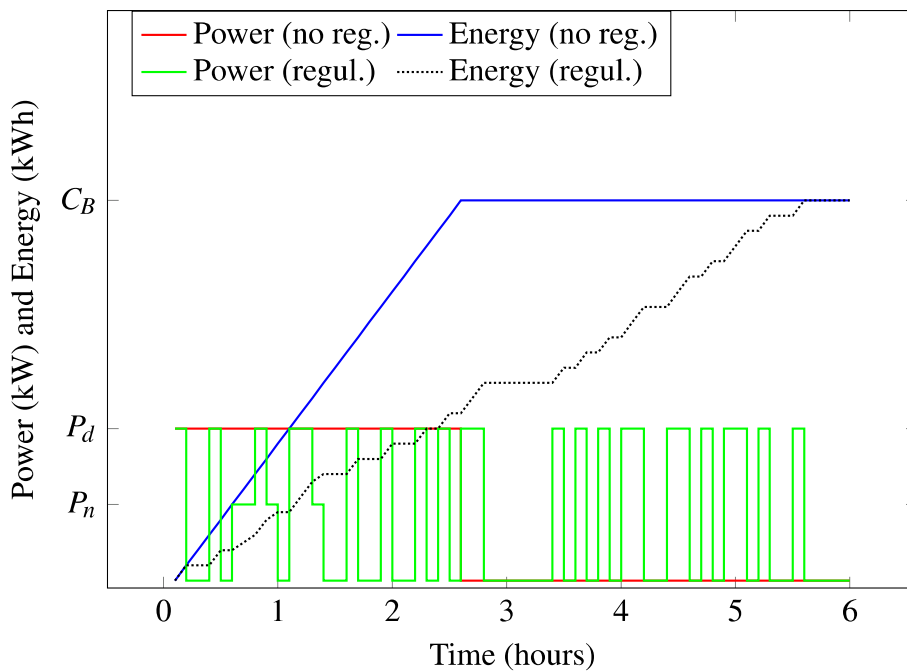

Fig. 3.1 Power and cumulated energy an EV obtained with and without regulation (simulation with $C_B = 50\text{kWh}$, $P_d = 20\text{kW}$, $P_n = 16\text{kW}$, $\Delta = 0.1\text{hour}$, $\rho_u = \rho_d = 0.45$)

There may be concerns that varying the recharging power for all EVs simultaneously and drastically following this “ping-pong” policy can lead to an oversupply of regulation, i.e., the aggregated increase or decrease in power is larger than that actually needed by the grid operator. This is hardly possible since in the scale of a grid operator, the disposable regulation capacity scattered in EVs is non-dominant if not negligible given the current penetration levels. For example data from RTE (Réseau de transport d’électricité), the biggest independent system operator in France, show that the regulation-down demand in 30 minutes² can easily go over 100 MWh, a quantity that could only be absorbed by at least

²<http://clients.rte-france.com/lang/fr/visiteurs/vie/mecanisme/jour/volume.jsp>

10 thousand EVs doing level 2 recharging³ (19.2kW) at the same time. Since the whole country has an EV population of 30 thousand, sharing 8600 public recharging facilities, the regulation oversupply problem is not of concern so far. But it can rapidly become one if EV penetration increases; nevertheless we expect that in this case, the incentives to provide regulation will be adjusted (regulation being rewarded less) so that market mechanisms will reduce supply. In addition, demand for regulation is likely to increase in the next future, with the development of renewable energy production which cannot be controlled like fossil-based electricity plants do: the overall supply-demand balance will be more difficult to maintain, hence a probable larger need for ancillary services such as regulation.

3.1.3 Monetary incentives

In return for providing regulation, the aggregator receives monetary recompenses, with respect to the wholesale price t . Since we assume that regulation requests are i.i.d random variables, the computation of their resulting recompenses can be simply resolved through calculation of the average gain per regulation slot. Unless otherwise mentioned, the following discussion is all limited to one slot, one EV.

Initially, before the regulation signal is revealed, the aggregator pays $tP_n\Delta$ to the grid operator, in order to preempt the energy it is supposed to recharge into its client's battery. In the case of "up" regulation, the aggregator is payed for reducing demand to 0. The incentive is denoted as a fraction $r_u \geq 1$ of the wholesale price: the aggregator thus receives an amount

$$tr_u(P_n - 0)\Delta = tr_uP_n\Delta.$$

In other words, the grid operator "re-buys" the energy at a unit price $r_ut \geq t$. As for regulation down, where EVs should consume more than planned, the grid operator offers a discount ratio of $r_d \geq 0$ on the normal price t , so that the aggregator buys the extra energy at a reduced price $(1 - r_d)t$, hence it only pays

$$t(1 - r_d)(P_d - P_n)\Delta.$$

Together with the probabilities of regulation-up (ρ_u) and down (ρ_d), the expected net revenue (possibly negative) over one regulation slot is:

$$E_\Delta = t(\rho_ur_uP_n - \rho_d(1 - r_d)(P_d - P_n) - P_n)\Delta. \quad (3.1)$$

³<http://www.sae.org/smartgrid/chargingspeeds.pdf>

To estimate the net remuneration brought by recharging one EV battery through regulation, we multiply the regulation revenue per slot, i.e., E_Δ in (3.1), by the average number of slots a regulating EV remains plugged-in before its battery is fully recharged, i.e., $C_B/(\bar{P}\Delta)$. To facilitate the writing we further divide the product, which has a unit of €, by the EV energy demand (C_B kWh), so that its final unit is €/kWh and has a form of

$$E_r := t(\rho_u r_u x - \rho_d(1 - r_d)(1 - x) - x) \frac{P_d}{\bar{P}}. \quad (3.2)$$

3.1.4 User preferences

We assume that each EV owner needs C_B kWh of energy, say, per day, and can possibly get it through

- simple recharging (*S-charging*): paying the aggregator at the price of T_s €/kWh with its battery being recharged at the maximum available power of P_d kW;

or through

- regulation recharging (*R-charging*): being imposed on a decreased unit price T_r €/kWh, meanwhile obliged to respond to regulation solicitations by varying its recharging power.

In case non of the options above favors the EV owner, he/she can choose

- no recharging (*no_charging*): to leave the system without paying anything or obtaining any energy.

Naturally, users are assumed to:

- prefer to recharge faster, i.e., at higher *average* power rate;
- and they are reluctant to *uncertainty* in the recharging power (and hence, in the recharging duration) caused by regulations. Additionally, batteries can be sensitive to power variations in the recharging process, another reason for EV owners to be reluctant to contribute to regulation.

Following these criteria, we define the user utility (willingness-to-pay minus price paid) for a recharging option as

$$U = \theta(\bar{P} - \gamma\delta(P)) - TC_B \quad (3.3)$$

where \bar{P} is the expected recharging power, and $\delta(P)$ its standard deviation. θ is user-specific: a type- θ user has a general sensitivity to power (including its variability) equal

to θ . We assume θ is exponentially distributed among EV owners and denote by $\bar{\theta}$ its mean. The parameter γ represents the reluctance toward power fluctuations, because of the unpredictability of the recharging duration and the possible damage to the battery. We assume γ is the same for all users, which rather favors the latter interpretation of γ being due to technical aspects. Interestingly, we may see an evolution of γ as the battery technology evolves, with γ getting smaller if batteries tend to be more robust to power variations.

If a client chooses *S-charging*, the power is a constant thus $\bar{P} = P_d$ and $\delta(P) = 0$; whereas in the perspective of *R-charging* clients:

$$\bar{P} = \rho_d P_d + \rho_n P_n \quad (3.4)$$

$$\delta(P) = \sqrt{\rho_u \bar{P}^2 + \rho_d (P_d - \bar{P})^2 + \rho_n (P_n - \bar{P})^2} \quad (3.5)$$

For notation simplicity, we write $P_A := \bar{P} - \gamma \delta(P)$, therefore P_A depends on the regulation signals probabilities (ρ_u, ρ_d), the default recharging power (P_n), and the user reluctance to variations (γ). We assume $P_A > 0$, to rule out the extreme case where user sensitivity to charging power variations is so high, that they will always decline the *R-charging* option no matter the price, unless being payed. In other words, taking energy in this way is a burden for the users rather than a benefit.

We assume users are rational, so they are supposed to make the choice that yields the highest utility. A pairwise comparison indicates that a type- θ user prefers:

- “*S-charging*” over “*no_charging*” if $\theta > \frac{T_s}{P_d} C_B$
- “*R-charging*” over “*no_charging*” if $\theta > \frac{T_r}{P_A} C_B$
- “*S-charging*” over “*R-charging*” if $\theta > \frac{T_s - T_r}{P_d - P_A} C_B$.

Figure 3.2 displays user utility for each of the three options, depending on their sensitivity parameter θ .

As a result, the proportions α_s and α_r of EV owners choosing *S-charging* or *R-charging* respectively, can be computed as functions of P_d , P_A and prices.

Table 3.1 summarizes the notations used in our model.

3.1.5 Recap

This section describes how could EVs provide frequency regulation while their batteries being recharged, and how much monetary remuneration they earn from this. Considering elastic user satisfaction towards this option, we assume each EV owner is assigned with a specific

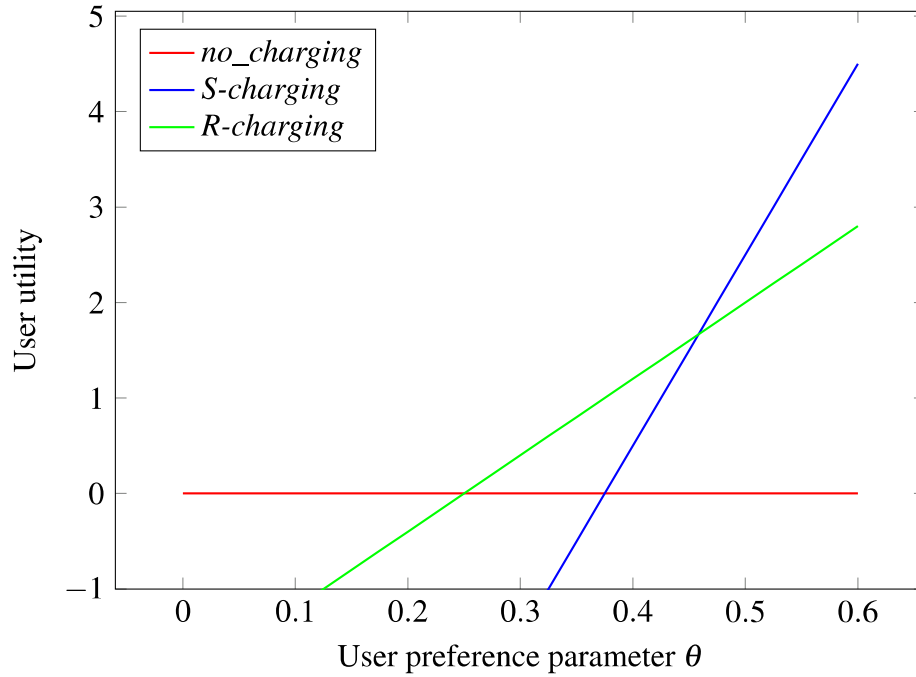

Fig. 3.2 User utility for the three charging options ($C_B = 50$, $P_d = 20$, $P_A = 8$, $T_s = 0.15$, $T_r = 0.04$): the best choice depends on the user sensitivity θ

Table 3.1 Model notations

t	unit price of energy paid by stations (unit: €/kWh)
r_u	remuneration ratio for regulation-up (no unit)
r_d	discount ratio for regulation-down (no unit)
ρ_u (resp., ρ_d)	probability of an “up” (resp., “down”) regulation signal
C_B	average energy recharged per EV per day
θ	user sensitivity to recharging power (including variability)
$\bar{\theta}$	average value of θ among users
γ	user reluctance to power variation
P_n (resp., P_d)	default (resp., “regulation-down”) recharging power
x	$\frac{P_n}{P_d}$
\bar{P}	$\rho_d P_d + (1 - \rho_u - \rho_d) P_n$
$\delta(P)$	$\frac{\sqrt{\rho_u \bar{P}^2 + \rho_d (P_d - \bar{P})^2 + (1 - \rho_u - \rho_d) (P_n - \bar{P})^2}}{\bar{P} - \gamma \delta(P)}$ (> 0)
$P_A(x)$, or P_A	$\bar{P} - \gamma \delta(P)$ (> 0)
α_r (resp., α_s)	probability of an EV owner choosing <i>R-charging</i> (resp., <i>S-charging</i>)
T_r (resp., T_s)	unit price of electricity for <i>R-charging</i> (resp., <i>S-charging</i>) clients

power sensitivity parameter, which determines whether he prefers *R-charging*, *S-charging*, or finds non of them appealing. The regulation mechanism, incentive composition and user preference presented here provides the background for the following sections in this chapter.

3.2 Monopolistic aggregator scenario

In this section, we will introduce a recharging aggregator. Being aware of the regulation mechanism and remuneration, as well as users' reactions, it decide whether to offer both recharging options namely *R-charging* together with *S-charging*, or merely the *S-charging* one. We are interested in the pricing strategy that suites this aggregator and the condition when *R-charging* worth being offered.

3.2.1 Aggregator strategic decisions

Initially, the aggregator's freedom is limited to choosing a recharging price and a recharging power. Since users tend to prefer higher powers, we simply assume that the aggregator offers the highest possible power, i.e., the power that we denoted by P_d and which is defined by the physical limitations of the power supply chain. When the aggregator additionally offers the possibility to recharge while contributing to the regulation service, it has to select separate unit prices: T_s for *S-charging* and T_r for *R-charging*. Also, the aggregator would have to choose the default charging power P_n , at which to charge the latter EVs when no regulation signal is received.

We compare two situations, with each time a revenue-maximizing aggregator:

- in an “initial (*S-charging* solely)” setting, the aggregator sets a recharging price and EVs are recharged at the maximum power;
- in a “two-options (*S-charging* plus *R-charging*)” setting, the aggregator additionally offers EVs the choice to recharge at a lower price, in exchange for the use of the recharging process to provide regulation to the grid, which we refer to as *R-charging*.

Note that in both settings, the EV owners are free to choose none of the option(s) the aggregator offered, i.e., an alternative of *no_charging* is always available.

Taking the point of view of the aggregator, we are now interested in optimizing the decision parameters to maximize its revenue. Using the classical *backward induction* method from game theory [79]⁴, we compute revenue-maximizing parameters based on anticipations

⁴we indeed have a leader-follower game, with the aggregator as the leader and users as followers

of user reactions to them. Then we investigate the viability of the *two-options* scenario, together with its impact in terms of user welfare and social welfare. We give analytical thresholds on regulation prices (r_d and r_u) above which strictly higher revenue is guaranteed for the aggregator by offering both recharging options rather than only *S-charging*.

3.2.2 Aggregator revenue

We know that users make decisions based on the electricity prices and recharging powers, as elaborated in Section 3.1.4. Their choices in turn determine the aggregator revenue.

- In the *initial* recharging scenario, EV owners make choices (to recharge or not) through comparing their sensitivity parameter and the electricity price. From our assumption of θ being exponentially distributed, we have the a proportion of α_{s0} users that would like to charge at the price of T_s and the resulting average aggregator revenue R_{s0} :

$$\alpha_{s0} = \exp\left(-\frac{T_s}{P_d \bar{\theta}} C_B\right) \quad (3.6)$$

$$R_{s0} = \exp\left(-\frac{T_s}{P_d \bar{\theta}} C_B\right) (T_s - t) C_B \quad (3.7)$$

- In the *two-options* scenario, based on different price combinations of T_r and T_s , we have the following possibilities:

1. If $\frac{T_r}{P_A} < \frac{T_s}{P_d}$ then $\frac{T_r}{P_A} < \frac{T_s}{P_d} < \frac{T_s - T_r}{P_d - P_A}$, so a user would chose *no_charging*, *R-charging*, or *S-charging* when his θ falls into the intervals $(0, \frac{T_r}{P_A} C_B)$, $(\frac{T_r}{P_A} C_B, \frac{T_s - T_r}{P_d - P_A} C_B)$ or $(\frac{T_s - T_r}{P_d - P_A} C_B, +\infty)$, respectively, the limit cases having probability zero. In this case:

$$\alpha_r = \exp\left(-\frac{T_r C_B}{P_A \bar{\theta}}\right) - \exp\left(-\frac{(T_s - T_r) C_B}{(P_d - P_A) \bar{\theta}}\right) \quad (3.8)$$

$$\alpha_s = \exp\left(-\frac{(T_s - T_r) C_B}{(P_d - P_A) \bar{\theta}}\right) \quad (3.9)$$

2. If $\frac{T_s}{P_d} \leq \frac{T_r}{P_A}$, then $\frac{T_s - T_r}{P_d - P_A} \leq \frac{T_s}{P_d} \leq \frac{T_r}{P_A}$. A θ -type user then selects *S-charging* if $\theta > \frac{T_s}{P_d} C_B$ and *no_charging* otherwise. Note that the *R-charging* option is never chosen, which means:

$$\alpha_r = 0 \quad (3.10)$$

$$\alpha_s = \exp\left(-\frac{T_s}{P_d \bar{\theta}} C_B\right) \quad (3.11)$$

The average aggregator revenue can be computed by:

$$R = \begin{cases} C_B \left(\exp\left(-\frac{T_r C_B}{P_A \bar{\theta}}\right) (T_r + E_r) + \exp\left(-\frac{(T_s - T_r) C_B}{(P_d - P_A) \bar{\theta}}\right) (T_s - t - T_r - E_r) \right) & \text{if } \frac{T_r}{P_A} < \frac{T_s}{P_d} \quad (3.12a) \\ \exp\left(-\frac{T_s}{P_d \bar{\theta}}\right) C_B (T_s - t) C_B & \text{otherwise} \quad (3.12b) \end{cases}$$

Aggregator's profit in the *initial* scenario as a function of *S-charging* electricity price T_s is illustrated in Figure 3.3.

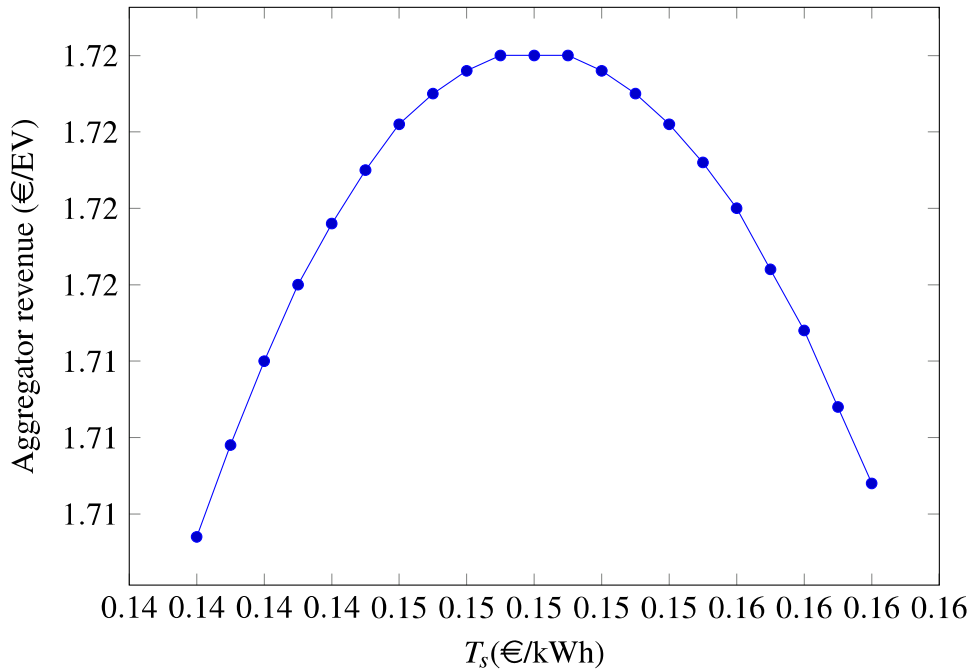

Fig. 3.3 Aggregator revenue as a function of T_s ($t = 0.03$, $C_B = 50kWh$, $\bar{\theta} = 0.3$).

The *two-options* scenario adds a dimension of T_r , thus the possibility of obtaining higher aggregator revenue, as presented in Figure 3.4 and 3.5. Since $\alpha_{s0} = \alpha_s$ when $\frac{T_r}{P_A} > \frac{T_s}{P_d}$, revenues from the two scenarios overlap in that region. Note that it is not always the case that *two-options* yields higher revenue, in the following two subsection, we are going to deal with the question of when does *two-options* proposal achieves the revenue maxima and wether it is preferable over the *initial* case.

3.2.3 Maximizing the aggregator revenue

To avoid exhaustive search for the revenue-maximizing prices, we try to find analytical solutions for them. Evidently, aggregator revenue as well as revenue-maximizing prices all

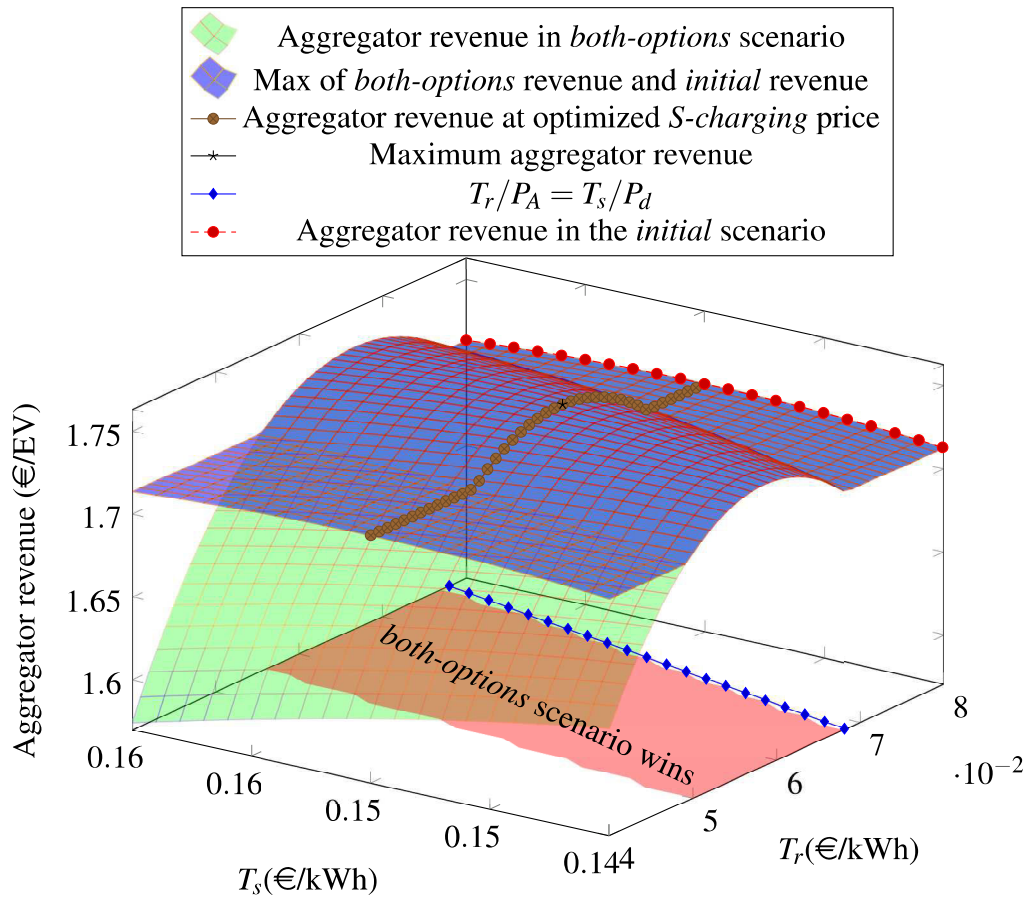

Fig. 3.4 Aggregator revenue as a function of T_r and T_s ($t = 0.03$, $r_d = 0.6$, $r_u = 2.0$, $C_B = 50kWh$, $\rho_d = 0.48$, $\rho_u = 0.48$, $\gamma = 0.05$, $\bar{\theta} = 0.3$, $x = 0.8$).

depend on x . Simply comparing Figure 3.5 with Figure 3.4 can give us an idea on how the effects could be.

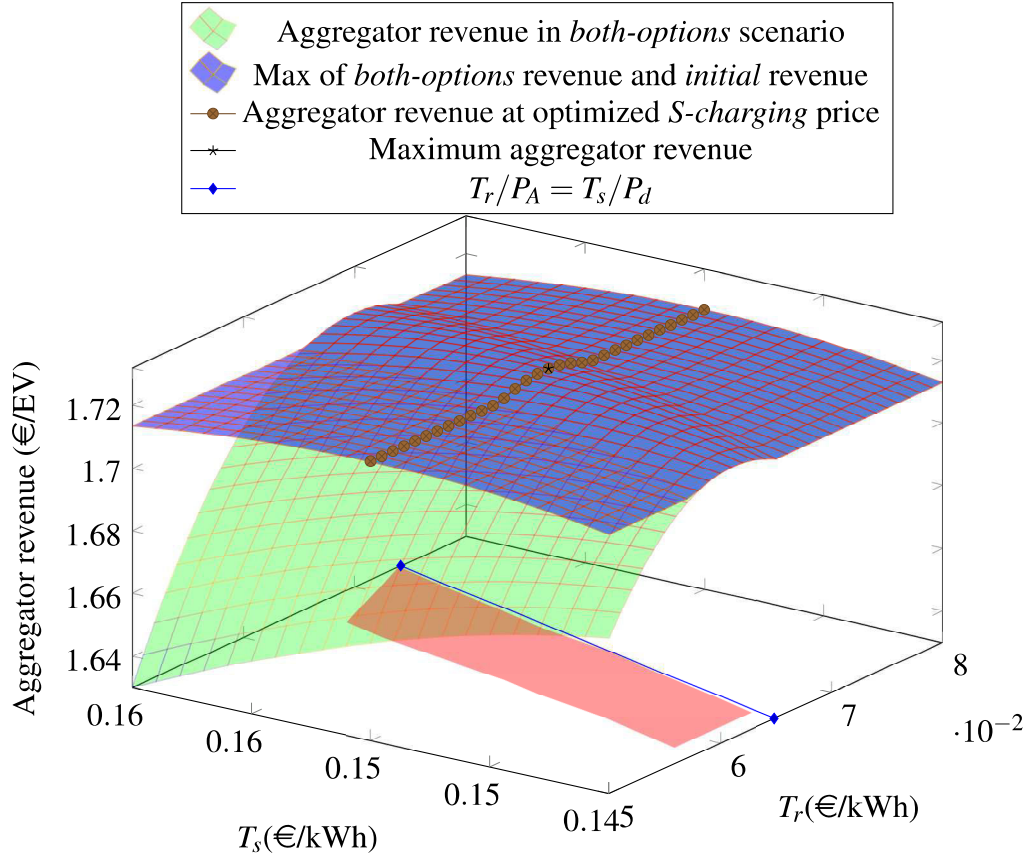

Fig. 3.5 Aggregator revenue as a function of T_r and T_s ($t = 0.03$, $r_d = 0.6$, $r_u = 2.0$, $C_B = 50kWh$, $\rho_d = 0.48$, $\rho_u = 0.48$, $\gamma = 0.05$, $\bar{\theta} = 0.3$, $x = 0.2$).

We start by supposing a fixed x in the following reasoning, and then search for the optimal x after that.

Optimal prices

To fairly compare the two settings, i.e., *two-options* vs. *initial*, we need to find for each of them the revenue-maximizing prices.

- Retrospecting the *initial* case revenue R_{s0} in (3.6), we find the first-order-condition gives an extreme-achieving price as:

$$T_s^M = t + \frac{P_d \bar{\theta}}{C_B}$$

Following examination of the concavity ensures that this is the revenue-maximizing price.

$$\frac{d^2 R_{s0}}{dT_s^2} \Big|_{T_s^M} = -\frac{C_B}{P_d \bar{\theta}} \exp\left(-1 - \frac{tC_B}{P_d \bar{\theta}}\right) < 0 \quad (3.13)$$

Accordingly, the optimized revenue R_{s0}^M is

$$R_{s0}^M = \exp\left(-1 - \frac{tC_B}{P_d \bar{\theta}}\right) P_d. \quad (3.14)$$

- The form of the revenue in (3.12) suggests that it is differentiable when $\frac{T_r}{P_A} < \frac{T_s}{P_d}$, thus provides us a pair of candidates for the optimal prices:

$$T_s^M = t + \frac{P_d \bar{\theta}}{C_B} \quad (3.15)$$

$$T_r^M = \frac{P_A \bar{\theta}}{C_B} - E_r \quad (3.16)$$

from $\frac{\partial R}{\partial T_s} = 0$ and $\frac{\partial R}{\partial T_r} = 0$. Moreover, after checking the second order partial derivatives, we have:

$$\frac{\partial^2 R}{\partial T_s^2} \Big|_{T_s^M, T_r^M} = -\frac{C_B}{(P_d - P_A) \bar{\theta}} \exp\left(-\frac{(T_s - T_r)C_B}{(P_d - P_A) \bar{\theta}}\right) < 0 \quad (3.17)$$

$$\begin{aligned} \frac{\partial^2 R}{\partial T_r^2} \Big|_{T_s^M, T_r^M} &= -3\frac{C_B}{P_A \bar{\theta}} \exp\left(-\frac{T_r C_B}{P_A \bar{\theta}}\right) \\ &\quad - \frac{C_B}{(P_d - P_A) \bar{\theta}} \exp\left(-\frac{(T_s - T_r)C_B}{(P_d - P_A) \bar{\theta}}\right) < 0 \end{aligned} \quad (3.18)$$

$$\frac{\partial^2 R}{\partial T_s \partial T_r} \Big|_{T_s^M, T_r^M} = \frac{C_B}{(P_d - P_A) \bar{\theta}} \exp\left(-\frac{(T_s - T_r)C_B}{(P_d - P_A) \bar{\theta}}\right) \quad (3.19)$$

$$= \frac{\partial^2 R}{\partial T_r \partial T_s} \Big|_{T_s^M, T_r^M} \quad (3.20)$$

$$\begin{aligned} \frac{\partial^2 R}{\partial T_s^2} \Big|_{T_s^M, T_r^M} \frac{\partial^2 R}{\partial T_r^2} \Big|_{T_s^M, T_r^M} - \frac{\partial^2 R}{\partial T_s \partial T_r} \Big|_{T_s^M, T_r^M} \\ = \frac{3C_B^2}{P_A(P_d - P_A) \bar{\theta}} \exp\left(-\frac{C_B}{\bar{\theta}} \left(\frac{T_r}{P_A} - \frac{T_s - T_r}{P_d - P_A}\right)\right) > 0 \end{aligned} \quad (3.21)$$

So the Hessian matrix:

$$\begin{bmatrix} \frac{\partial^2 R}{\partial T_r^2} & \frac{\partial^2 R}{\partial T_r \partial T_s} \\ \frac{\partial^2 R}{\partial T_s \partial T_r} & \frac{\partial^2 R}{\partial T_s^2} \end{bmatrix}$$

is symmetric and negative definite, thus the revenue achieves its maximum at T_s^M and T_r^M [16]. This optimized revenue is

$$R^M = \exp\left(-1 + \frac{E_r C_B}{P_A \bar{\theta}}\right) P_A + \exp\left(-1 - \frac{(t + E_r) C_B}{(P_d - P_A) \bar{\theta}}\right) (P_d - P_A) \quad (3.22)$$

Although the price pair T_s^M and T_r^M guarantees to achieve maximum revenue for the *two-options* setting, we still wonder whether the maximized revenue is strictly superior to the revenue when *R-charging* is not offered in the first place, namely, the *initial* scenario. To answer this question, a comparison is needed between the maximum revenue in the *two-options* case R^M in (3.22) and that R_{s0}^M in (3.14) yielded by the *initial* scenario:

$$R^M - R_{s0} = \frac{\bar{\theta}}{e} \left(P_A \exp\left(\frac{E_r C_B}{P_A \bar{\theta}}\right) + (P_d - P_A) \exp\left(-\frac{(t + E_r) C_B}{(P_d - P_A) \bar{\theta}}\right) - P_d \exp\left(\frac{-t C_B}{P_d \bar{\theta}}\right) \right) \quad (3.23)$$

where e is the base of the natural logarithm. But the form of (3.23) is not explicit enough to tell straight forwardly whether it is positive. So we write its derivative with respect to E_r :

$$\frac{\partial(R^M - R_{s0})}{\partial E_r} = \frac{1}{e} \left(\exp\left(\frac{E_r C_B}{P_A \bar{\theta}}\right) + \exp\left(-\frac{(t + E_r) C_B}{(P_d - P_A) \bar{\theta}}\right) \right) > 0 \quad (3.24)$$

as well as its boundary value

$$R^M - R_{s0} \Big|_{E_r = -\frac{t P_A}{P_d}} = 0. \quad (3.25)$$

Since $\frac{T_r^M}{P_A} < \frac{T_s^M}{P_d} \iff E_r > -\frac{t P_A}{P_d}$, $E_r > -\frac{t P_A}{P_d}$ is the sufficient and necessary condition for the *two-option* scenario to yield strictly higher revenue at T_r^M and T_s^M , than that of the *initial* case at T_s^M , thus the sufficient condition for the aggregator to offer *R-charging*.

Optimal default power P_n

To select the optimal power P_n at which to charge *R-charging* EVs in the absence of regulation signal (or equivalently, the optimal ratio x), we turn to numerical observations because of analytical intractability.

After repeated trials with different combinations of r_d and r_u , we have systematically observed that with the corresponding optimal prices, the revenue seems to be convex in x . A few sample curves are shown in Figure 3.6. We therefore conjecture that the optimal default recharging power is either 0 or the maximum possible power P_d (i.e., that the optimal

x is either 0 or 1). Although we still cannot tell which one performs better, comparing the revenues yielded by both values can be easily done numerically.

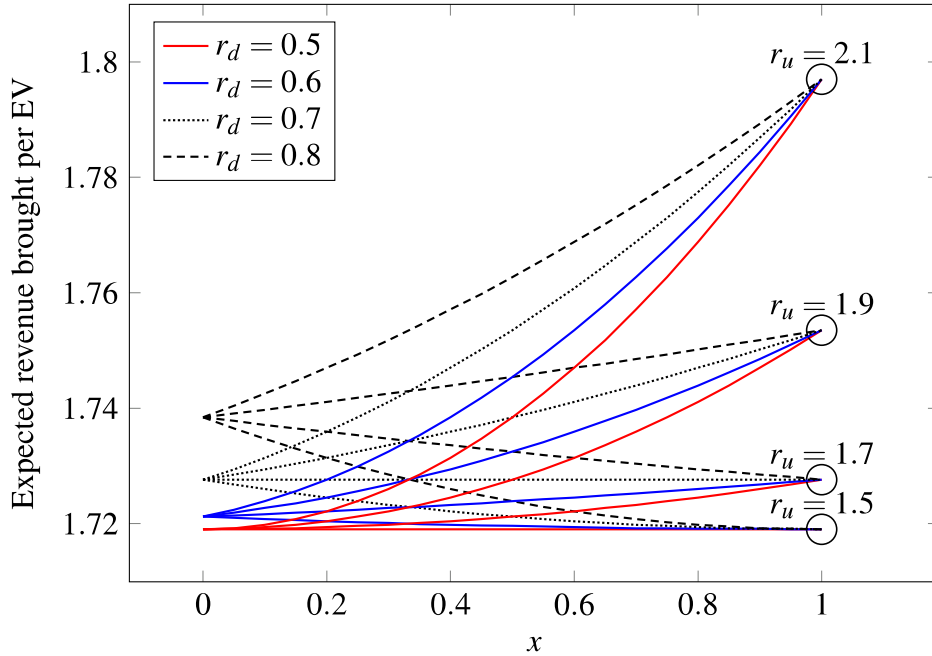

Fig. 3.6 Aggregator Revenue with multiple combinations of r_d and r_u

3.2.4 When will the aggregator offer an “R-charging” option?

In Section 3.2.3 we concluded that the sufficient condition for the aggregator to offer *R-charging* is $E_r > -\frac{tP_A}{P_d}$. If the independent variables of our model ($t, \rho_d, \rho_u, r_d, r_u, \gamma$) do not lead to solutions satisfying this inequality, then there is no room for revenue increment for the aggregator. In other words, even if some users are willing to participate to regulation for a discount in their recharging price, the aggregator will not offer that option because the rewards are too low.

We now consider in particular the regulation rewards r_d and r_u , in order to investigate whether EV-based regulation will occur or not in some markets. We focus on those values since, being prices, they are easily changeable (from market conditions or from regulation), and the observed values can dramatically differ from one market to another, and also vary significantly over time. Expanding the condition $E_r > -\frac{tP_A}{P_d}$ gives:

$$\rho_u r_u x - \rho_d (1 - r_d)(1 - x) - x > -P_d^{-2} \bar{P} (\bar{P} - \gamma \delta(P)). \quad (3.26)$$

From previous conjectures on the optimal value for x being 1 or 0, we further reduce (3.26) and get two inequalities respectively: $r_u > 2 - \rho_u + \gamma\rho_u^{-0.5}(1 - \rho_u)^{1.5}$ and $r_d > 1 - \rho_d + \gamma\sqrt{\rho_d - \rho_d^2}$. Each of them provides a sufficient condition for the aggregator to achieve higher profit from regulation. We define the thresholds of r_u and r_d as:

$$r_u^{\min^M} := 2 - \rho_u + \gamma\rho_u^{-0.5}(1 - \rho_u)^{1.5} \quad (3.27)$$

$$r_d^{\min^M} := 1 - \rho_d + \gamma\sqrt{\rho_d - \rho_d^2}. \quad (3.28)$$

If rewards from both up and down regulation are below those thresholds, (3.26) does not hold at either $x = 0$ or $x = 1$ —although it may hold somewhere in between, our observations tell that the chance is very small—then no *R-charging* option will be offered by the aggregator.

When r_u (resp., r_d) is above the threshold while r_d (resp., r_u) is not, choosing $P_n = P_d$ (resp., $P_n = 0$) earns the aggregator more than the initial case; when both of them are above their thresholds, we cannot tell which one gives higher profit so both $P_n = P_d$ and $P_n = 0$ need to be substituted so that the one yielding the largest revenue can be chosen. This procedure is described in the following algorithm.

Require: $P_d, \rho_u, \rho_d, \gamma, t, r_u, r_d$

- 1: $T_s = T_s^M$
- 2: **if** $r_d \leq r_d^{\min^M}$ **and** $r_u \leq r_u^{\min^M}$ **then**
- 3: *R-charging* not proposed
- 4: **else**
- 5: $T_r = T_r^M$
- 6: **if** $r_d \leq r_d^{\min^M}$ **and** $r_u > r_u^{\min^M}$ **then**
- 7: $P_n = P_d$
- 8: **else**
- 9: **if** $r_d > r_d^{\min^M}$ **and** $r_u \leq r_u^{\min^M}$ **then**
- 10: $P_n = 0$
- 11: **else**
- 12: **if** $R^*(x = 0) > R^*(x = 1)$ **then**
- 13: $P_n = 0$
- 14: **else**
- 15: $P_n = P_d$
- 16: **end if**
- 17: **end if**
- 18: **end if**
- 19: **end if**

20: **return** T_s, T_r, P_n

Figure 3.7 plots the average user utility. Note that we set $\bar{\theta}$ to 0.3 because this yields a *S-charging* price (T_s^M) of 0.15 €/kWh, which is the electricity price applied in France.

It is guaranteed that our proposal of allowing *R-charging* can never decrease user welfare, since *R-charging* just provides users with one more option without increasing the price of *S-charging*.

The increase of average user utility is due to the lower electricity price of *R-charging*. More attractive prices firstly win back some users who would have quit the system, and secondly, convert some clients that would have recharged through *S-charging* at a high price.

For a quite wide rewards region ($r_u \in [1.5, 2.1]$ and $r_d \in [0.5, 0.8]$), the *R-charging* price (T_r^M) is typically from 38% ($T_r^M = 0.057$ €/kWh, $T_s^M = 0.15$ €/kWh) to 48% ($T_r^M = 0.072$ €/kWh, $T_s^M = 0.15$ €/kWh) of the *S-charging* price. Finally, comparing Figure 3.7 with 3.6 we observe that the x that maximizes the aggregator revenue also maximizes user welfare, hence social welfare will also be maximized at the same time.

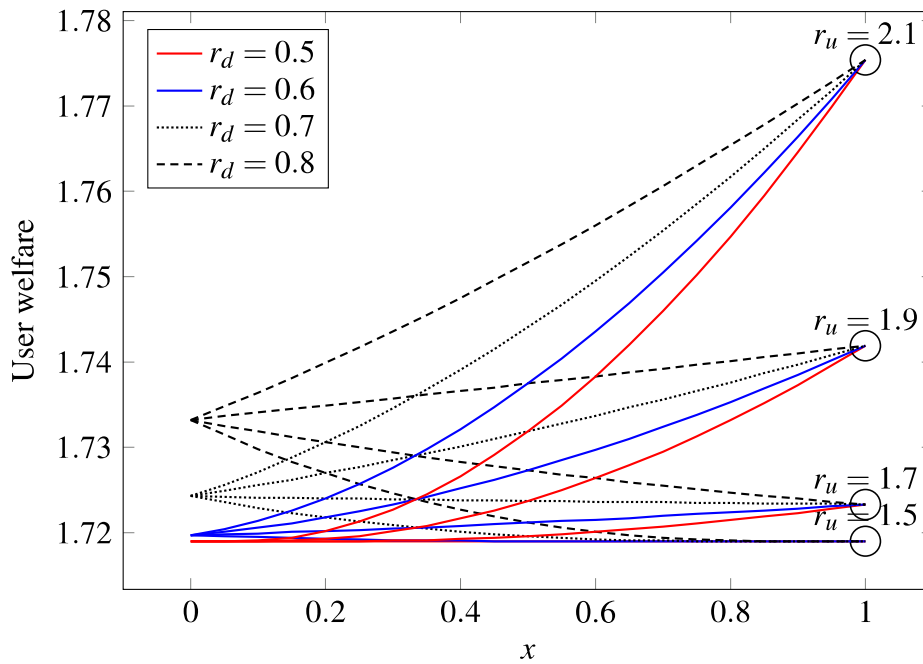

Fig. 3.7 User welfare with multiple combinations of r_d and r_u

3.2.5 Application in a real world market

The form of the thresholds in (3.27) confirms that a reduced user reluctance (γ) to power variance reduces the thresholds, thus enlarges the region for rewards $\{r_d, r_u\}$ leading to

R-charging being offered in existing regulation markets. We use empirical regulation up and down probabilities⁵ ($\rho_u = \rho_d = 0.48$) to calculate the thresholds $r_d^{\min^M}$ and $r_u^{\min^M}$, illustrated by the two lines plotted in Figure 3.8, one for $\gamma = 0.5$ and the other for $\gamma = 0.05$. This restates that if batteries become more robust to power variations, the chance for both aggregators and user to benefit from *R-charging* will increase.

To compare the thresholds with the prices actually settled in a real world market, we plot the ratios of regulation prices⁶ over corresponding wholesale electricity prices⁷ on the day of July 20, 2015 as well as daily average prices of that week (from July 20, 2015 to July 26, 2015). Despite the variations of regulation prices within a day, their daily averages can still be above our thresholds, hence some room for the aggregator to contract with the grid operator to assure constant and viable regulation prices throughout the day. To illustrate how the aggregator should set the default power P_n , we also show the region where $P_n = 0$ or $P_n = P_d$ is the optimal default charging power for *R-charging*.

3.2.6 Recap

This section models a monopolistic recharging agent—an aggregator, who sells energy to EV owners meanwhile sells regulation service to a grid operator. Depending on the level of remuneration offered by the grid operator, the aggregator can decide whether or not to carry out regulation. Our numerical results indicate that for at least half of a day, taking this extra option is profitable for the aggregator. We also deduced the forms of the optimal prices where maximal revenue is achieved. In the next section, we break the monopoly by splitting this single aggregator into two separate stations: a *R-charging* station and a *S-charging* one. Their competition is modelled as a game, whose outcomes at possible equilibria are of interest.

3.3 Competition Between Regulation-Providing and Fixed-Power Charging Stations for EVs

In this section we apply to the leader-follower game framework, with charging stations the leaders and users the followers. This enables us to solve the problem through the *backward induction* method. Different from the previous section, where both *S-charging* and *R-charging* are offered by an aggregator, which is a revenue maximizing monopoly, we now separate the two services and assign them to two competing stations.

⁵<http://clients.rte-france.com/lang/fr/visiteurs/vie/mecanisme/jour/volume.jsp>

⁶<http://clients.rte-france.com/lang/fr/visiteurs/vie/mecanisme/jour/volume.jsp>

⁷<https://www.epexspot.com/en/market-data/elix>

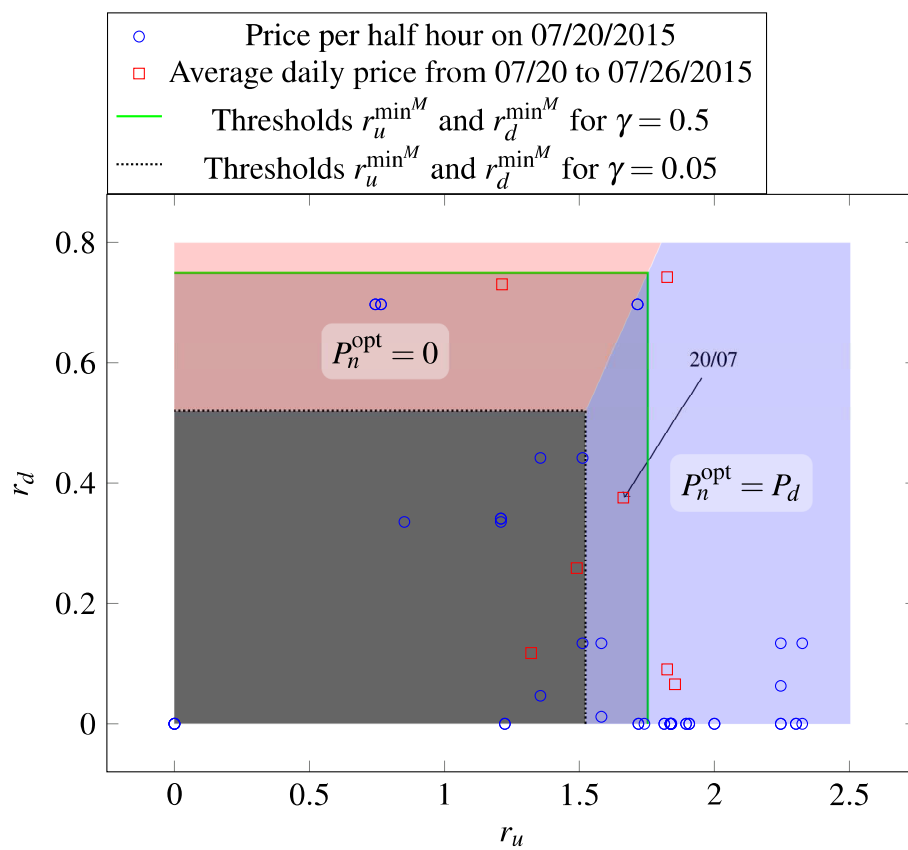

Fig. 3.8 Observed regulation prices, and thresholds for *R-charging* to be beneficial for the aggregator

We model the interactions among both stations (or sets of stations, each set controlled by a separate entity) as a noncooperative game since they compete over prices to attract EV owners. User preferences between price and charging power variations are assumed heterogeneous, so each station seeks the best tradeoff between market shares and per-client profit in order to maximize its expected revenue. We define the non-cooperative strategic game derived from the stations' pricing behaviors, before examining their best-response prices, and finally we analyze the Nash equilibria of the game.

3.3.1 Game definition

Regulation mechanism

Due to separated operation of *S-charging* and *R-charging*, the work of a monopolistic aggregator is now carried out by two charging stations, namely an *S-charging* station and an *R-charging* station, and the task of setting regulation parameters (P_n, T_r) goes to the *R-charging* station. Apart from that, the regulation procedure follows that described in Section A.3.1.

User preferences

The probability α_r (resp., α_s) that a user chooses the *R-charging* (resp., *S-charging*) station can then be expressed as

$$\alpha_r = \begin{cases} 1 - \exp\left(-\frac{C_B(T_s - T_r)}{\bar{\theta}(P_d - P_A)}\right) & \text{if } T_r < 0 \\ \exp\left(-\frac{C_B T_r}{\bar{\theta} P_A}\right) - \exp\left(-\frac{C_B(T_s - T_r)}{\bar{\theta}(P_d - P_A)}\right) & \text{if } 0 \leq T_r \leq \frac{P_A}{P_d} T_s \\ 0 & \text{otherwise} \end{cases} \quad (3.29)$$

$$\alpha_s = \begin{cases} \exp\left(-\frac{C_B T_s}{\bar{\theta} P_d}\right) & \text{if } T_s \leq \frac{P_d}{P_A} T_r \\ \exp\left(-\frac{C_B(T_s - T_r)}{\bar{\theta}(P_d - P_A)}\right) & \text{otherwise.} \end{cases} \quad (3.30)$$

Note that we allow negative charging prices with the *R-charging* station: indeed, since that station can make money from the grid thanks to EV owners, the corresponding rewards could be so large that the station would be willing to attract a large number of EVs, even by paying them. This case is for completeness of the model, we think it is not very likely to occur but we cover it in this proposal.

First we assume P_n (or equivalently x) fixed and analyze the pricing game. The outcome is dependent on x so the *R-charging* station can maximize its profit by playing an x in addition to

the price T_r . We examine the pricing game analytically whereas the chosen of x numerically due to complexity.

A game has at least two self-interested participants, whose actions result in different consequences, which in return motivate the players to adjust their actions. Now we give the formal definition of the pricing game:

Definition 3.3.1. *The pricing game between the S-charging station and the R-charging station can be specified by: $\langle \mathcal{N}, \mathcal{T}, (R_i) \rangle$, where the player set \mathcal{N} consists of the two stations, the price profile \mathcal{T} is a vector (T_s, T_r) on the semi-plane $\mathbb{R}_{\geq 0} \times \mathbb{R}$, and the payoff function $R_i : \mathcal{T} \rightarrow \mathbb{R}$ gives each station's expected revenue obtained from one EV.*

3.3.2 Best-response prices

S-charging station revenue and best-response price T_s^{br}

For the *S-charging station* owner, its average income R_s depends on the market share α_s , and the unit price T_s it offers:

$$R_s = C_B(T_s - t)\alpha_s = \begin{cases} C_B(T_s - t) \exp(-\frac{C_B T_s}{\bar{\theta} P_d}) & T_s \leq \frac{P_d}{P_A} T_r \\ C_B(T_s - t) \exp(-\frac{C_B(T_s - T_r)}{\bar{\theta}(P_d - P_A)}) & T_s > \frac{P_d}{P_A} T_r \end{cases} \quad (3.31a)$$

$$T_s > \frac{P_d}{P_A} T_r \quad (3.31b)$$

The price T_s that maximizes R_s is called the best-response price to its opponent's strategy T_r ,

Proposition 3.3.2. *The S-charging station has a unique best-response price as follows:*

$$T_s^{br}(T_r) = \begin{cases} t + (P_d - P_A) \frac{\bar{\theta}}{C_B} & \text{if } T_r < (t + (P_d - P_A) \frac{\bar{\theta}}{C_B}) \frac{P_A}{P_d} \\ t + P_d \frac{\bar{\theta}}{C_B} & \text{if } T_r > (t + P_d \frac{\bar{\theta}}{C_B}) \frac{P_A}{P_d} \\ T_r \frac{P_d}{P_A} & \text{otherwise} \end{cases} \quad (3.32a)$$

$$\text{if } T_r > (t + P_d \frac{\bar{\theta}}{C_B}) \frac{P_A}{P_d} \quad (3.32b)$$

$$\text{otherwise} \quad (3.32c)$$

Proof. The function (3.31) is continuous in T_s , and is differentiable over the intervals $(-\infty, \frac{P_d}{P_A} T_r)$ and $(\frac{P_d}{P_A} T_r, +\infty)$, with partial derivatives

$$\frac{\partial R_s}{\partial T_s} = \begin{cases} (1 + (T_s - t)(-\frac{C_B}{\bar{\theta} P_d})) C_B \exp(-\frac{C_B T_s}{\bar{\theta} P_d}) & T_s < \frac{P_d}{P_A} T_r \\ (1 + (T_s - t)(-\frac{C_B}{\bar{\theta}(P_d - P_A)})) C_B \exp(-\frac{C_B(T_s - T_r)}{\bar{\theta}(P_d - P_A)}) & T_s > \frac{P_d}{P_A} T_r \end{cases} \quad (3.33)$$

We observe from (3.31) that the revenue is negative if $T_s < t$ and positive for $T_s \geq t$, hence we can restrict our attention to $T_s \geq t$. In that region, each derivative is first strictly positive, then null at one point, then strictly negative, hence:

- if $t \geq \frac{P_d}{P_A} T_r$ only the interval $[t, +\infty)$ needs to be considered, and there is a unique revenue-maximizing price $t + (P_d - P_A) \frac{\bar{\theta}}{C_B}$ given by the first-order condition (note that it is an interior solution in the interval).
- if $t < \frac{P_d}{P_A} T_r$, the revenue has a unique maximum on each of the intervals $[t, \frac{P_d}{P_A} T_r]$ and $[\frac{P_d}{P_A} T_r, +\infty)$:
 - on the interval $[t, \frac{P_d}{P_A} T_r]$, the optimal price is $t + P_d \frac{\bar{\theta}}{C_B}$ if $t + P_d \frac{\bar{\theta}}{C_B} \leq \frac{P_d}{P_A} T_r$ (interior solution), and $\frac{P_d}{P_A} T_r$ otherwise (corner solution);
 - on the interval $[\frac{P_d}{P_A} T_r, +\infty)$, the optimal price is $t + (P_d - P_A) \frac{\bar{\theta}}{C_B}$ if $t + (P_d - P_A) \frac{\bar{\theta}}{C_B} \geq \frac{P_d}{P_A} T_r$ (interior solution), and $\frac{P_d}{P_A} T_r$ otherwise (corner solution).

□

Figure 3.9 illustrates the *S-charging* station revenue as a function of T_r , and the best-response $T_s^{br}(T_r)$.

***R-charging* station revenue and best-response price $T_r^{br}(T_s)$**

Let us now consider the *R-charging* station owner, having to decide its price T_r .

The average *R-charging* station revenue R_r consists of remuneration from providing regulation and income from charging EVs:

$$R_r = \begin{cases} C_B(T_r + E_r)[1 - \exp(-\frac{C_B(T_s - T_r)}{\bar{\theta}(P_d - P_A)})] & \text{if } T_r < 0 \\ C_B(T_r + E_r)[\exp(-\frac{C_B T_r}{\bar{\theta} P_A}) - \exp(-\frac{C_B(T_s - T_r)}{\bar{\theta}(P_d - P_A)})] & 0 \leq \text{if } T_r \leq \frac{P_A}{P_d} T_s \\ 0 & \text{otherwise} \end{cases} \quad (3.34)$$

The following result summarizes the optimal *R-charging* station reaction to its competitor.

Proposition 3.3.3. *The R-charging station has a unique best-response price as follows:*

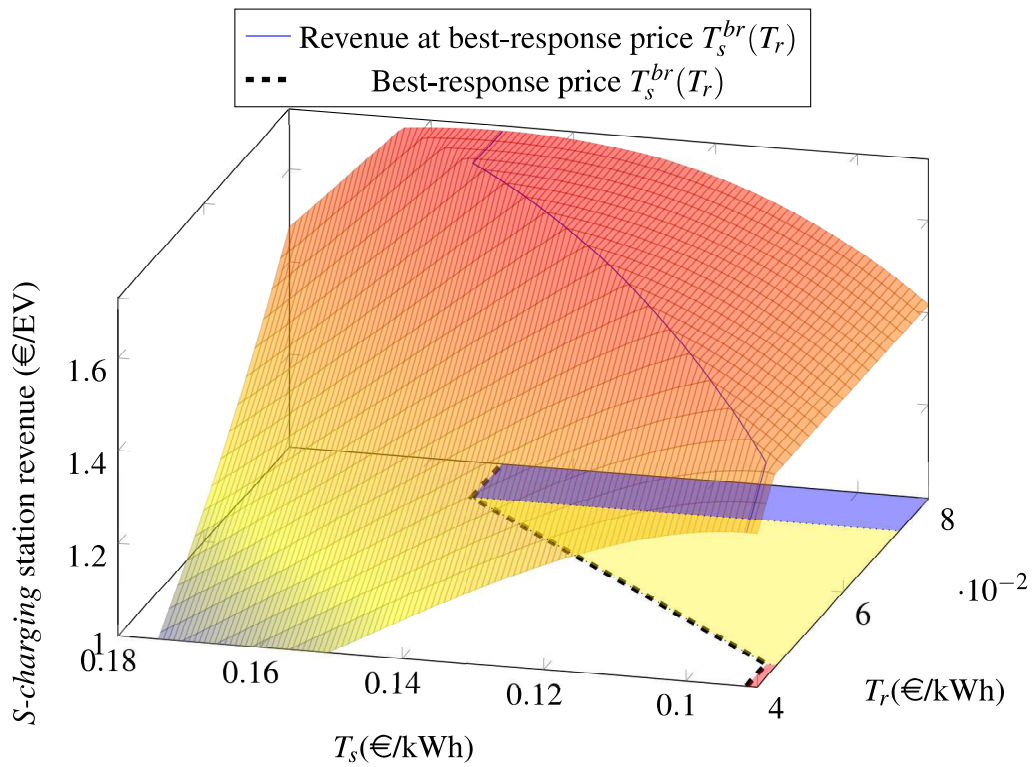

Fig. 3.9 *S*-charging station revenue as a function of T_r and T_s ($t = 0.03$, $\bar{\theta} = 0.3$, $C_B = 50kWh$, $x = 0.8$). The red, yellow and blue areas are separated by $T_r = (t + (P_d - P_A) \frac{\bar{\theta}}{C_B}) \frac{P_A}{P_d}$ and $T_r = (t + P_d \frac{\bar{\theta}}{C_B}) \frac{P_A}{P_d}$, referring to (3.32).

$$T_r^{br}(T_s) = \begin{cases} T_s \frac{P_A}{P_d} & \text{if } T_s \leq -E_r \frac{P_d}{P_A} & (3.35a) \\ 0 & \text{if } T_s : E_{r,1}(T_s) \leq E_r \leq E_{r,2}(T_s) & (3.35b) \\ \{T_r \in \mathbb{R} : \frac{\partial R_r}{\partial T_r} = 0\} & & (3.35c) \\ \subset (\min\{0, -E_r\}, \max\{0, \min\{\frac{\bar{\theta}P_A}{C_B} - E_r, \frac{P_A}{P_d}T_s\}\}) & \text{otherwise} & (3.35d) \end{cases}$$

where

$$E_{r,1}(T_s) = \frac{\bar{\theta}(P_d - P_A)(1 - \exp(-\frac{C_B T_s}{\bar{\theta}(P_d - P_A)}))}{C_B(\frac{P_d}{P_A} - 1 + \exp(\frac{C_B T_s}{\bar{\theta}(P_d - P_A)}))} \quad (3.36)$$

$$E_{r,2}(T_s) = E_{r,1}(T_s)(1 + (\frac{P_d}{P_A} - 1) \exp(\frac{C_B T_s}{\bar{\theta}(P_d - P_A)})). \quad (3.37)$$

Table 3.2 Solution of $\frac{\partial R_r}{\partial T_r} = 0$ in different circumstances

Conditions on E_r		$\frac{\partial R_r}{\partial T_r}$		Solution of $\frac{\partial R_r}{\partial T_r} = 0$	T_r^{br}	
		$T_r = 0^-$	$T_r = 0^+$			
$E_r < \frac{\bar{\theta}P_A}{C_B}$	$E_r < E_{r,2}$	$E_{r,1} < E_r$	> 0	< 0	None	0
		$E_r \leq E_{r,1}$	> 0	≥ 0	$\in [0, \min\{\frac{\bar{\theta}P_A}{C_B} - E_r, \frac{P_A}{P_d}T_s\})$	$\{T_r : \frac{\partial R_r}{\partial T_r} = 0\}$
	$E_{r,2} \leq E_r$	≤ 0	< 0	$\in (-E_r, 0]$	$\{T_r : \frac{\partial R_r}{\partial T_r} = 0\}$	
$\frac{\bar{\theta}P_A}{C_B} \leq E_r$	$E_r < E_{r,2}$	> 0	< 0	None	0	
	$E_{r,2} \leq E_r$	≤ 0	< 0	$\in (-E_r, 0]$	$\{T_r : \frac{\partial R_r}{\partial T_r} = 0\}$	

Proof. In the first place, it is non-trivial to verify that (3.35) defines a function, i.e.,

$$\nexists T_s \in \mathbb{R}_{\geq 0} : T_s \leq -E_r \frac{P_d}{P_A} \text{ and } E_{r,1}(T_s) \leq E_r \leq E_{r,2}(T_s). \quad (3.38)$$

This is true because $\forall T_s \in \mathbb{R}_{\geq 0}$, we have $0 < E_{r,1}(T_s) < E_{r,2}(T_s)$.

From (3.34) we know that the R -charging station has non-negative revenue if and only if:

$$-E_r \leq T_r \leq \frac{P_A}{P_d} T_s, \quad (3.39)$$

so the following is a prerequisite:

$$E_r \geq -\frac{P_A}{P_d} T_s \quad (3.40)$$

When this condition is not met, the *R-charging* station would rather leave the market by setting a price sufficiently high, i.e., $T_r^{br} \geq \frac{P_A}{P_d} T_s$ such that no client would come.

If $E_r \geq -\frac{P_A}{P_d} T_s$, and $-E_r \leq T_r \leq \frac{P_A}{P_d} T_s$, we further examine the partial derivative of the revenue function (3.34):

$$\frac{\partial R_r}{\partial T_r} = \begin{cases} C_B(1 - \exp[-\frac{C_B(T_s - T_r)}{\bar{\theta}(P_d - P_A)}][1 + \frac{C_B(T_r + E_r)}{\bar{\theta}(P_d - P_A)}]) & \text{if } T_r < 0 & (3.41a) \\ C_B\{\exp(-\frac{C_B T_r}{\bar{\theta} P_A})[1 - \frac{C_B(T_r + E_r)}{\bar{\theta} P_A}] & & (3.41b) \\ - \exp[-\frac{C_B(T_s - T_r)}{\bar{\theta}(P_d - P_A)}][1 + \frac{C_B(T_r + E_r)}{\bar{\theta}(P_d - P_A)}]\} & \text{if } T_r > 0 & (3.41c) \end{cases}$$

We begin with putting the boundaries of T_r into (3.41):

$$\frac{\partial R_r}{\partial T_r} \Big|_{T_r = -E_r} > 0 \quad \text{if } E_r \neq 0 \quad (3.42)$$

$$\frac{\partial R_r}{\partial T_r} \Big|_{T_r = 0^-} > 0; \quad \frac{\partial R_r}{\partial T_r} \Big|_{T_r = 0^+} > 0 \quad \text{if } E_r = 0 \quad (3.43)$$

$$\frac{\partial R_r}{\partial T_r} \Big|_{T_r = \frac{P_A}{P_d} T_s} < 0 \quad (3.44)$$

Then within those bounds, we claim that (3.41) is strictly decreasing on $(\min\{0, -E_r\}, \max\{0, \min\{\frac{\bar{\theta} P_A}{C_B} - E_r, \frac{P_A}{P_d} T_s\}\})$ because:

- when $T_r < 0$, (3.41a) is strictly decreasing;
- when $T_r > 0$, noticing that (3.41b) is positive iff $T_r < \frac{\bar{\theta} P_A}{C_B} - E_r$ and is strictly decreasing when positive, meanwhile (3.41c) is strictly decreasing and negative, $\frac{\partial R_r}{\partial T_r}$ is strictly decreasing for $T_r \in (0, \max\{0, \min\{\frac{\bar{\theta} P_A}{C_B} - E_r, \frac{P_A}{P_d} T_s\}\})$;
- when $T_r = 0$, $\frac{\partial R_r}{\partial T_r} \Big|_{T_r = 0^-} > \frac{\partial R_r}{\partial T_r} \Big|_{T_r = 0^+}$.

From the monotony of $\frac{\partial R_r}{\partial T_r}$, we know that there is either a unique solution of $\frac{\partial R_r}{\partial T_r} = 0$ or none. Table 3.2 summarizes the conditions for each of them to occur, together with the intervals wherein lie those possible solutions.

Jointly considering the first order optimality condition of $\frac{\partial R_r}{\partial T_r} = 0$ and the boundary values in (3.42) (3.43) and (3.44), we conclude that R_r achieves the maximum either at the unique solution of $\frac{\partial R_r}{\partial T_r} = 0$ (if it exists) or at $T_r = 0$, as stated in the last column of Table 3.2, thus the optimality of the best-response price in (3.35) is proved. □

Figure 3.10 shows the R -charging station revenue as well as the best-response price $T_r^{br}(T_s)$, as a function of T_s .

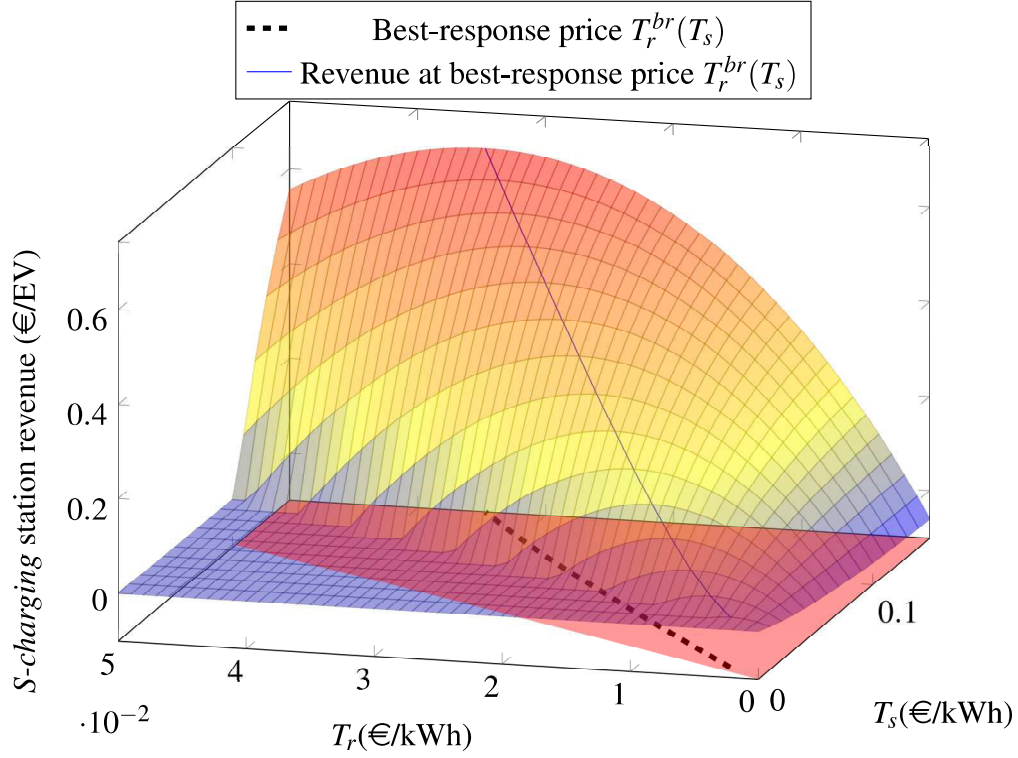

Fig. 3.10 R -charging Station revenue as a function of T_r and T_s ($t = 0.03$, $r_d = 0.7$, $r_u = 2.1$, $C_B = 50kWh$, $\rho_d = 0.48$, $\rho_u = 0.48$, $\gamma = 0.05$, $\bar{\theta} = 0.3$, $x = 0.8$). The red region corresponds to non-negative revenues, i.e., $\frac{T_r}{P_A} < \frac{T_s}{P_d}$

3.3.3 Nash equilibrium

Now we combine Proposition 3.3.2 and 3.3.3 to establish the existence of Nash equilibria.

Proposition 3.3.4. *The pricing game defined in A.3.1 has either a unique Nash equilibrium or a unique Pareto-dominant one when there exist an infinite number of Nash equilibria. The equilibrium prices in different circumstances are:*

$$N^E : \left\{ \begin{array}{l} T_r = -E_r; T_s = -\frac{P_d}{P_A} E_r \\ \text{if } E_r \leq -\frac{P_A}{P_d} [t + (P_d - P_A) \frac{\bar{\theta}}{C_B}] \end{array} \right. \quad (3.45a)$$

$$\left\{ \begin{array}{l} T_r \in (0, \min\{\frac{\theta P_A}{C_B} - E_r, \frac{P_A}{P_d} T_s\}); T_s = t + (P_d - P_A) \frac{\bar{\theta}}{C_B} \\ \text{if } -\frac{P_A}{P_d} [t + (P_d - P_A) \frac{\bar{\theta}}{C_B}] < E_r < E_{r,1} (t + (P_d - P_A) \frac{\bar{\theta}}{C_B}) \end{array} \right. \quad (3.45b)$$

$$\left\{ \begin{array}{l} T_r = 0; T_s = t + (P_d - P_A) \frac{\bar{\theta}}{C_B} \\ \text{if } E_{r,1} (t + (P_d - P_A) \frac{\bar{\theta}}{C_B}) \leq E_r \leq E_{r,2} (t + (P_d - P_A) \frac{\bar{\theta}}{C_B}) \end{array} \right. \quad (3.45c)$$

$$\left\{ \begin{array}{l} T_r \in (-E_r, 0); T_s = t + (P_d - P_A) \frac{\bar{\theta}}{C_B} \\ \text{if } E_{r,2} (t + (P_d - P_A) \frac{\bar{\theta}}{C_B}) < E_r \end{array} \right. \quad (3.45d)$$

Proof. We prove the existence and uniqueness of the Nash equilibrium through exhaustively combining (3.32a) (3.32b) (3.32c) and (3.35a) (3.35b) (3.35d), in order to find possible intersections between the two best-response prices.

First of all, (3.32b) can be easily excluded since according to Proposition 3.3.3, $T_r^{br}(T_s) \leq T_s \frac{P_A}{P_d}$, conflicts with the condition in (3.32b).

Then we check whether (3.32a) intersects with (3.35). Putting $T_s = t + (P_d - P_A) \frac{\bar{\theta}}{C_B}$ into (3.35) gives:

$$T_r^{br} \left\{ \begin{array}{l} = (t + (P_d - P_A) \frac{\bar{\theta}}{C_B}) \frac{P_A}{P_d} \\ < (t + (P_d - P_A) \frac{\bar{\theta}}{C_B}) \frac{P_A}{P_d} \end{array} \right. \quad \begin{array}{l} \text{if } t + (P_d - P_A) \frac{\bar{\theta}}{C_B} \leq -E_r \frac{P_d}{P_A} \\ \text{otherwise.} \end{array} \quad (3.46a)$$

$$\quad \quad \quad (3.46b)$$

Note that (3.46a) corresponds to the first case in (3.35) while (3.46b) covers the other cases. Comparing the values in (3.46a) with the condition in (3.32a), we can further rule out the (3.32a)(3.35a) pair.

As a result, if $-\frac{P_A}{P_d} [t + (P_d - P_A) \frac{\bar{\theta}}{C_B}] < E_r$, (3.32a) has an intersection with (3.35), which provides a Nash equilibrium. Depending on the value of E_r , the price profile of this equilib-

3.3 Competition Between Regulation-Providing and Fixed-Power Charging Stations for EVs

rium falls into different segments, as expressed in (3.45b), (3.45c) and (3.45d). Otherwise, when $E_r \leq -\frac{P_A}{P_d}[t + (P_d - P_A)\frac{\bar{\theta}}{C_B}]$, we end up with infinite intersections between (3.32c) and (3.35a). Among all the possible equilibria ($T_s \leq -E_r\frac{P_d}{P_A}$, $T_r = T_s\frac{P_A}{P_d}$), the specific pair $T_s = -E_r\frac{P_d}{P_A}$, $T_r = T_s\frac{P_A}{P_d}$ Pareto dominates the rest because the *R-charging* station is indifferent towards the choices of T_r given $T_r = T_s\frac{P_A}{P_d}$, whereas the *S-charging* station strictly prefers $T_s = -E_r\frac{P_d}{P_A}$ over $T_s < -E_r\frac{P_d}{P_A}$, since we have:

$$\left. \frac{dR_s(T_r = T_s\frac{P_A}{P_d})}{dT_s} \right|_{T_s \leq t + (P_d - P_A)\frac{\bar{\theta}}{C_B}} > 0 \quad (3.47)$$

The conditions for each equilibrium to occur are exclusive and cover all possible circumstances. \square

Note that $N^E(3.45a)$ which occurs when $E_r \leq -\frac{P_A}{P_d}[t + (P_d - P_A)\frac{\theta}{C_B}]$ is not profitable for the *R-charging* stations since zero revenue is obtained, and that the condition for a positive *R-charging* station revenue is $-\frac{P_A}{P_d}[t + (P_d - P_A)\frac{\theta}{C_B}] < E_r$. We will refer to this condition in Section 3.4.2.

Figure 3.11 and 3.12 illustrate the best-response prices and resulting Nash equilibria in four different circumstances.

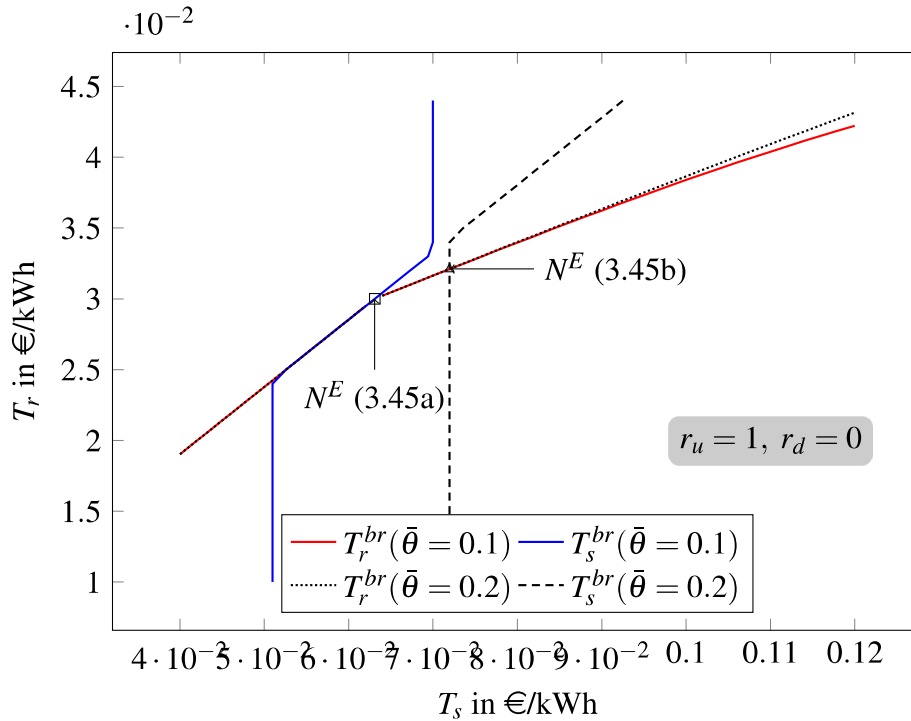

Fig. 3.11 Nash equilibria in case of small r_d and r_u

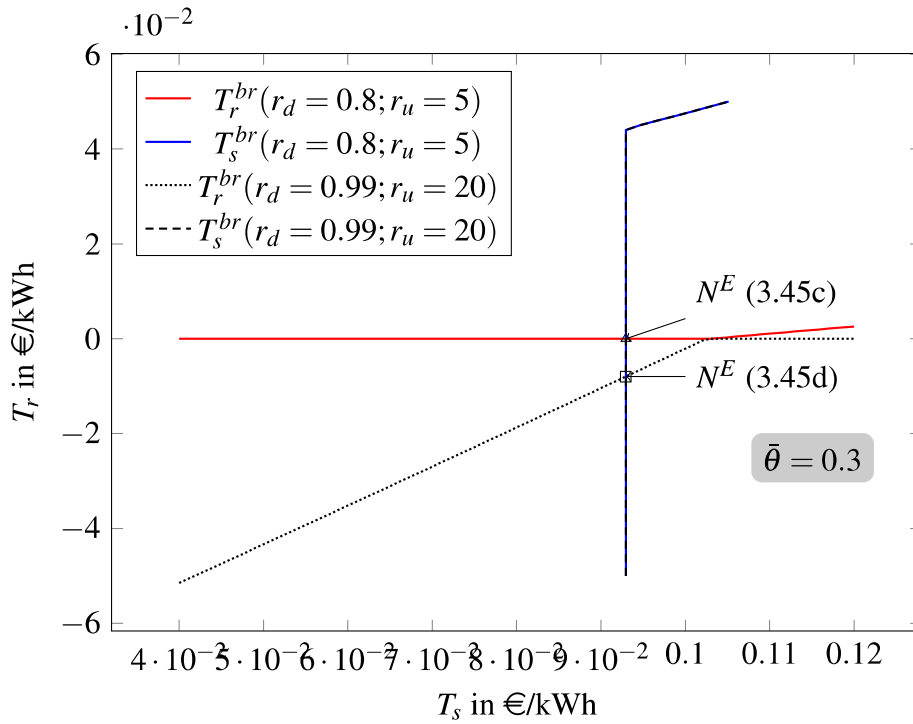

Fig. 3.12 Nash equilibria in case of large r_d and r_u

Note that equilibria (3.45c) and (3.45d) that result in free R -charging or even negatively priced R -charging can only be reached when regulation remunerations are extremely attractive, which seldom happens.

Optimization of P_n

The pricing game defined in A.3.1 is played given a fixed P_n , set by the R -charging station, who can afterwards modify its value to pursue a higher equilibrium revenue. Due to the complexity of the equilibrium price profile we resort to numerical search for the optimal P_n .

3.3.4 Recap

In this section, a leader-follower game is introduced to model the interaction between the R -charging station and the S -charging one. We define a pricing game between them and find possible equilibria after examination of their best response prices. In the next section, we will retrieve the result of section 3.2– the revenue maximizing electricity prices offered by the monopolistic aggregator, and compare the outcome of monopoly with that of competition.

3.4 Comparison between the Nash equilibrium and the Monopolistic case

After elaboration of the two proposed regulation-recharging models: the monopolistic one in Section 3.2 v.s. the competition one in Section 3.3, we can now compare their outcomes in terms of user utility and applicability in real world market.

3.4.1 Average user utility

The following formula of average user utility applies to both the monopolistic and competition case.

$$U = \int_{\frac{T_r C_B}{P_A}}^{\frac{(T_s - T_r) C_B}{P_d - P_A}} (\theta P_A - T_r C_B) \frac{1}{\theta} \exp\left(-\frac{\theta}{\bar{\theta}}\right) d\theta + \int_{\frac{(T_s - T_r) C_B}{P_d - P_A}}^{+\infty} (\theta P_d - T_s C_B) \frac{1}{\theta} \exp\left(-\frac{\theta}{\bar{\theta}}\right) d\theta \quad (3.48)$$

$$= \alpha_r \bar{\theta} P_A + \alpha_s \bar{\theta} P_d \quad (3.49)$$

Figure 3.13 shows a significant increase of average user utility (U^M for monopoly and U^E for equilibrium) after breaking a monopolistic station into two competing ones. Although the total station revenue decreases, the social welfare which is the user utility plus station revenue has a net increase of over 20%. Figure 3.14 illustrates an increase of EVs being served, thanks to a decrease of energy prices depicted in Figure 3.15.

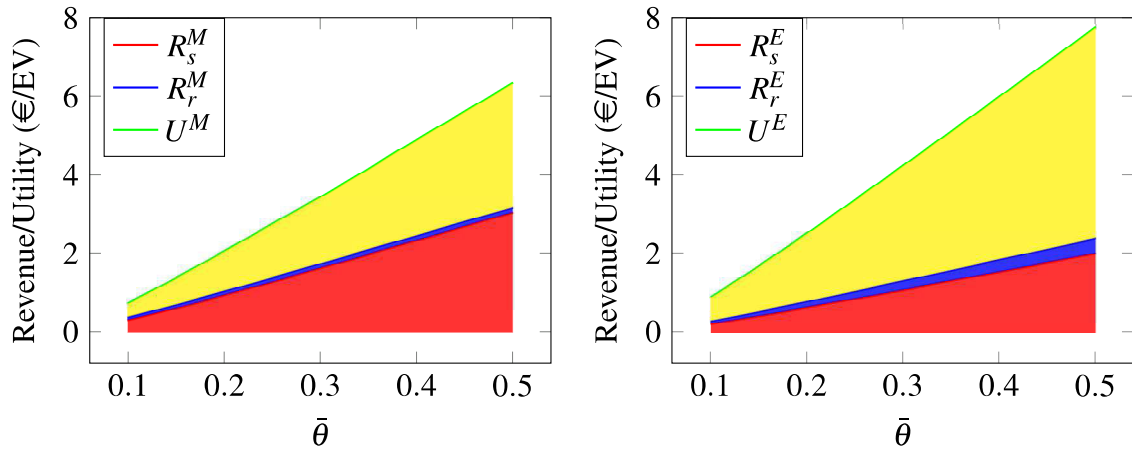

Fig. 3.13 Comparison between Monopoly (left-hand side) and Nash equilibrium (right-hand side), in terms of station revenue and user utility, with $t = 0.03$, $\bar{\theta} = 0.3$, $C_B = 50$, $\rho_d = \rho_u = 0.48$, $\gamma = 0.05$, $r_d = 0.4$, $r_u = 1.6$ (r_d and r_u are the daily average of 20/07/2015).

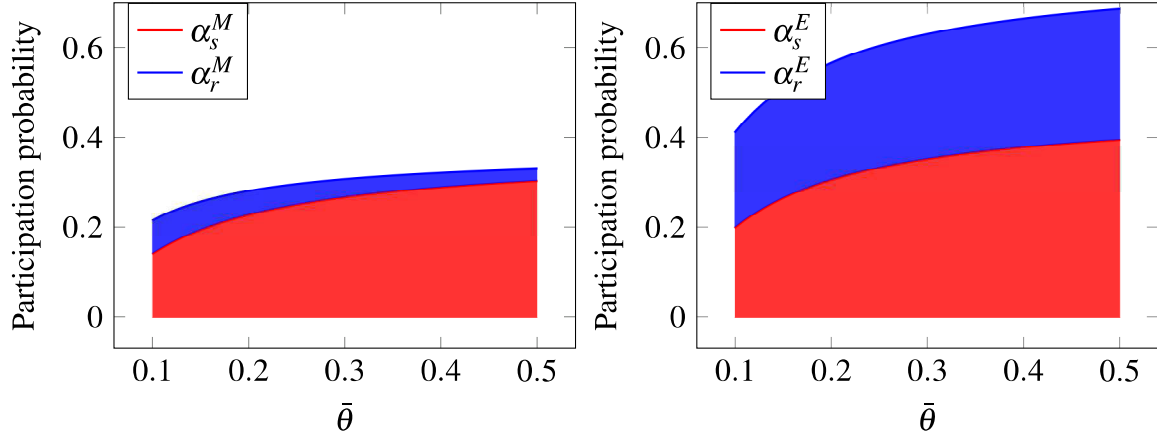

Fig. 3.14 Comparison between Monopoly (left-hand side) and Nash equilibrium (right-hand side), in terms of user participation, with $t = 0.03$, $\bar{\theta} = 0.3$, $C_B = 50$, $\rho_d = \rho_u = 0.48$, $\gamma = 0.05$, $r_d = 0.4$, $r_u = 1.6$ (r_d and r_u are the daily average of 20/07/2015).

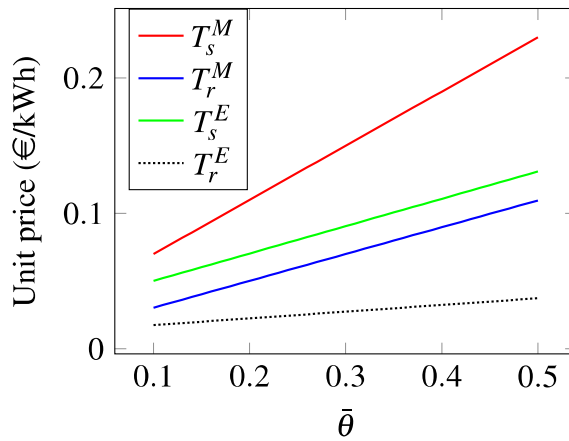

Fig. 3.15 Comparison between Monopoly (left-hand side) and Nash equilibrium (right-hand side), in terms of electricity prices, with $t = 0.03$, $\bar{\theta} = 0.3$, $C_B = 50$, $\rho_d = \rho_u = 0.48$, $\gamma = 0.05$, $r_d = 0.4$, $r_u = 1.6$ (r_d and r_u are the daily average of 20/07/2015).

3.4.2 Application in a real world market

Figure 3.16 compares the regions for rewards $\{r_d, r_u\}$ where offering *R-charging* is profitable. At equilibria (figures on the right-hand side), the black zones where *R-charging* is not preferred are remarkably smaller than those in the monopolistic case (left-hand side). This is because in a monopoly, the feasible region for rewards $\{r_d, r_u\}$ is composed of those that make the following equation of x solvable in the interval of $[0, 1]$ (referring to (3.26) in Section 3.2.4):

$$\rho_u r_u x - \rho_d(1 - r_d)(1 - x) - x + \bar{P}(x)P_A(x)P_d^{-2} > 0, \quad (3.50)$$

whereas in competition, (3.45a) and (3.45b) give the condition:

$$t(\rho_u r_u x - \rho_d(1 - r_d)(1 - x) - x + \bar{P}P_AP_d^{-2}) + \frac{1}{t}\bar{P}P_AP_d^{-2}[P_d - P_A]\frac{\bar{\theta}}{C_B} > 0 \quad (3.51)$$

Obviously the solution set of (3.50) is a proper subset of that of (3.51), so introducing competition enlarges the feasible region of $\{r_d, r_u\}$. To quantify this enlargement, we reduce (3.51) by replacing x by 0 and 1. Similarly with (3.27) in Section 3.2.4, we have two thresholds for r_d and r_u respectively:

$$r_u^{\min^E} := 2 - \rho_u + \gamma\rho_u^{-0.5}(1 - \rho_u)^{1.5} - \frac{P_d\bar{\theta}}{t^2C_B\rho_u}(\rho_u(1 - \rho_u)(1 - \gamma^2) + \gamma(1 - 2\rho_u)\sqrt{\rho_u(1 - \rho_u)}) \quad (3.52)$$

$$= r_u^{\min^M} - \frac{P_d\bar{\theta}}{t^2C_B\rho_u}(\rho_u(1 - \rho_u)(1 - \gamma^2) + \gamma(1 - 2\rho_u)\sqrt{\rho_u(1 - \rho_u)}) \quad (3.53)$$

$$r_d^{\min^E} := 1 - \rho_d + \gamma\sqrt{\rho_d - \rho_d^2} - \frac{P_d\bar{\theta}}{t^2C_B\rho_d}(\rho_d(1 - \rho_d)(1 - \gamma^2) + \gamma(1 - 2\rho_d)\sqrt{\rho_d(1 - \rho_d)}) \quad (3.54)$$

$$= r_d^{\min^M} - \frac{P_d\bar{\theta}}{t^2C_B\rho_d}(\rho_d(1 - \rho_d)(1 - \gamma^2) + \gamma(1 - 2\rho_d)\sqrt{\rho_d(1 - \rho_d)}). \quad (3.55)$$

The blue and red areas in Figure 3.16 are referring to the optimal default recharging power P_n in these regions, i.e., the optimal x after exhaustive search. In most combinations of $\{r_d, r_u\}$, this optimal x is either 0 or 1, except for a few $\{r_d, r_u\}$ observed in the gap between the blue region and the red, in the figures on the right hand side, especially when the average user preference on power is small: $\bar{\theta} = 0.1$ and user sensitivity to variation is great: $\gamma = 0.5$. We also plot the actual $\{r_d, r_u\}$ offered by a French operator RTE on these figures. The blue circles correspond to the 48 $\{r_d, r_u\}$ pairs on the day of 20/07/2015 and the red rectangles are showing the daily averages during the week from 20/07/2015 to 26/07/2015.

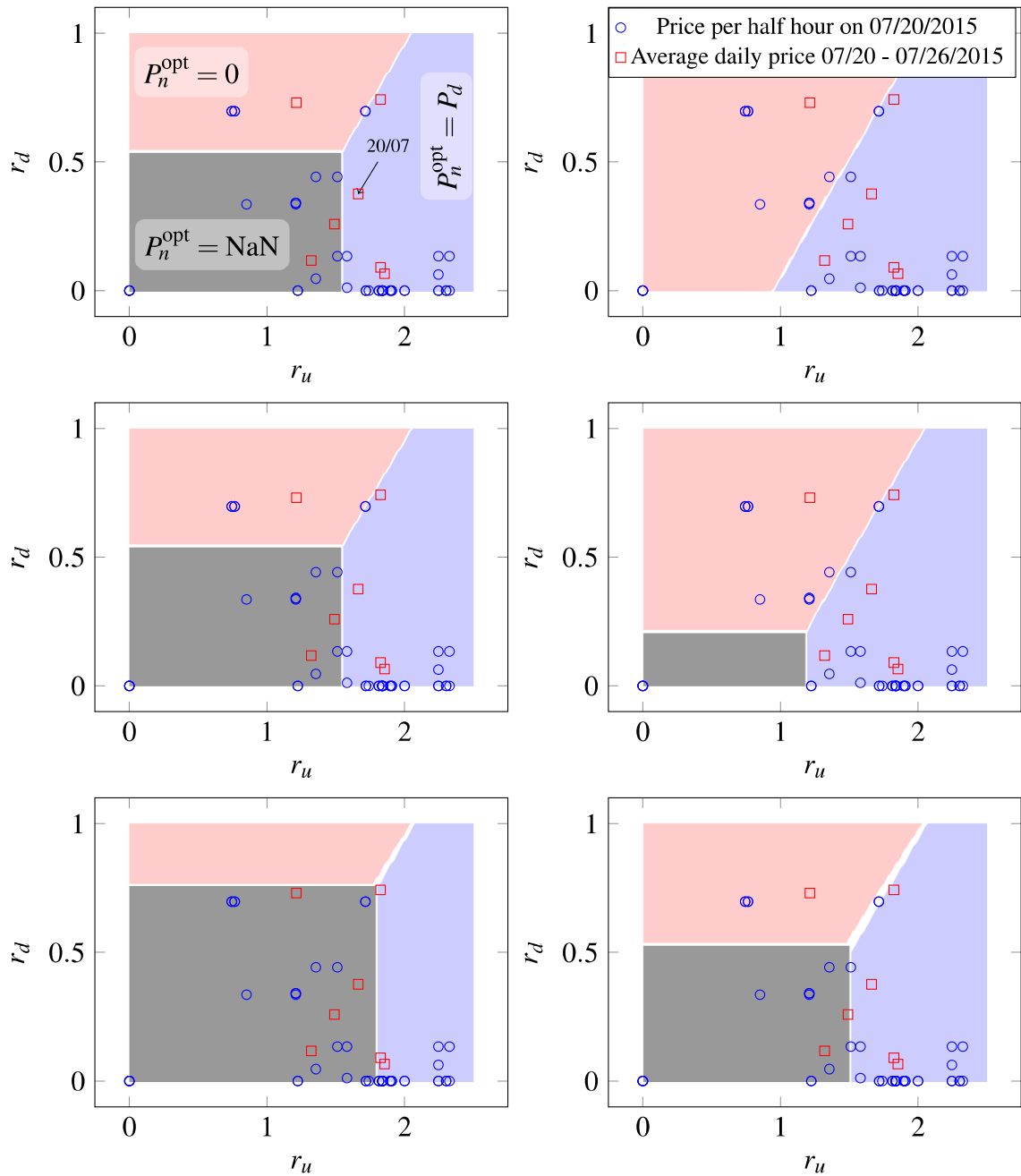

Fig. 3.16 Comparison of feasible regions on $r_d \times r_u$ plane and the optimal $x, t = 0.03, C_B = 50, \rho_d = \rho_u = 0.48, \bar{\theta} = 0.3, \gamma = 0.05$ for the first row, $\bar{\theta} = 0.1, \gamma = 0.05$ for the second, and $\bar{\theta} = 0.1, \gamma = 0.5$ for the third.

3.5 Summary

This chapter proposes firstly a control mechanism for an aggregator in charge of several charging stations for EVs. We allow the aggregator to provide frequency regulation by decreasing (increasing) the recharging power of EVs, pursuing for regulation incentives. Following the pricing policy we optimized, not only does the aggregator increase its revenue but also cheaper energy is offered to the EV owners. We highlight that even if EVs appear as a valuable asset for regulation because of their tolerance to changes in the consumed power, the revenue-oriented behavior of aggregators can dramatically affect the extent of regulation effectively provided by EVs. Under reasonable assumptions, the aggregator may even just not offer the possibility to participate in regulation, hence annihilating one of the leverages brought by the advent of EVs. Therefore, the incentives to participate in regulation should be carefully studied, so that the grid actually benefits from the considerable (and distributed) demand flexibility offered by EVs.

We move on by separating the traditional-fix-power recharging service and regulation-providing-variable-power recharging service and assign them to two competing self-interested charging stations. At the Nash equilibrium of this non-cooperative game, both stations tend to offer lower prices to EV owners than a monopolistic controller would do, thus more clients are attracted and greater regulation services are provided to the grid operator.

Chapter 4

Reducing grid dependency in transit areas

The soaring electricity demand due to EVs increases the urgency of the evolution from the power grid to the so-called *smart grid*, to manage demand peaks with minimal infrastructure costs.

In this chapter, we propose an approach close to Vehicle-to-Grid, where EVs can give back some energy from their batteries during peak times. But we also use EVs as energy transporters, by taking their energy where it is consumed. A typical example is a shopping mall with energy needs, benefiting from customers coming and going to alleviate its grid-based consumption, while EV owners make profits by reselling energy bought at off-peak periods.

Based on a simple model for EV mobility, energy storage, and electricity pricing, we quantify the reduction in energy costs for the EV-supported system, and investigate the conditions for this scenario to be viable.

4.1 Related work

EVs create a network of mobile energy containers; hence several propositions to use this energy during peak periods—the so-called Vehicle-to-Grid (V2G)—have been issued and studied [64, 80]. V2G can be implemented in residential areas to reduce the load of transformers [66, 67], to provide ancillary services for the grid [92] or to enhance its capability to face the penetration of renewable energy [18]. Research is quite abundant concerning these possibilities whereas their implementation requires broader cooperation between the grid operator and EV owners. Here, we consider an energy consumer which cannot avoid

usage during the peak hours, but fortunately is situated in a transit area where EVs stop by frequently.

On the other hand, the literature about managing aggregated EVs is quite abundant, but the majority of them [47, 42, 4, 9] emphasizes on charging EVs only, rather than discharging as we suggest here. In [47], the charging power of the EVs parked is locally optimized, considering their sojourn time. This requires EV owners to inform the controller of their predicted departure time, an assumption also made in [4]. Here we do not rely on such knowledge, since the departure time may be hard to predict by EV owners, who may also be reluctant to disclose it and/or willing to strategically declare it to maximize their benefit. We therefore stick to the simplest case where the facility does not know when EVs will be leaving; that knowledge could nevertheless yield further improvements, which can be studied in future work. Among the approaches that do not require users reporting their departure time, queueing theory can be used to model the dynamics of clients [9], whereas the goal is to serve the most EVs with limited energy for a network of fast charging stations. [42] also applies queueing theory to estimate the waiting time of EVs in a parking lot, and highlight the importance of the number of chargers in the parking lot. Interestingly, measurements shown in that paper illustrate a very good match between the power needs of the facility (a shopping center in the paper) and the arrivals of EVs, motivating further our approach of using EVs—some of which would be willing to sell energy—to reduce the grid-based consumption of the facility.

In this chapter, we consider that EV owners sell part of their stored energy directly to an entity with power needs. This has the advantage of avoiding benefit losses due to intermediaries, but also of avoiding energy losses due to transportation. Finally, this comes at no cost in terms of grid management. An illustrative use case is that of a shopping center with energy needs during the day, a time when electricity prices peak but also customers come and go, and we intend to benefit from EVs in the parking lot by installing dischargers for those willing to sell their energy to the shopping center, as illustrated in Figure A.2, where the first and second EV are discharging while the third one is not, due to the exhaustion of its surplus energy. When the power discharged from those EVs does not cover its needs, the facility can buy the rest from the power grid. Although our proposition seems opposite to the current practice of putting charging (not discharging) stations in parking lots, we rather think that our approach is complementary; the EV charging stations can either be seen as part of the consumption of the center, or as a separate (since managed from the grid) system. In this chapter we consider constant power needs of the center, fitting more with the latter interpretation, but future work can also consider demand variations due to EV charging. More generally, we are interested in a facility where EVs come and go during the day, and with

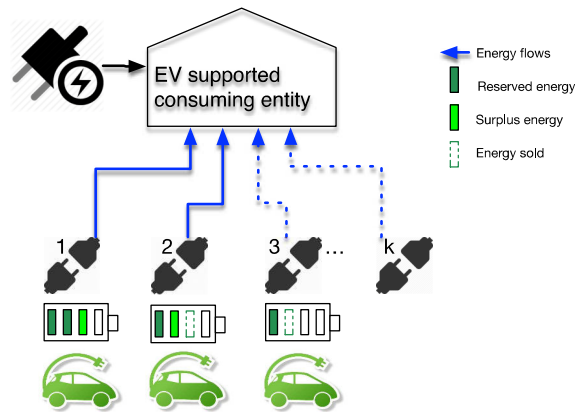

Fig. 4.1 System implementation: EVs can sell their surplus energy (bought off-peak) to make profit and reduce the facility grid dependency during peaks.

some electricity needs during that period (e.g., a shopping center, a bank, an administrative center... but also a factory that would be located near a shopping center). The facility can buy energy from the grid, at the (relatively high) on-peak price, or from the EVs that are present.

In this chapter, we take into account the costs involved with setting such a system, and perform a quantitative analysis of its economic interest. The main exogenous variables are the on-peak and off-peak electricity prices, the mobility of EV owners (arrival rate and sojourn time), the facility needs, and the energy EVs can sell; the decision variables include the number of discharging slots to install and the management of slots occupied by an EV with no more energy to sell. We propose two management schemes to discharge available EVs. For both we carry out an analytical study and show numerical results. Both schemes reduce energy costs for the facility (from 5% to 15%); the difference lies in the tradeoff between less management required and less discharging stations needed.

4.2 Model description

This subsection describes the assumptions we make regarding grid electricity prices, electricity needs for the consuming facility (hereafter simply called the facility), and EVs mobility and supply, in order to compute the overall electricity cost for the facility.

4.2.1 Time-of-use electricity pricing

We assume in this chapter that the grid charges for electricity usage depending on the *time* of consumption. More specifically, our model considers only two electricity prices: a low price during off-peak periods (typically, at night) and a high price during on-peak periods

(during the day). There may be several other prices (e.g., during the day), in which case our model also applies, by just ignoring the other day-time prices: what matters is just the current electricity price, and the price paid by EV owners to recharge. However, to optimally decide the number of discharging slots and the management, we would need a specific model of price variations over time, hence the simple choice here of a single day-time price.

Let us denote by g (in monetary units per kWh) the on-peak and by $v < g$ the off-peak prices respectively. Note that the latter is the price at which EVs can charge their batteries.

4.2.2 Electricity demand of the facility

We consider a simple model where the facility needs a constant power, denoted by P_f (in kW), during its activity periods. Without loss of generality we assume that those periods are included within peak-price periods, since during off-peak periods the facility can simply buy energy from the grid.

4.2.3 Potential supply from EVs

It is unrealistic to assume that EV owners perfectly predict the energy needs of their EVs for the next day, and charge their batteries accordingly. Instead, we think it is reasonable to consider that most EVs carry some surplus energy; when the owners realize during the day that they will not use all of the stored energy, they may choose to sell it to the facility. Because of the variety of battery models and of users distance left to cover within the day, the amount of energy that EVs can provide should be modeled as a random variable. To keep the analysis tractable we consider an exponential distribution, and denote its parameter by θ , so the average surplus energy per EV is $\frac{1}{\theta}$ kWh.

4.2.4 EV mobility

We assume that EVs arrive to the parking lot according to a Poisson process with parameter λ . This process assumption is reasonable, as the result of the uncoordinated behavior of many potential users. We also model the parking duration of each EV as independent random variables, exponentially distributed with mean $1/\mu$.

4.2.5 Costs faced by the facility

The facility undergoes several different costs related to its energy consumption, we list them below.

- *Grid electricity price.* As evoked previously, the facility can buy energy from the grid at a (high) on-peak price g (per kWh)
- *EV electricity price.* The price paid to EVs should at least compensate the owners' expenses to charge (at the night price v). Moreover, we assume that the facility provides 10% of the expense as an incentive to attract EV owners to joint the discharging program, i.e., they are payed 110% of the recharging cost, thus a relative benefit $\beta = 110\%$. According to [22] the battery recharging efficiency is over 88%, so conservatively we set $\eta = 88\%$. Discharging efficiency varies between 80% and 95% according to [15]. We model this loss through a Joule heating loss proportional to the square of the discharging power, hence equaling εP_0^2 for some loss factor ε . So only the power $P = P_0(1 - \varepsilon P_0)$ is retrieved by the facility if the transfer power is P_0 . In order to fit our setting to the loss values, we set ε so that at low discharging power ($P_0 = 5kW$), $1 - \varepsilon P_0 = 0.95$. Thus $\varepsilon = 0.01$ in our model. We consider that p_{EV}

$$p_{EV} := \frac{v\beta}{\eta(1 - \varepsilon P_0)} = \frac{v_0}{1 - \varepsilon P_0} \quad (4.1)$$

is the actual unit price seen by the facility (the EV actually sees v_0), where $v_0 = \frac{v\beta}{\eta}$.

- *Discharging slots costs.* Each discharging slot (discharger) is assumed to cost the facility an amount A_d per time unit, hence a trade-off with installing slots to retrieve more energy from EVs.
- *Management costs.* In addition to those costs, there may be some extra costs in some management solutions, namely, a cost for replacing an EV having sold all of its surplus energy with another one as described thereafter.

4.2.6 Management options

The main idea of our proposition is to reduce the electricity costs by discharging EVs through k dischargers. We will distinguish two possibilities:

- *scheme 1* refers to the “no unplugging” option, no action is carried out when an EV has sold all its energy surplus—that EV occupies the discharger until its departure from the parking lot—;
- *scheme 2* refers to the “unplugging” one. The facility can free a discharger manually or automatically, at a fixed cost U , when a new EV enters the system while all dischargers are occupied and at least one by an EV with no more energy to sell.

In the following section, for both management options we calculate the optimal number of dischargers to install to minimize the facility costs, and we compare those costs to the case without the EV discharging option.

Table A.1 summarizes the notations of the model, and specifies the values we consider for the numerical analysis.

Table 4.1 Model variables

Input	Value	Meaning and unit
P_f	200	Facility power needs (kW)
λ	10 to 30	EV arrival rate (hour ⁻¹)
$1/\mu$	1	Average parking duration (hour)
η	88%	Battery recharging efficiency
$1/\theta$	4 to 20	Average surplus energy per EV (kWh)
ε	0.01	Discharging inefficiency (kW ⁻¹)
g	0.25	On-peak grid electricity price (€/kWh)
v	0.1	Off-peak grid electricity price (€/kWh)
A_d	0.2	Cost per discharger (€/hour)
U	0.1	EV unplugging cost in Scheme 2 (€)
β	110%	EV owner relative benefit
Objectives		
min. C_1		Total cost of the facility, Scheme 1 (€/kWh)
min. C_2		Total cost of the facility, Scheme 2 (€/kWh)
Output Parameters		
k_1 (resp., k_2)		Number of dischargers in Scheme 1 (resp., 2)
P_{01} (resp., P_{02})		Discharge power per EV in Scheme 1 (resp., 2)

4.3 Analysis—Small k

In this subsection, we consider the decision variables of the facility with regard to the discharging system—namely, the discharging power to use and the number of dischargers to install—and analyze their optimal (i.e., cost-minimizing) values for both management schemes. We start by assuming the number of dischargers is sufficiently small such that even when all of them are conveying electricity to the facility, the energy flood won't exceed the amount needed. This can be expressed as $k_1 * P_1 \leq P_f$ for Scheme 1 and $k_2 * P_2 \leq P_f$ for Scheme 2, where P_1 (resp., P_2) is the power actually obtained by the facility while discharging EVs at

the power of P_{01} (resp., P_{02}).

$$P_1 = P_{01}(1 - \varepsilon P_{01}) \quad (4.2)$$

$$P_2 = P_{02}(1 - \varepsilon P_{02}) \quad (4.3)$$

We stick to the *small k* situation here in this section because in this way we do not need to curtail the discharging power in order to avoid cramming more energy into the facility than its actual demand. A stable discharging power is preferred due to the fact the constantly varying power level has a negatively effect on battery degradation.

4.3.1 Stochastic analysis

From the EV mobility model described in Subsection 4.2, the number of EVs parked and plugged to a discharger (which we denote by m_t) is a continuous-time Markov chain, whose evolution is that of an M/M/ k/k queue, with steady-state distribution

$$\mathbb{P}_{1\text{ steady-state}}(m_t = m) = \frac{\rho_0^m / m!}{\sum_{i=0}^{k_1} \rho_0^i / i!} \quad (4.4)$$

where $\rho_0 := \lambda / \mu$. Note that loss occurs when a newly arrived EV happens to find none of the k dischargers available. Since in Scheme 1, no effort is devoted to unplugging an EV from the discharger it is occupying, the chance of loss is simply $\mathbb{P}_{1\text{ steady-state}}(m_t = k)$, denoted by $B_1(k_1)$ and has the form of an Erlang B formula:

$$B_1(k_1) = \mathbb{P}_{1\text{ steady-state}}(m_t = k_1) = \frac{\rho_0^{k_1} / k_1!}{\sum_{i=0}^{k_1} \rho_0^i / i!} \quad (4.5)$$

Due to the fact that the sellable surplus energy of each EV is limited, one may not keep discharging before it departs. Therefore not all the m_t parked EVs are discharging: only n_t ($n_t \leq m_t$) of them are, then the process (n_t, m_t) is a continuous-time Markov chain whose transition diagram is depicted in Figure 4.2.

Thanks to the unplugging process in Scheme 2, higher throughput of EVs is enabled since those with a depleted battery are removed in case that they stand in the way of a newly arrived one. Adding this procedure gives a Markov chain as in Figure 4.3 and decreases the blocking probability to:

$$B_2(k_2) = \frac{\rho_2^k / k!}{\sum_{i=0}^k \rho_2^i / i!} \quad (4.6)$$

where $\rho_2 := \frac{\lambda}{\mu + \theta P_{02}}$.

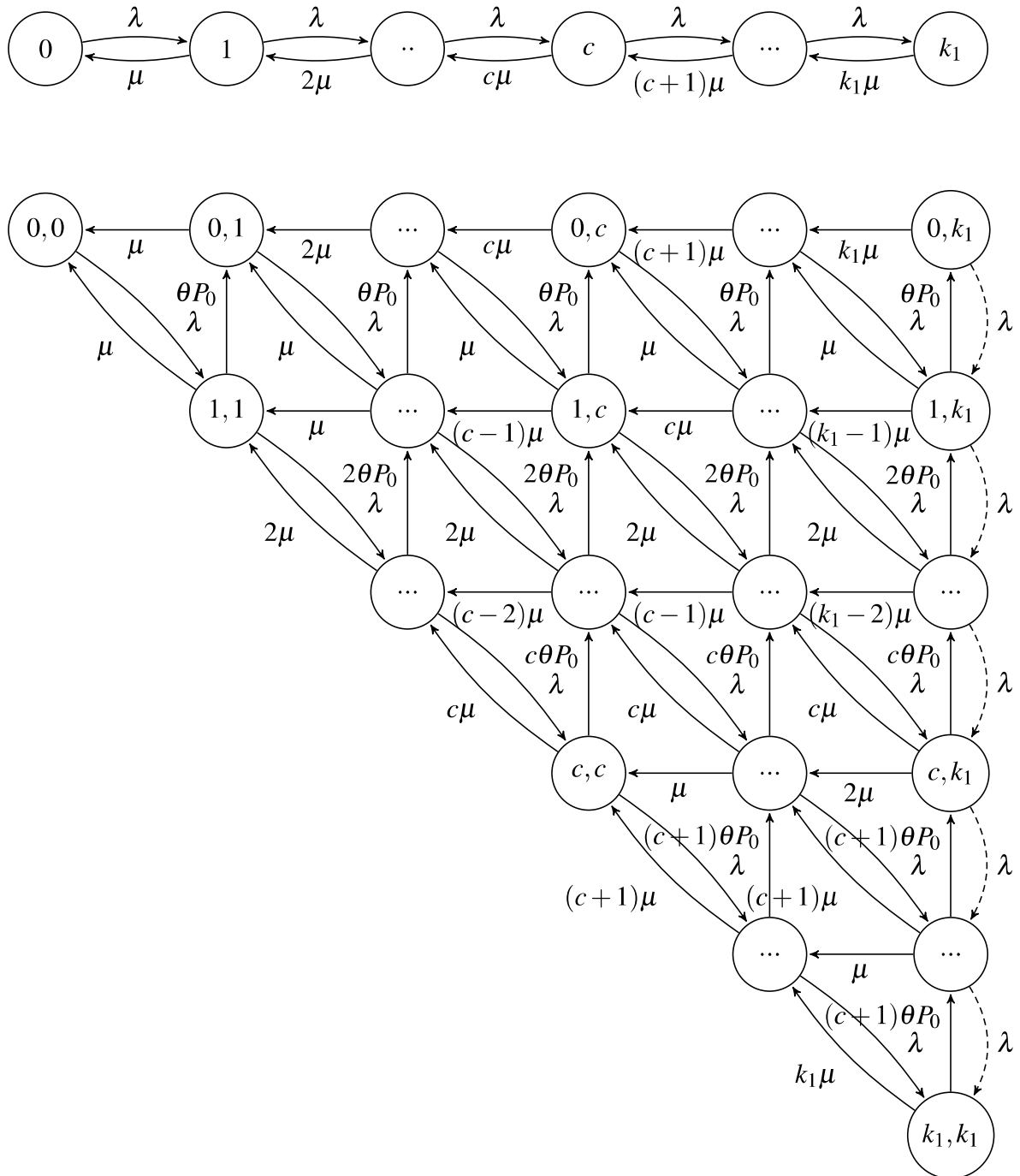

Fig. 4.2 Continuous-Time Markov Chains describing the evolution of the number of plugged EVs m_t (top) and of $(n_t, m_t)=(nb_discharging_EVs, nb_plugged_EVs)$ (bottom). Both are for Scheme 1

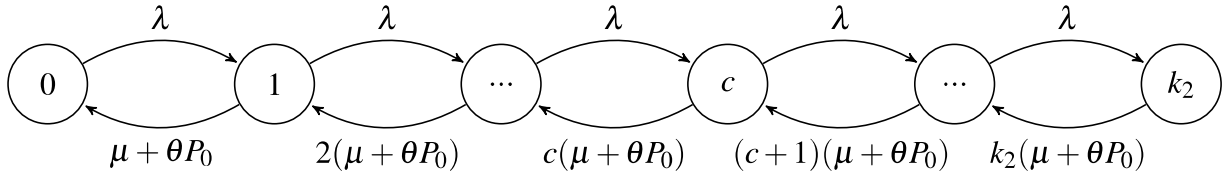

Fig. 4.3 Transition diagram for the number of discharging EVs in the unplugging scheme (Scheme 2)

In searching for the cost-minimizing discharging power, we are interested in the electricity output of the EV fleet in an average sense, so we compute the average number of discharging EVs through *Little's Law*:

$$\bar{N}_1(k_1) = \sum_{n=0}^{k_1} \mathbb{P}_{1\text{steady-state}}(n_t = n)n = \rho_1(1 - B_1(k)) \quad (4.7)$$

$$\bar{N}_2(k_2) = \sum_{n=0}^{k_2} \mathbb{P}_{2\text{steady-state}}(n_t = n)n = \rho_2(1 - B_2(k)) \quad (4.8)$$

where $\rho_1 := \frac{\lambda}{\mu + \theta P_0}$.

4.3.2 Cost function of the facility

As we elaborated in Section 4.2.5, the cost imposed on the facility mainly consists of two parts: electricity bill and management cost. The former comes from the electricity utility who sells energy at a relatively high *on peak* price (g \$/kWh), as well as from the EV owners (p_{EV} \$/kWh) who discharge their surplus electricity to feed the facility; the latter is composed of equipping and maintaining costs (A_d \$/h) of those dischargers, and possibly plus the cost (U \$/event) of deploying a system to unplug the depleted EVs (in Scheme 2).

When there are $n_t \in \{0, 1, 2, \dots, k_1 \text{ (or } k_2)\}$ EVs discharging simultaneously, the electricity cost of the facility is

$$C_{ins}^e(n_t) = n_t P_0 v_0 + (P_f - n \underbrace{P}_{=P_0(1-\varepsilon P_0)})g \quad (4.9)$$

no matter which scheme it is currently applying.

The two management schemes however, differ by resulting different steady-state-distributions on the numbers of EVs simultaneously discharging. We note them as $\mathbb{P}_{1\text{steady-state}}(n_t = n)$ and $\mathbb{P}_{2\text{steady-state}}(n_t = n)$. The average electricity cost is the instantaneous cost for each state, in (4.9), times the probability of occurring that state. And note that the discharging EV number can be replaced by its average value (\bar{N}), since the other coefficients are independent

of it.

$$C_1^e(k_1) = \sum_{n=0}^{k_1} C_{ins}(k_1, n) \mathbb{P}_{1\text{steady-state}}(n_t = n) \quad (4.10)$$

$$= P_f g - \bar{N}_1 P_{01} (g(1 - \varepsilon P_{01}) - v_0) \quad (4.11)$$

$$C_2^e(k_2) = \sum_{n=0}^{k_2} C_{ins}(k_2, n) \mathbb{P}_{2\text{steady-state}}(n_t = n) \quad (4.12)$$

$$= P_f g - \bar{N}_2 P_{02} (g(1 - \varepsilon P_{02}) - v_0) \quad (4.13)$$

Scheme 1 does not involve any intervention regarding those depleted EVs, so the final cost is simply that of the electricity plus a constant discharger cost per hour kA_d .

Scheme 2 introduces an extra cost, caused by unplugging the dischargers from an EV not any more contributing. This part is of course dependent on how many times this happens in an hour, i.e., the workload, which equals the throughput increment it yields:

$$W(k_2) = \lambda (B_1(k_2) - B_2(k_2)) \quad (4.14)$$

To summarize, the average costs that we aim to minimize are:

$$C_1(P_{01}, k_1) = P_f g - \bar{N}_1 P_{01} (g(1 - \varepsilon P_{01}) - v_0) + kA_d \quad (4.15)$$

$$C_2(P_{02}, k_2) = P_f g - \bar{N}_2 P_{02} (g(1 - \varepsilon P_{02}) - v_0) + kA_d + W(k_2)U \quad (4.16)$$

4.3.3 Optimal discharging power

To get better insight of the cost function in (4.15) we expand N_1 and rewrite it as:

$$P_f g - \underbrace{\lambda(1 - B_1)}_{\text{Part-1}} \underbrace{\left(\frac{P_{01}}{\mu + \theta P_{01}} (g(1 - \varepsilon P_{01}) - v_0) \right)}_{\text{Part-2}} + kA_d \quad (4.17)$$

Part-1 is how many EVs can be allowed into the system, which is independent of P_{01} because a car can only be removed by its owner after $\frac{1}{\mu}$ hours, i.e., depleting its battery won't quicken its departure so as to welcome a new arrived one. Part-2 is the average cost decrease an EV can produce, where $\frac{P_{01}}{\mu + \theta P_{01}}$ is the average amount of energy discharged per EV, and $g(1 - \varepsilon P_{01}) - v_0$ is how much monetary saving one kWh of electricity contributed by EVs can bring. So the problem of minimizing C_1 through adjusting P_{01} comes down to the maximization problem:

$$\max_{P_{01}} \frac{P_{01}}{\mu + \theta P_{01}} (g(1 - \varepsilon P_{01}) - v_0) \quad (4.18)$$

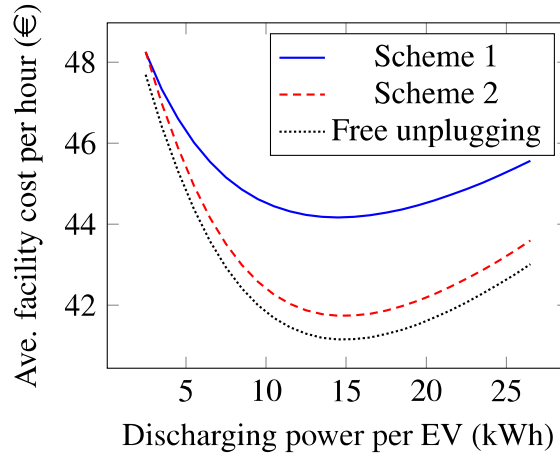

Fig. 4.4 Cost variation with different discharging powers ($\theta = 0.1$, $\lambda = 20$, $k_1 = k_2 = 7$).

Differentiating the objective function in (4.18), we obtain the discharging power of

$$P_{01}^* := \frac{\mu}{\theta} \left(\sqrt{1 + \frac{\theta}{\varepsilon\mu} \left(1 - \frac{v_0}{g}\right)} - 1 \right), \quad (4.19)$$

for which the differential is null, and the convexity at that point equals

$$\frac{\partial^2}{\partial P_{01}^2} \left(\frac{P_{01}}{\mu + \theta P_{01}} (g(1 - \varepsilon P_{01}) - v_0) \right) \Big|_{P_{01}=P_{01}^*} = -\frac{2\mu(\theta(g - v_0) + g\varepsilon\mu)}{(\mu + \theta P_{01}^*)^3} < 0, \quad (4.20)$$

which ensures that P_{01}^* is the cost-minimizing discharging power for Scheme 1, from which the facility actually extracts

$$P_1^* := P_{01}^* (1 - \varepsilon P_{01}^*) \quad (4.21)$$

per discharging EV. Expression (4.19) indicates that the discharging power per EV is independent of the power demand of the facility, which is a desirable property: that optimal discharging power would not change even if the facility demand varies over time, as long as $n \leq \frac{P_f}{P_{01}^*}$.

For Scheme 2, unfortunately the expression of $\frac{\partial C_2}{\partial P_{02}}$ is too complex to lead to a closed form solution. So we let $P_{02} = P_{01}$ although being aware of the fact that this is not always the cost-minimizing choice. Figure A.3 illustrate how does the discharging power affects the electricity plus managing cost for the facility.

4.4 Extension to larger k

Recall that the optimal discharging power calculated in Section 4.3.3 is only valid under the assumption that $k_1 \leq \frac{P_f}{P_1^*}$. Otherwise, it is possible that $n \leq k_1$ EVs are discharging whereas $nP_1 \geq P_f$, hence an over-supply if we maintain the discharging power to P_{01} . On the other hand, larger k_1 is perhaps preferred since it lets more EVs in, and possibly reduces costs further. In this case, the discharging power needs to be adjusted.

4.4.1 Setting the discharging power

For simplicity, we intuitively curtail the discharging power according to n , rather than searching for an optimal power for each possible value of it. The rule is: we apply power P_{01}^* when less than $\frac{P_f}{P_1^*}$ cars are discharging. When more than $\frac{P_f}{P_1^*}$ EVs are available for discharging, we reduce evenly the power out of each EV, so that their sum equals the whole demand P_f . Formally, the discharging power when there are n discharging EVs is then

$$P_{01}(n) = \begin{cases} P_{01}^* = \frac{\mu}{\theta} \left(\sqrt{1 + \frac{\theta}{\varepsilon\mu} \left(1 - \frac{v_0}{g}\right)} - 1 \right) & \text{if } n \leq \frac{P_f}{P_1^*} \\ \frac{1 - \sqrt{1 - 4\varepsilon P_f/n}}{2\varepsilon} & \text{otherwise.} \end{cases} \quad (4.22)$$

and at the same time, from the facility point of view, the energy extracted from each discharging EV is

$$\min \left(P_1^*, \frac{P_f}{n} \right),$$

with P_1^* given in (4.21).

Similarly, for the discharging power in Scheme 2, we set $P_{02} = P_{01}^*$ when no more than $\frac{P_f}{P_2}$ cars are discharging, and gradually decrease it as n increases.

4.4.2 Optimal number of dischargers to install

With discharging powers chosen, the cost-minimizing number of dischargers can be easily found by exhaustive search. Since k_1 and k_2 are integers and the cost functions are not time-consuming to compute, we find it quite doable not trying to optimize it analytically. Figure 4.5 shows the resulting costs from different discharger numbers.

The following reasoning gives an upper-bound of the value of k , beyond which searching is pointless. Consider a sufficiently large number of dischargers $k_0 > \frac{P_f}{P_1^*}$, we argue that installing more than k_0 dischargers is helpless with regard to cost saving. Suppose we index all the k_0 dischargers and use them orderly: a newly arrived EV is always assigned to the

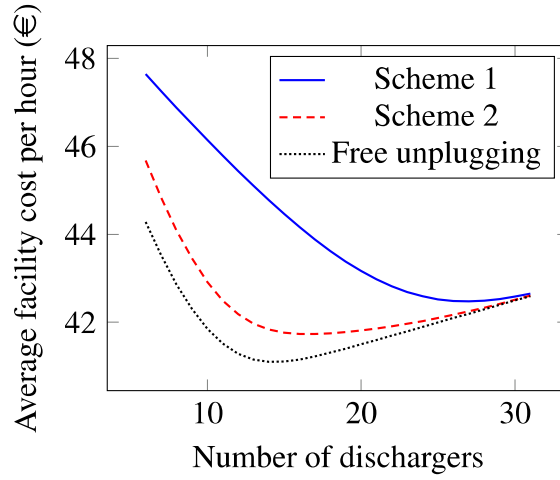

Fig. 4.5 Cost variation with different number of dischargers.

first discharger if it is unoccupied, otherwise, try the second, and so on. In this way the k_0 -th discharger would be the one used with least likelihood (strictly less than 1), and once so, it always discharge its client's battery at the power level of $P_{01}(k_0) = \frac{1 - \sqrt{1 - 4\varepsilon P_f/k_0}}{2\varepsilon}$. So the electricity bill it manages to save is strictly less than

$$\frac{P_{01}(k_0)}{\mu + \theta P_{01}(k_0)} (g(1 - \varepsilon P_{01}(k_0)) - v_0) \quad (4.23)$$

Noticing that each discharger has a fixed hourly cost of A_d , the sufficient condition for a discharger to be useless is when its net contribution is negative:

$$\frac{P_{01}(k_0)}{\mu + \theta P_{01}(k_0)} (g(1 - \varepsilon P_{01}(k_0)) - v_0) - A_d \leq 0 \quad (4.24)$$

This is the case when the discharging power is sufficiently low:

$$P_{01}(k_0) \leq \frac{g - v_0 - A_d \theta}{2g\varepsilon} \sqrt{(g - v_0 - A_d \theta)^2 - 4A_d g \mu \varepsilon} \quad (4.25)$$

Besides, $P_{01}(k)$ is a decreasing function of k . So the smallest k_0 that fulfills (4.25) provides a bound where the searching process for the optimal number of k should terminate. With the parameter values listed in Table A.1, we find the bound goes from 196 for $\theta = 0.25$ to 227 when $\theta = 0.05$.

4.5 Numerical results

This section shows the performance of our proposed schemes in terms of the cost they save for the facility, namely $1 - \frac{C_1(P_{01}, k_1)}{gP_f}$ for the no-unplugging scheme (Scheme 1) and $1 - \frac{C_2(P_{02}, k_2)}{gP_f}$ for the scheme with unplugging (Scheme 2). Note that this relative saving is always nonnegative, since the number of dischargers is optimized to minimize the cost; hence in the worst case no dischargers are installed and savings are null. Free unplugging, as a special case of Scheme 2, is plotted to give an idea of the impact of the unplugging cost. The parameter values used for this numerical analysis are those in Table A.1. For the value of the off-peak price we use the night price, and for that of the on-peak price we take the peak price for enterprise users, both offered by the French utility company EDF².

4.5.1 Optimal number of dischargers

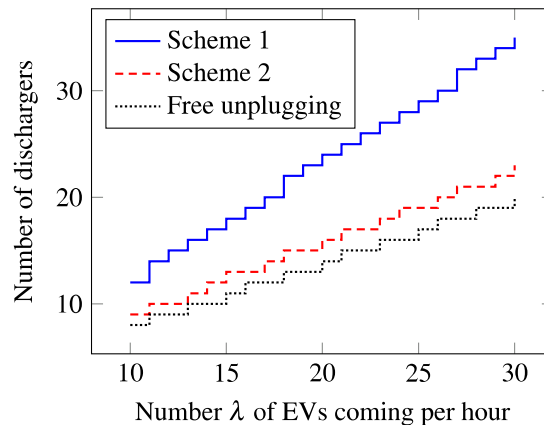

Fig. 4.6 Optimal number of dischargers according to EV arrival rate λ

Figures 4.6 and 4.7 show the optimal number of discharging stations to install for each scheme: interestingly, Scheme 2 needs much fewer dischargers than Scheme 1. And as the “free unplugging” benchmark shows, the unplugging cost has a direct effect on the optimal number of dischargers, conform to intuition (the higher the cost, the more dischargers to avoid unplugging situations). These optimal numbers of dischargers are applied in the following two subsections, which compare the performance of the two schemes.

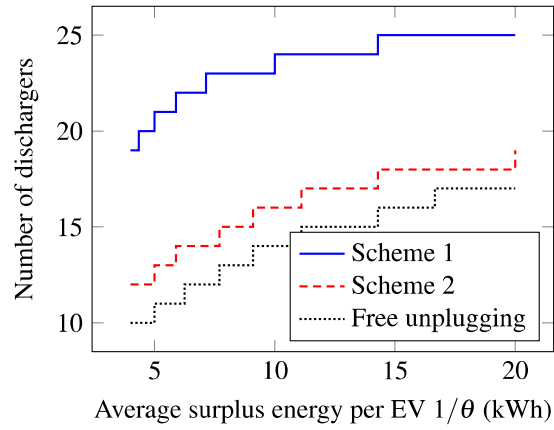

Fig. 4.7 Optimal number of dischargers versus average surplus energy $1/\theta$

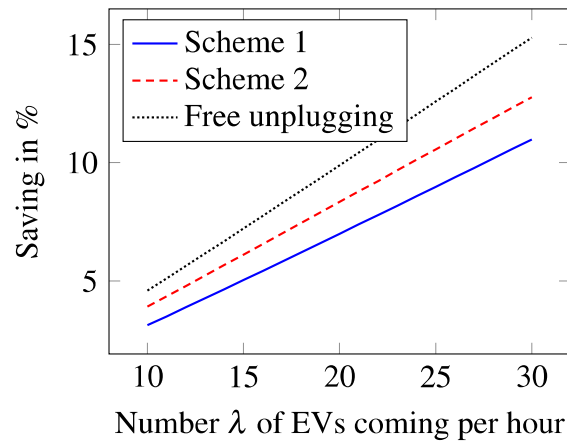

Fig. 4.8 Variation of saving according to the EV arrival rate λ

4.5.2 The difference between rush hour and vacant hour

It is not surprising to find that the more EVs come in a unit time (i.e., the larger λ is), the more saving they bring to the facility, as illustrated in Figure 4.8. The average surplus on-board energy $1/\theta$ is fixed at 10kWh, and the average time interval between two EVs' coming decreases from 6min to 1.5min. The gap between "Scheme 1" and "Scheme 2" increases since higher arrival rate results in more dischargers occupied by depleted EVs upon new arrivals, which is also causing the increase of the gap between curve "Scheme 2" and that of "Free unplugging".

4.5.3 Effect of the surplus energy in EVs

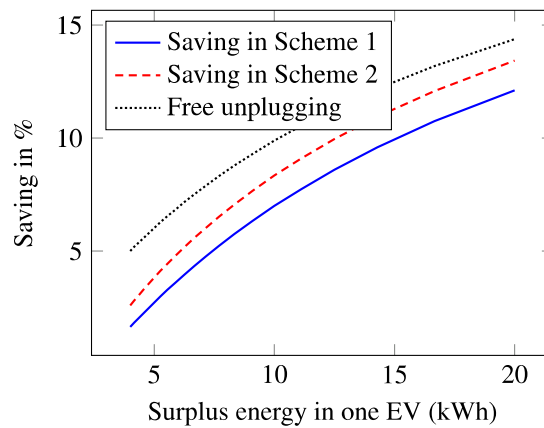

Fig. 4.9 Variation of saving versus average EV surplus energy $1/\theta$

Another key parameter is the available energy onboard parked EVs, whose average is denoted by $1/\theta$ in our model. According to a survey [62], more than 90% of daily travel is less than 100 miles, which consumes 34kWh of energy for a Tesla Model S whose battery capacity is 85 kWh, or 15kWh for a compact car whose battery capacity is typically 21kWh. So we range the average surplus energy from 4kWh to 20kWh, hence the probability of having an EV with more than 50kWh of sellable energy is between 0.0018% and 0.13%, which is very rare. So our system doesn't require unrealistically large battery size, even less than 10kWh of average surplus energy per EV can significantly reduce the facility electricity bill for the parameters we consider.

²http://entreprises.edf.com/fichiers/fckeditor/Commun/Entreprises/pdf/2014/BAREME_TARIF_VERT_01_11_2014.pdf

4.6 Summary

This chapter proposes to use the surplus energy in EVs gathered in a parking lot to support the energy needs of a facility: the mobility of EVs during the day brings energy on a quite regular basis, to an extent that possibly largely exceeds what could be stored in a unique (even large) battery that would be controlled by the facility. Leveraging the storage capabilities of EV batteries, our scheme benefits both

- EV owners, who can sell during peak times some energy bought during off-peak period and make some profit;
- and the facility, which can benefit from energy at lower-than-peak price, without installing large storage solutions.

We propose and evaluate two management schemes to discharge those EVs, namely without and with the possibility of removing depleted ones. Our numerical results suggest that we can save around 10% on the energy bill, and we don't need large amounts of surplus energy in each EV to realize that. Hence this approach is viable in our opinion, and could help reduce demand peaks that are observed in nowadays grids.

Chapter 5

Conclusion and future work

The background of the thesis is an ambitious blueprint of a modern electricity delivery network named Smart Grid. Motivated by the innovations in the domain of renewable energy harvesting and a growing penetration of Information and Communication Technologies (ICT), meanwhile urged by an increasing concern over energy independency together with a request for lower-carbon footprint of every single person, Smart Grid is drawing more and more attention and provides in itself an indispensable jigsaw piece of a bigger vision called the Smart City.

In fact, we consider the Smart Grid as an ever evolving process rather than a destination. The stakeholders in a power network have never being as diverse as nowadays: generators post their estimated production volumes online, waiting for reliable industrial clients to purchase; residential communities preempt nearby renewable energy at a low price; electricity vehicle manufacturers get a good bargain from the utilities so that their clients can get free recharges; householders equipped with solar panels and smart appliances keep an eye on real time electricity prices to seek for the best chance to sell their surplus or to cover their deficits.

When we scale up the picture to discover the opportunities for EVs in the crowd, we are at the intersection between the Smart Grid and economy. By all means, managing EV recharging or discharging behaviors is trying to solve an economic problem in a Smart Grid context. This is the case because energy is the product, price is a core concern, and other devices such as recharging facilities, smart meters and ICT services are all enablers for wise decisions, but in the center stand the EV owners, who are naturally assumed to be self-interested, i.e., profit-driven or cost-sensitive. The flexibility of EV charging means that they can be consumers in some instances and producers in others. In this thesis, we allow them to play both roles, in some specific contexts.

5.1 Summary of the thesis

The contribution of the thesis consists of the following three parts.

- We give a comprehensive survey of the state-of-the-art research on the economics of EV charging. We emphasize on the models that share a similar point of view with us, i.e., combining the charging management with the users' economic interests. We try to see how and how much EVs could benefit their owners and partners before clustering and comparing the mechanism proposals with respect to the scenarios they consider and the tools they adopt. Due to user anxieties over privacy and cyber-security, we further examine how information-demanding they are. The purpose of the survey is to help potential researchers to figure out the current trend and more importantly, to spot the promising areas that are worth their endeavor.
- We propose a recharging model for EVs. This proposal is trying to make the best of the demand-elasticity among EV owners, i.e., some of them have an imminent journey to cover so cannot afford to charge at low power, whereas some others don't need their car so urgently thus a longer recharging time with cheaper energy is a good option. Energy providers—the charging stations—are incentivized to offer the second type of users such a choice because the grid operator would remunerate them for doing so. A use case of this model is the frequency regulation market, from where we obtain the values needed by our model parameters to give some numerical results. First we assume a monopolistic station offering both high-power recharging to urgent users and low-and-variable power to patient ones, then we split this monopolist into two competing entities, with each of them offering one service. The comparison highlights the price reductions and efficiency gains due to competition.
- We propose a model considering discharging parked EVs to supply an adjacent consumer. In this proposal the EVs switch roles from consumers to suppliers. Noticing the electricity price fluctuations during a day, EV owners with cheap energy sources can take advantages of that by delivering electricity to a consumer in an area where, or at a time when, the price is high. Deliberately doing this may involve detours thus would be time and energy consuming for EV owners, so we'd rather assume that the procedure does not affect the convenience while they participating other activities, e.g. go to the supermarket or gymnasium. This brings uncertainties due to EV mobility. Using a Markov mobility model, we take the consumer's perspective, to see how much power it should take from those available EVs, and how many discharging slots it should maintain, to minimize the overall electricity bill.

5.2 Perspectives and work plan

For both our proposals, there are some directions to continue the work.

- We think the recharging model can be extended in several ways including: modeling in more actors such as charging stations with exclusive renewable energy sources; considering the actor of a “Grid” who can play with the wholesale electricity price imposed on both *R-charging* and *S-charging* station; or differentiating two charging stations by their locations, which affect users’ preferences among them. Another interesting direction is to assume that the potential EV-based regulation supply exceeds the grid needs, leading to dispatching problems for the regulation capacities and revenues. This could be the case in an isolated grid or micro-grid with small regulation demand.
- For the discharging proposal, possible extensions include considering an elastic EV supply, by relating the proportion of users who agree to discharge their batteries to the relative benefits provided by the facility, and then searching for the optimal incentives. Also, selecting upon arrivals EVs with sufficient sellable energy could significantly reduce the unplugging workload.

Out of the scope of the current work, we find the following topics of particular interest.

- How to control a fleet of EVs owned by a company and shared by its employees. The recharging and discharging process should be jointly optimized with the reservation assignment. This provides either a multi-objective optimization problem if the reservations are elastic, otherwise a constraint optimization problem. This is relevant because autonomous cars have already hit the road, although experts predict that the mass production is still 1 or 2 decades ahead of us, pilot projects are running in a few areas including Ontario, Canada and Wuhu, China. Widely spread autonomous cars would promote car sharing, thus make it possible for their owner to control them in a centralized manner.
- Another opportunity lies in wireless charging, or more specifically, on-road charging. Once the charging facilities are embedded in roads, not only the range anxiety is cured, but also electricity exchange can be realized almost all thought the day. Business models are still to be built and analyzed.

Publications

Peer-reviewed International Journal

- Shuai, W., Maillé, P., Pelov, A. (2016). Charging Electric Vehicles in the Smart City: A Survey of Economy-driven Approaches. *IEEE Transactions on Intelligent Transportation Systems*

Peer-reviewed International Conferences

- Shuai, W., Maillé, P., Pelov, A. (2015). Incentivizing Electric Vehicles to Provide Regulation While Recharging. In *IEEE PES Innovative Smart Grid Technologies (ISGT Asia)*
- Shuai, W., Maillé, P., Pelov, A. (2016). Exploiting Electric Vehicles Mobility to Reduce Grid Dependency in Transit Areas. In *IEEE Energy Conferences (EnergyCon)*
- **(Under review)** Shuai, W., Maillé, P., Pelov, A. (2016). Competition Between Regulation-Providing and Fixed-Power Charging Stations for Electric Vehicles. *IEEE PES Innovative Smart Grid Technologies (ISGT Europe)*

References

- [1] (2011). *Balancing and frequency control*. North American Electric Reliability Corporation (NERC).
- [2] (2013). Global EV outlook—understanding the electric vehicle landscape to 2020. Technical report, International Energy Agency (IEA).
- [3] Akhavan-Hejazi, H., Mohsenian-Rad, H., and Nejat, A. (2014). Developing a test data set for electric vehicle applications in smart grid research. In *IEEE 80th Vehicular Technology Conference (VTC Fall)*, pages 1–6.
- [4] Akhavan-Rezai, E., Shaaban, M., El-Saadany, E., and Karray, F. (2014). Priority-based charging coordination of plug-in electric vehicles in smart parking lots. In *IEEE PES General Meeting | Conference Exposition*, pages 1–5.
- [5] Alsabaan, M., Alasmay, W., Albasir, A., and Naik, K. (2013). Vehicular networks for a greener environment: A survey. *Commun. Surveys Tuts.*, 15(3):1372–1388.
- [6] Andersson, S.-L., Elofsson, A., Galus, M., Göransson, L., Karlsson, S., Johnsson, F., and Andersson, G. (2010). Plug-in hybrid electric vehicles as regulating power providers: Case studies of Sweden and Germany. *Energy Policy*, 38(6):2751–2762.
- [7] Ardakanian, O., Keshav, S., and Rosenberg, C. (2014). Real-time distributed control for smart electric vehicle chargers: From a static to a dynamic study. *IEEE Trans. Smart Grid*, 5(5):2295–2305.
- [8] Balram, P., Le Anh, T., and Bertling Tjernberg, L. (2012). Effects of plug-in electric vehicle charge scheduling on the day-ahead electricity market price. In *IEEE PES International Conference and Exhibition on Innovative Smart Grid Technologies (ISGT Europe)*, pages 1–8.
- [9] Bayram, I., Michailidis, G., Devetsikiotis, M., and Granelli, F. (2013). Electric power allocation in a network of fast charging stations. *IEEE Journal on Selected Areas in Communications*, 31(7):1235–1246.
- [10] Beaude, O., Lasaulce, S., and Hennebel, M. (2012). Charging games in networks of electrical vehicles. In *6th International Conference on Network Games, Control and Optimization (NetGCooP)*, pages 96–103.
- [11] Ben-Tal, A., El Ghaoui, L., and Nemirovski, A. (2009). *Robust Optimization*. Princeton University Press.

- [12] Bertsekas, D. P. (2012). *Dynamic Programming and Optimal Control*. Athena Scientific, 4 edition.
- [13] Bessa, R., Matos, M., Soares, F., and Lopes, J. (2012). Optimized bidding of a EV aggregation agent in the electricity market. *IEEE Trans. Smart Grid*, 3(1):443–452.
- [14] Binetti, G., Davoudi, A., Naso, D., Turchiano, B., and Lewis, F. (2015). Scalable real-time electric vehicles charging with discrete charging rates. *IEEE Trans. Smart Grid*, 6(5):2211–2220.
- [15] Bizon, N. (2012). Energy efficiency of multiport power converters used in plug-in/V2G fuel cell vehicles. *Applied Energy*, 96(0):431 – 443.
- [16] Boyd, S. and Vandenberghe, L. (2004). *Convex optimization*. Cambridge University Press.
- [17] Budischak, C., Sewell, D., Thomson, H., Mach, L., Veron, D. E., and Kempton, W. (2013). Cost-minimized combinations of wind power, solar power and electrochemical storage, powering the grid up to 99.9% of the time. *J. Power Sources*, 225:60–74.
- [18] Chukwu, U. and Mahajan, S. (2014). V2G parking lot with PV rooftop for capacity enhancement of a distribution system. *IEEE Transactions on Sustainable Energy*, 5(1):119–127.
- [19] Clarke, E. H. (1971). Multipart pricing of public goods. *Public Choice*, 11:17–33.
- [20] Conejo, A., Morales, J., and Baringo, L. (2010). Real-time demand response model. *IEEE Trans. Smart Grid*, 1(3):236–242.
- [21] Cover, T. M. and Thomas, J. A. (2012). *Elements of information theory*. John Wiley & Sons.
- [22] Deilami, S., Masoum, A., Moses, P., and Masoum, M. (2011). Real-time coordination of plug-in electric vehicle charging in smart grids to minimize power losses and improve voltage profile. *IEEE Trans. on Smart Grid*, 2(3):456–467.
- [23] Dickerman, L. and Harrison, J. (2010). A new car, a new grid. *IEEE Power Energy Mag.*, 8(2):55–61.
- [24] Dow, L., Marshall, M., Xu, L., Aguero, J., and Willis, H. (2010). A novel approach for evaluating the impact of electric vehicles on the power distribution system. In *IEEE Power and Energy Society General Meeting*, pages 1–6.
- [25] Escudero-Garzas, J., Garcia-Armada, A., and Seco-Granados, G. (2012). Fair design of plug-in electric vehicles aggregator for V2G regulation. *IEEE Trans. Veh. Technol.*, 61(8):3406–3419.
- [26] Escudero-Garzas, J. and Seco-Granados, G. (2012). Charging station selection optimization for plug-in electric vehicles: An oligopolistic game-theoretic framework. In *IEEE PES Innovative Smart Grid Technologies (ISGT)*, pages 1–8.
- [27] European Parliament and Council of the European Union (2009). Directive 2009/72/EC of the European Parliament and of the Council. *Official Journal of the European Union*.

- [28] Fan, Z., Kulkarni, P., Gormus, S., Efthymiou, C., Kalogridis, G., Sooriyabandara, M., Zhu, Z., Lambotharan, S., and Chin, W. H. (2013). Smart grid communications: Overview of research challenges, solutions, and standardization activities. *Commun. Surveys Tuts.*, 15(1):21–38.
- [29] Federal Energy Regulatory Commission (1999). *Docket No. RM99-2-000; Order No. 2000*. Federal Energy Regulatory Commission.
- [30] Foley, A., Tyther, B., Calnan, P., and Gallachóir, B. Ó. (2013). Impacts of electric vehicle charging under electricity market operations. *Applied Energy*, 101:93–102.
- [31] Franco, J., Rider, M., and Romero, R. (2015). A mixed-integer linear programming model for the electric vehicle charging coordination problem in unbalanced electrical distribution systems. *IEEE Trans. Smart Grid*, 6(5):2200–2210.
- [32] Fudenberg, D. (1998). *The theory of learning in games*. MIT Press.
- [33] Fudenberg, D. and Tirole, J. (1991). *Game Theory*. MIT Press, Cambridge, Massachusetts.
- [34] Galus, M. D. and Andersson, G. (2008). Demand management of grid connected plug-in hybrid electric vehicles (PHEV). In *Proc. of IEEE Energy 2030 Conference*, pages 1–8.
- [35] Galus, M. D. and Andersson, G. (2009). Integration of plug-in hybrid electric vehicles into energy networks. In *IEEE Bucharest Power Tech Conference*, pages 1–8.
- [36] Gan, L., Topcu, U., and Low, S. (2013). Optimal decentralized protocol for electric vehicle charging. *IEEE Trans. Power Syst.*, 28(2):940–951.
- [37] Gao, Y., Chen, Y., Wang, C.-Y., and Liu, K. (2013). A contract-based approach for ancillary services in V2G networks: Optimality and learning. In *Proc. IEEE INFOCOM*, pages 1151–1159.
- [38] Gerding, E. H., Robu, V., Stein, S., Parkes, D. C., Rogers, A., and Jennings, N. R. (2011). Online mechanism design for electric vehicle charging. In *Proc. of The 10th International Conference on Autonomous Agents and Multiagent Systems (AAMAS)*, pages 811–818.
- [39] Gerding, E. H., Stein, S., Robu, V., Zhao, D., and Jennings, N. R. (2013). Two-sided online markets for electric vehicle charging. In *Proc. of the 12th International conference on Autonomous Agents and Multiagent Systems (AAMAS)*, pages 989–996.
- [40] Gkatzikis, L., Koutsopoulos, I., and Salonidis, T. (2013). The role of aggregators in smart grid demand response markets. *IEEE Journal on Selected Areas in Communications*, 31(7):1247–1257.
- [41] Gonder, J., Markel, T., Thornton, M., and Simpson, A. (2007). Using global positioning system travel data to assess real-world energy use of plug-in hybrid electric vehicles. *Transportation Research Record: Journal of the Transportation Research Board*, 2017:26–32.

- [42] Gong, Q., Midlam-Mohler, S., Serra, E., Marano, V., and Rizzoni, G. (2013). PEV charging control for a parking lot based on queuing theory. In *American Control Conference (ACC)*, pages 1124–1129.
- [43] Green, R. C., Wang, L., and Alam, M. (2011). The impact of plug-in hybrid electric vehicles on distribution networks: A review and outlook. *Renewable and Sustainable Energy Reviews*, 15(1):544–553.
- [44] Groves, T. (1973). Incentives in teams. *Econometrica*, 41(3):617–631.
- [45] Guo, Q., Xin, S., Sun, H., Li, Z., and Zhang, B. (2014). Rapid-charging navigation of electric vehicles based on real-time power systems and traffic data. *IEEE Trans. Smart Grid*, 5(4):1969–1979.
- [46] Han, S., Han, S., and Sezaki, K. (2010). Development of an optimal Vehicle-to-Grid aggregator for frequency regulation. *IEEE Trans. Smart Grid*, 1(1):65–72.
- [47] He, Y., Venkatesh, B., and Guan, L. (2012). Optimal scheduling for charging and discharging of electric vehicles. *IEEE Transactions on Smart Grid*, 3(3):1095–1105.
- [48] Hu, J., Yang, G., and Bindner, H. (2015). Network constrained transactive control for electric vehicles integration. In *IEEE Power Energy Society General Meeting*, pages 1–5.
- [49] Hu, J., You, S., Lind, M., and Ostergaard, J. (2014). Coordinated charging of electric vehicles for congestion prevention in the distribution grid. *IEEE Trans. Smart Grid*, 5(2):703–711.
- [50] Hutson, C., Venayagamoorthy, G., and Corzine, K. (2008). Intelligent scheduling of hybrid and electric vehicle storage capacity in a parking lot for profit maximization in grid power transactions. In *IEEE Energy 2030 Conference*, pages 1–8.
- [51] Kamboj, S., Decker, K., Trnka, K., Pearre, N., Kern, C., and Kempton, W. (2010). Exploring the formation of electric vehicle coalitions for vehicle-to-grid power regulation. In *AAMAS workshop on agent technologies for energy systems (ATES)*, pages 1–8.
- [52] Kamboj, S., Kempton, W., and Decker, K. S. (2011). Deploying power grid-integrated electric vehicles as a multi-agent system. In *Proc. of The 10th International Conference on Autonomous Agents and Multiagent Systems (AAMAS)*, pages 13–20.
- [53] Kamien, M. I. and Schwartz, N. L. (1983). Conjectural Variations. *Canadian Journal of Economics*, 16(2):191–211.
- [54] Kelly, F. (1997). Charging and rate control for elastic traffic. *European Transactions on Telecommunications*, 8(1):33–37.
- [55] Kelly, F. P., Maulloo, A. K., and Tan, D. K. H. (1998). Rate control in communication networks: Shadow prices, proportional fairness and stability. *Journal of the Operational Research Society*, 49:237–252.
- [56] Kempton, W. and Letendre, S. E. (1997). Electric vehicles as a new power source for electric utilities. *Transportation Research Part D: Transport and Environment*, 2(3):157–175.

- [57] Kempton, W. and Tomić, J. (2005a). Vehicle-to-grid power fundamentals: Calculating capacity and net revenue. *J. Power Sources*, 144(1):268–279.
- [58] Kempton, W. and Tomić, J. (2005b). Vehicle-to-grid power implementation: From stabilizing the grid to supporting large-scale renewable energy. *J. Power Sources*, 144(1):280–294.
- [59] Khaligh, A. and Dusmez, S. (2012). Comprehensive topological analysis of conductive and inductive charging solutions for plug-in electric vehicles. *IEEE Trans. Veh. Technol.*, 61(8):3475–3489.
- [60] Kirby, B. (2007). Ancillary services: Technical and commercial insights. Technical report, Wärtsilä North America Inc.
- [61] Krumm, J. (2012a). How people use their vehicles: Statistics from the 2009 national household travel survey. Technical report, Microsoft Corporation.
- [62] Krumm, J. (2012b). How people use their vehicles: Statistics from the 2009 national household travel survey.
- [63] Lee, S., Huh, J., Park, C., Choi, N.-S., Cho, G.-H., and Rim, C.-T. (2010). On-line electric vehicle using inductive power transfer system. In *IEEE Energy Conversion Congress and Exposition (ECCE)*, pages 1598–1601.
- [64] Letendre, S. and Kempton, W. (2002). The V2G concept: A new model for power? *Public Utilities Fortnightly*, 140(4):16–26.
- [65] Leterme, W., Ruelens, F., Claessens, B., and Belmans, R. (2014). A flexible stochastic optimization method for wind power balancing with PHEVs. *IEEE Trans. Smart Grid*, 5(3):1238–1245.
- [66] Liang, H., Choi, B. J., Zhuang, W., and Shen, X. (2012). Towards optimal energy store-carry-and-deliver for PHEVs via V2G system. In *Proc. IEEE INFOCOM*, pages 1674–1682.
- [67] Liang, H., Choi, B. J., Zhuang, W., and Shen, X. (2013). Optimizing the energy delivery via V2G systems based on stochastic inventory theory. *IEEE Trans. Smart Grid*, 4(4):2230–2243.
- [68] Liu, C., Wu, J., and Long, C. (2014). Joint charging and routing optimization for electric vehicle navigation systems. In *International Federation of Automatic Control*.
- [69] Lukic, S. and Pantic, Z. (2013). Cutting the cord: Static and dynamic inductive wireless charging of electric vehicles. *IEEE Electrific. Mag.*, 1(1):57–64.
- [70] Ma, Z., Callaway, D., and Hiskens, I. (2013). Decentralized charging control of large populations of plug-in electric vehicles. *IEEE Trans. Control Syst. Technol.*, 21(1):67–78.
- [71] Maillé, P. and Tuffin, B. (2006). Pricing the internet with multibid auctions. *IEEE/ACM Trans. Netw.*, 14(5):992–1004.
- [72] Mankiw, N. G. (2014). *Principles of Microeconomics*. South-Western College Pub, 7 edition.

- [73] Mohrehkesh, S. and Nadeem, T. (2011). Toward a wireless charging for battery electric vehicles at traffic intersections. In *14th International IEEE Conference on Intelligent Transportation Systems (ITSC)*, pages 113–118.
- [74] Mohsenian-Rad, A.-H., Wong, V., Jatskevich, J., Schober, R., and Leon-Garcia, A. (2010). Autonomous demand-side management based on game-theoretic energy consumption scheduling for the future smart grid. *IEEE Trans. Smart Grid*, 1(3):320–331.
- [75] Mohsenian-Rad, H. and Ghamkhari, M. (2015). Optimal charging of electric vehicles with uncertain departure times: A closed-form solution. *IEEE Trans. Smart Grid*, 6(2):940–942.
- [76] Monderer, D. and Shapley, L. S. (1996). Potential games. *Games and Economic Behaviour*, 14:124–143.
- [77] Myerson, R. B. (1978). Optimal auction design. *Mathematics of Operations Research*, 6(1):58–73.
- [78] Nisan, N., Roughgarden, T., Tardos, E., and Vazirani, V. V. (2007). *Algorithmic Game Theory*. Cambridge University Press.
- [79] Osborne, M. J. and Rubinstein, A. (1994). *A Course in Game Theory*. MIT Press.
- [80] Pillai, J. and Bak-Jensen, B. (2011). Integration of Vehicle-to-Grid in the western Danish power system. *IEEE Trans. Sustain. Energy*, 2(1):12–19.
- [81] Puterman, M. (2014). *Markov Decision Processes: discrete stochastic dynamic programming*. John Wiley & Sons.
- [82] Qin, H. and Zhang, W. (2011). Charging scheduling with minimal waiting in a network of electric vehicles and charging stations. In *Proc. of the 8th ACM International Workshop on Vehicular Inter-networking, VANET '11*, pages 51–60, New York, NY, USA. ACM.
- [83] Quinn, C., Zimmerle, D., and Bradley, T. H. (2010). The effect of communication architecture on the availability, reliability, and economics of plug-in hybrid electric vehicle-to-grid ancillary services. *J. Power Sources*, 195(5):1500–1509.
- [84] Samadi, P., Mohsenian-Rad, A.-H., Schober, R., Wong, V., and Jatskevich, J. (2010). Optimal real-time pricing algorithm based on utility maximization for smart grid. In *IEEE International Conference on Smart Grid Communications (SmartGridComm)*, pages 415–420.
- [85] Santos, A., McGuckin, N., Nakamoto, H., Gray, D., and Liss, S. (2011). Summary of travel trends: 2009 national household travel survey. Technical report, U.S. Department of Transportation Federal Highway Administration (FHWA).
- [86] Shafiee, S., Fotuhi-Firuzabad, M., and Rastegar, M. (2013). Investigating the impacts of plug-in hybrid electric vehicles on power distribution systems. *IEEE Trans. Smart Grid*, 4(3):1351–1360.
- [87] Shapley, L. S. (1953). A value for n -person games. In Kuhn, H. and Tucker, A., editors, *Contributions to the Theory of Games, volume II, Annals of Mathematical Studies*, pages 307–317. Princeton University Press.

- [88] Shin, J., Song, B., Lee, S., Shin, S., Kim, Y., Jung, G., and Jeon, S. (2012). Contactless power transfer systems for on-line electric vehicle (OLEV). In *IEEE International Electric Vehicle Conference (IEVC)*, pages 1–4.
- [89] Sortomme, E. and El-Sharkawi, M. (2011). Optimal charging strategies for unidirectional Vehicle-to-Grid. *IEEE Trans. Smart Grid*, 2(1):131–138.
- [90] Soshinskaya, M., Crijns-Graus, W. H., Guerrero, J. M., and Vasquez, J. C. (2014). Microgrids: Experiences, barriers and success factors. *Renewable and Sustainable Energy Reviews*, 40(0):659 – 672.
- [91] Sun, S., Dong, M., and Liang, B. (2013). Real-time welfare-maximizing regulation allocation in aggregator-EVs systems. In *IEEE Conference on Computer Communications Workshops*, pages 13–18.
- [92] Sun, S., Dong, M., and Liang, B. (2014). Real-time welfare-maximizing regulation allocation in dynamic aggregator-EVs system. *IEEE Trans. Smart Grid*, 5(3):1397–1409.
- [93] Tomić, J. and Kempton, W. (2007). Using fleets of electric-drive vehicles for grid support. *J. Power Sources*, 168(2):459–468.
- [94] Tushar, W., Saad, W., Poor, H., and Smith, D. (2012). Economics of electric vehicle charging: A game theoretic approach. *IEEE Trans. Smart Grid*, 3(4):1767–1778.
- [95] Vasirani, M., Kota, R., Cavalcante, R., Ossowski, S., and Jennings, N. (2013). An agent-based approach to virtual power plants of wind power generators and electric vehicles. *IEEE Trans. Smart Grid*, 4(3):1314–1322.
- [96] Vickrey, W. (1961). Counterspeculation, auctions, and competitive sealed tenders. *Journal of Finance*, 16(1):8–37.
- [97] White, C. D. and Zhang, K. M. (2011). Using vehicle-to-grid technology for frequency regulation and peak-load reduction. *J. Power Sources*, 196(8):3972–3980.
- [98] Wu, C., Mohsenian-Rad, H., and Huang, J. (2012a). PEV-based reactive power compensation for wind DG units: A Stackelberg game approach. In *IEEE International Conference on Smart Grid Communications (SmartGridComm)*, pages 504–509.
- [99] Wu, C., Mohsenian-Rad, H., and Huang, J. (2012b). Vehicle-to-aggregator interaction game. *IEEE Trans. Smart Grid*, 3(1):434–442.
- [100] Wu, H., Gilchrist, A., Sealy, K., Israelsen, P., and Muhs, J. (2011). A review on inductive charging for electric vehicles. In *IEEE International Electric Machines and Drives Conference (IEMDC)*, pages 143–147.
- [101] Xie, L., Gu, Y., Eskandari, A., and Ehsani, M. (2012). Fast MPC-based coordination of wind power and battery energy storage systems. *Journal of Energy Engineering*, 138(2):43–53.
- [102] Yan, Y., Qian, Y., Sharif, H., and Tipper, D. (2013). A survey on smart grid communication infrastructures: Motivations, requirements and challenges. *Commun. Surveys Tuts.*, 15(1):5–20.

-
- [103] Yang, Z., Sun, L., Ke, M., Shi, Z., and Chen, J. (2014). Optimal charging strategy for plug-in electric taxi with time-varying profits. *IEEE Trans. Smart Grid*, 5(6):2787–2797.
- [104] Yilmaz, M. and Krein, P. (2012). Review of integrated charging methods for plug-in electric and hybrid vehicles. In *IEEE International Conference on Vehicular Electronics and Safety (ICVES)*, pages 346–351.
- [105] Yilmaz, M. and Krein, P. (2013). Review of battery charger topologies, charging power levels, and infrastructure for plug-in electric and hybrid vehicles. *IEEE Trans. Power Electron.*, 28(5):2151–2169.
- [106] Zhou, C., Qian, K., Allan, M., and Zhou, W. (2011). Modeling of the cost of EV battery wear due to V2G application in power systems. *IEEE Trans. Energy Convers.*, 26(4):1041–1050.

Appendix A

Gestion du système des véhicules électriques avec des acteurs rationnels

A.1 Introduction

La diminution de l'offre de pétrole et l'augmentation des préoccupations environnementales motivent fortement les efforts de recherche vers l'électrification des transports, et les progrès technologiques ont favorisé l'arrivée des véhicules électriques (VEs) sur le marché. Cependant, la charge des VEs a un impact immense sur les parties prenantes dans les domaines de l'électricité, comme les producteurs, les opérateurs de réseaux électriques, les détaillants et les consommateurs [23]. De plus, une pénétration élevée avec une charge non contrôlée menace la durabilité des réseaux de distribution [43]. Ces travaux de recherche aboutissent à un consensus sur le fait que la recharge des VEs devrait être contrôlée pour éviter la congestion. En même temps, grâce au fait que leurs demandes sont relativement souples et que leurs batteries peuvent être temporairement utilisées pour supporter le réseau électrique, les VEs peuvent être collaborateurs actifs au lieu de consommateurs passifs.

Dans cette thèse, nous supposons que les VEs appartiennent à des clients ayant leur préférences spécifiques, qui ne renonceraient pas au contrôle du processus de recharge sans être compensés suffisamment. Ces incitations peuvent prendre plusieurs formes, comme une récompense fixe, ou un prix variant selon le temps. Nous pensons donc que la recharge des VEs doit être gérée à l'aide de mécanismes de marché, où les participants seront supposés avoir des objectifs différents. De ce fait, un cadre approprié pour la gestion VE est celui de l'économie, et en particulier de la théorie des jeux.

A.2 Charger des véhicules électriques dans la ville intelligente: état de l'art

Nous présentons et classifions les schémas de charge proposés dans la littérature pour exploiter les avantages et éviter les effets indésirables sur le réseau des VEs entrant dans l'écosystème. Cet état de l'art couvre à la fois la charge unidirectionnelle (l'énergie passe seulement du réseau vers la batterie du VE) ainsi que le commerce d'énergie bidirectionnel (le réseau peut également prendre de l'énergie à partir des batteries embarquées des VEs).

A.2.1 Environnement techno-économique des VEs

Dans un marché de l'électricité, les utilisateurs finaux ont des contrats avec un opérateur du réseau d'électricité qui achète l'électricité produite par des producteurs. Pour faire correspondre instantanément l'offre à la demande d'électricité, l'opérateur du réseau exploite des marchés de services auxiliaires, où il achète des services auxiliaires auprès de producteurs et/ou de consommateurs capables de modifier leur production ou leur consommation. Un service auxiliaire typique qui maintient une fréquence/puissance de transmission stable est nommé la *régulation*. Nous rappelons les acteurs pertinents et définissons le vocabulaire comme suit.

- Véhicule Électrique (VE) : Un véhicule électrique physique ou son propriétaire.
- La station de recharge VE : Le propriétaire et/ou l'opérateur d'une ou de plusieurs installations de charge à proximité physique, qui autorise la recharge et/ou la décharge VE dans le but de maximiser les revenus.
- Opérateur du réseau (ou simplement réseau) : Une entité qui maintient le système de transmission dans une zone donnée. Il fixe une contrainte pour la charge VE agrégée en fonction de la capacité du transformateur. Il achète aussi la régulation lorsque cela est nécessaire afin de maintenir l'équilibre offre-demande.

A.2.2 Mécanismes de charge unidirectionnels

Cette section passe en revue les principales approches économiques pour gérer la charge (unidirectionnelle) des VEs. Nous décrivons d'abord les approches *statiques* pour le partage de l'énergie (où l'objectif et les décisions sont basés sur un instantané du système indépendamment des impacts possibles sur le futur), puis nous étendons le problème de partage aux scénarios *dynamiques* (où l'incertitude des événements futurs est prise en compte).

Recharge statique unidirectionnelle

Les modèles statiques traitent le problème d'allocation d'énergie dans un intervalle de temps indivisible, c'est-à-dire que seules les demandes actuelles sont considérées et qu'il n'y a aucune incertitude quant aux événements futurs (variations de l'offre et/ou de la demande). Dans ce cadre, pour les modèles sans topologie réseau [34], la consommation des VE est limitée par leurs installations de charge, les batteries et en même temps freinée par l'équipement d'alimentation. Alors que lorsqu'une topologie du réseau de distribution spécifique est considérée [71], les choix réalisables sont encore plus étroits, en raison des débits des transformateurs aux nœuds.

Nous pouvons également considérer la dimension temporelle lors de la planification VE charge. Une période de temps est divisé en plusieurs intervalles de temps. La variable de décision est non seulement la quantité d'électricité à allouer parmi les VE, mais aussi son expansion dans le temps, c'est-à-dire un vecteur, afin d'exploiter la flexibilité temporelle de l'allocation de la demande. Par conséquent, le problème est de remodeler la charge agrégée (*courbe de charge*) sous contraintes sur l'énergie totale transférée. Il existe des modèles visant à former une courbe de charge constante [10], d'autres visant à former une courbe de charge arbitraire [70].

Modèles dynamiques

Dans certains modèles, les acteurs doivent s'engager pour des créneaux horaires avant que toutes les informations pertinentes soient disponibles. Par exemple, un utilisateur peut optimiser sa consommation actuelle en fonction du prix actuel [35], tout en sachant que les variations de prix futures lui auraient permis d'obtenir un gain encore meilleur ; de même, un propriétaire de VE informé du prix de l'électricité à venir, mais incapable de prévoir précisément son heure de départ, ne peut rien faire de mieux que de minimiser son coût de l'électricité *en espérance* [75]. D'autres types d'informations inconnues sont apportés par les clients à venir, comme la quantité et l'élasticité de leurs demandes. Des *algorithmes d'adaptation dynamique* (également appelés algorithmes en ligne) anticipant et s'adaptant à ces nouvelles informations doivent donc être définis pour une telle optimisation au cours du temps.

Un scénario typique de cadre dynamique est l'arrangement de charge en tenant compte de la mobilité. Nous pouvons effectuer une analyse économique, en incluant le point de vue des propriétaire de VE [82], ou celui des agrégateurs/stations de recharge. [26].

A.2.3 Commerce d'énergie bidirectionnel

Grâce à la technologie V2G (Vehicle-to-Grid) les VEs ne peuvent pas seulement acheter de l'électricité à partir du réseau, mais aussi le vendre.

Le prix de l'électricité bidirectionnelle (c'est-à-dire un prix pour l'achat d'énergie à partir du réseau et un autre prix pour le revendre) offre aux VEs la possibilité d'arbitrer, c'est-à-dire d'acheter de l'électricité lorsque les prix sont bas et d'attendre que le réseau la rachète lors des pics de consommation. Noter que les pertes de conversion d'énergie et/ou de conversion AC/DC devraient être considérées. Pour qu'un VE puisse obtenir un revenu d'arbitrage plus élevé, les prix de l'électricité bidirectionnelle jouent un rôle essentiel, ainsi que la mobilité du VE. La littérature fournit deux façons d'analyser ce paramètre [50].

Kempton et Tomić [57] suggèrent que la *régulation* fait partie des services que les VEs peuvent rendre au réseau électrique, car il exploite au mieux les forces des VEs: temps de réponse rapide, faibles coûts de réserve et faible coût d'investissement par kW. Une étude [93] suggère qu'à quelques exceptions près, lorsque la valeur marchande annuelle de la régulation est faible, le service de régulation est rentable pour les VE. Les schémas de répartition de la régulation et les modèles d'allocation des recettes peuvent être trouvés dans [25].

La production du parc éolien et la génération solaire sont inconstants et seulement partiellement prévisibles, ce qui constitue un obstacle à l'utilisation large et efficace de l'énergie renouvelable. Les VEs, avec leurs batteries embarquées, peuvent fournir des services de stockage grâce à la technologie V2G, c'est-à-dire absorber le surplus et le libérer si nécessaire, pour maintenir un niveau de sortie stable et compenser ces limites de l'éolien et du solaire.

A.3 Recharge VE et régulation : étude du comportement des stations

Dans cette section, nous faisons une première proposition, consistant à utiliser le processus de recharge des VEs pour fournir un service de régulation au réseau électrique, en adaptant la puissance instantanée de charge. Nous conduisons une analyse économique des incitations en jeu, en incluant le point de vue des VEs et celui des stations de recharge.

A.3.1 Mécanisme de régulation

La régulation se produit sur une variété d'échelles de temps [1]. Ici, nous nous attendons à une période de temps de régulation entre 6min et 15min.

La figure A.1 compare deux modes de charge, montrant les profils de puissance et l'énergie accumulée : l'un (no reg.) est une recharge à pleine puissance P_d kW et l'autre (regul.) est une recharge s'adaptant aux besoins de régulation. On désigne par C_B l'énergie totale demandée par un VE, par Δ l'échelle de temps de régulation et par ρ_u (resp., ρ_d) la probabilité de convocation de la régulation à la hausse (resp. à la baisse). P_n représente la puissance de recharge par défaut si la régulation n'est pas exigée, c'est-à-dire avec probabilité $1 - \rho_u - \rho_d$.

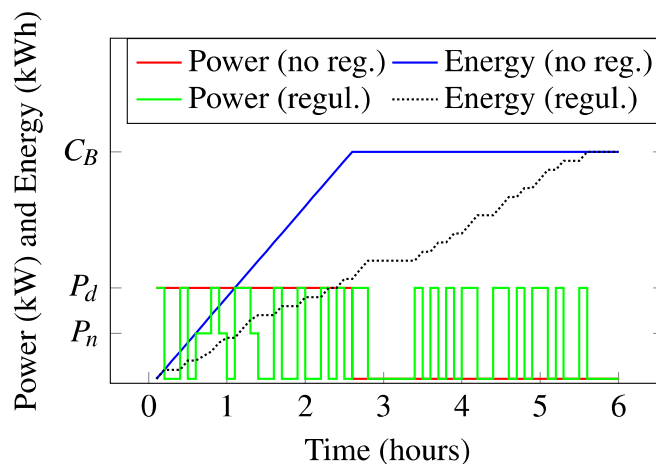

Fig. A.1 Puissance et énergie accumulée un EV obtenu avec et sans ajustement (simulation avec $C_B = 50$ kWh, $P_d = 20$ kW, $P_n = 16$ kW, $\Delta = 0.1$ hour, $\rho_u = \rho_d = 0.45$)

En contrepartie de la régulation, la station reçoit une rétribution monétaire (pour plus de détails sur sa composition, veuillez voir la thèse) dont le montant est proportionnel à la quantité de régulation fournie. D'autre part, les propriétaires de VEs ne reçoivent pas de rémunération directement de l'opérateur du réseau, mais ils sont encouragés par la baisse des prix de l'électricité offerte par la station (la recharge avec régulation est moins coûteuse).

Nous supposons que chaque VE peut obtenir sa demande quotidienne d'électricité par

- Recharge simple (*S-charging*): au prix de T_s €/kWh avec sa batterie rechargée à la puissance maximale disponible de P_d kW;

ou par

- Recharge-régulation (*R-charging*): au prix T_r €/kWh, avec la puissance de recharge qui s'adapte aux sollicitations de régulation.

Dans le cas où aucune des options ci-dessus ne convient au propriétaire du VE, il peut également n'en choisir aucune (*no_charging*).

Considérant les préférences de l'utilisateur vis-à-vis de ces options, nous supposons qu'à chaque propriétaire de VE correspond un paramètre de sensibilité spécifique, qui détermine s'il préfère *R-charging*, *S-charging* ou *no_charging*, en fonction des prix.

A.3.2 Agent de recharge en monopole

Cette étude est initialement conduite dans le cas d'un monopole, avec un agent (agrégateur), qui peut offrir une *S-charging* ou une *R-charging*, comme indiqué dans la Figure A.2, côté gauche.

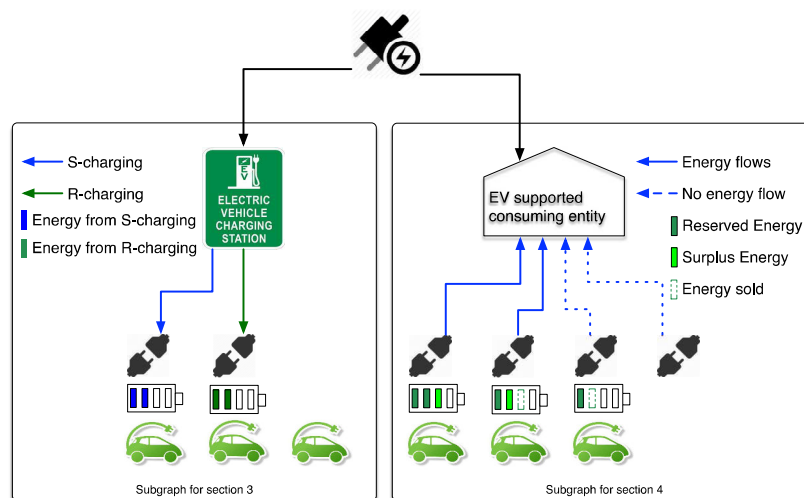

Fig. A.2 Illustrations des modèles des sections A.3 et A.4

Conscient du mécanisme de régulation, du niveau de rémunération que l'opérateur du réseau offre et de l'anticipation des réactions des VE, l'agrégateur peut décider d'effectuer ou non une régulation, en fonction du calcul du revenu de régulation attendu. Nous analysons les valeurs des incitations à la régulation qui sont suffisantes pour qu'une offre de *R-charging* soit bénéfique à la fois pour l'agrégateur et l'opérateur du réseau.

A.3.3 Compétition entre *R-charging* station et *S-charging* station

Nous regardons ensuite l'impact de la compétition. Pour cela, nous étudions à l'aide de la théorie des jeux, la compétition entre une station n'offrant que *R-charging*, et une autre n'offrant que *S-charging*. Nous appliquons au cadre de jeu leader-suiveur, avec les stations de recharge ayant le rôle de leader (fixant les prix en premier), les utilisateurs étant les suiveurs (choisissant leur option de recharge). Les deux stations rivalisent sur les prix pour attirer les propriétaires de VE. Cela nous permet de résoudre le problème grâce à la méthode *backward induction* issue de la théorie des jeux.

Comme dans le cas du monopole, les préférences des utilisateurs entre les variations de prix et de puissance de recharge sont supposées hétérogènes. Chaque station cherche le meilleur compromis entre les parts de marché et le profit par client afin de maximiser ses revenus escomptés. Nous avons donc un jeu non-coopérative, formulé comme suit.

Definition A.3.1. *Le jeu de prix entre la station de S-charging et la station de R-charging est spécifié par: $\langle \mathcal{N}, \mathcal{T}, (R_i) \rangle$, où l'ensemble de joueurs \mathcal{N} se compose des deux stations, le profil de prix \mathcal{T} est un vecteur sur le demi-plan $\mathbb{R}_{\geq 0} \times \mathbb{R}$, et la fonction $R_i : \mathcal{T} \rightarrow \mathbb{R}$ donne le revenu espéré de chaque station obtenue par VE.*

L'analyse du jeu nous donne le résultat suivant.

Proposition A.3.2. *Le jeu de prix défini dans A.3.1 possède soit un équilibre de Nash unique, soit un unique Pareto-dominant quand il existe un nombre infini d'équilibres de Nash.*

A.3.4 Comparaison entre l'équilibre de Nash et le modèle monopolistique

La compétition semble préférable pour les utilisateurs et pour la société, puisque les prix sont alors plus bas qu'avec le monopole, et que la participation aux services de régulation est bien plus élevée.

A.4 Réduire la dépendance du réseau dans les zones de transit

Nous proposons d'utiliser une autre propriété des VEs, à savoir leur capacité de stockage d'énergie. En effet, les VEs peuvent se charger pendant les heures de faible demande, donc à des prix réduits, et éventuellement revendre une partie de l'énergie accumulée pendant les pics de demande. Nous définissons un scénario où un établissement utilise même la mobilité des VEs, en consommant l'énergie apportée par des VEs, par exemple dans un centre commercial où certains clients revendent une partie de leur électricité pendant leur durée de visite, comme illustrée en figure A.2, côté droit.

Basé sur un modèle simple pour la mobilité des VEs, le stockage de l'énergie et la tarification de l'électricité, nous quantifions la réduction des coûts pour l'établissement grâce à la décharge des VEs et étudions les conditions pour que ce scénario soit viable.

A.4.1 Description du modèle

Nous décrivons ici les hypothèses que nous faisons.

- Nous supposons que le réseau impose le prix d'électricité en fonction de l'heure de consommation. Plus précisément, notre modèle ne considère que deux prix de l'électricité : un prix élevé pendant les périodes de pointe (pendant la journée) et un prix bas pendant les périodes creuses (généralement pendant la nuit).
- Nous considérons un modèle simple où l'établissement a besoin d'une puissance constante au cours de ses périodes d'activité pendant les périodes de pointe.
- En raison de la variété des modèles de batteries et de la distance à couvrir après la décharge, la quantité d'énergie que les VE peuvent fournir être modélisée comme une variable aléatoire avec une distribution exponentielle.
- Nous supposons que les VE arrivent au parking selon un processus de Poisson. Nous modélisons également la durée de parking de chaque VE en tant que variable aléatoire indépendante distribuée de façon exponentielle.
- L'établissement supporte plusieurs coûts différents liés à sa consommation d'énergie:
 - *Prix de l'électricité de réseau.* Comme évoqué précédemment, le prix de pointe.
 - *Prix de l'électricité de VE.* Le prix payé aux VEs dépend du prix hors pointe, de l'avantage relatif offert aux VE propriétaires pour les encourager à revendre, et particulièrement de la puissance de décharge.
 - *Le coût d'équipement de décharge.* Chaque borne de décharge coûte à l'établissement un montant par unité de temps (e.g. une heure).
 - *Frais de gestion.* Dans certaines solutions de gestion (comme décrit ci-après), il y a un coût pour le basculement d'un VE ayant vendu toute son énergie excédentaire vers un autre (re-branchement).

Nous distinguerons deux possibilités de gestion:

- Le *schéma 1 (scheme 1)* fait référence à l'option "sans déconnexion" (no unplugging), aucune action n'est effectuée lorsqu'un VE a vendu tout son excédent d'énergie –le VE occupe la borne jusqu'à son départ–;
- Le *schéma 2 (scheme 2)* se réfère à l'option avec "déconnexion" (unplugging). L'établissement peut libérer une borne manuellement ou automatiquement, lorsqu'un nouveau VE entre

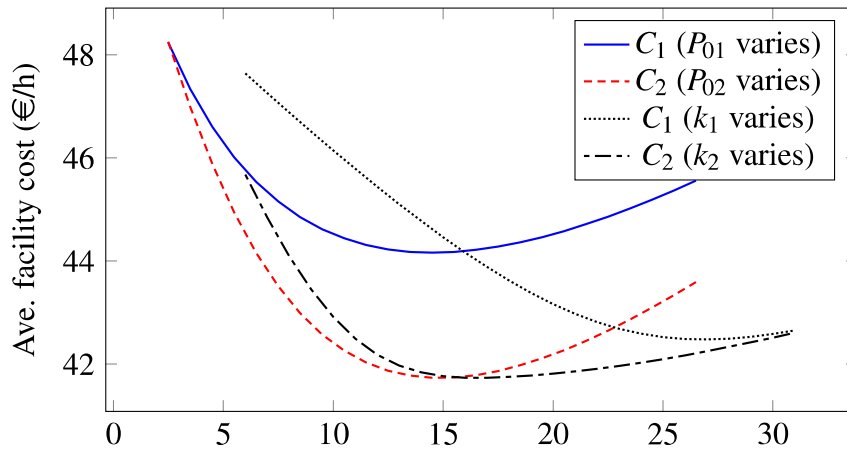

Discharging power P_{0*} (kW) per EV (solid line) or number of dischargers k_* (dashed line)

Fig. A.3 Variation de coût avec différentes puissances de décharge (ligne pleine) et nombre variable de bornes de décharge (ligne en pointillés) lorsque $\theta = 0.1$, $\lambda = 20$.

dans le système alors que tous les bornes sont occupées dont au moins une par un VE sans plus d'énergie à vendre.

Table A.1 Variables du modèle

Objectif	
min. C_1 (resp. C_2)	Coût global pour l'établissement, Schéma 1 (Schéma 2)(€/kWh)
Variable contrôlée	
k_1 (resp., k_2)	Nombre de bornes de décharge pour Schéma 1 (resp., Schéma 2)
P_{01} (resp., P_{02})	Puissance de décharge par VE pour Schéma 1 (resp., Schéma 2)

A.4.2 Analyse

La table A.1 résume les variables du modèle. L'idée principale de notre modèle est de réduire les coûts de l'établissement C_* . Des compromis apparaissent dans le choix P_{0*} , des puissances de décharge (pertes versus décharge insuffisante si le temps de séjour des véhicules est court), et dans le choix du nombre k_* de bornes de décharge à installer (probabilité de blocage versus coûts de maintenance), comme illustré dans la figure A.3.

A partir de valeurs réalistes des marchés de l'électricité, nous déterminons numériquement les conditions pour qu'un tel scénario soit viable, et quantifions les économies qu'il peut apporter. En conclusion, notre proposition bénéficie à la fois

- aux propriétaires de VEs, qui peuvent faire des profits en vendant de l'énergie pendant les heures de pointe, achetée pendant les périodes creuses;
- et à l'établissement, dont la dépendance au réseau d'énergie est allégée par l'achat d'énergie aux propriétaires VE à des prix inférieurs au tarif de pointe.

Nos résultats numériques suggèrent que nous pouvons économiser environ 10% de la facture, et cela peut être réalisé sans la nécessité d'une grande quantité d'excédent d'énergie.

A.5 Récap

La contribution de la thèse se compose des trois parties: une étude de la littérature axée sur l'économie de la charge des VEs, deux modèles de recharge pour les VEs et un modèle envisageant de décharger des VEs pour fournir un consommateur tiers.

Résumé

L'arrivée des véhicules électriques (VEs) a un impact non négligeable sur le réseau électrique, à cause de la grande quantité d'énergie demandée. La stabilité du réseau est susceptible d'être menacée. Cependant, dans l'optique de la transition du réseau électrique vers le Smart Grid, les VEs peuvent aussi être vus comme offrant de nouvelles opportunités. Grâce à la flexibilité des VE demande, leur présence ouvre la voie à des optimisations via le processus de recharge ou même par l'utilisation de cette nouvelle capacité de stockage d'énergie distribuée. Dans cette thèse, nous nous intéressons aux aspects économiques liés à la VE recharge, en prenant en compte le fait que l'écosystème associé aux VEs implique un grand nombre d'acteurs divers, aux objectifs rarement alignés et chaque acteur peut prendre des décisions stratégiques.

Je présente d'abord un état de l'art structuré des modèles de la littérature introduits pour ces problèmes. Nous décrivons et comparons les principales approches, en mettant en évidence les besoins en communication des mécanismes correspondants, et les principales propriétés économiques afin de souligner les résultats les plus significatifs ainsi que les éventuels manques.

Nous faisons ensuite une proposition consistant à utiliser le processus de VE recharge pour fournir un service de régulation au réseau électrique, en adaptant la puissance instantanée de charge. Nous conduisons une analyse économique des incitations en jeu. En particulier, nous analysons les valeurs des incitations à la régulation qui sont suffisantes pour qu'une offre de recharge-régulation soit bénéfique à la fois pour l'agrégateur et le réseau. Cette étude étant initialement conduite dans le cas d'un monopole qui peut offrir une recharge normale ou une recharge-régulation. Nous regardons ensuite l'impact de la compétition, entre un agrégateur n'offrant que des recharges à puissance fixe, et un autre n'offrant que de la recharge-régulation. La compétition semble préférable pour les utilisateurs et pour la société, puisque les prix sont alors plus bas qu'avec le monopole, et que la participation aux services de régulation est bien plus élevée.

Enfin, nous proposons d'utiliser une autre propriété des VEs, à savoir leur capacité de stockage d'énergie. En effet, les VEs peuvent se charger pendant les heures de faible demande, donc à des prix réduits, et éventuellement revendre une partie pendant les pics de demande. Nous menons une étude économique des gains et coûts d'une telle approche. A partir de valeurs réalistes des marchés de l'électricité, nous déterminons numériquement les conditions pour qu'un tel scénario soit viable, et quantifions les économies qu'il peut apporter.

Cette dissertation se conclut par une prise de recul sur les contributions et sur les extensions qui pourraient y être apportées.

Mots-clés : Smart Grid, Véhicule électrique, Prix de l'électricité; Jeux non-coopératifs

Abstract

Electric Vehicles (EVs), as their penetration increases, are not only challenging the sustainability of the power grid, but also stimulating and promoting its upgrading. Indeed, EVs can actively reinforce the development of the Smart Grid if their charging processes are properly coordinated through two-way communications, possibly benefiting all types of actors. Because grid systems involve a large number of actors with nonaligned objectives, we focus on the economic and incentive aspects, where each actor behaves in its own interest. We indeed believe that the market structure will directly impact the actors' behaviors, and as a result the total benefits that the presence of EVs can earn the society, hence the need for a careful design.

The thesis first provides an overview of economic models considering unidirectional energy flows, but also bidirectional energy flows, i.e., with EVs temporarily providing energy to the grid. We describe and compare the main approaches, summarize the requirements on the supporting communication systems, and propose a classification to highlight the most important results and lacks.

We propose to use the recharging processes of EVs to provide regulation to the grid by varying the instantaneous recharging power. We provide an economic analysis of the incentives at play, including the EV owners point of view (longer recharging durations and impact on battery lifetime versus cheaper energy) and the aggregator point of view (revenues from recharging versus regulation gains). In particular, we analyze the range of regulation rewards such that offering a regulation-oriented recharging benefits both EV owners and the aggregator. After that, we split the monopolistic aggregator into two competing entities. We model a non-cooperative game between them and examine the outcomes at the Nash equilibrium, in terms of user welfare, station revenue and electricity prices. As expected, competing stations offer users with lower prices than the monopolistic revenue-maximizing aggregator do. Furthermore, the amount of regulation service increases significantly than that in the monopolistic case.

Considering the possibility of discharging, we propose an approach close to Vehicle-to-Grid, where EVs can give back some energy from their batteries during peak times. But we also use EVs as energy transporters, by taking their energy where it is consumed. A typical example is a shopping mall with energy needs, benefiting from customers coming and going to alleviate its grid-based consumption, while EV owners make profits by reselling energy bought at off-peak periods. Based on a simple model for EV mobility, energy storage, and electricity pricing, we quantify the reduction in energy costs for the EV-supported system, and investigate the conditions for this scenario to be viable.

Keywords : Smart Grid; Electric Vehicle, Electricity Pricing; Non-cooperative games



n° d'ordre : 2016telb0408

Télécom Bretagne

Technopôle Brest-Iroise - CS 83818 - 29238 Brest Cedex 3

Tél : + 33(0) 29 00 11 11 - Fax : + 33(0) 29 00 10 00