



HAL
open science

Régulation de l'expression du brain-derived neurotrophic factor par le récepteur des glucocorticoïdes dans le neurone

Hui Chen

► **To cite this version:**

Hui Chen. Régulation de l'expression du brain-derived neurotrophic factor par le récepteur des glucocorticoïdes dans le neurone. Biochemistry, Molecular Biology. Université Paris Saclay (COMUE), 2017. English. NNT: 2017SACLS242 . tel-01598656

HAL Id: tel-01598656

<https://theses.hal.science/tel-01598656>

Submitted on 29 Sep 2017

HAL is a multi-disciplinary open access archive for the deposit and dissemination of scientific research documents, whether they are published or not. The documents may come from teaching and research institutions in France or abroad, or from public or private research centers.

L'archive ouverte pluridisciplinaire **HAL**, est destinée au dépôt et à la diffusion de documents scientifiques de niveau recherche, publiés ou non, émanant des établissements d'enseignement et de recherche français ou étrangers, des laboratoires publics ou privés.

Neuronal Glucocorticoid Receptor Regulation of Brain-Derived Neurotrophic Factor Expression

Thèse de doctorat de l'Université Paris-Saclay
préparée à l'Université Paris-Sud

École doctorale n°568 Signalisation et Réseaux Intégratifs en Biologie
Spécialité de Doctorat : Aspects Moléculaires et Cellulaires de la Biologie

Thèse présentée et soutenue à Kremlin-Bicêtre, le 21 Septembre 2017, par

Madame Hui CHEN

Composition du Jury :

Monsieur Michael SCHUMACHER DR, INSERM (Université Paris-Sud-UMR-S 1195)	Président
Madame Laurence LANFUMEY-MONGREDIEN DR, INSERM (Université Paris Descartes-UMR-S 894)	Rapporteur
Monsieur Charbel MASSAAD PU, INSERM (Université Paris Descartes-UMR-S 1124)	Rapporteur
Madame Sophie PEZET MCU, CNRS (ESPCI Paris-UMR 8249)	Examineur
Monsieur Marc LOMBES DR, INSERM (Université Paris-Sud-UMR-S 1185)	Directeur de thèse
Monsieur Damien LE MENUET CR, INSERM (Université Paris-Sud-UMR-S 1185)	Co-Directeur de thèse

天行健，君子以自强不息；
地势坤，君子以厚德载物。

-易经

As heaven maintains vigor through movements,
a gentle man should constantly strive for self-perfection.

As earth's condition is receptive devotion,
a gentle man should hold the outer world with broad mind.

From I Ching, translated by Changquan Li

有志者事竟成。

-刘秀

Where there is a will, there is a way.

By Xiu Liu

ACKNOWLEDGEMENTS

I would like to express my heartfelt gratitude to all the persons who helped me during my PhD study and research.

Foremost, my deepest gratitude first goes to my supervisor, Dr. Marc Lombès, who is so gentle and humorous. Thanks to him for giving me an opportunity to work in the lab of Inserm UMR1185. He sets a good example to us due to the expert suggestions, detailed interpretations and patient attitude on the experimental designs and performances as well as article and theses writing. What moves me very much is his continuous support and encouragement during all the time of my PhD study.

I would like to express my sincerest appreciation to my co-supervisor, Dr. Damien Le Menuet, who deserves my enormous esteem and gratitude. Thanks to him for teaching me all the techniques I need, paying great patience and enthusiasm, and always showing me his optimism and honesty. His guidance, valuable suggestions, encouragement, as well as his well-rounded character will benefit me throughout my entire life. Besides, he also helps me a lot and gives me much understanding in the daily life. I appreciate all of these very much.

I extend my sincere thanks to all the members of the jury. I would like to thank Dr. Michael Schumacher for accepting to be the president of my thesis committee. I am grateful to Dr. Laurence Lanfumey-Mongredien and Prof. Charbel Massaad for reviewing this thesis carefully and helping me ameliorate the quality of the thesis. I am also thankful to the examiner, Dr. Sophie Pezet for accepting to examine and evaluate my work.

Special thanks to China Scholarship Council for the financial support for my PhD studies in France.

I would like to thank my colleagues in our lab, which is just like a family, for the enthusiastic assist on my experiments, numerous stimulating discussions, insightful suggestions and kind patience. I warmly thank Dr. Say Viengchareun for his regular care and warm gifts for me and my family. I am pleased to thank Dr. Larbi Amazit for picking up my husband and me at the airport when we arrived in Paris for the first time four years ago. I am grateful to Dr. Jérôme Fagart for driving me home when there was a strike of public transport system. Thanks to Dr. Laëtitia Martinerie for offering me useful information on the registration in hospital when I

was pregnant. I greatly appreciate Dr. Stéphanie Chauvin for providing us the commercial N2a cell line, and thank Dr. Isabelle Beau and Dr. Justine Bouilly for the Renilla plasmid. Special thanks to Dr. Nadine Binart for her Doliprane when I had a serious backache. Thanks to Dr. Bruno Francou for his help on plasmid sequencing.

I want to express my big thanks to Florian Le Billan for his help on the inscription in the doctoral school and translation because of my poor French. I am grateful to Ingrid Lema for her explanation on the thesis defence procedure. I also owe a special debt of gratitude to Mirella Hage for inviting me to the dinners in restaurant and lunches on the grass. I would like to express gratitude to Mohsen Ayrout for his help on Western Blot and to G aldine Vitellius for her help on bacterial transformation. Thanks to Geoffrey Boulate for his help on answering telephone when I had communication trouble with people just speaking French. Very big thanks to Simon Travers for his help on measuring steroid concentrations using LC/MS-MS method and special thanks to Fanny Jung for her preliminary data support for my thesis. I am thankful to Christophe Lhadj for aiding me settling down the troubles with my computer. I appreciate to the happy crepes hour that Vianney Demeocq brought us.

I want to express my warm gratitude for their moral support: Dr. Anne Guiochon, Dr. J r me Bouligand, Dr. S verine Trabado and Dr. Peter Kamenicky. I also would like to thank the girls, Emmanuelle Kuhn, Segol ne Hescot, Anne-Lise Lecoq, Khadija Lamribet, Val rie Bernard, Charlotte Sonigo, Laurence Dumeige, Sophie Lamothe, Nelly Ramos, Thi-An Vu, Cl mence Delcour, Laura Bessi ne and Fran oise Magnin. I appreciate greatly for their accompanying and helping in my life bit by bit. I feel so happy and lucky to have met them at UMR 1185 in Paris. I really wish them the best future.

Thanks to secretaries, Madame Claudia Grangetaud, Madame Esther Kingue-Tiki and Madame Cindy De Biase, for their efficient help in facilitating my lab life. I am thankful to Meriem Messina for providing us clean and organized working environment.

I want to thank my friends with whom I spent such many happy hours in Paris and always feel deep care and precious happiness. I am grateful to Xiaoyan Zhu and Jianguo Wang for every call we made for information communication, every delicious and warm dinner we cooked, every trip we accompanied each other, and every talk from our hearts. I am often moved by your painstaking care, valuable advice and pervasive assist. I hope your baby grow up with consummate love and health. I also owe big thanks to my friends Yueyi Wang and Yongchao

Xu, for helping us on registration in hospital when I was pregnant; for preparing the documents and driving us back home from the hospital after I gave birth to a baby; for communicating with the director of creche for applying a position for my daughter. Thanks for Xiaoqing Liu and Xiubin Li for the care and help during the travels and greeting us when I was pregnant. I also want to thank Zhenyu Wang and Jing Hao for visiting my baby and me in hospital and their kind gifts. Thanks to Yuxiang Song, Liheng Yin, Wenwen Gao, Lin Lei, and Dawei Liu for their selfless help and regular care to my family. I will never forget these good memories constituted with all of you and I hope we could continue composing our friendship movement until the last day of our lives.

Very special thanks to our landlord, the Thomas family, for providing us kind help whatever we need and warm presents on every Christmas Day and my daughter's birthday. I will never forget you called the doctor for my daughter who had a serious fever at 2:00 a.m. before dawn.

I would like to express my deepest gratitude and love to my husband Liang Zhang. I am thankful for his inclusive love like the vast sea, his understanding on my every word and deed, his encouragement and support in the hard moments, and his general heart which allows me to be a free-and-easy child. "It is the best day when I met the best you. What could I repay to such a good person like you?" 今夕何夕，见此良人。子兮子兮，如此良人何！

I appreciate to my daughter, Hezhuo Zhang, whose arrival brings me so much happiness and power. Even though we encountered many difficulties and challenges taking care of her, every small smile from her cures all the discomforts. I wish my little sweet baby growing with health, love, sunshine and courage.

Last but not the least, I would like to give my most sincere gratitude to my parents, my parents-in-law, my younger brother and his family, my younger sister and her family, my elder sister-in-law and her family. It is all of them who give us the unconditional love, constant encouragement and spiritual support.

Finally, I want to present a famous Chinese poem to my parents and parents-in-law:

游子吟

孟郊

慈母手中线，游子身上衣。

临行密密缝，意恐迟迟归。

谁言寸草心，报得三春晖。

Hymn of the Traveller

By Jiao Meng; Translated by Chris Pereira

Threads adeptly brandished by a loving mother,
sewed into garments for a son so soon to depart.

Her sewing picks up pace as the date approaches,
worries of belated return echoing in her heart.

Who dare claim that the green grass
might somehow repay the sun for its warm hearth?

Régulation de l'expression du *Brain Derived Neurotrophic Factor* par le récepteur des glucocorticoïdes dans le neurone

Résumé

Le facteur de croissance *brain-derived neurotrophic factor* (BDNF) est un acteur clé de la fonction neuronale. BDNF est fortement exprimé dans tout le cerveau, mais son niveau d'expression le plus élevé se trouve dans l'hippocampe, une structure limbique d'importance majeure pour les fonctions cognitives, telles que la mémorisation, l'apprentissage, le comportement, le stress, les émotions et l'humeur. Dans le système nerveux central (SNC), le BDNF régule la survie neuronale, la différenciation et la croissance. Une quantité importante de données indique que le BDNF est également impliqué dans l'homéostasie neuronale et les processus liés à la plasticité du cerveau tels que la mémoire, l'apprentissage et l'addiction, ainsi que la potentialisation à long terme. Les modifications des niveaux d'expression de BDNF dans des sous-populations spécifiques de neurones ont été associées à diverses pathologies, y compris la dépression, l'épilepsie, la maladie d'Alzheimer, les maladies de Huntington et de Parkinson. Le BDNF fonctionne principalement en se liant à son récepteur à haute affinité, la kinase B (TrkB) associée à la tropomyosine, activant plusieurs voies telles que MAP kinase, PI3 kinase et Phospholipase C. Le gène *Bdnf* murin présente une structure génomique complexe comprenant au moins 9 exons (I à IX), qui sont alternativement épissés pour générer des variantes de transcription BDNF spécifiques sur un exon IX commun et unique à l'extrémité terminale 3' codant pour la protéine. La génération d'un grand nombre d'isoformes de transcription est probablement d'importance biologique car dans les cultures neuronales d'hippocampe de rat, il a été démontré que les variants d'ARNm de BDNF sont distribués différemment dans des compartiments dendritiques spécifiques afin de réguler la disponibilité locale de la protéine BDNF. Dans l'ensemble, la complexité des événements régulant quantitativement et qualitativement l'expression de BDNF mettent en évidence sa contribution cruciale à la fonction du SNC en physiologie et pathologie.

Les hormones glucocorticoïdes (GC) exercent également des actions pleiotropiques sur les neurones en se liant et en activant le récepteur des glucocorticoïdes (GR, NR3C1), ainsi que le récepteur des minéralocorticoïdes (MR, NR3C2). Ce dernier témoigne d'une grande affinité du ligand et, par conséquent, il est presque toujours occupé par les GC, tandis que le GR est activé principalement sous des concentrations élevées de GC circulant, comme dans les

conditions de stress ou au pic circadien de l'hormone. Les deux récepteurs sont fortement exprimés dans l'hippocampe, agissant de concert ou de manière opposée pour réguler divers processus physiologiques et neurologiques tels que les réponses au stress, la survie, l'apoptose et la potentialisation à long terme. GR associé à son ligand fonctionne comme un facteur de transcription, se liant directement aux éléments de réponse des glucocorticoïdes sur l'ADN des séquences régulatrices ou alternativement il interagit indirectement avec d'autres facteurs de transcription, pour activer ou réprimer la transcription des gènes cibles. La régulation de l'expression de BDNF par le stress a des conséquences importantes sur la pathophysiologie des troubles de l'humeur et dans le mécanisme d'action des agents antidépresseurs. Comme l'exposition au stress aigu ou chronique déclenche une augmentation des concentrations circulantes de GC, un rôle de ces hormones dans la modulation de l'expression de BDNF a souvent été suggéré, mais la plupart de ces études sont basées sur des preuves indirectes et sont parfois contradictoires en fonction du modèle, de la dose et de la durée du traitement. Dans l'ensemble, les mécanismes moléculaires par lesquels les GC régulent l'expression de BDNF ne sont pas encore clairement définis à ce jour.

Dans le présent travail, nous avons démontré que les niveaux élevés de GC répriment l'expression de l'ARNm totale de *Bdnf* via GR dans divers modèles cellulaires neuronaux *in vitro* par des analyses qPCR. Dans des cultures primaires neuronales d'hippocampe de souris et la lignée immortalisée BZ, l'expression des transcrits contenant les exons I, IV et IV de *Bdnf* est réprimé par ce mécanisme de régulation, mais ceux qui sont épissés à partir des exons VII et VIII ne le sont pas, indiquant une régulation spécifique de certains exons par GR. En outre, par transfection transitoire réalisé dans des cellules N2a, nous avons montré que les activités de transcription du promoteur 1 et 4 étaient diminuées par GR au niveau transcriptionnel. De plus, grâce à des expériences de mutagenèse dirigée et d'immunoprécipitation de chromatine, nous avons révélé que la répression induite par GR sur la transcription de *Bdnf* se produit en se liant à, au moins en partie, une petite région de promoteur en amont de l'exon IV. En ce qui concerne la (les) séquence (s) d'ADN répondant au recrutement de GR sur le promoteur 4 de BDNF, alors que deux sites de liaison pour AP1 et deux autres pour CREB ont été exclus, d'autres éléments de réponse sur l'ADN pour AhR et NeuroD sont des candidats potentiels. Dans l'ensemble, nous proposons que l'un des mécanismes responsables de la répression de l'expression de *Bdnf* par DEX soit la liaison de GR juste en amont de l'exon IV, à travers des complexes ternaires avec des facteurs de transcription qui doivent encore être déterminés. Il convient de noter que cette région en

amont de l'exon IV présente un degré élevé d'homologie entre les espèces de mammifères mettant l'accent sur leur importance biologique.

En résumé, ces résultats contribuent à une meilleure compréhension des mécanismes sur la façon dont GR régule l'expression de *Bdnf*, ce qui apporte de nouveaux éléments sur les interactions moléculaires entre les voies de signalisation des glucocorticoïdes et celles des neurotrophines dans les neurones, les deux voies étant cruciales en physiologie et pathologie du système nerveux central.

TABLE OF CONTENTS

LIST OF FIGURES AND TABLES	1
LIST OF ABBREVIATIONS.....	3
FOREWORD.....	5
INTRODUCTION.....	7
1. Brain-Derived Neurotrophic Factor (BDNF) in the CNS	12
1.1 BDNF expression and signaling pathways	12
1.2 Pathophysiological functions of BDNF and related diseases	14
1.2.1 Physiological functions of BDNF	14
a. Role of BDNF on neurogenesis	14
b. BDNF and LTP associated with memory and learning	15
c. BDNF and exercise	17
1.2.2 BDNF and related diseases	18
a. BDNF and Alzheimer’s disease (AD)	19
b. BDNF and Huntington’s disease (HD).....	20
c. BDNF and Parkinson’s disease (PD)	20
d. BDNF and depression.....	21
e. BDNF and epilepsy.....	22
f. BDNF and neuropathic pain.....	23
g. BDNF and drug addiction	24
1.2.3 Conclusion.....	26
1.3 Bdnf gene and protein	27
1.3.1 Bdnf gene structure.....	27
1.3.2 BDNF protein processing.....	30
1.3.3 BDNF Val66Met variant.....	31
1.4 Regulation of BDNF expression	32

2. Glucocorticoid receptor (GR) in the brain	36
2.1 Glucocorticoids (GC) act in the brain by binding to GR and MR.....	36
2.2 GR signaling pathways.....	40
2.3 Physiological functions and pathological association of GR and MR in the brain	45
2.3.1 GR roles in stress response and exercise	46
2.3.2 Synaptic and behavioral effects of GR	47
2.3.3 GR effects on neuronal survival and neurogenesis	50
2.3.4 GR and neurodegenerative disorders.....	51
2.3.5 Conclusion.....	53
2.4 Summary	53
3. Interaction between BDNF and GC in the CNS	55
3.1 GC regulate BDNF expression via GR	55
3.1.1 Regulation of BDNF transcript expression by GR.....	55
3.1.2 Regulation of BDNF signaling by GC	57
3.2 BDNF influences GR signaling	58
OBJECTIVES.....	61
RESULTS.....	65
Part I : Characterization on several in vitro neuron-like cell models and preliminary analysis on GC effects on BDNF expression	67
1. Introduction	69
2. Preliminary results	69
2.1. Neuronal differentiation of embryonic stem (ES) cells to study the regulation of BDNF by GC	69
2.2. Primary cultures of mouse hippocampal neurons as a good in vitro cell model.....	73
2.3. BZ cells as a model for studying kinetic mechanisms	76
2.4. N2A cell line as a model to analyze Bdnf promoter sequence activities.....	79
3. Conclusion	82

Part II : Glucocorticoid receptor represses brain-derived neurotrophic factor expression in neuron-like cells	83
1. Introduction	85
2. Supplementary results and discussion.....	87
2.1. Potential GR-binding DNA sequence and other transcription factors within the small region upstream of exon IV.....	87
2.2. Promoter 1 activity was repressed by GR.....	90
3. Conclusion and Perspectives.....	92
GENERAL DISCUSSION AND PERSPECTIVES.....	95
1. BDNF expression is regulated by GR at the transcriptional level.....	97
2. GR and BDNF promoters are involved in neuronal activity	98
3. Exon-specificity of BDNF expression in brain pathophysiology	99
4. Spatial distribution of BDNF transcripts	99
5. Conservation of BDNF SP4 sequence between human and mouse	101
GENERAL CONCLUSIONS.....	105
REFERENCES.....	111

LIST OF FIGURES AND TABLES

Figure 1: Hippocampal structure.....	12
Figure 2: Signaling pathways evoked by neurotrophins and their receptors.....	13
Figure 3: Schematic of long term potentiation (LTP) formation.....	16
Figure 4: Exon/intron structure and alternative transcripts of mouse and rat Bdnf genes.....	28
Figure 5: BDNF gene structures in the rodent and human.....	29
Figure 6: Regulation of glucocorticoid hormone secretion by the hypothalamic-pituitary-adrenal (HPA) axis.....	37
Figure 7: GR splice variants.....	39
Figure 8: GR signaling pathways.....	41
Figure 9: Simplified illustration of the mechanisms of glucocorticoid actions on the CNS...	42
Figure 10: The neuronal differentiation of ES cells.....	70
Figure 11: BDNF (a), MR (b) and GR (c) mRNA expression in mouse brain and ES-derived neurons (ES).....	71
Figure 12: Corticosteroid effects on BDNF mRNA expression in ES cell-derived neurons...	72
Figure 13: Isolation of hippocampal neurons from prenatal mice, adapted from Beaudoin et al.....	73
Figure 14: Primary cultures of hippocampal neurons from prenatal mice.....	74
Figure 15: Aldo effects on BDNF mRNA expression in PCN expressing MR.....	75
Figure 16: DEX effects on BDNF mRNA expression in PCN.....	76
Figure 17: BZ cell culture.....	77
Figure 18: BDNF and MAP2 mRNA expression in BZ cells increase with time.....	77
Figure 19: FK effects (5×10^{-6} M) on total BDNF mRNA expression in BZ cells.....	78
Figure 20: N2A cell neuronal differentiation.....	79
Figure 21: Corticosterone effect on total BDNF mRNA expression in N2A cells.....	80
Figure 22: DEX effects on GRE2.luc activity in N2A cells and BZ cells.....	80

Figure 23: The arrangement of functional cis-elements and the corresponding transcription factors in Bdnf promoter IV, according to Zheng et al.	88
Figure 24: GR-dependent inhibitory effects on the activity of a small Bdbf promoter construct SP4.74.....	89
Figure 25: Aryl hydrocarbon receptor response element (AhR.RE) and Neuro/oligo response element (Neuro/oligo. RE) in SP4.74, as well as two CREs.....	90
Figure 26: GR-dependent inhibitory effects on LP1 activity.....	91
Figure 27: The analysis on homology of mouse and human SP4 DNA sequence, as well as the similarity of potential response elements of AP1, CREB, AhR and Neuro/oligo family.....	102
Figure 28: Schematic drawing of interplay between GC and BDNF signaling pathways in the neurons.....	107
Table 1: Comparison of physiological functions of activated MR and GR on LTP and synaptic plasticity; memorization and learning; neuronal survival and neurogenesis.....	49

LIST OF ABBREVIATIONS

11 β HSD2: 11 β -hydroxysteroid dehydrogenase type 2
A β : amyloid- β
ACTH: adrenocorticotrophic hormone
ADX: adrenalectomized
AhR: aryl hydrocarbon receptor
AhR.RE: aryl hydrocarbon receptor response element
Aldo: aldosterone
AMPA: alpha-amino-3-hydroxy-5-methyl-4-isoxazolepropionic acid
AMPA: alpha-amino-3-hydroxy-5-methyl-4-isoxazolepropionic acid receptor
BDNF: brain-derived neurotrophic factor
bHLH: basic helix-loop-helix
CA: Cornus Ammonis
CaRE: calcium response elements
CaRF: calcium-responsive transcription factor
CARM1: coactivator-associated arginine methyltransferase
ChIP: Chromatin Immunoprecipitation
ChIP-seq: Chromatin Immunoprecipitation and sequencing
CNS: central nervous system
Cort: corticosterone
CPE: carboxy peptidase E
CREB: cAMP response element-binding
CRH: corticotropin releasing hormone
DBD: DNA-binding domain
DCC: dextran charcoal-coated
DEX: dexamethasone
DG: dentate gyrus
DRG: dorsal root ganglion
EBs: embryoid bodies
ERK: extracellular signal-regulated kinase
ESC: embryonic stem cells
FBS: fetal bovine serum
FK: Forskolin
FKBP5: FK506-binding protein 5
GABA: γ -aminobutyric acid
GC: glucocorticoids
GFAP: glial fibrillary acidic protein
GR: glucocorticoid receptor
GRE: glucocorticoid response element
HDAC: histone deacetylase
hMR: human mineralocorticoid receptor
HPA: hypothalamic-pituitary-adrenal
HTT: huntingtin
JNK: c-Jun N-terminal kinase
KA: kainic acid
KIV: knockout of exon IV
LBD: ligand binding domain
LIF: leukemia inhibitory factor

LTD: long-lasting synaptic depression
LTP: long term potentiation
L-VGCC: L type voltage gated calcium channel
MAP2: Microtubule-Associated Protein 2
MAPK: mitogen-activated protein kinase
mBDNF: mature brain-derived neurotrophic factor
MDD: major depressive disorder
MEM: non-essential amino acids
mGluR: metabotropic glutamate receptor
MR: mineralocorticoid receptor
N2A: Neuro-2A cells
NCoR: nuclear receptor corepressor
NFκB: nuclear factor-κB
NGF: nerve growth factor
nGRE: negative glucocorticoid response element
NMDA: N-methyl-D-aspartate
NMDAR: N-Methyl-D-aspartic Acid receptor
NP: neuropathic pain
NSCs: neural stem cells
NT3: neurotrophin-3
NT4/5: neurotrophin-4/5
NTD: N-terminal domain
P75NTR: P75 neurotrophin receptor
PCN: primary cultures of hippocampal neurons
PEPCK: phosphoenolpyruvate carboxykinase
PER1: Period 1
PI3K-Akt: phosphatidylinositol-3-kinase Akt
PKAc: catalytic subunit of protein kinase A
PLCγ: phospholipase Cγ
PNS: peripheral nervous system
PSG: penicillin, streptomycin, glutamine
PVN: paraventricular nucleus
RACE: 5' rapid amplification of cDNA ends
RRS: repetitive restrain stress
RT-qPCR: real-time quantitative PCR
RU: RU486 (Mifepristone)
SAGE: serial analysis of gene expression
SGK1: serum- and glucocorticoid- inducible kinase 1
SGZ: subgranular zone
Shc: *Src* homologous and collagen-like protein
SMRT: silencing mediator of retinoid and thyroid hormone receptors
SNP: single nucleotide polymorphism
SRC: steroid receptor coactivator
SVZ: subventricular zone
TRH: thyrotrophin-releasing hormone
TrkB: tropomyosin-related kinase B
TSA: trichostatin A
USF1/2: upstream stimulatory factor 1/2
UTR: 3' untranslated region

FOREWORD

When I obtained the master degree in Jilin University in China four years ago, a PhD program under convention between China Scholarship Council (CSC) and University Paris-SUD attracted me. Therefore, I contacted Dr. Marc Lombès' team, whose research projects were very interesting, asking for a PhD position in University Paris-SUD. Fortunately, they accepted my request and helped me successfully to pass the strict PhD candidate selection. Being financed by CSC, now I have finished my PhD project with the help of Dr. Marc Lombès and Dr. Damien Le Menuet.

As part of Inserm UMR 1185 lab, "Hormone Signaling, Endocrine and metabolism Physiopathology", belonging to the University Paris-Sud and University Paris-Saclay, Marc Lombès' team which main interests is to decipher the effects and molecular mechanisms of mineralocorticoid receptor (MR, NR3C2) and glucocorticoid receptor (GR, NR3C1) signaling in various cellular contexts, to identify new molecular targets of MR and GR, and to study the mechanisms regulating their expression. Brain-derived neurotrophic factor (BDNF), a main neurotrophin, was suspected to be a potential GR target gene in the conditions of stress for several reasons. First, glucocorticoid (GC) receptors MR and GR as well as BDNF are co-expressed in hippocampal neurons. Second, BDNF exerts many overlapping but sometime opposite actions with those of GR. Third, the cellular events of BDNF effect, including the expression levels, activation of its receptor as well as many cascade proteins involved in BDNF signaling pathways, are mediated tightly by GR activation. However, few have been discovered on the molecular mechanisms involved in GR regulation of BDNF expression.

The aim of this thesis was to study the effects of GR on BDNF expression, as well as the underlying regulatory molecular mechanisms, in various in vitro neuron-like cellular models, which is important to understand the contribution of GR and BDNF to function and pathology of the central nervous system (CNS). Here, I present the principal results we have gotten during my doctoral period.

Before describing and discussing the results of our work, I begin with a bibliographic introduction including three parts: 1) BDNF in the CNS, 2) GR in the brain, and 3) interaction between BDNF and GC in the CNS. The introduction is followed by our data concerning the GR effects on BDNF expression. Using essentially cellular and molecular biology approaches, we demonstrated that GR was responsible for the repression of BDNF acting on a specific

DNA sequence. In the manuscript, the experimental data are presented in part as an original article, 'Glucocorticoid receptor represses brain-derived neurotrophic factor expression in neuron-like cells', published in *Molecular Brain* in 2017, with additional data presented before and after the article. Finally, a short general discussion allows to put in perspective our results with the current bibliographic context, which is followed by a general conclusion and the bibliography.

INTRODUCTION

General introduction

As the center of the nervous system, the mammalian brain is a crucial organ that could integrate internal and external information, respond to various stimuli, and finally control the endocrine status and behavior of the organism. The brain is composed of neurons, glial cells, neural stem cells and blood vessels, protected by the cover of meninges. Neurons are the basic functional units of the brain, spinal cord, central nervous system (CNS), and the ganglia of the peripheral nervous system (PNS), acting by receiving, integrating and processing information. A typical neuron is composed of a cellular body (soma), multiple dendrites arising from the soma and often extending for hundreds of micrometers, and a unique cellular extension termed an axon. All neurons are electrically excitable and connect to each other *via* synapses to form neural networks, which carry trains of electrical and chemical signals to distant parts of the brain or body targeting specific recipient cells (Arbib, Érdi et al. 1998).

Dysfunctions and injuries of the human brain cause major deficits in intelligence, memory, personality, and coordination. Except for the physical damage and infectious factors, the brain is also susceptible to neurodegenerative disorders, such as Alzheimer's disease (AD), Parkinson's disease (PD) and Huntington's disease (HD), as well as motor neuron diseases caused by the gradual death of individual neurons, leading to diminution in movement control (ataxia), memory, and cognition. Moreover, numerous psychiatric conditions, such as clinical depression, schizophrenia, bipolar disorders and post-traumatic stress disorders, are thought to be associated with brain dysfunctions (Skerrett, Malm et al. 2014).

Synaptic plasticity is thought to be critical for the processing and encoding of information by neuronal networks (Bliss and Collingridge 1993) and it appears to be the leading mechanism involved in learning and memory. Of note, synaptic plasticity reinforces functional connections by a positive feedback, which is of importance for dynamic brain activity. In the CNS, the limbic system encompassing the hippocampus, the amygdala, and the prefrontal cortex, is one of the most crucial structure for cognitive functions such as behavior, memorization, learning, mood and emotions (McEwen 2007). The hippocampus is located under the cerebral cortex and in the medial temporal lobe in humans and other mammals, forming a bilateral structure on each side of the brain. Actually, the hippocampus is a structure of major importance for cognitive processes (McEwen 2007, Joels, Krugers et al. 2009), the stress response and brain structural and functional plasticity.

The discovery of stress hormone receptors acting in the hippocampus has been the starting point to the investigation of the mechanisms of stress and adrenal steroid action. In the brain, adrenal corticosteroid hormones such as glucocorticoids (GC) and mineralocorticoids are known to exert important effects on the neurocognitive processes, binding to intracellular or membrane receptors with several distinct but possibly additive mechanisms (Barnes 1998, Sapolsky, Romero et al. 2000, de Kloet, Joels et al. 2005, Viengchareun, Le Menuet et al. 2007). The two corticosteroid receptors, mineralocorticoid receptor (MR, *NR3C2*) and glucocorticoid receptor (GR, *NR3C1*), are expressed in hippocampal neurons and are involved in various physiological processes and psychiatric diseases. Both neuronal GR and MR in the hippocampus are involved in the stress response (de Kloet, Joels et al. 2005, Scheuer 2010, Hawkins, Gomez-Sanchez et al. 2012), memorization (Zhou, Bakker et al. 2010), learning, mood, as well as neuroprotection (Abraham, Harkany et al. 2001) and neurogenesis (Kim, Ju et al. 2004, Munier, Law et al. 2012). The large spectrum of activity of corticosteroids as well as their cognate receptors on the brain cells (neurons and glial cells) might exert deep influences on the cognitive processes both directly, by affecting the different phases of learning and memory, and indirectly, by promoting neuronal functioning and survival.

Beside adrenal glucocorticoids, there is a class of mediators implicated in the stress, brain plasticity, and hippocampal neurogenesis, called neurotrophins. Neurotrophin family, comprising nerve growth factor (NGF), brain-derived neurotrophic factor (BDNF), neurotrophin-3 (NT3), and neurotrophin-4/5 (NT4/5). Neurotrophins are peptidic growth factors that bind to specific receptors to promote survival, growth, and plasticity of neural networks. The discovery of BDNF provided important insights into the formation of neuronal communication during the development of the nervous system and into synaptic plasticity, memory, learning, stress response and neurogenesis in the adult brain (Tyler, Alonso et al. 2002, Yamada, Mizuno et al. 2002, Lipsky and Marini 2007, Bernd 2008).

Some studies suggest that both neuronal GR and MR are involved in regulating BDNF expression in the hippocampus (Hansson, Cintra et al. 2000, Kino, Jaffe et al. 2010). Exerting many overlapping actions with GR and MR, BDNF could be a potential target gene of GR and MR, as it has been recently proposed in rat cortical neuron primary cultures (Hansson, Cintra et al. 2000). Therefore, considering the importance of glucocorticoid and neurotrophin signaling pathways in physiology and pathology, we intend to determine whether BDNF is a

new molecular target gene of GR and/or MR in neurons, and to study further the underlying regulatory mechanisms.

1. Brain-Derived Neurotrophic Factor (BDNF) in the CNS

1.1 BDNF expression and signaling pathways

As described above, BDNF is a member of the neurotrophin family that includes NGF, NT3, and NT4/5. Over 20 years after the discovery of NGF, BDNF was discovered by Barde et al. in 1982, isolated from the pig brain as a factor able to promote neuronal survival (Barde, Edgar et al. 1982). In 1989, the full primary structure of BDNF and its sites of expression in the brain have been identified (Leibrock, Lottspeich et al. 1989). Of note, the four neurotrophins and their genes showed a marked homology in terms of DNA and peptidic sequences as well as a similar structure (Lessmann, Gottmann et al. 2003).

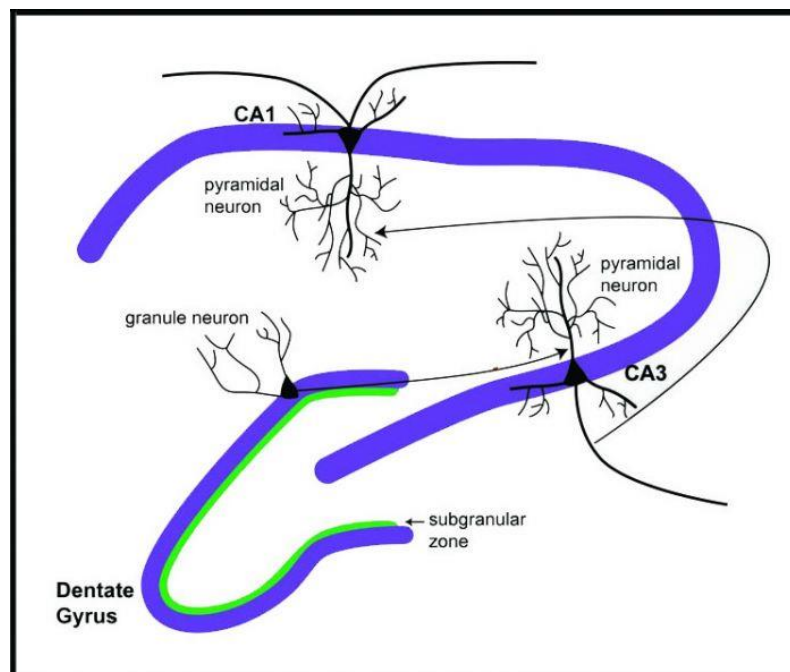

Fig. 1 Hippocampal structure. The hippocampus is composed of the dentate gyrus (DG) including the subgranular zone (SGZ), and three Cornu Ammonis (CA) subfields that are called CA1, CA2 and CA3 (Joels, Krugers et al. 2009). The information flow in hippocampus is generally unidirectional, from the axons of granule neurons in DG, to the dendrites of pyramidal neurons in CA3, through axons to the dendrites of pyramidal neurons in CA1 (Colgin, Denninger et al. 2009).

In the developing and mature mammalian brains, BDNF is strongly and widely expressed throughout the cerebral structures (Ernfors, Wetmore et al. 1990, Hohn, Leibrock et al. 1990), and its strongest expression is found within the hippocampus both at the mRNA and protein levels (Kawamoto, Nakamura et al. 1996, Yan, Rosenfeld et al. 1997). Beside the CNS, BDNF is also expressed in peripheral nervous tissues (Timmusk, Palm et al. 1993, Bishop, Mueller et al. 1994), as well as in several non-neural tissues at low levels, including testis,

lung, thymus, heart, liver and spleen (Aid, Kazantseva et al. 2007) where its function is less characterized. The hippocampus is constituted of several structures such as Cornus Ammonis (CA) subdivided in CA1, CA2 and CA3 subregions and the dentate gyrus (DG) (Joels, Krugers et al. 2009), presenting a specific neuronal organization which is described in Figure 1.

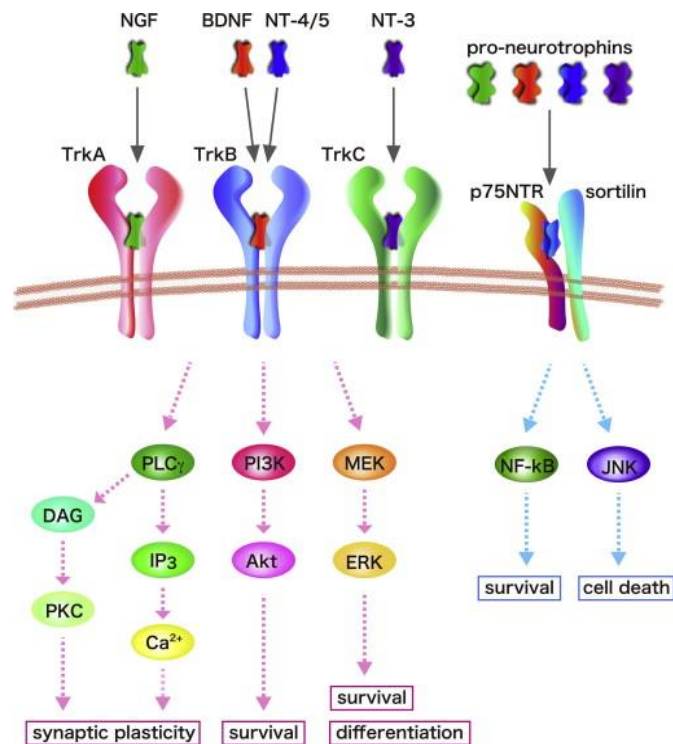

Fig. 2 Signaling pathways evoked by neurotrophins and their receptors (Numakawa, Adachi et al. 2013). Mammalian neurotrophins (NGF, BDNF, NT-3, and NT-4/5) stimulate intracellular signaling through binding to Trk receptors and a common receptor p75NTR. The mature BDNF binds to its specific TrkB receptor with high affinity, while pro-BDNF interacts with p75NTR with high affinity. TrkB activation stimulates three main signaling cascades including PLC γ , MAPK/ERK, and PI3K-Akt to exert beneficial effects on neurons. Activation of p75NTR is capable of inducing cell death or survival.

BDNF could bind to two types of receptors, the higher affinity receptor, tropomyosin-related kinase B (TrkB) (Chao 2003), and the lower affinity P75 neurotrophin receptor (P75NTR) (Fayard, Loeffler et al. 2005). BDNF functions mainly by binding to TrkB, activating downstream signaling cascades, predominant among which are mitogen-activated protein kinase (MAPK) /extracellular signal-regulated kinase (ERK), phospholipase C γ (PLC γ), and the phosphatidylinositol-3-kinaseAkt (PI3K-Akt) pathways (Reichardt 2006) (Fig. 2). Briefly, a BDNF homodimer is captured by two TrkB receptors, which results in auto-phosphorylation of the intracellular domain of TrkB. The phosphorylation of TrkB initiates signal transduction of MAPK/ERK, PI3K-Akt, and PLC γ pathways, with the recruitment and phosphorylation of

Src homologous and collagen-like protein (Shc) (Chao 2003, Huang and Reichardt 2003, Yoshii and Constantine-Paton 2010). Activation of BDNF/TrkB-dependent intracellular signaling contributes to neuronal survival and differentiation, morphological changes, and synaptic plasticity in the CNS.

In conclusion, as the most abundant and widely distributed neurotrophin in the mammalian CNS, BDNF binds to its receptors, activating different signaling pathways, leading to distinct functions.

1.2 Pathophysiological functions of BDNF and related diseases

1.2.1 Physiological functions of BDNF

In the CNS, BDNF controls various neural processes during development and in adulthood, especially related to synaptic formation and functions. BDNF regulates neuronal homeostasis and survival (Lipsky and Marini 2007), differentiation and growth (Bernd 2008) of the neurons. Growing evidence indicates that BDNF is also involved in several other functions, including brain plasticity-related processes such as memory (Yamada, Mizuno et al. 2002) and learning (Tyler, Alonso et al. 2002, Yamada, Mizuno et al. 2002) which are associated to long term potentiation (LTP) (McAllister, Katz et al. 1999) in the hippocampus. In this chapter, we discuss the importance of BDNF in all these processes.

a. Role of BDNF on neurogenesis

Much attention has been paid to the ability of BDNF and its receptors to modulate adult neurogenesis. In adulthood, the neural stem cells (NSCs), which maintain their capacity to proliferate and generate new neurons *via* a series of intermediate progenitor cells (Lledo, Alonso et al. 2006), are found in the subgranular zone (SGZ) in the DG of the hippocampus (Fig. 1) and the subventricular zone (SVZ) of the lateral ventricles. Both high levels of BDNF and TrkB expression in the SVZ niche were detected (Galvao, Garcia-Verdugo et al. 2008), and many studies showed that BDNF and BDNF/TrkB signaling pathways were tightly linked to the neuroblast migration along the rostral migratory stream, a special route by which the precursor neurons migrate from the SVZ to the main olfactory bulb (Snayyan, Lemasson et al. 2009, Bagley and Belluscio 2010). Meanwhile, it has been suggested that BDNF signaling may participate to the maturation of specific interneurons within the olfactory bulb in both

mice and rats (Berghuis, Agerman et al. 2006, Galvao, Garcia-Verdugo et al. 2008). Significantly, knockdown of BDNF in the DG and conditional deletion of TrkB in rat NSCs inhibited neurogenesis, while an increased neurogenesis was shown in response to BDNF injection (Scharfman, Goodman et al. 2005, Taliaz, Stall et al. 2010). Moreover, BDNF heterozygous (BDNF^{+/-}) mice also exhibited reduced survival of new cells in the adult hippocampus (Sairanen, Lucas et al. 2005). Besides, BDNF may also facilitate differentiation of progenitor cells into granule neurons (Tozuka, Fukuda et al. 2005), which compose the middle or granular layer of the DG, and their maturation in the SGZ by enhancing γ -aminobutyric acid (GABA, the inhibitory neurotransmitter) release from parvalbumin-expressing GABA-ergic interneurons (Waterhouse, An et al. 2012). Furthermore, consistent to the results above, decreased levels of central BDNF in CNS-specific BDNF knockout mice induce deficits in terminal differentiation, dendritic complexity, migration of new granule neurons and GABA-mediated effects on neurogenesis (Chan, Cordeira et al. 2008). Taken together, BDNF promotes several neurogenic processes, such as migration, differentiation, maturation and survival, in progenitor cells from both SVZ and SGZ.

b. BDNF and LTP associated with memory and learning

In addition to its roles in neuronal proliferation, neurogenesis and differentiation, BDNF exerts its critical function by regulating activity-dependent structural and functional modification of the synapses, which is the major mechanism promoting a crucial phenomenon called long-term potentiation (LTP) and involved in memorization. Synaptic plasticity refers to any lasting up-regulation or down-regulation of synaptic strength and is thought to be of much importance for the processing and encoding of information by neuronal networks (Bliss and Collingridge 1993). Activity-dependent plasticity seems to be the dominant mechanism involved in learning and memory. There is a general consensus that LTP, in which a brief high frequency synaptic stimulation triggers a long-lasting increase in synaptic strength, results in a reinforcement of the neuronal connection. This has been considered as the major mechanism involved in memory coding and the acquisition of learning (Nicoll and Roche 2013). The constitution of LTP depends on synaptic plasticity, partly on high-frequency pre-synaptic release of glutamate (usually from an axon termination) that activates receptors on post-synaptic dendritic spine (small membranous protrusion from a dendrite) (Fig. 3). Glutamate receptors, including N-methyl-D-aspartate (NMDA) and non-NMDA receptors, exert distinct roles in synaptic plasticity. The opening of NMDAR channel triggers a calcium

influx and activation of Protein kinase C that results in long-lasting potentiation of alpha-amino-3-hydroxy-5-methyl-4-isoxazolepropionic acid receptor (AMPA, non-NMDA receptor) excitatory post-synaptic current (Fig. 3). Both NMDAR and AMPAR are ionotropic receptors.

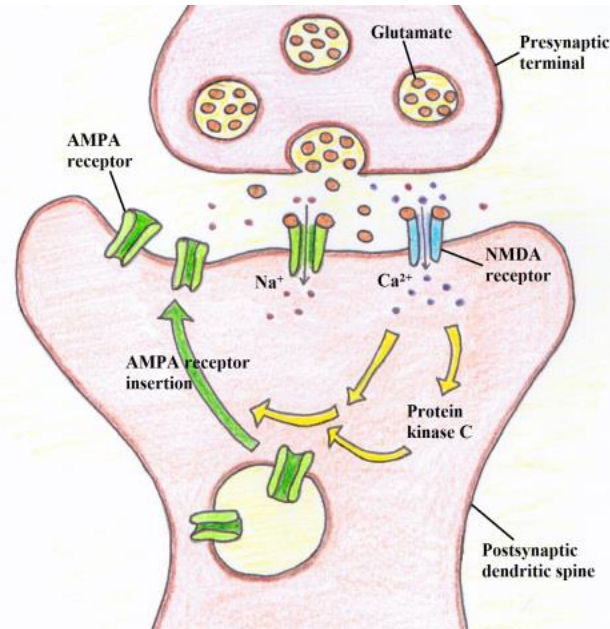

Fig. 3 Schematic of long term potentiation (LTP) formation. Pre-synaptic release of glutamate activates receptors NMDAR on post-synaptic dendritic spine (Nicoll and Roche 2013). The opening of NMDAR channel triggers a calcium influx and activation of Protein kinase C, causing long-lasting potentiation of AMPAR excitatory post-synaptic current (Nicoll and Roche 2013).

Another important mechanism involved in synaptic plasticity and in memory formation is long-lasting synaptic depression (LTD) (Steele and Mauk 1999). Contrary to LTP, LTD reduces the efficacy of neuronal synapses, mediated typically by metabotropic glutamate receptors (mGluRs, that do not form ionic channels), in several areas of the brain including the hippocampus (Collingridge, Peineau et al. 2010). Taken together, LTP and LTD are forms of activity-dependent synaptic plasticity that increase or decrease, respectively, the strength of synaptic transmission and memory formation (Malenka and Bear 2004).

BDNF effects on both memory formation and LTP have been demonstrated previously (Malenka and Bear 2004). Several decades ago, two independent studies showed that BDNF knockout (BDNF^{-/-}) mice, which presented with altered sensory neuron development and usually died between 2 and 4 weeks after birth (Ernfors, Lee et al. 1994, Jones, Farinas et al. 1994), displayed severe impairments in LTP at the CA1 synapses in hippocampus (Korte, Carroll et al. 1995, Patterson, Abel et al. 1996). Furthermore, this phenotype was rescued by

either acute administration of exogenous recombinant BDNF or virus-mediated BDNF gene transfer (Korte, Griesbeck et al. 1996, Patterson, Abel et al. 1996). Consistently, BDNF heterozygous knockout (BDNF^{+/-}) mice, which presented with approximately half the level of BDNF protein in the brain than wild type animals, also exhibited LTP impairments and learning deficits in the hippocampus-dependent paradigms (Linnarsson, Bjorklund et al. 1997, Liu, Lyons et al. 2004). More directly, it was reported later that by activating its signaling pathways, BDNF may induce LTP and further promote neurophysiological foundation for learning and memory (Rex, Lin et al. 2007, Kemppainen, Rantamaki et al. 2012). Other animal studies showed that inhibition of BDNF signaling by hippocampus-specific gene knockout or infusion of antisense BDNF impairs spatial learning and memory (Heldt, Stanek et al. 2007). Along the same line, another group found severe spatial memory defects in forebrain-specific BDNF homozygous knockout mice (Gorski, Balogh et al. 2003). Moreover, infusion of BDNF antisense oligonucleotides or anti-BDNF antibodies also induced impaired spatial memory (Ma, Wang et al. 1998, Mu, Li et al. 1999).

As a key mediator of memory processing, BDNF exerts its effects at different molecular levels, by regulating cation channels including several subtypes of Na⁺ and K⁺ channels, by modulating ligand-gated channels like NMDA and AMPA receptors (Cunha, Brambilla et al. 2010), and by greatly affecting protein synthesis by transcriptional and translational mechanisms. From another aspect, the potential mechanism by which BDNF supports activity-dependent modification of synapses and brain function has been suggested by several studies. One of them hypothesized that the formation and occurrence of LTP require BDNF release from the presynaptic vesicles (Zakharenko, Patterson et al. 2003, Jia, Gall et al. 2010). Furthermore, BDNF may facilitate vesicle docking at the presynaptic active zone (Pozzo-Miller, Gottschalk et al. 1999). The postsynaptic involvement has also been suggested by one study showing that postsynaptic BDNF secretion is required for the long-term structural change of synaptic dendritic spines, important structures for LTP generation (Tanaka, Horiike et al. 2008). Taken together, presynaptic and postsynaptic BDNF release may exert their distinct actions, facilitating the induction and the maintenance phase of LTP, respectively.

c. BDNF and exercise

There is a growing body of evidence showing that exercise improves both cognition (Smith, Blumenthal et al. 2010, Roig, Nordbrandt et al. 2013) and mood (Rethorst and Trivedi 2013,

Josefsson, Lindwall et al. 2014), as well as much evidence suggesting that BDNF activity may be involved in these effects (Vaynman, Ying et al. 2004, van Praag, Shubert et al. 2005, Erickson, Miller et al. 2012, Heyman, Gamelin et al. 2012). Numerous studies on both human and animal models (Zoladz and Pilc 2010, Huang, Larsen et al. 2014) provide strong evidence that BDNF levels increase following exercise in humans and in rodents. For instance, enhanced BDNF mRNA expression in motoneurons in rats is observed after voluntary exercise (Gomez-Pinilla, Ying et al. 2002) or treadmill training (Neeper, Gomez-Pinilla et al. 1996, Wilhelm, Xu et al. 2012). Conversely, in neuron-specific knockout for BDNF or TrkB in mice, the effect of exercise is completely lost (Wilhelm, Xu et al. 2012, English, Liu et al. 2013). Using sensitive assays, it was shown that BDNF protein levels in serum were elevated after exercise protocols, such as moderate daily exercise for 2 weeks in mice in a nerve repair model (Park and Hoke 2014).

Altogether, exercise could be considered as a potential strategy for inducing BDNF activity to improve mood or cognition, due to the beneficial effect of BDNF on numerous cognitive processes, as well as on synaptic plasticity, neurogenesis and neuronal survival. It was hypothesized by Gordon and coworkers (Al-Majed, Tam et al. 2004) that exercise could promote axon regeneration in the peripheral nervous system (PNS) by a BDNF signaling mechanism in mice, thereby treating peripheral nerve injury (Wilhelm, Xu et al. 2012). Moreover, animal experiments provide support for various mechanisms by which exercise-stimulated BDNF increases result in improved cognition. For example, as little as one week of exercise may improve subsequent learning in animals, but this effect was abolished by BDNF blockade in the hippocampus using a TrkB-IgG chimera (Vaynman, Ying et al. 2004). Actually, some studies suggested that exercise could enhance cognitive abilities and quality of life of dementia patients (Forbes, Forbes et al. 2015, Ojagbemi and Akin-Ojagbemi 2017). Therefore, regular exercise provides beneficial effects not only on mood (Asmundson, Fetzner et al. 2013, Josefsson, Lindwall et al. 2014) and cognition (Smith, Blumenthal et al. 2010, Erickson, Miller et al. 2012) but also on extensive physical health (Alford 2010).

1.2.2 BDNF and related diseases

There are a large number of studies to suggest that changes of BDNF levels or function in specific neuron subpopulations may result in neuronal dysfunction, which contribute to various pathologies, including AD, HD, PD, depression, epilepsy, pain and drug addiction (Bibel and Barde 2000, Murer, Yan et al. 2001, Binder and Scharfman 2004, Bolanos and

Nestler 2004, Castren 2004, Cattaneo, Zuccato et al. 2005, Russo-Neustadt and Chen 2005). Subsequently, due to the wide expression of BDNF and TrkB in the CNS and their robust neuroprotective effects, exogenous administration of this neurotrophin, such as gene delivery and protein administration, could be considered as an appropriate therapeutic strategy for treating certain CNS disorders. However, a key and unavoidable challenge in the field of BDNF therapy is drug delivery into the CNS, because as a moderately sized and charged protein, BDNF cannot easily cross the blood-brain barrier *via* peripheral administration. Potential approaches including intraparenchymal protein infusion and gene delivery using viral vectors may solve this issue, and other methods to increase BDNF bioavailability (*i.e.*, epigenetics, drug-induced endogenous BDNF modulation, peptide mimetics of BDNF, exercise and diet) will be effective (Nagahara and Tuszynski 2011).

a. BDNF and Alzheimer's disease (AD)

AD is a neurodegenerative disease characterized by a progressive dementia that occurs in middle or late life (Querfurth and LaFerla 2010). Initially, this disease is linked to decreased levels of cholinergic synapses in the cerebral regions such as basal forebrain, the cortex and hippocampus. The key pathologic changes are increased levels of amyloid- β (A β) peptide in the form of extracellular senile plaques, as well as hyperphosphorylated tau protein as the intracellular neurofibrillary network tangles in some regions of brain (Reitz, Brayne et al. 2011).

BDNF was found to be associated with neuropsychiatric disorders (Angelucci, Brene et al. 2005, Autry and Monteggia 2012, Li, Chang et al. 2016) and neurodegenerative (Zuccato and Cattaneo 2009) progressions of AD (Rohe, Synowitz et al. 2009, Doi, Takeuchi et al. 2013). The expression level of BDNF is lower in AD patients than that in healthy controls (Connor, Young et al. 1997, Hock, Heese et al. 2000, Peng, Wu et al. 2005). Similar results were also found in AD animal models (Francis, Kim et al. 2012, Naert and Rivest 2012, Meng, He et al. 2013). Both decreased mRNA and protein levels of BDNF were observed in several regions such as in the hippocampus and the parietal cortex (Holsinger, Schnarr et al. 2000, Garzon, Yu et al. 2002). As described above, numerous studies have shown that BDNF could stimulate survival and genesis of several types of neurons in the CNS, including those from the basal forebrain, hippocampus and cortex (Murer, Yan et al. 2001). Therefore, BDNF could help to prevent neuronal death in AD, and central local administration of exogenous

BDNF might be beneficial for the treatment of AD, by stopping or delaying the progression of neuronal loss and its cognitive consequences (Nagahara and Tuszynski 2011).

b. BDNF and Huntington's disease (HD)

HD, an autosomal dominant inheritable and neurodegenerative disorder, is characterized by dramatic motor dysfunction, cognitive decline, and psychiatric symptoms (Ross and Tabrizi 2011), which leads to progressive dementia and death approximately 15-20 years after the onset (Landles and Bates 2004). The pathogenesis of HD is due to mutations (expanded CAG repeats) in the huntingtin (*HTT*) gene, leading to an increased number of polyglutamine repeats in the encoded protein HTT (McMurray and McMurray 2001). The molecular mechanisms by which mutant HTT protein leads to neuronal dysfunction and neurodegeneration remained to be identified, and no therapy is currently available for patients to date, beside some symptomatic treatments.

A large number of laboratories have shown that BDNF expression, trafficking, and signaling have been strongly reduced in numerous HD mouse models (Zuccato and Cattaneo 2009, Plotkin, Day et al. 2014). Because the mutant HTT protein causes transcriptional downregulation of the *Bdnf* gene (Buckley, Johnson et al. 2010), both cortical and striatal BDNF levels were shown to be reduced in postmortem HD brain (Her and Goldstein 2008, Wu, Fan et al. 2010). Moreover, it has been reported that the expression and trafficking of BDNF and TrkB are significantly altered in human HD tissues and HD mouse models (Zuccato, Liber et al. 2005, Gines, Bosch et al. 2006). Importantly, overexpressing BDNF rescues alterations of neuron structure and function in HD model mice (Zuccato, Liber et al. 2005, Lu, Nagappan et al. 2014), while BDNF knockout mice recapitulate atrophy phenotype of the striatum, the striped mass of white and grey matter controlling movement and balance, observed in HD patients (Antoniades and Watts 2013). Therefore, previous studies have suggested BDNF to be a prime putative candidate for the treatment of HD by preventing the underlying neuronal loss seen in HD patients (Alberch, Perez-Navarro et al. 2004, Fink, Deng et al. 2015).

c. BDNF and Parkinson's disease (PD)

PD is also a progressive neurodegenerative disorder, characterized by difficulty in initiating movements, slowness of movement, rigidity, resting tremor, postural instability and gait

changes (Lang and Lozano 1998, Fahn 2003), as well as multiple cognitive impairments in visuospatial, attentional, executive and memory functions (Robbins and Cools 2014). The etiology of PD is still not well understood, however, several neuroinflammatory mechanisms, such as nitric oxide, oxidative stress and mitochondrial dysfunction, were proposed to be involved in the pathophysiology of this disease (Dauer and Przedborski 2003).

A large body of literature has shown alterations in BDNF levels in the blood or brain of PD patients. For instance, reduced levels of BDNF mRNA and protein expression were reported in the substantia nigra of PD patients, as well as in the putamen, a structure involved in motor skills (Mogi, Togari et al. 1999, Parain, Murer et al. 1999). Besides, low levels of serum BDNF were also observed in newly diagnosed PD patients (Scalzo, Kummer et al. 2010). Of note, it has been demonstrated that treatment with anti-parkinsonian drugs increases BDNF levels (Gyarfas, Knuuttila et al. 2010). These findings suggest that BDNF may be implicated in the pathogenic mechanisms of PD. Because of its important role in the survival and maintenance of neurons improving motor performance (Cohen, Tillerson et al. 2003), BDNF could be a useful agent in the treatment of PD in humans.

d. BDNF and depression

Depression is a neuropsychiatric disorder, with high lifetime prevalence, a low mood state and a high rate of suicide. The causes of depression are very diverse, including life events such as childhood abuse, personality, medical treatments, as well as psychiatric syndromes and non-psychiatric illnesses like PD, stroke and diabetes. It seems that the pathophysiology of depression is not due to neuron loss but rather to neuronal atrophy and monoaminergic neurotransmitter deficiency leading to a reduced synaptic transmission (Duman 2004) and signal transduction (Duman 2002).

A considerable number of studies have demonstrated that BDNF plays a key role in the pathophysiology and treatment of depression (Shelton 2007, Krishnan and Nestler 2008). The tight relationship between BDNF expression/signaling and mood disorders has been extensively investigated in both human and rodent models (Duman and Monteggia 2006, Martinowich, Manji et al. 2007, Bouille, van den Hove et al. 2012), and BDNF deficits are thought to contribute to depression. Numerous papers have indicated that BDNF and TrkB expression was significantly reduced in the hippocampus as well as in the circulating peripheral blood of depressed patients, suggesting that BDNF could be considered as a

valuable biomarker in severe depressive conditions (Dwivedi, Rizavi et al. 2003, Schmidt and Duman 2007, Hashimoto 2010, Martinotti, Pettorruso et al. 2016). On the other hand, analyses of postmortem tissues determined that hippocampal BDNF concentrations were much less reduced in patients treated with antidepressants, compared to those without antidepressant treatments (Chen, Dowlatshahi et al. 2001). Furthermore, BDNF injections in the hippocampus or the midbrain region in rodents resulted in similar effectiveness than antidepressants, as reviewed by Castren (Castren 2004), showing that BDNF downregulation may be causal in depression. Previous studies have indicated that rats exposed to chronic stress showed a reduced hippocampal level of BDNF mRNA, as well as a downregulation of its signaling pathways. This effect was counteracted by antidepressant treatment (Roceri, Hendriks et al. 2002, Blendy 2006, Castren and Rantamaki 2010, Razzoli, Domenici et al. 2011). Furthermore, a growing body of evidence demonstrated that rodents with BDNF signaling deficiency were more prone to depression, while injection of BDNF into the hippocampus reduces depression-like behavior and mimics the effects of antidepressants (Castren and Rantamaki 2010, Castren and Kojima 2017). Additional published studies supported the theory that antidepressant effects were mediated, at least in part, through an increase in hippocampal BDNF levels (Shirayama, Chen et al. 2002, Duman and Monteggia 2006, Tsankova, Berton et al. 2006, Taliaz, Stall et al. 2010).

e. BDNF and epilepsy

Epilepsy is a disease characterized by periodic and unpredictable occurrence of transient symptoms due to spontaneous abnormal cerebral activity, which are called seizures (Fisher, Acevedo et al. 2014). In humans and in animal models of epilepsy, decrease in memory (Helmstaedter and Kockelmann 2006) and learning abilities (Bell, Lin et al. 2011), inflammation, gliosis, neuronal loss in the hippocampus (Pitkanen and Sutula 2002, Lopim, Vannucci Campos et al. 2016) have been observed.

A large number of studies with animal models as well as analyses of postmortem brains from patients with epilepsy have shown that BDNF mRNA and protein expression levels were increased after epileptic seizures, indicating that epileptic activity may upregulate the BDNF protein level *via* a transcriptional activation. For example, increased levels of BDNF mRNA and protein have been detected in patients suffering epilepsy, in the DG and the CA1-CA3 pyramidal cell layers of the hippocampus (Murray, Isackson et al. 2000, Wang, Li et al. 2011).

In neuron-specific BDNF^{-/-} mice, a moderate prevention in epileptogenesis was observed using the kindling model, consisting with a repeated electric stimulation of the brain (He, Kotloski et al. 2004). Moreover, using the heterozygous BDNF^{+/-} mice, it was shown that the seizure-induced increase in BDNF concentration was reduced, and the kindling effect on seizure was lower compared to wild-type mice (Kokaia, Ernfors et al. 1995). Conversely, kainic acid-induced BDNF overexpressing mice have more severe seizures and display spontaneous seizures occasionally after treatment (Croll, Suri et al. 1999). Meanwhile, in mice, BDNF levels increased by transgene overexpression or acute infusion into the hippocampus could also enhance seizure severity (Croll, Suri et al. 1999, Scharfman, Goodman et al. 2002). However, it is worth noting that a decreased BDNF level in serum has been found in adult epileptic patients (LaFrance, Leaver et al. 2010). It is clear that BDNF may have a role in epileptogenesis, perhaps as a result of its positive regulatory function on neuronal excitability within the hippocampus (Binder, Croll et al. 2001). As a whole, BDNF has been thought to be a pro-epileptogenic factor (Rivera, Voipio et al. 2004), possibly because its expression was stimulated after seizure as an appropriate and physiological response to epilepsy in order to refrain neuronal death. Conversely, it was reported that delivery of intrahippocampal BDNF could attenuate or postpone the development of epilepsy in animal models, unraveling its complex role in the development of this pathology that is still a matter of debate (Koyama and Ikegaya 2005, Paradiso, Marconi et al. 2009).

f. BDNF and neuropathic pain

Pain is a very complex and subjective phenomenon generally caused by intense and damaging stimuli that accompanies a large variety of clinical syndromes. Neuropathic pain (NP) (Treede, Jensen et al. 2008) is associated either with various PNS lesions or injuries in relay structures of CNS. While the former is mainly characterized by intense alterations of gene expression pattern and protein interaction network, including inflammatory molecules such as leukocyte adhesion molecules (Max and Stewart 2008, Belfer and Dai 2010), the latter arises from metabolic disorders, traumatic injury or neurotoxicity (Calvino and Grilo 2006). Generally, NP is caused by acute or chronic trauma, neurotoxins, diabetes, tumor compression, viral infections or side effects of chemotherapy.

Changes in BDNF expression levels in the nervous system associated with numerous animal models for pain, including peripheral inflammation and neuropathic pain paradigms, have

been widely reported. Generally speaking, upregulated endogenous BDNF levels have been reported following nerve injury or inflammation in peripheral tissues (Shu, Llinas et al. 1999, Narita, Yajima et al. 2000) as well as in the spinal cord (Cho, Kim et al. 1997, Geng, Liao et al. 2010, Lin, Ro et al. 2011). This increase in BDNF quantity is responsible for synaptic remodeling and thus the development of chronic pain (Obata and Noguchi 2006). Moreover, several other groups have also demonstrated that BDNF expression levels were dramatically increased in the dorsal root ganglion (DRG) under distinct experimental conditions, including after spinal nerve ligation in rats (Fukuoka, Kondo et al. 2001) and in models of inflammatory pain where BDNF may function as a neuromodulator (Pezet, Malcangio et al. 2002, Zhang, Wang et al. 2016). Conversely, in neuropathic pain models where partial injury to peripheral nerves was provoked, BDNF was decreased in injured sensory neurons while increased in uninjured ones (Cho, Kim et al. 1998, Zhou, Chie et al. 1999, Fukuoka, Kondo et al. 2001). Additionally, enduring tactile allodynia (sensitization by normally non-painful stimuli) and thermal hyperalgesia (overreaction to a painful stimulus) could be induced by intrathecal BDNF injections in mouse vertebra, indicating a direct link between BDNF and neuropathic pain (Yajima, Narita et al. 2005). Some other groups found an opposite effect of BDNF on pain, pointing out that exogenous BDNF could exert analgesic effects in neuropathic pain (Eaton, Blits et al. 2002). Even though the role of BDNF in neuropathic pain is contentious, previous evidence obtained from several animal models has proposed that BDNF exerts a crucial role in neuropathic pain pathways, acting as a neuromodulator when released from the nociceptive neurons (Kerr, Bradbury et al. 1999, Thompson, Bennett et al. 1999, Pezet, Malcangio et al. 2002, Zhang, Wang et al. 2016). In models of neuropathic pain, due to the downregulation of BDNF in injured fibers, it seems reasonable that exogenous BDNF administration with proper dose and time would exert beneficial anti-nociceptive effect, as already suggested previously (Miki, Fukuoka et al. 2000, Eaton, Blits et al. 2002).

g. BDNF and drug addiction

Drug addiction is a complex behavioral disorder with a large variety of causes, including genetic and environmental influences, as well as drug-induced changes in the brain (Kreek, Nielsen et al. 2005). Developed drug addiction is characterized by a loss of control over a substance use or a behavior (for instance, gambling), a concern with substance or behavior, a compulsive drug use despite adverse consequences, and relapses even after long periods of withdrawal (Moss, Chen et al. 2014, Sharma, Bruner et al. 2016). Laboratory experiments on

animal models have indicated that activation of the dopaminergic pathway in the brain seems to be the driver link that has a central role in the rewarding effects of drug abuse and in the learning process required to form connections between contextual stimuli and rewarding or aversive events (Spanagel and Weiss 1999, Cadet and Bisagno 2014, Koskela, Back et al. 2017).

Alterations in BDNF mRNA and protein expression have been determined in various brain regions, especially in relation with the dopaminergic system, following administration or withdrawal of different classes of addictive compounds in rodents (Russo, Mazei-Robison et al. 2009). For example, chronic opiate administration in rodents led to a significant increase of BDNF mRNA levels in diverse cerebral regions, including the nucleus accumbens, medial prefrontal cortex, ventral tegmental area, and orbitofrontal cortex (Liu, Lu et al. 2006, Chu, Zuo et al. 2007, Graham, Edwards et al. 2007, Russo, Mazei-Robison et al. 2009). However, opiate withdrawal after a chronic exposure also resulted in a rapid and prolonged induction of both BDNF and TrkB mRNA in the locus coeruleus, a structure linked to anxiety (Numan, Lane-Ladd et al. 1998). In addition, both acute and chronic cocaine administration have been reported to increase BDNF mRNA and protein levels in the rodent striatum (Zhang, Zhang et al. 2002, Liu, Lu et al. 2006, Graham, Edwards et al. 2007). Because of its involvement, particularly in the regulation of activity-dependent neuronal function and synaptic plasticity (in part by controlling dopamine receptor expression), BDNF plays a key role in the molecular and cellular adaptations leading to addictive behavior (Guillin, Diaz et al. 2001, Russo, Dietz et al. 2010), and is of major interest in addiction-related research.

Alcohol use disorders are widespread problems afflicting approximately 10% of the population worldwide (World Health Organization, 2014), characterized by increased alcohol consumption over time, loss of control over alcohol drinking and persistent alcohol use despite negative consequences. Studies have shown that alcohol abuse can lead to cognitive impairments and behavioral problems in animal models, including anxiety, depression, deficits in attention, reversal learning and extinction learning (Heinz, Beck et al. 2011, Kuzmin, Liljequist et al. 2012, Hermens, Lagopoulos et al. 2013, Broadwater, Liu et al. 2014, Badanich, Fakhri et al. 2016). One potential mechanism caused by alcohol consumption could be neurodegeneration in some hippocampal regions such as CA1, CA2, CA3 and DG (Morris, Eaves et al. 2010, Taffe, Kotzebue et al. 2010), by altering synaptic plasticity and related neuronal function (Koob 2003).

Since disruption of BDNF signaling and prenatal alcohol exposure result in overlapping detrimental effects, the interactions between alcohol and BDNF may contribute to the damaging effects of developmental alcohol exposure on neuroplasticity, learning, and memory measures. A growing body of work has been done to determine how prenatal alcohol exposure affects BDNF levels in the brain, but these studies highlight the variety of BDNF alterations depending on species, sex, kinetics and brain regions. Both mice and rats exposed to alcohol prenatally presented with decreased levels of BDNF protein and mRNA transcripts in adulthood in the medial prefrontal cortex (Feng, Yan et al. 2005, Caldwell, Sheema et al. 2008), pointing to decreased BDNF production in hippocampus following prenatal alcohol exposure. On the other hand, using C57BL/6J mice, Lanfumey's group has more recently provided evidence for a different effect and unraveled the underlying mechanism by which alcohol consumption impacts neuroplasticity, BDNF expression and signaling pathways at the cellular and behavioral levels. The authors reported that chronic and moderate ethanol intake induced chromatin remodeling at histone level, such as Histone H3, within the BDNF promoters (Stragier, Massart et al. 2015), as well as decreased DNA methylation within the *Bdnf* gene in the hippocampus (Stragier, Martin et al. 2015). These epigenetic regulations resulted in elevated BDNF expression (Stragier, Massart et al. 2015) and hippocampal signaling pathways, but impaired learning and memory capacities analyzed in the contextual fear conditioning test and the novel object recognition task (Stragier, Martin et al. 2015). These data suggest that neuroplasticity involving BDNF signaling pathway could be an adaptive response to the cognitive deficits induced by ethanol consumption.

Altogether, addictive substance use disorders have been characterized as diseases of maladaptive plasticity (Luscher and Malenka 2011, Nestler 2013), and BDNF seems to be involved in the mechanisms of cocaine and alcohol addiction.

1.2.3 Conclusion

To summarize, BDNF levels are associated with a large range of physiological and pathological processes, including learning, memorization, neuronal survival, differentiation, growth, LTP in the hippocampus, as well as stress response, depression, epilepsy, and various psychological disorders. These data emphasize the importance of BDNF expression level in health and diseases. Therefore, it is of much importance to study the mechanisms involved in the regulation of BDNF expression.

1.3 Bdnf gene and protein

1.3.1 Bdnf gene structure

The *Bdnf* gene in mammals has a very complex structure consisting of multiple 5'-non-coding exons, which are alternatively spliced to generate exon-specific BDNF transcript variants, with one common BDNF coding exon on the 3'-C terminal end (Liu, Walther et al. 2005, Aid, Kazantseva et al. 2007, Pruunsild, Kazantseva et al. 2007). It was hypothesized that such a complex architecture of the *Bdnf* gene may endow neuronal cells with the ability to differentially target select BDNF transcripts to specific cellular locations (Chiaruttini, Sonogo et al. 2008, Baj, D'Alessandro et al. 2012) and to modulate their stimulus-responsivity and translatability (Lauterborn, Rivera et al. 1996, Tao, West et al. 2002).

Previously, it was reported that rodent *Bdnf* gene consists of four 5'-non-coding exons (termed exons I-IV) that are spliced onto the common 3' coding exon (exon V) (Timmusk, Palm et al. 1993). However, more recently, Aid et al have reported that both rat and mouse *Bdnf* gene contains at least eight 5'-non-coding exons (named exons I-VIII) and one 3'-exon (exon IX) coding pro-BDNF protein (Aid, Kazantseva et al. 2007) (Fig. 4). Here, we use the new nomenclature. By performing 5' rapid amplification of cDNA ends (5' RACE) from rat hippocampal RNA, it was found that each exon contains a transcription initiation site and the mRNAs spliced from all of the exons are transcribed from distinct and separate promoters (termed promoters 1-9), with tissue- and cellular-specific expression (Timmusk, Palm et al. 1993, Aid, Kazantseva et al. 2007). In general, closely located exons in the genome are expressed in a similar manner: all BDNF mRNA isoforms are expressed in brain-enriched patterns, while exons IV, V and VI are also widely expressed in non-neural tissues (Aid, Kazantseva et al. 2007).

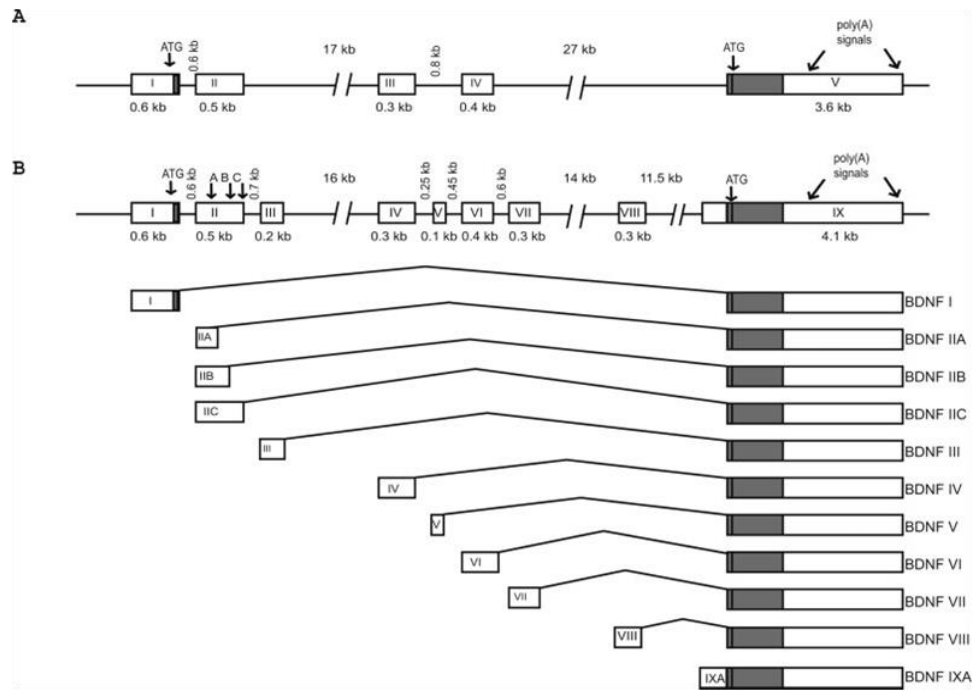

Fig. 4 Exon/intron structure and alternative transcripts of mouse and rat *Bdnf* genes. A: Rat *Bdnf* gene structure as described by Timmusk et al (Timmusk, Palm et al. 1993). Exons are shown as boxes and introns are shown as lines. **B:** The new arrangement of exons and introns of mouse and rat *Bdnf* genes determined by Aid et al (Aid, Kazantseva et al. 2007). The schematic representation of BDNF transcripts in relation to the gene is shown below the gene structure. UTRs of the exons are indicated by open boxes, and the region coding for mature BDNF protein is indicated by the filled boxes. Each transcription unit may use one of the two alternative polyadenylation signals in the 3' exon (arrows). For exon II, three different transcript variants, IIA, IIB, IIC, are generated as a result of using alternative splice-donor sites in exon II (arrows marked A, B, and C).

Furthermore, the various BDNF transcripts display distinct subcellular localization (Aid, Kazantseva et al. 2007), suggesting that spatially restricted effects occur as a function of molecular and physiological regulation. More specifically, Aliaga et al. (Aliaga, Mendoza et al. 2009) reported that in mouse hippocampal neurons, while transcripts I and II mRNA appear to be weakly expressed and distributed within the cytoplasmic compartment, exon IV mRNA is concentrated in the soma, surrounding the nucleus and exon VI mRNA is strongly expressed in the soma and the proximal dendrites. A similar localization of these exon-containing transcripts has been observed in cortical neurons (Pattabiraman, Tropea et al. 2005). On the other hand, with two polyadenylation signals in exon IX, generating either a short or a long 3'untranslated region (3'UTR), the *Bdnf* gene produces two populations of transcripts (Timmusk, Palm et al. 1993). A previous study showed that the short 3'UTR BDNF mRNA is only expressed in cell bodies while the long form is also present in the dendrites, being exported from the perikaryon of cortical and hippocampal neurons of rodent models (An, Gharami et al. 2008). The lack of the long 3'UTR BDNF mRNA, which seems

essential for late phase of dendritic spine maturation, may contribute to disease such as obesity in the mice, as reported by another study (Liao, An et al. 2012). Altogether, the modalities of this spatial code of exon-specific BDNF expression still need to be clarified.

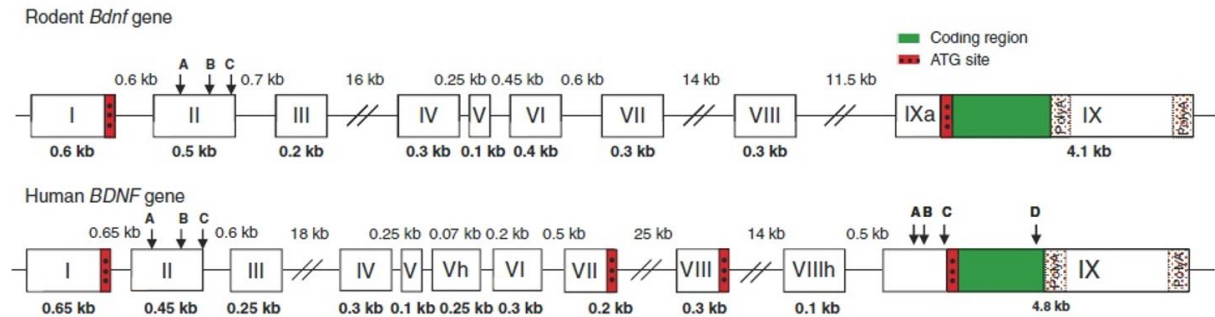

Fig. 5 BDNF gene structures in the rodent and human. Exons are shown as boxes and introns are shown as lines. UTRs of the exons are indicated by open boxes, and the region coding for mature BDNF protein is indicated by the filled boxes. Each transcription unit may use one of the two alternative polyadenylation signals in the 3' coding exon (exon IX). For exons II and IX, several different transcript variants are generated as a result of using alternative splice-donor sites in exon II (arrows marked A, B, C and D). The start codon ATG marking the initiation of transcription is represented by the red boxes. The green box shows the region of exon IX coding for the pro-BDNF protein. Adapted from Boulle et al. 2012 (Boulle, van den Hove et al. 2012).

In comparison, the structure of the human *BDNF* gene determined by Pruunsild et al. (Pruunsild, Kazantseva et al. 2007) is similar, although more complex, than that reported by Aid et al. in rodents (Aid, Kazantseva et al. 2007) (Fig. 5). Briefly, the human *BDNF* gene spans about 70 kb and consists of 11 exons (I–V, Vh, VI–VIII, VIIIh and IX), with two more exons (Vh and VIIIh) than the rodent *Bdnf*; adding more complexity to the regulation of human *BDNF* (Pruunsild, Kazantseva et al. 2007). The transcription initiation sites in human *BDNF* gene are generally conserved with the respective regions in rodents (Pruunsild, Kazantseva et al. 2007). Pruunsild et al. (Pruunsild, Kazantseva et al. 2007) pointed out that exons I, VII and VIII in human *BDNF* gene also contain alternative translation start sites that lead to a pre-pro-BDNF protein with longer N-termini, whereas for exons II, III, IV, V, Vh, VI and VIIIh- containing transcripts, translation starts from exon IX. In human, exon IX is further subjected to internal splicing and/or transcription-initiation, leading to the generation of alternative transcripts (exons IXa, IXb, IXc and IXd), forming three distinct exon IX containing mRNAs composed of IXbd, IXabd and IXabcd, while the transcript containing exon IX is the only form in rodents (the counterpart in human is IXabcd) (Aid, Kazantseva et al. 2007, Pruunsild, Kazantseva et al. 2007). In addition, Pruunsild et al. (Pruunsild, Kazantseva et al. 2007) also found that BDNF transcripts containing exons II, III, IV, V and

VII are mostly brain specific, whereas the others, in addition to the brain, are also expressed in non-neuronal tissues. Likewise the expression pattern of BDNF mRNAs in rodents, it was also reported that the most abundant transcripts in human non-neural tissues were messengers containing exons VI and IXabcd (Pruunsild, Kazantseva et al. 2007).

In summary, both rodent and human *BDNF* genes are transcribed from multiple promoters to generate a heterogeneous population of BDNF mRNA, together with the complex transcriptional regulatory mechanisms that may act at different levels, leading to a complex and fine-tuning regulation of BDNF expression. Transcriptional control of BDNF expression through activation of distinct promoters and usage of different polyadenylation sites could influence BDNF mRNA stability, translatability, localization and the kinetics of stimulus-responsiveness, thus providing the possibility of powerful control in the modulation of the expression of this key neurotrophin. This testifies probably the crucial physiological importance of this gene.

1.3.2 BDNF protein processing

According to the initiation codon within the *BDNF* transcript variants, BDNF is initially synthesized as a unique precursor protein known as pre-pro-BDNF in the endoplasmic reticulum. This precursor protein contains a signal peptide for the secretory pathway, N-linked glycosylation sites, and pairs of basic amino acids that are recognized by processing enzymes (Binder and Scharfman 2004). After the signal peptide is removed, the 32 kDa proBDNF is transported into the Golgi for sorting into either constitutive or regulated secretory vesicles (Greenberg, Xu et al. 2009). Pro-BDNF may be cleaved into biologically active mature BDNF (mBDNF, 14 kDa) intracellularly in the trans-Golgi by the calcium-dependent serine protease furin, or in the immature secretory granules by proprotein convertases (Mowla, Pareek et al. 1999), at a dibasic cleavage site in the middle of the precursor protein (Seidah, Benjannet et al. 1996, Greenberg, Xu et al. 2009). Along this line, it has been shown that pro-BDNF is colocalized with mBDNF in secretory granules (Dieni, Matsumoto et al. 2012), and BDNF is secreted as a mixture of pro-BDNF and mature BDNF (McCarthy, Brown et al. 2012).

Actually, the pro-region of BDNF may regulate the sorting of the pro-BDNF, by binding to the lipid-raft-associated carboxy peptidase E (CPE) and by interacting with the transmembrane protein sortilin (Lou, Kim et al. 2005). Following that, BDNF is sorted into

regulated secretory pathways through the trans-Golgi network, and transported to releasing vesicles for activity-dependent secretion (Lessmann, Gottmann et al. 2003). In axons, BDNF is transported mainly in the anterograde direction through the fast axonal flow, and released to postsynaptic neurons in an activity-dependent manner (Kohara, Kitamura et al. 2001). In dendrites, BDNF is transported to the distal parts and is released also in an activity-dependent manner, which requires Ca^{2+} influx (Chen, Patel et al. 2004).

It was initially thought that only the secreted mBDNF was biologically active, while pro-BDNF just serves as an inactive precursor, exclusively localized intracellularly. However, a growing body of evidence has shown that pro-BDNF may be secreted and converted to mBDNF *in vitro* by plasmin and regulate its own sorting, just as already described above, indicating the biological activities of this precursor protein (Pang, Teng et al. 2004). It has been also reported that pro-BDNF may interact with the low-affinity p75NTR (Fayard, Loeffler et al. 2005), which is less specific, thus inducing differential signaling pathways, including the c-Jun N-terminal kinase (JNK) signaling cascade and nuclear factor- κ B (NF- κ B) signaling (Roux and Barker 2002, Reichardt 2006) (Fig. 2). Pro-BDNF has altered binding characteristic and distinct biological activity in comparison with mature BDNF protein (Lee et al 2001; Teng et al 2005). Interestingly, there are several points for crosstalks between the TrkB and p75NTR cascades (Bibel, Hoppe et al. 1999). However, neurotrophin-mediated effects through these two pathways often exert opposing actions (Miller and Kaplan 2001). For example, TrkB receptor activation promotes neuronal survival and differentiation (Barnabe-Heider and Miller 2003, Yang, Liang et al. 2017), while the engagement of p75NTR frequently, but not invariably, promotes apoptosis (Lee, Kermani et al. 2001, Teng, Teng et al. 2005, Sun, Lim et al. 2012, Gaub, de Leon et al. 2016).

Taken together, these findings indicate a complexity not only in the mechanisms underlying the synthesis of the mature form of BDNF, the secretory pathway, and its dendritic trafficking, but also in the biological activities of pro-BDNF.

1.3.3 BDNF Val66Met variant

Within the human *BDNF* gene, at codon 66 in the pro-domain of the BDNF molecule (Anastasia, Deinhardt et al. 2013), a functional single nucleotide polymorphism (SNP) produces a non-conservative substitution from valine to methionine, generating three possible genotypes (Val/Val, Val/Met and Met/Met), indicating clues for potential functions of the

pro-domain (Egan, Kojima et al. 2003). In a European-American population, the Val/Met substitution has been identified in 28% of the subjects, while Val/Val was found in 67% and Met/Met in remaining 5% of the individuals (Egan, Kojima et al. 2003). However, these percentages vary in individuals of other ethnicities.

It was shown that the presence of the methionine allele in *BDNF* Val66Met was associated with altered BDNF trafficking and localization, and with a reduction in activity-dependent BDNF secretion when transfected in rat hippocampal neuron culture (Egan, Kojima et al. 2003). In a functional neuroimaging study, individuals carrying the Met allele showed less hippocampal activation during memory encoding and retrieval than the Val homozygotes (Hariri, Goldberg et al. 2003). Consistent behavioral results were observed in another study, with Met homozygotes exhibiting significantly poorer performances on a verbal episodic memory test when compared with Val homozygotes (Egan, Kojima et al. 2003). Moreover, there is now accumulating evidence that the *BDNF* Val66Met polymorphism modulates human neuroplasticity. In particular, results from a number of studies suggest that the Met allele confers reduced plasticity in the motor cortex (Antal, Chaieb et al. 2010, Fritsch, Reis et al. 2010). Collectively, the human phenotypes associated with the Val66Met polymorphism in neuropsychiatric disorder conditions have been linked to impaired sorting and secretion of BDNF, leading to impaired neuronal plasticity, hippocampal activation and cognitive behaviors.

In conclusion, the presence of this genetic variation *BDNF* Val66Met gives rise to an additional impairment in the translation and complexity in the regulation of *BDNF* gene in humans. However, *BDNF* Val66Met polymorphism provides an illustration on how a specific genetic variant may have direct implications in neuroplasticity and cognitive performances (Pascual-Leone, Freitas et al. 2011).

1.4 Regulation of BDNF expression

During postnatal development, BDNF levels are dynamically regulated, in part, by neuronal activity-dependent mechanisms (Poo 2001). Interestingly, BDNF is not only required for synaptic plasticity and brain function, but also its expression is also triggered by neuronal activity both *in vitro* and *in vivo*. This is consistent with the notion that gene transcription and new protein synthesis are required for both LTP and memory formation (Kandel 2001, Malenka and Bear 2004). BDNF transcription is significantly induced by calcium influx and

neural activity. For example, calcium influx through L type voltage gated calcium channel (L-VGCC) (Tao, Finkbeiner et al. 1998) or NMDAR (Tabuchi, Nakaoka et al. 2000, Zheng, Zhou et al. 2011) robustly increases BDNF mRNA in cultured neurons. Electrical activity such as high frequency stimulation which induces LTP, also stimulates BDNF transcription in brain slices (Patterson, Grover et al. 1992). In living rats, enrichment of BDNF transcripts has been reported after physical exercise (Neeper, Gomez-Pinilla et al. 1995), training of contextual learning (Hall, Thomas et al. 2000), exposure to a novel environment (Young, Lawlor et al. 1999), chronic exposure to drugs of abuse (Wang, Lv et al. 2010), as well as kainic acid (KA)-induced seizure (Timmusk, Palm et al. 1993). Intriguingly, BDNF transcription leads to various BDNF mRNA isoforms (Timmusk, Palm et al. 1993, Lubin, Roth et al. 2008) in different cell types in response to different neuronal activities. For example, fear conditioning increases BDNF mRNA containing exon I and IV in hippocampus (Lubin, Roth et al. 2008, Fuchikami, Yamamoto et al. 2010) and amygdale (Rattiner, Davis et al. 2004, Ou and Gean 2007), whereas fear memory extinction enhances exon I and IV-containing BDNF transcripts in prefrontal cortex (Bredy, Wu et al. 2007).

The molecular events involved in the stimulation of BDNF expression by synaptic plasticity were extensively analyzed at the transcriptional level. Several transcription factors contributing to the regulation of BDNF promoters have been already characterized, such as cAMP response element-binding (CREB) protein (Tao, Finkbeiner et al. 1998), upstream stimulatory factor 1/2 (USF1/2) (Shieh, Hu et al. 1998), and calcium-responsive transcription factor (CaRF) (Tao, West et al. 2002). Thus far, among all of the promoters that control the transcription of distinct exons, regulation of exon IV has received most attention. Along this line, it was proposed that exon IV-containing BDNF mRNA is the major form induced by neuronal activity in cortical neurons (Tao, Finkbeiner et al. 1998, Zheng and Wang 2009, Zheng, Zhou et al. 2011).

In addition to the regulation by synaptic activity and transcription factors, epigenetic mechanisms including direct methylation of DNA and chromatin remodeling also mediate BDNF expression, either repressing or promoting gene transcription. DNA methylation is an important epigenetic mechanism for BDNF transcription. For example, maltreatment of rat pups, such as exposure to stressed foster mothers, may produce long-term changes in BDNF expression through DNA methylation in the prefrontal cortex (Roth, Lubin et al. 2009). In general, DNA hypermethylation leads to the reduction of BDNF transcription, possibly due to

the reduced binding and assembly of transcription machinery (Levenson, Roth et al. 2006, Sharma, Tun et al. 2008). Moreover, it seems that such epigenetic regulation of BDNF transcription may vary depending upon the type of neurons and the nature of stimulation. Modifications in chromatin structure result from the post-translational modification on histone proteins by acetylation, methylation, and phosphorylation (Bird 2007). HDAC2 (histone deacetylase 2) knockout mice demonstrated that HDAC2 enhanced synaptic plasticity and memory formation, whereas HDAC2 over-expressing animals displayed learning deficits (Guan, Haggarty et al. 2009). Furthermore, treatment of trichostatin A (TSA), a classical inhibitor of HDAC1 and HDAC2, increased histone H3 and H4 acetylation at *Bdnf* promoter I in Neuro-2A cells (Ishimaru, Fukuchi et al. 2010). Altogether, inhibition of HDAC activity in neuronal cells increases BDNF expression, which may be involved in enhanced synaptic plasticity and learning process.

BDNF expression was also reported to be profoundly modulated by stress (Tsankova, Berton et al. 2006), which depend upon the dose and duration of stressors (Tapia-Arancibia, Rage et al. 2004). It has been demonstrated by several studies that BDNF expression, at both mRNA and protein levels, were significantly downregulated, predominantly in the DG and CA3 hippocampal subfields, as demonstrated by *in situ* hybridization and immunocytochemistry, following both acute (2-8 h) (Smith, Makino et al. 1995, Ueyama, Kawai et al. 1997, Lee, Saruta et al. 2008) and chronic (10 days to 6 weeks) (Murakami, Imbe et al. 2005, Tsankova, Berton et al. 2006, Nair, Vadodaria et al. 2007, Rothman, Herdener et al. 2012) stresses. In contrast, BDNF transcripts containing exons I, II, III were transiently increased in the hippocampus after shorter stress sessions (15 min to 1 h) (Marmigere, Givalois et al. 2003). Therefore, the relationship between stress and BDNF is complex. Additionally, exposure to acute or chronic stress is a physiological state in which enhanced levels of circulating glucocorticoids (GC) are observed (Herman and Cullinan 1997, Jankord and Herman 2008). Thus, the involvement of GC in regulating the effects of stress on BDNF expression levels has often been proposed (Smith, Makino et al. 1995, Murakami, Imbe et al. 2005, Dwivedi, Rizavi et al. 2006, Asadi, Hedman et al. 2008, Gourley, Kedves et al. 2009, Cheung, Leung et al. 2011, Kumamaru, Numakawa et al. 2011), indicating that the effects of stress and high GC exposure on BDNF expression are similar within the hippocampus. Functional interactions between GC and BDNF have been studied and reviewed extensively (Kumamaru, Numakawa et al. 2011, Jeanneteau and Chao 2013, Numakawa, Adachi et al. 2013, Suri and Vaidya 2013), but are not clearly defined yet, especially at the molecular level.

In summary, the dynamic regulation on BDNF expression at multiple levels has indicated how cellular signaling and genomic processing enable excitable neurons to cope with the environmental changes. Importantly, altered expression of BDNF as well as mutations of many transcription regulators are involved in a large variety of neurological disorders including depression (Duman and Aghajanian 2012), neurodegeneration (Milnerwood and Raymond 2010, Allen, Watson et al. 2011) and addiction (Russo, Mazei-Robison et al. 2009). Several levels of regulation of BDNF action, including the expression, protein processing, distinct receptors and signaling cascades, may explain how this neurotrophin exerts so many different functions. It could be expected that a better understanding of the regulation of BDNF expression levels and of its function may open new therapeutic options.

2. Glucocorticoid receptor (GR) in the brain

As mentioned in Chapter 1, BDNF expression is dynamically regulated by various factors, among which the involvement of glucocorticoids (GC) has often been proposed (Smith, Makino et al. 1995, Murakami, Imbe et al. 2005, Dwivedi, Rizavi et al. 2006, Asadi, Hedman et al. 2008, Gourley, Kedves et al. 2009, Cheung, Leung et al. 2011, Kumamaru, Numakawa et al. 2011). In the brain, GC act by binding to its two receptors, the mineralocorticoid receptor (MR, or NR3C2) and glucocorticoid receptor (GR, or NR3C1) localized in the cytoplasm when unbound then translocating into the nucleus in the presence of hormone. More recently, MR and GR were also described to be located at the membrane (de Kloet, Joels et al. 2005, Ayrou, Simon et al. 2017). GC and its receptors are associated with numerous physiological and pathological processes in the hippocampus (Oitzl and de Kloet 1992, Pavlides, Ogawa et al. 1996, Pavlides and McEwen 1999, de Kloet, Joels et al. 2005, Abrari, Rashidy-Pour et al. 2009, Scheuer 2010, Hawkins, Gomez-Sanchez et al. 2012, Munier, Law et al. 2012, Fitzsimons, van Hooijdonk et al. 2013). Ligand-bound GR and MR can bind to specific DNA response elements as homo- or heterodimers, to activate transcription of several sets of target genes (Trapp and Holsboer 1996, Mifsud and Reul 2016, van Weert, Buurstedde et al. 2017), that may include BDNF which is involved in the same functions.

2.1 Glucocorticoids (GC) act in the brain by binding to GR and MR

GC are steroid hormones of much importance in vertebrates. These hormones are synthesized and released by the adrenal cortex in a circadian manner as well as in response to stress and their secretion is tightly regulated by the hypothalamic-pituitary-adrenal (HPA) axis (Fig. 6). The internal signals like circadian clock or external ones such as stressful changes act on the paraventricular nucleus (PVN) in the hypothalamus to produce corticotropin releasing hormone (CRH), which controls the synthesis and secretion of adrenocorticotrophic hormone (ACTH) in the anterior pituitary. Subsequently, in periphery, ACTH stimulates the production and secretion of GC released from the adrenal cortex. Moreover, GC could mediate the stress responses in many organs, including the CNS. GC levels in the brain present similar patterns than in the plasma, although delayed by diffusion through the blood brain barrier, maintaining the ultradian pulses and the stress responses between the periphery and the CNS (Droste, de Groote et al. 2008). In the CNS, GC also limit both the magnitude and duration of the GC increase by inhibiting the production and release of CRH and ACTH in a classic negative

feedback loop (Fig. 6) (Joels and Baram 2009), resulting in a return of the HPA axis to homeostasis (Meaney, Diorio et al. 1996, De Kloet, Vreugdenhil et al. 1998).

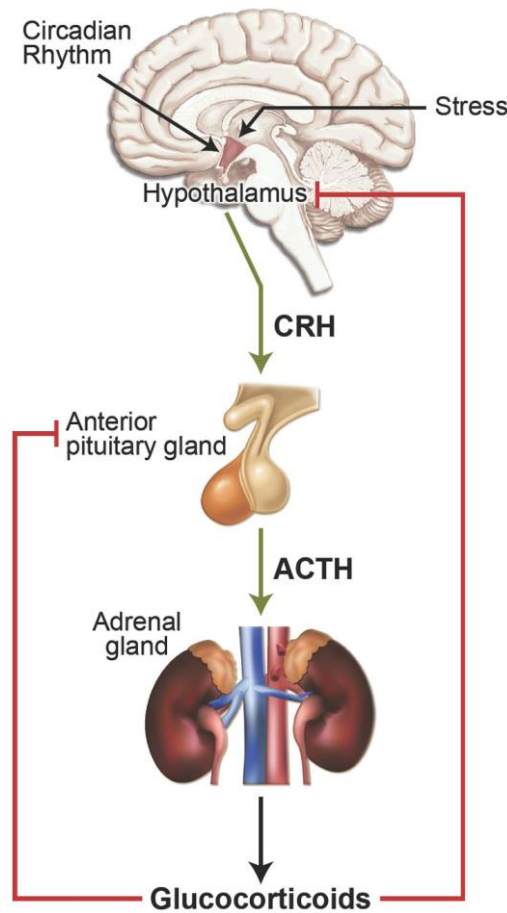

Fig. 6 Regulation of glucocorticoid hormone secretion by the hypothalamic-pituitary-adrenal (HPA) axis (Oakley and Cidlowski 2013). The hypothalamus secretes the corticotrophin releasing hormone (CRH) under the control of the environment, stress and the circadian rhythm. CRH in the portal blood stimulates anterior pituitary gland to produce adrenocorticotropin hormone (ACTH) that triggers the secretion of glucocorticoids (GC) by the adrenal glands. GCs also act on the hypothalamus and anterior pituitary gland to limit the GC increase by inhibiting the production and release of CRH and ACTH in a classic negative feedback loop.

Generally, GC act on maintaining homeostasis both in normal circadian clock response and in the conditions of stressful perturbations. Regulating a plethora of physiological processes, GC are strongly associated to cognition, behavior, emotions, skeletal growth, reproduction, immune function, and intermediary metabolism (Barnes 1998, Sapolsky, Romero et al. 2000). Due to their powerful anti-inflammatory and immune-suppressive actions, synthetic GC are one of the most widely prescribed drugs for treating inflammatory and autoimmune diseases, such as asthma, allergy, multiple sclerosis, sepsis, and ulcerative colitis (Rhen and Cidlowski 2005, Busillo and Cidlowski 2013). However, the glucocorticoid therapeutic benefits are

limited because the patients chronically treated with these hormones develop severe side effects, which affect many physiological systems, triggering Cushing-like symptoms, hypertension, diabetes, osteoporosis, skin atrophy, but also depression, asthma, behavioral effects, impaired stress response, adrenal suppression, and immunosuppression (Miner, Hong et al. 2005, Rhen and Cidlowski 2005).

In MR and/or GR target tissues, GC may bind to its two receptors MR and GR, or preferentially to one of them, depending on the GC levels, the relative receptor affinities as well as the intracellular environments. Both GR and MR belong to the nuclear receptor superfamily and mainly act as ligand-dependent transcription factors (Committee 1999, Viengchareun, Le Menuet et al. 2007). Of note, MR is highly expressed only in neurons of the limbic system, especially in the hippocampus, while GR is ubiquitously expressed throughout the brain. While GR mainly binds GC, MR is a target for both mineralocorticoids, mainly aldosterone and GC. In the plasma, glucocorticoid concentrations are at least one hundred times higher than that of mineralocorticoids (de Kloet, Van Acker et al. 2000). Mineralocorticoid and glucocorticoid hormones are often referred to as corticosteroid hormones. Furthermore, MR displays a 10-fold higher affinity for GC than GR (Reul and de Kloet 1985, de Kloet, Van Acker et al. 2000), thus MR should be mainly considered as a GC-activated receptor which is very likely fully occupied at physiological levels of GC, whereas GR is only significantly occupied and activated under high GC concentrations, such as at its peak of the circadian rhythm or under stress (Trapp and Holsboer 1996). Once bound by GC, MR and GR function as transcription factors, directly binding to glucocorticoid response elements (GRE) or indirectly interacting with other transcription factors, to activate or repress the transcription of target genes (Trapp and Holsboer 1996, Mifsud and Reul 2016, van Weert, Buurstedde et al. 2017).

In epithelial cells, the 11 β -hydroxysteroid dehydrogenase type 2 (11 β HSD2) enzyme converts cortisol and corticosterone into inactive metabolites (cortisone and 11-dehydrocorticosterone, respectively). In contrast, in non-epithelial MR target cells such as neurons this enzyme is not expressed. Because of the presence of the blood-brain barrier which is poorly permeable to aldosterone, the main mineralocorticoid hormone, and the lack of the enzyme 11 β HSD2, it is assumed that GC function by binding to both the two types of receptors, GR and MR in the CNS (de Kloet, Joels et al. 2005). That is, through this one hormone-two receptor system working in balance, GC mediate a large spectrum of actions in the brain.

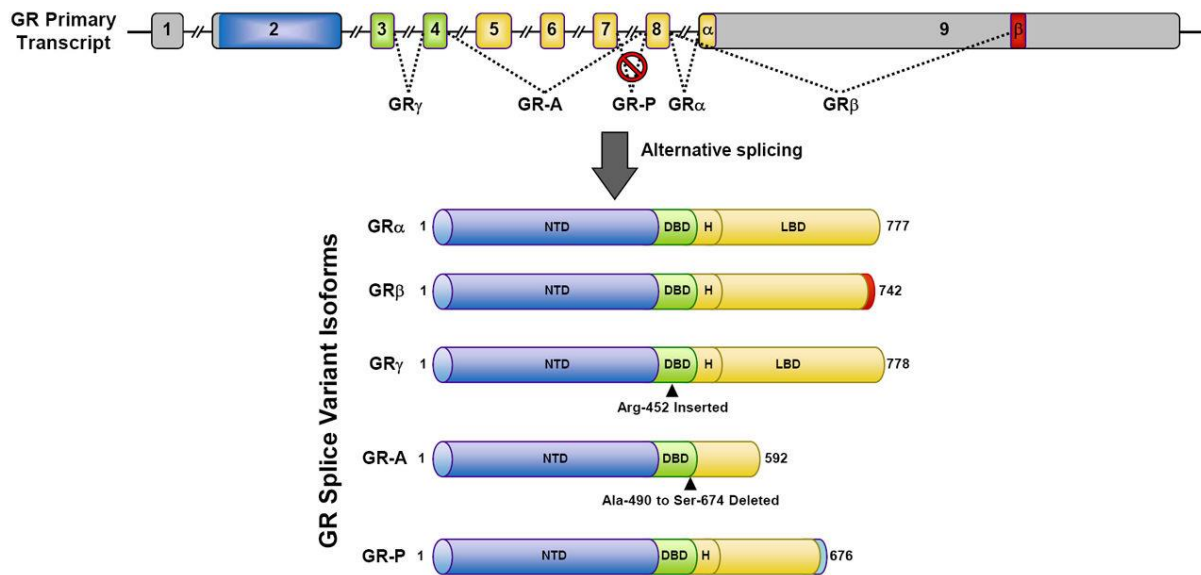

Fig. 7 GR splice variants (Oakley and Cidlowski 2013). The GR primary transcript is composed of 9 exons. Exon 2 encodes the NTD, exons 3-4 encode the DBD, and exons 5-9 encode the hinge region (H) and LBD. GR α results from splicing exon 8 to the beginning of exon 9. GR β , GR γ , GR-A, and GR-P are generated by the depicted alternative splicing events.

GR is structured in three major domains: an N-terminal domain (NTD) which contains several functions for transactivation, a central DNA-binding domain (DBD), and a C-terminal ligand binding domain (LBD) (Fig. 7) (Kumar and Thompson 2005). Besides, a flexible region of the protein termed the hinge region exists separating the DBD and LBD. Among them, the DBD is the most conserved domain across the nuclear receptor family and contains two zinc finger motifs that recognize and bind the specific target DNA sequence GREs. The human *NR3C1* gene, encoding GR, consists of 9 exons. The NTD is encoded by exon 2, the DBD by exons 3 and 4, and the hinge region and LBD by exons 5-9 (Fig. 7). Two main receptor isoforms, termed GR α and GR β , were generated by the alternative splicing in exon 9 (Fig. 7) (Bamberger, Bamberger et al. 1995, Oakley, Sar et al. 1996). The former is the classic GR protein that mediates GC actions and is highly expressed, while the latter does not bind glucocorticoid agonists and does not transactivate on glucocorticoid-responsive reporter genes (Lewis-Tuffin and Cidlowski 2006, Kino, Su et al. 2009). Furthermore, alternative translation initiation from GR α mRNA transcript gives rise to an additional cohort of GR α N-terminal isoforms, including GR α -A, GR α -B, GR α -C1, GR α -C2, GR α -C3, GR α -D1, GR α -D2, and GR α -D3 (Yudt, Jewell et al. 2003, Lu and Cidlowski 2005). Thanks to additional alternative splicing and alternative translation initiation, multiple GR proteins exist, derived from a single gene. Moreover, various post-translational modifications occur on these functionally distinct GR subtypes that further modulate their signaling properties (Oakley and Cidlowski 2013).

Exhibiting the classical structure of members of the nuclear receptor super family, MR is also composed of three main functional domains, NTD, DBD, and LBD (Arriza, Simerly et al. 1988, Pascual-Le Tallec and Lombes 2005, Huang, Chandra et al. 2010, Huyet, Pinon et al. 2012). Each of them is of much importance for transcriptional responses (Fuller, Yao et al. 2012, Faresse 2014). Of note, MR protein shows highly conserved primary sequences with that of GR in DBD and LBD regions, but a weaker homology within NTD region (Bledsoe, Montana et al. 2002, Baker, Funder et al. 2013). Furthermore, a multiple alignment of the LBD sequence of vertebrate MR and GR has been used for phylogenetic analysis of the closely related MR and GR, as well as to identify sites that could be important in functional divergence of vertebrate MR from the GR (Baker and Katsu 2017).

2.2 GR signaling pathways

The physiological and pharmacological actions of GC are mediated by GR. Partly through binding to the GRE sequences, glucocorticoid-bound GR induces or represses transcription of target genes which could comprise up to 10-20% of the human genome (Galon, Franchimont et al. 2002, Lu, Collins et al. 2007, Ren, Oakley et al. 2012). Importantly, since MR and GR share the same ligands, as well as the same genomic targets located in DNA regulatory sequences (Trapp and Holsboer 1996, Mifsud and Reul 2016, van Weert, Buurstede et al. 2017), the relative contribution and role of neuronal MR and GR and the regulation of their potential target genes should be investigated together.

In the cytoplasm of target cells, hormone-free GR combines with multiple proteins, including chaperone proteins (hsp90, hsp70, and p23) and immunophilins of the FK506 family (FKBP51 and FKBP52), forming a large hetero-oligomeric complex (Fig. 8) (Pratt and Toft 1997, Grad and Picard 2007). This combination with these proteins maintains the receptors in a transcriptionally inactive conformation but does favor binding to high affinity ligands. In the CNS, upon GC binding, GR undergoes conformational changes that lead to the dissociation of the associated proteins, and activation of the two nuclear localization signals (Pratt and Toft 1997, Grad and Picard 2007). Given that these signals were exposed due to the structural rearrangement, GR is rapidly translocated into the nucleus through nuclear pores (Freedman and Yamamoto 2004, Oakley and Cidlowski 2013).

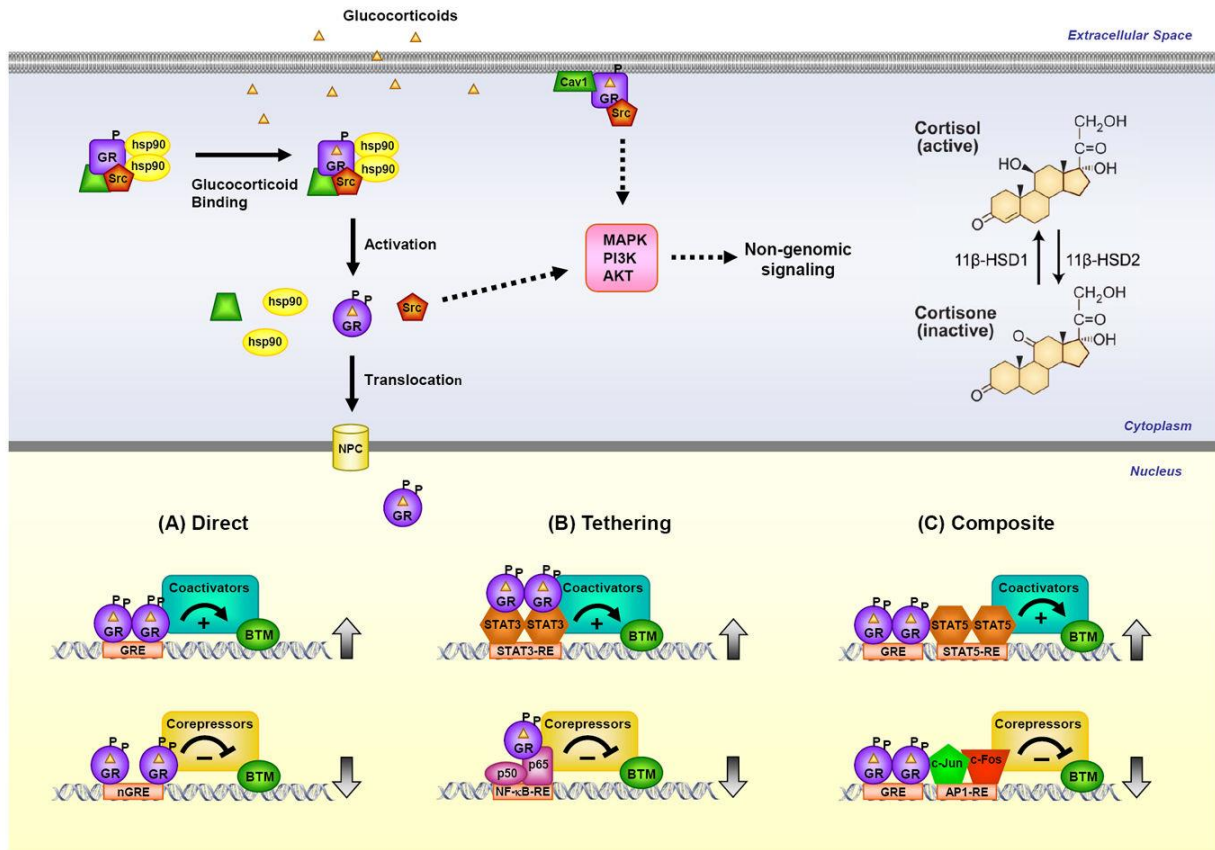

Fig 8. GR signaling pathways (Oakley and Cidlowski 2013). Glucocorticoid-activated GR regulates gene expression in 3 primary ways: binding directly to DNA (A), tethering itself to other DNA-bound transcription factors (B), or binding directly to DNA and interacting with neighboring DNA-bound transcription factors (C). GR can also signal in a non-genomic manner through alterations in the activity of various kinases.

Once inside the nucleus, GR could bind directly to GREs and regulates the expression of target genes (Fig. 8) (Beato 1989, Freedman 1992). The consensus GRE sequence, GGAACAnnnTGTTCT, is an imperfect palindrome, composed of two 6 bp half sites. GR binds this element as a homodimer or heterodimer with MR, with one receptor monomer occupying each half site (Trapp and Holsboer 1996, Mifsud and Reul 2016, van Weert, Buurstede et al. 2017). Between these two half sites, 3 nucleotide spacing is strictly required for GR to dimerize on this element. It has been shown that the GRE is able to regulate the glucocorticoid-dependent induction of many genes (Bamberger, Schulte et al. 1996, Jin and Choi 2017) and therefore is often referred to as an activating or positive GRE. Additionally, a conserved inverted repeated negative GRE (nGRE) mediating glucocorticoid-dependent repression of specific genes has also been characterized (Surjit, Ganti et al. 2011, Hua, Paulen et al. 2016). Differing from the classic GRE in sequence, the consensus nGRE sequence, CTCC(n)₀₋₂GGAGA, has a variable spacer that ranges from 0 to 2 nucleotides. This motif could be occupied by two GR monomers that do not homodimerize (Hudson, Youn et al. 2013,

Hua, Paulen et al. 2016). These nGREs are localized abundantly throughout the genome, but more investigation is needed to clarify to which extent GR binds this motif to directly repress target genes (Oakley and Cidlowski 2013). Another important question remains whether MR is also able to interact to this sequence, and whether this element could also constitute a gene expression activator.

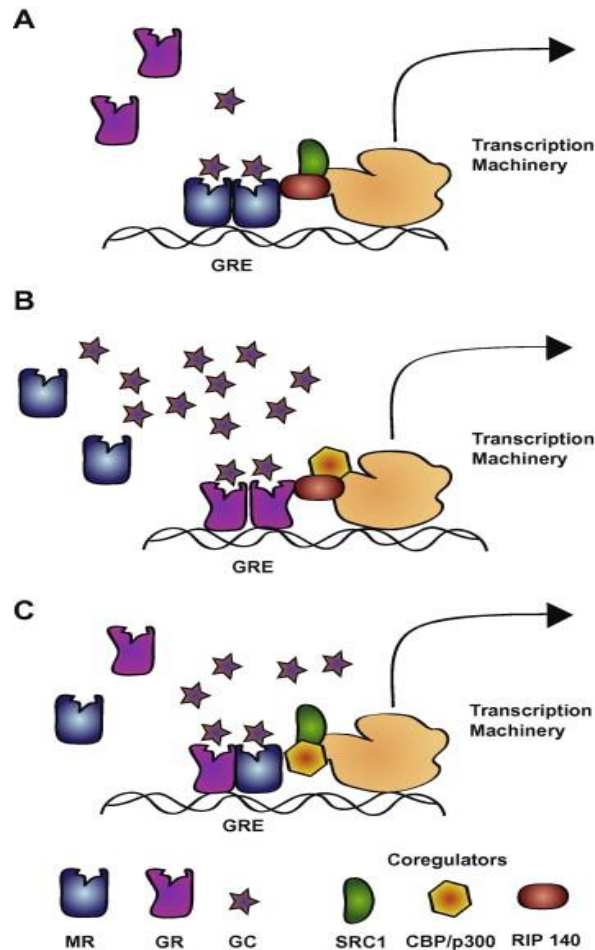

Fig 9. Simplified illustration of the mechanisms of glucocorticoid actions on the CNS (Le Menuet and Lombes 2014). (A) at low glucocorticoid (GC) concentration, MR is already fully occupied by GC, recruits a distinct set of coregulators (e.g., SRC1, CBP/p300, RIP 140), binds to glucocorticoid response elements (GRE) on the DNA to activate transcription of a specific set of genes. (B) at high GC concentration, liganded GR binds to its own set of GRE, interacts with coactivators to stimulate transcription. (C) at intermediary levels of GC, MR and GR likely form heterodimers on some target gene regulatory sequences.

It has been revealed, by global GR recruitment assays using Chromatin Immunoprecipitation and sequencing (ChIP-seq) experiments, that the specifically bound GREs vary in a tissue-specific manner due to differences in chromatin accessibility and exposure (John, Sabo et al. 2011). These data indicated that various actions of GC on diverse tissues could be partially attributed to cell-type, specific differences in the chromatin landscape that influence which

GREs are accessible for MR/GR binding. The corticosteroid receptor binding sites have been screened in adrenalectomized (ADX) rat hippocampus using Chromatin Immunoprecipitation (ChIP) with anti-GR and anti-MR antibodies followed by sequencing (Polman, de Kloet et al. 2013, van Weert, Buurstedde et al. 2017). According to the most recent report of van Weert et al, 918 and 1450 non-overlapping binding sites were found for MR and GR, respectively, as well as 475 loci co-occupied by both MR and GR. It was proposed that low corticosterone concentrations promote MR homodimer binding while higher doses trigger GR activation (Fig. 9) (Le Menuet and Lombes 2014). On the other hand, heterodimerization of GR and MR may occur on target sequences under some specific conditions (Fig. 9) (Le Menuet and Lombes 2014).

Since GR cycles between bound and unbound states every few seconds, the interaction of GR with DNA is highly dynamic (McNally, Muller et al. 2000). Once bound to the GRE, the receptor undergoes additional conformational and post-translational changes resulting in the recruitment of coregulators and chromatin-remodeling complexes, which finally modulates gene transcription levels (Jenkins, Pullen et al. 2001, Rosenfeld and Glass 2001, Lonard and O'Malley 2005). Cofactors regulating transcriptional activation include steroid receptor coactivators (SRC 1-3) of the p160 family, the histone acetyltransferases CBP/p300, and the nuclear methylase coactivator-associated arginine methyltransferase (CARM1). Corepressors such as nuclear receptor corepressor 1 (NCoR) and silencing mediator of retinoid and thyroid hormone receptors (SMRT) are recruited to GR bound to nGREs. The specific assembled cofactors and corepressors, as well as their subsequent activity of the transcriptional complexes, are dependent on both the nature of the glucocorticoid ligands and the specific GRE sequence bound by the receptors (Meijsing, Pufall et al. 2009, Ronacher, Hadley et al. 2009). Using serial analysis of gene expression (SAGE) experiments on ADX rats treated either by low (activating MR) or high (activating GR) concentrations of corticosterone, the distinct control of gene expression by MR and GR in the hippocampus was investigated at the genomic level (Datson, van der Perk et al. 2001). It was shown that subsets of genes regulated by MR and GR did not overlap much, since 98 MR-responsive genes and 72 GR-responsive ones were identified and 33 genes were regulated by both receptors, even if the two receptors share the same DNA binding sequence GRE. These genes were associated to functions ranging from metabolism to neuronal connectivity and neurotransmission (Datson, van der Perk et al. 2001). These diversities between MR and GR target genes could be partially accounted for their ability to interact with different sets of coactivators or corepressors (Fig. 8)

(Pascual-Le Tallec, Simone et al. 2005), as well as the distinct protein-DNA binding patterns (Mifsud and Reul 2016). Recently, with serial and tandem ChIP analyses, Mifsud et al. proposed that in rats, after forced swim stress, MR and GR bind concomitantly to the same GRE sites within *FK506-binding protein 5 (Fkbp5)* and *period circadian clock 1 (Per1)*, as both homo- and heterodimers, but the GREs within *serum- glucocorticoid- inducible kinase 1 (Sgk1)* only recruit homodimers of MR or GR, indicating a gene-dependent pattern of each receptor binding (Mifsud and Reul 2016). All these findings provide insight into how MR and GR interact with the hippocampal genome.

Besides, GR could also regulate transcription of target genes, independently from classical GRE binding but rather by physically interacting with other transcription factors (Fig. 8), by tethering or composite manners. For example, interacting with specific members of the STAT family, either apart from or in conjunction with GRE binding, GR has been shown to enhance the transcription of responsive genes (Rogatsky and Ivashkiv 2006). An alternative mechanism called transrepression represents the main mechanism by which activated GR represses the activity of a growing list of pro-inflammatory transcription factors, including AP1, NF- κ B and CREB, partially explaining why GC suppress inflammation. In brief, GR directly binds to the Jun subunit of AP1 or the p65 subunit of NF- κ B and interferes with the transcriptional activation of these two proteins (Yang-Yen, Chambard et al. 1990, Nissen and Yamamoto 2000). For some genes such as NF- κ B, the repressing function is achieved by GR tethering to these DNA-bound proteins without direct GR binding to any specific GRE. However, for other genes, GR acts in a composite manner, binding directly to a GRE and physically associating with AP1 bound to a neighboring site on the DNA. In addition, it has also been reported that GR and CREB show mutual functional interference of their corresponding transcriptional activities (Stauber, Altschmied et al. 1992). One example of such positive transcriptional outcome was documented for the somatostatin and phosphoenolpyruvate carboxykinase (PEPCK) promoters, on which GR and CREB positively and mutually influence each other binding to GRE and CRE elements, respectively (Imai, Miner et al. 1993, Liu, Papachristou et al. 1994). On the other hand, a negative transcriptional outcome was also recently described for the CREB-controlled *thyrotrophin-releasing hormone (TRH)* gene promoter, which contains a number of GRE half sites and one extended CRE element (Ratman, Vanden Berghe et al. 2013). It was reported that GC or cAMP rapidly increase *Trh* transcription in primary cultures of the hypothalamus, and ChIP assays revealed binding of activated CREB and GR in cells treated with cAMP or with GC (Ratman, Vanden

Berghe et al. 2013). Furthermore, using both *in vivo* (rats) and *in vitro* models (primary cultures of hypothalamic cells), Sotelo-Rivera recently provided evidence for a mechanism for the mutual interference between GC and cAMP signaling pathways: their co-stimulation promotes an interaction between activated GR and the catalytic subunit of protein kinase A (PKAc) (Sotelo-Rivera, Cote-Velez et al. 2017). This interaction of these two molecular effectors restrains their nuclear translocation, curtailing stimuli-induced CREB phosphorylation and, together with GR, their binding to *Trh* promoter, leading to reduced *Trh* transcription (Sotelo-Rivera, Cote-Velez et al. 2017).

Although the main effects of GC are controlled by transcriptional responses that occur within minutes to hours, accumulating evidence demonstrated that GR may also act *via* non-genomic mechanisms. This mechanism elicits rapid cellular responses that occur within a few seconds to minutes and do not require modifications in target gene expression (Fig. 8) (Groeneweg, Karst et al. 2012, Samarasinghe, Witchell et al. 2012, Ayrout, Simon et al. 2017). Multiple mechanisms have been proposed to be involved in these signaling events that ultimately involved the activity of various kinases, such as PI3K, AKT and MAPKs. Moreover, glucocorticoid activation of membrane associated GR has been reported to be linked to these mechanisms (Samarasinghe, Di Maio et al. 2011, Ayrout, Simon et al. 2017). The existence of non-genomic signaling adds greater complexity and diversity to GC signaling and GC biological actions, and raises the possibility that selective modulators of GR-dependent genomic or non-genomic pathways may be therapeutically advantageous.

2.3 Physiological functions and pathological association of GR and MR in the brain

As nuclear receptors that bind to and are activated by the same ligands, GR and MR physiologically work in combination in neurons. Both neuronal GR and MR are involved in the stress response (de Kloet, Joels et al. 2005, Scheuer 2010, Hawkins, Gomez-Sanchez et al. 2012), the regulation of neuron excitability, LTP (Pavlidis, Ogawa et al. 1996, Pavlidis and McEwen 1999) associated with memorization (Zhou, Bakker et al. 2010), leaning and mood, as well as neuroprotection (Abraham, Harkany et al. 2001) and neurogenesis (Kim, Ju et al. 2004) in the hippocampus. Of note, most of the roles exerted by GR and MR are overlapping with those of BDNF, according to what was described above (Chapter 1). Even though MR acts in balance with GR (Fischer, von Rosenstiel et al. 2002, Kim, Ju et al. 2004), MR and GR exert differential effects, sometimes in an opposite manner. For instance, MR activation exerts a positive effect on LTP (Pavlidis, Ogawa et al. 1996, Pavlidis and McEwen 1999) and an

anti-apoptotic role (Chantong, Kratschmar et al. 2012), while that of GR inhibits LTP (Pavlidis, Ogawa et al. 1996, Pavlidis and McEwen 1999) and promotes neuron apoptosis (Chantong, Kratschmar et al. 2012). Accumulating evidence suggests that membrane MR and GR may also exert rapid non-genomic actions in the brain, although with a lower affinity for corticosterone for MR (Joels, Karst et al. 2008, Sarabdjitsingh, Joels et al. 2012), providing additional complexity in corticosteroid receptor signaling pathways. Of note, numerous studies mostly focused on corticosteroid-bound GR actions in the CNS, which we mainly discuss here, because MR is already occupied even as the lower GC physiological concentrations.

2.3.1 GR roles in stress response and exercise

Stress is an adaptive reaction to various adverse events or factors to trigger an appropriate physiological response. The acute effects of stress on GC levels have been well established (Ulrich-Lai and Herman 2009, Allen, Kennedy et al. 2014), showing that various acute stressors significantly increase circulating GC levels in plasma in humans, as well as in rodents (Dickerson and Kemeny 2004, Cockrem 2013). In the limbic system, GR and MR exert differential functions in the response to stress. Generally, it has been proposed that, responding to harmful stimuli, MR triggers the stress response and the evaluation of the new situation, while GR is responsible for the termination of the stress response and for peripheral action allowing the mobilization of energy reserves from the body (de Kloet, Joels et al. 2005). Specially, in parallel to the increased GC levels induced by chronic stress and in depression, decreased MR and GR have been consistently reported in both humans and rodents. For instance, postmortem analyses of brains of patients with major depressive disorder (MDD) showed a decrease in MR mRNA expression in various brain regions including the hippocampus, compared to non-depressed subjects (Klok, Alt et al. 2011). Moreover, downregulation of GR in the brain, especially in the hippocampus, induced by chronic stress is thought to be important in the pathophysiology of depression (Barden 2004, Anacker, Zunszain et al. 2011, Anacker, Zunszain et al. 2011). Furthermore, many GR target genes have been already identified as transcriptionally regulated in the hippocampus by distinct stressors, such as the well-known glucocorticoid target genes *Fkbp5*, *Per1*, and *Sgk1* (Mifsud and Reul 2016). These genes are involved in GR ligand binding affinity (Jaaskelainen, Makkonen et al. 2011), circadian neuronal activity (Rawashdeh, Jilg et al. 2014), and neuronal plasticity processes (Tsai, Chen et al. 2002), respectively. Altogether, GR plays a

crucial role in the stress response at the cognitive, physiological and genomic levels, while acting in balance with MR. Thus, this dual system containing one hormone and two receptors finely mediate highly specific responses to stress, being able to differentially regulate similar subsets of target genes.

Surprisingly but interestingly, despite increasing GC levels in a similar manner to stress (Heitkamp, Huber et al. 1996, Li and Cheng 2007), exercise exerts various beneficial effects, including reducing depressive mood (Rethorst, Wipfli et al. 2009, Brown, Pearson et al. 2013, Chen, Nakagawa et al. 2017) and improving memorization (Colcombe and Kramer 2003, Smith, Blumenthal et al. 2010, Hindin and Zelinski 2012, Roig, Nordbrandt et al. 2013). However, it was reported that chronic exercise either increases or does not affect GR expression in the hippocampus of rodents, depending on the exercise protocols used (Fediuc, Campbell et al. 2006, Droste, Chandramohan et al. 2007, Griesbach, Tio et al. 2012, Clemmensen, Pehmoller et al. 2013).

Why chronic stress and exercise drive such distinct and opposite effects, while both situations result in high plasma GC levels? One potential answer is due to their different influences on MR and GR, while another proposition may be related to distinct regulation of BDNF expression level (Chen, Nakagawa et al. 2017). As described above, chronic stress decreases BDNF in various brain regions (Hill, Hellemans et al. 2012, Numakawa, Adachi et al. 2013, Suri and Vaidya 2013), while BDNF level is widely reported to be increased by exercise (Vaynman, Ying et al. 2004, Zoladz and Pilc 2010, Voss, Vivar et al. 2013, Huang, Larsen et al. 2014). These data indicate that interestingly in chronic stress and exercise, GC and BDNF expression levels seem to be somehow negatively correlated.

2.3.2 Synaptic and behavioral effects of GR

The synaptic and behavioral actions of GC are largely dependent on brain regions and the relative expression of GR and MR (de Kloet 2013). Here, we focus on hippocampus because not only MR and GR but also BDNF are highly expressed.

The synaptic actions of GC at the cellular level in the hippocampus (predominantly in CA1 pyramidal neurons) have been well characterized (Joels, Sarabdjitsingh et al. 2012, Yi, Brown et al. 2017). It was reported that corticosteroids highly affect LTP in the hippocampus by binding to MR and GR. Specifically, MR activation induces the occurrence of LTP while GR

activation reduces it (Pavlidis, Ogawa et al. 1996, Pavlidis and McEwen 1999, Yi, Brown et al. 2017). Actually, activation of MR increases neuronal excitability by inducing the formation of LTP, due to increased probability of glutamate release, suppressed potassium conductance, and increased glutamate receptor trafficking (Karst, Berger et al. 2005, Groc, Choquet et al. 2008). Conversely, the effects of elevated GC are mediated primarily by GR. Particularly, activation of GR results in enhanced calcium influx, decreased calcium efflux, and increased calcium-dependent potassium current, all of which cause suppression of neuronal excitability (Karst and Joels 2005). Meanwhile, synaptic plasticity is also repressed by GR activation due to impaired LTP (Yi, Brown et al. 2017). Furthermore, the inhibiting effect of GR on neuronal excitability and synaptic plasticity is presumably to normalize hippocampal activity after stress and to protect information acquired during the stressful experience, respectively (Joels and de Kloet 1989, Pavlidis, Ogawa et al. 1996, Groc, Choquet et al. 2008). The effects of chronic stress on synaptic plasticity in the CA1 hippocampal area are likely GR-mediated, as blockade of GR prevents the effects of stress on LTP (Krugers, Goltstein et al. 2006). Moreover, animals with a history of chronic stress have GR-dependent increases in calcium influx into CA1 neurons at basal levels of corticosterone, which may contribute to impaired synaptic plasticity (Karst and Joels 2007). This underlies some of the cognitive impairments observed after chronic stress exposure. Surprisingly though, the rapid non-genomic activation of the membrane-associated MR and GR are also involved in the effects of GC on cellular synaptic plasticity. For instance, corticosterone increases hippocampal glutamate release within 5 min and this effect is lacking in selective MR knockout mice and prevented by pretreatment with MR antagonists (Karst, Berger et al. 2005). Similarly, rapid GR-dependent effects were observed in the amygdala (Karst, Berger et al. 2010).

As with the cellular effects of GC in the hippocampus, the role of GC in hippocampal-dependent behaviors, including learning and memory, has been extensively studied. Similar to GC actions at the synapse, the effects of GC on learning and memory are temporally- and context-dependent (Diamond and Rose 1994). The physiological roles of MR and GR in emotional memory have been investigated using fear conditioning, with specific receptor antagonists. Zhou et al. reported that mifepristone (RU486, a GR antagonist) induced contextual memory, a conscious recall of the source and circumstances of a specific memory, on the short term, but reduced it on the long term in mice (Zhou, Bakker et al. 2010). Meanwhile, treatment with spironolactone (a MR antagonist) decreased contextual memories

prior to training but had no influence after training (Zhou, Bakker et al. 2010). Altogether, these findings underscored that while exerting differential effects, MR and GR are of much importance for the capacity for both holding a small amount of information for a short period of time (short-term memorization) and storing the informative knowledge for long periods of time (long-term memorization). Moreover, stress may facilitate the formation of emotionally salient memories in the short term, which are important for adaptation (de Kloet, Oitzl et al. 1999, Smeets, Wolf et al. 2009). Along this line, MR is important for initial appraisal and strategy selection in a novel spatial orientation task and for acquisition of fear memory (Oitzl and de Kloet 1992, Khaksari, Rashidy-Pour et al. 2007). Conversely, GR mediates consolidation of context-relevant information to optimize adaptation and survival in a variety of spatial and fear-related memory tasks (Oitzl and de Kloet 1992, Abrari, Rashidy-Pour et al. 2009, Fitzsimons, van Hooijdonk et al. 2013). Thus, elevated GC levels are important for the acquisition and consolidation of effectively relevant information and the disruption of memory processes that are less relevant for adaptation, which are mediated by MR and GR. However, several behavioral studies also indicated a role of MR and GR in non-genomic corticosteroid actions. Specifically, non-genomic inhibition of memory retrieval was abolished by pretreatment with MR antagonists (Khaksari, Rashidy-Pour et al. 2007). Conversely, membrane-associated GR is required for facilitation of memory consolidation and inhibition of working memory by corticosteroids (Barsegyan, Mackenzie et al. 2010, Roozendaal, Hernandez et al. 2010).

Physiological functions	MR Activation	GR Activation
LTP and synaptic plasticity		↓
Memorization and learning	↑	↓ On the short-term ↑ On the long-term
Neuronal survival and neurogenesis		↓

Table 1. Comparison of physiological functions of activated MR and GR on LTP and synaptic plasticity; memorization and learning; neuronal survival and neurogenesis (Meijer and de Kloet 1998, Le Menuet and Lombres 2014). Promoted effects are presented by ↑ while the inhibitory ones are shown as ↓.

In conclusion, both GR and MR are involved in GC actions at both synaptic and behavioral levels, physiologically and under stress conditions. Likewise at the cellular level, MR activation promotes LTP and increases neuronal excitability while GR activation inhibits LTP and suppresses neuronal excitability and synaptic plasticity (Table 1). Moreover, at the behavioral level, GC *via* GR and MR in the hippocampus, are of much importance for mediating short-term and long-term memorization and learning (Table 1). As mentioned above, it was reported that BDNF induces LTP and further promotes neurophysiological foundation for learning and memory, which may be involved in the synaptic and behavioral actions of MR and GR. Therefore, it is supposed that the BDNF and MR/GR signaling pathways are connected in the mechanism of regulating LTP and behavior.

2.3.3 GR effects on neuronal survival and neurogenesis

In addition to their effects on stress response as well as cognitive and behavioral functions, it is increasingly appreciated that GC and their receptors also play important roles in regulating neuronal survival and proliferation /differentiation.

It has been proposed that GC act as double-sided hormones on neuronal survival, beneficial effects at low doses are mediated in part by MR while deleterious ones under higher levels of hormones result in a fully occupied GR. In male rodents, stress-induced elevated GC levels or direct application of GC (corticosterone or dexamethasone) suppresses cell proliferation and survival and promotes cell death in the hippocampus (Gould, Woolley et al. 1991, Tanapat, Hastings et al. 2001, Wong and Herbert 2004, Mirescu and Gould 2006, Brummelte and Galea 2010). Along with these findings, adrenalectomy abolishes the stress-induced suppression of cell proliferation in male rats (Tanapat, Hastings et al. 2001). Both MR and GR play a role in mediating the suppressive effect of GC on neurogenesis (Wong and Herbert 2005, Montaron, Drapeau et al. 2006). Consistently, in adult female mice, the GR antagonist RU486 was reported to inhibit neuronal apoptosis during a forced swim test (Llorens-Martin and Trejo 2011). In addition, the pro-apoptotic effect of GR activation was more pronounced in aging animals than that in younger ones (Hassan, von Rosenstiel et al. 1996). Using neuronal differentiation models of embryonic stem cells (ESC), MR was shown to be a pro-survival factor in neurons (Munier, Law et al. 2012). Furthermore, MR switches the balance of anti-/pro-apoptotic factor expression toward survival, while GR drives an opposite action (Crochemore, Lu et al. 2005, Munier, Law et al. 2012). Taken together, all these data

provided strong evidence supporting the pro-survival effect of neuronal MR as well as the pro-apoptotic effect of fully activated neuronal GR (Munier, Law et al. 2012).

MR and GR are also associated with neurogenesis in the DG, beside their direct functions on neuronal survival and degeneration. Many studies have demonstrated that stress and GR activation consistently decreased hippocampal neurogenesis *in vitro* and *in vivo* (Gould, Woolley et al. 1991, Kim, Ju et al. 2004, Fujioka, Fujioka et al. 2006, Chetty, Friedman et al. 2014). Specifically, treatment with dexamethasone for 9 days led to a decrease of cell proliferation in ADX rats, as well as in rat hippocampus primary cell cultures (Kim, Ju et al. 2004). On the other hand, it was reported that treatment with aldosterone for 1 month increased granule cell proliferation in ADX rats (Fischer, von Rosenstiel et al. 2002). In addition, in the pathophysiology of the central and peripheral nervous system, GR is involved in the functions of glial cells (Desarnaud, Bidichandani et al. 2000, Fonte, Grenier et al. 2005, Fonte, Trousson et al. 2007). For example, GC-activated GR was shown to regulate myelin formation and to stimulate proliferation of Schwann cells (Fonte, Grenier et al. 2005), that can bring another layer of complexity in these hormones functions.

Collectively, neuronal MR activation exerts pro-survival effects and increases neuron differentiation and neurogenesis while GR activation leads pro-apoptotic effects and impairs neurogenesis and neuron maturation (Table 1).

2.3.4 GR and neurodegenerative disorders

Until now, there is very little information on how GC-bound GR exactly contributes to the pathophysiology and progression of neurodegenerative diseases. Thus, in this part we will discuss also how GC and GR impact neurodegenerative processes in HD, AD and PD. It has been postulated that the GC-GR responses to different stressors are affected in these neurodegenerative diseases.

HD patients have significantly higher circulating cortisol levels compared to age-matched control subjects (Heuser, Chase et al. 1991, Leblhuber, Peichl et al. 1995). Furthermore, Aziz et al. (Aziz, Pijl et al. 2009) surmised that feedback regulation of HPA axis is altered in HD patients and because these alterations occur during the peak period of the diurnal rhythm, the underlying cause may altered GR activity at the level of the hypothalamus and CNS. Consistently, increase in circulating corticosterone levels was also reported in an HD mouse

model, R6/2 mice (Bjorkqvist, Petersen et al. 2006). However, there are yet no studies on whether GR activity is deregulated in specific brain regions in HD such as in the hippocampus and whether GR function is affected by mutant HD protein. Further work is also needed to evaluate whether increased cortisol levels are involved in some of the HD symptoms such as cognitive deficits, decreased hippocampal volume, sleep disturbance and glucose intolerance (Vyas and Maatouk 2013).

There have been several reports of high cortisol levels in AD patients (Greenwald, Mathe et al. 1986, Rasmuson, Andrew et al. 2001, Hoogendijk, Meynen et al. 2006), which have been negatively associated with memory scores as revealed by several correlative studies of cortisol levels and cognition (Csernansky, Dong et al. 2006, Elgh, Lindqvist Astot et al. 2006). Since chronically high GC levels are known to impair memory, it is speculated that GC play a role in progressive cognitive decline in AD. Specifically, data from studies on the effects of GC on memory show that, on one hand, GC facilitate memory consolidation and, on the other hand, impair memory retrieval processes (de Kloet, Oitzl et al. 1999, Smeets, Wolf et al. 2009). Another putative mechanism by which GC-GR could affect hippocampal functions in AD is its modulation of neurogenesis in subgranular zone (SGZ) in DG. Adult neurons originating from this region have been implicated in hippocampal-dependent memory processes such as spatial memory. Recently, the critical role of GC-GR in maturation of these neurons has been reported, showing that selectively GR knockdown by the perfect match shRNA in mice increased the number of mature dendritic spines and mossy fiber boutons (Fitzsimons, van Hooijdonk et al. 2013). In summary, high cortisol levels in AD patients are negatively correlated with cognition. Since hippocampus with high GR expression is a major region affected in this disease, experimental studies have focused on how stress-activated GR modifies the molecular mechanisms of hippocampal-dependent memory processes. Therefore, studying the underlying molecular mechanisms by which GR regulates hippocampal BDNF expression is of much importance owing to the involvement of BDNF in AD pathophysiology.

Likewise in HD and AD, plasma cortisol levels are significantly higher in PD patients compared to control subjects, as shown in several studies (Stypula, Kunert-Radek et al. 1996, Ros-Bernal, Hunot et al. 2011). Stress was one of the earliest proposed causes of PD and although it may not be a major etiological factor, there are clinical reports showing that stress triggers the appearance of PD symptoms or exacerbates the motor symptoms (Smith, Castro et al. 2002, Metz 2007). Although the molecular mechanisms are not well understood requiring

further demonstration, it is possible that chronic stress-induced high GC levels through GR activity inhibit synaptic plasticity (Day, Wang et al. 2006, Gerfen and Surmeier 2011), exacerbating motor deficits in the animal models of PD (Barrot, Abrous et al. 2001, Ros-Bernal, Hunot et al. 2011).

Of note, an important consequence of chronically elevated levels of GC is likely to be maladaptive responses of GR to stressful stimuli and aging that could well be significantly vital for progression of neurodegenerative processes.

2.3.5 Conclusion

In the CNS, MR and GR are involved in a tightly regulatory system of two receptors activated by one class of corticosteroid hormones. Both the two related receptors exert widespread actions on many aspects of neuronal physiology and pathology, such as memory, learning, behavior, neurogenesis, neuroprotection, stress and depression, as well as the neurodegenerative disorders. Briefly, while MR activation mostly results in beneficial actions on neurons (Berger, Wolfer et al. 2006, Rozeboom, Akil et al. 2007, Munier, Law et al. 2012), GR over-activation displays detrimental effects on mental health. Thus, the GR antagonist mifepristone (RU486) has been considered as an important classical therapeutic drug in patients developing psychotic depression associated with high cortisol levels (DeBattista, Belanoff et al. 2006), and as a potential drug for treating neurodegenerative diseases such as HD, AD and PD. As a consequence, development of new compounds able to selectively activate MR signaling pathways and/or inhibit GR signaling pathways, and even better, molecules capable to increase BDNF expression levels in the hippocampus, may constitute a novel therapeutic option for the management of some CNS disorders.

2.4 Summary

In summary, the cellular response to GC depends mainly on binding and activating the corticosteroid receptors as well as on the concentrations of the steroid. The specific transcriptional signature of GC suggests that their binding confers specific GR conformations that lead to differences in DNA binding, chromatin remodeling, and/or coregulator recruitment (Oakley and Cidlowski 2013). Advances in the understanding of GC signaling have uncovered a variety of mechanisms that contribute to the wide functions of GC in both healthy and diseased tissues. Furthermore, a greater understanding of the effect of GC

signaling pathways on BDNF expression, would be helpful in the development of safer and more effective GC therapies.

3. Interaction between BDNF and GC in the CNS

3.1 GC regulate BDNF expression via GR

In animal models of depression, changes in GC levels, GR expression, and alterations in BDNF signaling are observed (Mizoguchi, Yuzurihara et al. 2001, Ridder, Chourbaji et al. 2005, Schulte-Herbruggen, Chourbaji et al. 2006, Molteni, Calabrese et al. 2010, Chiba, Numakawa et al. 2012). The effects of systemic administration of GC on the expression of BDNF mRNA within multiple brain regions have been examined extensively, showing a decline in hippocampal BDNF expression following GC administration in most studies (Barbany and Persson 1992, Smith, Makino et al. 1995, Schaaf, Hoetelmans et al. 1997, Schaaf, de Jong et al. 1998, Hansson, Cintra et al. 2000, Vellucci, Parrott et al. 2001, Hansson, Sommer et al. 2006). Although there is not enough direct and strong evidence, it is hypothesized that GC regulation of BDNF expression and signaling may occur at multiple levels, from transcriptional control (in both direct and indirect manner) of the distinct exon-specific BDNF transcripts to modulating BDNF translation, protein processing, trafficking, its secretion and signaling pathways (Suri and Vaidya 2013).

3.1.1 Regulation of BDNF transcript expression by GR

Accumulating evidence shows that both MR and GR are involved in mediating BDNF expression in the hippocampus, as examined in several studies. One related study was published by Kino's team (Kino, Jaffe et al. 2010). The authors reported that aldosterone and dexamethasone, respectively, increased and suppressed the mRNA, protein expression and secretion of BDNF in rat primary cortical neuronal cells, while corticosterone showed a biphasic effect, stimulating the secretion at lower concentrations and suppressing it at higher doses. Meanwhile, eplerenone and RU486, specific MR and GR antagonists, respectively, completely blocked the effect of aldosterone or dexamethasone on BDNF mRNA expression in these cells, indicating that alteration of this mRNA expression by these steroids are mediated by MR and GR, respectively. Some other studies (Chao and McEwen 1994, Hansson, Cintra et al. 2000, Kino, Jaffe et al. 2010) also indicate that ligands for GR and MR, corticosterone and aldosterone, regulate hippocampal BDNF transcript expression. However, the conclusions from other groups were somewhat different. For instance, treatment with the MR antagonists, spironolactone (McCullers and Herman 1998) or eplerenone (Hlavacova, Bakos et al. 2010), does not seem to alter basal BDNF mRNA expression in rat hippocampal

pyramidal neurons or its protein concentrations in hippocampus, respectively, as observed in several reports. These studies raise the possibility of differential effects of MR and GR on BDNF expression, which are particularly relevant while considering the results of sustained GC exposure. The dose range utilized in most studies (Barbany and Persson 1992, Smith, Makino et al. 1995, Schaaf, Hoetelmans et al. 1997, Schaaf, de Jong et al. 1998, Hansson, Cintra et al. 2000, Vellucci, Parrott et al. 2001, Hansson, Sommer et al. 2006) suggests a likely recruitment of GR to mediate the GC-evoked decline in BDNF. However, this needs to be carefully examined by addressing whether the effects of acute and chronic GC treatment are blocked by administration of selective GR or MR antagonists, and to address whether these GC receptors exert differential effects on BDNF in a brain region-specific manner.

One interesting finding is that GR knockout could modify BDNF expression. Many different GR mutant mice have been generated (Kolber, Wiczorek et al. 2008, Arnett, Kolber et al. 2011), including total and forebrain-selective (Boyle, Brewer et al. 2005) knockouts, total (Ridder, Chourbaji et al. 2005) and forebrain-selective (Wei, Lu et al. 2004) over-expressing mutants and DNA-binding mutants (Reichardt, Umland et al. 2000). Nervous system specific heterozygous GR knockout mice (GR^{+/-}), developed by using homologous recombination (Tronche, Kellendonk et al. 1999), have been reported to exhibit either no change in basal BDNF mRNA (Molteni, Calabrese et al. 2010), or a reduction in BDNF protein levels in the hippocampus (Kronenberg, Kirste et al. 2009). Studies with GR-overexpressing mice, named YGR mice that carry two additional copies of GR, generated by a transgenic approach (Reichardt, Umland et al. 2000), indicated increased hippocampal BDNF expression (Ridder, Chourbaji et al. 2005). A caveat to keep in mind prior to interpretation of the molecular changes observed in GR mutant models is whether changes in BDNF are a direct consequence of altered GR signaling within the brain region examined, or rather secondary to an alteration in circulating hormones, stress-responsiveness and behavior (Kolber, Wiczorek et al. 2008).

Even though a detailed mechanistic description on how GC influence specific BDNF promoters is lacking, several studies have demonstrated basal and stimulus-evoked alterations in BDNF exon IV and VI-containing transcripts by GC (Dwivedi, Rizavi et al. 2006, Hansson, Sommer et al. 2006). Using *in situ* hybridization, Hansson et al (Hansson, Sommer et al. 2006) found that corticosterone down-regulated exon II- and IV-containing transcript levels, but had no effect on exon I and III-containing mRNA levels in hippocampal subregions of ADX rats. Furthermore, they also assumed that the effects of corticosterone on BDNF were not cell type-

but region-dependent. What should be paid into attention is that all of these findings on the effects of stress and/or GC on BDNF isoforms are not well documented, most of them just relying on *in situ* hybridization analyses for quantification. Understanding the mechanisms on how GC/GR regulate BDNF expression will be helpful to assess the involvement of BDNF in stress responses or neurodegenerative diseases.

Very recently, Makhathini et al examined how repetitive restrain stress (RRS) affects BDNF, GR and MR levels (Makhathini, Abboussi et al. 2017). RRS was induced in rats by restraining the animals for 6 h per day for 28 days. Using ELISAs, the authors found that animals exposed to repetitive stress had significantly increased plasma corticosterone levels and significantly decreased hippocampal BDNF concentrations (Makhathini, Abboussi et al. 2017). Moreover, they also reported that the mRNA and protein expression levels of BDNF, GR and MR were significantly decreased in the stressed group compared to control animals (Makhathini, Abboussi et al. 2017). However, no experiments have clearly addressed on the exact underlying regulatory mechanisms of GC-mediated regulation on the expression of total BDNF or its distinct exon-containing isoforms so far.

3.1.2 Regulation of BDNF signaling by GC

In addition to the regulation of BDNF mRNA and protein expression and stability, GC could affect BDNF signaling, by regulating the expression of related receptors, TrkB and P75NTR, as well as effectors of their downstream cascades. Here, we focus on GC regulation on TrkB expression in hippocampus. Kutiyawalla et al reported that long-term treatment with corticosterone caused a decline in TrkB protein, but not in TrkB mRNA levels in the hippocampus (Kutiyawalla, Terry et al. 2011). Conversely, acute stress has been shown to enhance hippocampal TrkB mRNA expression (Shi, Shao et al. 2010) but also evoked a rapid down-regulation of TrkB transcript expression in the pituitary suggesting spatiotemporal differences in TrkB transcriptional regulation following stress (Givalois, Marmigere et al. 2001). Several studies have reported that chronic stress appears to predominantly enhance hippocampal TrkB mRNA expression (Nibuya, Takahashi et al. 1999, Vellucci, Parrott et al. 2002, Shao, Shi et al. 2010). Furthermore, GC regulation of BDNF signaling could occur at multiple levels, from the modulation of receptor expression (TrkB), processing and coupling to signaling cascades (including pERK1/2, pPLC, pAKT), to interactions of specific adaptor proteins within the BDNF signaling pathways (Kassel, Sancono et al. 2001, Gourley, Wu et al. 2008, Jeanneteau, Garabedian et al. 2008, Munhoz, Sorrells et al. 2010). In conclusion, factors

involved in BDNF signaling pathways, including the related receptors and their downstream cascades, might be also regulated by GC. However, a systematic characterization of GC effects on TrkB activity and its downstream cascades has not been carried out.

3.2 BDNF influences GR signaling

As described above, GC and BDNF display some overlapping, but sometimes opposite effects. Both GC and BDNF influence LTP, hippocampal structural (Fuchs, Flugge et al. 2001, Yoshii and Constantine-Paton 2010) and synaptic plasticity (Schmidt and Duman 2007, Schoenfeld and Gould 2012), as well as hippocampal functions (Kim and Diamond 2002, Lu, Christian et al. 2008) and behavior (Duman and Monteggia 2006, Joels 2008). Moreover, *in vitro* evidence (Kumamaru, Numakawa et al. 2008) provides insights into crosstalk between GC and BDNF signaling by demonstrating that the BDNF-mediated enhancement in neurite outgrowth of cortical neurons is blocked by pretreatment with dexamethasone. It was hypothesized that some of the GC effects in the hippocampus may be a consequence of a decline in BDNF expression and BDNF signaling (Smith 1996, Kunugi, Hori et al. 2010). Many studies have focused on the modulation by GC of the levels of BDNF expression, associated with a number of psychiatric diseases, including depression (Shirayama, Chen et al. 2002, Angelucci, Brene et al. 2005, Schmidt and Duman 2010) and anxiety (Chen, Jing et al. 2006, Soliman, Glatt et al. 2010).

However, some reports showed that BDNF signaling could also regulate GR transcriptional activity in a cell-autonomous manner, homeostatic feedback control of glucocorticoid action (Jeanneteau, Lambert et al. 2012). Furthermore, Jeanneteau and his colleagues demonstrated that BDNF signaling *via* TrkB activation regulates GR transcriptional activity on its target genes expression in primary neurons partly through alterations in GR phosphorylation (Jeanneteau, Lambert et al. 2012). Phosphorylation is the first identified and most extensively studied covalent modification of GR (Kumar and Calhoun 2008, Beck, Vanden Berghe et al. 2009, Galliher-Beckley and Cidlowski 2009). To date, multiple highly conserved, phosphorylated serine residues have been identified in human, rat, and mouse GR (Webster, Jewell et al. 1997). The BDNF-TrkB signaling-induced GR phosphorylation occurs at S155 and S287 residues and modulates GR cofactor recruitment to affect GR transcriptional activation and repression (Lambert, Xu et al. 2013). Most notably, BDNF signaling not only alters the GR transcriptome by affecting the regulation of known GR-response genes, such as *Sgk1* induction, but also facilitates the recruitment of GR cofactors at specific promoters as

well as a combinatorial binding of GR with CREB (Lambert, Xu et al. 2013). Moreover, mutating these BDNF-sensitive sites results in the inhibition of the neuroplasticity response to chronic stress, unraveling a crosstalk between GC and BDNF signaling pathways. Interestingly, these events were observed not only in primary cortical neurons and PVN cells harboring endogenous GR and TrkB expression, but also in HEK 293 cells co-transfected with TrkB, and GR expressing vectors, suggesting that BDNF and TrkB are sufficient to modulate GR phosphorylation and transcriptional regulatory functions. As a consequence, these findings provide a foundation for studying how GR activity is modulated in response to extracellular signaling pathways and the interplay between BDNF and GC signaling in disorders featuring alteration of BDNF and glucocorticoid levels, indicating a beneficial action of GR working together with BDNF.

TrkB-mediated GR phosphorylation fosters cofactor recruitment and changes the transcription of specific target genes involved with neuronal plasticity. Numerous neuronal genes including CRH respond to BDNF and GC (Lambert, Xu et al. 2013), and some of them depend on GR phosphorylation at the BDNF-sensitive sites. Moreover, MAPKs were previously characterized as capable to phosphorylate GR (Wang, Chen et al. 2007, Gallihier-Beckley and Cidlowski 2009), and to activate BDNF signaling. Mechanistically, activation of a TrkB-MAPK pathway triggered GR phosphorylation and the expression of genes promoting neuroplasticity.

Besides, the potential role of BDNF regulation on the HPA axis *in vivo* has been described using several animal models for psychiatric disorders. It was previously found that BDNF mRNA expression levels increased after immobilization stress and were followed by upregulation of CRH in the PVN of the hypothalamus in male rats (Givalois, Naert et al. 2004). In addition, intra-cerebroventricular administration of BDNF also stimulated the HPA axis (Givalois, Naert et al. 2004), as well as the CRH expression (Toriya, Maekawa et al. 2010). *In vivo* studies showed that BDNF enhanced CRH expression, involving a role for TrkB-mediated effects on CREB (Jeanneteau, Lambert et al. 2012). Furthermore, CREB was suggested to interact with GR in the regulation of CRH expression by BDNF (Jeanneteau, Lambert et al. 2012).

This is an interesting example on how the GR and BDNF pathways may interact to differentially modulate target gene expression, and provide impetus for future studies to

examine in depth the crosstalk between these pathways, in particular in the context of their modulation of hippocampal plasticity.

It is conceivable that a reciprocal homeostatic sensing mechanism exists between GR and BDNF-TrkB signaling pathways to adjust GR transcriptional output. Furthermore, consistent with this idea, the rapid feed-forward kinetics of BDNF-induced GR phosphorylation occurs within minutes, while the slower feedback phase of the dexamethasone-induced TrkB phosphorylation occurs over hours. The synchronization of these events may be crucial to balance GR and TrkB activity in response to corticosteroid and neurotrophic signals, and disruption of this process may lead to neurological disorders in animal models and in humans (Jeanneteau, Lambert et al. 2012).

OBJECTIVES

As mentioned in the Chapter 1, alterations in BDNF expression are associated with various CNS pathologies, including depression, epilepsy, and neurodegenerative disorders such as AD, HD and PD. Thus, unraveling the molecular mechanisms regulating BDNF expression is important to understand its contribution to CNS function and pathology. Some studies suggest that stress or high levels of GC reduce BDNF expression and that both neuronal MR and GR may be involved in its regulation in the hippocampus. Of note, as described extensively above, many works analyzed GC effects on BDNF expression using animal models giving sometimes some contradictory results. Exerting many overlapping actions with MR and GR signaling together with BDNF, it has been suggested, but never definitely established, that *Bdnf* gene harbors several putative GREs in its promoters (Timmusk, Palm et al. 1993, Schaaf, De Kloet et al. 2000, Huynh and Heinrich 2001), which could explain direct genomic effects of GC on BDNF transcription through these specific BDNF promoters. In addition to binding GRE, GC could also influence the expression of its target genes by modulating the activity of other transcription factors, such as AP-1 complex and CREB. However, the underlying molecular mechanisms by which GC regulates BDNF expression were not clearly defined.

As the effects of GC on BDNF expression were difficult to unravel using animal models, here we used a more reductionist approach based on cellular models: mouse primary cultures of hippocampal neurons and established cell lines of neuronal origin. The later includes neurons differentiated from mouse embryonic stem cells, N2A mouse neuroblastoma cells, and BZ cell line previously derived from the hippocampus of a targeted oncogenesis transgenic mouse model generated in our laboratory. We mainly focused on GR action on BDNF expression, according to the previous evidence as well as the preliminary results we obtained, which we will describe and discuss in more details in the following chapters. We investigated whether GR regulates directly or indirectly BDNF expression in neurons using mostly an *ex vivo* approach with neuron-like cellular models that allow a tight control of experimental conditions. Meanwhile, we also examined which BDNF exon-containing transcript isoforms were involved in GR regulation. We were committed to identify if BDNF is a new GR target gene, to study which promoter regions within *Bdnf* gene are involved in the regulatory mechanisms, and if accurate, to localize the precise DNA sequences on which GR acts, directly on GRE or *via* functional interaction with other transcription factors. Moreover, further work on a potential MR regulation on BDNF expression is envisaged.

Eventually, a better knowledge of the mechanisms on how GC mediate BDNF expression should help to better understand the pathophysiological processes involved in neurogenesis, memorization and neuroprotection. The aim of this work was to bring new insights into the molecular interactions between the GC signaling and the neurotrophin signaling in neurons, both pathways being of importance in the physiology and pathology of the CNS.

RESULTS

Part I :

Characterization on several *in vitro* neuron-like cell models and preliminary analysis on GC effects on BDNF expression

1. Introduction

As we have described in the introduction section, BDNF expression has been previously reported to be altered under stress and high levels of GC in the hippocampus. In this project, we examined the effects of GC on BDNF expression in several *in vitro* cellular models from neuronal origin. Furthermore, we aimed at analyzing if GC actions on BDNF expression were mediated by GR and MR, whether BDNF was one of their direct target genes, and finally we wanted to decipher the molecular mechanisms involved in this regulation. Most of this research had been published in Molecular Brain (Chen, Lombes et al. 2017) and is presented in the next chapter of this thesis. However, the initial steps and some data of this study which were not published, as well as the different cellular models used are herein presented in this chapter.

In the brain, neurons represent only a fraction of the cell population, thus searching for neuron-specific molecular mechanisms is facilitated by the use of adequate *in vitro* neuronal cell based systems. Therefore, in this work, we used several neuron-like cell models, including embryonic stem (ES)-derived neurons, the newly characterized neuron-like, immortalized BZ cell line and the commercially available N2A cells, as well as mouse primary cultures of hippocampal neurons (PCN).

2. Preliminary results

2.1. Neuronal differentiation of embryonic stem (ES) cells to study the regulation of BDNF by GC

ES cell lines are derived from mouse blastocysts and undifferentiated ES cells are able to proliferate indefinitely. In appropriate conditions, ES cells are also able to undergo *in vitro* differentiation, into various cell lineages including neuronal differentiation (Ogrodnik, Salmonowicz et al. 2014) *via* the formation of embryoid bodies (EBs). These cell lineages could be enriched following specific culture conditions and recently have been widely used for basic and therapeutic research, such as pharmacological treatments, knocking down of gene expression by siRNA, derivation of new ES cell lines from preexisting mouse models.

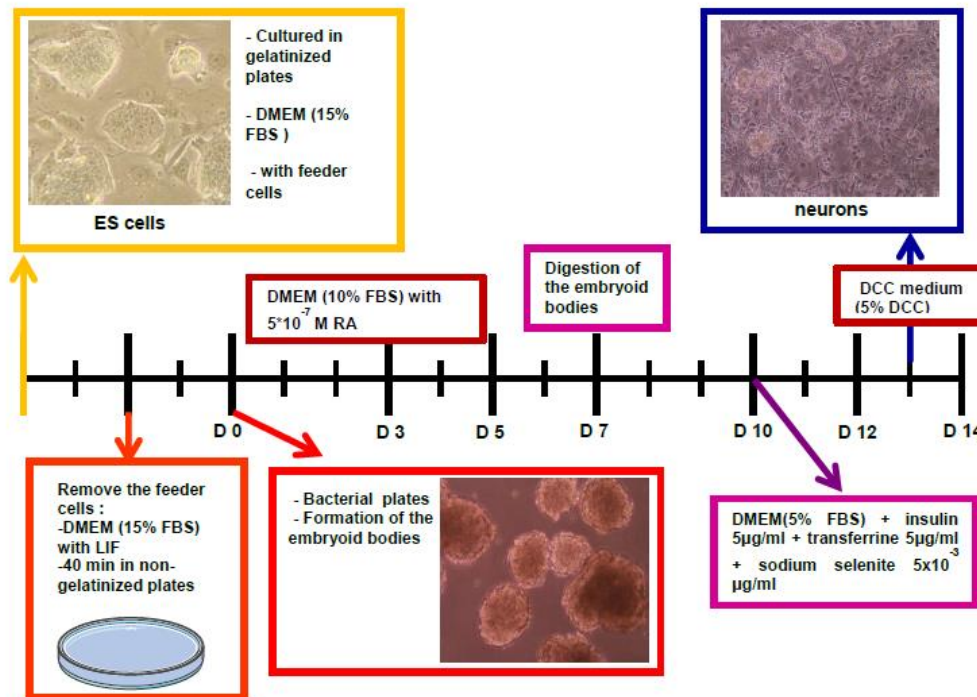

Fig. 10 The neuronal differentiation of ES cells. More details about the protocol of neuronal differentiation derived from ES cells could be found in the text.

Models of neuronal differentiation of mouse ES cells had been previously developed in the laboratory (Fig. 10) (Munier, Meduri et al. 2010, Munier, Law et al. 2012). Briefly, ES cells were grown on 0.1% gelatin-coated plates and with the feeder cells for two days in ES medium (DMEM with 4500 mg/L of glucose, containing 15% fetal bovine serum (FBS), 100 U/ml penicillin, 100 µg/ml streptomycin, 2 mM glutamine, (PSG), 1 x non-essential amino acids (MEM), 20 mM HEPES, and 100 µM β-mercaptoethanol) at 37 °C in a humidified incubator in presence of 5% CO₂. The feeder cells were pretreated with 15 µg/ml mitomycin C for 4 h, and leukemia inhibitory factor (LIF) 1000 U/mL were used for another 2 days after the feeder cells were removed. Then the ES cells that were detached and dissociated with 0.25 % trypsin were plated at a density of 4×10^6 cells in a bacterial dish and cultured with the differentiation medium (DMEM with 10% FBS, PSG, MEM, HEPES) with 5×10^{-7} M retinoic acid to form the EBs, which were maintained for one week. Afterwards, EBs were dissociated and digested by 0.25 % trypsin and 1 mg/mL collagen and the cell suspension were filtered through a 40 µm nylon cell strainer. Eventually, the suspended neurons were incubated in neuron medium (DMEM with 5% FBS, PSG, MEM, HEPES, 5 µg/ml Insulin, 5 µg/ml Transferrin, 5×10^{-3} M Sodium Selenite) until Day 13 in adherence in tissue culture dishes.

In recent years, ES cell models of differentiation have been proven to be a useful tool to study the action of steroid receptors in various cellular contexts, including analyses of GC signaling pathways (Munier, Meduri et al. 2010, Le Menuet, Munier et al. 2012, Munier, Law et al. 2012). The neuronal differentiation of ES cell is considered as an interesting model among them. MR and GR expression levels are pivotal factors for corticosteroid actions in target tissues. This is particularly germane for hippocampal MR and GR that cooperatively act to regulate expression of their target genes. Meanwhile, BDNF is also abundantly expressed during the neuronal differentiation of ES cells. Therefore, we used this cell model to study the effects of MR and GR agonists, GC and Aldo, on BDNF expression.

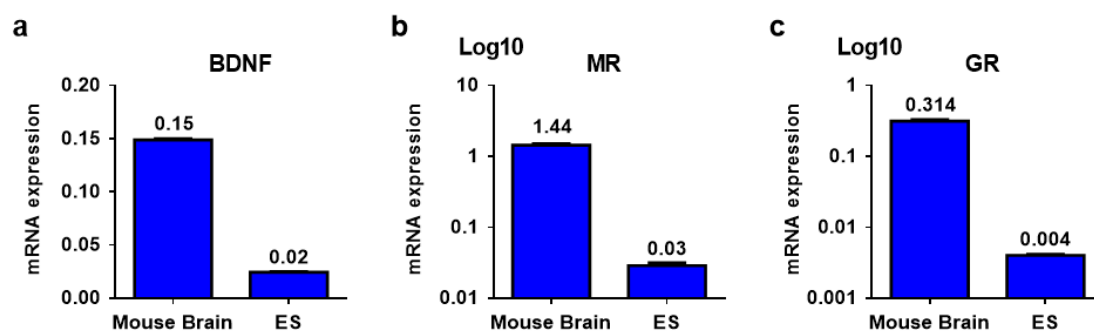

Fig. 11 BDNF (a), MR (b) and GR (c) mRNA expression in mouse brain and ES-derived neurons (ES). Results are normalized by 36B4 expression in the same samples. A logarithm scale on Y axis is used.

This ES cell-derived neurons expresses substantial levels of BDNF, MR and GR (Fig. 11) however at much lower levels than those quantified in the mouse brain used as positive control. The same tendency was observed for neuronal markers, including Microtubule-Associated Protein 2 (MAP2), N-Methyl-D-aspartic Acid receptor (NMDAR) and synaptophysin (data not shown). After steroid depletion using dextran charcoal-coated (DCC) stripped serum, cells were treated with various steroids: corticosterone (Cort) 10^{-9} M to activate MR, Cort 10^{-7} M to activate both MR and GR and aldosterone (Aldo) 10^{-8} M to specifically activate MR. Cells were harvested at different time points (1, 2, 6, and 24 h), RNA were extracted, reverse transcribed and the expression of BDNF was assessed by real-time quantitative PCR (RT-qPCR) (see supplemental table of the article for primer sequences).

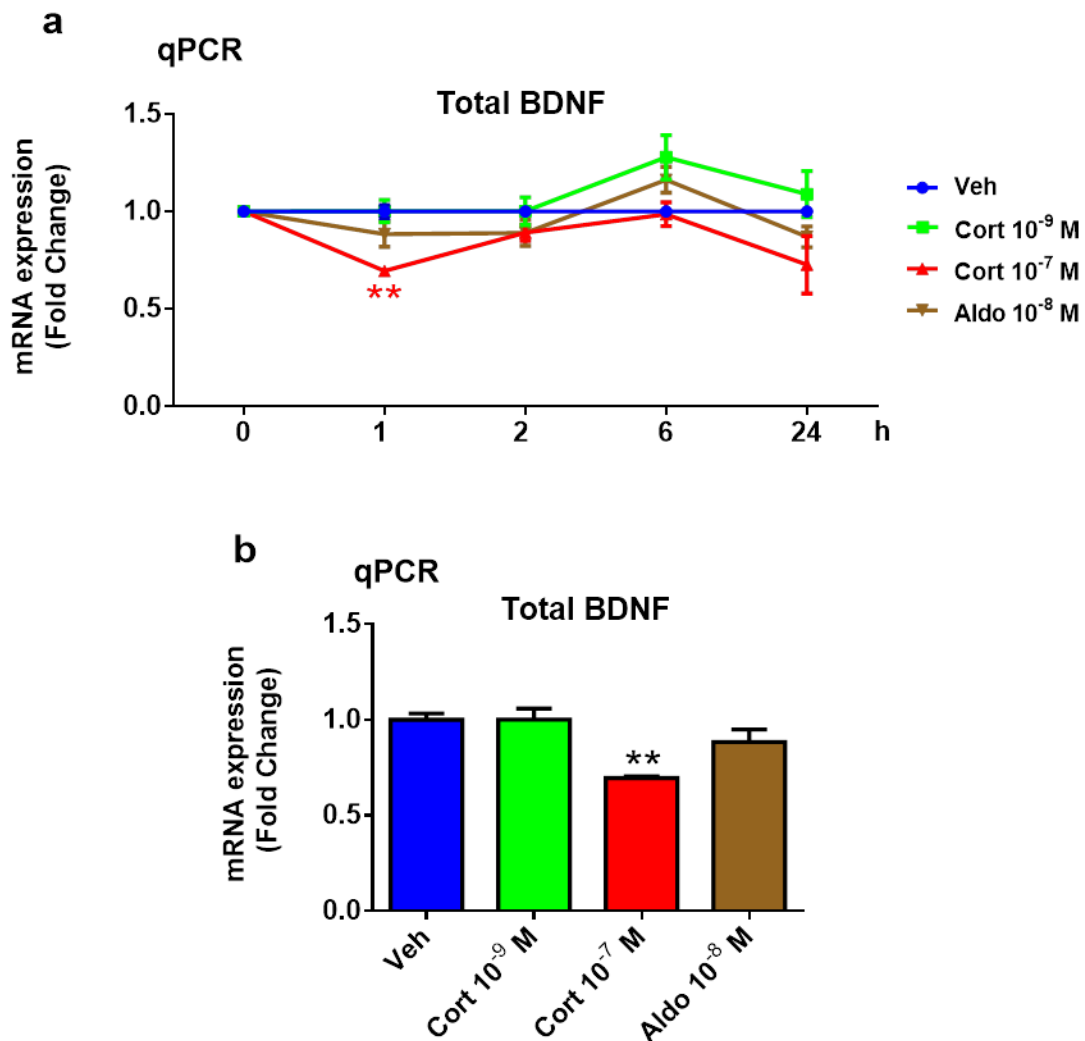

Fig. 12 Corticosteroid effects on BDNF mRNA expression in ES cell-derived neurons. a, Time course (1, 2, 6, and 24 h) studies on Cort 10^{-9} M (activating MR), Cort 10^{-7} M (activating GR), and Aldo 10^{-8} M (specifically activating MR) effects on total BDNF mRNA levels. **b,** Effects of Cort 10^{-9} M, Cort 10^{-7} M, and Aldo 10^{-8} M treatment for 1 h on total BDNF mRNA levels. Values are given as arbitrary units of *Bdnf* expression normalized to *36B4* gene expression, and represent mean \pm SEM (n=6 per condition). The relative *Bdnf* expression in control cells was arbitrary set at 1. Statistical analysis was performed using a nonparametric Mann-Whitney U test. ** p<0.01.

RT-qPCR results showed that total BDNF expression, assessed by measuring exon IX-containing mRNA levels, was significantly reduced (by approximately 30%, p<0.01) after 1 h incubation with Cort 10^{-7} M, but not with other treatments (Fig. 12), compatible with the involvement of GR activation. Although MR was clearly detected by qPCR in this cell line (Fig. 11), neither Cort 10^{-9} M nor Aldo 10^{-8} M, both activating MR, did not have any effect on BDNF transcript expression (Fig. 12). This may be explained by the fact that neuronal ES cell differentiation does not preferentially lead to the generation of hippocampal-like neurons

and/or that presumably differentiated cells do not express sufficient functional MR above a critical threshold level.

To conclude, this cell model is suitable for studying GC effects on BDNF expression, while presenting many neuronal characteristics *in vitro*, consistent with a high degree of differentiation and a high proportion of well differentiated neurons. However, one of the main limitations is that the cell culture and differentiation process takes at least 3 weeks and that the repeatability of the differentiation process is very variable leading to strong disparities within presumably similar experiments. Therefore, we took advantage of some other cell models to expand our research, including primary cultures of mouse hippocampal neurons (PCN), BZ and N2A cell lines.

2.2. Primary cultures of mouse hippocampal neurons as a good *in vitro* cell model

The primary culture of fetal hippocampal neurons constitutes a high physiological relevance cell based-system. Hippocampal cultures have been extensively used in molecular biology for about three decades, including to study specific cellular pathways, chemical modification and treatment as well as target localization, due to the relatively simple architecture of the neuron population in the hippocampus (Kaech and Banker 2006).

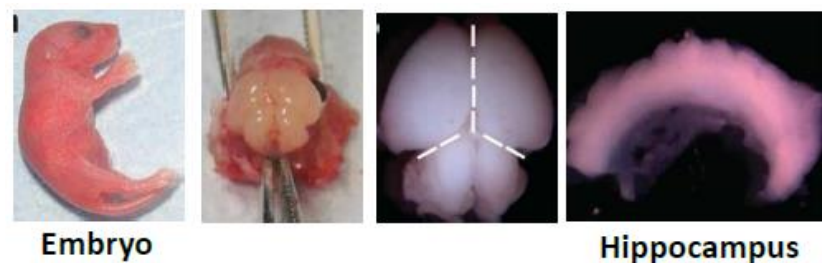
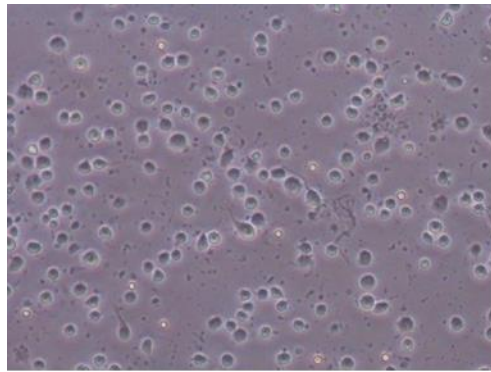
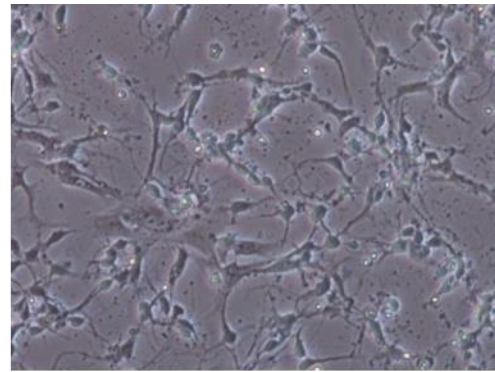

Fig. 13 Isolation of hippocampal neurons from prenatal mice, adapted from Beaudoin et al. (Beaudoin, Lee et al. 2012). The embryos at 18 or 19 days post-fertilization were euthanized and hippocampal neurons were isolated and cultured.

Pregnant *SWISS* mice were euthanized at day 18 or 19 post coitum and hippocampal neurons were isolated and cultured from the E18-19 embryos (Fig. 13), as shown in a video from Journal of Visual Experiments (Seibenhener and Wooten 2012). The PCN isolation was performed according to the supplier's protocol of the Pierce Primary Neuron Isolation Kit. More details about the PCN culture can be found in the Methods part of the article presented in the next chapter.



Day 1



Day 3

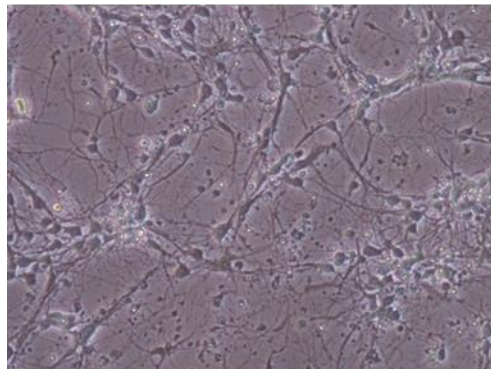

Day 6

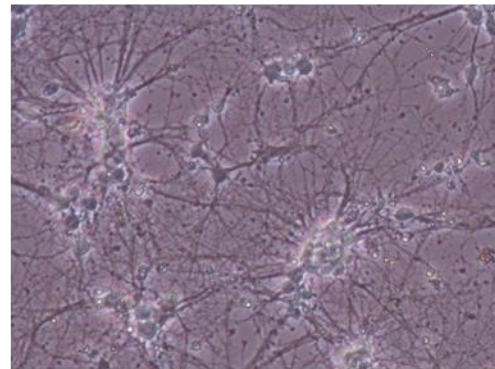

Day 9

Fig. 14 Primary cultures of hippocampal neurons from prenatal mice. Cell growth 1 day post-plating. Neurons are attached well after 6 h culture and neuronal processes begin to be visible during Day 1; Cell growth 3 day post-plating, neurites extend well and form a network; Cell growth 6 day post-plating, neuronal processes have been already branched and overlapping. Cell growth 9 day post-plating, neurites are enriched and form a dense network; magnification x10.

Likewise all other neurons, neural cells grown from hippocampal cultures require critical amino acids, hormones and growth factors, which are physiologically originating from glial cells in the brain. By growing a "feeder" layer of glial cells along with the cultured neurons, this symbiotic relationship could also be carried into a culture environment (Seibenhener and Wooten 2012). Alternatively, to allow neuron survival in culture without glial cell cocultures, we used a cocktail containing various growth factors and hormones provided by the furnisher which is probably related to the widely used B27 supplement that contains corticosterone (Uhlenhaut, Barish et al. 2013). Thus, we measured the GC final concentration in the culture medium by the highly sensitive and specific LC/MS-MS method (Travers, Martinerie et al. 2017) and found that this medium contains very substantial levels of corticosterone (2×10^{-8} M) as well as a lower level of cortisol (10^{-9} M), (data not shown). The later may be from the fetal bovine serum which was supplemented in the medium. Under these culture conditions, it

is very likely that partial activation of GR may already occur before the cells were treated with dexamethasone (DEX). Unfortunately, cells could not be maintained without this supplement as they died within few hours in its absence. The morphological features of PCN from prenatal mice are shown in Figure 14. Moreover, we compared MR expression in mouse brain and PCN by RT-qPCR. We discovered that MR expression level in PCN is around 1/25 of that quantified in the brain, which is far for being negligible (Fig. 15a).

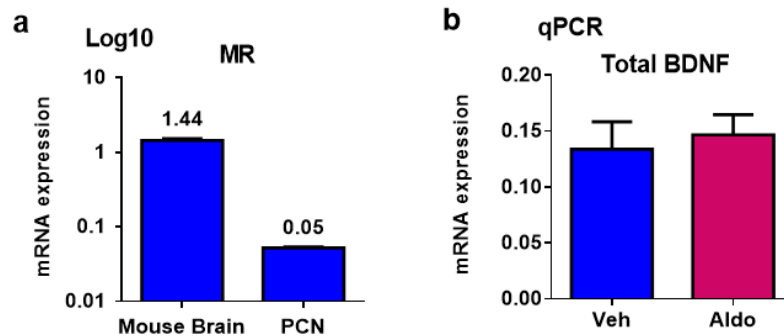

Fig. 15 Aldo effects on BDNF mRNA expression in PCN expressing MR. a, MR mRNA expression in mouse brain and PCN. Results are normalized to *36B4* mRNA expression in the same samples. A logarithm scale on Y axis is used. b, Aldo effects (10^{-8} M) on BDNF mRNA expression in PCN after 6 h treatment. Data are given as attomol of BDNF transcripts normalized to attomol of *36B4* mRNA, and expressed as mean \pm SEM (n=6 per group). Statistical analysis was performed using a nonparametric Mann-Whitney U test.

Firstly, PCN were treated with Aldo 10^{-8} M for 6 h and BDNF transcript level was not modified by Aldo stimulation (Fig. 15b), indicating that the corticosterone presented in the supplement may have already occupied all or at least most of the LBD sites on MR before the hormone was added, preventing any hormone-mediated effect to be detected. This obviously excluded any study of MR functions on its target genes in this cell model. Therefore, the synthetic GC agonist, DEX, 10^{-7} M was administrated to the PCN, and incubated with the neurons for 1 h or 3 h. RT-qPCR results demonstrated that BDNF mRNA expression was not modified by DEX 10^{-7} M whatever the time period tested (Fig. 16a). As a consequence, we used a higher DEX concentration (10^{-6} M) in a time course experiment (1, 2, 4, 6 h). It was observed that after 1 h treatment, the total BDNF mRNA level was significantly reduced by 10^{-6} M DEX, while those were not altered after 2, 4, or 6 h treatment (Fig. 16b).

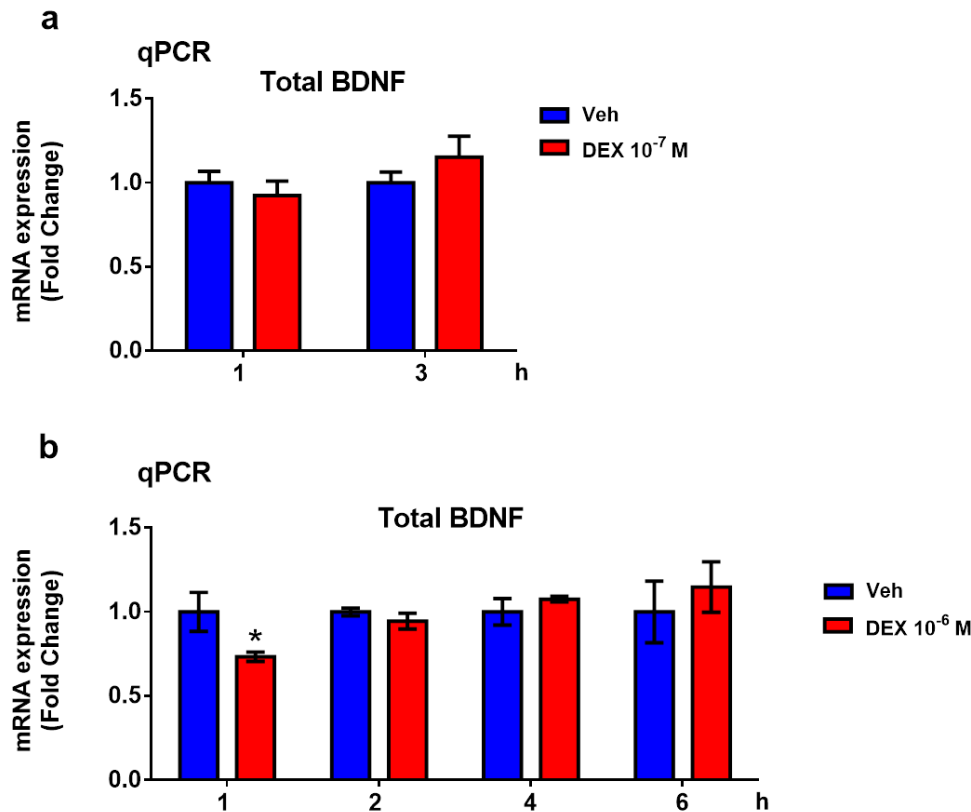

Fig. 16 DEX effects on BDNF mRNA expression in PCN. **a**, DEX effect (10^{-7} M) on total BDNF mRNA levels after 1 h or 3 h treatment. **b**, DEX effect (10^{-6} M) on total BDNF mRNA levels after 1, 2, 4 and 6 h treatment. Data are given as arbitrary units of *Bdnf* and *36B4* gene, as mean \pm SEM (n=6 per group), and represent the relative expression compared with that obtained with control cells, which was arbitrary set at 1. Statistical analysis was performed using a nonparametric Mann-Whitney U test. * $p < 0.05$.

The concentration of corticosterone we measured in the culture medium (2×10^{-8} M) is likely to be also sufficient to partially occupy GR and to saturate MR (Le Menuet and Lombes 2014). To summarize, primary cultures of mouse fetal hippocampal neurons constitutes a high physiological relevance *in vitro* cell based-system. However, analysis of GC action in this model is somehow difficult given the presence of GC in the medium preventing the detection of any significant GC impact.

2.3. BZ cells as a model for studying kinetic mechanisms

Due to the limitation of ES cells-derived neurons and PCN, we used a new model, the BZ cells that had been previously generated in the laboratory. It originates from a transgenic mouse hippocampus by targeted oncogenesis (Le Menuet, Viengchareun et al. 2000). As we may appreciate on Figure 17, after 4-day differentiation period, consisting in lowering from

10 % to 1 % the serum concentration in the medium, BZ cells present with neuronal features, displaying an elongated morphology harboring multiple short neuronal processes.

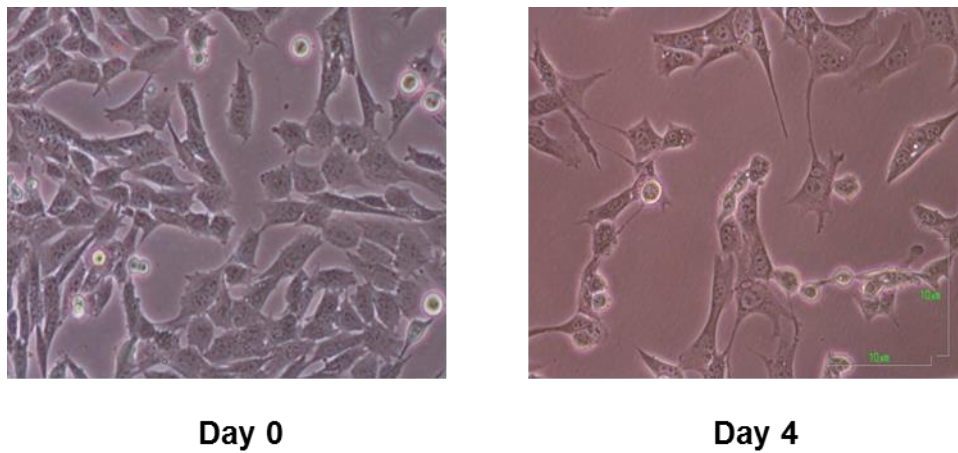

Fig. 17 BZ cell culture. BZ cells display some short cellular processes on Day 0 (magnification x 20), while an elongated morphology harboring multiple longer ones was observed on Day 4 (magnification x 20).

Under these culture conditions, we compared the BDNF and neuronal marker MAP2 transcript expression in BZ cells before or 4 days after incubation in differentiation medium. RT-qPCR results showed that mRNA expression levels of both BDNF and MAP2 were significantly higher on Day 4, compared to those on Day 0 (Fig. 18). Moreover, beside MAP2 and BDNF, this cell line also expresses the glutamate receptor NMDAR, GR but very little and probably non-functional MR as assayed by RT-qPCR.

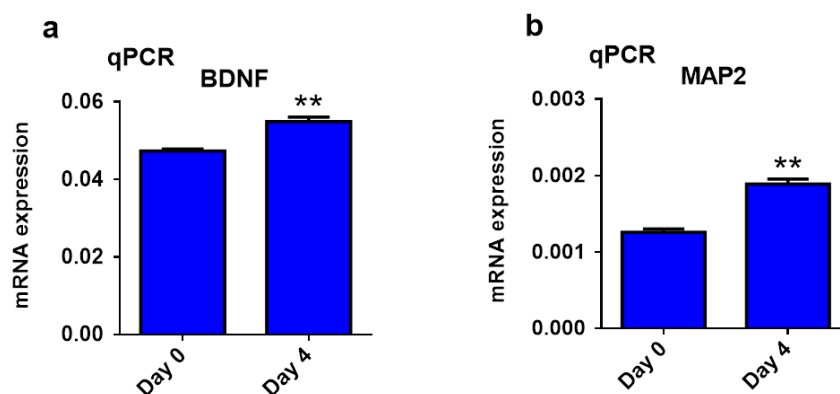

Fig. 18 BDNF and MAP2 mRNA expression in BZ cells increase with time. **a**, Total BDNF mRNA expression on Day 0 and Day 4 cultures of BZ cells. **b**, MAP2 mRNA expression on Day 0 and Day 4 cultures of BZ cells. Data are given as attomol of BDNF or MAP2 transcripts normalized to attomol of *36B4* mRNA, and expressed as mean \pm SEM (n=6 per group). Statistical analysis was performed using a nonparametric Mann-Whitney U test. ** p<0.01.

Furthermore, the expression level of glial marker, glial fibrillary acidic protein (GFAP), was more than 10^4 times lower in BZ cells than in mouse brain (Supplemental Fig. S1d from our article in Molecular Brain), indicating a more pronounced neuronal phenotype of BZ cells. It is well established that Forskolin (FK) could activate cAMP signaling in intact cells, which results in the activation of CREB and subsequent activation of this pathway. The FK stimulation was shown to increase expression of cAMP target genes including BDNF (Tao, Finkbeiner et al. 1998). BZ cells were thus treated by 5×10^{-6} M FK for 1 to 4 h.

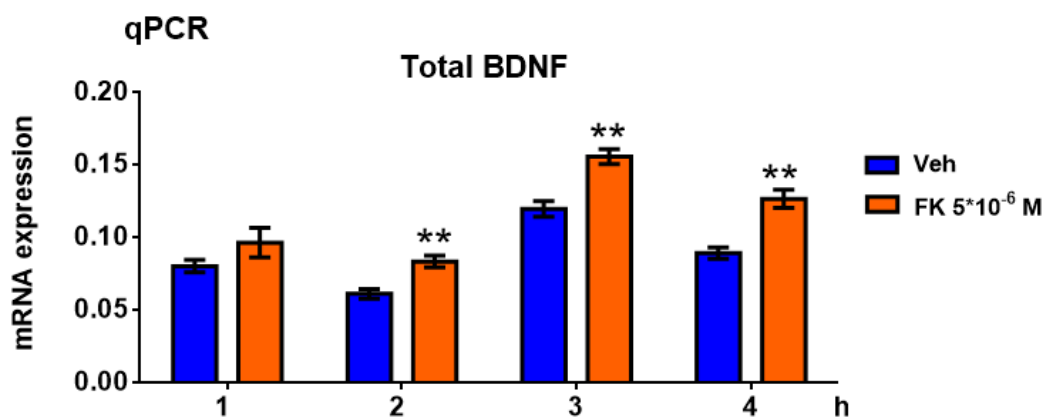

Fig. 19 FK effects (5×10^{-6} M) on total BDNF mRNA expression in BZ cells. Data are given as attomol of BDNF transcripts normalized to attomol of 36B4 mRNA, and expressed as mean \pm SEM (n=6 per group). Statistical analysis was performed using a nonparametric Mann-Whitney U test. ** p<0.01

Following RT-qPCR analysis, we showed that higher levels of BDNF were observed when BZ cells incubated with FK for 2, 3, or 4 h, compared to the control condition (Fig. 19). These findings indicate *Bdnf* gene expression is stimulated by cAMP signaling pathway in BZ cells, consistent with previous results reported in neurons (Yamamoto, Sobue et al. 1993, Conti, Cryan et al. 2002). This finding demonstrates that the BZ cell line exhibits similar responses to the cAMP/CREB pathway than in neurons. Further characterization on BZ cells and DEX effects on BDNF expression may be found in the paper presented in the next part. According to the data we have already obtained, BZ cell line constitutes a good cell-based system to investigate the molecular mechanisms including kinetic aspects on action of GR on BDNF expression, due to the high expression levels of both BDNF and GR. However, transient transfection efficiency is quite low in BZ cells (see Fig. 22b), prompting us to seek for another cellular model to characterize in more details the effect of GR on BDNF promoter activity.

2.4. N2A cell line as a model to analyze *Bdnf* promoter sequence activities

Mouse neuroblastoma N2A cell line (ATCC number: CCL-131) has been widely used to study neuronal differentiation, neurite growth, synaptogenesis and signaling pathways (LePage, Dickey et al. 2005, Ogrodnik, Salmonowicz et al. 2014, Salto, Vilchez et al. 2015). After 7-day culture with differentiation medium, consisting again in lowering the serum concentration from 10 to 1%, N2A cells present with several small processes (Fig. 20). The N2A cells express GR (Ct values are around 24 with 40 cycles of amplification by qPCR) and various neuronal markers such as MAP2 (Ct: 27), NMDAR (Ct: 26) and synaptophysin (Ct: 24), but a low BDNF level (Ct 31) and an undetectable MR level. A time course (1 - 24 h) of Cort treatment (10^{-7} M) on N2A cells showed that BDNF mRNA expression was inhibited by Cort 10^{-7} M by more than 40% at 6 h time point (Fig. 21), stressing that *Bdnf* expression level is regulated by GC. This finding is consistent with the results obtained in ES differentiated-neurons cells and PCN, even though BDNF and MR expression level in N2A cells is very low and the kinetic mechanism of BDNF transcription is not exactly the same than that on the former two cell models. In order to anticipate subsequent promoter analysis of *Bdnf* transcriptional activity, we examined the transfection efficiency of N2A cells. Cotransfection of a plasmid harboring two response elements for glucocorticoid receptor driving luciferase reported gene expression (GRE2.luc) with a GR expression vector in absence or presence of DEX allowed to compare the transfection efficiency in BZ and N2A cells.

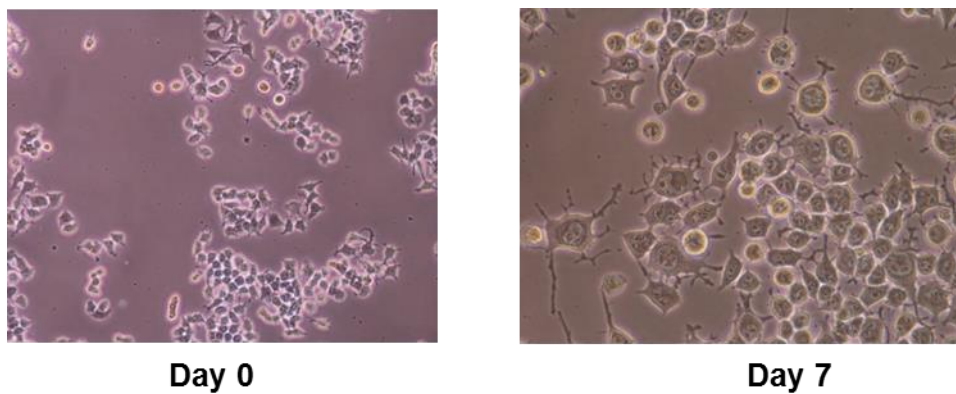

Fig. 20 N2A cell neuronal differentiation. After 7-day differentiation, N2A cells present with several small dendrite-like arborization; magnification x10.

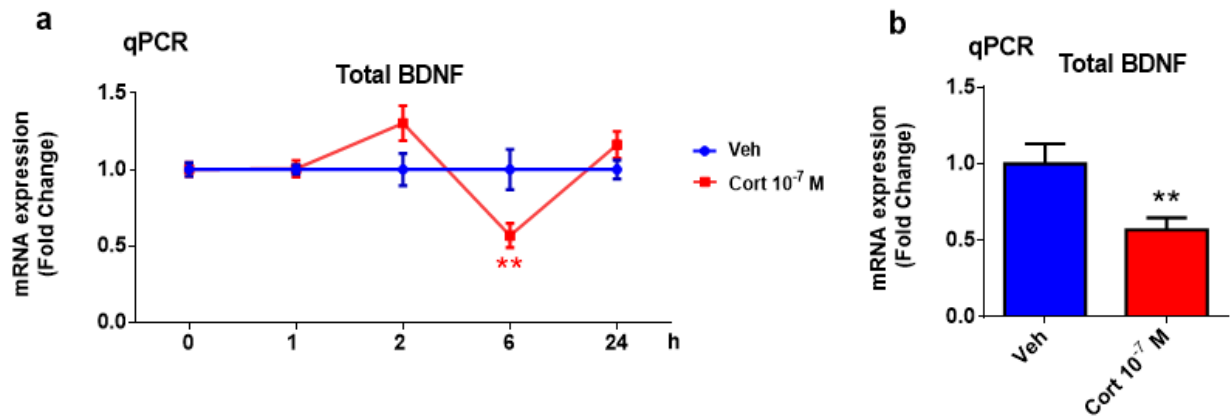

Fig. 21 Corticosterone effect on total BDNF mRNA expression in N2A cells. **a**, Time course (1, 2, 6, and 24 h) effect of Cort (10^{-7} M) on total BDNF mRNA levels. **b**: Cort 10^{-7} M on total BDNF mRNA levels, one time point (6 h) from Fig. 21a. Data are given as arbitrary units of *Bdnf* and *36B4* gene, and are expressed as mean \pm SEM (n=6 per group). Relative expression obtained with control cells, was arbitrary set at 1. Statistical analysis was performed using a nonparametric Mann-Whitney U test. ** p<0.01.

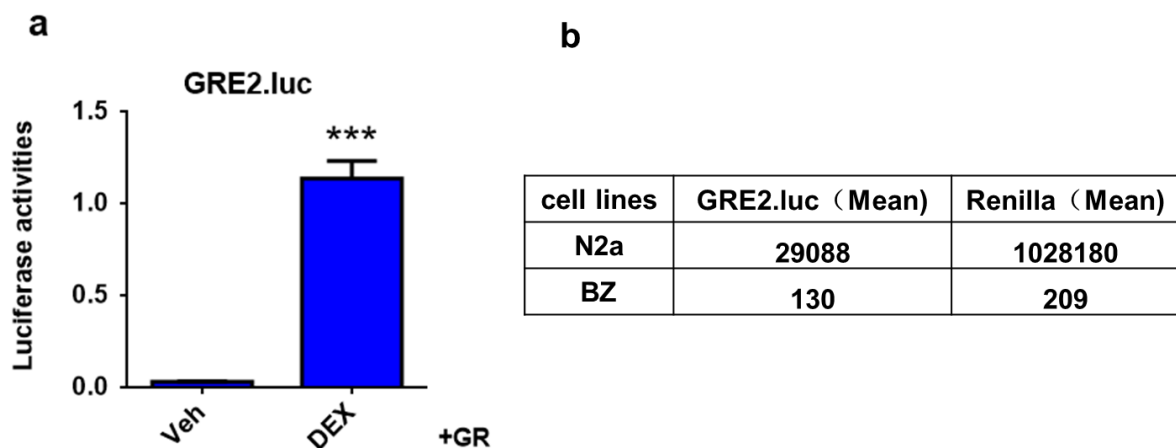

Fig. 22 DEX effects on GRE2.luc activity in N2A cells and BZ cells. **a**, DEX 10^{-7} M effect on GRE2.luc activity in N2A cells, co-transfected with GR expression vector and Renilla plasmid for normalization. Results are expressed as the ratio of the Firefly /Renilla luciferase activities. n=16, Mean \pm SEM; ***P<0.005; Mann Whitney U-tests. **b**, comparison of the basal values of firefly and Renilla luciferase activities in N2A and BZ cells, presented as Mean.

Results showed that luciferase activities increased by a 40-fold factor (Fig. 22a) after DEX exposure (10^{-7} M) in N2A cells. However, both the luciferase and Renilla activity values at baseline were more than 200 times higher in N2A cells than those measured in BZ cells (Fig. 22b). These data indicate that N2A cell line exhibits a quite good transfection efficiency compared to BZ cells. In addition, N2A cells are easier to culture and transfect than ES cell-derived neurons or PCN, and the results are more stable and repeatable with weak standard

errors than in BZ cells. Altogether, even though N2A cells express a very low level of BDNF and MR, it constitutes a highly efficient transfection model suitable for promoter characterization.

3. Conclusion

In this part I of results, we analyzed the GC effects on BDNF mRNA expression in ES-derived neurons and PCN, and characterized two immortalized cell lines of neuronal origin, BZ and N2A cells. We demonstrated that BDNF transcript expression is rapidly repressed by GC in neurons derived from ES cells, PCN, as well as N2A and BZ cells (as shown in Part II), although at different time points of hormone exposure. Moreover, these four cell lines display neuronal characteristics with some distinct specificities, including for PCN and ES cells-derived neurons functional structures (axons and neurites) and expression of some neuronal markers. Additionally, we were unable to demonstrate the presence of any functional MR in BZ cells or in N2A cells (data not shown). Consequently, we analyzed the effects of GR on *Bdnf* expression within these cellular models without any potential interference from MR.

Despite their intrinsic characteristics of the cellular models, likewise any cell-based system, these cell lines display some advantages as well as disadvantages or limitations with respect to expression levels of related genes, transfection efficiency and transcription potency. Therefore, neuronal differentiation of ES cells was used in the preliminary analysis on GC regulation on *Bdnf* expression while primary cultures of mouse hippocampal neurons were used as an *in vitro* cell model with characteristic close to the ones on the brain. Additionally, as BZ cells express very high levels of BDNF and functional GR, we use it for studying the GR action on *Bdnf* expression (as shown in Part II); N2A cells have been considered as a transfection model for promoter study.

Part II :

Glucocorticoid receptor represses brain-derived neurotrophic factor expression in neuron-like cells

1. Introduction

In the result part I, we have shown that *Bdnf* expression is mediated by GR agonists, such as Cort 10^{-7} M in ES-derived neurons and N2A cells, as well as DEX 10^{-6} M in mouse PCN. Previous evidence showed that GR is involved in GC-mediated *Bdnf* expression in the hippocampus (Chao and McEwen 1994, Hansson, Cintra et al. 2000, Kino, Jaffe et al. 2010). Meanwhile, several GR antagonists such as RU486 was used for determining the GR regulation on BDNF mRNA expression (Kino, Jaffe et al. 2010). Furthermore, several studies have demonstrated that *Bdnf* exon IV and VI-containing transcripts are involved in GC-evoked decline in total *Bdnf* expression, after three weeks of treatments in rat frontal cortex (Dwivedi, Rizavi et al. 2006, Hansson, Sommer et al. 2006). However, the conclusions from different studies were somewhat different and sometime contradictory. Beyond the effect of GR on BDNF transcript levels, one of the important issues should be addressed: the molecular mechanisms of GR-mediated changes in BDNF expression.

To better understand the mechanisms on how GC regulates *Bdnf* expression *via* GR will be helpful for revealing the dialogue between GR and neurotrophin signaling pathways involved in stress response or neurodegenerative diseases. However, no experiments have clearly addressed the exact underlying regulatory mechanisms of GR-mediated regulation of total *Bdnf* expression or its distinct exon-containing isoforms so far. Therefore, the objectives of this part are to investigate by qPCR if GC regulates the expression of total BDNF transcripts as well as of its variant splices *via* GR activation, to study which *Bdnf* promoter regions are involved in GR regulation by transient transfection experiments, and to target and localize the DNA sequences and transcription factors interacting with GR using mutagenesis and ChIP analyses.

The principal findings obtained are presented in the following article.

Article

Glucocorticoid receptor represses brain-derived neurotrophic factor expression in neuron-like cells

Hui Chen, Marc Lombès and Damien Le Menuet

Molecular Brain (2017) 10:12, DOI 10.1186/s13041-017-0295-x

RESEARCH

Open Access



Glucocorticoid receptor represses brain-derived neurotrophic factor expression in neuron-like cells

Hui Chen¹, Marc Lombès^{1,2} and Damien Le Menuet^{1*} 

Abstract

Brain-derived neurotrophic factor (BDNF) is involved in many functions such as neuronal growth, survival, synaptic plasticity and memorization. Altered expression levels are associated with many pathological situations such as depression, epilepsy, Alzheimer's, Huntington's and Parkinson's diseases. Glucocorticoid receptor (GR) is also crucial for neuron functions, *via* binding of glucocorticoid hormones (GCs). GR actions largely overlap those of BDNF. It has been proposed that GR could be a regulator of BDNF expression, however the molecular mechanisms involved have not been clearly defined yet. Herein, we analyzed the effect of a GC agonist dexamethasone (DEX) on BDNF expression in mouse neuronal primary cultures and in the newly characterized, mouse hippocampal BZ cell line established by targeted oncogenesis. Mouse *Bdnf* gene exhibits a complex genomic structure with 8 untranslated exons (I to VIII) splicing onto one common and unique coding exon IX. We found that DEX significantly downregulated total BDNF mRNA expression by around 30%. Expression of the highly expressed exon IV and VI containing transcripts was also reduced by DEX. The GR antagonist RU486 abolished this effect, which is consistent with specific GR-mediated action. Transient transfection assays allowed us to define a short 275 bp region within exon IV promoter responsible for GR-mediated *Bdnf* repression. Chromatin immunoprecipitation experiments demonstrated GR recruitment onto this fragment, through unidentified transcription factor tethering. Altogether, GR downregulates *Bdnf* expression through direct binding to *Bdnf* regulatory sequences. These findings bring new insights into the crosstalk between GR and BDNF signaling pathways both playing a major role in physiology and pathology of the central nervous system.

Keywords: Glucocorticoid receptor, Brain-derived neurotrophic factor, Glucocorticoids, Promoters

Introduction

The neurotrophin brain-derived neurotrophic factor (BDNF) is a key player in neuronal function. BDNF is highly expressed throughout the brain [1, 2], yet its strongest expression level is found within the hippocampus, a limbic structure of major importance for cognitive functions, such as memorization, learning, behavior, stress, emotions, and mood [3, 4]. In the central nervous system (CNS), BDNF regulates neuronal survival [5], differentiation and growth [6]. Growing evidence indicates that BDNF is also involved in neuronal homeostasis and brain plasticity-

related processes such as memory, learning [7, 8] and drug addiction [9], as well as in long term potentiation [10]. Alterations in BDNF expression levels within specific neuron subpopulations have been associated with various pathologies, including depression, epilepsy, Alzheimer's, Huntington's and Parkinson's diseases [11–16]. BDNF mainly functions by binding to its high-affinity receptor, tropomyosin-related kinase B (TrkB) activating several pathways such as MAP kinase, PI3 kinase and Phospholipase C [17]. Rodent *Bdnf* gene exhibits a complex genomic structure comprising of at least 9 exons (I to IX), which are alternatively spliced to generate exon-specific BDNF transcript variants with one common and unique coding exon IX at the 3' terminal end [18]. Generation of a large set of transcript isoforms is

* Correspondence: damien.le-menuet@u-psud.fr

¹Inserm 1185, Fac Med Paris Sud, Université Paris-Saclay, Le Kremlin-Bicêtre, France

Full list of author information is available at the end of the article



probably of biological significance as in rat hippocampal neuronal cultures, it has been demonstrated that BDNF mRNA variants are differentially distributed in specific dendritic compartments in order to regulate the local availability of BDNF protein [19]. Moreover, BDNF expression was reported to be reduced with aging and associated with a repressed chromatin state on some of its gene regulatory regions [20]. Along this line, epigenetic histone modifications and DNA methylation marks have recently been identified as complex and crucial mechanisms enabling modified expression of various BDNF mRNA isoforms [21]. Altogether, several layers of events driving quantitatively and qualitatively BDNF expression highlight its crucial contribution to CNS function in physiology and pathology [22–24].

Glucocorticoid hormones (GCs) also exert pleiotropic actions on neurons by binding to and activating the glucocorticoid receptor (GR, NR3C1), as well as to the mineralocorticoid receptor (MR, NR3C2) [25, 26]. The latter exhibits a high ligand affinity, and as a consequence it is almost permanently occupied by GCs, while GR is mostly activated under high circulating GC concentrations such as during stress conditions or at the circadian peak of GCs. Both receptors are highly expressed in the hippocampus, acting in balance to regulate various physiological and neurological processes such as stress responses, apoptosis survival and long term potentiation [27]. Interestingly, BDNF activation of TrkB receptors regulates positively GR activity on its target gene expression by phosphorylating two key serine residues on the receptor [28]. Mutating these BDNF-sensitive sites results in the inhibition of the neuroplasticity response to chronic stress [29], unraveling a crosstalk between GC and neurotrophin signaling pathways. On the other hand, regulation of BDNF expression by stress [30] has important consequences on the pathophysiology of mood disorders [31] and in the mechanism of action of antidepressant agents [32]. As exposure to acute or chronic stress triggers a surge of circulating GC concentrations [33, 34], a role of these hormones in modulating BDNF expression has often been suggested [35–41], but most of these reports are based on indirect evidence, and are sometimes contradictory depending on the model and the treatment timeline [42–44]. As a whole, the molecular mechanisms by which GCs regulate BDNF expression are not clearly defined. In the present study, we demonstrated that, upon exposure to the glucocorticoid agonist dexamethasone (DEX), GR directly downregulates *Bdnf* expression, at least in part, by its binding to a specific DNA region upstream of exon IV. Interestingly, this promoter fragment was already characterized as stimulated by synaptic activity in humans and rats [45, 46]. Along with primary cultures

of fetal hippocampal neurons (PCN), we used the newly characterized BZ cell line which was previously generated by targeted oncogenesis strategy [47] from a mouse hippocampus and which expresses a high level of both BDNF and GR. Altogether, this work unravels new insights about the repression by GR of *Bdnf* expression, findings that may be of potential physiological importance.

Methods

Primary cultures of fetal mouse hippocampal neurons

Pregnant SWISS mice at 18 or 19 days post-fertilization were euthanized by decapitation. Dissection was performed according to a video published in the Journal of Visual Experiments [48]. Hippocampal neurons were isolated and cultured from the embryos using the Pierce Primary Neuron Isolation Kit (Thermo scientific, Courtaboeuf, France) following the manufacturer's instructions. This kit contained a neuronal media culture supplement (reference: 88286). Cells were typically seeded on culture plates coated with 10 µg/mL poly-D-lysine (Sigma-Aldrich, Lyon, France), at the density of 2.5×10^5 cells/cm² and grown for 9 days at 37 °C in a 5% CO₂ incubator.

Cell culture and reagents

BZ and Neuro-2a (N2A, ATCC number: CCL-131) growth medium was composed of DMEM (PAA, Vélizy-Villacoublay, France) containing 10% fetal bovine serum (FBS) (AbCys SA, Paris, France), 1x nonessential amino acids (PAA), 2 mM glutamine (PAA), 100 U/ml penicillin (PAA), 100 µg/ml streptomycin (PAA), 20 mM HEPES (PAA). For BZ differentiation experiments, serum concentration was lowered to 1% for 2 days. N2A differentiation medium was similar to BZ medium but was supplemented with 5 µg/ml insulin (Sigma-Aldrich), 5 µg/ml transferrin (Sigma-Aldrich), 29 nM sodium selenate (Sigma-Aldrich) and 1 µM retinoic acid (Sigma-Aldrich). For hormonal treatment, cells were grown in Dextran Charcoal Coated-treated (DCC) FBS. Dexamethasone (DEX) (Sigma-Aldrich) and RU 486 (RU) (Sigma-Aldrich) were used at the indicated concentrations diluted in ethanol. For RNA stability analysis, 10 µg/ml of 5, 6-Dichlorobenzimidazole-1-β-D-ribofuranoside (DRB) (Sigma-Aldrich) diluted in DMSO was applied.

Immunocytochemistry

BZ cells cultured in x-well tissue culture chambers (Sarstedt, Numbrecht, Germany) were fixed with PBS containing 4% paraformaldehyde (Sigma-Aldrich) solution for 15 min at room temperature. Cells were permeabilized with 0.5% Triton X-100 (Sigma-Aldrich) for 5 min and blocked by 1% non-fat milk in PBS

with 0.1% Tween-20 (PBST) for 1 h at 37 °C. Cells were incubated with anti β -tubulin III antibody TU20 (sc-51670, Santa Cruz, La Jolla, CA, [49]) or with anti-GR antibody M20 (sc-23476, Santa Cruz, [50]) overnight at 4 °C and then with secondary antibody Cy3 (Interchim, Thermo scientific) for 45 min in PBST with 1% milk. After washing, BZ cells were incubated with DAPI (4',6'-diamidino-2-phenylindole), 1:1000 in PBST for 2 min and observed with a fluorescence Olympus microscope AX70 (Olympus, Hambourg, Germany).

RNA extraction and quantitative real-time PCR

Gene expression was quantified by reverse transcription (RT) followed by quantitative PCR (qPCR). Cells were harvested and total RNAs were extracted with Trizol reagent (Invitrogen, Cergy-Pontoise, France) according to the manufacturer's instructions and their concentrations were determined using a Nanodrop 2000 spectrophotometer (Thermo scientific). RNAs were reverse-transcribed and processed for real-time PCR on an ABI Step One Plus (Applied Biosystems, Courtaboeuf, France). Briefly, 1 μ g of total RNA was treated by DNase I (Invitrogen), then reverse-transcribed with 50 U MultiScribe reverse transcriptase (Applied Biosystems). After 10-fold dilution, 1/40 of the RT reaction was used for qPCR using the Fast SYBR Green PCR master mix (Applied Biosystems). Final primer concentrations were 300 nM for each primer. Primer sequences for each gene are listed in Additional file 1: Table S1. Reaction parameters were 95 °C for 20 s followed by 40 cycles at 95 °C for 3 s and 60 °C for 30 s. For plasmids used for standard curves, amplicons were purified from agarose gels and subcloned into pGEMT-easy plasmid (Promega, Charbonnières, France), then sequenced to confirm the identity of each fragment. Standard curves were generated using serial dilutions of standard plasmids, spanning six orders of magnitude and yielding correlation coefficients more than 0.98 and efficiencies of at least 0.95, in all experiments. Standard and sample values were determined in duplicate from each sample. Relative expression within a given sample was calculated as the ratio: attomol of specific transcripts/attomol of 36B4 transcripts.

Protein extraction and Western blotting

Protein expression was assessed by Western blotting. Cells were harvested from the culture plates and total cellular proteins were extracted by lysis buffer containing 1% Triton X-100, 1% proteasome inhibitor cocktail (Sigma-Aldrich). Lysates were cleared by centrifugation at 13,000 g for 20 min and protein concentrations were measured using the BC Assay Protein Quantitation Kit (Uptima, Oakland, CA). Total protein lysates (50 μ g)

were fractionated on 15% SDS-PAGE then transferred to nitrocellulose membranes (GE Healthcare Life Sciences, Vélizy-Villacoublay, France). Membranes were blocked for 1 h in PBST with 2.5% BSA, and then incubated with primary antibodies overnight at 4 °C, rabbit polyclonal anti-BDNF (sc-546, Santa Cruz [51]) at 1:200 and mouse monoclonal anti- α -tubulin (Clone DM1A, Sigma-Aldrich) at 1:10,000. Incubation with secondary antibodies conjugated to infrared fluorophores (goat anti-rabbit IgG Dylight 800 and anti-mouse IgG Dylight 680 at 1:10,000 from Thermo Scientific) was performed for 1 h. An Odyssey infrared imaging system (LI-COR, Bad Homburg, Germany) was used to scan membranes at a wavelength of 680 nm (anti-mouse) or 800 nm (anti-rabbit). Data were analyzed with Image Studio 1.1 software (Li-COR).

Luciferase assays

pCDNA3-GR plasmid was generated by subcloning human GR (*NR3C1*) into pCDNA3 vector (Invitrogen). *Bdnf* promoter reporter plasmids were constructed by inserting PCR fragments from *Bdnf* promoter regions into PGL4-basic luciferase reporter vector (Promega), see Additional file 1: Table S1 for primer sequences. These fragments, named LP6, SP6, LP4, and SP4, are localized according to the distance to exon VI transcription starting site that was set at +1 (see Fig. 4). Specific genomic sequences were amplified by PCR from mouse genomic DNA and inserted into the PGL4 cloning vector in the *Xho I* and *Hind III* restriction sites using pGEMT easy vector kit (Promega), then transformed in JM109 E.Coli. Plasmids were sequenced to confirm the identity and orientation. The renilla activities driven by the expression vector PRL-TK (Promega) or total protein concentrations were used for normalizing expression.

On the day prior to transfection, N2A cells were plated in 96-well plates at a density of 2×10^4 cells per well in the N2A differentiation medium. Medium was changed for OptiMEM medium (PAA) on the next day, and cells were transfected using Lipofectamine 2000 reagent (Invitrogen). Plasmid concentrations per well were 50 ng PGL4-*Bdnf* promoter vectors, 25 ng pCDNA3-GR or empty vector, 13.3 ng PRL-TK renilla expression vector. Six h post-transfection, OptiMEM medium was replaced by N2A DCC medium. Cells were treated with Ethanol (Veh), DEX and/or RU486 24 h after transfection and then were harvested after another 24 h with Passive Lysis Buffer from the dual luciferase reporter assay system kit (Promega). Lysates were transferred to 96-well clearbottom microplates (Fisher), and luminescence intensities were measured with a TRISTAR LB941 automatic luminometer (Berthold, Thoiry, France) with dual injectors. Normalized values were used for

statistical analyses. Each experiment was performed with 8 replicates and repeated at least three times.

Chromatin immunoprecipitation (ChIP)

ChIP experiments were performed using the Ideal-ChIP for transcription factor kit (Diagenode, Liège, Belgium) following the manufacturer's protocol. Specifically, 4×10^6 BZ cells per well of 6-well plates grown in 1% DCC medium were treated by vehicle (ethanol), Dex 10^{-7} M or Dex 10^{-7} M together with RU 10^{-6} M for 1 h. Cells were then fixed by a mix of formaldehyde 16% and fixation buffer from the kit (4: 1 ratio), 1/100 volume final for 8 min. ChIP experiments were performed according to Le Billan et al [52]. Chromatin samples (300 μ l) were sheared by 12 cycles 30 s ON and 30 s OFF with the Diagenode Bioruptor Pico system and 2.5 μ l samples were kept for input measurements. Two hundred and fifty μ l of sheared chromatin samples were incubated overnight at 4 °C with 1 μ g IgG from the kit as control or 5 μ g anti-GR antibody H300 (Santa Cruz sc-8992-X [53]). Chromatin shearing was controlled on a 1.5% agarose gel and typically a smear was visualized ranging from 100 to 500 bp. qPCR amplifications of eluted DNA were performed with primers encompassing a short upstream sequence of exon IV, or on *Per1* and *Ucp1* promoters (Additional file 1: Table S1 for primer sequences). Raw data are expressed as percentage of inputs, according to the Percent of Input Method, ChIP analysis; Thermo Fischer Scientific.

Immunoprecipitation

Immunoprecipitations were performed using 30 μ l protein A-coated magnetic beads (Diagenode). Beads were washed 3 times with C1 buffer of the High Cell ChIP kit (Diagenode) and incubated for 4 h with anti-GR antibody H300 (Santa Cruz) at 4 °C with protease inhibitors and 0.2% BSA. Then, 350 μ g of proteins from BZ cell lysates were incubated overnight with antibody-coated beads. The following day, beads were washed 3 times with buffer C1 and once with buffer W1 (High Cell ChIP kit), and immunoprecipitated proteins were eluted from the beads with 20 μ l of Laemmli buffer at 95 °C for 5 min and loaded on a 10% SDS-PAGE gel for Western blotting. Membranes were hybridized with anti-GR antibody M20 (sc-23476, Santa Cruz, [54]).

Targeted mutagenesis

Targeted mutations of *Bdnf* promoter construct plasmids were performed using the Quickchange II XL kit (Agilent Technologies, Les Ulis, France) following the manufacturer instructions. Briefly, 10 ng of SP4 luciferase plasmid was amplified by PCR with sense and antisense mutated primers for 18 cycles. PCR reactions were transformed in XL1 blue ultracompetent E. Coli strain

(Agilent, les Ulis, France) on LB Agar Ampicillin petri dishes. Bacterial colonies were picked up. Plasmid DNA were extracted and sequenced by Eurofins (Ivry sur Seine, France) to check for the introduction of the mutation and sequence integrity. Primers for mutagenesis are available in Additional file 1: Table S1. Plasmids were transfected in N2A cells as stated for the luciferase assay.

Statistical analyses

Results are expressed as mean \pm SEM of at least six samples for each condition unless stated otherwise. Statistical analyses were performed using nonparametric Mann-Whitney U-tests, unless stated otherwise, using Prism 5 (GraphPad Software, Inc., San Diego, CA).

Results

GR represses *Bdnf* expression in primary mouse hippocampal cultures

To determine the effect of GCs on *Bdnf* expression in neurons, we used day 9 primary cultures of mouse hippocampal neurons (PCN), a model of high physiological relevance that expresses both BDNF and GR (Additional file 2: Figure S1a and c). Bright field microscopy at day 3 in vitro (D3 IV, Fig. 1a upper panel) already showed a nearly homogenous neuronal culture that developed in a dense neuronal network at day 9 (D9 IV, Fig. 1a, lower panel). Neuronal marker MAP2 transcripts expression measured by qPCR was in the same range in PCN than in mouse brain while glial marker GFAP expression, assessed as an estimation of astrocyte contamination displayed a more than two hundred times lower expression in PCN culture than in mouse brain (Additional file 2: Figure S1b and d), indicating a high neuronal enrichment in PCN culture. Additionally, GR mRNA and protein were clearly expressed in D9 IV cultures, as shown in qPCR (Additional file 2: Figure S1c) and in Western blot (Additional file 2: Figure S1e). One h treatment with dexamethasone (DEX), a synthetic GR agonist (10^{-6} M), was sufficient to significantly repress by 30% total BDNF mRNA expression (Fig. 1b), measured by qPCR on the common exon IX abundance. This inhibition was fully reversed by co-treatment with the GR antagonist RU486 (RU). These results were consistent with a previous study performed on rat PCN [42]. These experiments were performed using a neuronal media supplement (Pierce neuronal isolation kit, reference 88286) that was required for the survival of PCN and that did contain GC. We were unable to maintain the cells in culture in the absence of the supplement even for a few h. Of note, the culture medium with the supplement contains a substantial concentration of corticosterone ($\sim 2.10^{-8}$ M), as measured by LC/MS-MS (data not shown), that is sufficient to partially bind and activate GR.

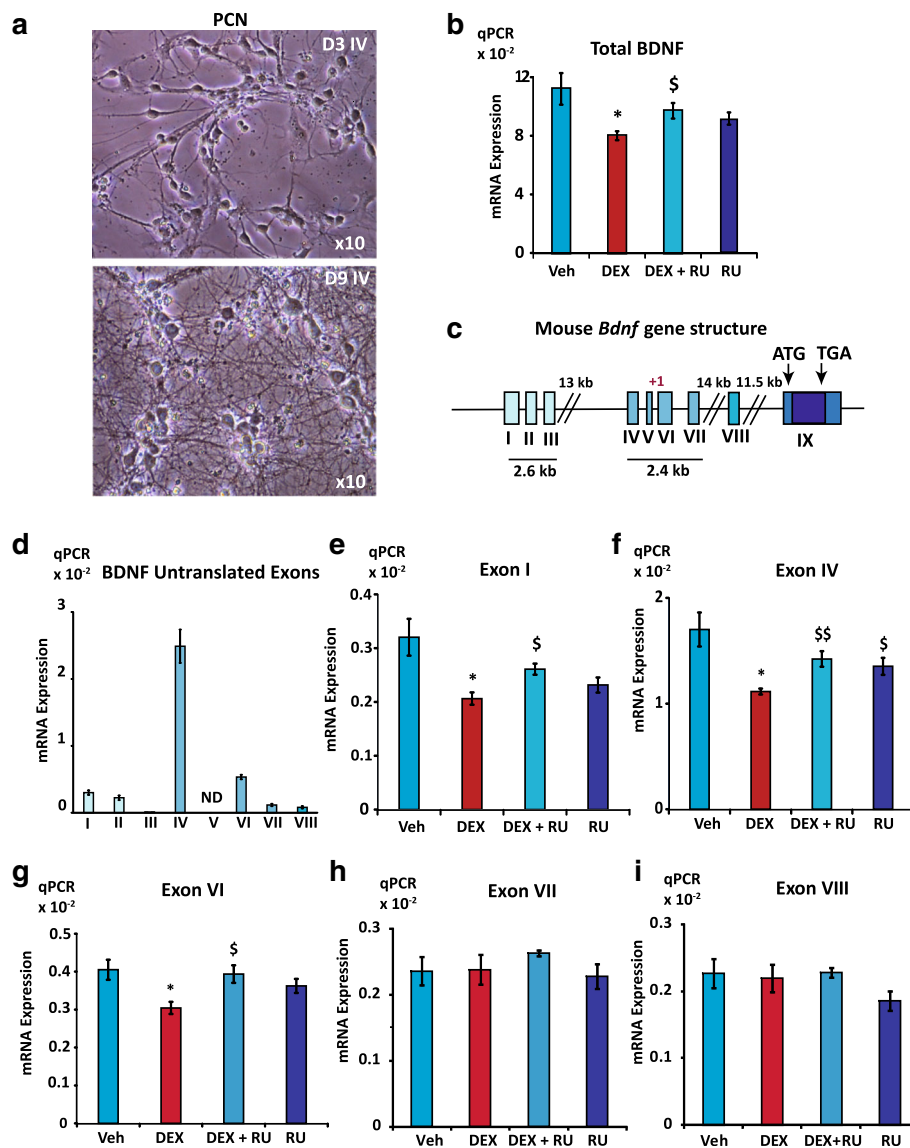

Fig. 1 GR inhibits *Bdnf* expression in 9-day PCN. **a**, Bright field microscopy showed that PCN developed a morphology with multiple cellular processes on Day 3 in vitro (D3 IV, upper panel), while a denser neuronal network was visible on Day 9 (D9 IV); magnification x10. **b**, Total BDNF mRNA expression was significantly repressed by DEX. Relative expression of total BDNF mRNA assessed by qPCR on exon IX under vehicle, (Veh, ethanol) dexamethasone (DEX; 10⁻⁷ M) or DEX and GR antagonist RU486 (RU; 10⁻⁶ M) treatments (1 h). Results are expressed as attomol of BDNF mRNA/attomol of 36B4 mRNA ($n = 6$, Mean \pm SEM); * Veh vs DEX, $P < 0.05$; \$ DEX vs DEX + RU, $P < 0.05$, Mann Whitney U-tests. **c**, Schematic representation of mouse *Bdnf* gene according to Aid et al [18]. Eight untranslated exons (I to VIII) splice onto one common coding exon IX, with two regulatory regions that drive the expression of mainly 2 clusters of untranslated exons (I, II, III and IV, V, VI, respectively). **d**, Relative expression of *Bdnf* untranslated exons in 9-day PCN ($n = 6$, Mean \pm SEM) as measured by RT-qPCR. Exons IV and VI containing transcripts are the most expressed isoforms, followed by that of exon I containing mRNA. ND: non determined. **e, f, g, h, i**, Expression of exon I, IV, and VI containing transcripts was downregulated by DEX while expression of exon VII and VIII containing transcripts was not modified by DEX treatment. qPCR analyses of exon I, IV, VI, VII and VIII mRNA levels in the same samples than in (a), Mean \pm SEM; * ($P < 0.05$) vs Veh; \$ $P < 0.05$; \$\$ $P < 0.01$ vs DEX; Mann Whitney U-tests

In order to better understand the mechanisms by which GCs decrease neuronal *Bdnf* expression, it is worth noting that mouse *Bdnf* gene exhibits a complex genomic structure with 8 untranslated exons (I to VIII) that splice onto the common coding exon IX and two clusters of promoters upstream of I, II, III and IV, V, VI,

respectively (Fig. 1c) [18, 55]. We determined the relative expression of the untranslated exon-containing transcripts by RT-qPCR and found that exon IV containing mRNA isoform was by far the most expressed one followed by exon VI and I containing isoforms (Fig. 1d). Expression of all of these 3 exon-containing messengers

was repressed by DEX while RU suppressed this effect (Fig. 1e, f and g). Conversely, DEX did not exert any effect on exons VII and VIII containing transcripts (Fig. 1h and i), highlighting an exon-specific regulation of GR on *Bdnf* gene. Altogether, these data showed that GR was able to repress BDNF mRNA expression in PCN by downregulating specific isoforms even in the presence of noticeable amounts of GCs in the medium.

The BZ cell line is a glucocorticoid responsive model expressing BDNF

In PCN, the presence of corticosterone in the culture supplement was likely able to interfere with investigation on GR action on BDNF expression. Nonetheless, the BZ cell line previously generated from a mouse hippocampus by targeted oncogenesis [56] displayed several interesting characteristics to study this issue. BZ cells appeared in light microscopy as slightly elongated and connected by short processes when grown in 1% fetal bovine serum (FBS, Fig. 2a, upper left panel). Immunolabeling revealed the presence of the β -tubulin III neuronal marker in BZ cells (Fig. 2a, upper right panel and lower panels), indicating they present with some neuron-like features. Moreover, GR was readily detected by immunocytochemistry as a nucleocytoplasmic labeling in BZ cells (Fig. 2b). As shown by the DAPI counterstaining, GR expression is expressed in all BZ cells. In addition, expression of *Gr*, *Bdnf* as well as the neuronal marker *Map2* and the *Nmdar* ζ 1 (*Grin1*) isoform was observed in BZ cells as measured by RT-PCR (Fig. 2c), and compared to embryonic stem cell derived neurons (ES) and mouse brain. Quantification by qPCR of BDNF and GR mRNAs showed that their relative levels were in the same range in BZ cells and PCN (Additional file 2: Figure S1a and c), although lower when compared to those measured in the brain. While BZ cell expression of *Map2* neuronal marker was comparatively lower than the one measured in PCN and brain, it was similar to that found in ES derived-neuron cultures (Additional file 2: Figure S1b). It is worth noting that the main BDNF receptor TrkB was not expressed in BZ cells (data not shown), thus any observed effect on BDNF expression is not due to a negative feedback loop resulting from TrkB receptor activation. BDNF protein was clearly detected by Western blotting on lysates from BZ cells and PCN as well as mouse brain (Fig. 2d). GR expression in BZ cells was further demonstrated by immunoprecipitation assays as revealed by the ~100 kDa molecular mass band observed in both input and GR immunoprecipitated complexes lanes (Fig. 2e). BZ cells were transfected with a plasmid containing two glucocorticoid response elements fused with the luciferase gene (GRE2.Luc). Although transfection efficiency was low, DEX treatment was able to transactivate GRE2.Luc starting from a dose

of 10^{-8} M indicating that a functional GR is expressed in BZ cells (Fig. 2f). We optimized the BZ cell culture conditions by lowering fetal bovine serum concentration from 10 to 1% for 48 h and showed that this experimental condition increased the expression of the MAP2 neuronal marker mRNAs (Fig. 2g). As BDNF and GR transcripts expression are identical between all culture conditions, this effect is probably specific. Thus, BZ cells were routinely expanded using 10% FBS, plated at 12,500 cells/cm² and grown in low serum concentration (1%) 48 h before hormonal treatments. Altogether, the BZ cell line of hippocampal origin exhibits neuronal features and expresses substantial amounts of both GR and BDNF at the messenger and protein levels, enabling to investigate the impact of GR activation on *Bdnf* expression.

GR represses *Bdnf* expression in BZ cells

The effect of DEX on total BDNF mRNA expression was analyzed on time course experiments, using a 10-fold lower concentration (10^{-7} M) than in PCN. DEX significantly decreased total BDNF transcript abundance by 30% after 3 and 4 h treatment (Fig. 3a). At this dose, no effect was observed on PCN probably because of the presence of corticosterone in the culture medium (data not shown). Parallel measurements of the GR target gene *Sgk1* transcript levels revealed, as expected, a strong induction (3 to 5 fold) already detected after 1 h stimulation, thus validating GC treatment effectiveness, and the BZ cell ability to respond to GCs (Additional file 3: Figure S2a). In the presence of the transcription inhibitor DRB, there was no difference in the rate of BDNF mRNA turnover between Veh and DEX, suggesting that the DEX-induced reduction of BDNF transcript levels was related to transcriptional repression rather than RNA decay mechanisms (Fig. 3b). These findings also demonstrated that the half-life time of BDNF transcripts in BZ cells was evaluated at around 2 h, which is consistent with a rapid detection of BDNF mRNA level diminution upon GC exposure. Co-treatment with RU for 3 h abolished the effect of DEX on *Bdnf* expression, demonstrating that DEX repression is indeed mediated by GR (Fig. 3c). As a control, under the same experimental conditions, *Sgk1* activation by DEX was fully repressed by addition of RU (Additional file 3: Figure S2b). The relative expression of *Bdnf* untranslated exons in BZ cells was somehow different from the one observed in PCN since exon VI-containing mRNA represented the highest expressed isoform in BZ cells, followed by exon VII and VIII then exon IV mRNA while the expression of exon I-containing transcript was negligible (Fig. 3d). Examination of exon IV and VI isoform expression

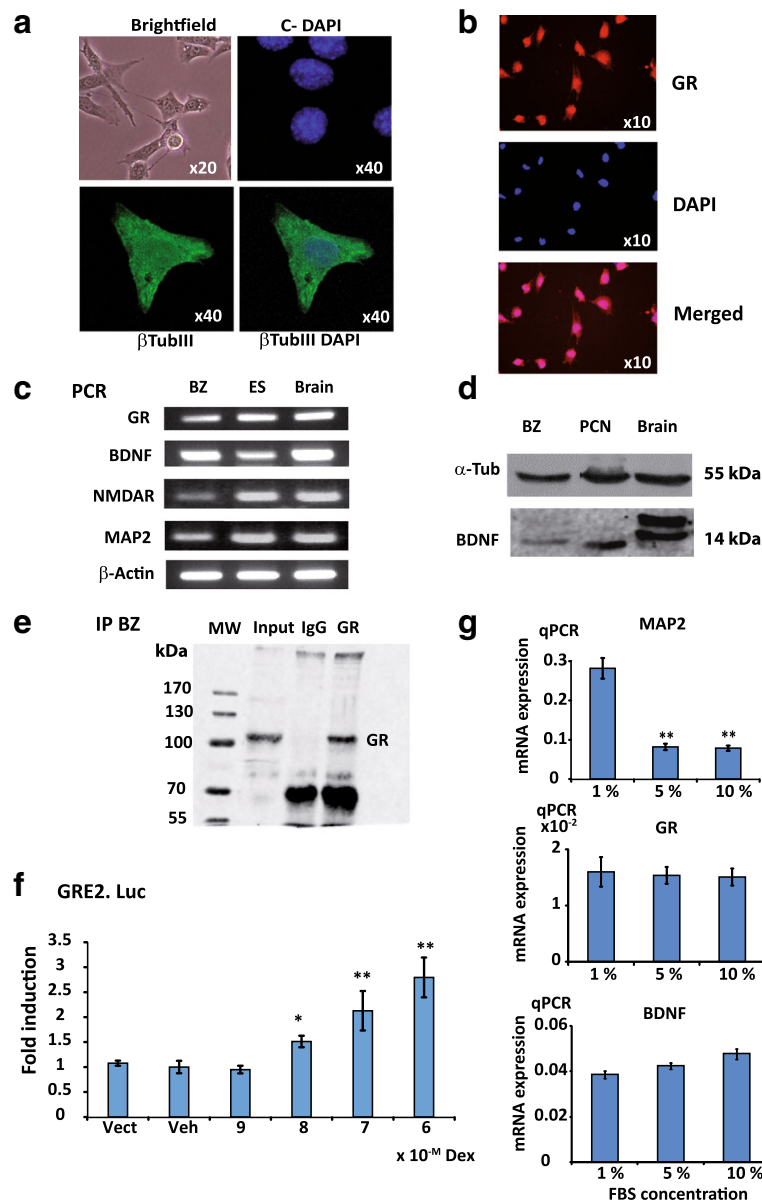

Fig. 2 Characterization of the BZ cell line. BZ cells are cultured in DMEM supplemented with 1% FBS unless stated otherwise. **a**, BZ cells present with neuronal features. BZ cells display an elongated morphology harboring multiple short cellular processes, brightfield microscopy (magnification x20, upper left panel). Immunolabeling images (x40) with negative control secondary antibody and DAPI counterstaining (upper right panel), β-tubulin III (lower left panel) and merged DAPI and β-tubulin III (lower right panel). **b**, GR is expressed in BZ cells. Immunocytochemistry of GR staining on BZ cells grown in 10% FBS, showing a homogenous expression of GR in this cell line. GR, upper panel, DAPI, middle panel, Merged, lower panel (**c**), Analytical RT-PCR of GR, BDNF, NMDA receptor ζ (NMDAR) and MAP2 mRNA expression (30 cycles of amplification with DreamTaq (Thermo Scientific)) on BZ cells compared with neurons derived from mouse embryonic stem cells (ES) and mouse brain. **d**, Western Blot on BDNF protein in BZ cells, primary cultures of mouse hippocampal neurons (PCN), and mouse brain, showing that BDNF protein was clearly detected in all of the 3 samples. **e**, Immunoprecipitation in BZ cell lysates with anti-GR antibody, further demonstrating GR expression, MW: molecular weight markers in kDa, IgG: rabbit immunoglobulins, GR band is around 105 kDa. **f**, DEX was able to transactivate GRE2.Luc, indicating the presence of a functional GR in BZ cells. Transfection of BZ with a PGL3-Gre2.Luc plasmid under DEX dose responses (10⁻⁹ to 10⁻⁶ M, n = 8, Mean ± SEM); Vect, GRE2.Luc; Veh set at 1; * P < 0.05, ** P < 0.01, Mann Whitney U-tests. **g**, Increased expression of neuronal marker MAP2 transcripts at low FBS (1%) concentration. MAP2 (higher panel), GR (middle panel) and BDNF (lower panel) mRNA expression in BZ cells under various FBS concentrations from 1 to 10%; n = 6, Mean ± SEM; ** P < 0.01 vs 1% condition, Mann Whitney U- tests

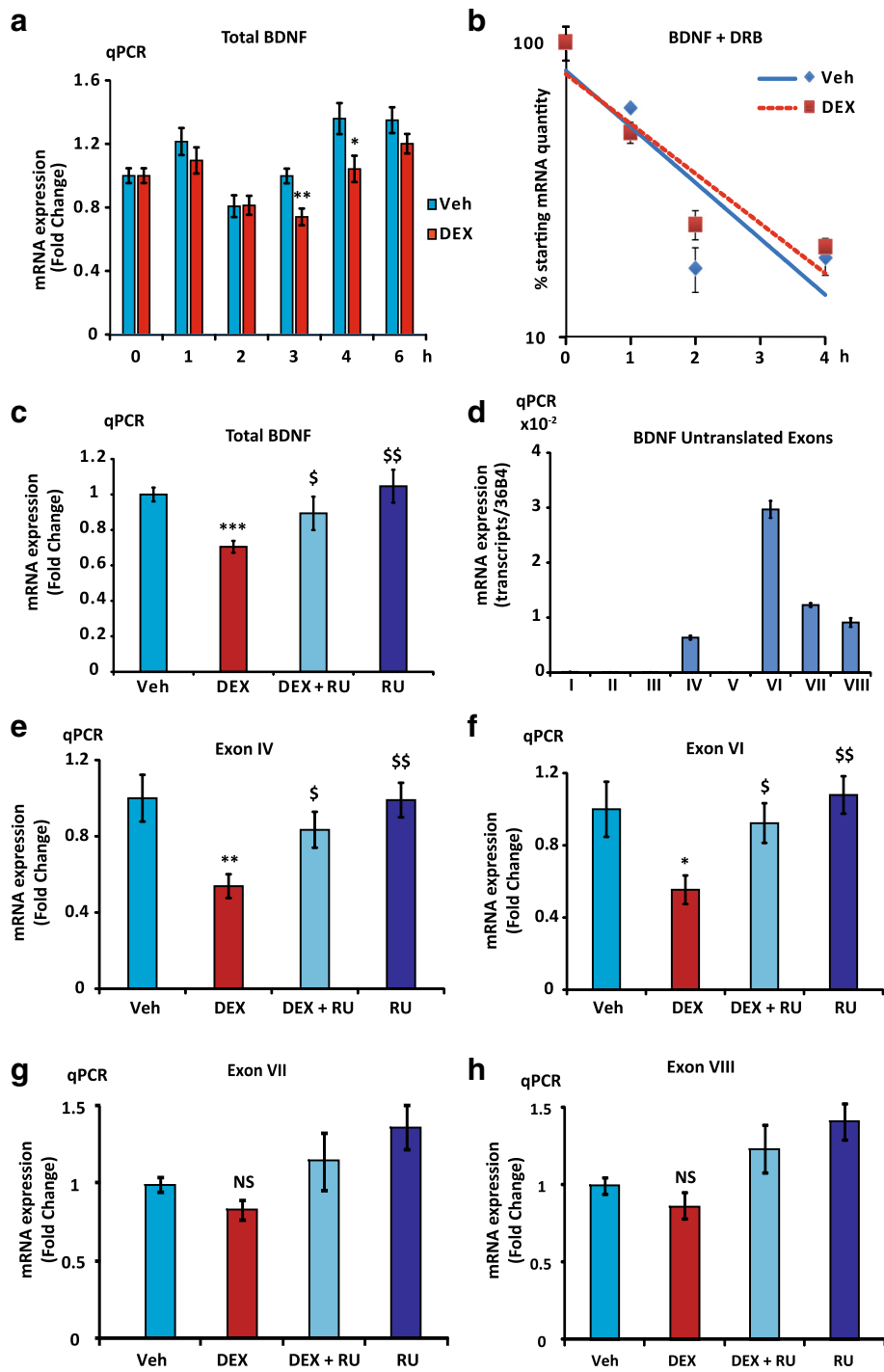

Fig. 3 (See legend on next page.)

(See figure on previous page.)

Fig. 3 GR downregulates BDNF expression in BZ cells. **a**, The total BDNF transcript abundance was decreased by 30% after 3 and 4 h DEX treatment. Time course of total BDNF transcript expression under 10^{-7} M DEX or vehicle treatment, time 0 is set at 1, $n = 12$, Mean \pm SEM; * $P < 0.05$, ** $P < 0.01$ vs Veh, Mann Whitney U-tests. **b**, Repression of BDNF mRNA expression is transcriptional. Time course assessment of total BDNF mRNA expression under DRB in the presence or absence of DEX. Note the logarithmic scale of the y-axis. Total BDNF transcript half-life time was estimated at approximately 2 h. The corresponding slopes were not significantly different with ANCOVA test ($P = 0.14$) **(c)**, GR effect is inhibited by RU. RT-qPCR on common exon IX, 3 h treatment with DEX 10^{-7} M and/or RU 10^{-6} M ($n = 12$, Mean \pm SEM); Veh vs DEX *** $P < 0.001$, RU and DEX + RU vs DEX, \$ $P < 0.05$, \$\$ $P < 0.01$. **d**, Relative expression of BDNF untranslated exons containing mRNA in 4-day BZ cultures ($n = 6$, Mean \pm SEM) as measured by RT-qPCR. The highest expressed isoform in BZ cells is exon VI-containing transcript, followed by exon VII and VIII, then exon IV, while exon I mRNA expression was negligible. **e, f, g, h**, GR specifically repressed exon IV and VI expression but was ineffective on exon VII and VIII expression. qPCR on exon IV, VI, VII and VIII ($n = 12$, Mean \pm SEM) containing transcript levels in the same samples than in **(c)**; Veh set at 1, * ($P < 0.05$), and ** ($P < 0.001$) vs Veh; \$ ($P < 0.05$) and \$\$ ($P < 0.01$) vs Dex, Mann Whitney U-tests

after 3 h DEX treatment showed a similar pattern of repression than with total BDNF transcripts, which was fully prevented by coincubation with RU (Fig. 3e and f). Interestingly, DEX-induced repression was stronger with isoform IV and VI (around 50%) than for total BDNF transcripts. Likewise in PCN, there was no effect of DEX on exon VII and VIII (Fig. 3g and h), indicating once again the specificity of the DEX-repressive action on exon IV and VI expression. These findings suggested a GR mediated effect through a repressive mechanism on the promoter regions upstream of exon IV and/or VI (see Fig. 1c).

GR represses *Bdnf* expression by acting upstream of exon IV

Exons IV and VI are in a close vicinity on mouse *Bdnf* gene, located in a ~ 1.5 kbp sequence (Fig. 4a). To clarify the mechanisms by which activated GR represses neuronal *Bdnf* expression, we generated several *Bdnf* promoter luciferase constructs including four fragments of this region, LP6 (1.8 kb, -1563; +227) and SP6 (837 bp, -610; +227) flanking exon VI, LP4 (543 bp, -1593; -1021) and SP4 (275 bp -1315; -1041) flanking exon IV. The first base-pair of exon VI was arbitrarily set at +1 for the sequence numbering (see Fig. 4a). The activities of these fragments inserted upstream of the reporter luciferase gene were investigated for their responses to GCs using luciferase assays in the neuroblastoma tumor cell line N2A. This model has been preferred to BZ cells given that these latter cells exhibit a very low transfection efficiency. DEX dose response curves (10^{-9} to 10^{-6} M) were generated with the four constructs while cotransfecting a GR expression vector. Whereas the luciferase activities driven by the SP6 construct were not modified by DEX whatever the GC dose (Fig. 4b), LP6-driven activities were significantly reduced even at the lowest DEX concentration (10^{-9} M) (Fig. 4c). Co-treatment with RU abolished DEX inhibitory effect, stressing that this repression was mediated by GR (Fig. 4d). To determine the location of the regulatory regions on which DEX-activated GR affected *Bdnf* expression, we narrowed down our promoter analyses by focusing on two shorter DNA fragments, LP4 and SP4, upstream of exon IV (see

Fig. 4a) since DEX did not regulate SP6 activity. Luciferase activities driven by both the two shorter fragments were significantly reduced by GR with DEX compared with vehicle, likewise what was observed with the LP6 fragment, in a dose-response manner (Fig. 4e and g). While DEX was able to repress LP4 construct, (Fig. 4f), significant antagonist effect of RU was observed with the SP4 construct (Fig. 4h) indicating that activated GR may act directly or indirectly on this short 275 bp region upstream of exon IV in an inhibitory fashion.

AP1 and CRE response elements do not mediate GR transrepression

To investigate the molecular mechanisms of the glucocorticoid-dependent repression, we analyzed *in silico* the GR-sensitive SP4 sequence (275 bp; -188, +87 from exon IV transcription start site) using Jaspar database (URL: http://jaspar.genereg.net/cgi-bin/jaspar_db.pl) but were not able to identify any potential GR response elements (GRE). In contrast, we found two Jun/Fos response elements, comprising two potential AP1 binding sites (positions -127 and -101), as well as two cAMP response elements (CRE), for CREB1 (position -38) and CREB3L2 (position -14), see Fig. 5a. Given that GR is able to repress SP4 sequence transactivation ability (see Fig. 4h), it was tempting to speculate that GR effect was the result of a transrepression mediated by its interaction with AP1 and/or CRE binding transcription factors as it has been previously proposed [57]. Of interest, in humans and rats, these CRE response elements, which are evolutionary conserved were characterized as positively regulated by synaptic activity [46], while constructs harboring the AP1 sites were not sensitive to a previously described BDNF-positive feedback loop [58]. To test this hypothesis, deletion mutants of AP1 (mAP1-1 and mAP1-2) and CRE (mCRE1 and mCRE2) binding sites were generated from SP4-luciferase plasmid, as well as double mutants with deletion of the two potential AP1 binding sites (dmAP1) or the two CRE binding sites (dmCRE) sites (Fig. 5a, the deleted bases are indicated in white lettering). All AP1 and CRE mutants, as well as the double mutants showed a strong reduction of their basal transcriptional activities in N2A

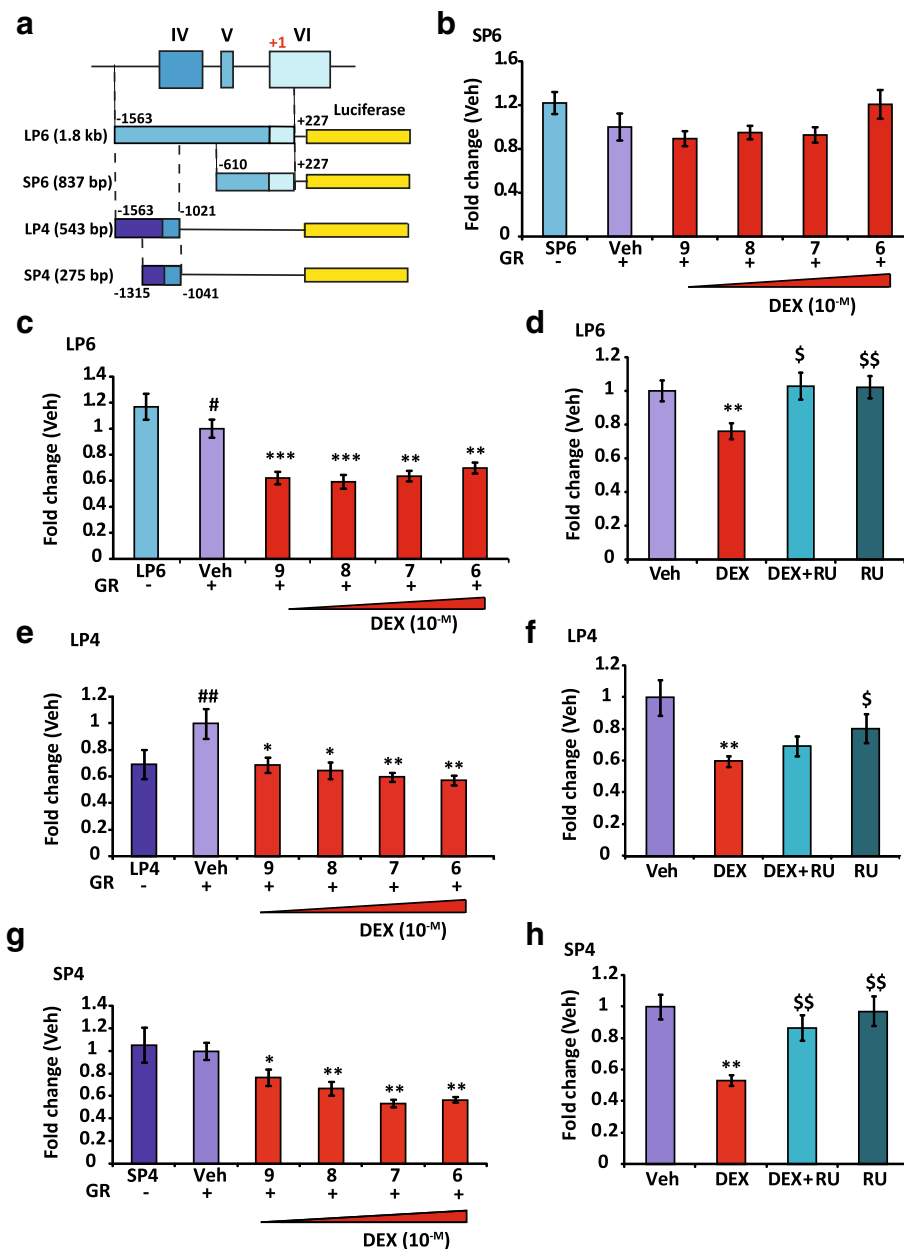

Fig. 4 GR-dependent inhibitory effects on BDNF promoter 4 activity relies on a short sequence upstream of exon IV. **a**, Map of transfected constructs, LP6, SP6, LP4 and SP4 regions. These sequences were subcloned into PGL4 luciferase plasmid, setting the first base of exon VI at +1: a long (LP6, 1.8 kb, -1563, +227, containing exon IV, V and part of VI) and three short regions (SP6, 837 bp, -610, +227, partly encompassing exon VI; LP4, 543 bp, -1563, -1021; SP4, 275 bp, -1315, -1041; LP4 and SP4 are upstream of exon IV and include its transcription start site). **b**, DEX dose responses (Veh, Ethanol for 24 h) of SP6 transfected in N2A cells, co-transfected with GR expression vector and Renilla plasmid for normalization. Results are expressed as fold change of the luciferase/Renilla value of SP6 transfected alone. No significance was observed whatsoever ($n = 16$), showing SP6-driven activities were not modified by DEX. **c**, Same as in (b) with LP6 construct, Veh condition is set at 1; $n = 16$, Mean \pm SEM; # $p < 0.05$, LP6 vs Veh; *** $p < 0.01$, **** $p < 0.005$, DEX vs Veh; Mann Whitney U-tests. Luciferase activities driven by LP6 were already decreased by DEX at a low concentration. **d**, Transfection of LP6 in N2A cells, 24 h treatment with Veh, DEX (10^{-7} M), RU (10^{-6} M) and both; $n = 16$, Mean \pm SEM; \$ $p < 0.05$, \$\$ $p < 0.01$, vs DEX; Mann Whitney U-tests. The DEX repression is inhibited by RU. **e**, DEX dose responses of LP4 transfected in N2A cells. Results are expressed as fold change of the luciferase/protein value of LP4 transfected alone. Veh condition is set at 1; $n = 8$; ## $p < 0.01$, LP4 vs Veh; * $p < 0.05$, ** $p < 0.01$, DEX vs Veh; Mann Whitney U-tests. DEX reduced the LP4 activities in a dose-response manner. **f**, Transfection of LP4 construct plasmid in N2A cells, 24 h treatment with Veh, DEX (10^{-7} M), RU (10^{-6} M) or both; $n = 16$, Mean \pm SEM; * $p < 0.05$ vs Veh; \$ $p < 0.05$, vs DEX; Mann Whitney U-tests. The DEX effect was not reversed by RU. **g**, Same as in (e) with SP4 construct. DEX vs Veh; * $p < 0.05$ and ** $p < 0.01$. DEX repressed SP4 activity. **h**, SP4 fragment is repressed by GR. Same as in (f) with SP4 construct; ** $p < 0.01$ vs Veh; \$\$ $p < 0.01$ vs DEX

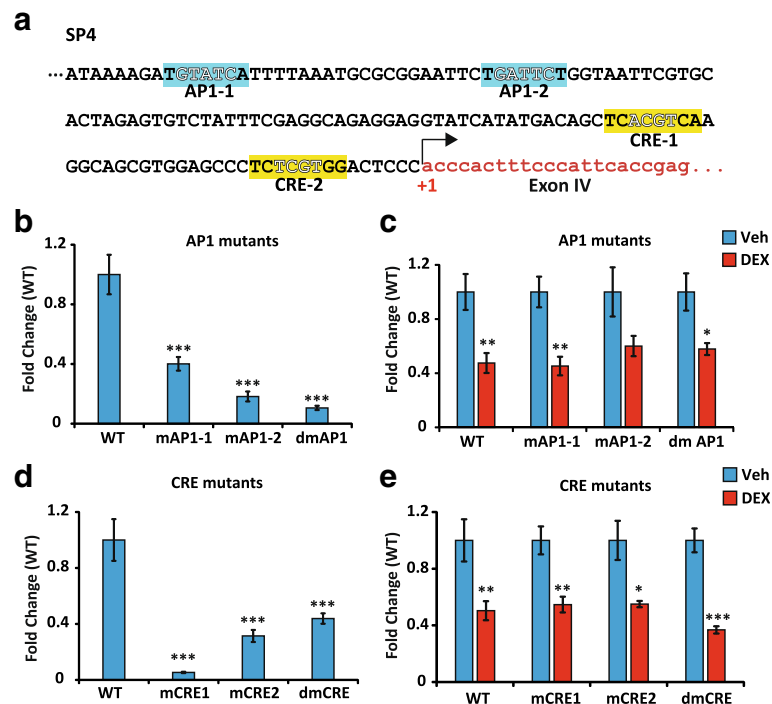

Fig. 5 AP1 and CRE response elements do not mediate GR transrepression. **a**, Sequence analysis of a short fragment upstream of exon IV, and included in SP4 sequence that contains two potential AP1 binding sites, TGTATCA and TGATTCT, as well as two potential cAMP Response-Elements (CRE): CRE-1 (for CREB1, TCACGTCA) and CRE-2 (for CREB3L2, TCTCGTGG) according to the Jaspas database; +1 is the transcription start site of exon IV. **b**, Luciferase activity of WT and AP1 mutants. mAP1-1: construct with AP1-1 deletion, mAP1-2, construct with deletion of AP1-2 sequence, dmAP1, deletion of both sites. Deleted based are shown in white lettering in Fig. 5a. Basal transcriptional activity driven by the WT sequence was arbitrarily set at 1, Means \pm SEM; *** $P < 0.005$; Mann Whitney U-tests, $n = 8$. **c**, Luciferase activities of promoter mutants with AP1 deletions were still repressed by DEX. * $P < 0.05$ DEX (red) vs vehicle (blue). Mean \pm SEM; ** $P < 0.01$, DEX vs Veh of the same construct. Mann Whitney U-tests, $n = 8$; all Veh conditions were set at 1. **d**, Luciferase activity of WT and CRE mutants. mCRE-1: construct with CRE1-1 deletion, mCRE-2, construct with deletion of CRE-2 sequence, dmCRE, deletion of both sites. Deleted based are shown in white lettering in Fig. 5a. Basal transcriptional activity driven by the WT sequence was arbitrarily set at 1, *** $P < 0.005$; Mann Whitney U-tests, $n = 8$. **e**, Luciferase activities of promoter mutants with CRE deletions were still repressed by DEX. mCRE-1: construct with CRE-1 deletion, mCRE-2, construct with deletion of CRE1-2 sequence, dmCRE, deletion of both sites. * $P < 0.05$ DEX (red) vs vehicle (blue). Means \pm SEM; ** $P < 0.01$, DEX vs Veh for the same construct, *** $P < 0.005$, DEX vs Veh for the same construct, Mann Whitney U-tests, $n = 8$; all Veh conditions were set at 1

cells compared to the WT plasmid indicating they are functional sequences in SP4 construct (Fig. 5b and d). The transcriptional response to DEX was measured setting the vehicle condition value at 1 for each construct (Fig. 5c and e). For all these mutants, as well as for AP1 and CRE double mutants (dmAP1 and dmCRE), DEX treatment still led to the repression of their transcriptional activities in a similar fashion than with the SP4 wild type fragment. In the absence of classical GRE and other response elements for transcription factors known to interact with GR in the SP4 sequence, these data excluded the possibility of an interaction between GR and AP1 and/or CRE response elements to transrepress *Bdnf* expression in these neuron-like cells.

GR binds upstream of exon IV upon DEX treatment

Even if no specific DNA response element was identified for DEX responses, transfection data strongly suggest a direct involvement of GR to repress SP4 transcriptional

activity. To determine whether GR does bind to *Bdnf* SP4 promoter fragment, chromatin immunoprecipitation (ChIP) experiments were undertaken in BZ cells using specific primers (see Additional file 1: Table S1), the targeted sequence and primer pair being schematized in Fig. 6a. DEX treatment led to a ~3-fold enrichment of GR recruitment compared to the control condition (Veh) or IgG, while cotreatment with RU significantly reduced GR binding (Fig. 6b). As a positive control, we also examined the capacity of GR to interact with the regulatory sequence of a well-known GR target gene *period circadian clock 1* (*Per1*) [52]. Under such experimental conditions, a 10-fold enrichment of GR upon DEX exposure was measured that was antagonized by RU (Fig. 6c). Besides, as a negative control, no GR recruitment was detected on a genomic sequence comprising a fragment of *Ucp1* promoter (Kuhn et al, unpublished observations), a gene whose expression is mostly restricted to brown adipocytes [59] (Fig. 6d),

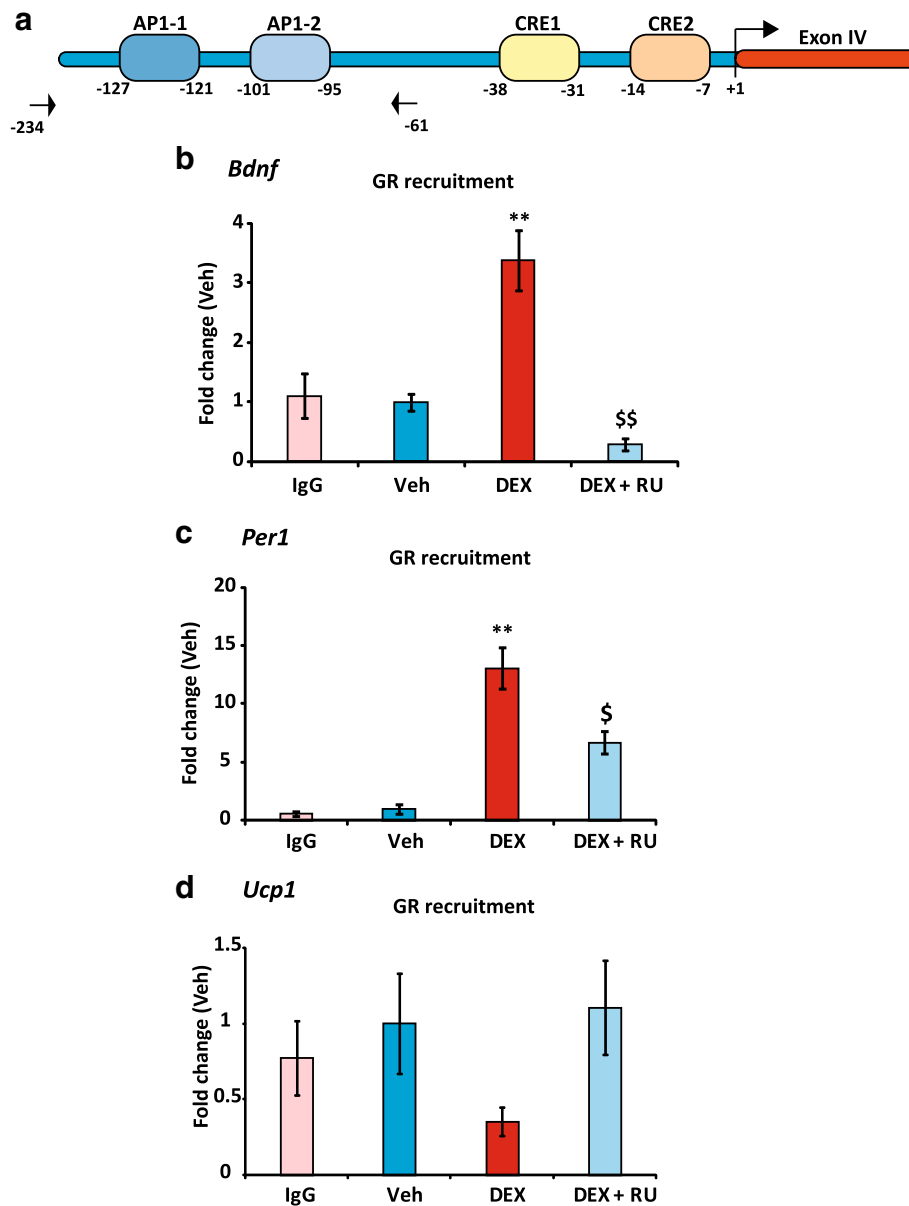

Fig. 6 GR recruitment on *Bdnf* DNA sequence. **a**, Schematic representation of a short fragment upstream of exon IV that contains the two potential AP1 binding sites, AP1-1 and AP1-2 as well as two potential cAMP Response-Elements CRE-1 and CRE-2 according to the Jaspar database. Exon IV transcription start site is set at +1. Primers for ChIP are indicated by arrows. **b**, ChIP-qPCR results showing GR recruitment upstream of exon IV region in BZ cells after treatment with DEX (10^{-7} M) or DEX together with RU (10^{-6} M) for 1 h. IgG: ChIP-qPCR with IgG negative control antibodies on the same sequence. Results of 3 different experiments are pooled setting the vehicle mean value at 1 ($n = 6$, Mean \pm SEM), and showed as fold change of the percentage of input value of Veh. ** $P < 0.01$, DEX vs Veh; \$\$ $P < 0.01$, DEX + RU vs DEX; Mann Whitney U-tests. **c**, ChIP-qPCR results (same samples than in B) of GR recruitment on *Per1* gene regulatory sequence used as positive control in BZ cells under DEX or DEX + RU treatment for 1 h. ** $P < 0.01$, DEX vs Veh. \$ $P < 0.05$, DEX + RU vs DEX. **d**, same as in (c) with GR recruitment on *Ucp1* gene used as negative control. Primers for genomic PCR amplification are listed in Additional file 1: Table S1

further demonstrating that GR recruitment on *Bdnf* and *Per1* promoters was specific. Taken together, ChIP experiments provided evidence that DEX inhibits *Bdnf* transcriptional activity, at least partly by specific GR recruitment onto a short fragment (SP4) directly upstream of exon IV.

Discussion

BDNF, the main neurotrophin is a key factor regulating neuronal function in health and diseases, such as survival, growth, synaptic structure and activity. Thus, understanding the molecular mechanisms involved in the regulation of neuronal *Bdnf* expression is a major issue.

However, the effect of glucocorticoids on *Bdnf* neuronal expression is still a matter of debate [60]. Given the complexity of the central nervous system anatomy and its functional organization, where neurons represent only a small fraction of the total number of cells, we focused our attention in the present study to in vitro neuronal models in order to investigate GC action on *Bdnf* expression. Besides, GC bind to two receptors in the brain; the high affinity MR, which is occupied even at low concentrations of hormones, and GR with a lower affinity for ligands thus more sensitive to hormonal regulation and variation [27]. In the present work, we decipher the role of GR as a mediator of GC actions and for this purpose we use the glucocorticoid agonist dexamethasone (DEX) that exhibits a low MR activating capacity [61, 62].

We have demonstrated that DEX exposure led to a marked downregulation of BDNF transcript expression in neuronal cells that was mediated by GR. More precisely, total BDNF mRNA levels were reduced after GC treatment in primary hippocampal neuron cultures, but also in the neuron-like cell line BZ. In both models, BDNF transcripts containing exons IV and VI isoforms were highly expressed and specifically repressed by GR activation. Transfection experiments were performed using a long 1.8 kb DNA fragment (LP6) encompassing the closely packed exon IV, V and VI and their 5' regulatory sequences. LP6-driven activity was significantly repressed by DEX yet prevented by addition of GR antagonist RU. Functional characterization of the transcriptional activity of LP6 construct fragments by luciferase reporter assays led to identify a short 275 pb sequence (SP4) directly upstream of exon IV, and encompassing its transcription start site, which might account for the inhibitory effects of GCs. Analysis by Jaspar online software (URL: http://jaspar.genereg.net/cgi-bin/jaspar_db.pl), revealed that two Jun/Fos response elements, constituting AP1 binding sites, were located on this region as well as two cAMP response elements (CRE), a CREB1 and a closely related CREB312 response element, all being located just upstream of the exon IV transcription start site (see Fig. 6a). Chromatin immunoprecipitation assays demonstrated that GR binds to this sequence, GR recruitment being prevented by GR antagonist RU. However, promoter constructs with deletion of AP1 and CREB binding sites were still repressed by DEX excluding their involvement in GR regulation of *Bdnf* expression. Altogether, we propose that one of the mechanisms responsible for the repression of *Bdnf* expression by DEX is the binding of GR just upstream of exon IV, through ternary complexes with transcription factors that are still to be determined. Such a repression of gene expression by GR tethered to various transcription factor complexes has been reported in several studies [57, 63].

Nonetheless, no other response elements for proteins susceptible to interact with GR, such as NF κ B, were identified on the SP4 sequence using Jaspar software. Another proposed mechanism of direct GR repression was uncovered recently in the form of negative GRE (nGRE) with a specific sequence (CTCCXGGAG) that clearly differed from positive GRE [64]. Anyhow, none of putative nGRE was identified in the SP4 sequence. Eventually, one might speculate that GR binds to a specific GRE outside the long LP6 fragment that lacks any GRE and acts on *Bdnf* promoter by a folding DNA loop, a mechanism that has been recently described for GR [65]. However, such a mechanism is very unlikely given that GR interacts with the SP4 sequence as demonstrated by transfection and ChIP assays. Nonetheless, we believe these results are of important since they excluded the involvement of specific response elements for transcription factors known to be transrepressed by GR (Jun/fos and CREB) in the SP4 sequence. This raises the hypothesis of a new mechanism involving some partners mediating GR transrepression that remains to be identified.

It is worth noting that this region upstream of exon IV, which displays a high degree of homology between mammalian species emphasizing its biological importance, has been extensively characterized in previous studies by several groups as positively regulated by calcium [45, 66, 67], synaptic activity [46] and BDNF itself [58] in humans and rats. Moreover the two CRE elements for CREB (CRE1) and CREB312 (CRE2) we identified in the mouse sequence are conserved and involved in this regulation, CRE2 being formerly reported as a BHLHB2 response element [46, 68]. In sum, we unraveled that GR represses the activity of exon IV promoter that was previously shown to be stimulated by synaptic activity [46]. This is consistent with the adverse effects of the overactivation of glucocorticoid pathways on brain physiology [27].

The BZ cell line was derived few years ago from a mouse hippocampus. Herein, a more detailed characterization of this neuronal cell line was undertaken and revealed that BZ cells constitute a suitable cellular tool to investigate the regulation of BDNF expression. In comparison, the commercially available N2A cell line expresses very low levels of BDNF transcripts, impairing analysis of isoform expression even if total BDNF transcripts could be measured by the sensitive qPCR technique and we found that GC were able to repress *Bdnf* expression in this model (data not shown). Beyond that, BZ cells appear to be a suitable cell-based system for studying GR signaling pathways in a neuron-like cell context in vitro.

In the present study, quantification of BDNF protein abundance by Western blot in PCN and BZ cells, did

not show any significant change with short term (6 h) or long term (24 h) DEX treatments (data not shown). Even if we could not exclude that GCs might reduce BDNF protein expression on a different timeline, recent studies underscored that BDNF mRNA isoforms localization might be a major factor regulating its functions [69]. For instance, transcripts containing exon IV and VI in rat primary hippocampal neuron cultures were found to display a more distal localization relative to the soma than those including exon I, while they were able to stimulate dendritic branching [19]. Based on this fine-tuning spatial code, it could be proposed that the localization of BDNF mRNA isoform translation would be related to distinct BDNF sites of action. Thus, it is very likely that total expression of BDNF or secretion level of the protein might constitute inappropriate indexes to define BDNF biological function.

Altogether, we provide evidence for a functional cross-talk between activated GR and *Bdnf* expression in mouse neurons that is, at least in part, mediated by GR binding to a restricted sequence upstream of exon IV. In sum, high circulating glucocorticoid levels prevailing under certain circumstances such as stress may alter neuronal *Bdnf* expression [44] and specifically its transcripts distribution leading to a remodeling of dendrite and synapse architecture and function. This could be of physiological importance in processes such as memorization and behavior as well as causal in various pathologies associated with modification of GR and BDNF pathways.

Additional files

Additional file 1: Table S1. Primer table. (DOCX 15 kb)

Additional file 2: Figure S1. Gene expression in PCN and BZ cells. (EPS 1379 kb)

Additional file 3: Figure S2. GR stimulates *Sgk1* expression in BZ cells. (EPS 1437 kb)

Abbreviations

BDNF: Brain-derived neurotrophic factor; DEX: Dexamethasone; GCs: Glucocorticoids; GR: Glucocorticoid receptor; GRE: GR response element; PCN: Primary cultures of hippocampal Neurons; N2A: Neuro-2A cells; RU: RU486 (Mifepristone)

Acknowledgements

We are indebted to Patrice Penfornis for the initial derivation and subcloning of the BZ cell line (present address: Cancer Institute, University of Mississippi Medical Center, Jackson, MS, USA). We thank Fanny Jung for part of the BZ cell line characterization during her practical training for her advance technology degree (BTS) in biotechnologies. We also thank Simon Travers (*Service de Génétique Moléculaire, Pharmacogénomique et Hormonologie, Bicêtre Hospital*) for corticosterone measurements by LC/MS-MS.

Funding

This work was supported by grants from the *Institut National de la Santé et de la Recherche Médicale*, the *Université Paris-Sud* and *Agence Nationale de la Recherche* (Grant 11-BSV1-028-01). HC was funded by a China Scholarship Council (CSC) fellowship.

Availability of data and materials

The datasets supporting the conclusions of this article are included within the article and its additional files.

Authors' contributions

ML, HC, and DL designed the study. HC and DL performed the experiments. ML, HC, and DL wrote the manuscript. All authors read and approved the final manuscript.

Competing interests

The authors declare that they have no competing interests.

Consent for publication

Not applicable.

Ethics approval and consent to participate

Swiss mice were housed and handled according to the National Institutes of Health Guidelines. The animal work is part of an approved project by the ethical comity CEEA 26 (#2012_021). DL has an agreement to conceive and perform animal procedure (N°R-75UPMC-F1-08) by the French state agency 'Ministère de l'Agriculture, de l'Agroalimentaire et de la Forêt'.

Publisher's Note

Springer Nature remains neutral with regard to jurisdictional claims in published maps and institutional affiliations.

Author details

¹Inserm 1185, Fac Med Paris Sud, Université Paris-Saclay, Le Kremlin-Bicêtre, France. ²Service d'Endocrinologie et des Maladies de la Reproduction, Assistance Publique-Hôpitaux de Paris, Hôpital de Bicêtre, Le Kremlin Bicêtre F-94275, France.

Received: 27 October 2016 Accepted: 5 April 2017

Published online: 12 April 2017

References

1. Erfors P, Wetmore C, Olson L, Persson H. Identification of cells in rat brain and peripheral tissues expressing mRNA for members of the nerve growth factor family. *Neuron*. 1990;5(4):511–26.
2. Hohn A, Leibrock J, Bailey K, Barde YA. Identification and characterization of a novel member of the nerve growth factor/brain-derived neurotrophic factor family. *Nature*. 1990;344(6264):339–41.
3. Kawamoto Y, Nakamura S, Nakano S, Oka N, Akiguchi I, Kimura J. Immunohistochemical localization of brain-derived neurotrophic factor in adult rat brain. *Neuroscience*. 1996;74(4):1209–26.
4. Yan Q, Rosenfeld RD, Matheson CR, Hawkins N, Lopez OT, Bennett L, Welcher AA. Expression of brain-derived neurotrophic factor protein in the adult rat central nervous system. *Neuroscience*. 1997;78(2):431–48.
5. Lipsky RH, Marini AM. Brain-derived neurotrophic factor in neuronal survival and behavior-related plasticity. *Ann N Y Acad Sci*. 2007;1122:130–43.
6. Bernd P. The role of neurotrophins during early development. *Gene Expr*. 2008;14(4):241–50.
7. Yamada K, Mizuno M, Nabeshima T. Role for brain-derived neurotrophic factor in learning and memory. *Life Sci*. 2002;70(7):735–44.
8. Tyler WJ, Alonso M, Bramham CR, Pozzo-Miller LD. From acquisition to consolidation: on the role of brain-derived neurotrophic factor signaling in hippocampal-dependent learning. *Learn Mem*. 2002;9(5):224–37.
9. Bolanos CA, Nestler EJ. Neurotrophic mechanisms in drug addiction. *Neuromolecular Med*. 2004;5(1):69–83.
10. McAllister AK, Katz LC, Lo DC. Neurotrophins and synaptic plasticity. *Annu Rev Neurosci*. 1999;22:295–318.
11. Bibel M, Barde YA. Neurotrophins: key regulators of cell fate and cell shape in the vertebrate nervous system. *Genes Dev*. 2000;14(23):2919–37.
12. Binder DK, Scharfman HE. Brain-derived neurotrophic factor. *Growth Factors*. 2004;22(3):123–31.
13. Castren E. Neurotrophins as mediators of drug effects on mood, addiction, and neuroprotection. *Mol Neurobiol*. 2004;29(3):289–302.
14. Cattaneo E, Zuccato C, Tartari M. Normal huntingtin function: an alternative approach to Huntington's disease. *Nat Rev Neurosci*. 2005;6(12):919–30.

15. Murer MG, Yan Q, Raisman-Vozari R. Brain-derived neurotrophic factor in the control human brain, and in Alzheimer's disease and Parkinson's disease. *Prog Neurobiol.* 2001;63(1):71–124.
16. Russo-Neustadt AA, Chen MJ. Brain-derived neurotrophic factor and antidepressant activity. *Curr Pharm Des.* 2005;11(12):1495–510.
17. Chao MV. Neurotrophins and their receptors: a convergence point for many signalling pathways. *Nat Rev Neurosci.* 2003;4(4):299–309.
18. Aid T, Kazantseva A, Piirsoo M, Palm K, Timmusk T. Mouse and rat BDNF gene structure and expression revisited. *J Neurosci Res.* 2007;85(3):525–35.
19. Baj G, Leone E, Chao MV, Tongiorgi E. Spatial segregation of BDNF transcripts enables BDNF to differentially shape distinct dendritic compartments. *Proc Natl Acad Sci U S A.* 2011;108(40):16813–8.
20. Palomer E, Martin-Segura A, Baliyan S, Ahmed T, Balschun D, Venero C, Martin MG, Dotti CG. Aging triggers a repressive chromatin state at bdnf promoters in hippocampal neurons. *Cell Rep.* 2016;16(11):2889–900.
21. Karpova NN. Role of BDNF epigenetics in activity-dependent neuronal plasticity. *Neuropharmacology.* 2014;76 Pt C:709–18.
22. Nair A, Vadodaria KC, Banerjee SB, Benekareddy M, Dias BG, Duman RS, Vaidya VA. Stressor-specific regulation of distinct brain-derived neurotrophic factor transcripts and cyclic AMP response element-binding protein expression in the postnatal and adult rat hippocampus. *Neuropsychopharmacology.* 2007;32(7):1504–19.
23. Zhang Y, Gu F, Chen J, Dong W. Chronic antidepressant administration alleviates frontal and hippocampal BDNF deficits in CUMS rat. *Brain Res.* 2010;1366:141–8.
24. Nair B, Wong-Riley MT. Transcriptional Regulation of Brain-derived Neurotrophic Factor Coding Exon IX: Role of Nuclear Respiratory Factor 2. *J Biol Chem.* 2016;291(43):22583–593.
25. McEwen BS. Physiology and neurobiology of stress and adaptation: central role of the brain. *Physiol Rev.* 2007;87(3):873–904.
26. Joels M, Krugers HJ, Lucassen PJ, Karst H. Corticosteroid effects on cellular physiology of limbic cells. *Brain Res.* 2009;1293:91–100.
27. Le Menuet D, Lombes M. The neuronal mineralocorticoid receptor: from cell survival to neurogenesis. *Steroids.* 2014;91:11–9.
28. Lambert WM, Xu CF, Neubert TA, Chao MV, Garabedian MJ, Jeanneteau FD. Brain-derived neurotrophic factor signaling rewrites the glucocorticoid transcriptome via glucocorticoid receptor phosphorylation. *Mol Cell Biol.* 2013;33(18):3700–14.
29. Arango-Lievano M, Lambert WM, Bath KG, Garabedian MJ, Chao MV, Jeanneteau F. Neurotrophic-priming of glucocorticoid receptor signaling is essential for neuronal plasticity to stress and antidepressant treatment. *Proc Natl Acad Sci U S A.* 2015;112(51):15737–42.
30. Tsankova NM, Berton O, Renthal W, Kumar A, Neve RL, Nestler EJ. Sustained hippocampal chromatin regulation in a mouse model of depression and antidepressant action. *Nat Neurosci.* 2006;9(4):519–25.
31. Duman RS, Monteggia LM. A neurotrophic model for stress-related mood disorders. *Biol Psychiatry.* 2006;59(12):1116–27.
32. Li Y, Luikart BW, Birnbaum S, Chen J, Kwon CH, Kernie SG, Bassel-Duby R, Parada LF. TrkB regulates hippocampal neurogenesis and governs sensitivity to antidepressant treatment. *Neuron.* 2008;59(3):399–412.
33. Herman JP, Cullinan WE. Neurocircuitry of stress: central control of the hypothalamo-pituitary-adrenocortical axis. *Trends Neurosci.* 1997;20(2):78–84.
34. Jankord R, Herman JP. Limbic regulation of hypothalamo-pituitary-adrenocortical function during acute and chronic stress. *Ann N Y Acad Sci.* 2008;1148:64–73.
35. Murakami S, Imbe H, Morikawa Y, Kubo C, Senba E. Chronic stress, as well as acute stress, reduces BDNF mRNA expression in the rat hippocampus but less robustly. *Neurosci Res.* 2005;53(2):129–39.
36. Dwivedi Y, Rizavi HS, Pandey GN. Antidepressants reverse corticosterone-mediated decrease in brain-derived neurotrophic factor expression: differential regulation of specific exons by antidepressants and corticosterone. *Neuroscience.* 2006;139(3):1017–29.
37. Gourley SL, Kedves AT, Olausson P, Taylor JR. A history of corticosterone exposure regulates fear extinction and cortical NR2B, GluR2/3, and BDNF. *Neuropsychopharmacology.* 2009;34(3):707–16.
38. Smith MA, Makino S, Kvetnansky R, Post RM. Stress and glucocorticoids affect the expression of brain-derived neurotrophic factor and neurotrophin-3 mRNAs in the hippocampus. *J Neurosci.* 1995;15(3 Pt 1):1768–77.
39. Asadi A, Hedman E, Widen C, Zilliacus J, Gustafsson JA, Wikstrom AC. FMS-like tyrosine kinase 3 interacts with the glucocorticoid receptor complex and affects glucocorticoid dependent signaling. *Biochem Biophys Res Commun.* 2008;368(3):569–74.
40. Cheung LW, Leung KW, Wong CK, Wong RN, Wong AS. Ginsenoside-Rg1 induces angiogenesis via non-genomic crosstalk of glucocorticoid receptor and fibroblast growth factor receptor-1. *Cardiovasc Res.* 2011;89(2):419–25.
41. Kumamaru E, Numakawa T, Adachi N, Kunugi H. Glucocorticoid suppresses BDNF-stimulated MAPK/ERK pathway via inhibiting interaction of Shp2 with TrkB. *FEBS Lett.* 2011;585(20):3224–8.
42. Kino T, Jaffe H, Amin ND, Chakrabarti M, Zheng YL, Chrousos GP, Pant HC. Cyclin-dependent kinase 5 modulates the transcriptional activity of the mineralocorticoid receptor and regulates expression of brain-derived neurotrophic factor. *Mol Endocrinol.* 2010;24(5):941–52.
43. Ridder S, Chourbaji S, Hellweg R, Urani A, Zacher C, Schmid W, Zink M, Hortnagl H, Flor H, Henn FA, et al. Mice with genetically altered glucocorticoid receptor expression show altered sensitivity for stress-induced depressive reactions. *J Neurosci.* 2005;25(26):6243–50.
44. Daskalakis NP, De Kloet ER, Yehuda R, Malaspina D, Kranz TM. Early Life Stress Effects on Glucocorticoid-BDNF Interplay in the Hippocampus. *Front Mol Neurosci.* 2015;8:68.
45. Shieh PB, Hu SC, Bobb K, Timmusk T, Ghosh A. Identification of a signaling pathway involved in calcium regulation of BDNF expression. *Neuron.* 1998;20(4):727–40.
46. Pruunsild P, Sepp M, Orav E, Koppel I, Timmusk T. Identification of cis-elements and transcription factors regulating neuronal activity-dependent transcription of human BDNF gene. *J Neurosci.* 2011;31(9):3295–308.
47. Le Menuet D, Zennaro MC, Viengchareun S, Lombes M. Transgenic mouse models to study human mineralocorticoid receptor function in vivo. *Kidney Int.* 2000;57(4):1299–306.
48. Seibenhener ML, Wooten MW. Isolation and culture of hippocampal neurons from prenatal mice. *J Vis Exp.* 2012;(65). doi:10.3791/3634.
49. Martinez Y, Bena F, Gimelli S, Tirefort D, Dubois-Dauphin M, Krause KH, Preynat-Seauve O. Cellular diversity within embryonic stem cells: pluripotent clonal sublines show distinct differentiation potential. *J Cell Mol Med.* 2012;16(3):456–67.
50. Sarabdjitsingh RA, Meijer OC, de Kloet ER. Specificity of glucocorticoid receptor primary antibodies for analysis of receptor localization patterns in cultured cells and rat hippocampus. *Brain Res.* 2010;1331:1–11.
51. Zuccotti A, Kuhn S, Johnson SL, Franz C, Singer W, Hecker D, Geisler HS, Kopschall I, Rohbock K, Gutsche K, et al. Lack of brain-derived neurotrophic factor hampers inner hair cell synapse physiology, but protects against noise-induced hearing loss. *J Neurosci.* 2011;32(25):8545–53.
52. Le Billan F, Khan JA, Lamribet K, Viengchareun S, Bouligand J, Fagart J, Lombes M. Cistrome of the aldosterone-activated mineralocorticoid receptor in human renal cells. *FASEB J.* 2015.
53. Mifsud KR, Reul JM. Acute stress enhances heterodimerization and binding of corticosteroid receptors at glucocorticoid target genes in the hippocampus. *Proc Natl Acad Sci U S A.* 2016;113(40):11336–41.
54. Haffner MC, Jurgeit A, Berlato C, Geley S, Parajuli N, Yoshimura A, Doppler W. Interaction and functional interference of glucocorticoid receptor and SOCS1. *J Biol Chem.* 2008;283(32):22089–96.
55. Salerno KM, Jing X, Diges CM, Cornuet PK, Glorioso JC, Albers KM. Sox11 modulates brain-derived neurotrophic factor expression in an exon promoter-specific manner. *J Neurosci Res.* 2012;90(5):1011–9.
56. Le Menuet D, Viengchareun S, Penfornis P, Walker F, Zennaro MC, Lombes M. Targeted oncogenesis reveals a distinct tissue-specific utilization of alternative promoters of the human mineralocorticoid receptor gene in transgenic mice. *J Biol Chem.* 2000;275(11):7878–86.
57. Oakley RH, Cidlowski JA. The biology of the glucocorticoid receptor: new signaling mechanisms in health and disease. *J Allergy Clin Immunol.* 2013;132(5):1033–44.
58. Tuvikene J, Pruunsild P, Orav E, Esvald EE, Timmusk T. AP-1 Transcription Factors Mediate BDNF-Positive Feedback Loop in Cortical Neurons. *J Neurosci.* 2016;36(4):1290–305.
59. Penfornis P, Viengchareun S, Le Menuet D, Cluzeaud F, Zennaro MC, Lombes M. The mineralocorticoid receptor mediates aldosterone-induced differentiation of T371 cells into brown adipocytes. *Am J Physiol Endocrinol Metab.* 2000;279(2):E386–394.
60. Numakawa T, Adachi N, Richards M, Chiba S, Kunugi H. Brain-derived neurotrophic factor and glucocorticoids: reciprocal influence on the central nervous system. *Neuroscience.* 2013;239:157–72.

61. Hellal-Levy C, Couette B, Fagart J, Souque A, Gomez-Sanchez C, Rafestin-Oblin M. Specific hydroxylations determine selective corticosteroid recognition by human glucocorticoid and mineralocorticoid receptors. *FEBS Lett.* 1999;464(1-2):9–13.
62. Lombes M, Kenouch S, Souque A, Farman N, Rafestin-Oblin ME. The mineralocorticoid receptor discriminates aldosterone from glucocorticoids independently of the 11 beta-hydroxysteroid dehydrogenase. *Endocrinology.* 1994;135(3):834–40.
63. Dougherty EJ, Elinoff JM, Ferreyra GA, Hou A, Cai R, Sun J, Blaine KP, Wang S, Danner RL: Mineralocorticoid Receptor (MR) Trans-Activation of Inflammatory AP-1 Signaling: Dependence on DNA Sequence, MR Conformation, and AP-1 Family Member Expression. *J Biol Chem* 2016.
64. Hua G, Paulen L, Chambon P. GR SUMOylation and formation of an SUMO-SMRT/NCoR1-HDAC3 repressing complex is mandatory for GC-induced IR nGRE-mediated transrepression. *Proc Natl Acad Sci U S A.* 2016;113(5):E626–634.
65. Vockley CM, D'Ippolito AM, McDowell IC, Majoros WH, Safi A, Song L, Crawford GE, Reddy TE. Direct GR Binding Sites Potentiate Clusters of TF Binding across the Human Genome. *Cell.* 2016;166(5):1269–81. e1219.
66. Tao X, Finkbeiner S, Arnold DB, Shaywitz AJ, Greenberg ME. Ca²⁺ influx regulates BDNF transcription by a CREB family transcription factor-dependent mechanism. *Neuron.* 1998;20(4):709–26.
67. Tao X, West AE, Chen WG, Corfas G, Greenberg ME. A calcium-responsive transcription factor, CaRF, that regulates neuronal activity-dependent expression of BDNF. *Neuron.* 2002;33(3):383–95.
68. Jiang X, Tian F, Du Y, Copeland NG, Jenkins NA, Tessarollo L, Wu X, Pan H, Hu XZ, Xu K, et al. BHLHB2 controls Bdnf promoter 4 activity and neuronal excitability. *J Neurosci.* 2008;28(5):1118–30.
69. Mallei A, Baj G, Ieraci A, Corna S, Musazzi L, Lee FS, Tongiorgi E, Popoli M: Expression and Dendritic Trafficking of BDNF-6 Splice Variant are Impaired in Knock-In Mice Carrying Human BDNF Val66Met Polymorphism. *Int J Neuropsychopharmacol.* 2015;18(12).

Submit your next manuscript to BioMed Central and we will help you at every step:

- We accept pre-submission inquiries
- Our selector tool helps you to find the most relevant journal
- We provide round the clock customer support
- Convenient online submission
- Thorough peer review
- Inclusion in PubMed and all major indexing services
- Maximum visibility for your research

Submit your manuscript at
www.biomedcentral.com/submit



Legend of Supplemental Figures

Supplemental Figure S1.

Comparison of gene expression in various models. BDNF (A), MAP2 (B), GR(C) and GFAP (D) mRNA expressions were measured by RT-qPCR and normalized to 36B4 expression in PCN, BZ cells, differentiated neurons from ES cells (ES-Neuron) and brain (n=3, means \pm SEM). Results are depicted with logarithmic y-scales owing to the large variation in expression levels between models. The gene expression/36B4 expression ratio values are indicated upon each histogram bars for clarity. E, Western blot on PCN, BZ cells and E18 mouse hippocampus (Hp E18), using 25 μ g of protein lysate with anti-GR and anti- α -tubulin antibodies.

Supplemental Figure S2.

GR stimulates *Sgk1* expression in BZ cells. A, Time course of SGK1 transcript expression under 10^{-7} M DEX (red) or vehicle treatment (blue), as measured by RT-qPCR. Results are expressed as attomol of SGK1 mRNA/ attomol of 36B4 mRNA. n=12; ** $P < 0.01$ vs Veh Mann Whitney U-tests. B, RT-qPCR analysis after 3 h treatment with 10^{-7} M DEX in the presence or absence of 10^{-6} M RU; vs Veh, n=12, means \pm SEM; * $P < 0.01$; vs DEX \$\$ $P < 0.01$.

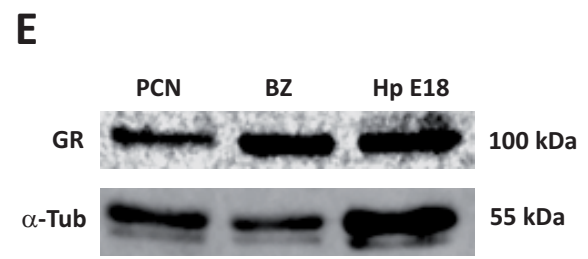
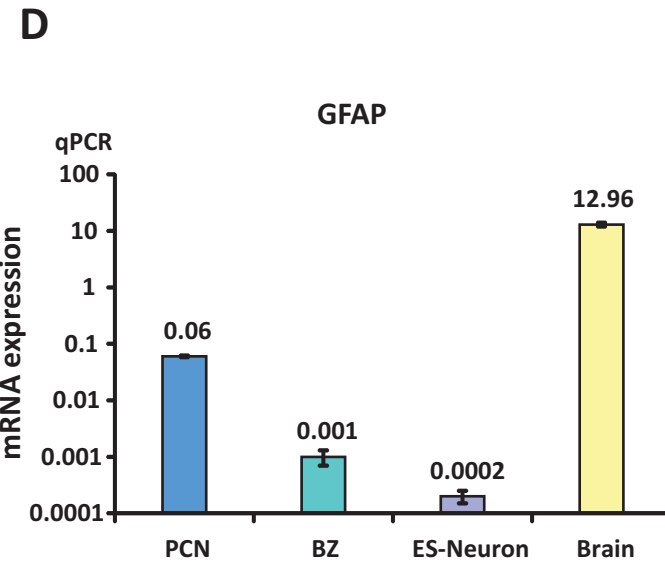
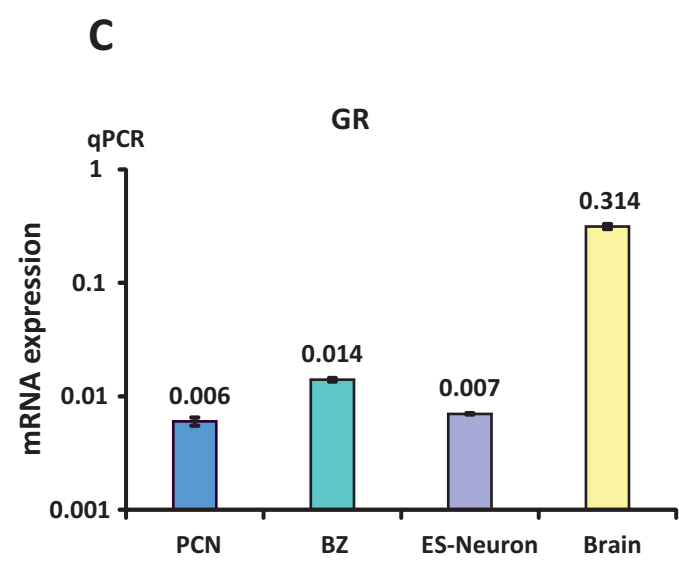
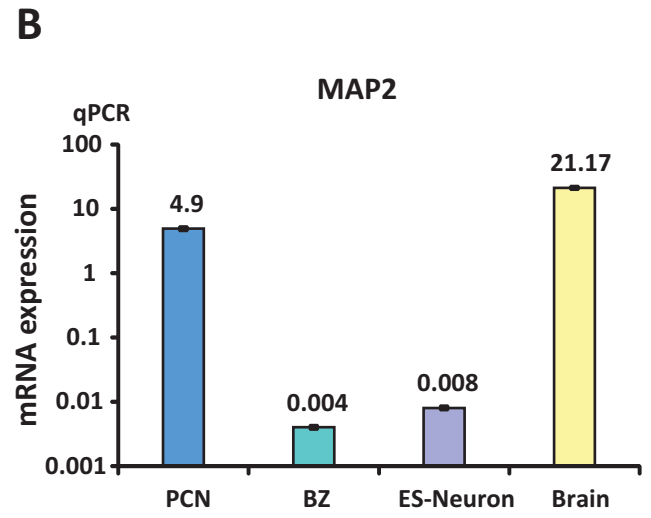
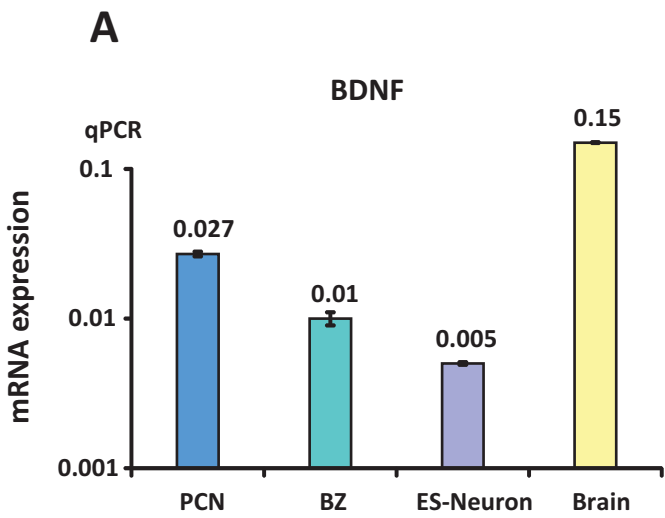

Supplemental Figure S1

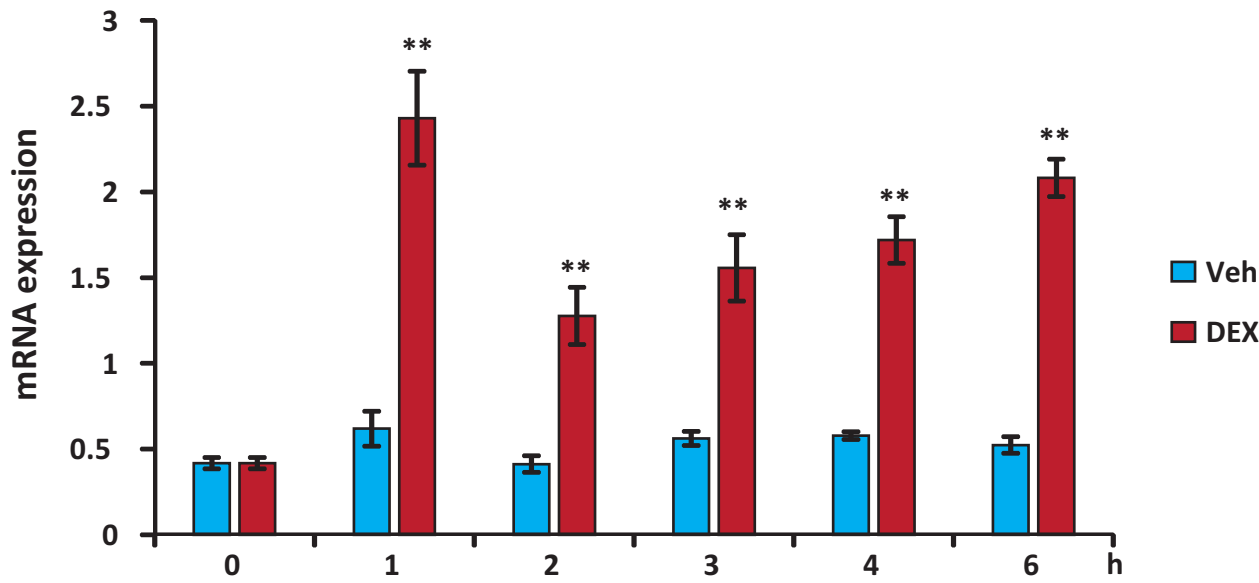
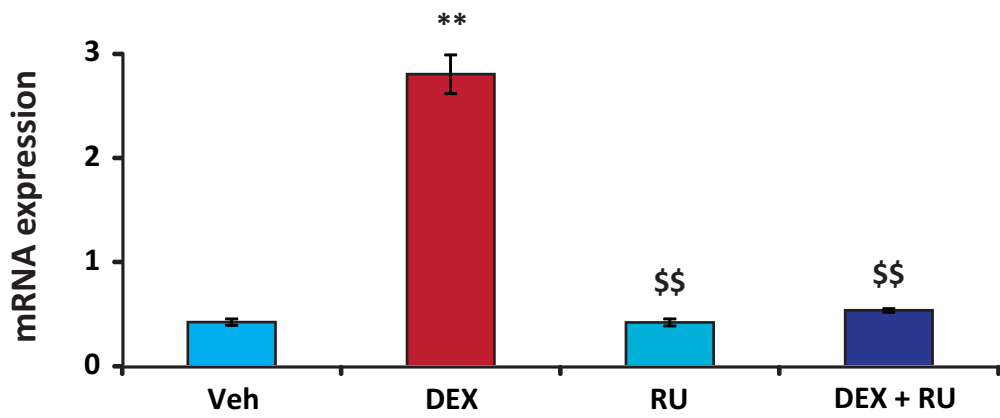
A**Sgk1 mRNA****B****Sgk1 mRNA**

Additional file 1: Table S1

Primer name	Sequence (5' to 3')
PCR	
BDNF exon IX F	AAAGTCCCCGGTATCCAAAGGCCAA
BDNF exon IX R	TAGTTCGGCATTGCGAGTTCCAGT
BDNF exon I F	CCTGCATCTGTTGGGGAGAC
BDNF exon I R	GCCTTGCCGTGGACGTTTA
BDNF exon II F	CTAGCCACCGGGGTGGTGTAA
BDNF exon II R	AGGATGGTCATCACTCTTCTC
BDNF exon III F	CTTCCTTGAGCCCAGTTCC
BDNF exon III R	CCGTGGACGTTTACTTCTTTT
BDNF exon IV F	CAGAGCAGCTGCCTTGATGTT
BDNF exon IV R	GCCTTGCCGTGGACGTTTA
BDNF exon VI F	CTGGGAGGCTTTGATGAGAC
BDNF exon VI R	GCCTTCATGCAACCGAAGTA
BDNF exon VII F	CTTACTTACAGGTCCAAGGTCAACG
BDNF exon VII R	CAGAGGGTCGGATACAGGCTG
BDNF exon VIII F	TCCCATCTACCCACACACTTTTATG
BDNF exon VIII R	TGTTCCGGCTCCACTGAGGCG
36B4 F	AGCGCGTCCTGGCATTGTCTGT
36B4 R	GGGCAGCAGTGGTGGCAGCAGC
GR F	TTCTGTTTCATGGCGTGAGTAC
GR R	CCCTTGGCACCTATTCCAGTT
NMDAR F	CAGGCTCAGAAACCCCTCAGA
NMDAR R	GATGGCCTCAGCTGCACTCT
MAP2 F	CCGGTCATCCATCCGAGTTA
MAP2 R	TCGACTAAGTGTGATCGTCCTT
β -Actin F	AAGTACCCCATTTGAACATGGCA
β -Actin R	CATCTTTTTCACGGTTGGCCTTA
Sgk1 F	TCACTTCTCATTCCAGACCGC
Sgk1 R	ATAGCCCAAGGCACTGGCTA
Promote rconstructs	
SP6BDNF F (with <i>XhoI</i>)	CGCCCTCGAGA AATTCTATTAGGCACACTCC
SP6BDNF R (with <i>HindIII</i>)	CGCTAAGCTT GGCAGTTGAAGGAACC
LP6BDNF F (with <i>XhoI</i>)	CGCCCTCGAG ACAGCTAAATGAAAGTAGCC
LP6BDNF R (with <i>HindIII</i>)	CGCTAAGCTT GGCAGTTGAAGGAACC
SP4BDNF F (with <i>XhoI</i>)	CGCCCTCGAG TGGAAGTGAAAACATCTACA
SP4BDNF R (with <i>HindIII</i>)	CGCTAAGCTT CTGGGAGATTTTCATGCTA
LP4BDNF F (with <i>XhoI</i>)	CGCCCTCGAG ACAGCTAAATGAAAGTAGCC
LP4BDNF R (with <i>HindIII</i>)	CGCTAAGCTT CCATTTGATCTAGGCAGA
Mutagenesis	
mAP1-1 F	CTGGAACGGAATTCTTCTAATAAAAAGATATTTTAAATGCGCGGAATTC
mAP1-1 R	GAATTCGCGCATTTTAAAATATCTTTTATTAGAAGAATTCGGTCCAG
mAP1-2 F	AAATGCGCGGAATTCTGCTGGTAATTCGTGCACT
mAP1-2 R	AGTGCACGAATTACCAGCAGAATTCGCGCATTT
mCRE1 F	GCTCCACGCTGCCTTGAGCTGTCATATGATA
mCRE1 R	TATCATATGACAGCTCCAAGGCAGCGTGGAGC
mCRE2 F	CGTGGAGCCCTCGGACTCCCACCC
mCRE2 R	GGGTGGGAGTCCGAGGGCTCCACG
ChIP	

BDNF PIV F	TAGATAATGACAGGCTTGG
BDNF PIV R	GCCTCGAAATAGACACTCT
Per1 F	ACCCCCTTCCTCCTAACTGTCT
Per1 R	CCAGCGCACTAGGGAACATC
UCP1 F	GGTGCCCTGTAAATGGTGTCT
UCP1 R	TGGCAGGAAGAGTGGAAGG

The primer sequences for BDNF (exon IX) are from Almeida et al., Mol Cell Neurosci, 2014; BDNF exons I, II, III, IV and VI are from Zajac et al., Hippocampus, 2010; BDNF exons VII and VIII are from Salerno et al., J Neurosci Res, 2012; the others are designed by authors. F: Forward primers, R: Reverse primers.

2. Supplementary results and discussion

In this article, we deciphered GR roles on regulating *Bdnf* expression and found a transrepression mechanism by which GR inhibits *Bdnf* transcriptional activity *via* tethering with other undetermined transcription factors, using several *in vitro* models. However, many issues are still needed to be illustrated carefully and some perspectives for answering to these questions are listed in the conclusion part of this chapter. For example, given that no GRE has been identified in the SP4 sequence, other transcription factors might probably cooperate to account for the GC-mediated downregulation of BDNF expression. Moreover, we did not analyze a potential MR action on BDNF expression, because neither BZ nor N2A cells express functional MR, limiting the study on this issue. Here, we depict and discuss some additional data obtained since the publication of the article.

2.1. Potential GR-binding DNA sequence and other transcription factors within the small region upstream of exon IV

As we have shown in the paper, we analyzed the potential binding sites in the 275 bp SP4 fragment just upstream of *Bdnf* exon IV, but we did not find any functional GRE sites, and we excluded as well two AP1 sites and two CRE sites. Interestingly, studies using ChIP-seq, have showed that GR occupies AP1 response elements, even in the absence of AP1-binding protein complexes suggesting that the tethering model (protein-protein interaction) is sometime insufficient to explain GR action on AP1 binding sites (Biddie, John et al. 2011, Uhlenhaut, Barish et al. 2013, Lim, Uhlenhaut et al. 2015). Additionally, Weikum et al reported very recently that GR binds directly to AP1 response elements via sequence-specific contacts to a GRE half-site embedded within the AP1 sites in a DNA-binding-dependent manner, to transrepress a subset of inflammatory genes (Weikum, de Vera et al. 2017). These findings show that GR utilizes multiple mechanisms to achieve context-specific transcriptional outcome and further expand our understanding of this complex multifaceted transcription factor. However, since the transcriptional activities of mutagenesis on motives AP1-1 and AP1-2 were still repressed by DEX treatment in a similar fashion than with the SP4 wild type fragment, and the deletion of these potential AP1 binding site sequence was targeted in the middle position nucleotides, this mechanism is likely to be excluded.

Some other groups have also analyzed the functionality of exon IV flanking sequence. Analyses on BDNF exon IV-containing transcript suggested that a 170 bp upstream exon IV

(totally included in SP4 sequence) contains three calcium response elements (CaRE), referred to as CaRE1, 2 and 3 (Fig. 23) (Zheng, Zhou et al. 2012).

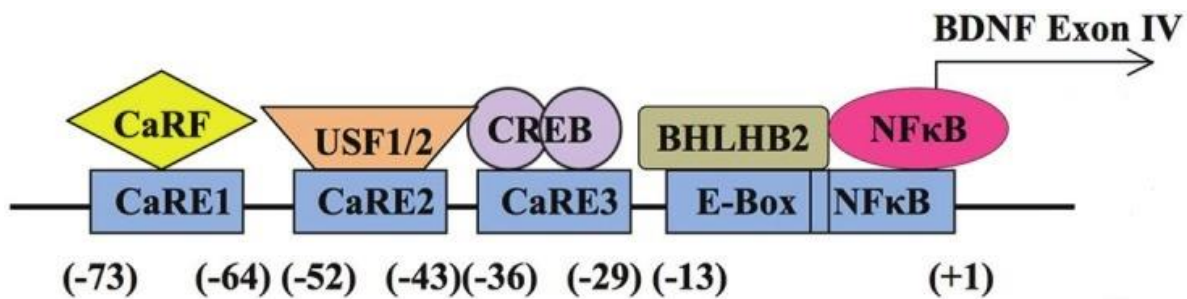

Fig. 23 The arrangement of functional cis-elements and the corresponding transcription factors in *Bdnf* promoter IV, according to Zheng et al. (Zheng, Zhou et al. 2012). The relative location of the sequences to the transcription initiation site (+1) is labeled. The E-Box and the NFκB sequence have one base pair overlap.

CaRE1, is located at -73 to -64 relative to the exon IV transcriptional initiation site, binding calcium-responsive transcription factor (CaRF); CaRE2 is located at -52 to -43, binding members of the basic helix-loop-helix (BHLH) family, USF1/2; CaRE3 locates between -36 and -29, binding CREB in vitro (Fig. 23) (Tao, Finkbeiner et al. 1998). Interestingly, the CaRE3 which has previously been reported to be a BHLHB2 binding element (Martinez-Levy, Rocha et al. 2017), is disrupted by our CRE2 mutant. In addition to the CaREs, accumulating evidence has also implicated the function of other cis-elements in regulating BDNF IV transcription. An NFκB site and a class B E-box (Lipsky, Xu et al. 2001, Jiang, Tian et al. 2008), have also been demonstrated to exist in a 22 bp segment spanning from -21 to +1 of the initiation site (Fig. 23). However, these sites did not show up with Jasp analysis and were reported in the rats but not in the mice. In order to identify the site of GR binding, we further narrowed down our promoter analysis by focusing on a shorter 74 bp DNA fragment upstream of exon IV, which was subcloned and was a part of the 275 bp SP4 (SP4.74, Fig. 24a). Its promoter activity was assessed by transient transfection experiments in N2A cells. Luciferase activities driven by this small DNA sequence were greatly decreased by GR agonist DEX 10^{-7} M, while coincubation with GR antagonist RU 486 reversed the repressing effect of DEX (Fig. 24b), indicating that even this tiny fragment still maintains the GR-induced repressing effect on *Bdnf* transcriptional activity, and more importantly, SP4.74 contains probably a site for GR repression. As a control, a PGL3.pro plasmid containing a minimal promoter was not regulated by DEX (Fig. 24c), stressing the specificity of GR action on SP4.74.

a

SP4 TGG AAGT GAAA ACAT CTACA AAGCAT GCAAT GCCCT GGAAC GGAATTC
 TTCTAATAAAAAGATGTATCATT TTTAAATGCGCGGAATTCTGATTCTGGTA
 ATTCGTGCACTAGAGTGTCTATTTTCGAGGCAGAGGAG **GTATCATATGAC**
AGCTCACGTCAAGGCAGCGTGGAGCCCTCTCGTGGACTCCCaccactttcc
cattcaccgaggagaggactgctctcgctgccgctccccccaccacccccggcgagctagcat
 gaaatctcccag

SP4.74 GTATCATATGACAGCTCACGTCAAGGCAGCGTGGAGCCCTCTCGTGGGA
 CTCCCaccactttcccattcaccga

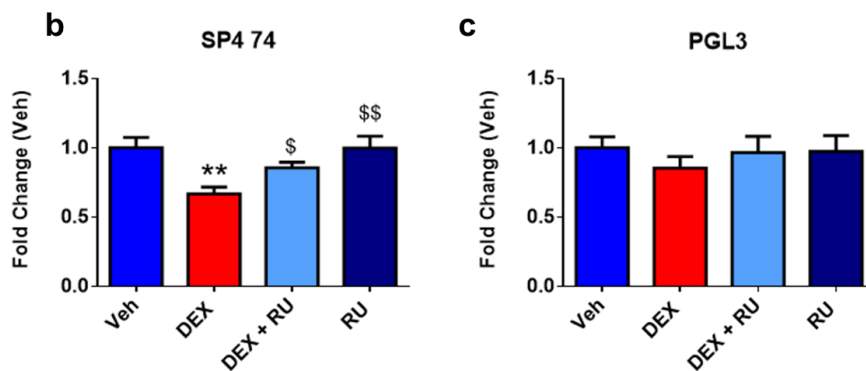

Fig. 24 GR-dependent inhibitory effects on the activity of a small *Bdbf* promoter construct SP4.74. a, Comparison of DNA sequences of SP4 and SP4.74, the latter being highlighted by the blue lines below within the former. The nucleotide sequence is from NCBI website. The black capital letters are sequence from promoter 4, while the red lowercase letters represent that from the beginning of exon IV. b, Transfection of SP4.74 in N2A cells, 24 h treatment with Veh, DEX (10^{-7} M), RU (10^{-6} M) and a combination of both. c, Transfection of PGL3 in N2A cells, 24 h treatment with Veh, DEX, RU and both. Results are expressed as fold change of the luciferase/protein values. Veh condition is arbitrary set at 1; n=8, Mean \pm SEM; ** $P < 0.01$, DEX vs Veh; \$ $p < 0.05$, \$\$ $p < 0.01$, vs DEX; Mann Whitney U-tests.

We extensively analyzed this smaller fragment with Jaspar website (URL: http://jaspar.genereq.net/cqi-bin/jaspar_db.pl), discovering several interesting candidate element sites, such as an aryl hydrocarbon receptor (AhR, a xenobiotic receptor) response element (AhR.RE) located in -26 to -21 and a member of Neuro D/Oligo neuronal transcription factor response element family, located in -51 to -41 (Fig. 25). It has been reported that both of these transfection factors can interact with GR (Sakata, Woo et al. 2009, van Weert, Buurstede et al. 2017). For example, Wang et al concluded that the AhR functionally interacts with the GR, through which GR transactivation activity is further enhanced, and in contrast, AhR transactivation activity is inhibited (Sakata, Woo et al. 2009). Furthermore, Jin et al. recently provided a molecular mechanism of crosstalk between AhR

and GR in target gene expression in human retinal pigment epithelial cells (Jin and Choi 2017), indicating that the AhR-RE in SP4.74 may be a good candidate for GR transrepression. Concerning Neuro D factors, a recent study demonstrated that 3 NeuroD family members (Neurod1, Neurod2 and Neurod6) acted as DNA-binding dependent coactivators for both MR and GR in reporter assays in heterologous HEK293 cells, likely *via* indirect interactions with the receptors (van Weert, Buurstede et al. 2017). However, identification of these motifs as mediator of GR repression *via* functional interaction with these binding proteins remains to be further investigated by mutagenesis of SP4.74 luciferase plasmid and transfection together with ChIP experiments in order to fully validate this hypothesis.

Neuro/oligo.RE
CRE1
AhR.RE
CRE2

SP4.74 **GTATCATATGACAGCTCACGTC**AAGGC**AGCGTG**GAGCCCT**TCTCGTGGA**

CTCCC**accactttccattcaccga**

Response element name	Score
Ahr::Arnt	8.070
Neurog1	6.041
Neurog2	4.456
oligo2	3.819
oligo3	3.628

Fig. 25 Aryl hydrocarbon receptor response element (AhR.RE) and Neuro/oligo response element (Neuro/oligo. RE) in SP4.74, as well as two CREs. The black letters are sequence from promoter 4, while the red ones are that from exon IV. The yellow highlighted regions are putative CRE sites, the pink AhR.RE site and the green Neuro/oligo.RE site (analyzed by the Jaspar database). The scores for AhR.RE and Neuro/oligo.RE obtained by Jasper database are listed below the map of SP4.74.

2.2. Promoter 1 activity was repressed by GR

As shown in the paper, we found that GR has an inhibitory effect on the expression of exons I, IV, and VI containing transcripts, but not that of exons VII or VIII, indicating that this mechanism could be important for exon specific repression of *Bdnf* expression. In the present study, we did not focus much on exon I because its expression level was lower than exon IV and VI in PCN and extremely low in BZ cells. Moreover, the sequence upstream exon IV being well characterized by other groups (Tao, Finkbeiner et al. 1998, Martinez-Levy, Rocha et al. 2017) in the context of neuronal excitability, we were interested in investigating the action of GC signaling on this promoter. Anyhow, we have assessed exon I promoter activity

on a 2.5 kb region driven luciferase construct LP1. We found that the luciferase activity of LP1 was also repressed by DEX, which was antagonized by RU486 (Fig. 26a). However, the exon I regulatory sequence exhibited a more than 10-fold lower transcriptional activity than the large LP6 fragment we analyzed (Fig. 26b), upstream of exon IV and VI, indicating that exon I regulation was likely of lesser importance under these experimental conditions. Additionally, the relative expression of exon I-containing transcripts was also much lower in PCN compared to that of exon IV and VI, and the fact that exon I was poorly expressed in BZ cells limits the interest of such investigations. In summary, given that exon I expression and promoter activity were lower than those of exon IV and VI in PCN as well as in BZ cells, it is very unlikely that exon I plays a major role in BDNF action in our models.

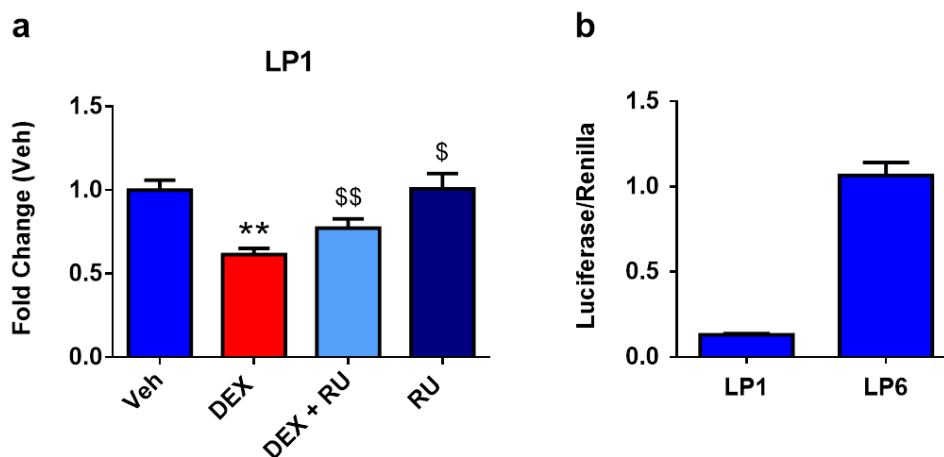

Fig. 26 GR-dependent inhibitory effects on LP1 activity. a, Transfection of LP1 in N2A cells, 24 h treatment with Veh, DEX (10^{-7} M), RU (10^{-6} M) and a combination of both. Results are expressed as fold change of the luciferase/Renilla values. Veh condition is arbitrary set at 1; n=16, Mean \pm SEM; ** $P < 0.01$, DEX vs Veh; \$ $p < 0.05$, \$\$ $p < 0.01$, vs DEX; Mann Whitney U-tests. b, Luciferase activity normalized to Renilla activity of LP1 and LP6 *Bdnf* promoter fragments transfected in N2A Cells.

3. Conclusion and Perspectives

In this second part, we analyzed the effect of DEX on BDNF expression in mouse PCN and in the BZ cell line, demonstrating that DEX significantly downregulated total BDNF mRNA expression. Expressions of the abundant exon IV and VI BDNF containing transcripts as well as the weakly expressed exon I-containing isoform, were also reduced by DEX, but not that of exons VII and VIII. Furthermore, RU486 abolished these DEX-induced effects, consistent with GR-mediated action. Moreover, a short 275 bp region (recently even further narrowed down to a 74 bp fragment) within exon IV promoter and responsible for GR-mediated BDNF repression was identified as a critical regulatory sequence using transient transfection assays. ChIP experiments determined GR recruitment onto this region maybe through transcription factor tethering. In conclusion, in the present work, we demonstrated that GR represses BDNF expression through binding to, at least in part, just upstream exon IV transcription start site. In this manner, GC signaling seems to antagonize neuronal activity and synaptic plasticity acting on the same promoter region than different factors that promote it such as the AP-1 and CREB.

As many promising aspects of this study just start to be investigated, this project will be carried on in the laboratory along different directions. An important point is that, even if PCN are a model of choice in neuroscience, the utilization of survival cocktails, such as the widely used B27, that contains several growth factors and hormones, including glucocorticoids, presents with some limitations to decipher the action of GR and particularly MR. To circumvent this problem, the use of a B27 cocktail exempt of glucocorticoid may be a solution, if the neuronal culture quality is not drastically affected. This strategy could be useful to investigate the potentially dose- and time-dependent effects of corticosteroid hormones on BDNF expression mediated by GR and MR. More generally, the contribution of each receptor to many aspects of neuron functioning being still a matter of debate (Polman, de Kloet et al. 2013, van Weert, Buurstede et al. 2017), the possibility to grow PCN, even for a short time without glucocorticoids is attractive.

To investigate the role of MR on BDNF expression, we have recently generated some BZ cell lines stably transfected with human MR (*hMR*) expression vector pCDNA3-hMR, some of them expressing a high level of *hMR* mRNA and are currently under characterization. Indeed, there is no commercially available immortalized neuronal cell line that expresses substantial amounts of functional MR. Of note, an optimization of the BZ cell transfection protocol

facilitated the generation of the stably transfected clones. Given that BZ cells express high level of BDNF and GR, a cellular model that could stably express endogenous MR would be extremely helpful to study the regulation of BDNF expression by corticosteroids, especially if culture of glucocorticoid-free PCN is not possible. Particularly, the balance between MR and GR action on BDNF expression could be analyzed in this cell line.

GENERAL DISCUSSION AND PERSPECTIVES

As mentioned in the introduction section, BDNF and GC have been shown to be extensively involved in behavioral and cognitive processes (Kang, Welcher et al. 1997, Tyler, Alonso et al. 2002, Pang, Teng et al. 2004, Radecki, Brown et al. 2005, Nooshinfar, Akbarzadeh-Baghban et al. 2011). In the present work, we were committed to decipher the crosstalk between those two molecules in neurons. Here, we will put in perspective our findings with previous works from the literature.

1. BDNF expression is regulated by GR at the transcriptional level

Comparing to the well characterized regulation on *Bdnf* expression by neuronal activity, few research has been done on its transcriptional regulation by GC. Particularly, among all the promoters, the regulatory feature of the promoter 4 upstream of exon IV has received most attention. Additionally, epigenetic regulation of the *Bdnf* gene induced by some major environmental factors in rodents mainly focused on the modifications at promoter 4 (Boulle, van den Hove et al. 2012). Incidentally, we focus on the GR involvement in regulating the transcriptional activity of promoter 4, using transient transfections, mutagenesis and ChIP experiments. We demonstrated that GR inhibits the promoter 4 activity by binding to the small DNA sequence upstream of exon IV, probably by interacting with other transcription factors. However, mutagenesis analyses did not provide a clear answer to the question on which DNA motifs GR recruitment occurs, even though the involvement of the putative binding sites for two types of transcription factors, JUN/FOS and CREB, was excluded. Taken together, GR regulates *Bdnf* expression at a transcriptional level in these cellular models.

It has been suggested that changes in BDNF mRNA expression levels predominantly arose as a consequence of altered transcription rather than through possible changes on mRNA stability. Furthermore, we also demonstrated in BZ cells that DEX did not affect the rate of the BDNF mRNA turnover in the presence of a transcription inhibitor DRB, consistent with the hypothesis that DEX reduced BDNF transcript levels through a transcriptional repression but not *via* mRNA degradation. However, GR regulation on *Bdnf* was hypothesized to occur in part through the modification of mRNA stability, translation efficiency, processing, trafficking and secretion, in addition to the transcriptional level (Suri and Vaidya 2013). However, experimental evidence in support to this idea is currently limited, and potential effects of GC on both transcription and degradation of BDNF mRNAs still need to be tested. It is unknown whether the stability of BDNF transcript isoforms is somehow altered by GC

exposure. In addition to the effects at the level of BDNF mRNA, GC could also influence BDNF synthesis (Shah, Kimball et al. 2000), secretion (Kino, Jaffe et al. 2010) and processing. However, this has not been clearly addressed experimentally.

2. GR and BDNF promoters are involved in neuronal activity

Consistent with what we found in neuronal cell culture models, high GC concentration was reported to repress hippocampal BDNF expression levels *via* GR activation in living rodents as well (Alboni, Tascetta et al. 2011, Wosiski-Kuhn, Erion et al. 2014), resulting in aberrant synaptic plasticity (Zhou, Zhang et al. 2000, Alboni, Tascetta et al. 2011, Wosiski-Kuhn, Erion et al. 2014, Park, Lee et al. 2015). Recently, using a transgenic mouse model of obesity and diabetes (leptin receptor deficient, db/db mice), which presents a high GC level, Wosiski-Kuhn et al. revealed that synaptic deficits evoked by exposure to elevated GC levels may be attributable to GR-mediated transrepression of AP-1 actions at BDNF promoters 1 and 4 (Wosiski-Kuhn, Erion et al. 2014). Through coimmunoprecipitation analysis with antibodies against GR and Fos, a component of the AP1 heterodimer, they found that nuclear GR associates with Fos in db/db mice, but not in wildtype mice. ChIP experiments with an anti-Fos antibody have been also performed in hippocampal tissues from db/db and wildtype mice. It was showed a weaker Fos recruitment onto BDNF promoter 1 and 4 in db/db mice than that in wildtype mice (Wosiski-Kuhn, Erion et al. 2014). Additionally, GR involvement in this mechanism was determined by the use of a corticosterone synthesis inhibitor, metyrapone (Wosiski-Kuhn, Erion et al. 2014). These findings indicate that exposure to elevated GC in the hippocampus impaired synaptic plasticity and spatial memory by repressing BDNF promoter activities. Moreover, it was proposed that, of the eight BDNF promoters, promoters 1 and 4 are the most responsive to neuronal activity both *in vitro* and *in vivo* (Timmusk, Palm et al. 1993, Tao, Finkbeiner et al. 1998, Rattiner, Davis et al. 2004).

Given previous work indicating the importance of promoter 1- and 4-mediated transcriptional activation of BDNF for activity-dependent plasticity (Pruunsild, Sepp et al. 2011, Wosiski-Kuhn, Erion et al. 2014), we focus on analyzing the expression and promoter activity of exon I, IV, and VI. In fact, we found that high GC level transrepressed the transcriptional activities of BDNF promoter 1 and 4 in the *in vitro* cellular models we used, such as the inhibitory regulation of high GC on the expression of exon I, IV and VI- containing transcripts in PCN and BZ cells as well as on the luciferase activation driven by promoter 1 and 4 in N2A cells. However, the mRNA expression of transcript isoforms spliced from exon VII or VIII was not

changed, indicating a differential effect of GR on *Bdnf* mRNA isoform expression in neuronal cells.

3. Exon-specificity of BDNF expression in brain pathophysiology

BDNF is an important neurotrophin involved in brain pathophysiology, and in particular, epigenetic inactivation of promoter 4 has been reported in depressed patients (Keller, Sarchiapone et al. 2010, Hing, Davidson et al. 2012) and stressed animals (Tsankova, Berton et al. 2006, Fuchikami, Morinobu et al. 2009). Using a knockout of exon IV (KIV) mouse model, young adult mice lacking promoter 4-driven BDNF but carrying the other 8 promoters and the BDNF protein-coding region (Sakata, Woo et al. 2009), the Sakata's group has shown causal evidence that defective promoter 4 leads to depression-like behavior (Sakata, Jin et al. 2010). In addition to stress-related diseases, the activities of different BDNF promoters have been also reported to be involved in pathological processes of other CNS disorders. Beta-amyloid (A β) is an important pathological hallmark in AD. A treatment of A β in cortical neuron cultures resulted in a short time increase (3 - 5 h) in BDNF expression, that seemed to be driven by increased expression of transcripts I and IV (Aliaga, Silhol et al. 2010). Very recently, it was reported that in the cortex of epilepsy patients, a significant increase of both BDNF transcripts I and VI was found as compared to the control group, as well as an increased expression of *CREB* and *GR* genes (Martinez-Levy, Rocha et al. 2017). Altogether, these findings indicate an exon-specificity of BDNF expression in the pathophysiological processes of various brain disorders.

4. Spatial distribution of BDNF transcripts

The complexity of the multiple *Bdnf* transcripts is probably of importance in the regulation of the multiple functions of BDNF protein. Along this line, based on several studies, a "spatial code" hypothesis of BDNF transcripts was proposed by Tongiorgi's group, according to which different BDNF splice variants, through the spatial segregation of their mRNA, constitute a code to selectively direct BDNF protein to differential subcellular localization in the soma or dendrites. This represents a mechanism by which local synthesis of proteins at distinct sites triggers local effects (Pattabiraman, Tropea et al. 2005, Chiaruttini, Sonogo et al. 2008, Baj, Leone et al. 2011, Baj, D'Alessandro et al. 2012, Baj, Del Turco et al. 2013).

Using densitometric analysis of quantification of in situ hybridization data on the subcellular distribution of the most abundant BDNF transcripts, it was shown that exons II and VI localized into distal dendrites, whereas exons I and IV were restricted to the soma in the hippocampus and cortex during epilepsy in rat (Pattabiraman, Tropea et al. 2005, Chiaruttini, Sonogo et al. 2008). Furthermore, silencing individual endogenous transcripts or overexpressing BDNF-GFP transcripts in cultured neurons demonstrated that whereas some transcripts (I and IV) were found selectively in proximal dendrites, others (II and VI) were found in distal dendrites (Baj, Leone et al. 2011). These studies indicate that spatial segregation of BDNF transcripts enables BDNF proteins to differentially shape distinct dendritic compartments. In this manner, the effect of DEX on the subcellular localization of BDNF isoforms in PCN is of interest.

Additionally, dendritic enrichment of BDNF transcripts encoding exons VI and VII in CA1, exons I, VI, and IXa in CA3 of the hippocampus, and exons V, VI, VII, and VIII in DG, were found in rats, with the exon VI being the main transcript in dendrites (Baj, Del Turco et al. 2013). Interestingly, the hippocampus of rats treated by pilocarpine, a muscarinic receptor agonist, displayed enhanced network excitability (Knopp, Kivi et al. 2005), exhibited an increase of BDNF exon IV- and VI- containing transcripts in dendrites (Baj, Del Turco et al. 2013). These results provide further support for the hypothesis of spatial code to differentially regulate BDNF in the somatic or dendritic compartments in response to local synaptic activity.

The detailed description of the spatial code for BDNF transcripts proposed by Tongiorgi's group asks the question on the general function of this spatial code in stress response, neuronal plasticity and physical exercise. It was hypothesized that the antidepressant treatments and physical exercise exert their beneficial effects through upregulation of BDNF in limbic brain regions, which is required to support survival and differentiation of newly generated DG or neurons (Cotman and Berchtold 2002, Castren 2004, Russo-Neustadt and Chen 2005, Duman and Monteggia 2006). Indeed, several lines of evidence was provided to show that antidepressants, antipsychotic drugs, and physical exercise regulate selectively expression of BDNF transcript isoforms (Garza, Ha et al. 2004, Khundakar and Zetterstrom 2006, Baj, D'Alessandro et al. 2012). For instance, it was shown that physical exercise and antidepressants induce a general increase of BDNF mRNA and protein in the soma of hippocampal neurons and a selective increase of BDNF in dendrites of CA3 neurons, which

was accounted for by exon VI variant (Baj, D'Alessandro et al. 2012). These results add one further piece of evidence for the hypothesis of antidepressant actions through neurotrophin regulation and function in the hippocampus and that of spatial code for a selective expression of *Bdnf* in specific subcellular districts. This spatial code hypothesis predicts that these therapies may specifically upregulate BDNF splice variants in one region of the dendritic tree, which may result in activation and reinforcement of specific neural networks (Baj, D'Alessandro et al. 2012). Thus, to define the specific localization of BDNF transcripts derived from distinct exons, contributing to the therapeutic effects of pharmacological or behavioral treatments, may provide key information about the neuronal circuits involved in these responses (Baj, D'Alessandro et al. 2012, Baj, Del Turco et al. 2013).

In our work, total BDNF protein levels assessed by Western Blot after 6 and 24 h treatment with DEX were not affected, neither in PCN nor in BZ cells (data not shown). Since it seems that alteration of *Bdnf* expression induced by GR occurs at the transcriptional level, it can be concluded that not only the expression levels of total BDNF mRNA but also those of its transcript isoforms are important for BDNF action. Furthermore, the spatial code of BDNF transcript distribution determining in which subcellular regions the variant splices are produced, translated and secreted, as well as exerting their actions, may be of more importance than total amount of BDNF protein measured in a whole sample.

5. Conservation of BDNF SP4 sequence between human and mouse

Homology of human and rodent BDNF 5' untranslated exons ranges from 95% to 45%, reaching 95% for exon I, 91% for exon IV, 86% for exon VI (Liu, Walther et al. 2005, Aid, Kazantseva et al. 2007). Moreover, we analyzed the conservation of the small 275 bp region and found the precise homology between human and rodent SP4 sequence is 92%. Of note, the beginning of exon IV included in the short 275 bp fragment shows a lower similarity comparing the upstream promoter sequence (Fig. 27). Furthermore, we analyzed the SP4 fragment from human *Bdnf* gene with Jaspas website, discovering that all of the potential DNA motifs for AP1, CREB, AhR and Neuro/oligo binding sites are conserved in human, and their sequences show an almost 100% similarity to those in mouse, except a CREB site (Fig. 27). Interestingly, two additional Neuro/oligo response elements are detected in the SP4 equivalent region of the human gene (Fig. 27), which may indicate important transcriptional regulation *via* this region with additional functions in humans. Taken together, the high conservation of the exon IV and VI, especially of the SP4 fragment and of the putative

transcription factor DNA binding sites, are of importance in searching the regulatory mechanisms of mouse *Bdnf* expression and function, as well as the molecular events involved in GR-mediated transcriptional alterations on BDNF exon IV and VI.

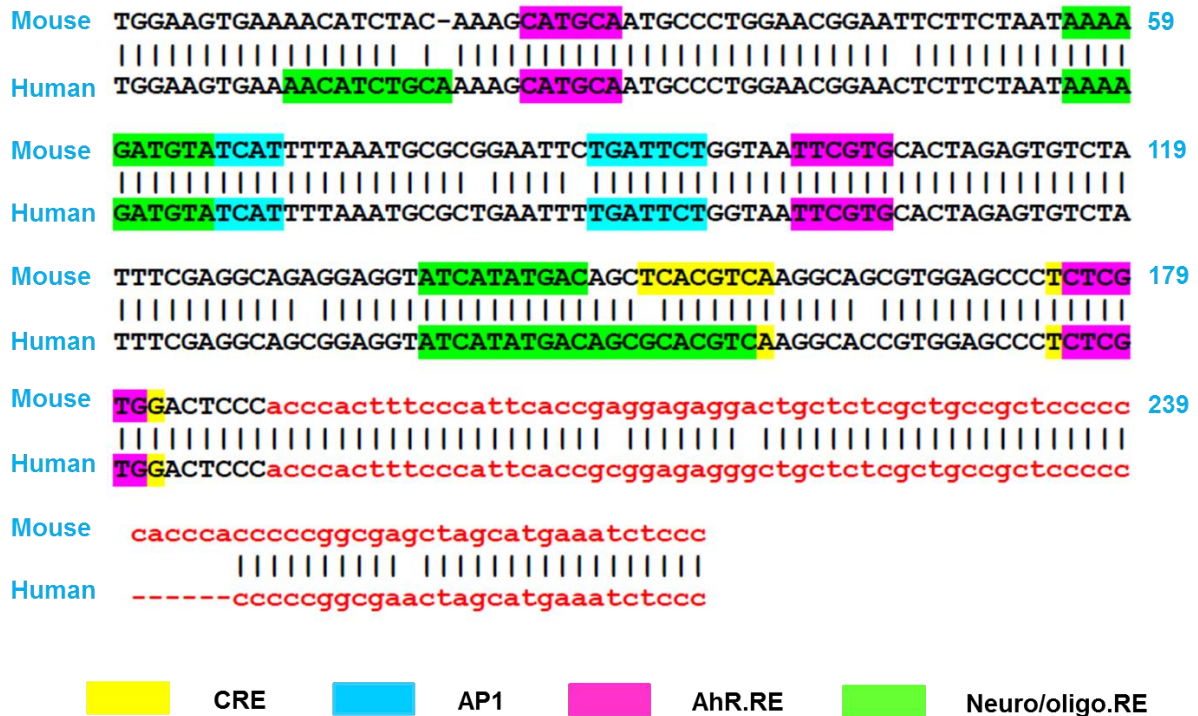

Fig. 27 The analysis on homology of mouse and human SP4 DNA sequence, as well as the similarity of potential response elements of AP1, CREB, AhR and Neuro/oligo family.

The black letters are sequence from promoter 4, while the red ones are that from exon IV. The homological score of SP4 sequences between human and mouse is 92%. The yellow highlighted regions are putative CRE sites; the blue ones are potential AP1 sites; the pink ones are AhR.RE sites and the green ones are Neuro/oligo.RE sites (analyzed by the Jaspar database). Some sequences of response elements are overlapped.

As the SP4 GR responsive sequence we defined was already characterized as sensitive to synaptic activity, an interesting perspective would be to study the interaction between compounds that stimulate neuronal activity (FK, KCl and kainic acid) as well as some neurotoxic compounds (peroxide) and the MR/GR signaling pathways. This could be performed by analyzing *Bdnf* expression level, as well as the various signaling pathways affected by neuronal activity and corticosteroid hormone actions, using our current models (BZ, PCN and N2A cells) and the ones currently under development such as BZ-hMR and glucocorticoid-free PCN cultures. Eventually, this work will be carried on in the laboratory to investigate the different issues we have just described. Indeed, it is of importance to better understand the crosstalks between the two corticosteroid receptors in neurons, MR and GR

and the neurotrophin signaling for the sake of scientific knowledge, but also because these two pathways are involved in many neurological disorders.

GENERAL CONCLUSIONS

It was reported that alterations in BDNF expression and functions are associated to numerous neuropsychiatric and neurodegenerative diseases. Decrease of BDNF expression promotes pathological processes whereas an increase of BDNF signaling facilitates neuronal recovery. Implementation of “BDNF therapies”, however, challenges a large number of methodological and pharmacokinetic issues. A better knowledge of the mechanisms regulating BDNF expression and signaling is of importance in the process to solve these issues (Jeanneteau and Chao 2013).

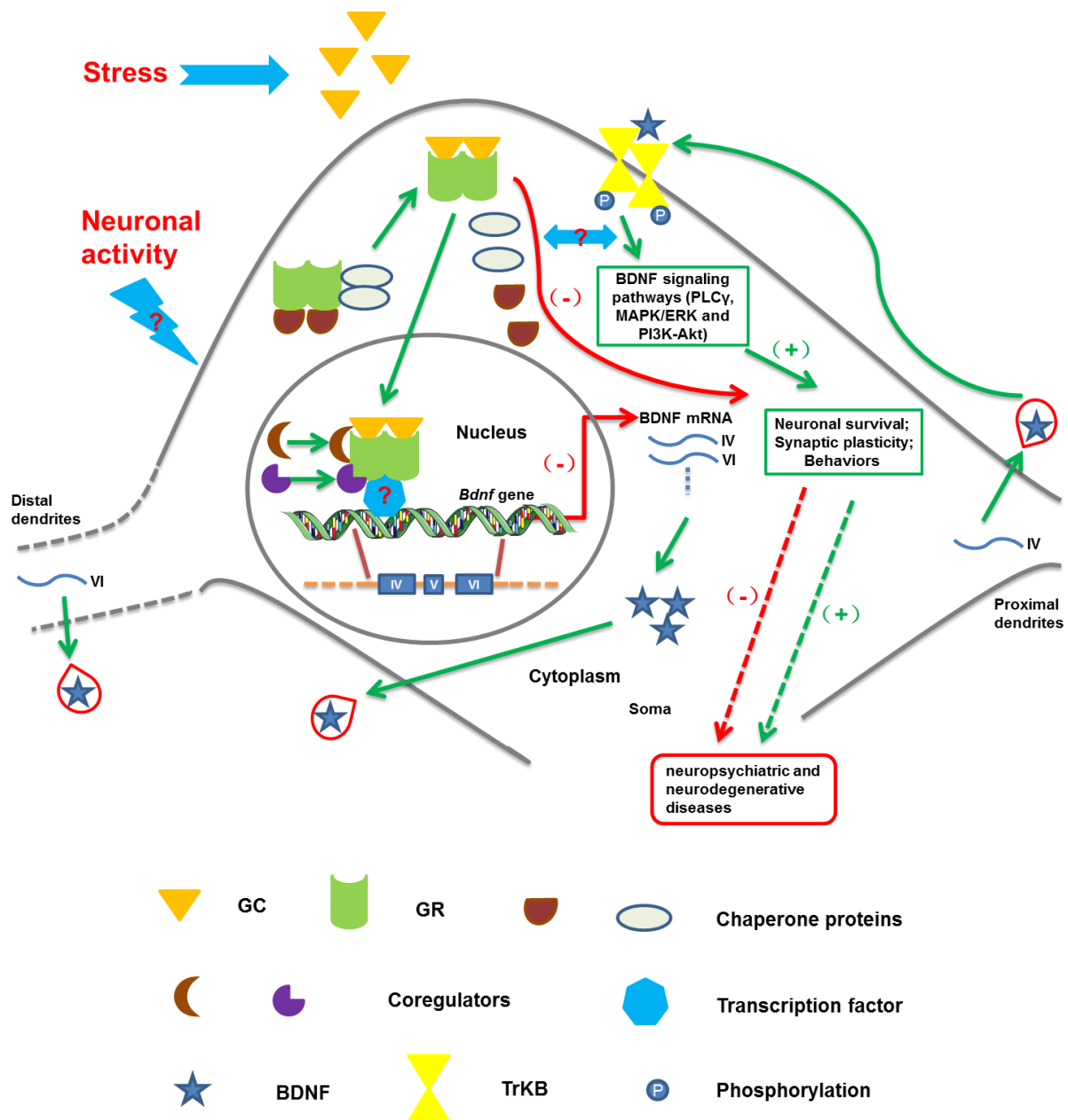

Fig. 28. Schematic drawing of interplay between GC and BDNF signaling pathways in the neurons. Glucocorticoid receptor (GR) is kept in the cytoplasm under an inactive form by its binding with the chaperone proteins. When glucocorticoid (GC) concentrations are elevated, such as under stress, GC bind

GR. Ligand-activated GR translocates into the nucleus, where it binds to some undefined transcription factors bound to the DNA sequence upstream of exon IV within *Bdnf* gene, resulting at least in part in the transcriptional repression of *Bdnf*. BDNF mRNAs, comprising a large amount of exon IV- and VI-containing transcripts, are translated into a common protein, which is secreted from the soma, proximal or distal dendrites. BDNF binds to its receptor TrkB, activating distinct signaling pathways that promote neuronal survival, synaptic plasticity and behaviors. It is hypothesized that these processes are also regulated by GR, whose signaling may interact with that of BDNF, eventually affecting the pathology of neuropsychiatric and neurodegenerative diseases.

Glucocorticoids are stress-related hormones, while *Bdnf* is a stress-sensitive gene, and both of them are involved in the modulation of the cognitive and behavioral processes (Fig. 28) (Kang, Welcher et al. 1997, Tyler, Alonso et al. 2002, Pang, Teng et al. 2004, Radecki, Brown et al. 2005, Nooshinfar, Akbarzadeh-Baghbani et al. 2011). High GC level exposure decreases dendritic arborization and synaptic density in the hippocampus (Tata, Marciano et al. 2006), while increased BDNF levels reinforce the maintenance of synapses and dendritic fields in the adult nervous system (Poo 2001). Furthermore, downregulation of BDNF expression induced by stress/GC mediates deleterious effects of prolonged GR activation on neuronal survival, synaptic plasticity and behavior, which correlate with cognitive deficits and mood disorders (Duman, Heninger et al. 1997, Duman and Monteggia 2006). Imbalance of the GC and neurotrophic systems may impair neural connectivity and precipitate the development of psychiatric disorders as previously proposed (Duman, Heninger et al. 1997, Krishnan and Nestler 2008). Therefore, it was hypothesized that BDNF and GC activities are calibrated, and the tuning between both BDNF and GC activities may determine a wide range of effects from synaptic plasticity to various CNS disorders such as neurodegenerative diseases (Jeanneteau and Chao 2013).

We used several *in vitro* cellular models treated with high levels of GC, mimicking stress conditions, and demonstrated that GC downregulate BDNF mRNA expression levels, especially exon IV- and VI- containing transcripts, at a transcriptional level (Fig. 28). All of the GC actions are considered due to a GR action, because they are suppressed by a GR antagonist, mifepristone (RU486), which is widely used by other groups in the functional and mechanistic study on GR. Although total BDNF protein expression was not altered by GC in several cellular models, the subcellular localization and secretion of distinct BDNF variant splices may be more pivotal for its functions. According to the literatures (Pattabiraman, Tropea et al. 2005, Chiaruttini, Sonogo et al. 2008), we propose that in the basal status, exon IV variant splice is concentrated into the soma and functions on the proximal dendrites, while exon VI is mainly expressed in the distal dendrites (Fig. 28). Of note, exon IV is sensitive to

neuronal activity and is reported to be transferred to distal dendrites where it exerts effects cooperating with exon VI.

However, many questions on the interplay between GC and BDNF signaling in the CNS are still open. For example, in which manner does GR bind to *Bdnf* gene sequence upstream of exon IV, on which exact region this mechanism occurs, and which coregulators and transcription factors are needed during these genetic and epigenetic processes (Fig. 28)? To date to our knowledge, GR DNA-binding response elements have not been identified in many promoters of the *Bdnf* gene, including promoter 4. Furthermore, does this alteration of *Bdnf* expression induced by GR affect the neurotrophin signaling pathways as well as GR signaling, both of which contribute to regulate synaptic plasticity and behaviors (Fig. 28)? On the other hand, neuronal network activity contributes to BDNF expression (Lu 2003), and stimulates BDNF secretion, which may result in strengthening and maintenance of active synapses (Snider and Lichtman 1996, Poo 2001). Based on this theory, does neuronal activity alter or even reverse this GR-mediated regulation on BDNF (Fig. 28)? Additionally, due to the limited presence of functional MR in the cellular models we used, we did not go further with MR actions on this potential target gene. However, analyzing specific effects and mechanisms induced by MR agonists and antagonists in some appropriate cellular models will be of much importance and interest. Another critical step of practical significance is research on animal models, such as stress-induced depressed rodents, that should be utilized to investigate the hypotheses already proposed in the light of a potential MR and GR acting dialogue on BDNF signaling.

Altogether, characterizing the molecular mechanisms by which GC and BDNF signaling pathways interact, may provide targets to prevent the harmful effects of GC excess and to reinforce the beneficial actions of BDNF, which prime the resilience and recovery from severe stressful experiences and contribute to the rescue of neuropsychiatric and neurodegenerative diseases.

REFERENCES

- Abraham, I. M., T. Harkany, K. M. Horvath and P. G. Luiten (2001). "Action of glucocorticoids on survival of nerve cells: promoting neurodegeneration or neuroprotection?" J Neuroendocrinol **13**(9): 749-760.
- Abrari, K., A. Rashidy-Pour, S. Semnanian, Y. Fathollahi and M. Jadid (2009). "Post-training administration of corticosterone enhances consolidation of contextual fear memory and hippocampal long-term potentiation in rats." Neurobiol Learn Mem **91**(3): 260-265.
- Aid, T., A. Kazantseva, M. Piirsoo, K. Palm and T. Timmusk (2007). "Mouse and rat BDNF gene structure and expression revisited." J Neurosci Res **85**(3): 525-535.
- Al-Majed, A. A., S. L. Tam and T. Gordon (2004). "Electrical stimulation accelerates and enhances expression of regeneration-associated genes in regenerating rat femoral motoneurons." Cell Mol Neurobiol **24**(3): 379-402.
- Alberch, J., E. Perez-Navarro and J. M. Canals (2004). "Neurotrophic factors in Huntington's disease." Prog Brain Res **146**: 195-229.
- Alboni, S., F. Tascetta, D. Corsini, C. Benatti, F. Caggia, G. Capone, N. Barden, J. M. Blom and N. Brunello (2011). "Stress induces altered CRE/CREB pathway activity and BDNF expression in the hippocampus of glucocorticoid receptor-impaired mice." Neuropharmacology **60**(7-8): 1337-1346.
- Alford, L. (2010). "What men should know about the impact of physical activity on their health." Int J Clin Pract **64**(13): 1731-1734.
- Aliaga, E., M. Silhol, N. Bonneau, T. Maurice, S. Arancibia and L. Tapia-Arancibia (2010). "Dual response of BDNF to sublethal concentrations of beta-amyloid peptides in cultured cortical neurons." Neurobiol Dis **37**(1): 208-217.
- Aliaga, E. E., I. Mendoza and L. Tapia-Arancibia (2009). "Distinct subcellular localization of BDNF transcripts in cultured hypothalamic neurons and modification by neuronal activation." J Neural Transm (Vienna) **116**(1): 23-32.
- Allen, A. P., P. J. Kennedy, J. F. Cryan, T. G. Dinan and G. Clarke (2014). "Biological and psychological markers of stress in humans: focus on the Trier Social Stress Test." Neurosci Biobehav Rev **38**: 94-124.
- Allen, S. J., J. J. Watson and D. Dawbarn (2011). "The neurotrophins and their role in Alzheimer's disease." Curr Neuropharmacol **9**(4): 559-573.
- An, J. J., K. Gharami, G. Y. Liao, N. H. Woo, A. G. Lau, F. Vanevski, E. R. Torre, K. R. Jones, Y. Feng, B. Lu and B. Xu (2008). "Distinct role of long 3' UTR BDNF mRNA in spine morphology and synaptic plasticity in hippocampal neurons." Cell **134**(1): 175-187.
- Anacker, C., P. A. Zunszain, L. A. Carvalho and C. M. Pariante (2011). "The glucocorticoid receptor: pivot of depression and of antidepressant treatment?" Psychoneuroendocrinology **36**(3): 415-425.

- Anacker, C., P. A. Zunszain, A. Cattaneo, L. A. Carvalho, M. J. Garabedian, S. Thuret, J. Price and C. M. Pariante (2011). "Antidepressants increase human hippocampal neurogenesis by activating the glucocorticoid receptor." Mol Psychiatry **16**(7): 738-750.
- Anastasia, A., K. Deinhardt, M. V. Chao, N. E. Will, K. Irmady, F. S. Lee, B. L. Hempstead and C. Bracken (2013). "Val66Met polymorphism of BDNF alters prodomain structure to induce neuronal growth cone retraction." Nat Commun **4**: 2490.
- Angelucci, F., S. Brene and A. A. Mathe (2005). "BDNF in schizophrenia, depression and corresponding animal models." Mol Psychiatry **10**(4): 345-352.
- Antal, A., L. Chaieb, V. Moliadze, K. Monte-Silva, C. Poreisz, N. Thirugnanasambandam, M. A. Nitsche, M. Shoukier, H. Ludwig and W. Paulus (2010). "Brain-derived neurotrophic factor (BDNF) gene polymorphisms shape cortical plasticity in humans." Brain Stimul **3**(4): 230-237.
- Antoniades, C. A. and C. Watts (2013). "Huntington's disease and cell therapies: past, present, and future." Methods Mol Biol **1010**: 19-32.
- Arbib, M. A., P. Érdi and J. Szentágothai (1998). "Neural Organization: Structure, Function, and Dynamics." The MIT Press.
- Arnett, M. G., B. J. Kolber, M. P. Boyle and L. J. Muglia (2011). "Behavioral insights from mouse models of forebrain--and amygdala-specific glucocorticoid receptor genetic disruption." Mol Cell Endocrinol **336**(1-2): 2-5.
- Arriza, J. L., R. B. Simerly, L. W. Swanson and R. M. Evans (1988). "The neuronal mineralocorticoid receptor as a mediator of glucocorticoid response." Neuron **1**(9): 887-900.
- Asadi, A., E. Hedman, C. Widen, J. Zilliacus, J. A. Gustafsson and A. C. Wikstrom (2008). "FMS-like tyrosine kinase 3 interacts with the glucocorticoid receptor complex and affects glucocorticoid dependent signaling." Biochem Biophys Res Commun **368**(3): 569-574.
- Asmundson, G. J., M. G. Fetzner, L. B. Deboer, M. B. Powers, M. W. Otto and J. A. Smits (2013). "Let's get physical: a contemporary review of the anxiolytic effects of exercise for anxiety and its disorders." Depress Anxiety **30**(4): 362-373.
- Autry, A. E. and L. M. Monteggia (2012). "Brain-derived neurotrophic factor and neuropsychiatric disorders." Pharmacol Rev **64**(2): 238-258.
- Ayrout, M., V. Simon, V. Bernard, N. Binart, J. Cohen-Tannoudji, M. Lombes and S. Chauvin (2017). "A novel non genomic glucocorticoid signaling mediated by a membrane palmitoylated glucocorticoid receptor cross talks with GnRH in gonadotrope cells." Sci Rep **7**(1): 1537.
- Aziz, N. A., H. Pijl, M. Frolich, A. W. van der Graaf, F. Roelfsema and R. A. Roos (2009). "Increased hypothalamic-pituitary-adrenal axis activity in Huntington's disease." J Clin Endocrinol Metab **94**(4): 1223-1228.
- Badanich, K. A., M. E. Fakhri, T. S. Gurina, E. K. Roy, J. L. Hoffman, A. R. Uruena-Agnes and C. L. Kirstein (2016). "Reversal learning and experimenter-administered chronic intermittent ethanol exposure in male rats." Psychopharmacology (Berl) **233**(19-20): 3615-3626.

- Bagley, J. A. and L. Belluscio (2010). "Dynamic imaging reveals that brain-derived neurotrophic factor can independently regulate motility and direction of neuroblasts within the rostral migratory stream." Neuroscience **169**(3): 1449-1461.
- Baj, G., V. D'Alessandro, L. Musazzi, A. Mallei, C. R. Sartori, M. Sciancalepore, D. Tardito, F. Langone, M. Popoli and E. Tongiorgi (2012). "Physical exercise and antidepressants enhance BDNF targeting in hippocampal CA3 dendrites: further evidence of a spatial code for BDNF splice variants." Neuropsychopharmacology **37**(7): 1600-1611.
- Baj, G., D. Del Turco, J. Schlaudraff, L. Torelli, T. Deller and E. Tongiorgi (2013). "Regulation of the spatial code for BDNF mRNA isoforms in the rat hippocampus following pilocarpine-treatment: a systematic analysis using laser microdissection and quantitative real-time PCR." Hippocampus **23**(5): 413-423.
- Baj, G., E. Leone, M. V. Chao and E. Tongiorgi (2011). "Spatial segregation of BDNF transcripts enables BDNF to differentially shape distinct dendritic compartments." Proc Natl Acad Sci U S A **108**(40): 16813-16818.
- Baker, M. E., J. W. Funder and S. R. Kattoula (2013). "Evolution of hormone selectivity in glucocorticoid and mineralocorticoid receptors." J Steroid Biochem Mol Biol **137**: 57-70.
- Baker, M. E. and Y. Katsu (2017). "Evolution of the mineralocorticoid receptor: sequence, structure and function." J Endocrinol.
- Bamberger, C. M., A. M. Bamberger, M. de Castro and G. P. Chrousos (1995). "Glucocorticoid receptor beta, a potential endogenous inhibitor of glucocorticoid action in humans." J Clin Invest **95**(6): 2435-2441.
- Bamberger, C. M., H. M. Schulte and G. P. Chrousos (1996). "Molecular determinants of glucocorticoid receptor function and tissue sensitivity to glucocorticoids." Endocr Rev **17**(3): 245-261.
- Barbany, G. and H. Persson (1992). "Regulation of Neurotrophin mRNA Expression in the Rat Brain by Glucocorticoids." Eur J Neurosci **4**(5): 396-403.
- Barde, Y. A., D. Edgar and H. Thoenen (1982). "Purification of a new neurotrophic factor from mammalian brain." Embo j **1**(5): 549-553.
- Barden, N. (2004). "Implication of the hypothalamic-pituitary-adrenal axis in the pathophysiology of depression." J Psychiatry Neurosci **29**(3): 185-193.
- Barnabe-Heider, F. and F. D. Miller (2003). "Endogenously produced neurotrophins regulate survival and differentiation of cortical progenitors via distinct signaling pathways." J Neurosci **23**(12): 5149-5160.
- Barnes, P. J. (1998). "Anti-inflammatory actions of glucocorticoids: molecular mechanisms." Clin Sci (Lond) **94**(6): 557-572.
- Barrot, M., D. N. Abrous, M. Marinelli, F. Rouge-Pont, M. Le Moal and P. V. Piazza (2001). "Influence of glucocorticoids on dopaminergic transmission in the rat dorsolateral striatum." Eur J Neurosci **13**(4): 812-818.

- Barsegyan, A., S. M. Mackenzie, B. D. Kurose, J. L. McGaugh and B. Roozendaal (2010). "Glucocorticoids in the prefrontal cortex enhance memory consolidation and impair working memory by a common neural mechanism." Proc Natl Acad Sci U S A **107**(38): 16655-16660.
- Beato, M. (1989). "Gene regulation by steroid hormones." Cell **56**(3): 335-344.
- Beaudoin, G. M., 3rd, S. H. Lee, D. Singh, Y. Yuan, Y. G. Ng, L. F. Reichardt and J. Arikath (2012). "Culturing pyramidal neurons from the early postnatal mouse hippocampus and cortex." Nat Protoc **7**(9): 1741-1754.
- Beck, I. M., W. Vanden Berghe, L. Vermeulen, K. R. Yamamoto, G. Haegeman and K. De Bosscher (2009). "Crosstalk in inflammation: the interplay of glucocorticoid receptor-based mechanisms and kinases and phosphatases." Endocr Rev **30**(7): 830-882.
- Belfer, I. and F. Dai (2010). "Phenotyping and genotyping neuropathic pain." Curr Pain Headache Rep **14**(3): 203-212.
- Bell, B., J. J. Lin, M. Seidenberg and B. Hermann (2011). "The neurobiology of cognitive disorders in temporal lobe epilepsy." Nat Rev Neurol **7**(3): 154-164.
- Berger, S., D. P. Wolfer, O. Selbach, H. Alter, G. Erdmann, H. M. Reichardt, A. N. Chepkova, H. Welzl, H. L. Haas, H. P. Lipp and G. Schutz (2006). "Loss of the limbic mineralocorticoid receptor impairs behavioral plasticity." Proc Natl Acad Sci U S A **103**(1): 195-200.
- Berghuis, P., K. Agerman, M. B. Dobszay, L. Minichiello, T. Harkany and P. Ernfors (2006). "Brain-derived neurotrophic factor selectively regulates dendritogenesis of parvalbumin-containing interneurons in the main olfactory bulb through the PLCgamma pathway." J Neurobiol **66**(13): 1437-1451.
- Bernd, P. (2008). "The role of neurotrophins during early development." Gene Expr **14**(4): 241-250.
- Bibel, M. and Y. A. Barde (2000). "Neurotrophins: key regulators of cell fate and cell shape in the vertebrate nervous system." Genes Dev **14**(23): 2919-2937.
- Bibel, M., E. Hoppe and Y. A. Barde (1999). "Biochemical and functional interactions between the neurotrophin receptors trk and p75NTR." Embo j **18**(3): 616-622.
- Biddie, S. C., S. John, P. J. Sabo, R. E. Thurman, T. A. Johnson, R. L. Schiltz, T. B. Miranda, M. H. Sung, S. Trump, S. L. Lightman, C. Vinson, J. A. Stamatoyannopoulos and G. L. Hager (2011). "Transcription factor AP1 potentiates chromatin accessibility and glucocorticoid receptor binding." Mol Cell **43**(1): 145-155.
- Binder, D. K., S. D. Croll, C. M. Gall and H. E. Scharfman (2001). "BDNF and epilepsy: too much of a good thing?" Trends Neurosci **24**(1): 47-53.
- Binder, D. K. and H. E. Scharfman (2004). "Brain-derived neurotrophic factor." Growth Factors **22**(3): 123-131.
- Bird, A. (2007). "Perceptions of epigenetics." Nature **447**(7143): 396-398.

- Bishop, J. F., G. P. Mueller and M. M. Mouradian (1994). "Alternate 5' exons in the rat brain-derived neurotrophic factor gene: differential patterns of expression across brain regions." Brain Res Mol Brain Res **26**(1-2): 225-232.
- Bjorkqvist, M., A. Petersen, K. Bacos, J. Isaacs, P. Norlen, J. Gil, N. Popovic, F. Sundler, G. P. Bates, S. J. Tabrizi, P. Brundin and H. Mulder (2006). "Progressive alterations in the hypothalamic-pituitary-adrenal axis in the R6/2 transgenic mouse model of Huntington's disease." Hum Mol Genet **15**(10): 1713-1721.
- Bledsoe, R. K., V. G. Montana, T. B. Stanley, C. J. Delves, C. J. Apolito, D. D. McKee, T. G. Consler, D. J. Parks, E. L. Stewart, T. M. Willson, M. H. Lambert, J. T. Moore, K. H. Pearce and H. E. Xu (2002). "Crystal structure of the glucocorticoid receptor ligand binding domain reveals a novel mode of receptor dimerization and coactivator recognition." Cell **110**(1): 93-105.
- Blendy, J. A. (2006). "The role of CREB in depression and antidepressant treatment." Biol Psychiatry **59**(12): 1144-1150.
- Bliss, T. V. and G. L. Collingridge (1993). "A synaptic model of memory: long-term potentiation in the hippocampus." Nature **361**(6407): 31-39.
- Bolanos, C. A. and E. J. Nestler (2004). "Neurotrophic mechanisms in drug addiction." Neuromolecular Med **5**(1): 69-83.
- Boulle, F., D. L. van den Hove, S. B. Jakob, B. P. Rutten, M. Hamon, J. van Os, K. P. Lesch, L. Lanfumey, H. W. Steinbusch and G. Kenis (2012). "Epigenetic regulation of the BDNF gene: implications for psychiatric disorders." Mol Psychiatry **17**(6): 584-596.
- Boyle, M. P., J. A. Brewer, M. Funatsu, D. F. Wozniak, J. Z. Tsien, Y. Izumi and L. J. Muglia (2005). "Acquired deficit of forebrain glucocorticoid receptor produces depression-like changes in adrenal axis regulation and behavior." Proc Natl Acad Sci U S A **102**(2): 473-478.
- Bredy, T. W., H. Wu, C. Crego, J. Zellhoefer, Y. E. Sun and M. Barad (2007). "Histone modifications around individual BDNF gene promoters in prefrontal cortex are associated with extinction of conditioned fear." Learn Mem **14**(4): 268-276.
- Broadwater, M. A., W. Liu, F. T. Crews and L. P. Spear (2014). "Persistent loss of hippocampal neurogenesis and increased cell death following adolescent, but not adult, chronic ethanol exposure." Dev Neurosci **36**(3-4): 297-305.
- Brown, H. E., N. Pearson, R. E. Braithwaite, W. J. Brown and S. J. Biddle (2013). "Physical activity interventions and depression in children and adolescents : a systematic review and meta-analysis." Sports Med **43**(3): 195-206.
- Brummelte, S. and L. A. Galea (2010). "Chronic high corticosterone reduces neurogenesis in the dentate gyrus of adult male and female rats." Neuroscience **168**(3): 680-690.
- Buckley, N. J., R. Johnson, C. Zuccato, A. Bithell and E. Cattaneo (2010). "The role of REST in transcriptional and epigenetic dysregulation in Huntington's disease." Neurobiol Dis **39**(1): 28-39.

- Busillo, J. M. and J. A. Cidlowski (2013). "The five Rs of glucocorticoid action during inflammation: ready, reinforce, repress, resolve, and restore." Trends Endocrinol Metab **24**(3): 109-119.
- Cadet, J. L. and V. Bisagno (2014). "Glial-neuronal ensembles: partners in drug addiction-associated synaptic plasticity." Front Pharmacol **5**: 204.
- Caldwell, K. K., S. Sheema, R. D. Paz, S. L. Samudio-Ruiz, M. H. Laughlin, N. E. Spence, M. J. Roehl, S. N. Alcon and A. M. Allan (2008). "Fetal alcohol spectrum disorder-associated depression: evidence for reductions in the levels of brain-derived neurotrophic factor in a mouse model." Pharmacol Biochem Behav **90**(4): 614-624.
- Calvino, B. and R. M. Grilo (2006). "Central pain control." Joint Bone Spine **73**(1): 10-16.
- Castren, E. (2004). "Neurotrophic effects of antidepressant drugs." Curr Opin Pharmacol **4**(1): 58-64.
- Castren, E. (2004). "Neurotrophins as mediators of drug effects on mood, addiction, and neuroprotection." Mol Neurobiol **29**(3): 289-302.
- Castren, E. and M. Kojima (2017). "Brain-derived neurotrophic factor in mood disorders and antidepressant treatments." Neurobiol Dis **97**(Pt B): 119-126.
- Castren, E. and T. Rantamaki (2010). "The role of BDNF and its receptors in depression and antidepressant drug action: Reactivation of developmental plasticity." Dev Neurobiol **70**(5): 289-297.
- Cattaneo, E., C. Zuccato and M. Tartari (2005). "Normal huntingtin function: an alternative approach to Huntington's disease." Nat Rev Neurosci **6**(12): 919-930.
- Chan, J. P., J. Cordeira, G. A. Calderon, L. K. Iyer and M. Rios (2008). "Depletion of central BDNF in mice impedes terminal differentiation of new granule neurons in the adult hippocampus." Mol Cell Neurosci **39**(3): 372-383.
- Chantong, B., D. V. Kratschmar, L. G. Nashev, Z. Balazs and A. Odermatt (2012). "Mineralocorticoid and glucocorticoid receptors differentially regulate NF-kappaB activity and pro-inflammatory cytokine production in murine BV-2 microglial cells." J Neuroinflammation **9**: 260.
- Chao, H. M. and B. S. McEwen (1994). "Glucocorticoids and the expression of mRNAs for neurotrophins, their receptors and GAP-43 in the rat hippocampus." Brain Res Mol Brain Res **26**(1-2): 271-276.
- Chao, M. V. (2003). "Neurotrophins and their receptors: a convergence point for many signalling pathways." Nat Rev Neurosci **4**(4): 299-309.
- Chen, B., D. Dowlatshahi, G. M. MacQueen, J. F. Wang and L. T. Young (2001). "Increased hippocampal BDNF immunoreactivity in subjects treated with antidepressant medication." Biol Psychiatry **50**(4): 260-265.
- Chen, C., S. Nakagawa, Y. An, K. Ito, Y. Kitaichi and I. Kusumi (2017). "The exercise-glucocorticoid paradox: How exercise is beneficial to cognition, mood, and the brain while increasing glucocorticoid levels." Front Neuroendocrinol **44**: 83-102.

- Chen, H., M. Lombes and D. Le Menuet (2017). "Glucocorticoid receptor represses brain-derived neurotrophic factor expression in neuron-like cells." **10(1)**: 12.
- Chen, Z. Y., D. Jing, K. G. Bath, A. Ieraci, T. Khan, C. J. Siao, D. G. Herrera, M. Toth, C. Yang, B. S. McEwen, B. L. Hempstead and F. S. Lee (2006). "Genetic variant BDNF (Val66Met) polymorphism alters anxiety-related behavior." Science **314**(5796): 140-143.
- Chen, Z. Y., P. D. Patel, G. Sant, C. X. Meng, K. K. Teng, B. L. Hempstead and F. S. Lee (2004). "Variant brain-derived neurotrophic factor (BDNF) (Met66) alters the intracellular trafficking and activity-dependent secretion of wild-type BDNF in neurosecretory cells and cortical neurons." J Neurosci **24**(18): 4401-4411.
- Chetty, S., A. R. Friedman, K. Taravosh-Lahn, E. D. Kirby, C. Mirescu, F. Guo, D. Krupik, A. Nicholas, A. C. Geraghty, A. Krishnamurthy, M. K. Tsai, D. Covarrubias, A. T. Wong, D. D. Francis, R. M. Sapolsky, T. D. Palmer, D. Pleasure and D. Kaufer (2014). "Stress and glucocorticoids promote oligodendrogenesis in the adult hippocampus." Mol Psychiatry **19**(12): 1275-1283.
- Cheung, L. W., K. W. Leung, C. K. Wong, R. N. Wong and A. S. Wong (2011). "Ginsenoside-Rg1 induces angiogenesis via non-genomic crosstalk of glucocorticoid receptor and fibroblast growth factor receptor-1." Cardiovasc Res **89**(2): 419-425.
- Chiaruttini, C., M. Sonogo, G. Baj, M. Simonato and E. Tongiorgi (2008). "BDNF mRNA splice variants display activity-dependent targeting to distinct hippocampal laminae." Mol Cell Neurosci **37**(1): 11-19.
- Chiba, S., T. Numakawa, M. Ninomiya, M. C. Richards, C. Wakabayashi and H. Kunugi (2012). "Chronic restraint stress causes anxiety- and depression-like behaviors, downregulates glucocorticoid receptor expression, and attenuates glutamate release induced by brain-derived neurotrophic factor in the prefrontal cortex." Prog Neuropsychopharmacol Biol Psychiatry **39**(1): 112-119.
- Cho, H. J., J. K. Kim, H. C. Park, J. K. Kim, D. S. Kim, S. O. Ha and H. S. Hong (1998). "Changes in brain-derived neurotrophic factor immunoreactivity in rat dorsal root ganglia, spinal cord, and gracile nuclei following cut or crush injuries." Exp Neurol **154**(1): 224-230.
- Cho, H. J., J. K. Kim, X. F. Zhou and R. A. Rush (1997). "Increased brain-derived neurotrophic factor immunoreactivity in rat dorsal root ganglia and spinal cord following peripheral inflammation." Brain Res **764**(1-2): 269-272.
- Chu, N. N., Y. F. Zuo, L. Meng, D. Y. Lee, J. S. Han and C. L. Cui (2007). "Peripheral electrical stimulation reversed the cell size reduction and increased BDNF level in the ventral tegmental area in chronic morphine-treated rats." Brain Res **1182**: 90-98.
- Clemmensen, C., C. Pehmoller, A. B. Klein, C. Ratner, J. F. Wojtaszewski and H. Brauner-Osborne (2013). "Enhanced voluntary wheel running in GPRC6A receptor knockout mice." Physiol Behav **118**: 144-151.
- Cockrem, J. F. (2013). "Individual variation in glucocorticoid stress responses in animals." Gen Comp Endocrinol **181**: 45-58.

- Cohen, A. D., J. L. Tillerson, A. D. Smith, T. Schallert and M. J. Zigmond (2003). "Neuroprotective effects of prior limb use in 6-hydroxydopamine-treated rats: possible role of GDNF." J Neurochem **85**(2): 299-305.
- Colcombe, S. and A. F. Kramer (2003). "Fitness effects on the cognitive function of older adults: a meta-analytic study." Psychol Sci **14**(2): 125-130.
- Colgin, L. L., T. Denninger, M. Fyhn, T. Hafting, T. Bonnevie, O. Jensen, M. B. Moser and E. I. Moser (2009). "Frequency of gamma oscillations routes flow of information in the hippocampus." Nature **462**(7271): 353-357.
- Collingridge, G. L., S. Peineau, J. G. Howland and Y. T. Wang (2010). "Long-term depression in the CNS." Nat Rev Neurosci **11**(7): 459-473.
- Committee, N. R. N. (1999). "A unified nomenclature system for the nuclear receptor superfamily." Cell **97**(2): 161-163.
- Connor, B., D. Young, Q. Yan, R. L. Faull, B. Synek and M. Dragunow (1997). "Brain-derived neurotrophic factor is reduced in Alzheimer's disease." Brain Res Mol Brain Res **49**(1-2): 71-81.
- Conti, A. C., J. F. Cryan, A. Dalvi, I. Lucki and J. A. Blendy (2002). "cAMP response element-binding protein is essential for the upregulation of brain-derived neurotrophic factor transcription, but not the behavioral or endocrine responses to antidepressant drugs." J Neurosci **22**(8): 3262-3268.
- Cotman, C. W. and N. C. Berchtold (2002). "Exercise: a behavioral intervention to enhance brain health and plasticity." Trends Neurosci **25**(6): 295-301.
- Crochemore, C., J. Lu, Y. Wu, Z. Liposits, N. Sousa, F. Holsboer and O. F. Almeida (2005). "Direct targeting of hippocampal neurons for apoptosis by glucocorticoids is reversible by mineralocorticoid receptor activation." Mol Psychiatry **10**(8): 790-798.
- Croll, S. D., C. Suri, D. L. Compton, M. V. Simmons, G. D. Yancopoulos, R. M. Lindsay, S. J. Wiegand, J. S. Rudge and H. E. Scharfman (1999). "Brain-derived neurotrophic factor transgenic mice exhibit passive avoidance deficits, increased seizure severity and in vitro hyperexcitability in the hippocampus and entorhinal cortex." Neuroscience **93**(4): 1491-1506.
- Csernansky, J. G., H. Dong, A. M. Fagan, L. Wang, C. Xiong, D. M. Holtzman and J. C. Morris (2006). "Plasma cortisol and progression of dementia in subjects with Alzheimer-type dementia." Am J Psychiatry **163**(12): 2164-2169.
- Cunha, C., R. Brambilla and K. L. Thomas (2010). "A simple role for BDNF in learning and memory?" Front Mol Neurosci **3**: 1.
- Datson, N. A., J. van der Perk, E. R. de Kloet and E. Vreugdenhil (2001). "Identification of corticosteroid-responsive genes in rat hippocampus using serial analysis of gene expression." Eur J Neurosci **14**(4): 675-689.
- Dauer, W. and S. Przedborski (2003). "Parkinson's disease: mechanisms and models." Neuron **39**(6): 889-909.

- Day, M., Z. Wang, J. Ding, X. An, C. A. Ingham, A. F. Shering, D. Wokosin, E. Ilijic, Z. Sun, A. R. Sampson, E. Mugnaini, A. Y. Deutch, S. R. Sesack, G. W. Arbuthnott and D. J. Surmeier (2006). "Selective elimination of glutamatergic synapses on striatopallidal neurons in Parkinson disease models." Nat Neurosci **9**(2): 251-259.
- de Kloet, E. R. (2013). "Functional profile of the binary brain corticosteroid receptor system: mediating, multitasking, coordinating, integrating." Eur J Pharmacol **719**(1-3): 53-62.
- de Kloet, E. R., M. Joels and F. Holsboer (2005). "Stress and the brain: from adaptation to disease." Nat Rev Neurosci **6**(6): 463-475.
- de Kloet, E. R., M. S. Oitzl and M. Joels (1999). "Stress and cognition: are corticosteroids good or bad guys?" Trends Neurosci **22**(10): 422-426.
- de Kloet, E. R., S. A. Van Acker, R. M. Sibug, M. S. Oitzl, O. C. Meijer, K. Rahmouni and W. de Jong (2000). "Brain mineralocorticoid receptors and centrally regulated functions." Kidney Int **57**(4): 1329-1336.
- De Kloet, E. R., E. Vreugdenhil, M. S. Oitzl and M. Joels (1998). "Brain corticosteroid receptor balance in health and disease." Endocr Rev **19**(3): 269-301.
- DeBattista, C., J. Belanoff, S. Glass, A. Khan, R. L. Horne, C. Blasey, L. L. Carpenter and G. Alva (2006). "Mifepristone versus placebo in the treatment of psychosis in patients with psychotic major depression." Biol Psychiatry **60**(12): 1343-1349.
- Desarnaud, F., S. Bidichandani, P. I. Patel, E. E. Baulieu and M. Schumacher (2000). "Glucocorticosteroids stimulate the activity of the promoters of peripheral myelin protein-22 and protein zero genes in Schwann cells." Brain Res **865**(1): 12-16.
- Diamond, D. M. and G. M. Rose (1994). "Stress impairs LTP and hippocampal-dependent memory." Ann N Y Acad Sci **746**: 411-414.
- Dickerson, S. S. and M. E. Kemeny (2004). "Acute stressors and cortisol responses: a theoretical integration and synthesis of laboratory research." Psychol Bull **130**(3): 355-391.
- Dieni, S., T. Matsumoto, M. Dekkers, S. Rauskolb, M. S. Ionescu, R. Deogracias, E. D. Gundelfinger, M. Kojima, S. Nestel, M. Frotscher and Y. A. Barde (2012). "BDNF and its pro-peptide are stored in presynaptic dense core vesicles in brain neurons." J Cell Biol **196**(6): 775-788.
- Doi, Y., H. Takeuchi, H. Horiuchi, T. Hanyu, J. Kawanokuchi, S. Jin, B. Parajuli, Y. Sonobe, T. Mizuno and A. Suzumura (2013). "Fingolimod phosphate attenuates oligomeric amyloid beta-induced neurotoxicity via increased brain-derived neurotrophic factor expression in neurons." PLoS One **8**(4): e61988.
- Droste, S. K., Y. Chandramohan, L. E. Hill, A. C. Linthorst and J. M. Reul (2007). "Voluntary exercise impacts on the rat hypothalamic-pituitary-adrenocortical axis mainly at the adrenal level." Neuroendocrinology **86**(1): 26-37.
- Droste, S. K., L. de Groote, H. C. Atkinson, S. L. Lightman, J. M. Reul and A. C. Linthorst (2008). "Corticosterone levels in the brain show a distinct ultradian rhythm but a delayed response to forced swim stress." Endocrinology **149**(7): 3244-3253.

- Duman, R. S. (2002). "Synaptic plasticity and mood disorders." Mol Psychiatry **7 Suppl 1**: S29-34.
- Duman, R. S. (2004). "Role of neurotrophic factors in the etiology and treatment of mood disorders." Neuromolecular Med **5**(1): 11-25.
- Duman, R. S. and G. K. Aghajanian (2012). "Synaptic dysfunction in depression: potential therapeutic targets." Science **338**(6103): 68-72.
- Duman, R. S., G. R. Heninger and E. J. Nestler (1997). "A molecular and cellular theory of depression." Arch Gen Psychiatry **54**(7): 597-606.
- Duman, R. S. and L. M. Monteggia (2006). "A neurotrophic model for stress-related mood disorders." Biol Psychiatry **59**(12): 1116-1127.
- Dwivedi, Y., H. S. Rizavi, R. R. Conley, R. C. Roberts, C. A. Tamminga and G. N. Pandey (2003). "Altered gene expression of brain-derived neurotrophic factor and receptor tyrosine kinase B in postmortem brain of suicide subjects." Arch Gen Psychiatry **60**(8): 804-815.
- Dwivedi, Y., H. S. Rizavi and G. N. Pandey (2006). "Antidepressants reverse corticosterone-mediated decrease in brain-derived neurotrophic factor expression: differential regulation of specific exons by antidepressants and corticosterone." Neuroscience **139**(3): 1017-1029.
- Eaton, M. J., B. Blits, M. J. Ruitenberg, J. Verhaagen and M. Oudega (2002). "Amelioration of chronic neuropathic pain after partial nerve injury by adeno-associated viral (AAV) vector-mediated over-expression of BDNF in the rat spinal cord." Gene Ther **9**(20): 1387-1395.
- Egan, M. F., M. Kojima, J. H. Callicott, T. E. Goldberg, B. S. Kolachana, A. Bertolino, E. Zaitsev, B. Gold, D. Goldman, M. Dean, B. Lu and D. R. Weinberger (2003). "The BDNF val66met polymorphism affects activity-dependent secretion of BDNF and human memory and hippocampal function." Cell **112**(2): 257-269.
- Elgh, E., A. Lindqvist Astot, M. Fagerlund, S. Eriksson, T. Olsson and B. Nasman (2006). "Cognitive dysfunction, hippocampal atrophy and glucocorticoid feedback in Alzheimer's disease." Biol Psychiatry **59**(2): 155-161.
- English, A. W., K. Liu, J. M. Nicolini, A. M. Mulligan and K. Ye (2013). "Small-molecule trkB agonists promote axon regeneration in cut peripheral nerves." Proc Natl Acad Sci U S A **110**(40): 16217-16222.
- Erickson, K. I., D. L. Miller and K. A. Roecklein (2012). "The aging hippocampus: interactions between exercise, depression, and BDNF." Neuroscientist **18**(1): 82-97.
- Ernfors, P., K. F. Lee and R. Jaenisch (1994). "Mice lacking brain-derived neurotrophic factor develop with sensory deficits." Nature **368**(6467): 147-150.
- Ernfors, P., C. Wetmore, L. Olson and H. Persson (1990). "Identification of cells in rat brain and peripheral tissues expressing mRNA for members of the nerve growth factor family." Neuron **5**(4): 511-526.
- Fahn, S. (2003). "Description of Parkinson's disease as a clinical syndrome." Ann N Y Acad Sci **991**: 1-14.

- Faresse, N. (2014). "Post-translational modifications of the mineralocorticoid receptor: How to dress the receptor according to the circumstances?" J Steroid Biochem Mol Biol **143**: 334-342.
- Fayard, B., S. Loeffler, J. Weis, E. Vogelín and A. Kruttgen (2005). "The secreted brain-derived neurotrophic factor precursor pro-BDNF binds to TrkB and p75NTR but not to TrkA or TrkC." J Neurosci Res **80**(1): 18-28.
- Fediuc, S., J. E. Campbell and M. C. Riddell (2006). "Effect of voluntary wheel running on circadian corticosterone release and on HPA axis responsiveness to restraint stress in Sprague-Dawley rats." J Appl Physiol (1985) **100**(6): 1867-1875.
- Feng, M. J., S. E. Yan and Q. S. Yan (2005). "Effects of prenatal alcohol exposure on brain-derived neurotrophic factor and its receptor tyrosine kinase B in offspring." Brain Res **1042**(2): 125-132.
- Fink, K. D., P. Deng, A. Torrest, H. Stewart, K. Pollock, W. Gruenloh, G. Annett, T. Tempkin, V. Wheelock and J. A. Nolte (2015). "Developing stem cell therapies for juvenile and adult-onset Huntington's disease." Regen Med **10**(5): 623-646.
- Fischer, A. K., P. von Rosenstiel, E. Fuchs, D. Goula, O. F. Almeida and B. Czeh (2002). "The prototypic mineralocorticoid receptor agonist aldosterone influences neurogenesis in the dentate gyrus of the adrenalectomized rat." Brain Res **947**(2): 290-293.
- Fisher, R. S., C. Acevedo, A. Arzimanoglou, A. Bogacz, J. H. Cross, C. E. Elger, J. Engel, Jr., L. Forsgren, J. A. French, M. Glynn, D. C. Hesdorffer, B. I. Lee, G. W. Mathern, S. L. Moshe, E. Perucca, I. E. Scheffer, T. Tomson, M. Watanabe and S. Wiebe (2014). "ILAE official report: a practical clinical definition of epilepsy." Epilepsia **55**(4): 475-482.
- Fitzsimons, C. P., L. W. van Hooijdonk, M. Schouten, I. Zalachoras, V. Brinks, T. Zheng, T. G. Schouten, D. J. Saaltink, T. Dijkmans, D. A. Steindler, J. Verhaagen, F. J. Verbeek, P. J. Lucassen, E. R. de Kloet, O. C. Meijer, H. Karst, M. Joels, M. S. Oitzl and E. Vreugdenhil (2013). "Knockdown of the glucocorticoid receptor alters functional integration of newborn neurons in the adult hippocampus and impairs fear-motivated behavior." Mol Psychiatry **18**(9): 993-1005.
- Fonte, C., J. Grenier, A. Trousson, A. Chauchereau, O. Lahuna, E. E. Baulieu, M. Schumacher and C. Massaad (2005). "Involvement of {beta}-catenin and unusual behavior of CBP and p300 in glucocorticosteroid signaling in Schwann cells." Proc Natl Acad Sci U S A **102**(40): 14260-14265.
- Fonte, C., A. Trousson, J. Grenier, M. Schumacher and C. Massaad (2007). "Opposite effects of CBP and p300 in glucocorticoid signaling in astrocytes." J Steroid Biochem Mol Biol **104**(3-5): 220-227.
- Forbes, D., S. C. Forbes, C. M. Blake, E. J. Thiessen and S. Forbes (2015). "Exercise programs for people with dementia." Cochrane Database Syst Rev(4): Cd006489.
- Francis, B. M., J. Kim, M. E. Barakat, S. Fraenkl, Y. H. Yucel, S. Peng, B. Michalski, M. Fahnestock, J. McLaurin and H. T. Mount (2012). "Object recognition memory and BDNF expression are reduced in young TgCRND8 mice." Neurobiol Aging **33**(3): 555-563.

- Freedman, L. P. (1992). "Anatomy of the steroid receptor zinc finger region." Endocr Rev **13**(2): 129-145.
- Freedman, N. D. and K. R. Yamamoto (2004). "Importin 7 and importin alpha/importin beta are nuclear import receptors for the glucocorticoid receptor." Mol Biol Cell **15**(5): 2276-2286.
- Fritsch, B., J. Reis, K. Martinowich, H. M. Schambra, Y. Ji, L. G. Cohen and B. Lu (2010). "Direct current stimulation promotes BDNF-dependent synaptic plasticity: potential implications for motor learning." Neuron **66**(2): 198-204.
- Fuchikami, M., S. Morinobu, A. Kurata, S. Yamamoto and S. Yamawaki (2009). "Single immobilization stress differentially alters the expression profile of transcripts of the brain-derived neurotrophic factor (BDNF) gene and histone acetylation at its promoters in the rat hippocampus." Int J Neuropsychopharmacol **12**(1): 73-82.
- Fuchikami, M., S. Yamamoto, S. Morinobu, S. Takei and S. Yamawaki (2010). "Epigenetic regulation of BDNF gene in response to stress." Psychiatry Investig **7**(4): 251-256.
- Fuchs, E., G. Flugge, F. Ohl, P. Lucassen, G. K. Vollmann-Honsdorf and T. Michaelis (2001). "Psychosocial stress, glucocorticoids, and structural alterations in the tree shrew hippocampus." Physiol Behav **73**(3): 285-291.
- Fujioka, A., T. Fujioka, Y. Ishida, T. Maekawa and S. Nakamura (2006). "Differential effects of prenatal stress on the morphological maturation of hippocampal neurons." Neuroscience **141**(2): 907-915.
- Fukuoka, T., E. Kondo, Y. Dai, N. Hashimoto and K. Noguchi (2001). "Brain-derived neurotrophic factor increases in the uninjured dorsal root ganglion neurons in selective spinal nerve ligation model." J Neurosci **21**(13): 4891-4900.
- Fuller, P. J., Y. Yao, J. Yang and M. J. Young (2012). "Mechanisms of ligand specificity of the mineralocorticoid receptor." J Endocrinol **213**(1): 15-24.
- Gallagher-Beckley, A. J. and J. A. Cidlowski (2009). "Emerging roles of glucocorticoid receptor phosphorylation in modulating glucocorticoid hormone action in health and disease." IUBMB Life **61**(10): 979-986.
- Galon, J., D. Franchimont, N. Hiroi, G. Frey, A. Boettner, M. Ehrhart-Bornstein, J. J. O'Shea, G. P. Chrousos and S. R. Bornstein (2002). "Gene profiling reveals unknown enhancing and suppressive actions of glucocorticoids on immune cells." Faseb j **16**(1): 61-71.
- Galvao, R. P., J. M. Garcia-Verdugo and A. Alvarez-Buylla (2008). "Brain-derived neurotrophic factor signaling does not stimulate subventricular zone neurogenesis in adult mice and rats." J Neurosci **28**(50): 13368-13383.
- Garza, A. A., T. G. Ha, C. Garcia, M. J. Chen and A. A. Russo-Neustadt (2004). "Exercise, antidepressant treatment, and BDNF mRNA expression in the aging brain." Pharmacol Biochem Behav **77**(2): 209-220.

- Garzon, D., G. Yu and M. Fahnstock (2002). "A new brain-derived neurotrophic factor transcript and decrease in brain-derived neurotrophic factor transcripts 1, 2 and 3 in Alzheimer's disease parietal cortex." J Neurochem **82**(5): 1058-1064.
- Gaub, P., A. de Leon, J. Gibon, V. Soubannier, G. Dorval, P. Seguela and P. A. Barker (2016). "HBpF-proBDNF: A New Tool for the Analysis of Pro-Brain Derived Neurotrophic Factor Receptor Signaling and Cell Biology." PLoS One **11**(3): e0150601.
- Geng, S. J., F. F. Liao, W. H. Dang, X. Ding, X. D. Liu, J. Cai, J. S. Han, Y. Wan and G. G. Xing (2010). "Contribution of the spinal cord BDNF to the development of neuropathic pain by activation of the NR2B-containing NMDA receptors in rats with spinal nerve ligation." Exp Neurol **222**(2): 256-266.
- Gerfen, C. R. and D. J. Surmeier (2011). "Modulation of striatal projection systems by dopamine." Annu Rev Neurosci **34**: 441-466.
- Gines, S., M. Bosch, S. Marco, N. Gavalda, M. Diaz-Hernandez, J. J. Lucas, J. M. Canals and J. Alberch (2006). "Reduced expression of the TrkB receptor in Huntington's disease mouse models and in human brain." Eur J Neurosci **23**(3): 649-658.
- Givalois, L., F. Marmigere, F. Rage, G. Ixart, S. Arancibia and L. Tapia-Arancibia (2001). "Immobilization stress rapidly and differentially modulates BDNF and TrkB mRNA expression in the pituitary gland of adult male rats." Neuroendocrinology **74**(3): 148-159.
- Givalois, L., G. Naert, F. Rage, G. Ixart, S. Arancibia and L. Tapia-Arancibia (2004). "A single brain-derived neurotrophic factor injection modifies hypothalamo-pituitary-adrenocortical axis activity in adult male rats." Mol Cell Neurosci **27**(3): 280-295.
- Gomez-Pinilla, F., Z. Ying, R. R. Roy, R. Molteni and V. R. Edgerton (2002). "Voluntary exercise induces a BDNF-mediated mechanism that promotes neuroplasticity." J Neurophysiol **88**(5): 2187-2195.
- Gorski, J. A., S. A. Balogh, J. M. Wehner and K. R. Jones (2003). "Learning deficits in forebrain-restricted brain-derived neurotrophic factor mutant mice." Neuroscience **121**(2): 341-354.
- Gould, E., C. S. Woolley, H. A. Cameron, D. C. Daniels and B. S. McEwen (1991). "Adrenal steroids regulate postnatal development of the rat dentate gyrus: II. Effects of glucocorticoids and mineralocorticoids on cell birth." J Comp Neurol **313**(3): 486-493.
- Gourley, S. L., A. T. Kedves, P. Olausson and J. R. Taylor (2009). "A history of corticosterone exposure regulates fear extinction and cortical NR2B, GluR2/3, and BDNF." Neuropsychopharmacology **34**(3): 707-716.
- Gourley, S. L., F. J. Wu, D. D. Kiraly, J. E. Ploski, A. T. Kedves, R. S. Duman and J. R. Taylor (2008). "Regionally specific regulation of ERK MAP kinase in a model of antidepressant-sensitive chronic depression." Biol Psychiatry **63**(4): 353-359.
- Grad, I. and D. Picard (2007). "The glucocorticoid responses are shaped by molecular chaperones." Mol Cell Endocrinol **275**(1-2): 2-12.

- Graham, D. L., S. Edwards, R. K. Bachtell, R. J. DiLeone, M. Rios and D. W. Self (2007). "Dynamic BDNF activity in nucleus accumbens with cocaine use increases self-administration and relapse." Nat Neurosci **10**(8): 1029-1037.
- Greenberg, M. E., B. Xu, B. Lu and B. L. Hempstead (2009). "New insights in the biology of BDNF synthesis and release: implications in CNS function." J Neurosci **29**(41): 12764-12767.
- Greenwald, B. S., A. A. Mathe, R. C. Mohs, M. I. Levy, C. A. Johns and K. L. Davis (1986). "Cortisol and Alzheimer's disease, II: Dexamethasone suppression, dementia severity, and affective symptoms." Am J Psychiatry **143**(4): 442-446.
- Griesbach, G. S., D. L. Tio, J. Vincelli, D. L. McArthur and A. N. Taylor (2012). "Differential effects of voluntary and forced exercise on stress responses after traumatic brain injury." J Neurotrauma **29**(7): 1426-1433.
- Groc, L., D. Choquet and F. Chaouloff (2008). "The stress hormone corticosterone conditions AMPAR surface trafficking and synaptic potentiation." Nat Neurosci **11**(8): 868-870.
- Groeneweg, F. L., H. Karst, E. R. de Kloet and M. Joels (2012). "Mineralocorticoid and glucocorticoid receptors at the neuronal membrane, regulators of nongenomic corticosteroid signalling." Mol Cell Endocrinol **350**(2): 299-309.
- Guan, J. S., S. J. Haggarty, E. Giacometti, J. H. Dannenberg, N. Joseph, J. Gao, T. J. Nieland, Y. Zhou, X. Wang, R. Mazitschek, J. E. Bradner, R. A. DePinho, R. Jaenisch and L. H. Tsai (2009). "HDAC2 negatively regulates memory formation and synaptic plasticity." Nature **459**(7243): 55-60.
- Guillin, O., J. Diaz, P. Carroll, N. Griffon, J. C. Schwartz and P. Sokoloff (2001). "BDNF controls dopamine D3 receptor expression and triggers behavioural sensitization." Nature **411**(6833): 86-89.
- Gyarfas, T., J. Knuutila, P. Lindholm, T. Rantamaki and E. Castren (2010). "Regulation of brain-derived neurotrophic factor (BDNF) and cerebral dopamine neurotrophic factor (CDNF) by anti-parkinsonian drug therapy in vivo." Cell Mol Neurobiol **30**(3): 361-368.
- Hall, J., K. L. Thomas and B. J. Everitt (2000). "Rapid and selective induction of BDNF expression in the hippocampus during contextual learning." Nat Neurosci **3**(6): 533-535.
- Hansson, A. C., A. Cintra, N. Belluardo, W. Sommer, M. Bhatnagar, M. Bader, D. Ganten and K. Fuxe (2000). "Gluco- and mineralocorticoid receptor-mediated regulation of neurotrophic factor gene expression in the dorsal hippocampus and the neocortex of the rat." Eur J Neurosci **12**(8): 2918-2934.
- Hansson, A. C., W. H. Sommer, M. Metsis, I. Stromberg, L. F. Agnati and K. Fuxe (2006). "Corticosterone actions on the hippocampal brain-derived neurotrophic factor expression are mediated by exon IV promoter." J Neuroendocrinol **18**(2): 104-114.
- Hariri, A. R., T. E. Goldberg, V. S. Mattay, B. S. Kolachana, J. H. Callicott, M. F. Egan and D. R. Weinberger (2003). "Brain-derived neurotrophic factor val66met polymorphism affects human memory-related hippocampal activity and predicts memory performance." J Neurosci **23**(17): 6690-6694.

- Hashimoto, K. (2010). "Brain-derived neurotrophic factor as a biomarker for mood disorders: an historical overview and future directions." Psychiatry Clin Neurosci **64**(4): 341-357.
- Hassan, A. H., P. von Rosenstiel, V. K. Patchev, F. Holsboer and O. F. Almeida (1996). "Exacerbation of apoptosis in the dentate gyrus of the aged rat by dexamethasone and the protective role of corticosterone." Exp Neurol **140**(1): 43-52.
- Hawkins, U. A., E. P. Gomez-Sanchez, C. M. Gomez-Sanchez and C. E. Gomez-Sanchez (2012). "The ubiquitous mineralocorticoid receptor: clinical implications." Curr Hypertens Rep **14**(6): 573-580.
- He, X. P., R. Kotloski, S. Nef, B. W. Luikart, L. F. Parada and J. O. McNamara (2004). "Conditional deletion of TrkB but not BDNF prevents epileptogenesis in the kindling model." Neuron **43**(1): 31-42.
- Heinz, A. J., A. Beck, A. Meyer-Lindenberg, P. Sterzer and A. Heinz (2011). "Cognitive and neurobiological mechanisms of alcohol-related aggression." Nat Rev Neurosci **12**(7): 400-413.
- Heitkamp, H. C., W. Huber and K. Scheib (1996). "beta-Endorphin and adrenocorticotrophin after incremental exercise and marathon running--female responses." Eur J Appl Physiol Occup Physiol **72**(5-6): 417-424.
- Heldt, S. A., L. Stanek, J. P. Chhatwal and K. J. Ressler (2007). "Hippocampus-specific deletion of BDNF in adult mice impairs spatial memory and extinction of aversive memories." Mol Psychiatry **12**(7): 656-670.
- Helmstaedter, C. and E. Kockelmann (2006). "Cognitive outcomes in patients with chronic temporal lobe epilepsy." Epilepsia **47 Suppl 2**: 96-98.
- Her, L. S. and L. S. Goldstein (2008). "Enhanced sensitivity of striatal neurons to axonal transport defects induced by mutant huntingtin." J Neurosci **28**(50): 13662-13672.
- Herman, J. P. and W. E. Cullinan (1997). "Neurocircuitry of stress: central control of the hypothalamo-pituitary-adrenocortical axis." Trends Neurosci **20**(2): 78-84.
- Hermens, D. F., J. Lagopoulos, J. Tobias-Webb, T. De Regt, G. Dore, L. Juckes, N. Latt and I. B. Hickie (2013). "Pathways to alcohol-induced brain impairment in young people: a review." Cortex **49**(1): 3-17.
- Heuser, I. J., T. N. Chase and M. M. Mouradian (1991). "The limbic-hypothalamic-pituitary-adrenal axis in Huntington's disease." Biol Psychiatry **30**(9): 943-952.
- Heyman, E., F. X. Gamelin, M. Goekint, F. Piscitelli, B. Roelands, E. Leclair, V. Di Marzo and R. Meeusen (2012). "Intense exercise increases circulating endocannabinoid and BDNF levels in humans--possible implications for reward and depression." Psychoneuroendocrinology **37**(6): 844-851.
- Hill, M. N., K. G. Hellemans, P. Verma, B. B. Gorzalka and J. Weinberg (2012). "Neurobiology of chronic mild stress: parallels to major depression." Neurosci Biobehav Rev **36**(9): 2085-2117.

- Hindin, S. B. and E. M. Zelinski (2012). "Extended practice and aerobic exercise interventions benefit untrained cognitive outcomes in older adults: a meta-analysis." J Am Geriatr Soc **60**(1): 136-141.
- Hing, B., S. Davidson, M. Lear, G. Breen, J. Quinn, P. McGuffin and A. MacKenzie (2012). "A polymorphism associated with depressive disorders differentially regulates brain derived neurotrophic factor promoter IV activity." Biol Psychiatry **71**(7): 618-626.
- Hlavacova, N., J. Bakos and D. Jezova (2010). "Eplerenone, a selective mineralocorticoid receptor blocker, exerts anxiolytic effects accompanied by changes in stress hormone release." J Psychopharmacol **24**(5): 779-786.
- Hock, C., K. Heese, C. Hulette, C. Rosenberg and U. Otten (2000). "Region-specific neurotrophin imbalances in Alzheimer disease: decreased levels of brain-derived neurotrophic factor and increased levels of nerve growth factor in hippocampus and cortical areas." Arch Neurol **57**(6): 846-851.
- Hohn, A., J. Leibrock, K. Bailey and Y. A. Barde (1990). "Identification and characterization of a novel member of the nerve growth factor/brain-derived neurotrophic factor family." Nature **344**(6264): 339-341.
- Holsinger, R. M., J. Schnarr, P. Henry, V. T. Castelo and M. Fahnstock (2000). "Quantitation of BDNF mRNA in human parietal cortex by competitive reverse transcription-polymerase chain reaction: decreased levels in Alzheimer's disease." Brain Res Mol Brain Res **76**(2): 347-354.
- Hoogendijk, W. J., G. Meynen, E. Endert, M. A. Hofman and D. F. Swaab (2006). "Increased cerebrospinal fluid cortisol level in Alzheimer's disease is not related to depression." Neurobiol Aging **27**(5): 780.e781-780.e782.
- Hua, G., L. Paulen and P. Chambon (2016). "GR SUMOylation and formation of an SUMO-SMRT/NCoR1-HDAC3 repressing complex is mandatory for GC-induced IR nGRE-mediated transrepression." Proc Natl Acad Sci U S A **113**(5): E626-634.
- Huang, E. J. and L. F. Reichardt (2003). "Trk receptors: roles in neuronal signal transduction." Annu Rev Biochem **72**: 609-642.
- Huang, P., V. Chandra and F. Rastinejad (2010). "Structural overview of the nuclear receptor superfamily: insights into physiology and therapeutics." Annu Rev Physiol **72**: 247-272.
- Huang, T., K. T. Larsen, M. Ried-Larsen, N. C. Moller and L. B. Andersen (2014). "The effects of physical activity and exercise on brain-derived neurotrophic factor in healthy humans: A review." Scand J Med Sci Sports **24**(1): 1-10.
- Hudson, W. H., C. Youn and E. A. Ortlund (2013). "The structural basis of direct glucocorticoid-mediated transrepression." Nat Struct Mol Biol **20**(1): 53-58.
- Huyet, J., G. M. Pinon, M. R. Fay, M. E. Rafestin-Oblin and J. Fagart (2012). "Structural determinants of ligand binding to the mineralocorticoid receptor." Mol Cell Endocrinol **350**(2): 187-195.
- Huynh, G. and G. Heinrich (2001). "Brain-derived neurotrophic factor gene organization and transcription in the zebrafish embryo." Int J Dev Neurosci **19**(7): 663-673.

- Imai, E., J. N. Miner, J. A. Mitchell, K. R. Yamamoto and D. K. Granner (1993). "Glucocorticoid receptor-cAMP response element-binding protein interaction and the response of the phosphoenolpyruvate carboxykinase gene to glucocorticoids." J Biol Chem **268**(8): 5353-5356.
- Ishimaru, N., M. Fukuchi, A. Hirai, Y. Chiba, T. Tamura, N. Takahashi, A. Tabuchi, M. Tsuda and M. Shiraiishi (2010). "Differential epigenetic regulation of BDNF and NT-3 genes by trichostatin A and 5-aza-2'-deoxycytidine in Neuro-2a cells." Biochem Biophys Res Commun **394**(1): 173-177.
- Jaaskelainen, T., H. Makkonen and J. J. Palvimo (2011). "Steroid up-regulation of FKBP51 and its role in hormone signaling." Curr Opin Pharmacol **11**(4): 326-331.
- Jankord, R. and J. P. Herman (2008). "Limbic regulation of hypothalamo-pituitary-adrenocortical function during acute and chronic stress." Ann N Y Acad Sci **1148**: 64-73.
- Jeanneteau, F. and M. V. Chao (2013). "Are BDNF and glucocorticoid activities calibrated?" Neuroscience **239**: 173-195.
- Jeanneteau, F., M. J. Garabedian and M. V. Chao (2008). "Activation of Trk neurotrophin receptors by glucocorticoids provides a neuroprotective effect." Proc Natl Acad Sci U S A **105**(12): 4862-4867.
- Jeanneteau, F. D., W. M. Lambert, N. Ismaili, K. G. Bath, F. S. Lee, M. J. Garabedian and M. V. Chao (2012). "BDNF and glucocorticoids regulate corticotrophin-releasing hormone (CRH) homeostasis in the hypothalamus." Proc Natl Acad Sci U S A **109**(4): 1305-1310.
- Jenkins, B. D., C. B. Pullen and B. D. Darimont (2001). "Novel glucocorticoid receptor coactivator effector mechanisms." Trends Endocrinol Metab **12**(3): 122-126.
- Jia, Y., C. M. Gall and G. Lynch (2010). "Presynaptic BDNF promotes postsynaptic long-term potentiation in the dorsal striatum." J Neurosci **30**(43): 14440-14445.
- Jiang, X., F. Tian, Y. Du, N. G. Copeland, N. A. Jenkins, L. Tessarollo, X. Wu, H. Pan, X. Z. Hu, K. Xu, H. Kenney, S. E. Egan, H. Turley, A. L. Harris, A. M. Marini and R. H. Lipsky (2008). "BHLHB2 controls Bdnf promoter 4 activity and neuronal excitability." J Neurosci **28**(5): 1118-1130.
- Jin, H. L. and Y. Choi (2017). "Crosstalk between Aryl Hydrocarbon Receptor and Glucocorticoid Receptor in Human Retinal Pigment Epithelial Cells." **2017**: 5679517.
- Joels, M. (2008). "Functional actions of corticosteroids in the hippocampus." Eur J Pharmacol **583**(2-3): 312-321.
- Joels, M. and T. Z. Baram (2009). "The neuro-symphony of stress." Nat Rev Neurosci **10**(6): 459-466.
- Joels, M. and E. R. de Kloet (1989). "Effects of glucocorticoids and norepinephrine on the excitability in the hippocampus." Science **245**(4925): 1502-1505.
- Joels, M., H. Karst, R. DeRijk and E. R. de Kloet (2008). "The coming out of the brain mineralocorticoid receptor." Trends Neurosci **31**(1): 1-7.
- Joels, M., H. J. Krugers, P. J. Lucassen and H. Karst (2009). "Corticosteroid effects on cellular physiology of limbic cells." Brain Res **1293**: 91-100.

- Joels, M., R. A. Sarabdjitsingh and H. Karst (2012). "Unraveling the time domains of corticosteroid hormone influences on brain activity: rapid, slow, and chronic modes." Pharmacol Rev **64**(4): 901-938.
- John, S., P. J. Sabo, R. E. Thurman, M. H. Sung, S. C. Biddie, T. A. Johnson, G. L. Hager and J. A. Stamatoyannopoulos (2011). "Chromatin accessibility pre-determines glucocorticoid receptor binding patterns." Nat Genet **43**(3): 264-268.
- Jones, K. R., I. Farinas, C. Backus and L. F. Reichardt (1994). "Targeted disruption of the BDNF gene perturbs brain and sensory neuron development but not motor neuron development." Cell **76**(6): 989-999.
- Josefsson, T., M. Lindwall and T. Archer (2014). "Physical exercise intervention in depressive disorders: meta-analysis and systematic review." Scand J Med Sci Sports **24**(2): 259-272.
- Kaech, S. and G. Banker (2006). "Culturing hippocampal neurons." Nat Protoc **1**(5): 2406-2415.
- Kandel, E. R. (2001). "The molecular biology of memory storage: a dialog between genes and synapses." Biosci Rep **21**(5): 565-611.
- Kang, H., A. A. Welcher, D. Shelton and E. M. Schuman (1997). "Neurotrophins and time: different roles for TrkB signaling in hippocampal long-term potentiation." Neuron **19**(3): 653-664.
- Karst, H., S. Berger, G. Erdmann, G. Schutz and M. Joels (2010). "Metaplasticity of amygdalar responses to the stress hormone corticosterone." Proc Natl Acad Sci U S A **107**(32): 14449-14454.
- Karst, H., S. Berger, M. Turiault, F. Tronche, G. Schutz and M. Joels (2005). "Mineralocorticoid receptors are indispensable for nongenomic modulation of hippocampal glutamate transmission by corticosterone." Proc Natl Acad Sci U S A **102**(52): 19204-19207.
- Karst, H. and M. Joels (2005). "Corticosterone slowly enhances miniature excitatory postsynaptic current amplitude in mice CA1 hippocampal cells." J Neurophysiol **94**(5): 3479-3486.
- Karst, H. and M. Joels (2007). "Brief RU 38486 treatment normalizes the effects of chronic stress on calcium currents in rat hippocampal CA1 neurons." Neuropsychopharmacology **32**(8): 1830-1839.
- Kassel, O., A. Sancono, J. Kratzschmar, B. Kreft, M. Stassen and A. C. Cato (2001). "Glucocorticoids inhibit MAP kinase via increased expression and decreased degradation of MKP-1." Embo j **20**(24): 7108-7116.
- Kawamoto, Y., S. Nakamura, S. Nakano, N. Oka, I. Akiguchi and J. Kimura (1996). "Immunohistochemical localization of brain-derived neurotrophic factor in adult rat brain." Neuroscience **74**(4): 1209-1226.
- Keller, S., M. Sarchiapone, F. Zarrilli, A. Videtic, A. Ferraro, V. Carli, S. Sacchetti, F. Lembo, A. Angiolillo, N. Jovanovic, F. Pisanti, R. Tomaiuolo, A. Monticelli, J. Balazic, A. Roy, A. Marusic, S. Cocozza, A. Fusco, C. B. Bruni, G. Castaldo and L. Chiariotti (2010). "Increased BDNF promoter methylation in the Wernicke area of suicide subjects." Arch Gen Psychiatry **67**(3): 258-267.

- Kemppainen, S., T. Rantamaki, A. Jeronimo-Santos, G. Lavasseur, H. Autio, N. Karpova, E. Karkkainen, S. Staven, H. Vicente Miranda, T. F. Outeiro, M. J. Diogenes, S. Laroche, S. Davis, A. M. Sebastiao, E. Castren and H. Tanila (2012). "Impaired TrkB receptor signaling contributes to memory impairment in APP/PS1 mice." Neurobiol Aging **33**(6): 1122.e1123-1139.
- Kerr, B. J., E. J. Bradbury, D. L. Bennett, P. M. Trivedi, P. Dassan, J. French, D. B. Shelton, S. B. McMahon and S. W. Thompson (1999). "Brain-derived neurotrophic factor modulates nociceptive sensory inputs and NMDA-evoked responses in the rat spinal cord." J Neurosci **19**(12): 5138-5148.
- Khaksari, M., A. Rashidy-Pour and A. A. Vafaei (2007). "Central mineralocorticoid receptors are indispensable for corticosterone-induced impairment of memory retrieval in rats." Neuroscience **149**(4): 729-738.
- Khundakar, A. A. and T. S. Zetterstrom (2006). "Biphasic change in BDNF gene expression following antidepressant drug treatment explained by differential transcript regulation." Brain Res **1106**(1): 12-20.
- Kim, J. B., J. Y. Ju, J. H. Kim, T. Y. Kim, B. H. Yang, Y. S. Lee and H. Son (2004). "Dexamethasone inhibits proliferation of adult hippocampal neurogenesis in vivo and in vitro." Brain Res **1027**(1-2): 1-10.
- Kim, J. J. and D. M. Diamond (2002). "The stressed hippocampus, synaptic plasticity and lost memories." Nat Rev Neurosci **3**(6): 453-462.
- Kino, T., H. Jaffe, N. D. Amin, M. Chakrabarti, Y. L. Zheng, G. P. Chrousos and H. C. Pant (2010). "Cyclin-dependent kinase 5 modulates the transcriptional activity of the mineralocorticoid receptor and regulates expression of brain-derived neurotrophic factor." Mol Endocrinol **24**(5): 941-952.
- Kino, T., Y. A. Su and G. P. Chrousos (2009). "Human glucocorticoid receptor isoform beta: recent understanding of its potential implications in physiology and pathophysiology." Cell Mol Life Sci **66**(21): 3435-3448.
- Klok, M. D., S. R. Alt, A. J. Irurzun Lafitte, J. D. Turner, E. A. Lakke, I. Huitinga, C. P. Muller, F. G. Zitman, E. R. de Kloet and R. H. Derijk (2011). "Decreased expression of mineralocorticoid receptor mRNA and its splice variants in postmortem brain regions of patients with major depressive disorder." J Psychiatr Res **45**(7): 871-878.
- Knopp, A., A. Kivi, C. Wozny, U. Heinemann and J. Behr (2005). "Cellular and network properties of the subiculum in the pilocarpine model of temporal lobe epilepsy." J Comp Neurol **483**(4): 476-488.
- Kohara, K., A. Kitamura, M. Morishima and T. Tsumoto (2001). "Activity-dependent transfer of brain-derived neurotrophic factor to postsynaptic neurons." Science **291**(5512): 2419-2423.
- Kokaia, M., P. Ernfors, Z. Kokaia, E. Elmer, R. Jaenisch and O. Lindvall (1995). "Suppressed epileptogenesis in BDNF mutant mice." Exp Neurol **133**(2): 215-224.

- Kolber, B. J., L. Wiczorek and L. J. Muglia (2008). "Hypothalamic-pituitary-adrenal axis dysregulation and behavioral analysis of mouse mutants with altered glucocorticoid or mineralocorticoid receptor function." Stress **11**(5): 321-338.
- Koob, G. F. (2003). "Alcoholism: allostasis and beyond." Alcohol Clin Exp Res **27**(2): 232-243.
- Korte, M., P. Carroll, E. Wolf, G. Brem, H. Thoenen and T. Bonhoeffer (1995). "Hippocampal long-term potentiation is impaired in mice lacking brain-derived neurotrophic factor." Proc Natl Acad Sci U S A **92**(19): 8856-8860.
- Korte, M., O. Griesbeck, C. Gravel, P. Carroll, V. Staiger, H. Thoenen and T. Bonhoeffer (1996). "Virus-mediated gene transfer into hippocampal CA1 region restores long-term potentiation in brain-derived neurotrophic factor mutant mice." Proc Natl Acad Sci U S A **93**(22): 12547-12552.
- Koskela, M., S. Back, V. Voikar, C. T. Richie, A. Domanskyi, B. K. Harvey and M. Airavaara (2017). "Update of neurotrophic factors in neurobiology of addiction and future directions." Neurobiol Dis **97**(Pt B): 189-200.
- Koyama, R. and Y. Ikegaya (2005). "To BDNF or not to BDNF: that is the epileptic hippocampus." Neuroscientist **11**(4): 282-287.
- Kreek, M. J., D. A. Nielsen, E. R. Butelman and K. S. LaForge (2005). "Genetic influences on impulsivity, risk taking, stress responsivity and vulnerability to drug abuse and addiction." Nat Neurosci **8**(11): 1450-1457.
- Krishnan, V. and E. J. Nestler (2008). "The molecular neurobiology of depression." Nature **455**(7215): 894-902.
- Kronenberg, G., I. Kirste, D. Inta, S. Chourbaji, I. Heuser, M. Endres and P. Gass (2009). "Reduced hippocampal neurogenesis in the GR(+/-) genetic mouse model of depression." Eur Arch Psychiatry Clin Neurosci **259**(8): 499-504.
- Krugers, H. J., P. M. Goltstein, S. van der Linden and M. Joels (2006). "Blockade of glucocorticoid receptors rapidly restores hippocampal CA1 synaptic plasticity after exposure to chronic stress." Eur J Neurosci **23**(11): 3051-3055.
- Kumamaru, E., T. Numakawa, N. Adachi and H. Kunugi (2011). "Glucocorticoid suppresses BDNF-stimulated MAPK/ERK pathway via inhibiting interaction of Shp2 with TrkB." FEBS Lett **585**(20): 3224-3228.
- Kumamaru, E., T. Numakawa, N. Adachi, Y. Yagasaki, A. Izumi, M. Niyaz, M. Kudo and H. Kunugi (2008). "Glucocorticoid prevents brain-derived neurotrophic factor-mediated maturation of synaptic function in developing hippocampal neurons through reduction in the activity of mitogen-activated protein kinase." Mol Endocrinol **22**(3): 546-558.
- Kumar, R. and W. J. Calhoun (2008). "Differential regulation of the transcriptional activity of the glucocorticoid receptor through site-specific phosphorylation." Biologics **2**(4): 845-854.
- Kumar, R. and E. B. Thompson (2005). "Gene regulation by the glucocorticoid receptor: structure: function relationship." J Steroid Biochem Mol Biol **94**(5): 383-394.

- Kunugi, H., H. Hori, N. Adachi and T. Numakawa (2010). "Interface between hypothalamic-pituitary-adrenal axis and brain-derived neurotrophic factor in depression." Psychiatry Clin Neurosci **64**(5): 447-459.
- Kutiyawalla, A., A. V. Terry, Jr. and A. Pillai (2011). "Cysteamine attenuates the decreases in TrkB protein levels and the anxiety/depression-like behaviors in mice induced by corticosterone treatment." PLoS One **6**(10): e26153.
- Kuzmin, A., S. Liljequist, J. Meis, V. Chefer, T. Shippenberg and G. Bakalkin (2012). "Repeated moderate-dose ethanol bouts impair cognitive function in Wistar rats." Addict Biol **17**(1): 132-140.
- LaFrance, W. C., Jr., K. Leaver, E. G. Stopa, G. D. Papandonatos and A. S. Blum (2010). "Decreased serum BDNF levels in patients with epileptic and psychogenic nonepileptic seizures." Neurology **75**(14): 1285-1291.
- Lambert, W. M., C. F. Xu, T. A. Neubert, M. V. Chao, M. J. Garabedian and F. D. Jeanneteau (2013). "Brain-derived neurotrophic factor signaling rewrites the glucocorticoid transcriptome via glucocorticoid receptor phosphorylation." Mol Cell Biol **33**(18): 3700-3714.
- Landles, C. and G. P. Bates (2004). "Huntingtin and the molecular pathogenesis of Huntington's disease. Fourth in molecular medicine review series." EMBO Rep **5**(10): 958-963.
- Lang, A. E. and A. M. Lozano (1998). "Parkinson's disease. Second of two parts." N Engl J Med **339**(16): 1130-1143.
- Lauterborn, J. C., S. Rivera, C. T. Stinis, V. Y. Hayes, P. J. Isackson and C. M. Gall (1996). "Differential effects of protein synthesis inhibition on the activity-dependent expression of BDNF transcripts: evidence for immediate-early gene responses from specific promoters." J Neurosci **16**(23): 7428-7436.
- Le Menuet, D. and M. Lombes (2014). "The neuronal mineralocorticoid receptor: from cell survival to neurogenesis." Steroids **91**: 11-19.
- Le Menuet, D., M. Munier, G. Campostrini and M. Lombes (2012). "Mineralocorticoid receptor and embryonic stem cell models: Molecular insights and pathophysiological relevance." Mol Cell Endocrinol **350**(2): 216-222.
- Le Menuet, D., S. Viengchareun, P. Penfornis, F. Walker, M. C. Zennaro and M. Lombes (2000). "Targeted oncogenesis reveals a distinct tissue-specific utilization of alternative promoters of the human mineralocorticoid receptor gene in transgenic mice." J Biol Chem **275**(11): 7878-7886.
- Leblhuber, F., M. Peichl, C. Neubauer, F. Reisecker, F. X. Steinparz, E. Windhager and W. Maschek (1995). "Serum dehydroepiandrosterone and cortisol measurements in Huntington's chorea." J Neurol Sci **132**(1): 76-79.
- Lee, R., P. Kermani, K. K. Teng and B. L. Hempstead (2001). "Regulation of cell survival by secreted proneurotrophins." Science **294**(5548): 1945-1948.

- Lee, T., J. Saruta, K. Sasaguri, S. Sato and K. Tsukinoki (2008). "Allowing animals to bite reverses the effects of immobilization stress on hippocampal neurotrophin expression." Brain Res **1195**: 43-49.
- Leibrock, J., F. Lottspeich, A. Hohn, M. Hofer, B. Hengerer, P. Masiakowski, H. Thoenen and Y. A. Barde (1989). "Molecular cloning and expression of brain-derived neurotrophic factor." Nature **341**(6238): 149-152.
- LePage, K. T., R. W. Dickey, W. H. Gerwick, E. L. Jester and T. F. Murray (2005). "On the use of neuro-2a neuroblastoma cells versus intact neurons in primary culture for neurotoxicity studies." Crit Rev Neurobiol **17**(1): 27-50.
- Lessmann, V., K. Gottmann and M. Malcangio (2003). "Neurotrophin secretion: current facts and future prospects." Prog Neurobiol **69**(5): 341-374.
- Levenson, J. M., T. L. Roth, F. D. Lubin, C. A. Miller, I. C. Huang, P. Desai, L. M. Malone and J. D. Sweatt (2006). "Evidence that DNA (cytosine-5) methyltransferase regulates synaptic plasticity in the hippocampus." J Biol Chem **281**(23): 15763-15773.
- Lewis-Tuffin, L. J. and J. A. Cidlowski (2006). "The physiology of human glucocorticoid receptor beta (hGRbeta) and glucocorticoid resistance." Ann N Y Acad Sci **1069**: 1-9.
- Li, M., H. Chang and X. Xiao (2016). "BDNF Val66Met polymorphism and bipolar disorder in European populations: A risk association in case-control, family-based and GWAS studies." Neurosci Biobehav Rev **68**: 218-233.
- Li, T. L. and P. Y. Cheng (2007). "Alterations of immunoendocrine responses during the recovery period after acute prolonged cycling." Eur J Appl Physiol **101**(5): 539-546.
- Liao, G. Y., J. J. An, K. Gharami, E. G. Waterhouse, F. Vanevski, K. R. Jones and B. Xu (2012). "Dendritically targeted Bdnf mRNA is essential for energy balance and response to leptin." Nat Med **18**(4): 564-571.
- Lim, H. W., N. H. Uhlenhaut, A. Rauch, J. Weiner, S. Hubner, N. Hubner, K. J. Won, M. A. Lazar, J. Tuckermann and D. J. Steger (2015). "Genomic redistribution of GR monomers and dimers mediates transcriptional response to exogenous glucocorticoid in vivo." Genome Res **25**(6): 836-844.
- Lin, Y. T., L. S. Ro, H. L. Wang and J. C. Chen (2011). "Up-regulation of dorsal root ganglia BDNF and trkB receptor in inflammatory pain: an in vivo and in vitro study." J Neuroinflammation **8**: 126.
- Linnarsson, S., A. Bjorklund and P. Ernfors (1997). "Learning deficit in BDNF mutant mice." Eur J Neurosci **9**(12): 2581-2587.
- Lipsky, R. H. and A. M. Marini (2007). "Brain-derived neurotrophic factor in neuronal survival and behavior-related plasticity." Ann N Y Acad Sci **1122**: 130-143.
- Lipsky, R. H., K. Xu, D. Zhu, C. Kelly, A. Terhakopian, A. Novelli and A. M. Marini (2001). "Nuclear factor kappaB is a critical determinant in N-methyl-D-aspartate receptor-mediated neuroprotection." J Neurochem **78**(2): 254-264.

- Liu, I. Y., W. E. Lyons, L. A. Mamounas and R. F. Thompson (2004). "Brain-derived neurotrophic factor plays a critical role in contextual fear conditioning." J Neurosci **24**(36): 7958-7963.
- Liu, J. L., D. N. Papachristou and Y. C. Patel (1994). "Glucocorticoids activate somatostatin gene transcription through co-operative interaction with the cyclic AMP signalling pathway." Biochem J **301** (Pt 3): 863-869.
- Liu, Q. R., L. Lu, X. G. Zhu, J. P. Gong, Y. Shaham and G. R. Uhl (2006). "Rodent BDNF genes, novel promoters, novel splice variants, and regulation by cocaine." Brain Res **1067**(1): 1-12.
- Liu, Q. R., D. Walther, T. Drgon, O. Polesskaya, T. G. Lesnick, K. J. Strain, M. de Andrade, J. H. Bower, D. M. Maraganore and G. R. Uhl (2005). "Human brain derived neurotrophic factor (BDNF) genes, splicing patterns, and assessments of associations with substance abuse and Parkinson's Disease." Am J Med Genet B Neuropsychiatr Genet **134b**(1): 93-103.
- Lledo, P. M., M. Alonso and M. S. Grubb (2006). "Adult neurogenesis and functional plasticity in neuronal circuits." Nat Rev Neurosci **7**(3): 179-193.
- Llorens-Martin, M. and J. L. Trejo (2011). "Mifepristone prevents stress-induced apoptosis in newborn neurons and increases AMPA receptor expression in the dentate gyrus of C57/BL6 mice." PLoS One **6**(11): e28376.
- Lonard, D. M. and B. W. O'Malley (2005). "Expanding functional diversity of the coactivators." Trends Biochem Sci **30**(3): 126-132.
- Lopim, G. M., D. Vannucci Campos, S. Gomes da Silva, A. A. de Almeida, R. Lent, E. A. Cavalheiro and R. M. Arida (2016). "Relationship between seizure frequency and number of neuronal and non-neuronal cells in the hippocampus throughout the life of rats with epilepsy." Brain Res **1634**: 179-186.
- Lou, H., S. K. Kim, E. Zaitsev, C. R. Snell, B. Lu and Y. P. Loh (2005). "Sorting and activity-dependent secretion of BDNF require interaction of a specific motif with the sorting receptor carboxypeptidase e." Neuron **45**(2): 245-255.
- Lu, B. (2003). "BDNF and activity-dependent synaptic modulation." Learn Mem **10**(2): 86-98.
- Lu, B., G. Nagappan and Y. Lu (2014). "BDNF and synaptic plasticity, cognitive function, and dysfunction." Handb Exp Pharmacol **220**: 223-250.
- Lu, N. Z. and J. A. Cidlowski (2005). "Translational regulatory mechanisms generate N-terminal glucocorticoid receptor isoforms with unique transcriptional target genes." Mol Cell **18**(3): 331-342.
- Lu, N. Z., J. B. Collins, S. F. Grissom and J. A. Cidlowski (2007). "Selective regulation of bone cell apoptosis by translational isoforms of the glucocorticoid receptor." Mol Cell Biol **27**(20): 7143-7160.
- Lu, Y., K. Christian and B. Lu (2008). "BDNF: a key regulator for protein synthesis-dependent LTP and long-term memory?" Neurobiol Learn Mem **89**(3): 312-323.

- Lubin, F. D., T. L. Roth and J. D. Sweatt (2008). "Epigenetic regulation of BDNF gene transcription in the consolidation of fear memory." J Neurosci **28**(42): 10576-10586.
- Luscher, C. and R. C. Malenka (2011). "Drug-evoked synaptic plasticity in addiction: from molecular changes to circuit remodeling." Neuron **69**(4): 650-663.
- Ma, Y. L., H. L. Wang, H. C. Wu, C. L. Wei and E. H. Lee (1998). "Brain-derived neurotrophic factor antisense oligonucleotide impairs memory retention and inhibits long-term potentiation in rats." Neuroscience **82**(4): 957-967.
- Makhathini, K. B., O. Abboussi, D. J. Stein, M. V. Mabandla and W. M. U. Daniels (2017). "Repetitive stress leads to impaired cognitive function that is associated with DNA hypomethylation, reduced BDNF and a dysregulated HPA axis." Int J Dev Neurosci **60**: 63-69.
- Malenka, R. C. and M. F. Bear (2004). "LTP and LTD: an embarrassment of riches." Neuron **44**(1): 5-21.
- Marmigere, F., L. Givalois, F. Rage, S. Arancibia and L. Tapia-Arancibia (2003). "Rapid induction of BDNF expression in the hippocampus during immobilization stress challenge in adult rats." Hippocampus **13**(5): 646-655.
- Martinez-Levy, G. A., L. Rocha, F. Rodriguez-Pineda, M. A. Alonso-Vanegas, A. Nani, R. M. Buentello-Garcia, M. Briones-Velasco, D. San-Juan, J. Cienfuegos and C. S. Cruz-Fuentes (2017). "Increased Expression of Brain-Derived Neurotrophic Factor Transcripts I and VI, cAMP Response Element Binding, and Glucocorticoid Receptor in the Cortex of Patients with Temporal Lobe Epilepsy." Mol Neurobiol.
- Martinotti, G., M. Pettorruso, D. De Berardis, P. A. Varasano, G. Lucidi Pressanti, V. De Remigis, A. Valchera, V. Ricci, M. Di Nicola, L. Janiri, G. Biggio and M. Di Giannantonio (2016). "Agomelatine Increases BDNF Serum Levels in Depressed Patients in Correlation with the Improvement of Depressive Symptoms." Int J Neuropsychopharmacol **19**(5).
- Martinowich, K., H. Manji and B. Lu (2007). "New insights into BDNF function in depression and anxiety." Nat Neurosci **10**(9): 1089-1093.
- Max, M. B. and W. F. Stewart (2008). "The molecular epidemiology of pain: a new discipline for drug discovery." Nat Rev Drug Discov **7**(8): 647-658.
- McAllister, A. K., L. C. Katz and D. C. Lo (1999). "Neurotrophins and synaptic plasticity." Annu Rev Neurosci **22**: 295-318.
- McCarthy, D. M., A. N. Brown and P. G. Bhide (2012). "Regulation of BDNF expression by cocaine." Yale J Biol Med **85**(4): 437-446.
- McCullers, D. L. and J. P. Herman (1998). "Mineralocorticoid receptors regulate bcl-2 and p53 mRNA expression in hippocampus." Neuroreport **9**(13): 3085-3089.
- McEwen, B. S. (2007). "Physiology and neurobiology of stress and adaptation: central role of the brain." Physiol Rev **87**(3): 873-904.
- McMurray, S. E. and C. T. McMurray (2001). "Huntington's disease. A sports star and a cook." Lancet **358 Suppl**: S38.

- McNally, J. G., W. G. Muller, D. Walker, R. Wolford and G. L. Hager (2000). "The glucocorticoid receptor: rapid exchange with regulatory sites in living cells." *Science* **287**(5456): 1262-1265.
- Meaney, M. J., J. Diorio, D. Francis, J. Widdowson, P. LaPlante, C. Caldji, S. Sharma, J. R. Seckl and P. M. Plotsky (1996). "Early environmental regulation of forebrain glucocorticoid receptor gene expression: implications for adrenocortical responses to stress." *Dev Neurosci* **18**(1-2): 49-72.
- Meijer, O. C. and E. R. de Kloet (1998). "Corticosterone and serotonergic neurotransmission in the hippocampus: functional implications of central corticosteroid receptor diversity." *Crit Rev Neurobiol* **12**(1-2): 1-20.
- Meijsing, S. H., M. A. Pufall, A. Y. So, D. L. Bates, L. Chen and K. R. Yamamoto (2009). "DNA binding site sequence directs glucocorticoid receptor structure and activity." *Science* **324**(5925): 407-410.
- Meng, C., Z. He and D. Xing (2013). "Low-level laser therapy rescues dendrite atrophy via upregulating BDNF expression: implications for Alzheimer's disease." *J Neurosci* **33**(33): 13505-13517.
- Metz, G. A. (2007). "Stress as a modulator of motor system function and pathology." *Rev Neurosci* **18**(3-4): 209-222.
- Mifsud, K. R. and J. M. Reul (2016). "Acute stress enhances heterodimerization and binding of corticosteroid receptors at glucocorticoid target genes in the hippocampus." *Neurosci Lett* **613**(40): 11336-11341.
- Miki, K., T. Fukuoka, A. Tokunaga, E. Kondo, Y. Dai and K. Noguchi (2000). "Differential effect of brain-derived neurotrophic factor on high-threshold mechanosensitivity in a rat neuropathic pain model." *Neurosci Lett* **278**(1-2): 85-88.
- Miller, F. D. and D. R. Kaplan (2001). "Neurotrophin signalling pathways regulating neuronal apoptosis." *Cell Mol Life Sci* **58**(8): 1045-1053.
- Milnerwood, A. J. and L. A. Raymond (2010). "Early synaptic pathophysiology in neurodegeneration: insights from Huntington's disease." *Trends Neurosci* **33**(11): 513-523.
- Miner, J. N., M. H. Hong and A. Negro-Vilar (2005). "New and improved glucocorticoid receptor ligands." *Expert Opin Investig Drugs* **14**(12): 1527-1545.
- Mirescu, C. and E. Gould (2006). "Stress and adult neurogenesis." *Hippocampus* **16**(3): 233-238.
- Mizoguchi, K., M. Yuzurihara, A. Ishige, H. Sasaki, D. H. Chui and T. Tabira (2001). "Chronic stress differentially regulates glucocorticoid negative feedback response in rats." *Psychoneuroendocrinology* **26**(5): 443-459.
- Mogi, M., A. Togari, T. Kondo, Y. Mizuno, O. Komure, S. Kuno, H. Ichinose and T. Nagatsu (1999). "Brain-derived growth factor and nerve growth factor concentrations are decreased in the substantia nigra in Parkinson's disease." *Neurosci Lett* **270**(1): 45-48.
- Molteni, R., F. Calabrese, S. Chourbaji, C. Brandwein, G. Racagni, P. Gass and M. A. Riva (2010). "Depression-prone mice with reduced glucocorticoid receptor expression display an altered

- stress-dependent regulation of brain-derived neurotrophic factor and activity-regulated cytoskeleton-associated protein." J Psychopharmacol **24**(4): 595-603.
- Montaron, M. F., E. Drapeau, D. Dupret, P. Kitchener, C. Aurousseau, M. Le Moal, P. V. Piazza and D. N. Abrous (2006). "Lifelong corticosterone level determines age-related decline in neurogenesis and memory." Neurobiol Aging **27**(4): 645-654.
- Morris, S. A., D. W. Eaves, A. R. Smith and K. Nixon (2010). "Alcohol inhibition of neurogenesis: a mechanism of hippocampal neurodegeneration in an adolescent alcohol abuse model." Hippocampus **20**(5): 596-607.
- Moss, H. B., C. M. Chen and H. Y. Yi (2014). "Early adolescent patterns of alcohol, cigarettes, and marijuana polysubstance use and young adult substance use outcomes in a nationally representative sample." Drug Alcohol Depend **136**: 51-62.
- Mowla, S. J., S. Pareek, H. F. Farhadi, K. Petrecca, J. P. Fawcett, N. G. Seidah, S. J. Morris, W. S. Sossin and R. A. Murphy (1999). "Differential sorting of nerve growth factor and brain-derived neurotrophic factor in hippocampal neurons." J Neurosci **19**(6): 2069-2080.
- Mu, J. S., W. P. Li, Z. B. Yao and X. F. Zhou (1999). "Deprivation of endogenous brain-derived neurotrophic factor results in impairment of spatial learning and memory in adult rats." Brain Res **835**(2): 259-265.
- Munhoz, C. D., S. F. Sorrells, J. R. Caso, C. Scavone and R. M. Sapolsky (2010). "Glucocorticoids exacerbate lipopolysaccharide-induced signaling in the frontal cortex and hippocampus in a dose-dependent manner." J Neurosci **30**(41): 13690-13698.
- Munier, M., F. Law, G. Meduri, D. Le Menuet and M. Lombes (2012). "Mineralocorticoid receptor overexpression facilitates differentiation and promotes survival of embryonic stem cell-derived neurons." Endocrinology **153**(3): 1330-1340.
- Munier, M., G. Meduri, S. Viengchareun, P. Leclerc, D. Le Menuet and M. Lombes (2010). "Regulation of mineralocorticoid receptor expression during neuronal differentiation of murine embryonic stem cells." Endocrinology **151**(5): 2244-2254.
- Murakami, S., H. Imbe, Y. Morikawa, C. Kubo and E. Senba (2005). "Chronic stress, as well as acute stress, reduces BDNF mRNA expression in the rat hippocampus but less robustly." Neurosci Res **53**(2): 129-139.
- Murer, M. G., Q. Yan and R. Raisman-Vozari (2001). "Brain-derived neurotrophic factor in the control human brain, and in Alzheimer's disease and Parkinson's disease." Prog Neurobiol **63**(1): 71-124.
- Murray, K. D., P. J. Isackson, T. A. Eskin, M. A. King, S. P. Montesinos, L. A. Abraham and S. N. Roper (2000). "Altered mRNA expression for brain-derived neurotrophic factor and type II calcium/calmodulin-dependent protein kinase in the hippocampus of patients with intractable temporal lobe epilepsy." J Comp Neurol **418**(4): 411-422.
- Naert, G. and S. Rivest (2012). "Age-related changes in synaptic markers and monocyte subsets link the cognitive decline of APP(Swe)/PS1 mice." Front Cell Neurosci **6**: 51.

- Nagahara, A. H. and M. H. Tuszynski (2011). "Potential therapeutic uses of BDNF in neurological and psychiatric disorders." Nat Rev Drug Discov **10**(3): 209-219.
- Nair, A., K. C. Vadodaria, S. B. Banerjee, M. Benekareddy, B. G. Dias, R. S. Duman and V. A. Vaidya (2007). "Stressor-specific regulation of distinct brain-derived neurotrophic factor transcripts and cyclic AMP response element-binding protein expression in the postnatal and adult rat hippocampus." Neuropsychopharmacology **32**(7): 1504-1519.
- Narita, M., Y. Yajima, T. Aoki, S. Ozaki, H. Mizoguchi, L. F. Tseng and T. Suzuki (2000). "Up-regulation of the TrkB receptor in mice injured by the partial ligation of the sciatic nerve." Eur J Pharmacol **401**(2): 187-190.
- Neeper, S. A., F. Gomez-Pinilla, J. Choi and C. Cotman (1995). "Exercise and brain neurotrophins." Nature **373**(6510): 109.
- Neeper, S. A., F. Gomez-Pinilla, J. Choi and C. W. Cotman (1996). "Physical activity increases mRNA for brain-derived neurotrophic factor and nerve growth factor in rat brain." Brain Res **726**(1-2): 49-56.
- Nestler, E. J. (2013). "Cellular basis of memory for addiction." Dialogues Clin Neurosci **15**(4): 431-443.
- Nibuya, M., M. Takahashi, D. S. Russell and R. S. Duman (1999). "Repeated stress increases catalytic TrkB mRNA in rat hippocampus." Neurosci Lett **267**(2): 81-84.
- Nicoll, R. A. and K. W. Roche (2013). "Long-term potentiation: peeling the onion." Neuropharmacology **74**: 18-22.
- Nissen, R. M. and K. R. Yamamoto (2000). "The glucocorticoid receptor inhibits NFkappaB by interfering with serine-2 phosphorylation of the RNA polymerase II carboxy-terminal domain." Genes Dev **14**(18): 2314-2329.
- Nooshinfar, E., A. Akbarzadeh-Baghban and E. Meisami (2011). "Effects of increasing durations of immobilization stress on plasma corticosterone level, learning and memory and hippocampal BDNF gene expression in rats." Neurosci Lett **500**(1): 63-66.
- Numakawa, T., N. Adachi, M. Richards, S. Chiba and H. Kunugi (2013). "Brain-derived neurotrophic factor and glucocorticoids: reciprocal influence on the central nervous system." Neuroscience **239**: 157-172.
- Numan, S., S. B. Lane-Ladd, L. Zhang, K. H. Lundgren, D. S. Russell, K. B. Seroogy and E. J. Nestler (1998). "Differential regulation of neurotrophin and trk receptor mRNAs in catecholaminergic nuclei during chronic opiate treatment and withdrawal." J Neurosci **18**(24): 10700-10708.
- Oakley, R. H. and J. A. Cidlowski (2013). "The biology of the glucocorticoid receptor: new signaling mechanisms in health and disease." J Allergy Clin Immunol **132**(5): 1033-1044.
- Oakley, R. H., M. Sar and J. A. Cidlowski (1996). "The human glucocorticoid receptor beta isoform. Expression, biochemical properties, and putative function." J Biol Chem **271**(16): 9550-9559.
- Obata, K. and K. Noguchi (2006). "BDNF in sensory neurons and chronic pain." Neurosci Res **55**(1): 1-10.

- Ogrodnik, M., H. Salmonowicz, R. Brown, J. Turkowska, W. Sredniawa, S. Pattabiraman, T. Amen, A. C. Abraham, N. Eichler, R. Lyakhovetsky and D. Kaganovich (2014). "Dynamic JUNQ inclusion bodies are asymmetrically inherited in mammalian cell lines through the asymmetric partitioning of vimentin." Proc Natl Acad Sci U S A **111**(22): 8049-8054.
- Oitzl, M. S. and E. R. de Kloet (1992). "Selective corticosteroid antagonists modulate specific aspects of spatial orientation learning." Behav Neurosci **106**(1): 62-71.
- Ojagbemi, A. and N. Akin-Ojagbemi (2017). "Exercise and Quality of Life in Dementia." J Appl Gerontol: 733464817693374.
- Ou, L. C. and P. W. Gean (2007). "Transcriptional regulation of brain-derived neurotrophic factor in the amygdala during consolidation of fear memory." Mol Pharmacol **72**(2): 350-358.
- Pang, P. T., H. K. Teng, E. Zaitsev, N. T. Woo, K. Sakata, S. Zhen, K. K. Teng, W. H. Yung, B. L. Hempstead and B. Lu (2004). "Cleavage of proBDNF by tPA/plasmin is essential for long-term hippocampal plasticity." Science **306**(5695): 487-491.
- Paradiso, B., P. Marconi, S. Zucchini, E. Berto, A. Binaschi, A. Bozac, A. Buzzi, M. Mazzuferi, E. Magri, G. Navarro Mora, D. Rodi, T. Su, I. Volpi, L. Zanetti, A. Marzola, R. Manservigi, P. F. Fabene and M. Simonato (2009). "Localized delivery of fibroblast growth factor-2 and brain-derived neurotrophic factor reduces spontaneous seizures in an epilepsy model." Proc Natl Acad Sci U S A **106**(17): 7191-7196.
- Parain, K., M. G. Murer, Q. Yan, B. Faucheux, Y. Agid, E. Hirsch and R. Raisman-Vozari (1999). "Reduced expression of brain-derived neurotrophic factor protein in Parkinson's disease substantia nigra." Neuroreport **10**(3): 557-561.
- Park, H. J., S. Lee, J. W. Jung, B. C. Kim, J. H. Ryu and D. H. Kim (2015). "Glucocorticoid- and long-term stress-induced aberrant synaptic plasticity are mediated by activation of the glucocorticoid receptor." Arch Pharm Res **38**(6): 1204-1212.
- Park, J. S. and A. Hoke (2014). "Treadmill exercise induced functional recovery after peripheral nerve repair is associated with increased levels of neurotrophic factors." PLoS One **9**(3): e90245.
- Pascual-Le Tallec, L. and M. Lombes (2005). "The mineralocorticoid receptor: a journey exploring its diversity and specificity of action." Mol Endocrinol **19**(9): 2211-2221.
- Pascual-Le Tallec, L., F. Simone, S. Viengchareun, G. Meduri, M. J. Thirman and M. Lombes (2005). "The elongation factor ELL (eleven-nineteen lysine-rich leukemia) is a selective coregulator for steroid receptor functions." Mol Endocrinol **19**(5): 1158-1169.
- Pascual-Leone, A., C. Freitas, L. Oberman, J. C. Horvath, M. Halko, M. Eldaief, S. Bashir, M. Vernet, M. Shafi, B. Westover, A. M. Vahabzadeh-Hagh and A. Rotenberg (2011). "Characterizing brain cortical plasticity and network dynamics across the age-span in health and disease with TMS-EEG and TMS-fMRI." Brain Topogr **24**(3-4): 302-315.
- Pattabiraman, P. P., D. Tropea, C. Chiaruttini, E. Tongiorgi, A. Cattaneo and L. Domenici (2005). "Neuronal activity regulates the developmental expression and subcellular localization of cortical BDNF mRNA isoforms in vivo." Mol Cell Neurosci **28**(3): 556-570.

- Patterson, S. L., T. Abel, T. A. Deuel, K. C. Martin, J. C. Rose and E. R. Kandel (1996). "Recombinant BDNF rescues deficits in basal synaptic transmission and hippocampal LTP in BDNF knockout mice." Neuron **16**(6): 1137-1145.
- Patterson, S. L., L. M. Grover, P. A. Schwartzkroin and M. Bothwell (1992). "Neurotrophin expression in rat hippocampal slices: a stimulus paradigm inducing LTP in CA1 evokes increases in BDNF and NT-3 mRNAs." Neuron **9**(6): 1081-1088.
- Pavlidis, C. and B. S. McEwen (1999). "Effects of mineralocorticoid and glucocorticoid receptors on long-term potentiation in the CA3 hippocampal field." Brain Res **851**(1-2): 204-214.
- Pavlidis, C., S. Ogawa, A. Kimura and B. S. McEwen (1996). "Role of adrenal steroid mineralocorticoid and glucocorticoid receptors in long-term potentiation in the CA1 field of hippocampal slices." Brain Res **738**(2): 229-235.
- Peng, S., J. Wu, E. J. Mufson and M. Fahnstock (2005). "Precursor form of brain-derived neurotrophic factor and mature brain-derived neurotrophic factor are decreased in the pre-clinical stages of Alzheimer's disease." J Neurochem **93**(6): 1412-1421.
- Pezet, S., M. Malcangio and S. B. McMahon (2002). "BDNF: a neuromodulator in nociceptive pathways?" Brain Res Brain Res Rev **40**(1-3): 240-249.
- Pitkanen, A. and T. P. Sutula (2002). "Is epilepsy a progressive disorder? Prospects for new therapeutic approaches in temporal-lobe epilepsy." Lancet Neurol **1**(3): 173-181.
- Plotkin, J. L., M. Day, J. D. Peterson, Z. Xie, G. J. Kress, I. Rafalovich, J. Kondapalli, T. S. Gertler, M. Flajolet, P. Greengard, M. Stavarache, M. G. Kaplitt, J. Rosinski, C. S. Chan and D. J. Surmeier (2014). "Impaired TrkB receptor signaling underlies corticostriatal dysfunction in Huntington's disease." Neuron **83**(1): 178-188.
- Polman, J. A., E. R. de Kloet and N. A. Datson (2013). "Two populations of glucocorticoid receptor-binding sites in the male rat hippocampal genome." Endocrinology **154**(5): 1832-1844.
- Poo, M. M. (2001). "Neurotrophins as synaptic modulators." Nat Rev Neurosci **2**(1): 24-32.
- Pozzo-Miller, L. D., W. Gottschalk, L. Zhang, K. McDermott, J. Du, R. Gopalakrishnan, C. Oho, Z. H. Sheng and B. Lu (1999). "Impairments in high-frequency transmission, synaptic vesicle docking, and synaptic protein distribution in the hippocampus of BDNF knockout mice." J Neurosci **19**(12): 4972-4983.
- Pratt, W. B. and D. O. Toft (1997). "Steroid receptor interactions with heat shock protein and immunophilin chaperones." Endocr Rev **18**(3): 306-360.
- Pruunsild, P., A. Kazantseva, T. Aid, K. Palm and T. Timmusk (2007). "Dissecting the human BDNF locus: bidirectional transcription, complex splicing, and multiple promoters." Genomics **90**(3): 397-406.
- Pruunsild, P., M. Sepp, E. Orav, I. Koppel and T. Timmusk (2011). "Identification of cis-elements and transcription factors regulating neuronal activity-dependent transcription of human BDNF gene." J Neurosci **31**(9): 3295-3308.

- Querfurth, H. W. and F. M. LaFerla (2010). "Alzheimer's disease." N Engl J Med **362**(4): 329-344.
- Radecki, D. T., L. M. Brown, J. Martinez and T. J. Teyler (2005). "BDNF protects against stress-induced impairments in spatial learning and memory and LTP." Hippocampus **15**(2): 246-253.
- Rasmuson, S., R. Andrew, B. Nasman, J. R. Seckl, B. R. Walker and T. Olsson (2001). "Increased glucocorticoid production and altered cortisol metabolism in women with mild to moderate Alzheimer's disease." Biol Psychiatry **49**(6): 547-552.
- Ratman, D., W. Vanden Berghe, L. Dejager, C. Libert, J. Tavernier, I. M. Beck and K. De Bosscher (2013). "How glucocorticoid receptors modulate the activity of other transcription factors: a scope beyond tethering." Mol Cell Endocrinol **380**(1-2): 41-54.
- Rattiner, L. M., M. Davis and K. J. Ressler (2004). "Differential regulation of brain-derived neurotrophic factor transcripts during the consolidation of fear learning." Learn Mem **11**(6): 727-731.
- Rawashdeh, O., A. Jilg, P. Jedlicka, J. Slawska, L. Thomas, A. Saade, S. W. Schwarzacher and J. H. Stehle (2014). "PERIOD1 coordinates hippocampal rhythms and memory processing with daytime." Hippocampus **24**(6): 712-723.
- Razzoli, M., E. Domenici, L. Carboni, T. Rantamaki, J. Lindholm, E. Castren and R. Arban (2011). "A role for BDNF/TrkB signaling in behavioral and physiological consequences of social defeat stress." Genes Brain Behav **10**(4): 424-433.
- Reichardt, H. M., T. Umland, A. Bauer, O. Kretz and G. Schutz (2000). "Mice with an increased glucocorticoid receptor gene dosage show enhanced resistance to stress and endotoxic shock." Mol Cell Biol **20**(23): 9009-9017.
- Reichardt, L. F. (2006). "Neurotrophin-regulated signalling pathways." Philos Trans R Soc Lond B Biol Sci **361**(1473): 1545-1564.
- Reitz, C., C. Brayne and R. Mayeux (2011). "Epidemiology of Alzheimer disease." Nat Rev Neurol **7**(3): 137-152.
- Ren, R., R. H. Oakley, D. Cruz-Topete and J. A. Cidlowski (2012). "Dual role for glucocorticoids in cardiomyocyte hypertrophy and apoptosis." Endocrinology **153**(11): 5346-5360.
- Rethorst, C. D. and M. H. Trivedi (2013). "Evidence-based recommendations for the prescription of exercise for major depressive disorder." J Psychiatr Pract **19**(3): 204-212.
- Rethorst, C. D., B. M. Wipfli and D. M. Landers (2009). "The antidepressive effects of exercise: a meta-analysis of randomized trials." Sports Med **39**(6): 491-511.
- Reul, J. M. and E. R. de Kloet (1985). "Two receptor systems for corticosterone in rat brain: microdistribution and differential occupation." Endocrinology **117**(6): 2505-2511.
- Rex, C. S., C. Y. Lin, E. A. Kramar, L. Y. Chen, C. M. Gall and G. Lynch (2007). "Brain-derived neurotrophic factor promotes long-term potentiation-related cytoskeletal changes in adult hippocampus." J Neurosci **27**(11): 3017-3029.

- Rhen, T. and J. A. Cidlowski (2005). "Antiinflammatory action of glucocorticoids--new mechanisms for old drugs." N Engl J Med **353**(16): 1711-1723.
- Ridder, S., S. Chourbaji, R. Hellweg, A. Urani, C. Zacher, W. Schmid, M. Zink, H. Hortnagl, H. Flor, F. A. Henn, G. Schutz and P. Gass (2005). "Mice with genetically altered glucocorticoid receptor expression show altered sensitivity for stress-induced depressive reactions." J Neurosci **25**(26): 6243-6250.
- Rivera, C., J. Voipio, J. Thomas-Crusells, H. Li, Z. Emri, S. Sipila, J. A. Payne, L. Minichiello, M. Saarma and K. Kaila (2004). "Mechanism of activity-dependent downregulation of the neuron-specific K-Cl cotransporter KCC2." J Neurosci **24**(19): 4683-4691.
- Robbins, T. W. and R. Cools (2014). "Cognitive deficits in Parkinson's disease: a cognitive neuroscience perspective." Mov Disord **29**(5): 597-607.
- Roceri, M., W. Hendriks, G. Racagni, B. A. Ellenbroek and M. A. Riva (2002). "Early maternal deprivation reduces the expression of BDNF and NMDA receptor subunits in rat hippocampus." Mol Psychiatry **7**(6): 609-616.
- Rogatsky, I. and L. B. Ivashkiv (2006). "Glucocorticoid modulation of cytokine signaling." Tissue Antigens **68**(1): 1-12.
- Rohe, M., M. Synowitz, R. Glass, S. M. Paul, A. Nykjaer and T. E. Willnow (2009). "Brain-derived neurotrophic factor reduces amyloidogenic processing through control of SORLA gene expression." J Neurosci **29**(49): 15472-15478.
- Roig, M., S. Nordbrandt, S. S. Geertsen and J. B. Nielsen (2013). "The effects of cardiovascular exercise on human memory: a review with meta-analysis." Neurosci Biobehav Rev **37**(8): 1645-1666.
- Ronacher, K., K. Hadley, C. Avenant, E. Stubbsrud, S. S. Simons, Jr., A. Louw and J. P. Hapgood (2009). "Ligand-selective transactivation and transrepression via the glucocorticoid receptor: role of cofactor interaction." Mol Cell Endocrinol **299**(2): 219-231.
- Roosendaal, B., A. Hernandez, S. M. Cabrera, R. Hagewoud, M. Malvaez, D. P. Stefanko, J. Haettig and M. A. Wood (2010). "Membrane-associated glucocorticoid activity is necessary for modulation of long-term memory via chromatin modification." J Neurosci **30**(14): 5037-5046.
- Ros-Bernal, F., S. Hunot, M. T. Herrero, S. Parnadeau, J. C. Corvol, L. Lu, D. Alvarez-Fischer, M. A. Carrillo-de Sauvage, F. Saurini, C. Coussieu, K. Kinugawa, A. Prigent, G. Hoglinger, M. Hamon, F. Tronche, E. C. Hirsch and S. Vyas (2011). "Microglial glucocorticoid receptors play a pivotal role in regulating dopaminergic neurodegeneration in parkinsonism." Proc Natl Acad Sci U S A **108**(16): 6632-6637.
- Rosenfeld, M. G. and C. K. Glass (2001). "Coregulator codes of transcriptional regulation by nuclear receptors." J Biol Chem **276**(40): 36865-36868.
- Ross, C. A. and S. J. Tabrizi (2011). "Huntington's disease: from molecular pathogenesis to clinical treatment." Lancet Neurol **10**(1): 83-98.

- Roth, T. L., F. D. Lubin, A. J. Funk and J. D. Sweatt (2009). "Lasting epigenetic influence of early-life adversity on the BDNF gene." Biol Psychiatry **65**(9): 760-769.
- Rothman, S. M., N. Herdener, S. Camandola, S. J. Texel, M. R. Mughal, W. N. Cong, B. Martin and M. P. Mattson (2012). "3xTgAD mice exhibit altered behavior and elevated Abeta after chronic mild social stress." Neurobiol Aging **33**(4): 830.e831-812.
- Roux, P. P. and P. A. Barker (2002). "Neurotrophin signaling through the p75 neurotrophin receptor." Prog Neurobiol **67**(3): 203-233.
- Rozeboom, A. M., H. Akil and A. F. Seasholtz (2007). "Mineralocorticoid receptor overexpression in forebrain decreases anxiety-like behavior and alters the stress response in mice." Proc Natl Acad Sci U S A **104**(11): 4688-4693.
- Russo-Neustadt, A. A. and M. J. Chen (2005). "Brain-derived neurotrophic factor and antidepressant activity." Curr Pharm Des **11**(12): 1495-1510.
- Russo, S. J., D. M. Dietz, D. Dumitriu, J. H. Morrison, R. C. Malenka and E. J. Nestler (2010). "The addicted synapse: mechanisms of synaptic and structural plasticity in nucleus accumbens." Trends Neurosci **33**(6): 267-276.
- Russo, S. J., M. S. Mazei-Robison, J. L. Ables and E. J. Nestler (2009). "Neurotrophic factors and structural plasticity in addiction." Neuropharmacology **56 Suppl 1**: 73-82.
- Sairanen, M., G. Lucas, P. Ernfors, M. Castren and E. Castren (2005). "Brain-derived neurotrophic factor and antidepressant drugs have different but coordinated effects on neuronal turnover, proliferation, and survival in the adult dentate gyrus." J Neurosci **25**(5): 1089-1094.
- Sakata, K., L. Jin and S. Jha (2010). "Lack of promoter IV-driven BDNF transcription results in depression-like behavior." Genes Brain Behav **9**(7): 712-721.
- Sakata, K., N. H. Woo, K. Martinowich, J. S. Greene, R. J. Schloesser, L. Shen and B. Lu (2009). "Critical role of promoter IV-driven BDNF transcription in GABAergic transmission and synaptic plasticity in the prefrontal cortex." Proc Natl Acad Sci U S A **106**(14): 5942-5947.
- Salto, R., J. D. Vilchez, M. D. Giron, E. Cabrera, N. Campos, M. Manzano, R. Rueda and J. M. Lopez-Pedrosa (2015). "beta-Hydroxy-beta-Methylbutyrate (HMB) Promotes Neurite Outgrowth in Neuro2a Cells." PLoS One **10**(8): e0135614.
- Samarasinghe, R. A., R. Di Maio, D. Volonte, F. Galbiati, M. Lewis, G. Romero and D. B. DeFranco (2011). "Nongenomic glucocorticoid receptor action regulates gap junction intercellular communication and neural progenitor cell proliferation." Proc Natl Acad Sci U S A **108**(40): 16657-16662.
- Samarasinghe, R. A., S. F. Witchell and D. B. DeFranco (2012). "Cooperativity and complementarity: synergies in non-classical and classical glucocorticoid signaling." Cell Cycle **11**(15): 2819-2827.
- Sapolsky, R. M., L. M. Romero and A. U. Munck (2000). "How do glucocorticoids influence stress responses? Integrating permissive, suppressive, stimulatory, and preparative actions." Endocr Rev **21**(1): 55-89.

- Sarabdjitsingh, R. A., M. Joels and E. R. de Kloet (2012). "Glucocorticoid pulsatility and rapid corticosteroid actions in the central stress response." Physiol Behav **106**(1): 73-80.
- Scalzo, P., A. Kummer, T. L. Bretas, F. Cardoso and A. L. Teixeira (2010). "Serum levels of brain-derived neurotrophic factor correlate with motor impairment in Parkinson's disease." J Neurol **257**(4): 540-545.
- Schaaf, M. J., J. de Jong, E. R. de Kloet and E. Vreugdenhil (1998). "Downregulation of BDNF mRNA and protein in the rat hippocampus by corticosterone." Brain Res **813**(1): 112-120.
- Schaaf, M. J., E. R. De Kloet and E. Vreugdenhil (2000). "Corticosterone effects on BDNF expression in the hippocampus. Implications for memory formation." Stress **3**(3): 201-208.
- Schaaf, M. J., R. W. Hoetelmans, E. R. de Kloet and E. Vreugdenhil (1997). "Corticosterone regulates expression of BDNF and trkB but not NT-3 and trkC mRNA in the rat hippocampus." J Neurosci Res **48**(4): 334-341.
- Scharfman, H., J. Goodman, A. Macleod, S. Phani, C. Antonelli and S. Croll (2005). "Increased neurogenesis and the ectopic granule cells after intrahippocampal BDNF infusion in adult rats." Exp Neurol **192**(2): 348-356.
- Scharfman, H. E., J. H. Goodman, A. L. Sollas and S. D. Croll (2002). "Spontaneous limbic seizures after intrahippocampal infusion of brain-derived neurotrophic factor." Exp Neurol **174**(2): 201-214.
- Scheuer, D. A. (2010). "Regulation of the stress response in rats by central actions of glucocorticoids." Exp Physiol **95**(1): 26-31.
- Schmidt, H. D. and R. S. Duman (2007). "The role of neurotrophic factors in adult hippocampal neurogenesis, antidepressant treatments and animal models of depressive-like behavior." Behav Pharmacol **18**(5-6): 391-418.
- Schmidt, H. D. and R. S. Duman (2010). "Peripheral BDNF produces antidepressant-like effects in cellular and behavioral models." Neuropsychopharmacology **35**(12): 2378-2391.
- Schoenfeld, T. J. and E. Gould (2012). "Stress, stress hormones, and adult neurogenesis." Exp Neurol **233**(1): 12-21.
- Schulte-Herbruggen, O., S. Chourbaji, S. Ridder, C. Brandwein, P. Gass, H. Hortnagl and R. Hellweg (2006). "Stress-resistant mice overexpressing glucocorticoid receptors display enhanced BDNF in the amygdala and hippocampus with unchanged NGF and serotonergic function." Psychoneuroendocrinology **31**(10): 1266-1277.
- Seibenhener, M. L. and M. W. Wooten (2012). "Isolation and culture of hippocampal neurons from prenatal mice." J Vis Exp(65).
- Seidah, N. G., S. Benjannet, S. Pareek, D. Savaria, J. Hamelin, B. Goulet, J. Laliberte, C. Lazure, M. Chretien and R. A. Murphy (1996). "Cellular processing of the nerve growth factor precursor by the mammalian pro-protein convertases." Biochem J **314** (Pt 3): 951-960.
- Shah, O. J., S. R. Kimball and L. S. Jefferson (2000). "Among translational effectors, p70S6k is uniquely sensitive to inhibition by glucocorticoids." Biochem J **347**(Pt 2): 389-397.

- Shao, S. H., S. S. Shi, Z. L. Li, M. S. Zhao, S. Y. Xie and F. Pan (2010). "Aging effects on the BDNF mRNA and TrkB mRNA expression of the hippocampus in different durations of stress." Chin J Physiol **53**(5): 285-293.
- Sharma, B., A. Bruner, G. Barnett and M. Fishman (2016). "Opioid Use Disorders." Child Adolesc Psychiatr Clin N Am **25**(3): 473-487.
- Sharma, R. P., N. Tun and D. R. Grayson (2008). "Depolarization induces downregulation of DNMT1 and DNMT3a in primary cortical cultures." Epigenetics **3**(2): 74-80.
- Shelton, R. C. (2007). "The molecular neurobiology of depression." Psychiatr Clin North Am **30**(1): 1-11.
- Shi, S. S., S. H. Shao, B. P. Yuan, F. Pan and Z. L. Li (2010). "Acute stress and chronic stress change brain-derived neurotrophic factor (BDNF) and tyrosine kinase-coupled receptor (TrkB) expression in both young and aged rat hippocampus." Yonsei Med J **51**(5): 661-671.
- Shieh, P. B., S. C. Hu, K. Bobb, T. Timmusk and A. Ghosh (1998). "Identification of a signaling pathway involved in calcium regulation of BDNF expression." Neuron **20**(4): 727-740.
- Shirayama, Y., A. C. Chen, S. Nakagawa, D. S. Russell and R. S. Duman (2002). "Brain-derived neurotrophic factor produces antidepressant effects in behavioral models of depression." J Neurosci **22**(8): 3251-3261.
- Shu, X. Q., A. Llinas and L. M. Mendell (1999). "Effects of trkB and trkC neurotrophin receptor agonists on thermal nociception: a behavioral and electrophysiological study." Pain **80**(3): 463-470.
- Skerrett, R., T. Malm and G. Landreth (2014). "Nuclear receptors in neurodegenerative diseases." Neurobiol Dis **72 Pt A**: 104-116.
- Smeets, T., O. T. Wolf, T. Giesbrecht, K. Sijstermans, S. Telgen and M. Joels (2009). "Stress selectively and lastingly promotes learning of context-related high arousing information." Psychoneuroendocrinology **34**(8): 1152-1161.
- Smith, A. D., S. L. Castro and M. J. Zigmond (2002). "Stress-induced Parkinson's disease: a working hypothesis." Physiol Behav **77**(4-5): 527-531.
- Smith, M. A. (1996). "Hippocampal vulnerability to stress and aging: possible role of neurotrophic factors." Behav Brain Res **78**(1): 25-36.
- Smith, M. A., S. Makino, S. Y. Kim and R. Kvetnansky (1995). "Stress increases brain-derived neurotrophic factor messenger ribonucleic acid in the hypothalamus and pituitary." Endocrinology **136**(9): 3743-3750.
- Smith, M. A., S. Makino, R. Kvetnansky and R. M. Post (1995). "Stress and glucocorticoids affect the expression of brain-derived neurotrophic factor and neurotrophin-3 mRNAs in the hippocampus." J Neurosci **15**(3 Pt 1): 1768-1777.

- Smith, P. J., J. A. Blumenthal, B. M. Hoffman, H. Cooper, T. A. Strauman, K. Welsh-Bohmer, J. N. Browndyke and A. Sherwood (2010). "Aerobic exercise and neurocognitive performance: a meta-analytic review of randomized controlled trials." Psychosom Med **72**(3): 239-252.
- Snappyan, M., M. Lemasson, M. S. Brill, M. Blais, M. Massouh, J. Ninkovic, C. Gravel, F. Berthod, M. Gotz, P. A. Barker, A. Parent and A. Saghatelian (2009). "Vasculature guides migrating neuronal precursors in the adult mammalian forebrain via brain-derived neurotrophic factor signaling." J Neurosci **29**(13): 4172-4188.
- Snider, W. D. and J. W. Lichtman (1996). "Are neurotrophins synaptotrophins?" Mol Cell Neurosci **7**(6): 433-442.
- Soliman, F., C. E. Glatt, K. G. Bath, L. Levita, R. M. Jones, S. S. Pattwell, D. Jing, N. Tottenham, D. Amso, L. H. Somerville, H. U. Voss, G. Glover, D. J. Ballon, C. Liston, T. Teslovich, T. Van Kempen, F. S. Lee and B. J. Casey (2010). "A genetic variant BDNF polymorphism alters extinction learning in both mouse and human." Science **327**(5967): 863-866.
- Sotelo-Rivera, I., A. Cote-Velez, R. M. Uribe, J. L. Charli and P. Joseph-Bravo (2017). "Glucocorticoids curtail stimuli-induced CREB phosphorylation in TRH neurons through interaction of the glucocorticoid receptor with the catalytic subunit of protein kinase A." **55**(3): 861-871.
- Spanagel, R. and F. Weiss (1999). "The dopamine hypothesis of reward: past and current status." Trends Neurosci **22**(11): 521-527.
- Stauber, C., J. Altschmied, I. E. Akerblom, J. L. Marron and P. L. Mellon (1992). "Mutual cross-interference between glucocorticoid receptor and CREB inhibits transactivation in placental cells." New Biol **4**(5): 527-540.
- Steele, P. M. and M. D. Mauk (1999). "Inhibitory control of LTP and LTD: stability of synapse strength." J Neurophysiol **81**(4): 1559-1566.
- Stragier, E., V. Martin, E. Davenas, C. Poilbout, R. Mongeau and R. Corradetti (2015). "Brain plasticity and cognitive functions after ethanol consumption in C57BL/6J mice." **5**: e696.
- Stragier, E., R. Massart, M. Salery, M. Hamon, D. Geny, V. Martin, F. Bouille and L. Lanfumey (2015). "Ethanol-induced epigenetic regulations at the Bdnf gene in C57BL/6J mice." Mol Psychiatry **20**(3): 405-412.
- Stypula, G., J. Kunert-Radek, H. Stepień, K. Zylinska and M. Pawlikowski (1996). "Evaluation of interleukins, ACTH, cortisol and prolactin concentrations in the blood of patients with parkinson's disease." Neuroimmunomodulation **3**(2-3): 131-134.
- Sun, Y., Y. Lim, F. Li, S. Liu, J. J. Lu, R. Haberberger, J. H. Zhong and X. F. Zhou (2012). "ProBDNF collapses neurite outgrowth of primary neurons by activating RhoA." PLoS One **7**(4): e35883.
- Suri, D. and V. A. Vaidya (2013). "Glucocorticoid regulation of brain-derived neurotrophic factor: relevance to hippocampal structural and functional plasticity." Neuroscience **239**: 196-213.
- Surjit, M., K. P. Ganti, A. Mukherji, T. Ye, G. Hua, D. Metzger, M. Li and P. Chambon (2011). "Widespread negative response elements mediate direct repression by agonist-liganded glucocorticoid receptor." Cell **145**(2): 224-241.

- Tabuchi, A., R. Nakaoka, K. Amano, M. Yukimine, T. Andoh, Y. Kuraishi and M. Tsuda (2000). "Differential activation of brain-derived neurotrophic factor gene promoters I and III by Ca²⁺ signals evoked via L-type voltage-dependent and N-methyl-D-aspartate receptor Ca²⁺ channels." J Biol Chem **275**(23): 17269-17275.
- Taffe, M. A., R. W. Kotzebue, R. D. Crean, E. F. Crawford, S. Edwards and C. D. Mandyam (2010). "Long-lasting reduction in hippocampal neurogenesis by alcohol consumption in adolescent nonhuman primates." Proc Natl Acad Sci U S A **107**(24): 11104-11109.
- Taliaz, D., N. Stall, D. E. Dar and A. Zangen (2010). "Knockdown of brain-derived neurotrophic factor in specific brain sites precipitates behaviors associated with depression and reduces neurogenesis." Mol Psychiatry **15**(1): 80-92.
- Tanaka, J., Y. Horiike, M. Matsuzaki, T. Miyazaki, G. C. Ellis-Davies and H. Kasai (2008). "Protein synthesis and neurotrophin-dependent structural plasticity of single dendritic spines." Science **319**(5870): 1683-1687.
- Tanapat, P., N. B. Hastings, T. A. Rydel, L. A. Galea and E. Gould (2001). "Exposure to fox odor inhibits cell proliferation in the hippocampus of adult rats via an adrenal hormone-dependent mechanism." J Comp Neurol **437**(4): 496-504.
- Tao, X., S. Finkbeiner, D. B. Arnold, A. J. Shaywitz and M. E. Greenberg (1998). "Ca²⁺ influx regulates BDNF transcription by a CREB family transcription factor-dependent mechanism." Neuron **20**(4): 709-726.
- Tao, X., A. E. West, W. G. Chen, G. Corfas and M. E. Greenberg (2002). "A calcium-responsive transcription factor, CaRF, that regulates neuronal activity-dependent expression of BDNF." Neuron **33**(3): 383-395.
- Tapia-Arancibia, L., F. Rage, L. Givalois and S. Arancibia (2004). "Physiology of BDNF: focus on hypothalamic function." Front Neuroendocrinol **25**(2): 77-107.
- Tata, D. A., V. A. Marciano and B. J. Anderson (2006). "Synapse loss from chronically elevated glucocorticoids: relationship to neuropil volume and cell number in hippocampal area CA3." J Comp Neurol **498**(3): 363-374.
- Teng, H. K., K. K. Teng, R. Lee, S. Wright, S. Tevar, R. D. Almeida, P. Kermani, R. Torkin, Z. Y. Chen, F. S. Lee, R. T. Kraemer, A. Nykjaer and B. L. Hempstead (2005). "ProBDNF induces neuronal apoptosis via activation of a receptor complex of p75NTR and sortilin." J Neurosci **25**(22): 5455-5463.
- Thompson, S. W., D. L. Bennett, B. J. Kerr, E. J. Bradbury and S. B. McMahon (1999). "Brain-derived neurotrophic factor is an endogenous modulator of nociceptive responses in the spinal cord." Proc Natl Acad Sci U S A **96**(14): 7714-7718.
- Timmusk, T., K. Palm, M. Metsis, T. Reintam, V. Paalme, M. Saarma and H. Persson (1993). "Multiple promoters direct tissue-specific expression of the rat BDNF gene." Neuron **10**(3): 475-489.
- Toriya, M., F. Maekawa, Y. Maejima, T. Onaka, K. Fujiwara, T. Nakagawa, M. Nakata and T. Yada (2010). "Long-term infusion of brain-derived neurotrophic factor reduces food intake and

- body weight via a corticotrophin-releasing hormone pathway in the paraventricular nucleus of the hypothalamus." J Neuroendocrinol **22**(9): 987-995.
- Tozuka, Y., S. Fukuda, T. Namba, T. Seki and T. Hisatsune (2005). "GABAergic excitation promotes neuronal differentiation in adult hippocampal progenitor cells." Neuron **47**(6): 803-815.
- Trapp, T. and F. Holsboer (1996). "Heterodimerization between mineralocorticoid and glucocorticoid receptors increases the functional diversity of corticosteroid action." Trends Pharmacol Sci **17**(4): 145-149.
- Travers, S., L. Martinerie, C. Bouvattier, P. Boileau, M. Lombes and E. Pussard (2017). "Multiplexed steroid profiling of gluco- and mineralocorticoids pathways using a liquid chromatography tandem mass spectrometry method." J Steroid Biochem Mol Biol **165**(Pt B): 202-211.
- Treede, R. D., T. S. Jensen, J. N. Campbell, G. Cruccu, J. O. Dostrovsky, J. W. Griffin, P. Hansson, R. Hughes, T. Nurmikko and J. Serra (2008). "Neuropathic pain: redefinition and a grading system for clinical and research purposes." Neurology **70**(18): 1630-1635.
- Tronche, F., C. Kellendonk, O. Kretz, P. Gass, K. Anlag, P. C. Orban, R. Bock, R. Klein and G. Schutz (1999). "Disruption of the glucocorticoid receptor gene in the nervous system results in reduced anxiety." Nat Genet **23**(1): 99-103.
- Tsai, K. J., S. K. Chen, Y. L. Ma, W. L. Hsu and E. H. Lee (2002). "sgk, a primary glucocorticoid-induced gene, facilitates memory consolidation of spatial learning in rats." Proc Natl Acad Sci U S A **99**(6): 3990-3995.
- Tsankova, N. M., O. Berton, W. Renthal, A. Kumar, R. L. Neve and E. J. Nestler (2006). "Sustained hippocampal chromatin regulation in a mouse model of depression and antidepressant action." Nat Neurosci **9**(4): 519-525.
- Tyler, W. J., M. Alonso, C. R. Bramham and L. D. Pozzo-Miller (2002). "From acquisition to consolidation: on the role of brain-derived neurotrophic factor signaling in hippocampal-dependent learning." Learn Mem **9**(5): 224-237.
- Ueyama, T., Y. Kawai, K. Nemoto, M. Sekimoto, S. Tone and E. Senba (1997). "Immobilization stress reduced the expression of neurotrophins and their receptors in the rat brain." Neurosci Res **28**(2): 103-110.
- Uhlenhaut, N. H., G. D. Barish, R. T. Yu, M. Downes, M. Karunasiri, C. Liddle, P. Schwalie, N. Hubner and R. M. Evans (2013). "Insights into negative regulation by the glucocorticoid receptor from genome-wide profiling of inflammatory cistromes." Mol Cell **49**(1): 158-171.
- Ulrich-Lai, Y. M. and J. P. Herman (2009). "Neural regulation of endocrine and autonomic stress responses." Nat Rev Neurosci **10**(6): 397-409.
- van Praag, H., T. Shubert, C. Zhao and F. H. Gage (2005). "Exercise enhances learning and hippocampal neurogenesis in aged mice." J Neurosci **25**(38): 8680-8685.
- van Weert, L. T., J. C. Buurstedde, A. Mahfouz, P. S. Braakhuis, J. A. Polman, H. C. Sips, B. Roozendaal, J. Balog, E. R. de Kloet, N. A. Datson and O. C. Meijer (2017). "NeuroD factors discriminate

- mineralocorticoid from glucocorticoid receptor DNA binding in the male rat brain." Endocrinology.
- Vaynman, S., Z. Ying and F. Gomez-Pinilla (2004). "Exercise induces BDNF and synapsin I to specific hippocampal subfields." J Neurosci Res **76**(3): 356-362.
- Vaynman, S., Z. Ying and F. Gomez-Pinilla (2004). "Hippocampal BDNF mediates the efficacy of exercise on synaptic plasticity and cognition." Eur J Neurosci **20**(10): 2580-2590.
- Vellucci, S. V., R. F. Parrott and M. L. Mimmack (2001). "Down-regulation of BDNF mRNA, with no effect on trkB or glucocorticoid receptor m RNAs, in the porcine hippocampus after acute dexamethasone treatment." Res Vet Sci **70**(2): 157-162.
- Vellucci, S. V., R. F. Parrott and M. L. Mimmack (2002). "Chronic dexamethasone-treatment alters mineralocorticoid receptor, truncated trkB and selected glutamate receptor subunit mRNA expression in the porcine hippocampus." Neuropeptides **36**(4): 291-298.
- Viengchareun, S., D. Le Menuet, L. Martinerie, M. Munier, L. Pascual-Le Tallec and M. Lombes (2007). "The mineralocorticoid receptor: insights into its molecular and (patho)physiological biology." Nucl Recept Signal **5**: e012.
- Voss, M. W., C. Vivar, A. F. Kramer and H. van Praag (2013). "Bridging animal and human models of exercise-induced brain plasticity." Trends Cogn Sci **17**(10): 525-544.
- Vyas, S. and L. Maatouk (2013). "Contribution of glucocorticoids and glucocorticoid receptors to the regulation of neurodegenerative processes." CNS Neurol Disord Drug Targets **12**(8): 1175-1193.
- Wang, F. J., C. M. Li, X. H. Hou, X. R. Wang and L. M. Zhang (2011). "Selective upregulation of brain-derived neurotrophic factor (BDNF) transcripts and BDNF direct induction of activity independent N-methyl-D-aspartate currents in temporal lobe epilepsy patients with hippocampal sclerosis." J Int Med Res **39**(4): 1358-1368.
- Wang, L., Z. Lv, Z. Hu, J. Sheng, B. Hui, J. Sun and L. Ma (2010). "Chronic cocaine-induced H3 acetylation and transcriptional activation of CaMKIIalpha in the nucleus accumbens is critical for motivation for drug reinforcement." Neuropsychopharmacology **35**(4): 913-928.
- Wang, Z., W. Chen, E. Kono, T. Dang and M. J. Garabedian (2007). "Modulation of glucocorticoid receptor phosphorylation and transcriptional activity by a C-terminal-associated protein phosphatase." Mol Endocrinol **21**(3): 625-634.
- Waterhouse, E. G., J. J. An, L. L. Orefice, M. Baydyuk, G. Y. Liao, K. Zheng, B. Lu and B. Xu (2012). "BDNF promotes differentiation and maturation of adult-born neurons through GABAergic transmission." J Neurosci **32**(41): 14318-14330.
- Webster, J. C., C. M. Jewell, J. E. Bodwell, A. Munck, M. Sar and J. A. Cidlowski (1997). "Mouse glucocorticoid receptor phosphorylation status influences multiple functions of the receptor protein." J Biol Chem **272**(14): 9287-9293.

- Wei, Q., X. Y. Lu, L. Liu, G. Schafer, K. R. Shieh, S. Burke, T. E. Robinson, S. J. Watson, A. F. Seasholtz and H. Akil (2004). "Glucocorticoid receptor overexpression in forebrain: a mouse model of increased emotional lability." Proc Natl Acad Sci U S A **101**(32): 11851-11856.
- Weikum, E. R., I. M. S. de Vera, J. C. Nwachukwu, W. H. Hudson, K. W. Nettles, D. J. Kojetin and E. A. Ortlund (2017). "Tethering not required: the glucocorticoid receptor binds directly to activator protein-1 recognition motifs to repress inflammatory genes." Nucleic Acids Res.
- Wilhelm, J. C., M. Xu, D. Cucoranu, S. Chmielewski, T. Holmes, K. S. Lau, G. J. Bassell and A. W. English (2012). "Cooperative roles of BDNF expression in neurons and Schwann cells are modulated by exercise to facilitate nerve regeneration." J Neurosci **32**(14): 5002-5009.
- Wong, E. Y. and J. Herbert (2004). "The corticoid environment: a determining factor for neural progenitors' survival in the adult hippocampus." Eur J Neurosci **20**(10): 2491-2498.
- Wong, E. Y. and J. Herbert (2005). "Roles of mineralocorticoid and glucocorticoid receptors in the regulation of progenitor proliferation in the adult hippocampus." Eur J Neurosci **22**(4): 785-792.
- Wosiski-Kuhn, M., J. R. Erion, E. P. Gomez-Sanchez, C. E. Gomez-Sanchez and A. M. Stranahan (2014). "Glucocorticoid receptor activation impairs hippocampal plasticity by suppressing BDNF expression in obese mice." Psychoneuroendocrinology **42**: 165-177.
- Wu, L. L., Y. Fan, S. Li, X. J. Li and X. F. Zhou (2010). "Huntingtin-associated protein-1 interacts with pro-brain-derived neurotrophic factor and mediates its transport and release." J Biol Chem **285**(8): 5614-5623.
- Yajima, Y., M. Narita, A. Usui, C. Kaneko, M. Miyatake, M. Narita, T. Yamaguchi, H. Tamaki, H. Wachi, Y. Seyama and T. Suzuki (2005). "Direct evidence for the involvement of brain-derived neurotrophic factor in the development of a neuropathic pain-like state in mice." J Neurochem **93**(3): 584-594.
- Yamada, K., M. Mizuno and T. Nabeshima (2002). "Role for brain-derived neurotrophic factor in learning and memory." Life Sci **70**(7): 735-744.
- Yamamoto, M., G. Sobue, M. Li, Y. Arakawa, T. Mitsuma and K. Kimata (1993). "Nerve growth factor (NGF), brain-derived neurotrophic factor (BDNF) and low-affinity nerve growth factor receptor (LNGFR) mRNA levels in cultured rat Schwann cells; differential time- and dose-dependent regulation by cAMP." Neurosci Lett **152**(1-2): 37-40.
- Yan, Q., R. D. Rosenfeld, C. R. Matheson, N. Hawkins, O. T. Lopez, L. Bennett and A. A. Welcher (1997). "Expression of brain-derived neurotrophic factor protein in the adult rat central nervous system." Neuroscience **78**(2): 431-448.
- Yang-Yen, H. F., J. C. Chambard, Y. L. Sun, T. Smeal, T. J. Schmidt, J. Drouin and M. Karin (1990). "Transcriptional interference between c-Jun and the glucocorticoid receptor: mutual inhibition of DNA binding due to direct protein-protein interaction." Cell **62**(6): 1205-1215.
- Yang, J. W., Z. Liang, S. D. Deng, W. Ma, X. B. Wang, X. T. Li, T. T. Wang, Y. F. Dai, J. H. Guo and L. Y. Li (2017). "Brain-derived neurotrophic factor promotes growth of neurons and neural stem cells

- possibly by triggering the phosphoinositide 3-kinase /AKT/ glycogen synthase kinase-3beta /beta-catenin pathway." CNS Neurol Disord Drug Targets.
- Yi, J. H., C. Brown, G. Whitehead, T. Piers, Y. S. Lee, C. M. Perez, P. Regan, D. J. Whitcomb and K. Cho (2017). "Glucocorticoids activate a synapse weakening pathway culminating in tau phosphorylation in the hippocampus." Pharmacol Res **121**: 42-51.
- Yoshii, A. and M. Constantine-Paton (2010). "Postsynaptic BDNF-TrkB signaling in synapse maturation, plasticity, and disease." Dev Neurobiol **70**(5): 304-322.
- Young, D., P. A. Lawlor, P. Leone, M. Dragunow and M. J. During (1999). "Environmental enrichment inhibits spontaneous apoptosis, prevents seizures and is neuroprotective." Nat Med **5**(4): 448-453.
- Yudt, M. R., C. M. Jewell, R. J. Bienstock and J. A. Cidlowski (2003). "Molecular origins for the dominant negative function of human glucocorticoid receptor beta." Mol Cell Biol **23**(12): 4319-4330.
- Zakharenko, S. S., S. L. Patterson, I. Dragatsis, S. O. Zeitlin, S. A. Siegelbaum, E. R. Kandel and A. Morozov (2003). "Presynaptic BDNF required for a presynaptic but not postsynaptic component of LTP at hippocampal CA1-CA3 synapses." Neuron **39**(6): 975-990.
- Zhang, D., L. Zhang, D. W. Lou, Y. Nakabeppu, J. Zhang and M. Xu (2002). "The dopamine D1 receptor is a critical mediator for cocaine-induced gene expression." J Neurochem **82**(6): 1453-1464.
- Zhang, L., G. Wang, J. Ma, C. Liu, X. Liu, Y. Zhan and M. Zhang (2016). "Brain-derived neurotrophic factor (BDNF) in the rostral anterior cingulate cortex (rACC) contributes to neuropathic spontaneous pain-related aversion via NR2B receptors." Brain Res Bull **127**: 56-65.
- Zheng, F. and H. Wang (2009). "NMDA-mediated and self-induced bdnf exon IV transcriptions are differentially regulated in cultured cortical neurons." Neurochem Int **54**(5-6): 385-392.
- Zheng, F., X. Zhou, Y. Luo, H. Xiao, G. Wayman and H. Wang (2011). "Regulation of brain-derived neurotrophic factor exon IV transcription through calcium responsive elements in cortical neurons." PLoS One **6**(12): e28441.
- Zheng, F., X. Zhou, C. Moon and H. Wang (2012). "Regulation of brain-derived neurotrophic factor expression in neurons." Int J Physiol Pathophysiol Pharmacol **4**(4): 188-200.
- Zhou, J., F. Zhang and Y. Zhang (2000). "Corticosterone inhibits generation of long-term potentiation in rat hippocampal slice: involvement of brain-derived neurotrophic factor." Brain Res **885**(2): 182-191.
- Zhou, M., E. H. Bakker, E. H. Velzing, S. Berger, M. Oitzl, M. Joels and H. J. Krugers (2010). "Both mineralocorticoid and glucocorticoid receptors regulate emotional memory in mice." Neurobiol Learn Mem **94**(4): 530-537.
- Zhou, X. F., E. T. Chie, Y. S. Deng, J. H. Zhong, Q. Xue, R. A. Rush and C. J. Xian (1999). "Injured primary sensory neurons switch phenotype for brain-derived neurotrophic factor in the rat." Neuroscience **92**(3): 841-853.

- Zoladz, J. A. and A. Pilc (2010). "The effect of physical activity on the brain derived neurotrophic factor: from animal to human studies." J Physiol Pharmacol **61**(5): 533-541.
- Zuccato, C. and E. Cattaneo (2009). "Brain-derived neurotrophic factor in neurodegenerative diseases." Nat Rev Neurol **5**(6): 311-322.
- Zuccato, C., D. Liber, C. Ramos, A. Tarditi, D. Rigamonti, M. Tartari, M. Valenza and E. Cattaneo (2005). "Progressive loss of BDNF in a mouse model of Huntington's disease and rescue by BDNF delivery." Pharmacol Res **52**(2): 133-139.

Titre : Régulation de l'expression du *brain-derived neurotrophic factor* par le récepteur des glucocorticoïdes dans le neurone

Mots clés : *Brain-Derived Neurotrophic Factor*, Neurones, Récepteur des glucocorticoïdes, Récepteur des minéralocorticoïdes

Résumé : Dans le système nerveux central (SNC), l'hippocampe est une structure majeure pour les fonctions cognitives et comportementales. Le *Brain-Derived Neurotrophic Factor* (BDNF), un acteur clé dans ces fonctions neuronales, est fortement exprimé dans l'hippocampe. La structure du gène *Bdnf* murin est complexe, comportant 8 exons non codants (I à VIII), chacun avec un promoteur spécifique (1 à 8) et un exon IX codant commun. Les glucocorticoïdes (GC) exercent des actions pleiotropes sur ces processus neuronaux en se liant et en activant le récepteur des glucocorticoïdes (GR), et le récepteur des minéralocorticoïdes (MR). Le GR est un facteur de transcription, modulant la transcription de ses gènes cibles, en se liant directement aux éléments de réponse des glucocorticoïdes ou en interagissant indirectement sur d'autres facteurs de transcription. Il a été suggéré que l'expression de *Bdnf* est régulée par le stress et les concentrations élevées de GC. Cependant, il reste à définir si BDNF est un gène cible du GR et quels sont les mécanismes moléculaires impliqués.

Dans ce travail, nous avons démontré que les fortes concentrations de GC diminuent l'expression de l'ARNm de *Bdnf* via le GR dans divers modèles cellulaires neuronaux. Dans des cultures primaires de neurones hippocampiques de souris et dans les cellules BZ, les transcrits de BDNF contenant l'exon IV et VI sont reprimés par le GR. Par ailleurs les transfections transitoires démontrent que l'activité du promoteur 4 est diminuée par GR. Les expériences de mutagenèse et de ChIP ont révélé que la répression induite par le GR sur l'expression et l'activité transcriptionnelle de *Bdnf* implique un petit fragment de 74 bp situé dans le promoteur en amont de l'exon IV. La localisation précise de l'interaction génomique du GR et les facteurs de transcription potentiels mis en jeu restent à identifier. Ce travail a contribué à une meilleure compréhension des mécanismes impliqués dans la régulation de l'expression de *Bdnf* par GR. Il apporte de nouveaux éléments sur les interactions moléculaires et fonctionnelles entre la signalisation GC et celle de BDNF dans les neurones, d'importance majeure dans la physiopathologie du SNC.

Title : Neuronal Glucocorticoid Receptor Regulation of Brain-Derived Neurotrophic Factor Expression

Keywords : Brain-derived neurotrophic factor, Neurons, Glucocorticoid receptor, Mineralocorticoid receptor

Abstract : In the central nervous system (CNS), the hippocampus is a structure of major importance for cognitive and behavioral functions. The brain-derived neurotrophic factor (BDNF), a key player in such neuronal functions is highly expressed in the hippocampus. Rodent *Bdnf* gene structure is relatively complex, composed of 8 noncoding exons (I to VIII), each one with a specific promoter (1 to 8), and one common coding exon IX. Glucocorticoids (GC) exert pleiotropic actions on neuronal processes by binding to and activating the glucocorticoid receptor (GR), as well as the mineralocorticoid receptor (MR). GR functions as a transcription factor, directly by interacting to glucocorticoid response elements or indirectly by interacting with other transcription factors, leading to the regulation of target gene transcription. It has been suggested that *Bdnf* expression is regulated by stress and high GC concentrations. However, it remains to define whether *Bdnf* is a GR target gene and what are the underlying molecular mechanisms.

Herein, we demonstrate that high GC levels downregulate total *Bdnf* mRNA expression via GR in various *in vitro* neuron-like cellular models. In primary cultures of mouse hippocampal neurons and BZ cells, BDNF IV- and VI-containing transcripts are involved in this regulatory mechanism. Moreover, in transient transfections, promoter 4 activity was reduced by activated GR. Furthermore, ChIP analysis and mutagenesis experiments demonstrate that the GR-induced repression on *Bdnf* expression and transcriptional activities occurs through GR binding to a small 74 bp promoter sequence upstream of exon IV. The exact GR binding site on DNA and its putative transcription factor partners are currently under investigation. Altogether, these findings contribute to a better understanding of the mechanisms by which GR represses BDNF expression. Our study brings new insights into the molecular interactions between GC signaling and BDNF signaling in neurons, both important pathways in the pathophysiology of the CNS.

Intitulé et adresse du laboratoire où la thèse a été effectuée :

Inserm U1185, Signalisation Hormonale, Physiopathologie Endocrinienne et Métabolique
Faculté de Médecine Paris Sud, 63 rue Gabriel Péri, 94276, Le Kremlin-Bicêtre Cedex
Directeur : Dr Marc Lombès

Université Paris-Saclay

Espace Technologique / Immeuble Discovery

Route de l'Orme aux Merisiers RD 128 / 91190 Saint-Aubin, France

