



HAL
open science

Contribution to a modelling framework of integrated vehicle health management : a generic health management module supporting the integration of diagnostics and prognostics

Ioana Geanta

► **To cite this version:**

Ioana Geanta. Contribution to a modelling framework of integrated vehicle health management : a generic health management module supporting the integration of diagnostics and prognostics. Automatic Control Engineering. Université de Lorraine, 2014. English. NNT : 2014LORR0212 . tel-01647218

HAL Id: tel-01647218

<https://theses.hal.science/tel-01647218>

Submitted on 24 Nov 2017

HAL is a multi-disciplinary open access archive for the deposit and dissemination of scientific research documents, whether they are published or not. The documents may come from teaching and research institutions in France or abroad, or from public or private research centers.

L'archive ouverte pluridisciplinaire **HAL**, est destinée au dépôt et à la diffusion de documents scientifiques de niveau recherche, publiés ou non, émanant des établissements d'enseignement et de recherche français ou étrangers, des laboratoires publics ou privés.



AVERTISSEMENT

Ce document est le fruit d'un long travail approuvé par le jury de soutenance et mis à disposition de l'ensemble de la communauté universitaire élargie.

Il est soumis à la propriété intellectuelle de l'auteur. Ceci implique une obligation de citation et de référencement lors de l'utilisation de ce document.

D'autre part, toute contrefaçon, plagiat, reproduction illicite encourt une poursuite pénale.

Contact : ddoc-theses-contact@univ-lorraine.fr

LIENS

Code de la Propriété Intellectuelle. articles L 122. 4

Code de la Propriété Intellectuelle. articles L 335.2- L 335.10

http://www.cfcopies.com/V2/leg/leg_droi.php

<http://www.culture.gouv.fr/culture/infos-pratiques/droits/protection.htm>



Ecole Doctorale IAEM Lorraine
Formation Doctorale Automatique



Centre de Recherche en Automatique de Nancy
CNRS UMR 7039

Thèse

Présentée pour l'obtention du titre de
Docteur de l'Université de Lorraine
en Automatique, Traitement du Signal et des Images, Génie Informatique

par **Ioana Geanta**

Contribution à un cadre de modélisation de gestion intégrée de l'état de santé de véhicules : Proposition d'un module générique de gestion de la santé support à l'intégration du diagnostic et du pronostic

Soutenue à huis clos le 10 décembre 2014

Membres du Jury :

Président :

Prof. Christophe Berenguer – Professeur à l'Institut National Polytechnique de Grenoble

Rapporteurs :

Prof. Frédéric Kratz – Professeur à l'Ecole Nationale Supérieure d'Ingénieurs de Bourges

Prof. François Peres – Professeur à l'Ecole Nationale d'Ingénieurs de Tarbes

Examineurs :

Patrick Freneuill – Sphera Test & Services, Toulouse (Directeur Technique)

Prof. Benoit Iung – Professeur à l'Université de Lorraine, Nancy (Directeur de Thèse)

Prof. Mustapha Ouladsine – Professeur à l'Université d'Aix-Marseille

Michel Schieber – Sphera Test & Services, Elancourt (Encadrant industriel)

Prof. Didier Theilliol – Professeur à l'Université de Lorraine, Nancy (Directeur de Thèse)

Invité :

Dr. Jean-Baptiste Leger – Président de Predict, Vandœuvre lès Nancy

**Contribution to a Modelling Framework of
Integrated Vehicle Health Management:
A Generic Health Management Module Supporting
the Integration of Diagnostics and Prognostics**

Ioana Geanta

In life there is a role for everyone you meet:

some raise you, some teach you, some challenge you, and some love you.

The ones who are truly important are the ones who bring out the best in you.

This book is dedicated to these rare and amazing people.

Acknowledgements

After three years, three months and ten days of PhD journey, it feels sensational to be a Doctor! Challenging but rewarding, arduous but fascinating, constraining but purposeful, my PhD has been accomplished with the support of wonderful people. While writing a full list of people within a page is certainly unreasonable, I cannot complete this last moment of my thesis without thanking the most important ones.

First and foremost, I am deeply grateful to my two PhD supervisors, Benoit Iung and Didier Theilliol. Your complementary guidance, fruitful discussions and constructive reflections about my work, have been essential for the success of my PhD thesis. You always believed in me, motivated me, and showed an undeniably stimulating attitude for my research topic. Thank you so much!

I would like to thank Michel Schieber, who took me under his wing at Cassidian. You have supported me, challenged me and encouraged my innovative ideas. I am stronger today thanks to our collaboration.

I would also like to thank my PhD committee members, M. Frédéric Kratz, M. François Pérès, M. Christophe Berenguer, M. Patrick Freneuil, M. Mustapha Ouladsine, and M. Jean-Baptiste Leger for their evaluation of my PhD thesis, for their appreciation, and interesting insight of my work.

I am grateful to Yann Fusero for accepting me with open arms within his department at Cassidian, and for providing me with a wonderful working environment.

This unique experience has been shared with many colleagues at Cassidian Test & Services, and at CRAN-CNRS, which were there for me in the good, but also in the tough moments of this journey. Special thanks to Caroline Plana-Robert, and Gilles Ballanger, I will certainly miss you as colleagues and friends! Guillaume Bastard, Julien Pulice and Loïc Frette, thank you for your involvement in the demonstrator of the thesis, I really appreciated your dedication, flexibility and good humor throughout the last months of the thesis! Gabriela Medina-Oliva, Fabien Bouffaron, Antonio Giovannini thank you for sharing your PhD journeys along mine!

Special thanks to my dear friend Dr. Alexandru-Robert Guduvan firstly for his recommendation at Cassidian, secondly for having shared his PhD journey along with mine at Cassidian, and thirdly for his invaluable friendship.

I would like to give a heartfelt thanks to my family. My parents, Valentina and Adrian Geanta and my brother, Dan-Gabriel Geanta, always believed in me, and have offered me their full support through my life and taught me to love and enjoy science! Thank you for everything! Special thanks to Maryse, Jean-Claude and Sébastien Eballard for your understanding and encouragement.

Finally, the most important person in my life, Julien Eballard, thank you for your unconditional support and love during this long journey!

Abstract

Cassidian Test & Services (renamed Sphera), initiator of the PhD thesis, is a leading provider of Automatic Test Equipment (ATE) solutions for aerospace and military vehicles' maintenance. The company's interest in Integrated Vehicle Health Management (IVHM) research is motivated by occurrence of No Fault Found (NFF) events detected by ATE, and determining superfluous maintenance activities and consequently major wastes of time, energy and money. IVHM, through its advanced diagnostics and prognostics capabilities, and integration at enterprise level of vehicle health management could solve NFF events occurring during operational-level maintenance. Nevertheless, IVHM systems proposed so far are most of the times developed and matured empirically, for specific vehicle systems, founded on proprietary concepts, and lacking of consensual structuring principles. This results in a lack of consensus in both the structuring principles of IVHM systems and their Systems Engineering. Today, the challenge is to provide an IVHM modelling framework independent from the type of supported system and usable for IVHM Systems Engineering. Towards such framework, the main contributions developed in this thesis progressively build the foundation and pillars of an IVHM modelling framework. The notion of system of systems drives our first proposal of defining principles of an overall IVHM system. From this system vision, the focus of the thesis is oriented on the function of IVHM centred on the vehicle as catalyst of maintenance decisions at operational level, having the ability to solve NFF problems at the genesis of the thesis. The key structuring principles of this function upon three dimensions (functional dimension, a dimension of abstraction, and distribution between the on-board /on-ground segment) are the basis of the proposal of a generic modelling framework IVHM, considering both vehicle and enterprise centric functions. This framework is built upon a Model-based Systems Engineering (MBSE) approach, supported by SysML. Consistent with this MBSE approach, the modelling, within this framework of IVHM, of generic Health Management Module (gHMM) is the support for integration of diagnostics and prognostics, key processes of health management. The gHMM formalization enables to integrate diagnostics and prognostics not only in the conventional way: from diagnosis to prognosis, but also in an original one: from prognostics to diagnostics with the purpose of reducing ambiguity groups; the latter is illustrated through the proposal of an algorithm for one of the elementary activities of the gHMM. The gHMM engineering thus leads to a generic modelling framework, which, by a principle of instantiation, allows the construction of an IVHM system designed for the health management of individual vehicle systems. Towards such particularization, the thesis investigates characteristics impacting selection of appropriate supporting algorithms. This analysis enables to identify ten generic macro-criteria, which are further formalized and used within a multi-criteria based methodology suited for selecting diagnostics and prognostics algorithms for vehicle health management. Finally, the validation protocol of the scientific contributions is proposed, and applied at different scales of implementation in the field of wind turbine and UAV health management.

Keywords: IVHM, modelling framework, diagnostics, prognostics.

Table of Contents

General introduction	1
1 Towards an Integrated Vehicle Health Management framework	5
1.1 Introduction	5
1.2 Industrial problem statement	6
1.3 IVHM problem statement.....	15
1.3.1 Origin and evolution of IVHM.....	16
1.3.2 From industrial to scientific problems in IVHM.....	23
1.4 Conclusion.....	37
2 Definition of an IVHM modelling framework	39
2.1 Introduction	39
2.2 “I” – “V” – “HM”.....	40
2.2.1 IVHM as system of systems.....	40
2.2.2 “V” – the system-of-interest.....	41
2.2.3 “HM” – enabling system	44
2.2.4 “I” – binding in IVHM system of systems	46
2.3 Focus on vehicle health management function.....	50
2.3.1 Sample of standards and systems associated to IVHM	50
2.3.2 Three dimensions of vehicle centric IVHM function.....	52
2.3.3 Synthesis of IVHM related standards and systems	62
2.3.4 General guidelines for defining an IVHM framework	64
2.4 IVHM modelling framework approach	65
2.4.1 MBSE – a sustainable approach for an IVHM modelling framework	65
2.4.2 Formalization language	68
2.4.3 Formalization scope of the IVHM modelling framework.....	70
2.5 Conclusion.....	73
3 A generic Health Management Module.....	74
3.1 Introduction	74
3.2 gHMM MBSE phases.....	75
3.2.1 Requirements analysis.....	76

3.2.2	Functional analysis	85
3.2.3	Design synthesis	92
3.3	Diagnostics and prognostics integration supported by gHMM	106
3.3.1	From diagnostics to prognostics.....	107
3.3.2	From prognostics to diagnostics.....	109
3.4	Conclusion.....	121
4	Designing health management in an IVHM modelling framework	122
4.1	Introduction	122
4.2	Developing a particular IVHM based on the gHMM.....	123
4.2.1	gHMM instantiation principle	123
4.2.2	gHMM instantiation phases	125
4.3	Multi-Criteria determinant in health management design.....	129
4.3.1	Formalization of multi-criteria	130
4.3.2	Multi-criteria representation.....	143
4.4	Multi-Criteria based selection	146
4.4.1	Multi-criteria knowledge engineering	146
4.4.2	Multi-criteria reasoning engine	148
4.4.3	Synthesis on gHMM instantiation procedure.....	153
4.5	Conclusion.....	154
5	Feasibility of contributions.....	155
5.1	Introduction	155
5.2	Verification & validation protocol	156
5.3	Verification & validation phases	157
5.3.1	Verification of the SysML-based gHMM model	157
5.3.2	Validation of the gHMM instantiation in an IVHM modelling framework.....	159
5.4	Conclusion.....	186
	General conclusion	188
	Synthesis of contributions.....	188
	Perspectives	190
	Bibliography.....	194
	Résumé en français.....	214
	Appendices	222

Appendix A: Systems Engineering glossary	222
Appendix B: Model-based Systems Engineering phases	225
Requirement analysis	225
Functional analysis	225
Design synthesis	227
Appendix C: Description and breakdown of A1 – A8	228
Breakdown of standards and systems	239
A1: OSA-CBM standard	239
A2: Open architecture for IVHM	240
A3: Generic supervision system	241
A4: Embedded IVHM architecture	242
A5: .NET IVHM architecture	243
A6: Tri-reasoner IVHM system	244
A7: SIMP - Integrated proactive maintenance system	245
A8: 4D/RCS (4 dimensional real-time control system)	246
Appendix D: gHMM model	248
gHMM stakeholders needs from gHMM	248
gHMM model	252
Appendix E: Reduce Ambiguity Group using RUL pseudocode	265
Appendix F: OSA-CBM data structures	267

Table of Figures

Figure 1.1.	ATE hardware and software architecture	7
Figure 1.2.	Results of NFF perception in aerospace organization – Khan et al., 2012	8
Figure 1.3.	Evaluating BITE false alarms – Malcolm, 1982	10
Figure 1.4.	Fault progression characterisation – Byington et al., 2006	11
Figure 1.5.	Impact of prognostics performance - Mikat et al., 2014	12
Figure 1.6.	Maintenance strategies	17
Figure 1.7.	Reliability in terms of failure rate - Kothamasu et al., 2006	19
Figure 1.8.	Evolution of maintenance strategies	20
Figure 1.9.	IVHM major events.....	21
Figure 1.10.	General functionalities of IVHM based on Felke et al., 2010.....	26
Figure 1.11.	Business and mission centric IVHM - Scandura, 2005.....	27
Figure 1.12.	Diagnostic methods classification - Venkatasubramanian, 2003	30
Figure 1.13.	Residual generation and estimation methods - Zang et al., 2003	31
Figure 1.14.	Three steps of a CBM program - Jardine et al., 2006	32
Figure 1.15.	Taxonomy of ISHM algorithms - Schwabacher et al., 2006.....	33
Figure 1.16.	Links between industrial and scientific problems	37
Figure 1.17.	Dependency between chapters	38
Figure 2.1	Conceptual perception of systems views based on Davidz, 2006	41
Figure 2.2	System life cycle stages and stakeholders.....	42
Figure 2.3	System development process – INCOSE, 2010	43
Figure 2.4	System life cycle – NFF occurrence	44
Figure 2.5	System-of-Interest and enabling systems of an aircraft based on Negele, 2000	45
Figure 2.6	System-of-interest (aircraft) and IVHM life cycles	45
Figure 2.7	Complexity of interoperability between enterprise systems - Auzelle et al., 2008	47
Figure 2.8	Vehicle and enterprise centric functions of IVHM	48
Figure 2.9	Complexity of interoperability between IVHM functions	49
Figure 2.10	Synthesis of health management functionalities	55
Figure 2.11	HADataEvent data structure – OSA-CBM v 3.3.1	57
Figure 2.12	PADataEvent data structure – OSA-CBM v 3.3.1	58

Figure 2.13	Black and white-box system representation.....	59
Figure 2.14	Synthesis on the three dimensions of health management	63
Figure 2.15	MBSE formalization approach based on Hoffmann, 2011	66
Figure 2.16	Relation between UML and SysML / SysML diagrams - OMG SysML, 2013	69
Figure 2.17	Integration enabled by SysML/MBSE	69
Figure 2.18	UML class – SysML block – Roques, 2011.....	70
Figure 2.19	Contextual view of IVHM.....	70
Figure 3.1.	gHMM formalization phases.....	75
Figure 3.2.	Identification of gHMM stakeholders – contextual view	77
Figure 3.3.	HM engineer requirements.....	81
Figure 3.4.	gHMM use case diagram.....	82
Figure 3.5.	Component and performance RUL	83
Figure 3.6.	Link with stakeholder requirements for use case n°1.....	84
Figure 3.7.	UC1 black-box activity diagram	86
Figure 3.8.	Use cases merge - block diagram.....	89
Figure 3.9.	Use cases merge block diagram – gHMM core actions	90
Figure 3.10.	gHMM core processes.....	98
Figure 3.11.	gHMM block definition diagram	99
Figure 3.12.	Detection horizon – Marzat et al., 2012	101
Figure 3.13.	Diagnostics process white-box functional flow – activity diagram	103
Figure 3.14.	Prognostics process white-box functional flow – activity diagram.....	104
Figure 3.15.	Detect_Failures elementary activity	105
Figure 3.16.	AmbiguityGroupDataEvent block definition diagram	107
Figure 3.17.	Prognostics process DataEvents block definition diagram.....	108
Figure 3.18.	Zoom on diagnostics to prognostics collaboration in a gHMM use case.....	108
Figure 3.19.	Zoom on white-box activity diagram of use case n°2	110
Figure 3.20.	Hypothesis T1-T3 for reducing ambiguity using RUL	113
Figure 3.21.	Component RUL evaluation before mission M.....	114
Figure 3.22.	System Σ	115
Figure 3.23.	<i>Prioritize_LRUs_in_Ambiguity_Groups</i> outputs	117
Figure 3.24.	Link between component and system level.....	118
Figure 3.25.	<i>Reduce_Ambiguity_using_RUL</i> outputs.....	119

Figure 3.26.	Generalization of update step.....	120
Figure 4.1.	OMG meta-modelling pyramid.....	123
Figure 4.2.	gHMM instances represent the VHM function and conform to gHMM.....	124
Figure 4.3.	Block definition diagram of gHMM instances.....	125
Figure 4.4.	Hierarchical view of gHMM instances	127
Figure 4.5.	gHMM instantiation principle illustration.....	128
Figure 4.6.	Relation between algorithm – elementary activity in a gHMM instance.....	129
Figure 4.7.	Conceptual perception of systems thinking – Davidz, 2006.....	131
Figure 4.8.	Three genericity levels of multi-criteria.....	133
Figure 4.9.	Generic mission profile – Gallagher et al., 1992.....	137
Figure 4.10.	Event tree analysis of HM tools - Esperon Miguez, 2013.....	138
Figure 4.11.	CBA framework - Mikat et al., 2012	139
Figure 4.12.	Cost - criterion n°8.....	140
Figure 4.13.	Fault progression characterisation – Byington et al., 2006	141
Figure 4.14.	Semantic continuum based on Wilmering, 2004.....	144
Figure 4.15.	Multi-criteria ontology-based representation	145
Figure 4.16.	Architecture of a multi-criteria KBS.....	147
Figure 4.17.	Three steps reasoning engine	148
Figure 4.18.	Step n°5.1 reasoning.....	148
Figure 4.19.	Main method classes for diagnostics / prognostics	149
Figure 4.20.	Step n°5.2 – correspondence table	150
Figure 4.21.	Yaw drive of a wind turbine.....	151
Figure 4.22.	Synthesis of gHMM instantiation	153
Figure 5.1.	MBSE formalization approach based on Hoffmann, 2011	156
Figure 5.2.	Verification and validation of gHMM concept.....	157
Figure 5.3.	Steps of black-box gHMM instantiation phase.....	160
Figure 5.4.	Breakdown of wind turbine simulator of KK electronics	161
Figure 5.5.	Wind turbine HM contextual view.....	161
Figure 5.6.	Wind turbine hierarchical distribution	163
Figure 5.7.	Wind turbine simulator black-box gHMM instances.....	165
Figure 5.8.	Steps of gHMM instantiation procedure	166
Figure 5.9.	UAV test case.....	168

Figure 5.10.	UAV mission phases – Bastard, 2014.....	168
Figure 5.11.	UAV HM functional architecture - contextual view	170
Figure 5.12.	Association to use case n°3 of HME_1 requirement.....	171
Figure 5.13.	UAV hierarchical levels distribution.....	172
Figure 5.14.	gHMM instances and underlying processes	173
Figure 5.15.	Energy management gHMM instance.....	174
Figure 5.16.	Battery multi-criteria representation.....	175
Figure 5.17.	Multi-criteria selection for energy management instance	176
Figure 5.18.	Battery ageing factor – Pulice, 2014	177
Figure 5.19.	HM architecture internal block diagram.....	179
Figure 5.20.	Energy management gHMM instance Simulink/SysML Diagrams – Frette, 2014....	181
Figure 5.21.	Energy management and UAV gHMM instances – Frette, 2014.....	182
Figure 5.22.	Update of battery SoH based on Pulice, 2014.....	183
Figure 5.23.	Illustration of a future mission energy consumption based on Bastard, 2014.....	185
Figure C.1.	Synthesis of contributions	188
Figure A.1	ISO/IEC 15288 - Representation of process and activity concepts.....	223
Figure A.2	Contextual view of IVHM requirement analysis phase.....	225
Figure A.3	Functional analysis phase.....	226
Figure A.4	Design synthesis phase.....	227
Figure A.5	OSA-CBM processing blocks	228
Figure A.6	On-board functions - Gorinevsky et al., 2010	230
Figure A.7	A generic supervision system - Ribot, 2009.....	231
Figure A.8	Embedded IVHM information flow – Schoeller et al., 2007	232
Figure A.9	.NET-based IVHM architecture - Chen et al., 2012.....	233
Figure A.10	Tri-reasoner IVHM architecture – Atlas et al., 2001.....	235
Figure A.11	SIMP architecture – Muller et al., 2005	237
Figure A.12	4D/RCS architectural node – Albus et al., 2006	238
Figure A.13	gHMM MBSE project tree.....	252
Figure A.14	UC1 link to stakeholders requirements	253
Figure A.15	UC2 link to stakeholders requirements	254
Figure A.16	UC3 link to stakeholders requirements	254
Figure A.17	UC4 link to Stakeholders Requirements	255

Figure A.18	UC5 link to stakeholders requirements	255
Figure A.19	UC6 link to stakeholders requirements	256
Figure A.20	UC7 link to stakeholders requirements	257
Figure A.21	UC8 link to stakeholders requirements	257
Figure A.22	UC9 link to stakeholders requirements	258
Figure A.23	UC10 link to stakeholders requirements	258
Figure A.24	UC1 Black-box functional flow	259
Figure A.25	UC2 Black-box functional flow	260
Figure A.26	UC3 Black-box functional flow	261
Figure A.27	UC4 Black-box functional flow	261
Figure A.28	UC5 Black-box functional flow	262
Figure A.29	UC6 Black-box functional flow	262
Figure A.30	UC6 Black-box functional flow	263
Figure A.31	UC8 Black-box functional flow	263
Figure A.32	UC9 Black-box functional flow	264
Figure A.33	UC10 Black-box functional flow	264
Figure A.34	DADataEvent - OSA-CBM v3.3.1	267
Figure A.35	DMDataEvent - OSA-CBM v3.3.1	268
Figure A.36	SDDataEvent - OSA-CBM v3.3.1	269
Figure A.37	PropEvent - OSA-CBM v3.3.1	270

Table of Tables

Table 1.1.	Synthesis of NFF causes	14
Table 1.2.	Main IVHM contributors	23
Table 1.3.	Plethora of existing definitions of IVHM	25
Table 1.4.	Architectural needs from developer and user Perspectives - Chen et al., 2012	35
Table 2.1	Sample of standards and systems associated to IVHM.....	51
Table 2.2	Generic supervision system processes/activities breakdown	53
Table 2.3	Guiding principles for defining an IVHM framework	64
Table 2.4	Vehicle operator accountabilities – Expected needs from vehicle health management... 71	
Table 3.1	Accountabilities – needs for HM engineer stakeholder	80
Table 3.2	Black-box actions mapped to IVHM standards and systems.....	95
Table 3.3	Uncovered black-box actions.....	95
Table 3.4	gHMM Processes – black-box actions allocation table	97
Table 3.5	Diagnosis hypothesis of $\Delta_{\Sigma}(M)$	116
Table 3.6	List of Sorting Parameters and their values	116
Table 4.1	Synthesis of system views and criteria	132
Table 4.2	Synthesis of environmental factors for an A/C system.....	138
Table 4.3	Severity – probability assessment (NASA, 2007)	142
Table 4.4	Yaw Drive multi-criteria characterization	152
Table 5.1	Fault scenario of wind turbine simulator	164
Table 5.2	UAV mission phases.....	169
Table 5.3	Parameters set for illustration of Figure 5.23.....	185
Table A.2	OSA-CBM processes/activities breakdown.....	240
Table A.3	Open architecture for IVHM processes/activities breakdown	240
Table A.4	Generic supervision system processes/activities breakdown	242
Table A.5	Embedded IVHM architecture processes/activities breakdown	243
Table A.6	.NET-based IVHM architecture processes/activities breakdown	244
Table A.7	Tri-reasoner IVHM architecture processes/activities breakdown.....	245
Table A.8	SIMP processes/activities breakdown.....	246
Table A.9	4D/RCS architecture processes/activities breakdown.....	247

Table of Abbreviations

ATE	Automatic Test Equipment
BITE	Built In Test Equipment
HM	Health Management
CBM	Condition-based Maintenance
D-level	Depot Level Maintenance
gHMM	generic Health Management Module
HUMS	Health and Usage Monitoring System
I-Level	Intermediate Level Maintenance
INCOSE	International Council of Systems Engineering
IVHM	Integrated Vehicle Health Management
LISI	Levels of Information Systems Interoperability
LRU	Line Replaceable Unit
MBSE	Model-based Systems Engineering
NASA	National Aeronautic and Space Administration
NFF	No Fault Found
O-Level	Operational Level Maintenance
OSA-CBM	Open System Architecture for Condition-Based Maintenance
PHM	Prognostics and Health Management
RCM	Reliability Centric Maintenance
ROI	Return On Investment
SE	Systems Engineering

SRU	Shop Replaceable Unit
TUA	Test Unit Adapter
UUT	Unit under Test
V&V	Verification & Validation

General introduction

Cassidian Test & Services (renamed Spherea), the industrial initiator of the thesis, is a leading provider of Automatic Test Equipment (ATE) for aerospace and military vehicles' maintenance. ATE are key systems for Intermediate level (I-level) maintenance, as the return to service of Line Replaceable Units (LRU) is conditioned by "GO" test result delivered by the maintenance test platform. Currently, I-level maintenance experiences high rates of No Fault Found (NFF) events (Khan et al., 2012), causing superfluous maintenance activities and consequently major wastes of time, energy and money (Burchell, 2007). NFF is defined as the situation where a removed LRU meets its airworthiness conditions in order to be returned to service, but no reason for the removal can be confirmed (MIL STD 2165, 1985). Several factors are responsible for occurrence of NFF including ambiguity groups in vehicle diagnostics (Khan et al., 2012), uncertainty associated to remaining useful life of vehicle components (Kumar et al., 2008), as well as false alarms occurring during vehicle's operations (Byington et al., 2006).

The NFF issue is tackled within Integrated Vehicle Health Management (IVHM) and Prognostics and Health Management (PHM) communities by addressing the vehicle health management in a unified manner (Rajamani et al., 2013), which provides the solution for effective vehicle maintenance, throughout operational, intermediate and depot levels. The IVHM concept could be considered by analogy with the concept of interoperability between enterprise systems in the manufacturing field, today structured around ERP, MES elements (Doumeingts et al., 2007). Similarly, IVHM emerges from the global interaction and coordination across organizational boundaries of vehicle and enterprise centric IVHM functions, deployed in interoperable systems, and sustainable throughout vehicles life cycle (Kumar et al. 2000). The vehicle centric functionalities have the capability to reduce NFF by transforming measures of relevant parameters of the vehicle's health into actionable information enabling decision support for enterprise level functions (Goebel et al., 2011).

Despite the relative youth of the IVHM concept, frameworks of IVHM functionalities are already available from scientific and industrial communities (Benedettini et al. 2009, Reveley et al. 2010, Esperon Miguez et al. 2013, Jennions 2013). However, to date these solutions of IVHM systems are mostly developed and organized empirically for specific systems as they are based on proprietary concepts (Mikat et al., 2014). This results in a lack of consensus in both the structuring principles of IVHM systems and in their engineering. Thus, a major scientific challenge is to define a generic modelling framework supporting IVHM Systems Engineering

(Benedettini et al. 2009), usable to designing specific IVHM systems, which would provide a solution for NFF issues. The thesis is built on this challenge with the major objective of proposing the foundations of an IVHM modelling framework, and its fundamental element, the generic Health Management module (gHMM), formalizing the vehicle centric function of IVHM. The integration of diagnostics and prognostics within the gHMM aims at contributing to the effective reduction of the NFF. This framework could be integrated at term within current product portfolio of the company. In line with this objective, the current technological level (TRL)¹ required by the company for the thesis contributions is situated at level 4.

Within this IVHM modelling framework, the thesis first originality involves the system concept and principles (ISO/IEC/IEEE 42010, 2011) based on which are founded the IVHM modelling framework main constituents, and its formalization approach, supported by Model-Based Systems Engineering. This comprehensive definition of the framework is at the cornerstone of the effective design of IVHM systems, which will ultimately result in reduced NFF.

A second major originality of the thesis, driven by the NFF issues, involves the fundamental element of the proposed IVHM modelling framework, defined as a generic Health Management Module (gHMM). More particularly, the integration of diagnostics and prognostics, key reasoning processes of the gHMM, takes a new direction beyond the classical way from diagnostics to prognostics (Sikorska et al., 2011), by proposing a method of connecting prognostics to diagnostics.

Based on the gHMM proposal, the design of particular vehicle health management within the IVHM modelling framework drives the proposal of a multi-criteria decision tool for reasoning about selection of health management algorithms. As outlined by Esperon Miguez et al., 2013, the suitable combination of health management algorithms represents a major challenge in IVHM Systems Engineering. Towards this goal, the identification and the ontology-based formalization of determinant multi-criteria represent the third originality of the thesis, being based on general systems principles applied to vehicle and to IVHM systems, and leading to ten generic multi-criteria tied to health management algorithms selection. This originality is in straight connexion with resolution of NFF by selecting the suitable combination between diagnostics and prognostics algorithms.

In regard of these main originalities, the thesis is structured into five chapters, which progressively build the foundation and the pillars of an IVHM modelling framework.

¹ TRLs are a systematic metric/measurement system that supports assessment of the maturity of a

Chapter 1. The first chapter introduces the industrial problem statement on intermediate level (I-level) maintenance, more particularly on the NFF event and its relation with unsolved operational-level (O-level) maintenance issues standing at the genesis of the thesis. These problems lead to a generalized reflection, and address current challenges of the Integrated Vehicle Health Management framework, with a specific focus on its vehicle health management function, as enabler of operational maintenance decisions leading to NFF occurrence. Based on this problem statement on IVHM, the four scientific problems which are tackled by the thesis represent the output of this first chapter of the thesis.

Chapter 2. In order to tackle the lack of a framework for IVHM Systems Engineering covering the whole life cycle of the vehicle system, the second chapter proposes an Integrated Vehicle Health Management (IVHM) modelling framework around the unifying concept of thesis - the notion of system. The structuring principles of an IVHM framework are established through analysis of its three complementary concepts: “Vehicle” – as system of interest, “Health Management” – as one of its enabling systems, and “Integrated” – as binding realizing integration between vehicle and enterprise centric functions of health management. This system vision of IVHM is further refined on the vehicle health management function through a synthesis of eight IVHM related standards and systems, such as OSA-CBM, and SIMP (Integrated Predictive Maintenance System). Based on this foundation on IVHM design, an IVHM modelling framework, capable of sustaining this vision, is proposed following a Model-based Systems Engineering approach. The IVHM modelling framework refines one of the life cycle stages of the vehicle, in straight connexion with the NFF problem, proposing a contextual view of the framework.

Chapter 3. In logical continuity of the proposed IVHM modelling framework, the third chapter tackles its fundamental element, formalized following a Model-based Systems Engineering (MBSE) approach as a generic Health Management Module (gHMM). The gHMM formalization phases have as central piece of the workflow the SysML-based gHMM model, and progressively perform the generic modelling of the vehicle health management function from requirement analysis to black-box functional analysis and white-box design synthesis of the gHMM. The proposal of four core processes of health management based on their common purposes: health monitoring, diagnostics, prognostics, and decision support makes the bridge between black and white-box functional flows. Compliant with OSA-CBM data structures, the gHMM architectural design is further analysed with regards to integration between two of its core processes: diagnostics and prognostics, catalyst of reduction of NFF occurrences. To this extent, the gHMM formalization enables to integrate these two key processes of health management, not

only in a conventional way: from diagnostics to prognostics, but also in an original one: from prognostics to diagnostics with the purpose of reducing ambiguity groups; the latter makes the object of a generic algorithm supporting one of the elementary activities of the gHMM, and responding to the initial NFF problem of the thesis.

Chapter 4. The fourth chapter provides the IVHM modelling framework with methodological means of designing specific IVHM systems, based on the generic contribution exposed in the previous chapter. Towards this goal, a principle of instantiation of the gHMM is firstly enounced, and composed out of black and white-box instantiation phases progressively designing the structure and behaviour of a health management functional architecture formed out of gHMM instances. In order to support the white-box instantiation, a major contribution of this chapter is the formalization of multi-criteria determinant for the selection of health management algorithms supporting instantiated gHMM activities. This contribution is in logical continuity of the structuring principles of IVHM founded at Chapter 2, which are refined and formalized in ten generic multi-criteria, specified using ontology-based representation. In support of this formalization, the main elements of a knowledge-based system are proposed for supporting a multi-criteria selection tool of health management algorithms.

Chapter 5. The last chapter of the thesis aims at tackling the verification and validation of contributions in two complementary aspects: firstly by proposing a protocol supporting the verification and validation of the contributions, and secondly by exposing the verification and validation steps which have been conducted in line with the established protocol, which enable us to bring an answer to the initial industrial questions raised at the genesis of this thesis.

Finally, the overall research results are discussed in the general conclusion of the thesis opening a series of scientific and industrial perspectives for the IVHM modelling framework.

Chapter 1

Towards an Integrated Vehicle Health Management framework

“To know what you know and what you do not know, that is true knowledge.”

- Confucius

1.1 Introduction

Systems are defined as wholes composed of interconnected, communicating, heterogeneous parts, which exhibit one or more properties, not obvious from the properties of individual parts (INCOSE, 2010). Among the different classes of systems, vehicles² are highly complex, safety-critical systems composed of hundreds of interconnected subsystems and thousands of underlying components. Throughout their life cycle, they are subject to multiple conditions of stress, known or unanticipated operating and environmental conditions. In the course of time these circumstances originate degradations, defined as irreversible evolutions of at least one characteristic property or parameter of the system from the nominal condition related to the time, duration of use, or to an external cause (ISO 13381, 2004). Their evolution might lead to failures, defined as permanent interruptions of a system’s ability to perform a required function under specified operating conditions (Isermann et al., 1997). Within this context, maintenance appears as a fundamental activity for restoring the system’s required performance and worthiness, defined as the combination of technical, administrative and managerial actions carried out during the life cycle of an item and intended to retain it in or restore it to a state in which it can perform its required function (NF EN 13306, 2001). Today, vehicle’s maintenance experiences high rates of unnecessary replacements of Line Replaceable Units, referred to as No Fault Found (NFF) events (Khan et al., 2012), causing superfluous maintenance activities and consequently major wastes of time, energy and money (Burchell, 2007).

NFF issues could be overcome within the Integrated Vehicle Health Management (IVHM) framework, introduced by NASA in 1992 (NASA-CR-192656, 1992) for designating the

²Finding its origin early 17th century from French *véhicule* or Latin *vehiculum*, from *vehere* 'carry' (OED, 2010).

future maintenance approach applied to space vehicles, proposing the concepts required for enhancing safety while reducing maintenance costs in their next generation vehicles. Since then, the goal of IVHM has extended, becoming synonym to optimizing the vehicles operability – the vehicles' ability to meet the operational requirements in terms of operational reliability – percentage of successful missions which do not encounter operational or maintenance related interruptions, operational risk – combination of unscheduled maintenance events and their consequences, and costs – maintenance and operation costs (Goodloe et al., 2010). Today, IVHM is considered as the following evolutionary step in condition-based maintenance (Schoeller et al., 2007) enabling intelligent, informed, and appropriate decisions based on the assessment of current and future vehicle condition (Benedettini et al., 2009). However, IVHM faces numerous industrial and scientific challenges, which are outlined throughout this chapter with the aim of isolating the scientific problems addressed by this thesis in straight connexion with industrial questions raised by the initiator of this thesis.

Straightforwardly, the next section provides an industrial problem statement which consists of analysis of NFF issues standing at the genesis of the thesis. In the third section, industrial questions lead to exploring the IVHM framework and its challenges with a specific focus on its vehicle centric function, as enabler of operational level maintenance decisions upstream of potential occurrence of NFF events. The state of the art on IVHM unveils current scientific problems related to industrial ones, and sets the scientific objectives to be tackled by the thesis.

1.2 Industrial problem statement

The industrial initiator of the thesis is a leading provider of test solutions and services for Avionics, Defence and Space industries. One of the main product lines of the company is constituted of automatic test equipment (ATEs) tied to intermediate-level (I-level) maintenance of electronics and optronics systems.

Intermediate maintenance represents one of the three maintenance levels, which together carry out the end-to-end maintenance process of a vehicle system (Yarnall et al., 2011):

- Operational level (O-level), also known as line maintenance, corresponds to minor maintenance and repair of equipment using procedures that do not require detailed technical knowledge of the equipment or system functionality and design. This maintenance level includes Line Replaceable Unit (LRU) replacement, inspection, cleaning, servicing, preservation, lubrication of vehicle components;

- Intermediate level (I-level) maintenance, also called shop maintenance, includes activities which are performed in a maintenance workshop after LRU have been deposited, such as LRU testing, repair, and Shop Replaceable Unit (SRU) replacement;
- Depot level (D-level) maintenance is composed of heavy maintenance tasks involving disassembly of components or subsystems;

ATEs represent key systems for I-level maintenance, as the return to service of LRUs is conditioned by “GO” test result delivered by the maintenance test platform. Furthermore the ATE confirms the reason of LRU removal from the vehicle, by delivering a “NO GO” test result. The LRU is then either repaired in the maintenance workshop by replacement of faulty SRU or sent to its Original Equipment Manufacturer (OEM) for repair or recycling. Thus, the ATE’s main mission is to increase LRU availability by detecting failed SRU components and by checking operability of repaired LRUs before their return to service.

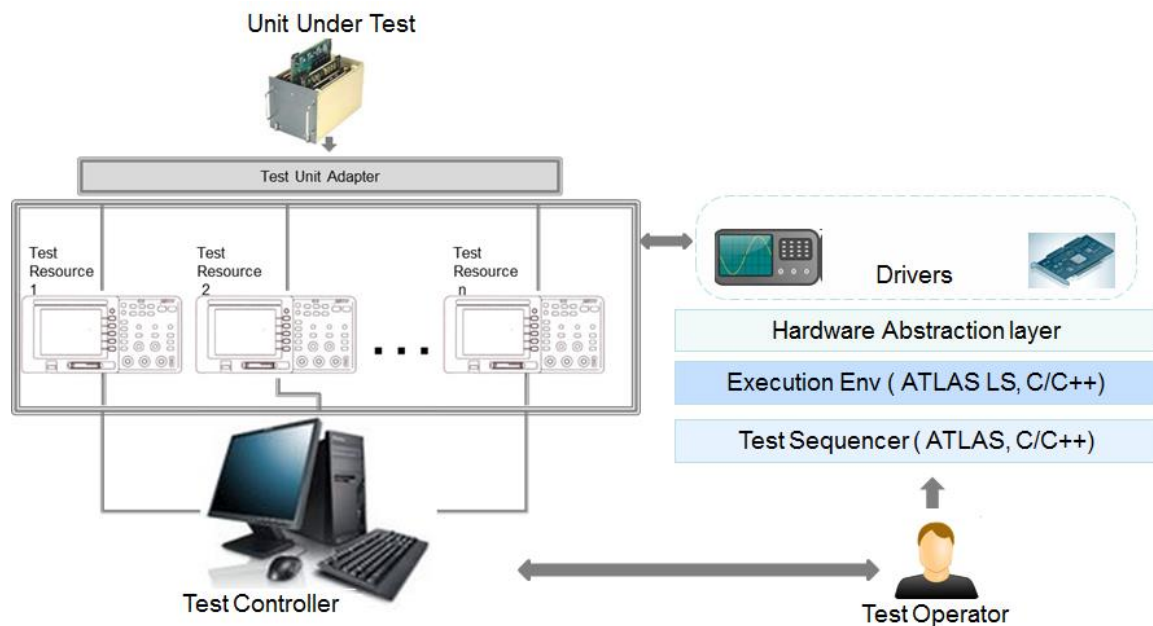

Figure 1.1. ATE hardware and software architecture

The company’s ATE provide broad technology coverage, modularity, ergonomics, compatibility with obsolete equipment, and compliance with market standards (COTS). Military ATEs possess specific features such as: shelter or mobile carrier uses, transport by air, road, rail, off-road, storage at temperatures between -40°C and 70°C , operation at temperatures between -25°C and 55°C , protection against sand and dust. Figure 1.1 provides the hardware and software architecture of an ATE, the Unit Under Test (UUT) corresponding to an electronics or optronics LRU which is tested at I-level maintenance. The test controller interacts with the test

I Towards an Integrated Vehicle Health Management framework

resources through the test control network, the test resources interact with the Test Unit Adapter (TUA) through the test interaction networks. The TUA is an element essential for general purpose automatic test equipment, as it performs the commutation required between the test resources and the UUT. Regarding the software architecture of the ATE, hardware interaction is completely transparent for the test program set developer and operator, which renders independency between high level test programs instructions and instrumentation of the test resources and the UUT. This is an essential characteristic for the maintainability of test programs, as Test Program Sets are independent from the material implementation on the test bench, so they could be easily adapted on another configuration of test benches as long as the test language remains the same.

Within this context, I-level maintenance currently experiences high rates of No Fault Found (Definition 1.1), one of the factors determining superfluous maintenance activities, and consequently impacting vehicles' availability, and ownership costs (Burchell, 2007).

Definition 1.1. (*No Fault Found*). NFF is the situation where a removed LRU meets its airworthiness conditions in order to be returned to service, but no reason for the removal can be confirmed (MIL STD 2165, 1985).

A quantification of this issue is given by an European airline company, which stated for 7 removed item, 5 correspond to NFF, meaning 71,43% of removals are classified as NFF (Cassidian T&S, 2009). Furthermore, Khan et al., 2012 underline that an inconsistent terminology is used with regard to NFF, both in scientific and industrial communities. This statement relies on a survey conducted in 120 aerospace organizations, and shows that from the total of NFF, only 56% refers to it by using this term (Figure 1.2).

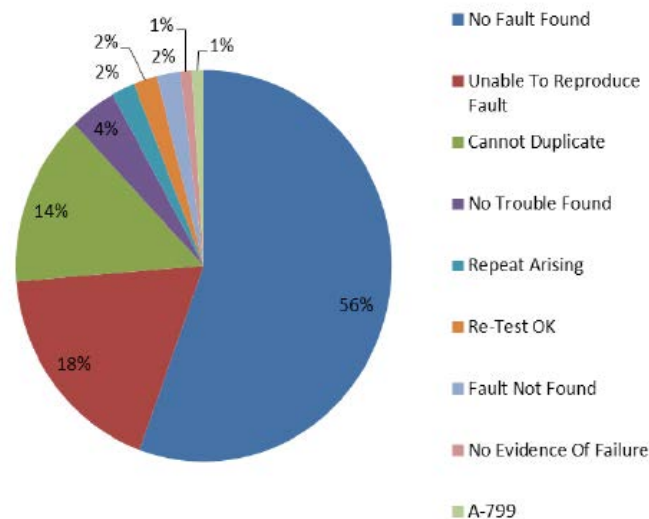

Figure 1.2. Results of NFF perception in aerospace organization – Khan et al., 2012

Khan et al., 2012 cites a leading aircraft manufacturer concerned with the lack of understanding in the “real drivers of NFF”. This need to understand the NFF issue and to tackle the key drivers of reducing NFF, stands at the genesis of the PhD thesis, and constitutes an area of R&D for the company, motivated by the major challenge of increasing vehicle availability and decreasing life cycle cost within Aeronautics, Defence and Space industries (Byington et al., 2006). From this perspective, the first question raised by the company is:

Industrial question 1: What are the catalysts of NFF reduction that could increase vehicle availability and decrease life cycle costs?

NFF events can occur on healthy LRUs, known as real NFF, but also on failed ones, in which case the unit under test is a rogue unit and is quarantined for further analysis in the maintenance shop (Lam, 2009). The factors impacting real NFF are discussed in the remainder of this section, and reveal industrial objectives of the thesis.

Definition 1.2. (*Diagnostics*). Diagnostics is the determination of the current condition of a component or system by examination of symptoms. (ISO 13372, 2012).

From a technological standpoint, real NFF events are impacted by technological causes associated to vehicle operations, as well as to O and I-levels maintenance operations. The first category encompasses insufficient isolation in vehicle diagnostics (Definition 1.2) resulting in ambiguity groups (Definition 1.3), false alarms during vehicles’ operation resulting in no detection of the reported symptom on ATE, while high uncertainty in prognostics evaluations determine too early replacements of LRUs.

Definition 1.3. (*Ambiguity Group*). Ambiguity groups characterize the situation where a diagnostics results is composed of several diagnosis hypothesis able to explain failure occurrence, among which only one is a valid (MIL STD 2165, 1985).

When diagnostics at vehicle and subsystem level are not precise enough, ambiguity groups in root causes isolation are insufficient for accurately troubleshoot only those LRUs that do not meet their worthiness conditions in order to be returned to service. In such case, several LRUs are removed from the vehicle, while just a part of them are failed. An explanation of the data flow in the field of aircraft (A/C) diagnostics systems is given by Belard, 2012: Monitoring functions are implemented at system level for generating discrepancies between nominal and current behaviour, sent to flight warning system (FWS) when discrepancies are symptomatic of failures with operational impacts, and to Built-in Test Equipment (BITE) when they are symptomatic of failures with operational maintenance impacts. BITE messages and FWS aircraft effects are then correlated by a centralized maintenance system in order to obtain a vehicle level

diagnostics, which explains into a Post Flight Report (PFR) the logical expression of LRUs failure modes and operational conditions which are the cause of BITE messages and FWS aircraft effects occurred during the flight. The PFR is then used within the troubleshooting procedure by a maintenance operator in order to confirm, isolate and replace failed LRUs before the next mission of the aircraft can depart without any “NO GO” status reported by FWS aircraft effects. At this stage of end-to-end maintenance process, NFF occurs if the diagnostics result is not accurate enough, leading to unjustified removals of LRUs by the line maintenance operator.

Ambiguity groups are quantified using fault isolation as “percentage of time where the isolation goes down to one item, the percentage of time where the isolation goes down to N or fewer items”, which need to be weighted by failure rates in order to reflect diagnostics effectiveness (MIL STD 2165, 1985). Ambiguity groups can be caused by inaccurate fault isolation, by intermittence in fault detection, by false alarms reported by Built-in Test Equipment (BITE) and warning systems (Byington et al., 2006, Khan et al., 2012). False alarms (FA), illustrated in Figure 1.3 are defined as “an indicated fault where no fault exists” occurring during systems operation (IEEE 1232, 2010) due to imprecise sensitivity to fault presence of the fault detection.

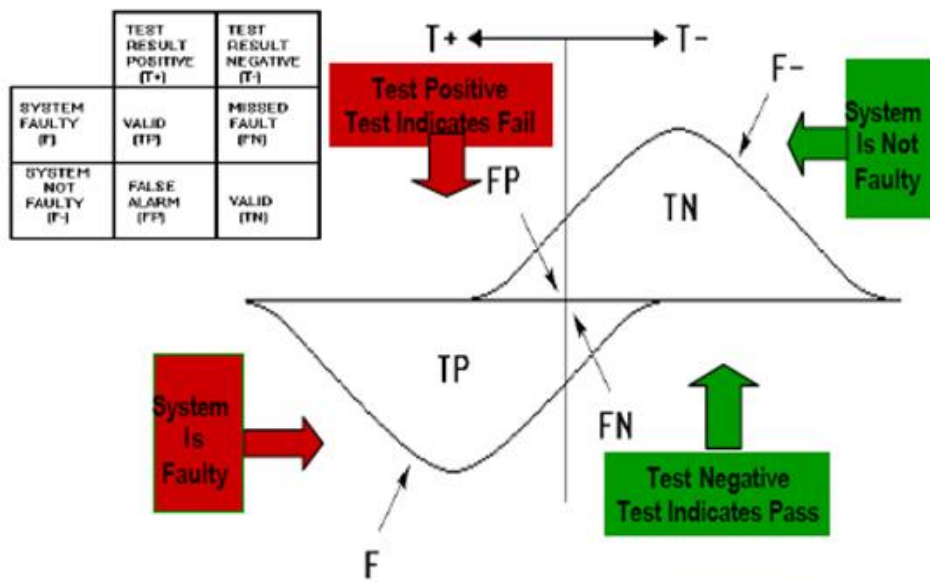

Figure 1.3. Evaluating BITE false alarms – Malcolm, 1982

Moreover, intermittency in fault detection can lead to suspect healthy LRUs in fault isolation. As figured in Figure 1.4, intermittent faults can be classified as repeatable or random, in the first case intermittence and persistence thresholds could overcome their presence in ambiguity groups.

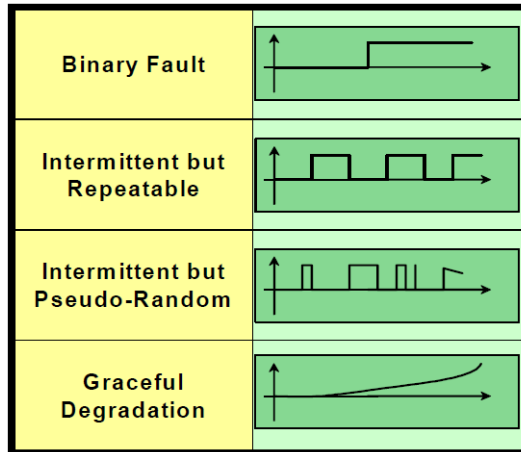

Figure 1.4. Fault progression characterisation – Byington et al., 2006

This preliminary analysis of ambiguity groups in vehicle diagnostics has raised the second industrial question at the origin of the thesis:

Industrial question 2: How could ambiguity groups in vehicle diagnostics be reduced with the objective to decrease NFF rates?

As depicted in Figure 1.4, the last class of faults are slow progression faults targeted by prognostics (Definition 1.4) for remaining useful life (RUL) evaluation based on dynamic monitoring of degradation and making the object of Condition-based Maintenance (CBM).

Definition 1.4. (*Prognostics*). Prognostics is an estimation of the time to failure and of the risk existence or subsequent occurrence of one or more failure modes (ISO 13381-1, 2004).

In the aerospace field, this type of fault is referred to as a “Class 4” fault (Byington et al., 2006). This class of faults could lead to NFF (Kumar et al., 2008) in case of inaccurate remaining useful life evaluations, determining too early replacements of components, and impacting systems availability due to superfluous maintenance operations. In this regard, Mikat et al., 2014 underline that waste of useful life should be minimized by increased prognostics accuracy, as illustrated in Figure 1.5; the uncertainty of remaining useful life estimation has a double impact on system availability and on logistics footprint. In this regard, Hoffmann et al., 2011 outline the need to adapt the service life limit (SLL) of components based on their real health condition, calculated by the fatigue strength, and depending on component geometry, properties of material and on component loads measures arising from the system operating context. In order to explore the full potential of Condition-based Maintenance, Hoffmann, 2014 proposes an end-to-end Usage-based Maintenance (UBM) process for rotorcraft systems, which could sustain the individual service life limit by estimating health condition computed by an embedded Health and Usage Monitoring

I Towards an Integrated Vehicle Health Management framework

System (HUMS). Schoeller et al., 2007 extends the scope of implementation of HUMS, targeting flight critical areas in an aerospace vehicle, such as electromechanical actuators (EMA) used in flight control and operational duties, drive train, engine performance and vibration, and structural health monitoring.

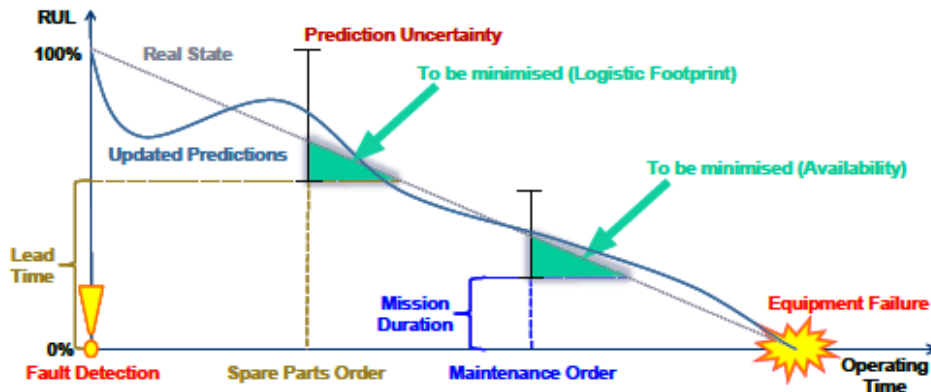

Figure 1.5. Impact of prognostics performance - Mikat et al., 2014

However, maturity and performance in prognostic health management is judged insufficient by Sheppard et al., 2008, outlining that the key of efficient prognostics is yet to be found, as PHM technologies are still at their commencement. This leads to the third industrial question at the genesis of the thesis.

Industrial question 3: How to increase prognostics accuracy in order to avoid too early replacements of components?

Other technological factors leading to unjustified LRU removals during operational level maintenance include ground test equipment errors such as poor design of operating environment, discrepancies in test procedures, insufficient test coverage, and inadequate performance measures.

Human factors also play a major role in maintenance operations (Khan et al., 2012), and represent a potential cause of NFF events. In order to minimize this factor, maintenance operations tasks need to be appropriately designed, and interoperate with diagnostics and prognostics evaluations. Adequate guidance for the maintenance operator to the most likely LRUs to be replaced with an information display respecting readability requirements (Guduvan, 2013) is a research topic in its own right. In this regard Lieber et al., 2013 discuss interactions between human factors and systems engineering, proposing human factors requirements used to perceive the right meaning of properties of technical objects with the context of maintenance operations.

Organizational aspects of NFF events have been analysed by ARINC 672 report, which provides the basis for a structured process to identify, analyse and resolve NFF issues. The report

includes guidance for decision making pertinent to identification of root causes of NFF, enabling action in an early stage of the component repair cycle, reducing costs involved with units unnecessarily removed from an aircraft (e.g. maintenance practices, operational factors, training, documentation etc.), highlighting the need for addressing the causes of NFF through system design, and improvement of maintenance processes. Nevertheless, ARINC 672 committee states that there is no generic solution for reducing NFF rates, as they all depend on the maintenance organization, philosophy and strategies (Burchell, 2007). In the aeronautic industry, for instance, different solutions can be proposed depending on maintenance stakeholders: 1) Does the airline perform its own line (O-level) and shop (I-level) maintenance?, 2) Does it only retain line maintenance? 3) Does it only operate the A/C and does not perform the maintenance? Answers to these questions are a prerequisite for traceability of the NFF event. To this extent, the company plays a major role in identifying NFF rates and could contribute on its reduction, since the witness of the NFF issue remains the ATE, which can confirm or infirm the reason for the equipment removal, so it could also compute the NFF rate. Capitalizing the information issued from tests at ATE level could quantify NFF rates, but the difficulty at this point is that the NFF issue remains confidential and is not shared between stakeholders involved in the different sources of NFF. In this context, the company only provides ATE to its customers, but does not have access to data issued of the test programs executed on the test bench. As such, the link between operational and intermediate level maintenance that could provide further analysis of NFF events is currently burdened by organizational objectives, even though it is technologically feasible due to standardization initiatives which have led to defining IEEE 1232 – 2010 Artificial Intelligence Exchange and Service Tied to All Test Environments (AI-ESTATE) standard. The purpose of AI-ESTATE is to standardize interfaces for functional elements of diagnostics systems between distinct reasoners by formal information models. The use of this standard could facilitate interoperability between health management systems at different maintenance levels (Wilmering, 2004). This paragraph outlines the fourth question raised by the company:

Industrial question 4: What framework could provide a maintenance organization, philosophy and strategy that could decrease NFF rates?

Additionally to the here-above stated factors of NFF, system complexity also plays a major role in accuracy of diagnostic and prognostics assessments, and in time required for vehicle trouble-shooting (Lauffer, 2012). In particular, embedded system complexity is due to the exponential evolution of hardware electronic equipment, and thus of the software over hardware proportion required for functional and dysfunctional logic of the system. As such, systems complexity also increases BITE system complexity and costs, without improving NFF rates, but

I Towards an Integrated Vehicle Health Management framework

on the contrary determining higher false alarms rates and lower confidence of BITE results. Another consequence is reflected on ATE systems, which are constrained to follow the growing system's complexity and thus become more complex themselves. For instance, in the scope of aircraft systems, Chérière, 2014 outlines that complexity in degradation and fault isolation grows with propagation and accumulation of faults. Lauffer, 2012 also outlines that increased diagnostics and prognostic capabilities in complex, critical systems needs to incorporate true system health management values in their system engineering, such as reliability, testability, maintainability, and cost – a critical factor today. In the same direction, Esperon Miguez et al., 2013 outlines that the best combination of diagnostics and prognostics methods in a complex system is a real challenge to optimizing vehicle health management, yet this key has not been discovered, as stated by Sheppard et al., 2008. This lead to the fifth industrial question addressed at the beginning of the thesis:

Industrial question 5: How to efficiently integrate diagnostics and prognostics in a complex system, with the goal of minimizing NFF?

Category	Cause
Technological	Ambiguity groups in diagnostics results
	False Alarms during vehicle operation
	Inaccuracy of prognostics evaluations
	Ground test equipment errors
	ATE errors
	System complexity impact on integration between diagnostics and prognostics
Organizational	Maintenance Processes
	System Design Processes
	Integration of health management data across vehicle operation and maintenance levels
Human	Vehicle Operator Error
	Maintenance Operator Error

Table 1.1. Synthesis of NFF causes

To synthesize this industrial oriented problem statement, NFF causes are categorized in Table 1.1, highlighting in blue the ones which are tackled in this research. Moreover, from the industrial questions raised in this section, we point out the complexity of the industrial context of the thesis for the following main reasons:

- NFF problem is strongly related to organization of vehicle maintenance in three main levels, where the company is involved mainly in I-level maintenance; information exchanged between distinct levels is not easily available, an integrated framework would be required in order to correctly trace an LRU's health in an end-to-end maintenance philosophy;
- Accuracy of diagnostics, prognostics, and of decision support at O-level is mandatory in order to reduce occurrence of NFF events;
- Increasing complexity of vehicle system makes NFF issue a real challenge, as failure initiation and propagation within the vehicle system requires a sound and effective design of vehicle health management.

The five industrial questions which have been raised in this section follow these observations and gravitate around a framework where No Fault Found events could be resolved, framework which is put forward in the remainder of the thesis: Integrated Vehicle Health Management.

1.3 IVHM problem statement

As stated in the beginning of this chapter, Integrated Vehicle Health Management has been introduced as a framework aimed at enabling intelligent, informed, and appropriate decisions based on the assessment of the current and future vehicle condition. The shift from NFF problem to IVHM framework is realized by an abductive research approach, as industrial problems could find their answers within IVHM. Peirce, 1901 firstly defined abductive reasoning as “guessing”, considering that to abduct a hypothetical explanation from an observed surprising circumstance is to surmise that the explanation may be true because then the circumstance would be a matter of course. Abduction is a non-monotonic form of reasoning that can be represented by the inference rule in (1-1). From the occurrence of b and with the rule that a implies b , infer an occurrence of a , as being a plausible hypothesis of explanation for b . Contrary to deduction, and similarly with induction, abduction is a form of “guessing” that the solution is plausible and submitted to verification, allowing to characterize the relation between a and b with a wide degree of freedom, such as for example a is the reason for b being true (Merziger, 1992).

$$\frac{a \longrightarrow b, b}{a} \quad (1-1)$$

In the case of the research conducted in this thesis, the relation expressed here-above can be translated into: from the occurrence of NFF events identified of the previous section, as *industrial issues*, and with the rule that IVHM framework could supply the answers for solving NFF issues, infer the *IVHM framework scientific problems* as being a plausible hypothesis of explanation for NFF events.

$$\frac{IVHM_scientific_problems \longrightarrow industrial_issues, industrial_issues}{IVHM_scientific_problems} \quad (1-2)$$

In a nutshell, the problem statement on IVHM realizes the bridge between NFF problem and IVHM framework through a set of scientific findings, and identifies scientific problems in straight connexion to the industrial ones. To this extent, an overview on IVHM evolution is firstly presented with the aim of outlining the recent emergence of this concept, and secondly a solid foundation is established through a state of the art on IVHM, as fundamental step for outlining current challenges in IVHM and for identifying the scientific problems tackled by the thesis.

1.3.1 Origin and evolution of IVHM

IVHM has been first introduced by NASA in 1992 for designating the future maintenance approach applied to spacecraft. This concept was used within a goals & objectives document, the NASA-CR-192656 (NASA, 1992), proposing the concepts required for enhancing safety while reducing maintenance costs in their next generation vehicles. Since then, NASA has been one of the major scientific contributors to IVHM within its IVHM project (NASA, 2008), which is still active and is now developed for the Second Generation Reusable Launch Vehicle, crew, and cargo transfer vehicles. NASA characterizes IVHM as a highly integrated system within the vehicle and its ground support systems, enabling informed decision making based on advanced health management technologies and logistics management. The final goals expressed by NASA are to obtain significant vehicle and crew safety improvements, increasing chance of mission completion, but also improving reliability, availability, and cost of operations.

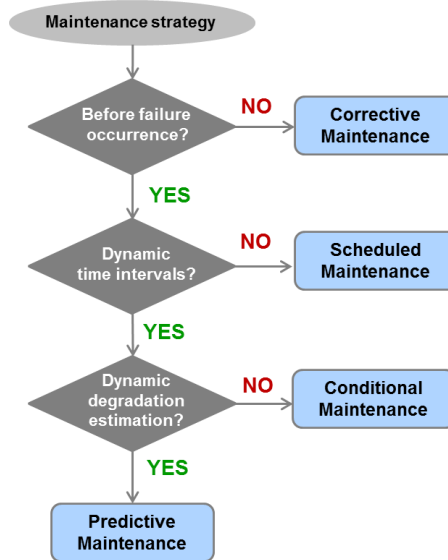

Figure 1.6. Maintenance strategies

IVHM origins are found in predictive maintenance, where Prognostics and Health Management (PHM) is defined as a health management approach utilizing measurements, models and software to perform incipient fault detection, condition assessment and failure progression prediction (Kalgren et al., 2006). As depicted in Figure 1.6, several criteria related to failure occurrence, periodicity of maintenance interventions and dynamic monitoring of the systems' degradations are tied to different maintenance strategies applied within vehicle subsystems, referred to as local maintenance strategies (NF EN 13306, 2001). The global set of local strategies of Figure 1.6 is gathered in a global maintenance strategy of a vehicle system (NF EN 13306, 2001).

We now approach the maintenance strategies with the governing problem of the thesis in our minds, as implementation of processes supporting a maintenance strategy is a major driver for decreasing NFF occurrence.

Corrective maintenance is carried out after fault recognition and intended to put an item into a state in which it can perform a required function. From a historical perspective, the beginning of corrective maintenance is traced to the time when Tubal Caïn, a person mentioned in the Hebrew Bible, was instructing artificers (Jennions, 2011). In those days vehicles were very simple, and their maintenance was ensured with basic skills-of-hand. This maintenance strategy has persisted until the industrial revolution, when new risks for operators became obvious after industrial accidents where people were killed. Basic instrumentation and safety devices were then introduced. Corrective maintenance is the strategy with the simplest decision making rule: waiting for the observation of failure. Nevertheless this strategy might have catastrophic consequences on

safety and availability of the system, but also on the environment (Cocheteux, 2009). Within this context, diagnostics (Definition 1.2) becomes the process of isolating the possible causes (failure modes) from their manifestation into symptoms (failures). Reducing ambiguity groups resulting from diagnostics is one of our research objectives, as it represents a technological cause of NFF occurrence, as pointed out in the previous sections.

Intended to reduce the probability of failure or degradation of the functioning of an item, preventive maintenance is carried out at predetermined intervals or according to prescribed criteria. While the occurrence of a failure might cause a total loss of performance, its prevention avoids this situation by mastering the timing and system status which trigger preventive maintenance operations. With regards to NFF occurrence, this strategy has a major impact on superfluous maintenance actions, and on early replacements of healthy components (Ahmadi, 2010). Scheduled maintenance is a type of preventive maintenance carried out in accordance with an established time schedule or established number or units of use. This type of maintenance has been introduced between the two world wars due to the rapid development of aircraft. At that time, scheduling preventive maintenance was believed to improve the reliability of many of 1930s aircraft fleets (Jennions, 2011). This switch to conditional maintenance became necessary after the 1954 crash of the Comet jet airlines, caused by unsupervised metal fatigue (Jennions, 2011). “On-condition” type of maintenance interventions introduced by Reliability Centred Maintenance (RCM) lead to conditional maintenance, type of preventive maintenance based on performance and/or parameter monitoring and the subsequent actions, which in the 1970s consisted of manual inspections and simple data trending, thus based on the degradation of the material and not on its failure.

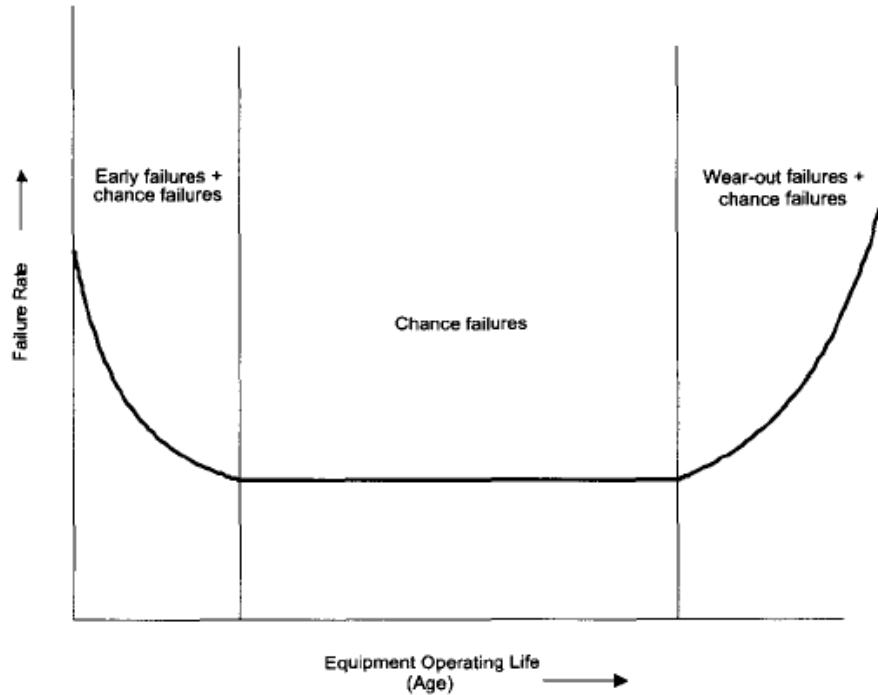

Figure 1.7. Reliability in terms of failure rate - Kothamasu et al., 2006

Stanley Nowlan, Howard Heap, Bill Mentzer and Tom Matteson, (Nowlan et al., 1978) formed a part of a Maintenance Steering Group, which found that 80% of failures were random, and only a minority were age related (Jennions, 2011). As argued by Kothamasu et al., 2006, the “bathtub” based strategy (Figure 1.7) is insufficient, as it does not consider complex interactions within a system, nor random variations in systems’ operational and environmental conditions. To overcome this problem, Health and Usage Monitoring Systems (HUMS) are introduced in the 1980s in rotorcraft systems promising to provide safety benefits through early detection of faults, and thus extend the diagnostics perimeter in order to isolate not only causes of failures, but also causes of degradations manifested in the system (Hoffmann et al., 2011).

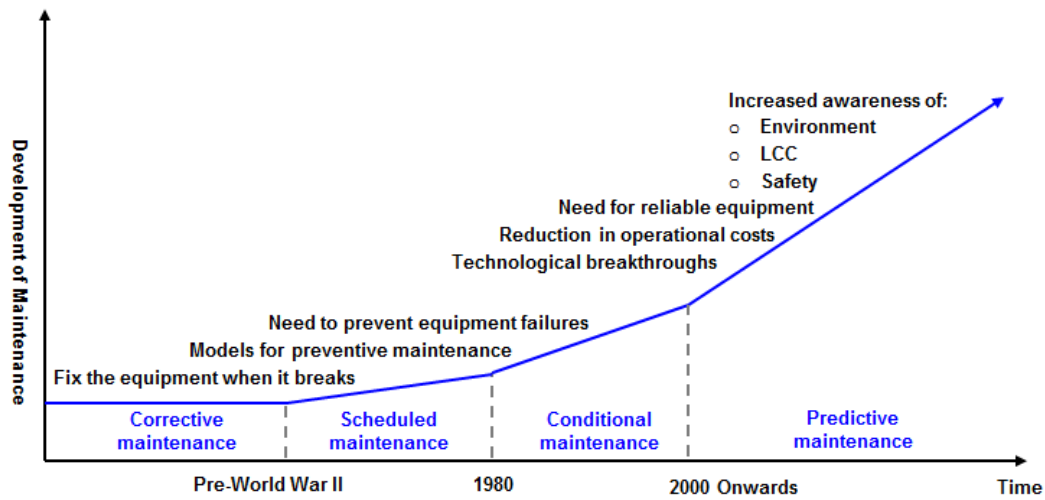

Figure 1.8. Evolution of maintenance strategies

As depicted in Figure 1.8 predictive maintenance has been enabled by revolutionary technological evolutions occurred after 1980 (Jennions, 2011), and is enabled by prognostics and health management (PHM) firstly introduced within U.S. military applications, and then spread out in the industry. Predictive maintenance distinguishes itself from other maintenance strategies by forecast of remaining useful life derived from the analysis and evaluation of the significant parameters of the degradation of the system of interest. This forecast is performed by prognostics (Definition 1.4), and constitutes the key for reducing too early replacements of components (Ahmadi, 2010), attached to one of our industrial questions.

Introduction of standards for condition monitoring and diagnostics of machines (ISO 13374, 2012) and with the Open System Architecture for Condition-Based Maintenance (OSA-CBM) standard in 2001 by an industry team funded by the US Navy through a Dual Use Science and Technology (DUST) program, are the cornerstone for open system architecture of distributed software model facilitating integration and interchange between hardware and software components, and enabling predictive maintenance. In 2002, the US Department of Defense highlighted the Joint Strike Fighter (JSF) as true prognostics capable aircraft which must enable condition-based maintenance, through its Autonomic Logistics System (Smith, 2003). The JSF Autonomic Logistics System (ALS) automatically responds to maintenance/failure events, based on PHM technology embedded in the aircraft, a technology-enabled maintenance operator and of a distributed information system which serves as decision support and communication tool within the logistics infrastructure (Hess, 2004). In this context, Health Management is defined as the capability to make appropriate decisions about maintenance actions based on diagnostics and prognostics information, available resources and operational demand.

Several controversial facts are found in the literature about the JSF ALS. For instance, NASA points out that technologies used in F-35 JSF could offer the space transportation further reduction in launch cost by leveraging IVHM program, as well as lower life cycle cost (Losik, 2012); while in 2011, a Pentagon study team identified the ALS as one of areas of concern that remained to be addressed in the JSF F-35 (DoD, 2011).

The growing nature of IVHM in the twenty-first century lead Boeing to help start an IVHM centre with Cranfield University in 2008, in order to act as a world leading IVHM research hub. The IVHM centre has since then published three volumes on IVHM, addressing general concepts, business cases and technology related to IVHM (Jennions, 2011, 2012, and 2013a), and is currently involved in a IVHM standardization initiative, launched by SAE International. The HM-1 steering committee aims at examining the construct of an IVHM system in order to provide a top-level view from business, design, architecture, operations, technologies and support points of view, and addressing general implementation concerns and potential benefits (SAE, 2014). The company, through its participation to SAE's IVHM standardization committee, has provided an important knowledge source for our research from the latest HM-1 working groups results.

To conclude the IVHM historical review, major events in IVHM since 1992 up until now are synthetized in Figure 1.9.

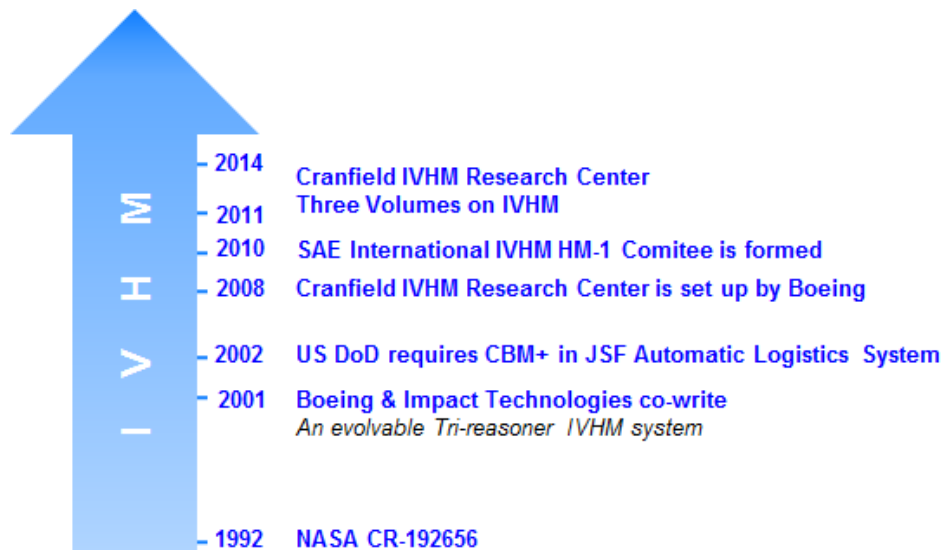

Figure 1.9. IVHM major events

The emergence of the IVHM concept also reflects in the multitude of IVHM solutions proposed by scientific and industrial IVHM communities, and is justified by the shift of mindset regarding maintenance, which is now considered as a strategic focus by system stakeholders (Kumar et al., 2000). The major contributors in IVHM have been identified through the surveys of

I Towards an Integrated Vehicle Health Management framework

Benedettini et al. 2009, Reveley et al. 2010, and Esperon Miguez et al. 2013, proving the research in IVHM is shared by both academia and industry.

Academic Contributors	Industrial Contributors
<ul style="list-style-type: none"> • IVHM Centre of Cranfield University: Benedettini et al., 2009 Esperon Miguez et al., 2013 Jennions 2011, 2012, and 2013a • Applied Research Laboratory of Pennsylvania University: Banks et al., 2009 Rodger, 2012 • Intelligent Control Systems Laboratory of Georgia Institute of Technology: Vachtsevanos, 2006 • Department of Mechanical and Management Engineering, Politecnico di Bari: Benedettini et al., 2009 • LAAS-CNRS: Ribot, 2009 Belard, 2012 Vinson, 2013 • CRAN-CNRS: Muller et al., 2005 Cocheteux et al., 2009 Geanta et al., 2012 • Montana State University: 	<ul style="list-style-type: none"> • NASA, within the NASA IVHM project: NASA, 1992 Reveley et al., 2010 • The Boeing Company: Atlas et al., 2001 Wilmering, 2003 Sheppard et al., 2008 • U.S. DoD, within the JSF autonomic logistics support: Hess et al., 2002, 2004 • Honeywell Corporation: Scandura, 2005 Felke et al., 2010 Gorinevsky et al., 2010 • Rockwell Collins: Swearingen et al., 2007-a,-b Dunsdon, 2008 • Lockheed Martin: Gandy et al., 2003 • Impact Technologies: Atlas et al., 2001 Schoeller et al., 2007 • SAE International

<p>Sheppard et al., 2008, 2012</p> <ul style="list-style-type: none"> • CALCE: <p>Kumar et al., 2008</p>	<p>HM-1 Integrated Vehicle Health Management Committee: SAE, 2014</p> <ul style="list-style-type: none"> • Airbus Group: <p>Buderath et al., 2012 a,b</p> <p>Gupta et al., 2012</p> <p>Hoffmann et al., 2011</p> <p>Hoffmann, 2014</p> <p>Mikat et al., 2012, 2014</p> <p>Lojr et al., 2012</p>
--	---

Table 1.2. Main IVHM contributors

The historical explanation of IVHM leads to the following finding, related to the fifth industrial question addressed in the previous section:

Scientific finding n°1: IVHM is applied to complex vehicle systems, and aims at making appropriate decisions about maintenance and operational actions based on diagnostics and prognostics information.

1.3.2 From industrial to scientific problems in IVHM

In the previous section, a chronological evolution of maintenance strategies leading to IVHM has been provided, and attached to the NFF problem. With such background, one might ask, “What is defining an IVHM system?”, “How is it structured and which are its main functions?”, “Does IVHM answer to industrial questions raised by the thesis?”, “What IVHM challenges must be overcome to solve industrial problems?”. This section is devoted to providing answers to these questions and ultimately serves for identifying scientific problems which are tackled by the thesis in straight connexion with the NFF problem.

1.3.2.1 IVHM definitions

No universally accepted and applicable definition exists for IVHM (Table 1.3), having as consequence a mix of architectural and organizational considerations within its definitions (Benedettini et al., 2009). Furthermore other terms are used in order to designate concepts similar

I Towards an Integrated Vehicle Health Management framework

to IVHM, such as IVHMS – Integrated Vehicle Health Maintenance System – Rodger, 2012, or HMM – Health Monitoring and Management – Buderath et al., 2012.

For instance, Scandura et al., 2005 considers IVHM as a driving force during the design phase for satisfying and balancing reliability, maintainability and safety requirements. While Schoeller et al., 2007 defines IVHM as a highly integrated, enabling decision support tool within its target system and its constituents; its ultimate goal is to provide significant aircraft life cycle benefits, achieved by optimizing operational cost and increasing operability of the aircraft.

Synthesis of IVHM Definitions	IVHM Contributors
<p>The unified capability of a system of systems to assess the current or future state of the member system health and integrate that picture of system health within a framework of available resource and operational demand.</p>	<p>Jennions, 2013b</p>
<p>A condition monitoring system that delivers value in supporting efficient fault detection and reaction planning. It offers the capability to make intelligent, informed, and appropriate decisions based on the assessment of the current and future vehicle condition.</p>	<p>Benedettini et al., 2009</p>
<p>Combination of diagnostics and prognostic tools put together to deliver a certain degree of health monitoring capability. This includes all the hardware and software necessary both on-board and off-board to deliver this capability.</p>	<p>Esperon Miguez et al., 2013</p>
<p>IVHM is more than just fault models, algorithms and sensor processing software. While an IVHM system utilizes these components to perform its intended function, a true IVHM system incorporates a philosophy, methodology and process that focus on design and development for safety, operability, maintainability, reliability and testability.</p>	<p>Scandura, 2005</p>

I Towards an Integrated Vehicle Health Management framework

<p>IVHM is the next evolutionary step in condition based asset management, endeavouring to build on the safety and readiness benefits obtained from legacy HUMS (Health and Usage Maintenance Systems), while also enhancing the scope of the systems covered beyond the traditional drive train monitoring.</p>	<p>Schoeller, 2007</p>
<p>IVHM is the transformation of system data into information to support operational decisions that results in:</p> <ul style="list-style-type: none"> • Reduced life cycle costs • Minimized maintenance actions • Reduced redundancies • Improved readiness and availability of expensive complex vehicles. 	<p>Keller, 2008</p>
<p>IVHM is a capability that focuses on determining the condition (health) of every element in a complex system (detect anomalies, diagnose causes, prognosis of future anomalies), and provide data, information and knowledge to control systems for safe and effective operation.</p>	<p>Reveley, 2010</p>
<p>IVHM is the process of assessing, preserving and restoring system functionality across flight and ground systems.</p>	<p>Paris, 2005</p>

Table 1.3. Plethora of existing definitions of IVHM

As no real consensus is found from the plethora of possible interpretations of IVHM (Table 1.3), the definition adopted in this thesis is mainly in line with definitions provided by Scandura, 2005, Benedettini et al., 2009, and by Jennions, 2013b due to their Systems Engineering vision and to different typologies of decision support proposed by within the definitions, among which maintenance oriented decision support is straightly connected to NFF events.

Definition 1.5. (*Integrated Vehicle Health Management*). IVHM is a Systems Engineering discipline providing methods, processes, hardware and software for designing a system of systems aimed at detecting, isolating, predicting and resolving faults of a vehicle system in a unified manner.

The vehicle system is found to be an aerospace system in the majority of IVHM contributions (Benedettini et al., 2009), yet IVHM systems are recently investigated in the scope of land vehicles (Balaban et al., 2011), and furthermore on other classes of systems, such as production and industrial machines, and power generation plants such as wind turbine systems (Vachtsevanos et al., 2006).

Definition 1.6. (Vehicle). Vehicle systems are machines transporting passengers or cargo, such as wagons, bicycles, land vehicles (motorcycles, cars, trucks, buses, and trains), watercraft (ships, boats), aircraft and spacecraft (Hasley, 1979).

With regards with these heterogeneous applications, vehicle system’s definition used in the frame of our contributions to Integrated Vehicle Health Management is in-line with Definition 1.6.

1.3.2.2 How is IVHM structured and which are its main functions?

The general transformations and functionalities of an IVHM system applied to an aircraft system, as proposed by Felke et al., 2010, are illustrated in Figure 1.10, covering vehicle (measure, extract, interpret, act) and enterprise (interact) centric functionalities.

Measure and extract functionalities are vehicle centric, they listen on the vehicles Input/Output (I/O) data just as “a stethoscope listens to internal sounds of human body” (Atlas et al., 2001). Their continuously observe input and output data, filter it, and generate failures/degradation indicators. Vehicle I/O data could encompass parametric values, fault indicators, status and events, usage data, consumable status, and interactive data, which are produced by common sensors already available on the vehicle or by specific IVHM sensors which might be required for structural or vibration monitoring (Gorinevsky et al., 2010).

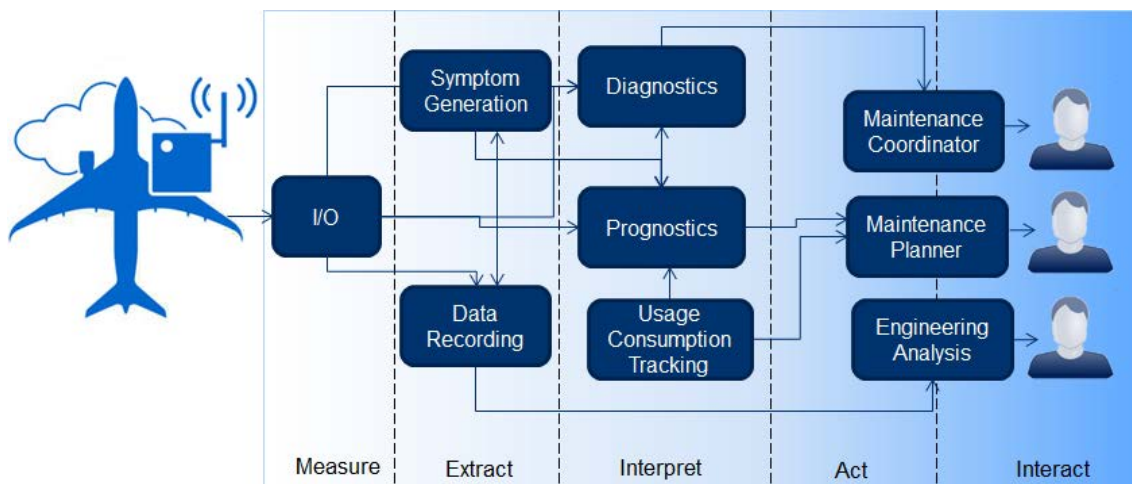

Figure 1.10. General functionalities of IVHM based on Felke et al., 2010

Interpret functionalities assess in real-time the vehicle's functional health, and predict the remaining useful life of near failure components. Within this scope, suitable and reliable combination of diagnostics and prognostics represents the key reasoning capability of the vehicle health management (Esperon Miguez et al., 2013).

Act functionalities use this information for realizing the link with enterprise centric functions; they are aimed at improving operational decisions required for interact with maintenance planning and operations, which benefit from reduced occurrences of unexpected faults, as the health management system will provide early identification of failure precursors, and with command and control functions, which rely on improved awareness of the vehicle condition.

Finally, **interact functionalities** correspond to enterprise level functions, such as maintenance planning operations, logistics, mission planning, down-stream from the decision support provided by vehicle health management. Scandura, 2005 incorporates enterprise centric functions into an enterprise perspective of IVHM, formed out of business and mission cycles, and providing development/improvement of the vehicle, and planning/execution of the vehicles mission. An IVHM system being highly integrated with the enterprise level support functions, interact functionalities are essential for the effectiveness of IVHM systems. Wilmering, 2003 outlines that enterprise centric IVHM functionalities should benefit from the development of the decision support strategies within system health management.

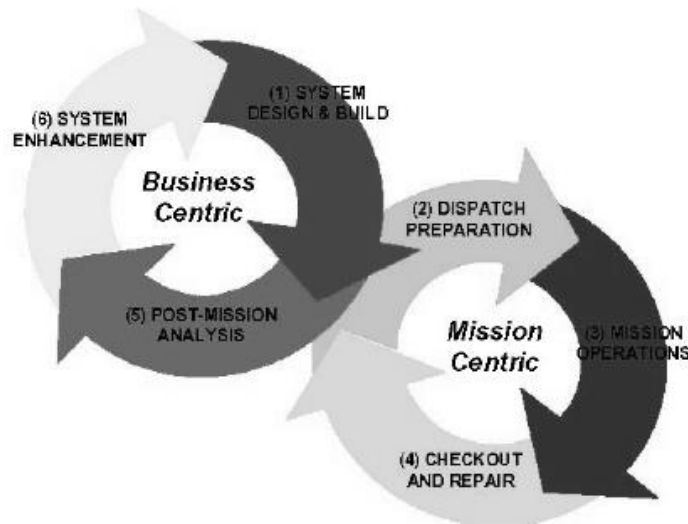

Figure 1.11. Business and mission centric IVHM - Scandura, 2005

Based on this set of functionalities, and with regards to IVHM definition provided in Definition 1.5, the vehicle centric function of IVHM, incorporating measure, extract, interpret,

and act functionalities have the ability to tackle industrial questions n°2 and n°3 raised in the Section 1.2, in order to reduce ambiguity in diagnostics, and increase certainty in prognostics. By integrating diagnostics and prognostics into interpret functionalities, the vehicle health management function of IVHM becomes the focus of the thesis, in order to tackle technological causes of NFF events. This makes the object of the following finding.

Scientific finding n°2: IVHM integrates diagnostics and prognostics processes within the vehicle health management function, their efficient combination representing the key of an efficient IVHM system.

Therefore it is important to state at this stage that this finding orients the thesis on vehicle health management function of IVHM, as it is upstream of the operational maintenance decisions impacting NFF occurrence. The perimeter of the vehicle health management function, considered by the thesis is proposed in the following definition, in line with Felke et al., 2010 functionalities and with Goebel et al., 2011, as observing signals from the system and then reasoning over the signals in order to determine the state of health, possible causes or faults, remaining life and suitable mitigation strategies.

Definition 1.7. (*Vehicle Health Management Function*). The Vehicle Health Management function is an IVHM function transforming measures of relevant parameters of the vehicle's health into actionable information enabling decision support for enterprise level functions.

Heterogeneity between existing definitions (Table 1.3) reveals both technological and methodological considerations in designing IVHM systems. Regarding methodological considerations, Scandura, 2005 defines it as a driving force during the design phase for satisfying and balancing reliability, maintainability and safety requirements. The author outlines the need to elevate IVHM to the status of Systems Engineering (SE) discipline. The key factors for successful deployment of an IVHM process involve establishment of common definition, standards, and processes, designing IVHM from the beginning of a program and not adding it on at later life cycle stages, ensuring the IVHM principles and roles are well understood and correctly managed within an organization. The Systems Engineering status of IVHM extends its perimeter as standalone system to an enterprise-wide system being vehicle and enterprise centric, and thus handling both the vehicle health management, as well as its integration with the enterprise-level support functions (Figure 1.11). As for the technological considerations of the IVHM, Schoeller et al., 2007 defines it as a highly integrated, enabling decision support tool within its target system and its constituents, being both vehicle and enterprise centric. As outlined by Reveley et al., 2010, a plethora of IVHM contributions are technological ones, focusing on application of health

management techniques for a panel of damage conditions tied to different technological nature of vehicle subsystems and components. For instance, among the analysed damage conditions, detection and prediction of icing conditions in propulsion systems is mapped to seven different references, where numerous models are proposed by IVHM scientific contributions. These considerations are synthesized in scientific finding n°3, and are strongly related to industrial questions n°1, and n°4, raised in the first section: “What are the drivers for NFF that could increase vehicle availability and decreasing life cycle cost?”, “What framework could provide a maintenance organization, philosophy and strategy that could decrease NFF rates?”.

Scientific finding n°3: IVHM methodological and technological considerations are mandatory for an effective design of IVHM systems and are essential for increasing vehicle’s availability, while reducing life cycle cost through application of Systems Engineering principles.

The scientific findings of this section have established a clear understanding of an IVHM systems’ scope and functionalities enabling the vehicle health management function, and methodologies to consider for their design; these findings lead us to consider that IVHM framework could provide answers for industrial questions raised by the thesis. Towards this objective, the remaining IVHM challenges to be tackled for solving the NFF problem are identified in the remainder of this section, and set the scientific objectives of the thesis.

1.3.2.3 What IVHM challenges need to be tackled for solving industrial problems?

Among the current IVHM challenges, three main ones associated to industrial questions are isolated based on IVHM surveys of Benedettini et al., 2009, Reveley et al., 2010, and Esperon Miguez et al., 2013, as well as on three volumes on IVHM published by SAE (Jennions, 2011, 2012, 2013). Realizing a good overview of the current advances in IVHM, these references tackle both the state-of-the-art, as well as scientific gaps which need to be addressed for designing IVHM systems. The systemic approach in designing IVHM systems (**Challenge n°2**) based on generic design principles (**Challenge n°3**), the suitable combination of diagnostics and prognostics into the vehicle health management function (**Challenge n°1**), originate the scientific problems to be tackled by the thesis with the ultimate goal of solving NFF.

Challenge n°1: Joint Consideration Diagnostics and Prognostics

Diagnostics and prognostics are considered the key reasoning capabilities of IVHM systems (Schoeller et al., 2007, Sheppard et al., 2008, Esperon Miguez et al., 2013). However, for their successful interoperation within an IVHM system, the challenge, beyond the selection and development of appropriate and effective algorithms (Gupta et al., 2012), is to integrate them

within the overall system, in order to achieve a vehicle level perspective (Esperon Miguez et al., 2013, Reveley et al., 2010). Therefore this challenge must tackle both the selection, and the integration of diagnostics and prognostics within the vehicle health management functions, leading to identify two scientific problems.

Regarding the selection of diagnostics and prognostics algorithms, Scandura et al., 2005 outlines that implementing suitable diagnostics and prognostics has become a bottleneck for systems engineers, because conventional criteria used for selection of methods do not respond to current needs in IVHM anymore. In order to correctly address the challenge of suitable selection of diagnostics and prognostics, the following provides a synthesis of existing classifications of diagnostics and prognostics, going beyond the borders of IVHM. Standard classifications of diagnostics and prognostics techniques are often based on classes of a-priori knowledge on the system and they rarely tackle with both diagnostics and prognostics considerations. Existing approaches of fault diagnostics are reviewed in several domains of application, based on the a-priori knowledge on the target system. Venkatasubramanian, 2003 approaches process industries applications, considering a-priori knowledge as most important discriminant feature in diagnostic systems.

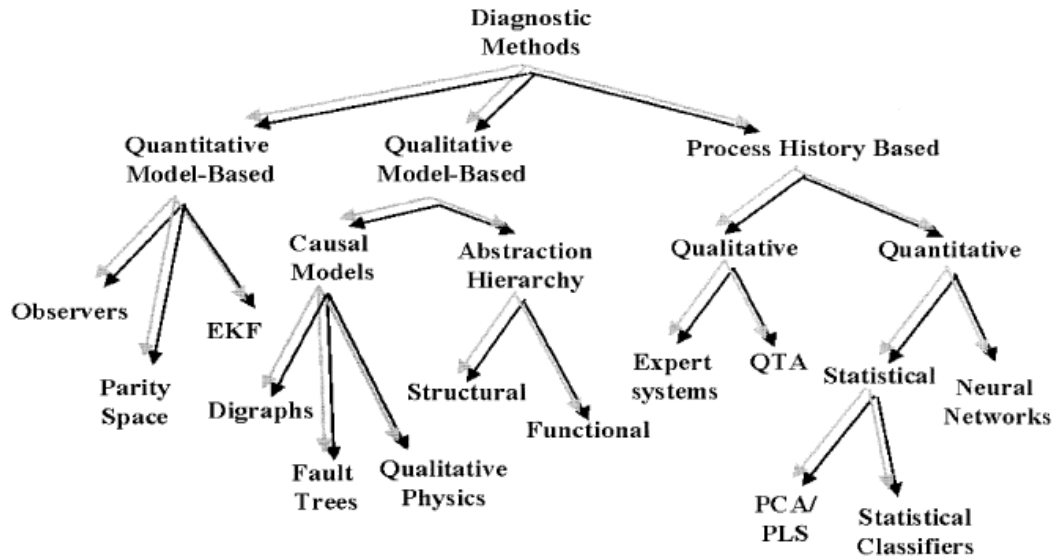

Figure 1.12. Diagnostic methods classification - Venkatasubramanian, 2003

Based on this feature, Venkatasubramanian classifies diagnostic methods into three broad categories of methods (Figure 1.12):

- Model-based methods rely on a fundamental understanding of the physics of the system

- Quantitative model-based methods: a-priori knowledge is expressed in terms of mathematical functional relationships between input and outputs of the system under diagnosis.
- Qualitative model-based methods: a-priori knowledge is expressed in terms of qualitative functions.
- Process history methods rely on amount of system data accumulated over a large period of time, depending on the degree of understanding of data they are divided into qualitative and quantitative methods.

Marzat et al., 2012 approaches model-based fault diagnosis used in aerospace applications, reviewing methods applied to different types of vehicles. The author outlines the need to assess fault diagnosis algorithms in flight tests in order to assess that no false alarm is raised during operation, since latest contributions in diagnosis algorithms are simulated.

Zhang et al., 2008 reviews multiple domains applications of model-based fault detection and diagnostics. This overview takes a step further the classification of Venkatasubramanian, 2003, by categorizing techniques used within model-based diagnostics methods (Figure 1.13) for residual generation, and estimation, revealing that distinct methods could be combined within diagnostics.

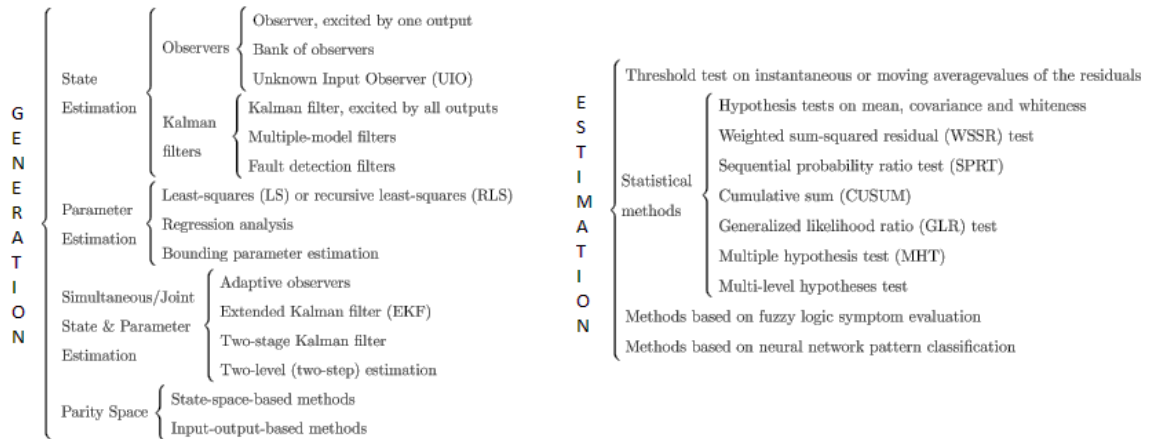

Figure 1.13. Residual generation and estimation methods - Zang et al., 2003

On the other hand, another category of reviews follows the evolution of several approaches throughout a period of time: Isermann et al., 1997 reviews the trends in the application of fault detection and diagnosis methods over a period of 5 years, while in Sheppard et

al., 2012, the terminology and historical evolution of methods and tool employed for health management purposes are synthesized.

The latest category of reviews (Jardine et al., 2006, Kothamasu et al. 2006, Sheppard et al., 2008, Schwabacher et al., 2007, Mikat et al., 2014) focuses on research and development implementing CBM (Condition-based Maintenance).

Diagnostics and prognostics of mechanical systems are reviewed separately in Jardine et al., 2006, with emphasis on models, algorithms and technologies for data processing and decision making. The paper proposed to breakdown a CBM system into three steps: data acquisition, data processing and decision making (Figure 1.14).

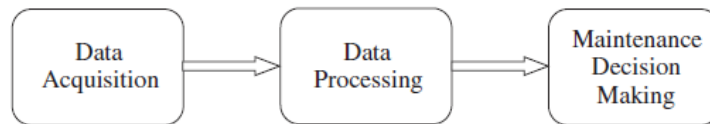

Figure 1.14. Three steps of a CBM program - Jardine et al., 2006

The third step, “Maintenance Decision Making”, is divided into two categories: diagnostics, aimed at detecting, isolating and identifying fault when they occur, and prognostics whose goal is to predict fault before they occur. Prognostics are judged superior to diagnostics by Jardine et al., 2006, as it could lower maintenance cost by proactively planning maintenance operations. Nevertheless, it is outlined that prognostics could not replace diagnostics due unpredictable faults and failures, but also to uncertainty introduced by prediction techniques.

Jardine et al., 2006 also emphasize that CBM is a better choice than conventional run-to-failure (corrective) or time-based (systematic) maintenance, but requires expert knowledge on both the application field and on reliability and maintenance theory. Kothamasu et al. 2006 reviews philosophies and methods for CBM in process industries, which have the potential of improving reliability and reducing unscheduled downtime, while Sheppard et al., 2008 briefly classifies approaches applied to CBM, with the conclusion that the “key” for an effective health management system is still to be found.

Schwabacher et al., 2007 emphasizes that few prognostics surveys exist in the literature, as this discipline has been recently recognized within systems health management. The survey proposed by the authors classifies health monitoring, diagnostics and prognostics algorithms used for integrated systems health management in four main classes issued of model-based and data-driven-methods, which are depicted in Figure 1.15. Model-based algorithms use human knowledge in the system model, which is based either on physics, or on artificial intelligence. In

contrast, data-driven algorithms build the system model based on historical data, either by using numerical algorithms or machine learning and data mining algorithms. Each of these four categories is exemplified at the bottom of Figure 1.15.

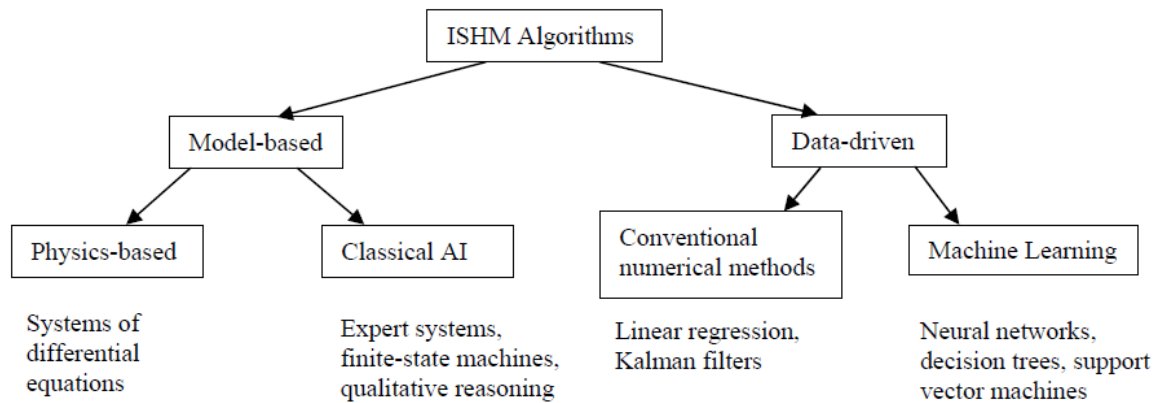

Figure 1.15. Taxonomy of ISHM algorithms - Schwabacher et al., 2006

Based on the above mentioned surveys, Mikat et al., 2014 emphasize that preliminary choices of prognostics approaches depend on limiting factors of the system to prognosticate, such as economical, mission or safety critical functions, and technological maturity of available data collection and algorithms.

From the myriad of available surveys, selection and design of suitable diagnostics and prognostics is a difficult task as conventional criteria, used for their selection, do not respond to current needs in IVHM anymore as defended in Swearingen et al., 2007-b. This statement leads to the conclusion that beyond the usual classification, IVHM needs to be approached by considering new criteria suitable for the system-of-interest and for its IVHM system, formulated into the first scientific problem of the thesis.

Scientific problem n°1: IVHM lacks of methodology for appropriately designing diagnostics and prognostics based on vehicle and IVHM systems considerations.

A plethora of methods exists for diagnostics and prognostics, yet few authors tackle their integration in a common framework. As outlined by Sikorska et al., 2011, the delimitation between the two processes is still vague, and their integration represents an emerging topic within system health management research. In this regard, a part of IVHM contributions tackle diagnostics and prognostics integration from financial and risk assessment perspective towards finding the best combination of diagnostics and prognostics (Esperon Miguez, 2013), while others focus on diagnostics engineering (Gould, 2012) by integrating prognostics performance

requirements into diagnostics engineering and analysis tools, as they provide infrastructures for producing overall measures of prognostics effectiveness. Gupta et al., 2012, considers the lack of a formal framework for reasoning about integration of diagnostics/prognostics as a bottleneck for systems engineers, while Esperon Miguez et al., 2013 point out the lack of definition and standardization of the different parameters regarding performance of diagnostics and prognostics. Furthermore, operating and environmental conditions affect directly monitored parameters upstream of diagnostics and of prognostics, and thus impact health management performance. Esperon Miguez et al., 2013 outline that this issue has not been tackled in the literature under real operational and environmental conditions of existing health management systems. Recently, model-based frameworks integrating diagnostics and prognostics have been proposed in Bregon et al., 2012, Chen et al., 2012, and Vinson et al., 2013. Yet a-priori knowledge required by their models is a major limitation for their scalability at system level, where integration between diagnostics and prognostics is an essential driver for an accurate health assessment of the vehicle, which ultimately results in reducing NFF rates. This major challenge of integrating diagnostics and prognostics, leads us to formulate the second scientific problem of the thesis.

Scientific problem n°2: Diagnostics and prognostics, key processes of health management, suffer a necessary formalization of their interactions.

Challenge n°2: Systemic approach in designing IVHM systems

Benedettini et al., 2009 report the state-of-the-art of IVHM research, overviewing IVHM concepts, existing IVHM applications, design guidelines and drivers. Among the current challenges, the survey points out that IVHM needs to be approached as a Systems Engineering (SE) process, and that systematic research is required in order to support knowledge development and to improve IVHM SE methods and tools. In this regard, some contributions focus on developing requirements for IVHM (Wheeler et al., 2010, Puttini et al., 2013, Rajamani et al., 2013, Saxena et al. 2013), while others address physical and functional design either by developing in-house solutions (Byington, 2004) or by using COTS software, such as MADeTM, and CATIATM (Niculita et al, 2012, 2013, and 2014), eXpressTM (Lauffer, 2012), and Reason ProTM (Schoeller, 2007). Gorinevsky et al., 2010 state that the fleet-wide data collected on-ground from many aircraft over a long period of time have the potential to optimize vehicle health management. Yet this data is not appropriately considered, as the definition of an IVHM system does not evolve as required throughout vehicles' life cycle. In this same direction, Hoffmann et al., 2011 outline that future fleet management systems will have the duty to converge all necessary information in order to provide a real benefit out of CBM (Condition-based Maintenance), supporting individual and fleet-wide mission analysis. There is a real need to

incorporate these elements within a life cycle vision of IVHM, which must tap the full potential of existing contributions, in order to increase vehicle's operability while reducing life cycle cost; this analysis leads to the third scientific issue of the thesis.

Scientific problem n°3: IVHM systems require a framework for IVHM Systems Engineering, covering the whole life cycle of the vehicle system.

Challenge n°3: Genericity in IVHM design

Another major challenge in IVHM design is outlined by Chen et al., 2012, which proposes a .NET component-based architecture guided by desirable features of an IVHM framework, such as modularity, interoperability, programming language independence, simplified deployment, required to meet developer and user needs (Table 1.4). The authors outline the lack genericity in IVHM frameworks, and more particularly in design of architectures integrating diagnostics and prognostics, key processes of health management.

Developer Needs	User Needs
Modularity	Ergonomy
Flexibility	Simplified Deployment
Interoperability	Ease of Update

Table 1.4. Architectural needs from developer and user Perspectives - Chen et al., 2012

The need of genericity in IVHM design is also identified by Esperon Miguez et al., 2013, when tackling with a major challenge of retrofitting IVHM to in-service vehicles, matching the characteristics of different diagnostics and prognostics techniques and of IVHM tools with the requirements of legacy aircraft. This is currently an important industrial challenge, as several vehicles' stakeholders are trying to implement IVHM to existing vehicles. However an IVHM system, as part of the vehicles' enabling systems, is intended to be designed into its system-of-interest, during its early life-cycle stages when the design of the IVHM system can still benefit from and to the design of the vehicle system. Among the challenges of applying IVHM, and in particular to legacy vehicles, unified, generic IVHM capabilities could prevent from contradictory results. Therefore the IVHM research is now required to focus on developing unified systems enabling IVHM Systems Engineering. The authors further outline the lack of a common

architecture for developing IVHM tools, a multiplicity of specific HM systems existing in IVHM research and industry.

Furthermore, Reveley et al., 2010, within the scope of NASA IVHM project, point out that generic processes and integration lack in the development of IVHM System. As most of IVHM technologies are developed and matured at specific levels, they are not yet tested and integrated within the overall system. This finding is confirmed in the survey of Benedettini et al., 2009 which point out that IVHM solutions are most of the times developed and matured empirically, and are often proprietary, requiring important investments for engineering and sustaining IVHM systems and consequently Cost-Benefit Analysis (CBA) as decision enablers of their development. Furthermore, when attempting to propose an open architecture for IVHM, Gorinevsky et al., 2010 point out that IVHM misses of standardized processes and formalized information flows. This determines IVHM community to turn to other standards outside its scope, such as OSA-CBM standard. The last scientific problem of the thesis, issued of the genericity challenge identified in IVHM design, is formulated as follows.

Scientific problem n°4: IVHM Systems Engineering lacks of genericity, being developed on case by case basis, and are most of the times founded on proprietary and specific concepts.

The challenges in IVHM addressed in this section have set the perimeter of the scientific problems to be tackled in the following chapters of this thesis. Mainly focused on its vehicle centric function, as enabler of decision making at operational level maintenance, these scientific problems will be investigated in connection with the NFF issue raised by the company; the conclusion section that follows synthetises both industrial and scientific problems, and gives a glimpse into the following chapters.

1.4 Conclusion

Throughout this chapter an industrial problem statement has revealed the NFF problem through a set of industrial questions standing at the genesis of the thesis. Industrial questions mainly address the drivers of the NFF problem, and the necessary technological and organizational means to combat this problem. An abductive research strategy is adopted in order to generalize the industrial problem, and shifts the problem space into the IVHM framework, as it could provide the necessary organizational and technological capabilities to reduce NFF rates. To this extent, the problem statement has revealed scientific problems, which require to be addressed in order to overcome existing IVHM challenges in straight connection with industrial questions (Figure 1.16).

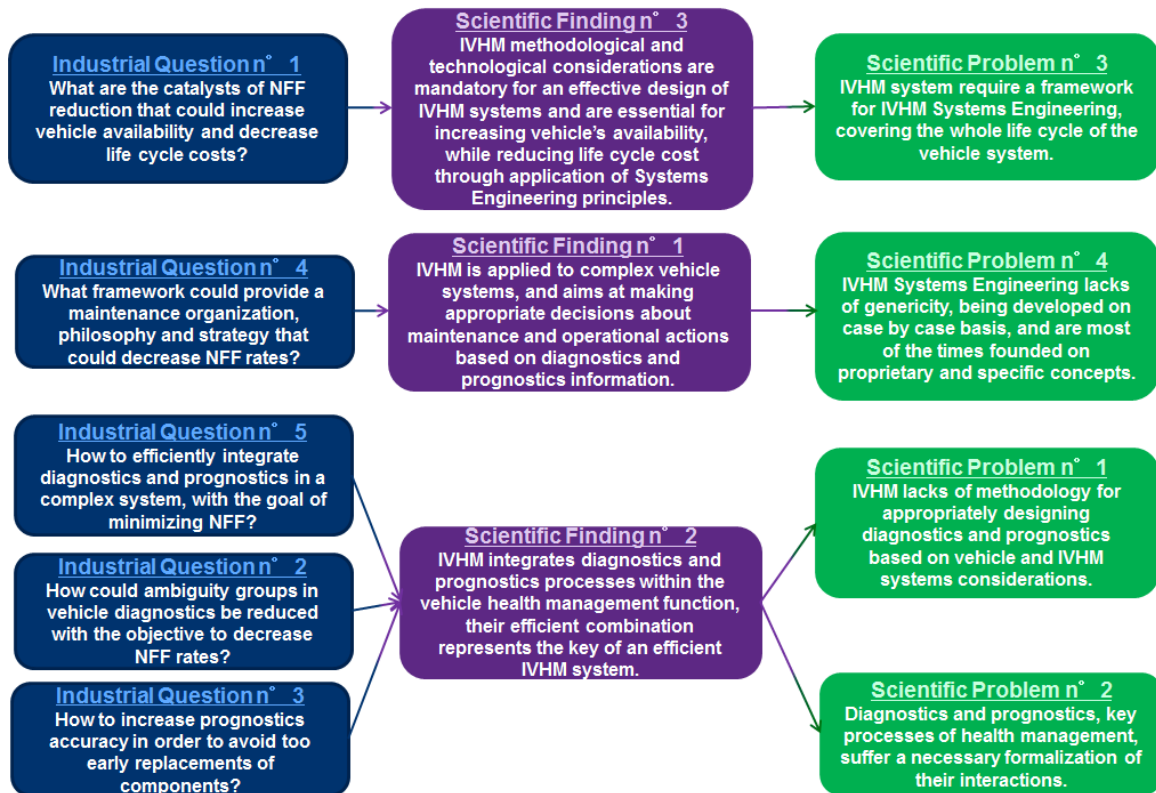

Figure 1.16. Links between industrial and scientific problems

In a nutshell, this chapter has presented a problem statement from industrial and scientific perspectives, and unveiled the scientific problems to be addressed by the thesis. They become the focus of the contributions provided to IVHM in the following chapters of the thesis, ultimately realizing the bridge towards reducing NFF issues. To this extent, the following chapters of the thesis are organized as follows (Figure 1.17):

- **Chapter 2** tackles the Scientific Problem n°3, by setting the foundations of an IVHM modelling framework deeply grounded in Systems Engineering;
- **Chapter 3** contributes with the formalization of a generic Health Management Module (gHMM), as fundamental element of the proposed IVHM modelling framework, addressing Scientific Problem n°4; the integration of diagnostics and prognostics within the gHMM proposes a bi-directional communication between the two processes, by tackling Scientific Problem n°2 of the thesis;
- **Chapter 4** tackles Scientific Problem n°1 by contributing with the methodological means required to design health management in an IVHM modelling framework, by particularizing the gHMM into specific instances of health management, and by formalizing the multi-criteria determinant for selection of supporting algorithms in accordance with both the system-of-interest and with IVHM system;
- **Chapter 5** contributes with the verification and validation protocol of overall contributions in line with their technological maturity level, its three phases demonstrate the feasibility of the scientific contributions carried out for two distinct classes of systems. Moreover, it allows concluding on the industrial questions addressed at the genesis of the thesis.

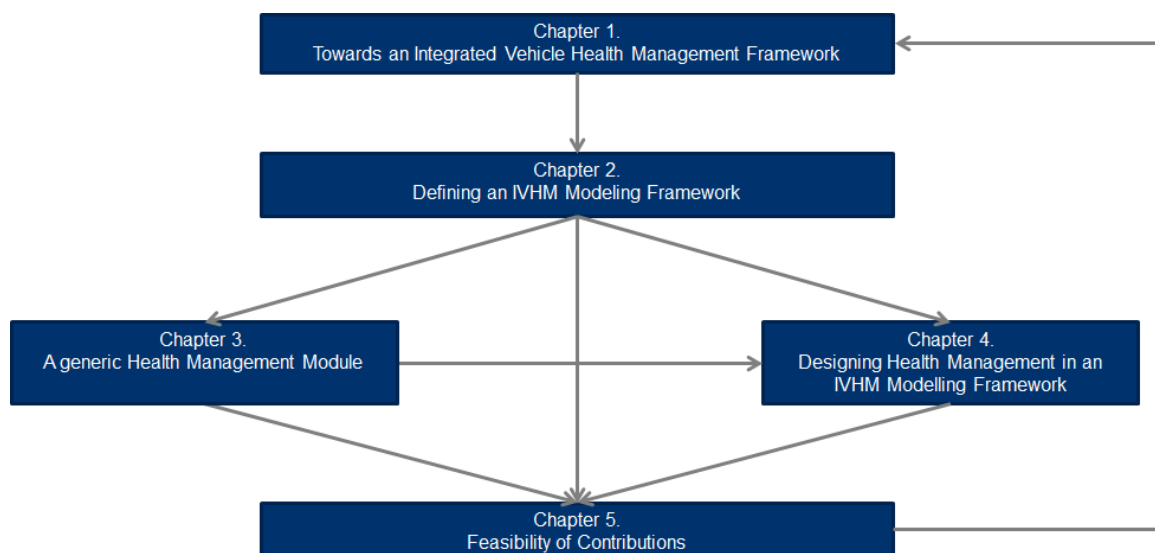

Figure 1.17. Dependency between chapters

Chapter 2

Definition of an IVHM modelling framework

“I think probably the most important thing is having good fundamentals.”
- Gordon Moore

2.1 Introduction

The unifying concept of thesis is the notion of system, around which this chapter establishes an Integrated Vehicle Health Management (IVHM) modelling framework in order to tackle with Scientific Problem n°3: *IVHM systems require a framework for IVHM Systems Engineering, covering the whole life cycle of the vehicle system.*

Towards this goal, the second section demonstrates that IVHM is a system of systems through its three complementary constituents: “Vehicle” – as system of interest, “Health Management” – as one of its enabling systems, and “Integrated” – as binding realizing integration between vehicle and enterprise centric functions of health management.

From this system vision, the focus of our research orients on the vehicle centric function of Health Management, as it has the potential to tackle causes of No Fault Found (NFF) problem raised in Chapter 1. The refinement of this function upon its three structuring dimensions (functional decomposition, hierarchical level distribution, and on-board/on-ground segments repartition) performs a synthesis of eight standards and systems related to IVHM. This synthesis reveals a lack of consensus between the analysed standards and systems, and of functionalities addressing NFF, and outlines the need of proposing a consensual framework supporting IVHM Systems Engineering. This framework is thus unveiled in the fourth section, as a generic modelling framework of IVHM defined following a Model-based Systems Engineering approach, able to sustain IVHM Systems Engineering throughout the life cycle of the vehicle.

This chapter being closely related to Systems Engineering concepts, frequently used terms from this field are defined in Appendix A of the thesis.

2.2 “I” – “V” – “HM”

From the definition of IVHM provided to the reader in Chapter 1 (Definition 1.5), Systems Engineering becomes the governing discipline on which complementary concepts of Vehicle, Integration, and Health Management rely on for defining an IVHM system. Their omnipresent relation with SE federates the contribution unveiled in this section.

A comprehensive system vision of Integrated Vehicle Health Management is proposed based on SE guidelines (INCOSE, 2010, and EADS, 2013) and standards (ISO/IEC 15288:2008, and ANSI/EIA 632), on scientific works of Takata et al., 2005, Cochetoux, 2009, which propose life cycle approaches for maintenance in the field of manufacturing systems, and on the field of enterprise modelling where integration has already reached scientific (Doumeingts et al., 2007, Grabot et al., 2008) and technological (Ferrarini, et al, 2006, Berre et al, 2007) maturity.

2.2.1 IVHM as system of systems

A prerequisite for positioning **Systems Engineering** (SE) as foundational frame of IVHM, is to demonstrate that IVHM is a system of systems, by examining the defining properties of such concept, and their particularization to IVHM systems elements.

Definition 2.1 (*Systems of Systems*). System of systems applies to a system of interest whose system elements are themselves systems; typically these entail large scale interdisciplinary problems with multiple, heterogeneous, distributed systems (INCOSE, 2010).

Based on Definition 2.1, a system of systems is composed out of interconnected, communicating, heterogeneous systems, which exhibits one or more properties, not obvious from the properties of individual systems. A general understanding of these properties emerges from the "formulation and derivation of those principles which are valid for 'systems' in general" "whatever the nature of the component elements and the relations or 'forces' between them", defining general systems theory (von Bertalanffy, 1968). This formulation characterizes the types of interactions existing between the systems parts: physical, functional (ISO/IEC/IEEE 42010, 2011), dysfunctional (Kulkarni et al., 2012, Chérière, 2014), with its external environment: operational interactions (DoD, 2001), and of their temporal evolution throughout the system life cycle (ISO/IEC 15288:2008). The different types of interactions form the views in which a system can be regarded to, throughout different time scales of its life cycle (Figure 2.1f):

- **Physical:** defines how a system is constituted internally;

- **Functional:** how a system manifests internally;
- **Dysfunctional:** defines how a system degrades and fails to provide its intended function;
- **Operational:** defines how a system manifests externally.

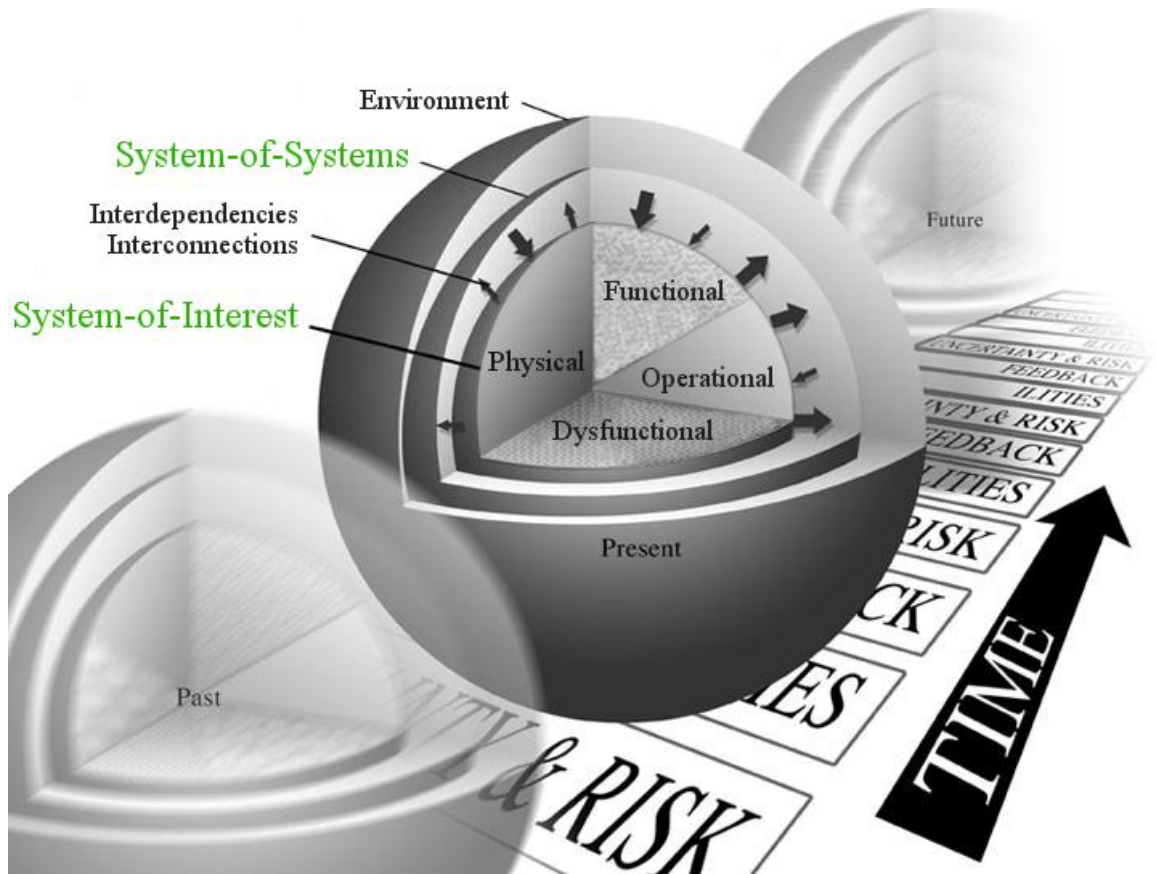

Figure 2.1 Conceptual perception of systems views based on Davidz, 2006

This general perception of systems views is soundly illustrated in Figure 2.1, based on Davidz, 2006 conceptual understanding of system’s thinking. These system views, and the interconnections into a system of systems, are now examined upon the System-of-Interest (Vehicle), unified with its health management system into an Integrated Vehicle Health Management System, in order to demonstrate its membership to System-of-Systems.

2.2.2 “V” – the system-of-interest

In the scope of our research, the system-of-interest in Figure 2.1 is a vehicle system, whose life cycle is under consideration (INCOSE, 2010), and whose defining system views are considered sine-qua-non for evaluating effectiveness of an IVHM system (Mikat et al., 2012).

II Definition of an IVHM modelling framework

However, our analysis is generalized as much as possible to a system, in order to consider its future application to other classes of systems.

The temporal evolution (Figure 2.1) of the system-of-interest is defined by its life cycle stages, which are delimited by decision gates in order to determine the readiness of the system to move from one stage to the other. Based on ISO/IEC 15288:2008, Figure 2.2 depicts the generic life cycle stages of a vehicle system, as well as an overall view of stakeholders involved in the system throughout its life cycle.

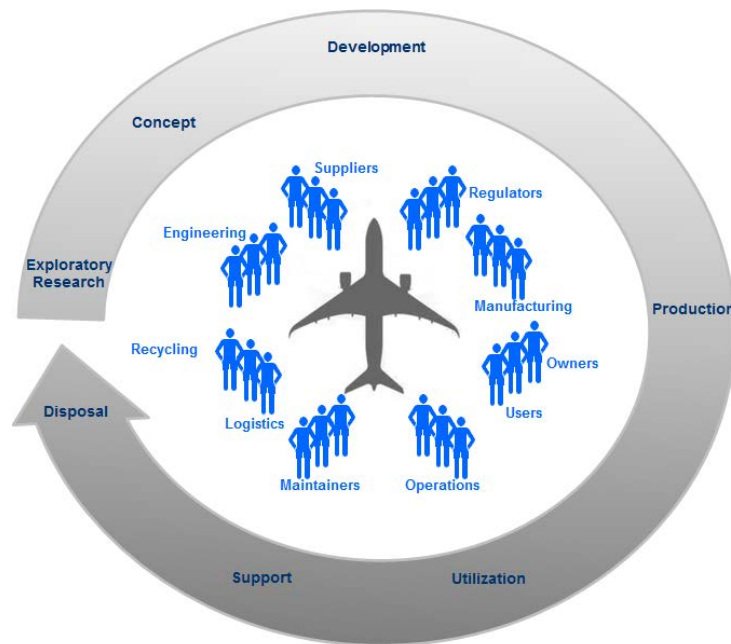

Figure 2.2 System life cycle stages and stakeholders

As illustrated in Figure 2.2, the vehicle life cycle stages are presented here below, and attached to the NFF event occurrence.

Exploratory research is aimed at exploring ideas and technologies which could satisfy potential stakeholders' needs, which are refined during the **concept** stage, for the proposal of feasible solutions.

The **development** stage is composed of several sub-stages, depicted in Figure 2.3 (specification, design, and implementation, integration of system elements, and validation and verification of the system), which as a whole achieve the system-of-interest based on the stakeholder's requirements, identification of system functions, and their allocation to physical system elements (INCOSE, 2010).

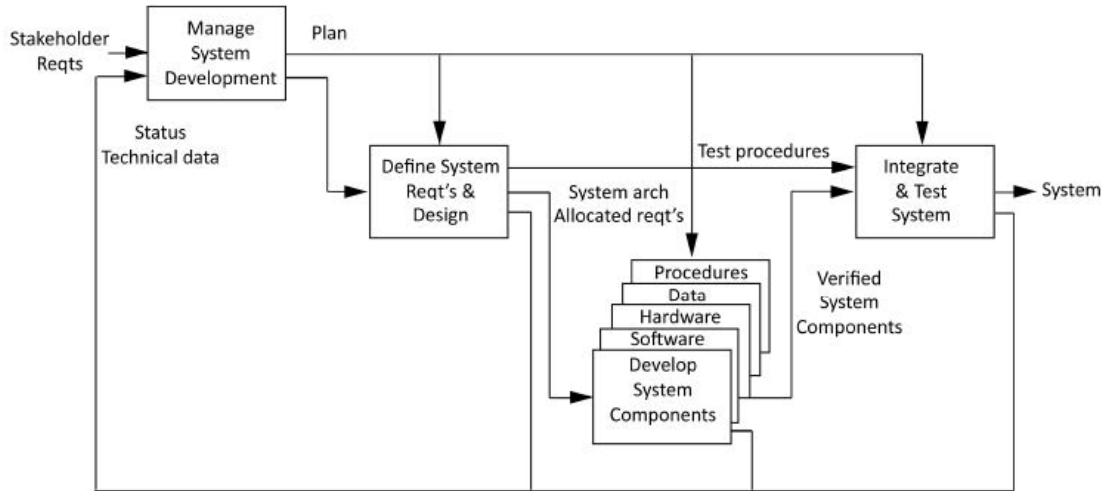

Figure 2.3 System development process – INCOSE, 2010

This allocation makes the bridge between the system’s **functional view** and its repartition into system’s **physical view** in hierarchical elements, which begin their own life cycles correlated with their upper levels as depicted in Figure 2.4. Transition to **production** is made at the end of the development process; production stage is aimed at manufacturing the system, inspecting and validating it before entry into service.

Utilization is the stage where the system is in operation. At this stage of the systems life cycle, system elements interact internally in physical, functional, and dysfunctional system views, but also externally (operational view) with its environment in order to ensure the system’s mission. Concurrent with utilization stage, the **support** stage provides the system with the services enabling its continued operation. At this stage, maintenance represents an essential process sustaining the capability of the system to provide its intended services, achieved through three levels: operational, intermediate and depot, in the case of a vehicle system (Section 1.2).

These two concurrent life cycle stages (utilization and support) are directly connected to NFF events, and to their technological causes occurring upstream during vehicle’s operation (Figure 2.4). This identification justifies the refinement of the proposed IVHM framework upon utilization life cycle stage in Section 0.

II Definition of an IVHM modelling framework

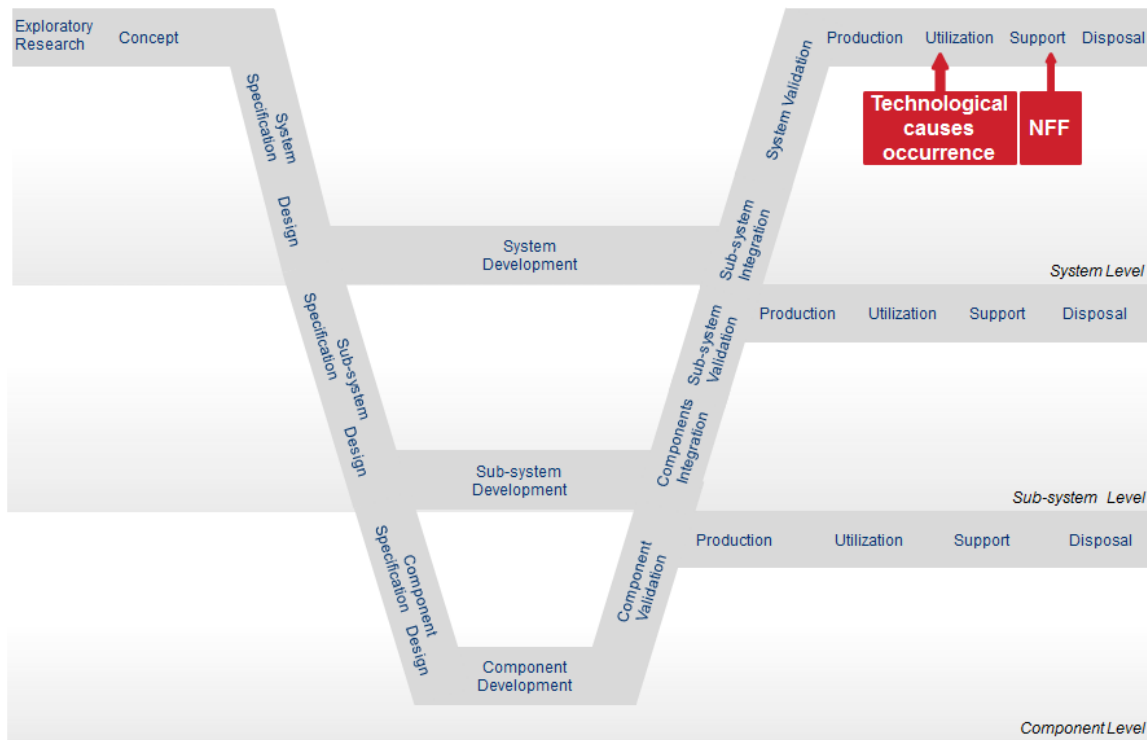

Figure 2.4 System life cycle – NFF occurrence

Finally, **disposal** corresponds to the stage where the system and its related services are no longer in operation.

The health management system is now examined as constituent system of an IVHM system-of-systems, sine-qua-non for reducing NFF rates during utilization and support life cycle stages of the vehicle.

2.2.3 “HM” – enabling system

Each life cycle stage of the system-of-interest, described in the previous section is made possible by other systems, defined as enabling systems (ANSI/EIA 632). The system-of-interest and its enabling systems are closely bounded, evolving throughout the life cycle synchronically with stakeholders needs (INCOSE, 2010). Let us take for instance an aircraft enabling systems depicted in Figure 2.5 based on Negele, 2000. They provide means necessary for operational functions of aircraft, but do not participate in its functions (Negele, 2000). The link between the IVHM system and the system-of-interest becomes self-evident as a driving force of the system’s support life cycle stage (Scandura, 2005).

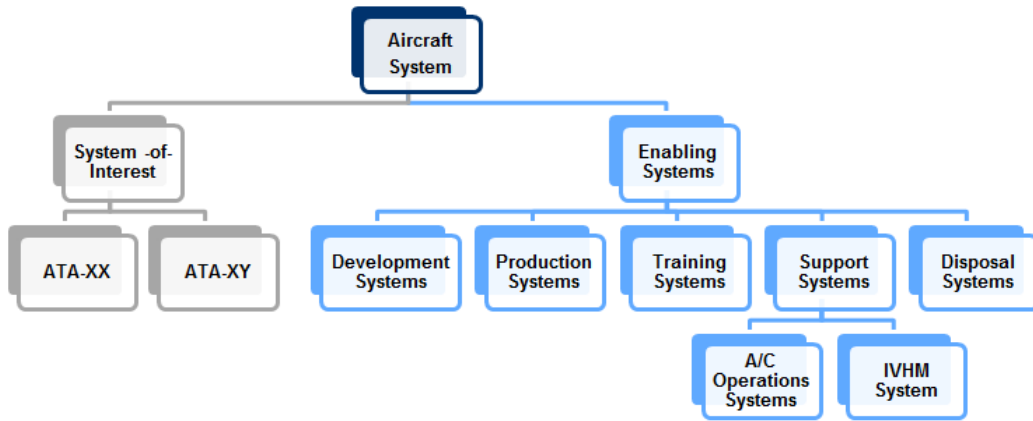

Figure 2.5 System-of-Interest and enabling systems of an aircraft based on Negele, 2000

The vision proposed of an IVHM system within this thesis goes a step further, as it is not limited to enabling system of the support stage, as typically used in existing IVHM systems (Benedettini et al., 2009). It extends the IVHM life cycle from the beginning of concept stage of the system-of-interest, when the design of the IVHM system will benefit from and to the design of the vehicle system, to the end of vehicle’s disposal stage (Figure 2.6).

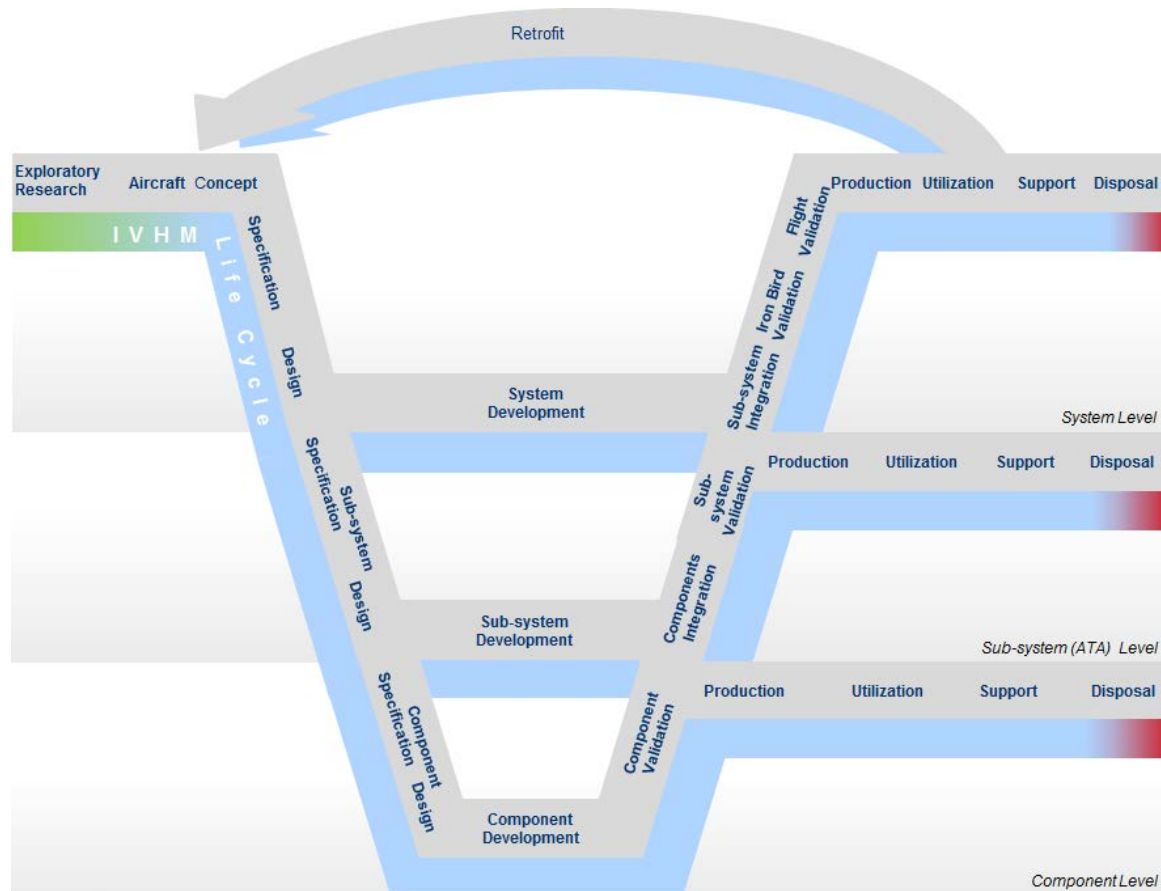

Figure 2.6 System-of-interest (aircraft) and IVHM life cycles

II Definition of an IVHM modelling framework

This **life cycle vision of IVHM** could meet health management needs evolving throughout vehicles' life cycle, and would satisfy the demand of decreased life cycle cost by considering an **iterative** and **reusable** definition of vehicle health management, adapted to its stakeholder's need at each life cycle of its supported system. For instance, let us consider the vehicle's disposal stage, as increasingly vehicles are designed by taking into consideration reusability and recycling requirements. Recycling stakeholders require assessments of remaining useful life of vehicle parts, as well as the condition of reusable material which, once recovered and processed, could be used to produce other goods. Recycling requirements are complementary to utilization and support stage requirements, where assessment of remaining useful life takes into consideration future vehicle missions. Hence, this vision must consider that different life cycle stages could be associated to common health management requirements, and thus could share health management functionalities.

Our proposed vision is in-line with life cycle approaches, explored outside the scope of IVHM in the field of maintenance of manufacturing systems, proposed by Takata et al, 2005, as a life cycle management approach of maintenance strategies, which is further considered by Cocheteux et al., 2009 as vision sustaining prognostics process engineering by coupling the design of systems-of-interest and of maintenance system.

In order to sustain this life cycle vision, the IVHM system's life cycle stages are synchronically correlated with the system-of-interest from early concept until disposal stage (Figure 2.6), bounded by their integration, concept which is put forward in the following section in order to demonstrate the membership of IVHM to System-of-Systems.

2.2.4 “I” – binding in IVHM system of systems

Non-consensual understanding of what “Integrated” stands for in IVHM has direct impact on No Fault Found (NFF) rates, on health management performance, and ultimately on vehicle life cycle costs, as argued Mikat et al., 2012. Moreover, integration concept of IVHM is burdened by its implementation for in-service vehicles as argued Esperon Miguez et al., 2013, on the contrary to the fact that an IVHM system, as part of the vehicles' enabling systems, is intended to be designed into its system-of-interest during early life-cycle stages (Schoeller et al., 2007).

In order to correctly address integration in IVHM systems, a parallel to the field of Enterprise Systems (ES) is proposed, where integration has already been established, and proves to be essential for organizational tools, where integrated real-time view of core business processes, using common databases maintained by database management systems facilitates error

free transactions and production (Doumeingts et al., 2007). This parallel is essential for demonstrating the membership to system-of-systems of IVHM.

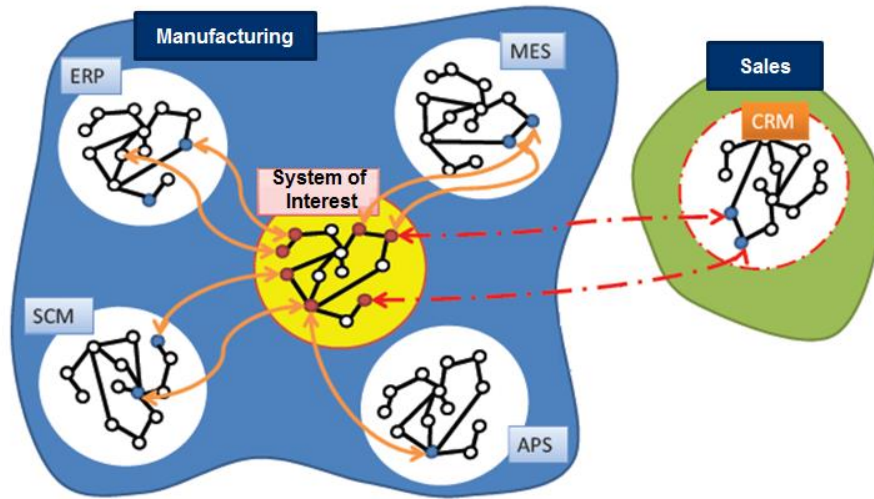

Figure 2.7 Complexity of interoperability between enterprise systems - Auzelle et al., 2008

The complexity of interoperability between enterprise systems is depicted in Figure 2.7: enterprise systems are considered as Components of the Shelf (COTS), and their integration must take into account properties and functionalities of the larger assembly in which they evolve, while conserving their specific operating conditions. As defended by Panetto et al. 2008, during ES evolution, the integration paradigm that has prevailed so far shows its limitations and leads to organizational interoperability, where processes and IT management tools are interconnected, despite their often heterogeneous characteristics, with the purpose of collaborative activities – long-lasting or transitory – creative of value in the business process. The shift from integrated to interoperable system of systems clearly illustrates the emergence of business networks (Baptiste et al., 2007).

Similarly to these considerations of ES, IVHM emerges from the global interaction and coordination across organizational boundaries of vehicle and enterprise centric IVHM functions deployed in interoperable systems. In this regard, our proposed functional view of IVHM constituent systems is depicted in Figure 2.8. As defined in Chapter 1 (Definition 1.7), the vehicle centric function provides actionable information enabling operational and maintenance decision making based on the current and future health of the vehicle, as well as data and information required for engineering analysis. This function is upstream of enterprise level IVHM functions, which encompass:

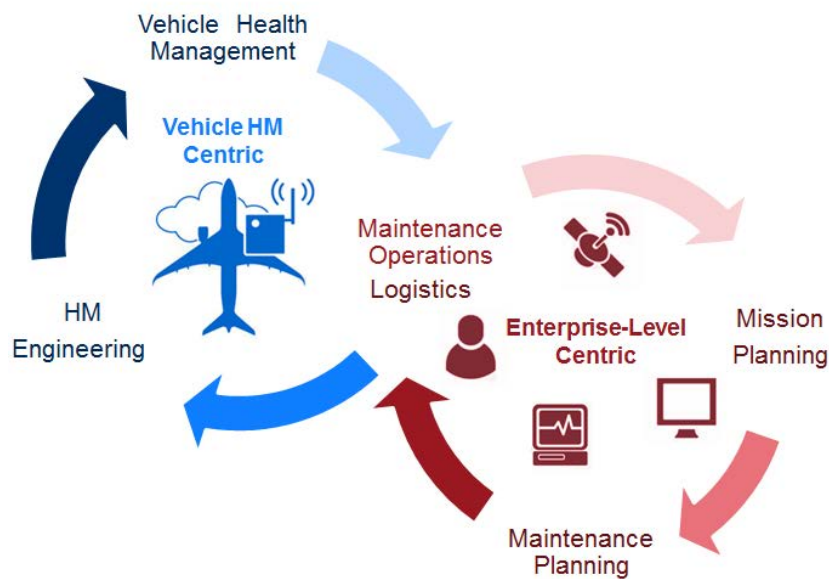

Figure 2.8 Vehicle and enterprise centric functions of IVHM

- **Maintenance planning** function performs elaboration, application and update of maintenance programme of the vehicle with respect to the vehicle maintenance programme, and with the vehicles' health condition (Mobley, 2008).
- **Maintenance operations** function insures the execution of overall maintenance actions performed at O, I and D levels, which have been defined earlier in the thesis in Section 1.2 of the first chapter;
- **Logistics** function represents an important function of any organization aiming to maximize resource availability while minimizing cost, ensuring level of inventory, period and due dates of resource delivery, reliability and high capability utilization (Jennions, 2013). Its activities involve planning and executing acquisition, movement and maintenance of resources required for sustaining the vehicle operations (Wheeler, 2010).
- **Mission planning** function ensures scheduling of future vehicle's missions, supervision of on-going missions, and communication with the vehicle in case of change in mission profile.
- **Health Management Engineering** is concerned with applying engineering concepts to the development, deployment and maturation of health management systems in order to achieve better maintainability, reliability, and availability of vehicles (Mobley, 2008).

When assembled, vehicle and enterprise centric IVHM functions provide as a whole the end-to-end health management of the vehicle, when taken apart they can be assembled to other IVHM systems (Figure 2.9). Hence, "integrated" of IVHM must address more than a simple

integration, vehicle and enterprise functions being deployed in interoperable systems, demonstrating IVHM system's belonging to **system of systems**.

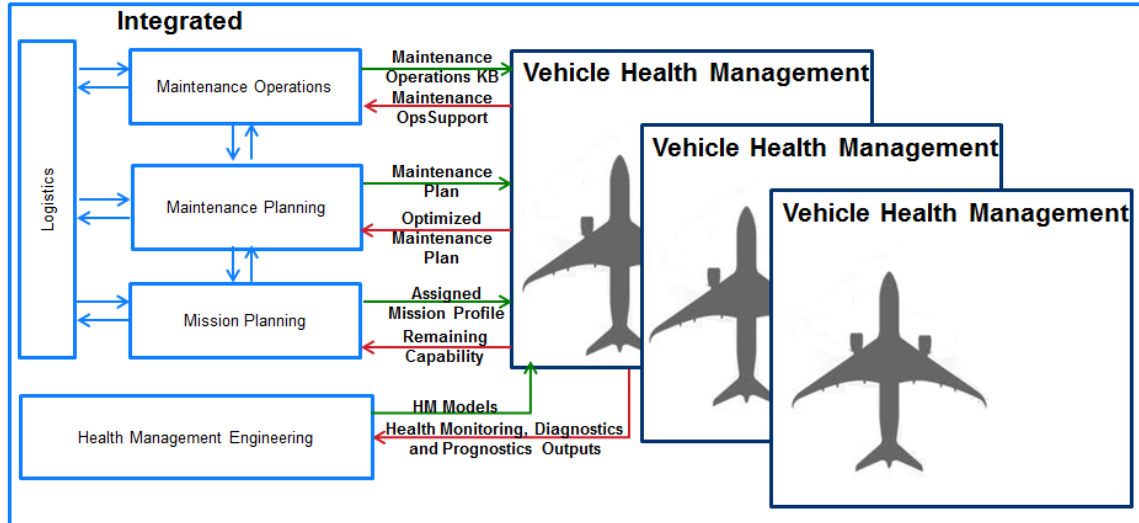

Figure 2.9 Complexity of interoperability between IVHM functions

Interoperability between IVHM functions is a significant feature to be considered in the design of IVHM systems, as it ensures sustainability of a system of systems by enabling the capacity for heterogeneous, changing systems, managed by different organizations to cooperate effectively (IEEE 100, 2000). Next to existing IVHM contributions, interoperability between IVHM functions is a new consideration required for sustaining a multi-organizational IVHM system of systems. As highlighted by Benedettini et al., 2009, the majority of IVHM contributions are technology-based and focus on advanced intelligent functions and their deployment issues on vehicle subsystems. However this does not ensure optimization of maintenance and operational decisions based on the vehicle health condition, as information between vehicle and enterprise levels suffers a necessary formalization of their models ensuring their interoperability.

This section has demonstrated that IVHM is a multi-organizational system of systems encompassing vehicle and enterprise centric level IVHM functions whose interoperation achieves detection, isolation, resolution, and prediction of faults within a vehicle system in a unified manner. In order to delve deeper into this vision of an IVHM system, our focus is oriented on its vehicle centric function, as it has the potential to respond to our initial NFF problem. In this regard, the following section provides a foundation of this function based on the synthesis of eight standards and systems associated to IVHM.

2.3 Focus on vehicle health management function

To delve deeper into our analysis, a solid foundation of the vehicle health management function is achieved by analysis of structuring principles of eight standards and systems associated to IVHM. Being upstream of the operational maintenance decisions impacting NFF occurrence, the vehicle health management function represents the focus of our contribution to the IVHM framework.

The search strategy employed for finding the sample of IVHM related standards and systems is firstly enounced. A three dimensional synthesis over the resulting standards and systems realizes the baseline knowledge required for formalizing the vehicle health management function in an IVHM framework. Furthermore, this synthesis aims at investigating if analysed standards and systems, which integrate diagnostics and prognostics, tackle with NFF technological causes identified in Chapter 1 (Table 1.1).

2.3.1 Sample of standards and systems associated to IVHM

Benedettini et al., 2009 highlight that few examples of IVHM systems are found in the literature. The vehicle health management design analysis is based on six standards and systems from IVHM field and on other two systems of other domains of application, identified through the following search heuristic:

1. From IVHM surveys of Benedettini et al. 2009, Esperon Miguez et al. 2013 and Reveley et al. 2010, a list of the main IVHM contributors has been extracted in the previous chapter (Table 1.1)
2. Following this first finding, relevant publication databases, covering conference proceedings, journals, technical reports such as IEEE, AIAA, Elsevier, PHM Society have been searched for these main contributors.
3. This lead to identifying a set of six standards and systems associated to IVHM. Two similar systems from the fields of predictive maintenance of manufacturing systems and real-time control systems have been considered for comparison purposes (Table 2.1), where A[x] addresses each of analysed standards and systems. A detailed description of the studied standard and systems is provided to the reader in Appendix C.

System/ Standard	Contributor(s)	References	Year
------------------	----------------	------------	------

II Definition of an IVHM modelling framework

A1	MIMOSA OSA-CBM standard	Boeing, Caterpillar	Discenzo et al.	2001
		Rockwell Automation	Lebold et al.	2002
		Rockwell Science Center	Dunsdon et al.	2008
		Penn State University / Applied Research Laboratory	Swearingen et al.	2007
			Mikat et al	2012
			Lojr et al.	2012
		Buderath et al.	2012	
A2	Open Architecture for IVHM	NASA	Gorinevsky et al.	2010
		Boeing	Felke et al.	2010
		Honeywell		
A3	Generic Supervision System	LAAS-CNRS	Ribot et al.	2009
			Vinson et al.	2013
A4	Embedded IVHM Architecture	Impact Technologies	Schoeller et al.	2007
A5	.NET IVHM Architecture	Georgia Tech	Chen et al.	2012
		Impact Technologies		
A6	Tri-Reasoner IVHM System	University of Washington	Atlas et al.	2001
		Boeing		
		Impact Technologies		
A7	Integrated System of Proactive Maintenance – SIMP	CRAN-CNRS	Muller	2008
			Cocheteux	2010
A8	4D/RCS	Intelligent Systems Division of NIST	Albus	2006

Table 2.1 Sample of standards and systems associated to IVHM

2.3.2 Three dimensions of vehicle centric IVHM function

In order to compare their functional coverage, each of analysed standards and systems is decomposed into processes and elementary activities following ISO/IEC 15288 representation of process and activity concepts (Appendix A). Moreover, this representation is aimed at investigating if functionalities addressing NFF reduction are included in their functional breakdown. For instance, processes and underlying activities of A4 are provided in Table 2.2, based on the Ribot et al.,2009, and on Vinson et al., 2013.

Process Name	Activities Description
Generic Supervision System: Surveillance	Observation: acquisition of relevant parameters for the health monitoring of the component / sub-system / system.
	Filtering: filters the observed signals.
	Detection: detects failure modes at component level using nominal behavior patterns and pattern of behavior in the presence of faults.
Generic Supervision System: Diagnostics	Local diagnostics: provides the set of candidates which explain the failure modes detected at sub-system level.
	Global diagnostics: verifies if the candidates proposed by each of the local diagnostics are globally consistent, by using a strategy of overall compatibility, which eliminates incompatible candidates inconsistent with the observations of the system.

<p>Generic Supervision System: Prognostics</p>	<p>Local prognostics: determines the aging of component parameters in terms of fault probability. Uses online observations provided by the surveillance process, and knowledge of the components of the subsystem aging, known and aging laws.</p>
<p>Generic Supervision System: Decision Support</p>	<p>Global prognostics: computes failure probabilities for each function implemented by the system, by fusion of the fault probabilities provided by local prognostics. Uses the functional model of the system.</p> <p>Providing maintenance recommendations for the overall system: replacing one or several components based on the results provided by the diagnostics and prognostics processes as well as on the future mission goals of the system before the next phase of scheduled maintenance. Each fault detected by the diagnostics is associated to a risk according to the impact it may have on the accomplishment of the mission, and to a cost - repair costs they generate in case the system fails before the next maintenance phase.</p>

Table 2.2 Generic supervision system processes/activities breakdown

The processes/activities breakdown such as the one in Table 2.2 was performed laboriously, as analysed systems are not designed following a SE approach. By using this representation, three dimensions of interest for vehicle health management design, attached to its functional and physical views (ISO/IEC/IEEE 42010, 2011) make the bridge to our analysis of the system-of-interest from Section 2.2.1:

- **Functional view:** several processes form a functional flow from the measure of relevant parameters to the decision of maintenance or mission control actions;
- **Physical view** reveals that the vehicle health management is designed as a reflection of its supported system upon two dimensions:

II Definition of an IVHM modelling framework

- **Hierarchical level distribution:** each hierarchical level within an IVHM system is associated to a set of functions, distributed within the hierarchical architecture of the vehicle system;
- **On-board/on-ground IVHM segments repartition:** each of the on-board/off-board components is associated to a different or complementary set of functions.

These three dimensions are analysed here-after upon the sample of IVHM related standards and systems, with a particular focus on functionalities which could drive NFF reduction.

2.3.2.1 Functional view

As mentioned earlier in this section, the functional components of analysed health management standards and systems are not formalized following an SE approach. Only A1 provides a syntactic formalization of its functional elements using Unified Modelling Language (UML) classes compliant with specification of A2. In this regard, A2 functional decomposition and A1 data structures are used as references by the IVHM community, as IVHM lacks of a better functional decomposition. However, A1 and A2 are not designed for machinery less complex than IVHM systems. Moreover, the semantics of underlying data manipulated by A1 layers remain unclear, as no formal support guarantees the semantic integrity of information shared between OSA-CBM compliant applications (Wilmering, 2004).

Following the analysis of their functional composition, no consensus has been found within the sample of standards/systems, making clear the need to formalize the vehicle health management function by using unambiguous representation of functional decomposition, behaviours and interactions. This non-consensus is illustrated on this first dimension in Figure 2.10 by using Felke et al., 2010 functionalities, developed in the state of the art on IVHM in the first chapter (Section 1.3.2.2).

II Definition of an IVHM modelling framework

Functionality/ Architecture	A1: OSA-CBM A2: Open Architecture for IVHM	A6: Tri-reasoner IVHM architecture	A5: .NET IVHM Architecture	A3: Generic Supervision Module	A7: SIMP	A4: IVHM Embedded Architecture	
Measure	Data Acquisition	I/O Measures		Detection	Functional Parameters	Enhanced HUMS	
Extract	Data Manipulation State Detection	Anomaly Reasoner	Reasoner Integration Manager		Feature extraction		Monitoring Process
Interpret	Health Assessment Prognostics Assessment	Diagnostics Reasoner Prognostics Reasoner	Reasoner Integration Manager	Fault Diagnosis Failure Prognosis	Diagnostics Prognostics	Prognostics	Low- Mid- High- reasoning Level
Act	Advisory Generation				Decision Aid	Decision Support Process	

Figure 2.10 Synthesis of health management functionalities

As depicted in Figure 2.10, all the studied standards/systems tackle with measure, extract and interpret functionalities, however they are performed heterogeneously. In order to correctly analyse this heterogeneity between functionalities, the following provides a comparative analysis of A1, A2, A3, and A5 with regards to processes/activities of interpret functionality within these systems. Realized through model-based diagnostics and prognostics in A3, and A5, and through health assessment and prognostics assessment functional blocks in A1, and A2, the interpret functionality, incorporating diagnostics and prognostics, is identified as focus of our research with regards to technological causes of NFF events (Chapter 1 - Table 1.1):

- Increasing prognostics accuracy in order to avoid too early replacement of components;
- Reducing ambiguity groups produced by diagnostics.

A3, proposed by Ribot, 2009, and Vinson, 2013, and A5, proposed by Chen et al. 2012, address quantitative frameworks involving diagnostics and prognostics. They represent some of the few existing quantitative model-based frameworks in vehicle health management (Ribot, 2009), while other model-based frameworks can be found outside the scope of IVHM, such as Dong et al., 2007, Bregon et al., 2012, and Tobon-Mejia et al., 2012.

Vinson, 2013 defines the output of global diagnosis Δ^Σ at a given time t of a system Σ composed out of n components $\{C_1, \dots, C_n\}$ as a tuple formed out of possible systems modes $m^\Sigma(t)$ and health states $HS^\Sigma(t)$ that explain the system's current behaviour:

$$\Delta^\Sigma(t) = \langle m^\Sigma(t), HS^\Sigma(t) \rangle \quad (2-1)$$

II Definition of an IVHM modelling framework

In A3, the output of global diagnosis is transmitted to prognosis which computes a global prognosis $\Pi^\Sigma(t)$ as a sequence of system diagnoses at every predicted time of mode changes t_1, t_2, \dots, t_n :

$$\Pi^\Sigma(t) = \{\Delta^\Sigma(t), \Delta^\Sigma(t_1), \Delta^\Sigma(t_2), \dots\} \quad (2-2)$$

The method proposed by Vinson, 2013 (A3) has been successfully tested on a single component failure mode, yet the author identified a limit for applying the proposed method at system level due algorithmic complexity. In conclusion, the quantitative method proposed by Vinson, 2013 would require an interface with another class of methods used at system level, in order to overcome this limitation. Moreover, uncertainty is not specifically quantified, thus this framework could not respond to our needs regarding NFF reduction.

Chen et al. 2012 (A5) proposes the utilization of the particle filtering, a sequential Monte Carlo method that uses any state-space fault models for estimating and predicting the failing behaviour of a system. The particle filtering technique is used by Chen et al. 2012 at component level, as it is well known to be appropriate for solving real-time state estimation, as it incorporates process data into a-priori state estimation by considering the likelihood of sequential measurements. This is achieved in two steps:

- Prediction of prior probability density function (PDF) of states using a non-linear system function f_k :

$$x_k = f_k(x_{k-1}, \omega_{k-1}) \quad (2-3)$$

, where x_k is the system state vector at time k, and ω_{k-1} is an independent and identically distributed process noise.

- Update of prior density to gain the posterior density, by use of a non-linear function h_k mapping systems states and noisy measurements:

$$y_k = h_k(x_k, v_k) \quad (2-4)$$

, where y_k represents the measurement vector, v_k an independent and identically distributed process noise. Equations (2-3) and (2-4) are then used by Chen et al., 2012 into a Monte Carlo simulation, which enables to compute a fault indicators comparing the current state with a baseline state PDF, which can be defined from statistical or historical information on the system to diagnose. When a fault is detected by diagnostics, system model (2-3) is used by successively computing an expectation for obtaining RUL of faulty components. Chen et al. 2012 have efficiently tested this method for detection and prediction of bearing spalling. However, the

authors do not use future operating conditions in calculating the RUL, as the proposed method is intended to be used for life time calculation, rather than failure prognostics. Thus, this method would not respond to NFF reduction need, which requires considering the vehicle operating context in prognostics assessment. Beyond this limitation related to our initial problem, the two model-based methods have as major limitations their scalability to system level, and the consideration of operating conditions for prognostics evaluations. These limitations outline the need of a system approach in designing vehicle health management, which must incorporate several methods and algorithms for different functionalities of health management in order to achieve a vehicle level perspective.

The standards analysed in the sample of IVHM systems, OSA-CBM (A1) and ISO 13374 (A2), address required health management functionalities independently from implemented algorithms, being focused on functional decomposition and exchanged information flows.

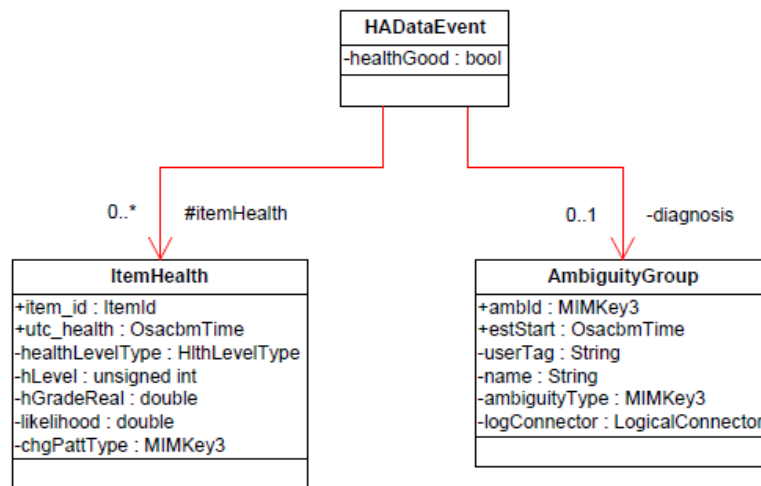

Figure 2.11 HADataEvent data structure – OSA-CBM v 3.3.1

OSA-CBM expresses data structures exchanged and manipulated by processing blocks specified in ISO 13374. Two layers of processing, health assessment (Figure 2.11) and prognostics assessment (Figure 2.12), are associated to interpret functionalities. The health assessment layer is expressed in *HADataEvent* object by including a health initialization vector (*ItemHealth*) and a logical expression of faulty or degraded items (*AmbiguityGroup*). Based on outputs produced by health assessment, the prognostics assessment layer calculates *PADataEvent* (Figure 2.12). This object encompasses a set of vectors for health level projection *FutureHealth* and *FutureHlthTrend*, and for RUL evaluation of items under prognosis, either by a *RUL*, or as a distribution *RULDistrbn*, as depicted in the figure below.

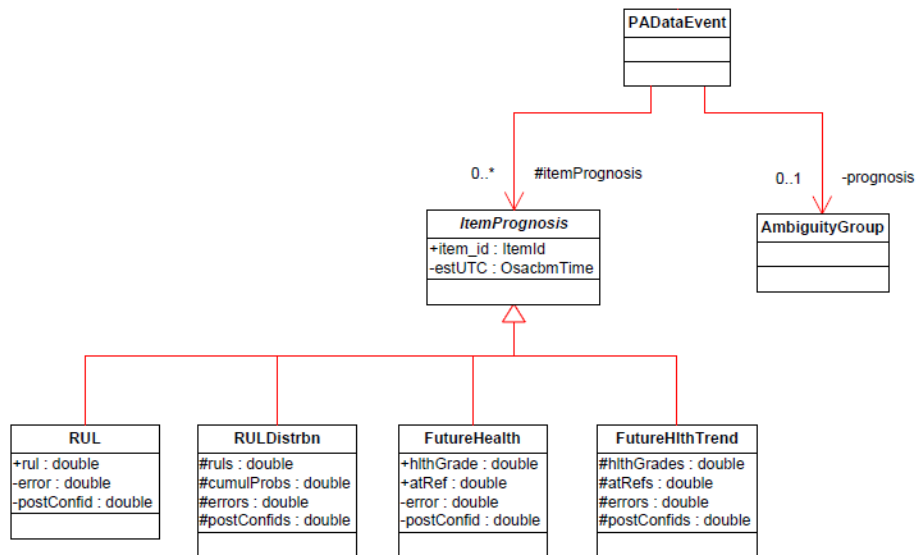

Figure 2.12 PADATAEvent data structure – OSA-CBM v 3.3.1

With regards to NFF technological drivers targeted by our research (increasing prognostics accuracy in order to avoid too early replacement of components, and reducing ambiguity groups in diagnostics), they are not directly tackled within the analysed sample of standards/systems. Only A4 encompasses false alarm and real fault probability estimations, as well as fault intermittence detection, which can contribute to NFF reduction by minimizing false alarms during operation, as argued in Chapter 1 - Table 1.1.

This lack of consensus in health management design is further reflected in their distribution upon levels of hierarchy.

2.3.2.2 Hierarchical level distribution

With regard to hierarchical level (Definition 2.2) distribution, two complementary **physical views** (Figure 2.13), "black" and "white" of the same system (Heylighen, 1998), are used to illustrate a general principle: systems are structured hierarchically, consisting of several distributed hierarchical levels.

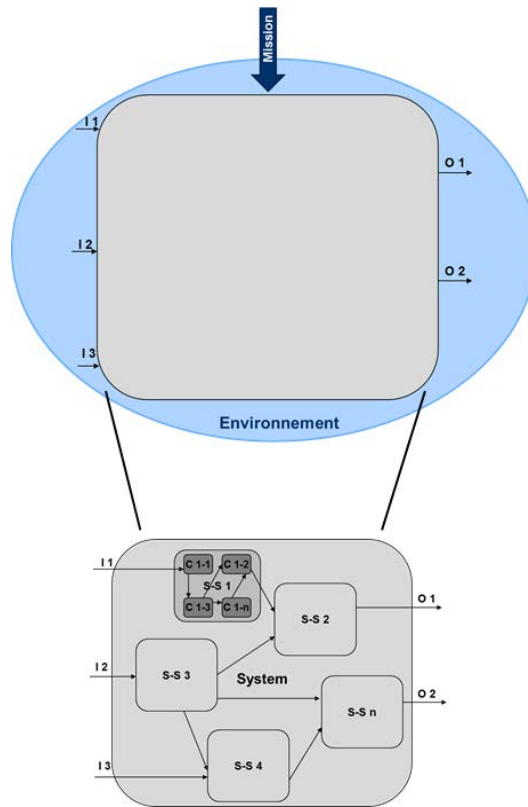

Figure 2.13 Black and white-box system representation

At the higher level, the physical view is an abstract view of the system as whole without any detail of the components or parts. A zoom at the lower levels gives a detailed view on interacting parts but without understanding how they are organized to form the whole.

Definition 2.2 (*Level of hierarchy*). The level of hierarchy represents the relationship of one item of hardware/software with respect to items above and below in the relative order of things (NASA, 2012).

This general principle is not approached consensually within the sample of studied systems. However, the main hierarchical levels consider health management as a reflection of its supported system, from component all the way up to vehicle level:

- Vehicle (system) level: corresponds to a single vehicle system entity, according to Definition 1.6,
- Sub-system level: corresponds to a set of parts which accomplish together a system function,
- Component level: the lowest hierarchical level corresponding to the elementary entity of a system.

II Definition of an IVHM modelling framework

The lowest level of hierarchy within a system (Definition 2.3) is related to operational level maintenance, during which a maintenance operator performs a set of maintenance actions where Line Replaceable Units (LRU) are replaced or repaired, out of which a part of the replaced LRUs corresponds to NFF items. A similar granularity in defining components is employed in Belard et al., 2011 and Chérière, 2014, where LRUs are defined as atoms of maintenance, and their underlying failure modes as atoms of diagnostics and prognostics.

Definition 2.3 (*Component*). A component is an elementary entity of a system which can be replaced by a line maintenance operator.

Our analysis revealed a heterogeneous functional allocation to the three levels: A5 is focused on specific diagnostics and prognostics at component level, while A3, A4 and A6 are structured upon three hierarchical levels. Moreover, there is no unanimity between the health management functionalities associated to each hierarchical level.

At **component level**, A4 sorts out evidence provided by diagnostic features, identifies the failure mode most likely present at component level, estimates RUL of the component, and the severity level of the failure mode. A6 identifies deviations from the baseline performance, assesses components current health, and predicts the component's future health in two directions: is the component good for the future mission, estimate the time before a certain type of fault will occur. A3 implements mechanisms for monitoring, detection and filtering to generate relevant indicators from the information recorded by the sensors, achieves the diagnosis of a component, and computes RUL of components by using observations provided by the supervision module and knowledge on the usage and aging of components.

At **subsystem level** A3 provides failure modes detected at sub-system level. A4 confirms the suspected failure modes of its encompassed components, identifies upstream components which could be the root cause for failure of downstream components, and computes remaining functional capability of the sub-system based on components health states. A6 evaluates raw data and extract features for correlation or measures of evidence for fault conditions, achieves through model-based approach a set of candidate hypothesis ranked according to a heuristic (simplest explanation, likelihood etc.), and predicts the future health of components within a subsystem given available health monitoring information.

At **vehicle level** A3 achieves the fusion of local diagnostics by using a global coherence strategy i.e. eliminating incompatible candidate with the observations of the system, provides probabilities of failure of the system functions by fusion of local prognosis and a functional model of the system, and recommends maintenance actions for the overall system. A4 examines the

functional capabilities of all constituent subsystems, in order to determine the overall capability of the system to perform the functions or actions required to maintain operations within a predetermined list of mission critical requirements. A6 correlates anomalies that occur across subsystems and separate the upstream causes from the downstream effects, constructs an integrated perspective of the vehicle's health and determine fault sources, and examines attributes of all prognostic reasoners across a vehicle in order to prioritize the most probable failure modes to be concerned with.

Moreover, the studied systems do not tackle hierarchical interoperation and information flow exchanged between different hierarchical levels in a formalized manner. As pointed out by Wilmering, 2004, interoperability between hierarchical levels of an IVHM system is a key enabler of a sound vehicle level health management view.

2.3.2.3 On-board/on-ground segments repartition

A third dimension structuring the physical view of vehicle health management is represented by repartition of functionalities between on-board and off-board segments. As outlined by Gorinevsky et al., 2010, the frontier between on-board and on-ground IVHM physical segments is not clear. This is confirmed by our analysis, as no common repartition is found within the studied systems.

Among the studied systems, A4 structures IVHM into an on-board system and an on-ground system, which are interoperable. The on-board system's goal is to provide autonomous, timely and accurate assessments of the vehicle's health and functions availability to operations personnel, while on ground IVHM system uses knowledge gained from on-board IVHM, for operations, maintenance, and logistics infrastructure and personnel, enabling condition based asset management and support. Thus in this case, only the decision support is on-ground, while up-stream reasoning is implemented on-board.

A2 provides the clearest repartition: on-board segment comprises the processes required for autonomous, timely and accurate assessments of the vehicle's health and functions availability, while on-ground segment uses this knowledge for maintenance and mission decision support, consolidating diagnostics and prognostics based on fleet-wide knowledge. It distinguishes four main classes of systems to which IVHM functions can be attributed. The first three classes are mapped on hierarchical levels of their target system, being aimed at aircraft and sub-system levels IVHM functions.

II Definition of an IVHM modelling framework

- On-board critical systems: host direct action functions which need to be certified to DO 178-B / DO 254 levels A and B – fault tolerance, redundancy management and closed-loop reconfiguration control.
- On-board non-critical systems: host deferred actions function. This class of systems is the main industry focus of IVHM research.
- On-ground systems: host deferred actions functions. Aircraft CBM and maintenance decision support are already part of the industry and DoD state of the art.
- Data management systems: provide on-board data collections, data exchange between the on-board and on-ground segments and on-ground knowledge management functions.

The studied systems do not tackle with methodologies selecting which functionality should be implemented on which segment (on-board or on-ground). In this regard, Felke et al., 2010 state that on-board and on-ground functional distribution generally reflects the hierarchical structure of the supported asset. IVHM's on-board segment is a highly distributed system employing appropriate communication protocols for centralizing the health management information at vehicle level, while distributing data acquisition and processing load at component and sub-system levels, while IVHM's on-ground segment provides health management information to enterprise level functions of IVHM.

2.3.3 Synthesis of IVHM related standards and systems

From this analysis on IVHM related standards and systems, the need of a generic framework supporting IVHM Systems Engineering is outlined by the non-consensual structuring of the vehicle health management function, illustrated in Figure 2.14 upon the three structuring dimension of the vehicle health management function of IVHM.

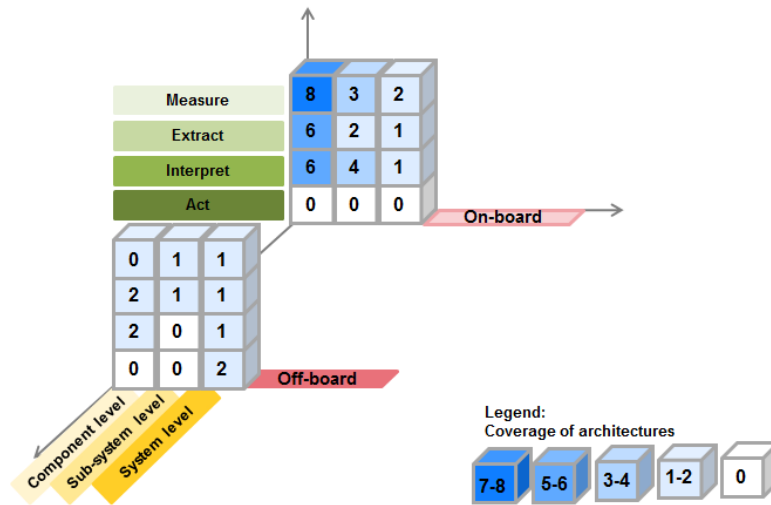

Figure 2.14 Synthesis on the three dimensions of health management

From the total of eight analysed standards and systems, this chart provides the number tackling each of the dimensions. This synthetic view of the three dimensions shows the following conclusions:

- The functional view is tackled heterogeneously and it covers only partially the four functionalities of the vehicle health management function (measure, extract, interpret and act). The interpret functionality, encompassing diagnostics and prognostics, is tackled heterogeneously upon the two other dimensions, being mostly adopted at component and implemented on the on-board segment;
- The physical view:
 - Three main hierarchical levels are revealed from the study (component, sub-system and system levels), however the distribution of health management functionalities upon each level is non-consensual, and their integration within the overall system in order to achieve a vehicle level perspective is not tackled by the studied systems;
 - On-board/on-ground IVHM segments repartition is arbitrary, as it is highly dependent on the system-of-interest. The majority of systems are studied for an on-board implementation, as they are mainly focused on the health assessment of the vehicle, achieved through measure, extract and interpret functionalities, and less on decision support enabled by act functionalities.

Beyond the three structuring dimensions of vehicle health management, this analysis has revealed that technological causes leading to NFF, such as decrease of false alarms, and of ambiguity groups in vehicle diagnostics and increase of certainty in prognostics assessments,

II Definition of an IVHM modelling framework

identified in Chapter 1 (Table 1.1), are not directly tackled within the sample of IVHM standards and systems.

2.3.4 General guidelines for defining an IVHM framework

Based on the system vision of Integrated Vehicle Health Management proposed in Section 2.2, and on the synthesis of IVHM related standards and systems proposed in this section, five major guiding principles are drawn for defining the IVHM framework (Table 2.3). The guiding principles are utilized in the following section, for proposing an approach which could enable the definition of a modelling framework supporting IVHM Systems Engineering.

No.	Guiding Principles for defining an IVHM Framework
1.	System Engineering: IVHM must incorporate SE philosophy and apply SE principles, as IVHM involves complex, interoperable, cross organizational system of systems.
2.	Life Cycle Approach: Consider potential health management stakeholders needs for the entire life cycle of the vehicle, as early as possible in the development cycle, in order to minimize impacts of retrofitting the system.
3.	Interoperability: The design of an IVHM modelling framework must enable interoperability between IVHM functions.
4.	Iterative Design: Define IVHM systems based on iterative approach in order to enable evolutivity throughout the vehicle's life cycle.
5.	Reusable Design: Generic, and modular design of IVHM systems enhances reusability of IVHM components, which will ultimately decrease definition, development, integration, and certification costs.

Table 2.3 Guiding principles for defining an IVHM framework

2.4 IVHM modelling framework approach

The synthesis presented in the previous sections of this chapter is a prerequisite for selecting an approach supporting the definition of an IVHM framework, as it provides the key principles to consider for selecting such an approach (Table 2.3). This section justifies that Model-based Systems Engineering (MBSE) enables a comprehensive and sustainable definition of an IVHM modelling framework; and refines this definition for a life cycle stage of the vehicle (the utilization stage) associated to drivers of NFF events (Section 2.2.2).

2.4.1 MBSE – a sustainable approach for an IVHM modelling framework

While traditional SE practices are document-based and focus primarily on defining and integrating SE stages by correctly tracing overall system requirements through a plethora of documents (Scott, 2011), these approaches lack of a necessary formalization of information, enhancing the comprehension, reusability, and interoperability in the systems design. Therefore, these traditional approaches do not meet reusability and interoperability principles demanded in Table 2.3. The interoperation between IVHM functions in an effective and sustainable manner within multi-organizational system of systems can be managed by using models (Definition 2.4) in SE, as outlined by INCOSE, 2008.

Definition 2.4 (*Model*). A model is defined as an approximation, representation, or idealization of selected aspects of the structure, behaviour, operation, or other characteristics of a real-world process, concept, or system (IEEE 610.12, 1990), i.e. an abstraction.

Models are used for better understanding systems. Minsky, 1965, in his framework for representing knowledge stated: “To an observer A, an object M is a model of an object O to the extent that A can use M to answer question that interest him about O”. This phrase has later created new paradigm in programming and in Systems Engineering.

A model usually offers different views in order to serve different purposes. A view is defined a representation of a system from the perspective of related concerns or issues (IEEE 1471, 2000). Different types of models and views enable the representation of a system at different life cycle stages, and to refine the system representation in the same stage, for instance the requirement analysis is independent from the solution, the architectural and detailed design are platform independent, while the development and deployment are platform dependent of the platform. Moreover, modelling enables the separations of concerns: applications areas,

II Definition of an IVHM modelling framework

deployment platforms (hardware, software, technological), and system constraints, which can be defined iteratively in different types of models. In this regard, the use of models satisfies the life cycle approach, and iterativity principles (Table 2.3) required for defining the IVHM modelling framework.

In the frame of SE, Model-based Systems Engineering (MBSE) and Model-driven Engineering (MDE) are two main approaches which use models as primary means of representing systems. MDE is defined as a system development approach using models to support various stages of the development life cycle stage, relying on technologies automating model transformation increasing usability (Schmidt, 2006); this approach being focused on the development stage, it does not respond to the need of covering the whole life cycle of an IVHM system (Principle 2 in Table 2.3). MBSE, in contrast is defined by INCOSE Systems Engineering Vision 2020 (INCOSE, 2007), as the formalized application of modelling to support system requirements, design, analysis, verification and validation activities beginning in the conceptual design stage and continuing throughout development and later life cycle stages. MBSE is a sustainable approach involving an iterative process, enabling to include contributions of stakeholders from different disciplines in the requirements of the system during its whole life cycle (INCOSE, 2010); it is thus in line with iterative design principle (Table 2.3) required for defining an IVHM modelling framework.

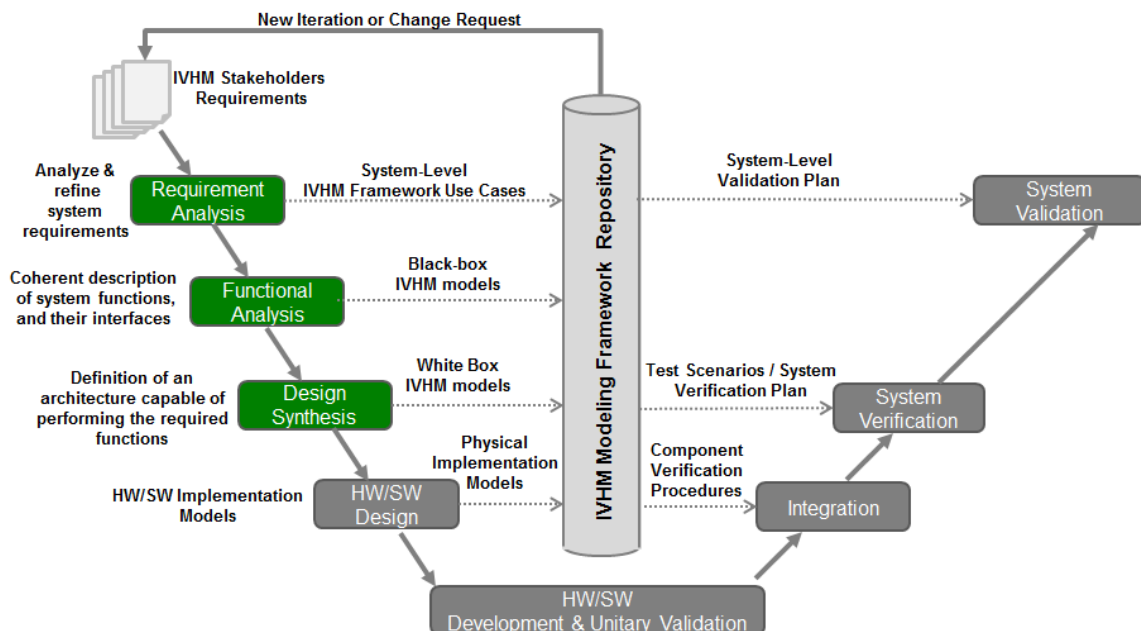

Figure 2.15 MBSE formalization approach based on Hoffmann, 2011

The shift to MBSE requires a different mind-set, as modelling is used to capture the majority of system data, managed in a multi-user repository where unambiguous views of the system's parts, their behaviours and interaction are stored (Figure 2.15). The system's design and solution, as described in the modelling environment, evolve with increasing details and changes added when required.

As depicted in Figure 2.15, the model of the IVHM framework represents the central piece of the formalization, providing a comprehensive modelling of health management from identification of stakeholders, mapping their health management needs to IVHM use cases, which are further modelled in black and white-boxes, to design of elementary activities and exchanged information flows. The IVHM modelling framework formalization phases are depicted in Figure 2.15 by means of the classical V cycle (Hoffmann, 2011). Each of its development phases is linked to a type of model in the MBSE process (a detailed view on the MBSE process of Figure 2.15 and of models implied at each phase is further provided in Appendix B of the thesis):

- The left side of the V involves top-down design flow: from requirement analysis to system functional analysis, and design;
- The bottom of the V consist in the system development;
- The right side of the V involves the bottom-up integration: from unitary testing to the final system acceptance.

The input of the IVHM MBSE (Figure 2.15) consists of systems operational and support goals expressed by IVHM stakeholders. Identification of IVHM stakeholders and their expressed needs is thus sine qua non in defining the IVHM modelling framework, as their requirements represent the entry point of the MBSE process. In this regard, related work in IVHM focuses specifically on requirements (Wheeler et al., 2010, Puttini et al., 2013, Rajamani et al., 2013, Saxena et al. 2013), yet does not uses it into model-based approaches for designing of IVHM systems. For instance, Saxena et al., 2013 examines the various stages of the SE process with the purpose of identifying important aspects impacting IVHM related requirements in order to ensure appropriate IVHM functions are built into the system design. Currently, there is on-going standardization initiative on writing IVHM requirements for aerospace systems – ARP 6883. In this regard, Rajamani et al., 2013 provide the thesis of the proposed guidelines, and provide a Landing Gear case study in order to illustrate the proposed set of requirements. Yet association between stakeholder's needs, IVHM requirements and their down-streams implications within an IVHM modelling framework has not been addressed yet within IVHM community. To this extent, a non-negligible advantage offered by the MBSE approach is model-based simulation enabling

II Definition of an IVHM modelling framework

system validation to be performed before the real development of the IVHM system, and thus easing the demonstration of requirement coherence and of expected benefits out of IVHM.

This overall view on MBSE approach enables us to define an IVHM modelling framework in Definition 2.5.

Definition 2.5 (*IVHM Modelling Framework*). An IVHM modelling framework is a coherent set of MBSE components used for the Systems Engineering of all or of a part of an IVHM system.

The MBSE approach proposed in this section represents the backbone of the IVHM modelling framework developed in the remainder of the thesis, whose modelling phases are supported by the SysML modelling language, put forward in the following section.

2.4.2 Formalization language

The best practice for MBSE approach is the synergetic application of SysML, as model-based language supported by model-based frameworks, and model-based processes (INCOSE, 2010). In-line with this best practice recommended by INCOSE, the MBSE process, proposed for the IVHM modelling framework (Figure 2.15) is supported by the SysML language.

SysML, as its name implies, is a modelling language supporting MBSE, originated from an initiative of INCOSE Model Driven Systems Design workgroup aimed at customizing the Unified Modelling Language (UML) for Systems Engineering applications, and adopted by the Object Management Group (OMG) in 2006. SysML is an extension of a subset of the Unified Modelling Language (UML) using UML's profile mechanism (Figure 2.16). It is defined as a general-purpose graphical modelling language for specifying, analysing, designing, and verifying complex systems that may include hardware, software, information, personnel, procedures, and facilities. In particular, the language provides graphical representations, in the form of diagrams (Figure 2.16) with a semantic foundation for modelling system requirements, behaviour, structure, and parametric, which is used to integrate with other engineering analysis models (OMG SysML, 2013).

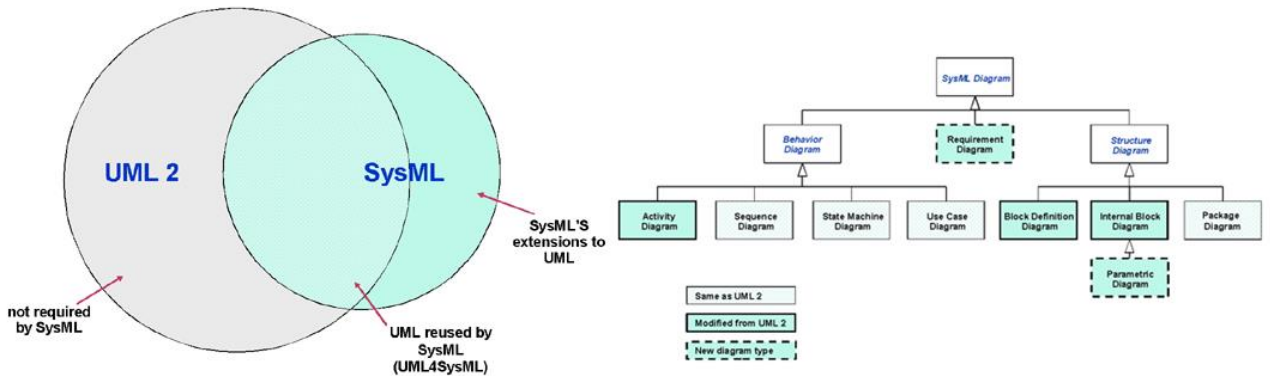

Figure 2.16 Relation between UML and SysML / SysML diagrams - OMG SysML, 2013

As argued by Friendenthal, 2010, SysML is sine qua non condition for MBSE, as it provides the means of integrated system modelling addressing multiple aspects of the system. As illustrated in the following figure (Figure 2.17), SysML encompasses functional and behavioural models, performance models, physical models, and enables other engineering analysis models, which integrated form the system model. Selecting SysML for formalizing an IVHM modelling framework is an enabler of integration between IVHM models with the system-of-interest model, both vertically between implementation disciplines, and horizontally to support the SE lifecycle processes. As MBSE becomes the standard for future vehicle programs (Negele, 2000), and since IVHM must be designed into its system-of-interest and not added on at later development phases, we believe that IVHM Systems Engineering must follow this path.

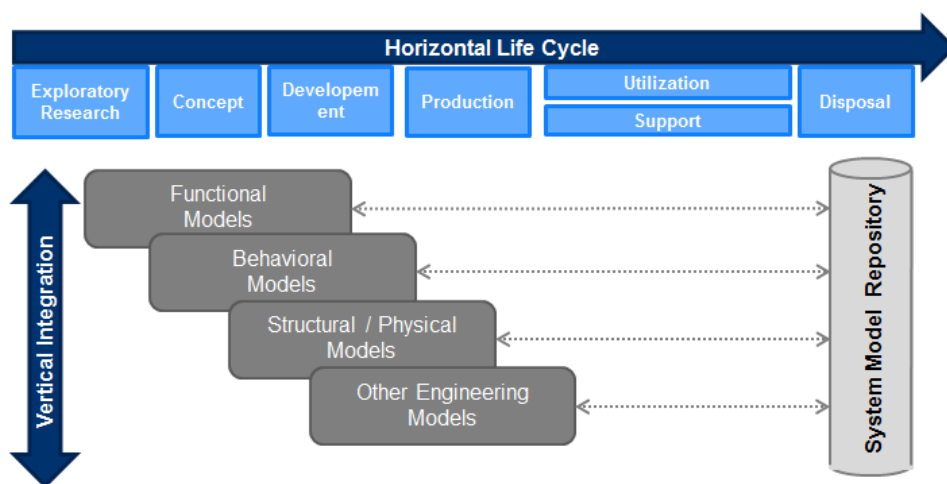

Figure 2.17 Integration enabled by SysML/MBSE

Lastly, selecting SysML as modelling language of the IVHM framework enables reusability of standardized data structures proposed by A1 (OSA-CBM), which are formalized as

II Definition of an IVHM modelling framework

UML classes. Importing OSA-CBM data structures is enabled by the relation Class – Block components between UML – SysML languages (Roques, 2011), illustrated in Figure 2.18.

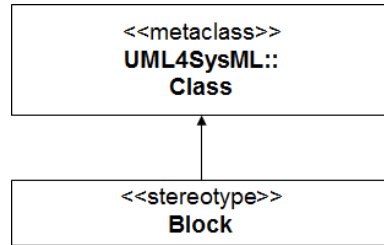

Figure 2.18 UML class – SysML block – Roques, 2011

2.4.3 Formalization scope of the IVHM modelling framework

The scope of the formalization is narrowed to utilization stage of the vehicle – as NFF causes’ resolution have been attached to this life cycle stage in Section 2.2.3. Within this perimeter, the development of the MBSE approach for defining the vehicle health management function of the IVHM modelling framework follows the guiding principles (Table 2.3) in order to propose a generic formalization to support IVHM Systems Engineering which ultimately responds to the NFF problem. It represents **a first iteration on the MBSE process**, formalizing generically the vehicle health management in an IVHM modelling framework.

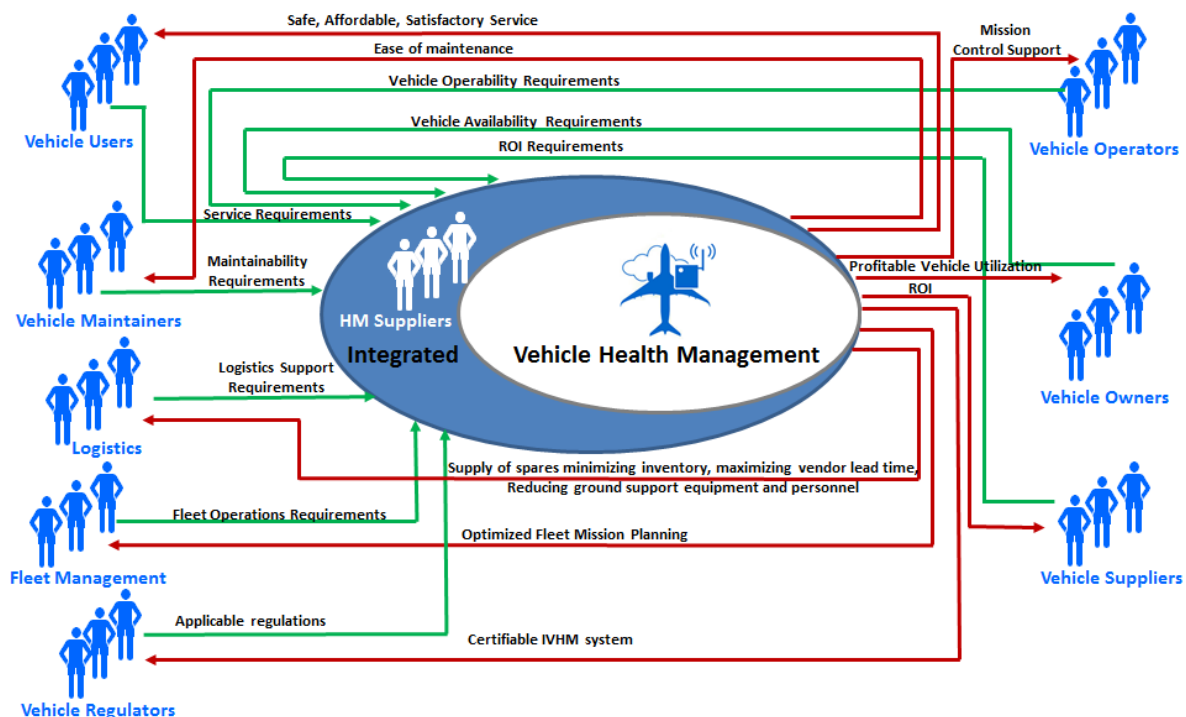

Figure 2.19 Contextual view of IVHM

Within this scope, Figure 2.19 depicts a contextual view of interactions between IVHM and its stakeholders, based on the knowledge extracted from IVHM requirement’s contributions of Dibsdale, 2011, Rajamani, 2013, and by Wheeler et al., 2010, and in line with the standardization initiative of SAE, 2014. The green lines represent generic groups of requirements enounced by IVHM stakeholders, while the red lines represent features provided by IVHM to its stakeholders. Figure 2.19 adds to the contextual view a synthetic view of stakeholder requirements and of IVHM services; in the MBSE they are to be formalized within requirement diagrams.

For instance vehicle operators’ include the crew and the operating company (e.g. the airline, USAF, etc., if not the owner). They require from the IVHM system, information that increases certainty in future actions and commands for preserving the safety of flight and of mission success (Jennions, 2012). Related to vehicles’ operators accountabilities in IVHM, a set of services expected from the vehicle health management function are proposed in the following table.

Task	Needs expected to be fulfilled by IVHM
<p>Task 1. Operates the vehicle according the mission profile and insure the successful execution of the mission.</p>	<p>Provide means to evaluate the remaining functional capability of the vehicle.</p>
<p>Task 2. Assesses the needs of change or reconfiguration of the vehicle mission, based on the actionable information provided or observed on the vehicle and by the vehicle heath management system</p>	<p>Provide means to assess the vehicle’s ability to fulfil the mission profile, and to generate recommendations for its adjustment during operation.</p>
<p>Task 3. Report health and usage related issues</p>	<p>Interface with a log function by a textual description or by using an explicit semantic which can be post-processed by a machine.</p>

Table 2.4 Vehicle operator accountabilities – Expected needs from vehicle health management

II Definition of an IVHM modelling framework

The establishment of generic IVHM stakeholders' requirements in the IVHM modelling framework takes a step further existing contributions in IVHM; the difficulty of establishing such requirements lies in the diversity of stakeholders and their expectations towards vehicles' utilization. In this regard, many contributions have focused on Cost Benefit Analysis (Kacprzyński et al, 2002, Ashby et al., 2002, Banks et al., 2007, and 2009) on explicit customer expectations from IVHM systems. Nevertheless, the expected benefits are hardly predictable, and traceable from different stakeholder's perspectives.

From the contextual view of the IVHM modelling framework illustrated in Figure 2.19, a perimeter of stakeholders associated to the vehicle health management function will be refined by the proposal of the fundamental functional element of the IVHM modelling framework, this element is proposed in a logical continuity in the next chapter of the thesis.

2.5 Conclusion

Motivated by the lack of consensus in IVHM Systems Engineering, the contribution developed in the second chapter has tackled Scientific Problem n°3 by proposing an IVHM modelling framework based on Model-based Systems Engineering in support of IVHM Systems Engineering.

Towards the proposal of this framework, a system analysis of IVHM chief constituents has demonstrated its belonging to system-of-systems, and thus the need to consider its omnipresent relation with Systems Engineering for a comprehensive definition of an IVHM system.

The IVHM system analysis is then refined on the vehicle health management function, as enabler of maintenance decisions impacting No Fault Found occurrence. This system analysis is enabled by eight IVHM related standards and systems. Their synthesis reveals three design dimensions of vehicle health management (functional decomposition, hierarchical level distribution, and on-board/on-ground segments repartition). The non-consensual approach of these three dimensions and the lack of functionalities tackling the causes which lead to NFF occurrence outline the need of a generic framework to guide their consensual design following SE principles. This framework has thus been unveiled in the fourth section, following Model-based Systems Engineering, an approach which can support a comprehensive design of an IVHM modelling framework, sustainable throughout the vehicle's life cycle. As such, this generic framework is not limited to resolution of NFF issues, as it incorporates generic needs of health management of all stakeholders in an IVHM system. A contextual view of the IVHM modelling framework is refined for the utilization life cycle towards tackling drivers of NFF reduction. From this contextual view, the fundamental element of the framework corresponding to the vehicle health management makes the object of the contribution developed in the next chapter.

Chapter 3

A generic Health Management Module

“Genius is one percent inspiration, ninety-nine percent perspiration.”

-Thomas Edison

3.1 Introduction

The problem statement developed in the first chapter of the thesis argued that IVHM Systems Engineering lacks of genericity, being most of the times founded on specific, proprietary concepts (**Scientific Problem n°4**). The major contribution of this chapter tackles this scientific problem by the proposal of a generic Health Management Module (gHMM), usable for designing the vehicle centric function in an IVHM modelling framework.

This contribution relies on Model-based Systems Engineering (MBSE) approach proposed in Chapter 2, which becomes the backbone of the SysML-based gHMM model from requirement analysis to black and white boxes functional analysis and synthesis design of the gHMM. The essence of the formalization is represented by four core generic processes of Health Management (HM): health monitoring, diagnostics, prognostics, and decision support. In coherence with the studied IVHM systems, their white-box functional flow makes use of standardized data structures of OSA-CBM standard, by proposing a functional flow which could drive No Fault Found (NFF) reduction.

Toward this goal, the integration of diagnostics and prognostics processes in the gHMM is proposed in order to tackle **Scientific Problem n°2**: *“Diagnostics and prognostics, key processes of health management, suffer a necessary formalization of their interactions”*. Their integration within the gHMM is proposed not only in a conventional way: from diagnostics to prognostics, but also in an original one: from prognostics to diagnostics with the purpose of reducing ambiguity groups; the latter makes the object of an algorithm supporting one of the elementary activities of the gHMM.

Quantitatively, the results of the MBSE formalization of the gHMM are included in the Appendix D.

3.2 gHMM MBSE phases

The generic modelling of the vehicle health management function is aimed at supporting the design of vehicle health management function (illustrated in Chapter 2, Figure 2.9) in an IVHM modelling framework. In order to attain this objective, the gHMM model specifies generic functionalities, and information flows of health management enabling to design specific occurrences of health management within a system. Thus, from a modelling standpoint, the SysML-based gHMM model is designed as a meta-model³ of vehicle health management function of IVHM (Definition 3.1).

Definition 3.1 (*generic Health Management Module*). The generic Health Management Module (gHMM) is a generic, functional meta-model of the vehicle centric function of an IVHM modelling framework.

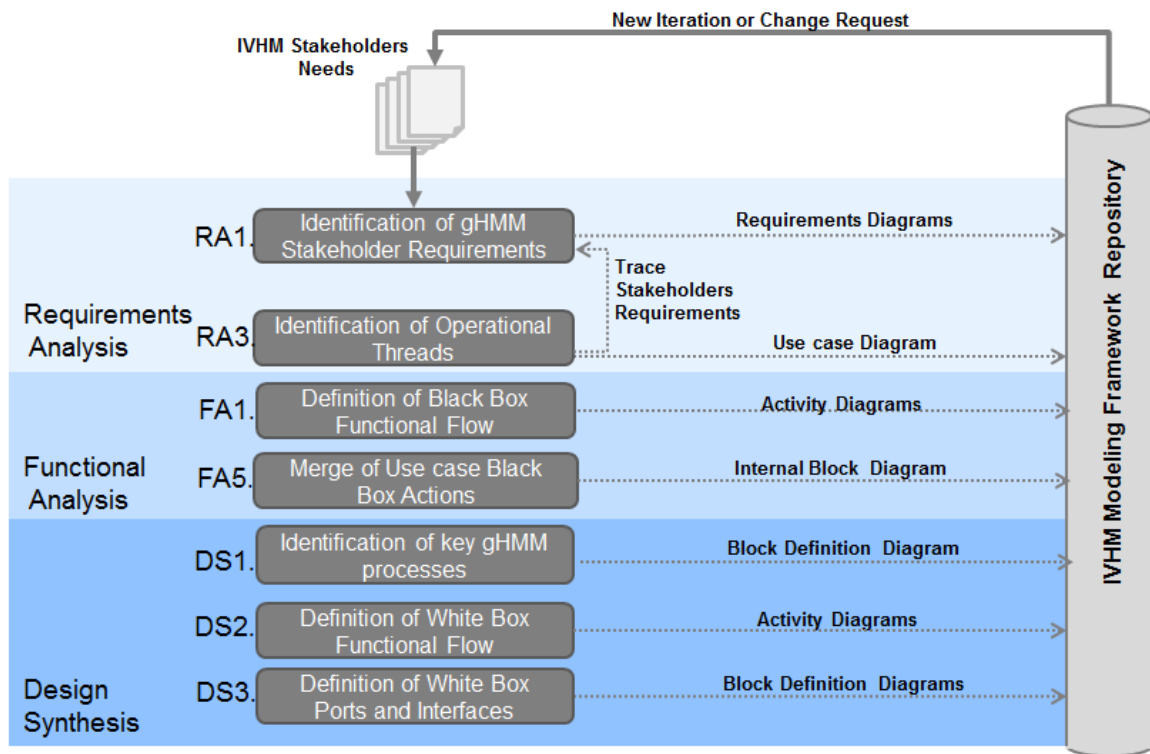

Figure 3.1. gHMM formalization phases

³ A meta-model is a special kind of model that specifies the abstract syntax of a modelling language. It can be understood as the representation of the class of all models expressed in that language. (Génova, 2009).

The gHMM MBSE phases, illustrated in Figure 3.1, are completely in-line with the ones proposed in Chapter 2 (Figure 2.15), consisting of:

- **Requirement Analysis:** defines what the system must do (functional requirements) and how well it must perform (QoS requirements) in order to satisfy systems stakeholders needs;
- **Functional Analysis:** aims at transforming the functional system requirements into a coherent black-box description of the system use cases;
- **Design Synthesis:** defining the white-box architecture capable of performing the required use cases.

A first iteration on the MBSE phases depicted in Figure 3.1 defines the gHMM in the following sub-section, as fundamental element of an IVHM modelling framework, supported by the MBSE approach Harmony, embedded in IBM® Rational® Rhapsody®, a visual modelling development environment for systems engineers based on SysML.

With regard to the knowledge required by gHMM MBSE formalization phases, the IVHM design synthesis achieved in Chapter 2, standardization initiative of SAE (SAE, 2014) to which the company participates, and internal workshops of the company (Geanta, 2014) represent the main knowledge sources used in the MBSE formalization phases. This knowledge is captured in the SysML-based gHMM model, as central piece of the MBSE approach, providing a comprehensive modelling from identification of stakeholders, mapping their health management needs to gHMM use cases, which are further modelled in black and white-box functional flows (Definition 3.2), until elementary activities and input/output flows are formalized.

Definition 3.2 (*Functional Flow*). A functional flow is defined by its actions, and shows how these actions are linked to each other (Hoffmann, 2011).

The remainder of this section goes through the MBSE phases performing this first iteration of the gHMM definition through requirement analysis, functional analysis and design synthesis.

3.2.1 Requirements analysis

As stakeholders' requirements govern systems development, they are sine-qua-non for defining the scope of the development project (INCOSE, 2010). In this regard, the requirement analysis phase of MBSE aims at defining what the system must do (functional requirements) and how well it must perform (QoS requirements) in order to satisfy systems stakeholders needs (Hoffmann, 2011). This is achieved in three main steps (Appendix B), relied by tracing

stakeholder requirements to system requirements, and respectively use cases to system requirements. Within the frame of the thesis, the second step of the requirement analysis has been skipped, the gHMM use cases being directly linked to stakeholders' requirements. Hence, as illustrated in Figure 3.1, the following sub-sections presents **RA1 (Definition of stakeholders' requirements)**, and **RA3 (Definition of system use cases)** steps, as well as the link from use cases performed up to stakeholders' requirements.

3.2.1.1 RA1: Definition of stakeholders' requirements

This step of gHMM formalization consists in identifying the required capabilities of the gHMM, formalized into requirement diagrams. In order to perform this step, the informal knowledge found in IVHM research focused on requirements (Wheeler et al., 2010, Puttini et al., 2013, Rajamani et al., 2013, Saxena et al. 2013), and the standardization initiative of SAE, 2014 represent the baseline knowledge for building the contextual view in Figure 3.2.

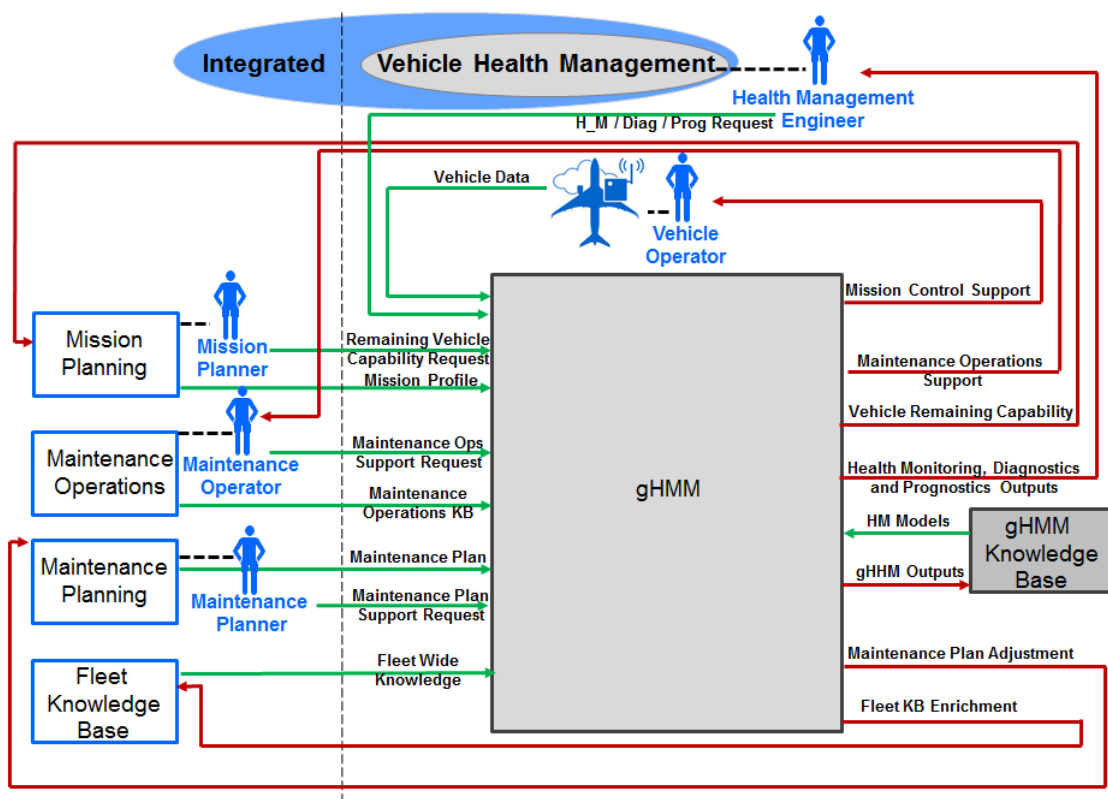

Figure 3.2. Identification of gHMM stakeholders – contextual view

III A generic Health Management Module

This contextual view of the gHMM (Figure 3.2) encompasses:

- gHMM stakeholders, as part of IVHM stakeholders identified in Chapter 2 in direct interaction with vehicle health management function;
- Interactions from stakeholders to gHMM in green, and in the opposite direction in red. For instance, the gHMM must provide maintenance operations support (in red) to a Maintenance Operator in charge of maintenance operations, following the request of decision support (in green).

At this step of the MBSE process, stakeholder's accountabilities in IVHM are used for determining their needs from the vehicle health management function. The following provides a description of gHMM stakeholders, and exemplifies a sample of requirements for the Health Management Engineer. Appendix D provides requirement diagrams for the rest of gHMM stakeholders.

The **health management engineer** stakeholder is in charge of applying engineering concepts to the optimization of health management system in order to achieve better maintainability, reliability, and availability of vehicles (Mobley, 2008). This stakeholders' role is essential for tackling the technological causes of NFF events through an efficient design, development, and maturation of vehicle health management function (Scandura, 2005).

Vehicle operators include the crew and the operating company (e.g. the airline, USAF, etc., if not the owner); they require from the IVHM system information that increases certainty in future actions and commands for preserving the safety and success of missions. The vehicle operator is in charge of operating the vehicle according to its assigned mission profile (Jennions, 2012). The gHMM is expected to deliver an adequate decision support for assessing vehicle's ability to fulfil the mission profile, and to generate recommendations for its adjustment during operation.

The **mission planner** is part of the fleet management, which are accountable of making the fleet wide decisions affecting life extension, operational costs and future mission planning. Mission planners require maximized availability and mission success, while minimizing cost and resource usage (Wheeler, 2010), in order to plan the future missions allocated to a perimeter of vehicles, to supervise the execution of their current missions, and to communicate any change in the mission profile to the vehicle operator. The gHMM must provide to the mission planner the functional capability of the vehicle, and its adequacy with a future mission profile assigned to the vehicle.

The **maintenance planner** is in charge of elaborating, applying, and updating the maintenance planning in accordance with the vehicle maintenance programme, and with the vehicles' health condition (Mobley, 2008). The gHMM is expected to provide the maintenance planner with decision support for optimizing maintenance planning based on the vehicle health assessment, aimed at reducing superfluous maintenance actions (Hoffmann, 2014).

O-level **maintenance operators** are in charge of performing maintenance tasks, as specified in trouble shooting and maintenance manuals, executed during Turn Around Time (TAT), time intervals between consecutive vehicle missions (Mobley, 2008). Regarding its needs from the gHMM, a maintenance operator expects to be provided with decision support for optimizing maintenance operations and trouble-shooting procedures (Chérière, 2014).

Other IVHM stakeholders with an indirect impact on the gHMM include logistics, certification authorities, vehicle suppliers and owners. For instance, vehicle regulators (e.g. airworthiness, certification authorities) are concerned mainly with establishing regulation amendments and new rules taking advantage of health management information (Wheeler, 2010). A certification authority (for instance EASA – European Aviation Safety Agency) is in charge of certifying the air-worthiness of the vehicle system, in accordance with applicable regulations, implementing and monitoring safety rules, type-certification of vehicle and components, as well as the approval of organizations involved in the design, manufacture and maintenance of vehicle products (EASA, 2013). Accordingly, the gHMM implementation must respect the vehicle worthiness regulations, as IVHM procedures of critical components of the vehicle require approval by certification authorities (Hoffmann et al., 2011).

From the identified stakeholders, a set of generic IVHM stakeholders' requirements are expected to be fulfilled by gHMM, formalized as requirement diagrams.

Stakeholder Accountabilities in IVHM	Stakeholder Needs from gHMM
Task 1. Analysis of repetitive equipment failures, false alarms and their consequences, imprecise diagnostics, estimation of remaining useful life of equipment, with the aim of maturing implemented models and algorithms of the vehicle health management system;	The gHMM must provide data and information required for detecting and analysing repetitive equipment failures, false alarms, ambiguity in diagnostics, and certainty of prognostics.
Task 2. Manage appropriate and	The gHMM uses as input the gHMM

III A generic Health Management Module

comprehensive selection, coherent design, implementation, update and maturation of vehicle health management algorithms;	knowledge base and the fleet knowledge base.
	The gHMM uses the algorithms developed by health management engineers for supporting its processes and their encompassed activities.
	The gHMM must feed the knowledge base with data and information generated by its processes.
Task 3. Management of coherent design, implementation, update and maturation of vehicle and fleet health management knowledge bases.	The gHMM must provide means of selection of the appropriate health management algorithms for every elementary activity, in accordance with the relevant criteria of selection.
	The gHMM must provide means to evaluate the interoperability of selected algorithms, whose supporting activities are interacting with one another.

Table 3.1 Accountabilities – needs for HM engineer stakeholder

In order to illustrate this step, Table 3.1 shows the association between IVHM accountabilities of the health management engineer and his needs from the gHMM, while Figure 3.3 gathers the identified requirements for this stakeholder into a Requirement Diagram.

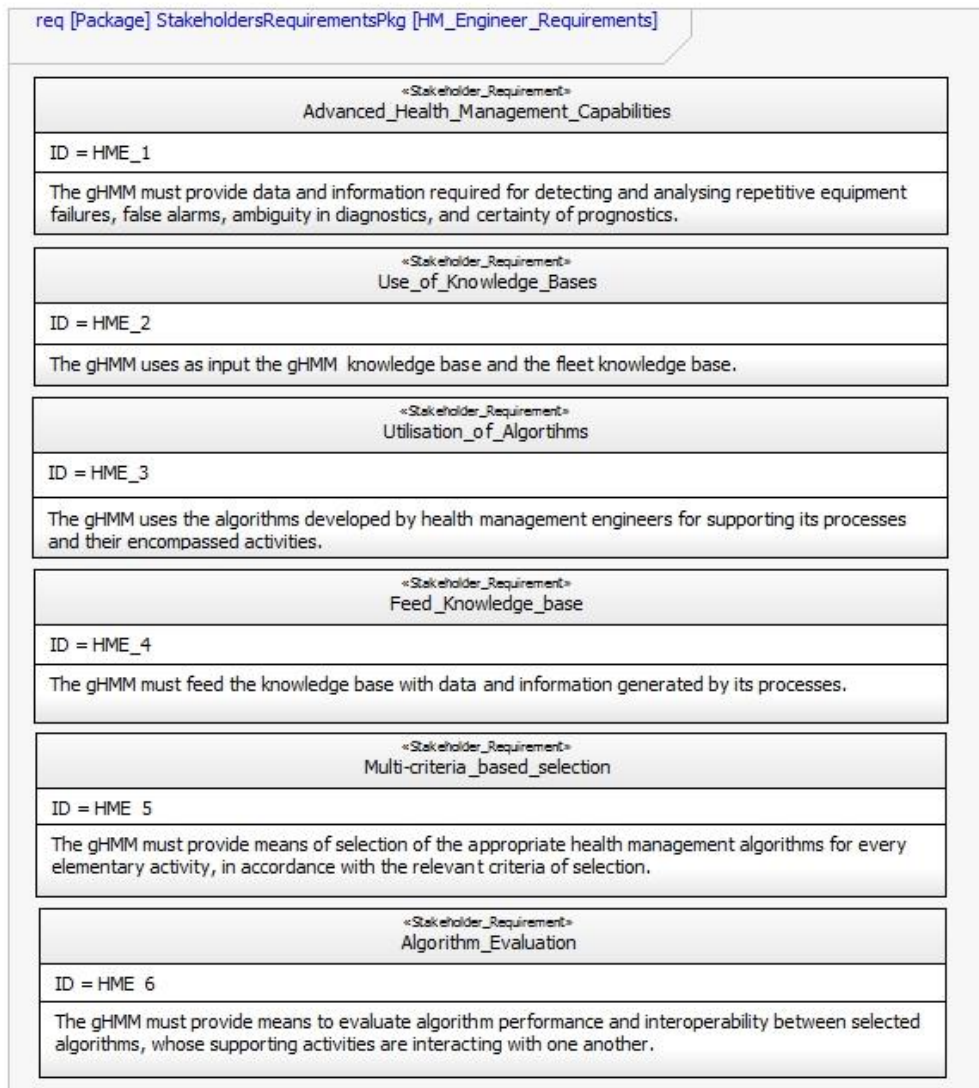

Figure 3.3. HM engineer requirements

Each need in Figure 3.3 is expressed as a stakeholder requirement, composed of:

- A unique identifier, for example HME_1;
- A title, for example “Advanced_Health_Management_Capabilities”;
- A description, for example “The gHMM must provide data and information required for detecting and analysing repetitive equipment failures, false alarms, ambiguity in diagnostics, and certainty of prognostics”.

Gathering the complete set of stakeholder requirement diagrams becomes the entry point for the next step of the MBSE process, and is an essential input for identifying operational threads required by the gHMM stakeholders in the following phase of the requirement analysis.

3.2.1.2 RA3: Definition of gHMM use cases

The definition of system use cases is a major step of the requirement analysis. Based on the complete set of stakeholders' requirements, operational aspects of systems are identified and enable the specification of behaviour of the gHMM as perceived by its stakeholders (Hoffmann, 2011).

The gHMM use cases modelled in the use case diagram in Figure 3.4 mark out the perimeter of the vehicle health management function of IVHM (Definition 1.7), as function enabling the decision support for enterprise level function of IVHM, by transformation of raw measures of relevant parameters of the vehicle's health into actionable information for vehicle maintenance and operations. This function is achieved through ten operational threads forming gHMM use cases, aimed at meeting stakeholders' requirements. They have been proposed following internal work sessions focused on IVHM use cases synthesized in an internal technical document of the company, and are reinforced by current standardization initiative of SAE, 2014.

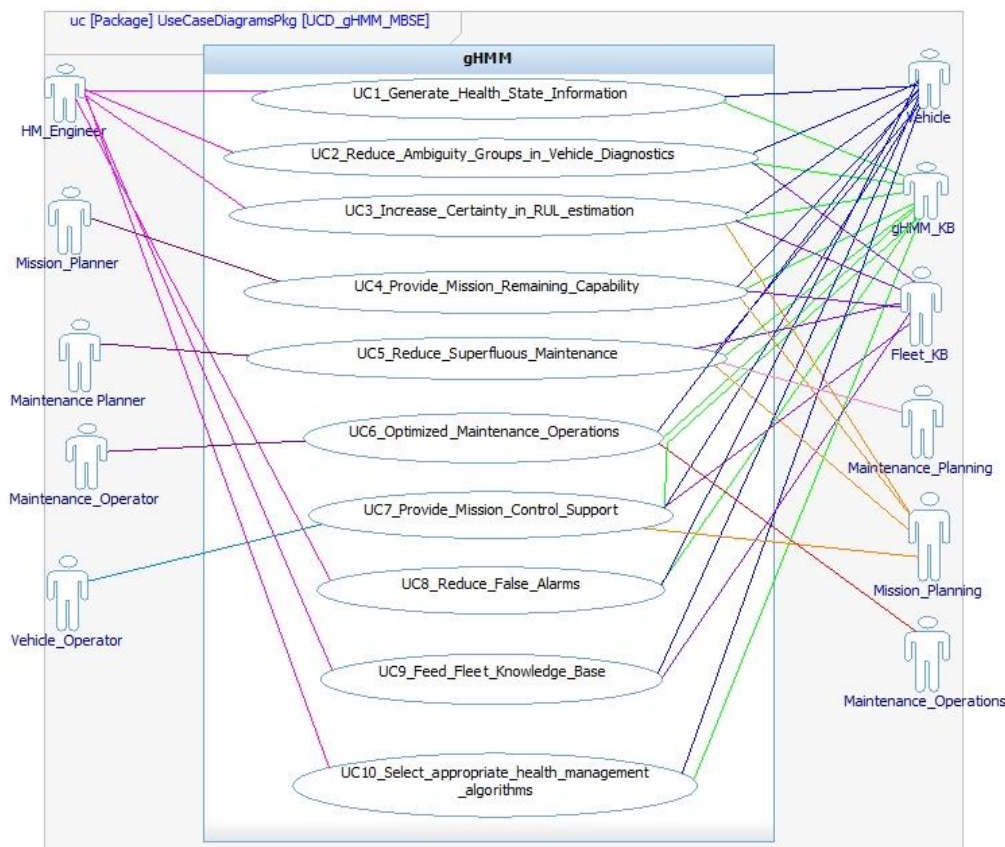

Figure 3.4. gHMM use case diagram

The ten gHMM use cases, proposed for the formalization, illustrated in Figure 3.4 are the following:

- **UC1: Generate Health State Information** generates indicators of health of the monitored item, making them available to HM engineer upon his request.
- **UC2: Reduce Ambiguity Groups in Vehicle Diagnostics** assesses the set of LRUs at the origin of failures and degradations occurred within the vehicle. This use case makes the bridge to Industrial Question n°2 raised in Chapter 1.
- **UC3: Increase Certainty in RUL Estimation** assesses the RUL of an item, which is composed of RUL of encompassed components ranked by the most probable failure modes to be concerned with, and the prediction of the future functional performance of the item. These two types of RUL evaluation (component and functional) are illustrated in Figure 3.5. This use case is directly linked to Industrial Question n°3 raised in Chapter 1.

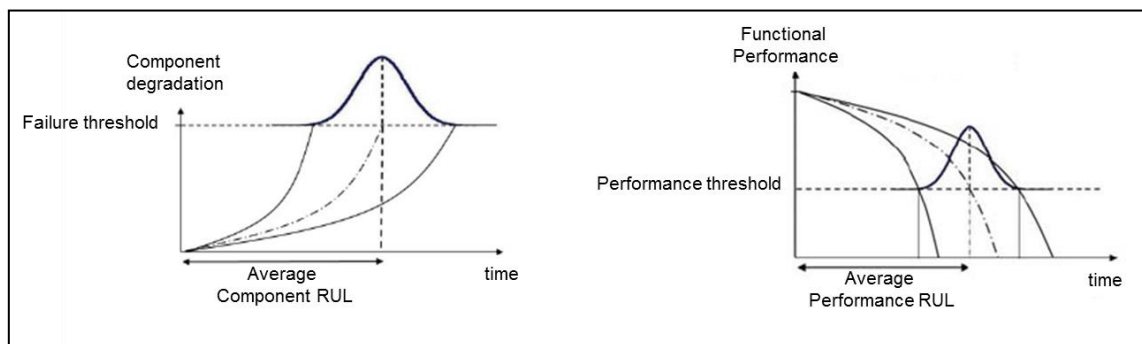

Figure 3.5. Component and performance RUL

- **UC4: Provide Mission Remaining Capability** assesses the functional RUL for the requested item for its current or next mission. The functional RUL is then used by the Mission Planner for the coherent assignment of missions based on the remaining functional life of the vehicle.
- **UC5: Reduce Superfluous Maintenance** has as purpose adjustment of the maintenance plan based on the health assessment of the specified vehicle item.
- **UC6: Optimize Maintenance Operations** has as purpose optimization of maintenance tasks execution by a maintenance operator.
- **UC7: Mission Control Support** provides the decision support required by vehicle operators for adjustment of the mission profile based on the vehicle's health condition.
- **UC8: Reduce False Alarms** is aimed at detecting those health monitoring indicators, which could be responsible of false alarms occurring during vehicle operation, as they are potential causes of ambiguity groups in diagnostics.

III A generic Health Management Module

- **UC9: Feed fleet KB** provides to the fleet knowledge base all the available outputs produced by the gHMM.
- **UC10: Select Appropriate HM algorithms** performs selection of health management algorithms to be implemented for elementary activities of the gHMM; this use case tackles with Scientific Problem n°1, and is tackled in Chapter 4 of the thesis, in order to select the appropriate health management algorithms for the gHMM’s elementary activities.

The link between use cases and stakeholders’ requirements justifies the consideration of each use case for the formalization of the gHMM. In this regard, the relation between gHMM use cases and stakeholders’ requirements is depicted in Figure 3.6 for UC1, and in Appendix D for the following ones.

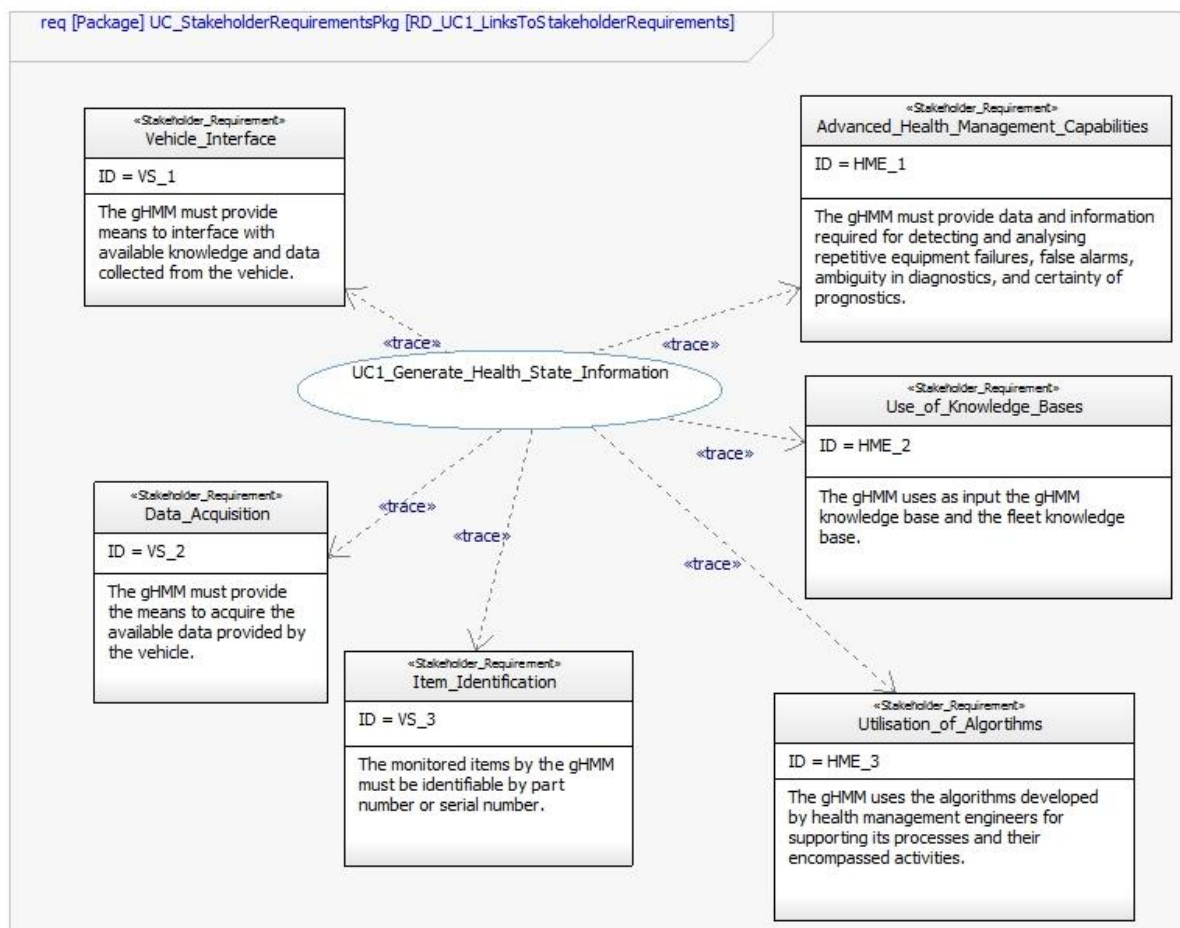

Figure 3.6. Link with stakeholder requirements for use case n°1

Tracing stakeholders’ requirements is essential for justifying and validating implementation of IVHM functions, and is enabled by the MBSE process. As argued in the second chapter, most of IVHM SE contributions currently focus on defining requirements

(Wheeler et al., 2010, Puttini et al., 2013, Rajamani et al., 2013, Saxena et al. 2013). At this level, the gHMM model contributes with a generic expression of their requirements expressed in SysML requirement diagrams traceable to each operational thread required from the vehicle health management function.

As the reader may notice a direct link between stakeholder's needs and use cases is achieved. The second step of the requirement analysis, defining system requirements, would be required in order to complete the requirement analysis phase – this constitutes a future industrial perspective of our work.

3.2.2 Functional analysis

Based on identified use cases issued of requirement analysis, the functional analysis phase aims at formalizing a coherent black-box description of the system use cases (Hoffmann, 2011). The following achieves the black-box functional flow of the gHMM through **FA1 (Use Case Black-box Functional Flow Definition)**, and merges black-box actions at **FA5 (Merge Use Cases)** in line with the proposed steps in Figure 3.1. These two steps are thus defining the overall black-box actions performed by the gHMM, and the black-box information flow defining interactions between actions.

3.2.2.1 FA1: Use Case black-box functional flow definition

The Use Case Black-box Functional Flow Definition aims at defining a functional flow formed out of actions, and their information flow exchanged between each other, formalized in activity diagrams. The black-box operational threads specified in each use case are founded on the knowledge issued from synthesis of IVHM standards and systems (Section 2.3), and on internal work sessions focused on functional flows synthetized in an internal technical document of the company. This step of the gHMM formalization is refined for the first use case (UC1) in this section, while the remainder of use cases are enclosed in Appendix D.

III A generic Health Management Module

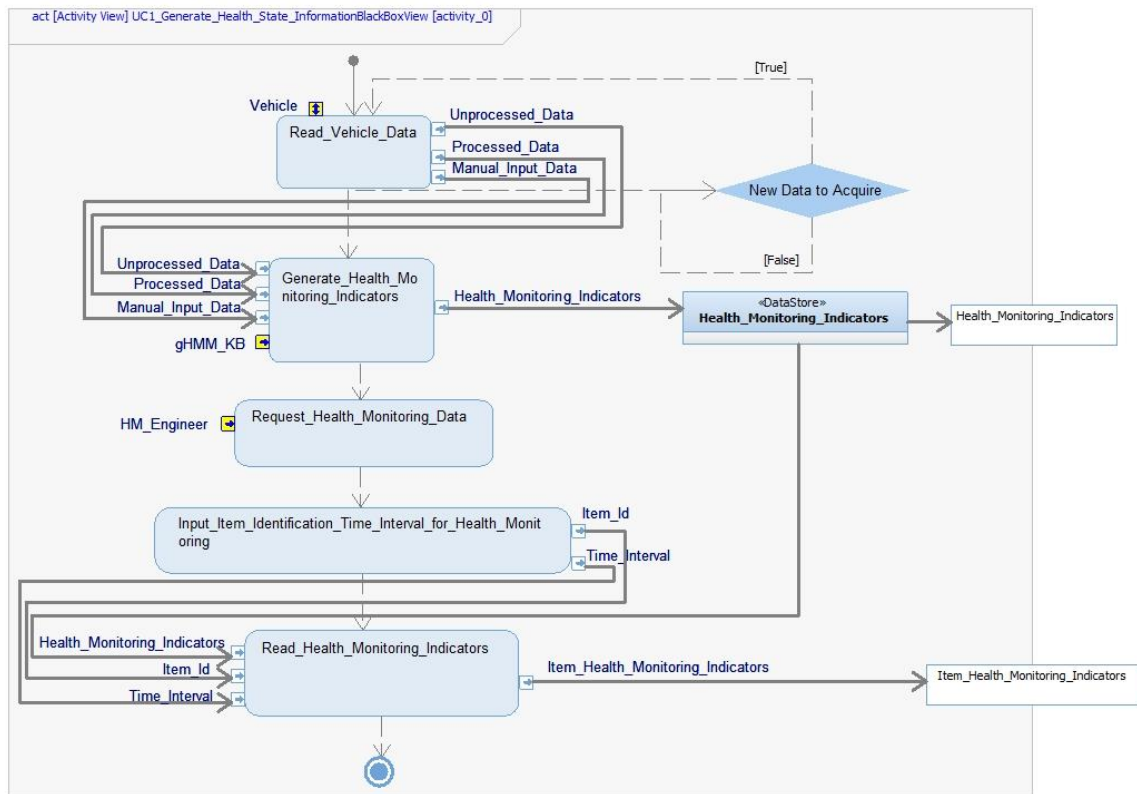

Figure 3.7. UC1 black-box activity diagram

As illustrated in Figure 3.7 stakeholders involved in the first use case (depicted as yellow input pins) are the vehicle system, providing data available for health monitoring to the gHMM, the gHMM_KB providing models required for the health monitoring of the vehicle system, and the HM_Engineer which requires health monitoring indicators from the gHMM.

The use case is decomposed into the following black-box actions:

- **Read_Vehicle_Data** action receives health monitoring relevant data provided by the vehicle system, and classifies it into three main types corresponding to automatically (**Unprocessed_Data** input pin) of manually input (**Manual_Input_Data** input pin) data, and information (**Processed_Data** input pin). This categorization of acquired data from the system, in terms of raw, processed and manual inputs could handle cases of vehicles already equipped with health monitoring processing capabilities, such as Built-in-Tests (BIT), condition monitoring, warnings and alarms, or control parameters; For instance, Mikat et al., 2014 identifies usage monitoring for structural parts and engine trend monitoring as available capabilities to be used in input of health management.

- **Generate_Health_Monitoring_Indicators** is the main action of the use case, having as purpose to generate relevant indicators (representative of failure or degradation of the monitored system) calculated from output of Read_Vehicle_Data action;
- **Request_Health_Monitoring_Data** action represents the interaction with the HM engineer;
- **Input_Item_Identification_Time_Interval_for_Health_Monitoring_Indicators** action represent the interaction with the HM engineer which inputs the monitored item id and of monitoring time interval;
- **Read_Health_Monitoring_Indicators** action uses as input the item id and monitoring time interval for retrieving the corresponding health monitoring indicators which are produced in output of the use case.

Actions illustrated in Figure 3.7 are linked by a control flow which provides the path through the use case. Yet this does not provide any information regarding the temporal scale and sequencing between actions. For instance the generation of health monitoring indicators can be completely decorrelated from the request of these indicators by a health management engineer. The specific temporal path through the use case and state-based behaviour make the object of complementary functional analysis phases (FA2, and FA4 – Appendix B).

As illustrated in Figure 3.7, the black-box information flow provides the semantic representation of the interactions between actions. At this step of the functional analysis, these interfaces between actions define the meaning of the transported information:

- Between two interacting black-box actions, formalized as Input/Output action pins;
- As output of the use-case, formalized as Activity parameters (on the right side of the activity diagram).

The gHMM use cases, formalized by their black-box functional flow through FA1 step thus lead to identifying black-box actions and input/output information flows. All distinct black-box actions issued out of this MBSE stage are to be used by the merge use cases step, in order to identify the set of actions to be further formalized as white-box functional flow.

As the reader may notice, three functional analysis steps (FA2 – FA4) have not been included in our formalization for temporal constraints. However, these steps could provide complementary level of formalization of the gHMM regarding temporal sequencing of black-box actions, and state-based behaviour of black box actions. However these steps require a detailed analysis in order to decide if a generic temporal and state-based behaviour can be established for vehicle health management components.

3.2.2.2 FA 5: Merge use cases

The merge of use cases step of the functional analysis phase (Figure 3.1) represents the union of black-box actions. i.e. the set of all distinct actions modelled within gHMM use cases. This set of black-box actions represents the output of the functional analysis phase, which is formalized as Internal Block Diagram, illustrated in Figure 3.8.

Among the black-box actions identified through the use case merge, a subset corresponds to **core heath management** actions, being elaborated by the following MBSE phases, in coherence with IVHM standards and systems synthetized in Chapter 2. The other set of actions correspond to:

- **Interface** actions perform interactions of gHMM with boundary systems and stakeholders,
- **Algorithm selection** actions perform selection of health management algorithms supporting core health management actions.

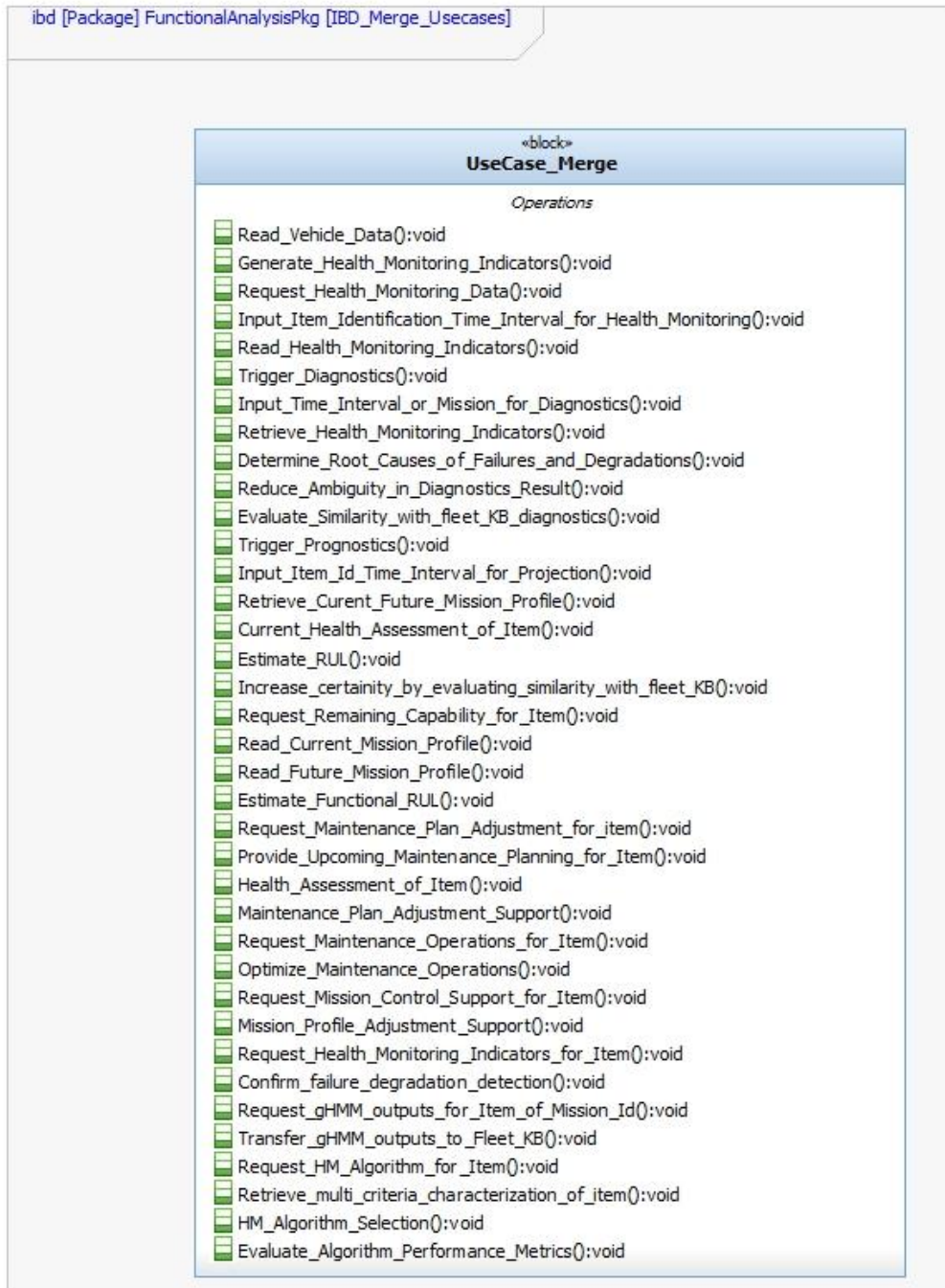

Figure 3.8. Use cases merge - block diagram

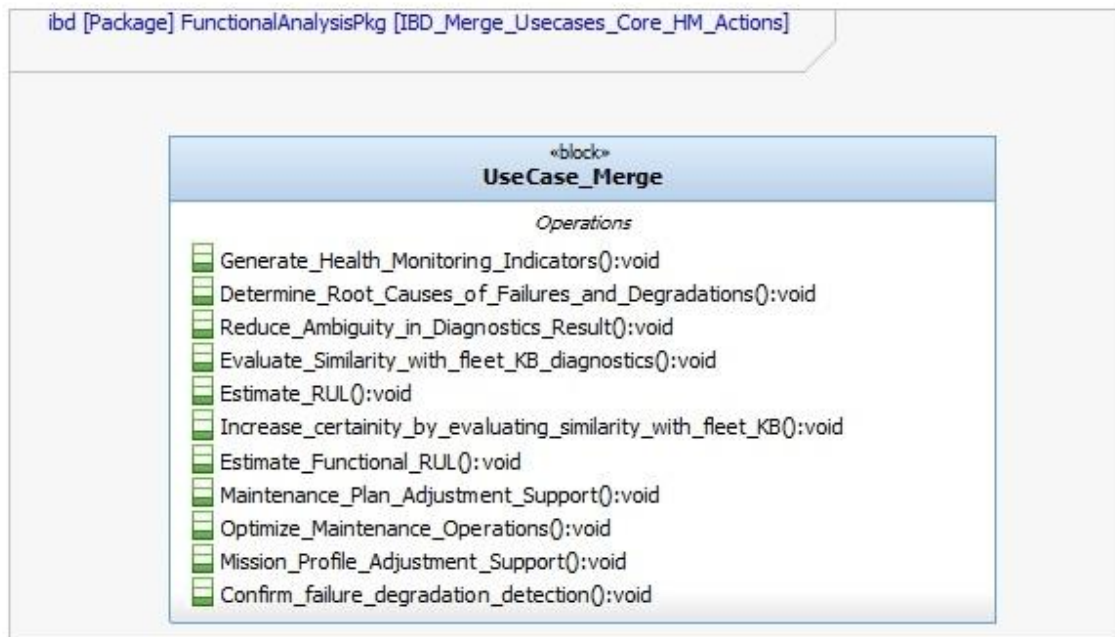

Figure 3.9. Use cases merge block diagram – gHMM core actions

The block diagram in Figure 3.9 represents the black-box core health management actions gathered from gHMM use case, whose purposes are enounced here after.

Generate_Health_Monitoring_Indicators is the main action of use case n°1, and has as purpose the generation of relevant indicators representative of failure or degradation of the monitored system, calculated from the measured or manually input data, available information and knowledge on the vehicle.

Determine_Root_Causes_for_Failures_and_Degradations action is the main action of the use case n°2. The output of this action is a diagnostics result consisting of the suspected LRU sets within a monitored item, as root causes of failures and degradation, occurred within the mission or time interval specified in input of the actions. In case of ambiguity groups in the diagnostics results, **Reduce_Ambiguity_in_Diagnostics_Result** and **Evaluate_similarity_with_fleet_KB_diagnostics** actions are triggered by the gHMM in order to reduce ambiguity, and thus reduce NFF occurrence through optimizing diagnostics isolation.

Estimate_RUL and **Estimate_Functional_RUL** actions are the main actions of use cases n°3 and n°4, having as purpose evaluation of RUL for a vehicle item, which is composed of RUL (Remaining Useful life) of components ranked by the most probable failure modes to be concerned with, and the prediction of the future functional performance of the item. The estimation uses in input the current health assessment and the future mission profile, which provides operational and environmental contextualization for projection of degradation indicators

of the item. **Increase_certainty_by_evaluating_similarity_with_fleet_KB** is aimed at increasing accuracy of prognostics results by comparison with similar prognostics results available within the fleet.

Maintenance_Plan_Adjustment_Support action performs the decision support for adjustment of the maintenance plan based on the health assessment of the specified item.

Optimize_Maintenance_Operations action evaluates maintenance operations strategy for optimizing a set of objectives, such as minimized troubleshooting duration, cost, and risk, maximized coverage of LRUs within executed maintenance operations procedures. **Mission_Profile_Adjustment_Support** action provides recommendations for adjusting the vehicle's mission profile based on its health assessment. The output of the action is an adjusted mission profile, which is provided by the gHMM to vehicles' operators.

Confirm_failure_degradation_detection action uses characteristics of health monitoring indicators such as temporal ones (intermittence and persistence of indicators), with the purpose of reducing false alarms and missed detections.

This set of core management actions identified within the use case black-box functional flow and their merge in the gHMM Internal Block Diagram (Figure 3.9) represent a genuine scientific contribution formalizing generic functional flows which links black-box actions and information flows in use cases capable of meeting IVHM stakeholders' requirements.

From this black-box functional flow of the gHMM, the following phase of the MBSE aims at proposing the white-box view of the gHMM design capable of performing these required actions.

3.2.3 Design synthesis

The design synthesis phase of MBSE aims at defining a functional architecture capable of performing the required black-box actions, following a top-down approach from black-box to white-box functional flow (Hoffmann, 2011). This functional architecture is defined by allocating black-box actions to gHMM core processes⁴, and secondly by formalizing white-box functional flows by their elementary activities⁴ and I/O information flow inter-relating gHMM processes. Thus the allocation of black-box actions does not refer to a physical allocation, but to a functional one, which aims at grouping black-box actions into a gHMM process by their common health management purpose.

The design synthesis of MBSE is composed out of three main steps (Hoffmann, 2011), which are addressed in the following sections:

DS 1. Architectural Analysis: Defines how the system will achieve black-box action determined by the functional analysis;

DS 2. Architectural Design: Allocates actions to processes, defined graphically into white-box activity diagrams. Focus on the collaboration between different processes, taking into consideration the allocation of activities;

DS 3. Detailed Architectural Design: Defines ports and interfaces, as well as state-based behaviour of the system blocks at the lowest level of the architectural decomposition.

3.2.3.1 DS1: Architectural analysis – Definition of key gHMM processes

The functional analysis phase has defined what the gHMM should do, but not how it should be done. The objective of the architectural analysis stage of MBSE is to identify a functional architecture capable of achieving the required capability in a rational manner, meaning to identify the how (Hoffmann, 2011).

This stage consists in grouping the gHMM black-box actions in such a way that each group can be realized within a gHMM process. This grouping is firstly based on a comparison with IVHM related architectures synthesized in Chapter 2, which enables to find common functionalities with existing architecture, but also original ones which are drivers of decreasing

⁴ Processes / activities concepts of SE are defined in Appendix A.

NFF occurrence. Following this synthesis, developed in Section 3.2.3.1.1 the four gHMM core health management processes (health monitoring, diagnostics, prognostics and decision support) are proposed and represent the output of this phase of MBSE (Section 3.2.3.1.2).

3.2.3.1.1 Black-box comparison with IVHM standards and systems

In order to group black-box actions into key gHMM processes, the core gHMM actions have been firstly mapped onto IVHM standards and systems analysed in Chapter 2 (Table 3.2). The correspondence was not direct as IVHM standard and systems (Chapter 2 - Table 2.1) are not formalized following an SE approach, information flows exchanged between their functionalities being most of the times unformalized in the publications describing these systems. Moreover, the correspondence is partial; as shown in Table 3.2 only a part of gHMM black-box actions have found a homologue in the analysed systems, while uncovered actions are provided in Table 3.3. This incomplete coverage justifies the need of a new proposal in order to perform all of the required black-box actions, and thus be able to realize all of the gHMM use cases.

gHMM Black-box Action	A n°	Correspondent in studied IVHM standards/systems
UC1: Generate_Health_Monitoring_Indicators	A1	Data acquisition, data manipulation, and state detection processing blocks are providing health monitoring indicators in grey scale and binary indicators.
	A2	Equivalent to A1 for noncritical systems.
	A3	A monitoring module provides relevant indicators based on the on-line information provided by the system sensors.
	A4	A PHM module provides diagnostics features and condition indicators.
	A5	Data processing and feature extraction transform raw data into known indicators.
	A6	Anomaly reasoner evaluates the raw data and extracted features for correlation and measures of evidence for fault conditions.
	A7	Acquire, pre-process and detection activities compute degradation/failure indicators.
UC2:Determine_Root_Causes_for_Failures_and_Degradations	A1	The health assessment processing block provides ambiguity group data structure, enabling formulation of diagnostics results by means of logical expressions.
	A2	Equivalent to A1 for noncritical systems.
	A3	Diagnosis module divided into local modules and in their fusion into a system level

III A generic Health Management Module

		diagnosis module.
	A4	Model-based diagnostics reasoning at low and mid-level.
	A5	Particle-filtering based diagnostics module applicable at component level.
	A6	Diagnostics reasoner at subsystem and vehicle levels isolates fault sources in order to construct an integrated air-vehicle perspective.
UC3: Estimate_RUL UC4: Estimate_Functional_RUL	A1	Prognostics assessment provides the data structures required for projection into future of current health assessment and for RUL estimation.
	A2	Equivalent to A1 for noncritical systems.
	A3	Prognosis module based on a model-based method, divided into local modules and in their fusion into a system level prognosis module.
	A4	Low-level to high-level prognostics reasoning, including component and functional RUL evaluations.
	A5	Particle-filtering based prognostics module applicable at component level.
	A6	Tri-level prognostics reasoners assessing and prioritizing component RUL.
	A7	Generic prognostics process evaluating both component and functional RUL.
UC5: Maintenance_Plan_Adjustment_based on_Health_Assessment	A1	Advisory generation enables direct requests of maintenance for assets and segments.
	A2	Equivalent to A1 for noncritical systems. For critical systems it relies on fault tolerance, redundancy management and closed-loop reconfiguration control.
	A3	Decision support module provides maintenance recommendations for the overall system.
	A4	Maintenance decision support.
	A6	Reasoning Integration Manager prioritizes recommended maintenance actions.
	A7	Decision Support process schedules maintenance actions according to RUL assessments of the production system.
UC7: Mission_Profile_Adjustment_Support	A6	High level reasoning determines the overall capability of the system to perform the functions or actions required to maintain operations.

	A7	Decision support process updates the utilization scenarios of the production system.
UC8: Confirm_failure_degradation_detection	A6	Forgetting factor evaluation for weighting indicators in input of diagnostics reasoning.

Table 3.2 Black-box actions mapped to IVHM standards and systems

The correspondence table reinforces the conclusion of Chapter 2 with regards to the non-consensual functional coverage based on existing systems. Moreover, the gap between gHMM black-box actions and existing systems involves actions of use cases 2, 3, 4, and 6 (Table 3.3) for which no correspondent was found within A1-A7.

Use Case	Uncovered Black-box Actions
UC2	Reduce_Ambiguity_in_Diagnostics_Result
	Evaluate_similarity_with_fleet_KB_diagnostics
UC3 and UC4	Increase_certainty_by_evaluating_similarity_with_fleet_KB
UC6	Optimize_Maintenance_Operations

Table 3.3 Uncovered black-box actions

As listed in Table 3.3, uncovered actions are mainly oriented on optimizing health management systems with actions targeting reduction of NFF occurrence by tapping the full potential out of existing knowledge (such as for instance fleet knowledge). **Reduce_Ambiguity_in_Diagnostics_Result** action in UC2 is an original contribution to health management, having as purpose to prioritize diagnosis hypothesis based on a set of objectives,

III A generic Health Management Module

such as confidence level of detection; reliability, functional unavailability, size of diagnosis hypothesis; and in a second step based on prognostics outputs. This proposal responds directly to a technological cause of NFF problem, identified in Chapter 1 (Table 1.1); an algorithm giving substance to this action is further proposed in Section 3.3.2.

Evaluate_similarity_with_fleet_KB_diagnostics depends on capitalization at fleet level of health management information and on the availability of this information for health management at vehicle level. As stated by Gorinevsky et al., 2010 fleet-wide data collected on-ground from many aircraft over a long period of time, could be used as input for the vehicle health management function. In the same line, **Increase_certainty_by_evaluating_similarity_with_fleet_KB** action of UC3 and UC4 is aimed at increasing certainty in RUL evaluation by using similar prognostics results available within the fleet.

Optimize_Maintenance_Operations action provides in UC6 actionable information for optimizing maintenance operations based on a set of objectives, such as minimized troubleshooting duration, cost, and risk, or maximized coverage of LRUs within executed maintenance operations procedures; this action is thus intended to decrease NFF occurrence probability by proposing the most likely set of maintenance tasks that could resolve the system's faults.

Based on the use case merge step, the complete set of gHMM actions has been identified and is now allocated to gHMM core processes in the following section.

3.2.3.1.2 Proposal of gHMM core processes

Grouping of black-box actions in gHMM core health management processes (Table 3.4) is achieved based on their purposes, in-line with four major topics of research of NASA’s IVHM project (Srivastava et al., 2009). Four generic health management processes form the core of the gHMM, illustrated in Figure 3.10. They represent the output of this phase of MBSE.

Process	Black-box Action
Health Monitoring	Generate_Health_Monitoring_Indicators
Diagnostics	Confirm_failure_degradation_detection
	Determine_Root_Causes_for_Failures_and_Degradations
	Reduce_Ambiguity_in_Diagnostics_Result
	Evaluate_similarity_with_fleet_KB_diagnostics
Prognostics	Estimate_RUL
	Estimate_Functional_RUL
	Increase_certainty_by_evaluating_similarity_with_fleet_KB
Decision Support	Optimize_Maintenance_Operations
	Maintenance_Plan_Adjustment_Support
	Mission_Profile_Adjustment_Support

Table 3.4 gHMM Processes – black-box actions allocation table

The **health monitoring** process purpose is to monitor the systems health by providing degradation and failure indicators to diagnostics and prognostics. As specified in ISO13374 this process is dependent on the nature of the processed data, while the next ones are independent from the technological characteristics of the monitored item. Identification of set of LRUs explaining failures and degradations observed within the monitored item is the purpose assigned to **diagnostics** process. Based on outputs of the diagnostics process, and on future operating conditions, the **prognostics** process aims at predicting future physical and functional failures, by estimation of component and functional RUL. Finally, the **decision support** process aims at providing actionable support aimed at retarding, halting, preventing, and resolving failures.

III A generic Health Management Module

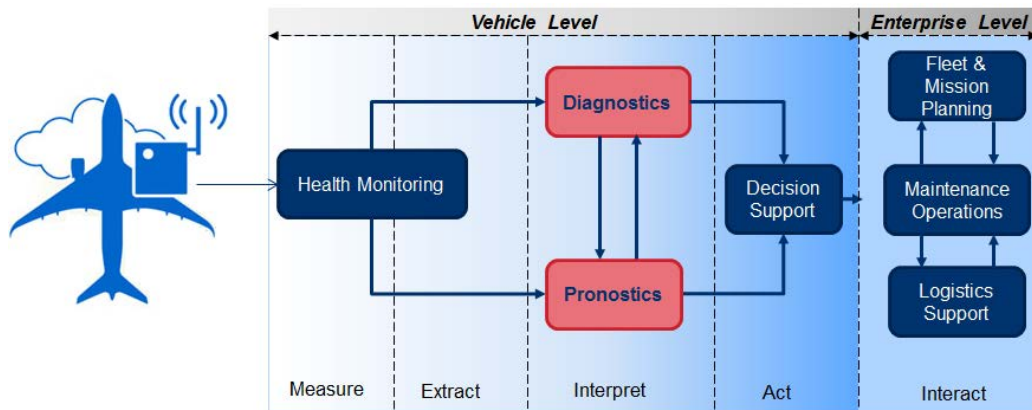

Figure 3.10. gHMM core processes

This proposal of gHMM core health management design is a major contribution of the thesis, as it enables to identify health management processes based on the MBSE approach, providing a comprehensive formalization of the vehicle health management function into four core processes of health management. Given the major interest of our proposal to IVHM model-based design, it could be submitted for review to SAE IVHM standardization work group (SAE, 2014). Moreover, the scope of the vehicle health management proposed through its four main processes is coherent with the one proposed by Felke et al., 2010, where the four functionalities (measure, extract, interpret and act) are associated to this function of IVHM. In this regard, Figure 3.10 makes the bridge between the proposal of gHMM key processes and IVHM functionalities analysed by IVHM problem statement (Section 1.3.2.2).

From this identification of core gHMM processes, the gHMM architectural design proposes, in the following section, the generic elementary activities of the four processes which build the white-box functional flow of the core health management processes of the gHMM, in compliance with OSA-CBM data structures.

3.2.3.2 DS2: Architectural design

At DS2 phase of the design synthesis (Figure 3.1), the functional breakdown of the gHMM is captured in the Block Definition Diagram in Figure 3.11. This breakdown into three parts of the gHMM block corresponds to the three classes of actions identified during architectural analysis phase through their purposes:

Part 1. **gHMM_Interface** encompasses interactions of gHMM with boundary systems and stakeholders.

Part 2. **gHMM_Core** encompasses four core health management processes: health monitoring, diagnostics, prognostics and decision support, modelled as subparts of the gHMM_Core.

Part 3. **gHMM_AlgorithmSelector** provides selection of health management algorithms supporting core health management actions.

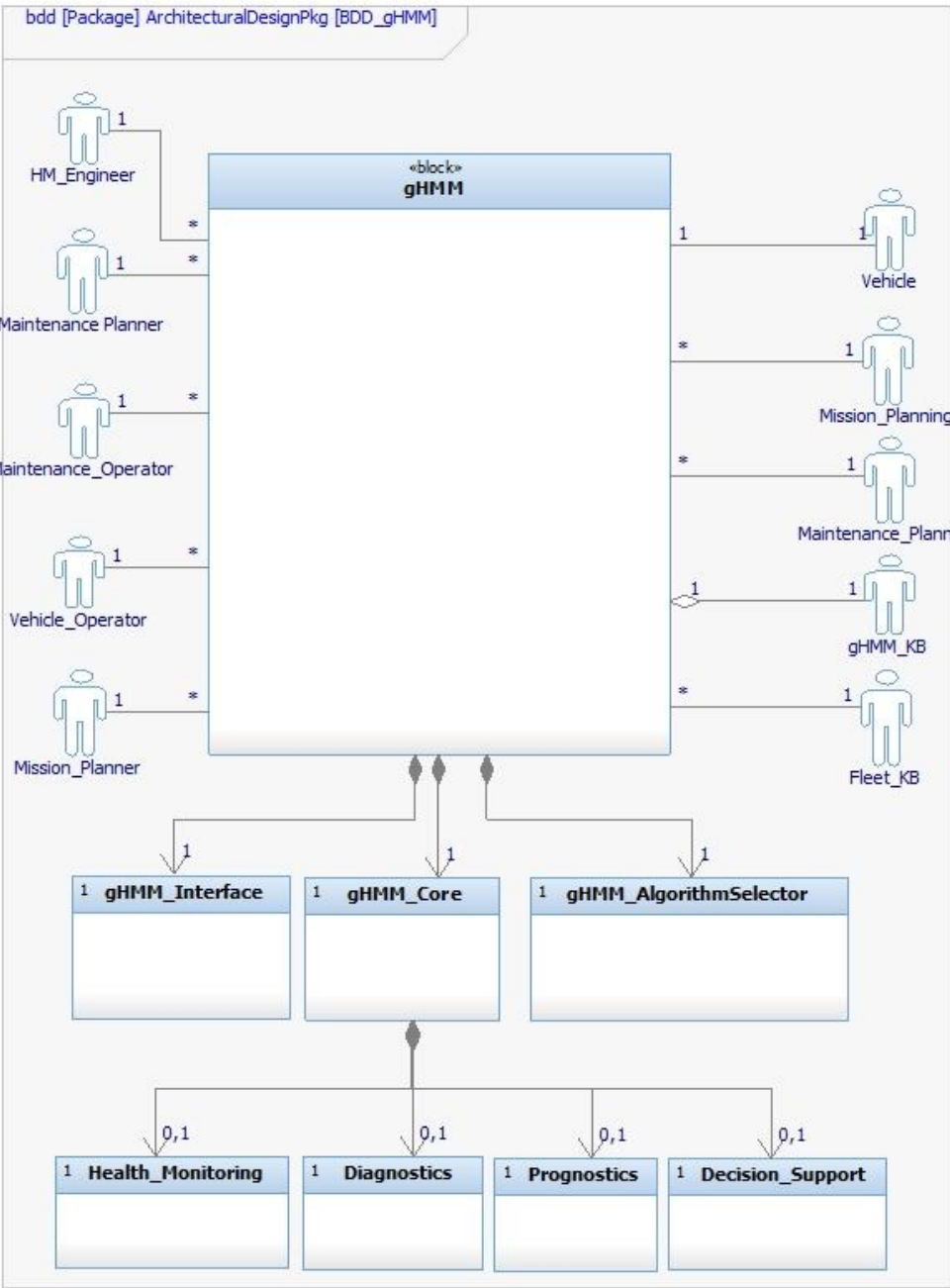

Figure 3.11. gHMM block definition diagram

III A generic Health Management Module

The architectural design stage of the gHMM is further focused on elaboration of white-box activity functional flow for gHMM_Core part, taking into consideration two main aspects realized in white-box activity diagrams:

- Derivation of gHMM core health management processes into elementary activities;
- Collaboration between processes in gHMM use cases.

The white-box information flow exchanged between elementary activities is firstly based on the semantic flows issued out of the functional analysis phase. Based on this black-box representation of information flow, the design synthesis gives substance to each of the flows, by association of a type, modelled as SysML Block. This association of types for defining white-box information flows makes use of standardized data structures of OSA-CBM standard (OSA-CBM 3.3.0), as our motivation is to be compliant as far as possible with standards and systems related to IVHM, analysed in Chapter 2. In this regard, the association between gHMM white-box information flow and the OSA-CBM standardized data structures is tackled in the detailed architectural design phase, developed in Section 3.2.3.3.

With regards to the focus of the thesis on diagnostics and prognostics processes, the elementary activities forming the two processes white-box functional flow are explained in the remainder of this section.

A. Diagnostics

Diagnostics process white-box functional flow and I/O white-box information flow are depicted in the activity diagram in Figure 3.13. The white-box actions forming the diagnostics process are in line with the detection, isolation and identification steps of FDI scheme, linked with activities that meet the need of reducing ambiguity groups in diagnostics outputs.

Detect_Failures calculates discrepancies from the nominal behaviour representative of failure modes, based on extracted features sent by the health monitoring process. **Detect_Degradations** in grey scale degradation indicators from the nominal behaviour is detecting degradation in a monitored item based on extracted features.

Confirm_Failure_Modes, and **Confirm_Degradation_Modes** aim as associating known failure and respectively degradation modes to a set of properties: part of occurrence, mode designation, severity, confidence level, intermittence, persistence, and operational context for indicators. The persistence period is defined as the time interval from the first detection of an indicator to its first non-detection, while intermittence period is the time interval from the first

non-detection of the failure indicator to the first detection of the failure indicator (Marzat et al., 2012).

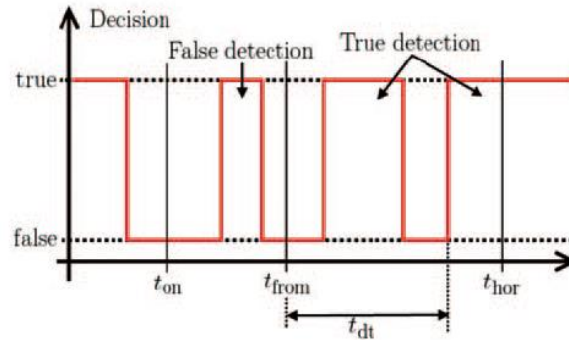

Figure 3.12. Detection horizon – Marzat et al., 2012

If indicators cannot be confirmed – for instance unpersistent or intermittent failure indicators – or associated to any known failure or degradation mode, they are logged by Log_Unconfirmed_Indicators activity.

Isolate_Root_Causes: Isolate the suspected LRUs, which explain failure modes reported by the **Confirm_Failure_Modes** activity, and degradation modes reported by the **Confirm_Degradation_Modes** activity or by diagnostics processes of inferior hierarchical levels. The result of the root causes isolation encompasses suspected failed and degraded LRUs which explain failures and degradation which have occurred within the system. This could be expressed as a disjunction of diagnosis hypothesis Δ_j (Chérière, 2014) forming an ambiguity group in case $GA > 1$:

$$\Delta_{\Sigma} = \bigvee_{j=1}^{GA} \Delta_j \quad (3-1)$$

Each diagnosis hypothesis is formed out of a conjunction of failure and degradation modes of LRUs able to explain failures and degradation which have occurred within the system.

In case of ambiguity groups in the diagnostics results ($GA > 1$), the following activities are executed, with the aim of reducing ambiguity groups, by prioritization of suspected LRUs in ambiguity groups and by consolidation of diagnosis hypothesis using prognostics results and/or fleet diagnostics results:

- **Prioritize_LRUs_in_Ambiguity_Groups:** The suspected failed items determined by the root causes isolation, are sorted according to criteria such as criticality, confidence level, operational and maintenance impact, LRU reliability.

- If the diagnostics result contains prognosticable LRUs, two situations are possible:
 - RUL evaluations are already available, in which case **Reduce_Ambiguity_by_using_RUL** activity is triggered.
 - RUL evaluations are not available, in which case **Reduce_Ambiguity_by_triggering_RUL_evaluation** launches the prognostics process.

The two activities use outputs of the prognostics process in order to reduce ambiguity in the diagnostics result. In the context of IVHM, this activity is required in order for identifying the diagnosis hypothesis to be considered in priority upstream of operational level maintenance.

Evaluate_Similarity_with_fleet_KB_diagnostics aims at consolidating diagnostics result by comparing it with similar diagnostics results from fleet KB. Based on similarity reasoning, algorithms supporting this activity could use case-based reasoning, data-driven methods, knowledge-driven methods (ontologies).

The ultimate goal of applying activities reducing ambiguity groups is to put the valid diagnosis hypothesis in the top of the sorted list of diagnosis hypothesis, which is essential for reducing No Fault Found (NFF) rates at O-level maintenance. A valid diagnosis implies that at least one of the diagnosis hypothesis of ambiguity group represent the complete set of failed and degraded LRUs within the item.

B. Prognostics

Prognostics process white-box functional flow and I/O white-box information flow are depicted in Figure 3.14. The white-box actions forming the prognostics process are described mainly in line with the generic decomposition of the prognostics process of SIMP architecture (Muller et al., 2005, Cochetoux et al., 2009), and make use of OSA-CBM data structures for their exchanged information flows.

Initialize_state_and_performance provides a starting point for “Project into future” activity, updating the current state of the item to prognosticate and its underlying components with the latest data available from diagnostics process. It provides a synchronic view of the monitored item and its components. If the current state cannot be associated to any known starting point, they are log by the **log_uninitilaized_state_performance** action for further analysis.

Project_into_future determines the evolution of degradation and failures of the item in order to have a diachronic view (throughout the time) of the system. The projection takes into account the future mission profile assigned to the vehicle. The mission profile provides operational and environmental conditions to be used for the projection.

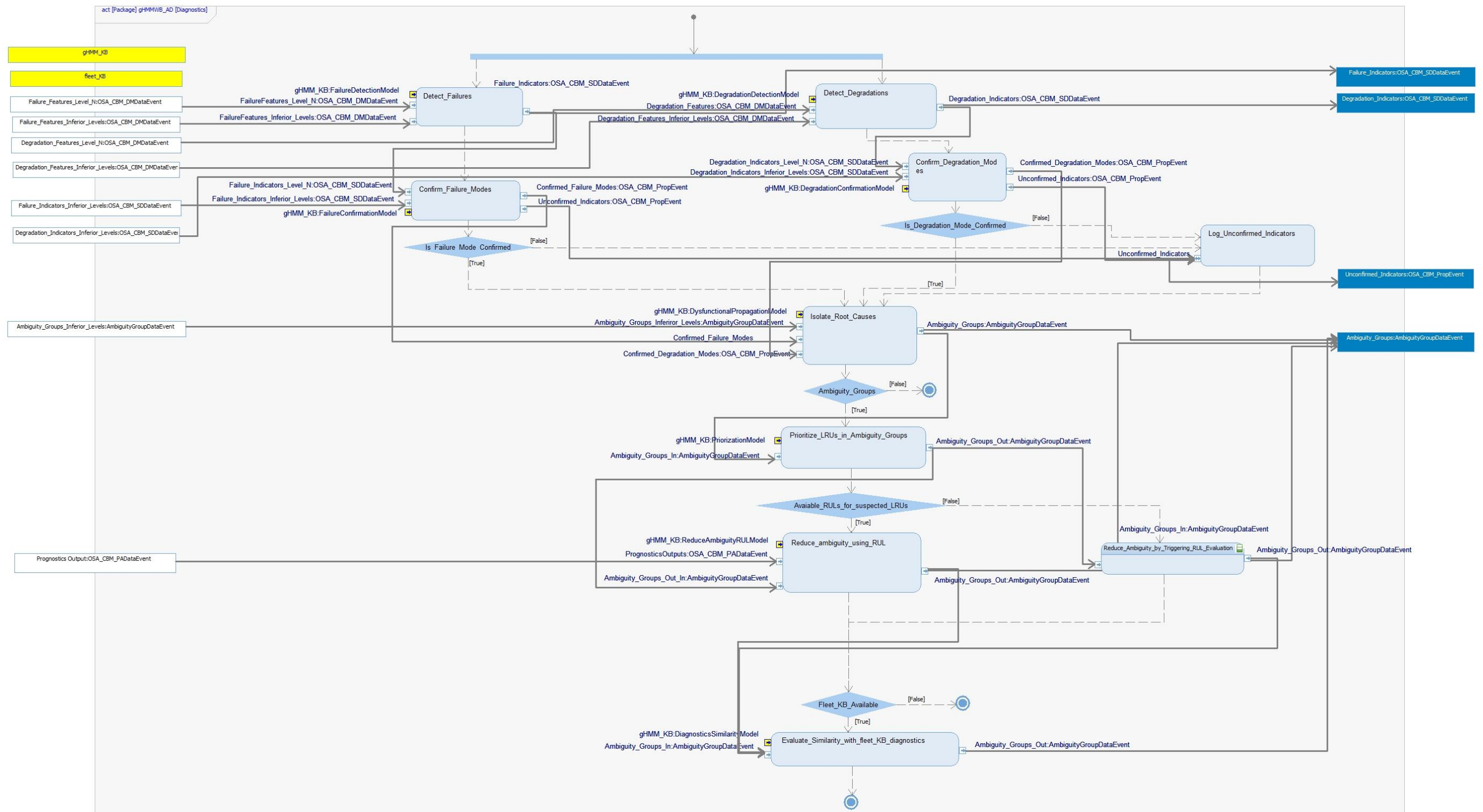

Figure 3.13. Diagnostics process white-box functional flow – activity diagram

III A generic Health Management Module

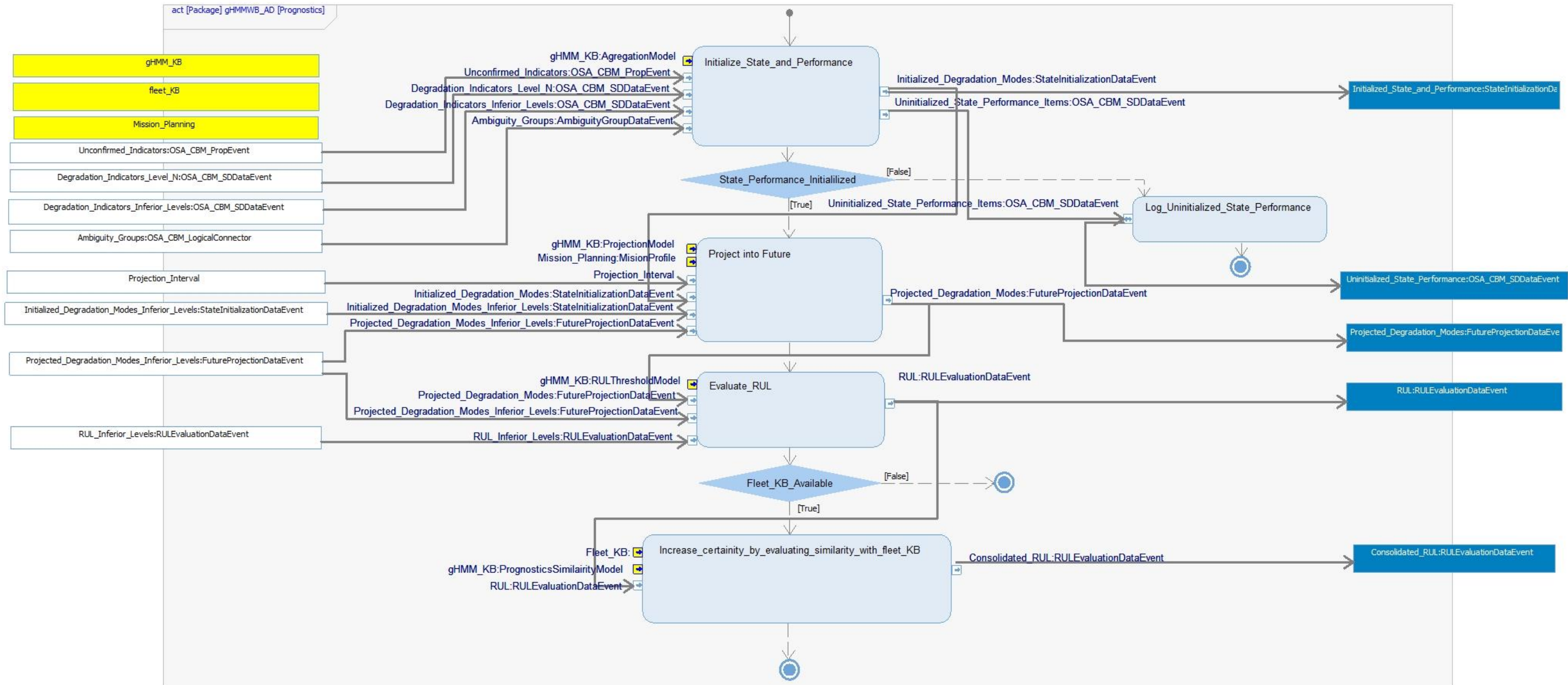

Figure 3.14. Prognostics process white-box functional flow – activity diagram

Evaluate_RUL calculates the time when the projected degradation levels will cross a pre-defined threshold, corresponding to failure occurrence. This time interval is defined as RUL, and is always associated to an uncertainty level.

Increase_certainty_by_evaluating_similarity_with_fleet_prognostics compares results obtained from the previous activity with similar prognostics results from fleet KB, in order to consolidate the certainty level given to the RUL estimation.

From the white-box functional flow developed in this section, the definition of I/O flows is required in order to type data structures exchanged between each elementary activity of the gHMM processes. This definition of information flows makes the object of the next step of the design synthesis.

3.2.3.3 DS3: Detailed architectural design

As illustrated in Figure 3.13 and Figure 3.14, input and output ports of each of diagnostics and prognostics elementary activities are given a name and a type. Associating a type to each I/O port makes the object of the detailed architectural design.

This step of the design synthesis is compliant with standardized data structures of OSA-CBM, which are typed by the prefix “OSA_CBM_”. This association between gHMM white-box information flow and OSA-CBM data structures is performed by analysis of each of the activity purpose, required inputs and produced output. As illustrated in activity diagrams in Figure 3.13 and Figure 3.14, not all of the required information flows have found correspondents in OSA-CBM standard, requiring data structures which are not covered by the standard, such as for instance the *MissionProfile* data structure.

Let us take **Detect_Failure_Activity** and develop its input and output flows, which are illustrated in Figure 3.15.

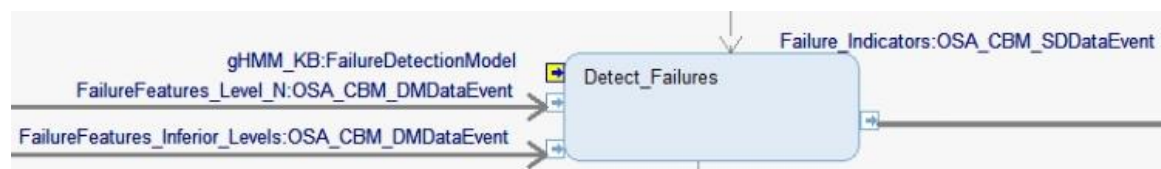

Figure 3.15. Detect_Failures elementary activity

This action purpose is to detect discrepancies from the nominal behaviour representative of failure modes (typed by *OSA_CBM_SDDataEvent*), based on extracted features (typed by *OSA_CBM_DMDataEvent*) sent by the health monitoring process, and using a

FailureDetectionModel provided by gHMM knowledge base (gHMM_KB). OSA_CBM data structures *DMDataEvent* and *SDDataEvent* formalization is enclosed in Appendix E.

In order to delve deeper into the **collaboration between diagnostics and prognostics processes** proposed in Figure 3.13 and Figure 3.14, the following section delves deeper into the detailed architectural design phase of the gHMM by tackling two main aspects:

- White-box information flows exchanged between gHMM's two key processes (diagnostics and prognostics);
- Behaviour which produces these information flows.

3.3 Diagnostics and prognostics integration supported by gHMM

This section addresses diagnostics and prognostics processes integration within the gHMM **detailed architectural design (DS3)** from two complementary perspectives: information flow modelling and algorithms which both give substance to integration between the two processes. As outlined by Sikorska et al., 2011, integrating diagnostics and prognostics represents an emerging topic within system health management research, representing one of our major contributions to the detailed architectural design of the gHMM for tackling the Scientific Problem n°2 raised in Chapter 1, which is reminded here after:

Scientific Problem n°2: Diagnostics and prognostics, key processes of health management, suffer a necessary formalization of their interactions.

In order to address this scientific problem, the detailed architectural design of the gHMM is proposed through the proposal of a two way bridge for integration of diagnostics and prognostics processes. The first way takes a step further the proposal of OSA-CBM for linking diagnostics to prognostics, while the opposite direction contributes with an original relation from prognostics to diagnostics, supported by the proposal of an algorithm.

In a nutshell, this section captures the essence of the interrelation between gHMM's two core processes, diagnostics and prognostics.

3.3.1 From diagnostics to prognostics

In the same line as the sample of studied standards and systems from IVHM in Chapter 2 (Table 2.2), the collaboration between diagnostics and prognostics processes is realized from diagnostics to prognostics. Based on the data structures of OSA-CBM standard, the gHMM detailed architectural design (DS3) goes a step further, by separating data event structures for each of the elementary activity output of diagnostics and prognostics. This leads to the following data structures, illustrated in Block Definition Diagram in figures Figure 3.16 and Figure 3.17:

- *AmbiguityGroupDataEvent* is produced as output of diagnostics process based on OSA-CBM *AmbiguityGroup* data structure;

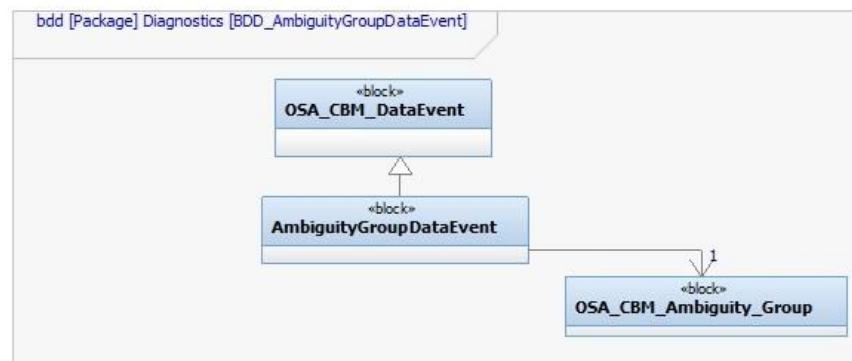

Figure 3.16. AmbiguityGroupDataEvent block definition diagram

- *ItemHealth* is produced by *Initiliaze_State_and_Performance* activity of prognostics process;
- *FutureHealth* and *FutureHlthTrend* are produced by *Project_into_Future* activity of prognostics process;
- *RUL* and *RULDistrbn* are produced by *Project_into_Future* activity of prognostics process;

III A generic Health Management Module

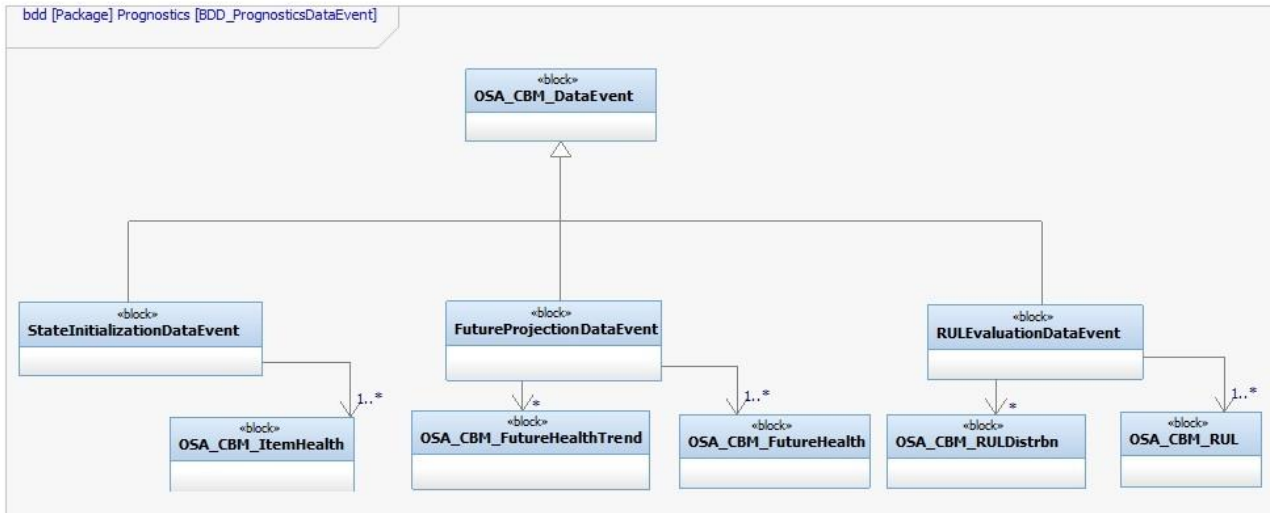

Figure 3.17. Prognostics process DataEvents block definition diagram

In order to illustrate the utilization of these data structures for collaboration between diagnostics and prognostics within gHMM use cases, the following activity diagram represents a zoom on use case n°7, which integrates diagnostics and prognostics processes for mission decision support.

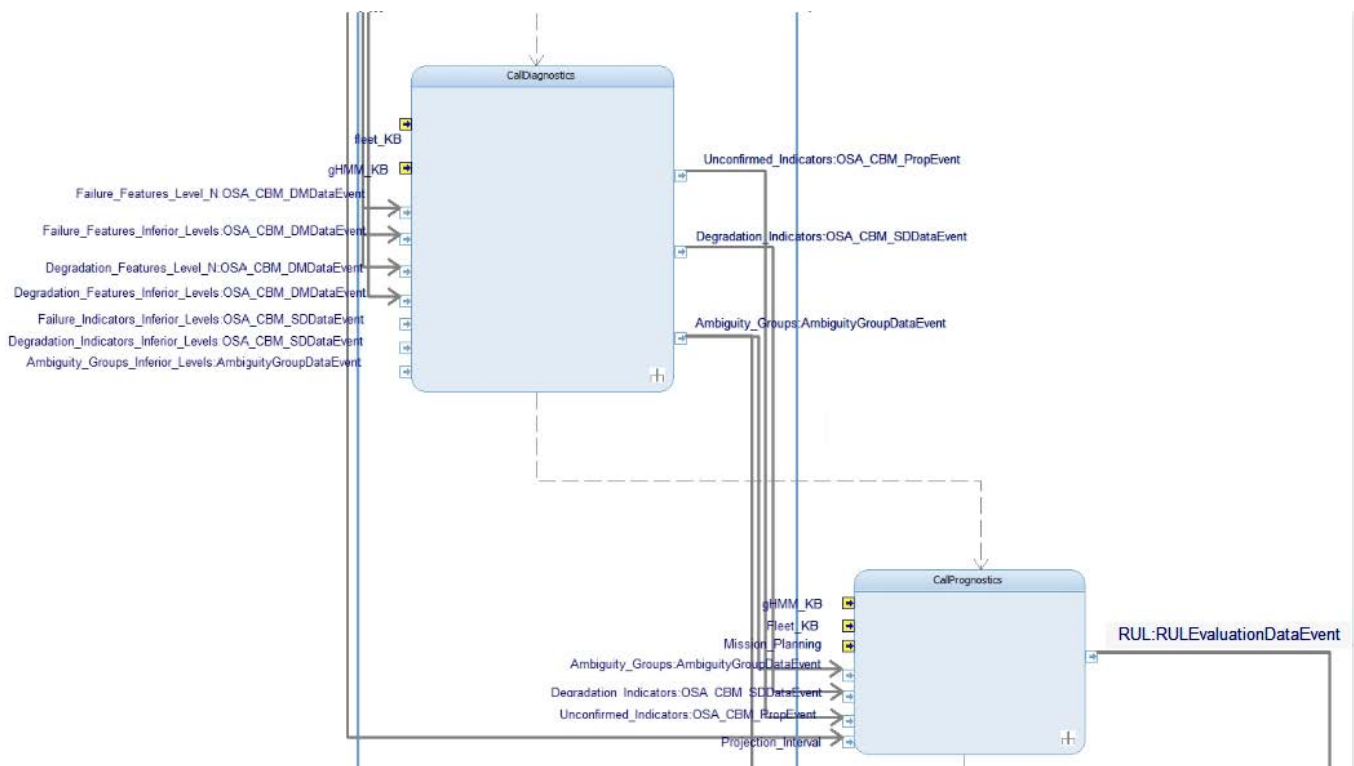

Figure 3.18. Zoom on diagnostics to prognostics collaboration in a gHMM use case

In this regard, the white-box information flow exchanged from diagnostics to prognostics in Figure 3.18 encompasses:

- Root causes identification output of diagnostics processes, by using *AmbiguityGroupDataEvent* data structure (Figure 3.16);
- Degradation indicators, by using the *SDDataEvent* of OSA-CBM standard (class diagram is provided in Appendix F);
- Unconfirmed failure indicators, not associated to failure modes are forwarded to prognostics (*PropEvent* of OSA-CBM standard – whose class diagram is provided in Appendix F) as they could represent an indicator of an incipient failure of a monitored item.

Moving a step forward to the detailed architectural design, our proposal takes a new way from the classical integration from diagnostics to prognostic, by proposing to link prognostics to diagnostics into an activity titled *Reduce Ambiguity using RUL*. This activity responds to reduce ambiguity in vehicle diagnostics requirement expressed in the gHMM formalization, and making the object of use case n°2 of the gHMM. This original activity is proposed in the remainder of this section, an analytical expression giving substance to this proposal.

3.3.2 From prognostics to diagnostics

As argued in the previous section (3.3.1), diagnostics to prognostics is usually conducted from diagnostics to prognostics in the analysed standards and systems related to IVHM (Chapter 2, Section 2.3.2.1). Yet, this integration does not solve ambiguity groups in root causes isolation causing NFF issues at operational level. The main contribution of this section tackles this problem in two aspects: it addresses elements of the SysML-based gHMM model aimed at reducing ambiguity groups, and secondly proposes an analytical expression backing up this proposal.

In this regard, gHMM use case n°2 provides the functional flow realizing ambiguity group reduction in system diagnostics; a detailed view of this use case is provided in Appendix D. A zoom on diagnostics process activities *Isolate_Root_Causes*, *Prioritize_LRUs_in_Ambiguity_Groups*, and *Reduce_Ambugity_using_RUL*, involved in this use case, is illustrated in Figure 3.19.

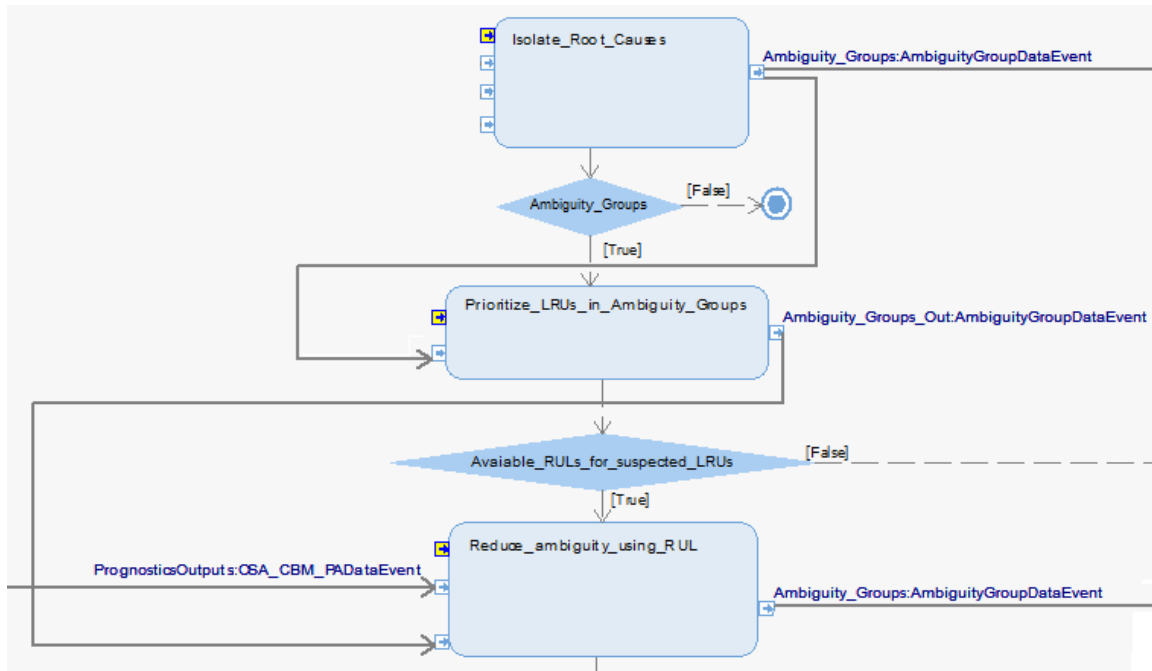

Figure 3.19. Zoom on white-box activity diagram of use case n°2

Among the activities figured here-above, *Reduce_ambiguity_using_RUL*, uses prognostics outputs, typed by *PADataEvent* of OSA-CBM, for sorting diagnosis hypothesis in an ambiguity group. In order to support this activity, a method is proposed in the following section, by weighting diagnosis hypothesis in ambiguity groups based on predicted degradation levels and RUL evaluation. The method is formulated analytically with respect to information flows of the SysML formalization, simplified by the notation here-after.

3.3.2.1 Data structures and notation

For the sake of simplicity, a part of attributes from data structures of the SysML-based gHMM model are to be used in the proposed method, for which the notation is proposed in this section.

Let Σ be the system-of-interest and $\{LRU_1, LRU_2, \dots, LRU_n\}$ the complete set of LRUs of Σ to be handled by the gHMM. Each LRU possesses several failure and degradation modes, which could be suspected in the diagnostics result. The notation hereafter uses LRU_i for any of its suspected failure/degradation modes, for i between 1 and n .

A. Diagnostics data structures notation

Isolate_Root_Causes activity output is an ambiguity group formed out of a disjunction of diagnosis hypothesis, from which only one represents the health assessment of the system under

diagnosis. Under the gHMM SysML formalization, this is represented by using *AmbiguityGroupDataEvent* block, which is noted $\Delta_{\Sigma}(M)$ resulting from diagnostics performed after a mission M, formulated by:

$$\Delta_{\Sigma}(M) = \bigvee_{j=1}^{GA_M} \Delta_j^M \quad (3-2)$$

, where GA_M is the ambiguity group size, and Δ_j^M is a diagnosis hypothesis.

Δ_j^M is composed of a set of suspected LRU failure/degradation modes. Δ_j^M is formalized as follows in the proposed method:

$$\Delta_j^M = \bigwedge_{i=1}^{S_j} LRU_i \quad (3-3)$$

, where LRU_i is a suspected LRU failure/degradation mode, and S_j is the size of the diagnosis hypothesis Δ_j^M . Note that indices i are used for LRUs, while j for diagnosis hypothesis.

Each of suspected elements in the diagnosis hypothesis Δ_j^M is associated a weight, w_i , forming the tuple $\langle w_i, LRU_i \rangle$. The average weight w_j of the diagnosis hypothesis Δ_j^M is calculated by weighting the sum of individual weights by the size of the diagnostics hypothesis:

$$w_j = \frac{\sum_{i=1}^{S_j} w_i}{S_j} \quad (3-4)$$

A normalized weight $\overline{w_j}$ is then calculated for each diagnosis hypothesis Δ_j^M using (3-5):

$$\overline{w_j} = \frac{w_j}{\sum_{k=1}^{GA_M} w_k} \quad (3-5)$$

Weights are firstly used in *Prioritize_LRUs_in_Ambiguity_Groups* activity for sorting diagnosis hypothesis based on criteria, such as LRU reliability (Weber et al., 2008), confidence of detection (OSA-CBM standard), and functional unavailability related to a failure mode of an LRU (Schoeller et al., 2007). This activity's output is a sorted set of diagnosis hypothesis:

$${}^{GA_M}_{j=1} \left\{ \left\langle \overline{w_j}, \Delta_j^M \right\rangle \right\} \quad (3-6)$$

III A generic Health Management Module

, where $\overline{w_1} \geq \overline{w_2} \geq \dots \geq \overline{w_{GA_M}}$.

B. Prognostics process data structures notation

Let the set of prognosticable LRU failure modes noted from l to p , where $p \leq n$:

$$\{LRU_1, LRU_2, \dots, LRU_p\} \quad (3-7)$$

The following notation is used for prognostics activities outputs:

- *Initialize_state_and_performance* activity's output is formalized by *ItemHealthDataEvent* data structure in the SysML-based gHMM model. Attribute *hGradeReal* designates the level of degradation as a percentage.

The level of degradation of LRU_i measured after a mission M is noted h_i^M .

Output of *Initialize_state_and_performance* activity performed after mission M is the set of health grades of prognosticable LRUs: $\left. \begin{matrix} P \\ i=1 \end{matrix} \right\} \{h_i^M\}$.

- *Project_into_future* activity's output is formalized by *FutureHealthDataEvent* data structure in the SysML-based gHMM model. Attribute *hlthGrade* designates the future level of degradation as a percentage.

The future level of degradation of LRU_i for the projection interval $\hat{\varphi}$ of the next mission M+1 is noted $f \hat{h}_i^{M+1}$.

Output of *Project_into_future* activity performed after mission M is the set of future health grades of prognosticable LRUs: $\left. \begin{matrix} P \\ i=1 \end{matrix} \right\} \{f \hat{h}_i^{M+1}\}$.

- *Evaluate_RUL* activity's output is formalized by *RULDataEvent* data structure of the SysML-based gHMM model. Attributes *RUL* and *postConfid* designate RUL in hours and the confidence level of the evaluation as a percentage, noted as a tuple $\langle RUL, confid \rangle_i^M$ for an evaluation after mission M for LRU_i . Output of *Evaluate_RUL* activity performed after mission M is the set of tuples: $\left. \begin{matrix} P \\ i=1 \end{matrix} \right\} \langle RUL, confid \rangle_i^M$.

3.3.2.2 Hypothesis

The method proposed for reducing ambiguity using RUL is based on a set of assumptions depicted in the figure below:

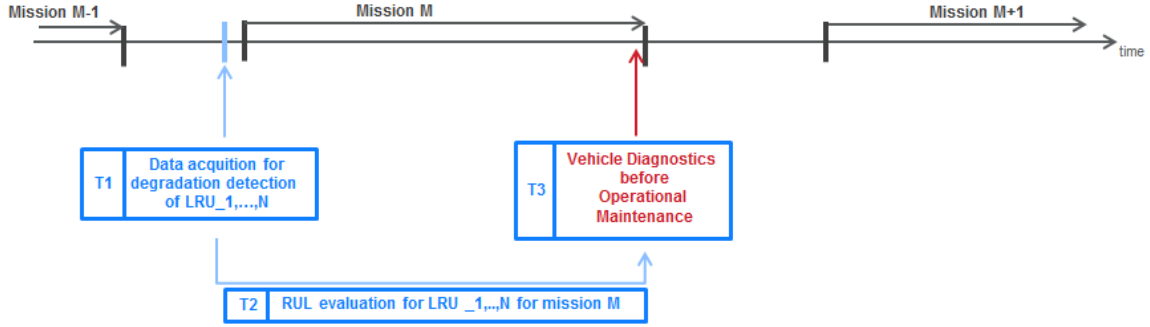

Figure 3.20. Hypothesis T1-T3 for reducing ambiguity using RUL

T0: The nominal health state of the vehicle implies that no diagnosis hypothesis is found in isolation of root causes and that degradation levels of prognosticable LRUs are equal to zero. This hypothesis is represented by the following equations:

- $\Delta_{\Sigma}(M) = \sqrt{\sum_{j=1}^{GA_M} \Delta_j^M}$, where $GA_M = 0$ in case of nominal state.
- $h_i^{M-1} = 0$ for all i from 1 to p is produced by *Initialize_state_and_performance* activity.
- $f \hat{h}_i^M = 0$ for all i from 1 to p is produced by *Project_into_future* activity.

T1: Data acquired for degradation detection of LRUs might require an intrusive operation or relies on data extracted while the vehicle is on ground, which cannot be achieved while the vehicle is in operation. For instance, Massé et al. 2012 indicate that aircraft engine oil consumption function relies on oil level extractions captured at constant ground idle speed when the switch based level indication changes, while Anderson, 2012 states that aircraft wiring intermittent faults detection which might cause NFF can only be performed on ground. Moreover, Alber, 2013 and Ugle, 2013 studies on internal resistance measurement of batteries are realized off-line, requiring a removal of the battery from the system-of-interest.

T2: The level of degradation of an LRU is used for establishing the system readiness for the next mission by evaluation of RUL with a projection horizon equal or greater than the next mission duration (Figure 3.21). Outputs generated by prognostics activities before mission M are:

- $\{h_i^M\}_{i=1}^p$ *Initialize_state_and_performance* activity's output;

- $\left\{ f \hat{h}_i^{M+1} \right\}_{i=1}^p$ *Project_into_future* activity's output;
- $\left\langle RUL, confid \right\rangle_i^M$ *Evaluate_RUL* activity's output.

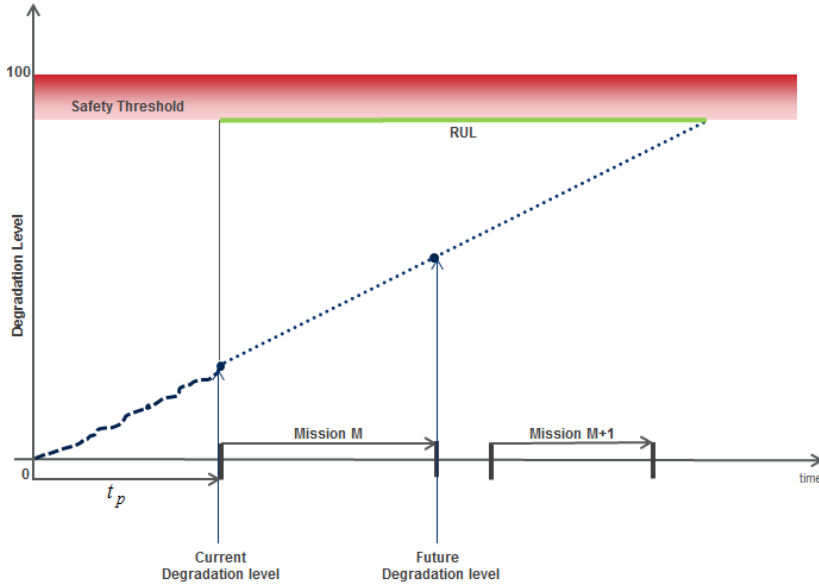

Figure 3.21. Component RUL evaluation before mission M

T3: Diagnostics of failure/degradation modes detected throughout mission M is achieved upstream of decision support for maintenance operations performed during Turn Around Time.

3.3.2.3 Reduce_Ambiguity_using_RUL algorithm

Resulting diagnosis hypothesis sorted by their weights from *Prioritize_LRUs_in_Ambiguity_Groups* activity are in input of *Reduce_ambiguity_using_RUL* activity. The purpose of the latter is to update the weight of each prognosticable LRU, based on available prognostics outputs.

Let $\langle w_i^t, LRU_i \rangle$ be a tuple belonging to diagnosis hypothesis Δ_j^M , where w_i^t has been calculated by *Prioritize_LRUs_in_Ambiguity_Groups* activity.

Consider LRU_i a prognosticable failure mode, where $f \hat{h}_i^M$ and $\langle RUL, confid \rangle_i^M$ are its projected degradation level, and respectively the remaining useful life calculated by the prognostic process.

The update of the weight w_i^t is realized in case the confidence level $confid$ of the RUL evaluation crosses a predefined confidence threshold. The following equation uses the confidence level, the projected degradation level, and the remaining life percentage of LRU_i :

$$w_i^{t+1} = w_i^t + \frac{confid * f \hat{h}_i^M}{RUL\%} \tag{3-8}$$

, where $RUL\%$ represents the percentage of remaining useful life defined as $RUL\% = \frac{RUL}{t_p + RUL}$, and t_p current age of LRU_i as depicted in Figure 3.21.

The proposed method uses equation (3-8) for updating the weight of each prognosticable element in ambiguity groups. Based on the updated weight w_i assigned to LRU_i , diagnosis hypothesis weights are recalculated using equation (3-4), normalized using (3-5), and sorted by decreasing normalized weight. The two loops required for diagnosis hypothesis transversal are formalized in form of pseudo-code in Appendix D.

In order to illustrate the proposed method consider a system Σ composed of 50 LRU where one failure mode LRU_0 is prognosticable. For the sake of simplicity, consider Σ composed out of two hierarchical levels, as depicted below:

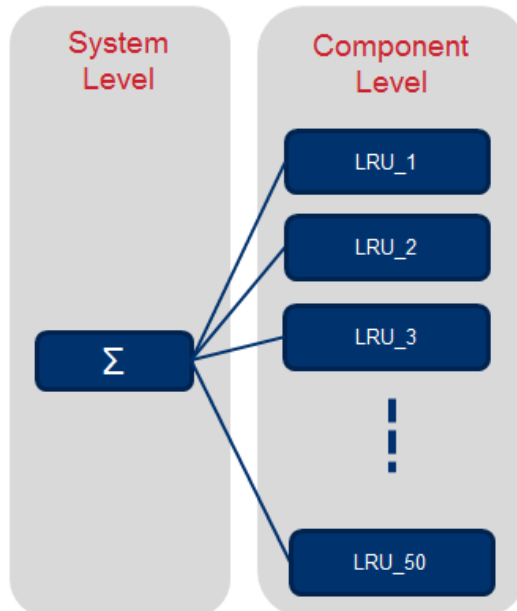

Figure 3.22. System Σ

III A generic Health Management Module

Table 3.5 provides an example of output produced by *Isolate_root_causes* activity at system level at the end of mission M $\Delta_{\Sigma}(M) = \bigvee_{j=1}^{GA_M} \Delta_j^M$, where the ambiguity group size GA_M is equal to 3.

Δ_1^M	$LRU_1 \wedge LRU_2$
Δ_2^M	$LRU_3 \wedge LRU_4 \wedge LRU_5 \wedge LRU_6$
Δ_3^M	$LRU_7 \wedge LRU_8 \wedge LRU_9 \wedge LRU_{10} \wedge LRU_{11}$

Table 3.5 Diagnosis hypothesis of $\Delta_{\Sigma}(M)$

Prioritize_LRUs_in_Ambiguity_Groups activity uses the *Isolate_root_causes* activity's output for calculating weights for each LRU, based on which diagnosis hypothesis are prioritized. For illustration purposes, four equally weighted criteria have been considered:

- Criterion 1: Confidence level of failure mode detection, noted *detconfid* ;
- Criterion 2: Reliability based lifetime percentage $\frac{t_p}{MTBF}$;
- Criterion 3: Functional unavailability, noted *fuav* ;
- Criterion 4: Size of hypothesis S_j .

LRU weights are calculated using equivalent criteria values for all suspected LRUs:

Confidence level in detection	<i>detconfid</i>	75%
Reliability based lifetime percentage	$\frac{t_p}{MTBF}$	$\frac{1000h}{10000h} = 10\%$
Functional unavailability	<i>fuav</i>	100%

Table 3.6 List of Sorting Parameters and their values

For instance, w_1 of LRU_1 , equal to 2.35 is obtained by $w_1 = \frac{t_p}{MTBF} + detconfid + fuav + S_1$.

Diagnosis weight of Δ_1^M equal to 2.35 is obtained by $w_{\Delta_1^M} = \frac{w_1 + w_2}{2}$, and when normalized is equal to 0.36, obtained by $\overline{w_{\Delta_1^M}} = \frac{w_{\Delta_1^M}}{w_{\Delta_1^M} + w_{\Delta_2^M} + w_{\Delta_3^M}}$.

The chart below depicts the repartition of weights before applying *Reduce_Ambiguity_using_RUL* activity. Hypothesis Δ_1^M is considered in priority to the other ones, based on the four criterions.

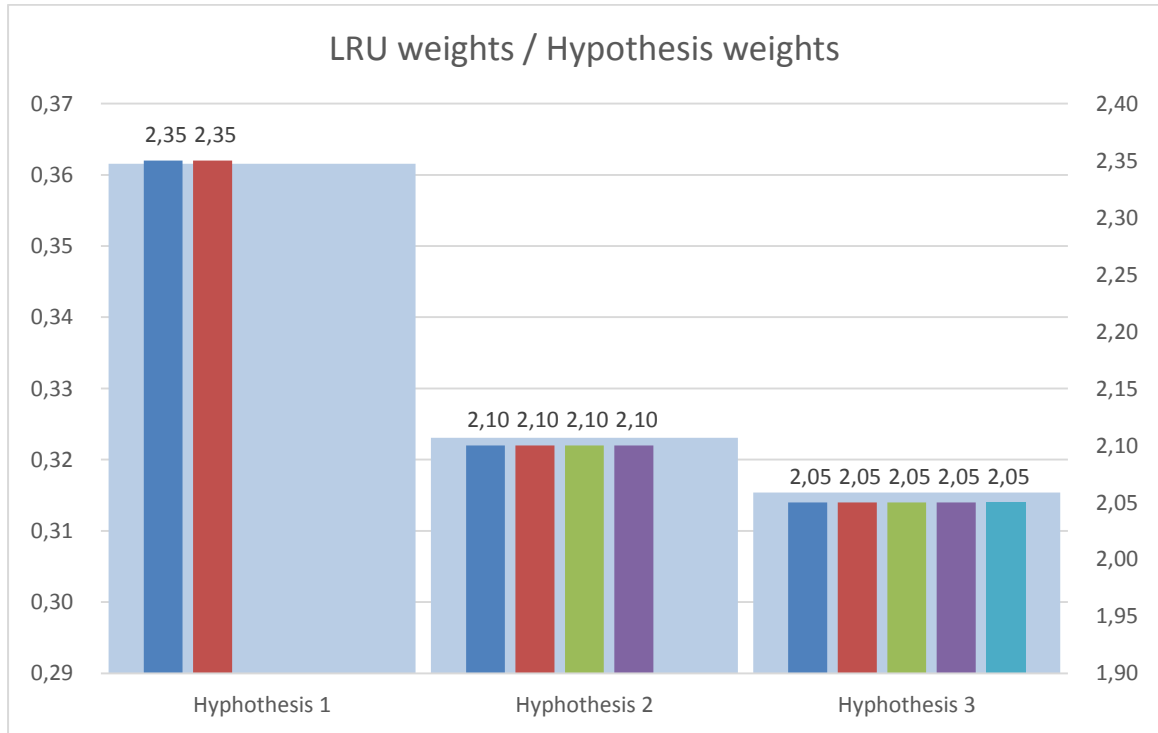

Figure 3.23. *Prioritize_LRUs_in_Ambiguity_Groups* outputs

As one of the diagnosis hypothesis, Δ_3^M comprises a prognosticable failure mode for LRU_9 , the method proposed for *Reduce_Ambiguity_using_RUL* is applied for sorting diagnosis hypothesis. Let us consider the following values assigned to prognostics outputs of LRU_9 :

- $f_{h_9}^M = 70\%$;

III A generic Health Management Module

- $(RUL, confid)_9^M = (500h, 90\%);$

The link between the component level LRU_9 prognostic process and the system level Σ diagnostics process is enabled by instantiating the generic gHMM processes. Figure 3.24 gives an insight to the particularization of the gHMM for a specific system, which makes the object of the scientific contribution developed in the following chapter.

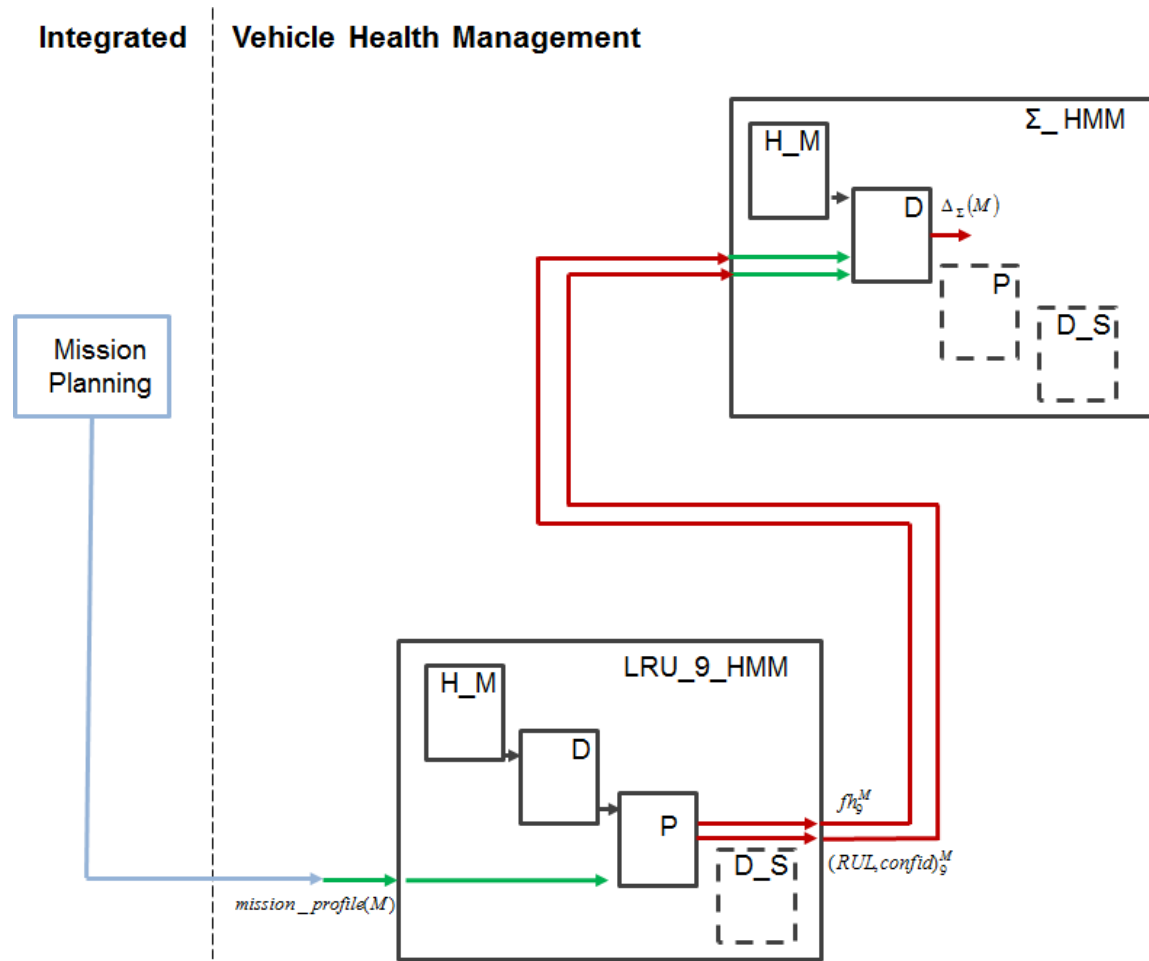

Figure 3.24. Link between component and system level

As depicted in Figure 3.25, diagnosis hypothesis order changes after applying equation 3-12, putting Δ_3^M on the top of suspected diagnosis hypothesis. The example assumes the certainty of 90% for RUL estimation as confident enough for applying the weight update for LRU_9 . Uncertainty of prognostics estimation is an essential parameter to be considered before applying the update step in order to avoid the injection of further uncertainty in the diagnostics result. In this regard, a comparison between the detection level in diagnostics and the certainty level in the estimated RUL could be further achieved in order to judge if the RUL estimation provides more valuable information than the failure detection.

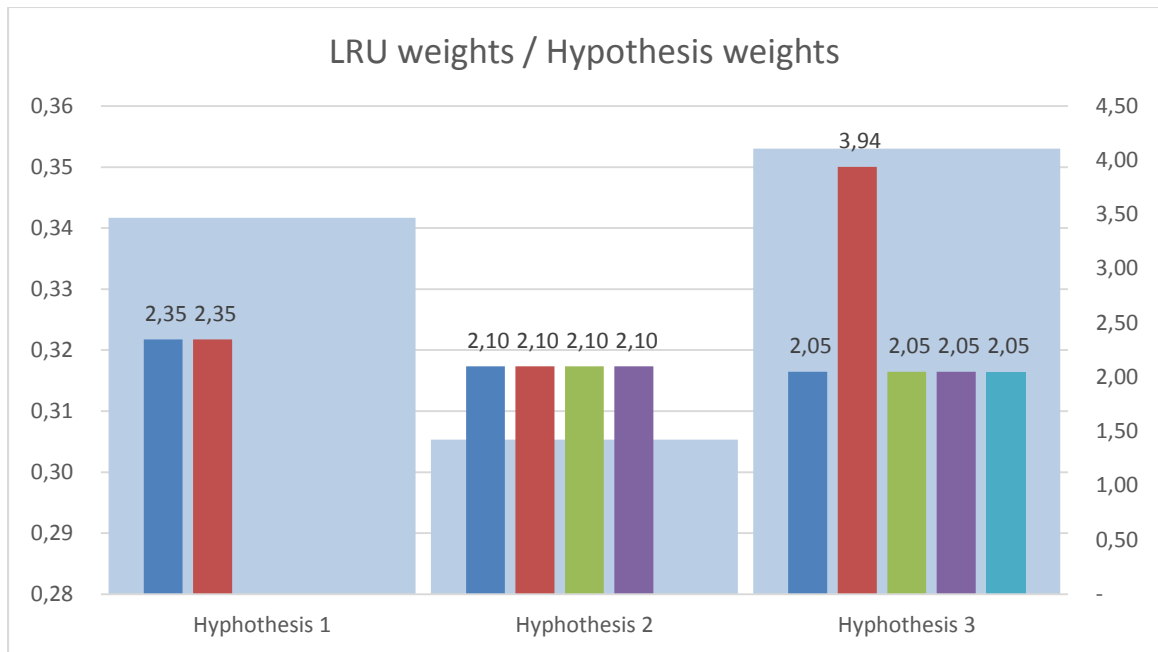

Figure 3.25. *Reduce_Ambiguity_using_RUL* outputs

This example has illustrated the purpose of this method, but did not demonstrate its application to a real system, nor its added value. Further steps of experimentation, refinement and increasing realistic testing of this method are in the perspectives of our work. A Monte Carlo simulation of possible inputs could be used in order to assess the validity of the update step for a random set of inputs. Based on this result, real system prognostics and diagnostics results, and maintenance historical information, would be necessary to judge if the use of prognostics could have improved the priority given to diagnosis hypothesis in input of troubleshooting and maintenance operations procedures.

3.3.2.4 Perspective on generalizing the update step

The update step proposed in equation (3-8) could be used as a recursive operation, where the prioritization of the current ambiguity group estimate is based on the estimate of RUL at the previous state, and of root causes isolation of the current step (Figure 3.26).

III A generic Health Management Module

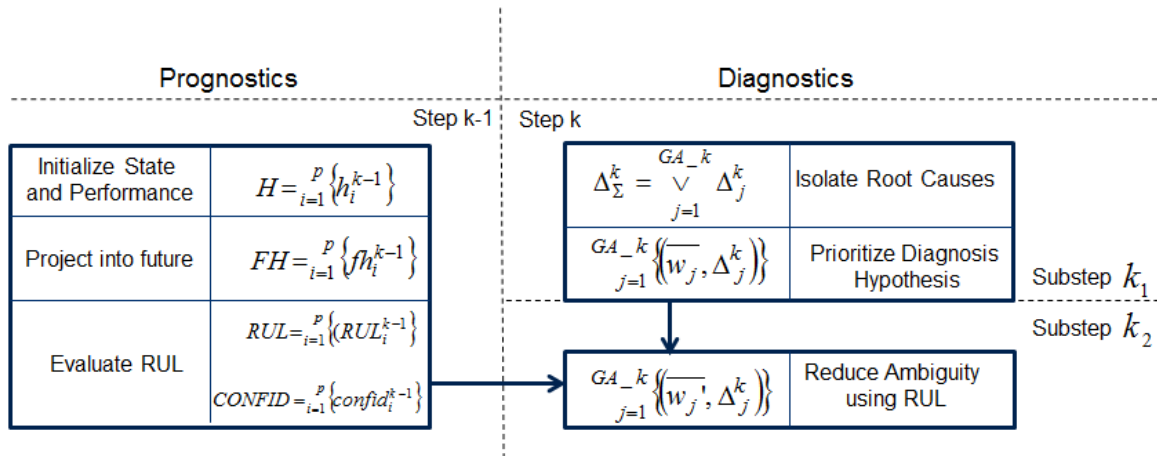

Figure 3.26. Generalization of update step

$FH = \prod_{i=1}^p \left\{ f \hat{h}_i^{k-1} \right\}$, $RUL = \prod_{i=1}^p \left\{ RUL_i^{k-1} \right\}$, $CONFID = \prod_{i=1}^p \left\{ confid_i^{k-1} \right\}$ are prognostics process

outputs generated at step k-1.

At step k, root causes isolation produces $\Delta_\Sigma^k = \bigvee_{j=1}^{GA_k} \Delta_j^k$, which are prioritized by *Prioritize_LRUs_in_Ambiguity_Groups*, and by *Reduce_ambiguity_using_RUL*, which produces $GA_k \left\{ \overline{w}_j^k, \Delta_j^k \right\}$. For an LRU_i encompassed in a diagnosis hypothesis Δ_j^k the updated weight at step k is based on the following equation:

$$w_i^{k2} = w_i^{k1} + \frac{confid * f \hat{h}_i^{k-1}}{RUL\%} \quad (3-9)$$

Generalizing the update step could open a larger perspective for using the proposed method in an on-line context, such as for instance in the scope of use case n°7 for mission control purposes.

3.4 Conclusion

The major contribution developed in this chapter has went through a first iteration on the MBSE process for defining the generic Health Management Module (gHMM), as fundamental element of an IVHM modelling framework.

The SysML-based model of the gHMM has thus been defined through the major phases of the MBSE process: requirement analysis, functional analysis and design synthesis. This definition represents a genuine scientific contribution formalizing generic functional flows which links black/white-box actions and information flows in gHMM use cases capable of meeting IVHM stakeholders' requirements.

By following this MBSE approach, four generic processes of health management are defined at the transition between black and white-box functional analyses, proposing to group black-box actions according to their common purposes. As such, health monitoring, diagnostics, prognostics and decision support represent the four core processes of the gHMM. Their white-box functional flow, compliant with OSA-CBM standard, has modelled their collaboration within gHMM use cases. More particularly, integration between diagnostics and prognostics processes within the gHMM has been proposed as the key of the vehicle health management function. This integration has been tackled as a two way bridge: not only in the conventional way: from diagnostics to prognostics, but also in an original one: from prognostics to diagnostics with the purpose of reducing ambiguity groups in diagnostics output. The latter has been supported by the proposal of an algorithm weighting diagnosis hypotheses based on future degradation level, remaining useful life and confidence level produced by prognostics process. This contribution illustration has shown that prognostics output could be a valuable information in changing the priority of diagnostics hypotheses in an ambiguity group.

In conclusion, this chapter's two main contributions have provided to an IVHM modelling framework with its fundamental functional element formalizing the vehicle health management function, and integrating diagnostics and prognostics.

Based on this generic proposal, the next chapter focuses on the methodological means required for designing particular health management instances in an IVHM modelling framework.

Chapter 4

Designing health management in an IVHM modelling framework

“You can only predict things after they have happened.”

- Eugène Ionesco

4.1 Introduction

The contribution exposed in this chapter is aimed at providing the IVHM modelling framework with methodological means of designing specific IVHM systems based on the generic contribution exposed in the previous chapter, by tackling Scientific Problem n°1 raised in the first chapter:

“IVHM lacks of methodology for appropriately designing diagnostics and prognostics based on vehicle and IVHM systems considerations.”

Towards this goal, a principle of instantiation of the generic Health Management Module (gHMM) is firstly enounced. This principle exploits the generic contribution of Chapter 3 for developing a particular IVHM built on multiple gHMM instances by defining the required elements to guide its development both structurally (black-box) and behaviourally (white-box).

In order to support the behavioural instantiation, a major contribution of this chapter is the formalization of multi-criteria determinant for the selection of health management algorithms supporting instantiated gHMM activities. This contribution is in logical continuity with the structuring principles of IVHM founded in Chapter 2, which are refined and formalized in ten generic multi-criteria, specified using an ontology-based formalization.

In support of this formalization, the fourth section exposes the main elements of a knowledge-based system, proposed for designing a multi-criteria selection tool.

4.2 Developing a particular IVHM based on the gHMM

This section enounces the instantiation principle of the gHMM aimed at transforming the SysML-based gHMM model into particular gHMM instances relying on transformation between meta-modelling levels. This principle is performed in two instantiation phases which define gHMM instances both structurally (black-box) and behaviourally (white-box).

4.2.1 gHMM instantiation principle

From a modelling standpoint, the link between the gHMM and its particularization into health management of a vehicle system could take two main directions: instantiation, and specialization. The latter is employed for transforming a design pattern to create an occurrence of it, which is formed by the equivalent attributes, relations and constraints as its template (Morbach et al., 2007), while the first one is employed for transforming models through different abstraction levels of the meta-modelling pyramid (Liu et al., 2010), illustrated in Figure 4.1.

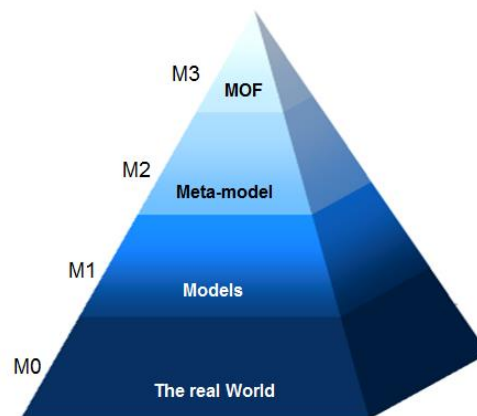

Figure 4.1. OMG meta-modelling pyramid

As argued in Chapter 3, the gHMM is designed as a meta-model of the vehicle health management function, thus the first direction is necessary for its instantiation into a gHMM instance, whose definition is proposed in Definition 4.1.

Definition 4.1. (*gHMM instance*). A gHMM instance is the realization of the generic activities and information flows of the gHMM meta-model for a particular element within the vehicle.

Figure 4.1 depicts the main levels of modelling, as defined by the Object Management Group (OMG). According to this hierarchisation, a meta-model is the model that serves for

IV Designing health management in an IVHM modelling framework

explaining and defining relationships among components of the applied model itself (Génova, 2009). With respect to the OMG meta-modelling pyramid, the relation between M0, M1 and M2 levels is illustrated for the gHMM, and its instances in Figure 4.2. The model of vehicle health management conforms to the gHMM, and represents the functional view of a vehicle health management system.

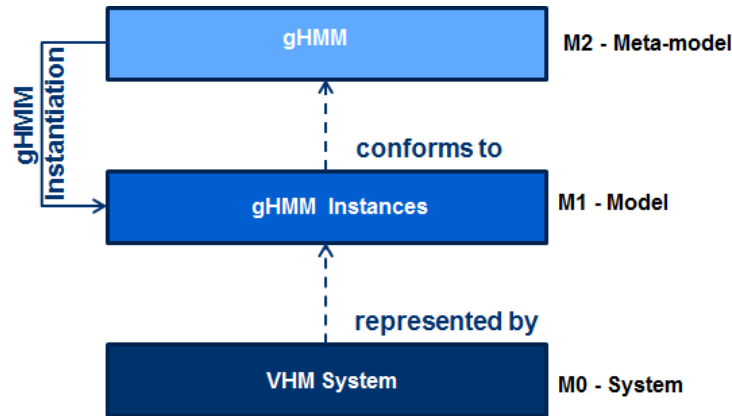

Figure 4.2. gHMM instances represent the VHM function and conform to gHMM

Therefore, the gHMM instantiation provides the methodology to be followed for designing particular occurrences of health management into several interconnected gHMM instances. The functional architecture composed out of gHMM instances realizes as a whole the health management function, defined in the first chapter (Definition 1.7) as: *“The Vehicle Health Management is an IVHM function enabling the decision support for enterprise level functions, transforming raw measures of relevant parameters of the vehicle’s health into actionable information for maintenance and operations”*.

From a modelling standpoint, this is illustrated as a block definition diagram in Figure 4.3, where the stakeholders of the gHMM are linked to the health management functional architecture composed out of several gHMM instances.

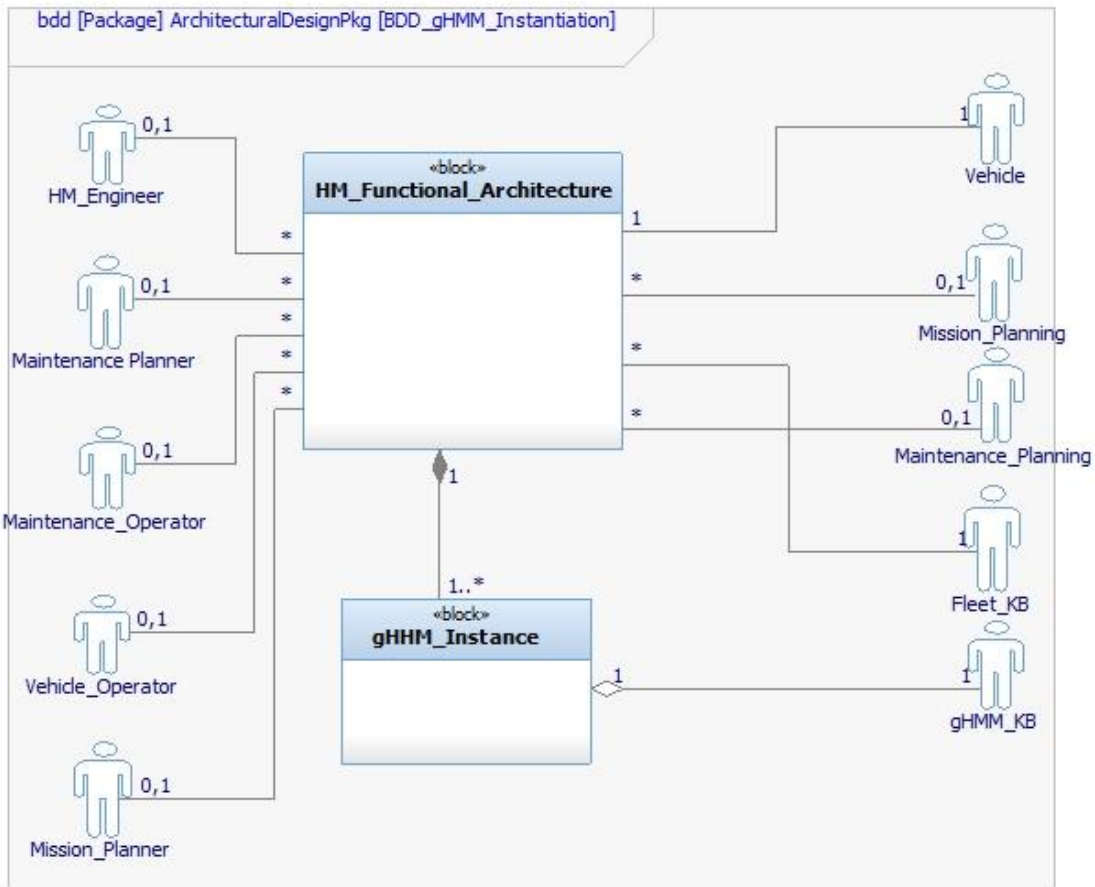

Figure 4.3. Block definition diagram of gHMM instances

The Block Definition Diagram in Figure 4.3 would enable a flat view of gHMM instances forming the HM architecture, their identification and interconnections are defined in two main phases (black and white-box phases), exposed in the following section.

4.2.2 gHMM instantiation phases

The gHMM instances are designed following an instantiation procedure whose main phases progressively develop the black-box (Phase 1), and white-box (Phase 2) HM functional architecture. The main steps of these two phases are the following:

Black-box instantiation phase

- Step 1. Selection of HM stakeholders and their interactions with the vehicle health management function.** A gHMM instance could interoperate with other functions of an IVHM system, for instance as depicted in the Figure 4.5, for receiving parameters of the current and future vehicles mission, which are required by decision support process.

Step 2. Identification of gHMM instances. The required gHMM instances for performing the use cases issued out of Step n°1 are identified based on the hierarchical distribution of the vehicle system.

Step 3. Selection of gHMM processes and of their interconnections. Based on the identified gHMM instances issued of Step n°2, and on the instantiated use cases from Step n°1, the selection of health management processes to be instantiated for each gHMM instance and of their interconnection is performed.

White-box instantiation phase

Step 4. Selection of elementary activities and of their interconnections. Elementary activities required to perform each of the instantiated processes, as well as the information flow between selected elementary activities are identified.

Step 5. Selection of algorithms supporting elementary activities. The behaviour of a gHMM instance is defined by considering a set of multi-criteria characterizing the gHMM instance and its supported element based on which the selection of algorithms supporting each of gHMM elementary activities is performed.

Step 6. Dynamic reconfiguration of gHMM instances. The temporal evolution of multi-criteria can impact availability of input required by activities. In this case, algorithm reconfiguration for each of the instantiated activities is defined, as well as their cascading impact on other gHMM instances receiving outputs from the reconfigured one.

Step 7. Simulation of gHMM instances. Based on the implementation of defined behaviour of each elementary activity in order to validate their integrated behaviour within the vehicle health management function; the execution of gHMM instances is enabled by the modelling environment of the gHMM (IBM Rational Rhapsody) in the IVHM modelling framework.

4.2.2.1 Black-box instantiation

The black-box instantiation phase is aimed at defining the structure of the health management functional architecture for a system-of-interest defined by gHMM instances and their underlying processes.

The first step of this black-box phase (**Step 1**) goes through health management stakeholders needs for the system-of-interest, with the aim of isolating a set of requirements out of the generic ones to be considered for the gHMM instantiation. Based on this set of requirements

applicable for the system-of-interest, gHMM use cases to be instantiated can be identified by using the links between requirements and use cases of SysML-based gHMM model (Chapter 3 – Figure 3.6).

Based on the instantiated gHMM use cases, the output of this first step of the instantiation is represented by the interactions between HM functional architecture and its stakeholders, defined for each of the instantiated use cases. This set of interactions is used within the following step (**Step 2**) for identifying gHMM instances required for realizing the instantiated use cases, and their interactions within the hierarchical functional architecture, which reflects the hierarchical levels of the system-of-interest. This step’s output is illustrated in Figure 4.4, for a three hierarchical level HM functional architecture, composed of system, N sub-systems and their underlying components. This step is the key for identifying all of the gHMM instances required for each element of the system’s hierarchical architecture.

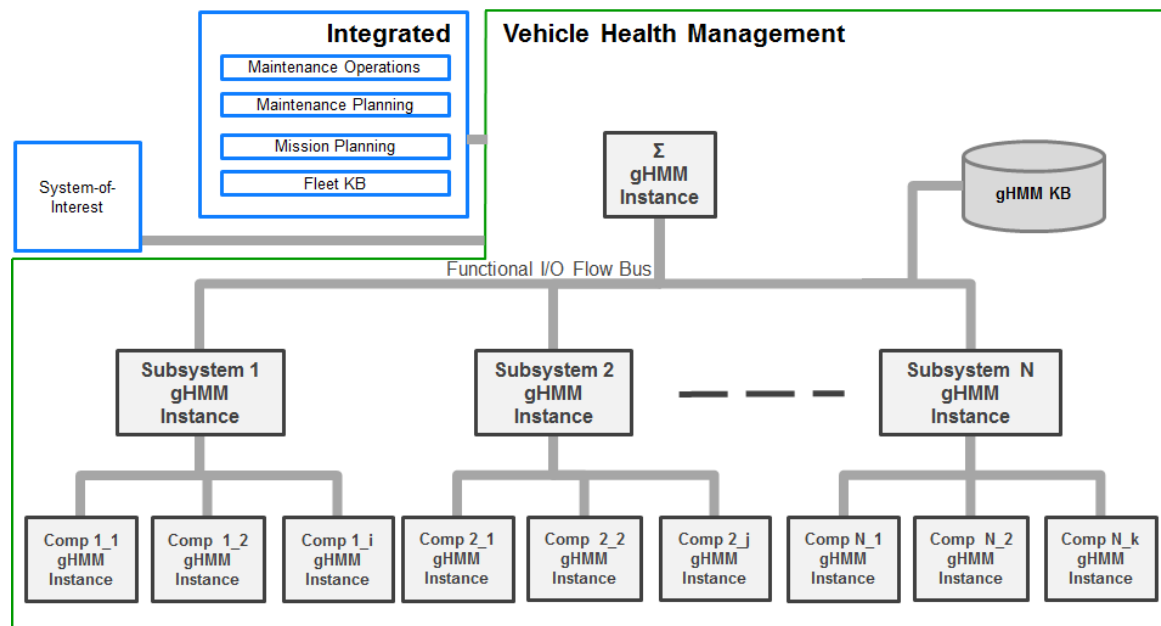

Figure 4.4. Hierarchical view of gHMM instances

Based on the identified gHMM instances, the next step of the black-box instantiation (**Step 3**), identifies the processes involved in each of the instantiated use cases, determined based on use case activity diagrams, and distributed within gHMM instances for the system of interest. A possible output of Step n°3 illustrating the processes selected for gHMM instances is provided in Figure 4.5, for two hierarchical levels gHMM instances (system and sub-system), interconnected with enterprise level functions of IVHM (maintenance operations, and mission planning).

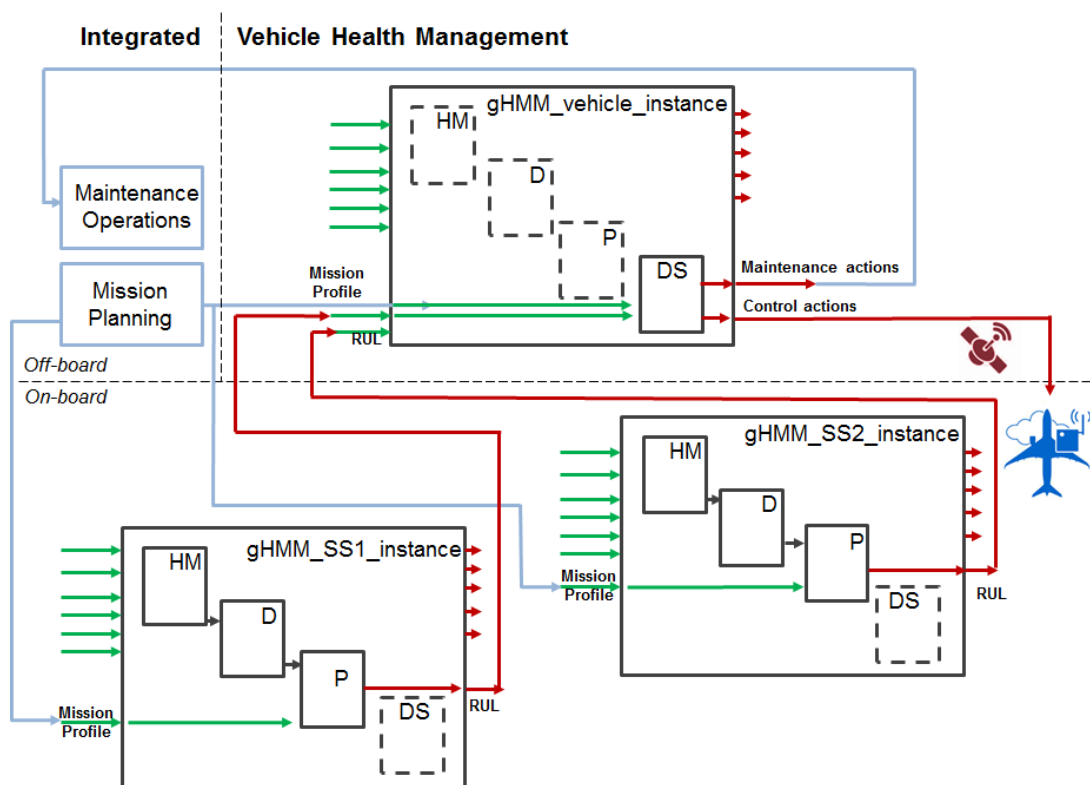

Figure 4.5. gHMM instantiation principle illustration

As output of these three steps, a black-box functional architecture is built encompassing gHMM instances, their underlying processes, and their interconnections. The following white-box instantiation steps, refining the black-box health management architecture are enounced in the following section.

4.2.2.2 White-box instantiation

Based on the black-box architecture, the white-box phase's goal is to define the behaviour of each gHMM instance by algorithms supporting each elementary activity, and by input/output information flow exchanged between its elementary activities. The white-box phase is structured into four main instantiation steps, which go through the selection of required gHMM elementary activities, and information flow within each of the processes (**Step n°4**) identified in output of the black-box phase.

Based on the identified activities at **Step n°4**, the selection of algorithms supporting each of the elementary activities is achieved at **Step n°5**. In order to perform this step, the white-box instantiation requires an analysis of the criteria determinant for the selection of algorithms supporting each elementary activity of the gHMM, which is delved deeper in the following section. The temporal evolution of criteria could impact availability of activity input and can thus

trigger algorithms' reconfiguration, which is performed iteratively at **Step n°6**. In fact, this reconfiguration is enabled by the relation container – content between an instantiated elementary activity and its supporting algorithm. This dynamic relation where an elementary activity is a container of an algorithm (content) selected in accordance with the multi-criteria characterization is illustrated generically in Figure 4.6.

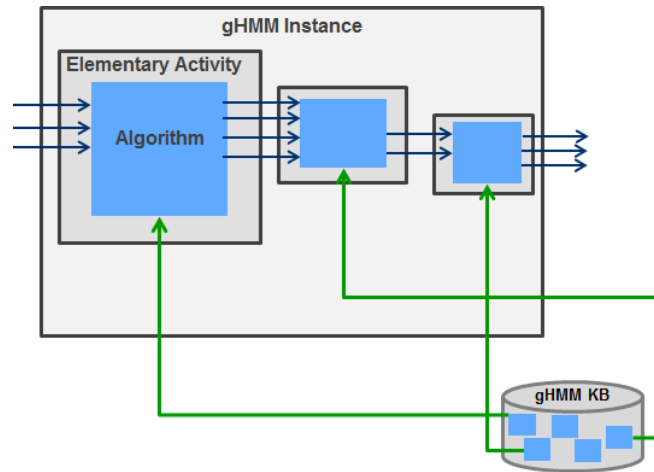

Figure 4.6. Relation between algorithm – elementary activity in a gHMM instance

The final instantiation step (**Step n°7**) harmonizes the overall gHMM instances issued out of the previous steps into a simulation which is aimed at validating their integrated behaviour within the vehicle health management function; the execution of gHMM instances is enabled by the modelling environment of the gHMM (IBM Rational Rhapsody) in the IVHM modelling framework.

Among the four steps of the white-box instantiation, Step n°5's operational thread corresponds to one of the gHMM use cases (Use Case n°10⁵), whose main actions perform the selection and evaluation of algorithm performance. The multi-criteria analysis, formalization, and selection of health management algorithms represent the main contribution to the white-box gHMM instantiation, and are tackled in the remainder of this chapter.

4.3 Multi-Criteria determinant in health management design

Designing a suitable combination of algorithms supporting health management is considered as the key of an IVHM system (Esperon Miguez, 2013). Towards this goal, the

⁵ Its activity diagram is found in Appendix D, Figure A.33.

challenge of selecting a suitable health management algorithm based on the myriad of existing surveys on diagnostics and prognostics methods has been addressed in the problem statement of the thesis (Section 1.3.2.3), and has lead us to identify the lack of a methodology of appropriately designing diagnostics and prognostics based on vehicle and IVHM systems considerations (Scientific Problem n°1).

This section is thus aimed at tackling this problem, in continuity of the system vision of an IVHM modelling framework, proposed in Chapter 2. The leitmotif of the section is thus the concept of system, dissected from its four perspectives proposed in Chapter 2 in order to identify multi-criteria determining health management behavioural design.

4.3.1 Formalization of multi-criteria

The purpose of this analysis is to define the set of criteria characterizing the four system views proposed in Chapter 2 (Section 2.2.1), and determinant for accordance and effective selection of health management algorithms next to vehicle, and to IVHM systems' characteristics. In this regard, the figure introduced at that point of the thesis is reproduced here-after. Being based on Davidz, 2006 conceptual perception of systems thinking, Figure 4.7 encompasses general system views evolving at different time scales throughout its life cycle, which have been defined in Chapter 2 as:

- **Physical:** defines how a system is constituted internally;
- **Functional:** defines how a system manifests internally;
- **Operational:** defines how a system manifests externally;
- **Dysfunctional:** defines how a system degrades and fails to provide its intended function.

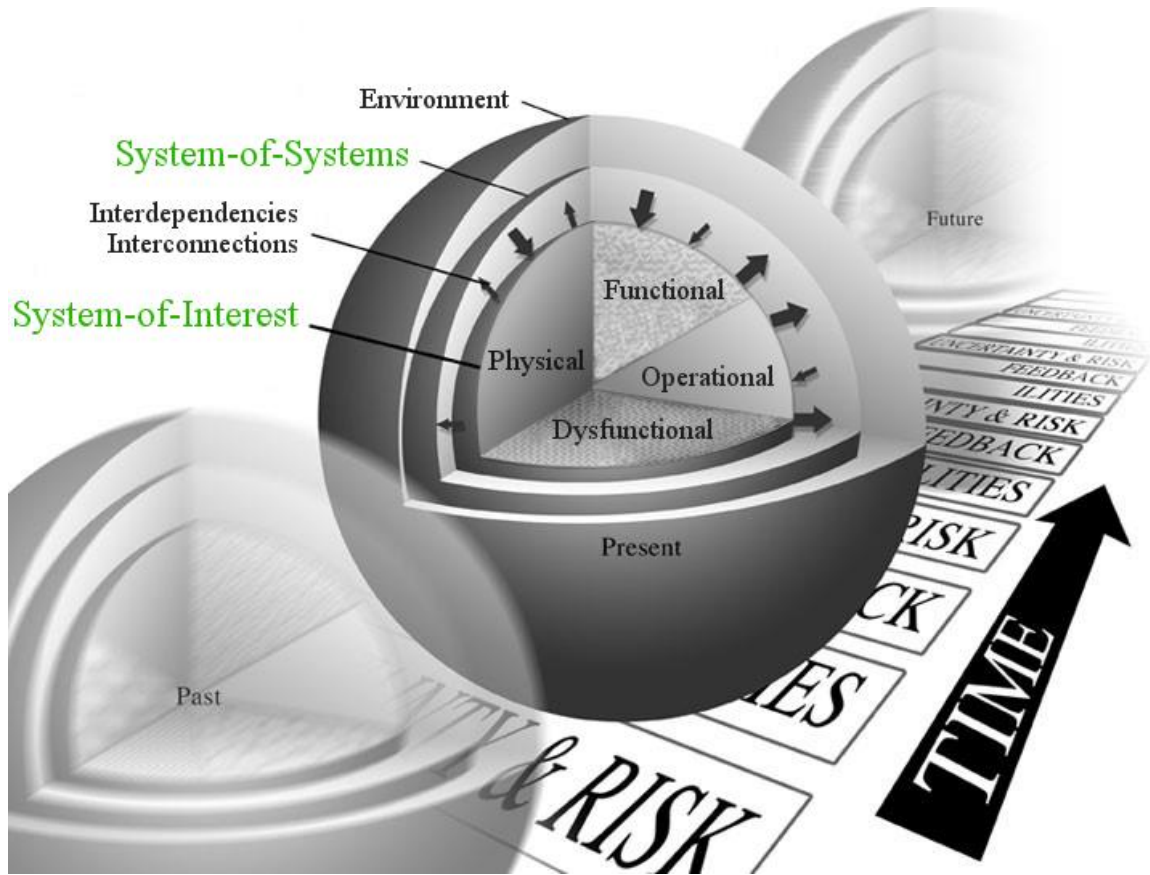

Figure 4.7. Conceptual perception of systems thinking – based on Davidz, 2006

Based on this representation of system views, issued of General System Theory (Laszlo et al., 1998) and of Systems Engineering (INCOSE, 2010) general principles, the multi-criteria composing these four systems views are synthetized in Table 4.1. Their description is provided here-after, with the purpose of identifying relationships between criteria, their nature, and value ranges. This investigation is a pre-requisite for the proposal of a knowledge representation (Figure 4.15) of the multi-criteria determining the selection of health management algorithms in an IVHM modelling framework.

System View	N°	Macro-Criteria	Nature
Physical	1	Hierarchical level	qualitative
	2	On-board/on-ground implementability	qualitative
	3	Distribution	qualitative

IV Designing health management in an IVHM modelling framework

	4	Technological heterogeneity	qualitative
Functional	5	Dynamic modelling	quantitative and qualitative
	6	Performance evaluation	quantitative and qualitative
Operational	7	Mission Profile	quantitative and qualitative
	8	Costs	quantitative and qualitative
Dysfunctional	9	Dysfunctional characterization	quantitative and qualitative
	10	Knowledge on the System-of-Interest	qualitative

Table 4.1 Synthesis of system views and criteria

4.3.1.1 Physical view

As the analysis of health management systems revealed in Chapter 2, the **hierarchical level (Criterion n°1)** impacts HM algorithm selection for a specific item of the vehicle system. It also impacts the integration of a selected algorithm with interacting items and on higher hierarchical level parts of the system. Regarding distribution within the systems structure, it is approached in two complementary aspects: **on-board/on-ground implementability (Criterion n°2)**, and **level of distribution (Criterion n°3)** within the vehicle. These two criteria impact an algorithm selection and respectively configuration. For instance an on-ground algorithm is not constrained to limited computational performance, however it is constrained by availability and performance of communication means between the vehicle and a ground stations (Hoffmann et al., 2011), often associated to the nature of the vehicle mission (Mikat et al., 2011), revealing a constraint relationship between **Criterion n°2**, and the mission type assigned to the vehicle (**Criterion n°7.1**).

Regarding the level of **distribution (Criterion n° 3)** within the on-board segment, Swearingen et al., 2007 considers that an IVHM system should be distributed across components, sub-systems and system, as a reflection of the systems structure. This criterion is thus an attribute of the system-of-interest entity (**Criterion n°1**). “Listening to an aircraft health, like a stethoscope” (Atlas et al., 2001) outlines that health management should take advantage of this distribution in order to detect any deviation from the nominal behaviour of the system and its constituents. In case of a distributed architecture, health management data can be acquired and

processed locally, preventing signal losses and providing fast responses to degradation or failure detection. On the other hand, a centralized architecture would acquire the health management data centrally having as consequence losses in signal acquisition and possibly lower feedbacks for impending faults, which should be considered for the selection of an appropriate health monitoring algorithm.

Lastly the physical view of the system is determined by technological characteristics and interactions between its parts (DoD, 2001). **Technological heterogeneity (Criterion n°4)** is thus an attribute of each of the hierarchical elements identified by **Criterion n°1**. Vehicle health management design must take into consideration all the technologies embedded in the system, mainly represented by mechanics, electrical, electro-mechanics, electronics, hydraulics and optronics (Reveley, 2010). These technological types are thus value ranges of **Criterion n°4**. As outlined by Reveley et al., 2010, a plethora of IVHM contributions are technological ones, focusing on application of health management techniques for a panel of damage condition tied different technological nature of vehicle subsystems and components. From this perspective, the multi-criteria could be refined upon three complementary genericity levels associated to:

- General health management models/algorithms can be applied independently from the application field;
- Domain models/algorithms are related to their application field;
- Specific model/algorithms are applied for a particular class of systems.

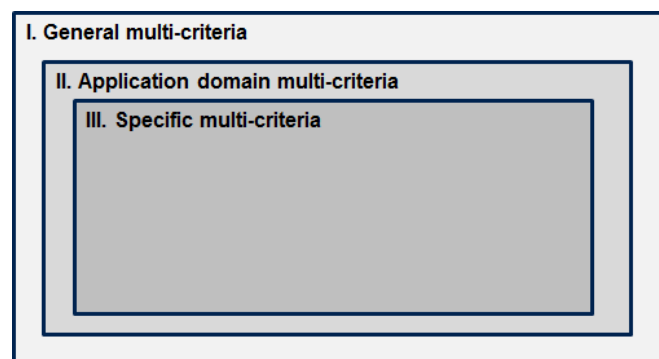

Figure 4.8. Three genericity levels of multi-criteria

For instance, the algorithm proposed in Chapter 3 for reduction of ambiguity groups activity is not dependent on its application field (Class I of Figure 4.8), while in Kalgren et al. 2007, the authors study failure mechanisms through accelerated aging on electronic components, for prognostics purposes, thus being part of the Class III of Figure 4.8. Still, in the case of electronic systems, health monitoring and prognostics are challenging topics for identification of

failure precursors and mechanisms is a concern because of increasing electronics to control safety-critical vehicle sub-systems (Kulkarni et al., 2012).

4.3.1.2 Functional view

In complex systems, components interactions are most of the times nonlinear, difficult to define by cause to effect relations, their complex interdependencies can be understood by their common purpose at the level of the whole (Heylighen, 1998), which can be meaningless at component level and vice-versa. To this extent, the functional view defines how the physical parts of the systems dynamically collaborate for accomplishing the system's functions, being evaluated qualitatively, quantitatively and temporally (Richards et al., 1998). Two functional criteria emerge from this statement, where **dynamical modelling (Criterion n°5)** of the system represent functional and inter-functional relationships (DoD, 2001); while **performance evaluation (Criterion n°6)** measures the effectiveness of the vehicle health management function of IVHM.

Regarding **Criterion n°5**, three main classes of dynamic models can be distinguished: discrete, continuous and hybrid dynamic models (Sethumadhavan et al., 2011) have a direct correlation with classes of algorithms to select for health monitoring process of the part under monitoring. A discrete event system is characterized by discrete states, which evolve under certain changes in its environmental context or inputs, which are called events (Sheppard et al., 2008). Examples of discrete event systems include embedded systems, traffic and transportation systems, digital circuits. Continuous models are representations of the system based on continuous time, typically expressed by differential or integral equations, which can be resolved by analytical and numerical simulations. Current modelling techniques of modern vehicle systems comprise both discrete and continuous models which mix discrete difference equations and continuous differential or integral equations. Such dynamic models are called hybrid (Schlegl et al., 1997). From this description **Criterion n°5** takes mainly three qualitative values, and characterizes a part of a vehicle, therefore being an attribute of **Criterion n°1**.

Performance evaluation (Criterion n°6) represents the **relationship** between an algorithm and its supported part, characterizing through a set of quantitative and qualitative measures, effectiveness of vehicle health management algorithms. This criterion is often considered in diagnostics and prognostic surveys of Venkatasubramanian, 2003, and Marzat et al., 2012, from which a set of sub-criteria have been derived:

- Computational complexity (**Criterion n°6.1**) represents the mathematical characterization of the difficulty of a mathematical problem which describes the resources required by a computing machine to solve the problem.
- Response rapidity (**Criterion n°6.2**) is the time required for the diagnostics/prognostic algorithm to react to failure/degradations detection.
- Robustness (**Criterion n°6.3**) characterizes the persistence of the behaviour expected from the activity under perturbations or conditions of uncertainty.
- Adaptability (**Criterion n°6.4**) characterizes the capability of an algorithm to evolve to due changes in inputs or other changes due to structural, operating and environmental conditions, and to availability of new information from the system-of-interest.
- Validity (**Criterion n° 6.5**) implies the correct assessment of the system's current and future health. A valid diagnostic result implies that at least one of the elements in ambiguity groups represents the complete set of failed LRUs within the item (Belard, 2012), while in case of prognostics, a valid prognostics result implies that RULs are evaluated for the right degradations in the system: functional degradation and/or component degradations (Vinson, 2013).
- Certainty (**Criterion n°6.6**) provides an estimation of uncertainties impact on health management outputs, expressed as a percentage (OSA-CBM 3.3.0). Different types of uncertainties exist (Goebel et al., 2012):
 - Systematic ones are model uncertainties, which can be caused by numerical errors, un-modelled phenomenon, system, and health management models;
 - Statistical uncertainties may be caused by input and manufacturing variability;
 - Unknown uncertainties are linked with the way data and information is collected and processed and may be caused by sensor noise, and coverage, loss of information in pre-processing, simplification, and approximation;
 - A mix of all the above types can characterize operating environment uncertainties, such as unforeseen future load and conditions, variability in the mission profile.

4.3.1.3 Operational view

Moving forward to systems' operational view, mission and operational environment (Mitall et al., 2013) impacting system's physical and functional condition, represent entities which are associated to the system (Criterion n°1).

The **mission profile (Criterion n° 7)** assigned to the vehicle system is a factor determining operational environment during which the vehicle and its IVHM system should perform their required functions. Variability in the mission profile impacts selection of prognostics algorithms, as they infer on this information to produce a future evolution of degradations within the item. Such models are dependent on variability of the mission profile of the vehicle system (Goebel et al., 2010), and can be divided into:

- Statistical methods based on reliability: estimate the evolution of degradations under nominal usage conditions, such as for instance Weibull analysis;
- Statistical methods based on stress: estimate the evolution of degradation under specific usage conditions (loads, vibration), such as for instance proportional hazard models;
- Model-based methods: estimate the evolution of degradation modelling specific usage and degradation conditions such as cumulative damage model, particle filtering state estimation method.

Criterion n° 7 is divided into several sub-criteria characterizing **mission type (Criterion n°7.1)**, its **phases (Criterion n°7.1)**, **variability (Criterion n°7.1)** of mission profiles assigned to the vehicle, and environmental conditions impacting vehicle's health condition (DoD, 2001). These characteristics are not generic ones, depending on the class of systems they are applied to (Class II in Figure 4.8). For instance, the main mission phases of a military A/C system (Gallagher et al., 1992) are depicted in the following figure:

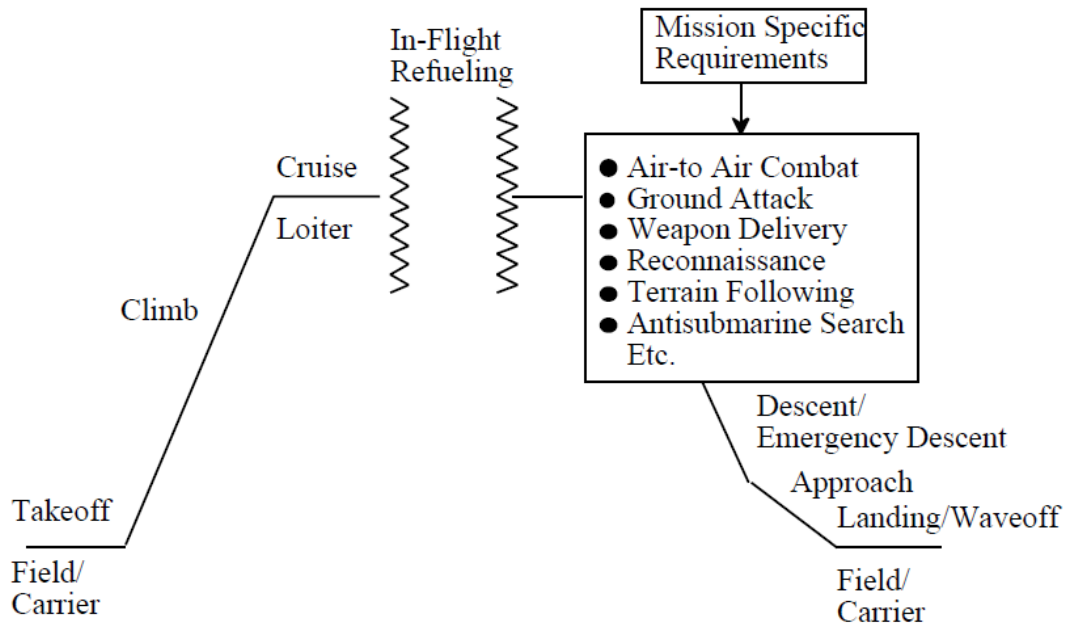

Figure 4.9. Generic mission profile – Gallagher et al., 1992

Operating conditions of each **mission phase (Criterion n°7.2)** are determined by the location and orientation in which an element of the system is installed; their level of protection in the system, and the environment that influences its operation. Moir et al., 2008 categorizes factors impacting operating conditions in two main categories:

- Generated externally (**Criterion n°7.2.1**) by the environment in which the system operates;
- Generated internally (**Criterion n°7.2.2**) by the system itself additional to external factors.

External	Internal
External temperature	Temperature generated by the system's operation it-self
Rain, humidity, moisture	Vibration
Wind	Acoustic Noise
Salt Fog and Mist	Contamination by fluids (fuel, oil, grease, de-icing fluid, wash fluid, hydraulic fluid)
Sand and Dust	
Altitude, environmental pressure	

IV Designing health management in an IVHM modelling framework

Solar radiation	Explosive Atmosphere
Immersion	RF Radiation
Fungus	
Vibration	
Shock (heavy landings, deliberate air-drop, violet manoeuvres)	
RF Radiation	

Table 4.2 Synthesis of environmental factors for an A/C system

With respect to the operational view, the second chapter has argued that IVHM systems design is governed by assessment of operational benefits it could provide to system stakeholders. This statement reflects in the multitude of contributions focusing on cost benefit analysis (CBA) as decision enablers of its development. Two of these contributions are discussed here-after where cost (**Criterion n°8**) measures the benefits produced by the IVHM system throughout the vehicle's life cycle. For instance, Esperon Miguez, 2013 contributes to IVHM cost-benefit analysis by establishing a mathematical expression for maintenance cost and time affected to each failure mode of a system as function of diagnostics and prognostics reliability (Figure 4.10):

Detectability with IVHM			Cost	Downtime	
Long Term Prognosis	Short Term Prognosis	Diagnosis			
P_F	$1-P_{LP}$ SUCCESS		C_{LP}	t_{LP}	
	P_{LP} FAILURE	$1-P_{SP}$ SUCCESS	C_{SP}	t_{SP}	
		P_{SP} FAILURE	$1-P_{FN}$ SUCCESS	C_D	t_D
			P_{FN} FAILURE	C_{FN}	t_{FN}
$1-P_F$		$1-P_{FA}$ SUCCESS	0	0	
		P_{FA} FAILURE	C_{FA}	t_{FA}	

Figure 4.10. Event tree analysis of HM tools - Esperon Miguez, 2013

$$C = P_F((1 - P_F)C_{LP} + P_{LP}((1 - P_{SP})C_{SP} + P_{SP}((1 - P_{FN})C_D + P_{FN}PC_{FN}))) + (1 - P_F)P_{FA}C_{FA} \quad (4- 1)$$

$$t = P_F \left((1 - P_F) C_{LP} + P_{LP} \left((1 - P_{SP}) C_{SP} + P_{SP} \left((1 - P_{FN}) C_D + P_{FN} P t_{FN} \right) \right) \right) + (1 - P_F) P_{FA} t_{FA} \quad (4-2)$$

, where C is used for costs, P designates probabilities, and t represent a period of time.

In the same direction, Mikat et al., 2012 proposes a hierarchical framework assessing the benefits of implementing condition-based maintenance to ensure customer satisfaction criteria, based on the following hierarchical criteria:

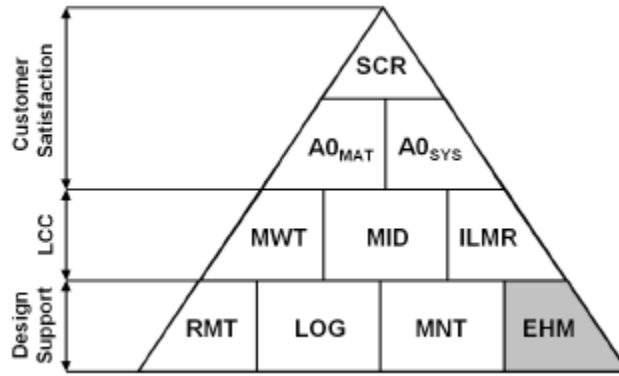

Figure 4.11. CBA framework - Mikat et al., 2012

Customer satisfaction (SCR) is at the top of Mikat et al., 2012 pyramid, derived in operational availabilities of the system-of-interest (AO_{SYS}) and resources required to support the system specific services (AO_{MAT}), which can vary from the field of military missions to transporting passengers in civil transportation or cargo for industrial purposes.

$$SCR = AO_{MAT} * AO_{SYS} \quad (4-3)$$

,where AO_{MAT} is the operational availability of resources required to support the system's mission, such as payload for aircraft missions, products or material for commercial or industrial use, and AO_{SYS} the operational availability of the system-of-interest, defined as:

$$AO_{SYS} = \frac{1}{1 + \lambda_{SYS}(MTTR_{SYS} + MWT_{SYS})} \quad (4-4)$$

,where λ_{SYS} is the overall failure rate $MTTR_{SYS}$ is the mean time to repair of calculated based on each LRU failure mode failure rate λ_i and individual $MTTR_i$,calculated by (4-5). MWT_{SYS} denotes how much time is lost for waiting resources.

$$MTTR_{SYS} = \frac{\sum_i \lambda_i \cdot MTTR_i}{\sum_i \lambda_i} \quad (4-5)$$

Esperon Miguez, 2013, and Mikat et al., 2012 clearly outline the financial factors which constrain IVHM systems development; however the link between the cost and health management algorithms selection is not clearly identified. It is our belief, that this criterion binds the system-of-interest with associated algorithms by a cost relationship.

Based on these two frameworks proposals, and in-line with the life cycle vision of an IVHM system, we conclude that integrating health management capabilities must be driven by trade-offs analysis during early design assessing **cost (Criterion n° 8)** estimations for the life cycle stages (Figure 4.12) against stakeholders' performance requirements.

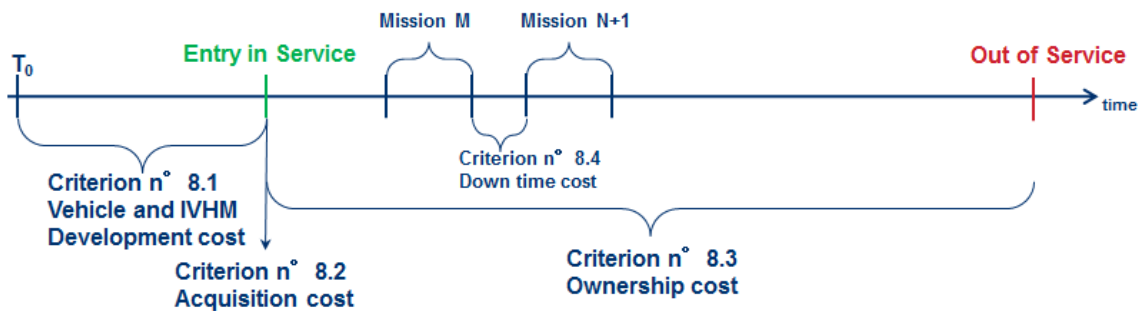

Figure 4.12. Cost - criterion n°8

Financial justification in IVHM development lead to consider different cost types, characterizing both vehicle and IVHM costs: vehicle and IVHM development cost, vehicle acquisition cost, cost of vehicle down time, overall ownership cost, and benefit generated by IVHM development.

4.3.1.4 Dysfunctional view

The **dysfunctional characterisation (Criterion n°9)** of the vehicle system is concerned with failure and degradation propagation throughout the target system. Dysfunctional paths from degradation and failure modes to their effects within the system are sine-qua-non for isolation of root causes of failures, as well as for component and functional remaining useful life (RUL) evaluation. Moreover, the coverage of failure and degradation modes within the system can be established through dysfunctional analysis of the system of interest, such as Failure Mode and Criticality Analysis (FMECA) and Hazard and Operability (HAZOP) which are used for identifying temporal characteristics, severity, and temporal frequency sub-criteria. These sub-

criteria are thus attributes characterizing a failure mode, attributed to a part of the system-of-interest.

Temporal progression (Criterion n°9.1) of failures determines the ones which are prognosticable. In this regard, Byington et al., 2006 classification is reminded in the following figure, leading to four classes of fault progression, from whom the authors classify the last one as candidate to prognostics assessments.

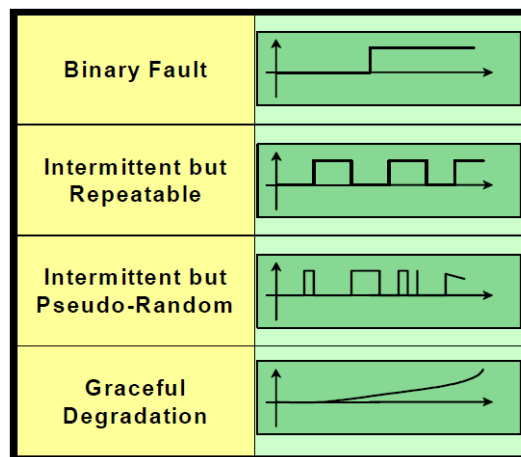

Figure 4.13. Fault progression characterisation – Byington et al., 2006

Severity (Criterion n°9.2) is issued of the FMECA, assessing the worst potential consequence, defined by the degree of injury or damage which could occur. This criterion is used for ranking failures and degradation modes and putting the priority on the most critical ones. The following levels are issued on the NASA classification (NASA, 2007):

IV) Negligible: Condition that would require first aid treatment, though would not adversely affect personal safety or health, but is a violation of specific criteria;

III) Marginal: Condition that may cause minor injury or occupational illness, or minor property damages to facilities, systems, or equipment;

II) Critical: Condition that may cause severe injury or occupational illness, or major property damage to facilities, systems or flight hardware;

I) Catastrophic: Condition that may cause loss of life or permanently disabling injury, facility or system destruction on the ground, or loss of crew, major systems or vehicle during the mission.

Frequency of occurrence (Criterion n°9.3) is classified into five classes classification (NASA, 2007):

IV Designing health management in an IVHM modelling framework

$10^{-3} \geq X$ E: Improbable to occur (No known occurrences on similar products or processes);

$10^{-3} > X > 10^{-6}$ D: Unlikely to occur (Low - relatively few failures);

$10^{-2} \geq X > 10^{-3}$ C: May occur in time (Moderate -occasional failures);

$10^{-1} \geq X > 10^{-2}$ B: Probably will occur in time (High - repeated failures);

$X > 10^{-1}$ A: Likely to occur in time (Very high - failure is almost inevitable).

Based on these severity and frequency of occurrence criterions, a **criticality** index is associated to each failure mode; the following table provides NASA's criticality calculation.

	PROBABILITY ESTIMATE				
SEVERITY CLASS	A	B	C	D	E
I	1	1	2	3	4
II	1	2	3	4	5
III	2	3	4	5	6
IV	3	4	5	6	7

Table 4.3 Severity – probability assessment (NASA, 2007)

Standard classifications of diagnostics and prognostics techniques are often based on available **knowledge on the system-of-interest (Criterion n° 10)** characterized by observability of the system-of-interest, and classes of a-priori knowledge representing the relationship between the system item and a health management algorithm. Based on the classification developed in section 1.3.2.3 of the first chapter, the following main classes of **a-priori knowledge (Criterion n° 10.1)** on the system-of-interest are employed for health management purposes (Geanta et al., 2012):

- **Quantitative model-based knowledge:** accurate mathematical and physical functional equations, as well as degradation and reliability laws and models,
- **Qualitative model-based knowledge:** qualitative functional, dysfunctional and degradation, reliability relationships,
- **Hybrid (quantitative and qualitative) knowledge:** integrate complementary features of quantitative and qualitative model based knowledge,
- **History-based knowledge:** feature extraction from large amount of historical data on the target system,

- **Expert-based knowledge:** domain expertise on reliability, dysfunctional and stochastic degradation data.

Criterion n° 10's values evolve at different time scales throughout the systems' life cycle determining the need of a dynamic selection of health management algorithms appropriate for their supported system. **A-priori knowledge (Criterion n° 10.1)** increases from the entry into service of the vehicle until its disposal and could thus determine update of health management algorithms, or considering new knowledge sources activating gHMM elementary activities. For instance, fleet knowledge gained throughout the utilization stage is in input of `Evaluate_Similarity_with_fleet_KB_diagnostics` aiming at consolidating diagnostics result by comparing it with similar diagnostics results from fleet knowledge base. As outlined by Monin et al., 2011 considering fleet component similarities and heterogeneities enhances health management when this knowledge becomes available within the fleet. At a more reduced time scale, changes in **observability (Criterion n° 10.2)** of the element under monitoring could change the link between available inputs and corresponding health management algorithms, and thus lead to dynamic changes of algorithms during the systems' operation.

4.3.2 Multi-criteria representation

From the investigation of criteria described here-above, the elements required for their representation can be identified as classes⁶ (for instance Mission- Criterion n°7), attributes⁶ (for instance Hierarchical Level- Criterion n°1), and relationships⁶ (for instance Cost - Criterion n°8). These required elements correspond to the primitives used for knowledge representation by ontology based representations (Monnin et al., 2011). Ontologies can be defined as a level of abstraction of data models intended for modelling knowledge about entities, their attributes, and their relationships to other entities.

Definition 4.2. (*Ontologies*). Ontologies specify semantics of terminology systems in a well-defined and unambiguous manner, by formally and explicitly representing shared understanding about domain concepts and relationships between concepts (Guarino, 1998).

⁶ Classes represent type of objects, interconnected by relationships, and characterized by attributes (properties, parameters or characteristic of objects). (Noy et al., 2001)

IV Designing health management in an IVHM modelling framework

Three main objectives of the representation lead us to select an ontology-based representation. The first one is the semantic⁷ modelling of the multi-criteria into a taxonomy whose entities, attributes and relationships, could enable its interpretation and interoperability (Yang et al., 2006), within a complex, cross-organizational system of systems (i.e. within an IVHM system). In this regard, several approaches of semantic representation enable different levels of semantic interoperability. Figure 4.14 shows the semantic continuum, as it has been defined in Uschold, 2003, as well as its utilisation in Wilmering, 2004, where seven existing approaches to software component information sharing are placed on the semantics continuum. Further an approach is found on the semantic continuum (Figure 4.14), more its semantic interoperability is high. For instance, OSA-CBM standard is situated by Wilmering, 2004 under XML schema, while AI-ESTATE standard is placed under formal information modelling languages, as standard which can solve semantic interoperability between diagnostics reasoners at different maintenance levels. Wilmering, 2004 places ontologies under formal information representation on the semantic continuum (Figure 4.14), as they are based on model-theoretic and axiomatic descriptions semantics.

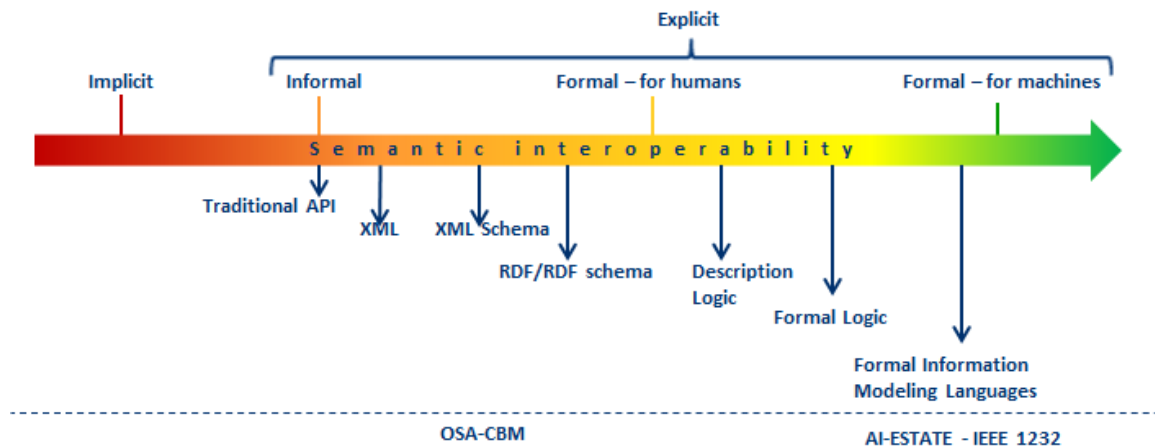

Figure 4.14. Semantic continuum based on Wilmering, 2004

The second objective of the multi-criteria representation is its specification at different genericity scales, enabling thus the three genericity levels of multi-criteria (Figure 4.8). In this regard, an ontology-based representation enables to define a generic taxonomy using the ten

⁷ Semantics is defined as the study of meanings of tokens and symbols in a particular context. (Meriam-Webster, An encyclopaedia Britannica On-line Dictionary).

generic criteria investigated in the previous section, while more specific criteria and their relationships can be implemented for more specific domain knowledge modelling.

Lastly, the third objective is a technical one, and seeks to represent the multi-criteria independently from its software implementation platform. As outlined in Monnin, et al., 2012, a great advantage of ontologies allows shifting from software technical problems to defining of the generic knowledge of the problem by a domain expert.

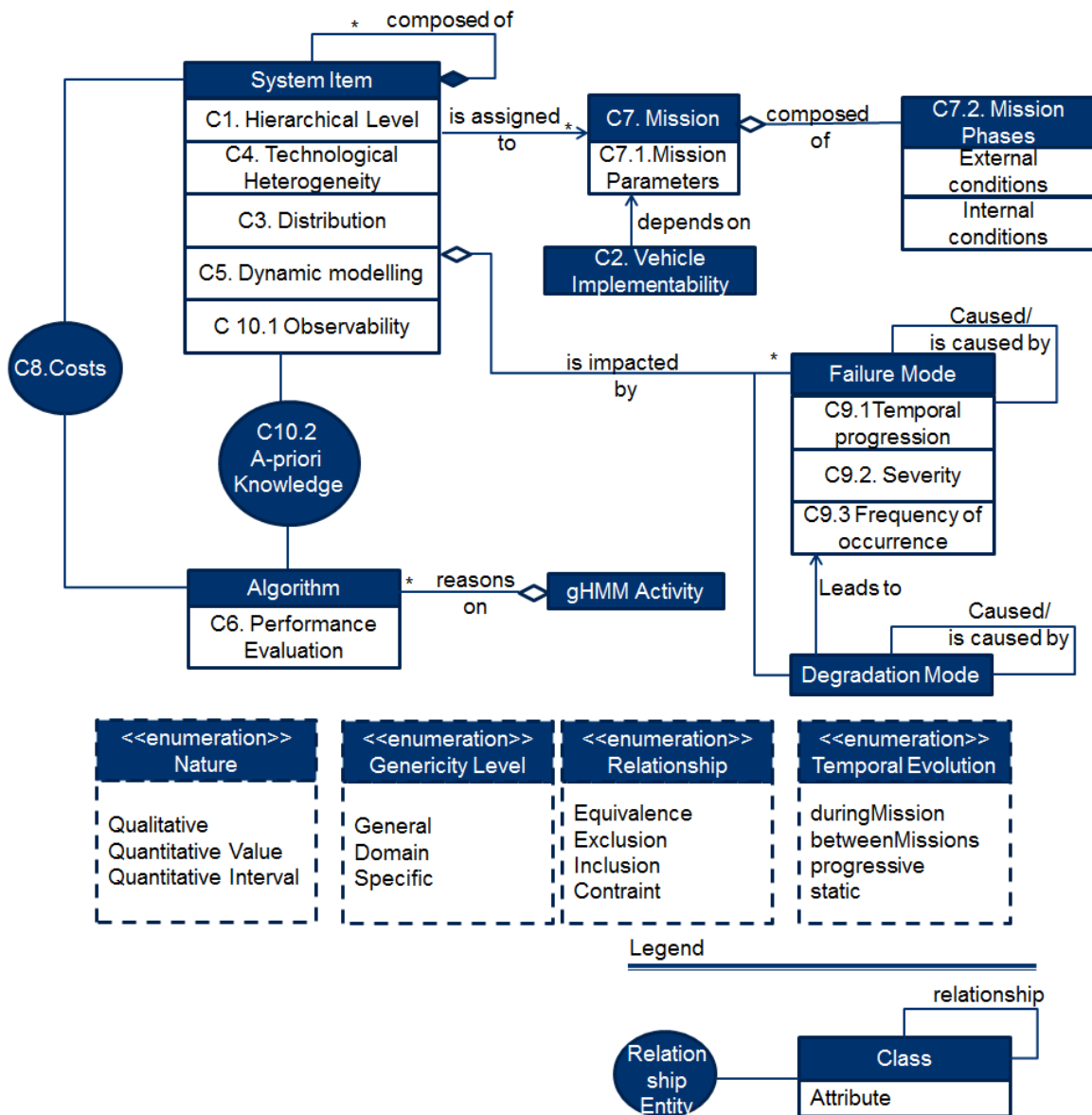

Figure 4.15. Multi-criteria ontology-based representation

Following these considerations, the use of ontologies for representing the multi-criteria (illustrated in Figure 4.15) enables the representation of classes, attributes and relationships

investigated in Section 4.3 and well as its semantic interoperability within an IVHM system in an unambiguous manner, by formally and explicitly representing a shared understanding of vehicle and its health management multi-criteria for selection of appropriate supporting algorithms.

Each entity of the multi-criteria (class, attribute and relationship) is characterized by a set of properties represented by enumerations (at the bottom of the figure) associated to concepts revealed in the Section 4.3:

- genericity level, following the three classes defined in Figure 4.8;
- temporal evolution intervals where criteria values are subject to change at different time scales throughout the system's life cycle;
- typology of criteria values: qualitative, quantitative interval, or value;
- relationships type between criteria.

Based on this multi-criteria representation, the remainder of the chapter focuses on their use within the white-box instantiation phase of the gHMM for selection of appropriate health management algorithms.

4.4 Multi-Criteria based selection

From representation of multi-criteria (the “what”) in the previous section, this section proposes their utilisation (the “how”) for appropriately selecting diagnostics and prognostics algorithms, as response to the scientific problem enounced in the beginning of this chapter. This utilization is directly connected to the IVHM modelling frameworks, more particularly it responds to Step n°5 of the white-box gHMM instantiation, proposed at Section 4.2.2 aimed at defining the behaviour of each gHMM instance by algorithms supporting each elementary activity. In order to perform the Step n°5, the multi-criteria selection of algorithms is formalized as Knowledge-Based Systems (KBS), where the selection is realized by a multi-criteria reasoning engine.

4.4.1 Multi-criteria knowledge engineering

The transition from an art into an engineering discipline of knowledge engineering in the 20th century (Studer et al., 1998) has lead to establishing appropriate methods, languages and tools for development of KBS. As underlined by Falquet, 2013, a KBS addresses knowledge representation, knowledge acquisition methods, as well as mathematical logic and reasoning.

Transposed to our multi-criteria selection problem, the multi-criteria KBS addressed the following elements (Figure 4.16):

- Representation of multi-criteria, and of their inter-relations into a knowledge base (KB), based on the proposal developed in the previous section;
- Mapping of input values in multi-criteria value of the KB;
- Acquiring new knowledge associating multi-criteria values to suitable health management algorithms;
- Reasoning Engine for the multi-criteria based selection of appropriate algorithms.

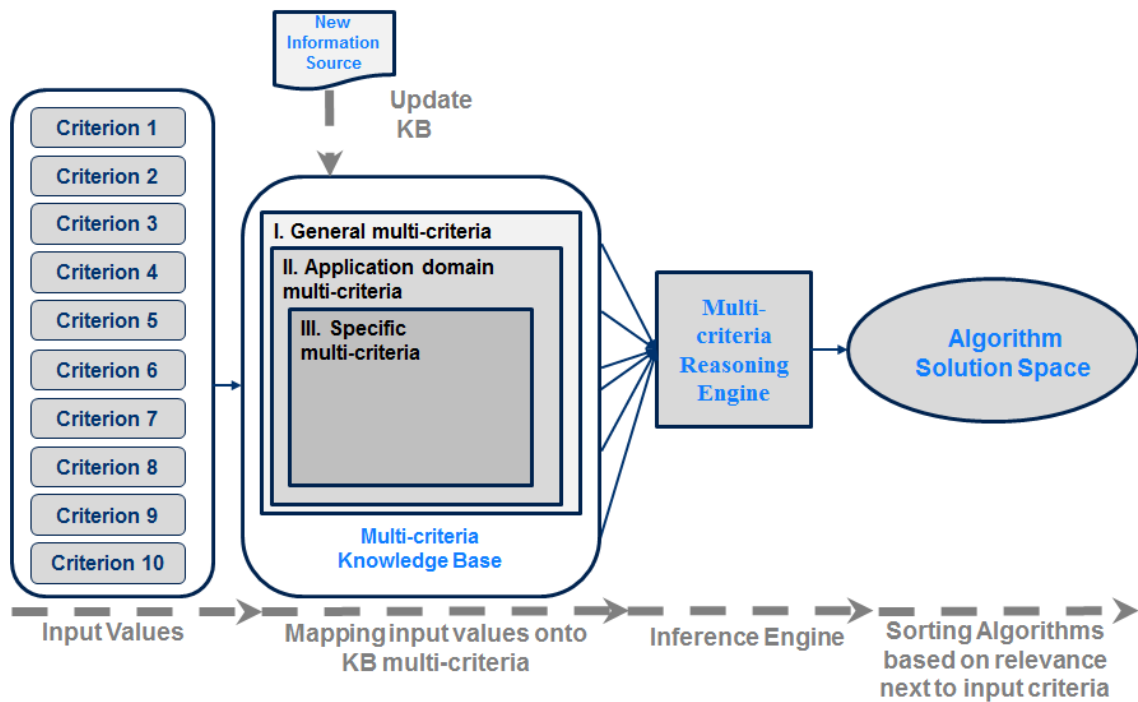

Figure 4.16. Architecture of a multi-criteria KBS

This multi-criteria KBS is directly connected to the IVHM modelling framework, more particularly it supports the white-box instantiation phase for selection of algorithms supporting instantiated activities of the gHMM based on the multi-criteria provided in input. This selection is based on a reasoning engine (Figure 4.16), whose main reasoning steps are proposed in the following section.

4.4.2 Multi-criteria reasoning engine

The reasoning engine of the multi-criteria KBS (Figure 4.16) infers on the multi-criteria knowledge base for finding the optimal solution space associated to input criteria. Three reasoning steps are proposed towards finding a solution space (Figure 4.17) for diagnostics and prognostics algorithms by using the three levels of genericity in the multi-criteria knowledge base.

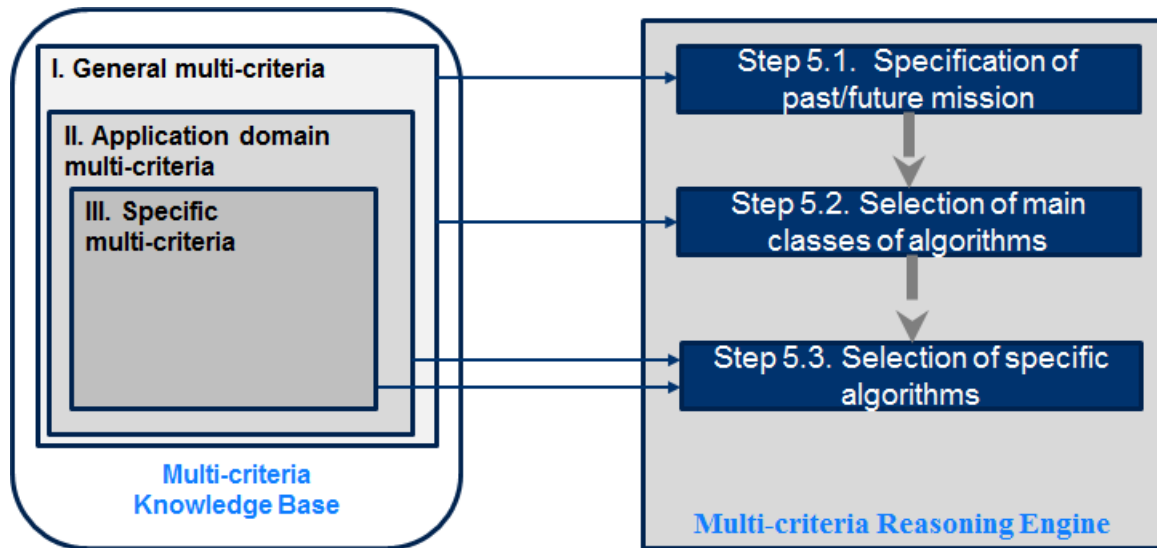

Figure 4.17. Three steps reasoning engine

Step n°5.1. The first step takes into consideration the future mission profile (**Criterion n°7**), and its modelling into a-priori knowledge (**Criterion n°10.1**) in order to recommend similar/heterogeneous selection of diagnostics and prognostics algorithms. This step leads to three cases issued out of the following processing:

```

IF a-priori knowledge (Criterion 10.1) models future mission profile THEN
    Select diagnostics and prognostics algorithms;
    IF mission profile (Criterion 7) is constant THEN
        Predefined mission profile for prognostics;
    ELSE
        Model the future mission profile for prognostics;
    END IF
ELSE
    Select only diagnostics algorithms;
END IF
    
```

Figure 4.18. Step n°5.1 reasoning

Case 1. If health management is based solely on available past utilization characteristics of the system, then diagnostics could only be considered.

Case 2. If systems' mission characteristics are constant, then selection of prognostics algorithms could be based on a predefined profile mission, thus future operating conditions are considered similar to past ones.

Case 3. If past and future mission characteristics of the target system are available, then the selection of prognostics algorithms should consider modelling of specific mission profile characteristics.

Step n°5.2. For the three above cases, diagnostics and prognostics classification synthesized in the first chapter (Section 1.3.2.3) are used as references for realizing a first categorization in four main classes of methods employed for IVHM illustrated in Figure 4.19. At this step three determinant criteria of the classification link the system-of-interest hierarchical level with health management algorithms based on a-priori knowledge and on cost (Figure 4.15).

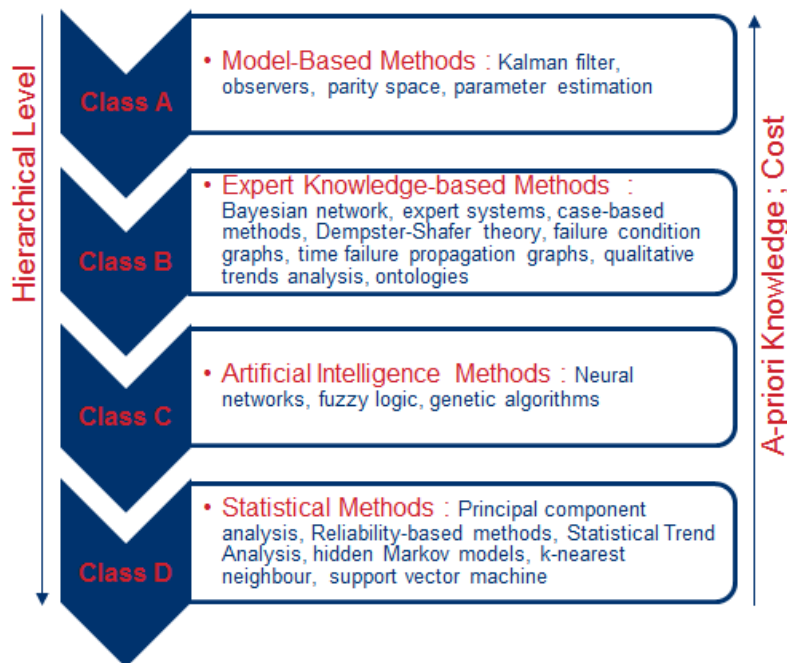

Figure 4.19. Main method classes for diagnostics / prognostics⁸

Based on **Criterion n°1**, class A is usually suited to component level, while the next classes could be applied at all hierarchical level of a system. This list is sorted by degree of a-

⁸ Note that considered methods in Figure 4.19 are not exhaustive.

IV Designing health management in an IVHM modelling framework

priori knowledge (**Criterion n°10.1**), and by implementation cost (**Criterion n°8.1**) required by algorithms. These three determinant criteria can thus be used in order to obtain a first solution space within one of the four classes:

C1. Hierarchical Level	C10.1. A-priori Knowledge	C8.1 Implementation cost	Algorithm Class
Component	Quantitative model-based	High	Class A
	Qualitative model-based	High	Class B
	Hybrid model-based	High	Class A
	Expert	High	Class B
	History-based	Moderate	Class C
		Low	Class D
Subsystem	Quantitative model-based	High	Class A
	Qualitative model-based	High	Class A
	Hybrid model-based	High	Class A
	Expert	High	Class B
	History-based	Moderate	Class C
		Low	Class D
System	Qualitative model-based	High	Class B
	Expert	High	Class B
	History-based	Moderate	Class C
		Low	Class D

Figure 4.20. Step n°5.2 – correspondence table

Step n°5.3. In a third step, domain application (Class II.) and specific (Class III.) levels of the multi-criteria KB provide further characterization of the each method class. This knowledge originates from already acquired research and applications from fields where A, B, C, and D have been adopted. At this step remaining criteria from Figure 4.15 should be considered, as well as integrating algorithms inputs and outputs with superior and inferior hierarchical level algorithms. The inter-level interactions are mandatory as no vehicle health management system could be achieved by using a single method of diagnostics and prognostics (Schwabacher et al., 2007).

In order to illustrate this step in an application domain, our research has been supported by the final thesis of Bastard, 2013 in the field of wind turbine health management, proposed by the company in order to test the genericity range of our contribution. As argued in Chapter 1, Section 1.3.2.1, IVHM systems are under investigation on systems different than vehicles, such as wind turbine systems (Vachtsevanos et al., 2006). As such, the analysis of Bastard, G. is

performed following a bottom-up approach⁹ resulting in multi-criteria classification of health monitoring algorithms applied to wind turbines, aiming at investigating applicability of the generic criteria for this class of systems.



Figure 4.21. Yaw drive of a wind turbine

Bastard, 2013 has followed a series of questions based on the multi-criteria, which are illustrated in Table 4.4 for the yaw engine of a wind turbine, a critical component of the horizontal axis wind turbines' yaw system. To ensure the wind turbine is producing the maximal amount of electric energy at all times, the yaw engine is used to keep the rotor facing into the wind as the wind direction changes (Figure 4.21).

⁹ Depends directly on data; is called data-driven or bottom-up processing (Eysenck, 1998)

IV Designing health management in an IVHM modelling framework

Step 1	Question n° 1 : Variability of mission profile (Criterion n° 7.1)	Constant mission profile
Step 2	Question n° 2 : Classes of a-priori knowledge (Criterion n° 10.1) available on the system-of-interest	Quantitative model-based History-based
	Question n° 3 : Hierarchical level (Criterion n° 1) in the system	Component Level. The yaw engine is part of the yaw sub-system
	Question n° 4 : Classify failures modes by cost of down time (Criterion n° 8.4) implied by their occurrence	Critical Failures \approx 2,5 days of wind turbine down time •Electrical engine failure - causes a detectable orientation error of the platform, compared to the wind direction •Brake failure - puts abnormal braking pressure and misdirection of the nacelle
Step 3	Question n° 5 : Observability means (Criterion n° 10.2)	Analytical redundancy ; Temperature, current, yaw error analysis; Vibration analysis.
	Question n° 6 : Technological heterogeneity (Criterion n° 4) of subsystems	Electro-mechanical

Table 4.4 Yaw Drive multi-criteria characterization

Based on these questions, the solution space corresponding to yaw engine health monitoring algorithms is found in analytical redundancy algorithms in Class A. Yet, this solution space is too large, and should be narrowed to a smaller one, in order to enable the selection of an algorithm. This shows the limits of our generic proposal of ten multi-criteria, and the need of specifying domain application and specific genericity level in the multi-criteria representation.

The algorithm selection, proposed up to this point, has proposed an original contribution for appropriately selecting health management algorithms in accordance with four system view characteristics, corresponding to a step of the white-box gHMM instantiation procedure. This is a first proposal towards achieving an automated instantiation procedure within the IVHM modelling framework.

Concerning the implementation of the multi-criteria KBS, the solution space obtained in output of the multi-criteria selection KBS (Figure 4.16) could result from:

- (a) manual expertise or
- (b) automatic processing.

The later opens a research perspective to be supported by multi-criteria decision making (MCDM) concerned with ranking of decision alternatives based on preference reasoning over a number of criteria (Deng et al., 2011). In this regard, the MCDM survey of Ananda et al., 2009 evaluates more than 60 individual studies, classified by the method used, number and type of criteria, serving as guide for selecting particular MCDM approaches. In the light of heterogeneous

typology of processed multi-criteria (typology of criteria values), of their inter-relations and of their evaluation by experts using natural language statements rather than numerical values, fuzzy logic is one of the major orientations for the multi-criteria selection methodology (Noor-E-Alam et al., 2011), and represents one of the perspectives discussed in the conclusion of the chapter.

4.4.3 Synthesis on gHMM instantiation procedure

The overall view on the black and white-box phases and their underlying steps of the gHMM Instantiation are grouped in Figure 4.22. This synthetic perspective of the gHMM instantiation procedure is used as a guideline for the validation of our proposal in Chapter 5.

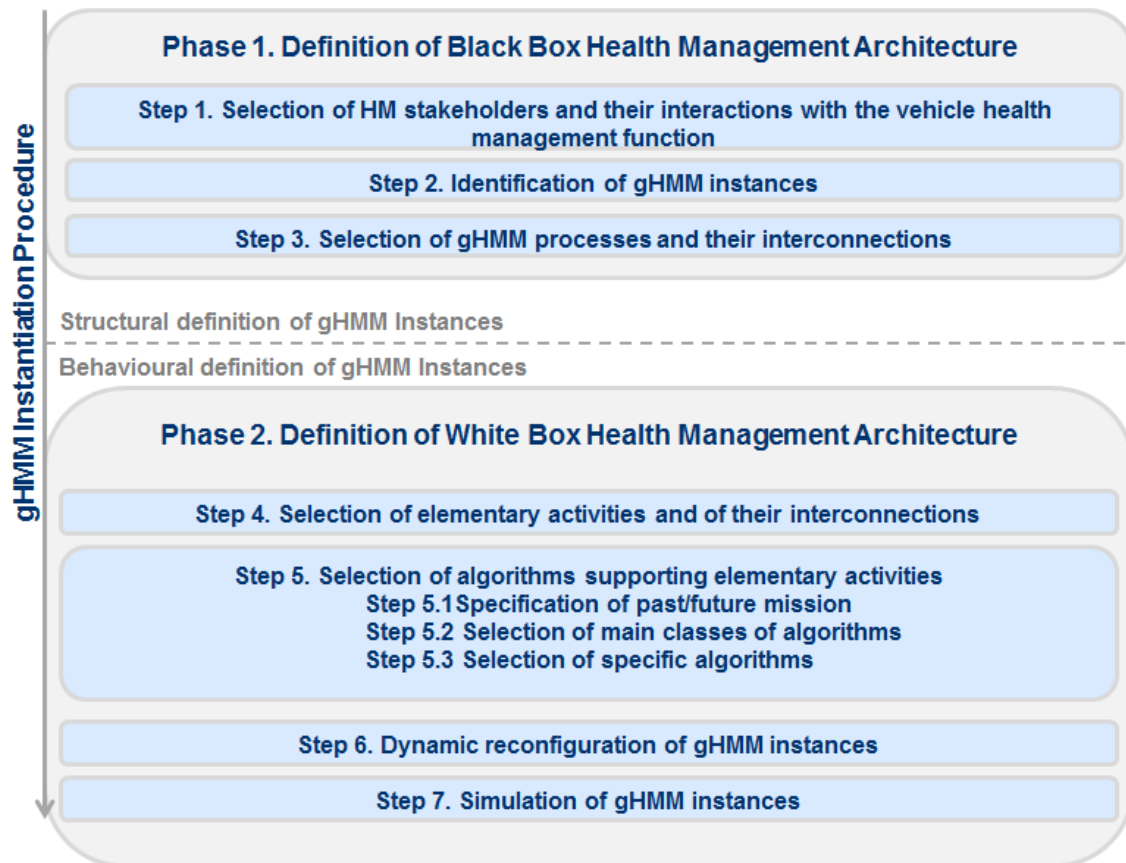

Figure 4.22. Synthesis of gHMM instantiation

4.5 Conclusion

This chapter has contributed to IVHM modelling framework with first methodological proposals required for designing vehicle health management architectures based on the generic contributions developed in Chapter 3 and in line with the system vision which dominates this thesis.

The first section of the chapter has tackled the design of the vehicle health management function in an IVHM modelling framework. An instantiation principle composed out of the black-box and white-box phases was proposed in order to design a functional HM architecture structure and behaviour.

Based on this principle, the white-box instantiation has been tackled through ontology-based representation of multi-criteria determinant for the selection of health management algorithms, constituting the major contribution of this chapter. The vehicle and IVHM characteristics impacting the selection of appropriate health management algorithms are analysed upon the four system views proposed in Chapter 2 (physical, functional, operational, and dysfunctional). Ten general multi-criteria determining the accordancy and effective selection between the system-of-interest and health management algorithms supporting gHMM activities have emerged from this analysis. Given their nature, and relationships, a first taxonomy of the multi-criteria was proposed by using an ontology-based representation.

Based on this representation, a knowledge-based system, reasoning on the multi-criteria, has been proposed. Its reasoning engine, composed out of three main reasoning steps infers on the multi-criteria knowledge base for finding an optimal solution space of algorithms corresponding to the input criteria. The three reasoning steps of algorithm selection have been investigated on an application class, which revealed that this proposal requires investigating domain application, and specific classes of systems for the multi-criteria analysis and representation, and showing that our proposal requires to be completed across the three levels of genericity, in order to enable the selection of a more precise solution space. Moreover, other emerging scientific issues of multi-criteria reasoning engine involve evidence of existence and optimality of the solution space, weighting of criteria based on IVHM requirements, and finally usability of the KBS.

Up to this point of the thesis, the reader has been provided with contributions forming the foundational elements of an IVHM modelling framework, in support of IVHM Systems Engineering. It is now time to focus on a protocol which could support the validation and maturation of such proposals, making the object of the fifth chapter of this thesis.

Chapter 5

Feasibility of contributions

*“When you innovate, you make mistakes. It is best to admit them quickly,
and get on with improving your other innovations.”*

- Steve Jobs

5.1 Introduction

This chapter is attached to illustrating the feasibility of the scientific contributions defended by this thesis, based on a Verification and Validation (V&V) protocol coherent with the Systems Engineering approach supporting IVHM modelling framework.

As such, verification and validation of the contribution to the IVHM modelling framework are tackled in two complementary aspects: firstly by proposal of a protocol supporting the overall V&V of contributions, and secondly by exposing three verification and validation steps conducted in line with the established protocol.

As such, the second section proposes the main phases of the validation protocol across technological readiness levels defined by NASA from the verification of the proposals, to analytical and laboratory-based validation of the generic Health Management Module (gHMM), and of its utilization in an IVHM modelling framework for “real world” systems health management.

In line with the protocol, the third section applies the three phases of V&V for two classes of systems proposed by the company in-line with its industrial strategy: wind turbines, and Unmanned Aerial Vehicle (UAV) systems, and conducted in collaboration with a third party validation group formed by three final year trainee engineers from the company. The results achieved based on the gHMM instantiation are discussed with regards to reduction of No Fault Found (NFF) events, thus providing answers to industrial problem at the genesis of the thesis.

Finally, the overall results and problems encountered during V&V, along with areas of improvement of the contributions are discussed in the last section.

5.2 Verification & validation protocol

In line with the Systems Engineering approach supporting the IVHM modelling framework, the V&V protocol of the scientific contributions focuses on the right leg of the V cycle, illustrated in Figure 2.15. Remember that this same V cycle has proposed the modelling approach of the IVHM framework in Chapter 2, and more precisely the left leg phases of the V cycle (in green) have been followed for the gHMM formalization in Chapter 3. The right leg phases (in blue) are the focus of the V&V, aiming at answering two complementary questions: “Do we build the system right?” through system **verification** and “Do we build the right system?” through system **validation** (Hoffmann, 2011).

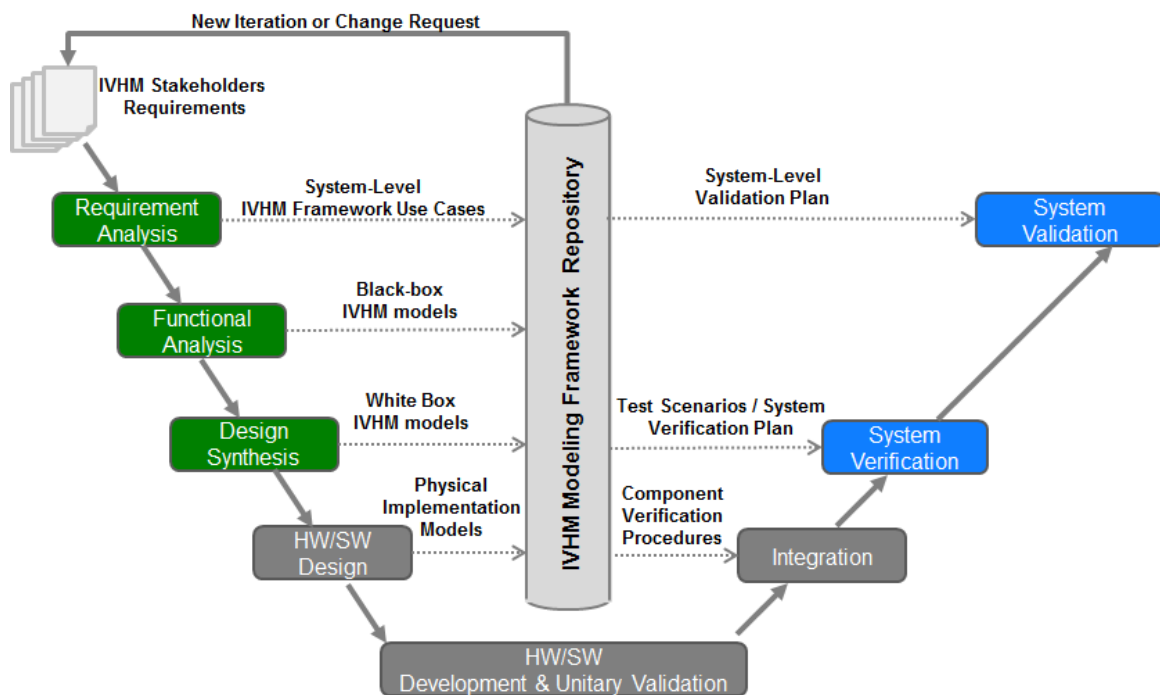

Figure 5.1. MBSE formalization approach based on Hoffmann, 2011

Accordingly, the V&V protocol is achieved in two main phases performing gHMM verification, and its validation by its instantiation to two classes of systems. This protocol is adapted to the Technology Readiness Level (TRL) 4 requested by the company at the beginning of the research for our scientific contributions. Based on NASA’s TRL scale (Mankins, 1995), the objective of the V&V protocol aims at proving feasibility of applying the scientific contributions in analytical studies and laboratory-based experimentation integrating the contribution to achieve “concept-enabling levels of performance for a component and/or breadboard” (Mankins, 1995). This validation should “support the concept that was formulated

earlier, and should also be consistent with the requirements of potential system applications” (Mankins, 1995).

In line with these objectives, the V&V protocol is achieved in three main phases (Figure 5.2) performing verification of the gHMM model, and validation of the gHMM instantiation for designing health management in an IVHM modelling framework. The validation phase is divided in two steps whose complementary objectives are analytical feasibility of the gHMM instantiation (static validation), and experimentation of gHMM instantiation on a laboratory-based demonstrator (dynamic validation).

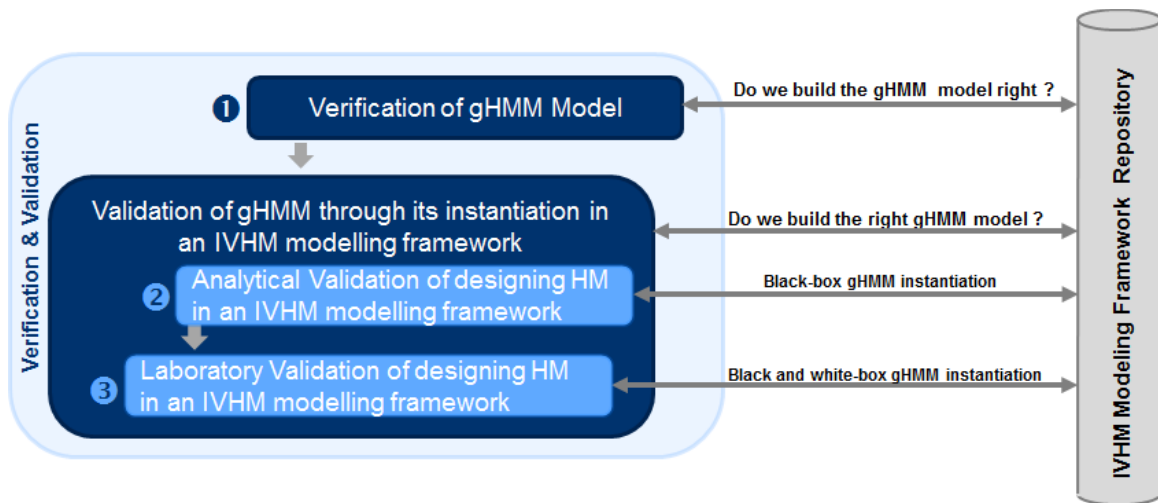

Figure 5.2. Verification and validation of gHMM concept

The following section details objectives, results, and perspectives of the V&V phases, performed over a period of six month in collaboration with a third party validation group formed by three final year trainee engineers at the company (Bastard, 2014, Frette, 2014, and Pulice, 2014). As a side note, the reader is alerted that the three references are unavailable for confidentiality reasons. However, this has absolutely no impact on data, and results presented in this chapter.

5.3 Verification & validation phases

5.3.1 Verification of the SysML-based gHMM model

5.3.1.1 Objective

The verification phase (Figure 5.2) aims at guaranteeing that the designed SysML model of the gHMM is syntactically and semantically correct with respect to the SysML standard, and

respectively to knowledge encompassed in gHMM model. The verification of the gHMM Model has aimed at performing a first verification of the IBM Rational Rhapsody MBSE project, giving to our proposal a first degree of confidence based on which the validation phase can be performed.

5.3.1.2 Verification outcomes

Firstly, it is essential to underline that selection of MBSE approach Harmony embedded in IBM® Rational® Rhapsody® for design of the gHMM model, has ensured a first degree of confidence in the produced SysML model. This is achieved by the following implicit verification features embedded in the modelling environment:

- Verification of the complete utilization of interactions between stakeholders and use cases based on the use case diagram;
- Identification of the complete set of black-box actions in output of the functional analysis phase, and of overlapping actions between distinct use cases;
- Coherence between elements modelled in black and white-box phases, by transfer of use case activity diagrams elements from functional analysis to design synthesis;

These essential features have thus enhanced our productivity in realizing the gHMM modelling phases by automation of transitions between distinct phases, and implicit verification features.

From this first degree of confidence in the gHMM model, manual model verification has been performed by a third party possessing an expert knowledge on the SysML language. The auditing of the IBM Rational Rhapsody MBSE project has carried out by a trainee engineer expert in Systems Engineering, during several work sessions focused on reading, comprehension and syntactic and semantic verification of the SysML-based gHMM model. The output of this phase has consisted in two main reviews of the gHMM model (syntactic and semantic), which have ensured:

- Consistency with the SysML standard of gHMM model diagrams;
- Scope of the gHMM in the IVHM modelling framework, and of the genericity of elements of the gHMM model with respect to this scope;
- Association with OSA-CBM data structures for Input/Output information flows.

Another outcome of this phase has consisted in absorbing the content of the gHMM model by the trainee engineer so as to use it in the next phases of validation.

This manual verification has resulted in four design loops updating the SysML-based gHMM model, documented in an internal technical report of the company (Geanta, 2014), enabling to obtain sufficient confidence in the gHMM model in order to comfort its utilization within the validation phase. However, this verification is manual and should be complete by automatic verification activities; this perspective on the verification phase is discussed in the conclusion of this chapter. Thus, the SysML-based gHMM model issued of the verification phase is now considered for validation of our contributions through its instantiation in an IVHM modelling framework.

5.3.2 Validation of the gHMM instantiation in an IVHM modelling framework

As depicted in Figure 5.2 the validation phase aims at providing answers to “Do we build the right gHMM model?” through the gHMM instantiation to different classes of systems, in order to design their health management in an IVHM modelling framework.

In order to reach this objective, two complementary steps of validation apply the black and white-box instantiation phases proposed in Chapter 4 – Section 4.2.2, for two classes of systems of interest for the company: wind turbine, and Unmanned Aerial Vehicle (UAV) systems. This section details the complementary objectives of the two steps of validation, their results and perspectives, and finally their role in reduction of NFF events.

5.3.2.1 Black-box gHMM Instantiation of wind turbine health management

5.3.2.1.1 Objective

The first validation step aims at performing an analytical validation of the gHMM instantiation, by **feasibility analysis of black-box instantiation phase** proposed in Chapter 4, for a class of systems, represented by wind turbine systems.

The reason for selecting this class of systems for analytical validation is twofold. Firstly, it is industry strategic for the company, as wind turbines fall within the planned development of maintenance solutions for renewable energy industry. The second one enables to analyse the genericity of the proposal to systems where IVHM concepts could be applied, one of these classes encompasses wind turbine systems (Vachtsevanos et al., 2006) as argued at Chapter 1.

The black-box phase of gHMM instantiation procedure (Figure 5.3) is illustrated for a wind turbine system, aiming at validating the feasibility of the three steps through:

V Feasibility of contributions

- Instantiation of the generic stakeholders,
- Coverage of generic stakeholders,
- Allocation of gHMM instances, and their underlying processes within a hierarchical HM architecture.



Figure 5.3. Steps of black-box gHMM instantiation phase

These three objectives have been successfully achieved within a feasibility study on a wind turbine system, based on the knowledge sources introduced in the following section.

5.3.2.1.2 Knowledge sources

Several sources of information form this wind turbine validation case at different scales of its representation required by the steps of the gHMM black-box instantiation. Among these sources, the integration of a wind turbine in a wind farm providing an integrated infrastructure of operation and maintenance, required for Step 1 of the black-box gHMM instantiation, is issued from the wind farm of Arfons, France (Valorem, 2014). The knowledge source required for the next steps of the black-box instantiation is based on a fault diagnosis Wind Turbine simulator (Odgaard et al., 2009). The wind turbine simulator is used at Step 2, for representing a single instance of a wind turbine system, and its hierarchical distribution into four sub-systems (illustrated in Figure 5.4), as well as the failure indicators involved in the simulation of nine fault scenarios, which enable to analyse Step 3 of the black-box instantiation for one of the wind turbine subsystem – the blade & pitch subsystem.

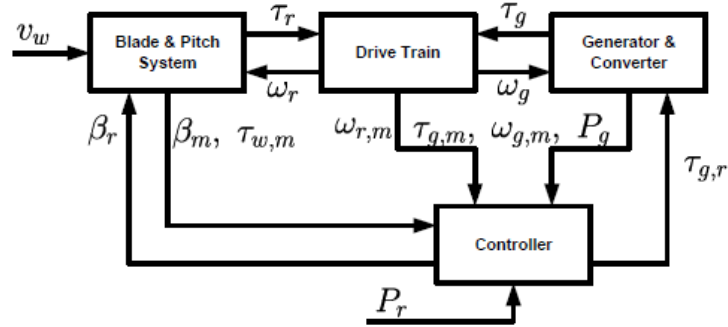

Figure 5.4. Breakdown of wind turbine simulator of KK electronics

5.3.2.1.3 Step n°1: Selection of health management stakeholders and their interactions with the vehicle health management

Selection of Health Management stakeholders achieved by Step n°1 of the gHMM instantiation (Figure 5.3), aims at illustrating the feasibility of generic health management stakeholders to wind turbine health management and of their interactions with the Health Management (HM) functional architecture.

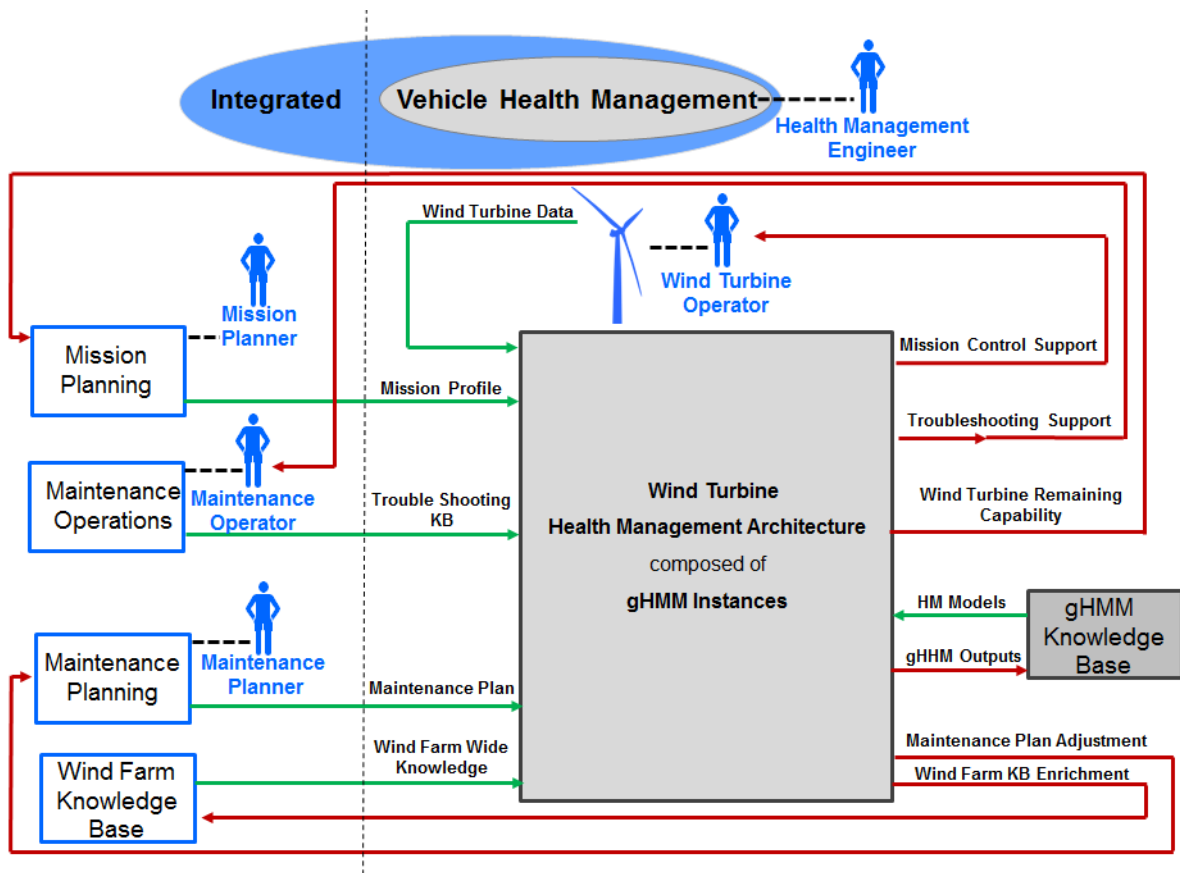

Figure 5.5. Wind turbine HM contextual view

V Feasibility of contributions

This is achieved by analysis of stakeholders involved in the health management of wind turbine system. In this regard, Figure 5.5 depicts a contextual view of wind turbine stakeholders' instantiation for a wind farm (Valorem, 2014).

Their accountabilities in wind turbine health management and their need from the wind turbine health management are analysed, producing as output of this first step of instantiation the association of stakeholders' requirements to use cases, and of their interactions with the health management functional architecture, defined for each of the instantiated use cases.

Regarding the wind turbine operations, **Mission Planners** constituted of Valemo, and Alstom Wind work on a control centre, ensuring a dynamic follow-up of missions, based on the weather forecast. **Wind Turbine Operator** is a technical supervisor of Valemo performing the remote supervision and monitoring operation of the wind turbine. The **Health Management Engineer** is represented by an engineering team formed by CNRS, CETIM and Valemo (Valorem, 2014). Wind Farm of Arfons is equipped with embedded and on-ground health monitoring systems providing vibration analysis, icing detection, and monitoring alarm signals and turbine shutdowns. A research program for adding complementary processing on the embedded health monitoring system is on-going (Valorem, 2014).

The **gHMM Knowledge base** is represented by a system managed by the HM engineering team, automatically connected to the wind turbine for data retrieval and transfer into a specific database. **Wind Farm KB** is a knowledge base managed by the HM engineering team for analysing the farm's performance by storing electrical data from the power substation, comparing it with the theoretical wind potential, and assessing wind farm availability.

Maintenance Planner stakeholder is realized by a maintenance control center of VALEMO, which plans the need of filed intervention of **Maintenance Operators**.

The coverage of generic stakeholders of gHMM instantiated to wind farm health management stakeholders and analysis of their interactions with the wind turbine health management (Figure 5.5) enables to consider the ten gHMM use cases for this class of systems.

Based on this step, the following considers the ten use cases in order to identify the required gHMM instances for realizing the wind turbine health management.

5.3.2.1.4 Step n°2: Identification of gHMM instances

The feasibility of the following two steps of the black-box instantiation (Steps n°2, and n°3 in Figure 5.3) require to analyse a single wind turbine system, in order to study interactions between gHMM instances within the HM functional architecture, as well as the selection of gHMM processes required for each of the instantiated use cases.

Based on the hierarchical distribution of a wind turbine system (Figure 5.6) in four hierarchical levels, Step n°2 of the gHMM instantiation identifies required gHMM instances for a full coverage of the wind turbine elements from component all the way up to system level. Based on this hierarchical representation, a gHMM instance is associated to each of the elements, and interconnected to the higher level elements up to the wind turbine gHMM instance.

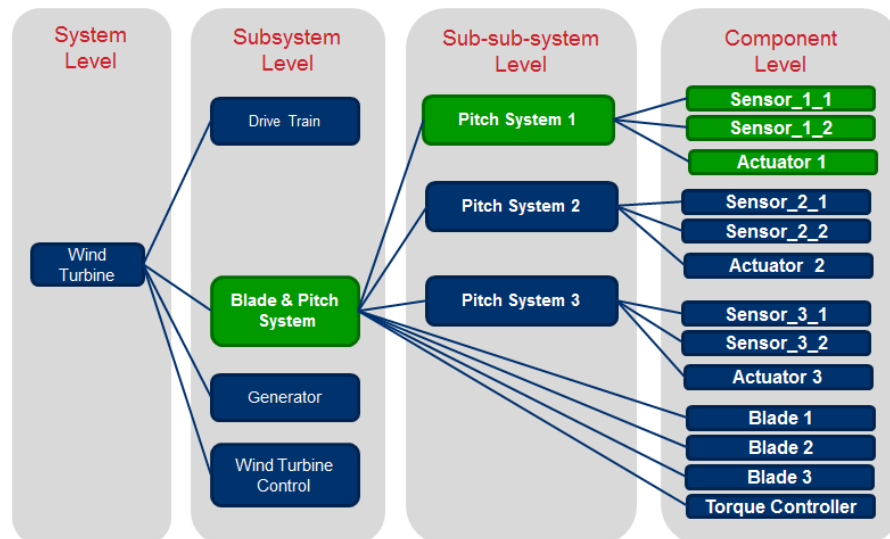

Figure 5.6. Wind turbine hierarchical distribution

5.3.2.1.5 Step n°3: Selection of gHMM processes and of their interconnections

Based on identified gHMM instances at Step n°2, and on the instantiated use cases from Step n°1, Step's n°3 purpose is the selection of health management processes for each gHMM instance in order to realize the instantiated use cases.

In order to illustrate this step, one of the ten use cases (use case n°2) is analysed for a wind turbine sub-system depicted in green in Figure 5.6 (Blade & Pitch subsystem), based on the available information on the wind turbine system provided by the FDI simulator.

V Feasibility of contributions

The use case n°2 realizes ambiguity group reduction in diagnostics applied to the blade & pitch system. Based on the black-box functional flow of this use case¹⁰, the processes involved in and their interconnection are identified at this step. The diagnostics process of the blade & pitch system producing the set of failed LRUs within the sub-system, requires failure features produced by the health monitoring process of underlying three pitch level gHMM instances.

Figure 5.7 depicts these four gHMM instances, their underlying processes and exchanged information flows illustrate Step n°3 of the gHMM black-box instantiation. The interconnection between instantiated processes of Figure 5.7 is based on the analysis of the five fault scenario in Table 5.1, as well as on availability of monitored parameters on the FDI wind turbine benchmark.

Failure Mode	Severity	Temporal Evolution	Fault Scenario n°
Pitch Sensor Fixed Value	Low	Medium	1; 3
Pitch Sensor Scaling Error	Low	Medium	2
Pitch Actuator Changed Dynamics	High	Slow	6;7

Table 5.1 Fault scenario of wind turbine simulator

In this regard, failure modes simulated on the blade & pitch system (Table 5.1) involve two pitch sensors failure modes: fixed value and scaling error and one pitch actuator failure mode: changed dynamics. These technical failure mode are monitored by Pitch 1 instance, whose outputs provides the failure features requires for their detection by the diagnostics process of higher level (i.e. by the blade & pitch instance).

Based on this information, the black-box information flow illustrated in Figure 5.7 instantiates the following generic flows as outputs transmitted from Pitch 1 instance to Blade & Pitch instance:

- **Failure features** instantiated by `S1m1_Stuck_Ct_V`, and `S1m2_Stuck_Ct_V` indicate if measured sensors values are constant or oscillate near the measured position, modelled as a Gaussian noise in the Wind Turbine simulator.
- **Failure features** instantiated by `FDE_beta_1_m1` and `FDE_beta_1_m2` on Figure 5.7 are elaborated for observing the physical pitch position (`beta1`), and the measured pitch angles (`S1_m1` and `S1_M2`), by using actuator dynamics. Based on the two failure features values, the upper level instance isolates the faulty sensors, and actuator for Fault Scenarios n°2, 6, and 7 (Table 5.1).

¹⁰ Activity Diagram is provided in Appendix D, Figure A.25

By using these four failure indicators produced by each of the three Pitch gHMM instance, the superior level instance's purpose (Figure 5.7 – Blade_Pitch gHMM Instance) is to isolate the failed components within the Blade & Pitch Subsystem.

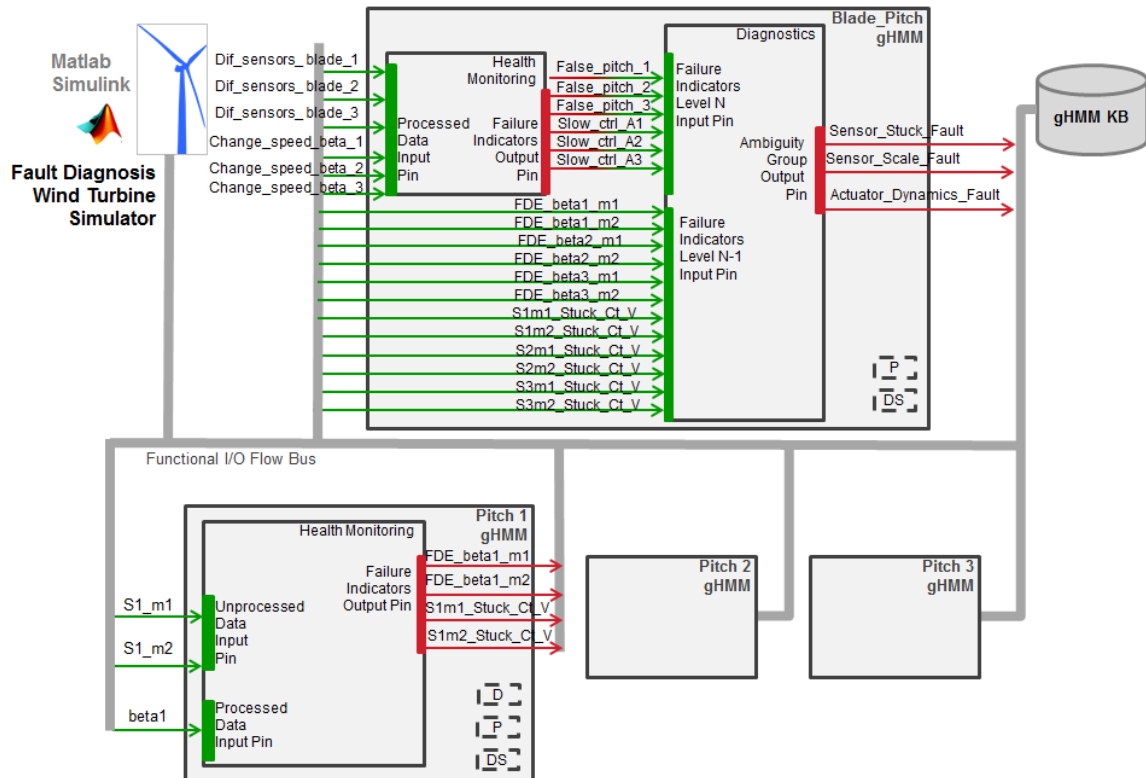

Figure 5.7. Wind turbine simulator black-box gHMM instances

Figure 5.7 represents the output of the black-box gHMM instantiation, for the Blade & Pitch sub-system. This feasibility analysis of the three steps of the instantiation has validated the proposal and coverage of generic health management stakeholders of the gHMM by their particularization to a wind turbine system, as well as allocation of gHMM instances, and underlying processes integrated within a health management functional architecture. Moreover, this first validation phase has illustrated that the proposed concepts are not vehicle specific, and can be applied to other classes of systems.

Based on the results of this first validation phase, the following validation phase objective is in a logical complementarity by tackling the validation of the gHMM instantiation by its white-box design, development and experimentation to class of vehicle systems: UAV systems.

5.3.2.2 gHMM instantiation of UAV health management

5.3.2.2.1 Objective

The second validation phase (Figure 5.2) aims at demonstrating the feasibility of the gHMM instantiation to a vehicle system, by implementing all of the steps of the gHMM instantiation procedure proposed in Chapter 4, reminded in Figure 5.8 . The main focus of this phase of validation, complementary to the previous one, is the white-box gHMM instantiation, implementing the four steps illustrated in Figure 5.8 in order to validate the behaviour of each gHMM instance, and of their interaction within a laboratory-based simulation of the vehicle health management function.

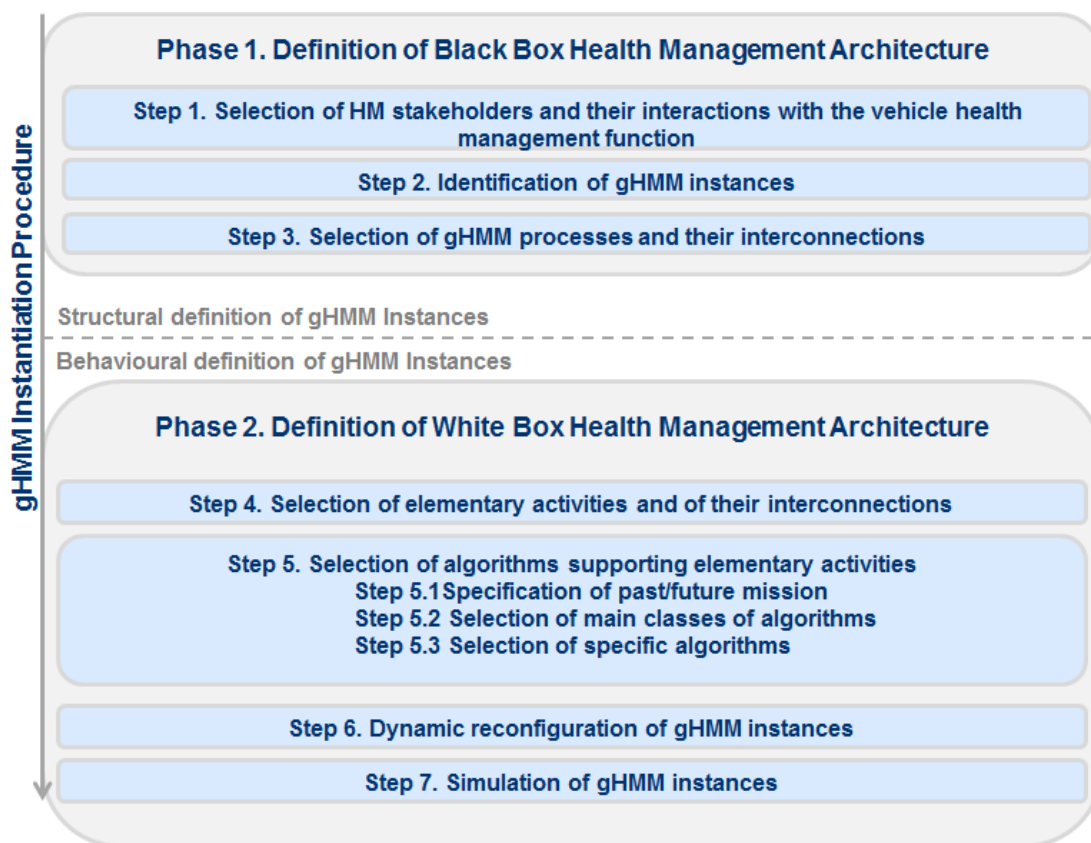

Figure 5.8. Steps of gHMM instantiation procedure

The results of the simulation issued out of the white-box instantiation are essential for arguing how integration of diagnostics and prognostics processes contributes to optimizing UAV health management. Moreover this simulation is attached to illustrating how our contributions could meet reduction of NFF events, raised at the genesis of the thesis.

5.3.2.2.2 Knowledge sources

The domain application for this gHMM validation phase, selected by the company, is represented by Unmanned Aerial Vehicle (UAV), defined as an aircraft with no pilot on board, being remotely controlled from a ground station or flying autonomously based on pre-programmed flight plans or more complex dynamic automation systems (UAV, 2014).

The reason for selecting this application field for the gHMM instantiation is two-fold. Firstly, UAV health management is a challenging field of research in IVHM, which is considered as essential driver for their operational reliability with regards to specific UAV requirements (Pelham et al., 2013). In this context, reducing NFF rates occurring on UAV is sine-qua-non for UAV maintenance operators as outlined by Khella et al., 2010. Moreover, the lack of human on-board requires higher levels of system integration, and therefore a system level view of UAV health management; while mission duration requires a specific aircraft and IVHM system design suitable for long endurance operations. Secondly, this class of systems is currently industry strategic for the company, whose interest is to propose suitable maintenance solutions in this emerging field, both at operational and intermediate level maintenance. Current applications of UAV systems are both military and civil, such as:

- Military missions (UAV, 2014):
 - Target/decoy provide simulate an enemy aircraft or missile;
 - Reconnaissance enable battlefield intelligence;
 - Combat are capable of attack for high-risk missions;
- Civil missions, such as disaster research and management (Adams, 2011), ecological measurement (Fly'n'Sense, 2010), infrastructure inspection (Delair-Tech, 2014); this application is expected to expand with current evolution of air traffic regulations (Higgon, et al., 2014)
- Research and development UAV are used to further develop technologies integrated into UAV systems, such as autonomous PHM (Stecki, 2014), and dual use IVHM (Pelham et al., 2013).

In this context, the validation case proposed by the company belongs to the last category, R&D UAV systems. It is based on Parrot® AR.Drone.2.0 UAV model (Figure 5.9), a small size electric quad rotor UAV, which is instrumented by Arduino™, an open-source electronics platform based on easy-to-use hardware and software. The battery component of this electric UAV is the second most costly LRU of the system ($\cong 17\%$ of the UAV cost), and the most

V Feasibility of contributions

affected by NFF due to premature battery replacements securing UAV operations, as outlined by Toksoz et al., 2011. In this regard, Williard et al., 2011 consider that the ability to estimate remaining state of charge (SoC) and state of health (SoH) of the battery is a major requirement for next generation electric UAV, representing mission and maintenance critical information. Therefore the validation case illustrates how integration of diagnostics and prognostics within the gHMM instances could improve the certainty of remaining battery SoC and SoH evaluation. In this regard, the need expressed from the UAV concerns analysis of remaining SoC, and SoH by a health management engineer with the aim of integrating diagnostics and prognostics in the gHMM instantiation, as well as for proposing algorithms supporting gHMM instances forming the UAV health management architecture.

For UAV data acquisition purposes, the UAV mission consists in an equilateral triangle with 2 meters side at altitude of 1m in a closed room, illustrated in Figure 5.9.

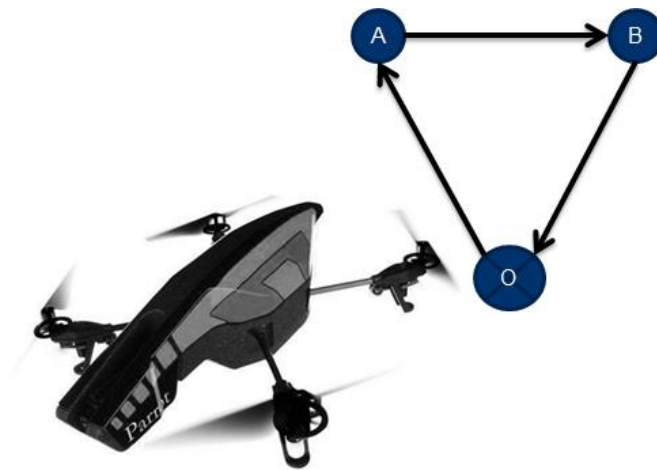

Figure 5.9. UAV test case

The UAV mission is divided into seven phases, depicted in Figure 5.10 (in blue - total instantaneous power consumption of the four engine; other four colours correspond to instantaneous power consumption of each engine).

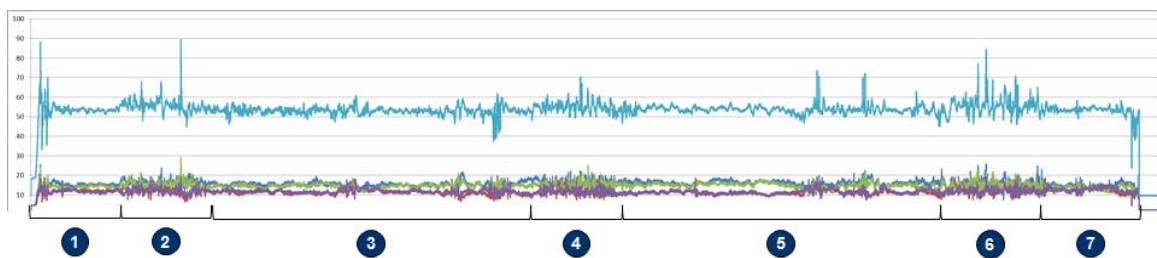

Figure 5.10. UAV mission phases – Bastard, 2014

Phase	Description of Mission Phase
Phase 1.	Take-off, then hover for 30 seconds at point O
Phase 2.	Fly from O to A for 30 seconds
Phase 3.	Hover for 2 minutes at point A
Phase 4.	Fly from A to B for 30 seconds
Phase 5.	Hover for 2 minutes at point B
Phase 6.	Fly from B to O for 30 seconds
Phase 7.	Hover for 30 seconds and land at point O

Table 5.2 UAV mission phases

Based on this illustration case, the gHMM instantiation has been performed as six months R&D project between the company and Lorraine University, involving a third party validation group formed by three final year trainee engineers. This validation phase is thus based on their contributions:

- Frette, 2014 has focused on verifying the SysML model of the gHMM (Section 5.3.), as well as on simulating gHMM instances by coupling of IBM Rational Rhapsody with Matlab/Simulink;
- Pulice, 2014 has focused on battery SoH with the aim of instantiating the gHMM to UAV energy management subsystem;
- Bastard, 2014 has focused on system level SoC, and its application to UAV energy monitoring.

Based on this R&D project's results, this validation phase is developed firstly by synthesizing the black-box instantiation phase, and secondly by developing the white-box gHMM instantiation phase to UAV health management. Finally, the results of this validation phase are discussed next to the initial problems enounced at the genesis of the thesis, in order to illustrate how our contributions could meet reduction of NFF events.

5.3.2.2.3 Step n°1: Selection of health management stakeholders and their interactions with the vehicle health management

The black-box phase of gHMM instantiation procedure (Figure 5.3) is performed for the experimental UAV system with the aim of identifying the gHMM instances, and their underlying processes to be developed throughout the white-box instantiation phase. The following figure (Figure 5.11) provides the contextual view of the UAV functional HM architecture performed at Step n°1.

The **Health Management Engineer** stakeholder is represented by the engineering team formed by the three trainee engineers, responsible of design, development, and maturation of vehicle health management function. Their results are essential for tackling the technological causes of NFF events occurring on the battery LRU, based on SoC and SoH evaluation.

The **gHMM Knowledge base** is managed by the HM engineering team, connected to the UAV system for data retrieval and transfer into a specific database.

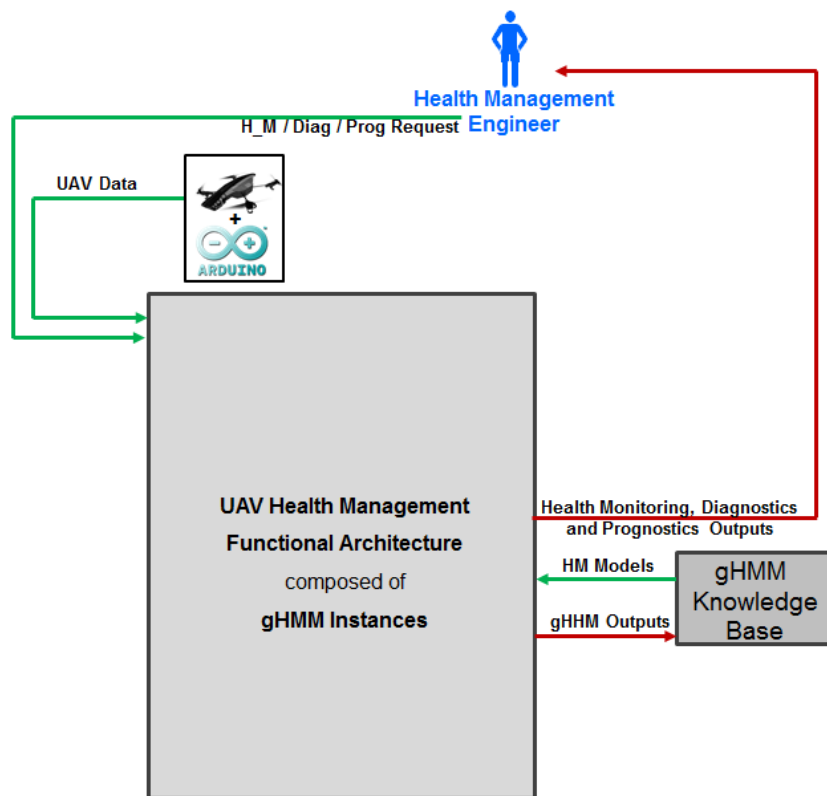

Figure 5.11. UAV HM functional architecture - contextual view

The requirements expressed by the health management engineer are based on the Functional Analysis, and on a Failure Mode Effects, and Criticality Analysis (FMECA) performed on the UAV system, from which the HM engineering team has classified critical LRUs

and functions for UAV operations. According to this study, SoH of battery and SoC of UAV are the object of the two requirements expressed by the HM Engineer, being attached to:

- **Requirement 1: Remaining UAV state of charge evaluation**, critical for UAV operations, based on two main energy consumers and producers in the UAV system, and on future environmental conditions of UAV missions;
- **Requirement 2: Remaining battery state of health evaluation**, as potential driver of reducing NFF event occurring on this LRU.

Based on the two requirements, their corresponding generic requirement from the gHMM model is used in order to identify the instantiated use case. In this regard, the requirement title “Advanced Health Management Capabilities”, with id HME_1 is associated to the two requirements, and enable to identify the **use case n°3** based on the requirement diagram extracted from the gHMM model (Figure 5.12).

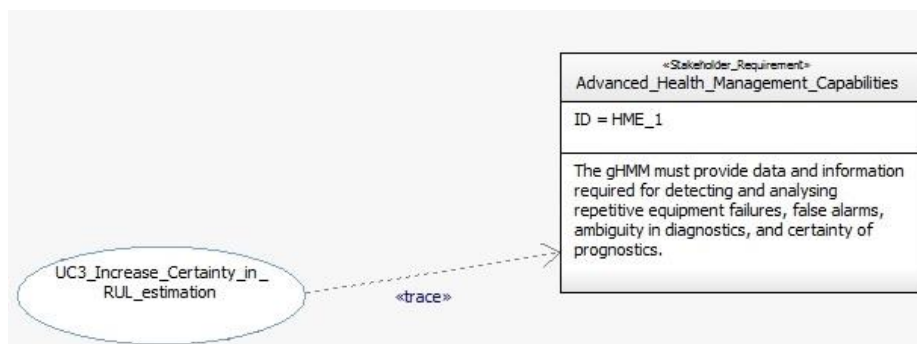

Figure 5.12. Association to use case n°3 of HME_1 requirement

The use case n°3 required for UAV SoC and battery SoH evaluations represents the output of this first step of instantiation.

5.3.2.2.4 Step n°2: Identification of gHMM instances

Step n°2 of the gHMM instantiation identifies required gHMM instances for performing the use cases issued out of Step n°1. This step is based on hierarchical level distribution of the UAV system, illustrated in Figure 5.13. gHMM instances required for performing use case n°3 for estimation of SoC of UAV system required both energy consumers (propulsion) and producer (battery) for estimation of remaining SoH, and are depicted in green in Figure 5.13.

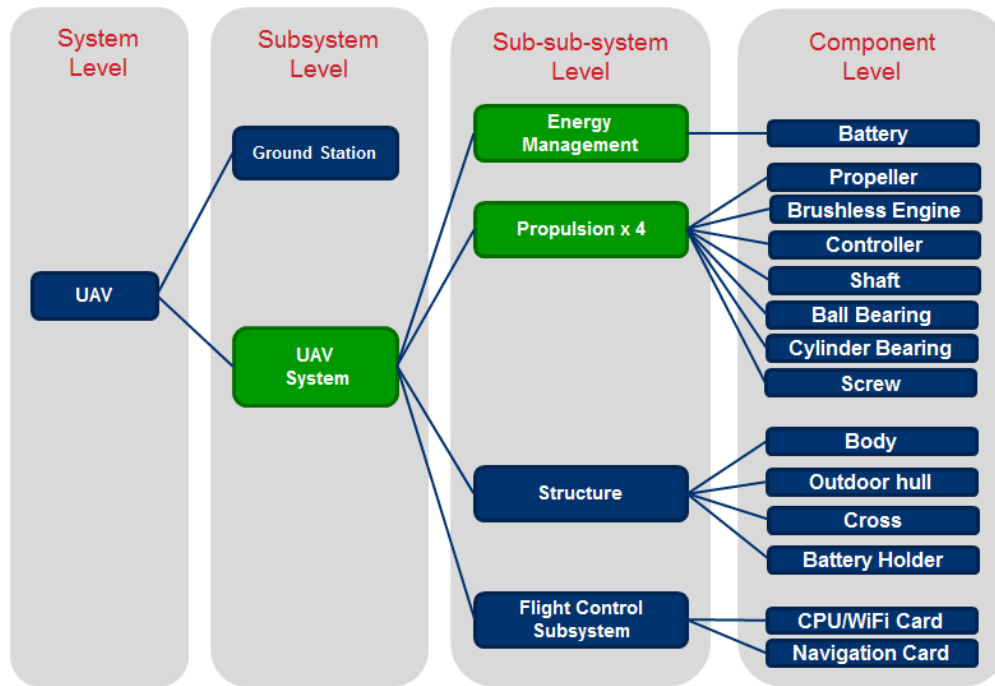

Figure 5.13. UAV hierarchical levels distribution

5.3.2.2.5 Step n°3: Selection of gHMM processes and of their interconnections

Based on the identified gHMM instances issued of Step n°2, and on the instantiated use cases from Step n°1, Step's n°3 purpose is the selection of health management processes and of their interconnections to be instantiated for each gHMM instance in order to realize the instantiated use cases.

In order to do so, each of the gHMM instances issues of Step n°2 is analysed with regards to required processes for each of the instantiated use cases. In our case use case n°3 is instantiated at UAV level for evaluating the remaining SoC, and at energy management level for computing the remaining battery SoH. To this extent, the UAV system SoC established by the diagnostics process is projected into future by the prognostics process in order to produce the projected SoC, by considering the future mission profile, as well as the projected SoH of underlying subsystems (energy management and propulsion gHMM instance). The remaining battery SoH is evaluated by the prognostics process of the energy management gHMM instance, based on the current SoH produced by diagnostics, and on the future mission profile assigned to the UAV.

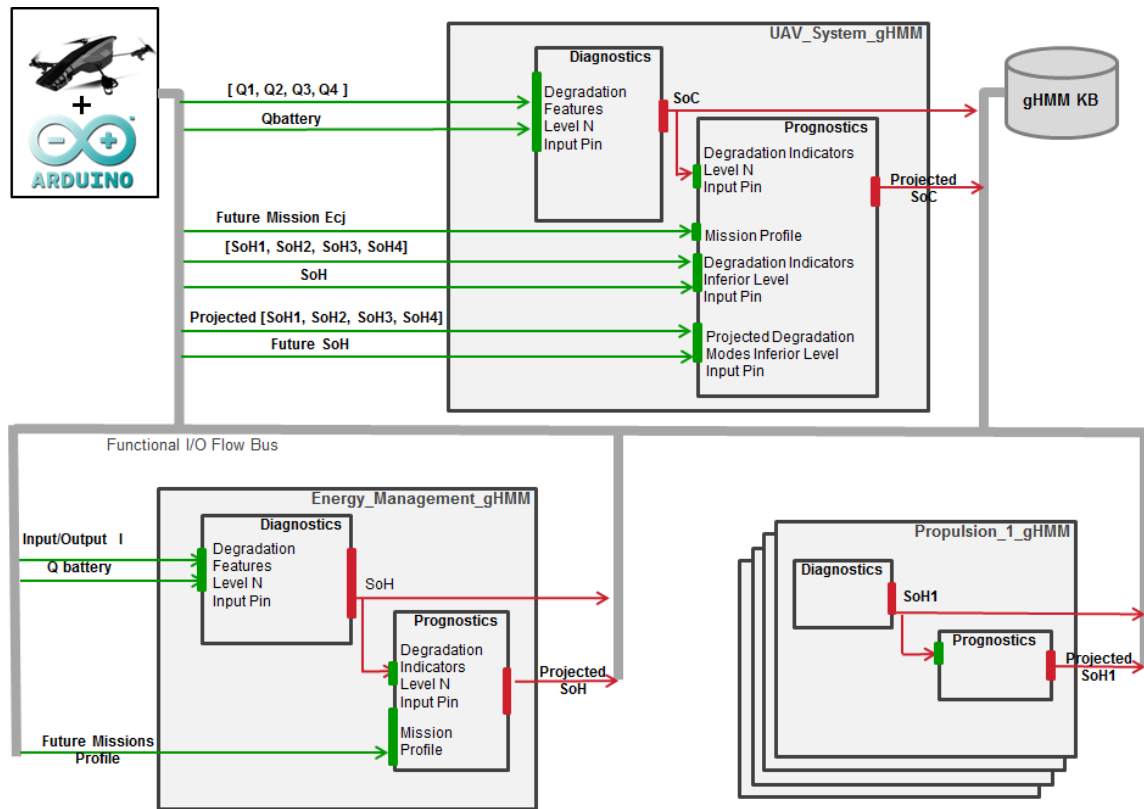

Figure 5.14. gHMM instances and underlying processes

In this respect, the processes, and information flows involved in the use case n°3 for the gHMM instances identified at Step n°2 are illustrated in Figure 5.14, representing the output of the black-box instantiation phase. Based on these outputs, the white-box gHMM instantiation steps are illustrated in the remaining section of this chapter.

5.3.2.2.6 Step n°4: Selection of elementary activities and of their interconnections

Step n°4 goal is to select the elementary activities required in order to realize each of the instantiated processes issued out of **Step n°3**, as well as the white-box information flow interconnecting elementary activities. In order to illustrate this step, Figure 5.15 depicts the elementary activities of the energy management gHMM instance, as well as exchanged white-box information flows between the activities:

- **Detect Degradations** activity of diagnostics process detects the remaining SoH, which is produced in output of the activity by instantiating the data structure `OSA_CBM_SDDDataEvent`¹¹;

¹¹ OSA-CBM SDDDataEvent data structure is provided in Figure A.36 of Appendix F.

V Feasibility of contributions

- **Project into future** activity of prognostics process produces the remaining SoH project into future by considering the mission profile which is assigned to the UAV. The output of the activity is the projected SoH instantiating data structure FutureProjectionDataEvent¹²;

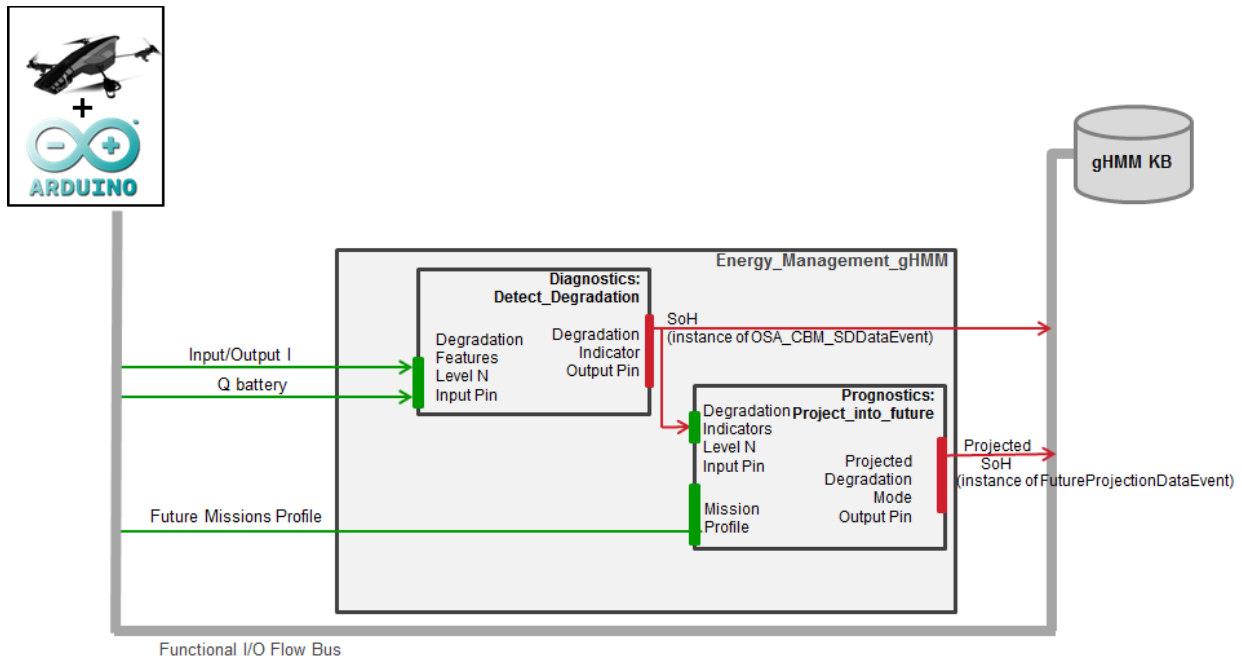

Figure 5.15. Energy management gHMM instance

5.3.2.2.7 Step n°5: Selection of algorithms supporting elementary activities

In order to define the behaviour of each of the elementary activities issued out of **Step n°4**, the appropriate selection of algorithms supporting these elementary activities is performed at **Step n°5** of the gHMM instantiation, by using the multi-criteria formalization proposed in Chapter 4 (Figure 4.14).

This step is analysed on the energy management gHMM instance, for which algorithms supporting **Detect Degradations** and **Project into future** activities must be selected. In this regard, the energy management's gHMM instance multi-criteria, illustrated in Figure 5.16, instantiate the generic multi-criteria representation proposed in Chapter 4.

¹² FutureProjectionDataEvent data structure is provided in Figure 3.17 of Chapter 3.

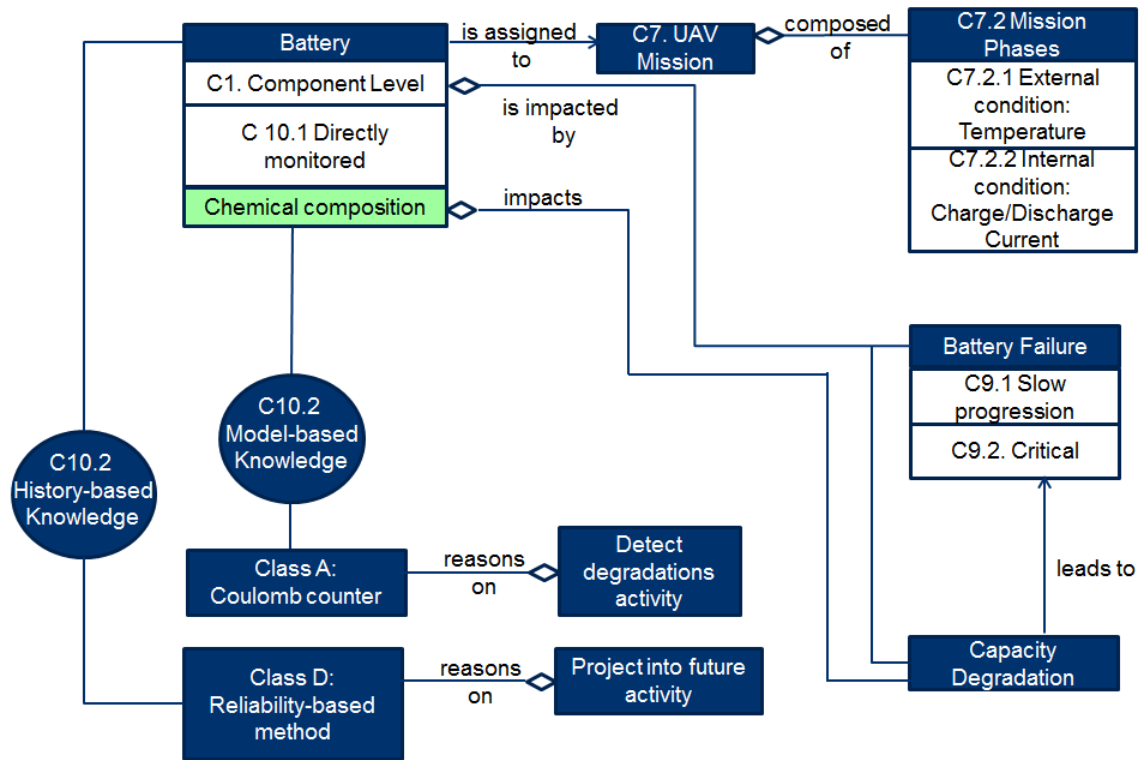

Figure 5.16. Battery multi-criteria representation

Based on this multi-criteria representation (Figure 5.16), the energy management gHMM instance covers the battery component (Criterion n°1), which is directly monitored by Input/Output current (Criterion n°10.1). The mission (Criterion n°7) assigned to the UAV is composed out of several mission phases (Table 5.2), whose external conditions (Criterion n°7.2.1) are modelled by temperature, and whose internal conditions (Criterion n°7.2.2) are modelled by charge/discharge currents impacting battery usage.

This representation of multi-criteria is used for the three sub-steps of algorithm selection, proposed in Chapter 4 (Section 4.4.2). Based on the criteria illustrated in Figure 5.17, sub-steps n°5.1 and n°5.2 of algorithm selection enable to isolate the two main classes of methods for the two elementary activities of the energy management gHMM instance, based on:

- the knowledge on past and future mission profile at Step n°5.1 in Figure 4.18;
- the correspondence table between criteria and four main classes of methods at Step n°5.2 in Figure 4.20 .

V Feasibility of contributions

Step n° 5 : Algorithm Selection			
S 5.1	Question n° 1 : Variability of mission profile (Criterion n° 7.1)	Variable mission profile with known future mission	Select Diagnostics Prognostics based on specific future mission characteristics
S 5.2	Question n° 2 : Classes of a-priori knowledge (Criterion n° 10.1) available on battery	Detection of Degradation : Model-based Degradation Evolution: History-based	Detect Degradation : Class A Project into future : Class D
	Question n° 3 : Hierarchical level (Criterion n° 1) in the system	Component Level. The battery is part of the energy management sub-system	
	Question n° 4 : Classify failures modes by cost of down time (Criterion n° 8.4) implied by their occurrence	Critical Failure Cost of failure = UAV system cost	

Figure 5.17. Multi-criteria selection for energy management instance

Based on these two reasoning steps, the corresponding outputs are illustrated in Figure 5.17, leading to select:

- **Class A**: model-based method for **Detect degradations** activity;
- **Class D**: statistical method for **Project into future** activity.

In order to narrow these two solution spaces at sub-step n°5.3. of the multi-criteria selection, specific criteria characterizing the battery are required. Based on a bottom-up approach conducted by Pulice, 2014, the following multi-criteria specific to the battery component are identified for selecting algorithms of **Detect degradations** and **Project into future** activities.

For **detect degradations** activity, the main criteria impacting algorithm selection concerns observable parameters available on the battery (Pulice, 2014). **Observability** (Criterion n°10.1) of the battery specified by Input/Output current on the battery for detection of capacity degradation; based on input and output current Pulice, 2014 has modelled deliverable battery capacity at current time t , as:

$$Q_{delivarable}(t) = Q_{MAX} + \int_0^t I(t)dt \quad (5-1)$$

, where Q_{MAX} represents the maximum battery capacity after recharge, $Q_{deliverable}(t)$ the remaining capacity at t , and $\int_0^t I(t)dt$ is the transit capacity in the battery. In case of charge it is

positive, and in case of discharge it is negative. Therefore the battery's state of health (SoH) is defined by the ratio between the maximal capacity after recharge and the nominal battery capacity provided by the Original Equipment Manufacturer:

$$SoH = \frac{Q_{MAX}}{Q_{nominal}} \quad (5-2)$$

Based on these available parameters, the solution space is narrowed to **Coulomb counter with the model-based method class (Class A)** for detect degradations activity.

With regards to the projection in future activity, specific criteria of the battery degradation use only a part of the multi-criteria representation of Figure 5.16:

- **External factors** (Criterion n°7.2.1) impacting battery degradation projection: environmental temperature; These factors impact the battery SoH's projection, based on known future mission profiles. Based on Waldmann et al., 2014, a law has been established by Pulice, 2014 in equation (5-3) where the battery state of health (SoH) evolves with battery charge/discharge cycles at variable temperatures (Figure 5.18). The blue curve represents our aging factor for temperature comprised between [-20; 25 [° C, while the red curve represents our aging factor discharge [25; 70] ° C.

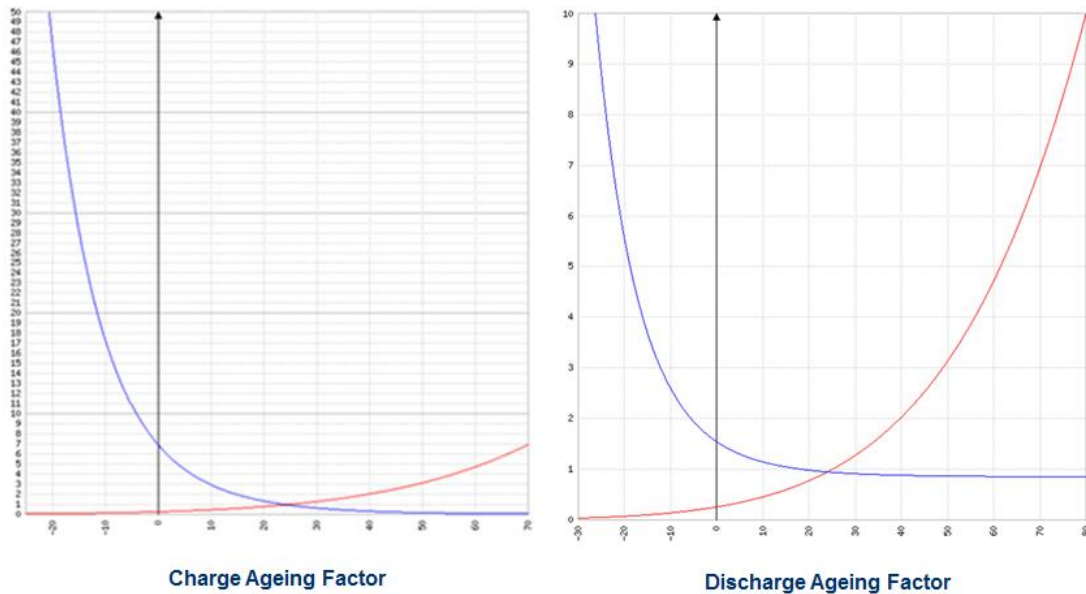

Figure 5.18. Battery ageing factor – Pulice, 2014

$$SoH_{k+1} = SoH_k - \frac{1}{5 * MCTF} * k * \frac{C + D}{2} \quad (5-3)$$

, where *MCTF* represents the mean cycle to failure, by analogy to mean time to failure, a fiabilistic parameter provided by the OEM at 500 cycles. *k* represents the number of charge/discharge cycles. *C* and *D* represent battery ageing factors corresponding to charge and discharge, which can accelerate or slow down the nominal degradation of the battery.

V Feasibility of contributions

C and D are calculated by the following equation based on degradation law in Figure 5.18:

$$C = \frac{\int_0^t c(T)dt}{t}; D = \frac{\int_0^t d(T)dt}{t} \quad (5-4)$$

- **Internal factors** (C7.2.1) impacting battery degradation projection: charge and discharge current; Charge/discharge current impacting the battery degradation projection into future have been quantified based on Dubarry et al., 2011, in order to be considered in the battery SoH calculation for successive charge/discharge cycles, leading to the following state of health projection equation:

$$SoH_{k+1} = SoH_k - \frac{1}{5 * MCTF} * k * \frac{V_c * C + V_d * D}{2} \quad (5-5)$$

, where V_c, V_d represents factors for charge and discharge degradation law based on Dubarry et al., 2011.

- **Adaptability** (Criterion n°6.4) to other mission factors is required for the projection into future activity.

Beyond these criteria, the **chemical composition** of the battery is required in order to establish the temporal evolution of the battery SoH. This criterion should thus be considered in a multi-criteria representation specific to this class of components. In our case, the battery is composed out of a 3 cell battery 3.7V / 1500mAH series polymer lithium-ion, for which two types of anode exist: variable composition based on Li Co O or Li Mn O. Without any detailed information on exact battery composition, Pulice, 2014 has taken the hypothesis of a cross-composition of the two traditional types of anode and cathode type of carbon for LiPo batteries (lithium-ion polymer). This criterion has a direct impact on the degradation law considered for the projection into future of the battery SoH.

These criteria specific to the battery component have narrowed the solution space issued of Step n°5.2, to **reliability-based method of Class D** for project into future activity (Figure 5.16).

This step of the instantiation has revealed that generic multi-criteria proposed at Chapter 4, are not sufficient for realizing the Step n°5.3 of the algorithm selection, as they require a multi-criteria representation appropriate for this specific class of components. These criteria should be analysed with regard to the multi-criteria representation proposed in Chapter 4 in order to specify

the third level of genericity of this representation for battery components. This becomes a future scientific perspective of our work which is discussed in the conclusion of this chapter.

5.3.2.2.8 Step n°6: Dynamic reconfiguration of gHMM instances

Based on this algorithm selection at Step n°5 of the instantiation, the following step (Step n°6) is iterative as it considers the temporal evolution of multi-criteria impacting availability on activity inputs, and therefore dynamic reconfiguration of the algorithm supporting the gHMM instance, and of interconnected gHMM instances.

With regards to our experimentation, a static selection of algorithms for elementary activities of gHMM instances, issued out of Step n°5. Based on the designed gHMM instances at **Step n°4 and n°5**, their simulation within Step n°7 of the white-box instantiation is presented in the following section by coupling two environments: IBM® Rational® Rhapsody® (modelling environment of the gHMM instances) and Matlab/Simulink (simulation environment for the proposed algorithms).

5.3.2.2.9 Step n°7: Simulation of gHMM instances

The gHMM instances simulation’s role within Step n°7 of the gHMM instantiation is two-fold. Firstly, it aims at validating the behaviour of the proposed gHMM instances and algorithms. Secondly, the simulation of gHMM instances aims modelling the functional architecture of gHMM instances, independently from the implementation language of algorithms, in order to consider the possible reconfiguration of algorithms within gHMM instances. In this regard, a flat view of the gHMM instances involved in the simulation is provided in the Internal Block Diagram in Figure 5.19. With regards to gHMM instantiation principle proposed in Chapter 4, this figure is homologue to Figure 4.3 applied for the UAV system.

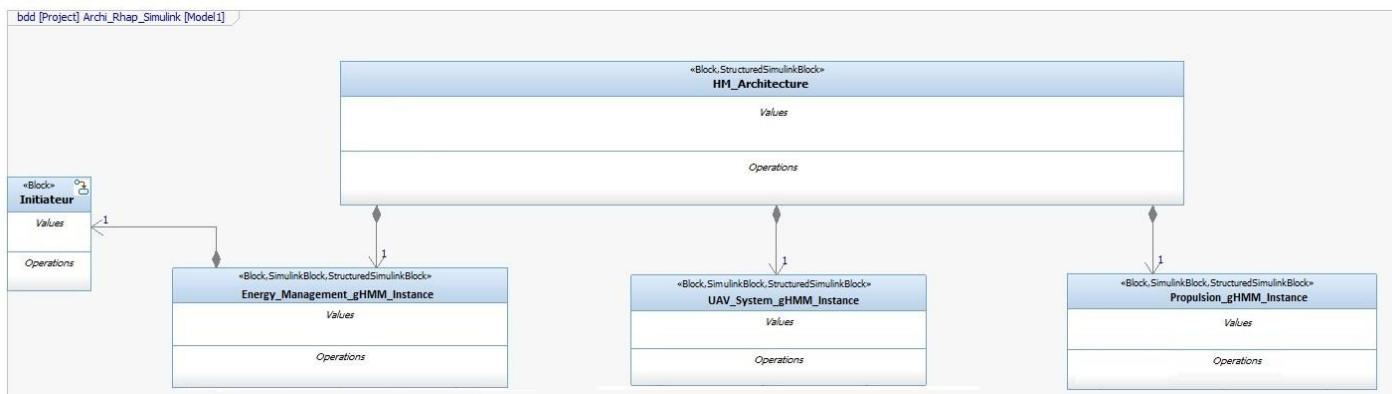

Figure 5.19. HM architecture internal block diagram

V Feasibility of contributions

In order to reach these objectives, the co-simulation of the proposed algorithms is realized by using IBM Rational Rhapsody, and Matlab/Simulink environments (Frette, 2014). The first environment supports the SysML-based model of the HM functional architecture, while the second one is used for implementation of algorithms proposed in the two previous sections. The co-simulation is enabled by “Plant Integration Model” feature of IBM Rational Rhapsody enabling to test parallel execution of algorithm’s under the two environments.

Two strategies have been followed in order couple SysML with Simulink models for algorithm simulation:

Strategy 1. Generation of SysML blocks in Internal Block Diagrams based on Simulink blocks already modelled;

Strategy 2. Generation of Simulink blocks based on gHMM instance modelling under SysML Internal Block Diagrams.

The first strategy has been realized in the case of the Energy Management gHMM instance, as diagnostics and prognostics algorithms developed by Pulice, 2014 were completed under Matlab/Simulink.

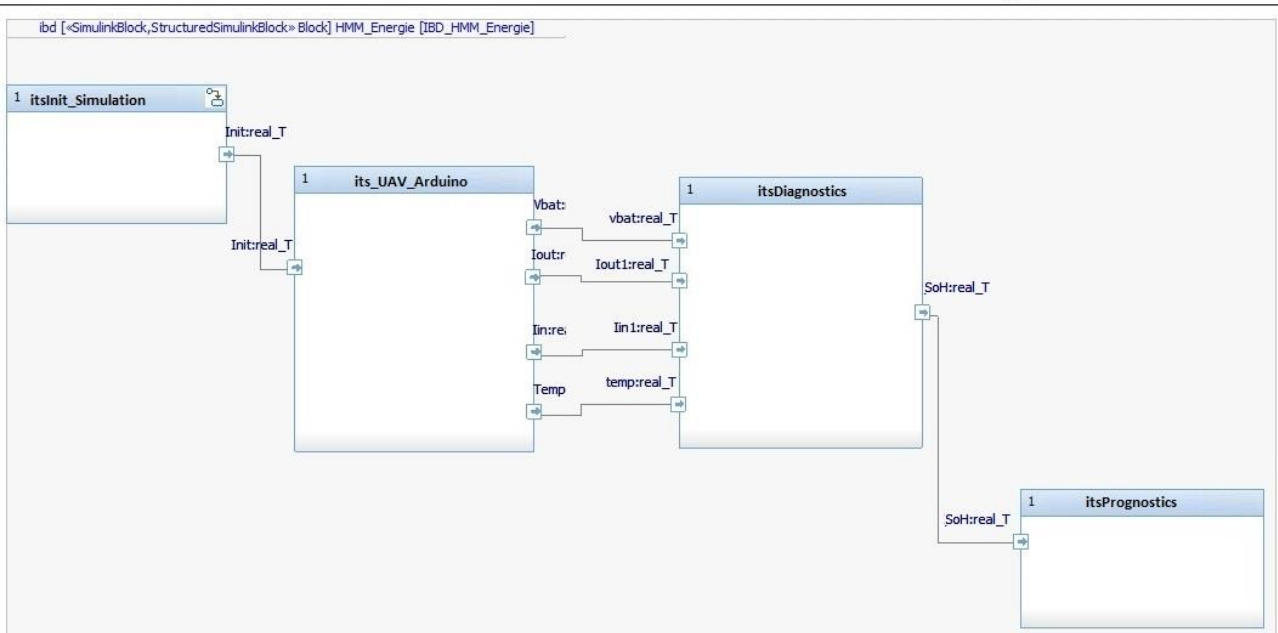
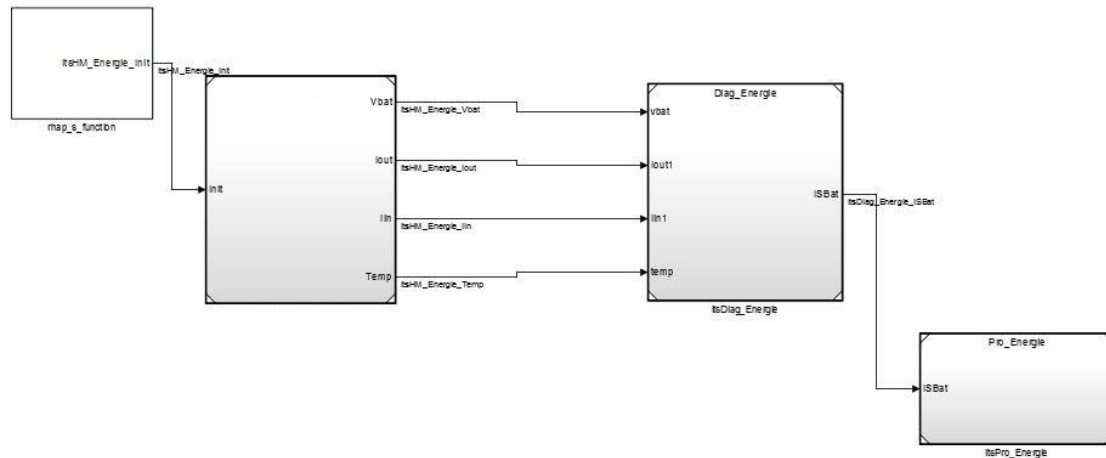

Figure 5.20. Energy management gHMM instance Simulink/SysML Diagrams – Frette, 2014

The translation of the Matlab/Simulink blocks into SysML (illustrated in Figure 5.20) has then enabled to model the information flow sent by the energy management gHMM instance to superior level (UAV system) gHMM instance, which are illustrated in Figure 5.21, based on the white-box information flows identified at Step n°4 of the gHMM instantiation. Based on these information flows in SysML, the development of the UAV system gHMM instance has been performed following the second strategy (Strategy 2), by generation of Simulink blocks based on gHMM instance modelling under SysML Internal Block Diagrams.

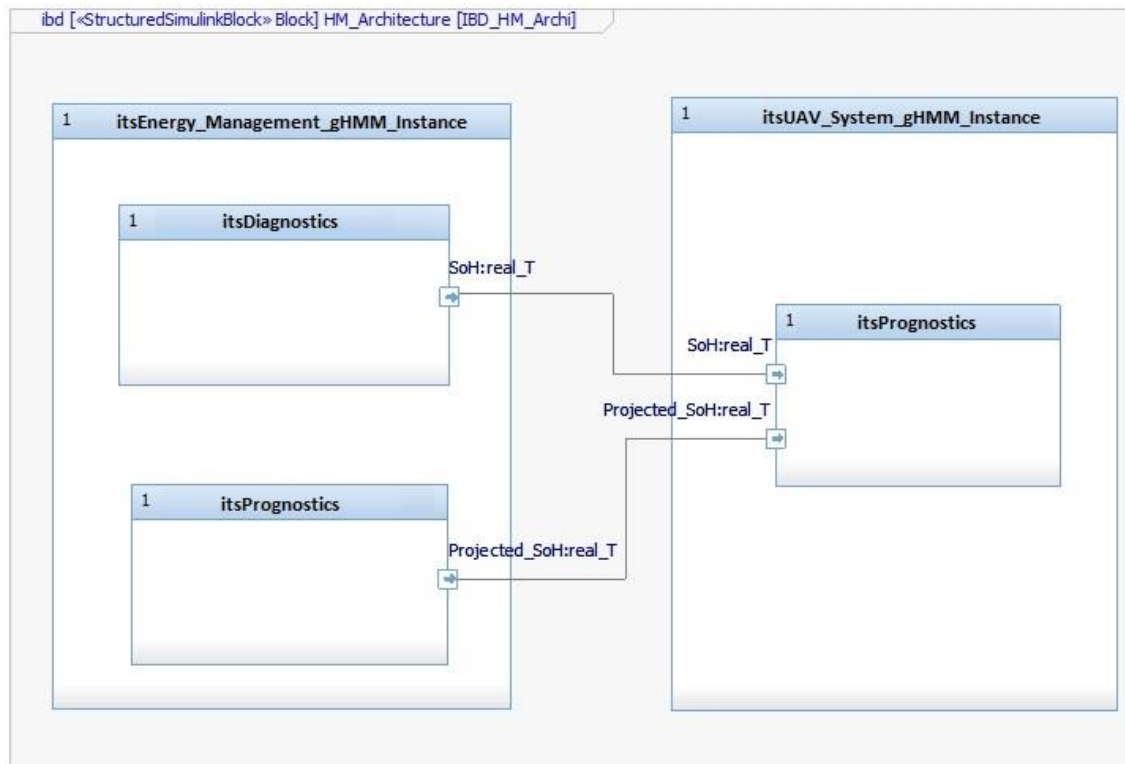

Figure 5.21. Energy management and UAV gHMM instances – Frette, 2014

The simulation results are discussed here-after for the energy management gHMM instance, and for the UAV system gHMM instance.

A. Energy Management gHMM Instance simulation

Based on diagnostics and prognostics integration in the energy management gHMM instance proposed at **Step n°5** (Section 5.3.2.2.7), the future remaining SoH of the battery is evaluated using a reliability-based model, using as input flows the current SoH, evaluated based on Coulomb counter supporting detect degradation activity, and on future mission conditions modelled by temperature and charge/discharge currents.

The results obtained by integrating diagnostics and prognostics in this gHMM instance update the battery projected SoH after each simulated charge and discharge of the battery; this update is illustrated in Figure 5.22 , as well as the decreasing maximum battery capacity simulated at the end of each charge.

In direct connexion with NFF events occurring on this LRU, the battery SoH projected at the end of the discharge of a future mission could be utilized in order to prevent too early replacement of degraded batteries. Our results open a perspective for quantification of NFF event

occurring on this LRU and on implementation of a benchmark for demonstrating the added value of this proposal.

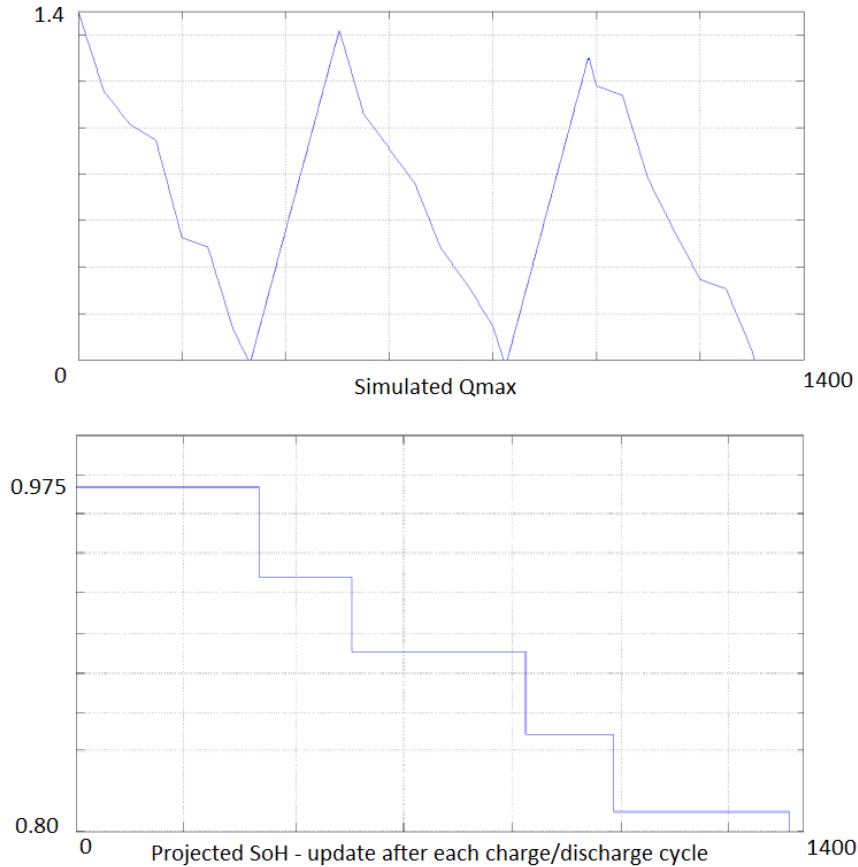

Figure 5.22. Update of battery SoH based on Pulice, 2014

B. UAV System gHMM Instance simulation

The UAV system gHMM instance simulation results are essential for validating the interoperation between gHMM instances from sub-system to system level, required for estimation of the remaining UAV SoC with respect to its future mission profile.

In order to reach this objective, the system's remaining SoC is based on the remaining battery energy to be consumed by the four propulsion assemblies, taking into consideration their respective state of health, simulated by a hybrid method based on the following elements:

- A structural electrical method based on Linzey, 2006, enabling to aggregate sub-system degradations (battery SoH and propulsion SoH) at system level;
- Utilisation of Mission, Environment, Ressources approach (Peysson et al., 2008) for modelling the future mission profile assigned to the UAV system;

V Feasibility of contributions

- System-level capacity to achieve the mission based on the quantification of required energy (Bole et al., 2014).

Based on these three methods, Bastard, 2014 formulates a simplified qualitative estimation of remaining energy based on the following equation:

$$E_{UAV} = E_{battery} * FD_{battery} - EnvF * \left(\sum_{i=1}^4 E_i^{propulsion} * FD_i \right) \quad (5-6)$$

, where E_{UAV} represents the remaining UAV energy, $E_{battery}$ represents the battery remaining energy, $E_1^{propulsion}, E_2^{propulsion}, E_3^{propulsion}, E_4^{propulsion}$ represent the energy consumption of each of the four propulsion sub-systems, which is multiplied by $EnvF$, an environmental factor impacting energy consumption. $FD_{battery}, FD_1, FD_2, FD_3, FD_4$ represent functional degradation indicators of each of energy management and four propulsion subsystems, calculated from battery SoH and propulsion SoH produced by sub-system gHMM instances.

In the scope of the simulation performed at Step n^o7, the degradation estimation (SoH1, SoH2, SoH3, SoH4 produced by diagnostics process) of propulsion sub-system are based on Chamseddine et al., 2012, while their projection into future (Future SoH1, SoH2, SoH3, SoH4 produced by prognostics process) is based on a gamma process based on van Noortwijk, 2009. Moreover, functional degradation indicators $FD_{battery}, FD_1, FD_2, FD_3, FD_4$, are expressed based on the following simplification:

$$FD = 1 - SoH \quad (5-7)$$

By using these hypotheses, the output of the UAV system gHMM instance illustrates in Figure 5.23 the diagnosed SoC at UAV level, and the predicted remaining SoC estimated at t= 101s from the beginning of the UAV mission. The estimation of Figure 5.23 considers a fixed uncertainty of 20% on the projected SoC, and the following static values for parameters of equations (5-6) and (5-7).

Parameter	Value
$SoH_{battery}$	0,45
SoH_1	0,2
SoH_2	0,2
SoH_3	0,2
SoH_4	0,2
$EnvF$	1

Table 5.3 Parameters set for illustration of Figure 5.23

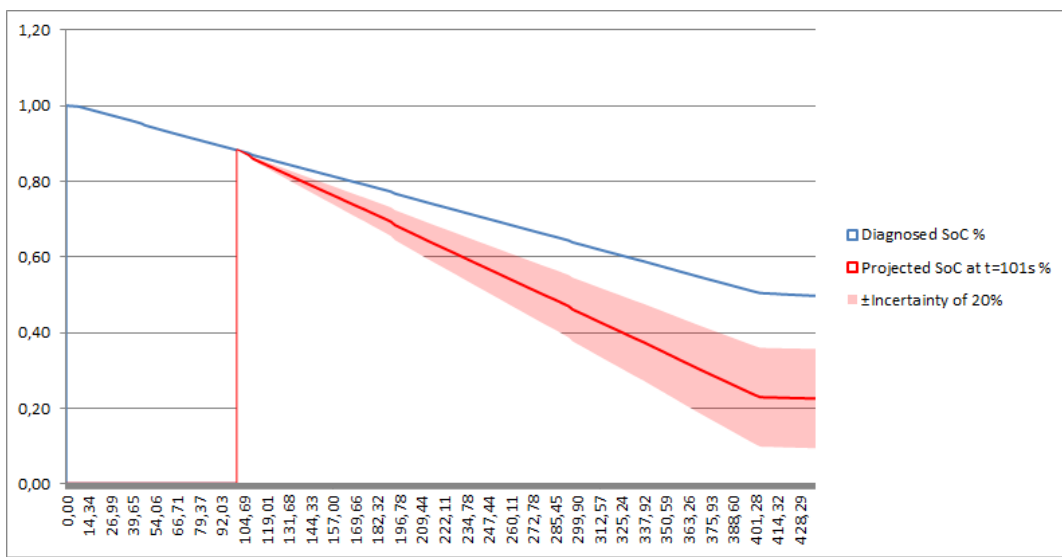

Figure 5.23. Illustration of a future mission energy consumption based on Bastard, 2014

The simulation of the gHMM instances performed at **Step n°7** of the gHMM instantiation has demonstrated the feasibility of interoperation between gHMM instances for evaluation of system level remaining SoC based on underlying sub-systems SoH, and on future mission conditions of the UAV system. Moreover, the results of coupling SysML-based models to Matlab/Simulink models proposed by Frette, 2014 opens a perspective for a methodological contribution for designing gHMM instances within the IBM Rational Rhapsody environment, which is complementary to the MBSE approach proposed for the IVHM modelling framework definition in the second chapter of the thesis.

The white-box instantiation applied to the UAV system has revealed a mission element within the gHMM instantiation methodology. A transversal instantiation step, which manages information flow required by each gHMM instance should provide a methodology to be followed for managing interfaces between each gHMM instance, which is particularly required when gHMM instances are managed separately. This was the case in our R&D project, as Pulice, 2014,

and Bastard, 2004 have defined distinct gHMM instances. This lack in the gHMM instantiation makes the object of a perspective for the gHMM instantiation procedure.

5.4 Conclusion

This chapter has tackled the verification & validation of the scientific contributions proposed by the thesis, firstly by proposal of a V&V protocol in line with TRL 4; and secondly by applying it for designing wind turbine, and for UAV health management in the IVHM modelling framework.

Throughout the chapter, the phases of the V&V protocol have realized a progressive demonstration of feasibility of the proposed generic health management module and of its instantiation feasibility by following the black and white-box instantiation phases. These validation phases have been successfully carried out in collaboration with three final year trainee engineers during six months, and have contributed to the maturity of both the SysML-based gHMM Model, and of its instantiation procedure.

A first manual verification of the gHMM model has been performed by a third party, and gave a sufficient degree of confidence to the gHMM model in input of the validation phases.

Based on the verification output, the black-box gHMM instantiation has been analysed to wind turbine health management, has validated the proposed methodology within the three instantiation steps, and has illustrated that that the proposed concepts of the IVHM modelling framework could be applied to other classes of systems.

Based on these results of the black-box instantiation, the following validation phase has tackled the white-box gHMM instantiation implemented to an experimental UAV system, illustrating the feasibility of integration of diagnostics and prognostics the energy health management gHMM instance for increasing accuracy of future SoH evaluation, and from two distinct hierarchical levels for increasing accuracy of future SoC evaluation. Based on the simulation results, the integration of diagnostics and prognostics for estimation of future battery state of health by considering future mission profile within the energy management gHMM instance has connected our proposal to the industrial problem raised at the genesis of the thesis.

A general perspective for the gHMM instantiation identified throughout the validation phase aims at enhancing the productivity of designing gHMM instances. This involves its implementation as an interactive GUI to be used by a health management engineer for designing the HM architecture in the IVHM modelling framework. Moreover, this perspective would be in

the same line as Guduvan, 2013 research initiated by the company, proposing a model-driven GUI for development of tests for avionics embedded systems.

The results of this three V&V phases have illustrated the overall feasibility of scientific contributions in the scope of TRL4, from manual verification of the SysML-based gHMM Model, to analytical and laboratory-based validation of methodologies of designing specific health management instantiating the gHMM. Moreover, the validation phases have revealed the limits of our contributions which opened a series of perspectives to be tackled in the future research on the IVHM modelling framework.

Lastly, integrating diagnostics and prognostics for estimation of future battery state of health has been connected to the industrial problem standing at the genesis of this thesis. This contribution opens a perspective for “Reduce ambiguity using RUL” activity for a system meeting the hypothesis of the proposed algorithm (ambiguity groups at system level diagnostics, and prognostics evaluations available of LRU level). However, diagnostics and prognostics are not representing an end in themselves; the quantification of NFF events and demonstration of added value of our proposals as catalyst of reduction of NFF rates is a perspective of our work.

General conclusion

Both vertical and wide in its scope, this thesis has progressively built the foundation and the pillars of an IVHM modelling framework. The main contributions and originalities of our proposals are synthesized in this final chapter by arguing how they have responded to industrial and scientific issues identified by the problem statement of the thesis. Based on this assessment, the remaining elements to be tackled in continuity of our proposals, as well as new challenges identified based on our work have opened scientific and industrial perspectives, which are discussed in the second part of this final chapter.

Synthesis of contributions

The following figure is the homologue of Figure 1.16 of Chapter 1, illustrating the connection between industrial questions at the genesis of the thesis, which have lead to scientific problems of the thesis, and our four main contributions which have tackled these problems throughout the five chapters of the thesis.

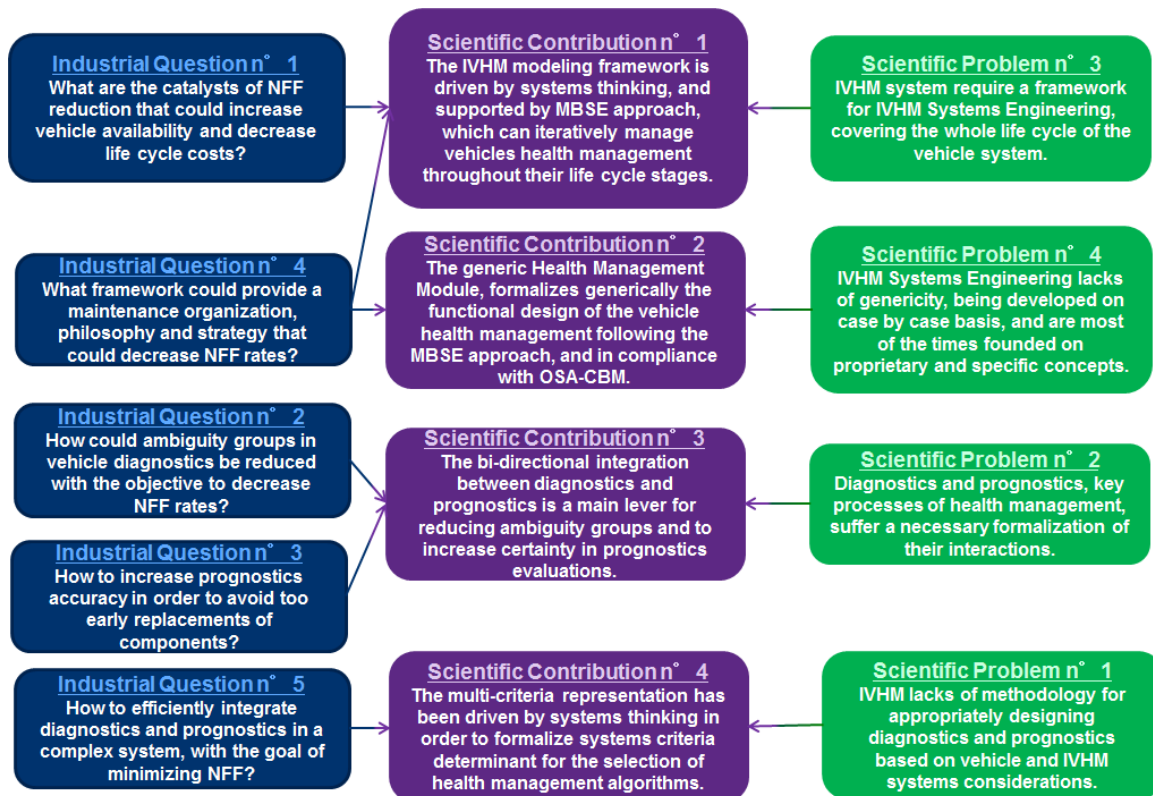

Figure C.1. Synthesis of contributions

The **first contribution** of the thesis, addressed in Chapter 2 for tackling scientific problem n°3, has first argued that IVHM is a system of systems through analysis of its main constituents as prerequisite for positioning Systems Engineering as foundational frame of the IVHM modelling framework. Based on Model-based Systems Engineering approach, the proposed IVHM modelling framework is able to cover vehicles health management throughout their life cycle in a comprehensive manner, based on iterative design, model reusability, and interoperability between vehicle and enterprise centric IVHM functions. As depicted in Figure C.1, this contribution provides answers to industrial questions n°1 and n°4, firstly by generalizing the industrial problem within IVHM in Chapter 1, and secondly by proposing the IVHM modelling framework in Chapter 2.

The **second contribution** of the thesis tackles scientific problem n°4 by proposing the fundamental element of the IVHM modelling framework, as a generic Health Management Module formalizing the vehicle health management function in an IVHM modelling framework, independently from the type of supported system. This major contribution to the IVHM modelling framework responds to industrial question n°4, as the gHMM represents the IVHM function upstream of operational decisions leading to NFF events, its formalization being sine-qua-non for tackling NFF causes occurring during vehicle utilization. Supported by the MBSE approach, the SysML-based model of the gHMM structures the vehicle health management function into four core generic processes: health monitoring, diagnostics, prognostics and decision support, whose information flows are compliant with standardized data structures of OSA-CBM. The functional flow of the gHMM responds the need of reducing ambiguity groups in vehicle diagnostics and of increasing certainty in prognostics results, by proposing a bi-directional integration between diagnostics and prognostics processes. This represents our **third contribution** to the IVHM modelling framework tackling scientific problem n°2. The original gHMM activity utilizing prognostics outputs for ambiguity group reduction is supported by an algorithm proposal exposed in Chapter 3, being in straight connexion with NFF events caused by insufficient root causes isolation required for accurately troubleshoot only those LRUs which need to be replaced during operational-level maintenance. Thus it responds directly to industrial question n°2 raised by the company with regards to NFF rates reduction.

The **fourth contribution** to design of vehicle health management in the IVHM modelling framework, has tackled scientific problem n°1 by proposing ten generic multi-criteria determinant for selecting health management algorithms, and their formalization using an ontology-based representation. This contribution is part of the methodology proposed for instantiating the gHMM into a vehicle health management functional architecture, responding to industrial question n°5.

General conclusion

Lastly, the overall contributions have been verified and validated by a third party group of engineers. This phase has firstly enabled to give sufficient confidence in the proposed gHMM model, in order to apply its instantiation procedure to design of health management for two classes of systems. The two classes of systems represent technological heterogeneous applications, which have been proposed by the company: wind turbines, and unmanned aerial vehicles. The results of this validation phase are in-line with the requirement of passing TRL 4 for the proposed IVHM modelling framework, objective of the company.

However, our research process has not completely solved all of the initial questions as the scope of the research has been narrowed through several hypotheses. Moreover, our research has lead us to identify new scientific challenges which could be tackled in the future. These remaining and new challenges are discussed in the following section, opening scientific and industrial perspectives for the IVHM modelling framework.

Perspectives

The main axes of perspectives open by the thesis are identified based on:

- Remaining elements to be tackled in continuity of our proposals, and in line with the company needs and industrial strategy:
 - Quantification of the NFF issue
 - Modelling other IVHM functions, and other life cycle stages of the vehicle within the IVHM modelling framework
 - Maturing the “Reduce ambiguity using RUL” algorithm proposal
 - Automation of the verification phase
- New needs which have emerged from our contributions, and which open new scientific perspectives:
 - Coupling MBSE and MDE for the gHMM Instantiation
 - Specification and automation of the multi-criteria selection
 - Generalizing the gHMM to other classes of Systems

1. Quantification of the NFF issue

The quantification of the NFF issues and the comparison between their current rate and the ones which could be reached following design of vehicle health management within the IVHM modelling framework is a perspective open by the formalization of the gHMM and of its instantiation procedure. More particularly this perspective is attached to demonstration of

relevance and accuracy of algorithmic proposal of Chapter 3, as well as UAV's battery diagnostics and prognostics integration in Chapter 5. In order to quantify, and trace the NFF issue, the three maintenance operations levels (operational, intermediate, and depot), interacting between themselves, could be positioned as the key element of this assessment.

2. Modelling other IVHM functions, and other life cycle stages of the vehicle within the IVHM modelling framework

As argued in Chapter 1, IVHM could enable the traceability of LRUs throughout the distinct levels of maintenance; hence it could enable NFF quantification throughout vehicles' life cycle. Based on the IVHM modelling framework, this traceability has started with the design of the vehicle health management function, upstream of NFF event occurrence; therefore it should be continued with downstream functions, involving the three levels of maintenance operations. Moreover, as argued in Chapters 2, and 3, our gHMM proposal has tackled the vehicle health management function of the IVHM modelling framework, formalizing one of the vehicle's life cycle stages, the utilization stage, in order to tackle technological causes of NFF events. Therefore, other IVHM functions, as well as other life cycle stages should be modelled in the future within the IVHM modelling framework. As the company's current product portfolio encompasses operational and intermediate level maintenance solutions, their modelling within the IVHM modelling framework is a future step integrating the gHMM proposal. With regards to other life cycle stages of interest for the IVHM modelling framework, the development stage could enable the full benefits of designing IVHM into its vehicle system from the beginning of the design stage. Moreover, this life cycle stage could integrate the gHMM with current test solutions of the company, based on U-TEST® Real-Time System for the development stage.

3. Maturing the “Reduce ambiguity using RUL” algorithm proposal

With regards to bi-directional integration of diagnostics and prognostics processes within the gHMM, the algorithm's credibility should be comforted by its feasibility to a system meeting the hypothesis of the proposed algorithm (ambiguity groups at system level diagnostics, and prognostics evaluations available of LRU level). Moreover, this contribution should be further validated against operational systems inputs in order to conclude to its relevance and accuracy. Other perspectives identified for this method include investigation of using past mission profile for RUL evaluation in case the confidence level of the RUL computed before the mission is not considered relevant.

4. Automation of the verification phase

The perspectives identified for the verification phase of the V&V protocol proposed in Chapter 5 aim at automating the syntactical verification of the SysML-based gHMM model, enabled by IBM Rational Rhapsody tool. This automatic functionality is achieved through model execution using use case scenarios / use case state-based behaviour. A pre-requisite for automatic verification would require modelling gHMM use cases as sequence and/or state chart diagrams, the focus being to verify the correctness and completeness of the gHMM model based on visual inspection of the generated model behaviour. Moreover, this perspective could impact the communication principle proposed statically in Figure 5.7, which could be further formalized in SysML sequence diagrams of each fault scenario, in order to analyse the temporal sequencing of the proposed processes execution. Therefore, this perspective requires an update of the gHMM model to be considered in future iteration on the model.

5. Coupling MBSE and MDE for the gHMM Instantiation

A major perspective open by the use of models for the gHMM, and for its instantiation in the IVHM modelling framework, could couple the MBSE approach with Model-driven Engineering (MDE) in order to automate the gHMM instantiation procedure in a modelling environment. This perspective is attached to the definition of the gHMM, as meta-model of the vehicle health management function, and of its gHMM instances, as models of the vehicle health management function in an IVHM modelling framework. This transition from gHMM, to gHMM instances, defined in the instantiation procedure could make use of MDE, relying on technologies automating model transformation increasing usability. Moreover, MDE could enable the verification of compliance between the gHMM, as a meta-model, and its gHMM instances, the models. This perspective identified for the gHMM instantiation is in direct connexion with other R&D projects conducted by the company, in the field of model-driven development of tests for avionic embedded systems by Guduvan, 2013.

6. Multi-criteria selection perspectives

The multi-criteria representation, proposed in Chapter 4, and its application at Chapter 5 for selection battery diagnostics and prognostics algorithms has revealed the gap between the general multi-criteria, and the specific on which were required for the battery component. This gap corresponds to domain application and specific multi-criteria upon which a precise solution space of health management algorithms could be reached at Step n°5.3 of the gHMM instantiation. In this regard, a perspective opens for specification of two underlying levels of genericity, and their validation based on expert knowledge. Other emerging scientific issues in

achieving this goal include the proof of existence and optimality of the solution space, the proper weighting of criteria based on IVHM requirements, and finally the automation of the multi-criteria decision making tool.

7. Generalizing the gHMM to other classes of Systems

Finally, a perspective open by our contributions involves generalizing the proposed IVHM modelling framework to other classes of systems. For the company, this perspective is important as automatic test equipment are themselves systems, their availability being sine-qua-non for the intermediate-level maintenance operations. In this context, the generalization, and instantiation of the gHMM into an ATE own health management function can be as well foreseen.

Bibliography

Adam, S.M., Friedland, C.J. (2011). A survey of unmanned aerial vehicle (UAV) for imagery collection in disaster research and management. 9th International Workshop on Remote Sensing for Disaster Response. Stanford University. pp. 1-8.

Ahmadi, A. (2010). Aircraft Scheduled Maintenance Programme Development. Decision Support Methodologies and Tools. Division of Operation and Maintenance Engineering. Lulea University of Technology. Lulea. Sweden.

Alber, G. (2013). Predicting Battery Performance Using Internal Cell Resistance. Technical Report. Boca Raton, FL, USA.

Albus, J., and Barbera, A. (2006). Intelligent Control and Tactical Behavioural Development: A long term NIST Partnership with the Army. 11th Robotic and Remote Systems for Hazardous Environments of the American Nuclear Society. Salt Lake City. USA.

Ananda, J., and Herath, G. (2009). A critical multi-criteria decision making methods with special reference to forest management and planning. Ecological Economics. Vol. 68. pp. 2535-2548.

Anderson, K. (2012). Intermittent fault detection and isolation system. Departement of Defense Maintenance Symposium and Exhibition. Grand Rapids, MI, USA.

Angulo, C. Gonzalez, G., Raya, C., and Catala, A. (2007). An OSA-CBM Multi-Agent Vehicle Health Management Architecture for Self-Health Awareness. International Journal of Intelligent Control and Systems. Vol. 12. pp. 158 – 166.

ANSI/EIA – 632 (1998). Processes for Engineering a System.

ARINC (2008). Report 672 Guidelines for the Reduction of No Fault Found (NFF). ARINC 672

ARP 6883 (2014) Aerospace Recommended Practice. Guidelines for writing IVHM requirements for aerospace systems. SAE Standard ARP 6883. Work in Progress.

Ashby, M.J., and Byer R.J. (2002). An approach for conducting a cost benefit analysis of aircraft engine prognostics and health management functions. IEEE Aerospace Conference Proceedings. Vol. 6. pp. 2847 – 2856.

Atlas, L., Bloor, G., Brotherton, T., Howard, L., Jaw, L., Kacprzyński, G., Karsai, G., Mackey, R., and Mesick, J. (2001). An Evolvable Tri-Reasoner IVHM System. IEEE Aerospace Conference Proceedings. Big Sky, Montana, USA.

Auzelle, J.P., Morel, G., Panetto, H., and Mayer, F. (2008). Using Systems of Systems Engineering to Improve the Integration of Enterprise Control Systems. Insight Journal of INCOSE. Vol 11. n°. 3.

Balaban, E., Narasimhan, S., Daigle, M., Celaya, J., Roychoudhury, I., Saha, B., Saha, S., and Goebel, K. (2011). A Mobile Robot Testbed for Prognostics-Enabled Autonomous Decision Making. Annual Conference of the Prognostics and Health Management Society. Montreal, Quebec, Canada. pp. 1-16.

Banks, J., and Merenich, J. (2007). Cost Benefit Analysis for Asset Health Management Technology. Reliability and Maintainability Symposium. Orlando, FL, USA. pp. 96 – 100.

Banks, J., Reichard, K., Crow, E., and Nickell, K. (2009). How engineers can conduct cost-benefit analysis for PHM system. IEEE Aerospace and Electronic Systems Magazine. Vol 24, no. 3, pp. 22-30.

Baptiste, P., Bernard, A., Bourrières, J.-P., Lopez, P., Morel, G., Pierreval, H. and Portmann, M.-C. (2007). ERP committee of experts: research prospects.

Bastard, G. (2013). Etude Bibliographique sur le domaine Eolien et ses systèmes de maintenance associés. Rapport Interne Cassidian Test & Services.

Bastard, G. (2014). Pronostic de Performance de Niveau Système d'un Véhicule, Application au Suivi de la Performance Energétique d'un Drone. Rapport Article Scientifique - Master Recherche. Université de Lorraine. Nancy, France.

Belard, N., Pencolé, Y., and Combacau, M. (2011). A Theory of Meta-Diagnosis: Reasoning about Diagnostic Systems. Proceedings of the Twenty-Second International Joint Conference on Artificial Intelligence. pp. 1-8. Barcelona, Spain.

Belard, N. (2012). Reasoning about models: Detecting and Isolating Abnormalities in Diagnostic Systems. PhD Thesis. University of Toulouse, France.

Bibliography

Benedettini, O., Baines, T., and Greenough, R. (2009). State of the art in Integrated Vehicle Health Management. Proceedings of the institution of mechanical engineers, Part G: journal of aerospace engineering. Vol. 223 (2), pp. 157-170.

Berre, A. (2007). Specification of Interoperability Framework and Profiles, Guidelines and Best Practices. ATHNEA – Advanced Technologies for Interoperability of Heterogonous Enterprise Networks and their Application. FP6-IST- 507849.

Bezivin, J., Paige, R., Aßmann, U., Rumpe, B., and Schmidt, D. (2008). Model Engineering for Complex Systems. Dagstuhl Seminar Proceedings.. pp. 1-4. Dagstuhl, Germany.

Bole, B., Daigle, M., and Gorospe, G. (2014). Online prediction of battery discharge and estimation parasitic loads for an electric aircraft. Second European Conference of the Prognostics and Health Management Society. Nantes, France.

Bregon, A., Daigle, M., Roychoudhury, I. (2012). An integrated framework for Model-based distributed Diagnosis and Prognosis. Annual Conference of the Prognostics and Health Management Society. MI, USA. pp. 1-11.

Buderath, M., and Adhikari, P. (2012). Simulation Framework and Certification Guidance for Condition Monitoring and Prognostic Health Management. First European Conference of Prognostics and Heath Management Society. Dresden, Germany.

Buderath, M., and Rissiek, J. (2012). EADS Aspiration to Develop PHM Technologies and Services. First European Conference of the Prognostics and Health Management Society. Dresden, Germany.

Burchell, B. (2007). Untangling No Fault Found. Aviation Week Magazine - Overhaul and Maintenance. <http://aviationweek.com/>

Byington, C., Watson, M., Edwards, D., and Stoelting, P. (2004). A model-based approach to prognostics and health management for flight control actuators. IEEE Aerospace Conference, Big Sky, MT, USA.

Byington, C., Kalgren, P., Johns, R., and Beers, R. (2006). Embedded diagnostic/prognostic reasoning and information continuity for improved avionics maintenance. Impact Technologies LLC., State College, PA, USA.

- Cassidian Test & Services (2008). False Alarm Definition. V2. N° 11082008 GIFAS. pp. 1-53.
- Cassidian Test & Services (2009). Testability, Diagnostic and Prognostic, 3 pillars for Health Management Systems. T-Watch. p. 8.
- Chamseddine, A., Zhang, Y., Rabbath, C.A., and Theilliol, D. (2012). Trajectory planning and replanning strategies applied to a quadrotor unmanned aerial vehicle. *Journal of Guidance, Control and Dynamics*. Vol. 35. Is. 5. pp. 1667 – 1671.
- Chen, C., Brown, D., Sconyers, C., Zhang, B., Vachtsevanos, G., and Orchard M. (2012). An integrated architecture for fault diagnosis and failure prognosis of complex engineering systems. *Elsevier Expert Systems with Applications*. Vol 39. pp. 9031 – 9040.
- Chérière, V. (2014). Aircraft preventive diagnosis based on failure condition graphs. 2nd European Conference of the Prognostics and Health Management Society. Nantes, France.
- Cocheteux, P., Voisin, A., Levrat E., and Iung, B. (2009). Methodology for assessing system performance loss within a proactive maintenance framework.
- Davidz, H.L. (2006). Enabling Systems Thinking to Accelerate the Development of Senior Systems Engineers. Massachusetts Institute of Technology (MIT).
- Delair-tech (2011). <http://www.delair-tech.com>
- Deng, Y., Chan, F., Wu, Y., and Wang, D. (2011). A new linguistic MCDM method based on multiple-criterion data fusion. *Expert Systems with Applications*. Elsevier. Vol. 38. Is. 6. pp. 6985-699.
- Dibsdale C. (2011). The development of maintenance and the role of integrated vehicle health maintenance. *IVHM Perspectives on an Emerging Field*. SAE International. pp. 9- 15. Warrendale, PE, USA.
- Discenzo, F.M., Nickerson, W., Mitchell, C.E, and Keller, K. (2001). Open systems architecture enables health management for next generation system monitoring and maintenance. Development White Paper, OSA-CBMTM Development Group.
- DoD. (2001). *Systems Engineering Fundamentals*. Defence Acquisition University Press. Fort Belvoir, Virginia, USA.

Bibliography

- DoD (2011). F-35 Joint Strike Fighter Concurrency Quick Look Review. Washington, USA.
- Dong, M., and He, D. (2007). A segmental hidden semi-Markov model (HSMM)-based diagnostics and prognostics framework and methodology. *Mechanical Systems and Signal Processing*. Vol 21. pp. 2248 – 2266.
- Doumeingts, G., Müller, J., Morel, G., and Vallespir, B. (2007). *Enterprise Interoperability: New challenges and opportunities*. Springer Science and Business Media. ISBN-13: 9781846287138.
- Dubarry, M., Truchot, C., Liaw, B.Y., Gering, K., Sazhin, S., Jamison, D., and Michelbacher, C. (2011). Evaluation of commercial lithium-ion cells based on composite positive electrode for plug-in hybrid electric vehicle applications. Part II. Degradation mechanism under 2C cycle aging. *J. Power Sources* Vol. 196. pp. 10336–10343.
- Dubrovsky, V. (2004). Toward system principles: General system theory and the alternative approach. *Systems Research and Behavioral Science*. Vol. 21, pp. 109-122.
- Dunsdon, J., and Harrington, M. (2008). The application of Open System Architecture for Condition Based Maintenance to complete IVHM. *IEEE Aerospace Conference*. Big Sky, Montana, USA.
- EADS (2013). *Systems Engineering Basic Training*, V 3.0.
- EASA (2013). <http://easa.europa.eu>.
- Ebrahimipour, V. K. Rezaie, K., and Shokravi, S. (2010). An ontology approach to FMEA studies. *Expert Systems with Applications*. Elsevier. Vol. 37. Issue 7 . pp. 671 – 677.
- Escriba, C., Fourniols, J., and Lastapis, M. (2012). New Real-Time Structural Health Monitoring MicroSystem for Aircraft Propeller Blades. *IEEE Aerospace and Electronic Systems Magazine*. Vol. 27. pp. 29 – 41.
- Esperon Miguez, M. (2013). Financial and risk assessment and selection of health monitoring system design options for legacy aircraft. Phd Thesis IVHM Research Center. Cranfield, UK.
- Esperon Miguez, M., John, P., and Jennions, I. (2013). A review of Integrated Vehicle Health Management tools for legacy platforms: Challenges and opportunities. *Progress in Aerospace Sciences*. Vol. 56. pp. 19 –34.

Eysenck, M.W. (1998). Psychology: an integrated approach. Harlow: Addison Wesley Longman. p. 156.

Falquet, G. (2013). Knowledge Engineering Some Definitions. University of Geneva. University Center of Computer Science. Geneva, Switzerland.

Feigenbaum, E., and McCorduck, P. (1983). The fifth generation (1st Ed.), Reading, MA: Addison-Wesley. ISBN 978-0-201-11519-2.

Felke, T., Hadden, G., Miller, D., and Mylaraswamy, D. (2010). Architectures for Integrated Vehicle Health Management. AIAA Infotech@Aerospace Conference. Atlanta, GA, USA.

Ferrarini, L., Kalogeras, A., and Lüder, A. (2006). PABADIS' Promise Next Generation Control Devices. PABADIS based Product Oriented Manufacturing Systems for Reconfigurable Enterprises. FP6- IST-016649.

Fly'n'Sense (2010). <http://www.fly-n-sense.com/>

Frette, L. (2014). Investiguer, développer et valider de nouvelles technologies utilisées sur des produits de type IVHM (Integrated Vehicle Health Management). Rapport Master Ingénierie de Systèmes Complexes. Université de Lorraine. Nancy, France.

Friedenthal S., Moore A., and Steiner R. (2009). OMG Systems Modeling Language Tutorial. INCOSE.

Friedenthal S. (2010). Model-based Systems Engineering (MBSE) using SysML. Third International Conference on MBSE. Fairfax, VA, USA.

Gallagher, G., Higgins, L., Khinoo, L., and Pierce, P. (1992). Fixed Wind Performance. U.S. NAVAL TEST PILOT SCHOOL. FLIGHT TEST MANUAL. USNTPS-FTM-NO. 108. Chapter 10. p. 10.1.

Gandy, M., and Line, K. (2003). Joint Strike Fighter – Prognostics and Health Management. Technica Report. Ref. AER200301014.

Geanta, I. (2014). Generic Health Management Module Formalization. V4.1. Internal Technical Report. Cassidian Test & Services.

Bibliography

Geisert, Madrona A., and Jackson, S. (2000). The application of Systems Engineering to the Synthesis of Enabling Products: An aircraft support system. INCOSE Proceedings. Minneapolis, MN, USA.

Génova, G. (2009). What is a meta-model: the OMG's meta-modelling infrastructure. Knowledge Reuse Group. Universidad Carlos III de Madrid, Madrid, Spain. pp. 1-18.

Goebel, K., and Vachtsevanos, G. (2011). Algorithms and their impact on Integrated Vehicle Health Management. Integrated Vehicle Health Management, Business Case Theory and Practice. Vol. 1. SAE International. Warrendale, PE, USA.

Goebel., K., Saxena, A., Daigle, M., Celaya, J., and Roychoudhury, I. (2012). Introduction to Prognostics. First European Conference of the Prognostics and Health Management Society. pp. 1 – 72. Dresden. France.

Gorinevsky, D. Gordon, G., Beard, S. Kumar, A., and Chang, F.K. (2005). Design of Integrated SHM System for Commercial Aircraft Applications. 5th International Workshop on Structural Health Monitoring, Stanford, CA, USA.

Gorinevsky, D., Smotrich, A., Mah, R., Srivastava, A., Keller, K., and Felke, T. (2010). Open Architecture for Integrated Vehicle Health Management. AIAA Infotech@Aerospace Conference. Atlanta, GA, USA.

Gould, E. (2011). Diagnostics “after” prognostics: Steps towards a prognostics-informed analysis if system diagnostic behavior. IEEE Prognostics and Health Management Conference. Montreal, QC, Canada.

Grabot, B., Mayère, A., and Bazet, I. (2008). ERP Systems and Organisational Change. A Socio-technical Insight. Springer Series in Advanced Manufacturing. ISBN-13: 9781848002824.

Guarino, N. (1998). Formal ontology and information systems. Proceedings of Formal Ontology in Information Systems. Trento, Italy. pp. 3 – 15.

Guduvan, A. (2013). A model-driven development of tests for avionic embedded systems. ISAE. Toulouse, France. p.27.

Gupta, J., Trinquier, C., Lorton, A., and Feuillard, V. (2012). Characterisation of prognosis methods: an industrial approach. First European Conference of the Prognostics and Health Management Society. Dresden, Germany.

Halsey, W.D. (1979). MacMillan Contemporary Dictionary. MacMillan Publishing. London, UK. p. 1106.

Hess, A., Calvello, G., and Dabney, T. (2004). PHM a key enabler for the JSF autonomic logistics support concept. Vol. 6. Pp. 3543 – 3550.

Heylighen, F. (1998). Basic Concepts of the Systems Approach. Principia Cybernetica Web. Brussels, Belgium.

Higsons, R. Lee, O, and Connolly, J. (2014). Unmanned Aerial Vehicles – Growing markets in a changing world. Market research report QI3 Ltd.

Hoffmann J.P. (2011). Systems Engineering Best Practices with the Rational Solution for System and Software Engineering. V 3.1.2. Somers, NY, USA.

Hoffmann, F., Rabourdin, A., Wurzel, G., Bendisch, S., and Konstanzer, P. (2011). Usage based maintenance for dynamic components of rotorcraft. American Helicopter Society 67th Annual Forum. Virginia, USA.

Hoffmann, F. (2014). Enabling Condition Based Maintenance for Helicopters. Keynote Lecture. Second European Conference of Prognostics and Health Management Society. Nantes, France.

IEEE (1990). Standard Computer Dictionary: A Compilation of IEEE Standard Computer Glossaries. New York, NY, USA.

IEEE 610.12 (1990). IEEE Standard Glossary of Software Engineering Terminology.

IEEE 100 (2000). Standard Information Network. The Authoritative Dictionary of IEEE Standards Terms, Seventh Edition. NY, USA.

IEEE 1471 (2000). IEEE Recommended Practice for Architectural Description for Software-Intensive Systems.

IEEE 1232 (2010). IEEE 1232-2010. Standard for Artificial Intelligence Exchange and Service Tie to All Test Environments (AI-ESTATE).

Bibliography

- INCOSE (2007). Systems Engineering Vision 2020.
- INCOSE (2008). Survey of Model-Based Systems Engineering (MBSE) Methodologies. pp. 9-10.
- INCOSE (2010). Systems Engineering Handbook, A guide for system life cycle processes and activities. V.3.2. San Diego, CA, USA.
- Isermann, R., and Ballé, P. (1997). Trends in the Application of Model-Based Fault Detection and Diagnosis of Technical Processes. Control Engineering Practices. Vol. 5. pp. 709 - 719.
- ISO 13372 (2012). Condition monitoring and diagnostics of machine – Vocabulary. International Organization for Standardization.
- ISO 13374 (2012). Condition monitoring and diagnostics of machines – Data processing, communication and presentation. Parts 1, 2, and 3. International Organization for Standardization.
- ISO 13381-1 (2004). Condition monitoring and diagnostics of machines -- Prognostics -- Part 1: General guidelines. International Organization for Standardization.
- ISO/IEC 15288:2008 (2008). Systems and software engineering – System life cycle processes. Geneva. Switzerland.
- ISO/IEC/IEEE 42010 (2011). Systems and software engineering – Architecture description. Geneva. Switzerland.
- Jardine A., Lin D., and Banjevic D. (2006). A review on machinery diagnostics and prognostics implementing condition-based maintenance. Mechanical Systems and Signal Processing. Vol. 20. pp. 1483-1510.
- Jennions, I. (2011). Integrated Vehicle Health Management. Perspectives on an Emergine Field. SAE International. Warrendale, PE, USA.
- Jennions, I. (2012). Integrated Vehicle Health Management: Business Case Theory and Practice. SAE International. Warrendale, PE, USA.
- Jennions, I. (2013).a. Integrated Vehicle Health Management: The Technology. SAE International. Warrendale, PE, USA.
- Jennions, I. (2013).b. The developing field of Integrated Vehicle Health Management. Journal of Aerospace Sciences and Technologies. Vol. 65. Is. 1A. pp. 69-78.

Johnson, S., Day, J. (2011). System Health Management Theory and Design Strategies. AIAA Infotech Aerospace Conference. St. Louis. MI, USA.

Jones, J.V. (2006). Integrated Logistics Support Handbook. McGraw-Hill. 3rd Edition. NY, USA.

Kacprzyński, G.J, Roemer, M.J., and Hess A. (2002). Health management system design: Development, simulation and cost/benefit optimization. IEEE Aerospace Conference Proceedings. Vol. 6. pp. 3065 – 3072.

Kalgren, P., Byington, C., Roemer, M. (2006). Defining PHM, a lexical evolution of maintenance and logistics. IEEE Autotestcon Proceedings. Anaheim, CA, USA.

Kalgren, P., Baybutt, M., Dabney, T., Ginart, A., Minnella, C., and Roemer, M.J. (2007). Application of Prognostic Health Management in Digital Electronic Systems. IEEE Aerospace Conference. pp. 1 – 9. Big Sky, MT, USA.

Karray, M.H., Chebel Morello, B., and Zehouni, N. (2009). Towards a maintenance semantic architecture. World Congress of Engineering Asses Management. Athens. Greece. pp. 1-14.

Kast, F., and Rosenzweig, J. (1972). General systems theory: Application for Organization and Management. Academy of Management Journal, Washington, USA. pp. 447 – 467.

Keller. K. (2008). Health management technology integration. IET Seminar on Aircraft Health Management for New Operational and Enterprise Solutions, London.UK. pp. 1-19.

Khan, S., Phillips, P., Hockley, C., and Jennions, I. (2012). No Fault Found, Retest OK, Cannot Duplicate or Fault Not Found? – Towards a standardized taxonomy. 1st International Conference on Through-life Engineering Services TESConf 2012. Cranfield, UK. pp. 1- 8.

Khella, M., Martin, T., Pearson, J., and Dixon, R. (2010). Systems approach for health management design: A simple fuel system case study. IN: 5th International Conference on System of Systems Engineering (SoSE), Loughborough, UK. pp. 1 -6.

KK electronic. (2009). Wind Turbine Benchmark Model. <http://www.kk-electronic.com/Default.aspx?ID=9497>

Kothamasu, R., Huang , S.H., and VerDuin, W. (2006). System health monitoring and prognostics - a review of current paradigms and practices”, The International Journal of Advanced Manufacturing Technology. Vol. 28. pp. 1012-1024.

Bibliography

Kulkarni, C.S., Celaya, J.R., Biswas, G., Goebel, K. (2012). Prognostics of Power Electronics, methods and validation experiments. IEEE AutoTestCon Proceeding. Anaheim, CA, USA.

Kumar, S., Torres, M., Chan, Y.C., and Pecht, M. (2008). A hybrid prognostics methodology for electronic products. IEEE World Congress on Computational Intelligence. Hong Kong, China.

Kumar, U., and Ellingsen, H.P. (2000). Design and development of maintenance performance indicator for the Norwegian oil and gas industry. Proceedings of the 15th European Maintenance Congress: Euromaintenance. Gothenburg, Sweden. pp. 224-228.

Kurien, J., R-Moreno, M.D. (2008). Cost and Benefits of Model-based Diagnosis. IEEE Aerospace Conference. Big Sky, MT, USA.

Lam, M. (2009). Demystifying No Fault Found. In Aviation Week Magazine – Overhaul and Maintenance. <http://aviationweek.com/>

Langlois, R. (1983). System theory, knowledge, and the social sciences. The Study of Information: Interdisciplinary Messages. pp. 581 – 600. John Wiley: New York, USA.

Laszlo, A., and Krippner, S. (1998). Systems Theories: their origins, foundations, and development. Systems theories and a priori aspects of perception. Elsevier Science. Ch. 3. pp. 47 – 74.

Lauffer, J. (2012). Diagnostics Driven PHM: The Balanced Solution. First European Conference of the Prognostics and Health Management Society. Dresden. Germany. Pp. 93 – 102.

Lebold, M., Reichard, K., Byington, C., and Orsagh, R. (2002). OSA-CBM architecture development with emphasis on XML implementations. Maintenance and Reliability Conference. Knoxville, TN, USA.

Lieber, R., Dupont, J.M., Bouffaron, F., and Morel, G. (2013). Improving physical-physiological interaction requirements for maintenance enabling systems specification. 12th IFAC/IFIP/IFORS/IEA Symposium on Analysis, Design, and Evaluation of Human-Machine Systems. Las Vegas, NV, USA.

Linzey, W.G. (2006). Development of an Electrical Wire Interconnect System Risk Assessment Tool. U.S. Department of Transportation Federal Aviation Administration Office of Aviation

Research and Development. Technical Report no. DOT/FAA/AR-TN06/17. Washington DC, USA.

Liu, H., and Jia, X. (2010). Model Transformation using a simplified meta-model. *Software Engineering and Applications*. Vol. 3 pp. 653 – 660.

Lojr, A., Haines, C., and Buderath, M. (2012). Data Management Backbone for Embedded and PC-based Systems Using OSA-CBM and OSA-EAI. *First European Conference of Prognostics and Health Management Society*. Dresden, Germany.

Losik, L. (2012). Using the Prognostics Health Management Program on the Air Force Next Generation Reusable Launch Vehicle. *American Institute of Aeronautics and Astronautics Space Conference*. Pasadena. CA. USA. pp. 1 – 20.

Malcolm, J. G. (1982). BIT false alarms - An important factor in operational readiness. *Annual Reliability and Maintainability Symposium*, Los Angeles, CA, USA, pp. 206-212.

Manskins, J.C. (1995). Technology Readiness Levels. White Paper. *Advanced Concepts Office of Space Access and Technology - NASA*. pp. 1-5.

Marzat, J., Piet-Lahanier, H., Damongeot F. and Walter, E. (2012). Model-based fault diagnosis for aerospace systems: a survey. *Proceedings of the Institution of Mechanical Engineer, Part G.: Journal of Aerospace*. Vol. 226. No. 10. pp. 1-32.

Massé, J.R., Hmad, O., and Boulet, X. (2012). System PHM Algorithm Maturation. *1st European Conference of PHM Society*. Dresden, Germany.

Medina-Oliva, G., Voisin, A., Monnin, M., Peysson, F., and Leger, J.B. (2012). Prognostics Assessment Using Fleet-wide Ontology. *Annual Conference of the Prognostics and Health Management Society*. Minneapolis, MN, USA. Pp. 1-10.

Merziger, G. (1992). Approaches to abductive reasoning. *German Research Center for Artificial Intelligence*. Kaiserslautern. Germany.

Mikat, H., Siddiolon, A., Buderath, M. (2012). Virtual Framework for Validation and Verification of System Design Requirements to enable Condition Based Maintenance. *First European Conference of Prognostics and Health Management Society*. Dresden, Germany.

Bibliography

Mikat, H., Siddiolon, A., Buderath, M. (2014). Development of Diagnostics & Prognostics for Condition-based Decision Support. Second European Conference of Prognostics and Health Management Society. Nantes, France.

MIL STD 2165 (1985). Testability Program for Electronic Systems and Equipments. Department of Defense. Washington, WS, U.S. pp 1-80.

Minsky, M. (1965). Matter, Mind and Models. International Federation of Information Processing Congress, Vol. 1, pp. 45-49.

Mittal, S., Risco Martin, J.L. (2013). Model-driven Systems Engineering for net-centric Systems of System with DEVS unified process. Proceedings of the 2013 Winter Simulation Conference.

Mobley K., Higgins L., Lindley, and Wikoff D. (2008). Maintenance Engineering Handbook, McGraw-Hill Professional, Seventh Edition. NY, USA.

Moir, I., and Seabridge, A. (2008). Aircraft Systems: Mechanical, electrical, and avionics subsystems integration. Chapter 13. Environmental Conditions. , Third Edition. John Wiley and Sons. pp. 478 – 497.

Monnin, M., Abichou, B., Voisin, A., and Mozzati, C. (2011). Fleet historical cases for predictive maintenance. International Conference on acoustical and vibratory methods in surveillance and diagnostics, Surveillance 6, Compiègne, France.

Morbach, J., Wiesner, A., and Marquardt, W. (2007). A meta model for the design of domain specific ontologies. Technical Report. Aachen University. Germany. pp. 1 – 72.

Muller, A. (2005). Contribution to the predictive maintenance of production systems by formalizing the prognostics process. PhD Thesis. University Henri Poincaré. Nancy, France.

Muller A., Suhner M.-C., and Iung B. (2008). Formalisation of a new prognosis model for supporting proactive maintenance implementation on industrial system. Reliability Engineering & System Safety Vol. 93 Issue 2. pp. 234-253.

NASA (1992). Research and technology goals and objectives for integrated vehicle health management (IVHM). Report NASA-CR-192656. NASA Technical Reports Server.

NASA (2007). NASA's Beyond Einstein Program – An Architecture for Implementation. Washington, D.C., USA. p. 67.

NASA (2008). NASA IVHM Project homepage. IVHM homepage.

NASA (2012). System Hierarchy and Work Breakdown Structure Module. Fundamentals of Systems Engineering Conference. pp. 7-8.

Negele, H. (2000). Systems Engineering – A Key to Competitive Advance for All Industries. ISBN 3-89675-935-3. p. 125.

NF EN 13306. (2001). Maintenance Terminology. Paris, France.

Niculita, O., Irving P., and Jennions, I. (2012). Use of COTS Functional Analysis Software as an IVHM design tool for Detection and Isolation of UAV Fuel System Faults. Annual Conference of the Prognostics and Health Management Society. Minneapolis, Minnesota, USA.

Niculita, O., Jennions, I., and Irving P. (2013). The Integrated Vehicle Health Management Development Process: Verification and Validation of Simulation Models. Chemical Engineering Transactions. Vol. 33. pp. 121 – 126.

Niculita, O., Jennions, I., and Medina Valdez, M. (2014). Towards an Integrated COTS Toolset for IVHM Design. Second European Conference of the Prognostics and Health Management Society. Nantes, France.

Noor-E-Alam, M., Ferdousi Lipi, T., Ahsan Akhtar Hasin, M., and Ullah, A.M.M.S. (2011). Algorithms for fuzzy multi expert multi criteria decision making (ME-MCDM), Knowledge-Based Systems. Elsevier. Vol. 24. Is. 3. pp. 367-377.

Nowlan, F.S, and Heap, H.F. (1978). Reliability Centered Maintenance. United Airlines Publication, San Francisco, CA, USA.

Noy, N.F., McGuinness, D.L. (2001). Ontology Development 101: A Guide to Creating Your First Ontology. Protégé Stanford Publications. Stanford University, Stanford, CA, USA.

Odgaard, P.F., Stoustrup, J., and Kinnaert M. (2009). Fault Tolerant Control of Wind Turbines – a benchmark model. IFAC Fault Detection, Supervision and Safety of Technical Processes. pp. 155 – 160. Sants Hotel, Spain.

OSA-CBM website : <http://www.mimosa.org/?q=resources/specs/osa-cbm-330>

Oxford English Dictionary. (2010). Vehicle, n. Oxford University Press. Oxford, UK.

Bibliography

Panetto, H., Molina, A (2008). Enterprise integration and interoperability in manufacturing systems: Trends and issues. Elsevier Computers in Industry. Vol. 59. Pp. 641-646.

Paris, D.E., Trevino, L.C., and Watson, M.D. (2005). A framework for integration of IVHM technologies for intelligent integration for vehicle management. IEEE Aerospace Conference. Big Sky, MT, USA. pp. 3843 – 3852.

Peirce, C. S . (1901). On the Logic of drawing History from Ancient Documents especially from Testimonies(1901), Collected Papers v. 7, paragraph 219.

Pelham, J., Fan, I.S., Jennions, I., and McFeat, J. (2013). Dual Use IVHM for UAS Health Management. SAE Aerotech Congress and Exhibition. Montréal, Quebec, Canada.

Pernick, R., Wilter, C., and Winnie, T. (2013). Clean energy trends. Clean Edge. <http://www.cleandedge.com/reports/clean-energy-trends-2013>.

Peyson, F., Ouladsine, M., and Outbib, R. (2009). Complex System Prognostics: a New Systemic Approach. Annual Conference of the Prognostics and Health Management Society. San Diego, CA, USA.

Pulice, J. (2014). Combinaison d'une méthode de diagnostic et d'une méthode de pronostic hybride au sein d'une architecture IVHM. Article Scientifique - Master Recherche. Université de Lorraine. Nancy, France.

Puttini L.C. (2013). IVHM Development and the Big Data Paradigm. SAE Aerotech Congress. Montreal, Canada.

Rajamani R., Saxena A., Kramer F., Augustin M. (2013). Developing IVHM Requirements for Aerospace Systems. SAE Aerotech Congress. Montreal, Canada.

Rapoport, A. (1968). General System Theory. The international encyclopedia of social sciences. Vol. 15 pp. 452 – 458. David L. Sill. Edition. New York, USA.

Ravi, V., and Zimmerman, H.-J. (2000). Fuzzy rule based classification with Feature Selector and modified threshold accepting. European Journal of Operational Research. Vo. 123. Is. 1. pp. 16–28.

Reveley, M., Kurtoglu, T., Leone, K., Briggs, J., and Withrow, C. (2010). Assessment of State of the Art in Integrated Vehicle Health Management Technologies as Applicable to Damage Conditions. NASA/TM – 2010-216911.

Ribot, P. (2009). Diagnosis and prognosis for the maintenance of complex systems. IEEE International Conference on Systems, Man and Cybernetics. pp. 4146 – 4151. San Antonio, TX, USA.

Ribot, P., Pencolé, Y., and Combacau, M. (2009). Diagnosis and prognosis for the maintenance of complex systems. IEEE International Conference on Systems, Man, and Cybernetics. San Antonio, USA.

Rodger, J. (2012). Towards reducing failure risk in an integrated vehicle health maintenance system: A fuzzy multi-sensor data fusion Kalman filter approach for IVHMS. Expert Systems with Applications. Volume 39, Issue 10, pp. 9821–9836

Roques, P. (2011). SysML vs. UML 2: A detailed comparison. Models Conference. Wellington, New Zealand. pp. 1-80.

Rouquette, N. Jenkins, S. (2010). OWL Ontologies and SysML Profiles: Knowledge Representation and Modeling. OMG/Eclipse Symposium. California, USA.

SAE International (2014). HM-1 Integrated Vehicle Health Management Committee website: HM-1 homepage

Saxena, A. Celaya, J. Balaban, B. Goebel, K., Saha, B. and Schwabacher, M. (2008). Metrics for Evaluation Performance of Prognostic Techniques. International Conference of Prognostics and Health Management. Denver, CO, USA.

Saxena A., Roychoudhury I., Goebel K., and Lin W. (2013). Towards Requirements in System Engineering for Aerospace IVHM Design. AIAA Infotech@Aerospace Conference. Boston. MA, USA.

Scandura P. (2005). Integrated Vehicle Health Management as a System Engineering Discipline. Digital Avionics Systems Conference., Phoenix, Arizona. pp 1-10.

Schmidt, D.C. (2006). Model-driven Engineering. IEEE Computer. Vol. 39. Is.2. pp.25-31.

Bibliography

Schoeller, M., Roemer, M.J., Leonard, M., and Derriso, M. (2007). Embedded Reasoning Supporting Aerospace IVHM. AIAA Conference. Rohnert Park, CA, USA.

Schreiber, G. (2000). Knowledge Engineering and Management. MIT Press. ISBN: 9780262193009.

Schreiber, G., and Aroyo, L. (2008). Principles for Knowledge Engineering on the Web. Proceedings of the 16th international conference on Knowledge Engineering: Practice and Patterns. Sicily, Italy.

Schwabacher, M., and Goebel, K. (2007). A survey of artificial intelligence for prognostics. AAAI Fall Symposium. Arlington, VA, USA.

Scott, Z. (2011). Model-based Systems Engineering. Asia Pacific Council of Systems Engineering. Seoul, South Korea.

Sethumadhavan, S. Roberts, R., and Tsvividis, Y. (2011). A case for hybrid discrete-continuous architectures. IEEE Computer Architecture Letters. Vol. 10. No.2.

Sheppard, J. Kaufman, M., and Wilmering, T. (2008). IEEE Standards for Prognostics and Health Management. IEEE Autotestcon Proceedings. Baltimore, MD, USA. pp. 97-103.

Sheppard J., and Wilmering T. (2012). Diagnostic Modelling and Application Development. IEEE AutoTestCon Seminars. Anaheim, CA, USA.

Sikorska, J.Z., Hodkiewicz, M. (2011). Prognostic modelling options for remaining useful life estimation by industry. Mechanical Systems and Signal Processing. Vol 25. pp. 1803 – 1836.

Smith, T. (2003). USAF condition-based maintenance plus (CBM+) initiative. Air Force Logistics Management Agency. Maxwell AFB. Gunter Annex, Alabama, USA.

Srivastava, A.N, Mah, R.W., and Meyer, C. (2009). Integrated Vehicle Health Management. Automated detection, diagnosis, prognosis to enable mitigation of adverse events during flight. Technical Plan. V 2.03. pp. 1 – 73.

Studer, R., Richard Benjamins, V., and Fensel, D. (1998). Knowledge Engineering: Principle and Methods. Data & Knowledge Engineering. Elsevier. Vol. 25. Pp. 161 – 197.

Swearingen, K. and Keller, K. (2007). Health Ready Systems. IEEE AutoTestCon Proceedings. Baltimore, MD, USA. pp. 625-631.

Swearingen, K., Majkowsi, W., Burggeman, B., Gilbertson, D., Dunsdon, J., and Sykes B. (2007). An Open System Architecture for Condition Based Maintenance Overview. IEEE Aerospace Conference. Big Sky, Montana, USA.

Takata, S. Kimura, F., Van Houten, A.M., Weskämper, E., Shiptalni, M., Ceglarek, D., and Lee, J. (2005). Maintenance: changing role in life cycle management. CIRP Anals- Manufacturing Technology, Vol. 53(2).

Tanebaum A., and Van Steen M. (2007). Distributed Systems Principles and Paradigms. p. 2.

Tavner P. (2013). A survey of wind turbine condition monitoring experience in Europe. Supergen Wind Research Consortium.

Tavner, P., Xiang, J., and Spinato, F. (2007). Reliability analysis for wind turbines. Wind Energy. Vol. 10. pp. 1- 18.

Thompson, C. (2010). Diagnostic/Prognostic: Vehicle Health Management Systems. PHM Lecture. Lyle School of Engineering. Dallas, TX, USA.

Tobon-Mejia, D.A., Medjaher, K., and Zerhouni, N. (2012). CNC machine tool's wear diagnostic and prongostic by using dynamic Bayesian networks. Mechanical Systems and Signal Processing. Vol 28. pp. 167 – 182.

Toksoz, T., Redding, J., Michini, M., Michini, B., How, J.P., Vavrina, M., and Vian, J. (2011) Automated Battery Swap and Recharge to Enable Persistent UAV Missions. AIAA Infotech@Aerospace Conference. St. Louis, MO, USA. pp. 1-10.

Treur, J., and Wetter, Th. (1993). Formal specification of complex reasoning systems. Ellis Horwood. NY, USA. ISBN: 9780133367850.

Ugle, R.A. (2013). Effects of Internal Resistance on Performance of Batteries for Electric Vehicles. University of Wisconsin. Milwaukee, WI, USA.

Unified Modelling Language Website: <http://www.uml.org/>

Unmanned Aerial Vehicle website (2014). <http://www.theuav.com/>

Bibliography

Uschold, M. (2003). Where are the semantic in the web? AAAI - American Association of Artificial Intelligence - AI Magazine Vol 24 Nb 3. pp 25 – 36.

Vachtsevanos, G., Lewis, F., Roemer, M.J., Hess, A., and Wu, B. (2006). Intelligent fault diagnosis and prognosis for engineering systems. NJ, USA. John Wiley & Sons.

Valerdi, R., and Wheaton, M. (2005). ANSI/EIA 632 As a Standardized WBS for COSYSMO. AIAA Fifth Aviation, Technology, Integration, and Operations Conference. Arlington, Virginia, USA. pp. 1-6.

Valorem (2014). Wind Farm Arfons. <http://www.parc-eolien-de-arfons.fr/>

Van Harmelen, F., Lifschitz, V., and Porter, B. (2008). Handbook of Knowledge Representation. Elsevier. Ch. 25. Pp. 929- 945.

Van Horenbeek, A., Van Ostaeyen, J., Dufloy, J.R., and Pintelon, L. (2013). Quantifying the added value of an imperfectly performing condition monitoring system - Application to a wind turbine gearbox. Elsevier. Reliability Engineering & System Safety Vol. 111. pp. 45-57.

van Noortwijk, J.M. (2009). A survey of application of gamma processes in maintenance. Reliability Engineering and Safety. Vol. 94. Is.1. pp. 2-21.

Venkatasubramanian, V. (2003). A review of process fault detection and diagnosis Parts I-III: Quantitative model-based methods, Qualitative models and search strategies, Process history based methods. Computers & Chemical Engineering, Vol. 27. pp. 293-346.

Verbruggen, T.W. (2013). Wind Turbine Operation & Maintenance based on Condition Monitoring WT-Ω. ECN Wind Energy. ECN-C-03-047.

Vinson, G., Ribot, P., Prado, T., and Combacau, M. (2013). A generic diagnosis and prognosis framework: application to permanent magnets synchronous machines. Chemical Engineering Transactions, Vol. 33. pp. 1039 – 1044.

von Bertalanffy, L. (1968). General system theory: Essays on its foundation and development. George Braziller Ed. New York, USA.

Weber, P., Theilliol, D., and Aubrun, C. (2008). Component reliability in fault-diagnosis decision making based on dynamic Bayesian networks. Proceedings of the Institution of Mechanical Engineers Part O: Journal of Risk and Reliability. Vol. 222. pp. 161-172.

Wheeler, K., Kurtoglu, T., and Poll, S. (2010). A survey of Health Management User Objectives Related to Diagnostic and Prognostic Metrics. *International Journal of Prognostics and Health Management*. Vol 1.3.

Williams Z. (2006). Benefits of IVHM: An analytical approach. *IEEE Aerospace Conference*. Big Sky. MT. USA.

Williard, N., He, W., Osterman, M., Pecht, M. (2011). Predicting Remaining Capacity of Batteries for UAVs and Electric Vehicle Applications. *IMAPS Advanced Technology Workshop on High Reliability Microelectronics for Military Applications*, Linthicum Heights, MD, USA.

Wilmering, T. (2003). When good diagnostics go bad – why maturation is still hard. *IEEE Aerospace Conference*. Big Sky, Montana, USA. pp. 3137 – 3147.

Wilmering, T. (2004). Approaches to semantic interoperability for advanced diagnostic architectures. *IEEE AUTOTESTCON*. pp. 466-474. San Antonio, TX, USA.

Yang, Q.Z., and Zang, Y. (2006). Semantic interoperability in building design: Methods and tools. *Journal of Computer-aided Design*. Elsevier. Vol. 38. pp. 1099-1112.

Yarnall W.H., Moore C., and Dussault P. (2011). BIT/BITE/ED/EP/IVHM and ATE in DA. *IEEE AutoTestCon Proceedings*. pp. 87-91. Baltimore, MD, USA.

Zhang Y., and Jiang J. (2008). Bibliographical review on reconfigurable fault-tolerant control systems”, *Annual Review in Control*. Vol. 32. pp. 229-252.

Zhang, X., Zhang, Q., Zhao, S. Ferrari R., Polycarpou, M., and Parisini, T. (2011). Fault Detection and Isolation of the Wind Turbine Benchmark: An Estimation-Based Approach. *IFAC World Congress*, Vol. 18, Part 1, pp. 8295 – 8300. Milano, Italy.

Résumé en français

Spherea (anciennement Cassidian Test & Services), l'initiateur industriel de la thèse, est un fournisseur leader des systèmes automatiques de test (ATE) pour la maintenance des véhicules aéronautiques et de défense. Les ATE sont des systèmes clés pour le niveau intermédiaire de maintenance, car la remise en service des unités remplaçables en ligne (URL) est conditionnée par le résultat "GO" délivré par la plate-forme de test en maintenance. Actuellement, la maintenance de niveau intermédiaire se confronte avec des taux élevés d'évènements « No Fault Found » (NFF) (Khan et al., 2012), causant des activités de maintenance superflues et par conséquent des pertes importantes de temps, d'énergie et d'argent (Burchell, 2007). L'évènement NFF est défini comme la situation où une URL déposée respecte ses conditions de navigabilité afin d'être remise en service, mais aucune raison pour le retrait ne peut être confirmée (MIL STD 2165, 1985). Plusieurs facteurs sont responsables de l'occurrence de NFF y compris les groupes d'ambiguïté dans le diagnostic de véhicules (Khan et al., 2012), l'incertitude associée à la durée de vie résiduelle de composants de véhicules (Kumar et al., 2008), ainsi que les fausses alarmes survenant pendant l'opération (Byington et al., 2006).

Cette problématique de NFF, ainsi que des processus qui s'y attachent (surveillance de la santé, diagnostic, pronostic et aide à la décision) est adressée au sein des communautés scientifiques « Integrated Vehicle Health Management » (IVHM) et « Prognostics and Health Management » (PHM) en abordant la gestion de l'état de santé de véhicules de manière unifiée (Rajamani et al., 2013). Cette vision IVHM-PHM constitue la base pour une maintenance efficace de véhicules, à travers les niveaux opérationnels (NTI1), intermédiaires (NTI2) et de dépôt (NTI3). Le concept d'IVHM, par analogie avec le concept d'interopérabilité entre les systèmes d'entreprise aujourd'hui structurés autour des niveaux ERP, MES (Doumeings et al., 2007), émerge de l'interaction globale et de la coordination au-delà des frontières organisationnelles des fonctions de gestion intégrée de l'état de santé centrées sur le véhicule et sur l'entreprise, déployées dans des systèmes interopérables, et durables tout au long du cycle de vie de véhicules (Kumar et al., 2000). En particulier, les fonctionnalités IVHM centrées sur le véhicule ont la capacité de réduire l'occurrence des NFF en transformant les mesures des paramètres pertinents de l'état de santé de véhicules en informations permettant l'aide à la décision en maintenance pour les fonctionnalités IVHM de niveau entreprise (Goebel et al., 2011).

Malgré la relative jeunesse du concept IVHM, des cadres proposant les fonctionnalités IVHM attendues sont déjà disponibles auprès des communautés scientifiques et industrielles

(Benedettini et al. 2009, Reveley et al. 2010, Esperon Miguez et al. 2013, Jennions 2013). Cependant, à ce jour, ces solutions de systèmes IVHM sont principalement développées et organisées de manière empirique pour des systèmes spécifiques et basées sur des concepts propriétaires (Mikat et al., 2014). Ainsi, un enjeu scientifique majeur est de définir un cadre de modélisation générique afin de soutenir l'ingénierie des systèmes IVHM (Benedettini et al., 2009), utilisable pour la conception de systèmes IVHM spécifiques. L'utilisation du cadre générique pour la conception de systèmes intégrés de gestion de la santé pourrait ainsi répondre au problème industriel soulevé par l'initiateur de nos travaux de recherche. La thèse est construite sur ce défi avec l'objectif majeur de proposer les bases d'un cadre de modélisation d'IVHM, et son élément fondamental, le module générique de gestion de l'état de santé (gHMM), formalisant la fonction de l'IVHM centrée sur le véhicule. L'intégration du diagnostic et du pronostic dans le gHMM vise à contribuer à une réduction efficiente de l'occurrence d'évènements NFF.

Dans ce cadre de modélisation d'IVHM, la première originalité de la thèse se construit sur l'exploitation du concept de système et de ses principes (ISO / IEC / IEEE 42010, 2011) fondant les éléments principaux du cadre de modélisation d'IVHM, ainsi que son approche de formalisation, supportée par l'ingénierie système basée sur des modèles (MBSE). Cette définition globale du cadre est la pierre angulaire de la conception efficace des systèmes IVHM.

Une deuxième originalité majeure de la thèse est matérialisée par la formalisation d'un module générique de gestion de la santé de véhicules (gHMM) considéré comme l'élément pivot du cadre de modélisation. Plus particulièrement, l'intégration du diagnostic et du pronostic, processus de raisonnement clés du gHMM, est envisagée au-delà de la voie classique du diagnostic vers le pronostic (Sikorska et al., 2011), dans une voie innovante en proposant une méthode de connexion du pronostic vers le diagnostic.

Sur la base de la proposition générique du gHMM, la conception de systèmes spécifiques de gestion de l'état de santé de véhicules repose sur un principe d'instanciation, capable de supporter sa définition structurelle et comportementale. Dans le cadre de la procédure d'instanciation proposée, un des défis majeurs constatés dans l'ingénierie des systèmes IVHM, tel que souligné par Esperon Miguez et al., 2013, concerne la combinaison appropriée d'algorithmes de gestion de l'état de santé. Pour s'attaquer à ce problème, la troisième originalité majeure de la thèse porte sur l'identification de multicritères déterminant pour la sélection d'algorithmes de diagnostic et de pronostic, ainsi que sur leur formalisation basée sur des ontologies.

Au regard de ces principales originalités, la thèse est structurée en cinq chapitres qui construisent progressivement les fondements d'un cadre de modélisation d'IVHM.

Chapitre 1. Le premier chapitre présente l'énoncé du problème industriel au niveau intermédiaire de maintenance (NTI2). Celui-ci se focalise plus particulièrement sur l'événement NFF et sa relation avec les problèmes non-résolus au niveau opérationnel de maintenance (NTI1), et qui constituent la genèse de la thèse. Ces problèmes conduisent à une réflexion généralisée adressant les défis actuels de la gestion intégrée de l'état de santé de véhicules, avec un accent particulier sur sa fonction centrée sur le véhicule, comme catalyseur des décisions opérationnelles de maintenance menant à l'occurrence des événements NFF. Sur la base de cet énoncé du problème portant sur le cadre IVHM et focalisé sur la résolution du problème NFF, les quatre problèmes scientifiques représentent la sortie de ce premier chapitre de la thèse :

- La modélisation d'un cadre pour l'ingénierie des systèmes IVHM couvrant le cycle de vie du système principal,
- La définition générique d'un système IVHM,
- La formalisation informationnelle et comportementale de l'intégration entre le diagnostic et le pronostic,
- Une méthodologie pour la sélection appropriée d'algorithmes support au diagnostic et au pronostic.

Chapitre 2. Afin de répondre à l'absence de méthodes et outils adaptés à l'ingénierie des systèmes IVHM et soutenant l'ensemble du cycle de vie du véhicule, le deuxième chapitre propose un cadre de modélisation de gestion intégrée de l'état de santé de véhicules autour du concept unificateur de la thèse - la notion de système. Les principes structurants d'un cadre pour l'ingénierie des systèmes IVHM sont établis par l'analyse de ses trois concepts complémentaires: "véhicule" - en tant que système d'intérêt, "gestion de l'état de santé" - comme l'un de ses systèmes contributeurs, et «intégré» - le lien réalisant l'intégration entre les fonctions de l'IVHM centré sur le véhicule et sur le processus de niveau entreprise. Cette vision du système IVHM est raffinée pour la fonction de gestion de l'état de santé de véhicules par une synthèse de huit architectures (porté ou non par des normes), comme OSA-CBM et SIMP (Système intégré de maintenance prévisionnelle).

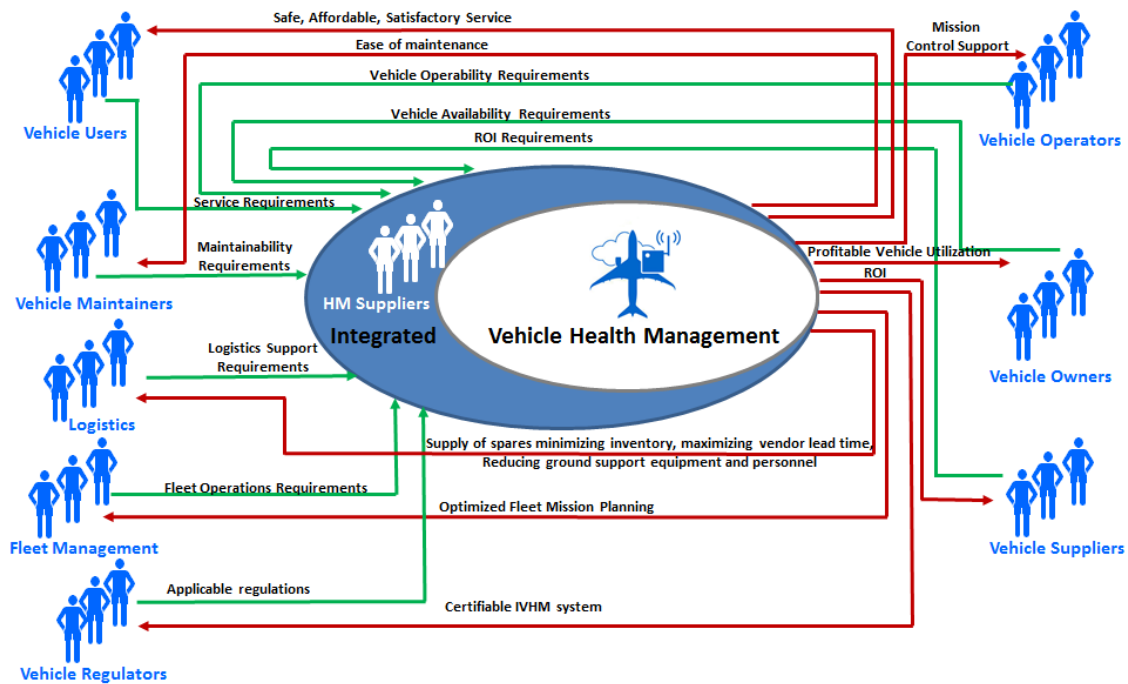

Figure R.1. Vue contextuelle d'un système IVHM

A partir de ces principes, un cadre de modélisation d'IVHM est proposé suivant une approche d'ingénierie système basée sur des modèles (MBSE). Le cadre de modélisation d'IVHM est détaillé sur l'une des étapes du cycle de vie du véhicule, la phase d'exploitation, pour laquelle une vue contextuelle du cadre IVHM est enfin proposée (Figure R.1).

Chapitre 3. Dans la continuité logique du cadre de modélisation d'IVHM proposé, le troisième chapitre adresse son élément fondamental : un module générique de gestion de la santé générique. Les phases de formalisation du gHMM ont comme élément central le modèle SysML du gHMM, effectuant progressivement la modélisation générique de la fonction de gestion de l'état de santé du véhicule à partir de l'analyse des besoins, l'analyse fonctionnelle en boîte noire et la synthèse de conception en boîte blanche du gHMM. La proposition de quatre processus clés de gestion de l'état de santé en fonction de leurs finalités communes (monitoring de l'état de santé, diagnostic, pronostic et aide à la décision) fait le pont entre les flux fonctionnels formalisés en boîte noire et en boîte blanche (Tableau 1).

Processus	Finalité
Health Monitoring	Surveiller la santé des systèmes en fournissant des indicateurs de dégradation et de défaillance

Diagnostic	Identification des ensembles des URL expliquant les défaillances et les dégradations observées dans l'élément surveillé
Pronostic	Estimation des RUL physiques et fonctionnelles basées sur les résultats du processus de diagnostic, et sur les conditions d'exploitation futures
Aide à la décision	Recommandations visant à retarder, arrêter, prévenir et résoudre les défaillances

Tableau R.1. 4 Processus clé du gHMM

Etant compatible avec les structures de données OSA-CBM, la conception architecturale du gHMM est analysée par la suite en se rapportant à l'intégration entre deux de ses processus clés: le diagnostic et le pronostic. En ce sens, la formalisation du gHMM permet d'intégrer ces deux processus clés de la gestion de l'état de santé non seulement de manière classique: du diagnostic vers le pronostic, mais aussi dans un sens original: du pronostic vers le diagnostic avec le but de réduire les groupes d'ambiguïté; ce dernier sens fait l'objet d'un algorithme générique soutenant l'une des activités élémentaires du module gHMM, et répondant ainsi au problème des NFF à la genèse de la thèse.

Chapitre 4. Le quatrième chapitre vient compléter la contribution du cadre générique de modélisation, par une méthodologie permettant l'exploitation du cadre pour la définition de systèmes spécifiques de gestion de la santé de véhicules.

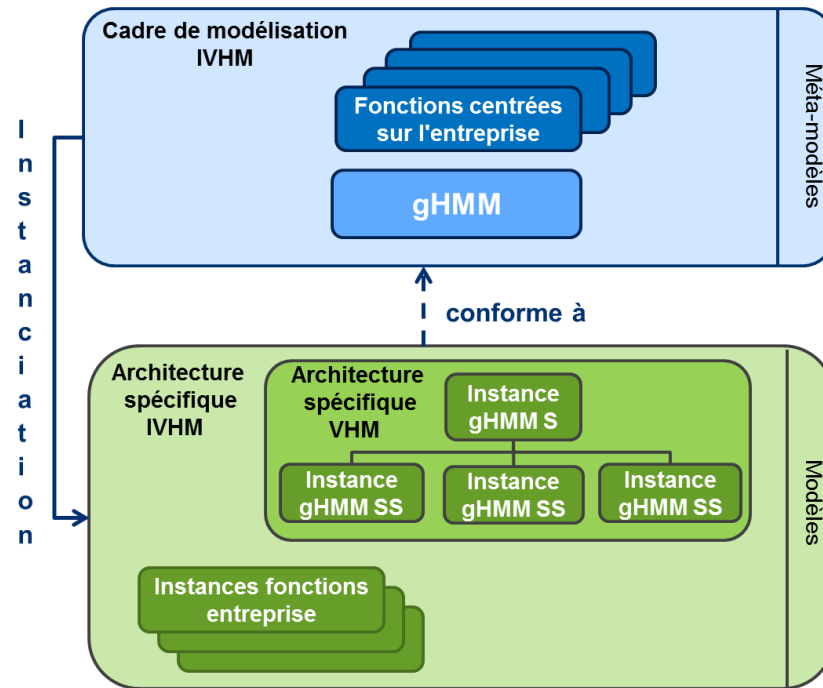

Figure R.2. Principe d'instanciation

Afin d'atteindre cet objectif, un principe d'instanciation du module gHMM est d'abord fondé sur la transformation entre niveaux de modélisation (Figure R.2). Composé de phases d'instanciation en boîte noire et en boîte blanche, ce principe permet de concevoir progressivement la structure et le comportement d'une architecture fonctionnelle de gestion de l'état de santé formée à partir d'instances gHMM (Figure R.3). Dans la phase d'instanciation en boîte blanche, une contribution majeure de ce chapitre est la formalisation de multicritères déterminants la sélection d'algorithmes de gestion de l'état de santé support aux activités instanciées de diagnostic et de pronostic. Cette contribution s'inscrit dans la continuité logique des principes structurants de systèmes IVHM fondés dans le chapitre 2, qui sont maintenant raffinés et formalisés à base d'ontologies en dix multicritères génériques. À l'appui de cette formalisation, les principaux éléments d'un système basé sur la connaissance sont proposés pour la conception d'un outil de sélection multicritères d'algorithmes de gestion de l'état de santé.

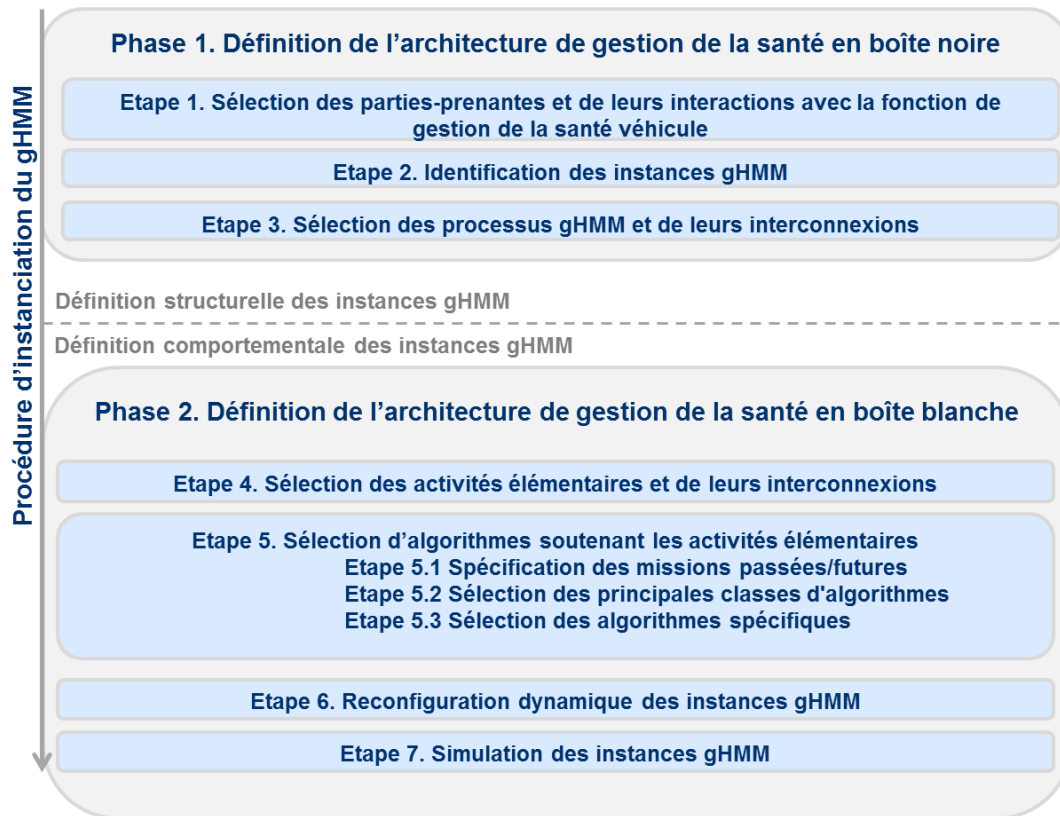

Figure R.3. Procédure d'instanciation

Chapitre 5. Le dernier chapitre de la thèse a pour objet la vérification et la validation des contributions sous deux aspects complémentaires: d'une part en proposant un protocole supportant la vérification et la validation des contributions, et d'autre part en exposant les étapes de vérification et de validation qui ont été menées en ligne avec le protocole établi. Cette étape de vérification/validation doit permettre d'apporter une réponse aux questions industrielles soulevées à la genèse de cette thèse.

Ce dernier chapitre expose donc premièrement la vérification du modèle gHMM effectué analytiquement avec un ingénieur expert en MBSE. Cette étape de vérification confère un degré de confiance dans le modèle suffisant afin de dérouler la validation de l'instanciation du modèle pour des occurrences spécifiques de gestion de la santé. Cela fait l'objet de la validation de la procédure d'instanciation du gHMM, qui est premièrement analysées en boîte noire pour la gestion de la santé d'un système d'éolienne et deuxièmement elle est appliquée en intégralité pour le prototypage d'une architecture de gestion de la santé pour un système de drone. Cette dernière étape de la validation a permis de construire un prototype de démonstration de nos contributions.

Conclusion Générale

Enfin, les résultats globaux de notre travail de recherche sont abordés dans la conclusion générale de la thèse, permettant de synthétiser les contributions de la thèse en lien avec les problèmes scientifiques positionnés dans le Chapitre 1, mais également avec les problèmes industriels à la genèse de la thèse (Figure R.4).



Figure R.4. Synthèse des contributions

Ce dernier chapitre propose également une série de perspectives scientifiques et industrielles pour le cadre de modélisation d'IVHM.

Appendices

Appendix A: Systems Engineering glossary

The material presented in this appendix is completely brought from the INCOSE Systems Engineering Handbook (INCOSE, 2010), from ISO/IEC 15288:2008 standard, from IEEE Standard Computer Dictionary (IEEE, 1990), NASA –Systems Engineering Handbook (NASA, 2007), and System Safety Handbook (NASA, 2011).

Availability – Function of operating time (reliability) and downtime (maintainability/supportability). Three categories of availability are often expressed as requirements:

- **Operational availability** – Includes logistics and administrative delay times that are not typically under the control of suppliers.
- **Inherent availability** – Includes on the inherent Reliability & Maintainability characteristics of the item under analysis.
- **Measured availability** – Requires the effective measurement of failures, their cause and the subsequent restorative action (maintenance). This also requires that effective measurement processes and systems are in place that is acceptable to the user, acquirer and supplier stakeholders as part of an agreed feedback process.

Enabling System – A system that supports a system-of-interest during its life-cycle stages, but does not necessarily contribute directly to its function during operation.

Environment – The surroundings (natural or man-made) in which the system-of-interest is utilized and supported: or in which the system is being developed, produced or retired.

Function – A process performed to achieve a desired outcome.

Life Cycle Cost – The total cost to the organization of acquisition and ownership of a system over its entire life. It includes all costs associated with the system and its used in the concept; development, production, utilization, support and retirement stages.

Maintainability – The ease with which a system or component can be modified to correct faults, improve performance, or other attribute, or adapt to a changing environment. It is concerned with keeping the system working and the ease of putting things right once they have gone wrong.

Performance – A quantitative measure characterizing a physical or functional attribute relating to the execution of a process, function, activity; Performance attributes include quantity – how many or how much), quality (how well), timeliness (how responsive, how frequent), and readiness (when, under which circumstances).

Process/Activities – Set of interrelated activities that, together, transform inputs into outputs. Activity – The elementary unit of a process. A set of actions that consume time and resources and whose performance is necessary to achieve, or contribute to the realization of one or more outcomes.

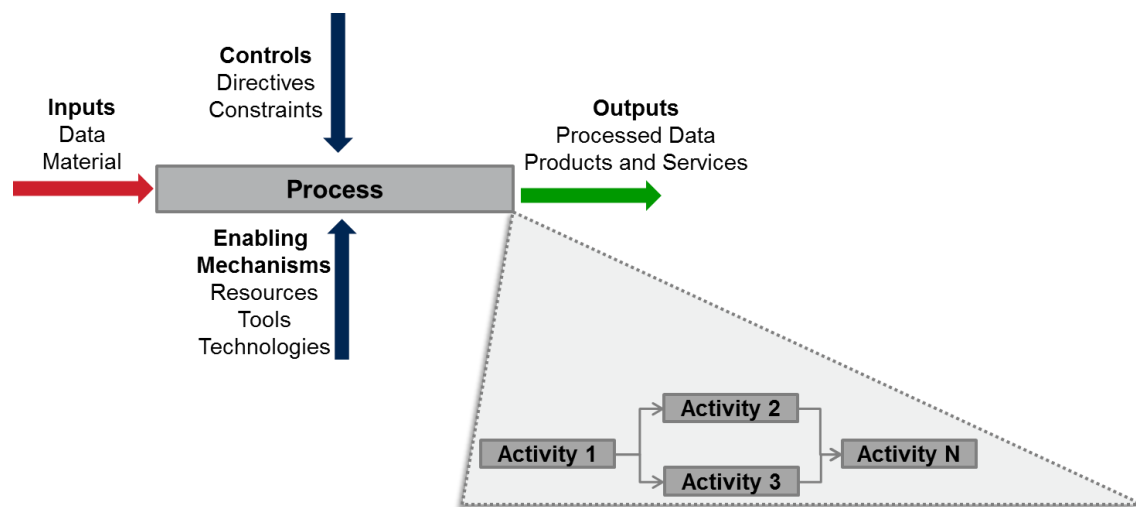

Figure A.1 ISO/IEC 15288 - Representation of process and activity concepts

Reliability – The ability of a system or component to perform its required/intended functions under stated conditions for a specified period of time. It is concerned with the probability of the system-of-interest working when it should.

System – A whole that cannot be divided into independent part without losing its essential characteristics as a whole.

System-of-Interest – The system whose life cycle is under consideration.

Systems Engineering – An interdisciplinary approach and means to enable the realization of successful systems. It focuses on defining customer needs and required functionality early in the development cycle, documenting requirements, and then proceeding with design synthesis and system validation while considering the complete problem: operations, cost and schedule, performance, training and support, test, manufacturing, and disposal. SE considers both the business and the technical need of all customers with the goal of providing a quality product that meets the user needs.

Appendices

System Safety – The application of engineering and management principles, criteria, and techniques to optimize safety within the constraints of operational effectiveness, time, and cost throughout all stages of the system’s life cycle. System safety is to safety as systems engineering is to engineering. When performing appropriate analysis, the evaluation is performed holistically by tying into systems engineering practices and ensuring that system safety has an integrated system-level perspective.

System of Systems – A system-of-interest whose system elements are themselves systems; typically these entail large scale inter-disciplinary problems with multiple, heterogeneous, distributed systems.

Value – Measure of worth (benefit divided by cost) of a specific product or service by a customer, and potentially other stakeholders and is a function of the product’s usefulness in satisfying a customer need, the relative importance of the need being satisfied, the availability of the product relative to when it is needed and the cost of ownership to the customer.

Appendix B: Model-based Systems Engineering phases

This appendix provides the description of MBSE phases used in the gHMM formalization, including purposes, steps of each phases and SysML models involved at each step. The MBSE phases follow the IBM Harmony process provided in Hoffmann, 2011.

Requirement analysis

Requirement Analysis goal is to define what the system must do (functional requirements) and how well it must perform (QoS requirements). This is achieved in three phases listed below and depicted in the following figure:

RA 1. Definition of stakeholders’ requirements is focusing on required capabilities;

RA 2. Definition of system requirements is focusing on required system functions;

RA 3. Definition of system use cases.

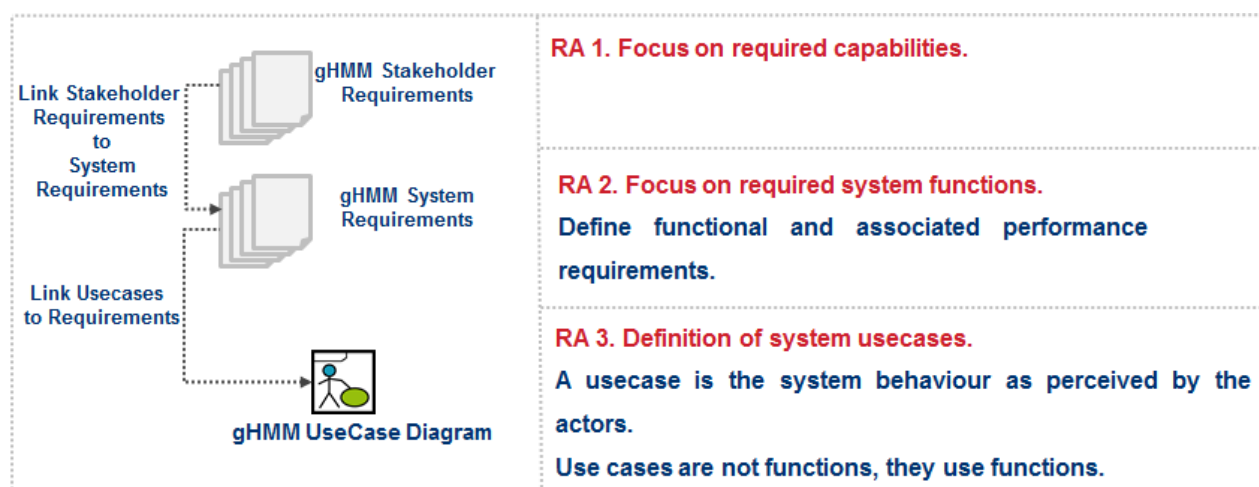

Figure A.2 Contextual view of IVHM requirement analysis phase

Functional analysis

Functional Analysis phase aims at transforming the functional system requirements into a coherent black-box description of the system use cases. It consists of five phases:

FA 1. Use Case Black-box Functional Flow Definition: Group requirements in actions, and shows how these actions are linked to each other;

FA 2. Use Case Black-box Scenario Definition: Describe a specific path through the use case and defines the interactions (messages) between actions and actors;

FA 3. Ports and Interfaces Definition: Static description of input/output flows, and actions of the use case into an Internal Block Diagram;

FA 4. Use Case state-based Behaviour Derivation: Derive from use case black-box activity diagrams and sequence diagrams a state-based behaviour;

FA 5. Merge Use Cases blocks into the gHMM Internal block diagram.

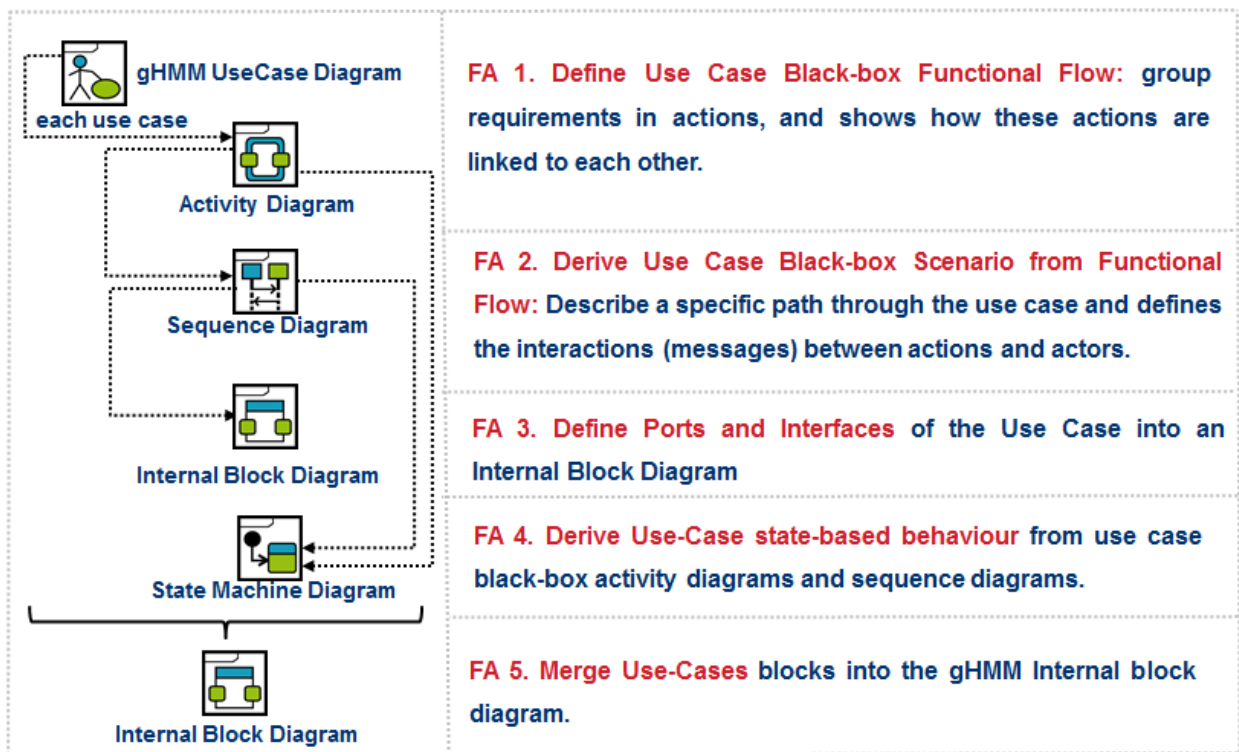

Figure A.3 Functional analysis phase

Design synthesis

Design Synthesis phase aims at defining the white-box architecture capable of performing the required use cases within the prescribed performance constraints. It consists out of three phases:

DS 1. Architectural Analysis: Defines how the system will achieve the usecases determined by the functional analysis, by means of a trade study;

DS 2. Architectural Design: Allocates actions to processes, defined graphically into white-box activity diagrams. Focus on the collaboration between different processes, taking into consideration the allocation of activities;

DS 3. Detailed Architectural Design: Defines ports and interfaces, as well as state-based behaviour of the system blocks at the lowest level of the architectural decomposition.

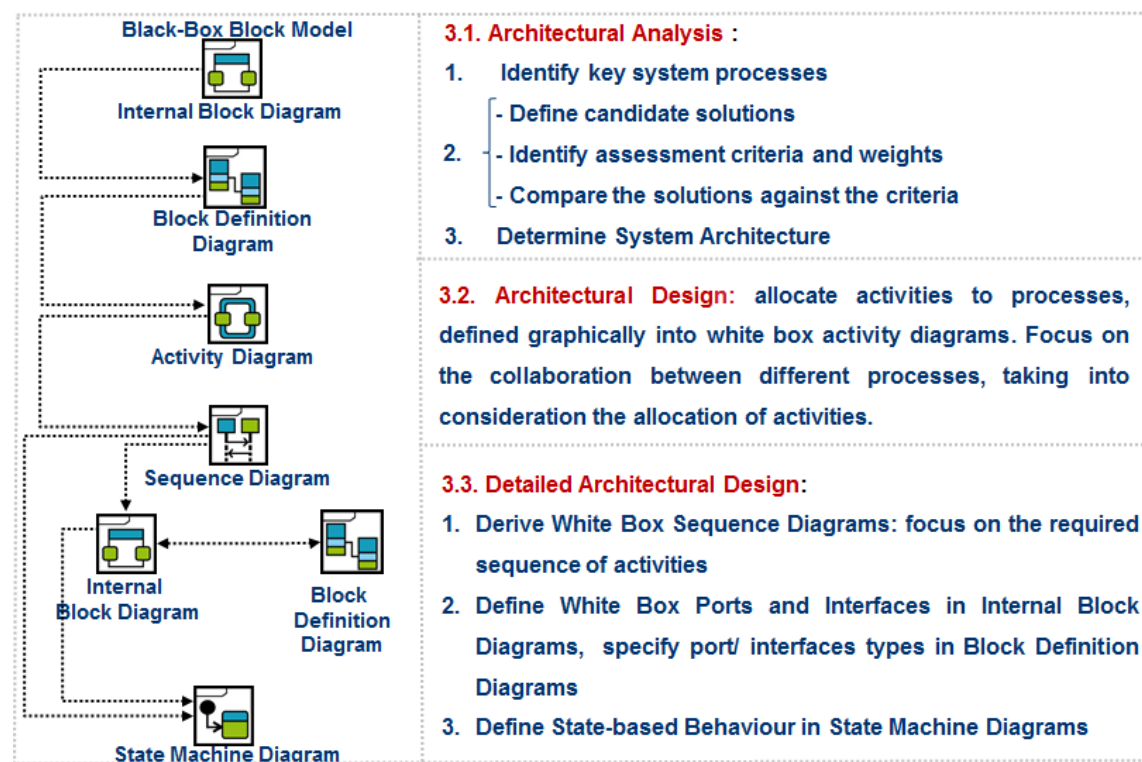

Figure A.4 Design synthesis phase

Appendix C: Description and breakdown of A1 – A8

A1: OSA-CBM standard

OSA-CBM (Open System Architecture for Condition Based Maintenance) standard was proposed in 2001 by an industry team partially funded by the U.S. Navy through a DUST (Dual Use Science and Technology) program. The main contributors were: Boeing, Caterpillar, Rockwell Automation, Rockwell Science Center, Newport News Shipbuilding, and Oceana Sensor Technologies, the Penn State University / Applied Research Laboratory. The standard was supported by MIMOSA (Machinery Information Management Open Standards Alliance), a standards body that manages open information standards for operations and maintenance in manufacturing, fleet, and facility environments.

The architecture is developed using a model-driven approach supported by Unified Modeling Language (UML), guaranteeing its platform-specific independence, and its easy instantiation to different programming languages. For instance, Dunsdon et al., 2008 have implemented in C++, the UML specification of OSA-CBM, while in Swearingen et al., 2007 introduce an XML based approach, enabling its implementation on embedded IVHM platforms.

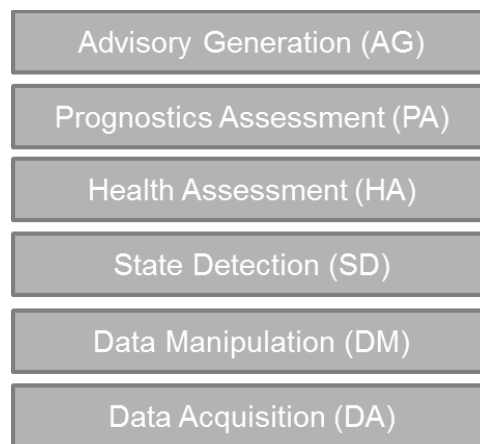

Figure A.5 OSA-CBM processing blocks

OSA-CBM is a six layer architecture – each layer representing a different process in a CBM (Condition-based Maintenance) system (Lebold et al., 2002). The former version of OSA-CBM comprised a 7th layer corresponding to the presentation of the decision support into a MMI (Man/Machine Interface). This layer has been deleted from the architecture for compliance with

the ISO 13374 functional blocks and for the independence of the standard regarding the field of use.

- DA – data acquisition converts sensors output into digital data;
- DM – data manipulation implements signal processing of raw data measurement;
- SD – state detection detects abnormalities and support the nominal operation modeling;
- HA – health assessment provides diagnostics of fault/health condition;
- PA – prognostics assessment provides computed remaining useful life , forecasts faults and future health conditions;
- AG – advisory generation provides decision aid.

Classes breakdown and attribute types can be extracted from the UML description of OSA-CBM, providing a reference architecture for condition-based maintenance; yet, the semantics of underlying data manipulated by OSA-CBM layers remain unclear (Wilmering, 2004), as no formal support guarantees the semantic integrity of information shared between OSA-CBM compliant applications. Despite this lack of semantics, Esperon Miguez et al., 2013 state that OSA-CBM standard is currently spreading within the aerospace industry, due to the lack of IVHM specific standards.

A2: Open architecture for IVHM

Gorinevsky et al., 2010, gathering NASA, Boeing and Honeywell vision on IVHM, introduce an open architecture for Integrated Vehicle Health Management, structured according to several criteria, such as on on-line/off-line modularity, on-board/off-board functions, and hierarchical architecture of on-board functions.

On-line functions are divided according to safety critical functions into:

- Direct actions systems typically requires DO-178¹³ Level A, and B, their development is very expensive, thus they are difficult to update.
- Deferred action system typically require DO-178 Levels C, D or E, is the focus of condition-based maintenance and represent the main justification for the deployment of IVHM.

Off-line functions gather knowledge management and intermediate level maintenance functions.

13

Deferred action IVHM system is divided into on-board and off-board functions. Off-board platform only has interfaces with maintenance operations and with logistics systems, while the on-board IVHM platform is working with the aircraft's on-board sensors. The hierarchical architecture of the on-board functions is defined as a three layers system comprising IVHM sensors, subsystem HM and a vehicle level reasoner.

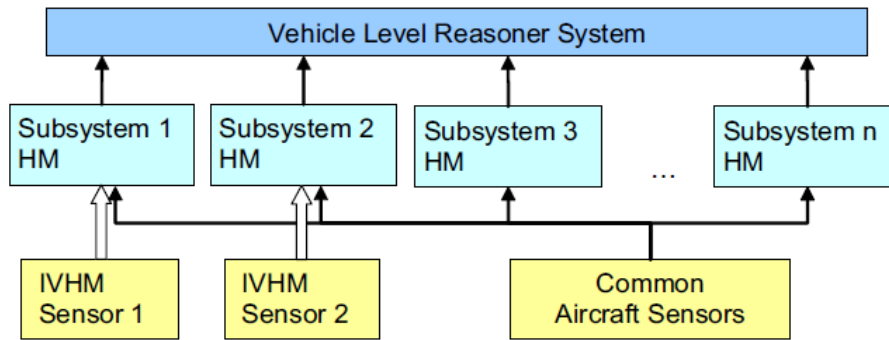

Figure A.6 On-board functions - Gorinevsky et al., 2010

Deferred action IVHM sub-system could be based on ISO 13374 standard, which establishes general guidelines for information flow between processing block of condition monitoring and diagnostics for machines. The standard was developed for less complex systems than aerospace IVHM systems, and is the basis of OSA-CBM standard. However, it provides a high level decomposition of the main IVHM functions. Gorinevsky et al., 2010 consider the first three layers of ISO 133274, as low-level (subsystem and component levels) application specific, while the last three are required for system level health management to operations and maintenance personnel. The decomposition proposed here-above is currently used by the aerospace IVHM community, as there is a lack of a better functional decomposition standard. However, the authors state that NASA's IVHM project is currently considering an organization on four higher processes: detection, diagnostics, prognostics, and mitigation.

A3: Generic supervision system

A generic supervision system is proposed by the LAAS-CNRS laboratory in Ribot, 2009 and then used in Belard, 2012 for meta-diagnosis of implemented diagnostics systems, and by Vinson, 2013 for prognosis of EMA actuators. The generic supervision system encompasses four main processes divided into two modules: surveillance, diagnostics, prognostics are grouped into the supervision module and decision support process is placed into a distinct module of the system. The reasoning within diagnostics and prognostics processes is model-based, and it is

divided into local (at component and sub-system levels) and global (by fusion of the local reasoning at system level).

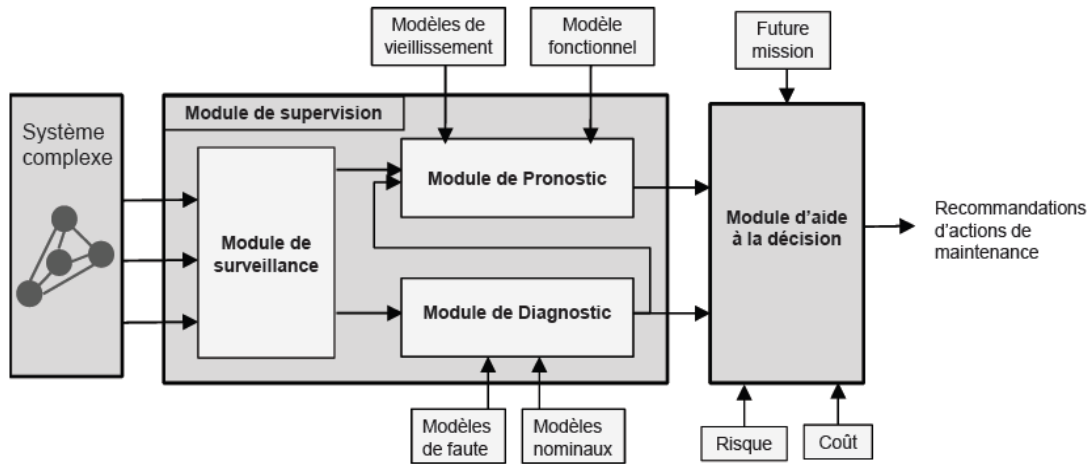

Figure A.7 A generic supervision system - Ribot, 2009

The surveillance process provides to diagnostics and prognostics processes the online observations, thus it contains all the sensors available on the components of the system to be monitored, as well as all communication protocols between these sensors, the generated indicators, and the other process of the supervision architecture. The diagnostics process realizes local fault diagnosis of a components and subsystems, as well as a global system diagnosis achieved by a strategy of global compatibility of local diagnosis. The prognostics process aims firstly at determining the remaining useful life of the system components, and secondly at obtaining the failure probabilities of the functions implemented within the systems, by fusion of the components fault probabilities. The decision support process aims at recommending maintenance actions for the overall system, during a phase of schedules maintenance, by taking into consideration the global diagnosis and prognosis, as well as parameters of the future mission of the system.

A4: Embedded IVHM architecture

Schoeller et al., 2007 exposed their vision of an IVHM embedded architectures developed by one of the major contributors to IVHM research – Impact Technologies.

A framework developed by Impact Technologies, PHM Design™ is firstly introduced as it represents the cornerstone of the architecture. PHM Design™ is a modeling environment which provides two parallel graphical environments of the functionality of a health management system: functional model and health management design. The reasoning logic of the IVHM architecture is based on the models designed within the two environments, i.e. the functional model of the target system and their respective health management capabilities, in order to determine root-cause failure modes at the vehicle level.

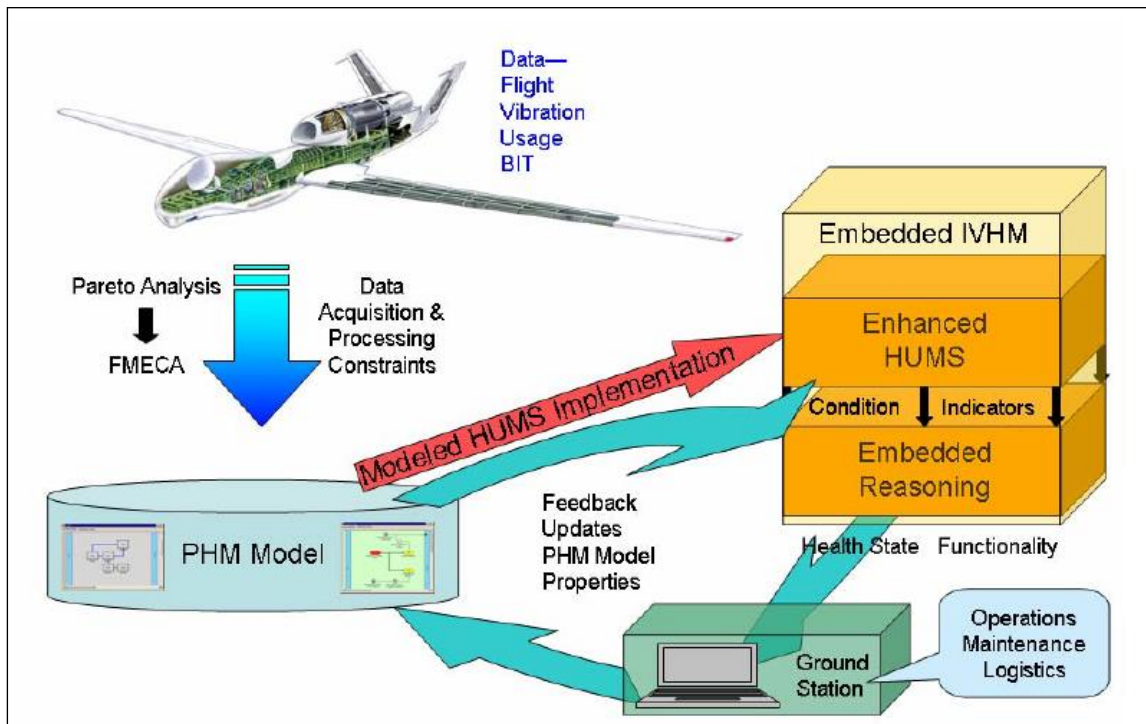

Figure A.8 Embedded IVHM information flow – Schoeller et al., 2007

Secondly, the embedded IVHM architecture is built in two complementary directions (Figure A.8). The scope of an embedded HUMS has been expanded in order to supply condition indicators to a downstream embedded reasoning module. The tree abstraction levels of diagnostics/prognostic in an embedded reasoning module realize a global view of the vehicle current and future health and capability assessment: from a low-level (component) to a high-level (vehicle) reasoning.

The demonstration of A4 on an embeddable hardware platform reveals determinant factors for implementing an embedded IVHM system:

- Processing capabilities: advanced multi-rate signal acquisition and processing requirements;

- Physical characteristics: light weight, small form factor;
- Data management architecture: data transfer and algorithm interaction should be handled by a multi-cast distribution approach;
- Sensors availability, selection and placement;
- Maximum use of COTS.

A5: .NET IVHM architecture

Chen et al., 2012, gathering Georgia Institute of Technology and Impact Technologies LLC, propose an integrated software architecture of an on-line, real-time IVHM reasoner divided into 4 processes: data processing, feature extraction, fault diagnosis and fault prognosis. The authors clearly identify as scientific gap, which drives their proposal: a lack of modular and flexible software architecture integrating diagnostics and prognostics.

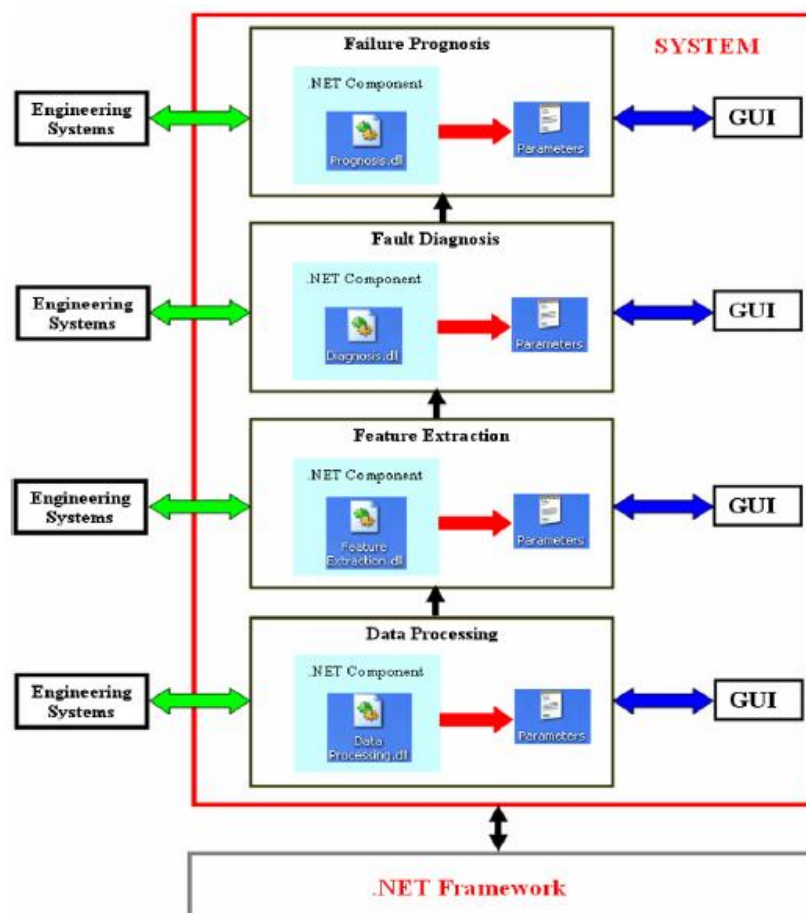

Figure A.9 .NET-based IVHM architecture - Chen et al., 2012

The definition of their functional perimeter and of information flow between the four components is not clearly specified, as the paper emphasizes implementation choices and features provided by the proposed architecture. Fault diagnosis and prognosis are based on the particle filtering technique, a Bayesian state estimation technique, which is well known to be appropriate for solving real-time state estimation, as it incorporated process data into a-priori state estimation by considering the likelihood of sequential measurements. Particle filtering is defined a sequential Monte Carlo method that can use any state-space fault models for estimating and predicting the failing behaviour of a system. Fault diagnosis and prognosis processes at component level have the following purposes:

- Fault diagnosis: the fault state PDF (Probability Density Function) at a given time is a fault indicator comparing the current state with the baseline state PDF representing the statistical/historical information about the normal operational states of the system.
- Failure prognosis: carry out long-term (multi-step) prediction; obtain the RUL of faulty components.

The platform is built as a .NET framework, a window-based software network developed by Microsoft™. This technical choice is justified by inherent features provided by the .NET framework, such as modularity, interoperability, programming language independence, simplified deployment, a base class library including a wide range of functions, which meet the developer and the user needs.

A6: Tri-reasoner IVHM system

In Atlas et al., 2001, the Boeing Company proposes a conceptual architecture for an evolvable tri-reasoner integrated IVHM system.

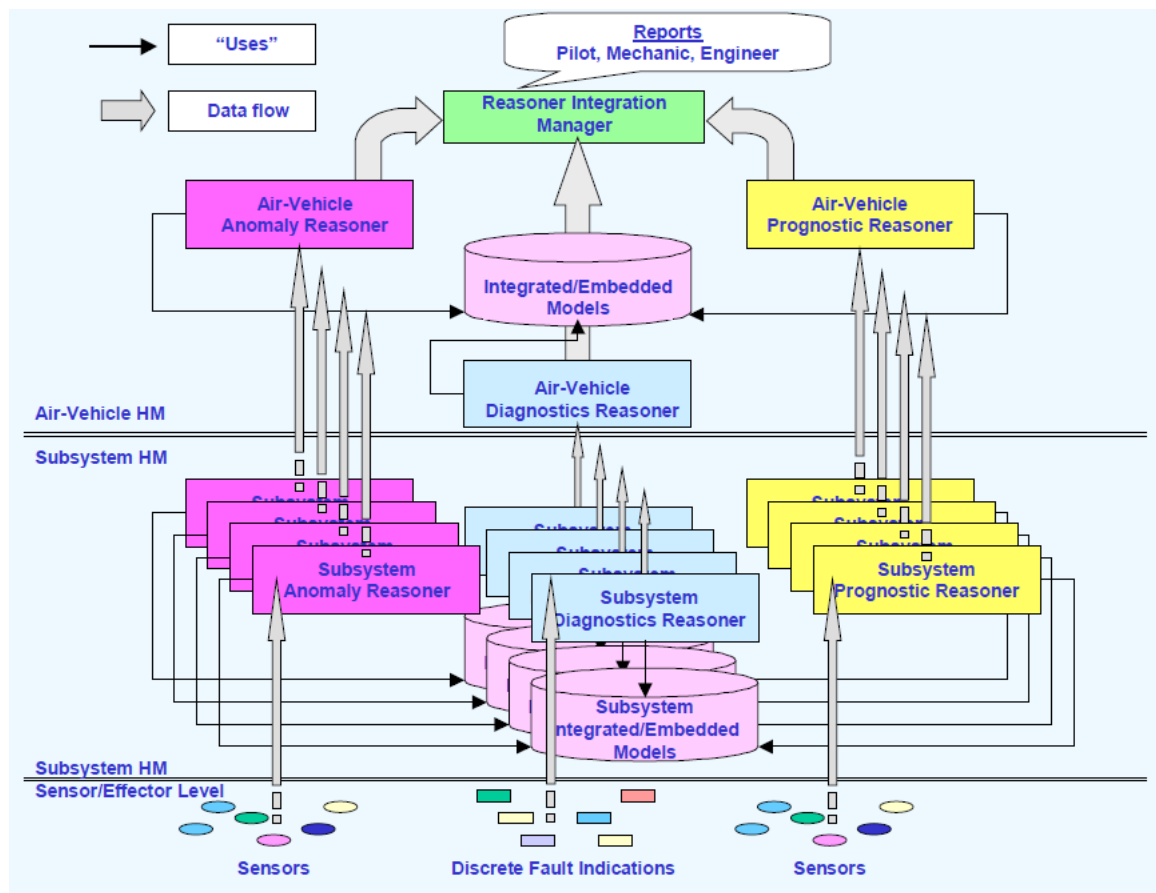

Figure A.10 Tri-reasoner IVHM architecture – Atlas et al., 2001

The conceptual tri-reasoner IVHM architecture in is composed out of the following elements:

- a (RIM) reasoner integration manager, providing a methodical algorithmic process that manages and evaluates the progression of anomalies, diagnosis and prognosis across the vehicle; through direct algorithms interaction with an integrated model and corroborating at vehicle level individual reports, it prioritizes the most probable fault or failure modes to be reported for operators, maintenance personal of engineering support staff.
- and three independent view of the vehicles health, created through the use of three system reasoners (anomaly, diagnostics, prognostics) whose algorithms come across the integrated model and their interrelationships:
 - mapping observations about the system to active or incipient failures
 - connection between the RIM and the integrated model is issued from the way the dedicated A/D/P (Anomaly/Diagnostics/Prognostics) algorithms are linked into the model.

	Anomaly Detection & Reasoning	Diagnostic Reasoner	Prognostic Reasoner
Component	Identify deviations from the baseline performance	Assess the components current health	Prediction of the component’s future health in two directions: is the component good for the future mission, estimate the time before a certain type of fault will occur.
Subsystem	Evaluate the raw data and extract features for correlation or measures of evidence for fault conditions	Achieves through model-based approach a set of candidate hypothesis ranked according to a heuristic (simplest explanation, likelihood etc.)	Prediction of the future health of the components within a subsystem given available health monitoring information.
Air-vehicle	Correlate anomalies that occur across subsystems and separate the upstream causes from the downstream effects.	Construct an integrated perspective of the vehicle’s health and determine isolate the fault sources.	Examine the attributes of all prognostic reasoners across the air vehicle and prioritize the most probable failure modes to be concerned with.

Table A.1 IVHM Tri-reasoner

The tri-reasoner algorithms are aimed to be generic ones, decoupled from any domain knowledge in order to enable to utilization of algorithms that have withstood a wide variety of applications, thus increasing their integrity. Integrating anomaly, diagnostics and prognostics across the levels of abstraction of the target system is considered by the authors determinant for the effective isolation of root causes of occurred failures as well as for their propagation up and downstream of their effects.

Architectures from other fields of application

Architectures and standards for condition-based maintenance have already been developed for machinery less complex than aircraft IVHM systems. As stated by Gorinevsky et al., 2, and by Esperon Miguez et al., 2013, the lack of a better functional decomposition standards and architectures leads to consider other application area of integrated health management

systems. For instance, the ISO 13374 and OSA-CBM standards, which have been presented in the previous section, establishing general guidelines and information flow between processing block of condition monitoring of machines, have already been adopted by the aerospace IVHM community, as baseline decomposition.

Two architectures are presented hereafter for comparison purposes, one in the field of health management of production systems, and the second one in the field of real time control systems.

A7: SIMP - Integrated proactive maintenance system

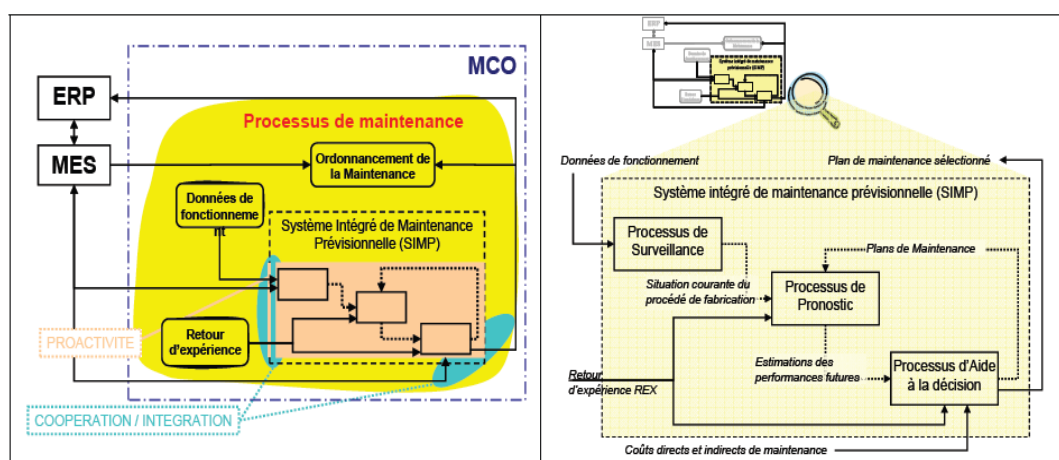

Figure A.11 SIMP architecture – Muller et al., 2005

The scientific contributions within predictive maintenance proposed by the CRAN scientific laboratory, have first started with J.B. Leger thesis in 1999, which proposes the formalization of a frame of modelling for a predictive maintenance system, by advocating an integrated vision within enterprise information systems. In-line with this contribution, Muller et al., 2005 proposes an integrated proactive maintenance system applied to manufacturing systems. SIMP is a proactive maintenance system integrated with other enterprise level systems such as maintenance operations, production, whose main processes are: surveillance process, prognostics and decision support.

As specific focus is given to the generic decomposition of the prognostics process into the following activities:

- Prognostics process steering: controls the prognostics activities flow;
- State/performance initialization: provides a starting point for the future projection activity, by updating the current state of the system and its components with the latest data available from

health monitoring and diagnostics processes. It provides a synchronic view of the system and its components;

- Future projection: determines the evolution of degradation / failures and the performance across components/ sub-system/system in order to have a diachronic view (throughout the time) of the system. The projection takes into account operational and environmental conditions of the future mission;
- RUL evaluation: calculates the time when the projected degradation/performance levels will cross a pre-defined component/performance threshold, corresponding to a failure occurrence or to time period after which one of the system's function is no longer performing as required.

A8: 4 Dimensional real-time control system

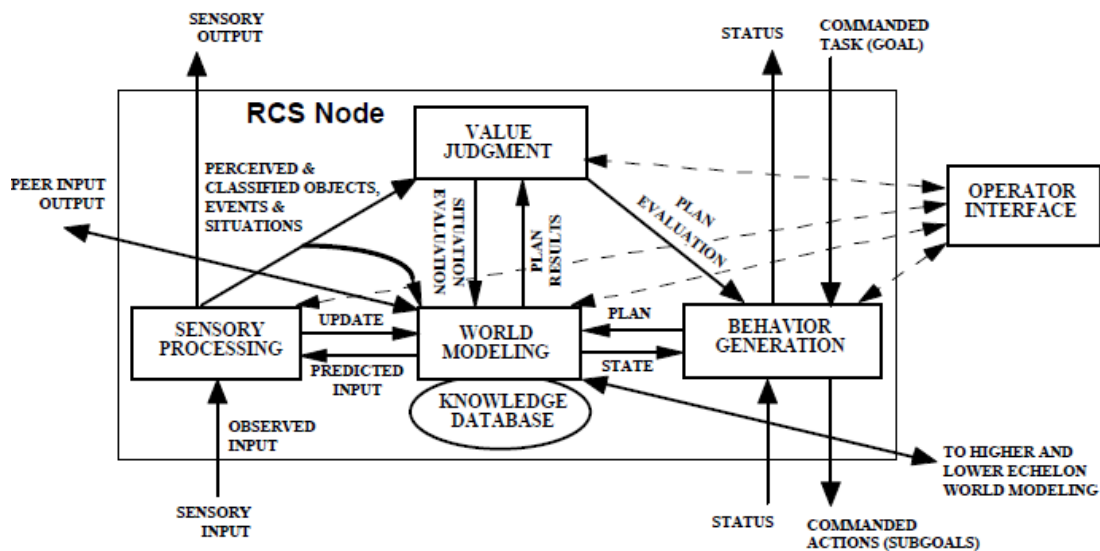

Figure A.12 4D/RCS architectural node – Albus et al., 2006

Albus et al., 2006 research in real-time control systems proposes a multi-layered organizational hierarchy composed of computational nodes, named 4D/RCS (4 Dimensional Real-Time Control System) node, encompassing four generic functions supported by a knowledge database. Despite the difference in purposes between 4D/RCS and IVHM architectures, functional design and information flows present several similarities:

- The functional flow has the 4 main phases similar to the IVHM system : from measure to decision making;

- Organization and communication between 4D/RCS nodes is similar to the one proposed within the IVHM framework, reflecting the functional distribution of the supported system;
- Distribution of on-platform/off-platform functions also reflects the level of abstraction within the controlled asset; the knowledge management being similar to the one proposed in IVHM.

Based on Figure A.1 presented in Appendix A, each architecture has been broken down into processes and its encompassed activities, which are presented here-after in the form of tables:

Breakdown of standards and systems

A1: OSA-CBM standard

Process Name	Activities Description
OSA-CBM : Data acquisition	Access to digital sensor or transducer data
OSA-CBM : Data manipulation	Signal processing
	Transformation for feature extraction
OSA-CBM : State Detection	Evaluation of the features against their specified values, limits for computing condition indicators
OSA-CBM : Health Assessment	Determination of the current health of the monitored system, sub-system or component, by taking into consideration the history of health assessment and maintenance, operational conditions (status and loading).
OSA-CBM : Prognosis Assessment	Projection into the future of the current health assessment of the component
	Estimation of the RUL by considering future usage profiles
OSA-CBM : Advisory generation	Enabler of the direct request of maintenance for assets and segments

Table A.2 OSA-CBM processes/activities breakdown

A2: Open architecture for IVHM

Process Name	Activities Description
Open Architecture for IVHM: Data acquisition	Conversion of sensors output to a digital data. The sensors used are already available aircraft sensors (common aircraft sensors), specialized sensors, for structural monitoring or vibration monitoring
Open Architecture for IVHM: Data manipulation	Signal processing: Implementation of low level signal processing of raw measurements
Open Architecture for IVHM: State Detection	Detection of abnormalities, based on the modeling of normal operation
Open Architecture for IVHM: Health Assessment	Computation of diagnostics of fault
	Computation of diagnostics of health condition
Open Architecture for IVHM: Prognostics Assessment	Forecasting of fault: based on current data and projected usage load
	Forecasting of health condition: based on current data and projected usage load
	Computation of remaining useful life
Open Architecture for IVHM: Advisory Generation	Providing actionable information related to health management

Table A.3 Open architecture for IVHM processes/activities breakdown

A3: Generic supervision system

Process Name	Activities Description
<p>Generic Supervision System: Surveillance</p>	<p>Observation: acquisition of relevant parameters for the health monitoring of the component/ sub-system/ system</p>
	<p>Filtering</p>
	<p>Detection : generation of relevant indicators from the information recorded by the sensors</p>
<p>Generic Supervision System: Diagnostics</p>	<p>Detection of failure modes at component level : using nominal behavior patterns and pattern of behavior in the presence of faults</p>
	<p>Local diagnostics: provides the set of candidates which explain the failure modes detected at sub-system level</p>
	<p>Global diagnostics: verifies if the candidates proposed by each of the local diagnostics are globally consistent, by using a strategy of overall compatibility, which eliminates incompatible candidates inconsistent with the observations of the system.</p>
<p>Generic Supervision System: Prognostics</p>	<p>Local prognostics: determines the aging of component parameters in terms of fault probability. Uses online observations provided by the surveillance process, and knowledge of the components of the subsystem aging, known and aging laws.</p>
	<p>Global prognostics: computes failure probabilities for each function implemented by the system, by fusion of the fault probabilities provided by local prognostics. Uses</p>

	the functional model of the system.
Generic Supervision System: Decision Support	Providing maintenance recommendations for the overall system: replacing one or several components based on the results provided by the diagnostics and prognostics processes as well as on the future mission (goals of the system before the next phase of scheduled maintenance. Each fault detected by the diagnostics is associated to a risk according to the impact it may have on the accomplishment of the mission, and to a cost - repair costs they generate in case the system fails before the next maintenance phase

Table A.4 Generic supervision system processes/activities breakdown

A4: Embedded IVHM architecture

Process Name	Activities Description
Embedded IVHM Architecture: Enhanced HUMS	Data acquisition: analog data acquired from sensors , or digital data obtained from other sources
	Data processing
	Condition indicators generation: capture and reflect the current health state of LRUs (Line Replaceable Units) comprising the various functional levels.
Embedded IVHM Architecture: Low level reasoner	Failure mode identification: Sorts out the evidence provided by diagnostic features and to identify the failure mode most likely present at component level.
	Component failure mode severity estimation
	Component RUL estimation
Embedded IVHM	Failure mode confirmation: confirms the suspected failure

Architecture: Mid-level reasoner	modes of its components.
	Upstream root-causes identification: Identifies upstream components which could be the root cause for failure of downstream components.
	Remaining functional capability assessment of the sub-system based on the health states if the encompassed components: <ul style="list-style-type: none"> ▪ Independent components ▪ Serial dependence between components ▪ Parallel dependence between components
Embedded IVHM Architecture: High level reasoner	Overall capability assessment: Examines the functional capabilities of all the constituent subsystems, in order to determine the overall capability of the system to perform the functions or actions required to maintain operations within a predetermined list of mission critical requirements.

Table A.5 Embedded IVHM architecture processes/activities breakdown

A5: .NET IVHM architecture

Process Name	Activities Description
.NET-based IVHM Architecture: Data processing	Data acquisition : possibly at several frequency rates
	Signal filtering
.NET-based IVHM Architecture: Feature extraction	Feature extraction
	Mapping of the features to known fault modes
.NET-based IVHM Architecture: Fault Diagnosis	Particle-Filtering Prediction: estimate the prior probability density function of the states by using a nonlinear system model, representing the evolution of the system states over time, which predicts the system state vector at time k, based

	on the system state vector at time k-1 and on the process noise at time k-1
	Particle-Filtering Update: modifies the prior density to gain the posterior density.
	Component Fault Detection: A fault indicator is generated by comparing the current state PDF with the baseline state PDF that represents the statistical/historical information about the normal operational states of the system. The statistical confidence is also associated to the fault indicator
.NET-based IVHM Architecture: Failure prognosis	Particle-Filtering Prediction
	Particle-Filtering Update
	RUL computation: successively computes the expectation of the system model, which is used in the prediction step, and use this expectation in order to estimate the RUL.

Table A.6 .NET-based IVHM architecture processes/activities breakdown

A6: Tri-reasoner IVHM system

Process Name	Activities Description
Tri reasoner IVHM: Anomaly detection and reasoning	Evaluation of the raw data
	Extraction of features for correlation or measures of evidence for fault conditions
	Anomaly detection: the mechanism for characterizing baseline performance and identifying deviations from the baseline. The anomaly is any off-nominal behavior including any failure described as incipient, intermittent or active.
Tri reasoner IVHM:	Isolation of fault sources: by constructing an integrated air-

Diagnostic reasoning	vehicle perspective.
Tri reasoner IVHM:	Assess the current health of the component
Prognostic reasoning	Predict into the future its health in two directions: is the component good for the future mission, estimate the time before a certain type of fault will occur
Tri reasoner IVHM: Reasoning integration manager	Priorization of the most probable fault and recommended maintenance actions

Table A.7 Tri-reasoner IVHM architecture processes/activities breakdown

A7: SIMP - Integrated proactive maintenance system

Process Name	Activities Description
SIMP: Surveillance	Data acquisition
	Data pre-processing
	Diagnostics of failure /degradation
SIMP: Prognostics	Drive the prognostics process: controls the prognostics activities flow
	State/performance initialization: provides a starting point for the future projection activity, by updating the current state of the system and its components with the latest data available from health monitoring and diagnostics processes. It provides a synchronic view of the system and its components
	Future projection : Determines the evolution of degradation / failures and the performance across components/ sub-system/system in order to have a

	<p>diachronic view (throughout the time) of the system. The projection takes into account operational and environmental conditions of the future mission,</p>
	<p>RUL evaluation: Calculates the time when the projected degradation/performance levels will cross a pre-defined component/performance threshold, corresponding to a failure occurrence or to time period after which one of the system's function is no longer performing as required.</p>
SIMP: Decision Support	<p>Schedule maintenance actions according to the dynamic monitoring and the RUL assessments of the production system</p>
	<p>Update the utilization scenarios of the production system</p>

Table A.8 SIMP processes/activities breakdown

A8: 4D/RCS (4 dimensional real-time control system)

Process Name	Activities Description
4D/RCS: Sensory Processing	Transformation of the sensor data into perceived and classified objects, events and situations
4D/RCS: World Modeling	Maintaining the knowledge database : the best estimate of the world at a scale and resolution that is appropriate for the behaviour generation planner and executor processes
	Generation of predictions for BG planning and SP recursive estimation
4D/RCS: Value Judgment	Computation of the level of confidence assigned to the information extracted from sensory input by SP

	Assigning of worth to perceived objects, events and situations stored in KD
4D/RCS: Behavior Generation	Planning of actions
	Execution of actions

Table A.9 4D/RCS architecture processes/activities breakdown

Appendix D: gHMM model

gHMM stakeholders needs from gHMM

Stakeholder	Accountabilities in IVHM	Associated Needs
HM Engineer	Task 1. Analysis of repetitive equipment failures, false alarms and their consequences, imprecise diagnostics, estimation of remaining useful life of equipment, with the aim of maturing implemented models and algorithms of the vehicle health management system;	The gHMM must provide data and information required for detecting and analysing repetitive equipment failures, false alarms, ambiguity in diagnostics, and certainty of prognostics.
	Task 2. Manage appropriate and comprehensive selection, coherent design, implementation, update and maturation of vehicle health management algorithms;	The gHMM uses as input the gHMM knowledge base and the fleet knowledge base.
		The gHMM uses the algorithms developed by health management engineers for supporting its processes and their encompassed activities.
		The gHMM must feed the knowledge base with data and information generated by its processes.
	Task 3. Management of coherent design, implementation, update and maturation of vehicle and fleet health management knowledge bases.	The gHMM must provide means of selection of the appropriate health management algorithms for every elementary activity, in accordance with the relevant criteria of selection.

		<p>The gHMM must provide means to evaluate the interoperability of selected algorithms, whose supporting activities are interacting with one another.</p>
Vehicle Operator	<p>Task 1. Operates the vehicle according the mission profile and insure the successful execution of the mission;</p>	<p>Provide means to evaluate the remaining functional capability of the vehicle.</p>
	<p>Task 2. Report usage and failure related issues.</p>	<p>Provide means to assess the vehicle's ability to fulfil the mission profile, and to generate recommendations for its adjustment during operation.</p>
	<p>Task 3. Assesses the needs of change or reconfiguration of the vehicle mission, based on the actionable information provided or observed on the vehicle and by the vehicle health management system;</p>	<p>The gHMM must interface with a log function.</p> <p>The gHMM outputs could thus be logged by using a textual description or by using an explicit semantic which can be post-processed by a machine.</p>
Mission Planner	<p>Task 1. Plan optimal mission allocation for its perimeter of vehicles;</p>	<p>The gHMM must provide to mission planning, the remaining functional capability of the vehicle, and its adequacy with the future mission profile.</p>
	<p>Task 2. Supervise the execution of the current vehicle mission;</p>	<p>The gHMM must provide means to evaluate the remaining capability of</p>

Appendices

		<p>the vehicle for the current mission.</p> <p>In case of insufficient capability, the gHMM must provide the decision support required for mission profile adjustment.</p>
	Task 3. Communicate any change in the mission profile to vehicle and IVHM system.	<p>The gHMM must interface with mission planning in order to receive mission profile before the mission, and updates of the mission profile throughout the mission.</p>
Maintenance Planner	Task 1. Manages the elaboration, implementation and update of the maintenance plan for the allocated perimeter of vehicles;	<p>The gHMM must interface with the maintenance planning, in order to receive the scheduled maintenance task list, but also to update the maintenance planning based on the vehicle health assessment.</p>
	Task 2. Estimates the maintenance costs and evaluation of maintenance alternatives;	<p>The gHMM must provide decision support required for comparison of maintenance alternatives.</p>
	Task 3. Applies scheduling and project management principles to build maintenance planning;	N/A
	Task 4. Assesses required maintenance tools and skills required for efficient maintenance of equipment;	N/A
	Task 5. Assesses the needs for equipment replacements and forwards it to logistics support;	<p>The gHMM must provide the decision support required for assessing the need of equipment replacement.</p>

	Task 6. Reviews personnel transfers to and from maintenance organizations, required for maintenance planning.	N/A
O-level Maintenance Operator	Task 1. Execute the maintenance operations tasks between the TAT;	Decision support for maintenance operations and trouble-shooting procedures.
	Task 2. Report any anomaly occurred during the execution of trouble-shooting procedures;	The gHMM must interface with a log function. The gHMM outputs could thus be commented by using a textual description or by using an explicit semantic which can be post-processed by a machine.
	Task 3. Complete the maintenance tasks as specified in the Maintenance and Troubleshooting Manuals;	The gHMM must provide means to confirm that a suspected LRU is found faulty.
	Task 4. After completion of all of the maintenance tasks, check that the status of the vehicle is GO for the next mission.	The gHMM must provide means to trigger diagnostics and prognostics on demand by the maintenance operator.

gHMM model

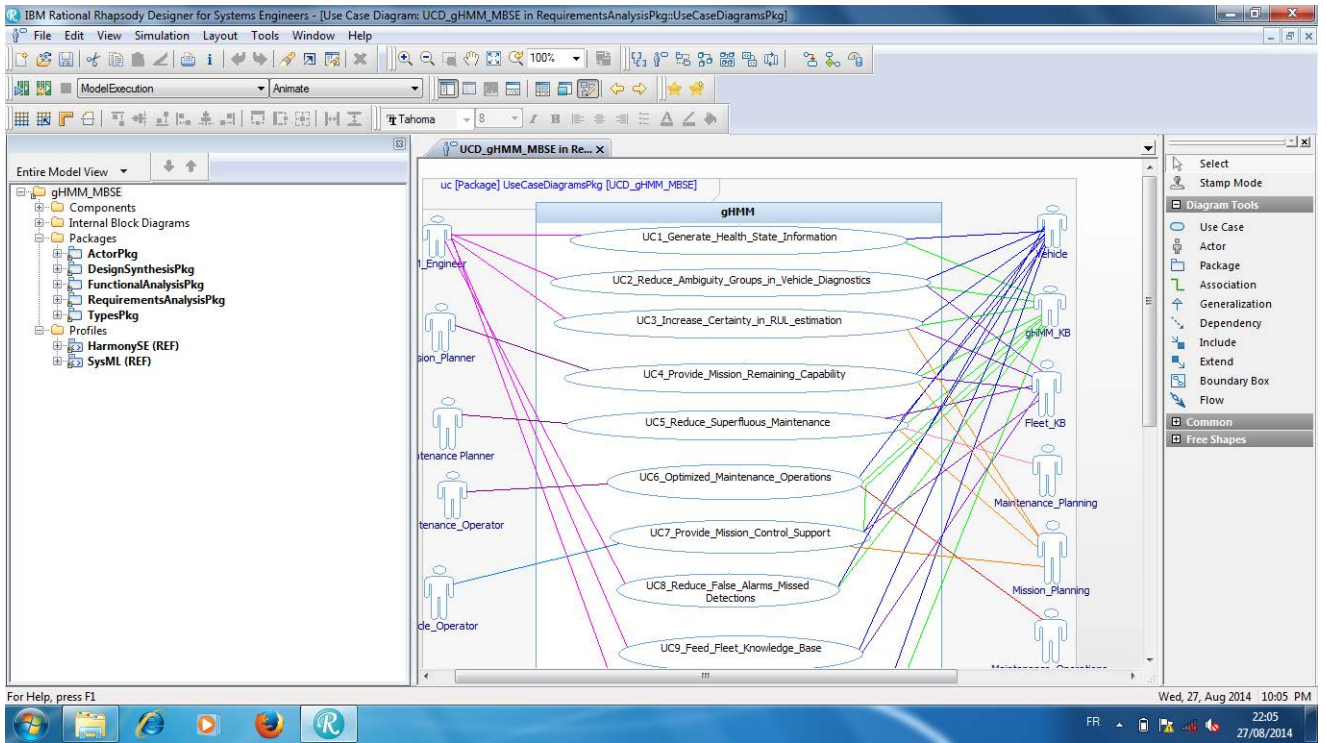

Figure A.13 gHMM MBSE project tree

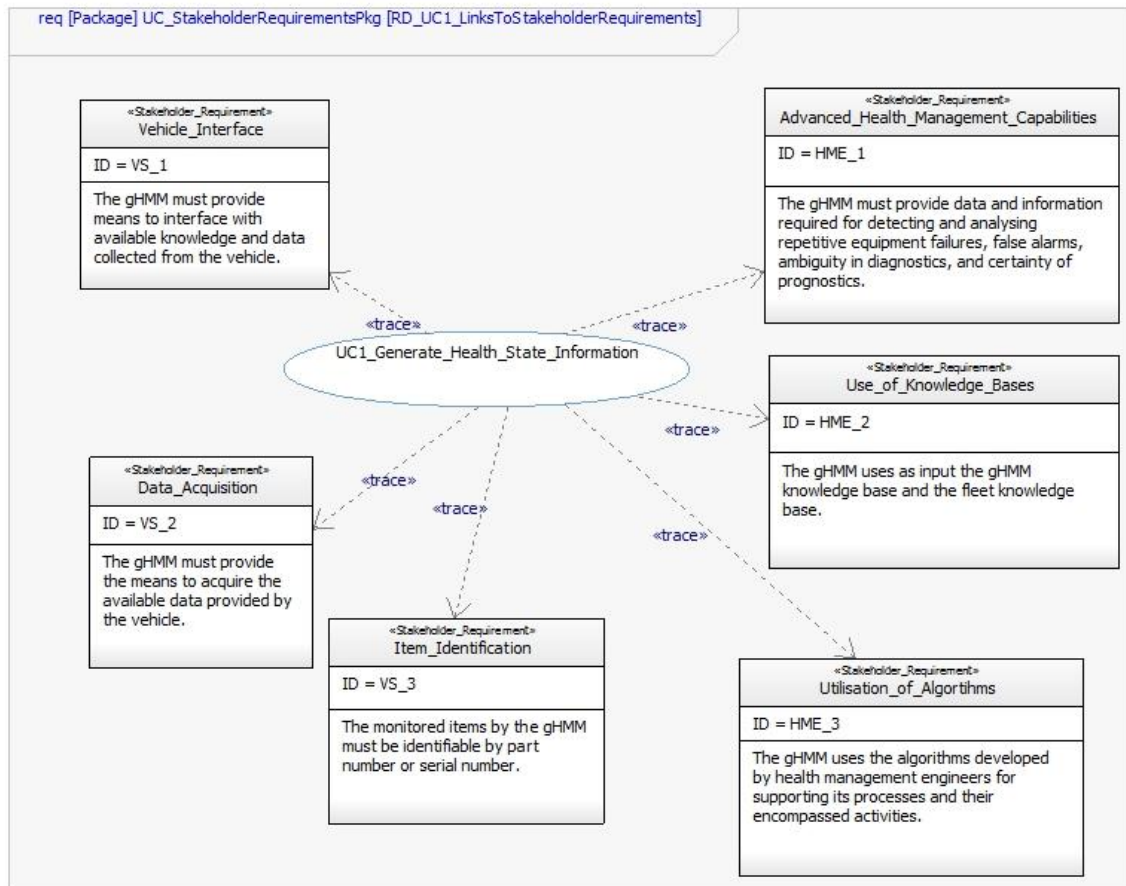

Figure A.14 UC1 link to stakeholders requirements

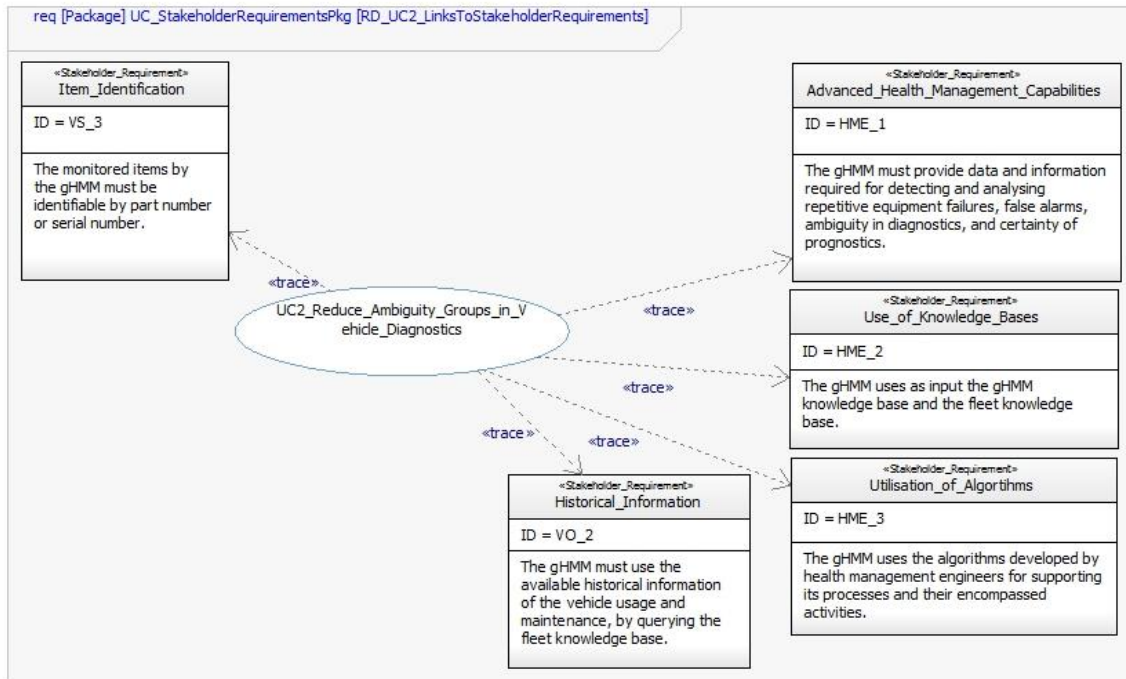

Figure A.15 UC2 link to stakeholders requirements

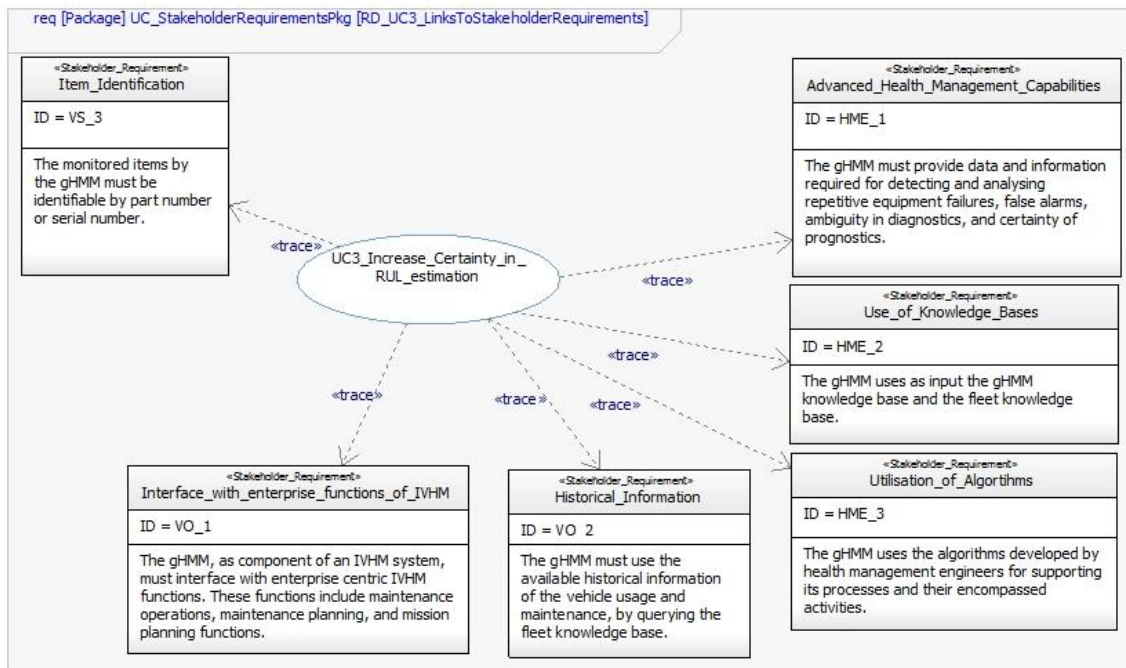

Figure A.16 UC3 link to stakeholders requirements

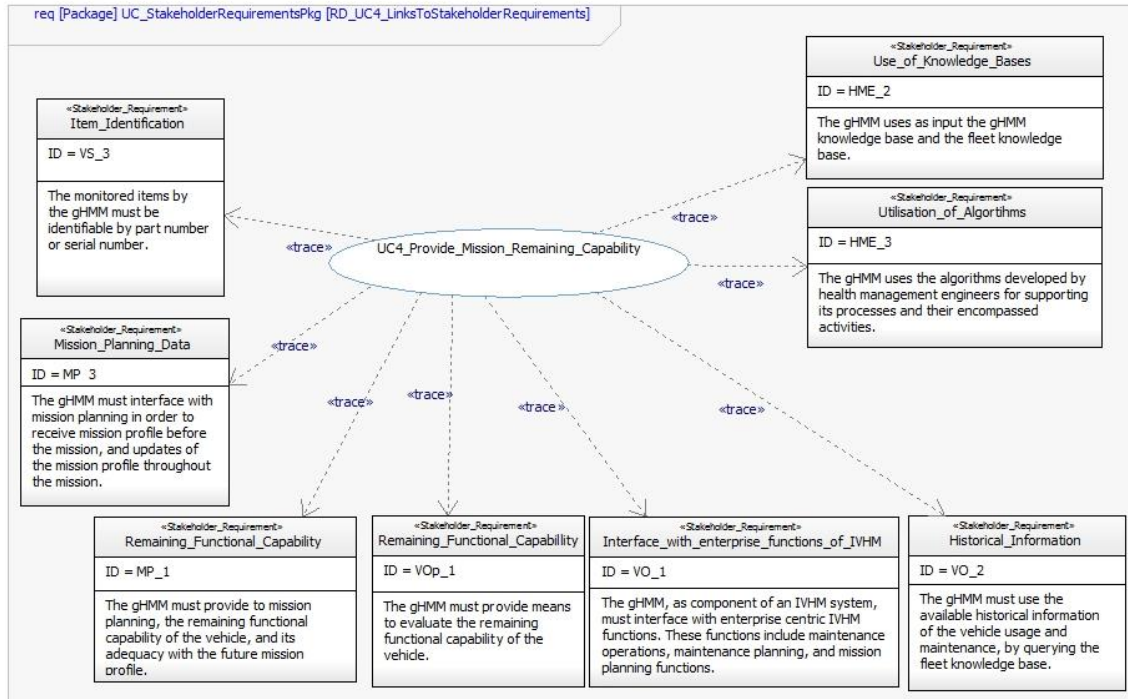

Figure A.17 UC4 link to Stakeholders Requirements

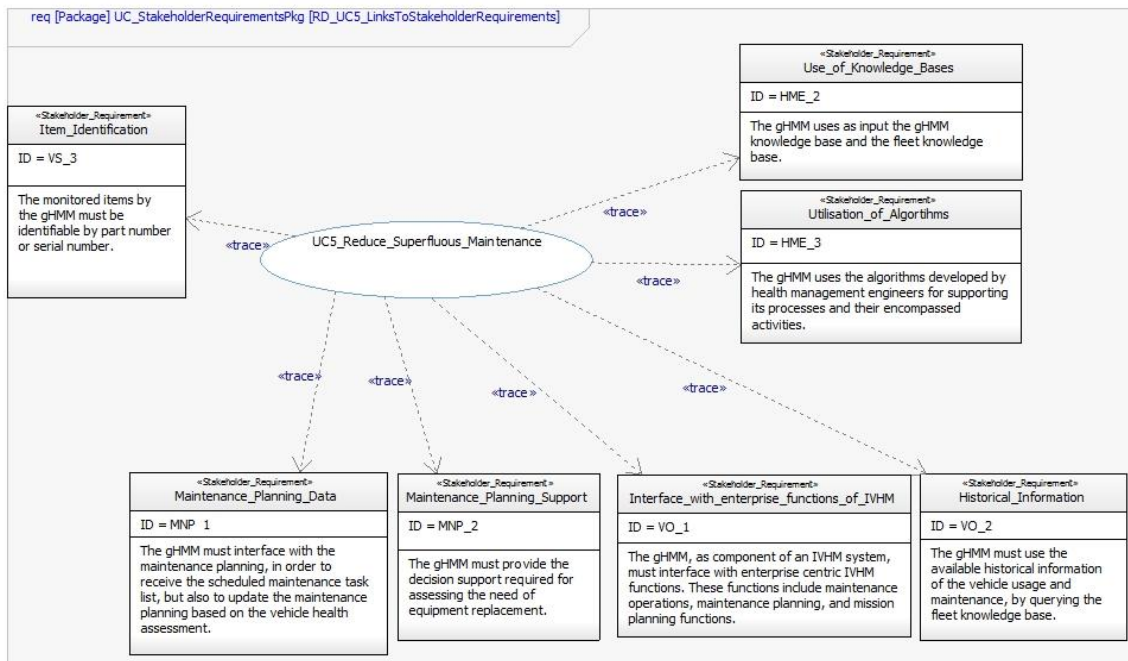

Figure A.18 UC5 link to stakeholders requirements

Appendices

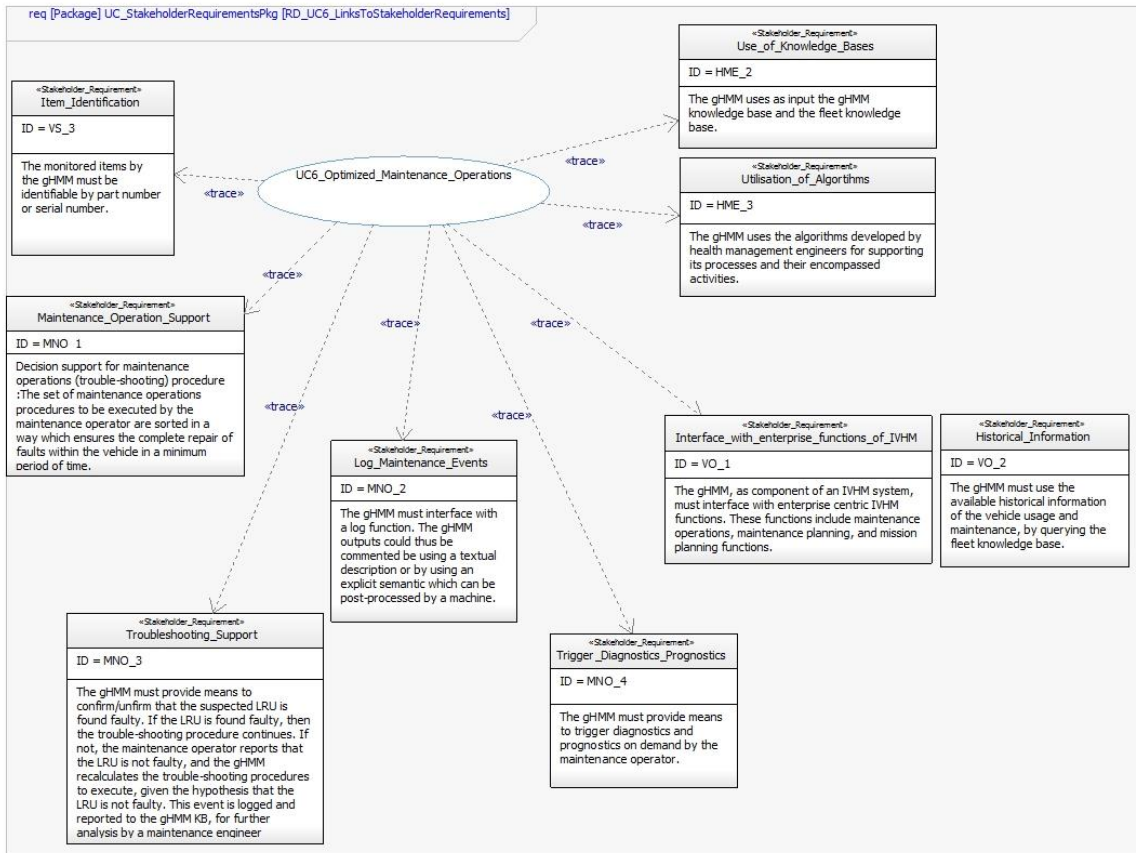

Figure A.19 UC6 link to stakeholders requirements

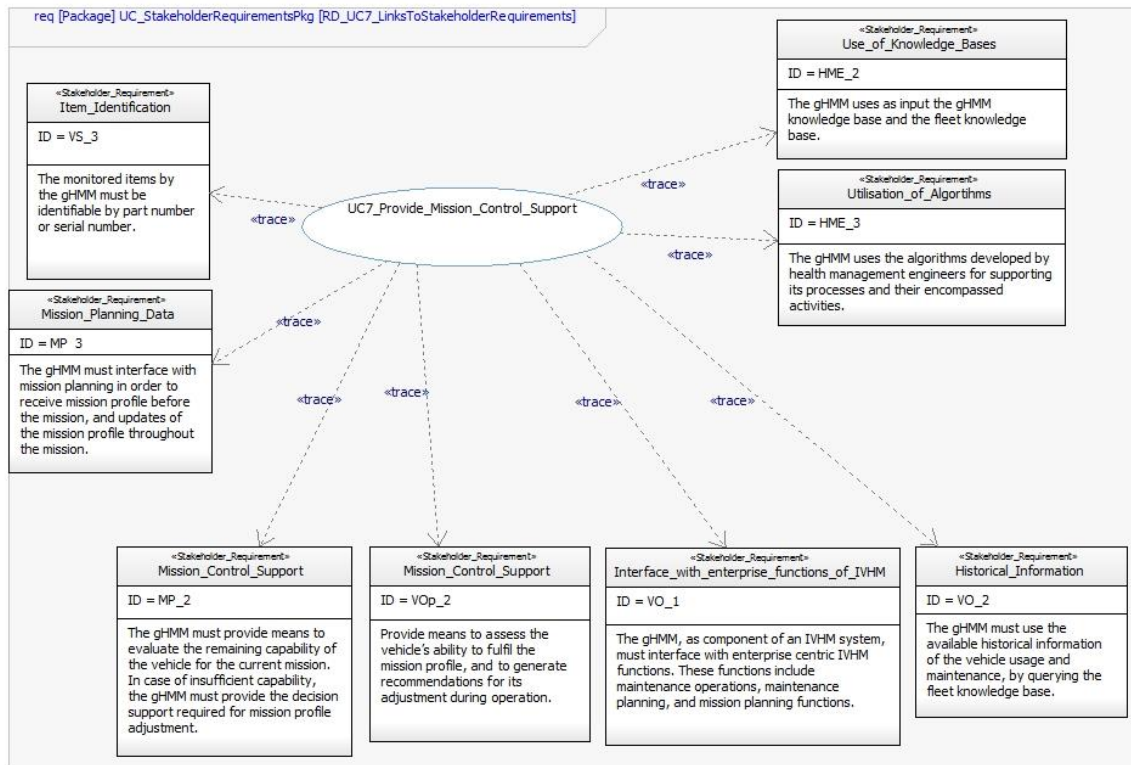

Figure A.20 UC7 link to stakeholders requirements

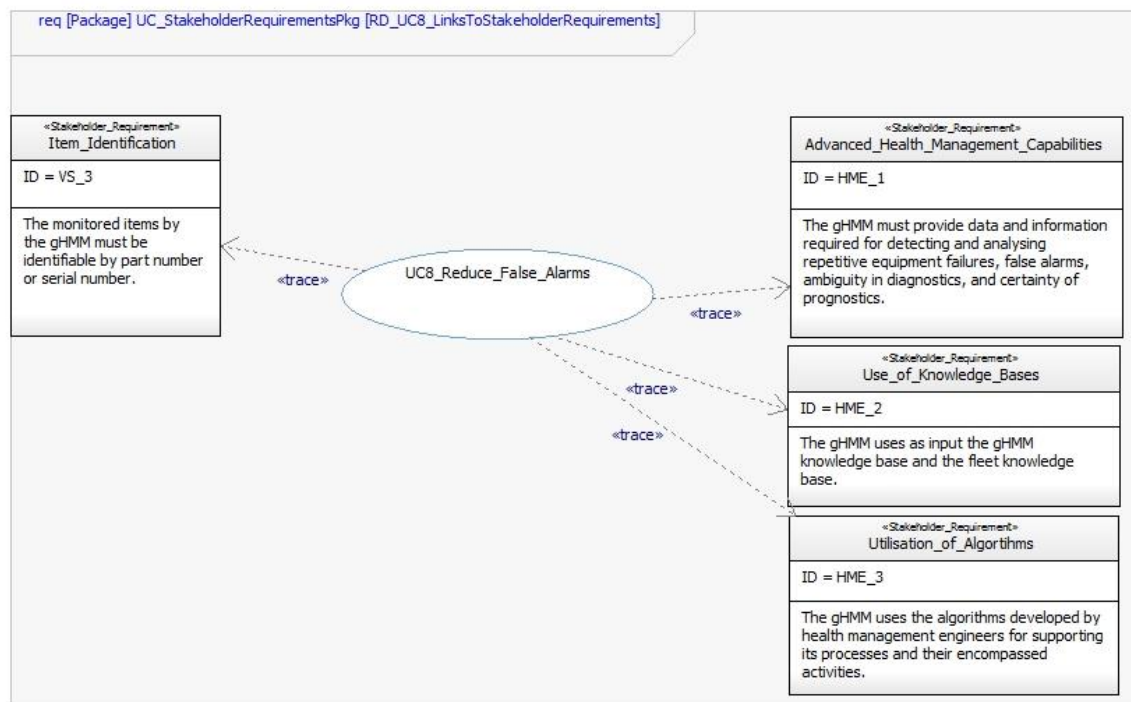

Figure A.21 UC8 link to stakeholders requirements

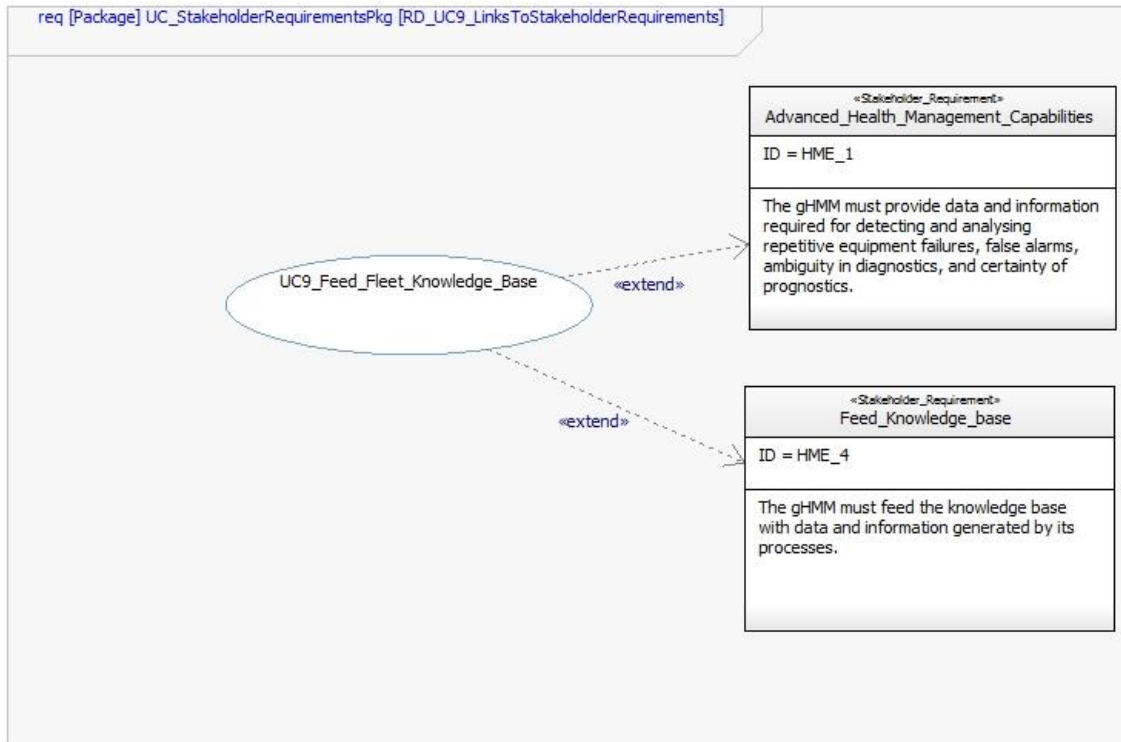

Figure A.22 UC9 link to stakeholders requirements

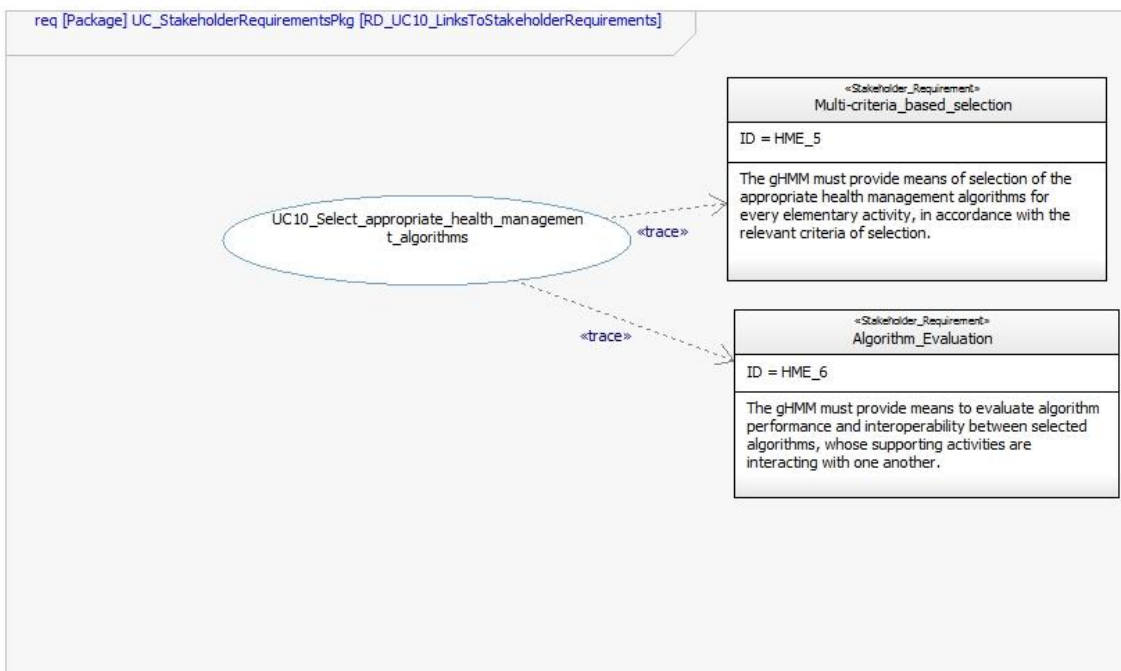

Figure A.23 UC10 link to stakeholders requirements

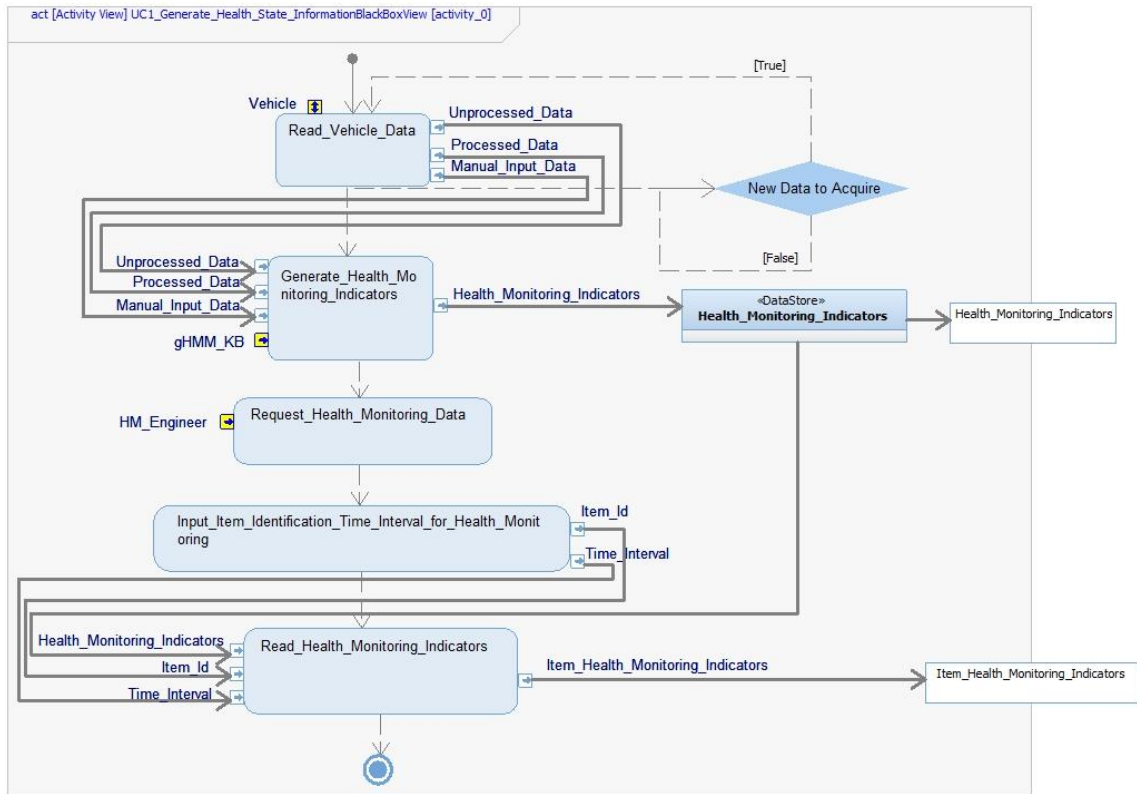

Figure A.24 UC1 Black-box functional flow

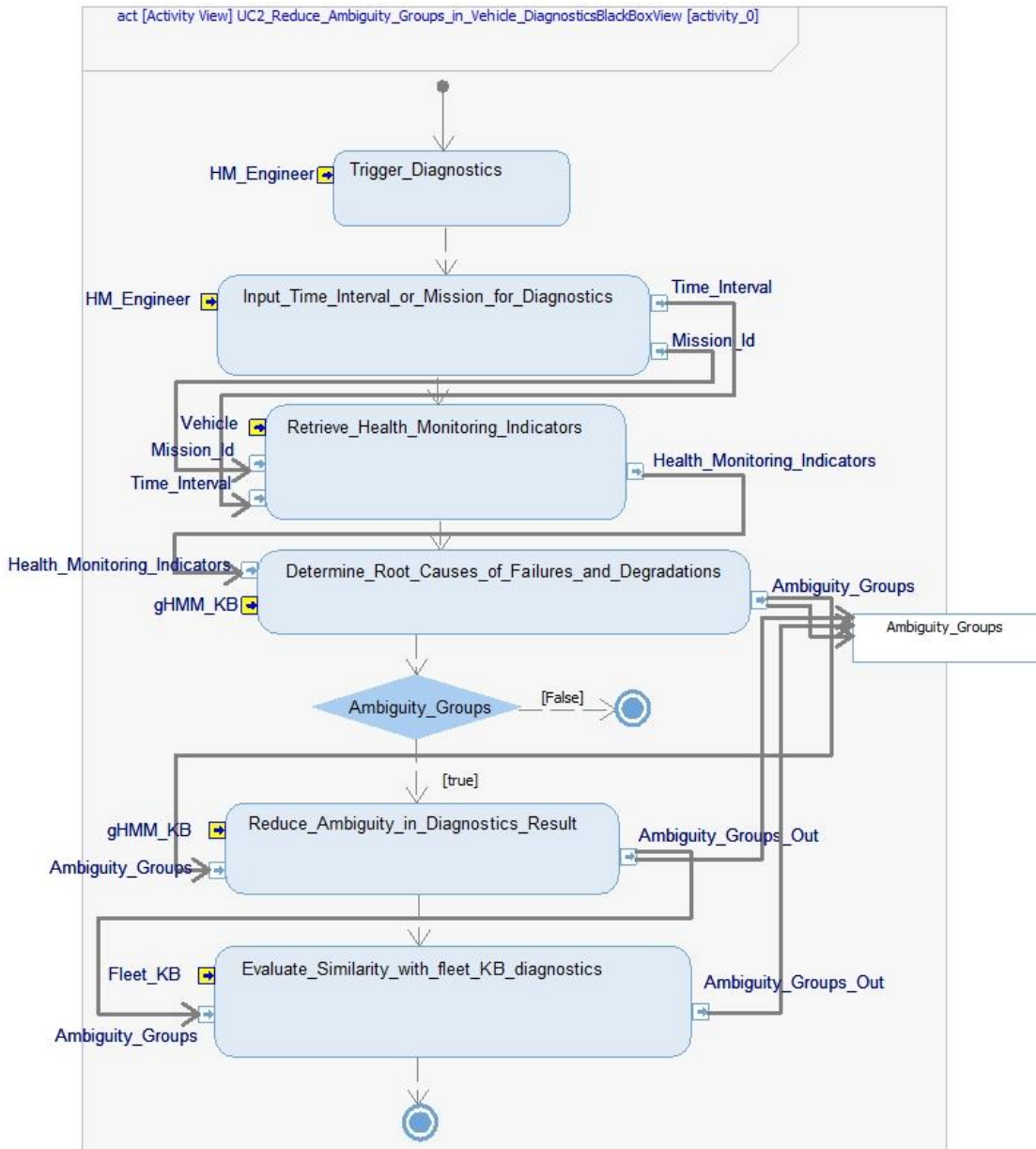

Figure A.25 UC2 Black-box functional flow

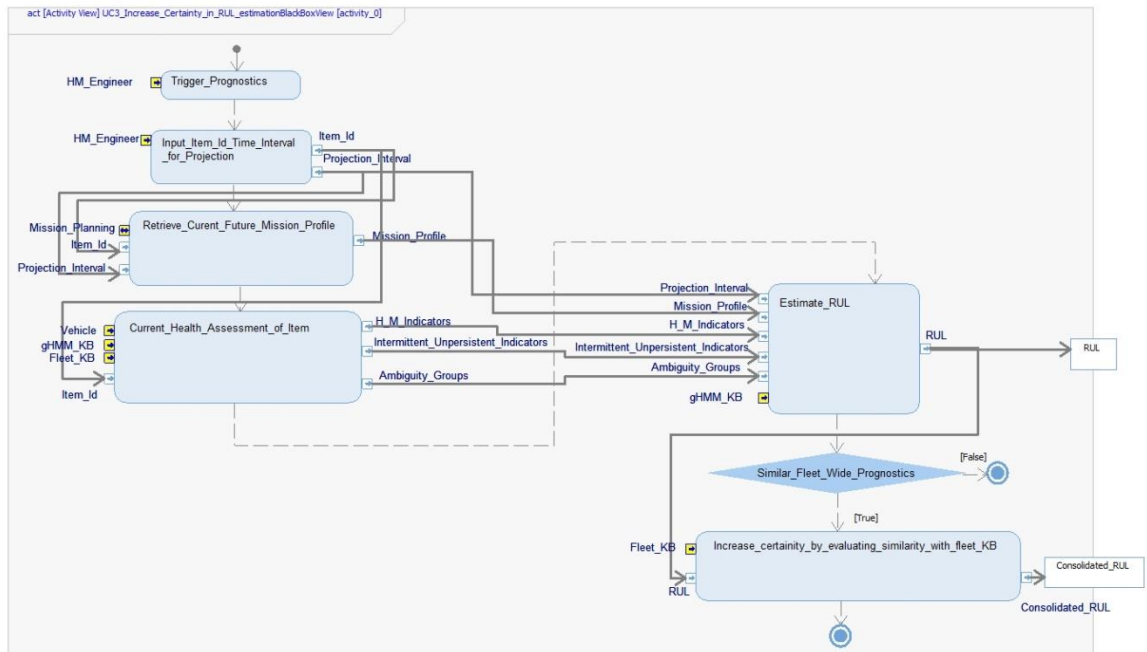

Figure A.26 UC3 Black-box functional flow

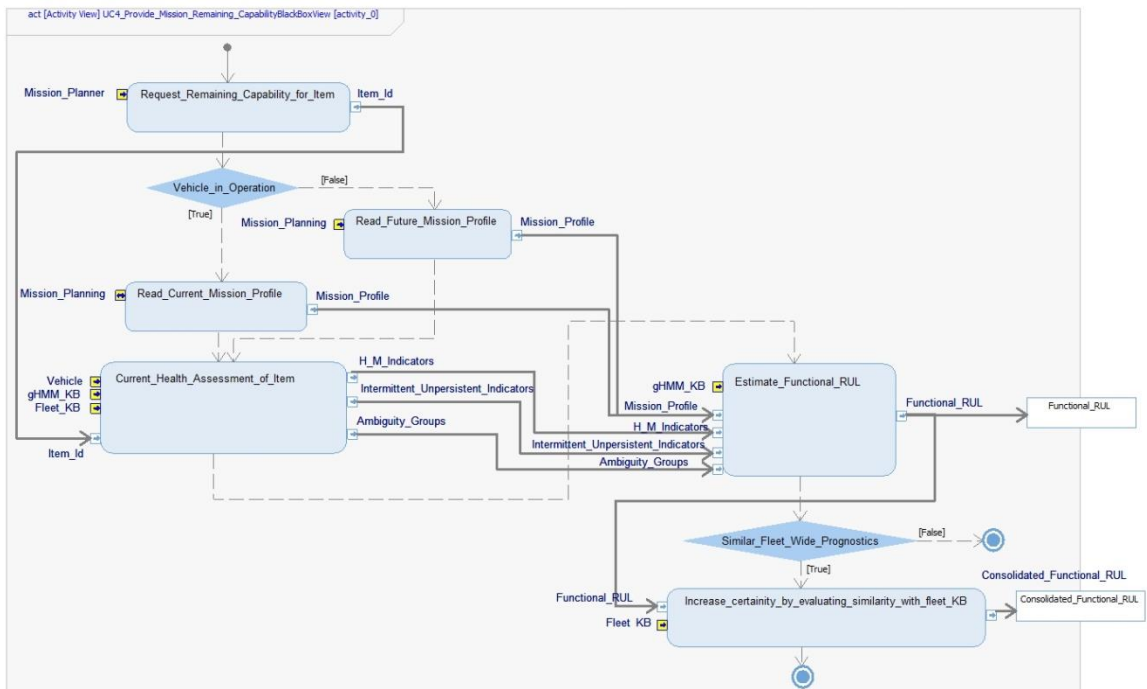

Figure A.27 UC4 Black-box functional flow

Appendices

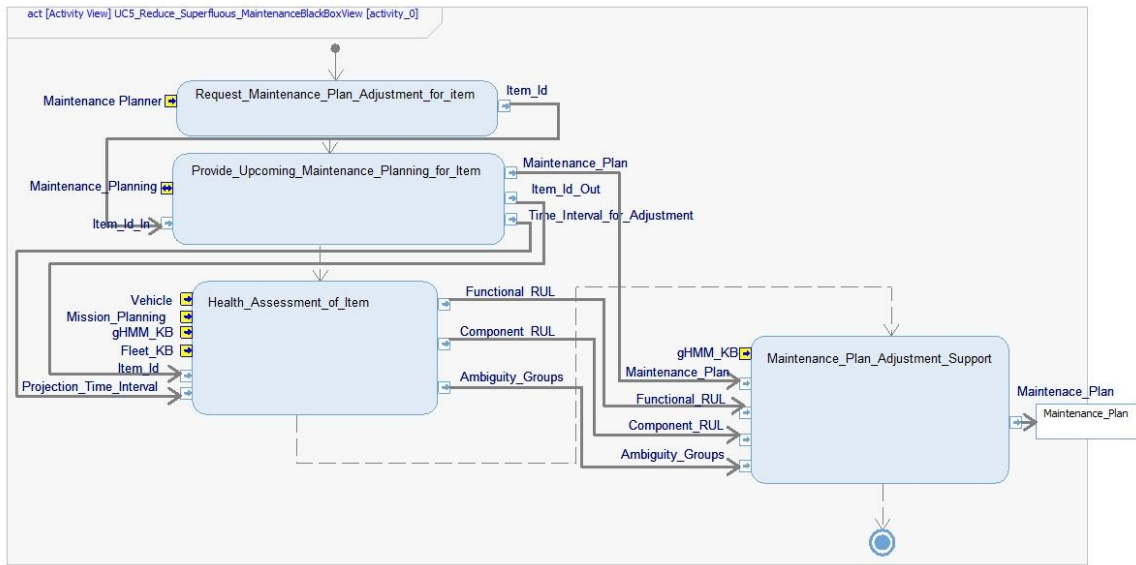

Figure A.28 UC5 Black-box functional flow

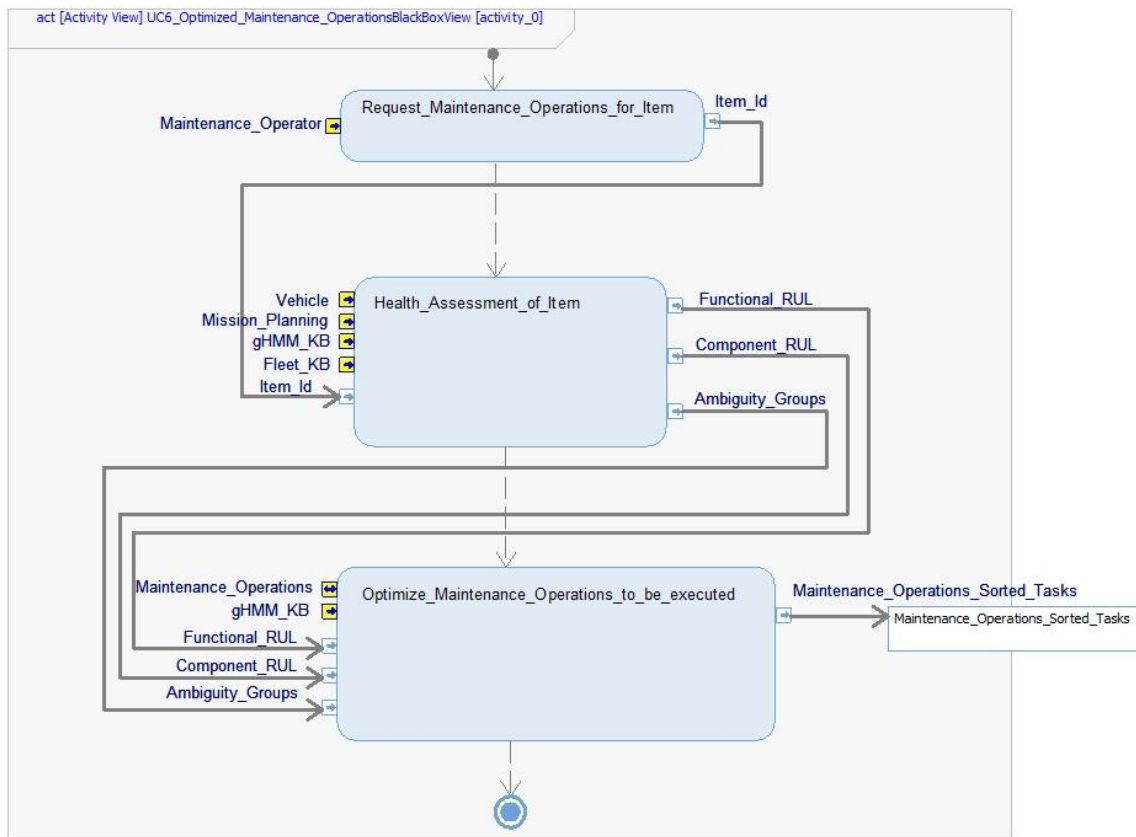

Figure A.29 UC6 Black-box functional flow

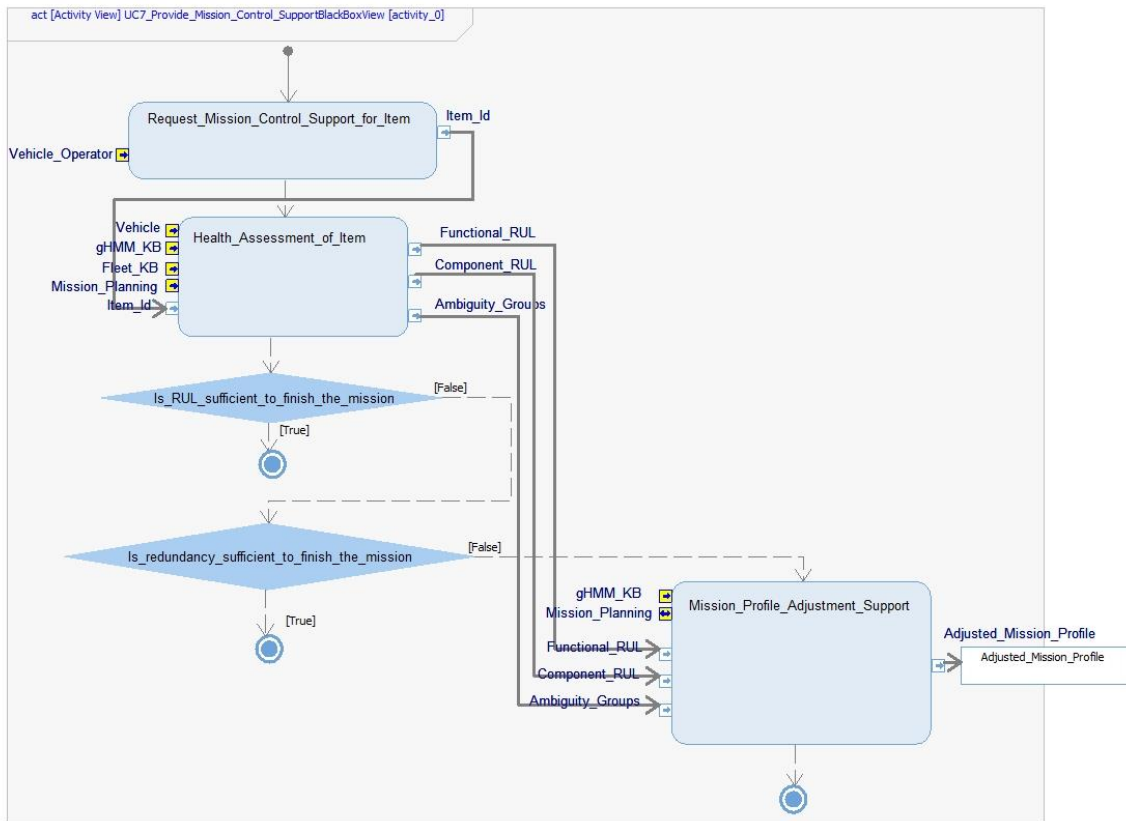

Figure A.30 UC6 Black-box functional flow

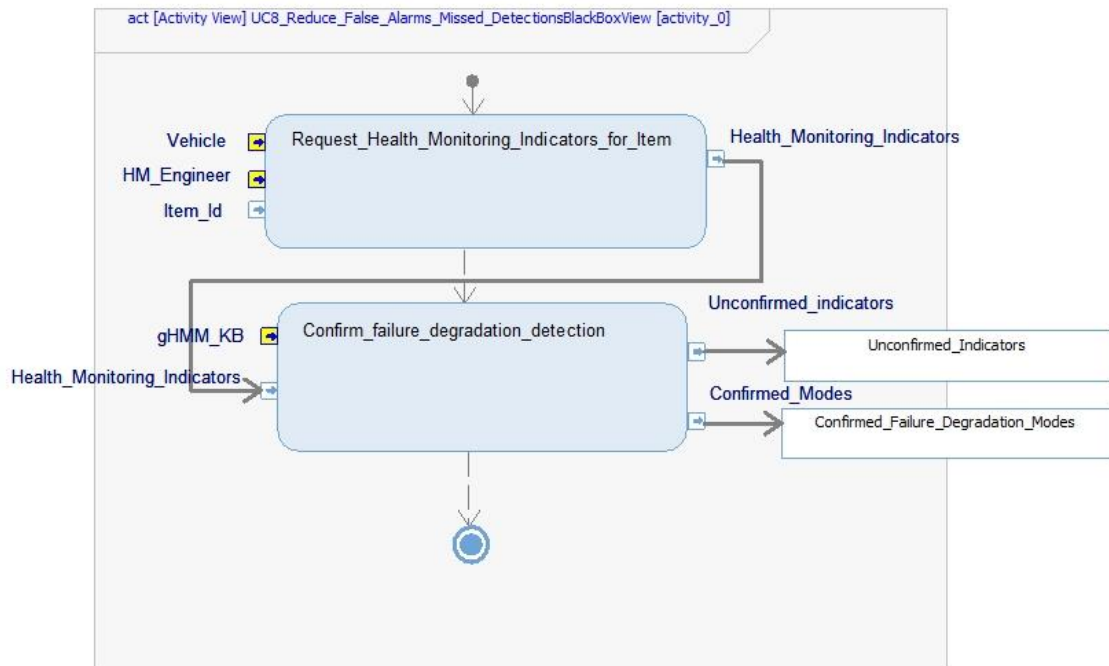

Figure A.31 UC8 Black-box functional flow

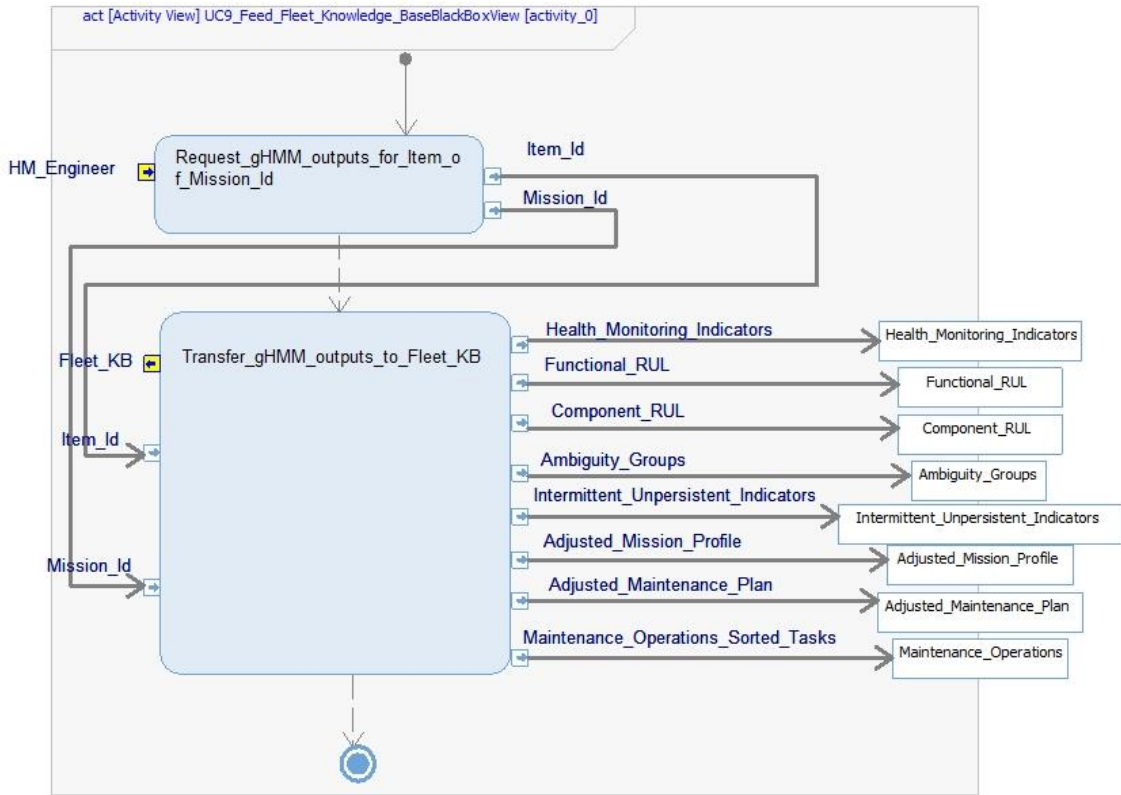

Figure A.32 UC9 Black-box functional flow

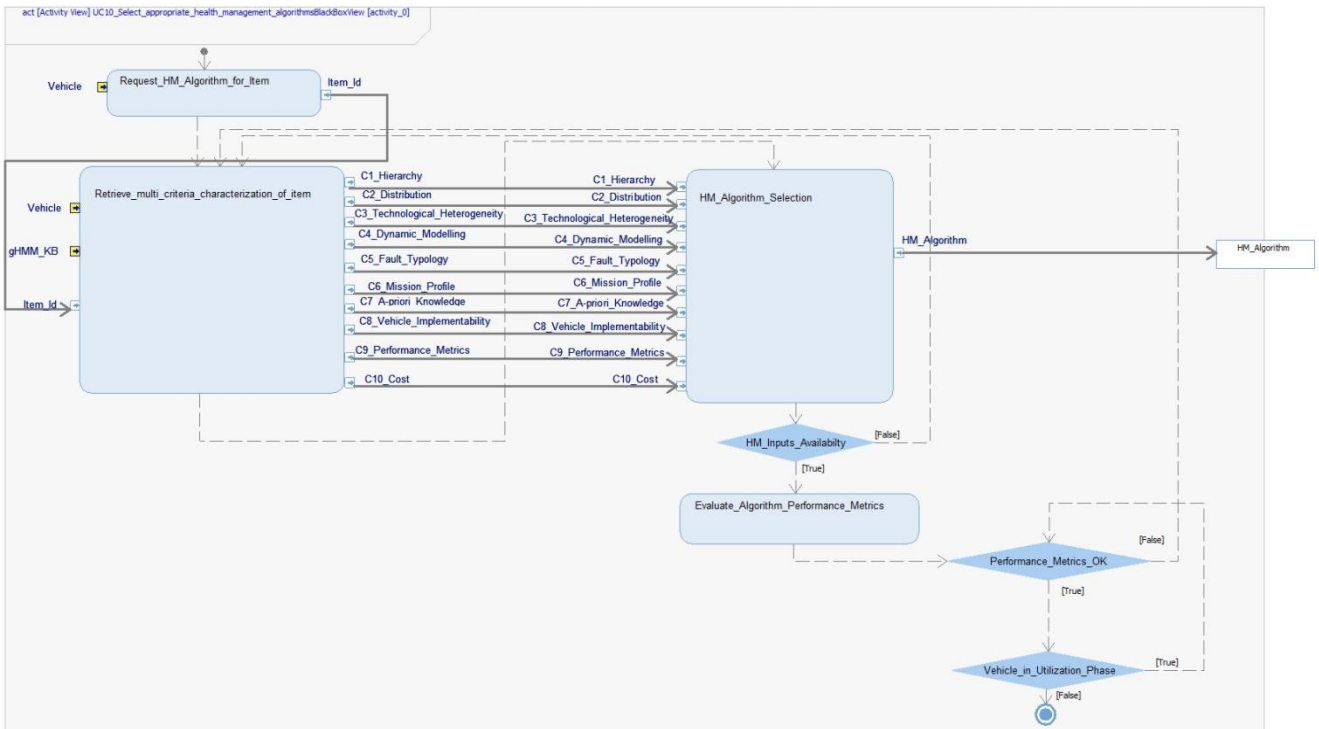

Figure A.33 UC10 Black-box functional flow

Appendix E: Reduce Ambiguity Group using RUL pseudocode

<u>Inputs</u>
<p>Inputs from Diagnostics process:</p> $\text{Isolate_Root_Causes } \Delta_{\Sigma}(M) = \bigvee_{j=1}^{GA_M} \Delta_j^M$ $\text{Prioritize_LRUs_in_Ambiguity_Groups } \left\{ \overline{w}_j^t, \Delta_j^M \right\}, \text{ where } \overline{w}_1 \geq \overline{w}_2 \geq \dots \geq \overline{w}_{GA_M}$ <p>Inputs from Prognostics process:</p> $\text{Initialize_State_and_Performance } \left\{ h_i^M \right\}_{i=1}^P$ $\text{Project_into_future } \left\{ \hat{h}_i^{M+1} \right\}_{i=1}^P$ $\text{Evaluate_RUL } \left\{ RUL, \text{confid} \right\}_i^M$ <p>Inputs from gHMM KB</p> $\text{upTime_of_LRUs} \leftarrow \left\{ \text{upTime}_i \right\}_{i=1}^P$ $\text{confidT} \leftarrow \left\{ \text{confidT}_i \right\}_{i=1}^P$
<u>Output</u>
$\text{Reduce_Ambiguity_using_RUL } \left\{ \overline{w}_j^{t+1}, \Delta_j^M \right\}_{j=1}^{GA_M}, \text{ where } \overline{w}_1 \geq \overline{w}_2 \geq \dots \geq \overline{w}_{GA_M}$
<u>Algorithm</u>
<p>FOR EACH $\left\langle \overline{w}_j^t, \Delta_j^M \right\rangle$ IN $\left\{ \overline{w}_j, \Delta_j^M \right\}_{j=1}^{GA_M}$</p> <p style="padding-left: 2em;">FOR EACH $\left(\left\langle w_i^t, LRU_i \right\rangle \right)$ IN Δ_j^M</p> <p style="padding-left: 4em;">IF $(LRU_i \text{ IN } \{LRU_1, LRU_2, \dots, LRU_p\})$ THEN</p> <p style="padding-left: 6em;">Get upTime from $\left\{ \text{upTime}_i \right\}_{i=1}^P$</p>

Get $f \hat{h}_i^{M+1}$ from $\prod_{i=1}^P \{f h_i^{M+1}\}$

Get *confid* and *RUL* from $\prod_{i=1}^P \{RUL, confid\}_i^M$

IF (*confid* \geq *confidT_i*) THEN

$$RUL\% \leftarrow \frac{RUL}{upTime + RUL} // \text{compute percentage of remaining life}$$

$$w_i^{t+1} = w_i^t + \frac{confid * f \hat{h}_i^{M+1}}{RUL\%} // \text{update the weight of suspected LRU}$$

END IF

END IF

END FOR

Compute weight w_j^{t+1} of Diagnostics hypothesis Δ_j^M ;

END FOR

FOR EACH $\langle w_j^{t+1}, \Delta_j^M \rangle$ IN $\prod_{j=1}^{GA-M} \{ \langle w_j^{t+1}, \Delta_j^M \rangle \}$

Normalize weight of $\Delta_j^M \rightarrow \overline{w}_j^{t+1}$

Sort $\prod_{j=1}^{GA-M} \{ \langle \overline{w}_j^{t+1}, \Delta_j^M \rangle \}$

END FOR

Appendix F: OSA-CBM data structures

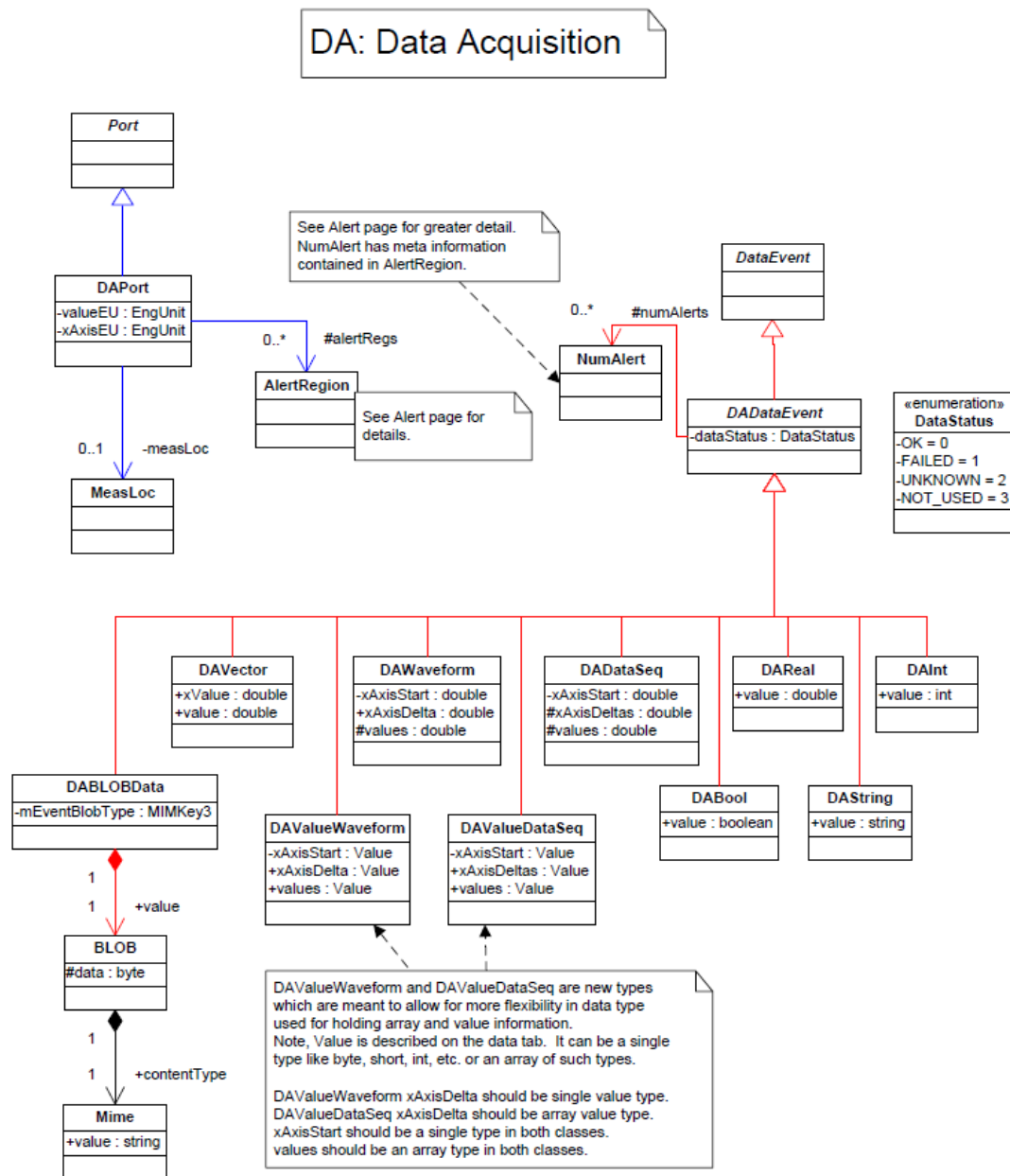

Figure A.34 DADataEvent - OSA-CBM v3.3.1

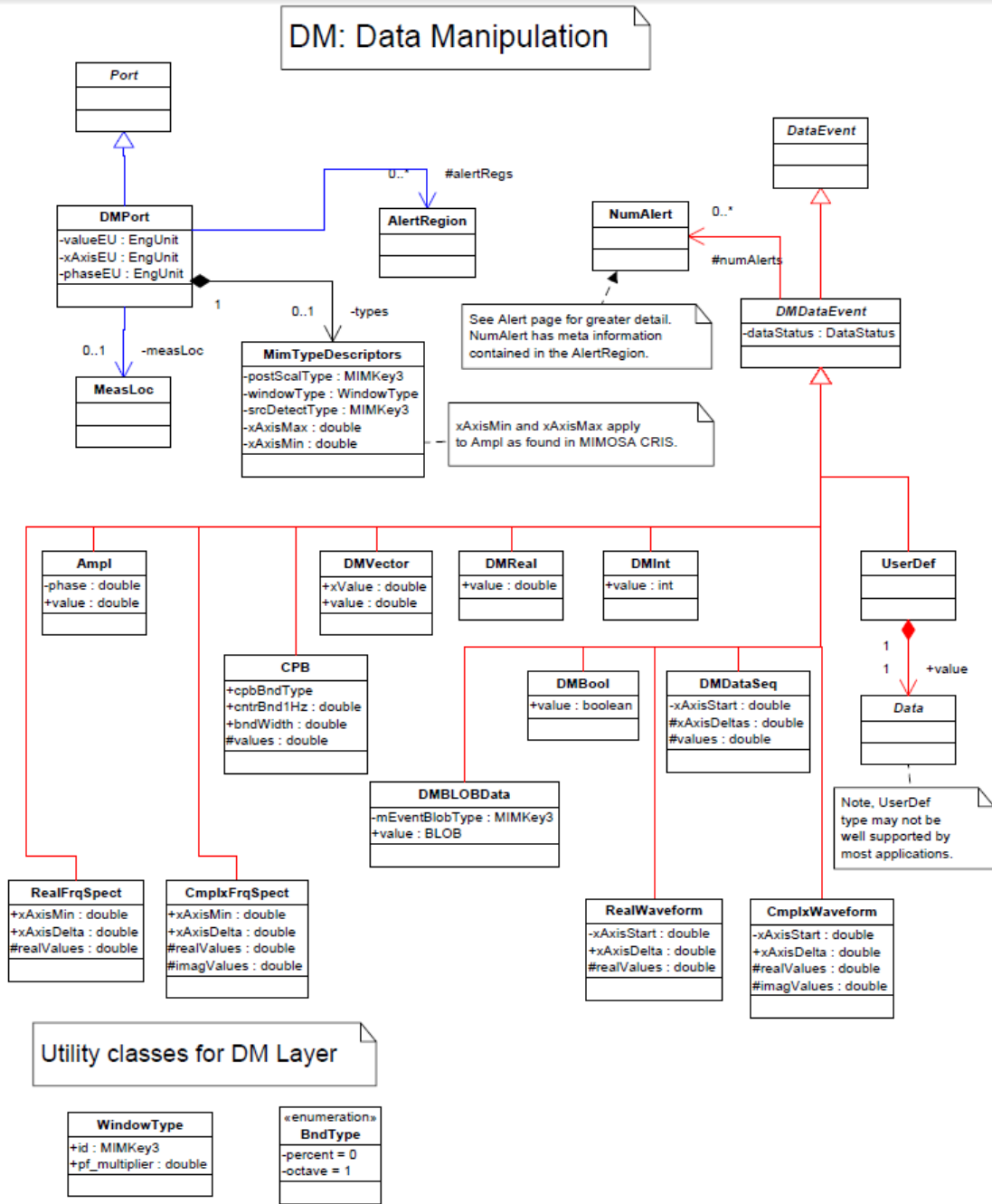

Figure A.35 DMDDataEvent - OSA-CBM v3.3.1

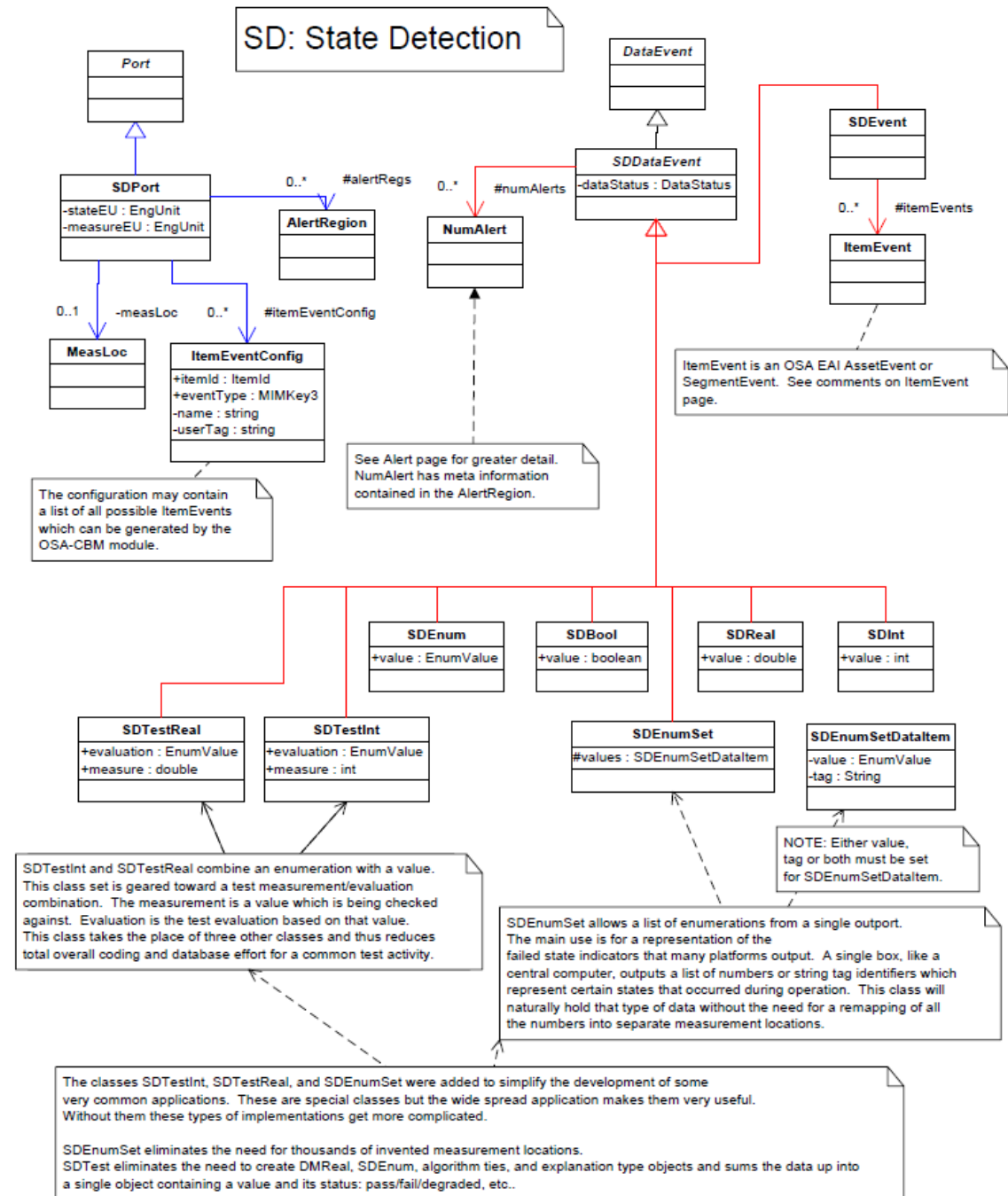

Figure A.36 SDDataEvent - OSA-CBM v3.3.1

<i>PropEvent</i>
+itemId : ItemId
+eventType : MIMKey3
-estStart : OsacbmTime
-estEnd : OsacbmTime
-severityType : MIMKey3
-criticality : int
-chgPattType : MIMKey3
-userTag : String
-name : String
#hypEventType : MIMKey3
#funcs : Function

Figure A.37 **PropEvent - OSA-CBM v3.3.1**