



HAL
open science

Dégradation de l'habitat et réponse au stress : de la physiologie à la biologie de la conservation

Rémy Josserand

► **To cite this version:**

Rémy Josserand. Dégradation de l'habitat et réponse au stress : de la physiologie à la biologie de la conservation. Ecologie, Environnement. Université Pierre et Marie Curie - Paris VI, 2016. Français. NNT : 2016PA066711 . tel-01648210

HAL Id: tel-01648210

<https://theses.hal.science/tel-01648210v1>

Submitted on 25 Nov 2017

HAL is a multi-disciplinary open access archive for the deposit and dissemination of scientific research documents, whether they are published or not. The documents may come from teaching and research institutions in France or abroad, or from public or private research centers.

L'archive ouverte pluridisciplinaire **HAL**, est destinée au dépôt et à la diffusion de documents scientifiques de niveau recherche, publiés ou non, émanant des établissements d'enseignement et de recherche français ou étrangers, des laboratoires publics ou privés.

Université Pierre et Marie Curie

Ecole doctorale 227 MNHN-UPMC « Sciences de la Nature et de l'Homme :
évolution et écologie »

*Institut d'Ecologie et des Sciences de l'Environnement de Paris, équipe Ecophysiologie
Evolutive*

Dégradation de l'habitat et réponse au stress :

De la physiologie à la biologie de la conservation

Par Rémy Josserand

Thèse de doctorat d'Ecologie

Dirigée par Sandrine Meylan et Jean-François Le Galliard

Présentée et soutenue publiquement le 23 Novembre 2016

Devant un jury composé de :

Mme Maïbèche Martine, Professeur Université Pierre et Marie Curie	Présidente du Jury
M. Joly Pierre, Professeur Université Claude Bernard Lyon 1	Rapporteur
M. Angelier Frédéric, Chargé de recherche CNRS	Rapporteur
Mme Habold Caroline, Chargé de recherche CNRS	Examineur
M. Cote Julien, Chargé de recherche CNRS	Examineur
Mme Meylan Sandrine, Professeur Université Paris Sorbonne-ESPE	Directrice de thèse
M. Le Galliard Jean-François, Chargé de recherche CNRS	Directeur de thèse



Table des matières

Remerciements	3
Introduction générale.....	5
Le rôle des glucocorticoïdes dans un monde changeant	8
Les glucocorticoïdes constituent un médiateur de la réponse à une perturbation	8
Les glucocorticoïdes ont des effets multiples et complexes.....	10
La physiologie de la conservation : les GC comme indicateur de l'état des populations. ...	12
Le modèle allostatique	14
Description générale.....	14
Le " <i>reactive scope model</i> "	17
Dégradation de l'habitat et allostasie	20
Objectifs de la thèse	21
Objectif général	21
Le modèle biologique.....	22
Choix des indicateurs de la charge allostatique	25
Synthèse des résultats.....	28
Partie I : Dégradation de l'habitat, corticostérone et traits démographiques	28
Partie II : Effets directs, indirects et à long terme d'un stress chronique.....	31
Discussion	33
Des mesures à affiner et à compléter.....	35
La nécessité de prendre en compte les besoins spécifiques associés au cycle de vie	39
Bibliographie.....	41
Article 1.....	47
Article 2.....	82
Article 3.....	121
Article 4.....	152

Remerciements

N'étant pas un grand orateur et écrivain je serais bref, mais sachez que mes remerciements sont sincères.

Je voudrais commencer par remercier Sandrine Meylan et Jean-François Le Galliard qui m'ont fait confiance pour mener cette thèse durant ces trois ans, qui m'ont aidé à mener à bien ces travaux tant au niveau théorique que pratique sur le terrain. Je les remercie aussi de m'avoir soutenue durant les moments difficiles, sans eux ce document n'aurait pas vu le jour.

Je remercie aussi les différents membres du jury pour le temps qu'il m'accorde et pour le jugement qu'ils apporteront à ce travail.

Je tiens aussi à remercier tout le personnel technique pour leur bonne humeur. Claudy pour son aide et ses conseils inestimables lors des dosages hormonaux. Samuel avec qui nous avons conçu des systèmes expérimentaux qui n'auront malheureusement pas duré très longtemps... Amandine et Alexis pour être venus promptement m'aider lorsque les dits systèmes ont décidé de céder sous un violent orage. Et bien sûr je remercie chaleureusement Beatrix et Simon qui m'ont aidé dans la capture, l'élevage et surtout, surtout le nourrissage des centaines de lézard que nous avons suivi durant ces trois années.

Je tiens aussi à remercier tous les stagiaires qui ont travaillé avec moi et sans qui mes travaux n'auraient pas pu être menés. Vincent, Pierre, Aurore, Camille, merci. Alexis je suis vraiment content que tu es enfin fini par avoir ta thèse, je finis, tu commences c'est un cycle. Je te remercie vraiment pour ton aide dans les enclos et surtout pour ton travail qui m'a évité des mois de codage, alors un grand merci à toi. Isabelle, Manon, pipelettes invétérés, même si vous parliez parfois un peu trop vous mettiez de la bonne humeur dans le laboratoire et ça, c'est cool. Je pense que je me souviendrai pendant bien des années de nos petits dimanches soirs films d'horreur, petit moment de "détente" que nous partagions. Enfin, même s'il n'a jamais été mon stagiaire, Willem, tu m'auras été d'un grand secours dans l'analyse des spectres de coloration et pour cela, merci.

Et puisque qu'aucun travail n'est possible sans financement et infrastructures, je souhaiterais remercier la région Île-de-France qui m'a financé durant ces trois années, l'Institut d'Ecologie et des Sciences de l'Environnement de Paris qui m'a accueilli et le Centre de Recherche en Ecologie Expérimentale et Prédictive pour m'avoir permis d'utiliser leurs installations durant ces trois années.

J'aimerais aussi laisser un petit message à Loïc, Nathalie et Thierry. Merci de m'avoir accueilli et encadré lors de mes études à Lyon, vous m'avez donné goût à la recherche et m'avez soutenu même quand, malheureusement, je n'ai pas pu poursuivre mes travaux avec vous. Je sais que je ne communique pas beaucoup, mais je vous remercie pour tout.

Pour finir, je voudrais remercier ma famille qui m'a soutenu moralement et financièrement, et peut être tout particulièrement ma mère sans qui je n'aurais jamais suivi cette voie et mon père qui m'a toujours fait confiance.

Mailys, toi qui attends ces lignes avec impatience, sache que tu auras été mon plus grand soutien durant ces années à Paris. Je ne dirais pas ce que tu sais déjà parce que plein de personnes vont lire ça. Mais sache que je louerai toujours ces petites rainettes vertes qui nous ont réunis.

Introduction générale

Durant ces dernières décennies, nous avons vu le monde changer à grande vitesse. L'anthropisation croissante a engendré des perturbations de l'environnement de natures diverses : chimique avec par exemple l'apparition dans l'environnement de perturbateurs endocriniens (Norris 2000), physique avec l'augmentation autour des villes et des infrastructures routières de la pollution sonore (Forman and Alexander 1998) ou lumineuse (Hölker et al. 2010) mais aussi climatique avec une tendance globale au réchauffement vraisemblablement accompagnée de changements dans la variance climatique. En effet, il a été démontré que les activités humaines sont à l'origine des changements climatiques majeurs observés dans les moyennes de température ou des précipitations durant les dernières décennies (Steffensen et al. 2008; Buntgen et al. 2011), et il est attendu que ces changements se traduiraient par une augmentation des phénomènes extrêmes. Les changements climatiques altèrent la qualité des habitats naturels et le fonctionnement des écosystèmes (Seebacher and Franklin 2012). Ces changements environnementaux globaux affectent les espèces vivantes qui doivent faire face à de nouvelles perturbations brutales ou à des changements graduels jamais vus dans le passé et s'adapter pour ne pas risquer de disparaître (Ghalambor et al. 2007). Notre discipline s'est donc fixée naturellement comme grand objectif scientifique de comprendre et de tenter de prédire la réponse des organismes aux changements environnementaux.

A l'échelle d'une espèce, on peut proposer que les réponses écologiques aux changements globaux dépendent en grande partie d'une cascade de réponses impliquant la physiologie des organismes et sa sensibilité à l'environnement externe (Seebacher and Franklin 2012). Impliqués dans la régulation des constantes de l'organisme par le processus de l'homéostasie (i.e. ensemble des systèmes de régulation des facteurs clés de

l'organisme comme la température ou la glycémie), les processus physiologiques contribuent au contrôle de la croissance corporelle structurelle, au stockage des réserves ou à la balance oxydative, et donc déterminent indirectement les stratégies de vie d'un organisme ainsi que l'état démographique de la population (Angelier and Wingfield 2012). En particulier, quand l'environnement change de manière brutale ou graduelle, l'organisme répond en mettant en place diverses régulations physiologiques impliquant, par exemple, le système nerveux autonome ou le système endocrinien qui participent à une éventuelle inflexion de la trajectoire de développement et donc de l'état futur de l'individu. Cette inflexion, plus ou moins réversible selon les situations, contribue à la capacité d'un organisme d'un même génotype à exprimer différents phénotypes selon les conditions environnementales, c'est-à-dire la plasticité phénotypique (Dufty et al. 2002).

Dans ce contexte, il devient légitime de se poser une série de questions d'intérêt général. **Par quels processus physiologiques spécifiques les signaux environnementaux induisent-ils des changements phénotypiques ? Quelles sont les contraintes qui limitent les possibilités de plasticité permettant aux individus de faire face aux changements environnementaux ? Est-ce que la plasticité est adaptative et contribue-t-elle favorablement à la capacité de la biodiversité à faire face aux changements globaux ?** Les réponses à ces questions pourraient se trouver dans l'étude du fonctionnement des systèmes endocriniens qui sont fortement impliqués dans les processus développementaux responsables de la plasticité phénotypique. En effet, les hormones constituent de bonnes candidates pour l'étude de ces questions écologiques car, chez les espèces pluricellulaires, l'intégration des informations relatives à l'environnement de l'individu est prise en charge en grande partie par le système neuroendocrinien. De plus, le système neuroendocrinien est un véritable système de contrôle qui participe à la régulation d'un grand nombre de processus critiques et dont le

dysfonctionnement sous l'action de stress brefs ou répétés peut conduire à des répercussions graves pour l'organisme. Les réponses du système endocrinien à des changements de l'environnement peuvent produire des changements rapides et durables dans la transcription des gènes et la modification du métabolisme des cellules cibles affectant alors profondément le phénotype.

Il existe un grand nombre d'hormones différentes qui agissent sur différentes fonctions de l'organisme. Certaines provoquent des réactions d'urgence (l'adrénaline, la corticostérone), tandis que d'autres jouent un rôle de régulation (l'insuline, qui régule le taux de glucose dans notre sang). Parmi les différentes familles d'hormones, on distingue les **hormones thyroïdiennes** qui sont essentielles à la croissance et à la différenciation de toutes les cellules de l'organisme, les **hormones stéroïdiennes** qui agissent sur différents aspects du fonctionnement de l'organisme tels que le métabolisme glucidique, lipidique et protéique (corticostérone et cortisol), l'homéostasie hydrique (aldostérone) et la reproduction (androgènes, estrogènes, progestogènes). Si les hormones peuvent ainsi modifier directement certains traits, elles peuvent aussi agir de manière indirecte en influençant d'autres hormones et même en interagissant avec une autre hormone pour permettre son action. Par exemple, Rosenblatt et al. (1994) a démontré que l'oestradiol et la progestérone sont toutes deux nécessaires pour induire les soins maternels chez les rats. En effet, le mode d'action des hormones est souvent complexe. La plupart des hormones, notamment les hormones stéroïdiennes et thyroïdiennes, circulent dans le sang fixées à des protéines mais ne sont actives biologiquement qu'à l'état libre (Nelson 1994). De ce fait, tout changement de concentration en protéines du sang peut moduler l'influence de ces hormones. De même, les hormones sont spécifiques à des cellules cibles qui possèdent un nombre de récepteurs qui peut varier dans le temps. Généralement, quand les cellules cibles sont confrontées à des faibles niveaux hormonaux, le nombre de

récepteurs augmente et accroît ainsi sa sensibilité. Les récepteurs eux-mêmes peuvent avoir des affinités différentes pour une hormone, et des individus exposés à une même dose hormonale peuvent alors répondre différemment. De même, si les hormones peuvent agir directement sur l'individu en modifiant un caractère précis, de plus en plus d'études démontrent qu'elles peuvent aussi agir de manière indirecte sur le phénotype en agissant à différents moments du développement du phénotype (Dufty et al. 2002). Toutes ces caractéristiques font des hormones de bons médiateurs de la plasticité phénotypique (Lessells 2008). Au cours de mes différents travaux, je me suis concentré sur les glucocorticoïdes (GC) et plus particulièrement la corticostérone, principal glucocorticoïde sécrété par les reptiles, amphibiens, rongeurs et oiseaux et responsable de nombreuses modulations physiologiques et comportementales (Sapolsky et al. 2000; Wingfield 2003).

Le rôle des glucocorticoïdes dans un monde changeant

Les glucocorticoïdes constituent un médiateur de la réponse à une perturbation

Lors de la perception d'une perturbation, différents mécanismes vont s'activer afin de permettre à l'individu de s'adapter aux nouvelles contraintes rencontrées comme des changements comportementaux ou physiologiques (Johnson et al. 1992). Un processus physiologique majeur impliqué dans cette réponse est la réponse de l'axe HPA (hypothalamo-hypophyso-surrénalien) ou HPI (hypothalamo-hypophyso-interrénal) en fonction des espèces, plus couramment appelé axe du « stress ». La stimulation de cet axe par une perturbation brutale de l'environnement aboutit à une augmentation de la sécrétion de glucocorticoïdes (GC, voir figure 1). Il est reconnu que la sécrétion de GC permet aux individus de faire face aux perturbations en mettant en place diverses réponses physiologiques et comportementales ayant pour vocation d'éviter tout effet délétère direct et à court terme (Sapolsky et al. 2000; Peckett et al. 2011; Crespi et al. 2013). Les modulations de l'axe HPA peuvent survenir aussi bien lors d'évènements

imprévisibles (comme l'attaque d'un prédateur) que lors d'évènements prévisibles (par exemple, l'engagement de la reproduction) afin de faciliter l'allocation des ressources vers les fonctions en réclamant (Schulkin 2011; Crespi et al. 2013).

Dans le cadre des changements globaux, les nouvelles perturbations rencontrées par les individus leur demandent d'allouer du temps et de l'énergie pour faire face à des changements imprévisibles et parfois durables, accentuant les compromis d'allocation déjà existants entre les différentes tactiques d'histoire de vie (Wingfield 2008; Angelier and Wingfield 2013). On peut par exemple citer l'existence du compromis entre reproduction et survie chez de nombreuses espèces d'oiseaux, et l'implication des glucocorticoïdes dans l'abandon du nid par les parents lors d'une perturbation imprévisible afin de favoriser la survie immédiate (Wingfield 2003). Ces changements d'allocation entre les différentes fonctions ont un impact sur la valeur adaptative présente des individus, ou fitness immédiate, mais aussi sur leur descendance via la transmission d'effets parentaux (Meylan et al. 2012), et donc par extension sur la dynamique des populations (Beckerman et al. 2002). De ce fait, l'étude des réponses individuelles mises en place par la sécrétion des glucocorticoïdes, à la fois au niveau physiologique et démographique, constitue un aspect important dans la compréhension des impacts des changements globaux (Angelier and Wingfield 2013).

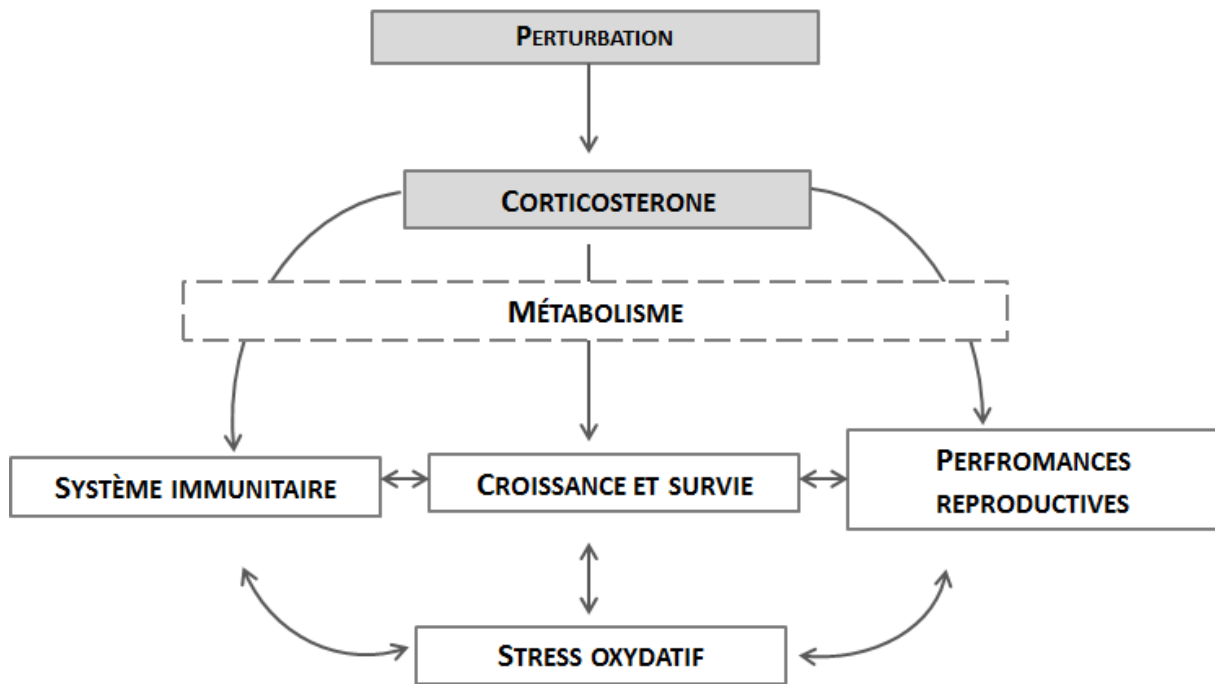

Figure 1 : La corticostérone se situe à l'interface entre les perturbations expérimentées par les individus et les compromis entre reproduction, croissance et immunitaire.

Les glucocorticoïdes ont des effets multiples et complexes

L'axe HPA, et plus spécifiquement la sécrétion des GC le long de cet axe, a reçu énormément d'attention durant ces dernières années notamment à travers les modèles physiologiques que constituent le « *reactive scope model* » (Romero et al. 2009) et le modèle allostatique (McEwen and Wingfield 2003) que nous détaillerons plus tard. Cet intérêt particulier pour les GC peut s'expliquer par plusieurs aspects mis en relief dans une synthèse d'Angelier et Wingfield en 2013. Les réponses mises en place lors de la sécrétion de GC sont variables et dépendent à la fois de l'intensité de la sécrétion mais aussi de sa durée (Dhabhar and McEwen 1997; Sapolsky et al. 2000; McEwen and Wingfield 2003; Landys et al. 2006; Schulkin 2011). Les GC vont donc impacter les décisions d'allocation des ressources différemment en fonction de l'histoire de l'individu (Beckerman et al. 2002), de son statut (McEwen and Wingfield 2003; Bonier et al. 2009) et de la nature de la perturbation (McEwen and Wingfield 2003). Chez le lézard vivipare

(*Zootoca vivipara*), il a ainsi été mis en évidence que les réponses physiologiques et comportementales des animaux traités avec de la corticostérone dépendaient du niveau de satiété des animaux (Cote et al. 2010a). Enfin, de plus en plus d'études mettent en évidence que la réponse à une perturbation via la sécrétion de GC est en partie héritable et peut aussi se transmettre entre les générations par des effets parentaux (Catalani et al., 2000; Marasco, Spencer, Robinson, Herzyk, & Costantini, 2013; Meylan & Clobert, 2005; Schöpfer, Palme, Ruf, & Huber, 2011)

Du fait de leur implication dans de nombreuses voies de régulation sur de nombreux tissus, les GC jouent un rôle majeur dans le processus d'homéostasie. Il est cependant admis que, si les GC possèdent à court terme des effets bénéfiques, ils peuvent aussi engendrer des effets délétères dans la durée (McEwen and Wingfield 2003; Schulkin 2011). Les GC permettent de mobiliser l'énergie stockée dans les réserves (Sapolsky et al. 2000; Landys et al. 2006). La corticostérone permet de transférer l'énergie depuis les réserves vers les tissus cibles en stimulant la gluconéogenèse et la libération d'acide gras stocké dans le foie, les muscles et les tissus adipeux via la lipolyse de ces derniers (Landys et al. 2006; Peckett et al. 2011), mais aussi en facilitant l'acquisition de nourriture (Sapolsky et al. 2000; Landys et al. 2006). Les GC sont aussi connus pour engendrer à court terme une stimulation du système immunitaire, à la fois inné et acquis, ou encore de réallouer les défenses immunitaires vers les « postes de combat » (Dhabhar and McEwen 1997; Dhabhar 2002). A plus long terme, la sécrétion de GC peut entraîner plusieurs effets délétères pour les organismes. La mobilisation des ressources par les GC et l'activation du métabolisme peuvent conduire à la production de radicaux libres (ROS) qui peuvent déséquilibrer la balance oxydative et engendrer un stress oxydatif (Costantini 2008). De plus, la sécrétion prolongée de GC peut entraîner des dérégulations physiologiques, notamment en engendrant une diminution de la

sensibilité à l'insuline ou encore en conduisant à des pathologies comme l'hyperphagie (Sapolsky et al. 2000; Karatsoreos et al. 2010). Enfin, au niveau immunitaire, la sécrétion prolongée de GC peut entraîner l'inhibition du système immunitaire (Sapolsky et al. 2000). Par exemple, chez le moineau (*Passer domesticus*), la pose d'implants sous-cutanés durant 3 jours provoque une dépression du système immunitaire cellulaire (Martin et al. 2005).

La physiologie de la conservation : les GC comme indicateur de l'état des populations

Avec l'émergence des changements globaux et la multiplication de leurs conséquences sur les populations naturelles, la capacité à détecter et à prévenir le déclin démographique des espèces est devenue un enjeu majeur de la biologie de la conservation (Wikelski and Cooke 2006). La physiologie de la conservation constitue maintenant une branche de cette discipline qui peut être définie comme « l'application des outils, concepts et approches de la physiologie dans le but de résoudre des problèmes de conservation et d'apporter une compréhension mécanistique de l'impact des perturbations environnementales sur les réponses physiologiques, ainsi que sur les fonctions écologiques, la persistance des populations et la survie des espèces » (Seebacher and Franklin 2012). Une des propositions que fait la physiologie de la conservation est que des variables physiologiques telles que l'immunité, le stress oxydatif ou encore les niveaux hormonaux, notamment de GC, peuvent être utilisés pour évaluer l'état d'un individu ou d'une population dans le cadre de programmes de conservation. De par leur rôle central dans la réponse aux perturbations, les taux circulants de GC et particulièrement le taux basal en GC a rapidement été proposé comme bio-indicateur afin d'évaluer l'état des populations (Wikelski and Cooke 2006; Madliger et al. 2015). De nombreuses études ont pu ainsi mettre en évidence la relation entre une perturbation

anthropique et le taux basal en GC au sein des populations naturelles. Par exemple, chez la chouette effraie (*Tyto alba*), le degré d'anthropisation de l'habitat est positivement lié aux taux basaux de corticostérone chez les jeunes (Almasi et al. 2015). De même, une augmentation du tourisme dans l'habitat s'accompagne d'une augmentation du taux basal de corticostérone chez l'Outarde canepetière (*Tetrax tetrax*) durant les week-ends où l'affluence est la plus forte (Tarjuelo et al. 2015).

Par ailleurs, une relation entre perturbation, GC et valeur adaptative a pu être mise en évidence chez certaines espèces (Romero and Wikelski 2002; Bonier et al. 2009; Jaatinen et al. 2013). Par exemple, l'introduction du crapaud buffle (*Rhinella marina*), une espèce envahissante, a entraîné chez *Platymantis vitiana*, une grenouille endémique des îles Fidji, une diminution du succès reproducteur. Cette diminution du succès reproducteur s'est accompagnée de plusieurs changements physiologiques, notamment la suppression de la sécrétion des hormones reproductives (testostérone, œstradiol et progestérone) et une augmentation du niveau basal de la corticostérone (Narayan et al. 2015). Cependant, il faut remarquer que cette relation entre dégradation de l'environnement, niveaux de corticostérone élevés et diminution de la reproduction ou de la survie n'est pas toujours vérifiée. Par exemple, chez l'hirondelle bicolore (*Tachycineta bicolor*), aucune relation entre le taux basal de GC et la qualité de l'environnement n'est observée (Madliger et al. 2015). Cette variabilité des liens entre environnement, GC et dynamique de populations n'est pas forcément étonnante étant donnée la variabilité des effets de la corticostérone selon sa dose, sa durée et également le moment du cycle de vie. Par exemple, plusieurs études démontrent que la dynamique de sécrétion de GC en réponse à un stress varie en fonction de l'âge, de l'état reproducteur ou encore de la condition corporelle des individus (Crespi et al. 2013). Ainsi, si le taux basal de GC ne semble pas lié aux caractéristiques environnementales chez l'hirondelle bicolore, la

manipulation de la demande énergétique par écrêtage des plumes, entraîne une augmentation du taux basal de corticostérone durant la période de nidification chez cette même espèce (Madliger et al. 2015). De ce fait, il semble essentiel de prendre en compte à la fois l'état et l'histoire de l'individu, mais aussi la nature des perturbations de l'environnement afin de mieux comprendre la relation entre environnement, GC et valeur adaptative (Bonier et al. 2009). C'est ce que propose de faire le modèle allostatique (McEwen and Wingfield 2003) en se focalisant sur les variations des besoins énergétiques d'un individu au cours du temps et des demandes énergétiques causées par des perturbations.

Le modèle allostatique

Description générale

Le terme d'allostasie a été initialement décrit en 1988 par Peter Sterling et Joseph Eyer afin de mettre en relation les réponses physiologiques et la perception par l'organisme d'un stimulus. Les auteurs partent du constat que lorsque « les mesures du milieu interne sont faites sur des organismes intacts, non euthanasiés, les résultats convergent très peu vers le modèle homéostatique » mais au contraire les mesures se maintiennent à des niveaux élevés ou inférieurs par rapport aux niveaux basaux attendus dans le cas de l'homéostasie. En 2003, McEwen et Wingfield reprennent le concept d'allostasie, et proposent le modèle allostatique, qui est un modèle énergétique de la réponse physiologique à une perturbation. Le concept d'allostasie est alors défini comme « l'instauration de la stabilité au travers du changement » et permet de supporter l'homéostasie, c'est-à-dire l'équilibre interne de l'individu (McEwen and Wingfield 2003). De ce fait, l'allostasie est définie par des variations de la demande énergétique dues à l'ensemble des mécanismes physiologiques et/ou comportementaux, qui vont varier au cours du temps et de la vie de l'individu afin de maintenir les fonctions vitales

de l'individu dans un état fonctionnel, c'est-à-dire de maintenir l'homéostasie. Afin de prendre en compte les variations saisonnières et journalières des demandes énergétiques d'un organisme et de définir des états délétères, ce modèle définit trois concepts que sont l'état allostatique, la charge allostatique et la surcharge allostatique.

Au cours de sa vie, un individu traverse différents états allostatiques (définis dans le modèle par des niveaux de dépenses énergétiques), c'est-à-dire des états « altérés » dus à des changements prévisibles ou non du milieu interne ou externe. La somme des augmentations de dépense énergétique causées par ces changements est appelée la charge allostatique, définie comme le coût énergétique des perturbations. Chaque individu est capable de supporter une certaine charge allostatique en fonction de son statut (i.e. réserve énergétique, condition corporelle ou âge) et des conditions externes (disponibilités énergétiques de l'environnement). Le modèle fait donc l'hypothèse que les variations de la charge allostatique vont s'accompagner de modulation de la demande énergétique de l'individu (encadré 1). De plus, les GC sont proposés par McEwen et Wingfield comme les principaux médiateurs de la charge allostatique pour les raisons évoquées plus tôt dans ce mémoire. Dans le cadre des changements globaux, notamment de la dégradation des habitats, on s'attend à ce que les organismes mettent en place des réponses physiologiques afin de s'adapter à ces changements. Ces réponses peuvent alors conduire à un changement de la charge allostatique (McEwen and Wingfield 2003; Angelier and Wingfield 2013). Il peut alors arriver que l'énergie disponible pour l'individu ne soit pas suffisante pour supporter la charge allostatique. Dans ce cas, la charge allostatique va engendrer un état délétère pour l'individu pouvant aller jusqu'à la mort, une situation que le modèle décrit par la notion de surcharge allostatique.

Plus spécifiquement, McEwen et Wingfield proposent deux cas de figure. Dans le premier, l'énergie disponible ne permet pas de subvenir aux besoins de la charge

allostatique, on parlera de surcharge allostatique de type 1 (Encadré 1). Les auteurs proposent que cette situation favorise la mise en place d'une stratégie d'histoire de vie individuelle alternative, ou *emergence life history stage* (ELHS), c'est-à-dire un changement dans les tactiques de reproduction, de croissance et de survie afin de faire redescendre la charge allostatique dans une gamme supportable pour l'individu. Dans le second cas, la charge allostatique augmente chroniquement sans excéder l'énergie disponible pour l'individu, mais l'aspect chronique de la charge allostatique est susceptible d'engendrer des effets délétères. On parlera alors de surcharge allostatique de type 2 (Encadré 1).

Encadré 1 : Le modèle allostatique utilise les différents niveaux d'énergie et leur modulation (la charge allostatique) afin de définir des états allostatiques (McEwen and Wingfield 2003; Landys et al. 2006). EA est l'énergie nécessaire aux activités de l'individu et au maintien de l'homéostasie, EE est l'énergie disponible dans l'environnement. EA varie au cours du temps (i) et lors d'une perturbation EA augmente (ii), si $EA < EE$ alors l'individu peut supporter la charge allostatique, si $EA > EE$ alors la charge est trop forte, c'est une surcharge de type I et l'individu doit changer de stratégie afin de faire redescendre EA (iii). Enfin, si la perturbation est chronique ou permanente, EA se maintient au cours du temps, c'est le cas d'une surcharge de type II (iv). On peut alors définir différents états allostatique (Landys et al. 2006).



Schéma adapté de l'article de McEwen et Wingfield (2003)

Le "reactive scope model"

Le modèle « reactive scope » (Romero et al. 2009) a été proposé afin de pallier à des lacunes du modèle allostatique. Tout d'abord, comme le souligne Romero *et al.* (2009), le modèle allostatique propose d'utiliser l'énergie comme un proxy de la charge allostatique subie par les individus. Cependant, les dépenses énergétiques peuvent être extrêmement variables entre les espèces (par exemple entre ectothermes vs endothermes) et une

balance positive entre énergies entrante et dépensé ne reflète pas nécessairement une condition non-stressante (i.e. hyperphagie). A l'inverse, une balance énergétique négative ne constitue pas nécessairement un "stress" et peut faire partie intégrante d'une étape du cycle de vie (voir Walsberg 2003). De plus, le modèle allostatique repose presque intégralement sur l'utilisation des GC comme médiateurs de la charge allostatique de par leur action notamment au niveau de la gluconéogenèse. Cependant, Romero *et. al.* (2009) indiquent que la plupart des études sur ce sujet sont effectuées sur des animaux affamés et que les liens entre GC et gluconéogenèse peuvent varier en fonction de l'état de satiété de l'individu. Nos études vont d'ailleurs dans ce sens avec des modulations des niveaux de triglycérides circulants non liés aux modulations du taux basal de corticostérone (article 1 & 2). De plus, nous mettons en évidence qu'une augmentation des dépenses énergétiques basales en réponse à un stress chronique n'est pas forcément observable (article 2 & 3).

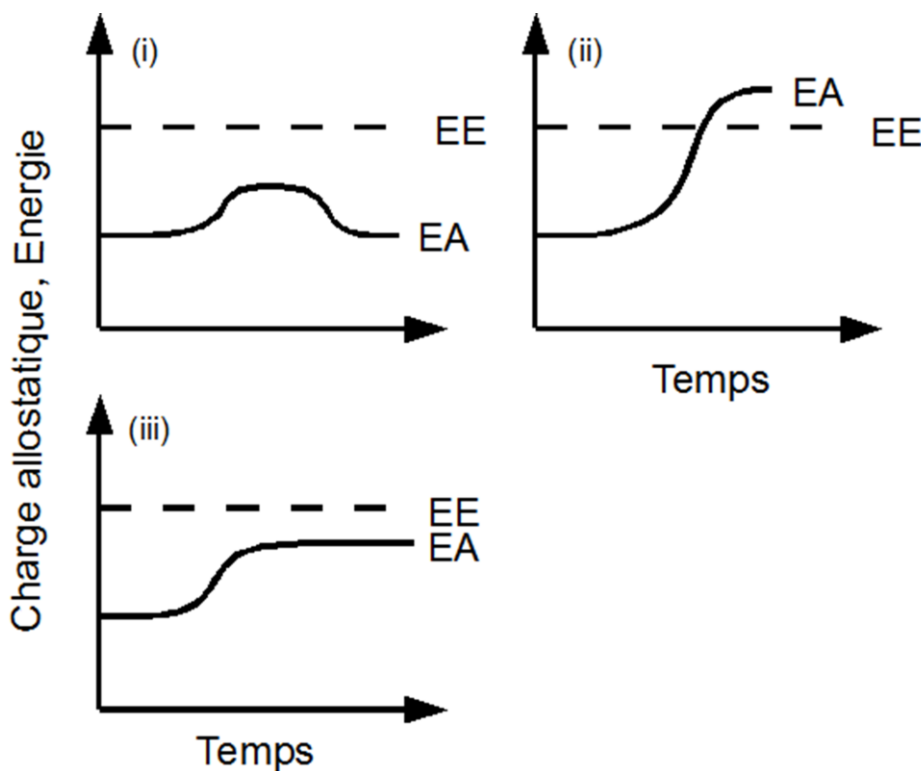
Le « *reactive scope model* » propose donc de reprendre le modèle allostatique en le précisant tout en remplaçant le concept d'homéostasie au centre de la réponse à une perturbation et en prenant en compte les variations saisonnières et journalières des traits physiologiques comme dans le cas du modèle allostatique. L'un des points essentiels du *reactive scope model* est la notion de coût associé à la perturbation qui diffère de celle du modèle allostatique. En effet, le coût du modèle allostatique était considéré comme un coût énergétique ayant pour médiateur la concentration en GC, là où le « *reactive scope model* » propose d'utiliser plusieurs réponses physiologiques et/ou comportementales, telles que l'immuno-dépression ou l'abandon d'une occasion de reproduction comme mesure des coûts. Le « *reactive scope model* » utilise les modulations des médiateurs physiologiques (GC mais aussi immunité, catécholamine, etc...) afin de déterminer l'état allostatique que les auteurs appellent dans ce cas le « reactive homeostasis » (Encadré 2). La sécrétion de ces médiateurs en réponse à une perturbation va engendrer une « usure »

conceptualisée par la notion de « wear and tear » rejoignant le principe de la charge allostatique du modèle McEwen et Wingfield (2003), c'est le coût de la réponse à la perturbation. Cet aspect du modèle est particulièrement intéressant car là où le modèle allostatique et les études associées se focalisent sur le taux basal de corticostérone, le « *reactive scope model* » prédit l'implication de plusieurs médiateurs physiologiques dans le phénomène « d'usure ». Par exemple, chez l'iguane des Galapagos, il a été mis en évidence que la survie des animaux suite à une diminution des ressources en nourriture induite par un effet El Niño était liée à l'efficacité de la boucle de rétroaction de la sécrétion de la corticostérone (le retour au taux basal après un stress ponctuel) et non au taux basal avant la perturbation, mettant en évidence le concept de « *wear and tear* » (voir encadré 2, figure B, Romero 2011). Cela met en relief la nécessité d'élargir la gamme des paramètres physiologiques si l'on souhaite pouvoir utiliser les données de la physiologie dans le cadre de la conservation car la restriction à un ou deux paramètres ne serait pas assez informatif étant donnée la complexité des processus impliqués. Cette précaution est déjà pratiquée en médecine avec l'utilisation de plusieurs bio-marqueurs de la charge allostatique (Crews 2007; Morrison et al. 2013).

Encadré 2 : Le « *reactive scope model* » utilise les changements dans l'expression des médiateurs physiologiques afin de caractériser la charge allostatique ici définie comme « l'usure ». Pour cela, les auteurs définissent 4 zones de réponses des médiateurs. (1) l'expression des médiateurs entraîne la rupture de l'homéostasie (HF, "*homeostatic failure*"), (2) expression attendue des médiateurs au cours du cycle de vie, comprenant les variations saisonnières et journalières (PH, « *predictive homeostasis* ») (3) les organismes sont capables de répondre (RH, "*reactive homeostasis*") mais cette réponse entraîne le phénomène « d'usure » et (4) l'expression des médiateurs physiologiques entraîne des effets délétères (HO, "*homeostatic overload*"). Lors d'une perturbation les médiateurs physiologiques augmentent et entraînent « l'usure », ce qui va diminuer la capacité des individus à faire face à de nouvelles perturbations (diminution de RH, voir graphique B). Il y a alors deux façons d'entrer dans la zone de surcharge homéostatique (HO) soit par une augmentation forte des médiateurs (graphique A), soit par leur sécrétion prolongée.



Schéma du « *reactive scope model* » adapté de Romero et al (2009). La flèche rouge représente l'apparition d'une perturbation et les flèches grises la réponse physiologique. (A) Perturbation sévère mais courte entraînant l'augmentation drastique des médiateurs physiologiques, (B) perturbation chronique initiant « l'usure ».

Dégradation de l'habitat et allostase

Lors d'une dégradation substantielle d'un habitat, on s'attend à ce que la charge allostatique, et donc les niveaux de GC des animaux, augmente en réponse à la perturbation (McEwen and Wingfield 2003; Wingfield 2013a). Cependant, plusieurs études vont à l'encontre de cette hypothèse, par exemple chez les iguanes des Galápagos, le taux basal de corticostérone avant et après un événement de jeûne ne change pas

(McEwen and Wingfield 2010). De même chez le lézard *Uta stansburiana*, les animaux issus de milieux urbain et rural ne présentent pas de différence dans leur taux basal de corticostérone (Lucas and French 2012). Ces résultats ne sont pas nécessairement étonnants si on considère le fait que la prolongation d'un état de surcharge de type I, qui devrait être caractérisé par une forte élévation des GC, devrait conduire à une mort rapide des individus ou à l'apparition d'un changement de stratégie de vie ou *emergency life stage* (ELHS) qui devrait induire une baisse de la charge allostatique (McEwen and Wingfield 2003). Ainsi, bien que Lucas *et al* (2012) ne mettent pas évidence de changement dans les taux de corticostérone basaux entre les populations rurales et urbaines de lézards, ils observent un changement dans les traits d'histoire de vie de l'animal avec une augmentation du nombre de jeunes produits dans les populations urbaines. Ils observent aussi que les animaux de populations urbaines sont moins aptes à soigner leurs blessures. Pris ensemble, ces résultats indiquent que les populations urbaines de lézards ont ajusté à la fois leurs traits physiologiques et démographiques.

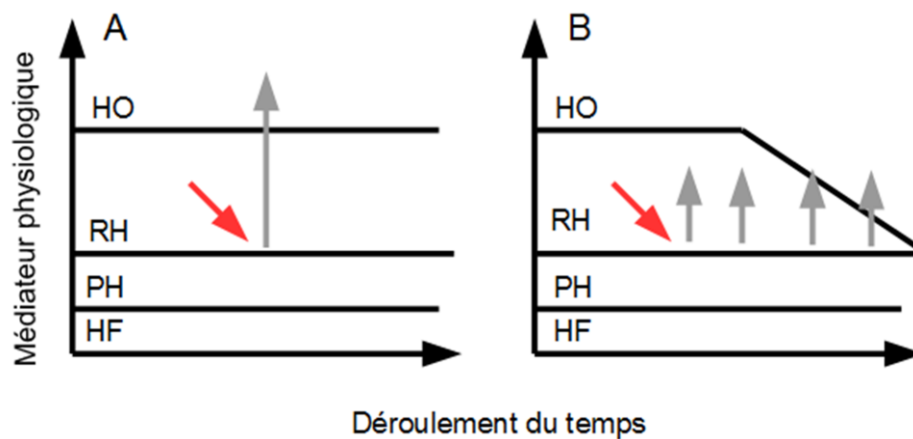
Objectifs de la thèse

Objectif général

L'objectif de cette thèse est de mettre en lien la dégradation de l'habitat avec des indicateurs physiologiques, dont les niveaux circulants de glucocorticoïdes (article 1), et de mieux comprendre comment un stress chronique, caractérisé par une augmentation des taux circulants de glucocorticoïdes, peut impacter la valeur adaptative d'un individu au cours de sa vie à travers la caractérisation de la charge allostatique et du comportement (article 1, 2, 3 et 4, voir figure 2). Ces deux objectifs complémentaires sont particulièrement d'actualité car les relations entre dégradation de l'habitat et charge

allostatique restent encore floues (voir ci-dessus). De même, l'histoire des animaux, comprenant les perturbations expérimentées passées, est rarement prise en compte.

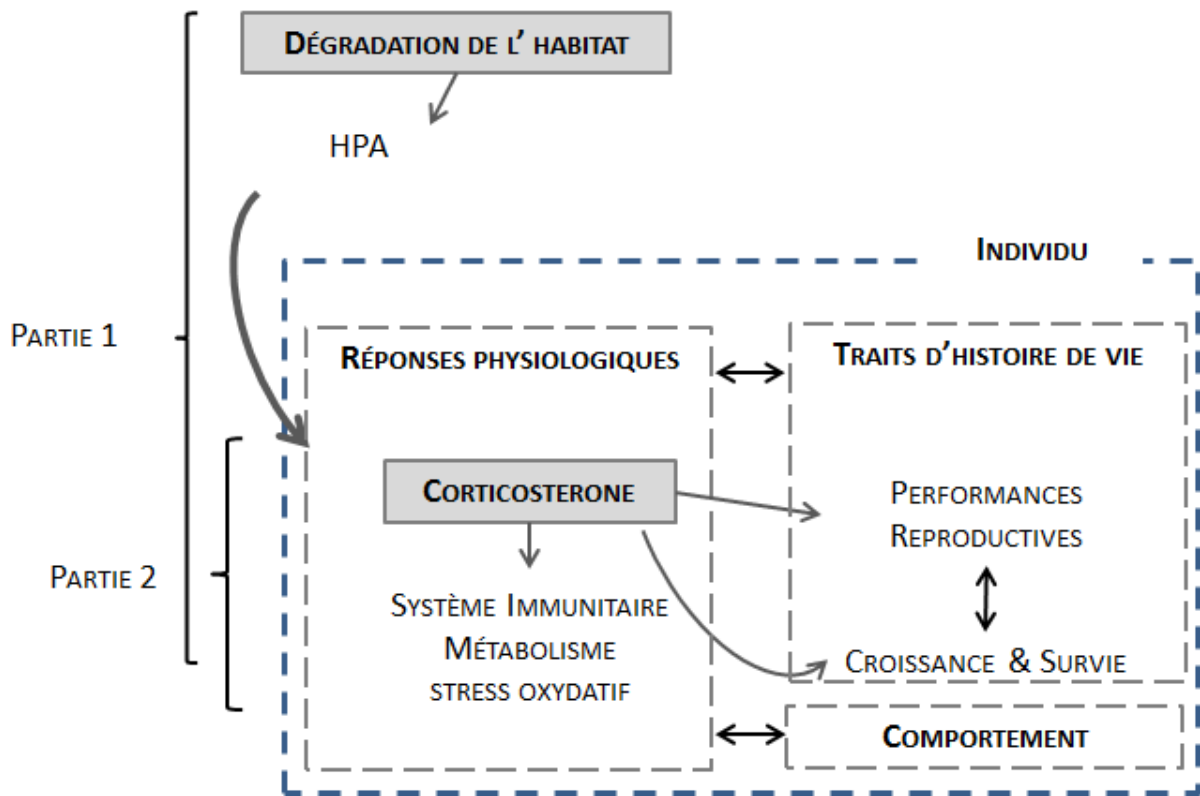

Figure 2 : Schéma récapitulatif des deux grandes thématiques abordées lors de cette thèse.

Le modèle biologique

Durant cette thèse, nous avons utilisé comme modèle biologique le lézard vivipare, *Zootoca vivipara*. Cette espèce est répandue en Eurasie et dispose d'une très large aire de distribution mais ses populations sont très fragmentées car l'espèce vit préférentiellement dans les prairies humides et les tourbières qui sont menacées par les activités humaines et les changements climatiques (Ma et al. 2010). Par exemple, on estime à environ 67% les zones humides qui ont disparues depuis le début du 20e siècle en France continentale, cette perte se retrouvant également au niveau mondial. Dans cette étude, nous avons travaillé sur des populations semi-naturelles maintenues au Centre de Recherche en Ecologie Expérimentale et Prédictive (CEREEP) en Ile-de-France. Les populations sont

maintenues dans des enclos d'environ 100m² délimités par des plaques PVC. La végétation est variée et ne dépasse pas 40 cm afin d'éviter toute évasion. La végétation est entretenue par des coupes (à 20 cm du sol environ) quand nécessaire (environ 1 fois par mois) durant les périodes d'inactivité des animaux (avant 8h30 le matin ou après 20h le soir). Les enclos sont munis de 2 bacs d'eau de 40 litres pour favoriser l'accès à l'eau et de 4 pierriers pour la thermorégulation et les cachettes. Plusieurs pièges à rongeurs sont distribués dans les enclos (4 à 6) afin d'éviter toute invasion. Les enclos sont protégés par des filets empêchant la prédation par les oiseaux.

Le lézard vivipare est un petit Lacertidae et est caractérisé par une durée de vie moyenne pouvant aller de 3 à 4 ans. Les populations sont structurées en 3 classes d'âges : les jeunes de l'année qui sont donc âgés de moins d'un an (juvéniles), les individus âgés de 1 an (sub-adultes) et les animaux âgés de deux ans et plus (adultes). Dans nos populations, une partie des animaux de 1 an sont capables de se reproduire quand les conditions sont favorables pour la croissance juvénile, et généralement l'intégralité des animaux de deux ans se reproduit. La période d'accouplement commence à l'émergence des femelles fin mars et se prolonge jusqu'à mi-mai (Bauwens and Verheyen 1985). L'ovulation suit les accouplements. Au cours du passage de l'œuf depuis l'ovaire jusqu'à l'utérus, celui-ci s'entoure d'une fine couche d'albumen et d'une membrane coquillière fine et extensive (Heulin et al. 2002). La durée de la gestation dépend beaucoup des conditions climatiques mais se situe en moyenne autour de 2 mois. Les femelles mettent bas de 1 à 13 jeunes lorsque le développement de ceux-ci est achevé.

Il a été montré que des paramètres environnementaux, telles que les conditions climatiques ou la disponibilité des ressources, pouvaient impacter les traits d'histoire de vie du lézard vivipare (Sorci et al. 1996; Le Galliard et al. 2005; Mugabo et al. 2010; Mugabo et al. 2011). Par exemple, l'augmentation des précipitations et la diminution des

températures durant la gestation ont été associées à une augmentation du nombre d'œufs non viables produits (Le Galliard et al. 2010), au contraire les précipitations durant la vitellogénèse sont associées positivement à la taille de ponte (Bleu et al. 2013). De même, il a été montré que les températures durant la vie précoce des individus (août de l'année précédente) affectent positivement la croissance et le nombre de jeunes produit par les femelles (Chamaille-Jammes et al. 2006). Chez le lézard vivipare, la corticostérone est le principal GC sécrété lors d'un événement stressant. Le taux basal de corticostérone varie en fonction du moment de la journée (Dauphin-Villemant and Xavier 1987) mais aussi au cours du cycle de vie des animaux, en particulier lors de la reproduction chez les femelles (Dauphin-Villemant et al. 1990).

Chez notre espèce, la sécrétion de corticostérone et ses effets aux niveaux comportemental ou physiologique peuvent être modulés par des facteurs environnementaux spécifiques, comme la disponibilité des ressources nutritives ou la présence de parasites (Oppliger et al. 1998; Cote et al. 2010a). Cependant, nous ne disposons pas chez cette espèce de données permettant de relier la qualité de l'habitat aux niveaux de corticostérone des individus et aux conséquences en termes de valeur adaptative. La manipulation en laboratoire du taux basal de corticostérone a permis de montrer que la sécrétion chronique de corticostérone avait des effets comportementaux, physiologiques et démographiques. Au niveau comportemental, il a été montré que les mâles traités avec de la corticostérone augmentent le nombre d'approches en vue de s'accoupler avec une femelle (Gonzalez-Jimena and Fitze 2012) ou encore augmentent leur activité journalière (Cote et al. 2006; Cote et al. 2010a). Au niveau physiologique, la manipulation des taux basaux de corticostérone a permis de montrer une augmentation du métabolisme basal chez les femelles et une augmentation de l'activité de la catalase, une enzyme anti-oxydante (Meylan et al. 2010). Certains effets physiologiques sont sexe-

dépendants. En effet, chez les mâles, on observe une diminution du métabolisme et une augmentation des dégâts oxydatifs (Cote et al. 2010a; Cote et al. 2010b). Au niveau démographique, l'augmentation du taux de corticostérone affecte positivement le taux de survie chez les mâles adultes (Cote et al. 2006) mais aussi la survie des jeunes mâles dont la mère a reçu de la corticostérone durant la gestation (Meylan and Clobert 2005). De la même façon, l'augmentation du taux basal de corticostérone au cours de la gestation entraîne une diminution du succès reproducteur, avec un taux de mortalité plus fort par ponte, des jeunes en moins bonne condition et une date de mise bas retardée (Meylan et al. 2010).

Choix des indicateurs de la charge allostatique

La charge allostatique est définie comme une quantité d'énergie nécessaire aux activités prévisibles ou imprévisibles des individus et les GC ont été proposés comme indicateur associé, notamment le taux basal (McEwen and Wingfield 2003). Dans nos études, nous avons donc utilisé comme proxy de la charge allostatique le taux basal de corticostérone, principal GC chez notre espèce modèle. De plus, il s'agit de l'indicateur historique proposé par le modèle allostatique et la physiologie de la conservation (McEwen and Wingfield 2003; Wikelski and Cooke 2006) et des méthodes non-invasives via la salive ou les fèces existent pour mesurer ce taux chez les espèces animales (Strazdins et al. 2005; Palme 2012). Plus précisément, nous avons quantifié le taux basal circulant de corticostérone dans le plasma, comprenant la corticostérone libre et la corticostérone liée à des globulines.

Cependant, pour les raisons évoquées précédemment à travers le « *reactive scope model* », l'utilisation de plusieurs indicateurs de la charge allostatique nous a paru pertinente. Nous avons donc aussi choisi de mesurer la réponse immunitaire (via la phytohaemagglutinine, PHA), car elle peut contribuer, à travers les coûts associés à

l'activation et au maintien du système immunitaire, à la charge allostatique (Lochmiller and Deerenberg 2000). La réponse immunitaire à la PHA est classiquement utilisée pour déterminer la réponse cellulaire des organismes via des mécanismes adaptatifs à travers la prolifération des cellules T (ici du thymus) et des mécanismes innés impliquant d'autres leucocytes comme les granulocytes et les macrophages (Vinkler et al. 2010). Nous avons utilisé cette propriété en exposant une première fois les animaux à une injection (nous permettant aussi de standardiser les individus ayant des histoires d'exposition à la PHA différentes), puis en mesurant les réponses successives mises en place par les individus lors d'une deuxième exposition à la PHA. Nous avons aussi mesuré le stress oxydatif, c'est-à-dire le déséquilibre dans la balance oxydative en faveur d'éléments pro-oxydants tels que les ROS (Dowling and Simmons 2009). La production de ROS peut contribuer à la charge allostatique de plusieurs manières, soit en induisant un coût pour l'organisme via l'allocation de ressources telles que les caroténoïdes ou les vitamines vers les défenses anti-oxydantes ou par la production de défenses anti-oxydantes enzymatiques, mais aussi en dégradant par exemple l'ADN ou des protéines (Dowling and Simmons 2009).

Le modèle allostatique repose sur la capacité des animaux à faire face au coût énergétique des changements imprévisibles et prévisibles au cours de la vie de l'animal. Pour cette raison, nous avons mesuré différents paramètres régissant la balance énergétique des animaux. Tout d'abord, nous avons mesuré le métabolisme standard (SMR), c'est-à-dire le métabolisme des individus au repos. Comme dit précédemment, la corticostérone est intimement liée à la balance énergétique (Sapolsky et al. 2000), qui va à son tour contrôler les traits d'histoire de vie des animaux (croissance, reproduction, survie) (Steyermark 2002; Artacho and Nespolo 2009). Nous nous sommes aussi intéressés aux dépenses énergétiques au niveau cellulaire dans les organelles responsables

de la production de la plus grande partie de l'énergie, les mitochondries. Le métabolisme mitochondrial au travers de la respiration et de la production d'ATP (adénosine triphosphate) se situe au croisement entre l'énergie disponible (endogène ou exogène) et son allocation vers les différentes fonctions métaboliques. Il peut être caractérisé par des niveaux de consommation d'oxygène, production d'ATP et production de ROS sur des mitochondries dans différents états *in vitro*. Le ratio de production d'ATP sur consommation d'oxygène (ATP/O) mesure l'efficacité mitochondrial, c'est-à-dire la quantité d'ATP produite à partir d'une molécule d'oxygène. Ce ratio est particulièrement intéressant car l'utilisation d'oxygène durant les processus d'oxydation et de réduction dans la chaîne respiratoire entraîne la production de radicaux libres (ROS) (Brand 2005). La consommation d'oxygène, la production d'ATP et celle de ROS sont connues pour être plastiques et influencées différents paramètres tels que la reproduction (Metcalf and Alonso-Alvarez 2010) ou la survie (Robert and Bronikowski 2010). Enfin, nous nous sommes intéressés au métabolisme lipidique à travers la concentration des lipides circulants chez les individus. Les GC stimulent la lipolyse mettant en circulation les acides gras stockés sous forme de tri-acide-glycérol ou au contraire vont stimuler le stockage des lipides. La mise à disposition des lipides ou leur stockage peuvent dépendre du niveau de satiété des individus et donc du statut énergétique de l'animal (Peckett et al. 2011). Les acides gras, une fois libres dans le plasma, peuvent être utilisés par les différents tissus comme substrats pour les processus d'oxydation/ réduction de la respiration.

Synthèse des résultats

Partie I : Dégradation de l'habitat, corticostérone et traits démographiques

La physiologie de la conservation propose les GC pour évaluer l'impact d'une perturbation sur les populations animales. La théorie prédit que la dégradation d'un habitat va augmenter la charge allostatique à travers la sécrétion de GC qui va lors d'une sécrétion prolongée entraîner des effets délétères notamment au niveau démographique (Wikelski and Cooke 2006) Dans cette partie, nous avons cherché à mieux comprendre la relation entre dégradation de l'habitat, corticostérone (ou GC en général) et réponse démographique.

Nous avons utilisé pour cela 24 populations semi-naturelles de lézard vivipare (*Zootoca vivipara*), chacune composée de 3 classes d'âges (juvéniles, sub-adultes et adultes), que nous avons suivies durant 1 an. Les enclos ont été répartis en trois groupes de traitement qui diffèrent par l'accès à l'eau, la disponibilité des places de thermorégulation et des refuges ainsi que par le couvert végétal : (i) des enclos de bonne qualité correspondant à des conditions optimales pour le lézard vivipare, (ii) des enclos de qualité intermédiaire avec une dégradation légère et (iii) des habitats de mauvaise qualité avec une dégradation forte de l'habitat (voir article 1 pour plus de détails méthodologiques). Les différents traitements ont été mis en place au milieu du mois de juin et les lézards ont été aléatoirement répartis dans les 24 enclos. Nous avons alors suivi les individus sur une année grâce à deux sessions de capture : l'une avant l'hiver et l'autre au printemps après la fin des accouplements. Lors de la première session, les animaux sont capturés et mesurés dans la journée. Lors de la seconde session de capture, les animaux sont mis en élevage au laboratoire et, afin de poursuivre la manipulation des conditions environnementales, un traitement se focalisant sur la disponibilité en eau a été mis en place au laboratoire. Ainsi, la moitié des animaux de chaque type d'habitat a été

assignée à l'un de deux régimes hydriques possibles (control ou restreint). Nous avons mesuré avant le stress hydrique trois traits physiologiques: le taux basal de corticostérone, la concentration en lipides circulants des individus et la réponse immunitaire via la PHA. Sur l'année de l'expérimentation, la survie, la croissance et différents paramètres de reproduction ont été mesurés afin de déterminer l'impact de la dégradation sur la valeur adaptative des individus et la possible relation avec les différents indicateurs physiologiques, soit la charge allostatique.

Nous avons fait les hypothèses que (i) la dégradation de l'habitat entraînerait une augmentation de la charge allostatique se traduisant par une augmentation du taux de corticostérone et une modulation de l'immunité et des lipides circulants, (ii) que les changements dans les traits physiologiques augmenteraient linéairement avec le degré de dégradation de l'habitat, (iii) mais aussi que la dégradation de l'habitat interagirait avec les demandes prévisibles de l'organisme (i.e. la reproduction) créant des charges allostatiques différentes en fonction du cycle de vie des animaux et de leur sexe. (iv) Nous nous attendions en parallèle des changements physiologiques à des changements dans les traits d'histoire de vie traduisant une surcharge allostatique. (v) De plus, nous avons fait l'hypothèse que la restriction en eau pourrait avoir un effet cumulatif, accentuant la charge allostatique, se traduisant par des effets au niveau de la reproduction plus marqués chez les femelles d'habitat dégradé ou à l'inverse des effets plus marqués chez les animaux d'habitat de bonne qualité, traduisant une possible adaptation au « stress » par la suppression de la réponse.

Nos résultats indiquent que la dégradation de l'habitat a eu des effets différents en fonction des classes d'âges et de la saison (article 1). Lors de la période pré-hivernale, nous n'avons pas détecté d'effets de la manipulation de l'habitat sur les traits physiologiques et démographiques. Au contraire, après l'hiver, les traits physiologiques

ont été affectés par la manipulation environnementale, mais de manière variable en fonction du sexe et de l'âge des individus. En accord avec nos prédictions, les effets sur la charge allostatique ont été les plus marqués durant la reproduction chez les classes d'âges matures sexuellement (individus âgés de deux ans et plus à la fin de l'expérience). En particulier, la dégradation de l'habitat a induit une augmentation des taux basaux de corticostérone chez les animaux les plus âgés. Chez les juvéniles, ce sont les niveaux de triglycérides qui ont été affectés par la dégradation de l'habitat. Finalement, la réponse immunitaire chez les animaux de deux ans tend à décroître avec la dégradation de l'habitat tandis que l'inverse est observé chez les animaux de plus de deux ans. La perturbation environnementale a également affecté les traits d'histoire de vie des adultes : nous avons ainsi observé (i) une baisse de la survie chez les mâles adultes et sub-adultes, (ii) un retard dans la date de mise-bas chez l'ensemble des femelles, et (iii) un nombre de jeunes vivants produits plus faible en moyenne. L'exposition au stress hydrique n'a en revanche pas eu d'effets additifs comme nous l'avions prédit. Ce traitement étant appliqué sur la dernière phase de gestation pendant une année particulièrement favorable à la reproduction (taille de ponte et proportion de femelles plus élevée que la normale, pers. obs.), cette absence d'effets peut simplement indiquer que les traits reproducteurs étaient déjà déterminés lors du traitement hydrique.

Si cette étude indique que les niveaux basaux de corticostérone peuvent en effet être de bons bio-indicateurs de la qualité de l'habitat, en revanche elle souligne l'importance de prendre en compte les différentes contraintes énergétiques auxquelles doivent faire face les individus. La partie II de cette thèse a justement l'objectif d'étudier plus en profondeur les mécanismes physiologiques de la réponse au stress des organismes en essayant d'intégrer les fonctions physiologiques principales (système immunitaire, stress oxydatif et métabolisme).

Partie II : Effets directs, indirects et à long terme d'un stress chronique

Le modèle allostatique propose d'utiliser le taux basal de GC comme indicateur de la charge allostatique, c'est-à-dire de l'énergie dépensée par un individu pour maintenir son homéostasie. Nous avons donc choisi de manipuler la charge allostatique via un apport exogène de corticostérone (article 2 & 3). Pour cela, nous avons utilisé une méthode non-invasive par application topique développée dans notre équipe par Sandrine Meylan sur le lézard vivipare (Meylan et al. 2003). Les animaux ont été traités durant 21 jours avec une « pommade » contenant de la corticostérone puis la charge allostatique des individus a été mesurée en intégrant plusieurs traits physiologiques et démographiques décrits plus haut. Nous avons alors pu mettre en évidence des effets à court terme du traitement hormonal mais également à long terme. Une période de 21 jours correspond approximativement à 15-20% de la période d'activité annuelle d'un lézard vivipare, et donc couvre l'étendue probable d'un stress chronique lié à une dégradation sévère de l'habitat par un stress climatique saisonnier par exemple.

A court terme, l'augmentation chronique du taux basal de corticostérone entraîne une immunodépression (article 2), paradoxalement à un stress oxydatif plus faible dû à une baisse du taux de radicaux libres (article 2 & 3), ainsi qu'une augmentation du stockage des lipides dans le foie (article 3) qui se traduit également par une prise de masse plus importante chez les animaux traités avec de la corticostérone (article 2). En revanche, toutes ces modifications ne s'accompagnent pas de changements dans le niveau de dépenses énergétiques (mesuré par la production de CO₂) au niveau de l'organisme entier (via la mesure de SMR), ni au niveau intracellulaire (via la consommation d'oxygène des mitochondries *in vitro*, voir l'article 3). En revanche, le traitement hormonal a induit une augmentation du nombre de mitochondries et la diminution de la fuite d'électrons durant le processus de respiration de la mitochondrie (article 3).

Grâce au suivi dans des enclos en conditions semi-naturelles sur une année des différents paramètres physiologiques et démographiques dans le cadre de l'une de ces expériences, nous avons aussi pu montrer que l'augmentation chronique de la corticostérone impactait à long terme les traits physiologiques des individus. Contrairement à notre première étude sur la dégradation de la qualité de l'habitat qui démontrait un effet âge-dépendant de la réponse à la perturbation de l'environnement, l'élévation expérimentale des taux de corticostérone a affecté de la même manière les différentes classes d'âges mais a eu certains effets sensiblement différents sur les sexes (article 2). L'élévation expérimentale des niveaux de corticostérone a réduit de manière durable le stress oxydatif (i.e. un mois après l'arrêt du traitement). Par ailleurs, si l'élévation des niveaux de corticostérone n'a pas affecté à court et moyen termes les niveaux de triglycérides circulants, sur le long terme, nous avons pu observer que les femelles traitées l'année précédente par la corticostérone présentaient des concentrations plus élevées de triglycérides dans le plasma que les individus placebo alors qu'aucune différence n'a été observée chez les mâles. De même, les mâles traités à la corticostérone avaient une réponse immunitaire plus importante un an après l'arrêt du traitement au moment de la période de reproduction. En revanche, le suivi des paramètres démographiques à court et à long termes n'a pas mis en évidence d'effet de l'élévation des niveaux de corticostérone sur les paramètres de reproduction ou de survie, bien que nos données par classe d'âge et de sexe semblent indiquer que la survie des mâles adultes pourrait être favorisée comme dans une étude précédente (voir l'article 2 pour une discussion plus approfondie à ce sujet).

Ces travaux indiquent donc clairement que les mesures physiologiques doivent être interprétées avec précaution :

(i) Une seule mesure ne semble pas à elle seule pouvoir refléter l'état général de l'individu et dans notre cas, sa charge allostatique. Nous avons par exemple pu démontrer que les mesures de taux métaboliques standards au niveau de l'organisme (production de CO₂ dans un état de repos) ne reflètent pas toujours les modifications observées à une échelle plus petite (au niveau mitochondrial) ou sur d'autres paramètres comme la production de ROS par exemple (article 3). Cependant, nos travaux suggèrent que l'utilisation d'indicateurs complémentaires comme l'immunité ou la circulation des lipides plasmatiques permet de mieux caractériser les demandes individuelles et de mieux estimer la charge allostatique des animaux (article 2).

(ii) Un suivi sur plusieurs mois est nécessaire pour mieux appréhender l'effet d'un stress chronique sur les différents paramètres physiologiques et les traits d'histoire de vie des individus. De plus, selon la période du cycle de vie étudiée, les réponses mises en place suite à une perturbation seront ou non détectables. Nos résultats indiquent clairement que l'exposition à un stress chronique va, en plus des effets à court terme attendus (article 2 & 3), engendrer des effets à long terme qui se manifestent durant les périodes de contraintes énergétiques (ici la reproduction). Ce point était déjà suggéré lors de notre étude menée sur l'effet de la dégradation de l'habitat (article 1).

(iii) Il semble exister un réel découplage entre les modifications physiologiques et démographiques. Nous avons par exemple observé différents effets physiologiques de la corticostérone avec peu de conséquences sur les traits d'histoire de vie.

Discussion

Durant cette thèse, nous avons essayé de mieux comprendre au travers du modèle allostatique les réponses physiologiques et démographiques mises en place lors d'un stress chronique. Nous aboutissons à plusieurs conclusions majeures. Tout d'abord, le modèle allostatique prédit une forte relation entre GC et dépenses énergétiques que nous

n'avons pas observées directement dans nos études aux niveaux de l'organisme et cellulaire avec la quantification du métabolisme respiratoire (figure 3). Cependant, cette augmentation est indirectement suggérée par l'augmentation du nombre de mitochondries dans un tissu cible de notre étude (le foie, voir article 3). En revanche, nous avons pu clairement mettre en évidence des changements physiologiques et démographiques tels que l'inhibition du système immunitaire, une diminution de la production de radicaux libres, une baisse de la survie chez les mâles et une baisse du nombre de jeunes vivants produits par les femelles (figure 3). Ces résultats corroborent pour une partie les arguments avancés par Romero et al (2009), mais aussi par Walsberg (2003), suggérant que l'utilisation des niveaux basaux de GC comme proxy entre perturbation et énergie n'est pas toujours vérifiée, et que l'utilisation des médiateurs physiologiques serait plus appropriée afin de déterminer la charge allostatique. Cependant, nos résultats semblent indiquer que le taux basal de corticostérone peut être utilisé comme indicateur des paramètres démographiques suite à une dégradation d'un habitat et par extension être utilisé dans le cadre de la physiologie de la conservation avec une certaine limite. En effet, lors de notre première étude (article 1), nous avons mis en évidence que la dégradation de l'habitat entraînait, chez les adultes, une augmentation du taux de corticostérone basal qui était associée à des changements démographiques (survie et reproduction). Mais nous avons aussi observé chez les animaux plus jeunes (sub-adultes), des effets de la dégradation de l'habitat sur ces mêmes paramètres sans augmentation significative du taux de corticostérone. De la même façon, une année après l'application chronique de corticostérone, nous avons observé chez les femelles traitées à la corticostérone un taux de lipides circulants plus important, sans différence significative du taux de corticostérone (article 2)

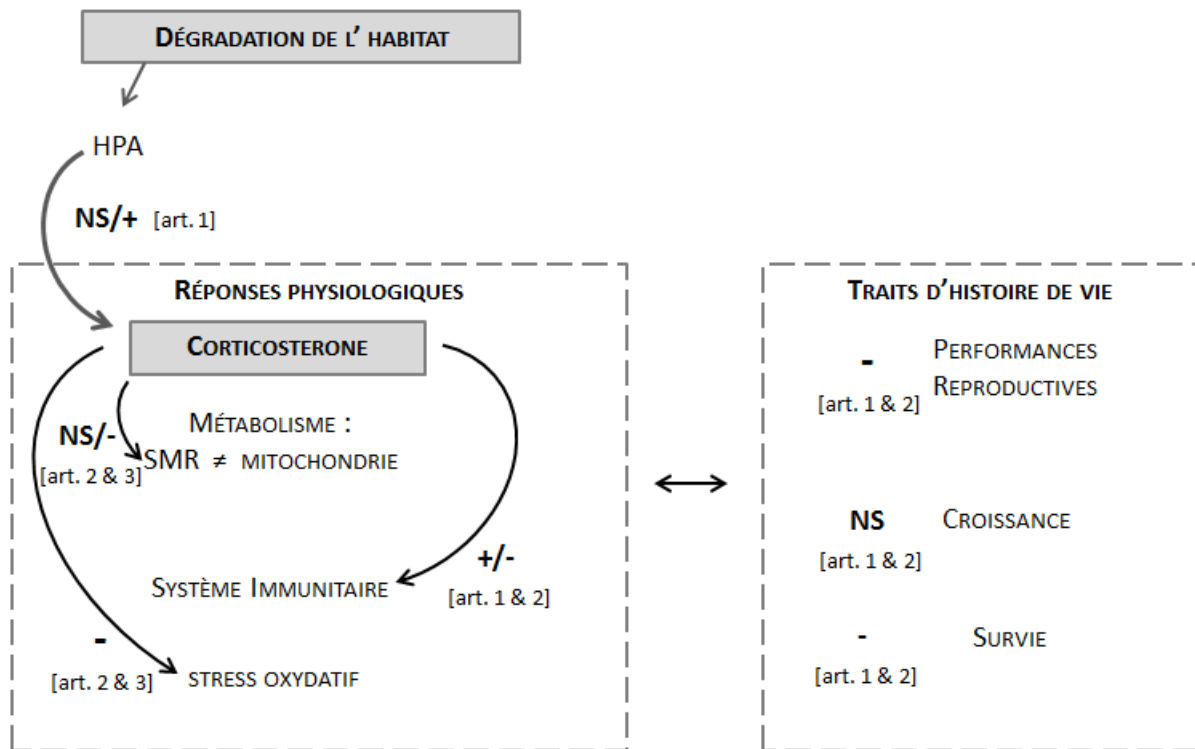

Figure 3 : Présentation de l'ensemble des résultats obtenus durant la thèse. Un signe (+) indique une relation positive, un signe (-) une relation négative, l'absence de relation est signalée par un (NS). Entre crochets sont notés les articles dont sont issues les relations.

Des mesures à affiner et à compléter

Ces différents résultats nous poussent à nous interroger sur la pertinence et la signification des taux basaux de corticostérone. Ne faudrait-il pas y associer d'autres composantes de cette réponse hormonale telles que la réponse au stress (après une manipulation) et la résilience (la capacité des individus à retourner à l'état initial)? Plusieurs études ont montré que la réponse au stress pouvait être modulée par une perturbation chronique. Par exemple, chez le manchot des antipodes (*Megadyptes antipodes*), la réponse hormonale suite à un stress de manipulation est plus importante chez les animaux présents sur des sites les plus touristiques (Ellenberg et al. 2007) alors que les taux basaux ne diffèrent pas entre les sites. Chez notre espèce, l'étude de la

réponse à un stress aigu n'avait été étudiée qu'à deux reprises (Dauphin-Villemant and Xavier 1987, Mugabo et al en révision). Dans les deux cas, on observe une augmentation de l'ordre de 50 à 100% de la sécrétion de corticostérone plusieurs minutes après l'application d'un « stress » ponctuel. Dans un projet de cette thèse s'intéressant aux personnalités, nous avons suggéré un lien entre la réponse au stress suite à une manipulation courte et l'agressivité des individus. En revanche, aucun lien entre le comportement et les taux basaux de corticostérone n'a été observé (article 4). Ce résultat suggère que la réponse au stress pourrait être un meilleur indicateur des réponses comportementales chez notre espèce.

D'autre part, chez l'iguane des Galápagos, la capacité des animaux à rétrocontrôler leur sécrétion de corticostérone (résilience) a été associée à une meilleure capacité à survivre suite à un événement de jeûne, suggérant que les animaux n'étant pas capables de rapidement rétrocontrôler leur sécrétion entrent dans ou maintiennent plus longtemps un état délétère (Romero and Wikelski 2010). Ce dernier point a été soulevé par John C. Wingfield (Wingfield 2013a; Wingfield 2013b) mais reste peu étudié à notre connaissance. Des changements dans la réponse au stress ou la résilience des individus pourraient expliquer pourquoi nous observons des effets démographiques (article 1) et physiologiques (article 2) sans changement significatif du taux basal de corticostérone. Il est à noter cependant que la mesure de la cinétique de la réponse au stress, donc de la résilience, requiert des échantillonnages de plasma répétés qui posent des problèmes protocolaires et éthiques sur des petites espèces comme notre lézard. Nous avons donc tenté de développer au cours d'une étude préliminaire en début de thèse des méthodes alternatives non invasives basées sur les fèces ou des prélèvements de salive, mais nos premiers résultats avec ces approches ne sont pas très concluants (données personnelles non publiées). Ainsi, nous avons tenté durant le mois d'avril 2014 de prélever de la

salive chez des mâles adultes de lézard vivipare via un morceau de coton. Cependant, cette méthode s'est avérée peu efficace chez notre espèce pour deux raisons (i) du fait de la quantité très faible de matériel récupéré et (ii) de gammes de mesures très peu variables allant de 1.04 à 3.2 ng/ml. Ces valeurs sont environ dix fois inférieures à ce qui est dosé dans le plasma chez cette espèce et sont trop proches de la limite de détection des kits que nous utilisons.

Une autre explication pourrait venir de la manière dont nous mesurons le taux basal de corticostérone. Lors de nos études, nous avons mesuré indistinctement la corticostérone libre et celle couplée à des globulines (CBG pour "*corticosterone binding globulins*"), mais il est connu que la concentration totale de corticostérone peut varier indépendamment de la fraction disponible pour les tissus (Breuner et al. 2013). Dans leur revue récente sur le sujet, Breuner et al (2013) soulignent le fait que l'application d'un stress entraînerait une modulation de la proportion de CBG, ce qui suggère que les CBG pourraient agir comme un réservoir (*reservoir hypothesis*). Une étude chez le macareux huppé (*Fratercula cirrhata*) a ainsi pu mettre en évidence que les proportions de CBG et de corticostérone libre variaient au cours du cycle de vie avec une proportion libre plus importante durant la période de reproduction (Williams et al. 2008) De plus, les auteurs observent une relation positive entre la proportion de CBG et l'indice de masse corporelle, tandis que l'utilisation du taux total de corticostérone indique une relation négative suggérant que la proportion de CBG peut être modulée par des facteurs internes (ici l'acquisition de nourriture). Chez le bruant à couronne blanche (*Zonotrichia leucophrys*), la fraction libre de corticostérone augmente drastiquement lors d'une réponse à un stress de manipulation mais surtout elle varie en fonction des contraintes environnementales (ici l'altitude) sans que des différences ne soient observées sur la concentration totale (Breuner et al. 2003). Une autre étude a montré que lors des phases

de déclin chez le lapin américain (*Lepus americanus*) la concentration en cortisol libre augmentait (Boonstra 2004). Dans le cas de notre première expérience où la qualité de l'habitat a été manipulée, mais aussi dans le cas des études des effets à long terme d'un stress chronique, des différences dans les proportions de CBG et de corticostérone libre pourraient aussi expliquer les patrons physiologiques et démographiques observés. Par exemple, malgré l'absence significative de changements des taux basaux totaux sur le long terme entre animaux ayant subi un stress chronique et ceux n'en n'ayant pas expérimenté (article 1 & 2), il est possible que des changements dans la fraction libre de corticostérone aient contribué à certains traits physiologiques observés.

L'un dans l'autre, il apparaît donc que l'utilisation du taux basal de corticostérone comme indicateur de la charge allostatique ne soit pas entièrement satisfaisante dans la mesure où des effets physiologiques et démographiques ne sont pas toujours reflétés par des variations de cet indicateur. Cela n'exclut pas que des mesures plus complètes de la résistance et de la résilience de la sécrétion de corticostérone en réponse à un stress aigu, mais aussi des proportions de corticostérone libre, pourraient permettre une description plus complète et plus satisfaisante de la contribution de la sécrétion de corticostérone à la charge allostatique. En particulier, l'étude de la résilience et de la résistance au stress, qui pourraient être mesurées de façon non-invasive via la salive si le protocole testé dans cette thèse était amélioré, constituerait une approche intéressante à poursuivre dans des travaux de physiologie de la conservation sur notre espèce modèle. Notre étude suggère aussi que l'utilisation d'indicateurs complémentaires tels que l'immunité ou le taux de lipides circulants semblent constituer une piste intéressante à considérer. En effet, le découplage entre les variations de ces indicateurs et les variations du taux basal de corticostérone chez notre espèce permet de mieux cerner les effets d'un stress chronique (article 1 & 2). Des résultats similaires ont été obtenus chez une espèce d'iguane (French

et al. 2010) où les animaux issus de sites perturbés par le tourisme ne présentent pas de différences significatives dans leur taux basaux de corticostérone, mais des différences dans leur immunité et leur paramètres démographiques.

La nécessité de prendre en compte les besoins spécifiques associés au cycle de vie

Un autre point qui nous semble important de discuter ici est l'importance de prendre en compte le cycle de vie des animaux et les demandes spécifiques des sexes afin de déterminer le choix des indicateurs de la charge allostatique. Nos deux études menées à long terme (article 1 & 2) n'ont pas pu mettre en évidence d'effets des différents traitements durant la période précédant l'hiver (à la fin de la saison estivale et donc d'activité). L'été 2014 a été particulièrement favorable avec d'importantes précipitations en début d'été et une survie et une croissance annuelle élevées, suivies d'une très bonne année de reproduction en 2015. Ces conditions favorables et donc peu contraignantes auraient pu permettre aux individus de faire des réserves énergétiques leur permettant alors de faire face aux différentes perturbations. Cela peut en partie expliquer l'absence d'effets de nos traitements (dégradation de l'habitat et hormonaux) à cette période. Cependant, les résultats observés lors de la saison de reproduction indiquent clairement que les contraintes propres aux animaux (statut de reproduction et âge) vont avoir une importance cruciale en venant s'ajouter à la charge allostatique déjà expérimentée par les individus. De même, il a été montré des changements saisonniers à la fois dans les taux basaux de corticostérone et les taux associés à la réponse au stress entre saisons, avec généralement un taux basal plus fort et une réponse plus faible durant la saison de reproduction (Romero 2002). Par exemple, Liebl et al (2012) ont mis en évidence chez le moineau domestique que la réponse au stress était plus forte pendant la reproduction que durant la période de mue (après reproduction). Les auteurs ont également observé des

changements dans l'expression des ARN messagers codant pour les récepteurs des GC et des minéralocorticoïdes lors de ces deux périodes.

En dehors de ces effets saisonniers (voir articles 1 & 2) chez notre espèce, plusieurs études ont déjà montré les actions condition-dépendantes de la corticostérone. Plus précisément, des élévations expérimentales des niveaux de corticostérone ont eu des effets différents sur l'activité en fonction du statut nutritif des animaux (Cote et al. 2010a) sur le comportement de dispersion des jeunes en fonction de l'âge de la mère (Meylan et al. 2004) et sur le métabolisme en fonction du sexe des individus (Cote et al. 2010a; Meylan et al. 2010). Nos travaux vont aussi dans ce sens avec des effets différents entre les classes d'âge et de sexe et soulignent donc l'importance de considérer l'ensemble de la population afin d'avoir une véritable idée de l'effet d'une perturbation.

Bibliographie

- Almasi B, Beziers P, Roulin A, Jenni L (2015) Agricultural land use and human presence around breeding sites increase stress-hormone levels and decrease body mass in barn owl nestlings. *Oecologia* 179:89–101. doi: 10.1007/s00442-015-3318-2
- Angelier F, Wingfield JC (2013) Importance of the glucocorticoid stress response in a changing world: Theory, hypotheses and perspectives. *Gen Comp Endocrinol* 190:118–128. doi: 10.1016/j.ygcen.2013.05.022
- Artacho P, Nespolo RF (2009) Natural selection reduces energy metabolism in the garden snail, *Helix aspersa* (Cornu aspersum). *Evolution (N Y)* 63:1044–1050. doi: 10.1111/j.1558-5646.2008.00603.x
- Bauwens D, Verheyen RF (1985) The Timing of Reproduction in the Lizard *Lacerta Vivipara* - Differences between Individual Females. *J Herpetol* 19:353–364. doi: 10.2307/1564263
- Beckerman A, Benton TG, Ranta E, et al (2002) Population dynamic consequences of delayed life-history effects. *Trends Ecol Evol* 17:263–269. doi: 10.1016/S0169-5347(02)02469-2
- Bleu J, Le Galliard JF, Fitze PS, et al (2013) Reproductive allocation strategies: a long-term study on proximate factors and temporal adjustments in a viviparous lizard. *Oecologia* 171:141–151. doi: 10.1007/s00442-012-2401-1
- Bonier F, Martin PR, Moore IT, Wingfield JC (2009) Do baseline glucocorticoids predict fitness? *Trends Ecol Evol* 24:634–642. doi: 10.1016/j.tree.2009.04.013
- Boonstra R (2004) Coping with changing northern environments: The role of the stress axis in birds and mammals. *Integr Comp Biol* 44:95–108. doi: 10.1093/icb/44.2.95
- Brand MD (2005) The efficiency and plasticity of mitochondrial energy transduction. *Biochem Soc Trans* 33:897–904. doi: 10.1042/BST20050897
- Breuner CW, Delehanty B, Boonstra R (2013) Evaluating stress in natural populations of vertebrates: total CORT is not good enough. *Funct Ecol* 27:24–36. doi: 10.1111/1365-2435.12016
- Breuner CW, Orchinik M, Hahn TP, et al (2003) Differential mechanisms for regulation of the stress response across latitudinal gradients. *Am J Physiol Regul Integr Comp Physiol* 285:1–3. doi: 10.1152/ajpregu.00748.2002
- Buntgen U, Tegel W, Nicolussi K, et al (2011) 2500 Years of European Climate Variability and Human Susceptibility. *Science (80-)* 331:578–582. doi: 10.1126/science.1197175
- Catalani A, Casolini P, Scaccianoce S, et al (2000) Maternal corticosterone during lactation permanently affects brain corticosteroid receptors, stress response and behaviour in rat progeny. *Neuroscience* 100:319–325. doi: 10.1016/S0306-4522(00)00277-3
- Chamaille-Jammes S, Massot M, Aragon P, Clobert J (2006) Global warming and positive fitness response in mountain populations of common lizards *Lacerta vivipara*. *Glob Chang Biol* 12:392–402. doi: 10.1111/j.1365-2486.2005.01088.x

- Costantini D (2008) Oxidative stress in ecology and evolution: Lessons from avian studies. *Ecol Lett* 11:1238–1251. doi: 10.1111/j.1461-0248.2008.01246.x
- Cote J, Clobert J, Meylan S, Fitze PS (2006) Experimental enhancement of corticosterone levels positively affects subsequent male survival. *Horm Behav* 49:320–327. doi: 10.1016/j.yhbeh.2005.08.004
- Cote J, Clobert J, Poloni LM, et al (2010a) Food deprivation modifies corticosterone-dependent behavioural shifts in the common lizard. *Gen Comp Endocrinol* 166:142–151. doi: 10.1016/j.ygcen.2009.11.008
- Cote J, Meylan S, Clobert J, Voituren Y (2010b) Carotenoid-based coloration, oxidative stress and corticosterone in common lizards. *J Exp Biol* 213:2116–2124. doi: 10.1242/jeb.040220
- Crespi EJ, Williams TD, Jessop TS, Delehanty B (2013) Life history and the ecology of stress: how do glucocorticoid hormones influence life-history variation in animals? *Funct Ecol* 27:93–106. doi: 10.1111/1365-2435.12009
- Crews DE (2007) Composite estimates of physiological stress, age, and diabetes in American Samoans. *Am J Phys Anthropol* 133:1028–1034. doi: 10.1002/ajpa.20612
- Dauphin-Villemant C, Leboulenger F, Xavier F, Vaudry H (1990) Adrenal activity in the female lizard *Lacerta vivipara* jacquin associated with breeding activities. *Gen Comp Endocrinol* 78:399–413. doi: 10.1016/0016-6480(90)90029-L
- Dauphin-Villemant C, Xavier F (1987) Nychthemeral variations of plasma corticosteroids in captive female *Lacerta vivipara* Jacquin: Influence of stress and reproductive state. *Gen Comp Endocrinol* 67:292–302. doi: 10.1016/0016-6480(87)90183-3
- Dhabhar FS (2002) Stress-induced augmentation of immune function - The role of stress hormones, leukocyte trafficking, and cytokines. *Brain Behav Immun* 16:785–798. doi: 10.1016/S0889-1591(02)00036-3
- Dhabhar FS, McEwen BS (1997) Acute stress enhances while chronic stress suppresses cell-mediated immunity in vivo: a potential role for leukocyte trafficking. *Brain Behav Immun* 11:286–306. doi: 10.1006/brbi.1997.0508
- Dowling DK, Simmons LW (2009) Reactive oxygen species as universal constraints in life-history evolution. *Proc Biol Sci* 276:1737–45. doi: 10.1098/rspb.2008.1791
- Dufty AM, Clobert J, Moller AP (2002) Hormones, developmental plasticity and adaptation. *Trends Ecol Evol* 17:190–196. doi: 10.1016/s0169-5347(02)02498-9
- Ellenberg U, Setiawan AN, Cree A, et al (2007) Elevated hormonal stress response and reduced reproductive output in Yellow-eyed penguins exposed to unregulated tourism. *Gen Comp Endocrinol* 152:54–63. doi: 10.1016/j.ygcen.2007.02.022
- Forman RTT, Alexander LE (1998) Roads and Their Major Ecological Effects. *Annu Rev Ecol Syst* 29:207–231. doi: 10.1146/annurev.ecolsys.29.1.207
- French SS, DeNardo DF, Greives TJ, et al (2010) Human disturbance alters endocrine and immune responses in the Galapagos marine iguana (*Amblyrhynchus cristatus*). *Horm Behav* 58:792–799. doi: 10.1016/j.yhbeh.2010.08.001

- Ghalambor CK, McKay JK, Carroll SP, Reznick DN (2007) Adaptive versus non-adaptive phenotypic plasticity and the potential for contemporary adaptation in new environments. *Funct Ecol* 21:394–407. doi: 10.1111/j.1365-2435.2007.01283.x
- Gonzalez-Jimena V, Fitze PS (2012) Blood corticosterone levels and intersexual selection games: best-of-bad-job strategies of male common lizards. *Behav Ecol Sociobiol* 66:305–315. doi: 10.1007/s00265-011-1278-z
- Heulin B, Ghielmi S, Vogrin N, et al (2002) Variation in eggshell characteristics and in intrauterine egg retention between two oviparous clades of the lizard *Lacerta vivipara*: Insight into the oviparity-viviparity continuum in squamates. *J Morphol* 252:255–262. doi: 10.1002/jmor.1103
- Hölker F, Moss T, Griefahn B, et al (2010) The Dark Side of Light: A Transdisciplinary Research Agenda for Light. *Ecol Soc* 15:13. doi: 10.1890/080129
- Jaatinen K, Seltmann MW, Hollmén T, et al (2013) Context dependency of baseline glucocorticoids as indicators of individual quality in a capital breeder. *Gen Comp Endocrinol* 191:231–238. doi: 10.1016/j.ygcen.2013.06.022
- Johnson EO, Kamilaris TC, Chrousos GP, Gold PW (1992) Mechanisms of Stress - a Dynamic Overview of Hormonal and Behavioral Homeostasis. *Neurosci Biobehav Rev* 16:115–130. doi: 10.1016/s0149-7634(05)80175-7
- Karatsoreos IN, Bhagat SM, Bowles NP, et al (2010) Endocrine and Physiological Changes in Response to Chronic Corticosterone: A Potential Model of the Metabolic Syndrome in Mouse. *Endocrinology* 151:2117–2127. doi: 10.1210/en.2009-1436
- Landys MM, Ramenofsky M, Wingfield JC (2006) Actions of glucocorticoids at a seasonal baseline as compared to stress-related levels in the regulation of periodic life processes. *Gen Comp Endocrinol* 148:132–149. doi: 10.1016/j.ygcen.2006.02.013
- Le Galliard JF, Ferriere R, Clobert J (2005) Juvenile growth and survival under dietary restriction: are males and females equal? *Oikos* 111:368–376. doi: 10.1111/j.0030-1299.2005.14163.x
- Le Galliard JF, Marquis O, Massot M (2010) Cohort variation, climate effects and population dynamics in a short-lived lizard. *J Anim Ecol* 79:1296–1307. doi: 10.1111/j.1365-2656.2010.01732.x
- Lessells CM (2008) Neuroendocrine control of life histories: what do we need to know to understand the evolution of phenotypic plasticity? *Philos Trans R Soc B Biol Sci* 363:1589–1598. doi: 10.1098/rstb.2007.0008
- Lochmiller RL, Deerenberg C (2000) Trade-Offs in Evolutionary Immunology: Just What Is the Cost of Immunity? *Oikos* 88:87–98. doi: 10.1034/j.1600-0706.2000.880110.x
- Lucas LD, French SS (2012) Stress-Induced Tradeoffs in a Free-Living Lizard across a Variable Landscape: Consequences for Individuals and Populations. *PLoS One* 7:10. doi: 10.1371/journal.pone.0049895
- Ma Z, Cai Y, Li B, Chen J (2010) Managing wetland habitats for waterbirds: An international perspective. *Wetlands* 30:15–27. doi: 10.1007/s13157-009-0001-6

- Madliger CL, Semeniuk CAD, Harris CM, Love OP (2015) Assessing baseline stress physiology as an integrator of environmental quality in a wild avian population: Implications for use as a conservation biomarker. *Biol Conserv* 192:409–417. doi: 10.1016/j.biocon.2015.10.021
- Marasco V, Spencer KA, Robinson J, et al (2013) Developmental post-natal stress can alter the effects of pre-natal stress on the adult redox balance. *Gen Comp Endocrinol* 191:239–246. doi: 10.1016/j.ygcen.2013.07.003
- Martin LB, Gilliam J, Han P, et al (2005) Corticosterone suppresses cutaneous immune function in temperate but not tropical House Sparrows, *Passer domesticus*. *Gen Comp Endocrinol* 140:126–135. doi: 10.1016/j.ygcen.2004.10.010
- McEwen BS, Wingfield JC (2003) The concept of allostasis in biology and biomedicine. *Horm Behav* 43:2–15. doi: 10.1016/s0018-506x(02)00024-7
- McEwen BS, Wingfield JC (2010) What is in a name? Integrating homeostasis, allostasis and stress. *Horm Behav* 57:105–111. doi: 10.1016/j.yhbeh.2009.09.011
- Metcalfe NB, Alonso-Alvarez C (2010) Oxidative stress as a life-history constraint: The role of reactive oxygen species in shaping phenotypes from conception to death. *Funct Ecol* 24:984–996. doi: 10.1111/j.1365-2435.2010.01750.x
- Meylan S, Clobert J (2005) Is corticosterone-mediated phenotype development adaptive? - Maternal corticosterone treatment enhances survival in male lizards. *Horm Behav* 48:44–52. doi: 10.1016/j.yhbeh.2004.11.022
- Meylan S, De Fraipont M, Clobert J (2004) Maternal size and stress and offspring philopatry: An experimental study in the common lizard (*Lacerta vivipara*). *Ecoscience* 11:123–129.
- Meylan S, Dufty AM, Clobert J (2003) The effect of transdermal corticosterone application on plasma corticosterone levels in pregnant *Lacerta vivipara*. *Comp Biochem Physiol a-Molecular Integr Physiol* 134:497–503. doi: Pii s1095-6433(02)00343-4.1016/s1095-6433(02)00343-4
- Meylan S, Haussy C, Voituron Y (2010) Physiological actions of corticosterone and its modulation by an immune challenge in reptiles. *Gen Comp Endocrinol* 169:158–166. doi: 10.1016/j.ygcen.2010.08.002
- Meylan S, Miles DB, Clobert J (2012) Hormonally mediated maternal effects, individual strategy and global change. *Philos Trans R Soc B-Biological Sci* 367:1647–1664. doi: 10.1098/rstb.2012.0020
- Morrison S, Shenassa ED, Mendola P, et al (2013) Allostatic load may not be associated with chronic stress in pregnant women, NHANES 1999-2006. *Ann Epidemiol* 23:294–297. doi: 10.1016/j.annepidem.2013.03.006
- Mugabo M, Marquis O, Perret S, Le Galliard JF (2010) Immediate and delayed life history effects caused by food deprivation early in life in a short-lived lizard. *J Evol Biol* 23:1886–1898. doi: 10.1111/j.1420-9101.2010.02052.x
- Mugabo M, Marquis O, Perret S, Le Galliard JF (2011) Direct and socially-mediated effects of food availability late in life on life-history variation in a short-lived lizard. *Oecologia* 166:949–960. doi: 10.1007/s00442-011-1933-0

- Narayan EJ, Jessop TS, Hero JM (2015) Invasive cane toad triggers chronic physiological stress and decreased reproductive success in an island endemic. *Funct Ecol* 29:1435–1444. doi: 10.1111/1365-2435.12446
- Nelson RJ (1994) *An Introduction to Behavioural Endocrinology*, Sinauer. Sunderland, MA
- Norris DO (2000) Endocrine Disruptors of the Stress Axis in Natural Populations: How Can We Tell? *Am Zool* 40:393–401. doi: 10.1668/0003-1569(2000)040[0393:EDOTSA]2.0.CO;2
- Oppliger A, Clobert J, Lecomte J, et al (1998) Environmental stress increases the prevalence and intensity of blood parasite infection in the common lizard *Lacerta vivipara*. *Ecol Lett* 1:129–138.
- Palme R (2012) Monitoring stress hormone metabolites as a useful, non-invasive tool for welfare assessment in farm animals. *Anim Welf* 21:331–337. doi: 10.7120/09627286.21.3.331
- Peckett AJ, Wright DC, Riddell MC (2011) The effects of glucocorticoids on adipose tissue lipid metabolism. *Metabolism* 60:1500–1510. doi: 10.1016/j.metabol.2011.06.012
- Romero LM (2011) Using the reactive scope model to understand why stress physiology predicts survival during starvation in Galapagos marine iguanas. *Gen Comp Endocrinol* 176:296–299. doi: 10.1016/j.ygcen.2011.11.004
- Romero LM, Dickens MJ, Cyr NE (2009) The reactive scope model - A new model integrating homeostasis, allostasis, and stress. *Horm Behav* 55:375–389. doi: 10.1016/j.yhbeh.2008.12.009
- Romero LM, Wikelski M (2002) Severe effects of low-level oil contamination on wildlife predicted by the corticosterone-stress response: Preliminary data and a research agenda. *Spill Sci Technol Bull* 7:309–313. doi: Pii s1353-2561(02)00067-110.1016/s1353-2561(02)00067-1
- Romero LM, Wikelski M (2010) Stress physiology as a predictor of survival in Galapagos marine iguanas. *Proc Biol Sci* 277:3157–3162. doi: 10.1098/rspb.2010.0678
- Romero ML (2002) Seasonal changes in plasma glucocorticoid concentrations in free-living vertebrates. *Gen Comp Endocrinol* 128:1–24. doi: 10.1016/S0016-6480(02)00064-3
- Sapolsky RM, Romero LM, Munck AU (2000) How do glucocorticoids influence stress responses? Integrating permissive, suppressive, stimulatory, and preparative actions. *Endocr Rev* 21:55–89. doi: 10.1210/er.21.1.55
- Schöpfer H, Palme R, Ruf T, Huber S (2011) Chronic stress in pregnant guinea pigs (*Cavia aperea f. porcellus*) attenuates long-term stress hormone levels and body weight gain, but not reproductive output. *J Comp Physiol B Biochem Syst Environ Physiol* 181:1089–1100. doi: 10.1007/s00360-011-0591-1
- Schulkin J (2011) Evolutionary conservation of glucocorticoids and corticotropin releasing hormone: Behavioral and physiological adaptations. *Brain Res* 1392:27–46. doi: 10.1016/j.brainres.2011.03.055
- Seebacher F, Franklin CE (2012) Determining environmental causes of biological effects: the

need for a mechanistic physiological dimension in conservation biology Introduction. *Philos Trans R Soc B-Biological Sci* 367:1607–1614. doi: 10.1098/rstb.2012.0036

- Sorci G, Clobert J, Belichon S (1996) Phenotypic plasticity of growth and survival in the common lizard *Lacerta vivipara*. *J Anim Ecol* 65:781–790. doi: 10.2307/5676
- Steffensen JP, Andersen KK, Bigler M, et al (2008) High-resolution Greenland Ice Core data show abrupt climate change happens in few years. *Science* (80-) 321:680–684. doi: 10.1126/science.1157707
- Steyermark AC (2002) A high standard metabolic rate constrains juvenile growth. *Zoology (Jena)* 105:147–151. doi: 10.1078/0944-2006-00055
- Strazdins L, Meyerkort S, Brent V, et al (2005) Impact of saliva collection methods on sIgA and cortisol assays and acceptability to participants. *J Immunol Methods* 307:167–171. doi: 10.1016/j.jim.2005.09.010
- Tarjuelo R, Barja I, Morales MB, et al (2015) Effects of human activity on physiological and behavioral responses of an endangered steppe bird. *Behav Ecol* 26:828–838. doi: 10.1093/beheco/arv016
- Vinkler M, Bainova H, Albrecht T (2010) Functional analysis of the skin-swelling response to phytohaemagglutinin. *Funct Ecol* 24:1081–1086. doi: 10.1111/j.1365-2435.2010.01711.x
- Walsberg GE (2003) How useful is energy balance as a overall index of stress in animals? *Horm Behav* 43:16–17. doi: 10.1016/S0018-506X(02)00033-8
- Wikelski M, Cooke SJ (2006) Conservation physiology. *Trends Ecol Evol* 21:38–46. doi: 10.1016/j.tree.2005.10.018
- Williams CT, Kitaysky AS, Kettle AB, Buck CL (2008) Corticosterone levels of tufted puffins vary with breeding stage, body condition index, and reproductive performance. *Gen Comp Endocrinol* 158:29–35. doi: 10.1016/j.ygcen.2008.04.018
- Wingfield JC (2003) Control of behavioural strategies for capricious environments. *Anim Behav* 66:807–815. doi: 10.1006/anbe.2003.2298
- Wingfield JC (2013a) Ecological processes and the ecology of stress: the impacts of abiotic environmental factors. *Funct Ecol* 27:37–44. doi: 10.1111/1365-2435.12039
- Wingfield JC (2008) Comparative endocrinology, environment and global change. *Gen Comp Endocrinol* 157:207–216. doi: 10.1016/j.ygcen.2008.04.017
- Wingfield JC (2013b) The comparative biology of environmental stress: Behavioural endocrinology and variation in ability to cope with novel, changing environments. *Anim Behav* 85:1127–1133. doi: 10.1016/j.anbehav.2013.02.018

Article 1

Habitat degradation increases stress-hormone levels during the breeding season and decreases survival and reproduction in adult common lizard. (Soumis à Oecologia).

Habitat degradation increases stress-hormone levels during the breeding season and decreases survival and reproduction in adult common lizards

Rémy Josserand*¹, Andréaz Dupoué¹, Simon Agostini², Claudy Haussy¹, Jean-François Le Galliard^{1,2} and Sandrine Meylan^{1,3,1}

¹ Sorbonne Universités, UPMC Université Paris 6, CNRS, IRD, INRA, Institut d'écologie et des sciences de l'environnement (IEES), 75005 Paris, France

² Ecole normale supérieure, PSL Research University, Département de biologie, CNRS, UMS 3194, Centre de recherche en écologie expérimentale et prédictive (CEREPEP-Ecotron IleDeFrance), 78 rue du château, 77140 Saint-Pierre-lès-Nemours, France

³ ESPE de Paris, Université Sorbonne Paris IV, 10 rue Molitor, 75016 Paris, France

* Author for correspondence

E-mail address: remy.josserand@etu.upmc.fr

Running headline: Chronic stress and the demographic costs of allostasis

¹ Author contribution: RJ, SM and JFLG conceived and designed this study, performed statistical analyses and wrote the manuscript. RJ, SM, JFLG, AD and SA performed the experiment. RJ, AD and CH provided molecular analyses.

ABSTRACT

The allostatic model describes how individuals maintain homeostasis in challenging environment and posits that costs induced by a chronic perturbation (i.e., allostatic load) are correlated to the secretion of glucocorticoids, such as corticosterone. Habitat perturbations from anthropogenic activities are multiple and functional responses to those are still unclear. Here, we manipulated the habitat quality in 24 semi-natural populations of the common lizard during one year. We tested the predictions of the allostatic model that habitat degradation should increase baseline corticosterone levels, and should induce concomitant physiological changes such as lipid mobilization and lower immunocompetence. It should also impact individual trait, such as body growth, survival and/or reproductive performances. Our results highlight stage-dependent effects of habitat degradation on physiological traits during the breeding season: breeding lizards had higher baseline corticosterone levels and younger had a lower inflammatory response than non-breeding individuals, whereas juveniles had higher circulating lipid than yearlings and adults without concomitant change in corticosterone levels. In addition, habitat degradation reduces the performances of adults but not of juveniles: in low habitat quality populations, males had a lower survival and females had smaller fecundity. Our results are in accordance with the allostatic model given that allostatic load was detected only during the season and in life stages of maximal energy expenditure. This underlines the importance to account for individual energy requirements to better understand demographic responses to habitat perturbation

Keywords: Allostasis, Corticosterone, Fitness, Immunocompetence, Triglycerides

INTRODUCTION

Anthropogenic global changes increase the species exposure to unpredictable environmental changes such as nutritional deficiency, human disturbance, pollution, or excessive warming (e.g., Wingfield 2008; Janin et al. 2010). Such stressors can have dramatic impact on the life history strategies of organisms and ultimately on population dynamic (Holmgren et al. 2001; Angelier and Wingfield 2013). In vertebrates, one central mechanism mediating these effects is the secretion of glucocorticoids, a class of steroid hormones synthesized in the adrenal cortex (Kuznetsov et al. 2004; Navarro-Castilla et al. 2014; Tarjuelo et al. 2015). For example, more frequent human disturbance and land use conversion due to intensive agriculture both impair nestling quality in barn owls and cause a rise in basal, plasma glucocorticoid levels (Almasi et al. 2015). Similarly, exposure to marine oil pollution increases glucocorticoid secretion and responsiveness, and is associated with higher adult mortality and a significant population decline about one year after in marine iguanas (Romero and Wikelski 2002; Wikelski et al. 2002). The glucocorticoid response is indeed one major physiological process by which vertebrates deal with chronic and acute perturbations in their environment, and may be an ideal biomarker to assess the population health (Wikelski and Cooke 2006). Yet, whether the regulation of the glucocorticoid response underpins adaptive responses to changing environments, such as changes in behavior, breeding phenology or life history strategies, it remains largely unexplored (Meylan et al. 2002; Angelier and Wingfield 2013).

Corticosterone and cortisol are the main glucocorticoids secreted under chronic perturbation in vertebrates (Nelson 1994). A short term increase in corticosterone level generates a wide range of physiological and behavioral responses that allow an individual to promote immediate survival by re-allocating energy from storage to activity (reviewed in Sapolsky, Romero, and Munck 2000). In particular, corticosterone facilitates the transfer of

energy from storage to the bloodstream by stimulating release of amino acids and mobilization of free fatty acids from muscle, fat tissue and liver, and increasing the generation of glucose substrates from non-carbohydrate sources (i.e. gluconeogenesis, Johnson et al. 1992; Peckett, Wright, and Riddell 2011) . However, prolonged periods of elevated corticosterone secretion also induce the catabolism of muscle tissue, negative nitrogen balance, and can suppress reproduction and immunocompetence (Sapolsky et al. 2000a). These negative effects may impair individual performances and cause demographic decline at the population level during a chronic perturbation (Wikelski and Cooke 2006). Still, studies that have tested the relation between physiological and demographic consequences of chronic stress in wild vertebrates have yielded contradictory results (Bonier et al. 2009). Some have shown that prolonged elevation of corticosterone may reduce fitness through infertility or impaired resistance to disease, which is in line with the so-called “corticosterone-fitness” hypothesis (Sapolsky et al. 2000b; Bonier et al. 2009; Romero and Wikelski 2010). In contrast, other studies suggested that elevated corticosterone can help compensate for deleterious effects of a chronic perturbation, a scenario known as the “corticosterone adaptation” hypothesis (Bonier et al. 2009; Romero and Wikelski 2010).

The allostatic model posits that species adjust their physiology and behavior to both predictable and unpredictable events (McEwen and Wingfield 2003; McEwen and Wingfield 2010). It provides a conceptual framework to account for these contradictory effects of corticosterone secretion and to predict changes in life history traits and demography in response to chronic environmental stress (e.g., Fefferman and Romero 2013). This model assumes that energetic demand to ensure physiological homeostasis (i.e., "allostatic load") increases in response to a perturbation, which induces the secretion of corticosterone. The intensity and the duration of allostatic load thus define the cumulative costs to the individual of allostasis such that the balance between these energetic costs and the energy available in

the environment determines under which condition a chronic stress may induce deleterious demographic and physiological effects (i.e. allostatic overload, Bonier et al. 2009; Fefferman and Romero 2013). The allostatic model posits that basal corticosterone levels reflect the cumulative costs of allostasis. It predicts notably that the variable effects of corticosterone release may come from differences in energetic constraints between life history stages and environmental conditions. For example, it has been shown that a chronic increase in plasma corticosterone levels has contrasted effects depending on nutritional state (Cote et al. 2010) or immune status in the common lizard (Meylan et al. 2010). However, the allostatic model has been criticized because the relationship between basal corticosterone secretion and energy expenditure is often more complex than hypothesized (Bonier et al. 2009). The use of basal corticosterone concentration as a proxy for energy expenditure and cost of allostasis have also been questioned (Romero et al. 2009). A joint quantification of the physiological and demographic responses to a chronic perturbation is thus necessary to assess the validity and the usefulness of the allostasis model.

Here, we manipulated the habitat quality in semi-natural populations of the common lizard (*Zootoca vivipara*) and evaluated both physiological and demographic responses during a one-year period including a breeding and a non-breeding season and different life stages. We compared three habitat quality levels differing by water access, availability of basking and refuge microhabitat as well as vegetation cover since these are critical determinants of population abundance in the wild (Lorenzon et al. 2001; Penalver-Alcazar et al. 2016). After one year of exposure to contrasted field conditions, we further exposed gravid females to different water access conditions in the laboratory including control and water deprivation treatments (Lorenzon et al. 1999; Lorenzon et al. 2001). This manipulation was done to extend the chronic perturbation during gestation and to assess cumulative effects of habitat quality before and during gestation. The allostatic model predicts condition-dependent

responses to this chronic perturbation because individuals may differ in their energy requirements according to age, sex and time of the year (Wingfield 2013a). In the common lizard, a species with continuous growth and sexual dimorphism in adults, we identified three contrasted life stages (González-Suárez et al. 2011; Bleu et al. 2013). Before adulthood, lizards have the lowest energy requirements and prioritize energy allocation to growth and sexual maturation. After adulthood, lizards prioritize energy allocation to reproduction: costs of reproduction are strong in adult females and include nutrient allocation to egg and energetic cost of viviparity (Bleu et al. 2013), whereas reproductive costs are paid essentially during the mating period in adult males. We recorded body growth rate, survival and reproductive performances to evaluate the effects of the habitat degradation on fitness of each life stage and population dynamics. At the same time, we quantified plasma concentration of basal corticosterone and lipids as well as the skin swelling response, a measure of the inflammatory response (e.g., Vinkler et al. 2010). Measuring lipid circulation and skin swelling response provide us with a rough evaluation of energy mobilization and immunocompetence, respectively. Accumulating evidence in the common lizard suggests a substantial role of corticosterone in modulating behavior and life history strategies. Elevation of corticosterone in the laboratory increases food consumption and behavioral activity (Cote et al. 2010) enhances future survival in males (Cote et al. 2010) and changes reproductive parameters in females (Vercken et al. 2007; Meylan et al. 2010). The skin swelling response is associated with ectoparasite resistance in adults and exposure to ectoparasites in yearlings (Mugabo et al. 2015).

In accordance with the allostatic model, we predicted that habitat degradation increases on average baseline corticosterone concentration. We also expected potential increase in the plasma concentration of circulating lipids, which would last if corticosterone secretion increases food consumption and/or enough food resources are available in low quality

habitats. We further expected that chronic corticosterone secretion would decrease the skin swelling response and fitness parameters in the case of allostatic overload. Moreover, allostatic load caused by habitat degradation should interact with lizard life stage and physiological state, such that effects on both physiological and fitness traits are higher during the breeding season (Escribano-Avila et al. 2013). Finally, we hypothesized that water deprivation during gestation would have cumulative or non-cumulative effects on allostatic load in adult females. Non-cumulative effects could be due to a suppression or a reduction of the corticosterone stress response to water deprivation in adult females coming from chronically stress environments (Homan et al. 2003; Ellenberg et al. 2007).

MATERIAL AND METHODS

Model species

The common lizard *Zootoca vivipara* is a small viviparous species (adult snout-vent length SVL : 53-77 mm) inhabiting humid habitats across northern Eurasia. It is characterized by a 3 to 4 year life expectancy, continuous growth and plastic life history that is sensitive to food availability (Le Galliard et al. 2005; Mugabo et al. 2010; Mugabo et al. 2011) and abiotic conditions like habitat humidity (Lorenzon et al. 2001; Marquis et al. 2008), or air temperature (Sorci et al. 1996; Chamaille-Jammes et al. 2006; Le Galliard et al. 2010a). Natural populations are structured in three age classes: juveniles (newborns individuals), yearlings (1 to 2 years old individuals) and adults (2 years old or more). In our study site, males start to emerge from hibernation around the beginning of March, followed shortly by juveniles and by females few weeks later. Mating period starts upon emergence of females (Bauwens and Verheyen 1985; Bauwens et al. 1989). From June to July, females lay an average clutch of five non-calcified eggs (range 1-13). Offspring hatch shortly after parturition and are immediately autonomous. Lizards enter in hibernation in October.

Capture and rearing condition

Between 18 and 26 May 2014, 203 adult females, 75 adult males, 164 yearling females and 160 yearling males were captured by hand in outdoor enclosures (10 × 10 m) at the Centre de Recherche en Ecologie Expérimentale et Prédictive (Saint-Pierre-lès-Nemours, France, 48°17'N, 2°41'E). Animals were identified by their unique toe clip code and measured for body size (SVL, ± 0.5 mm) and body mass (± 1 mg). They were then maintained in individual terraria (25 × 15 × 16 cm) with a shelter, peat soil as substrate and opportunities for optimal thermoregulation. We used incandescent light bulbs (25 W) for 9 h/d to ensure a thermal gradient from room temperature at 17-23°C to 35-38°C below the bulb during daytime. Room temperature was maintained at 16°C from 21:00 to 7:30. We provided lizards with water and food *ad libitum*. Gravid females were maintained in captivity until the parturition. Immediately after parturition, newborns (hereafter called juveniles) were separated from their mother, marked by toe clipping and measured for their SVL and body mass.

Habitat and water deprivation manipulation

Our experimental design combined a field manipulation of habitat quality with a laboratory manipulation of water deprivation in gravid females at the end of the habitat manipulation. We first manipulated the physical environment and vegetation of 24 outdoor enclosures each measuring 10m × 10m and allowing population-level investigations of the common lizard (Mugabo et al. 2013). We changed simultaneously several habitat features to generate potential multi-factorial changes in habitat quality, and produced three treatment groups with 8 enclosures per treatment. In "control" enclosures, we used the standard physical set-up and maintenance procedures (see Lecomte and Clobert 1996). Each enclosure was equipped with two permanent watering holes (40L plastic tanks), four piles of stones and logs used as shelters and basking sites by lizards, and a dense and tall vegetation (approximately 40 cm high) was kept throughout the experiment. In the "low quality" enclosures, watering holes,

logs and stones were removed, and grass was regularly cut to maintain a maximum vegetation height of 20 cm. In order to avoid direct disturbance or injury of lizards, mowing was done every 2 weeks on average before or after the time of the day when lizards are active or during cloudy and rainy days. Grass is used by lizards during thermoregulation and foraging activities (pers. obs.): mowing the grass decreases abundance of orthoptera, which are food resources for lizards (Uchida and Ushimaru 2014), and further reduces soil moisture and shading (Shao et al. 2012). To disentangle effects of vegetation cover from effects of microhabitat diversity and water availability, we further produced "intermediate quality" enclosures where grass was not manipulated but all watering holes, logs and rocks were removed.

At the beginning of the experiment, we released 8-10 adult females, 3-4 adult males, 7-11 yearling females, 6-7 yearling males, 27-30 female and 26-28 male juveniles in each enclosure. Males and non-gravid females were released in a randomly chosen experimental enclosure between June 12 and 14. Gravid females and their offspring were released the day of parturition. Juveniles from the same family were divided into three groups each randomly released in one habitat treatment. At the onset of the experiment, we did not observe differences between habitat quality treatments for SVL (mixed-effects ANOVA, adults and yearlings : $\chi^2 = 2.41$, $df = 2$, $P = 0.299$; juveniles : $\chi^2 = 2.46$, $P = 0.293$) and body condition (adults and yearlings : $\chi^2 = 2.59$, $P = 0.273$; juveniles : $\chi^2 = 2.63$, $P = 0.267$). Populations were then sampled before winter and after winter according to a protocol described in the next section.

At the end of the experiment, gravid females were returned to the laboratory and water availability was manipulated during the last 2-3 week of the gestation, (i.e., from 1 to 18 June 2015). Each gravid female was assigned randomly to one hydric treatment. In the control treatment, terraria were sprayed with water three times a day and water was permanently

provided with a plastic cup, which corresponds to our standard, *ad libitum* breeding conditions. In the water deprived treatment, terraria were sprayed only once per day in the morning and no permanent access to water was provided. This water deprivation regime decreases humidity during the day (80% to 40% in the afternoon) and mimics a dry environment where only morning dew is available (Lorenzon et al. 1999).

Demographic measurements

We monitored populations during two successive capture sessions to assess body size and condition, growth, survival and female reproductive performances. In a pre-winter recapture session (15-22 September 2014, between 10:30 pm and 5:00 am), we recaptured 5 adult and yearling lizards and about 9 (8-10) juveniles in each enclosure. In a post-winter recapture session (18-28 May 2015), we recaptured all surviving individuals. Lizards were identified by their unique toe clip code. At each recapture, animals were measured for body size and mass. Body growth rates were calculated as the change in SVL between two captures divided by the time interval. For the post-winter session, we subtracted the number of inactive days spent in hibernation and emergence assumed to be from end of October to beginning of March. We estimated annual survival probabilities between the release and post-winter recapture, assuming that capture probability was very close to 1 (Le Galliard et al. 2005). In June and July 2015, gravid females from the two hydric treatments (see above) were maintained until parturition in the laboratory to assess their reproductive traits. We counted live newborns, dead newborns and aborted or unfertilized eggs of each clutch. Parturition date, total fecundity (live, dead and aborted newborns), fit fecundity (live newborns) and juvenile characteristics were recorded.

Physiological measurements

We took a blood sample of animals larger than 2 g at each capture session to assess plasma corticosterone and triglyceride concentrations. Blood was sampled in the infra-orbital sinus of

the lizards using 2 to 3 20 μ L microhematocrit tubes. Blood was separated in two samples for corticosterone and triglyceride assays. All samples were collected within 3 min of removal of an animal from its home cage (laboratory measurements) or enclosure (field measurements) to avoid the handling-induced stress effects. Plasma were obtained by centrifugation and stored at -20°C until assay. Corticosterone levels were measured with a competitive enzyme-immunoassay method using corticosterone EIA (IDS Corticosterone EIA kit, ref AC-14F1, Immunodiagnostic Systems Ltd, France) after 1:10 dilution of all samples. This method quantifies total plasmatic corticosterone using a polyclonal corticosterone antibody and is based on a highly repeatable colorimetric assay of absorbance at 450 nm (17 plates with 4 repeats per plate: intra-plate repeatability: $r = 0.89$, $F_{3,60} = 102.61$, $P < 0.001$; inter-plate repeatability: $r = 0.93$, $F_{16,47} = 51.3$, $P < 0.001$, (Lessells and Boag 1987).

Levels of circulating triglycerides were measured in plasma by colorimetric assays using 2.5 μ l of plasma (Triglyceride Colorimetric Assay kit, ref. 10010303, Cayman Chemical, USA). This method quantifies the total triglycerides by using a chain of three enzymatic reactions ending up in hydrogen peroxide production, which is converted into quinoneimine dye quantified by absorbance at 540 nm. The quantification was highly repeatable (intra-plate repeatability: $r = 0.96$, $F_{98,194} = 71.16$, $P < 0.001$; inter-plate repeatability: $r = 0.98$, $F_{17,63} = 145.56$, $P < 0.001$). Body condition was not correlated with triglyceride (summer 2014 : $\chi^2 = 1.84$, $df = 1$, $P = 0.175$; pre-winter session : $\chi^2 = 0.03$, $df = 1$, $P = 0.857$, post-winter session : $\chi^2 = 0.33$, $df = 1$, $P = 0.569$) or corticosterone concentrations (summer 2014 : $\chi^2 = 1.59$, $df = 1$, $P = 0.206$; pre-winter session : $\chi^2 = 1.11$, $df = 1$, $P = 0.292$, post-winter session : $\chi^2 = 2.35$, $df = 1$, $P = 0.125$)

We further assessed immunocompetence at the beginning of the experiment (June 2014) and at each recapture session by measuring secondary skin-swelling in response to an injection of a mitogen, the phytohaemagglutinin (PHA). This procedure triggers a local

haemagglutination and leukocyte infiltration and involves both adaptive and innate immune components (Martin et al. 2006; Brown et al. 2011). In 2014 prior to the first measurement, we injected all animals with a solution of PBS containing 2.5 mg/mL of PHA (PHA-M, Sigma-Aldrich; reference 9008-97-3) in the right posterior leg in order to elicit a primary response. In 2015, we used the same protocol to stimulate the primary response in juveniles not tested in 2014. We then administered a subcutaneous injection of the same PBS-PHA solution in the right posterior leg to measure the secondary skin-swelling response. Time elapsed between the two injection was of a minima of 7 days: previous study have shown no correlation between first and second injection, but an increase in the PHA response (Mugabo et al. 2015). Just before and 12h after the injection, we measured the thickness of the right posterior leg using a spessimeter (Mitutoyo, ID-C112, Kanagawa, Japan) with an accuracy of 0.01 mm. We spaced the two measurements by 12 hours, because previous experiments had found that this coincided with the greatest swelling response (Mugabo et al. 2015). Swelling response was calculated as the difference in thickness between the post- and pre-injection measurements. At the start of the experiment we did not find difference between habitat quality treatments for PHA response (adults and yearlings : $\chi^2 = 4.69$, $df = 2$, $P = 0.1$), corticosterone concentration (adults and yearlings : $\chi^2 = 2.95$, $df = 2$, $P = 0.228$) and triglyceride concentration (adults and yearlings : $\chi^2 = 1.76$, $df = 2$, $P = 0.414$).

Statistical analyses

All analyses were performed with R 3.1.0 (R Core Team 2014, [https:// www.r-project.org/](https://www.r-project.org/)) and statistical procedures available in the *lmer* package (Bates et al. 2015). Data recorded in the summer 2014, the pre-winter and the post-winter capture sessions were analysed separately in juveniles and in older individuals. SVL, body condition (body mass corrected for size) and body growth rate of adult and yearling lizards were analysed with linear mixed models with enclosure as random effect. All initial models included fixed effects of habitat

Dégradation de l'habitat et réponse au stress : de la physiologie à la biologie de la conservation

manipulation, age class (in older individuals), sex and their first-order interactions. Similar models were used to analyze the PHA response, corticosterone and triglyceride concentrations, and corticosterone and triglyceride concentrations were log transformed to improve the normality of the residuals. In the case of body growth, we included also the effect of initial SVL to control for growth deceleration with increasing body size and the effect of the date of release to control for seasonal changes in growth rates. In the case of juveniles, we further included the additive random effect of family identity since similarity among siblings can influence juvenile performances. Annual survival was similarly analysed with mixed-effect logistic regressions including a logit link and binomial error term. Enclosure was used as random effect and habitat manipulation, age class (in older individuals) and sex were included as fixed effects together with their first-order interactions. Initial SVL was used as covariate to control for size effect on survival.

All yearling and adult females except one bred at the end of the experiment, whereas the proportion of breeding females among released juveniles was less than 50% on average. The proportion of females breeding at the age of one year was analysed with mixed-effect logistic regressions including a logit link and a binomial error term. The logistic regression included enclosure as a random effect and habitat manipulation, growth rate and initial SVL as fixed effects. We further tested the effects of habitat manipulation, water deprivation and their interaction on reproductive traits of gravid females with a data set including all age classes. Parturition date and offspring characteristics (SVL and body condition) were analysed with linear mixed models. Total fecundity and fit fecundity were analysed with mixed effect log regressions including a log link and a Poisson error term. In all cases, parameters of linear mixed models were estimate with REML (restricted maximum likelihood) procedure, whereas a Laplace approximation of the maximum likelihood was used in the case of logistic and Poisson regressions. Fixed effects were tested with Wald χ^2 statistics. A minimum adequate

model was obtained by a backward procedure where we removed non-significant terms one by one. Assumptions of normality and homoscedasticity were verified and over-dispersion of logistic and log regression were tested with a Pearson's chi squares. When a minimum adequate model was found, we used the Tukey's procedure to conduct post hoc tests (pairwise comparisons) with the *lsmeans* package (Lenth 2015). Results are presented mean \pm standard error or [lower,upper] at 95% confidential interval unless otherwise stated.

RESULTS

Growth and morphology

Body growth rate was not influenced by habitat manipulation before (juveniles : $\chi^2 = 2.11$, $df = 2$, $P = 0.348$; yearlings and adults : $\chi^2 = 3.38$, $df = 2$, $P = 0.18$) and after wintering (juveniles : $\chi^2 = 2.13$, $df = 2$, $P = 0.345$; yearlings and adults : $\chi^2 = 2.20$, $df = 2$, $P = 0.332$, see Table 1). Pre-winter growth rate was positively correlated with the date of release (juveniles : slope = 0.002 ± 0.001 mm/day², $\chi^2 = 5.11$, $df = 2$, $P = 0.024$; yearlings and adults : slope = 0.0007 ± 0.0002 mm/day², $\chi^2 = 10.07$, $df = 1$, $P = 0.001$). In juveniles, post-winter growth rate was higher in females than in males (contrast = 0.015 ± 0.001 mm/day², $\chi^2 = 134.62$, $df = 1$, $P < 0.001$). In older lizards, body growth rate was smaller in adults than in yearlings (pre-winter : $\chi^2 = 14.66$, $df = 1$, $P < 0.001$; post-winter : $\chi^2 = 83.26$, $df = 1$, $P < 0.001$, Table 1) and decreased with initial SVL (pre-winter : slope = -0.003 ± 0.001 day⁻¹, $\chi^2 = 17.59$, $df = 1$, $P < 0.001$; post-winter : slope = -0.0007 ± 0.0002 day⁻¹, $\chi^2 = 15.5$, $df = 1$, $P < 0.001$). Not surprisingly given these results, the SVL of lizards at the end of experiment was similar between habitat quality treatments in all age classes (all $P > 0.224$).

Body condition (mass corrected by SVL) was similar between treatments in juveniles (pre-winter: $\chi^2 = 0.96$, $df = 2$, $P = 0.62$; post-winter: $\chi^2 = 1.77$, $df = 2$, $P = 0.413$) as well as in yearling and adult lizards during the pre-winter session : ($\chi^2 = 0.07$, $df = 2$, $P = 0.967$). Post-winter body condition of adults and yearlings changed among treatments in females but not in

males (habitat manipulation \times sex: $\chi^2 = 6.85$, $df = 2$, $P = 0.032$). Females had a higher body condition in the intermediate habitat quality treatment than in control (Tukey post hoc test: estimate = 0.44 ± 0.16 , adjusted $P = 0.02$) and low habitat quality treatment (estimate = 0.55 ± 0.16 , adjusted $P = 0.003$).

Annual survival

We found no effect of habitat quality manipulation, sex, and SVL at birth on the annual juvenile survival (habitat manipulation: $\chi^2 = 0.32$, $df = 2$, $P = 0.85$; control = 0.25 [0.18, 0.33], intermediate = 0.28 [0.21, 0.37], low = 0.27 [0.19, 0.35]). In adults and yearlings, the annual survival of males tended to decrease with habitat degradation, while there was no difference in females (habitat manipulation \times sex: $\chi^2 = 8.79$, $df = 2$, $P = 0.012$, Figure 1).

Reproductive traits

The proportion of females breeding at the age of one year was independent of the habitat quality manipulation ($\chi^2 = 3.19$, $df = 2$, $P = 0.203$; control = 0.53 [0.27, 0.78], intermediate = 0.26 [0.1, 0.54], low = 0.18 [0.06, 0.43]). Juvenile females were more likely to breed at the age of one year if they grew faster earlier in life ($\chi^2 = 18.13$, $df = 1$, $P < 0.001$). Among breeding females, time at parturition was delayed by 3 to 4 days in the low quality treatment (Tukey post hoc test: control versus low quality: estimate = -3.5 ± 1.38 days, adjusted $P = 0.05$; intermediate versus low quality: estimate = -4.37 ± 1.47 days, adjusted $P = 0.02$), but it was not influenced by water deprivation (Table 2). Total fecundity did not differ among habitat quality and water deprivation treatments, and increased with age (adults = 8.58 [8.02, 9.19], yearlings = 7.49 [6.99, 8.03], juveniles = 4.81 [4.31, 5.36], Table 2). Water deprivation did not influence fit fecundity but females from the low quality treatment had a smaller fit fecundity than females from control (estimate = -0.23 ± 0.09 , adjusted $P = 0.046$) or intermediate habitat quality treatment (estimate = -0.30 ± 0.10 adjusted $P = 0.002$).

Offspring body condition and SVL were not significantly affected by mother habitat

quality and maternal water deprivation treatments (all $P > 0.4$). Mother SVL was a strong positive predictor of offspring body condition (slope = 0.0018 ± 0.00002 , $\chi^2 = 67.72$, $df = 1$, $P < 0.001$) and SVL (slope = 0.07 ± 0.01 , $\chi^2 = 41.60$, $df = 1$, $P < 0.001$), and female offspring were longer than males on average ($\chi^2 = 393.67$, $df = 1$, $P < 0.001$).

Physiological traits

During the pre-winter period, habitat manipulation did not influence significantly plasma corticosterone and triglyceride concentrations nor the PHA swelling response (Table 3, Figures 2A-C). There was a marginal trend towards higher corticosterone concentrations for lizards from intermediate habitat quality populations (Figure 2A). The swelling response also tended to differ among treatments, with a marginally higher immune response in low habitat quality (Figure 2C). In contrast, physiological traits measured during the post-winter period were significantly different among treatments (Table 3). First, plasma corticosterone concentrations changed with habitat quality in an age-dependent manner. Corticosterone concentration was higher in adults from low habitat quality populations relative to the two other treatments (Tukey post hoc test: adjusted $P < 0.06$), but not in yearlings and juveniles (Figure 2D). In addition females had on average higher plasma corticosterone concentrations than males, especially in adults and yearlings (results not shown). Second, juveniles had higher circulating triglyceride levels than adults and yearlings, and higher levels in low habitat quality than in intermediate quality treatment (adjusted $P = 0.016$, see Figure 2E). Third, the PHA swelling response of juveniles was not influenced by treatments, but swelling response tended to increase in adults with habitat degradation whereas it decreased in yearlings (Figure 2F).

DISCUSSION

Our experiment reveals stage-dependent and season effects of habitat degradation on the baseline corticosterone level, lipid concentration and immunocompetence in the common

lizard. These effects were dependent upon age class and sex, and were more pronounced after the wintering period than during the pre-winter period. In addition, habitat degradation led to small but significant changes in life history traits suggesting slight, deleterious effects on the fitness of adult males and females undergoing chronic disturbance on the long term but little effects in younger individuals. Water deprivation during gestation had no significant effect on the reproductive performances of adult females independent of the habitat quality manipulation prior to gestation. This last result suggests that reproductive traits were determined prior to gestation, which is in line with our field observations that water availability during vitellogenesis, but not during gestation, influences reproductive effort (Bleu et al. 2013).

During the pre-winter period, food availability is high, thermal conditions are more favorable for basking and feeding, and lizards are prioritizing food acquisition to grow or to restore their body reserves (Bleu et al. 2013). At that time, we did not detect any significant effects of the habitat quality manipulation on physiological traits nor on life history traits. Three potential explanations for the absence of short-term effects of habitat degradation on physiology and demography are (i) that the intensity of the chronic perturbation was too moderate relative to the energetic needs of individuals (McEwen and Wingfield 2003; Wingfield 2013b), (ii) that the persistence of chronic perturbation led to acclimatization or selection (reviewed in Wingfield et al. 2011), or (iii) that there was more variation among individuals due to predictable differences in life stage (e.g. breeding state, Landys, Ramenofsky, and Wingfield 2006) than between treatments. The last hypothesis is unlikely given that none of the individuals was in a breeding state during the pre-winter period and we found no difference in physiological traits (corticosterone, triglycerides and immunocompetence) between age and sex classes. We can also reject the acclimatization –selection hypothesis because the physiological state of some individuals responded during the post-winter session and survival

is usually high during the summer. Thus, the most plausible explanation is that allostatic load was not strong enough during the pre-winter period in all age and sex classes. For example, there was no difference in body growth, body size, body condition and circulating lipid concentrations among habitat quality treatments. At that time of the year, baseline corticosterone levels were lower on average than during the post-winter session and lipid concentrations were relatively high and similar to the values recorded under well-fed conditions in the laboratory prior to the experiment. This suggests that food availability and energy allocation to growth were not different between treatments (Le Galliard et al. 2005; Mugabo et al. 2010). The summer season was also characterized by frequent rainfall events and relatively short periods of drought (Josserand, *pers. obs.*), implying that hydric constraints might have been weakly influenced by the habitat manipulation. Additional data on food and microclimatic conditions inside enclosures would be needed to test these hypotheses. Under these conditions, an increase of allostatic load associated with a higher corticosterone secretion is not expected because no additional energy expenditure is required to cope with stress (e.g. Landys, Ramenofsky, and Wingfield 2006). For example, iguanas inhabiting tourist-visited islands did not respond to the perturbation induced by human presence when supplemented in food (Knapp et al. 2013).

Annual survival rate of adult and yearling males decreased in low habitat quality as expected if low habitat quality generates chronic stress, whereas survival rate of adults and yearlings females did not change among treatments. Sexual differences in the survival of common lizards have already been reported with lower average survival of males after adulthood and more variable survival in males than in females, especially according to temporal changes in early spring weather condition (e.g., Massot et al. 1992; Le Galliard et al. 2010b; Mugabo et al. 2013). This low and more variable survival of breeding males could be due to secretion of testosterone during the mating period (i.e. immune-competence handicap

hypothesis, Folstad and Karter 1992). In addition, in low habitat quality enclosures, number of live offspring decreased in the litter of adult females, but not in younger females, and parturition date was delayed from 3 to 4 days in all age classes, whereas offspring characteristics remained unchanged. Meanwhile, adult and yearling males and females increased their corticosterone secretion in low quality habitats. These results are in agreement with the "corticosterone-fitness" hypothesis (Bonier et al. 2009). Previous studies have shown that increased plasma corticosterone levels during gestation decrease reproductive success, delay the parturition date, and can also influence offspring characteristics in the common lizard (Meylan and Clobert 2005; Meylan et al. 2010).

A higher plasma corticosterone concentration suggests that allostatic load increased in adults and yearlings from low quality habitats. In support of this and as expected we also found a decrease of immunocompetence in yearling lizards from low quality habitat. However, circulating triglyceride rates and body condition were not affected by habitat degradation contrary to our predictions based on the most common effects of corticosterone on energy metabolism metabolism (e.g., Johnson et al. 1992; Sapolsky, Romero, and Munck 2000). Pecket et al. (2011) reported in humans and rodents both positive and negative effects of corticosterone secretion on circulating free fatty acids concentration depending of fasted state. Under nonfasted state, corticosterone secretion can promote lipid storage by activate lipogeneses and adipogenesis. In the common lizard, a prolonged corticosterone elevation promotes behaviours associated with food intake including basking and exploratory activity (De Fraipont et al. 2000; Cote et al. 2006; Cote et al. 2010). Moreover, we have recently shown that three weeks of corticosterone application increases liver mass, suggesting that liver may store more fatty acids during a chronic stress (Voituron et al unpublished). We therefore propose that corticosterone elevation in low quality habitat may have stimulated food acquisition and/or lipid storage, thus explaining the absence of difference in body mass,

Dégradation de l'habitat et réponse au stress : de la physiologie à la biologie de la conservation
size growth and circulating triglyceride concentration between habitat qualities.

In contrast, juveniles from low habitat quality enclosures had higher triglyceride concentrations in the plasma suggesting more pronounced fatty acid release despite no significant change in corticosterone level, body growth and body condition. The fitness of male juveniles was not influenced by habitat degradation, whereas juvenile females reaching sexual maturity at the age of one year delayed their parturition date by 3 to 4 days like adult and yearling females. Thus, the physiological responses of juveniles differed from those observed during the pre-winter period only for circulating triglyceride levels. We suggest that allostatic load was too low to cause a detectable rise in corticosterone levels in juveniles, but that stress caused by habitat degradation was strong enough to induce the necessity of mobilizing the lipid reserves in order to maintain homeostasis. In favor of this scenario, which assumes low energetic constraints in juveniles, levels of circulating triglycerides were very high in juveniles compared to yearlings and adults and sexual maturation of females was independent of habitat quality.

Altogether, our results were generally in accordance with the “corticosterone-fitness” hypothesis in adults (Bonier et al. 2009). In addition, as suggested by allostatic model (McEwen and Wingfield 2003) our study demonstrates that life stage and environmental constraints are important factors to take into account in order to understand effects of perturbations on demographic and physiological responses. This suggests that baseline corticosterone level can be used as an indicator of population health or individual fitness in response to habitat perturbations, but only under certain circumstances.

ACKNOWLEDGEMENTS

We are thankful to students and staff and especially Samuel Perret at the CEREEP for assistance in the field and laboratory. This study was funded by the CNRS, the Agence

Dégradation de l'habitat et réponse au stress : de la physiologie à la biologie de la conservation Nationale de la Recherche (ANR-13-JSV7-0011-01 to S.M.) and the Région Île-de-France R2DS program (grant 2013-08 to S.M., J.F.L.G. and R.J.). Protocols were done under the agreement with the Regional ethics committee in animal experiment N°3 of the Région Île-de-France. The authors declare that they have no conflict of interest.

REFERENCES

- Almasi B, Beziere P, Roulin A, Jenni L (2015) Agricultural land use and human presence around breeding sites increase stress-hormone levels and decrease body mass in barn owl nestlings. *Oecologia* 179:89–101. doi: 10.1007/s00442-015-3318-2
- Angelier F, Wingfield JC (2013) Importance of the glucocorticoid stress response in a changing world: Theory, hypotheses and perspectives. *Gen Comp Endocrinol* 190:118–128. doi: 10.1016/j.ygcen.2013.05.022
- Bates D, Maechler M, Bolker B, Walker S (2015) Fitting Linear Mixed-Effects Models Using lme4. *J Stat Softw* 67:1–48. doi: 10.18637/jss.v067.i01
- Bauwens D, Vandamme R, Verheyen RF (1989) Synchronization of Spring Molting with the Onset of Mating-Behavior in Male Lizards, *Lacerta-Vivipara*. *J Herpetol* 23:89–91. doi: 10.2307/1564326
- Bauwens D, Verheyen RF (1985) The Timing of Reproduction in the Lizard *Lacerta-Vivipara* - Differences between Individual Females. *J Herpetol* 19:353–364. doi: 10.2307/1564263
- Bleu J, Le Galliard JF, Fitzer PS, et al (2013) Reproductive allocation strategies: a long-term study on proximate factors and temporal adjustments in a viviparous lizard. *Oecologia* 171:141–151. doi: 10.1007/s00442-012-2401-1
- Bonier F, Martin PR, Moore IT, Wingfield JC (2009) Do baseline glucocorticoids predict fitness? *Trends Ecol Evol* 24:634–642. doi: 10.1016/j.tree.2009.04.013
- Brown GP, Shilton CM, Shine R (2011) Measuring amphibian immunocompetence: validation

Dégradation de l'habitat et réponse au stress : de la physiologie à la biologie de la conservation

of the phytohemagglutinin skin-swelling assay in the cane toad, *Rhinella marina*.

Methods Ecol Evol 2:341–348. doi: 10.1111/j.2041-210X.2011.00090.x

Chamaille-Jammes S, Massot M, Aragon P, Clobert J (2006) Global warming and positive fitness response in mountain populations of common lizards *Lacerta vivipara*. Glob Chang Biol 12:392–402. doi: 10.1111/j.1365-2486.2005.01088.x

Cote J, Clobert J, Meylan S, Fitze PS (2006) Experimental enhancement of corticosterone levels positively affects subsequent male survival. Horm Behav 49:320–327. doi: 10.1016/j.yhbeh.2005.08.004

Cote J, Clobert J, Poloni LM, et al (2010) Food deprivation modifies corticosterone-dependent behavioural shifts in the common lizard. Gen Comp Endocrinol 166:142–151. doi: 10.1016/j.ygcen.2009.11.008

De Fraipont M, Clobert J, John H, Alder S (2000) Increased pre-natal maternal corticosterone promotes philopatry of offspring in common lizards *Lacerta vivipara*. J Anim Ecol 69:404–413. doi: 10.1046/j.1365-2656.2000.00405.x

Ellenberg U, Setiawan AN, Cree A, et al (2007) Elevated hormonal stress response and reduced reproductive output in Yellow-eyed penguins exposed to unregulated tourism. Gen Comp Endocrinol 152:54–63. doi: 10.1016/j.ygcen.2007.02.022

Escribano-Avila G, Pettorelli N, Virg??s E, et al (2013) Testing Cort-Fitness and Cort-Adaptation hypotheses in a habitat suitability gradient for roe deer. Acta Oecologica 53:38–48. doi: 10.1016/j.actao.2013.08.003

Fefferman NH, Romero LM (2013) Can physiological stress alter population persistence? A model with conservation implications. Conserv Physiol 1:13. doi: cot01210.1093/conphys/cot012

Folstad I, Karter AJ (1992) Parasites, Bright Males, and the Immunocompetence Handicap. Am. Nat. 139:603–622.

- González-Suárez M, Le Galliard J-F, Claessen D (2011) Population and Life-History Consequences of Within-Cohort Individual Variation. *Am Nat* 178:525–537. doi: 10.1086/661906
- Holmgren M, Scheffer M, Ezcurra E, et al (2001) El Nino effects on the dynamics of terrestrial ecosystems. *Trends Ecol Evol* 16:89–94. doi: 10.1016/s0169-5347(00)02052-8
- Homan RN, Reed JM, Romero LM (2003) Corticosterone concentrations in free-living spotted salamanders (*Ambystoma maculatum*). *Gen Comp Endocrinol* 130:165–171. doi: Pii s0016-6480(02)00578-6 10.1016/s0016-6480(02)00578-6
- Janin A, Lena J-P, Joly P (2010) Beyond occurrence: Body condition and stress hormone as integrative indicators of habitat availability and fragmentation in the common toad. *Biol Conserv* 144:1008–1016. doi: 10.1016/j.biocon.2010.12.009
- Johnson EO, Kamilaris TC, Chrousos GP, Gold PW (1992) Mechanisms of Stress - a Dynamic Overview of Hormonal and Behavioral Homeostasis. *Neurosci Biobehav Rev* 16:115–130. doi: 10.1016/s0149-7634(05)80175-7
- Knapp CR, Hines KN, Zachariah TT, et al (2013) Physiological effects of tourism and associated food provisioning in an endangered iguana. *Conserv Physiol* 1:1–12. doi: 10.1093/conphys/cot032.Introduction
- Kuznetsov VA, Tchabovsky A V, Kolosova IE, Moshkin MP (2004) Effect of habitat type and population density on the stress level of midday gerbils (*Meriones mefidianus pall.*) in free-living populations. *Biol Bull* 31:628–632. doi: 10.1023/B:BIBU.0000049736.02912.e2
- Landys MM, Ramenofsky M, Wingfield JC (2006) Actions of glucocorticoids at a seasonal baseline as compared to stress-related levels in the regulation of periodic life processes. *Gen Comp Endocrinol* 148:132–149. doi: 10.1016/j.ygcen.2006.02.013
- Le Galliard JF, Ferriere R, Clobert J (2005) Juvenile growth and survival under dietary

restriction: are males and females equal? *Oikos* 111:368–376. doi: 10.1111/j.0030-1299.2005.14163.x

Le Galliard JF, Marquis O, Massot M (2010a) Cohort variation, climate effects and population dynamics in a short-lived lizard. *J Anim Ecol* 79:1296–1307. doi: 10.1111/j.1365-2656.2010.01732.x

Le Galliard JF, Marquis O, Massot M (2010b) Cohort variation, climate effects and population dynamics in a short-lived lizard. *J Anim Ecol* 79:1296–1307. doi: 10.1111/j.1365-2656.2010.01732.x

Lecomte J, Clobert J (1996) Dispersal and connectivity in populations of the common lizard *Lacerta vivipara* : an experimental approach. *Acta oecologica* 17:585–598.

Lenth R (2015) Using Lsmmeans. 1–28.

Lessells CM, Boag PT (1987) Unrepeatable {Repeatabilities}: {A} {Common} {Mistake}. *Auk* 104:116–121. doi: 10.2307/4087240

Lorenzon P, Clobert J, Massot M (2001) The contribution of phenotypic plasticity to adaptation in *Lacerta vivipara*. *Evolution* (N Y) 55:392–404.

Lorenzon P, Clobert J, Oppliger A, John-Alder H (1999) Effect of water constraint on growth rate, activity and body temperature of yearling common lizard (*Lacerta vivipara*). *Oecologia* 118:423–430. doi: 10.1007/s004420050744

Marquis O, Massot M, Le Galliard JF (2008) Intergenerational effects of climate generate cohort variation in lizard reproductive performance. *Ecology* 89:2575–2583. doi: 10.1890/07-1211.1

Martin LB, Han P, Lewittes J, et al (2006) Phytohemagglutinin-induced skin swelling in birds: histological support for a classic immunoecological technique. *Funct Ecol* 20:290–299. doi: 10.1111/j.1365-2435.01094.x

Massot M, Clobert J, Pilorge T, et al (1992) Density Dependence in the Common Lizard :

Demographic Consequences of a Density Manipulation. 73:1742–1756.

McEwen BS, Wingfield JC (2003) The concept of allostasis in biology and biomedicine.

Horm Behav 43:2–15. doi: 10.1016/s0018-506x(02)00024-7

McEwen BS, Wingfield JC (2010) What is in a name? Integrating homeostasis, allostasis and

stress. Horm Behav 57:105–111. doi: 10.1016/j.yhbeh.2009.09.011

Meylan S, Belliure J, Clobert J, de Fraipont M (2002) Stress and body condition as prenatal

and postnatal determinants of dispersal in the common lizard (*Lacerta vivipara*). Horm

Behav 42:319–326. doi: 10.1006/hbeh.2002.1827

Meylan S, Clobert J (2005) Is corticosterone-mediated phenotype development adaptive? -

Maternal corticosterone treatment enhances survival in male lizards. Horm Behav 48:44–

52. doi: 10.1016/j.yhbeh.2004.11.022

Meylan S, Haussy C, Voituron Y (2010) Physiological actions of corticosterone and its

modulation by an immune challenge in reptiles. Gen Comp Endocrinol 169:158–166.

doi: 10.1016/j.ygcen.2010.08.002

Mugabo M, Marquis O, Perret S, Le Galliard JF (2010) Immediate and delayed life history

effects caused by food deprivation early in life in a short-lived lizard. J Evol Biol

23:1886–1898. doi: 10.1111/j.1420-9101.2010.02052.x

Mugabo M, Marquis O, Perret S, Le Galliard JF (2011) Direct and socially-mediated effects

of food availability late in life on life-history variation in a short-lived lizard. Oecologia

166:949–960. doi: 10.1007/s00442-011-1933-0

Mugabo M, Perret S, Decenciere B, et al (2015) Density-dependent immunity and parasitism

risk in experimental populations of lizards naturally infested by ixodid ticks. Ecology

96:450–460. doi: 10.1890/14-0524.1

Mugabo M, Perret S, Legendre S, Le Galliard JF (2013) Density-dependent life history and

the dynamics of small populations. J Anim Ecol 82:1227–1239. doi: 10.1111/1365-

- Navarro-Castilla A, Barja I, Olea PP, et al (2014) Are degraded habitats from agricultural crops associated with elevated faecal glucocorticoids in a wild population of common vole (*Microtus arvalis*)? *Mamm Biol* 79:36–43. doi: 10.1016/j.mambio.2013.08.004
- Nelson RJ (1994) *An Introduction to Behavioural Endocrinology*, Sinauer. Sunderland, MA
- Peckett AJ, Wright DC, Riddell MC (2011) The effects of glucocorticoids on adipose tissue lipid metabolism. *Metabolism* 60:1500–1510. doi: 10.1016/j.metabol.2011.06.012
- Penalver-Alcazar M, Aragon P, Breedveld MC, Fitze PS (2016) Microhabitat selection in the common lizard: implications of biotic interactions, age, sex, local processes, and model transferability among populations. *Ecol Evol* 6:3594–3607.
- R Core Team (2014) *R: A Language and Environment for Statistical Computing*.
- Romero LM, Dickens MJ, Cyr NE (2009) The reactive scope model - A new model integrating homeostasis, allostasis, and stress. *Horm Behav* 55:375–389. doi: 10.1016/j.yhbeh.2008.12.009
- Romero LM, Wikelski M (2002) Severe effects of low-level oil contamination on wildlife predicted by the corticosterone-stress response: Preliminary data and a research agenda. *Spill Sci Technol Bull* 7:309–313. doi: Pii s1353-2561(02)00067-110.1016/s1353-2561(02)00067-1
- Romero LM, Wikelski M (2010) Stress physiology as a predictor of survival in Galapagos marine iguanas. *Proc Biol Sci* 277:3157–3162. doi: 10.1098/rspb.2010.0678
- Sapolsky RM, Romero LM, Munck AU (2000a) How do glucocorticoids influence stress responses? Integrating permissive, suppressive, stimulatory, and preparative actions. *Endocr Rev* 21:55–89. doi: 10.1210/er.21.1.55
- Sapolsky RM, Romero LM, Munck AU (2000b) How do glucocorticoids influence stress responses? Integrating permissive, suppressive, stimulatory, and preparative actions.

- Shao C, Chen J, Li L, Zhang L (2012) Ecosystem responses to mowing manipulations in an arid Inner Mongolia steppe: An energy perspective. *J Arid Environ* 82:1–10. doi: 10.1016/j.jaridenv.2012.02.019
- Sorci G, Clobert J, Belichon S (1996) Phenotypic plasticity of growth and survival in the common lizard *Lacerta vivipara*. *J Anim Ecol* 65:781–790. doi: 10.2307/5676
- Tarjuelo R, Barja I, Morales MB, et al (2015) Effects of human activity on physiological and behavioral responses of an endangered steppe bird. *Behav Ecol* 26:828–838. doi: 10.1093/beheco/arv016
- Uchida K, Ushimaru A (2014) Biodiversity declines due to abandonment and intensification of agricultural lands: patterns and mechanisms. *Ecol Monogr* 84:637–658. doi: 10.1890/13-2170.1
- Vercken E, de Fraipont M, Dufty AM, Clobert J (2007) Mother's timing and duration of corticosterone exposure modulate offspring size and natal dispersal in the common lizard (*Lacerta vivipara*). *Horm Behav* 51:379–386. doi: 10.1016/j.yhbeh.2006.12.006
- Vinkler M, Bainova H, Albrecht T (2010) Functional analysis of the skin-swelling response to phytohaemagglutinin. *Funct Ecol* 24:1081–1086. doi: 10.1111/j.1365-2435.2010.01711.x
- Wikelski M, Cooke SJ (2006) Conservation physiology. *Trends Ecol Evol* 21:38–46. doi: 10.1016/j.tree.2005.10.018
- Wikelski M, Wong V, Chevalier B, et al (2002) Marine iguanas die from trace oil pollution. *Nature* 417:607–608. doi: 10.1038/417607a
- Wingfield JC (2013a) The comparative biology of environmental stress: behavioural endocrinology and variation in ability to cope with novel, changing environments. *Anim Behav* 85:1127–1133. doi: 10.1016/j.anbehav.2013.02.018
- Wingfield JC (2013b) Ecological processes and the ecology of stress: the impacts of abiotic

R. Josseland

Dégradation de l'habitat et réponse au stress : de la physiologie à la biologie de la conservation

environmental factors. *Funct Ecol* 27:37–44. doi: 10.1111/1365-2435.12039

Wingfield JC (2008) Comparative endocrinology, environment and global change. *Gen Comp*

Endocrinol 157:207–216. doi: 10.1016/j.ygcen.2008.04.017

Wingfield JC, Kelley JP, Angelier F (2011) What are extreme environmental conditions and

how do organisms cope with them? *Curr Zool* 57:363–374. doi: 10.1093/czoolo/57.3.363

TABLES

Table 1. Growth rate (mm.day⁻¹) of adult, yearling and juvenile common lizards before and after wintering in each habitat quality treatment.

Results shown as mean ± SE.

	Pre-winter period			Post-winter period		
	Control	Intermediate	Low	Control	Intermediate	Low
Adults	0.044±0.008	0.041±0.008	0.037±0.008	0.007±0.003	0.010±0.003	0.005±0.003
Yearlings	0.078±0.007	0.072±0.007	0.060±0.007	0.029±0.003	0.032±0.003	0.027±0.003
Juveniles	0.318±0.012	0.295±0.011	0.303±0.012	0.154±0.003	0.151±0.003	0.148±0.003

Table 2. Effects of habitat manipulation, water deprivation during late gestation and age class on reproductive traits of female common lizards. Results are from linear mixed-effects models for parturition date (A) and generalized mixed-effects models for fecundity (B) and fit fecundity (C). Significant P values are bolded (i.e., $P < 0.05$).

	Factor	df	Wald χ^2	P value
A. Parturition date	Habitat manipulation	2	10.54	0.005
	Water deprivation	1	0.02	0.883
	Age class	2	102.69	<0.001
	Habitat manipulation \times Age class	4	3.90	0.419
	Habitat manipulation \times Water deprivation	2	0.92	0.631
B. Total fecundity	Habitat manipulation	2	4.22	0.121
	Water deprivation	1	0.16	0.694
	Age class	2	81.64	<0.001
	Habitat manipulation \times Age class	4	4.02	0.403
	Habitat manipulation \times Water deprivation	2	0.61	0.738
C. Fit fecundity	Habitat manipulation	2	11.76	0.003
	Water deprivation	1	0.07	0.79
	Age class	2	27.14	<0.001
	Habitat manipulation \times Age class	4	10.39	0.03
	Habitat manipulation \times Water deprivation	2	2.42	0.29

Age = factor with three levels (juveniles, yearlings and adults)

Table 3: Effects of habitat manipulation on physiological traits, including the plasma corticosterone concentration (A), circulating triglyceride levels (B) and the PHA skin swelling response (immunocompetence). Significant P values are bolded (i.e., $P < 0.05$).

	Factor	Pre-winter session			Post-winter session		
		df	Wald χ^2	P value	df	Wald χ^2	P value
A. Corticosterone	Habitat manipulation	2	4.9	0.085	2	6.78	0.034
	Age class	1	0.42	0.516	2	2.34	0.309
	Sex	1	0.29	0.591	1	43.69	<0.001
	SVL	1	0.94	0.331	1	0.19	0.666
	Age class \times Habitat manipulation	2	1.47	0.479	4	16.71	0.002
	Sex \times Habitat manipulation	2	1.32	0.251	2	0.49	0.784
	Age class \times Sex	1	3.00	0.223	2	6.39	0.041
B. Triglycerides	Habitat manipulation	2	3.70	0.15	2	2.10	0.350
	Age class	1	0.50	0.477	2	32.19	<0.001
	Sex	1	0.19	0.662	1	3.90	0.048
	SVL	1	0.07	0.786	1	0.30	0.585
	Age class \times Habitat manipulation	2	0.37	0.831	4	18.54	<0.001
	Sex \times Habitat manipulation	2	2.69	0.260	2	1.23	0.542
	Age class \times Sex	1	1.37	0.241	2	2.59	0.274
C. PHA response	Habitat manipulation	2	5.56	0.062	2	0.2	0.905
	Age class	1	0.01	0.939	2	7.83	0.02
	Sex	1	0.05	0.817	1	10.84	<0.001
	SVL	1	3.97	0.046	1	2.16	0.142
	Age class \times Habitat manipulation	2	2.10	0.350	4	10.47	0.033
	Sex \times Habitat manipulation	2	0.95	0.623	2	3.76	0.153
	Age class \times Sex	1	0.16	0.689	2	2.97	0.227

Age class pre-winter session = factor with two levels (yearling and adult lizards). Age class post-winter session = factor with three levels (juveniles, yearlings and adults).

FIGURE LEGENDS

Figure 1. Annual survival probability of juveniles (grey circle), adult and yearling females (empty circle) and males (black circle) in each habitat quality treatment group. Results are shown as means \pm 95% confidence intervals.

Figure 2. Plasma corticosterone concentration, circulation triglyceride concentration and secondary skin swelling response after PHA injection of adult (squared), yearling (circle) and juvenile (triangle) common lizards per habitat quality treatment group during the pre-winter (A, B and C) and the post-winter capture sessions (D, E and F). Results are shown as means \pm SE.

FIGURE 1

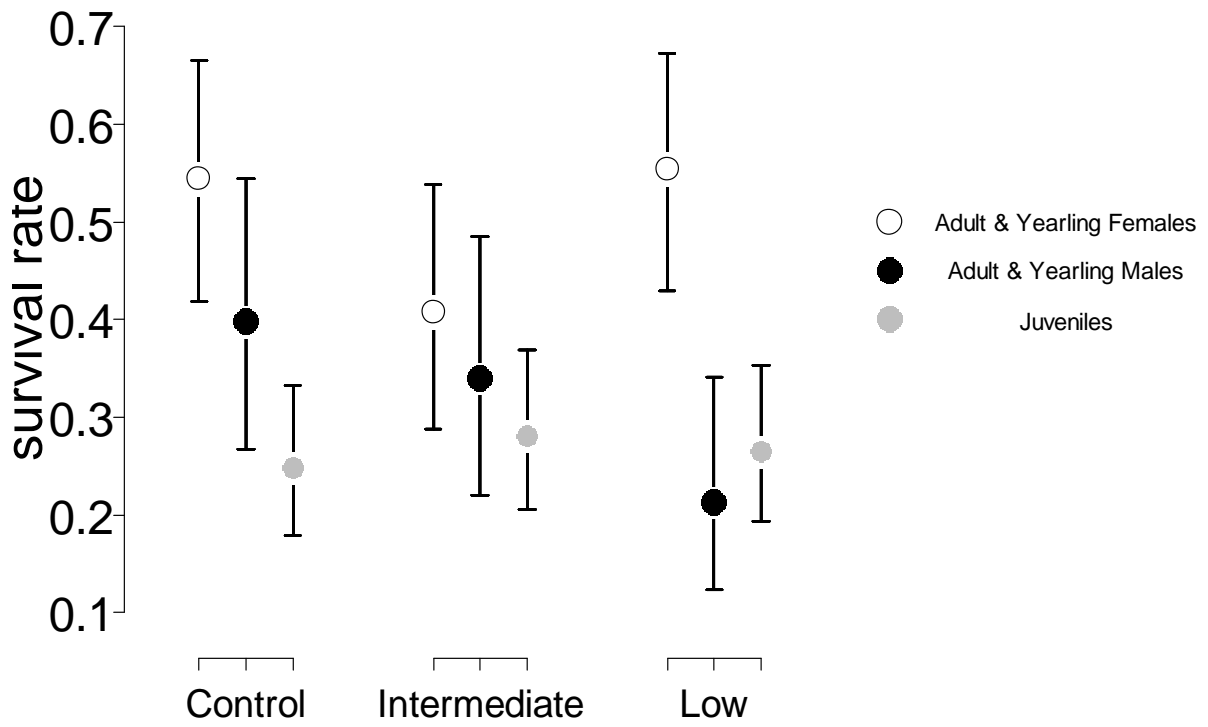
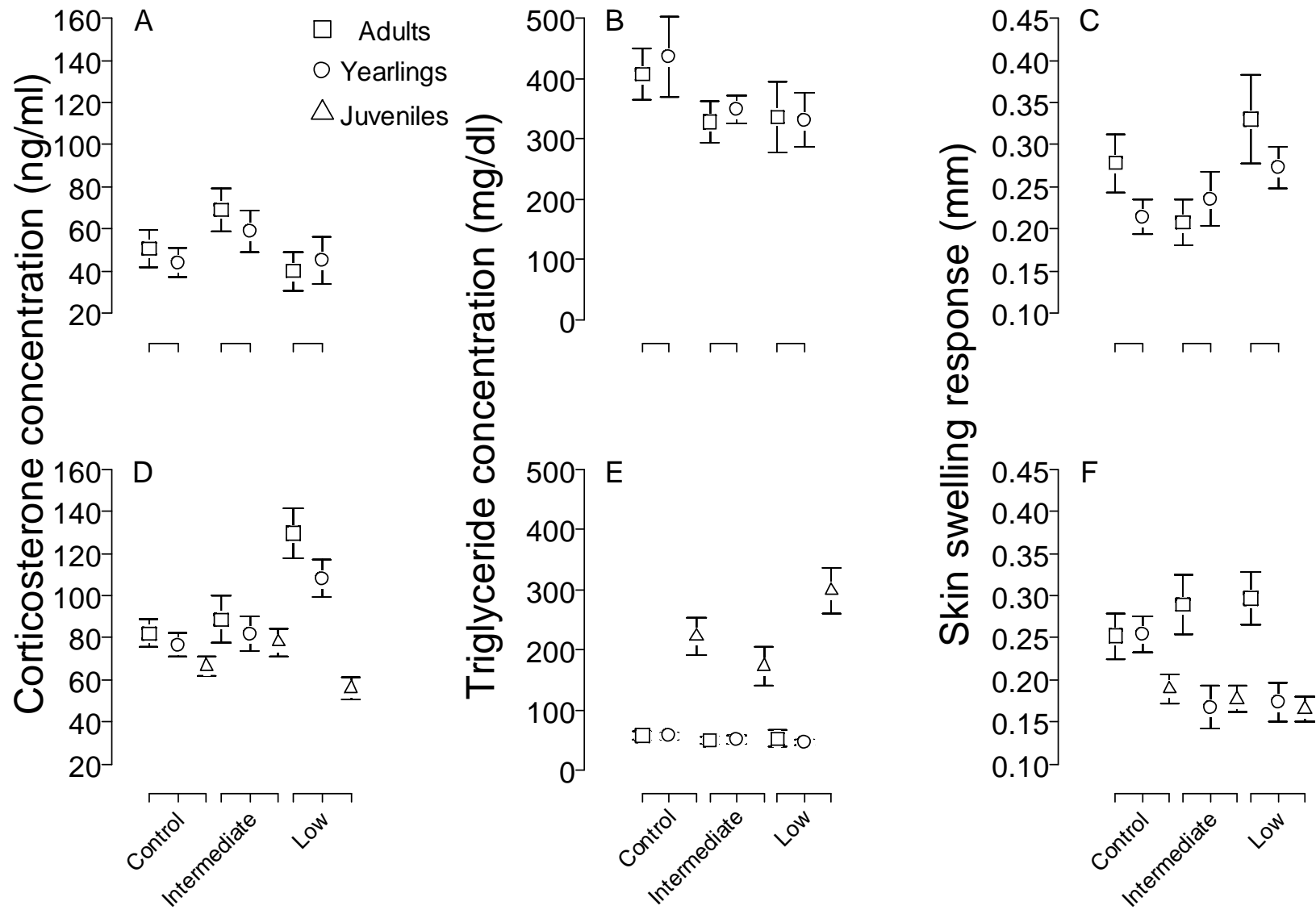

FIGURE 2



Article 2

*Delayed, long lasting and intergenerational effect of a chronic corticosterone elevation during the summer activity period in the common lizard, *Lacerta vivipara*. (En préparation pour *Functional Ecology*)*

Delayed, long lasting and intergenerational effect of a chronic corticosterone elevation during the summer activity period in the common lizard, *Lacerta vivipara*

Rémy Josserand¹, Claudy Haussy¹, Simon Agostini², Beatriz Decencièrè², Jean-François Le Galliard*^{1,2} and Sandrine Meylan^{1,3}

¹ Sorbonne Universités, UPMC Université Paris 6, CNRS, IRD, INRA, Institut d'écologie et des sciences de l'environnement (IEES), 75005 Paris, France

² Ecole normale supérieure, PSL Research University, Département de biologie, CNRS, UMS 3194, Centre de recherche en écologie expérimentale et prédictive (CEREPEP-Ecotron IleDeFrance), 78 rue du château, 77140 Saint-Pierre-lès-Nemours, France

³ ESPE de Paris, Université Sorbonne Paris IV, 10 rue Molitor, 75016 Paris, France

* Author for correspondence

Rémy Josserand

Abstract

1. Individuals have to cope with various stressful events throughout their life. Chronic stressors experienced late in life can have profound impacts on life history strategies on the short term, but whether consequences of chronic stress propagate in time through delayed intra-generational and/or inter-generational effects remains poorly investigated.
2. We used a combined laboratory and field experiment to test if chronic stress late in life has direct and delayed effects on physiological and demographic traits in the common lizard, *Zootoca vivipara*. Using a non-invasive method, we increased artificially plasma corticosterone levels in male and female adults and yearlings during three weeks of the summer, post-reproductive season. We quantified short-term responses in the laboratory, delayed intra-generational effects in field enclosures one month and one year later during the next reproductive season, and delayed inter-generational effects in the first generation of offspring.
3. Our assays of the physiological responses include data on maintenance metabolism, immune capacities (skin swelling response), lipid metabolism (plasma circulating triglycerides) and oxidative stress (plasma antioxidant barriers and oxidative damages).
4. Relative to placebos, lizards treated with corticosterone had higher body condition and lower oxidative damages but a decreased skin swelling response after the laboratory manipulation.
5. Delayed responses in field enclosures were of the three types. First, we found catch-up growth for body mass such the placebos had similar body conditions as soon as one month after the laboratory manipulation. Second, we found persistent differences in oxidative damages during a month but not during a year after the experiment. Third, during the next reproductive season, corticosterone-treated females had higher levels of plasma lipids, whereas corticosterone-treated individuals had a higher skin swelling response.
6. Thus, the chronic corticosterone increase had no effect on life history strategies (growth, survival and reproduction) despite multiple, independent effects on physiological traits.

Introduction

Throughout their life, individuals face different stressors, such as predation, competition or environmental changes, and behavioral and physiological strategies have evolved to avoid deleterious effects of such stressors. Among vertebrates, the adrenocortical response, characterized by a rapid rise of glucocorticoid secretion in response to a wide range of stressor stimuli, is one of the most conserved physiological mechanisms for that purpose (Wingfield 2003). The elevation of glucocorticoid secretion after a stressful event induces a cascade of changes to promote immediate survival by reallocating energy from storage to activity (Sapolsky, Romero & Munck 2000; Crespi *et al.* 2013). Indeed, glucocorticoids are intimately associated to metabolic activities involved in energy balance (Sapolsky *et al.* 2000; Solomon *et al.* 2011), which in turn controls growth, reproduction, and survival (Steyermark 2002; Artacho & Nespolo 2009). Increased glucocorticoid secretion facilitates food acquisition (Sapolsky *et al.* 2000) and transfer of energy from storage to the blood stream by stimulating gluconeogenesis and mobilization of free fatty acids from muscle, fat tissue, and liver (Peckett, Wright & Riddell 2011).

In addition, glucocorticoids are powerful regulators of immune functions (Johnson *et al.* 1992; Dhabhar & McEwen 1997; Dhabhar 2002; Kusnecov & Rossi-george 2002). High chronic levels of plasma glucocorticoid can suppress immune functions, which may promote energy conservation to deal with the immediate demands imposed by the stressors (Sapolsky *et al.* 2000). A high secretion of glucocorticoids has also been associated to oxidative stress increase (Sahin & Gümüşlü 2007). Therefore, the extension of the stressful event and the increase of glucocorticoids associated can also induce deleterious effects such as immune depression, lower survival or reproduction failures (reviewed in Crespi *et al.* 2013). The allostatic load model of McEwen & Wingfield (2003) proposes that the balance between these benefits and costs of the glucocorticoid stress response depends on the energetic demands induced by a stressor (called the "allostatic load") to relative to the amount of energy available in the environment. The allostatic load, defined as the energy requirement to support the demands of daily and seasonally stressful activities, should increase with higher levels of circulating glucocorticoids

and should provide an integrative measure of the physiological and life history changes induced by environmental stressors (Stewart 2006).

The ecological relevance of these glucocorticoid effects has been well investigated in both captive and natural populations (Crespi *et al.* 2013) where energy expenditure, immunity and oxidative stress responses can be potentially important fitness related traits (e.g., Eraud *et al.* 2005; Alonso-Alvarez *et al.* 2006). Physiological and demographic responses are generally measured during or right after the stressful event and could be referred to as “direct” effects of chronic elevation of glucocorticoids. Yet, the life of individuals is made out of a series of critical events or life stages, and there is accumulating evidence that variation at given life stage can impact the following life stages through delayed, intra-generational effects or even through inter-generational effects (Braastad 1998; Beckerman *et al.* 2002; Kaiser & Sachser 2005). In particular, a prolonged stressful event, such as food restriction or increased competition among conspecifics, can have long lasting effects throughout the entire life of the individual and may shift its life history strategy (reviewed in Beckerman *et al.* 2002). Yet, we currently lack information to determine if short-term, direct effects of glucocorticoids can persist throughout life, or if compensatory mechanisms exist as observed for other physiological processes in fluctuating environments (e.g., body growth: Metcalfe and Monaghan 2001).

A chronic elevation of glucocorticoids may have organizational effects and thus could influence ontogenic trajectories of morphology and behavioral traits on the long-term (Schoech, Rensel & Heiss 2011). For example, Spencer *et al.* (2003) supplemented nestlings of zebra finch (*Taeniopygia guttata*) with corticosterone (the major glucocorticoid in birds, amphibians, reptiles and rodents) from 5 to 30 days post-hatch and found direct, negative effects on growth as well as delayed, long-term effects on song characteristics in adults. In the same way, Kitaysky *et al.* (2003) found that corticosterone exposure during development impaired learning and spatial abilities over the long-term. In particular, exposure to elevated glucocorticoids early in life may have profound long-term effects on the physiology, behavior, and life history (Dufty, Clobert & Moller 2002; Matthews 2002; Meylan & Clobert 2005; Blas *et al.* 2007). Exposure to early life stressors can disrupt HPA axis

regulation, and cause elevated basal glucocorticoids (Kitaysky *et al.* 2005; Walker, Boersma & Wingfield 2005) and increased glucocorticoid responsiveness to acute stress (Schoech *et al.* 2011). These organizational effects can even be transmitted across generations through maternal effects (Catalani *et al.* 2000; Schöpper *et al.* 2011). Corticosterone is known to induce phenotypic plasticity at adulthood as well (Dufty *et al.* 2002), but long lasting, delayed effects of stressful events in late life stages have been little investigated so far.

Here, we used common lizards (*Zootoca vivipara*) as a model system to investigate for the first time the joint direct and delayed physiological and demographical effects of a prolonged glucocorticoid increase late in life, including both intra-generational and inter-generational responses. Direct effects of chronic corticosterone increase in adult common lizards induce changes in resting and activity metabolism, immune capacities, oxidative stress, and several behaviors such as food consumption, locomotion and basking (e.g., Cote, Clobert, Meylan and Fitze 2006, Meylan and Clobert 2005, Meylan, Haussy and Voituron 2010). Moreover, a chronic corticosterone increase in the laboratory improves future survival of adult males but not females suggesting sex-specific long lasting, delayed effects (Cote *et al.* 2006). The species is ovoviparous and has an extended gestation period characterized by water and mineral transfers between mothers and embryos (Stewart, Ecaj & Heulin 2009). Increased corticosterone secretion during gestation can change the morphology, activity and dispersal behavior of juveniles at birth (De Fraipont *et al.* 2000; Meylan *et al.* 2002; Meylan, De Fraipont & Clobert 2004), but can also influence their growth and survival rate later in life (Meylan & Clobert 2005). However, we do not know if increased corticosterone secretion in females outside of the gestation period can cause maternal effects.

To quantify the potential for long-lasting intra- and inter-generational effects of glucocorticoids, we used a three-stage laboratory and field experiment where we first exposed yearling and adult males and females to a chronic corticosterone exposure during the summer, post-reproductive season. We next released them in outdoor populations until the next reproductive season, and then followed for an additional season their first generation of offspring. In yearling and adults, we measured

physiological and demographical consequences of the corticosterone manipulation directly after the treatment, one month later in the field and one year later in the field. We investigated four sets of physiological parameters to identify most relevant components of the adrenocortical response, including standard metabolic rate, immune capacities, oxidative stress and blood lipid concentration. Consequences on life history strategies were estimated by quantifying reproductive performances, growth, survival rate and the intergenerational effects on the first generation of offspring. Directly after the end of the laboratory manipulation, we expected an increase of baseline corticosterone in each age class, as well as of triglyceride concentration due to the corticosterone action on lipolysis (Karatsoreos *et al.* 2010; Peckett *et al.* 2011), of oxidative stress (Cote *et al.* 2010b), and of body leanness (Cote *et al.* 2006, 2010a). In contrast, we predicted no change in immune response in accordance with previous work (Meylan, Haussy & Voituren 2010) but an increase of standard metabolic rates in females and a decrease in males (Cote *et al.* 2010a; Meylan *et al.* 2010). Since previous works have shown sex-specific delayed effects on survival in adults (Cote *et al.* 2006), we expected different long-lasting physiological responses between sexes. If chronic corticosterone exposure increases allostatic load, we predicted a long-term decrease of immune capacities and an increase of oxidative stress, blood lipid circulation and baseline corticosterone (McEwen & Wingfield 2003; Cote *et al.* 2006; Romero, Dickens & Cyr 2009). Moreover, since the energetic costs of maintenance change between age classes, sex and reproductive cycles (McEwen & Wingfield 2003; Massot *et al.* 2011), we would expect stronger delayed effects during the reproductive period, one year after the manipulation, when energetic demands are highest.

Material and methods

Model species

The lizard *Zootoca vivipara* is a small ovoviparous (adult snout-vent length SVL : 53-77 mm) species inhabiting humid habitats across northern Eurasia. It is characterized by a 3 to 4 year life expectancy, continuous growth and plastic life history (Le Galliard *et al.* 2005, Mugabo *et al.* 2010,

Mugabo et al 2011) Natural populations are structured in three age classes: juveniles (newborns individuals), yearlings (1 to 2 year old individuals) and adults (2 year old or more). In our study site, males start to emerge from hibernation around the beginning of March, followed shortly by juveniles and by females few weeks later. Mating period starts upon emergence of females (Bauwens et al 1989, Bauwens and Verheyen 1985). From June to July, females lay an average clutch of five non-calcified eggs (range 1-13). Offspring hatch shortly after parturition and are immediately autonomous. Lizards enter in hibernation in October.

Capture and rearing condition

Lizards were captured between 18 and 26 May 2014 in outdoor enclosures (10 × 10 m) at the Centre de Recherche en Ecologie Expérimentale et Prédictive (Saint-Pierre-lès-Nemours, France, 48°17'N, 2°41'E) and returned to the laboratory (Lecomte & Clobert 1996). At laboratory, animals were identified by their unique toe clip code and measured for body size (SVL, ± 0.5 mm) and body mass (± 1 mg). They were then maintained in individual terraria (25 × 15 × 16 cm) with a shelter, peat soil as substrate and opportunities for optimal thermoregulation. We used incandescent light bulbs (25 W) for 9 h/d to ensure a thermal gradient from room temperature at 17-23°C to 35-38°C below the bulb during daytime. Room temperature was maintained at 16°C from 21:00 to 7:30 (night time) and at 25°C during daytime. We provided lizards with water and food *ad libitum* and kept all individuals under strictly identical conditions until gravid females gave birth (20 June to 14 July). Immediately after parturition, newborns were separated from their mother, marked by toe clipping and measured for their SVL and body mass, and immediately released in an outdoor enclosure.

Experimental design

We selected randomly 69 adult and 61 yearling females and 34 adult and 60 yearling males in our capture sample. At day 1 of the experiment, lizards were then randomly distributed into a corticosterone group or a placebo group. At day 0, prior to the start of the experiment, there was no difference in SVL ($\chi^2 = 0.35$, $df = 1$, $p = 0.553$) and body mass ($\chi^2 = 0.14$, $df = 1$, $p = 0.70$) between

treatment groups. We increased the circulating levels of corticosterone using a non-invasive method designed by Meylan et al. (2003). This method allows simulating a realistic, chronic physiological stress response because the increase of the baseline concentration of corticosterone stays within the natural range of variation and lasts during the treatment. Moreover, this method did not cause mortality during the treatment in lizards or abortion in pregnant females. We diluted corticosterone (Sigma-Aldrich, France, C2505-500mg 92%, C₂₁H₃₀O₄) in commercial sesame oil, which facilitates skin penetration of corticosterone, to reach a final concentration of 3µg corticosterone for 1µl of sesame oil. During the laboratory experiment, we applied 4.5 µL of corticosterone mixture (corticosterone group) or pure sesame oil (placebo) each evening between 20:00 h and 21:00 local time. Lizards were treated during 21 days, a duration corresponding to 10-20% of the yearly activity period. Previous studies have shown that this treatment period was sufficient to cause physiological and demographic effects in this species without mortality during the treatment experiment (Meylan, Dufty & Clobert 2003; Cote *et al.* 2006).

At the end of the laboratory experiment, all lizards were released randomly in 10 outdoor enclosures from 20 July to 6 August. We used the standard physical set-up and maintenance procedures in each enclosure (see Lecomte and Clobert 1996). Enclosures were all equipped with two permanent watering holes (40L plastic tanks), four piles of stones and logs used as shelters and basking sites by lizards, and a dense and tall vegetation (approximately 40 cm high) was kept throughout the experiment. We visited all enclosures repeatedly between 2 to 10 September 2014 and recaptured all live animals. Captured lizards were then maintained during 4 days in laboratory for subsequent measurements (see below) before being released in their capture enclosure. A second visit after the wintering period was done between 18 May to 12 June and captured lizards were again maintained in the laboratory. Gravid females were maintained until the parturition to assess their reproductive traits (see below). Immediately after parturition, newborns were separated from their mother, marked by toe clipping and measured for their SVL and body mass and each family were randomly assigned to one of the 10 populations. Newborns from corticosterone and placebo

groups were recaptured in September 2015 and May-June 2016 to assess size, growth body mass, and annual survival.

Demographic measurements

We monitored populations during one year to assess body size and condition, growth, survival and female reproductive performance one year after the manipulation. We recaptured 164 lizards from the two treatment groups in September 2014 and 107 individuals in May-June 2015. During the summer 2015, 342 juveniles were born and randomly released in 10 outdoor enclosures. We recaptured all surviving juveniles in May-June 2016 (N=70). At each time step of the experiment (pre-experimental, post-experimental, September 2014, and May-June 2015), we sampled blood and measured immune-competence for all animals and whole-organism metabolism for a subset of lizards (see below). At each recapture, lizards were identified by their unique toe clip code and measured for body size and mass. Body growth rates were calculated as the change in SVL between two captures divided by the time interval. We subtracted the number of inactive days spent in hibernation for the growth rate whenever needed. Hibernation is assumed to be from end of October to beginning of March. We estimated annual survival probabilities between summer 2014 and summer 2015 for adult and yearling lizards and between summer 2015 and summer 2016 for juveniles. We assumed that capture probability was very close to 1 (Le Galliard, Ferriere & Clobert 2005). To assess reproductive performance of females, we counted live newborns, dead newborns and aborted or unfertilized eggs of each clutch. Parturition date, total fecundity (live, dead and aborted newborns), fit fecundity (live newborns) and newborn characteristics (sex, SVL, body mass) were recorded.

Blood sample and plasma measurements

Blood was always sampled in the infra-orbital sinus of lizards. All samples were collected within 3 min of removal of an animal from its home cage to avoid the handling-induced increase in plasma corticosterone levels (Dauphin-Villemant & Xavier 1987). Plasma was obtained by centrifugation at c.a. 5,000 G for 3 minutes of the blood samples and was stored at -40°C until assay. At each

session, we randomly subsampled from each age class, sex and treatments a balanced number of plasma samples. For subsequent analyses, 2-6 individuals from each class per session were assigned to the corticosterone level measurement and 3-10 individuals were used to measure triglyceride, antioxidant barrier and oxidative damage. Corticosterone level was measured with a competitive enzyme-immunoassay method using corticosterone EIA (IDS Corticosterone EIA kit, ref AC-14F1, IDS EURL Paris, France) after 1:10 dilution of all samples. This method quantifies total plasmatic corticosterone using a polyclonal corticosterone antibody and is based on a colorimetric assay of absorbance at 450 nm. Estimates of corticosterone levels were highly repeatable (intra-plate repeatability: $n = 63$, $F_{3,60} = 102.61$, $P < 0.001$, $r = 0.89$; inter-plate repeatability: $n = 63$, $F_{16,47} = 51.3$, $P < 0.001$, $r = 0.93$). Levels of circulating triglyceride were measured in plasma by colorimetric assays using 2.5 μL of plasma (Triglyceride Colorimetric Assay kit, ref. 10010303, Cayman Chemical, USA). This method quantifies the total triglyceride by using a chain of three enzymatic reactions ending up in hydrogen peroxide production, which is converted into quinoneimine dye quantified by absorbance at 540 nm. The quantification was highly repeatable (inter-plate repeatability: $n = 24$, $F_{4,20} = 795.48$, $P < 0.001$, $r = 0.99$, intra-plate repeatability : $n = 24$, $F_{2,22} = 728.06$, $P < 0.001$, $r = 0.98$).

To assess oxidative stress in lizards, we used two complementary colorimetric tests. First, we used d-ROMs test (MC003, Diacron International, Via Zircone 8, 58100 Grosseto (GR), Italy) to assess the concentration of reactive oxygen metabolites in 4 μL plasma sample. Hydroperoxide of samples was reacted in presence of iron to generate alkoxyl and peroxy radicals. These radicals were oxidized in an alkyl-substituted aromatic amine thus transforming them in a pink-colored derivative, and samples were read at 540nm after 75mn of incubation at 37°C. Second, to assess the antioxidant barrier of plasma, we used the OXY-Absorbent test (MC435, Diacron International, Via Zircone 8, 58100 Grosseto (GR), Italy) after 1:100 dilution of 3 μL of plasma. Five μL of diluted samples were used. This method is initiated with the saturation of the antioxidant barrier by addition of hypochlorous acid (HClO). After 10mn of incubation at 37°C, the residual HClO is

transformed to alkyl-substituted aromatic amine thus giving a pink-colored derivative and samples are read at 540nm. These two tests were also highly repeatable (d-ROMs test : inter-plate repeatability : $n = 16$, $F_{4,12} = 37.53$, $P < 0.001$, $r = 0.91$; intra-plate repeatability : $n = 16$, $F_{2,14} = 46.69$, $P < 0.001$, $r = 0.88$ and OXY test : inter-plate repeatability : $n = 18$, $F_{4,14} = 153.26$, $P < 0.001$, $r = 0.88$; intra-plate repeatability : $n = 18$, $F_{3,15} = 214.96$, $P < 0.001$, $r = 0.98$). Prior to the beginning of the manipulation, no difference were observed between treatment groups for corticosterone ($\chi^2 = 0.99$, $df = 1$, $p = 0.318$), triglyceride concentration ($\chi^2 = 0.06$, $df = 1$, $p = 0.81$), oxidative damage ($\chi^2 = 0.09$, $df = 1$, $p = 0.756$) and antioxidant barrier capacity ($\chi^2 = 0.15$, $df = 1$, $p = 0.693$).

Evaluation of immune capacities

Immuno-competence was assessed by measuring skin swelling in response to an injection of a mitogen, the phytohaemagglutinin (PHA), which does not require blood sample. This procedure triggers a local haemagglutination and leukocyte infiltration and involves both adaptive and innate immune components (Martin *et al.* 2006; Brown, Shilton & Shine 2011). This implies that primary responses measured in naive animals may differ from the secondary responses measured in animals already exposed to PHA earlier in their life. In order to avoid biases due to differences between first and subsequent injections, we injected all animals with a solution of phosphate buffered saline (PBS) containing 2.5 mg/mL of PHA (PHA-M, Sigma-Aldrich; reference 9008-97-3) in the right posterior leg in order to elicit a primary response. To obtain our subsequent measurements, we then administered a second subcutaneous injection of the same PBS-PHA solution in the right posterior leg and quantified the secondary skin-swelling response. Time elapsed between the two injections was of a minima of 7 days. Previous study in this species have shown no correlation between the primary and the secondary swelling responses, but an increase in the swelling response after a first exposure to PHA (Mugabo *et al.* 2015). Just before and 12h after the injection, we measured the thickness of the right posterior leg using a spessimeter (Mitutoyo, ID-C112, Kanagawa, Japan) with an accuracy of 0.01 mm. We spaced the two measurements by 12 hours because previous

experiments had found that this coincided with the greatest swelling response (Mugabo *et al.* 2010).

Swelling response was calculated as the difference in leg thickness between the post- and pre-injection measurements. At the start of the experiment, we did not find difference between treatment groups for PHA response ($\chi^2 = 0.72$, $df = 1$, $p = 0.394$).

Whole-organism metabolic expenditure

We defined a random sub-sample of 60 males from the two age classes and 60 females from the two age classes to measure repeatedly the resting metabolic rate during the four measurement periods. All individuals were measured during the pre-experiment and post-experiment sessions and only recaptured animals were measured during the sessions of September 2014 and May-June 2015, causing unequal sample sizes. The resting metabolic rate, or standard metabolic rate (SMR) for ectotherms, is the minimum energetic cost of maintenance estimated in fasting individuals at rest and at a given temperature, during the time period when the animals are normally active. Here, we measured the SMR after a fasting period of 3 days to ensure a post-absorptive state (Artacho, Jouanneau & Le Galliard 2013). Before the measurement, lizards were moved in a dark room maintained at 20°C during 3-4 hours and were then placed in their metabolic chamber during 1 hour at 16°C before the beginning of the measurements. This temperature was chosen because it is a body temperature where common lizards are at rest. All measurements were recorded between 08:00 pm and 08:00 am. The CO₂ production was sampled during 40 mins for each animal with a multiple-channel, flow-through respirometry system (Qubit Systems, Kingston, ON, Canada) compounded of a CO₂ analyzer (S157) connected to a respirometry software (QS Research). Incoming air flowed through columns of sodalime (Spherasorb, Wokingham, Berkshire, RG41 2RZ, UK) and drierite to remove CO₂ and H₂O, respectively. After the absorbent columns, air was pushed through seven channels of a multiplexer at 150 mL.min⁻¹. Six channels were used for measuring lizards and one channel for the CO₂ reference. Outgoing air was pushed into the CO₂ analyzer at 50 mL.min⁻¹. Metabolic records of CO₂ were processed by a macro program C950 data acquisition software (Qubit systems) in order to transform the ppm measure of CO₂ production in

mL per hour, which takes into account the flow rate. One of the measurements out of 377 failed due to poor convergence of the CO₂ production curve. From three previous studies of SMR in the common lizard, we are confident that the CO₂ production reflects well variation in whole-organism respiration because (1) measures of CO₂ production have a greater signal-to-noise ratio with respect to O₂ consumption and are thus more reliable; (2) measures of O₂ consumption and CO₂ production are typically correlated but their ratio (RQ) is unreliable when calculated separately for each individual (Artacho *et al.* 2013); and (3) measures of SMR accounting for O₂ consumption and corrected for RQ are very strongly correlated with measures of CO₂ consumption (Le Galliard, unpub. data).

Statistical analyses

Analyses were performed with R 3.1.0 (R Core Team 2014, [https:// www.r-project.org/](https://www.r-project.org/)) using the *lmer* statistical procedure available in the *lme4* package for linear mixed models (Bates et al. 2015) and *lm* procedure from *stats* package for linear models. Analyses of variance procedure were done with the *Anova* procedure from *Car* package (John & Weisberg 2011). Analyses of corticosterone and triglyceride concentrations, antioxidant barrier and oxidative damage, swelling response, CO₂ production and body mass from the post-experimental session were done by calculating the difference between the post-experimental (after 20 days of treatment application) and the initial measurement and using this as a response variable in a linear model. Data for corticosterone, triglyceride concentrations, antioxidant barrier, oxidative damage, swelling response and CO₂ production were log-transformed to meet the normality assumption. All initial models included as fixed factors the effects of treatment group, age class, sex and their first-order interactions. Because metabolism and so CO₂ production may vary depending on the mass, we used the mass gain between pre and post experimental session as covariate. SVL was used as covariate in other model except for body mass gain where the differential SVL between pre and post experimental session was used. In all models, we used initial measurement (pre-experimental session) as covariate.

During the September 2014 session, we analyzed the same traits with linear mixed models including population identity as a random factor. physiological measurements were also log-transformed to fit the normality assumption. To assess the body mass change and the CO₂ production, we used the difference between the September and the post-experimental measurements since repeated measures on the same animals were obtained for these traits. All initial models included as fixed factors the effects of treatment group, age class, sex and their first-order interactions. In addition, we used SVL as covariate or the differential SVL between the September 2014 session and the post-experiment session as covariate for body mass. Instead of the differential SVL, we used in the case of the CO₂ production the differential mass between September 2014 session and the post-experimental. The same procedures were used to analyze data collected during the May-June 2015 session. In addition, we analyzed body size growth rate from September 2014 to May-June 2015 with a linear mixed model and population as random effect. Initial model included as fixed factors the effects of treatment group, age class, sex and their first-order interactions, we included also the effect of initial SVL to placebo for growth deceleration with increasing body size and the effect of the date of release to placebo for seasonal changes in growth rates. Annual survival was similarly analyzed with mixed-effect logistic regressions including a logit link and binomial error term. Initial SVL was used as covariate to placebo for size effect on survival. All adult and yearling females bred during the summer 2015. Parturition date and offspring characteristics (SVL and body condition) were analyzed with linear mixed models. Total fecundity and fit fecundity were analyzed with mixed effect log regressions including a log link and a Poisson error term. Body growth and annual survival of individuals born during the session of the May-June 2015 were analyzed with the same procedures including the mother identity as an additive random effect in mixed models.

In all cases, parameters of linear mixed models were estimate with REML (restricted maximum likelihood) procedure, whereas a Laplace approximation of the maximum likelihood was used in the case of logistic and Poisson regressions. Fixed effects of mixed models were tested with

Wald χ^2 statistics or Fisher test in the case of linear models. A minimum adequate model was obtained by a backward procedure where we removed non-significant terms one by one. Assumptions of normality and homoscedasticity were verified and over-dispersion of logistic and log regression were tested with a Pearson's chi squares. When a minimum adequate model was found, we used the Tukey's procedure to conduct post hoc tests (pairwise comparisons) with the lsmeans package (Lenth 2015). Results are presented mean \pm standard error or [lower,upper] at 95% confidential interval unless otherwise stated.

Results

Direct physiological effects

Relative to the placebo, the corticosterone treatment increased significantly corticosterone concentration until the end of the laboratory manipulation (Table 1, Figure 1A) and tended to decrease swelling response (Table 1, Figure 1C), but it did not influence circulating plasma triglyceride concentration (Table 1, Figure 1B), antioxidant barrier (Table 2, Figure 2A), and standard metabolic rate ($F_{1,114} = 0.06$, $P = 0.807$). In addition, oxidative damages were more important in placebo than in corticosterone-treated lizards (Table 2, Figure 2B). Body mass increased slightly on average during the laboratory experiment and corticosterone treatment significantly increased body mass change (ANOVA: $F_{1,207} = 11.94$, $P < 0.001$; contrast = 0.2 ± 0.06 g, Figure 3A). Moreover, body mass change was significantly higher in females than in males ($F_{1,207} = 7.3$, $P = 0.007$, contrast = 0.16 ± 0.06) and in adults than in yearlings ($F_{1,207} = 227.65$, $P < 0.001$, contrast = 1.25 ± 0.08). Body mass change was also negatively related to the initial body mass ($F_{1,207} = 358.74$, $P < 0.001$, estimate = -0.73 ± 0.04).

Delayed physiological and demographical effects

After the manipulation, baseline corticosterone concentration returned to similar levels between placebo and treatment groups (Figure 1D), with significant differences between age and sex classes during the pre-winter period (Table 1). In sharp contrast, we found a delayed effect on triglyceride concentration and swelling response in May-June 2015 but not in September 2014. Triglyceride

concentration was significantly higher in females from the corticosterone group than the placebo (contrast = 0.94 ± 0.036 , $df = 22.48$, $t = 2.36$, adjusted $P = 0.027$) but not in males (contrast = -0.53 ± 0.37 , $df = 19$, $t = -1.43$, adjusted $P = 0.17$), whereas swelling response of the corticosterone-treated group was significantly higher than in placebo group (see Table 1, Figure 1H & 1I). At the same time, we found delayed effects on oxidative damage but not for antioxidant barrier (see Figure 2C-F and Table 2): oxidative damage was significantly lower in corticosterone-treated group than the placebo in September 2014 (Figure 2D). We did not observe delayed effect of corticosterone treatment on standard metabolic rate (September 2014: $\chi^2 = 0.07$, $df = 1$, $P = 0.789$; May-June 2015: $\chi^2 = 0.39$, $df = 1$, $P = 0.532$).

Adult and yearling body growth between release in 2014 and recapture in May-June 2015 included a negative effect of initial SVL (slope = -0.0028 ± 0.0002 , $\chi^2 = 200.54$, $df = 1$, $p < 0.001$) and a sex effect ($\chi^2 = 254.8$, $df = 1$, $p < 0.001$) with females growing faster than males (post-hoc test: contrast = 0.036 ± 0.002 , $t = 17.326$, $df = 97.13$ adjusted $P < 0.001$). There was however no difference between treatment groups (placebo: 0.0164 ± 0.0015 mm.days⁻¹, corticosterone: 0.0151 ± 0.0016 mm.days⁻¹; $\chi^2 = 0.43$, $df = 1$, $p = 0.513$). During the interval time between release and September 2014, lizards from the corticosterone treatment gained less body mass than placebos ($\chi^2 = 9.67$, $df = 1$, $P = 0.002$, Figure 3). Body mass change during this period was positively related to size growth (estimate = 0.07 ± 0.02 , $\chi^2 = 12.25$, $df = 1$, $P < 0.001$) and differed between sex and age classes ($\chi^2 = 10.64$, $df = 1$, $P = 0.001$) with a significantly higher body mass gain in yearling males than in yearling females (contrast = 0.28 ± 0.08 , $T = 3.355$, adjusted $P = 0.006$), but without sexual difference in adults (contrast 0.15 ± 0.1 , $t = 1.4$, $df = 149.06$, adjusted $P = 0.5$). Moreover adult females gain more mass than yearling females during this period (contrast = 0.54 ± 0.15 , $t = 3.58$, adjusted $P = 0.003$) but we did not observe difference between age classes in males (contrast = 0.11 ± 0.15 , $t = 0.76$, adjusted $P = 0.872$). We found a marginal difference between treatment groups for mass change between September 2014 and the post experimental session ($\chi^2 = 3.48$, $df = 1$, $P = 0.062$) with a lower mass gain in corticosterone-treated group (contrast = $0.18 \pm 0.06g$). Mass gained

during this time interval was positively correlated with SVL gained (estimate = 0.06 0.01, $\chi^2 = 12.25$, $df=1$, $P < 0.001$) and negatively correlated to the post-experimental mass value (estimate = -0.39 0.07, $\chi^2 = 31.45$, $df=1$, $P < 0.001$). Annual survival rate was not different between treatment groups (placebo = 0.40 [0.26, 0.56] 95%CI and corticosterone = 0.52 [0.37, 0.67], $\chi^2 = 2.61$, $df = 1$, $P = 0.11$) and between sexes ($\chi^2 = 2.18$, $df = 1$, $P = 0.14$) but survival rate of yearling lizards was slightly higher than adults (adults = 0.35[0.22, 0.50]; yearlings = 0.58[0.43,0.71], $\chi^2 = 3.88$, $df = 1$, $P = 0.049$). Similarly, we found no delayed effects of corticosterone enhancement on female reproductive traits, including parturition date, number of live offspring and reproductive effort (all $P > 0.1$).

Inter-generational effects

Juvenile born from corticosterone-treated females did not differ from those born from placebo females for body size (SVL: $\chi^2 = 0.54$, $df = 1$, $p = 0.46$) and body condition ($\chi^2 = 0.8$, $df = 1$, $p = 0.37$), however juvenile females were longer than males ($\chi^2 = 68.81$, $df = 1$, $p < 0.001$) and males were in better condition at birth ($\chi^2 = 21.97$, $df = 1$, $p < 0.001$) than females. Annual survival rate of juveniles between 2015 and 2016 was not different between treatment groups of mothers (placebo = 0.19[0.13, 0.27], corticosterone = 0.24[0.18, 0.32], $\chi^2 = 0.97$, $df = 1$, $P = 0.323$) such as sex (males = 0.25[0.19, 0.33], females = 0.18[0.11, 0.25], $\chi^2 = 2.58$, $df = 1$, $P = 0.108$) and body condition ($\chi^2 = 0.17$, $df = 1$, $P = 0.679$). The annual body growth rate of juveniles born from corticosterone-treated females did not differ from placebo and treatment females (placebo = 0.1279 ± 0.0023 and corticosterone = 0.1301 ± 0.003 , $\chi^2 = 0.68$, $df = 1$, $p = 0.411$). Female juveniles grew faster than males (Post hoc test: estimate difference = 0.0053 ± 0.0025 , $t = 2.08$, $df = 64.09$ adjusted $P = 0.041$ / $\chi^2 = 3.92$, $df = 1$, $p = 0.048$) and growth rate was negatively correlated with the birth date (estimate = -0.0008 ± 0.0003 , $\chi^2 = 8.77$, $df = 1$, $p = 0.003$).

Discussion

Our combined laboratory and field experiment evidenced direct and delayed effects of chronic corticosterone elevation on physiological parameters related to lipid metabolism, immune capacities

Dégradation de l'habitat et réponse au stress : de la physiologie à la biologie de la conservation and oxidative stress, independently of age classes but with some differences between sexes. In addition, body mass increased more rapidly in the laboratory in corticosterone-treated lizards, but we later observed compensatory responses in the field with stronger relative body mass change in placebo-treated lizards. In contrast, maintenance metabolism, survival, reproduction of lizards and the demographic traits of their first generation of offspring were relatively insensitive to our corticosterone manipulation. Thus, experimental enhancement of corticosterone concentration, which was used to simulate a chronic stressful event during adulthood, was a critical determinant of physiology and body mass dynamics, but not of the life history strategy.

Lasting and delayed effect on immune and antioxidant capacities

As in previous studies using the same method of hormonal manipulation (Meylan *et al.* 2003, 2010; Cote *et al.* 2006, 2010a), a cutaneous application of corticosterone for 21 days induced an increase of individual corticosterone level about 3 times higher in the corticosterone group (placebo concentration = 48.34 ng.ml^{-1} vs $167.34 \text{ ng.ml}^{-1}$). This short-term elevation was associated with a slightly lower immune response and less oxidative damage. The inhibition of the swelling response by the corticosterone treatment is in accordance with the immunosuppressive actions of the chronic secretion of corticosterone (Dhabhar & McEwen 1997; Berger *et al.* 2005; Martin *et al.* 2005), but runs counter the conclusions of a previous study done in the same species on pregnant females, where no effect was detected (Meylan *et al.* 2010). These results may be explained by the specific constraints imposed by gestation on the adrenocortical response. Indeed, during the reproduction and especially during gestation, the elevation of corticosterone often facilitates some functions to prevent deleterious effect (Landys, Ramenofsky & Wingfield 2006; Crespi *et al.* 2013). Conserving high cellular defenses during the reproduction period can be essential because of the importance of cellular defenses against diseases caused by sexual interactions (Richard *et al.* 2012) and because of the costs for embryos of maternal immune depression.

This decrease of the swelling response in corticosterone-treated lizards did not last in the field one month after the end of the laboratory manipulation. Instead, the swelling response measured

several months after the end of the laboratory manipulation, during the next reproductive season, was higher in corticosterone-treated lizards than in placebo group, which runs in the opposite direction of the short-term direct effect observed in the laboratory. We hypothesize that this response may be adaptive. For example, it has been shown that a higher basal level of corticosterone in males resulted in an increase in the number of mating attempts, which may expose individuals to more injury or pathogens (Gonzalez-Jimena & Fitze 2012; Richard *et al.* 2012).

Whereas the immunosuppressive effect of glucocorticoids is well documented (Dhabhar & McEwen 1997; Sapolsky *et al.* 2000; Kusnecov & Rossi-george 2002), the observed decrease of oxidative damage was more surprising, especially since the treatment did not influence the antioxidant barrier. A chronic application of corticosterone was previously found to increase oxidative stress under some circumstances, as shown by higher levels of lipid peroxidation in muscular tissues, but had complex and contrasted effects on antioxidant enzyme activities (Cote, Meylan, Clobert, & Voituren, 2010; Meylan, Haussy, & Voituren, 2010). However, our result is in accordance with a recent study in this species using the same laboratory protocol, where we found that liver mitochondria from corticosterone-treated lizards produced less reactive oxygen species without change in the metabolic rate or oxygen consumption (Voituren *et al.* unpublished). During a chronic stress, oxidative damage is expected to level up because higher circulating levels of corticosterone should increase the basal metabolic rate, locomotor activity and foraging behaviors (Costantini, Marasco & Møller 2011). The use of oxygen by metabolism produces reactive oxygen species (ROS), which in turn can result in oxidative damage if ROS generation exceeds antioxidant defenses. In our study, the standard metabolic rate of lizards did not change between treatment groups, implying that the decrease of oxidative damage during the laboratory manipulation was not due to changes in the maintenance energetic costs. Instead, we propose that the decrease of oxidative damage may be an indirect consequence of the decrease of the inflammatory response, which is known to produce free radicals in the blood (Dowling & Simmons 2009; Ashley, Weil & Nelson 2012). The significant difference between groups observed during the September 2014,

Dégradation de l'habitat et réponse au stress : de la physiologie à la biologie de la conservation
despite no change of the immune response nor of corticosterone concentration or antioxidant barrier, suggests a carry-over effect of the laboratory manipulation on oxidative damages.

Direct and delayed effect on body mass and lipid metabolism but not on metabolism

Although a positive effect of corticosterone enhancement on basal metabolic rate might be expected (Cote *et al.* 2010a; Meylan *et al.* 2010), the experimental evidence is rather contradictory. In birds, corticosterone elevation has been associated with a reduction of nocturnal metabolism (Buttemer, Astheimer & Wingfield 1991). In contrast, Wikelski *et al.* (1999) found no apparent relationship with resting metabolic rate and corticosterone levels in the white-crowned sparrows (*Zonotrichia leucophrys gambelii*). In our species, the effect of the corticosterone on metabolism appears to be sex and stage dependent. Meylan *et al.* (2010) found an increase of the standard metabolic rate after 21 days of corticosterone application in pregnant females; whereas Cote *et al.* (2010) found a decrease of the standard metabolic rate after 10 days of treatment in adult males and a recent study (Voituron *et al.* unpublished) found no effects in yearlings. These authors proposed that corticosterone-induced modifications of mitochondrial functioning are poorly reflected by the whole-organism metabolism and that whole-organism metabolic rate cannot by itself be assumed to indicate neither ROS production nor energy supply (Salin *et al.* 2015).

Despite the lack of both direct and delayed effects of corticosterone enhancement on whole-organism metabolism, we observed a significantly higher mass gain in the corticosterone-treated group followed by higher mass gain from placebo lizards in the field, which indicates a compensatory response from placebo groups. The laboratory result is in contradiction with previous studies (Cote *et al.* 2006, 2010a) done with other food items (*Pyralis sp* larva instead of *Acheta domestica*) provided in much smaller quantities (250 mg every 5 days instead of 300-400 mg every 2 days), which are insufficient for sustained body growth in the laboratory. Thus, our laboratory protocol brought food in excess compared to previous studies and allowed for significant size growth like in the field (personal obs). In the common lizard, a prolonged corticosterone elevation promotes behaviors associated with food intake including basking and exploratory activity (De

Fraipont *et al.* 2000; Cote *et al.* 2006, 2010a). Corticosterone also induced lipid storage in non-fasted state by activating lipogenesis and adipogenesis (Peckett *et al.* 2011). Thus, the body mass gain during the laboratory experiment could result from the increase of lipid storage. Indeed, a three weeks corticosterone application, with the same diet as we used, increases liver mass, suggesting that liver may store more fatty acids during a chronic stress (Voituron *et al.* unpublished). In the September 2014 session, the body mass gain in corticosterone-treated group was lower than body mass gain in placebo group, and a post hoc test indicates that body mass between the two groups was not different (contrast = -0.03, $t = -0.53$, $df = 148.9$, adjusted $P = 0.595$). This suggests that corticosterone-treated lizards used their extra body mass stored during the laboratory manipulation and/or had a lower food intake in the field relative to placebo lizards.

Finally, when we explored the effect of chronic corticosterone enhancement on triglyceride concentration, we did not find differences between treatment groups in the laboratory and one month after the end of the laboratory manipulation, but females from corticosterone-treated group had much higher triglyceride levels than placebo group during the next reproductive season. Difference between sexes could be explained by the higher baseline corticosterone levels in females and its action on lipolysis (Pecket 2011) and also by the costs associated with gestation. Since females from corticosterone-treated group tended to have a higher baseline corticosterone concentration, this result could suggest a higher allostatic load in females during the gestation and therefore long-lasting effects of chronic stress on allostasis.

Demographic and intergenerational effects

Contrary to our predictions, the chronic corticosterone elevation in the laboratory had no intra-generational delayed effects on demographic traits, including body size growth, annual survival, and future reproduction, and no inter-generational effects on the demographic traits of the first generation offspring. The absence of delayed, intra-generational effects on survival is particularly surprising because earlier studies using a rather similar protocol (apart for feeding conditions, see above) found an improved annual survival rate for adult males following corticosterone

enhancement in the laboratory (Cote et al. 2006). However in the present study, our sample included both adult and yearling males, and our sample size of adult males might be too small to demonstrate an age-dependent effect of the treatment. In support of this explanation, the computation of annual survival for adult males (see Figure 4) revealed a similar quantitative pattern to that obtained by Cote et al (2006). Thus, we could lack statistical power to detect significant effects of chronic stress on survival in adult males. Overall, however, this suggests that experimental enhancement of corticosterone had little effects on life history strategies despite multiple changes in physiological traits.

Inter-generational effects were predicted on the basis of earlier findings where reproductive traits of females and the phenotype of their offspring changed following a chronic, increase in the baseline corticosterone concentration during gestation (Meylan & Clobert 2005). In addition, In ovoviparous lizards, it has been shown that corticosterone elevation during the gestation can impair embryonic development (Cree *et al.* 2003). In these experiments, chronic exposure to corticosterone was done during gestation and could influence the characteristics of offspring several days or weeks after the manipulation. Instead, we tested here for long-lasting and inter-generational effects on offspring caused by experimental enhancement of corticosterone several months before gestation. These carry over effects may be too weak to be detected.

Acknowledgments

We are thankful to student and staff and especially Alexis Dollion for his assistance in the development of an extraction routine of the metabolic data. This study was funded by the CNRS, the Agence Nationale de la Recherche (ANR-13-JSV7-0011-01 to S.M.) and the Région Île-de-France R2DS program (grant 2013-08 to S.M., J.F.L.G. and R.J.). Protocols were done under the agreement with the Regional ethics committee in animal experiment N°3 of the Région Île-de-France. The authors declare that they have no conflict of interest.

References

Alonso-Alvarez, C., Bertrand, S., Devevey, G., Prost, J., Faivre, B., Chastel, O. & Sorci, G. (2006)

Dégradation de l'habitat et réponse au stress : de la physiologie à la biologie de la conservation
An experimental manipulation of life-history trajectories and resistance to oxidative stress.

Evolution, **60**, 1913–1924.

Artacho, P., Jouanneau, I. & Le Galliard, J.F. (2013) Interindividual Variation in Thermal Sensitivity of Maximal Sprint Speed, Thermal Behavior, and Resting Metabolic Rate in a Lizard. *Physiological and Biochemical Zoology*, **86**, 458–469.

Artacho, P. & Nespolo, R.F. (2009) Natural selection reduces energy metabolism in the garden snail, *helix aspersa* (*Cornu aspersum*). *Evolution*, **63**, 1044–1050.

Ashley, N.T., Weil, Z.M. & Nelson, R.J. (2012) Inflammation: Mechanisms, Costs, and Natural Variation. *Annual Review of Ecology, Evolution, and Systematics*, **43**, 385–406.

Beckerman, A., Benton, T.G., Ranta, E., Kaitala, V. & Lundberg, P. (2002) Population dynamic consequences of delayed life-history effects. *Trends in Ecology and Evolution*, **17**, 263–269.

Berger, S., Martin, L.B., Wikelski, M., Romero, L.M., Kalko, E.K. V, Vitousek, M.N. & Rödl, T. (2005) Corticosterone suppresses immune activity in territorial Galápagos marine iguanas during reproduction. *Hormones and Behavior*, **47**, 419–429.

Blas, J., Bortolotti, G.R., Tella, J.L., Baos, R. & Marchant, T.A. (2007) Stress response during development predicts fitness in a wild, long lived vertebrate. *Proceedings of the National Academy of Sciences of the United States of America*, **104**, 8880–8884.

Braastad, B.O. (1998) Effects of prenatal stress on behaviour of offspring of laboratory and farmed mammals. , 159–180.

Brown, G.P., Shilton, C.M. & Shine, R. (2011) Measuring amphibian immunocompetence: validation of the phytohemagglutinin skin-swelling assay in the cane toad, *Rhinella marina*. *Methods in Ecology and Evolution*, **2**, 341–348.

Buttemer, W.A., Astheimer, L.B. & Wingfield, J.C. (1991) The effect of corticosterone on standard metabolic rates of small passerine birds.

Catalani, A., Casolini, P., Scaccianoce, S., Patacchioli, F.R., Spinozzi, P. & Angelucci, L. (2000) Maternal corticosterone during lactation permanently affects brain corticosteroid receptors,

- Costantini, D., Marasco, V. & Møller, A.P. (2011) A meta-analysis of glucocorticoids as modulators of oxidative stress in vertebrates. *Journal of Comparative Physiology B: Biochemical, Systemic, and Environmental Physiology*, **181**, 447–456.
- Cote, J., Clobert, J., Meylan, S. & Fitze, P.S. (2006) Experimental enhancement of corticosterone levels positively affects subsequent male survival. *Hormones and Behavior*, **49**, 320–327.
- Cote, J., Clobert, J., Poloni, L.M., Haussy, C. & Meylan, S. (2010a) Food deprivation modifies corticosterone-dependent behavioural shifts in the common lizard. *General and Comparative Endocrinology*, **166**, 142–151.
- Cote, J., Meylan, S., Clobert, J. & Voituren, Y. (2010b) Carotenoid-based coloration, oxidative stress and corticosterone in common lizards. *Journal of Experimental Biology*, **213**, 2116–2124.
- Cree, A., Tyrrell, C.L., Prest, M.R., Thorburn, D. & Guillette, L.J. (2003) Protecting embryos from stress: corticosterone effects and the corticosterone response to capture and confinement during pregnancy in a live-bearing lizard (*Hoplodactylus maculatus*). *General and Comparative Endocrinology*, **134**, 316–329.
- Crespi, E.J., Williams, T.D., Jessop, T.S. & Delehanty, B. (2013) Life history and the ecology of stress: how do glucocorticoid hormones influence life-history variation in animals? *Functional Ecology*, **27**, 93–106.
- Dauphin-Villemant, C. & Xavier, F. (1987) Nychthemeral variations of plasma corticosteroids in captive female *Lacerta vivipara* Jacquin: Influence of stress and reproductive state. *General and Comparative Endocrinology*, **67**, 292–302.
- Dhabhar, F.S. (2002) Stress-induced augmentation of immune function - The role of stress hormones, leukocyte trafficking, and cytokines. *Brain, Behavior, and Immunity*, **16**, 785–798.
- Dhabhar, F.S. & McEwen, B.S. (1997) Acute stress enhances while chronic stress suppresses cell-mediated immunity in vivo: a potential role for leukocyte trafficking. *Brain, behavior, and*

- Dowling, D.K. & Simmons, L.W. (2009) Reactive oxygen species as universal constraints in life-history evolution. *Proceedings. Biological sciences / The Royal Society*, **276**, 1737–45.
- Dufty, A.M., Clobert, J. & Moller, A.P. (2002) Hormones, developmental plasticity and adaptation. *Trends in Ecology & Evolution*, **17**, 190–196.
- Eraud, C., Duriez, O., Chastel, O. & Faivre, B. (2005) The energetic cost of humoral immunity in the Collared Dove, *Streptopelia decaocto*: Is the magnitude sufficient to force energy-based trade-offs? *Functional Ecology*, **19**, 110–118.
- De Fraipont, M., Clobert, J., John, H., Alder, S. & Meylan, S. (2000) Increased pre-natal maternal corticosterone promotes philopatry of offspring in common lizards *Lacerta vivipara*. *Journal of Animal Ecology*, **69**, 404–413.
- Le Galliard, J.F., Ferriere, R. & Clobert, J. (2005) Juvenile growth and survival under dietary restriction: are males and females equal? *Oikos*, **111**, 368–376.
- Gonzalez-Jimena, V. & Fitze, P.S. (2012) Blood corticosterone levels and intersexual selection games: best-of-bad-job strategies of male common lizards. *Behavioral Ecology and Sociobiology*, **66**, 305–315.
- John, F. & Weisberg, S. (2011) An R companion to applied regression. *Sage*.
- Johnson, E.O., Kamilaris, T.C., Chrousos, G.P. & Gold, P.W. (1992) Mechanisms of Stress - a Dynamic Overview of Hormonal and Behavioral Homeostasis. *Neuroscience and Biobehavioral Reviews*, **16**, 115–130.
- Kaiser, S. & Sachser, N. (2005) The effects of prenatal social stress on behaviour: Mechanisms and function. *Neuroscience and Biobehavioral Reviews*, **29**, 283–294.
- Karatsoreos, I.N., Bhagat, S.M., Bowles, N.P., Weil, Z.M., Pfaff, D.W. & McEwen, B.S. (2010) Endocrine and Physiological Changes in Response to Chronic Corticosterone: A Potential Model of the Metabolic Syndrome in Mouse. *Endocrinology*, **151**, 2117–2127.
- Kitaysky, A.S., Romano, M.D., Piatt, J.F., Wingfield, J.C. & Kikuchi, M. (2005) The adrenocortical

Dégradation de l'habitat et réponse au stress : de la physiologie à la biologie de la conservation
response of tufted puffin chicks to nutritional deficits. *Hormones and Behavior*, **47**, 606–619.

- Kitaysky, A.S., Kitaiskaia, E. V., Piatt, J.F. & Wingfield, J.C. (2003) Benefits and costs of increased levels of corticosterone in seabird chicks. *Hormones and Behavior*, **43**, 140–149.
- Kusnecov, A.W. & Rossi-george, A. (2002) Stressor-induced modulation of immune function : a review of acute , chronic effects in animals. *Acta Neuropsychiatrica*, 279–291.
- Landys, M.M., Ramenofsky, M. & Wingfield, J.C. (2006) Actions of glucocorticoids at a seasonal baseline as compared to stress-related levels in the regulation of periodic life processes. *General and Comparative Endocrinology*, **148**, 132–149.
- Lecomte, J. & Clobert, J. (1996) Dispersal and connectivity in populations of the common lizard *Lacerta vivipara* : an experimental approach. *Acta oecologica*, **17**, 585–598.
- Lenth, R. (2015) Using Lsmmeans. , 1–28.
- Martin, L.B., Gilliam, J., Han, P., Lee, K. & Wikelski, M. (2005) Corticosterone suppresses cutaneous immune function in temperate but not tropical House Sparrows, *Passer domesticus*. *General and Comparative Endocrinology*, **140**, 126–135.
- Martin, L.B., Han, P., Lewittes, J., Kuhlman, J.R., Klasing, K.C. & Wikelski, M. (2006) Phytohemagglutinin-induced skin swelling in birds: histological support for a classic immunoecological technique. *Functional Ecology*, **20**, 290–299.
- Massot, M., Clobert, J., Montes-Poloni, L., Haussy, C., Cubo, J. & Meylan, S. (2011) An integrative study of ageing in a wild population of common lizards. *Functional Ecology*, **25**, 848–858.
- Matthews, S.G. (2002) Early programming of the hypothalamo-pituitary-adrenal axis. *Trends in Endocrinology and Metabolism*, **13**, 373–380.
- McEwen, B.S. & Wingfield, J.C. (2003) The concept of allostasis in biology and biomedicine. *Hormones and Behavior*, **43**, 2–15.
- Metcalf, N.B. & Monaghan, P. (2001) Compensation for a bad start: Grow now, pay later? *Trends in Ecology and Evolution*, **16**, 254–260.

- Meylan, S., Belliure, J., Clobert, J. & de Fraipont, M. (2002) Stress and body condition as prenatal and postnatal determinants of dispersal in the common lizard (*Lacerta vivipara*). *Hormones and Behavior*, **42**, 319–326.
- Meylan, S. & Clobert, J. (2005) Is corticosterone-mediated phenotype development adaptive? - Maternal corticosterone treatment enhances survival in male lizards. *Hormones and Behavior*, **48**, 44–52.
- Meylan, S., Dufty, A.M. & Clobert, J. (2003) The effect of transdermal corticosterone application on plasma corticosterone levels in pregnant *Lacerta vivipara*. *Comparative Biochemistry and Physiology a-Molecular & Integrative Physiology*, **134**, 497–503.
- Meylan, S., De Fraipont, M. & Clobert, J. (2004) Maternal size and stress and offspring philopatry: An experimental study in the common lizard (*Lacerta vivipara*). *Ecoscience*, **11**, 123–129.
- Meylan, S., Haussy, C. & Voituron, Y. (2010) Physiological actions of corticosterone and its modulation by an immune challenge in reptiles. *General and Comparative Endocrinology*, **169**, 158–166.
- Mugabo, M., Marquis, O., Perret, S. & Le Galliard, J.F. (2010) Immediate and delayed life history effects caused by food deprivation early in life in a short-lived lizard. *Journal of Evolutionary Biology*, **23**, 1886–1898.
- Mugabo, M., Perret, S., Decenciere, B., Meylan, S. & Le Galliard, J.F. (2015) Density-dependent immunity and parasitism risk in experimental populations of lizards naturally infested by ixodid ticks. *Ecology*, **96**, 450–460.
- Peckett, A.J., Wright, D.C. & Riddell, M.C. (2011) The effects of glucocorticoids on adipose tissue lipid metabolism. *Metabolism: Clinical and Experimental*, **60**, 1500–1510.
- Richard, M., Massot, M., Clobert, J. & Meylan, S. (2012) Litter quality and inflammatory response are dependent on mating strategy in a reptile. *Oecologia*, **170**, 39–46.
- Romero, L.M., Dickens, M.J. & Cyr, N.E. (2009) The reactive scope model - A new model integrating homeostasis, allostasis, and stress. *Hormones and Behavior*, **55**, 375–389.

- Sahin, E. & Gümüşlü, S. (2007) Immobilization stress in rat tissues: alterations in protein oxidation, lipid peroxidation and antioxidant defense system. *Comparative biochemistry and physiology. Toxicology & pharmacology : CBP*, **144**, 342–7.
- Salin, K., Auer, S.K., Rudolf, A.M., Anderson, G.J., Cairns, A.G., Mullen, W., Hartley, R.C., Selman, C., Metcalfe, N.B., Gj, A., Ag, C., Mullen, W. & Rc, H. (2015) Individuals with higher metabolic rates have lower levels of reactive oxygen species in vivo. , 4–7.
- Sapolsky, R.M., Romero, L.M. & Munck, A.U. (2000) How do glucocorticoids influence stress responses? Integrating permissive, suppressive, stimulatory, and preparative actions. *Endocrine Reviews*, **21**, 55–89.
- Schöpfer, H., Palme, R., Ruf, T. & Huber, S. (2011) Chronic stress in pregnant guinea pigs (*Cavia aperea f. porcellus*) attenuates long-term stress hormone levels and body weight gain, but not reproductive output. *Journal of Comparative Physiology B: Biochemical, Systemic, and Environmental Physiology*, **181**, 1089–1100.
- Schoech, S.J., Rensel, M. a & Heiss, R.S. (2011) Short- and long-term effects of developmental corticosterone exposure on avian physiology, behavioral phenotype, cognition, and fitness: A review. *Current Zoology*, **57**, 514–530.
- Spencer, K.A., Buchanan, K.L., Goldsmith, A.R. & Catchpole, C.K. (2003) Song as an honest signal of developmental stress in the zebra finch (*Taeniopygia guttata*). *Hormones and Behavior*, **44**, 132–139.
- Solomon, M.B., Jankord, R., Flak, J.N. & Herman, J.P. (2011) Chronic stress, energy balance and adiposity in female rats. *Physiology & Behavior*, **102**, 84–90.
- Stewart, J. a. (2006) The detrimental effects of allostasis: allostatic load as a measure of cumulative stress. *Journal of physiological anthropology*, **25**, 133–145.
- Stewart, J.R., Eday, T.W. & Heulin, B. (2009) Calcium provision to oviparous and viviparous embryos of the reproductively bimodal lizard *Lacerta (Zootoca) vivipara*. *The Journal of*

- Steyermark, A.C. (2002) A high standard metabolic rate constrains juvenile growth. *Zoology (Jena, Germany)*, **105**, 147–151.
- Walker, B.G., Boersma, P.D. & Wingfield, J.C. (2005) Field endocrinology and conservation biology. *Integrative and Comparative Biology*, **45**, 12–18.
- Wikelski, M., Lynn, S., Breuner, C. & Wingfield C., J. (1999) Energy metabolism, testosterone and corticosterone in white-crowned sparrows. *Journal of Comparative Physiology A*, **185**, 463–470.
- Wingfield, J.C. (2003) Control of behavioural strategies for capricious environments. *Animal Behaviour*, **66**, 807–815.

Table 1

Direct and delayed (September 2014 and May-June 2015) effects of experimental treatment (corticosterone vs placebo) on plasma corticosterone (A) and triglyceride (B) concentration as well as the swelling response (C), a measure of the inflammatory immune response. Value in bold are significant (<0.05) and italicized values are marginally significant (<0.1). Number of lizards used for test is underlined. We used ANOVA to test effect between post and pre-experimental session measurement. Linear mixed model with population as random effect were used to test delayed.

Factor	Difference between post and pre-experimental measurement			September 2014				May-June 2015			
	F	P	N	X ²	df	P	N	X ²	df	P	N
A. Corticosterone concentration (ng.ml-1)											
Treatments	F1,27 = 7.75	0.01		0.29	1	0.891		0.54	1	0.462	
Age	F1,24 = 2,763.56	0.11		5.94	1	0.015		8.23	1	0.004	
Sex	F1,25 = 1.4	0.247		18.92	1	<0.001		5.29	1	0.021	
SVL	F1,26 = 0.54	0.468		7.63	1	0.006		4.67	1	0.031	
Initial measurement	F1,27 = 17.71	<0.001		NA	NA	NA		NA	NA	NA	
Age × Treatments	F1,21 = 2.50 9.11	0.129		0.03	1	0.871		0.65	1	0.422	
Sex × Treatments	F1,21 = 0.59	0.451		0.67	1	0.414		0.02	1	0.883	
Age × Sex	F1,21 = 0.01	0.914	<u>30</u>	0.26	1	0.608	<u>35</u>	0.5	1	0.481	<u>27</u>
B. Triglyceride concentration (mg.dl-1)											
Treatments	F1,32 = 1.72	0.199		0.50	1	0.479		0.62	1	0.433	
Age	F1,31 = 0.2	0.659		3.03	1	<i>0.0819</i>		3.41	1	<i>0.065</i>	

R. Josserand
 Dégradation de l'habitat et réponse au stress : de la physiologie à la biologie de la conservation

	Sex	F1,29 = 0.05	0.818		1.12	1	0.3		22.83	1	<0.001
	SVL	F1,30 = 0	0.981		0.49	1	0.484		1.16	1	0.28
	Initial measurement	F1,32 = 43.5	<0.001		NA	NA	NA		NA	NA	NA
	Age × Treatments	F1,26 = 0.03	0.864		0.94	1	0.333		0.77	1	0.379
	Sex × Treatments	F1,26 = 0.27	0.608		2.04	1	0.153		7.63	1	0.006
	Age × Sex	F1,26 = 0.53	0.475	<u>34</u>	0.05	1	0.919	<u>58</u>	0.05	1	0.825 <u>27</u>
C. Swelling response (mm)	Treatments	F1,217 = 3.74	0.05		0.05	1	0.827		5.47	1	0.019
	Age	F1,217 = 26.39	<0.001		0.01	1	0.913		1.85	1	0.174
	Sex	F1,216 = 0.42	0.515		0.18	1	0.671		0.1	1	0.755
	SVL	F1,214 = 2.66	0.104		15.42	1	<0.001		10.08	1	0.001
	Initial measurement	F1,217 = 277.56	<0.001		0.87	1	0.35		0.1	1	0.747
	Age × Treatments	F1,212 = 0.18	0.668		2.55	1	0.11		2.47	1	0.116
	Sex × Treatments	F1,212 = 1.34	0.249		2.28	1	0.131		3.02	1	0.082
	Age × Sex	F1,215 = 1.92	0.167	<u>218</u>	0.61	1	0.436	<u>161</u>	0	1	0.999 <u>103</u>

Table 2

Direct and delayed (September 2014 and May-June 2015) effect of experimental treatment (corticosterone vs placebo) on oxidative stress, including (A) the oxidative damage and (B) the antioxidant barrier. Value in bold are significant (<0.05) and italic value are marginally significant (<0.1). Number of lizards used for test is underline. We used ANOVA to test effect between post and pre-experimental measurement. Linear mixed model with population as random effect were used to test delayed.

		Difference between post and pre experimental measurement			September 2014			May-June 2015			
Factor	F	P	N	X ²	df	P	N	X ²	df	P	N
A. Oxidative damage (Conc_U)											
Treatments	F _{1,53} = 6.19	<i>0.016</i>		3.92	1	0.048		0.01	1	0.929	
Age	F _{1,51} = 2.38	0.128		1.46	1	0.227		0.27	1	0.604	
Sex	F _{1,50} = 1.85	0.18		5.8	1	0.016		3.41	1	<i>0.064</i>	
SVL	F _{1,52} = 2.03	0.16		6.19	1	0.013		2.08	1	0.15	
Initial measurement	F _{1,53} = 16.75	<0.001		NA	NA	NA		NA	NA	NA	
Age × Treatments	F _{1,47} = 2.09	0.155		1.73	1	0.189		0.16	1	0.688	
Sex × Treatments	F _{1,47} = 0.51	0.361		0.09	1	0.761		0.94	1	0.332	
Age × Sex	F _{1,47} = 0.85	0.427	<u>56</u>	1.28	1	0.27	<u>59</u>	1.78	1	0.182	<u>30</u>

R. Josserand
 Dégradation de l'habitat et réponse au stress : de la physiologie à la biologie de la conservation

B. Antioxydant barrièr ($\mu\text{l}_{\text{HClO}}\text{.ml}$)										
Treatments	F1,50 = 2.24	0.141		0.16	1	0.695		0.40	1	0.525
Age	F1,47 = 0.04	0.844		0.81	1	0.368		0.78	1	0.675
Sex	F1,49 = 1.43	0.237		3.47	1	0.063		3.01	1	0.083
SVL	F1,48 = 0.7	0.41		0.51	1	0.476		0.18	1	0.675
Initial measurement	F1,50 = 230.04	<0.001		NA	NA	NA		NA	NA	NA
Age \times Treatments	F1,45 = 1.16	0.287		3.03	1	0.082		0.73	1	0.393
Sex \times Treatments	F1,45 = 0.08	0.779		1.1	1	0.295		0.08	1	0.775
Age \times Sex	F1,45 = 0.67	0.418	<u>53</u>	1.59	1	0.107	<u>58</u>	0.12	1	0.726 <u>31</u>

Figure legends

Figure 1. Direct effects of treatment application on physiological traits (A-C) and delayed effects in September 2014 (D-F) and May-June 2015 (G-I) for females (black) and males (empty). Panels A-C represents the differences between post and pre-experimental values, while panels D-K represent measured values. Values are presented as means \pm SE.

Figure 2. Antioxidant barrier (A-C-E) and oxidative damage (B-D-F) of lizards from corticosterone group and placebo group. Panels A and B represent differences between post and pre-experimental values, while panels C to F represent final values. Values are presented as means \pm SE.

Figure 3. Body mass gain at the post-experimental session and at the September 2014 session for corticosterone group (black circle) and placebo group (empty circle). Values are presented as means \pm SE.

Figure 4. Survival rate \pm CI of adult males one year after the laboratory experiment.

Figure 1

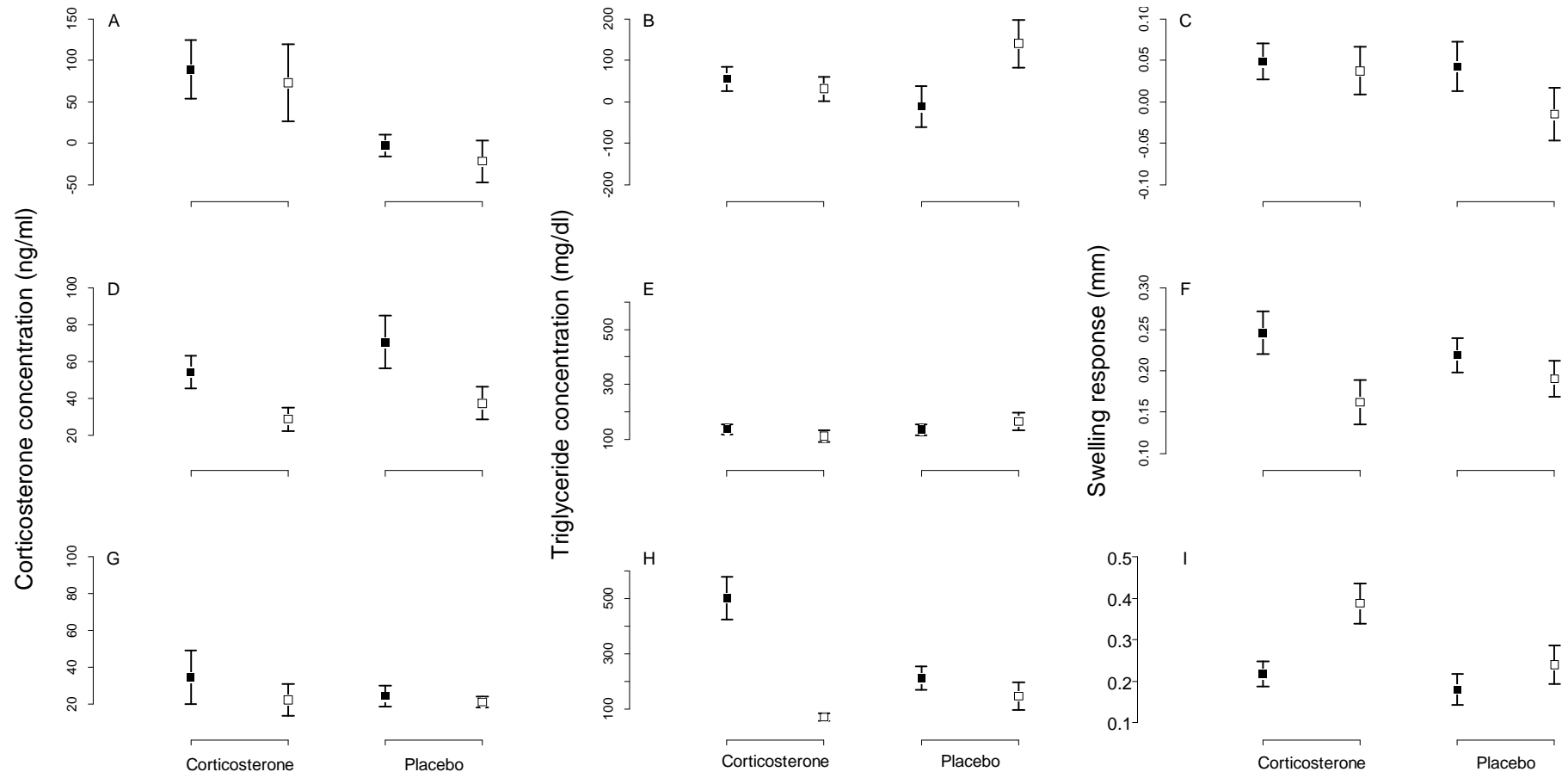

Figure 2

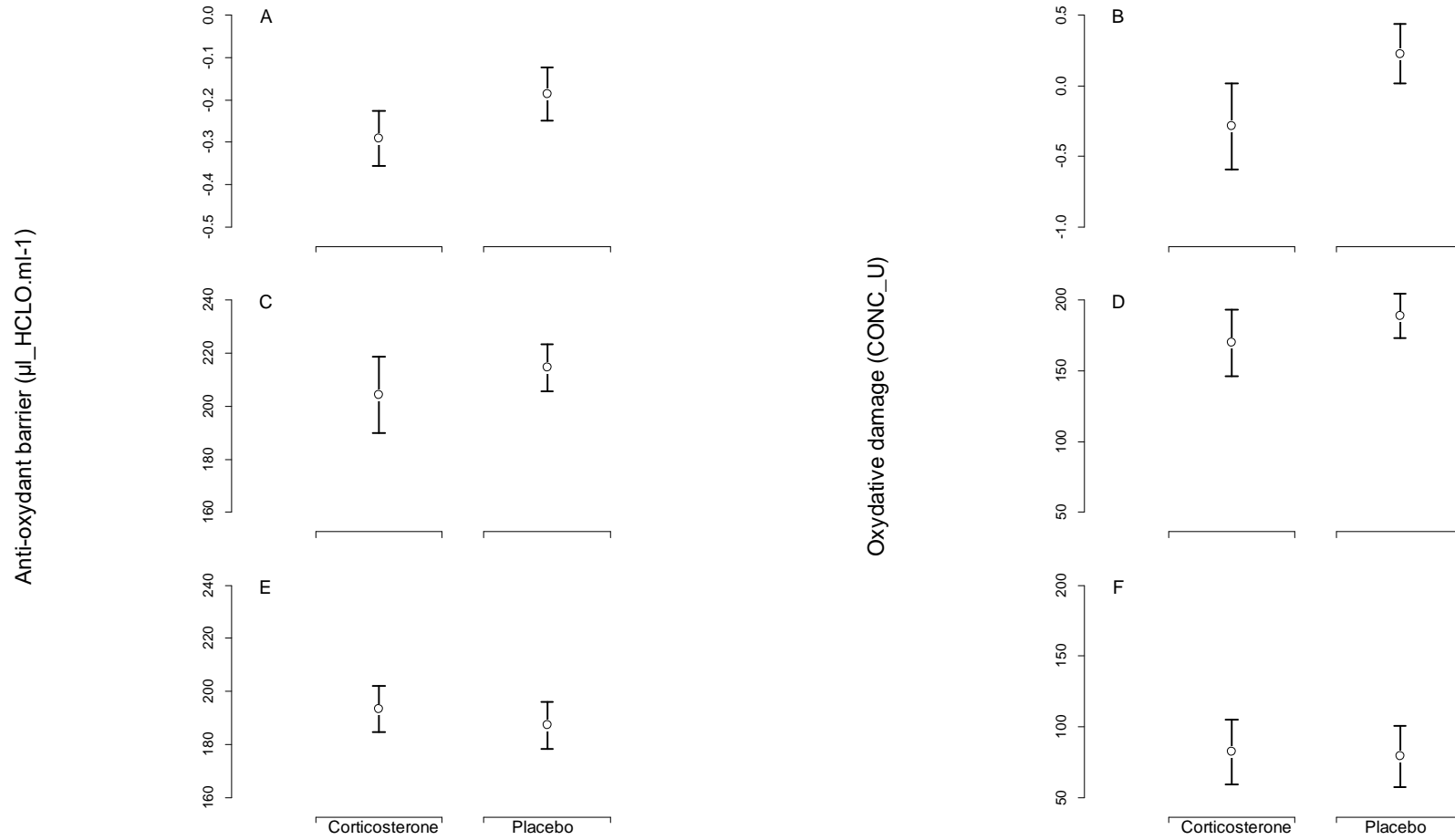

Figure 3

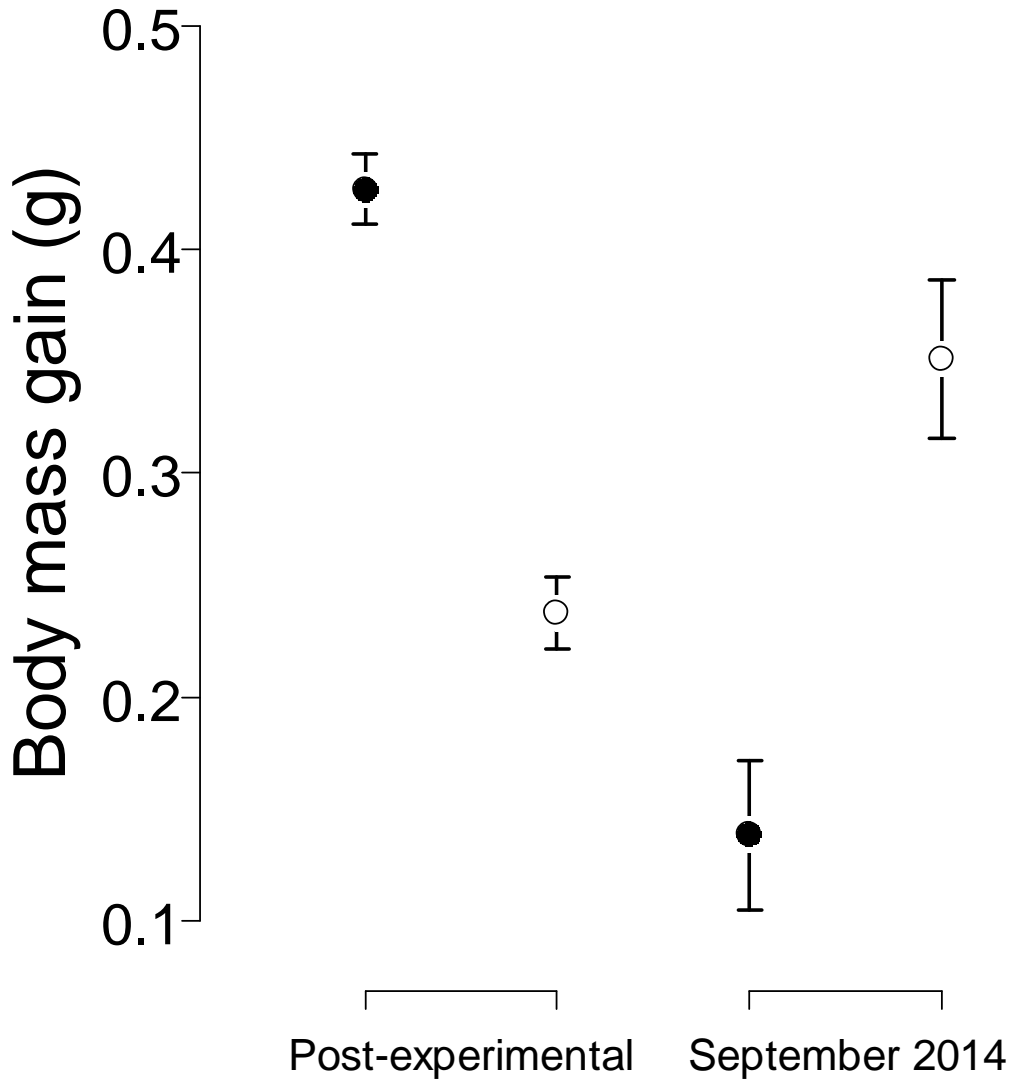
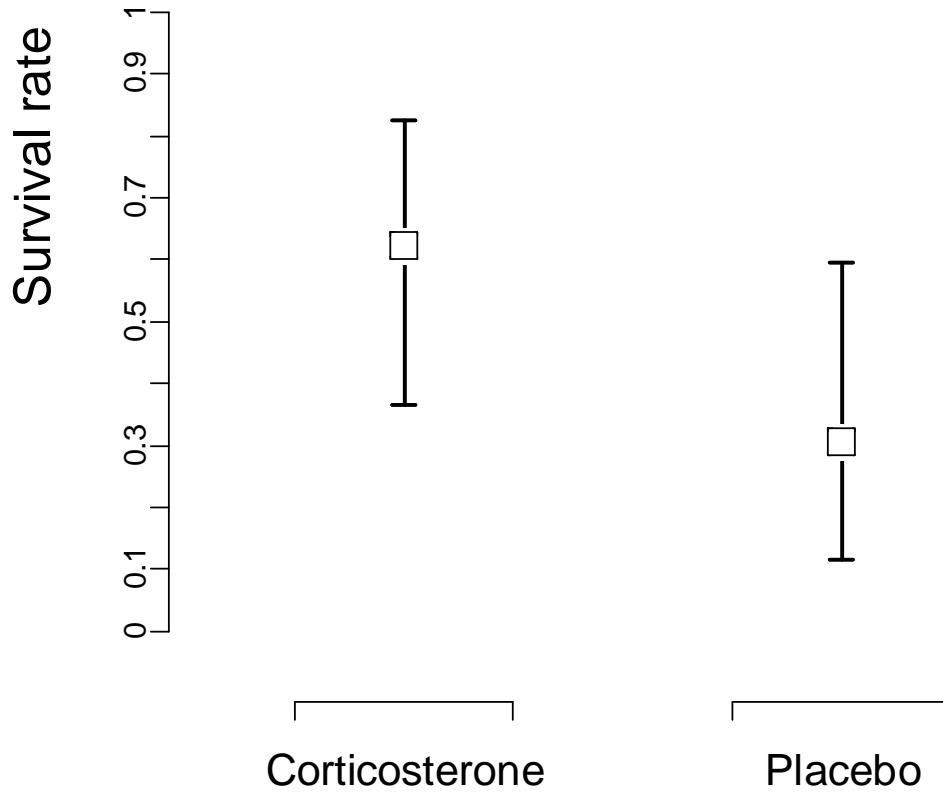

Figure 4



Article 3

Chronic stress, mitochondrial function and free radical production in a reptile. (Soumis à General and Comparative Endocrinology)

Chronic stress, mitochondrial function and free radical production in a reptile

Yann Voituron^{1*}, Rémy Josserand², Jean-François Le Galliard^{2,3}, Claudy Haussy², Damien Roussel¹, Caroline Romestaing¹ and Sandrine Meylan^{2,4}

1. Laboratoire d'Ecologie des Hydrosystèmes Naturels et Anthropisés (U.M.R. CNRS

5023), Université Claude Bernard Lyon1, Université de Lyon; Bd du 11 novembre 1918, Bât. Darwin C; 69622 VILLEURBANNE Cedex, France

2. Institut d'Ecologie et des Sciences de l'Environnement de Paris (iEES Paris) – UPMC-

CNRS; Bat. A, 7ème étage cc237; quai Saint Bernard; 75252 Paris Cedex 05, France.

3. CEREEP – Ecotron IleDeFrance. CNRS/ENS, UMS 3194, École normale supérieure, 78

rue du Château, 77140 St-Pierre-lès-Nemours, France.

4. ESPE de Paris, Université Sorbonne Paris IV, 10 rue Molitor, 75016 Paris, France

* To whom correspondence should be addressed: Tel: +33 4 72 43 15 20; Fax: +33 4 72 43 11 71; E-mail: yann.voituron@univ-lyon1.fr

Running title: Stress and mitochondria in a lizard

Abstract

Stress hormones, like corticosterone, play a crucial role in orchestrating physiological reaction patterns shaping adapted responses to stressful environments. Concepts aiming at predicting individual and population responses to environmental stress typically consider that stress hormones and their effects on metabolic rate provide appropriate proxies for the energy budget. However, uncoupling between the biochemical processes of respiration, ATP production and free radical production in mitochondria may play a fundamental role in the stress response and associated life histories. In this study, we aim at dissecting sub-cellular mechanisms that link these three processes by investigating both whole-organism respiration, liver mitochondrial oxidative phosphorylation processes (O_2 consumption and ATP production) and ROS production in *Zootoca vivipara* individuals exposed 21 days to corticosterone relative to a placebo. Corticosterone enhancement had no effect on mitochondrial activity and efficiency. In parallel, the corticosterone treatment increased liver mass and mitochondrial protein content suggesting a higher liver ATP production. We found a negative correlation between mitochondrial ROS production and plasma corticosterone level.

These results provide a proximal explanation for enhanced survival after chronic exposure to corticosterone in this species. Importantly, none of these modifications affected resting whole-body metabolic rate. Oxygen consumption, ATP and ROS production were thus independently affected in responses to corticosterone increase suggesting that concepts and models aiming at linking environmental stress and individual responses may misestimate energy allocation possibilities.

R. Josserand

Dégradation de l'habitat et réponse au stress : de la physiologie à la biologie de la conservation

Keywords: Corticosterone, Reptile, Mitochondrial efficiency, Allostatic overload, ROS and ATP production, Oxygen consumption

1. Introduction

Chronic exposure to a stressor has long been supposed to induce negative consequences, including immuno-deficiency, neural degeneration and premature mortality (, reviewed in). However more integrated studies that include interactions between hormones and behaviour, ecology or social environment demonstrate that other effects are likely to mitigate such costs. For instance, the sustained activation of hormonal secretion has been recently demonstrated to increase survival and reproductive effort . Therefore, it is now clear in ecology that glucocorticoids like corticosterone orchestrate physiological reaction patterns that promote adaptive responses to stressful environments .

Recent conceptual advances in stress responses and adaptation, like the "allostatic load" concept and the "reactive scope model", place glucocorticoids as key biological mediators with increased and sustained secretion when organismal energy expenditure is not balanced by available environmental energy (see . Mitochondria are at the crossroad of energy needs for organisms' performances and energy disposal from environment and/or endogenous storage. These cell organelles use oxidative phosphorylation to couple fuel oxidation and oxygen reduction (i.e. respiration) with the production of ATP, the main form of useable cellular energy that organism can ultimately allocate to fitness, growth, and activity depending on ecological circumstances . The ATP/O value (i.e. mitochondrial efficiency) is an important parameter of mitochondrial bioenergetics as it describes how much oxygen, and so how much redox cofactors, are used to run mitochondrial energy transduction processes . In parallel, mitochondria also constantly produce reactive oxygen species (ROS), namely superoxide anion ($O_2\bullet$), which is the precursor of most ROS that are known to strongly impact cellular macromolecules and life history traits when produced in excess. These three mitochondrial processes (oxygen consumption, ATP production and ROS production) are

known to be plastic with variable degrees of coupling among them . Variations and covariations in each process can influence growth , survival , reproduction such that mitochondrial functioning is now described as a mediator of life history traits variation .

Surprisingly, despite the fact that both mitochondria are key components of the stress response, the link between mitochondrial functioning and glucocorticoids like corticosterone is still unclear, especially in non-model species. In a recent paper on chronic psychosocial stress and pathogenesis, Picard, Juster and McEwen proposed the concept of “mitochondrial allostatic load” defined as the “structural and functional changes that mitochondria undergo in response to” glucocorticoid-mediated environmental stresses. These authors also pleaded for a better knowledge of mitochondrial responses to chronic stress such as mitochondrial fragmentation, ROS production, accumulation of mtDNA damages and ATP generating capacity. Indeed, in-depth understanding of the cellular mechanisms underpinning the stress' effects will undoubtedly have biomedical applications but will also provide new visions in ecology regarding the energy allocation concept, and relation with life-history traits ecology and evolution.

In the present paper, we characterized the effects of a chronic increase in plasma corticosterone levels on mitochondrial functioning in the liver of male common lizards (*Zootoca (Lacerta) vivipara*). Previous studies on muscles of this species demonstrated that high, sustained corticosterone levels were associated with higher levels of lipid peroxidation (a measure of oxidative stress) and lower antioxidant capacities under well-fed conditions in adult males, raising questions about free radical production . In addition, chronic administration of corticosterone also slightly increased metabolic rates at rest in pregnant females . The last result is in contradiction with other studies in other lizard species where oxygen consumption rate was reduced by experimental increase in corticosterone . With the

aim to clearly dissect sub-cellular mechanisms that link corticosterone and mitochondrial functioning, we thus investigated key parameters of mitochondrial function, including oxygen consumption, ATP and ROS production, and the mitochondrial oxidative phosphorylation efficiency (ATP/O ratio) in isolated mitochondria from common lizards chronically exposed to corticosterone in the laboratory. We hypothesized that corticosterone treatment would increase whole-organism metabolic rate and also consequently enhance mitochondrial oxygen consumption, ATP production and ROS production. This should also reduce the mitochondrial efficiency (total production of ATP per unit time per oxygen consumed).

2. Material and methods

2.1. Capture and rearing condition

1. The common lizard (*Zootoca vivipara*) is a small lacertid species (adult's snout-vent length SVL ranging from 50–70 mm, mean juvenile SVL = 18-20 mm) widely distributed across Europe and Asia. In 2014, twenty-four sub-adult males (1 year old) were captured by hand in outdoor enclosures (10 × 10 m) at CEREEP (Centre de Recherche en Ecologie Expérimentale et Prédictive; Saint-Pierre-lès-Nemours, France, 48°17'N, 2°41'E) field station from May 19 to June 9. Animals were identified by their unique toe clip code and measured for body size (SVL, ± 0.5 mm) and body mass (± 1 mg). All animals were then maintained in individual terraria (25 × 15 × 16 cm) with a shelter, peat soil as substrate and opportunities for optimal thermoregulation. We used incandescent light bulbs (25 W) for 8 hours per day from 09:00 to 17:00 local time to ensure a thermal gradient ranging from 17-23°C to 35-38°C. We provided lizards with water *ad libitum* and, every other day, with 300 ± 20 mg of food (*Acheta domestica*). The present investigation was carried out according to the ethical

principles of the Préfecture de Seine-et-Marne under agreement A77-341-1 of the Préfecture de Seine-et-Marne.

2. 2.2. *Hormonal manipulation and plasmatic corticosterone assays*

Circulating levels of corticosterone were manipulated during 3 weeks (21 days) using a non-invasive method designed by Meylan *et al.* to induce chronic stress in the common lizard. We diluted corticosterone (Sigma-Aldrich, France, C2505-500mg 92%, $C_{21}H_{30}O_4$) in commercial sesame oil according to two doses: a high dose of $3\mu\text{g}$ of corticosterone per $1\mu\text{L}$ of sesame oil (H treatment) like in Meylan *et al.* , and a low dose of $1.5\mu\text{g}\cdot\mu\text{L}^{-1}$ (L treatment) of half the high dose value. At day 1 of the experiment, lizards were randomly distributed into one of three groups (two treatments and one placebo group (P) with 8 individuals per group). Each evening between 20:00 h and 21:00 local time and during 21 days, $4.5\mu\text{L}$ of corticosterone mixture or pure sesame oil (placebo) were topically applied on lizards' back. At day 0 prior to the experiment, there was no statistical difference in SVL (ANOVA, $F_{2,21} = 1.30$, $P = 0.29$) and body mass ($F_{2,21} = 0.23$, $P = 0.79$) between the groups. Body mass was measured one day after the end of the experiment (day 22).

Blood was sampled at day 22, before the euthanasia, from the infraorbital sinus of the lizards using 2–3 $50\mu\text{L}$ microhematocrit tubes. All samples were collected within 3 min of removal of an animal from its home cage to avoid the handling-induced increase in plasma corticosterone levels. Previous studies showed that corticosterone levels remain stable during the 5 first minutes of blood sampling . Plasma was obtained by centrifugation at c.a. $1,000\text{ xg}$ for 5 minutes of the blood samples and was stored at -40°C until assay. Corticosterone level was measured with a competitive enzyme-immunoassay method using corticosterone EIA (IDS Corticosterone EIA kit, ref AC-14F1, IDS EURL Paris, France) after 1:10 dilution of all samples. This method quantifies total plasmatic corticosterone using a polyclonal

corticosterone antibody and is based on a colorimetric assay of absorbance at 450 nm. The reported sensitivity of the kit is 0.55 ng.mL^{-1} , and our estimates of corticosterone levels were indeed highly repeatable (intra-plate repeatability: $n = 49$, $F_{1,47} = 495.8$, $P < 0.0001$, intra-class correlation coefficient $r = 0.91 \pm 0.03$). Animals were also measured for their standard metabolic rates 17 days after the start of the experiment and mitochondrial functioning was analysed at day 22 (see below).

3. *Whole-organism metabolism*

The resting metabolic rate, or standard metabolic rate (SMR) for ectotherms, is the minimum energetic cost of maintenance estimated in fasting individuals at rest and at a given temperature, during the time period when the animals are normally active. Here, we measured the SMR after a fasting period of 3 days to ensure a post-absorptive state. Before the measurement, lizards were moved in a dark room maintained at 20°C for 3-4 hours and were then placed in their metabolic chamber during 1 hour at 16°C (at rest temperature) before the measurements. The CO_2 production was sampled for 40 minutes for each animal with a multiple-channel, flow-through respirometry system (Qubit Systems, Kingston, ON, Canada) compounded of a CO_2 analyzer (S157) connected to a respirometry software (QS Research). Incoming air flowed through columns of sodalime (Spherasorb, Wokingham, Berkshire, RG41 2RZ, UK) and drierite to remove CO_2 and H_2O , respectively. After the absorbent columns, air was pushed through seven channels of a multiplexer at 150 mL.min^{-1} . Six channels were used for measuring lizards and one channel for the CO_2 reference. Outgoing air was split in two parts, including one part entered to the CO_2 analyzer at 50 mL.min^{-1} . Metabolic records of CO_2 were processed by a macro program C950 data acquisition software (Qubit systems) in order to transform the ppm measure of CO_2 production in mL per hour, which takes into account the flow rate. One of the measurements failed due to poor

convergence of the CO₂ production curve. From three previous studies of SMR in the common lizard, we are confident that the CO₂ production reflects well variation in whole-organism respiration because (1) measures of CO₂ production have a greater signal-to-noise ratio with respect to O₂ consumption and are thus more reliable; (2) measures of O₂ consumption and CO₂ production are typically correlated but their ratio (RQ) is unreliable when calculated separately for each individual ; and (3) measures of SMR accounting for O₂ consumption and corrected for RQ are very strongly correlated with measures of CO₂ consumption (Le Galliard, unpub. data).

2.4. Extraction of liver and functional analyses of mitochondria

Animals were euthanized by decapitation at day 22. Following death, the liver was immediately dissected, weighted and homogenized with a Potter-Elvehjem homogenizer (three passages) in 2 mL of ice-cold isolation medium (250 mM sucrose, 1 mM EGTA, 20 mM Tris-HCl, pH 7.4, at 4°C). The liver homogenate was centrifuged at 900 g for 10 min. The supernatant was collected, filtered and centrifuged at 9,000 g for 10 min. The resulting mitochondrial pellet was re-suspended in isolation medium and centrifuged at 9,000 g for 10 min. Finally, the pellet was re-suspended and stored in 50 µL of ice-cold isolation medium. The protein concentration was spectrophotometrically measured at 540 nm using the biuret method with bovine serum albumin as a standard. The lizard mitochondrial preparations contained a dark pigment which absorbed at 540 nm; therefore the absorbance of the same volume of mitochondria in a solution containing 0.6% deoxycholate and 3% NaOH (biuret solution without copper) was subtracted.

Mitochondrial oxygen consumption was measured at 25°C in a closed and thermostatically controlled chamber of 500 µL fitted with a Clark oxygen electrode (Rank Brother Ltd., Cambridge, UK). Liver mitochondria were incubated at 1.0-1.6 mg.mL⁻¹ in

respiratory medium containing 120 mM KCl, 1 mM EGTA, 5 mM KH_2PO_4 , 2 mM MgCl_2 , 20 mM glucose, 1.5 $\text{U}\cdot\text{mL}^{-1}$ hexokinase, 0.3% of essentially free fatty acid bovine serum albumin, 3 mM HEPES adjusted at pH 7.4. The respiration was started by the addition of a mixture of respiratory substrates consisting of 5 mM pyruvate, 2.5 mM malate and 5 mM succinate. The fully active state of mitochondrial respiration (state 3) was recorded and the mitochondrial ATP synthesis was followed by glucose-6-phosphate accumulation in the presence of 500 μM ADP as described previously for liver mitochondria . After recording the state 3 of respiration for 3 min, four 100 μL aliquots of mitochondrial suspension were withdrawn and immediately quenched in 100 μL of perchloric acid solution (10% HClO_4 , 25 mM EDTA) every 1 min. Denatured proteins were centrifuged at 15,000 g for 5 min, supernatants were neutralized with a KOH solution (0.2 M KOH, 0.3 M MOPS), and centrifuged 15,000 g for 5 min. The glucose-6-phosphate content of the resulting supernatants was measured by spectrophotometry at 340 nm in an assay medium (50 mM triethanolamine-HCl, 7.5 mM MgCl_2 , 3.75 mM EDTA, pH 7.4) supplemented with 0.5 mM NAD^+ and 0.5 U glucose-6-phosphate dehydrogenase. The rate of mitochondrial ATP production was calculated from the slope of the linear accumulation of glucose-6-phosphate over the sampling time interval (4 min). To ensure that the rates we measured were specific to mitochondrial ATP synthase activity, we determine oxygen consumption and ATP synthesis rates at the basal non-phosphorylating respiration (state 4), in the presence of oligomycin (2 $\mu\text{g}\cdot\text{mL}^{-1}$).

We also measured the reactive oxygen species production by mitochondria. To do so, the rate of H_2O_2 released from mitochondria was measured at 25°C in thermostatically controlled cuvette of 1.5 mL with constant stirring, using a fluorescence spectrophotometer (Xenius, SAFAS Monaco) at excitation and emission wavelengths of 563 and 587 nm, respectively. The respiratory buffer (1mL) was supplemented with 5 $\text{U}\cdot\text{mL}^{-1}$ horseradish

peroxidase and 1 μ M Amplex red fluorescent dye. In the first step, mitochondria were added to measure background rate of ROS production. Thereafter, pyruvate/malate/succinate were added to start the reaction. The values of H_2O_2 release were corrected from background rate of product formation in the absence of exogenous substrate. The fluorescent signal was calibrated using a standard curve obtained after successive addition of H_2O_2 (20 to 400 nM). Free radical electrons leak was calculated as the fraction (%) of total electrons flow that reduces O_2 into oxygen-free radicals at the respiratory chain instead of reaching cytochrome-c oxidase to reduce O_2 into H_2O .

2.5. Statistical analyses

3. All statistical analyses were performed with linear models in R 3.1.0 . We compared experimental groups (categorical factor) for all variables but we also tested for a potential correlation with the plasmatic concentration of corticosterone at the end of the experiment (continuous response), except for models of body mass change. In the starting models, we included SVL as a covariate to control for effects of body size, but SVL had no significant effects (not shown) except for liver mass (see below) and was therefore removed from all models. The significance of the treatment effect (categorical factor or continuous responses) was tested with type III F statistics. Because the standard deviations for plasmatic corticosterone levels were significantly different between experimental groups (Bartlett's test, K-squared = 18.62, $P < 0.0001$), we log-transformed the concentration of corticosterone prior to statistical analysis (Bartlett test, K-squared = 3.31, $P = 0.19$). Otherwise, all assumptions of the models (normality of residuals and homogeneity of variance) were fulfilled. We used the Tukey's procedure to conduct post hoc tests (pairwise comparisons between the experimental groups) with the *lsmeans* package. Results are presented as mean \pm standard error unless otherwise stated.

3. Results

At the end of the experimental periods, the two treatments increased significantly the plasma concentrations of corticosterone (range = 72.2 ng.mL⁻¹ to 287.1 ng.mL⁻¹, see Table 1) relative to the placebo (range = 26.8 ng.mL⁻¹ to 54.8 ng.mL⁻¹), but we found no difference between the low and the high corticosterone dose (post-hoc test: $t = -0.67$; $df = 21$; $P = 0.77$, see Table 1). Experimental groups did not differ for body mass change (Table 1). The mass of liver, expressed relative to body size, was lower in the placebo group compared to the treated groups but did not differ between the low and the high dose (post-hoc test: $t = -1.11$; $df = 20$; $P = 0.51$, Table 1), and liver mass also increased with plasma levels of corticosterone. Similar results were obtained for the ratio of liver mass to body mass (relative liver mass, logistic regression reported in Table 1).

In addition, the specific liver mitochondrial proteins (mg of mitochondrial protein per g of liver) was significantly higher in treatment groups than in placebo, but did not differ between the low and high dose (post-hoc test: $t = 0.29$; $df = 19$; $P = 0.95$, see Table 2).

The whole-organisms mean of CO₂ production, our measure of SMR, was not different between experimental groups, and was poorly related to corticosterone concentrations (Table 1). In the same way, at the mitochondrial level, the treatment had no effect on rates of ATP synthesis and oxygen consumption, and mitochondrial oxidative phosphorylation efficiency (ratio ATP/O, see Table 2) nor was corticosterone concentration correlated with these parameters (not shown).

In contrast, the basal ROS production was smaller in lizards treated with corticosterone (Table 3) but no difference appeared between low and high-dose treatments (post hoc test : $t = 0.23$; $df = 21$; $P = 0.97$). The basal ROS production also decreased significantly with an

increase of the plasma corticosterone level (see Table 3). In parallel, the electron leak defined by the ratio between basal ROS production upon basal oxygen consumption showed a trend for a decrease in lizards treated with corticosterone, which was significant only in the continuous model. The basal non-phosphorylating O₂ consumption did not differ between groups (Table 3).

4. Discussion

Our data provide clear evidences of a complex relationship between chronic corticosterone increase and mitochondrial functioning, which is a pivotal determinant of the cellular and the whole-animal oxygen consumption, ROS production and ATP production and a key mediator of life history traits variation . More specifically, we showed here (i) a positive treatment effect on liver mass and possibly mitochondrial protein content but (ii) in the same time, a diminution of ROS production, with no changes in mitochondrial oxidative phosphorylation activities and efficiency. Importantly, these modifications of mitochondrial properties were poorly reflected by the maximal mitochondrial respiration and the whole-organism metabolism at rest.

The effects of a chronic corticosterone increase on mitochondria have been well described in different species mainly in mammals. Results like the higher liver mass and mitochondrial protein content with corticosterone enhancement agree well with those of previous studies. For example, chronic corticosterone increase causes increased liver mass in rat probably due to lipid storage with higher number and size of lipid droplets . In addition, glucocorticoids can induce higher expression of key autosomal genes (in the cell nucleus) that are required to produce new mitochondria . This process of mitochondrial biogenesis

increases the total number of mitochondria per cell, and thus total cellular energy capacity. The higher mitochondrial protein yield (+29%) observed in corticosterone-treated individuals are in congruence with those previous data. However, our results highlighting no corticosterone effect on liver mitochondrial oxygen consumption, ATP production and oxidative phosphorylation efficiency clearly contrast with several previously published data. Indeed, both liver mitochondrial oxidative activities, and mitochondrial dehydrogenases and/or electron transfer chain complexes activities are often reduced by chronic glucocorticoid administration. Furthermore, chronic glucocorticoid administration should lower liver mitochondrial oxidative phosphorylation efficiency (e.g. ATP/O ratio) by increasing basal mitochondrial proton conductance.

The discrepancies between the literatures cited above, mainly carried out on laboratory bred mammals, and the present study may involve phylogenetic differences in the susceptibility of different taxa towards a chronic corticosterone increase. Alternatively, it may also reveal the within-species adaptability of oxidative phosphorylation processes in response to the glucocorticoids which can modulate mitochondrial function in a dose- and time-dependent biphasic, inverted U-shaped, manner. Hence, acute (hours) and chronic (days) glucocorticoids enhancement increases and decreases mitochondrial respiratory activity, respectively; whereas glucocorticoids at moderate or high dose did not alter the rate of liver mitochondrial oxygen consumption after a long-term (4 weeks) exposure. Similar non-linear dose and time patterns are available regarding mitochondrial free radicals production in rats, with an increase of ROS production following 5 days of glucocorticoids treatment but no changes after 4 weeks of chronic exposure. Collectively, these data suggest that mitochondria undergo functional changes to overcome deleterious effects of glucocorticoids on its bioenergetics function on the long-term. In the present study, lizards were chronically exposed to corticosterone during 3 weeks, equivalent to 10-20% of the total annual activity

budget. Such a treatment was thus long enough to induce mitochondrial proliferation (increased mitochondrial protein content) and promote mitochondrial oxidative phosphorylation resilience.

In addition, corticosterone enhancement had also a surprising significant negative effect on the mitochondrial ROS production and, to some extent, on free radical electrons leak. Indeed, mitochondria from corticosterone-treated individuals produced around 61% less ROS compared to those of control individuals. This lower ROS production was partly explained by a decrease of the electron leak within the respiratory chain (-48%) meaning that electrons are better channelled to the oxygen. However, the H₂O₂ released from mitochondria also depends upon its antioxidant capacities. It has been previously shown a lower superoxide dismutase activity in corticosterone-treated male . Therefore, this suggests a decrease mitochondrial ROS production in chronically stressed individuals.

Altogether, the present data strongly suggest that the liver of chronically stressed individuals produced more ATP and in the same time less ROS. The coupling between oxygen consumption, ATP and ROS productions being plastic in response to corticosterone enhancement, it could be hypothesized that optimizing an ATP/ROS ratio provides a better capacity to respond to the energetic demands imposed by the environment. Such optimization constitutes a proximal explanation of the increase in survival of male common lizards with corticosterone enhancement .

From an ecological point of view, our data challenge some of the critical assumptions of dominant concepts and models that attempt to predict the effects of environmental stress on individual physiology and life history, and population dynamics. For instance, McEwen and

Wingfield (2003) suggest that allostatic overload, a concept describing the state in which organisms can no longer cope with external requirements, occur when energy requirements are beyond the capacity of the organism to replace from environmental resources. This situation should trigger an elevation of plasma corticosterone levels to divert the body's bioenergetics resources away from non-essential functions to those activities that help the organism deal with the threat. Other theoretical approaches of energy management, like the dynamic energy budget theory and metabolic theory of ecology, are based on the prediction that observable energy and heat fluxes are linear combinations of individually unobservable fluxes. Their description of metabolism involves a weighted sum of the chemical equations' stoichiometry and is defined as the rate of oxygen consumption or CO₂ production. Respiration is thus considered as the optimal proxy of contributions from assimilation, growth, dissipation and (for adults) reproduction. A major assumption of these important concepts and models is that increased metabolism is associated to higher life history productivity (because more energetic expenditure) at the cost of lifetime expectancy (because of free radical production and costs of productivity). However, mitochondrial ROS and ATP synthesis can have a variable degree of coupling to oxygen consumption. The coupling of mitochondrial functions may vary in a phylogenetic manner and in response to environmental factors, such as season, diet and temperature. Consequently, whole-body metabolic rate cannot by itself be assumed to indicate neither ROS nor ATP production. We therefore encourage future studies to consider the multivariate and potentially uncoupled dimensions of mitochondria functioning, including respiration, ATP production and ROS production, in order to better understand the stress response and the proximal causes of resources allocation between growth, survival and reproduction.

5. Acknowledgements

We are thankful to field assistants and technical staff at CEREEP-Ecotron IleDeFrance for their support, especially Hugo Mell. This study was funded by the Centre National de la Recherche Scientifique (CNRS), the Agence Nationale de la Recherche (ANR-13-JSV7-0011-01 to S.M.) and the Région Île-de-France R2DS program (grant 2013-08 to S.M., J.F.L.G. and R.J.).

6. Bibliography

Allan, E.H., Chisholm, A.B., Titheradge, M.A., 1983. The stimulation of hepatic oxidative phosphorylation following dexamethasone treatment of rats. *Biochimica et biophysica acta* 725, 71-76.

Artacho, P., Jouanneau, I., Le Galliard, J.F., 2013. Interindividual variation in thermal sensitivity of maximal sprint speed, thermal behavior, and resting metabolic rate in a lizard. *Physiological and biochemical zoology* : PBZ 86, 458-469.

Arvier, M., Lagoutte, L., Johnson, G., Dumas, J.F., Sion, B., Grizard, G., Malthiery, Y., Simard, G., Ritz, P., 2007. Adenine nucleotide translocator promotes oxidative phosphorylation and mild uncoupling in mitochondria after dexamethasone treatment. *American journal of physiology. Endocrinology and metabolism* 293, E1320-1324.

Beavis, A.D., Lehninger, A.L., 1986. The upper and lower limits of the mechanistic stoichiometry of mitochondrial oxidative phosphorylation. *Eur. J. Biochem.* 158, 315-322.

Brand, M.D., 2000. Uncoupling to survive? The role of mitochondrial inefficiency in ageing. *Experimental gerontology* 35, 811-820.

Brand, M.D., 2005. The efficiency and plasticity of mitochondrial energy transduction. *Biochemical Society transactions* 33, 897-904.

Brown, J.H., Gillooly, J.F., Allen, A.P., Savage, V.N., West, G.B., 2004. Toward a metabolic theory of ecology. *Ecology* 85, 1771-1789.

Caro, P., Gomez, J., Sanz, A., Portero-Otin, M., Pamplona, R., Barja, G., 2007. Effect of graded corticosterone treatment on aging-related markers of oxidative stress in rat liver mitochondria. *Biogerontology* 8, 1-11.

Cote, J., Clobert, J., Meylan, S., Fitze, P.S., 2006. Experimental enhancement of corticosterone levels positively affects subsequent male survival. *Hormones and behavior* 49, 320-327.

Cote, J., Meylan, S., Clobert, J., Voituron, Y., 2010. Carotenoid-based coloration, oxidative stress and corticosterone in common lizards. *The Journal of experimental biology* 213, 2116-2124.

Crossin, G.T., Love, O.P., Cooke, S.J., Williams, T.D., 2016. Glucocorticoid manipulations in free-living animals: considerations of dose delivery, life-history context and reproductive state. *Funct. Ecol.* 30, 116-125.

Dauphin-Villemant, C., Xavier, F., 1987. Nycthemeral variations of plasma corticosteroids in captive female *Lacerta vivipara* Jacquin: influence of stress and reproductive state. *General and comparative endocrinology* 67, 292-302.

Desquiret, V., Loiseau, D., Jacques, C., Douay, O., Malthiery, Y., Ritz, P., Roussel, D., 2006. Dinitrophenol-induced mitochondrial uncoupling in vivo triggers respiratory adaptation in HepG2 cells. *Biochimica et biophysica acta* 1757, 21-30.

Dhabhar, F.S., McEwen, B.S., Spencer, R.L., 1997. Adaptation to prolonged or repeated stress--comparison between rat strains showing intrinsic differences in reactivity to acute stress. *Neuroendocrinology* 65, 360-368.

Dowling, D.K., Simmons, L.W., 2009. Reactive oxygen species as universal constraints in life-history evolution. *Proceedings. Biological sciences / The Royal Society* 276, 1737-1745.

Du, J., Wang, Y., Hunter, R., Wei, Y., Blumenthal, R., Falke, C., Khairova, R., Zhou, R., Yuan, P., Machado-Vieira, R., McEwen, B.S., Manji, H.K., 2009. Dynamic regulation of mitochondrial function by glucocorticoids. *Proceedings of the National Academy of Sciences of the United States of America* 106, 3543-3548.

Duclos, M., Gouarne, C., Martin, C., Rocher, C., Mormede, P., Letellier, T., 2004. Effects of corticosterone on muscle mitochondria identifying different sensitivity to glucocorticoids in Lewis and Fischer rats. *American journal of physiology. Endocrinology and metabolism* 286, E159-167.

Dumas, J.F., Simard, G., Roussel, D., Douay, O., Foussard, F., Malthiery, Y., Ritz, P., 2003. Mitochondrial energy metabolism in a model of undernutrition induced by dexamethasone. *The British journal of nutrition* 90, 969-977.

Durant, S.E., Romero, L.M., Talent, L.G., Hopkins, W.A., 2008. Effect of exogenous corticosterone on respiration in a reptile. *General and comparative endocrinology* 156, 126-133.

Goetsch, D.D., Mc Donald, L. E., 1962. Glucocorticoid effects on respiration and metabolism by rat liver homogenates. *The American journal of physiology* 202, 343-346.

Isaksson, C., Sheldon, B.C., Uller, T., 2011. The challenges of integrating oxidative stress into life-history biology. *Bioscience* 61, 194-202.

Jani, M.S., Telang, S.D., Katyare, S.S., 1991. Effect of corticosterone treatment on energy metabolism in rat liver mitochondria. *The Journal of steroid biochemistry and molecular biology* 38, 587-591.

Kerppola, W., 1960. Uncoupling of the oxidative phosphorylation with cortisone in liver mitochondria. *Endocrinology* 67, 252-263.

Kimberg, D.V., Loud, A.V., Wiener, J., 1968. Cortisone-induced alterations in mitochondrial function and structure. *The Journal of cell biology* 37, 63-79.

Kooijman, S.A.L.M., 2010. *Dynamic Energy Budget theory for metabolic organisation*, 3rd edition ed. Cambridge University Press.

McEwen, B.S., 2007. Physiology and neurobiology of stress and adaptation: central role of the brain. *Physiological reviews* 87, 873-904.

McEwen, B.S., Wingfield, J.C., 2003. The concept of allostasis in biology and biomedicine. *Hormones and behavior* 43, 2-15.

Metcalf, N.B., Alonso-Alvarez, C., 2010. Oxidative stress as a life-history constraint: the role of reactive oxygen species in shaping phenotypes from conception to death. *Funct. Ecol.* 24, 984-996.

Meylan, S., Clobert, J., 2005. Is corticosterone-mediated phenotype development adaptive? Maternal corticosterone treatment enhances survival in male lizards. *Hormones and behavior* 48, 44-52.

Meylan, S., Dufty, A.M., Clobert, J., 2003. The effect of transdermal corticosterone application on plasma corticosterone levels in pregnant *Lacerta vivipara*. *Comparative biochemistry and physiology. Part A, Molecular & integrative physiology* 134, 497-503.

Meylan, S., Haussy, C., Voituron, Y., 2010. Physiological actions of corticosterone and its modulation by an immune challenge in reptiles. *General and comparative endocrinology* 169, 158-166.

Miles, D.B., Calsbeek, R., Sinervo, B., 2007. Corticosterone, locomotor performance, and metabolism in side-blotched lizards (*Uta stansburiana*). *Hormones and behavior* 51, 548-554.

Monaghan, P., Metcalfe, N.B., Torres, R., 2009. Oxidative stress as a mediator of life history trade-offs: mechanisms, measurements and interpretation. *Ecology letters* 12, 75-92.

Monternier, P.A., Marmillot, V., Rouanet, J.L., Roussel, D., 2014. Mitochondrial phenotypic flexibility enhances energy savings during winter fast in king penguin chicks. *The Journal of experimental biology* 217, 2691-2697.

Morici, L.A., Elsey, R.M., Lance, V.A., 1997. Effects of long-term corticosterone implants on growth and immune function in juvenile alligators, *Alligator mississippiensis*. *The Journal of experimental zoology* 279, 156-162.

Nisbet, R.M., Jusup, M., Klanjscek, T., Pecquerie, L., 2012. Integrating dynamic energy budget (DEB) theory with traditional bioenergetic models. *The Journal of experimental biology* 215, 892-902.

Palacios, M.G., Sparkman, A.M., Bronikowski, A.M., 2012. Corticosterone and pace of life in two life-history ecotypes of the garter snake *Thamnophis elegans*. *General and comparative endocrinology* 175, 443-448.

Pandya, J.D., Agarwal, N.A., Katyare, S.S., 2004. Effect of dexamethasone treatment on oxidative energy metabolism in rat liver mitochondria during postnatal developmental periods. *Drug and chemical toxicology* 27, 389-403.

Picard, M., Juster, R.P., McEwen, B.S., 2014. Mitochondrial allostatic load puts the 'gluc' back in glucocorticoids. *Nature reviews. Endocrinology* 10, 303-310.

Price, C.A., Weitz, J.S., Savage, V.M., Stegen, J., Clarke, A., Coomes, D.A., Dodds, P.S., Etienne, R.S., Kerkhoff, A.J., McCulloh, K., Niklas, K.J., Olf, H., Swenson, N.G., Chave, J., 2012. Testing the metabolic theory of ecology. *Ecology letters* 15, 1465-1474.

Psarra, A.M., Sekeris, C.E., 2011. Glucocorticoids induce mitochondrial gene transcription in HepG2 cells: role of the mitochondrial glucocorticoid receptor. *Biochimica et biophysica acta* 1813, 1814-1821.

Ricklefs, R.E., Wikelski, M., 2002. The physiology-life history nexus. *Trends in Ecology and Evolution* 17, 462-468.

Robert, K.A., Bronikowski, A.M., 2010. Evolution of senescence in nature: Physiological evolution in populations of garter snake with divergent life histories. *American Naturalist* 175, 147-E159.

Roma, L.P., Souza, K.L., Carneiro, E.M., Boschero, A.C., Bosqueiro, J.R., 2012. Pancreatic islets from dexamethasone-treated rats show alterations in global gene expression and mitochondrial pathways. *General physiology and biophysics* 31, 65-76.

Romero, L.M., Dickens, M.J., Cyr, N.E., 2009. The Reactive Scope Model - a new model integrating homeostasis, allostasis, and stress. *Hormones and behavior* 55, 375-389.

Roussel, D., Dumas, J.F., Augeraud, A., Douay, O., Foussard, F., Malthiery, Y., Simard, G., Ritz, P., 2003. Dexamethasone treatment specifically increases the basal proton conductance of rat liver mitochondria. *FEBS letters* 541, 75-79.

Roussel, D., Dumas, J.F., Simard, G., Malthiery, Y., Ritz, P., 2004. Kinetics and control of oxidative phosphorylation in rat liver mitochondria after dexamethasone treatment. *The Biochemical journal* 382, 491-499.

Salin, K., Auer, S.K., Rey, B., Selman, C., Metcalfe, N.B., 2015. Variation in the link between oxygen consumption and ATP production, and its relevance for animal performance. *Proceedings. Biological sciences / The Royal Society* 282, 20151028.

Salin, K., Luquet, E., Rey, B., Roussel, D., Voituron, Y., 2012a. Alteration of mitochondrial efficiency affects oxidative balance, development and growth in frog (*Rana temporaria*) tadpoles. *The Journal of experimental biology* 215, 863-869.

Salin, K., Roussel, D., Rey, B., Voituron, Y., 2012b. David and goliath: a mitochondrial coupling problem? *Journal of experimental zoology. Part A, Ecological genetics and physiology* 317, 283-293.

Sapolsky, R.M., Romero, L.M., Munck, A.U., 2000. How do glucocorticoids influence stress responses? Integrating permissive, suppressive, stimulatory, and preparative actions. *Endocrine reviews* 21, 55-89.

Sinervo, B., 1999. Mechanistic Analysis of Natural Selection and a Refinement of Lack's and William's Principles. *American Naturalist* 154 S26-S42.

Sinervo, B., DeNardo, D.F., 1996. Costs of reproduction in the wild: Path analysis of natural selection and experimental tests of causation. *Evolution* 50, 1299-1313.

Sommer, A.M., Portner, H.O., 2004. Mitochondrial function in seasonal acclimatization versus latitudinal adaptation to cold in the lugworm *Arenicola marina* (L.). *Physiological and biochemical zoology* : PBZ 77, 174-186.

Strack, A.M., Bradbury, M.J., Dallman, M.F., 1995. Corticosterone decreases nonshivering thermogenesis and increases lipid storage in brown adipose tissue. *The American journal of physiology* 268, R183-191.

Team, R.D.C., 2008. R: A language and environment for statistical computing. R Foundation for Statistical Computing, Vienna, Austria.

Zera, A.J., Potts, J., Kobus, K., 1998. The physiology of life-history trade-offs: experimental analysis of a hormonally induced life-history trade-off in *Gryllus assimilis*. *Am Nat* 152, 7-23.

Tables

Table 1. Effects of exogenous treatment of corticosterone (high dose: 3 μ g of corticosterone per μ L of sesame oil; low dose of 1.5 μ g. μ L⁻¹; placebo: only sesame oil) during 21 days in *Zootoca vivipara*. The organismal traits studied include plasma corticosterone levels, liver mass (total mass and relative to body mass) and standard metabolic rates (CO₂ production). Effects are reported for the models that included categorical effects of experimental groups or continuous effect of post-treatment corticosterone levels ($n = 8$ per group). Significant p-values are in bold.

Categorical model	Mean value \pm SE			ANOVA treatment	P-value
	Placebo	Low dose	High dose		
Plasma corticosterone (ng.mL ⁻¹)	47.30 \pm 3.24	167.56 \pm 25.26	143.5 \pm 22.92	F _{2,21} = 22.89	<0.001
Body mass change (g)	0.05 \pm 0.09	0.26 \pm 0.10	0.16 \pm 0.09	F _{2,21} = 1.36	0.27
Total liver mass (mg)	75.42 \pm 3.98	108 \pm 7.79	103.37 \pm 5.09	F _{2,20} = 9.44	0.001
Relative liver mass (%)	2.83 \pm 0.14	3.72 \pm 0.16	3.45 \pm 0.11	F _{2,21} = 11.28	<0.001
Mean CO ₂ production (μ L.g ⁻¹ .h ⁻¹)#	51.08 \pm 3.43	47.68 \pm 2.65	44.59 \pm 3.86	F _{2,17} = 0.89	0.44
Continuous model	Slope coefficient \pm SE			ANOVA regression	P-value
Total liver mass (mg)	17.24 \pm 4.51			F _{1,21} = 14.59	<0.001
Relative liver mass (% of body mass)	0.16 \pm 0.04			F _{1,22} = 15.41	<0.001
Mean CO ₂ production (μ L.g ⁻¹ .h ⁻¹)#	-1.86 \pm 3.058			F _{1,18} = 0.36	0.07

|| This model included a positive effect of SVL

We removed three measurements of high CO₂ production (> 600 mL/min) including two placebos and one high-dose, which could be due to non-resting behavior of test animals. However, the results were the same with the full data set ($F_{2,20} = 0.88$, $P=0.42$).

Table 2. Effects of exogenous treatment of corticosterone (high dose: 3 μ g of corticosterone per μ L of sesame oil; low dose of 1.5 μ g. μ L⁻¹; placebo: only sesame oil) during 21 days on mitochondrial traits (see methods for details on variables) in *Zootoca vivipara*. Effects are reported for the models that included categorical effects of experimental groups or continuous effect of post-treatment corticosterone levels ($n = 8$ per group). Significant p-values are in bold.

Categorical model	Mean value \pm SE			ANOVA treatment	P-value
	Placebo	Low dose	High dose		
Mitochondrial proteins concentration (mg.g fresh liver ⁻¹)*	27.45 \pm 1.86	35.44 \pm 1.36	36.35 \pm 2.95	F _{2,19} = 5.43	0.01
ATP synthesis (nmol ATP.min ⁻¹ .mg protein ⁻¹)	33.28 \pm 6.46	30.21 \pm 3.57	24.77 \pm 2.12	F _{2,21} = 0.95	0.4
Phosphorylating oxygen consumption (nmol O.min ⁻¹ .mg protein ⁻¹)	17.16 \pm 2.9	17.51 \pm 1.8	14.22 \pm 1.59	F _{2,21} = 0.61	0.51
Basal non-phosphorylating oxygen consumption (nmol O.min ⁻¹ .mg protein ⁻¹)	3.83 \pm 0.46	3.72 \pm 0.53	3.82 \pm 0.71	F _{2,21} = 0.01	0.99
Mitochondrial oxidative phosphorylation efficiency (ATP/O)	1.92 \pm 0.14	1.74 \pm 0.13	1.78 \pm 0.06	F _{2,21} = 0.66	0.52
Continuous model	Slope coefficient \pm SE			ANOVA regression	P-value
Mitochondrial protein concentration (mg.g fresh liver ⁻¹)*	4.25 \pm 2.09			F _{1,20} = 4.12	0.06
ATP synthesis (nmol ATP.min ⁻¹ .mg protein ⁻¹)	-3.87 \pm 3.97			F _{1,22} = 0.95	0.33
Phosphorylation oxygen consumption (nmol O.min ⁻¹ .mg protein ⁻¹)	-1.27 \pm 1.92			F _{1,22} = 0.42	0.52
Basal non-phosphorylating oxygen consumption (nmol O.min ⁻¹ .mg protein ⁻¹)	-0.25 \pm 0.51			F _{1,22} = 0.23	0.63
Mitochondrial oxidative phosphorylation efficiency (ATP/O)	0.06 \pm 0.1			F _{1,22} = 0.29	0.59

* One missing data in high dose group and one in low dose group due to the sampling.

Table 3. Effects of exogenous treatment of corticosterone (high dose: 3 μ g of corticosterone per μ L of sesame oil; low dose of 1.5 μ g. μ L⁻¹; placebo: only sesame oil) during 21 days on reactive oxygen species production by mitochondria in *Zootoca vivipara* (see methods for details on variables). Effects are reported for the models that included categorical effects of experimental groups or continuous effect of post-treatment corticosterone levels ($n = 8$ per group). Significant p-values are in bold.

Categorical model	Mean value \pm SE			ANOVA treatment	P-value
	Placebo	Low dose	High dose		
Basal ROS production (nmol H ₂ O ₂ .min ⁻¹ .mg protein ⁻¹)	0.2 \pm 0.06	0.07 \pm 0.02	0.08 \pm 0.01	F _{2,21} = 3.42	0.05
Basal oxygen consumption (nmol O ₂ .min ⁻¹ .mg protein ⁻¹)	4.07 \pm 0.56	3.40 \pm 0.43	3.28 \pm 0.33	F _{2,21} = 0.89	0.42
Electron leak	0.05 \pm 0.01	0.02 \pm 0.01	0.03 \pm 0.01	F _{2,21} = 2.16	0.13
Continuous model	Slope coefficient \pm SE			ANOVA regression	P-value
Basal ROS production (nmol H ₂ O ₂ .min ⁻¹ .mg protein ⁻¹)	-0.08 \pm 0.04			F _{1,22} = 4.61	0.043
Basal oxygen consumption (nmol O ₂ .min ⁻¹ .mg protein ⁻¹)	-0.34 \pm 0.4			F _{1,22} = 0.72	0.4
Electron leak	-0.01 \pm 0.01			F _{1,22} = 4.02	0.06

Article 4

Do personalities co-vary with metabolic expenditure and glucocorticoid stress response in adult lizards ? (publié dans Behavioural Ecology and Sociobiology)

Do personalities co-vary with metabolic expenditure and glucocorticoid stress response in adult lizards?

Hugo Mell, Rémy Josserand, Beatriz Decencière, Paulina Artacho, Sandrine Meylan & Jean-François Le Galliard

Behavioral Ecology and Sociobiology

ISSN 0340-5443

Behav Ecol Sociobiol

DOI 10.1007/s00265-016-2117-z

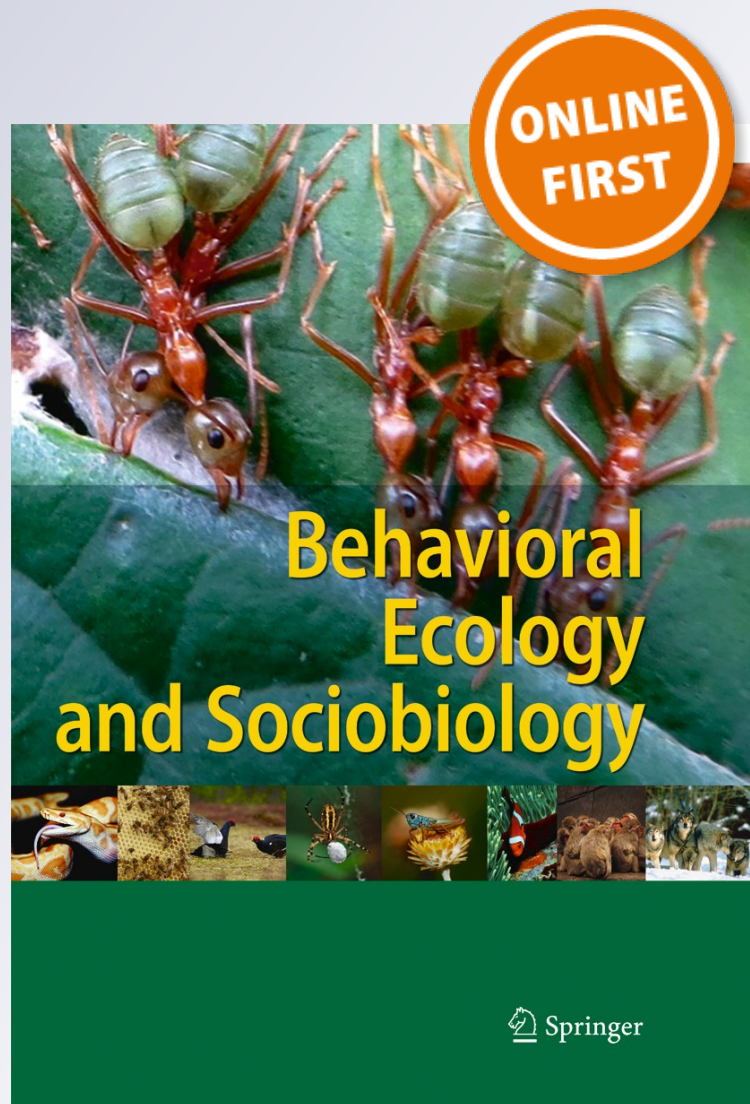

Your article is protected by copyright and all rights are held exclusively by Springer-Verlag Berlin Heidelberg. This e-offprint is for personal use only and shall not be self-archived in electronic repositories. If you wish to self-archive your article, please use the accepted manuscript version for posting on your own website. You may further deposit the accepted manuscript version in any repository, provided it is only made publicly available 12 months after official publication or later and provided acknowledgement is given to the original source of publication and a link is inserted to the published article on Springer's website. The link must be accompanied by the following text: "The final publication is available at link.springer.com".



Do personalities co-vary with metabolic expenditure and glucocorticoid stress response in adult lizards?

Hugo Mell¹ · Rémy Josserand¹ · Beatriz Decencièrè² · Paulina Artacho³ · Sandrine Meylan^{1,4} · Jean-François Le Galliard^{1,2}

Received: 18 January 2016 / Revised: 29 March 2016 / Accepted: 30 March 2016
© Springer-Verlag Berlin Heidelberg 2016

Abstract

Stable differences in physiology among individuals may facilitate the evolution of consistent individual differences in behavior. In particular, according to the pace-of-life syndrome (POLS) hypothesis, individual variation in metabolic expenditure and stress physiology should be linked with exploration, aggression, or risk-taking behaviors. Previous studies have uncovered stable individual differences in metabolic expenditure and circulating glucocorticoids in common lizards (*Zootoca vivipara*). We tested the correlations between standard metabolic rates (SMR), glucocorticoid stress response, and behavioral traits (activity, aggressiveness, risk taking, and sociability) in males. In ectotherms, the thermal dependence of SMR should be included in the POLS hypothesis; we

therefore measured SMR at three temperatures from rest to preferred body temperature. Activity, aggressiveness, and risk taking, but not sociability, exhibited significant, short-term repeatability, and little correlation was found between behavioral traits. The SMR of lizards with a low metabolism at rest increased faster with body temperature. The SMR at rest was negatively correlated with behavioral variation in sociability and activity but not with risk-taking behavior. In addition, the plasma corticosterone level after an acute handling stress increased slightly but not significantly with aggressiveness. We discuss alternative interpretations for these relationships and conclude that the link between inter-individual variation in physiology and behavior is trait-dependent in the common lizard.

Significance statement

Selection better promotes the evolution of consistent differences in behavior, or personalities, when they are coupled with differences in physiology. In adult common lizards, inter-individual differences in metabolic expenditure and glucocorticoid stress response are consistent and could play a crucial role in the maintenance of personalities. This study supported partially this hypothesis. We found that more sociable and active personality types had a lower metabolic expenditure, while more aggressive personality types tended to have a higher physiological stress response. At the same time, physiology was not correlated with individual differences in risk-taking behavior and drove little part of behavioral variation. The coupling between personalities and physiology appears to be trait-dependent, suggesting that behaviors may be relatively free to evolve independently from physiology.

Communicated by T. Madsen

Electronic supplementary material The online version of this article (doi:10.1007/s00265-016-2117-z) contains supplementary material, which is available to authorized users.

✉ Jean-François Le Galliard
galliard@biologie.ens.fr

¹ iEES Paris, UMR 7618 Université Pierre et Marie Curie, CNRS, 7 Quai St. Bernard, 75005 Paris, France

² Centre de recherche en écologie expérimentale et prédictive (CEREEP-Ecotron IleDeFrance), UMS 3194, Ecole normale supérieure, PSL Research University, CNRS, 78 rue du Château, 77140 St-Pierre-lès-Nemours, France

³ Instituto de Ciencias Ambientales y Evolutivas, Campus Isla Teja, Universidad Austral de Chile, Valdivia, Chile

⁴ ESPE de Paris, Université Sorbonne Paris IV, 10 rue Molitor, 75016 Paris, France

Keywords Locomotion · Metabolism · Corticosterone · Temperament · Personality · Reptiles

Introduction

The concept of “animal personality” refers to consistent inter-individual differences (CIDs) in behavior across time and/or contexts (Réale et al. 2007). Empirical evidence of CIDs in behavior is widespread in the animal kingdom (reviewed in Bell et al. 2009), and personality traits may play a crucial role in some ecological and evolutionary processes (Sih et al. 2004a; Réale et al. 2007; Dingemanse and Wolf 2010). Animal personalities are generally organized along a few major behavioral dimensions, including activity and exploration, risk taking, aggressiveness, and sociability (Réale et al. 2007). Two or more of these dimensions may be associated with suites of correlated traits called behavioral syndromes (reviewed in Sih et al. 2004b), particularly the syndrome linking activity, exploration, risk taking, and aggressiveness (Sih and Bell 2008). This syndrome, found in several species, is referred to as the shy-bold axis (Wilson et al. 1994) or the reactive-proactive continuum (Koolhaas et al. 1999).

A potential explanation for the occurrence of repeatable, consistent, and correlated differences in behavior is that suites of behavioral traits may co-vary with stable differences in physiology (Biro and Stamps 2010; Coppens et al. 2010; Dingemanse and Wolf 2010). In particular, CIDs in behavior along the reactive-proactive continuum should be linked to the physiological stress response (i.e., stress-coping style hypothesis; Koolhaas et al. 1999, 2010; Øverli et al. 2007; Coppens et al. 2010). The reactive and proactive behavioral types are considered adaptations for life in unstable and stable environments, respectively; thus, shy and reactive individuals are characterized by higher levels of physiological stress responses than bold and proactive individuals (Cockrem 2007). In vertebrates, the physiological stress response involves activation of the hypothalamo-pituitary-adrenal (HPA) axis, where exposure to stress stimulates secretion of glucocorticoids (e.g., Cockrem 2007). In turn, glucocorticoid secretion elicits a cascade of physiological and behavioral processes that are essential to cope with stressful events (Wingfield and Ramenofsky 1999; Landys et al. 2006). The stress-coping style hypothesis makes the specific predictions that proactive and bold individuals should have lower baseline concentrations of glucocorticoids and a less reactive HPA axis. These predictions are well supported by research with domestic and laboratory-bred animals (Koolhaas et al. 1999; Groothuis and Carere 2005), especially lines selected for coping styles in mice (Veenema et al. 2003) and great tits (Carere et al. 2003; Baugh et al. 2012), but less by more recent field studies (Lendvai et al. 2011; Baugh et al. 2013). They have not yet been tested in squamate reptiles (lizards and snakes).

In addition, a link could exist between energy expenditure and behavior (Careau et al. 2008; Biro and Stamps 2010; Careau and Garland 2012) because energy acquisition and allocation constraints should influence behavioral traits

involved in net energy gain (e.g., foraging) and/or those that are energetically costly (e.g., aggressiveness, see Mathot and Dingemanse 2015). In particular, the basal metabolic rate (BMR, a measure of the minimal energy expenditure in post-absorptive individuals at rest) is both repeatable and consistent through time (Nespolo and Franco 2007) and should be correlated with activity, risk taking, exploration, and aggressiveness (Wolf and McNamara 2012). Two opposite scenarios have been proposed to explain the partition between BMR and the total energy expenditure (Careau et al. 2008; Mathot and Dingemanse 2015). The first states that higher total energy expenditure might imply investment in physiological processes and anatomical features that support higher productivity. In this case, we expect a higher BMR to correlate with bolder and/or more proactive behaviors (i.e., production model of bioenergetics; Careau et al. 2008; Careau and Garland 2012). Examples include numerous studies of aggression, risk taking, and exploration in fishes, mammals, and a few bird species (e.g., Cutts et al. 2001; Mathot and Dingemanse 2015). In contrast, a negative relationship between BMR and proactivity is expected when the amount of energy spent in maintenance is unavailable to sustain net energy gain and energy is limited (i.e., allocation model of bioenergetics; Careau et al. 2008; Careau and Garland 2012). This prediction has received less support (Mathot and Dingemanse 2015), despite evidence that BMR may represent a cost to growth and survival (e.g., Steyermark 2002; Artacho and Nespolo 2009).

Energy metabolism, glucocorticoid stress response, and personality should thus be integrated into a general syndrome called the pace-of-life syndrome or POLS (Ricklefs and Wikelski 2002; Careau et al. 2009; Réale et al. 2010; Le Galliard et al. 2013). However, intra-individual variation induced by thermal conditions (neglected thus far) might complicate the relationship between metabolic expenditure and behavior in ectothermic species (Artacho et al. 2013). In previous studies, metabolic rates were obtained by repeated measurements at a single temperature. In ectotherms, the standard metabolic rate (SMR, a measure of BMR at a given temperature) significantly increases with body temperature, and the thermal dependence of SMR might differ markedly among individuals (Nespolo et al. 2003; Careau et al. 2014). Hence, energetic data in ectotherms should preferably be calculated from SMR obtained along a thermal gradient. For example, a recent study of the slimy salamander (*Plethodon albagula*) by Careau et al. (2014) found significant inter-individual variation in the thermal dependence of metabolism in such a way that the metabolic ranking of individuals changed with body temperature. Thus, additional data on ectotherms is needed in order to rigorously assess the relationship between personality traits and metabolism after taking into account intra-individual differences in metabolic thermal sensitivity.

To explore the links between personality traits, standard metabolic rates, and the glucocorticoid stress response, we conducted two independent observational studies with male common lizards, *Zootoca vivipara*. In a first study, we measured covariation between personality traits and resting metabolic rates measured at three relevant body temperatures. In a second study, we tested for covariation between personality traits and individual plasmatic levels of corticosterone, quantified both in the field and in the laboratory after exposure to an acute stress. Rather than examining the correlation between physiology and a single personality trait (reviewed in Mathot and Dingemanse 2015), we measured several behavioral dimensions simultaneously, including activity, risk taking, sociability, and aggressiveness. CIDs in behavior have been documented previously for activity, exploration, sociability, and risk taking in juvenile common lizards (Cote and Clobert 2007; Le Galliard et al. 2013, 2015), and there is independent variation in activity, risk taking, and sociability (Le Galliard et al. 2015). In adults, measurements of SMR are repeatable and consistent over short time periods (e.g., Artacho et al. 2013). The link between SMR and behavioral activity has been explored in juvenile lizards but no significant correlation was found (Le Galliard et al. 2013). However, by taking into account intra-individual variation in metabolism and several behavioral traits, we expect to gain greater insight into the relationship between behavioral syndromes and metabolism. In addition, plasma corticosterone levels of common lizards are repeatable over several days in the laboratory (SM and J-FLG unpubl. data) and increased corticosterone secretion in response to a stressor modifies activity and foraging behaviors (de Fraipont et al. 2000; Cote et al. 2006). Whether this intra-individual variation parallels inter-individual variation along a general proactive-reactive continuum remains to be tested.

Materials and methods

Study species

The common lizard (*Z. vivipara*) is a small viviparous lacertid (50–70-mm adult snout-vent length) widely distributed in Eurasia. In our study populations at the Centre de Recherche en Ecologie Expérimentale et Prédictive, France (48°17'N, 2°41'E), hibernation takes place from October to February–March for males, while females emerge a few weeks later in March–April. Mating season begins upon the emergence of females and lasts 2–4 weeks. The size of our semi-natural enclosures (each 100 m²) is similar to the area occupied by overlapping ranges of several lizards. Dispersal was prevented, lizards were protected from terrestrial and avian predators, and no food or water supplements were provided. Only male individuals were considered in this study so as to

avoid interferences of gravidity on metabolic measurements and general sex differences in physiology and behavior. To minimize observer bias, blinded methods were used: the persons in charge of recording and analyzing behavioral data were not aware of the physiological scores of lizards, and different persons collected and processed behavioral and physiological data.

Study 1: covariation between behavior and metabolism

Thirty-nine adult males ($n = 7$ two-year old and $n = 32$ more than two-year old) were captured in 2011 between May 16 and 19 from ten enclosures and measured for snout-vent length (SVL, range = 53–63 cm, mean = 57.7) and body mass. Right after their capture, all the lizards were placed in individual terraria (25 × 16 × 15 cm) and kept under standardized day-night (16-h night:8-h day) and temperature conditions (16 °C night:23 °C day) with food and water ad libitum (see Le Galliard et al. 2003 for detailed protocols). Individuals were measured once for three behavioral traits, activity ($N = 29$), boldness ($N = 30$), and sociability ($N = 30$), within 8 days of capture. Then, from July 1 to July 10, the SMR was measured for each lizard at 15, 25, and 35 °C (see details below). These temperatures were chosen because they cover the range of variation of body temperatures experienced during different activities, including temperature at rest, preferred body temperature, and an intermediate value (Le Galliard et al. 2003). We did not take repeated measurements of activity, boldness, and sociability. However, short-term repeatability estimates were calculated at the same time from another sample of adult lizards maintained in the same conditions and tested twice for the same behaviors the same year. In the data set involving measurement of repeatability, behaviors were also recorded within 8 days of recapture of individuals, and repeated measures were taken the same day a few hours apart.

Study 2: covariation between behavior and stress response

For this study, 50 adult males ($n = 13$ two-year old and $n = 37$ older than two years) were captured on March 31, 2014 from ten different enclosures and measured for SVL (range = 48–62 cm, mean = 57.5 cm) and body mass. Blood samples were taken immediately following capture. In order to avoid biases due to capture and handling stress, we performed short visits to each enclosure (in general, less than 5 min) and collected all blood samples within less than 3 min of capture. To account for potential stress due to our visits to the enclosures, we measured the time between each capture and the first visit for each lizard (hereafter called time spent in the enclosure). Lizards were then transferred into individual terraria and held under the same conditions as lizards experienced in study 1. Activity, boldness and aggressiveness were measured during a first series of behavioral tests starting on day 7. On day 7, half

of the lizards were tested for activity and aggressiveness, while the other half were measured for boldness and aggressiveness. On day 8, each group was tested for the behavior not measured during day 7 and then fed with a standard quantity of live crickets to ensure similar digestive state before the next measurements. The second session started on day 9 and followed the same procedure as the first one to obtain repeated measures. At day 11, another blood sample was collected in order to assess the corticosterone stress response under laboratory conditions. To ensure that peak corticosterone levels were reached, lizards were exposed to handling and simulated predation stress by scaring them with a paint brush for 10 min before blood sampling (Dauphin-Villemant and Xavier 1987). Plasma corticosterone levels were assessed using an immunoenzymatic reaction following protocols previously used in Meylan et al. (2003).

Collection of behavioral data

We used a neutral arena test to investigate exploratory behavior and locomotor activity (Le Galliard et al. 2013). All tests were done during the daily activity period between 10 a.m. and 5 p.m. Each lizard was placed in a plastic box (44.5 × 24 × 26 cm) maintained in a room at a standard temperature of 23–25 °C with one heat source (40-W bulb) at the center and two white light sources (Iguana Light 10.0 UV-B, ZooMed, 40 W). The soil was covered with clean sand before each trial to avoid interference with odors from conspecifics. Each lizard was placed in the plastic box for a 10-min acclimation period and then filmed from above for 30 min with a webcam (Hercules Deluxe). The film was downloaded using Virtual Dub 1.7.8, and image sequence from each video was obtained (one frame per second). From these videos, we recorded lizard position (x – y coordinates) in ImageJ v1.40 (<http://rsbweb.nih.gov/ij/>) using a particle analysis procedure (Mallard et al. 2013). We calculated the percentage of time spent walking and the travel distance during each trial. For study 2, we also calculated the total time spent basking and the total time spent scratching the wall with real-time recordings of behaviors.

We measured risk-taking (or boldness) behavior based on the behavior of a lizard after a simulated attack by a human (e.g., López et al. 2005; Le Galliard et al. 2015). Plastic boxes were equipped with a cardboard shelter on one corner to provide a refuge and with a heat source on the opposite corner to provide a stimulus for basking. After the acclimation period, we simulated several consecutive predator attacks with a paintbrush, softly touching the tail to force the lizard into the shelter. If the lizard was already inside the shelter, we simulated attacks around the shelter to force the head of the lizard into the shelter. We then filmed the behavior from above and calculated the time spent hiding (body and head inside the refuge) before leaning out of the refuge (body inside the

refuge but tip of the nose emerging from the shelter), the time spent before emerging from the refuge (body and head outside the refuge), and the time spent before basking under the heat source on the opposite side of the box. Recordings stopped after 60 min. This procedure allowed for “censoring” of boldness scores for one lizard in each study (i.e., less than 3 % of recordings). We replaced boldness scores by the maximum value (3600 s) for these animals.

We quantified sociability by scoring the preference of lizards for odors of adult males during a simultaneous choice test of 20 min (Le Galliard et al. 2015). Two identical plastic shelters were placed on each side of the terrarium. We put a piece of absorbent paper impregnated with the odor of adult males under one shelter and a piece of odorless paper under the other shelter. Lizards were filmed from above, and two indices of sociability were measured: an absolute index calculated as the difference between time spent in the shelter with the odor and time under the shelter without the odor scaled to the total duration of the test, and a relative index, where time difference was divided by the total time spent hidden (Cote and Clobert 2007; Cote et al. 2008; Le Galliard et al. 2015). In each study, odors were obtained from four groups of three randomly chosen adult males after a minimum period of 6 days. Odorless papers were collected from a cage without lizards located in the same room.

We measured aggressiveness in response to capture and handling when we removed the lizards from the exploration and risk-taking tests. One experimenter grabbed the lizard in his hand and held it in front of himself until it was relatively immobile. The experimenter then touched the tip of the nose with the side of his finger four times in order to elicit aggressive reactions and counted the total number of biting attempts. The score thus ranged from 0 (no bite) to 4, and scores are reported as “aggressiveness after exploration” and “aggressiveness after risk taking” depending upon the behavioral test preceding the measurement.

Measurement of metabolic rate

The standard metabolic rate (SMR) is defined as the minimum rate of energy expenditure under post-absorptive conditions in a resting phase at dark and at a given temperature within the animal's range of activity (Andrews and Pough 1985). Metabolic rates were estimated with a multiple-channel flow-through respirometry system (Qubit Systems, Canada) coupled with a differential O₂ analyzer (DOX; S104 Differential Oxygen Analyzer) and a CO₂ analyzer (S157) connected to respirometry software (QS Research). Metabolic records were processed by a macro program recorded in ExpeData software (Sable Systems) to transform the measurements from parts per million to milliliters per hour, taking into account the flow rate (140 mL/min). SMR was measured once at each of the three body temperatures

(15 °C: minimum temperature, 25 °C: intermediate body temperature during activity, and 35 °C: inside the range of preferred body temperature) after a fasting period of 72 h to ensure post-absorption conditions. Individuals were placed in a room at a constant temperature of 15 °C the night before recording, and were kept in the dark until being weighted and placed in the measurement chamber for an hour of acclimation at the test temperature. Excurrent O₂ and CO₂ concentrations were then measured continuously for 45 min at the same temperature. The average respiratory quotient of the population, calculated from the production of CO₂ and consumption of O₂ obtained from all individuals, was then used to convert the values of CO₂ production (mL/h), averaged over the recording, into energy expenditure (J/h).

Statistical analyses

All statistical analyses were carried out in R 3.0.3 (<https://www.r-project.org/>). Repeated measurements of the three focal behaviors, activity, risk taking, and aggressiveness, were analyzed with linear mixed-effects models (LMM) using the *lme* function (Pinheiro and Bates 2000). The LMM fitted to each behavioral variable included a fixed time effect to control for changes in behavior across repeated measures and a random individual effect. From this, we assessed the significance of random effects with likelihood ratio tests (LRT) and calculated a repeatability coefficient as the intra-class correlation coefficient (Wolak et al. 2012), which equals to the ratio of between-individual variance to total (between-individual and residual) variance. Since the between-individual variance can take only positive values, the χ^2 statistics of the LRT is distributed as an equally weighted mixture of χ^2 distributions with one and zero degrees of freedom (Careau et al. 2014 and references therein). Thus, we halved the *p* values obtained from the standard χ^2 distribution with one degree of freedom (equivalent to $\chi^2_{0:1}$ in results below). In addition, behavioral syndromes were explored using principal component analyses (PCAs) of the mean, individual values of each behavioral trait. PCAs were implemented with the function *dudi.pca* in the R package *ade4* using a correlation matrix implicitly rescaling all variables (Chessel et al. 2004). The number of principal components retained for the analysis was determined on the basis of the broken-stick method (Legendre and Legendre 1998). We identified statistically significant contributions to the different PCs by calculating the inertia attributed to each variable. The contribution of the variable was considered significant when its inertia was greater than the mean inertia.

We analyzed the thermal sensitivity of SMR using individual linear regressions computed to calculate an intercept score (SMR value predicted at 15 °C) and an intercept slope score (SMR thermal sensitivity) for each individual. We also calculated the thermal repeatability of SMR (Nespolo et al. 2003;

Careau et al. 2014) by running a linear mixed-effects model. This model included a fixed effect of body temperature and random variation among individuals for the mean SMR across the thermal gradient. To obtain the thermal repeatability (R_T), we used the variance components (residual and between-individual variation) and calculated the ratio of between-individual to total variation. We tested the significance of the random inter-individual based on a LRT (see above). The SMR data were log-transformed prior to the analyses, which resulted in a better statistical distribution of the residuals and improved linearity of effects.

We used the PC scores obtained from the PCAs described above to explore the covariation between behavioral traits and physiology (SMR and plasma corticosterone levels). For SMR, we fitted a linear model with the SMR as a dependent variable and the individual scores for each PC, age class, and body mass as fixed-effect-independent variables. For plasma corticosterone, field levels were analyzed with a linear model including fixed effects of age, SVL, and individual scores for each PC as well as time spent in the enclosure before capture. Laboratory stress-induced corticosterone levels were analyzed with the same model including the basal plasma corticosterone levels as a covariate to control for differences in basal secretion of corticosterone prior to handling stress. In all the cases, model assumptions (normality and homogeneity of variance of the residuals) were fulfilled, and the best model was chosen by a stepwise selection procedure based on AIC (Burnham and Anderson 1998). Several individuals came from the same enclosures in both studies but addition of a random effect of enclosure identity did not change the conclusions of our statistical analyses since there was very little variation among enclosures (all $p > 0.08$, results not shown). We report the mean and standard error of mean of estimates unless otherwise stated.

Results

Consistent individual differences in behavior

We found consistent individual differences for most behavioral variables, except for time with head hidden during study 2 and for sociability scores and time spent walking in study 1 (Table 1). The PCAs suggested different patterns of behavioral covariation in the two studies (Table 2). In study 1, we retained three major axis explaining 85 % of the total variance. The first principal component (PC1) loaded significantly with two variables measuring risk taking, while variables related to sociability (and to some extent activity) showed a strong positive correlation with PC2. PC3 was positively correlated with variables measuring activity and one boldness score. Thus, PC1 measured variation in risk taking, and PC2 score indicated variation in sociability, while PC3 scored activity and

Table 1 Repeatability estimates (REP), likelihood ratio test (LRT) statistics, and associated *p* values computed to assess the significance of the inter-individual variance for each behavioral trait in the first and second studies. Significant REP values are shown in bold

		Study 1 of personality		Study 2 of personality	
	Behavior	LRT	REP	LRT	REP
Activity	Movement distance	$\chi^2_{0:1} = 4.49, p = 0.017$	0.48	$\chi^2_{0:1} = 15.4, p < 0.0001$	0.51
	Time spent walking	$\chi^2_{0:1} = 0.29, p = 0.29$	0.27	$\chi^2_{0:1} = 20.9, p < 0.0001$	0.58
	Time spent scratching	/	/	$\chi^2_{0:1} = 25.2, p < 0.0001$	0.71
	Time spent basking	/	/	$\chi^2_{0:1} = 35.3, p < 0.0001$	0.63
Risk taking	Time head hidden	$\chi^2_{0:1} = 17.3, p < 0.0001$	0.52	$\chi^2_{0:1} = 0.97, p = 0.32$	0.14
	Time body hidden	$\chi^2_{0:1} = 3.69, p = 0.027$	0.45	$\chi^2_{0:1} = 19.0, p < 0.0001$	0.56
	Time until basking	$\chi^2_{0:1} = 2.95, p = 0.043$	0.43	$\chi^2_{0:1} = 20.9, p < 0.0001$	0.58
Sociability	Absolute sociability score	$\chi^2_{0:1} = 0.94, p = 0.17$	0.34	/	/
	Relative sociability score	$\chi^2_{0:1} = 0.20, p = 0.32$	0.25	/	/
Aggressiveness	Aggressiveness after exploration	/	/	$\chi^2_{0:1} = 17.5, p < 0.0001$	0.54
	Aggressiveness after risk taking	/	/	$\chi^2_{0:1} = 18.4, p < 0.0001$	0.56

exploration. In study 2, we retained three major axes explaining 81 % of the variance. PC1 was positively correlated to variables related to activity and negatively correlated to risk taking. PC2 was negatively correlated to mobility and risk taking but positively correlated to basking time. PC3 loaded only significantly with the variables related to aggressiveness.

The removal of one outlier for boldness scores in study 1 influenced the correlation pattern represented by PC2 and PC3 (Supplementary Material 1: Table S1). Without the outlier, the second principal component (PC2) was positively related to activity and sociability, while PC3 had a strong negative correlation with variables measuring activity but was positively correlated with sociability. Thus, PC2 score indicated

variation in both activity and sociability (and not only sociability like in Table 2), while PC3 scores discriminated more sociable and less active lizards from less sociable and more active lizards.

Covariation between metabolism and personality

The SMR increased significantly and almost linearly with body temperature on the log scale (mixed-effects model, body temperature effect: slope = 0.10 ± 0.0048 , $F_{1,79} = 437.1$, $p < 0.001$; Fig. 1a). According to individual regressions, slopes (log SMR, mean = 0.10 ± 0.009 SD) and intercepts at

Table 2 Principal component analysis (PCA) of mean individual behavioral data in each study was done on the correlation matrix, thus implicitly rescaling all variables, and the table shows the loading scores for each of the three retained principal components. Bold typeface indicates the statistically significant loadings (based on the mean inertia criterion, see main text) for each variable

Behavioral traits	Study 1 (n = 39)			Study 2 (n = 50)		
	PC1	PC2	PC3	PC1	PC2	PC3
Movement distance	-0.460	0.486	0.659	0.714	-0.450	0.386
Mobility	-0.525	0.420	0.652	0.695	-0.478	0.406
Time spent scratching	/	/	-0.570	0.726	-0.089	0.010
Time spent basking	/	/	0.335	-0.465	0.671	-0.122
Time head hidden	0.457	-0.029	0.325	-0.668	-0.548	0.052
Time body hidden	0.906	-0.034	-0.369	-0.816	-0.544	0.045
Time until basking	0.903	-0.041	-0.303	-0.787	-0.541	0.080
Absolute sociability score	0.299	0.812	/	/	/	/
Relative sociability score	0.337	0.834	/	/	/	/
Aggressiveness after exploration	/	/	/	-0.321	0.303	0.824
Aggressiveness after risk taking	/	/	/	-0.284	0.380	0.784
Statistics of PC scores						
Eigenvalue	2.54	1.77	1.63	3.65	2.01	1.63
Variance explained	36.26	25.33	23.31	40.46	22.37	18.14

15 °C (log SMR, mean = 1.65 ± 0.47 SD) were strongly negatively correlated (Pearson moment-correlation $r = -0.85$, $p < 0.0001$). Given this pattern of crossing thermal sensitivity curves (Fig. 1a), the thermal repeatability of SMR was small ($R_T = 0.052$) and not significant ($\chi^2_{0.1} = 0.30$, $p = 0.27$). The best model (adjusted $R^2 = 0.126$) describing metabolic expenditure of an individual (intercept at 15 °C) included the PC2 score measuring variation in sociability (slope = -0.103 ± 0.05 ,

$F_{1,36} = 4.21$, $p = 0.047$, Fig. 1b) and a marginal negative effect of PC1 score (slope = -0.08 ± 0.04 , $F_{1,36} = 3.30$, $p = 0.077$). This effect of PC1 did not hold when we removed one outlier for boldness score (Supplementary Material 1: Table S2).

Covariation between glucocorticoid stress response and personality

Mean plasma corticosterone levels were higher in the field than after exposure to a handling stress in the laboratory (mean level in the field $56.3 \text{ ng/mL} \pm 2.33$, range 21.4–92.8; mean stress-induced level 35.0 ± 2.66 , range 6.98–117.6, paired t test: $t_{49} = 7.35$, $p < 0.001$; Fig. 2a). We found no significant effects of behavioral scores (PC1, PC2 and PC3 scores), SVL, time spent in the enclosure, and age class on plasma corticosterone concentration in the field (all $p > 0.21$). The best model (adjusted $R^2 = 0.16$) selected to describe variation in stress-induced corticosterone levels in the laboratory included two variables, a positive effect of field corticosterone (slope = 0.41 ± 0.15 SE, $F_{1,47} = 6.32$, $p = 0.015$) and a marginal, negative effect of PC3 score, which is positively correlated to aggressiveness (slope = 3.60 ± 1.92 SE, $F_{1,47} = 3.49$, $p = 0.068$, Fig. 2b). The removal of one “outlier” for corticosterone titer (Fig. 2a) weakened the effect of PC3 (slope = 2.69 ± 1.60 SE, $F_{1,46} = 2.85$, $p = 0.099$, Fig. 2b), as well as the correlation between field corticosterone and the stress response (slope = 0.21 ± 0.13 SE, $F_{1,46} = 1.94$, $p = 0.17$, Fig. 2a).

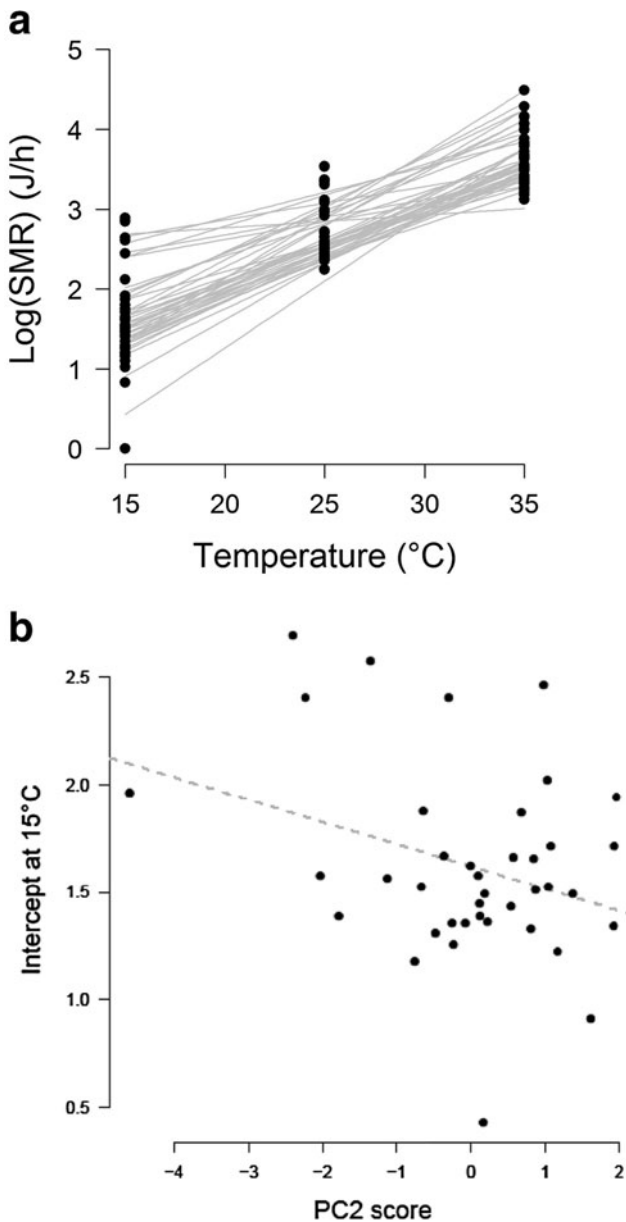

Fig. 1 Relationship between behavioral variation and standard metabolic rate (SMR) in male common lizards ($n = 39$). **a** The SMR increases significantly with body temperature. *Black circles* represent the observed SMR values, and the *gray lines* the predicted thermal reaction norms obtained from the individual linear regressions. **b** The individual intercept for SMR at 15 °C is negatively correlated with the PC2 score measuring correlated behavioral variation in activity and sociability

Discussion

In male common lizards, behavioral traits describing variation in activity, aggressiveness, and risk taking exhibited significant, short-term repeatability. These results agree with previous findings of consistent individual differences in behavior in juveniles (Cote and Clobert 2007; Le Galliard et al. 2013, 2015). However, individual differences in the sociability of adults were not repeatable, whereas sociability was consistent on the short term in juveniles (Le Galliard et al. 2015). Differences in short-term consistency of sociability between adults and juveniles are not just a consequence of a small and relatively homogeneous data set of adult males in this study, because it was confirmed in a longitudinal study including both sexes and more age classes (HM and J-FLG unpubl. data). The higher consistency of sociability in juveniles than that in older individuals may be due to a more pronounced sensitivity to odors of adult males in juveniles than that in adults, and/or changes in the ecological relevance of the test with age (Bell et al. 2009). For example, sociability is involved in dispersal behavior and consistently associated with the natal dispersal type in juveniles but may be of limited relevance in adults, since this age class disperses less (Le Galliard et al. 2005). The use of

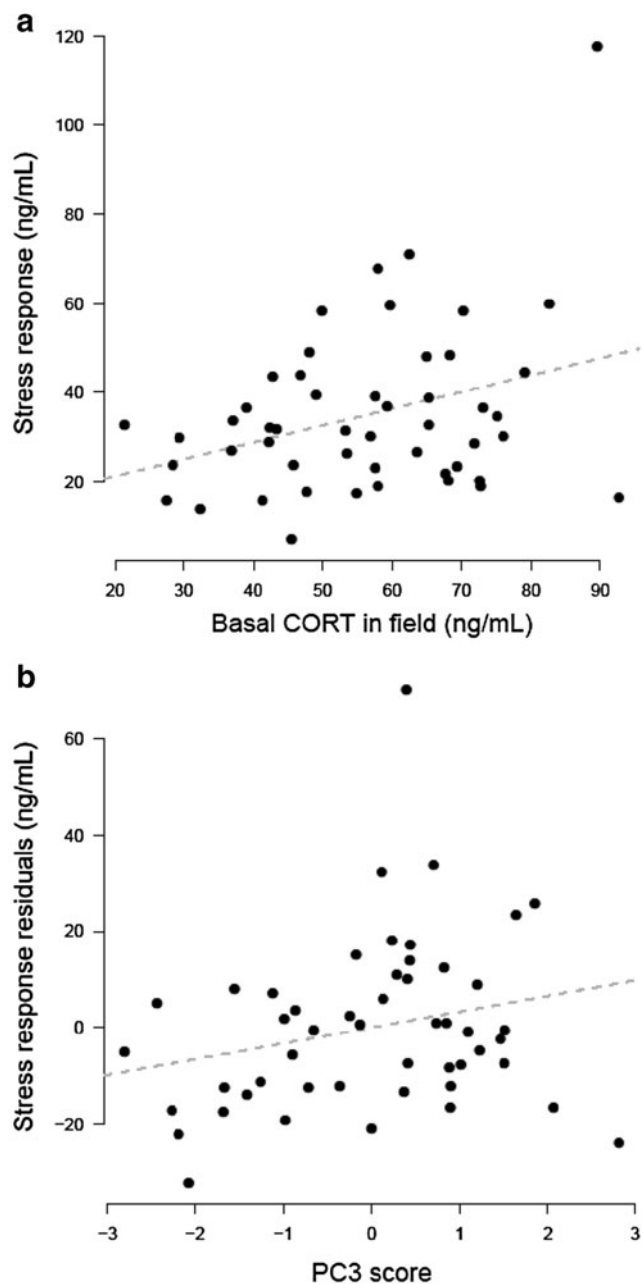

Fig. 2 Relationship between behavioral variation and plasma corticosterone levels in male common lizards. **a** The basal corticosterone level measured in the field was positively correlated with the stress response measured in the laboratory after a handling stress. **b** The residuals of the stress response regressed on the basal level of corticosterone in the field decreased marginally with PC3 score measuring behavioral variation in aggressiveness. There was one outlier for corticosterone titer (stress response >100 ng/mL)

a shelter choice experiment in adults may also be problematic since adult males tend to prioritize direct social interactions and are bolder and less attracted to the shelter than juveniles (J-FLG pers. obs.).

The principal component analyses highlighted relatively weak and non-significant associations between most

personality traits. Yet, there was evidence of a positive association between activity and risk taking in study 2 for PC1. In study 1, the association between activity and risk taking for PC1 was in the same direction but was not significant based on the inertia criterion. Activity was also associated positively with sociability in study 1. Behavioral syndromes have been little investigated so far in squamate reptiles relative to other taxa. Similar to our results, a behavioral syndrome linking independent measures of activity, boldness, sociability, and/or aggression was not found in juvenile common lizards (Le Galliard et al. 2015) and in adult White's skinks (McEvoy et al. 2015). Rodriguez-Prieto et al. (2011) also suggested that exploration, sociability, and boldness represent three independent facets of the personality of adult Iberian wall lizards (but see Stapley and Keogh 2004). Considering these results with our own could indicate that behavioral syndromes are not organized in squamate reptiles as they are in other vertebrate taxa. However, it could be that we lacked statistical power to detect small but meaningful correlations among traits. Larger sample sizes (here, $N < 50$) and more repeated measurements (here, 1 to 2) may be needed to score personality when traits are poorly repeatable (here, $0.14 < r < 0.70$) and to obtain unbiased estimates of correlations (reviewed in Garamszegi et al. 2012).

Regarding the individual variation in the standard metabolic rate (SMR), we found variation among individuals at the lowest body temperature (intercept), in addition to showing that lizards with a low intercept had a greater increase of their SMR with body temperature. Although these results must be considered with some caution, as we only tested animals once at each temperature, they suggest crossing thermal sensitivity curves for SMR (Careau et al. 2014). This could indicate that lizards that minimize basal energy expenditure at rest (low body temperatures) have higher basal expenditures at activity (high body temperatures). The robustness and generality of this pattern remains to be tested in larger samples of common lizards and in other species, and with several repeated measures at each temperature. In addition, we found that individuals with high values of sociability, and to some extent activity, were characterized by a lower SMR at 15 °C.

At first glance, the negative relationship obtained between the SMR at 15 °C and the sociability-activity axis seems to support the allocation model of energy management, where SMR constrains the expression of energetically costly behaviors (Careau et al. 2008; Careau and Garland 2012; Mathot and Dingemanse 2015). However, a more detailed examination of the results cautions against such a straightforward explanation. First, PC1 and PC3 scores directly related to risk taking and activity were not correlated with SMR even though these may reflect variation in energetically costly behaviors (Mathot and Dingemanse 2015). Second, even after accounting for the effect of PC2 score, much variation in SMR remained. Third, despite good evidence that SMR represents

a significant part of total energy expenditure in lizards (e.g., Niewiarowski and Waldschmidt 1992), no empirical study has yet examined among-individual partitioning of energy into maintenance, activity, and other energetic expenses. Given that an increased SMR does not seem to impair mean growth, survival, or reproduction in this species (Le Galliard et al. 2013; Artacho et al. 2015), we cannot tell with certainty that differences in SMR represent a significant energetic constraint at the individual level. Fourth, our study indicates that conclusions from correlation patterns between behavior and physiology obtained with measures of SMR at one body temperature may be misleading. Since low SMR at 15 °C was strongly, negatively associated with the thermal sensitivity of RMR, more sociable and active lizards did not necessarily have the lowest SMR at the highest body temperatures. Thus, when thermal repeatability of RMR is low, correlative studies linking animal personality and energetics may lead to results supporting the allocation model, the performance model, or none of them, depending on temperature used during measurements. While estimates of SMR at one body temperature are generally repeatable over time (Nespolo and Franco 2007), the thermal repeatability of SMR can be low when individuals vary in the thermal sensitivity of their metabolism (Careau et al. 2014). This suggests that relevant aspects of thermal biology should be considered when examining behavioral and physiological syndromes in ectotherms. In particular, we advocate for future investigations of covariation patterns between behaviors and physiology by repeatedly measuring all traits at several body temperatures.

The plasmatic levels of corticosterone varied importantly among individuals, as was found in previous studies (Meylan et al. 2003; Fitze et al. 2009). Field plasmatic levels of corticosterone were positively correlated with, but also higher than, the stress-induced levels measured in the laboratory. This surprising difference could be due to the need of elevated levels of corticosterone to sustain the locomotor activity and mating behavior of adult males in the field. In addition, the stress induced by confinement in the laboratory does not last more than a day in the common lizard (Dauphin-Villemant and Xavier 1987), and lizards might have returned to low basal levels before we started the handling stress measurements. Unfortunately, we did not measure basal levels in the laboratory prior to handling stress. The plasmatic level of corticosterone after exposure to a handling stress in the laboratory, corrected for basal variation in corticosterone levels from the field, was weakly and almost significantly positively correlated with aggressiveness. This link was tenuous and did not hold when we removed one extreme data point.

These results contradict the hypothesis that the glucocorticoid stress response constitutes a causal proximate mechanism behind the activity-aggressiveness-risk-taking behavioral syndrome, since we found no correlation with activity and

boldness. In addition, the weak correlation found for aggressiveness, if real, contrasts with findings in some bird and mammal species, where more aggressive individuals have a lower HPA axis activity and reactivity in response to a stressor (i.e., proactive coping style; Koolhaas et al. 1999; Groothuis and Carere 2005; Cockrem 2007). For example, house mice selected for low aggression have higher basal corticosterone levels during daytime and prolonged corticosterone secretion in response to a strong stressor (Veenema et al. 2003). Similarly, great tits (*Parus major*) selected for slow exploration speed are less aggressive and have more elevated corticosterone in response to a social stress than birds selected for fast exploration (Carere et al. 2003; Groothuis and Carere 2005; Baugh et al. 2012). The short-term increase of corticosterone concentration in response to a stressor also differs among individual birds, with stronger increase in slow than in fast explorers in *P. major* and *Passer domesticus* (Lendvai et al. 2011; Baugh et al. 2013).

There is also some evidence of a positive correlation between measures of risk taking and/or exploration and reactivity of the HPA axis in zebra finches (Martins et al. 2007) and in domestic leghorns (reviewed in Groothuis and Carere 2005). Similar to the trend we found, this suggests that reactive coping at the physiological level may not be systematically coupled with a less aggressive, bold, and exploratory behavioral type. In the only study to date on behavioral coping in lizards, Rodriguez-Prieto et al. (2011) found that more exploratory lizards habituated faster to a novel stress and thus were more “reactive” because they acquired better and faster information about their environment. Additional data on behavioral coping styles are needed to confirm that this represents a general pattern in lizards.

Overall, our study uncovered some (albeit weaker than expected) relationships between behavior and physiology that were predicted by the pace-of-life syndrome hypothesis, which states that behavioral syndromes are generally associated with physiological syndromes of the pace-of-life. The SMR at rest (measured at the lowest body temperature) was negatively correlated with behavioral variation in sociability and activity, and the plasma corticosterone level after an acute handling stress increased slightly but not significantly with aggressiveness. Thus, correlations between physiology and behavior were trait-dependent and less consistent than predicted. In addition, even though we had reasonable sample size in this study, the observed correlations should be treated with some caution, because correlations with the behavioral traits most likely to be linked with physiology were not observed, correlations between behavior and physiology could be sensitive to a few extreme values, and the ranking of individual scores of metabolic expenditure was temperature-dependent. This suggests that stress physiology and metabolism drove only a small part of the inter-individual variation in behavior in the common lizard.

Acknowledgments We thank Léna Baraud for her calculations of metabolic rate data, Samuel Perret and Julia Saravia for their assistance in the laboratory, and Claudy Haussy for the assistance with hormonal assays. Gabrielle Names kindly corrected an earlier version of this manuscript. This research was supported by the Centre National de la Recherche Scientifique (CNRS), an Agence Nationale de la Recherche grant (ANR-13-JSV7-0011-01) to SM and a post-doctoral grant from Becas Chile to PA.

Compliance with ethical standards

Conflict of interest The authors declare that they have no conflict of interest.

Authors' contributions J-FLG, PA, SM, and RJ designed the study. All authors contributed data collection, and HM analyzed the data. HM and J-FLG wrote the first draft, and all authors contributed to the writing.

Ethical approval All applicable international, national, and/or institutional guidelines for the care and use of animals were followed. Experiments were conducted under agreement A77-341-1 delivered by the Préfecture de Seine-et-Marne. Animals were captured and manipulated under authorization 2007-198-005 delivered by the Prefecture de Seine-et-Marne.

References

- Andrews RM, Pough FH (1985) Metabolism of squamate reptiles—allo-metric and ecological relationships. *Physiol Zool* 58:214–231
- Artacho P, Nespolo RF (2009) Natural selection reduces energy metabolism in the garden snail, *Helix aspersa* (*Cornu aspersum*). *Evolution* 63:1044–1050
- Artacho P, Jouanneau I, Le Galliard J-F (2013) Interindividual variation in thermal sensitivity of maximal sprint speed, thermal behavior, and resting metabolic rate in a lizard. *Physiol Biochem Zool* 86:458–469
- Artacho P, Saravia J, Ferrandière BD, Perret S, Le Galliard J-F (2015) Quantification of correlational selection on thermal physiology, thermoregulatory behavior, and energy metabolism in lizards. *Ecol Evol* 5:3600–3609
- Baugh AT, Schaper SV, Hau M, Cockrem JF, de Goede P, van Oers K (2012) Corticosterone responses differ between lines of great tits (*Parus major*) selected for divergent personalities. *Gen Comp Endocrinol* 175:488–494
- Baugh AT, van Oers K, Naguib M, Hau M (2013) Initial reactivity and magnitude of the acute stress response associated with personality in wild great tits (*Parus major*). *Gen Comp Endocrinol* 189:96–104
- Bell AM, Hankison SJ, Laskowski KL (2009) The repeatability of behaviour: a meta-analysis. *Anim Behav* 77:771–783
- Biro PA, Stamps JA (2010) Do consistent individual differences in metabolic rate promote consistent individual differences in behavior? *Trends Ecol Evol* 25:653–659
- Burnham KP, Anderson DR (1998) Model selection and inference: a practical information-theoretical approach. Springer Verlag, New York
- Careau V, Garland TJ (2012) Performance, personality and energetics: correlation, causation and mechanism? *Physiol Biochem Zool* 85:543–571
- Careau V, Thomas D, Humphries MM, Réale D (2008) Energy metabolism and animal personality. *Oikos* 117:641–653
- Careau V, Bininda-Emonds ORP, Thomas DW, Réale D, Humphries MM (2009) Exploration strategies map along fast–slow metabolic and life-history continua in muroid rodents. *Funct Ecol* 23:150–156
- Careau V, Gifford ME, Biro PA (2014) Individual (co)variation in thermal reaction norms of standard and maximal metabolic rates in wild-caught slimy salamanders. *Funct Ecol* 28:1175–1186
- Carere C, Groothuis TGG, Möstl E, Daan S, Koolhaas JM (2003) Fecal corticosteroids in a territorial bird selected for different personalities: daily rhythm and the response to social stress. *Horm Behav* 43:540–548
- Chessel D, Dufour A-B, Thioulouse J (2004) The ade4 package—I— one-table methods. *R News* 4:5–10
- Cockrem J (2007) Stress, corticosterone responses and avian personalities. *J Ornithol* 148:169–178
- Coppens CM, de Boer SF, Koolhaas JM (2010) Coping styles and behavioural flexibility: towards underlying mechanisms. *Philos T Roy Soc B* 365:4021–4028
- Cote J, Clobert J (2007) Social personalities influence natal dispersal in a lizard. *Proc R Soc Lond B* 274:383–390
- Cote J, Clobert J, Meylan S, Fitze PS (2006) Experimental enhancement of corticosterone levels positively affects subsequent male survival. *Horm Behav* 49:320–327
- Cote J, Dreiss A, Clobert J (2008) Social personality trait and fitness. *Proc R Soc Lond B* 275:2851–2858
- Cutts CJ, Adams CE, Campbell A (2001) Stability of physiological and behavioural determinants of performance in Arctic char (*Salvelinus alpinus*). *Can J Fish Aquat Sci* 58:961–968
- Dauphin-Villemant C, Xavier F (1987) Nycthemeral variations of plasma corticosteroids in captive female *Lacerta vivipara* Jacquin: influence of stress and reproductive state. *Gen Comp Endocrinol* 67:292–302
- de Fraipont M, Clobert J, John-Alder H, Meylan S (2000) Increased prenatal maternal corticosterone promotes philopatry of offspring in common lizards *Lacerta vivipara*. *J Anim Ecol* 69:404–413
- Dingemanse NJ, Wolf M (2010) Recent models for adaptive personality differences: a review. *Philos T Roy Soc B* 365:3947–3958
- Fitze PS, Cote J, San-Jose LM, Meylan S, Isaksson C, Andersson S, Rossi J-M, Clobert J (2009) Carotenoid-based colours reflect the stress response in the common lizard. *PLoS ONE* 4:e5111
- Garamszegi LZ, Gábor M, Herczeg G (2012) A meta-analysis of correlated behaviours with implications for behavioural syndromes: mean effect size, publication bias, phylogenetic effects and the role of mediator variables. *Evol Ecol* 26:1213–1235
- Groothuis TGG, Carere C (2005) Avian personalities: characterization and epigenesis. *Neurosci Biobehav R* 29:137–150
- Koolhaas JM, Korte SM, de Boer SF, van der Vegt BJ, van Reenen CG, Hopster H, de Jong IC, Ruis MAAW, Blokhuis HJ (1999) Coping styles in animals: current status in behavior and stress physiology. *Neurosci Biobehav R* 23:925–935
- Koolhaas JM, de Boer SF, Coppens CM, Buwalda B (2010) Neuroendocrinology of coping styles: towards understanding the biology of individual variation. *Front Neuroendocrin* 31:307–321
- Landys MM, Ramenofsky M, Wingfield J (2006) Actions of glucocorticoids at a seasonal baseline as compared to stress-related levels in the regulation of periodic life processes. *Gen Comp Endocrinol* 148:132–149
- Le Galliard J-F, Le Bris M, Clobert J (2003) Timing of locomotor impairment and shift in thermal preferences during gravidity in a viviparous lizard. *Funct Ecol* 17:877–885
- Le Galliard J-F, Ferrière R, Clobert J (2005) Effect of patch occupancy on immigration in the common lizard. *J Anim Ecol* 74:241–249
- Le Galliard J-F, Paquet M, Cisel M, Montes-Poloni L (2013) Personality and the pace-of-life syndrome: variation and selection on activity, metabolism and locomotor performances. *Funct Ecol* 27:136–144
- Le Galliard JF, Paquet M, Mugabo M (2015) An experimental test of density-dependent selection on temperament traits of activity, boldness and sociability. *J Evol Biol* 28:1144–1155
- Legendre P, Legendre L (1998) Numerical ecology. Developments in environmental modelling, vol 20. Elsevier Science, Amsterdam

- Lendvai AZ, Bókonyi V, Chastel O (2011) Coping with novelty and stress in free-living house sparrows. *J Exp Biol* 214:821–828
- López P, Hawlena D, Polo V, Amo L, Martín J (2005) Sources of individual shy-bold variations in antipredator behaviour of male Iberian rock lizards. *Anim Behav* 69:1–9
- Mallard F, Le Bourlot V, Tully T (2013) An automated image analysis system to measure and count organisms in laboratory microcosms. *PLoS ONE* 8:e64387
- Martins TL, Roberts ML, Giblin I, Huxham R, Evans MR (2007) Speed of exploration and risk-taking behavior are linked to corticosterone titres in zebra finches. *Horm Behav* 52:445–453
- Mathot KJ, Dingemanse NJ (2015) Energetics and behavior: unrequited needs and new directions. *Trends Ecol Evol* 30:199–206
- McEvoy J, While GM, Sinn DL, Carver S, Wapstra E (2015) Behavioural syndromes and structural and temporal consistency of behavioural traits in a social lizard. *J Zool* 296:58–66
- Meylan S, Dufty AJ, Clobert J (2003) The effect of transdermal corticosterone application on plasma corticosterone levels in pregnant *Lacerta vivipara*. *Comp Biochem Phys A* 134:497–503
- Nespolo RF, Franco M (2007) Whole-animal metabolic rate is a repeatable trait: a meta-analysis. *J Exp Biol* 210:2000–2005
- Nespolo RF, Lardies MA, Bozinovic F (2003) Intrapopulational variation in the standard metabolic rate of insects: repeatability, thermal dependence and sensitivity (Q10) of oxygen consumption in a cricket. *J Exp Biol* 206:4309–4315
- Niewiarowski PH, Waldschmidt SR (1992) Variation in metabolic rates of a lizard: use of SMR in ecological contexts. *Funct Ecol* 6:15–22
- Øverli Ø, Sørensen C, Pulman KGT, Pottinger TG, Korzan W, Summers CH, Nilsson GE (2007) Evolutionary background for stress-coping styles: relationships between physiological, behavioral, and cognitive traits in non-mammalian vertebrates. *Neurosci Biobehav R* 31:396–412
- Pinheiro JC, Bates DM (2000) *Mixed-effect models in S and S-plus*. Statistics and Computing. Springer, New York
- Réale D, Reader SM, Sol D, McDougall PT, Dingemanse NJ (2007) Integrating animal temperament within ecology and evolution. *Biol Rev* 82:291–318
- Réale D, Garant D, Humphries MM, Bergeron P, Careau V, Montiglio PO (2010) Personality and the emergence of the pace-of-life syndrome concept at the population level. *Philos T Roy Soc B* 365:4051–4063
- Ricklefs RE, Wikelski M (2002) The physiology/life-history nexus. *Trends Ecol Evol* 17:462–468
- Rodriguez-Prieto I, Martin J, Fernandez-Juricic E (2011) Individual variation in behavioural plasticity: direct and indirect effects of boldness, exploration and sociability on habituation to predators in lizards. *Proc R Soc Lond B* 278:266–273
- Sih A, Bell AM (2008) Insights for behavioral ecology from behavioral syndromes. *Adv Stud Behav* 38:227–281
- Sih A, Bell A, Johnson JC (2004a) Behavioral syndromes: an ecological and evolutionary overview. *Trends Ecol Evol* 19:372–377
- Sih A, Bell AM, Johnson JC, Ziemba RE (2004b) Behavioral syndromes: an integrative overview. *Q Rev Biol* 79:241–277
- Stapley J, Keogh JS (2004) Exploratory and antipredator behaviours differ between territorial and nonterritorial male lizards. *Anim Behav* 68:841–846
- Steyermark AC (2002) A high standard metabolic rate constrains juvenile growth. *Zoology* 105:147–151
- Veenema AH, Meijer OC, de Kloet ER, Koolhaas JM, Bohus BG (2003) Differences in basal and stress-induced HPA regulation of wild house mice selected for high and low aggression. *Horm Behav* 43:197–204
- Wilson DS, Clark AB, Coleman K, Dearstyne T (1994) Shyness and boldness in humans and other animals. *Trends Ecol Evol* 9:442–446
- Wingfield JC, Ramenofsky M (1999) Hormones and the behavioral ecology of stress. In: Palm PHM (ed) *Stress physiology in animals*. Biological Sciences Series. Sheffield Academic Press, Sheffield, pp 1–51
- Wolak ME, Fairbairn DJ, Paulsen YR (2012) Guidelines for estimating repeatability. *Methods Ecol Evol* 3:129–137
- Wolf M, McNamara JM (2012) On the evolution of personalities via frequency-dependent selection. *Am Nat* 179:679–692