



HAL
open science

Identification of the molecular origins of disease in a cohort of patients with suspected congenital disorders of glycosylation (CDG)

Sahar Sabry Zaki Tlep

► **To cite this version:**

Sahar Sabry Zaki Tlep. Identification of the molecular origins of disease in a cohort of patients with suspected congenital disorders of glycosylation (CDG). Tissues and Organs [q-bio.TO]. Université Pierre et Marie Curie - Paris VI, 2016. English. NNT : 2016PA066715 . tel-01653081

HAL Id: tel-01653081

<https://theses.hal.science/tel-01653081v1>

Submitted on 1 Dec 2017

HAL is a multi-disciplinary open access archive for the deposit and dissemination of scientific research documents, whether they are published or not. The documents may come from teaching and research institutions in France or abroad, or from public or private research centers.

L'archive ouverte pluridisciplinaire **HAL**, est destinée au dépôt et à la diffusion de documents scientifiques de niveau recherche, publiés ou non, émanant des établissements d'enseignement et de recherche français ou étrangers, des laboratoires publics ou privés.

ED 394 - Physiologie, physiopathologie et thérapeutique

INSERM UMR 1149 – Centre de recherche sur l’inflammation – Faculté de
Médecine – Xavier Bichat

A thesis submitted for the degree of PhD

29th November 2016

***Identification of the molecular origins of disease
in a cohort of patients with suspected congenital disorders of
glycosylation (CDG)***

Submitted by

Sahar SABRY ZAKI TLEP

Under the supervision of

Stuart MOORE PhD

Jury members

Dr. Gisèle Bonne

Dr. Katell Peoc'h

Dr. François Foulquier

Pr. Laurent Gouya

Dr. Stuart Moore

President

Reporter

Reporter

Examiner

Thesis supervisor

Acknowledgments

Firstly, I would like to thank my thesis supervisor, Dr. Stuart MOORE, for his efforts and help as it was the first time for me to work on the glycosylation topic, and I am grateful for his guidance in the experimental work and the writing of my thesis.

I would like to express my recognition to the glycobiology team at Bichat Hospital, Prof. Nathalie SETA, Dr. Sandrine VUILLAUMIER-BARROT, Dr. Arnold BRUNEEL, and Dr. Thierry DUPRÉ, for their collaboration and continuous help.

My thanks to the jury committee members, Dr. Gisèle BONNE (the committee president), Prof. Laurent GOUYA as well as the reporters in the jury committee, Dr. Katell PEOC'H, and Dr. François FOULQUIER for their insightful comments and remarks about my thesis.

I thank the 'Inflammatory and stress responses in chronic liver diseases' team which supported and helped me during my PhD, and it was such an honor to be one of the team for these years. I would like to thank Dr. Richard MOREAU, Dr. Sophie LOTERSZTAJN, Dr. Philippe LETTERON, Dr. Nathalie PILARD, Dr. Jinhong WAN, Magali FASSEU, Dr. Florence REYL-DESMARS, Dina CHOKR, Dr. Pushpa HEDGE, and Dr. Abdellah MANSOURI. I also would like to thank Dr. Isabelle CHANTRET for teaching me many techniques that were helpful in my PhD.

I am really thankful to my true friend, Arige TARHUNI, who stood by my side when I first came to France and helped me a lot.

My sincere gratitude to the Biochemical Genetics team in Egypt, my seniors: Prof. Ekram FATEEN and Dr. Mona IBRAHIM for great support all the time. Special thank to my master, Prof. Amr GOUDA who gave me the opportunity to get this scholarship and come to France and who has always been an example of how the leader should be. My friends whom I'm so lucky to have as labmates in Egypt: Azza EL-BAZ, Amira RADWAN, Wala SAMY, Mai ABDUL-RAHEM, Soha NOSIR, Marwa DAKROURY, Zeinab YOUSSEF, Mostafa EL-SHARKAWY.

Last but not least, I would like to dedicate this work to my family:

My mother... You have always been an inspiration to me with your strength and patience. You've believed in me all the time and kept telling me never to give up and do my best.... I owe every success in my life to you and I hope I never let you down.

My father's soul ... I know that you've been watching me from heaven... I hope to become the person you would wish to see and make you proud.

My sisters, you've always been there for me, supporting me spiritually and wishing me the best.

List of Content

List of Figures	7
List of Abbreviations	8
Chapter 1	13
General Introduction	13
1] Biochemical aspects of glycosylation	15
1.1] <i>Where does glycosylation take place in the cell?</i>	15
1) Glycosylation in the endomembrane system	15
2) Nuclear and cytoplasmic glycosylation	15
3) Mitochondrial glycosylation	16
1.2] <i>Biological importance of macromolecule glycosylation</i>	17
1.2.1) Tissue Construction	17
1.2.2) Regulation of biological activity	18
1.2.3) Ligands for Glycan Binding Proteins (GBPs)	18
a) Intrinsic glycan-recognition:	19
a.1) Intracellular intrinsic glycan-recognition	19
a.2) Extracellular intrinsic-glycan recognition	21
b) Extrinsic glycan-recognition:	22
1.3] <i>How does a GBP interact with its corresponding glycan?</i>	25
1.4] <i>Biosynthesis of glycans</i>	26
1) General considerations	26
2) Chemistry of the glycosylation reaction	26
3) Glycosylation reactions can require multiple components	27
3.1) Activated Sugars	27
3.2) Nucleotide sugar transporters	29
3.3) Glycosyltransferases	31
1.5] <i>Types of Glycoconjugate</i>	33
A) Glycoproteins	33
A.1) N-glycoproteins	33
○ <i>N-glycan biosynthesis</i>	34
A.2) O-glycoproteins	37
○ <i>O-glycosylation versus N-glycosylation</i>	37
○ <i>Types of O-glycans</i>	37
I) N-acetylgalactosamine-O-Ser/Thr glycans (O-GalNAc)	37
○ O-GalNAc glycan core structure	37
○ The biological importance of O-GalNAc glycans	38
○ Biosynthesis of O-GalNAc glycans	38
II) Mannose-O-Ser/Thr glycans (O-Man glycans)	39
○ O-Man glycan core structure	39
○ The biological importance of O-Man glycans	39
○ Biosynthesis of O-Man glycans	41
III) Fucose-α-O-Ser/Thr glycans	42
○ O-Fuc glycan core structure	42
○ The biological importance of O-Fuc glycans	42
○ Biosynthesis of O-Fuc glycans	43
VI) Glucose-β-O-Ser/Thr glycans (O-Glc glycans)	44

V) Galactose- β -O-hydroxy-Lys/Pro glycans	44
B) Proteoglycans	45
o Proteoglycan structure	45
o The biological importance of proteoglycans	45
o Biosynthesis of GAGs	46
C) Glycosylphosphatidylinositol anchored proteins (GPI-anchor)	48
o GPI anchor structure	48
o Biological roles of GPI anchors	48
o Biosynthesis of GPI anchored proteins	48
D) Glycosphingolipids (GSLs)	50
o Historical background	50
o GSL structure	51
o Biological importance of GSLs	52
o GSLs nomenclature	53
o Biosynthesis of GSLs	54
2] Human Glycosylation Disorders	58
2.1] Age-associated hypoglycosylation	58
1) Immunodeficiency	58
2) Age-associated dementia	58
3) Alzheimer's disease (AD)	58
AD is associated with many protein hypoglycosylation events. For example:	58
2.2] Secondary hypoglycosylation disorders	59
a) Classic galactosemia	59
b) Hereditary fructosemia intolerance (HFI)	59
2.3] Congenital Disorders of Glycosylation (CDGs)	60
2.3.1] Discovery of CDG	60
2.3.2] Molecular levels of CDG	60
2.3.3] Nomenclature and Classification of CDGs	62
2.3.4] Clinical presentation of CDGs	63
2.3.5] Mode of inheritance of CDGs	64
2.3.6] Diagnosis	65
2.3.6.1] CDG diagnostic biomarkers	65
a) Glycoprotein biomarkers	65
a.1) Plasma glycoproteins	65
1) N-glycoproteins:	65
2) O-glycoprotein	66
a.2) Cell-derived glycoproteins	66
b) GPI anchor markers	67
c) GSL markers	67
2.3.6.2] Glycomics	67
o Mass spectrometry (MS)	68
o Electrophoresis	68
o Sodium dodecyl sulfate-polyacrylamide gel electrophoresis (SDS-PAGE)	69
2.3.7] Treatment approaches for CDGs	70
2.3.7. A] Etiologic treatment	70
2.3.7. B] Symptomatic treatment	72
Chapter 2	74
CDG-Diagnostic Procedures at Hôpital Bichat-Claud Bernard Faculté de Médecine	74
Step 1: Referral of CDG-suspected patients to Hôpital Bichat-Claude Bernard	75

<i>Step 2: CDG-diagnosis protocol followed at Hôpital Bichat-Claude Bernard</i>	75
a) Biochemical analysis	75
1) Serum glycoproteins glycosylation status detection	75
2) PMM2 and MPI enzymatic activity assay	76
b) Causative-mutation detection	76
1) Sanger sequencing	76
2) Whole exome sequencing (WES)	76
<i>Step 3: Biochemical exploration of glycosylation pathways in skin biopsy fibroblasts</i>	77
Chapter 3	79
Studied CDG-X Patients	79
<i>Abstracts of studied CDG patients</i>	80
Patient I	83
1] Introduction.....	83
1.1] Fucntional studies in cells from a cohort of CDG-Ix patients	83
<i>The whole CDG-Ix cohort results:</i>	83
<i>I) Results of CDG-diagnostic procedures followed at Hôpital Bichat-Claude Bernard</i>	83
<i>II) Results of biochemical study of the whole cohort performed in the glycobiology lab at UMR 1149-INSERM- Faculté de Médecine Xavier Bichat</i>	84
1.2] The role of DHDDS in the biosynthesis of dolichol.....	87
1.2.1] Dolichol	87
1.2.1.1] Structure and occurrence of dolichol in nature	87
1.2.1.2] Dolichol biosynthesis	88
<i>Figure (29) enzyme key: MVAK, mevalonic acid kinase; PMVAK, phosphomevalonic acid kinase; IPP, isoprene phosphate; GPPS, geranyl pyrophosphate synthase; FPPS, farnesyl pyrophosphate synthase; SRD5A3, steroid 5α reductase type 3.</i>	89
1.2.1.3] Dolichol and its role in glycosylation	90
1.2.2] DHDDS	91
1.2.2.1] DHDDS is a cis-prenyltransferase	91
1.2.2.2] DHDDS structure and mechanism of action	92
2] Article (Patient I).....	94
3] Discussion	108
Patient II	114
1] Introduction	114
1.2] Introduction to experimental work	114
1.2.1] Cellular Sialome.....	115
1.2.2] Sialoglycans biosynthesis	116
1.2.3] Biological importance of sialylation	117
<i>1) Sialoglycans mediate many biological processes</i>	117
<i>2) Sialoglycans are recognized by viruses and bacteria</i>	117
<i>3) The lectin-independent roles of sialoglycans</i>	118
1.2.4] Sialic acid structure and biosynthesis.....	118
1.2.5] Solute Carrier family 35 (CMP-Sia transporter, CST) member 1 (SLC35A1)	119
2] Results presented in the form of a manuscript	120
4] Discussion and Conclusion.....	146
Discussion	146
Conclusion	151
Chapter 4	152
General Conclusions	152

Chapter 5	154
<i>Bibliography</i>	154
Chapter 6	167
Appendix.....	167
<i>A) Dolichol Biosynthesis Defects</i>	169
<i>B) Sugar Donor Biosynthesis Defects</i>	170
<i>C) Sugar Donors Transport Defects</i>	174
<i>D) Glycans synthesis and conjugation with macromolecules:</i>	175
I- N- acetylhexosaminylation Defects	175
a) Protein N-acetylhexosaminylation Defects	175
b) GSL N-acetylhexosaminylation Defects	178
c) GAGs N-acetylhexosaminylation Defects	178
d) GPI anchors N-acetylhexosaminylation Defects.....	179
II- Mannosylation Defects	180
a) Glycoproteins Mannosylation Defects	180
b) GPI-anchors Mannosylation Defects	184
III) Glucosylation Defects	185
IV) Glucuronylation Defects	186
V) Galactosylation Defects	187
a) GAGs Galactosylation Defects	187
b) Glycoproteins Galactosylation Defects	187
VI) Sialylation Defects	188
VII) Defective GA-resident proteins	189
VIII) Miscellaneous.....	191

List of Figures

Figure 1: M6P biosynthetic pathway in the cis-GA.	20
Figure 2: M6P-labelled lysosomal hydrolase targeting from the Golgi apparatus to the lysosome.	20
Figure 3: Glycan-recognition in an LPS-induced inflammatory response.	23
Figure 4: The “key-lock” theory of glycan-GBP interaction.	25
Figure 5: Bimolecular nucleophilic substitution (SN ₂) reaction of a monosaccharide addition to an acceptor via glycosidic linkage formation.....	26
Figure 6: The biosynthetic and interconversion pathways of UDP-Glc and UDP-Gal in the cytoplasm.....	27
Figure 7: The biosynthetic and interconversion pathways of GDP-Man and GDP-Fuc in the cytoplasm.....	28
Figure 8: The biosynthetic and interconversion pathways of UDP-GlcNAc and UDP-GalNAc in the cytoplasm	28
Figure 9: The biosynthetic pathway of CMP-Sia from UDP-GlcNAc.	29
Figure 10: The transport mechanism of a nucleotide sugar across an organelle membrane by its specific NST.	30
Figure 11: N-glycan structures showing their glycosidic linkages.....	33
Figure 12: A simplified scheme showing protein N-glycosylation in the ER lumen and modifications in the GA	35
Figure 13: N-acetylgalactosamine-O-Ser/Thr glycan (O-GalNAc) biosynthesis in the GA	39
Figure 14: The intracellular localization of O-mannosylated α -DG demonstrating its role in connecting the ECM to components of cytoskeleton.....	40
Figure 15: O-Man glycan biosynthesis in the ER and GA.....	41
Figure 16: Protein-O-fucosylation of EGF- and TS-repeats	43
Figure 17: Glycosaminoglycans (GAGs) biosynthesis in the ER and GA.	47
Figure 18: GPI anchor structure	48
Figure 19: GPI-anchor biosynthesis and attachment to protein in the ER.....	54
Figure 20: The Egyptian Sphinx and sphingolipid structure	50
Figure 21: Glucosylceramide (GlcCer) structure.....	51
Figure 22: Ceramide structure	51
Figure 23: The biosynthesis of glycosphingolipids (GSLs).....	60
Figure 24: Defective biochemical events in glycosylation process.....	61
Figure 25: Flow chart of CDG diagnostics at Hôpital Bichat and the Faculté de médecine Xavier Bichat	77
Figure 26: TLC of oligosaccharides released from DLO that was derived from metabolically [2- ³ H]mannose-radiolabeled cells from the cohort of CDG-Ix patients.	84
Figure 27: TLC of oligosaccharides released from DLO that was derived from metabolically [6- ³ H]glucosamine radiolabeled cells from a cohort of CDG-Ix	91
Figure 28: Structure of dolichol (α -saturated) and polyprenol. The number of isoprene units is indicated in square brackets.	87
Figure 29: De novo dolichol biosynthesis and phosphorylation.....	89
Figure 30: The metabolic fates of dolichol and dolichol phosphate.....	90
Figure 31: Mechanism of action of trans- and cis-prenyltransferases	91
Figure 32: A model for the bacterial cis-prenyltransferase UPPS.....	93
Figure 33: TLC of dolichols extracted from DHDDS-CDG and control.....	109
Figure 34: Levels of individual dolichols (right panel) and C15/C45 ratio in the patient and control.....	110
Figure 35: The production of farnesol (C15) in the presence of reduced DHDDS activity.....	110
Figure 36: WB of expression level of Nogo B receptor in fibroblasts	111
Figure 37: DLO (left) and NLO (right) profiles of ZA-treated fibroblasts	112
Figure 38: Different sialoglycan classes, showing their structure and arrangement on the cells surface	121
Figure 39: CMP-Sialic acid biosynthesis and utilization in sialoglycan biosynthesis	116
Figure 40: N-acetylneuraminic acid (sialic acid) structure	118

List of Abbreviations

A

AchR	Acetylcholine Receptor
AchE	Acetylcholine Esterase
α -DG	α -dystroglycan
AD	Alzheimer's Disease
Apo C-III	Apolipoprotein C-III
ar RP	Autosomal Recessive Retinitis Pigmentosa
AJ	Ashkenazi Jews
ASGRs	Asialoglycoprotein Receptors
ALG	Asparagine Linked Glycosylation

B

β -DG	β -dystroglycan
-------------	-----------------------

C

CRDs	Carbohydrate-Recognition Domains
CI-MPR	Cation-Independent Mannose-Phosphate-Receptor
CD-MPR	Cation-Dependent Mannose-Phosphate-Receptors
CNX	Calnexin
CRT	Calreticulin
CE	Capillary Electrophoresis
CERT	Ceramide Transport protein
CHO	Chinese Hamster Ovary
CS	Chondroitin Sulfate
CPT	<i>cis</i> -Prenyltransferase
CST	CMP-Sia Transporter
ColGalT	Collagen Galactosyltransferases
CDG	<i>Congenital Disorder of Glycosylation</i>
CMS	Congenital Myasthenic Syndrome
CDGS	Carbohydrate Deficient Glycoprotein Syndrome
CMP-Sia	Cytidine 5'-Monophosphosialic acid

D

DAMP	Dimethyl allyl phosphate
DS	Dermatan Sulfate
DHDDS	Dehydrodolichol Diphosphate Synthase
DOLK	Dolichol Kinase
DLO	Dolichol-linked Oligosaccharide
Dol-P-Man	Dolichol Phosphomannose
DPMS	Dolichol Phosphomannose Synthase
Dol-P-Glc	Dolichol Phosphoglucose
DPGS	Dolichol Phosphoglucose Synthase

E

EGF	Epidermal Growth Factor
ESI	Electro Spray Ionization
ERAD	ER-Associated Degradation
ERQC	ER-Quality Control
ECM	Extracellular Matrix
EGF	Epidermal Growth Factor (EGF)-like
EPO	Erythropoietin

F

FBS	Fetal Bovine Serum
FPP	Farnesyl pyrophosphate
FucTn	Fucosyltransferase
F1P	Fructose-1-phosphate

G

Gal1P	Galactose-1-phosphate
GALT	Galactose-1-phosphate uridyltransferase
GalCer	Galactosylceramide
GC	Gas Chromatography
GDP-Fuc	Guanosine diphosphate fucose
GDP-Man	Guanosine diphosphate mannose
GMPPB	GDP-Man pyrophosphorylase B
GPP	Geranyl pyrophosphate
GlcCer	Glucosylceramide
GA	Golgi Apparatus
GlcUA	Glucuronic Acid
GlcTn	Glucosyltransferase
GlcNSO ₃	Glucosamine sulfate
GFPT 1	Glutamine: fructose-6-phosphate transaminase 1
GAGs	Glycosaminoglycans
GIT	Gastrointestinal Tract
GSLs	Glycosphingolipids
GBP	Glycan Binding Protein
GPI	Glycosylphosphatidylinositol
GNE	UDP- <i>N</i> -acetylglucosamine 2-epimerase (GlcNAc 2-epimerase) and <i>N</i> -acetylmannosamine kinase (ManNAc).

H

HUS	Hemolytic Uremic Syndrome
HS	Heparin Sulfate
HFI	Hereditary Fructosemia Intolerance
HIBM II	Hereditary Inclusion Body Myopathy type II
HDL	High Density Lipoprotein
HEVs	High Endothelial Venules
HPLC	High Performance Liquid Chromatography
HPTLC	High Performance Thin Layer Chromatography
hCGT	Human Chorionic Gonadotropin
hCST	Human CMP-Sia Transporter
hUGT	Human UDP-Gal Transporter

I	
IEMs	Inborn Errors of Metabolism
IMM	Inner Mitochondrial Membrane
ICAM-1	Intercellular Adhesion Molecule 1
IP	Isoelectric Point
IEF	Isoelectric Focusing
IPP	Isoprenyl Pyrophosphate
J	
K	
kDa	Kilo Dalton
KS	Keratan Sulfate
L	
LacCer	Lactosylceramide
LAD II	Leukocyte Adhesion Deficiency type II
LGMD	Limb Girdle Muscle Dystrophy
LPS	Lipopolysaccharide
LH	Luteinizing Hormone
LAMP 1	Lysosomal Associated Membrane Protein 1
LSDs	Lysosomal Storage Diseases
M	
ManTn	Mannosyltransferase
MS	Mass Spectrometry
MS/MS	Mass/ Mass spectrometry
MALDI	Matrix Assisted Laser Desorption Ionization
M6P	Mannose-6-Phosphate
MPI	Mannose Phosphate Isomerase
MPR	Mannose-Phosphate-Receptor
MRI	Magnetic Resonance Imaging
MCAD	Medium Chain AcylCoA Dehydrogenase
MO	Morpholino
MAG	Myelin-Associated Glycoprotein
N	
GlcNAc	N-acetylglucosamine
Neu5Ac	N-acetylneuraminic acid
NCAM 1	Neural Cell Adhesion Molecule 1
NgBR	Nogo B Receptor
NLO	N-linked Oligosaccharide
NMR	Nuclear Magnetic Resonance
NST	Nucleotide Sugar Transporter
O	
OGT	O-GlcNAc transferase
OGA	O-GlcNAcase
OMM	Outer Mitochondrial Membrane
OST	Oligosaccharide Transferase
OMIM	Online Mendelian Inheritance in Man
P	
PAPA	3'-phosphoadenosine-5'-phosphosulfate Paroxysmal Nocturnal Hemoglobinuria type I

PNH	Pathogen-Associated Molecular Pattern
PAMP	Pattern-Recognition Receptor
PRR	Phosphomannomutase 2
PMM2	Polyunsaturated Fatty Acid
PUFA	Polysialic Acid
PSA	Protein Disulfide Isomerase
PDI	Pyruvate Dehydrogenase complex component X
PDHX	Protein-O-Mannosyltransferase
POMT	Protein-O-Fucosyltransferase
POFUT	Protein-O-Glucosyltransferase
POGLUT	
Q	
R	
rER	Rough Endoplasmic Reticulum
S	
SN ₂	Bimolecular Nucleophile Substitution
SLC	Solute Carrier
SDS/PAGE	Sodium Dodecyl Sulfate-Polyacrylamide Gel Electrophoresis
Sia	Sialic acid
STn	Sialyltransferase
SRD5A3	Steroid 5 α Reductase type 3
SCP-2	Sterol Carrier Protein-2
SGAG-BPs	Sulfated Glycosaminoglycans-Binding Proteins
T	
TLC	Thin Layer Chromatography
TSR 1	Thrombospondin type 1 Repeats
TM	Transmembrane
TMD	Transmembrane Domain
TLR	Toll-Like Receptor
Tf	Transferrin
TCA	Tricarboxylic Acid cycle
U	
UDP-Gal	Uridine diphosphate galactose
UDP-GalNAc	Uridine diphosphate N-acetylgalactosamine
UDP-Glc	Uridine diphosphate glucose
UDP-GlcNAc	Uridine diphosphate N-acetylglucosamine
UDP-GlcUA	Uridine glucuronic acid
UDP-Xyl	Uridine diphosphate xylose
UPPS	Undecaprenol diphosphate synthase
V	
VNTRs	Variable Number of Tandem Repeats
W	
WS	West syndrome
WES	Whole exome sequencing

X

Y

Z

ZA

ZP

Zaragozic Acid

Zona Pellucida

Chapter 1

General Introduction

1] Biochemical Aspects of Glycosylation

1] Biochemical aspects of glycosylation

Glycosylation is a biological process in which macromolecules like proteins and lipids are enzymatically modified with sugars to form glycoconjugates. The cell content of glycans linked to macromolecules (lipids or proteins) is called The Cellular Glycome¹. Glycosylation occurs in eukaryotes as well as prokaryotes.

1.1] Where does glycosylation take place in the cell?

1) Glycosylation in the endomembrane system

In eukaryotes, glycosylation processes take place mainly in two subcellular compartments; the rough endoplasmic reticulum (rER) and the Golgi apparatus (GA). Each compartment possesses its specific enzyme-machinery (glycosyltransferases and glycosidases) either bound to its membranes (most glycosyltransferases are type II transmembrane (TM) proteins with their catalytic carboxyl-terminal oriented towards the ER- or GA lumen whereas their amino-termini are oriented to the cytosolic-face of the compartment) or soluble glycosyltransferases. For example, O-fucosyltransferase is a soluble enzyme within the lumen of the ER. In addition, the ER and the GA have a specific sugar-transport system in the form of membrane-bound transporters for each of the nucleotide sugars that are synthesized in the cytoplasm¹.

Moreover, these two sites contain the glycan acceptors whether it is a nascent protein in the lumen of the ER in the case of protein N-glycosylation, or an ER-synthesized lipid (ceramide) that is then translocated to the luminal face of the GA to produce the glycosphingolipids (GSLs). Other factors within the ER and the GA are responsible for providing the appropriate conditions for the glycosylation process. For instance, the ER-lumen represents the optimum environment for glycoprotein quality control processes that occur as an important step of protein N-glycosylation (see below). The ER-lumen contains the chaperone-machinery, Ca²⁺ reservoir, and protein disulfide isomerase (PDI) that is required to form disulfide bonds in the folding protein².

Another example is the contribution of both, the ER and GA, to the recycling of dolichol, (see below). The dolichol-synthesizing enzymes are ER-located while the dolichol-recycling enzymes (phosphatases) with all the required divalent cations are both ER- and GA-located³.

In prokaryotes where the ER-GA system is absent, cell surface glycans are synthesized in the periplasm (the zone between the cytoplasmic membrane and the cell wall)¹. Exceptionally, in eukaryotes hyaluronan, a polysaccharide containing D-glucuronic acid (GlcUA) and N-acetylglucosamine (GlcNAc) is synthesized at the plasma membrane¹.

2) Nuclear and cytoplasmic glycosylation

Glycosylation processes are not restricted to the endomembrane systems but also take place in the nucleus and cytoplasm⁴. Lectin binding studies revealed the presence of glycans that contain mannose, GlcNAc and fucose in the cytoplasm and nucleus^{4,5}.

Some ideas were proposed to identify the source of these glycans. First, concerning the glycosylation machinery, the cytoplasm and nucleus could contain soluble glycosyltransferases. Second, these glycans found in the nucleocytoplasmic compartment could be degradation products of proteasome-mediated degradation of misfolded glycoproteins translocated from the ER to the cytoplasm by the bidirectional Sec61/63 translocator^{4,6}.

Now, nucleocytoplasmic protein O-GlcNAcylation is one of the most intensely studied glycosylation events. This process involves a dynamic cycle of O-GlcNAc addition and removal mediated by cytosolic O-GlcNAc transferase (OGT) and cytosolic O-GlcNAcase (OGA)⁷. Other nucleocytoplasmic glycans probably exist, but have not been characterized due to technical limitations such as the possible lack of specificity of some lectins and the difficulty in purifying proteins from the nuclear and cytosolic compartments without contamination with proteins from other cellular organelles⁴.

3) Mitochondrial glycosylation

Mitochondria represent another site for glycosylation. However, unlike the ER and GA wherein almost all types of glycosylation occur, mitochondria are involved only in protein O-GlcNAcylation that is mediated by mitochondrial splice variants of O-GlcNAc transferase (OGT) and O-GlcNAcase (OGA)⁸. Disruption of the mitochondrial O-GlcNAcylation cycle has been shown to cause impaired mitochondrial functions such as cellular respiration and glycolysis (especially under stress conditions).

Experimental studies revealed that mitochondrial OGT/OGA-overexpressing cells showed markedly reduced expression levels of mitochondrial proteins such as respiratory chain proteins (e.g. complex I protein NDUFA 9), β -oxidation enzymes (e.g. MCAD, medium chain acylCoA dehydrogenase), tricarboxylic acid (TCA) cycle components (e.g. PDHX, pyruvate dehydrogenase complex component X) and some transport proteins in both inner mitochondrial membrane (IMM) and outer mitochondrial membrane (OMM)⁸. Interestingly, a galactolipid was detected to be synthesized in mitochondrial membranes of plants⁴.

1.2] Biological importance of macromolecule glycosylation

As they are widely expressed with great structural diversity in all types of cells and tissues, Glycans are directly or indirectly involved in several biological processes.

The outermost protective layer of eukaryotic cells is called the glycocalyx and is composed of glycoconjugates that link the cell to the extracellular matrix. During many biological events, the glycocalyx mediates intercellular communication⁹.

In humans, the major functions of glycans can be grouped as follows:

1.2.1) Tissue Construction

Glycans play a major role in the physical properties of tissues in terms of integrity, porosity rigidity and stability^{10,11}. Glycans are expressed in a tissue-specific way where each tissue contains different glycans in distinct proportions¹¹.

Collagen, for example, is one of the major types of O-glycoprotein, and constitutes 25 – 35 % of the total body protein content. It represents a major constituent of connective tissues in skin, bone, cornea, teeth and cartilages¹².

Similarly, glycosaminoglycans (GAGs) are linked to the proteoglycans of different types of connective tissue where they contribute directly to organ function. For example, the GAG keratan sulfate type I (KS I) is highly abundant in collagen fibrils of the cornea and is required to maintain the spatial arrangement of the fibrils that is essential for the passage of light¹³.

Being integrated into tissues to a high extent, glycans can function as a reservoir for a lot of biologically important molecules. For example, during the angiogenesis process, heparin, which is one of the GAGs, is found in the extracellular matrix where it binds to growth factors preventing their diffusion into surrounding tissues. In this way, non-specific proteolytic degradation of growth factors is prevented until they are required¹⁴.

In humans, the mucosa of almost all the physiological systems is coated with a heavy layer of glycans of different structure and therefore, different functions¹⁵. The major role of these glycan layers is to act as a barrier to protect the underlying tissue. Complex glycoproteins and GSLs, for example, are involved in lining the whole respiratory system¹⁵. In addition, the pulmonary secretions contain mucin (O-glycoprotein) which is a hydrating molecule that protects bronchi and bronchioles from dryness and provides a physical protection against external microbes and foreign particles¹⁵. The gastrointestinal tract (GIT) mucosa possesses GSLs on its surface that function as ligands for gastric commensal bacteria (symbiotic bacteria or gut microbiota)¹⁶.

1.2.2) Regulation of biological activity

The activity of many biological mediators such as hormones and enzymes can be regulated by their glycosylation¹⁷. The glycosylation effect on the biomolecules can range from fine-adjustment (tuning) to switching on or off the activity¹¹.

For example, the activity of human chorionic gonadotrophin (hCGT) is abolished when it is deglycosylated and it becomes unable to stimulate adenylate cyclase¹⁸.

Certain glycoconjugates have an indirect activity-regulating role¹⁹. For example, membrane-bound GSLs undergo self-association in response to some stimuli (antibody, for an example) forming lipid rafts that consist of clusters of GSLs²⁰. This clustering causes physical changes in which the membrane-bound tyrosine kinase is brought closer to its substrates such as Epidermal Growth Factor (EGF) and insulin receptors to be phosphorylated and thereby, modulating their activity. These GSL clusters are called glyco-synapses because of their signaling enhancing properties¹⁹.

1.2.3) Ligands for Glycan Binding Proteins (GBPs)

Glycan binding proteins are antibodies, lectins or sulfated GAG binding proteins. According to their cellular location, GBPs are classified into:

- 1) Membrane-associated GBPs that upon interaction with their specific glycans mediate many cellular events like endocytosis, cell-cell signaling, and cell adhesion.
- 2) Soluble GBPs that recognize glycans in non-restricted sites i.e. can bind to their ligands in the surrounding tissues or in the blood stream²¹.

Lectins are macromolecules that contain carbohydrate-recognition domains (CRDs). They show high specificity toward the terminal non-reducing sugars of glycans²². They comprise a large family of proteins that show selectivity for diverse glycan structures. Lectins are found in animals, plants, viruses and bacteria²².

Via their interaction with their cognate glycans, lectins mediate several biological processes in those organisms²². The interaction takes place when the specific sugar is physically embedded in a well-defined binding pocket²².

Lectins are classified into four major classes according to their cognate sugar. These classes are: *i) Siglecs and selectins*: sialic acid-recognizing lectins^{23,24}, *ii) Galectins*; which bind to galactose-terminated glycans^{23,25}, *iii) P-lectins*, that bind to mannose-6-phosphate (M6P)-labeled glycoproteins²⁶, and *iv) C-lectins*: they bind many sugars in a Ca²⁺-dependent process²⁷.

Another type of GBP is the sulfated GAG-binding proteins (SGAG-BPs). Unlike lectins, SGAG-BPs interact specifically with the negatively charged sugars of GAGs. These SGAG-BPs display clusters of positively charged amino acids on the cell surface²⁸. For example, heparin binds to anti-thrombin in this way to mediate the anti-coagulating action^{28,29}. Here, the anti-thrombin protein contains 2-positively charged amino acids that specifically interact with an internal pentasaccharide sequence in heparin^{28,29}.

The GBPs exist either in the same glycan-producing organism or they can recognize glycans that have been made by another organism. Accordingly, GBP recognition modes can be classified as follows¹⁷:

a) Intrinsic glycan-recognition:

This type of recognition underlies many biological events. The biological consequences occur at the single cell and whole organism level. Here, glycans produced by one organism or within the same cell are recognized by GBPs within the same organism (extracellular) or the same cell (intracellular). Accordingly, intrinsic glycan-recognition can be sub-classified into extracellular and intracellular processes.

Here are examples of some of these biological events in which intrinsic glycan-recognition is involved:

a.1) Intracellular intrinsic glycan-recognition

These include biological processes that take place inside the cells and are regulated by glycan-GBP interactions. Some examples are:

- ***Lysosomal enzyme sorting***

After being synthesized in the ER (Figure 1), lysosomal hydrolases are transported along the secretory pathway to the *cis*-GA where they are labeled with a M6P molecule (Figure 2)³⁰.

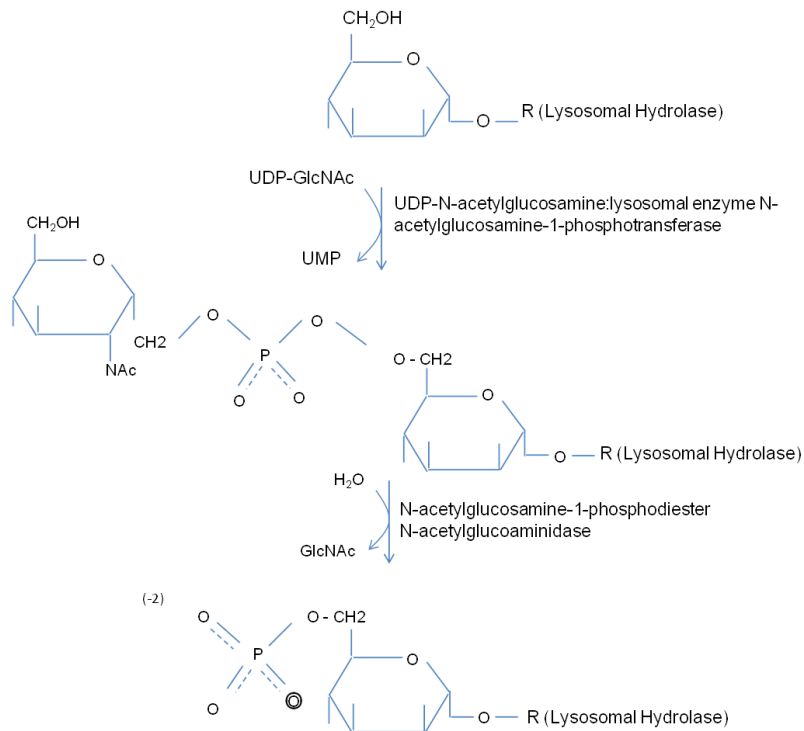

Figure 1: M6P biosynthetic pathway in the *cis*-GA.

This M6P tag is recognized by specific mannose-phosphate-receptors (MPRs) on the lysosomal surface. There are two types of lysosomal MPRs³¹: i) Cation-independent MPRs (CI-MPRs) which are large receptors that can bind two molecules of M6P and do not require divalent cations ii) Cation-dependent MPRs (CD-MPRs), which are smaller receptors that can bind only one M6P molecule in a divalent cation-dependent manner. After binding to their specific receptors on the lysosomal surface, M6P-tagged hydrolases dissociate from their receptors in the acidic pH of the pre-lysosomal early endosomal compartment (Figure 2)^{31,32}.

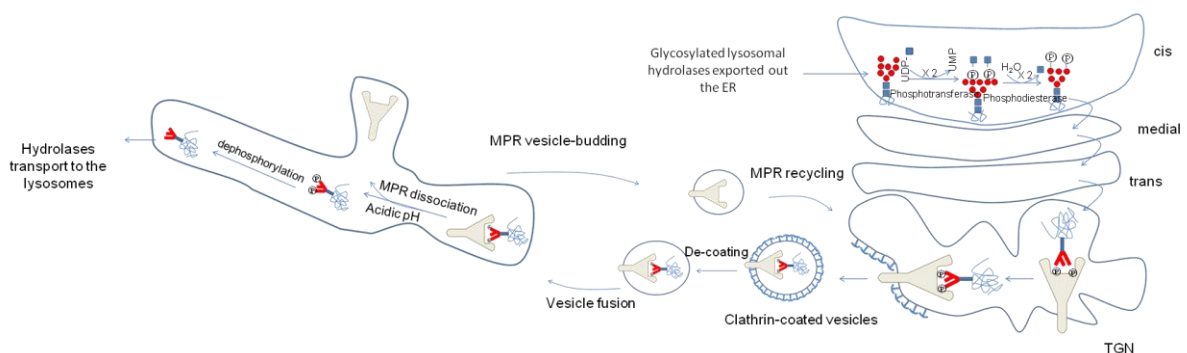

Figure 2: M6P-labelled lysosomal hydrolase targeting from the Golgi apparatus to the lysosome.

- ***ER-quality control (ERQC)***

Intrinsic glycan-recognition represents the principle feature of N-glycoprotein ER-situated ER-quality control (ERQC) and ER-associated degradation (ERAD) processes. These processes take place during, and soon after, protein synthesis and post-translational N-glycosylation in the ER lumen. The role of the ERQC system is to ensure correct protein folding. The three terminal glucose residues of an N-glycan chain (*Figure 11*) function as a signal for the N-glycoprotein to enter the ERQC process³³. The ER-resident lectins (calnexin; CNX and calreticulin; CRT) bind to the N-glycoprotein by specifically recognizing glycans with a terminal α 1-3 glucose residue in a Ca^{2+} -dependent manner³⁴. CNX is a transmembrane protein that recognizes glycans close to the ER-membrane. Conversely, CRT is a soluble lectin that recognizes glycans in the ER-lumen³⁵. This binding occurs during several folding/refolding cycles until the glycoprotein is properly folded.

a.2) Extracellular intrinsic-glycan recognition

They include the biological processes that take place within one organism and are regulated by glycan-GBP interactions. Some examples are:

- ***Lymphocyte homing to the lymph nodes***

Circulating lymphocytes home into peripheral lymph nodes in a glycan-recognition mediated process. Lymphocytes carry L-selectin receptors on their surface. These receptors recognize the Lewis^X determinants on O-GalNAc-terminated glycoproteins on the surface of high endothelial venules (HEVs), thereby assuring the delivery of lymphocytes to lymph nodes and lymphatic organs³⁶.

- ***Hormone clearance by the liver***

Internal glycan-recognition plays a major role in *liver-mediated* clearance of glycosylated plasma proteins where glycan epitopes are recognized by specific asialoglycoprotein receptors (ASGRs) on liver cells³⁷. For example, the ovulatory cycle in mammals is regulated by the internal glycan-recognition mode: here the clearance of glycosylated luteinizing hormone (LH) from the circulation is assured by the terminal sulfated GalNAc- β 1-4GalNAc LH epitope that is recognized by liver as well as Kupffer cells³⁷.

b) Extrinsic glycan-recognition:

In this mode, the glycans of one organism are recognized by GBPs from a different organism. As a result, certain processes are initiated such as:

○ The reproduction process in mammals

In most of the mammalian species, but not human, the glycocalyx coating both the egg and sperm is the key element in the fertilization process³⁸. The mammalian egg glycocalyx is called the zona pellucida (ZP). It is a three-dimensional glycoprotein matrix that surrounds and protects the unfertilized oocyte. Three genes that are conserved in all the mammals, ZPA, ZPB and ZPC, encode three ZP glycoproteins, zp1, zp2, and zp3. These glycoproteins have been characterized in both humans and mice³⁹.

Conversely, the mammalian sperm glycocalyx is composed of hundreds of glycoconjugates. Compared to the glycocalyx of somatic cells, the sperm glycocalyx is 2 – 6 times thicker and it has a four dimensional structure³⁸. The sperm surface is highly negatively charged due the fact that 40 % of its glycocalyx is accounted for by sialic acid (Sia)³⁸. After ejaculation, glycosyltransferases and glycosidases in the epididymal lumen provoke changes in the sperm surface glycoconjugates that are suggested to be essential for sperm maturation.

The fertilization process is initiated when lectins on the sperm surface specifically recognize their cognate glycoconjugates on the oviduct epithelium. This glycan-lectin interaction leads to the formation of a reservoir of sperm in the oviduct prior to the egg fertilization, and ensures adequate sperm maturation (capacitation) and viability^{38,40}.

The next step of oocyte fertilization is the sperm acrosome reaction. Here, the acrosome, a vesicle situated over the nucleus in the anterior of the sperm head, starts an exocytic process that releases hydrolytic enzymes that favourise sperm penetration of the ZP^{38,40}. This penetration is a secondary lectin-glycan binding process. Sperm adhesion molecules, AQN and AWN, for example, are lectins on the porcine sperm surface that specifically bind Gal β 1-3GalNAc and Gal β 1-4GalNAc epitopes on glycoproteins of pig ZP³⁸.

○ Microbial invasion of hosts

Another biological event that can be mediated by extrinsic glycan-recognition mode is the invasion of a host by microbes causing severe pathological consequences⁴¹. The attacking microorganism masks its surface with glycans of a structure similar to those of the host organism in order to escape immune surveillance.

Some infections cause serious pathological consequences when the attacking microorganism recognizes the host glycans. For example, *Campylobacter jejuni* is a diarrhea-causing

bacterium that synthesizes an exopolysaccharide whose sugar structures are similar to the neuronal glycans, especially the ganglioside GD1a⁴². After infection, the host generates antibodies against the *c. jejuni* glycans, which react also with the host's glycans. Consequently, the body attacks its own nerves causing paralysis. *Campylobacter jejuni* infections are the commonest origin of Guillain Barré syndrome⁴³.

○ *Innate immunity and inflammatory response*

Extrinsic glycan-recognition is the principle underlying mechanism during induction of innate immunity. Eukaryotic innate immunity against bacterial infection is mediated by recognition of a bacterial pathogen-associated molecular pattern molecules (PAMPs) by host cell receptors known as pattern-recognition receptors (PRRs)⁴⁴.

Gram-negative bacteria lipopolysaccharide (LPS) is one of the most extensively studied examples⁴⁵. LPS contains a highly conserved PAMP called lipid A that is composed of a glucosamine-associated phospholipid. A host cell Toll-like receptor called TLR-4 recognizes the glycan. Upon glycan-receptor interaction, TLR-4 forms a complex with CD-14, which is another host cell surface protein, initiating a series of inflammatory and anti-microbial responses such as pro-inflammatory cytokine release by the host cell (Figure 3)⁴⁶.

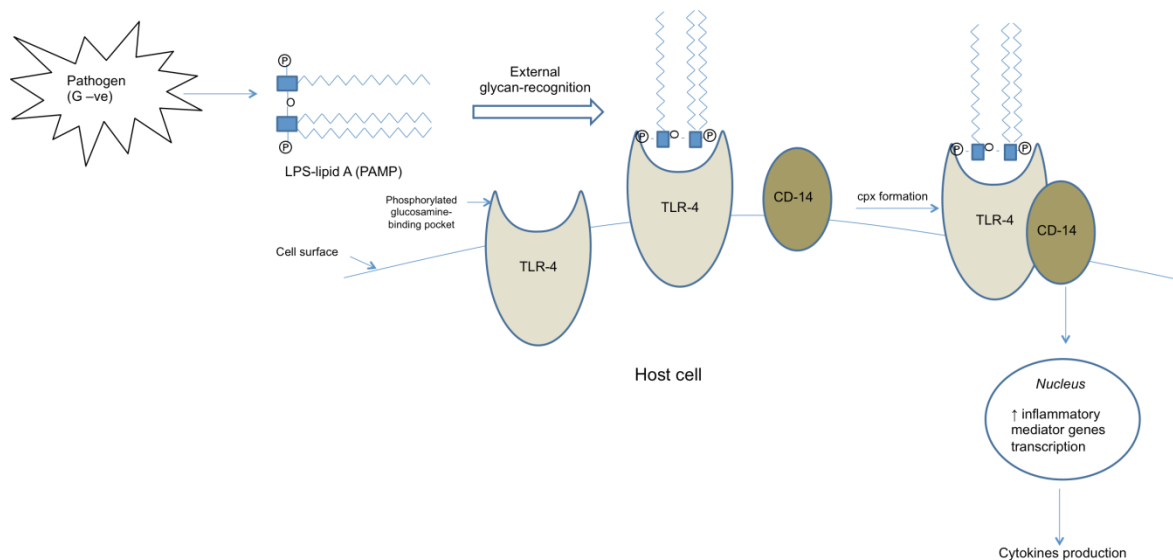

Figure 3: Glycan-recognition in an LPS-induced inflammatory response.

All the above-described glycan-GBP interactions have been exploited in biotechnology and pharmaceutical industries in order to produce several glycomimetics. A glycomimetic is a pharmaceutical compound that contains the essential glycan core of a glycoconjugate that has been modified to ameliorate its pharmacological properties such as stability (hence bioavailability), and solubility. For example, an early event of the inflammatory response is the glycan/GBP-initiated leukocytes extravasation and recruitment to the site of inflammation. Studies on the inflammation in animal models revealed that the synthetic sialylated Lewis^X glycomimetics have physiological effects comparable to those of the natural sialylated Lewis^x molecules^{47,48}.

1.3] How does a GBP interact with its corresponding glycan?

In 1894, the Nobel Prize laureate, Emil Fisher described the key-lock theory for substrate-enzyme interaction⁴⁹. Later, Laschteschenko observed lysozyme action, and then another Nobel Prize laureate, Sir Alexander Fleming, coined the name lysozyme. Lysozymes are antimicrobial glycosidases that hydrolyze the glycosidic linkages in some glycans in bacterial cell wall peptidoglycans conferring an antimicrobial activity. More specifically, lysozyme hydrolyzes the β 1-4 glycosidic link between N-acetylmuramic and GlcNAc residues in peptidoglycans of the bacterial cell wall⁵⁰.

Hydrogen bonding, van der Waals interaction, electrostatic interaction, and dipole attraction mediate all the known ligand-receptor interactions. Glycan-GBP interactions are also mediated by all those forces⁵¹. The mechanism of glycan-GBP interaction involves a solvation/desolvation process (Figure 4). The surfaces of the glycan and GBP are both solvated i.e. hydrated with water molecules that interact with the highly abundant glycan-hydroxyl groups in the glycan and amino acids on the GBP surface⁵². If the key (glycan) fits the lock (GBP), water molecules will be displaced from both sides, that is to say the glycan and GBP will be desolvated, and then the interaction takes place driven by one or several of the previously mentioned forces⁵¹⁻⁵³.

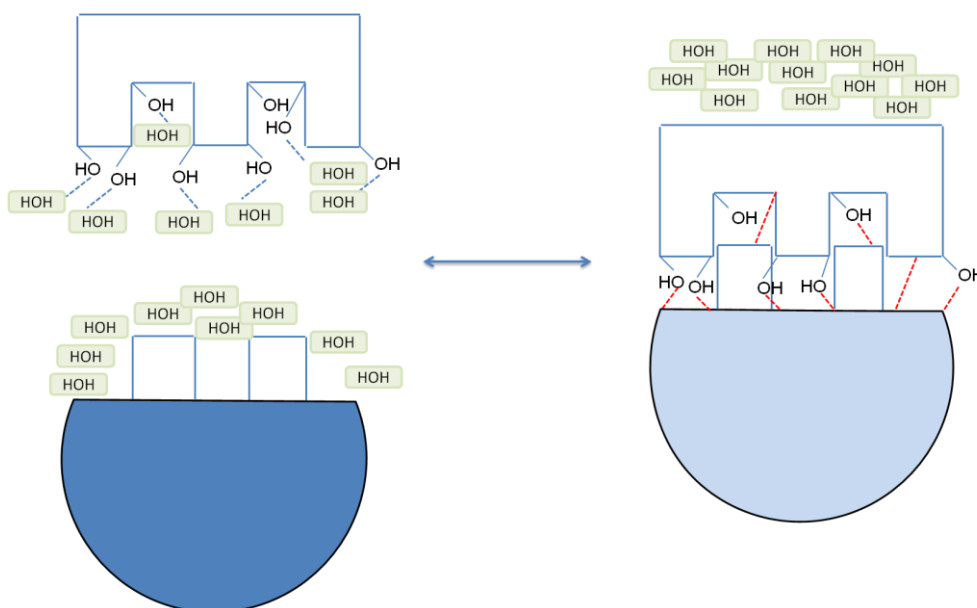

Figure 4: The “key-lock” theory of glycan-GBP interaction.

The dashed lines represent different binding mechanisms.

1.4] Biosynthesis of glycans

1) General considerations

Despite the fact that genes encode enzymes, transporters and chaperones of the glycosylation process, the biochemical modification itself is not, and the glycan products are secondary gene products. In other words, there are no specific templates for glycan structures (protein sequences have their specific patterns coded by DNA) and this fact explains the absence of a well-defined steady state cellular glycome¹.

The glycosylation process and the structure of its glycan products are controlled by many factors, which include regulation of gene expression and availability of nucleotide sugar donors as well as glycan acceptors. The situation is further complicated by the fact that certain sugar donor pools are required for several glycosylation processes.

Moreover, there is continuous competition between different glycosyltransferases for the same glycan acceptor and that results in diversity of glycan structures¹.

Some glycans display a tissue-specific and or differentiation-dependent mode of production.

Physiological and pathological factors, for instance, such as malignancies and inflammation, greatly control the rate of production and composition of glycans¹.

2) Chemistry of the glycosylation reaction

As a chemical reaction, glycosylation is an S_N2 (bimolecular nucleophile substitution) reaction⁵⁴. In this type of reaction, a nucleophile (sugar acceptor) attacks an electrophile (sugar donor) forming a bond (glycosidic bond). This reaction results in an inversion in the C1 stereochemistry i.e. from α - to β -configuration (Figure 5)⁵⁴⁻⁵⁶.

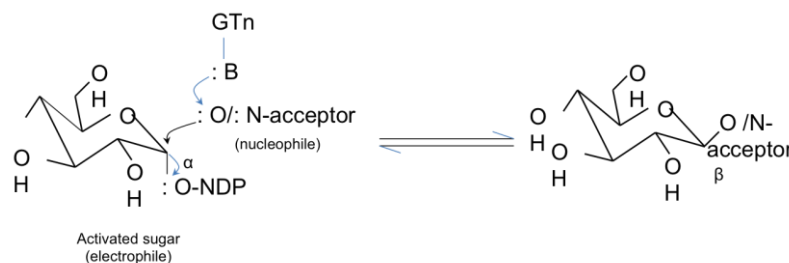

(Taken from Rini J. et al., 2009)

Figure 5: Bimolecular nucleophilic substitution (S_N2) reaction of a monosaccharide addition to an acceptor via glycosidic linkage formation

3) Glycosylation reactions can require multiple components

Glycosylation reactions may require sugar donors, sugar donor transporters, glycosyltransferases, chaperone proteins, divalent cations, and sugar acceptors. Each member will be discussed in more details in the coming sections.

3.1) Activated Sugars

Activated sugars are high-energy nucleotide sugars, which serve as sugar donors in the glycosylation process. They are utilized by specific glycosyltransferases to form a glycosidic bond with certain stereochemistry in relation to the acceptor anomeric (chiral) carbon. They include GDP-Man, GDP-Fuc, UDP-Glc, UDP-Gal, UDP-Xyl, UDP-GlcUA, UDP-GlcNAc, UDP-GalNAc and CMP-Sia. Sugar donors are synthesized in the cytoplasm except for Sia donor; CMP-Sia, which is synthesized in the nucleus^{57,58}. The biosynthesis and interconversion of nucleotide sugars are illustrated in figures 6-9.

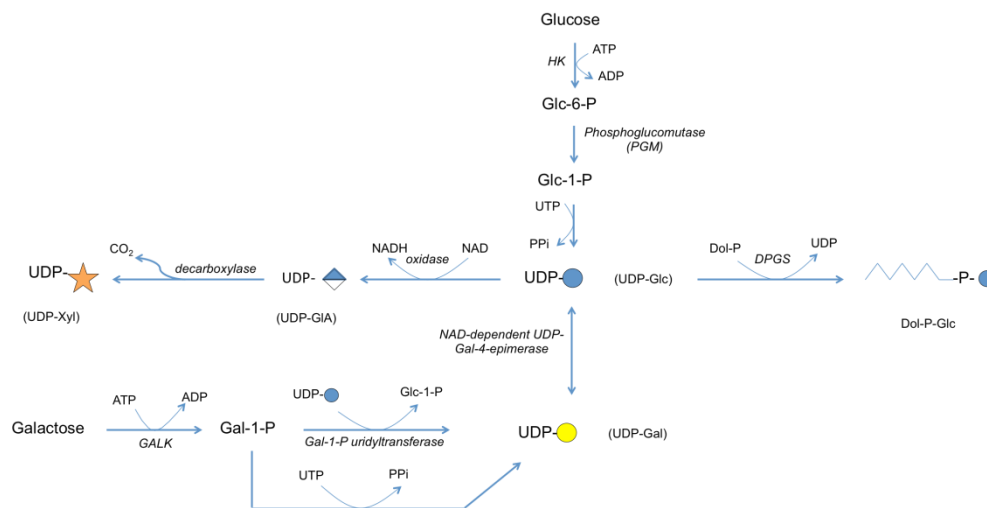

Figure 6: The biosynthetic and interconversion pathways of UDP-Glc and UDP-Gal in the cytoplasm

Figure (6) enzyme key: DPGS, dolichol phosphoglucoase synthase; HK, hexokinase; GALK, galactokinase

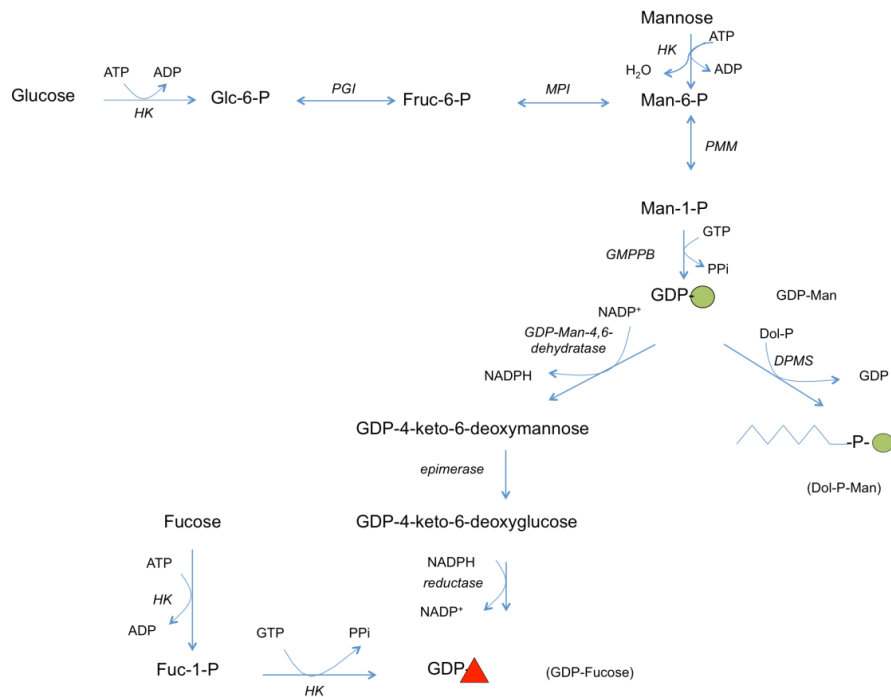

Figure 7: The biosynthetic and interconversion pathways of GDP-Man and GDP-Fuc in the cytoplasm

Figure (7) enzyme key: HK, hexokinase; GPI, glucose phosphate isomerase; MPI, mannose phosphate isomerase; PMM, phosphomannose mutase; DPMS, dolichol phosphomannose sunthase

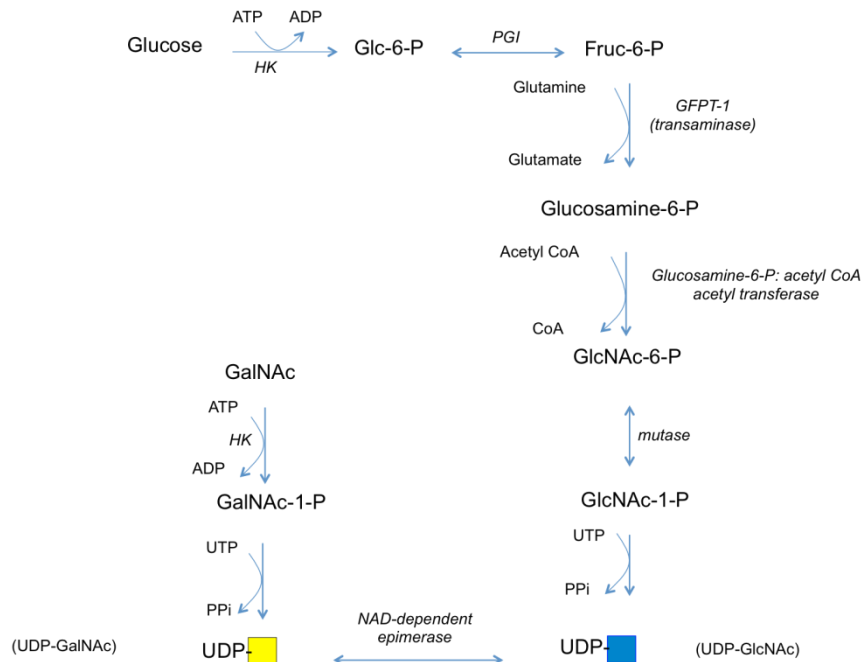

Figure 8: The biosynthetic and interconversion pathways of UDP-GlcNAc and UDP-GalNAc in the cytoplasm

Figure (8) enzyme key: HK, hexokinase; GFPT1, Glutamine-fructosephosphate transaminase.

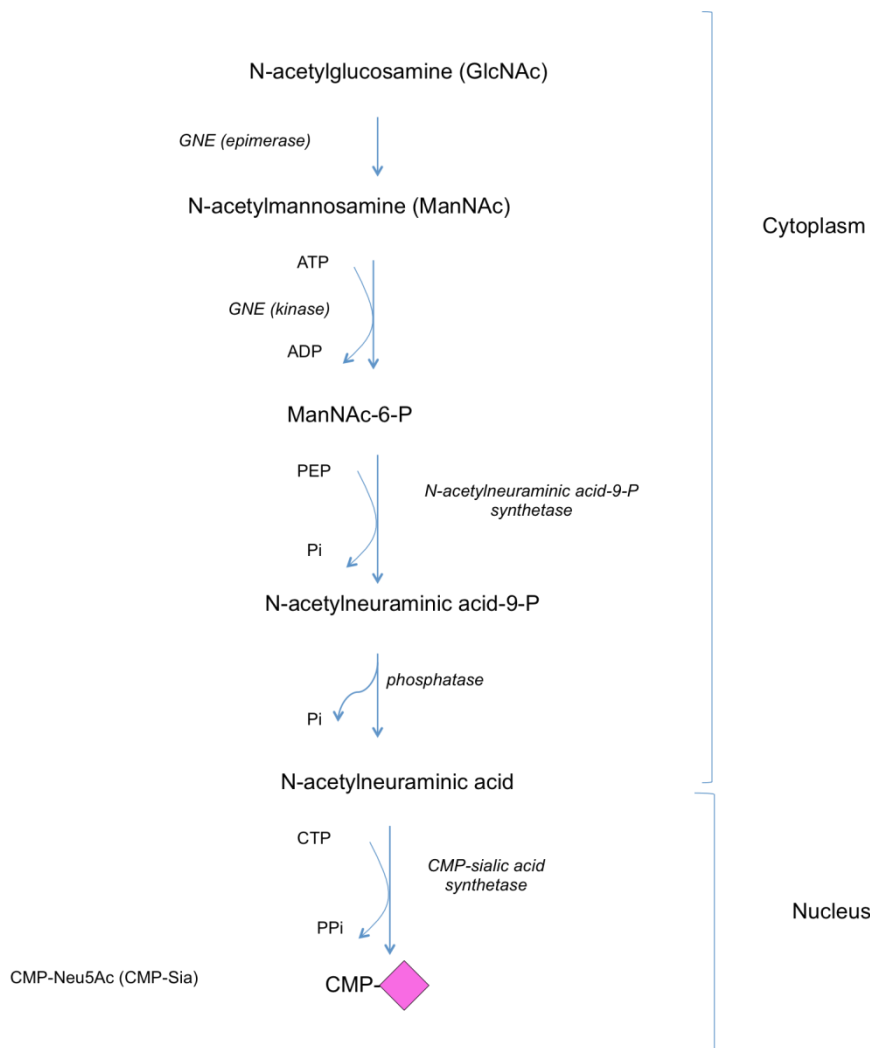

Figure 9: The biosynthetic pathway of CMP-Sia from UDP-GlcNAc.

3.2) Nucleotide sugar transporters

Activated sugars are transported through membranes by specific nucleotide sugar transporters (NSTs) in an ATP-independent process. These transporters are called antiporters because they transport two different molecules in two opposite directions⁵⁹. NSTs deliver the activated sugar into the lumen of subcellular organelles (GA, for example) wherein glycosyltransferases release the nucleoside mono- or diphosphate byproducts, which then cross the membrane to be recycled in the cytoplasm (Figure 10). NSTs are competitively inhibited by their specific mono- or diphosphate nucleosides, but not by the free sugar^{59,60}.

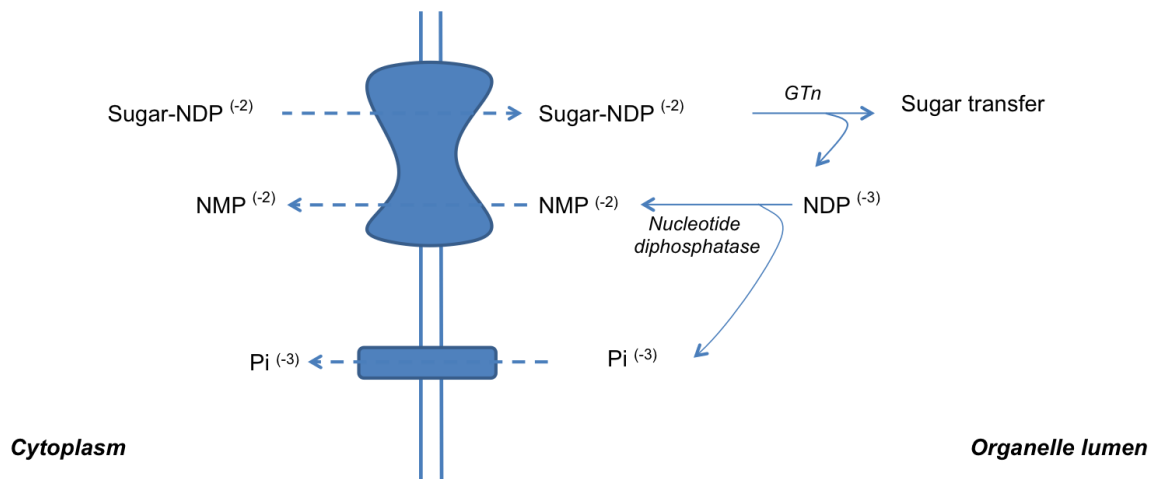

Figure 10: The transport mechanism of a nucleotide sugar across an organelle membrane by its specific NST.

In humans, the solute carriers (SLCs) are transporters that translocate different solutes across the hydrophobic membranes of subcellular organelles. SLCs are grouped into 52 subfamilies based upon both the transport mechanism and the type of solute that is transported⁶⁰. The SLC35 subfamily comprises the highly conserved human NSTs, and is sub-classified into seven subfamilies (SLC35A-G) based on sequence homology considerations. Within each of these subfamilies, there is another classification according to the nucleotide sugar(s) being transported⁶⁰. Table 1, represents some examples for NSTs that have been characterized in human and their relative abundance in the ER and GA.

Table 1: Human NST selectivity and subcellular localization

SLC35 subfamily name	NBCI name	Nucleotide sugar(s)	ER/Golgi localisation
SLC35A1	CMP-Sia transporter (CST)	CMP-Sia	GA
SLC35A2	UDP-Gal transporter (UGT)	UDP-Gal	GA>>> ER
SLC35A3	UDP-GlcNAc transporter (NGT)	UDP-GlcNAc	GA>>> ER
SLC35B2	PAPS transporter 1	PAPS	GA
SLC35B3	PAPS transporter 2	PAPS	GA
SLC35B4	UDP-Xyl (YEA)	UDP-Xyl, UDP-GlcNAc	GA>>> ER
SLC35C1	GDP-Fuc transporter (GFT)	GDP-Fuc	GA>>>ER
SLC35D1	UDP-GlcA/ UDP-GalNAc dual transporter	UDP-GlcA, UDP-GalNAc	GA>>> ER
-	UDP-Glc transporter	UDP-Glc	ER >>> GA

(PAPS) 3'-Phosphoadenosine-5'-Phosphosulfate, (>) means more abundant

Nucleotide sugars are not the only sugar donors in the glycosylation process. Dolichol phosphate acts as a sugar carrier in many glycosylation processes. Dolichol phosphate carries mannose and glucose during protein N-glycosylation. During protein O-glycosylation and GPI-anchored protein biosynthesis, dolichol carries only mannose. Dol-P-mannose (DPM) and Dol-P-glucose (DPG) are synthesized by two ER-bound enzymes, DPM synthase (DPMS) and DPG synthase (DPGS), respectively.

Dolichol metabolism will be treated in more detail later because it is an important aspect of my experimental work.

3.3) Glycosyltransferases

Glycosyltransferases comprise a large family of sugar-linking enzymes in which subfamilies have been identified. They are encoded by 1-2 % of the human genome. Ninety glycosyltransferase families have been identified. They include 30,000 glycosyltransferases with great variability in many aspects^{54,61}. Here are some features of glycosyltransferases.

Substrate specificity

Within the same family, all the glycosyltransferases use the same sugar donor but can catalyze the formation of a glycosidic linkage with different specific stereochemistry. For example, α 2-3, α 2-6 and α 2-8 glycosidic linkages of sialic acid (Sia) are formed by different sialyltransferases (STns) of the same family^{62,63}.

Some glycosyltransferases, by contrast, are non-specific i.e. they catalyze the formation of more than one glycosidic linkage with different stereochemistry. For example, fucosyltransferase (III) forms α 1-3 or α 1-4 linkages⁵⁴.

One single glycosyltransferase can be specific for transferring two different sugars to their acceptors. Chondroitin synthase, for example, possesses two catalytic domains that are both involved in the biosynthesis of chondroitin sulfate (one of the GAGs). One domain has β 1-3-glucuronic acid transferase activity, and another domain has β 1-4 N-acetylgalactosaminyltransferase activity^{64,65}.

Tissue-specific expression

In mammals, many glycosyltransferases are expressed in a tissue-specific way. Let us take the example of STns that transfer a terminal sialic acid residue onto a galactose residue forming an α 2- 3 glycosidic linkage, ST3GalTs. ST3Gal (I) is expressed in liver, spleen and

bone marrow, ST3Gal (II) is expressed in the brain and ST3Gal (III) and (IV) are expressed in most tissues^{37,63}.

In another example, the α 1-2 fucosyltransferases (α 1-2 FucT) that transfer fucose residues onto galactose during the biosynthesis of H, A and B determinants on blood groups show distinct tissue distribution. The H α 1-2 FucT which is encoded by (H) group loci and expressed in red cell precursors, and Se α 1-2 FucT which is encoded by (Se) group loci is expressed in secretory tissues like salivary glands and the GIT-lining epithelium^{37,66}.

Acceptor specificity

Glycosyltransferases recognize their acceptors by specific amino sequences in the acceptor protein as in the case of oligosaccharide transferase (OST) that recognizes the N-glycosylation consensus sequence (-Asn-X-Ser/Thr) (where X could be any amino acid residue except proline) that exists in almost two thirds of proteins⁶⁷.

A similar type of glycosyltransferase-acceptor specificity appears when a specific motif (Pro-X-Arg/Lys) in hCGT hormone is recognized by N-acetylgalactosaminettransferase^{54,68}.

Glycosyltransferase complex formation

One of the most characteristic properties of glycosyltransferases is their formation of multi-enzyme complexes with other glycosyltransferases, and it has been shown that complex formation greatly affects the glycosyl-transfer activity. In GSL biosynthesis, for example, there are two multi-glycosyltransferase complexes that have been identified in CHO-K1 cells (Chinese Hamster Ovary wild type cells). A complex is formed from galactosyltransferase (GalT2) and N-acetylgalactosaminyltransferase (GalNAcT), and another one consists of GalT1, STn1 and STn2. In the latter case, it has been shown that the activity of STn1 was increased by 2.5 fold in CHO-K1 cells that express high levels of the STn2 enzyme⁶⁹.

1.5] Types of Glycoconjugate

A] Glycoproteins

In humans, more than one half of proteins are post- or co-translationally glycosylated. Glycans can represent from 1 to 80 % of the total molecular weight of a glycosylated protein⁷⁰.

Glycoproteins are classified according to the functional group of the amino acid residue to which the first sugar residue is attached. In N-glycoproteins, the sugar residue (GlcNAc) is linked to the amino group (-NH₂) of asparagine in the (-Asn-X-Ser/Thr-) consensus sequence, while in the case of O-glycoproteins, the first sugar residue (N-acetylgalactosamine, xylose, fucose, mannose or galactose) is linked to the hydroxyl group (-OH) of serine or threonine residues. For C-glycoproteins, the C2 of a tryptophan residue is mannosylated¹.

A.1) N-glycoproteins

One of the functions of N-glycans is to confer some hydrophilicity to the glycosylated proteins in order to improve their solubility and, in some cases, provoke conformational changes that improve their activities⁷¹.

Structurally, N-glycans are subdivided into three subtypes: i) oligomannose ii) complex and iii) hybrid (Figure 11).

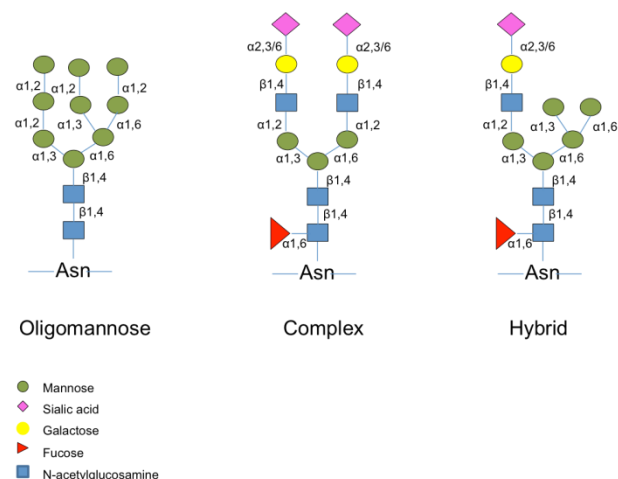

Figure 11: N-glycan structures showing their glycosidic linkages.

- ***N-glycan biosynthesis***

Protein N-glycosylation involves the biosynthesis of a dolichol linked oligosaccharide (DLO) carrier and subsequent transfer of the oligosaccharide onto nascent proteins in the lumen of the ER. This process can be divided into four phases (Figure 12).

Phase I involves the synthesis of the dolichol-linked oligosaccharide (DLO) on the cytoplasmic face of the ER membrane. Many genes that code for glycosyltransferases involved in DLO biosynthesis are known as (*ALGs*) for Asparagine Linked Glycosylation and were originally identified in the yeast *Saccharomyces cerevisiae*^{72,73}. Two multi-ALGs complexes mediate this phase. The first complex is composed of UDP-N-acetylglucosamine: dolichol phosphate N-acetylglucosamine phosphotransferase (*ALG7*) that generates Dol-PP-GlcNAc from Dol-P and UDP-GlcNAc and UDP-N-acetylglucosamine: GlcNAc-PP-Dol N-acetylglucosamine transferase (*ALG13/ALG14*). This complex initiates the N-glycosylation process. Another multi-ALG complex consisting of three GDP-Man-requiring mannosyltransferases (*ALG1/ALG2/ALG11*) elongates GlcNAc₂-PP-Dol to yield Man₅GlcNAc₂-PP-Dol. This structure is then flipped onto the luminal surface of the ER by the action of a flippase whose function is enhanced by a protein encoded by the *RFT1* gene^{74,75,76}.

Exceptionally for glycosyltransferases, which usually add single sugars to glycans, three of the mannosyltransferases involved in DLO biosynthesis transfer two mannose residues. During this phase, the *ALG2*-encoded mannosyltransferase transfers α 1-3 followed by α 1-6 mannose residues, then the *ALG11*-encoded mannosyltransferase transfers consecutively two α 1-2 linked mannose residues.

Phase II takes place in the ER lumen and concerns the elongation of Man₅GlcNAc₂-PP-Dol. Here, Dol-P-Man- and Dol-P-Glc-dependent mannosyl- and glucosyltransferases sequentially add 4 mannose and 3 glucose residues, respectively, to the growing DLO to yield Glc₃Man₉GlcNAc₂-PP-Dol, which is the mature DLO species⁷⁴⁻⁷⁶.

Phase III takes place in the ER lumen and involves the co- or post-translation transfer of the glycan chain from mature DLO onto protein in the ER lumen by the OST complex. OST catalyzes the formation of a hydrogen bond with the asparagine (Asn) residue in a glycosylation consensus sequence to yield Glc₃Man₉GlcNAc₂-Asn-X-Ser/Thr-polypeptide⁷⁴⁻⁷⁶. Now, the N-glycosylated protein will be subjected to the ERQC system we have described before to ensure proper protein folding^{77,78}.

Phase IV involves the GA-mediated N-glycoprotein modification during which sequential removal and addition of monosaccharides to the N-glycoprotein occurs. The different GA sub-compartments, contain distinct groups of glycosyltransferases that work in concert to convert N-glycans into their final structure (oligomannose, complex or hybrid N-glycans)⁷⁴.

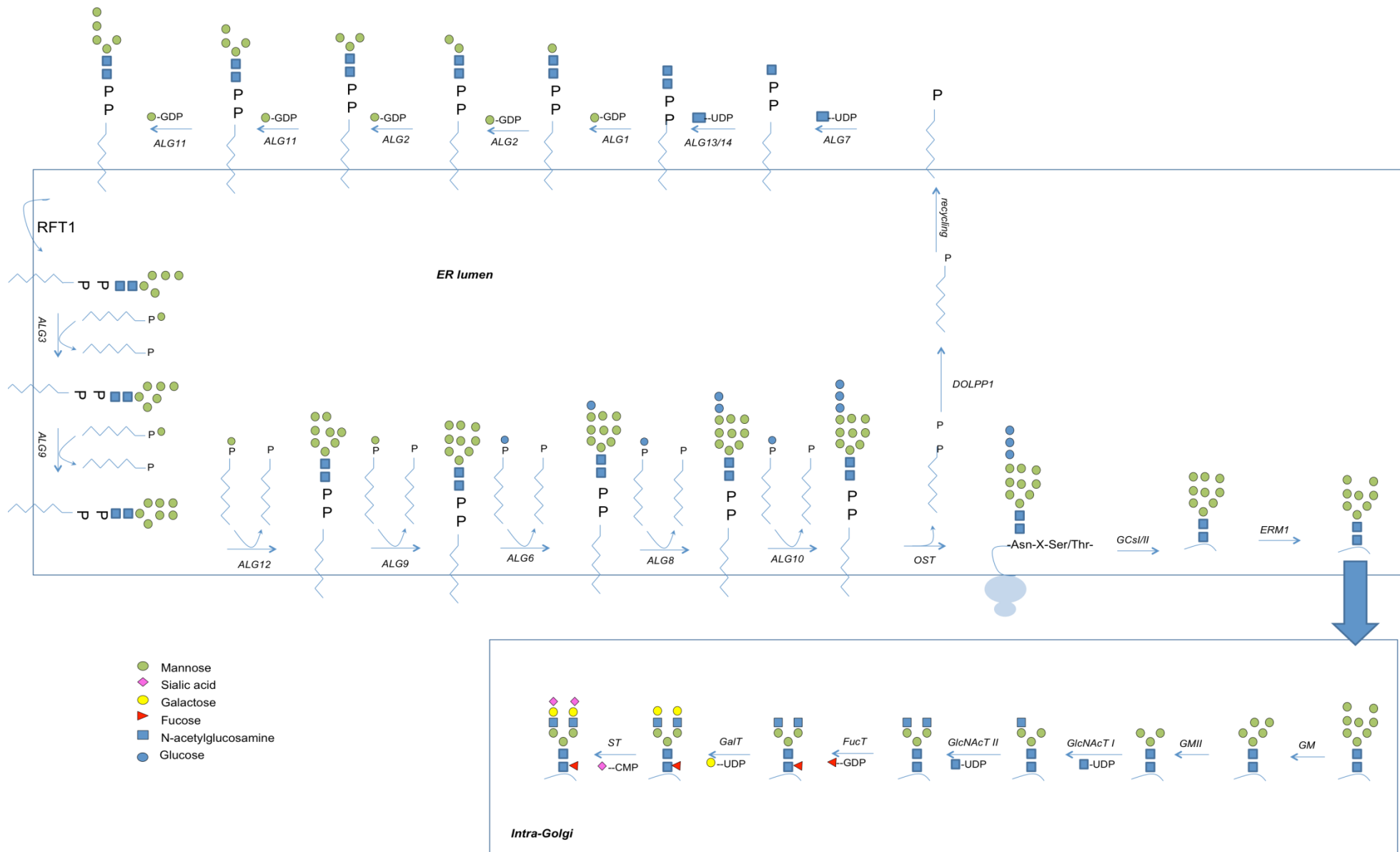

Figure 12: A simplified scheme showing protein N-glycosylation in the ER lumen and modifications in the GA

Figure (12) enzyme key: ALG7, UDP-GlcNAc: Dol-P-GlcNAc phosphotransferase; ALG13/14, UDP-N-acetylglucosamine:GlcNAc-PP-Dol N-acetylglucosamine transferase; ALG1, GDP-Man:Dol-PP-GlcNAc₂ β 1-4Mannosyltransferase, ALG2, GDP-Man:Dol-PP-GlcNAc₂Man1 α 1-3mannosyltransferase and GDP-Man:Dol-PP-GlcNAc₂Man₂ α 1-6 mannosyltransferase; ALG11, GDP-Man:Dol-PP-GlcNAc₂Man₃ α 1,2 mannosyltransferase and GDP-Man:Dol-PP-GlcNAc₂Man₄ α 1-2 mannosyltransferase; ALG3, Dol-P-Man:Dol-PP-GlcNAc₂Man₅ α 1-3mannosyltransferase; ALG9, Dol-P-Man:Dol-PP-GlcNAc₂Man₆ α 1,3mannosyltransferase and Dol-P-Man:Dol-PP-GlcNAc₂Man₈ α 1-2 mannosyltransferase; ALG12, Dol-P-Man:Dol-PP-GlcNAc₂Man₇ α 1,6 mannosyltransferase; ALG6, Dol-P-Glc:Dol-PP-GlcNAc₂Man₉ α 1-3glucosyltransferase; ALG8, Dol-P-Glc:Dol-PP-GlcNAc₂Man₉Glc₁ α 1-3glucosyltransferase; ALG10, Dol-P-Glc:Dol-PP-GlcNAc₂Man₉Glc₂ α 1-2glucosyltransferase; OST, oligosaccharide transferase; GCI/II, glucosidase, ERM1; ER mannosidase, GM; Golgi mannosidase, GMII; Golgi α -mannosidase II, GlcNAcTI, UDP-N-acetylglucosamine: α 3-D-mannoside β 1-2-N-acetylglucosaminyltransferase I; GlcNAcT2,UDP-N-acetylglucosamine:alpha-3-D-mannoside β 1-2-N-acetylglucosaminyltransferase II; FucTn, α 1-3 fucosyltransferase; GalT, β 1-4 galactosyltransferase; ST, α 2-3/2-6 sialyltransferase.

A.2) O-glycoproteins

Protein is O-glycosylated by the formation of a covalent bond between a sugar residue and the hydroxyl group of a serine (Ser) or threonine (Thr) residue.

○ O-glycosylation versus N-glycosylation

- 1) Whereas N-glycosylation starts in the ER and subsequent N-glycan processing takes place in the GA, O-glycosylation is initiated either in the ER-lumen or within the GA depending on the O-glycosylation type.
- 2) GlcNAc is the only monosaccharide that forms a direct covalent bond with the amino group of asparagine residues in N-glycoproteins. By contrast, residues of N-acetylgalactosamine (GalNAc), mannose (Man), fucose (Fuc), glucose (Glc), and xylose (Xyl), can be linked to the hydroxyl group of serine or threonine residues. O-glycans display a high degree of variation in their structure. This variation results from core extension mediated by glycosyltransferases specific for the core monosaccharides⁷⁹.
- 3) O-glycoprotein biosynthetic pathways do not involve glycosidases as is the case for N-glycosylation where processing involves removal of many sugar residues by ER- and GA-resident glycosidases.
- 4) On the other hand, protein N- and O-glycosylation do share some biochemical features. For instance, as well as being required for DLO biosynthesis, DPM is the mannose donor for the generation of an interesting O-glycan found on the protein α -dystroglycan (α -DG)⁸⁰. Another common feature is that terminal α 2-3 and α 2-6 sialic acid residues are added to both N- and O-glycans by the same STns.

○ Types of O-glycans

O-glycans can be classified according to whether the first monosaccharide is attached to the hydroxyl group of Ser/Thr residues, or attached to hydroxyl lysine/proline residue⁷⁹.

1) N-acetylgalactosamine-O-Ser/Thr glycans (O-GalNAc)

○ O-GalNAc glycan core structure

O-glycoproteins in which GalNAc is linked to the hydroxyl group of serine or threonine via α -glycosidic link are usually known as Mucins⁸¹.

- ***The biological importance of O-GalNAc glycans***

O-GalNAc constitutes up to 80 % of the total molecular weight of mucin. Mucins are found in mucous secretions as soluble molecules and as TM glycoproteins with the glycans exposed towards the extracellular medium. Mucins are encoded by about 20 genes (*MUC* genes), which have a tissue-specific mode of expression suggesting that each mucin performs a specific biological function⁸¹.

- ***Biosynthesis of O-GalNAc glycans***

Synthesis of O-GalNAc glycans takes place in the *cis*-GA where the catalyzing enzymes; polypeptide N-acetylgalactosamine transferases (pp GalNAcTns), are located (Figure 13)⁸². The pp GalNAcTns recognize specific regions in the acceptor proteins called Variable Number of Tandem Repeats (VNTRs) that are rich in Ser and Thr as well as proline amino acids. The role of the proline residue is thought to expose Ser and/or Thr residues in a β -turn conformation facilitating O-GalNAcylation⁸². The resulting Ser/Thr-O-GalNAc motif is called the Tn-antigen, and it has antigenic properties. Ser/Thr-O-GalNAc is further extended by specific glycosyltransferases to produce four core structures (Figure 13)⁸³.

Core structures were found to have pathological significance in cancer and other diseases. In leukemia and other cancer cells, large amounts of sialylated cores 1 and 2 have been observed. Core 2 was shown to be correlated to cancer metastasis⁸⁴. Some other pathological conditions such as inflammatory bowel disease are accompanied with elevated levels of non-substituted T-antigen⁸⁵.

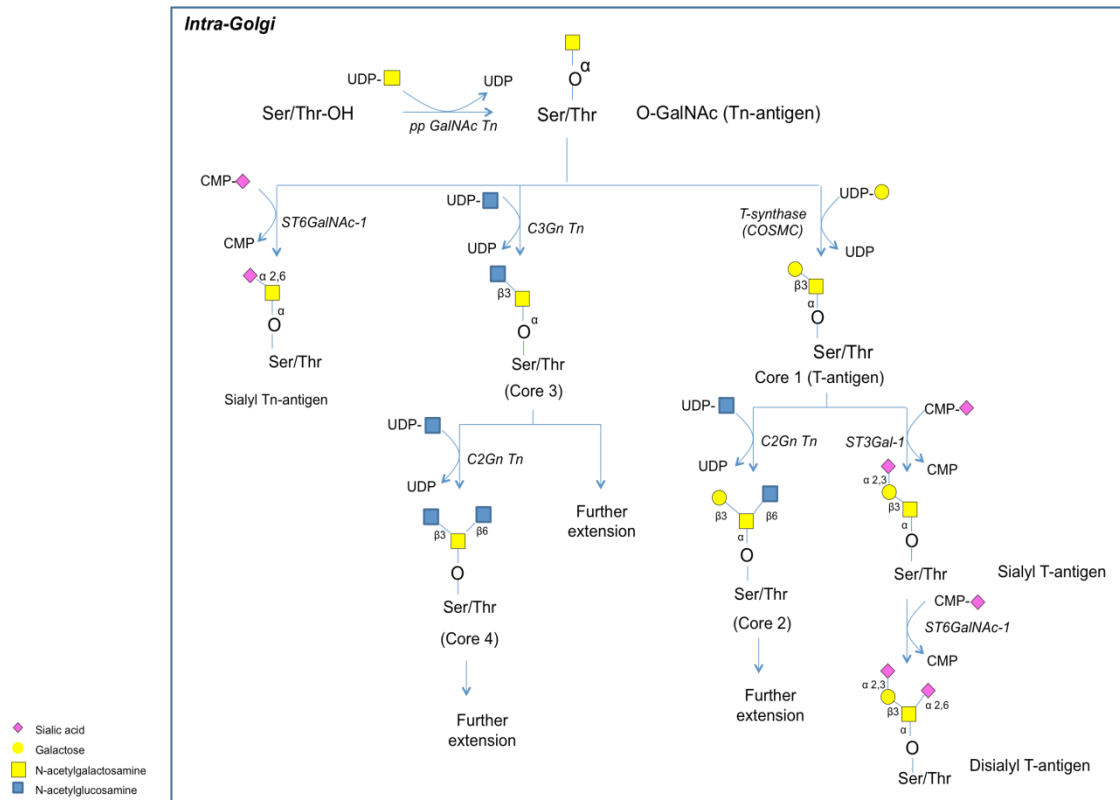

Figure 13: N-acetylgalactosamine-O-Ser/Thr glycan (O-GalNAc) biosynthesis in the GA

Figure (13) enzyme key: *ppGalNAcT-1*, polypeptide N-acetylgalactosamine; *C1GalT-1* or *T synthase*, Core 1 β 1-3 galactosyltransferase; *C2GnT-1/C2GnT-3*, Core 2 β 1-6 n-acetylglucosaminyltransferase; *C3GnT-1*, Core 3 β 1-3 N-acetylglucosaminyltransferase; *C2GnT-2*, Core 2/4 β 1-6 N-acetylglucosaminyltransferase; *ST3GalI/ST3GalIV*, Core 1 α 2-3 sialyltransferase; *ST6GalNAc I/II/III or IV*, α 2-6 sialyltransferase.

II) Mannose-O-Ser/Thr glycans (O-Man glycans)

○ O-Man glycan core structure

In this type of O-glycosylation a mannose residue is attached to the hydroxyl group of a Ser or Thr residue via an α -glycosidic link. O-mannose glycans represent one third of brain O-glycans⁸⁶.

○ The biological importance of O-Man glycans

The importance of studying these O-glycans emerged in the early 2000s when dystroglycanopathies, a group of congenital muscular dystrophies, were discovered⁸⁷. These diseases are caused by defective α -DG (also known as cranin) that was later characterized as an O-mannosylated glycoprotein⁸⁷.

Dystroglycan is expressed in almost all tissues but mainly in the brain and skeletal muscles. The major function of dystroglycan is to connect the cytoskeleton to extracellular matrix (ECM) proteins like laminin via a dystrophin-dystroglycan complex (Figure 14).

The *DAG1* gene encodes a proprotein that is cleaved to yield α -DG and β -dystroglycan (β -DG), which subsequently dimerise to form mature dystroglycan. *DAG*^{-/-} mice showed embryonic lethality due to deformed basement membranes^{87,88}.

α -DG is the soluble-glycosylated subunit of dystroglycan. It has both N- and O-glycosylation sites and the latter is a prerequisite for its function. α -DG has O-GalNAc and O-mannose glycans, but its function has shown to be dependent on O-mannosylation only. The binding of α -DG to laminin requires mannose linked to glucuronic acid-xylose repeats via a phosphodiester bond (Figure 14)⁸⁹.

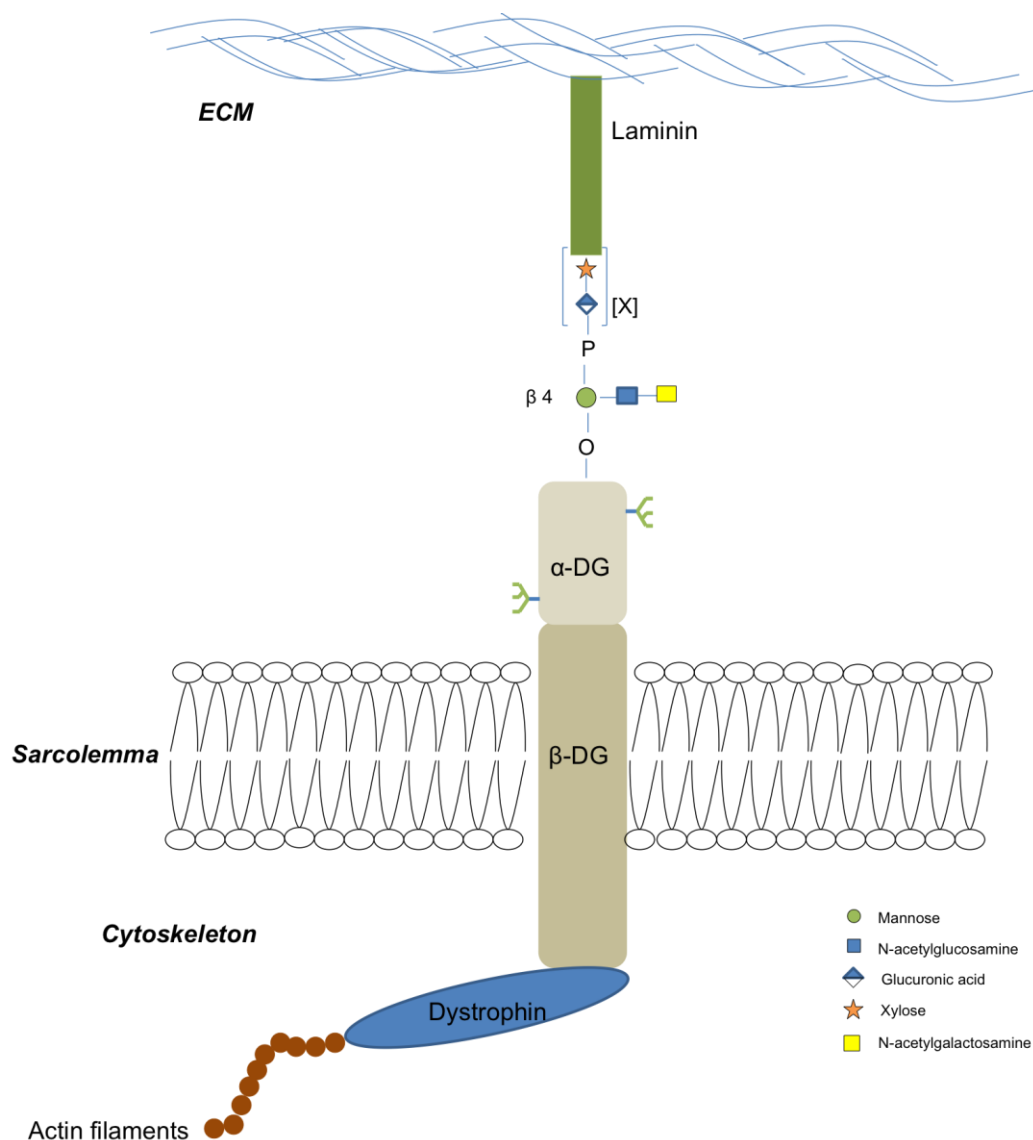

Figure 14: The intracellular localization of O-mannosylated α -DG demonstrating its role in connecting the ECM to components of cytoskeleton.

In addition to connecting the cytoskeleton to ECM proteins, α -DG was identified as a cell surface receptor for many arenaviruses and the O-Man glycan was found to facilitate virus entry to the cells⁹⁰.

○ **Biosynthesis of O-Man glycans**

N-glycosylation and O-mannosylation of α -DG take place in the ER. After transport to GA processing of both glycan occurs (Figure 15)⁸⁰. O-mannosylation is initiated in the ER by the DPM-dependent protein-O-mannosyltransferases (POMT1/2)⁸⁰.

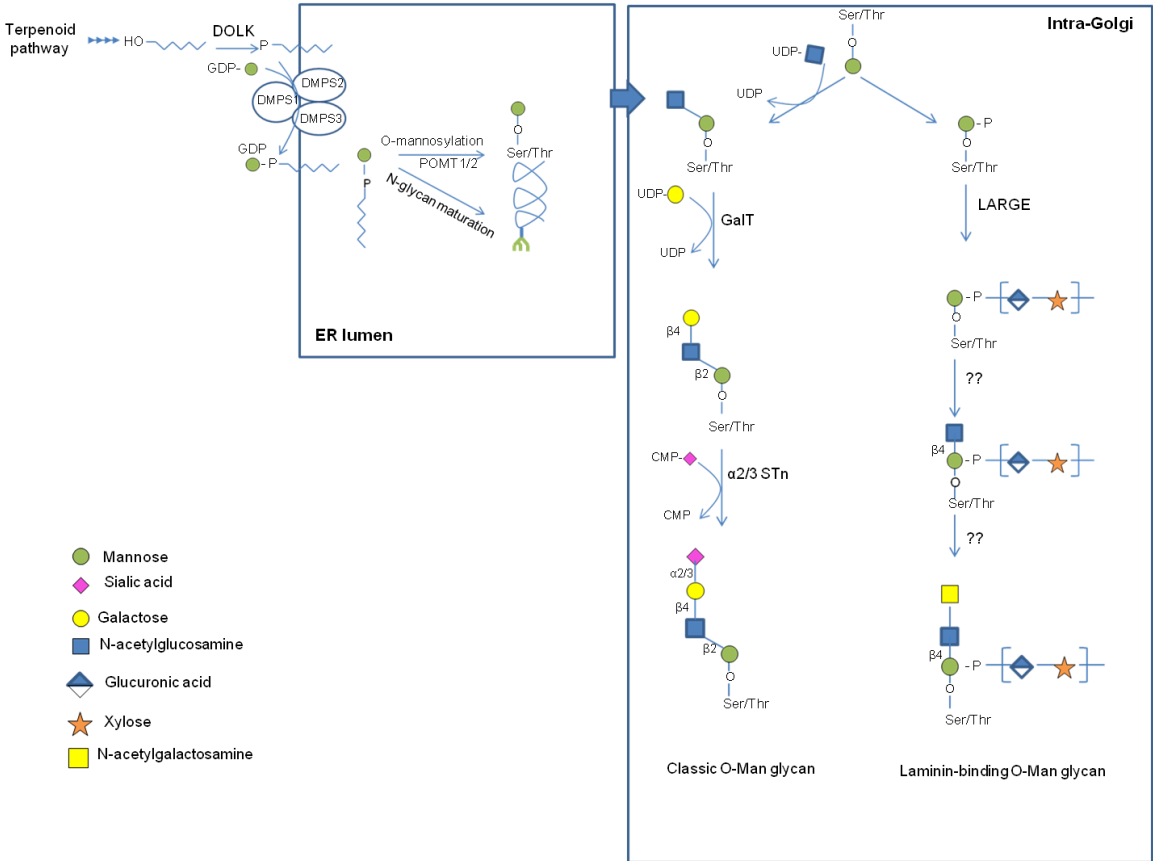

Figure 15: O-Man glycan biosynthesis in the ER and GA

Figure (15) enzyme key: DOLK, dolichol kinase; DPMDs, dolichol phosphomannose synthase; POMT1/2, protein-O-mannosyltransferase; POMGnT, protein-O-mannose β 1-2Glucosamine

transferase; GalTn; protein-O-mannose β 1-2Glucosamine β 1-4 galactosyltransferase; ST3, α 2-3 sialyltransferase; POMK, protein-O-mannose kinase; LARGE, like-acetylglucosaminyltransferase

III) Fucose- α -O-Ser/Thr glycans

- ***O-Fuc glycan core structure***

A fucose residue is linked in α -configuration to the hydroxyl group of a serine or threonine residue by one of two ER-located protein-O-fucosyltransferases (POFUT1 and POFUT2).

- ***The biological importance of O-Fuc glycans***

O-fucosylation was first discovered when the structure Glc β 1-3Fuc α -Thr was detected in human urine⁸⁶.

Later, O-Fuc glycans were extensively studied and found to be present in many biologically important molecules such as clotting factors and receptors of various signaling pathways. O-fucosylation only takes place after correct folding of acceptor proteins^{86,91}.

Interestingly, there are two protein repeats (motifs) that are O-fucosylated and it has been shown that their function is highly regulated by fucosylation. These repeats possess O-fucosylation sites with six conserved cysteine residues forming three disulfide bonds. A specific fucosyltransferase (FucTn) recognizes each of the two repeats. Epidermal Growth Factor (EGF)-like repeats and thrombospondin type 1 repeats (TSRs) exist in hundreds of cell surface receptors as well as many secretory proteins.

EGF-like repeats are small protein sequences (~ 40 amino acid residues) found in many blood clotting factors and members of the Notch receptor family.

Similarly, thrombospondin type 1 repeats (TSRs) are protein sequences consisting of 50-60 amino acid residues, and they are involved in protein-protein interactions and the Notch-signaling pathway⁹².

The Notch signaling pathway exists in most multicellular organisms, and Notch receptors are expressed on the surface of many mammalian cells where their activation is involved in cell proliferation. Defective Notch-signaling pathways are associated with many human pathological conditions such as different types of cancer and developmental diseases (e.g. neurodegenerative disorders)^{92,93}.

○ **Biosynthesis of O-Fuc glycans**

O-fucosylation of both repeats takes place within the ER lumen wherein O-FucTns recognize specific sequences around the Ser/Thr acceptor sites (Figure 16). For EGF-like repeats, the O-fucosylation site is C²X_{4,5} (S/T) C³.⁹² The fucose residue is transferred by the action of POFUT1.

Subsequent extension on the O-Fuc residue takes place in the GA by a specific β1-3 N-acetylglucosaminyltransferase (also known as Fring) that transfers a GlcNAc residue to the O-Fuc forming a β1-3 glycosidic bond. Fring was first identified in drosophila as a Notch-activity modifier (Figure 16). It has been shown that Notch-receptors without N-acetylglucosamine-extended O-Fuc glycans have no ability to bind to their activating ligands⁹². The TSR specific O-fucosylation site is C¹X_{2,3} (S/T) C²X₂G. TSR are selectively fucosylated by POFUT2⁹¹. By contrast with EGF-like repeats, α-O-Fuc in TSRs is substituted with a β3-linked glucose residue by β1-3 glucosyltransferase (β3GlcTn) that is located within the ER lumen (Figure 16)⁹⁴.

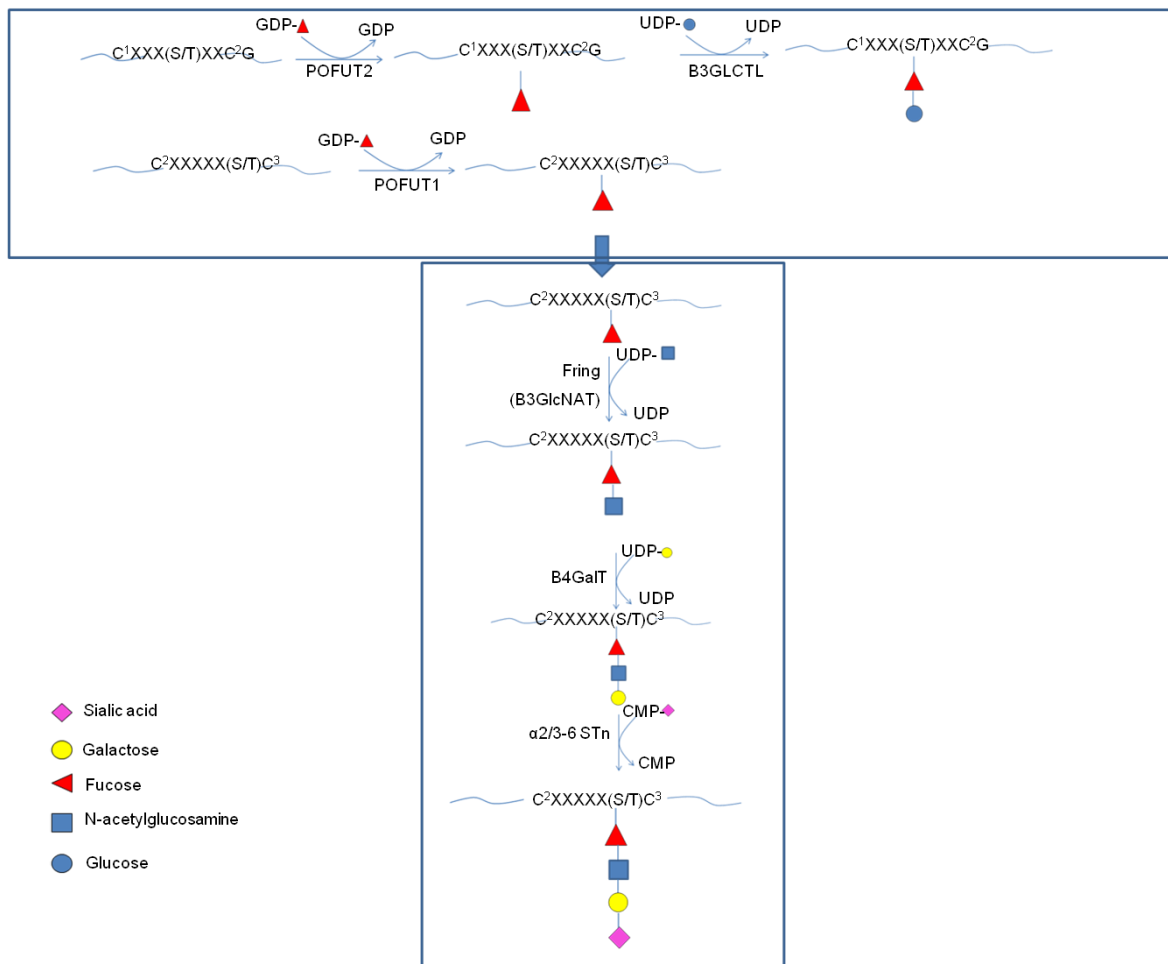

Figure 16: Protein-O-fucosylation of EGF- and TS-repeats

Figure (16) enzyme key: POFUT1 /2, protein-O-fucosyltransferase; B3GLCTL, β1-3-glucosyltransferase; B3GlcNAT, β1-3 N-acetylglucosaminyltransferase; B4GalT, β1-4 galactosyltransferase; ST3/6; α2-3/2-6 sialyltransferase

VI) Glucose- β -O-Ser/Thr glycans (O-Glc glycans)

These structures are found in EGF-like repeats where O-Glc is covalently linked to Ser or Thr residue in a C¹X (S/T) XPC2 consensus site⁹⁵. The enzyme responsible for O- β -Glc addition is the ER-resident protein-O-glucosyltransferase (POGLUT 1).

The O- β -Glc glycan is extended to yield the trisaccharide (Xyl α 1-3Xyl α 1-3Glc that is found in clotting factors VII and IX. Notch receptors also carry O- β -Glc glycans and it has been suggested that they play a role in Notch-signaling in drosophila⁹⁶.

V) Galactose- β -O-hydroxy-Lys/Pro glycans

Collagens are the most abundant proteins in the human body. The structure of collagen was elucidated in 1969 by Miller and Matukas, and a disaccharide (Glc α 1-2Gal) was found to be linked to hydroxylysine or hydroxyproline⁹⁷.

In the lumen of the ER, hydroxylation of lysine and proline takes place by three lysyl hydroxylases and four prolyl hydroxylases⁹⁸. Hydroxy lysine/proline is then substituted with a residue of galactose or the disaccharide Glc α 1-2Gal β by the action of collagen galactosyltransferases (ColGalT) and glucosyltransferase (GlcTn).

B] Proteoglycans

o Proteoglycan structure

Proteoglycans consist of a core protein to which one or more polysaccharide chains known as glycosaminoglycans (GAGs) are attached via a glycosidic bond. GAGs exhibit a heterogeneous structure resulting from the diversity in composition of the polysaccharide chains.

With respect to molecular weight, proteoglycans carry GAG chains that comprise up to 80 sugar residues producing a molecular weight of 20 kDa. This is in contrast to N-glycans, which generally contain 10 - 20 sugar residues.

The GAG chains consist of repeating disaccharides that comprise an amino sugar (GalNAc or GlcNAc) and an uronic acid (GlcUA or iduronic acid).

The core glycan structure (GlcA β 1-3Gal β 1-4Xyl-Ser) is shared by most of the GAG classes. The xylose (Xyl) residue is attached to the hydroxyl group of a serine residue acid via a β -glycosidic link.

An exception is one class of GAGs called keratan sulfate (KS) in which the polylactosamine chains are linked to the (NH₂) group of an Asn residue or the hydroxyl group of Ser or Thr residues. It is classified as either keratan sulfate (KS) I or II according to its core glycan structure.

According to the type of repeating disaccharide unit, GAGs are classified into four major classes:

- 1) *Chondroitin sulfate (CS: GalNAc β 1-4GlcA β 1)*
- 2) *Dermatan sulfate (DS: GalNAc β 1-4IdoA β 1)*
- 3) *Keratan sulfate (KS: Gal β 4GlcNAc β 1)*
- 4) *Heparan sulfate (HS: GlcNAc β 1-4GlcA β 1).*

o The biological importance of proteoglycans

All mammalian cells synthesize GAGs in highly variable amounts, and these structures can occur on the cell surface and in the ECM as well as intracellularly.

GAGs are classified into four major classes according to their tissue-specific biological role^{99,100}.

- 1) Interstitial GAGs, which include CS, KS and DS, are present in the ECM and perform a tissue-stabilizing function. For example, KS (I) supports the collagen

fibrils in corneal tissue. For example, KS (II), or skeletal KS with core 2 glycans with poly lactosamine chains, is found in high levels in connective tissues, especially cartilage and plays an important role in providing structural integrity to connective tissues^{100,101}.

- 2) Cytoplasmic secretory granule GAGs include CS and heparin. These granules are found mainly in endocrine, endothelial and hematopoietic cells. Serglycin is major member of this class of GAG.
- 3) Basement membrane GAGs contain mainly HS. HS plays an important role in cellular differentiation, embryogenesis and morphogenesis of cartilages. These GAGs are also found at the neuromuscular junction where they form aggregates with acetylcholine receptors (AChRs). Members of this class include perlecan and agrin.
- 4) Membrane-bound (cell surface) GAGs include CS and HS. Their function is to facilitate cellular interactions with extracellular molecules such as growth factors and signal transmission mediators. Here, the proteoglycans are expressed as TM molecules that undergo specific cleavage mediated by metalloproteases, and then the released GAG fragments bind to extracellular ligands. Members of this class are known as syndecans^{99,100}.

- ***Biosynthesis of GAGs***

The biosynthesis of HS, CS, and DS is initiated within the ER by the formation of a glycosidic link between Xyl and the hydroxyl group of a Ser or a Thr residue by the action of two ER-located xylosyltransferase isoforms (XTn1/2). Then the Xyl-O-Ser/Thr containing polypeptides are exported to the GA where they are elongated to yield the different GAGs (Figure 17)¹⁰⁰.

Biosynthetic pathways of KI and KII are distinguishable from the other GAGs. For instance, KI biosynthesis begins as a protein N-glycosylation process. Once the N-glycosylated glycoprotein has been exported to the GA, again N-glycan processing similar to that of N-glycoproteins is initiated. However, one of the N-glycan antennae is further elongated by addition of poly N-acetyl lactosamine chains (Figure 17). On the other hand, KSII biosynthesis is initiated in the GA by elongation of core 2 (O-GalNAc glycan) with addition of poly N-acetyl lactosamine chains (Figure 17)¹⁰¹.

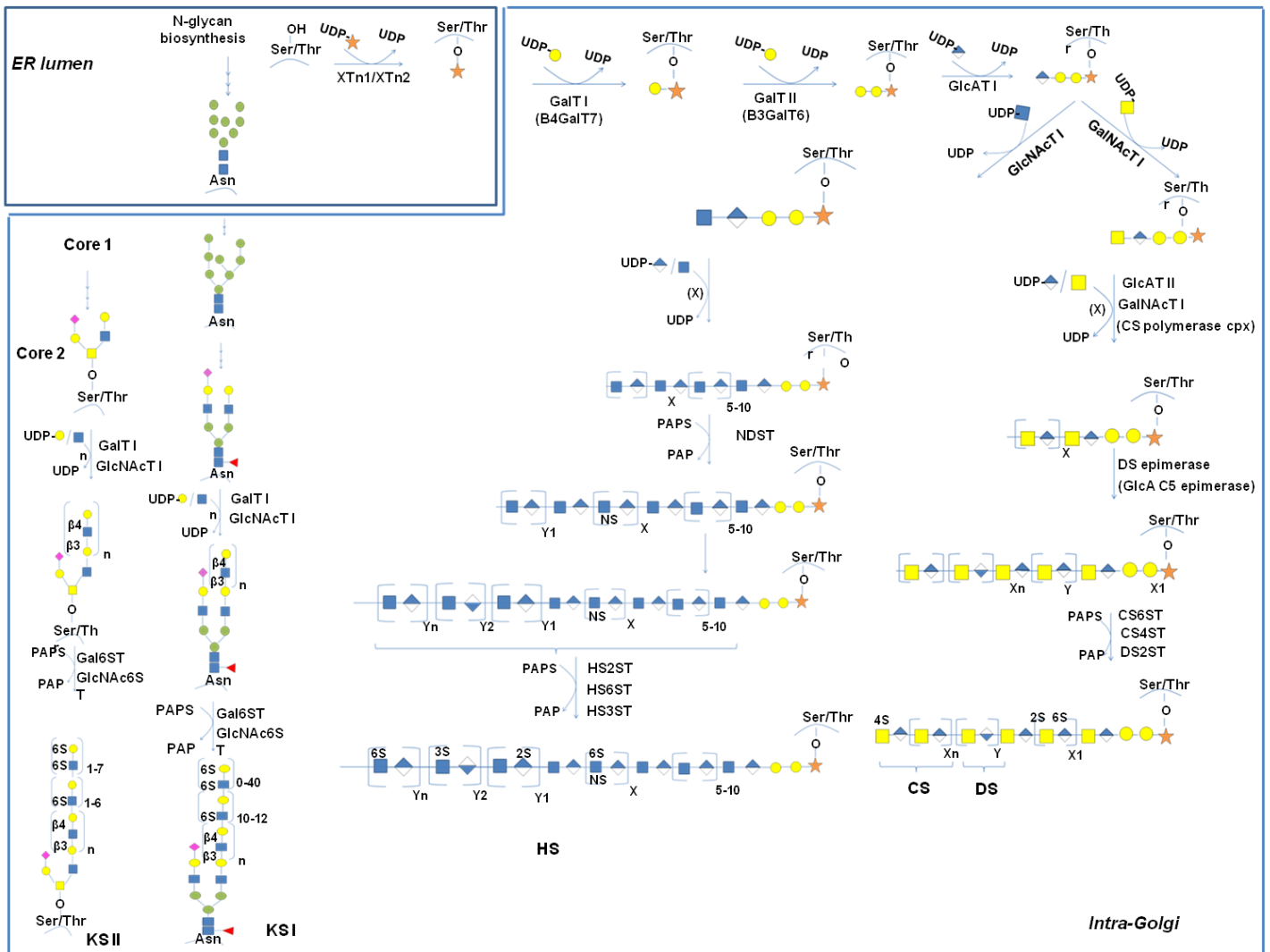

Figure 17: Glycosaminoglycans (GAGs) biosynthesis in the ER and GA.

Figure (17) enzyme key: XTn1/2, UDP-Xyl: *O*-serine *D*-xylosyltransferase; B4GalT7, β 1-4 galactosyltransferase; B3GalT6, β 1-3 galactosyltransferase; GlcAT, β 1-3 glucuronyltransferases, GalNAcT1, β 1-4 *N*-acetylgalactosaminyltransferase; GlcNAcT1, α 1-3 *N*-acetylglucosaminyltransferase; NDST, *N*-deacetylase sulfotransferase; HS2/3/6STn, heparan sulfate 2/3/6-*O*-sulfotransferase; CS 6/4/2STn, chondroitin sulfate 6/4/2-*O*-sulfotransferase; DS epimerase, dermatan sulfate epimerase; Gal6STn, Gal-6-*O*-sulfotransferase; GlcNAc6STn, GlcNAc-6-*O*-sulfotransferase; PAPS, 3' -phosphoadenyl-5'-phosphosulfate.

C] Glycosylphosphatidylinositol anchored proteins (GPI-anchor)

○ **GPI anchor structure**

The GPI-anchor consists of a tetrasaccharide unit (6Man α 1-2Man α 1-6Man α 1-4GlcN) whose glucosamine residue is α 1-6 linked to a phosphatidylinositol group that is substituted with one or two long chain (C18:0 and C24: 4) fatty acids. An ethanolamine phosphate link anchors a protein to the terminal non-reducing mannose residue of the tetrasaccharide (Figure 18). Human acetylcholine esterase and alkaline phosphatase are examples of GPI-anchored proteins¹⁰².

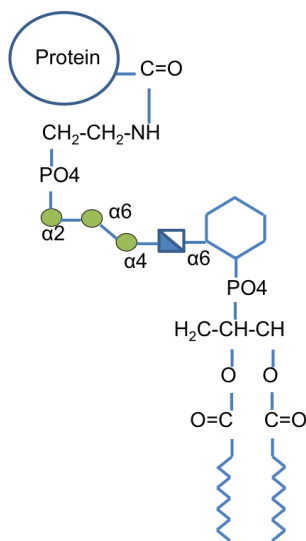

Figure 18: GPI anchor structure

○ **Biological roles of GPI anchors**

Proteins “anchored” in membranes with GPI moieties are found in lipid rafts of the plasma membrane. It has been suggested that the GPI-moiety is bound to lipids and TM proteins to increase their solubility in the surrounding medium¹⁰³.

○ **Biosynthesis of GPI anchored proteins**

The biosynthesis of the GPI-anchor takes place in four steps: i) phosphatidylinositol group biosynthesis on the cytoplasmic face of the ER; ii) tetrasaccharide core biosynthesis and association with a protein molecule in the lumen of the ER; iii) fatty acid and carbohydrate side chain modifications in the ER, and iv) GPI anchor insertion into lipid rafts in the GA the export to cell surface (Figure 19)¹⁰⁴.

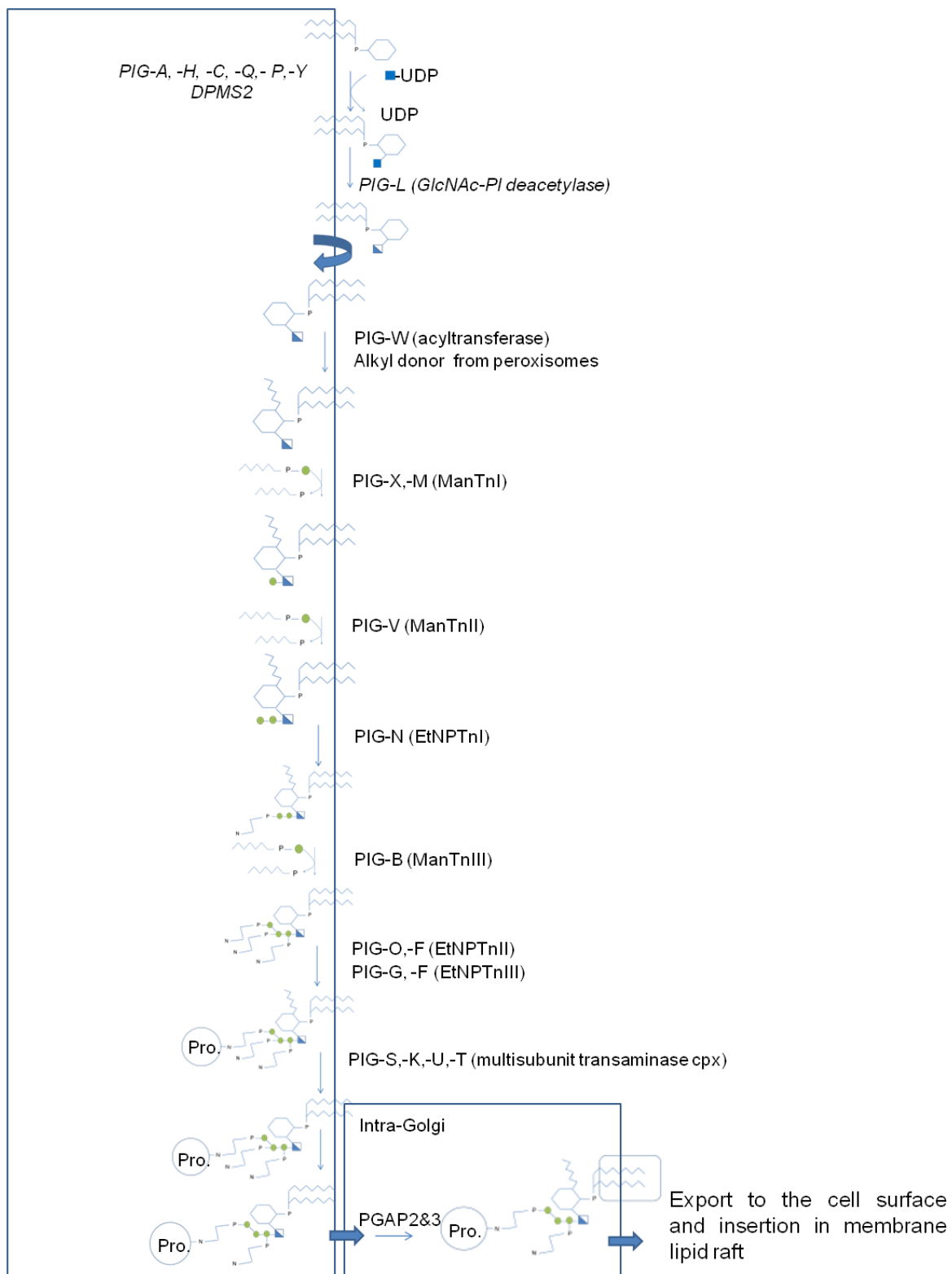

Figure 19: GPI-anchor biosynthesis and attachment to protein in the ER

Figure (19) enzyme key: PIG-, phosphatidyl inositol glycan anchor biosynthesis class-, ManTn1/2/3, mannosyltransferase 1/2/3; EtNPTn, ethanolamine phosphate transferase; PAGP, Post GPI-Attachment to Proteins.

D] Glycosphingolipids (GSLs)

○ *Historical background*

Johan L.W. Thudichum discovered GSLs in 1884¹⁰⁵. He analyzed ethanol-extracts of brain and characterized an assembly of three components. He found a fatty acid molecule and a sugar residue that turned out to be D-galactose. The third component was an alkaloid with a structure that was mysterious to Thudichum, so he called it sphingosin after the great mythological Egyptian Sphinx¹⁰⁵.

As Egyptologists had been trying to uncover the enigmatic structure of the Sphinx, with its head of a royal pharaoh and a body of a lion looming before the Egyptian Pyramids, lipidologists characterized the structure of the sphingolipid. The phospho-ethanolamine group is the head while the ceramide is the body and the resulting compound is called sphingomyelin. If the head group is a glycan, the resulting compound is a GSL (Figures 20 and 21).

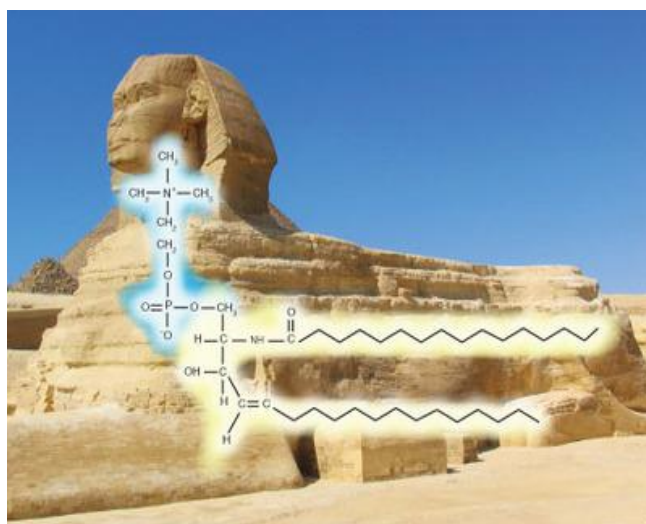

Figure 20: The Egyptian Sphinx and sphingolipid structure

Image taken from¹⁰⁶

Head group	Sphingolipid
Monosaccharide	Glycosphingolipid (GSL)
Phosphocholine	Sphingomyelin
H	Ceramide

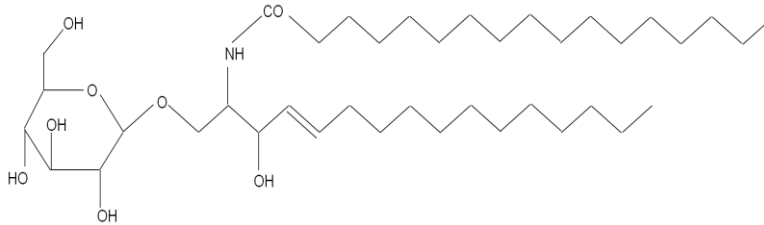

Figure 21: Glucosylceramide (GlcCer) structure.

○ **GSL structure**

Ceramide, the lipid molecule in GSLs, is composed of a long chain fatty acid linked to a sphingoid base through an amide linkage (Figure 22).

The ceramide moiety of GSLs is inserted in the plasma membrane, leaving the glycan head group on the cell surface to mediate several biological processes. The ceramide fatty acid chain length, and sphingoid base stereochemistry have a significant impact on the biological function of GSLs^{107,108}.

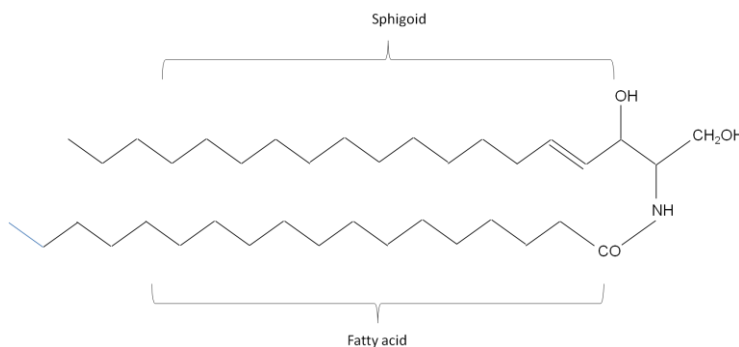

Figure 22: Ceramide structure

Due to their extreme structural diversity, GSLs have been variously classified according to different criteria.

For example, GSLs are commonly classified according to their charge:

- i) Acidic sialylated GSLs (also known as gangliosides)
- ii) Neutral GSLs that are not sialylated.

A more useful classification based upon the nature of the monosaccharide that is linked to the ceramide moiety, has been described¹⁰⁹. Using this approach, GSLs are separated into two major classes:

1) *β Glucosylceramides (β GlcCer)*

The majority of GSLs possess a glucosyl-ceramide core. This core is substituted with a galactose residue resulting in lactosylceramide (LacCer, Galβ1-4Glc-Cer).

There are 3 LacCer-containing GSL series:

- 1.1) Ganglio-series: The basic glycan core is Galβ1-4GalNAcβ1-4Galβ1-4GlcCer. This core is decorated with various constituents yielding a high degree of structure complexity.
- 1.2) Globo- and isoglobo-series: The core structures are Galα1-4Galβ1-4GlcCer and Galα1-3Galβ1-4GlcCer for the globo- (Gb3 and Gb4) and isoglobo-series (iGb3 and iGb4), respectively. The ‘globo’ root name was derived from the globular precipitate formed by these GSLs.
- 1.3) Lacto- and neo Lacto-series: The glycan core of the lacto-series is Galβ1-3GlcNAcβ1-3Galβ1-4GlcCer (also known as type II core) and is expressed in secretory organs. The neo lacto-series is synthesized in hematopoietic cells especially leukocytes and its core glycan is Galβ1-4GlcNAcβ1-4Galβ1-4GlcCer (type I core)¹⁰⁹.

2) *β Galactosylceramides (β GalCer)*

Here, galactose is linked directly to ceramide (β GalCer). GalCer is modified at the hydroxyl group at C3 by addition of a sulfate group to produce *sulfatide* (SM4) or 3-O-sulfogalactosylceramide.

○ *Biological importance of GSLs*

GSLs, along with cholesterol and phospholipids, constitute a major part of plasma membrane lipid rafts¹⁰⁹. GSLs represent a major component of the cellular glycocalyx. Their glycans are much closer to the cell surface in comparison with those of glycoproteins that have glycans extending 1μm from the cell surface¹¹⁰.

In humans, this class of glycoconjugate displays a great degree of diversity in terms of structure, biological function, and tissue-distribution¹¹⁰. The GSL-producing cell type is the major factor that determines the structure and expression level of GSLs. GSLs exist in all types of tissue and are highly expressed in neural tissues where they play pivotal roles in development and function¹¹⁰.

Examples for biological functions of GSLs include:

- 1) β GalCer and its sulfatide play a principle role in nervous system development and function, and are responsible for the proper arrangement of myelin end-feet from a multi-layer sheath around the axon to create the ‘nodes of Ranvier’¹¹¹.
- 2) Members of the ganglio-series are variably expressed in almost all tissues and those with complex structure are highly abundant in the mammalian nervous system¹¹¹.
- 3) The globoids (Gb3 and Gb4) are mainly expressed on human erythrocytes as blood group determinants. They are also receptors for shiga and shiga-like toxins produced by *Shigella dysenteriae* and shigatoxigenic strains of *E. coli*, respectively, where globoids facilitate the entry of these bacteria into target cells¹¹².
- 4) Another tissue-specific GSL is a sulfated glycerolipid called seminolipid. Seminolipid constitutes more than 90 percent of glycolipid in the mammalian testis¹⁰⁹.

○ **GSLs nomenclature**

Many systems have been used to describe the different classes of GSLs. IUPAC-IUB systematic naming, for instance, is based upon the nature and linkages of the sugars in GSLs¹¹³. Additionally, this system describes the ceramide backbone structure in terms of the number of hydroxyl groups, sphingosine base chain length and its number of double bonds as well as the amide-linked fatty acid chain length. Using this nomenclature, the GSL, GM1a, for example, is referred to as: Neu5Ac α 2-3 (Gal β 1-3GalGalNAc β 1-4) Gal β 1-4Glc β 1Cer (d18: 1/C18:0), where (d) is for di-(OH)¹⁰⁷.

Another system uses Roman numerals to describe the sugar residue in the GSL-core with respect to its position to the ceramide backbone, a superscript to indicate which hydroxyl group in that sugar residue is substituted, and a root structure (Gg_n) that describes the number of GSL core sugar residues. For example, GM1 is identified as: II³NeuAc-Gg₄Cer. That is to say: the GSL-core is a tetrasaccharide (Gg₄) of which the galactose residue located next to the ceramide-bound glucose (II) is substituted, on the hydroxyl group at C3 with a Sia residue¹⁰⁷. Both systems are quite complex and are not presently in common use.

Nowadays, the more convenient and simple Svennerholm nomenclature system is the most commonly used. The general formula of the Svennerholm nomenclature is GN_(n) where G is for ganglioside, N is the number of Sia residues (Mono-, Di-, Tri,...) and (n) is the order of migration of a GSL on a thin layer chromatography (TLC) plate according to its molecular weight i.e. n = 1 means higher molecular weight than n = 2 or 3 etc. For example, GM1: G is for ganglioside, M is for mono-sialylated and (1) is its order of migration on a TLC in relation with the other mono-sialylated gangliosides^{114,115}.

- ***Biosynthesis of GSLs***

The first step of GSL biosynthesis takes place in the ER where the ceramide is synthesized. Ceramide is transported to the GA by a specific ER-situated Ceramide Transport protein (CERT). With the exception of GalCer, which is synthesized within the ER lumen, all GlcCer –based GSLs are synthesized in the GA (Figure 23). First, the core of all GlcCer GSLs, LacCer, is synthesized by sequential addition of glucose and galactose residues. LacCer is the branching point in GSLs biosynthesis. Many glycosyltransferases compete for LacCer whose further extension results in the synthesis of both the acidic (gangliosides) and neutral GSLs (Figure 23).

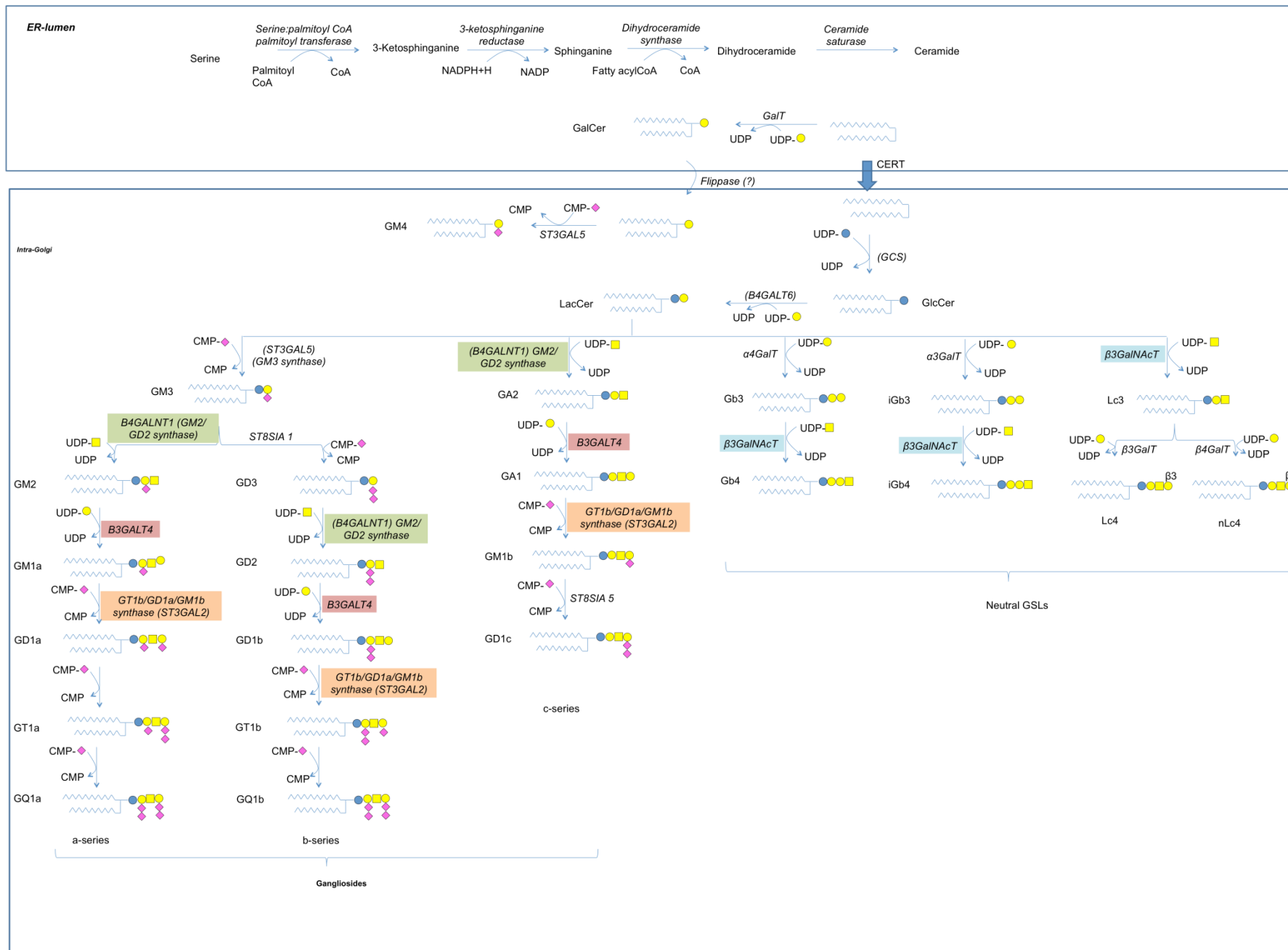

Figure 23: The biosynthesis of glycosphingolipids (GSLs).

Figure (13) enzyme key:

B4GALNT1, β 1-4-N-acetylgalactosaminyl transferase-1; *B3GALT4*, UDP-Gal: β N-acetylgalactosamine β 1-3 galactosyltransferases; *ST3GAL2*, galactoside α 2-3 sialyltransferase 2; *ST8Sia5*, α 2-8 sialyltransferase 5; *α 4GalT*, α 1-4 galactosyltransferase; *α 3GalT*, α 1-3 galactosyltransferase; *β 3GalNAcT1*, β N-acetylgalactosamintransferase 1; *β 3GalT*, UDP-Gal : β N-acetyl-glucosamine β 1-3 galactosyltransferase; *β 4GalT1*, UDP-Gal : β N-acetyl-glucosamine β 1-4 galactosyltransferase.

2] Human Glycosylation Disorders

2] Human Glycosylation Disorders

By considering the biological functions of the glycoconjugates that have been described in the previous chapter, it would be logical to think that any abnormality in the glycosylation process that results in hypoglycosylated protein or lipid would have serious consequences for several biological systems. A glycosylation abnormality can be secondary to a pathological condition, or genetically inherited. Although hypoglycosylation is generally associated with disease, it is also a part of the normal physiological ageing process, and age-related disorders.

Accordingly, human glycosylation disorders can be classified into:

2.1] Age-associated hypoglycosylation

Hypoglycosylation takes place as a consequence of the ageing process and some disorders are known to be associated with ageing. This can result in phenotypes with variable degrees of severity. These phenotypes involve:

1) Immunodeficiency

This occurs in the majority of aged people, where the enzymatic activity of β 1-4 galactosyltransferase is decreased with a concomitant increase in β 1-4 galactosidase. Serum IgG, for instance, becomes agalactosylated resulting in less efficient binding to the Fc receptors.

2) Age-associated dementia

During ageing, the biantennary agalactosylated structures with an α 1-6 fucosylated core (NGA2F) increase at the expense of the normal digalactosylated structures with the α 1-6 fucosylated core (NA2F). The ratio NGA2F/NA2F (in the GlycoAge Test) is used as an effective biomarker of ageing. Aged persons having dementia show high a GlycoAge Test value in comparison to controls with matched age¹¹⁶.

3) Alzheimer's disease (AD)

AD is associated with many protein hypoglycosylation events. For example:

- Brains of AD patients display a decrease in glucose uptake and hence, metabolism. As a consequence, there is reduced O-GlcNAcylation, resulting in hypo-O-GlcNAcylated Tau protein with a corresponding increase in its phosphorylation. Tau is an O-GlcNAcylated protein that is associated with dying and degenerating neurons. Phosphorylated Tau protein is used as a biomarker in AD¹¹⁶.
- Reelin is a glycoprotein of molecular weight 420 kDa. During brain development, reelin plays a cytoarchitectonic (pertaining to cell shape and organization) role in many brain areas. Hypoglycosylated reelin of molecular weight 180 kDa was found in CSF of AD patients¹¹⁶.

2.2] Secondary hypoglycosylation disorders

Hypoglycosylation is sometimes secondary to another inherited metabolic disorder. Some inborn errors of metabolism (IEM) result from an inherited abnormality of sugar metabolism, which in turn will be reflected on that sugar utilization in the glycosylation processes. Galactosemia and hereditary fructose intolerance, for instance, are IEMs in which patients were found to have hypoglycosylated proteins.

a) Classic galactosemia

This IEM is caused by a decreased activity in galactose-1-phosphate uridylyltransferase (GALT) that catalyzes the interaction between galactose-1-phosphate (Gal1P) and UDP-Glc resulting in UDP-Gal production. Galactosemia is a fatal metabolic disorder for neonates. The typical clinical picture is diarrhea, dehydration, vomiting, hepatomegaly, hypoglycemia, cataract and failure to thrive¹¹⁷.

Analysis of plasma glycoproteins revealed hypoglycosylation of both N- and O-glycoproteins. Elevated levels of high-mannose and truncated N-glycans with corresponding reduced levels of complex sialic acid and galactose-containing N-glycans were detected in plasma of galactosemic neonates¹¹⁷.

They also had increased levels of O-glycan core 1 (Tn-antigen) accompanied with decreased levels of monosialylated T-antigen (Figure 13). Gal1P, at high concentrations, competitively inhibits hepatic glycosyltransferases, and hence, disturbs glycosylation. Galactosemia-caused hypoglycosylation could explain why some galactosemic patients have serious clinical manifestations such as white matter hypomyelination while other patients have a milder presentation. Defective UDP-Gal biosynthesis results in hypogalactosylation of brain GSLs and glycoproteins which may lead to long-term complications of galactosemia that cannot be relieved by galactose-restriction treatment¹¹⁸. Galactosemia patients on galactose-free diet show normalized glycosylation of serum transferrin (Tf)^{117,119}.

b) Hereditary fructosemia intolerance (HFI)

This is another IEM where secondary hypoglycosylation is noted. HFI is caused by congenital defective fructose 1-6-bisphosphate aldolase B resulting in an accumulation in fructose-1-phosphate (F1P). HFI patients manifest severe hypoglycemia, vomiting on fructose intake, hepatomegaly, jaundice, hemorrhage, proximal renal tubular syndrome, hepatic failure and death. Here, the accumulated F1P inhibits mannose phosphate isomerase (MPI) (Figure 7). Serum of HFI patients shows hypoglycosylated Tf glycoforms¹²⁰.

2.3] Congenital Disorders of Glycosylation (CDGs)

These diseases were formerly called Carbohydrate Deficient Glycoprotein Syndromes (CDGS), and are inherited diseases that result from defective glycosylation of macromolecules (lipids and/or proteins).

These disorders constitute one of the major classes of IEMs and their identification is increasing rapidly compared to other IEMs because recently developed, time-efficient and cost-effective techniques are used to determine the often complex glycosylation profiles of multiple glycoconjugates in different biological samples.

2.3.1] Discovery of CDG

The first CDG case was reported in the 1980s by Helena Stibler and Jaak Jaeken¹²¹. The case presented with severe neurological manifestations including psychomotor retardation, ataxia and seizures. The clinical picture also involved coagulation defects, hepatic involvement, immune system involvement and gastrointestinal problems¹²¹.

This presentation was misleading to the physicians because it overlapped with those of other IEMs such as aminoacidopathies, some lysosomal storage diseases (LSDs) and mitochondrial disorders. However, a distinguishing feature of the CDG case was the presence of hypoglycosylated serum Tf with missing glycan chains¹²².

2.3.2] Molecular levels of CDG

The underlying causes of CDG affect the glycosylation process at different levels. Over 100 CDG subtypes have been discovered¹²³. This high number of CDG subtypes results from the presence of many defective factors (including glycosyltransferases, nucleotide sugar transporters, and dolichol biosynthesis enzymes), which were found to be the underlying reasons of CDG. For instance, one defective biochemical event in two glycosylation pathways can result in different subtypes of CDG in terms of biochemical and clinical phenotypes. For example, defective protein mannosylation caused by a mutation in one of the mannosyltransferases can take place in different glycosylation steps i.e. either initiation or elongation (as in case of N-glycans biosynthesis) (Figure 12) or the initiation step of α -DG in the ER (Figure 15), and in each case, a totally different CDG subtype takes place. Figure 24 shows the biochemical defects that underlie the majority of CDG subtypes. It displays the perturbed glycosylation biochemical reaction and the affected glycoconjugate assigned to the subcellular compartment.

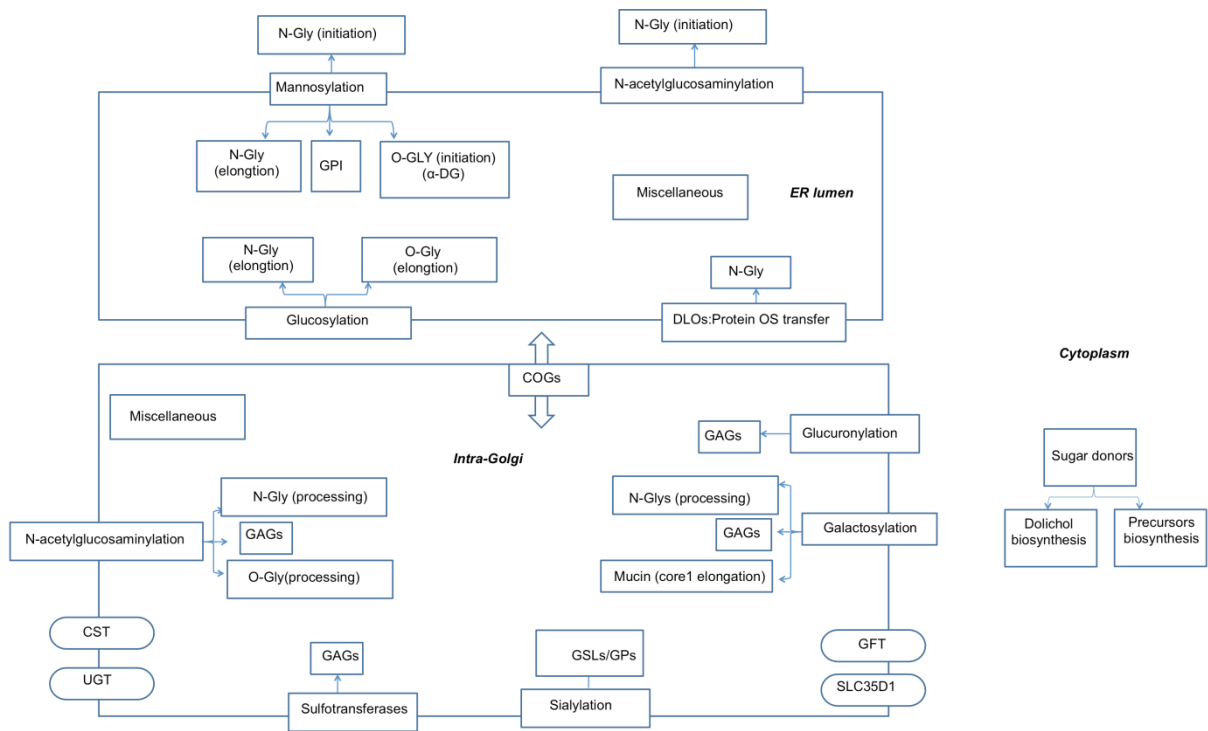

Figure 24: Defective biochemical events in glycosylation processes.

2.3.3] Nomenclature and Classification of CDGs

Originally, CDGs were classified into two major types. Type I CDG (CDG-I) includes diseases caused by mutations in genes required for the biosynthesis of DLO and transfer of the oligosaccharide from DLO onto protein in the ER (Figure 1). Type II-CDG (CDG II) comprises diseases provoked by mutations in genes required for correct processing of N-glycans in either the ER or GA¹²⁴. For both CDG-I and CDG-II, disease subtypes were denoted alphabetically according to the chronology of their discovery. Accordingly, phosphomannomutase 2-deficiency was originally called CDG-Ia because it was the first CDG to be discovered in which DLO biosynthesis is perturbed¹²⁴.

In 2009, a new nomenclature was introduced in which the name of the mutated gene is appended to the abbreviation “-CDG” (for example, PMM2-CDG)¹²⁵. The new nomenclature of CDGs is more useful because the old nomenclature focused on defects in protein N-glycosylation¹²⁵.

Clinicians have tried to classify CDGs according to the clinical presentations. However, the same clinical picture could result from many different IEMs. For example, PMM2-CDG (Appendix P.170) has been classified as a neurodegenerative disorder because the patients’ MRI (Magnetic Resonance Imaging) showed deformed cerebellar hemispheres with severely decreased volume accompanied with abnormally enlarged fissures¹²⁶. However, in some cases, the neurologic manifestations were misleading. For example, three patients with neurodegeneration were misdiagnosed with mitochondrial disease, which turned out to be PMM2-CDG eventually confirmed by hypoglycosylated serum Tf¹²⁷.

Another example is West syndrome (WS) (Appendix P188), which is an epileptic encephalopathic syndrome that develops progressively into a more severe syndrome called Lenox Gusto syndrome with difficult-to-manage epilepsy. WS causative mutations have been identified in *ARX* and *CDKL5* genes that are known to play a role in normal brain development and function. Recently, a mutation in one of the STns (ST3Gal III) was characterized as another underlying cause of WS with unknown mechanism. The patients showed the typical WS clinical picture and progressively developed the more serious prognosis, Lenox Gusto syndrome¹²⁸.

Consequently, I attempted to classify CDG from a biochemical perspective to avoid the overlapping between different subtypes with similar clinical pictures (see Chapter 5, Appendix).

2.3.4] Clinical presentation of CDGs

The majority of CDGs are multisystem disorders, and this could be due to many reasons. First, a high percentage of proteins including enzymes, hormones, receptors, inflammatory or immune mediators... etc. are glycosylated and any disturbance in their glycosylation could severely affect many biological systems (see “Biological importance of macromolecule glycosylation”, P17).

A second reason could be that many elements that are rate limiting to the glycosylation process such as glycosyltransferases and activated sugar pools are common to the synthesis of glycoproteins and GSLs, each with its specific biological functions. For example, most STns are involved in sialylation of glycoproteins and GSLs and utilize the same CMP-Sia pool in the GA.

A third reason is that most of the glycosyltransferases (for example the *ALG* family) are glycoproteins that are produced by the action of other glycosyltransferases or they undergo an autoglycosylation¹²⁹. In this case, a defect in one glycosylation pathway might lead to a secondary defect in another one.

One characteristic feature of CDG is that in a few CDG subclasses, two different mutations in the same glycosyltransferase were shown to result in two completely different syndromes.

One example is GM3 synthase (or *ST3GAL5*), a sialyltransferase that transfers a Sia residue to LacCer to produce GM3, which is the precursor for all the complex gangliosides (Figure 23). Two mutations in GM3 synthase have been shown to cause two different syndromes. One mutation produces a truncated protein that is unable to bind to LacCer and the resulting disease is called Amish infantile syndrome. The other mutation produced an intact but likely disordered protein where the enzyme can bind LacCer but with less efficiency than normal causing a disease called salt and pepper syndrome (OMIM: 609056)¹³⁰(Appendix; P.188).

Another example is the *GNE* enzyme, which has two enzymatic activities, UDP-*N*-acetylglucosamine 2-epimerase (GlcNAc 2-epimerase) and *N*-acetylmannosamine kinase (ManNAc). *GNE* is the key enzyme in Sia biosynthesis. Two different disorders result from mutated *GNE*. Hereditary inclusion body myopathy type II (HIBM II) (or Nonka myopathy) is a neuromuscular disorder with late onset of myopathy limited to legs. Muscle biopsies from patients show vacuoles and cytoplasmic inclusions¹³¹. Neural Cell Adhesion Molecule 1 (NCAM 1) is hyposialylated in HIBM II patient muscles¹³². The second disorder is Sialuria (or French type Sialuria, OMIM: 269921). It results from defective allosteric regulation of GNE2-epimerase, which in turn leads to excessive uncontrolled production of Sia that is excreted in urine. Patients have mild mental retardation, coarse facies, and hepatomegaly. Serum O-glycoprotein, apoC III, is hypersialylated while serum N-glycans are normally sialylated¹³³ (App, P170).

As a part of the enigmatic clinical picture of CDG, there are a few CDGs associated with absent or mild manifestations. Bombay phenotype (OMIM: 616754) is an interesting example of CDG where severe clinical manifestations are absent. Y. M. Bhende reported the first case in 1952 in Bombay. In this phenotype the serum interacted with all blood types¹³⁴.

Bombay phenotype is a condition caused by a congenital deficiency of α 1-2 FucTn that adds a fucose residue to galactose residue during the synthesis of blood group determinants A, B or H. Bombay individuals are healthy in their appearance but they are incompatible with all blood groups and they can receive blood from donors with the same phenotypes¹³⁵.

A mild clinical presentation is noticed in MPI-CDG (mannosephosphate isomerase) (OMIM: 602579). MPI is the enzyme that catalyzes the reversible conversion of fructose-6-phosphate to M6P in the cytoplasm (Figure 7). MPI-CDG patients show manifestations that are limited to gastrointestinal disorders like diarrhea, and protein-losing enteropathy (App, P.170). MPI-CDG GIT disorders are treatable by oral mannose supplementation (see below)¹²⁴.

2.3.5] Mode of inheritance of CDGs

CDGs are monogenic autosomal recessive disorders except for two disorders that are inherited in an autosomal dominant mode (EXT1/EXT2-CDG, OMIM: 133700, and sialuria, OMIM: 269921) and some others are X-linked disorders (SSR4-CDG, OMIM: 300934¹³⁶, ALG13-CDG, OMIM: 300884¹³⁷ and SLC35A2-CDG, OMIM: 300896¹³⁸) (App., P. 186, 170, 174).

2.3.6] Diagnosis

2.3.6.1] CDG diagnostic biomarkers

a) Glycoprotein biomarkers

a.1) Plasma glycoproteins

1) N-glycoproteins:

- Transferrin (Tf)

The story behind using Tf as a diagnostic biomarker for CDG began in the late 1970s when Helena Stibler used serum Tf as a tool for detecting chronic alcohol abuse where she demonstrated that serum Tf was hyposialylated in persons with chronic alcohol consumption¹²². Afterwards, she and Jaak Jaeken discovered CDG¹²¹. Since then Tf glycosylation profile has become an important diagnostic tool for suspected CDG cases ever since.

Tf is a glycoprotein with two N-glycan chains and each contains two Sia residues (tetrasialylated). In the case of defective N-glycan chain biosynthesis, asialo- and di-sialo Tf levels increase, while in the case of defective N-glycan processing in the GA all the hyposialylated Tf isoforms, (asialo-, mono-sialo-, di-sialo, and trisialo), are increased.

The analysis of Tf glycosylation profiles is based on the charge imparted to the Tf molecule by Sia residues. Isoelectric focusing (IEF) and capillary electrophoresis (CE) are techniques that are used to detect hyposialylated Tf. More recently, CDG diagnosis laboratories use mass spectrometry (MS) to detect the hypoglycosylated Tf.

Plasma Tf as a CDG diagnostic biomarker has the advantage of being highly abundant (5 % of all plasma proteins) and its glycosylation profile can be easily detected. However, using plasma Tf as the only CDG diagnostic biomarker has some drawbacks¹³⁹.

First, hypoglycosylated plasma Tf can result from some pathological conditions other than CDG such as hepatic insufficiency or infection with sialidase-producing bacteria. Second, many CDG subtypes show normally glycosylated plasma Tf (ALG13-, ALG14-, SLC35A3-, SLC35C1-, GFPT1-, GNE-, and PGM3-CDG)¹³⁹ (Chapter 5, Appendix).

Additionally, some patients with ALG2-CDG showed hypoglycosylated plasma Tf while some others had normal or marginally hypoglycosylated isoforms¹⁴⁰.

Third, because Tf is an N-glycoprotein it cannot be used as an indicator for the hypoglycosylation of other glycoconjugates such as GSLs, GPI anchors, and O-glycoproteins.

There are a lot of other plasma N-glycoprotein biomarkers synthesized in the liver such as orsomucoid (5 N-glycan chains), haptoglobin (4 N-glycan chains), alpha-1-anti-trypsin (3 N-glycan chains), which are also used as CDG diagnostic biomarkers¹⁴¹.

2) *O-glycoprotein*

- *Apolipoprotein C-III (Apo C-III)*

Apo C-III is an O-glycoprotein with a single core 1 mucin structure linked to hydroxyl group of Thr residue (*Figure 13*). Like Tf, Apo C-III is synthesized in the liver. Apo C-III function is to inhibit clearance of lipoproteins VLDL or LDL by hepatic lipases¹⁴².

Apo C-III has 3 glycoforms, Apo C-III₀₋₂, corresponding to the asialo, mono-sialo, and di-sialo-isoforms, respectively. In the case of a defect in O-glycan biosynthesis the Apo C-III₀ and Apo C-III₁ levels increase with a corresponding decrease in Apo C-III₂ with respect to total Apo C-III¹⁴².

The major problem associated with using the Apo C III sialylation profile as a CDG diagnostic marker is the false positive results take place in some pathological conditions such as the acute phase of hemolytic uremic syndrome (HUS) caused by *Streptococcus pneumoniae*, which produces neuraminidase (sialidase) that promotes glycoconjugates desialylation¹³³.

Conversely, increased Apo C-III₂ relative to Apo c-III₁ (i.e. hypersialylation), was detected in patients with sialuria¹³³ due to the uncontrolled biosynthesis of CMP-Sia as well as in patients with chronic renal dysfunction¹⁴³. The Apo C-III sialylation profile can be analyzed using MS and IEF.

a.2) Cell-derived glycoproteins

The most commonly used membrane glycoproteins are ICAM-1 (Intercellular adhesion molecule 1) and LAMP-1 (Lysosomal associated membrane protein 1).

ICAM-1 (or CD54 for Cluster of Differentiation 54) is a heavily glycosylated transmembrane protein. ICAM-1 was found to be hypoglycosylated in PMM2-, MPI-, and ALG1-CDG subtypes where it appeared to be expressed at reduced levels in these patient fibroblasts in comparison to controls¹⁴⁴. ICAM-1 is not only used as a CDG diagnostic marker but also as a marker to monitor therapy. For example, its expression level was restored to normal when MPI-deficient cells were supplemented with mannose¹⁴⁴.

LAMP-1 (also called CD107a) is a lysosomal TM glycoprotein. It contains 18 N-glycosylation sites¹⁴⁵. It has been used recently as a CDG diagnostic biomarker in patients with NgBR-CDG (Nogo B receptor) where they had hypoglycosylated fibroblasts-derived

LAMP-1 appeared as many bands of molecular weight inferior to the fully glycosylated molecule¹⁴⁶.

b) GPI anchor markers

Assessment of change in GPI anchor glycosylation profile is used as a marker for some CDG subtypes such as PIGA-CDG (Figure 19) or paroxysmal nocturnal hemoglobinuria type I (PNH, OMIM: 300818) (Ap., P.179). PNH patients have repeated hemolysis episodes and increased incidence of leukemia and thrombosis. PNH results from defective biosynthesis of GPI anchored proteins CD55 and CD59 (are complement regulatory proteins) that exist on the surface of many cell types such as leukocytes, red blood cells, platelets, epithelial, and endothelial cells^{147,148}.

c) GSL markers

GSLs are used as markers for certain CDG subtypes. Unlike the situation where a single glycoprotein is used as a marker (ICAM-1, for example) that suggests the presence or absence of a defect in the glycosylation process (either N- or O-glycosylation) without giving information about the exact site of the defect, GSLs are analyzed as a total profile in which the precursors and the products exist together without any derivatization or analysis pre-treatment. Consequently, it is feasible to detect the site of the glycosylation defect.

Additionally, given that gangliosides and neutral GSLs share the same precursor, LacCer (Figure 23), in certain CDG subtypes with defective GSLs biosynthesis, a global image can be obtained when analyzing both types of GSL. For example, Amish infantile epilepsy syndrome caused by mutated ST3GAL5 (Lactosylceramide α 2-3 STn, or GM3 synthase) the decreased levels of GM3 and all the subsequent complex gangliosides was accompanied with a significant increase in the neutral GSLs (Gb3 and Gb4)^{130,149}.

2.3.6.2] Glycomics

Glycomics is the extensive study of glycomes (P.15) using several approaches to analyze glycan structure and expression level under different conditions (genetic, environmental.... etc.)¹⁵⁰. The prefix ‘Glyco-‘ refers to sugars and the suffix ‘-omics’ as in genomics, proteomics, and lipidomics ...etc. refers to the qualitative and quantitative analysis of specific molecules (DNA, protein, lipid, ...etc.) that exist in all the biological systems and how these molecules perform their biological roles in those systems¹⁵¹.

o **Mass spectrometry (MS)**

MS is the approach of choice to analyze the glycome of a biological sample for many reasons:

- i) High sensitivity and ability to detect low amounts of glycans (fmol).
- ii) High resolution, where MS can be used to analyze individual glycans in complex mixtures.
- iii) Can be coupled online with many other techniques such as High Performance Liquid Chromatography (HPLC), CE, High Performance Thin Layer Chromatography (HPTLC), and Gas Chromatography (GC) to adapt different separation methods and cover all glycan types.
- iv) MS/MS analysis can be applied to provide detailed information about the glycan structure.
- v) Specific proteome analysis can be useful to detect the glycan linkage-sites in specific glycoprotein¹⁵².

MS, however, is like any other technique has its limitations. These include:

- i) Biological samples require purification steps before their analysis by MS.
- ii) MS is destructive to the samples.
- iii) Complicated troubleshooting¹⁵⁰.

In glycomics, the most commonly used MS machines are MALDI (Matrix Assisted Laser Desorption Ionization) and ESI (Electro Spray Ionization). Each MS machine has a different way of ionization, which can be selected depending on the type of glycan to be analyzed¹⁵⁰. For some glycoproteins, analysis by MS requires release of the glycan from the protein molecule by PNGase F enzyme for N-glycans or chemical hydrolysis for O-glycans. Then the released glycans can be derivatized before MS analysis. Conversely, GSLs are MS-analyzed directly i.e. the glycan does not need to be hydrolyzed from the ceramide moiety. HPTLC coupled with MS is the most applicable technique for GSLs analysis¹⁵⁰.

o **Electrophoresis**

The commonly used electrophoresis approaches for glycan analysis are Isoelectric focusing (IEF) and Capillary Electrophoresis (CE).

The principle of IEF is based on separation of proteins based on their charge in a pH gradient and electric field. At low pH, protein molecules acquire positive charge, so, they migrate towards the negatively charged cathode. As the proteins migrate, pH increases in the gel and

hence, the protein charge decreases until it becomes neutral and stops migrating. The point at which the protein molecule is neutralized and does not migrate toward either electrode is called isoelectric point (IP). Each protein has its specific IP, accordingly, proteins can be separated as sharp bands according to differences of their charge state, which in the case of a given glycoprotein is determined by number of Sia residues on either N-glycans (Tf) or O-glycans (Apo C-III). Limitations of the IEF technique include being time-consuming and non-quantitative¹⁵³.

○ *Sodium dodecyl sulfate-polyacrylamide gel electrophoresis (SDS-PAGE)*

1) Western Blot

It is a commonly used approach to separate glycoproteins based on their molecular weight. Glycoproteins with one or more missing glycans will appear as bands migrating faster than the fully glycosylated protein.

2) Lectin Blot

Lectin blots are a type of western blot where lectins, and not antibodies, are used to detect the sugar residues of glycoproteins.

There are many other techniques that are currently used in glycome analysis each one has its advantages and disadvantages with respect to sensitivity, specificity, time-consumption, cost effectiveness, etc. Nuclear Magnetic Resonance (NMR) and flow cytometry are also widely used techniques for glycan analysis.

2.3.7] Treatment approaches for CDGs

Depending on the glycosylation defect, there are a few CDG subtypes that are treated etiologically. In most cases, however, symptomatic treatments are the only treatments that are available.

2.3.7. A] Etiologic treatment

This type of treatment is based on a direct intervention in the glycosylation process by supplementing the patient with specific a sugar that can bypass the defective point in the glycosylation pathway. This type of treatment is applied in the following CDG subtypes:

1) MPI-CDG (OMIM: 602579)

Glycosylation defect: It is caused by defective MPI that reversibly converts fructose-6-phosphate to M6P (

Figure 12 and Figure 24 (App, P.170).

Clinical presentation: MPI-CDG patients manifest a mild clinical picture that involves gastrointestinal disorders (diarrhea, proteinuria) and hepatomegaly. Their serum Tf is hypoglycosylated upon IEF analysis.

Treatment: Oral supplementations of these patients with mannose at a dose of 0.1 - 0.2 g/kg body weight every 4 hrs for 3 – 5 times/day results in remarkable improvement.

Upon mannose therapy, serum Tf glycosylation is restored to normal and GIT disturbances are almost completely relieved. Other symptoms, however, such as hepatomegaly are refractory to mannose supplementation¹⁵⁴.

The treatment approach here depends on introducing an exogenous monosaccharide beyond the defective point in the glycosylation pathway thereafter that monosaccharide can be further processed to give the required precursors.

Unfortunately, the positive outcomes with mannose therapy are not absolute because of the toxicity of mannose. “Honeybee syndrome” was discovered when honeybees were fed mannose. When free mannose enters the insect’s cells it is immediately phosphorylated by hexokinase into M6P with consumption, and consequent depletion of ATP leading to death. The same phenomenon was determined to be the underlying reason for teratogenicity that takes place in rat embryos when their mothers are fed mannose⁵⁸. Mannose therapy is like any other treatment in terms of being not tolerated by some patients, accordingly, MPI-CDG patients on mannose treatment should be under strict monitoring¹⁵⁴.

2) *SLC35C1*-CDG (OMIM: 266265)

Glycosylation defect: This disease, also known as Leukocyte Adhesion Deficiency type II (LAD II), is caused by a mutation in the *SLC35C1* gene that encodes the GDP-Fuc transporter. This transporter translocates GDP-Fuc synthesized in the cytoplasm into the GA where it is utilized by FucTns (Figure 12 and Figure 24). As a consequence, LAD II patients have a significantly reduced production of fucosylated glycoconjugates¹⁵⁵ (App, P.174).

The biochemical hallmarks of this disorder are i) the defective migration of leukocytes toward the site of inflammation resulting from the reduced expression of fucosylated Lewis^X and sialyl-Lewis^X epitopes on leukocytes. This leads in turn to a disruption in the interaction between these epitopes and their P- and E-selectins on the surface of activated endothelia, ii) Bombay phenotype, where the patient's erythrocytes do not carry the fucosylated H-antigen, which is the precursor for A, B, and O blood group determinants¹⁵⁶ (P.63).

Clinical presentation: It involves severe psychomotor retardation, dwarfism, characteristic facial appearance, and recurrent infections due to immune insufficiency¹⁵⁶.

Treatment: Fucose administration via gastrointestinal tube in a dose of 25 mg/kg body weight 5 times/day. The fucose single doses were gradually increased to reach 492 mg/kg body weight after 277 days.

Fucose supplementation partially corrected both biochemical and clinical phenotypes. Clinically, psychomotor improvement was noticed, and there were no fever-causing infections upon fucose therapy.

Biochemically, neutrophil binding to P- and E-selectins was elevated to 50 percent of the controls. Fucosylation of serum N-glycoproteins that normally possess α 1-6 fucosylated core such as IgM (μ chain) was also corrected after fucose therapy.

The Bombay phenotype, however, did not disappear and no hemolysis due to serum anti-H took place upon fucose therapy¹⁵⁶.

In 2001 Etzioni A and co-workers demonstrated that some LAD II patients were unresponsive to fucose supplementation therapy. They reported 2 Israeli and 1 Turkish LAD II patients. The Turkish patient responded to fucose therapy and showed a clinical improvement while the 2 Israeli patients had no response to fucose therapy¹⁵⁵.

3) *PIG-M*-CDG (OMIM: 610293)

Glycosylation defect: It is caused by a mutation in the promoter region of *PIG-M* gene that encodes for the ER-located mannosyltransferase that transfers the 1st mannose residue in GPI anchored protein biosynthesis (Figure 19). Mutation in the conserved promoter region inhibits the binding of the transcription factor SP1, which results in reduced *PIG-M* mRNA levels.

Clinical presentation: Portal vein thrombosis and hypertension, general hypotonia, dependence on a wheel chair, and seizures. GPI anchored proteins (CD59 and CD24) were expressed in low levels on hematopoietic cells¹⁵⁷ (App, P.184).

Treatment: Sodium phenylbutyrate at a dose of 20 mg/kg body weight 3 times/day and after two months, the dose was increased to 30 mg/kg body weight 3 times/day¹⁵⁴.

Sodium phenylbutyrate treatment resulted in a significant amelioration in the clinical symptoms, where the patients could walk and feed themselves and this was accompanied with a remission of seizures. Additionally, GPI anchored proteins expression levels were normalized after sodium phenylbutyrate treatment.

The described mutation in the *PIG-M* gene promoter results in inhibition of histone acetylation. Histone acetylation is a prerequisite for SP1 binding and *PIG-M* transcription. Sodium phenylbutyrate acts as a histone deacetylase inhibitor and hence, it increases *PIG-M* mRNA levels and GPI anchored proteins biosynthesis^{154,157}.

4) *SLC39A8-CDG (OMIM: 616721)*

Glycosylation defect: It is caused by mutations in the *SLC39A8* gene that encodes for a manganese (Mn^{2+}) and zinc (Zn^{2+}) transporter, which is localized to the cell surface, mitochondrial, and lysosomal membranes¹⁵⁸. The GA-resident β 1-4 galactosyltransferase requires Mn^{2+} for its activity. Defective *SLC39A8* results in hypoglycosylated serum Tf with increases in mono-, di-, and tri-sialo isoforms¹⁵⁹ (App, P.189).

Clinical presentation: It is a multisystem development disorder. Patients present with psychomotor retardation, severe hypotonia, seizures, intellectual disability, and dwarfism.

Treatment: Galactose supplementation via gastrointestinal pump feeding at a dose of 1 g/kg body weight 5 times/day for two weeks, then the dose is increased to 2 g/kg body weight 5 times/day for four weeks. The treatment was stopped for two weeks then restarted with 3.75 g/kg body weight over 22 hrs. Galactose supplementation was accompanied with uridine supplement at a dose of 150 mg/kg body weight to provide the essential uridine for UDP-Gal biosynthesis. After galactose supplementation therapy, a spectacular restoration of serum Tf glycosylation with increase in tetra-sialo isoforms was noticed¹⁵⁹.

2.3.7. B] Symptomatic treatment

This type of treatment aims to alleviate the symptoms of the disease without any interference in the underlying glycosylation defect. Some CDG subtypes are considered as Congenital Myasthenic Syndromes (CMSs). CMS is a genetically inherited defective neuromuscular

transmission and patients manifest variable onset of muscle weakness from childhood till adulthood¹⁶⁰. Assembly of acetylcholine receptor (AChR) pentamers as well as its export to the cell surface depends on its glycosylation. Accordingly, any defective AChR glycosylation can lead to disruption of Ach-AChR interaction and reduced synaptic response to Ach^{161,162}.

Treatment of CMS in CDG subtypes: A cholinergic agonist such as pyridostigmine is used. This inhibits acetylcholine esterase (AChE) in the synaptic cleft to decrease the rate of acetylcholine hydrolysis and increasing the number of activated AChRs¹⁶⁰. CDG-CMS subtypes are:

1) GFPT1-CDG (OMIM: 610542)

Glutamine: fructose-6-phosphate transaminase 1 (GFPT 1) is involved in the biosynthesis of UDP-GlcNAc sugar donor (

Figure 8) (App, P170). Patients show limb-girdle muscle weakness due to decreased AChRs expression¹⁶³.

2) DPAGT1-CDG (OMIM: 608093)

DPAGT1 (or *ALG7*) is UDP-GlcNAc: Dol-P-GlcNAc phosphotransferase catalyses the synthesis of GlcNAc-P-Dol (Figure 12) (APP, P.170). Patients show progressive fatigue and weakness, intellectual disability, and autistic features. These patients also have decreased AChR expression level¹⁶⁴.

3) ALG2-CDG (OMIM: 616228)

ALG2 gene encodes a mannosyltransferase that transfers two mannose residues to the growing N-glycosylation DLO precursor in the ER cytoplasmic side (Figure 12) (APP, P.180). Patients show slowly progressive deterioration, wheelchair dependency, proximal joints contractures, distal joint laxity, psychomotor retardation, hypomyelination, and seizures¹⁴⁰.

4) ALG14-CDG (OMIM: 616227)

ALG14-encoded enzyme forms a complex with the enzymes encoded by *ALG13* and *ALG7* genes in the initial steps in N-glycosylation for GlcNAc₂-PP-Dol biosynthesis (Figure 12) (App, P. 170). Patients show difficulty in walking, running, and climbing stairs. There is generalized limb and trunk weakness and multiple joints contractures. AChR expression on the cell surface was markedly reduced¹⁴⁰.

5) GMPPB-CDG mild form (OMIM: 615352)

GDP-Man pyrophosphorylase B (GMPPB) is the enzyme that catalyzes the conversion of M6P to GDP-Man (Figure 7). GMPPB-CDG patients present with limb girdle muscle dystrophy (LGMD)¹⁶⁵.

Chapter 2

***CDG-Diagnostic Procedures at Hôpital
Bichat-Claud Bernard Faculté de
Médecine***

Before presenting my work I will explain how molecular CDG diagnosis is achieved at Hôpital Bichat, and how the patients are selected for in depth biochemical explorations.

The process of CDG diagnosis encompasses 3 major steps:

Step 1: Referral of CDG-suspected patients to Hôpital Bichat-Claude Bernard

As described in Chapter 1, CDG is associated with a complex multisystem clinical picture that is often referred to as the CDG syndrome. However, there is a large overlap of this clinical picture with those of other rare metabolic diseases with pediatric expression. Clinicians from hospitals all over France refer patients to be screened for the presence of CDG after some other IEM are excluded. For instance, patients could be screened for some mitochondrial disorders, galactosemia, fructosemia, etc., and if none of the previously mentioned disorders are confirmed to be the pathological reason, some clinicians suspect the presence of a glycosylation disorder. Accordingly, a blood sample is sent to one of the reference centers in France. One such center is the Service Biochimie A at Hôpital Bichat, run by Professor Nathalie Seta, where a strategy for the diagnosis of CDG has evolved over 20 years.

Step 2: CDG-diagnosis protocol followed at Hôpital Bichat-Claude Bernard

Before starting the diagnostic procedures, a signed consent made by the Comité de protection des personnes d'Île de France 2 (CPP IDF2) is obtained from the patient parents.

CDG-diagnostic procedures involve biochemical analysis and causative-mutation detection:

a) Biochemical analysis

1) Serum glycoproteins glycosylation status detection

As previously mentioned (P.65), the biochemical hallmark of CDG is the presence of hypoglycosylated serum glycoproteins, and the N-glycosylation status of serum Tf is examined using 2D-electrophoresis and SDS-PAGE/WB, and the O-glycosylation status of Apo C-III is evaluated using 2D gel electrophoresis. If an abnormal glycosylation profile is observed then, depending on the type of hypoglycosylation observed, distinct targeted gene sets are sequenced. When entire N-glycans are missing from serum Tf then genes involved in DLO biosynthesis and the transfer of the oligosaccharide from DLO onto proteins are sequenced.

At this stage, the patients are classified as CDG-Ix because they present with CDG-like syndrome, which is associated with serum Tf that is missing one or two whole glycans, but whose molecular origin remains unknown. Alternatively, if all Tf glycans are present but possess abnormal structures then the patients are classified as CDG-IIx and genes involved in N-glycan processing are sequenced. Likewise, if serum Apo C-III O-glycans are aberrant, the patients are classified as CDG-IIx and the appropriate gene set is sequenced.

2) *PMM2 and MPI enzymatic activity assay*

As a screening for the most common CDG subtype (PMM2-CDG) and one of the treatable CDG subtype (MPI-CDG), the activities of PMM2 and MPI enzymes are assessed in patient-derived leukocytes.

b) Causative-mutation detection

To identify the disease-causing mutation, DNA extracted from the patient's blood sample will be subjected to either one or two steps:

1) *Sanger sequencing*

Here, targeted gene sequencing is performed for some genes encoding for proteins involved in DLO biosynthesis. These genes are, *PMM2*, *ALG6*, *ALG2*, *ALG1*, *ALG11*, *ALG7*, *ALG13*, *ALG14*, *MPUD1*, *DPM1/2/3*, and *DHDDS*. Sanger sequencing can reveal a previously described mutation, and in that case the diagnosis is considered to be complete. When Sanger analysis reveals a new mutation in one of the sequenced genes or no mutation has been detected in these genes, a skin biopsy is taken from the patient and step 3 is followed.

2) *Whole exome sequencing (WES)*

This approach is used when Sanger targeted gene sequencing does not reveal any detectable mutations in one of the previously mentioned genes. Now, this WES could reveal the presence of mutations in some genes that were not previously reported to cause CDG. The results analysis is performed using special WES libraries based on the filtering process to narrow the window within which the diagnostic measures could be resumed. The technical details have been described in the next chapter (P.94). To start biochemical exploration, a skin biopsy is taken from the patient and step 3 is followed.

Step 3: Biochemical exploration of glycosylation pathways in skin biopsy fibroblasts

This step takes place in the glycobiology lab at UMR 1149-INSERM- Faculté de Médecine Xavier Bichat where several biochemical approaches could be applied. These approaches involve:

a) Metabolic radiolabeling of patient-derived fibroblasts with sugars, which allows identification of the step at which glycosylation is blocked. Additionally, the metabolic radiolabeling approach is useful for confirming the presence of previously reported damaging mutations if, for example, there is ambiguity in the sequencing data.

b) *In vitro* direct enzyme activity measurement in fibroblasts-derived microsomes is another approach for validating sequencing data.

c) Setting up a planned strategy that includes different experiments, which are more specific for the suspected defect. The specific biochemical approaches followed during my PhD for conducting an extended biochemical study for each patient will be described in detail in the coming chapter.

Figure 25 represents a simple diagram of the diagnostic protocol of a CDG-X patient at Hôpital Bichat-Claude Bernard.

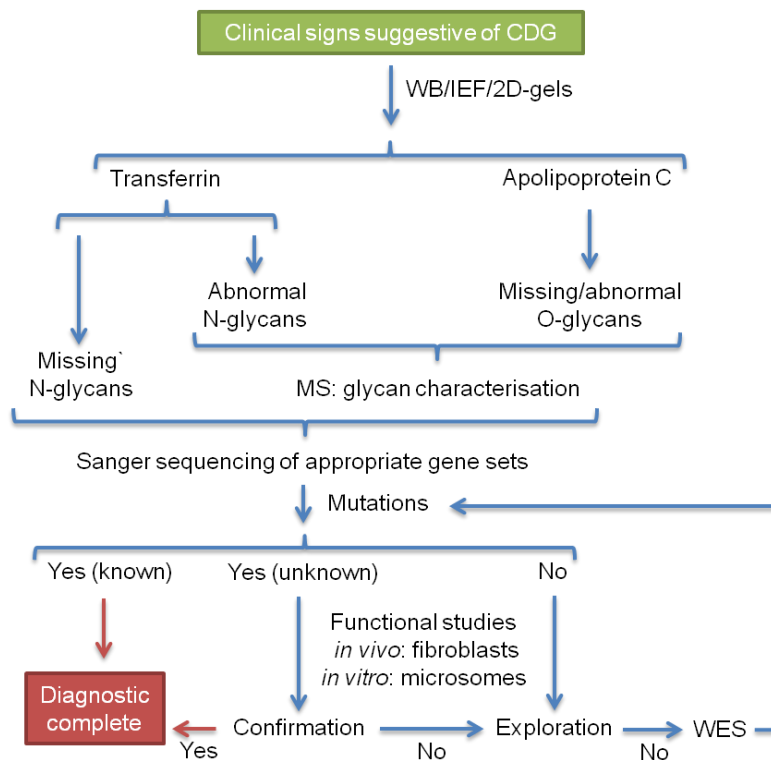

Figure 25: Flow chart of CDG diagnostics at Hôpital Bichat and the Faculté de médecine Xavier Bichat

The bulk of the experimental work undertaken during my PhD studies concerned investigations into the molecular origins of two cases of suspected CDG. The first part (patient I) selected for detailed study had been through all the diagnostic steps have been described before. Patient I was chosen from a cohort of eleven patients who presented with CDG-like syndromes associated with hypoglycosylation of serum Tf.

The second part (patient II) had a different situation, where the case was referred to Hôpital Bichat-Claude Bernard with a previous knowledge of the suspected defect that might be the underlying reason of the disease. Accordingly, this patient did not follow the regular CDG diagnosis protocol, and the specific biochemical study has been commenced directly.

Chapter 3

Studied CDG-X Patients

Abstracts of studied CDG patients

Patient I

Abstract:

Background: Type I congenital disorders of glycosylation (CDG-I) are mostly complex multisystemic diseases associated with hypoglycosylated serum glycoproteins. A subgroup harbour mutations in genes necessary for the biosynthesis of the dolichol-linked oligosaccharide (DLO) precursor that is essential for protein N-glycosylation. Here, our objective was to identify the molecular origins of disease in such a CDG-Ix patient presenting with axial hypotonia, peripheral hypertonia, enlarged liver, micropenis, cryptorchidism and sensorineural deafness associated with hypo glycosylated serum glycoproteins.

Results: Targeted sequencing of DNA revealed a splice site mutation in intron 5 and a non-sense mutation in exon 4 of the dehydrolipichol diphosphate synthase gene (*DHDDS*). Skin biopsy fibroblasts derived from the patient revealed ~20 % residual *DHDDS* mRNA, ~35 % residual *DHDDS* activity, reduced dolichol-phosphate, truncated DLO and N-glycans, and an increased ratio of [2-³H]mannose labeled glycoprotein to [2-³H]mannose labeled DLO. Predicted truncated *DHDDS* transcripts did not complement *rer2*-deficient yeast. SiRNA-mediated down-regulation of *DHDDS* gene in human hepatocellular carcinoma HepG2 cells largely mirrored the biochemical phenotype of cells from the patient. The patient also harboured the homozygous *ALG6* (F304S) variant. WES did not reveal other strong candidate causal genes. There was no significant difference between the patient and the control in the levels of short chain length dolichols isolated from fibroblasts. Zaragozic acid supplementation reduced the level of truncated protein-linked oligosaccharides (NLOs) without a noticeable effect on the lipid-linked oligosaccharides (DLOs) in the patient fibroblasts. Defective Nogo B receptor (NgBR) was ruled out to be the reason of decreased *DHDDS* expression level.

Conclusions: We describe a patient presenting with severe multisystem disease associated with *DHDDS* deficiency. As retinitis pigmentosa is the only clinical sign in previously reported cases, this report broadens the spectrum of phenotypes associated with this condition. The biochemical hallmark of this patient was the reduced size of endogenous dolichol phosphate pool, which could be corrected by supplementing the patient cells with zaragozic acid. Restoration of N-glycoproteins biosynthesis by zaragozic acid could be suggestive for a possible treatment in the future.

Patient II

Abstract

Background - The CMP-sialic acid (CMP-Sia) transporter (SLC35A1) translocates CMP-Sia from the cytoplasm into the Golgi apparatus where sialyltransferases assure glycoconjugate sialylation. The two cases of congenital disorders of glycosylation (CDG) caused by SLC35A1 mutations (SLC35A1-CDG) so far described, presented with macrothrombocytopenia. One of the patients also presented with hyposialylated plasma glycoproteins associated with CNS deficits and dysmorphias. Here biochemical findings in two siblings presenting with thrombocytopenia and CNS deficits associated with a biallelic, likely damaging, *SLC35A1* (Ser147Pro) variant are reported.

Results - 2-D electrophoresis and mass spectrometry revealed hyposialylated N-, and O-glycoproteins in serum from the patients. Sia assay revealed a 65 % reduction of total glycoconjugate sialylation in skin biopsy fibroblasts from the patient compared to control cells. CMP-Sia levels were variable in patient cells but within the normal range. Lectinoblot using Sia-specific lectins could not detect glycoprotein hyposialylation in extracts of patient cells. Glycosphingolipids (GSL) pattern in patient-derived fibroblasts showed absent a-series gangliosides with abnormally increased GM3 level. GSLs pattern has shown some changes when patient cells had been grown under high- and low-serum culturing conditions. Patient fibroblasts supplementation with exogenous Sia resulted in biosynthesis of some of b-series gangliosides.

Conclusions - These patients add to the previously reported SLC35A1-CDG cases where serum glycoprotein hypoglycosylation, thrombocytopenia and CNS defects are associated with mutations in the CMP-Sia transporter gene. Mutated CMP-Sia transporter is associated with defective a-series gangliosides biosynthesis in an unknown mechanism. Exogenous Sia supplementation has altered gangliosides profile in SLC35A1-CDG patient;

Perspectives - The capacity of the *SLC35A1* (Ser147Pro) variant to restore glycoconjugate sialylation in Lec2 cells is being evaluated. Mass spectrometry is being used to provide more structural information about the altered GSL pattern in patient-derived fibroblasts. The capacity of Sia supplementation to normalize GSL profiles in patient cells is underway.

Patient I

Patient I

1] Introduction

1.1] Functional studies in cells from a cohort of CDG-Ix patients

The whole CDG-Ix cohort results:

A cohort of eleven CDG-Ix patients (Table 2) was referred to our lab to perform biochemical studies after it had been through the diagnostic process that has been explained in the previous chapter (Chapter 2).

I] Results of CDG-diagnostic procedures followed at Hôpital Bichat-Claude Bernard

Plasma protein hypoglycosylation secondary to galactosemia or fructosemia was ruled out in only one case among the cohort subjects. Enzymatic activity of PMM2 and MPI was measured in the patient-derived leukocytes. The activity of both enzymes was within the normal range for all the patients (normal range is > 3.4 U/g and > 5.5 U/g, respectively). The whole cohort was subjected to Sanger sequencing. Two cases did not have detectable mutations in any of the targeted genes. This could mean the presence of protein hypoglycosylation that is secondary to liver insufficiency or that there is mutation in a gene that is not known to be involved in protein N-glycosylation or that a mutation has been missed due to technical problem.

Table 2: CDG-Ix diagnostics performed at Hôpital Bichat

Pt	Age ^a	Sex	Con-sang ^b	Clinical manifestations	Galactosemia/fructosemia ^c	Tf profile ^d	PMM2 (U/g) ^e	MPI (U/g) ^f	Sanger ^g
1	4 y	M	Yes	Psychomotor retardation, hepatomegaly, epilepsy	nd	CDG-I	6.1	11.4	
2	2 m	M	No	Multisystem dysfunction	nd	CDG-I	4.5	7.1	DHDDS
3	12 m	M	nd	West syndrome	nd	CDG-I	10.3	8.2	RFT1
4	6 m	F	nd	Isolated hyperinsulinism			7.7	6.2	
5	1 m	F	No	Anemia, metabolic acidosis, malabsorption syndrome	nd	CDG-I	10.4	14.6	
6	10 m	M	nd	MR, nystagmus, axial hypotonia, convulsions, vomiting	Yes/nd	CDG-I	nd	nd	ALG3
7									
8	10 m	?	nd	Epilepsy, hypotonia, hypertrophic cardiomyopathy	nd	CDG-I	5.6	nd	ALG11
9	8 y	M	nd	Generalized behavior retardation	nd	CDG-I	5.6	12.9	ALG 6
10	6 y	??	nd	Generalized behavior retardation	nd	CDG-I	5.2	11.6	ALG 6
11	12 m	M	No	Axial hypotonia, hyperlactemia	Yes/Yes	CDG-I	4.8	11.1	POLG

^a Age at time of diagnosis, ^b Consanguinity, ^c In some cases galactosemia and/or fructosemia were ruled out of the diagnosis, nd: not determined, ^d serum transferrin (Tf) was analyzed by SDS-PAGE/WB and in all cases a CDG-I profile revealing glycoforms missing one or two N-glycans was noted, ^e phosphomannomutase 2 (PMM2) activity, ^f mannose phosphate isomerase (MPI) activity. ^g Sanger sequencing identified potentially causal mutations in the indicated genes and where no gene name is given, Sanger sequencing was performed but no mutations were found.

II) Results of biochemical study of the whole cohort performed in the glycobiology lab at UMR 1149-INSERM- Faculté de Médecine Xavier Bichat

The metabolic radiolabelling results, shown in figure 26, reveal coherence between sequencing results in some subjects.

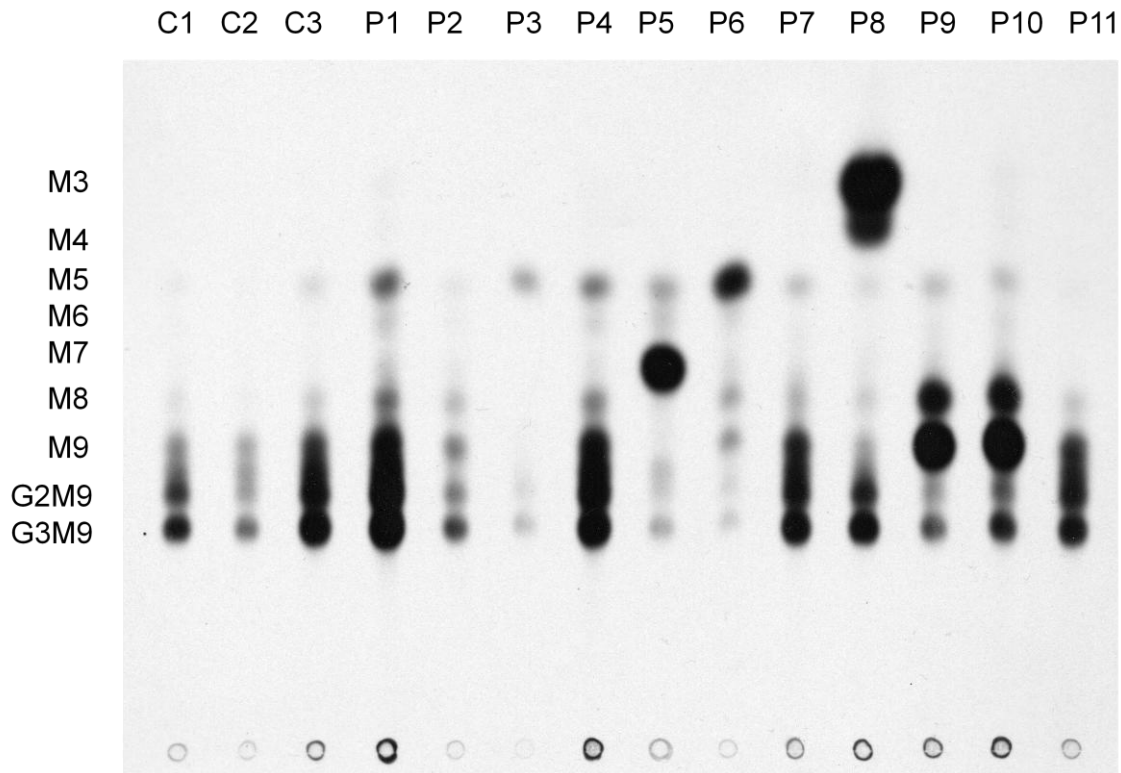

Figure 26: TLC of oligosaccharides released from DLO that was derived from metabolically [2-³H]mannose-radiolabeled cells from the cohort of CDG-Ix patients.

Patients (P1-11) and 3 control subjects (C1-3). Patient 7 was later revealed not have a CDG-like syndrome and presented with an unrelated disease (see footnote to Table 2).

Patients 9 and 10 have mutations in the *ALG6* gene that encodes for the α 1-3 glucosyltransferase that catalyzes the transfer of the 1st glucose residue onto DLO, to produce $G_1M_9GlcNAc_2$ -PP-Dol (Figure 12). The fibroblasts of these two patients showed the anticipated accumulation of $M_9GlcNAc_2$ -PP-Dol, which is the acceptor substrate of this enzyme. Patients 3 and 6 revealed increased levels of $M_5GlcNAc_2$ -PP-Dol (Figure 26). These data reinforce the sequencing data that revealed patient 3 to harbor mutations in *RFT1*, which encodes a protein required for the flipping of $M_5GlcNAc_2$ -PP-Dol into the ER lumen, and patient 6 to harbor mutations in *ALG3* gene, which encodes the enzyme that catalyzes the transfer of the 6th mannose residue onto the growing DLO, to produce $M_6GlcNAc_2$ -PP-Dol (Figure 12).

The DLO profile in cells from Patient 5 reveals an accumulation of $M_7GlcNAc_2-PP-Dol$ (Figure 26), which is the intermediate that accumulates in ALG12-CDG, but Sanger sequencing did not reveal mutations in *ALG12* gene, which encodes the $\alpha 1-6$ mannosyltransferase that catalyzes the transfer of the 8th mannose residue in the growing DLO (Figure 12).

Patients 1, 4, 7, and 11 revealed normal DLO profiles when the fibroblasts were radiolabeled with $[2-^3H]$ mannose indicating a possible block in the steps required $Man_1GlcNAc_2-PP-Dol$ biosynthesis (Figure 26). As mentioned in a footnote to Table 2, it was subsequently noted that Patient 7 presented to the hospital with a disease unrelated to CDG. Metabolic radiolabelling of the fibroblasts with $[2-^3H]$ glucosamine (Figure 27) did not reveal DLO profiles with accumulation of either $GlcNAc_2-PP-Dol$ or $GlcNAc-PP-Dol$. This suggests the absence of ALG1-CDG in which the addition of the first mannose residue to the growing DLO is deficient (Figure 12).

These TLC profiles (Figure 27) may also indicate the absence of patients with ALG13-CDG and ALD14-CDG where the addition of the second residue of $GlcNAc$ onto the growing DLO (Figure 12) is defective.

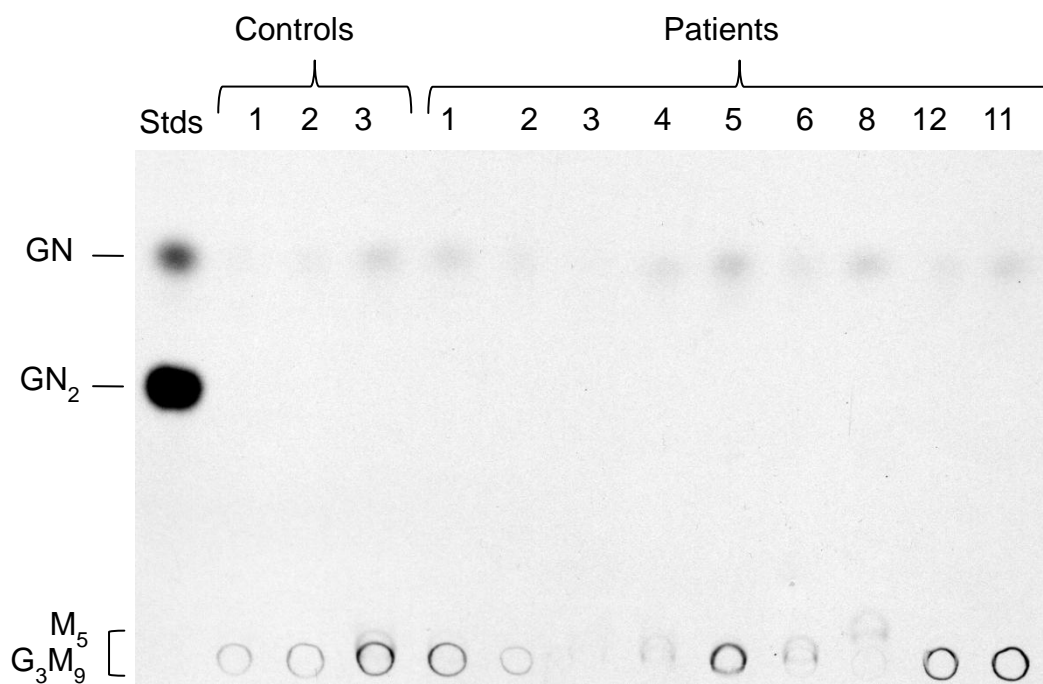

Figure 27: TLC of oligosaccharides released from DLO that was derived from metabolically $[6-^3H]$ glucosamine radiolabeled cells from a cohort of CDG-Ix

Sanger sequencing did not reveal mutations in genes required for protein glycosylation in any of these patients, Patient 11 did harbor mutations in *POLG*, which encodes a mitochondrial protein called polymerase gamma. Mutations in *POLG* have previously been shown to underlie mitochondrial diseases, which can sometimes cause a secondary plasma glycoprotein hypoglycosylation.

Finally, Sanger sequencing of DNA from patient 2 revealed two mutations in the *DHDDS* gene, and fibroblasts from this patient showed accumulation of $\text{Man}_{5,9}\text{GlcNAc}_2\text{-PP-Dol}$ species.

We got interested in this case for many reasons: first, in comparison to the previously described *DHDDS*-mutated cases (K42E) who reported to have a very mild clinical picture restricted to autosomal recessive retinitis pigmentosa¹⁶⁶, while Patient 2 presented with severe clinical manifestations, which almost all the organ systems.

Second, recently, a new CDG type has been reported and one of the most characteristic phenotypes was the extremely reduced *DHDDS* activity of the patients along with reduced mannose incorporation in oligosaccharides¹⁴⁶.

Accordingly, it was decided to subject that case to extended biochemical study to identify the molecular defect underlies that disorder.

1.2] The role of DHDDS in the biosynthesis of dolichol

1.2.1] Dolichol

1.2.1.1] Structure and occurrence of dolichol in nature

Dolichol belongs to a large family of fatty alcohols called polyisoprenoid alcohols. The polyisoprenol family encompasses two major subfamilies: polyprenols and dolichols³. Both subfamilies possess structural variations, though they share the same terpenoid biosynthetic pathway. Dolichol chain lengths range from 14 to 24 isoprene units with an α -saturated isoprene unit adjacent to the alcohol group. Conversely, polyprenols are relatively shorter (5 to 21 isoprene units) and their α -isoprene unit is unsaturated (Figure 28)^{3,167}.

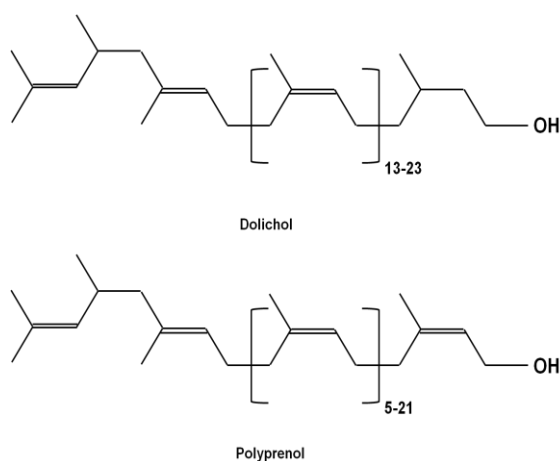

Figure 28: Structure of dolichol (α -saturated) and polyprenol. The number of isoprene units is indicated in square brackets.

Typical dolichols and polyprenols display one important structural feature: they are poly-*cis* alcohols with two or three *trans* isoprene units at the ω end. One exception to this is solanesol, which is the only all-*trans* polyisoprenol¹⁶⁸.

Polyisoprenoid alcohols are widely distributed in nature. They exist in bacteria as well as higher animals. Each organism has a specific polyisoprenoid alcohol in terms of the number of isoprene units and structural variations (α -saturation, *trans/cis* ratio) within the polyisoprenol chain. Bacteria synthesize only one polyprenol (bactoprenol or undecaprenol), which is composed of 11 isoprene units. In other organisms polyisoprenoid alcohols occur as mixtures (isoprenologues). Higher plants contain polyprenols in their photosynthetic tissues (leaves) and dolichols in their roots. Animals, yeast, and fungi contain only dolichols³.

1.2.1.2] Dolichol biosynthesis

In humans, dolichol is synthesized in almost all tissues at variable levels. Human dolichol levels are 5-10 fold higher than the corresponding tissues in other mammals. Pituitary gland tissues contain the highest dolichol level followed by testis, liver then spleen. Animal studies showed that there is no equilibrium in tissue distribution of dolichol, and different dolichol pools do not seem to be linked by exchange through the circulation. The most abundant human dolichol contains 19 isoprene units (C95, D19) followed by 18 and 20 isoprene units and their ratio varies between tissues. Serum dolichol (80 % of total dolichol in human) is bound to circulating High Density Lipoprotein (HDL) at a concentration 300 ng/mL¹⁶⁸.

Dolichol synthesis takes place in two phases: i) A cytosolic phase in which the isoprene units are synthesized from acetoacetate producing mevalonate which through several steps gives rise to farnesyl pyrophosphate (FPP), the substrate for cholesterol, dolichol, and ubiquinone biosynthesis as well as protein prenylation, and ii) An ER phase in which dolichol biosynthesis is initiated by the sequential addition of isoprene units to FPP in a “head-to-tail” way by *cis*-prenyltransferase (CPT) (or DHDDS) which will be dephosphorylated, then reduced to give free dolichol, then re-phosphorylated to dolichol phosphate, the lipid carrier required for the N- glycosylation (Figure 12 and 29)^{168,169}.

Only 30 % of newly synthesized dolichol is converted to dolichol phosphate, whereas about 20 % of the remaining dolichol remains as free dolichol, and the rest is transformed into dolichol fatty acyl ester (oleate ester) in the ER (Figure 30)³.

Interestingly, dolichol biosynthesis is not restricted to the ER. It has been demonstrated that rat liver peroxisomes contain similar enzyme-machinery responsible for the synthesis of free dolichol, yet, it has not been shown if that machinery is also involved in the synthesis of polyprenols or in dolichol derivatives (fatty acyl esters and phosphorylated dolichol)^{170,171}. Peroxisomes account for almost one half of the total cellular dolichol content. Peroxisomal *cis*-IPTase is distinguishable from the ER-bound activity because: 1) it has higher affinity for FPP than squalene synthase, 2) Peroxisomal *cis*-IPTase requires a sterol carrier protein-2 (SCP-2), which exists in the cytosol and peroxisomes, and 3) Peroxisomal *cis*-IPTase is 4 fold more active than that of the ER-enzyme¹⁷².

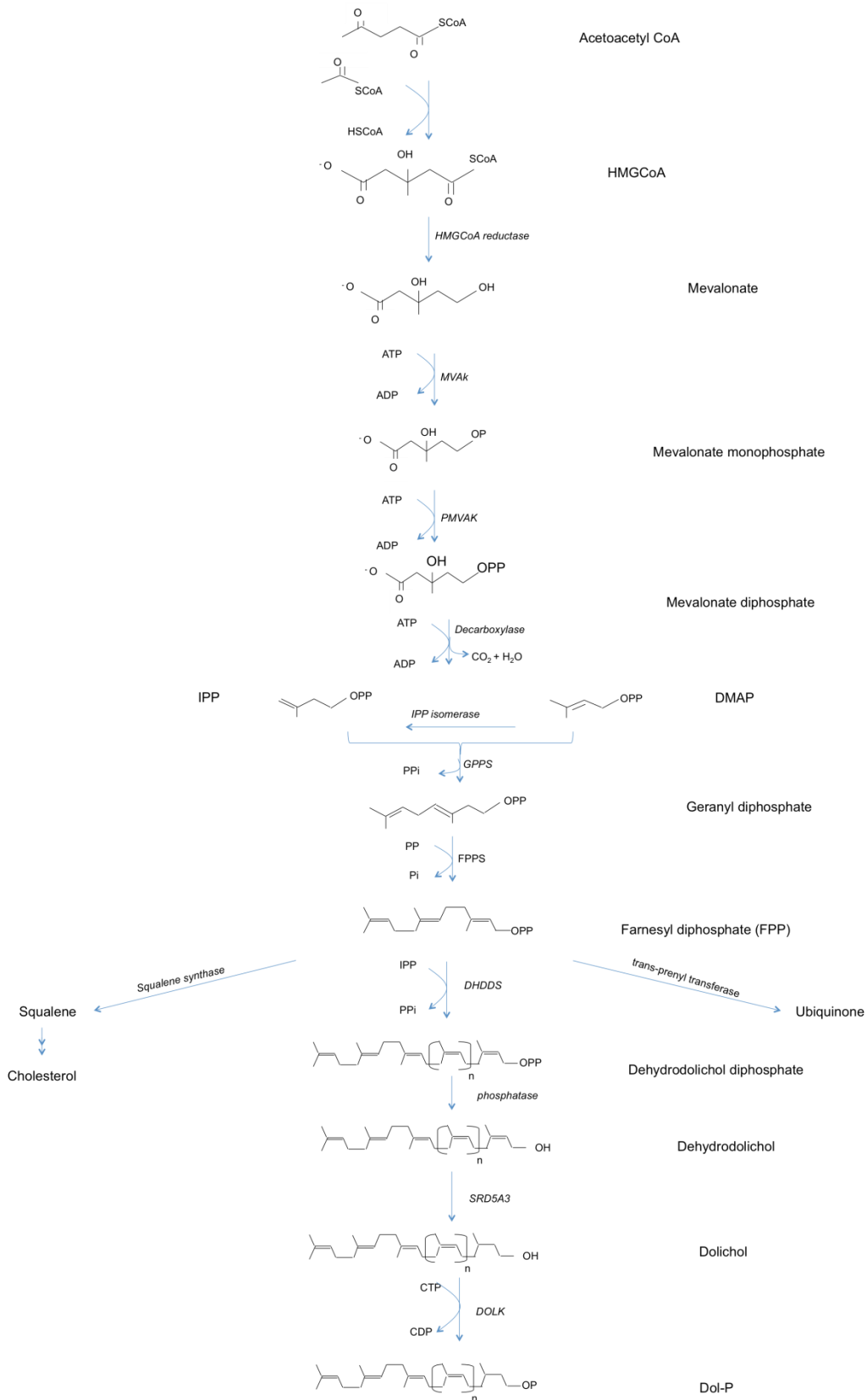

Figure 29: De novo dolichol biosynthesis and phosphorylation

Figure (29) enzyme key: MVAk, mevalonic acid kinase; PMVAk, phosphomevalonic acid kinase; IPP, isoprene pyrophosphate; GPPS, geranyl pyrophosphate synthase; FPPS, farnesyl pyrophosphate synthase; SRD5A3, steroid 5 α reductase type 3.

1.2.1.3] Dolichol and its role in glycosylation

Dolichol phosphate recycling, (Figure 30) is the second source for intracellular dolichol phosphate. Dolichol phosphate linked to sugars is released during the various glycosylation processes (Figure 12, Figure 15, and Figure 19). Along with the *de novo* synthesis of dolichol phosphate, this continuous dynamic recycling is responsible for the endogenous dolichol phosphate pool used in the glycosylation pathways within the ER^{173,174}.

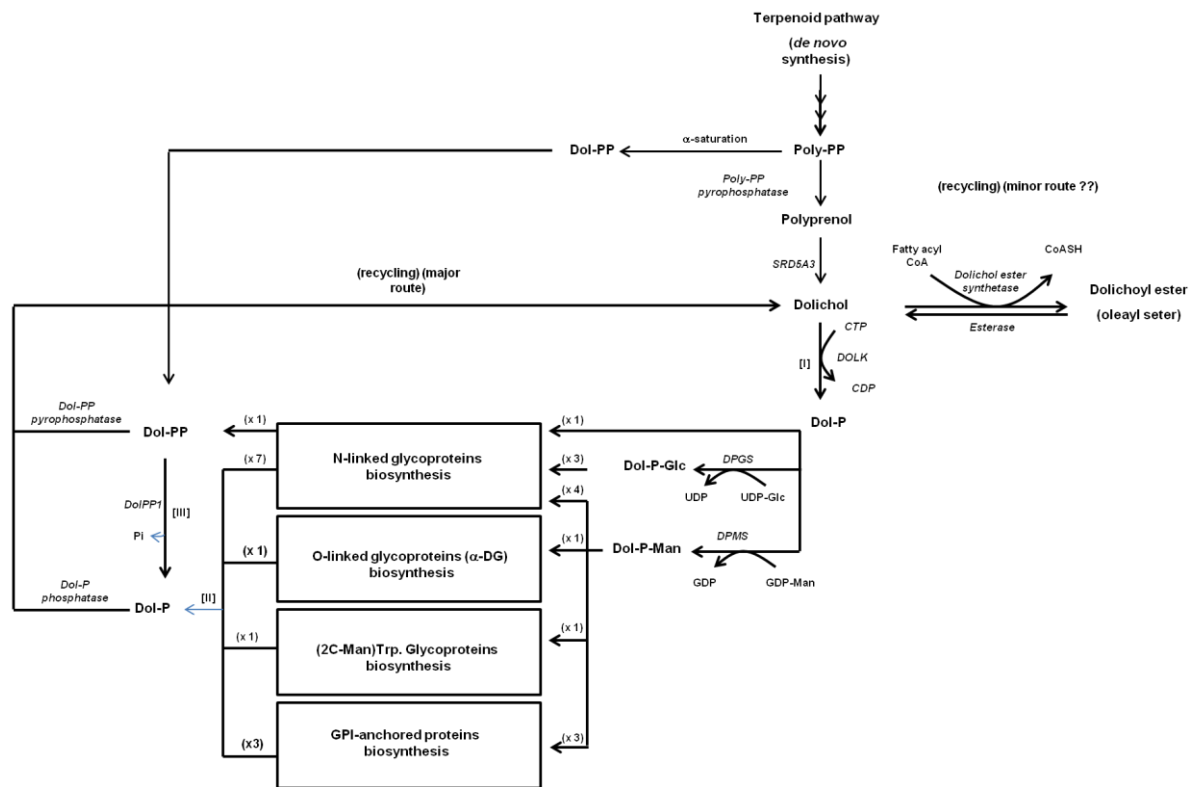

Figure 30: The metabolic fates of dolichol and dolichol phosphate.

Esterification to dolichol fatty esters, phosphorylation to dolichol phosphate that enters many glycosylation processes. The number of dolichol phosphate molecules required for the different glycosylation reactions are shown. **Figure (30) enzyme key:** SRD5A3, steroid 5 α reductase type 3; DOLK, CTP-dependent dolichol kinase; DPGS, dolichol phosphoglucose synthase; DPMS, dolichol phosphomannose synthase; DOLPP1; dolichol pyrophosphate phosphatase 1.

In addition to its major role in glycosylation processes, dolichol has a protective role in biological membranes through being a part of the anti-oxidant machinery in the cell membrane. This machinery comprises polyunsaturated fatty acid (PUFA), vitamin E and dolichol, which forms a free radical-transfer chain. A lot of PUFA molecules trap and store electrons which are then transferred to dolichol that delivers them to vitamin E, which in turn transfers the electrons to the cellular hydrophilic compartment. Rat liver cells have equimolar amount of vitamin E and dolichol in the cell membrane, and it has been shown that vitamin E protects dolichol from peroxidation¹⁷⁵.

1.2.2] DHDDS

1.2.2.1] DHDDS is a cis-prenyltransferase

Prenyltransferases are the key enzymes in polyisoprenoid alcohol biosynthesis. They catalyze polyisoprenoid alcohol elongation through a condensation reaction in which an isoprenyl pyrophosphate (IPP) unit (C5) is added to an acceptor. The IPP-acceptor could be a protein molecule, short chain allylic pyrophosphate such as FPP - or geranyl pyrophosphate (GPP), or quinone. The reaction starts with removal of the diphosphate group of the allylic pyrophosphate acceptor from C1 creating an allylic cation with subsequent “stereospecific” removal of a proton from C2 in the IPP being added. Depending on the “pro-chirality” status of the eliminated proton from C2, prenyltransferases are classified into: a) *trans*-(E)-prenyltransferases that add IPP to the acceptor in a *trans* (or E) configuration with removal of a pro-R C2 proton (e.g. FPP synthase, FPPS) b) *cis* (Z)-prenyltransferases that adds IPP in a *cis* (Z) configuration with removal of a pro-S C2 proton (e.g. Undecaprenol diphosphate synthase (UPPS), yeast *Saccharomyces cerevisiae* *cis*-prenyltransferase (RER2), and DHDDS)¹⁷⁶ (Figure 31).

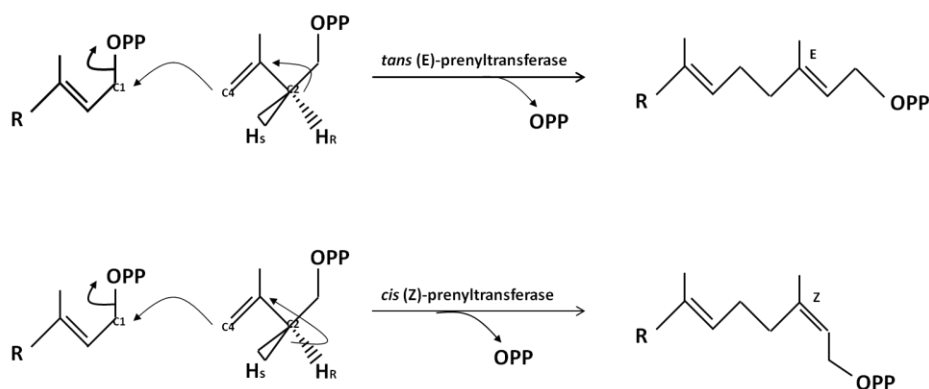

Modified from T. KOYAMA et al,
2006

Figure 31: Mechanism of action of *trans*- and *cis*-prenyltransferases

Products of both types of reaction are involved in many of biological processes. All-*trans* (E)-polyisoprenoid alcohols, for instance, include quinones that are involved in mitochondria respiratory chain reactions. On the other hand, *trans* (E)-*cis* (Z)-polyprenols are involved in protein farnesylation and geranylation as well as the biosynthesis of steroids, terpenes and dolichols¹⁷⁶.

1.2.2.2] DHDDS structure and mechanism of action

Based on the fact that *trans*- and *cis*-prenyltransferases catalyze almost the same reaction, it would be axiomatic to assume that they would have a similar 3D structure. Surprisingly, it has been demonstrated that the two types of prenyltransferase possess completely different amino acid motifs essential for their polyprenol-elongation activities. In 1989, Clarke *et al.*, cloned the cDNA of rat liver FPPS as the first characterized *trans* (E)-prenyltransferase¹⁷⁷. Thereafter, the full 3D structure of the enzyme was elucidated. FPPS has been shown to possess two aspartic-rich motifs (DDX₂₋₄D and DDXXD) that are indispensable for its catalytic function and substrate-binding activity¹⁷⁶.

Much less information about *cis*-prenyltransferase structure-activity relationships has been published¹⁷⁶. Almost a decade after the cloning of FPPS, a Japanese group (Shimitzu *et al.*, 1998) identified for the first time a bacterial UPPS in *Micrococcus luteus*¹⁷⁸. Using database alignment programs it has been shown that UPPS sequences contain several regions that are highly conserved among many *cis*-prenyltransferases such as DHDDS and its yeast ortholog RER2¹⁷⁸.

Unlike the *trans*-prenyltransferases, the *cis*-prenyltransferases do not have the aspartic-rich motifs¹⁷⁶. Instead, X-ray crystallography and site-directed mutagenesis studies on UPPS from *Micrococcus luteus* revealed the presence of many conserved motifs that create high-electrostatic potential regions for FPP binding¹⁷⁶.

A simplified model suggests that UPPS from *Micrococcus luteus* consists of two domains: 1) an FPP-binding hydrophobic cleft formed by helices (H3 and H2) and two sheet regions (S2 and S4). The FPP hydrocarbon chain is bound to hydrophobic amino acids, and 2) a structural P-loop made of four positively charged arginine residues which make electrostatic interactions with the diphosphate group of the FPP (acceptor) and IPP (carbon donor)¹⁷⁹ (Figure 32).

Briefly, the proposed mechanism of action for *cis*-prenyltransferase involves the elimination of the diphosphate group from FPP producing an allyl group with a positive end at C1 that forms a covalent bond with C4 of the incoming IPP unit. According to this model, the polyprenol remains bound in a kinky position in the hydrophobic cleft while IPP units are being continuously added, and once the final polyprenol chain length is attained, the full chain length polyprenol is released from the enzyme¹⁷⁹.

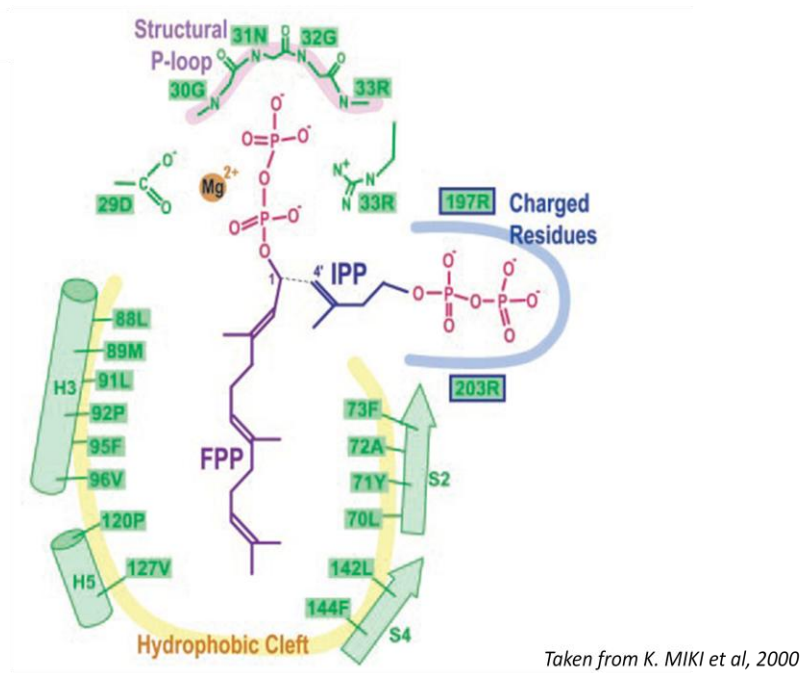

Figure 32: A model for the bacterial cis-prenyltransferase UPPS

(Has been published in Orphanet Journal of Rare Diseases- 2016)

Sabry et al. *Orphanet Journal of Rare Diseases* (2016) 11:84
DOI 10.1186/s13023-016-0468-1

Orphanet Journal of
Rare Diseases

RESEARCH

Open Access



A case of fatal Type I congenital disorders of glycosylation (CDG I) associated with low dehydrodolichol diphosphate synthase (DHDDS) activity

S. Sabry^{1,2,3,4}, S. Vuillaumier-Barrot^{1,2,5}, E. Mintet^{1,2}, M. Fasseu^{1,2}, V. Valayannopoulos⁶, D. Héron^{7,8}, N. Dorison⁸, C. Mignot^{7,8,9}, N. Seta^{5,10}, I. Chantret^{1,2}, T. Dupré^{1,2,5} and S. E. H. Moore^{1,2*}

Abstract

Background: Type I congenital disorders of glycosylation (CDG-I) are mostly complex multisystemic diseases associated with hypoglycosylated serum glycoproteins. A subgroup harbour mutations in genes necessary for the biosynthesis of the dolichol-linked oligosaccharide (DLO) precursor that is essential for protein N-glycosylation. Here, our objective was to identify the molecular origins of disease in such a CDG-Ix patient presenting with axial hypotonia, peripheral hypertonia, enlarged liver, micropenis, cryptorchidism and sensorineural deafness associated with hypo glycosylated serum glycoproteins.

Results: Targeted sequencing of DNA revealed a splice site mutation in intron 5 and a non-sense mutation in exon 4 of the dehydrodolichol diphosphate synthase gene (DHDDS). Skin biopsy fibroblasts derived from the patient revealed ~20 % residual DHDDS mRNA, ~35 % residual DHDDS activity, reduced dolichol-phosphate, truncated DLO and N-glycans, and an increased ratio of [2-³H]mannose labeled glycoprotein to [2-³H]mannose labeled DLO. Predicted truncated DHDDS transcripts did not complement *rer2*-deficient yeast. siRNA-mediated down-regulation of DHDDS in human hepatocellular carcinoma HepG2 cells largely mirrored the biochemical phenotype of cells from the patient. The patient also harboured the homozygous ALG6(F304S) variant, which does not cause CDG but has been reported to be more frequent in PMM2-CDG patients with severe/fatal disease than in those with moderate presentations. WES did not reveal other strong candidate causal genes.

Conclusions: We describe a patient presenting with severe multisystem disease associated with DHDDS deficiency. As retinitis pigmentosa is the only clinical sign in previously reported cases, this report broadens the spectrum of phenotypes associated with this condition.

Keywords: Protein N-glycosylation, Dolichol linked oligosaccharide, Retinitis pigmentosa, Endoplasmic reticulum

Background

Type I congenital disorders of glycosylation (CDG-I) are rare inborn errors in metabolism. A subgroup of CDG-I is caused by mutations in genes involved in the biosynthesis of the dolichol linked oligosaccharide (DLO) precursor required for protein N-glycosylation [1]. DLO is synthesized by a series of reactions, known as the

dolichol cycle (Fig. 1), in which dolichol phosphate (DoLP) is glycosylated with nucleotide sugars and DoLP-sugars, to yield the mature DLO, Glc₃Man₉GlcNAc₂-PP-dolichol [2, 3]. The sugar moiety of this donor is transferred from DLO onto nascent polypeptides by oligosaccharyltransferase (OST) while the byproduct of this reaction, dolichol-diphosphate (DoLPP), is recycled by a complex process requiring DoLPP phosphatase (DOLPP1) [2, 3]. A lack of mature DLO provokes protein hypoglycosylation. In addition to being recycled during protein N-glycosylation, DoLP is synthesized as one of the end

* Correspondence: stuart.moore@inserm.fr

¹INSERM U1149, Faculté de Médecine Xavier Bichat, 16 rue Henri Huchard, Paris, France

²Université Denis Diderot, Paris 7, Paris, France

Full list of author information is available at the end of the article



© 2016 The Author(s). **Open Access** This article is distributed under the terms of the Creative Commons Attribution 4.0 International License (<http://creativecommons.org/licenses/by/4.0/>), which permits unrestricted use, distribution, and reproduction in any medium, provided you give appropriate credit to the original author(s) and the source, provide a link to the Creative Commons license, and indicate if changes were made. The Creative Commons Public Domain Dedication waiver (<http://creativecommons.org/publicdomain/zero/1.0/>) applies to the data made available in this article, unless otherwise stated.

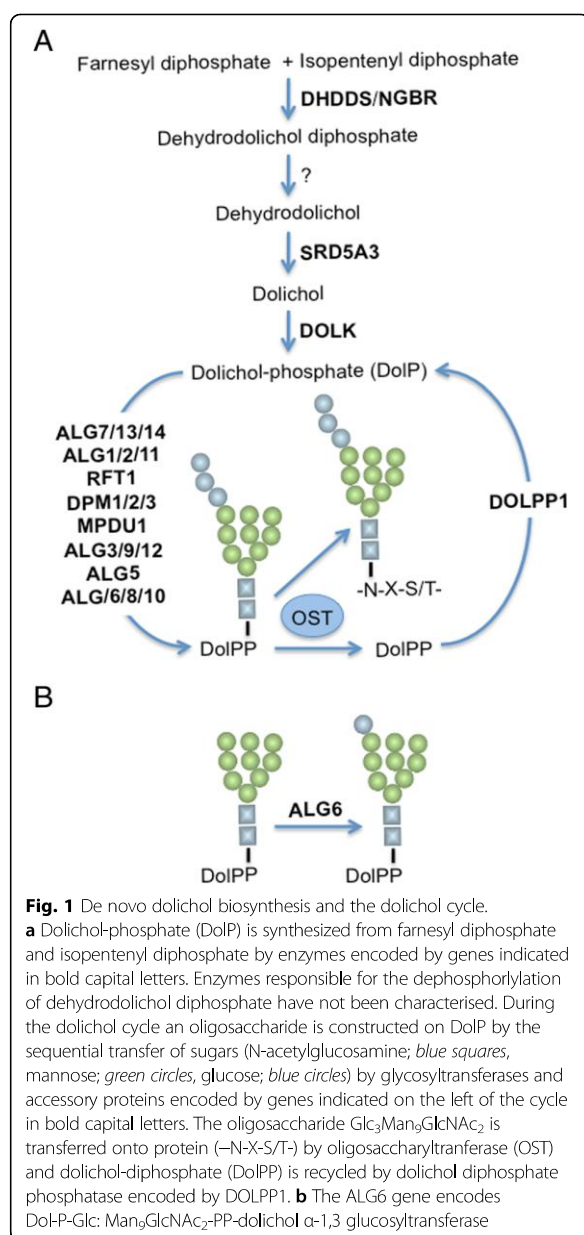

(dehydrodolichol reductase or steroid 5 α -reductase type 3: SDR5A3) to yield dolichol (Dol) [5] that is subsequently phosphorylated by dolichol kinase (DOLK) to yield DoIP (Fig. 1). Dolichol kinase deficiency (DOLK-CDG; MIM610768) presents with hypoglycosylated serum glycoproteins, cardiac myopathy, muscular hypotonia and ichthyosiform dermatitis [6, 7]. Patients with mutations in polyprenolreductase (SDR5A3-CDG: MIM 612379) display hypoglycosylated serum glycoproteins, developmental delay, ataxia, visual impairment (optic nerve atrophy, retinal coloboma, cataract, glaucoma), liver dysfunction, coagulation abnormalities and ichthyosiform dermatitis [5, 8, 9]. NGBR-CDG patients present with scoliosis, neurological impairment, refractory epilepsy, ocular deficits, and visual impairment [10]. By contrast, DHDDS-CDG patients (MIM 613861) have so far not presented with hypoglycosylated serum glycoproteins and clinical signs are limited to retinitis pigmentosa [11, 12]. In the present report we describe biochemical findings in a fatal case of CDG-I in which mutations in DHDDS were found. Two mutations leading to 80 % reduction in DHDDS mRNA were identified. Skin biopsy fibroblasts revealed variable amounts of truncated DLO and N-glycans, 35 % residual DHDDS activity, reduced DoIP, and down-regulation of DHDDS in HepG2 cells leads to truncated DLO. While whole exome sequencing confirmed the presence of the DHDDS mutations, it did not reveal strong alternative candidate genes involved in protein N-glycosylation.

Methods

Patient

The boy was the first child of non-consanguineous parents. During pregnancy intra-uterine growth retardation and decreased fetal movements were noted. He was born at 37 weeks of gestation with a weight of 2090 g (-3.25 SD), a length of 42 cm (-4 SD), an occipitofrontal circumference of 32 cm (-2 SD) and Apgar score 10/10. He had two episodes of severe bradycardia during his first day of life and was transferred to an intensive care unit. At clinical examination, the patient had axial hypotonia, peripheral hypertonia, enlarged liver, micropenis and cryptorchidism. He had a transient increase of serum transaminases, renal failure and developed epilepsy. Liver sonography revealed mild dilatation of the biliary duct. During his short life, the boy made little psychomotor acquisitions, had no eye contact, poor sucking with frequent regurgitations and failure to thrive. At 2 months, the fundus oculi displayed pale papillae and the electroretinogram showed no response to any type of stimulation. Brainstem evoked auditory potentials showed sensorineural deafness with an auditory threshold of 90 dB (right ear) and 100 dB (left ear). The patient died at 8 months during a status epilepticus.

products of the mevalonate pathway (Fig. 1). In the first committed step of dolichol biosynthesis the enzyme cis-prenyltransferase (dehydrodolichol diphosphate synthase: DHDDS) that forms a complex with the Nogo-B receptor (NgBR) elongates a farnesyl diphosphate residue by addition of several isopentenyl moieties derived from isopentenyl diphosphate to yield dehydrodolichol diphosphate [4]. After dephosphorylation of dehydrodolichol diphosphate by poorly characterized enzymes, the resulting dehydrodolichol is reduced by polyprenolreductase

Reagents

[2-³H]mannose (21.5 Ci/mmol), [6-³H]glucosamine (37.7 Ci/mmol), [¹⁴C]-isopentyl diphosphate (56.6 mCi/mmol), GDP-[¹⁴C]mannose (262 mCi/mmol), UDP-[¹⁴C]glucose (348 mCi/mmol), UDP-[³H]GlcNAc (37 Ci/mmol), ULTIMA GOLD and En³Hance were from Perkin Life Sciences, Fr. RPMI 1640 medium, penicillin-streptomycin (PS), fetal calf serum (FCS), OPTIMEM, stealth RNAi, Lipofectamine RNAiMAX and the BCA™ Protein assay kit were from Thermo Scientific, Cergy Pontoise, FR. Peptide N-glycanase, bacitracin, Dowex resins and protease inhibitors were obtained from SIGMA. The tripeptide acetyl-Asn-Tyr-Thr-NH₂ (Ac-NYT-NH₂) was purchased from Neosystem (Strasbourg, Fr.). TLC plates were obtained from Merck (Darmstadt, Germany).

Cell culture

Skin biopsy fibroblasts [13] and HepG2 cells [14] were cultivated as previously described.

Sequencing

For gene studies, signed informed consent protocols were obtained from the parents. Ethics approval was from the Comité de Protection des Personnes d'Île-de-France 2 (CPP IDF2). Targeted genomic Sanger sequencing of several genes encoding proteins required for DLO biosynthesis [PMM2 (NM_000303), ALG6 (NM_013339), DPM1/2/3 (NM_003859, NM_003863, NM_153741), MPDU1 (NM_004870), ALG2 (NM_033087), ALG7 (NM_001382), ALG1 (NM_019109), ALG13/14 (NM018466, NM_144988), ALG11 (NM_001004127)] and dolichol biosynthesis (DHDDS, NM_020438) was performed on DNA from fibroblasts derived from the patient. Primer sequences are available upon request. DNA from the parents was extracted from whole blood. Informed consent was obtained from the parents. WES libraries were prepared from 3 µg of genomic DNA, which was sheared by ultrasonication using a Covaris S220 Ultrasonicator. The 51 Mb SureSelect Human All Exon kit V5 (Agilent technologies) was used for exome capture, and sequencing of WES libraries was carried out on a HiSeq2500 sequencer (Illumina) [15]. The mean coverage depth was 244.51× ((98.22 > 30×; 99.74 > 15× and 99.93 > 5×). After de-multiplexing, sequences were aligned to the reference human genome hg19 using the Burrows-Wheeler Aligner. Downstream processing was carried out with the Genome Analysis Toolkit (GATK), SAMtools, and Picard, following documented best practices (https://www.broadinstitute.org/gatk/guide/bp_step.php). Variant calls were made with the GATK Unified Genotyper. The annotation process was based on the ensembl database (75), dbsnp (135) EVS (ESP6500SI-V2), 1000 genome (2011 05 21) and EXAC (0.3). Variants were annotated and analysed

using the Polyweb software interface designed by the Bioinformatics platform of University Paris Descartes and Imagine Institute [16].

siRNA-mediated down-regulation of DHDDS expression in HepG2 cells

HepG2 cells were transiently transfected with 25 pmol siRNA as previously described [14]. Three DHDDS-targeting sense sequences (1; AACAAAGUGCAGAU CGCCCAGGACCC, 2; CCAACCCGUUCUGUGGCCA GAGUAU, 3; CCGCUCUCCUCAUCCUGACAUCUUG) and a medium GC non-targeting control sequence were used. Cells were harvested 2, 4 and 6 days after transfection.

RNA extraction, reverse transcriptase and reverse QPCR

RNA was extracted from fibroblasts or HepG2 cells according to the manufacturer's instructions (RNeasy Plus Mini Kit, Qiagen). Reverse transcriptase reactions were performed with 1 µg RNA using the Verso cDNA synthesis kit (Thermo Scientific). RT PCR from cDNA exon 3 to 7 of the DHDDS gene (primer sequences: 3SRT cactcacagggtccaacaagc and 7RRT cggttgatagaggcattatc) was performed to confirm the splicing mutation. QPCR was performed using the Absolute Blue QPCR SYBER Green Mix Plus ROX vial (Thermo Scientific) in a Roche Light Cycler 480. Primers for QPCR of DHDDS and the HMBS housekeeping gene were purchased from Qiagen. Primer sequences for the S14 housekeeping gene are as follows: S14 Sense: TCACTCGGAAGAATACCATTTTTTG, S14 Reverse: CCGATTTCTGATTCTAACAGGAC.

Metabolic radiolabelling of cells

Confluent t25 cm² flasks of fibroblasts were metabolically radiolabelled for 30 min in glucose free RPMI 1640 medium supplemented with 0.5 mM glucose and 2 % dialysed foetal calf serum with 100 µCi [2-³H]mannose [17]. siRNA-treated HepG2 cells were radiolabeled for 30 min in 500 µL/well glucose-free RPMI 1640 medium supplemented with 1 mM glucose, 2 mM fucose, 2 % dialysed FCS and 50 µCi [2-³H]mannose [14].

Characterisation of dolichol linked oligosaccharides and N-glycans

The following experimental procedures are described in detail elsewhere [13]. Briefly, after washing with ice-cold PBS, cells were scraped into 1 volume 100 mM Tris-HCl (pH 7.4) containing 4 mM MgCl₂. Two volumes of methanol followed by 3 volumes of chloroform were added to the aqueous cell suspension. After vigorous shaking, the CHCl₃ and MeOH/H₂O phases were separated by centrifugation and removed. The interface pellet was extracted twice with 3 ml CHCl₃:CH₃OH:H₂O

(CMW, 10:10:3). The CHCl_3 phase and CMW fractions contain DLOs with small and large glycan chains, respectively. Both fractions were dried under vacuum and subjected to acid hydrolysis in 20 mM HCl. After desalting on combined Dowex 1-X2 (acetate form)/Dowex 50-X2 (H^+ form) resins the released oligosaccharides were dried under vacuum and, after pooling fractions derived from the two organic phases described above, were examined by thin layer chromatography (TLC). N-linked oligosaccharides (NLOs) were released from the interface protein pellets with PNGase F as previously described [18].

Dolichol-P-mannose synthase and DHDDS assays

Total HepG2 and fibroblast membranes were prepared as previously described [17]. Dolichol-P-mannose synthase (DPMS) was assayed as reported previously in either the presence or absence of DolP [18]. The same membranes were used to assay DHDDS in either the presence or absence of farnesyl diphosphate (FPP) [19]. For the latter assay, the 50 μL reactions were stopped by the addition of 500 μL $\text{CHCl}_3/\text{MeOH}$ (2:1) before transferring the mixtures to 15 mL tubes containing 3.5 mL $\text{CHCl}_3/\text{MeOH}$ (2:1). Two phases were then obtained after addition of 800 μL 4 mM MgCl_2 . The upper phase was removed and discarded whereas the lower phase was washed with 2×2 mLs 4 mM $\text{MgCl}_2/\text{MeOH}$ (1:1). Radioactivity in the lower phase was then assayed by scintillation counting.

Detection of endogenous Dol-P

Endogenous Dol-P levels were assayed in sealed ER vesicles as previously described [20]. A sample of sealed ER-vesicles (equivalent to 40 μg protein) was incubated in 50 mM Tris-HCl (pH 7.5) containing: 250 mM sucrose, bacitracin (400 $\mu\text{g}/\text{mL}$), acceptor peptide (35 μM), AMP (4 mM) and CaCl_2 and MgCl_2 (5 mM) in a total volume 30 μL . The reaction mixture was incubated for 10 min at 37 °C. GDP-[^{14}C]Man (3 μM) was added and the mixture was incubated for 2 min at 37 °C. After solvent extraction, radioactivity was assayed in the organic phase by scintillation counting. The assay was also performed in the absence of the synthetic acceptor peptide as a negative control. Blanks, without sealed ER-vesicles, were made for each condition.

Thin layer chromatography

Desalted DLOs and NLOs were resolved on silica-coated plastic TLC plates developed for 18 h in a mobile phase of propan-1-ol: acetic acid: water (3:3:2). After drying the plates, radioactive components were visualized by fluorography after spraying with En^3Hance .

Protein expression in skin biopsy fibroblasts and HepG2 cells

Proteins were extracted using a lysis buffer containing 20 mM Tris-HCl, 150 mM NaCl, 1 % TX-100, 1 % protease and phosphatase inhibitors, and subjected to SDS-PAGE using NuPage 4–12 % Bis-Tris gels (Fisher-Thermo Scientific). The following primary antibodies were used: anti-ICAM-1 sc-107 (Santa Cruz), anti-PDI (Cell Signaling), anti-ATF-6 α (F-7) sc-166659 (Santa Cruz), anti-p-PERK (Thr 981) sc-32577 (Santa Cruz), anti-NgBR IMG-5342-A (Imgenex), anti-Calnexin 610823BD (BD Transduction Laboratories), anti-GRP75 BiP ab-21685 (Abcam), anti-Actin (I-19) sc-1616 (Santa Cruz).

Complementation of RER2-deficient *S. cerevisiae* with wild-type and mutant human DHDDS forms

True clone DHDDS (SC321506, NM-205861; 1) was mutated with QuickChange site-directed mutagenesis kit (Stratagene) in K42E and W64X and then subcloned into the yeast p416TEF plasmid [21]. Wt RER2 was obtained by cloning PCR from yeast DNA in plasmid pCR2.1 (TA cloning) and then subcloned into p416TEF. The mutated DHDDS was tested in the RER2-TET-off strain cultivated in the presence of 0.3 μM doxycycline. Yeast strains in which the RER2 (*rer2DR*), ALG14 (*alg14DR*), ALG13 (*alg13DR*) and ALG7 (*alg7DR*) genes are under the control of the TET repressor were cultivated, alongside a parental strain, in the presence of increasing concentrations of doxycycline for two overnight passages in order to induce gene down regulation. During the second passage, culture growth was measured by turbidometry, and inhibition of growth with respect to that seen in the absence of doxycycline was calculated. Subsequent to cultivation of *alg14DR* and *rer2DR* cells in either the absence or presence of 1.0 and 0.3 $\mu\text{g}/\text{mL}$ doxycycline, respectively, as described above, cell extracts [22] were submitted to SDS-PAGE and Western Blot using an antibody directed to carboxypeptidase Y (CPY).

Results

Glycosylation profile of plasma glycoproteins

Figure 2a shows Western blotting of the plasma glycoproteins α 1-antitrypsin (AAT), transferrin (TF), haptoglobin (HAPTO) and orosomucoid (OROSO) derived from the patient (P), a patient diagnosed with PMM2-CDG and a normal subject (N). The patient manifests additional AAT, HAPTO and OROSO glycoforms of inferior molecular weight reflecting hypoglycosylation [23].

Analysis of protein N-glycosylation in patient fibroblasts

Metabolic radiolabelling of skin biopsy fibroblasts with [$^2\text{-}^3\text{H}$]mannose revealed that cells from the patient

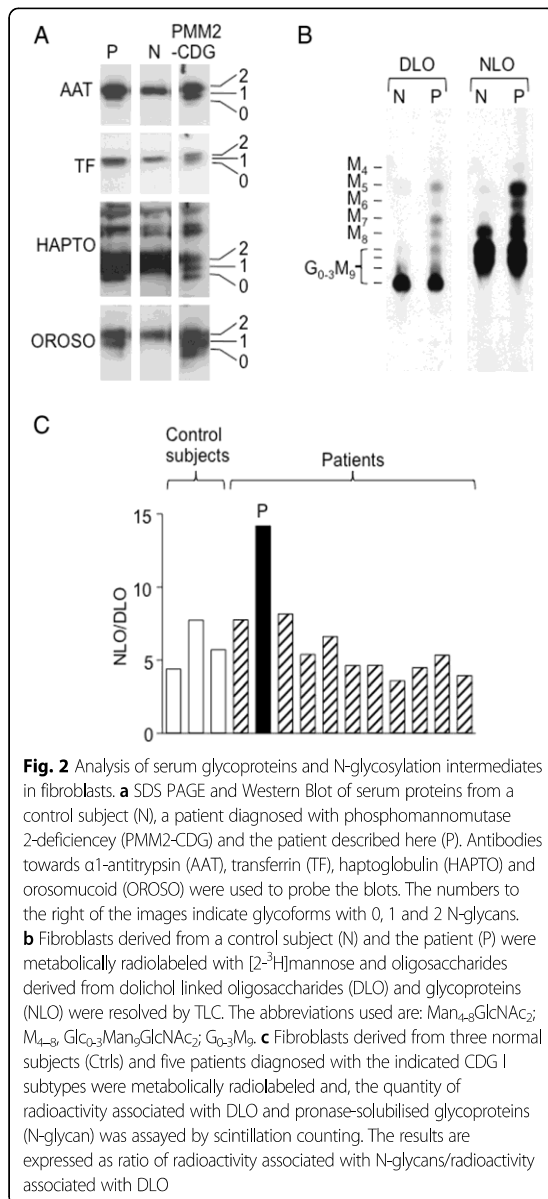

generated elevated levels of truncated DLO possessing oligosaccharides bearing 5-9 residues of mannose as well as fully mannosylated species containing 1-2 residues of glucose (Fig. 2b). N-glycan (NLO) analysis also revealed truncated species bearing 4-8 residues of mannose. The experiment shown in Fig. 2b is representative of several radiolabeling experiments: in some experiments the truncated species were more apparent and in others less so and, more generally, this phenotype gradually became less apparent as a function of cell passage number. As the metabolic radiolabelling procedure is carried out in the presence of low glucose concentrations, which is

known to favour the appearance of truncated DLO, we investigated the role of the extracellular glucose concentration on the appearance of truncated DLO in two cell populations derived from separate skin biopsies obtained from the patient. It was noted that both cell populations behaved similarly and that when radiolabeling was performed in the presence of 2 mM glucose (instead of the usual 0.5 mM glucose) truncated DLO were still observed (results not shown). To conclude, oligosaccharide profiles did not point to an obvious block in the dolichol cycle. In addition to truncated DLO, it was noticed that the ratio of the quantity of radioactivity associated with NLO to that associated with DLO was high in cells from the patient compared either to control cells or those from other patients with CDG-I (Fig. 2c).

Mutations found in DHDDS gene

Routine targeted Sanger sequencing of several genes encoding proteins required for DLO biosynthesis (PMM2, ALG6, ALG7, ALG13/14, ALG1, ALG2, DPM1/2/3, DOLK MPDU1, and ALG11) did not reveal potential disease causing variants. The patient was found to be homozygous for the c.911 T > C (p.F304S) ALG6 variant (see Fig. 1b) that occurs in about one third of the population and does not cause CDG, but as will be discussed later, has been reported to be associated with severe disease signs in patients whose glycosylation pathway is otherwise compromised. While sequencing genes required for dolichol biosynthesis, two mutations in the DHDDS gene were found in DNA from the patient (Fig. 3a). After sequencing DNA from the parents it was found that the father harboured a nonsense mutation c.192G > A (p.W64X) in exon 4 (Fig. 3a; upper panel), and the mother possessed a splicing mutation (c.441-24A > G) in intron 5 (Fig. 3a; lower panel) that creates a cryptic donor splice site (with score of 0.99 rather than 0.65 for the normal exon 6 donor site) leading to: i) loss of exon 6, ii) a 63 base insertion into intron 5 (Fig. 3b), iii) a premature stop: c.440_543del102ins63 (p.C148EfsX11).

Complementation of RER2-deficient *S. cerevisiae* with wild-type and mutant human DHDDS forms

Both mutations potentially lead to the generation of severely truncated proteins devoid of the isopentenyl pyrophosphate-binding domain (Fig. 3c). A yeast complementation strategy was used to test the functionality of the truncated DHDDS(W64X) protein. In the yeast *S. cerevisiae*, the DHDDS gene is encoded by RER2 and the *rer2Δ* strain is not viable. RER2 function in *S. cerevisiae* can be evaluated using the TET-off system in which the RER2 gene is invalidated upon addition of doxycycline to the culture medium as shown in Fig. 4a. The data shows that down-regulation of RER2 causes striking growth retardation that is more pronounced than that

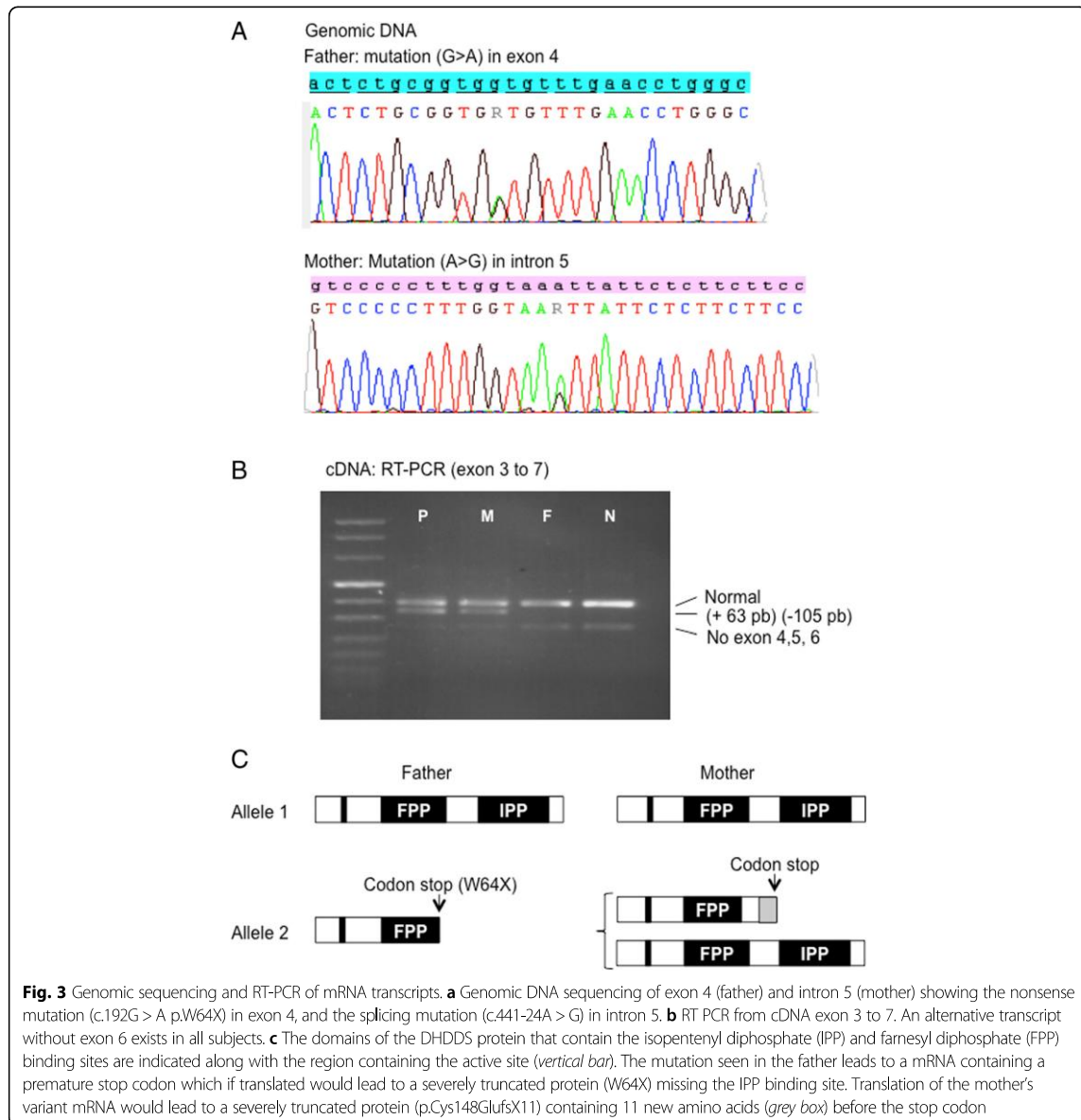

observed when genes required for early steps in DLO biosynthesis (ALG7, ALG13 and ALG14) are down-regulated in the same way. As shown in Fig. 4b, this growth reduction is accompanied by the appearance of hypoglycosylated carboxypeptidase Y (CPY), which is a well-known marker for *N*-glycosylation in *S. cerevisiae*. The functionality of the DHDDS(W64X) variant was tested in the RER2-TET-off strain cultivated in the presence of 0.3 μM doxycycline. Under these conditions, as shown in Fig. 4b, both growth and CPY *N*-glycosylation were restored when the RER2-TET-off strain was transduced with either wild type RER2 or wild type

human DHDDS, but not with plasmids containing either DHDDS(W64X) or the DHDDS(K42E) variant that is associated with retinitis pigmentosa.

Reduced DHDDS gene expression and biological activity in cells from the patient

The DNA sequencing data suggests that cells from the patient should manifest reduced DHDDS expression. The intronic mutation inherited from the mother does not exclude utilization of the normal splice site so some full length DHDDS mRNA is expected in cells from the patient. Full length DHDDS mRNA was quantitated in

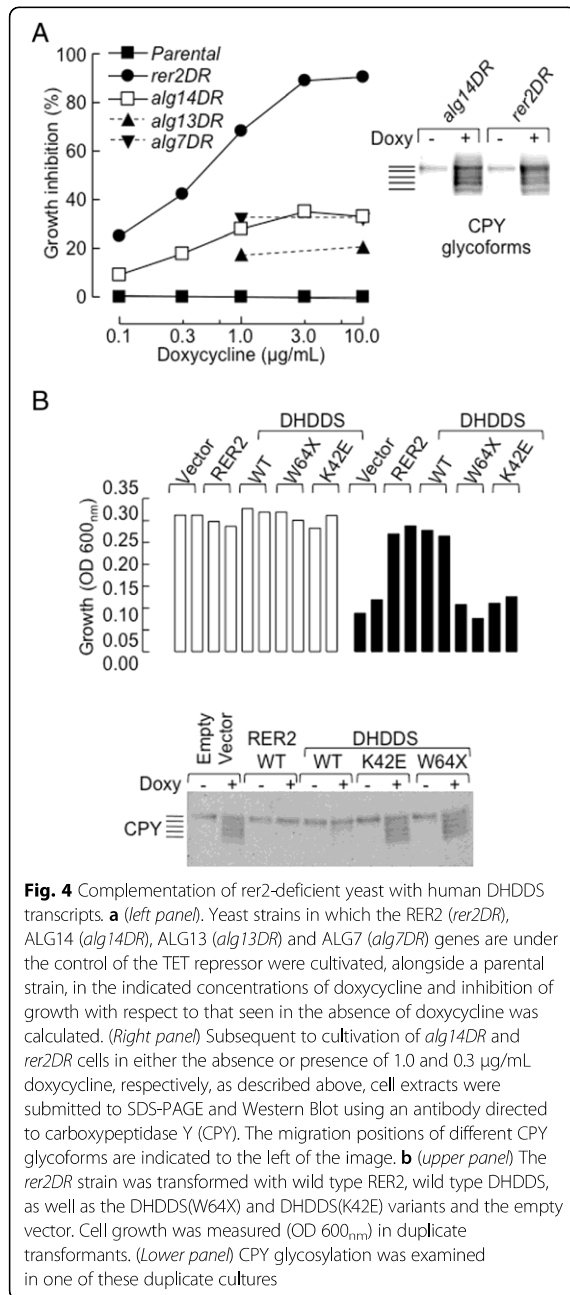

the skin biopsy fibroblasts from the patient and a normal subject, and, as shown in Fig. 5a, the patient possessed only 20–25 % normal DHDDS mRNA level. DHDDS activity in crude microsomal preparations derived from cells from the patient was found to be 35 % of that found in those of cells from normal subjects (Fig. 5b and c). By contrast, dolichol-P-mannose synthase (DPMS)

activity was found to be similar in the two microsome preparations (Fig. 5d).

Reduced dolichol-phosphate levels in sealed microsomes derived from cells of the patient

The DolP pool available for DLO biosynthesis was estimated in either the absence or presence of a synthetic acceptor peptide (Acetyl-Asn-Tyr-Thr-NH₂: NYT) that is known to provoke DolP recycling in sealed microsomes [20]. Addition of NYT to sealed microsomes causes DLO to be discharged: yielding glycopeptide and DolPP. DolPP phosphatase (DOLPP1, see Fig. 1) converts DolPP into DolP, which can then be quantitated as Dol-P-[¹⁴C]Man after addition of GDP-[¹⁴C]Man and by allowing DPMS action (that occurs at the same levels in microsomes derived from cells of the patient and control subject, Fig. 5d). Bacitracin complexes DolPP and incubations in the absence or presence of this antibiotic allow estimations of both DolPP-, and DolP-dependent Dol-P-[¹⁴C]Man production. As shown in Fig. 5e, bacitracin inhibits Dol-P-[¹⁴C]Man production even in the absence of NYT indicating Dol-PP production via the presence of endogenous substrates for OST. Dol-P-[¹⁴C]Man generation in the presence of bacitracin reveals a pre-existing DolP pool that, in microsomes from the patient, appears to be reduced by ~67 % compared to the control. Finally, it can be seen that microsomes from the patient also demonstrate lower NYT-provoked Dol-P-[¹⁴C]Man synthesis. The ensemble of these data demonstrates a deficit in the quantity of DolP available for synthesis of Dol-P-[¹⁴C]Man in the patient’s cells. In order to evaluate the consequences of the reduced DolP levels in the patient’s cells, the glycosylation status of ICAM was examined. Hypoglycosylated ICAM is rapidly degraded and this has been shown to yield low steady state levels of this protein in type I CDG cells [24]. Data presented in Fig. 5f indicate that although the ICAM level is low in the patient’s cells, this level is within the range of ICAM expression in the control cell lines. Protein hypoglycosylation in type I CDG may lead to increases in protein misfolding, ER stress and initiation of the Unfolded Protein Response (UPR) [25]. However, the level of the ER stress marker calnexin (CNX) is within the range displayed by the control cells. Interestingly, there is an inverse correlation between ICAM and CNX expression in both control and patient cells. The reason for the variable ICAM expression even within the control cell population is unknown but could be due to the different growth characteristics or passage number of the different cell lines. ATF46α is a UPR signaling protein [26], and when unfolded proteins accumulate in the ER the expression of full length ATF46α (Fig. 4f, ER; 90 kD) is increased as well as its proteolytic cleavage to generate the 57 kD

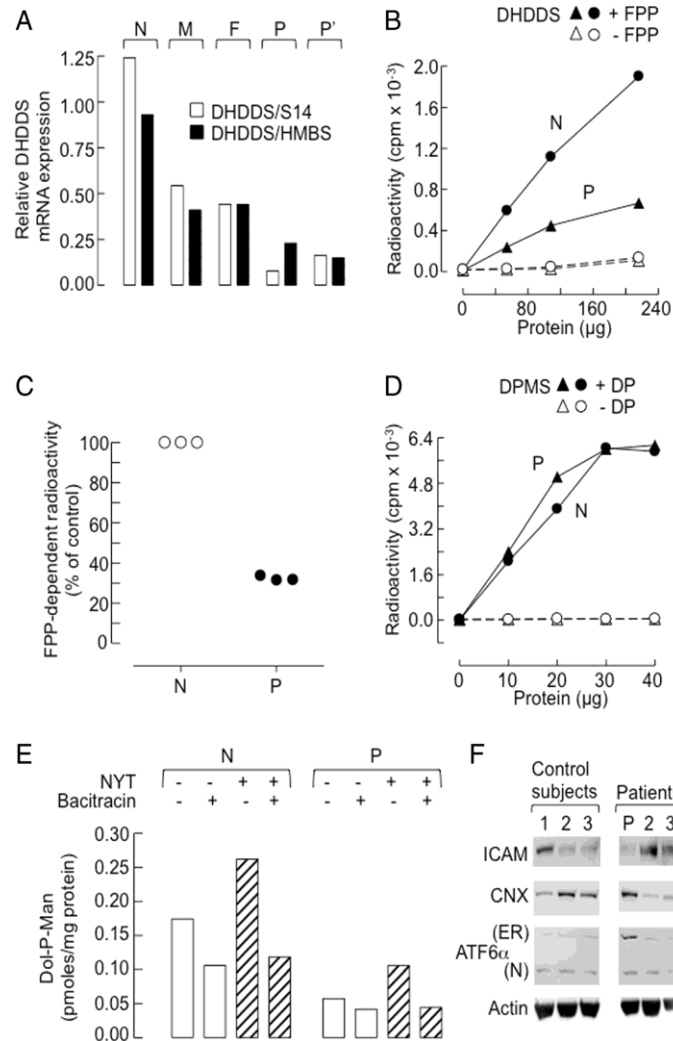

Fig. 5 Evaluation of the consequences of DHDDS mutations in fibroblasts. **a** Quantitation of DHDDS cDNA generated from mRNA derived from fibroblasts obtained from two cell populations from the patient (P and P'), a normal subject (N) and whole blood cell extracts from the father (F) and mother (M). QRT-PCR using either ribosomal protein S14 (S14) or hydroxymethylbilane synthase (HMBS) as housekeeping genes was performed. **b** DHDDS activity was assayed using farnesyl diphosphate (FPP) as acceptor. **c** After subtracting background values (– FPP) from the data points, the initial slopes of the curves shown in **(b)** and two other similar experiments were estimated. The values $(Slope^P/Slope^N) \times 100$ are plotted (*solid circles*). $Slope^N$ is set at 100 % for each experiment (*open circles*). **d** Dol-P-Man synthase (DPMS) activity was measured in the same microsomes preparations as used in **(b)** using GDP-[¹⁴C]mannose and DolP (DP) as acceptor. **e** Measurement of endogenous DolP levels in microsomes prepared from fibroblasts derived from the patient (P) and a normal subject (N). Incubations were carried out with GDP-[¹⁴C]Man in the absence or presence of the glycosylation acceptor peptide (NYT) and bacitracin as indicated. The specific activity of the GDP-[¹⁴C]Man is used to calculate the pmoles Dol-P-Man recovered from the organic phase after stopping the reactions. **f** Extracts of fibroblasts from three control subjects, the patient (P), and patients diagnosed with ALG12-CDG (Patient 2) and DPM2-CDG (Patient 3) were subjected to SDS-PAGE and Western Blot. The blots were probed with antibodies directed towards intercellular adhesion molecule-1 (ICAM), calnexin (CNX), activating transcription factor 6 alpha (ATF6α) and actin

nuclear from (N) [26]. The ER form of ATF4α is expressed at a higher level in the patient's cells than in both control cells, and those from other CDG-I patients. However, this increased expression was not accompanied by increased proteolytic cleavage to generate the active nuclear form of the protein (Fig. 5f).

Knock-down of DHDDS expression in HepG2 cells

The data presented above demonstrate the presence of mutations in the DHDDS gene that lead to: 1) reduced DHDDS mRNA levels, 2) reduced DHDDS activity, 3) reduced DolP levels, and 4) small but significant changes in DLO/N-glycan profiles in metabolically radiolabeled

fibroblasts derived from the patient. In order to determine whether or not reduced DHDDS expression could lead to the changes in early steps of the N-glycosylation pathway that were noted in the cells from the patient, human hepatocellular carcinoma HepG2 cells were transfected with siRNA duplexes targeting DHDDS. As shown in Fig. 6a, DHDDS mRNA expression was decreased by three DHDDS-targeting duplexes (1-3) compared to the non-targeting duplex (*nt*), and siRNA(1) was the most efficient at reducing DHDDS

expression. SiRNA(2) provoked an increase in non adherent cells (not shown), a reduction in protein associated with adherent cells (Fig. 6b), and reduced protein synthesis as measured by [¹⁴C]leucine incorporation into precipitable cellular proteins (Fig. 6c). Because siRNA(1) provoked more effective DHDDS mRNA down-regulation than siRNA(3) and siRNA(2) manifested toxicity not apparent with the other duplexes, the former duplex was selected for the following experiments. In order to assay DHDDS activity in

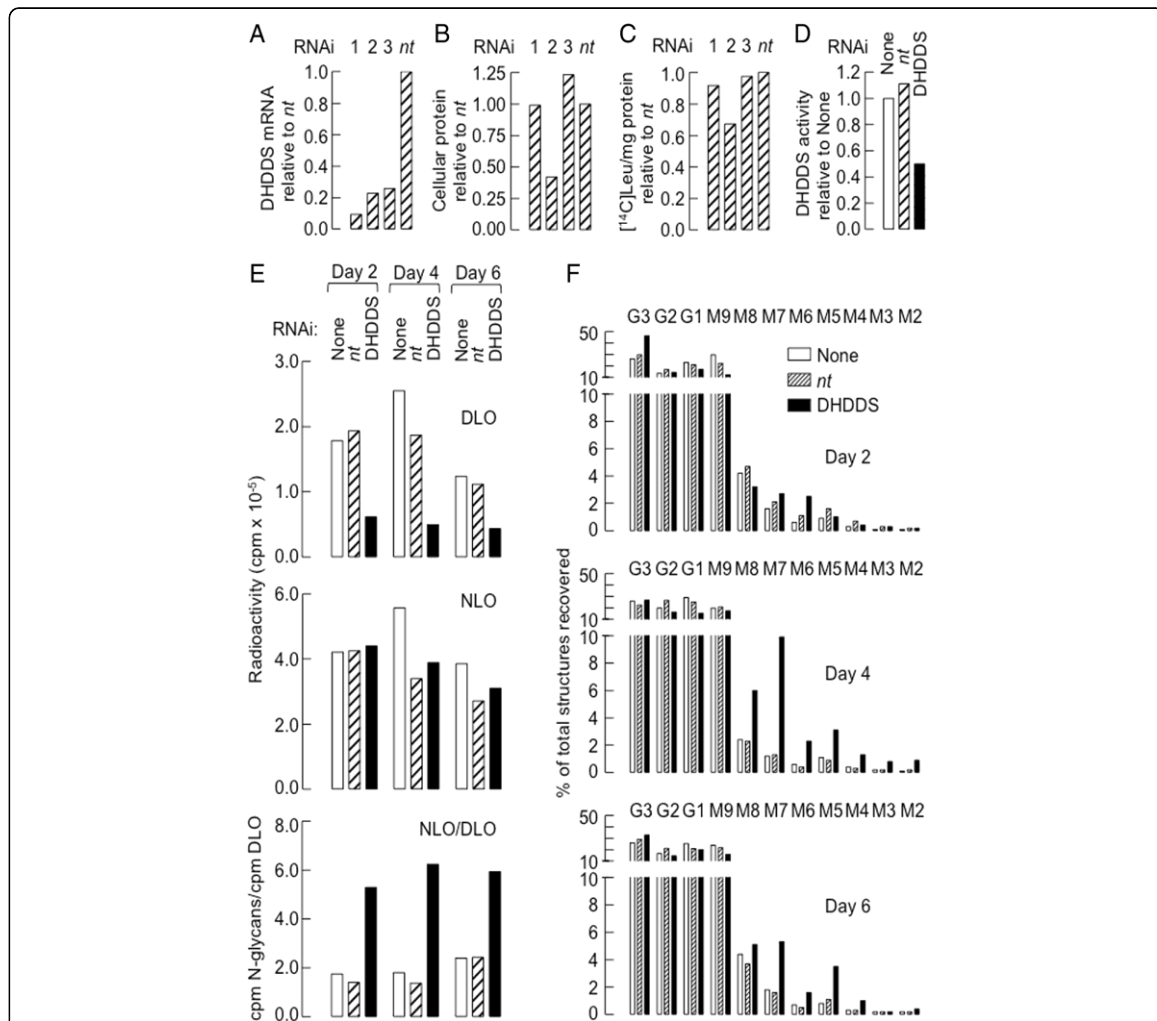

Fig. 6 Down-regulation of DHDDS expression in HepG2 cells. HepG2 cells were transfected with three siRNA targeting DHDDS or a control non-targeting siRNA (*nt*) and were harvested 4 days later. **a** Cellular mRNA was extracted and DHDDS cDNA was quantitated by qRT-PCR. **b** Total adherent cell protein was assayed. **c** Cells were radiolabeled with [¹⁴C]leucine for 30 min, and radioactivity recorded in precipitated cellular proteins was calculated per mg protein and these values were expressed as a percentage of that found in cells transfected with the control non-targeting siRNA. **d** DHDDS activity was measured in the three cell populations. **e** HepG2 cells were mock transfected (None), or transfected with either the control non-targeting siRNA (*nt*) or siRNA(1) targeting DHDDS, and at 2, 4 and 6 days post transfection the cells were metabolically radiolabeled with [2-³H]mannose. Radioactivity associated with DLO (*upper panel*) and glycoproteins (NLO: *middle panel*) was measured as described in the legend to Fig. 2c, and the ratio of incorporation of radioactivity into NLO to that into DLO is shown in the lower panel. **f** Oligosaccharides released from DLO were resolved by TLC and visualized by fluorography. Regions corresponding to the migration positions of the indicated oligosaccharides were eluted from the plate and assayed by scintillation counting. The abbreviations are as follows: G3-1; Glc₃Man₉GlcNAc₂, M9-2; Man₉₋₂GlcNAc₂

HepG2 cells that were transfected with siRNA(1), cells were harvested 4 days post transfection and crude microsomal fractions were prepared. Data shown in Fig. 6d indicates a 50 % reduction in DHDDS activity in cells treated with DHDDS-targetting siRNA(1) compared to that found in cells treated with the non-targetting siRNA (*nt*) or sham transfected cells (None). Next, cells were metabolically radiolabeled with [2-³H]mannose as described for Fig. 2b. As shown in Fig. 6e, transfection of the cells with the DHDDS-targetting siRNA(1) reduced radiolabel incorporation into DLO (upper panel) without strikingly affecting the quantity of radioactivity associated with N-glycans (middle panel). The resulting high ratio of [2-³H]DLO/[2-³H]N-glycan (lower panel) in the DHDDS-down-regulated cells is similar that seen with the fibroblasts derived from the patient (Fig. 2c). TLC examination of the DLO structures generated under the different conditions demonstrates the presence of various truncated DLO associated with DHDDS down-regulation at days 4 and 6 post-transfection (Fig. 6f). Finally, down-regulation of DHDDS in HepG2 cells did not lead to changes in the expression of ICAM, calnexin and ATF46 α (results not shown). To summarize, as was noted in fibroblasts from the patient, DHDDS down-regulation in HepG2 cells provokes the appearance of truncated DLO and an elevated [³H]DLO/[³H]N-glycan ratio.

Whole exome sequencing

The clinical phenotype of the patient reported here resembles that of other CDG-I patients and contrasts with the retinitis pigmentosa phenotype of the first reported DHDDS-deficient patients. This different phenotype could be explained by the presence of a mutation in another gene that regulates N-glycosylation, or the association of DHDDS mutations with mutations in genes that regulate N-glycosylation. Sanger sequencing revealed the patient to be homozygous for the c.911 T > C (p.F304S) ALG6 variant (see Fig. 1b) that does not cause CDG, but is associated with severe disease signs in patients who have mutations in other genes of the N-glycosylation pathway. In order to look for other potentially disease causing or disease modifying variants, whole exome capture and next-generation sequencing (WES) on an Illumina platform was performed on DNA from fibroblasts of the patient. After filtering out variants occurring at > 1 % in human population data banks (the c.911 T > C (p.F304S) ALG6 variant was detected but filtered out because it occurs at a frequency of 20-30 %), and selecting those associated with glycosylation or dolichol metabolism pathways, two genes were found with two variants: DHDDS and TNKS1 (Tables 1 and 2). TNKS1 (Tankyrase, TRF1-Interacting Ankyrin-Related ADP-Ribose Polymerase) functions include NAD⁺-dependent ADP-ribosyltransferase activity. Poly-ADP-ribosyltransferases are

involved in various processes such as Wnt signaling, telomere length maintenance and vesicle trafficking [27]. In certain situations, the chromosomal location of the TNKS1 gene (8p23.1) is linked to a form of monogenic diabetes [28]. Despite being lean and in other respects normal, TNKS1-deficient mice display hyperphagia and altered fatty acid metabolism without liver steatosis [28]. WES also identified several heterozygous variants in genes of the N-glycosylation pathway (Table 2) including ALG8, ALG9, DDOST, MPDU1, ALG6, and STT3A. Even though single mutations in these genes do not cause CDG, the possibility that reduced activity/expression of the proteins that they encode could amplify the phenotype caused by reduced DHDDS expression cannot be excluded. The possibility of further CDG gene variants hiding in an intron or poorly covered region during WES cannot be excluded, but it was found that for the 26 genes presently known to underlie CDG, WES coverage was at least 30x.

Discussion

This case is of considerable interest because other patients so far described with mutations in the DHDDS gene present with a mild clinical picture restricted to retinitis pigmentosa [11, 12, 29]. The present patient showed a fatal clinical syndrome accompanied with hypoglycosylated serum glycoproteins and truncated DLO species, pointing to CDG-I. Two mutations in DHDDS leading to 20–25 % DHDDS mRNA expression and 35 % residual DHDDS activity were found. In accordance with these data microsomes derived from the patient's cells revealed low levels of DolP. As our studies progressed, and the passage number of the fibroblasts increased, we noted a gradual disappearance of the glycosylation phenotype. Although it is not clear why this should occur, it is possible that as the cells become less metabolically active their glycosylation requirements are reduced and there is less strain on the dolichol cycle. The disappearance of the glycosylation phenotype, and the fatal outcome in this case, made it no longer feasible to try to normalize either the abnormal DLO profile or [2-³H]mannose incorporation into DLO by transfecting cells from the patient with wild-type hDHDDS. In an alternative approach to investigate the origin of the biochemical phenotype, DHDDS expression was down regulated in HepG2 cells. To date, there have been no attempts to knockdown DHDDS expression in mice or mammalian cells in vivo. It was noted that whereas DHDDS-down regulation in HepG2 cells provoked an 80–90 % reduction in DHDDS RNA, only a 50 % reduction in DHDDS activity could be detected. This result was surprising and raises the possibility of an alternative mechanism for dolichol biosynthesis that is relatively more important in HepG2 cells than in fibroblasts. Alternative dolichol biosynthetic

Table 1 Whole exome sequence filtering

SNVs ^a	Variations	Genes
All variants	9061	6301
Unknown or known variants <1 % (dbSNP132/1 K genome/EVS ExAC) and in-house database filtering (929) ^b	785	861
Glycosylation genes	19	19
Dolichol related genes	3	3
Gene(s) with two mutated alleles	2	2

^aSNVs single nucleotide variants

^bdbSNP132: <http://www.ncbi.nlm.nih.gov/SNP/>

1 K genome; 1000 genomes (<http://www.1000genomes.org/>), EVS; Exome Variant Server (<http://evs.gs.washington.edu/EVS/>), ExAC; <http://exac.broadinstitute.org/>, in-house database filtering; variant excluded if already seen at the homozygous state in 929 exomes performed in the platform

routes postulated previously [30, 31] remain controversial [32]. Nevertheless, such a route might explain the shorter dolichol chain lengths that have been observed in NGBR- and DHDDS-deficient patients [10, 33]. Here we demonstrate that siRNA-mediated knockdown of DHDDS did not reduce the incorporation of [2-³H]-mannose into glycoproteins, but did reduce strikingly the incorporation of [2-³H]mannose into DLO, and provoked a transient increase in the proportion of truncated DLO species (Man₆₋₈GlcNAc₂-PP-dolichol). One explanation for the occurrence of truncated DLO in DHDDS-deficient cells with reduced DolP is that the synthesis of Dol-P-Man and Dol-P-Glc are more adversely affected than Dol-PP-GlcNAc. This would lead to a DLO profile similar to that seen in MPDU1-CDG where the ability of these two precursors to contribute to DLO elongation is compromised [34]. Alternatively, the slightly shorter dolichol chains that have been shown

to occur in previously described DHDDS- and NGBR-deficient patients may also hinder Dol-P-Man and Dol-P-Glc utilization. The mechanism underlying the paradoxical apparent increase in incorporation of radioactivity into N-glycans with respect to that incorporated into DLO is also not clear. One explanation might be that the reduced DolP pool size could lead to a higher specific activity of the radioactive DPM and DLO pools compared to control cells. Accordingly, assuming that protein synthesis rates are similar and that the DLO pools are not limiting in control and DHDDS-deficient cells then a higher incorporation of radioactivity into N-glycans might be expected. An alternative hypothesis for the inability of DHDDS down regulation to inhibit the incorporation of radioactivity into N-glycans despite reducing radioactivity associated with DLO is that the DLO pool required for protein glycosylation is a sub pool of total DLO, and that this sub pool is less dependent upon DHDDS than the remaining DLO. To summarise, in both cells from the patient and DHDDS-deficient HepG2 cells, changes in the incorporation of [2-³H]mannose into DLO and N-glycans along with changes in the DLO profiles were detected. Therefore it is concluded that the biochemical phenotype of cells from the patient is compatible with reduced DHDDS expression.

The previously described patients with mutations in the DHDDS gene that present only with retinitis pigmentosa [11, 12, 29], do not present with serum glycoprotein hypoglycosylation. In these patients serum and urine dolichols are abnormal [33]. Serum and urine samples from our patient were not available. The DHDDS ortholog, RER2, is an essential gene in yeast,

Table 2 Glycosylation or dolichol related genes with mutated alleles

Gene	SNP ^a	Type of mutation ^b	Frequency data if already described ^c
DHDDS	c.192G > A (p.W64X)	Stop	-
	c.441-24A > G (p.C148EfsX11)	Intron (splice)	ExAC: 0.00001663
TNKS	c.1945G > A (p.D649N)	Missense (Polyphen pathogen, SIFT benign)	-
	c.899-16362A > T	Intron/ncRNA	-
ALG8	c.1068C > G (p.P356=)	Exon synonymous	-
ALG9	c.-37-77G > A	Intron	-
DDOST	c.679A > G (p.I227V)	Missense (Polyphen and SIFT benign)	ExAC: 0.00004444
MPDU1	c.393C > T, p.V131 = (rs79286384)	Exon synonymous	Av. he: 0.004 ExAC: 0.0007853
ALG6	c.987 + 43 T > C (rs181709997)	Intron	Av. he: 0.003 ExAC: 0.003458
STT3A	c.88 + 131 T > C (rs191172467)	Intron	Av. he: 0.001+/-0.024 ExAC: no data

^aGenomic positions are on UCSC genome Browser (hg19)

^bPolyphen : <http://genetics.bwh.harvard.edu/pph/>, SIFT: <http://sift.jcvi.org/>

^cAv. he: average heterozygosity (source dbSNP) or allele frequency ExAC

and DOLK-CDG, SRD5A3-CDG and NGBR-CDG patients, who have mutations in other genes required for the *de novo* biosynthesis of dolichol, present with moderate to severe multisystemic manifestations [5, 10, 35]. Several explanations are possible for the differences in these DHDDS-CDG phenotypes.

First, the K42E mutation, associated with isolated retinitis pigmentosa, is perhaps not particularly damaging. Functional glycosylation studies and DHDDS assays have not been performed in fibroblasts from these patients, so no comparison can be made with the findings in cells from the present patient. Nevertheless, we report here that wild-type hDHDDS, but not hDHDDS(K42E), is able to normalise both impaired growth and carboxypeptidase Y hypoglycosylation in RER2-deficient *S. cerevisiae*. Interestingly, we present data indicating that doxycycline-induced knockdown of other essential yeast glycosylation genes (ALG7, ALG13 and ALG14) has much less impact on *S. cerevisiae* growth than down-regulation of RER2. This observation suggests that the RER2-dependent dolichol pool is required for important cellular functions other than protein N-glycosylation, or that RER2 itself has a role in yeast homeostasis independent of its role in dolichol production. Although the hDHDDS(K42E) variant is unable to complement growth or N-glycosylation defects in *S. cerevisiae*, its ability to support N-glycosylation in mammalian/human cells maybe quite different due to the fact that efficient dolichol biosynthesis by the hDHDDS-encoded protein requires the hNGBR-encoded protein [4, 10, 36]: a complex between hDHDDS(K42E) and the yeast NgBR ortholog (nus1) may not be as productive as that comprising both human proteins. More recently, however, it has been demonstrated that membranes derived from *nus1Δrer2Δ* yeast complemented with hDHDDS(K42E) and wild-type hNGBR display about 30 % the activity of those derived from the same strain complemented with wild-type hDHDDS and hNgBR [10]. Therefore hDHDDS(K42E) does not support efficient DHDDS activity.

Second, the reduced DHDDS activity caused by the K42E variant may not be too serious for cells (apart from those in the retina). However, reduced expression of the DHDDS protein may be far more serious. DHDDS knockdown in fertilized zebrafish eggs caused primarily retinal photoreceptor degeneration, but, depending on the degree of knockdown, provoked other phenotypic changes that suggest roles for DHDDS are not restricted to retinal photoreceptor maintenance in this organism. Accordingly, reduced DHDDS expression may be more damaging than normal expression of the inactive hDHDDS(K42E) variant, potentially suggesting that DHDDS has important functions that are independent of its DHDDS activity. Nevertheless, an understanding

of the impact of DHDDS knockdown on mammalian physiology will have to await the generation of mice models. The DHDDS protein forms a complex with the NgBR to form the fully active dehydrololichol diphosphate synthase activity. NgBR also forms a complex of unknown function with the Nogo-B protein, and a complex with the Niemann-Pick C2 protein (NPC2) that is known to regulate cholesterol metabolism. NGBR knockout is embryonically lethal in mice and NGBR-deficient cells, derived from either patients with mutations in NGBR or mouse embryonic fibroblasts derived from conditional NGBR^{-/-} mice, display 10-17 % residual DHDDS activity, reduced ICAM expression and about 50 % reduction in [2-³H]mannose incorporation into glycoproteins [10]. Accordingly, one of the consequences of reduced DHDDS protein expression, that is independent of reduced enzyme activity, might be an excess of “free” NgBR that could deregulate cholesterol metabolism or pathways that depend on the Nogo-B protein.

Third, Sanger sequencing revealed that the patient is homozygous for the ALG6(F304S) variant, which is more frequent in PMM2-CDG patients with severe disease than in those with moderate symptoms [37]. The ALG6(F304S) variant is not as efficient at complementing ALG6-deficient yeast as the wild type allele [38], but is not thought to cause CDG because it occurs in 27–33 % of the population, and 4–6 % of the population are homozygous for this variant [37, 39, 40]. DLO analyses in fibroblasts derived from the patient did reveal accumulations of Man₉GlcNAc₂-PP-dolichol above control levels (Fig. 2b), but other DLO species accumulated to a greater extent, and this DLO profile is not indicative of ALG6-CDG. WES of our patient revealed two variants in the tankyrase 1 (TNKS1) gene along with heterozygous variants in other genes (ALG6, ALG8, ALG9, DDOST, MPDU1, and STT3A) required for N-glycosylation. A role for these variants in the fatal outcome of this disease cannot be excluded.

Conclusions

We describe a patient presenting with severe multi-system disease associated with DHDDS deficiency. As retinitis pigmentosa is the only clinical sign in previously reported cases of DHDDS deficiency our data broaden its phenotypic spectrum. This case adds to those in which the ALG6(F304S) variant is associated with a severe/fatal disease presentation.

Abbreviations

CDG, congenital disorders of glycosylation; DHDDS, dehydrololichol diphosphate synthase; DLO, dolichol linked oligosaccharide; DolP, dolichol phosphate; DolPP, dolichol diphosphate; NgBR, Nogo-B receptor; OST, oligosaccharyltransferase; siRNA, short interfering RNA.

Acknowledgements

Olivier Alibeu and Marc Bras from, respectively, the *Genomic and Bioinformatic Platforms*, INSERM UMR 1163, Imagine Institute, Paris, France, are thanked for performing the WES analyses.

Funding

This work was partially supported by grant ERARE11-135 of the ERA-Net for Research Programs on Rare Diseases Joint Transnational Call 2011 (EURO-CDG), the European Union FP6-Coordination Action EUROGLYCANET (LSHM-CT-2005-512131), and institutional funding from Institut National de la Santé et de la Recherche Médicale (INSERM). The whole exome study was funded by the association Connaitre les Syndromes Cérébelleux (CLC). The funding bodies played no role in the design, execution and reporting of this study.

Availability of data and supporting material

Not applicable.

Authors' contributions

DH, ND and CM performed the clinical evaluations and provided patient care. SS, SV-B, EM, MF, TD, IC, and SM performed experiments and interpreted data. SS, NS, TD, MF, IC and SM conceived experiments. SM wrote the MS with the help of all authors. All authors read and approved the final manuscript.

Competing interests

The authors declare that they have no competing interests.

Consent for publication

A signed consent form pertaining to genetic studies and the publication of scientific data was obtained.

Ethics approval and consent to participate

For gene studies, signed informed consent protocols were obtained from the parents. Ethics approval was from the Comité de Protection des Personnes d'Île-de-France 2 (CPP IDF2).

Author details

¹INSERM U1149, Faculté de Médecine Xavier Bichat, 16 rue Henri Huchard, Paris, France. ²Université Denis Diderot, Paris 7, Paris, France. ³Université Pierre et Marie Curie, Paris 6, Paris, France. ⁴Biochemical Genetics Department, Human Genetics Division, National Research Center NRC, Cairo, Egypt. ⁵AP-HP, Hôpital Bichat-Claude Bernard, Biochimie, Paris, France. ⁶Département de Pédiatrie, AP-HP, Hôpital Necker-Enfants Malades, Paris, France. ⁷Département de Génétique & Centre de Référence Déficiences Intellectuelles de Causes Rares, Hôpital Pitié Salpêtrière, Paris, France. ⁸Groupe de Recherche Clinique « Déficience Intellectuelle et Autisme » UPMC, Paris, France. ⁹Neuropédiatrie, Hôpital Trousseau, Paris, France. ¹⁰Université Paris Descartes, Paris, France.

Received: 2 March 2016 Accepted: 15 June 2016

Published online: 24 June 2016

References

- Jaeken J. Congenital disorders of glycosylation. *Handb Clin Neurol*. 2013;113:1737–43.
- Aebi M, Hennet T. Congenital disorders of glycosylation: genetic model systems lead the way. *Trends Cell Biol*. 2001;11(3):136–41.
- Burda P, Aebi M. The dolichol pathway of N-linked glycosylation. *Biochim Biophys Acta*. 1999;1426(2):239–57.
- Harrison KD, Park EJ, Gao N, Kuo A, Rush JS, Waechter CJ, Lehrman MA, Sessa WC. Nogo-B receptor is necessary for cellular dolichol biosynthesis and protein N-glycosylation. *Embo J*. 2011;30(12):2490–500.
- Cantagrel V, Lefeber DJ, Ng BG, Guan Z, Silhavy JL, Bielas SL, Lehle L, Hombauer H, Adamowicz M, Swiezewska E et al. SRD5A3 is required for converting polyprenol to dolichol and is mutated in a congenital glycosylation disorder. *Cell*. 2010;142(2):203–17.
- Kranz C, Jungeblut C, Denecke J, Erlekotte A, Sohlbach C, Debus V, Kehl HG, Harms E, Reith A, Reichel S et al. A defect in dolichol phosphate biosynthesis causes a new inherited disorder with death in early infancy. *Am J Hum Genet*. 2007;80(3):433–40.
- Lieu MT, Ng BG, Rush JS, Wood T, Basehore MJ, Hegde M, Chang RC, Abdenur JE, Freeze HH, Wang RY. Severe, fatal multisystem manifestations in a patient with dolichol kinase-congenital disorder of glycosylation. *Mol Genet Metab*. 2013;110(4):484–9.
- Grundahl JE, Guan Z, Rust S, Reunert J, Muller B, Du Chesne I, Zerres K, Rudnik-Schoneborn S, Ortiz-Bruchle N, Hausler MG, et al. Life with too much polyprenol: polyprenol reductase deficiency. *Mol Genet Metab*. 2012;105(4):642–51.
- Kasapkara CS, Tumer L, Ezgu FS, Hasanoglu A, Race V, Matthijs G, Jaeken J. SRD5A3-CDG: a patient with a novel mutation. *Eur J Paediatr Neurol*. 2012;16(5):554–6.
- Park EJ, Grabinska KA, Guan Z, Stranecky V, Hartmannova H, Hodanova K, Baresova V, Sovova J, Jozsef L, Ondruskova N, et al. Mutation of Nogo-B receptor, a subunit of cis-prenyltransferase, causes a congenital disorder of glycosylation. *Cell Metab*. 2014;20(3):448–57.
- Zelinger L, Banin E, Obolensky A, Mizrahi-Meisssonier L, Beryozkin A, Bandah-Rozenfeld D, Frenkel S, Ben-Yosef T, Merin S, Schwartz SB, et al. A missense mutation in DHDDS, encoding dehydrodolichyl diphosphate synthase, is associated with autosomal-recessive retinitis pigmentosa in Ashkenazi Jews. *Am J Hum Genet*. 2011;88(2):207–15.
- Zuchner S, Dallman J, Wen R, Beecham G, Naj A, Farooq A, Kohli MA, Whitehead PL, Hulme W, Konidari I, et al. Whole-exome sequencing links a variant in DHDDS to retinitis pigmentosa. *Am J Hum Genet*. 2011;88(2):201–6.
- Chantret I, Dupre T, Delenda C, Bucher S, Dancourt J, Barnier A, Charollais A, Heron D, Bader-Meunier B, Danos O, et al. Congenital disorders of glycosylation type Ig is defined by a deficiency in dolichyl-P-mannose: Man7GlcNAc2-PP-dolichyl mannosyltransferase. *J Biol Chem*. 2002;277(28):25815–22.
- Chantret I, Fasseu M, Zaoui K, Le Bizec C, Sadou Yaye H, Dupre T, Moore SE. Identification of roles for peptide: N-glycanase and endo-beta-N-acetylglucosaminidase (Engase1p) during protein N-glycosylation in human HepG2 cells. *PLoS One*. 2010;5(7), e11734.
- Guimier A, Gabriel GC, Bajolle F, Tsang M, Liu H, Noll A, Schwartz M, El Malti R, Smith LD, Klena NT, et al. MMP21 is mutated in human heterotaxy and is required for normal left-right asymmetry in vertebrates. *Nat Genet*. 2015;47(11):1260–3.
- Kannengiesser C, Borie R, Menard C, Reocreux M, Nitschke P, Gazal S, Mal H, Taille C, Cadranet J, Nunes H, et al. Heterozygous RTEL1 mutations are associated with familial pulmonary fibrosis. *Eur Respir J*. 2015;46(2):474–85.
- Dupre T, Vuillaumier-Barrot S, Chantret I, Sadou Yaye H, Le Bizec C, Afenjar A, Altuzarra C, Barnerias C, Burglen L, de Lonlay P, et al. Guanosine diphosphate-mannose: GlcNAc2-PP-dolichol mannosyltransferase deficiency (congenital disorders of glycosylation type Ik): five new patients and seven novel mutations. *J Med Genet*. 2010;47(11):729–35.
- Dancourt J, Vuillaumier-Barrot S, de Baulny HO, Sfaello I, Barnier A, le Bizec C, Dupre T, Durand G, Seta N, Moore SE. A new intronic mutation in the DPM1 gene is associated with a milder form of CDG Ie in two French siblings. *Pediatr Res*. 2006;59(6):835–9.
- Crick DC, Scocca JR, Rush JS, Frank DW, Krag SS, Waechter CJ. Induction of dolichyl-saccharide intermediate biosynthesis corresponds to increased long chain cis-isoprenyltransferase activity during the mitogenic response in mouse B cells. *J Biol Chem*. 1994;269(14):10559–65.
- Rush JS, Gao N, Lehrman MA, Waechter CJ. Recycling of dolichyl monophosphate to the cytoplasmic leaflet of the endoplasmic reticulum after the cleavage of dolichyl pyrophosphate on the luminal monolayer. *J Biol Chem*. 2008;283(7):4087–93.
- Mumberg D, Muller R, Funk M. Yeast vectors for the controlled expression of heterologous proteins in different genetic backgrounds. *Gene*. 1995;156(1):119–22.
- Chantret I, Dancourt J, Barbat A, Moore SE. Two proteins homologous to the N- and C-terminal domains of the bacterial glycosyltransferase Murg are required for the second step of dolichyl-linked oligosaccharide synthesis in *Saccharomyces cerevisiae*. *J Biol Chem*. 2005;280(10):9236–42.
- Seta N, Barnier A, Hochedez F, Besnard MA, Durand G. Diagnostic value of Western blotting in carbohydrate-deficient glycoprotein syndrome. *Clin Chim Acta*. 1996;254(2):131–40.
- He P, Ng BG, Losfeld ME, Zhu W, Freeze HH. Identification of intercellular cell adhesion molecule 1 (ICAM-1) as a hypoglycosylation marker in

- congenital disorders of glycosylation cells. *J Biol Chem*. 2012;287(22):18210–7.
25. Lecca MR, Wagner U, Patrignani A, Berger EG, Hennet T. Genome-wide analysis of the unfolded protein response in fibroblasts from congenital disorders of glycosylation type-I patients. *FASEB J*. 2005;19(2):240–2.
 26. Haze K, Yoshida H, Yanagi H, Yura T, Mori K. Mammalian transcription factor ATF6 is synthesized as a transmembrane protein and activated by proteolysis in response to endoplasmic reticulum stress. *Mol Biol Cell*. 1999;10(11):3787–99.
 27. Haikarainen T, Krauss S, Lehtio L. Tankyrases: structure, function and therapeutic implications in cancer. *Curr Pharm Des*. 2014;20(41):6472–88.
 28. Yeh TY, Beiswenger KK, Li P, Bolin KE, Lee RM, Tsao TS, Murphy AN, Hevener AL, Chi NW. Hypermetabolism, hyperphagia, and reduced adiposity in tankyrase-deficient mice. *Diabetes*. 2009;58(11):2476–85.
 29. Lam BL, Zuchner SL, Dallman J, Wen R, Alfonso EC, Vance JM, Pericak-Vance MA. Mutation K42E in dehydrodolichol diphosphate synthase (DHDDS) causes recessive retinitis pigmentosa. *Adv Exp Med Biol*. 2014;801:165–70.
 30. Appelkvist EL, Kalen A. Biosynthesis of dolichol by rat liver peroxisomes. *Eur J Biochem/FEBS*. 1989;185(3):503–9.
 31. Grunler J, Olsson JM, Dallner G. Estimation of dolichol and cholesterol synthesis in microsomes and peroxisomes isolated from rat liver. *FEBS Lett*. 1995;358(3):230–2.
 32. Wanders RJ, Waterham HR. Biochemistry of mammalian peroxisomes revisited. *Annu Rev Biochem*. 2006;75:295–332.
 33. Wen R, Lam BL, Guan Z. Aberrant dolichol chain lengths as biomarkers for retinitis pigmentosa caused by impaired dolichol biosynthesis. *J Lipid Res*. 2013;54(12):3516–22.
 34. Schenk B, Imbach T, Frank CG, Grubenmann CE, Raymond GV, Hurvitz H, Korn-Lubetzki I, Revel-Vik S, Raas-Rotschild A, Luder AS, et al. MPDU1 mutations underlie a novel human congenital disorder of glycosylation, designated type If. *J Clin Invest*. 2001;108(11):1687–95.
 35. Kranz C, Basinger AA, Guccavas-Calikoglu M, Sun L, Powell CM, Henderson FW, Aylsworth AS, Freeze HH. Expanding spectrum of congenital disorder of glycosylation Ig (CDG-Ig): sibs with a unique skeletal dysplasia, hypogammaglobulinemia, cardiomyopathy, genital malformations, and early lethality. *Am J Med Genet A*. 2007;143A(12):1371–8.
 36. Harrison KD, Miao RQ, Fernandez-Hernando C, Suarez Y, Davalos A, Sessa WC. Nogo-B receptor stabilizes Niemann-Pick type C2 protein and regulates intracellular cholesterol trafficking. *Cell Metab*. 2009;10(3):208–18.
 37. Westphal V, Kjaergaard S, Schollen E, Martens K, Grunewald S, Schwartz M, Matthijs G, Freeze HH. A frequent mild mutation in ALG6 may exacerbate the clinical severity of patients with congenital disorder of glycosylation Ia (CDG-Ia) caused by phosphomannomutase deficiency. *Hum Mol Genet*. 2002;11(5):599–604.
 38. Imbach T, Grunewald S, Schenk B, Burda P, Schollen E, Wevers RA, Jaeken J, de Klerk JB, Berger EG, Matthijs G, et al. Multi-allelic origin of congenital disorder of glycosylation (CDG)-Ic. *Hum Genet*. 2000;106(5):538–45.
 39. Goreta SS, Dabelic S, Pavlinic D, Lauc G, Dumic J. Frequency Determination of alpha-1,3 Glucosyltransferase p.Y131H and p.F304S Polymorphisms in the Croatian Population Revealed Five Novel Single Nucleotide Polymorphisms in the hALG6 Gene. *Genet Test Mol Biomarkers*. 2012;16(1):50–3.
 40. Vuillaumier-Barrot S, Le Bizec C, Durand G, Seta N. The T911C (F304S) substitution in the human ALG6 gene is a common polymorphism and not a causal mutation of CDG-Ic. *J Hum Genet*. 2001;46(9):547–8.

Submit your next manuscript to BioMed Central and we will help you at every step:

- We accept pre-submission inquiries
- Our selector tool helps you to find the most relevant journal
- We provide round the clock customer support
- Convenient online submission
- Thorough peer review
- Inclusion in PubMed and all major indexing services
- Maximum visibility for your research

Submit your manuscript at
www.biomedcentral.com/submit



3] Discussion

DHDDS-CDG patient

Historical background

In 2010, Pericak-Vance MA. *et al.*, studied an Ashkenazi Jewish (AJ) family in which three of four siblings presented with retinitis pigmentosa (RP). WES revealed a single nucleotide mutation c.124A>G in exon 3 of *DHDDS* (MIM: 608172) causing the highly conserved lysine residue at position 42 to be substituted with glutamic acid¹⁸⁰.

At the same time, another group had been studying the different underlying genetic deficits in autosomal recessive retinitis pigmentosa (ar RP) in an AJ population. Out of eight families, three patients were homozygous for a certain region in chromosome 1p.36.11. that contained the *DHDDS* gene. Accordingly, a cohort of 121 AJ patients with RP was screened for the mutation c.124A>G in the *DHDDS* gene and 12 patients (almost 10 %) had the homozygous c.124A>G (K42E) *DHDDS* variant¹⁸¹.

The impact of the Lys42Glu mutation on DHDDS activity was examined by Pericak-Vance MA. *et al.*, in 2011. Using the MODELER software they created a model of an FPP/Mg²⁺ complex with human DHDDS. According to this model, FPP binds inside the hydrophobic cleft using ion-pairing interactions between the pyrophosphate group of the FPP molecule and the basic amino acid Arg 38. This interaction is facilitated by the basic-basic amino acid repulsive forces between Arg38 and Lys42, where Arg38 is sterically oriented towards the FPP molecule. Substitution of Lys42 with Glu is predicted to cause a complete loss of the activity because Glu42 will compete with the pyrophosphate group for ion-pairing with Arg38¹⁸¹.

Unfortunately, neither of the groups assessed the impact of K42E mutation on enzymatic activity of DHDDS in AJ patients. However, due to the crucial role that dolichol plays in the glycosylation process, the previously diagnosed patients with K42E mutation in *DHDDS* were screened for hypoglycosylated serum Tf. Using IEF, it was demonstrated that none of the patients had abnormal N-glycosylation¹⁶⁶.

○ *Potential impact of low DHDDS expression level on dolichol chain lengths*

The chain lengths of polyprenols/dolichols are characteristic for each *cis*-prenyltransferase among different species¹⁷³. For instance, when yeast *cis*-IPTase (*rer2*), which makes polyprenols of chain length C70-80, was substituted with bacterial UPPS the synthesized polyprenol has a chain length of C55¹⁸².

Using HPLC analysis, the ratio of dolichol species containing 18 and 19 isoprene units (D18 = C90 and D19 = C95, respectively) in plasma and urine from three patients with homozygous K42E mutated *DHDDS* was 8.7 times higher than normal. This ratio was also used to distinguish these patients from carriers of the same mutation, and the patients with the

biallelic K42E mutation had a D18/19 ratio that was 2.7 times higher than that of the carriers¹⁸³.

In a study of another CDG subtype, NUS1-CDG, in which cells from the patient showed reduced DHDDS activity (20 % of the control), the HPLC/MS analysis revealed that the D18/D19 ratio for dolichol recovered from urine and serum of the patient was about 6 times higher than that of the control¹⁴⁶.

In our study, we did not have serum or urine samples from the patient, so we attempted to characterize the dolichol chain length in skin fibroblasts isolated from the patient. We were not able to detect the full chain length dolichols (C90 and C95) in lipid extracts from our control or patient fibroblasts. This might be due to the high limit of detection of TLC method we followed in our study. Instead, we could detect shorter (C15 to C45) polyprenols (Figure 33). We determined the ratio of the shortest isoprenol that could be detected, farnesol (C15) and the longest dolichol (C45). C15/C45 was slightly lower in our patient than in the control (Figure 34).

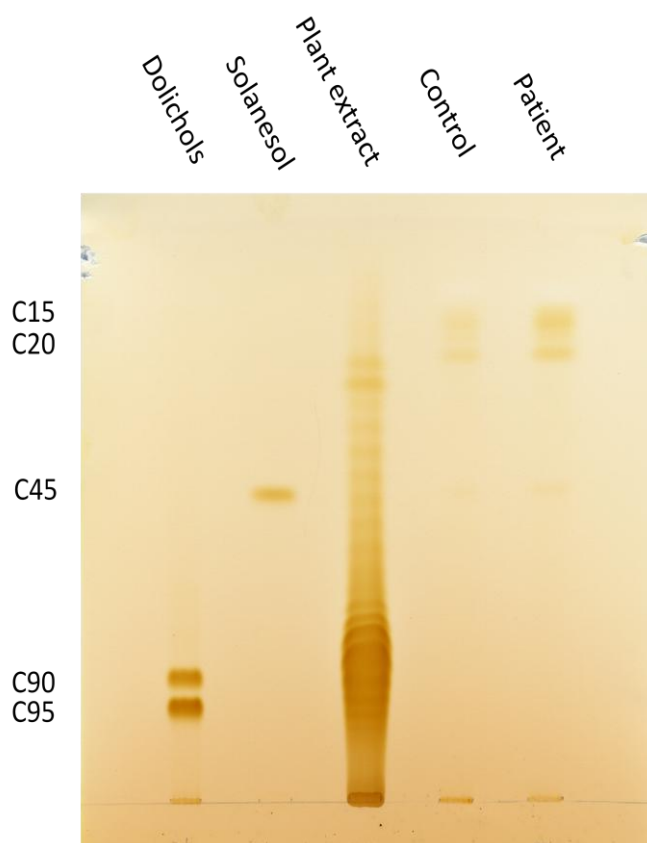

Figure 33: TLC of dolichols extracted from DHDDS-CDG and control

Lipids were extracted according to Wen et al., 2013¹⁸³, and after saponification, dolichols were extracted into n-hexane and analyzed using RP-TLC (98:2 acetone:H₂O). These results are representative for two separate experiments.

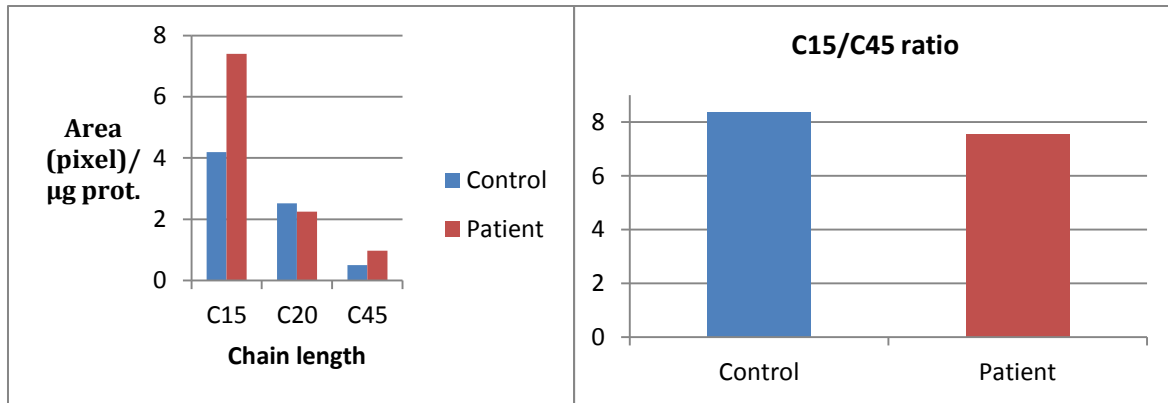

Figure 34: Levels of individual dolichols (right panel) and C15/C45 ratio in the patient and control

Our hypothesis is that, the reduced DHDDS expression level results in accumulation of its substrate FPP, which in turn is dephosphorylated by farnesyl diphosphatase to produce the corresponding alcohol, *trans-trans* (2E, 6E)-farnesol (Figure 35).

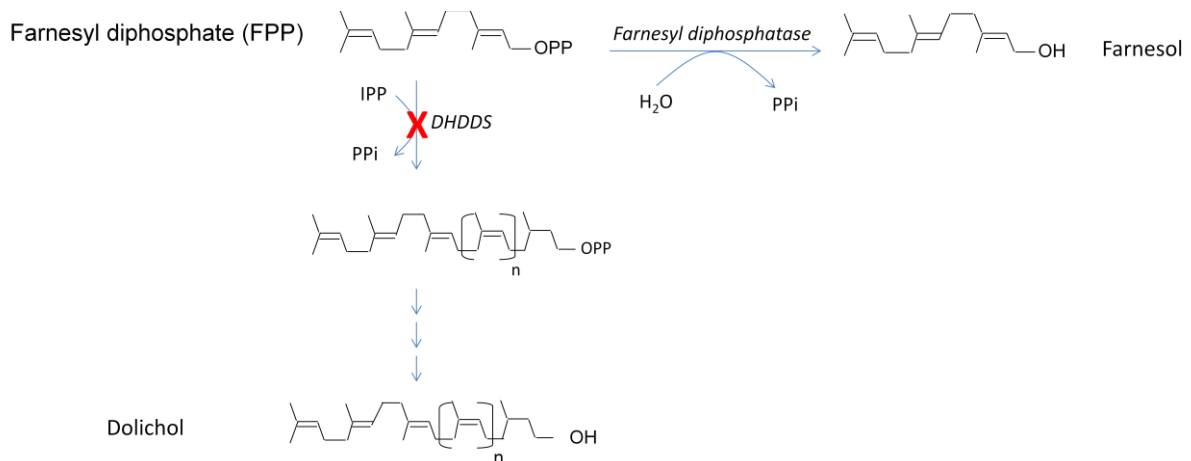

Figure 35: The production of farnesol (C15) in the presence of reduced DHDDS activity

○ *DHDDS accessory proteins*

Immunofluorescence studies show that DHDDS is located to the ER membrane. However, DHDDS has no signal peptide or TM domain. It is now known that DHDDS forms a complex with the Nogo B receptor (NgBR), which is an ER-situated TM protein that is encoded by *NUS1* gene¹⁸⁴, and as it has mentioned before (P. 108), mutated *NUS1* has been associated with reduced DHDDS activity¹⁴⁶. This complex is essential for DHDDS activity. For instance, expression of human DHDDS in the *rer2Δ* yeast strain caused a modest increase in dolichol biosynthesis. However, co-expression of NgBR and DHDDS resulted in a remarkable

elevation of long chain dolichol level. On the other hand, when *rer2Δ* mutant strain was complemented with NgBR alone no dolichol was detected¹⁸⁴.

In our patient fibroblasts, western blotting revealed normally translated amount of NgBR (Figure 36) and WES did not reveal detectable mutations in the *NUS1* gene. Thus, the reduced DHDDS expression level in our patient cell does not result from low NgBR expression. Nevertheless, it is possible that NgBR is not localized correctly in our patient cells.

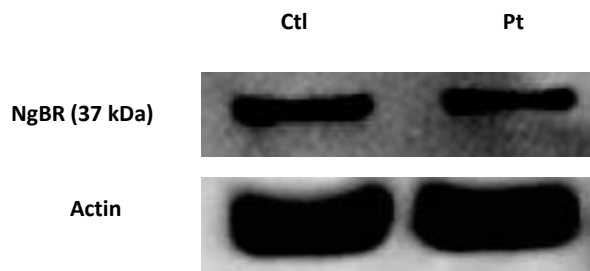

Figure 36: WB of expression level of Nogo B receptor in fibroblasts

(Abcam antibody used: ab168351)

○ *Zaragozic acid (ZA)-induced reduction of truncated N-glycans in skin fibroblasts*

In an attempt to correlate the decreased level of endogenous dolichol phosphate with the high level of truncated oligosaccharides, we treated our patient skin fibroblasts with ZA. This drug is a competitive inhibitor of squalene synthase, the key enzyme in cholesterol biosynthesis, and could divert FPP and IPP, which are the substrates of squalene synthase, toward the dolichol and dolichol phosphate biosynthesis¹⁸⁵.

It has been shown that the size of dolichol phosphate pool in skin fibroblasts from a patient with DPM1-CDG, where there is a defect in dolichol phosphate mannose synthase, was increased from 65 to 120 % of the control after treatment with ZA. In the ZA-treated cells, a reduction in dolichol- and protein-linked M₅GlcNAc₂ was also noted¹⁸⁵.

In our experiment, the DLO fraction showed ZA-induced reduced levels of relatively increased oligosaccharides (M₇ and M₈) in the patient fibroblasts (Figure 37, left panel, lane 6) resulting in a profile similar to that of non-treated control cells (Figure 37, left panel, lane 1). The effect of ZA on NLOs is more profound in comparison with DLOs in both cell populations. Accordingly, the N-linked Man₅GlcNAc₂ species is strikingly reduced in the patient cells that were treated with ZA (Figure 37, right panel, lanes 1 and 6). Incorporation of radioactivity into NLOs is reduced with ZA in both control and patient cells, without striking decreases of incorporation of radioactivity into DLOs.

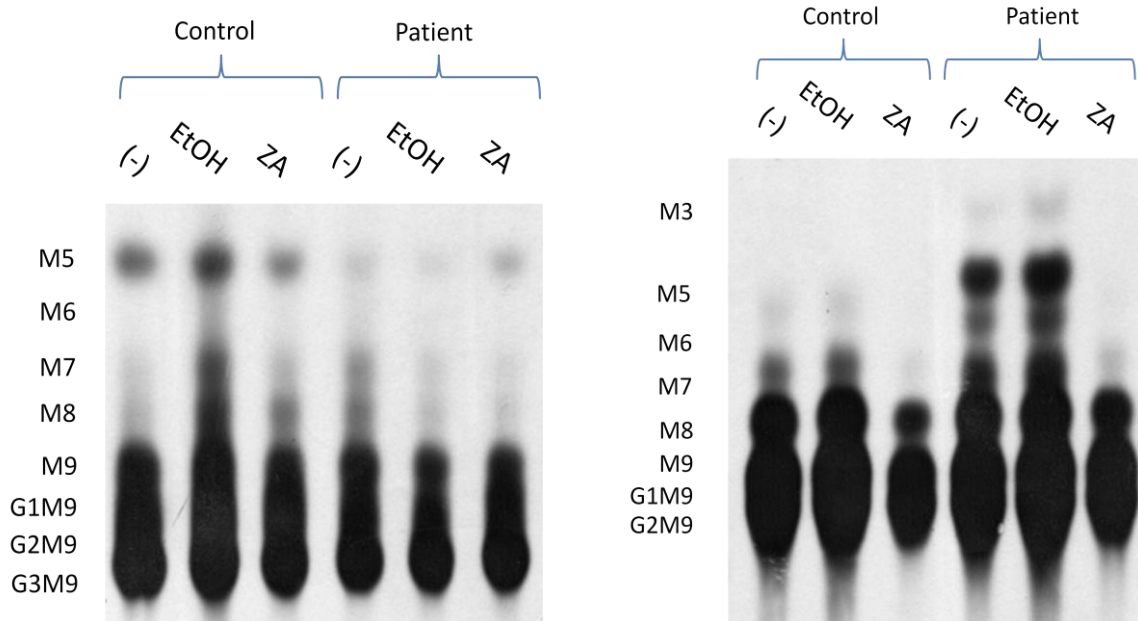

Figure 37: DLO (left) and NLO (right) profiles of ZA-treated fibroblasts

The DLO and NLO profiles were analyzed as described in the article.

Here, two things concerning the DLO profile in patient fibroblasts must be denoted, first, is the profile of non-treated cells (Figure 37, left panel, lane 3) is different from that observed in the first time the cells were metabolically labeled (the article section, Figure 2B, P. 97) suggesting the possibility of losing the phenotype by time. Second, the difference was subtle between the ethanol- and ZA-treated cells, except for M₅, which was higher in ZA-treated cells.

These findings partially agree with those of Haeuptle *et al.*, where ZA treatment of the DPM1-CDG patient skin fibroblasts reduced the amount of the dolichol- and protein-linked truncated oligosaccharides. He suggested that ZA increases the level of endogenous dolichol phosphate thereby allowing increased N-glycosylation process and a reduction in truncated DLO¹⁸⁵.

The data generated by Haeuptle *et al.*, and perhaps our own experiment, demonstrate that dolichol produced from *de novo* synthesis is crucial for normal protein glycosylation in addition to the dolichol phosphate that is recycled during protein N-glycosylation. Our experiment indicates that the beneficial effect of ZA on protein glycosylation is still apparent when the *de novo* dolichol biosynthesis is compromised by low DHDDS activity.

Patient II

Patient II

1] Introduction

1.2] Introduction to experimental work

The second part of my thesis concerns another CDG subtype that is different from Patient 1 in terms of the underlying defective glycosylation pathways and the clinical presentation of the patients.

This patient did not arise from the classic CDG diagnostic strategies outlined in Figure 25. In fact, the clinicians decided upon a WES strategy without any prior knowledge about protein hypoglycosylation. The finding of CST mutations led to the biochemical explorations that were carried out at Hôpital Bichat and in the glycobiology lab at UMR 1149-INSERM-Faculté de Médecine Xavier Bichat.

Here, we are studying the biochemical phenotype of biological material derived from two siblings presenting with thrombocytopenia associated with mutations in gene that encodes the GA-resident cytidine 5'-monophosphosialic acid (CMP-Sia) transporter (CST).

As will be explained in more detail later, CMP-Sia is the Sia donor that is utilized in the sialylation of glycoproteins and GSLs (gangliosides).

In the following subchapter I will present background information on the metabolic pathway of glycoconjugate sialylation and the biological role of CST.

1.2.1] Cellular Sialome

The term ‘‘Sialome’’ is used to describe the total sialoglycan content of an individual or a cell. It includes all the Sia with different linkages and structures that are produced by the cell. The sialome is cell-specific and shows great variability as it is regulated by several genetic, physiologic, pathologic and environmental factors^{111,186}.

The cell surface sialome comprises many types of sialoglycans, each one has several subtypes with different structures in terms of its constituent monosaccharides and glycosidic linkages. The cell surface sialome has been linked to a forest canopy. In this analogy, the terminal Sia residues represent the leaves that are linked to the branches (the rest of sialoglycan chain) via small stems (the α -links). The branches grow from a tree (the sialoglycan core, which could be a glycolipid or a glycoprotein) whose roots are deeply implanted the soil (the cell surface) (Figure 38). All the trees are arranged close to each other on the cell surface producing the glycocalyx which is the forest canopy¹⁸⁷.

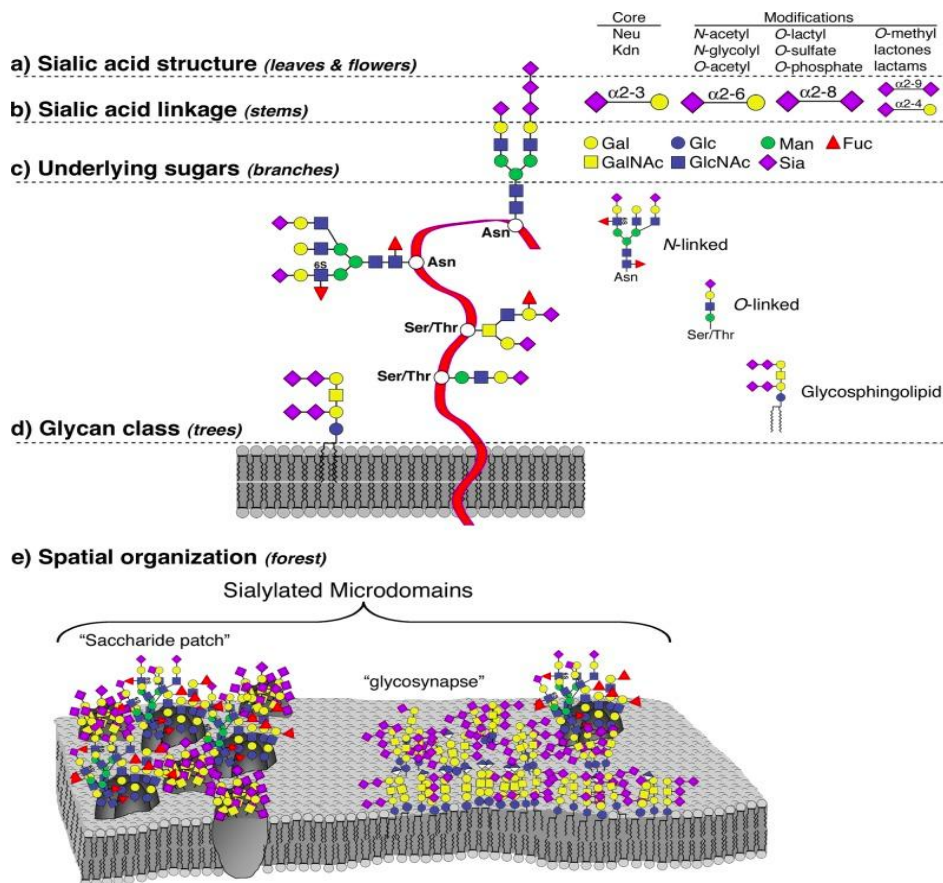

Taken from Hildebrant H. et al, 2014

Figure 38: Different sialoglycan classes, showing their structure and arrangement on the cells surface

1.2.2] Sialoglycan biosynthesis

The sialylation of N- and O-glycoproteins and gangliosides occurs in the GA by the action of about twenty STns of different α -linkage and acceptor specificities. These STns share two major and two minor conserved amino acid sequences called sialylmotifs that are essential for binding the sialic acid donor, CMP-Sia (Figure 39)^{63,188}.

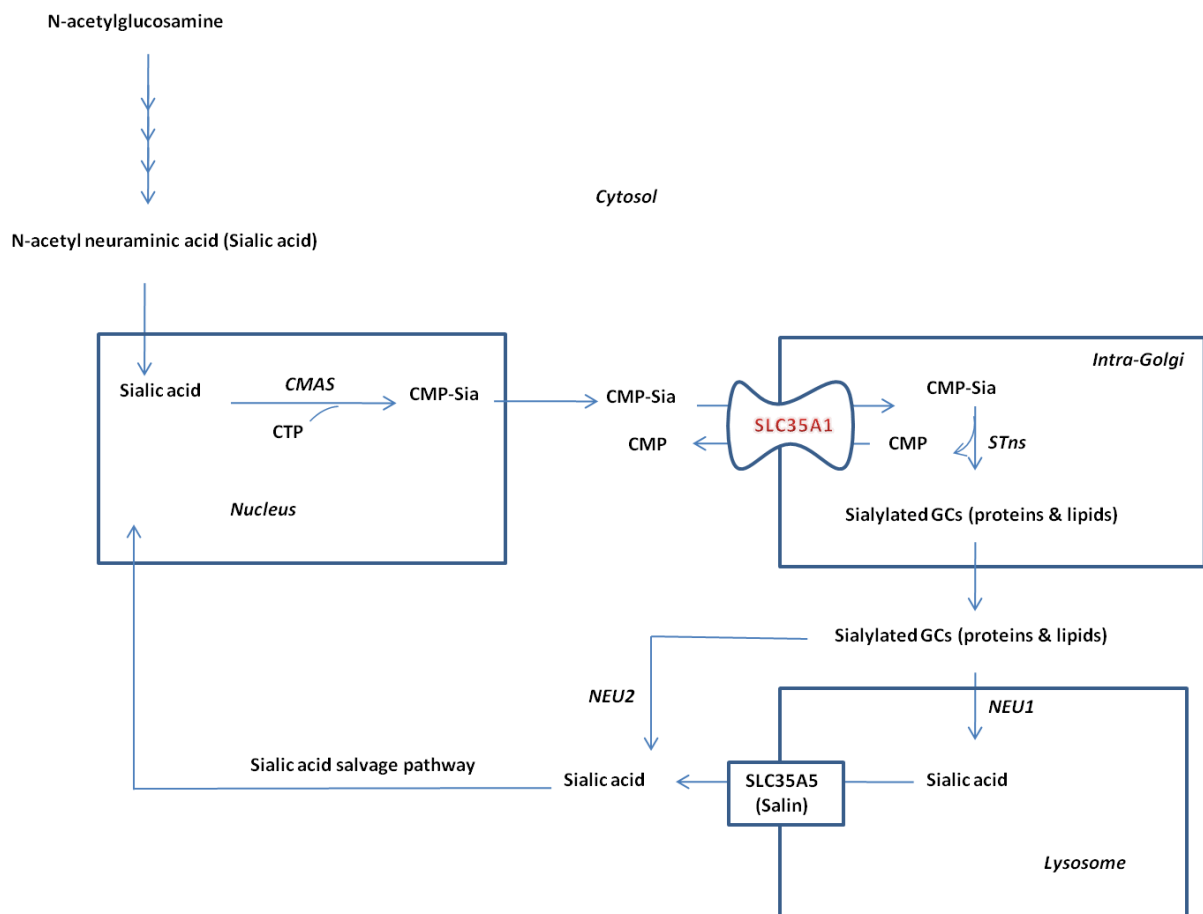

Figure 39: CMP-Sialic acid biosynthesis and utilization in sialoglycan biosynthesis

Figure (39) enzyme key: CMAS, CMP-Sia synthase; CTP, cytidine triphosphate; SLC35A1, solute carrier 35 member A1 or CMP-Sia transporter; NEU1, neuraminidase 1; SLC35A5, solute carrier 35 member A5 or lysosomal sialic acid transporter; NEU2, neuraminidase 2.

1.2.3] Biological importance of sialylation

The terminal non-reducing or “capping” sugar residue of a glycan usually has a determining role in the glycan function. In many glycans the capping sugar is Sia.

1) Sialoglycans mediate many biological processes

Through the specific interaction of their capping Sia residues with their cognate lectins, glycoproteins and GSLs play pivotal roles in many biological processes (see General Introduction, P.49). Based on the type of the lectin that recognizes the terminal Sia, a particular biological event will be initiated. Sia -recognizing lectins are categorized into two families: selectins and siglecs (Sia-binding immunoglobulin-like lectins). Table 3 presents the major characteristics of the two sialic acid binding lectins¹¹¹.

Table 3: Human Sia-binding lectins

	<i>Selectins</i>	<i>Siglecs</i>
Number of identified human lectins	3 lectins: P-, E-, and L-selectins	14 lectins
Biological events mediated by Sia-lectin interaction	Mediate leukocytes and platelets trafficking	<ul style="list-style-type: none"> ○ Involved in immune cell regulation ○ Siglec 4 in myelin stabilization
Sia-cognate specificity	GSLs and glycoproteins with terminal α 2-3 Sia residues linked to fucosylated core structures (for e.g. sialyl Lewis ^x)	Each siglec exclusively recognizes one Sia α - linkage (for e.g.) <ul style="list-style-type: none"> ○ Siglec2 \rightarrow α2-6 Sia residues ○ Siglec8 \rightarrow α2-3 Sia residues linked to galactose residue with C6-sulfate group ○ Siglec7 and Siglec8 \rightarrow α2-8 Sia residues ○ Siglec4 \rightarrow GD1a and GT1b gangliosides

2) Sialoglycans are recognized by viruses and bacteria

The mechanism by which many viruses and bacteria invade the human body involves host cell recognition of the terminal Sia residue on the sialoglycan produced by the invading microbe (see General Introduction, P.22). An example of a host/pathogen interaction mediated by the recognition of sialoglycans by GBPs is the infection by the influenza virus. Here, it is a GBP of the virus envelope, hemagglutinin that recognizes the terminal Sia residues of sialoglycans on the host cell surface^{189,190}. In general, the influenza virus is highly

specific regarding the glycosidic linkage type that is attacked¹⁹⁰. Hemagglutinin of human influenza virus, for instance, recognizes glycans with terminal α 2-6 Sia residues whereas that of the pig influenza virus recognizes glycans with terminal α 2-3 Sia residues¹⁹¹.

3) The lectin-independent roles of sialoglycans

NCAM is responsible for homophilic binding between neuronal cells. NCAM molecules contain variable numbers of polysialic acid (PSA) chains and because of their negative charge, these glycans hinder NACM-dependent homophilic binding. So, the physiological function of NCAM is tuned by of glycosylation¹⁹².

1.2.4] Sialic acid structure and biosynthesis

In 1936, Gunnar Blix isolated a crystalline substance from bovine submaxillary gland mucin and called it “Sialic” after “saliva”¹⁹³. A few years later the German scientist E. Klenk named the hydrolysis product of brain grey matter lipids “Neuraminic acid”¹¹¹. Sia is a nine-carbon acid monosaccharide (Figure 40). Fifty Sia(s) have been identified. Sia(s) display a high degree of structure diversity that results from their (α) linkage to the glycan chain and from their substitution in different positions. Sia forms α -linkages at position C2 with C3 and C6 of galactose residues, C6 of N-acetylgalactosamine residue and C8 of another Sia residue. Sia is modified by its substitution at C5 with an N-acetyl group to make the most common type of Sia, N-acetylneuraminic acid (Neu5Ac)¹⁸⁶.

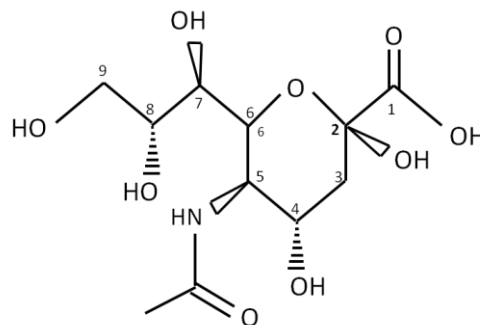

Figure 40: N-acetylneuraminic acid (sialic acid) structure

Free Sia biosynthesis in the cytoplasm is initiated by a bifunctional enzyme called GNE to produce N-acetylmannosamine-6-phosphate (ManNAc6P), which is then condensed with phosphoenolpyruvate to give sialic acid-9-phosphate (Sia9P) by the action of neuraminic acid-phosphate synthase. Sia9P is then dephosphorylated to produce Sia, which is then transported to the nucleus where it gets activated to CMP-Sia (Figure 9 and 40)¹⁸⁶.

1.2.5] Solute Carrier family 35 (CMP-Sia transporter, CST) member 1 (SLC35A1)

Subcellular location: CST is exclusively localized in the medial-trans Golgi stacks, while some other NSTs such as UDP-Gal, GDP-Fuc, UDP-GlcNAc transporters are localized in both ER and GA with different expression levels, (Table 1)⁵⁸.

Structure and topology: CST is a 337 amino acid protein with a molecular weight of 29 kD. CST shares with the other NSTs many structural features. CST is a type III TM protein and it has 10 TM domains (TMDs) where both carboxyl- and amino termini face the cytosol¹⁹⁴. These TMDs of CST were found to play different roles in CMP-Sia transport across the Golgi membranes. TMD 7, for instance, was found to be essential for substrate specificity, and TMDs 2 and 3 are important for the transport process¹⁹⁴. It was found that human CST (hCST) and human UDP-Gal transporter (hUGT) have structural similarity with about 43 % amino acid identity¹⁹⁵.

Function: CST translocates CMP-Sia synthesized in the cytoplasm to the GA lumen. CST is an antiporter. It transports CMP-Sia in exchange for an equal number of CMP molecules that have to be transported out the GA (Figure 10 and Figure 39). The CST is inhibited by CMP but not by Sia. Unlike some NSTs that can transport more than one nucleotide sugar (for example, SLC35D1 is a human transporter that transports UDP-GlcNAc and UDP-GlcA¹⁹⁶), CST shows a high specificity to CMP-Sia¹⁹⁵.

2] Work in progress, results presented in the form of a manuscript

A biochemical study of fibroblasts from patients with mutations in the CMP-Sialic acid transporter gene (*SLC35A1*) reveals a new disorder of gangliosides biosynthesis

Sabry, S.^{1,2,3,4}, *Bruneel, A.*⁵, *Maurey, H.*^{6,7}, *Vuillaumier-Barrot, S.*^{1,2,5}, *Dupré, T.*^{1,2,5}, *Melki, J.*^{6,7}, *Seta, N.*^{5,8}, *Moore, S.E.H.*^{1,2}

¹INSERM U1149, Paris, France, ²Université Denis Diderot, Paris 7, Paris, France, ³Université Pierre et Marie Curie, Paris 6, France, ⁴Biochemical Genetics Department, Human Genetics Division, National Research Center NRC, Cairo, Egypt, ⁵AP-HP, Hôpital Bichat-Claude Bernard, Biochimie, Paris France, ⁶INSERM UMR 1169, Le Kremlin Bicêtre, France, ⁷Université Paris Sud, Orsay, France, ⁸Université Paris Descartes, Paris, France.

Corresponding Author:

Stuart Moore (stuart.moore@inserm.fr)

INSERM Unit 1149, Faculté de Médecine Xavier Bichat, 16 rue Henri Huchard, Paris 75018, France.

Abstract

Background - The CMP-sialic acid (CMP-Sia) transporter (SLC35A1) translocates CMP-Sia from the cytoplasm into the Golgi apparatus where sialyltransferases assure glycoconjugate sialylation. The two cases of congenital disorders of glycosylation (CDG) caused by SLC35A1 mutations (SLC35A1-CDG) so far described, presented with macrothrombocytopenia. One of the patients also presented with hyposialylated plasma glycoproteins associated with CNS deficits and dysmorphias. Here biochemical findings in two siblings presenting with thrombocytopenia and CNS deficits associated with a biallelic, likely damaging, *SLC35A1* (Ser147Pro) variant are reported.

Results - 2-D electrophoresis and mass spectrometry revealed hyposialylated N-, and O-glycoproteins in serum from the patients. Sia assay revealed a 65 % reduction of total glycoconjugate sialylation in skin biopsy fibroblasts from the patient compared to control cells. CMP-Sia levels were variable in patient cells but within the normal range. Lectinoblot using Sia-specific lectins could not detect glycoprotein hyposialylation in extracts of patient cells. Glycosphingolipids (GSL) pattern in patient-derived fibroblasts showed absent a-series gangliosides with abnormally increased GM3 level. GSLs pattern has shown some changes when patient cells had been grown under high- and low-serum culturing conditions. Patient fibroblasts supplementation with exogenous Sia resulted in biosynthesis of some of b-series gangliosides.

Conclusions - These patients add to the previously reported SLC35A1-CDG cases where serum glycoprotein hypoglycosylation, thrombocytopenia and CNS defects are associated with mutations in the CMP-Sia transporter gene. Mutated CMP-Sia transporter is associated with defective a-series gangliosides biosynthesis in an unknown mechanism. Exogenous Sia supplementation has altered gangliosides profile in SLC35A1-CDG patient;

Perspectives - The capacity of the *SLC35A1* (Ser147Pro) variant to restore glycoconjugate sialylation in Lec2 cells is being evaluated. Mass spectrometry is being used to provide more structural information about the altered GSL pattern in patient-derived fibroblasts. The capacity of Sia supplementation to normalize GSL profiles in patient cells is underway.

Keywords - Protein glycosylation, glycosphingolipids, CMP-Sialic acid transporter, thrombocytopenia, Golgi apparatus, SLC35A1-CDG.

INTRODUCTION

Sialic acids (Sia) are structurally diverse and are the most abundant sugars found on glycoconjugates [1]. Sia-containing sugar motifs play important roles in fertilization [2, 3], immune cell interactions [4] and development and functioning of the central nervous system [1]. The commonest form

of Sia, N-acetylneuraminic acid (Neu5Ac), is a constituent of the the sialyl Lewis X antigen (SLe^x , NeuNAc- α 2-3Gal- β 1-4(Fuc- β 1-3) GlcNAc, and the homing of lymphocytes to sites of injury or infection is initiated by SLe^x /selectin-mediated rolling of lymphocytes along the inner

walls of blood vessels [4]. The extent of sialylation of platelet glycoconjugates is determinant in controlling the plasma half-life of platelets and therefore blood clotting [5]. Sialylated glycoconjugates including glycosphingolipids (GSLs) and polysialic acid-containing N-glycoproteins are crucial for brain development and function [1]. The importance of Sia is underlined by the identification of diseases that are caused by mutations in genes required for glycoconjugate sialylation [6, 7]. Glycoconjugates are sialylated by at least 20 sialyltransferases (STns) situated in the lumen of the Golgi apparatus (GA) [8]. These enzymes require the Sia donor CMP-Sia, which is generated by enzymes that are located in both the cytoplasm and nucleus (see Fig 1 for CMP-Sia biosynthesis) [9, 10]. CMP-Sia is then transported from the cytoplasm into the lumen of the GA [11] by the CMP-Sia transporter that is encoded by the *SLC35A1* gene [12].

Two cases of CMP-Sia transporter deficiency (*SLC35A1*-CDG) have been reported. The first patient presented with macrothrombocytopenia and variable neutropenia associated with life-threatening hemorrhagic episodes and recurrent infections, but was otherwise normal [13, 14]. Analysis of serum glycoproteins did not reveal glycan hyposialylation, and this patient died at 3 years of age from complications after a bone marrow transplant [13, 14]. By contrast, the second patient presented with macrothrombocytopenia associated with

hyposialylated serum glycoproteins, microcephaly, facial dysmorphism, intellectual disability, ataxia, and seizures [15].

Here we report on the molecular origin and biochemical findings in 2 siblings presenting with similar multisystem clinical pictures to that of the latter previously described *SLC35A1*-CDG patient [15]. Whole exome sequencing (WES) revealed a homozygous point mutation in the *SLC35A1* gene which gives rise to a CMP-Sia transporter (Ser147Pro) variant that is predicted to be damaged. Serum glycoproteins from patients revealed O- and N-glycan hyposialylation. Whereas glycoprotein hyposialylation could not be demonstrated in skin biopsy fibroblasts from the patients, GSL profiles were modified.

METHODS

Patients - A girl (Pt1), the first of two siblings born to consanguineous parents, was admitted to the clinic at 12 years of age with slow gain of height and weight, dysmorphism, low occipital-frontal circumference (-2DS), severe cognitive deficits, spastic paraplegia, hypotonia, mild epilepsy, thrombocytopenia and haemorrhagic colitis. The brother (Pt2) admitted to the clinic at the same time was 8 years old and presented with dysmorphism, severe cognitive deficits, spastic paraplegia, hypotonia, mild epilepsy, thrombocytopenia and chronic urticaria.

Fig 1

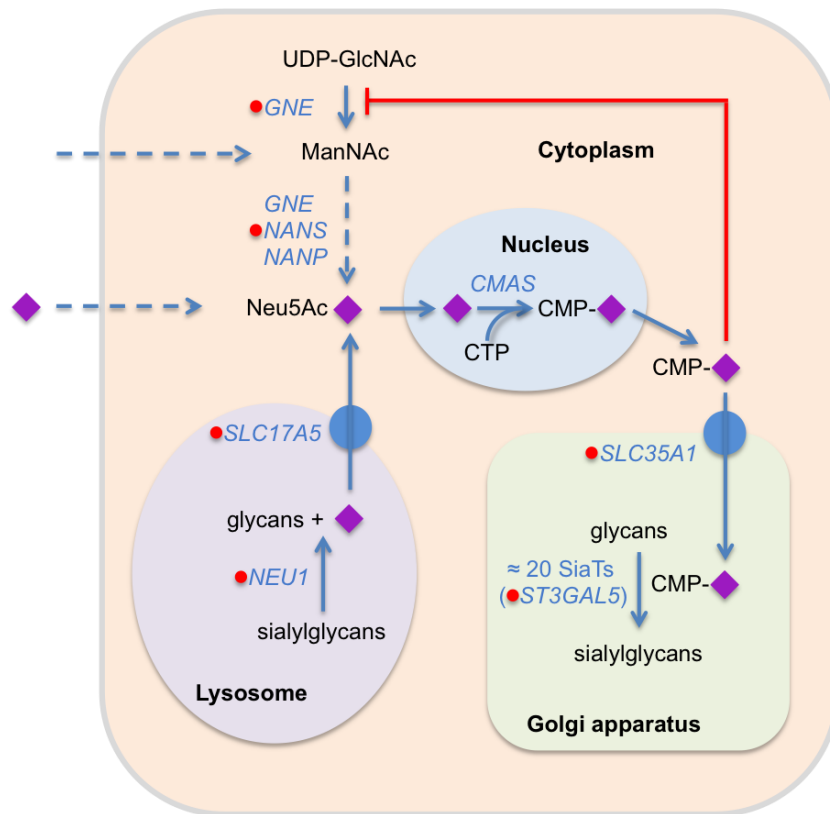

Figure1: The biosynthesis of CMP-Sia and sialylglycoconjugates in mammalian cells – Sialic acids are metabolised by complex pathways. Here, metabolic pathways for Neu5Ac, to commonest Sia in humans, are illustrated. The biosynthesis of Neu5Ac is initiated by the conversion of UDP-GlcNAc into ManNAc and UDP by the UDP-GlcNAc 2-epimerase domain of the GNE protein (*GNE* gene product). ManNAc is then converted to ManNAc-6P by the ManNAc kinase domain of the same GNE protein. ManNAc-6P and phosphoenolpyruvate are condensed to yield Neu5Ac-9P by Neu5Ac-9-phosphate synthase (*NANS* gene product). Neu5Ac-9P is dephosphorylated by Neu5Ac-9-phosphate phosphatase (*NANP* gene product) and the resulting Neu5Ac is activated in the nucleus by CMP-Sia synthase (*CAMS* gene product). Cellular CMP-Sia concentrations are maintained in part by a feedback loop where elevated CMP-Sia inhibits the UDP-GlcNAc 2-epimerase (but not the ManNAc kinase) activity of GNE. The importance of this feedback loop is underlined by the fact that there is no known degradation pathway for CMP-Neu5Ac. The control of glycoconjugate sialylation is determined in large part by cytoplasmic CMP-Neu5Ac concentrations and it has been shown that artificially increasing cytoplasmic CMP-Sia leads to hypersialylation of NCAM. Increasing CMP-Sia has been achieved by incubating cells with ManNAc or Sia. Sialyl glycoconjugates are desialylated in the lysosome by lysosomal neuraminidase (*NEU1*) and the resulting Sia is transported out of the lysosome into the cytoplasm by sialin (*SLC17A5*). Cytoplasmic sialylglycoconjugates are desialylated by cytoplasmic neuraminidase (*NEU2*). Cytoplasmic Sia can be reutilized by a scavenging pathway (not shown). The red dots associated with certain gene names indicate that mutations in these genes have been shown to underlie rare inherited diseases.

Reagents - RPMI 1640 medium, penicillin-streptomycin (PS), fetal bovine serum (FBS), and the BCA™ Protein assay kit were from Thermo Scientific, Cergy Pontoise, FR. Sialic acid, ganglioside standards and SPE EnviCarb columns were purchased from Sigma-Aldrich. Peptide N-glycosidase F (PNGase F) was from Roche Diagnostics, Meylan, Fr. Anti-Tf and anti-AAT antibodies were from Siemens Healthcare GmbH, Erlangen, De. Anti-Hpt and anti-Agp antibodies were from DAKO France, Les Ulis, France.

Cell culture - Skin biopsy fibroblasts [16] and the Chinese hamster ovary (CHO) K1 and Lec2 cell lines (kindly provided by Dr. François Foulquier, Unité de Glycobiologie Structurale et Fonctionnelle (UGSF) Université de Lille, France) were cultivated as previously described [17].

Two-dimensional electrophoresis (2-DE) and Western-blot of serum glycoproteins

Two μL of 10-fold diluted serum/plasma in deionized water was analyzed by 2-D electrophoresis (2-DE)/Western-blot as previously described [18]. 2-DE was carried out as described by the manufacturer's instructions (Life Technologies) using pH 4-7 ZOOM Strips for the first dimension and 4-12% NuPAGE Bis-Tris gels for the second dimension. Proteins were then transferred to nitrocellulose (100 Volts, 1 h) and glycoforms of transferrin (Tf), Aat, Hpt and Agp were detected on the same sheet using a mix of rabbit primary antibodies and HRP-linked anti-rabbit IgG secondary antibody. Antibody dilutions in Tris-buffered saline (TBS) were as follows: anti Tf: 1/4000, anti-Hpt: 1/5000, anti-AAT: 1/10000, anti-AGP: 1/2000 and secondary

anti-rabbit IgG: 1/5000. Finally, 2-DE profiles were acquired using the Chemidoc XRS camera system from Bio-Rad.

Mass spectrometry (MS)-based profiling of plasma N-glycans

Sample processing for N-glycomic profiling of the plasma samples was carried out essentially as described previously [19]. Plasma samples (5 μL) were diluted in 20 mM sodium phosphate buffer (pH 7.4) and 10 mM dithiothreitol solutions, and then heated at 95°C for 5 min. PNGase F digestion of the resulting solutions was then performed overnight at 37°C. After sample acidification, proteins were precipitated using ice-cold ethanol. Released N-glycans were purified using porous graphitic carbon solid phase extraction cartridges (Thermo Scientific, les Ulis, France). The native N-glycans were subsequently permethylated and purified on a C18 spin-column (Thermo Scientific) before analysis by matrix-assisted laser desorption/ionization time-of-flight mass spectrometry (MALDI-TOF MS).

The dried permethylated samples were resuspended in 10 μL of a 50% methanol solution. 0.5 μL of the sample was then spotted on the MALDI target and thoroughly mixed with 0.5 μL of 2, 5-dihydroxybenzoic acid solution (10 mg/mL in 50% methanol containing 10 mM sodium acetate). Glycan analyses were performed on an UltrafleXtreme instrument (Bruker Daltonics, Bremen, Germany) operating in the reflectron positive ion mode. Manual assignment of glycan sequences was done from MS and MS/MS data on the basis of previously identified structures [19] and using GlycoWorkBench software [20].

MALDI-TOF of serum apolipoprotein C-III (Apo C-III) glycoforms - MALDI-TOF analysis of plasma samples was performed as previously described [21]. Plasma samples were worked up as previously described [22]. Briefly, 1.0 μ L of plasma was diluted in 15 μ L of water/acetonitrile/trifluoroacetic acid (95:5:0.1), extracted using C4 Zip-Tip (Millipore) and eluted in 0.75 μ L of water/acetonitrile/trifluoroacetic acid (25:75:0.1). Eluates were applied to the MALDI target and mixed with an equal volume of sinapinic acid as the matrix (saturated solution in water/acetonitrile/trifluoroacetic acid, 50:50:0.1). After crystallization, samples were analyzed with a Voyager-DE STR MALDI-TOF MS (Applied Biosystems) operating in positive linear mode with 200 laser shots per sample (accelerating voltage: 25.000 V, grid voltage: 93%, extraction delay time: 350 nsec, acquisition mass range: 5000–15 000 Da). A laser power of 2211 was chosen after optimization of laser intensity was carried out to determine a power required for high signal to noise ratio with minimal terminal Sia removal. After background subtraction, internal calibration (m/z 9423, Apo C-III1), and smoothing of spectra (Gaussian smooth: 31 points), peaks corresponding to Apo C-III glycoforms were assigned and a peak intensity list was generated. For MALDI-TOF determination of CDG-negative reference values of Apo C-III glycoforms, samples were obtained from 15 CDG-negative patients (previously screened by normal Tf and Apo C-III electrophoresis patterns) encompassing a large clinical spectrum. Comparisons were made according to peak intensity percentages.

Assay of nucleotide sugars - Nucleotide sugars were determined after solid phase (SPE) extraction [23] and HPLC as previously described [24]. Cells were seeded ($1.0 - 2.5 \times 10^5$ cells per 25 cm^2 flask) and grown for 3-5 days prior to being extracted in ice-cold 75% ethanol. After centrifugation, supernatants were dried and loaded onto SupelcleanTM ENVITM-Carb SPE (3 ml) tubes (SIGMA-Aldrich SARL, Saint Quentin Fallavier, FR) in 5 ml 10 mM ammonium bicarbonate. The tubes were washed with the following solutions in the indicated order: 2 ml H₂O, 2 ml 25% acetonitrile in H₂O, 2 ml 50 mM triethylammonium acetate (TEAA), pH 7.0, before eluting sugar nucleotides with 4 ml 25% acetonitrile in 50 mM TEAA, pH 7.0. The sugar nucleotides were analysed by HPLC (Waters 600 solvent delivery system) on a reversed phase column (Inertsil ODS-4 (particle size, 3 μ m; 250 x 4.6 mm; GL Science) equilibrated in buffer A: 100 mM potassium phosphate buffer pH 6.4 containing 8 mM tetrabutylammonium hydrogensulphate. Sugar nucleotides were injected onto the column in a volume of 20 μ L and separated by elution with the same buffer at 0.5 ml / min for 50 min. Subsequently, a linear gradient 0 – 77 % buffer B (70 % buffer A and 30% acetonitrile) over 40 min was applied. Nucleotide sugars were detected by spectrophotometer (Waters 2487 Dual Wavelength Detector) at 254 nm.

Sialic acid assay – Free Sia was measured using the thiobarbituric acid (TBA) assay [25], after being released from whole cell pellets by heating with 50 mM H₂SO₄ at 100°C for 1h. After neutralization with equimolar barium acetate, the mixture was clarified by centrifugation and aliquots of

the supernatant were taken for assay. Control samples in which the hydrolysis step was omitted were included, and parallel cell pellets were taken for protein assay.

Analysis of GSLs - Lipids were extracted by the method of Svennerholm [26], using 4 x 225 cm² tissue culture flasks for each sample. The aqueous phase obtained, containing gangliosides, was evaporated to dryness, applied to a C18 Sep Pak cartridge, and washed extensively before eluting the gangliosides with 100 % methanol. After drying, the gangliosides were resuspended in chloroform/methanol, 2/1, by vol, and analyzed using high performance thin layer chromatography (HPTLC) (Silica gel 60) plates developed in chloroform/methanol/0.2% aqueous CaCl₂, 55/42/11, by vol (solvent system A). Visualization was performed using the orcinol/H₂SO₄ spray reagent. The organic phase obtained after the Svennerholm extraction, containing neutral GSLs, was evaporated to dryness, and after mild alkaline hydrolysis, the neutral GSLs were resuspended in chloroform/methanol, 4/1, by vol, and analyzed using HPTLC (Silica gel 60) plates developed in chloroform/methanol/formic acid/water, 65/25/8.9/1.1, by vol (solvent system B).

Lectinoblot - Proteins were extracted using a lysis buffer containing 20 mM Tris-HCl, 150 mM NaCl, 1 % TX-100, 1 % protease and phosphatase inhibitors, and subjected to SDS-PAGE using NuPage 4 -

12 % Bis-Tris gels (Fisher-Thermo Scientific). Lectinoblots were performed as previously described [27] using biotinylated *Maackia amurensis* (MAA) lectin II and *Sambucus niger* (SNA) lectin (Vector Laboratories) at a concentration of 5 µg / mL.

Supplementation of fibroblasts with sialic acid - 2 x 225 cm² tissue culture flasks with about 65 % confluent fibroblasts were supplemented with 5 mM (one supplementation) or 10 mM (3 supplementations) in RPMI medium containing 2 % FBS. The cells were harvested after 3 days supplementation with 5 mM Sia and 11 days with 10 mM Sia.

RESULTS

A biallelic *SLC35A1* mutation in siblings presenting with thrombocytopenia and CNS defects

Two siblings born of consanguineous parents presented with thrombocytopenia associated with CNS signs as detailed in the Table. WES of patient DNA revealed a homozygous mutation in the *SLC35A1* gene (NM_006416.4, c.439T>C, p.Ser147pro). As can be seen in the Table, although the two previously characterized *SLC35A1*-CDG patients also present with thrombocytopenia, only the case described by Mohamed *et al.* presented with CNS signs similar to those of the patients reported here.

Table: Clinical presentations and mutations of the two known cases of SLC35A1-CDG and the presently described siblings

Report	Willig T-N, et al. [13] Martinez-Duncker et al. [14]	Mohamed, et al. [15]	Present report
Sex / Age / Consanguinity	- Boy / 4 m / ?	- Girl / 7 y / yes	- Girl / 12 y / yes - Boy / 8 y / yes
At birth	Uneventful	Uneventful	Thrombocytopenia
CNS	- Intellectual disability - Seizures - Ataxia	- Cognitive disability - Spastic tetra-paresis - Epilepsy - Hypotonia	- Cognitive disability - Spastic tetra-paresis - Epilepsy - Hypotonia
Skeletal signs	- Microcephaly - Facial dysmorphism - Clinodactyly - Bilateral Hallux valgus - Joint hyperlaxity	- Dysmorphism - Abnormal movement of extremities - OFC: - ZDS	- Dysmorphism - Abnormal movement of extremities
Growth		- Retardation (height/weight)	
Blood	- Macrothrombocytopenia - Variable neutropenia - Life-threatening haemorrhagic episodes and repeated infections	- Macrothrombocytopenia	- Thrombocytopenia
Notes	Patient dies at 37 m after bone marrow transplant.	- Inflammatory digestive disease	- Chronic urticaria
Notes	Patient dies at 22 y after complications from emergent laparotomy with cholecystectomy		
Mutations	[c.147T>C + c.277del + c.281del] (father) + [c.752-157_752-156insCTCA] (mother)	[c.303G>C p. Gln101His] + [c.303G>C p. Gln101His]	[c.439T>C p.Ser147Pro] + [c.439T>C p.Ser147Pro]

Glycan profiling of serum glycoproteins

In the first reported case of SLC35A1-CDG, isoelectric focusing (IEF) revealed normal sialylation of serum Tf and Western Blot (WB) analysis also revealed normal glycosylation profiles for Tf, α 1-antitrypsin (Aat), haptoglobin (Hpt) and α 1-acid glycoprotein (Aag), which all possess N-glycans only [13, 14]. By contrast, in the second reported case of SLC35A1-CDG, IEF revealed hyposialylated Tf, and MS profiling of plasma total N-glycans also revealed increased amounts of hyposialylated structures [15].

Furthermore, IEF demonstrated hyposialylation of plasma Apo C-III, which possesses a single mucin-type O-glycan [15]. 2-D electrophoresis results of plasma proteins from the siblings reported here is shown in Figure 2 and it is apparent that the Tf, Aat and Hpt profiles are abnormal and reveal the increased presence of hyposialylated glycoforms. MS analysis of plasma total N-glycans is shown in Figure 3, where it can be seen that N-glycans from the control plasma comprise mainly the disialylated biantennary structure (m/z : 2792.4) and smaller amounts of its monosialylated counterpart (m/z : 2431.2), the trisialylated triantennary component (m/z : 3602.8) and smaller amounts of its disialylated counterpart (m/z : 3241.6) are also apparent. The N-glycan profiles derived from the patients' serum are different and are enriched in structures missing Sia residues so that the predominant biantennary and triantennary structures possess only a single Sia residue. 2-D electrophoresis followed by Apo C-III immunodetection, and MS of Apo C-III, shown in Figures 4A and 4B, respectively, demonstrate that the relative

amount of the glycoprotein containing the non-sialylated O-glycan (Apo C-III_{0c}) is increased in both patients, and the ratio of the relative amounts of Apo C-III bearing the monosialylated O-glycan (Apo C-III₁) to that with the monosialylated O-glycan (Apo C-III₂) is increased about two-fold. Accordingly, the biallelic *SLC35A1* (Ser147pro) variant is associated with hyposialylation of multiple serum N-glycoproteins and the O-glycoprotein, Apo C-III.

The *SLC35A1* Ser147pro substitution is predicted to destabilize a transmembrane helix that is important for CMP-Sia transport

Four prediction softwares predict a deleterious effect of the Ser147pro substitution on CMP-Sia transporter function: Align GVGD; C25 (GV: 30.92 - GD: 65.28), SIFT; deleterious (score: 0.02, median: 3.50), MutationTaster; disease causing (p-value: 1) and Polyphen2 (HumDiv 1 and HumVar 0.989) probably damaging. Bioinformatics and experimental approaches indicate that the CMP-Sia transporter comprises 10 transmembrane domains (TMDs) of which TMDs 2, 3, and 7 seem to be required for CMP-Sia binding whereas TMDs 5-8 have been suggested to form a hydrophilic pore [28, 29]. The amino acid sequence alignments shown in Figure 5 demonstrate that the TMD5 sequences are highly conserved in the CMP-Sia (14/19 residues conserved) and UDP-Gal (12/19 residues conserved) transporters, and despite each having its own signature sequence, 8 residues, including Ser147, are common to this TMD in both class of transporter. The short cytoplasmic loop between TMDs 4 and 5 is also important for CMP-Sia transporter activity because the genetically

engineered *SLC35A1*(Leu136Gly) variant is inactive [29]. It would appear, therefore, that a region comprising TMD5 along with the cytoplasmic loop that links this TMD to TMD4 is crucial for activity. When proline residues occur in TMDs they are often highly conserved (e.g. proline 162 in TMD5 of CMP-Sia transporters; see sequence alignment in Figure 5) [30]. These residues perform important

structural functions on account of their capacity to disrupt α -helices [31]. Accordingly, inappropriate insertion of a Pro residue into a TMD is predicted to have profound consequences [30].

Fig 2

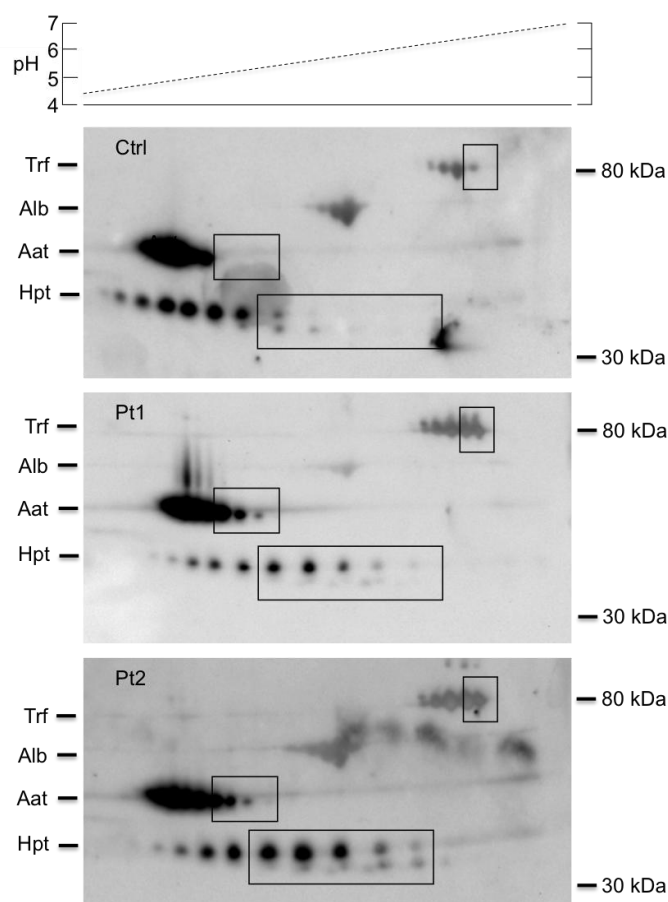

Figure 2: 2-D electrophoresis of plasma N-glycoproteins – A. 2-D electrophoresis of serum proteins derived from a control subject (Ctrl) and the patients (Pt1 and Pt2) was performed as described in Materials and Methods. In the first dimension, proteins were focused in a linear (4 - 7) pH gradient as indicated above the gel scans. After running in the second dimension proteins were transferred onto nitrocellulose membranes that were probed with an antibody mix containing antibodies against transferrin (Tf), albumin (Alb), α 1-antitrypsin (Aat) and haptoglobin (Hpt). The boxes indicate the migration positions of hyposialylated glycoforms.

Fig 3

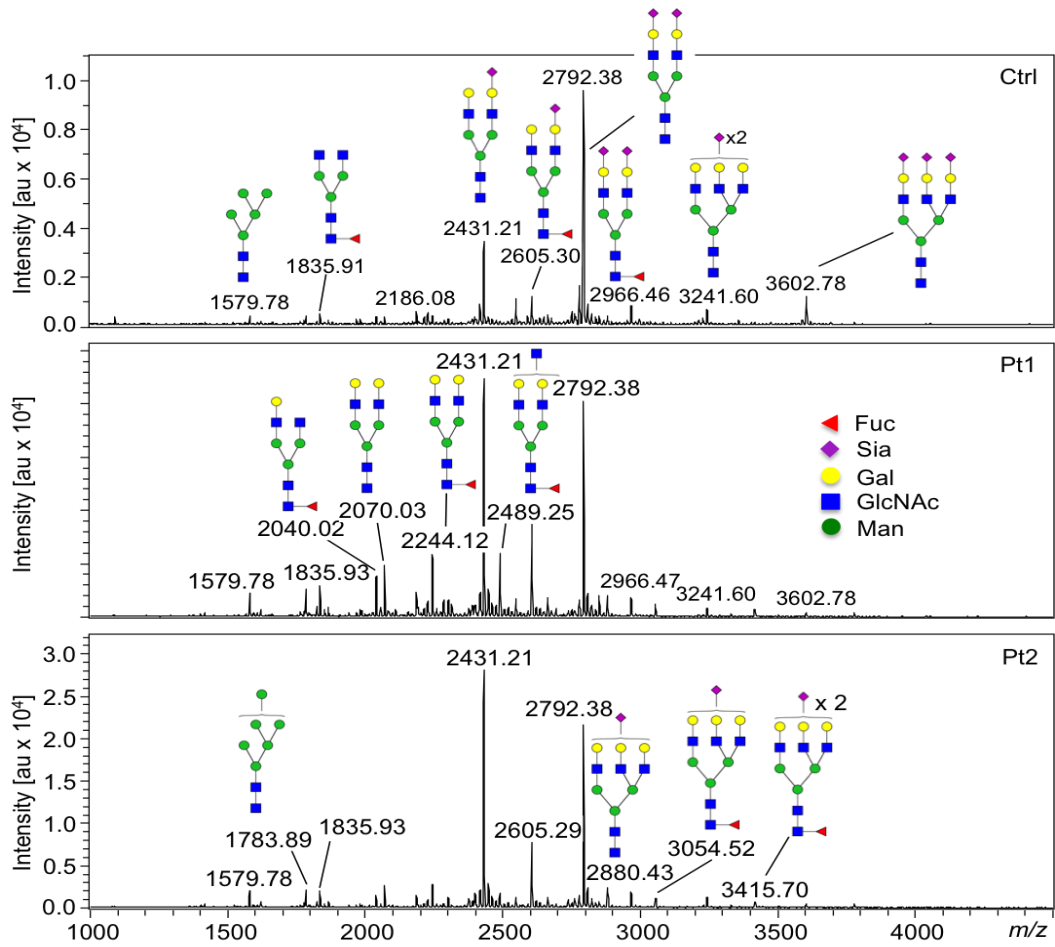

Figure 3: Characterization of whole serum N-glycans by mass spectrometry - Mass spectra of N-glycans released from total serum glycoproteins from a control subject (Ctrl) and the two patients (Pt1 and Pt2). au: arbitrary units, m/z: mass-to-charge ratio.

Fig 4

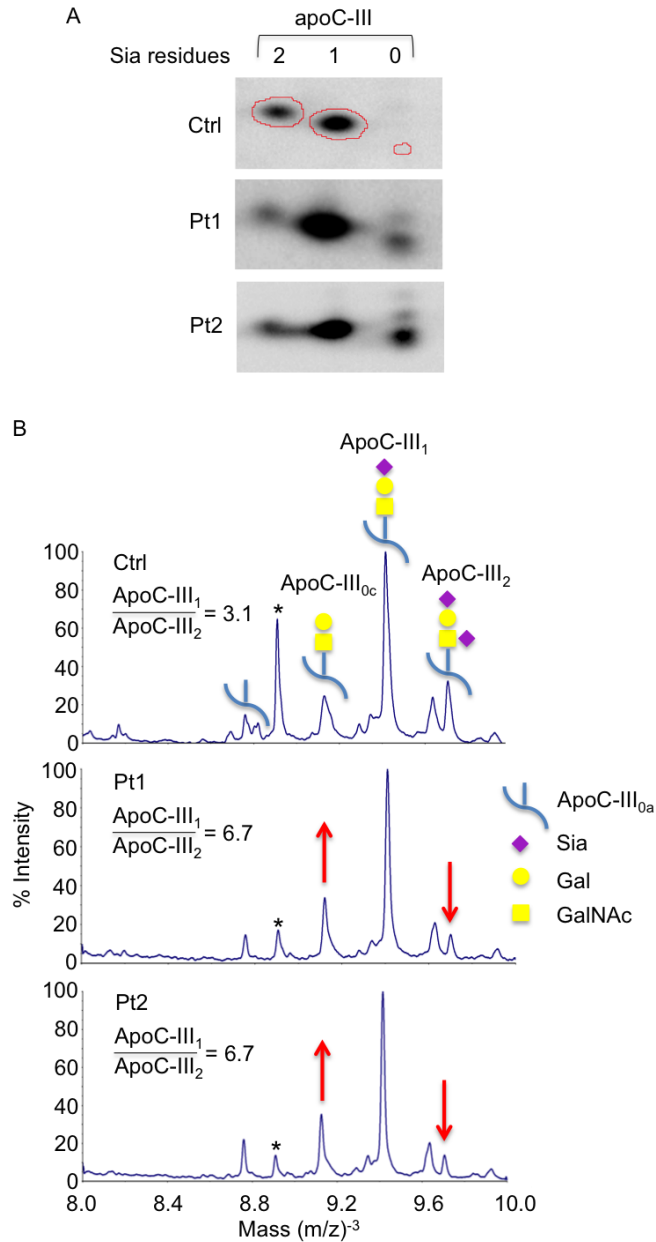

Figure 4: Analysis of plasma apolipoprotein C-III glycoforms - A. 2-D electrophoresis of serum proteins derived from a control subject (Ctrl) and the patients (Pt1 and Pt2) was performed as described in the legend to Figure 2. After transfer of proteins to nitrocellulose membranes, apolipoprotein C-III (Apo C-III) glycoforms were probed by immunodetection. The migration positions of Apo C-III glycoforms possessing 0, 1 and 2 Sia residues are indicated. B. MALDI-TOF spectra of affinity purified Apo C-III glycoforms. Peaks associated with unglycosylated (Apo C-III_{0a}), non-sialylated, (Apo C-III_{0c}), mono-sialylated (apo C-III₁) and di-sialylated (Apo C-III₂) Apo C-III are shown. The peak indicated with an asterisk corresponds to contaminating Apo C-III.

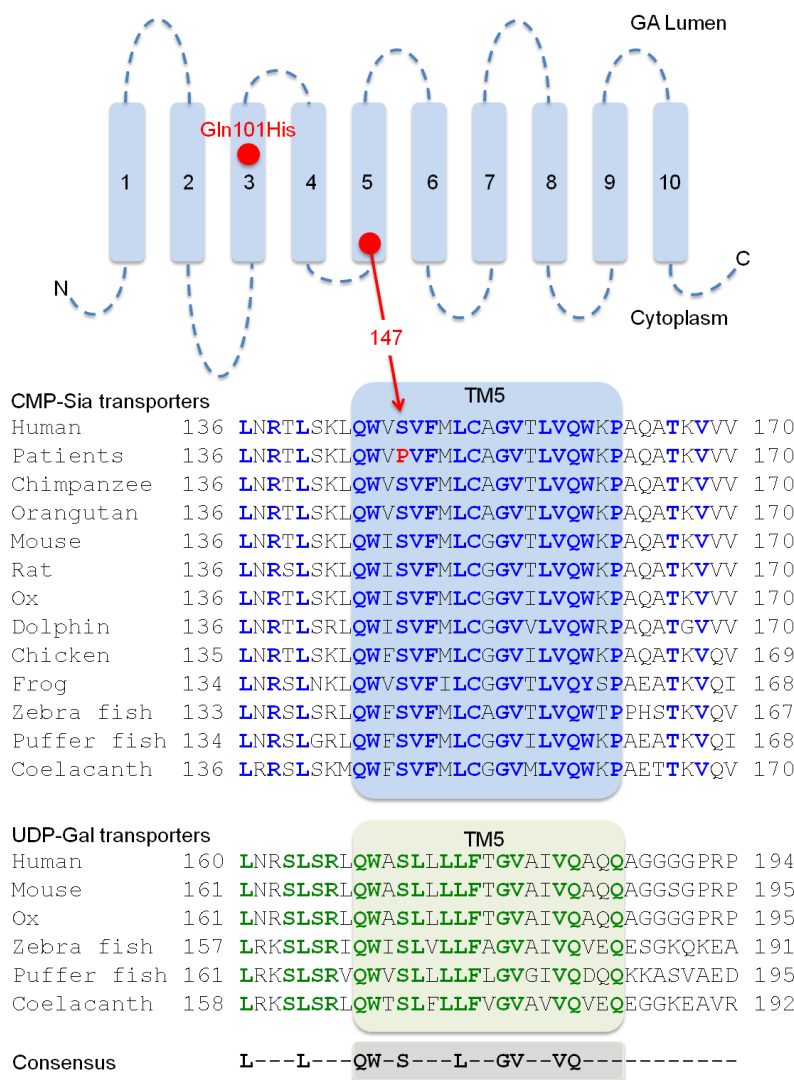

Figure 5: A point mutation in the CMP-Sia gene (*SLC35A1*) generates a Ser147Pro substitution in the 5th transmembrane region – A. Bioinformatic and biochemical approaches suggest the indicated model for the membrane organization of the CMP-Sia transporter [28]. The red spot in the TMD3 indicates the position of the Gln101His substitution that has previously been shown to be causal for SLC35A1-CDG [15]. The red spot in TMD5 region indicates the position of the Ser147Pro substitution, reported here. B. The amino acid sequences of TMD5 of CMP-Sia and UDP-Gal transporters of several species were aligned. CMP-Sia transporters: human, *H sapiens* (P78382); chimpanzee, *P troglodytes* (H2R738); orangutan, *P abelii* (Q5RAS4); mouse, *M musculus* (Q61420); rat, *R norvegicus* (A0A0G2JZH4); Ox, *B taurus* (Q3SZP1); dolphin, *T truncatus* (ENSTTRT00000008929.1); chicken, *G gallus* (F1P1R6); frog, *X tropicalis* (F7AZP3); zebra fish, *D rerio* (B3DIQ6); puffer fish, *T nigroviridis* (Q4RQX5); coelacanth, *L chalumnae* (H2ZTX2). UDP-Gal transporters: human, *H sapiens* (P78381); mouse, *M musculus* (A2AER4); Ox, *B taurus* (F1MZI7); zebra fish, *D rerio* (F1Q5Y0); puffer fish, *T nigroviridis* (H3CB02); coelacanth, *L chalumnae* (H3B0T5). The Ser residue at position 147 of the human CMP-Sia transporter polypeptide sequence is highly conserved in both the CMP-Sia and UDP-Gal transporters.

Analysis of CMP-Sia levels and glycoconjugate sialylation in patient fibroblasts

To date there is little information on the glycosylation status of fibroblasts from patients diagnosed with SLC35A1-CDG. CMP-Sia levels have been found to be similar in CMP-Sia transporter-deficient CHO cell lines, Lec2 cells, and wild type CHO-K1 cells [32, 33]. Nevertheless, blocks in both glycoprotein and glycolipid sialylation have been noted [32, 33]. First, CMP-Sia levels were assayed in patient and control skin biopsy fibroblasts as well as in the Lec2 and wild type CHO-K1 cell lines as shown in Figures 6A, B and C. CHO cells contain small amounts of CMP-Sia when compared to either UDP-Glc/Gal or UDP-GlcNAc/GalNAc. Lec2 cells contained more UV absorbing material co-eluting CMP-Sia than the wild type cells. Confirmation of the elution position of CMP-Sia in these analyses was achieved by mixing the cellular nucleotide sugar extracts with standard CMP-Sia. The quantities of CMP-Sia in control and patient fibroblasts were found to be variable with respect to the quantities of other nucleotide sugars present in the same samples. Assuming that that no other UV substances co-elute with CMP-Sia, we can conclude that CMP-Sia levels in the patient cells are within the range of those seen in the two control cell lines. Next, Sia, released from total cellular glycoconjugates by hydrolysis with 50 mM H₂SO₄, was measured using the highly specific TBA assay, as described in Methods. Because cells can scavenge Sia from serum glycoconjugates (See Figure 1), which could mask a subtle sialylation defect, cells were cultivated in medium

containing low (2%) and normal (10%) levels of fetal bovine serum (FBS). Results, shown in Figure 6D show that when cells are grown in medium containing 2% FBS there is a 65% decrease in total glycoconjugate Sia in patient fibroblasts compared to control cells. This difference is not apparent when cells are grown in medium containing 10% FBS, although both cell lines display higher levels of bound Sia. Next, in order to determine whether or not glycoproteins are hyposialylated in patient fibroblasts, SDS-PAGE of cell protein extracts were performed, glycoprotein sialylation was assessed using MAA lectin that selectively binds to α 2-3 linked Sia, and SNA lectin that binds both α 2-3 and α 2-6 linked Sia, with a preference for the latter [34]. Similar results were obtained with both lectins, and results obtained with MAA are shown in Figure 6E and F. First, MAA staining of membranes revealed little difference between proteins derived from the control and patient cell extracts (Figure 6E). In order to test the validity of this procedure, Lec2, CHO-K1, as well as the patient and control fibroblast cell extracts were treated with sialidase before SDS-PAGE. As a supplementary control, apo Tf was also treated with sialidase and submitted to SDS PAGE. The lectinoblots are shown in Figure 6F, and show that the sialidase treatment strikingly reduces the MAA signal. However, these MAA lectinoblots did not reveal glycoprotein hyposialylation in the Lec2 cells that have been previously shown, by other methods, to produce hyposialylated glycoproteins [32, 33].

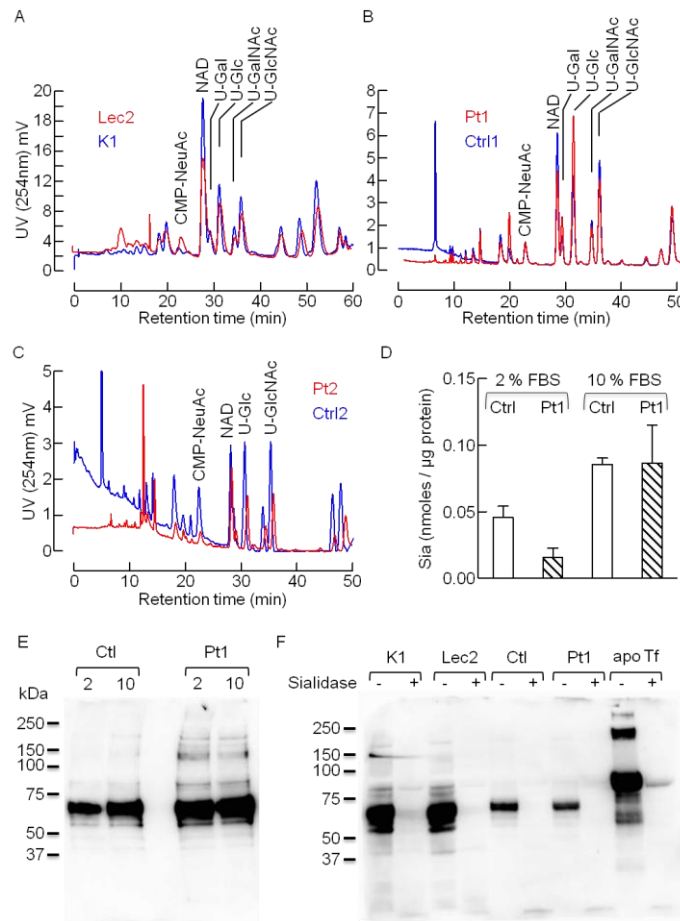

Figure 6: *CMP-Sia* levels and glycoconjugates sialylation in CHO-K1 and Lec2 cells and skin biopsy fibroblasts from the patients – A - C. CHO-K1 and Lec2 cells along with skin biopsy fibroblasts derived from the two patients (Pt1 and Pt2) and two normal subjects (Ctrl1 and Ctrl2) were cultivated in medium containing 10 % FBS. Cells were harvested, washed with PBS and then scraped from the flasks in ice-cold 75% ethanol. After centrifugation, the supernatants were dried under vacuum and nucleotide sugars were recovered from this material by SPE as described in Methods. Nucleotide sugars were resolved by reversed phase HPLC and detected by monitoring the UV absorbance of the column effluent at 254 nm. The quantity of material injected was not normalized for cell number. Cells from patient 2 grow slowly and fewer cells were harvested. The elution times of standard CMP-Sia (CMP-NeuAc), UDP-Glc (U-Glc), UDP-Gal (U-Gal), UDP-GlcNAc (U-GlcNAc) and UDP-GalNAc (U-GalNAc) are indicated. D. Control (Ctrl) and patient 1 (Pt1) fibroblasts were grown in media containing 2 % and 10 % FBS. Cells were harvested, washed with PBS and pelleted by centrifugation. Protein and total glycoconjugate-linked Sia was measured as described in Methods. The results are expressed as the mean and standard error of the mean of three experiments. E. Cells, grown as described above, were washed, lysed and submitted to SDS-PAGE as described in Methods. After transfer of proteins to nitrocellulose membranes, sialylglycoconjugates were detected using biotinylated MAA lectin and HRP-streptavidin. D. In another experiment the indicated cells were cultivated in medium containing 10 % FBS and lysed as described above. The cell lysates, and the sialylglycoprotein apo transferrin (apo Tf), were incubated in the presence or absence of sialidase for 1h at 37°C. The samples were then analyzed by SDS-PAGE as described above.

Altered GSL profiles in patient cells – GSLs extracted from Lec2 cells have previously been shown to be hyposialylated [32, 33]. Wild type CHO-K1 cells have unusual GSLs because GM2 synthase (B4GALNT1; [35]) and GD3 synthase (ST8SIA1;[36]) required for complex GSL biosynthesis are deficient (Figure 7A). Furthermore, Gb3 synthase (A4GALT) is also deficient, leading to an absence of the globo series GSLs, Gb3 and Gb4 [37]. Therefore CHO-K1 cells reveal a simple GSLs profile comprising mainly GM3 and smaller amounts of lactosylceramide (Figure 7A and 7B). As has been reported previously [32, 33], Lec2 cells synthesize GM3 inefficiently, and lactosylceramide accumulates (Figure 7A and 7B). By contrast, control human skin biopsy fibroblasts produce a complex mixture of GSLs comprising mainly Gb3, Gb4, GM3, and lesser amounts of structures that migrate in the regions of GM2 and GM1 (Figure 7C). Components with migration positions similar to GD1a and GD1b were also noted in the control cells. The profile of GSLs extracted from control cells did not vary strikingly as a function of the amount of FBS in the cell culture medium (Figures 7C and D). GSLs extracted from patient cells, however, revealed a different profile, with reductions

in GM2, and the components migrating in the GD1a and GD1b regions. In addition, a relatively less intense band was observed in position suspected to be the migration position of GD3 (no GD3 standard was loaded on the plate). Indeed, taking into account the amount of material loaded onto each lane (see legend to Figure 7C) it can be seen that GM3 and the neutral GSLs (GB3 and GB4) occur at higher levels in the patient cells. Finally, as shown in Figure 8A, cell supplementation with 5 mM Sia caused a significant increase of GM3 in patient cells compared to control cells. Nevertheless, in a second supplementation experiment in which the cells were supplemented 3 times with 10 mM Sia, it was noticed that a component migrating as GD1b was selectively increased in the patient cells. Under these conditions, GD1a was not detected in either the control or patient cells irrespective of Sia treatment, and GD1b was the major ganglioside detected in control cells in the absence of Sia supplementation.

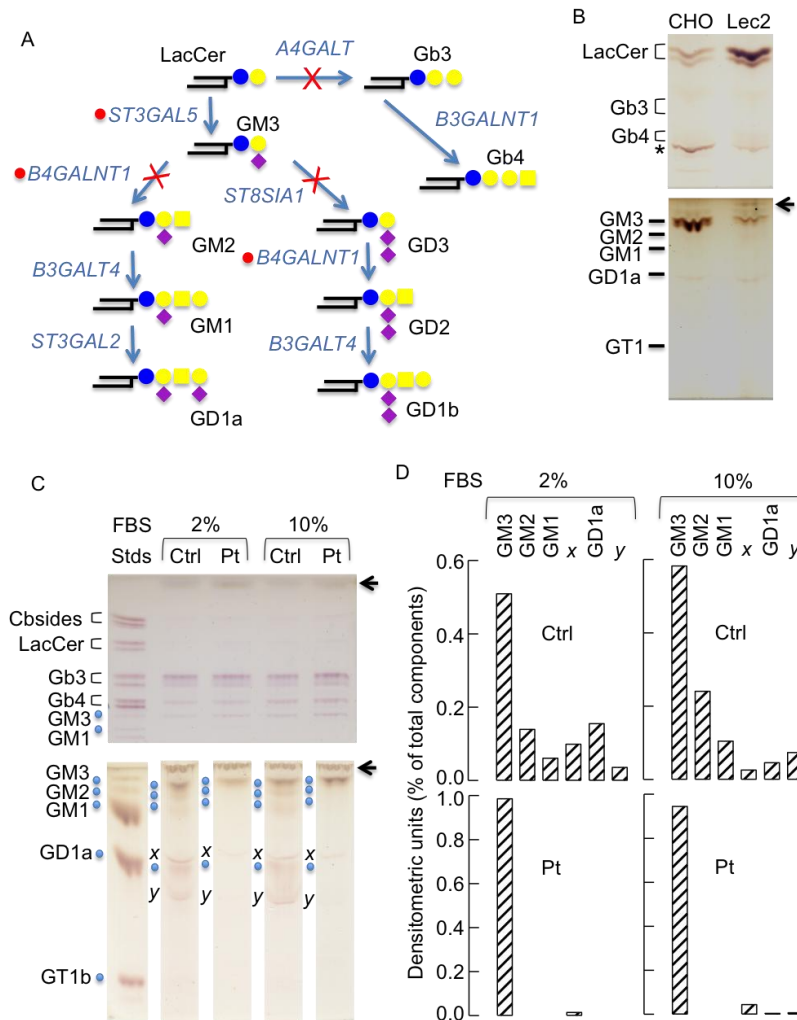

Figure 7: Analysis of GSLs in CHO-K1 and Lec2 cells and control and patient fibroblasts – A. A simplified scheme showing the biosynthetic relationships that exist between the GSLs mentioned in the text (LacCer, lactosylceramide). The genes encoding the enzymes are indicated. GM2/GD2 synthase is encoded by *B4GALNT1* whereas GM3 synthase is encoded by *STL3GAL5*, and mutations in these genes cause rare inherited diseases (red dots). The red crosses indicate enzyme reactions that are defective in CHO-K1 cells. B. CHO-K1 and Lec2 cells were harvested and GSLs were extracted according to the procedure of Svennerholm as described in Methods. After the phasing step, lower phase, mainly neutral components were resolved by HPTLC in solvent system A (upper panel) whereas upper phase components were resolved by HPTLC in solvent system B (lower panel). Both HPTLC plates were stained with the H_2SO_4 /orcinol reagent. The migration positions of standard GSLs are shown to the left of the chromatograms. The arrowhead indicates the position of the solvent front. C. Control and patient fibroblasts were grown as described in the legend to Figure 6D. After harvesting and washing with PBS, GSLs were extracted from the cell pellets and resolved by HPTLC as described above (upper panel, lower phase, mainly neutral, components; lower panel upper phase, mainly charged, components). Different protein equivalents were spotted in each lane: Ctrl (2% FBS), 185.1 μ g; Pt (2% FBS), 49.3 μ g; Ctrl (10% FBS), 343.9 μ g; Pt (10% FBS), 227.8 μ g. D. The plates shown in C were scanned and quantified and the amount of each component has been expressed as a fraction of the total recovered.

Fig 8

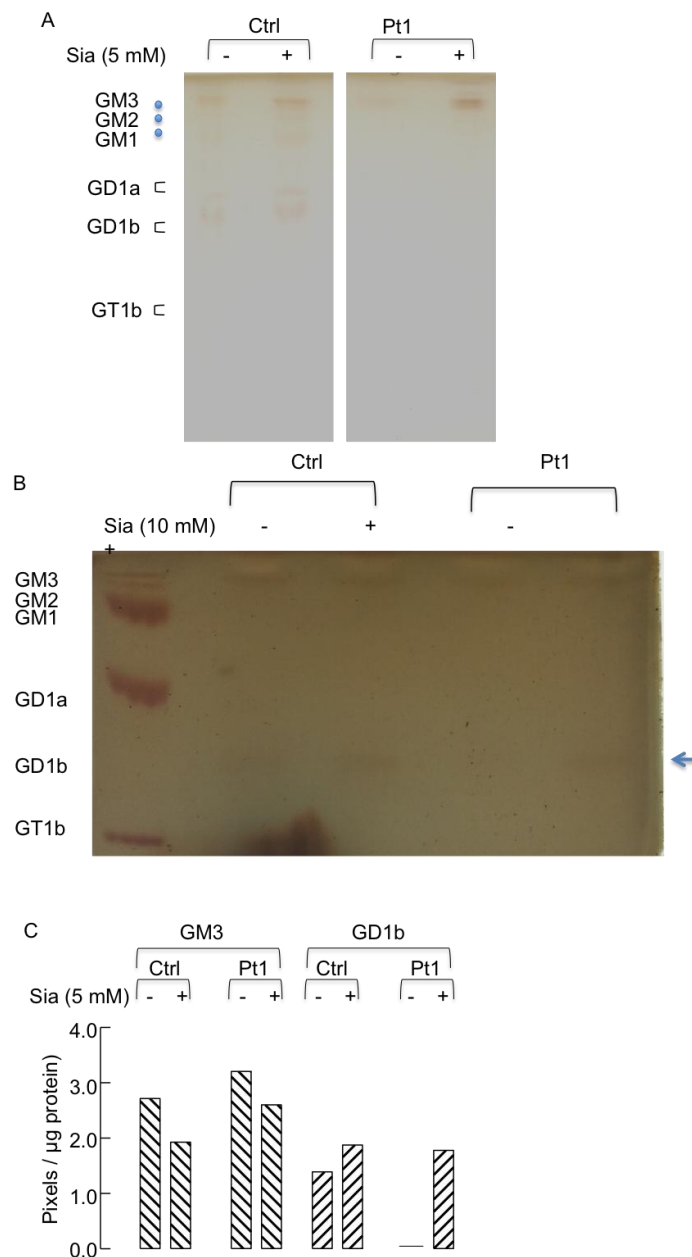

Figure 8: Culture of control and patient fibroblasts with exogenous sialic acid – Cells were cultivated in the presence of 5 mM Sia for once before harvesting and preparation of GSLs as described in the legend to Figure 7. A. HPTLC analysis of GSLs found in the upper phase of the organic solvent extraction procedure. In a second experiment, cells were grown in 5 mM Sia for 3 days. GSLs were submitted to HPTLC as described above. After staining with the orcinol/H₂SO₄ reagent, the chromatogram was scanned and the pixels recorded for bands that migrated in the positions of GM3 and GD1b are expressed per μg protein. B and C. HPTLC analysis of GSLs found in the upper phase of organic solvent extraction from cells were grown in 10 mM Sia for 11 days. The arrow points at the newly produced GSL species after Sia supplementation.

DISCUSSION

Here we report clinical findings in siblings who have a biallelic mutation in the *SLC35A1* gene that encoded the CMP-Sia transporter in the GA. The mutation is predicted to be damaging because it leads to the appearance of a proline residue in a TMD that is highly conserved in CMP-Sia transporter. Definitive proof that the mutation affects CMP-Sia transport activity is underway and we are testing the capacity of *SLC35A1* (Ser147Pro) variant to restore GSL sialylation in Lec2 cells.

Whether or not the *SLC35A1* (Ser147Pro) variant has diminished capacity to transport CMP-Sia into the GA, the two patients described here present with a rather similar clinical picture to that presented by the *SLC35A1*-CDG patient described by Mohamed *et al.* (see Table 1) [15]. Interestingly, these three patients have biallelic mutations that cause substitutions of amino acids that are conserved in both the CMP-Sia and UDP-Gal transporter families. The Gln101His substitution found in the case described by Mohamed *et al.* occurs in TMD3 that is thought to be important for CMP-Sia binding to the transporter [15]. On the other hand the Ser147Pro substitution occurs in TMD5, which has been proposed to be involved in forming a transmembrane channel [29]. These considerations are important when thinking about possible *SLC35A1*-CDG treatment strategies. If the transporter variant is a K_{uptake} mutant, then it is conceivable that raising cytoplasmic CMP-Sia levels could boost CMP-Sia transport into the GA. On the other hand, assuming that cytoplasmic CMP-Sia is saturating under physiological conditions, raising cytoplasmic CMP-Sia would not be expected to promote increased CMP-Sia

into the GA when the mutations affect, for example, the stability or subcellular location of the transporter.

The different clinical presentation of the *SLC35A1*-CDG patient reported by Mohamed *et al.* [15] to that of the patient presented by Willig *et al.* [13, 14] is also likely due to the different mutations found in these patients. The latter patient did not present with CNS signs, and this more restricted phenotype might be linked to the fact that one of the defective alleles in this patient contains an intronic CACT insertion that is proposed to effect splicing of exon 6. However, this CACT insertion may occur in up to 30 % of the population, and has been shown to be biallelic in several normal blood donors [13, 38]. It is therefore likely that the splicing defect caused by this insertion is leaky and that people with the biallelic insertion generate sufficient transporter to assure health [13]. Therefore the patient described by Willig *et al.* probably has more residual CMP-Sia transporter activity than the two patients reported here and the patient reported by Mohamed *et al.* [15].

It has been suggested that the neurological findings in *SLC35A1*-CDG are perhaps due to perturbed O-mannosylation of α -dystroglycan [39], which is a glycoprotein required for skeletal muscle and brain function [40, 41]. Mutations in genes of the O-mannosylation pathway underlie muscular dystrophy – dystroglycanopathy (MDDG) syndromes, which present with muscle, eye and brain symptoms including cognitive disabilities and seizures [40, 41]. As the O-mannose glycan of α -dystroglycan does not contain Sia, it is thought that the CMP-Sia transporter may be required to transport some as yet undescribed activated sugar, which is

required for O-mannosylation, into the GA [39]. To summarise, it is possible that residual CMP-Sia transporter activity is insufficient to allow appropriate platelet glycoconjugate sialylation in all the SLC35A1-CDG cases so far described, but is sufficient to allow correct O-mannosylation in the patient described by Wittig *et al.* [13, 14].

While trying to detect a biochemical phenotype in skin biopsy fibroblasts from the patients described here we were able to detect a 65% decrease in Sia content of total glycoconjugates after cells had been cultured in low serum-containing media. Why this difference is lost when cells are cultured in medium containing the more usual 10 % FBS is not clear. There are two possibilities: first, Sia could be scavenged from glycoconjugates in the FBS after endocytosis and lysosomal degradation as indicated in Figure 1. This Sia could be converted into CMP-Sia and boost cellular glycoconjugate sialylation. Second, sialylated glycoconjugates in the serum could associate with cells in a non-specific adsorption or bulk uptake process, and the presence of these undegraded components could falsify assay of endogenously synthesised Sia-containing glycoconjugates. We next sought to determine which glycoconjugates are hyposialylated. MAA and SNA lectin blots did not reveal hypoglycosylation in either Lec2 or patient cells. However, as glycoprotein hyposialylation has been demonstrated in Lec2 cells using metabolic radiolabelling techniques [32, 33]; we are now performing similar studies on the patient cells. Although we demonstrated reduced amounts of the sialylated ganglioside GM3 accompanied by accumulation of its non-sialylated

precursor lactosylceramide (LacCer) in Lec2 cells, we have shown that the GM3 level was elevated in the patient-derived fibroblasts with no observed change in the level of LacCer. Nevertheless, an unusual GSL pattern was seen in extracts from patient cells. Gb3, Gb4 and GM3 occur at higher levels in patient cells, whereas GM2, GD1a and GD1b are markedly reduced. This pattern would be anticipated if GM2/GD2 synthase (B4GALNT1) is deficient. As shown in Figure 7A, GM2/GD2 synthase is also involved in the generation of GD1b from GD3 via GD2 (b-series gangliosides). A small band that is suspected to be representative for GD3, which is known to migrate to a position slightly higher than GD1a, was observed in the gangliosides profile of the patient but not of the control. In one of the Sia supplementation studies increased GD1b was detected in patient cells and this would imply that the patient cells do possess normal B4GALNT1 activity. It is not clear how this data should be interpreted as another confirmatory GSL structural information is required, and only one patient and one control were analysed, nevertheless it is noteworthy that clinical signs of GM2/GD2 synthase (B4GALNT1)-deficiency include spastic tetraplegia, cognitive disabilities and dysmorphias [42]. We are presently using mass spectrometry to examine GSL profiles in several control samples as well as samples from both patients.

CONCLUSIONS

We describe a patient presenting with multisystem disease and hyposialylated plasma N-, and O-glycoproteins associated with a biallelic, probably damaging,

mutation in the gene encodes for CMP-Sia transporter. The patients described here add to the previously described SLC35A1-CDG case where a thrombocytopenia/bleeding disorder is

associated with CNS defects [15]. If the perturbed GSL pattern seen in patient fibroblasts can be extrapolated to neural tissue, then this could contribute to the CNS deficits seen in these patients.

List of abbreviations

CDG, congenital disorders of glycosylation; Sia, sialic acid; Neu5Ac, N-acetyl neuraminic acid, CMP, cytidine monophosphate; GSL, glycosphingolipids; TMD, transmembrane domain; MAA, *Maackia amurensis* lectin; SNA, *Sambucus nigra* lectin.

REFERENCES

1. Schnaar RL, Gerardy-Schahn R, Hildebrandt H: Sialic acids in the brain: gangliosides and polysialic acid in nervous system development, stability, disease, and regeneration. *Physiological reviews* 2014, 94(2):461-518.
2. Clark GF: The role of carbohydrate recognition during human sperm-egg binding. *Human reproduction* 2013, 28(3):566-577.
3. Clark GF: A role for carbohydrate recognition in mammalian sperm-egg binding. *Biochemical and biophysical research communications* 2014, 450(3):1195-1203.
4. Mitoma J, Bao X, Petryanik B, Schaerli P, Gauguet JM, Yu SY, Kawashima H, Saito H, Ohtsubo K, Marth JD *et al*: Critical functions of N-glycans in L-selectin-mediated lymphocyte homing and recruitment. *Nature immunology* 2007, 8(4):409-418.
5. Li R, Hoffmeister KM, Falet H: Glycans and the platelet life cycle. *Platelets* 2016, 27(6):505-511.
6. Willems AP, van Engelen BG, Lefeber DJ: Genetic defects in the hexosamine and sialic acid biosynthesis pathway. *Biochimica et biophysica acta* 2016, 1860(8):1640-1654.
7. Boccuto L, Aoki K, Flanagan-Steet H, Chen CF, Fan X, Bartel F, Petukh M, Pittman A, Saul R, Chaubey A *et al*: A mutation in a ganglioside biosynthetic enzyme, ST3GAL5, results in salt & pepper syndrome, a neurocutaneous disorder with altered glycolipid and glycoprotein glycosylation. *Human molecular genetics* 2014, 23(2):418-433.
8. Harduin-Lepers A, Vallejo-Ruiz V, Krzewinski-Recchi MA, Samyn-Petit B, Julien S, Delannoy P: The human sialyltransferase family. *Biochimie* 2001, 83(8):727-737.
9. Kean EL: Sialic acid activation. *Glycobiology* 1991, 1(5):441-447.
10. Sellmeier M, Weinhold B, Munster-Kuhnel A: CMP-Sialic Acid Synthetase: The Point of Constriction in the Sialylation Pathway. *Topics in current chemistry* 2015, 366:139-167.
11. Deutscher SL, Nuwayhid N, Stanley P, Briles EI, Hirschberg CB: Translocation across Golgi vesicle membranes: a CHO glycosylation mutant deficient in CMP-sialic acid transport. *Cell* 1984, 39(2 Pt 1):295-299.
12. Eckhardt M, Muhlenhoff M, Bethe A, Gerardy-Schahn R: Expression cloning of the Golgi CMP-sialic acid transporter. *Proceedings of the National Academy of Sciences of the United States of America* 1996, 93(15):7572-7576.
13. Martinez-Duncker I, Dupre T, Piller V, Piller F, Candelier JJ, Trichet C, Tchernia G, Oriol R, Mollicone R: Genetic complementation reveals a novel human congenital disorder of glycosylation of type II, due to inactivation of the Golgi CMP-sialic acid transporter. *Blood* 2005, 105(7):2671-2676.
14. Willig TB, Breton-Gorius J, Elbim C, Mignotte V, Kaplan C, Mollicone R, Pasquier C, Filipe A, Mielot F, Cartron JP *et al*: Macrothrombocytopenia with abnormal demarcation membranes in megakaryocytes and neutropenia with a complete lack of sialyl-Lewis-X antigen in leukocytes--a new syndrome? *Blood* 2001, 97(3):826-828.

15. Mohamed M, Ashikov A, Guillard M, Robben JH, Schmidt S, van den Heuvel B, de Brouwer AP, Gerardy-Schahn R, Deen PM, Wevers RA *et al*: Intellectual disability and bleeding diathesis due to deficient CMP--sialic acid transport. *Neurology* 2013, 81(7):681-687.
16. Chantret I, Dupre T, Delenda C, Bucher S, Dancourt J, Barnier A, Charollais A, Heron D, Bader-Meunier B, Danos O *et al*: Congenital disorders of glycosylation type Ig is defined by a deficiency in dolichyl-P-mannose:Man7GlcNAc2-PP-dolichyl mannosyltransferase. *The Journal of biological chemistry* 2002, 277(28):25815-25822.
17. Durrant C, Moore SE: Perturbation of free oligosaccharide trafficking in endoplasmic reticulum glucosidase I-deficient and castanospermine-treated cells. *The Biochemical journal* 2002, 365(Pt 1):239-247.
18. Bruneel A, Robert T, Lefeber D, Benard G, Loncle E, Djedour A, Durand G, Seta N: Two-dimensional gel electrophoresis of apolipoprotein C-III and other serum glycoproteins for the combined screening of human congenital disorders of O- and N-glycosylation. *Proteomics Clinical Applications* 2007, 1(3):321-324.
19. Goyallon A, Cholet S, Chapelle M, Junot C, Fenaille F: Evaluation of a combined glycomics and glycoproteomics approach for studying the major glycoproteins present in biofluids: Application to cerebrospinal fluid. *Rapid communications in mass spectrometry : RCM* 2015, 29(6):461-473.
20. Ceroni A, Maass K, Geyer H, Geyer R, Dell A, Haslam SM: GlycoWorkbench: a tool for the computer-assisted annotation of mass spectra of glycans. *Journal of proteome research* 2008, 7(4):1650-1659.
21. Yen-Nicolay S, Boursier C, Rio M, Lefeber DJ, Pilon A, Seta N, Bruneel A: MALDI-TOF MS applied to apoC-III glycoforms of patients with congenital disorders affecting O-glycosylation. Comparison with two-dimensional electrophoresis. *Proteomics Clinical applications* 2015, 9(7-8):787-793.
22. Nelsestuen GL, Zhang Y, Martinez MB, Key NS, Jilma B, Verneris M, Sinaiko A, Kasthuri RS: Plasma protein profiling: unique and stable features of individuals. *Proteomics* 2005, 5(15):4012-4024.
23. Rabina J, Maki M, Savilahti EM, Jarvinen N, Penttila L, Renkonen R: Analysis of nucleotide sugars from cell lysates by ion-pair solid-phase extraction and reversed-phase high-performance liquid chromatography. *Glycoconjugate journal* 2001, 18(10):799-805.
24. Nakajima K, Kitazume S, Angata T, Fujinawa R, Ohtsubo K, Miyoshi E, Taniguchi N: Simultaneous determination of nucleotide sugars with ion-pair reversed-phase HPLC. *Glycobiology* 2010, 20(7):865-871.
25. Hammond KS, Papermaster DS: Fluorometric assay of sialic acid in the picomole range: a modification of the thiobarbituric acid assay. *Analytical biochemistry* 1976, 74(2):292-297.
26. Svennerholm L, Fredman P: A procedure for the quantitative isolation of brain gangliosides. *Biochimica et biophysica acta* 1980, 617(1):97-109.

27. Lucq J, Tixier D, Guinault AM, Greffard A, Loisanche D, Pilatte Y: The target antigens of naturally occurring human anti-beta-galactose IgG are cryptic on porcine aortic endothelial cells. *Xenotransplantation* 2000, 7(1):3-13.
28. Eckhardt M, Gotza B, Gerardy-Schahn R: Membrane topology of the mammalian CMP-sialic acid transporter. *The Journal of biological chemistry* 1999, 274(13):8779-8787.
29. Hadley B, Maggioni A, Ashikov A, Day CJ, Haselhorst T, Tiralongo J: Structure and function of nucleotide sugar transporters: Current progress. *Computational and structural biotechnology journal* 2014, 10(16):23-32.
30. Peralvarez-Marín A, Bourdelande JL, Querol E, Padros E: The role of proline residues in the dynamics of transmembrane helices: the case of bacteriorhodopsin. *Molecular membrane biology* 2006, 23(2):127-135.
31. Nilsson I, Saaf A, Whitley P, Gafvelin G, Waller C, von Heijne G: Proline-induced disruption of a transmembrane alpha-helix in its natural environment. *Journal of molecular biology* 1998, 284(4):1165-1175.
32. Briles EB, Li E, Kornfeld S: Isolation of wheat germ agglutinin-resistant clones of Chinese hamster ovary cells deficient in membrane sialic acid and galactose. *The Journal of biological chemistry* 1977, 252(3):1107-1116.
33. Stanley P, Sudo T, Carver JP: Differential involvement of cell surface sialic acid residues in wheat germ agglutinin binding to parental and wheat germ agglutinin-resistant Chinese hamster ovary cells. *The Journal of cell biology* 1980, 85(1):60-69.
34. Knibbs RN, Goldstein IJ, Ratcliffe RM, Shibuya N: Characterization of the carbohydrate binding specificity of the leucoagglutinating lectin from *Maackia amurensis*. Comparison with other sialic acid-specific lectins. *The Journal of biological chemistry* 1991, 266(1):83-88.
35. Rosales Fritz VM, Daniotti JL, Maccioni HJ: Chinese hamster ovary cells lacking GM1 and GD1a synthesize gangliosides upon transfection with human GM2 synthase. *Biochimica et biophysica acta* 1997, 1354(2):153-158.
36. Daniotti JL, Zurita AR, Trindade VM, Maccioni HJ: GD3 expression in CHO-K1 cells increases growth rate, induces morphological changes, and affects cell-substrate interactions. *Neurochemical research* 2002, 27(11):1421-1429.
37. Keusch JJ, Manzella SM, Nyame KA, Cummings RD, Baenziger JU: Cloning of Gb3 synthase, the key enzyme in globo-series glycosphingolipid synthesis, predicts a family of alpha 1, 4-glycosyltransferases conserved in plants, insects, and mammals. *The Journal of biological chemistry* 2000, 275(33):25315-25321.
38. Jones C, Denecke J, Strater R, Stolting T, Schunicht Y, Zeuschner D, Klumperman J, Lefeber DJ, Spelten O, Zarbock A *et al*: A novel type of macrothrombocytopenia associated with a defect in alpha2,3-sialylation. *The American journal of pathology* 2011, 179(4):1969-1977.
39. Riemersma M, Sandrock J, Boltje TJ, Bull C, Heise T, Ashikov A, Adema GJ, van Bokhoven H, Lefeber DJ: Disease mutations in CMP-sialic acid transporter SLC35A1 result in abnormal alpha-dystroglycan O-mannosylation, independent from sialic acid. *Human molecular genetics* 2015, 24(8):2241-2246.

40. Endo T: Glycobiology of alpha-dystroglycan and muscular dystrophy. *Journal of biochemistry* 2015, 157(1):1-12.
41. Martin PT: Mechanisms of disease: congenital muscular dystrophies-glycosylation takes center stage. *Nature clinical practice Neurology* 2006, 2(4):222-230.
42. Harlalka GV, Lehman A, Chioza B, Baple EL, Maroofian R, Cross H, Sreekantan-Nair A, Priestman DA, Al-Turki S, McEntagart ME *et al*: Mutations in B4GALNT1 (GM2 synthase) underlie a new disorder of ganglioside biosynthesis. *Brain : a journal of neurology* 2013, 136(Pt 12):3618-3624.

4] Discussion and Conclusion

Discussion

Historical background

In 2001, Wilig T. *et al.* described the first case of dysmegakaryocytopoietic syndrome that was suggested to result from defective protein glycosylation¹⁹⁷. The patient was 4 months old and presented with severe bleeding in the posterior chamber of the right eye accompanied with skin hemorrhage. Blood analysis showed significant thrombocytopenia and neutropenia. For the next 30 months, the patient had many bleeding episodes including six severe pulmonary hemorrhage episodes causing acute respiratory distress and hypoxia.

He also had recurrent infections resulting in pneumonia, post-vaccinal abscess, and external otitis media. Biochemical analysis revealed markedly reduced sialyl Lewis^x levels on neutrophils as well as platelet membrane-bound glycoprotein GIIb, which also manifested an increased molecular weight that was suggested to be due to changed glycosylation. Sialyltransferases and fucosyltransferase activities were normal. The patient received a bone marrow transplant at 34 months of age, and passed away at 37 months of age. In spite of all these findings, the underlying molecular cause of this case remained obscure¹⁹⁷.

Later, Martinez-Duncker *et al.* found that serum Tf and other glycoproteins were normally sialylated suggesting that the clinical signs that were manifested by the patient were not due to a general hyposialylation of glycoconjugates, but were due to defective sialyl Lewis^x sialylation¹⁹⁸.

Deficient sialyl Lewis^x, along with deficiency in other fucosylated structures such as ABH antigens, was observed in LAD II (Leukocyte adhesion deficiency type II, OMIM: 266265) caused by defective GDP-Fuc transporter. Taking into account that the patient had normal sialyltransferase and fucosyltransferase activities, Martinez-Duncker *et al.* suggested that the deficient sialyl Lewis^x could have resulted from defective transport of CMP-Sia into the GA by CST¹⁹⁸. The DNA sequence analysis revealed the presence of two mutations in the *SLC35A1* gene, and neither of the mutant alleles could complement the CST-deficient CHO (Lec2) cells. However, it was explained why serum glycoproteins were normally sialylated while sialyl Lewis^x and platelet membrane-bound glycoprotein GIIb were defective. Many hypotheses were proposed such as sample contamination from repeated platelet transfusions, or that one of the mutations is a leaky mutation that allows the expression of some functioning CST¹⁹⁸.

In 2013 E. MORAVA *et al.* reported another case of mutated *SLC35A1*, however, the clinical picture involved multisystem deterioration¹⁹⁹. A 22-year-old female had a history of developmental delay and generalized seizures during childhood and developed into behavioral violent actions at puberty. She had microcephaly, dysmorphic features, hypotonia of lower extremities, hyporeflexia, mild ataxia, clinodactyly of 4th and 5th fingers of both hands, and systolic cardiac murmur. Blood analysis showed macrothrombocytopenia.

The case had a severe prognosis, and after surgery she had post-operative bleeding that developed into hemolytic anemia, fever, renal and respiratory failure, and death at 22 years of age. Serum glycoprotein analysis revealed increased tri- and di-sialo structures of serum Tf as well as increased mono- and asialo- Apo C-III isoforms. Genetic studies showed a homozygous mutation in CST encoding gene (*SLC35A1*). The mutation was predicted to be damaging, and when expressed in yeast, the activity of the CST variant was assessed and found to be about 50 % of the wild type protein¹⁹⁹.

Newly reported SLC35A1-CDG cases

In this study, we describe two siblings for which WES revealed the presence of a homozygous mutation in *SLC35A1* gene.

o CMP-Sia levels in patient fibroblasts

Hypothetically, a defective CST would result in accumulation of CMP-Sia in the cytosolic side of the GA. Using SPE/HPLC, we did not detect any accumulation of CMP-Sia in the patient fibroblasts, however, there was a slight increase in CMP-Sia level in Lec2 cells compared to the wild type cells (Manuscript, Figure 6A). The same method has been previously used for patients with an inherited disorder of defective sialic acid biosynthesis called sialuria (OMIM: 269921), and showed accumulated CMP-Sia in their fibroblasts¹³³.

Assessment of the sialylation status of the patient sialoglycans

o Glycoproteins

Glycoprotein glycosylation profiles of these patients remains enigmatic for two reasons. On one hand, IEF of serum Tf and Apo C-III revealed increased levels of hyposialylated isoforms and these results were confirmed by MS analysis of Apo C-III as well as total serum glycoproteins. On the other hand, when SNA or MAA lectinoblots were performed on extracts of patient fibroblasts we found sialylation profiles similar to those of the control. The difference in the sialylation status of, on one hand, plasma glycoproteins and fibroblast glycoproteins on the other hand, could result from the presence of bacterial sialidase in the plasma that can de-sialylate the circulating glycoproteins. This could be true for our patients who manifested chronic inflammation that can change their immune response to infection.

A technical factor cannot be ruled out; lectin blots may not be the method of choice to detect total membrane protein hyposialylation. What made the results more complicated was that the same results were obtained for CST-deficient Lec2 cells. That is to say, lectin blotting did not show any reduced sialylation in Lec2 cell protein extract. It has been reported that the detection of hyposialylation of total proteins by lectin-based cell surface staining of Lec2 cells is not a highly sensitive approach, and assessing the sialylation status of one single protein called erythropoietin (EPO) is a better way to detect the hyposialylation¹⁹⁴. Conversely, in another study, a reduced α 2-3 sialylation was detected in HAP1 cells using lectin blotting²⁰⁰.

- *Glycosphingolipids (GSLs)*
 - *Gangliosides (sialylated GSLs)*

In an attempt to detect the impact of the variant CST on sialoglycans other than glycoproteins, we analyzed the GSL profiles in control and patient skin fibroblasts. Examination of the ganglioside-containing aqueous phase of lipid extracts from the patient-derived fibroblasts revealed a remarkable accumulation of the simple ganglioside GM3 accompanied with an absence of all the subsequent complex gangliosides i.e. GM1, GM2, GD1a, GD1b, and GT1b. A faint band that appears to migrate slightly faster than GD1a, appears in the extracts of the patient cells (Manuscript, Figure 7C), and this could correspond to GD3. At present, it is not clear whether this compound occurs in the control cell extracts.

As described in Chapter 1 (Introduction, P49), GSLs are major constituents of plasma membranes where they play several biological roles some of which have been described and many are still to be elucidated¹⁰⁵. Adult human brain tissues express the four complex gangliosides: GM1, GD1a, GD1b, and GT1b, in levels significantly higher than any other tissue, they constitute about 97% of total brain gangliosides¹¹¹. Given that these complex gangliosides play a pivotal role in the neural tissue function and development¹¹⁰, the defective biosynthesis of complex gangliosides could be the underlying molecular cause of the neurologic manifestations observed in our patients.

Ganglioside deficiency has been extensively studied in animal models by knocking down enzymes involved in GSLs biosynthesis¹¹¹. For example, when the *BGALNT1* gene that encodes GM2/GD2 synthase was knocked-out in mice, the simple gangliosides, GM3 and GD3, were highly expressed in null mice brain without being converted to the complex gangliosides (Figure 23). The null mice had normal nervous system structure and normal behavior at birth. At 10 weeks of age, the null mice showed decreased nerve conduction²⁰¹. Upon ageing, mutant mice showed severe neuropathy in the form of defective motor activity accompanied with hyperactivity and whole-body tremors. *BGALNT1*^{-/-} null mice showed defective spinal cord myelination²⁰².

Myelin is the multilayered outer insulating sheath of axons in the nervous system. It also controls the action potential arrival at nodes of Ranvier for accelerated nerve conduction²⁰³. The role of complex gangliosides in axon myelination depends upon sialoglycan-siglec interactions where GD1a and GT1b expressed on the axon surface specifically bind to myelin-associated glycoprotein (MAG), which is also known as siglec4²⁰⁴. Interestingly, it was shown that when the biosynthesis of complex gangliosides was blocked by down-regulating the *GALT1* gene that encodes GalT1 that is required for GM2 and GD2 synthesis (Figure 23), the expression level of MAG was reduced by 77%²⁰⁵.

To summarise, all the above-mentioned facts could potentially help explain the CNS signs seen in our patients. For instance, the hypotonia could result from compromised nerve conductance caused by reduced interaction between GD1a / GT1b and MAG.

- *Neutral GSLs*

Given that LacCer is the substrate that is shared by ST3GAL5, A4GALT, and B3GNT5 enzymes to initiate the biosynthesis of gangliosides, globo-series and lacto-series, respectively (Figure 23), it would be axiomatic to assume that disturbance in one of the LacCer-consuming biosynthetic pathways, would be reflected on the two other pathways.

In our study, the decreased levels of the charged GSLs (gangliosides) were accompanied with a corresponding increase in neutral GSLs, Gb3 and Gb4. These results are in accordance with a previous study where it was shown that patients with defective ST3GAL5 (GM3 synthase) had almost no gangliosides but had significantly increased Gb3 and Gb4 species¹³⁰.

Is this is a case of defective sialylation?

- *Sialic acid content of total sialoglycans*

As shown in manuscript (Manuscript, Figure 6D), the Sia liberated from pellets prepared from patient fibroblasts that were grown in 2 % FBS (Fetal Bovine Serum) was about one third of that liberated from the control fibroblasts that were cultured under the same conditions. The point of growing the cells in low FBS-containing medium is to reduce the exposure of the cells to exogenous Sia salvaged from the glycoconjugates in the serum^{206,207}, assuming that the patient's sialidases and Sia lysosomal transporter (sialin) are normally functioning. This idea was supported by the fact that the level of Sia liberated from the patient fibroblasts, which were grown in 10 % FBS, was almost the same as that of the control cells grown under the same conditions.

Taking into account that the lectin blots (Manuscript, Figure 6E-F) did not reveal glycoprotein hyposialylation; we hypothesized that the decreased total sialoglycan-liberated free Sia released from the total cellular glycoconjugates must be due to reduced sialylation of GSL. However, because GM3 is also increased in the patient cells, it is not clear how much Sia is missing from "GSL" compartment.

- *GSL profile of patient fibroblasts cultured in 2% and 10% FBS-containing media*

As shown in the manuscript (Manuscript, Figure 7C-D), when the patient fibroblasts were cultured in medium containing 10% FBS, it was observed that GD1a, GD1b, and GT1b, were produced, but still at low levels in compared to the control fibroblasts. This finding supported the possibility that the mutation in CST might affect its Km for CMP-Sia. Therefore Sia could be salvaged from glycoproteins in the serum, activated into CMP-Sia, transported into the GA by CST, and incorporated into gangliosides. The mutated CST was able to transport enough CMP-Sia for GM3 synthase (ST3GAL5) to make at least normal levels of GM3. By contrast, the luminal concentration of CMP-Sia may be too low for efficient sialylation by the GD1a/GT1b synthesizing sialyltransferases (ST3GAL2 and ST3GAL3).

However, there are two caveats with this hypothesis: first, the GD1a and GT1b precursors, GM2 and GM1 that have one Sia residue (already present in GM3) were also absent in the patient fibroblasts. Second, a band, which is thought to correspond to GD3 is present in the patient fibroblasts, and GD3 has two Sia residues and is produced by sialylation of GM3 (Figure 23).

To investigate the possible effect of Sia on ganglioside profiles, the patient-derived fibroblasts were supplemented with Sia.

- *Sialic acid supplementation of patient fibroblasts*

It has been established that human skin fibroblasts²⁰⁶ and lymphoblasts²⁰⁸, can take up Sia from the surrounding medium. The scavenged Sia is activated to CMP-Sia, and incorporated into specific protein markers²⁰⁸. In another study where young rats were fed Sia, post-mortem analysis of brain sialoglycans showed that 80 % of exogenous sialic acid, which entered into their circulation was incorporated into brain gangliosides whereas only 20 % was incorporated into glycoproteins²⁰⁹.

Based on these observations, the patient fibroblasts were supplemented with free Sia in low serum-containing medium to find out if the exogenous Sia would have an effect on GSL profiles. Unfortunately, time did not allow two important parameters to be measured, first, we did not confirm conversion of the exogenous free Sia into CMP-Sia, and second, we did not measure the amount of acid-labile Sia in liberated from the total sialoglycans from fibroblasts-derived pellets.

Unfortunately, due to low cell numbers, we had faint gangliosides profile in the patient as well as the control fibroblasts, yet, the production of GD1b in the Sia-supplemented patient fibroblasts was clear. These results suggest that Sia can be transported across the Golgi membrane, and then be incorporated into certain gangliosides species.

Taking into account that GD3 may occur in the patient-derived fibroblasts but not in the control cells, and GD1b is produced in the Sia-supplemented patient fibroblasts, we can conclude that the biosynthesis of b-series gangliosides has been enhanced in the Sia-supplemented patient fibroblasts.

Now, a new question arises, how can the patient-derived fibroblasts be incapable of synthesizing the a-series gangliosides while they are able to synthesize the b-series gangliosides, given that GM2/GD2 synthase (B4GALNT1) is the initiating enzyme of both series? Moreover, how can the patient fibroblasts cultured in medium containing 10% FBS synthesize some of a-series gangliosides?

Conclusion

- The biallelic *SLC35A1* (Ser147Pro) variant is associated with hyposialylation of serum glycoproteins.
- Multisialylated complex ganglioside biosynthesis is compromised in cells derived from this patient although CMP-Sia can be transported into the GA lumen for GM3 biosynthesis.
- Sialic acid can be salvaged from serum glycoconjugates and incorporated into sialoglycans.
- Patient-derived fibroblasts grown in high serum-containing medium synthesized some multisialylated complex a-series gangliosides.
- Mutated CST was able to transport CMP-Sia produced from exogenous free Sia supplementation.
- Sialic acid supplementation increased the biosynthesis of b-series gangliosides.
- CST mutation is reported here for the first time to be associated with defective GSLs biosynthesis.

Prospectives

- The sialylation status of individual glycoproteins in cell extracts will be examined. Antibodies to CD15 (sialylated Lewis^X) could be used to probe the cell surface of patient-derived fibroblasts.
- The impact of Ser147pro mutation in *SLC35A1* on the CST will be assessed by:
 - Complementation studies of the Lec2 cells and looking for normalization of the GSL profile
 - Measurement of the CST transport activity in intact Golgi vesicles derived from yeast/Lec2 cells/patient fibroblasts that have been transduced with plasmids containing *SLC35A1* transcripts.
- GSLs extracted from control and patient-derived fibroblasts, cultured in either the absence or presence of Sia, will be characterized by MS.

Chapter 4

General Conclusions

From the previous studies and findings some conclusions can be drawn:

- An extended biochemical investigation beyond the routine diagnostic procedures for CDG subtypes is a prerequisite to uncover biochemical phenotypes that might be the underlying cause of the clinical manifestations, in other words, attempting to identify the clinical-glycosylation phenotype relationship.
- The aim of these expanded biochemical studies is to obtain a global image about the glycosylation state in a CDG subtype. It is necessary to assess the glycosylation profile of several glycomarkers in different biological samples. This type of extended analysis is important for glycoconjugates that show tissue-specific expression, and that in turn would explain the diversity of CDG clinical phenotypes (either mono- or multisystemic).
- Based on the findings of these investigations, supplementation-experiments with specific biochemical molecules could be conducted, and according to the results treatment strategies could be suggested.
- Another outcome of the extended biochemical studies of CDG could be the possible implication of the approaches used in these studies in the CDG-prenatal diagnosis to confirm the presence of a glycosylation defect when the molecular analysis is not enough to confirm the presence of biochemical consequences of the found mutation (carrier or affected case?).

Chapter 5

Bibliography

1. Varki A, Sharon N. *Historical Background and Overview*. Cold Spring Harbor Laboratory Press; 2009. <http://www.ncbi.nlm.nih.gov/pubmed/20301255>. Accessed May 4, 2016.
2. Trombetta ES, Parodi AJ. Quality control and protein folding in the secretory pathway. *Annu Rev Cell Dev Biol.* 2003;19:649-676. doi:10.1146/annurev.cellbio.19.110701.153949.
3. Rip JW, Rugar CA, Ravi K, Carroll KK. Distribution, metabolism and function of dolichol and polyprenols. *Prog Lipid Res.* 1985;24(4):269-309. <http://www.ncbi.nlm.nih.gov/pubmed/2819898>. Accessed May 4, 2016.
4. Hart GW, West CM. *Nucleocytoplasmic Glycosylation*. Cold Spring Harbor Laboratory Press; 2009. <http://www.ncbi.nlm.nih.gov/pubmed/20301242>. Accessed May 4, 2016.
5. Wang JL, Gray RM, Haudek KC, Patterson RJ. Nucleocytoplasmic lectins. *Biochim Biophys Acta.* 2004;1673(1-2):75-93. doi:10.1016/j.bbagen.2004.03.013.
6. Tsai B, Ye Y, Rapoport TA. Retro-translocation of proteins from the endoplasmic reticulum into the cytosol. *Nat Rev Mol Cell Biol.* 2002;3(4):246-255. doi:10.1038/nrm780.
7. Hart GW, Akimoto Y. *The O-GlcNAc Modification*. Cold Spring Harbor Laboratory Press; 2009. <http://www.ncbi.nlm.nih.gov/pubmed/20301273>. Accessed June 26, 2016.
8. Tan EP, Villar MT, E L, et al. Altering O-linked β -N-acetylglucosamine cycling disrupts mitochondrial function. *J Biol Chem.* 2014;289(21):14719-14730. doi:10.1074/jbc.M113.525790.
9. Sharon N, Lis H. Carbohydrates in cell recognition. *Sci Am.* 1993;268(1):82-89. <http://www.ncbi.nlm.nih.gov/pubmed/7678182>. Accessed May 4, 2016.
10. Lis H, Sharon N. Protein glycosylation. Structural and functional aspects. *Eur J Biochem.* 1993;218(1):1-27. <http://www.ncbi.nlm.nih.gov/pubmed/8243456>. Accessed May 4, 2016.
11. Varki A. Biological roles of oligosaccharides: all of the theories are correct. *Glycobiology.* 1993;3(2):97-130. <http://www.ncbi.nlm.nih.gov/pubmed/8490246>. Accessed May 4, 2016.
12. Shoulders MD, Raines RT. Collagen structure and stability. *Annu Rev Biochem.* 2009;78:929-958. doi:10.1146/annurev.biochem.77.032207.120833.
13. Funderburgh JL. Keratan sulfate biosynthesis. *IUBMB Life.* 2002;54(4):187-194. doi:10.1080/15216540214932.
14. Lindahl U. What Else Can Heparin Do? *Pathophysiol Haemost Thromb.* 1999;29(Suppl. 1):38-47. doi:10.1159/000054111.
15. Varki A, Freeze HH, Vacquier VD. *Glycans in Development and Systemic Physiology*. Cold Spring Harbor Laboratory Press; 2009. <http://www.ncbi.nlm.nih.gov/pubmed/20301237>. Accessed May 4, 2016.
16. Sonnenburg JL, Xu J, Leip DD, et al. Glycan foraging in vivo by an intestine-adapted bacterial symbiont. *Science.* 2005;307(5717):1955-1959. doi:10.1126/science.1109051.
17. Varki A, Lowe JB. *Biological Roles of Glycans*. Cold Spring Harbor Laboratory Press; 2009. <http://www.ncbi.nlm.nih.gov/pubmed/20301233>. Accessed May 4, 2016.
18. Kobata A. Structures and functions of the sugar chains of glycoproteins. *Eur J Biochem.* 1992;209(2):483-501. <http://www.ncbi.nlm.nih.gov/pubmed/1358608>. Accessed May 4, 2016.
19. Sonnino S, Mauri L, Chigorno V, Prinetti A. Gangliosides as components of lipid membrane domains. *Glycobiology.* 2007;17(1):1R-13R. doi:10.1093/glycob/cw1052.
20. Hancock JF. Lipid rafts: contentious only from simplistic standpoints. *Nat Rev Mol Cell Biol.* 2006;7(6):456-462. doi:10.1038/nrm1925.

21. Varki A, Etzler ME, Cummings RD, Esko JD. *Discovery and Classification of Glycan-Binding Proteins*. Cold Spring Harbor Laboratory Press; 2009. <http://www.ncbi.nlm.nih.gov/pubmed/20301249>. Accessed October 12, 2016.
22. Gabius H-J, Manning JC, Kopitz J, André S, Kaltner H. Sweet complementarity: the functional pairing of glycans with lectins. *Cell Mol Life Sci*. 2016;73(10):1989-2016. doi:10.1007/s00018-016-2163-8.
23. Drickamer K, Taylor ME. Biology of animal lectins. *Annu Rev Cell Biol*. 1993;9:237-264. doi:10.1146/annurev.cb.09.110193.001321.
24. Varki A, Angata T. Siglecs--the major subfamily of I-type lectins. *Glycobiology*. 2006;16(1):1R-27R. doi:10.1093/glycob/cwj008.
25. Rabinovich GA, Toscano MA, Jackson SS, Vasta GR. Functions of cell surface galectin-glycoprotein lattices. *Curr Opin Struct Biol*. 2007;17(5):513-520. doi:10.1016/j.sbi.2007.09.002.
26. Kornfeld S. Structure and function of the mannose 6-phosphate/insulinlike growth factor II receptors. *Annu Rev Biochem*. 1992;61:307-330. doi:10.1146/annurev.bi.61.070192.001515.
27. Helenius A, Aebi M. Roles of N-linked glycans in the endoplasmic reticulum. *Annu Rev Biochem*. 2004;73:1019-1049. doi:10.1146/annurev.biochem.73.011303.073752.
28. Esko JD, Linhardt RJ. *Proteins That Bind Sulfated Glycosaminoglycans*. Cold Spring Harbor Laboratory Press; 2009. <http://www.ncbi.nlm.nih.gov/pubmed/20301268>. Accessed May 4, 2016.
29. Li W, Johnson DJD, Esmon CT, Huntington JA. Structure of the antithrombin-thrombin-heparin ternary complex reveals the antithrombotic mechanism of heparin. *Nat Struct Mol Biol*. 2004;11(9):857-862. doi:10.1038/nsmb811.
30. Kim J-JP, Olson LJ, Dahms NM. Carbohydrate recognition by the mannose-6-phosphate receptors. *Curr Opin Struct Biol*. 2009;19(5):534-542. doi:10.1016/j.sbi.2009.09.002.
31. Dahms NM, Olson LJ, Kim J-JP. Strategies for carbohydrate recognition by the mannose 6-phosphate receptors. *Glycobiology*. 2008;18(9):664-678. doi:10.1093/glycob/cwn061.
32. Braulke T, Bonifacino JS. Sorting of lysosomal proteins. *BBA - Mol Cell Res*. 2008;1793:605-614. doi:10.1016/j.bbamcr.2008.10.016.
33. Hebert DN, Garman SC, Molinari M. The glycan code of the endoplasmic reticulum: asparagine-linked carbohydrates as protein maturation and quality-control tags. *Trends Cell Biol*. 2005;15(7):364-370. doi:10.1016/j.tcb.2005.05.007.
34. Caramelo JJ, Parodi AJ. Getting in and out from calnexin/calreticulin cycles. *J Biol Chem*. 2008;283(16):10221-10225. doi:10.1074/jbc.R700048200.
35. Freeze HH, Esko JD, Parodi AJ. *Glycans in Glycoprotein Quality Control*. Cold Spring Harbor Laboratory Press; 2009. <http://www.ncbi.nlm.nih.gov/pubmed/20301277>. Accessed May 6, 2016.
36. Wandall HH, Irazoqui F, Tarp MA, et al. The lectin domains of polypeptide GalNAc-transferases exhibit carbohydrate-binding specificity for GalNAc: lectin binding to GalNAc-glycopeptide substrates is required for high density GalNAc-O-glycosylation. *Glycobiology*. 2007;17(4):374-387. doi:10.1093/glycob/cwl082.
37. Stanley P, Cummings RD. *Structures Common to Different Glycans*. Cold Spring Harbor Laboratory Press; 2009. <http://www.ncbi.nlm.nih.gov/pubmed/20301230>. Accessed May 6, 2016.
38. Schröter S, Osterhoff C, McArdle W, Ivell R. The glycocalyx of the sperm surface. *Hum Reprod Update*. 5(4):302-313. <http://www.ncbi.nlm.nih.gov/pubmed/10465522>. Accessed May 7, 2016.
39. Akatsuka K, Yoshida-Komiya H, Tulsiani DR, Orgebin-Crist MC, Hiroi M, Araki Y. Rat zona pellucida glycoproteins: molecular cloning and characterization of the

- three major components. *Mol Reprod Dev.* 1998;51(4):454-467. doi:10.1002/(SICI)1098-2795(199812)51:4<454::AID-MRD13>3.0.CO;2-G.
40. Diekman AB. Glycoconjugates in sperm function and gamete interactions: how much sugar does it take to sweet-talk the egg? *Cell Mol Life Sci.* 2003;60(2):298-308. <http://www.ncbi.nlm.nih.gov/pubmed/12678495>. Accessed May 7, 2016.
 41. Rostand KS, Esko JD. Microbial adherence to and invasion through proteoglycans. *Infect Immun.* 1997;65(1):1-8. <http://www.ncbi.nlm.nih.gov/pubmed/8975885>. Accessed May 7, 2016.
 42. Yuki N, Odaka M. Ganglioside mimicry as a cause of Guillain-Barré syndrome. *Curr Opin Neurol.* 2005;18(5):557-561. <http://www.ncbi.nlm.nih.gov/pubmed/16155440>. Accessed May 7, 2016.
 43. Houlston RS, Yuki N, Hiramata T, et al. Recognition characteristics of monoclonal antibodies that are cross-reactive with gangliosides and lipooligosaccharide from *Campylobacter jejuni* strains associated with Guillain-Barré and Fisher syndromes. *Biochemistry.* 2007;46(1):36-44. doi:10.1021/bi062001v.
 44. Nizet V, Esko JD. *Bacterial and Viral Infections*. Cold Spring Harbor Laboratory Press; 2009. <http://www.ncbi.nlm.nih.gov/pubmed/20301271>. Accessed May 7, 2016.
 45. Munford RS, Varley AW. Shield as signal: lipopolysaccharides and the evolution of immunity to gram-negative bacteria. *PLoS Pathog.* 2006;2(6):e67. doi:10.1371/journal.ppat.0020067.
 46. Mazmanian SK, Kasper DL. The love-hate relationship between bacterial polysaccharides and the host immune system. *Nat Rev Immunol.* 2006;6(11):849-858. doi:10.1038/nri1956.
 47. Brown JR, Crawford BE, Esko JD. Glycan antagonists and inhibitors: a fount for drug discovery. *Crit Rev Biochem Mol Biol.* 42(6):481-515. doi:10.1080/10409230701751611.
 48. Bertozzi CR, Freeze HH, Varki A, Esko JD. *Glycans in Biotechnology and the Pharmaceutical Industry*. Cold Spring Harbor Laboratory Press; 2009. <http://www.ncbi.nlm.nih.gov/pubmed/20301231>. Accessed May 7, 2016.
 49. Emil Fischer—Unequalled Classicist, Master of Organic Chemistry Research, and Inspired Trailblazer of Biological Chemistry. December 2002.
 50. Human lysozyme: sequencing of a cDNA, and expression and secretion by *Saccharomyces cerevisiae*. *Biochem. Biophys. Res. Commun.* January 1988.
 51. Cummings RD, Esko JD. *Principles of Glycan Recognition*. Cold Spring Harbor Laboratory Press; 2009. <http://www.ncbi.nlm.nih.gov/pubmed/20301269>. Accessed May 7, 2016.
 52. Weis WI, Drickamer K. Structural basis of lectin-carbohydrate recognition. *Annu Rev Biochem.* 1996;65:441-473. doi:10.1146/annurev.bi.65.070196.002301.
 53. von der Lieth C, Siebert H, Kozár T, et al. Lectin ligands: new insights into their conformations and their dynamic behavior and the discovery of conformer selection by lectins. *Acta Anat (Basel).* 1998;161(1-4):91-109. <http://www.ncbi.nlm.nih.gov/pubmed/9780353>. Accessed May 7, 2016.
 54. Rini J, Esko J, Varki A. *Glycosyltransferases and Glycan-Processing Enzymes*. Cold Spring Harbor Laboratory Press; 2009. <http://www.ncbi.nlm.nih.gov/pubmed/20301247>. Accessed May 8, 2016.
 55. Qasba PK, Ramakrishnan B, Boeggeman E. Substrate-induced conformational changes in glycosyltransferases. *Trends Biochem Sci.* 2005;30(1):53-62. doi:10.1016/j.tibs.2004.11.005.
 56. Davies GJ, Gloster TM, Henrissat B. Recent structural insights into the expanding world of carbohydrate-active enzymes. *Curr Opin Struct Biol.* 2005;15(6):637-645. doi:10.1016/j.sbi.2005.10.008.
 57. NEUFELD EF, GINSBURG V. CARBOHYDRATE METABOLISM. *Annu Rev*

- Biochem.* 1965;34:297-312. doi:10.1146/annurev.bi.34.070165.001501.
58. Freeze HH, Elbein AD. *Glycosylation Precursors*. Cold Spring Harbor Laboratory Press; 2009. <http://www.ncbi.nlm.nih.gov/pubmed/20301253>. Accessed May 10, 2016.
 59. Varki A. Factors controlling the glycosylation potential of the Golgi apparatus. *Trends Cell Biol.* 1998;8(1):34-40. <http://www.ncbi.nlm.nih.gov/pubmed/9695806>. Accessed May 11, 2016.
 60. Hadley B, Maggioni A, Ashikov A, Day CJ, Haselhorst T, Tiralongo J. Structure and function of nucleotide sugar transporters: Current progress. *Comput Struct Biotechnol J.* 2014;10(16):23-32. doi:10.1016/j.csbj.2014.05.003.
 61. Breton C, Snajdrová L, Jeanneau C, Koca J, Imberty A. Structures and mechanisms of glycosyltransferases. *Glycobiology.* 2006;16(2):29R-37R. doi:10.1093/glycob/cwj016.
 62. Li Y, Chen X. Sialic acid metabolism and sialyltransferases: natural functions and applications. *Appl Microbiol Biotechnol.* 2012;94(4):887-905. doi:10.1007/s00253-012-4040-1.
 63. Harduin-Lepers A, Vallejo-Ruiz V, Krzewinski-Recchi MA, Samyn-Petit B, Julien S, Delannoy P. The human sialyltransferase family. *Biochimie.* 2001;83(8):727-737. <http://www.ncbi.nlm.nih.gov/pubmed/11530204>. Accessed May 12, 2016.
 64. Mikami T, Kitagawa H. Biosynthesis and function of chondroitin sulfate. *Biochim Biophys Acta.* 2013;1830(10):4719-4733. doi:10.1016/j.bbagen.2013.06.006.
 65. Silbert JE, SG. Biosynthesis of chondroitin/dermatan sulfate. *IUBMB Life.* 2002;54(4):177-186.
 66. Yamamoto F. Review: ABO blood group system--ABH oligosaccharide antigens, anti-A and anti-B, A and B glycosyltransferases, and ABO genes. *Immunohematology.* 2004;20(1):3-22. <http://www.ncbi.nlm.nih.gov/pubmed/15373665>. Accessed May 12, 2016.
 67. Cherepanova N, Shrimal S, Gilmore R. N-linked glycosylation and homeostasis of the endoplasmic reticulum. *Curr Opin Cell Biol.* 2016;41:57-65. doi:10.1016/j.ceb.2016.03.021.
 68. Fournier T, Guibourdenche J, Evain-Brion D. Review: hCGs: different sources of production, different glycoforms and functions. *Placenta.* 2015;36 Suppl 1:S60-5. doi:10.1016/j.placenta.2015.02.002.
 69. Spessott W, Crespo PM, Daniotti JL, Maccioni HJF. Glycosyltransferase complexes improve glycolipid synthesis. *FEBS Lett.* 2012;586(16):2346-2350. doi:10.1016/j.febslet.2012.05.041.
 70. E. J. Structural Biology of Glycoproteins. In: *Glycosylation*. InTech; 2012. doi:10.5772/48154.
 71. Stanley P, Schachter H, Taniguchi N. *N-Glycans*. Cold Spring Harbor Laboratory Press; 2009. <http://www.ncbi.nlm.nih.gov/pubmed/20301244>. Accessed May 12, 2016.
 72. Barnes G, Hansen WJ, Holcomb CL, Rine J. Asparagine-Linked Glycosylation in *Saccharomyces cerevisiae*: Genetic Analysis of an Early Step. *Mol Cell Biol.* 1984;4(11):2381-2388.
 73. Kornfeld R, Kornfeld S. Assembly of asparagine-linked oligosaccharides. *Annu Rev Biochem.* 1985;54:631-664. doi:10.1146/annurev.bi.54.070185.003215.
 74. Lannoo N, Van Damme EJM. Review/N-glycans: The making of a varied toolbox. *Plant Sci.* 2015;239:67-83. doi:10.1016/j.plantsci.2015.06.023.
 75. Suzuki T, Funakoshi Y. Free N-linked oligosaccharide chains: formation and degradation. *Glycoconj J.* 2006;23(5-6):291-302. doi:10.1007/s10719-006-6975-x.
 76. Harada Y, Hirayama H, Suzuki T. Generation and degradation of free asparagine-linked glycans. *Cell Mol Life Sci.* 2015;72(13):2509-2533. doi:10.1007/s00018-015-1881-7.

77. Caramelo JJ, Parodi AJ. A sweet code for glycoprotein folding. *FEBS Lett.* 2015;589(22):3379-3387. doi:10.1016/j.febslet.2015.07.021.
78. Tannous A, Pisoni GB, Hebert DN, Molinari M. N-linked sugar-regulated protein folding and quality control in the ER. *Semin Cell Dev Biol.* 2015;41:79-89. doi:10.1016/j.semcdb.2014.12.001.
79. Cylwik B, Lipartowska K, Chrostek L, Gruszewska E. Congenital disorders of glycosylation. part ii. defects of protein o-glycosylation. 2013.
80. Lefeber DJ, de Brouwer APM, Morava E, et al. Autosomal recessive dilated cardiomyopathy due to DOLK mutations results from abnormal dystroglycan O-mannosylation. *PLoS Genet.* 2011;7(12):e1002427. doi:10.1371/journal.pgen.1002427.
81. Brockhausen I, Schachter H, Stanley P. *O-GalNAc Glycans*. Cold Spring Harbor Laboratory Press; 2009. <http://www.ncbi.nlm.nih.gov/pubmed/20301232>. Accessed May 15, 2016.
82. Ten Hagen KG, Fritz TA, Tabak LA. All in the family: the UDP-GalNAc:polypeptide N-acetylgalactosaminyltransferases. *Glycobiology.* 2003;13(1):1R-16R. doi:10.1093/glycob/cwg007.
83. Hurtado-Guerrero R. Recent structural and mechanistic insights into protein O-GalNAc glycosylation. *Biochem Soc Trans.* 2016;44(1):61-67. doi:10.1042/BST20150178.
84. Cornelissen LAM, Van Vliet SJ. A Bitter Sweet Symphony: Immune Responses to Altered O-glycan Epitopes in Cancer. *Biomolecules.* 2016;6(2). doi:10.3390/biom6020026.
85. Raclawska DS, Ttofali F, Fletcher AA, et al. Mucins and Their Sugars. Critical Mediators of Hyperreactivity and Inflammation. *Ann Am Thorac Soc.* 2016;13 Suppl 1:S98-9. doi:10.1513/AnnalsATS.201511-743MG.
86. Freeze HH, Haltiwanger RS. *Other Classes of ER/Golgi-Derived Glycans*. Cold Spring Harbor Laboratory Press; 2009. <http://www.ncbi.nlm.nih.gov/pubmed/20301267>. Accessed May 16, 2016.
87. Dobson CM, Hempel SJ, Stalnaker SH, Stuart R, Wells L. O-Mannosylation and human disease. *Cell Mol Life Sci.* 2013;70(16):2849-2857. doi:10.1007/s00018-012-1193-0.
88. Moore CJ, Winder SJ. The inside and out of dystroglycan post-translational modification. *Neuromuscul Disord.* 2012;22(11):959-965. doi:10.1016/j.nmd.2012.05.016.
89. Endo T. Glycobiology of α -dystroglycan and muscular dystrophy. *J Biochem.* 2015;157(1):1-12. doi:10.1093/jb/mvu066.
90. Rojek JM, Kunz S. Cell entry by human pathogenic arenaviruses. *Cell Microbiol.* 2008;10(4):828-835. doi:10.1111/j.1462-5822.2007.01113.x.
91. Vasudevan D, Haltiwanger RS. Novel roles for O-linked glycans in protein folding. *Glycoconj J.* 2014;31(6-7):417-426. doi:10.1007/s10719-014-9556-4.
92. Stanley P. Regulation of Notch signaling by glycosylation. *Curr Opin Struct Biol.* 2007;17(5):530-535. doi:10.1016/j.sbi.2007.09.007.
93. Rampal R, Luther KB, Haltiwanger RS. Notch signaling in normal and disease States: possible therapies related to glycosylation. *Curr Mol Med.* 2007;7(4):427-445. <http://www.ncbi.nlm.nih.gov/pubmed/17584081>. Accessed June 24, 2016.
94. Heinonen TYK, Maki M. Peters'-plus syndrome is a congenital disorder of glycosylation caused by a defect in the beta1,3-glucosyltransferase that modifies thrombospondin type 1 repeats. *Ann Med.* 2009;41(1):2-10. doi:10.1080/07853890802301975.
95. Takeuchi H, Kantharia J, Sethi MK, Bakker H, Haltiwanger RS. Site-specific O-glycosylation of the epidermal growth factor-like (EGF) repeats of notch: efficiency of glycosylation is affected by proper folding and amino acid sequence of individual

- EGF repeats. *J Biol Chem.* 2012;287(41):33934-33944. doi:10.1074/jbc.M112.401315.
96. Leonardi J, Jafar-Nejad H. Structure-function analysis of Drosophila Notch using genomic rescue transgenes. *Methods Mol Biol.* 2014;1187:29-46. doi:10.1007/978-1-4939-1139-4_3.
 97. Ricard-Blum S. The collagen family. *Cold Spring Harb Perspect Biol.* 2011;3(1):a004978. doi:10.1101/cshperspect.a004978.
 98. Gorres KL, Raines RT. Prolyl 4-hydroxylase. *Crit Rev Biochem Mol Biol.* 2010;45(2):106-124. doi:10.3109/10409231003627991.
 99. Iozzo R V, Schaefer L. Proteoglycan form and function: A comprehensive nomenclature of proteoglycans. *Matrix Biol.* 2015;42:11-55. doi:10.1016/j.matbio.2015.02.003.
 100. Esko JD, Kimata K, Lindahl U. *Proteoglycans and Sulfated Glycosaminoglycans.* Cold Spring Harbor Laboratory Press; 2009. <http://www.ncbi.nlm.nih.gov/pubmed/20301236>. Accessed June 26, 2016.
 101. Funderburgh JL. Keratan sulfate biosynthesis. *IUBMB Life.* 2002;54(4):187-194. doi:10.1080/15216540214932.
 102. Ferguson MA, Kinoshita T, Hart GW. *Glycosylphosphatidylinositol Anchors.* Cold Spring Harbor Laboratory Press; 2009. <http://www.ncbi.nlm.nih.gov/pubmed/20301281>. Accessed October 4, 2016.
 103. Sangiorgio V, Pitto M, Palestini P, Masserini M. GPI-anchored proteins and lipid rafts. *Ital J Biochem.* 2004;53(2):98-111. <http://www.ncbi.nlm.nih.gov/pubmed/15646015>. Accessed June 26, 2016.
 104. Yu S, Guo Z, Johnson C, Gu G, Wu Q. Recent progress in synthetic and biological studies of GPI anchors and GPI-anchored proteins. *Curr Opin Chem Biol.* 2013;17(6):1006-1013. doi:10.1016/j.cbpa.2013.09.016.
 105. Wennekes T, van den Berg RJBHN, Boot RG, van der Marel GA, Overkleeft HS, Aerts JMFG. Glycosphingolipids--nature, function, and pharmacological modulation. *Angew Chem Int Ed Engl.* 2009;48(47):8848-8869. doi:10.1002/anie.200902620.
 106. Sphingolipids | Cayman Chemical. <https://www.caymanchem.com/article/2142>.
 107. Merrill AH. Sphingolipid and glycosphingolipid metabolic pathways in the era of sphingolipidomics. *Chem Rev.* 2011;111(10):6387-6422. doi:10.1021/cr2002917.
 108. Maula T, Al Sazzad MA, Slotte JP. Influence of Hydroxylation, Chain Length, and Chain Unsaturation on Bilayer Properties of Ceramides. *Biophys J.* 2015;109(8):1639-1651. doi:10.1016/j.bpj.2015.08.040.
 109. Schnaar RL, Suzuki A, Stanley P. *Glycosphingolipids.* Cold Spring Harbor Laboratory Press; 2009. <http://www.ncbi.nlm.nih.gov/pubmed/20301240>. Accessed June 26, 2016.
 110. Schengrund C-L. Gangliosides: glycosphingolipids essential for normal neural development and function. *Trends Biochem Sci.* 2015;40(7):397-406. doi:10.1016/j.tibs.2015.03.007.
 111. Schnaar RL, Gerardy-Schahn R, Hildebrandt H. Sialic acids in the brain: gangliosides and polysialic acid in nervous system development, stability, disease, and regeneration. *Physiol Rev.* 2014;94(2):461-518. doi:10.1152/physrev.00033.2013.
 112. Jacewicz M, Clausen H, Nudelman E, Donohue-Rolfe A, Keusch GT. Pathogenesis of shigella diarrhea. XI. Isolation of a shigella toxin-binding glycolipid from rabbit jejunum and HeLa cells and its identification as globotriaosylceramide. *J Exp Med.* 1986;163(6):1391-1404. <http://www.ncbi.nlm.nih.gov/pubmed/3519828>. Accessed October 4, 2016.
 113. Chester MA. IUPAC-IUB Joint Commission on Biochemical Nomenclature (JCBN). Nomenclature of glycolipids--recommendations 1997. *Eur J Biochem.*

- 1998;257(2):293-298. <http://www.ncbi.nlm.nih.gov/pubmed/9826173>. Accessed June 26, 2016.
114. SVENNERHOLM L. CHROMATOGRAPHIC SEPARATION OF HUMAN BRAIN GANGLIOSIDES. *J Neurochem.* 1963;10:613-623. <http://www.ncbi.nlm.nih.gov/pubmed/14066623>. Accessed June 26, 2016.
 115. Palmano K, Rowan A, Guillermo R, Guan J, McJarrow P. The role of gangliosides in neurodevelopment. *Nutrients.* 2015;7(5):3891-3913. doi:10.3390/nu7053891.
 116. Barone R, Sturiale L, Palmigiano A, Zappia M, Garozzo D. Glycomics of pediatric and adulthood diseases of the central nervous system. *J Proteomics.* 2012;75(17):5123-5139. doi:10.1016/j.jprot.2012.07.007.
 117. Liu Y, Xia B, Gleason TJ, et al. N- and O-linked glycosylation of total plasma glycoproteins in galactosemia. *Mol Genet Metab.* 2012;106(4):442-454. doi:10.1016/j.ymgme.2012.05.025.
 118. Coss KP, Byrne JC, Coman DJ, et al. IgG N-glycans as potential biomarkers for determining galactose tolerance in Classical Galactosaemia. *Mol Genet Metab.* 2012;105(2):212-220. doi:10.1016/j.ymgme.2011.10.018.
 119. Charlwood J, Clayton P, Keir G, Mian N, Winchester B. Defective galactosylation of serum transferrin in galactosemia. *Glycobiology.* 1998;8(4):351-357. <http://www.ncbi.nlm.nih.gov/pubmed/9499382>. Accessed June 26, 2016.
 120. Michelakakis H, Moraitou M, Mavridou I, Dimitriou E. Plasma lysosomal enzyme activities in congenital disorders of glycosylation, galactosemia and fructosemia. *Clin Chim Acta.* 2009;401(1-2):81-83. doi:10.1016/j.cca.2008.11.024.
 121. Jaeken, J., Stibler H. A newly recognized inherited neurological disease with carbohydrate deficient secretory glycoproteins. *Wenner-Gren Int Symp Ser London Macmillan Press.* 1989;51:69-80.
 122. Stibler H, Allgulander C, Borg S, Kjellin KG. Abnormal microheterogeneity of transferrin in serum and cerebrospinal fluid in alcoholism. *Acta Med Scand.* 1978;204(1-2):49-56. <http://www.ncbi.nlm.nih.gov/pubmed/685730>. Accessed June 27, 2016.
 123. Hennet T, Cabalzar J. Congenital disorders of glycosylation: a concise chart of glycoalyx dysfunction. *Trends Biochem Sci.* 2015;40(7):377-384. doi:10.1016/j.tibs.2015.03.002.
 124. Freeze HH, Schachter H. *Genetic Disorders of Glycosylation.* Cold Spring Harbor Laboratory Press; 2009. <http://www.ncbi.nlm.nih.gov/pubmed/20301259>. Accessed June 26, 2016.
 125. Jaeken J, Hennet T, Matthijs G, Freeze HH. CDG nomenclature: time for a change! *Biochim Biophys Acta.* 2009;1792(9):825-826. doi:10.1016/j.bbadis.2009.08.005.
 126. Feraco P, Mirabelli-Badenier M, Severino M, et al. The Shrunken, Bright Cerebellum: A Characteristic MRI Finding in Congenital Disorders of Glycosylation Type 1a. *Am J Neuroradiol.* 2012;33(11):2062-2067. doi:10.3174/ajnr.A3151.
 127. Briones P, Vilaseca MA, García-Silva MT, et al. Congenital disorders of glycosylation (CDG) may be underdiagnosed when mimicking mitochondrial disease. *Eur J Paediatr Neurol.* 2001;5(3):127-131. <http://www.ncbi.nlm.nih.gov/pubmed/11589167>. Accessed June 10, 2016.
 128. Edvardson S, Baumann A-M, Mühlenhoff M, et al. West syndrome caused by ST3Gal-III deficiency. *Epilepsia.* 2013;54(2):e24-7. doi:10.1111/epi.12050.
 129. Varki A, Esko JD, Colley KJ. *Cellular Organization of Glycosylation.* Cold Spring Harbor Laboratory Press; 2009. <http://www.ncbi.nlm.nih.gov/pubmed/20301251>. Accessed June 26, 2016.
 130. Boccuto L, Aoki K, Flanagan-Steet H, et al. A mutation in a ganglioside biosynthetic enzyme, ST3GAL5, results in salt & pepper syndrome, a neurocutaneous disorder with altered glycolipid and glycoprotein glycosylation.

- Hum Mol Genet.* 2014;23(2):418-433. doi:10.1093/hmg/ddt434.
131. Murakami N, Ihara Y, Nonaka I. Muscle fiber degeneration in distal myopathy with rimmed vacuole formation. *Acta Neuropathol.* 1995;89(1):29-34. <http://www.ncbi.nlm.nih.gov/pubmed/7709728>. Accessed September 13, 2016.
 132. Ricci E, Broccolini A, Gidaro T, et al. NCAM is hyposialylated in hereditary inclusion body myopathy due to GNE mutations. *Neurology.* 2006;66(5):755-758. doi:10.1212/01.wnl.0000200956.76449.3f.
 133. Wopereis S, Abd Hamid UM, Critchley A, et al. Abnormal glycosylation with hypersialylated O-glycans in patients with Sialuria. *Biochim Biophys Acta.* 2006;1762(6):598-607. doi:10.1016/j.bbadis.2006.03.009.
 134. Dipta TF, Hossain AZ. The Bombay blood group: are we out of risk? *Mymensingh Med J.* 2011;20(3):536-540. <http://www.ncbi.nlm.nih.gov/pubmed/21804525>. Accessed June 26, 2016.
 135. Kelly RJ, Ernst LK, Larsen RD, Bryant JG, Robinson JS, Lowe JB. Molecular basis for H blood group deficiency in Bombay (Oh) and para-Bombay individuals. *Proc Natl Acad Sci U S A.* 1994;91(13):5843-5847. <http://www.ncbi.nlm.nih.gov/pubmed/7912436>. Accessed June 26, 2016.
 136. Ng BG, Raymond K, Kircher M, et al. Expanding the Molecular and Clinical Phenotype of SSR4-CDG. *Hum Mutat.* 2015;36(11):1048-1051. doi:10.1002/humu.22856.
 137. Timal S, Hoischen A, Lehle L, et al. Gene identification in the congenital disorders of glycosylation type I by whole-exome sequencing. *Hum Mol Genet.* 2012;21(19):4151-4161. doi:10.1093/hmg/dds123.
 138. Ng BG, Buckingham KJ, Raymond K, et al. Mosaicism of the UDP-galactose transporter SLC35A2 causes a congenital disorder of glycosylation. *Am J Hum Genet.* 2013;92(4):632-636. doi:10.1016/j.ajhg.2013.03.012.
 139. Van Scherpenzeel M, Willems E, Lefeber DJ. Clinical diagnostics and therapy monitoring in the congenital disorders of glycosylation. *Glycoconj J.* 2016;33(3):345-358. doi:10.1007/s10719-015-9639-x.
 140. Cossins J, Belaya K, Hicks D, et al. Congenital myasthenic syndromes due to mutations in ALG2 and ALG14. *Brain.* 2013;136:944-956. doi:10.1093/brain/awt010.
 141. Clerc F, Reiding KR, Jansen BC, Kammeijer GSM, Bondt A, Wuhrer M. Human plasma protein N-glycosylation. *Glycoconj J.* 2016;33(3):309-343. doi:10.1007/s10719-015-9626-2.
 142. Ondrušková N, Honzík T, Kytnarová J, Matoulek M, Zeman J, Hansíková H. Isoelectric Focusing of Serum Apolipoprotein C-III as a Sensitive Screening Method for the Detection of O-glycosylation Disturbances. *Prague Med Rep.* 2015;116(2):73-86. doi:10.14712/23362936.2015.48.
 143. Holdsworth G, Stocks J, Dodson P, Galton DJ. An abnormal triglyceride-rich lipoprotein containing excess sialylated apolipoprotein C-III. *J Clin Invest.* 1982;69(4):932-939. <http://www.ncbi.nlm.nih.gov/pubmed/7076853>. Accessed September 16, 2016.
 144. He P, Ng BG, Losfeld M-E, Zhu W, Freeze HH. Identification of intercellular cell adhesion molecule 1 (ICAM-1) as a hypoglycosylation marker in congenital disorders of glycosylation cells. *J Biol Chem.* 2012;287(22):18210-18217. doi:10.1074/jbc.M112.355677.
 145. Carlsson SR, Roth J, Piller F, Fukuda M. Isolation and characterization of human lysosomal membrane glycoproteins, h-lamp-1 and h-lamp-2. Major sialoglycoproteins carrying polylectosaminoglycan. *J Biol Chem.* 1988;263(35):18911-18919. <http://www.ncbi.nlm.nih.gov/pubmed/3143719>. Accessed September 17, 2016.
 146. Park EJ, Grabińska KA, Guan Z, et al. Mutation of Nogo-B receptor, a subunit of

- cis-prenyltransferase, causes a congenital disorder of glycosylation. *Cell Metab.* 2014;20(3):448-457. doi:10.1016/j.cmet.2014.06.016.
147. Meri S, Morgan BP, Wing M, et al. Human protectin (CD59), an 18-20-kD homologous complement restriction factor, does not restrict perforin-mediated lysis. *J Exp Med.* 1990;172(1):367-370. <http://www.ncbi.nlm.nih.gov/pubmed/1694224>. Accessed September 17, 2016.
 148. Brodsky RA. Advances in the diagnosis and therapy of paroxysmal nocturnal hemoglobinuria. *Blood Rev.* 2008;22(2):65-74. doi:10.1016/j.blre.2007.10.002.
 149. Fragaki K, Ait-El-Mkadem S, Chaussenot A, et al. Refractory epilepsy and mitochondrial dysfunction due to GM3 synthase deficiency. *Eur J Hum Genet.* 2013;21(5):528-534. doi:10.1038/ejhg.2012.202.
 150. Wuhrer M. Glycomics using mass spectrometry. *Glycoconj J.* 2013;30(1):11-22. doi:10.1007/s10719-012-9376-3.
 151. Bertozzi CR, Sasisekharan R. *Glycomics*. Cold Spring Harbor Laboratory Press; 2009. <http://www.ncbi.nlm.nih.gov/pubmed/20301280>. Accessed September 21, 2016.
 152. Mulloy B, Hart GW, Stanley P. *Structural Analysis of Glycans*. Cold Spring Harbor Laboratory Press; 2009. <http://www.ncbi.nlm.nih.gov/pubmed/20301234>. Accessed October 5, 2016.
 153. Goreta SS, Dabelic S, Dumic J. Insights into complexity of congenital disorders of glycosylation. *Biochem medica.* 2012;22(2):156-170. <http://www.ncbi.nlm.nih.gov/pubmed/22838182>. Accessed September 21, 2016.
 154. Thiel C, Körner C. Therapies and therapeutic approaches in Congenital Disorders of Glycosylation. *Glycoconj J.* 2013;30(1):77-84. doi:10.1007/s10719-012-9447-5.
 155. Sturla L, Puglielli L, Tonetti M, et al. Impairment of the Golgi GDP-L-fucose transport and unresponsiveness to fucose replacement therapy in LAD II patients. *Pediatr Res.* 2001;49(4):537-542. doi:10.1203/00006450-200104000-00016.
 156. Marquardt T, Lühn K, Srikrishna G, Freeze HH, Harms E, Vestweber D. Correction of leukocyte adhesion deficiency type II with oral fucose. *Blood.* 1999;94(12):3976-3985. <http://www.ncbi.nlm.nih.gov/pubmed/10590041>. Accessed September 19, 2016.
 157. Almeida AM, Murakami Y, Baker A, et al. Targeted Therapy for Inherited GPI Deficiency. *N Engl J Med.* 2007;356(16):1641-1647. doi:10.1056/NEJMoa063369.
 158. Boycott KM, Beaulieu CL, Kernohan KD, et al. Autosomal-Recessive Intellectual Disability with Cerebellar Atrophy Syndrome Caused by Mutation of the Manganese and Zinc Transporter Gene SLC39A8. *Am J Hum Genet.* 2015;97(6):886-893. doi:10.1016/j.ajhg.2015.11.002.
 159. Park JH, Hoglebe M, Grüneberg M, et al. SLC39A8 Deficiency: A Disorder of Manganese Transport and Glycosylation. *Am J Hum Genet.* 2015;97(6):894-903. doi:10.1016/j.ajhg.2015.11.003.
 160. Engel AG, Shen X-M, Selcen D, Sine SM. Congenital myasthenic syndromes: pathogenesis, diagnosis, and treatment. *Lancet Neurol.* 2015;14(4):420-434. doi:10.1016/S1474-4422(14)70201-7.
 161. Gehle VM, Walcott EC, Nishizaki T, Sumikawa K. N-glycosylation at the conserved sites ensures the expression of properly folded functional ACh receptors. *Brain Res Mol Brain Res.* 1997;45(2):219-229. <http://www.ncbi.nlm.nih.gov/pubmed/9149096>. Accessed September 20, 2016.
 162. Wanamaker CP, Christianson JC, Green WN. Regulation of nicotinic acetylcholine receptor assembly. *Ann N Y Acad Sci.* 2003;998:66-80. <http://www.ncbi.nlm.nih.gov/pubmed/14592864>. Accessed September 20, 2016.
 163. Zoltowska K, Webster R, Finlayson S, et al. Mutations in GFPT1 that underlie limb-girdle congenital myasthenic syndrome result in reduced cell-surface expression of muscle AChR. *Hum Mol Genet.* 2013;22(14):2905-2913. doi:10.1093/hmg/ddt145.

164. Finlayson S, Palace J, Belaya K, et al. Clinical features of congenital myasthenic syndrome due to mutations in DPAGT1. *J Neurol Neurosurg Psychiatry*. 2013;84(10):1119-1125. doi:10.1136/jnnp-2012-304716.
165. Belaya K, Rodríguez Cruz PM, Liu WW, et al. Mutations in GMPPB cause congenital myasthenic syndrome and bridge myasthenic disorders with dystroglycanopathies. *Brain*. 2015;138(Pt 9):2493-2504. doi:10.1093/brain/awv185.
166. Lam BL, Züchner SL, Dallman J, et al. Mutation K42E in dehydrodolichol diphosphate synthase (DHDDS) causes recessive retinitis pigmentosa. *Adv Exp Med Biol*. 2014;801:165-170. doi:10.1007/978-1-4614-3209-8_21.
167. Surmacz L, Swiezewska E. Polyisoprenoids – Secondary metabolites or physiologically important superlipids? *Biochem Biophys Res Commun*. 2011;407(4):627-632. doi:10.1016/j.bbrc.2011.03.059.
168. Swiezewska E, Danikiewicz W. Polyisoprenoids: Structure, biosynthesis and function. *Prog Lipid Res*. 2005;44(4):235-258. doi:10.1016/j.plipres.2005.05.002.
169. Mizioro HM. Enzymes of the mevalonate pathway of isoprenoid biosynthesis. *Arch Biochem Biophys*. 2011;505(2):131-143. doi:10.1016/j.abb.2010.09.028.
170. Ericsson J, Appelkvist EL, Thelin A, Chojnacki T, Dallner G. Isoprenoid biosynthesis in rat liver peroxisomes. Characterization of cis-prenyltransferase and squalene synthetase. *J Biol Chem*. 1992;267(26):18708-18714. <http://www.ncbi.nlm.nih.gov/pubmed/1527001>. Accessed May 11, 2016.
171. Ericsson J, Appelkvist EL, Runquist M, Dallner G. Biosynthesis of dolichol and cholesterol in rat liver peroxisomes. *Biochimie*. 1993;75(3-4):167-173. <http://www.ncbi.nlm.nih.gov/pubmed/8507678>. Accessed May 11, 2016.
172. Ericsson J, Scallen TJ, Chojnacki T, Dallner G. Involvement of sterol carrier protein-2 in dolichol biosynthesis. *J Biol Chem*. 1991;266(16):10602-10607. <http://www.ncbi.nlm.nih.gov/pubmed/1645353>. Accessed May 11, 2016.
173. Schenk B, Fernandez F, Waechter CJ. The ins(ide) and out(side) of dolichyl phosphate biosynthesis and recycling in the endoplasmic reticulum. *Glycobiology*. 2001;11(5):61R-70R. <http://www.ncbi.nlm.nih.gov/pubmed/11425794>. Accessed May 11, 2016.
174. Rush JS, Gao N, Lehrman MA, Waechter CJ. Recycling of dolichyl monophosphate to the cytoplasmic leaflet of the endoplasmic reticulum after the cleavage of dolichyl pyrophosphate on the luminal monolayer. *J Biol Chem*. 2008;283(7):4087-4093. doi:10.1074/jbc.M707067200.
175. Bergamini E, Bizzarri R, Cavallini G, et al. Ageing and oxidative stress: a role for dolichol in the antioxidant machinery of cell membranes? *J Alzheimers Dis*. 2004;6(2):129-135. <http://www.ncbi.nlm.nih.gov/pubmed/15096696>. Accessed May 12, 2016.
176. Takahashi S, Koyama T. Structure and function of cis-prenyl chain elongating enzymes. *Chem Rec*. 2006;6(4):194-205. doi:10.1002/tcr.20083.
177. Clarke CF, Tanaka RD, Svenson K, Wamsley M, Fogelman AM, Edwards PA. Molecular cloning and sequence of a cholesterol-repressible enzyme related to prenyltransferase in the isoprene biosynthetic pathway. *Mol Cell Biol*. 1987;7(9):3138.
178. Shimizu N, Koyama T, Ogura K. Molecular Cloning, Expression, and Characterization of the Genes Encoding the Two Essential Protein Components of *Micrococcus luteus* B-P 26 Hexaprenyl Diphosphate Synthase. *J Bacteriol*. 1998;180(6):1578.
179. Fujihashi M, Zhang Y-W, Higuchi Y, Li X-Y, Koyama T, Miki K. Crystal structure of cis-prenyl chain elongating enzyme, undecaprenyl diphosphate synthase. *Proc Natl Acad Sci U S A*. 2001;98(8):4337. doi:10.1073/pnas.071514398.
180. Zelinger L, Banin E, Obolensky A, et al. A missense mutation in DHDDS, encoding dehydrodolichyl diphosphate synthase, is associated with autosomal-recessive

- retinitis pigmentosa in Ashkenazi Jews. *Am J Hum Genet.* 2011;88(2):207-215. doi:10.1016/j.ajhg.2011.01.002.
181. Züchner S, Dallman J, Wen R, et al. Whole-exome sequencing links a variant in DDDS to retinitis pigmentosa. *Am J Hum Genet.* 2011;88(2):201-206. doi:10.1016/j.ajhg.2011.01.001.
 182. Rush JS, Matveev S, Guan Z, Raetz CRH, Waechter CJ. Expression of functional bacterial undecaprenyl pyrophosphate synthase in the yeast rer2{Delta} mutant and CHO cells. *Glycobiology.* 2010;20(12):1585-1593. doi:10.1093/glycob/cwq107.
 183. Wen R, Lam BL, Guan Z. Aberrant dolichol chain lengths as biomarkers for retinitis pigmentosa caused by impaired dolichol biosynthesis. *J Lipid Res.* 2013;54(12):3516-3522. doi:10.1194/jlr.M043232.
 184. Harrison KD, Park EJ, Gao N, et al. Nogo-B receptor is necessary for cellular dolichol biosynthesis and protein N-glycosylation. *EMBO J.* 2011;30(12):2490-2500. doi:10.1038/emboj.2011.147.
 185. Haeuptle MA, Welti M, Troxler H, Hülsmeier AJ, Imbach T, Hennet T. Improvement of dolichol-linked oligosaccharide biosynthesis by the squalene synthase inhibitor zaragozic acid. *J Biol Chem.* 2011;286(8):6085-6091. doi:10.1074/jbc.M110.165795.
 186. Varki A, Schauer R. *Sialic Acids.* Cold Spring Harbor Laboratory Press; 2009. <http://www.ncbi.nlm.nih.gov/pubmed/20301246>. Accessed September 27, 2016.
 187. Cohen M, Varki A. The sialome--far more than the sum of its parts. *OMICS.* 2010;14(4):455-464. doi:10.1089/omi.2009.0148.
 188. Audry M, Jeanneau C, Imberty A, Harduin-Lepers A, Delannoy P, Breton C. Current trends in the structure-activity relationships of sialyltransferases. *Glycobiology.* 2011;21(6):716-726. doi:10.1093/glycob/cwq189.
 189. Olofsson S, Bergström T. Glycoconjugate glycans as viral receptors. *Ann Med.* 2005;37(3):154-172. doi:10.1080/07853890510007340.
 190. Esko JD, Sharon N. *Microbial Lectins: Hemagglutinins, Adhesins, and Toxins.* Cold Spring Harbor Laboratory Press; 2009. <http://www.ncbi.nlm.nih.gov/pubmed/20301238>. Accessed May 7, 2016.
 191. Sharon N, Lis H. History of lectins: from hemagglutinins to biological recognition molecules. *Glycobiology.* 2004;14(11):53R-62R. doi:10.1093/glycob/cwh122.
 192. Gahmberg CG, Tolvanen M. Why mammalian cell surface proteins are glycoproteins. *Trends Biochem Sci.* 1996;21(8):308-311. <http://www.ncbi.nlm.nih.gov/pubmed/8772385>. Accessed May 4, 2016.
 193. Lundblad A. Gunnar Blix and his discovery of sialic acids. Fascinating molecules in glycobiology. *Ups J Med Sci.* 2015;120(2):104-112. doi:10.3109/03009734.2015.1027429.
 194. Chan KF, Zhang P, Song Z. Identification of essential amino acid residues in the hydrophilic loop regions of the CMP-sialic acid transporter and UDP-galactose transporter. *Glycobiology.* 2010;20(6):689-701. doi:10.1093/glycob/cwq016.
 195. Eckhardt M, Gotza B, Gerardy-Schahn R. Membrane topology of the mammalian CMP-sialic acid transporter. *J Biol Chem.* 1999;274(13):8779-8787. doi:10.1074/JBC.274.13.8779.
 196. Muraoka M, Kawakita M, Ishida N. Molecular characterization of human UDP-glucuronic acid/UDP- N -acetylgalactosamine transporter, a novel nucleotide sugar transporter with dual substrate specificity. *FEBS Lett.* 2001;495(1-2):87-93. doi:10.1016/S0014-5793(01)02358-4.
 197. Willig TB, Breton-Gorius J, Elbim C, et al. Macrothrombocytopenia with abnormal demarcation membranes in megakaryocytes and neutropenia with a complete lack of sialyl-Lewis-X antigen in leukocytes--a new syndrome? *Blood.* 2001;97(3):826-828. <http://www.ncbi.nlm.nih.gov/pubmed/11157507>. Accessed September 29, 2016.
 198. Martinez-Duncker I, Dupré T, Piller V, et al. Genetic complementation reveals a

- novel human congenital disorder of glycosylation of type II, due to inactivation of the Golgi CMP-sialic acid transporter. *Blood*. 2005;105(7):2671-2676. doi:10.1182/blood-2004-09-3509.
199. Mohamed M, Ashikov A, Guillard M, et al. Intellectual disability and bleeding diathesis due to deficient CMP--sialic acid transport. *Neurology*. 2013;81(7):681-687. doi:10.1212/WNL.0b013e3182a08f53.
 200. Riemersma M, Sandrock J, Boltje TJ, et al. Disease mutations in CMP-sialic acid transporter SLC35A1 result in abnormal α -dystroglycan O-mannosylation, independent from sialic acid. *Hum Mol Genet*. 2015;24(8):2241-2246. doi:10.1093/hmg/ddu742.
 201. Takamiya K, Yamamoto A, Furukawa K, et al. Mice with disrupted GM2/GD2 synthase gene lack complex gangliosides but exhibit only subtle defects in their nervous system. *Proc Natl Acad Sci U S A*. 1996;93(20):10662-10667. <http://www.ncbi.nlm.nih.gov/pubmed/8855236>. Accessed October 7, 2016.
 202. Ma Q, Kobayashi M, Sugiura M, et al. Morphological study of disordered myelination and the degeneration of nerve fibers in the spinal cord of mice lacking complex gangliosides. *Arch Histol Cytol*. 2003;66(1):37-44. <http://www.ncbi.nlm.nih.gov/pubmed/12703552>. Accessed October 7, 2016.
 203. Trapp BD, Nave K-A. Multiple sclerosis: an immune or neurodegenerative disorder? *Annu Rev Neurosci*. 2008;31:247-269. doi:10.1146/annurev.neuro.30.051606.094313.
 204. De Vries GH, Zmachinski CJ. The lipid composition of rat CNS axolemma-enriched fractions. *J Neurochem*. 1980;34(2):424-430. <http://www.ncbi.nlm.nih.gov/pubmed/7411154>. Accessed October 7, 2016.
 205. Sun J, Shaper NL, Itonori S, Heffer-Lauc M, Sheikh KA, Schnaar RL. Myelin-associated glycoprotein (Siglec-4) expression is progressively and selectively decreased in the brains of mice lacking complex gangliosides. *Glycobiology*. 2004;14(9):851-857. doi:10.1093/glycob/cwh107.
 206. Bardor M, Nguyen DH, Diaz S, Varki A. Mechanism of uptake and incorporation of the non-human sialic acid N-glycolylneuraminic acid into human cells. *J Biol Chem*. 2005;280(6):4228-4237. doi:10.1074/jbc.M412040200.
 207. Brunner D, Frank J, Appl H, Schöffl H, Pfaller W, Gstraunthaler G. Serum-free cell culture: the serum-free media interactive online database. *ALTEX*. 2010;27(1):53-62. <http://www.ncbi.nlm.nih.gov/pubmed/20390239>. Accessed October 7, 2016.
 208. Oetke C, Hinderlich S, Brossmer R, Reutter W, Pawlita M, Keppler OT. Evidence for efficient uptake and incorporation of sialic acid by eukaryotic cells. *Eur J Biochem*. 2001;268(16):4553-4561. <http://www.ncbi.nlm.nih.gov/pubmed/11502217>. Accessed October 7, 2016.
 209. Carlson SE, House SG. Oral and intraperitoneal administration of N-acetylneuraminic acid: effect on rat cerebral and cerebellar N-acetylneuraminic acid. *J Nutr*. 1986;116(5):881-886. <http://www.ncbi.nlm.nih.gov/pubmed/3701463>. Accessed October 7, 2016.

Chapter 6

Appendix

Here, we present a new approach for CDG classification. CDG have been assigned, from a biochemical perspective, to the major steps involved in the different glycosylation processes. The glycosylation events according to which CDGs have been classified here involve the biosynthesis, inter-organelle transport, or transfer of a monosaccharide or a glycan onto an acceptor. Based on its role in these glycosylation events, defective element could be the underlying cause of diseases with different clinical pictures. Galactose, for example, is involved in N- and O-glycoprotein as well as GSL biosynthesis. Accordingly, disturbed galactosylation, which can result from compromised translocation of UDP-Gal from the cytoplasm to the GA or from a non-functioning galactosyltransferase (see the tables for more details), can cause different CDG subtypes.

CDGs can be classified into five major classes:

- A) Dolichol biosynthesis defects
- B) Sugar donor (activated sugars) defects
- C) Sugar donor transport defects
- D) Glycan biosynthesis and conjugation defects
- E) Defective Golgi-resident proteins
- F) Miscellaneous

In the following tables, the majority of CDG subtypes are presented with respect to 6 aspects:

- 1) The defective glycosylation step and its reference number in OMIM (phenotype description and molecular basis)
- 2) The role of the defective protein in the glycosylation process.
- 3) The types of glycoconjugate involved
- 4) Reported causative mutations
- 5) Glycosylation status markers (glycomarkers) evaluated in the reported cases
- 6) Clinical picture

A) Dolichol Biosynthesis Defects

<i>Defective step</i>	<i>Role in glycosylation</i>	<i>Glycoconjugates involved</i>	<i>Mutations</i>	<i>Glycomarkers</i>	<i>Clinical picture</i>
Dehydrodolichyl diphosphate synthase (DHDDS) DHDDS-CDG	Catalyzes cis-prenyl chain elongation to produce the polyprenyl backbone of dolichol	N- and O-glycans GPI anchors	LYS42GLU Tryp64X	Normal serum Tf Hypoglycosylated serum N-glycans, hypoglycosylated ICAM-1, ↓ endogenous Dol-P	Retinitis pigmentosa (K42E) (OMIM: 613861) Severe presentation (W64X): Intra-uterine growth retardation and decreased foetal movements. After birth, axial hypotonia, peripheral hypertonia, poor visual contact, epilepsy, liver and renal failure, facial dysmorphism, and failure to thrive.
Steroid 5- α -reductase 3 (SRD5A3) SRD5A3-CDG (OMIM: 612379)	Polyprenol reductase activity	N- and O-glycans GPI anchors	3-BP DEL/10-BP INS, NT286, TRP107TER, ARG142TER, TYR163TER, SER10TER, 1-BP DUP, 203C	↑ asialo-, disialo-Tf ↑ dolichols & polyprenols	Ichthyosiform dermatitis, Neurological disease (developmental delay, ataxia), Early visual impairment with optic nerve atrophy, Liver dysfunction, Retinal coloboma (a hole in the retina), Coagulation abnormality. NO cardiac or muscular pathology due to normal plasma levels of dolichol.
Dolichol kinase (DOLK) (DOLK-CDG) (OMIM: 610768)	Dolichol phosphorylation before entering glycosylation	N- and O-glycans GPI anchors	CYS99SER, TYR441SER, HIS408ASP, TRP304CYS, MET1ILE, MET1?		Ichthyosis, failure to thrive, hypotonia, hypoglycaemia, death in early childhood.
NogoB receptor NUS 1-CDG (OMIM: 617082)	Essential accessory protein for DHDDS function. It binds to DHDDS on the ER-cytosolic face	N-, O- glycans		Hypoglycosylated proteins LAMP & ICAM-1 ↑ dolichol D18 in plasma and urine	Scoliosis, severe epilepsy, muscle hypotonia, developmental delay, microcephaly, visual impairment.

B) Sugar Donor Biosynthesis Defects

<i>Defective step</i>	<i>Role in glycosylation</i>	<i>Glycoconjugates involved</i>	<i>Mutations</i>	<i>Glycomarkers</i>	<i>Clinical picture</i>
<p>Phosphomannomutase (PMM2)</p> <p>PMM2-CDG</p> <p>(The most common CDG subtype)</p> <p>(OMIM: 212065)</p>	<p>Conversion of Man6P to Man1P</p>	<p>N- glycans</p>	<p>ARG141HIS, ASN216ILE, VAL129MET</p> <p>,</p> <p>ARG162TRP, ASP65TYR, PHE119LEU, ASP188GLY, GLY117ARG</p> <p>,</p> <p>ASP223GLU, 357C-A, THR237ARG</p> <p>,</p> <p>CYS241SER, ILE132THR</p> <p>,</p> <p>VAL231MET</p> <p>,</p> <p>CYS9TYR, LEU32ARG, THR226SER, PRO113LEU, IVS7, C-T, VAL44ALA, 28-KB DEL, IVS3AS, G-C, -1, TYR106PHE</p>	<p>Asialo-, disialo- Tf</p> <p>↑ di-, mono- & unglycosylated β-TP CSF)</p>	<p><u>First stage (Infancy):</u> Failure to thrive, inverted nipples, lipodystrophy (subcutaneous fat pads), infection susceptibility, hepatic failure, bleeding episodes, hypertrophic cardiomyopathy.</p> <p><u>Second stage (early childhood):</u> seizures; sometimes misdiagnosed as febrile seizures with or without Todd's paralysis, Stroke-like episodes.</p> <p><u>Third stage (childhood):</u> Slowly progressive limb atrophy (d.t. demyelinating peripheral neuropathy), Severe ataxia, Intellectual disability, Esotropia (a form of strabismus, or "squint," in which one or both eyes turns inward), visual loss caused by progressive pigmentary degeneration.</p> <p><u>Fourth stage (adolescence and adulthood):</u> Fixed neurological deficit, Endocrinopathies in the form of hypergonadotropic, hypogonadism, Skeletal deformities (kyphoscoliosis)</p>

Sugar Donor Biosynthesis Defects (continued):

<i>Defective step</i>	<i>Role in glycosylation</i>	<i>Glycoconjugates involved</i>	<i>Mutations</i>	<i>Glycomarkers</i>	<i>Clinical picture</i>
Mannose-phosphate isomerase MPI- CDG (OMIM: 602579)	Conversion of Fru6P to Man6P	N- glycans	ARG219GLN, SER102LEU, MET138THR, 1-BP INS, 166C, ARG295HIS	Serum Tf hypoglycosylation	GIT system involvement, HM, fibrosis. Treatable by mannose supplementation.
Glutamine-fructose-phosphate transaminase 1 (GFPT 1) GFPT1-CDG (OMIM: 610542)	Fru6P → GlcNAc-6-P → GlcNAc-1-P → UDP-GlcNAc	N- glycans	ARG111CYS, 1-BP INS, 222A, TRP240TER, ASP348TYR, THR15ALA, 1-BP DEL, NT621	NM	Limb-girdle weakness: neuromuscular disorder with proximal weakness in griddles and sparing of ocular and facial muscles. NO clear genotype-phenotype correlation for GFPT 1 mutations. siRNA knocked down GFPT 1 shows ↓↓ cell surface AchRs expression.
UDP-GlcNAc2 epimerase GNE-CDG (OMIM: 605820)	The enzyme is the rate-limiting enzyme in the 1 st two steps in Sia synthesis	O-glycans	MET712THR, GLY576GLU, ALA631THR, ARG246GLN, ASP225ASN	↓ sialylated O-glycans but normal sialylated N-glycans	Hereditary inclusion body myopathy type II: neuromuscular disorder with late onset of myopathy limited to legs. It spares the quadriceps muscles.
Sialuria: UDP-N-acetylglucosamine2-epimerase/N/acetylglucosamine kinase (GNE) (OMIM: 269921)	The first two steps in the conversion of GlcNAc to sialic acid	O-glycans	ARG266TRP, ARG266GLN, ARG263LE	↑ disialylated proteins. Normal serum Tf	Mild phenotype: coarse facies, mild MR, hepatosplenomegaly, recurrent upper respiratory tract infection.

¹ NM : not mentioned

Sugar Donor Biosynthesis Defects (continued):

<i>Defective step</i>	<i>Role in glycosylation</i>	<i>Glycoconjugates involved</i>	<i>Mutations</i>	<i>Glycomarkers</i>	<i>Clinical picture</i>
<p>UDP-GlcNAc: Dol-P-GlcNAc phosphotransferase (ALG 7) DPAGT-CDG (OMIM: 608093)</p>	<p>UDP-GlcNAc + Dol-P → GlcNAc-PP-Dol</p>	N-glycans	<p>TYR170CYS, VAL117ILE, MET108ILE, 1-BP DUP, NT699, LEU120MET, VAL264GLY, ILE69ASN, IVS1DS, G-A, +5, ALA114GLY, ILE29PHE, LEU168PRO</p>	Type I serum Tf	<p>One of the CMS (congenital myasthenic syndromes: a gp of rare and heterogenous inherited disorders caused by mutations in genes encoding proteins that are essential for neuronal transmission)</p> <p>The patients show 10-fold decrease in AchR (nicotinic acetylcholine receptors) vs the controls. Clinical picture: progressive fatigable weakness since infancy, intellectual disability, autistic features (one case), life-threatening respiratory crisis, muscle cramps</p>
<p>GDP-Man pyrophosphorylase (GMPPB)</p>	<p>Man6P → GDP-Man</p>	N- and O-glycans	<p>ASP334ASN, ARG74TER, PRO22SER, ARG185CYS, PRO32LEU, ARG287GLN, ASP27HIS, VAL330ILE, ARG287TRP, VAL254MET, PRO103LEU</p>	<p>Hypoglycosylated DGA1 Normally glycosylated serum Tf</p>	<p>Large clinical spectrum of CMS:</p> <p><u>Mild</u>: limb girdle muscle dystrophy (LGMD) (OMIM: 615352) <u>Moderate</u>: congenital muscular dystrophy, isolated rhabdomyolysis with mental retardation (OMIM: 615351) <u>Severe</u>: congenital muscular dystrophy with structural brain and eye defects (OMIM: 615350)</p>

Sugar Donor Biosynthesis Defects (continued)

Defective step	Role in glycosylation	Glycoconjugates involved	Mutations	Glycomarkers	Clinical picture
DPM1-CDG (OMIM: 608799)	Dol-P-Man biosynthesis. DPMS1 is the catalytic cytosolic subunit of DPMS.	N-, O-glycans	ARG92GLY, 13-BP DEL, 1-BP DEL, 628C, SER248PRO, IVS4AS, T-A, -5, GLY152VAL, 100-KB DEL	Serum Tf of type I Hypoglycosylated trace protein in CSF. Hypoglycosylated α -DG Serum Tf of type I	Delayed psychomotor development, microcephaly, cerebellar ataxia with dysmetria, tremor, coordination problems, seizures, and partial optic nerve atrophy. Brain imaging suggested delayed myelination, but cerebellar atrophy was not present. Dysmorphic features included trigonocephaly, prominent forehead, thick metopic suture, hypertelorism, high nasal bridge, smooth philtrum, micrognathia, Gothic palate, malocclusion, hemangiomas, and camptodactyly. One case presented with dystroglycanopathy
DPM2-CDG (OMIM: 603564)	Dol-P-Man biosynthesis. DPMS2 is a regulatory subunit of DPMS and is located in the ER	N-, O-glycans GPI anchors	TYR23CYS IVS1AS, G-C, -1	\uparrow Dol-PP-NAC ₂ Man ₅ in fibroblasts. Type I CDG Hypoglycosylated α -DG Serum Tf.	Severe hypotonia, myopathic facies, and dysmorphic features, micrognathia, malocclusion, strabismus, severe congenital contractures of the joints and scoliosis. Generalized, or myoclonic seizures began between 3 and 5 months of age. Delayed psychomotor development without visual tracking, head control, or speech.
DPM3-CDG (OMIM: 612937)	Dol-P-Man biosynthesis. DPM3 stabilizes DPM1 subunit and is located in the ER independent of DMP2	N-, O-glycans	LEU85SER	Hypomannosylated α -DG Serum Tf of type I α -DG	Dilated cardiomyopathy, moderate muscular dystrophy, low-normal IQ

C) Sugar Donors Transport Defects

<i>Defective step</i>	<i>Role in glycosylation</i>	<i>Glycoconjugates involved</i>	<i>Mutations</i>	<i>Glycomarkers</i>	<i>Clinical picture</i>
GDP-fucose transporter (GFT) SLC35C1-CDG (OMIM: 266265).	Fucose transport to the GA Fucose-containing ligand of the selectin family of cell adhesion molecules. This ligand is required for recruitment of neutrophils to the infection sites.	Glycans with fucosylated core	R147C, T308R	Hypofucosylated serum proteins	Leukocyte Adhesion Deficiency type II syndrome (LAD II): recurrent bacterial infection with high leukocytes, Craniofacial dysmorphism, and severe growth and, psychomotor retardation. Patients have neutrophils lacking sialyl-Lewis ^x . Corrected by dietary fucose supplementation.
CMP-Sia transporter (CST) SLC35A1-CDG (OMIM: 605634)	Transports CMP-Sia residue to the GA		4-BP INS, CACT, 2-BP DEL, 277G and 281C, and 147T-C.	↓ sialylated Lewis ^x on neutrophils Normal Tf pattern	Marked thrombocytopenia and neutropenia, multiple episodes of bleeding, multiple recurrent bacterial infections.
SLC35D1-CDG (OMIM: 269250)	ER UDP-GlcUA /UDP-GalNAc transport for CS biosynthesis	GAGs	1-BP DEL, 125A-, TRP311TER, IVS7, G-T, +1, ARG107TER, IVS4DS, A-G, +3, 4.9-KB DEL, EX7, THR65PRO	NM	Schneckenbecken dysplasia: a rare severe skeletal dysplasia comprising platyspondylyl extremely short long bones and small ilia with snail like-appearance
SLC35A2-CDG (UGT) (OMIM: 300896) X-linked	UDP-Gal transport from the cytoplasm to the GA	N-, O-glycans and GSLs	c.15_91+48delinsA, VAL331ILE, MET1?, 2-BP DEL, 433TA, 1-BP DEL, 972T, SER213PH.	- ↓Sia-Gal from complex N-glycans antenna, ↑ lectin (GSII) binding to terminal βGlnAc in N-glycans, ↑ lectin (VVA) binding to terminal αGalNAc in O-glycans - all patients showed normalization of the abnormal Tf pattern with age without clinical improvement.	Brain imaging showed several anomalies, including cerebral and cerebellar atrophy, delayed myelination, and thin corpus callosum. Hypotonia, severely delayed psychomotor development, variable ocular anomalies, seizures, hypsarrhythmia, poor feeding, microcephaly, recurrent infections, dysmorphic features, shortened limbs, and coagulation defects. One patient had acute nephrotic syndrome and gastroesophageal reflux.

D) Glycans synthesis and conjugation with macromolecules:

I- N- acetylhexosaminylation Defects

a) Protein N-acetylhexosaminylation Defects

<i>Defective step</i>	<i>Role in glycosylation</i>	<i>Glycoconjugates involved</i>	<i>Mutations</i>	<i>Glycomarkers</i>	<i>Clinical picture</i>
ALG13-CDG X-linked disorder (OMIM: 300884)	Addition of the 2 nd GlcNAc residue to GlcNAc-PP-Dol	N-glycans	ASN107S ER, LYS94GL U, THR141L EU	- Serum Tf of type I (in one case) - Normal serum Tf in one case - Not reported for the rest	Refractory epilepsy, Hepatomegaly, recurrent infections, increased bleeding tendency, microcephaly, horizontal nystagmus, and bilateral optic nerve atrophy, extrapyramidal and pyramidal signs.
N- acetylglucosami nyl-transferase II MGAT 2 –CDG (OMIM: 212066)	Golgi modification	N-glycans	SER290PH E, HIS262AR G, ASN318A SP, CYS339T ER, LYS237A SN	↑ monoantennary glycan and its fucosylated equivalent , ↓ biantennary N- glycans, absent triantennary N- glycans, ↑ bisecting glycans, ↑β-TP di-, mono- & unglycosylated forms (CSF).	Craniofacial dysmorphism, skeletal abnormalities, psychomotor involvement, GIT disorders.
N- acetylgalctosami nyl transferase GALNT3 – CDG (OMIM: 211900)	One of the polypeptide GalNAc- transferases essential for O- glycosylation of fibroblasts growth factor 23 (FGF23) that regulates Ca ⁺² and P levels.	O-glycans	IVS7DS, G-A, +5, IVS1AS, A-T, -2, IVS7, G- A, +1, ARG162T ER.	NM	Familial hyperphosphatemic tumoral calcinosis: painful calcified subcutaneous masses with secondary infection. Hyperphosphatemia d.t. ↑ phosphate renal retention.

Protein N-acetylhexosaminylation Defects (Continued):

<i>Defective step</i>	<i>Role in glycosylation</i>	<i>Glycoconjugates involved</i>	<i>Mutations</i>	<i>Glycomarkers</i>	<i>Clinical picture</i>
Lunatic Fringe O-fucose specific β 1,3-N- acetylglucosamin yl transferase. SCDO3-CDG (OMIM: 609813)	Fringe is located in the Golgi apparatus. Addition of N- acetylglucosami ne to O- fucosylated Ser and Thr residues of epidermal growth factor (EGF-like domains) no. 12 which is a part of the binding site of Notch receptor. This O-fucosylation process takes place in the ER and catalyzed by protein-O- fucosyl transferase (POFUT 1).	O-glycans	PHE188L EU	NM	Spondylocostal dysostosis type 3 in notch-pathway severe vertebral phenotype with malsegmentation due to disruption of somitogenesis. Somites are precursors of the axial skeleton and associated musculature (a glycosyltransferase that regulates a signal transduction pathway)
ALG 14-CDG (OMIM: 616227)	A membrane protein that forms a cpx ALG13 and ALG7 for the in N-glycosylation	N-glycans	PRO65LE U, ARG104T ER	Normal serum Tf	CMS 15 (Congenital myasthnic syndrome 15) without tubular aggregates (d.t.↓ AchR. Cell surface expression), normal motor milestones, generalized proximal and truncal weakness, mild contractures, stable course on treatment.

Protein N-acetylhexosaminylation Defects (Continued):

<i>Defective step</i>	<i>Role in glycosylation</i>	<i>Glycoconjugates involved</i>	<i>Mutations</i>	<i>Glycomarkers</i>	<i>Clinical picture</i>
O-mannosyl- β -1,2-N-acetylglucosaminyl-transferase 1 (POMGNT1-CDG)	Catalyses the 2 nd step in synthesis of O-Man glycan core in the GA. It has two functions: 1) addition of β 1-2 GlcNAc to the non-reducing end of O-linked mannose residue, 2) building the classical and branched structure β 1-6 / β 1-2 found only in neuronal tissues (tissue-specificity).	α -DG	<p><u>MDDGA3:</u> 1-BP DEL, ARG442CYS, ARG311GLN, ARG63TER, 1-BP DEL, 1970G, PRO493ARG, 1-BP DEL, 1813C, SER550ASN, IVS17DS, G-A, +1, IVS17DS, G-T, +1</p> <p><u>MDDGB3:</u> ARG605PRO, 652+1G-A, CYS490TYR</p> <p><u>MDDGC3:</u> ASP556ASN, 9-BP DUP, -83</p> <p><u>RP76:</u> ILE287SER, ARG63TER, GLU156LYS, IVS21DS, G-A, +1, GLY502ALA, LEU120ARG</p>	Hypoglycosylated α -DG	<p>Muscular Dystrophy-dystroglycanopathy (with brain and eye anomalies) type A3 (MDDGA3) (OMIM: 253280): 2 subtypes: <u>POMGNT1-related Muscle-Eye-Brain disease (POMGNT1/MEB)</u>: hypotonia, early-onset glaucoma, psychomotor retardation, abnormal facies, seizures. <u>POMGNT1-related Walker-Warburg syndrome (POMGNT1/WWS)</u>: Brain malformations result in severe neurological manifestations with ocular involvement. There is a lack in phenotype-genotype correlation.</p> <p>Muscular Dystrophy-dystroglycanopathy (with brain and eye anomalies) type B3 (MDDGB3) (OMIM: 613151): Mental retardation, myopia, optic atrophy. Ch.ch. by cerebellar cysts.</p> <p>Muscular Dystrophy-dystroglycanopathy (with brain and eye anomalies) type C3 (MDDGC3) Limb Girdle type 20 (LGM20) (OMIM: 613157): proximal limb muscle weakness, positive Gowers sign (a patient that has to use their hands and arms to "walk" up their own body from a squatting position due to lack of hip and thigh muscle strength).</p> <p>Retinitis pigmentosa -76 (RP76) (OMIM: 617123): Constricted visual fields, severely reduced rod responses. Funduscopy revealed bone spicule pigmentation and attenuated retinal vessels. Salt and pepper pigmentation scattered throughout the retina, with macular involvement in both eyes. Night blindness.</p>

b) GSL N-acetylhexosaminylation Defects

<i>Defective step</i>	<i>Role in glycosylation</i>	<i>Glycoconjugates involved</i>	<i>Mutations</i>	<i>Glycomarkers</i>	<i>Clinical picture</i>
B4GALNT1-CDG GM2/GD2 synthase-CDG β1-4 N-acetylgalactosaminyl transferase-1 (OMIM: 609195)	Transfers β1-4 GalNAc to GM3 and GD3 to produce GM2 and GD2 respectively.	GSLs	1-BP DEL, 395C, ARG228T ER, 1-BP DUP, 263G, GLN120T ER, ASP433A LA	↑ GM3 ↓ GM2	Spastic paraplegia-26 (SPG26): onset in the first 2 decades of life of gait abnormalities due to lower limb spasticity and muscle weakness. Some patients have upper limb involvement. Intellectual disability, peripheral neuropathy, dysarthria, cerebellar signs, extrapyramidal signs, and cortical atrophy. Mild intellectual impairment, scoliosis, urinary symptoms, dyskinesia, dystonia, cataracts, and cerebellar signs. Hyporeflexia became apparent later in the disease course.

c) GAGs N-acetylhexosaminylation Defects

<i>Defective step</i>	<i>Role in glycosylation</i>	<i>Glycoconjugates involved</i>	<i>Mutations</i>	<i>Glycomarkers</i>	<i>Clinical picture</i>
EXT1/EXT2 – CDG (OMIM: 133700)	EXT1/EXT2 cpx in GA has glucuronyl-transferase and N-acetyl-D-hexosaminyltransferase activities → polymerization of HS	GAGs	1-BP DEL, 2120T, 1-BP DEL, 1364C, 4-BP INS, NT1035, ARG340LEU, 4-BP DEL, GLN172TER, IVS4AS, G-A, +1, ASP227ASN, TYR222TER, GLN258TER, IVS4AS, A-C, -2	Proteoglycans with ↓ HS	Multiple hereditary exostoses: Osteochondromas: multiple cartilaginous exostoses at the end of long bones they present at birth then their growth slows during adolescence and stops at adulthood. Complications result from compression of peripheral nerves and BVs. It is a monosystemic CDG.
Chonroitin synthase 1 (CHSY1) (OMIM: 605282)	GA-located. It has two catalytic domains: β1-3GlcA transferase and β1-4GalNAc transferase for CS synthesis	CS	30-BP DEL, NT55, BP DEL, 14G, LN69TER, IVS1AS, C-G, -3, PRO539ARG, 1-BP DEL, 96C.	↓ CS on proteoglycans	Temtamy-preaxial brachydactyly syndrome: digits malformation called preaxial brachydactyly with MR and growth retardation, facial dysmorphism and hearing loss.

d) GPI anchors N-acetylhexosaminylation Defects

<i>Defective step</i>	<i>Role in glycosylation</i>	<i>Glycoconjugates involved</i>	<i>Mutations</i>	<i>Glycomarkers</i>	<i>Clinical picture</i>
PIGA-CDG UDP-GlcNAc:PI α 1-6 N-acetylglucosaminyltransferase (GlcNAcTn)	One subunit of GlcNAc Tn complex catalyzes the first step in GPI anchors biosynthesis	GPI-anchors	1-BP DEL, T, IVSDS, TYR98TER, 1-BP INS, 460A, 1-BP DEL, 1114C, GLN55TER, 2-BP INS, 334GT, 1-BP DEL, 516C, 2-BP DEL, 1408CT, IVS5DS, G-A, +1, 2-BP INS/32-BP DUP, ARG412TER ARG412TER, 1-BP DUP, 76T, ARG77LEU, ILE206PHE, ARG119TRP, 3-BP DEL, 328CTT, PRO93LEU	Changed glycosylation pattern of CD59 on leukocytes Decreased expression of CD16 on granulocytes	- Paroxysmal nocturnal hemoglobinuria type I (OMIM: 300818): haemolytic anemia. The absence of GPI-anchored proteins renders RBCs sensitive to complement-mediated lysis leading to - - \uparrow Hb in urine. \uparrow leukemia incidence and thrombotic episodes Multiple congenital anomalies-hypotonia-seizures syndrome type II (OMIM: 300868) :Pierre-Robin sequence, a prominent occiput, enlarged fontanel, depressed nasal bridge, short, anteverted nose, malar flattening, upslanted palpebral fissures, overfolded helix, small mouth with downturned corners, and short neck. Severe infantile spasms, including myoclonic and generalized seizures. Cortical and cerebellar atrophy, neuronal loss, systolic murmur, atrial septal defect.

II- Mannosylation Defects

a) Glycoproteins Mannosylation Defects

<i>Defective step</i>	<i>Role in glycosylation</i>	<i>Glycoconjugates involved</i>	<i>Mutations</i>	<i>Glycomarkers</i>	<i>Clinical picture</i>
ALG 1-CDG GDP-Man: Dol-PP-GlcNAc ₂ (β1-4Mannosyltransferase) (OMIM: 608540)	Addition of mannose no. 1 to DLO	N-glycans	SER258LEU, GLU342PRO, SER150ARG, MET377VAL, GLY145ASP, ARG276TRP	GlcNAc ₂ -PP-Dol	Nephrotic syndrome Epilepsy, Severe psychomotor retardation, Blindness, Liver dysfunction Cardiomyopathy.
ALG 2-CDG - GDP-Man:Dol-PP-GlcNAc ₂ Man ₁ α1,3mannosyltransferase - GDP-Man:Dol-PP-GlcNAc ₂ Man ₂ α1,6mannosyltransferase	Addition of mannoses no. 2 & 3 to DLO	N-glycans N-glycans	NT214, VAL68GLY 1-BP DEL, 1040G, 393G-T, DEL/INS	Normally glycosylated Tf Hypoglycosylated Tf - ↑ Man ₁ - and Man ₂ GlcNAc ₂ -PP-Dol	CMS 14 (OMIM: 616228): Slowly progressive deterioration, Wheelchair dependency, Proximal joints contractures, Distal joint laxity, Psychomotor retardation, Hypomyelination, Seizures, Colobomas of iris, Hepatomegaly, Subsarcolemmal accumulated structurally normal mitochondria (one case). Multisystem disorder (OMIM: 607906): Early childhood (2 Ms): poor vision, bilateral cataract, nystagmus. At 4 Ms: infantile spasms and hyperrhythmia. At 5 Ms: severe hypomyelination, delayed motor and mental development and cardiac murmur.
ALG 11-CDG (OMIM: 613661) GDP-Man:Dol-PP-GlcNAc ₂ Man ₃ α1-2mannosyltransferase and GDP-Man:Dol-PP-GlcNAc ₂ Man ₄ α1-2mannosyltransferase	Addition of mannoses no. 4 & 5 to DLO (ER – cytosolic side)	N-glycans	LEU86SER, 18-BP DEL, NT623, TYR279SER, LEU381SER, GLU398LYS, GLN318PRO	M ₃ GlcNAc ₂ -PP-Dol and M ₄ 5GlcNAc ₂ -PP-Dol	Delayed pupil reflex, ch.ch. dysmorphic features, oscillation of body temperature, inverted nipples, fat pads, MR, delayed social interaction.
ALG3-CDG (OMIM: 601110) Dol-P-Man: Dol-PP-GlcNAc ₂ Man ₅ α1-3mannosyltransferase.	Addition of mannose no.6 to DLO (ER-lumen)	N-glycans	GLY118ASP, 37-BP DEL, NT160, ARG171GLN, TRP71ARG, MET157LYS	M ₅ GlcNAc ₂ -PP-Dol	Severe psychomotor retardation, Optic atrophy.

Glycoproteins Mannosylation Defects (continued):

<i>Defective step</i>	<i>Role in glycosylation</i>	<i>Glycoconjugates involved</i>	<i>Mutations</i>	<i>Glycomarkers</i>	<i>Clinical picture</i>
ALG 9- CDG Dol-P-Man:Dol-PP-GlcNAc ₂ Man ₆ α1-3mannosyltransferase - Dol-P-Man:Dol-PP-GlcNAc ₂ Man ₈ α1-,2 mannosyltransferase (OMIM: 608776)	Addition of mannose no. 7 & 9 to DLO	N-glycans	GLU523LYS, TYR286CYS	Man ₆ - and Man ₈ GlcNAc ₂ -PP-Dol	Severe microcephaly, Mild psychomotor retardation, Diffuse brain atrophy, Muscular hypotonia, Hepatomegaly.
ALG12-CDG Dol-P-Man:Dol-PP-GlcNAc ₂ Man ₇ α1,6 mannosyltransferase (OMIM: 607143)	Addition of mannose no. 8 to DLO (ER lumen)	N-glycans	PHE142VAL, THR61MET, ARG146GLN, GLY101ARG, LEU158PRO, TYR414TER	M7GlcNAc ₂ -PP-Dol	Facial dysmorphism, inverted nipples, Subcutaneous fat pads.

Glycoproteins Mannosylation Defects (continued):

Defective step	Role in glycosylation	Glycoconjugates involved	Mutations	Glycomarkers	Clinical picture
Protein-O-mannosyltransferase (POMT1-CDG)	Catalyses the 1st step in the synthesis of O-mannose linked core Gal β 1-4-GlcNAc β 1-2-man-O-Ser/Thr by transfer of mannose from Dol-P-M to the (-OH) Ser/Thr residue \rightarrow α -DG in the ER Dystroglycan binds to external proteins like laminin-2 through O-man and O-GlcNAc. DG-laminin cpx is important for the formation of glialimitans which prevents the neurons to migrate to the subarachnoid space (POMT 1) is type III TM proteins	α -DG	<u>MDDG A1:</u> GLY76ARG, GLN303TER, 1-BP INS, 2110G, 3-BP DEL, 1260CCT, 3-BP DEL, 418ATG, 1-BP DUP, 2167G <u>MDDG B1:</u> GLY65ARG, TRP582CYS, ARG514TER, GLN590HIS, GLY65ARG, ARG541TER, GLN590HIS, ALA669THR, IVS12DS, G-A, +1 <u>MDDG C1:</u> ALA200PRO, ASN144ASP, THR414MET	α -DG hypoglycosylation with \downarrow laminin-binding activity	Muscular dystro-dystroglycanopathy (congenital with brain and eye anomalies) type A1 (MDDG A1) (OMIM: 236670) <u>POMT1-related-Walker-Warburg syndrome (WWS):</u> neuronal migration disorder ch.ch. by brain and eye with muscle dystrophy. The brain lesions consist of cobblestone lissencephaly type II, agenesis of the corpus callosum, cerebellum hypoplasia, encephalocoele. Fatal course before 1 st yr. cleft lip, cleft palate, and intrauterine growth retardation. Ocular abnormalities included microphthalmia, cataract, immature anterior chamber angle, retinal dysplasia with or without retinal detachment, persistent hyperplastic primary vitreous, optic nerve hypoplasia, and coloboma. Fukuyama-type congenital muscular dystrophy (CMD) \rightarrow the mutation in fukin gene <u>POMT1-related-Muscle-Eye-Brain disease:</u> Less severe than WWS. Patients present with muscular dystrophy with brain abnormalities less severe than those seen in WWS. It involves eye abnormalities, such as congenital glaucoma, progressive myopia, retinal atrophy, and juvenile cataracts. Muscular dystro-dystroglycanopathy (congenital with mental retardation) type B1 (MDDG B1) (OMIM: 613155): Patients show a milder form of Walker-Warburg syndrome, with less severe structural brain abnormalities and absence of severe eye abnormalities, except for myopia in some cases. Muscular dystro-dystroglycanopathy (Limb-Gridle) type C1 (MDDG C1) (OMIM: 609308): Patients present with mental retardation and limb-girdle muscular dystrophy and positive Gowers sign. Some patients developed cardiomyopathy.

Glycoproteins Mannosylation Defects (continued):

Defective step	Role in glycosylation	Glycoconjugates involved	Mutations	Glycomarkers	Clinical picture
Protein-O-mannosyltransferase (POMT2-CDG) (OMIM : 613158)	Catalyse the 1st step in the synthesis of O-mannose linked core Gal β 1-4-GlcNAc β 1-2-man-O-Ser/Thr by transfer of mannose from Dol-P-M to the (-OH) Ser/Thr residue \rightarrow α -DG in the ER Dystroglycan binds to external proteins like laminin-2 through O-man and O-GlcNAc. DG-laminin cpx is important for the formation of glialimitans which prevents the neurons to migrate to the subarachnoid space (POMT1/2) are type III TM proteins	α -DG	<p><u>MDDG A2:</u> ARG638TE R, IVS8DS, G-A, +1, 1-BP DEL, 1261C, ARG413PR O, VAL373PHE , ILE198ASN, GLY353SER , GLY726GL U, IVS12AS, G-A, -14, GLY482VA L.</p> <p><u>MDDG B2:</u> TYR666CYS , TRP748ARG , GLY353SER , GLY726GL U, GLY246ASP , IVS1DS, G-C, +5</p> <p><u>MDDG C2:</u> THR184ME T, TRP748SER</p>	α -DG hypoglycosylation	<p>Muscular dystro-dystroglycanopathy (congenital with brain and eye anomalies) type A (MDDG A2) (OMIM: 613150) <u>POMT2-related-Walker-Warburg syndrome (WWS):</u> Brain malformations caused severe hypotonia, developmental delay, and poor vision. <u>POMT1-related-Muscle-Eye-Brain disease:</u> The patient had failure to thrive, respiratory insufficiency, severe mental retardation with only a few words, microcephaly, severe muscle weakness, macroglossia, contractures, and muscle hypertrophy of the lower limbs. Eye abnormalities, such as congenital glaucoma, progressive myopia, retinal atrophy, and juvenile cataracts.</p> <p>Muscular dystro-dystroglycanopathy (congenital with mental retardation) type B2 (MDDG B2) (OMIM: 613156): Patients had variable picture that involved hypotonia, microcephaly, and delayed psychomotor development associated with severe mental retardation. They had severe diffuse muscle weakness in the face, trunk, and girdle muscles, tongue and calf muscle hypertrophy, diffuse joint contractures, and decreased or absent deep tendon reflexes. Some patients had a severe spinal deformity with marked fixed hyperextension of cervical, dorsal, and lumbar regions. One patient died of respiratory failure.</p> <p>Muscular dystro-dystroglycanopathy (Limb-Gridle) type C2 (MDDG C2) (OMIM: 613158): The patient showed normal psychomotor development in the first year of life, but learned to walk at age 18 months.</p>

b) GPI-anchors Mannosylation Defects

<i>Defective step</i>	<i>Role in glycosylation</i>	<i>Glycoconjugates involved</i>	<i>Mutations</i>	<i>Glycomarkers</i>	<i>Clinical picture</i>
PIGM (OMIM: 610293)	ER-mannosyl transferase that adds 1 st mannose residue in the growing GPI-anchor	GPI-anchors	-270C-G	Decreased expression of GPI-linked proteins, including CD59 and CD24, on hematopoietic cells.	Splanchnic vein thrombosis, and epilepsy
PIGV (OMIM: 610274)	ER-mannosyl transferase that adds 2 nd mannose residue in the growing GPI-anchor	GPI-anchors	ALA341GLU, HIS385PRO, GLN256LYS, ALA341VAL, CYS156TYR, NT494C-A	Leukocytes have defective expression of GPI-anchored proteins	Mabry syndrome: hyperphosphatasia bec ALP is a GPI-anchored protein. MR, facial dysmprohism, variable neurological features.

III) Glucosylation Defects

<i>Defective step</i>	<i>Role in glycosylation</i>	<i>Glycoconjugates involved</i>	<i>Mutations</i>	<i>Glycomarkers</i>	<i>Clinical picture</i>
Glucosyltransferase I ALG6-CDG Dol-P-Glc:Dol-PP-GlcNAc ₂ Man ₉ α1-3glucosyltransferase (OMIM: 603147)	Addition of glucose no. 1 to DLO	N-glycans	ALA333VAL, SER478PRO, IVS3DS, G-A, +5, 3-BP DEL, 895ATA, 3-BP DEL, 897AAT, IVS7DS, T-G, +2, TYR131HIS	↑ M ₉ GlcNAc ₂ -PP-Dol ↑ monoglycosylated β-TP with absent aglycosylated form (CSF)	Less severe manifestations like psychomotor retardation, antithrombia, and dysmorphism. (The second most common CDG-subtype)
Glucosyltransferase II ALG8-CDG Dol-P-Glc:Dol-PP-GlcNAc ₂ Man ₉ Glc1 α1-3glucosyltransferase (OMIM: 608104)	Addition of glucose no. 2 to DLO	N-glycans	1-BP DEL, 413C, 1-BP INS, 396A, IVS1AS, A-G,2, THR47PRO, IVS6DS, A-G, +4, GLY275ASP	Glc ₁ M ₉ GlcNAc ₂ -PP-dol	Multiorgan failure
β 1,3-glucosyltransferase B3GALTL-CDG (β1-3 galactosyltransferase-like gene) (OMIM : 261540)	It is an ER-located enzyme. Addition of glucose to O-linked fucose on thrombospondin I (TSPI) involved in cell-cell and cell-matrix interactions. The O-fucosylation is catalyzed by protein-O-fucose transferase 2 (POFUT 2) which is located in the ER. B3GALTL enzyme also resides in the ER.	O-glycans	IVS6, G-A, +1, 1-BP INS, 230T, GLY393GLU.	NM	Peter's Plus syndrome: eye chamber defects in form of developmental delay and growth impairment caused by kerato-lenticular adhesion caused by developmental defect of the lens anterior eye chamber.

IV) Glucuronylation Defects

<i>Defective step</i>	<i>Role in glycosylation</i>	<i>Glycoconjugates involved</i>	<i>Mutations</i>	<i>Glycomarkers</i>	<i>Clinical picture</i>
β 1-3GlcUA transferase B3GAT3-CDG GLCAT1-CDG (OMIM: 608545)	Addition of 1 unit of glucuronic acid (GlcUA) to Ser-Xyl-Gal	GAGs	ARG277GLN	↓ HS, DS, CS on proteoglycans. Decorin without DS	Larsen syndrome: short stature, congenital heart disease and joint dislocation.
Chonroitin synthase 1 (CHSY1) (OMIM: 605282)	Has two catalytic domains: β 1-3GlcA transferase and β 1-4GalNAc transferase for CS synthesis in the GA	GAGs	30-BP DEL, NT55, 1-BP DEL, 14G, GLN69TER, IVS1AS, C-G, -3, PRO539ARG, 1-BP DEL, 96C	↓ CS chains on proteoglycans	Temtamy-preaxial brachydactyly syndrome: digits malformation called preaxial brachydactyly with MR and growth retardation, facial dysmorphism and hearing loss.
LARGE Like-glycosyltransferase	<ul style="list-style-type: none"> - A Golgi-resident enzyme - Has two catalytic domains mediate the addition of a disaccharide repeat (-α3GlcUA-β3Xyl-) - It has DXD motif (GT-A family member) - The exact position of this disaccharide repeats is not known 	α -DG	GLU509LYS, 1-BP INS, 1999T, 63-KB DEL, TRP495ARG, GLN87FS, SER331PHE, 667FS, 42.9-KB INS/4.1-KB DEL.	Absent α -DG Reduced expression of α -DG	<p>α-dystroglycanopathies: Muscular dystrophy dystroglycanopathy (congenital mental retardation) type A6 (MDDGA6) (OMIM: 613154): is both of the more severe form of Walker Warburg Syndrome (WWS) and the slightly less severe form of membrane-eye-brain disease (MEB)</p> <p>Muscular dystrophy dystroglycanopathy (congenital mental retardation) type B6 (MDDGB6) (OMIM: 608840): mental retardation and structural brain abnormalities.</p> <p>Overexpression of LARGE: 1- rescues the glycosylation in WWS and MEB cells 2- prevents metastasis of cancerous cells</p>

V) Galactosylation Defects

a) GAGs Galactosylation Defects

<i>Defective site</i>	<i>Role in glycosylation</i>	<i>Glycoconjugates involved</i>	<i>Mutations</i>	<i>Glycomarkers</i>	<i>Clinical picture</i>
Xyl β 1-4Gal transferase B4GALT 7-CDG (OMIM: 130070)	Addition of 1 st Gal residue to xylose in the GA.	GAGs	ALA186ASP, LEU206PRO, ARG270CYS	- \uparrow small DS - \downarrow mature GAG-bearing proteoglycans	Ehlers-Danlos syndrome with short stature and limb anomalies (EDSSLA) (progeroid type 1): ch.ch. by MR, connective tissue abnormalities like loose skin, osteopenia, and joint hyper mobility.

b) Glycoproteins Galactosylation Defects

<i>Defective step</i>	<i>Role in glycosylation</i>	<i>Glycoconjugates involved</i>	<i>Mutations</i>	<i>Glycomarkers</i>	<i>Clinical picture</i>
β 1-4 Gal transferase 1 B4GALT 1-CDG GTB Galactosyl transferase 1; GT1 or Glycoprotein 4- β -galactosyl transferase 2; GGTB2 (OMIM: 607091)	Elongation of N-glycans by the addition of galactose moieties to terminal GlcNAc in the GA.	N-glycans	1-BP INS, 1031C	\uparrow truncated bi- and triantennary with missing 1 or 2 Sia-Gal moiety of serum Tf	Two cases were identified: 1- Dandy-Walker malformation, no psychomotor retardation 2- HM no Dandy-Walker malformation
Core 1 β 1-3 Gal transferase C1GALT1 (OMIM: 300622)	Is a single enzyme in the GA catalyzes the extension O-GalNAc It requires COSMC chaperone for its folding	O-glycans	ASP131GLU, GLU152LYS, SER193PRO, MET1ILE	NM	Tn-syndrome: mild haematological disorder. Persons with Tn-syndrome are healthy and have only mild hemolytic anemia caused by polyagglutination of RBCs by the naturally occurring anti-Tn antibodies, with \downarrow platelets and leukocytes count. RBCs carry GalNAc or Tn-antigen on their surface. The disease is caused by mutation in COSMC gene.

VI) Sialylation Defects

<i>Defective step</i>	<i>Role in glycosylation</i>	<i>Glycoconjugates involved</i>	<i>Mutations</i>	<i>Glycomarkers</i>	<i>Clinical picture</i>
GM3 synthase (SIAT9, ST3GAL5, Lactosylceramide α 2-3 sialyltransferase)	The 1 st step in synthesis of gangliosides from lactosylceramide. Addition of α 2-3 Sia to lactosylceramide to produce GM3.	Gangliosides	ARG288TER (R232X)	↓↓↓↓lactosylceramide. Absent GM3 and complex gangliosides. ↑↑↑ Gb3 and Gb4. ↑ N-glycans with terminal galactose residue	Amish-infantile epilepsy: infantile-onset epilepsy with developmental retardation and blindness.
GM3 synthase (SIAT9, ST3GAL5, Lactosylceramide α 2-3 sialyltransferase) (OMIM: 609056)	The 1 st step in synthesis of gangliosides from lactosylceramide. Addition of α 2-3 Sia to lactosylceramide to produce GM3.	Gangliosides	GLU332LYS (E332K)	Normal lactosylceramide levels. Absent GM3 and complex gangliosides. Normal Gb3 and Gb4 levels. Ceramide with longer fatty acids. ↑↑ complex sialylated N- and O-glycans.	Salt and pepper syndrome: severe intellectual disability, hyper- and hypo-pigmented skin maculae at various locations, dysmorphic features, choreoathetosis, scoliosis, seizures, spasticity.
ST3Gal III β Galactose α 2-3 sialyltransferase	Transfers α 2-3 Sia to galactose residues.	ND	ALA320PRO	ND	West syndrome: infantile spasms with severe prognosis to Lenox Gastaut syndrome with difficult to control seizures.

VII) Defective GA-resident proteins

<i>Defective step</i>	<i>Role in glycosylation</i>	<i>Glycoconjugates</i>	<i>Mutations</i>	<i>Glycomarkers</i>	<i>Clinical picture</i>
<p>COG-CDG</p> <p>Conserved Oligomeric Golgi complex</p> <p>COG1-CDG (OMIM: 611209)</p> <p>COG4-CDG (OMIM: 613489)</p> <p>COG5-CDG (OMIM: 613612)</p> <p>COG6-CDG (OMIM: 614576)</p> <p>COG7-CDG (OMIM: 608779)</p> <p>COG8-CDG (OMIM: 611182)</p>	<p>It is an eight subunit (COG 1-8) peripheral GA membrane hetero-oligomeric protein complex. It is organized into lobes A (COG 2-4) and B (COG 5-7) and COGs 1 & 8 bridging these lobes. This cpx plays a critical role in vesicle tethering process involving retrograde Golgi transport of resident proteins (glycotransferases and sugar transporters) responsible for glycan biosynthesis.</p>	- N- and O-glycans	<p>COG7 :IVS1DS, A-C, +4, IVS1AS, A-G, -7</p> <p>COG6 : GLY549VAL, IVS12AS, A-G, -24</p> <p>COG5 : IVS14AS, T-C, -15</p> <p>COG8 : TYR537TER, IVS3, G-A, +3, 2-BP DEL, 1687TT</p> <p>COG1 : 1-BP INS, 2659C, IVS6DS, G-A, +5</p>	<p>Serum Tf showed trypsin II pattern on IEF and also apoC III. ↓ Sialylation of GPs in fibroblasts. ↑ M₅-, M₆-, M₇-, M₈- and M₉GlcNAc₂.</p> <p>- COG 7: ↑ T/ST ratio (with normal T level)</p> <p>- COG 4: ↑ T/ST ratio (with ↑ T and ↓ ST)</p>	<p>Common features: feeding problems, growth retardation, microcephaly, dysmorphism, hypotonia, and cerebral atrophy. Cerebrocostal-Mandibular like syndrome.</p> <p>COG 7: a lethal disorder (dying in 1st year of life), hyperthermia, atrial/ventricular septum defect, cholestatic liver disease.</p>
<p>TMEM 199 (OMIM: 616829)</p>	<p>Co-localizes with the ERGIC and COP I. Involved in GA homeostasis?</p>	N- and O-glycans	<p>ALA7GLU, ALA14PRO, IVS3AS, G-A, -1, ARG31PRO</p>	<p>Plasma agalactosylated and asialylated Tf and abnormal apo C III</p>	<p>Normal psychomotor development, ↑ liver transaminases, ↑↑ ALP, Hypercholesterolemia, ↓ ceruloplasmin, Steatosis.</p>
<p>TMEM 165 (OMIM: 614727)</p>	<p>Localized in the late GA. Involved in GA morphology maintenance?</p>	N-glycans	<p>IVS4DS, G-A, +182, ARG126HIS, ARG126CYS, GLY304ARG</p>	<p>Hyposialylated plasma N-glycans. Normally sialylated O-glycans.</p>	<p>Psychomotor retardation, Growth retardation, Short stature, Hypotonia, Eye abnormalities, Hepatomegaly, Skeletal dysplasia, Acquired microcephaly.</p>

Defective GA-resident proteins (continued):

Defective step	Role in glycosylation	Glycoconjugates involved	Mutations	Glycomarkers	Clinical picture
ATP6V0A2 defect (OMIM: 219200)	Vacuolar ATPase is a heteromultimeric enzyme allows the acidification of the membrane enclosed organelles. A2 subunit of the vesicular ATPase H ⁺ -pump involved in pH regulation in the GA along the secretory pathway	N- and O-glycans	GLN765TE R, ARG63TER, 10132G-A 7-BP DEL, NT2355, 1-BP INS, 100A.	- Tropo-elastin aggregates are found in the Golgi ↑ monosialylated and asialylated glycans	Cutis laxa type 2 (wrinkled skin syndrome): wrinkly skin at birth becomes less obvious with age. Joint laxity, Osteopenia, Ophthalmological abnormalities, Microcephaly and delayed motor development that improves with age.
SLC39A8-CDG (OMIM: 616721)	a transporter of several divalent cations, including manganese (Mn) and zinc (Zn), across the plasma membrane. These divalent cations are essential for GA located β1-4 galactosyltransferase.	N-, O-glycans GSLs	GLY38ARG , ILE340ASN, VAL33MET andSER335THR, GLY204CYS	Abnormal Tf glycosylation patterns, with ↓tetrasialo-Tf and ↑trisialo-, monosialo- and disialo-Tf in a type II pattern	Severe multisystem developmental disorder. Psychomotor retardation with delayed head control, severe hypotonia, inability to walk, variable ability to sit independently, and profound intellectual disability. Other features included strabismus, short stature, and recurrent infections.
SEC23P-CDG (OMIM: 224100)	SEC23P is one of the subunits of coating protein II (COP II). COP II a type of vesicle proteins that transports proteins from ER to Golgi apparatus (anterograde transport)	N-and O-glycans GSLs	GLU109LY S, ARG14TRP, ARG530TRP, ARG264TE R, ARG324TE R, ARG217TE R, VAL594GL Y, VAL164LE U	Hypoglycosylation of red blood cells surface glycoproteins. Abnormal N-glycosylation. It is associated with low mannosidase II expression and ↑ high mannose and hybrid glycans in RBCs glycoconjugates.	Congenital dyserythropoietic anemia type II (CDAN2) or Hereditary erythroblastic multinuclearity with a positive acidified serum (HEMPAS) test with increased susceptibility to lysis by anti-I antibody.

VIII) Miscellaneous

<i>Defective step</i>	<i>Role in glycosylation</i>	<i>Glycoconjugates involved</i>	<i>Mutations</i>	<i>Glycomarkers</i>	<i>Clinical picture</i>
STT3A-CDG (OMIM: 601134)	It is one of the catalytic subunits of Oligosaccharyltransferase (OST) complex. OST transfers Glc ₃ M ₉ GlcNAc ₂ -PP-Dol to the Asn residue in the nascent proteins.	N-glycans	VAL626ALA	Serum Tf hypoglycosylation	Developmental delay, failure to thrive, seizures, and hypotonia, inability to sit, weak visual tracking.
Flippase protein RFT1-CDG (OMIM: 612015)	Translocates Dol-PP-M ₅ GlcNAc ₂ from the cytosolic to the luminal side of ER	N-glycans	ARG67CYS, LYS152GLU, GLU298LYS, ILE296LYS, ILE296ARG, MET408VAL, ARG442GLN	- ↑ Man ₅ GlcNAc ₂ -PP-Dol and ↓ mature N-glycan	Feeding difficulties and failure to thrive in infancy. Dysmorphic features including microcephaly, micrognathia, short neck, adducted thumbs, valgus foot deformities, and inverted nipples. Severe mental retardation with limited development, hypotonia, seizures, myoclonic jerks, decreased visual acuity, and sensorineural deafness.
SSR4-CDG X-linked (OMIM: 300934)	It is the delta subunit of a heterotetramer complex called TRAP, which consists of SSR1-4 subunits. It is located in the ER translocon which is the entry of nascent proteins to the ER lumen. TRAP protein forms a complex with OST (oligosaccharide transferase multisubunit complex). The direct role of TRAP complex in N-glycosylation has not been evidenced.	N-glycans	1-BP DEL, 316T	- Hypoglycosylated serum Tf	At birth: Microcephaly, dysmorphic features (excess skin around the neck and micrognathia i.e. abnormally small lower jaw), fat pads, clinodactyly of the 4 th and 5 th toes bilaterally. Two episodes of respiratory distress. At 7 months of age: MR, hypotonia, gastroesophageal reflux, and seizures. Persistent bleeding and easily bruising.
MPDU1 MPDU1-CDG (OMIM: 609180)	↑ accessibility of Dol-P-Man and Dol-P-Glu to glycosyltransferases	N-glycan	GLY73GLU, LEU119PRO, MET1THR, 1-BP DEL, 511C, LEU74SER	Hypoglycosylated serum Tf	Scaly erythematous skin disorder, severe encephalopathy.

Miscellaneous (continued):

<i>Defective site</i>	<i>Role in glycosylation</i>	<i>Glycoconjugates involved</i>	<i>Mutations</i>	<i>Glycomarkers</i>	<i>Clinical picture</i>
Sulfotransferases	Sulfation of polymerized GAGs	GAGs			
1) Chondroitin 6-0 sulfotransferase CHST3-CDG (OMIM:143095)	Catalyzes the 6-0 sulfation of GalNAc found in chondroitin and dermatan sulfate	CS & DS	ARG304G LN, LEU259PRO, ARG222TRP	NM	Spondyloepiphyseal dysplasia with congenital joint dislocations (SEDCJD): dislocation of the knees and/or hips at birth, clubfoot, elbow joint dysplasia with subluxation and limited extension, short stature, and progressive kyphosis developing in late childhood.
2) Dermatan 4-sulfotransferase 1 CHST4-CDG (OMIM: 608429)	Transfers sulfate to 4-0 positions of GalNAc residues flanked on both sides by IduA. This specific acceptor recognition explains why it adds sulfate group on dermatan not chondroitin chains.	DS	1-BP DEL, 145G, ARG213PRO, TYR293CYS.	NM	Ehlers-Danlos syndrome (musculo-contractural type): craniofacial dysmorphism, kyphoscoliosis, joint hypermobility, and hypotonia.
3) GlcNAc-6-sulfotransferase CHST6-CDG (OMIM: 217800)	Transfers SO ₄ group to C6 of the terminal GlcNAc residue in keratan sulfate chains.	KS I	LYS174ARG, ASP203GLU	Measurement of the serum level of antigenic keratan sulfate (aKS) with a sensitive ELISA shows antigenic aKS is absent from both serum and corneal tissue.	Macular-Corneal dystrophy: progressive opacity of cornea. KS I maintains the spatial organization of the collagen fibrils in the cornea that promotes its transparency.

Miscellaneous (continued):

<i>Defective step</i>	<i>Role in glycosylation</i>	<i>Glycoconjugates involved</i>	<i>Mutations</i>	<i>Glycomarkers</i>	<i>Clinical picture</i>
PIGN (OMIM: 614080)	A subunit of ethanolamine phosphotransferase I that catalyzes the addition of 1 st ethanolamine phosphate group	GPI anchors	ARG709G LN, SER270PRO, 963G-A.	NM	Multiple congenital anomalies-hypotonia-seizures syndrome 1 (MCSH1): severe neurological manifestations, seizures, dysmorphic features, multiorgan failure. Normal ALP
PIGT (OMIM: 615398)	A subunit from transaminase cpx catalyzes the transfer of the nascent GPI to protein	GPI anchors	IVS10AS, A-G, -2	NM	Multiple congenital anomalies-hypotonia-seizures syndrome 3 (MCSH3): the symptoms are the same as PIGN-CDG. Reduced ALP with normal calcium level.
PIGL (OMIM: 280000)	Carries out the 2 nd step in the pathway; de-N-acetylation of N-acetylglucosaminylphosphatidylinositol	GPI anchors	LEU167PRO, 1-BP DEL, 274C, GLN218TER, IVS3AS, G-A, -1	NM	Ocular coloboma, heart defect, ichthyosis, mental retardation, and ear anomalies (CHIME syndrome)
PIGO (OMIM: 614749)	A subunit from ethanolamine phosphotransferase II that catalyzes the addition of 2 nd ethanolamine phosphate group	GPI anchors	LEU957PHE, 1-BP DUP, 2361C, IVS8DS, G-A, +5	NM	Hyperphosphatasia with MR syndrome

ABSTRACT

Background: Congenital disorders of glycosylation (CDGs) are rare inherited diseases caused by mutations in genes required for the biosynthesis of glycoconjugates. CDGs have a wide spectrum of clinical presentations ranging from monosystemic to multiorgan failure. Often these diseases are diagnosed at the biochemical level by the presence of hypoglycosylated serum proteins. In a few cases etiological treatments have been devised, and for the most part, CDGs are treated symptomatically. Molecular diagnosis of CDG is crucial for both antenatal diagnostics and development of treatment strategies.

Aims: To determine the molecular origins of disease in a cohort of cases of suspected CDG. Two cases were chosen for more extended biochemical explorations in order to investigate the consequences of the mutations and possible treatment strategies.

Subjects/Methods: Biochemical explorations of skin biopsy fibroblasts from a cohort of patients presenting with clinical pictures suggestive of CDG and serum protein hypoglycosylation.

Results and conclusions: Study 1 concerns a patient presenting with severe multisystemic disease suggesting CDG syndrome. Patient-derived cells revealed truncated dolichol-linked oligosaccharides and truncated polymannose-type N-glycans. Sanger sequencing uncovered mutations in the dehydrodolichol diphosphate synthase (DHDDS) gene. Low DHDDS activity accompanied low dolichol phosphate levels. Treatment of fibroblasts with the squalene synthase inhibitor, zaragozic acid, normalized the profile of polymannose-type N-glycans in patient-derived cells. As previous cases of DHDDS-CDG present with retinitis pigmentosa only, we describe the first case of a CDG syndrome associated with mutations in DHDDS. In study 2, two siblings presented with thrombocytopenia associated with CNS signs. Whole exome sequencing revealed a biallelic mutation in the gene that encodes the CMP-Sialic acid transporter (*SLC35A1*). In this case, hyposialylated serum glycoproteins were detected, however, hyposialylated glycoproteins could not be detected in patient-derived fibroblasts. Altered glycosphingolipid profiles were seen in patient-derived cells and supplementation of these cells with sialic acid enhanced the biosynthesis of b-series gangliosides.

RESUME

Les désordres congénitaux de la glycosylation (CDGs) sont des maladies génétiques rares dues à des mutations sur des gènes codant pour des protéines impliquées dans la biosynthèse des glycoconjugués. Les CDGs présentent un large spectre clinique pouvant aller jusqu'à une atteinte multiviscérale. Le plus souvent, ces maladies sont dépistées après mise en évidence de protéines hypoglycosylées dans le sérum. Dans quelques rares cas, des traitements étiologiques sont envisageables mais la plupart des CDGs sont uniquement traités symptomatiquement. Le diagnostic moléculaire des CDGs est très important dans le cadre du diagnostic prénatal et du développement de stratégies thérapeutiques.

Objectif : Tenter de déterminer les éventuelles mutations causales dans une cohorte de cas suspects de CDG. Deux cas ont fait l'objet d'explorations biochimiques approfondies afin de comprendre les conséquences des mutations et d'envisager des stratégies thérapeutiques.

Sujets/méthodes : Des explorations biochimiques ont été réalisées sur des fibroblastes cutanés d'une cohorte de patients présentant des signes cliniques et des anomalies de glycosylation des protéines sériques suggérant un CDG.

Résultats et conclusions:

Patient 1

Le patient présentait une maladie multisystémique sévère compatible avec un CDG. L'étude de ses fibroblastes a montré la présence de formes tronquées d'oligosaccharides liés au dolichol et de N-glycanes polymannosylés. Des mutations affectant le gène codant pour la dehydrodolichol diphosphate synthase (*DHDDS*) ont été trouvées. Une activité diminuée de *DHDDS* était accompagnée de la diminution du dolichol phosphate. Le traitement des fibroblastes par l'acide zaragosique, un inhibiteur de la squalène synthase, a normalisé le profil de glycosylation des N-glycanes polymannosylés des cellules du patient. A côté d'un cas précédemment décrit comme ne présentant qu'une atteinte rétinienne (retinitis pigmentosa), ce patient est le premier cas de *DHDDS*-CDG présentant une atteinte multiviscérale.

Patient 2

Ce patient présentait une thrombopénie associée à des atteintes neurologiques. Le séquençage d'exome a révélé une mutation bi-allélique dans le gène codant pour le transporteur golgien du CMP-Ac sialique (*SLC35A1*). Une hypoglycosylation des protéines sériques a été détectée mais l'étude de la sialylation des glycoprotéines des fibroblastes n'a pas révélé d'anomalies. Des profils anormaux des glycosphingolipides ont été mis en évidence dans les cellules du patient et leur supplémentation par de l'acide sialique a augmenté la biosynthèse des gangliosides des séries b.