



HAL
open science

Développement du système mixte hydroxypropyl-betacyclodextrine/ liposome en vue de l'encapsulation des constituants des huiles essentielles

Riham Gharib

► **To cite this version:**

Riham Gharib. Développement du système mixte hydroxypropyl-betacyclodextrine/ liposome en vue de l'encapsulation des constituants des huiles essentielles. Biochimie, Biologie Moléculaire. Université de Lyon; École doctorale des Sciences et de Technologie (Beyrouth), 2016. Français. NNT: 2016LYSE1312 . tel-01663496

HAL Id: tel-01663496

<https://theses.hal.science/tel-01663496>

Submitted on 14 Dec 2017

HAL is a multi-disciplinary open access archive for the deposit and dissemination of scientific research documents, whether they are published or not. The documents may come from teaching and research institutions in France or abroad, or from public or private research centers.

L'archive ouverte pluridisciplinaire **HAL**, est destinée au dépôt et à la diffusion de documents scientifiques de niveau recherche, publiés ou non, émanant des établissements d'enseignement et de recherche français ou étrangers, des laboratoires publics ou privés.



Université Claude Bernard Lyon 1

Doctorat Université Libanaise

THESE EN COTUTELLE

Pour obtenir le grade de Docteur délivré par

L'Université Claude Bernard Lyon 1

Ecole Doctorale de Chimie de Lyon

et

L'Université Libanaise

Ecole Doctorale des Sciences et Technologie

Spécialité : Biochimie/Biotechnologie

Présentée et soutenue publiquement par

GHARIB Riham

Le 13 Décembre 2016

**Développement du système mixte hydroxypropyl- β -
cyclodextrine/liposome en vue de l'encapsulation des constituants
des huiles essentielles**

Membres du Jury

M. Bernard Tinland , DR CNRS, Université Aix Marseille	Rapporteur
M. Mohamed Skiba , Pr, Université de Rouen	Rapporteur
M. Hatem Fessi , Pr, Université de Lyon 1	Examineur
M. Mohamed Tabcheh , Pr, Université Libanaise	Examineur
Mme Hélène Greige-Gerges , Pr, Université Libanaise	Directrice de thèse
Mme Catherine Charcosset , DR CNRS, Université de Lyon 1	Directrice de thèse
Mme Lizette Auezova , Pr, Université Libanaise	Co-encadrante de thèse

Remerciements

Remerciements

J'adresse ma vive gratitude à tout le corps administratif de l'Ecole Doctorale des Sciences et Technologie à l'Université Libanaise et de l'Ecole Doctorale de Chimie de Lyon pour faciliter les procédures d'inscription en thèse de doctorat en cotutelle.

Professeur Hélène Greige-Gerges

Je vous remercie vivement pour l'honneur que vous m'avez fait en me confiant ce sujet de thèse et pour l'aide précieuse que vous m'avez apportée tout au long de la réalisation de ce travail. Vous avez su me donner une grande liberté d'initiative tout en restant toujours présente pour discuter des difficultés que j'ai pu rencontrer.

Vos très hautes qualités humaines, votre modestie, et votre très grande compétence suscitent mon respect et mon admiration. Faire partie de vos disciples est à la fois un grand honneur et une immense fierté. J'ai beaucoup évolué, notamment sur le plan scientifique, grâce à vous. Je suis trop chanceuse de vous avoir eu comme directeur de thèse.

Docteur Catherine Charcosset

Je tiens à vous exprimer ma profonde reconnaissance pour avoir accepté de diriger ma thèse à l'Université de Lyon 1. Je vous remercie pour vos encouragements durant toute la période de cette thèse et pour votre aide. Merci pour votre présence et pour votre support quand le moral était bas. Vous étiez toujours à côté des étudiants pour les aider et les encourager. C'était un grand plaisir de faire votre connaissance et de travailler ensemble.

Professeur Lizette Auezova

Je tiens à vous remercier d'avoir accepté de faire partie de cette thèse. Je vous remercie pour votre soutien, vos encouragements et votre disponibilité.

Professeur Alia Jraij

Je vous remercie pour votre aide dans la réalisation des imageries par microscopie à force atomique, votre amitié et la disponibilité que vous m'avez toujours témoignées.

Docteur Amal Najjar

Je vous remercie pour votre aide dans la réalisation des études de microbiologie bactérienne.

Professeur Hatem Fessi

Veillez accepter ma vive gratitude pour tous les conseils que vous m'avez prodigués. Je vous remercie vivement pour votre générosité et vos qualités scientifiques. Merci de faire partie du jury de ma thèse.

Professeur Mohamad Skiba et Docteur Bernard Tinland

Je suis très sensible à l'honneur que vous me faites en acceptant de participer à ce jury de thèse et d'en être les rapporteurs. Je vous remercie pour l'intérêt que vous porterez à mon travail. En attendant vos conseils et suggestions constructives qui me permettront certes d'améliorer la qualité de mon manuscrit, veuillez accepter mes plus sincères remerciements.

Professeur Mohamed Tabcheh

Je suis très sensible de l'honneur que vous me faites en acceptant de siéger à notre jury et juger ce travail.

Professeur Roland Habchi

Je vous adresse mes remerciements pour votre aide à la réalisation des imageries par la microscopie à force atomique.

Géraldine Agusti

Je vous adresse mes remerciements pour votre présence au sein du laboratoire et votre aide à la réalisation des imageries par microscopie électronique à transmission au Centre Technologique des Microstructures, Université de Lyon 1.

Sébastien Urbaniak

Je vous remercie pour votre aide dans la réalisation des études de lyophilisation.

Catherine Bosser

Je vous adresse tous mes remerciements pour votre aide à la réalisation des mesures par spectroscopie Raman à l'Ecole Centrale de Lyon.

Je remercie **l'Université Libanaise** pour la bourse doctorale que vous m'avez accordée durant ma thèse et **l'Agence Universitaire de la Francophonie (Programme de Coopération**

Scientifique Inter-Universitaire, PCSI 2015-2017) pour le soutien financier qu'elle m'a accordée durant mon dernier séjour en France.

Mes amies

Je tiens aussi à remercier toutes mes amies Rola Abboud, Joyce Azzi, Hanine Lattouf et Sara Fahed. Je tiens à vous faire part de la gratitude pour toute l'aide que vous m'avez apportée durant ces années de thèse, chacune à sa façon. Merci pour votre présence amicale, votre gentillesse et votre soutien.

Ma famille

Enfin, aucune formule ne serait assez forte pour remercier ma famille, mon père Toufic, ma mère Mariam, ma sœur Ranal et mon frère Hicham, pour leur immense soutien moral tout au long de ces années. Merci de m'avoir supportée durant toute cette période. Merci pour vos encouragements inconditionnels. Sans vous je ne serais pas arrivée jusque-là.

Mon fiancé Habib El Chater

Un merci spécial à mon fiancé Habib. Merci d'avoir été toujours à côté de moi pour m'aider à surmonter les difficultés et le stress de la thèse.

Table des matières

Résumé	7
Abstract	9
Liste des abréviations	11
Introduction générale	12
Chapitre 1 : Système mixte à double encapsulation CD/liposomes	16
Introduction	17
Liposomes incorporating cyclodextrin-drug inclusion complexes: current state of knowledge.....	19
Chapitre 2 : Effet de l'HP-β-CD sur la fluidité membranaire et la stabilité des membranes lipidiques durant la lyophilisation	32
Introduction	33
Effect of HP- β -CD on fluidity, stability and freeze-drying of lipid membranes: application in drug-in-cyclodextrin-in-liposome delivery system	38
Chapitre 3 : Effet des monoterpènes et des phénylpropènes sur la membrane lipidique	59
Introduction	60
Interaction of selected phenylpropenes with dipalmitoylphosphatidylcholine membrane and their relevance to antibacterial activity	65
Effect of eucalyptol, pulegone, terpineol and thymol on DPPC membrane fluidity: role of the structure	94
Chapitre 4 : Préparation et caractérisation des liposomes encapsulant le complexe d'inclusion HP-β-CD/Ane	117
Introduction	118
Drug-in-cyclodextrin-in-liposomes as a carrier system for volatile essential oil components: application to Anethole	121
Chapitre 5 : Préparation des liposomes encapsulant le complexe d'inclusion HP-β-CD/Ane à grande échelle	129
Introduction	130
Preparation of drug-in-cyclodextrin-in-liposomes at a large scale using a membrane contactor: application to trans-anethole.....	134
Conclusion générale et perspectives	146
Communications	150

Résumé

Les monoterpènes (MT) et phénylpropènes (PP), constituants d'huiles essentielles, possèdent de nombreuses activités biologiques notamment antimicrobienne. Cependant, leur application est limitée en raison de leur faible solubilité aqueuse, volatilité et sensibilité à la lumière et l'oxygène. L'objectif principal de notre étude a été la mise au point de formulations liposomiales encapsulant des MT et PP en vue de développer des systèmes naturels et éco-compatibles ayant des applications potentielles dans les domaines alimentaire et pharmaceutique. Des liposomes conventionnels et un système mixte à double encapsulation cyclodextrine/liposome ont été étudiés. De ce fait, le manuscrit de thèse contient deux axes principaux. Le premier a porté sur l'interaction de l'hydroxypropyl- β -cyclodextrine (HP- β -CD) et de huit MT et PP (anéthol, estragole, eucalyptol, eugénol, isoéugénol, pulégone, terpinéol et thymol) avec des membranes lipidiques. La calorimétrie différentielle à balayage, la spectroscopie Raman et la polarisation de fluorescence du 1,6-diphényl-1,3,5-hexatriène sont utilisées pour déterminer l'effet de ces molécules sur la fluidité des vésicules lipidiques composées de dipalmitoylphosphatidylcholine (DPPC). L'HP- β -CD interagit avec les têtes polaires et les chaînes acyles des phospholipides et montre un effet fluidifiant sur les liposomes formés de DPPC et de Lipoid S100. Cependant, ce type de CD n'affecte pas la fluidité des membranes formées de phospholipides saturés comme le Phospholipon 80H et le Phospholipon 90H. De plus, l'HP- β -CD présent dans le compartiment aqueux interne des liposomes les protège durant la lyophilisation. Les MT et PP étudiés interagissent avec le groupe choline de la tête polaire et les chaînes alkyles de DPPC entraînant une augmentation du désordre dans la membrane d'où sa fluidification. L'effet fluidifiant est favorisé par la présence d'un groupement hydroxyle. Les composés les plus hydrophobes de la série, l'anéthol et l'estragole, ont été plus actifs contre *E. coli* que l'eugénol et l'isoéugénol. Le deuxième axe a été orienté vers la préparation des liposomes conventionnels et du système mixte d'encapsulation CD/liposome (ACL). La technique de double encapsulation (double loaded liposomes, ACL2) a été aussi appliquée. Les préparations sont faites à partir de phospholipides naturels de soja saturés (Phospholipon 90H) ou insaturés (Lipoid S100) par la méthode d'injection éthanolique. Les vésicules ont été caractérisées pour la taille, l'indice de polydispersité, le potentiel zêta, la morphologie, le rendement d'encapsulation et la cinétique de libération du principe actif. L'anéthol est utilisé comme un système modèle. Par rapport aux liposomes conventionnels, ACL et ACL2 ont permis d'améliorer le rendement d'encapsulation de l'anéthol et de ralentir sa libération. Les liposomes composés de Lipoid S100 ont montré une meilleure photoprotection de l'anéthol et un meilleur rendement d'encapsulation, que ceux préparés avec le Phospholipon 90H. Le Lipoid S100 a été ainsi utilisé pour préparer des liposomes à grande échelle par contacteur à membrane et à l'échelle pilote. Les deux types de vésicules obtenues à petite et grande échelle, ont présenté des caractéristiques proches ce qui témoigne d'une bonne reproductibilité de ces procédés de préparation. La formation des vésicules sphériques est confirmée par la microscopie électronique à transmission et par la microscopie à force atomique. Des études ultérieures sur l'encapsulation d'autres MT et PP et de leurs complexes d'inclusion dans des liposomes sont envisagées pour déterminer les paramètres physicochimiques de la molécule hôte qui peuvent influencer l'efficacité de ces systèmes d'encapsulation.

Mots clés : anéthol ; contacteur à membrane ; drug-in-CD-in-liposome ; *E. coli* ; fluidité ; hydroxypropyl- β -cyclodextrine ; injection éthanolique ; liposomes ; lyophilisation ; membrane ; monoterpènes ; phénylpropènes ; pilote.

Abstract

Monoterpenes (MT) and phenylpropenes (PP), constituents of essential oils, possess several biological activities such as antimicrobial. However, the application of these products is limited because of their low aqueous solubility, volatility and sensitivity to light and oxygen. The main objective of this work was the development of liposomal formulations encapsulating MT and PP in order to develop natural and eco-compatible systems with potential applications in the food and pharmaceutical fields. Conventional liposomes and drug-in-cyclodextrin-in-liposomes were studied. Specifically, the research works have been carried out along two main axes. The first axis focused on the interaction of hydroxypropyl- β -cyclodextrin (HP- β -CD) and series of MT and PP (anethole, estragole, eucalyptol, eugenol, isoeugenol, pulegone, terpineol and thymol) with lipid membranes. Differential scanning calorimetry (DSC), Raman spectroscopy, and fluorescence polarization of the 1,6-diphenyl-1,3,5-hexatriene, were used to determine the effect of these molecules on the fluidity of lipid vesicles composed of dipalmitoylphosphatidylcholine (DPPC). The HP- β -CD interacted with the polar heads and acyl chains of phospholipids and showed a fluidizing effect on liposomes formed with DPPC or Lipoid S100. However, this type of CD did not affect the fluidity of the membranes formed from saturated phospholipids such as Phospholipon 80H and Phospholipon 90H. In addition, the incorporation of HP- β -CD in the internal aqueous compartment of the liposomes protected them during lyophilization. The studied MT interact with the choline head group and the alkyl chains of DPPC membrane leading to an increase in the chain disorder, thereby raising the bilayer's fluidity. In addition, the most hydrophobic compounds of the series, anethole and estragole, were more active against *E. coli* than eugenol and isoeugenol. The second axis was oriented towards the preparation of conventional liposomes and drug-in-cyclodextrin-in-liposomes (ACL). The double loaded technique (double loaded liposomes, ACL2) was also applied. Natural hydrogenated (Phospholipon 90H) or non-hydrogenated (Lipoid S100) soybean phospholipids were used to prepare liposomes by the ethanol injection method. The vesicles were characterized in terms of size, polydispersity, zeta potential, morphology, loading rate and drug release kinetics. Anethole was used as a model system. Compared to conventional liposomes, ACL and ACL2 improve the loading rate of anethole and reduce its release. Liposomes prepared with Lipoid S100 showed the best photostability and the best loading rate than those with Phospholipon 90H. Lipoid S100 was used to prepare liposomes at large scale by membrane contactor and by pilot scale. The characteristics of the vesicles obtained at both scales were similar, thereby confirming the reproducibility of the two methods of preparation. The formation of spherical vesicles was confirmed by transmission electronic microscopy and atomic force microscopy. Further studies on the encapsulation of others MT and PP and their inclusion complexes in liposomes should be conducted to determine the physicochemical parameters of the guest molecule that can modulate the efficiency of these encapsulation systems.

Keywords: anethole; drug-in-CD-in-liposome; *E.coli*; ethanol injection; fluidity; hydroxypropyl- β -cyclodextrin; liposomes; lyophilization; membrane; membrane contactor; monoterpenes; phenylpropene; pilot.

Liste des abréviations

ACL: Anethole in cyclodextrin in liposomes

ACL-2: double loaded liposomes

AFM: Atomic Force Microscopy, microscopie à force atomique

Ane: Anéthol

CD: Cyclodextrine

DCL: Drug-in-cyclodextrin-in-liposome, système mixte à double encapsulation cyclodextrine/liposome

DLS: Dynamic Light Scattering, diffusion dynamique de la lumière

DPH: 1,6-diphényl-1,3,5-hexatriène

DPPC: Dipalmitoylphosphatidylcholine

DSC: Differential Scanning Calorimetry; calorimétrie différentielle à balayage

Est: Estragole

Euc: Eucalyptol

Eug: Eugénol

HE: Huile essentielle

HP- β -CD: Hydroxypropyl- β -cyclodextrine

Iso-eug: Isoeugénol

MLV: multilamellar vesicles, vésicules multilamellaires

MT: Monoterpène

PA: Principe actif

pdI: polydispersity index, indice de polydispersité

PP: Phénylpropène

Pul: Pulégone

TEM: Transmission Electronic Microscopy, microscopie électronique à transmission

Ter: Terpinéol

Ter M: Terpinéol, mélanges des isomères

Thy: Thymol

Introduction générale

L'utilisation des huiles essentielles (HEs) est en pleine croissance jusqu'à devenir depuis plus d'une vingtaine d'années une alternative aux agents antimicrobiens et constituer une médecine dite alternative. Les HEs trouvent de nombreux débouchés dans les secteurs pharmaceutique, agroalimentaire et cosmétique (Bakkali et al., 2008). Cela est dû à leurs propriétés biologiques telles que l'activité antimicrobienne, antioxydante, anti-inflammatoire et anticancéreuse (da Silveira et al., 2014 ; Nazzaro et al., 2013). Toutefois, les HEs souffrent d'une très faible solubilité dans l'eau; de plus, ce sont des composés volatils, sensibles aux conditions environnementales (lumière, chaleur, oxygène), ce qui limite leurs applications. Ces inconvénients peuvent être contournés par l'encapsulation. Dans ce travail, le *trans*-anéthol (Ane) a été choisi comme composé modèle pour l'encapsuler dans le système mixte cyclodextrine/liposome à petite et à grande échelle.

Les HEs sont bien connues par leurs effets antibactériens, d'où l'intérêt d'évaluer leur interaction avec la membrane. Les HEs et leurs composants tels que les monoterpènes (MTs) (eucalyptol, pulégone, terpinéol et thymol) et aussi phénylpropènes (PPs) (*trans*-anéthol, estragole, eugénol et isoéugénol) sont étudiés dans ce travail. Ces molécules diffèrent par leurs structures chimiques et leurs propriétés physico-chimiques telles que l'hydrophobicité, la solubilité et la volatilité.

Les cyclodextrines (CDs) sont des oligosaccharides cycliques constitués des unités de glucopyranose. Elles possèdent la structure d'un cône tronqué ayant une cavité interne hydrophobe et une surface externe hydrophile. Ceci leur confère la propriété de former des complexes d'inclusion (hôte/invité) avec des molécules lipophiles (Arun et al., 2008). Les CDs ont la capacité d'améliorer la solubilité aqueuse des molécules, leur biodisponibilité et leur stabilité et d'assurer une libération prolongée et contrôlée des principes actifs (PAs) (Hill et al., 2013 ; Nuchuchua et al., 2009). Les liposomes sont des vésicules phospholipidiques constituées de bicouches lipidiques renfermant un ou plusieurs compartiments aqueux. Ils ont été largement utilisés en tant que véhicules efficaces pour les médicaments hydrophiles et lipophiles (Anwekar et al., 2011). Cependant, les PAs hydrophobes peuvent être rapidement libérés à partir des bicouches lipidiques ce qui limite l'efficacité de ce système (Maestrelli et al., 2005). Le concept proposé pour la première fois par McCormack et Gregoriadis (1994) sur l'encapsulation des complexes d'inclusion dans les liposomes formant des systèmes mixtes « drug-in-cyclodextrin-in-liposome » (DCL) combine les avantages de ces deux systèmes d'encapsulation et peut améliorer les caractéristiques de chaque système. En effet, l'encapsulation d'une solution aqueuse du complexe d'inclusion CD/PA dans les liposomes permettrait l'encapsulation des PAs

hydrophobes dans le compartiment aqueux des liposomes. Ainsi les liposomes peuvent protéger les complexes d'inclusion CD/PA pour réduire et contrôler la vitesse de libération des PAs.

Ce travail de thèse est réalisé dans le Laboratoire de Molécules Bioactives (Faculté des Sciences, Section II, Université Libanaise) et le Laboratoire d'Automatique et de Génie des Procédés (Université Claude Bernard Lyon 1). Il porte principalement sur la préparation et la caractérisation des liposomes encapsulant le complexe d'inclusion CD/Ane à petite et grande échelle ainsi que l'évaluation de l'interaction de l'hydroxypropyl- β -cyclodextrine (HP- β -CD) et des différents MTs avec la membrane.

Au cours de ce travail, nous avons étudié l'interaction de l'HP- β -CD avec la membrane lipidique en utilisant les liposomes comme un modèle membranaire. De plus, l'effet de l'HP- β -CD sur la lyophilisation des liposomes a été également évalué.

Dans le but de comprendre la relation structure-activité et l'influence des propriétés physicochimique des HEs, nous avons étudié l'interaction des PPs et des MTs avec la membrane lipidique formée de dipalmitoylphosphatidylcholine (DPPC). Différentes techniques calorimétrique et spectroscopique ont été utilisées afin d'étudier l'interaction de l'HP- β -CD et des HEs avec la membrane lipidique. Nous avons ensuite préparé des liposomes encapsulant le complexe d'inclusion HP- β -CD/Ane et des « double loaded liposomes » où Ane est encapsulé dans la phase organique et dans la phase aqueuse par la méthode d'injection éthanolique en utilisant des phospholipides saturés (Phospholipon 90H) et insaturés (Lipoid S100). D'après les résultats obtenus, le Lipoid S100 a été choisi pour la production des liposomes encapsulant le complexe d'inclusion HP- β -CD/Ane à grande échelle utilisant le contacteur à membrane et le pilote. Nous avons utilisé des techniques spectroscopiques, analytiques et microscopiques pour caractériser les liposomes en termes de taille, indice de polydispersité (pDI), potentiel zêta, et le rendement d'encapsulation de l'Ane. Nous avons également évalué la capacité de ces liposomes en tant que systèmes de protection et de stockage de l'Ane ; finalement, l'activité antibactérienne des PPs a été évaluée.

Ce manuscrit est organisé en cinq chapitres présentés sous forme d'articles. Le premier chapitre présente une revue bibliographique qui porte sur les complexes d'inclusion CD/PA dans les liposomes et leurs propriétés. Le chapitre 2 présente les résultats obtenus sur l'effet de l'HP- β -CD sur la fluidité, stabilité et la lyophilisation des liposomes. Le chapitre 3 est constitué de deux articles. Le premier décrit l'effet des PPs sur la membrane et leurs effets antibactériens ; le

deuxième concerne l'interaction des autres MTs avec la membrane. Le rôle de la structure chimique et des propriétés physicochimiques des molécules étudiées sur l'interaction sont discutés. Dans les chapitres 4 et 5 nous présentons les résultats obtenus sur la préparation et la caractérisation des liposomes encapsulant des complexes d'inclusion HP- β -CD/Ane à petite et à grande échelle respectivement. Ce manuscrit s'achève par une conclusion générale et des perspectives pour la suite de ce travail.

Références

- Anwekar, H., Patel, S., & Singhai, A. K. (2011). Liposome as drug carriers. *International Journal of Pharmacy & Life Sciences*, 2, 945-951.
- Arun, R., Ashik Kumar, C. K., & Sravanthi, V. V. (2008). Cyclodextrins as Drug Carrier Molecule: A Review. *Sci Pharm*, 76, 567-598.
- Bakkali, F., Averbeck, S., Averbeck, D., & Idaomar, M. (2008). Biological effects of essential oils – A review. *Food Chem Toxicol*, 46, 446-475.
- de Cássia da Silveira E Sá, R., Andrade, L. N., Dos Reis Barreto de Oliveira, R., & de Sousa, D. P. (2014). A review on antiinflammatory activity of phenylpropanoids found in essential oils. *Molecules*, 19, 1459-1480.
- Hill, L. E., Gomes, C., & Taylor, T. M. (2013). Characterization of beta-cyclodextrin inclusion complexes containing essential oils (trans-cinnamaldehyde, eugenol, cinnamon bark, and clove bud extracts) for antimicrobial delivery applications. *LWT- Food Science and Technology*, 51, 86-93.
- Maestrelli, F., Gonzalez-Rodriguez, M. L., Rabasco, A. M., & Mura, P. (2005). Preparation and characterisation of liposomes encapsulating ketoprofen–cyclodextrin complexes for transdermal drug delivery. *International Journal of Pharmaceutics*, 298, 55-67.
- McCormack, B., & Gregoriadis, G. (1994). Drugs-in-cyclodextrins-in-liposomes: a novel concept in drug delivery. *International Journal of Pharmaceutics*, 112, 249-258.
- Nazzaro, F., Fratianni, F., De Martino, L., Coppola, R., & De Feo, V. (2013). Effect of essential oils on pathogenic bacteria. *Pharmaceutics*, 6, 1451-1474.
- Nuchuchua, O., Saesoo, S., Sramala, I., Puttipipatkachorn, S., Soottitantawat, A., & Ruktanonchai, U. (2009). Physicochemical investigation and molecular modeling of cyclodextrin complexation mechanism with eugenol. *Food Research International*, 42, 1178-1185

*Chapitre 1 : Système mixte à double
encapsulation CD/liposomes*

Introduction

Ce chapitre est présenté sous forme d'une revue bibliographique publiée en 2015 dans le journal « Carbohydrate Polymers ». Nous présentons dans cette revue, la littérature concernant l'encapsulation du complexe d'inclusion CD/PA dans des liposomes conventionnels, déformables et des liposomes préparés par la technique de double encapsulation à base de CD et de liposomes. Cette revue met en évidence les caractéristiques de chaque système et présente ses avantages et ses inconvénients.

Les trois CDs les plus fréquemment rencontrées sont l' α -, la β - et la γ -CD constituées respectivement de 6, 7 et 8 unités glucopyranosidiques. Toutefois, leur utilisation est généralement limitée en raison de la faible solubilité aqueuse. La modification chimique des CDs permet d'obtenir des dérivés possédant des propriétés physicochimiques différentes de celles des CDs natives et d'élargir ainsi leurs champs d'application. Il existe diverses techniques de préparation des complexes d'inclusion. La méthode de préparation doit être choisie selon les applications envisagées car elle influence sur les caractéristiques physicochimiques et la dissolution du complexe. La préparation peut s'effectuer en milieu liquide ou solide. Elle consiste généralement à dissoudre la CD en présence de PA puis laisser un équilibre s'établir (Del Valle, 2004 ; Marques, 2010). Les différentes méthodes de préparation de complexes d'inclusion en vue de leur encapsulation dans des liposomes sont présentées dans cette revue, telles que la co-évaporation, la formation de complexes d'inclusion en milieu aqueux, la lyophilisation, la pulvérisation et le pétrissage.

La classification des liposomes est principalement basée sur des critères structuraux, notamment la taille et la lamellarité (nombre de bicouches) (Rongen et al., 1997 ; Shaheen et al., 2006). On distingue alors les liposomes unilamellaires qui sont formés d'une seule bicouche concentrique enfermant un compartiment aqueux et les liposomes multilamellaires qui sont formés de plusieurs bicouches concentriques séparées par des couches de compartiments aqueux. Parmi les liposomes unilamellaires, on peut différencier les vésicules de petite taille (small unilamellar vesicles, SUV), allant de 20 jusqu'à 100 nm, et les vésicules de grande taille (large unilamellar vesicles, LUV) dont la taille varie de 100 à 1000 nm. Les vésicules multilamellaires (multilamellar vesicles, MLV) comptent plusieurs bicouches concentriques et font environ de 1 μ m jusqu'à 10 μ m de diamètre.

Les liposomes sont habituellement composés d'un ou plusieurs types de phospholipides. Le

cholestérol entre le plus souvent dans la constitution des liposomes. Les liposomes déformables sont formés de phospholipides et d'un agent tensioactif qui déstabilise la bicouche lipidique (Cevc, 2004). Ces liposomes sont considérés comme des meilleurs systèmes pour une administration transdermique de PA (Dragicevic-Curic et al., 2010). Les méthodes de préparation des liposomes couramment utilisées pour l'encapsulation des complexes d'inclusion CD/PA sont l'hydratation du film lipidique, l'évaporation en phase inverse, la congélation-décongélation, l'injection éthanolique et la lyophilisation.

Trois tableaux récapitulatifs sur la taille, l'efficacité d'encapsulation et la cinétique de libération du PA des liposomes encapsulant les complexes d'inclusions ont présenté. L'effet des CD sur le potentiel zêta, la morphologie et l'effet biologique du PA est également discuté. Ces propriétés sont comparées entre les liposomes conventionnels, déformables et les liposomes préparés par la technique de double encapsulation.

Références

- Cevc, G. (2004). Lipid vesicles and other colloids as drug carriers on the skin. *Adv Drug Deliv Rev*, 56, 675-711.
- Del Valle, E. M. (2004). Cyclodextrins and their uses: a review. *Process Biochem*, 39, 1033-1046.
- Dragicevic-Curic, N., Gräfe, S., Gitter, B., Winter, S., & Fahr, A. (2010). Surface charged temoporfin-loaded flexible vesicles: in vitro skin penetration studies and stability. *Int J Pharm*, 384, 100-108.
- Marques, H. M. (2010). A review on cyclodextrin encapsulation of essential oils and volatiles. *Flavour and Fragrance Journal*, 25, 313-326.
- Rongen, H., Bult, A., & Van Bennekom, W. P. (1997). Liposomes and immunoassays. *Immunological Methods*, 204, 105-133.
- Shaheen, S. M., Shakil, F. R., Hossen, M. N., Ahmed, M., Amran, M. S., & Ul-Islam, M. A. (2006). Liposome as a carrier for advanced drug delivery. *Pakistan Journal of Biological Sciences*, 9, 1181-1191.

Liposomes incorporating cyclodextrin-drug inclusion complexes: current state of knowledge

Riham Gharib¹, Hélène Greige-Gerges^{1*}, Sophie Fourmentin², Catherine Charcosset³, Lizette Auezova¹

¹Faculty of Sciences, Section II, Bioactive Molecules Research Group, Doctoral School of Sciences and Technologies, Jdaidet El-Matn, Lebanese University, Lebanon

²*Unité de Chimie Environnementale et Interactions sur le Vivant (UCEIV), ULCO, F-59140 Dunkerque, France*

³*Laboratoire d'Automatique et de Génie des Procédés, Université Claude Bernard Lyon I, France.*

Carbohydrate Polymers 129 (2015) 175–186



Contents lists available at ScienceDirect

Carbohydrate Polymers

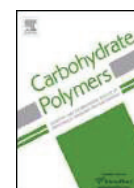
journal homepage: www.elsevier.com/locate/carbpol

Review

Liposomes incorporating cyclodextrin–drug inclusion complexes:
Current state of knowledgeRiham Gharib^a, H el ene Greige-Gerges^{a,*}, Sophie Fourmentin^b, Catherine Charcosset^c,
Lizette Auezova^a^a Faculty of Sciences, Bioactive Molecules Research Group, Doctoral School of Sciences and Technologies, Lebanese University, Lebanon^b Unit e de Chimie Environnementale et Interactions sur le Vivant (UCEIV), ULCO, F-59140 Dunkerque, France^c Laboratoire d'Automatique et de G enie des Proc ed es, Universit e Claude Bernard Lyon 1, France

ARTICLE INFO

Article history:

Received 12 March 2015

Received in revised form 17 April 2015

Accepted 18 April 2015

Available online 30 April 2015

Keywords:

Cyclodextrin

Drug-in-cyclodextrin-in-liposomes

Liposomes

ABSTRACT

Cyclodextrins (CDs) are cyclic oligosaccharides, consisting of glucopyranose units, which are able to form host–guest inclusion complexes with lipophilic molecules. The ability of CD to increase drug solubility may be used to increase drug entrapment in the aqueous compartment of liposomes and liposomes can protect CD/drug inclusion complexes until drug release. Liposomes are phospholipid vesicles composed of lipid bilayers enclosing one or more aqueous compartments. They have been widely used as safe and effective carriers for both hydrophilic and lipophilic drugs. However, lipophilic drugs incorporated in the membrane bilayers can be rapidly released, which limits the effectiveness of this drug delivery system. The coupling of both delivery systems by encapsulating CD/drug inclusion complex into liposomes is proposed to circumvent the drawbacks of each separate system. Here, we review the literature regarding the encapsulation of CD/drug inclusion complex into conventional, deformable and double loaded liposomes. The review highlights the characteristics of these systems and presents the advantages and disadvantages of each one.

  2015 Elsevier Ltd. All rights reserved.

Contents

1. Introduction	176
2. Cyclodextrins	176
2.1. Structure and derivatives	176
2.2. Preparation methods	179
3. Liposomes	181
3.1. Composition and classification	181
3.2. Deformable liposomes	181
3.3. Double loaded liposomes	181
3.4. Preparation methods	181
4. Characterization of DCLs	182
4.1. Size	182

Abbreviations: CD, cyclodextrin; CHO, cholesterol; CLSM, confocal laser scanning microscopy; Co-E, co-evaporation method; CPAP, complex preparation in aqueous phase; Crystmeb, partially methylated crystallized- β -CD; DCL, drug-in-CD-in-liposome; Dimeb, 2,6-dimethyl- β -CD; DMPC, dimyristoylphosphatidylcholine; DMPG, dimyristoylphosphatidylglycerol; DPPC, dipalmitoylphosphatidylcholine; FATMLV, MLV prepared by freeze and thaw; FD, freeze-drying; HPP- β -CD, hydroxypropyl- β -CD; HPP- γ -CD, hydroxypropyl- γ -CD; KM, kneading method; LUV, large unilamellar vesicles; MLV, multilamellar vesicles; MVL, multivesicular liposomes; NaD, sodium deoxycholate; PC, phosphatidylcholine; Rameb, randomly methylated β -CD; REV, reverse phase evaporation; SA, stearylamine; SDs, spray drying; SPC, soybean phosphatidylcholine; SUV, small unilamellar vesicles; TEM, transmission electron microscopy; TFH, thin-film hydration method; Trimeb, 2,3,6-trimethyl- β -CD.

* Corresponding author at: Faculty of Sciences, Section II, Bioactive Molecules Research Group, Lebanese University, B.P. 90656 Jdaide El-Matn, Lebanon. Tel.: +961 3 341011; fax: +961 1 689647.

E-mail addresses: greigegeorges@yahoo.com, hgreige@ul.edu.lb (H. Greige-Gerges).

<http://dx.doi.org/10.1016/j.carbpol.2015.04.048>

0144-8617/  2015 Elsevier Ltd. All rights reserved.

4.1.1.	Effect of CDs on conventional liposomes size	182
4.1.2.	Effect of CDs on the size of deformable liposomes	183
4.1.3.	Size comparison between CD/drug loaded-deformable and -conventional liposomes	183
4.1.4.	Effect of double loading technique on the vesicle size	183
4.2.	Morphology	183
4.3.	Zeta potential	184
4.4.	Encapsulation efficiency	184
4.4.1.	Effect of CD on encapsulation efficiency	184
4.4.2.	Correlation between EE and drug inclusion complex concentration	184
4.4.3.	Effect of surfactant on EE of deformable liposomes	184
4.5.	Release kinetics	184
4.6.	Biological effect of conventional and deformable DCLs	185
5.	Conclusion	185
	Conflicts of interest	185
	Acknowledgments	185
	References	185

1. Introduction

Liposomes are microscopic vesicles in which an aqueous volume is entirely enclosed by a membrane (Anwekar, Patel, & Singhai, 2011). They can encapsulate hydrophilic molecules in the aqueous core, lipophilic ones in the membrane and amphiphilic substances at the aqueous–lipid interface (Akbarieh, Besner, Galal, & Tawashi, 1992; Fielding, 1991; Uhumwangho & Okor, 2005). Liposomes are usually made of natural, biodegradable, non-toxic and non-immunogenic lipid molecules (Anwekar et al., 2011). They have been used as artificial model membranes (Wagner & Vorauer-Uhl, 2011) and as carriers to deliver active molecules *in vivo* (Lasic & Papahadjopoulos, 1998). Liposomes offer an excellent opportunity to selective drug targeting which is expected to optimize the pharmacokinetic parameters and the pharmacological effects, prevent local irritation, and reduce the drug toxicity (Barenholz, 2003; Budai & Szogyi, 2001).

Cyclodextrins (CDs) are cyclic oligosaccharides, formed by glucopyranose units. They are crystalline, homogeneous, and non-hygroscopic substances (Szejtli, 2004). Their internal cavity is relatively hydrophobic, while their outer surface is hydrophilic. As a result, CDs can entrap hydrophobic molecules (guests) to form inclusion complexes solubles in water (Szejtli, 1997). CDs are capable of forming inclusion complexes with many poorly soluble drugs thus enhancing their bioavailability. Besides, CD inclusion complexes improve physical and thermal stability of drugs and limit their toxic effects. The CD/drug inclusion complex can be administered through different routes such as transdermal (Baek et al., 2013; Loftsson & Masson, 2001), ophthalmic (Moya-Ortega et al., 2013), nasal (Loftsson et al., 2001), oral (Zhang et al., 2013), and intravenous (Clark et al., 2013).

It has been reported that highly lipophilic drugs incorporated in the liposome phospholipid membrane can be released rapidly after *in vivo* administration (Kirby & Gregoriadis, 1983; Maestrelli, Gonzalez-Rodriguez, Rabasco, & Mura, 2005; Takino, Konishi, Takakura, & Hashida, 1994). To ensure stable encapsulation of such drugs, an approach has been proposed by McCormack and Gregoriadis (1994) wherein CD/drug inclusion complexes are inserted into liposomes. This approach combines the relative advantages of both carriers in a single “drug-in-CD-in-liposome” (DCL) system. Indeed, the entrapment of water-soluble CD/drug inclusion complexes into liposomes would allow accommodation of insoluble drugs in the aqueous phase of vesicles (Nasir, Harikumar, & Kaur, 2012). A number of lipophilic bioactive molecules have been encapsulated in DCLs. They include anti-inflammatory drugs such as ketoprofen (Maestrelli et al., 2005; Maestrelli, Gonzalez-Rodriguez, Rabasco, & Mura, 2006),

celecoxib (Jain, Gupta, Jain, & Bhola, 2007), prednisolone (Fatouros, Hatzidimitriou, & Antimisariis, 2001), indomethacin (Chen, Gao, Wang, & Liang, 2007), betamethasone (Gillet, Gamménous, Evrard, & Piel, 2009; Piel et al., 2006); anti-cancer drugs such as β -lapachone (Cavalcanti et al., 2011), tretinoin (Ascenso et al., 2013), doxorubicin (Hagiwara, Arima, Hirayam, & Uekama, 2006), curcumin (Dhule et al., 2012); anesthetic drugs as benzocaine, butamben (Maestrelli, Gonzalez-Rodriguez, Rabasco, Ghelardini, & Mura, 2010), prilocaine (Bragagni, Maestrelli, Mennini, Ghelardini, & Mura, 2010); Ca^{2+} channel blocker drugs as nifedipine (Skalko, Brandl, Bedirevid-Ladan, Filipovid-Greie, & Jalsenjak, 1996), and immunosuppressive drugs, e.g. tacrotimus (Zhu et al., 2013).

DCLs have been characterized in terms of morphology, size, encapsulation efficiency (EE), and the rate of drug release. It is well known that these characteristics might be influenced by different factors such as liposomes composition, the liposome and CD/drug inclusion complex preparation methods as well as the type and concentration of CD used. Recently, a review was emerged reporting especially the application of DCLs as antitumor and transdermal carriers (Chen et al., 2014). In our review, the focus is done on the analysis of the factors that may affect the characteristics of DCLs formulations: conventional, deformable and double loaded liposomes. Here also, literature data are resumed into three tables (Tables 1–3) where comparisons are made between characteristics of DCLs and those of empty and drug loaded liposomes. The last section of the review deals with the biological effects of DCLs compared to drug loaded liposomes.

2. Cyclodextrins

2.1. Structure and derivatives

The most common cyclodextrins (CDs) are formed from six (α -CD), seven (β -CD) or eight (γ -CD) D-glucopyranose units, with their respective cavity sizes of approximately 0.5, 0.6, and 0.8 nm (Sharma & Sharma, 2001). CDs have a form of a truncated cone with an internal hydrophobic cavity and an external hydrophilic surface. This particular structure confers to CDs the host ability to include a large number of hydrophobic guest molecules to form inclusion complexes (Kfoury, Auezova, Fourmentin, & Greige-Gerges, 2014; Piel, Piette, Barillaro, Evrard, & Delattre, 2007). From the X-ray structures, it appears that in CDs the secondary hydroxyl groups (C2 and C3) of glucopyranose units are located on the wider edge of the ring and the primary hydroxyl group (C6) on the other edge (Del Valle, 2004).

Many CD derivatives have been synthesized by a variety of processes including amination, etherification and esterification

Table 1
Comparison of size between CD/drug-loaded liposomes and other liposomal preparations.

Drug	CD a. Type b. CD/drug complex preparation method	Liposomes a. Composition b. Preparation method c. Structure	Size	References
Betamethasone	a. HP γ -CD β -CD Crysmeb Dimeb Rameb Trimeb b. CPAP ^a	a. SPC:CHO:SA b. TFH ^b c. MLV	– No significant differences between CD/betamethasone-MLV (from 181 \pm 22 nm to 221 \pm 29 nm at [CD] = 10 mM or from 192 \pm 31 nm to 248 \pm 28 nm at [CD] = 40 mM) and betamethasone-MLV (206 \pm 62 nm) Exception: Rameb/betamethasone-MLV significantly larger (319 \pm 42 nm) at 40 mM	Piel et al. (2006)
Benzocaine Butamben	a. HP β -CD b. Co-E ^c	a. PC:CHO:SA b. TFH c. MLV	– No differences between double loaded liposomes (benzocaine: 661.2 \pm 0.3 nm or butamben: 680.8 \pm 0.2 nm) and those encapsulating free drug dissolved in the lipophilic phase (benzocaine: 720.2 \pm 0.2 nm or butamben: 703.6 \pm 0.2 nm) – Liposome encapsulating benzocaine dissolved in aqueous phase (390.2 \pm 12 nm) smaller than all above formulations – β -CD/celecoxib MLV (1.32 \pm 1.04 μ m) smaller than β -CD/celecoxib MVL (range between 6.52 \pm 1.54 μ m and 10.42 \pm 0.44 μ m)	Maestrelli et al. (2010)
Celecoxib	a. β -CD b. KM ^d	a. SPC:CHO:neutral oil b. REV ^e ; TFH c. MVL; MLV	– No differences between HP γ -CD/curcumin-MLV (98.2 \pm 30.1 nm) and curcumin-MLV (104.7 \pm 23.1 nm)	Jain et al. (2007)
Curcumin	d. HP γ -CD e. CPAP	a. DPPC:DMPG b. TFH c. MLV	– No differences between γ -CD/doxorubicin-PEGylated LUV (135.3 \pm 1.5 nm) and doxorubicin-PEGylated LUV (137.2 \pm 1.2 nm)	Dhule et al. (2012)
Doxorubicin	a. γ -CD b. Non-indicated	a. DSPE-PEG b. Dehydration–rehydration c. LUV	– No differences between HP β -CD/ketoprofen-MLV (3.16 \pm 0.1 μ m) larger than empty ones (1.58 \pm 0.08 μ m) and than ketoprofen-MLV (1.52 \pm 0.05 μ m) – HP β -CD/ketoprofen-MLV (3.71 \pm 0.01 μ m) and HP β -CD/ketoprofen-LUV (1.85 \pm 0.04 μ m) larger than empty ones (MLV: 1.58 \pm 0.08 μ m; LUV: 0.73 \pm 0.02 μ m)	Hagiwara et al. (2006)
Ketoprofen	a. β -CD HP β -CD b. Co-E	a. PC:CHO b. TFH c. MLV	– HP β -CD/ketoprofen-MLV (112 \pm 1.49 nm) significantly larger than β -lapachone-MLV (104 \pm 2.33 nm)	Maestrelli et al. (2005)
	a. HP β -CD b. Co-E	a. PC:CHO b. TFH; REV c. MLV; LUV	– No differences between HP β -CD/ β -lapachone-MLV (112 \pm 1.49 nm) significantly larger than β -lapachone-MLV (104 \pm 2.33 nm)	Maestrelli et al. (2006)
β -Lapachone	a. HP β -CD b. FD ^f	a. SPC:CHO:SA b. TFH c. MLV	– No differences between HP β -CD/nifedipine-SUV (155 nm) and nifedipine SUV (153 nm)	Cavalcanti et al. (2011)
Nifedipine	a. HP β -CD b. SD ^g	a. Lecithin b. Ethanol injection c. SUV	– No significant differences between CD/prednisolone-LUV, prednisolone-LUV and empty LUV (300–350 nm)	Skalko et al. (1996)
Prednisolone	a. β -CD HP β -CD b. CPAP	a. PC:CHO b. Dehydration–rehydration c. LUV	– No differences between prilocaine-MLV (433 \pm 38 nm), HP β -CD/prilocaine-MLV (479 \pm 51 nm), and double loaded MLV (375 \pm 46 nm) with respect to MLV (431 \pm 44 nm)	Fatouros et al. (2001)
Prilocaine	a. HP β -CD b. Co-E	a. PC:CHO:SA b. TFH c. MLV	– No differences between dimeb/tretinoin-transfersomes (117 \pm 0.9 nm) and tretinoin-transfersomes (128 \pm 1.8 nm)	Bragagni et al. (2010)
Tretinoin	a. Dimeb b. KM	a. SPC and Tween 80 b. Freeze and thaw c. LUV		Ascenso et al. (2013)

^a CPAP, complex preparation in aqueous phase.

^b TFH, thin-film hydration method.

^c Co-E, co-evaporation method.

^d KM, kneading method.

^e REV, reverse phase evaporation.

^f FD, freeze-drying.

^g SD, spray drying.

of primary and secondary hydroxyl groups. The solubility of the CD derivatives is usually different from that of their parent CDs. Thus, the substitution of any of the hydroxyl groups, even by hydrophobic moieties such as methoxy functions, results in

a remarkable increase in CDs aqueous solubility (Fromming & Szejtli, 1994). Virtually all derivatives have a changed hydrophobic cavity volume and these modifications can improve solubility and chemical stability of guest molecules (Del Valle, 2004). For

Table 2
Comparison of encapsulation efficiency between drug-loaded liposomes and CD/drug-loaded liposomes.

Drug	CD a. Type b. Preparation method	Liposomes a. Composition b. Preparation method c. Structure	Encapsulation efficiency	References
Betamethasone	a. HP γ -CD β -CD Crysmeb Dimeb Rameb Trimeb b. CPAP ^a	a. SPC:CHO:SA b. TFH ^b c. MLV	– EE of CD/betamethasone-MLV (from 0.56 \pm 0.28 to 1.18 \pm 0.16%) > EE of betamethasone-MLV (0.39 \pm 0.17%) whatever the CD used – For Rameb and Crysmeb EE values increased with the concentration of CD (2.78 \pm 0.28% and 2.21 \pm 0.3%) – EE of double loaded liposomes encapsulating benzocaine: 59.16 \pm 2.8% or butamben: 82.23 \pm 3.0% < EE of benzocaine-MLV 83.9 \pm 3.4% or butamben-MLV: 94.40 \pm 3.6% – EE of β -CD/celecoxib-MVL (62.24–88.24%) > EE of β -CD/celecoxib-MLV (27.68 \pm 2.9%)	Piel et al. (2006)
Benzocaine Butamben	a. HP β -CD b. Co-E ^c	a. PC:CHO:SA b. TFH c. MLV	– EE of β -CD/celecoxib-MVL (62.24–88.24%) > EE of β -CD/celecoxib-MLV (27.68 \pm 2.9%)	Maestrelli et al. (2010)
Celecoxib	a. β -CD b. KM ^d	a. SPC:CHO:neutral oil b. REV ^e ; TFH c. MVL; MLV	– EE of HP γ -CD/curcumin-MLV (50%) > EE of curcumin-MLV (30%)	Jain et al. (2007)
Curcumin	a. HP γ -CD b. CPAP	a. DPPC:DMPG b. TFH c. MLV	– No EE difference between doxorubicin-PEGylated liposomes (96.4 \pm 0.5%) and γ -CD/doxorubicin-PEGylated liposomes (91.1 \pm 1.1%)	Dhule et al. (2012)
Doxorubicin	a. γ -CD b. Non-indicated	a. DSPE-PEG b. Dehydration–rehydration c. LUV	– EE of CD/indomethacin-MLV significantly higher than EE of indomethacin-liposomes (1.6 \pm 0.09 μ g/mg) – No EE difference between HP β -CD/indomethacin-liposomes (2.48 \pm 0.12 μ g/mg) and β -CD/indomethacin-liposomes (2.38 \pm 0.16 μ g/mg) – EE of CD/ketoprofen-MLV < EE of ketoprofen-MLV (56.0 \pm 3.2%) – EE of HP β -CD/ketoprofen-MLV (33.8 \pm 2.0%) > EE of β -CD/ketoprofen-MLV (26.8 \pm 1.6%) – EE increased upon increasing the complex concentration up to 10 mM (75.1 \pm 0.7%) then it decreased at higher complex concentrations (57.3 \pm 5.5% and 59.9 \pm 4.2% at 15 and 20 mM respectively) – EE decreased from 68.6 \pm 3% to 50.2 \pm 1.2% at complex concentration 5 and 10 mM respectively for CD/ketoprofen-FATMLV – SUV showed the lowest EE (54.8 \pm 1.1%) than other types of liposomes	Hagiwara et al. (2006)
Indomethacin	a. β -CD HP β -CD b. FD ^f	a. SPC:CHO b. Dehydration–rehydration c. ND	– High EE of β -lapachone-MLV (97.09 \pm 0.02%) and HP β -CD/ β -lapachone-MLV (93.5 \pm 0.04%)	Chen et al. (2007)
Ketoprofen	a. β -CD HP β -CD b. Co-E a. HP β -CD b. Co-E	a. PC:CHO b. TFH c. MLV a. PC:CHO b. TFH; REV; extrusion c. MLV; LUV; SUV	– EE of HP β -CD/nifedipine-liposomes, dissolved in organic phase (77.7 \pm 3.2%) > EE of nifedipine-liposomes (56.2 \pm 6.3%) – EE of HP β -CD/nifedipine-liposomes, dissolved in aqueous solution (21.9 \pm 2.6%) < EE of nifedipine-liposomes (56.2 \pm 6.3%) – EE of CD/prednisolone-LUV significantly higher than EE of prednisolone-LUV (27.1 \pm 0.52%) – EE of HP β -CD/prednisolone-LUV (79.1 \pm 1.5%) > EE of β -CD/prednisolone-LUV (32.5 \pm 0.62%) – High EE (82–85%) for liposomes encapsulating prilocaine in lipophilic phase; liposomes encapsulating prilocaine in aqueous phase; HP β -CD/prilocaine loaded liposomes and double loaded liposomes – No EE difference between tretinoin-transfersomes (77.8 \pm 14.6%) and Dimeb/tretinoin-transfersomes (88.7 \pm 6.7%)	Maestrelli et al. (2005) Maestrelli et al. (2006)
β -Lapachone	a. HP β -CD b. FD	a. SPC:CHO:SA b. TFH c. MLV	– EE of HP β -CD/nifedipine-liposomes, dissolved in organic phase (77.7 \pm 3.2%) > EE of nifedipine-liposomes (56.2 \pm 6.3%) – EE of HP β -CD/nifedipine-liposomes, dissolved in aqueous solution (21.9 \pm 2.6%) < EE of nifedipine-liposomes (56.2 \pm 6.3%) – EE of CD/prednisolone-LUV significantly higher than EE of prednisolone-LUV (27.1 \pm 0.52%) – EE of HP β -CD/prednisolone-LUV (79.1 \pm 1.5%) > EE of β -CD/prednisolone-LUV (32.5 \pm 0.62%) – High EE (82–85%) for liposomes encapsulating prilocaine in lipophilic phase; liposomes encapsulating prilocaine in aqueous phase; HP β -CD/prilocaine loaded liposomes and double loaded liposomes – No EE difference between tretinoin-transfersomes (77.8 \pm 14.6%) and Dimeb/tretinoin-transfersomes (88.7 \pm 6.7%)	Cavalcanti et al. (2011)
Nifedipine	a. HP β -CD b. SD ^g	a. Lecihin b. Ethanol injection c. SUV	– EE of HP β -CD/prednisolone-LUV (79.1 \pm 1.5%) > EE of β -CD/prednisolone-LUV (32.5 \pm 0.62%) – High EE (82–85%) for liposomes encapsulating prilocaine in lipophilic phase; liposomes encapsulating prilocaine in aqueous phase; HP β -CD/prilocaine loaded liposomes and double loaded liposomes – No EE difference between tretinoin-transfersomes (77.8 \pm 14.6%) and Dimeb/tretinoin-transfersomes (88.7 \pm 6.7%)	Skalko et al. (1996)
Prednisolone	a. β -CD b. HP β -CD c. CPAP	a. PC:CHO b. Dehydration–rehydration c. LUV	– High EE (82–85%) for liposomes encapsulating prilocaine in lipophilic phase; liposomes encapsulating prilocaine in aqueous phase; HP β -CD/prilocaine loaded liposomes and double loaded liposomes – No EE difference between tretinoin-transfersomes (77.8 \pm 14.6%) and Dimeb/tretinoin-transfersomes (88.7 \pm 6.7%)	Fatouros et al. (2001)
Prilocaine	a. HP β -CD b. Co-E	a. PC:CHO:SA b. TFH c. MLV	– No EE difference between tretinoin-transfersomes (77.8 \pm 14.6%) and Dimeb/tretinoin-transfersomes (88.7 \pm 6.7%)	Bragagni et al. (2010)
Tretinoin	a. Dimeb b. KM	a. SPC and Tween 80 b. Freeze and thaw c. LUV	– No EE difference between tretinoin-transfersomes (77.8 \pm 14.6%) and Dimeb/tretinoin-transfersomes (88.7 \pm 6.7%)	Ascenso et al. (2013)

^a CPAP, complex preparation in aqueous phase.
^b TFH, thin-film hydration method.
^c Co-E, co-evaporation method.
^d KM, kneading method.
^e REV, reverse phase evaporation.
^f FD, freeze-drying.
^g SD, spray drying.

Table 3
Comparison of drug release between CD/drug-loaded liposomes and other liposomal formulations.

Drug	CD a. Type b. Preparation method	Liposomes a. Composition b. Preparation method c. Structure	Drug release	References
Betamethasone	a. HP γ -CD β -CD Crystmeb Dimeb Rameb Trimeb b. CPAP ^a	a. SPC:CHP:SA b. TFH ^b c. MLV	– The release rate increased in the order: HP β -CD \approx γ -CD < Rameb < HP γ -CD \approx without CD < Crystmeb at 10 mM CD concentration – At CD concentration (40 mM), betamethasone release rate increased – A correlations between the percentage of betamethasone released and the encapsulation efficiency were demonstrated whatever the CD type and the CD concentration – For the two CD used, betamethasone loaded deformable and non-deformable liposomes were stable for 1 month at 4 °C; the leakage of drug increased with increasing temperature (25 °C and 37 °C) – For both classical and deformable liposomes, the type of CD used did not affect significantly the percentage of betamethasone diffused in Franz diffusion cell – Betamethasone release from deformable liposomes (HP γ -CD: 75%; crystmeb: 70%) was improved compared to non-deformable liposomes (HP γ -CD: 60%; crystmeb: 50%) – Faster release of celecoxib from MLV (80% at 48 h) than from MVL (80% at 120 h)	Piel et al. (2006)
	a. HP γ -CD Crystmeb b. CPAP	a. PC or DMPC \pm NaD b. TFH c. MLV		Gillet et al. (2009)
Celecoxib	a. β -CD b. KM ^c	a. SPC:CHO: neutral oil b. REV ^d ; TFH c. MVL; MLV		Jain et al. (2007)
Doxorubicin	a. γ -CD b. Non-indicated	a. DSPE-PEG b. c. LUV	– Slower release of doxorubicin from γ -CD/doxorubicin-PEGylated liposomes than that from doxorubicin-PEGylated liposomes – The release of doxorubicin from CD/doxorubicin-PEGylated liposomes was significantly slower than that from doxorubicin-PEGylated liposomes	Hagiwara et al. (2006)
Indomethacin	a. β -CD HP β -CD b. FD ^e	a. SPC:CHO b. TFH c. MLV	– Slower release of drug from CD/indomethacin-liposomes compared to indomethacin-liposomes – No significant difference of release rate between β -CD/indomethacin-liposomes and HP β -CD/indomethacin-liposomes	Chen et al. (2007)
Ketoprofen	a. β -CD HP β -CD b. Co-E ^f	a. PC:CHO b. TFH c. MLV	– Ketoprofen permeated across artificial membrane in this order: ketoprofen-liposomes > HP β -CD/ketoprofen-liposomes > β -CD/ketoprofen-liposomes – The rate of ketoprofen release was in order: HP β -CD/ketoprofen LUV < HP β -CD/ketoprofen MLV = HP β -CD/ketoprofen FATMLV < HP β -CD/ketoprofen SUV	Maestrelli et al. (2005)
	a. HP β -CD b. Co-E	a. PC:CHO b. TFH; REV; c. MLV; LUV; SUV	Extrusion	Maestrelli et al. (2006)
β -Lapachone	a. HP β -CD b. FD	a. SPC:CHO:SA b. TFH c. MLV	– Slower release of β -lapachone from β -lapachone-liposomes compared to HP β -CD/ β -lapachone-liposomes	Cavalcanti et al. (2011)
Prednisolone	a. β -CD HP β -CD b. CPAP	a. PC:CHO b. c. LUV	– The release rate of prednisolone was in order prednisolone loaded liposomes (9.4%) < HP β -CD/prednisolone-liposomes (18.3%) < β -CD/prednisolone-liposomes (43%)	Fatouros et al. (2001)

^a CPAP, complex preparation in aqueous phase.
^b TFH, thin-film hydration method.
^c KM, kneading method.
^d REV, reverse phase evaporation.
^e FD, freeze-drying.
^f Co-E, co-evaporation method.

example, the cavities of 2,6-dimethyl- β -CD (Dimeb) and 2,3,6-trimethyl- β -CD (Trimeb) have a more hydrophobic character than that of β -CD (Nishiho, Shiota, Mazima, Mizuno, & Yoshida, 2000).

Among the CDs, β -CD, γ -CD, HP β -CD, Dimeb, Trimeb, partially methylated crystallized- β -CD (Crystmeb) and randomly methylated β -CD (Rameb) are used in the literature in DCL carrier systems (Fig. 1).

2.2. Preparation methods

In this section, we consider only the methods of preparation of CD/drug inclusion complexes that have been used in DCL preparations (Fig. 2).

- Co-evaporation, also known as solvent evaporation method: it involves mixing of the organic phase containing drug and

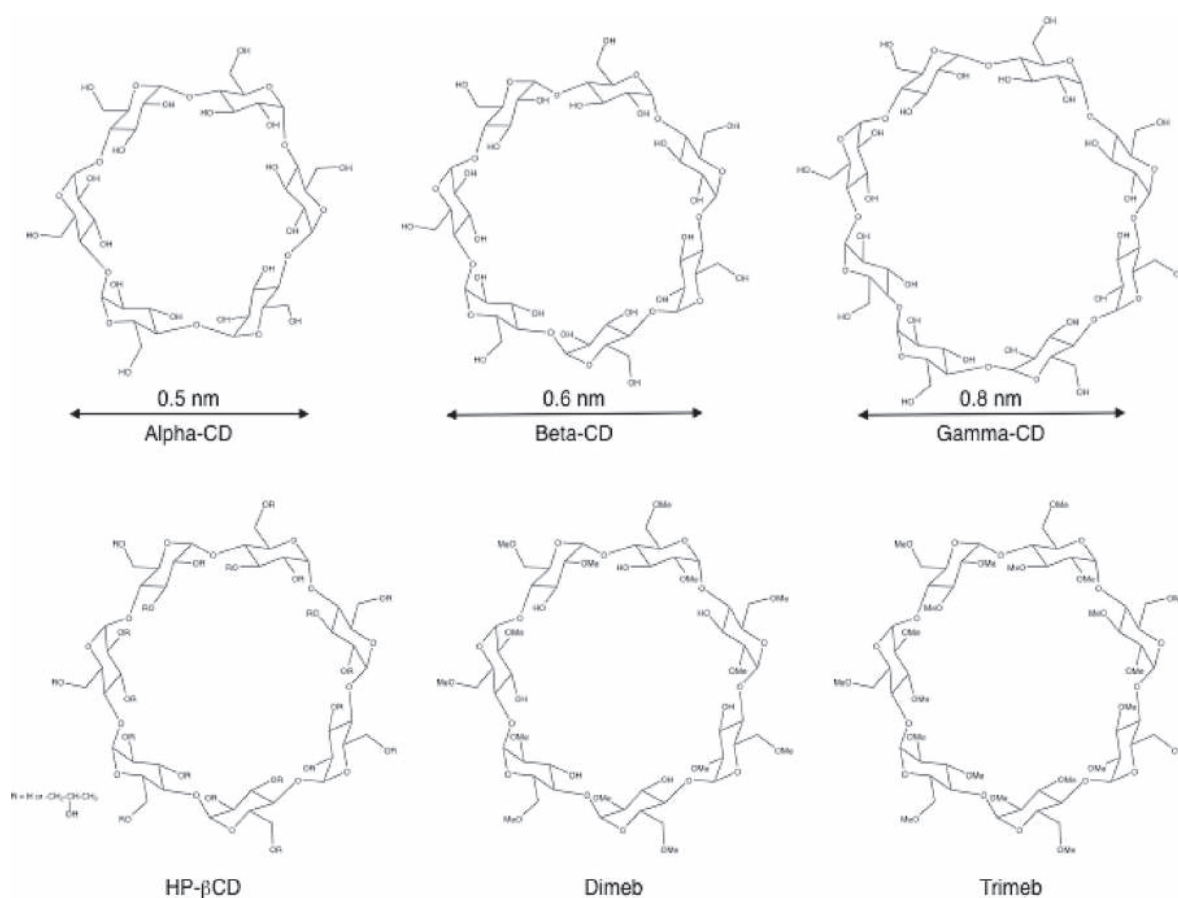

Fig. 1. Types of cyclodextrins and their derivatives.

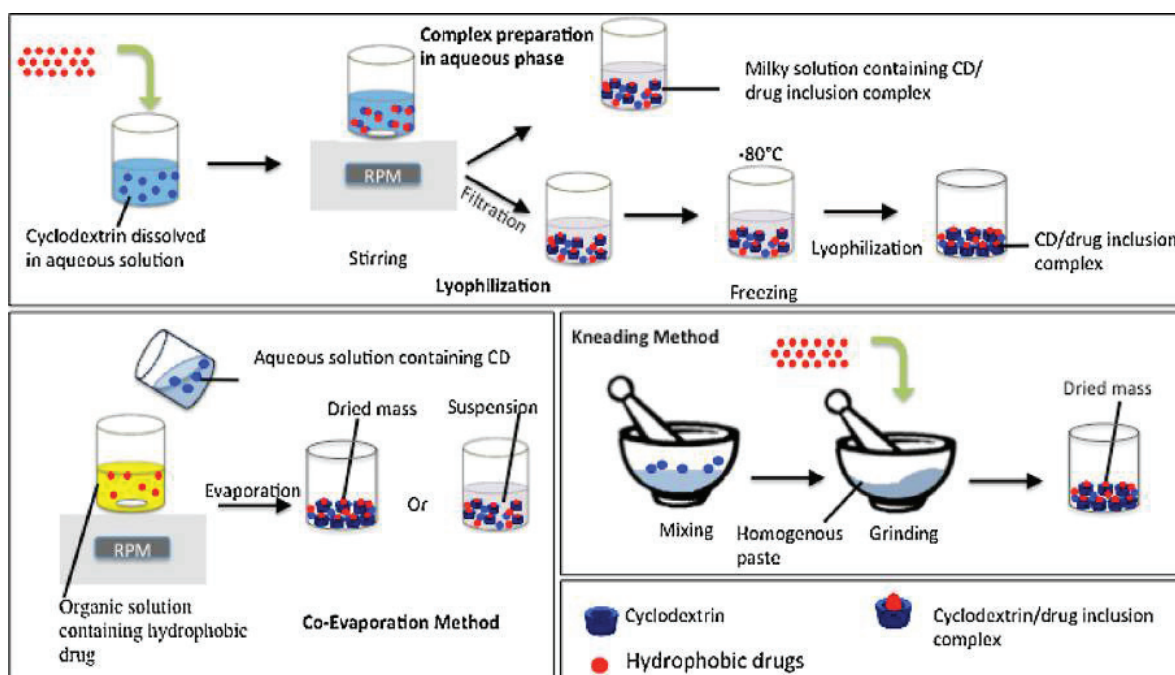

Fig. 2. Preparation methods of CD/drug inclusion complexes.

aqueous solution of CD by stirring to achieve molecular dispersion. The resulting suspension is centrifuged at 10,000 rpm to remove the undissolved drug (Zhu et al., 2013) or followed by evaporation of the solvent under vacuum until dried mass obtained. This latter is generally sieved to get the 75–150 μm granulometric fraction (Maestrelli et al., 2005, 2006, 2010).

- Complex preparation in aqueous phase: CD is dissolved in an aqueous phase (Dhule et al., 2012; Fatouros et al., 2001; Gillet et al., 2009; Piel et al., 2006) and the drug is then added. Water-soluble inclusion complexes are formed after stirring the mixture for a specific period of time at a specific temperature (Dhule et al., 2012; Fatouros et al., 2001; Piel et al., 2006).
- Freeze-drying (lyophilization): the drug and CD at 1:1 molar ratio are either dissolved in ethanol or water respectively (Cavalcanti et al., 2011) or both in the aqueous phase (Chen et al., 2007). The resulted solution is stirred for a specific time at a certain temperature and then filtered (Chen et al., 2007; Skalko et al., 1996), frozen and lyophilized under reduced pressure (Cavalcanti et al., 2011; Chen et al., 2007; Skalko et al., 1996).
- Spray drying: this technique involves mixing of an organic solution (ethanol) of drug with an aqueous solution of CD at 1:1 molar ratio. The resulting mixture is then stirred at room temperature to attain equilibrium followed by removing the solvent using spray drying (Sanjula, Mona, & Kanchan, 2005; Skalko et al., 1996).
- Kneading: CD and aqueous solution are mixed together in a mortar to make a homogenous paste; drug is then added slowly, while grinding, to dissolve the drug. The mixture was then ground with an appropriate quantity of water added to maintain a suitable consistency. The preparation is then dried in a rotary evaporator, and then the dried mass was sieved to collect the 75–150 μm granulometric fraction (Ascenso et al., 2013; Jain et al., 2007).

3. Liposomes

3.1. Composition and classification

Liposomes are spherical vesicles formed of one or more lipid bilayers separating two aqueous compartments (Anwekar et al., 2011). These bilayers are mainly constituted of phospholipids, stearylamine and may contain cholesterol (CHO) (Frezard, 1999). The most common phospholipids used in the preparation of liposomes for entrapping CD inclusion complexes are phosphatidylcholine (PC), dimyristoylphosphatidylcholine (DMPC), dipalmitoylphosphatidylcholine (DPPC) and dimyristoylphosphatidylglycerol (DMPG). CHO is often incorporated into liposomes to increase their mechanical stiffness and stability by decreasing membrane fluidity (Bloom, Evans, & Mouritsen, 1991; Raffy & Teissie, 1999). It is inserted into the membrane with its hydroxyl group oriented toward the aqueous phase and the aliphatic chain oriented parallel to the acyl chains in the center of the bilayer. The high solubility of CHO in phospholipid liposome has been attributed to both hydrophobic and polar interactions (Patil et al., 2005).

Liposomes are generally classified according to their size and number of bilayers. Small unilamellar vesicles (SUV) ranging between 20 and 100 nm and large unilamellar vesicles (LUV) (>100 nm) having a single lamella. While multilamellar vesicles (MLV) are large vesicles having size greater than 0.5 μm ; the lamellarity varies between 5 and 20 concentric lamella and depends on the lipid concentration and the liposome preparation method (Rongen, Bult, & Van Bennekom, 1997).

3.2. Deformable liposomes

Deformable liposomes or vesicles called transfersomes are the first generation of elastic vesicles introduced in the early 1990s

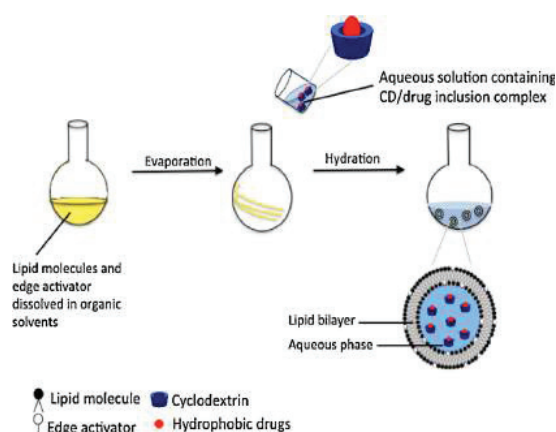

Fig. 3. Preparation of deformable liposomes by thin-film hydration method.

(Cevc & Blume, 1992). These vesicles are constituted from phospholipids and an edge activator. The latter is frequently a single chain surfactant that destabilizes the vesicles lipid bilayers and, as a result, increases the bilayers deformability (Cevc, 2004). While conventional liposomes have mainly local or rarely transdermal effects, deformable liposomes are considered as better carriers for dermal and transdermal drug delivery (Dragicevic-Curic, Gräfe, Gitter, Winter, & Fahr, 2010). Preparation of deformable liposomes involves methods similar to those used in the preparation of conventional liposomes. The thin-film hydration method is the most commonly used.

3.3. Double loaded liposomes

Double-loaded liposomes are vesicles loaded with lipophilic drug both in its free form (in the lipophilic bilayers) and in CD-complexed form (in the aqueous phase). As explained below, such a double encapsulation effectively increases the drug: lipid ratios to levels higher than those obtained by entrapping the drug only in the liposomal bilayer. The resulting carrier system shows advantages such as a fast onset of action and a prolonged effect (Bragagni et al., 2010).

3.4. Preparation methods

The methods of liposome preparation commonly used for CD/drug loading are thin-film hydration, reverse-phase evaporation, freeze and thaw, ethanol injection and freeze-drying.

- Thin-film hydration (Figs. 3 and 4): the MLV are obtained by dissolving the lipid with the minimum amount of organic solvent (chloroform), which is then removed under reduced pressure, obtaining a dried thin film. Finally, the film is hydrated by an aqueous solution containing CD/drug under agitation (Maestrelli et al., 2005; Piel et al., 2006).
- Reverse-phase evaporation (Fig. 5): the lipid phase is dissolved in organic solvent, and mixed with an aqueous solution containing CD/drug inclusion complex in an ultrasound bath at 0 °C to obtain a water-in-oil emulsion. The organic solvent is removed under low pressure leading to the formation of a viscous gel. The gel is thereafter subjected to vigorous agitation to obtain large liposomes (Maestrelli et al., 2006).
- Freeze and thaw: the SUV are prepared by adding phospholipids to a bilayer softening agent (e.g. Tween 80), followed by a buffer containing CD/drug inclusion complex under stirring. In order to

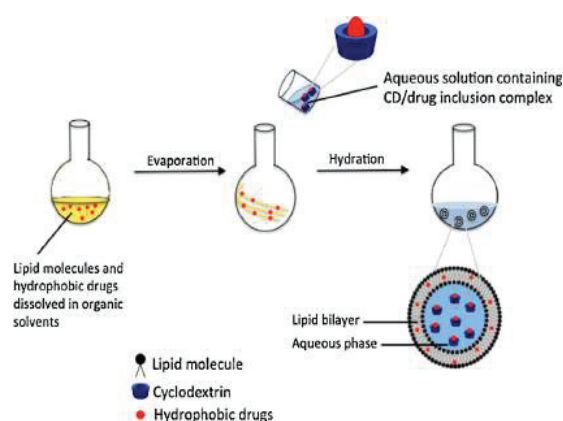

Fig. 4. Preparation of double loaded liposomes by thin-film hydration method.

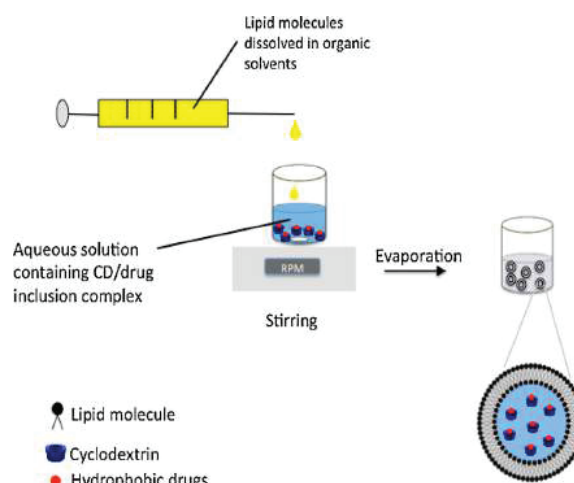

Fig. 6. Ethanol injection method.

obtain LUV, SUV are frozen and re-thawed repeatedly resulting in vesicles fusion (Ascenso et al., 2013).

- Ethanol injection (Fig. 6): the phospholipids are dissolved in ethanol, and the resulting organic phase is injected into an aqueous phase under magnetic stirring. CD/drug complex is either dissolved in buffer solution or in organic phase solution. After stirring, the ethanol is removed by rotary evaporation under reduced pressure (Skalko et al., 1996).
- Dehydration–rehydration (Fig. 7): phospholipids are dissolved in an organic solvent, which is then completely evaporated in a rotary evaporator to form a thin lipid film, and then hydrated with an aqueous phase (Chen et al., 2007; Fatouros et al., 2001) containing CD/drug complexes. The vesicles formed are freeze-dried and then rehydrated with NaCl solution to maintain the osmolarity (Chen et al., 2007; Fatouros et al., 2001).

4. Characterization of DCLs

In the sections below, we discuss the data reported in literature for DCLs in comparison with simple liposomes. Also, Tables 1–3 summarize their dimensions, encapsulation efficiency (EE) and drug release rate with respect to lipid composition, preparation method as well as the type and concentration of CD.

4.1. Size

Liposomes encapsulating free drug or CD/drug inclusion complexes have been characterized for the mean particle size using different techniques such as photocorrelation spectroscopy, transmission electron microscopy (TEM) and scanning electron microscopy.

In Table 1, we compared the size of DCL and other liposomal preparations. The polydispersity index (Pdl) values of all liposomal formulations were inferior to 0.3 suggesting homogenous size distribution of vesicles. From Table 1, we conclude that liposome size might be affected by the presence of drug, whether in its free form or encapsulated in CD.

4.1.1. Effect of CDs on conventional liposomes size

β -CD/ketoprofen- and HP β -CD/ketoprofen-loaded MLV and LUV as well as empty and ketoprofen-loaded MLV and LUV were prepared by Maestrelli et al. (2005, 2006). The vesicles were of micrometric size. The size of liposomes entrapping ketoprofen was similar to that of empty liposomes whereas larger vesicles were obtained in the presence of CD/ketoprofen complexes (Table 1).

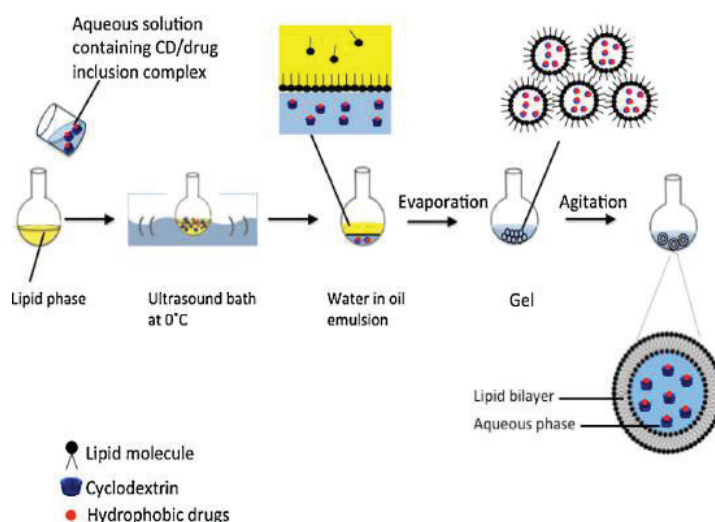

Fig. 5. Reverse phase evaporation method.

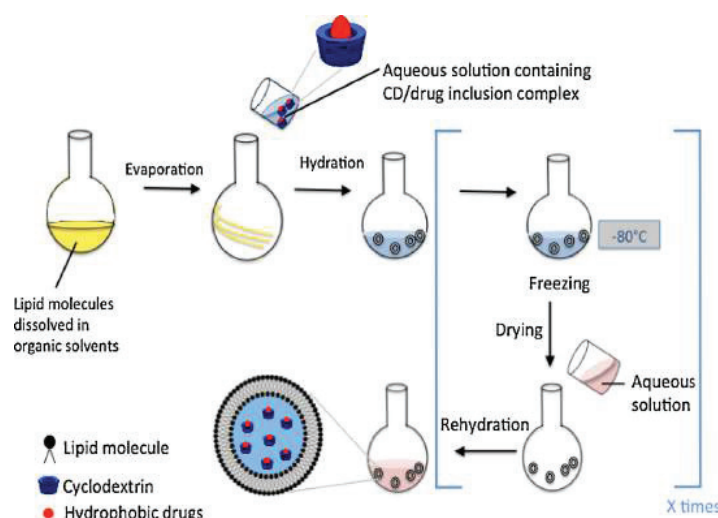

Fig. 7. Dehydration–rehydration method.

Similarly, HP β -CD/ β -lapachone-loaded MLV, were larger than β -lapachone-loaded liposomes (Cavalcanti et al., 2011) but the difference was not important.

Many others studies published contradictory results regarding the effect of the presence of CD on the liposomes size: MLV encapsulating betamethasone complexed with β -CD and different derivatives (HP γ -CD, Crystmeb, Dimeb, Rameb, Trimeb) were prepared at CD concentrations 10 mM and 40 mM (Piel et al., 2006). For both concentrations, no significant difference was found between the sizes of betamethasone- and CD/betamethasone-loaded liposomes. Similarly, no significant difference in size was found between the empty liposomes, prednisolone-loaded liposomes and CD/prednisolone-loaded liposomes (Fatouros et al., 2001).

HP β -CD/nifedipine complexes were prepared by two methods: the freeze-drying and spray drying. The complexes were encapsulated into liposomes by ethanol injection method. The size of CD/nifedipine loaded liposomes was about 150 nm and was similar to nifedipine-loaded liposomes (Skalko et al., 1996). Similarly, HP γ -CD/curcumin-loaded MLV and curcumin-loaded liposomes were of similar size (Dhule et al., 2012).

The discrepancy regarding the effect of CDs on the conventional liposome size may be due to the factors that affect the liposome size such as the composition of the liposomal formulation (phospholipid nature, presence of cholesterol, phospholipid to cholesterol molar ratio, CD/drug inclusion complex concentration) as well as the liposome preparation method.

4.1.2. Effect of CDs on the size of deformable liposomes

The mean size diameter was evaluated for tretinoin, Dimeb/tretinoin-loaded transfersome (Ascenso et al., 2013) and for doxorubicin, γ -CD/doxorubicin-loaded PEGylated liposomes (Hagiwara et al., 2006) and no effect of the presence of CD on liposomes size was obtained (Table 1).

4.1.3. Size comparison between CD/drug loaded-deformable and -conventional liposomes

Deformable liposomes containing HP γ -CD/betamethasone or Crystmeb/betamethasone complexes with sodium deoxycholate as the edge activator were compared to the corresponding formulation of conventional liposomes. Size analysis showed that deformable liposomes encapsulating CD/betamethasone complex showed a significantly smaller size than that of the corresponding

non-deformable liposome whatever the CD used. According to the authors, the reduction of the particle size for deformable PC liposomes may be ascribed to increased flexibility and reduced surface tension of the vesicles due to the presence of sodium deoxycholate (Gillet et al., 2009).

Opposite results were reported by Jain et al. (2007) where β -CD/celecoxib inclusion complexes loaded classical MLV liposomes were smaller than β -CD/celecoxib inclusion complexes loaded deformable multivesicular liposomes (MVLs). In the latter formulation, neutral oil was added as edge activator.

4.1.4. Effect of double loading technique on the vesicle size

Benzoicaine and butamben were encapsulated into deformable liposomes prepared using a mixture of PC, cholesterol and stearylamine (Maestrelli et al., 2010). The latter is added as an ionic surfactant in order to increase the bilayer deformability. No important differences in size were observed between double loaded liposomes and liposomes encapsulating free drug in the lipophilic phase.

However, when the drugs were dissolved in the aqueous phase, liposomes showed smaller size values compared to the above formulations. The authors explained their results by the presence of the drug in the bilayer, which can give rise to a rearrangement in the liposomal structure and as a consequence an increase in the vesicle dimensions (Maestrelli et al., 2010).

Another research group developed five different liposomal formulations: (1) empty vesicles; (2) HP β -CD/prilocaine in the aqueous phase; (3) hydrochloride prilocaine (PRL-HCl) in the aqueous phase; (4) free prilocaine base in the lipophilic phase; (5) double-loaded liposomes containing free prilocaine base in the organic phase and HP β -CD/prilocaine in the aqueous phase. In all cases, the drug was added at concentrations ranging from 1% to 5%. There was no significant size variation between all liposomal formulations. In addition, no correlation was found between the concentration of the drug and vesicle dimension. However, better homogeneity was obtained for liposomes prepared by the double loading technique (Bragagni et al., 2010).

4.2. Morphology

TEM and confocal laser scanning microscopy (CLSM) were used to visualize DCL systems. The presence of CD did not affect the MLV lamellar structure suggesting that the complex was

actually included in the vesicle (Maestrelli et al., 2005, 2010). HP β -CD/ketoprofen loaded MLV demonstrated a spherical shape and a homogeneous aspect, whereas precipitation of drug crystals was observed in β -CD/ketoprofen loaded MLV. On the other hand, CD/betamethasone loaded deformable liposomes have a more flattened shape in comparison with CD/betamethasone loaded liposomes due to their elastic properties (Gillet et al., 2009).

4.3. Zeta potential

A few studies, which characterized the DCL systems, have investigated the effect of CD presence on zeta potential values of liposomes. No significant difference in zeta potential values between drug- and CD/drug-loaded liposomes (Bragagni et al., 2010; Cavalcanti et al., 2011; Fatouros et al., 2001; Maestrelli et al., 2010) was reported.

4.4. Encapsulation efficiency

The separation of liposomes from unloaded molecules is generally conducted either by dialysis or ultracentrifugation and the EE is calculated based on drug quantification in the preparation before and after separation of unloaded molecules. Table 2 summarizes the EE values for conventional, deformable and double loaded liposomes. The comparison of EE values between drug- and CD/drug-loaded liposomes is also discussed in this section.

4.4.1. Effect of CD on encapsulation efficiency

Many studies demonstrated that the incorporation of a drug into liposomes in the form of CD/drug inclusion complex resulted in an improvement of EE (Chen et al., 2007; Dhule et al., 2012; Fatouros et al., 2001; Piel et al., 2006; Skalko et al., 1996) (Table 2). For doxorubicin, tretinoin and β -lapachone, the EE values were high in liposome formulations containing either drug or CD/drug inclusion complex (Ascenso et al., 2013; Cavalcanti et al., 2011; Hagiwara et al., 2006). However, the EE values of ketoprofen-in CD-in liposomes were smaller than ketoprofen loaded liposomes (Maestrelli et al., 2005). According to Maestrelli et al. (2005) this difference could be explained by the preparation method of these liposomes. In fact, the vesicles containing ketoprofen alone were prepared by its dissolution in the lipophilic phase, unlike those containing CD/ketoprofen. The latter was dissolved in the aqueous phase and therefore, the volume occupied by the aqueous phase, in the case of MLV, is smaller than that occupied by the lipid phase.

The effect of CD type on the encapsulation efficiency is also studied in literature. Compared to β -CD/drug inclusion complex, the EE values are highest when HP β -CD was used (Chen et al., 2007; Fatouros et al., 2001; Maestrelli et al., 2005) (Table 2). HP β -CD is characterized by the high lipophilic interior cavity and considerably higher aqueous solubility explaining the higher entrapment of HP β -CD/drug into the aqueous phase of vesicles (Fatouros et al., 2001; Maestrelli et al., 2005).

4.4.2. Correlation between EE and drug inclusion complex concentration

Using various CD types (HP γ /CD, β -CD, Crystmeb, Dimeb, Rameb, Trimeb), Piel et al. (2006) demonstrated a significant correlation between the CD–betamethasone complex concentration and EE (Piel et al., 2006). On the other hand, the EE value of ketoprofen increased with increasing complex concentration of HP β -CD–ketoprofen, reaching the maximal value at 10 mM (75.1%) and decreased thereafter (Maestrelli et al., 2006).

Besides, it has been demonstrated that cholesterol may improve the EE value of a drug in DCL systems and that depends on CD/drug:CHO ratio (Fatouros et al., 2001).

4.4.3. Effect of surfactant on EE of deformable liposomes

To improve the EE of drugs in DCL, two research groups prepared drug in CD in deformable liposomes (Gillet et al., 2009; Jain et al., 2007) (Table 2). According to Jain et al. (2007), the MVL formulations contain numerous nonconcentric aqueous chambers and the aqueous-to-lipid ratio is much higher. The neutral oil forms the part of corner or edges where bilayer membranes meet each other and stabilize the boundaries of inner aqueous compartments. Besides, triolein molecules, having a longer acyl chain, exist in the lipid bilayer membrane over a larger area thereby increase the size of inner aqueous compartments, which in turn contributes to higher EE.

Gillet et al. (2009) added that the presence of sodium deoxycholate in the bilayer may “solubilize” and “hold” the free betamethasone in the lipid bilayer and therefore enhance the EE of the deformable liposomes (Gillet et al., 2009). However, the same authors demonstrated that the results differ with the type of phospholipid used in liposome preparation.

4.5. Release kinetics

Release studies were conducted to compare drug release from drug-loaded liposomes and DCL system, in order to determine the effect of CD encapsulation on drug release. The rate of drug release between deformable and non-deformable liposomes and that between drug-loaded liposomes and double loaded liposomes were also reported. The main findings of these studies are discussed below and presented in Table 3.

Chen et al. (2007) and Maestrelli et al. (2006) demonstrated *in vitro* at pH 7.4 and 37°C that the presence of CD inhibited drug release from liposomes. According to Chen et al. (2007), the drug, indomethacin, was directly and rapidly released from the lipid bilayers since hydrophobic drug was mostly entrapped in the lipid bilayers. However, in DCLs, two routes may account for the drug release: (1) CD/drug inclusion complexes can be transported from inner aqueous phase to lipid bilayers and then released as intact complex in the medium; (2) the release of free drug in the aqueous phase, which is in equilibrium with the inclusion complex. Opposite results were reported by Cavalcanti et al. (2011) and Fatouros et al. (2001), where the release rate of drug was faster from DCL system in comparison with drug loaded liposomes.

Besides, the drug release rate from DCL can differ according to the CD type used in the preparation of the inclusion complexes (Fatouros et al., 2001; Maestrelli et al., 2005). According to Piel et al. (2006), the release rate of betamethasone from liposomes or DCL systems increased in the order: HP β -CD \approx γ -CD < Rameb < HP γ -CD \approx without CD < Crystmeb. Whereas, Gillet et al. (2009) reported that the type of CD (HP γ -CD and Crystmeb) did not affect significantly the drug release rate. Besides, Piel et al. (2006) demonstrated a significant correlation between the percentage of betamethasone released from DCL and the EE.

The liposome type seems also to affect the drug release rate. Indeed, it has been demonstrated that the rate of ketoprofen release was in the order HP β -CD/ketoprofen-loaded LUV < HP β -CD/ketoprofen-loaded MLV = HP β -CD/ketoprofen-loaded FATMLV < HP β -CD/ketoprofen-loaded SUV. The lowest drug release for LUV could be a consequence of the greater density and viscosity of such a liposomal dispersion. On the other hand, the faster drug release for SUV, particularly in the initial phase, may be attributable to their smaller size. The intermediate drug release rate determined for MLV and FATMLV vesicles was explained by the substantially analogous multilamellar structure of these liposomes (Maestrelli et al., 2006).

The effect of deformable liposomes on drug release was investigated in only two studies, which reported opposite results (Gillet

et al., 2009; Jain et al., 2007) (Table 3). Gillet et al. (2009) explained the improvement of drug release in deformable liposomes by the higher bilayer permeability due to the presence of an edge activator.

4.6. Biological effect of conventional and deformable DCLs

To the best of our knowledge, few studies have investigated the biological effects of a drug in DCL systems. HP γ -CD/curcumin inclusion complex into liposomes demonstrated promising anti-cancer activities both *in vitro* and *in vivo* against breast cancer cell lines (Dhule et al., 2012). Also HP β -CD/CLEFMA (curcuminoid 4-[3,5-bis(2-chlorobenzylidene-4-oxo-piperidine-1-yl)-4-oxo-2-butenoic acid]) inclusion complex in liposomes proved an anti proliferative potency against xenograft lung tumor and maintained non-toxic effect in normal lung fibroblasts (Agashe, Sahoo, Lagisetty, & Awasthi, 2011). Besides, the anesthetic effect of butamben, benzocaine (Maestrelli et al., 2010) and prilocaine (Bragagni et al., 2010) was studied. Compared to drug loaded liposomes, best results were obtained with liposomes prepared by the double-loading technique, which not only provided a fast release referring to the presence of free drug in the external bilayer, but also a prolonged effect due to the presence of the CD/drug inclusion complex in the internal core (Bragagni et al., 2010; Maestrelli et al., 2010)

Zhu et al. (2013) used Pluronic F127 in the preparation of tacrolimus and β -CD/tacrolimus loaded liposomes. After oral administration to rats, the authors demonstrated that compared to tacrolimus loaded liposomes, the DCLs improved the penetration capability of the drug to the epithelial surfaces through the mucus, allowing the drug to reach the underlying mucous membrane. In another *in vivo* study, compared to doxorubicin-pegylated liposomes, γ -CD/doxorubicin-PEGylated liposomes were elicited the retardation of tumor growth and improved the survival rate after intravenous injection to male mice (Arima, Hagiwara, Hirayam, & Uekama, 2006).

Finally, the MVL bearing β -CD/celecoxib inclusion complex were tested upon intra-peritoneal administration to albino rats for their anti-inflammatory activity. Compared to β -CD/drug solution and β -CD/drug loaded MLV, the MVL showed more sustained and prolonged anti-inflammatory effect (Jain et al., 2007).

5. Conclusion

We reviewed and compared the characteristics of drug-in-CD-in liposomes with blank liposomes and drug-loaded liposomal formulations. The presence of CD seems do not affect the size of conventional, deformable or double loaded liposomes having nanometric size. PDI and Zeta potential are not affected by the presence of CD. The results of many studies suggested more prolonged drug release from DCL system compared to conventional liposomes.

The EE of hydrophobic drugs in liposomes was shown to be improved through their incorporation as CD/drug inclusion complex. The EE of a drug in DCL could be affected by the method of liposome preparation and, consequently, the liposome structure. The type of CD and concentration of included CD/drug complex are also factors which could influence the EE. Finally, double loaded liposomes, allowing encapsulation of both free drug and complexed drug, present significant improvement of potency and duration of the drug therapeutic effect.

Conflicts of interest

The authors declare there are no conflicts of interest.

Acknowledgments

We thank Research Grant Program at the Lebanese University and the Doctoral School of Sciences and Technologies of Lebanese University for supporting the Bioactive Molecules Research Group.

References

- Agashe, H., Sahoo, K., Lagisetty, P., & Awasthi, V. (2011). Cyclodextrin-mediated entrapment of curcuminoid 4-[3,5-bis(2-chlorobenzylidene-4-oxo-piperidine-1-yl)-4-oxo-2-butenoic acid] or CLEFMA in liposomes for treatment of xenograft lung tumor in rats. *Colloids and Surfaces B: Biointerfaces*, 84, 329–337.
- Akbarieh, M., Besner, J. G., Galal, A., & Tawashi, R. (1992). Liposomal delivery system for the targeting and controlled release of praziquantel. *Drug Development and Industrial Pharmacy*, 18, 303–317.
- Anwekar, H., Patel, S., & Singhai, A. K. (2011). Liposome as drug carriers. *International Journal of Pharmaceutical and Life Sciences*, 2, 945–951.
- Arima, H., Hagiwara, Y., Hirayam, F., & Uekama, K. (2006). Enhancement of antitumor effect of doxorubicin by its complexation with γ -cyclodextrin in pegylated liposomes. *Journal of Drug Targeting*, 14, 225–232.
- Ascenso, A., Cruz, M., Euleterio, C., Carvalho, F. A., Santo, F. A., Marques, H. C., et al. (2013). Novel tretinoin formulations: A drug-in-cyclodextrin-in liposome approach. *Journal of Liposome Research*, 23, 211–219.
- Baek, J. S., Lim, J. H., Kang, J. S., Shin, S. C., Jung, S. H., & Cho, C. W. (2013). Enhanced transdermal drug delivery of zaltoprofen using a novel formulation. *International Journal of Pharmaceutics*, 453, 358–362.
- Barenholz, Y. (2003). Relevancy of drug loading to liposomal formulation therapeutic efficacy. *Journal of Liposome Research*, 13, 1–8.
- Bloom, M., Evans, E., & Mouritsen, O. G. (1991). Physical properties of the fluid-bilayer component of cell membranes: A perspective. *Quarterly Reviews of Biophysics*, 24, 293–397.
- Bragagni, M., Maestrelli, F., Mennini, N., Ghelardini, C., & Mura, P. (2010). Liposomal formulations of prilocaine: Effect of complexation with hydroxypropyl- β -cyclodextrin on drug anesthetic effect. *Journal of Liposome Research*, 20, 315–322.
- Budai, M., & Szogyi, M. (2001). Liposomes as drug carrier systems. Preparation, classification, and therapeutic advantages of liposomes. *Acta Pharmaceutica Hungarica*, 71, 114–118.
- Cavalcanti, I. M., Mendonça, E. A., Lira, M. C., Honrato, S. B., Camara, C. A., Amorim, R. V., et al. (2011). The encapsulation of β -lapachone in 2-hydroxypropyl- β -cyclodextrin inclusion complex into liposomes: A physicochemical evaluation and molecular modeling approach. *European Journal of Pharmaceutical Sciences*, 44, 332–340.
- Cevc, G., & Blume, G. (1992). Lipid vesicles penetrate into intact skin owing to the transdermal osmotic gradients and hydration force. *Biochimica et Biophysica Acta*, 1104, 226–232.
- Cevc, G. (2004). Lipid vesicles and other colloids as drug carriers on the skin. *Advanced Drug Delivery Reviews*, 56, 675–711.
- Chen, H., Gao, J., Wang, F., & Liang, W. (2007). Preparation, characterization and pharmacokinetics of liposomes-encapsulated cyclodextrins inclusion complexes for hydrophobic drugs. *Drug Delivery*, 14, 201–208.
- Chen, J., Lu, W. L., Gu, W., Lu, S. S., Chen, Z. P., Cai, B. C., et al. (2014). *Expert Opinion on Drug Delivery*, 11, 565–577.
- Clark, A. M., Kriel, R. L., Leppik, I. E., White, J. R., Henry, T. R., Brundage, R. C., et al. (2013). Intravenous topiramate: Safety and pharmacokinetics following a single dose in patients with epilepsy or migraines taking oral topiramate. *Epilepsia*, 54, 1106–1111.
- Del Valle, E. M. M. (2004). Cyclodextrins and their uses: A review. *Process Biochemistry*, 39, 1033–1046.
- Dhule, S. S., Penfornis, P., Frazier, T., Walker, R., Feldman, J., Tan, G., et al. (2012). Curcumin-loaded γ -cyclodextrin liposomal nanoparticles as delivery vehicles for osteosarcoma. *Nanomedicine*, 8, 440–451.
- Dragicevic-Curic, N., Gräfe, S., Gitter, B., Winter, S., & Fahr, A. (2010). Surface charged temoporfin-loaded flexible vesicles: In vitro skin penetration studies and stability. *International Journal of Pharmaceutics*, 384, 100–108.
- Fatouros, D. G., Hatzidimitriou, K., & Antimisiaris, S. G. (2001). Liposomes encapsulating prednisolone and prednisolone-cyclodextrin complexes: Comparison of membrane integrity and drug release. *European Journal of Pharmaceutical Sciences*, 13, 287–296.
- Fielding, M. R. (1991). Liposomal drug delivery: Advantages and limitations from a clinical pharmacokinetics and therapeutic perspective. *Clinical Pharmacokinetics*, 21, 155–164.
- Frezard, F. (1999). Liposomes: From biophysics to the design of peptide vaccines. *Brazilian Journal of Medical and Biological Research*, 32, 181–189.
- Fromming, K. H., & Szejtli, J. (1994). *Cyclodextrins in Pharmacy*. Dordrecht: Kluwer Academic Publishers.
- Gillet, A., Gammenous, A. C., Evrard, B., & Piel, G. (2009). Development of a new topical system: Drug-in-cyclodextrin-in-deformable liposome. *International Journal of Pharmaceutics*, 380, 174–180.
- Hagiwara, Y., Arima, H., Hirayam, F., & Uekama, K. (2006). Prolonged retention of doxorubicin in tumor cells by encapsulation of γ -cyclodextrin in pegylated liposomes. *Journal of Inclusion Phenomena and Macrocyclic Chemistry*, 14, 65–68.
- Jain, S. K., Gupta, Y., Jain, A., & Bholra, M. (2007). Multivesicular liposomes bearing celecoxib- β -cyclodextrin complex for transdermal delivery. *Drug Delivery*, 14, 327–335.

- Kfoury, M., Auezova, L., Fourmentin, S., & Greige-Gerges, H. (2014). Investigation of monoterpenes complexation with hydroxypropyl- β -cyclodextrin. *Journal of Inclusion Phenomena and Macrocyclic Chemistry*, *80*, 51–60.
- Kirby, C., & Gregoriadis, G. (1983). The effect of lipid composition of small unilamellar liposomes containing melphalan and vincristine on drug clearance after injection into mice. *Biochemical Pharmacology*, *32*, 609–615.
- Lasic, D. D., & Papahadjopoulos, D. (1998). *Medical applications of liposomes*. New York: Elsevier.
- Loftsson, T., & Masson, M. (2001). Cyclodextrins in topical drug formulations: Theory and practice. *International Journal of Pharmaceutics*, *225*, 15–30.
- Loftsson, T., Guðmundsdóttir, H., Sigurjónsdóttir, J. F., Sigurðsson, H. H., Sigfússon, S. D., Másson, M., et al. (2001). Cyclodextrin solubilization of benzodiazepines: Formulation of midazolam nasal spray. *International Journal of Pharmaceutics*, *212*, 29–40.
- Maestrelli, F., Gonzalez-Rodriguez, M. L., Rabasco, A. M., & Mura, P. (2006). Effect of preparation technique on the properties of liposomes encapsulating ketoprofen-cyclodextrin complexes aimed for transdermal delivery. *International Journal of Pharmaceutics*, *312*, 53–60.
- Maestrelli, F., Gonzalez-Rodriguez, M. L., Rabasco, A. M., & Mura, P. (2005). Preparation and characterisation of liposomes encapsulating ketoprofen-cyclodextrin complexes for transdermal drug delivery. *International Journal of Pharmaceutics*, *298*, 55–67.
- Maestrelli, F., Gonzalez-Rodriguez, M. L., Rabasco, A. M., Ghelardini, C., & Mura, P. (2010). New drug-in cyclodextrin-in deformable liposomes formulations to improve the therapeutic efficacy of local anaesthetics. *International Journal of Pharmaceutics*, *395*, 222–231.
- McCormack, B., & Gregoriadis, G. (1994). Drugs-in-cyclodextrins-in-liposomes: A novel concept in drug delivery. *International Journal of Pharmaceutics*, *112*, 249–258.
- Moya-Ortega, M. D., Alves, T. F., Alvarez-Lorenzo, C., Concheiro, A., Stefánsson, E., Thorsteinsdóttir, M., et al. (2013). Dexamethasone eye drops containing γ -cyclodextrin-based nanogels. *International Journal of Pharmaceutics*, *441*, 507–515.
- Nasir, A., Harikumar, S. L., & Kaur, A. (2012). Cyclodextrins: An excipient tool in drug delivery. *International Research Journal of Pharmacy*, *3*, 44–50.
- Nishiho, J., Shiota, S., Mazima, K., Mizuno, H., & Yoshida, J. (2000). Interactions of cyclodextrins with dipalmitoyl, distearoyl, and dimyristoyl phosphatidyl choline liposomes. A study by leakage of carboxyfluorescein in inner aqueous phase of unilamellar liposomes. *Chemical and Pharmaceutical Bulletin*, *48*, 48–52.
- Patil, S. G., Gattani, S. G., Gaud, R. S., Surana, S. J., Dewani, S. P., & Mahajan, H. S. (2005). Preparation of liposomes. *Pharmacological Reviews*, *18*, 53–58.
- Piel, G., Piette, M., Barillaro, V. C., Evrard, B., & Delattre, L. (2007). Study of the relationship between lipid binding properties of cyclodextrin and their effect on the integrity of liposomes. *International Journal of Pharmaceutics*, *338*, 35–42.
- Piel, G., Piette, M., Barillaro, V., Castagne, D., Evrard, B., & Delattre, L. (2006). Betamethasone-in-cyclodextrin-in-liposome: The effect of cyclodextrins on encapsulation efficiency and release kinetics. *International Journal of Pharmaceutics*, *312*, 75–82.
- Raffy, S., & Teissie, J. (1999). Control of lipid membrane stability by cholesterol content. *Biophysical Journal*, *76*, 2072–2080.
- Rongen, H., Bult, A., & Van Bennekom, W. P. (1997). Liposomes and immunoassays. *Journal of Immunological Methods*, *204*, 105–133.
- Sanjula, B., Mona, D., & Kanchan, K. (2005). Physicochemical characterization in-vitro dissolution behavior, and pharmacodynamics studies of rofecoxib-cyclodextrin inclusion compounds. *AAPS PharmSciTech*, *6*, 83–90.
- Sharma, L., & Sharma, A. (2001). Influence of cyclodextrin ring substituents on folding-related aggregation of bovine carbonic anhydrase. *European Journal of Biochemistry*, *268*, 2456–2463.
- Skalko, N., Brandl, M., Bedirevid-Ladan, M., Filipovid-Greie, J., & Jalsenjak, I. (1996). Liposomes with nifedipine and nifedipine cyclodextrin complex: Calorimetric and plasma stability comparison. *European Journal of Pharmaceutical Sciences*, *4*, 359–366.
- Szejtli, J. (2004). Past, present, and future of cyclodextrin research. *Pure and Applied Chemistry*, *76*, 1825–1845.
- Szejtli, J. (1997). Utilization of cyclodextrins in industrial products and processes. *Journal of Materials Chemistry*, *7*, 575–587.
- Takino, T., Konishi, K., Takakura, Y., & Hashida, M. (1994). Long circulating emulsion carrier systems for highly lipophilic drugs. *Biological and Pharmaceutical Bulletin*, *17*, 121–125.
- Uhumwangho, M. U., & Okor, R. S. (2005). Current trends in the production and biomedical applications of liposomes: A review. *Journal of Medicine and Biomedical Research*, *4*, 9–21.
- Wagner, A., & Vorauer-Uhl, K. (2011). Liposome technology for industrial purposes. *Journal of Drug Delivery*, *2011*, 591325.
- Zhang, L., Zhang, Z., Li, N., Wang, N., Wang, Y., Tang, S., et al. (2013). Synthesis and evaluation of a novel β -cyclodextrin derivative for oral insulin delivery and absorption. *International Journal of Biological Macromolecules*, *61*, 494–500.
- Zhu, Q., Guo, T., Xia, D., Li, X., Zhu, C., Li, H., et al. (2013). Pluronic F127-modified liposome-containing tacrolimus-cyclodextrin inclusion complexes: Improved solubility, cellular uptake and intestinal penetration. *Journal of Pharmacy and Pharmacology*, *65*, 1107–1117.

*Chapitre 2 : Effet de l'HP- β -CD
sur la fluidité membranaire et la
stabilité des membranes lipidiques
durant la lyophilisation*

Introduction

Bien que le système « drug-in-cyclodextrin-in-liposome » (DCL) ait été proposé et utilisé, l'effet de l'HP- β -CD sur la stabilité et la fluidité des membranes lipidiques reste mal étudié.

Les liposomes constituent l'un des modèles membranaires qui tentent de reproduire la structure et les propriétés des membranes biologiques. Ils sont largement utilisés pour l'étude des propriétés membranaires pour mieux comprendre les mécanismes moléculaires intervenant au niveau de la membrane comme la perméabilité, la stabilité et la fluidité. D'autre part, certains auteurs ont relié l'activité biologique exercée par certaines molécules à leur action au niveau de la membrane biologique. Ainsi, pour fournir une base moléculaire de cette activité, l'interaction de diverses molécules bioactives avec la membrane biologique a été étudiée en utilisant les liposomes comme modèles mimétiques de la membrane (Hou et al., 2013 ; Matos et al., 2012 ; Potamitis et al., 2011). Un large éventail de techniques a été développé. Elles donnent accès à des informations diverses, telles que la perméabilité, la fluidité ou encore l'organisation des vésicules.

Afin de comprendre l'effet de l'HP- β -CD sur la stabilité des membranes lipidiques durant la lyophilisation et sur la fluidité membranaire, nous avons préparé, en absence et en présence de l'HP- β -CD, différents types de liposomes avec différents types de phospholipides. En premier lieu, des MLVs ont été préparés par la méthode d'hydratation du film lipidique en utilisant le DPPC. Cette méthode est la plus utilisée pour la préparation des MLVs. Elle implique tout d'abord la dissolution de DPPC dans un solvant organique ou dans un mélange de solvants organiques qui est le plus souvent le chloroforme:méthanol (2:1). Le solvant organique est ensuite évaporé ce qui aboutit à la formation d'un film lipidique sur la paroi du ballon. Ce film lipidique est hydraté par l'ajout d'un tampon aqueux (Tris-HCl contenant l'HP- β -CD) ; la dispersion ainsi formée est vortexée pour une durée de quelques minutes. L'étape d'hydratation est réalisée à une température supérieure à la température de transition (T_m) du phospholipide utilisé (55°C). Les MLVs sont simples à préparer par ce procédé et une variété de molécules peut être encapsulée dans ces liposomes. Le composé à incorporer est ajouté, selon sa solubilité, soit dans la phase aqueuse, soit avec le mélange de phospholipides à dissoudre dans un solvant organique. Les inconvénients de cette méthode sont le faible volume interne, la faible efficacité d'encapsulation et la distribution hétérogène de taille des vésicules (Bangham et al., 1965). Différents rapports molaires DPPC:HP- β -CD ont été préparés : 100:0 ; 100:181 ; 100:454 ;

100:909 et 100:1363. Puis, des liposomes témoins et des liposomes encapsulant l'HP- β -CD ont été préparés par la méthode d'injection éthanolique, avec des phospholipides saturés (Phospholipon 80H et Phospholipon 90H) ou insaturés (Lipoid S100) en présence de cholestérol, dans les rapports molaires suivants : phospholipide: cholestérol:HP- β -CD 100:117:0, 100:117:181, 100:117:454, 100:117:909 et 100:117:1363.

Différentes techniques calorimétriques et spectroscopiques ont été utilisées afin d'étudier l'effet de l'HP- β -CD sur les propriétés physicochimiques des membranes lipidiques. Les caractéristiques thermodynamiques et la fluidité des membranes des vésicules lipidiques formées à partir de DPPC ont été étudiées par la calorimétrie différentielle à balayage et par la spectroscopie Raman. En plus, l'effet de l'HP- β -CD sur la fluidité membranaire a été évalué, en utilisant la polarisation de fluorescence du 1,6-diphényl-1,3,5-hexatriène (DPH) pour les deux types de liposomes.

La calorimétrie différentielle à balayage (DSC, Differential Scanning Calorimetry) est un outil pour étudier le comportement thermique des bicouches lipidiques. Elle permet la mesure des paramètres thermodynamiques de la pré-transition et de la transition de phase des phospholipides. Ces paramètres sont les températures de pré-transition et de transition, T_p et T_m , respectivement, et les quantités d'énergie absorbées au cours de la pré-transition et de la transition, ΔH_p et ΔH_m , respectivement (Demetzos 2008). En outre, cette technique permet d'étudier l'effet de l'incorporation d'une molécule sur les propriétés thermotropiques d'une bicouche lipidique. Cette molécule peut interagir avec la partie lipophile de la bicouche (chaînes hydrocarbonées) aboutissant à un changement au niveau de T_m et ΔH_m , et/ou avec la partie polaire des phospholipides conduisant à la disparition et/ou au déplacement du pic de pré-transition (Demetzos, 2008).

La spectroscopie Raman est une technique bien adaptée pour étudier les interactions des molécules exogènes avec les bicouches lipidiques ainsi que la structure des phospholipides (Fox et al., 2007). L'information obtenue est principalement qualitative. En surveillant les changements d'intensités des pics de diffraction Raman des vésicules phospholipidiques, la conformation des chaînes acyles, ainsi que l'ordre intra et intermoléculaire de la membrane sont déterminés (Fox et al., 2007). Par exemple, les rapports d'intensité de la hauteur des pics I_{2935}/I_{2880} et I_{2844}/I_{2880} sont attribués aux bandes d'étirements de liaisons C-H et I_{1090}/I_{1130} est attribué aux bandes d'étirements de liaisons C-C, qui sont des indicateurs globaux des changements intra-

(rapport gauche/*trans*) et intermoléculaires (ordre des chaînes lipidiques) (Potamitis et al., 2011 ; Gardikis et al., 2006). Le changement d'intensité du pic à 715 cm⁻¹ attribué à la bande d'étirement C-N indique l'interaction des molécules exogènes avec le groupement choline de la tête polaire des phospholipides (Gardikis et al, 2006 ; Potamitis et al., 2011).

La polarisation de la fluorescence du 1,6-diphényl-1,3,5-hexatriène (DPH), molécule hydrophobe qui s'intègre au sein de la bicouche lipidique est couramment utilisée comme une sonde dans les applications biochimiques, pour mesurer les associations protéiques, la fluidité et l'ordre des lipides. Le DPH est une molécule qui présente une forte augmentation de sa fluorescence après intercalation dans la membrane. L'anisotropie de fluorescence est définie par l'équation suivante :

$$r = \frac{I_{\parallel} - I_{\perp}}{I_{\parallel} + 2I_{\perp}}$$

où I_{\parallel} et I_{\perp} sont les composantes polarisées respectivement parallèle et perpendiculaire à la direction de polarisation de la lumière incidente (Lakowicz, 2006). L'anisotropie est inversement proportionnelle à la fluidité (Park et al., 2006). Il s'agit d'une technique sensible et largement utilisée.

Par rapport aux liposomes témoins, un changement d'intensité du pic à 715 cm⁻¹ et une disparition du pic de la pré-transition ont montré que l'HP-β-CD interagit avec le groupement choline de la tête polaire de DPPC. La température de transition augmente en présence de l'HP-β-CD, ce qui indique que les fractions glucidiques peuvent stabiliser la bicouche par liaisons hydrogène avec les lipides impliquant probablement le groupe phospho-diester du groupe de tête DPPC. Pour des rapports molaires DPPC:HP-β-CD 100:181 et 100:454, ΔH_m augmente ce qui suggère une interaction entre l'HP-β-CD et la tête du phospholipide, au niveau du groupe glycérol. Par contre, pour des rapports molaires DPPC:HP-β-CD 100:909 et 100:1363, ΔH_m diminue ; ces résultats pourraient être expliqués par la capacité de l'HP-β-CD à extraire les molécules de DPPC constituant les structures vésiculaires. Ces résultats sont confirmés par la spectroscopie Raman, où le rapport de l'intensité du pic I₂₈₄₄/I₂₈₈₀ diminue en présence de l'HP-β-CD en indiquant la formation de bicouches interdigitées et une augmentation des interactions entre les chaînes acyles.

La présence de l'HP-β-CD fluidifie la membrane formée de phospholipides saturés (DPPC ou Lipoid S100) à l'état de gel (28°C), lors de la transition (41°C) et à l'état liquide (50°C) en diminuant l'anisotropie de la DPH et en augmentant le rapport d'intensité I₁₀₉₀/I₁₁₃₀ déterminé par la technique Raman. Par contre, par rapport aux liposomes blancs formés de Phospholipon 80H et

Phospholipon 90H, la présence de HP- β -CD n'a pas affecté les valeurs DPH d'anisotropie pour tous les rapports molaires. Par conséquent la présence de cholestérol peut améliorer la stabilité des liposomes formés de phospholipides saturés.

La lyophilisation des liposomes a été proposée afin de résoudre les problèmes d'instabilité chimique et physique en milieu aqueux et les conserver à long terme (Chen et al., 2010). Trois étapes principales se déroulent lors de la lyophilisation (Abdelwahed et al., 2006): 1) la congélation qui permet de transformer l'eau libre en cristaux de glace et aboutit à une structure rigide; 2) le séchage primaire ou « dessiccation primaire » où l'eau est éliminée progressivement par sublimation de la glace, la dernière passe directement de l'état solide à l'état gazeux sans passer par l'état liquide grâce au vide créé ; 3) le séchage secondaire ou « dessiccation secondaire » qui consiste en l'élimination de l'eau non congelée qui est retenue sur le produit par adsorption. Cette étape permet d'atteindre la valeur d'humidité résiduelle qui conditionne la stabilité. Mais la lyophilisation d'une suspension liposomiale peut entraîner une dégradation des liposomes : des phénomènes d'agrégation/fusion des vésicules sont observés et donc une perte du matériel encapsulé (Harrigan et al., 1990 ; Darwis and Kellaway, 2002). Pour préserver les caractéristiques des liposomes après la phase de déshydratation/réhydratation, l'utilisation d'un agent cryo-protecteur tel que l'HP- β -CD est nécessaire (Van den Hoven et al., 2012). Les liposomes préparés par la méthode d'injection éthanolique avec le Phospholipon 90H, ont été lyophilisés et caractérisés en termes de taille, pDI et zêta potentiel avant et après lyophilisation par DLS. La taille et le pDI des liposomes témoins ont augmenté d'une manière significative après lyophilisation. Les liposomes préparés avec le rapport molaire phospholipide:cholestérol:HP- β -CD 100:117:909, ont conservé leurs caractéristiques après lyophilisation. Alors, l'HP- β -CD protège les liposomes pendant la lyophilisation, lorsqu'il est présent dans le compartiment aqueux interne des liposomes.

Ce chapitre est présenté sous forme d'un article.

Références

- Abdelwahed, W., Degobert, G., Stainmesse, S., & Fessi, H. (2006). Freeze-drying of nanoparticles: formulation, process and storage considerations. *Advanced Drug Delivery Reviews*, 58, 1688-1713.
- Bangham, A. D., Standish, M. M., & Watkins, J. C. (1965). Diffusion of univalent ions across the lamellae of swollen phospholipids. *Journal of Molecular Biology*, 13, 238-252.
- Darwis, Y., & Kellaway, I. W. (2002). The lyophilisation and aerosolisation of liposomes for pulmonary drug administration. *STP Pharma Sciences*, 12, 91-96.
- Demetzos, C. (2008). Differential Scanning Calorimetry (DSC): a tool to study the thermal behavior of lipid bilayers and liposomal stability. *J. Liposome Research*, 18, 159-173.
- Fox, C. B., Uibel, R. H., & Harris, J. M. (2007). Detecting phase transitions in phosphatidylcholine vesicles by Raman microscopy and selfmodeling curve resolution. *The Journal of Physical Chemistry B*, 111, 11428-11436.
- Gardikis, K., Hatziantoniou, S., Viras, K., & Demetzos, C. (2006a). Effect of a bioactive curcumin derivative on DPPC membrane: A DSC and Raman spectroscopy study. *Thermochimica Acta*, 447, 1-4.
- Harrigan, P. R., Madden, T. D., & Cullis, P. R. (1990). Protection of liposomes during dehydration or freezing. *Chemistry and Physics of Lipids*, 52, 139-149.
- Hou, G., Niu, J., Song, F., Liu, Z., & Liu, S. (2013). Studies on the interaction between ginsenosides and liposomes by equilibrium dialysis combined with ultrahigh performance liquid chromatography-tandem mass spectrometry. *Journal of Chromatography B, Analytical Technologies in the Biomedical and Life Sciences*, 923-924, 1-7.
- Lakowicz, J. R. (2006). *Principles of fluorescence spectroscopy*. New York: 3rd edn. Springer.
- Matos, C., Moutinho, C., & Lobao, P. (2012). Liposomes as a model for the biological membrane: Studies on daunorubicin bilayer interaction. *Journal of Membrane Biology*, 245, 69-75.
- Park, S. H., Oh, S. G., Mun, J. Y., & Han, S. S. (2006). Loading of gold nanoparticles inside the DPPC bilayers of liposome and their effects on membrane fluidities. *Colloids and Surfaces B: Biointerfaces*, 48, 112-118.
- Potamitis, C., Chatzigeorgiou, P., Siapi, E., Viras, K., Mavromoustakos, T., Hodzic, A., et al. (2011). Interactions of the AT1 antagonist valsartan with dipalmitoyl-phosphatidylcholine bilayers. *Biochem Biophys Acta*, 1808, 1753-1763.
- Van den Hoven, J. M., Metselaar, J. M., Gert Storm, G., Beijnen, J. H., & Nuijen, B. (2012). Cyclodextrin as membrane protectant in spray-drying and freeze-drying of PEGylated liposomes. *International Journal of Pharmaceutics*, 438, 209-216

Effect of HP- β -CD on fluidity, stability and freeze-drying of lipid membranes: application in drug-in-cyclodextrin-in-liposome delivery system

Riham Gharib^{1,2}, Sophie Fourmentin³, Catherine Charcosset², H  l  ne Greige-Gerges¹

¹Faculty of Sciences, Bioactive Molecules Research Group, Doctoral School of Sciences and Technologies, Lebanese University, Lebanon.

²Laboratoire d'Automatique et de G  nie des Proc  d  s, Universit   Claude Bernard Lyon 1, France.

³Unit   de Chimie Environnementale et Interactions sur le Vivant (UCEIV, EA 4492), SFR Condorcet FR CNRS 3417, ULCO, F-59140 Dunkerque, France

Submitted

Abstract

Although drug-in-cyclodextrin-in-liposomes has been proposed as a drug delivery system, the effect of hydroxypropyl- β -cyclodextrin (HP- β -CD) on the stability and fluidity of lipid membranes is poorly studied. In this study, liposomes are prepared by thin film hydration method and the effect of HP- β -CD on the dipalmitoyl phosphatidyl choline (DPPC) membrane is investigated for the first time by differential scanning calorimetry, Raman spectroscopy and DPH fluorescence anisotropy at various HP- β -CD to DPPC molar ratios. HP- β -CD interacted with the choline head group of phospholipids and with the DPPC alkyl chains leading to an increase in the chain disorder. HP- β -CD loaded liposomes were also prepared by the ethanol injection method using saturated and unsaturated phospholipids in the presence of cholesterol. HP- β -CD provoked disorder of unsaturated phospholipid bilayers while no effect appeared on saturated ones. Besides, this study demonstrated for the first time that HP- β -CD present in the aqueous phase of saturated phospholipid liposomes protected them during freeze-drying. On the overall, we conclude that the effect of HP- β -CD on the lipid vesicles depends on the liposome composition. Besides, vesicles containing required amounts of HP- β -CD in the aqueous phase are stable during freeze-drying.

Keywords: Differential Scanning Calorimetry; Fluorescence anisotropy; Freeze-drying; Hydroxypropyl- β -cyclodextrin; Membrane; Raman spectroscopy.

Abbreviations:

CD : cyclodextrin ; CHO : cholesterol ; DCL : drug-in-cyclodextrin-in-liposomes ; DPH: 1,6-diphenyl-1,3,5-hexatriene; DPPC: dipalmitoyl phosphatidylcholine; DSC: differential scanning calorimetry; HP- β -CD : hydroxypropyl- β -cyclodextrin; PL : phospholipid; Pop: population.

Introduction

Cyclodextrins (CDs) are cyclic oligosaccharides, formed by glucopyranose units. The most common CDs are formed from six (α -CD), seven (β -CD) or eight (γ -CD) D-glucopyranose units, with their respective cavity sizes of approximately 0.5, 0.6 and 0.8 nm (Arun et al. 2008). They are crystalline, homogeneous and non-hygroscopic substances. Their internal cavity is relatively hydrophobic, while their outer surface is hydrophilic. This particular structure confers to CDs the ability to include a large number of hydrophobic guests and to form inclusion complexes soluble in water (Nasir et al. 2012). It has been demonstrated that CD inclusion complexes improve the bioavailability, physical and thermal stability of drugs and limit their toxic effects (Ozdemir and Erkin 2012). Moreover, CDs are well known for their cryoprotectant ability during lyophilization (van den Hoven et al. 2012).

Previous researches proved that highly lipophilic drugs incorporated in the liposomes are released rapidly after in vivo administration (Maestrelli et al. 2005 and Takino et al. 1994). To ensure stable encapsulation, an approach has been proposed by McCormack and Gregoriadis (1994) wherein CD/drug inclusion complexes are inserted into liposomes. This approach established a novel system in drug delivery, combining liposomes and CD complexes of lipophilic drugs and named drug-in-CD-in-liposome (DCL).

However, drug release kinetics studies proved that DCL system did not delay drug release rate and in some cases the drug release was faster in DCL when compared to conventional liposomes (Cavalcanti et al. 2011; Fatouros et al. 2001). These findings are connected with the known ability of CDs to remove lipid components from cell membranes via forming inclusion complexes with them (Debouzy et al. 1998; Nishijo and Mizuno, 1998). In other words, membrane lipids may enter in the CD cavity and displace the drug from the complex, which in turn is released from the vesicles at the same rate as when it is incorporated into liposomes as plain drug.

The effect of CDs on different types of cell membranes has been studied (Fu et al., 2015; Singh et al., 2016). It was demonstrated that the CDs cytotoxicity is due to the extraction of vital components (cholesterol (CHO) and phospholipids (PL)) and to the membrane permeabilization regardless of cell type (Kainu et al., 2010). α -CD is the most potent in the extraction of PLs whereas β -CD specifically extracts CHO from the membrane (Irie and Uekema, 1997).

On the other hand, the effect of CDs on the synthetic membranes depends on the CD type. Indeed, using differential scanning calorimetry (DSC) it has been demonstrated that the reduction in the enthalpy of transition of DPPC lipid vesicles was in the order dimethyl- β -CD > α -CD = β -

CD = γ -CD > trimethyl- β -CD (Nishijo and Mizuno, 1998).

As for hydroxypropyl- β -CD (HP- β -CD), no effect on the thermotropic parameters of DPPC lipid vesicles was proved (Nishijo et al. 2000). Moreover, Sebaaly et al. (2016a) reported that HP- β -CD/eugenol loaded liposomes were stable after 1 month of storage at 4°C. Likewise, DCL system proved its effectiveness to reduce drug release from HP- β -CD/anethole loaded liposomes after 15 months of storage at 4°C (Gharib et al. 2016).

However, the PLs of the liposomal membrane, especially when dispersed in water, can slowly become oxidized or hydrolyzed (Chen et al. 2010; Zuidam et al. 1995). This could induce fusion of liposomes, leakage of the enclosed drug compound, and structural transformations of the liposomes, which might influence their performance (Ickenstein et al. 2006). Accordingly, many methods for stabilization of liposomes have been described, such as lyophilization, freezing, spray-drying and spray-chilling (Nedovic et al. 2011). Among these, lyophilization is the main approach used to extend the shelf-life of liposomes (Wieber et al. 2012; SanAnna and Brandelli 2011). Apart from a stabilization objective, dry liposomal formulations may offer opportunities for routes of administration other than parenteral use, e.g. as dry powder inhalation (van den Hoven et al. 2012).

Here, we studied the effect of HP- β -CD on the fluidity and stability of membranes of different composition at various molar ratios HP- β -CD: phospholipid. First, DPPC liposomes were prepared in the absence and presence of HP- β -CD by thin film hydration method and characterized by DSC, Raman spectroscopy and fluorescence anisotropy of 1,6-diphenyl-1,3,5-hexatriene (DPH). Also, various liposomal formulations were prepared by the ethanol injection method using saturated and unsaturated PL with CHO. The fluorescence anisotropy of DPH inserted in the lipid membranes of these formulations was also measured. Moreover, liposomes were freeze-dried and characterized in terms of particle size, polydispersity index (pDI) and Zeta potential before and after freeze-drying.

Materials and methods

Materials

Dipalmitoyl phosphatidylcholine (DPPC) was purchased from Lipoid GmbH (Germany). Hydrogenated phospholipon 80H (78.9% soybean phosphatidylcholine, 3.9% lysophosphatidylcholine, 0.5% water, 0.1% ethanol and the rest is phosphatidylethanolamine (PE) and some lysophosphatidylethanolamine, little amount of triglyceride), hydrogenated

phospholipon 90H (90% soybean phosphatidylcholine, 4% lysophosphatidylcholine, 2% triglycerides, 2% water, 0.5% ethanol, 1% iodine) and non-hydrogenated soy phosphatidylcholine Lipoid S100 (94% soybean phosphatidylcholine, 3% lysophosphatidylcholine, 0.5% N-acyl-phosphatidylethanolamine, 0.1% phosphatidylethanolamine, 0.1% phosphatidylinositol, 2% water, 0.2% ethanol) were supplied by Lipoid GmbH (Ludwigshafen, Germany). HP- β -CD-oral grade (MS=0.85) was purchased from Roquette (Lestrem, France), tetrahydrofuran from Sigma-Aldrich (USA), chloroform, methanol and buffer reagent Trizma base from Sigma-Aldrich (France), absolute ethanol and cholesterol from Sigma-Aldrich (Germany), HCl from VWR, France and DPH from Across organics (New Jersey, USA).

Preparation of liposomes

Thin film hydration method

Multilamellar vesicles (MLVs) were prepared by the thin film hydration technique. DPPC (25mg/mL) was solubilized in a solvent mixture of chloroform/methanol 2:1 (v/v). The preparation was then evaporated in a rotary evaporator (BÜCHI Rotavapor R-100) to form a thin lipid film. The latter was then hydrated with 2 ml of 0.1 M Tris-HCl (pH 7.4) containing HP- β -CD at DPPC:HP- β -CD molar ratios of 100:181; 100:454; 100:909 and 100:1363. Then, the dispersion was vortexed for 5 min and warmed in a water bath at 55 °C for 5 min. The cycle was repeated three times. The batch prepared at DPPC:HP- β -CD molar ratio of 100:0 was considered as blank. For each DPPC:HP- β -CD molar ratio, liposomes batches were prepared in triplicate.

Ethanol injection method

Blank and HP- β -CD loaded liposomes were prepared by the ethanol-injection method. Phospholipon 90H, Phospholipon 80H or Lipoid S100 and CHO at molar ratio PL/CHO of 100:117 were dissolved in absolute ethanol. The resulting organic phase (10 mL) was then injected, using a syringe pump (Fortuna optima, GmbH-Allemagne), into the aqueous phase (20 mL) at a temperature above the transition temperature of the PL (55 °C for Phospholipon 90H, Phospholipon 80H and 25 °C for Lipoid S100) under magnetic stirring at 400 rpm. Spontaneous liposome formation occurred as soon as the ethanolic solution was in contact with the aqueous phase. The liposomal suspension was then left for 15 min at 25 °C under stirring (400 rpm). Finally the ethanol was removed by rotary evaporation (BÜCHI Rotavapor R-100) under reduced pressure at 40 °C. HP- β -CD loaded liposomes were prepared with HP- β -CD dissolved in the aqueous phase at PL:CHO:HP- β -CD molar ratios of 100:117:181; 100:117:454; 100:117:909;

100:117:1363 and 100:117:1810.

Differential scanning calorimetry

DSC was performed using a DSC Q200 scanning calorimeter (TA Instruments, France). The scanning rate employed was 1°C/ min in a temperature range of 20–50°C. The reference pan was filled with 0.1 M Tris-HCl buffer (pH 7.4). The samples (10 µL) were encapsulated in hermetically sealed standard aluminum DSC pans. Enthalpies and temperature were evaluated from the DSC peak using the software of the TA processor. The measured parameters were as follows: the transition temperature (T_m) determined from the maximum of the recorded heat capacity, transition enthalpy (ΔH_m) obtained from the area under the peak, the respective parameters for the pre-transition (T_p and ΔH_p), and the temperature width at half peak height, $\Delta T_{1/2}$, which measures the sharpness of the phase transition. This latter is very sensitive to the presence of any additive. It will be taken as a measure for the cooperativity of the transition. $\Delta T_{1/2}$ is inversely proportional to the cooperativity (El Maghraby et al. 2005).

Raman spectroscopy

The Raman spectra were recorded with a LabRAM HR 800 (Horiba Jobin Yvon, Villemeuve d'Ascq, France) at Ecole Centrale de Lyon (Ingénierie et vieillissement des tissus vivants (IVTV) ANR-10-EQPX-06-01) equipped with a detector 1024x256 pixel. A laser power at 633 nm was used as excitation source. The spectra were obtained at 1cm⁻¹ resolution from 3100 to 600 cm⁻¹. The laser power was controlled to be constant at within 12mW during the experiments. Analysis of the spectra was carried out using a LabSpec software. An aliquot from the liposomal suspensions (10-15µL) was used for the Raman spectroscopy. Experiments were held at 25 °C in order to assess the change of the interaction between DPPC and HP-β-CD. An integrated camera was employed to acquire images of trapped vesicles (LxH=760x628 pixels).

Fluorescence anisotropy measurement

Changes in fluidity of vesicles membranes were measured by steady state fluorescence polarization using a Cary Eclipse Fluorescence Spectrophotometer (Agilent Technologies). DPH was dissolved in tetrahydrofuran. An aliquot of DPH solution ($4.30 \cdot 10^{-3}$ mol/L) was then added to the membrane suspension prepared as described above to obtain a molar ratio of DPH:PL equals to 1:500. The mixture was incubated overnight in the dark to allow the intercalation of the DPH molecules into the lipid bilayer. The final concentration of THF did not exceed 0.01% and

showed no effect on the fluorescence anisotropy (Whiting et al., 2000). The experiments were performed at 28, 41 and 50 °C for DPPC MLV liposomes, and at room temperature for Phospholipon 90H, Phospholipon 80H and Lipoid S100 liposomes. The probe was excited with a manual polarizer accessory (Cary Eclipse Manual Polarizer, Agilent Technologies; Malaysia) using vertically polarized light at 360 nm. The emission intensities were measured at 450 nm at both parallel and perpendicular to the polarization vector of the *exciting* light yielding components I_{VV} and I_{VH} , respectively. The Cary Eclipse Bio Software, delivered from the spectrophotometer, gives the fluorescence anisotropy (R), which is defined as

$$R = \frac{I_{\parallel} - I_{\perp}}{I_{\parallel} + 2I_{\perp}}$$

Where I_{\parallel} and I_{\perp} are the fluorescence intensities of the light emitted with its polarization plane parallel (\parallel) and perpendiculaire (\perp) to that of the exciting beam.

Freeze-drying

Freshly prepared blank and HP- β -CD loaded liposomes (5 mL) underwent ultracentrifugation at 170000 g for 1 h at 4 °C. The supernatant was discarded and the pellet was dispersed in 2 mL of water. The liposomes suspensions were freeze-dried in 10 mL glass vials. The vials were frozen at -20 °C over night. The frozen samples were then placed into the drying chamber of Cryonext 23020 freeze-dryer (France), pre-cooled to -20 °C, then lowered to -40 °C with a cooling profile of 0.5 °C/min. The product was stabilized for 30 min at -38 °C before the vacuum was applied. Primary drying was performed at a pressure of 150 μ bar for 3 h at -10 °C, and then the temperature of the drying chamber was progressively increased to 5 °C for 6 h at 250 μ bar, to reach finally 10 °C at 350 μ bar for 9 h. Temperature was adjusted so that the temperature of the product was higher than the sublimation temperature of water. The primary drying involves sublimation of ice from the frozen product. After this period, a secondary drying step for 10 h at 20 °C at 100 μ bar pressure was applied, which involves the removal of absorbed water from the product. This is the water that did not separate out as ice during the freezing and did not sublimate off (Abdelwahed et al. 2006). Finally, the vials were removed from the freeze-dryer, closed with rubber caps, and stored at 4 °C. The lyophilized liposomes were then reconstructed with ultra-pure water to its original volume (5 mL) prior to characterization and further analysis.

Size and zeta potential determined by dynamic light scattering analysis

Malvern Zetasizer Nanoseries (Zetasizer Nano ZS; Malvern Instruments Ltd, France) was used to determine the mean size of various liposomal batches. All batches were diluted 10-fold with ultrapure water. The particle-size distribution data were collected using the DTS (nano) software (version 5.10) provided with the instrument. The polydispersity index (PDI), which gives an indication of the width of particle size distribution, ranges from 0 (monodispersed) to 1 (very broad distribution). Data were expressed as the mean \pm standard deviation. Zeta potential was calculated by Smoluchowski's equation from the electrophoretic mobility of liposomes. All measurements were carried out at 25 °C after 3 min of equilibration and performed in triplicate.

Statistical analysis

Statistical analysis was performed using the Student T-test. *P* values equal or less than 0.05 were considered statistically significant.

Results and Discussion

Raman spectroscopy

The confocal Raman microscope allows lipid vesicles to be optically trapped in the laser focus providing visualization of blank and HP- β -loaded DPPC liposomes. Figure 1 shows examples of the images of blank liposomes (A) and HP- β -CD-loaded liposomes prepared at molar ratios DPPC: HP- β -CD of 100:181 (B), 100:454 (C), 100:909 (D) and 100:1363 (E). Spherical vesicles were obtained in the various batches with a size in the order of micrometers in accordance with published MLVs size prepared by thin film hydration method (Popovska 2014).

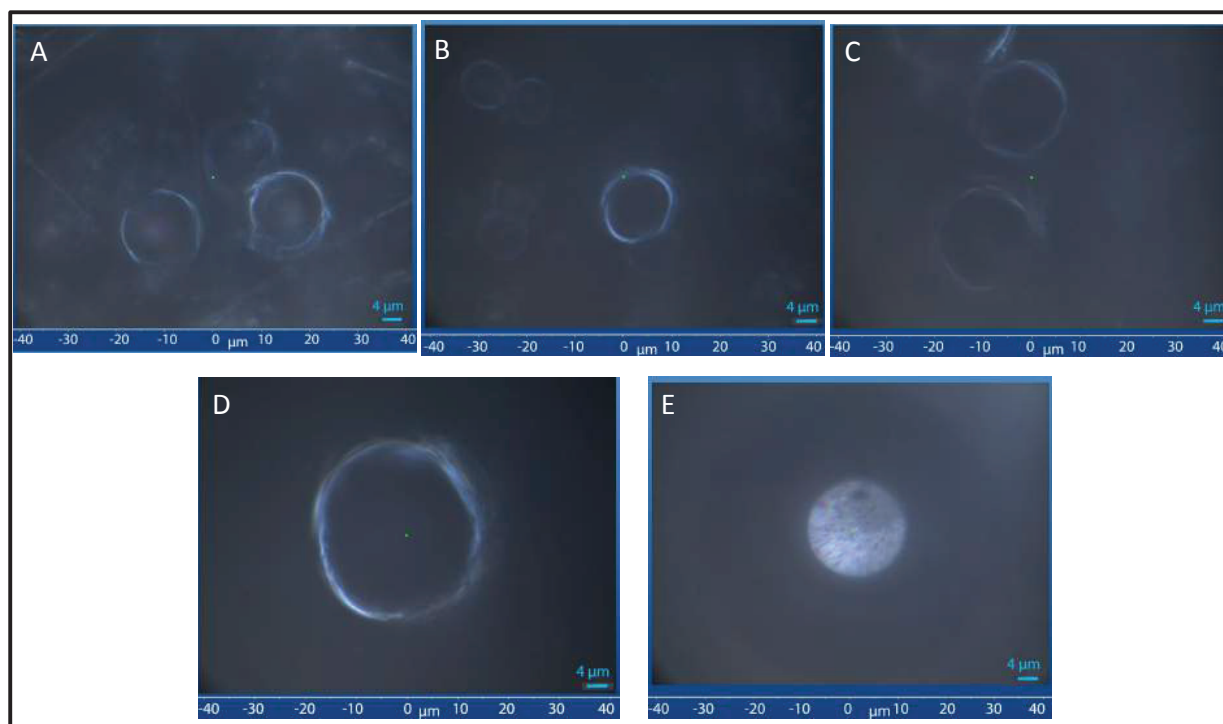

Figure 1: DPPC liposome trapping images for blank (A), HP- β -CD loaded liposomes prepared at molar ratio DPPC: HP- β -CD of 100:181 (B), 100:454 (C), 100:909 (D) and 100:1363 (E).

By monitoring changes in the peak intensities of Raman scattering from PL vesicles, differences in acyl chain conformation and the corresponding intra- and intermolecular membrane order can be determined (Fox et al. 2007). Indeed, the pure DPPC spectrum exhibits three characteristic areas from which useful information can be derived about the conformation of the molecule. These areas are 1) 2800–3000 cm^{-1} , 2) 1000–1200 cm^{-1} and 3) 700–800 cm^{-1} . Area 1 contains the peaks at 2844 and 2880 cm^{-1} which correspond to the symmetrical and asymmetrical vibration, respectively, of stretching of the C-H bond of the methylene groups. Area 1 also contains the peak at 2935 cm^{-1} which is attributed to the symmetrical vibration of stretching of the C-H bond of the final methyl group of the alkyl chain. The bands of area 1 are commonly used to monitor changes in the lateral packing properties and mobility of the lipid chains for the bilayer system (Potamitis et al. 2011).

Of interest are also the height intensity ratios I_{2935}/I_{2880} and I_{2844}/I_{2880} (Gardikis et al. 2006) I_{2935}/I_{2880} measures the effects originating from changes both in interchain and intrachain processes in the bilayer. It has been used as an overall indicator of both intramolecular (gauche/trans ratio) and intermolecular (packing order); as this ratio increases, more freedom of motion and rotational disorders are detected (Fox et al. 2007). In our study, an increase in the

rotational disorder of DPPC membrane was obtained in the presence of HP- β -CD at various DPPC: HP- β -CD molar ratios (Table 1) indicating an increase of the perturbation of the carbon-chain and the terminal methyl group of DPPC.

I_{2844}/I_{2880} describes the main changes occurring in the hydrocarbon chain domain of the lipids. It is sensitive to subtle changes in conformational order from rotations, kinks, twists and bends of the lipid chains (Potamitis et al. 2011). Compared to blank liposomes, a decrease of the ratio I_{2844}/I_{2880} was observed in the presence of HP- β -CD at DPPC:HP- β -CD molar ratio of 100:909. Also, a disappearance of the peak 2844cm^{-1} at molar ratio 100:1363 was obtained (Table 1). O'Leary and Levin (1984) reported that a decrease in the peak height intensity ratio I_{2844}/I_{2880} may result from the formation of interdigitated bilayers and indicates an increase in interactions between neighboring acyl chains.

The area 2 includes the stretching vibrations of the C-C bonds of the alkyl chains of the PLs. The peak at 1130 cm^{-1} is attributed to the stretching vibration of the C-C bond for the *trans* conformation of the alkyl chains, while the peak at 1090 cm^{-1} is attributed to the stretching vibration of the C-C bond for the *gauche* conformation of the alkyl chains. The height intensity ratio of these peaks, I_{1090}/I_{1130} also provides information about the proportion between disorder and order that exists in the bilayer. The presence of HP- β -CD increased the *gauche/trans* ratio and disturbed the lipid chain order at all DPPC:HP- β -CD molar ratios. This result suggests the interaction of HP- β -CD with the acyl chains of DPPC bilayers.

The area 3 contains the peak at 715 cm^{-1} , which represents the stretching vibration of the C-N bond of the choline group of DPPC (Gardikis et al. 2006). The presence of HP- β -CD decreased in a significant manner the intensity of this peak meaning an interaction of HP- β -CD with the polar head groups of PLs. This result was expected since the hydroxyl groups of HP- β -CD may interact with the polar moiety of PLs. Besides, Debouzy et al. (1998) demonstrated, using NMR, that α -CD interacts with the PL head group of liposomes.

Table 1: The intensity ratios for different peaks of Raman spectrum of HP- β -CD loaded DPPC-MLVs.

MLVs	I ₂₉₃₅ /I ₂₈₈₀	I ₂₈₄₄ /I ₂₈₈₀	I ₁₀₉₀ /I ₁₁₃₀	I ₇₁₅
DPPC (100:0)	0.43 \pm 0.00	1.01 \pm 0.04	0.61 \pm 0.01	448 \pm 31
DPPC: HP-β-CD				
100:181	0.47 \pm 0.02*	1.07 \pm 0.00	0.69 \pm 0.03*	356 \pm 16*
100:454	0.51 \pm 0.00*	1.07 \pm 0.00	0.76 \pm 0.02*	219 \pm 14*
100:909	0.93 \pm 0.07*	0.58 \pm 0.80*	0.82 \pm 0.01*	133 \pm 6.0*
100:1363	1.03 \pm 0.01*	0*	0.96 \pm 0.02*	39 \pm 3.0*

Values are expressed as the means of three repetitions \pm SD

* P<0.05 compared to the control value

Differential scanning calorimetry

The calorimetric heating curves of blank and HP- β -CD loaded DPPC liposomes are presented in Figure 2. Table 2 summarizes the calorimetric parameters.

Blank liposome, displayed a low enthalpic pre-transition ($L_{\beta'}$ to $P_{\beta'}$) at 34.85 ± 0.04 °C and a sharp main transition ($P_{\beta'}$ to L_{α}) at 40.14 ± 0.02 °C in accordance with Abboud et al. 2015. The enthalpy of the main transition was much higher (46.86 ± 0.78 J/g) than that of the pre-transition (5.62 ± 0.27 J/g). The sharpness of the main transition peak obtained for DPPC liposomes with $\Delta T_{1/2}$ value of 0.25 °C is an indication of the purity of the system and a highly cooperative transition.

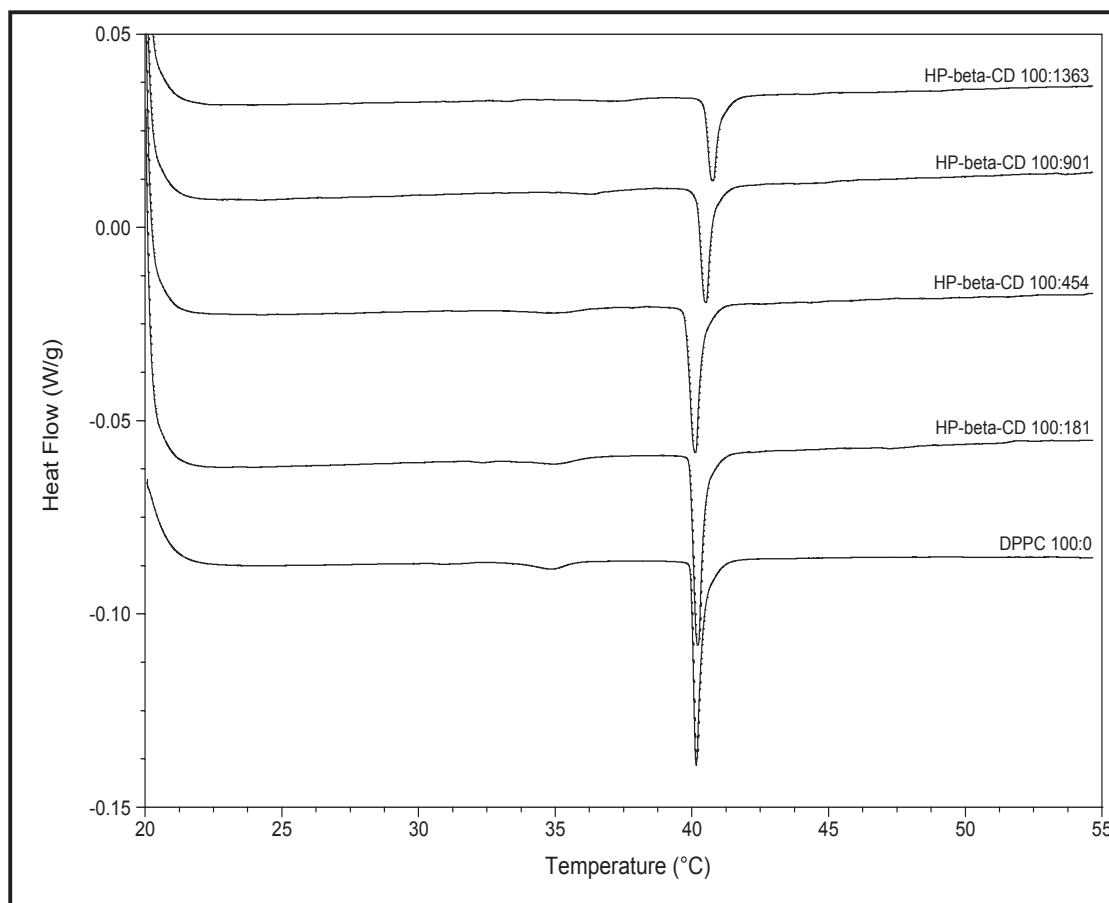

Figure 2: DSC scans of blank and HP- β -CD loaded DPPC liposomes prepared at DPPC: HP- β -CD molar ratios of 100:181; 100:454; 100:909 and 100:1363.

Table 2: Thermodynamic parameters of interaction of HP- β -CD with DPPC MLVs.

MLVs	T_p (°C)	ΔH_p (J/g)	T_m (°C)	ΔH_m (J/g)	$\Delta T_{1/2}$ (°C)
DPPC (100:0)	34.85 ± 0.04	5.62 ± 0.27	40.14 ± 0.02	46.86 ± 0.78	0.25 ± 0.02
DPPC: HP-β-CD					
100:181			$40.19 \pm 0.02^*$	$48.93 \pm 0.71^*$	$0.34 \pm 0.00^*$
100:454			$40.25 \pm 0.08^*$	$49.93 \pm 1.42^*$	$0.36 \pm 0.02^*$
100:909			$40.49 \pm 0.02^*$	$35.56 \pm 4.22^*$	$0.38 \pm 0.02^*$
100:1363			$40.67 \pm 0.18^*$	$29.21 \pm 6.20^*$	$0.37 \pm 0.00^*$

Values are expressed as the means of three repetitions \pm SD

* $P < 0.05$ compared to the control value

Compared to blank liposomes, the pre-transition peak was completely abolished in presence of HP- β -CD at various molar ratios DPPC: HP- β -CD. The pre-transition corresponds to the conversion of a lamellar gel phase to a rippled gel phase and is mainly related to the polar region

of lipid bilayers. The disappearance of the pre-transition peak upon addition of HP- β -CD (Table 2) suggests an interaction with the choline head group of PLs, in accordance with the Raman spectroscopy results. Similar results were obtained by Puglisi et al. (1996), where different CDs (β -CD; HP- β -CD; dimethyl- β -CD and trimethyl- β -CD) caused abolition of the pre-transition peak of DPPC vesicles.

The main transition temperature shifted to higher values in the presence of HP- β -CD in a concentration dependent manner. According to the literature (Puglisi et al. 1996), the carbohydrate moieties can stabilize bilayers via hydrogen bonding to lipids involving probably the phosphodiester group of the DPPC head group. Increase the HP- β -CD amount increased the number of hydrogen bonds and hence caused a shifting of T_m . Besides, ΔH_m , the enthalpy of the main phase transition, was obtained from the area under the main transition peak. Compared to blank liposomes, HP- β -CD increased the ΔH_m value at DPPC: HP- β -CD molar ratios of 100:181 and 100:454 suggesting that it can be rather interacted with the upper chain/glycerol/head group region of the lipid bilayer (Abboud et al. 2015). While, the contrary effect was obtained at DPPC:HP- β -CD molar ratios 100:909 and 100:1363, where ΔH_m decreased significantly when compared to blank batch (Table 2). These findings could be explained by the ability of HP- β -CD, at high concentration, to extract the PL molecules constituting the vesicular structures, reducing the required energy for the $P_{\beta'}$ to L_{α} transition. The ΔH_m decrease can be due to HP- β -CD interaction with the hydrophobic core of the DPPC lamellae, leading to perturbation of the packing order of DPPC and hence, to a reduction of the hydrophobic forces between acyl chains. Besides, when CDs extract DPPC molecules forming a soluble inclusion complex out of the membrane matrix, the number of PL molecules constituting the membrane decreases, resulting in a decrease in ΔH_m (Nishijo and Mizuno 1998).

Furthermore, an increase of the $\Delta T_{1/2}$ was observed at all DPPC:HP- β -CD molar ratios (Table 2). This result is justified by the ability of HP- β -CD to cause disorganization in the packing order of the bilayer and consequently a cooperativity reduction (Puglisi 1996).

Fluorescence anisotropy

The DPH probe inserts in the bilayer core because of its low aqueous solubility. Its depolarization property is influenced by the packing of the acyl chains (Lakowicz, 2006). Thus, the fluorescence anisotropy measurements of DPH in liposomes give information about the organization of the membrane environment around the fluorescent probe thereby reflect the effect of the drug on membrane fluidity (Reiner et al. 2013).

The DPH anisotropy values of blank and HP- β -CD-loaded DPPC liposomes are presented in Figure 3. Compared to blank liposomes, the presence of HP- β -CD reduced significantly the DPH anisotropy values in the gel state (28°C) at all molar ratios. The decrease was also observed at the transition temperature (41°C) and in the liquid crystalline phase (50°C) in a concentration dependent manner. These results suggest that the presence of HP- β -CD increase the DPPC membrane fluidity at various temperatures and are in accordance with Raman spectroscopy and DSC results proving the interaction of HP- β -CD with the acyl chains of DPPC bilayers.

It is worthy to mention that the extent of membrane destabilization due to HP- β -CD depends on the amount of the CD molecules present in solution. DPPC vesicles have saturated acyl chains that are tightly packed and highly stable, thus they require a relatively high concentration of HP- β -CD for solubilization (Huang and London 2013) mainly at room temperature where they are in the gel state.

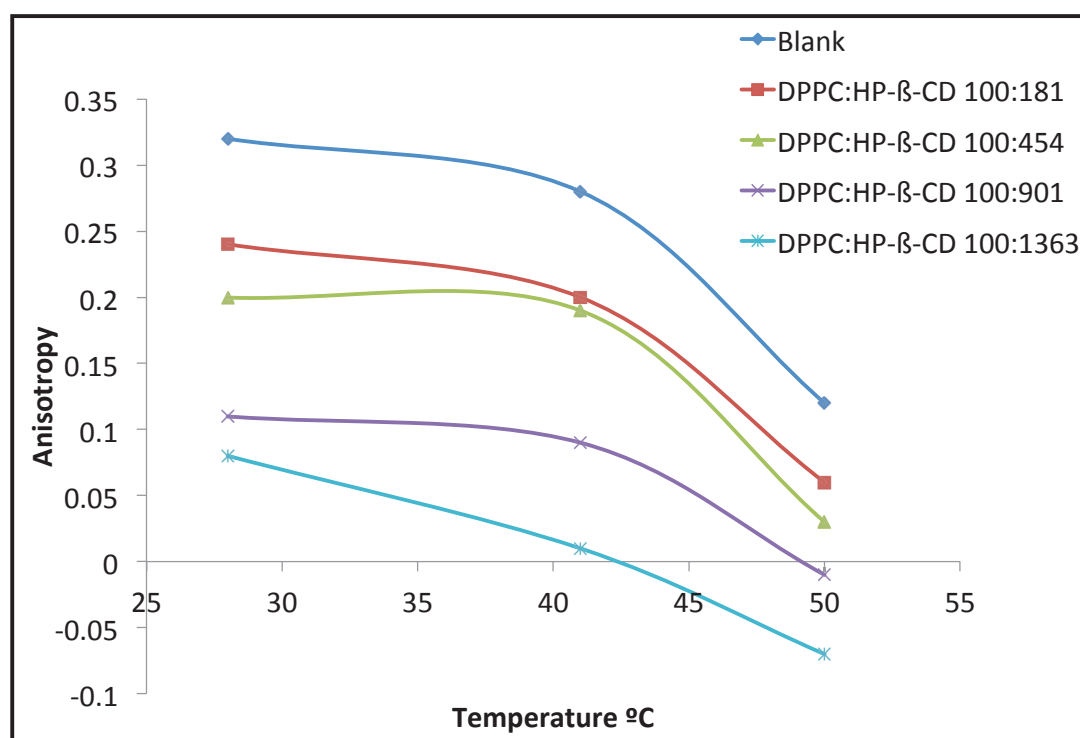

Figure 3: DPH anisotropy values for blank and HP- β -CD loaded DPPC liposomes prepared at DPPC: HP- β -CD molar ratios of 100:181; 100:454; 100:909 and 100:1363 at 28, 41 and 50°C.

The above results have to be taken into consideration in DCL carrier system design since the effect of HP- β -CD on liposome membrane cannot be neglected. The CD/drug association constant is also a factor that can play a critical role in this research because the CD molecules are

introduced in CD/drug inclusion complex form during the DCL preparation. The guests with high association constants with CDs cannot be displaced by CHO or other lipid components of liposome membranes. The CDs effect on membranes may become weaker.

The DPH anisotropy values were determined for HP- β -CD loaded Phospholipon 90H, Phospholipon 80H and Lipoid S100-liposomes at different molar ratios PL:CHO:HP- β -CD (Table 3). This effect is investigated in this research work for the first time. Compared to blank Phospholipon 90H or Phospholipon 80H liposomes, the presence of HP- β -CD did not affect the DPH anisotropy values at all molar ratios. While, compared to blank Lipoid S100 liposomes, the presence of HP- β -CD reduced significantly the DPH anisotropy values at all molar ratios. The lipid bilayers made from unsaturated Lipoid S100 were less densely packed and more flexible than those made from saturated Phospholipon 90H allowing a fluidizing and may be a perturbing effect of HP- β -CD. The fluidity of Phospholipon 90H or Phospholipon 80H liposomes was not affected by HP- β -CD, even at high concentration. The lipid composition modulated the interaction of the eugenol, a phenylpropanoid, with lipid monolayers at the air–water interface (Gonçalves et al., 2015). The presence of CHO may improve the liposome stability. Moreover, it has been reported that the presence of CHO in liposome formulations improved the oral bioavailability and the antioxidant activity of chlorogenic acid (Feng 2016). On the overall, results proved that saturated PLs in combination with CHO are more appropriate in designing the DCL formulations than unsaturated ones.

Table 3: DPH fluorescence anisotropy measurements for Phospholipon 90H, Phospholipon 80H and Lipoid S100 liposomes loading HP- β -CD at different molar ratios PL:CHO:HP- β -CD.

Liposomes PL: CHO: HP-β-CD	Phospholipon 90H	Phospholipon 80H	Lipoid S100
100:117:0	0.22 \pm 0.01	0.35 \pm 0.01	0.25 \pm 0.03
100:117:181	0.2 \pm 0.01	0.35 \pm 0.01	0.2 \pm 0.05*
100:117:454	0.21 \pm 0	0.33 \pm 0.005	0.18 \pm 0.01*
100:117:909	0.22 \pm 0.02	0.32 \pm 0.02	0.17 \pm 0.01*
100:117:1363	0.21 \pm 0.01	0.33 \pm 0.02	0.16 \pm 0.005*

PL:Phospholipid; CHO:cholesterol

Values are expressed as the means of three repetitions \pm SD

*P<0.05 compared with the control value

Freeze-drying

Based on the anisotropy results, Phospholipon 80H liposomes were chosen to test the potential cryoprotective effect of HP- β -CD present in the aqueous phase of vesicles on their stability during freeze-drying. The characteristics of blank and HP- β -CD loaded Phospholipon 80H liposomes in terms of mean particle size, pdI and Zeta potential values before and after freeze-drying are presented in Table 4.

Before freeze-drying, blank liposomes had a mean particle size in the same range of HP- β -CD loaded liposomes (139-194 nm) (Table 4). Besides, the polydispersity index values of all batches were lower than 0.3 suggesting their homogeneity. The Zeta potential values of all batches are negative ranging between -53 and -61 mV. The presence of phosphatidylethanolamine in Phospholipon 80H composition may explain the high potential values. The size and pdI of blank liposomes significantly increased after freeze-drying in accordance with literature (Sebaaly et al. 2016b). Similar results were obtained for HP- β -CD loaded liposomes at PL:CHO:HP- β -CD of 100:117:181 and 100:117:454 while HP- β -CD loaded liposomes prepared at molar ratios PL:CHO:HP- β -CD of 100:117:909, 100:117:1363 and 100:117:1810 conserved their characteristics after freeze drying. Upon lyophilization, the main transition temperature of the lipid membrane generally increases due to decreased head group spacing of the lipids in the dry state (Chen et al. 2010). Moreover, it has been reported that lyoprotectants (e.g. sugars) maintain the head group spacing and reduce the van der Waals interactions among the acyl chains of PLs (Crowe et al. 1996). They could also reduce the damage caused by ice crystals and inhibit vesicles aggregation/fusion (Chen et al. 2010). Besides, increasing the degree of lipid saturation led to a decrease in bilayer hydration. Subsequently, bilayer defects are reduced, enhancing the lateral packing of the acyl chains (Garbuzenko and Barenholz 2005). Supporting this concept, saturated lipids reinforce the membrane packing order, reduce the probability of pore or defect formation lowering thereby leakage of liposomal contents and thus avoid liposomes fusion upon lyophilization (Anderson and Omri 2004).

Table 4: The mean particle size, pdI and Zeta potential values of Phospholipon 80H liposomes before and after freeze-drying.

PL: CHO: HP-β-CD	Before lyophilization			After lyophilization		
	Size (nm)	pDI	Zeta (mV)	Size (nm)	pDI	Zeta (mV)
100:117:0	171.24 ± 11.44	0.25 ± 0.01	-58.93 ± 5.21	2-3 pop*	0.57 ± 0.12	-47.76 ± 4.75
100:117:181	144.13 ± 4.87	0.29 ± 0.03	-55.26 ± 0.83	3 pop*	0.86 ± 0.02*	-41.23 ± 2.68*
100:117:454	139.5 ± 4.85	0.25 ± 0.06	-51.40 ± 18.52	3 pop*	0.53 ± 0.06*	-40.33 ± 1.67
100:117:909	194.20 ± 13.37	0.25 ± 0.11	-61.73 ± 3.68	148.85 ± 6.15*	0.27 ± 0.07	-35.20 ± 2.54*
100:117:1363	176.86 ± 10.16	0.17 ± 0.01	-56.70 ± 2.00	171.53 ± 11.11	0.16 ± 0.01	-50.80 ± 0.88
100:117:1810	183.40 ± 5.62	0.19 ± 0.06	-53.13 ± 4.24	176.10 ± 8.48	0.19 ± 0.11	-46.80 ± 4.78

Pop: Population

Values are expressed as the means of three repetitions ± SD

*P<0.05 compared with the value before freeze-drying

Conclusion

In this study, the effect of HP-β-CD on the lipid membranes was investigated. Results proved that HP-β-CD interacted with the polar head groups of phospholipids as well as with the acyl chains leading to DPPC membrane disordering. The HP-β-CD effect depends on membrane composition. The presence of cholesterol seems to oppose HP-β-CD effect and saturated phospholipid liposomes are not affected by HP-β-CD unlike to unsaturated ones. Our study is the first to prove that HP-β-CD protect liposomes during freeze-drying when it is present in the interior aqueous compartment of liposomes e.g. in DCL carrier system. Finally, to obtain a stable DCL system, several factors should be taken into consideration like the lipid to CD molar ratio, the presence of cholesterol, the saturation of the phospholipid acyl chains and eventually the formation constant of CD/drug inclusion complex.

Acknowledgements

Authors are grateful to the Lebanese University for providing a scholarship to Riham Gharib, to Lebanese National Council for Scientific Research CNRSL (2015-2017) and to the Agence Universitaire de la Francophonie (Programme de Cooperation Scientifique Inter-Universitaire, PCSI 2015).

References

- Abboud, R., Charcosset, C., Greige-Gerges, H., 2015. Tetra- and Penta-Cyclic Triterpenes Interaction with Lipid Bilayer Membrane: A Structural Comparative Study. *J. Membr. Biol.* DOI 10.1007/s00232-016-9871-8.
- Abdelwahed, W., Degobert, G., Stainmesse, S., Fessi, H., 2006. Freeze-drying of nanoparticles: formulation, process and storage considerations. *Adv. Drug Deliver. Rev.* 58, 1688-713.
- Anderson, M., Omri, A., 2004. The effect of different lipid components on the in vitro stability and release kinetics of liposome formulations. *Drug. Deliv.* 11, 33-39.
- Arun, R., Ashik Kumar, C.K., Sravanthi, V.V.N.S.S., 2008. Cyclodextrins as Drug Carrier Molecule: A Review. *Sci. Pharm.* 76, 567-598.
- Cavalcanti, I.M., Mendonça, E.A., Lira, M.C., Honrato, S.B., Camara, C.A., Amorim, R.V., Mendes Filho, J., Rabello, M.M., Hernandes, M.Z., Ayala, A.P., Santos-Magalhães, N.S., 2011. The encapsulation of β -lapachone in 2-hydroxypropyl- β -cyclodextrin inclusion complex into liposomes: a physicochemical evaluation and molecular modeling approach. *Eur. J. Pharm. Sci.* 44, 332-340.
- Chen, C., Han, D., Cai, C., Tang, X., 2010. An overview of liposome lyophilization and its future potential. *J. Controlled Release* 142, 299-311.
- Crowe, J.H., Hoekstra, F.A., Nguyen, K.H., Crowe, L.M., 1996. Is vitrification involved in depression of the phase transition temperature in dry phospholipids. *Biochim. Biophys. Acta*, 1280, 187-196.
- Debouzy, J.C., Fauvelle, F., Crouzy, S., Girault, L., Chapron, Y., Göschl, M., Gabelle, A., 1998. Mechanism of alpha-cyclodextrin induced hemolysis. 2. A study of the factors controlling the association with serine-, ethanolamine-, and choline-phospholipids. *J. Pharm. Sci.* 87, 59-66.
- El Maghraby, G.M., Williams, A.C., Barry, B.W., 2005. Drug interaction and location in liposomes: correlation with polar surface areas. *Int. J. Pharm.* 292, 179-185.
- Fatouros, D.G., Hatzidimitriou, K., Antimisiaris, S.G., 2001. Liposomes encapsulating prednisolone and prednisolone-cyclodextrin complexes: comparison of membrane integrity and drug release. *Eur. J. Pharm. Sci.* 13, 287-296.
- Feng, Y., Sun, C., Yuan, Y., Zhu, Y., Wan, J., Firempong, C.K., Omari-Siaw, E., Xu, Y., Pu, Z., Yu, J., Xu, X., 2015. Enhanced oral bioavailability and in vivo antioxidant activity of chlorogenic acid via liposomal formulation. *Int J Pharm.* 501, 342-49.

- Fox, C.B., Uibel, R.H., Harris, J.M., 2007. Detecting phase transitions in phosphatidylcholine vesicles by Raman microscopy and selfmodeling curve resolution. *J. Phys. Chem. B* 111, 11428-11436.
- Fu, Y., Wang, X., Zhang, Y., Liu, Z., Xue, W., 2015. Effect of cyclodextrins on the structure and functions of blood components in vitro. *J Bioact Compat Pol: Biomed App.* 30, 541-554.
- Garbuzenko, O., Barenholz, Y., A., P., 2005. Effect of grafted PEG on liposome size and on compressibility and packing of lipid bilayer. *Chem. Phys. Lipids* 135, 117-129.
- Gardikis, K., Hatziantoniou, S., Viras, K., Demetzos, C., 2006. Effect of a bioactive curcumin derivative on DPPC membrane: A DSC and Raman spectroscopy study. *Thermochim. Acta* 447, 1-4.
- Gharib, R., Auezova, L., Charcosset, C., Greige-Gerges, H., 2017. Drug-in-cyclodextrin-in-liposomes as a carrier system for volatile essential oil components: application to anethole. *Food Chem.* 218, 365-371
- Gonçalves, G.E.G., de Souza, F.S., Lago, J.H.G. & Caseli, L., 2015. The interaction of eugenol with cell membrane models at the air–water interface is modulated by the lipid monolayer composition. *Biophys. Chem.* 207, 7-12.
- Huang, Z., London, E., 2013. Effect of cyclodextrin and membrane lipid structure upon cyclodextrin-lipid interaction. *Langmuir* 29, 14631-14638.
- Ickenstein, L.M., Sandström, M.C., Mayer, L.D., Edwards, K., 2006. Effects of phospholipid hydrolysis on the aggregate structure in DPPC/DSPE-PEG2000 liposome preparations after gel to liquid crystalline phase transition. *Biochim. Biophys. Acta: Biomembr* 1758, 171-180.
- Kainu, V., Hermansson, M., Somerharju, P., 2010. Introduction of phospholipids to cultured cells with cyclodextrin. *J Lipid Res.* 51, 3533-41.
- Irie, T., Uekama, K., 1997. Pharmaceutical applications of cyclodextrins III. Toxicological issues and safety evaluation. *J. Pharm. Sci.* 86, 147-162.
- Lakowicz, J.R., 2006. *Principles of fluorescence spectroscopy*. New York: 3rd edn. Springer.
- Maestrelli, F., Gonzalez-Rodriguez, M.L., Rabasco, A.M., Mura, P., 2005. Preparation and characterisation of liposomes encapsulating ketoprofen–cyclodextrin complexes for transdermal drug delivery. *Int. J. Pharm.* 298, 55-67.
- McCormack, B., Gregoriadis, G., 1994. Entrapment of cyclodextrin–drug complexes into liposomes: potential advantages in drug delivery. *J. Drug Target.* 2, 449-454.
- Nasir, A., Harikumar, S.L., Kaur, A., 2012. Cyclodextrins: an excipient tool in drug delivery. *Int. Res. J. Pharm.* 3, 44-50.

- Nedovic, V., Kalusevic, A., Manojlovic, V., Levic, S., Bugarski, B., 2011. An overview of encapsulation technologies for food applications. *Procedia Food Sci.* 1, 1806-15.
- Nishijo, J., Mizuno, H., 1998. Interactions of cyclodextrins with DPPC liposomes. Differential scanning calorimetry studies.. *Chem. Pharm. Bull.* 46, 120-124.
- Nishijo, J., Shiota, S., Mazima, K., Mizuno, H., Yoshida, J., 2000. Interactions of cyclodextrins with dipalmitoyl, distearoyl, and dimyristoyl phosphatidyl choline liposomes. A study by leakage of carboxyfluorescein in inner aqueous phase of unilamellar liposomes. *Chem. Pharm. Bull.* 48, 48-52.
- O'Leary, T.J., Levin, I.W., 1984. Raman spectroscopic study of an interdigitated lipid bilayer. Dipalmitoylphosphatidylcholine dispersed in glycerol. *Biochim. Biophys. Acta* 776, 185-189.
- Ozdemir, N., Erkin, J., 2012. Enhancement of dissolution rate and bioavailability of sulfamethoxazole by complexation with beta-cyclodextrin. *Drug Dev. Ind. Pharm.* 38, 331-340.
- Popovska, O., Simonovska, J., Kavrakovski, Z., Rafajlovska, V., 2014. An Overview: Methods for Preparation and Characterization of Liposomes as Drug Delivery Systems. *Int. J. Pharm. Phytopharmacol. Res.* 3, 182-189.
- Potamitis, C., Chatzigeorgiou, P., Siapi, E., Viras, K., Mavromoustakos, T., Hodzic, A., Pabst, G., Cacho-Nerin, F., Laggner, P., Rappolt, M., 2011. Interactions of the AT1 antagonist valsartan with dipalmitoyl-phosphatidylcholine bilayers. *Biochem. Biophys. Acta.* 1808, 1753-1763.
- Puglisi, G., Fresta, M., Ventura, C.A., 1996. Interaction of natural and modified β - cyclodextrins with a biological membrane model of dipalmitoylphosphatidylcholine. *J. Colloid Interf. Sci.* 180, 542-547.
- Reiner, G.N., Delgado-Marín, L., Olguín, N., Sánchez-Redondo, S., Sánchez-Borzone, M., Rodríguez-Farré, E., Suñol, C.; García, D.A., 2013. GABAergic pharmacological activity of propofol related compounds as possible enhancers of general anesthetics and interaction with membranes. *Cell Biochem Biophys.* 67, 515-525.
- SanAnna, V., Malheiros, P., Brandelli, A., 2011. Liposome encapsulation protects bacteriocin-like substance p34 against inhibition by maillard reaction products. *Food Res. Int.* 44, 326-330.
- Sebaaly, C., Charcosset, C., Stainmesse, S., Fessi, H., Greige-gerges, H., 2016a. Clove essential oil-in-cyclodextrin-in-liposomes in the aqueous and lyophilized states: from laboratory to large scale using a membrane contactor. *Carbohydr. Polym.* 138, 75-85.

- Sebaaly, C., Greige-Gerges, H., Stainmesse, S., Fessi, H., Charcosset, C., 2016b. Effect of composition, hydrogenation of phospholipids and lyophilization on the characteristics of eugenol-loaded liposomes prepared by the ethanol injection method. *Food Biosci.* 15, 1-10.
- Singh, N., Cheema, R.S., Kumar, A., Kaur, M., Dhaliwal, G. S., 2016. Effect of cholesterol loaded cyclodextrin on sperm traits, cholesterol content and protein tyrosine phosphorylation in cryopreserved buffalo bull semen. *Indian J. Anim. Repr.* 1, 11-14.
- Takino, T., Konishi, K., Takakura, Y., Hashida, M., 1994. Long circulating emulsion carrier systems for highly lipophilic drugs. *Biol. Pharm. Bull.* 17, 121-125.
- Van den Hoven, J.M., Metselaar, J.M., Gert Storm, G., Beijnen, J.H., Nuijen, B., 2012. Cyclodextrin as membrane protectant in spray-drying and freeze-drying of PEGylated liposomes. *Int. J. Pharm.* 438, 209-216.
- Whiting, K.P., Restall, C.J., Brain, P.F., 2000. Steroid hormone-induced effects on membrane fluidity and their potential roles in non-genomic mechanisms. *Life Sci.* 67, 743-757.
- Wieber, A., Selzer, T., Kreuter, J., 2012. Physico-chemical characterisation of cationic DOTAP liposomes as drug delivery system for a hydrophilic decapeptide before and after freeze-drying. *Eur. J. Pharm. Biopharm.* 80, 358-367.
- Zuidam, N.J., Gouw, H.K.M.E., Barenholz, Y., Crommelin, D.J.A., 1995. Physical (in) stability of liposomes upon chemical hydrolysis: the role of lysophospholipids and fatty acids. *Biochim. Biophys. Acta: Biomembranes*, 1240, 101-110

*Chapitre 3 : Effet des monoterpènes
et des phénylpropènes sur la
membrane lipidique*

Introduction

Les huiles essentielles (HEs) se forment dans un grand nombre de plantes comme sous-produits du métabolisme secondaire; elles ont par conséquent une composition complexe (Azevedo et al., 2001). On y trouve généralement de nombreux constituants appartenant principalement à deux grandes familles chimiques : les composés terpéniques et les composés aromatiques dérivés des phénylpropanes. Ces derniers sont subdivisés en sous-classes; parmi lesquelles les phénylpropènes (PPs), de faible poids moléculaire.

Les PPs sont largement répandus dans le monde végétal. Ils dérivent tous de l'acide *trans*-cinnamique. De ce fait, l'ensemble des PPs renferme un noyau aromatique et une chaîne latérale de trois carbones (C6-C3) issus du squelette carboné de la phenylalanine.

L'acétate de coumaryle et l'acétate de coniféryle sont reconnus par des enzymes spécifiques pour donner l'eugénol (Eug), l'isoeugénol (Iso-eug), le chavicol et le *trans*-anol. Ensuite, un groupement méthyle en position 4 du chavicol et du *trans*-anol est ajouté par voie enzymatique pour donner l'estragole (Est) et le *trans*-anéthol (Ane), respectivement (Koeduka et al., 2006).

Les composés terpéniques sont formés d'unités isopréniques (en C5) ; les HEs comprennent les monoterpènes (MTs) en (C10) et les sesquiterpènes (C15). Les MTs sont les plus simples constituants des terpènes dont la majorité est présentée dans les HEs (90%). Ils peuvent être acycliques, monocycliques ou bicycliques. En général, une HE est un mélange d'hydrocarbures et de composés oxygénés dérivés de ces hydrocarbures. Parmi ces composés oxygénés, on peut noter la présence d'alcools, d'esters, d'aldéhydes, de cétones, d'éther-oxydes et de carbures.

Le diphosphate de géranyle est le précurseur physiologique universel des MTs. Des enzymes spécifiques catalysent la conversion du cation α -terpényle en limonène et α -terpinéol (Ter). Ce dernier subit une cyclisation supplémentaire interne de l'oxygène alcoolique aboutissant à la formation d'un éther le 1,8-cinéole ou l'eucalyptole (Euc) (Degenhardt et al., 2009). Des réactions d'hydroxylation, déshydrogénation et isomérisation s'effectuent, à partir de limonène, pour donner le cétone pulégone (Pul) (McConkey et al., 2000).

Le thymol (Thy), est un phénol, naturellement synthétisé dans les plantes avec deux unités isopréniques qui elles-mêmes sont obtenues par la voie de l'acide mévalonique à partir du coenzyme A (Gershenzon, 1990).

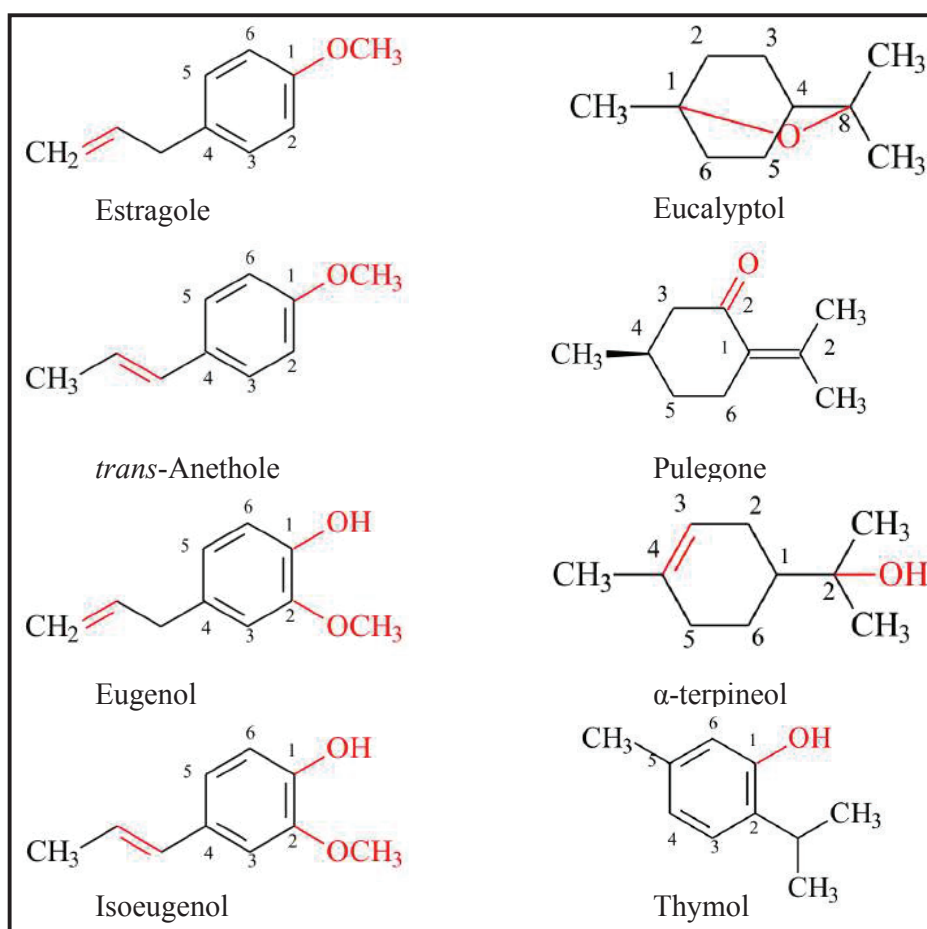

Les MTs et PPs sont bien connus par leurs effets antifongiques, antioxydants, anti-inflammatoires et antibactériens (Baakkali et al., 2008).

Divers facteurs influencent l'évaluation de l'activité antimicrobienne tels que la méthode d'évaluation de cette activité, la structure moléculaire des composés actifs et leur concentration ainsi que la nature du microorganisme testé. La structure moléculaire joue un rôle majeur dans les propriétés antibactériennes des HEs (Calsamiglia et al., 2007). En ce qui concerne les hydrocarbures, la structure cyclique et la nature des substituants du cycle semblent avoir un impact important sur leur activité (Amaral et al., 1998). Le caractère hydrophobe des HEs facilite leur pénétration dans la double couche phospholipidique de la membrane bactérienne. Cela explique pourquoi les bactéries Gram-(+) (leur paroi bactérienne est constituée de plusieurs couches de peptidoglycane) et Gram-(-) (possédant une membrane externe supplémentaire riche en lipopolysaccharides) réagissent différemment vis-à-vis de ces molécules. La présence d'une fonction oxygénée, surtout dans les phénols, renforce cette activité (Dorman & Deans, 2000). Les propriétés antibactériennes de plusieurs HEs ont été ainsi attribuées à leur contenu phénolique (Gaysinsky et al., 2007 ; Penalver et al., 2005, Santoyo et al., 2006 ; Tajkarimi et al., 2010).

Pour comprendre la relation structure-activité et l'influence des propriétés physicochimiques des MTs (Euc, Pul, Ter et Thy) et PPs (Est Ane, Eug et Iso-eug), nous avons étudié l'effet de ces molécules sur les propriétés membranaires telles que la fluidité, la structure de la membrane liposomiale. La localisation membranaire de ces molécules a été également étudiée. Les liposomes sont préparés par la méthode d'hydratation du film lipidique en utilisant le DPPC. Les caractéristiques thermodynamiques et la fluidité des membranes des vésicules lipidiques ont été étudiées par DSC, spectroscopie Raman et par polarisation de fluorescence du 1,6-diphényl-1,3,5-hexatriène (DPH).

Le changement d'intensité du pic à 715 cm^{-1} en spectroscopie Raman, et une disparition du pic de la pré-transition en DSC ont montré que tous les PPs et les MTs étudiés interagissent avec le groupement choline de la tête polaire des phospholipides. Les changements induits par les molécules au niveau des paramètres thermodynamiques (T_m et ΔH_m), des rapports d'intensité de la hauteur des pics Raman I_{2935}/I_{2880} et I_{2844}/I_{2880} et des fréquences des CH symétriques des chaînes acyles des phospholipides, impliquent leur localisation au niveau membranaire. La ΔH_m ne varie pas en présence de l'Euc et le Pul (dans les rapports molaires DPPC:Pul inférieures à 100:5) ce qui suggère que ces molécules s'intercalent dans la bicouche lipidique. Tandis que les autres induisent une variation de T_m et ΔH_m , ce qui suggère, en plus de leur insertion dans la bicouche, une possibilité de remplacer la molécule lipidique. L'Ane et l'Iso-eug interagissent avec le cœur lipophile de la bicouche. Elles s'insèrent au sein de la bicouche perturbant ainsi les fortes interactions hydrophobes entre les molécules de lipides. En outre, l'aspect du pic de transition en présence d'une molécule peut être modifié. En effet, il est élargi en présence de toutes les molécules étudiées, à l'exception de l'Euc. De plus, le Thy, dans les rapports molaires DPPC:Thy 100:5; 100:10 et 100:25 a démontré une décomposition du pic de transition suggérant une séparation de phase au niveau de la bicouche et éventuellement une formation des domaines riches et d'autres pauvres en molécule terpénique. Toutes les molécules étudiées fluidifient la membrane des liposomes à 28°, 41°C et 50°C comme ils ont produit une diminution de l'anisotropie de la DPH et augmentation du rapport d'intensité I_{1090}/I_{1130} déterminé par la technique Raman.

De plus, l'activité antibactérienne des PPs contre *E. coli* par la méthode «Macrobroth dilution» a été évaluée. Les résultats montrent que l'Ane et l'Est sont plus efficaces que l'Eug et l'Iso-eug

pour inhiber la croissance des bactéries. L'hydrophobicité élevée de l'Ane et l'Est peut contribuer à leur pénétration à travers la membrane bactérienne externe.

Les effets induits par les PPs et les MTs sur la membrane lipidique et sur les bactéries de type *E. coli* sont discutés en termes de structure chimique et de propriétés physicochimiques.

Les molécules possédant un groupe hydroxyle (Eug, Iso-eug, Ter et Thy) induit un effet fluidifiant plus important que les autres qui présentent une fonction cétone (Pul) ou éther (Ane, Est et Euc). Le groupe hydroxyle peut accepter ou donner une liaison hydrogène alors que le groupe cétone du Pul, et le groupe éther de l'Euc peut accepter seulement une liaison hydrogène. Le Thy, qui porte un groupe hydroxyle, augmente le désordre de la membrane lipidique et induit une séparation de phase au niveau de la bicouche.

Parmi les composés non-aromatiques (Euc, Pul, Ter), Ter s'emble s'insérer le plus dans la membrane. Le groupement hydroxyle pourrait en être la cause. D'autre part, la position de la double liaison dans le groupe propényle contrôle l'incorporation étant donné que les deux molécules (Iso-eug et Ane) s'insèrent plus que l'Eug et le Ane dans la bicouche.

Ce chapitre est présenté sous forme de deux articles :

1. Le premier article est en étape de révision dans « Journal of Membrane Biology ». Il présente les résultats sur les effets de quatre PPs (l'estragole, l'anéthol, l'eugénol et l'isoeugénol) sur la membrane et leurs effets antibactériens contre *E. coli*.
2. Le deuxième article est en préparation, il décrit l'interaction des quatre monoterpènes, le terpinéol, l'eucalyptol, le thymol et pulégone, avec la membrane et le rôle de la structure et des propriétés physicochimiques qui régissent l'interaction.

Références

- Amaral, J. A., Ekins, A., Richards, S. R., & Knowles, R. (1998). Effect of selected monoterpenes on methane oxidation, denitrification, and aerobic metabolism by bacteria in pure culture. *Applied and Environmental Microbiology*, 64, 520-525.
- Azevedo, N. R., Campos, I. F., Ferreira, H. D., Prtes, T. A., Santos, S. C., Seraphin, J. C., et al. (2001). Chemical variability in the essential oil of *Hyptis Suaveolens*. *Phytochemistry*, 733, 736.
- Bakkali, F., Averbeck, S., Averbeck, D., & Idaomar, M. (2008). Biological effects of essential oils – A review. *Food Chem Toxicol*, 46, 446-475.
- Calsamiglia, S., Busquet, M., Cardozo, P. W., Castillejos, L., & Ferret, A. (2007). Invited review: essential oils as modifiers of rumen microbial fermentation. *Journal of Dairy Science*, 90, 2580-2595.
- Degenhardt, J., Köllner, T. G., & Gershenzon, J. (2009). Monoterpene and sesquiterpene synthases and the origin of terpene skeletal diversity in plants. *Phytochemistry*, 70, 1621-1637.
- Dorman, H. J., & Deans, S. G. (2000). Antimicrobial agents from plants: antibacterial activity of plant volatile oils. *Journal of Applied Microbiology*, 88, 308-316.
- Gaysinsky, S., Taylor, T. M., Davidson, P. M., Bruce, B. D., & Weiss, J. (2007). Antimicrobial efficacy of eugenol microemulsions in milk against *Listeria monocytogenes* and *Escherichia coli* O157:H7. *Journal of Food Protection*, 70, 2631-2637.
- Gershenzon, J., & Croteau, R. (1990). Regulation of monoterpene biosynthesis in higher plants. *Recent Advances in Phytochemistry*, 24, 99-160.
- Koeduka, T., Fridman, E., Gang, D. R., Vassao, D. G., Jackson, B. L., Kish, C. M., et al. (2006). Eugenol and isoeugenol characteristic aromatic constituents of spices, are biosynthesized via reduction of a coniferyl alcohol ester. *Proc. Natl. Acad. Sci. U S A.*, 103, 10128-10133.
- McConkey, M. E., Gershenzon, J., & Croteau, R. (2000). Developmental Regulation of Monoterpene Biosynthesis in the Glandular Trichomes of Peppermint. *Plant Physiology*, 122, 215-223.
- Penalver, P., Huerta, B., Borge, C., Astorga, R., Romero, R., & Perea, A. (2005). Antimicrobial activity of five essential oils against origin strains of the enterobacteriaceae family. *APMIS*, 113, 1-6.
- Santoyo, S., Cavero, S., Jaime, L., Ibanez, E., Senorans, F. J., & Reglero, G. (2006). Supercritical carbon dioxide extraction of compounds with antimicrobial activity from *Origanum vulgare* L.: determination of optimal extraction parameters. *Journal of Food Protection*, 69, 369-375.
- Tajkarimi, M. M., Ibrahim, S. A., & Cliver, D. O. (2010). Antimicrobial herb and spice compounds in food. *Food Control*, 21, 1199-1218

Interaction of selected phenylpropenes with dipalmitoylphosphatidylcholine membrane and their relevance to antibacterial activity

Riham Gharib^{1,2}, Amal Najjar¹, Lizette Auezova¹, Catherine Charcosset², H  l  ne Greige-Gerges¹.

¹Bioactive Molecules Research Group, Faculty of Sciences, Doctoral School of Sciences and Technologies, Lebanese University, Lebanon.

²Laboratoire d'Automatique et de G  nie des Proc  d  s, Universit   Claude Bernard Lyon 1, UMR 5007, CNRS, CPE, 43 bd du 11 Novembre, 691622 Villeurbanne Cedex, France

In revision in “Journal of Membrane Biology”

Abstract

The effect of structurally closely related phenylpropenes (PPs), estragole, anethole, eugenol and isoeugenol, on the fluidity of dipalmitoyl phosphatidyl choline (DPPC) liposome membrane was investigated by DSC, Raman and fluorescence anisotropy of 1,6-diphenyl-1,3,5-hexatriene (DPH). Liposomes were prepared by thin film hydration method at various DPPC:PP molar ratios. The DPH anisotropy measurements of blank and PP-loaded liposomes were performed at 28, 41 and 50 °C, which correspond respectively to gel phase, main transition temperature of DPPC and liquid phase. The Raman images showed the formation of nano- and micrometric spherical multi-lamellar vesicles. All studied PPs exhibited a membrane fluidizing effect which was reinforced by the presence of phenolic hydroxyl group in eugenol and isoeugenol. The PPs interacted with the choline head group and the alkyl chains of DPPC membrane, wherein isoeugenol and anethole, with the same C7-C8 position of the double bond in the propenyl side chain, incorporated deeply in the bilayer. Additionally, the PPs were analyzed for antibacterial activity against *E. coli* by macrobroth dilution method. Anethole and estragole were more efficient in inhibiting the bacterial growth than eugenol and isoeugenol. We conclude that the fluidizing effect of PPs on the membrane is a common mechanism that is not related to the hydrophobicity of the PP molecule. Besides, other target sites may be involved in PPs antibacterial activity against Gram negative bacteria. The greater hydrophobicity of these PPs may contribute to their penetrability through the outer bacterial membrane.

Keywords: Antibacterial, DPPC membrane, DSC, Fluorescence anisotropy, Phenylpropenes, Raman spectroscopy.

1 Introduction

Phenylpropenes (PPs) are essential oil components found in a wide variety of plants (clove, anise, basil, tarragon, fennel, parsley, cinnamon, etc) (Jirovetz et al. 2006; Orav et al. 2008). They are composed of six-carbon aromatic phenol group and a three-carbon propene tail (Nazzaro et al. 2013). PPs play a vital role in plant defense against biotic and abiotic stresses (Ferrer et al. 2008). Moreover, they are known to possess antioxidant and anti-inflammatory properties (de Cássia da Silveira E Sá 2014; Senatore et al. 2013; Kang et al. 2012; Bachiega et al. 2012; Koeduka 2014; Pasay et al. 2010).

Four structurally closely related PPs, eugenol (Eug), isoeugenol (Iso-eug), anethole (Ane) and estragole (Est) (Fig. 1), were included in this study. These PPs are recognized as safe by the Food and Drug Administration (FDA) (Smith et al. 2005; Baskaran et al. 2010; Gary et al. 2014) and largely used as flavor agents in food industry (Freire et al. 2005; Zeller et al. 2009). Moreover, they can be used as food preservatives, due to their potential to preserve the quality and safety of fresh products (Miladi et al. 2010; Diao et al. 2014).

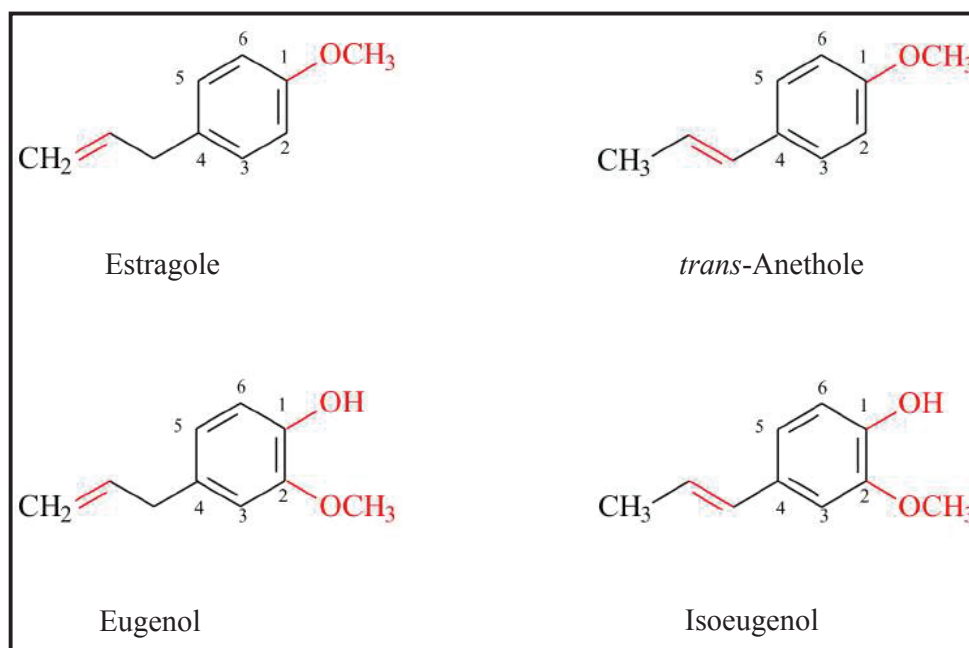

Fig. 1: Chemical structures of the studied phenylpropenes.

Biophysical studies of PP-membrane interactions were commonly performed using dipalmitoylphosphatidylcholine (DPPC) liposomes as model lipid bilayers (Tsuchiya 2015). Thus, several reports were published on two isomeric phenylpropenes, Eug and Iso-eug. In

particular, a fluidizing membrane effect was demonstrated for Eug (Tsuchiya & Mizogami 2014). Besides, the interaction of Iso-eug with polar choline head of DPPC phospholipids was shown (Fujisawa et al. 1987; Cristani et al. 2007). However, a detailed biophysical analysis of membrane interaction with several structurally closely related PPs allowing an examination of the structure-activity relationship, has not been done yet.

In addition, the four PPs were tested for the antibacterial activity against *Escherichia coli*. The antibacterial activity of PPs cannot be attributed to a single mechanism of action. Different biochemical effects are highlighted by researchers in various sites within or on the cell surface. These mechanisms are dependent on the structure of molecules (Nazzaro et al. 2013). It has been reported that the antimicrobial activity depends primarily on the type and the number of substitutions on the aromatic ring of PP. Yet, it also varies with the bacterial strain tested and the experimental conditions (Pauli & Kubeczka 2010).

Eug and Iso-eug are among the most thoroughly studied PPs. By comparing them to chemically related molecules, it had been suggested that most of their antimicrobial activity is conferred by their phenolic hydroxyl groups (Laekeman et al. 1990). The presence of the methoxy group and the double bond in the side chain of Eug was also considered important for the antimicrobial activity (Jung & Fahey 1893; Hyldgaard et al. 2012). Interestingly, Eug and Iso-eug exhibit higher activity against Gram-negative bacteria than Gram-positive bacteria (Hyldgaard et al. 2012).

Eug increases the membrane permeability by a non-specific permeabilization mechanism, associated with ATP and potassium leakage outside the cell (Walsh et al. 2003; Gill & Holley 2006; Hemaiswarya & Doble 2009). Besides, treatment with Eug may increase the amount of unsaturated phospholipids, which enhances the fluidity of the membrane of microbial cell (Di Pasqua et al. 2007). The alteration of the composition of fatty acids in response to Eug could affect not only membrane fluidity but also subsequently the permeability of microbial cell (Di Pasqua et al. 2006).

In this study, we investigated the effect of Eug, Iso-eug, Ane and Est on DPPC model lipid bilayers, using differential scanning calorimetry (DSC), Raman spectroscopy and fluorescence anisotropy of 1,6-diphenyl-1,3,5-hexatriene (DPH). The study was conducted at various DPPC:PP molar ratios. Moreover, the antibacterial effect of these PPs against *Escherichia coli* (*E. coli*) was determined. The relationship between the chemical structure, the physicochemical properties of the PPs and their antibacterial effects is discussed.

2 Materials and methods

2.1 Materials

DPPC was purchased from Lipoid GmbH (Germany). *trans*-Ane [1-methoxy-4-(1-propenyl)-benzene] (99%) was purchased from Sigma-Aldrich (Spain), Est from Sigma-Aldrich (China), Eug and Iso-eug from Sigma-Aldrich (Germany) and tetrahydrophuran from Sigma-Aldrich (USA). Chloroform, methanol and Trizma base were purchased from Sigma-Aldrich (France). HCl from VWR, France and DPH was from Across Organics (New Jersey, USA). Nutrient broth and nutrient agar were purchased from Conda (Spain). Peptone water was purchased from Scharlau (Spain).

2.2 Bacterial strain

E. Coli ATCC 25922 was purchased from American Type Culture Collection (ATCC) and was routinely maintained on nutrient agar along the experimental work.

2.3 Preparation of liposomes

MLVs were prepared by the thin film hydration technique described by Bangham et al. (1965). DPPC and PP were mixed in molar ratios of 100:0; 100:0.25; 100:0.5; 100:1; 100:2.5; 100:5; 100:10, and 100:25. DPPC (25 mg/ml) and PP were solubilized in a solvent mixture of chloroform:methanol 2:1 (v/v). The preparation was then evaporated in a rotary evaporator (BÜCHI Rotavapor R-124) to form a thin lipid film. The latter was then hydrated with 2 ml of Tris-HCl 0.1 M (pH 7.4) under mechanical stirring for 5 min in a water bath at 55 °C for 5 min. The cycle was repeated three times. The batch prepared at DPPC:PP molar ratio of 100:0 was considered as blank. For each DPPC:PP molar ratio, liposomes were prepared in triplicate.

2.4 Differential scanning calorimetry

DSC was performed using a DSC Q200 scanning calorimeter (TA Instruments, France). The scanning rate employed was 1 °C/min in a temperature range of 20–50 °C. The reference pan was filled with Tris-HCl 0.1 M (pH 7.4) buffer solution. The samples (10 µL) were encapsulated in hermetically sealed standard aluminum DSC pans. Enthalpies and temperature were evaluated from the DSC peak using the software of the TA processor.

The measured parameters were as follows: the transition temperature (T_m) determined from the maximum of the recorded heat capacity, the transition enthalpy (ΔH_m) obtained from the area

under the peak, the pre-transition temperature and enthalpy (T_p and ΔH_p respectively), and the temperature width at half peak height ($\Delta T_{1/2}$) which measures the sharpness of the phase transition. This latter is very sensitive to the presence of any additives. It is taken as a measure for the cooperativity of the transition. $\Delta T_{1/2}$ is inversely proportional to the cooperativity (El Maghraby et al. 2005).

2.5 Raman spectroscopy

The Raman spectra were recorded with a LabRAM HR 800 (Horiba Jobin Yvon, Villemeuve d'Ascq, France) at Ecole Centrale de Lyon (IVTV ANR-10-EQPX-06-01) equipped with a detector 1024x256 pixel. A laser power at 633 nm was used as excitation source. The spectra were obtained at wavenumbers ranging from 3100 to 600 cm^{-1} , at a resolution of 1 cm^{-1} . The laser power was controlled to be constant at within 12mW during the experiments. Analysis of the spectra was carried out using a LabSpec software. An aliquot from the liposomal suspensions (10-15 μL) was used for the Raman spectroscopy. Experiments were held at 25 °C in order to assess the change of the interaction between DPPC and PP. An integrated camera was employed to acquire images of trapped vesicles (LxH=760x628 pixels).

2.6 Fluorescence anisotropy measurement

Changes in lipid fluidity of liposomes were measured by steady state fluorescence polarization using a Cary Eclipse Fluorescence Spectrophotometer (Agilent technologies). DPH was dissolved in tetrahydrofurane. An aliquot of DPH solution 4.3 mM was then added to the membrane suspension prepared as described above, to obtain a 1:500 molar ratio of DPH:phospholipid. The mixture was incubated overnight in the dark to allow the intercalation of the DPH molecules into the lipid bilayer. The final concentration of tetrahydrofurane did not exceed 0.01% and showed to have no effect on the fluorescence anisotropy. The experiments were performed at 28, 41 and 50 °C. The probe was excited with a manual polarizer accessory (Cary Eclipse Manual Polarizer, (Agilent technologies) Malaysia), using vertically polarized light at 360 nm. The emission intensities were measured at 450 nm parallel and perpendicular to the plane of the excitation beam yielding components I_{VV} and I_{VH} , respectively. The Cary Eclipse Bio Software, delivered from the spectrophotometer, gives the fluorescence anisotropy (R), which is defined as:

$$R = \frac{I_{\parallel} - I_{\perp}}{I_{\parallel} + 2I_{\perp}}$$

Where I_{\parallel} and I_{\perp} are the fluorescence intensities of the light emitted with its polarization plane parallel (\parallel) and perpendicular (\perp) to that of the exciting beam.

2.7 Antibacterial activity of PPs against *E. coli* ATCC 25922

Nutrient broth culture medium was prepared and aliquoted in 5 ml volumes. Then the tubes were inoculated with a fixed volume of diluted preculture in its late log phase in order to obtain 10^6 CFU/ml of bacteria at baseline. Initial bacterial concentrations were verified by serial dilution of cultures in peptone water followed by total viable count determination on nutrient agar.

Assay bacterial cultures were prepared with different concentrations (125 to 1000 μ M) of the studied PPs. Intermediate solutions of the PPs at appropriate concentrations were prepared in DMSO from a stock solution (100 mM), and 25 μ l of the intermediate solutions were added to the 5-ml nutrient broth cultures. Thus, all tubes contained the same DMSO concentration of 0.5%. The lids of culture tubes were closed loosely to maintain continuous aerobic conditions. In each experiment, bacterial cultures were prepared in quadruplet for each concentration of PPs. Controls were set up as the negative control (containing 0.5% of DMSO) and as sterility control (containing culture medium only). All tubes were incubated at 37 °C during 18 h. Bacterial growth was evaluated spectrophotometrically at 660 nm.

The percentage of inhibition by a PP at a specific concentration was determined as follows:

$$\text{Percentage of inhibition} = \left[\frac{\text{Mean OD (control tube)} - \text{Mean OD (test tube)}}{\text{Mean OD (control tube)}} \right] \times 100$$

Where Mean OD (control tube) and Mean OD (test tube) are the optical density of the control and the sample with PPs respectively.

Linear regression curves were obtained and IC₅₀ (half minimal inhibitory concentration) values for each PP were determined from as the concentration that is able to reduce turbidity in bacterial cultures to half.

The experiments were repeated four times.

2.8 Statistical analysis

Statistical analysis was performed using the Student T-test. *P* values equal or less than 0.05 were considered statistically significant.

3 Results

In this study, DPPC was used to prepare phospholipid membranes since it is the major phospholipid present in most of biological membranes (Tsuchiya 2015). Interactions between PPs and DPPC vesicles were investigated by various methods to identify the functional groups of PP involved in the interaction with membrane phospholipids and to assess the effect of PP on the membrane characteristics.

3.1 Raman spectroscopy

The Raman microscopy allowed visualizing blank and PP-loaded liposomes. The images showed the formation of nano- and micrometric spherical vesicles in all batches. Fig. 2 shows some examples of the images of blank liposomes (a) and PP-loaded liposomes prepared at molar ratio DPPC:PP of 100:10 (b, c, d, and e for Ane, Est, Eug and Iso-eug, respectively). Similar images were obtained at other DPPC:PP molar ratios. On the other hand, f showed destruction of Iso-eug-loaded liposomes at molar ratio DPPC to Iso-eug of 100:25.

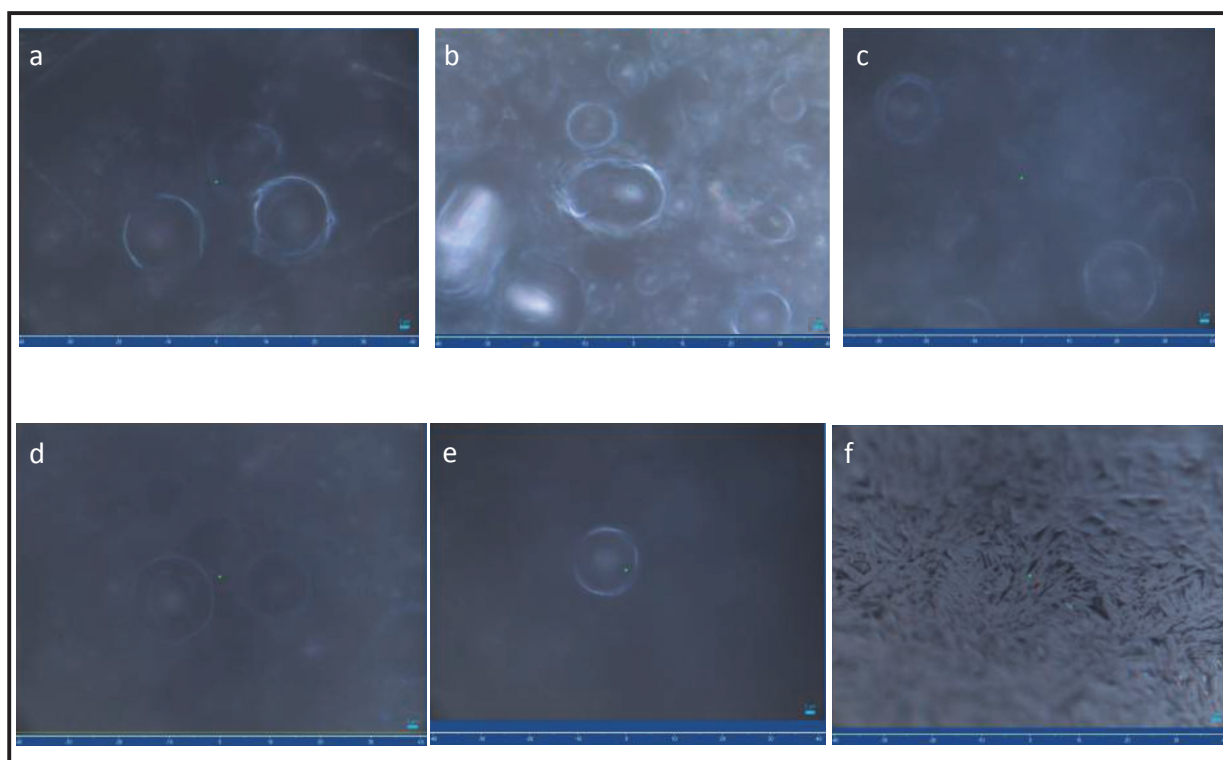

Fig. 2: DPPC liposome trapping images for Blank (a), Ane- (b), Est- (c), Eug- (d), Iso-eug- (e) loaded liposomes at DPPC:PP molar ratio of 100:10 and for Iso-eug at DPPC:Iso-eug molar ratio of Iso-eug 100:25 (f).

The pure DPPC Raman spectrum exhibited three characteristic areas: 1) 2800–3000 cm^{-1} , 2) 1000–1200 cm^{-1} and 3) 700–800 cm^{-1} (Fig. 3), providing useful information about the conformation of the DPPC molecules. In addition, Raman spectroscopy helps to specify the location of the compound in the DPPC lipid bilayer (Gardikis et al. 2006a).

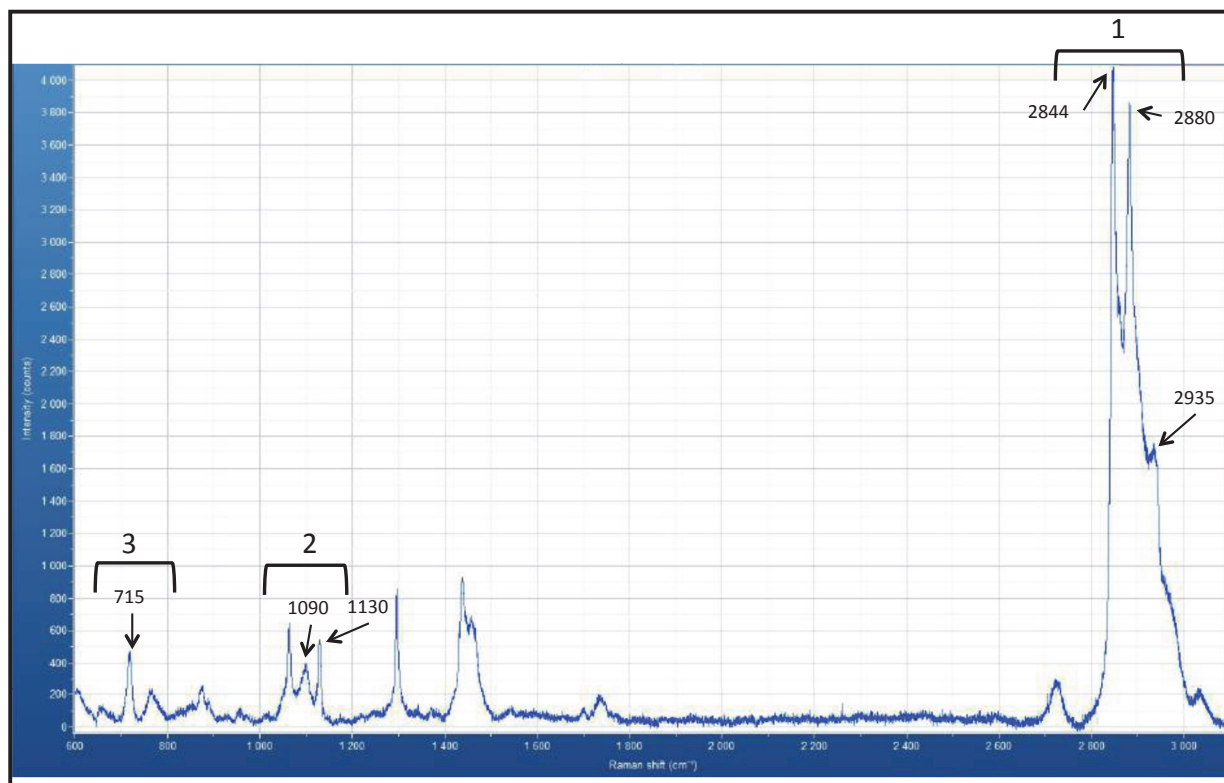

Fig. 3: The Raman spectra of DPPC liposomes.

Area 1 contains the peaks at 2844 and 2880 cm^{-1} which correspond, respectively, to the symmetrical and asymmetrical stretching vibrations of the C-H bond of the methylene groups. Area 1 also contains the peak at 2935 cm^{-1} which is attributed to the symmetrical stretching vibration of the C-H bond of the final methyl group of the alkyl chain. The bands of area 1 are commonly used to monitor changes in lateral packing and relative lateral mobility of lipid chains within the bilayer (Potamitis et al. 2011).

Of interest are also the height intensity ratios I_{2935}/I_{2880} and I_{2844}/I_{2880} (Gardikis et al. 2006a; 2006b). I_{2935}/I_{2880} measures the effects originating from changes both in interchain and intrachain processes in the bilayer. It has been used as an overall indicator of both intramolecular (gauche/trans ratio) and intermolecular (packing order); as this ratio increases, more freedom of motion and rotational disorders are detected (Fox et al. 2007). In our study, an increment in the

rotational disorder of DPPC membrane was obtained in the presence of Ane and Iso-eug at various DPPC: PP molar ratios and in the presence of Est at the two highest molar ratios while the effect of Eug was not important (Table 1).

I_{2844}/I_{2880} describes the main changes occurring in the hydrocarbon chain domain of the lipids. It is sensitive to subtle changes in conformational order from rotations, kinks, twists, and bends of the lipid chains (Potamitis et al. 2011). Compared to blank liposomes, an increase of the I_{2844}/I_{2880} ratio was observed with Ane at all DPPC:PP molar ratios studied and with Est above a DPPC:Est molar ratio of 100:2.5. No variation was observed in the presence of Eug or Iso-eug (Table 1).

The area 2 includes the stretching vibrations of the C-C bonds of the alkyl chains of the phospholipids. The peak at 1130 cm^{-1} is attributed to the stretching vibration of the C-C bond for the *trans*-conformations of the alkyl chains, while the peak at 1090 cm^{-1} is attributed to the stretching vibration of the C-C bond for the *gauche* conformations of the alkyl chains. The height intensity ratio of these peaks, I_{1090}/I_{1130} also provides information about the proportion between disorder and order that exists in the conformation of the alkyl chain. The studied PPs increased the *gauche/trans* ratio and disturbed the lipid chain order. This was observed at all DPPC:PP molar ratios used except for Est and Ane at low molar ratios.

The area 3 contains the peak at 715 cm^{-1} , which represents the stretching vibration of the C-N bond of the choline group of DPPC (Gardikis, Hatziantoniou, Viras, & Demetzos, Effect of a bioactive curcumin derivative on DPPC membrane: A DSC and Raman spectroscopy study, 2006a). The studied PPs modified in a significant manner the intensity of this peak meaning an interaction of PP with the polar head groups of phospholipids.

Table 1: The intensity ratios for the peaks of Raman spectrum of various PPs loaded DPPC MLVs.

MLVs	I_{715}	I_{1090}/I_{1130}	I_{2844}/I_{2880}	I_{2935}/I_{2880}
DPPC (100:0)	448 ± 31	0.61 ± 0.01	1.01 ± 0.04	0.43 ± 0.01
Estragole				
DPPC: Est (100:0.25)	$555 \pm 21^*$	0.62 ± 0.04	1.03 ± 0.03	0.43 ± 0.01
DPPC: Est (100:0.5)	$543 \pm 30^*$	$0.67 \pm 0.02^*$	1.06 ± 0.003	0.43 ± 0.01
DPPC: Est (100:1)	$578 \pm 21^*$	0.69 ± 0.05	1.06 ± 0.00	0.43 ± 0.005
DPPC: Est (100:2.5)	$642 \pm 34^*$	$0.72 \pm 0.006^*$	$1.07 \pm 0.02^*$	0.44 ± 0.01
DPPC: Est (100:5)	$202 \pm 31^*$	$0.78 \pm 0.04^*$	$1.08 \pm 0.03^*$	0.45 ± 0.01
DPPC: Est (100:10)	$265 \pm 50^*$	$0.78 \pm 0.01^*$	$1.08 \pm 0.02^*$	$0.46 \pm 0.01^*$

DPPC: Est (100:25)	216 ± 129*	0.81 ± 0.01*	1.10 ± 0.002*	0.50 ± 0.04*
t-Anethole				
DPPC: Ane (100:0.25)	228.43 ± 24*	0.64 ± 0.00	1.07 ± 0.02*	0.45 ± 0.007*
DPPC: Ane (100:0.5)	286.34 ± 14*	0.65 ± 0.04	1.08 ± 0.01*	0.47 ± 0.02*
DPPC: Ane (100:1)	296.7 ± 62*	0.67 ± 0.01*	1.08 ± 0.01*	0.48 ± 0.01*
DPPC: Ane (100:2.5)	75.92 ± 20*	0.70 ± 0.03*	1.1 ± 0.01*	0.49 ± 0.01*
DPPC: Ane (100:5)	32.8 ± 5*	0.83 ± 0.03*	1.12 ± 0.02*	0.51 ± 0.02*
DPPC: Ane (100:10)	31.95 ± 3*	0.90 ± 0.01*	1.14 ± 0.04*	0.55 ± 0.02*
DPPC: Ane (100:25)	25.94 ± 4*	0.94 ± 0.03*	1.17 ± 0.01*	0.61 ± 0.02*
Eugenol				
DPPC: Eug (100:0.25)	574 ± 7*	0.74 ± 0.01*	1.05 ± 0.002	0.44 ± 0.01
DPPC: Eug (100:0.5)	563 ± 27*	0.76 ± 0.01*	1.06 ± 0.001	0.43 ± 0.008
DPPC: Eug (100:1)	521 ± 35*	0.77 ± 0.05*	1.07 ± 0.007	0.44 ± 0.01
DPPC: Eug (100:2.5)	138 ± 16*	0.81 ± 0.02*	1.05 ± 0.006	0.45 ± 0.01
DPPC: Eug (100:5)	128 ± 13*	0.86 ± 0.003*	1.06 ± 0.005	0.44 ± 0.01
DPPC: Eug (100:10)	596 ± 69*	0.78 ± 0.05*	1.07 ± 0.01	0.44 ± 0.005
DPPC: Eug (100:25)	516 ± 22*	0.92 ± 0.02	1.06 ± 0.01	0.45 ± 0.01
Isoeugenol				
DPPC: Iso-eug (100:0.25)	525 ± 13*	0.74 ± 0.01*	1.05 ± 0.00	0.44 ± 0.00
DPPC: Iso-eug (100:0.5)	578 ± 8*	0.78 ± 0.01*	1.06 ± 0.00	0.46 ± 0.00*
DPPC: Iso-eug (100:1)	353 ± 44*	0.81 ± 0.04*	1.04 ± 0.01	0.46 ± 0.00*
DPPC: Iso-eug (100:2.5)	240 ± 73*	0.81 ± 0.00*	1.03 ± 0.01	0.46 ± 0.01*
DPPC: Iso-eug (100:5)	78 ± 0*	0.83 ± 0.05*	1.06 ± 0.02	0.51 ± 0.04*
DPPC: Iso-eug (100:10)	70 ± 1*	0.87 ± 0.02*	1.04 ± 0.00	0.54 ± 0.00*
DPPC: Iso-eug (100:25)	71 ± 16*	0.93 ± 0.04*	1.04 ± 0.01	0.68 ± 0.06*

Values are expressed as the means of three repetitions ± SD

*P<0.05 compared with the control value

3.2 Differential scanning calorimetry

The calorimetric heating curves of DPPC liposomes in absence and in presence of PPs at various DPPC:PP molar ratios are represented in Fig. 4-7. The calorimetric parameters were determined

and summarized in Table 2. The thermogram of blank DPPC shows two characteristic peaks at 34.85 ± 0.04 °C and 40.14 ± 0.02 °C. The first peak presents a low enthalpy transition attributed to the mobility of the choline polar head of DPPC, while the sharp enthalpy main transition is attributed to the mobility of the alkyl chains.

The presence of PPs in the fully hydrated DPPC lipid bilayer induces changes in the thermograms. Compared to blank liposomes, the pre-transition peak decreased in the presence of PPs and then disappeared. The pre-transition peak disappearance was obtained for all the molecules above a DPPC:PP molar ratio of 100:1.

A broadening of the main transition peak was observed for Est (at molar ratios of 100:10 and 100:25), Ane (starting from 100:1 molar ratio), Eug (at molar ratios of 100:5; 100:10 and 100:25), and for Iso-eug at all concentrations, leading to the abolition of the peak at a molar ratio of 100:25 (Fig. 4-7). The main transition temperature shifted to lower values in the presence of all PPs. Besides, compared to blank liposomes, the enthalpy of the main phase transition decreased significantly in presence of Est from molar ratio of 100:5 in a concentration-dependent manner. It decreased also for Eug-loaded liposomes (at molar ratios of 100:2.5, 100:10 and 100:25) and for Ane- and Iso-eug-loaded liposomes at all molar ratios in a concentration-dependent manner (Table 2). Furthermore, an increase of the $\Delta T_{1/2}$ was observed at all DPPC:PP molar ratios in a concentration-dependent way.

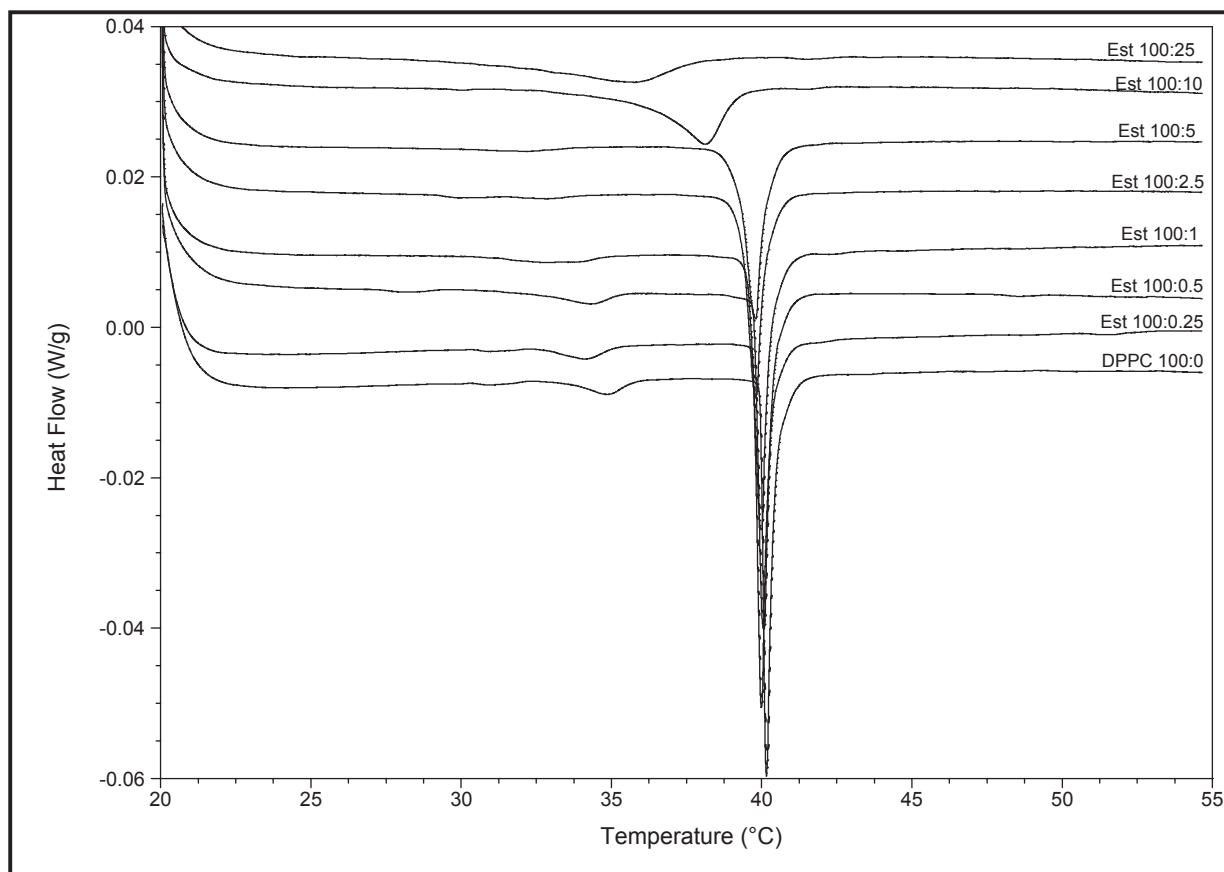

Fig. 4: DSC scans of Est-loaded DPPC liposomes at molar ratios of 100:0; 100:0.25; 100:0.5; 100:1; 100: 2.5; 100:5; 100:10; and 100:25.

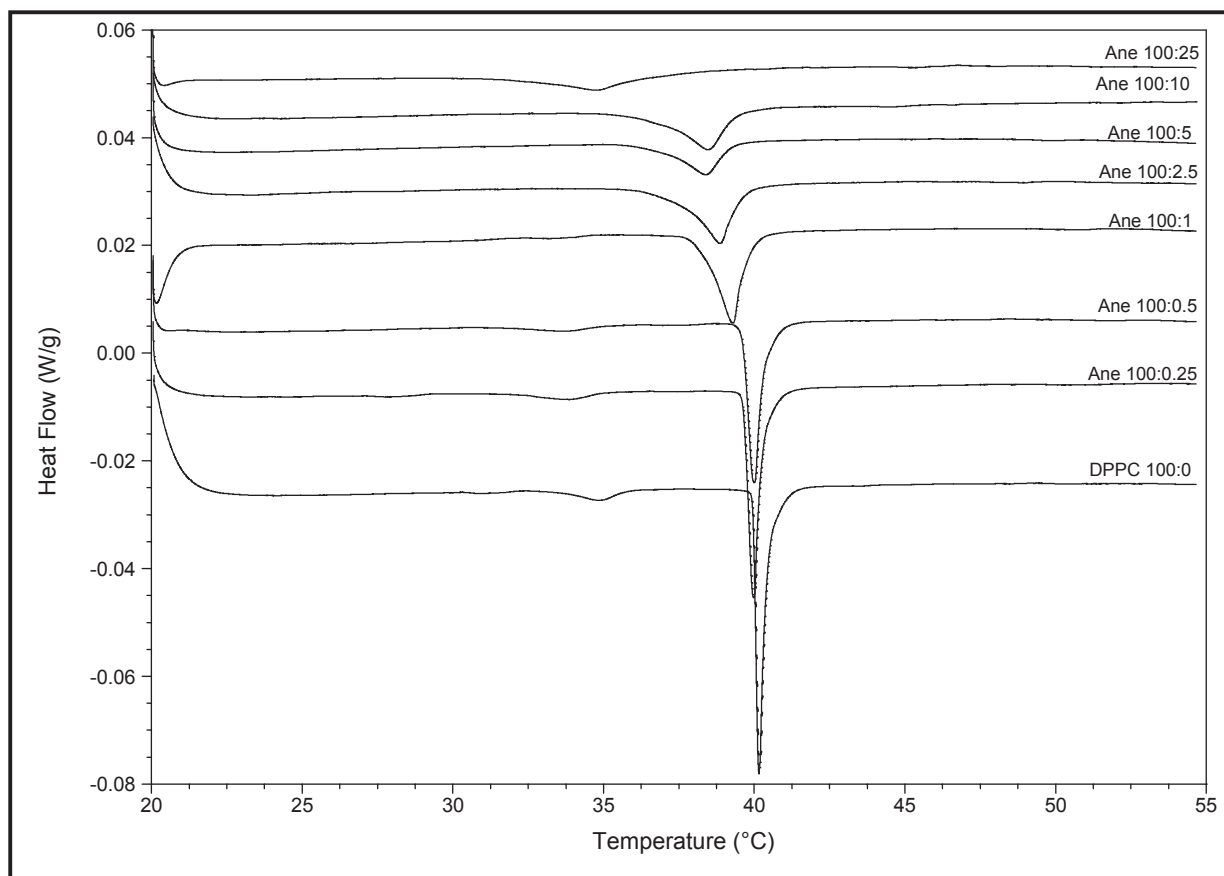

Fig. 5: DSC scans of ANE-loaded DPPC liposomes at molar ratios of 100:0; 100:0.25; 100:0.5; 100:1; 100: 2.5; 100:5; 100:10; and 100:25.

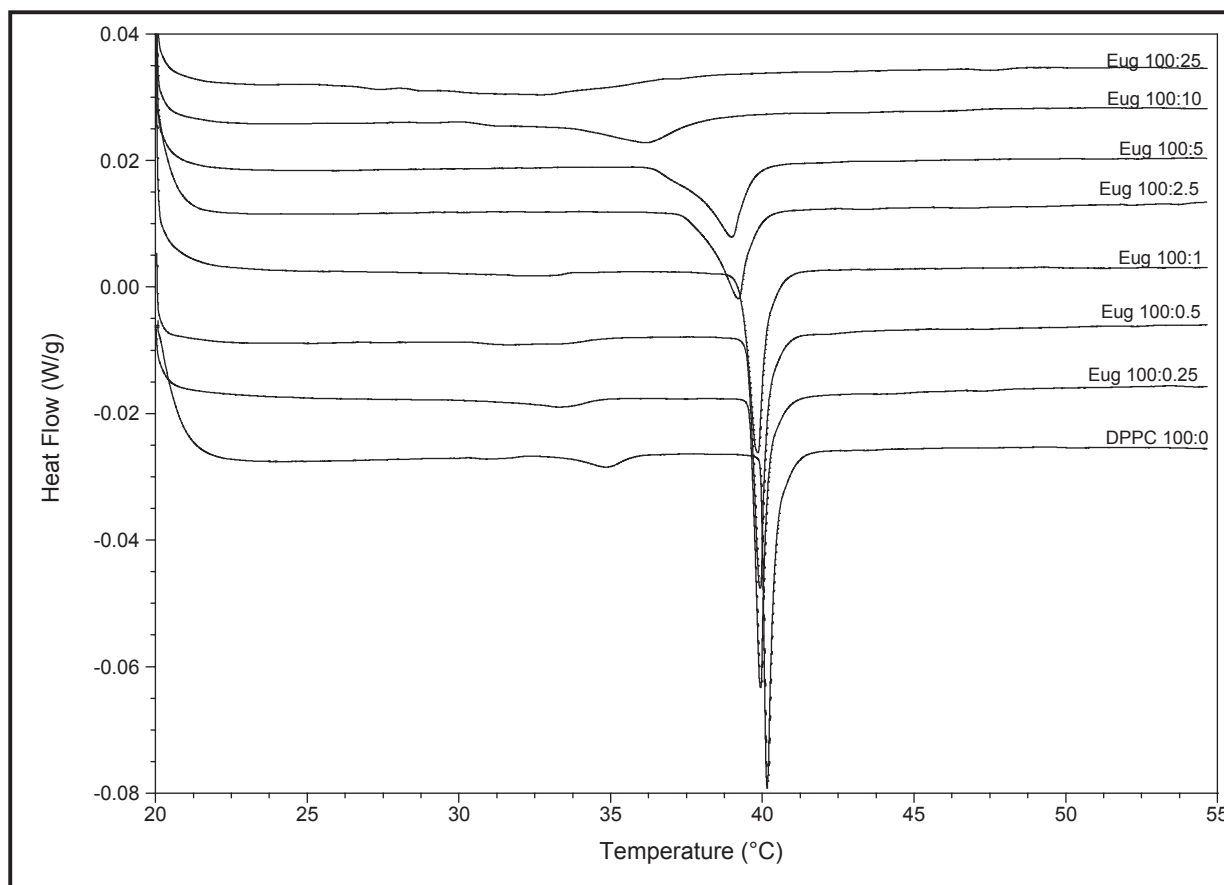

Fig. 6: DSC scans of Eug-loaded DPPC liposomes at molar ratios of 100:0; 100:0.25; 100:0.5; 100:1; 100: 2.5; 100:5; 100:10; and 100:25.

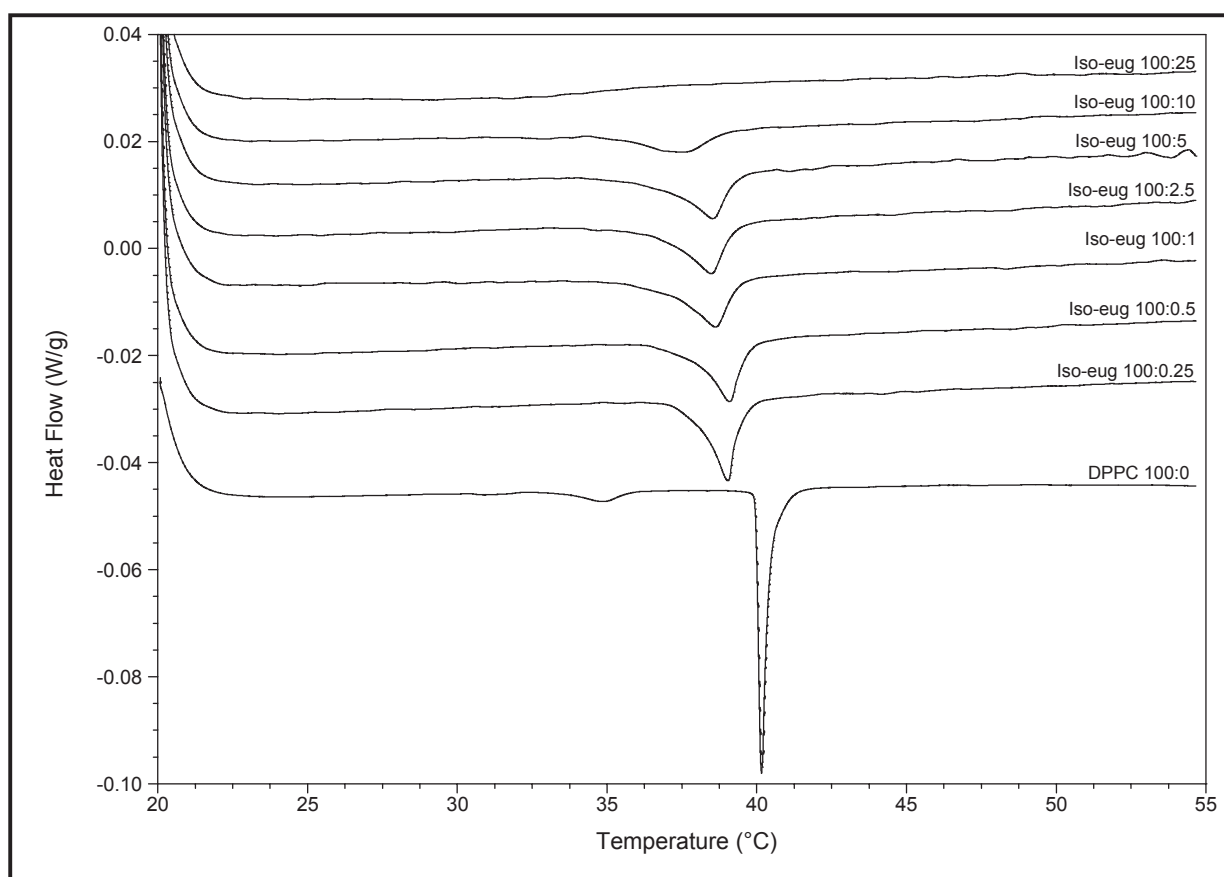

Fig. 7: DSC scans of Iso-eug-loaded DPPC liposomes at molar ratios of 100:0; 100:0.25; 100:0.5; 100:1; 100: 2.5; 100:5; 100:10; and 100:25.

Table 2: Calorimetric parameters of the interaction of PPs with DPPC MLVs.

MLVs	T_p (°C)	ΔH_p (J/g)	T_m (°C)	ΔH_m (J/g)	$\Delta T_{1/2}$ (°C)
DPPC (100:0)	34.85 ± 0.04	5.62 ± 0.27	40.14 ± 0.02	46.86 ± 0.78	0.25 ± 0.02
Estragole					
DPPC: Est (100:0.25)	$34.28 \pm 0.15^*$	$5.31 \pm 0.08^*$	$40.02 \pm 0.04^*$	46.69 ± 1.74	$0.30 \pm 0^*$
DPPC: Est (100:0.5)	$34.1 \pm 0.19^*$	$3.46 \pm 0.7^*$	$39.99 \pm 0.06^*$	46.92 ± 0.69	$0.37 \pm 0^*$
DPPC: Est (100:1)			40.00 ± 0.16	45.04 ± 2.72	$0.42 \pm 0.09^*$
DPPC: Est (100:2.5)			$39.85 \pm 0.03^*$	45.70 ± 1.04	$0.53 \pm 0.05^*$
DPPC: Est (100:5)			$39.75 \pm 0.07^*$	$45.00 \pm 0.76^*$	$0.59 \pm 0.07^*$
DPPC: Est (100:10)			$38.39 \pm 0.24^*$	$42.29 \pm 0.59^*$	$1.73 \pm 0.11^*$
DPPC: Est (100:25)			$36.27 \pm 0.53^*$	$34.79 \pm 0.89^*$	$3.51 \pm 0.72^*$
<i>t</i>-Anethole					
DPPC: Ane (100:0.25)	$33.5 \pm 0.53^*$	$2.76 \pm 1.27^*$	$39.93 \pm 0.05^*$	44.63 ± 1.97	$0.44 \pm 0.06^*$

DPPC: Ane (100:0.5)	33.21 ± 1.02	2.73 ± 0.99*	39.96 ± 0.06*	41.06 ± 2.87*	0.45 ± 0.02*
DPPC: Ane (100:1)			39.61 ± 0.28*	41.10 ± 0.95*	0.73 ± 0.11*
DPPC: Ane (100:2.5)			38.72 ± 0.31*	38.81 ± 3.34*	1.30 ± 0.22*
DPPC: Ane (100:5)			38.87 ± 0.368	39.82 ± 0.57*	1.19 ± 0.13*
DPPC: Ane (100:10)			38.16 ± 0.28*	31.05 ± 1.94*	1.53 ± 0.01*
DPPC: Ane (100:25)			34.80 ± 0.03*	15.51 ± 0.24*	2.41 ± 0.24*
Eugenol					
DPPC: Eug (100:0.25)	33.59 ± 0.21*	2.57 ± 0.38*	39.92 ± 0.07*	45.82 ± 3.07	0.36 ± 0.01*
DPPC: Eug (100:0.5)			39.91 ± 0.07*	44.10 ± 1.75	0.38 ± 0.04*
DPPC: Eug (100:1)			39.76 ± 0.10*	44.59 ± 3.15	0.46 ± 0.06*
DPPC: Eug (100:2.5)			39.52 ± 0.12*	44.69 ± 2.1*	0.53 ± 0.05*
DPPC: Eug (100:5)			39.27 ± 0.6	44.97 ± 2.52	1.29 ± 0.09*
DPPC: Eug (100:10)			35.98 ± 0.27*	34.99 ± 0.11*	3.14 ± 0.17*
DPPC: Eug (100:25)			32.24 ± 1.06*	25.41 ± 0.24*	6.07 ± 0.72*
Isoeugenol					
DPPC: Iso-eug (100:0.25)			39.23 ± 0.22*	39.24 ± 1.88*	0.89 ± 0.07*
DPPC: Iso-eug (100:0.5)			39.14 ± 0.08*	35.59 ± 4.81*	1.27 ± 0.36*
DPPC: Iso-eug (100:1)			38.45 ± 0.50*	30.67 ± 1.43*	1.48 ± 0.40*
DPPC: Iso-eug (100:2.5)			38.41 ± 0.19*	26.15 ± 0.79*	1.27 ± 0.21*
DPPC: Iso-eug (100:5)			38.2 ± 0.82*	21.63 ± 1.68*	1.56 ± 0.34*
DPPC: Iso-eug (100:10)			37.46 ± 0.67*	20.20 ± 1.55*	1.94 ± 0.32*
DPPC: Iso-eug (100:25)			0*	0*	0*

Values are expressed as the means of three repetitions ± SD

*P<0.05 compared with the control value

3.3 Fluorescence anisotropy

Due to its low aqueous solubility, a DPH fluorescent probe is able to be anchored in the hydrophobic core of a lipid bilayer (Lakowicz 2006; Yengo & Berger 2010). Moreover, its depolarization property is influenced by the packing of the acyl chains (Trevors, 2003; Yengo & Berger, 2010). Thus, fluorescence anisotropy measurements of DPH-probe MLVs allow to give information about the organization of the membrane environment around the fluorescent probe thereby reflecting the effect of the drug on membrane fluidity (Reiner et al. 2013a).

Table 3 shows the DPH anisotropy values of blank and PP-loaded liposomes at 28, 41 and 50 °C, which correspond respectively to gel phase, main transition temperature of DPPC and liquid phase. Fig. 8 presents the effect of PPs on the DPH-fluorescence anisotropy values at various DPPC:PP molar ratios at 28, 41 and 50 °C. Compared to blank liposomes, the presence of PPs reduced significantly the DPH anisotropy values in the gel state at all molar ratios. A decrease was also observed at the transition phase and in the liquid crystalline phase in a concentration-dependent manner. Iso-eug showed the highest effect with respect to other PPs.

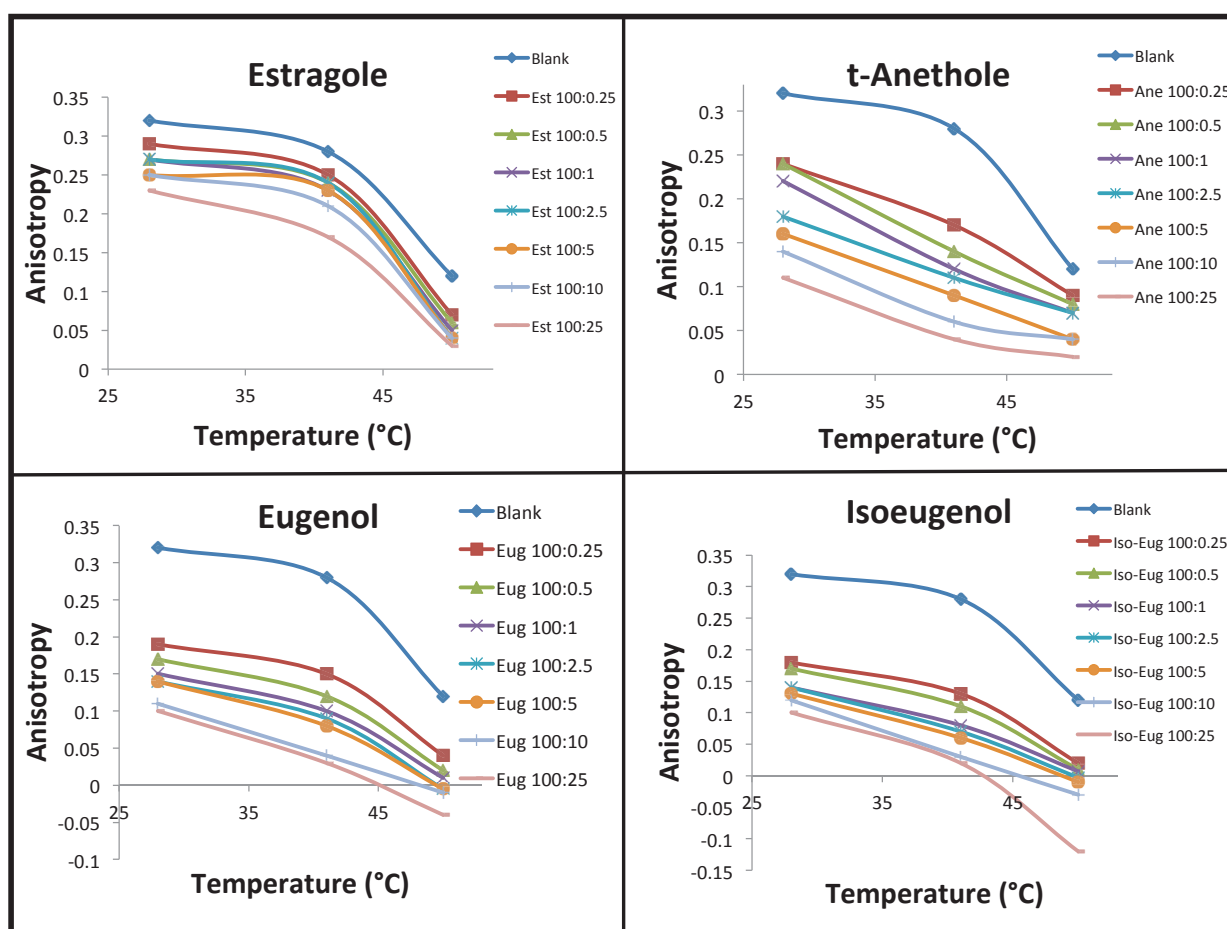

Fig. 8: Effect of Est, Ane, Eug and Iso-eug on DPH anisotropy in DPPC liposomes at different molar ratios at 28, 41 and 50 °C.

Table 3: DPH anisotropy values for blank and PPs-loaded DPPC MLVs at three temperatures.

MLVs	Anisotropy		
	28 °C	41 °C	50 °C
DPPC (100:0)	0.32 ± 0.00	0.27 ± 0.00	0.11 ± 0.000
Estragole			
DPPC:Est (100:0.25)	0.29± 0.000*	0.25 ± 0.00*	0.07 ± 0.000*
DPPC: Est (100:0.5)	0.27 ± 0.005*	0.24 ± 0.005*	0.06 ± 0.005*
DPPC: Est (100:1)	0.27 ±0.005*	0.23 ± 0.005*	0.05 ± 0.000 *
DPPC: Est (100:2.5)	0.27 ± 0.005*	0.24 ± 0.005*	0.04 ± 0.005*
DPPC: Est (100:5)	0.25 ± 0.011*	0.23 ± 0.011*	0.04 ± 0.005*
DPPC: Est (100:10)	0.25 ± 0.01*	0.21 ± 0.005*	0.04 ± 0.005*
DPPC: Est (100:25)	0.23 ± 0.005*	0.17 ± 0.01*	0.03 ± 0.005*
<i>t</i>-Anethole			
DPPC:Ane (100:0.25)	0.24 ± 0.005*	0.17 ± 0.00*	0.09 ± 0.00*
DPPC:Ane (100:0.5)	0.24 ± 0.00*	0.14 ± 0.005*	0.08 ± 0.005*
DPPC:Ane (100:1)	0.22 ±0.005*	0.12 ± 0.005*	0.07 ± 0.005*
DPPC:Ane (100:2.5)	0.18 ± 0.005*	0.11 ± 0.000*	0.07 ± 0.010*
DPPC:Ane (100:5)	0.16 ± 0.005*	0.09 ± 0.005*	0.04 ± 0.005*
DPPC:Ane (100:10)	0.14 ± 0.005*	0.06 ± 0.005*	0.04 ± 0.010*
DPPC:Ane (100:25)	0.11 ± 0.005*	0.04 ± 0.005*	0.02 ± 0.010*
Eugenol			
DPPC:Eug (100:0.25)	0.19 ± 0.005*	0.15 ± 0.005*	0.02 ± 0.010*
DPPC: Eug (100:0.5)	0.17 ± 0.005*	0.12 ± 0.005*	0.02 ± 0.000*
DPPC: Eug (100:1)	0.15 ±0.00*	0.10 ± 0.005*	0.01 ± 0.000*
DPPC: Eug (100:2.5)	0.14 ± 0.005*	0.09 ± 0.005*	-0.006 ± 0.002*
DPPC: Eug (100:5)	0.14 ± 0.00*	0.08 ± 0.010*	-0.005 ± 0.002*
DPPC: Eug (100:10)	0.11 ± 0.015*	0.04 ± 0.010*	-0.01 ± 0.005*
DPPC: Eug (100:25)	0.10 ± 0.011*	0.03 ± 0.010*	-0.04 ± 0.000*
Isoeugenol			
DPPC: Iso-eug (100:0.25)	0.18 ± 0.010*	0.13 ± 0.00*	0.02 ± 0.005*
DPPC: Iso-eug (100:0.5)	0.17 ± 0.010*	0.11 ± 0.005*	0.01 ± 0.005*
DPPC: Iso-eug (100:1)	0.14 ±0.005*	0.08 ± 0.005*	0.007 ± 0.001*

DPPC: Iso-eug (100:2.5)	0.14 ± 0.000*	0.07 ± 0.005*	-0.003 ± 0.000*
DPPC: Iso-eug (100:5)	0.13 ± 0.005*	0.06 ± 0.000*	-0.01 ± 0.000*
DPPC: Iso-eug (100:10)	0.12 ± 0.005*	0.03 ± 0.000*	-0.03 ± 0.011*
DPPC: Iso-eug (100:25)	0.10 ± 0.005*	0.01 ± 0.005*	-0.12 ± 0.005*

Values are expressed as the means of three repetitions ± SD

*P<0.05 compared with the control value

3.4 Antibacterial effect of PPs against *E. coli*

The percentages of inhibition of *E. coli* growth by PPs at various concentrations were calculated and plotted against PP concentration. Linear regression curves were fitted to the results; only concentrations giving a % of inhibition between 10% and 90% were used (Table 4). Half minimal inhibitory concentrations (IC50) were determined from linear region of the curves. Although bacterial growth inhibition is commonly reported as the minimal inhibitory concentration (MIC, the lowest concentration of drug that inhibits the growth of the organism), IC50 is also widely used giving more precise results (Soothill et al. 1992; Patel & Levitin 2014).

The four molecules showed important inhibition of *E. coli* ATCC 25922 growth in nutrient broth at concentrations in the hundreds micromolar range (Table 4). These values seem to be in the same range of activity of conventional antibiotics against *E. coli* (Patel & Levitin 2014).

Table 4: IC50 values of the studied PPs against *E. coli*.

PP	Range (µM)	Linear equation	r ²	IC50
Ane	125-500	y=0.0023x-0.2641	0.9757	330 ± 5%
Est	125-500	y=0.0019x-0.0719	0.9502	340 ± 9%
Eug	250-1000	y=0.0006+0.0122	0.9618	810 ± 5%
Iso-eug	250-1000	Y=0.0007x-0.0996	0.9562	925 ± 8%

4 Discussion

4.1 Interaction of PPs with the DPPC membranes and effect on the membrane fluidity

DPPC bilayers undergo phase transition upon increasing the temperature. DPPC in aqueous environment exists in two totally different phases known as L_α and L_β. The L_β crystalline form of DPPC corresponds to the gel phase while the L_α crystalline form corresponds to the liquid-crystalline phase. The transition from the gel phase to the liquid-crystalline phase can be done by

temperature rising (Gardikis et al. 2006b). Phosphatidylcholines with the choline polar head demonstrate an endothermic transition that happens prior to the main gel to liquid–crystalline transition. This thermotropic phenomenon is called pre-transition and creates bilayers with the lipid chains fully stretched and tilted ($L_{\beta'}$ phase). The tilt angle of the lipid chain is temperature dependable and is minimized at the pre-transition temperature. Then the crystalline phase is called ripple phase ($P_{\beta'}$) (Gardikis et al. 2006b; El Khoury & Patra 2016). DPPC liposome shows an expected pre-transition at 34.85 ± 0.04 °C, in accordance with the literature (Abboud et al. 2015; Natarajan et al. 2011). The pre-transition peak shifted then disappeared when PP was incorporated even at low DPPC:PP molar ratio of 100:0.25, indicating the interaction of PP with the polar head groups of phospholipids. This interaction is also proved by Raman spectroscopy where a change of the intensity of the peak at 715 cm^{-1} (Table 1) corresponding to C–N stretch vibrations of choline molecules was obtained (Gardikis et al. 2006a). Similar results were reported for Iso-eug, thymol, carvacol, p-cymen, γ -terpinene (Fujisawa et al. 1987; Cristani et al. 2007), limonene, perillaldehyde, perillyl alcohol and perillic acid (Duelund et al. 2012).

Changes of thermotropic parameters (ΔH_m , transition enthalpy; T_m , transition temperature) of lipid bilayers could be used for designing the location of drugs in the lipid bilayers (Matsingou et al. 2005). Blank liposomes show a sharp main transition (40.14 ± 0.02 °C), in accordance with published data (Abboud et al. 2015; Natarajan et al. 2011). PPs fluidized the membrane as their presence in liposomes produced a clear decrease of the T_m value. The same results were obtained for Eug (Fujisawa & Kadoma 1998; Fujisawa et al. 1987; Manabe et al. 1987) and Iso-eug (Fujisawa et al. 1987). Also, the DPH anisotropy results confirmed their fluidizing effect since a decrease of anisotropy values was obtained at various temperatures when compared to blank liposomes. These findings were in accordance with anisotropy results obtained in presence of phenol and Eug (Tsuchiya & Mizogami, Comparative Interactions of Anesthetic Alkylphenols with Lipid Membranes, 2014). Moreover, the increment of gauche/trans ratio (I_{1090}/I_{1130}) determined by Raman spectroscopy, suggests the incorporation of PPs molecules in the bilayers leading to an increase in the chain disorder, thereby raising the bilayer's fluidity.

Compared to the pure DPPC, $\Delta T_{1/2}$ increased in the presence of PPs in a concentration-dependent manner, indicating a disorder in lipid bilayers. The increase of the peak height intensity ratios I_{2935}/I_{2880} leads to an increase of the perturbation of the carbon-chain and the terminal methyl group of DPPC. This effect was noticed at all studied molar ratios for Ane and Iso-eug, suggesting that these PPs are deeply inserted in the lipid bilayer. Also, the broadening of the main transition peak was clearly observed in presence of the studied PPs at high molar ratios of DPPC

to PP. At the highest concentration of Iso-eug (DPPC:Iso-eug of 100:25), the main transition pic disappeared completely proving a change from more ordered liquid to more disordered liquid behavior caused by excessive drug incorporation (Natarajan et al. 2011). At this Iso-eug concentration, the observed effect was confirmed by liposomes destruction by Raman microscopy (Fig. 2f).

4.2 Antibacterial effect

The antibacterial assay against *E. coli* as model bacteria had given evidence that the four PPs possess a significant antibacterial effect at therapeutic concentrations. Interestingly, each couple of isomers presented similar half-minimal inhibitory concentrations. Growth inhibition by the isomers Ane and Est (IC₅₀ of 330 and 340 μ M respectively) was clearly higher than that by the isomers Eug and Iso-eug (IC₅₀ of 810 and 925 μ M, respectively). In addition, the linear equations describing the inhibition of *E. coli* with increasing concentration of PPs (Table 4) revealed that each couple of isomers presents similar slopes (0.0023 and 0.0019 for Ane and Est respectively, against 0.0006 and 0.0007 for Eug and Iso-eug respectively). This would suggest that Ane and Est present similar patterns of interaction with their target molecules that are obviously different than those of Eug and Iso-eug.

4.3 Structure-Activity relationship

Eug and Iso-eug depressed the pre-transition peak even at low concentration more than Est and Ane. This is due to the presence of phenolic hydroxyl group in Eug and Iso-eug. It has been demonstrated by RMN that Eug essentially affected the first hydrogen atoms in the choline group nearby the phosphate atom of egg phosphatidylcholine (Reiner et al. 2013b). Besides, compared to blank liposomes, T_m and ΔH_m decreased in presence of all the studied PPs. This indicates the intramolecular packing between PPs and the hydrophobic acyl chains of DPPC. The results are also in accordance with the values of I_{1090}/I_{1130} determined by Raman spectroscopy.

The ΔH_m values obtained for Iso-eug and Ane are lower than for Eug and Est, suggesting a deeper insertion of Iso-eug and Ane in the DPPC bilayer in comparison to Eug and Est. These results were confirmed by Raman spectroscopy, where the intensity ratio of I_{2935}/I_{2880} was more significant for Ane and Iso-eug. The location of double bond in the propenyl group seems to control drug incorporation.

Compared to blank liposomes, Iso-eug and Eug decreased the T_m values more than Ane and Est (Table 2). This is also in accordance with their highest effect on the anisotropy values at three

various temperatures where the effect was in the order: Iso-eug > Eug > Ane > Est (Table 3, Fig. 8).

The hydrophobicity is also another factor, which may affect the fluidizing and the antibacterial effect of many agents (Nazzaro et al. 2013). Indeed, the log P values of Eug, Iso-eug, Est and Ane were 1.89 (Reiner et al. 2009), 2.6 (Abe et al. 2011), 3.13 (Clare 2004) and 3.31 (Clare 2004) respectively. Our results demonstrated that the hydrophobicity is not the only factor that controls the fluidizing effect of PPs since a more fluidizing effect was observed for the less hydrophobic molecules, Eug and Iso-eug. The effect of PPs on cell membranes of microorganisms had been reported in literature by many authors (Nazzaro et al. 2013; Hyldgaard et al. 2012 & 2015; Faleiro 2011). It is suggested that PPs hydrophobicity enables them to accumulate in lipid bilayers constituting the cell membrane, and consequently alter the permeability of the bilayers (Burt & Reinders 2003; Sikkema et al. 1995; De Sousa et al. 2012). In our study, the most efficient PPs against *E. coli* were the most hydrophobic ones, Ane and Est. It could be explained by their enhanced penetrability through the lipophilic membranes of *E. coli*, a Gram-negative bacterium.

5 Conclusion

Different biophysical techniques applied in this study proved that the primary site of action of PPs in cells is the phospholipid membrane. All the studied PPs were able to fluidize the lipid bilayer; moreover, the presence of phenolic hydroxyl group in Eug and Iso-eug generated a greater fluidizing effect. All compounds interacted with the polar choline head groups and hydrophobic acyl chains of DPPC phospholipids, wherein Iso-eug and Ane incorporated deeply in the bilayer. Thus, the effect of PPs on the membrane is not only related to the hydrophobicity of the PP molecule. Ane and Est, the most hydrophobic among the studied PPs, were the most active against *E. coli* than Eug and Iso-Eug which demonstrated the most fluidizing effect. We conclude that the effect of PPs on the membrane is a common mechanism that is not related to the hydrophobicity of the PP molecule. Besides, other target sites may be involved in PPs antibacterial activity against Gram negative bacteria.

Acknowledgments

Authors are grateful to the Lebanese University for providing a scholarship to Riham Gharib, to the National Council for Scientific Research in Lebanon (CNRS-L) for supporting the research project and to the Agence Universitaire de la Francophonie (Programme de Cooperation Scientifique Inter-Universitaire, PCSI 2015-2017).

Conflict of Interest

The authors declare that they have no conflict of interest.

References

- Abboud R, Charcosset C, Greige-Gerges H (2015) Tetra- and Penta-Cyclic Triterpenes Interaction with Lipid Bilayer Membrane: A Structural Comparative Study. *J Membr Bio* DOI 10.1007/s00232-016-9871-8.
- Abe H, Kimura A, Shigehisa M (2011). Patent No. US 20110015421 A1.
- Bachiega TF, De Sousa JPB, Bastos JK, Sforcin JM (2012) Clove and eugenol in noncytotoxic concentrations exert immunomodulatory/antiinflammatory action on cytokine production by murine macrophages. *J Pharm Pharmacol* 64:610-616.
- Bangham AD, Standish MM, Watkins JC (1965) Diffusion of univalent ions across the lamellae of swollen phospholipids. *J Mol Biol* 13:238-252.
- Baskaran Y, Periyasamy V, Venkatraman AC (2010) Investigation of antioxidant, anti-inflammatory and DNA-protective properties of eugenol in thioacetamide-induced liver injury in rats. *Toxicol* 268:204-212.
- Burt SA, Reinders RD (2003) Antibacterial activity of selected plant essential oils against *Escherichia coli* O157:H7. *Lett Appl Microbiol* 36:162-167.
- Clare JR (2004). Patent No. US6723687 B2
- Cristani M, D'Arrigo M, Mandalari G (2007) Interaction of four monoterpenes contained in essential oils with model membranes: implications for their antibacterial activity. *J Agric Food Chem* 55:6300-6008.
- de Cássia da Silveira E Sá R, Andrade LN, Dos Reis Barreto de Oliveira R, de Sousa DP (2014) A review on antiinflammatory activity of phenylpropanoids found in essential oils. *Molecules* 19:1459-1480.
- De Sousa JP, de Araújo Torres R, Alves de Azerêdo G, Queiroz Figueiredo BRC, da Silva Vasconcelos MA, Leite de Souza E (2012) Carvacrol and 1,8-cineole alone or in combination at sublethal concentrations induce changes in the cell morphology and membrane permeability of *Pseudomonas fluorescens* in a vegetable-based broth. *Int J Food Microbiol* 158: 9-13.
- Di Pasqua R, Betts G, Hoskins N, Edwards M, Ercolini D, Mauriello G (2007) Membrane toxicity of antimicrobial compounds from essential oils. *J Agricul Food Chem* 55:4863-4870.
- Di Pasqua R, Hoskins N, Betts G, Mauriello G (2006) Changes in membrane fatty acids composition of microbial cells induced by addiction of thymol, carvacrol, limonene, cinnamaldehyde, and eugenol in the growing media. *J Agricul Food Chem* 54:2745-2749.

- Diao WR, Hu QP, Zhang H, Xu JG (2014) Chemical composition, antibacterial activity and mechanism of action of essential oil from seeds of fennel (*Foeniculum vulgare* Mill.). *Food Control* 35:109-116.
- Duelund L, Amiot A, Fillon A, Mouritsen OG (2012) Influence of the Active Compounds of *Perilla frutescens* Leaves on Lipid Membranes. *J Nat Prod* 75:160-166.
- El Khoury E, Patra D (2016) Length of hydrocarbon chain influences location of curcumin in liposomes: Curcumin as a molecular probe to study ethanol induced interdigitation of liposomes. *J Photochem Photobiol B* 158:49-54.
- El Maghraby GM, Williams AC, Barry BW (2005) Drug interaction and location in liposomes: correlation with polar surface areas. *Int J Pharm* 292:179-185.
- Faleiro ML (2011) The mode of antibacterial action of essential oils. *Science against Microbial Pathogens: Communicating Current Research and Technological Advances* 3:1143-1156.
- Ferrer JL, Austin MB, Stewart Jr. C, Noel JP (2008) Structure and function of enzymes involved in the biosynthesis of phenylpropanoids. *Plant Physiol Biochem* 46:356-370.
- Fox CB, Uibel RH, Harris JM (2007) Detecting phase transitions in phosphatidylcholine vesicles by Raman microscopy and selfmodeling curve resolution. *J Physical Chem B* 111:11428-11436.
- Freire RS, Morais SM, Catunda-Junior FE, Pinheiro DC (2005) Synthesis and antioxidant, anti-inflammatory and gastroprotector activities of anethole and related compounds. *Bioorg Med Chem* 13:4353-4358.
- Fujisawa S, Kadoma Y (1998) H NMR Spectroscopic Studies of the Interaction of Thymol with Phospholipid Liposomes. *Dental Mater J* 17:139-147.
- Fujisawa S, Kadoma Y, Masuhara E (1987) A calorimetric study of the interaction of synthetic phospholipid liposomes with lipid-soluble small molecules used as dental materials and devices. *J Biomed Mater Res* 21:89-98.
- Gardikis K, Hatziantoniou S, Viras K, Demetzos C (2006a) Effect of a bioactive curcumin derivative on DPPC membrane: A DSC and Raman spectroscopy study. *Thermochim Acta* 447:1-4.
- Gardikis K, Hatziantoniou S, Viras K, Wagner M, Demetzos C (2006b) A DSC and Raman spectroscopy study on the effect of PAMAM dendrimer on DPPC model lipid membranes. *Int J Pharm* 318:118-123.
- Gary W, Darryl H, Nigel C (2014) zoo animal and wildlife immobilization and anesthesia.

- Gill AO, Holley RA (2006) Disruption of *Escherichia coli*, *Listeria monocytogenes* and *Lactobacillus sakei* cellular membranes by plant oil aromatics. *Int J Food Microbiol* 108:1-9.
- Hemaiswarya S, Doble M (2009) Synergistic interaction of eugenol with antibiotics against Gram negative bacteria. *Phytomedicine* 16:997-1005.
- Hyldgaard M, Mygind T, Meyer RL (2012) Essential oils in food preservation: mode of action, synergies, and interactions with food matrix components. *Front Microbiol* 3:12.
- Hyldgaard M, Mygind T, Piotrowska R, Foss M, Meyer RL (2015) Isoeugenol has a non-disruptive detergent-like mechanism of action. *Front Microbiol* 28:754.
- Jirovetz L., Buchbauer G, Stoilova I, Stoyanova A, Krastanov A, Schmidt E (2006) Chemical composition and antioxidant properties of clove leaf essential oil. *J Agric Food Chem* 54:6303-6307.
- Jung HG, Fahey GC (1983) Nutritional implications of phenolic monomers and lignin: A review. *J Anim Sci* 57:206-219.
- Kang P, Kim KY, Lee HS, Min SS, Seol GH (2013) Anti-inflammatory effects of anethole in lipopolysaccharide-induced acute lung injury in mice. *Life Sci* 93:955-961.
- Koeduka T (2014) The phenylpropane synthase pathway and its applications in the engineering of volatile phenylpropanoids in plants. *Plant Biotech* DOI: 10.5511/plantbiotechnology.14.0801a.
- Laekeman GM, VanHoof L, Haemers A, Berghe DAV, Herman AG, Vlietinck AJ (1990) Eugenol a valuable compound for in vitro experimental research and worthwhile for further in vivo investigation. *Phytotherapy Research* 4:90-96.
- Lakowicz JR (2006) Principles of fluorescence spectroscopy. 3rd edn. Springer, New York.
- Manabe A, Nakayama S, Sakamoto K (1987) Effects of Essential Oils on Erythrocytes and Hepatocytes from Rats and Dipalmitoyl Phosphatidylcholine-Liposomes. *Jpn J Pharmacol* 44:77-84.
- Matsingou C, Hatziantoniou S, Georgopoulos A, Dimas K, Terzis A, Demetzos C (2005) Labdane-type diterpenes: thermal effects on phospholipid bilayers, incorporation into liposomes and biological activity. *Chem Physic Lipids* 138:1-11.
- Miladi H, Chaieb K, Ammar E, Bakhrouf A (2010) Inhibitory effect of clove oil (*Syzygium aromaticum*) against *Listeria Monocytogenes* cells incubated in fresh-cut salmon. *J Food Safety* 30:432-442.
- Natarajan JV, Chattopadhyay S, Ang M, Darwitan A, Foo S, Zhen M, Koo M, Wong TT, Venkatraman SS (2011) Sustained Release of an Anti-Glaucoma Drug: Demonstration of

- Efficacy of a Liposomal Formulation in the Rabbit Eye. PLoS One doi: 10.1371/journal.pone.0024513.
- Nazzaro F, Fratianni F, De Martino L, Coppola R, De Feo V (2013) Effect of essential oils on pathogenic bacteria. *Pharmaceuticals* 6:1451-1474.
- Orav A, Raal A, Arak E (2008) Essential oil composition of *Pimpinella anisum* L. fruits from various European countries. *Nat Prod Res* 22:227-232.
- Pasay C, Mounsey K, Stevenson G, Davis R, Arlian L, Morgan M, Vyszynski-Moher D, Andrews K, McCarthy J (2010) Acaricidal activity of eugenol-based compounds against scabies mites. *PLoS ONE* 5: e12079.
- Patel T, Levitin A (2014) *Escherichia Coli* Adaptive Resistance to Clinical Antibiotics. *JSM Microbiol* 2:1-5.
- Pauli A, Kubeczka KH (2010) Antimicrobial properties of volatile phenylpropanes. *Nat Prod Commun* 5:1387-1394.
- Potamitis C, Chatzigeorgiou P, Siapi E, Viras K, Mavromoustakos T, Hodzic A, Pabst G, Cachon-Nerin F, Laggner P, Rappolt M (2011) Interactions of the AT1 antagonist valsartan with dipalmitoyl-phosphatidylcholine bilayers. *Biochem Biophys. Acta* 1808:1753-1763.
- Reiner GN, Delgado-Marín L, Olguín N, Sánchez-Redondo S, Sánchez-Borzzone M, Rodríguez-Farré E, Suñol C, García DA (2013b) GABAergic pharmacological activity of propofol related compounds as possible enhancers of general anesthetics and interaction with membranes. *Cell Bioch Biophys* 67:515-525.
- Reiner GN, Fraceto LF, de Paula E, Perillo MA, García DA* (2013) Effects of Gabaergic Phenols on Phospholipid Bilayers as Evaluated by ¹H-NMR. *J Biomater Nanobiotechnol* 4:28-34.
- Reiner GN, Labuckas DO, García DA (2009) Lipophilicity of some GABAergic phenols and related compounds determined by HPLC and partition coefficients in different systems. *J Pharm Biomed Anal* 49:686-691.
- Senatore F, Oliviero F, Scandolera E, Tagliatalata-Scafati O, Roscigno G, Zaccardelli M, De Falco E (2013) Chemical composition, antimicrobial and antioxidant activities of anethole-rich oil from leaves of selected varieties of fennel [*Foeniculum vulgare* Mill. ssp. *vulgare* var. *azoricum* (Mill.) Thell]. *Fitoterapia* 90:214-219.
- Sikkema J, DeBont JAM, Poolman B (1995) Mechanisms of membrane toxicity of hydrocarbons. *Microbiol Rev* 59:201-222.

- Smith RL, Cohen SM, Doull J, Feron VJ, Goodman JI, Marnett LJ, Munro IC, Portoghese PS, Waddell WJ, Wagner BM, Adams TB (2005) Criteria for the safety evaluation of flavoring substances – The Expert Panel of the Flavor and Extract Manufacturers Association. *Food Chem Toxicol* 43:1141-1177.
- Soothill JS, Ward R, Girling AJ (1992) The IC50: an exactly defined measure of antibiotic sensitivity. *J Antimicrob Chemother* 29:137-139.
- Trevors JT (2003) Fluorescent probes for bacterial cytoplasmic membrane research.. *J Biochem Biophys Methods* 57,87–103.doi:10.1016/S0165- 022X(03)00076-9.
- Tsuchiya H (2015) Membrane Interactions of Phytochemicals as Their Molecular Mechanism Applicable to the Discovery of Drug Leads from Plants. *Molecules* 20:18923-18966.
- Tsuchiya H, Mizogami M (2014) Comparative Interactions of Anesthetic Alkylphenols with Lipid Membranes. *Open J Anesthesiol* 4:308-317.
- Walsh SE, Maillard JY, Russell AD, Catrenich CE, Charbonneau DL, Bartolo RG (2003) Activity and mechanisms of action of selected biocidal agents on Gram-positive and-negative bacteria. *J Appl Microbiol* 94:240-247.
- Yengo CM, Berger CL (2010) Fluorescence anisotropy and resonance energy transfer: powerful tools for measuring real time protein dynamics in a physiological environment. *Curr Opin Pharmacol* 10:731-737.
- Zeller A, Horst K, Rychlik M (2009) Study of the metabolism of estragolein humans consuming fennel tea. *Chem Res Toxicology* 22:1929-1937

Effect of eucalyptol, pulegone, terpineol and thymol on DPPC membrane fluidity: role of the structure

Riham Gharib^{1,2}, Lizette Auezova¹, Catherine Charcosset², H  l  ne Greige-Gerges¹.

¹Faculty of Sciences, Bioactive Molecules Research Group, Doctoral School of Sciences and Technologies, Jdaidet El-Matn, Lebanese University, Lebanon.

²Laboratoire d'Automatique et de G  nie des Proc  d  s, Universit   Claude Bernard Lyon 1, France.

To be submitted

Abstract

The interaction of four monoterpenes (MTs) (Eucalyptol, Pulegone, Terpineol, and Thymol) with dipalmitoylphosphatidylcholine (DPPC) liposomes was studied by Raman spectroscopy, differential scanning calorimetry and fluorescence anisotropy. Liposomes were prepared by the thin film hydration method at DPPC:MT molar ratios ranging from 100:0 to 100:25. The studied MTs interacted with the head groups and the alkyl chains of DPPC membrane leading to an increase in the disorder of the bilayer. The presence of a hydroxyl group in the MT structure seems to favor the MT effect. A mixture of isomers of Terpineol fluidized the membrane more than α -Terpineol. Euc may intercalate in the bilayer while Ter, Thy and Pul can rather substitute the lipid membrane components.

Keywords: DPPC membrane, DSC, Fluidity, Fluorescence anisotropy, Monoterpenes, Raman spectroscopy.

Abbreviations: DPH: 1,6-diphenyl-1,3,5-hexatriene; DPPC: dipalmitoyl phosphatidylcholine; DSC: differential scanning calorimetry; Euc : eucalyptol; MT : monoterpenes ; Pul: pulegone ; Ter: terpineol ; Ter M : terpineol mixture of isomers; Thy : thymol.

1 Introduction

Monoterpenes (MTs) are components of the volatile essence of flowers and constitute more 90% of the essential oils of herbs and spices (Bakkali et al., 2007). They are formed of two isoprene units giving different forms of monoterpenes skeleton that builds up to a distinctive type of monoterpenes by attachment to different functional groups (alcohol, ketone, acetate, carbonyl group, ether, phenol...) (Thakur et al., 2006; Degenhardt et al., 2009). MTs can be subdivided into 'acyclic', 'monocyclic' and 'bicyclic' categories based on the number of carbon-rings (Guimarães et al., 2013). Terpenes of natural origin have a 'Generally Regarded As Safe' (GRAS) status with the Federal Drug Administration of the United States of America (Thakur et al., 2006). Because of their flavoring effect, fragrance and biological importance, these molecules have found their way to be a part of everyday life, through food, cosmetics and pharmaceutical products. They defend many species of plant, animals and microorganisms against herbivores and pathogens (Gershenzon and Dudareva, 2007).

Herein, eucalyptol (Euc) a bicyclic ether, pulegone (Pul) a monocyclic ketone, α -terpineol (Ter), a monocyclic alcohol alone and in mixture of isomers (Ter M) and Thymol (Thy) a phenol (Figure 1), are included in this study. In nature, the isomeric compounds α -Ter, β -Ter and γ -Ter are among the most abundant Ter and often occur together in mixtures (Cornmell et al., 2016). These MTs possess antimicrobial, anti-oxidant and anti-inflammatory activities (Park et al., 2012; Salehi et al., 2005; Karpanen et al., 2008; Beena et al., 2013; Santos et al., 2004; Riella et al., 2012) and are widely used as flavoring agents, in perfumery, and in aromatherapy (Harborne and Baxter, 2001; Burdock, 2010).

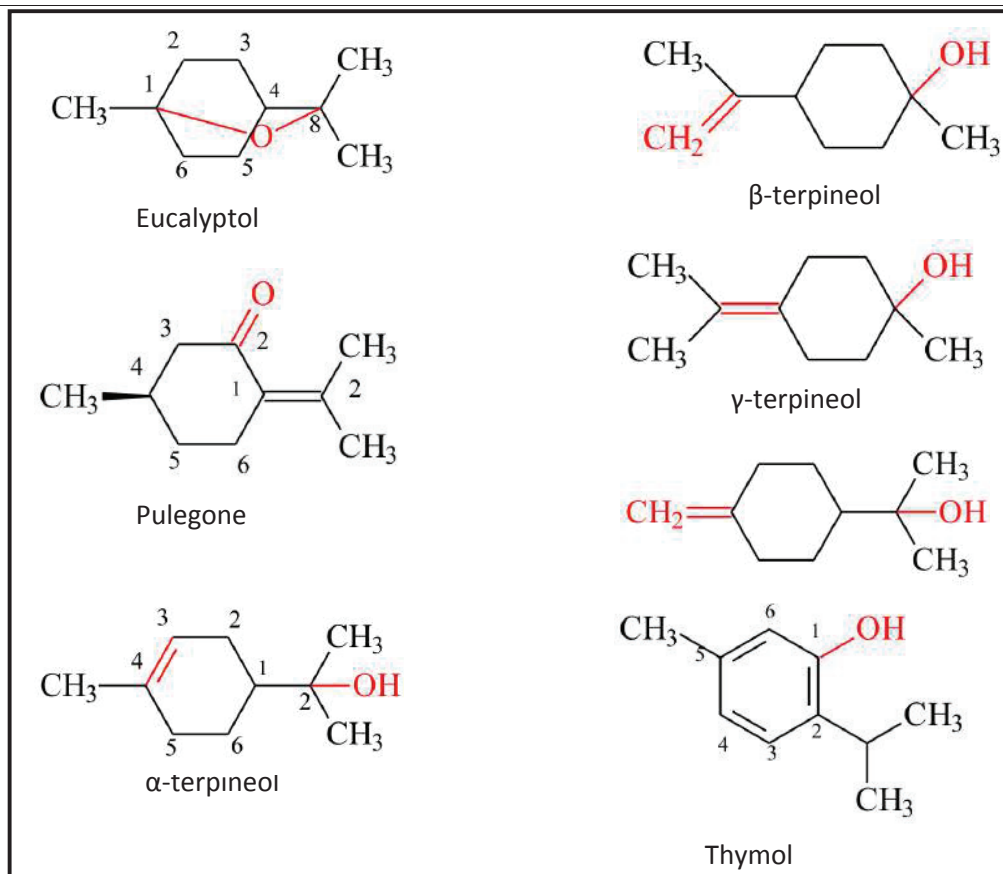

Figure 1: Chemical structure of eucalyptol, pulegone, α -terpineol, β -terpineol, γ -terpineol, δ -terpineol and Thymol.

The antimicrobial activity of the essential oils may result from their lipophilic character; monoterpenes preferentially partition from an aqueous phase into the lipid membranes (Sikkema et al. 1994; 1995). This may lead to an increase in membrane fluidity (Di Pasqua et al., 2006) and permeability (Cristani et al., 2007), disturbance of membrane-embedded proteins, inhibition of respiration and alteration of ion transport processes (Turina et al., 2006; Gill et al., 2006). The hydroxyl group of Thy is essential for its antimicrobial activity. Moreover, it has been reported that the presence of delocalized electrons in the MT structures enhances their antimicrobial action (Nazzaro et al. 2013). Thy induces alterations in the cytoplasmic membrane (Sikkema et al. 1995) and Euc increases membrane permeability and induces the loss of bacterial envelope integrity, which ultimately leads to cell death (De Sousa et al. 2012). Ter enhances cellular protein leakage in Gram-negative and Gram-positive bacteria (Oyedemi et al. 2009).

However, detailed biophysical analysis of the interaction of MTs with membranes has not been

performed yet; moreover the physicochemical properties of MTs that may modulate their interaction with lipid membranes are not discussed previously.

In this study, MTs presenting ether (Euc), ketone (Pul) or alcohol group (Ter, Thy) are included and studied for their interaction with lipid membranes. The latter are used as models to study the interaction and the effect of active molecules on lipid bilayer properties (Abboud et al., 2015; Habib et al., 2015). DPPC liposomes are prepared by the thin film hydration method in the absence and presence of selected molecules at various DPPC:MT molar ratios. The characteristics of the obtained liposomes were investigated by differential scanning calorimetry (DSC), Raman spectroscopy and fluorescence anisotropy of 1,6-diphenyl-1,3,5-hexatriene (DPH). Results related to the effect of MTs on the membrane fluidity are analyzed with respect to the structure and the hydrophobicity of MTs.

2 Materials and methods

2.1 Materials

DPPC was from Lipoid GmbH (Germany). (+)- α -Terpineol and pulegone were purchased from Sigma-Aldrich (Switzerland), terpineol mixture of isomers (α -Terpineol (55%); γ -Terpineol (23%); trans- β -Terpineol (13); cis- β -Terpineol (10%); δ -Terpineol (1%)) from Sigma-Aldrich (India), eucalyptol and tetrahydrofuran from Sigma-Aldrich (USA) and Thymol from Sigma-Aldrich (Germany). Chloroform, methanol and the buffer reagent Trizma base were from Sigma-Aldrich (France), HCl from VWR (France) and 1,6-diphenyl-1,3,5-hexatriene was from Across organics (USA).

2.2 Preparation of liposomes

MLVs were prepared by the thin film hydration technique (Bangham et al. 1965). DPPC and MT were mixed in molar ratios of 100:0; 100:0.25; 100:0.5; 100:1; 100:2.5; 100:5; 100:10, and 100:25. DPPC (25 mg/ml) and MT were solubilized in a solvent mixture of chloroform:methanol 2:1 (v/v). The preparation was then evaporated in a rotary evaporator (BÜCHI Rotavapor R-124) to form a thin lipid film. The latter was then hydrated with 2 ml of Tris-HCl 0.1 M (pH 7.4) under mechanical stirring for 5 min in a water bath at 55 °C for 5 min. The cycle was repeated three times. The batch prepared at DPPC:MT molar ratio of 100:0 was considered as blank. For each DPPC:MT molar ratio, liposomes were prepared in triplicate.

2.3 Differential scanning calorimetry

DSC was performed using a DSC Q200 scanning calorimeter (TA Instruments, France). The scanning rate employed was 1 °C/min in a temperature range of 20–50 °C. The reference pan was filled with Tris-HCl 0.1 M (pH 7.4) buffer solution. The samples (10 µL) were encapsulated in hermetically sealed standard aluminum DSC pans. Enthalpies and temperature were evaluated from the DSC peak using the software of the TA processor.

The measured parameters were as follows: the transition temperature (T_m) determined from the maximum of the recorded heat capacity, the transition enthalpy (ΔH_m) obtained from the area under the peak, the pre-transition temperature and enthalpy (T_p and ΔH_p respectively), and the temperature width at half peak height ($\Delta T_{1/2}$) which measures the sharpness of the phase transition. This latter is very sensitive to the presence of any additives. It is taken as a measure for the cooperativity of the transition. $\Delta T_{1/2}$ is inversely proportional to the cooperativity (El Maghraby et al., 2005).

2.4 Raman spectroscopy

The Raman spectra were recorded with a LabRAM HR 800 (Horiba Jobin Yvon, Villemeuve d'Ascq, France) at Ecole Centrale de Lyon (Ingénierie et vieillissement des tissus vivants (IVTV) ANR-10-EQPX-06-01) equipped with a detector 1024x256 pixel. A laser power at 633 nm was used as excitation source. The spectra were obtained at wavenumbers ranging from 3100 to 600 cm^{-1} , at a resolution of 1 cm^{-1} . The laser power was controlled to be constant at within 12mW during the experiments. Analysis of the spectra was carried out using a LabSpec software. An aliquot from the liposomal suspensions (10-15 µL) was used for the Raman spectroscopy. Experiments were held at 25 °C in order to assess the change of the interaction between DPPC and MT. An integrated camera was employed to acquire images of trapped vesicles (LxH=760x628 pixels).

2.5 Fluorescence anisotropy measurements

Membrane fluidity changes of liposomes were measured by steady state fluorescence polarization using a Cary Eclipse Fluorescence Spectrophotometer (Agilent technologies). DPH was dissolved in tetrahydrofuran (THF) to obtain a concentration of 4.3 mM. An aliquot of DPH solution was then added to the liposome suspension prepared as described above, to obtain a DPH:phospholipid molar ratio of 1:500. The mixture was incubated overnight in the dark to allow the intercalation of the DPH molecules into the lipid bilayer. The final concentration of

THF did not exceed 0.01% and showed to have no effect on the fluorescence anisotropy (Whiting et al., 2000). The experiments were performed at 28, 41 and 50 °C. The probe was excited with a manual polarizer accessory (Cary Eclipse Manual Polarizer, (Agilent technologies)), using vertically polarized light at 360 nm. The emission intensities were measured at 450 nm parallel and perpendicular to the plane of the excitation beam yielding components I_{VV} and I_{VH} , respectively. The Cary Eclipse Bio Software, delivered from the spectrophotometer, gives the fluorescence anisotropy (R), which is defined as:

$$R = \frac{I_{\parallel} - I_{\perp}}{I_{\parallel} + 2I_{\perp}}$$

Where I_{\parallel} and I_{\perp} are the fluorescence intensities of the light emitted with its polarization plane parallel (\parallel) and perpendicular (\perp) to that of the exciting beam.

2.6 Statistical analysis

Statistical analysis was performed using the Student T-test. P values equal or less than 0.05 were considered statistically significant.

3 Results

3.1 Raman spectroscopy

The Raman microscopy allowed visualizing blank and MT-loaded liposomes. The images showed the formation of nano- and micrometric spherical vesicles in all batches. Figure 2 shows examples of the images of blank (A) and MT-loaded liposomes prepared at a DPPC:MT molar ratio of 100:25 (B, C, D, E, and F for Euc, Pul, Ter, Ter M, and Thy respectively). Similar images were obtained at lowest DPPC:MT molar ratios. Table 1 resumes the Raman results of DPPC:MTs.

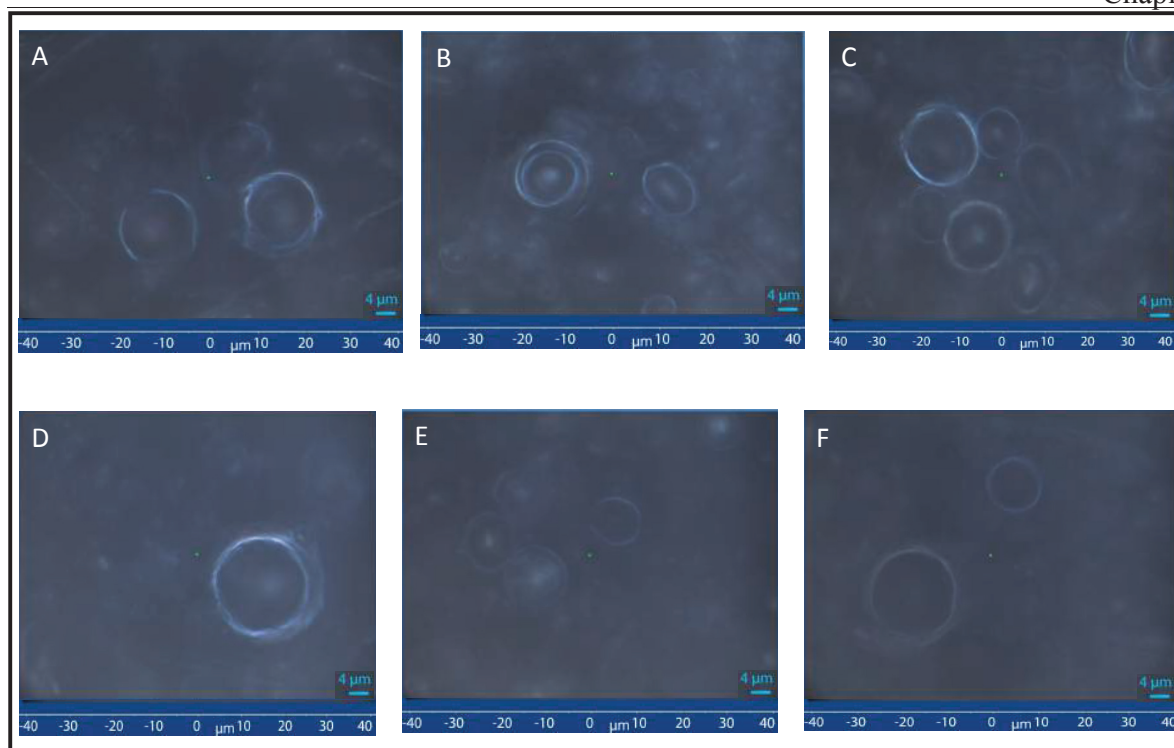

Figure 2: DPPC liposome trapping images for Blank (A), Euc 100:25 (B), Pul 100:25(C), Ter 100:25 (D), Ter M 100:25 (E) and Thy100:25 (F).

Table 1: Height intensity and intensity ratios for Raman peaks of blank- and MT loaded- DPPC vesicles.

MLVs	I_{750}	I_{1100}/I_{1130}	I_{2850}/I_{2880}	I_{2935}/I_{2880}
DPPC (100:0)	448 ± 31	0.61 ± 0.01	1.01 ± 0.04	0.43 ± 0.008
Eucalyptol				
DPPC: Euc (100:0.25)	487 ± 36	0.61 ± 0.01	1.07 ± 0.0	0.44 ± 0.01
DPPC: Euc (100:0.5)	$373 \pm 13^*$	0.62 ± 0.02	1.07 ± 0.01	0.44 ± 0.01
DPPC: Euc (100:1)	$591 \pm 57^*$	0.62 ± 0.04	1.08 ± 0.01	0.44 ± 0.00
DPPC: Euc (100:2.5)	402 ± 37	$0.64 \pm 0.01^*$	1.07 ± 0.00	0.44 ± 0.01
DPPC: Euc (100:5)	$306 \pm 52^*$	$0.68 \pm 0.02^*$	$1.09 \pm 0.01^*$	0.44 ± 0.01
DPPC: Euc (100:10)	$363 \pm 32^*$	$0.69 \pm 0.01^*$	$1.09 \pm 0.01^*$	0.44 ± 0.00
DPPC: Euc (100:25)	$359 \pm 18^*$	$0.72 \pm 0.03^*$	$1.09 \pm 0.01^*$	0.45 ± 0.01
Pulegone				
DPPC: Pul (100:0.25)	448 ± 78	0.62 ± 0.02	1.08 ± 0.04	0.43 ± 0.01
DPPC: Pul (100:0.5)	431 ± 37	0.62 ± 0.01	1.05 ± 0.01	0.44 ± 0.00

DPPC: Pul (100:1)	427 ± 55	0.64 ± 0.04	1.06 ± 0.00	0.45 ± 0.01
DPPC: Pul (100:2.5)	349 ± 31*	0.65 ± 0.01*	1.07 ± 0.02*	0.45 ± 0.00
DPPC: Pul (100:5)	337 ± 60*	0.66 ± 0.01*	1.08 ± 0.00*	0.45 ± 0.01
DPPC: Pul (100:10)	344 ± 40*	0.68 ± 0.04*	1.08 ± 0.01*	0.48 ± 0.00*
DPPC: Pul (100:25)	302 ± 42*	0.74 ± 0.01*	1.1 ± 0.01*	0.48 ± 0.02*
Terpineol				
DPPC: Ter (100:0.25)	461.04 ± 21	0.61 ± 0.01	1.03 ± 0.00	0.44 ± 0.01
DPPC: Ter (100:0.5)	395 ± 33	0.68 ± 0.01*	1.04 ± 0.02	0.44 ± 0.00
DPPC: Ter (100:1)	363 ± 30*	0.66 ± 0.03	1.04 ± 0.04	0.45 ± 0.00
DPPC: Ter (100:2.5)	308 ± 35*	0.68 ± 0.02*	1.03 ± 0.01	0.46 ± 0.01*
DPPC: Ter (100:5)	318 ± 20*	0.70 ± 0.02*	1.06 ± 0.01	0.47 ± 0.03
DPPC: Ter (100:10)	94 ± 15*	0.76 ± 0.01*	1.07 ± 0.01*	0.50 ± 0.01*
DPPC: Ter (100:25)	182 ± 27*	0.84 ± 0.03*	1.08 ± 0.01*	0.53 ± 0.03*
Terpineol M				
DPPC: Ter M (100:0.25)	352 ± 51*	0.65 ± 0.01*	1.06 ± 0.01	0.44 ± 0.01
DPPC: Ter M (100:0.5)	376 ± 18*	0.67 ± 0.02*	1.07 ± 0.00	0.44 ± 0.00
DPPC: Ter M (100:1)	358 ± 48 *	0.69 ± 0.03*	1.05 ± 0.01	0.44 ± 0.01
DPPC: Ter M (100:2.5)	344 ± 37*	0.71 ± 0.01*	1.07 ± 0.01	0.44 ± 0.01
DPPC: Ter M (100:5)	384 ± 12*	0.73 ± 0.02*	1.07 ± 0.01	0.44 ± 0.00
DPPC: Ter M (100:10)	354 ± 22*	0.77 ± 0.04*	1.07 ± 0.00	0.45 ± 0.01
DPPC: Ter (100:25)	220 ± 71*	0.87 ± 0.01*	1.07 ± 0.00*	0.45 ± 0.01
Thymol				
DPPC: Thy (100:0.25)	571 ± 25*	0.71 ± 0.01*	1.03 ± 0.02	0.45 ± 0.00
DPPC: Thy (100:0.5)	541 ± 40*	0.76 ± 0.02*	1.03 ± 0.01	0.45 ± 0.00
DPPC: Thy (100:1)	327 ± 7*	0.68 ± 0.00*	1.03 ± 0.00	0.44 ± 0.02
DPPC: Thy (100:2.5)	297 ± 15*	0.75 ± 0.4*	1.04 ± 0.00	0.44 ± 0.02
DPPC: Thy (100:5)	262 ± 15*	0.77 ± 0.02*	1.05 ± 0.00	0.44 ± 0.00
DPPC: Thy (100:10)	145 ± 32*	0.85 ± 0.03*	1.04 ± 0.00	0.46 ± 0.00*
DPPC: Thy (100:25)	71 ± 0*	0.93 ± 0.01*	1.03 ± 0.00	0.57 ± 0.03*

Values are expressed as the means of three repetitions ± SD

* P<0.05 compared with the control value

The pure DPPC spectrum exhibits three characteristic areas from which useful information can be extracted regarding the conformation of the DPPC molecules. These areas are 1) 2800–3000 cm^{-1} , 2) 1000–1200 cm^{-1} and 3) 700–800 cm^{-1} .

Area 1 contains the peaks at 2844 and 2880 cm^{-1} , which correspond to the symmetrical and asymmetrical vibration, respectively, of stretching of the C-H bond of the methylene groups. Area 1 also contains the peak at 2935 cm^{-1} , which is attributed to the symmetrical vibration of stretching of the C-H bond of the final methyl group of the alkyl chain. The bands of area 1 are commonly used to monitor changes in the lateral packing properties and mobility of the lipid chains for the bilayer system (Potamitis et al. 2011).

The height intensity ratios I_{2935}/I_{2880} and I_{2844}/I_{2880} give useful information on the acyl chains interaction. I_{2935}/I_{2880} measures the effects originating from changes both in interchain and intrachain processes in the bilayer. It has been used as an overall indicator of both intramolecular (gauche/trans ratio) and intermolecular (packing order) interaction; as this ratio increases, more freedom of motion and rotational disorders are detected (Fox et al. 2007). In our study, the intensity ratio was unchanged in presence of Euc and Ter M at all DPPC:MT molar ratios. While, a significant increment in the rotational disorder of DPPC membrane was obtained in the presence of Ter (at molar ratios DPPC:Ter of 100:2.5, 100:10 and 100:25), Pul and Thy (at molar ratios DPPC:MT of 100:10 and 100:25) (Table 1).

I_{2844}/I_{2880} describes the main changes occurring in the hydrocarbon chain region of the lipids. It is sensitive to subtle changes in conformational order from rotations, kinks, twists, and bends of the lipid chains (Potamitis et al. 2011). Compared to blank liposomes, an increase of the ratio I_{2844}/I_{2880} was observed in the presence of Euc (from molar ratio 100:5), Pul (from 100:2.5), Ter (at molar ratios 100:10 and 100:25) and Ter M (at DPPC: Ter M molar ratio of 100:25). While no variation was observed in the presence of Thy (Table 1).

The area 2 includes the stretching vibrations of the C-C bonds of the alkyl chains of the phospholipids. The peak at 1130 cm^{-1} is attributed to the stretching vibration of the C-C bond for the *trans*-conformations of the alkyl chains, while the peak at 1090 cm^{-1} is attributed to the stretching vibration of the C-C bond for the *gauche* conformations of the alkyl chains. The height intensity ratio of these peaks, I_{1090}/I_{1130} provides information about the proportion between disorder and order that exists in the conformation of the alkyl chain. The effect was significant for Euc, Pul and Ter starting from DPPC:MT molar ratio of 100:2.5 and for Ter M and Thy at all molar ratios.

The area 3 contains the peak at 715 cm^{-1} , which represents the stretching vibration of the C-N bond of the choline group of DPPC (Gardikis et al., 2006). All the components were able to modify in a significant manner the intensity of this peak. The dramatic variation was obtained with Ter and Thy especially at highest DPPC: MT molar ratios.

3.2 Differential scanning calorimetry

The calorimetric heating curves of blank- and MT loaded- DPPC liposomes are presented in Figures 3 (Euc), 4 (Pul), 5 (Ter and Ter M) and 6 (Thy). Table 2 summarizes the calorimetric parameters. The thermogram of blank DPPC shows a peak at $34.85 \pm 0.04\text{ }^{\circ}\text{C}$ and another one at $40.14 \pm 0.02\text{ }^{\circ}\text{C}$. The first peak presents a low enthalpy transition attributed to the mobility of the choline polar head of DPPC, while the sharp enthalpy main transition is attributed to the mobility of the alkyl chains.

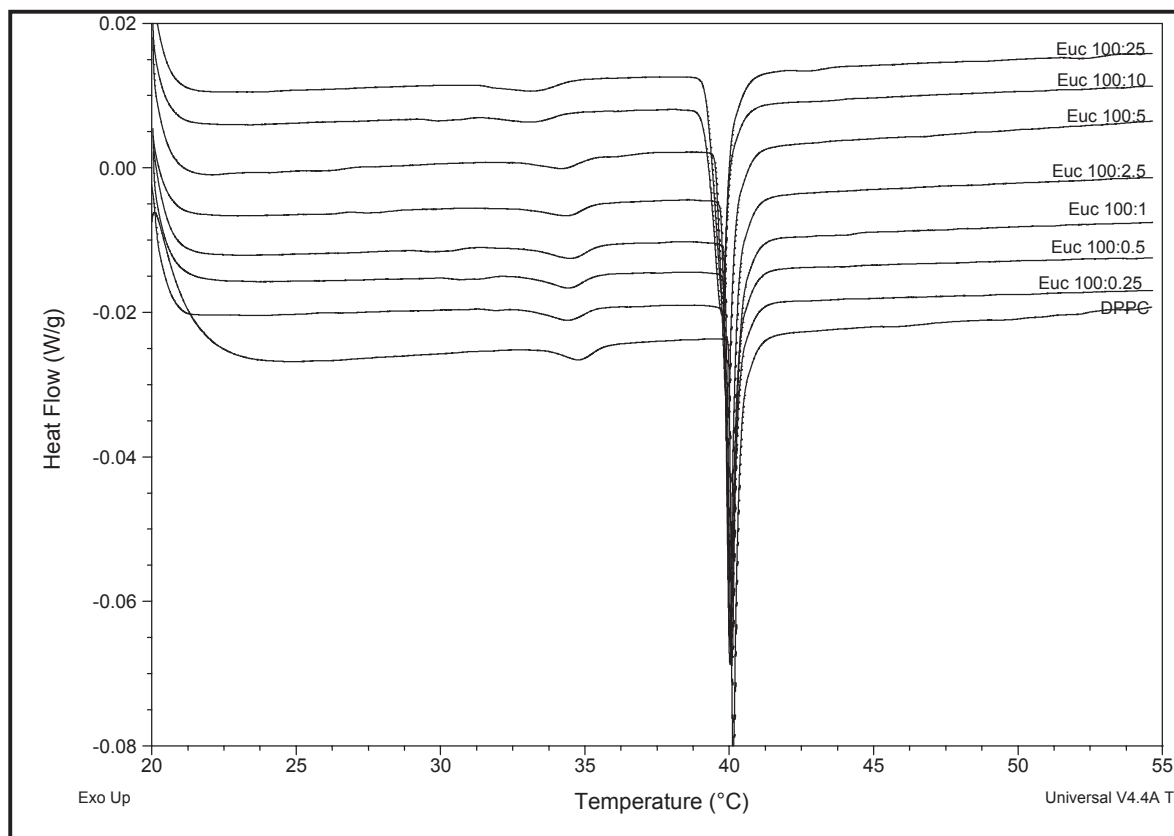

Figure 3: DSC scans of DPPC:Euc liposomes at molar ratios of 100:0; 100:0.25; 100:0.5; 100:1; 100: 2.5; 100:5; 100:10; and 100:25

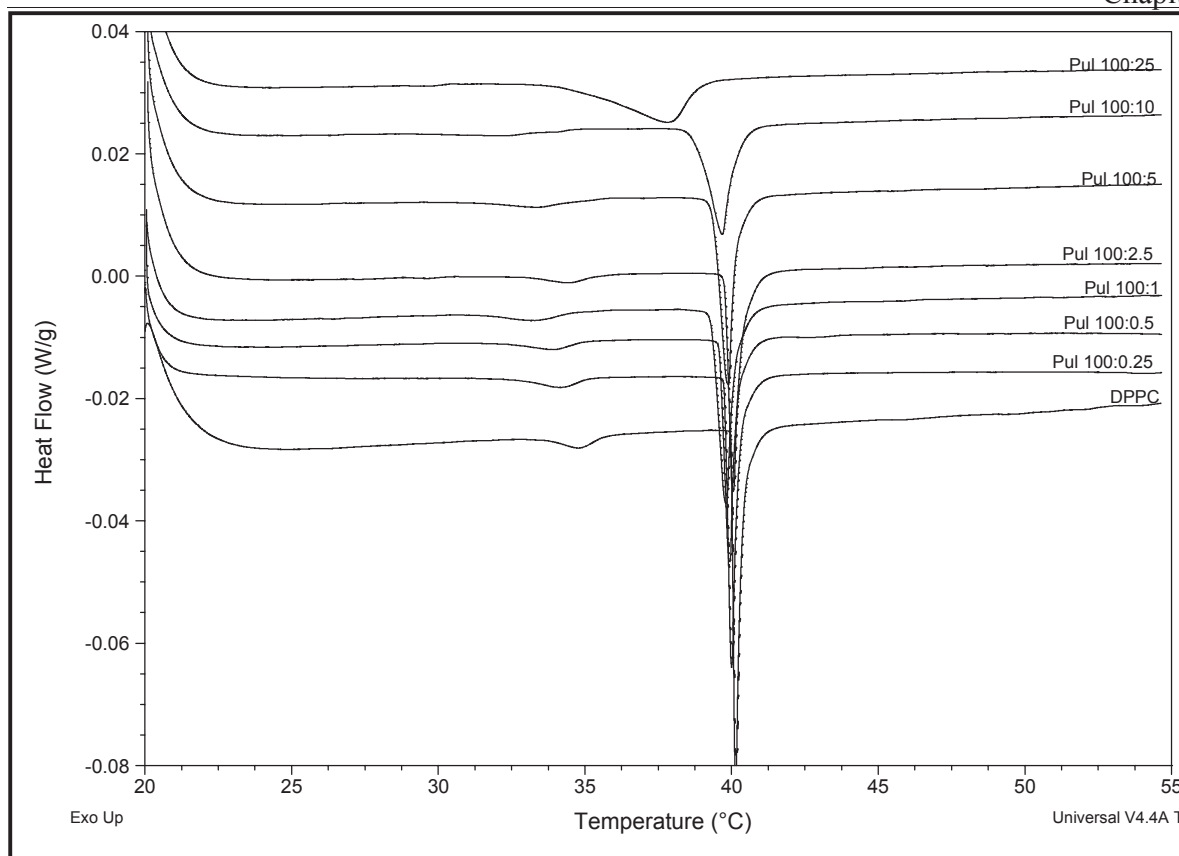

Figure 4: DSC scans of DPPC:Pul liposomes at molar ratios of 100:0; 100:0.25; 100:0.5; 100:1; 100: 2.5; 100:5; 100:10; and 100:25

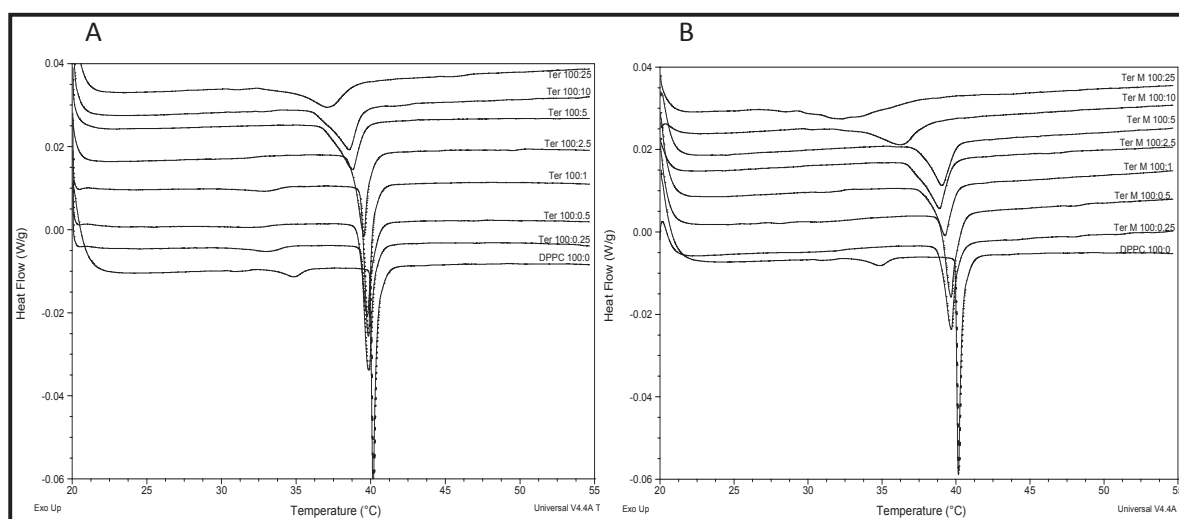

Figure 5: DSC scans of DPPC:Ter (A) and Ter M (B) liposomes at molar ratios of 100:0; 100:0.25; 100:0.5; 100:1; 100: 2.5; 100:5; 100:10; and 100:25

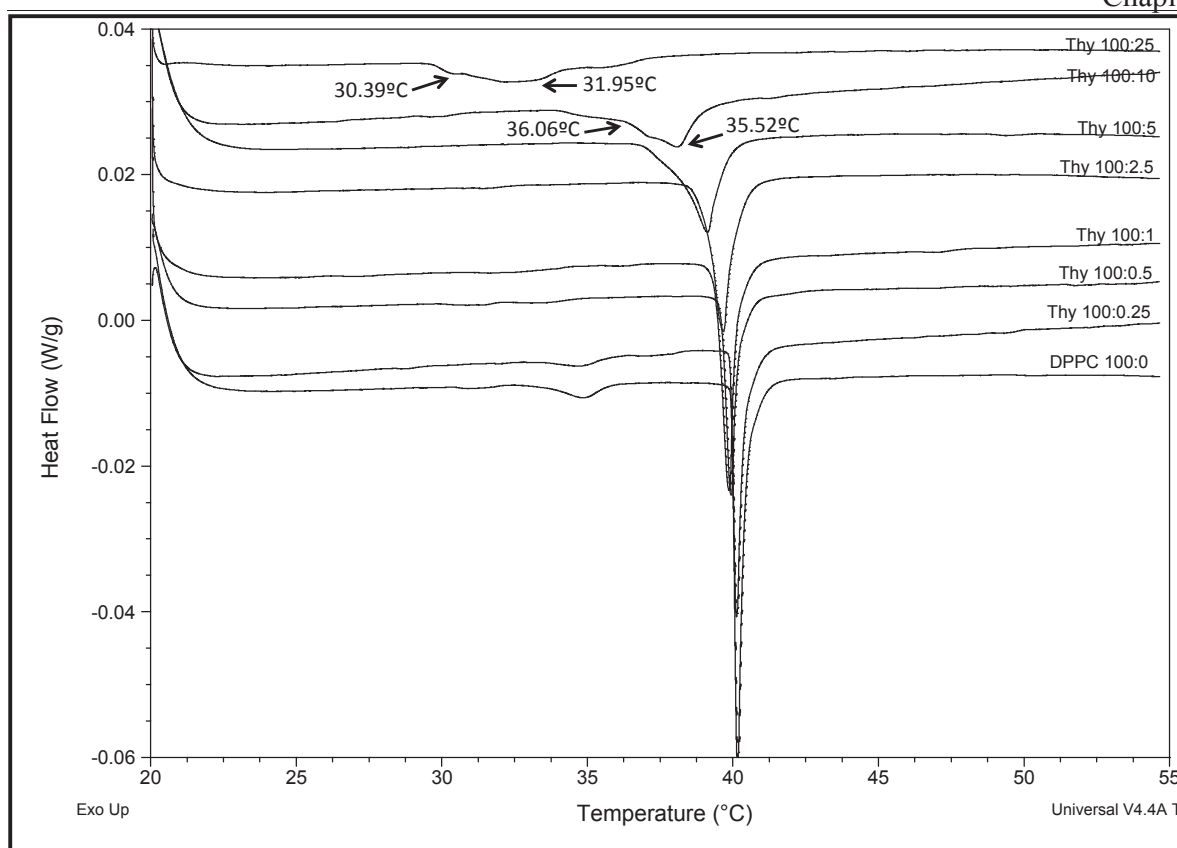

Figure 6: DSC scans of DPPC:Thy liposomes at molar ratios of 100:0; 100:0.25; 100:0.5; 100:1; 100: 2.5; 100:5; 100:10; and 100:25

Compared to blank liposomes, only a shift of the pre-transition peak was observed in presence of Euc. While, the pre-transition peak decreased and then abolished in the presence Pul, Ter, Ter M and Thy. Also, compared to blank liposomes, the main transition temperature shifted to lower values in the presence of all MTs. At the highest DPPC:MT molar ratio (100:25), the effect of Euc and Pul was less important when compared to other MTs. No variation of the enthalpy of the main phase transition (ΔH_m) was observed in the presence of Euc. ΔH_m showed a significant decrease for Pul only at the highest molar ratios (100:10 and 100:25), for Ter (from molar ratio of 100:2.5), Ter M (from molar ratio 100:0.5), and for Thy at all molar ratios (Table 2). Furthermore, compared to blank liposomes, an increase of the $\Delta T_{1/2}$ value was observed in the presence of all MTs. This increase was moderate for Euc and Pul (except at the highest molar ratio of DPPC:Pul) and strong for Ter, Ter M and Thy. Besides, a shoulder of the main calorimetric peak was observed only for Thy at the molar ratios DPPC:Thy of 100:5, 100:10 and 100:25 (Figure 6).

Table 2: Thermodynamic parameters for the interaction of MTs with DPPC-MLVs

MLVs	T _p (°C)	ΔH _p (J/g)	T _m (°C)	ΔH _m (J/g)	ΔT _{1/2} (°C)
DPPC (100:0)	34.85 ± 0.04	5.62 ± 0.27	40.14 ± 0.02	46.86 ± 0.78	0.25 ± 0.02
Eucalyptol					
DPPC: Euc (100:0.25)	34.58 ± 0.17	5.00 ± 0.74	40.03 ± 0.01*	45.92 ± 0.27	0.27 ± 0.02
DPPC: Euc (100:0.5)	34.59 ± 0.16*	5.41 ± 0.64	40.06 ± 0.03*	46.78 ± 2.7	0.29 ± 0.03
DPPC: Euc (100:1)	34.73 ± 0.16	4.98 ± 0.75	40.1 ± 0.01*	46.35 ± 2.27	0.26 ± 0.01
DPPC: Euc (100:2.5)	34.35 ± 0.18 *	5.60 ± 0.50	39.99 ± 0.06*	46.61 ± 0.25	0.34 ± 0.05
DPPC: Euc (100:5)	34.22 ± 0.16*	4.36 ± 0.31*	39.95 ± 0.03*	47.07 ± 1.05	0.37 ± 0.03*
DPPC: Euc (100:10)	33.58 ± 0.33*	3.94 ± 0.52*	39.83 ± 0.04*	44.53 ± 3.30	0.49 ± 0.02*
DPPC: Euc (100:25)	33.58 ± 0.46*	5.36 ± 0.74	39.84 ± 0.05*	44.81 ± 2.74	0.48 ± 0.02*
Pulegone					
DPPC: Pul (100:0.25)	34.33 ± 0.25*	5.09 ± 0.28*	40.01 ± 0.02*	45.60 ± 1.06	0.31 ± 0.03*
DPPC: Pul (100:0.5)	33.92 ± 0.16*	4.66 ± 1.14	39.92 ± 0.02*	44.82 ± 4.16	0.37 ± 0.02*
DPPC: Pul (100:1)	33.74 ± 0.4*	4.78 ± 0.53*	39.91 ± 0.08*	45.19 ± 1.84	0.43 ± 0.04*
DPPC: Pul (100:2.5)	34.1 ± 0.32 *	4.89 ± 0.93	40.00 ± 0.05*	45.67 ± 4.47	0.38 ± 0.04*
DPPC: Pul (100:5)	33.24 ± 0.11*	5.77 ± 0.32	39.77 ± 0.16*	44.75 ± 1.87	0.57 ± 0.18*
DPPC: Pul (100:10)			39.80 ± 0.10*	42.45 ± 2.36*	0.79 ± 0.15*
DPPC: Pul (100:25)			38.01 ± 0.26*	40.65 ± 0.31*	2.29 ± 0.13*
Terpineol					
DPPC: Ter (100:0.25)	33.65 ± 0.48*	4.42 ± 0.86	39.3 ± 0.05*	48.55 ± 1.45	0.42 ± 0.11
DPPC: Ter (100:0.5)			39.72 ± 0.07*	48.71 ± 0.98	0.37 ± 0.01*
DPPC: Ter (100:1)			39.83 ± 0.11*	46.61 ± 2.92	0.51 ± 0.07*
DPPC: Ter (100:2.5)			39.35 ± 0.23*	43.55 ± 1.98*	0.88 ± 0.17*
DPPC: Ter (100:5)			38.93 ± 0.12*	42.69 ± 0.72*	1.33 ± 0.09 *
DPPC: Ter (100:10)			37.83 ± 0.75*	40.71 ± 0.84*	2.07 ± 0.45*
DPPC: Ter (100:25)			36.94 ± 0.10*	37.47 ± 0.92*	2.5 ± 0.06*
Terpienol M					
DPPC: Ter M (100:0.25)			39.67 ± 0.29	43.56 ± 3.07	0.55 ± 0.19
DPPC: Ter M (100:0.5)			39.64 ± 0.32	41.74 ± 0.77*	0.71 ± 0.21*
DPPC: Ter M (100:1)			39.34 ± 0.16*	39.09 ± 1.68*	0.94 ± 0.23*
DPPC: Ter M (100:2.5)			39.09 ± 0.18*	39.80 ± 1.43*	1.15 ± 0.21*

DPPC: Ter M (100:5)			38.90 ± 0.17*	37.82 ± 3.08*	1.38 ± 0.07*
DPPC: Ter M (100:10)			36.78 ± 0.50*	34.34 ± 1.01*	2.49 ± 0.07*
DPPC: Ter M (100:25)			33.79 ± 2.24*	29.28 ± 2.38*	3.81 ± 1.10*
Thymol					
DPPC: Thy (100:0.25)	33.39 ± 0.42	2.23 ± 0.39*	40.09 ± 0.06*	34.02 ± 3.6*	0.31 ± 0.02*
DPPC: Thy (100:0.5)			39.92 ± 0.03*	34.15 ± 1.28*	0.40 ± 0.03*
DPPC: Thy (100:1)			39.78 ± 0.09*	38.48 ± 1.06*	0.47 ± 0.05*
DPPC: Thy (100:2.5)			39.66 ± 0.02*	39.37 ± 0.91*	0.64 ± 0.11*
DPPC: Thy (100:5)			39.16 ± 0.05*	36.92 ± 2.33*	1.09 ± 0.06*
DPPC: Thy (100:10)			37.93 ± 0.04*	35.52 ± 0.36*	2.01 ± 0.04*
DPPC: Thy (100:25)			32.21 ± 0.33*	31.95 ± 0.35*	3.67 ± 0.20*

Values are expressed as the means of three repetitions ± SD

*P<0.05 compared with the control value

3.3 Fluorescence anisotropy

The DPH probe inserts in the bilayer because of its low aqueous solubility. Its depolarization property is influenced by the packing of the acyl chains (Lakowicz, 2006). Thus, the fluorescence anisotropy measurements of DPH in liposomes give information about the organization of the membrane environment around the fluorescent probe thereby reflect the effect of the drug on membrane fluidity (Reiner et al. 2013).

Table 3 shows the DPH anisotropy values of blank and MT-loaded liposomes at 28, 41 and 50 °C, which correspond respectively to gel phase, main transition temperature of DPPC and liquid phase. Figure 7 presents the effect of MTs on the DPH-fluorescence anisotropy values at various DPPC:MT molar ratios. Compared to blank liposomes, the presence of MTs in vesicles reduced the anisotropy values significantly in the gel state, at the transition phase, and in the liquid crystalline phase at all molar ratios. The decrease of DPH anisotropy value was dramatic at the transition phase and in the liquid crystalline phase.

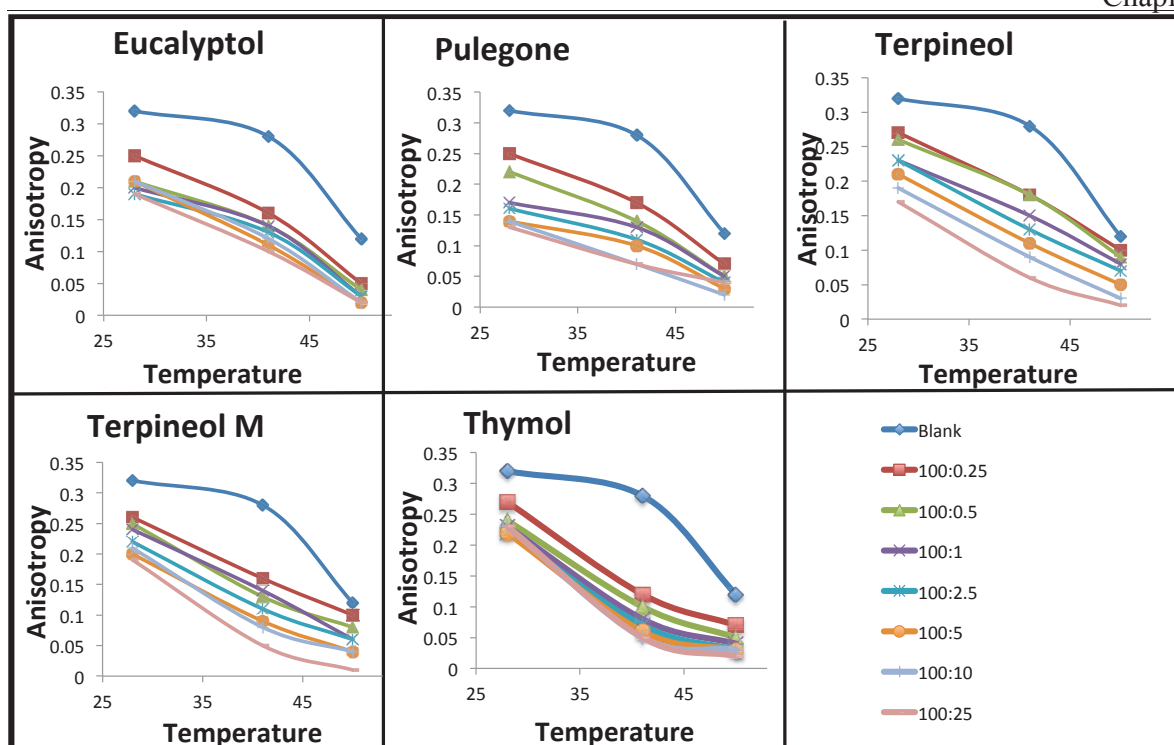

Figure 7: Effect of Euc, Pul, Ter, Ter M and Thy on DPH anisotropy in DPPC liposomes at different molar ratios at 28, 41 and 50°C.

Table 3: Fluorescence anisotropy of DPPC-MLVs incorporating MTs at 28, 41, and 50°C.

MLVs	Anisotropy		
	28 °C	41 °C	50 °C
DPPC (100:0)	0.32 ± 0.00	0.27 ± 0.00	0.11 ± 0.00
Eucalyptol			
DPPC: Euc (100:0.25)	0.25 ± 0.010*	0.16 ± 0.000*	0.05 ± 0.005*
DPPC: Euc (100:0.5)	0.21 ± 0.005*	0.14 ± 0.005*	0.04 ± 0.005*
DPPC: Euc (100:1)	0.20 ± 0.005*	0.15 ± 0.005*	0.03 ± 0.00 *
DPPC: Euc (100:2.5)	0.19 ± 0.005*	0.13 ± 0.005*	0.03 ± 0.005*
DPPC: Euc (100:5)	0.21 ± 0.010*	0.11 ± 0.005*	0.02 ± 0.005*
DPPC: Euc (100:10)	0.21 ± 0.000*	0.12 ± 0.005*	0.02 ± 0.005*
DPPC: Euc (100:25)	0.19 ± 0.005*	0.10 ± 0.005*	0.02 ± 0.005*
Pulegone			
DPPC: Pul (100:0.25)	0.25 ± 0.005*	0.17 ± 0.01*	0.07 ± 0.00*
DPPC: Pul (100:0.5)	0.22 ± 0.005*	0.14 ± 0.005*	0.05 ± 0.005*

DPPC: Pul (100:1)	0.17 ± 0.005*	0.13 ± 0.005*	0.05 ± 0.00 *
DPPC: Pul (100:2.5)	0.16 ± 0.000*	0.11 ± 0.010*	0.04 ± 0.000*
DPPC: Pul (100:5)	0.14 ± 0.005*	0.10 ± 0.01*	0.03 ± 0.005*
DPPC: Pul (100:10)	0.14 ± 0.01*	0.07 ± 0.005*	0.02 ± 0.005*
DPPC: Pul (100:25)	0.13 ± 0.01*	0.07 ± 0.01*	0.04 ± 0.00*
Terpineol			
DPPC: Ter (100:0.25)	0.27 ± 0.005*	0.18 ± 0.010*	0.1 ± 0.000*
DPPC: Ter (100:0.5)	0.26 ± 0.005*	0.18 ± 0.010*	0.09 ± 0.005*
DPPC: Ter (100:1)	0.23 ± 0.005*	0.15 ± 0.010*	0.08 ± 0.00 *
DPPC: Ter (100:2.5)	0.23 ± 0.005*	0.13 ± 0.005*	0.07 ± 0.005*
DPPC: Ter (100:5)	0.21 ± 0.000*	0.11 ± 0.005*	0.05 ± 0.005*
DPPC: Ter (100:10)	0.19 ± 0.005*	0.09 ± 0.005*	0.03 ± 0.005*
DPPC: Ter (100:25)	0.17 ± 0.005*	0.06 ± 0.005*	0.02 ± 0.005*
Terpineol Mixture			
DPPC: Ter M (100:0.25)	0.26 ± 0.010*	0.16 ± 0.005*	0.10 ± 0.000*
DPPC: Ter M (100:0.5)	0.25 ± 0.010*	0.13 ± 0.010*	0.08 ± 0.005*
DPPC: Ter M (100:1)	0.24 ± 0.005*	0.14 ± 0.005*	0.06 ± 0.00 *
DPPC: Ter M (100:2.5)	0.22 ± 0.000*	0.11 ± 0.005*	0.06 ± 0.000*
DPPC: Ter M (100:5)	0.20 ± 0.010*	0.09 ± 0.010*	0.04 ± 0.005*
DPPC: Ter M (100:10)	0.21 ± 0.01*	0.08 ± 0.01*	0.04 ± 0.005*
DPPC: Ter M (100:25)	0.19 ± 0.010*	0.05 ± 0.005*	0.01 ± 0.005*
Thymol			
DPPC: Thy (100:0.25)	0.27 ± 0.010*	0.12 ± 0.005*	0.07 ± 0.005*
DPPC: Thy (100:0.5)	0.24 ± 0.005*	0.10 ± 0.01*	0.05 ± 0.005*
DPPC: Thy (100:1)	0.23 ± 0.00*	0.08 ± 0.005*	0.04 ± 0.00 *
DPPC: Thy (100:2.5)	0.22 ± 0.000*	0.07 ± 0.005*	0.03 ± 0.005*
DPPC: Thy (100:5)	0.22 ± 0.010*	0.06 ± 0.005*	0.03 ± 0.005*
DPPC: Thy (100:10)	0.23 ± 0.010*	0.05 ± 0.000*	0.03 ± 0.010*
DPPC: Thy (100:25)	0.23 ± 0.000*	0.05 ± 0.010*	0.02 ± 0.005*

Values are expressed as the means of three repetitions ± SD

* P<0.05 compared with the control value

4 Discussion

The pre- and main phase transitions are often observed in lipid bilayers. The pre-transition corresponds to the conversion of a lamellar gel phase to a rippled gel phase and is mainly related to the polar region of phosphatidylcholine bilayers. DPPC liposome shows an expected pre transition at 34.85 ± 0.04 °C, in accordance with the literature (Abboud et al., 2015).

Compared to blank liposomes, the shifting (Euc) or the disappearance (Pul, Ter, Ter M, Thy) of the pre transition peak for MT loaded liposomes indicates their interaction with the polar head groups of phospholipids. This interaction is also proved by Raman spectroscopy since a change of the intensity of the peak at 715 cm^{-1} (Table 1), which corresponds to C–N stretch vibrations of choline molecules (Gardikis et al. 2006), was obtained. The interaction of other MTs with the polar head groups of lipid membranes was previously demonstrated for Thy (Fujisawa et al., 1987; Cristani et al., 2007), isoeugenol (Fujisawa et al., 1987; Gharib et al., in revision), carvacol, p-cymen, γ -terpinene (Cristani et al., 2007), limonene, perillaldehyde, perillyl alcohol, perillic acid (Duelund et al., 2012), estragole, anethole and eugenol (Gharib et al., in revision). Ter, Ter M and Thy, bearing a hydroxyl group, depressed the pre-transition peak at low molar ratios while Pul and Euc had no effect.

Changes of thermotropic parameters (ΔH_m and T_m) of lipid bilayers can be used as indicators for the insertion of agents in the membrane and provide information on their effect on the membrane fluidity (Matsingou et al., 2005). Blank liposomes showed a sharp main transition (40.14 ± 0.02 °C) in accordance with published data (Abboud et al., 2015). The presence of MTs in DPPC bilayers decreased the T_m and ΔH_m values and increased those of $\Delta T_{1/2}$, proving an enhancement of the disorder of the membrane. The results obtained by Raman spectroscopy in the presence of MTs (increase of I_{1090}/I_{1130}) indicate that MTs were able to increase the gauche conformers, producing a disorder inside the lipid bilayer. The studied MTs may weaken the van der Waals forces between the alkyl chains, introduce empty spaces in the deep interior of the bilayer, and provide the phospholipid acyl chain a higher degree of freedom (Gardikis et al., 2006). Also, the DPH anisotropy results confirmed their fluidizing effect since a decrease of anisotropy values was obtained at the various temperatures when compared to blank liposomes. Similar findings were reported for estragole and *trans*-anethole, (Gharib et al., in revision), p-crésol, p-cholorophénol, bromophénol (Fujisawa et al., 1987), carvacrol, p-cymène, γ -terpinène (Cristani et al., 2007), eugenol (Fujisawa and Kadoma 1998; Gharib et al., in revision), isoeugenol (Fujisawa et al. 1987; Gharib et al., in revision), menthol (Trombetta et al. 2005), phenol (Tsuchiya and Mizogami 2014) and Thy (Tsuchiya and Mizogami 2014).

Cristani et al. (2007) classified the molecules as interstitial or substitutional impurities according to the changes that may produce on the T_m and ΔH_m values. The molecules which cause changes in T_m and ΔH_m values act as “substitutional impurities” and may replace the lipid molecules. Others, which cause T_m variations without ΔH_m change, could act as “interstitial impurities” and be inserted among the flexible acyl chains of lipids. Since Ter, Ter M, Thy and Pul (at molar ratios of 100: 10 and 100:25) caused a decrease in T_m and ΔH_m , they can be classified as “substitutional impurities”. Euc and, Pul (at molar ratios below 5) may rather act as “interstitial impurities”.

Among the non-aromatic compounds (Ter, Pul and Euc), the ΔH_m values were the lowest for Ter loaded liposomes. This can be due to the presence of the hydroxyl group that can accept or donate a hydrogen bond while the ketone group of Pul and the ether group of Euc can act only as a hydrogen bond acceptor. The presence of a hydroxyl group may allow deep insertion of Ter in the membrane and consequently a more fluidizing effect. Thy, that bears also a hydroxyl group, was also able to increase the lipid membrane disorder.

When compared to blank liposomes, Ter M was more potent than α -Ter on the enthalpy changes of the main transition peak. Similarly the DPH anisotropy measurements suggest that Ter M fluidized the membrane more than α -Ter. It is worth noting that it has been recently reported that a mixture of isomers of Ter increased the antimicrobial activity against a wide range of microbes more than α -Ter (Cornmell et al., 2016).

Among the studied monoterpenes, Thy was the sole that produced a phase separation, which is evidenced by the split of the main peak into two peaks (Figure 6). Thy is the most hydrophobic among the studied MTs and may be localized in the membrane. The logP values of Euc, Ter, Pul and Thy were 2.74 (Li and Perdue, 1995), 2.98 (Li and Perdue, 1995), 3.08 (Griffin et al., 1999) and 3.3 (Hansch et al., 1997), respectively

5 Conclusion

In conclusion, this study proved that the four studied MTs interact with the polar head groups and the hydrophobic acyl chains of phospholipids, producing a fluidizing effect on the lipid membrane. Euc may intercalate in the bilayer while Ter, Thy and Pul can rather substitute the lipid membrane components. The presence of a hydroxyl group in the MT structure enhanced its fluidizing effect on the membrane. Ter M was more potent to produce membrane disorder than Ter.

References

- Abboud, R., Greige-Gerges, H., & Charcosset, C. (2015). Effect of progesterone, its hydroxylated and methylated derivatives, and dydrogesterone on lipid bilayer membranes. *Journal of membrane Biology*, *accepted in press*. DOI 10.1007/s00232-015-9803-z .
- Bakkali, F., Averbeck, S., Averbeck, D., & Idaomar, M. (2008). Biological effects of essential oils – A review. *Food Chem Toxicol* , *46*, 446-475.
- Bangham, A. D., Standish, M. M., & Watkins, J. C. (1965). Diffusion of univalent ions across the lamellae of swollen phospholipids. *Journal of Molecular Biology* , *13*, 238-252.
- Beena, Kumar, D., & Rawat, D. S. (2013). Synthesis and antioxidant activity of thymol and carvacrol based Schiff bases. *Bioorganic & Medicinal Chemistry Letters* , *23*, 641-645.
- Burdock, G. A. (2010). *Fenaroli's Handbook of Flavor Ingredients*. FL: Ed.; CRC Press: Boca Raton, .
- Cornmell, R. J., Diehl, M. A., Golding, G., Harp, J. R., Stott, J. P., Thompson, K. M., et al. (2016). *Patent No. EP2863750 B1*.
- Cristani, M., D'Arrigo, M., Mandalari, G., Castelli, F., Sarpietro, M. G., Micieli, D., et al. (2007). Interaction of four monoterpenes contained in essential oils with model membranes: implications for their antibacterial activity. *Journal of Agricultural and Food Chemistry* , *25*, 6300-6308.
- De Sousa, J. P., de Araújo Torres, R., Alves de Azerêdo, G., Queiroz Figueiredo, B. R., da Silva Vasconcelos, M. A., & Leite de Souza, E. (2012). Carvacrol and 1,8-cineole alone or in combination at sublethal concentrations induce changes in the cell morphology and membrane permeability of *Pseudomonas fluorescens* in a vegetable-based broth. *Int. J. Food Microbiol.* , *158*, 9-13.
- Degenhardt, J., Köllner, T. G., & Gershenzon, J. (2009). Monoterpene and sesquiterpene synthases and the origin of terpene skeletal diversity in plants. *Phytochemistry* , *70*, 1621-1637.
- Di Pasqua, R., Hoskins, N., Betts, G., & Mauriello, G. (2006). Changes in membrane fatty acids composition of microbial cells induced by addition of thymol, carvacrol, limonene, cinnamaldehyde, and eugenol in the growing media. *Journal of Agricultural and Food Chemistry* , *54*, 2745-2749.
- Duelund, L., Amiot, A., Fillon, A., & Mouritsen, O. G. (2012). Influence of the Active Compounds of *Perilla frutescens* Leaves on Lipid Membranes. *Journal of Natural Products* , *75*, 160-166.

- El Maghraby, G. M., Williams, A. C., & Barry, B. W. (2005). Drug interaction and location in liposomes: correlation with polar surface areas. *Int. J. Pharm.* , 292, 179-185.
- Fox, C. B., Uibel, R. H., & Harris, J. M. (2007). Detecting phase transitions in phosphatidylcholine vesicles by Raman microscopy and selfmodeling curve resolution. *The Journal of Physical Chemistry B* , 111, 11428-11436.
- Fujisawa, S., & Kadoma, Y. (1998). H NMR Spectroscopic Studies of the Interaction of Thymol with Phospholipid Liposomes. *Dental Materials Journal* , 17, 139-147.
- Fujisawa, S., Kadoma, Y., & Masuhara, E. (1987). A calorimetric study of the interaction of synthetic phospholipid liposomes with lipid-soluble small molecules used as dental materials and devices. *Journal of Biomedical Materials Research* , 21, 89-98.
- Gardikis, K., Hatziantoniou, S., Viras, K., & Demetzos, C. (2006a). Effect of a bioactive curcumin derivative on DPPC membrane: A DSC and Raman spectroscopy study. *Thermochimica Acta* , 447, 1-4.
- Gershenzon, J., & Dudareva, N. (2007). The function of terpene natural products in the natural world. *Nature Chemical Biology* , 3, 408-414.
- Gharib, R., Najjar, A., Auezova, L., Charcosset, C., & Greige-Gerges, H. (n.d.). Interaction of selected phenylpropenes with dipalmitoylphosphatidylcholine membrane and their relevance to antibacterial activity . *submitted* .
- Gill, A. O., & Holley, R. A. (2006). Disruption of *Escherichia coli*, *Listeria monocytogenes* and *Lactobacillus sakei* cellular membranes by plant oil aromatics. *International Journal of Food Microbiology* , 108, 1-9.
- Griffin, S., Wyllie, S. G., & Markham, J. (1999). Determination of octanol– water partition coefficient for terpenoids using reversed-phase high-performance liquid chromatography. *Journal of Chromatography A* , 864, 221-228.
- Guimarães, A. G., Quintans, J., & Quintans, L. J. (2013). Monoterpenes with analgesic activity--a systematic review. *Phytother Res* , 27, 1-15.
- Habib, L., Jraj, A., Khreich, N., Charcosset, C., & Greige-Gerges, H. (2015). Effect of erythrodiol, a natural pentacyclic triterpene from olive oil, on the lipid membrane properties. *J Membr Biol* , 248, 1079-1087.
- Hansch, C., Leo, A., & Hoekman, D. (1997). *Exploring QSAR - Hydrophobic, Electronic, and Steric Constants*. Washington, DC: American Chemical Society.
- Harborne, J. B., & Baxter, H. (2001). *Chemical Dictionary of Economic Plants*. U.K.: Eds.; Wiley: West Sussex.

- Karpanen, T. J., Worthington, T., Hendry, E. R., Conway, B. R., & Lambert, P. A. (2008). Antimicrobial efficacy of chlorhexidine digluconate alone and in combination with eucalyptus oil, tea tree oil and thymol against planktonic and biofilm cultures of *Staphylococcus epidermidis*. *Journal of Antimicrobial Chemotherapy* 62, 1031–1036 , 62, 1031-1036.
- Lakowicz, J. R. (2006). *Principles of fluorescence spectroscopy*. New York: 3rd edn. Springer.
- Li, J., & Perdue, E. M. (1995). *Preprints of Papers Presented at the 209th ACS National Meeting, Anaheim, CA, April 2-7, 1995, 35: 134-7.*
- Manabe, A., Nakayama, S., & Sakamoto, K. (1987). Effects of Essential Oils on Erythrocytes and Hepatocytes from Rats and Dipalmitoyl Phosphatidylcholine-Liposomes. *The Japanese Journal of Pharmacology* , 44, 77-84.
- Matsingou, C., Hatziantoniou, S., Georgopoulos, A., Dimas, K., Terzis, A., & Demetzos, C. (2005). Labdane-type diterpenes: thermal effects on phospholipid bilayers, incorporation into liposomes and biological activity. *Chemistry and Physics of Lipids* , 138, 1-11.
- Nazzaro, F., Fratianni, F., De Martino, L., Coppola, R., & De Feo, V. (2013). Effect of essential oils on pathogenic bacteria. *Pharmaceuticals* , 6, 1451-1474.
- Oyedemi, S. O., Okoh, A. I., Mabinya, L. V., Pirochenva, G., & Afolayan, A. J. (2009). *Afr J Biotechnol* , 8, 1280-1286.
- Park, S. N., Lim, Y. K., Freire, M. O., Cho, E., Jin, D., & Kook, J. K. (2012). Antimicrobial effect of linalool and a-terpineol against periodontopathic and cariogenic bacteria. *Anaerobe* , 18, 369-372.
- Potamitis, C., Chatzigeorgiou, P., Siapi, E., Viras, K., Mavromoustakos, T., Hodzic, A., et al. (2011). Interactions of the AT1 antagonist valsartan with dipalmitoyl-phosphatidylcholine bilayers. *Biochem. Biophysic. Acta.* , 1808, 1753-1763.
- Reiner, G. N., Delgado-Marín, L., Olguín, N., Sánchez-Redondo, S., Sánchez-Borzzone, M., Rodríguez-Farré, E., et al. (2013b). GABAergic pharmacological activity of propofol related compounds as possible enhancers of general anesthetics and interaction with membranes. *Cell Biochemistry and Biophysics* , 67, 515-525.
- Riella, K. R., Marinho, R. R., Santos, J. S., Pereira-Filho, R. N., Cardoso, J. C., Albuquerque-Junior, R. L., et al. (2012). Anti-inflammatory and cicatrizing activities of thymol, a monoterpene of the essential oil from *Lippia gracilis*, in rodents. *Journal of Ethnopharmacol* , 143, 656-663.

- Salehi, P., Sonboli, A., Eftekhari, F., Nejad-Ebrahimi, S., & Yousefzadi, M. (2005). Essential oil composition, antibacterial and antioxidant activity of the oil and various extracts of *Ziziphora clinopodioides* subsp. *rigida* (BOISS.) RECH. f. from Iran. *Biological and Pharmaceutical Bulletin*, 28, 1892-1896.
- Santos, F. A., Silva, R. M., Campos, A. R., de Araujo, R. P., Lima Junior, R. C., & Rao, V. S. (2004). 1,8-Cineole (eucalyptol), a monoterpene oxide attenuates the colonic damage in rats on acute TNBScolitis. *Food and Chemical Toxicology*, 42, 579-584.
- Sikkema, J., DeBont, J. A., & Poolman, B. (1995). Mechanisms of membrane toxicity of hydrocarbons. *Microbiological Reviews*, 59, 201-222.
- Sikkema, J., DeBont, J. A., & Poolman, B. (1994). Interactions of cyclic hydrocarbons with biological membranes. *The Journal of Biological Chemistry*, 269, 8022-8028.
- Thakur, R. A., Wang, Y., & Michniak, B. B. (2006). *Essential oils and terpenes. In Percutaneous Penetration Enhancers, 2nd ed.; Smith, E.W., Maibach, H.I., Eds.* FL USA: CRC Press: Boca Raton.
- Trombetta, D., Castelli, F., Sarpietro, M. G., Venuti, V., Cristani, M., Daniele, C., et al. (2005). Mechanisms of antibacterial action of three monoterpenes. *Antimicrobial Agents and Chemotherapy*, 49, 2474-2478.
- Tsuchiya, H., & Mizogami, M. (2014). Comparative Interactions of Anesthetic Alkylphenols with Lipid Membranes. *Open Journal of Anesthesiology*, 4, 308-317.
- Turina, A. V., Nolan, M. V., Zygodlo, J. A., & Perillo, M. A. (2006). Natural terpenes: Self-assembly and membrane partitioning. *Biophysical Chemistry*, 122, 101-113.
- Whiting, K. P., Restall, C. J., & Brain, P. F. (2000). Steroid hormone-induced effects on membrane fluidity and their potential roles in non-genomic mechanisms. *Life Sci.*, 67, 743-757

*Chapitre 4 : Préparation et
caractérisation des liposomes
encapsulant le complexe d'inclusion
HP-β-CD/Ane*

Introduction

Les HEs sont caractérisées par la propriété d'être liquides et volatiles à température ambiante. Elles sont souvent légèrement colorées et possèdent une odeur prononcée. Elles sont solubles dans les solvants organiques usuels et dites donc liposolubles. Cette lipophilicité leur confère une capacité majeure permettant leur diffusion dans l'organisme indépendamment de la voie d'administration (Kamatou et al., 2013). Les HEs présentent une stabilité réduite vis-à-vis de divers facteurs extrinsèques et intrinsèques. Dans cette étude, l'encapsulation des constituants d'HEs tels que le phénylpropène Ane dans l'HP- β -CD suivie de l'encapsulation des complexes d'inclusion résultants dans des liposomes a été appliquée afin d'améliorer les caractéristiques des liposomes conventionnels. L'Ane est un composant majeur des HEs d'anis étoilé et de fenouil. Jusqu'au XIXe siècle, ce produit était utilisé pour aromatiser le chocolat, la viande, le lait et la pâtisserie. De nos jours, mis à part le pain anisé qui est particulièrement répandu dans certains pays nordiques, son utilisation alimentaire est presque exclusivement réservée à certaines boissons et à la confiserie. Ces usages font de l'Ane l'une des substances aromatiques les plus consommées, du moins en Europe Occidentale. Son utilisation mondiale est de l'ordre de 400 à 600 tonnes par an ; 200 tonnes environ sont consommées en France. L'Ane est bien connu par son activité antimicrobienne (Kubo et al., 2008) et anti-inflammatoire (Domiciano et al., 2013). Cependant, son application est limitée par sa faible solubilité et sa volatilité. En outre, l'Ane présente une instabilité photochimique altérant ses propriétés. En effet, lors de l'exposition aux rayons UV et aux températures élevées, l'Ane subit une oxydation en anisaldéhyde et l'isomérisation du *trans*-Ane en sa forme *cis* dont la toxicité est 10 fois plus importante (Misharina & Polshkov, 2005).

L'encapsulation dans les CDs permet d'augmenter la solubilité de l'Ane ainsi que de générer des systèmes de protection, de stockage et de libération prolongée et contrôlée de l'Ane (Kfoury et al., 2014). Parmi les différentes CDs testées, l'HP- β -CD a montré une forte capacité de complexation et de solubilisation de l'Ane. Pour cette raison, l'HP- β -CD a été choisie pour préparer les systèmes mixtes à double encapsulation CD/liposomes.

Cette étude présente une comparaison entre les caractéristiques des liposomes conventionnels et celles des liposomes encapsulant le complexe d'inclusion HP- β -CD/Ane. Ce dernier a été préparé dans une solution aqueuse avec un rapport molaire HP- β -CD:Ane (1 :1). La méthode d'injection éthanolique a été utilisée pour encapsuler l'Ane et/ou HP- β -CD/Ane dans des liposomes. Cette

technique a été appliquée pour la première fois par Batzri et Korn (Batzri et Korn, 1973). Le principe de cette méthode est de préparer une solution de phospholipides dans l'éthanol puis l'injecter, en utilisant une pompe à seringue, dans un volume d'eau sous agitation magnétique. La formation spontanée des liposomes est produite dès que la solution éthanolique entre en contact avec la phase aqueuse. Enfin, l'éthanol et une partie de l'eau sont éliminés par évaporation rotative sous pression réduite (Jaafar-Maalej et al., 2010). Nous avons utilisé les phospholipides de soja saturés (Phospholipon 90H) ou insaturés (Lipoid S100) afin de déterminer l'effet de l'hydrogénation et de la composition des phospholipides sur les caractéristiques et la stabilité des liposomes préparés. En effet, le Phospholipon 90H contient environ 90% de phosphatidylcholine et 4 % de lysophosphatidylcholine, formées d'acides gras saturés. La préparation des liposomes s'effectue à une température au-dessus de la température de transition de phospholipides, qui est de 55°C pour le Phospholipon 90H et 25°C pour le Lipoid S100.

Cinq formulations liposomiales ont été préparées : 1) liposomes témoins ; 2) liposomes encapsulant l'HP- β -CD ; 3) liposomes encapsulant l'Ane ; 4) liposomes encapsulant le complexe d'inclusion HP- β -CD/Ane (ACL) ; 5) « double loaded liposomes » (ACL2) où le complexe d'inclusion HP- β -CD/Ane et l'Ane sont dissouts, respectivement, dans la phase aqueuse et dans la phase organique.

Les liposomes obtenus sont caractérisés par la taille, le pDI, le potentiel zêta en utilisant la diffusion dynamique de la lumière (DLS) et ils sont observés au microscope électronique à transmission (TEM). Le rendement d'encapsulation de l'Ane dans les liposomes a été déterminé par chromatographie en phase liquide à haute performance (HPLC). La photostabilité de l'Ane en solution aqueuse, dans le complexe d'inclusion HP- β -CD/Ane et dans les liposomes est étudiée après irradiation aux rayons UV pendant 4 jours. Ainsi, des études de cinétique de libération de l'Ane et de stabilité physicochimique après 15 mois de stockage à 4°C ont été également réalisées.

Par rapport aux liposomes témoins, la présence de CD et de l'Ane dans les liposomes n'affectent ni la taille des liposomes ni la distribution de taille qui est homogène avec les deux types de phospholipides. Les images de TEM obtenues pour les liposomes témoins constitués de Phospholipon 90H et Lipoid S100 révèlent la présence des vésicules sphériques, oligolamellaires, et de taille nanométrique conformément aux résultats de taille obtenus par DLS. D'un point de vue morphologique, il n'y a pas de différence observée entre les liposomes témoins et ceux

encapsulant l'Ane et/ou le complexe d'inclusion HP- β -CD/Ane pour les deux types de phospholipides utilisés.

Le système DCL améliore significativement le rendement d'encapsulation de l'Ane. En effet, les valeurs du rendement d'encapsulation de l'Ane les plus élevées ont été obtenues avec le Lipoid S100. Par ailleurs, la formulation ACL2 formée de Lipoid S100 montre le meilleur rendement. Les différents lots de liposomes protègent l'Ane contre la dégradation induite par l'irradiation aux rayons UV. L'encapsulation de l'Ane dans ACL 90H, ACL2-90H, ACL-S100 et ACL2-S100 permet d'accroître la stabilité de l'Ane, de 11,8 ; 36,1 ; 44,8 et 66,7 fois respectivement. L'effet protecteur le plus prononcé est donc observé en utilisant le Lipoid S100 plus particulièrement dans le cas du lot de type ACL2.

Enfin, en utilisant les deux types de phospholipides, toutes les formulations ont montré une bonne stabilité et ont conservé leur taille, leur pDI et zêta potentiel durant leur stockage pendant 15 mois à 4°C, à l'exception de ACL2-S100. Par contre, ACL2-S100 était stable après 6 mois de stockage. Le système DCL avec les deux types de phospholipides a prouvé son efficacité en réduisant la libération de l'Ane, après 15 mois de stockage à 4°C.

Ce chapitre est présenté sous forme d'un article publié dans « Food Chemistry ».

Références

- Batzri, S., & Korn, E. D. (1973). Single bilayer liposomes prepared without sonication. *Biochim Biophys Acta*, 298, 1015-1019.
- Domiciano, T. P., Dalalio, M. M., Silva, E. L., Ritter, A. M., Estevão-Silva, C. F., Ramos, F. S., et al. (2013). Inhibitory effect of anethole in nonimmune acute inflammation. *Naunyn Schmiedebergs Arch Pharmacol*, 386, 331-338.
- Jaafar-Maalej, C., Diab, R., Andrieu, V., Elaissari, A., & Fessi, H. (2010). Ethanol injection method for hydrophilic and lipophilic drug-loaded liposome preparation. *J Liposome Res*, 20, 228-243.
- Kamatou, G. P., Vermaak, I., Viljoen, A. M., & Lawrence, B. M. (2013). Menthol: a simple monoterpene with remarkable biological properties. *Phytochemistry*, 96, 15-25.
- Kfoury, M., Auezova, L., Greige-Gerges, H., Ruellan, S., & Fourmentin, S. (2014). Cyclodextrin, an efficient tool for trans-anethole encapsulation: Chromatographic, spectroscopic, thermal and structural studies. *Food Chemistry*, 164, 454-461.
- Kubo, I., Fujita, K., & Nihei, K. (2008). Antimicrobial activity of anethole and related compounds from aniseed. *Journal of the Science of Food and Agriculture*, 88, 242-247.
- Misharina, T. A., & Polshkov, A. N. (2005). Antioxidant properties of essential oils: Autoxidation of essential oils from laurel and fennel and of their mixtures with essential oil from coriander. *Applied Biochemistry and Microbiology*, 41, 610-618

**Drug-in-cyclodextrin-in-liposomes as a carrier system for volatile essential oil components:
application to Anethole**

Riham Gharib^{1,2}, Lizette Auezova¹, Catherine Charcosset², H el ene Greige-Gerges^{1*}

¹Faculty of Sciences, Bioactive Molecules Research Group, Doctoral School of Sciences and Technologies, Jdaidet El-Matn, Lebanese University, Lebanon.

²Laboratoire d'Automatique et de G enie des Proc ed es, Universit e Claude Bernard Lyon I, France.

Food Chemistry 218 (2017) 365-371



Drug-in-cyclodextrin-in-liposomes as a carrier system for volatile essential oil components: Application to anethole



Riham Gharib^{a,b}, Lizette Auezova^a, Catherine Charcosset^b, H el ene Greige-Gerges^{a,*}

^a Faculty of Sciences, Bioactive Molecules Research Group, Doctoral School of Sciences and Technologies, J daidet El-Matn, Lebanese University, Lebanon

^b Laboratoire d'Automatique et de G enie des Proc ed es, Universit e Claude Bernard Lyon 1, France

ARTICLE INFO

Article history:

Received 25 September 2015

Received in revised form 4 September 2016

Accepted 16 September 2016

Available online 17 September 2016

Keywords:

Anethole
Cyclodextrin
Double loading
Liposome

ABSTRACT

A combined approach based on cyclodextrin/drug inclusion complex formation and loading into liposomes was applied to improve the effectiveness of liposome loading with essential oils. Hydroxypropyl- β -cyclodextrin/ANE (HP- β -CD/ANE) inclusion complexes were prepared and encapsulated into liposomes (ACL). ANE-double-loaded liposomes (ACL2) were obtained with the HP- β -CD/ANE complex in the aqueous phase and ANE in the organic phase.

Liposomes were prepared from saturated (Phospholipon 90H) or unsaturated (Lipoid S100) phospholipids and characterized for size, polydispersity index, zeta potential, morphology, loading rate (LR) and photo- and storage stabilities. All liposome batches were nanometric oligolamellar-type vesicles. Compared to ANE-loaded liposomes, ACL-90H, ACL2-90H and ACL2-S100 displayed significantly increased ANE LR, with ACL2-S100 exhibiting the highest LR. All formulations provided ANE photoprotection, were physically stable after 15 months of storage at 4  C (with the exception of ACL2-S100), and retained more than 25% of the ANE initially present in the liposome suspensions.

  2016 Published by Elsevier Ltd.

1. Introduction

Liposomes are artificial lipid vesicles in which an aqueous phase is enclosed entirely by a membrane composed mainly of phospholipids (Anwekar, Patel, & Singhai, 2011). Liposomes can encapsulate hydrophilic, hydrophobic and amphiphilic substances (Uhumwangho & Okor, 2005), and offer an excellent opportunity to enhance drug stability (Laouini et al., 2012; Sebaaly, Jraj, Fessi, Charcosset, & Greige-Gerges, 2015). However, hydrophobic drugs incorporated in phospholipid membrane bilayers can be released rapidly (Maestrelli, Gonzalez-Rodriguez, Rabasco, & Mura, 2005) and may affect the lipid membrane properties (Abboud, Charcosset, & Greige-Gerges, 2015; Habib, Jraj, Khreich, Charcosset, & Greige-Gerges, 2015). Thus, an alternative approach has been suggested in which the drugs are encapsulated in the aqueous phase of the liposomes in the form of a cyclodextrin/drug inclusion complex (McCormack & Gregoriadis, 1994; Nasir, Harikumar, & Kaur,

2012). This combines the advantages of both carriers in a single "drug-in-cyclodextrin-in-liposome" (DCL) system. Cyclodextrins (CDs) are cyclic oligosaccharides formed from glucopyranose units. The most common CDs are formed from six (α -CD), seven (β -CD) or eight (γ -CD) d-glucopyranose units (Arun, Ashik Kumar, & Sravanthi, 2008). Hydrophilic CDs, such as hydroxypropyl- β -CD (OH-propyl- β -CD), have demonstrated effectiveness in enhancing the bioavailability of many substances that are poorly water-soluble (Gidwani & Vyas, 2014). The presence of CD in the aqueous compartment of liposomes does not affect the conventional liposome characteristics (Maestrelli, Gonzalez-Rodriguez, Rabasco, Ghelardini, & Mura, 2010). Moreover, CDs preserve liposomal structural integrity (Hatz, Mourtas, Klepetsanis, & Antimisiaris, 2007). The DCL system improves the encapsulation efficiency (EE) of hydrophobic drugs in liposomes (Matloob, Mourtas, Klepetsanis, & Antimisiaris, 2014) and prolongs drug release compared to conventional liposomes (Chen et al., 2014; Zhang et al., 2015). A CD/drug complex in liposomes prevents the dissociation of the CD/drug complex in plasma as well as renal excretion of the CD molecules (Agashe, Sahoo, Lagisetty, & Awasthi, 2011). In addition, compared with conventional liposome formation methods, the double-loading technique provides rapid release of the free drug in the external bilayer, as well as prolonged impact due to the presence of the CD/drug inclusion complex in the internal core (Maestrelli

Abbreviations: ANE, anethole; ACL, anethole-in-cyclodextrin-in-liposome; ACL2, double-loaded liposome; DCL, drug-in-cyclodextrin-in-liposome; EE, encapsulation efficiency; HP- β -CD, hydroxypropyl- β -cyclodextrin; LR, loading rate; Pdl, polydispersity index.

* Corresponding author at: Faculty of Sciences, Section II, Bioactive Molecules Research Group, Lebanese University, B.P. 90656, J daidet El-Matn, Lebanon.

E-mail addresses: greigegeorges@yahoo.com, hgreige@ul.edu.lb (H. Greige-Gerges).

<http://dx.doi.org/10.1016/j.foodchem.2016.09.110>
0308-8146/  2016 Published by Elsevier Ltd.

et al., 2010). Consequently, the DCL system can be useful for better control of the in vivo fate of hydrophobic drugs.

DCLs, in aqueous and lyophilized forms, are a promising carrier system to preserve volatile and hydrophobic drugs, enlarging their application in the cosmetic, pharmaceutical and food industries (Sebaaly et al., 2015).

In this study, anethole (ANE), an essential oil constituent, was chosen for encapsulation into a DCL system. ANE is the major component of star anise (90%) and fennel (68.53%) essential oils (Makadia & Siegel, 2011), which are used as flavoring agents in food products such as liqueurs, bread, pickles, pastries, and cheese (Diao, Hu, Zhang, & Xu, 2014). ANE is FDA approved (Smith et al., 2005) and has the potential to preserve the quality and safety of fresh products (Wang, Wang, & Chen, 2008). It has been shown that ANE possesses antimicrobial (Kubo, Fujita, & Nihei, 2008) and anti-inflammatory (Domiciano et al., 2013) effects. However, the use of ANE is limited because of its low water solubility. Additionally, upon exposure to UV rays and high temperatures, ANE undergoes oxidation to anisaldehyde and isomerization to *cis*-ANE; the latter is 10–12 times more toxic than *trans*-ANE (Misharina & Polshkov, 2005). The encapsulation of ANE in CDs is efficient and increases ANE solubility and photostability (Kfoury, Auezova, Greige-Gerges, Ruellan, & Fourmentin, 2014). Among various CDs tested, HP- β -CD was shown to be the best; the solubility of free ANE in aqueous solution was enhanced approximately 14 times by HP- β -CD/ANE complexation. HP- β -CD is highly soluble in water (Loftsson & Duchene, 2007) and does not affect the membrane cholesterol content (Hatzl et al., 2007).

In the present study, different liposomal formulations containing ANE and/or HP- β -CD/ANE complexes were prepared with saturated (Phospholipon 90H) or unsaturated (Lipoid S100) phospholipids using the ethanol-injection method. The liposomal suspensions were characterized for size, polydispersity index and zeta potential as well as morphology using transmission electron microscopy. The ANE concentration in the formulations was determined using HPLC, and loading rate (LR) was calculated. The effect of UV irradiation on the stability of ANE in these formulations was determined, and the stability of liposome formulations was assessed after 15 months of storage at 4 °C.

2. Materials and methods

2.1. Materials

trans-ANE [1-methoxy-4-(1-propenyl)-benzene] (99%) was purchased from Sigma-Aldrich (Madrid, Spain). HP- β -CD was purchased from Wacker-Chemie (Lyon, France). Hydrogenated Phospholipon® 90H (90% soybean phosphatidylcholine, 4% lysophosphatidylcholine, 2% triglycerides, 2% water, 0.5% ethanol, 1% iodine) and non-hydrogenated soy phosphatidylcholine Lipoid S100 (94% soybean phosphatidylcholine, 3% lysophosphatidylcholine, 0.5% *N*-acyl-phosphatidylethanolamine, 0.1% phosphatidylethanolamine, 0.1% phosphatidylinositol, 2% water, 0.2% ethanol) were supplied by Lipoid GMBH (Ludwigshafen, Germany). Thymol, absolute ethanol, cholesterol and HPLC grade methanol were purchased from Sigma-Aldrich (Steinheim, Germany). Milli-Q Water was purified using a Millipore® synergy system (Millipore, Billerica, Massachusetts, USA).

2.2. Preparation of HP- β -CD/ANE inclusion complexes

HP- β -CD/ANE inclusion complexes were prepared in aqueous solution. HP- β -CD (11.25 g) was dissolved in 450 mL ultrapure water and the required amount of ANE was added to obtain a 1:1 M ratio. The mixture was stirred (120 rpm for 24 h at 26 °C), filtered (0.45 μ m filter) and then used in DCL preparations. The

percentage of ANE in the CD/ANE complex solution was determined as follows:

Percentage of ANE in the complex

$$= \frac{\text{ANE mass in complex solution}}{\text{Initial ANE mass}} \times 100 \quad (1)$$

The mass of ANE in CD/drug inclusion complex was determined according to the HPLC method described below. Initial ANE mass was taken as the mass used to prepare the complex.

2.3. Preparation of liposomes

The liposomes were prepared by the ethanol-injection method. Phospholipon 90H or Lipoid S100 (10 mg/mL) and cholesterol (5 mg/mL) were dissolved in absolute ethanol. The resulting organic phase (10 mL) was later injected using a syringe pump (Fortuna optima, GmbH-Allemagne), into the aqueous phase (20 mL) at a temperature above the transition temperature of the phospholipid (55 °C for Phospholipon 90H and 25 °C for Lipoid S100) under magnetic stirring at 400 rpm. Spontaneous liposome formation occurred as soon as ethanolic solution came into contact with the aqueous phase. The liposomal suspension was then left for 15 min at 25 °C under stirring (400 rpm). The ethanol was removed by rotary evaporation (Heidolph GmbH, Germany) under reduced pressure at 40 °C. The obtained liposomal solution was stored at 4 °C. Five batches were prepared: (1) free liposomes; (2) ANE-loaded liposomes in which ANE was added in the organic phase at a concentration of 2.5 mg/mL; (3) HP- β -CD-loaded liposomes in which HP- β -CD (500 mg) was dissolved in the aqueous phase; (4) HP- β -CD/ANE inclusion complex-loaded liposomes (ACL) in which the HP- β -CD/ANE solution prepared previously was used as an aqueous phase; (5) double loaded liposomes (ACL2) where ANE was added to the organic phase (at 2.5 mg/mL) and the HP- β -CD/ANE complex solution was used as the aqueous phase.

2.4. Liposome characterization

2.4.1. Size and zeta potential determined by dynamic light scattering analysis

Malvern Zetasizer Nanoseries (Zetasizer Nano ZS; Malvern Instruments Ltd, France) was used to determine the mean size of the liposomal batches. All batches were diluted 10-fold with ultrapure water. The particle-size distribution data were collected using the DTS (nano) software (version 5.10) provided with the instrument. The polydispersity index (PDI), which gives an indication of the width of particle size distribution, ranges from 0 (monodispersed) to 1 (very broad distribution). Data were expressed as the mean \pm standard deviation. Zeta potential was calculated using Smoluchowski's equation from the electrophoretic mobility of liposomes. All measurements were carried out at 25 °C after 3 min of equilibration and were performed in triplicate.

2.4.2. Morphological characterization by transmission electron microscopy

Liposomal suspensions were imaged using a transmission electron microscope (TEM) (CM 120; Philips, Eindhoven, Netherlands) operating at an accelerating voltage of 120 kV. A drop of liposomal suspension was placed onto a carbon-coated copper grid for 3 min; the excess suspension was removed with a filter paper, leaving a thin liquid film stretched over the pores. Negative staining using a 1% sodium silicotungstate solution was directly made on the deposit over 30 s. The excess sodium silicotungstate solution was then removed with a filter paper and the stained samples were examined.

2.4.3. Determination of anethole loading rate

The concentration of ANE in the formulations was determined by HPLC. The standard solutions of ANE ranged from 1 to 250 µg/mL, and an internal standard solution of thymol (100 µg/mL) were prepared in methanol. To a solution of thymol (100 µL, 100 µg/mL) in methanol (200 µL) was added 100 µL of each solution (ANE standard, liposomal suspension, liposomal filtrate or HP-β-CD/ANE). The samples were sonicated for 10 min at 25 °C and then analyzed by HPLC using an analytical column (C18 15 cm × 4.6 mm, 5 µm (Supelco)). The mobile phase was a mixture of methanol and water (70/30). The flow rate was set at 1 mL/min, and the detection at 206 nm. The experiments were performed in triplicate.

To determine the loading rate (LR), aliquots were taken from the liposomal suspension (total ANE) and the filtrate (unloaded ANE). The filtrate was obtained using Vivaspin 500 centrifugal concentrators (Sartorius Stedim Biotech, Germany, MW cut-off = 10,000 Da): an aliquot of the liposomal suspension (500 µL) was placed in a filtration tube and submitted to centrifugation at 15,000 rpm for 2 h at 4 °C.

For ANE-loaded liposomes, the LR was calculated as follows:

$$LR_{\text{ANE-loaded liposomes}} = \frac{m_{\text{liposomal suspension}} - m_{\text{filtrate}}}{m_{\text{OP}}} \times 100 \quad (2)$$

where m_{OP} is the initial ANE mass added to the organic phase during the liposome preparation.

The LR for ACL was calculated by the following equation:

$$LR_{\text{ACL}} = \frac{m_{\text{liposomal suspension}} - m_{\text{filtrate}}}{m_{\text{initial}}} \times 100 \quad (3)$$

where m_{initial} is the initial mass of ANE added to HP-β-CD before filtration.

The LR for ACL2 was calculated as follows:

$$LR_{\text{ACL2}} = \frac{m_{\text{liposomal suspension}} - m_{\text{filtrate}}}{m_{\text{initial}} + m_{\text{OP}}} \times 100 \quad (4)$$

where $m_{\text{initial}} + m_{\text{OP}}$ is the sum of the initial ANE mass added to HP-β-CD before filtration and the ANE mass added to the organic phase during liposome preparation.

2.5. Photostability study

Aqueous solutions of free ANE, the CD/ANE inclusion complex and the ANE-loaded formulations were irradiated with a UV lamp at room temperature for 96 h. Samples were removed at different time intervals and analyzed by HPLC to determine the concentration of remaining ANE. The results were expressed as the percentage of remaining ANE ($C_t/C_0 \times 100$) where C_0 is the initial concentration of ANE and C_t the concentration at time t . The degradation rate constant (k) was calculated using the following equation:

$$\ln[\text{ANE}] = -Kt + b \quad (5)$$

2.6. Storage stability of liposomes

The particle size, PDI and zeta potential values of all liposome formulations were determined after 15 months of storage at 4 °C. Aliquots were taken from each formulation and analyzed by HPLC to determine the remaining ANE concentration. The percentage of remaining ANE was determined by the following equation:

$$\text{Percentage of remaining ANE} = \frac{[\text{ANE}]_t}{[\text{ANE}]_{t_0}} \times 100 \quad (6)$$

where $[\text{ANE}]_t$ and $[\text{ANE}]_{t_0}$ are the total concentration of ANE in the liposome suspension determined at t_0 and after 15 months of storage at 4 °C, respectively. The experiment was performed in triplicate.

2.7. Statistical analysis

Statistical analysis was performed using Student's t -test. P values equal to or less than 0.05 were considered statistically significant.

3. Results and discussion

3.1. Size, polydispersity index and zeta potential

The liposome formulations were characterized and compared in terms of mean particle size, polydispersity index (PDI) and zeta potential.

Table 1

Characteristics of blank, HP-β-CD-loaded liposomes, ANE-loaded liposomes, ACL and ACL2 prepared with Phospholipon 90H or Lipoid S100 at t_0 and after 15 months of storage at 4 °C.

Liposomal formulations	Size (nm)	PDI	Zeta (mV)	LR _t (%)
90H blank liposomes	176 ± 2.19	0.17 ± 0.04	-11.8 ± 1.27	
	159 ± 5.63	0.251 ± 0.04	-2.7 ± 0.05	
HP-β-CD-loaded 90H liposomes	179 ± 3.41	0.19 ± 0.01	-6.6 ± 1.24*	
	195 ± 29.6	0.30 ± 0.02	-5.9 ± 1.08	
ANE-loaded 90H liposomes	155 ± 9.12	0.17 ± 0.03	-11.75 ± 0.07	0.48 ± 0.07
	169 ± 3.18	0.42 ± 0.01	-11.1 ± 0.90	
ACL-90H	160 ± 4.27	0.18 ± 0.04	-4.85 ± 0.47*	0.83 ± 0.15*
	163 ± 10.39	0.19 ± 0.28	-7.34 ± 0.61	
ACL2-90H	155 ± 6.59	0.20 ± 0.02	-4.37 ± 1.00*	1.47 ± 0.50*
	151 ± 5.11	0.28 ± 0.02	-4.78 ± 2.07	
S100 blank liposomes	163 ± 8.62	0.17 ± 0.01	-13.55 ± 2.33	
	141 ± 18.95	0.21 ± 0.11	-20.15 ± 2.61	
HP-β-CD-loaded S100 liposomes	151 ± 3.95	0.19 ± 0.01	-12.2 ± 0.84	
	148 ± 3.15	0.17 ± 0.03	-22.05 ± 4.03	
ANE-loaded S100 liposomes	168 ± 7.00	0.18 ± 0.04	-14 ± 3.46	5.20 ± 1.05
	189 ± 5.01	0.14 ± 0.03	-24.8 ± 3.81	
ACL-S100	165 ± 6.29	0.29 ± 0.02	-11.3 ± 1.27	5.05 ± 0.29
	179 ± 0.98	0.25 ± 0.11	-15.3 ± 1.97	
ACL2-S100	160 ± 6.71	0.37 ± 0.01	-10.6 ± 2.23	7.67 ± 1.08*
	226 ± 27.12	0.63 ± 0.13	-18.7 ± 1.91	

Bold: after 15 months of storage at 4 °C

* $p < 0.05$ (compared to the blank liposomes or, for LR, to the ANE-loaded liposomes).

No significant difference was found between the size of the liposomes prepared with phospholipon 90H or lipid S100 (Table 1). The presence of CD or ANE did not affect the liposome size; Free and ANE-loaded conventional liposomes, as well as ACL and ACL2, were all similar in size.

PdI values for all the liposome formulations were less than 0.5, suggesting the liposomes were largely homogenous (Table 1). The highest PdI values were obtained for ACL and ACL2 from Lipoid S100 (Table 1). The presence of CD in the liposomal formulations did not affect the size distribution, which is in agreement with other studies (Ascenso et al., 2013; Cavalcanti et al., 2011).

Zeta potential is another parameter used to evaluate the physical stability of liposomal formulations. It characterizes the particles surface charge and gives an indication about repulsive forces between particles, thus allowing predicting stability of colloidal dispersions (Domingues, Santiago, Castanho, & Santos, 2008). All liposomal formulations prepared in this study presented a negative charge, resulting from the phosphatidylcholine head group

orientation at the surface of vesicles, with the phosphate group located above the choline group plane (Ascenso et al., 2013). Compared to blank liposomes, the presence of ANE did not affect the surface charge regardless of the type of phospholipid. However, the presence of CD caused a decrease in the zeta potential values of ACL and ACL2 when phospholipon 90H was used. CD may produce changes in phosphatidylcholine head group orientation at the surface of vesicles, allowing exposure of positively charged choline to the surface and thus reducing the vesicles' surface charge.

3.2. Transmission electron microscopy

The TEM images showed the formation of nanometer-sized vesicles (Figs. 1 and 2). The images in Fig. 1(A–E) are examples, respectively, of blank liposomes, HP- β -CD-loaded liposomes, ANE-loaded liposomes, ACL and ACL2, obtained from Phospholipon 90H. Similarly, Fig. 2(A–E) are examples of the images of Lipoid S100 liposomes.

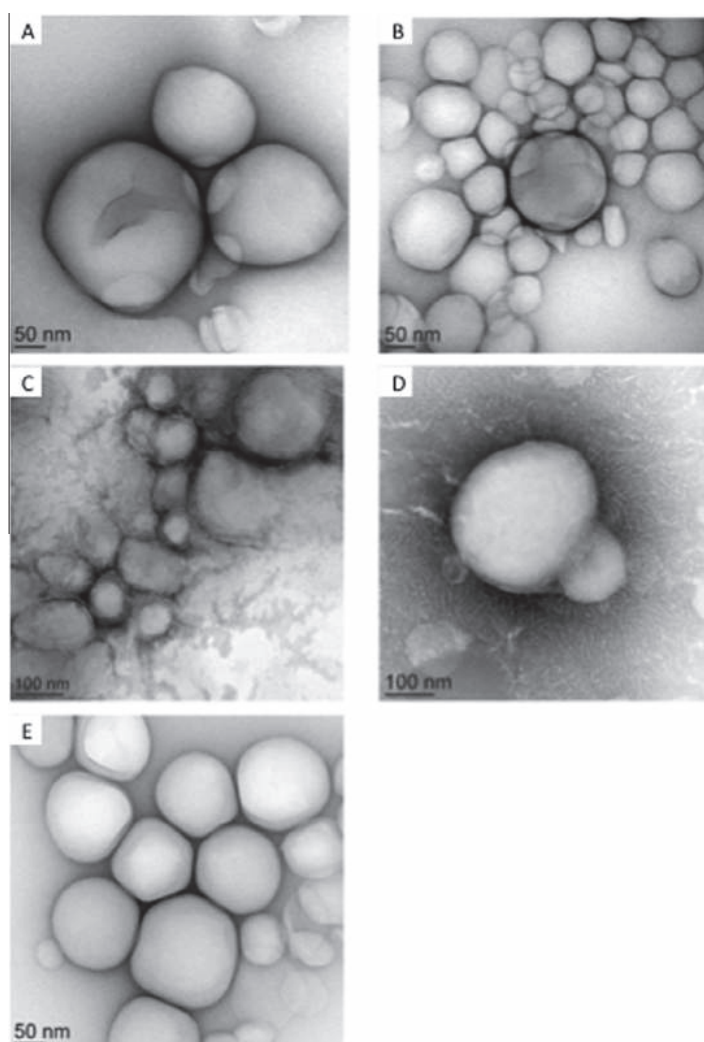

Fig. 1. TEM images of Phospholipon 90H liposomes: Blank (A); HP- β -CD-loaded liposomes (B); anethole-loaded liposomes (C); ACL (D) and ACL2 (E).

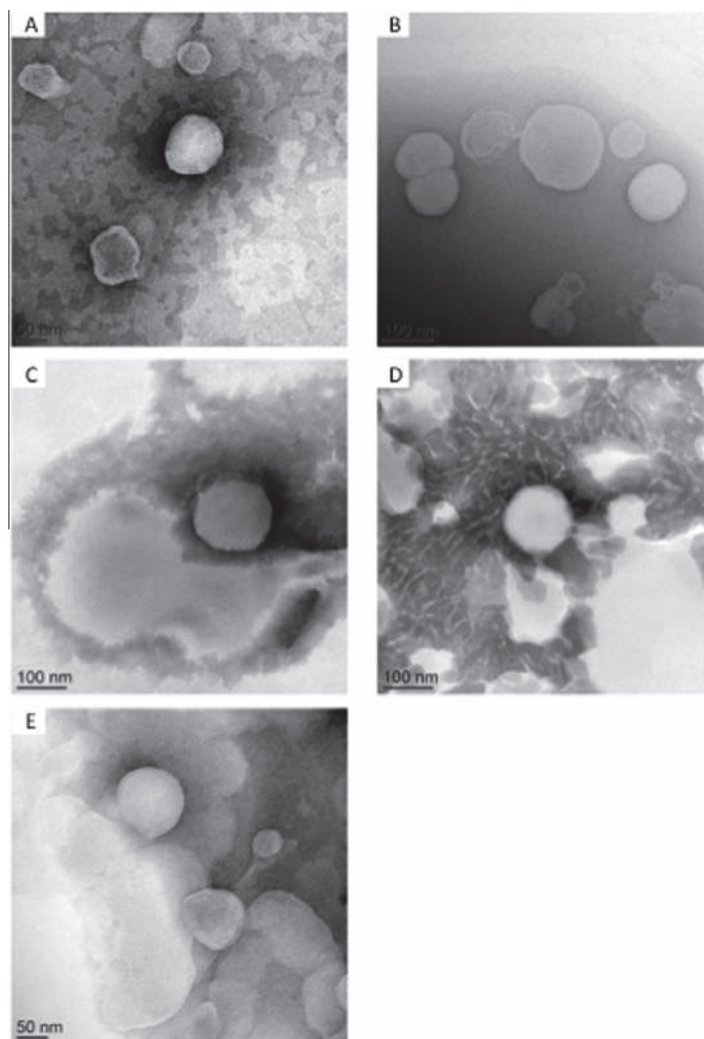

Fig. 2. TEM images of Lipoid S100 liposomes: Blank (A); HP- β -CD-loaded liposomes (B); anethole-loaded liposomes (C); ACL (D) and ACL2 (E).

These TEM results are in agreement with the dynamic light scattering results. The vesicles appeared to be oligolamellar and spherical in shape. The presence or absence of ANE, HP- β -CD or the HP- β -CD/ANE inclusion complex did not affect liposome lamellarity or morphology. The TEM images of double-loaded liposomes were successfully obtained in all cases, and the type of phospholipid did not influence the liposomal morphology.

3.3. Loading rate

The retention times of thymol (internal standard) and ANE on the HPLC were, respectively, 7.6 ± 0.04 and 12.3 ± 0.09 min. Calibration curves were constructed by plotting the ANE/thymol area ratio against the concentration of ANE in $\mu\text{g/mL}$. The linear relationships were evaluated by regression analysis with the least-squares method and the correlation coefficient ranged from 0.995 to 0.999.

The loading rate (LR) of ANE into conventional liposomes, ACL and ACL2 was determined according to Eqs. (2–4), respectively

(Table 1). The mass of ANE present as CD/drug inclusion complex was determined by HPLC. When prepared using a CD:ANE molar ratio of 1:1, the percentage of ANE present in CD/ANE aqueous solution was $34.14 \pm 1.23\%$ of ANE initially added to prepare the complex.

The DCL carrier system significantly improved the ANE loading rate. Indeed, the LR values were 2 and 3.5 times higher for ACL ($0.83 \pm 0.15\%$) and ACL2 ($1.47 \pm 0.50\%$), respectively, compared to ANE-loaded Phospholipon 90H liposomes ($0.48 \pm 0.07\%$). Additionally, the LR values were higher with Lipoid S100 compared to Phospholipon 90H. Two reasons can be considered to explain the differences between these types of phospholipids. The preparation of Phospholipon 90H liposomes requires heating at 51°C , above the main transition temperature of the phospholipid, which could induce the loss of volatile ANE during preparation. Lipoid S100 liposomes are prepared at room temperature. Also, the lipid bilayers made from unsaturated Lipoid S100 are less densely packed and more flexible than those made from saturated Phospholipon 90H, leading to higher incorporation of drugs (Sebaaly et al., 2015).

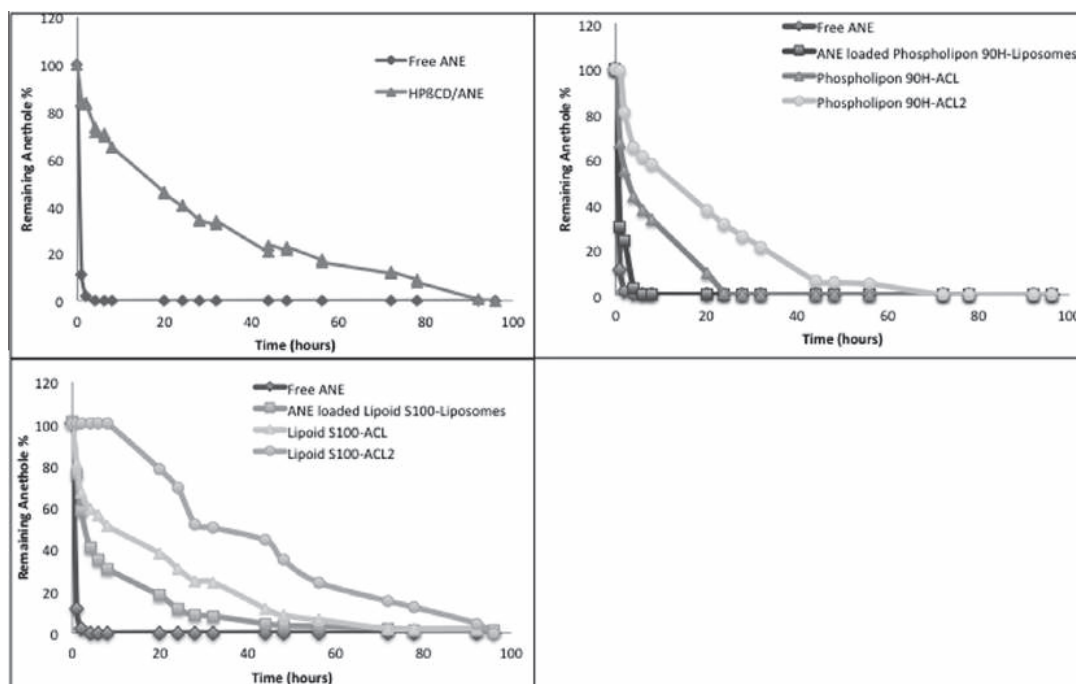

Fig. 3. Photostability of ANE in aqueous solutions of free ANE, HP-β-CD/ANE inclusion complex and in liposome-encapsulated forms under UV light irradiation.

3.4. Photostability study

The aqueous solutions of free ANE and the HP-β-CD/ANE inclusion complex, as well as various liposome batches, were exposed to UV light irradiation for 4 days in order to assess their photostability. Aliquots were withdrawn at the indicated intervals and the concentration of remaining ANE was determined by HPLC. The results were expressed as percentage of remaining ANE (Fig. 3). The plots reveal exponential asymptotic trends, indicating that the degradation of ANE follows apparent first-order kinetics. The degradation rate constant values were calculated using Eq. (5) (Table 2).

The free ANE in aqueous solution was found to be unstable upon exposure to UV irradiation. Indeed, the percentage of remaining ANE was only 11% after 1 h; ANE disappeared completely after 2 h. In sweet fennel oil stored for 2 months at room temperature under light, *trans*-ANE was shown to be completely transformed to anisaldehyde and *cis*-ANE through oxidation and isomerization reactions, respectively (Misharina & Polshkov, 2005). The storage of the marjoram essential oil in light has been shown to produce

considerable changes in the composition of the oil, caused by chemical transformation of terpenoids. A decline in the concentrations of eugenyl acetate, estragole and *trans*-ANE with a parallel increase in the concentrations of other compounds, such as *p*-cymene, eugenol and anisaldehyde, was demonstrated (Misharina, Polshkov, Ruchkina, & Medvedeva, 2003). Light can induce the formation of 4,4'-dimethoxystilbene which is thought to result from a photocycloaddition reaction between ANE and anisaldehyde (Miething, Seger, & Hansel, 1990).

Our results demonstrate that the encapsulation of ANE in HP-β-CD, liposomes and/or DCL provides a good protection against UV radiation. Compared to the ANE aqueous solution, a protection factor of 51 was obtained for ANE encapsulated in HP-β-CD (the percentage of remaining ANE was 45% after 20 h of exposure). The liposomal formulations protected ANE from UV light with various rates of effectiveness. Using Phospholipon 90H, the protection of ANE was significantly improved by 2.4, 11.8 and 36.1 times for the ANE-loaded liposomes, ACL and ACL2, respectively, compared to free ANE in aqueous solution. On the other hand, Lipoid S100-based liposomes appeared to be more effective in ANE protection; ANE stability was increased by 38.9, 44.8 and 66.7 times, respectively, in the ANE-S100-, ACL-S100- and ACL2-S100-loaded liposomes. Thus, liposomes prepared from Lipoid S100 showed higher protection than Phospholipon 90H liposomes. The same result was demonstrated for eugenol (Sebaaly et al., 2015): a higher eugenol protective effect was obtained with Lipoid S100 liposomes compared to Phospholipon 90H liposomes. These results can be due to the flexibility of the membrane made from Lipoid S100, which may allow deeper insertion of the compound in the lipid bilayer and thus increases its protection from UV light effect. Furthermore, the double loading technique showed the best protective effect on ANE, and the ACL2 made from Lipoid S100 was the most efficient system. This result can be evidently explained by the double protection of ANE (ANE-in-CD-in-liposome).

Table 2
Degradation rate constants of ANE in aqueous solutions of free ANE, CD/ANE inclusion complex and different liposome formulations after exposure to UV light irradiation.

Liposome formulations	Degradation rate constant K (h ⁻¹)	Protection factor
ANE aqueous solution	2.017 ± 0.801	
HP-β-CD/ANE inclusion complex	0.039 ± 0.000 [*]	51.7
ANE-loaded 90H liposomes	0.839 ± 0.054 [*]	2.4
ACL-90H	0.170 ± 0.035 [*]	11.8
ACL2-90H	0.055 ± 0.002 [*]	36.1
ANE-loaded S100 liposomes	0.051 ± 0.001 [*]	38.9
ACL-S100	0.045 ± 0.001 [*]	44.8
ACL2-S100	0.030 ± 0.000 [*]	66.7

^{*} p < 0.05 (compared to ANE aqueous solution).

3.5. Storage stability of liposomes

The mean particle size, the Pdl and zeta potential values of liposomes were examined after 15 months of storage at 4 °C (Table 1). All formulations demonstrated satisfactory stability, with the exception of ACL2-S100 for which a Pdl value above 0.5 was obtained. It is worth noting that after 6 months of storage at 4 °C, ACL2-S100 did show satisfactory size and pdl values (data not shown). In addition, TEM images obtained after 6 months of storage at 4 °C demonstrated the physical stability of the liposome structures (supplementary material).

For each formulation the total ANE concentration in the liposomal suspensions was determined after 15 months, and the values were compared to those obtained at t0. For formulations made of phospholipon 90H, the percentage of remaining ANE was 25 ± 0.20%, 54 ± 0.42% and 49 ± 0.05% for ANE-loaded liposomes, ACL and ACL2, respectively. The remaining ANE for those made from Lipoid S100 was 22 ± 1.62% (ANE loaded liposomes), 38 ± 3.20% (ACL) and 25 ± 2.27% (ACL-2). Thus, the retention of ANE in the various formulations is satisfactory, and the DCL carrier system was more effective in reducing ANE release with respect to conventional liposomes.

4. Conclusions

The results of this study contribute to our knowledge regarding DCL carrier systems. An improvement in the LR of ANE was demonstrated using a DCL carrier system. Among the tested ANE-loaded formulations, double-loaded liposomes provided the best LR. Concerning the phospholipid type used for liposome preparation, unsaturated Lipoid S100 phospholipids demonstrated the best protection of ANE from UV degradation and the best LR. Moreover, DCL system was demonstrated to be effective in reducing ANE release in comparison to conventional liposomes.

Acknowledgments

This project has been funded with support from the National Council for Scientific Research in Lebanon. Authors are grateful to the Lebanese University for providing a scholarship to Riham Gharib. Special thanks go to Géraldine Agusti (LAGEP) for TEM images.

Appendix A. Supplementary data

Supplementary data associated with this article can be found in the online version, at <http://dx.doi.org/10.1016/j.foodchem.2016.09.110>.

References

Abboud, R., Charcosset, C., & Greige-Gerges, H. (2015). Tetra- and penta-cyclic triterpenes interaction with lipid bilayer membrane: A structural comparative study. *Journal of Membrane Biology*. <http://dx.doi.org/10.1007/s00232-016-9871-8>.

Agashe, H., Sahoo, K., Lagisetty, P., & Awasthi, V. (2011). Cyclodextrin-mediated entrapment of curcuminoid 4-[3,5-bis(2-chlorobenzylidene-4-oxo-piperidine-1-yl)-4-oxo-2-butenic acid] or CLEFMA in liposomes for treatment of xenograft lung tumor in rats. *Colloids and Surfaces B: Biointerfaces*, 84, 329–337.

Anwekar, H., Patel, S., & Singhai, A. K. (2011). Liposomes as drug carriers. *International Journal of Pharmacy & Life Sciences*, 2, 945–951.

Arun, R., Ashik Kumar, C. K., & Sravanthi, V. V. (2008). Cyclodextrins as drug carrier molecule: A review. *Scientia Pharmaceutica*, 76, 567–598.

Ascenso, A., Cruz, M., Euleterio, C., Carvalho, F. A., Santo, F. A., Marques, H. C., & Simoes, S. (2013). Novel tretinoin formulations: A drug-in-cyclodextrin-in liposome approach. *Journal of Liposome Research*, 23, 211–219.

Caualcanti, I. M., Mendonça, E. A., Lira, M. C., Honrato, S. B., Camara, C. A., Amorim, R. V., ... Mendes Filho, J. (2011). The encapsulation of β -lapachone in 2-hydroxypropyl- β -cyclodextrin inclusion complex into liposomes: a physicochemical evaluation and molecular modeling approach. *European Journal of Pharmaceutical Sciences*, 44, 332–340.

Chen, J., Lu, W. L., Gu, W., Lu, S. S., Chen, Z. P., Cai, C. B., & Yang, X. X. (2014). Drug-in-cyclodextrin-in-liposomes: a promising delivery system for hydrophobic drugs. *Expert Opinion on Drug Delivery*, 11, 565–577.

Diao, W. R., Hu, Q. P., Zhang, H., & Xu, J. G. (2014). Chemical composition, antibacterial activity and mechanism of action of essential oil from seeds of fennel (*Foeniculum vulgare* Mill.). *Food Control*, 35, 109–116.

Domiciano, T. P., Dalalio, M. M., Silva, E. L., Ritter, A. M., Estevão-Silva, C. F., Ramos, F. S., et al. (2013). Inhibitory effect of anethole in nonimmune acute inflammation. *Naunyn Schmiedebergs Arch Pharmacology*, 386, 331–338.

Domingues, M. M., Santiago, P. S., Castanho, M. A., & Santos, N. C. (2008). What can light scattering spectroscopy do for membrane-active peptide studies? *Journal of Peptide Science*, 14, 394–400.

Gidwani, B., & Vyas, A. (2014). Synthesis, characterization and application of epichlorohydrin- β -cyclodextrin polymer. *Colloids and Surfaces B: Biointerfaces*, 114, 130–137.

Habib, L., Jraji, A., Khreich, N., Charcosset, C., & Greige-Gerges, H. (2015). Effect of erythrodil, a natural pentacyclic triterpene from olive oil, on the lipid membrane properties. *Journal of Membrane Biology*, 248, 1079–1087.

Hatzl, P., Mourtas, S., Klepetsanis, P. G., & Antimisiaris, S. G. (2007). Ntegrity of liposomes in presence of cyclodextrins: Effect of liposome type and lipid composition. *International Journal of Pharmaceutics*, 333, 167–176.

Kfoury, M., Auezova, L., Greige-Gerges, H., Ruellan, S., & Fourmentin, S. (2014). Cyclodextrin, an efficient tool for trans-anethole encapsulation: Chromatographic, spectroscopic, thermal and structural studies. *Food Chemistry*, 164, 454–461.

Kubo, I., Fujita, K., & Nihei, K. (2008). Antimicrobial activity of anethole and related compounds from aniseed. *Journal of the Science of Food and Agriculture*, 88, 242–247.

Laouini, A., Jaafar-Maalej, C., Limayem-Blouza, I., Sfar, S., Charcosset, C., & Fessi, H. (2012). Preparation, characterization and applications of liposomes: State of the art. *Journal of Colloid Science and Biotechnology*, 1, 147–168.

Loftsson, T., & Duchene, D. (2007). Cyclodextrins and their pharmaceutical applications. *International Journal of Pharmaceutics*, 329, 1–11.

Maestrelli, F., Gonzalez-Rodriguez, M. L., Rabasco, A. M., Ghelardini, C., & Mura, P. (2010). New “drug-in cyclodextrin-in deformable liposomes” formulations to improve the therapeutic efficacy of local anaesthetics. *International Journal of Pharmaceutics*, 395, 222–231.

Maestrelli, F., Gonzalez-Rodriguez, M. L., Rabasco, A. M., & Mura, P. (2005). Preparation and characterisation of liposomes encapsulating ketoprofen-cyclodextrin complexes for transdermal drug delivery. *International Journal of Pharmaceutics*, 298, 55–67.

Makadia, H. K., & Siegel, S. J. (2011). Poly lactic-co-glycolic acid (PLGA) as biodegradable controlled drug delivery carrier. *Polymer*, 3, 1377–1397.

Matloob, A. H., Mourtas, S., Klepetsanis, P., & Antimisiaris, S. G. (2014). Increasing the stability of curcumin in serum with liposomes or hybrid drug-in-cyclodextrin-in-liposome systems: A comparative study. *International Journal of Pharmaceutics*, 476, 108–115.

McCormack, B., & Gregoriadis, G. (1994). Drugs-in-cyclodextrins-in-liposomes: a novel concept in drug delivery. *International Journal of Pharmaceutics*, 112, 249–258.

Miething, H., Seger, V., & Hansel, R. (1990). Determination of photoanethole from a stored essential oil of anise fruits as 4,4'-dimethoxystilbene by high performance liquid chromatography-ultraviolet coupling. *Phytotherapy Research*, 4, 121–123.

Misharina, T. A., & Polshkov, A. N. (2005). Antioxidant properties of essential oils: Autoxidation of essential oils from laurel and fennel and of their mixtures with essential oil from coriander. *Applied Biochemistry and Microbiology*, 41, 610–618.

Misharina, T. A., Polshkov, A. N., Ruchkina, E. L., & Medvedeva, I. B. (2003). Changes in the composition of the essential oil of marjoram during storage. *Applied Biochemistry and Microbiology*, 39, 311–316.

Nasir, A., Harikumar, S. L., & Kaur, A. (2012). Cyclodextrins: an excipient tool in drug delivery. *International research journal of pharmacy*, 3, 44–50.

Sebaaly, C., Jraji, A., Fessi, F., Charcosset, C., & Greige-Gerges, H. (2015). Preparation and characterization of clove essential oil-loaded liposomes. *Food Chemistry*, 178, 52–62.

Smith, R. L., Cohen, S. M., Doull, J., Feron, V. J., Goodman, J. L., Marnett, L. J., ... Munro, I. C. (2005). Criteria for the safety evaluation of flavoring substances – The expert panel of the flavor and extract manufacturers association. *Food and Chemical Toxicology*, 43, 1141–1177.

Uhumwangho, M. U., & Okor, R. S. (2005). Current trends in the production and biomedical applications of liposomes: A review. *Journal of Medicine and Biomedical Research*, 4, 9–21.

Wang, C. Y., Wang, S. Y., & Chen, C. (2008). Increasing antioxidant activity and reducing decay of blueberries by essential oils. *Journal of Agricultural and Food Chemistry*, 56, 3587–3592.

Zhang, L., Zhang, Q., Wang, X., Zhang, W., Lin, C., Chen, F., Yang, X., et al. (2015). Drug-in-cyclodextrin-in-liposomes: A novel drug delivery system for flurbiprofen. *International Journal of Pharmaceutics*, 492, 40–45.

*Chapitre 5 : Préparation des
liposomes encapsulant le complexe
d'inclusion HP- β -CD/Ane à
grande échelle*

Introduction

Nous avons optimisé la préparation des liposomes encapsulant l'Ane et/ou son complexe d'inclusion HP- β -CD/Ane à petite échelle par la méthode d'injection d'éthanol. Nos résultats montrent que le Lipoid S100 améliore le rendement d'encapsulation de l'Ane et le protège contre la dégradation induite par les rayons UV. Nous avons ainsi envisagé de produire des liposomes à base d'Ane à grande échelle.

Dans ce but, nous avons utilisé un procédé de contacteur à membrane (Jaafar-Maalej et al., 2011). Dans ce procédé, une phase organique constituée de l'éthanol dans laquelle les phospholipides (Lipoid S100) et le cholestérol sont dissouts est poussée à travers la membrane ayant une taille des pores bien définie au moyen d'une pompe (Charcosset et al., 2015). Une membrane de type SPG (Shirasu Porous Glass) de nature hydrophile avec une taille moyenne des pores 1 μm a été utilisée. En même temps, la phase aqueuse circule tangentiellement à la membrane à l'aide d'une deuxième pompe. Les liposomes se forment spontanément lorsque les deux phases entrent en contact à l'intérieur du module membranaire. Le système est arrêté dès que des bulles d'air atteignent le tube connectant la phase organique au module membranaire, ce qui indique que le volume initial de la phase organique est entièrement consommé. Les débits des deux phases sont réglés de manière à ce qu'elles passent en un temps identique. On a préparé un volume de 600 mL pendant 48 s. La suspension liposomiale est ensuite soumise sous agitation à température ambiante pendant 15 min. Enfin, l'éthanol et une partie de l'eau sont éliminés sous pression réduite à l'aide d'un évaporateur rotatif (Charcosset et al., 2015 ; Jaafar-Maalej et al., 2011 ; Laouini et al., 2011). A la fin de l'expérience, la membrane est régénérée par circulation d'eau et d'éthanol. Ce procédé possède plusieurs avantages notamment la simplicité, la rapidité, la continuité, la reproductibilité, le contrôle de la taille des liposomes en réglant les paramètres du procédé, la préparation de grands volumes de liposomes, l'application à de nombreuses molécules avec des efficacités d'encapsulation élevées (Jaafar-Maalej et al., 2011 ; Laouini et al., 2011 ; Laouni et al., 2012 ; Greige-Gerges et Sebaaly, 2015).

De même, cinq formulations liposomiales ont été préparées : 1) liposomes témoins ; 2) liposomes encapsulant l'HP- β -CD; 3) liposomes encapsulant l'Ane; 4) ACL et 5) (ACL2).

En se basant sur le principe de l'injection d'éthanol et du contacteur à membrane, un pilote a été mis au point. Ce procédé a permis l'obtention de 3 L de liposomes, et des plus grands volumes

(jusqu'à 10 L) peuvent être obtenus (Charcosset et al., 2015). Le pilote est adapté pour les deux méthodes d'injection : tube ou membrane (Charcosset et al., 2015). Le procédé implique l'utilisation de deux réacteurs à double enveloppe de capacité 10 L équipés d'agitateur à hélice à 4 pales. Ils peuvent être chauffés jusqu'à 100°C à l'aide d'un bain de circulation. Le second réacteur est connecté à un régulateur de vide afin d'éliminer l'éthanol par évaporation sous pression réduite à la fin de la préparation. C'est un procédé continu et simple qui permet l'évaporation de l'éthanol directement sur le pilote. Le pilote peut être utilisé dans des conditions stériles. Pour la préparation à l'aide d'un pilote équipé d'une membrane SPG pour l'injection, un récipient supplémentaire contient la phase organique et le premier réacteur contient la phase aqueuse. La phase organique est poussée à travers la membrane au moyen d'une pompe. La phase aqueuse circule à l'intérieur de la membrane grâce à une seconde pompe. Les débits des deux phases sont réglés de manière à ce qu'elles passent en un temps identique. Un volume de 3 L a été préparé pendant 90 s. A la fin de la préparation, les suspensions liposomiales sont recueillies à la sortie de la membrane dans le deuxième réacteur à double enveloppe et soumises à agitation pendant 15 min (Charcosset et al., 2015). L'éthanol est éliminé par évaporation sous pression réduite soit directement sur le pilote ou bien à l'aide d'un évaporateur rotatif. Trois formulations liposomiales ont été préparées en utilisant le Lipoid S100: 1) liposomes témoins; 2) liposomes encapsulant l'Ane et 3) ACL.

Les liposomes obtenus sont caractérisés en termes de taille, pDI, potentiel zêta en utilisant la DLS. Les liposomes obtenus ont présenté une distribution de taille homogène, à l'exception de la formulation ACL2. Pour cette raison, ACL2 n'a pas été préparé par pilote. La taille moyenne des liposomes préparés par pilote (183-240 nm) a montré des valeurs plus élevées que ceux préparés par contacteur à membrane (151-168 nm). Par rapport aux liposomes témoins, la présence de l'HP- β -CD ou l'Ane n'affectait ni la distribution de taille ni le potentiel zêta des liposomes préparés par contacteur à membrane ou par pilote, quel que soit la méthode d'évaporation utilisée. Les résultats obtenus étaient similaires à ceux obtenus par la méthode d'injection éthanolique à petite échelle. Ce qui confirme que cette méthode peut être utilisée pour la production des liposomes à grande échelle. Les images obtenues par la microscopie électronique à transmission (TEM) et par la microscopie à force atomique (AFM), montraient la formation des vésicules sphériques, oligolamellaires et de taille nanométrique. La présence de l'HP- β -CD et/ou l'Ane n'a pas affecté la morphologie des liposomes. Notre étude est la première à présenter des images par AFM de liposomes encapsulant le complexe d'inclusion HP- β -CD/PA.

La stabilité des formulations, préparées par contacteur à membrane, est étudiée en déterminant la taille, le pDI et le potentiel zêta pendant 3 mois de stockage à 4°C. Les résultats ont montré une bonne stabilité des suspensions liposomiales.

Le rendement d'encapsulation de l'Ane a été également déterminé pour toutes les formulations liposomiales. La présence de l'HP- β -CD n'a pas affecté l'encapsulation de l'Ane pour les liposomes préparés par contacteur à membrane. En outre, les ACL2 ont présenté des valeurs de rendement d'encapsulation de l'Ane significativement supérieures à celles obtenues avec les ACL. Des résultats similaires de rendement d'encapsulation de l'Ane ont été obtenus pour les ACL et ACL2 encapsulant l'Ane ce qui indique la reproductibilité de l'incorporation de l'Ane. En utilisant le pilote, une augmentation du rendement d'encapsulation de l'Ane est obtenue pour les liposomes encapsulant l'Ane et ACL avec les deux méthodes d'évaporation.

Par ailleurs, la libération de l'Ane pour les liposomes encapsulant l'Ane, ACL et ACL2, préparés par contacteur à membrane, a été évaluée à 4 °C pendant 21 jours. Les résultats ont montré que, pour tous les liposomes, une petite quantité de l'Ane (au-dessous de 15%) a été libérée après 21 jours, ce qui suggère que le contacteur à membrane et le pilote sont appropriés pour la production des liposomes stables.

Ce travail a permis d'adapter avec succès la méthode d'injection éthanolique à la production à grande échelle des liposomes encapsulant le complexe d'inclusion HP- β -CD/Ane et l'évaporation de l'éthanol, réalisée directement sur le pilote qui présente les avantages d'être un procédé continu et simple.

Ce chapitre est présenté sous forme d'un article publié en 2016 dans le journal « Carbohydrate Polymers ».

Références

- Charcosset, C., Juban, A., Valour, J., Urbaniak, S., & Fessi, H. (2015). Preparation of liposomes at large scale using the ethanol injection method: Effect of scale-up and injection devices. *Chem. Eng Res Des*, 94, 508-515.
- Greige-Gerges, H., & Sebaaly, C. (2015). *Essential oils encapsulation technologies : application to cloves*. Lambert Academic Publishing.
- Jaafar-Maalej, C., Charcosset, C., & Fessi, H. (2011). A new method for liposome preparation using a membrane contactor. *J Liposome Res*, 21, 213-220.
- Laouini, A., Jaafar-Maalej, C., Limayem-Blouza, I., Sfar, S., Charcosset, C., & Fessi, H. (2012). Preparation, Characterization and Applications of Liposomes: State of the Art. *Journal of Colloid Science and Biotechnology*, 1, 147-168.
- Laouini, A., Jaafar-Maalej, C., Sfar, S., Charcosset, C., & Fessi, H. (2011). Liposome preparation using a hollow fiber membrane contactor – application to spironolactone encapsulation. *Int J Pharm*, 415, 53-61

Preparation of drug-in-cyclodextrin-in-liposomes at a large scale using a membrane contactor: application to trans-anethole

Riham Gharib^{1,2}, Hélène Greige-Gerges¹, Alia Jraij¹, Lizette Auezova¹, Catherine Charcosset².

¹Bioactive Molecules Research Group, Faculty of Sciences; Doctoral School of Sciences and Technologies, Lebanese University, Lebanon.

²Laboratoire d'Automatique et de Génie des Procédés, Université Claude Bernard Lyon 1, France.

Carbohydrate Polymers 154 (2016) 276–286



Contents lists available at ScienceDirect

Carbohydrate Polymers

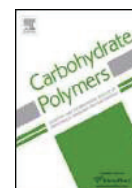
journal homepage: www.elsevier.com/locate/carbpol

Preparation of drug-in-cyclodextrin-in-liposomes at a large scale using a membrane contactor: Application to *trans*-anethole



Riham Gharib^{a,b}, H el ene Greige-Gerges^a, Alia Jrajai^a, Lizette Auezova^a, Catherine Charcosset^{b,*}

^a Bioactive Molecules Research Group, Faculty of Sciences, Doctoral School of Sciences and Technologies, Lebanese University, Lebanon

^b Laboratoire d'Automatique et de G enie des Proc ed es, Universit e Claude Bernard Lyon 1, France

ARTICLE INFO

Article history:

Received 1 March 2016

Received in revised form 15 June 2016

Accepted 17 June 2016

Available online 18 June 2016

Keywords:

Anethole

Cyclodextrin

Liposome

Double loading

Membrane contactor

Scale-up

ABSTRACT

The present study aimed to prepare liposomes loaded with cyclodextrin/drug inclusion complexes at a pilot scale based on the ethanol injection technique. Anethole (ANE), a major component of anise and fennel essential oils, was used as a model of a volatile and highly hydrophobic drug. Membrane contactor (600 mL) and a pilot plant (3 L) were used for liposome production. The liposome preparations obtained were characterized for size, polydispersity index, zeta potential, morphology, stability and ANE release rate. All experimental set-ups were shown to be appropriate for the preparation of small, multilamellar vesicles with narrow size distribution and good stability at 4  C. The drug release study showed that only a small amount of ANE was released from liposome formulations after 21 days of storage at 4  C. The loading rate of ANE was higher when ethanol was evaporated directly on the pilot plant compared to a rotary evaporation.

  2016 Elsevier Ltd. All rights reserved.

1. Introduction

Essential oils (EOs) are complex mixtures of volatile compounds produced by aromatic plants and composed mainly of monoterpenes, sesquiterpenes and phenylpropenes (Burt, 2004). They are known for their antimicrobial, anti-inflammatory, analgesic, sedative and spasmolytic properties (Bakkali, Averbek, Averbek, & Idaomar, 2008). Anethole (ANE) ((*E*)-1-methoxy-4-(1-propenyl)benzene), a phenylpropene, is the principle component of anise, star anise and fennel oils (Makadia & Siegel, 2011). ANE was reported to possess antimicrobial (Kubo, Fujita, & Nihei, 2008), estrogenic (Chen & deGraffenried, 2012) and antithrombotic effects (Tognolini et al., 2007). It is largely used as a flavor agent in food

industry, e.g., in cakes, ice creams and alcoholic beverages (Freire, Morais, Catunda-Junior, & Pinheiro, 2005). ANE presents some inconvenients such as a chemical instability in presence of light, heat and oxygen and poor water solubility. The encapsulation of ANE in systems like liposomes may overcome these drawbacks and allow its safe incorporation in food, pharmaceuticals and cosmetic preparations.

Liposomes, safe and effective drug carrier systems, are nanometric vesicles in which an aqueous phase is entirely enclosed by a membrane composed mainly of phospholipids (Anwekar, Patel, & Singhai, 2011; Goyal et al., 2005). They are able to encapsulate a hydrophilic drug within their aqueous compartment and a lipophilic drug within the lipid bilayer. Liposomes are administered orally or parentally. Topical and pulmonary administration routes are being considered also (Akbarzadeh et al., 2013).

Encapsulation of therapeutic agents within liposomes in sufficient amounts is one of the key desirable properties for liposomal carriers. However, the entrapment of lipophilic, poorly soluble drugs in liposomal vesicles requires the use of organic solvents and is limited by possible problems of bilayer destabilization (Gregoriadis, 2000). Moreover, drugs incorporated in the membrane bilayers rather than in the aqueous core of the vesicles, are rapidly released after administration. The entrapment of hydrophobic drugs in the aqueous core of liposomes as soluble inclusion

Abbreviations: ANE, *trans*-anethole; ACL, anethole-in-cyclodextrin-in liposome; ACL2, double loaded liposome; DCL, drug-in-cyclodextrin-in liposome; EE, encapsulation efficiency; HP- β -CD, hydroxypropyl- β -cyclodextrin; LR, loading rate; Pdl, polydispersity index.

* Corresponding author at: Laboratoire d'Automatique et de G enie des Proc ed es (LAGEP), UMR 5007, CNRS, CPE, 43 bd du 11 Novembre, 691622 Villeurbanne Cedex, France.

E-mail addresses: gharib.riham@hotmail.com (R. Gharib), hgreige@ul.edu.lb (H. Greige-Gerges), ajrajai@ul.edu.lb (A. Jrajai), lauezova@ul.edu.lb (L. Auezova), charcosset@lagep.univ-lyon1.fr (C. Charcosset).

<http://dx.doi.org/10.1016/j.carbpol.2016.06.074>

0144-8617/  2016 Elsevier Ltd. All rights reserved.

complexes with cyclodextrins (CDs) has been proposed as a promising alternative to the use of organic solvents in pharmaceutical preparations, thus obtaining drug-in-cyclodextrin-in-liposome (DCL) systems (McCormack & Gregoriadis, 1994, 1998). This approach can be useful to increase drug solubility and stability (Loukas, Vraka, & Gregoriadis, 1998) and to avoid the rapid release of poorly aqueous soluble drugs incorporated in the lipid bilayer of conventional liposomes (McCormack & Gregoriadis, 1994, 1998). Further advantages can be obtained using a double-loading technique, by preparing liposomes loaded with the free drug in the lipophilic phase and its CD inclusion complex in the aqueous phase, resulting in both a fast onset action and a prolonged effect (Bragagni, Maestrelli, Mennini, Ghelardini, & Mura, 2010).

CDs are a family of cyclic oligosaccharides obtained from enzymatic degradation of starch. The most common native CDs are α -cyclodextrin (α -CD), β -cyclodextrin (β -CD) and γ -cyclodextrin (γ -CD) composed of six, seven and eight (α -1,4)-linked α -D-glucopyranose units, respectively. Owing to their molecular structure, consisting of a hydrophilic outer surface and a hydrophobic cavity, CDs can form inclusion complexes with organic compounds, which enter partly or entirely into their cavity (Szejtli, 1998). CDs have been widely used as encapsulating agents to enhance the solubility, stability, release and bioavailability of natural compounds (Astray, Gonzalez-Barreiro, Mejuto, Rial-Otero, & Simal-Gandara, 2009; Marques, 2010; Pinho, Grootveld, Soares, & Henriques, 2014). Moreover, the formation of the CD/drug inclusion complex is capable to solve many problems associated with the delivery of different novel drugs through different delivery routes (Nasir, Harikumar, & Kaur, 2012).

Many techniques have been reported for liposome preparation including thin film hydration method, ethanol injection method, proliposome–liposome method, reverse-phase evaporation, and methods based on detergent removal (Wagner & Vorauer-Uhl, 2011). However, with the exception of the ethanol injection method, these methods tend to be unsuitable for large-scale production, since they require sonication or high-pressure extrusion in order to homogenize and reduce vesicle size.

The conventional ethanol injection technique first described by Batzri and Korn (1973) offers many advantages, such as simplicity, the absence of potentially harmful chemicals and complicated physical treatments, the possibility of small-sized liposomes production with minimal technical requirements and the possibility of scale-up (Wagner, Vorauer-Uhl, Kreismayr, & Katinger, 2002). Several novel approaches for scaling-up based on the ethanol injection technique were reported such as the microfluidic channel method (Jahn, Vreeland, Gaitan, & Locascio, 2004; Pradhan, Guan, Lu, Wang, & Lee, 2008), the cross flow injection technique (Wagner et al., 2002), cross-flow injection technique using a special Y connector combined with ultrafiltration and high-pressure extrusion procedures (Zhong et al., 2013), membrane contactor using Shirasu Porous Glass membrane (Charcosset, Juban, Valour, Urbaniak, & Fessi, 2015) and nickel micro-engineered membrane (Laouini, Charcosset, Fessi, Holdich, & Vladislavjević, 2013a, 2013b) or hollow fiber configuration (Laouini, Jaafar-Maalej, Sfar, Charcosset, & Fessi, 2011).

Membrane contactors, applied first for the preparation of emulsions (i.e., membrane emulsification) and precipitates (Charcosset, El Harati, & Fessi, 2005; Charcosset, 2004, 2006) were also reported for the preparation of polymeric and lipidic nanoparticles (Charcosset & Fessi, 2005; Charcosset et al., 2005; Limayem-Blouza, Charcosset, Sfar, & Fessi, 2006), liposomes (Charcosset, Juban, Valour, Urbaniak, & Fessi, 2015; Jaafar-Maalej et al., 2010; Laouini et al., 2011; Pham, Jaafar-Maalej, Charcosset, & Fessi, 2012) and niosomes (Pham et al., 2012).

In a previous work, we studied the encapsulation of ANE in DCL system prepared at laboratory scale. Saturated (Phospholipon 90H)

and unsaturated (Lipoid S100) alkyl chains phospholipids were used. Liposomes were prepared by the ethanol injection method (Jaafar-Maalej, Diab, Andrieu, Elaissari, & Fessi, 2010). Lipoid S100-liposomes were shown to possess high values of loading rate and anti-UV effect for ANE (Gharib, Auezova, Charcosset, & Greige-Gerges, submitted). To our knowledge, DCL were never produced on a large scale.

The present study aimed to scale-up the DCL preparation to semi-industrial scale. Thus, different liposomes formulations, encapsulating both ANE and HP- β -CD/ANE inclusion complex, were prepared with non-hydrogenated (Lipoid S100) phospholipids at a pilot scale using a membrane contactor and a pilot plant both equipped with a SPG (Shirasu Porous Glass) membrane for injection. The liposome preparations obtained were characterized for their size, polydispersity index (PDI) and zeta potential. The liposomes morphology was observed by transmission electronic microscopy (TEM) and atomic force microscopy (AFM). The loading rate (LR) and encapsulation efficiency (EE) values for ANE in different formulations were calculated based on HPLC analysis. Stability of liposomes was assessed during 3 months at 4 °C, and the release of ANE from the formulations was determined during 21 days.

2. Materials and methods

2.1. Materials

Trans-ANE (99%) and HP- β -CD were purchased from Acros Organics (New Jersey, USA). Non-hydrogenated soy phosphatidylcholine Lipoid S100 (94% soybean phosphatidylcholine, 3% lysophosphatidylcholine, 0.5% *N*-acyl-phosphatidylethanolamine, 0.1% phosphatidylethanolamine, 0.1% phosphatidylinositol, 2% water, 0.2% ethanol) was supplied by Lipoid GMBH (Ludwigshafen, Germany). Thymol, cholesterol, absolute ethanol and methanol-HPLC grade were purchased from Sigma Aldrich (France). Tubular SPG membranes were purchased from SPG Technology (Miyazaki, Japan). SPG membranes are prepared by phase-separated glass leaching in the Na₂O-CaO-MgO-Al₂O₃-B₂O₃-SiO₂ system, which is synthesized from volcanic ash, called *Shirasu*, used as the main raw material (Vladislavjević et al., 2007). The membrane was hydrophilic with a mean pore size of 1 μ m. The SPG membrane dimensions were as follows: 0.125 m length, 10⁻² m inner diameter, and 10⁻³ m thickness. Hence, the active membrane surface was 3.9 \times 10⁻³ m². Water was purified on a Milli-Q system obtained from a Millipore® Synergy system (Millipore, Billerica, Massachusetts, USA).

2.2. Methods

In this study, five batches were prepared using the ethanol injection method: 1) blank liposomes; 2) ANE-loaded liposomes; 3) free HP- β -CD-loaded liposomes; 4) HP- β -CD/ANE inclusion complex-loaded liposomes (ACL); 5) double loaded liposomes (ACL2). The preparation was done at large scale using a membrane contactor for intermediate volume injection (600 mL) and a pilot plant with a membrane for injection of larger volumes of preparation (3 L). All experiments were conducted at room temperature. Table 1 summarizes the volumes of organic and aqueous phases, and the flow rates of organic phase, for the two experimental set-ups. For all formulations, the volume ratio between the organic and aqueous phases was set to 0.5. At this ratio, small-sized particles with narrow size distribution were obtained by two methods, syringe injection (Jaafar-Maalej et al., 2010) and membrane contactor (Laouini et al., 2011). On the other hand, when using a membrane contactor, lipid aggregation may happen. To avoid this phenomenon, the two phases have to pass at the same time (Jaafar-Maalej, Charcosset, &

Table 1
Volumes of organic and aqueous phases and organic phase flow rate for the two injection methods.

	Volume (mL)		Volume ratio (organic phase/aqueous phase)	Total flow rate (mL/min)
	Organic phase	Aqueous phase		
Membrane contactor	200	400	0.5	750
Pilot plant	1000	2000	0.5	2000

Fessi, 2011). The mean flow rate Q (mL/min) was calculated according to the following formula: $Q = V/t$, where V was the total volume of preparation (mL) and t was the processing time (min).

2.2.1. Preparation of HP- β -CD/ANE inclusion complexes

HP- β -CD/ANE inclusion complexes were prepared in aqueous solution. HP- β -CD (10 g and 50 g) was dissolved in 400 mL and 2000 mL respectively of ultrapure water, and the required amount of ANE was added to obtain 1:1 molar ratio. The solutions obtained were stirred (120 rpm for 24 h at 25 °C), filtered (0.45 μ m filter) and then used as the aqueous phase in DCL preparations.

2.2.2. Membrane contactor

The experimental set-up used for the intermediate volume ($V = 600$ mL) included a membrane device for injection of the organic phase. For the blank liposomes preparation, Lipoid S100 (10 mg/mL) and cholesterol (5 mg/mL) were dissolved in absolute ethanol according to (Sebaaly, Greige-Gerges, Stainmesse, Fessi, & Charcosset, 2016). The experimental set-up included two positive displacement pumps. The first pump (Filtron, France) circulated the aqueous phase (400 mL) at a tangential velocity of 1.9 m/s from the inlet of the tubular membrane to the outlet. The second pump (Quattroflow 1000S, Life Sciences, France) pushed the organic phase at a flow rate of 250 mL/min through the membrane pores. Spontaneous formation of liposomes started as soon as the organic phase was brought in contact with the aqueous phase inside

the membrane tube. The experiment was stopped when air bubbles started to appear in the tube connecting the organic phase to the membrane module, indicating that all the organic phase had circulated through the membrane. The experiments were carried out in an open loop configuration to avoid recirculation of liposomes. Therefore, flow rates of the aqueous and organic phases were set to have both phases passed during the same time. At the end of the preparation, the liposomal suspension was kept under magnetic stirring (600 rpm) for 15 min at room temperature. Finally, the ethanol and a part of water were removed by rotary evaporation under reduced pressure (Rotavapor R-124, Büchi, Switzerland).

Five batches were prepared: 1) blank liposomes; 2) ANE-loaded liposomes where ANE was added in the organic phase at a concentration of 2.5 mg/mL; 3) free HP- β -CD-loaded liposomes where HP- β -CD (10 g) was dissolved in the aqueous phase; 4) HP- β -CD/ANE inclusion complex-loaded liposomes (ACL) where the solution of CD/ANE inclusion complex prepared previously was used as an aqueous phase as shown in Fig. 1; 5) double loaded liposomes (ACL2) where ANE was added in the organic phase at a concentration of 2.5 mg/mL and the solution of CD/ANE inclusion complex was used as an aqueous phase. Each batch was prepared in triplicate.

At the end of the experiment, the SPG membrane was regenerated. The washing was performed by flushing the membrane with 400 mL of water at the inner side of the membrane and 200 mL of ethanol at the outer side. A final rinsing step was realized by

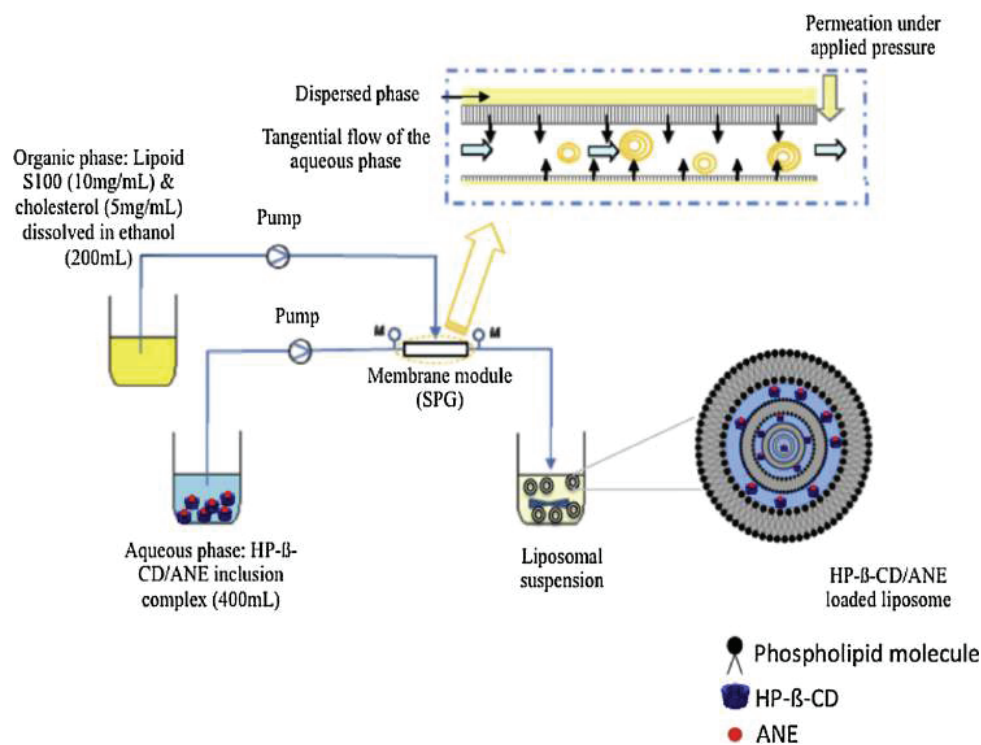

Fig. 1. Schematic drawing of the membrane contactor set-up for the preparation of ACL.

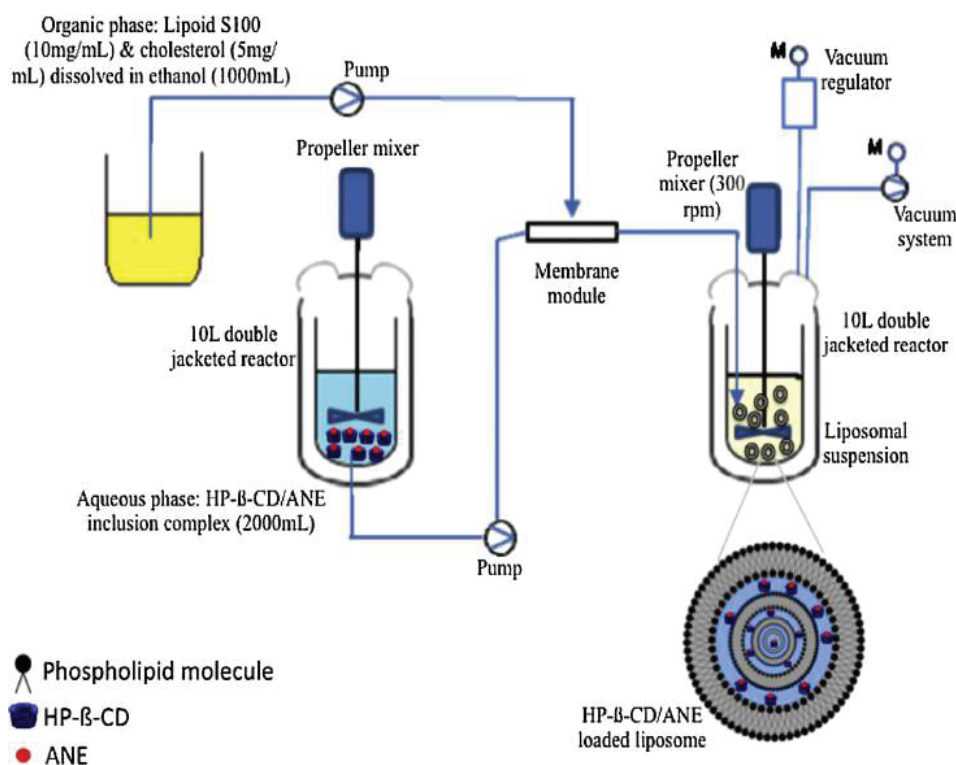

Fig. 2. Schematic drawing of the pilot plant set-up for the preparation of ACL.

flushing the membrane with 400 mL of water at the inner side and 200 mL of water at the outer side.

2.2.3. Pilot plant with membrane injection

The pilot plant can be used for preparation of liposomal suspensions up to 10L. In the present study, tests have been made for 3 L preparations to reduce consumption of reactants. The pilot plant using a SPG membrane for injection was adapted as previously described (Jaafar-Maalej, Charcosset, & Fessi, 2012). For the liposomes preparation, the required amounts of Lipoid S100 (10 mg/mL), cholesterol (5 mg/mL) were dissolved in absolute ethanol (1 L) at room temperature. An additional vessel contained the organic phase and the first double jacketed reactor contained the aqueous phase (2 L). Two 10L double jacketed reactors were equipped with impellers (propeller stirrer 4-bladed, digital stirrer Eurostar, IKA, France). The second double jacketed reactor was connected to a vacuum system (Ref B-169, Büchi, Switzerland) and a vacuum regulator (Ref Y457.1, Carl Roth GmbH, France) to remove ethanol by evaporation under reduced pressure at the end of the preparation.

The organic phase was injected at a flow rate of 666 mL/min through the membrane pores using a positive displacement pump (Quattroflow 1000S, Life Sciences, France). The aqueous phase circulated inside the tubular membrane using a second peristaltic pump (Ref 603S, Watson Marlow). During the preparation, the liposomal suspension was collected at the outlet of the tubular membrane inside the second double jacketed reactor. The stirring rate was set to 300 rpm. Both flow rates were set to have both phases passed during the same time (Table 1). At the end of the preparation, the liposomal suspension was kept under magnetic stirring at 600 rpm for 15 min at room temperature. Finally, the ethanol and a part of water were removed by evaporation under reduced pressure (Ref B-169, Büchi, Switzerland), directly on the pilot unit (stirring rate 250 rpm) or using the rotavapor (Rotava-

por R-124, Büchi, Switzerland), after collecting the preparation in an evaporation flask. Three batches were prepared: 1) blank liposomes; 2) ANE-loaded liposomes where ANE was added in the organic phase at 2.5 mg/mL; 3) HP-β-CD/ANE inclusion complex-loaded liposomes (ACL) where the solution of CD/ANE inclusion complex prepared previously was used as an aqueous phase (Fig. 2).

The membrane was regenerated as indicated above. Each batch was prepared in triplicate.

2.3. Liposome characterization

2.3.1. Size and zeta potential analysis

2.3.1.1. *Dynamic light scattering analysis.* Malvern Zetasizer Nanoseries (Zetasizer Nano ZS Malvern Instruments Ltd, France) was used to determine the mean size of various liposomal batches. Particle-size distribution data were collected using the DTS (nano) software (version 5.10) provided with the instrument. The Pdl, which is an indicator of the width of particle size distribution, ranges from 0 (monodispersed) to 1 (very broad distribution). Data were expressed as the mean \pm standard deviation. Zeta potential was measured by Smoluchowski's equation from the electrophoretic mobility of liposomes. All measurements were performed in triplicate and carried out at 25 °C after 3 min of equilibration.

2.3.2. Liposome storage stability

All liposomes formulations prepared by membrane contactor were stored at 4 °C for 3 months. The particle size, Pdl, Zeta potential were determined every month and compared to the initial values obtained at the preparation day.

2.3.3. Morphological characterization by transmission electron microscopy

Transmission electron microscopy was performed with a Philips CM120 microscope (Eindhoven, Netherlands) operating at “Centre Technologique des Microstructures” (University of Lyon, Villeurbanne, France). A dispersion drop was applied to a carbon-coated copper grid, left for 2 min, and the remaining liquid was removed using a filter paper. Negative staining using a 1% sodium silicotungstate solution was directly made on the deposit during 30 s. Finally, the excess of sodium silicotungstate solution was removed with a filter paper and dried samples were observed.

2.3.4. Atomic force microscopy study

AFM was performed using an Agilent 5420 (USA). Pyrex-Nitride Probes PNP-TR (NanoWord Innovative Technologies, NanoAnd-More, Paris) integrating oxide sharpened, pyramidal tips with a radius <10 nm have been used. Liposomes formulations were diluted in ultrapure water. The dilution factor varied between 10 and 50. Samples were deposited on freshly cleaved mica for 20 min. The samples were allowed to air dry at room conditions. Imaging of dried samples was performed in contact mode. Scanning speed was optimized to 3 Hz.

2.3.5. Determination of encapsulation efficiency and loading rate for anethole

The EE for ANE into liposomes was determined upon HPLC analysis of samples. Aliquots were taken from the liposomal suspension to determine the total ANE concentration ($[ANE]_{Total}$). The liposomal suspension underwent ultracentrifugation (Optima™ Ultracentrifuge, Beckman Coulter, USA) at 170,000g for 1 h at 4 °C. Aliquots were taken from the supernatant to determine the concentration of free ANE ($[ANE]_F$).

Stock standard solutions of ANE (1 mg/mL) and of the internal standard thymol (1 mg/mL) were prepared in methanol. Aliquots were taken from the ANE stock solution and diluted in methanol to obtain final concentrations of ANE ranging from 1 to 250 µg/mL. The diluted solution of thymol (100 µg/mL) was prepared in methanol.

One hundred µL of each solution (ANE standard, liposomal suspension, supernatant and aqueous solution of HP-β-CD/ANE inclusion complex), were added to 100 µL of thymol (100 µg/mL) and 200 µL of methanol. The samples were sonicated for 10 min at room temperature. The samples were analyzed by HPLC (Agilent Technologie 1200 series) using an analytical column (C18 15 cm × 4.6 mm, 5 µm, Agilent). The mobile phase was a mixture of methanol and water (70/30). The flow rate was fixed at 1 mL/min and the detection was set at 206 nm. EE for each preparation was calculated as follows:

$$EE (\%) = \frac{[ANE]_{Tot} - [ANE]_F}{[ANE]_{Tot}} \times 100 \quad (1)$$

where $[ANE]_{Tot}$ and $[ANE]_F$ correspond to the concentration of total and free ANE in liposomal suspension determined by HPLC. The encapsulation efficiency was determined in triplicate.

The LR was calculated following two ways. One is based on the mass of ANE present in HP-β-CD inclusion complex (LR_{IC}) solution, which is determined by HPLC (after the filtration step following the complex preparation). The second is based on the mass of ANE initially added to CD (LR_I) during the preparation of CD/ANE inclusion complex.

The LR_{IC} for ACL was calculated as follows:

$$LR_{IC} = \frac{m_{liposomal\ suspension} - m_{filtrate}}{m_{IC}} \times 100 \quad (2)$$

where $m_{liposomal\ suspension}$ stands for the total ANE mass in liposomal suspension, $m_{filtrate}$ is the unloaded ANE mass (determined in the

liposomal filtrate) and m_{IC} is the mass of ANE present in HP-β-CD inclusion complex determined by HPLC.

The LR_{IC} for ACL2 was calculated as follows:

$$LR_{IC} = \frac{m_{liposomal\ suspension} - m_{filtrate}}{m_{IC} + m_{OP}} \times 100 \quad (3)$$

where $m_{IC} + m_{OP}$ is the sum of the ANE mass determined by HPLC in HP-β-CD inclusion complex and the initial ANE mass added to the organic phase.

The LR_I for ACL was calculated by the following equation:

$$LR_I = \frac{m_{liposomal\ suspension} - m_{filtrate}}{m_{initial}} \times 100 \quad (4)$$

The LR_I for ACL2 was calculated as follows:

$$LR_I = \frac{m_{liposomal\ suspension} - m_{filtrate}}{m_{initial} + m_{OP}} \times 100 \quad (5)$$

where for ACL, $m_{initial}$ is the initial mass of ANE added to HP-β-CD before filtration. And for ACL2 $m_{initial} + m_{OP}$ is the sum of initial ANE mass added to the organic phase and the initial ANE mass added to HP-β-CD before filtration. For ANE-loaded liposomes, $m_{initial}$ is the initial ANE mass added to the organic phase.

2.4. Release kinetics

Liposomes suspensions (ANE-loaded liposomes, ACL and ACL2) prepared by the membrane contactor method, were incubated at 4 °C. For each formulation, the free ANE content was determined at different time intervals (0, 10, 24, 48, 96, 192, 240, 360 and 504 h) by the HPLC method described above. The free ANE was obtained by ultracentrifugation at 172000g for 1 h at 4 °C. The percentage of released ANE was determined by the following equation:

$$\text{Percentage of ANE released} = \frac{[ANE]_{Ft} - [ANE]_{F0}}{[ANE]_{Tot}} \times 100 \quad (6)$$

where $[ANE]_{Ft}$ and $[ANE]_{F0}$ are the concentration of free ANE at time t and at t = 0 respectively and $[ANE]_{Tot}$ is the total concentration of ANE. The experiment was done in triplicate.

2.5. Statistical analysis

Statistical analysis was performed using the Student T-test. A value of $P < 0.05$ was considered significant.

3. Results and discussion

In a previous study, five liposomes formulations were prepared by the ethanol injection method using Lipoid S100 and Phospholipon 90H. The obtained liposomes were oligolamellar and sized between 140 and 180 nm. Compared to phospholipon 90H, the lipoid S100-liposomes showed higher LR values, stability and the best protective effect of ANE from UV rays (Gharib et al., submitted).

In the present study, firstly liposomes preparations were scaled-up using the membrane contactor leading to a final volume of 600 mL in 48 s. Compared to the ethanol injection method with a syringe for injection, the process permits to increase 20 fold the volume of the preparation and to reduce 12.5 fold the time. Using a pilot plant with a membrane for injection, the volumes have been increased 100 fold in comparison with the syringe injection leading to a final volume of 3 L during 90 s. For evaporation, the ethanol was removed either directly on the pilot set-up or using rotary evaporation.

Table 2 summarizes the mean particles size, PDI and zeta potential of liposomes obtained by membrane contactor and pilot plant.

Table 2
Characteristics of liposomes prepared by membrane contactor and pilot plant.

	Preparation method	Size (nm)	pdl	Zeta (mV)	EE %	LR _{IC} %	LR _I %
Blank liposomes	Membrane contactor	153 ± 7.9	0.24 ± 0.03	-1.2 ± 1.2			
	Pilot plant: pilot evaporation	248 ± 22	0.24 ± 0.05	-0.1 ± 0.5			
	Pilot plant: rotavapor vaporation	210 ± 5	0.30 ± 0.07	-3.1 ± 1.3			
HP-β-CD-loaded liposome	Membrane contactor	161 ± 25.6	0.23 ± 0.06	-2.1 ± 1.5			
Anethole-loaded liposome	Membrane contactor	162 ± 19.2	0.29 ± 0.11	-1.9 ± 1.1	96.7 ± 1.4		6.5 ± 1.1
	Pilot plant: pilot evaporation	240 ± 45	0.25 ± 0.08	-0.7 ± 0.7	96.1 ± 1.8		35.6 ± 5.9
	Pilot plant: rotavapor evaporation	232 ± 18	0.31 ± 0.16	-2.7 ± 1.9	99.8 ± 0.1		21.4 ± 6.5
HP-β-CD/anethole-loaded liposome (ACL)	Membrane contactor	164 ± 7.5	0.40 ± 0.01	-0.9 ± 0.8	48.8 ± 4.9	9.39 ± 3.6	4.1 ± 0.2
	Pilot plant: pilot evaporation	189 ± 13	0.35 ± 0.11	-1.3 ± 0.3	47.6 ± 6.7	13.3 ± 2.12	9.6 ± 1.5
	Pilot plant: rotavapor evaporation	183 ± 3.0 [*]	0.56 ± 0.07 [*]	-1.3 ± 0.1	64.6 ± 6.3	24.02 ± 3.9	17.5 ± 2.8
Double loaded liposome (ACL2)	Membrane contactor	153 ± 19.9	0.63 ± 0.11 [*]	-1.2 ± 0.6	58.6 ± 5.9	9.59 ± 5.8	7.8 ± 5.9

Values are expressed as the means of three repetitions ±SD.

^{*} P < 0.05 compared with the blank liposomes value.

3.1. Polydispersity index

The pdl values for all liposomes formulations, prepared by membrane contactor and pilot plant using pilot or rotary evaporation were in general lower than 0.4 suggesting that the liposome populations were rather homogeneous. Moreover, there was no statistically significant difference between the pdl values for membrane contactor, pilot plant using pilot evaporation or rotary evaporation. Similar results were previously reported for Lipoid S100 liposomes encapsulating α-tocopherol prepared by membrane contactor and pilot plant (Charcosset et al., 2015). Thus, the ethanol injection method could be used for large-scale liposome production.

The highest Pdl value of 0.63 ± 0.11 was obtained for ACL2, prepared by membrane contactor. For this reason, ACL2 was not prepared by pilot plant. Similarly, using the ethanol injection method with a syringe for injection, the highest value of Pdl was

obtained for ACL2 (Gharib et al., submitted). Homogenous populations of DCL, prepared by membrane contactor were obtained for eugenol and clove essential oils (Sebaaly, Greige-Gerges, Agusti, Fessi, & Charcosset, 2015). Furthermore, for all formulations, the presence of CD did not affect the size distribution, which is in agreement with other studies (Ascenso et al., 2013; Bragagni et al., 2010; Cavalcanti et al., 2011; Maestrelli, Gonzalez-Rodriguez, Rabasco, Ghelardini, & Mura, 2010; Sebaaly, Charcosset, Stainmesse, Fessi, & Greige-gerges 2016).

3.2. Zeta potential

The zeta potential values ranged between -3.1 ± 1.3 mV and -0.1 ± 0.5 mV for all liposomes formulations. Therefore, compared to the blank liposomes, the presence of ANE and/or HP-β-CD did not affect the surface charge of Lipoid S100 liposomes, supporting

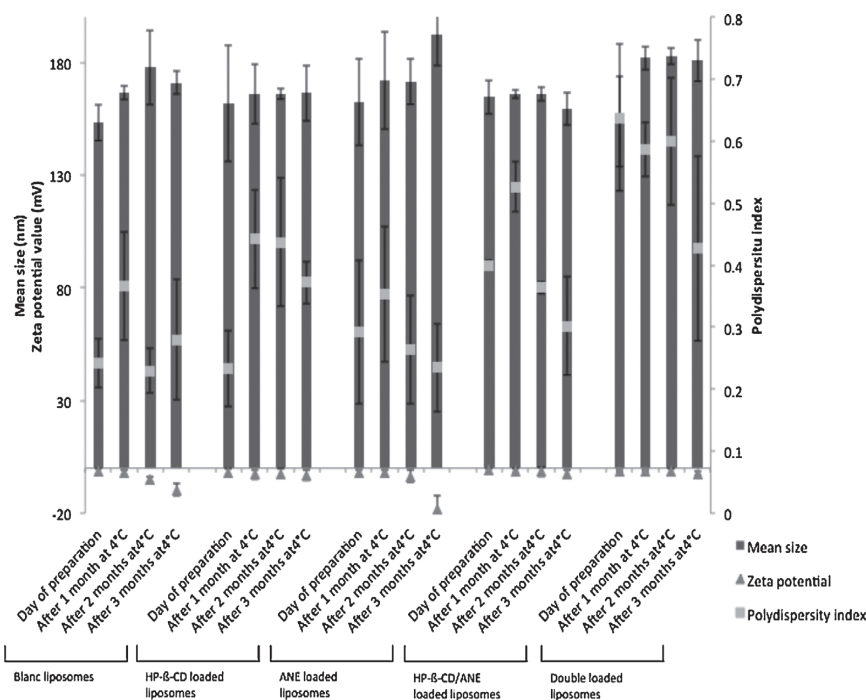

Fig. 3. Mean particle size, pdl and Zeta potential values of blank, HP-β-CD, ANE loaded liposomes, ACL and ACL2 prepared by membrane contactor at the day of preparation and during 3 months of storage at 4 °C.

our previous results (Gharib et al., submitted; Sebaaly et al., 2015; Sebaaly, Charcosset et al., 2016).

3.3. Size

The mean size of liposomes formulations prepared by membrane contactor varied between 153 nm and 164 nm. The same size range (151–168 nm) was obtained using syringe for injection (Gharib et al., submitted), indicating the reproducibility of the preparation process.

The mean vesicle size of blank, ANE-loaded liposomes and ACL, prepared at pilot plant, showed higher values (183–240 nm) than the formulations prepared by membrane contactor. This could be due to the very high total flow rate 2000 mL/min, which disfavors the formation of small vesicles.

ANE did not affect the vesicle size of Lipoid S100-liposomes. A similar result was reported for α -tocopherol loaded in the same phospholipid vesicles prepared by membrane contactor and pilot plant (Charcosset et al., 2015). Also, no effect on liposome size was observed for eugenol, clove essential oil (Sebaaly et al., 2015), caffeine and spironolactone (Pham et al., 2012), indicating that the liposome characteristics obtained by membrane contactor were very similar to those obtained with the syringe pump although the volumes had been increased by 20.

The presence of HP- β -CD did not affect the liposomes size (Table 2). Similar results was reported in other studies (Fatouros, Hatzidimitriou, & Antimisiaris, 2001; Maestrelli, Gonzalez-Rodriguez, Rabasco, & Mura, 2005; Sebaaly, Charcosset et al., 2016) when HP- β -CD was incorporated into liposomes.

These findings confirm that the ethanol injection method can be scaled-up for anethole encapsulation and the evaporation performed directly on the experimental set-up of pilot plant may present advantages of simplicity and continuous processing.

3.4. Liposomes stability

The mean particle size, Pdl and zeta potential values of five liposomes formulations, prepared by membrane contactor, were examined at 4 °C during 3 months of storage (Fig. 3). Slight increase in size (about 30 nm) was observed for blank liposomes and for the ANE-loaded liposomes after 3 months. For ACL2, the size increased from 150 nm to 180 nm after 1 month and then became stable during 3 months. Slight variation of Pdl values was observed during the stability test period. Besides, the zeta potential values remained nearly unchanged during the storage period. No aggregation or sedimentation was observed during storage. These results demonstrate a good stability of the liposomes suspensions and the preparation of adequate formulations. Sebaaly, Charcosset et al. (2016) reported that CD/eugenol inclusion complex-loaded phospholipon 90H prepared by the double loading technique were not stable after 1 month of storage at 4 °C. However, it has been reported that the α -tocopherol and eugenol-loaded Lipoid S100 liposomes were stable at 4 °C after 1 month of storage (Charcosset et al., 2015; Sebaaly et al., 2015).

3.5. Transmission electronic microscopy

All liposomal formulations were visualized by TEM. The liposomes were nanometric-sized and spherical shaped, in agreement with the DLS results. The vesicles appeared to be oligolamellar, composed of several phospholipids bilayers. Charcosset et al. (2015), Laouini et al. (2011), Pham et al. (2012), obtained the same morphological properties when liposomes were prepared by membrane contactor and pilot plant. The presence or absence of ANE, HP- β -CD and HP- β -CD/ANE inclusion complex did not affect either liposome lamellarity or morphology, in agreement

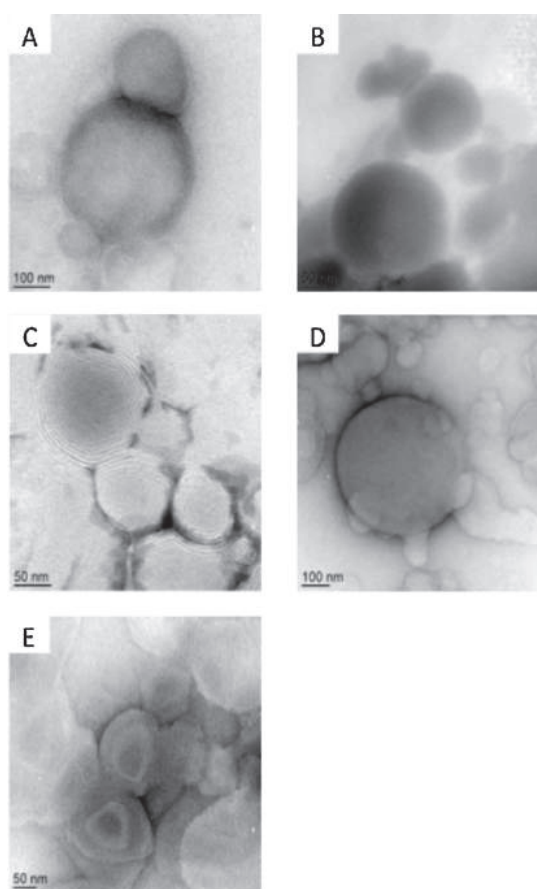

Fig. 4. TEM images of liposomes prepared by membrane contactor: Blank (A); HP- β -CD-loaded liposomes (B); anethole-loaded liposomes (C); ACL (D) and ACL2 (E).

with Maestrelli et al. (2005) and Maestrelli et al. (2010). Fig. 4 regroups (A–E) TEM images of blank liposomes, HP- β -CD-loaded liposomes, ANE-loaded liposomes, ACL and ACL2 respectively, prepared by membrane contactor. Similarly, Figs. 5 and 6(A–C) are examples of the images of blank liposomes, ANE-loaded liposomes and ACL prepared by pilot plant, with pilot and rotary evaporation, respectively.

3.6. Atomic force microscopy

All liposomes formulations were imaged by atomic force microscopy (AFM). Figs. 7 and 8 showed examples of AFM images obtained for liposomes prepared by membrane contactor and pilot plant, respectively. The images showed the formation of spherical liposomes. The vesicle sizes were in agreement with DLS results. The presence of HP- β -CD and/or ANE did not affect the liposomes morphology. The first AFM DCL images were reported by Ascenso et al. (2013) for dimethyl- β -CD/tertinoiin-loaded deformable liposomes. To our knowledge, our study is the first to present the AFM images for HP- β -CD/drug-loaded liposomes.

3.7. Encapsulation efficiency

The encapsulation efficiency (EE) of ANE-loaded liposomes was calculated using Eq. (1) and the values are listed in Table 2.

The EE value of ANE was 96.7 ± 1.4 , 96.1 ± 1.8 and $99.8 \pm 6.3\%$ for ANE-loaded liposome prepared respectively using the membrane contactor, the pilot plant with evaporation directly on the

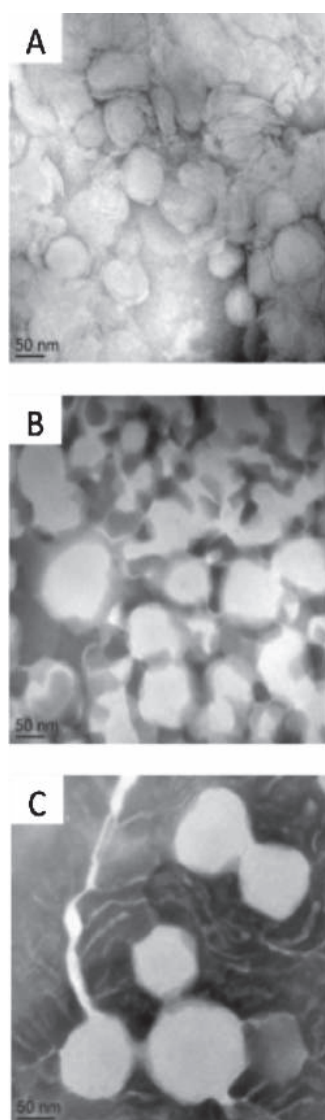

Fig. 5. TEM images of liposomes prepared by pilot plant with pilot evaporation: blank (A); ANE-loaded liposomes (B) and ACL (C).

pilot unit and the pilot plant with rotary evaporation (Table 2). These results indicate the possibility of liposomes production at large scale. Similarly, the EE of ACL was 48.8 ± 4.9 and $47.6 \pm 6.7\%$ using the membrane contactor and the pilot plant with evaporation directly on the pilot unit. The EE values increased significantly for ACL ($64.6 \pm 6.3\%$) prepared by pilot plant with rotary evaporation. Thus, the large-scale method could be used to prepare the DCL system. We notice that the EE of ANE for the ACL reduced by half compared to the ANE-loaded liposomes. This could be explained by the fact that ANE for the ANE-loaded liposomal preparations was dissolved in the organic phase which passed inside the membrane tube (Figs. 1 and 2) while HP- β -CD/ANE complex used for the ACL preparation was dissolved in the aqueous phase which passed by the membrane pore to brought in contact to the organic phase inside the membrane tube. There was evidently a loss of aqueous phase (HP- β -CD/ANE inclusion complex) that could not be entrapped into the liposomes. This hypothesis is also confirmed by the fact that the EE of ANE for ACL2 ($58.6 \pm 5.9\%$), which was only

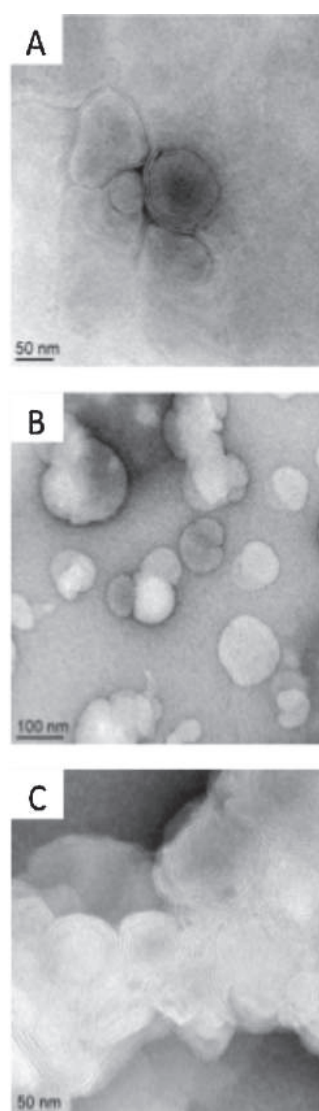

Fig. 6. TEM images of liposomes prepared by pilot plant with rotavapor: blank (A); ANE-loaded liposomes (B) and ACL (C).

prepared by membrane contactor, was higher than the EE values obtained with ACL ($48.8 \pm 4.9\%$).

3.8. Loading rate of ANE in liposomes

The concentration of ANE in HP- β -CD/ANE inclusion complex solution was determined and the mass of ANE was then calculated. The latter represents $35.41 \pm 1.9\%$ of the initial mass used to prepare the complex. This proved a relatively low entrapped quantity of ANE in the inclusion complex. A similar result was obtained by Kfoury, Auezova, Greige-Gerges, Ruellan, and Fourmentin (2014) where the complexation efficiency was found to be in the range of 17–34%.

The LR of ANE, for various batches, was calculated using Eqs. (2)–(5) and the values are listed in Table 2.

Using membrane contactor, the LR_{IC} values were $9.39 \pm 3.6\%$ and $9.59 \pm 5.8\%$ for ACL and ACL2 respectively. The LR_{IC} was $13.3 \pm 2.12\%$ and $24.02 \pm 3.9\%$ for ACL prepared by pilot plant with evaporation

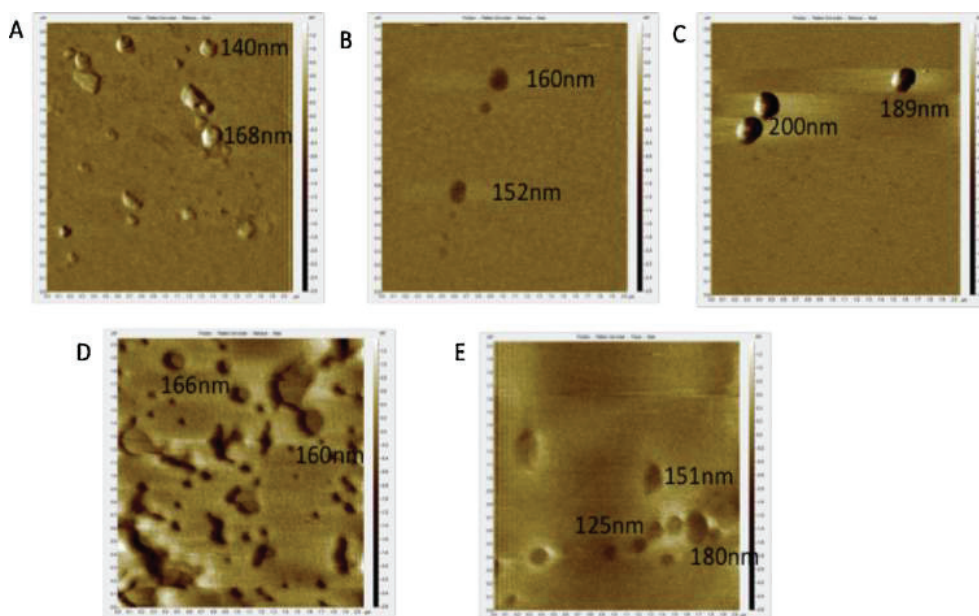

Fig. 7. AFM images of liposomes prepared by membrane contactor: blank (A); HP-β-CD-loaded liposomes (B); anethole-loaded liposomes (C); ACL (D) and ACL2 (E).

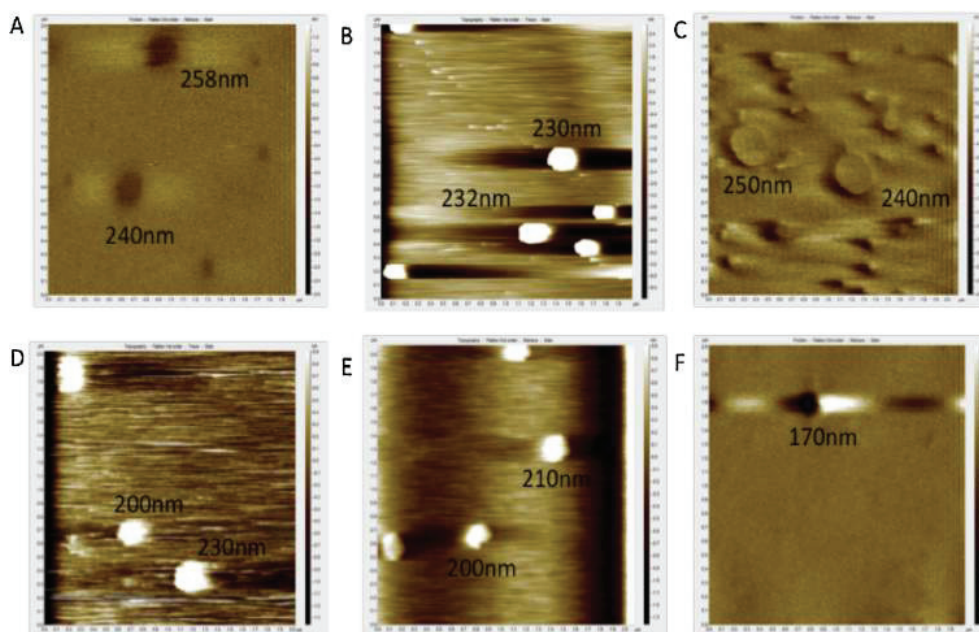

Fig. 8. AFM images of liposomes prepared by pilot plant with pilot evaporation: blank (A); anethole-loaded liposomes (B); ACL (C) and with rotavapor evaporation: blank (D); anethole-loaded liposomes (E); ACL (F).

directly on the pilot unit and with rotary evaporation respectively. The LR_I values are lower than LR_{IC} ones (Table 2).

There was no significant difference between LR_I of ANE for ANE-loaded liposomes ($6.5 \pm 1.1\%$) and ACL ($4.1 \pm 0.2\%$), prepared by membrane contactor (Table 2). Thus, the presence of CD did not affect the encapsulation of ANE, in agreement with (Ascenso et al., 2013; Cavalcanti et al., 2011; Hagiwara, Arima, Hirayam, & Uekama, 2006). The LR_I obtained with ACL2, prepared by membrane contactor ($7.8 \pm 5.9\%$), was 1.2 and 1.9 times higher than ANE-loaded liposomes and ACL respectively. These results are similar to those obtained by ethanol injection method with

syringe injection where the LR_I values were 5.2 ± 1.1 , 5.1 ± 0.2 and $7.7 \pm 1.1\%$ for ANE-loaded liposomes, ACL and ACL2, respectively (Gharib et al., submitted).

Using the pilot plant, important LR_I values were obtained for ANE-loaded liposomes and ACL, where ANE LR_I ranged between 9.6 ± 1.5 and $35.6 \pm 5.9\%$ with both methods of evaporation (Table 2). This result indicates that the membrane contactor and the pilot plant, being easy and continuous processes are suitable to DCL production and may improve the LR of volatile molecules when compared to vesicles prepared by the ethanol injection method using a syringe for injection (Gharib et al., submitted). Thus, the

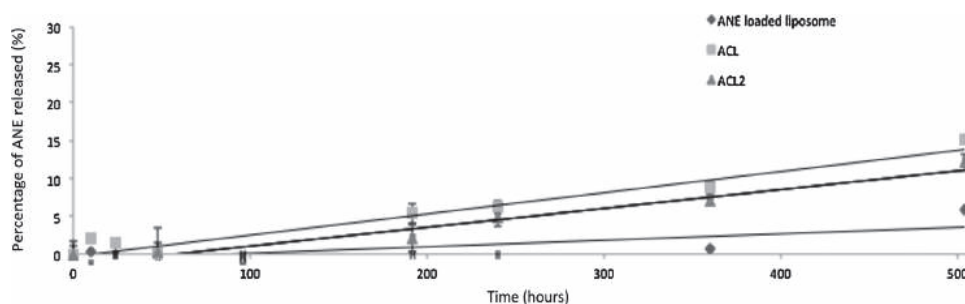

Fig. 9. Percentage of ANE released from ANE loaded liposomes, ACL and ACL2, prepared by membrane contactor. Each value represents the mean \pm SD.

membrane contactor and pilot plant could be useful to develop carrier systems encapsulating essential oils at large scale.

3.9. Release kinetics

The release of ANE from liposomes containing ANE, HP- β -CD/ANE inclusion complex (ACL) or from double loaded liposomes (ACL2), prepared by membrane contactor, was evaluated at 4 °C. Aliquots were withdrawn at the indicated times and the concentration of ANE released was determined by HPLC. The results are expressed as percentages of ANE released according to Eq. (6) (Fig. 9).

For all liposomes formulations, no release of ANE was obtained in the first 96 h (Fig. 9). Otherwise, a slower release pattern of ANE from ANE-loaded liposomes was observed when compared to the formulations containing the inclusion complex, ACL and ACL2. The percentage of ANE released after 504 h of incubation was 5.79, 12.09 and 15.11% for ANE-loaded liposomes, ACL2 and ACL respectively. Cavalcanti et al. (2011) and Fatouros et al. (2001) investigated the drug release at 37 °C of β -lapachone and prednisolone respectively. They reported that the drug was released faster from CD/drug-loaded liposomes than from drug-loaded liposomes. The results explained that the CD/drug complexes are released by, possibly leaking out through transient holes, which are forming on the liposomes membranes during lipid-CD interaction and membrane reconstruction (Fatouros et al., 2001).

However, these results showed that, in all cases, a relative small amount of ANE (below 15%) was released from liposomes after 21 days, suggesting that membrane contactor and pilot plant are appropriate for stable liposomes production.

4. Conclusion

In this study, liposomes preparation was scaled-up using a membrane contactor and a pilot plant both equipped with a SPG membrane, which allowed obtaining final volume of preparation of 600 mL and 3 L, respectively. It was applied for the first time to DCL carrier system preparation, for ANE encapsulation. It was demonstrated that all experimental set-ups were appropriate for the preparation of multilamellar, nanometric liposomes. The ANE loading rate was improved with pilot plant, compared to the preparations made at laboratory scale. The ethanol evaporation performed directly on the pilot plant has the advantages of being an easy and continuous process. In addition, liposomes formulations were stable at 4 °C and provided a controlled release as a small amount of ANE was released after 21 days. Thus, the ethanol injection method was suitable for large-scale production of DCL, encapsulating hydrophobic volatile drugs.

Acknowledgements

Authors are grateful to the Agence Universitaire de la Francophonie (Programme de Cooperation Scientifique Inter-Universitaire, PCSI 2015) and to the Lebanese University for providing a scholarship to Riham Gharib. Special thanks go to Géraldine Agusti (LAGEP) for TEM images and Dr Roland Habchi (The Platform for Research in Nano Sciences and Nanotechnology, Lebanese University) for AFM images.

References

- Akbarzadeh, A., Rezaei-Sadabady, R., Davaran, S., Joo, S. W., Zarghami, N., Hanifehpour, Y., et al. (2013). Liposome: classification, preparation, and applications. *Nanoscale Research Letters*, 8, 102.
- Anwekar, H., Patel, S., & Singhai, A. K. (2011). Liposome as drug carriers. *International Journal of Pharmacy & Life Sciences*, 2, 945–951.
- Ascenso, A., Cruz, M., Euleterio, C., Carvalho, F. A., Santo, F. A., Marques, H. C., et al. (2013). Novel tretinoin formulations: a drug-in-cyclodextrin-in liposome approach. *Journal of Liposome Research*, 23, 211–219.
- Astray, G., Gonzalez-Barreiro, C., Mejuto, J. C., Rial-Otero, R., & Simal-Gandara, J. (2009). A review on the use of cyclodextrins in foods. *Food Hydrocolloids*, 23, 1631–1640.
- Bakkali, F., Averbeck, S., Averbeck, D., & Idaomar, M. (2008). Biological effects of essential oils—a review. *Food Chemistry Toxicology*, 46, 446–475.
- Batzri, S., & Korn, E. D. (1973). Single bilayer liposomes prepared without sonication. *Biochimica Biophysica Acta*, 298, 1015–1019.
- Bragagni, M., Maestrelli, F., Mennini, N., Ghelardini, C., & Mura, P. (2010). Liposomal formulations of prilocaine: effect of complexation with hydroxypropyl- β -cyclodextrin on drug anesthetic effect. *Journal of Liposome Research*, 20, 315–322.
- Burt, S. (2004). Essential oils: their antibacterial properties and potential applications in foods—a review. *International Journal of Food Microbiology*, 94, 223–253.
- Cavalcanti, I. M., Mendonça, E. A., Lira, M. C., Honrato, S. B., Camara, C. A., Amorim, R. V., et al. (2011). The encapsulation of β -lapachone in 2-hydroxypropyl- β -cyclodextrin inclusion complex into liposomes: a physicochemical evaluation and molecular modeling approach. *European Journal of Pharmaceutical Sciences*, 44, 332–340.
- Charcosset, C., & Fessi, H. (2005). Preparation of nanoparticles with a membrane contactor. *Journal of Membrane Science*, 266, 115–120.
- Charcosset, C., El Harati, A., & Fessi, H. (2005). Preparation of solid lipid nanoparticles using a membrane contactor. *Journal of Controlled Release*, 108, 112–120.
- Charcosset, C., Juban, A., Valour, J., Urbaniak, S., & Fessi, H. (2015). Preparation of liposomes at large scale using the ethanol injection method: effect of scale-up and injection devices. *Chemical Engineering Research and Design*, 94, 508–515.
- Charcosset, C. L. (2004). The membrane emulsification process—a review. *Chemical Technology and Biotechnology*, 79, 209–218.
- Charcosset, C. (2006). Membrane processes in biotechnology: an overview. *Biotechnology Advances*, 24, 482–492.
- Chen, C. H., & deGraffenried, L. A. (2012). Anethole suppressed cell survival and induced apoptosis in human breast cancer cells independent of estrogen receptor status. *Phytomedicine*, 19, 763–767.
- Fatouros, D. G., Hatzidimitriou, K., & Antimisiaris, S. G. (2001). Liposomes encapsulating prednisolone and prednisolone-cyclodextrin complexes: comparison of membrane integrity and drug release. *European Journal of Pharmaceutical Sciences*, 13, 287–296.
- Freire, R. S., Morais, S. M., Catunda-Junior, F. E., & Pinheiro, D. C. (2005). Synthesis and antioxidant, anti-inflammatory and gastroprotector activities of anethole and related compounds. *Bioorganic and Medicinal Chemistry*, 13, 4353–4358.
- Gharib, R., Auezova, L., Charcosset, C., & Greige-Gerges, H. (2016). Drug-in-cyclodextrin-in-liposomes as a carrier system for volatile essential oil components: application to anethole. *Food Chemistry* (submitted).

- Goyal, P., Goyal, K., Kumar, S. G., Singh, A., Katore, O. P., & Mishra, D. N. (2005). Liposomal drug delivery systems—clinical applications. *Acta Pharmaceutica*, *55*, 1–25.
- Gregoriadis, G. (2000). *Liposome technology* (2nd ed.). Boca Raton, Florida, USA: CRC Press.
- Hagiwara, Y., Arima, H., Hirayama, F., & Uekama, K. (2006). Prolonged retention of doxorubicin in tumor cells by encapsulation of γ -cyclodextrin in pegylated liposomes. *Journal of Inclusion Phenomena and Macrocyclic Chemistry*, *14*, 65–68.
- Jaafar-Maalej, C., Diab, R., Andrieu, V., Elaissari, A., & Fessi, H. (2010). Ethanol injection method for hydrophilic and lipophilic drug-loaded liposome preparation. *Journal of Liposome Research*, *20*, 228–243.
- Jaafar-Maalej, C., Charcosset, C., & Fessi, H. (2011). A new method for liposome preparation using a membrane contactor. *Journal of Liposome Research*, *21*, 213–220.
- Jaafar-Maalej, C., Charcosset, C., & Fessi, H. (2012). Patent No. FR 2 956 594.
- Jahn, A., Vreeland, W. N., Gaitan, M., & Locascio, L. (2004). Controlled vesicle self-assembly in microfluidic channels with hydrodynamic focusing. *Journal of the American Chemical Society*, *126*, 2674–2675.
- Kfoury, M., Auezova, L., Greige-Gerges, H., Ruellan, S., & Fourmentin, S. (2014). Cyclodextrin, an efficient tool for *trans*-anethole encapsulation: chromatographic, spectroscopic, thermal and structural studies. *Food Chemistry*, *164*, 454–461.
- Kubo, I., Fujita, K., & Nihei, K. (2008). Antimicrobial activity of anethole and related compounds from aniseed. *Journal of the Science of Food and Agriculture*, *88*, 242–247.
- Laouini, A., Jaafar-Maalej, C., Sfar, S., Charcosset, C., & Fessi, H. (2011). Liposome preparation using a hollow fiber membrane contactor—application to spirinolactone encapsulation. *International Journal of Pharmaceutics*, *415*, 53–61.
- Laouini, A., Charcosset, C., Fessi, H., Holdich, R. G., & Vladislavljević, G. T. (2013a). Preparation of liposomes: a novel application of microengineered membranes—from laboratory scale to large scale. *Colloids Surface B*, *112*, 272–278.
- Laouini, A., Charcosset, C., Fessi, H., Holdich, R. G., & Vladislavljević, G. T. (2013b). Preparation of liposomes: a novel application of microengineered membranes—investigation of the process parameters and application to the encapsulation of vitamin E. *RSC Advance*, *3*, 5985–5994.
- Limayem-Blouza, I., Charcosset, C., Sfar, S., & Fessi, H. (2006). Preparation and characterization of spirinolactone-loaded nanocapsules for paediatric use. *International Journal of Pharmaceutics*, *325*, 124–131.
- Loukas, Y. L., Vrakka, V., & Gregoriadis, G. (1998). Drugs, in cyclodextrins, in liposomes: a novel approach to the chemical stability of drugs sensitive to hydrolysis. *International Journal of Pharmaceutics*, *162*, 137–142.
- Maestrelli, F., Gonzalez-Rodriguez, M. L., Rabasco, A. M., & Mura, P. (2005). Preparation and characterisation of liposomes encapsulating ketoprofen—cyclodextrin complexes for transdermal drug delivery. *International Journal of Pharmaceutics*, *298*, 55–67.
- Maestrelli, F., Gonzalez-Rodriguez, M. L., Rabasco, A. M., Ghelardini, C., & Mura, P. (2010). New drug-in cyclodextrin-in deformable liposomes formulations to improve the therapeutic efficacy of local anaesthetics. *International Journal of Pharmaceutics*, *395*, 222–231.
- Makadia, H. K., & Siegel, S. J. (2011). Poly lactic-co-glycolic acid (PLGA) as biodegradable controlled drug delivery carrier. *Polymer*, *3*, 1377–1397.
- Marques, H. M. (2010). A review on cyclodextrin encapsulation of essential oils and volatiles. *Flavour and Fragrance Journal*, *25*, 313–326.
- McCormack, B., & Gregoriadis, G. (1994). Drugs-in-cyclodextrins-in-liposomes: a novel concept in drug delivery. *International Journal of Pharmaceutics*, *112*, 249–258.
- McCormack, B., & Gregoriadis, G. (1998). Liposomes-mediated DNA immunization with a plasmid encoding a Mycobacterium leprae antigen. *Journal of Liposome Research*, *8*, 48–49.
- Nasir, A., Harikumar, S. L., & Kaur, A. (2012). Cyclodextrins: an excipient tool in drug delivery. *International Research Journal of Pharmacy*, *3*, 44–50.
- Pham, T. T., Jaafar-Maalej, C., Charcosset, C., & Fessi, H. (2012). Liposome and niosome preparation using a membrane contactor for scale-up. *Colloids Surface B*, *94*, 15–21.
- Pinho, E., Grootveld, M., Soares, G., & Henriques, M. (2014). Cyclodextrins as encapsulation agents for plant bioactive compounds. *Carbohydrate Polymers*, *101*, 121–135.
- Pradhan, P., Guan, J., Lu, D., Wang, P. G., & Lee, L. G. (2008). A facile microfluidic method for production of liposomes. *Anticancer Research*, *28*, 943–948.
- Sebaaly, C., Greige-Gerges, H., Agusti, G., Fessi, H., & Charcosset, C. (2015). Large-scale preparation of clove essential oil and eugenol-loaded liposomes using a membrane contactor and a pilot plant. *Journal of Liposome Research*, *23*, 1–13.
- Sebaaly, C., Charcosset, C., Stainmesse, S., Fessi, H., & Greige-gerges, H. (2016). Clove essential oil-in-cyclodextrin-in-liposomes in the aqueous and lyophilized states: from laboratory to large scale using a membrane contactor. *Carbohydrate Polymers*, *138*, 75–85.
- Sebaaly, C., Greige-Gerges, H., Stainmesse, S., Fessi, H., & Charcosset, C. (2016). Effect of composition, hydrogenation of phospholipids and lyophilization on the characteristics of eugenol-loaded liposomes prepared by the ethanol injection method. *Food Bioscience*, *15*, 1–10.
- Szejtli, J. (1998). Introduction and general overview of cyclodextrins chemistry. *Chemical Reviews*, *98*, 1743–1753.
- Tognolini, M., Ballabeni, V., Bertoni, S., Bruni, R., Impicciatore, M., & Barocelli, E. (2007). Protective effect of *Foeniculum vulgare* essential oil and anethole in an experimental model of thrombosis. *Pharmacological Research*, *56*, 254–260.
- Vladislavljević, G., Kobayashi, I., Nakajima, M., Williams, R. A., Shimizu, M., & Nakashima, T. (2007). Shirasu porous glass membrane emulsification: characterization of membrane structure by high-resolution X-ray microtomography and microscopic observation of droplet formation in real time. *Journal of Membrane Science*, *302*, 243–253.
- Wagner, A., & Vorauer-Uhl, K. (2011). Liposome technology for industrial purposes. *Journal of Drug Delivery*, 1–9.
- Wagner, A., Vorauer-Uhl, K., Kreismayr, G., & Kattinger, H. (2002). The crossflow injection technique: an improvement of the ethanol injection method. *Journal of Liposome Research*, *2*, 259–270.
- Zhong, J., Yao, X., Li, D. L., Li, L. Q., Zhou, L. F., Huang, H. L., et al. (2013). Large scale preparation of midkine antisense oligonucleotides nanoliposomes by a cross-flow injection technique combined with ultrafiltration and high-pressure extrusion procedures. *International Journal of Pharmaceutics*, *441*, 712–720.

Conclusion générale et perspectives

L'objectif de ce travail de thèse consiste à optimiser la formulation « drug-in-cyclodextrin-in liposomes » en vue de l'encapsulation de PAs volatils. Le phénylpropène Ane connu par avoir un large spectre d'activités biologiques, a été choisi comme modèle. Dans une première étape, nous avons préparé et caractérisé des liposomes et les DCL encapsulant l'Ane à l'échelle du laboratoire et à grande échelle. En second lieu, nous avons évalué l'interaction de l'HP- β -CD et des PAs tels que les monoterpènes (MT) et les phénylpropènes (PPs) avec la membrane.

L'étude portant sur l'effet de différentes concentrations de l'HP- β -CD sur des liposomes composés de DPPC a montré que l'HP- β -CD interagissait avec la tête polaire des phospholipides et avec les chaînes alkyles du DPPC, conduisant à une augmentation du désordre au niveau de la bicouche lipidique. L'effet de l'HP- β -CD sur la fluidité membranaire dépend de la composition de la membrane. La présence de cholestérol semble opposer l'effet de l'HP- β -CD ; les liposomes formés de phospholipides saturés ne sont pas affectés par l'HP- β -CD, contrairement à ceux insaturés. Par ailleurs, l'HP- β -CD a protégé les liposomes pendant la lyophilisation, lorsqu'il a été présent dans le compartiment aqueux interne des liposomes. Afin d'obtenir un système DCL stable, il s'avère nécessaire de prendre en considération plusieurs facteurs, en particulier le rapport molaire lipide:CD, le type de phospholipide et éventuellement de la CD, la présence de cholestérol. Lorsque le complexe d'inclusion est utilisé dans la préparation des DCLs, la constante de formation de complexe d'inclusion CD/PA pourrait aussi intervenir.

L'interaction des PPs (Eug, Iso-eug, Est, Ane) et des MTs avec la membrane composée de DPPC a montré que les PPs et les MTs étudiés interagissent avec le groupe choline de la tête polaire et les chaînes d'alkyle de DPPC, conduisant à une augmentation du désordre au niveau de la bicouche lipidique. L'Euc et Pul semblent entrer entre les chaînes acyles des phospholipides d'une façon modérée alors que les autres s'insèrent plus profondément dans la membrane et peuvent remplacer les molécules lipidiques. Différents motifs structuraux ont mené à cette localisation et par la suite à leur effet fluidifiant. Toutes les molécules étudiées ont montré un effet fluidifiant sur la membrane qui est renforcé par le groupement hydroxyle présent dans l'Eug, l'Iso-eug, le Ter et le Thy. Le Ter M augmente le désordre au niveau de la bicouche lipidique plus que le Ter, suggérant que les isomères n'affectent pas la membrane d'une manière similaire. L'Iso-eug et l'Ane sont incorporés profondément dans la bicouche lipidique en raison de la présence de la double liaison à la position C7-C8 dans la chaîne latérale propényle. Aussi, le caractère hydrophobe semble moduler l'interaction des PPs avec la membrane. En outre, l'Ane et

l'Est, les plus hydrophobes parmi les PPs étudiés, sont plus efficaces contre *E. coli* que l'Eug et l'Iso-eug, en inhibant la croissance des bactéries. Le Thy, induit la formation de domaines hétérogènes et une séparation de phase à des concentrations élevées. Une étude ultérieure mettant en jeu une série plus large des molécules pourrait être envisagée pour déterminer les motifs structuraux modulant l'interaction des MTs et des PPs avec les membranes synthétiques et biologiques.

Les résultats de la préparation des liposomes à petite échelle ont montré que les liposomes obtenus sont des vésicules nanométriques et oligolamellaires et la présence de l'HP- β -CD ou de l'Ane n'affecte pas la taille des liposomes. Le rendement d'encapsulation de l'Ane est amélioré en utilisant le système d'encapsulation DCL. En outre, les liposomes constitués de Lipoid S100 présentent un rendement d'encapsulation de l'Ane plus élevé par rapport à ceux constitués de Phospholipon 90H. En effet, la structure de la membrane composée du Lipoid S100 est plus flexible, ce qui peut conduire à l'incorporation plus élevée de l'Ane. Par ailleurs, la technique de double encapsulation a démontré le meilleur rendement de l'Ane et la meilleure protection de l'Ane contre la dégradation induite par les rayons UV. Toutefois, les liposomes résultants de cette encapsulation sont moins stables que les autres. En outre, le système DCL a prouvé son efficacité en réduisant la libération de l'Ane par rapport aux liposomes conventionnels après 15 mois de conservation à 4°C.

Dans la dernière partie de ce travail, des liposomes sont préparés à grande échelle par la technique du contacteur à membrane et pilote. Nous avons démontré que tous les montages expérimentaux sont appropriés pour la préparation des liposomes multilamellaires et nanométriques. Comparé à petite échelle, le rendement d'encapsulation de l'Ane dans les liposomes préparés par pilote a été amélioré. En outre, les formulations liposomiales ont été démontrées stables à 4°C et ont assuré une libération contrôlée de l'Ane durant 21 jours de stockage à 4°C. La méthode d'injection d'éthanol est appropriée pour la production des liposomes DCL à grande échelle, encapsulant des PAs hydrophobes et volatils.

Différents paramètres physicochimiques peuvent affecter l'encapsulation des monoterpènes dans l'HP- β -CD ainsi que dans les liposomes. Il serait intéressant, dans des futurs travaux, de déterminer les paramètres qui contrôlent l'efficacité d'encapsulation du principe actif comme sa solubilité aqueuse, la constante de Henry, son taux d'encapsulation dans la CD, et de déterminer

le rapport molaire optimal (HP- β -CD:MT). Il serait aussi important de comparer les caractéristiques des liposomes conventionnels encapsulant des MTs avec des liposomes encapsulant les complexes d'inclusion HP- β -CD/MT en utilisant le rapport molaire HP- β -CD/MT optimal.

D'autre part, il est nécessaire de continuer ce travail par la lyophilisation des liposomes encapsulant l'HP- β -CD/MT. Des études portant sur la stabilité des lyophilisats des liposomes à long terme pourraient être envisagées.

Communications

Orale

1. Effet de l'hydroxypropyl- β -cyclodextrine sur la stabilité et la fluidité des membranes lipidiques. Gharib R., Fourmentin S., Charcosset C., Greige-Gerges H. 17èmes Journées Cyclodextrines- 6-7 October 2016-Nancy France
2. Development of drug-in-cyclodextrin-in-liposome as carrier system for volatile essential oils: application to anethole. Gharib R., Auezova L., Charcosset C., Greige-Gerges H. The international conference of the school of pharmacy-Lebanese International University-18-20 October 2016, LIU Bekaa campus.

Par affiche

1. Encapsulation of anethole, a natural antimicrobial agent, in liposome as anethole-cyclodextrin inclusion complex. Gharib R., Auezova L., Charcosset C., Greige-Gerges H. 2nd STEMS Stem Cell Educational and Medical Symposium 2014-Fanar Liban.
2. Development of a nanoparticle system composed of cyclodextrin/drug inclusion complex in liposomes to preserve essential oil components. Gharib R., Sebaaly C., Jraij A., Auezova L., Charcosset C., Kayouka M., Greige-Gerges H. BioBeirut 4 International Meeting- Cancer Biology and Stem Cells Meeting 2014-Hadath, Liban.
3. Characterization of drug in cyclodextrin in liposomes by atomic force microscopy. Gharib R., Jraij A., Auezova L., Charcosset C., Greige-Gerges H. 4^{ème} Forum Doctoral-EDST-UL-2014-2015, Hadath-Liban.
4. Preparation and characterization of Cyclodextrin-anethole inclusion complex loaded liposomes. Gharib R., Jraij A., Auezova L., Charcosset C., Greige-Gerges H. Graduate School Meeting, 7 mai 2015, Lyon France.
5. Preparation and characterization of Cyclodextrin-anethole inclusion complex loaded liposomes. Gharib R., Auezova L., Charcosset C., Greige-Gerges H. Innovation in Food Packaging, Shelf Life and Food Safety-2015-Stadthalle Erding, Munich-Germany.
6. Préparation des liposomes encapsulant le complexe d'inclusion cyclodextrine/trans-anéthole à grande échelle en utilisant le contacteur à membrane et pilote. Gharib R., Greige-Gerges H., Auezova L., Charcosset C. Les Troisièmes Journées Franco-libanaises

- 3–EDST 2015, Hadath-Liban.
7. Drug-in-cyclodextrin-in-liposomes from laboratory to large scale using a membrane contactor: application to anethole. Gharib R., Auezova L., Charcosset C., Greige-Gerges H. 22nd International Scientific Conference of LAAS-2016, Holy Spirit University of Kaslik-Liban
 8. Hydroxypropyl- β -cyclodextrin, a membrane protectant during freeze-drying of conventional liposomes: application to phenylpropenes. Gharib R., Greige-Gerges H., Auezova L., Charcosset C. First Food Chemistry Conference - Shaping the Future of Food Quality, Health and Safety: 30 October-1 November 2016, Amsterdam, Netherlands.