



HAL
open science

Methodological proposition to evaluate polymer recycling in open-source additive manufacturing contexts

Fabio Alberto Cruz Sanchez

► To cite this version:

Fabio Alberto Cruz Sanchez. Methodological proposition to evaluate polymer recycling in open-source additive manufacturing contexts. Chemical and Process Engineering. Université de Lorraine, 2016. English. NNT : 2016LORR0291 . tel-01668459

HAL Id: tel-01668459

<https://theses.hal.science/tel-01668459v1>

Submitted on 20 Dec 2017

HAL is a multi-disciplinary open access archive for the deposit and dissemination of scientific research documents, whether they are published or not. The documents may come from teaching and research institutions in France or abroad, or from public or private research centers.

L'archive ouverte pluridisciplinaire **HAL**, est destinée au dépôt et à la diffusion de documents scientifiques de niveau recherche, publiés ou non, émanant des établissements d'enseignement et de recherche français ou étrangers, des laboratoires publics ou privés.



AVERTISSEMENT

Ce document est le fruit d'un long travail approuvé par le jury de soutenance et mis à disposition de l'ensemble de la communauté universitaire élargie.

Il est soumis à la propriété intellectuelle de l'auteur. Ceci implique une obligation de citation et de référencement lors de l'utilisation de ce document.

D'autre part, toute contrefaçon, plagiat, reproduction illicite encourt une poursuite pénale.

Contact : ddoc-theses-contact@univ-lorraine.fr

LIENS

Code de la Propriété Intellectuelle. articles L 122. 4

Code de la Propriété Intellectuelle. articles L 335.2- L 335.10

http://www.cfcopies.com/V2/leg/leg_droi.php

<http://www.culture.gouv.fr/culture/infos-pratiques/droits/protection.htm>

Methodological proposition to evaluate polymer recycling in open-source additive manufacturing contexts

Doctoral Dissertation

submitted and defended publicly on December 09th 2016

in a partial fulfillment of the requirements for obtaining a:

PhD title from the University of Lorraine

(Spec : Industrial Engineering)

by

Fabio Alberto CRUZ SANCHEZ

Doctoral Committee:

<i>Reviewers:</i>	<i>Prof.</i> Nicolas PERRY	ENSAM, Bordeaux - France
	<i>Dr.</i> Salim BELOUETTAR	LIST, Esch-sur-Alzette - Luxembourg
<i>Examiners:</i>	<i>Prof.</i> Joshua M. PEARCE	MTU, Michigan - USA
	<i>Prof.</i> Nadia BAHLOULI	Université de Strasbourg, Strasbourg - France
<i>Supervisors:</i>	<i>Prof.</i> Mauricio CAMARGO	<i>Director</i> , ERPI, Nancy - France
	<i>MCF.</i> Hakim BOUDAUD	<i>Co-Director</i> , ERPI, Nancy - France
	<i>Dr.</i> Sandrine HOPPE	<i>Co-Director</i> , LRGP, Nancy - France

Agradecimientos

Esta parte de agradecimientos es la que dejamos de última en una tesis, pero irónicamente es de las primeras cosas que aparece en el documento. O al menos, este ha sido mi caso. Estoy ciertamente convencido que agradecer, y el estar agradecido, son dos cualidades fundamentales que uno puede tener frente a la vida. Y por ello me permito escribir esta sección en español porque considero, que al igual que la poesía, agradecer es un acto del espíritu que reconforta no solo a la persona que es objeto de nuestro agradecimiento, sino también, a aquel que lo hace. Y por ello, es necesario expresarlo en la lengua materna para sentir el verdadero poder de las palabras que resuenan al pronunciarlas cuando se agradece.

En este camino de tesis, la primera persona que tengo que agradecer es al *profe* Mauricio Camargo. Nunca pensé que el hecho de haber participado en un seminario de una semana por allá en el año 2012 en Colombia, hubiese tenido tantas implicaciones personales y profesionales en mi vida. Ha sido una gran bendición para mí contar con su apoyo, con sus consejos, y sobretodo, con la oportunidad de poder cumplir el sueño de emprender este trabajo arduo.

Agradezco también a Hakim Boudaoud, quién es una persona que me ha apoyado enormemente desde el comienzo en esta jornada. Admiro su espíritu crítico y la forma como sus comentarios con respecto al trabajo han influido enormemente en el desarrollo de este manuscrito. Aprendo también de él, esa visión reflexiva y ese elemento de crítica constructiva que hace que el trabajo hecho al final, sea realmente algo valioso y de calidad.

Igualmente agradezco a Sandrine Hoppe. Ella, que está con mil cosas en la cabeza y con un millón de tareas administrativas por hacer día a día, siempre ha tenido una disposición sincera de ayuda y colaboración en lo que tuve necesidad en el laboratorio LRGP. Le agradezco inmensamente esa excelente disposición.

Soy afortunado del hecho de haber tenido estas tres personas como supervisores. Cada uno de ellos es diferente en su manera de trabajar, de pensar y de actuar. Sin embargo, en conjunto, cada uno aporta competencias complementarias que me ayudaron inmensamente a crecer profesionalmente. Sobretodo, resalto de ellos tres la humildad y la ética del trabajo que cada uno tiene en lo que hace. Siempre me trataron como uno mas del equipo, y de ello, aprendo mucho para el día que sea mi turno de dirigir un grupo.

Un agradecimiento especial a Laure Morel, la *jefa* del laboratorio ERPI. Le agradezco a ella porque me acuerdo muy bien el día que la primera vez que llamé desde Colombia al ERPI por telefono con el fin de tener una "*attestation*" para poder pedir la visa en la embajada francesa en Colombia. En mi rudimentario e incomprensible francés de aquella época, ella tuvo la paciencia y la disponibilidad de escucharme y ayudarme (e incluso hablarme en español) para tener todo para poder llegar por primera vez al viejo continente. Admiro de ella su carácter, que a mi parecer, es una fuerza de la naturaleza. Ella se hace notar, deja de qué hablar, y no va pasar desapercibida. Y ciertamente son cualidades que uno aprende.

En esos primeros momentos de llegada a un país y a un equipo nuevo de trabajo, hay personas que le ofrecen esa primera mano amiga. Por ello, hago una mención especial al equipo administrativo (presente y pasado) del laboratorio ERPI. Un mensaje especial Nicole Valence quién espero de todo corazón que Dios la siga bendiciendo. Igualmente, hago una mención especial a los diversos profesores del ENSGSI que han aportado de alguna o otra manera al desarrollo de este trabajo. Hago una mención especial a Patrick Truchot por su enorme ayuda en lo que fue la aventura de *Ma Thèse en 180s* (MT180).

Sin dejar de lado, quiero expresar un agradecimiento muy especial a mis colegas, homólogos, camaradas doctorante(a)s. Por aquellos que están y por los que se han ido también. Es claro que una tesis sin discusiones filosóficas de todo y de nada, sin sesiones de *coffestorming* durante el día a día, o inclusive pequeñas operaciones de *bière* en algún bar cercano, el camino de tesis no hubiera sido el mismo. Todos esa suma de pequeños momentos me han permitido crecer en mi universalidad del conocimiento.

To my folks, Agradezco mucho a mis amigos, Felipe, *le colombien* Gio, Dianita, Ricardito, David, Nico, Chiaretta, Mathilde. por la compañía y el apoyo durante este tiempo. Infinitas gracias les doy porque, durante este tiempo que he tenido en Francia, ha sido invaluable y todos momentos conviviales®han sido de gran alegría para mí. Cada uno sabe el aprecio que les tengo y lo incondicional de mi amistad.

Finalmente quiero agradecer a mi familia, mi papa, mi mamá y mi hermano. Es claro en mi cabeza que ustedes son mi base y tengo tanto por agradecerles, que una vida entera no alcanza. Mi vida siempre sera dedicada a ellos y espero seguir compartiendo mi mundo, y hacerlos participes en las cosas que la providencia tenga en guardadas para mi existencia. Mil gracias a la vida por esta oportunidad.

« Si tú, siguiendo la recta razón, hicieses lo que tienes entre manos con estudio, con empeño y buena voluntad, sin poner la mira en ninguna otra conveniencia ni diversión, antes bien, conservases tu espíritu por entonces tan puro como si ya lo hubieses de restituir a quien te lo ha dado; si, vuelvo a decir, llevares adelante tu obra no buscando otro bien ni huyendo de otro mal, sino dándote por satisfecho con hacer el presente trabajo conforme a la Naturaleza, y con hablar con suma entereza lo que hubieres de decir; vivirás feliz y dichoso; además de que no hay persona alguna que pueda impedírtelo.»

Meditaciones - Libro III, Ep. 12. Marco Aurelio

Dedicado a mi familia...

Contents

Graphical Abstract	xiii
Résumé étendu en français (Extended abstract in French)	xv
1 General Introduction	1
2 State of the Art	7
2.1 Introduction	9
2.2 Additive Manufacturing background	9
2.2.1 What is Additive Manufacturing?	9
2.2.2 Overview of the main AM processes	11
2.3 Open-source additive manufacturing - The case of the RepRap project-	22
2.3.1 Open-source 3DP architecture	22
2.3.2 Differences between Commercial and Open Source AM	23
2.3.3 Applications of RepRap in the literature	24
2.4 AM Sustainability on Society	25
2.5 Material Recycling in Additive Manufacturing	28
2.5.1 Definition of the Research Questions	28
2.5.2 Development of the Review Protocol	29
2.5.3 Identification of the relevant research	33
2.5.4 Selection of the primary studies	34
2.5.5 Data Extraction	35
2.5.6 Data synthesis	36
2.6 Conclusions	50
3 Towards a standard protocol for 3D printers characterization	53
3.1 Introduction	55
3.2 Benchmarking in open-source Additive Manufacturing	55
3.3 Methodology	56
3.3.1 A. Geometric Benchmarking Model	57
3.3.2 B. Design of Experiments	58
3.3.3 C. Fabrication and Measurement of Geometric Benchmarking Model	58
3.3.4 D. Results Accuracy Index and Statistical Analysis	58
3.4 Application to an OS AM System: the Case of the FoldaRap	59
3.4.1 Equipment	59
3.4.2 Benchmarking Models in Additive Manufacturing	60

3.4.3	Design of Experiments	63
3.4.4	Fabrication	65
3.5	Results and Discussion	66
3.5.1	Statistical Analysis	66
3.5.2	International Tolerance for the FoldaRap	68
3.5.3	Optimal control factors for the GBM	69
3.5.4	Discussion	73
3.6	Conclusion	75
4	Systematic methodology for recycling in OS AM	77
4.1	Introduction	79
4.2	Polymer recycling background	79
4.3	Methodology to evaluate 3D printing polymer recycling	84
4.3.1	Step 1 “Material definition”	87
4.3.2	Step 2 “Process assignment”	87
4.3.3	Step 3 “Fabrication of samples”	87
4.3.4	Step 4 “Evaluation ”	88
4.3.5	Step 5 “Recycling”	88
4.4	Application case: Recycling PLA for open-source 3D printers	88
4.4.1	Step 1- Material Definition: PLA	88
4.4.2	Step 2- Processes assignment	90
4.4.3	Step 3- Fabrication of samples	96
4.4.4	Step 4- Evaluation: Mechanical properties	99
4.4.5	Step 5- Recycling process: Plastic shredding	105
4.4.6	Experimental strategy	106
4.5	Conclusion	107
5	Experimental Results and Discussion	109
5.1	Introduction	111
5.2	Results of the experimentation	111
5.2.1	Reference process chain	111
5.2.2	3D Printing process chain	113
5.2.3	Feedstock process chain	116
5.2.4	3D Printing (Reference) process chain	117
5.3	Comparison of the different recycling process chains	119
5.3.1	Elastic Modulus	119
5.3.2	Tensile strength and Tensile strain	121
5.4	Conclusions	124
6	Conclusions and future work	125

List of Figures

1.1	Global trend of th open-source 3D printing	2
a	Number of attendees at Maker Faire per year. <i>Source Maker Faire</i>	2
b	Sales growth of the desktop (under \$5000) 3D printers. <i>Source Wohlers Report 2016</i>	2
1.2	Main contribution of this thesis	5
2.1	Generic AM process.	11
2.2	AM processes. Adapted from [5–7]	11
2.3	Stereolithography (SLA) process	12
a	SLA process using mask-based method	12
b	SLA process using focused UV beam	12
2.4	Selective Laser Sintering (SLS) process	13
2.5	Three-Dimensional printing (3DP)	14
2.6	LOM process	15
2.7	Ultrasonic consolidation process	16
2.8	Material preparation before extrusion	17
a	FDM process	17
b	Key features of the FDM process	17
2.9	Sectional view of the liquifier/nozzle	18
2.10	Parameters of the 3D printing process	20
2.11	First RepRap Machine called “Darwin” in May 2007.	22
2.12	Material preparation before extrusion	23
a	3D printer mechanical architecture	23
b	3D printer electronics	23
2.13	Systematic literature review methodology (adapted from [18]).	28
2.14	Study selection procedure for the primary studies (adapted from [18]).	34
a	Temporal distribution of the primary studies	36
b	Type of studies	36
c	Classification of the studies in function of the AM process and the state of the material.	36
2.16	Structuration of the data synthesis	36
2.17	Surface finish quality (“Orange peel”) in function of the MFI value of the recycled powder. Adapted from [20]	44
2.18	Methodology for polymer powder recycling. Adapted from [20]	45
a	Schematic methodology for metal powder recycling. Adapted from [19]	45

b	Methodology for polymer powder recycling. Adapted from [20]	45
2.19	Schematic proposition of “Cube Factory” project. Source from [201]	49
2.20	Schematic proposition of “Cube Factory” project. Adapted from [202].	49
3.1	Overview of the proposed methodology	57
3.2	Open Source 3D printer -FoldaRap-	59
3.3	Main components of the FoldaRap 3D printer	60
3.4	CAD version of the geometric benchmarking model (GBM) with referenced feature identification (IDs)	61
3.5	Coordinate system used in the manufacturing of the samples	65
3.6	Fabrication time of the control factor sorted in descending order	65
3.7	Surface finish of Sample 1 (slowest manufacturing time) and Sample 8 (fastest manufacturing time)	66
3.8	Distribution of the total of measurements of percent deviation	67
3.9	Density plot of the types of dimensional accuracy with the respective probabilities values between (-0.5%,0.5%)	67
3.10	Comparison of the maximum tolerance grade among different AM processes	68
3.11	Variation of the percent deviation value depending on the control factors	70
3.12	Ishikawa diagram of the factors that could affect in the open source 3D printers	71
3.13	Methodology of selection of the three best control factors	72
3.14	Frequencies of the control factors	72
3.15	Performance index of each control factor tested according to Taguchi’s array	73
3.16	Variation of the RSMD value of each feature of the GBM according to the four types of accuracy	74
4.1	Recycling strategies in industrial ecology for polymeric materials. Adapted from [30, 33]	80
4.2	Mechanical recycling steps (Adapted from [31, 259])	81
4.3	Modelling the Life Cycle of Recycled Polymers. Adapted from [36].	82
a	Multiple processing approach for evaluate thermo-mechanical degradation.	82
b	Methodology for thermo-oxidation degradation.	82
4.4	Key properties for quality assessment of recycled plastics. Adapted from [35, 36].	83
4.5	Key properties for quality assessment of recycled plastics. Source [37]	84
4.6	Recycling process for 3D printing adapted from [259]	85
4.7	Proposed methodology for measuring the degradation of plastic in the chain of 3D Printing	86
4.8	Mechanical sample according to the standard ISO 527-1B	89
4.9	Material preparation before extrusion	90
a	Vacuum drying oven	90
b	Polylactic Acid pellets	90
c	Sealable desiccator for preserving material until processing	90
4.10	Mechanical recycling steps for the case of fabrication of recycled filament.	91
4.11	Schematical extrusion process for fabrication of feedstock 3D printing material	93
4.12	Schematical view of the feeding system	93
4.13	Calibration curve for the feeding system	94
4.14	Overview of the extrusion process	94
a	Conical counter-rotating twin screw extruder	94
b	<i>Intensive mixing</i> screw of the extruder machine	94
4.15	Schematic diagram of the belt conveyor system	95
4.16	Micro-compounding machine used for fabrication of the mechanical samples	96
a	Machine	96
b	Micro-injection	96
c	Sample	96
d	Samples	96

4.17	Open source 3D printers used in the experimentation of the recycled filament	97
a	Open Source 3D printer -FoldaRap-	97
b	Open Source 3D printer -Mondrian-	97
4.18	Parameters of the 3D printing process	98
4.19	Parameters used for fabrication of mechanical samples	99
4.20	Test specimen measurements	99
4.21	Diagram of tensile test	100
4.22	Calculus of the <i>Elastic modulus E</i>	101
a	Elastic modulus by secante slope	101
b	Elastic modulus by regression slope	101
4.23	Universal testing machine and dynamic strain gauge extensometer used in the experimentation	101
a	Universal testing machine	101
b	Dynamic strain gauge extensometer	101
4.24	Important measurements	102
a	Mitutoyo digital caliper used.	102
b	Measurement of the width and thickness sample	102
4.25	Importance of alignment of the samples in the grips	103
4.26	Pre-stress in order to avoid toe region	103
a	TOE region in a typical stree-strain diagram.	103
b	Positive pre-stresses (σ_0)in order to avoid a toe region	103
4.27	Setting up the extensometer in the mechanical sample	104
a	Extensometer in the specimen	104
b	Marks in the samples in order to attach the extensometer	104
4.28	Machine used for the recycling process	106
4.29	Operational steps using the methodology of recycling	107
5.1	Experimental strategy for <i>Reference</i> process chain used for PLA degradation.	111
5.2	Mechanical properties of the recycled reference samples	112
a	Tensile-strain curve of the <i>Reference</i> samples	112
b	Elastic modulus of the <i>Reference</i> samples	112
c	Tensile properties of the <i>Reference</i> samples	112
d	Strain values of the <i>Reference</i> samples	112
5.3	Characteristic curve used for calibration of the extrusion process	113
5.4	Analysis of the extrusion process for the first recycling cycle	114
a	Filaments made from the four recycling cycle	114
b	3DP samples with a degradation of two 3D printing processes	114
5.5	Experimental strategy for <i>3D Printing</i> process chain.	115
5.6	Results of the <i>3D printing process chain</i> samples.	116
a	3D printed samples according to level of degradation.	116
b	Elastic modulus of the recycled 3DP samples.	116
c	Tensile values of the recycled 3DP samples.	116
d	Strain values of the recycled 3DP samples.	116
5.7	Experimental strategy for <i>Feedstock</i> process chain.	116
5.8	Results of the <i>Feedstock process chain</i> samples.	117
a	Elastic modulus of the <i>Feedstock</i> samples.	117
b	Tensile properties of the <i>Feedstock</i> samples.	117
c	Strain values of the <i>Feedstock</i> samples.	117
5.9	Experimental strategy for <i>3D Printing (Reference)</i> process chain.	118
5.10	Mechanical properties of the <i>3D Printing (Reference)</i> process chain samples.	119
a	Elastic modulus of the <i>3D Printing (Reference)</i> samples.	119
b	Tensile values of the <i>3D Printing (Reference)</i> samples	119

c	Strain values of the recycled <i>3D Printing (Reference)</i> samples	119
5.11	Evolution of Elastic modulus of in the recycling process chains	120
a	Mean elastic modulus value of the <i>Reference</i> and <i>3D printed</i> recycled samples . .	120
b	Mean elastic modulus value of the <i>Feedstock</i> and <i>3D printed (Reference)</i> recycled samples	120
5.12	Samples weight in function of the recycling process chains	121
5.13	Tensile properties of the recycled samples of the different recycling process chains	122
a	Mean tensile strength values of the <i>Reference</i> and <i>3D printed</i> recycled samples. .	122
b	Mean tensile strain values of the <i>Reference</i> and <i>3D printed</i> recycled samples. . .	122
c	Mean tensile strength values of the <i>Feedstock</i> and <i>3D printed (Reference)</i> recycled samples.	122
d	Mean tensile strain values of the <i>Feedstock</i> and <i>3D printed (Reference)</i> recycled samples.	122
5.14	Tensile strength in function of the samples weight and the recycling process chains . . .	123
6.1	Experimental recycling process chain for 3D printing.	126

List of Tables

2.1	Mechanical properties of ABS material in FDM context	21
2.2	Major research areas in Open source additive manufacturing	24
2.3	Overview of the studies in sustainability in AM processes	26
2.4	Research questions of the systematic literature review	28
2.5	Semantic group of keywords used for the review	30
2.6	Research strategy used for the review	30
2.7	Data collection of the studies	32
2.8	Quality assessment of the studies	33
2.9	Identification of relevant studies according to the used approach	33
2.10	The core set of the articles	34
2.11	Experimental primary studies related to material recycling	38
3.1	Benchmarking model feature descriptions	61
3.2	Corresponding geometric features of each type of dimensional accuracy	63
3.3	Control factors	64
3.4	Fixed factors	64
3.5	Taguchi's $L_9(3^4)$ orthogonal array	64
3.6	Tolerance grades for various manufacturing processes	69
3.7	Mean value of percent deviation	69
3.8	Mean effect of the control factors	69
3.9	ANOVA analysis	70
4.1	PLA 4043D for open source 3D printing	89
4.2	Overview of mechanical recycling studies of PLA	91
4.3	Parameters of the extrusion process	95
4.4	Parameters for micro-compounding and micro-injection process	97
4.5	Standard conditions	104
4.6	Database of mechanical results used in the experimentation.	104
5.1	Mean values of mechanical properties of recycled reference samples	113
5.2	Mechanical properties of recycled 3DP samples	115
5.3	Mean values of mechanical properties of selected recycled extrusion samples	117
5.4	Mean values of Mechanical properties of recycled 3DP samples (Compounding)	118

Graphical Abstract

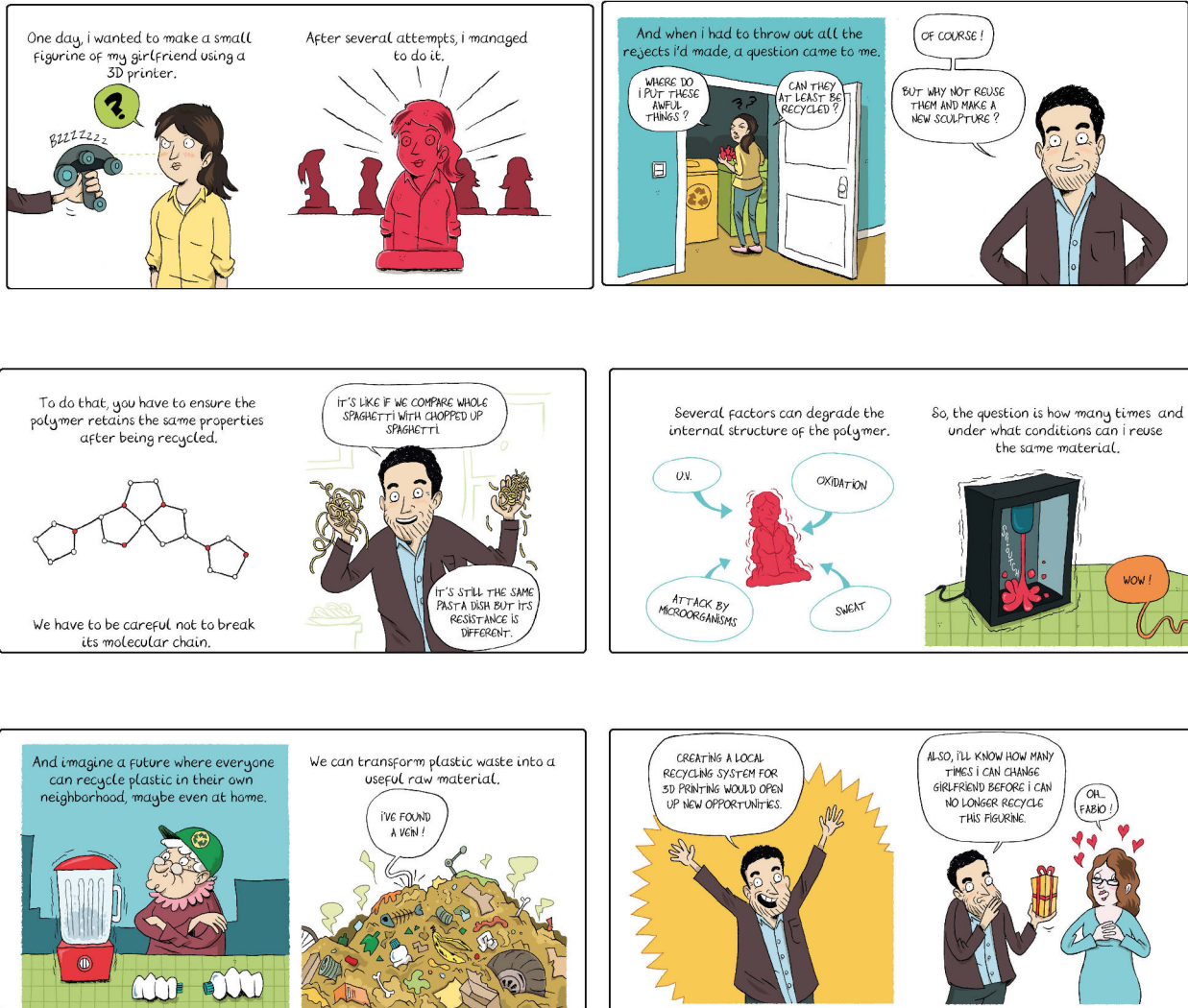

Ma thèse en 180 secondes (MT 180) is an event organized by the University of Lorraine. A comic about this thesis project was made by **Peb & Fox**. Also, a presentation was made, and it can be found in the next link:



Figure 2: Video MT180

Résumé étendu en français (Extended abstract in French)

En ce début de XXI^{ème} siècle, considérer qu'aujourd'hui encore, seul la technique transformerait la société toute entière, est clairement une hérésie. Certes, les révolutions techniques sont là: explosion de l'internet, interconnexion et échanges entre personnes (peer to peer), apparition de nouvelles formes d'énergie, de nouveaux procédés de production, de nouveaux matériaux etc... mais l'homme n'est plus un simple consommateur Keynésien sensible uniquement au prix et aux incitations de l'état. Il souhaite désormais, être acteur et participer à l'utilisation des nouvelles technologies mais de manière raisonnée et en intégrant les grands enjeux sociétaux tels que le partage et la sauvegarde des ressources et matières premières.

Dans le cadre de nos travaux nous présentons comment une révolution technologique telle que la fabrication additive (FA) open source peut se développer tout en intégrant les défis sociétaux actuels et plus particulièrement les enjeux environnementaux. En effet cette dernière, aussi connue comme *impression 3D open-source (OS)* est l'une des technologies identifiées comme ayant un fort potentiel d'impact sur les systèmes de production, mais aussi plus largement, sur notre style de vie dans les années à venir. Sa principale particularité par rapport à la FA classique est le caractère collaboratif de l'open source qui permet des évolutions rapides et créatives, et ceci à moindre coût. Dans le cadre de ces travaux, nous préconiserons dans un premier temps ce qu'est la FA au sens large et nous proposerons un état de l'art des études menées sur le recyclage dans le contexte de la FA. Puis nous présenterons les spécificités liés au contexte open source et positionnerons les machines de FA utilisées dans ce contexte, en effet contrairement à la FA additive classique professionnel dont la robustesse des machines est assurée par les fabricants; nous devons dans un premier temps nous interroger sur les possibilités et limites des machines utilisées dans le contexte open source.

Enfin, nous nous intéresserons au potentiel de recyclage de polymères dédiés à la FA open-source et nous proposerons une méthodologie permettant la caractérisation de la dégradation physique de la matière recyclée tout au long de la chaîne de recyclage et d'impression. Les résultats de l'application de la méthodologie proposée au cas particulier de l'acide polylactide (PLA), une matière largement utilisée dans l'impression 3D, seront présentées comme preuve du concept. Pour finir nous concluerons et rappellerons l'ensemble des avancées obtenues au cours de ces travaux et comme perspectives nous proposerons des voies de recherches permettant de mieux développer les innovations sur les systèmes de recyclage de déchets actuels grâce à la fabrication additive open-source et ainsi, contribuer tout du moins partiellement, à résoudre la problématique globale que représente l'accumulation de matière plastique dans la nature.

La Fabrication Additive (FA) commercial

La fabrication additive est le nom donné pour «*l'ensemble des procédés permettant de fabriquer, couche par couche et par ajout de matière, d'un objet physique à partir d'un objet numérique*» [1, 2].

Cette approche contraste avec les procédés traditionnels par enlèvement ou déformation de la matière tels que l'usinage, la fonderie ou la forge. Ce principe est la base de toutes les machines de

fabrication additive, avec quelques variations en fonction de la matière première utilisée, la technique pour la création de couches et le moyen physique pour agglomérer les couches déposées.

Diverses termes ont été utilisés pour faire référence à ces méthodes de fabrication tels que *prototypage rapide*, *fabrication par couches*, *fabrication digitale*, *production rapide*, *impression 3D*. Cependant, il faut remarquer que le principe physique sur lequel repose la FA a été utilisé dès la fin du XIXe siècle dans le cadre de la photo-sculpture et de la topographie [3, 4]. Il consiste à réaliser un produit grâce à un empilement successif de strates. La préparation de la maquette numérique permet de définir les sections de l'objet 3D à réaliser par son découpage successif par des plans parallèles. La distance entre chaque section correspond à l'épaisseur d'une couche. Pour reconstituer l'objet, les sections sont empilées de façon séquentielle les unes sur les autres.

Une approche usuelle pour classer les différents types de technologies de la FA, est par la prise en compte de l'état initial de la matière première utilisée. La figure 2.2 présente la classification proposée dans ce contexte.

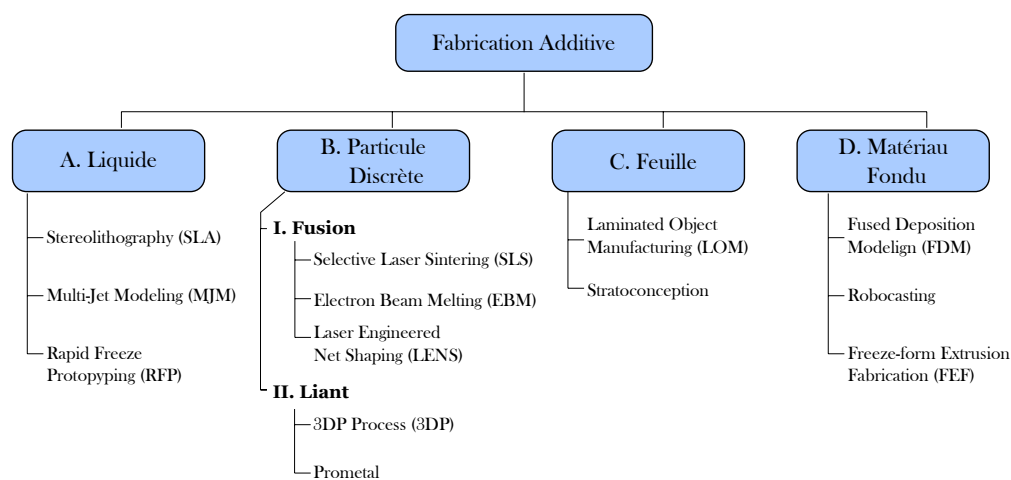

Figure 3: Classification des technologies de la FA. Adaptation de [5–7]

Dans le cadre de cette thèse, nous nous sommes focalisées sur le procédé de Fused Deposition Modeling (FDM). Il s'agit de l'une des technologies AM les plus répandues au niveau mondial.

Le principe de cette technologie réside dans la déposition d'un fil de matière fondue habituellement d'un filament plastique, sur un substrat à l'aide d'une tête mobile. Le matériau est chauffé à une température légèrement supérieure à son point de fusion dans la tête, puis extrudé par une buse sur un substrat et refroidi jusqu'à ce qu'il se solidifie et forme une couche. Les polymères thermoplastiques sont des matériaux usuellement utilisés dans cette technologie. Le brevet (US Patent 5121329) a été déposé en Juin 1992 [8, 9].

Définition de la FA Open-Source:

Depuis le milieu des années 2000, une nouvelle forme de FA est en train d'apparaître grâce à la démocratisation de cette technologie pour des communautés différentes de celles des entreprises et des communautés de la recherche. La notion de FA open-source (aussi connue comme *l'Impression 3D open-source (OS)*) est en train de se positionner comme une option viable de fabrication au vu de la conjonction de certains éléments tels que (1) l'expiration des premiers brevets protégeant la technologie commerciale de la FA (notamment le Fused Deposition Modeling -FDM-), (2) l'évolution des technologies d'information et de communication, et (3) les modes de développement et de production basés sur le travail collaboratif (common-based peer production [10]).

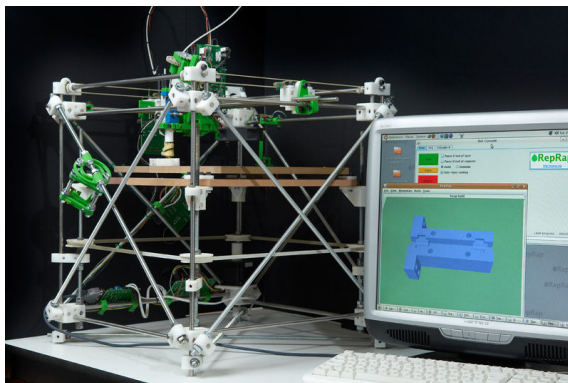

Figure 4: Premier machine **RepRap** appelée "Darwin" -Mai 2007-

Projet RepRap:

L'une des première initiative pour démocratiser la FA a été faite par Adrian Bowyer et son équipe à travers du conception la projet appelé **RepRap** (or **Replicating Rapid-prototyper**) [11–13]. RepRap est un projet britannique de l'Université de Bath, visant à créer une imprimante tridimensionnelle en grande partie auto-répliquative et libre (c'est-à-dire sans brevet, et dont l'information technique est disponible gratuitement pour tous) sous licence publique générale GNU. Ce projet est basé sur le principe de dépôt de filament fondu (Fused Filament Fabrication)¹. Le concept de cette machine est fondé sur une relation mutualiste d'interdépendance entre la machine et l'utilisateur. La machine fabrique les pièces et l'utilisateur assemble ces pièces. C'est pour cela, que la machine RepRap peut être définie comme «une machine cinématique assistée par ordinateur, auto-répliquante et fabricable soi-même» [13]. À partir de cette définition, il y a trois caractéristiques particulières:

1. Le nombre de machines et la richesse qu'elles créent pourraient croître exponentiellement.
2. La machine devient un sujet d'évolution par sélection artificielle.
3. La machine crée de la richesse avec une dépendance minimal de la production industrielle.

La Figure 5 confirme cette croissance exponentielle de ce type de machines. Dans un travail récent, Ford [14], positionne cette type de technologies open-source comme les machine de fabrication additive les plus utilisées à l'heure actuelle.

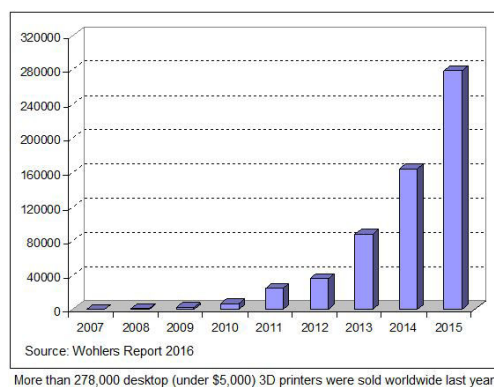

Figure 5: Nombre de ventes de machines open-source. Source *Wohlers Report 2016*

Grâce à la démocratisation de ces projets, la fabrication de produits complexes et de grande valeur est devenue accessible à tous [15, 16]. Le tableau 1 compare certaines caractéristiques de la fabrication

¹Fused Filament Fabrication (FFF) et Fused Deposition Modeling (FDM) sont des termes équivalentes, mais dû au fait que FDM est une marque déposée, le terme FFF a été employé

Table 1: Comparaison des machines open-source et commerciales.

	FA Open-Source	FA Commercial:
Principe:	CAD + GCode + Impression.	CAD + GCode + Impression.
Coût	< \$5000	\$5.000 jusqu'à \$800K
Méthodologie:	Open design	Closed Design (Patented)
Développé par:	Communauté globale	Quelques entreprises
Imprimante:	Personnalisé	Standardisé
Exemple:	Projet RepRap	Stratasys

additive open-source et commerciale. Les principaux éléments qui expliquent la croissance exponentiel et l'intérêt de ce types de machines pour un grand public sont : le coût réduit par rapport aux machines commerciales, la disponibilité de l'information technique, et le support de tout une communauté connectée sur l'internet autour de cette technologie. Ces éléments clés ont permis déclencher un processus de démocratisation de cette technologie. De plus, cette technologie peut avoir un impact positif sur les communautés comme les laboratoires universitaires, les écoles, et ouvrir de nouvelles dimensions à l'enseignement des sciences qui peut avoir un impact marqué dans les pays en voie de développement [17].

Le Recyclage dans la Fabrication Additive

Les possibilités et les caractéristiques de la FA ont été présentées. Nous rappelons que le but principal de cette thèse est d'avoir une meilleure compréhension du processus de recyclage des polymères afin d'établir une option de gestion durable des déchets pour cette technologie de FA open-source. Pour cela, un état de l'art a été fait avec le but principal de connaître les avancées en recherche et le développement de l'utilisation de la matière recyclé dans les technologies de la FA. Une méthodologie de revue systématique de la littérature a été adapté à notre cas particulier basse sur la recherche de Budgen and Brereton [18]. La figure 2.13 présente les trois principales étapes: (1) Planification, (2) Conduite, et (3) Rapport. Nous avons élaboré un protocole de recherche, en prenant en compte les questions de recherche (QR) et les données à extraire.

Planification

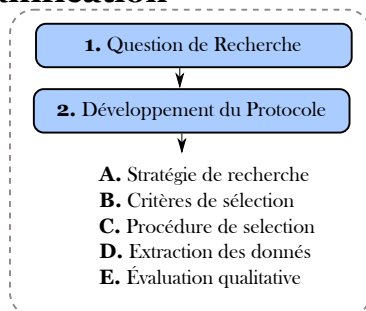

Conduite

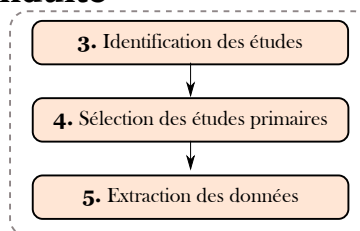

Rapports

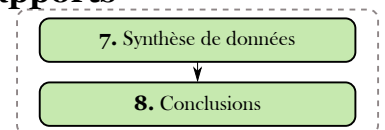

Figure 6: Méthodologie de revue systématique de la littérature. Adaptée de [18].

Le tableau 2.4 montre les deux questions de recherche utilisé pour la revue de la littérature:

En utilisant la classification des technologies de FA vu dans la figure 2.2 (*Liquide, Particule Discrete, Feuille et Matériau Fondu*), le but principale de la RQ1 est l'identification des éléments clés sur le recyclage (type de matière, protocole d'évaluation de la qualité, propriétés dans l'impression) de la littérature pour les différent technologies de la FA. Ces éléments permettent de comprendre la viabilité de l'utilisation de matériaux recyclés.

ID	Question de Recherche	But
QR1	Quel est l'état de la recherche et le développement sur la recyclabilité de matière première dans le contexte de la fabrication additive?	Faire un état de lieux sur recherches actuelles pour la réutilisation des matériaux, la technologie et les protocoles afin d'évaluer la qualité de la matière recyclé.
QR2	Quel sont les développement sur le recyclage de polymères afin d'être utilisées dans a FA open-source	Identifier les avancées majeures sur réutilisation polymères dans le contexte de la FA open-source.

Table 2: Question de recherche utilisées dans la revue de la littérature

Dans le cas de QR2, nous concentrons la recherche sur le recyclage des polymères utilisés pour les machines open-source. De la même façon, le but est d'identifier les développements au niveau expérimental/machine et de recherche méthodologique pour comprendre la faisabilité de ce processus.

En utilisant ces deux questions de recherche, nous avons trouvé dans la littérature 47 articles concernant notre cadre d'étude. Un premier résultat de notre revue est la mise en évidence que les études de recyclabilité dans le contexte des procédés de FA *Liquide* et *Sheet* restent encore un champ de recherche à explorer. Par contre, plusieurs propositions ont été identifiées dans les procédés *Particule Discrète* et *Matériau Fondu*.

Dans le cadre des technologies FA commercial, des méthodologies de recyclage ont été identifiées afin d'évaluer l'évolution de la matière première que n'a pas été utilisée lors du processus d'impression. Nandwana et al. [19] explicitent formellement une méthodologie utilisée pour évaluer le recyclage des poudres métalliques dans le procédé EBM. Dans le cas de polymère, Dotchev and Yusoff [20] ont présenté une approche méthodologique pour évaluer les bonnes pratiques établies pour le recyclage des poudres dans le frittage de poudre (SLS), en utilisant du polyamide (nylon).

Dans le cadre de la FA open-source, un des concepts importants à souligner est celui du **recyclage distribué**. Ce concept consiste en l'utilisation de déchet plastique pour les transformer en matière première pour l'imprimante 3D grâce au développement des extrudeuses issues aussi de l'open-source. Ce couplage des imprimantes 3D avec le développement des extrudeuses a été exploré comme une nouvelle approche prospective afin d'optimiser la matière première pour ces machines. Certains projets tels que Precious plastic [21], Plastic Bank², Precious plastic³ [21] sont basés sur ce concept.

L'intérêt principal de cette approche est la réduction des coûts et des émissions de gaz à effet de serre liés à la collecte et au transport des déchets ainsi qu'à l'impact environnemental de la fabrication de pièces en plastique sur mesure. Cette approche de **recyclage des polymères distribués** pourrait être une alternative supplémentaire au **recyclage centralisé classique** des polymères [22–26]. Compte tenu de l'adoption croissante significative de la FA open-source, l'approche du recyclage distribué des polymères pourrait être très pertinente car les taux actuels de recyclage sont particulièrement faibles.

D'un point de vue économique, les coûts de filaments commerciaux se situent entre \$18.86 et \$175.20 par kg, qui est de 20 à 200 fois supérieur au coût du plastique brut. Kreiger et al. [23] and Witbrodt et al. [27] ont prouvé la faisabilité économique d'un modèle distribué avec le recyclage local des matières plastiques (filament recyclé) pour les imprimantes OS 3D dans lequel 1kg de filament recyclé a été fabriqué à partir d'environ 20 bouteilles de lait pour moins de 10 cents US en utilisant le prototype d'extrudeuse open-source appelée «Recyclebot». Concernant l'aspect énergétique, Baechler, DeVuono, and Pearce [22] and Kreiger and Pearce [25] ont prouvé le concept pour le recyclage des déchets de polymères de grande valeur, où les économies se situaient entre 69 % et 82 % d'énergie intrinsèque pour le recyclage distribué par rapport à l'approche centralisée de recyclage traditionnel. Par conséquent, il existe un intérêt dans le recyclage de matériaux polymères pour un contexte d'impression 3D en open source.

Cependant, afin de comprendre le processus de recyclage des polymères pour établir une option de

²<http://plasticbank.org/>

³<http://preciousplastic.com/>

gestion durable des déchets pour cette technologie de FA open-source, il faut prendre en compte deux éléments fondamentaux:

1. Vu la nature open-source des machines, il est nécessaire établir une caractérisation afin de comprendre la performance de ces machines par rapport à l'ensemble de procédés de fabrication. En outre, la relation entre les paramètres de fabrication / procédé / propriétés obtenus doit être clarifié.
2. Une fois la performance des machines OS est caractérisé, nous nous intéressons pour le processus de dégradation des propriétés physico-chimiques du polymère à chaque cycle de recyclage, à la manière de traiter et de valider la pertinence et le nombre de fois qu'un matériau peut être recycle

Ces deux éléments sont étudiés par la suite.

Vers une protocole standards pour la caractérisation des imprimantes OS

La détermination des propriétés des objets faits à partir d'un processus de fabrication additive est un élément important en ingénierie. Il permet d'évaluer la capacité d'une machine, connaître ses avantages et ses inconvénients et pouvoir positionner cette machine dans le spectre des technologies disponibles aujourd'hui. En connaissant les propriétés de la machine et les propriétés du matériau, nous pouvons alors fabriquer un objet qui répond à un besoin particulier. La nature open-source des ce technologie fait qu'il est difficile de caractériser et positionner la performance de ces machines par rapport à l'ensemble de procédés de fabrication traditionnel.

Il existe deux méthodologies afin d'évaluer la performance d'une machine et/ou d'un processus ; (1) à travers une série de mesures directes sur la machine et des caractéristiques du processus, et (2) à travers des mesures d'objets d'essais manufacturés par la machine. Dans le contexte de la fabrication additive, la première méthodologie pour mesurer des caractéristiques tels que la vitesse, le positionnement, est difficile à réaliser. En revanche, l'utilisation d'un modèle ou d'un objet de référence joue un rôle très important pour diagnostiquer et caractériser des machines et des processus dans la fabrication additive. C'est pour cela que le design d'un modèle d'analyse comparative permet d'évaluer les composants d'une machine,

Dans le cadre de cette thèse, nous proposons une méthodologie pour évaluer la performance d'une imprimante OS avec deux but principaux. Le première est l'évaluation de la performance géométrique en termes de la précision dimensionnelle suivantes:

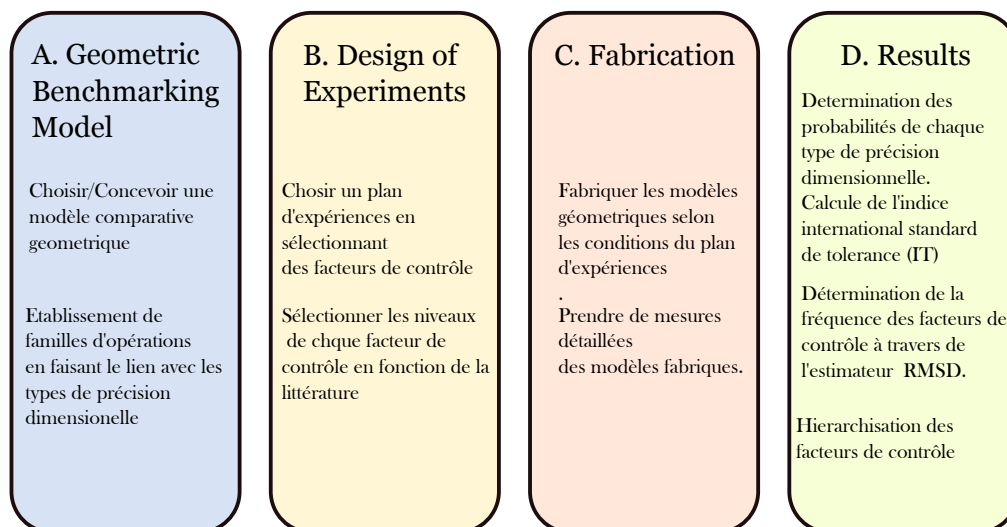
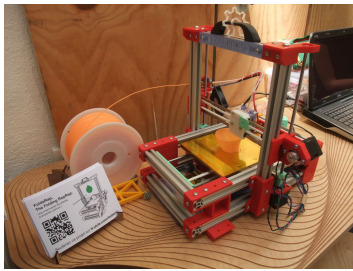
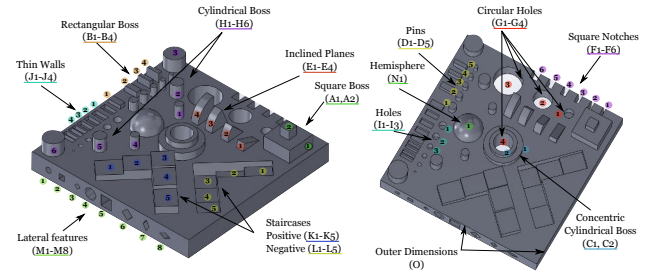

Figure 7: Méthodologie pour la caractérisation de performance dimensionnelle d'une imprimante open-source



(a) Imprimante open-source utilisée dans l'expérimentation



(b) Modèle comparatif utilisé (Geometric Benchmarking Model)

Figure 8: Modèle comparatif et imprimante 3D utilisée dans les cas expérimental

- Plane **XY**
- Axe **Z**
- Opérations Circulaires -**D**-
- Opérations de parois fin -**T**-

Le deuxième but est de trouver les paramètres de fabrication de la machine qui donnent la plus haute précision dimensionnelle possible pour la fabrication d'un modèle. La figure 7 présente un aperçu des différentes étapes de la méthodologie proposée.

Nous avons testé cette méthodologie avec l'évaluation d'une imprimante représentative: la FoldaRap (figure 8a). Le modèle comparatif de référence utilisée est présentée dans la figure 8b. Le plan d'expérience est couplé à l'approche Taguchi. 18 échantillons ont été fabriqués. Les résultats de cette méthodologie peuvent être résumés comme suivie:

1. Niveau de Précision: Probabilité 82.14% pour avoir une mesure (-%5,5)
2. International Standard Tolerance : **(IT14-IT16)**
3. Meilleur compromis des paramètres de fabrication:
 - Épaisseur de couche (Layer thickness): 0.18mm
 - Largeur de la trame (Raster width) :0.71mm
 - Vitesse de mouvement (Nozzle speed movement): 50 mm/s

Sur la base de ces résultats, nous pouvons assurer que l'imprimante 3D est une machine suffisamment reproductible pour la fabrications des pièces. Nous pouvons donc maintenant à continuation à caractériser le processus de recyclage des polymères pour cette technologie.

Méthodologie pour recycler des polymères pour la fabrication additive

Recyclage de polymères

Le développement de matériaux polymères a permis la fabrication d'une large gamme de produits peu coûteux, de faible poids et de haute performance et il est devenu un élément essentiel du développement technologique et sociétal [28]. Cependant, l'un des principaux problèmes est l'impact environnemental des résidus de plastique en raison de leur longévité qui peut atteindre plusieurs décennies [29].

Dans l'écologie industrielle des polymères, différentes stratégies ont été étudiées pour la gestion des déchets plastiques, allant de la réutilisation et du recyclage (Mécanique, Chimique) jusqu'à des processus de thermolyse / récupération [29–31].

Dans le contexte de recyclage des thermoplastiques, une des stratégies développées pour le traitement de déchets est le recyclage mécanique. Le recyclage mécanique est défini comme un processus qui permet de réutiliser directement des déchets plastiques dans le procédé de fabrication des nouveaux produits. Dans ce cas, il n'y a pas de destruction significative de la structure chimique du polymère,

tout au plus quelques modifications de ses propriétés physiques [29, 31–34]. En ce sens, le couplage de tests de caractérisation avec de multiples procédés d'extrusion ou de moulage par injection est une approche éprouvée pour évaluer la recyclabilité de matériaux polymères afin de simuler le cycle de vie prolongé des produits recyclés. La figure 9 présente un schéma générale de cette approche:

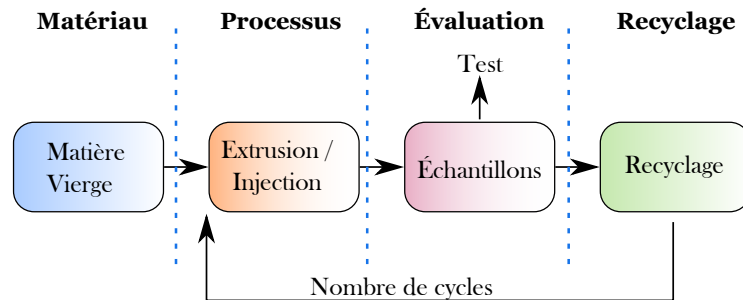

Figure 9: Mechanical recycling steps for the case of fabrication of recycled filament.

Dans ce modèle, une phase de départ est de considérer l'étude d'une *Matière Vierge*. Une autre considération à remarquer est l'évaluation de la matière en circuit fermé, dont il n'y a pas d'ajout supplémentaire de matière une fois le processus de recyclage commence. La dégradation de la matière est directement liée au procédé utilisé et à la quantité de cycles étudiés dans le recyclage. Il est nécessaire de définir l'étape *Évaluation* afin d'avoir une quantification des propriétés du matériau recyclé. Dans le cas de matière plastique recyclé, Karlsson [35] and Vilaplana and Karlsson [36] ont identifié trois axes majeurs pour l'évaluation de la qualité qui peuvent être résumées de la manière suivante:

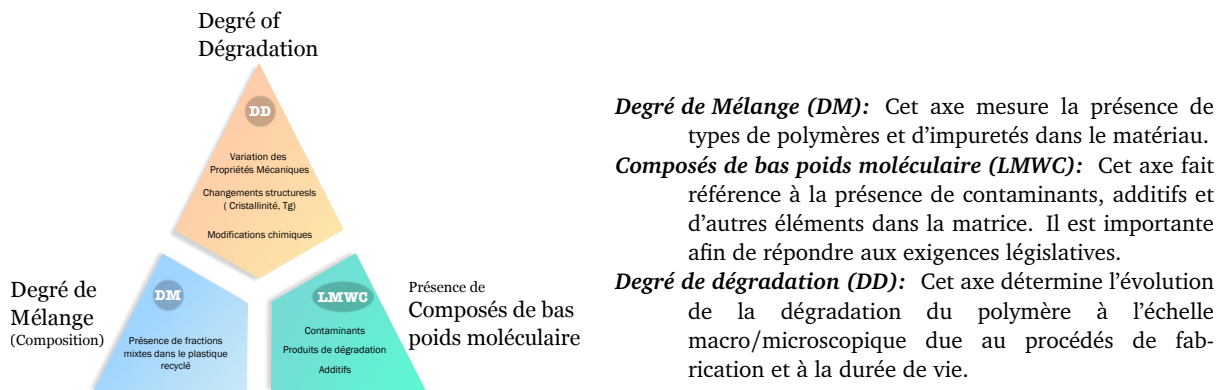

Figure 10: Cadre d'évaluation de la matière plastique recyclé

Le travaux de Badia and Ribes-Greus [37] présentent une caractérisation multi-niveaux complète dans lequel sont représentées les différentes axes d'analyse (*DM*, *LMWC*, *DD*), ainsi que les techniques analytiques couramment utilisées pour tester l'état de performance et / ou de dégradation du matériau résultant. Enfin, en fonction de la (ou les) propriété(s) qui seront analysées lors du processus de recyclage mécanique, de protocoles expérimentaux adéquats peuvent être mis en œuvre. Finalement, une étape de recyclage est caractérisé a fin de pouvoir réutiliser la matière.

Méthodologie pour évaluer le potentiel de recyclabilité

Basée sur les caractéristiques du processus de recyclage mécanique, nous proposons d'adapter un méthodologie systématique pour évaluer la dégradation des polymères thermoplastiques dans la chaîne des procédés de l'impression 3D. Cette méthodologie permet de comparer la dégradation de la matière en utilisant un procédé *standard* de fabrication (e.g. injection) par rapport à l'impression. En plus, un deuxième but est de quantifier l'impact du procédé d'impression lui-même sur la dégradation de la matière. La figure 11 montre la méthodologie proposée.

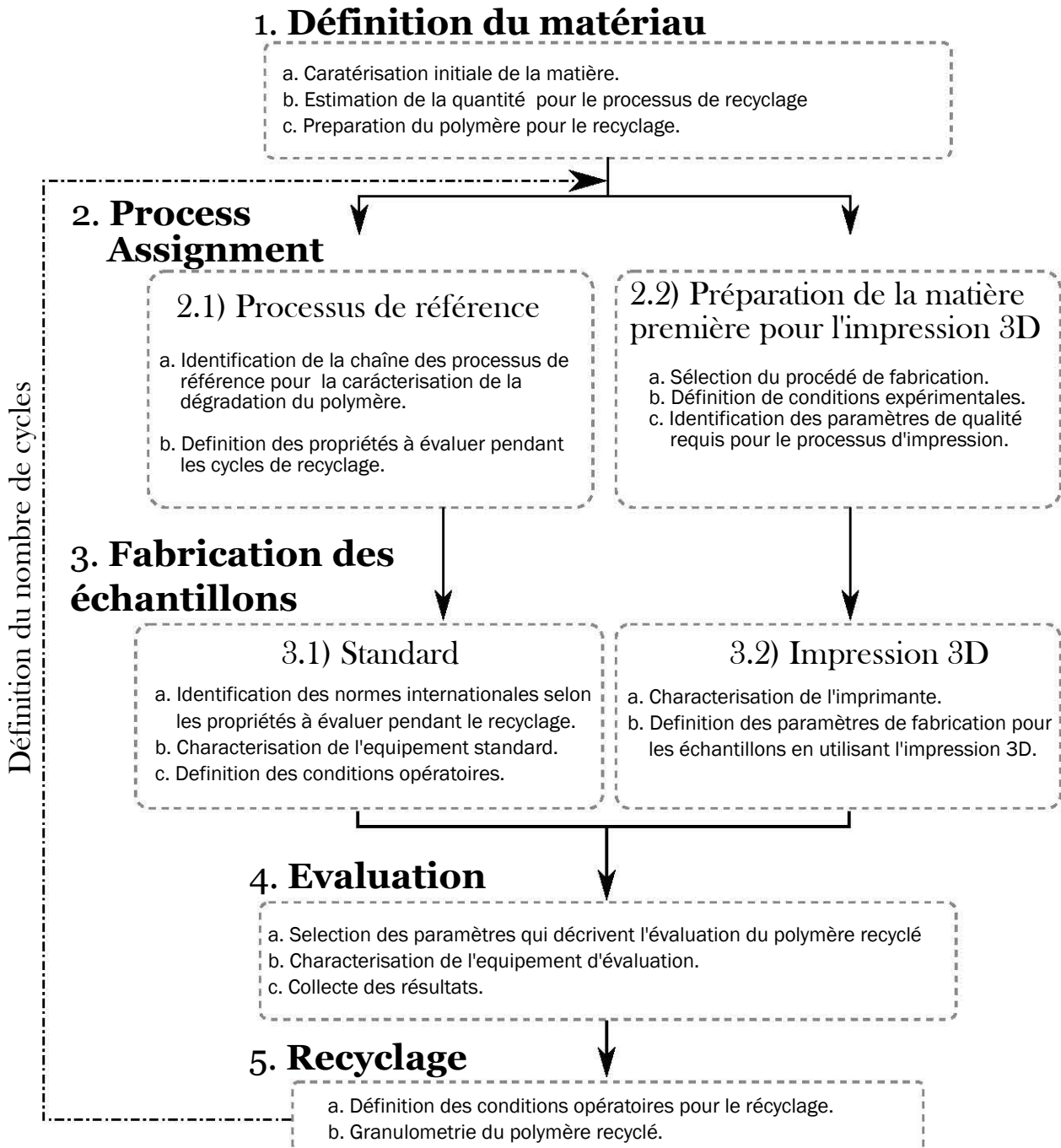

Figure 11: Méthodologie pour évaluer la faisabilité de recyclage dans la FA open-source

Etape 1 “Définition du matériau” :

Le but principale de cette étape, appelé “**Définition du matériau**” (figure 11), est la caractérisation de la matière première à étudier. Les caractéristiques données par le fournisseur du polymère doivent être prises en compte pour l'établissement initial des conditions opératoires.

De même, la quantité de matière nécessaire total pour l'étude globale doit être estimée. Cependant, dans le but d'avoir une estimation réelle de la quantité de matière, il est nécessaire de prendre en compte des éléments qui seront définis dans les étapes subséquentes. Ces éléments sont:

- Identification des propriétés du matériau à étudier lors du processus de recyclage (étape détaillée dans le [step 2](#))
- Définition des chaînes de processus de recyclage nécessaires pour la caractérisation de la matière dégradé (étape détaillée dans le [step 3](#))
- Définition du nombre de cycles à tester.
- Estimation de la perte de matière éventuelle pendant les cycles de recyclage, afin de prévoir dès le début de l'expérimentation les quantités adéquates de matière.

Etape 2 “Procédés” :

Cette étape est divisée en deux parties:

- “**Chaînes de processus de recyclage**”: Il s'agit de l'identification des chaînes de processus de recyclage qui seront utilisées pour la caractérisation des propriétés du polymère recyclé. Afin de mettre en évidence les effets des différents procédés sur le matériau, au moins quatre chaînes de recyclage sont nécessaires pour comparer la dégradation du matériau:
 - *Référence*: Il est utilisé comme une référence de la dégradation pour le matériau recyclé.
 - *3D Printing*: Il est utilisé pour évaluer la dégradation du matériau à la suite du processus d'impression 3D avec des échantillons réalisés à l'aide d'une imprimante 3D avec des paramètres établis.
 - *Feedstock*: Il est utilisé pour évaluer l'impact de la dégradation dû à la fabrication de la matière première pour les machines d'impression 3D considérées (c'est-à-dire les filament, les granules, la poudre, etc ...).
 - *3DP (Référence)*: Il est utilisé pour évaluer la dégradation du matériau dû au processus d'impression 3D en utilisant l'équipement standard.

En outre, plusieurs éléments caractéristiques mécaniques, thermiques, rhéologiques et morphologiques peuvent illustrer la dégradation du polymère [36, 38]. Pendant cette étape, l'expérimentateur doit déterminer son choix, en sélectionnant les propriétés qui seront étudiées par le processus de recyclage.

- “**Préparation de la matière première pour l'impression 3D**”: Le but de cette étape est d'identifier le(s) procédé(s) requis pour la fabrication de la matière première pour l'imprimante. Donc, la caractérisation de ces procédés et l'établissement des conditions opératoires est indispensable afin de définir les différentes propriétés. En plus, une définition de la qualité de la matière obtenue est essentielle afin de garantir la qualité pendant le processus d'impression.

Etape 3 “Fabrication des échantillons” :

Il y a deux buts principaux dans cette étape:

1. D'abord, deux types de procédés sont proposés afin de comparer la dégradation de la matière: les procédés *Standard* et *l'Impression 3D*:
 - “*Standard*”: Ce procédé servira de référence pour comparer les résultats obtenus de dégradation avec le procédé d'impression 3D. Il est nécessaire de caractériser l'équipement

et définir les conditions opératoires à utiliser pour la fabrication des échantillons qui seront le référence de dégradation. C'est la raison pour laquelle, il est impératif d'identifier les normes internationales par rapport aux propriétés choisies dans le étape précédente (Step 2- Processus de référence).

- “*Impression 3D*”: Dans un premier moment, le but est de caractériser l'imprimante open-source utilisé dans l'expérimentation. Dans un deuxième moment, la définition des paramètres de fabrication pour les échantillons. Une revue de la littérature sur la propriété sélectionnée dans le contexte de fabrication additive commerciale peut donner un aperçu initial des paramètres importants à considérer.

Etape 4 “Évaluation” :

Le principaux objectifs de cette étape sont la définition des paramètres qui décrivent les propriétés ciblées et la définition de l'équipement sélectionné pour l'évaluation. Les tests sont effectués afin de recueillir les données selon les procédures internationales, et en considérant également l'ensemble des échantillons selon les chaînes de recyclage proposés.

Etape 5 “Recyclage” :

Finalement, le but de cette étape est d'acconditionner la matière recyclée pour le retraitement. Le processus de recyclage est réalisé individuellement pour chaque chaîne de recyclage. Une caractérisation de l'équipement de recyclage utilisé et une description des caractéristiques du matériau recyclé obtenu sont réalisées.

Recyclage de l'Acide Polylactique (PLA) pour l'Impression 3D

Nous appliquons la méthodologie présenté dans la figure 11 à un cas particulier. Le matériau sélectionné est l'acide polylactique (PLA) type 4043D (NatureWorks). Ce matériau est destiné à la fabrication de matière première pour les imprimantes 3D selon les spécifications du fabricant.

L'acide polylactique (PLA) est l'un des plus importants polymères bio-sourcés, biodégradables et biocompatibles [39–43]. Le PLA est un polyester aliphatique thermoplastique obtenue à partir des ressources renouvelables (e.g. pomme de terre, l'amidon du maïs, la canne à sucre et le sucre de maïs) en usant un procédé de polymérisation par ouverture de cycle du lactide [44–46]. Le PLA offre des potentiels avantages nombreuses pour une large gamme d'applications de produits tels que des bouteilles, des plateaux, des conteneurs, entre autres. Le tableau 3 montre un résumé des éléments les plus importants qui ont été considérés lors de l'application de la méthodologie.

Table 3: Application de la méthodologie au cas du recyclage du PLA pour l'impression 3D

Étape	Éléments à Définir	Notre cas expérimental
1. Définition du matériau		Acide Polylactique (PLA)
2.1 Procédés de Référence	Chaines de recyclage Propriété à évaluer	Quatre chaînes de recyclage Propriétés mécaniques
2.2 Matière première pour l'Impression 3D	Procédé de fabrication Paramètre de Qualité	Extrusion Diamètre du Filament
3.1 Fabrication Standard	Normes Internationaux	ISO 527-1B (Propriétés Mécaniques)
3.2 Fabrication Impression 3D	Caractérisation des Imprimantes Paramètres	<i>FoldaRap, Mondrian</i> Deux type d'éprouvettes (0/90 – 45/45)

Table 3 – continuation de la page précédente

Étape	Éléments à Définir	Notre cas expérimental
4. Evaluation	Paramètres	Elastic Modulus, tensile strength and tensile strain values
5. Recyclage	Procédé Granulométrie	Broyage 0.2-2 mm

Une adaptation du processus de recyclage mécanique a été fait afin de définir les chaînes de recyclages. La figure 12 présente les quatre chaînes de recyclage qui ont pour but final de qualifier la dégradation des propriétés mécaniques dû au effet des divers procédés.

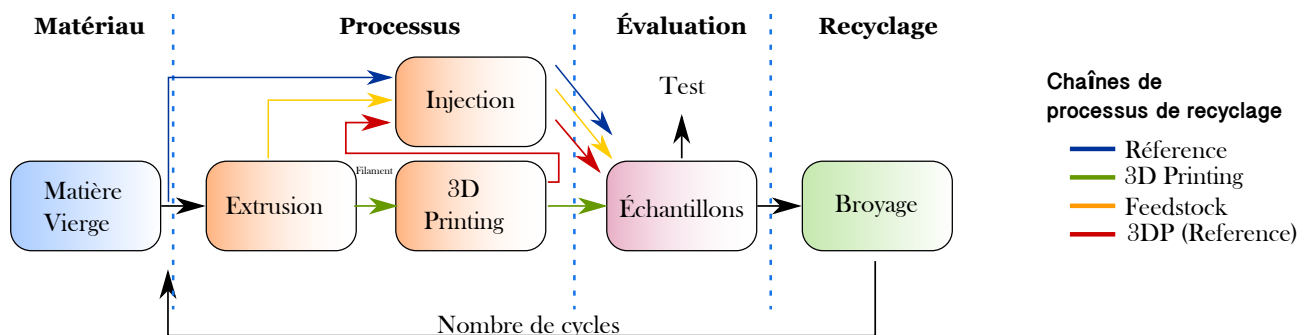

Figure 12: Chaînes de recyclage pour évaluer la dégradation du matériau.

A partir des quatre chaînes de recyclage, il est possible de comparer la dégradation du matériau en utilisant un procédé traditionnel tels que l'injection et le procédé d'impression 3D. La figure 13 présente le résultat de notre démarche expérimentale.

Nous avons sélectionné 8 échantillons pour chaque chaîne de recyclage afin d'avoir suffisamment de reproductibilité dans nos résultats. Dans le cas de la chaîne *3D Printing*, 16 échantillons ont été sélectionnés 8 pour le remplissage 0/90 et 8 pour le cas de 45/45. Une première observation de la comparaison est que dans tous le cas, les échantillons injectés présentent des meilleure propriétés que ceux imprimés tel qu'il est présenté dans la figure 13a. La différence entre ces deux procédés de fabrication est d'environ 10 MPa dans le première cycle, qui est en accord avec la littérature [47, 48]. Cependant, cette différence augmente jusqu'à environ 20 MPa dans le cinquième cycle.

Les résultats représentés dans la figure 13b montrent que le module élastique peut être considéré comme indépendant du processus de recyclage et de fabrication. Il pourrait être considéré comme constant pour les échantillons injectés (chaîne *Reference*) dans une intervalle de variation entre 3300 – 3500 MPa. Pour le cas des échantillons imprimés (45/45 et 0/90), une faible augmentation du module élastique est observée du premier au dernier cycle avec de valeurs moyennes de 3277.7 à 3432.6 MPa respectivement.

Une possible explication à cette augmentation du module d'élasticité pour les échantillons imprimés, est qu'elle est associée au changement de viscosité du matériau, conséquence du procédé de recyclage. Les caractéristiques de la méso-structure et de la liaison fibre-fibre des échantillons d'impression changeront aussi à mesure que le nombre de cycles de recyclage augmente. Selon la littérature, certains défauts internes qui affectent la qualité structurale des pièces imprimées sont les vides, les pores et les vides sous-périmétriques dus à la forme arrondie et oblongue du matériau déposé [49, 50]. Dans le procédé d'impression, le matériau imprimé se propage dans une forme oblongue dont la vitesse d'étalement et

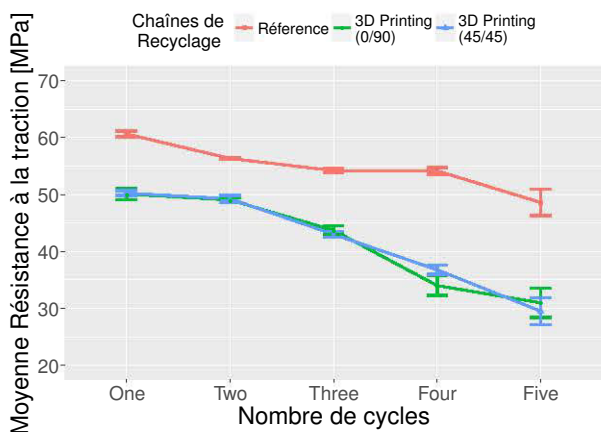

(a) Valeurs moyennes de résistance à la traction pour les chaînes *Référence* et *3D Printing*

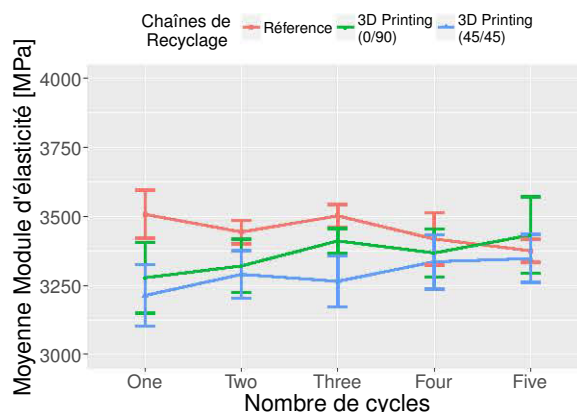

(b) Valeurs moyennes du module d'élasticité pour les chaînes *Référence* et *3D printing*

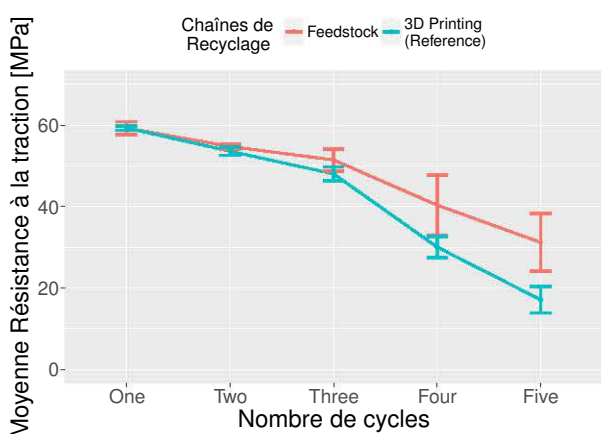

(c) Valeurs moyennes de résistance à la traction pour les chaînes *Feedstock* et *3D printing (Référence)*

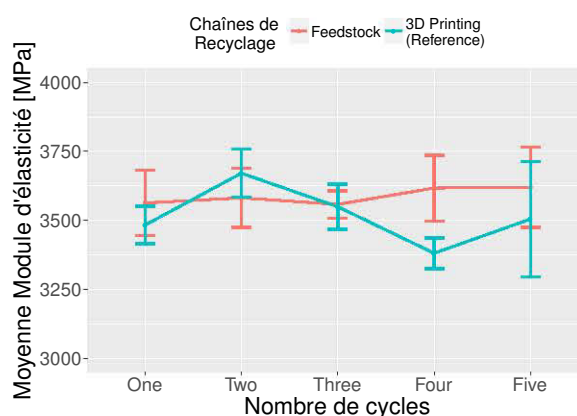

(d) Valeurs moyennes du module d'élasticité pour les chaînes *Feedstock* et *3D Printing (Référence)*

Figure 13: Évolution des propriétés mécaniques des chaînes de recyclage

la forme finale dépend de la viscosité de la matière fondue et des énergies de surface relatives de la trame déposée et de la surface sur laquelle elle est imprimée [50]. Finalement, les propriétés mécaniques globales de la pièce dépendront de la zone de contact entre les trames (et les couches) déposées, de la taille des vides et des propriétés du matériau elles-mêmes.

Par conséquent, une hypothèse pour expliquer le comportement similaire entre les chaînes de processus *Reference* et *3D Printing* en termes de module élastique à la fin du cinquième cycle est qu'il y a une réduction appréciable des défauts internes, provoquée par la diminution de la viscosité du matériau, ce qui facilite l'homogénéisation des couches déposées. Nous pouvons alors présumer, que la méso-structure interne des échantillons imprimés pourrait être similaire à celle de l'injection. Néanmoins, cette réduction de la viscosité est une conséquence de la dégradation du matériau, entraînant l'un changement de propriétés de traction.

D'autre part, les figures 13c et 13d montrent les résultats des propriétés mécaniques des chaînes de recyclage *Feedstock* et *3D Printing (Référence)*. L'unique différence entre ces deux chaînes est un processus d'impression 3D dans la dégradation du matériau. Concernant le module d'élasticité, nous pouvons voir que cette propriété reste virtuellement constante pendant le cycles. Nous pouvons constater qu'il existe un effet de l'impression 3D sur le matériau. Il est négligeable quand la matière est vierge, par contre, cette influence augmente au fur et à mesure que le matériau est de plus en plus dégradé. Il est important d'analyser ces résultats d'un point de vue chimique afin de caractériser la dégradation au niveau microscopique.

Tableau 4 Les résultats spécifiques peuvent être résumés comme suit:

Table 4: Variation des propriétés mécaniques du PLA après cinq cycles de recyclage

Chaîne de Recyclage	Réduction des propriétés mécaniques				
	Module d'élasticité	Résistance à la tension	Résistance à la rupture	Déformation à la tension	Déformation à la rupture
Référence	-3.7%	-19.81%	-15.95%	-27.31%	-40.65%
3D Printing (0/90)	+4.1%	-38.15%	-39.29%	-52.20%	-57.43%
3D Printing (45/45)	+4.7%	-41.27%	-40.08%	-53.08%	-56.53%
Feedstock	<i>Constant</i>	-47.56%	-42.52%	-58.57%	-70.84%
3D Printing (Reference)	<i>Constant</i>	-71.34%	-72.58%	-78.93%	-86.49%

Une conclusion importante des résultats de cette thèse est la faisabilité technique pour l'utilisation de matière recyclée pour la technologie de la fabrication additive open-source, plus ponctuellement pour les machines qui sont basées sur le procédé de dépôt de filament (*Fused Filament Fabrication (FFF)*). En outre, Un protocole expérimental a été établi avec deux objectifs principaux: (1) évaluer la qualité de l'imprimante 3D en termes de précision dimensionnelle. Et (2), pour identifier le lien entre les paramètres du processus et la qualité du processus d'impression. Nous avons démontré que ce type de machine open-source peuvent être comparables avec les systèmes commerciaux en termes de précision dimensionnelle. D'autre part, sur la base d'une première littérature sur la fabrication additive (FA), une large piste de recherche a été identifiée et pourrait être explorée afin de souligner les avantages potentiels de l'AM sur les questions de durabilité. Une des pistes pour continuer le développement de ces travaux sont liées à la caractérisation du point de vue chimique et microscopique sur la dégradation de la matière. Cela devrait permettre de mieux comprendre les phénomènes physiques de dégradation présent dans le processus de l'impression 3D. D'autre part, des éléments logistiques, économiques et de modélisation de la filière pour recycler sont des pistes importantes pour formaliser cet approche distribuée de recyclage. Et notamment, ces éléments peuvent être intégrés dans un concept de *Green Fablab*, dont ces matières recyclées peuvent être réutilisées dans ces espaces de co-création.

General Introduction

Since the middle of the 20th century, the environmental issues have increasingly gained attention at different levels of our society. The United Nations (UN) decided to include the environmental issues to the UN's list of global problems at the *Conference on the Human Environment* (Stockholm, 1972) [51]. This decision can be seen as one consequence of the profound impact of realizing that the earlier expectations of industrial development and unlimited economic growth were no longer reasonable without considering the environmental impact for the human development of the next generations [51–53]. Seminal research works, as *The Limits of Growth* [54] and *Our Common Future* [55], outlined the first features of a new paradigm towards sustainable development which has become widely known throughout the world. Thus, the international scientific community has been inquired to identify and establish different long-term environmental goals and strategies to mitigate the impact of human activity to the Earth. And therefore, commitments such as the *Kyoto Protocol* in 1997, the *Horizons 2030* and agreements taken at the *COP21*¹ held on December 2015, can be seen as a result of this dynamic.

The *Green Engineering* concept has been positioned as a response to the question of how to achieve the sustainability goals through science and technology [56]. The objective of these initial efforts on green engineering was to work with existing industrial infrastructure and modify practices, programs, and processes in order to evolve from a treatment perspective (*end-of-pipe*), passing to *Pollution Prevention* (Reduce, Reuse, Recycle), *Design for Environment* (ISO 1400) and leading towards the *Sustainable Development* [52]. A certain number of principles of *Green Engineering* have been developed as a framework for scientists and engineers to engage when dealing with design architecture (material, products, process) [56]. The final purpose is to create an industrial ecology, ensuring that the use of humankind's natural resources will not affect the quality of life due either to losses in future economic opportunities or to adverse impacts on social conditions, human health and the environment.

On the other hand, since late 1980s, Additive Manufacturing (AM) have emerged as an innovative set of technologies to produce objects layer-by-layer with higher flexibility, greater efficiency with respect to traditional manufacturing, impacting the product development time, cost reduction, human interaction and consequently, improving the product development cycle [6, 57, 58]. Moreover, in the light of the principles of green manufacturing, given the nature of the layer-by-layer of AM technologies, it is possible to consider it as a technology targeted toward waste-free design in which inputs are designed to be a part of the desired output. For these reasons, there is a marked driving force from industry and scientific community to make AM techniques evolve from rapid prototyping (RP) towards rapid tooling (RT) and Direct digital manufacturing (DDM) [7, 59].

In the mid-2000s, taking into account a set of elements such as (1) the patent expiration of Fused Deposition Modeling (FDM), which is one of the main AM technologies, (2) the evolution of the modern information and communication technologies (ICT), and (3), the commons-based peer production approach, an open-source additive manufacturing (or open-source 3D printing) have been taking place during the recent years. One of the pioneers is Adrian Bowyer and his team, from United King-

¹<http://www.cop21.gouv.fr/>

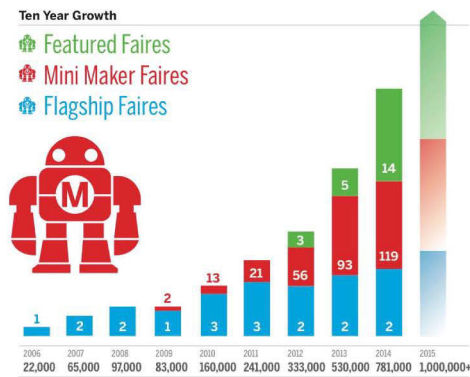

(a) Number of attendees at Maker Faire per year. Source *Maker Faire*

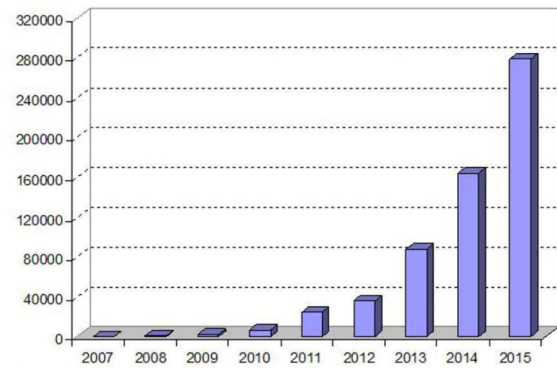

(b) Sales growth of the desktop (under \$5000) 3D printers. Source *Wohlers Report 2016*

Figure 1.1: Global trend of the open-source 3D printing

dom, through the development of the self-replicating systems called **RepRap** (or **Replicating Rapid-prototyper**) based on the Fused Deposition Modeling (FDM) technique. The FDM principle consists on using polymer material which is liquefied inside a small reservoir, then it flows out through a nozzle and bond with adjacent material before solidifying. RepRap is a low-cost (\$5000 or less) desktop rapid prototyper which manufactures approximately 57% of its own mechanical components (excluding fasteners, bolts and nuts) under the concept of open design process [11–13]. The arrival of low-cost additive manufacturing equipment has further pushed the migration of this technology to home-users allowing *hobbyists* and *do-it-yourselfers* (*DIY*) to have access to the AM technology, and also, to create a community around this type of projects. Since then, new systems based on the RepRap model have been developed and a considerable range of applications using this technology have been developed. In fact, through the use of open-source 3D printers combined to other kind of open-source technologies, a new type of platforms, called Fab-Labs², Hackerspaces³ or Makerspaces⁴, for the development of innovation and invention have appeared. For instance, in the case of Fab-Labs, they began as an outreach project from MIT’s Center for Bits and Atoms (CBA), and became into a collaborative and global network. These spaces share the values related to the technology, development of High-Tech projects and the interest in knowledge exchange, which has allowed the democratization of the technology and the emergence of a social movement called the *Maker movement* [60–62].

One of the remarkable elements of the open-source 3D printer and its environment is the exponential growth in terms of 3D printers themselves and the community interest around this as we can see from figure 1.1. The maker movement, as it exists today, began to organize “*Maker Faire*”⁵ conventions in order to bring people together around this interest. The first held in the San Francisco Bay area in 2006, and since then, the convention have enjoyed a growth in popularity during the last years, as illustrated in figure 1.1a. On the other hand, according to Wohlers Associates⁶, a well-known industry report, the figure 1.1b confirms the growing interest of the open-source machinery with more than 278.000 open-source 3D printers (under \$5000) sold worldwide last year. These two facts reflect a sign of a societal growing interest for this technology, considering that open-source 3D printing could have a positive impact in essential societal elements such as STEM (Science, Technology, Engineering and Mathematics) education [17].

However, in terms of *green engineering*, more precisely in *green manufacturing*, comprehensive approaches are required to consider the environmental impacts of the open-source technology and the

²<https://www.fablabs.io>

³<http://hackerspaces.org/>

⁴<https://makerspace.com/>

⁵<http://makerfaire.com>

⁶<https://wohlersassociates.com>

implication of its marked growing trend [63, 64]. In our case, the concept of *green manufacturing* for the open-source 3D printing technology is related to the awareness of the 3D printer impact on the environment and resources, and include such impact in its overall efficiency planning and control. The environmental impact of the 3D printer could be categorized in toxic chemicals releases, waste generation, energy consumption, and carbon emissions [64]. For example, one of the most pressing issues in estimating the environmental impact of AM technologies is to evaluate the potential toxicological health and environmental risks that can occur from handling, using and disposal of the AM materials [65]. In this thesis, we will concentrate us on the *waste generation* category and we will study the strategy of *pollution prevention* control in order to evaluate the **polymer material recycling process** for the open-source 3D printers.

70 years ago, at the beginning of this ‘plastic age’, Yarsley and Couzens told with much optimism [66, 67]:

“It is a world free from moth and rust and full of colour, a world largely built up of synthetic materials made from the most universally distributed substances, a world in which nations are more and more independent of localised naturalised resources, a world in which man, like a magician, makes what he wants for almost every need out of what is beneath and around him...” Yarsley and Couzens [68, p. 152]

Today, the reality is other. We can not deny that the development of polymer materials has allowed the manufacture of a wide range of low-cost, low weight, high performance products and it has become a core part of technological and societal development [28]. However, The low recycling rate of polymers is still a humankind challenge due to energy, economic and logistic issues. And one of the main issues is the environmental impact of plastic residues due to their longevity which can reach several decades (if not millennia) [29]. Currently, RepRap is more widely used than any other additive manufacturing system [14]. And taking into account that as most of the RepRas machines are based in the FDM (also known as Fused Filament Fabrication (FFF)⁷), which consumes polymer material as feedstock, there is a huge potential that this technology impact negatively the environment with more polymer wastes. In fact, only in 2014, 25.8 million tonnes of post-consumer plastics waste ended up in the waste upstream in Europe [69]. Only 7.7 million tonnes were recovered through a recycling using the centralized facilities. In U.S. case, only 6.5% (equivalent to 2.2 million tonnes) of the used plastics are recycled in conventional centralized recycling process [70]. Therefore, substantial quantities of plastic are already being accumulated in the natural environment and in landfills. The coupling of open-source 3D printers and polymer processing could potentially offer the bases of a new paradigm of distributed recycling. This could be an innovative process that could positively impact the society. We are conscious that whole range integral approaches are necessary in order to find a legitimate solution for a problem raised 70 years ago.

Our vision is to define a concept of ***Green Fablab (or Hackerspace, or Makespace)***. In these geographically distributed spaces, the polymer recycling process of the surrounding areas (street, neighborhood, or even town) will be carried out at small lot sizes minimizing, energy consumptions, and carbon emissions compared to the tradition centralized systems, as some research have already explored this path [22–24]. We would like to understand the conditions in order to deploy a notion of circular economy with the feedstock of the OS 3D printers. Benefits will be obtained, not only by minimizing use of the environment as a sink for residuals but – perhaps more importantly – by minimizing the use of virgin materials. Hence, the environmental impact of this technology is significantly reduced. Moreover, taking into account the exponential growth of these spaces (Fablab, Hackerspace, Makespace), they could help to increase the efficiency to the problem of polymer recycling through the development of a distributed recycling approach. In fact, in the European Union action plan for the circular economy, we can confirm the deep interest in advocating actions for developing polymer recycling innovations

⁷Fused Filament Fabrication (FFF) is sometimes called Fused Deposition Modelling (FDM). But this latter phrase is trademarked by Strataysys Inc., and so is not in unconstrained use. FFF was coined by the members of the RepRap project to give a synonymous term that could be used by all unrestrictedly

that can contribute to the 2030 Sustainable Development Goals [71, 72]. Therefore, we can see that this vision of *Green Fablab* is aligned with the current priority areas

We have to consider several questions before arriving to this vision. As we stated before, the open-source AM technology has been developed in a organic way, thanks to the synergy of factors as the emerging digital fabrication capabilities, the information and communication technologies and the commons-based peer production approach (e.g. the self-selection of tasks by the participants, modularity design) [15, 73]. We can affirm that thanks to the work of a global community around this project, this manufacturing technology have evolved and democratized to the point that everyone can propose new options. This is finally one of the main difference with respect to the commercial AM. However, this multiplicity of actors implies greater challenges in terms of arriving to standards that allows users to have a common notion of quality. Important questions arise from this analysis:

- Can open-source 3D printers be considered as a reliable manufacturing tool?
- How the quality of a open-source 3D printer can be evaluated?
- Where are the OS 3D printers positioned in the global set of manufacturing technologies in terms of quality?

Therefore, before studying how to conceive a circular economy intended to the feedstock material of this technology, it is necessary to understand its capabilities and prove that it can be considered, not only as a gadget device, but a decisive resource for the development of new inventions to humankind. In this way, it will be possible to establish minimum standards of performance and make an inference about the suitability of this technology to use recycled materials.

Once we are sure about the quality of open source 3D printing, we can focus our attention to the material recycling issues. And specifically for the case of this thesis, we will focus on the polymer recycling process. In order to achieve this vision of *Green FabLab*, a first step is to prove the recycling feasibility of the materials. Several questions arise from this goal:

- Are there already recycling processes in the context of Additive Manufacturing technologies?
- More specifically, are there polymer recycling practices/methodologies intended for open-source AM?

This thesis aspires to contribute to respond at these questions. And more important, to play a part in this new distributed recycling paradigm taking into account that the traditional paradigm of centralized recycling of polymers is often uneconomic and energy intensive due to transportation embodied energy.

Goals of the research

The overall goal of this thesis is to have a better understanding on the polymer recycling process in order to establish a sustainable waste management option for this technology.

The main contributions of this thesis can be summarized as follows:

- Establishment of a standard protocol methodology in order to evaluate the quality of the 3D printer in terms of dimensional accuracy. This protocol allows users to compare the performance of the open-source 3D printer with respect to the global set of manufacturing technologies.
- Proposition of a general methodology in order to evaluate the recyclability of polymers used as feedstock by 3D printing machines. The importance of this methodology relies on the feasibility evaluation of using recycled material by OS 3D printers. This allows us to fully understand the polymer degradation in the 3D printing process chain. The proposed methodology is applied to the recycling study of the PLA in order to understand the evolution of the mechanical properties using fused filament fabrication (FFF).

Organization of the thesis

The thesis is organized as follows.

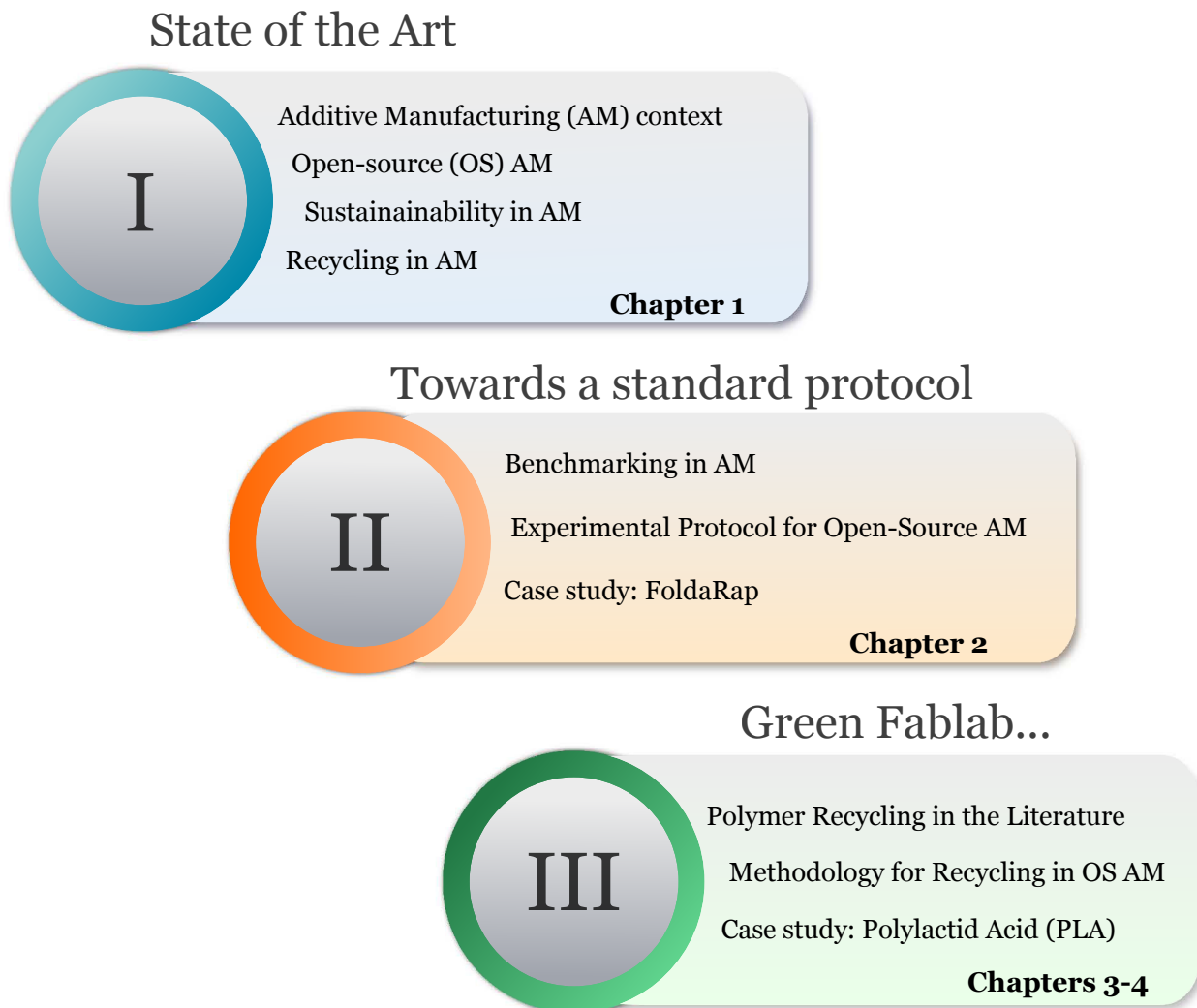

Figure 1.2: Main contribution of this thesis

- **Chapter 1:** An overview of the main additive manufacturing (AM) technologies is presented together with an analysis of the role that AM plays in the sustainable development. Furthermore, a systematic literature review is described in order to understand how the material recycling process is performed in the different AM technologies. The characterization methods for the feedstock material and for the printed part are mapped. Finally, a particular emphasis is made to the polymer recycling process for open-source additive manufacturing technologies. It is presented the social and practical implication of the recycling process for this open-source technology.
- **Chapter 2:** The first element to analyze in the OS 3D printing process chain is effectively the OS 3D printer. Before proving the suitability of this technology to use recycled material, it is required an evaluation of the system performance in order to prove as the reliability as a manufacturing tool. Moreover, it is necessary to understand the influence of the parameters process in the quality of the printed object. Therefore, a proposition of an experimental protocol for machine qualification is presented. The main goal is to qualify the dimensional performance of the OS 3D printer, and to find the process parameters that gives the highest

quality possible. Moreover, this methodology allow us to compare the performance of the OS 3D printer with respect to the other AM processes and to other type of manufacturing process thanks to the use of an International Standard Tolerance Grade

- **Chapter 3:** Once the machine qualification is guaranteed, we can focus our attention to the material recycling process. Based on a literature of the polymer recycling field, the contribution of this chapter is to propose a general methodology to evaluate the recyclability of thermoplastic polymers used as feedstock by 3D printing machines. The proposed methodology is applied to the recycling study of the PLA in order to understand the evolution of the mechanical properties using fused filament fabrication (FFF).
- **Chapter 4:** Finally, in this chapter, the aim is to present the detailed results of the experimentation based on the application of the methodology described in the chapter before. Main conclusions form the technical results are presented in order to evaluate the feasibility of use recycled PLA in the OS 3D printing chain.

This documents finish presenting the main conclusions and perspectives that synthesize our contributions.

This thesis has been financially supported by a grant of the French Government, in the *Équipe de Recherche sur les Processus Innovatifs -ERPI-* (Research Team in Innovative Process) using its research platform *Lorraine Fab Living Lab* and the *Laboratoire Réactions et Génie des Procédés -LRGP-* (Laboratory of Reactions and Chemical Engineering) in Nancy, France. One scientific paper has been published in the *Virtual and Physical Rapid Prototyping Journal*. The second paper has recently been submitted for publication in the *Additive Manufacturing Journal*.

Contents

2.1	Introduction	9
2.2	Additive Manufacturing background	9
2.2.1	What is Additive Manufacturing?	9
2.2.2	Overview of the main AM processes	11
	A. Liquid	11
	B. Discrete Particle	12
	C. Solid Sheet	15
	D. Molten Material	16
2.3	Open-source additive manufacturing - The case of the RepRap project-	22
2.3.1	Open-source 3DP architecture	22
2.3.2	Differences between Commercial and Open Source AM	23
2.3.3	Applications of RepRap in the literature	24
2.4	AM Sustainability on Society	25
2.5	Material Recycling in Additive Manufacturing	28
2.5.1	Definition of the Research Questions	28
2.5.2	Development of the Review Protocol	29
	A. Search strategy	29
	B. Study selection criteria	31
	C. Study selection procedure	31
	D. Data extraction strategy	31
	E. Study quality assessment check	32
2.5.3	Identification of the relevant research	33
2.5.4	Selection of the primary studies	34
2.5.5	Data Extraction	35
	-Overview of the selected studies	35
2.5.6	Data synthesis	36
	I. Material Recyclability in the Additive Manufacturing Context. (RQ 1)	37
	II. Polymer Recycling in the Open-Source Additive Manufacturing(RQ2)	46
2.6	Conclusions	50

2.1 Introduction

This chapter introduces a literature review covering the areas of interest to our research. In a first moment, the additive manufacturing (AM) concept and its main technologies commercially developed are presented. We present the working principle of this technology, a general classification and major advantages and disadvantages. Next, we focus our attention to the potential that AM technologies have on sustainability issues. Likewise, we present the major challenges to overcome and the research paths proposed in order to fully develop sustainable AM processes. Based on this research paths, we develop a systematic literature review targeted to the material recycling research intended for AM technologies. The aim is to have a background about the research, developments and practices in this field. We defines the each stage of the systematic literature review and we present methodically the result of each phase. Finally, we present the discussion and conclusions about the literature found.

2.2 Additive Manufacturing background

2.2.1 What is Additive Manufacturing?

Additive Manufacturing (AM) is the name given to all the fabrication technologies in which the working principle is the layer-by-layer material deposition, as a contrast to the more traditional subtractive manufacturing methodologies [2]. This basic principle drives nearly all AM machines, with some variations in terms of the techniques used for creating layers and in bonding them together. Different synonyms have been evoked (e.g. rapid prototyping, additive fabrication, additive processes, additive techniques, additive layer manufacturing, layer manufacturing, solid freeform fabrication) throughout the development of this manufacturing process [5, 74–76]. However, it has to be noted that this concept has its roots in topography and photosculpture which exist since almost 150 years ago [3, 4].

One essential element of AM is the capacity to translate virtual solid model data into physical models in a quick and easy process. The part's geometry is therefore clearly reproduced by the AM machine without having to adjust for additional manufacturing processes. This aspect is an advantage with respect to forming or machining manufacturing process where it is absolutely imperative to take into account aspects such as cooling paths, undercuts, draft angles and other features. Therefore, it is possible to affirm that the AM machine is a *What You See Is What You Build (WYSIWYB)* which is particularly valuable for parts of complex geometry [7]. This capacity represents several competitive advantages with respect to the other manufacturing technologies [77–79]:

- **Part flexibility:** AM technology allows a huge range of designs with complex geometries. The fabrication of free-form enclosed structures is then possible (e.g. For cooling purposes) which it is not possible using other types of manufacturing.
- **Material efficiency:** The reduction of raw materials quantity used can be up to 75 %, minimizing the carbon footprint compared to conventional manufacturing technologies [3]. In the metal sector, case studies show that the waste of raw material is reduced by up to 40% when using additive technologies instead of subtractive (machining) technologies [78]. In applications for racing cars components including suspension mounting brackets and drive shaft spiders using LENS, a material reduction of more than 90% , reduced time and cost [57].
- **Time-to-market reduction:** The new product development cycle is optimized because of the speed fabrication of prototypes.
- **Mass customization:** AM facilitates to individualize and customize goods manufacturing [77].
- **Production flexibility:** AM machines do not require costly setups and hence is economical in small batch production.

- **Reduction of human errors in fabrication:** The quality of the parts relies mostly on the process rather than operator skills.
- **Supply chain optimization:** Production can be easily synchronized with customer demand. In addition, the problems of line balancing and production bottlenecks are virtually eliminated because complex parts are produced in single pieces.
- **No auxiliary tools, moulds or punches are needed.** The printed part is obtained directly from its 3D CAD model. There is an inherent in terms that almost absolute absence of human errors in production.
- **Separation of product design from manufacturing capabilities:** Since design and manufacturing can be developed independently, it is easier to share designs and outsource the manufacturing process.

On the other hand, there are limits and challenges to accomplish with the purpose of enabling the AM process evolves from a *rapid prototyping* to direct digital manufacturing approach.

- **Size limitations:** AM processes often use liquid polymers, or a powder comprised of resin or plaster, to build object layers. These materials makes AM unable to produce large- sized objects due to lack of material strength. Moreover, Large-sized objects also often are impractical due to the extended amount of time need to complete the build process
- **Material characterization:** Validation of mechanical and thermal properties of existing materials and AM technologies. The inner nature of AM processes causes printed parts with anisotropic properties as a function of the direction and parameters of fabrication, the mechanical properties will be different different.
Hence, a end-user will fully trust AM technologies when the proper part characterization is done.
- **Surface Quality:** The stair stepping effect is created by the placement of one layer on top of another, affecting surface quality and roughness.
- **Support structure:** As the material used for the support structure cannot be recycled, it should be minimized by a good build-up orientation
- **Automation design and process planning.** The overall trend in production processes (no matter if subtractive, forming or additive) is the development of automatic assessment tools. There are several parameters that are considered when one designs for AM. And consequently, there is a need to improve the understanding and quantification of all of them in order to automate decision making in AM [78].
- **Cost:** Commercial AM equipment is considered an expensive investment. The minimum prices range from approximately \$5.000 and can go as high as \$50.000 for higher-end models, not including the cost of accessories and resins or other operational materials [79].
- **Legal issues:** The availability of CAD design software descriptions on the Web has significant implications for intellectual property security. The legal implications of 3D printing are not clearcut and could entail issues for policymakers [80].

Figure 2.1 presents the schematic process for AM chain. The data is broken down into a series of 2D cross-sections of a finite thickness. These cross-sections are fed into AM machines so that they can be combined, adding them together in a layer-by-layer sequence to form the physical part.

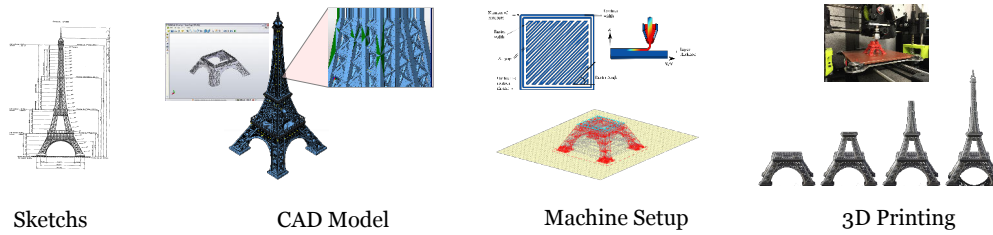

Figure 2.1: Generic AM process.

2.2.2 Overview of the main AM processes

There are numerous ways to classify AM technologies. A usual approach to classify the AM processes is based on the technology used, e.g.. laser, extrusion process, printer technology. Another option is according to the way the shape is built, e.g. point-by-point or surface-by-surface [5]

Within the framework of this thesis, the criteria used for classification is the initial state of the feedstock material, as indicated in figure 2.2:

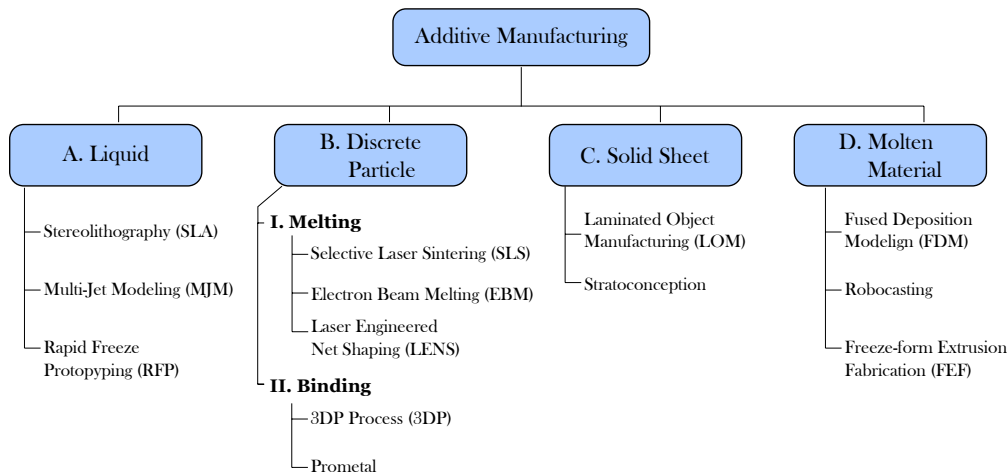

Figure 2.2: AM processes. Adapted from [5–7]

Even if the application of this research will be focused on the FDM process, we consider that it is important to position it among the different AM technologies. Therefore in the next pages, a description of the most important available technologies is made.

A. Liquid

- Stereolithography (SLA)

Developed by 3D Systems Inc., it is the first and one of the most widely spread commercial AM technology. The patent for SLA (US Patent 4575330) was awarded on March 11, 1986 [81].

It is characterized by the conversion of a liquid photosensitive resin vat into solid objects through the use of a laser beam. Here, the process uses a photosensitive monomer resin (usually highly cross-linked) and the object is formed layer by layer via photoinduced polymerization. This technique usually uses two distinct methods of irradiation [82], as presented in the figure 2.3. The 1st method is a mask-based method in which an image is transferred to a liquid polymer by irradiating through a patterned mask (figure 2.3b). The 2nd method is a direct writing process using a focused UV beam to produce polymer structures (figure 2.3a). The main goal of the light source is to initiate polymerization through the photodegradation of an photo-initiator to form radicals, cations, or carbone-like species [83]. The role of the photo-initiator is to convert the physical energy of the incident light into chemical energy in the form of reactive intermediates. Figure 2.3 presents schematically a SLA machine with the main subsystems,

including the laser and optics, the platform and elevator, the vat and resin-handling subsystem, and the recoater system.

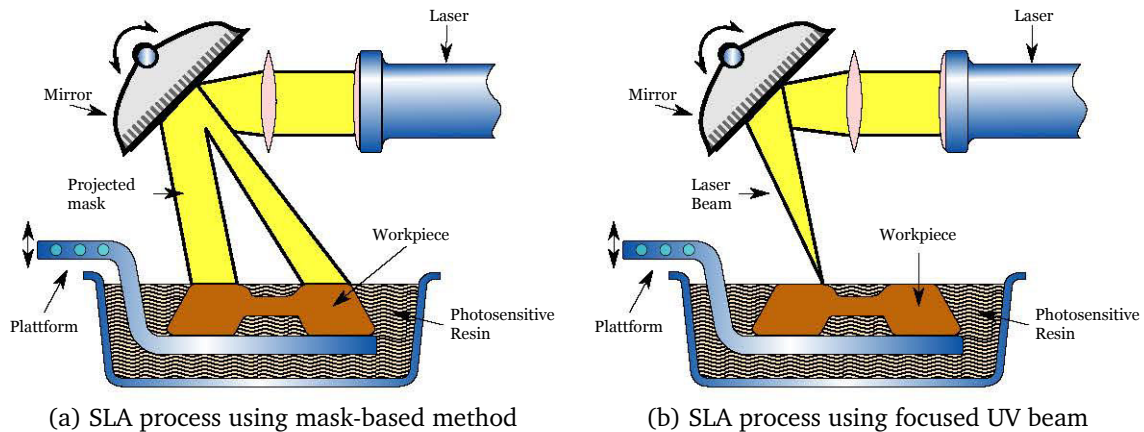

Figure 2.3: Stereolithography (SLA) process

On every single layer, the light source traces the part's cross-section on the surface of the liquid resin with the purpose of solidifying the traced pattern. After that, the build platform is descended by one layer thickness and a resin-filled blade sweeps across the part's cross-section in order to coat the part thoroughly with fresh resin. The successive layer is then scanned, adhering to the previous one. The curing (solidification) reaction of stereolithographic resins is an exothermic polymerisation process characterized by chemical cross-linking reactions that create an infusible, insoluble, and highly cross-linked 3D network [84]. Once the part is completed, the support structures may be removed manually, and the part must be cleaned, post-cured, and finished.

Two of the main advantages of SLA technology over other AM technologies are surface finish and dimensional precision. They are comparable to numerical controlled milling which is particularly suitable in the manufacturing industry. These characteristics led to the widespread usage of SLA parts as form, fit, and, to a lesser extent, functional prototypes [7].

On the other hand, main disadvantages are related to the cost of the material¹ which is expensive and toxic and it must be shielded from light to avoid premature polymerization. By the fact that the process works with liquid materials, changing the resin in the vat is a lengthy and costly procedure. It is messy and this is considered as a disadvantage. The product size is small, roughly no larger than a 2-cubic feet. Moreover, there is only a limited choice of resins compared to other AM processes [79]. And also, the part may be brittle and it needs supports which may affect the surface finish when removed.

B. Discrete Particle

This category of AM processes (Melting and Binding) are centered around the application of material in powder form and on the selective formation of the part. It has evolved into various techniques that have similar working principles but use different binding mechanisms. The set of processes share basic characteristics. These include, for example, one or more thermal sources for inducing fusion between powder particles, a method for controlling powder fusion to a prescribed region of each layer, and mechanisms for adding and smoothing powder layers [7].

First, we present the technology using the melting approach. After that, an overview of the technology using the binder approach will be described.

I. Melting Approach

¹The photopolymer alone costs \$300 to \$500 per kg, not to mention the machine itself (up to \$800 K) ??.

- Selective Laser Sintering (SLS)

Selective Laser Sintering (SLS) represents the start of the powder bed fusion technology in 1988 [85]. Developed at the University of Texas at Austin (USA), SLS was the first commercialized powder bed fusion process.

Figure 2.4 presents a schematic SLS system. The principle of SLS is the use of a high-powered pulse laser (tipycally a CO_2 laser) to selectively fuse and sinter particles of plastic, metal, or glass powders into a desired three-dimensional shape based on the CAD model. The surface is scanned at rates between 2 and $100 \frac{cm}{s}$. Once the layer has been scanned, the powder bed is lowered by one layer thickness (typically $\sim 0.1mm$). A new layer of material is placed on the top, and the process is repeated until the part is completed. A cool-down period is also required to allow the parts to uniformly come to a low-enough temperature to be handled and exposed to ambient temperature and atmosphere.

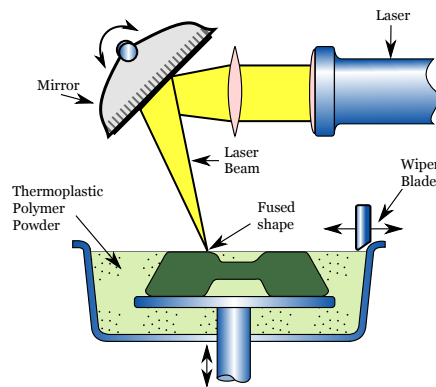

Figure 2.4: Selective Laser Sintering (SLS) process

Powder material is preheated and maintained at an elevated uniform temperature (close to the melting or glass transition temperature) with the aim to minimize the laser power requirements and to prevent warping of the part during the build due to nonuniform thermal expansion and contraction (curling) [7]. Moreover, an inert gas atmosphere inside of the building chamber is required in order to prevent oxidation or degradation of the printed part.

Concerning the quality of the printed part, it depends on a number of process parameters that can be divided in four classes:

Laser parameters: Laser power, powder density, fill laser power, spot size, pulse duration, pulse frequency, etc.

Scan operations: Scan size, scan speed, scan spacing, and scan pattern.

Powder characteristics: Particle shape, size and size distribution, powder bed density, flowability, layer thickness, material properties, ratio of the mixture powders (virgin/reused), etc.

Temperature settings: Powder bed temperature, powder feeder temperature, temperature uniformity,

These parameters are strongly interdependent and are mutually interacting [7, 86]. For example, studies of polycarbonate have shown that the mechanical properties of the final material depend on the power of the laser which influences the porosity of the printed part [87] (Low energy density represents weakly sintered part while high energy density induces material degradation).

One of the advantages of this technology is that the printed part is supported by the surrounding powder, which eliminates the need to produce additional supports. Furthermore, the un-sintered powder remains in place to support the structure and may be cleaned away and recycled once the build is complete. Another element to consider is the great variety of materials that could be used: plastics, metals, combination of metals, combinations of metals and polymers, and combinations of metals and ceramics [76, 86]. Polycarbonate powders, and Bishphenol-A polycarbonate have been first used as the starting materials for both experimentation and modeling in SLS.

Concerning the limitations of this technology, one can cite that the observed defects such as balling or agglomeration of the powders, tearing or stress cracking, curling of layers, poor cohesion, and porous or irregular surfaces. These features affect the porosity of the printed part which reduces the mechanical properties, increase the surface roughness and induce dimensional inaccuracy [86, 88].

II. Binding Approach

- Three-Dimension Printing (3DP)

Developed at MIT, Sachs, Cima, and Cornie [89] reported the initial works on Three-Dimensional Printing (3DP) process and the patent (US Patent 5204055) was awarded on April 20, 1993 [90] and licensed to ZCorp (Rock Hill, SC) in 1995. This process is called 3DP because of the similarity approach that the inkjet printing process used for printing paper.

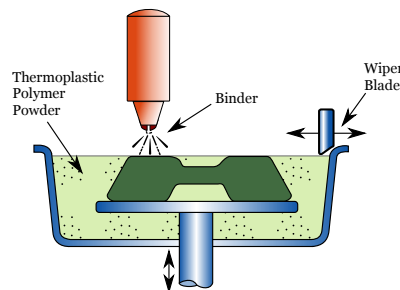

Figure 2.5: Three-Dimensional printing (3DP)

The working principle of 3DP process is the deposition of a thin powder layer with a roller and then the layer is selectively joined using a binder sprayed through a nozzle (drop-on-powder, or drop-on-bed (DoB) deposition [91]) A misting process with water droplet is used in order to avoid excessive disturbance when the binder is sprayed to the surface. After the printing process, the part may be further post-processing by subjecting it to a firing at high temperature to further strengthen the bonding. This is the main difference of 3DP with respect to SLS process which in instead of laser (in SLS), a multichannel jetting head will deposit a water-based liquid adhesive to bond the particles of powdered material together and shapes the 2D cross section of the object for that layer. The thickness of layers is about 90–200 μm [92].

One important feature is the capability of applying directly color in the printed part which is useful in the evaluation of conceptual models for testing aesthetic appearance [91]. As the case of SLS, one of the main characteristics in this process is the multivariate materials that can be used. This include metal, ceramic, silica and polymeric components of any geometry for a wide range of applications [93]. Moreover, 3DP process has the ability of 3DP to fabricate functionally graded material (FGM) parts by means of local composition control (LCC) which allows designers to explore new possibilities [94]. A FGM parts are made by depositing several binders and/or slurries onto the powder bed through several jets. This is possible through the precise control deposition of material from multiples print heads. LCC refers to a capability of the 3D printing process to locally tailor the material composition of a part by means of precise control of a multiple-material print head.

On the other hand, the most important drawbacks for using 3DP for applications are issues related with porosity which is in close relation with the mechanical properties of the printed object. The presence of internal defects (cracks, voids, oxide layers) and internal stresses reduces this property [88]. Another research field is the improvement of dimensional accuracy, surface roughness in order to guarantee aesthetic appearance.

C. Solid Sheet

- Laminated Object Manufacturing (LOM)

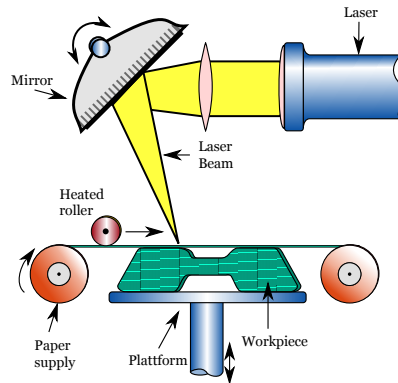

Figure 2.6: LOM process

Laminated Object Manufacturing combines the additive and the subtractive manufacturing techniques to build layer-by-layer the object. The patent for LOM (US Patent 4752352) was awarded on June 21, 1988.

In this process, the principle working consists in the overlaying of sheet materials that are supplied from a roll, and the contour of each layer is cut with a CO_2 laser that is carefully modulated to penetrate a depth of exactly one layer thickness. Layers can be bonded together by pressure and heat application using a thermal adhesive coating. In consequence, the 3D parts are then fabricated by sequentially laminating and cutting 2D cross-sections [95, 96].

LOM process can be categorized based on the mechanism employed to achieve bonding between layers [7]:

Gluing or adhesive bonding: There are two approaches:

- **Bond-then-Form:** In this approach, the building process consist in three steps: (1) placing the laminate, (2) bonding it to the substrate, and (3)cutting it according to the slice contour. The original LOM machines used this process with adhesive-backed rolls of material, where a heated roller melted the plastic coating, causing it to adhere to the previous layer.
- **Form-then-Bond:** In this case, the sheet material is cut to shape first and then bonded to the substrate. This approach is popular for construction of parts in metallic or ceramic materials that are thermally bonded but implementation has primarily been at the research level. The form-then-bond approach facilitates construction of parts with internal features and channels because in each layer, the material excess is retired. However, this imply that external supports for building overhanging features; and some type of tooling or alignment system to ensure a newly bonded layer is registered properly with respect to the previous layers or a flexible material carrier that can accurately place material regardless of geometry.

Thermal bonding processes: in this approach, the fabrication of 3D parts are made from metallic sheets and foils employing diffusion bonding, laser spot welding, and brazing techniques [97, 98].

The main disadvantages of sheet metal lamination approaches are the difficulties tp remove support material (using bond-then-form approach) and the issues related to automatization and alignment for arbitrary, complex geometries (using form-then-bond approach). Therefore, there has not been commercial interest for further development [7]

Clamping: in this approach, the sheets are simply clamp together using bolts and/or a clamping mechanism rather than using an adhesive or thermal bonding method.

The major advantage of this approach is the ease with which the layers can be clamped. On the other hand, the main drawback is that the mechanical properties of the printed part are function of the direction of the laminate interface.

Ultrasonic Consolidation: This AM process is a hybrid sheet lamination operation that sequentially bonds metal foils using ultrasonic metal welding (USW) layer-by-layer, as illustrated in figure 2.7. It integrates computer controlled milling operations in situ to create intricate internal cooling channels and to create the desired geometry [99].

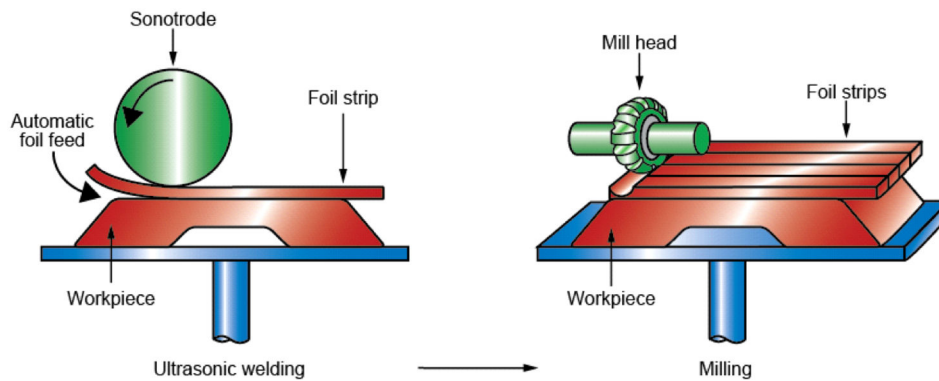

Figure 2.7: Ultrasonic consolidation process

One of the abilities of this process is to join dissimilar materials (bonded thermally and/or mechanically) to each other in the solid state. Moreover, it is possible to embed sensitive/functional components (optical fibers, shape memory alloys for sensing devices, strengthening fibers) between the foil layers and bond the structure into a dense metal matrix in order to create composite material with specific properties.

In general, advantages of LOM process include the wide range of relatively cheap materials available, and also the speed fabrication. LOM process can be about 5–10 times faster than other processes [75]. On the other hand, considering the disadvantages, it is possible to state the material waste considering that the sheet of material used is wider than the build area so that, once the part cross-section has been cut, the edges of the sheet remain intact. Another element is the post-processing operation in hollow parts due to the difficulty in removing the core and there are serious problems with undercuts and re-entrant features.

D. Molten Material

As stated at the beginning of this section, within the context of this thesis, the attention will be focused on the Fused Deposition Modeling (FDM) process which will be used as experimental case to illustrate the proposed methodology.

- Fused Deposition Modeling (FDM)

Fused Deposition Modeling is one of the most wide spread AM technologies. In 1988 Scott Crump developed the FDM process which uses thermofusion control mechanisms for low temperature thermoplastics [9]. The patent for FDM (US Patent 5121329) was awarded on June 9, 1992 [8]. Figure 2.8 present the schematic FDM process.

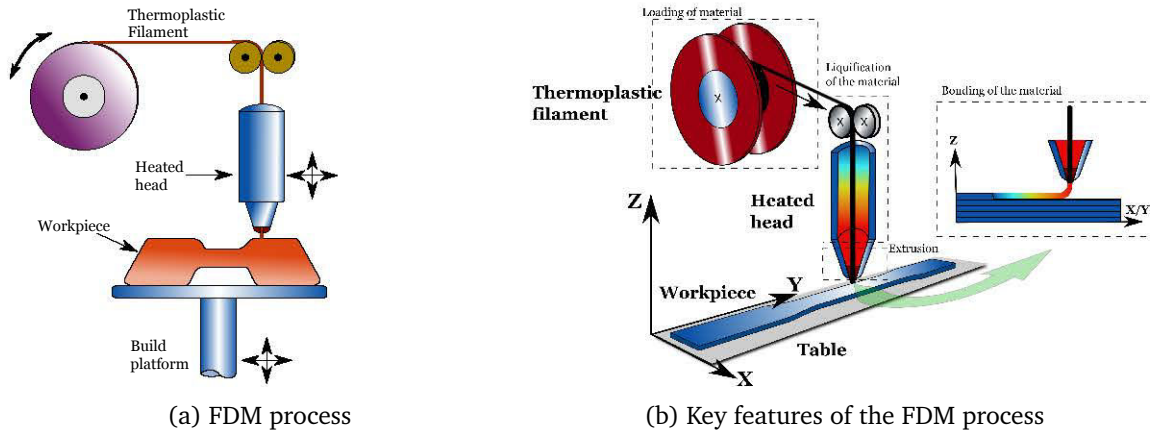

Figure 2.8: Material preparation before extrusion

This process deposits a thread of molten material usually from a plastic filament, onto a substrate with the use of a movable head. The material is heated to a temperature slightly above its melting point within the head, then extruded through a nozzle to a substrate and cooled down until it solidifies and forms a layer. In the context of extrusion-based systems like FDM process, the key features showed in the figure 2.8b are important for the development of the process [7, 50].

1. Loading of material:

Concerning the loading of material, extrusion-based systems need a continuous supply of raw material into the chamber in order to guarantee a constant material extrusion. This ensures a regular extrusion pressure which guarantees a constant diameter of extruded material. Therefore, the loading of material is a function of the state of material (liquid or solid). If the material is in a liquid form, the ideal approach is to pump it. If the material is in a solid form, options such as pellets, powder or filament forms are suitable methods of supply. In the literature, Reddy, Reddy, and Ghosh [100] worked in the design and development of an extruder deposition system. This system uses a screw extruder able to treat polymeric pellets of ABS on a computer-controlled positioning system to build the components.

However, it is more usual to use feedstocks of thermoplastic polymer in filaments form of about 1.75-3mm. In this case, a pinch roller mechanism impulsed by a stepper motor is used to pull the filament in order to carry on the filament to the liquefier chamber. The leading portion of filament is melted before exiting the nozzle. The solid portion of the filament acts as piston in order to generate enough input pressure for pushing the fused material out of the nozzle. Therefore, the filament is in compression between the rollers and the heated liquifier and this stress thus becomes the driving force behind the extrusion process [101].

2. Liquification of the material

Once the material arrives at the liquifier chamber, the goal is to transform the physical state of the material in order to extrude it through a die or nozzle. Doing that, the parts can be made layer by layer. The liquifier chamber is generally a metal block with a channel machined for the filament/melt to flow through. The use of the temperature is the common approach to control the state of the material. Therefore, resistance heating is typically used with either a coiled heating element surrounding the liquifier chamber or one or more cartridge heaters embedded in the liquifier assembly [7, 50]. However, another approach is to use a chemical change to cause a solidification. In this cases, a curing agent, residual solvent, reaction with the air or simply drying of a "wet" material permits bonding to occur. Parts may therefore cure or dry out to become fully stable [7].

The feeding material system and the temperature control are two important parameters in the correct operations of the liquifier [102]. Heat flux to the liquifier chamber must be enough to

melt the material. However, in the case of thermoplastic material, it should be take care that excessive temperature can lead to polymer degradation which leads to break down the polymer chains, weakening the finished part and leaving residue inside of the melt channel.

3. Extrusion

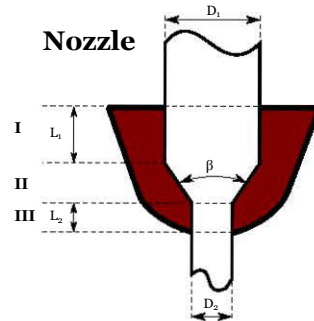

Figure 2.9: Sectional view of the liquefier/nozzle

Concerning the extrusion process, the mass flow through the nozzle is a function of the nozzle geometry, the material properties (viscosity) and the pressure made by the pinch roller mechanism in the feeding system. These parameters are directly related with the performance of the process. However, the understanding of these variables in FDM process is a complex phenomena due to the unsteady movement of the viscous melting fluid, the nonlinear dependence of the material properties on the temperature and the shear rate [50]

The required force to extrude the melt must be sufficient to overcome the pressure drop across the system, which depends on the viscous properties of the melt as well as on the geometry of the liquefier and nozzle [101].

The nozzle's diameter represents the shape and the resolution that may be achieved in the final object. Typically nozzle diameters are in the range of 0.2 – 0.5mm and the nozzle angle value is β 120° which is the tip angle of the drill. Yardimci, Hattori, and Guceri [102] investigated the impact of the nozzle design in the printing process. The contraction angles combined with large contraction ratios of 6:1 ($\phi_{filament} : \phi_{nozzle}$) may result in the formation of *cornervortices*. The presence of these *vortical regions* is especially critical for particle loaded materials, since the regions may create flow instabilities and eventual clogging of the nozzle. Bellini, Guceri, and Bertoldi [101] and Bellini, Shor, and Guceri [103] investigated the dynamics of the liquefier in the FDM process in order to understand the pressure drop in the nozzle in function of variables as geometry, shear rate and material properties (e.g. viscosity). Experimental and modeling approaches are used to explain the relationship of these elements.

4. Solidification and bonding of the material:

After the printing process, the material should ideally prevail without modification in terms of shape of the raster and object's size once the printing process is finished. However, phenomns such as die swelling, shrinkage and warpage are problems faced by FDM process.

Die swelling is a phenomenon of radial expansion of the melt once it leaves the nozzle. The elastic behavior of the polymer melt is largely responsible for the swelling of the extrudate upon leaving the die. This is primarily due to the elastic recovery of the deformation of the polymer in the die. A die with a short land length will cause a large amount of swelling, while a die with long land length will reduce the amount of swelling. [104]. The swelling ratio s is a quantitative measure between the maximum diameter of the extruder material and the nozzle diameter ($s = \phi_{extrudate} / \phi_{nozzle}$). This value is a function of the material properties and the geometry of the extrusion nozzle. Reported values for FDM-like processes ranged from 1.05 to 1.3 [50]

Nevertheless, this phenomenon is an active area of polymer rheology research and plays a role in determining the resolution achieved in this AM process.

Concerning the bonding process, we can expect that the strength of the printed part will be limited fundamentally by the strength of the bonding between the neighboring beads in the part. This bonding process can be visualized in terms of energy stored in the material by means of heating and its subsequent redistribution into the part through conduction and by lateral convection in the cooling phase. The redistribution of thermal energy activate the surfaces of the adjacent regions ensuring bonding at the interfaces of deposited roads [105]. There are upper and lower bonds on the magnitude of this thermal energy. The upper limit is related to issues as polymer chain degradation at high temperatures and the geometrical instability problems due to the low polymer viscosity. The lower limit is related to the need of achieving a minimum of thermal energy level in order to assure the bonding between roads and layers.

Moreover, the thermal history of interfaces plays an important role in determining the bonding quality. This temperature history depends upon the rate at which the filament cools upon leaving the extrusion head. Experiments showed that the temperature of a road increases almost instantaneously when a melt layer is deposited on top of it followed by a rapid decay (about 2s) [50]. Thus, a consequence of that is the dependence of the mechanical properties on toolpaths and part orientation.

In resume , the mechanical integrity of the printed part is directly related with the solidification and bonding processes. The elements like the energy adhesion/cohesion, the growth of the contact area formed between the adjacent beads, the molecular diffusion and randomization of the polymer chains across the interface, and a minimum residence times at elevated temperature in order to assure adequate levels of diffusive bonding [102, 105, 106]

5. Part finishing:

Due to the layer-by-layer fabrication nature, there is a staircase effect in the printed parts which impedes the acquisition of smooth surface. This disadvantage is especially important when the object is fabricated with a layer thickness particularly high. In the literature, two primary approaches are used to achieve smooth surfaces on parts: chemical and mechanical smoothing [50].

Chemical smoothing systems expose the part to solvent vapors which are allowed to condense on the surface and partially melt it to smooth small ridges. Thanks to the influence of gravity and liquid surface tension, the staircase surface slowly becomes smoothed. The longer the part is polished, the more surface is dissolved, which also may affect the precision of the object and its surface roughness [107].

Mechanical abrasion may also be used to smooth part surfaces, though this has limitations on parts with complex surface geometries due to inherent difficulties in abrasive materials to enter into small cavities, crevices or other features. Application of surface coatings is another approach to achieving a desired surface finish, in addition to adding strength to a finished part. Examples of coating may include primers, paints or metallic electroplated coatings.

Parameters of fabrication in Fused Deposition Modeling:

There exists important parameters that affect the quality of parts fabricated with 3D printing process. They can be defined as follows [108–110]:

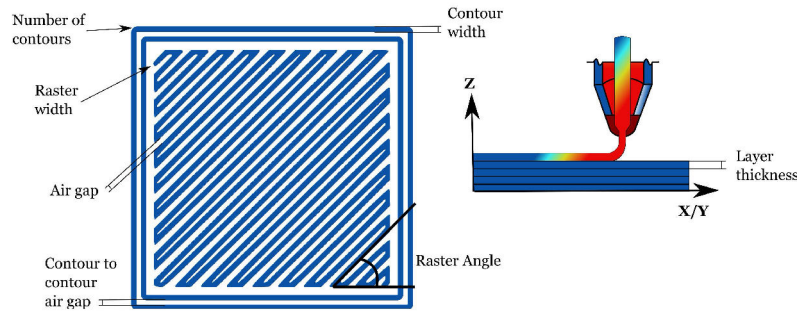

Figure 2.10: Parameters of the 3D printing process

- *Part building direction*: It refers to the inclination of the part in a build platform with respect to X, Y and Z axis. X and Y-axis are considered parallel to build platform and Z – axis
- *Layer thickness*: It is the thickness of layer deposited by nozzle and therefore of any single layer. It is usually one half of the bead width.
- *Bead width (raster width)*: It is the width of the filament deposited by nozzle that fills interior regions of part. Its most common value ranges from 0.3mm to 1mm.
- *Raster angle*: It refers to the inclination of the deposited beads of filament with respect to the x – axis of the build table. A typical configuration is $+45^\circ / -45^\circ$.
- *Air gap*: It is the gap between two adjacent filaments of material on same layer. A zero value means that the rasters touch each other. Positive value means there is a gap. Negative value imply that rasters are overlapped.
- *Number of contours*: Defines the lowest number of solid contours for the object perimeter.

Mechanical properties of the polymers used in FDM:

In the literature, it has been reported theoretical and experimental studies in order to characterize the mechanical properties using this AM technique

One of the main conclusions in the literature is that FDM parts will present anisotropic behavior. The mechanical properties are function of the processing parameters because they will affect meso-structure and fibre-to-fibre bond strength. Es-Said et al. [111] argue that strength anisotropy is affected by the directional processing of the 2D laminates, i.e., directionality of the polymer molecules parallel to the extrusion orientation within the layers. Likewise, weak interlayer bonding or inter-layer porosity in any orientation can lead to layer delamination along that orientation during loading.

Studies have concluded that parameters such as build orientation, air gap, raster orientation, number of contours affect the mechanical properties [108, 110, 112, 113].

In order to evaluate the mechanical properties of ABS in FDM process, a conventional approach is to compare the properties of ABS in FDM process with respect to the properties of ABS injection. Typical tensile strength for FDM parts are ranged between 10-73% of the strength of injection molded parts. In the case of compressive strengths, the FDM specimens ranged from 80 to 90 percent of those for injection molded ABS Ahn et al. [110] and Es-Said et al. [111]. In the context of open source FDM machines, Tymrak, Kreiger, and Pearce [47] have found an average tensile strength of ABS samples of 28.5MPa and average elastic moduli of 1807 MPa.

There have been several attempts in order to model, optimize and predict the mechanical properties of the ABS parts made by FDM process. Mathematical models have been developed using ABS polymer in order to understand the influence of the process parameters in the part's properties, to predict the mechanical behavior and for analysis purposes. [112, 114] Using approaches like the response surface methodology and evolutionary algorithms of optimization, several studies worked on assessment of mechanical properties e.g. tensile, compressive, flexural and impact strength in order to derive an

empirical model between the processing parameters and mechanical properties. Five important control factors such as layer thickness, part build orientation, raster angle, raster width and air gap have been considered for the model. Once the equations are validated, they can be used to envisage theoretical possible best parameter setting to attain maximum in response characteristics Sood, Ohdar, and Mahapatra [109] and Panda et al. [115]. One main conclusion is the complexity for obtaining good functional relationship between responses and process parameters. The effect of different factors and their interactions can be observed. However, it is difficult to assign exact reasons.

In another study made by Croccolo, De Agostinis, and Olmi [108], they investigated the influence of factors such as building direction and number of contour lines on tensile properties of ABS-M30 using a experimental and numerical approach. Results showed that the number of contours influence the maximum strength obtained in the part. Moreover, when the number of contour increases, the percentage of elongation to failure decreases, indicating a more brittle behavior. The effectiveness of the theoretical model for predicting the mechanical behavior of FDM part have a mean error of 4% with respect to the experimental results.

Table 2.1 resumes the max and min values of mechanical properties found in the studies made for evaluating mechanical properties of ABS on FDM context showing the process parameters used.

Table 2.1: Mechanical properties of ABS material in FDM context

Material	Machine	Parameters	Max mechanical values reported				Reference
			$\sigma_{tensile}$ [MPa]	E [MPa]	$\sigma_{compression}$ [MPa]	$\sigma_{flexural}$ [MPa]	
ABS P400	FDM 1650	Orientation Build plane	15.987	1652.523			[112] [116]
ABS P400	FDM 1650	Air Gap Road width Model Temperature ABS Color Orientation of rasters	23.40		1.54		[110, 117]
ABS P400	FDM 1650	Raster angle	20.6			44.4	[111]
ABS		Build Orientation	29.7	2117			[118]
ABS P400	FDM 1650	Contour lines Build direction				41.26	[113]
ABS P400	FDM Vantage SE	Layer thickness Orientation Raster angle Raster width Air gap	18.0913		17.4751	39.2423	[115] [109] [119]
ABS-M30		Build Orientation Contour lines	29.7	2117			[108]
ABS-M30	MOST RepRap	Raster angle Layer thickness	29.7	1875			[47]
	Lulzbot Prusa Mendel						
PC	FDM Vantage SE	Build orientations Layer thickness	35.7	1576			[120]

2.3 Open-source additive manufacturing - The case of the RepRap project-

Thanks to the expiration of Fused Deposition Modeling (FDM) patent in the mid-2000s [8], Adrian Bowyer and his team at the University of Bath worked on the concept of self-replicating machines which are able of manufacturing their own parts by themselves. They designed in order to be simple and easy to use that anyone would be able to build them [11–13]. This was the start of the RepRap project (or **Re**plicating **R**apid-prototyper). Figure 2.11 shows the first model of RepRap machine.

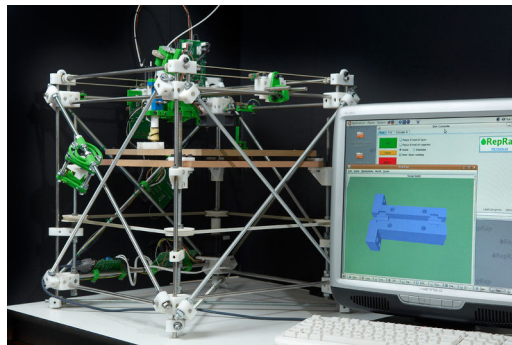

Figure 2.11: First RepRap Machine called “Darwin” in May 2007.

RepRap is an open-source self-replicating rapid prototyping machine. This project was conceived in a biomimetical approach considering extant naturally evolved strategies for reproduction. Through its own ability to self-manufacture and the assistance from humans, it becomes an assisted self-replicating machine. In other words, RepRap is a kinematic *assisted self-replicating* and *self-manufacturing* machine. It is important to state that the idea behind the RepRap project is to demonstrate self-manufacture, which does not imply self-assembly. In consequence, there is a *mutualism* relationship between the machine and the person who assembles the machine [13, 121]. Its replication ratio is about 57% of its own mechanical components (excluding fasteners, bolts and nuts).

2.3.1 Open-source 3DP architecture

An open source 3D printer can be characterized by three fundamental axes:

1. **Machine’s architecture:** it refers to the mechanical components of the 3D printer, namely Cartesian robot, thermoplastic extruder, end-stops, print bed and frame.
2. **Electronics:** they are the electric components of the machine (i.e., micro-controller, main board, motor drivers, stepper motors, and temperature sensors.).
3. **Software:** the host software or printer interface, is where the entire personal 3D printer toolchain comes together.

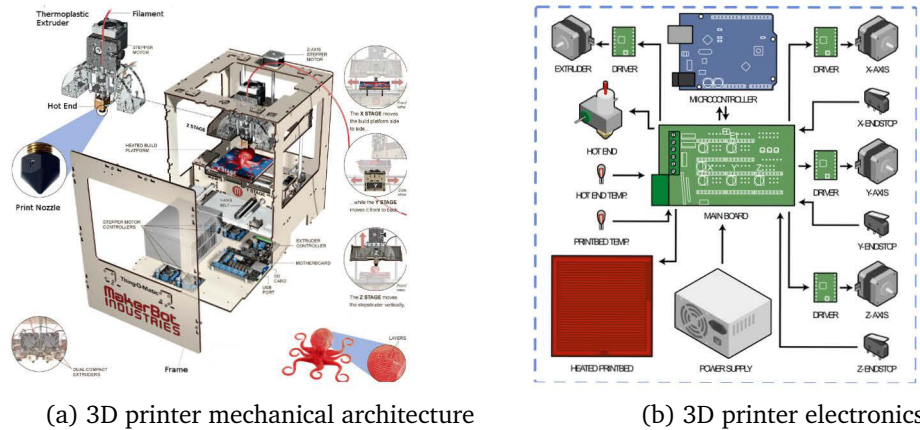

(a) 3D printer mechanical architecture

(b) 3D printer electronics

Figure 2.12: Material preparation before extrusion

2.3.2 Differences between Commercial and Open Source AM

One of the main differences between commercial AM and the open source AM technologies is precisely the concept of the open-source. Among the set of design choices for the RepRap project, the use of open design approach and consequently the use of free software movement principles with the purpose to distribute every piece of information required to build a RepRap machine has an enormous impact on the democratization of this technology to society. Vallance, Kiani, and Nayfeh [122] presents the following general terms specified under an open design license:

- Documentation of a design is available for free,
- Anyone is free to use or modify the design by changing the design documentation,
- Anyone is free to distribute the original or modified designs (for fee or for free), and
- Modifications to the design must be returned to the community (if redistributed).

The impact of using this open-source approach for the RepRap project can lead in the following competitive advantages [11]:

Advancement of the technology: Open design approach treats the engineering design as a science, and design information as scientific data. By placing design information in a public repository, designers have access to an archive of design knowledge and wheels do not require reinvention.

Rapid evolution of design: In conventional proprietary designs, the evolution of the project occurs through discrete generations. Designs are slow to evolve and improve. On the other hand, in an open design project, every individual instance of the device can potentially be a new design generation, incorporating the latest feedback and experimenting with new approaches.

Efficient debugging: One of the most important features in an open-source approach is that there is no meaningful distinction between users (or customers) and developers of open source/open design products. Given to a large base of user-developers, the probability of detecting any given bug increases. Once a problem is identified it can potentially be tackled by a number of individuals or teams, resulting in a number of possible solutions. The community is then free to select the solution that considers the most efficient.

Technological uncertainty: Sharing information and results allows individuals to adopt a trial and error approach, without fear of losing ground to a competitor. Therefore, a greater number of experimenters allows a wider range of approaches to be investigated. It induces to a multiplicity of possibilities in which technology can be developed, and therefore, a technological uncertainty.

The consequences of this open source approach can be related to the exponential growing of machines since the start of the project to the point that the RepRap machines are more widely used than any other additive manufacturing system [14]

2.3.3 Applications of RepRap in the literature

Table 2.2 presents an overview of the research field in which opens source additive manufacturing, like RepRap machines, have been used as a useful tool.

Using a framework analysis made for Fused Deposition Modeling where it can be adapted to open source context [123]. The following major categories are used to classify the research and developments in open source additive manufacturing:

1. Part Quality Improvement.
2. Process Improvement
3. New Material Development
4. Material Properties
5. Applications

Concerning the *part quality improvement*, a central element is the research and development in order to improve the properties of the printed part such as accuracy, surface finish, build orientation when an open-source 3D printer is used. In the *Process Improvement*, efforts have been focused to develop better support structures, process design and the development of numerical model for a better understanding of the general process. With respect to the *New Material Development*, an increasing number of works have been undertaken to develop new materials for the use of this technology. A wide range of materials including metals, ceramics, composites of metal/polymer and biomaterials play an important role for the development of new applications. Considering the *Material Properties*, a vital aspect is the determination of the properties of the printed parts obtained with open source machines with the purpose of establishing a comparison with the commercial processing technologies. Finally, in the literature a remarkable variety of *Applications* that have been found in the recent years, which confirms the growing interest on this technology and the potential impact to society in the future.

Research focus	Subcategory	Keywords	References
Part quality improvement	Dimensional accuracy	Dimensional accuracy, shrinkage, process parameters effects	[124–126]
	Surface finish	Surface roughness, process parameters effects	
	Slicing Build orientation		
Process improvement	Design of machine		[127, 128]
New material development	Metal		[129]
Material properties	Mechanical Properties	Tensile, compressive, flexural, impact, stiffness	[47, 48]
	Modeling		
Applications	Education		[17, 130–134]
	Industrial		[15, 135]
	Medical		[136–138]
	Scientific equipment		[16, 139–141]
	Social Sciences		[60, 142, 143]
	Sustainable development		[144–148]

Table 2.2: Major research areas in Open source additive manufacturing

2.4 AM Sustainability on Society

According to the United Nations Brundtland Report [52], sustainable development is “development that meets the needs of the present without compromising the ability of the future generations to meet their needs”. Furthermore, it can be pointed out that sustainable development is a function of three major dimensions, namely economic, social, and environmental [52].

It is reasonable to expect that Additive Manufacturing (AM) will positively impact the societal development in the next decades to come. The development of sustainable principles, applications and practices play a key role in research activity in order to enable environmentally friendly, economically advantageous, and societal benefit-driven AM methodologies [149]. Energy, material consumption and environmental impact are vital aspects that AM can better act to optimize in the manufacturing industrial context. On the basis of these concepts, some major goals have been outlined in order to fully incorporate sustainability principles in the AM processes, they include [149]:

- Reduced manufacturing costs, material and energy use.
- Reduced industrial waste, toxic, hazardous materials and adverse environmental effects.
- Improved personnel health, safety and security in AM processes and use of products made by AM.
- Demonstrated reparability, reusability, recoverability, recyclability and disposability of products produced from AM.

These goals in order to make a sustainable AM process, represent a crucial benefit for the society. In section 2.2.1, some general competitive advantages of AM were stated. Now, making an emphasis on the potential benefits of sustainable AM process, it is possible to highlight the five major areas where AM could generate positive environmental impacts: [79, 150–152]:

1. Material utilization:

- Reduction of the raw material required in the supply chain.
- No auxiliary inputs: There is no/minimal material requirements such as cutting fluids, casting release compounds or forging lubricants. Thus, less pollution to the terrestrial, aquatic and atmospheric ecosystems.

2. Product design optimization:

- Topological optimization: Lighter weight parts reduce raw material consumption in the fabrication of the part, and reduction in fuel consumption when it is transported.
- Design optimization: More efficient components by incorporating conformal cooling and heating channels, gas flow paths, etc.

3. Manufacturing processes:

- Assembly optimization: AM processes can optimize the design stage by combining multiple parts into one with the purpose of reducing time/cost in assembly operations.
- No specialized tooling or fixtures required for AM.

4. Supply Chain:

- Distributed manufacturing: Parts could be manufactured closer to the point of consumption. It implies simplified supply chain which induces to increase efficiency and responsiveness in demand fulfillment. The net effect is the reduction of the need for warehousing, transportation, and packaging.

5. Life-cycle performance:

- Potential for repairing/remanufacturing approach: A large amount of energy is saved when a part is repaired or refurbished and placed back in service rather than being replaced and disposed [153].

There is a great potential of AM to contribute to a sustainable manufacturing. Besides, one major issue in the literature of AM is the study of the energy consumption which is specified in terms of energy consumption rate (ECR), (e.g. energy consumed per unit mass of material used). The energy consumption contribute significantly to the overall emission of greenhouse gases which are thought to be the key driver of global warming. Thus, the reduction of energy consumption in manufacturing is the key to limiting the overall emission of greenhouse gases.

Table 2.3 presents an overview of the studies conducting on AM related to this issue [65, 154].

Sustainability Research	Subcategory	AM Process	References
Environmental Impact Assessment (EIA)	Energy consumption	SLS	[155]
	Energy consumption	Thermojet, FDM, SLS	[156]
	Energy consumption and emissions		[157]
		SLS	[155]
	Energy, Fluid and Material Consumptions		[158, 159]
	Thermodynamic framework to characterize the material and energy resources		[160]
	Energy consumption	SLS	[150, 161]
Life Cycle Analysis (LCA)	Sustainability characterization for AM		[162]
	Sustainability implications of 3DP concerning industrial manufacturing		[163]
	LCA	SLA, SLS, FDM	[164]
Analysis (LCA)	Main research challenges of the sustainability in AM		[165]
	Environmental assessment of a novel (SLA) process,	SLA	[166]

Table 2.3: Overview of the studies in sustainability in AM processes

However, there are certain barriers to overcome with the goal of fully exploiting the potentialities of a sustainable AM process.

- There is clearly a need for more robust process and material property data, which will only be valid if it is collated and disseminated against an established set of standards
- The need to develop readily available metrics to measure the sustainability in their products and processes using AM.
- There is a need of tools and methodologies in order to better understand how AM can be used to realize design products [159]
- There is need to understanding the waste streams associated with different AM processes. It is known that some polymeric AM processes have very high waste streams (e.g., SLS – powder refresh, FDM/OBJET/SLA – support structure materials)

Therefore, potential research fields can be envisioned in order to overcome these barriers starting from divers perspectives, as follows [149]:

1. Product design and development

- Using AM to produce components in the energy industry
- Morphing multi-lifecycle products
- Maintenance, Repair, and Overhaul (MRO) in the aerospace industry and, more generally, remanufacturing in other industries as potentially lucrative applications of AM

2. Manufacturing processes and systems (including reverse manufacturing processes/systems):

- One of the critical issues that AM can greatly contribute to addressing is the reuse or remanufacturing of parts or products.
- Separation of heterogeneous materials for efficient recycling in the end-of-life of a product
- System and methodology to recycle metal alloys and plastic polymers
- Reuse chips from machining processes in AM (industrial ecology).

3. Engineering materials:

- Exploration of AM feedstock generation from other manufacturing process waste streams.
- Develop sustainable (green) materials to replace eco-toxic materials (e.g., lead, mercury).
- Enabling technology for passive energy systems
- Develop next-generation alloys to achieve specific objectives (light weight, high strength, etc.)
- Explore bio-based and biodegradable materials.

4. Natural resource conservation (including reduced energy consumption):

- Increase efficient use of raw materials in powder/liquid form by displacing machining of solid billets to save energy and reduce solid wastes.
- The use of Renewable energy (e.g., solar energy) seems to be the a potential and sustainable solution for reducing our dependence on oil.

5. Enterprise systems:

- Reverse logistics optimization.
- Green supply chain.
- Theoretical and practical cradle-to-grave life cycle inventory of engineering materials for AM processes

6. Application tools (including hardware and software tools and related methodologies and technologies):

- Develop cradle-to-grave lifecycle inventoring of engineering materials ofr AM processes.
- Equitable indicators for assessing sustainability in products and AM products
- Models for predicting the sustainability of the printed parts.
- Life cycle value engineering model.
- CAD/design methodology and an appropriate set of tools and standard practices for better decision-making.
- Design rules for sustainable process.
- Models to quantitatively compare energy consumption and environmental performance between AM and Traditional manufacturing processes.
- Material performance databases for better design for the environment.

7. Governmental regulations and education issues:

- Government-driven incentives for development of sustainability metrics energy consumption models, material flow analysis models, and for adoption of ideas that use and leverage AM parts and technologies.

- Support self-directed learning and problem based learning since the early education stages (K-12)

Using this global spectrum of research possibilities, in the context of this thesis we will focus our attention to material recycling on AM processes. In the next section, we will present a systematic literature review which allow to understand the advances, the strategies and methods of recycling in function of the AM process. Specially, we are interested in the polymer recycling for open source AM technologies.

2.5 Material Recycling in Additive Manufacturing

Until now, the possibilities and characteristics of the commercial and the open-source Additive Manufacturing have been presented. From this point, we would like to focus on the questions of this thesis concerning the material recycling process for AM technologies. We recall that the overall objective of this thesis is to have a better understanding on the conditions and scale of the recycling process, and the implications on the diffusion of this growing technology. Therefore, in the next section the current literature about the subject of recycling material for the specific case of AM is explored.

A formal systematic literature review has been adopted for our purpose, based on guidelines proposed by [18]. Figure 2.13 outlines the three major stages in the process, namely (1) Planning, (2) Conducting, (2) Reporting. As part of the process, we developed a protocol that provides a plan for the review in terms of the method to be followed, including the research questions and the data to be extracted. The steps are described in detail in the following sub-sections.

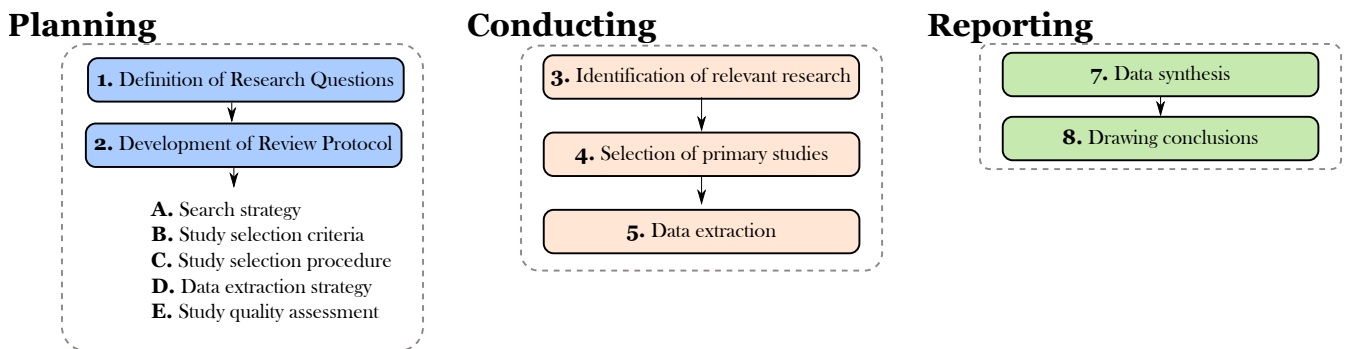

Figure 2.13: Systematic literature review methodology (adapted from [18]).

2.5.1 Definition of the Research Questions

In order to understand the potential of the additive manufacturing in the context of material recycling, this work investigates the following research questions:

ID	Research questions	Aim
RQ1	How much research activity has there been about recyclability in the Additive Manufacturing Context?	To provide a background of the current research about recyclability in AM identifying materials, technology and protocols with the purpose to evaluate recycled material quality.
RQ2	What are the developments of open-source additive manufacturing in the polymer recycling context?	To identify the major advances of use polymer recycled material in the open-source additive manufacturing context.

Table 2.4: Research questions of the systematic literature review

Concerning the RQ1, we are interested in the identification of the literature related to the evaluation of the material recyclability for being used in AM processes. Using the classification presented in section 2.2.2 of AM processes (Liquid polymer, Discrete particle, Molten material, Solid sheet). The literature review for each type of material state and the AM process related will be presented. The goal is to identify crucial elements such as the material and its process fabrication the specific AM process, a possible protocol of recycling process and a protocol of material evaluation if it is presented. These elements allow to understand the viability of use recycled materials.

In the case of RQ2, we focus our research in the polymer material used in the open-source additive manufacturing context. It has been noted that one of the main characteristics of the open source additive manufacturing is the exponential growth of this technology by different type of communities. This exponential growth can be accompanied with a exponential need for resources. Therefore, one of the key technical barrier to be overcome is the development of inexpensive feedstocks with locally available materials for this technology [147]. The availability (and conservation) of local resources is an important aspect to consider in order to enable open-source 3D printing become an *appropriate technology (AT)* for local communities in order to meet their needs. The ability to transform recycled materials into functional printed objects would lead, not only to prevent the erosion of cost advantages for local production, but also can impact positively in communities that might have an abundance of discarded plastics readily available for their application as feedstock materials.

Using these two research questions, in the following sub-sections the research protocol and the data analysis are further detailed below.

2.5.2 Development of the Review Protocol

The main goal of the review protocol is to reduce the potential researcher bias and to allow a replication of the review in the future. Therefore, the review protocol is used to undertake the selection of the primary studies that will be considered. The research protocol is composed by five stages which will be explained and defined in detail. They are:

- A. **Search strategy:** The goal of search strategy is to establish the procedure to follow in order to find the primary studies to analyze. This procedure includes the definition of the search terms (e.g. keywords) to be used and the resources to be searched (e.g. digital libraries, specific journals, and conference proceedings.)
- B. **Study selection criteria:** The main purpose of study selection criteria is to set a group of statements with the goal of delimit the characteristics of the studies. These criteria are particularly helpful for subset the studies that are related on our search.
- C. **Study selection procedure:** This item of the protocol describes how the selection criteria will be applied. It defines the steps and the elements to consider to accept or reject a particular study.
- D. **Data extraction strategy:** The procedure for how the information required from each primary study will be obtained is defined in this stage.
- E. **Study quality assessment:** The purpose of the quality assessment is to evaluate the pertinence of a study with respect to our research questions. In the case of this thesis, this evaluation will not be based on the study itself but in the verification if the study presents goals, methodologies, results and perspectives for material recycling for AM processes. Quality checklists is the tool for assess the pertinence of the study.

According to our own gathered experiences during the process, we iteratively improved the design of the review protocol. A summary of the final protocol is given in sub-sections A to E.

A. Search strategy

The following sub-sections outline the search strategy used to conduct the searches for the review.

- *Definition of the type of documents.*
The documents considered in this study are essentially limited to journal articles and conference proceedings.
- *Identification of the keywords to perform*
On the basis of our research questions, we derived several keywords for the search as detailed in table 2.5. The keywords were defined from the preliminary review of the literature on additive manufacturing and they were gathered into three distinct groups and expanded by several synonyms. The first group of keywords is related to commercial and open-source additive manufacturing. The second group is related to the recycling process. Finally, the third group is related specifically to the polymer material.

Keyword group 1 (Additive manufacturing..)	Keyword group 2 (Recycling.)	Keyword group 3 (Polymer..)
3D Printing Additive manufacturing Rapid prototyping Fused Filament Fabrication Open source additive manufacturing Low cost additive manufacturing Melt extrusion manufacturing Extrusion-based systems	Recycling Reuse	Polymer Plastic

Table 2.5: Semantic group of keywords used for the review

The research terms were created by joining groups using the Boolean operators *OR*, *AND*, and by using search operator (***) in order to avoid the syntactic problem of the plural.

The search string is composed by the terms representing the *Population AND Intervention* (Table 2.6) Two approach were used in order to give response to the research questions. The “*Global*” approach is intended to find the literature of RQ1. The “*Specific*” approach is intended to find the literature for the RQ2.

Approach	Population		Intervention		
Global	((3D print*) OR (additive manufacturing)) OR (rapid prototyping))	AND	(recycl*) OR (reus*)		
Specific	(3D print*) OR (extrusion-based systems) OR (melt extrusion manufacturing) OR (fused filament fabrication)OR ((open source OR low cost) AND (additive manufacturing))	AND	(recycl*) OR (reus*)	AND	(polymer) OR (plastic)

Table 2.6: Research strategy used for the review

Our lists of search terms were adapted to match each research questions and the individual requirements of each search engines. The search was based on title, keywords and abstract. The last update of the protocol in terms of identification of the potential studies was carried on July 2016.

- *Definition of the sources of information*

The following databases were searched using the keywords:

- ScienceDirect.
- Scopus.
- Spring Journal.
- Web of Science.

Additional searches were made directly on key conference proceedings, journals and authors in order to ensure did not overlook any important material.

B. Study selection criteria

The selection of primary studies was based on the following inclusion and exclusion criteria.

Material *included* in this review are:

- Only scientific articles or conference proceedings were considered.
- Published material dated from 1980-June 2016.
- Articles that describes conceptually or experimentally the use of recycled material intended for additive manufacturing technology.
- Papers should be related to engineering field.
- Only articles written in English were considered.

On the other hand, the criteria for *exclusion* are:

- Grey literature was not considered.
- Informal literature from magazines about 3D printing.
- Literature related related exclusively on material recycling for other field or manufacturing process different from AM was discarded.

C. Study selection procedure

A first selection of the primary sources was made based on a review of the title, keywords and abstract. Although this was extended to include the conclusions section in the cases where the title, keywords and abstract provided were insufficient information. At this stage, only those publications that appeared to be completely out of our scope were excluded.

Full copies of all primary sources not excluded in this initial selection process were obtained, and were then confronted against the inclusion/exclusion criteria described in section 2.5.2. Mendeley software has been used as bibliographic package for the record of each study and also Metagear package for R-project were useful bibliometric tools [167, 168].

D. Data extraction strategy

The goal of *data extraction strategy* is to define the elements to extract from the studies in order to have a context of the research. We extracted data from the selected studies with the aim of completing the characterization methods used in the material recycling process intended for AM.

Table 2.7 presents the properties extracted from each selected study.

Additive manufacturing process (P1)

The objective of P3 is to identify the AM process with more frequency on material recycling studies. Therefore, in each revised studies, the information about the machine or about the AM process is collected. The AM processes are categorized using the framework presented in the figure 2.2 in section 2.2.2.

- Liquid

ID	Property	Observations
P1	Additive Manufacturing process	Categorization of the AM process
P2	Material state in the AM process	Liquid, Powder, Filament, Sheet
P3	Material	Reference of the material used in the paper
P4	Characterization methods for the feedstock material	Methods for evaluate the quality of the AM feedstock material
P5	Characterization methods for the recycled printed part	Evaluation test used to the printed part in order to assess the quality
P6	Variables to control the quality of recycled material	AM parameters used to control the material degradation

Table 2.7: Data collection of the studies

- Discrete Particle
- Molten Material
- Solid Sheet

Material state in the AM process (P2)

The goal of P2 is to categorize the state of starting material used in the AM process. Depending of the material state, the recycling process can specific and the methods for defining the quality of material can be different. According to the AM literature, four broad categories main states can be used as reference [3, 57]:

- Liquid
- Filament
- Powder
- Solid Sheet

Material (P3)

The purpose of P4 is to identify the material used in the recycling process in order to have a picture of the materials that can be recycled and correlate it to the respective AM process.

Characterization methods for the feedstock material (P4)

The goal of P5 is to map the characterization methods for quality assessment of the AM feedstock material in function of the material state.

Characterization methods for the recycled printed part (P5)

From the inspected studies, the different methods used for the characterization of the recycled printed part were extracted. These methods are tools in order to define the quality of the printing process using a recycled material. Furthermore, it is possible to compare the performance differences of the printing process among the total of AM techniques using recycled material, and establish the minimum material requirements for each AM process.

Variables to control the quality of recycled material (P6)

The purpose of P6 is to map the parameters that can define the material quality taking into account the material state and the AM technique. These variables can allow us to observe the influence on the printing process, and also to establish minimum requirements for the AM feedstock materials.

E. Study quality assessment check

The *study quality assessment* can be used to guide the interpretation of the synthesis finding and to determine the strength of the elaborated inferences [18]. In our case, we have performed the *study quality assessment* focused on the quality of reporting than the quality itself of the article. Therefore, the selected studies were evaluated according to the questions presented in table 2.8.

The aim of QA1 is to categorized the nature of the article using as reference the following framework:

ID	Quality assessment criteria	Options
QA1	Type of paper	Experimental or Conceptual
QA2	Is there a specific recycling methodology explicitly presented in the paper?	Yes/No
QA3	Are there practical implications presented in the AM process for material recycling?	Yes/No
QA4	Are there social implications of material recycling in AM technology?	Yes/No

Table 2.8: Quality assessment of the studies

- **Experimental research.** This category refers to any type of research undertaken or case studies describing actual experiences in the process of material recycling for additive manufacturing technology. The character of the research can include the construction or testing of a methodology of recycling, testing of data, empirical, or scientific research.
- **Conceptual:** This category describes studies that present visionary approaches or implications of the use of recycled material in the AM technologies. These papers will not be based on research but will develop hypotheses.

Concerning QA2, our intention is to map the recycling methodologies developed in order to evaluate the recyclability of a material used for AM technologies. This will be focused on the studies categorized as *experimental research*. Therefore, we check if the authors of the study presented clearly a recycling methodology followed in the investigation.

On the other hand, the purpose of QA3 is to find the implications of material recycling in terms of the process itself. We check if in the study the authors presented recommendations or guidelines or some kind of practical implications in the process when dealing with the use of recycled material based on the obtained technical results. This is interesting because on the basis of the technical studies, it will be possible to draw elements in order to arrive at the “*best recycling practices*” for each type of material and AM process related.

Finally in QA4, the goal is to identify possible studies that explore some social implications of the use of material recycling for AM technologies. We check if in the authors' outline element beyond the technical aspects of material recycling.

These elements of quality assessment will be systematically explored in the set of primary studies selected.

2.5.3 Identification of the relevant research

We identified a total of 916 potential studies from the selected scientific databases. Table 2.9 summarizes the studies founded in function of the approach used. Evaluating the title and the **Direct Object Identifier -DOI-**, it was possible to identify the duplicated studies.

Table 2.9: Identification of relevant studies according to the used approach

Approach	Web of Science	Scopus	Spring journal	Science Direct	Total studies		Studies retained
					retrieved	Duplicated	
Global	271	261	131	110	773	169	604
Specific	20	49	163	207	439	66	373
Total Primary Studies	193	290	259	235	977	61	916

After having the total database, a screening process was made in order to evaluate the title, keywords and abstract (conclusions if necessary) in order to obtain a first potential studies to revise more in detail. In the next section the primary studies selected will be presented.

2.5.4 Selection of the primary studies

Figure 2.14 illustrates in detail how the publications retrieved from the databases were reduced to the final primary studies. A total of 916 studies were screened. 642 studies were discarded according to the selection criteria established in the section 2.5.2 Afterwards, the diminished pool of papers for full reading-text to 274. In the final stage, 47 papers remained after filtering out studies that we found to be irrelevant after assessing the full-text and those that were out of our scope.

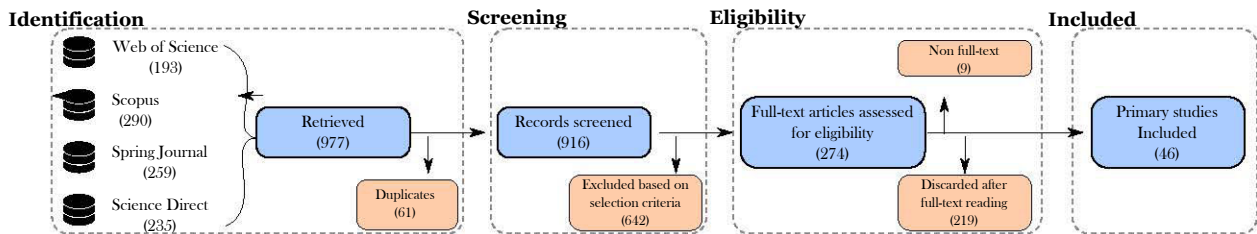

Figure 2.14: Study selection procedure for the primary studies (adapted from [18]).

Table 2.15a presents the primary studies included for our systematic literature research.

Table 2.10: The core set of the articles

Reference	Year	Type of AM Process	Type of material	QA1	QA2	QA3	QA4
1 Fahad, Dickens, and Gilbert [169]	2013	DP	Liquid	Exp.	No	Yes	No
2 Marchelli et al. [170]	2011	DP	Resin Powder	Exp.		Yes	Yes
3 Gaytan et al. [171]	2009	DP	Glass	Exp.	No	Yes	No
4 Murr et al. [172]	2009	DP	PM	Exp.			
5 Mohammadhosseini et al. [173]	2014	DP	PM	Exp.	No	No	Yes
6 Slotwinski et al. [174]	2014	DP	PM	Exp.	Yes	Yes	No
7 Slotwinski et al. [175]	2014	DP	PM	Exp.	Yes	Yes	No
8 Tang et al. [176]	2015	DP	PM	Exp.	Yes	Yes	No
9 Jelis et al. [177]	2015	DP	PM	Exp.	No	Yes	No
10 Nandwana et al. [19]	2016	DP	PM	Exp.	Yes	Yes	No
11 Pham, Dotchev, and Yusoff [178]	2008	DP	PP	Exp.	Yes	Yes	No
12 Dotchev and Yusoff [20]	2009	DP	PP	Exp.	Yes	Yes	No
13 Kuehnlein et al. [179]	2010	DP	PP	Exp.	No	No	No
14 Starr, Gornet, and Usher [180]	2011	DP	PP	Exp.	No	Yes	No
15 Toth-Tascau et al. [87]	2012	DP	PP	Exp.	No	No	No
16 Johnson, Bingham, and Wimpenny [181]	2013	DP	PP	Exp.	No	Yes	Yes
17 Wudy et al. [182]	2014	DP	PP	Exp.	No	No	No
18 Mägi, Krumme, and Pohlak [183]	2016	DP	PP	Exp.	Yes	Yes	Yes
19 Slotwinski et al. [184]	2016	DP	PP	Exp.	No	No	No
20 Tröger et al. [185]	2008	Liquid	Liquid	Exp.			
21 Radharamanan [186]	2011	MM	Resin	Exp.	No	Yes	Yes
22 Baechler, DeVuono, and Pearce [22]	2013	MM	Fil.	Exp.	No	Yes	Yes
23 Letcher and Waytashek [187]	2014	MM	Fil.	Exp.	No	Yes	No

DP= Discrete Particle; MM= Molten Material
 PM=Powder Metal; PP=Polymer Powder; Fil.= Filament
 Exp.= Experimental; Conc.= Conceptual

Continued on
 next page

Table 2.10 – continued from previous page

Reference	Year	Type of AM Process	Type of material	QA1	QA2	QA3	QA4
24 Singh, Singh, and Singh [188]	2016	MM	Fil.	Exp.	Yes	Yes	Yes
25 Mogas-Soldevila, Duro-Royo, and Oxman [189]	2014	MM	Liquid Resin	Exp.	No	Yes	Yes
26 Pearce [190]	2015			Conc.	No	Yes	Yes
27 Munguía, Ciurana, and Riba [191]	2008	DP		Conc.	No	Yes	No
28 Hiller and Lipson [192]	2009	DP		Conc.	Yes	Yes	No
29 Slotwinski and Garboczi [193]	2015	DP	PM	Conc.	No	Yes	No
30 Clayton, Millington-Smith, and Armstrong [194]	2015	DP	PM	Conc.	No	Yes	No
31 Gebbe et al. [195]	2015	DP	PM	Conc.	No	No	Yes
32 Seifi et al. [196]	2016	DP	PM	Conc.	No	Yes	No
33 Hebert [197]	2016	DP	PM	Conc.	No	Yes	No
34 Spears and Gold [198]	2016	DP	PP	Conc.	No	No	No
35 Czvikovszky [199]	2003	Liquid	Liquid Resin	Conc.	No	Yes	No
36 Keating and Oxman [200]	2013	MM	Fil.	Conc.	No	Yes	No
37 Kreiger and Pearce [25]	2013	MM	Fil.	Conc.	No	Yes	Yes
38 Kreiger et al. [23]	2014	MM	Fil.	Conc.	No	Yes	Yes
39 Feeley, Wijnen, and Pearce [26]	2014	MM	Fil.	Conc.	Yes	Yes	Yes
40 Heyer et al. [201]	2014	MM	Fil.	Conc.	Yes	Yes	Yes
41 Hunt et al. [145]	2015	MM	Fil.	Conc.	No	Yes	Yes
42 Chong et al. [202]	2015	MM	Fil.	Conc.	Yes	Yes	Yes
43 Muschard and Seliger [203]	2015	MM	Fil.	Conc.	No	Yes	Yes
44 Laplume, Anzalone, and Pearce [204]	2015	MM	Fil.	Conc.	No	Yes	Yes
45 Freitas et al. [205]	2016	MM	Fil.	Conc.	No	Yes	Yes
46 Laplume, Petersen, and Pearce [206]	2016	MM	Fil.	Conc.	No	No	Yes

DP= Discrete Particle; MM= Molten Material
 PM=Powder Metal; PP=Polymer Powder; Fil.= Filament
 Exp.= Experimental; Conc.= Conceptual

Prior to presenting the results and analysis for each question research, we give a short overview of the general characteristics of the studies registered in the table 2.10

2.5.5 Data Extraction

-Overview of the selected studies

The reviewed papers were published between 2003 and 2016 as displayed in figure 2.15a. This seems to indicate an increased interest to the study of material recycling. The inspected publications were classified according to the type of article as defined earlier in section 2.5.2. In proportion, experimental research represents 65.95% the and conceptual studies 34.04% as can be seen in figure 2.15b. In fact, figure 2.15c details this group of experimental research, segmenting by the type of AM process and the state of the material. We can see that more of the about 47% of the article are related to *Discrete Particle* AM processes (e.g. SLS, EBM) using polymer or metal powder materials.

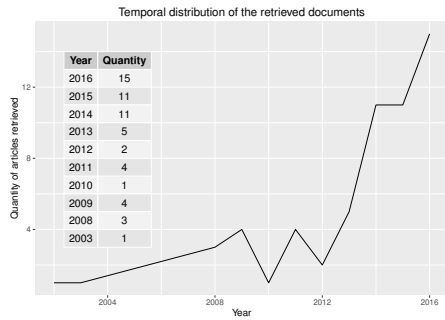

(a) Temporal distribution of the primary studies

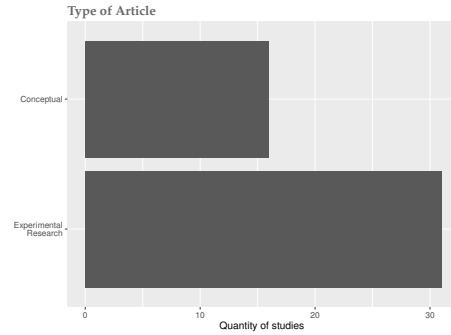

(b) Type of studies

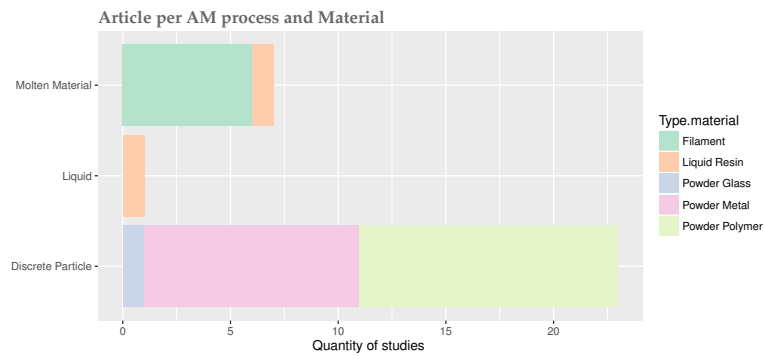

(c) Classification of the studies in function of the AM process and the state of the material.

In the following section, the research questions stated in the table 2.4, section 2.5.1 will be answered.

2.5.6 Data synthesis

Figure 2.16 presents the structuration of our systematic literature review. Therefore, in the following section, we will present the results according to each research question (RQ) proposed in the section 2.5.1.

I. RQ 1. How much research activity has there been about recyclability in the Additive Manufacturing Context?

- a) Liquid
- b) Discrete Particle
- c) Molten Material
- d) Recycling Methodologies / Practices

II. RQ 2. What are the developments of open-source additive manufacturing in the polymer recycling context?

- a) Experimental
- b) Conceptual propositions
- c) Social / practical implications

Figure 2.16: Structuration of the data synthesis

I. Material Recyclability in the Additive Manufacturing Context. (RQ 1)

The goal with this research question is to obtain an input about the current works about the recyclability in the additive manufacturing technologies. We are interested in mapping the characterization methods used for the feedstock material and for the printed part made from recycled material. On the basis of these studies, it is possible to get an overview of the recycling practices for this technologies and the issues to consider in order to assure the quality of the recycled objects.

One element to highlight until this point is that in our selected primary studies, we have not found any article that investigates the material recycling process in *Solid Sheet* AM processes. Hence, in the following subsections we explore the results for the other AM categories. The table 2.11 presents the analyses based on the frameworks established in section 2.5.2 of the experimental selected primary studies.

Table 2.11: Experimental primary studies related to material recycling

Ref.	Type		Material P3	Machines	Characterization methods				
	Process (P1)	Material (P2)			Feedstock (P4)	Printed part (P5)	Material Quality (P6)		
1	[169]	DP	Liquid Resin		Methylcellulose		Surface Tension Texture Analysis Viscosity		
2	[170]	DP	Glass		Glass		Shrinkage Apparent Porosity Bulk density		
3	[171]	DP	PM		Ti-6Al-4V	Arcam EBM	Chemical Composition	Optical Metallography SEM, TEM Hardness Tensile Strength	Oxygen, Vanadium and Aluminium content
4	[172]	DP	PM						
5	[173]	DP	PM		Ti-6Al-4V	Arcam EBM	Morphology, Particle Size Distribution, Chemical Composition, Flowability		Oxygen, , Nitrogen Hydrogen and Carbon content
6	[174]	DP	PM		Stainless Steel 17-4SS Cobalt Chrome (CoCr)	DMLS	Density of Particles Particle Size Distribution, Particle Size Morphology Particle Cristalline Phases Composition Particle Element Particle Surface Molecular/ Chemical Composition		
7	[175]	DP	PM		Stainless Steel 17-4, Cobalt Chrome CoCr	Arcam EBM	Particle Size Distribution, Chemical Composition Morphology		
8	[176]	DP	PM		Ti-6Al-4V	Arcam A2 EBM	Chemical Composition,	Tensile Strength	Oxygen content.

DP= Discrete Particle; MM= Molten Material; PM=Powder Metal; PP=Polymer Powder

Continued on next page

Table 2.11 – continued from previous page

Ref.	Type		Material	Machines	Characterization methods			
	Process (P1)	material (P2)			P3	Feedstock (P4)	Printed part (P5)	Material Quality (P6)
					Surface Features Particle Size Distribution Apparent Density Tap Density Morphology Flowability Oxygen Content	Density		
9	[177]	DP	PM	Steel alloy 4340	EOSINT M270 DMLS	Morphology, Chemical Composition	Tensile Strength Analysis of Microstructure Hardness Chemical Composition	Oxygen content
10	[19]	DP	PM	Inconel 718 Ti-6Al-4V	Arcam A2 EBM	Powder Size Distribution, Chemical Composition Flowability	Oxygen and Aluminum content	Metallization
11	[178]	DP	PP	Polyamide (PA12)	12 EOSINT P700 Sinterstation 2500HiQ	Morphology Thermal Properties	Visual “Orange Peel”	Melt Flow Index
12	[20]	DP	PP	Polyamide (Pa12)	12 EOSINT P700 Sinterstation 2500HiQ	MFI GPC	Visual “Orange Peel”	Melt Flow Index.
13	[179]	DP	PP	Polyamide 12		Thermal Properties Melt Volume Rate Viscosity Number	Mechanical Properties	
14	[180]	DP	PP	Polyamide 12 (Duraform)	Sinterstation 2500 plus		Mechanical test	
15	[87]	DP	PP	Polyamide PA200	EOS Formiga P100		Energy-melt ratio Porosity	
16	[181]	DP	PP	Polyamide PA2200	EOS P100 Formiga LS		Impact Energy, Maximum penetration limit	

DP= Discrete Particle; MM= Molten Material; PM=Powder Metal; PP=Polymer Powder

Continued on next page

Table 2.11 – continued from previous page

Ref.	Type		Material	Machines	Characterization methods		
	Process (P1)	material (P2)			Feedstock (P4)	Printed part (P5)	Material Quality (P6)
17 [182]	DP	PP	Polyamide 12	DTM, Sinterstation 200	Viscosity Number Melt Volume Rate	Tensile Strength	
18 [183]	DP	PP	Polyamide (PA12)	Formiga P100 (EOS GmbH) Vellman K8200 FDM printer	Tensile Strength (ISO 527-B)		
19 [184]	DP	PP	Glass bead-filled Polyamide		Particle Size Distribution, Thermal Gravimetric Analysis	Mechanical Properties Density Dimensional Accuracy Surface Quality	
20 [185]	Liquid	Liquid Resin					
21 [186]	MM	Filament	ABS, HDPE	MakerBot Cupcake CNC 3D printer			
22 [22]	MM	Filament	HDPE	Recycleboots	Filament diameter Mass per unit length Energy consumption Process time		
23 [187]	MM	Filament	PLA	MakerBot Replicator 2x	Tensile Strength	Tensile Strength Flexural Fatigue Morphology	
24 [188]	MM	Filament	Nylon-6, (Charge)	Al2O3 u-Print-SE FDM	MFI	Dimensional accuracy	MFI
25 [189]	MM	Liquid Resin	Kuka KR1100	Agilus Chitosan	Rheology	Dimensional Accuracy	

DP= Discrete Particle; MM= Molten Material; PM=Powder Metal; PP=Polymer Powder

a). Recycling *Liquid* AM Processes

In our database, we have not found much research about material recycling in the context of *Liquid* AM processes. Nevertheless, based on the theory of radiation chemistry of polymers, where a crosslinkable monomer (oligomer) mixture is polymerized through use of a laser application, Czikovszky [199] presented a possible research path related to the concept of *compatibilization*.

Compatibilization through radiation enables both, the recycling of commingled polymer wastes, and manufacturing new type of alloys through an approach of engineering interface. Recycling of the mixed polymer waste materials is limited because of inherent thermodynamical incompatibilities of most thermoplastics. To overcome this incompatibility, it is proposed to form some crosslink type or grafted bridges between the different polymer chains. The collective excitation, occurring during the mutual irradiation of the different polymer waste materials to be recycled, in the presence of some modest quantity of radiation-reactive monomers or oligomers may well serve this purpose. This research could be another field of knowledge, but unfortunately, for the purposes of this systematic literature review, we have not found additional studies. However, in order to deepen about this field, it could be possible that it is necessary to re-adapt the keywords more specifically to this domain of radiation processing of polymers.

b). Recycling *Discrete Particle* AM Processes

Most of the retrieved articles belongs to the AM category of *Discrete Particle*. As stated in section 2.2.2, the state of the material in processes related to this AM is in powder form. Polymer and metal powders have been the type of materials the most studied in the literature. Therefore, the AM processes were in accordance with the material. In the case of metal powder, AM processes such as Selective Laser Melting (SLM) and Electron Beam Melting (EBM) provide the ability to melt selective uniform powder bed layer of metal powder. In the case of polymer powder, Selective Laser Sintering (SLS) has been the most investigated.

One important condition for *Discrete Particle* AM technologies is that consistent powder characteristics are very important for ensuring not only the process quality but also the final product quality. The relationship between material-process-product needs to be fully understood. Variability in feedstock can lead to inconsistent bulk density, nonuniform layering, increased porosity, low mechanical properties, and poor surface finish quality [194]. It is vital to understand how the powder flows and packs as the layers are formed. In that way, feedstock and product certification and standards should be developed for discrete particle AM processes. In fact, the characterization of the feedstock material (virgin and recycled) used in metal-based AM technologies is a necessary condition for industry to be able to reliably select powder and produce consistent parts with known and predictable properties [174, 193]. Standards are finally tools that ultimately provide the user the *confidence* that various measurement methods, specifications, practices and terms are being used *correctly* and *consistently* [193]. Recent efforts in order to address this need of standards have been undertaken by two international standards development organizations, ASTM and ISO. The respective committees are: ASTM F42: Additive Manufacturing Technologies [207] and ISO Technical Committee (TC) 261: Additive Manufacturing [208]. As a recent example for standardization in AM industry, ASTM released the Standard Guide for Characterization Properties of Metal Powders Used for Additive Manufacturing Processes (ASTM F3049) [209].

Concerning the point of certification part, Gaytan et al. [171] explored a strategy for quality control (or quality assurance) using a build process which is continuously monitored. This monitoring process is embedded in continuous product temperature profiles and a build log which annotates any irregularities in the beam experiences with each layer processing, including preheat and melt cycles. Another approach in order to attack these qualification issues in metal AM is proposed through the *ICME* (Integrated Computational Materials Engineering) approach on the platform *MiCloud.AM*² [196]. The purpose of this platform is to integrate efforts in order to understand the microstructure (i.e. morphology, and crystallography), defects and source(s) of defect generations.

²<http://micloud.am/>

On the other hand, according to the table 2.11, we can see the characterization methods for the feedstock material (P4) that have been used in the commercial AM technologies in order to evaluate the evolution of the material while the recycling process is made. For the *Discrete Particle* AM technologies, important characteristics include [198]:

- **Chemical properties:** this category is related to the powder chemical composition, surface chemistry and crystal structure. In metal-based processes, the concentration of elements such as oxygen, aluminium, carbon and vanadium in alloys are usually studied because changes in powder properties could introduce variation in the process. The importance of the chemical composition during the recycling process is the correlation of the micro-structure with the macro-properties and its suitability for specific fields [172]. For instance, it is necessary to evaluate the suitability of the printed part for certain applications like biomedical where the quantity of components are established [171].

Moreover, the exposition of the powder feedstock to the environment can influence the oxygen content through moisture adsorption of the material. Jelis et al. [177] worked with recycled iron-powder steel alloy 4340 in *Direct Metal Laser Sintering (DMLS)* process, and because of the significant oxygen concentration in the recycled powder, the iron-based melt pool does not effectively wet on an oxide surface. As consequence, it leads to bailing of the melt pool. This bailing phenomenon give raise to an increase in porosity which will induce a reduction of the mechanical properties of the components.

- **Density:** This group includes the properties such as true/true and tap powder density, particle density, morphology, particle size distribution and particle shape distribution. The importance of these parameters for the AM process relies on describing the powder ability of packing and ability to flow during the printing process. This elements will also influence the heat balance of the printing [198].

The particle size establishes the lower limit on both the layer thickness and the minimum feature size that can be obtained. The particle size/shape distribution influences the flowability during the recoat process [198].

The density of particles represents the true density of the powders. The importance of this parameter relies on the determination of the built part porosity, which finally is related to the mechanical properties of the printed object [174]. However, Slotwinski and Garboczi [193] suggest that laboratory methods for measuring powder density, including both bulk density and tap density, also are not representative of the true powder packing density of a powder in an AM system's powder bed, especially after the powder has been spread. The true density is critically important because it is needed as an input into high-fidelity physics-based models of AM processes. Currently, some nascent work is underway to develop measurement methods to measure the true in situ powder-bed density and packing

There is a need for better quantitative understanding of the relationships between particle shape/size distribution with the printing process.

- **Powder flow properties:** These properties will directly influence in the recoater and powder handling systems of the AM machines. Poor flow could lead to build crashes or recoat nonuniformities. The importance of this property relies on the fact that it is expected that the flowability influences the continuity and uniformity of each layer of powder spread on the powder bed. For instance, metal powders with high tap density may favor the formation of a higher density deposition layer [176]. Moreover, environmental factors can impact powder flow and packing characteristics. In the case of polymers, the flowability depends on its chemical structure [179]. Therefore, changes in the flow characteristics of the recycled polymer provide information about variations in the polymer structure and molecular weight.

There remains a need for an efficient method to correlate powder rheology characteristics to machine performance characteristics to enable a best representative of the flow situation in an additive machine.

- **Thermal properties:** in the case of polymer-based AM process, the importance relies on the study of the polymers behavior when they are heated [178]. Therefore if the thermal transition is for the virgin and the recycled material is different, it will affect the parameters of the process.

We can conclude that these four categories of properties (*Chemical properties, Density, Powder flow properties and Thermal properties*) are systematically studied in the context of *Discrete Particle* AM technologies. Spears and Gold [198] presents a summary of standard tests and procedures for characterization of these four properties.

On the other hand, concerning the methods of characterization for the recycled printed part (P5), we can see from the table 2.11 that the following characteristics are evaluated:

- **Mechanical properties:** These properties include tensile, flexural strength and hardness. This is one of the most direct criteria in order to define the quality of the printed part made with recycled material.
For instance, in the case of metal-based AM systems, Tang et al. [176] demonstrated that titanium (Ti-6Al-4V) reused powder exhibited no measurable undesired influence on the tensile properties on the Electron Melting (EBM) process. In fact, Jelis et al. [177] worked with steel alloy 4340 powder, and the results showed that the tensile mechanical properties of the printed part with recycled powder after once are comparable to wrought steel alloy 4340.
- **Chemical Composants:** In metal-based AM processes, the nominal chemical composition of elements such as oxygen, aluminium and vanadium and its evolution during the recycling process are important because in application fields as biomedical implant, there are strict regulations about the maximal quantity allowed. For instance, Mohammadhosseini et al. [173] concluded that the recycled titanium (Ti-6Al-4V) powder can not be used for manufacturing surgical implants, due to the fact that the oxygen content in the powder was more than the required amount.
- **Microstructure:** In metal-based AM processes, the aim of this property is to correlate the microstructures of the printed parts obtained with the corresponding mechanical properties (e.g. hardness)
- **Visual “Orange Peel”:** This property were evaluated for *Discrete* AM processes using polymer powder. When a polymer powder is recycled many times without (or very small) recovery of additional new material, a phenomenon that affect the surface finish show ups in of the printed part which it resembles the skin of a peeled orange [20, 178]. This is a undesired characteristic for polymer-based AM processes. Dotchev and Yusoff [20] developed a recycling methodology (see below in sub-section d.) for controlling the apparition of this feature in the SLS process.

Finally, concerning the identification of variables in order to control the quality of the recycled material (P6) in the context of *Discrete Particle* AM processes, we can divided between metal and polymer based AM process.

In the context of metal-based AM process, even if the oxygen content can be used as indicator of the “quality” of the feedstock material [176], more research is needed in order to evaluate AM metal powders and the relationship between powder properties and part properties [193]. There remains a need for understanding the influence of feed powder characteristics on the process as well as quantitative correlations between process sensor responses, process variables, and quality metrics [198]. There

have been several efforts in terms of research and development by the industry, academia, and the government with the purpose of overcome these challenges. Standardization efforts including the release of ASTM F3049, the first AM powder-specific standard, may lead to greater understanding of metal-AM technologies. These contributions could help to develop more adequate material specifications.

On the other side, the degradation of the polymer powders materials can be associated to two steps of the printing process. First, polymer powder material are preheated and maintained at an elevated uniform temperature, (close to the melting or glass transition temperature) with the aim to minimize the laser power requirements and to prevent warping. And second, this preheating process are for the *warm-up*, *build* and *cooling down* stages which in function of the object to be fabricated, this could considerable periods of time (50-80 h for a typical SLS process). Therefore, materials such as polyamides (PA12) experiment an increased mobility known as *Brownian motion* at temperatures higher that the glass transition (T_g) [178]. This mobility encourages the unstable molecules, *free radicals*, to attract more molecules to be attached to the molecules'chain segments. The consequence is an increase of the molecular weight, which can be coupled with a decrease of the polymer's Melt Flow Index (MFI) value. This means that the more time the un-sintered polymer stays in the SLS machine at higher temperatures, the longer the molecular molecular chains will become and the more degraded the polymer will be.

It was found that Melt Flow Index (MFI) has been identified as one of the key parameters that can measure the feedstock material quality for SLS process. The research works of [20, 178, 210] concluded that a MFI of 25–26 g/10min for a polyamide (PA12) material can be considered as a minimum value to maintain acceptable and consistent part quality in terms of the surface finish and the phenomenon called “orange peel”.

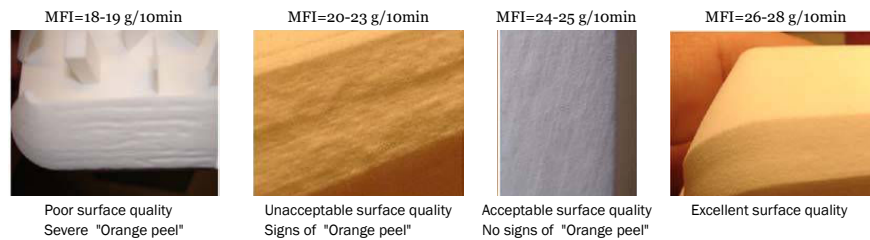

Figure 2.17: Surface finish quality (“Orange peel”) in function of the MFI value of the recycled powder. Adapted from [20]

c). Recycling in Molten Material AM Processes

Considering the material recycling in the context of *Molten Material* processes, we identified less experimental work than the *Discrete Particle* case. As stated in section 2.2.2, the state of the raw material in this category is a filament form in most of the cases. However, we can highlight that Mogas-Soldevila, Duro-Royo, and Oxman [189] worked with biodegradable hydrogel composites, such as chitosan and sodium alginate, through an extrusion system that can produce large-scale 3D shapes and objects. Using chitosan, as it is soluble in water; its concentrations can be tuned to additively manufacture functional gradients. They performed an initial material bonding and flow-rate consistency tests obtaining printed part with minimum features sizes of about $0.7 \sim 1 \text{ mm}$. The recyclability of the printed part was evaluated using a conical prototype ($mass = 51 \text{ g}$, $diam. \phi = 30 \text{ mm}$, $height h = 30 \text{ mm}$) which i was dissolved in 200ml of water after 20min. This biodegradability feature could represent an interesting field for sustainable AM of biodegradable material systems.

On the other hand, Singh, Singh, and Singh [188] propose an interesting approach to recycle the waste of composite material of Nylon-6 reinforced with Al and Al_2O_3 with the aim of preparing feedstock for Fused Deposition Modeling (FDM), matching the characteristics of a FDM filament ABS-P430. The aim is the fabrication of patterns for the investment casting process. The characterization methods for the feedstock material (P4) for the recollected nylon waste was the MFI value, and for the feedstock of the FDM system, the diameter of the filament was considered. In this case, the object printed was considered as an intermediation between the wasted nylon and the final casted aluminium matrix

composite fabricated. Therefore, the dimensional precision was considered for the printed part which for our purposes can be considered as a characterization methods for the recycled printed part (P5).

In our study of the systematic literature review, we did not find the same dynamic research about material recycling for *Molten Material* AM systems as we found it in *Discrete Particle* AM systems. We have not found methodological proposals for material recycling, neither any international standards for characterizing the feedstock material for this type of AM technologies. One of the reasons could be attributed to the fact that FDM process is the most popular system inside of the *Molten Material* AM processes. The feedstock material in this FDM process is thermoplastic filament, as stated before in the overview of AM, (section 2.2.2). Since the development of the plastic materials, there has been an increase awareness about polymer recycling issues [211], which finally is another field of knowledge. For the purposes of our systematic literature review, we did not consider studies related only for polymer recycling issue. In fact, we established this as one of the criteria selection, stated before in the subsection 2.5.2. We only considered research studies of material recycling intended for AM. This is one of the reasons that motivated the development of this thesis observing this gap in the scientific literature. Nevertheless, with the research question (RQ2) presented in an upcoming subsection below (see paragraph II.), we explored some contributions identified for the case of polymer recycling intended for open-source AM.

d). Recycling Methodologies / Practices (QA2)

Concerning the recycling methodologies, Nandwana et al. [19] explicits formally the methodology used for assessing the metal powder recycling in Electron Beam Melting (EBM) process. In the case of polymer powder, Dotchev and Yusoff [20] presented a methodological approach to evaluate the established good practices for powder recycling in Selective Laser Sintering (SLS). Both methodologies could be analyzed in the light of the three phases *Materials*, *AM process* and *Recycling Process* as indicated in the figure 2.18.

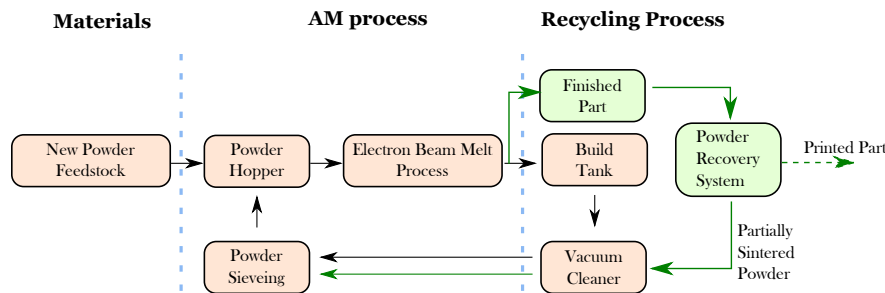

(a) Schematic methodology for metal powder recycling. Adapted from [19]

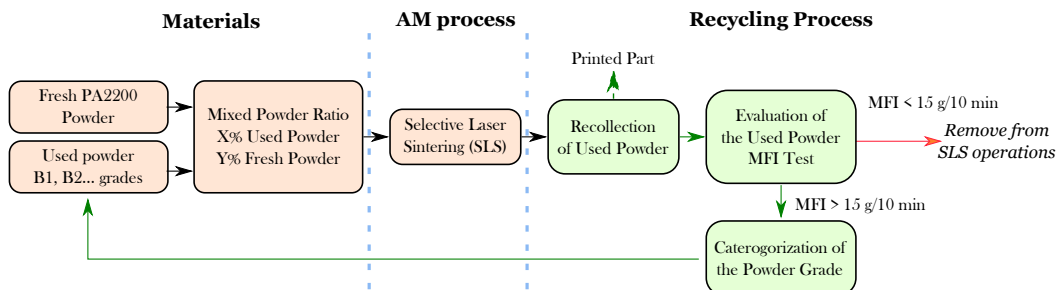

(b) Methodology for polymer powder recycling. Adapted from [20]

Figure 2.18: Methodology for polymer powder recycling. Adapted from [20]

Figure 2.18a plots the schematic methodology for the recycling study used in the research made by Nandwana et al. [19]. In this research, the height dimensions of the benchmark object were designed

with the purpose that at the end of each build, the hoppers would completely run out of powder, thus exposing all the powder to the electron beam. With that in mind, the experiment was designed in order to understand the worst-case scenario. This methodology starts with a virgin material which is deposited in the machine hopper for processing. The unused powder is recycled through the use of a vacuum cleaner. Once the printing process is made, the printed part is blasted in a powder recovery system in order to recover the partially sintered powder, and then, the powder is carried to the vacuum cleaner. The recycled powder is finally sieved where the powder greater than $150\ \mu\text{m}$ is discarded.

Considering the side of polymer powder, figure 2.18b plots the methodological proposition made by [19] for powder recycling polyamide (PA2200) in SLS systems, having as a quality indicator the MFI value of the recycled material. The main characteristic to control in the printed part is the phenomenon explained before known as “orange peel”. This research suggests an interesting scale to differentiate the recycled powder in three grades according to:

1. **Grade A:** Fresh PA2200 with MFI value higher than $50\text{g}/10\text{min}$
2. **Grade B:** Reused powder with a MFI between $18 - 50\text{g}/10\text{min}$. Six sub-grades (B1-B6) are proposed with its corresponding range of MFI value.
3. **Grade C:** Reused powder with a MFI below than $15 - 18\text{g}/10\text{min}$. This represent the most degraded powder which could be used for fabrication without considered the quality of the final piece or be discarded.

Therefore, based on this powder categories, the methodology proposes the use of a mix of fresh and used powder (according to the category) having a main criteria a minimum MFI value of about $25 - 26\ \text{g}/10\text{min}$. After the print part is made, the recollected powder is then evaluated through the MFI test in order to evaluated the degradation level, and hence it is categorized in order to be reused (or not) in subsequent printing processes.

These methodologies are particularly important taking into account that the recycling practices in *Discrete Particle* AM systems are not well consolidated. In fact, Munguía, Ciurana, and Riba [191] made a study in order to find the users’ best-practices in the AM fields through the use of survey methodology. One of the considered elements was the *material recycling* practices. The results showed that a 100 per cent of the surveyed centres that own laser sintering equipment (metal or plastic) perform material recycling. However, there was not a unique agreement about the mixing ratio applied between virgin and used material. Since the majority of the answers showed variable mixing ratios, it could be inferred that the final part’s quality also tends to be variable, thus showing one area for standards development. On the other hand, the survey showed that users with a pre-defined blend level mentioned some other specific practices followed on a regular basis:

- As a rule of thumb, a quantity from 30% – 35% of virgin material must be used for each new build.
- All materials to be fed to the equipment must be in the first in-first out order to prevent on-shelf aging.
- The un-sintered powder resulting from spraying, brushing, cleaning, as well as powder tightly adhered to the surface shall not be use for subsequent builds.
- Better mixing is achieved through semi automated mixers in at least two simultaneous axes.

Even if these methodologies formalize some strategies for material recycling / practices, it is still a work in progress in order to arrive to reliable practices for better material recycling. It is necessary to understand the influence of the recycled material on other type of properties (e.g. mechanical properties).

In the next subsection we will explain the results concerning our specific research question (RQ2), where we explore the advances in the polymer recycling literature for open-source AM.

II. Polymer Recycling in the Open-Source Additive Manufacturing(RQ2)

a). Experimental

Our main goal of this research question is to have an state of the art about the research made for the polymer recycling used in the open-source additive manufacturing context. As we have presented before, one of the differences between commercial AM and open-source AM is related to the initial cost of the equipment, which is reflected in the difference in terms of availability of this technologies for different communities as fablabs, laboratories etc.

One of the main facts that we found in the open-source area is that in the same manner that there has been a growing interest in the development of open-source 3D printers devices, different initiatives for the development of small-scale plastic extruders and projects for fabrication of filament have been taking place in the recent years. Some contributions to this are Lyman Filament Extruder [212], the Filabot [213], Recyclebot [22], RepRap Recycle Add-on [214], Precious plastic [21].

In our systematic literature review database, Baechler, DeVuono, and Pearce [22] evidenced a proof-of-concept about the recycling of high-density polyethylene (HDPE) using the open-source extruder called "RecycleBot". The characterization methods for the feedstock material (P4) have been the filament diameter measurement taken at 100mm intervals and the mass per unit length of these 100mm sections. In the same way, the recycling process (shredding, extrusion process) was evaluated in the light of energy consumption and the time required for the fabrication of the filament. Several difficulties in terms of technical design and performance were highlighted such as problems in inconsistent rate extrusion and physical assistance required to draw the filaments from the extruder. Nevertheless, beyond this technical issues, the implication of this research is that this represents a proof-of-concept for the development of a *distributed recycling concept* which it will be discussed in more detail in the later sub-section (paragraph III). Radharamanan [186] presents another example of this recycling approach of using an open-source device for recycling. He describes a technical development through the design of an open-source system for direct extrusion with the purpose to convert the reuse scrap ABS into 3mm filament. Even if the project is to develop a technical system for recycling, this is also inscribed within academical purposes with learning aims for students enrolled in the manufacturing courses.

b). Conceptual primary studies (QA1)

As a remainder, in this category of *conceptual* papers (QA1), the goal was to explore visionary approaches or implications of the use of recycled material in the AM technologies. We are interested in the development of prospective hypothesis going beyond than the technical aspect of the recycling process in AM.

Based on the selected primary studies, the notion of *Distributed Manufacturing* and its reciprocal *Distributed Recycling* emerged as one conceivable impact of the open-source 3D printing growth. We could define distributed manufacturing as a form of decentralized local production developed thanks to the synergy among emerging digital fabrication capabilities, the information and communication technologies and the commons-based peer production approach (e.g. the self- selection of tasks by the participants, modularity design) [15, 73]. The main advantages of decentralized production structures are a higher flexibility to reflect local customer, lower logistics costs and shorter delivery times [215]. As OS 3D printers improve progressively in performance, reliability, material options and declining in cost, these devices would play an important role in the deployment of the distributed manufacturing. In fact, Kreiger and Pearce [25] worked on the environmental impact of distributed manufacturing polymer products made from OS 3D printers. The results showed that distributed manufacturing requires less cumulative energy than conventional (*centralized*) manufacturing. Joining 3D printing capabilities with the photovoltaic grid, the impact could be even lesser. From an economical point of view, [27] proved the attractiveness of this technology for an average US household, until a point that it could become a mass-market mechatronic device.

Moreover, knowing that OS 3D printing have the potential to boost the feasibility of the distributed manufacturing context, this technology could be an essential part of a global concept of *open-source appropriate technology (OSAT)*. Defining *open-source appropriate technology (OSAT)* as those technologies adopted by local communities to meet their needs, respecting the triple bottom line of the sustainability concept (Economic, Environmental and Social) while being designed in the same fashion as free and

open source software [216]. This concept focuses on the small-scale, locally relevant, sometimes low-tech technologies in order to promote grassroots development and serve the world's underprivileged populations. Pearce et al. [147] and Pearce [148] explored the development path and necessary barriers that open-source 3D printing has to overcome with the purpose of this technology contributes to OSAT applications which the finally goal is to support the sustainable development of a local community. They have pointed out that the technology of open source 3D printing is far from its evolutionary climax. The ideal functional requirements of a 3D printer include:

- Inexpensive machine ideally self-replicated and fabricated with locally available materials
- Inexpensive feed-stocks with locally available raw materials.
- Free and open access to designs and designing software.
- Inexpensive and rapidly fabricated parts.
- Low energy use and powered by locally available renewable energy source (e.g. solar photovoltaic cells).
- Open/freely available technical support and knowledge.
- Minimal negative health, social and environmental effects of use or construction of the 3D printer.

Starting from these ideal requirements, the following key additional technical barriers need to be overcome to make 3D printing a viable technique for OSAT deployment:

- Development of locally available materials for printing
- The size of printed object and print speed need to be increased
- An increased and improved material selection for 3D printing is necessary
- The development of a solar powered 3D printer/computer for deployment in rural developing communities.

Within this framework, the development of *Distributed Recycling* approach could be an interesting research path, for local communities including fab-labs, research labs, rural communities, among others.

c). Social and practical implications for recycling (QA3-QA4):

Considering the social aspect, Baechler, DeVuono, and Pearce [22] compared the conventional rural recycling of high-density polyethylene (HDPE) to a distributed recycling model for fabricating filament feedstock for an OS 3D printer. The results reinforced the idea that distributed model uses less embodied energy in the process which is traduced by savings between 69 to 82% thanks to the transport reduction, which minimizes the environmental impact. Indeed, Kreiger et al. [23] estimated that more than 100 millions MJ of energy could be conserves per annum along with the corresponding reductions in greenhouse gas emissions if the current HDPE wastes in U.S were recycled in a distributed process.

An interesting proposition of technical system combining the potentialities of *Distributed* and *Manufacturing and Recycling* is “The Cube Factory”³ project [201, 203]. This project is an integrated learning environment for people with no or limited knowledge about manufacturing and recycling. It is formed by four modules which are *manufacturing* (Fused Deposition Modeling (FDM) 3D printer), *recycling device* (plastic recycler for the production of 3D printer filament), *energy supply* (solar cells) and *knowledge transfer* (tablet interface). The mobile mini-factory pursues the vision of new forms of social learning developing the knowledge, tools and training required to address the challenge of sustainability. From the economic perspective, this desktop machine tool provides the possibilities to produce customized goods at mass-produced products prices. Indeed, the energy supply allows the entire system to increase the geographical flexibility with no further cost. From the social aspect, the transfer of knowledge is the main element to consider. The learned operating skills and improved technical knowledge increase the workers abilities and thus the chance of a positive impact. And from the environmental perspective, based on the “Cradle to Cradle” framework, this project intends a reduced ecological footprint. Therefore, the main aim is to engage local communities with a particular focus on the qualification of unskilled

³<http://cubefactory.org/>

people for the application of sustainable value creation in areas with poorly supported infrastructure. Figure 2.19 plots the schematic proposition.

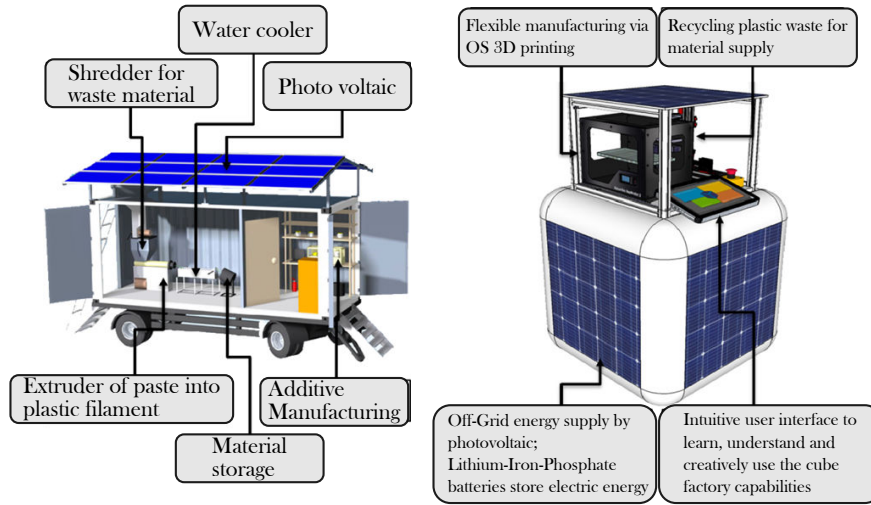

Figure 2.19: Schematic proposition of “Cube Factory”project. Source from [201]

Considering the “Cradle to Cradle” approach where the close loop material cycles are a essential part to reduce the environmental impact, Chong et al. [202] proposes an “Cradle to Cradle” framework for 3D printing with “zero waste” as the ultimate goal. Figure 2.20 presents an adaptation of this framework, considering the three stage that we have managed in this thesis, *materials*, *AM process* and *Recycling process*.

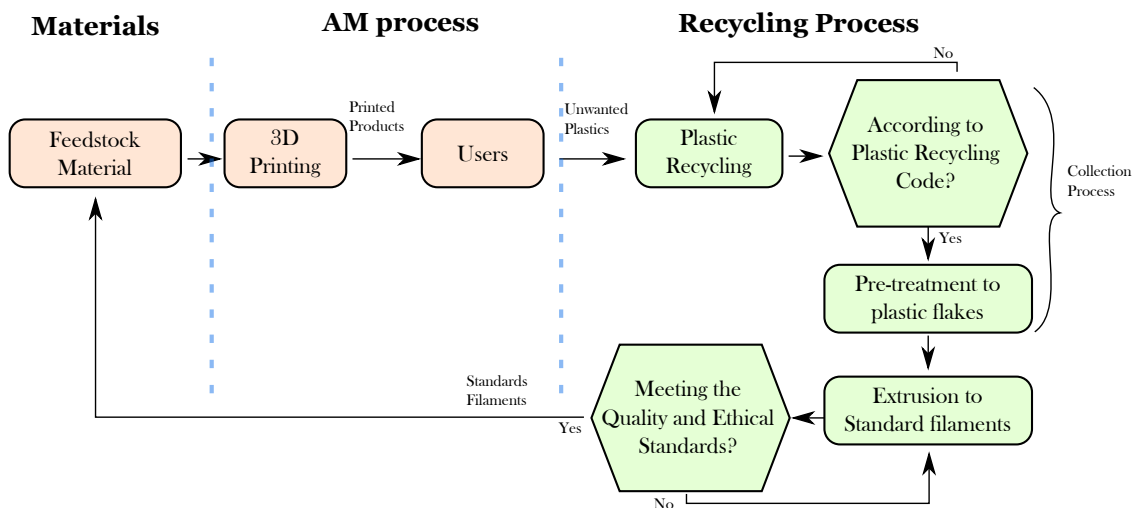

Figure 2.20: Schematic proposition of “Cube Factory” project. Adapted from [202].

An important element of this “Cradle to Cradle” framework is related to the definition of *plastic recycling code* and to *quality and ethical standards* for filament. For the former, Hunt et al. [145] proposed a recycling code model based off the resin identification codes developed in China. This code allows a more flexible and specific categorization of the polymer material that could be used in the context of OS 3D printing. Indeed, this research proposed a script in order to be included in the printing process which allows the user to recognize the type of material used in the printed object based on this proposed codification. Currently, seven types of plastics are commonly recycled with its specific number, namely:

- ① Polyethylene terephthalate (PET)
- ② High-density polyethylene (HDPE),
- ③ Polyvinyl chloride (PVC)
- ④ Low-density polyethylene (LDPE)
- ⑤ Polypropylene (PP),
- ⑥ Polystyrene (PS)
- ⑦ “Others”, (primarily PC and ABS)



This codification is advocated on a centralized recycling model, which currently dominates polymer recycling in the U.S. In fact, these six main resins account for 75% of the plastic market [69, 217]. However, making a prospective with the current growth of distributed 3-D printing for manufacturing, the plastic waste produced will no longer necessarily continue to be limited to these six resins. Indeed, there is a wide development of new filaments including a larger range of materials.

For the *quality and ethical standards* case, Feeley, Wijnen, and Pearce [26] conceptualize an “ethical product standard” for 3-D filament based upon a combination of existing fair-trade standards and technical and life cycle analysis of recycled filament production and 3-D printing manufacturing. These standards apply to businesses that can enable the economic development of waste pickers and include:

- Minimum pricing
- Fair trade premium
- Labor standards
- Environmental and technical standards
- Health and safety standards and
- Social standards (cover discrimination, harassment, freedom of association, collective bargaining and discipline)

Feeley, Wijnen, and Pearce [26] argues that waste plastic recycling into 3-D printer filament is technically viable, and it has been demonstrated by many research groups and successfully commercialized projects. Therefore, the growth of 3-D printing users provides a market demand for filament and the existing market for socially responsible goods can provide a similar impetus for ethical, fair trade or social filament.

2.6 Conclusions

In this chapter, an overview of the additive manufacturing (AM) technologies, categorizing the main AM technologies according to the raw material state was presented. The manufacturing principles of the main techniques were explained showing advantages and disadvantages of each technique. We presented also the characteristics of the open-source additive manufacturing (or open-source 3D printing) and the differences with the commercial AM. One element to retain of this open-source option is the exponential growth that this technology has had since its creation.

We focused our attention on the potential benefits of this technology in terms of sustainable manufacturing. Several authors agree that the additive manufacturing technologies offers good environmental characteristics particularly to the fact that the additive nature of the process which leads to a reasonable use of the feedstock material [164]. Moreover, different elements in the industrial context (e.g. new design product, supply chain, distribution chain) can also be influenced by the advantages of these additive processes [165]. Nevertheless, it is also recognized that there still are certain barriers to overcome with the goal of fully exploiting the potentialities of a sustainable AM process. One of these barriers is related to the need of understanding the waste streams associated with different AM processes and the recycling strategies developed for address this issues. Based on this considerations,

we performed a systematic literature review in order to have an state of the art about material recycling process intended for AM technologies. We based our exploration on two main research questions:

RQ1 : How much research activity has there been about recyclability in the Additive Manufacturing Context?

RQ2: What are the developments of open source additive manufacturing in the polymer recycling context?

From the *RQ1*, we can conclude that there is a strong dynamic of research in terms of the feedstock characterization of virgin and recycled material for *Discrete Particle* AM processes, for metals and polymers as well. We mapped the several properties for characterization of feedstock, printed object and for controlling in the recycling process. In fact, there have been efforts from international organisms for creating international characterization standards taking into account a set of relevant properties. One element to highlight is the fact that the recycling methodologies identified do not consider the recycling process of the printed part. It means, in the case of powder polymer, the recycling process is defined in terms of the study of the un-used powder. Once the printed object is made, it is not considered again in the study. On the other hand, we did not find the same research dynamic for the other type of AM systems. In the case of *Molten Material* AM systems, we found some experimental propositions for recycling but we did not find systematic methodological propositions in order to assess the suitability of a recycled material for this AM techniques.

Considering the *RQ2*, we targeted to find experimental and conceptual research about the polymer recycling for open-source additive manufacturing. We found that there has been empirical and experimental attempts to control the recycling process chain (shredding + small-scale extrusion + collection) for manufacturing recycled filament in order to be used in the OS 3D printers. Moreover, we also identified a certain number of social impacts within the development of a concept called *Distributed Manufacturing and Recycling*. However, we did not find a systematical propositions for evaluate the polymer recycling process for OS 3D printers neither.

Before to evaluate the material degradation, and consequently, the material recycling process in open-source 3D printers, we need to understand if the 3D printers are reproducible enough for considering as a manufacturing tool because in the evaluation of the recycling material, we will face to a degradation due to the material itself but also a degradation of the properties due to the manufacturing process defects. For this reason, in the chapter 3 we will focus our attention to characterize the OS 3D printers and its performance. A methodology in order to understand the main important parameters is developed, and the main aim is to answer the question if these OS 3D printers, even if they are designed and fabricated from an community, are good enough in terms of reproducibility and dimensional performance for fabrication of standards testing specimens. Once the quality of the 3D printer as a manufacturing tool is validated, we will continue in the chapter 4 with the development of the methodology in order to study the recycling process. Finally, in the chapter 5, we will present the results of a case study of recycling made based on the proposed methodology.

Towards a standard protocol for 3D printers characterization

Contents

3.1 Introduction	55
3.2 Benchmarking in open-source Additive Manufacturing	55
3.3 Methodology	56
3.3.1 A. Geometric Benchmarking Model	57
3.3.2 B. Design of Experiments	58
3.3.3 C. Fabrication and Measurement of Geometric Benchmarking Model	58
3.3.4 D. Results Accuracy Index and Statistical Analysis	58
3.4 Application to an OS AM System: the Case of the FoldaRap	59
3.4.1 Equipment	59
3.4.2 Benchmarking Models in Additive Manufacturing	60
3.4.3 Design of Experiments	63
3.4.4 Fabrication	65
3.5 Results and Discussion	66
3.5.1 Statistical Analysis	66
3.5.2 International Tolerance for the FoldaRap	68
3.5.3 Optimal control factors for the GBM	69
a). Using the DOE approach to select the most relevant control factors	69
b). Proposed method	71
3.5.4 Discussion	73
3.6 Conclusion	75

3.1 Introduction

In the chapter 2, we explored the additive manufacturing (AM) processes and its impact on sustainability elements. we have identified that the technological development of open-source (OS) 3D printers is creating more affordable AM machines for society in different applications. We can expect that the growing trend of adoption of this technology continues in the years to come. One of the implications of this trend concerns to the material consumption issue and how to establish a material recycling process. Before studying how to draw a systematic recycling methodology intended for this technology, it is necessary to understand the capability of the opens-source 3D printer and prove that these devices can be considered as a manufacturing tool. It is a key element to have a performance comparative of these open-source devices with respect to the traditional manufacturing processes in order to establish minimum standards of performance.

Therefore, this chapter deals with the development, manufacture and testing of a geometrical benchmarking model (GBM) in order to evaluate the geometrical accuracy performance of open-source 3D printers. A methodology is proposed and applied to a case study based on fused filament fabrication (FFF) OS 3D printer. The case study positions the evaluated machine according to ANSI-ISO's International Standard tolerance grade (IT). Furthermore, root-mean-square deviation (RMSD) value is employed as an accuracy estimator, while Taguchi tools are employed to determinate the control factors with the highest accuracy for the fabrication of the GBM.

3.2 Benchmarking in open-source Additive Manufacturing

As stated in chapter 2, with the expiration of Fused Deposition Modelling (FDM) patents [8] in the mid-2000s, Adrian Bowyer envisioned the concept of self-replicating machines, capable of manufacturing their own parts by themselves, and so simple and easy that anyone would be able to build them [11–13]. This was the start of the **RepRap** project (or **Replicating Rapid-prototyper**). RepRap is a low-cost desktop rapid prototyper which manufactures approximately 57% of its own mechanical components (excluding fasteners, bolts and nuts). This project has been developed using an Open Design approach in which detailed information on the technical design and operations of the device is publicly available on the internet. In the literature, RepRaps have been proved to be useful tools in fields such as transport [143], education [218], engineering [12, 15], tissue engineering [219], chemical reaction wire, customizing scientific equipment [220–222], electronic sensors [223], wire embedding [224] and appropriate technology related for sustainable development [147].

Characteristics of the RepRap project, such as its open source nature and its customization and self-replication capability, open up the possibility for exponential growth for both products and 3D printer systems. The RepRap project has been an object of social experimentation, creating numerous enthusiasts and communities interested in supporting various RepRap models. Different parallel open source systems have emerged, such as Fab@Home 3D printer [225], the CupCake CNC and Thing-O-Matic 3D printers by MakerBot Inc [226] and others. The RepRap website invites machine developers to register their project in a database in order to collect the total of different prototypes and projects. According to this database, there are approximately 500 models [227]. This exponential growth makes it essential to evaluate the capabilities of machines in order to characterize and differentiate them. In fact, attention has been drawn to the relevance of logical evaluation tools for individuals to allow a fair comparison of the performance of a given unit to another through the use of a benchmarking process [124, 125].

In the context of commercial additive manufacturing, several benchmarking propositions have been made to evaluate the performance of the techniques. Mahesh et al. [228] present a methodology for identifying the best achievable quality characteristics to serve as a benchmark process using a case study involving the Direct Laser Sintering (DLS) process. Scaravetti, Dubois, and Duchamp [229] worked on a benchmarking model and a procedure using a correlation matrix, in order to identify the defects of SL processes for establishing whether their origins are machine or material linked. In the case of open

source Additive Manufacturing, Johnson et al. [230] have evaluated an open source AM system based on FDM technique through use of a benchmarking model in order to assess the dimensional accuracy, feature size and geometry limitation, geometric and dimensional tolerance. The fabricated model was evaluated using a 3D laser scanning system, which has an accuracy of 0.0089 mm far below than the minimum feature size limitation of the used printer (0.08 mm). Using nearly 3 million of data point, they observed a standard deviation of 0.3101 mm between the fabricated model and the CAD model, with 98.146% of the points within ± 2 standard deviations.

Roberson, Espalin, and Wicker [125] propose a framework to evaluate the performance of a set of five 3D printer units, establishing a ranking method based on four factors (manufacturing time, cost of machine, material cost and dimensional accuracy) in order to establish a hierarchy among them. However, the authors recognised that a robust evaluation and comparison of the various AM systems are required and this research is still at an early stage. Indeed, it remains to be demonstrated that open-source systems are capable of making objects in a robust way with good reproducibility. This evaluation, from the AM system user's point of view, will make it possible to know the performance of the different open source systems. On the other hand, from the point of view of an AM system developer, the evaluation of the reproducibility will enable to determine optimal parameters of the process in order to replicate the system, ensuring the evolution of performance from generation to generation of the machines.

Following this path of research, this chapter proposes an experimental protocol of geometrical performance evaluation in order to characterize open source 3D printers in a robust manner. Based on Design of Experiments (DoE) and integrating different families of geometrical objects, the dimensional accuracy of a representative 3D printer is intensively studied.

This chapter is structured as follows: in section 3.3 an overview of the methodology is proposed. Subsequently, in section 3.4, the proposed methodology is applied in the case of the open source 3D printer FoldaRap. The results and the discussion are shown in section 3.5 and concluding remarks and perspective are given in section 3.6.

3.3 Methodology

There are two goals in the deployment of the methodology. The first is to evaluate the performance of an open source AM machine in terms of dimensional accuracy and reproducibility through statistical analysis of the set of manufactured samples. This quantitative qualification will make it possible to establish a characterization of machine performance, in terms of four types of dimensional accuracy, as follows:

- XY- Plane
- Z-Axis.
- Circular features -D-
- Thin walls -T-

Once the degree of reproducibility of the machine is verified, the second goal is to find the parameters of the 3D printer machine among the parameters tested that give the lowest dimensional accuracy discrepancies as possible for the fabrication of a benchmarking model. Figure 3.1 shows an overview of the different steps of the proposed methodology. These steps will be detailed as follows:

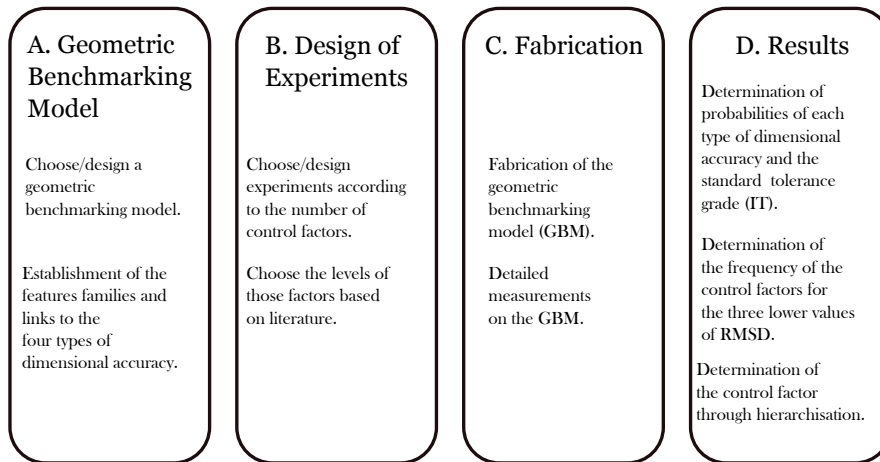

Figure 3.1: Overview of the proposed methodology

3.3.1 A. Geometric Benchmarking Model

Benchmarking is a tool for comparing the performance of different similar systems (processes, organizations, machines) in order to establish standards of performance. It aims to identify the best achievable practices and processes. In this step, the goal is to identify a model of reference intended for the evaluation of the open source AM system. Once a benchmarking model is adopted, it is intended to link different types of feature families with the four types of dimensional accuracies proposed.

In the commercial AM field, there have been several efforts to perform benchmarking studies for different processes through the use of comparative models. Kruth [231] was the first to mention a benchmarking part for comparing AM processes, citing a study done by two Dutch companies using a U-shaped artefact with various geometric features such as circular shells (in various orientations), circular bosses, square holes and angled surfaces. This benchmark part focuses on the overall performance of the AM systems. Ippolito, Iuliano, and Gatto [232] worked on the development, manufacture and test of a benchmarking model in order to investigate dimensional accuracy and surface finish of various AM techniques such as SL, SLS, FDM, LOM and SGC. Reilly aim to lay the groundwork for the development of standards to measure various performance factors such as repeatability, warpage, curl, creep, shrinkage and tensile strength in a quantitative way; test parts were designed for studying SL, SLS, LOM and FDM techniques. In 2000, Xu, Wong, and Loh [233] presented a benchmarking model to evaluate differences on the material property, accuracy, surface finish, building cost-time, machinability and environmental effects of the SL, SLS, FDM and LOM processes. Mahesh et al. [228] proposed a benchmarking model using a Six-sigma approach in order to (1) minimise process inconsistencies and defects of fabrication, and (2), to identify a best process/procedure to achieve desirable geometric accuracy and surface roughness in the Direct Laser Sintering (DLS) process. Fahad and Hopkinson [234] proposed a geometric benchmarking part for evaluating the accuracy, tolerances and repeatability of parts produced by different AM processes. In summary, Mahesh [235] identifies three types of benchmarking models in AM, as follows:

Geometric Benchmark: used to check the geometric and dimensional accuracy of the prototype (i.e. tolerances, accuracy, repeatability and surface finish).

Mechanical Benchmark: used to characterize the mechanical properties (i.e. tensile/compression strength, shrinkage, curling and creep characteristics.)

Process Benchmark: used to establish process related parameters (part orientation, support structures, layer thickness, speed)

In addition, Moylan et al. [236] summarize some items to consider in order to establish “rules” for a geometric benchmarking model. Globally, benchmarking models should:

- Be large enough to test the performance of the machine near the edges of the platform as well as near the centre.
- Have a substantial number of small, medium and large features.
- Not take long to build.
- Not consume a large quantity of material.
- Be easy to measure.
- Have many features of a 'real' part.
- Have simple geometrical shapes, allowing perfect definition and easy control of the geometry.
- Require no post-treatment or manual intervention (No support structures).
- Allow repeatability measurements.

Based in this literature, the objective of this step is to reach a final design of a Geometric Benchmarking Model (GBM). This design should incorporate geometric shapes and features that provide important information of the capabilities and limitations of the open source 3D printer analyzed.

3.3.2 B. Design of Experiments

The goal of this step is to establish the control factors to evaluate, the fixed factors to consider, and the sequence and quantity of samples to manufacture. One of the available approaches is the *Taguchi* method, which has been proven to be successful for improvement of product quality and process performance. This method provides an efficient and systematic approach to optimize a number of experiments and the feasibility of studying of interaction effects among parameters, while maintaining valid conclusions [237, 238]. In the literature of commercial AM, there have been several attempts to improve the dimensional accuracy of prototypes using adjustment of the process parameters. Using *Taguchi* method, Zhou, Herscovici, and Chen [239] worked on the accuracy of rapid prototyped SL parts analysing five factors, namely layer thickness, hatch spacing, overcure, blade gap and position on the build plane. They used ANOVA approach to develop a second-order regression model establishing the best parameters to reduce the dimensional error to the smallest value. Anitha, Arunachalam, and Radhakrishnan [240] assessed the influence of the layer thickness, road width and speed deposition on the surface roughness of the prototypes produced by the FDM process in order to minimize the surface roughness. The results indicate that layer thickness is the most influential process parameter affecting roughness, followed by road width and deposition speed. Mahesh et al. [228] used the *Taguchi* method on the Direct Laser Sintering (DLS) process in order to determine the setting of the key control factors for obtaining the best achievable result in terms of geometric accuracy and surface roughness for different individual geometric features such as sphere circle, cone, cylinders, square boss and wedge. Sood, Ohdar, and Mahapatra [241] investigated the effects of process parameters (orientation, layer thickness, raster angle, raster width and air gap) on FDM dimensional accuracy in order to reduce the percentage change in length, width and thickness of a test specimen. Results show shrinkage is dominant along the length and width of the test part, whereas thickness is always more than the desired value.

Based on this literature, we are persuaded the suitability of this *Taguchi* method with the purpose of characterizing the performance of the open-source 3D printer.

3.3.3 C. Fabrication and Measurement of Geometric Benchmarking Model

The fabrication of the Geometric Benchmarking Model (GBM) is performed according to the instructions of the experiment design previously defined. It is intended in this protocol to use AM systems of an open-source nature (less than US\$5000). The selection of the machine to evaluate should be representative among the ensemble of AM systems currently in existence.

3.3.4 D. Results Accuracy Index and Statistical Analysis

The goal of this step is to quantify the dimensional accuracy of the machine, establishing a range of tolerance and confidence interval of the machine for every kind of dimensional accuracy proposed and

to quantify the probability of reproducibility of the machine inside a range of deviation. The second goal is to establish an accuracy index for the control factors, which will make it possible to rank the set of combinations of control factors in order to determinate those with the highest dimensional accuracy. In the next section, the approach will be illustrated by means of the evaluation of an open-source AM system.

3.4 Application to an OS AM System: the Case of the FoldaRap

In this section we will develop a case study applying the methodology proposed in the section 3.3. In a first moment, we will present the selected open-source 3D printer for this experimentation. Next, we select the geometric benchmarking model (GBM), doing the correlation of the GBM features to the four dimensional accuracies types. Then, we specify the control factors, and after that, we select the adequate Design of Experiment (DoE) according to the Taguchi method. Finally, we present the fabrication process and we conclude with the discussion of the results.

3.4.1 Equipment

A derivative version of the RepRap machine, called FoldaRap [242] (see figure 3.2) was selected for this investigation. It is the first open-source 3D printer designed to fold into a very small size to be completely portable. It is an open-source design and it comes from a derivation of eMAKER Huxley [243], VertX [244] and Pocket Laser Engraver [245]. The FoldaRap machine is a representative 3D printer among the set of open source machines developed by the RepRap community. Indeed, as can be seen in the open source 3D printer family tree [16], the FoldaRap derives from the main branch (XZ Head, Y Bed): Darwin-Sells Mendel-Prusa Mendel.

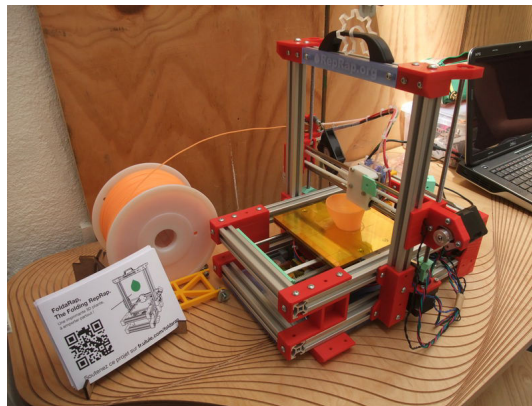

Figure 3.2: Open Source 3D printer -FoldaRap-

This system can be described through three fundamental axes [246, 247]:

1. Machine architecture
2. Electronic hardware
3. Software

Regarding the FoldaRap's architecture, it is a Cartesian 3D printer where the extrusion system can be displaced in the vertical plane XZ and the heated print bed can be displaced in the horizontal direction -Y. The work capability is $140 \times 140 \times 155 \text{ mm}^3$. Using a mechanical coupling stepper motor-drive gear, the extrusion system forces a Polylactic Acid (PLA) polymer filament with a diameter of 1.75mm into an aluminium melt chamber, then the filament is extruded through a 0.5mm nozzle. The linear motion for positioning axis XY is achieved through machined plastic bushings and smooth rods 6mm in diameter using a transmission mechanism of timing belts and pulleys. For axis Z, threaded rods M5 and hexagonal

nuts are coupled with a stepper motor with a minimum resolution of 0.00025mm. The heated print bed is made of aluminium joined with a Peltier cell and it uses a top layer of kapton in order to improve the adherence of the piece with the print bed.

Concerning the electronic hardware and software, the FoldaRap machine uses a Melzi v2.0 controller board which makes it possible to control the machine via a USB connection [248]. Marlin is used as firmware software, Slic3r software is used to convert the .STL files into G-codes, and Pronterface software is used as the system’s host software. All these elements are open source.

Foldarap has an indicated minimum value of layer height tested at 0.1 mm and it does not include the capacity to fabricate support structures. Figure 3.3 shows the structure of the machine schematically.

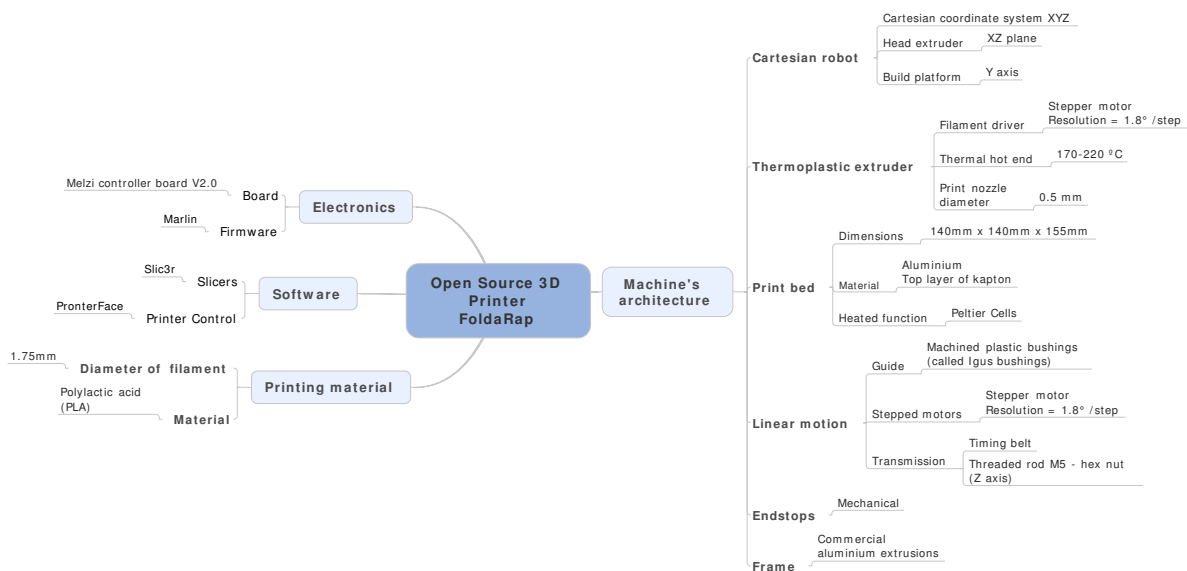

Figure 3.3: Main components of the FoldaRap 3D printer

3.4.2 Benchmarking Models in Additive Manufacturing

Based on the discussion of section 3.3.1, this experiment uses a modified version of the geometric benchmarking model (GBM) of the National Institute of Standards and Technology (NIST) [236]. The selected model is shown in figure 3.4 and table 3.1 summarizes the features and characteristics. The modifications made in the benchmarking models have been in order to link different types of features with different types of accuracies of the machine proposed in this investigation.

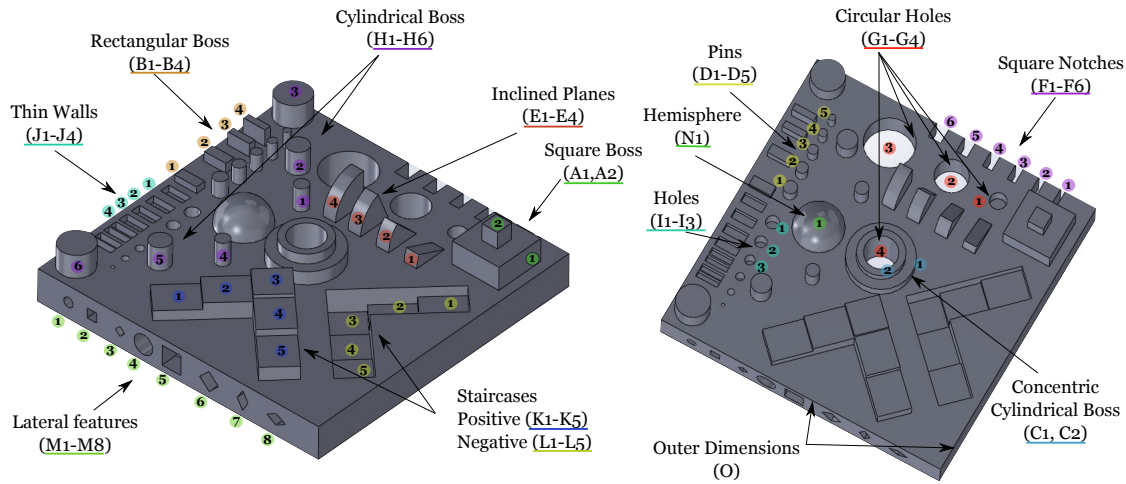

Figure 3.4: CAD version of the geometric benchmarking model (GBM) with referenced feature identification (IDs)

The geometric benchmarking model is divided into 15 different types of family groups. Each family group is formed by various related features where each feature is systematically identified with a letter (A-O) and a number. Every feature is associated with at least one of the four types of dimensional accuracy (**XY**, **Z**, **D**, **T**) defined in section 3.3. The 3D printer performance in terms of dimensional quality can be analyzed thanks to these different features of the model. Therefore, the four types of dimensional accuracy are measured from a set of features. This approach will make it possible to characterize the performance of the open source 3D printer, and consequently it will make it possible to differentiate the machine from the other open source machines.

Table 3.1: Benchmarking model feature descriptions

ID	Family of features	Features	Description
A	Square Boss	A1-A2	A1=15x15X17 mm A2= 5x5X22 mm
B	Rectangular Boss	B1-B4	B1= 7x3X12 mm, B2= 7x3x13mm B3= 7x2x14 mm, B4= 7x2x15mm,
C	Concentric cylindrical boss	C1-C2	C1=Ø 20mm C2=Ø 14mm
D	Pins	D1-D5	D1=Ø 4mm, D2= Ø 3.5mm, D3=Ø3mm, D4=Ø 2.5mm & D5=Ø 2mm.
E	Inclines	E1-E4	E1=13.83 mm (15°), E2=17.07mm (45°) E3=19.24mm (75°), E4=20mm (90°).
F	Square Notches	F1-F6	F1=1.5mm, F2=2mm, F3=2.5mm, F4=3mm, F5=3.5mm, F6=4mm,
G	Circular Holes	G1-G4	G1=Ø 5mm . (Prof. 5mm) G2= Ø10mm, G3 = Ø15mm, G4 = Ø10mm

Table 3.1 – continued from previous page

ID	Family of features	Features	Description
H	Cylindrical Boss	H1-H6	H1,H4= \emptyset 4mm. H2,H5 = \emptyset 6mm. H3,H6 = \emptyset 10mm.
I	Holes	I1-I3	I1= \emptyset 4mm, I2= \emptyset 3.5mm, I3= \emptyset 3mm Prof. 5mm.
J	Thin walls	J1-J4	J1= 2mm, J2= 1.5mm J3= 3mm , J4= 3mm
K	Positive Staircases	K1-K5	Height 2, 4, 5, 6, & 7mm. width 10mm.
L	Negative Staircases	L1-L5	Height 2, 4, 5, 6 & 7mm. width 10mm.
M	Lateral Features	M1-M8	M1= \emptyset 3mm, M2=3x3mm,M3=3x3mm, M4= \emptyset 6mm, M5=6x6mm, M6=6x6mm M7=6mm(Z-axis), M8=6mm. Features in the vertical plane .
N	Hemisphere	N1	r=8mm.
O	Outer dimensions	X-Y-Z	90x90X10mm

Table 3.2: Corresponding geometric features of each type of dimensional accuracy

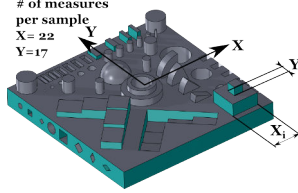
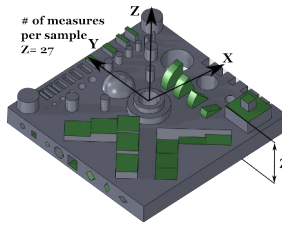
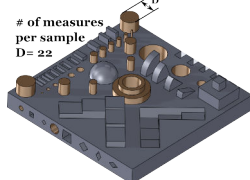
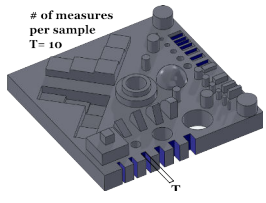
Dimensional Accuracy	Features	
<p>XY Plane</p>	<p>A1,A2 B1-B4 K1-K5 L1-L5 M2,M3,M5,M6,M8 O</p>	
<p>Z- Direction</p>	<p>A1,A2 B1-B4 E1-E4 K1-K5 L1-L5 M2,M3,M5,M6,M7 N1 O</p>	
<p>Diameters</p>	<p>C1,C2 D1-D5 G1-G4 H1-H6 I1-I3 M1,M4</p>	
<p>Thin walls</p>	<p>F1-F6 J1-J4</p>	

3.4.3 Design of Experiments

Based on the literature described in section 3.3.2, three control factors have been considered in this investigation. They are briefly defined as follows [249, 250].

- *Layer thickness*: The thickness of a layer deposited by the nozzle, which depends upon the type of nozzle used.
- *Extrusion width*: The value of the width of the filament that leaves the printer nozzle.
- *Nozzle speed*: The speed of the printer nozzle when it fabricates the object. (Speed of perimeters, small perimeters, external perimeters, infill -solid, top, bottom layers -).

Table 3.3 shows the respective levels of each factor.

Table 3.3: Control factors

Control factors	ID	Levels			Units
		1	2	3	
Layer thickness	A	0.13	0.18	0.25	mm
Raster width	B	0.54	0.62	0.71	mm
Nozzle speed	C	25	50	75	mm/s

On the other hand, fixed factors considered in this investigation are shown in table 3.4.

Table 3.4: Fixed factors

Parameters	Value	Units
Bed temperature	52	
Nozzle temperature	190	
# of perimeters	2	
Top solid layers	2	
Bottom solid layers	2	
Fill density	30	%
Material	PLA	
# of repetitions	2	
Travel speed	200	mm/s
Nozzle diameter	0.5	mm
Filament Diameter	1.75	mm
Support	Non	
Slic3r software for generation of G-code		

In a classical Design of Experiments (DOE), the study of three factors at three levels would require 27 (3^3) experiments. Using Taguchi's approach, a reliable estimation of the effect of factors can be obtained by using an *orthogonal array* with fewer experiments. The appropriate orthogonal array for this experiment is $L_9(3^4)$. This array consists of nine rows for the experiment conditions of the control factors and four columns for assigning the factors or interactions. Columns 1,2 and 4 are used for control factors A, B and C respectively. Table 3.5 shows the L_9 orthogonal array used in this investigation.

Table 3.5: Taguchi's $L_9(3^4)$ orthogonal array

# Sample	Control factors		
	A	B	C
1	1	1	1
2	1	2	2
3	1	3	3
4	2	1	3
5	2	2	1
6	2	3	2
7	3	1	2
8	3	2	3
9	3	3	1

3.4.4 Fabrication

Using Taguchi’s array proposed in the previous section, and the geometric benchmarking model developed in section 3.4.2, the open source 3D printer “FoldaRap” manufactured a total of eighteen samples. That means that two samples were fabricated for each row of the array. Figure 3.5 shows the coordinates system used by the 3D printer for manufacturing the samples. It is 45° with respect to the outer edges of the model.

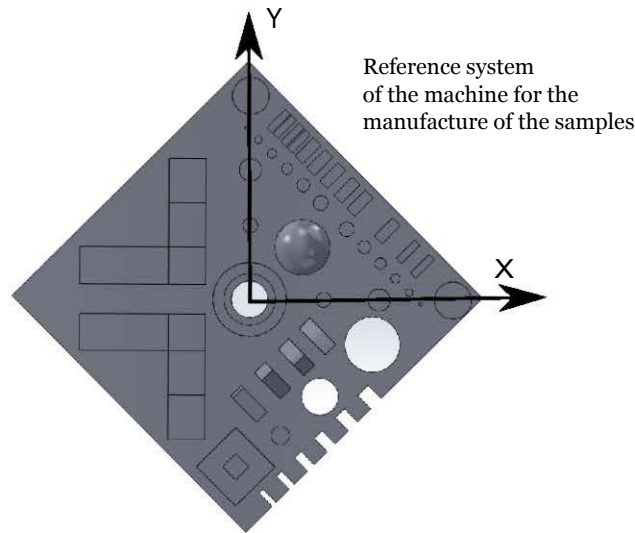

Figure 3.5: Coordinate system used in the manufacturing of the samples

The total time consumed by the machine was approximately 60 hours. Figure 3.6 shows the time for each sample.

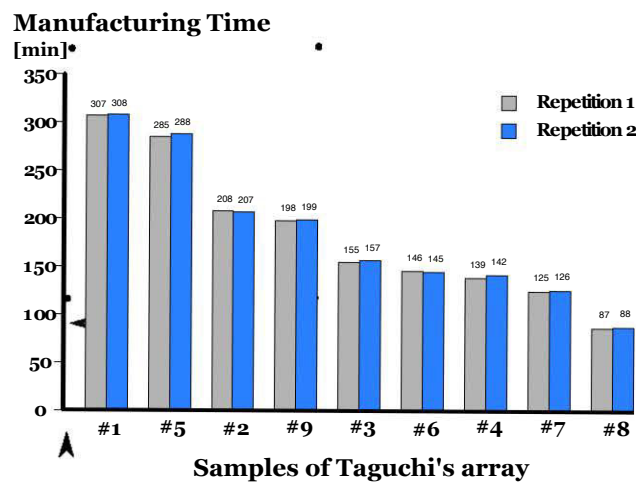

Figure 3.6: Fabrication time of the control factor sorted in descending order

The results show that control factors #1 (Layer thickness = 0.13 mm, Raster width = 0.54 mm and Nozzle speed = 25 mm/s) are the most time-consuming during fabrication. On the other hand, the control factors #8 (Layer thickness = 0.25 mm, Raster width = 0.62 mm and Nozzle speed = 75 mm/s) were systematically the fastest. However, the fabricated samples showed that the surface finish is not the same for both control factors. These parameters have a major influence on this as shown in figure 3.7:

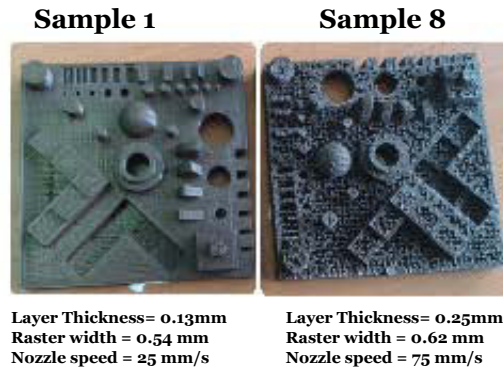

Figure 3.7: Surface finish of Sample 1 (slowest manufacturing time) and Sample 8 (fastest manufacturing time)

Based on this results, it is possible to inferred that this parameters can also play a role in the mechanical properties. This time consumption criterion is a relevant factor in a tool for selection and characterization of an open source 3D printer.

3.5 Results and Discussion

In this part, we will first present a statistical analysis of all the previous measurements. Then we will compare the dimensional accuracy obtained with our open source 3D printer and professional 3D printers.

As explained in the methodology (section 3.4.3), we considered three control factors (A, B, C) leading to the set of combinations shown in table 3.3. In order to obtain the best set of parameters regarding the geometrical accuracy, two approaches will be propose.

3.5.1 Statistical Analysis

Upon completion of the fabrication of samples, the measurements were performed using a digital Mitutoyo caliper with a measurement degree of 0.01mm. Each feature of the benchmarking model was measured twice, reducing the incertitude of the measurement. Therefore, a total of 3528 measurements were taken from the 18 samples fabricated. For each feature of the benchmarking model ($A_i - N_i$), mean percent deviation value $Y1$ for the first repetition and $Y2$ for second repetition were found using equation (3.1):

$$\% \Delta Y = \frac{|Y - Y_{CAD}|}{Y_{CAD}} 100\% \quad (3.1)$$

Figure 3.8 shows the histogram of the database. Using the classification of section 3.4.2, it is possible to establish the probability of the machine for making features that fall within a particular range of dimensional percentage change. This is achieved by using the probability density function for each type of dimensional accuracy proposed and for the total of data. In this way, it is feasible to compare each accuracy level in order to characterize the performance of the machine.

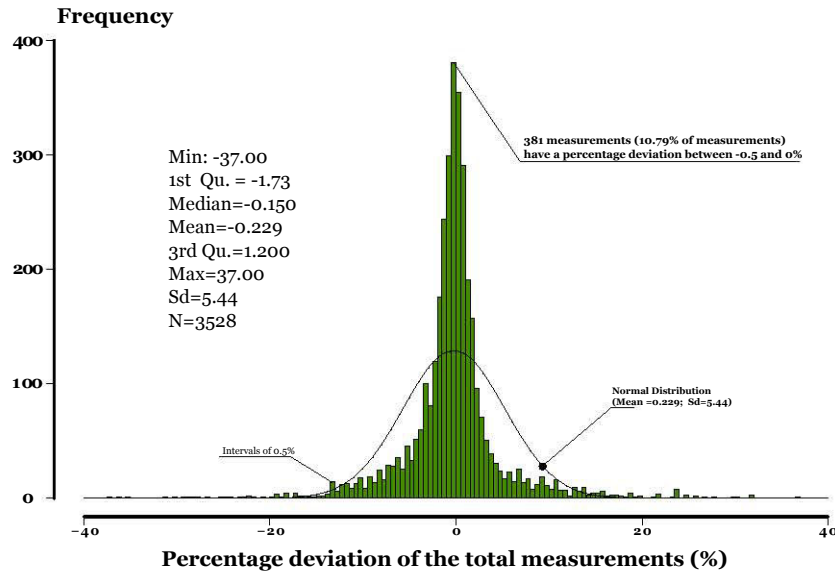

Figure 3.8: Distribution of the total of measurements of percent deviation

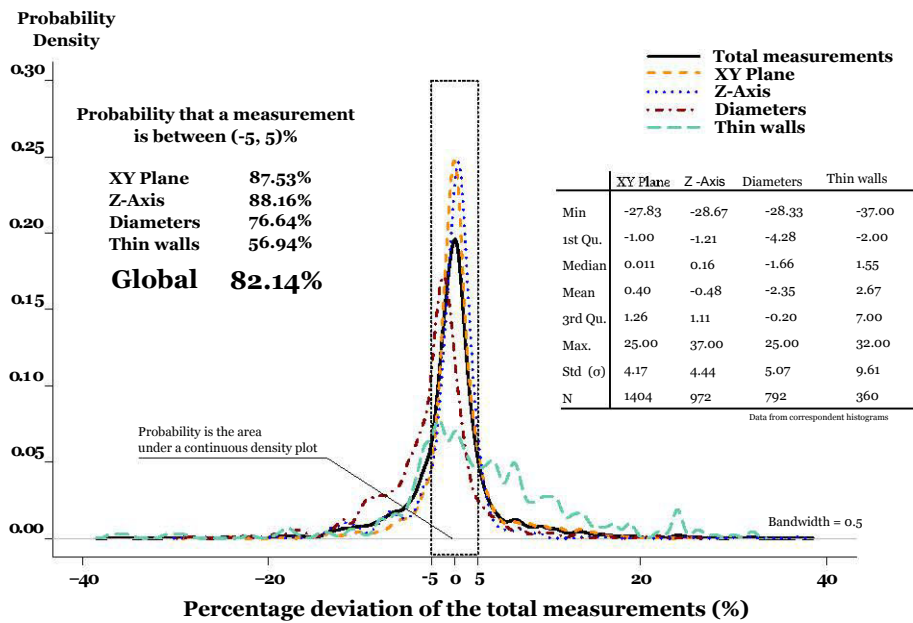

Figure 3.9: Density plot of the types of dimensional accuracy with the respective probabilities values between (-0.5%,0.5%)

In figure 3.9, the area under the curve of each type of accuracy gives the probability of the machine for manufacturing the geometric benchmarking model within a specific range of deviation. In this research, a range of (-5%, 5%) with respect to a target measurement is selected as the initial criteria. The ideal machine is one whose probability is 100 % within an infinitesimal range close to zero. In this case, the results show that the overall probability of the machine is 82.14%. Similarly, the probability to obtain a measurement in this range is 87.53% in the XY plane , 88.16% in the Z-Axis, 76.64% in Diameters and 56.94% in thin walls. It should be emphasized that each of those probabilities was obtained from a different quantity of data N. The features of the geometric benchmarking model were divided into the four types; however, this division was not equal in the number of data obtained.

3.5.2 International Tolerance for the FoldaRap

Introducing the International Tolerance (IT) grade established by ISO-ANSI standards UNI EN 20286-I (1995) based on the total set of measurements taken and the corresponding deviations, the maximum tolerance grade obtained for the samples is calculated. This value places the dimensional performance of the FoldaRap machine with respect to the performance of other AM techniques. The standard tolerance value considers a tolerance factor “ i ” (μm) indicated by equation (3.2):

$$i = 0.45 \sqrt[3]{D} + 0.001D \tag{3.2}$$

Where D is the geometric mean of the range of nominal size in mm. In this case, the standard tolerance value is calculated for a range of nominal size. For a generic nominal dimension D_{CAD} , the number of tolerance unit n is evaluated as follows [251].

$$n * i = 1000(D_{CAD} - D_{mea}) \tag{3.3}$$

Where D_{mea} is the measured dimension. Using equation (3.3), the maximum value ni among the set of measures obtained from the fabrication of the 18 samples is yielded. On a global scale, this value makes it possible to compare the performance of the open source machine 3D printer with the other AM technologies. Figure 3.10 positions the results of the FoldaRap’s case with regard to the work developed by Ippolito, Iuliano, and Gatto [232].

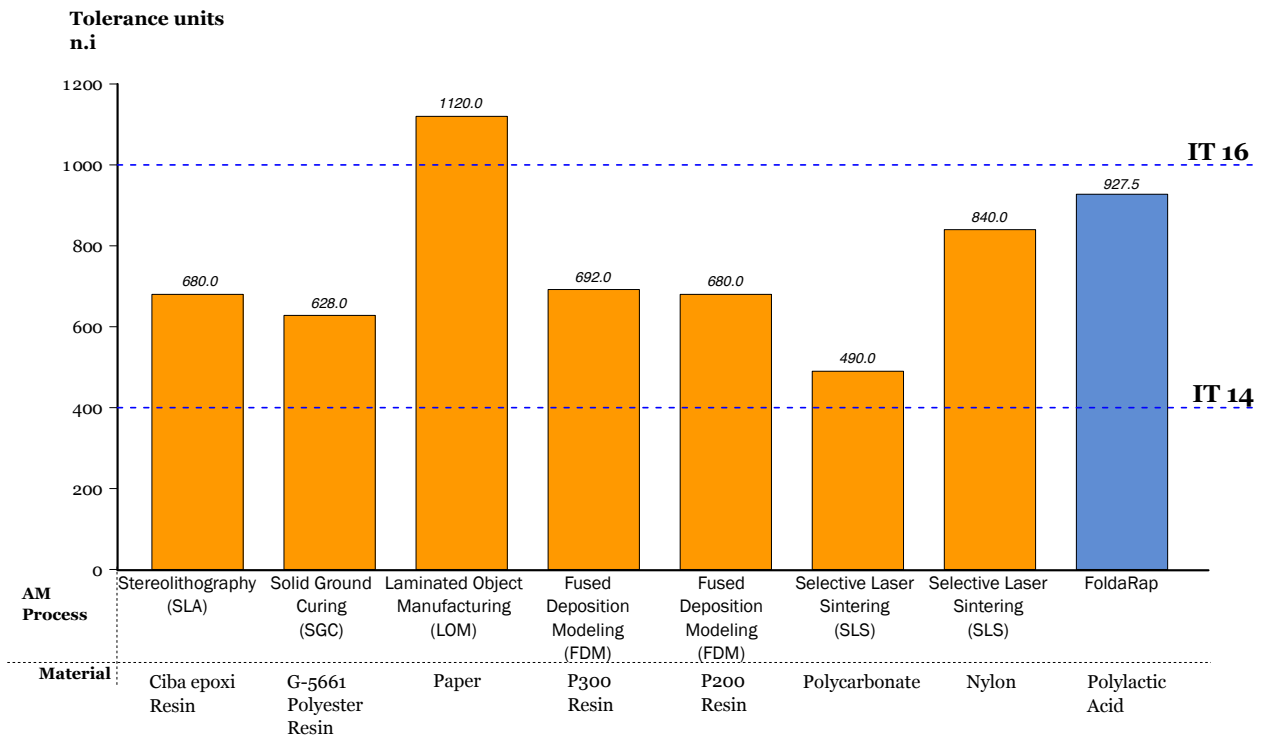

Figure 3.10: Comparison of the maximum tolerance grade among different AM processes

Table 3.6 shows the comparison of IT grades for conventional manufacturing processes, including the AM techniques [251].

We can see through figure 3.10 that, though the precision level of the FoldaRap machine is lower with respect to the different commercial AM techniques, the performance of the machine is within the range of standard tolerance grades (IT14 - IT16). This means that the tolerance of machine is from $IT14 = 400i[\mu m]$ and $IT16 = 1000i[\mu m]$, where i is calculated based on equation (3.2).

Table 3.6: Tolerance grades for various manufacturing processes

Process	IT GRADES										
	6	7	8	9	10	11	12	13	14	15	16
Sand Casting											
Die Casting											
Hot Forging											
Material Removal Processes											
RP Techniques											

3.5.3 Optimal control factors for the GBM

a). Using the DOE approach to select the most relevant control factors

Quantifying the effect of the control factors identified in section 3.4.3 with the DoE method, should help to reduce the number of measurements required to evaluate the performance of the 3D printers. The nine experiments listed in the Taguchi table $L_9(3^4)$ gave the following results concerning the mean percent deviation value $\Delta\bar{Y}_1$ for the first repetition and $\Delta\bar{Y}_2$ for the second repetition.

Table 3.7: Mean value of percent deviation

# Sample	Factors			Reponse	
	A	B	C	$\Delta\bar{Y}_1$	$\Delta\bar{Y}_2$
1	1	1	1	3.307	2.113
2	1	2	2	2.398	2.752
3	1	3	3	2.678	4.213
4	2	1	3	2.476	3.053
5	2	2	1	2.328	3.202
6	2	3	2	2.308	3.178
7	3	1	2	2.498	2.930
8	3	2	3	5.227	5.901
9	3	3	1	2.935	3.299

Calculating the mean effect of the control factors gives the following results shown in figure 3.11

Table 3.8: Mean effect of the control factors

Control factors	Level	Mean value	Effect
Layer Thickness (mm)	1	2.91	-0.25
	2	2.76	-0.40
	3	3.80	0.64
Raster width (mm)	1	2.73	-0.43
	2	3.63	0.48
	3	3.10	-0.05
Nozzle speed (mm/s)	1	2.86	-0.29
	2	2.68	-0.48
	3	3.92	0.77

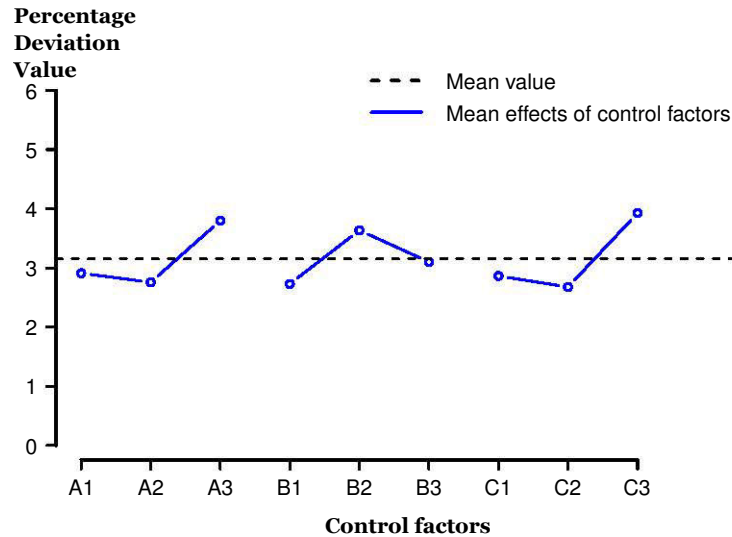

Figure 3.11: Variation of the percent deviation value depending on the control factors

At first glance, there is no overriding effect of control factors and it does not seem possible to reduce the model of the accuracy of the 3D printers. In order to provide a correct interpretation of the effect of factors, an ANOVA analysis is necessary. This provides significance rating of the relative influence of each factor analyzed in this study. Factors which significantly influence the percent deviation of the model can be identified. A variable possessing the maximum value of variance is said to have the most significant effect on the experiment. Therefore, based on the responses of the means percentage deviation values $\Delta Y1$ and $\Delta Y2$ showed in Table 3.7, the ANOVA computations were carried out.

Table 3.9: ANOVA analysis

Factors	DOF	SS	V	F value	Pr(>F)	Contribution	
Y1	Layer thickness [mm]	2	3.791	1.895	3.629	0.061	21.7%
	Raster width [mm]	2	2.483	1.241	2.377	0.138	14.2%
	Nozzle speed [mm/s]	2	5.430	2.715	5.198	0.025	31.1%
	Residuals	11	5.746	0.522			32.9%
	Total	17	17.450				

ANOVA results (Table 3.9) show that the only significant control factor is the Nozzle speed, but more importantly, that there are unusually large residuals (contribution: 32.9%). This confirms that the noise produced by this type of machine has more impact than the effect of the control factors. Elements of noise that can affect the experimentation are shown in fig 3.12.

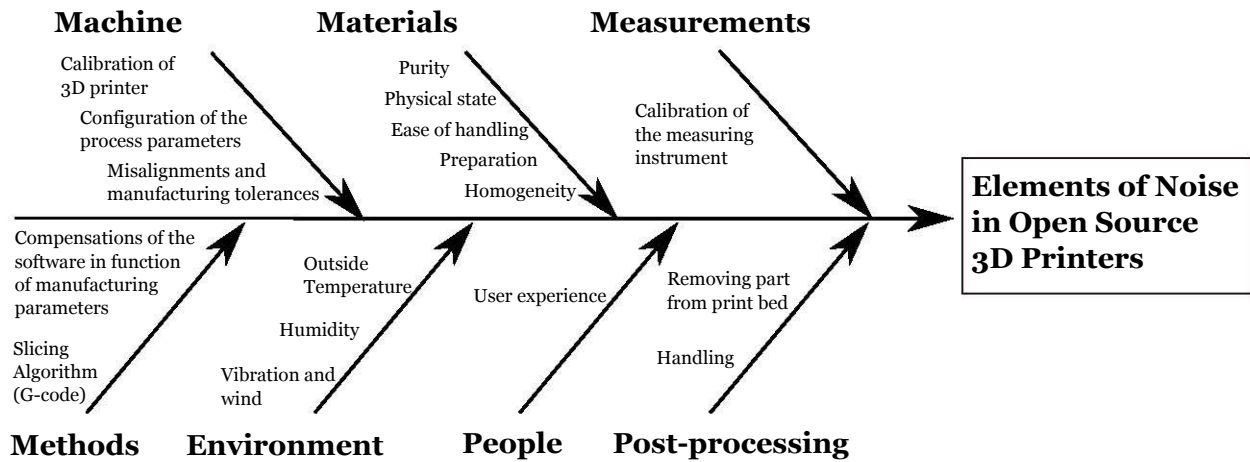

Figure 3.12: Ishikawa diagram of the factors that could affect in the open source 3D printers

The DoE approach is therefore not relevant for machines with this precision level. Consequently, another methodology to obtain the best combination of control factors for fabrication of the GBM is proposed.

b). Proposed method

The objective is to rank the control factors according to Taguchi’s array proposed in section 3.4.3, in order to find within the nine combinations those control factors with the highest accuracy. As an estimator parameter, the root-mean-square deviation (RMSD) is used. This was calculated as follows:

$$RMSD_i = \sqrt{\left(\sum_{i=1}^m \frac{x_i - \bar{x}}{m}\right)^2 + \left(\frac{\sum_{i=1}^m x_i}{m} - Y_{CAD}\right)^2} \tag{3.4}$$

Where the first term is the variance (σ^2) of the measurements obtained and the second term is the deviation of the mean value \bar{Y} with respect to the target value (Y_{CAD}). The m value is the quantity of measurements taken for each feature. If the RMSD value of a feature is zero, this would mean that every measurement taken is always the same ($\sigma^2 = 0$) and this measurement is always equal to the corresponding CAD model measurement ($\bar{x} = 0$), thus, the lower the RMSD value, the more accurate the feature. Using this approach, the RMSD value of each feature gives an estimation of the machine’s performance when it uses a control factor of the Taguchi array. In that way, this RMSD measurement makes it possible to rank, from best to worst, every control factor for every feature of each manufactured sample.

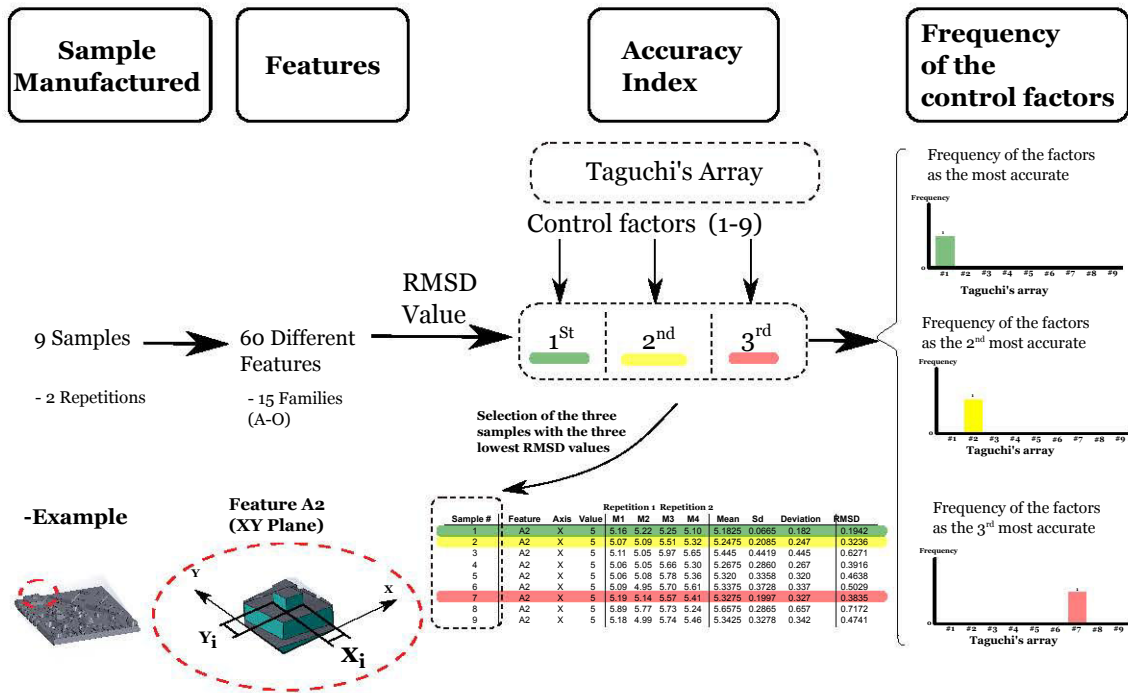

Figure 3.13: Methodology of selection of the three best control factors

It is intended to collect in a database the three control factors with the minimum value of RMSD for each feature. Figure 3.13 schematically shows the proposed strategy. The interest of this strategy is to obtain the frequency of every control factor when they are selected as the *most accurate*, the *second most accurate* and the *third most accurate*.

Using this frequency, we can establish a link between the performance of the 3D printer in terms of dimensional precision and the process parameters of the process. Figure 3.14 shows the histograms of the control factors for each type of frequency.

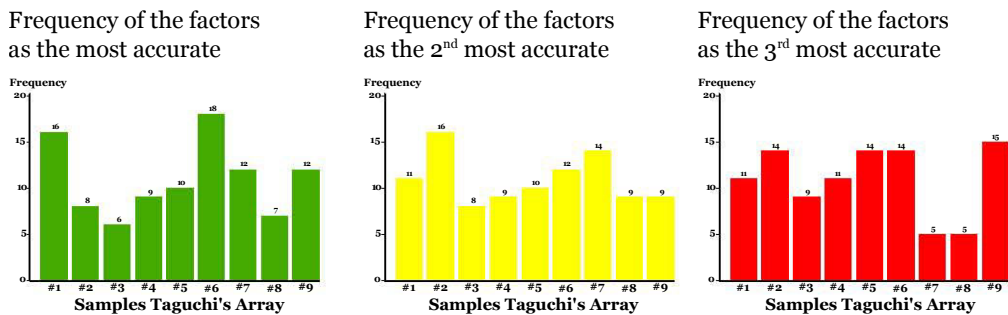

Figure 3.14: Frequencies of the control factors

Through the use of these frequencies, the purpose is to determine a hierarchy of the control factors in order to find out which of them has systematically been the most accurate throughout the set of measurements of the benchmarking model. As a result, a *Global Index* of performance is established with three relative weights w_i for pondering the significance of each type of frequency, giving more importance to a set of frequencies of the factors qualified as the most accurate.

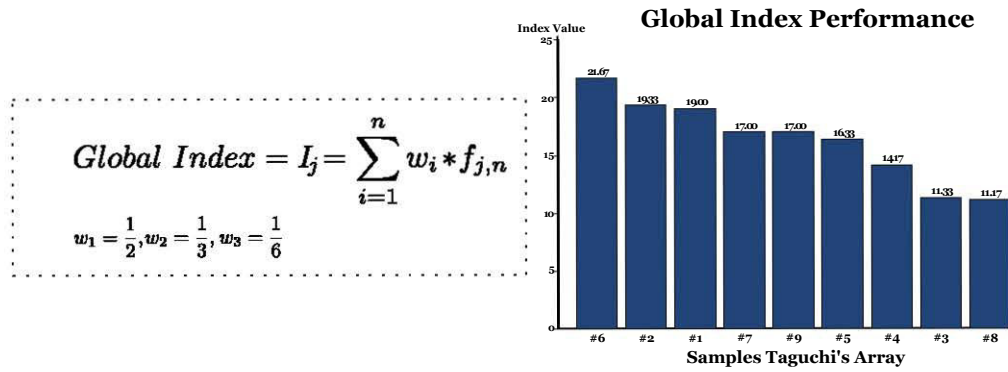

Figure 3.15: Performance index of each control factor tested according to Taguchi's array

Figure 3.15 shows the results of this approach. Taguchi's control parameters #6 (Layer thickness = 0.18mm, Raster width = 0.71mm and Nozzle speed movement = 50 mm/s) were identified as the best parameters within the total of parameters established through the use of Taguchi array.

3.5.4 Discussion

The first comment can be made with regard to build time needed for the 18 samples. In fact, it has taken nearly 60 hours to print all the samples. In order to reduce this time, it will be interesting to simplify the GBM. In figure 3.16, the RSMD value is calculated for every feature (A-O) of each sample table 3.1. In this figure, dimensional accuracy in the XY plane and the Z-Axis for the lateral features are those having the lowest geometrical performance. Further experimentation is then needed in order to determinate whether this weakness is specific to the FoldaRap 3D printer or if it could be generalized to the cartesian family of printers.

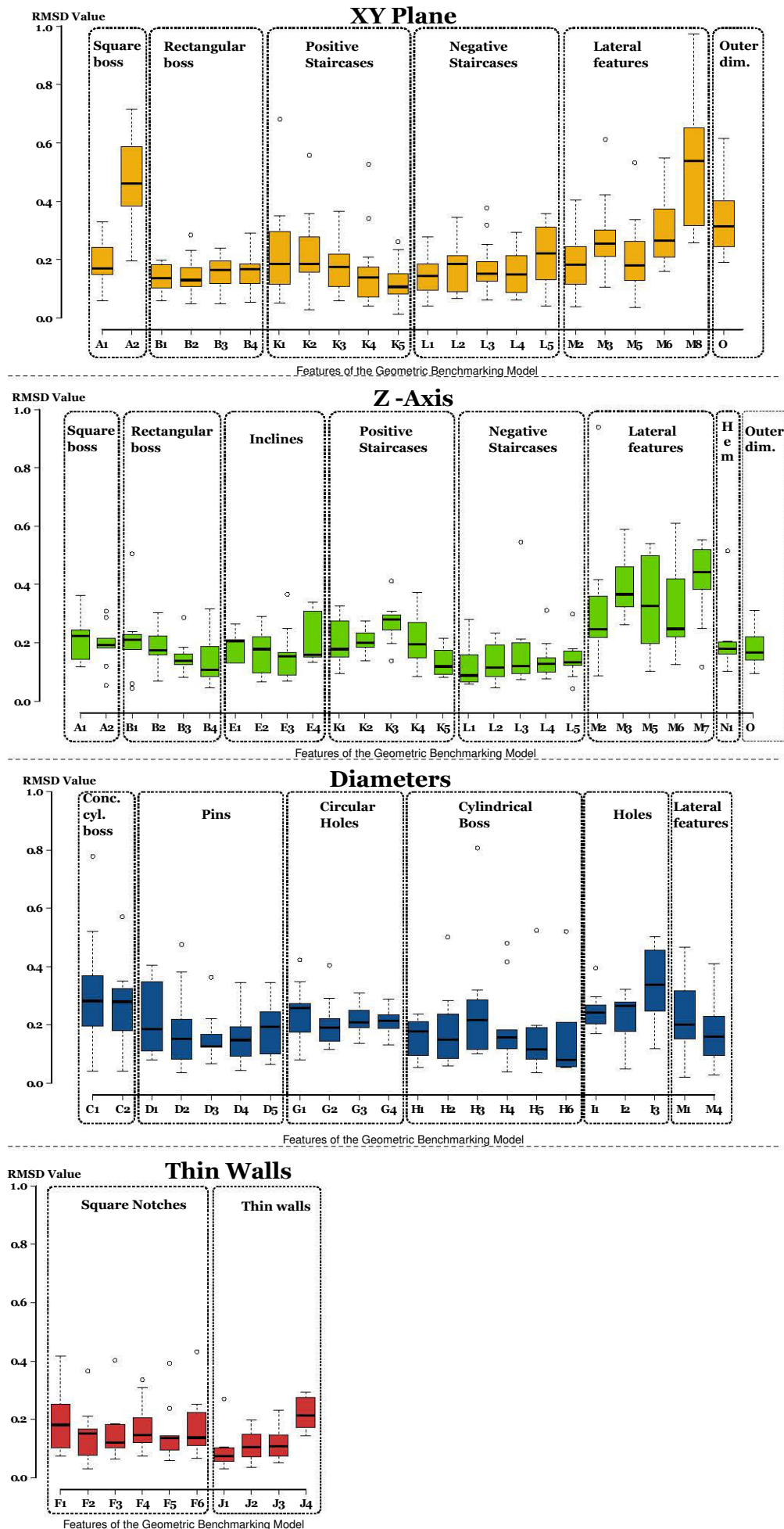

Figure 3.16: Variation of the RSMD value of each feature of the GBM according to the four types of accuracy

3.6 Conclusion

In the present chapter, an experimental protocol to evaluate open source 3D printers regarding dimensional accuracy has been proposed. We use the proposed protocol on a representative 3D printer: the FoldaRap. It was found that the International Standard Tolerance Grade of this machine is situated between IT14 and IT16.

On the other hand, the process parameters that give the highest accuracy for the fabrication of the geometric benchmarking model have been obtained using the Taguchi approach coupled with the root-mean-square deviation (RMSD) value as an accuracy estimator. The results of this approach showed that the following parameters: Layer thickness = 0.18mm , Raster width = 0.71mm and Nozzle speed movement = 50 mm/s have been systematically present with a low RMSD value in the fabrication of the 18 samples of the geometrical benchmarking model. Nevertheless, results regarding deviation of the features used suggest that the proposed protocol could be optimized in order to reduce the overall experimental time (60 hours).

On the base of these results, we can assure that the open-source 3D printer is reproducible tool for manufacturing. Moreover, we found the influence of key parameters in the quality of printing (dimensional but also we can inferred mechanical properties). This conclusion allow us to consider this 3D printer as a part of overall process to study of the recycled material degradation. The goal being to determine the operational conditions and parameters, that will enable Fablab spaces to become recycling hubs.

Systematic methodology for recycling in OS AM

Contents

4.1	Introduction	79
4.2	Polymer recycling background	79
4.3	Methodology to evaluate 3D printing polymer recycling	84
4.3.1	Step 1 “Material definition”	87
4.3.2	Step 2 “Process assignment”	87
4.3.3	Step 3 “Fabrication of samples”	87
4.3.4	Step 4 “Evaluation ”	88
4.3.5	Step 5 “Recycling”	88
4.4	Application case: Recycling PLA for open-source 3D printers	88
4.4.1	Step 1- Material Definition: PLA	88
4.4.2	Step 2- Processes assignment	90
	Step 2.1) Reference process: Mechanical Recycling	90
	Step 2.2) 3D Printing Feedstock Process: Extrusion	92
	I. Feeding system	93
	II. Extrusion Process	94
	III. Conveyor system	95
4.4.3	Step 3- Fabrication of samples	96
	Step 3.1) Standard: Micro-compounding extrusion and injection molding	96
	Step 3.2) Fabrication using 3D Printing process: Fused Filament Fabrication (FFF)	97
4.4.4	Step 4- Evaluation: Mechanical properties	99
	Procedure for mechanical testing	102
4.4.5	Step 5- Recycling process: Plastic shredding	105
4.4.6	Experimental strategy	106
4.5	Conclusion	107

4.1 Introduction

In the chapter 3, we characterized the performance of a representative OS 3D printer. The obtained results allow us to confirm the relevance of these devices as a manufacturing tool. From this point, we can focus our attention to the material recycling issues. And specifically, we will focus on the polymer recycling process and the importance of a systematic protocol development for assessing the feasibility of the recycled material to be used by OS 3D printers.

Nowadays, the low recycling rate of polymers is still a humankind challenge due to energy, economic and logistic issues. In the additive manufacturing context, there is an exponential use of thermoplastic materials in the industrial and public open source 3D printing sector, leading to an increase of the global polymer consumption and waste generation. However, the coupling of open-source 3D printers and polymer processing could potentially offer the bases of a new paradigm of distributed recycling of polymers as it reverses the traditional paradigm of centralized recycling of polymers which is often uneconomic and energy intensive due to transportation embodied energy. In order to achieve this goal, a first step is to prove the recycling feasibility of the materials to be used.

The contribution of this chapter is to propose a general methodology to evaluate the recyclability of polymers used as feedstock of 3D printing machines. The proposed methodology is applied to the recycling study of the PLA in order to understand the evolution of the mechanical properties using fused filament fabrication (FFF).

The reminder of the chapter is organized as follows: in section 4.2, we present a polymer background explaining the main concepts concerning the quality assessment of polymer recycled materials. Next in section 4.3, the proposed methodology to evaluate the feasibility of a thermoplastic polymer recycling is presented in order to contribute to the understanding of the influence of the material physico-chemical degradation on its mechanical properties and then, on its potential distributed recyclability. Finally, section 4.4 shows in a detailed manner the application of the methodology to the case of PLA. Then, the main results of this case study are presented in the chapter 5.

4.2 Polymer recycling background

The development of polymer materials has allowed the manufacture of a wide range of low-cost, low weight, high performance products and it has become a core part of technological and societal development [28]. However, one of the main issues is the environmental impact of plastic residues due to their longevity which can reach several decades (if not millennia) [29]. The plastic industry is almost completely dependent of fossil oil and gas, using about 4% of worldwide oil production which is translated in approx. 299 million metric tonnes per annum in the year 2012 [69, 217].

In the industrial ecology for polymers, different strategies have been studied for plastic waste management, ranging from reuse and recycling (Mechanical, Chemical, Feedstock) until thermolysis/recovery processes as illustrated by figure 4.1 [29–31]. They can be defined as follows [31, 252]:

Reuse: It covers a range of nondestructive activities that finds a second or further use for end-of-first-life solid materials [253]. For example, a number of detergent manufacturers market refill sachets for bottled washing liquids and fabric softeners. However, reuse is not widely practiced in relation to plastic packaging, and in general, plastic products tend to be discarded after first use [45].

Mechanical recycling It is the process in which discarded plastic is used in the manufacturing of plastic products via mechanical means, using recyclates, fillers and/or virgin polymers [29, 31–33]. This process include phases such as the separation of polymer types, decontamination, size reduction, remelting and extrusion into pellets [254].

Chemical recycling: Chemical recycling is a term used to refer to advanced technology processes which convert plastic materials into smaller molecules, usually liquids or gases, which are suitable for use as a feedstock for the production of new petrochemicals and plastics [31].

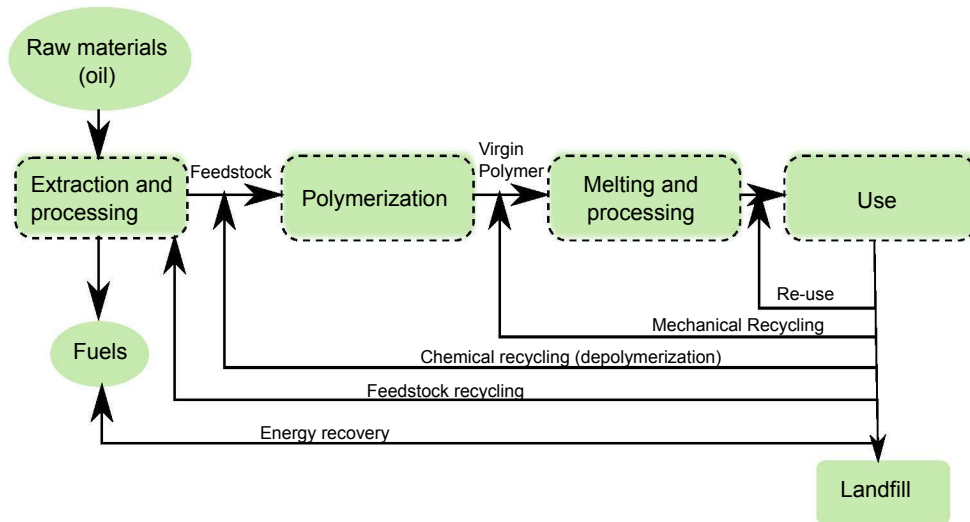

Figure 4.1: Recycling strategies in industrial ecology for polymeric materials. Adapted from [30, 33]

Feedstock recycling: The category refers to the recycling technologies that breaks down the solid polymeric materials into a spectrum of basic chemical components. These processes involve the use of high temperatures to cleave the bonds in the backbone of the polymer; they can be carried out in the absence of air (pyrolysis), in the presence of a high partial pressure of hydrogen (hydrocracking), or of a controlled amount of oxygen (gasification) [33].

The main advantage of feedstock (and chemical) recycling is the possibility of treating heterogeneous and contaminated polymers with limited use of pre-treatment [31].

Energy recovery: This category encompasses the combustion processes in order to recover the energy value of products after their useful life. They are used if wasted material cannot be mechanically recycled because of excessive contamination, separation difficulties, or polymer property deterioration [33]. Modern energy recovery facilities burn solid wastes in special combustion chambers, and use the resulting heat energy to generate steam and electricity [255].

Landfilling: It is the conventional approach to waste management where disposal are discarded in an open area. A major drawback to landfills from a sustainability aspect is that none of the material resources used to produce the plastic is recovered—the material flow is linear rather than cyclic [29].

From the energy and environmental perspective, the research works of Perugini, Mastellone, and Arena [33], Arena, Mastellone, and Perugini [256], and Piemonte [257] have highlighted that mechanical recycling process has been identified as the most suitable recovery route for relatively clean and homogeneous plastic and bioplastic waste streams with respect to landfilling or incineration options. In particular, they showed the suitability of mechanical recycling which entails the production through physical means of new plastic products from plastic waste. However, the difficulties of this process are mainly related to the degradation of recyclable materials, heterogeneity of plastic wastes and the related logistics to the process [31]. Indeed, in U.S. only 6.5% of the used plastics are recycled in conventional centralized recycling process [70]. In Europe, only 26% (equivalent to 6.6 million tonnes in 2012) of post-consumer plastic wastes were recycled [69, 217]. The low recycling rates could be explained by factors such as the price variation of the recycled material (due to uncertainty of petroleum supply and the cost associated), the lower mechanical properties of the recycled polymer compared with virgin polymer, the associated cost of recycling process (collection, sorting and transportation). In fact, one of the main drawbacks is that there is no net economical benefit from recycling plastic materials [258]. Moreover, the limited scientific knowledge about the influence of recycling processes on the composition, structure, and properties of polymeric materials makes difficult for an industrial segment of polymer recycling, to compete with the manufacturers of virgin polymers. Indeed, the quality proper-

ties of the virgin synthesized materials can be assessed reliably and it is possible to define the suitability for specific applications. This is not the case for recycled material [29, 36]. These general bottlenecks restrict the effective implementation of recycling activities.

We will focus on the mechanical recycling process taking into account that the other recycling processes (chemical, feedstock, recovery) are not in the same order of magnitude that we are exploring. One important element to consider in mechanical recycling process is the heterogeneity and compatibility issues of the polymers. The more complex and contaminated the waste is, the more difficult to perform the process is.

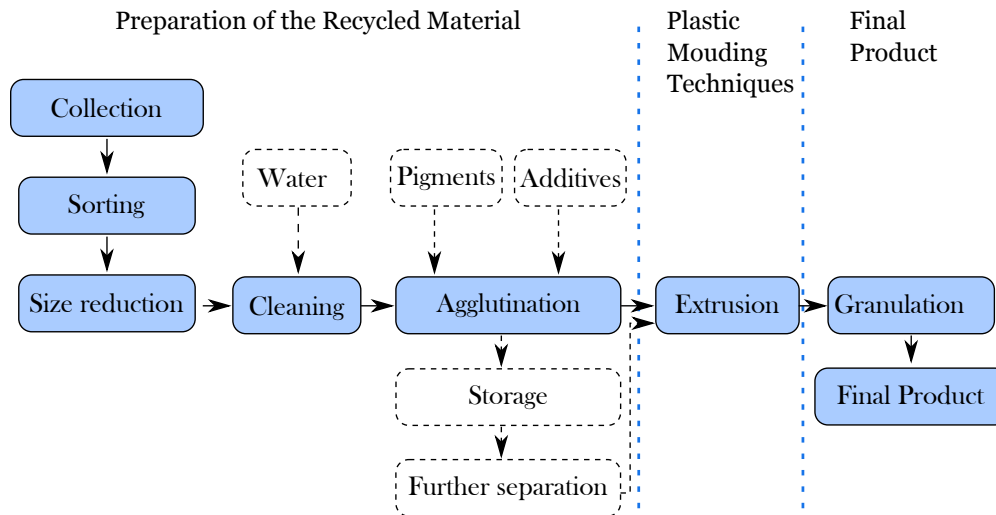
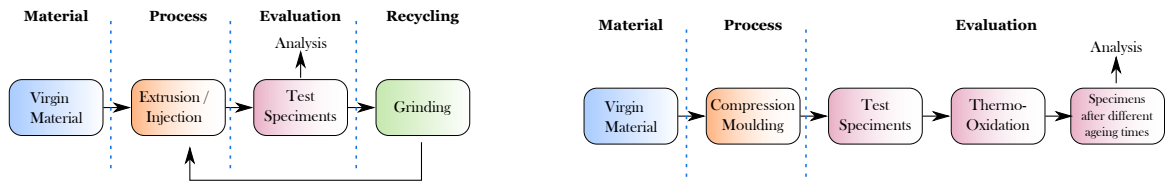

Figure 4.2: Mechanical recycling steps (Adapted from [31, 259])

Figure 4.2 provides the usual steps involved in the mechanical recycling process [29, 259]. Three general phases have to be considered. In the first phase “Preparation of the recycled material” the material is conditioned through different steps to prepare it for the extrusion process. Being a costly and energy intense process, mechanical recyclers try to reduce these steps and working hours as much as possible [31]. Once the material is prepared, a plastic molding technique (e.g. extrusion, injection...) is used in order to prepare a final product. The final product could be a product made of virgin/recycled compounding or a type of recycled pellet that could be used in other manufacturing process [260].

In the scientific literature, the modeling of the life cycle of recycled products is an usual approach to investigate the mechanisms and effects of the degradation processes to which recycled products are exposed. Polymeric materials are exposed to *thermo-mechanical* and *thermo-oxidative* degradation [36]. Thermo-mechanical degradation occurs in its processing where high shear forces and high temperatures can cause chain scission and chemical reactions. On the other hand, thermo-oxidative degradation can produce physical and chemical changes in the polymeric structure due to exposure of specific environmental conditions during service life. Thermo-mechanical and thermo-oxidative degradations are responsible for changes in structural and morphological characteristics of the polymers such as mechanical-rheological-thermal properties, degree of crystallinity, viscosity, and molecular composition [36]. This information can be used as quality assessment of the recycled material, and also, it can also provide important inputs about the control of the processing conditions/parameters during recycling process. The methodological approaches to investigate the thermo-mechanical and thermo-oxidative degradation are illustrated in the 4.3:



(a) Multiple processing approach for evaluate thermo-mechanical degradation.

(b) Methodology for thermo-oxidation degradation.

Figure 4.3: Modelling the Life Cycle of Recycled Polymers. Adapted from [36].

The procedures for modeling the life cycle of recycled plastics can be decomposed the four phases *material*, *process*, *evaluation* and *recycling* (for multiple processing). For both cases, *material* is the initial step which has as main goal to characterize the initial condition of the polymer. Figure 4.3a presents the methodology of multiple processing in order to analyze the structural and morphological changes induced by consecutive processing steps. In this sense, multiple extrusion or injection molding process is a well-tried approach to assess the recyclability of polymeric materials in order to simulate the extended life cycle. The main aim of this approach is to have information about the progressive material degradation due to the *process* phase. In this way, it is possible to optimize the processing conditions during mechanical recycling in order to avoid further degradation. For example, the choice of temperatures range and/or further addition of stabilizers and other additives are possible options. On the other hand, figure 4.3b plots the approach for modelling the service life trough different accelerated ageing tests. The goal of this test is to mimic accurately the environmental conditions to which polymer materials are exposed during the life service (humidity, temperature, air, chemical environment -e.g. radiation, biological and microbial attack, pH or salt content-) [36]. Parameters such as temperature, time and type of environment are carefully select to model real conditions. In conclusion, these two strategies allow study the degradation processes undergone by synthetic polymers during their first use and subsequent mechanical recycling processing. Recent approaches have tried to combine reprocessing and accelerated ageing to obtain an overall picture of the extent of the degradation processes that affect the polymers during the entire life cycle [36].

On the other hand, it is necessary to define the quality characteristics which are assessed in the phase *evaluation* in the model presented in figure 4.3. These quality characteristics have to consider the macro/microscopic properties in order to fulfill the requirements of manufacturers and consumers, and to guarantee the performance of recycled products in second-market applications [35]. Traditionally in the plastic industry (plastic producer or processor), the melt flow index (MFI) is one property that is needed in order to evaluate whether the same process can be used irrespective of whether it uses virgin or recycled polymers. This will indicates if it is possible to process the recycled polymeric materials in the same set-up as usual. However, several additional properties are needed in order to have a holistic assessment of the material degradation. Karlsson [35] and Vilaplana and Karlsson [36] developed a conceptual framework in order to evaluate the quality assessment of recycled plastics, as detailed in figure 4.4 in three main axes:

They can be defined as follows:

Degree of degradation (DD): it determines the evolution of polymer degradation at macro-microscopic scale due to the processing and service life.

Degree of Mixing (DM): it is related to the presence of polymeric impurities as a consequence of impure plastic waste streams and poor separation in recycling plant.

Low molecular weight compounds (LMWC): it is related to the presence of additives, contaminants and degradation products in the polymer structure. These element are important in order to fulfill legislation requirements.

For each axis, there are numerous analytical strategies and characterization tests in order to appropriately evaluate the degradation of the material. For example, in the category of *degree of degradation*

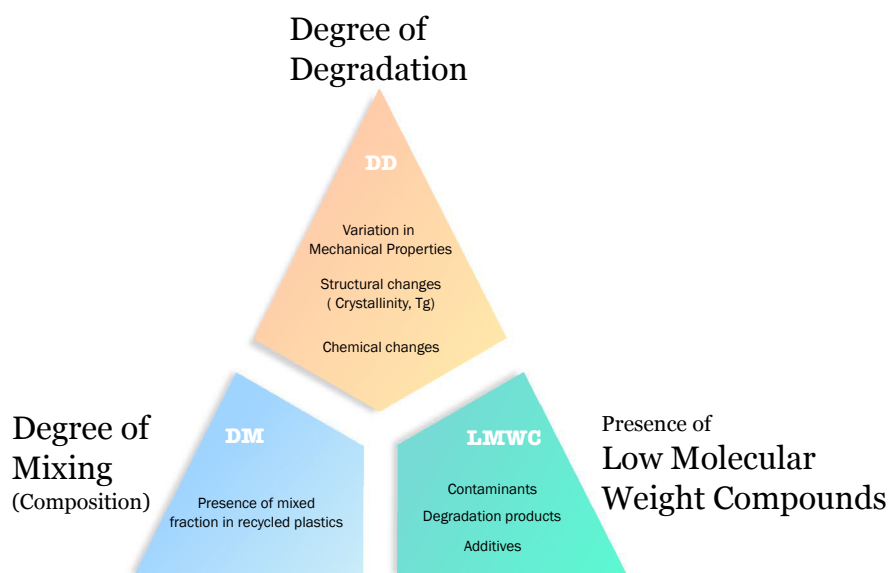

Figure 4.4: Key properties for quality assessment of recycled plastics. Adapted from [35, 36]

(*DD*), the mechanical properties (tensile, compression, flexural strength) are one of the most common measurement of the material quality. Concerning *degree of mixing (DM)*, thermal analysis techniques, and in particular differential scanning calorimetry (DSC), are becoming routine analyses for the characterization of polymer composition. And for *Low molecular weight compounds (LMWC)*, chromatographic techniques such as gas chromatography (GC) and high-performance liquid chromatography (HPLC) are widely employed for the determination of low molecular weight compounds. Using different detectors such as mass spectrometry (MS), diode-array detector (DAD), and flame ionisation detector (FID), it is possible the identification and quantification of these analytes. Badia and Ribes-Greus [37] present a complete multi-level characterization of recycled polymers as evident in the figure 4.5. A multi-level scheme in which the different stages of assessment of mechanical recycling performed in lab-scale facilities are represented, along with the analytical techniques commonly used to test the performance and/or degradation state of the resulting material. Finally, it depends on the investigator to select the property (or properties) that will be analyzed during the mechanical recycling process. Therefore, the adequate experimental protocols is implemented.

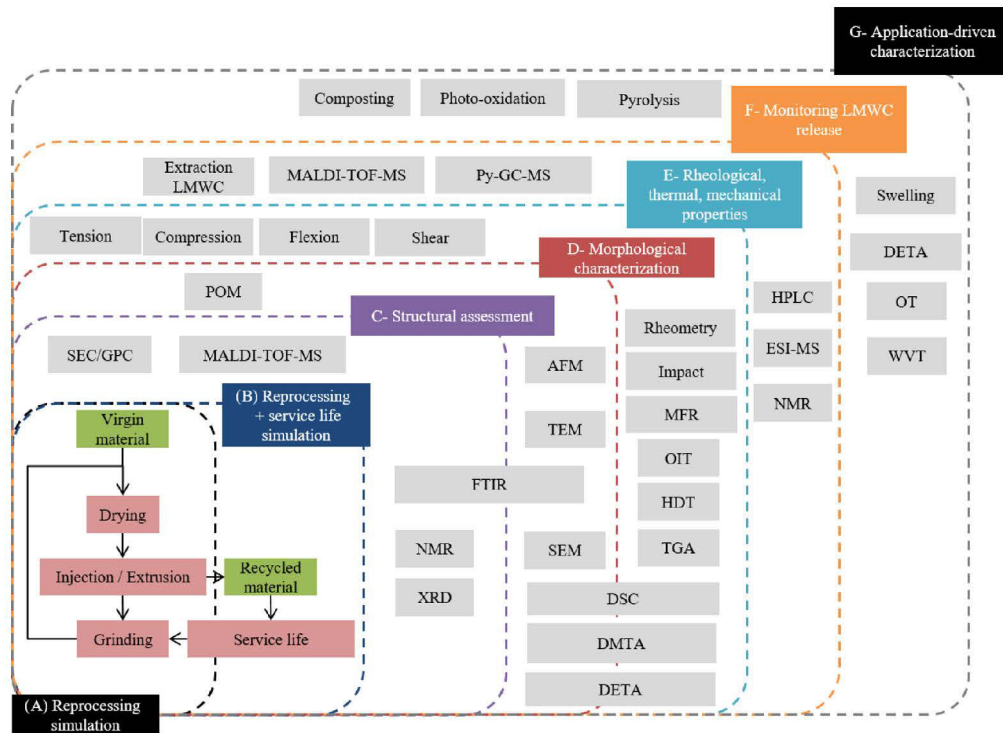

Figure 4.5: Key properties for quality assessment of recycled plastics. Source [37]

4.3 Methodology to evaluate 3D printing polymer recycling

In recent years, several types of polymer materials have been used in the additive manufacturing (AM) sector in order to produce plastic prototypes [57]. Projects such as **RepRap** (or **Replicating Rapid-prototyper**) and **Fab@Home** are *Molten Material* AM systems, which use a fused-filament fabrication (FFF) approach in order to make engineering components and other products from a variety of thermoplastic polymers. Thanks to the democratization of these projects, the fabrication of complex and high-value products has become accessible for everyone [15, 16]. Moreover, the affordable costs of 3D printers can positively impact communities like Fablabs, university laboratories or schools, and open new dimensions to science education that can make a marked impact in developing countries [17].

Recently, the adaptation of open-source (OS) 3D printers with domestic waste plastic extruders has been explored as a new prospective approach to polymer recycling in order to prepare 3D printer feedstock material. The major interest of this approach is the reduction of cost and greenhouse gas emissions related to waste collection and transportation as well as the environmental impact of manufacturing custom plastic parts. This distributed polymer recycling approach could be an additional alternative to the conventional centralized polymer recycling [22–26]. Taking into account the significant growing adoption of open-source (OS) 3D printing, distributed polymer recycling approach could be highly relevant as current recycling rates are particularly low. Currently, numerous open-source plastic extruders and projects for transforming post-consumer plastic into feedstock for 3D printers have been proposed: Lyman Filament Extruder [212], the Filabot [213], Recyclebot [22], RepRap Recycle Add-on [214], Precious plastic [21], Plastic Bank ¹, Precious plastic ² [21]. Polylactic Acid (PLA) and Acrylonitrile-Butadiene-Styrene (ABS) filaments, ranging from 1.75 to 3 mm of diameter, are the two most common polymers in the open-source (OS) 3D printing context.

From an economical point of view, commercial filament costs are in the range between \$18.86 and \$175.20 per kg, which is 20 to 200 times above the cost of raw plastic. Kreiger et al. [23] and Wittbrodt et al. [27] proved the economic feasibility for a distributed model with local plastic material recycling

¹<http://plasticbank.org/>

²<http://preciousplastic.com/>

(recycled filament) for OS 3D printers in which 1 kg of recycled filament was fabricated from about 20 milk jugs for under 10 US cents using the prototype of open-source plastic extruder called “Recyclebot”. In terms of energy, Baechler, DeVuono, and Pearce [22] and Kreiger and Pearce [25] have shown a proof of concept for recycling of high-value polymer waste where savings were between 69% and 82% embodied energy for distributed recycling over a centralized recycling approach. Therefore, there is an interest in recycling polymeric materials for a 3D printing open-source context.

Therefore, a first step to study is the physical characterization at the micro and macro level of the recycled material in order to assure new potential uses. Moreover, the physical characterization is a key element to understand in order to prove the viability of distributed recycling process. The main goal here is to present a generic method to evaluate the opportunity, interest and processes to recycle thermoplastic polymers in order to use them as feedstock for open source 3D printers. Different aspects have to be studied in order to quantify the degradation of the physical properties of the recycled plastic through 3D printing process chain. Considering the complexity of the global process (figure 4.6), within the framework of the present thesis, the first phase of the recycling process “Preparation of the Recycled Material” will not be considered. As a second assumption, we consider virgin materials as fully recycled.

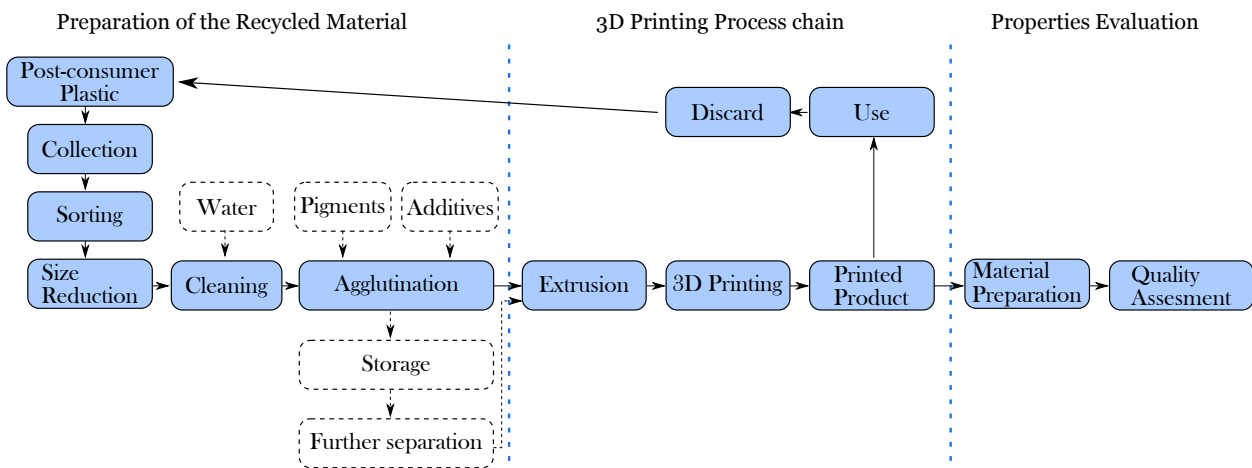

Figure 4.6: Recycling process for 3D printing adapted from [259]

The proposed methodology is shown in (figure 4.7). It has been structured in five main steps that will be described as follows:

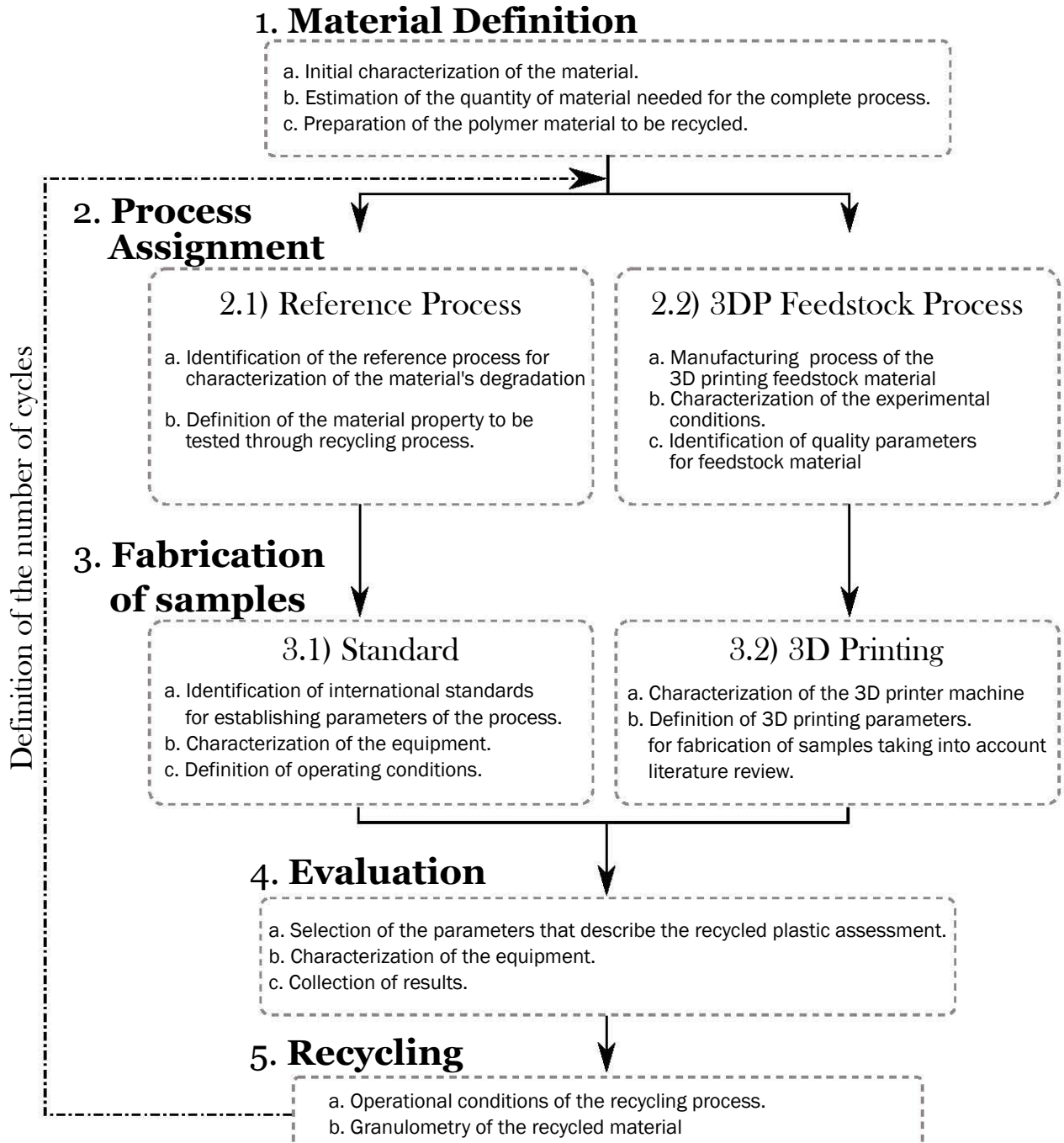

Figure 4.7: Proposed methodology for measuring the degradation of plastic in the chain of 3D Printing

4.3.1 Step 1 “Material definition”

The main purpose of this step, called “*Material Definition*” (figure 4.7), is to characterize the material to study. The polymer characteristics given by the supplier have to be taken into account for initial establishment of the operating parameters for processing. Also, the material quantity needed for the overall experimentation has to be estimated. However, in order to have a real estimation of the material quantity, it is necessary to take into account elements that are defined in subsequent steps. The particular elements to consider in the establishment of the quantity material are:

- The definition by the investigator of the material properties to be studied during the recycling processes (detailed in section 4.3.2).
- The quantity of material needed for the fabrication of a single test sample, which is function of the type of test that will be performed.
- The definition of the recycling process chains needed (detailed in section 4.3.3).
- The definition of the number of recycling cycles that have to be made.
- Considerations of the eventual material loss during cycles.

Finally, the preliminary preparation stages before processing must be defined.

4.3.2 Step 2 “Process assignment”

This step is divided into two parts: (figure 4.7)

- The “*Reference Process*” refers to the identification of the processes/procedures used for the characterization of the recycled plastic properties. Different mechanical, chemical and rheological properties are able to illustrate the polymer degradation [36, 38]. During this step, the experimenter has to determine his choice, selecting the properties that will be studied through the recycling process.
- The “*3DP Feedstock Process*” step refers to the definition of how the feedstock material will be elaborated. It is necessary to specify the different processes that will be used to get the feedstock in usable form for 3D printers. The different fabrication parameters of the feedstock material and definition of the material quality obtained are addressed here.

4.3.3 Step 3 “Fabrication of samples”

The main goals of the “*Fabrication of Samples*” step (figure 4.7) are:

1. Two types of manufacturing processes are proposed in order to compare the material degradation: *Standard* and *3D Printing* fabrication.
 - The “*Standard*” process, will serve as reference for the purpose of comparing the obtained results with the 3D printing process. For that reason, it is required to define the equipment and fabrication parameters of the samples using a *Standard* process. Therefore, it is necessary to identify the appropriate international standard according to each selected property of the previous step (see *Reference Process*).
 - In the “*3D Printing*” process, the main goals are: first, to characterize the open source 3D printer, and second, to establish the manufacturing parameters of the samples. Literature review about the selected property in the additive manufacturing context can give an initial insight into important parameters to consider.
2. In order to highlight the effects of the different processes on the material, at least four recycling chains are needed to compare the material degradation:
 - *Reference*: used as degradation reference for the recycled material.

- *Feedstock*: used to evaluate the degradation impact due to fabrication of the feedstock material for the 3D printing machines considered (i.e. filament, pellets, powder...).
- *3DP (Reference)*: used to evaluate the degradation of the material as a consequence of the 3D printing process using the reference equipment.
- *3D Printing*: used to evaluate the degradation of the material as a result of the 3D printing process with samples made using a 3D printer with established parameters.

4.3.4 Step 4 “Evaluation ”

The goals of the “*Evaluation*” step (figure 4.7) are: to define the set of variables that describe the targeted properties and to describe the selected equipment for the evaluation. The tests are conducted in order to collect the data according to the international procedures and also considering the entire set of samples according to the recycling process chains (see *Fabrication*).

4.3.5 Step 5 “Recycling”

To finish, the main goal of the “*Recycling*” process step is to adapt the recycled plastic material for reprocessing. The recycling process is made individually for each recycling process chain. A characterization of the recycling equipment used and a description of the characteristics of the recycled material obtained are made.

In the following sections, we will present the use of this methodology using an case study.

4.4 Application case: Recycling PLA for open-source 3D printers

As an application case, in this part we will illustrate the proposed methodology (section 4.3) by considering the opportunity to recycle one of the thermoplastic materials most widely used in the open source context: the Polylactic Acid (PLA). The main interest of using open-source 3D printers is that these systems are the more widely used than any other additive manufacturing system [14]. We recall that these open-source systems use fused filament fabrication (FFF) approach as working principle.

4.4.1 Step 1- Material Definition: PLA

Polylactic Acid (PLA) is one of the most important bio-based, biodegradable and biocompatible polymers [39–43]. PLA is a thermoplastic aliphatic polyester obtained from the ring-opening polymerization of lactide, which may be derived from renewable resources such as potato, starch, sugar cane and corn sugar. [44–46]. PLA offers great promise in a wide range of commodity applications such as bottles, trays, containers and so on. Moreover, PLA can be processed by injection molding, blow molding, or be extruded into films, fibers, and sheets [39, 261–264]. Therefore, PLA is considered a promising alternative to reduce the municipal solid waste (MSW) disposal issues by offering additional end-of-life scenarios [40, 43, 265, 266].

The selected material for this study was PLA type 4043D, a product of NatureWorks supplied by NaturePlast (Caen, France). This material is intended for fabrication of 3D printers feedstock according to the manufacturer’s specifications.

a. Initial characterization of the material:

The properties of the selected PLA 4043 D are showed in the table 4.1:

Table 4.1: PLA 4043D for open source 3D printing

Physical Properties	Value	Units	ASTM Method
Density	1.24	gr/cm^3	D792
Melt Flow Rate	6	$g/10min (210^\circ C / 2.16 Kg)$	D1238
Relative Viscosity	4		D5225
Clarity	Transparent	$^\circ C$	D3418
Peak Melt Temperature	145-160		
Glass Transition Temperature	55-60	$^\circ C$	D3418
Mechanical Properties			
Tensile Yield Strength	60	MPa	D882
Tensile Strength at Break	53	MPa	D882
Tensile Modulus	3.6	MPa	D882
Tensile Elongation	6	%	D882
Notched Izod Impact	16	j/m	D256
Flexural Strength	83	MPa	D790
Flexural Modulus	3.8	MPa	D790
Heat Distortion Temperature	55	$^\circ C$	E2092

b. Estimation of the material quantity:

We will consider the four recycling process chain as previously defined in section 4.3. One of the criteria was the achievement of at least 8 samples for each cycle in every recycling process chain. It will generate at least $4 \times 8 \times (\text{number of cycles})$ test samples. The establishment of the material quantity used in this study will be specified with more details in the section 4.4.6 once the parameters of the experimentation are defined in the subsequent steps.

However, a initial estimation can be made. The mechanical sample used for this experimentation is according to the standards ISO 527-B as indicated in the figure 4.8. It is intended to fabricate 60 samples per cycle, which it is 15 samples per type of recycling process. Therefore, a total of about $\sim 600 gr$ of PLA is a first estimation amount of material to use. However, it is necessary to consider the material that can be lost during the process extrusion and 3DP. Using a security factor of 4 for considering these losses, the amount of material to use is about $\sim 2400 gr$.

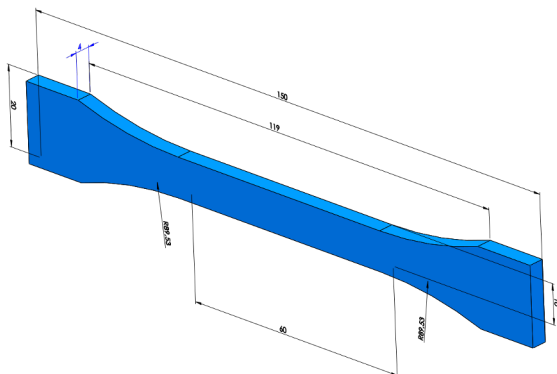

Parameters	Value	Units
Volume	8017.66	mm^3
PLA density	1.24	g/cm^3
Weight	9.9	gr per sample

Figure 4.8: Mechanical sample according to the standard ISO 527-1B

Appropriate care was taken in order to reduce the material loss between each cycle and also to avoid additional degradation due to environmental conditions.

c. *Preparation of the material:*

One of the important elements to consider in processing PLA is the degradation mechanism via hydrolysis, which is controlled by the water diffusion in the free volume amorphous phase. It exists a concomitant phenomenon associated with molar mass reduction due to the plasticizing effect of the water molecules diffusing into the amorphous region. It provokes an increase of the chain segmental motion [267]. Therefore, the pellets must be dried prior to melt processing to prevent the loss of physical properties. Processes that have long residence times or high temperatures approaching 240°C should dry resins below 50ppm (0.005%, *w/w*) moisture content in order to achieve maximum retention of molecular weight [264]. The PLA supplier recommends that resins should be dried to 250ppm (0.025%, *w/w*) moisture content or below before extrusion.

In the case of this experimentation, PLA is dried by natural convection during 4h at 80°C in a vacuum drying oven in order to remove humidity as much as possible. The material was spread in on aluminum trays in order to increase superficial contact area as it is showed in the figure 4.9.

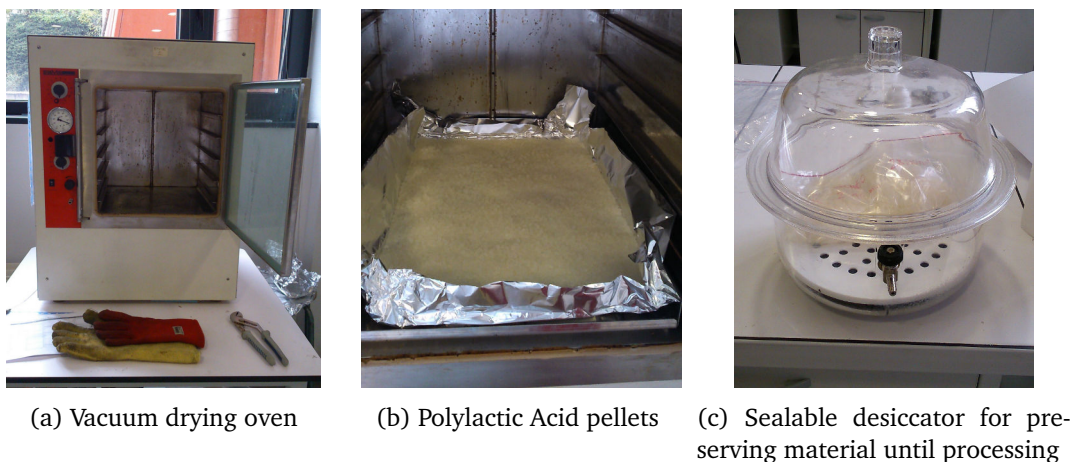

Figure 4.9: Material preparation before extrusion

Once the material is dried, it is stored in a sealable desiccator in order to preserve the material from environmental humidity. Appropriate care was taken in order to reduce the material loss between each cycle and also to avoid additional degradation due to environmental conditions.

4.4.2 Step 2- Processes assignment

Step 2.1) Reference process: Mechanical Recycling

a. *Identification of the reference process:*

Based on the general mechanical process and the multiple processing approach for evaluating thermo-mechanical presented in figures 4.2 and 4.3a, we adapted the general scheme for the particular case of fabrication of recycled filament. This methodological proposition considers the four recycling chains to compare the material degradation, specified in the methodology section 4.3.3. Nevertheless, these four recycling process chains will be explain in more detail the following sections. Figure 4.10 illustrates the defined approach.

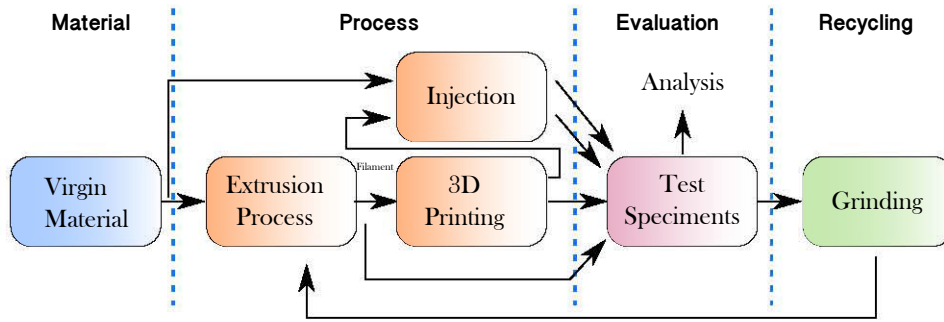

Figure 4.10: Mechanical recycling steps for the case of fabrication of recycled filament.

We defined the stage *Material* in the precedent section, making the assumption that we start from virgin materials to perform the recycling process, as stated in the section 4.3. Concerning *Process* stage, we assume that the material will be degraded by these three processes (Injection, Extrusion and 3D printing). The four recycling chain will allow us to understand and compare the impact of each process in the material degradation.

b. *Definition of the properties to be tested and registered:*

In section 4.2, we presented a framework with the three axes for quality assessment of recycled plastics founded in the literature. Based on this, it is possible to select main parameters/methods in order to assess the quality of the recycled material (*Evaluation* stage of figure 4.10),

For our purposes, we selected to analyze the ***Degree of degradation (DD)*** axis which determines the evolution of polymer degradation at macro-microscopic scale due to the processing and service life Vilaplana and Karlsson [36]. Therefore, mechanical properties will be used as an indicator of the quality of the recycled material.

Table 4.2 presents a short overview concerning the works of mechanical recycling of PLA in the light of the axes of quality assessment of recycled plastics [43, 45]. Based on this literature, we have the first insights about the variation of the mechanical properties for polylactic acid (PLA). On the other hand, injection process, by means of micro-compounding technique, was selected in order to have a reference of degradation. The characterization of the equipment and the parameters used are discussed in more detail in section 4.4.3.

Table 4.2: Overview of mechanical recycling studies of PLA

Reference	Material	Recycling Process	Evaluation			Comments
			DM	LMWC	DD	
Pillin et al. [268]	PLLA L900	Injection			X	Thermal, mechanical and rheological properties were studied after seven cycles. Oxidative stabilizers were tested in order to evaluate the effect on the recycled material
Le Duigou et al. [269]	PLLA L900 Flax fibres	Injection	X		X	Blends (20% and 30% in weight) were made through single extruding process. Modification of mechanical, thermal, rheological and molecular properties were investigated after six cycles.
Żenkiewicz et al. [270]	PLA 2002D	Extrusion	X		X	Material was recycled ten times using extrusion process. Mechanical properties (tensile and impact), melt flow rate, thermal properties and water vapour and oxygen transmission rates were studied

Table 4.2 – continued from previous page

Reference	Material	Recycling Process	Evaluation			Comments
			DM	LMWC	DD	
Hamad, Kaseem, and Deri [271]	PLA (ESUN A-1001) PS (Sabic 125PS)	Extrusion			X	Blend of PLA/PS (50/50) was prepared using a single screw extruding process. Four recycling cycles were performed by extrusion process. Modification on mechanical and rheological properties were explored
Lopez et al. [272]	PLLA L9000 Mater-Bi TF01U/095R Mater-Bi YI014U/C Cellulosic fibres	Injection	X		X	Recycling process of three commercial bioplastics matrices is conducted. In all cases, the blend was 30 wt%. Mechanical, MFI, and thermal characterization was conducted
Badia et al. [273]	PLA 2002D	Injection	X		X	Characterization on mechanical, thermal properties and segmental dynamics up to five recycling process was studied.
Stephens et al. [274]	PLA / ABS			X		Measurement of the ultrafine particle (UFP) concentration resulting from the operation of two types of desktop 3D printers.
Kim et al. [275]	PLA / ABS			X		Evaluation of the emission of particulate matter and gaseous materials during FDM 3D printing
Azimi et al. [276]	PLA/ABS / HIPS/PCTPE / Nylon/PC			X		Quantification of the emission rates of particles and a broad range of speciated volatile organic compounds (VOCs) from five available desktop FFF 3D printers. They explore difference in particle and VOC emissions based on filament material and printer characteristics.
Steinle [277]	PLA/ABS			X		characteristics. Ultrafine aerosol (UFA) emissions and volatic organic compounds (VOC) were measured from a desktop FFF 3D printer.

Step 2.2) 3D Printing Feedstock Process: Extrusion

a. Manufacturing process of the 3D printing feedstock material :

A considerable number of open source 3D printers are inscribed in the context of extrusion-based systems, where the loading of material is in form of continuous filament plastic of 1.75–3mm in diameter [7, 50]. In that respect, extrusion of the polymer into monofilament may be achieved by melt spinning, which is one of the most important techniques for continuously melt processing of PLA [262, 263]. For the purpose of this experiment, we will consider this process as a sum of three systems, namely, (I) Feeding system, (II) Extrusion process and (III) Conveyor system, as it can be seen in figure 4.11.

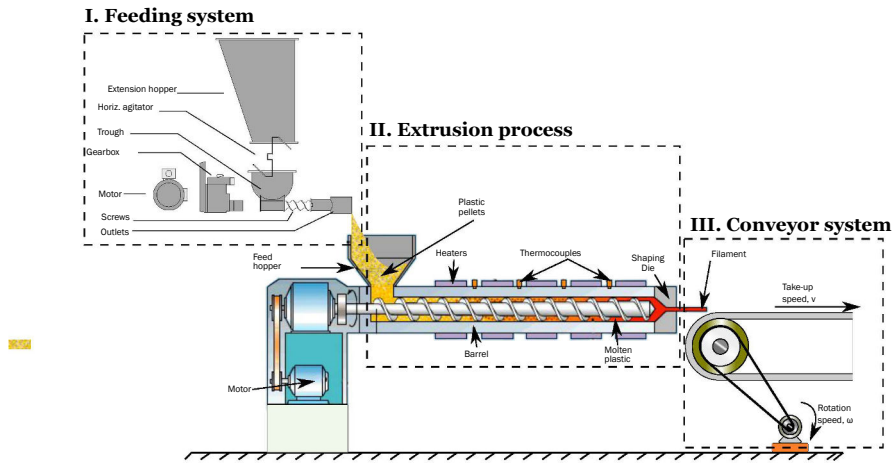

Figure 4.11: Schematical extrusion process for fabrication of feedstock 3D printing material

b. Characterization of the experimental conditions:

I. Feeding system

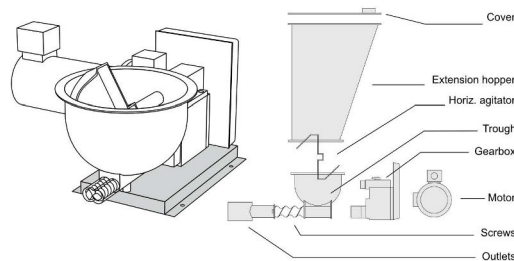
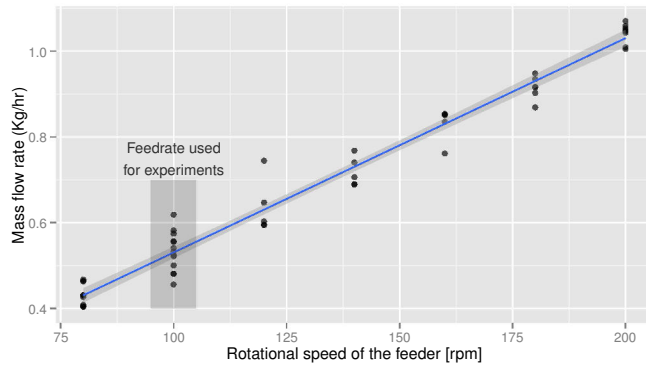

Figure 4.12: Schematical view of the feeding system

The feeding system is performed using a twin screw volumetric feeder K-TRON (K-MV-KT20). All parts in contact with the material being fed are stainless steel. The horizontal agitator gently moves the bulk material to the large throat and then into the screws. The material is transported from the refill system to the hopper onto the feed screw. A motor drives the feed screw and the horizontal agitator (screw filler). The feed screws transport the bulk material outwards in a constant flow. The feed rate is controlled via the speed of the motor and the gearing reduction.

Figure 4.13 shows the calibration curve for pellets PLA. The parameters conditions of the feeding system is 100 RPM for the motor using a granulometry of the pellets. The feedrate used was established at $0.53 \pm 0.04 \text{ Kg/hr}$.



Granulometry	Feedrate (Kg/h)
Pellets	0.53 ± 0.04

Figure 4.13: Calibration curve for the feeding system

II. Extrusion Process

Hot Melt Extrusion (HME) process is the most important technique for forming homogeneous PLA. The material is heated, molten, pressurized, and forced through a die. Commercial grade PLA resins typically can be processed using a conventional extruder equipped with a general-purpose screw of L/D ratio of 24-30 [263, 264].



(a) Conical counter-rotating twin screw extruder

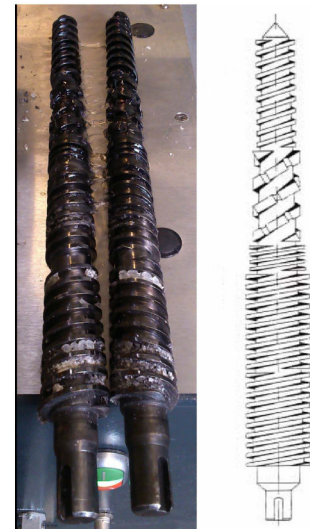

(b) Intensive mixing screw of the extruder machine

Figure 4.14: Overview of the extrusion process

The extrusion process is performed in order fabricate the filament used in the process of 3D printing. It was performed using a laboratory scale HAAKE™ Rheomex CTW 100 OS counter-rotating conical twin screw extruder. The range speed operation of this machine is between 0-250 rpm. The screw speed was set at 60 rpm. The temperature profile selected was 160,170,180°C .

Table 4.3 shows the important parameters for the extrusion process:

Table 4.3: Parameters of the extrusion process

Parameters	Value	Units
Feeding rate	0.53	Kg/h
Speed collection	50-100	rpm
Nozzle diameter	1.75	mm
Rotation speed of extruder	30-60	rpm
Profile temperature	180/170/160	$^{\circ}C$
Granulometry	Pellets - Grinding	

III. Conveyor system

Finally, a conveyor system was adapted in order to control properly the take-up speed of the filament after extrusion process. A belt conveyor system is used in order to cool (by natural convection) and to collect the extruded filament.

The system is made of a metal frame with rollers at either end of a flat metal bed and a belt is looped around each of the rollers. One of the rollers is powered by an electrical motor, which it makes that the belt slides across the solid metal frame bed, moving the filament with a linear speed of collection v_{linear} which it is function of the rotation speed of the motor ω_{motor} . Figure 4.15 show the schematic model.

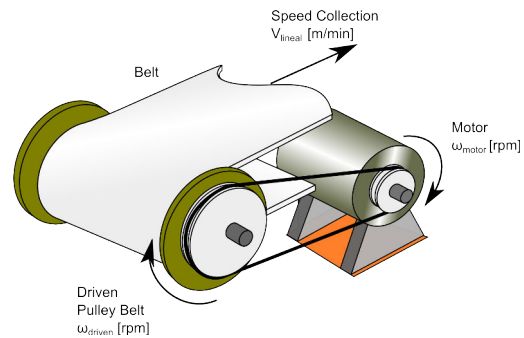
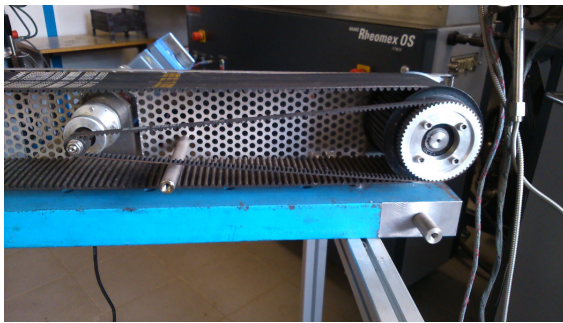

Figure 4.15: Schematic diagram of the belt conveyor system

c. Identification of quality parameters feedstock material:

There are certain elements to consider concerning the requirements for feedstock material for 3D printers. From the point of view of mechanical properties, it is necessary to ensure that the filament has certain characteristics such as:

- High flexural modulus and strength to enable continuous spooling and unspooling operations,
- High compressive strength to not break after passing through the rollers of the 3D printer, and
- High elastic modulus, geometrical and rheological properties in order to be extruded without buckling effect leading to a failure mode of the filament.

The parameter selected for establishing the quality feedstock was diameter regularity (ϕ). This value is an input for our the printing process. Therefore, a protocol for measuring and the results of this protocol are presented in the results section.

4.4.3 Step 3- Fabrication of samples

Step 3.1) Standard: Micro-compounding extrusion and injection molding

a. Identification of international standards:

This study is focused on *Degree of degradation* in terms of variation of mechanical properties of the material of the recycled material (See section 4.4.2). Therefore, tensile properties were studied according to ISO 527. Tensile specimen is a dog-bone geometry of 150 mm length and central dimensions of $10 \times 4 \text{ mm}^2$.

b. Characterization of the equipment:

The Micro-compounding process was selected as our standard manufacturing process. It provides a basis for comparison between the different recycled materials. Microcompounders enable to work with a small amount of material (i.e. 3 to 15 g) with the similar processing history as in conventional twin-screw extruders.

The polymer material was processed using a DSM Xplore intermeshing co-rotating twin screw batch microcompounder with a 5 cm^3 capacity. The screw diameter of this device tapers from 1 cm to 0.43 cm along its 10.75 cm length.

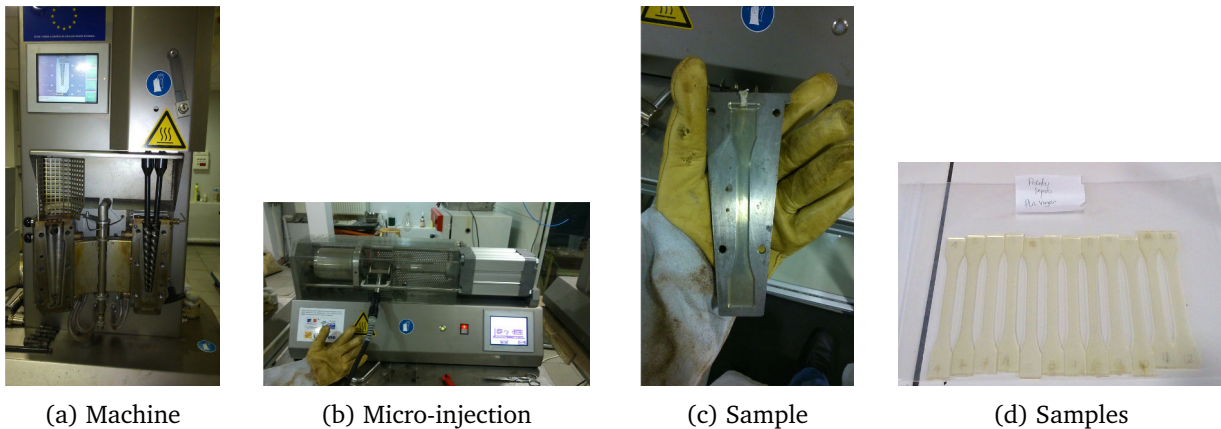

Figure 4.16: Micro-compounding machine used for fabrication of the mechanical samples

c. Definition of the operating conditions:

A constant temperature from the feed throat to the die of 180°C and a screw speed of 100 rpm in co-rotating mode were the parameters adopted. The extruded material was taken after a mixing time of 3 min. The temperatures of the melt and the mold were 190°C and 45°C respectively. The melt was directly injected using the transfer cylinder of DSM Xplore 10 ml injection molding machine in order to obtain mechanical samples. The injection and holding pressures were set to 9 bars for 30s. Specimens were carefully removed from the mold after 5 min of cooling. Table 4.4 summarizes the parameters considered for the standard manufacturing process of the samples.

Table 4.4: Parameters for micro-compounding and micro-injection process

Parameter	Value	Units
Screw Speed	100	<i>rpm</i>
Barrel temperature	180	$^{\circ}\text{C}$
Mixing time	3	<i>min</i>
Injection pressure	9	<i>bar</i>
Mold temperature	45	$^{\circ}\text{C}$
Time of injection	45	<i>sec</i>

Step 3.2) Fabrication using 3D Printing process: Fused Filament Fabrication (FFF)

The goals of this step are, first, to characterize the open source 3D printer, and second, to establish the manufacturing parameters of the mechanical samples using the OS 3D printer. As we stated before in the chapter 3, one of the principal characteristics of open-source 3D printing is that it has been an object of social experimentation, where numerous enthusiasts and communities have developed a significant number of 3D printer machine architectures [15]. Therefore, due to the high customization nature, there are different machine architecture configurations which result in inherent variability among different 3D printers. It is necessary to characterize the open source 3D printer in order to ensure reproducibility of the printed parts [126].

a. Characterization of the 3D printing machine:

Figure 4.17a presents the two types of 3D printers selected for the fabrication of the samples in this study. They are representative 3D printer among the set of OS machines developed by the RepRap community called *Mondrian* and *FoldaRap* [126, 278, 279]. Indeed, as can be seen in the open-source 3D printer family tree [16], they derive from the main branch (XZ Head, Y Bed): Darwin-Sells Mendel-Prusa Mendel. They are a variant of the RepRap machine with a work capability of $140 \times 140 \times 155(\text{mm}^3)$ and $200 \times 200 \times 200(\text{mm}^3)$ for *FoldaRap* and *Mondrian* respectively. The extrusion system can be displaced in the horizontal plane XY and the heated print bed can be displaced in the vertical direction $-Z$. The resolution depicted is in plane $XY = 0.0125\text{mm}$, $Z = 0,00025\text{mm}$ with m5 rods and an accuracy: 0.1mm . The heated print bed is made of aluminium joined with a Peltier cell and it uses a top layer of kapton in order to improve the adherence of the piece with the print bed.

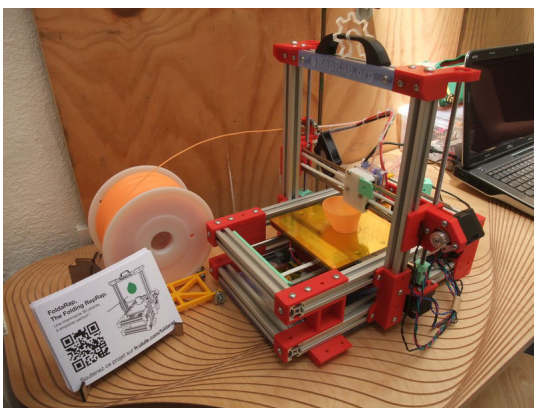

(a) Open Source 3D printer -FoldaRap-

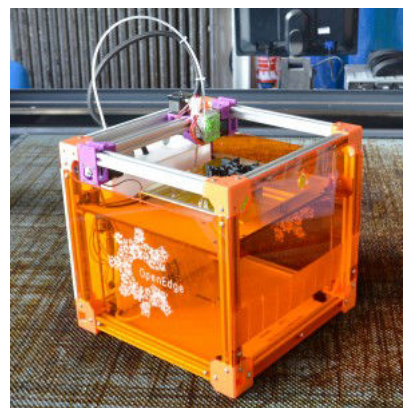

(b) Open Source 3D printer -Mondrian-

Figure 4.17: Open source 3D printers used in the experimentation of the recycled filament

b. Definition of 3D printing parameters:

Figure 4.18 shows the process parameters to be considered in the fabrication of the printed samples. They can be defined as follows: [108–110]

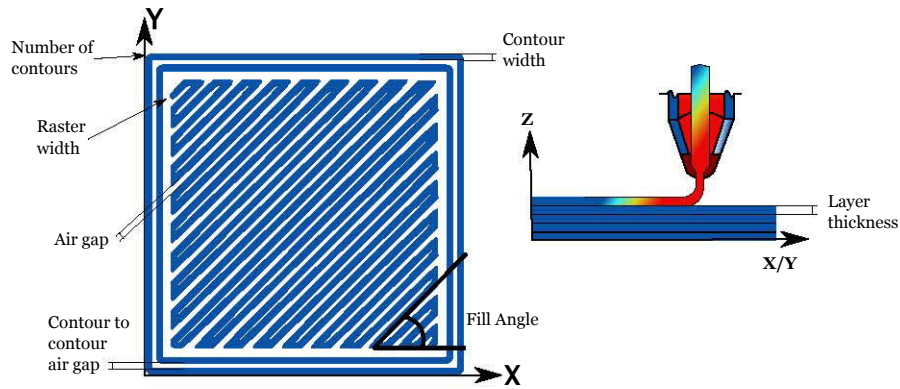

Figure 4.18: Parameters of the 3D printing process

- *Part building direction*: It refers to the inclination of the part in a build platform with respect to X, Y and Z axis. X and Y-axis are considered parallel to build platform. Z – axis is considered the printing axis.
- *Layer thickness*: It is the height of layer deposited by nozzle. It is usually one half of the bead width.
- *Bead width (raster width)*: It is the width of the filament deposited by nozzle that fills interior regions of part.
- *Fill angle*: It refers to the inclination of the deposited beads of filament with respect to the x – axis of the build table. Typical configurations are 90/90 and 45/45.
- *Air gap*: It is the gap between two adjacent filaments of material on same layer. A zero value means that the rasters touch each other. Positive value means there is a gap. Negative value implies that rasters are overlapped.
- *Number of contours*: Defines the number of solid perimeters for the object.
- *Nozzle speed*: It is the speed of the printer nozzle when it fabricates the object. (Speed of perimeters, small perimeters, external perimeters, infill – solid, top, bottom layers)

From the point of view of dimensional accuracy, there have been attempts in order to characterize the dimensional performance of the open source 3D printers [124–126, 230]. From our obtained results in the chapter 3, it was found that according to the International Standard Tolerance Grade of these type of machines could be situated between IT14 and IT16. Another conclusion of the chapter 3 was that parameters such as layer thickness, raster width and nozzle speed movement can have an impact in the machine accuracy [126].

On the other hand, considering the material's mechanical properties in additive manufacturing technology based on extruded-based systems, one important conclusion of the literature is that there exists anisotropic behavior. It means that the material is directionally dependent. Mechanical integrity of the printed part is directly related to factors like the energy adhesion/cohesion between the layers and deposited beads, the growth of the contact area formed between the adjacent beads, the molecular diffusion and randomization of the polymer chains across the interface, and a minimum residence time at elevated temperature in order to assure adequate levels of diffusive bonding [49, 102, 105, 106]. Moreover, the thermal history of interfaces plays an important role in determining the bonding quality. Uneven heating and cooling cycles due to inherent nature of printing process results in stress accumulation in the built part, which is primarily responsible for weak bonding and thus affecting the strength. For that reason, there exists a dependence of the mechanical properties on toolpaths and part orientation. Therefore, mechanical properties are function of parameters of fabrication because they affect meso-structure and fibre-to-fibre bond strength [47, 108–111, 113, 116, 119, 280].

Finally, taking into account the factors regarding dimensional and mechanical performances of the 3D printer, figure 4.19 shows the parameters used in the fabrication of the test samples.

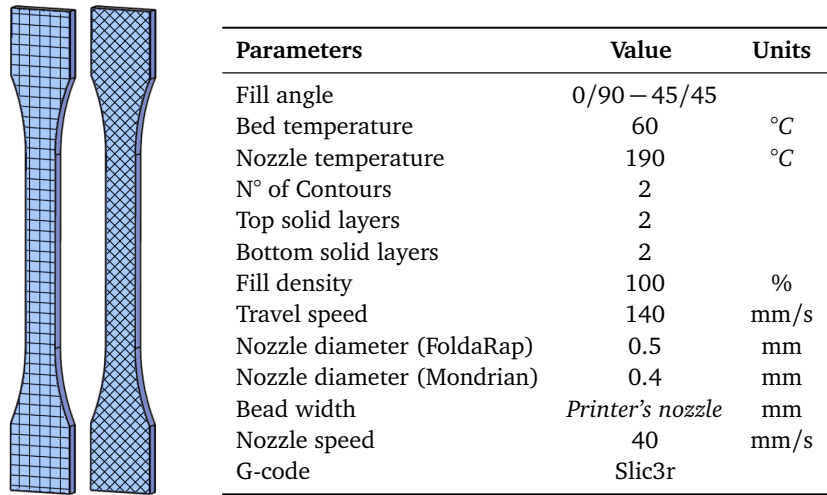

Figure 4.19: Parameters used for fabrication of mechanical samples

4.4.4 Step 4- Evaluation: Mechanical properties

The standard ISO 597 is used in order to determinate tensile properties of the recycled material. The specimen used is ISO 527 1B. Table 4.20 shows the respective measurements of this specimen. This standard covers plastics as filled and unfilled molding, extrusion and cast materials, plastic film and sheets, as well as long fiber reinforced composites.

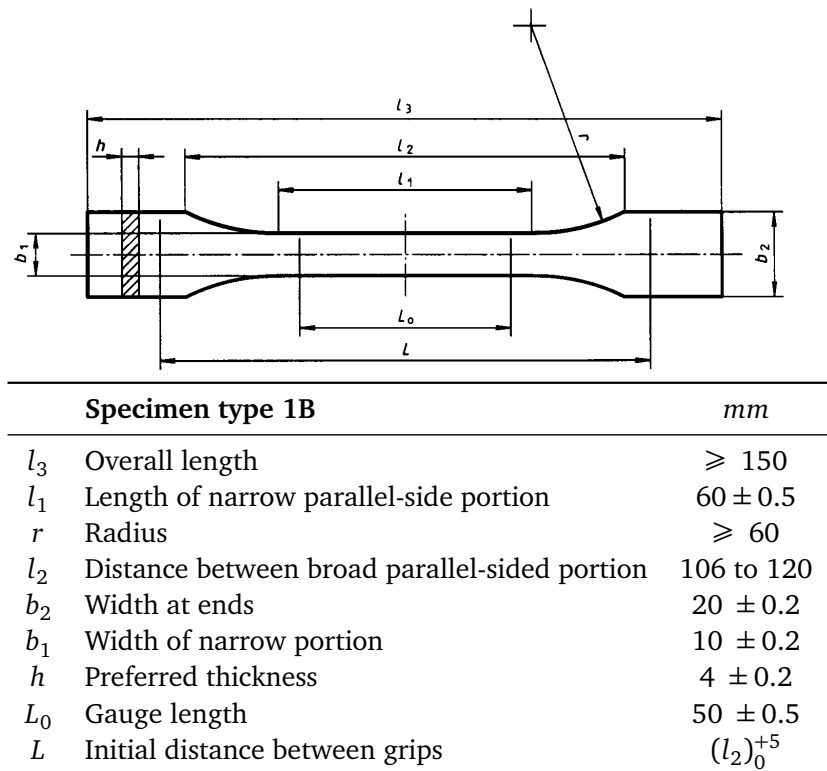

Figure 4.20: Test specimen measurements

The principle of this test is performed by elongating a specimen and measuring the load carried by the specimen. Knowing the specimen dimensions, the load and deflection data can be translated into a stress-strain curve. The main mains properties that can be extracted from the stress-strain curve are:

- Tensile strength and tensile strength at break (σ_m, σ_B [MPa])
- Tensile strain and nominal strain at break (ϵ_m, ϵ_B [%])
- Elastic modulus (E [MPa])

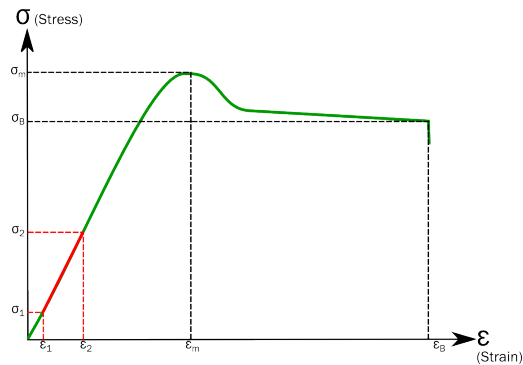

Figure 4.21: Diagram of tensile test

Tensile strength (σ_m) is the maximum tensile stress sustained by the test specimen during the test. In the case of the *tensile stress at break* σ_B , it is the stress at which the test specimen ruptures. The calculation of stress values are based on the initial average original cross-sectional area of the specimen :

$$\sigma = \frac{F}{A} \quad (4.1)$$

Where,

- σ is the tensile stress value in question, expressed in megapascals [MPa]
- F is the measured force concerned, in newtons N
- A the initial cross-sectional area of the specimen, in mm^2

On the other hand, *strain value* (ϵ), is defined as the increase in length per unit original length of the gauge. This value can be expressed as a dimensionless ratio, or in percentage (%). The *tensile strain* is the corresponding value of strain at the point to tensile strength. In the same way, *nominal strain at break* is the strain value at the tensile stress at break. These values can be calculated as follows:

$$\epsilon = \frac{\Delta L_0}{L_0} \quad (4.2)$$

$$\epsilon(\%) = 100 \times \frac{\Delta L_0}{L_0} \quad (4.3)$$

- ϵ is the strain value in question, expressed as dimensionless ratio, or in percentage
- L_0 is the gauge length of the test specimen, in mm
- ΔL_0 is the increase in the specimen length between the gauge marks, in mm

Finally, the *elastic modulus* E is defined as the ratio of stress (nominal) to corresponding strain below the proportional limit of the material. In the diagram of figure 4.23a, it is the slope in the stress-strain diagram between 0.05% (ϵ_1) and 0.25% (ϵ_2) strain. This value can be calculated by secant slope or by linear regression between the strain values ϵ_1 and ϵ_2 as it is showed in figure 4.22.

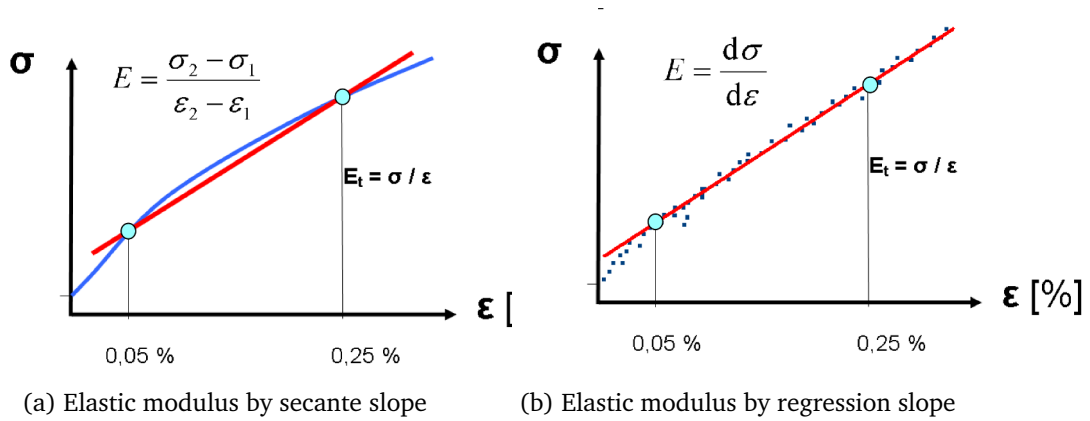

Figure 4.22: Calculus of the Elastic modulus E

a. Selection of parameters:

The selected parameters then were the tensile strength (σ_M [MPa]), tensile strain (ϵ_M [mm/mm]) tensile stress at break (σ_B [MPa]), strain at break (ϵ_B [mm/mm]) and elastic modulus (E [MPa]). These parameters can describe the changes in macroscopic mechanical properties of the recycled material.

b. Characterization of equipment:

An Instron 5569 electromechanical testing machine is used to test material in tension. The drive system moves the crosshead up to apply a tensile load on the specimen using a load cell of 50 KN.

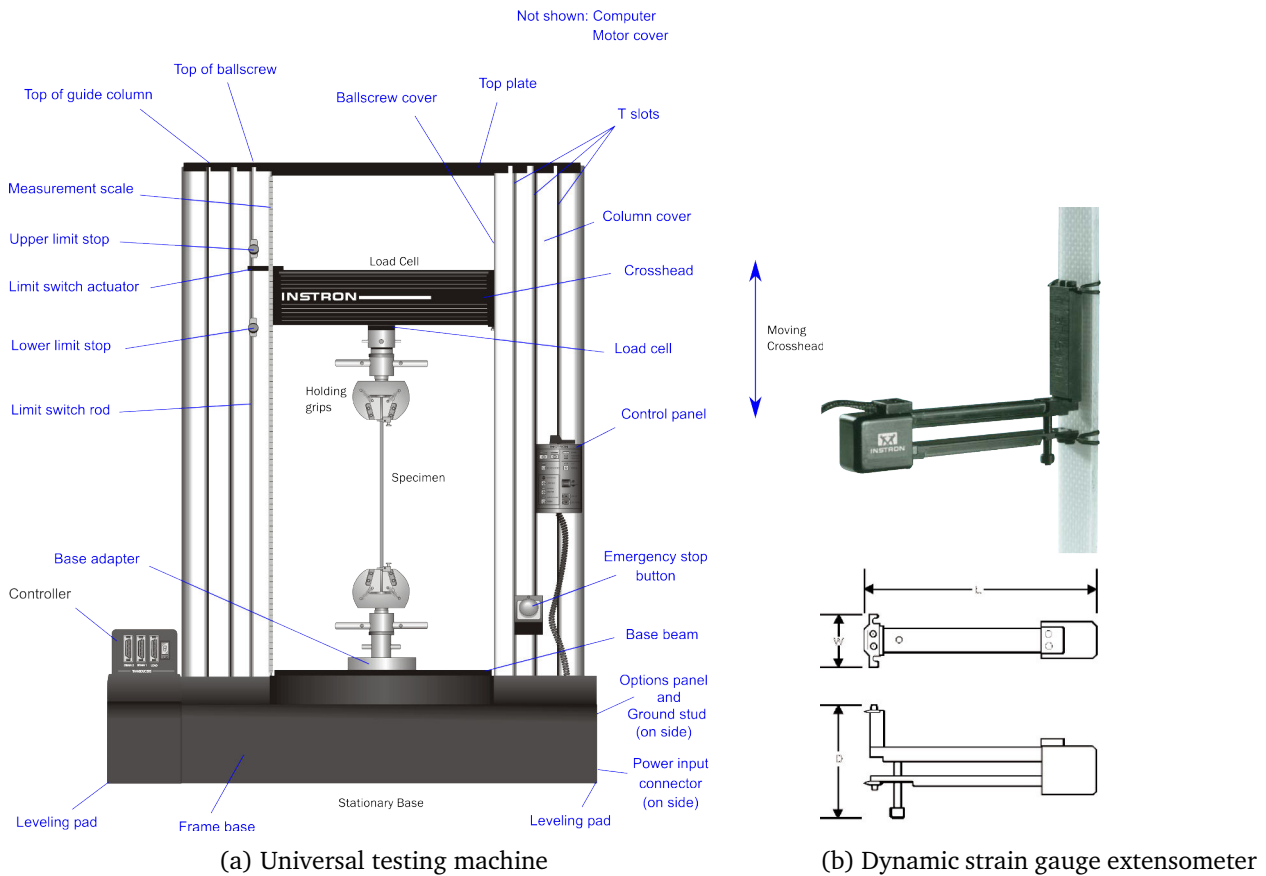

Figure 4.23: Universal testing machine and dynamic strain gauge extensometer used in the experimentation

The universal testing system showed in figure 4.23a is composed by a frame that contains the mechanical

and electrical components that power the frame, the drive system, and the controller panel. A rigid, rectangular, load bearing beam from which the ballscrew and guide column extend up to the top plate. This base Adapter enables a specimen, grip, or fixture to be connected to the base beam. The controller is connected to the frame base where there are a load channel connector (load cell) and two optional strain channel connectors. The controller makes possible the communication between the transducer (load cell or extensometer) and the computer. A control panel is localized in one of the column and it facilitates performing many of the functions directly at the frame.

Figure 4.23b shows a dynamic strain gauge extensometer that is used in order to provide the strain data for the *Modulus-of-Elasticity measurements* and for tensile strain values. The strain error is 0.0001 mm/mm.

Static tensile tests were performed with a 50kN load cell.

Procedure for mechanical testing

The procedure to follow in order to test the mechanical samples are:

- (a) Measure of the width and thickness of each specimen.
- (b) Place the specimen in the grips of testing machine.
- (c) Set the parameters of the testing machine.
- (d) Attach the extension indicator.

The measurement of width and thickness of the specimen is made using a electronic caliper with a resolution of 0.01mm. According to the standard, the measurement are made in the center of each specimen and within 5mm of each end of the gage length. In the injection samples, there are draft angles of 1 – 2 to facilitate demolding are allowed. Therefore, variations in thickness of up to 0.1 mm are acceptable for the standard specimen of type 1B ($h_{max} - h \leq 0.1 \text{ mm}$).

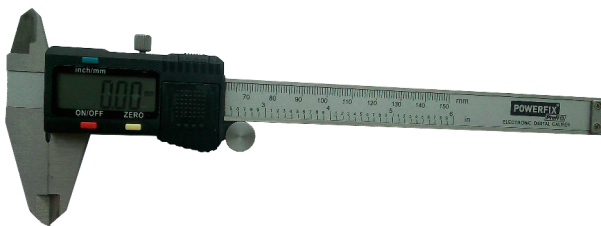

(a) Mitutoyo digital caliper used.

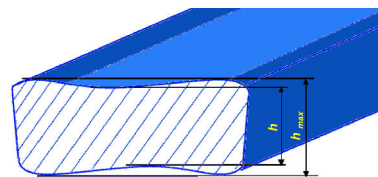

(b) Measurement of the width and thickness sample

Figure 4.24: Important measurements

Concerning the placement of specimens in the grips of the testing machine, it is necessary to take care to align the long axis of the specimen and the grips with an imaginary line joining the point of attachment of the grips to the machine. A misalignment can produce reduction in the tensile resistance of the samples because of concentration of stress in certain points as it is showed in the figure 4.25. The distance between the ends of the gripping surfaces are indicated in the 4.20.

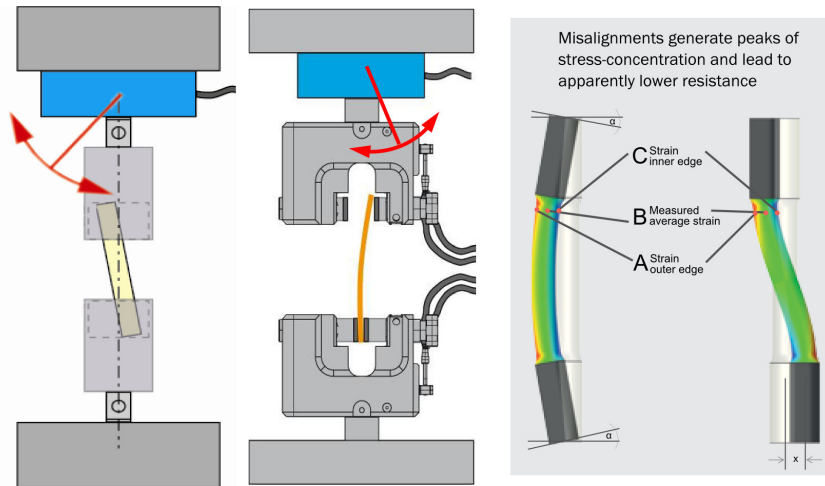

Figure 4.25: Importance of alignment of the samples in the grips

Concerning the setting of tensile machine parameters, one of the important parameter to consider in the testing machine is the pre-stress of the sample. In a typical stress-strain curve there is a *toe region*, AC, that does not represent a property of the material. It is caused by a takeup of slack and alignment or seating of the specimen. Small positive pre-stresses (σ_0) are necessary to avoid a toe region (figure 4.26a) at the start of the stress/strain diagram. This definition ensures a repeatable starting point of the test which is quite independent from operator or equipment influences.

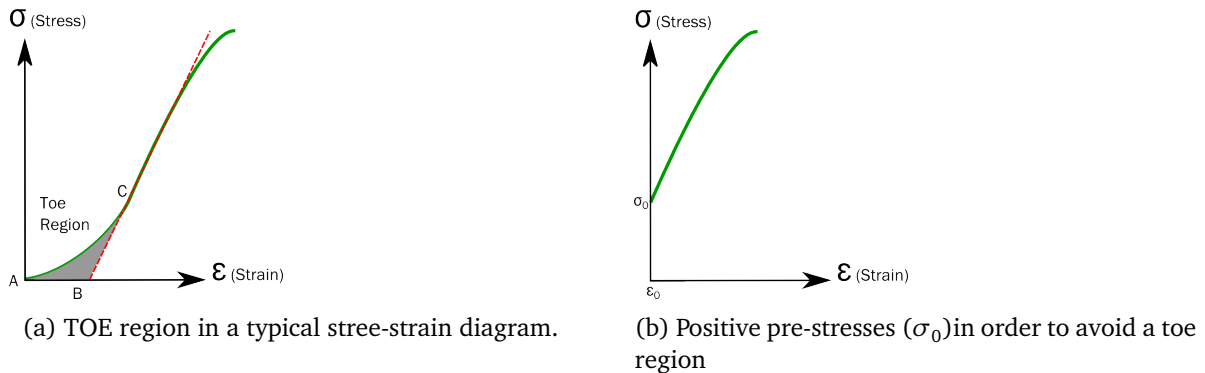

Figure 4.26: Pre-stress in order to avoid toe region

The pre-stresses (σ_0) shall not exceed the following value:

$$|\sigma_0| \leq 5 \times 10^{-4} E_t, \quad \text{for modulus measurement} \quad (4.4)$$

$$\sigma_0 \leq 10^{-2} \sigma_m, \quad \text{for relevant stresses} \quad (4.5)$$

In the case of this experimentation, the value of pre-stress has been set to $\sigma_0 = 0.5 \text{ MPa}$ in order to obtain both, modulus and stresses measurements.

Once it is balanced the prestresses, it is necessary to attach the extensometer in the center of the sample as it is showed in the figure 4.27. The initial gauge length is 50mm.

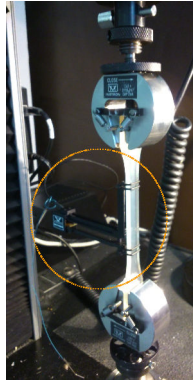

(a) Extensometer in the specimen



(b) Marks in the samples in order to attach the extensometer

Figure 4.27: Setting up the extensometer in the mechanical sample

In the matter of speed of testing, v , which is the rate of separation of the grips of the testing machine. It is typically established a range between $0.125 - 0.75 \text{ mm/min}$ for calculation of the elastic modulus and 5 or 50 mm/min for measuring strength and elongation. For the purpose of this experimentation, a speed of testing value of 1 mm/min is established.

Concerning the observance of defined conditioning and ambient conditions with regard to temperature and humidity is of great importance with regard to the comparability of test results. The tests are carried out in a *standard atmosphere*, as specified in ISO 291 and presented in table 4.5.

Table 4.5: Standard conditions

Parameter	Value	Units
Temperate atmosphere	23 ± 2	$^{\circ}\text{C}$
Relative humidity	50 ± 10	%

As previously stated, it is necessary to consider the amount of moisture absorbed by the polymer from atmosphere conditions [41]. Therefore procedure is to keep specimens in a standard temperature and inside of sealable desiccator in order to preserve the material from environmental humidity for at least 48 hours prior to the test.

c. *Collection of results:*

Once the specimens are tested, the table 4.6 is proposed in order to collect the necessary data for further statistical analysis for each recycling process chains.

Table 4.6: Database of mechanical results used in the experimentation.

Type of information	Parameters	Units	Observations
Identification of material	Initial quantity	(gr)	
	Drying	dd/mm/yyyy	Date and conditions of drying.
Description	Sample	1, 2, 3...	
	Recycling process chain	Ref/3DP/ Feed/3DP(Ref)	Type of recycling process chain
	Degradation	One - Five	Number of cycles of the sample

Continued on next page.

Table 4.6 – continued from previous page

Type of information	Parameters	Units	Observations
of the sample	Thickness	(mm)	
	Width	(mm)	
	Area	(mm^2)	
	Weight	(gr)	
Description of the 3DP feedstock material (Only for 3DP samples)	Profile Extrusion		Torque and nozzle pressure profile in the extrusion process.
	Collection Speed		Collection speed used for recollection of the filament
of the 3DP feedstock material (Only for 3DP samples)	Diameter measurement	mm	Diameter of filament
	Fill angle	45/45 – 0/90	
	Date of sample	$dd/mm/yyyy$	Date of fabrication of printed sample
Description of the test	Date of test	$dd/mm/yyyy$	
	Speed	(mm/min)	
	Pre-stress	(MPa)	
	Validity	Yes / No	
	Comments		
Mechanical Properties	Young	E (MPa)	
	Tensile load	L (N)	
	Tensile strength	σ_M (MPa)	
	Tensile elongation	Elo (mm)	
	Tensile strain	ϵ_M (mm/mm)	
	Tensile load at break	L_B (N)	
	Tensile elongation machine at break	(mm)	
	Tensile stress at break	σ_B (MPa)	
	Tensile elongation at break	Elo_B (mm)	
	Nominal strain at break	ϵ_B (mm/mm)	

4.4.5 Step 5- Recycling process: Plastic shredding

Size reduction of the samples of each recycling cycle is required in order to reprocess the material.



Figure 4.28: Machine used for the recycling process

a. *Operational conditions of the recycling process:*

A cutting mill machine SM 300 Retsch® with a selectable speed range from 700 to 3,000 *rpm* was used. The selected speed was 700 *rpm*.

b. *Granulometry of recycled material:*

The final fineness achieved was in a range of 0.2 – 2 *mm*.

4.4.6 Experimental strategy

Figure 4.29 resumes the followed experimental strategy in order to compare the material degradation of the four proposed recycling process chains : *Reference*, *Feedstock*, *3DP reference* and *3DP evaluated* (horizontal axis of Figure 4.29) as explained in section 4.3.3. Then, for each recycling process chain, the initial material, have been reprocessed using the operational steps (vertical axis Figure 4.29) until 5 recycling cycles have been reached. Each recycle process chain is described in terms of the operational steps (A,B,C...) to be followed in order to deploy the global recycling process.

On the other hand, a more accurate estimation of the material quantity requirement can be made at this point. Considering that the properties to be studied, equipment of reference, 3D printing process and the quantity of the cycles are clearly defined. In preliminary attempts, the loss of material was estimated in the micro-compounding process as $\sim 50\text{gr}$, and for the plastic shredding as $\sim 30\text{gr}$. Therefore, a initial mass of 500 *gr* for the Reference was established. Regarding to extrusion process, the losses of material were about $\sim 200\text{gr}$. As a consequence, a initial mass of 3*kg* was established for the others recycling process chains (3D Printing (Evaluated), Feedstock and 3DP (Reference)).

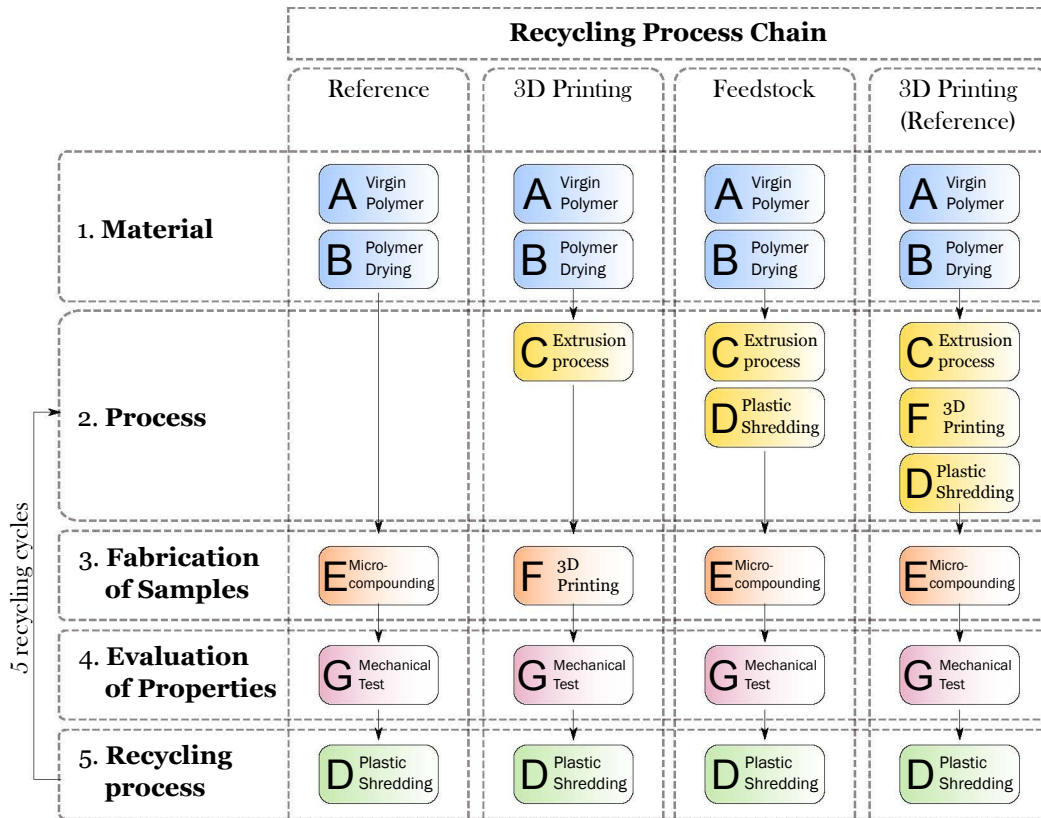

Figure 4.29: Operational steps using the methodology of recycling

4.5 Conclusion

In this chapter, we propose a general methodology to characterize the recycling of polymers used as feedstock for open source 3D printing machines. This general methodology was proposed based on the literature of polymer recycling. The definitions of polymer degradation, types of degradation and methods/tools for assessing the quality material were presented. The proposed methodology was applied to study the conditions for reusing polylactid acid (PLA), which is a material widely used in the context of open source 3D printing using the fused filament fabrication (FFF) technique. The mechanical properties of the recycled material (*Degree of Degradation -DD-*) were selected as an estimator of the material degradation. we have to highlight that these mechanical properties represent only a partial evaluation of the material. Nevertheless, we selected this properties because in a large perspective, we have to define if the recycled material is resistant enough to the mechanical solicitations. Starting from this base, it will possible to study later other characteristics such as the changes in the micro-structure properties, or even in the change in the manufacturing conditions of the feedstock and printing parts.

On the other hand, in our study we decided to use laboratory machines. As stated in the chapter 2 section 2.5.6, there have been some contributions to the development of open-source extruder systems (Lyman Filament Extruder [212], Filabot [213], Recyclebot [22], RepRap Recycle Add-on [214], Precious plastic [21]). However, we decided to use laboratory systems that allow us to ensure the reproducibility of the conditions for recycling. These recycling conditions from a laboratory experiment enable to have a first reference model for comparing to other extrusion processes. Therefore, it is interesting to replicated the presented methodology using an open-source extruder machine in order to observe the difference in the material degradation. Also, it is interesting to qualify this OS machines acknowledging that there is a difference in terms of cost, performance and reliability of the open-source versus commercial extruders.

In the next chapter, the results of this case study will be presented.

Experimental Results and Discussion

Contents

5.1 Introduction	111
5.2 Results of the experimentation	111
5.2.1 Reference process chain	111
5.2.2 3D Printing process chain	113
A. Calibration of the extrusion process	113
B. Analysis of the Extrusion process for the first recycling cycle	114
C. Analysis of the mechanical results of the recycling process chain	114
5.2.3 Feedstock process chain	116
5.2.4 3D Printing (Reference) process chain	117
5.3 Comparison of the different recycling process chains	119
5.3.1 Elastic Modulus	119
5.3.2 Tensile strength and Tensile strain	121
5.4 Conclusions	124

5.1 Introduction

In chapter 4, we proposed a general methodology to evaluate the recyclability of polymers used as feedstock for 3D printing systems. The proposed methodology was applied to the recycling study of the polylactic acid (PLA) order to understand the evolution of the mechanical properties using fused filament fabrication (FFF). Therefore, the contribution of this chapter is to present the obtained results for the formerly proposed four recycling process chains.

1. Reference
2. 3D printing
3. Feedstock
4. 3D printing (Reference)

We analyze the degradation of the mechanical properties for each recycling process chains comparing our results with those found in the PLA literature. Afterwards, we compare the mechanical properties evolution of the first two cycles (*Reference - 3D printing*) and then, the other two (*Feedstock - 3D printing (Reference)*) This approach allow us to identify the performance differences between the traditional process as injection and 3D printing process using a recycled material. Moreover, it is possible to estimate the impact of each process in the material degradation. Finally we present some conclusions for this experimental study.

5.2 Results of the experimentation

In the following subsections, the obtained results of each recycling process chain *Reference*, *3D printing*, *Feedstock*, *3D printing (Reference)* will be presented.

5.2.1 Reference process chain

As outlined earlier, the purpose of this process chain is to set a degradation reference for the recycled material. The obtained results in this process chain will then be compared with those of the extrusion or 3D printing processes. As a consequence, the impact of those processes on the material degradation can be evaluated.

Following the general methodology shown in figure 5.1, the evolution of the mechanical properties was evaluated and registered as presented in figure 5.2.

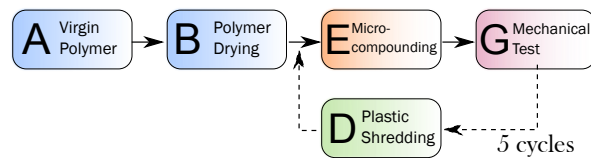

Figure 5.1: Experimental strategy for *Reference* process chain used for PLA degradation.

The evaluated properties are : elastic modulus (E), tensile properties (σ_M and σ_B), as well as the strain values (ϵ_M and ϵ_B) as illustrated in figs. 5.2a to 5.2d respectively.

Figure 5.2a presents the stress–strain curves for reference process chain samples in function of the number of cycles. Moreover, in figure 5.2b, it can be seen that here the recycling process induces a low diminution of the elastic modulus. The mean value of the elastic modulus during the five cycles was $E = 33.449 \pm 81$ MPa. Therefore, it could be considered that the material strength in the elastic zone is slightly affected by the number of recycling cycles. This result is in good agreement with previous studies in which injection molding was used for the recycling process [268, 273]. In figure 5.2c, after five cycles, a progressive diminution of tensile strength σ_M ($\sim 19.81\%$) and stress at break σ_B ($\sim 15.95\%$) can be observed. In the same way, there was a significant reduction in the tensile strain ϵ_M ($\sim 27.31\%$)

and the nominal strain at break ϵ_B ($\sim 40.65\%$) of the material as detailed in figure 5.2d. This trend is consistent with the results of previous PLA recycling studies [43, 45, 272].

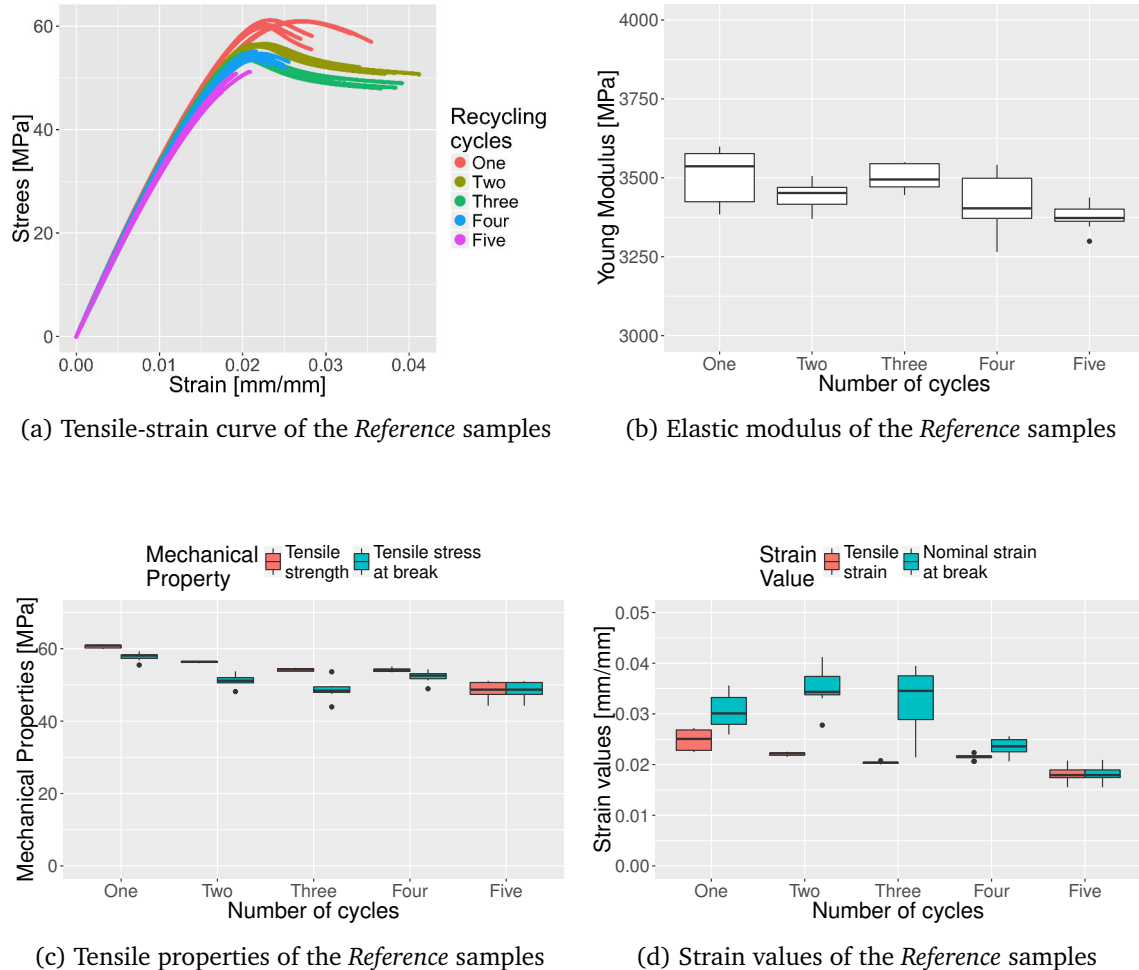

Figure 5.2: Mechanical properties of the recycled reference samples

The reduction of the mechanical properties observed here can be related to the chain scission of the polymeric chains, which leads to a progressive embrittlement of the reprocessed material. In fact, it can be seen that the tensile strength value (σ_M) as well as the tensile strain value (ϵ_M) are converging during the five cycles with respect to the tensile strength at break (σ_B) and the nominal tensile strain value (ϵ_B) (figure 5.2a and table 5.1). Factors such as a decrease in the polymer chain length, reduction in the molecular weight, and increase in the degree of crystallinity induces the crack propagation above the elastic domain [43, 268, 281].

An experimental observation is that nominal strength at break after the first cycle seems relatively weak with respect to studies of mechanical properties using the same material PLA 4043D [282, 283]. This could be attributed to differences in operating conditions during processing. Nevertheless, the reduction trend of this strain value is coherent with the literature about PLA recycling.

Number of cycles	Samples	Elastic Modulus	Tensile Strength	Strength at Tensile break	Tensile strain	Nominal Strain at break
		E [MPa]	σ_M [MPa]	σ_B [MPa]	ϵ_M [mm/mm]	ϵ_B [mm/mm]
One	8	3507.5 ± 87.2	60.6 ± 0.4	57.7 ± 1.1	0.025 ± 0.0022	0.030 ± 0.0035
Two	8	3443.7 ± 42.4	56.3 ± 0.1	51.1 ± 1.6	0.022 ± 0.0004	0.035 ± 0.0040
Three	8	3502.1 ± 41.0	54.2 ± 0.4	48.6 ± 0.4	0.020 ± 0.0002	0.032 ± 0.0069
Four	8	3418.2 ± 95.2	54.1 ± 0.5	52.2 ± 0.5	0.021 ± 0.0006	0.023 ± 0.0017
Five	8	3375.6 ± 42.2	48.6 ± 2.3	48.5 ± 2.3	0.018 ± 0.0016	0.018 ± 0.0016

Table 5.1: Mean values of mechanical properties of recycled reference samples

5.2.2 3D Printing process chain

In this section we will analyze the results of the 3D printing process. Before presenting the mechanical results of this recycling process chain, we will present an analysis of the filament quality. For the sake of simplicity, we will present the calibration of the extrusion process and the analysis of the extrusion process for the first recycling cycle. The analysis for the other cycles are presented in the annexe A.

A. Calibration of the extrusion process

As stated in the section 4.4.2 of the chapter 4, the extrusion process was selected in order to fabricate the feedstock material of the open-source 3D printer. Using the process parameters for extrusion presented in section 4.4.2 of the chapter 4, we developed an experimental characteristic curve generated for the PLA processing as shown in figure 5.3.

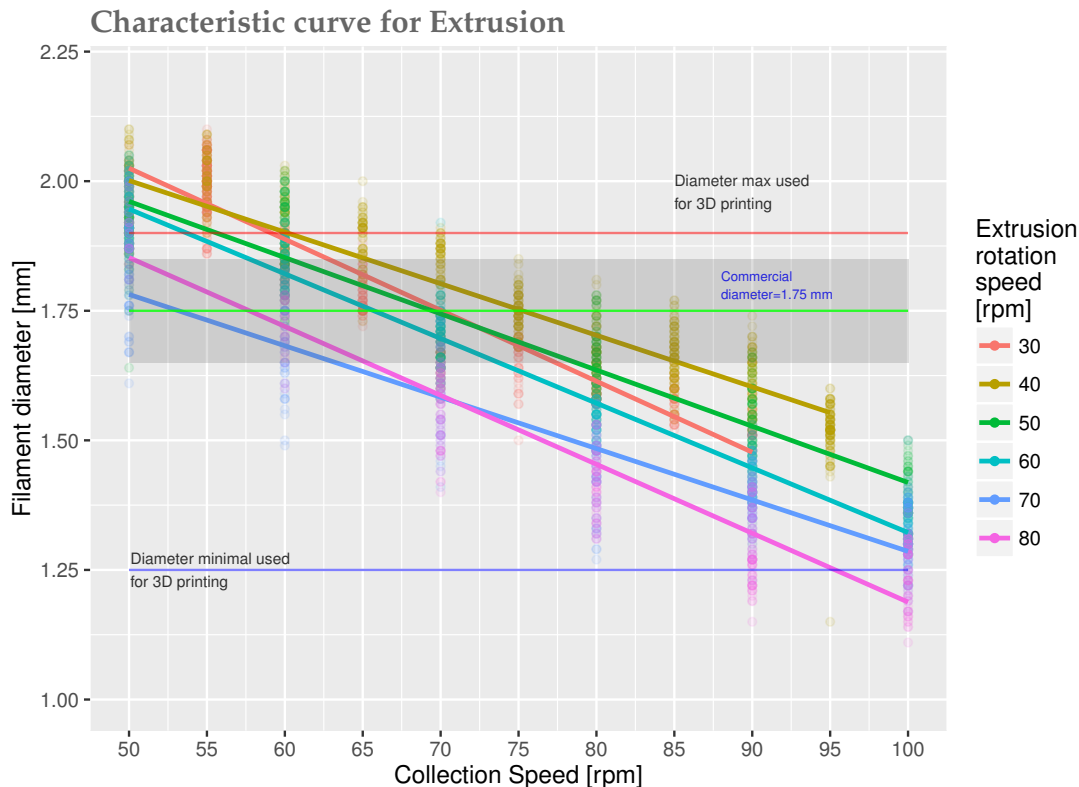

Figure 5.3: Characteristic curve used for calibration of the extrusion process

In this figure, the relation between the extrusion speed, the speed of collection and the obtained diameter is presented. Normally the commercial filament is $1.75 \pm 0.5 \text{ mm}$ which is presented in the grey zone. For the case of our experimentation, the range between $\phi_{\text{filament}} = 1.25 - 1.8 \text{ mm}$ was selected. Experimental observations made during the case study allow us

to confirm that for the set of selected 3D printers, outside of this range, the printing process was not efficient, nor reliable enough.

B. Analysis of the Extrusion process for the first recycling cycle

In order to achieve a regular diameter of the extrudate on every cycle, the filaments were taken after 10 min. of transition phase (figure 5.4). Segments of filament were taken every five minutes of the process and were called systematically with a capital letter. Each segment of filament was measured in order to have a mean value of the diameter, and thus, it could be an input parameter for 3D printing process.

Parameters such as torque and the nozzle extrusion pressure were monitored during the extrusion process of the filament as we can see from figure ???. The objective was to obtain steady conditions for the extrusion process.

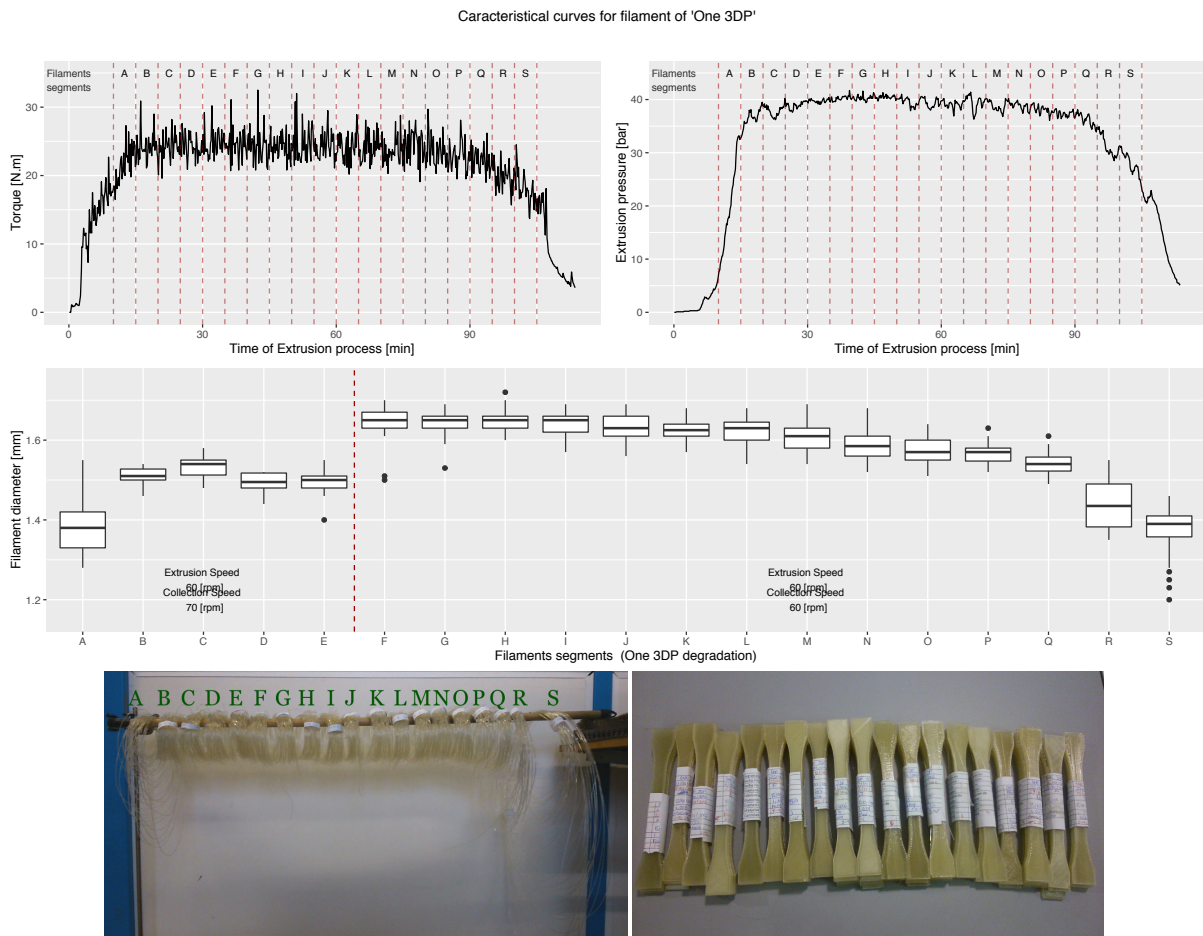

(a) Filaments made from the four recycling (b) 3DP samples with a degradation of two 3D printing processes

Figure 5.4: Analysis of the extrusion process for the first recycling cycle

Figure 5.4b presents the printed samples obtained from this feedstock batch. In the next section we present the mechanical properties of the recycled printed samples.

C. Analysis of the mechanical results of the recycling process chain

The main purpose of this process chain is to obtain directly recycled printed test samples. The methodology illustrated in figure 5.5 was followed. As mentioned before, feedstock material in the form of filament was obtained in order to be used in the 3D printing process for each cycle. For the purpose of

assuring the quality of the printed samples, diameter measurements were taken in order to use mean values for the printed samples.

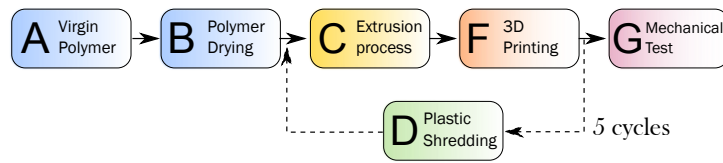

Figure 5.5: Experimental strategy for 3D Printing process chain.

Figure 5.6 and table 5.2, shows the mechanical properties from the printed samples using the parameters mentioned in section 4.4.3. The printed samples with *one cycle* of degradation presented a mean values of tensile strength ($\sigma_M = 50.16 \text{ MPa}$), tensile strain ($\epsilon_M = 0.020 \text{ mm/mm}$), tensile strength at break ($\sigma_B = 49.23 \text{ MPa}$), nominal strain at break ($\epsilon_B = 0.023 \text{ [mm/mm]}$) and an elastic modulus of $E = 3332.5 \text{ MPa}$. Moreover, two types of fill angle (0/90 - 45/45) were tested in order to evaluate the changes in the mechanical performance of the samples. However, as detailed in figure 5.6c, it was found that the mechanical properties of samples 0/90 with one cycle are quantitatively similar to those made with fill angle 45/45. These results of the samples with *one cycle* of degradation are coherent with those reported in the literature by [47, 48]. These results corroborated that the 3-D printed components from open source 3DP are comparable in tensile strength and elastic modulus to the parts printed on commercial 3-D printing systems [47].

Number of cycles	Fill Angle	Samples	Elastic Modulus	Tensile Strength	Strength at break	Tensile strain	Nominal Strain at break
			$E \text{ [MPa]}$	$\sigma_M \text{ [MPa]}$	$\sigma_B \text{ [MPa]}$	$\epsilon_M \text{ [mm/mm]}$	$\epsilon_B \text{ [mm/mm]}$
One	0/90	8	3277.7 ± 128.5	50.1 ± 1.0	49.3 ± 1.4	0.021 ± 0.0030	0.024 ± 0.0047
Two	0/90	8	3320.6 ± 96.9	49.0 ± 0.4	47.9 ± 1.9	0.019 ± 0.0008	0.020 ± 0.0014
Three	0/90	8	3411.3 ± 43.8	43.7 ± 0.8	43.5 ± 1.1	0.016 ± 0.0007	0.016 ± 0.0008
Four	0/90	8	3367.5 ± 87.5	34.0 ± 1.7	33.6 ± 2.1	0.012 ± 0.0006	0.012 ± 0.0010
Five	0/90	8	3432.6 ± 138.9	31.0 ± 2.6	29.9 ± 2.7	0.010 ± 0.0009	0.010 ± 0.0011
One	45/45	8	3213.3 ± 111.5	50.2 ± 0.4	49.2 ± 2.4	0.021 ± 0.0010	0.022 ± 0.0026
Two	45/45	8	3290.0 ± 85.8	49.3 ± 0.6	48.1 ± 1.6	0.020 ± 0.0005	0.023 ± 0.0041
Three	45/45	8	3264.8 ± 92.1	43.0 ± 0.5	41.8 ± 2.0	0.016 ± 0.0005	0.017 ± 0.0006
Four	45/45	8	3335.7 ± 98.2	36.8 ± 0.8	36.3 ± 1.4	0.013 ± 0.0006	0.013 ± 0.0006
Five	45/45	8	3347.4 ± 87.0	29.5 ± 2.4	29.5 ± 2.4	0.010 ± 0.0010	0.010 ± 0.0010

Table 5.2: Mechanical properties of recycled 3DP samples

Concerning the recycling process, it could be observed from table 5.2 and figure 5.6 that all studied mechanical properties of both types of samples (45/45 and 0/90) follow the same degradation pattern. The obtained results could confirm that the meso-structure characteristic had virtually no influence on the mechanical properties.

Figure 5.6b shows that the elastic modulus presents a slight growth as the number of cycles increases for both types of fill angle. On the other hand, from table 5.2 and figures 5.6c-5.6d, the existence of a significant deterioration of mechanical properties could be observed. For the samples 45/45, there is a reduction of tensile strength σ_M ($\sim 41.27\%$), the tensile strength at break σ_B ($\sim 40.08\%$), tensile strain ϵ_M ($\sim 53.08\%$) and nominal strain at break of about ϵ_B ($\sim 56.53\%$). A similar trend was obtained for the samples 90/90, as the reductions were tensile strength σ_M ($\sim 38.15\%$), tensile strength at break σ_B ($\sim 39.29\%$), tensile strain ϵ_M ($\sim 52.20\%$) and nominal strain at break ϵ_B ($\sim 57.43\%$).

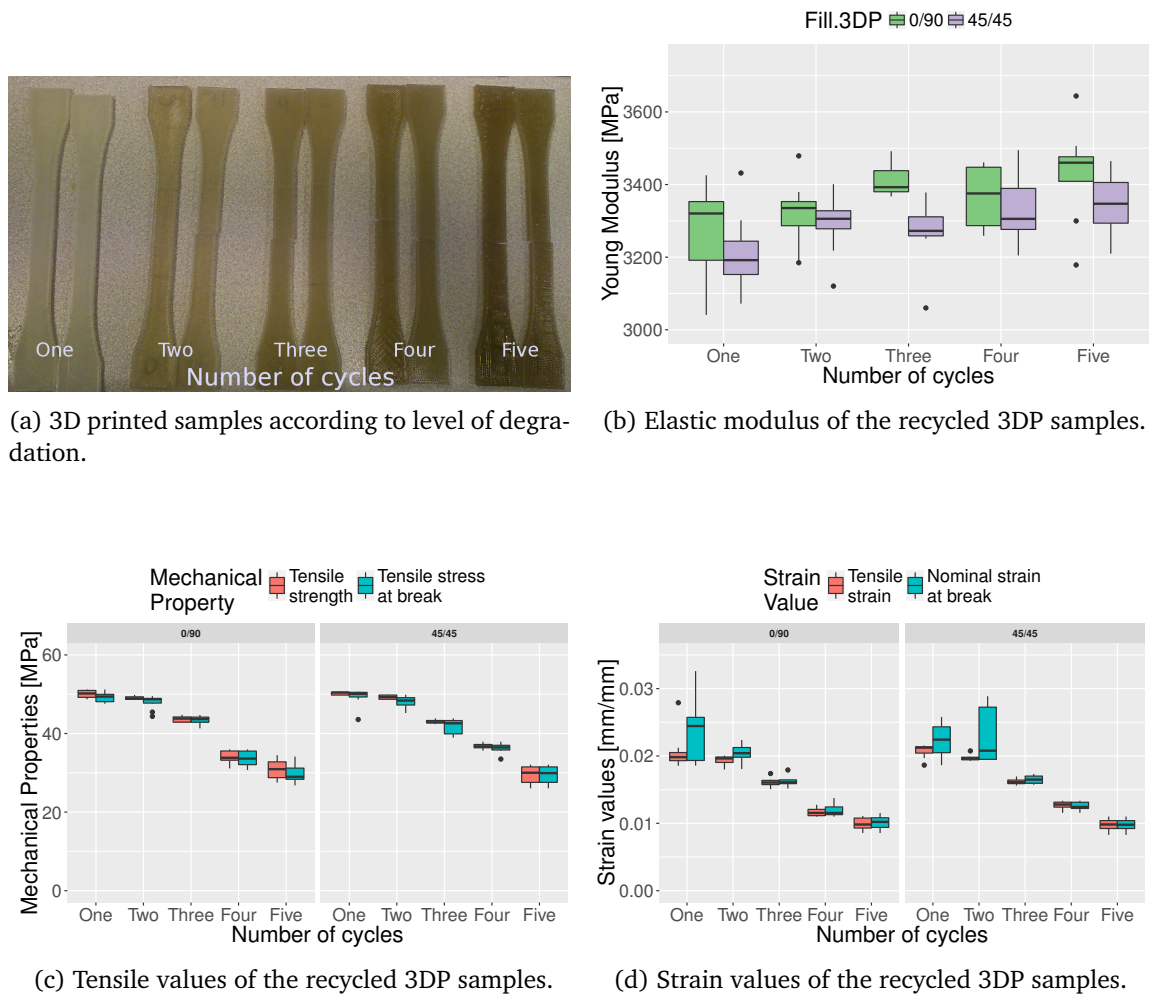

Figure 5.6: Results of the 3D printing process chain samples.

5.2.3 Feedstock process chain

The main purpose of this recycled process chain is to quantify the material degradation due to the feedstock manufacturing process of 3DP material. After each cycle, the micro-compounding process was used in order to obtain the mechanical test sample, which means that the number of times that the material is processed will be proportional to the number of cycles plus one from the micro-compounding process. The methodology followed is illustrated in the figure 5.7.

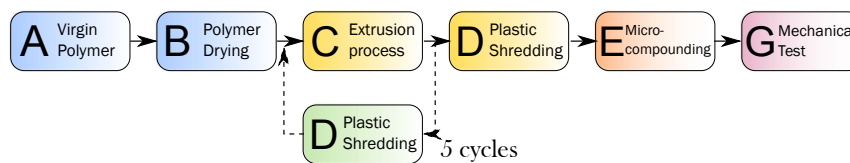

Figure 5.7: Experimental strategy for Feedstock process chain.

Considering the literature for the multiple extrusion approach to assessing the recyclability, the study conducted by Żenkiewicz et al. [270] shows the effect of multiple processing (up to ten times) of PLA (type 2002D NatureWorks[®], USA). They conclude that after ten extrusions, there are reductions in tensile strength (5.2%) and the tensile strength at break (8.3%). On the other hand, the elastic modulus did not significantly vary with the number of the extrusion processes. In our case, as one can see from figure 5.8a, there is practically no variation in the elastic modulus and a mean value of 3587.12 ± 109.9

MPa for this property for the five cycles was registered. These results are in concordance with the literature of PLA recycling and with our *Reference* process chain of section 5.2.1. However, considering the tensile properties, from figure 5.8b a considerable reductions in tensile strength σ_M and tensile strength at break σ_B of about $\sim 47.40\%$ and $\sim 42.50\%$ respectively, after the five cycles, was observed. In the same way, a considerable reduction of the tensile strain ϵ_M and nominal strain at break ϵ_B values of about $\sim 58.57\%$ and $\sim 70.84\%$ was observed. The mechanical properties can be found in table 5.3.

Number of cycles	Samples	Elastic Modulus	Tensile Strength	Strength at break	Tensile strain	Nominal Strain at break
		E [MPa]	σ_M [MPa]	σ_B [MPa]	$\epsilon_M \ \sigma_B$ [mm/mm]	[mm/mm]
One	8	3562.9 ± 118.6	59.3 ± 1.5	53.534 ± 2.9	0.023 ± 0.0021	0.032 ± 0.007
Two	8	3581.4 ± 118.6	54.7 ± 0.6	51.819 ± 3.4	0.020 ± 0.0004	0.023 ± 0.0031
Three	8	3557.6 ± 49.5	51.4 ± 2.6	50.868 ± 3.0	0.018 ± 0.0017	0.018 ± 0.0019
Four	7	3608.6 ± 126.3	42.5 ± 4.4	41.433 ± 5.0	0.013 ± 0.0019	0.013 ± 0.0020
Five	8	3619.9 ± 144.9	31.1 ± 7.1	30.778 ± 7.5	0.009 ± 0.0026	0.009 ± 0.0025

Table 5.3: Mean values of mechanical properties of selected recycled extrusion samples

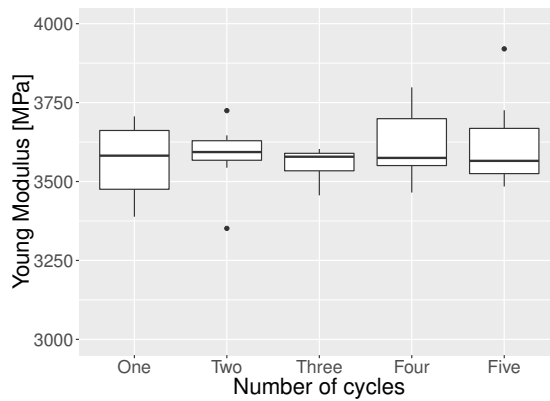

(a) Elastic modulus of the *Feedstock* samples.

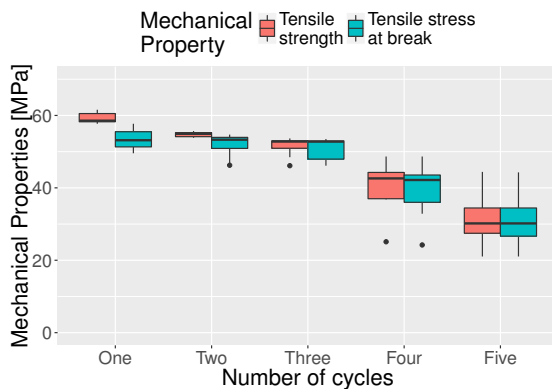

(b) Tensile properties of the *Feedstock* samples.

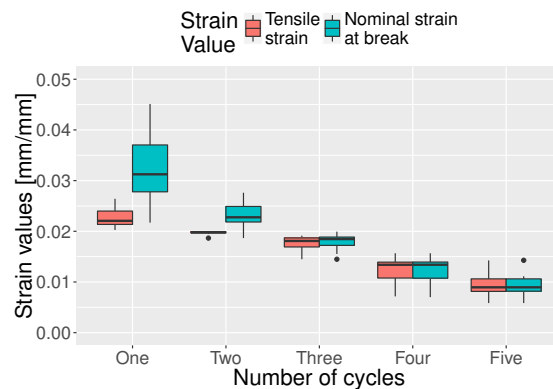

(c) Strain values of the *Feedstock* samples.

Figure 5.8: Results of the *Feedstock process chain* samples.

5.2.4 3D Printing (Reference) process chain

The main goal of this process chain is to be able to consider directly the material degradation after the printing process and evaluate the effects of the anisotropic behavior of the matter. Figure 5.9 sums up the methodology used for the characterization.

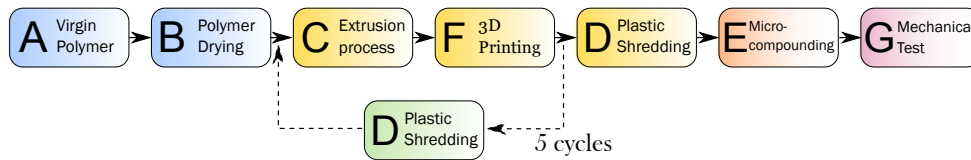

Figure 5.9: Experimental strategy for 3D Printing (Reference) process chain.

At every cycle, once the material was printed, it was collected; milled and injected in the micro-compounder in order to obtain mechanical samples. Albeit, it must be recognized that using this approach, inevitably one additional degradation process will be applied to the material, this recycling process chain can allow us to have a quantitatively measurement of the material after the printing process.

Table 5.4 presents the evolution of the mechanical properties of the material after the printing process. In figure 5.10a, as observed, the elastic modulus E remains approximately constant through the five cycles. Nevertheless, a strong variability in the results during the fifth cycle was registered which could be attributed to the difficult fabrication of the test samples due to the fluidity of the material. It has to be noted that this process chain presented the highest reduction in mechanical properties through the five cycles. Tensile strength σ_M decreased $\sim 71.34\%$, tensile strength at break $\sigma_B \sim 72.58\%$, tensile strain $\epsilon_M \sim 78.93\%$ and nominal strain at break $\epsilon_B \sim 86.49\%$. In fact, figure 5.10b indicates that in the fourth and fifth recycled material, there could be a influence of the micro-compounding process on account of the appreciable reduction in tensile strength.

Number of cycles	Samples	Elastic Modulus	Tensile Strength	Strength at break	Tensile strain	Nominal Strain at break
		E [MPa]	σ_M [MPa]	σ_B [MPa]	$\epsilon_M \sigma_B$ [mm/mm]	[mm/mm]
One	8	3482.7 ± 67.8	59.3 ± 0.5	53.6 ± 2.7	0.0242 ± 0.0010	0.0333 ± 0.0054
Two	7	3670.7 ± 87.1	53.6 ± 0.9	50.4 ± 1.7	0.0179 ± 0.0008	0.0218 ± 0.0044
Three	8	3549.2 ± 82.4	48.0 ± 1.7	47.6 ± 1.5	0.0159 ± 0.0012	0.0159 ± 0.0012
Four	8	3380.6 ± 55.7	30.0 ± 2.5	29.1 ± 3.4	0.0093 ± 0.0008	0.0094 ± 0.0008
Five	8	3504.6 ± 209.0	17.0 ± 3.2	14.7 ± 7.0	0.0051 ± 0.0010	0.0045 ± 0.0019

Table 5.4: Mean values of Mechanical properties of recycled 3DP samples (Compounding)

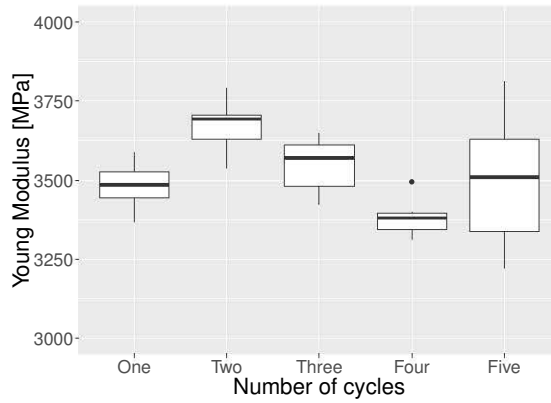

(a) Elastic modulus of the 3D Printing (Reference) samples.

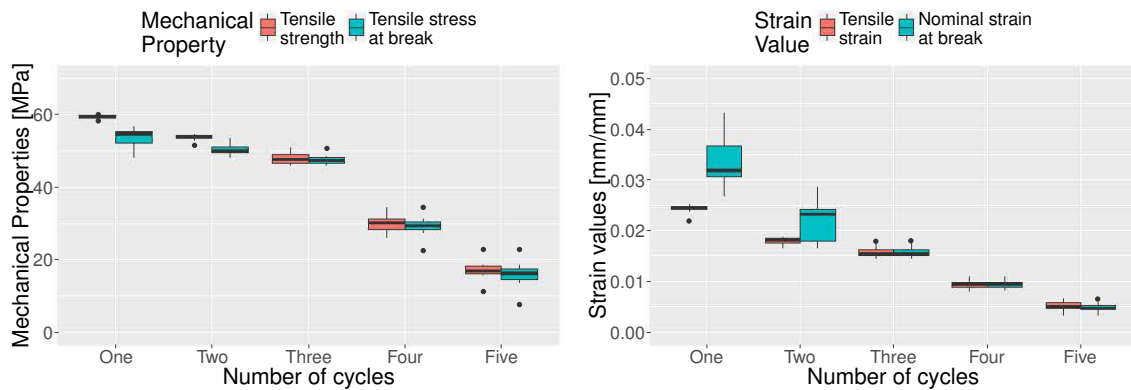

(b) Tensile values of the 3D Printing (Reference) samples (c) Strain values of the recycled 3D Printing (Reference) samples

Figure 5.10: Mechanical properties of the 3D Printing (Reference) process chain samples.

5.3 Comparison of the different recycling process chains

In this part, two different comparisons of the obtained results in terms of elastic modulus E and tensile strength ($\sigma_M - \sigma_B$) and strain ($\epsilon_M - \epsilon_B$) for the previous recycling process chains will be carried out. First, the Reference and the 3D Printing process chain will be compared in order to qualify the differences between injected samples and 3D printed test samples (0/90 – 45/45). Then, a comparison between Feedstock and 3D Printing (Reference) process chains will allow us to qualify the material’s degradation due to the 3DP printing process.

5.3.1 Elastic Modulus

Figure 5.11 shows that the elastic modulus can be assumed as being independent from the recycling and fabrication process. It could be considered constant for the injected test samples (Reference, Feedstock and 3D Printing (Reference) process chains), within a range of variation between 3200-3500 MPa with a mean value throughout the recycling process of 3517 ± 126.4 MPa. Although for the printed test samples (3D Printing 45/45 and 0/90 process chains), a weak increase of elastic modulus is observed from the first to the last cycle with a mean value of 3277.7 to 3432.6 MPa respectively.

(a) Mean elastic modulus value of the *Reference* and *3D printed* recycled samples(b) Mean elastic modulus value of the *Feedstock* and *3D printed (Reference)* recycled samples

Figure 5.11: Evolution of Elastic modulus of in the recycling process chains

It could be argued that due to the change of material viscosity, which is a consequence of the recycling process, the meso-structure and fiber-to-fiber bond characteristics of the printing samples will also change as the number of recycling processes increases. According to the literature, one of the internal defects that affects the structural quality of printed parts is the voids, pores, and sub-perimeter voids due to the rounded, oblong shape of the deposited material [49, 50]. In the printing process, the printed material will spread into an oblong shape with the spreading rate and final shape dependent on the viscosity of the melt and the relative surface energies of the bead and the surface on which it is printed [50]. Ultimately, the overall mechanical properties of the part will depend on the contact area between the deposited beads (and layers), the size of the voids and the material properties themselves.

Therefore, one hypothesis for explaining the similar behavior between *Reference* and *3D Printing* process chains in terms of the elastic modulus at the end of the fifth cycle is that there is an appreciable reduction of the internal defects (voids, pores) caused by the increase in material viscosity, which facilitates the homogenization of the deposited layers. It could be assumed that the internal meso-structure of the printed samples could be similar to its relative injected one. Nevertheless, this reduction in vis-

cosity is one consequence of the material degradation. And as a result of this degradation, the tensile properties are affected as can be seen below.

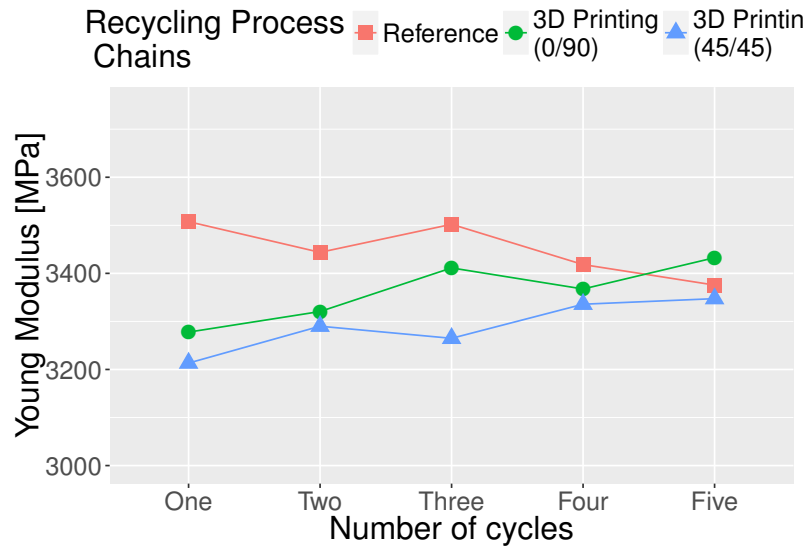
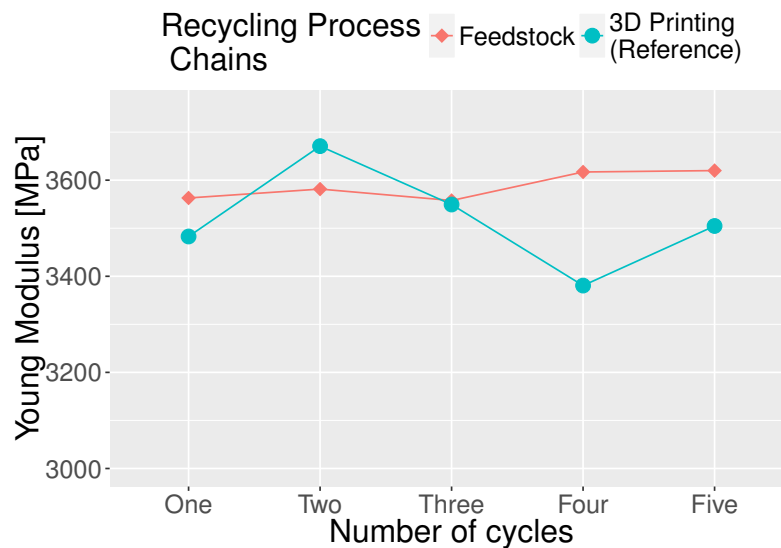
On the other hand, another consequence of the change in the material viscosity for the *3D printing* recycling process chain is related to the change slightly change in the samples weight, as illustrated in figure 5.12. It could be deduced that one main difference of the *Standard* (Micro-compounding) and the *3D printing* manufacturing process is related to the reproducibility of the fabrication of samples. The three recycling process chains that use the *standard* process present virtually no difference in the weight of the sample, which is finally independent of the material degradation. On the other hand, the 3D printing process presents a slight increase of the sample weight. An initial estimation of the weight ($w = 9.9\text{gr}$) was made from the CAD version, this weight value present a modest rise as the number of recycles increases This feature could add element to the hypothesis that the reduction of material viscosity help to the homogenization of the printed sample.

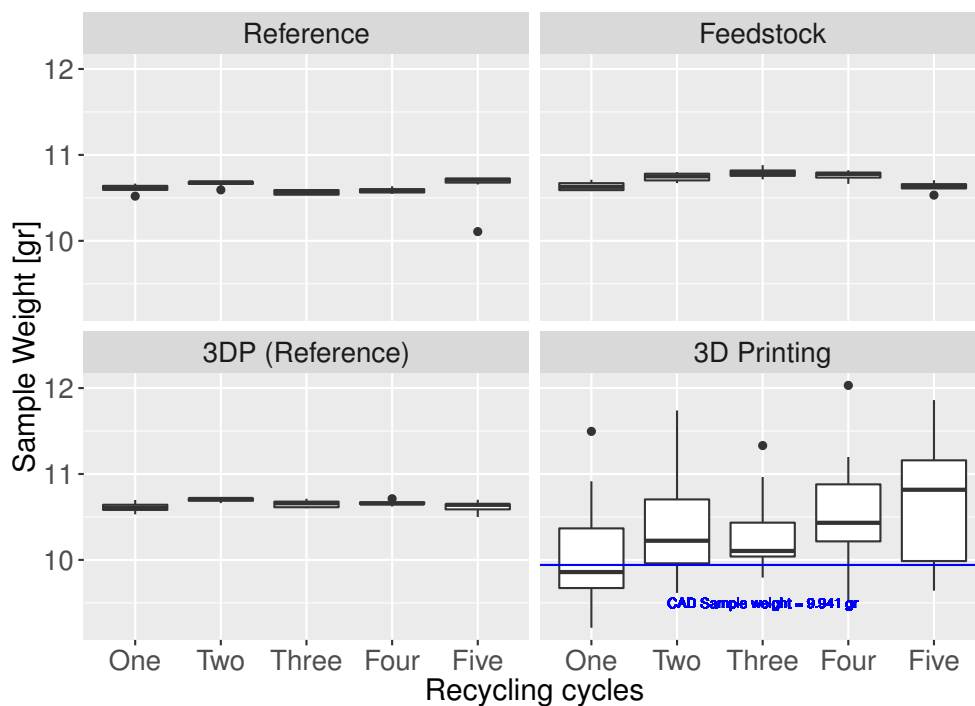

Figure 5.12: Samples weight in function of the recycling process chains

In the next section, the comparison of the tensile properties among the recycling process chains is made.

5.3.2 Tensile strength and Tensile strain

Considering the tensile strength and strain, as expected, there is a reduction in the mechanical properties in each recycling process chains as illustrated in figure 5.13.

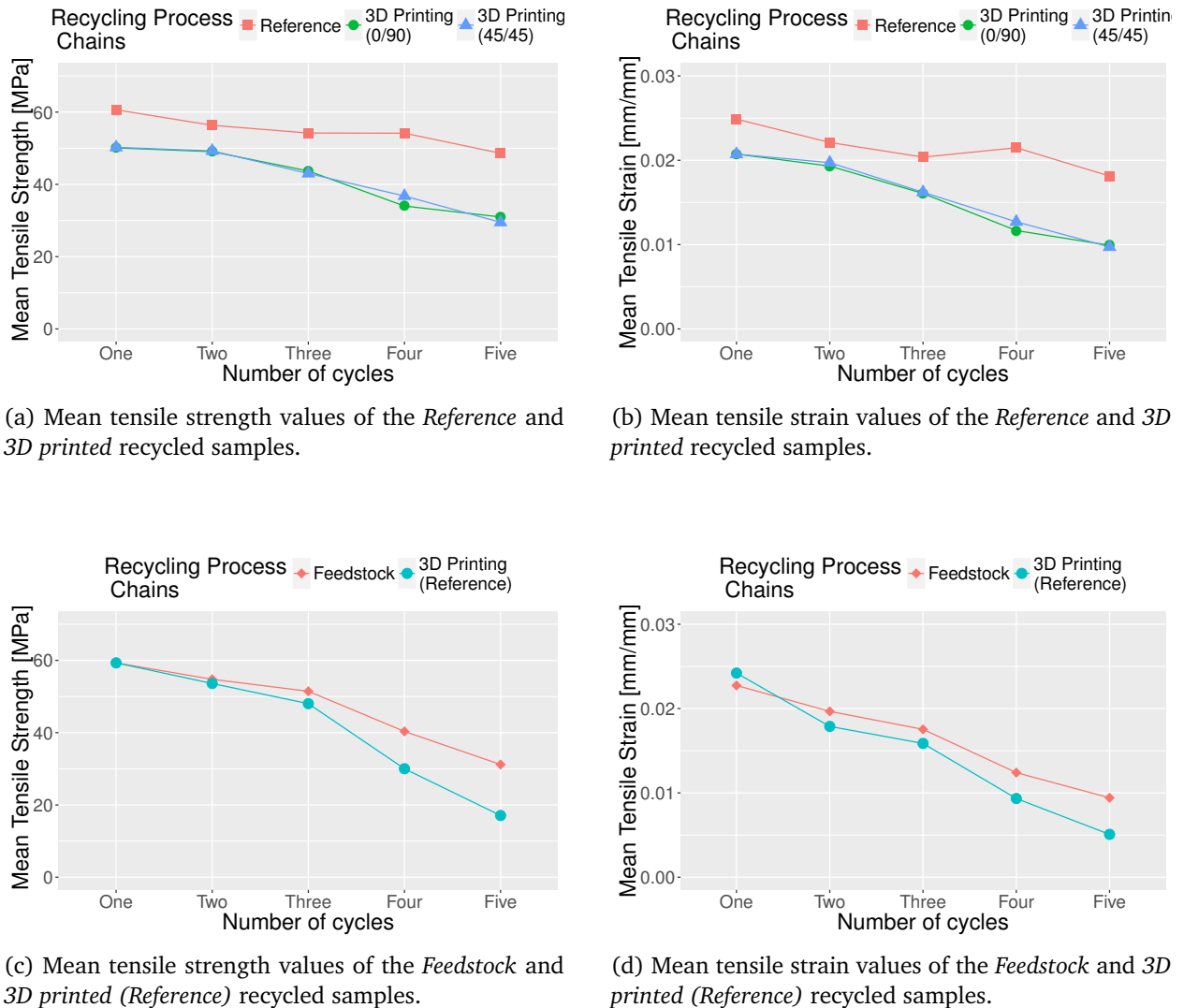

Figure 5.13: Tensile properties of the recycled samples of the different recycling process chains

The figures 5.13a and 5.13b compares the mechanical properties of the *Reference* and *3D printing* process chains. This comparison is made with the purpose of evaluate the mechanical performance of the recycled material between the injected and the printed samples. The *Reference* process chain presented the lowest reduction of mechanical properties with a difference of nearly 10 MPa during the first and second cycles with respect to the *3D printing* process chain. This is in accordance with some previous work by [47, 48]. However, if one considers the subsequent recycling cycles, a growing gap in these properties could be observed. The same trend can be seen with regard to the strain values (figure 5.13b) in which there is a constant difference for the first two cycles, but after that, the difference is increased.

Moreover, figures 5.13c and 5.13d show that there is a growing difference between the *Feedstock* and the *3D Printing (Reference)* process chains. As remarked previously, in these two processes, for each cycle, there is the same number of extrusion and plastic shredding processes. The only difference between these two process chains is that in the *3D printing (Reference)*, we have additionally n printing processes with n the number of recycling cycles. According to the figures 5.13c and 5.13d, it seems clear that the printing process has an effect on the material degradation as the number of processing cycles increases. One can be see that the material start with a same properties level and systematically the material without 3D printing process (*Feedstock*) is superior to the material that have been printed (*3D printing (Reference)*). This effect has a direct impact on the mechanical properties of the printed

samples, as evident in the figure 5.13a. Therefore, 3D printing effect is weak for the two first cycles, but increases as the material degradation increases.

On the other hand, considering the cycles *three, four and five* in figure 5.13, it can be observed that the mechanical properties for the *3D printing* process chain (green and blue lines in figures 5.13a and 5.13b) are better than the properties of *3D Printing (Reference)* recycling process chain in the same number of cycles (blue line in figures 5.13c and 5.13d). This could be explained by two simultaneous opposed effects. First, the effect of the 3DP printing process which reduces the mechanical properties in each cycle, as remarked previously. And second, the polymer degradation induces the increase of material viscosity. As previously mentioned in section 5.3.1, the material viscosity could be an important parameter in the 3D printing process because it induces better filled printed samples. At this point, it is also recognized that another element that can affect the material degradation is the micro-compounding process, as it is mentioned in the section 5.2.4.

Figure 5.14 presents a comparison of the tensile strength among the different recycling process chains. Considering the sample weight as one possible aspect of quality the fabrication of the mechanical sample, this figure present systematically the reduction of the properties in function this value. We observed virtually no changes in the weight for sample made using *standard process* (micro-compounding). In the case of *3D printing process*, we observed a more variability, and recognizing that the mechanical properties of the printed part is directly related to the deposited material. As stated before, *Reference* recycling process chain presented the lowest reduction while the *3D P (Reference)* presented the highest reduction of the mechanical properties. In the case of the printed samples, even if there is a great variability in the samples weight, the mechanical propoerties were independent of this value. Therefore, this figure could prove that the reduction of the mechanical properties is effectively because of the material degradation and not by defects of the manufacturing process of the sample (particularly in the case of the 3D printing process).

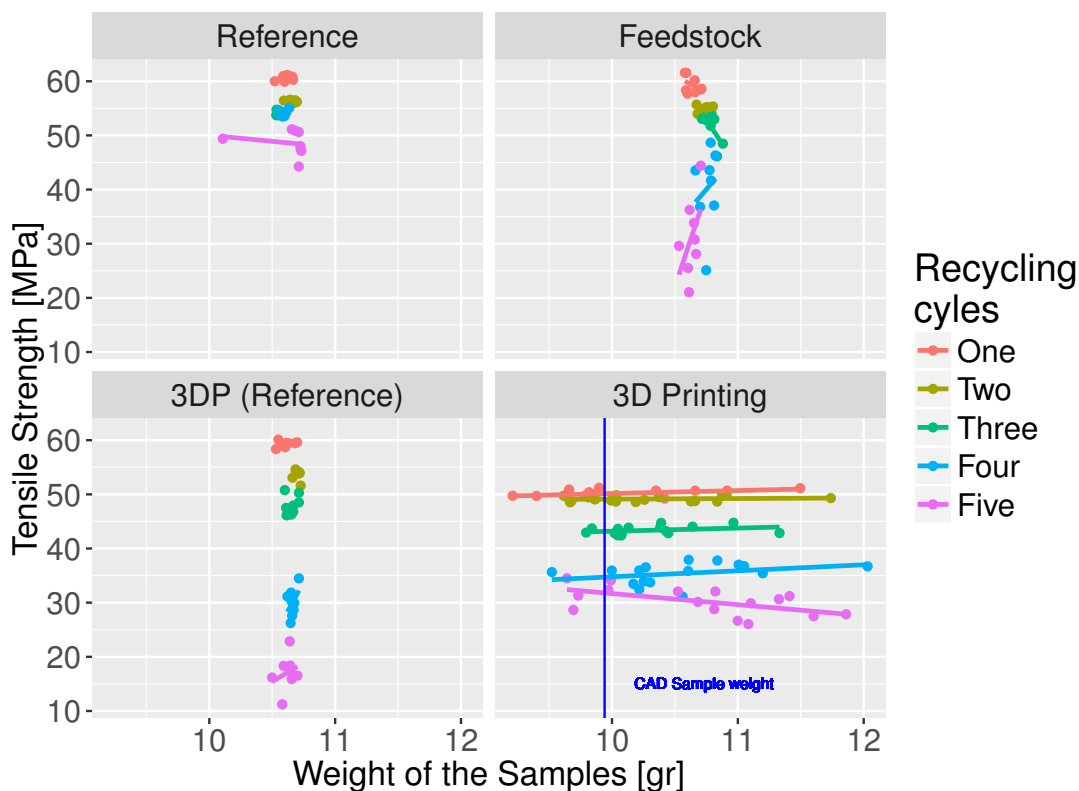

Figure 5.14: Tensile strength in function of the samples weight and the recycling process chains

5.4 Conclusions

In this chapter, we presented the results and the discussion of the general methodology proposed in chapter 4. A case study was examined through the polylactid acid (PLA) recycling intended for open-source 3D printers using the fused filament fabrication (FFF) technique.

In order to accomplish these results, four different recycling process chains (*Reference*, *Feedstock*, *3D Printing* and *3D Printing (Reference)*) were proposed for the purpose of evaluating the degradation of the mechanical properties after five recycling cycles. These recycling process chains allow us to compare the mechanical performance of the material using a standard process and open-source 3D printing process. Moreover, it allow us to evaluate the impact of the printing process on the material degradation. Specific results are summarized as follows:

- *Reference*: This recycling process chain presented the lowest reduction in mechanical properties. A progressively diminution of tensile strength (19.81%), stress at break (15.95%), tensile strain (27.31%), and nominal strain at break (40.65%) was evidenced. These values are useful in order to compare the degradation of the material with respect to the other cycles. The elastic modulus registered a mean value of $33.449 \pm 81 \text{ MPa}$
- *3D Printing* : For samples 0/90, there was a reduction of tensile strength ($\sim 38.15\%$), tensile strength at break ($\sim 39.29\%$), tensile strain ($\sim 52.20\%$) and nominal strain at break ($\sim 57.43\%$). For samples 45/45, there was a reduction in tensile strength ($\sim 41.27\%$), the tensile strength at break ($\sim 40.08\%$), tensile strain ($\sim 53.08\%$) and nominal strain at break ($\sim 56.53\%$).
- *Feedstock*: The degradation due to feedstock material fabrication for the 3D printing process registered a considerable reduction in tensile strength and tensile strength at break of about $\sim 47.56\%$ and $\sim 42.52\%$ respectively after the five recycling cycles. In the same way, a considerable reduction of the tensile strain and nominal strain at break values of about $\sim 58.57\%$ and $\sim 70.84\%$ was observed.
- *3DP (Reference)*: This cycle presented the highest reduction in mechanical properties through the five recycling operations. Tensile strength decreased ($\sim 71.34\%$), tensile strength at break ($\sim 72.58\%$), tensile strain ($\sim 78.93\%$) and nominal strain at break ($\sim 86.49\%$).

On the other hand, results showed that the elastic modulus of the recycled samples is virtually constant in the injection process. Nevertheless, for the printed samples, results highlighted a relatively increase of the elastic modulus as the number of recycling cycles increases. The main hypothesis to explain this behavior is that there is an appreciable reduction in internal defects (voids, pores) caused by the reduction of the material viscosity, which facilitates the homogenization of the deposited layers in the printing process. Further studies should be addressed for confirming this hypothesis.

The results of this study are comparable to the literature of PLA recycling using traditional processes. In the same way, the results of the mechanical properties of the printed samples in the first cycle support the idea that 3D printed components from open source 3DP are comparable in tensile strength and elastic modulus to the parts printed on commercial systems [47]. To the authors' knowledge, this is the first study to investigate characterization of the polymer degradation in the context of open-source 3D printing. Our results from the recycling process provide compelling evidence of the feasibility of using recycled PLA for open source 3D printing. However, as a main result we highlighted that the 3D printing process reduces the mechanical properties. One has to consider this effect and, in conclusion, one cannot recycle material as many times as in an injection process. Most notably, this finding is promising and it could serve as a basis for the study of recyclability of other industrial polymers in order to establish the viability for use in the 3D printing chain. Eventually, the viability of an industrial sector focused on the polymer waste in 3D printing technology could be a subject of study. Future work should focus on the chemical and thermal degradation of the polymer, as well as the determination of molecular weight reduction and changes in the temperatures of the polymer during the recycling process. Moreover, issues concerning the use of composite materials should be addressed.

Conclusions and future work

In this document, an effort has been done to propose (hopefully original) methodological tools for strengthening the development of the open-source (OS) additive manufacturing (AM) technology. This was done with the conviction that the development of this technology will open up new possibilities and will generate a positive impact on the society in the near future, not only in terms of *distributed manufacturing*, but also in *distributed recycling* actions. Our vision with this thesis is to contribute to the development of a **green fablab** concept which could lead towards more sustainable manufacturing processes/practices. Seen from this perspective, our research has been focused around this fundamental question:

- Is it feasible to use recycled material in the context of open-source 3D printing?

Beyond responding this question with a *Yes/No* answer, what really concern us is to explore what material recycling means for the AM processes. And more specifically, how we could systematically evaluate the technical feasibility for using recycled polymer in open-source 3D printers. The overall goal of this thesis is to have a better understanding on the polymer recycling process in order to establish a sustainable waste management option for this technology. Therefore, this research is focused on the study of the physical degradation of the material properties in the printing process chain.

The first contribution of this research, based on an initial additive manufacturing (AM) literature, a wide range of research paths were identified, and they could be explored in order to emphasize the potential benefits on AM on sustainable issues. Then, making a focus on material recycling, a systematic literature review methodology was followed with the aim to map the current practices and methods/tools used for the verification of the recycled material quality in the main commercial (AM) technologies. It was noted that in the context of commercial AM, particularly for *Discrete Particle* AM processes (e.g. Selective Laser Sintering (SLS), Electron Beam Melting (EBM)) using metal/polymer powders, there have been several efforts for characterizing the quality of the recycled feedstock. More precisely, the notion of recycling in these *discrete* processes is related to the reutilization of the unused (or un-sintered) material. Nevertheless, one main conclusion is that there is still a lack of understanding the relationship among material/process/properties for the products fabricated with this AM processes.

In the context of *molten material* AM (e.g. Fused Deposition Modeling (FDM)) including the open-source 3D printing, there has been empirical and experimental efforts to propose a recycling process chain (shredding + small-scale extrusion + collection) for manufacturing recycled filament in order to be used in the OS 3D printers. This proved that there exist an interest in developing solutions to reuse thermoplastic materials. However, we did not find any methodological propositions that allow users to understand the quality of the recycled material, and even more, to understand the physical changes in the material due to the recycling process. Therefore, the notion of quality of this recycled materials still remains unclear for the recycled printed object as well as for the feedstock material used in the 3D printer.

Figure 6.1 presents the proposed generic approach to the recycling process for open-source 3D printers. The stages *Material*, *Process*, *Evaluation* and *Recycling* represent schematically the necessary elements to take into account in the recycling process chain of 3D printing.

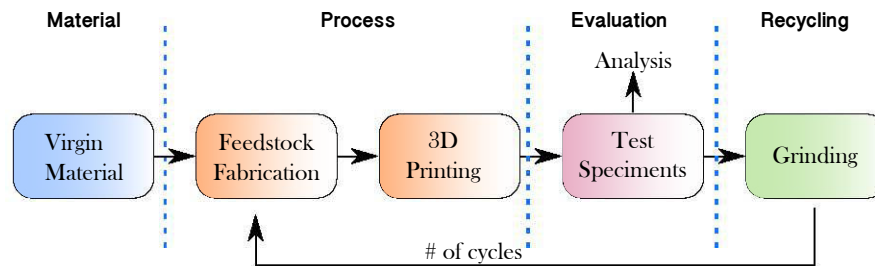

Figure 6.1: Experimental recycling process chain for 3D printing.

In this linear model, it can be inferred that the quality of the *test specimens* are a function of the *virgin material*, *feedstock fabrication* and the *3D printing* processes. Likewise, the material degradation during the recycling process is due to the type of material, the impact of the necessary steps for feedstock fabrication and the printing process itself. Therefore, before studying the quality evolution of the *virgin material* in the recycling procedures, it is absolutely necessary to characterize each of these stages for understanding the global process.

Therefore, the second contribution is related to understanding the notion of quality for the stage of *3D printing* process, using as case study a representative OS 3D printer named *FoldaRap*. An experimental protocol was established with two main purposes: (1) to evaluate the quality of the 3D printer in terms of dimensional accuracy. And (2), to identify the link between the process parameters and the quality of the printing process. This protocol considers four main phases (*Geometric benchmarking model*, *Design of experiments*, *Fabrication and results*), correlating the results to an International Standard Tolerance (IT) Grade (ISO-ANSI standards UNI EN 20286-I (1995)). We found that according to this international standard, the dimensional precision of our case study was situated between IT14 and IT16, which is comparable with the commercial manufacturing processes. On the other hand, it was not possible to identify the most relevant control factors (3D printer parameters) using of the DoE (Taguchi method) coupled with the ANOVA approach. There are noise effects produced in this type of machine that has more impact than the effect of the control factors. Elements of noise that can affect the experimentation were highlighted through an Ishikawa diagram. Acknowledging this obstacle, a *Global Index* was developed using an estimator parameter (root-mean-square deviation (RMSD)) with the aim of rank the control factors according to Taguchi's array used, and therefore, to identify the control factors with the highest accuracy. In this way, the link between process parameters and printer's performance could be established. The main conclusion of this first contribution is the validation of the open-source 3D printing system as a manufacturing tool, comparable to other set of technologies currently used in the commercial AM and subtractive manufacturing [126]. Moreover, the *Global Index* of performance, based on the root-mean-square deviation (RMSD) value, allowed us to find the manufacturing parameters that present systematically the highest dimensional performance.

Once the performance of a representative OS 3D printer was characterized and the suitability of these devices as a manufacturing tool was proved, we can focus our attention to the material recycling issues. The third contribution of this thesis is the proposition of a general methodology in order to evaluate the recyclability of the thermoplastic polymers used as feedstock of 3D printing machines. The importance of this methodology relies on the feasibility evaluation of using recycled material by OS 3D printers.

As stated before, we did not find any methodological proposition to evaluate the whole recycling process chain in our systematic literature review. Therefore, the advances in the field of polymer recycling were explored in order to have an insight about the definition of polymer degradation, the methods and tools that are commonly used in this knowledge area. Based on this literature, a systematic framework composed of five steps (*Material definition*, *Processes assignment*, *Fabrication of samples*, *Evaluation*

and Recycling) was proposed. This approach allow us to follow the evolution of the material properties in the recycling procedure. A set of minimum four types of recycling process chains were proposed in order to evidence the evolution of the material degradation. They are defined as follows:

- *Reference*: used as degradation reference for the recycled material;
- *Feedstock*: used to evaluate the degradation impact due to the feedstock material fabrication for the 3D printing machines considered (i.e. filament, pellet, powder...);
- *3DP (Reference)*: used to evaluate the degradation of the material as a result of the 3D printing process using the reference equipment;
- *3D printing*: used to evaluate the degradation of the material as a result of the 3D printing process with samples made using a 3D printer with established parameters.

The proposed methodology was applied to the recycling study (up to five cycles) of the polylactic acid (PLA), material widely used in the OS 3D printing context. Two open-source 3D printers named *FoldaRap* and *Mondrian* were used, and the process parameters were selected using the protocol proposed in chapter 3. The mechanical properties of the recycled material were followed in the four recycling process chains. A first main conclusion of this experimental work is that our results support the idea that 3D printed components from open-source 3D printing are comparable in tensile strength and elastic modulus to the parts printed on commercial systems [47]. Concerning the recycling process, the *Reference* process chain presented the lowest reduction of mechanical properties, as expected. After five recycling cycles, the tensile strength presented a progressively diminution of 19.81% with respect ot its initial value. On the other hand, in the case of *3D Printing* recycling process chain, the tensile strength was reduced 38.15% and 41.27%) for samples 0/90 and 45/45, respectively. Therefore, we can concluded that for the case of PLA, the impact on the recycling process intended for OS 3D printing was an additional degradation of $\sim 20 - 22\%$ of the tensile properties. Moreover, We found that for the printed samples, a relatively increase in the elastic modulus E was perceived as the recycling process was made. The main hypothesis to explain this behavior is that there is an appreciable reduction in internal defects (voids, pores) caused by the increase in material viscosity, which facilitates the homogenization of the deposited layers in the printing process. Further studies should be addressed to confirm this hypothesis. These mechanical results of this experimental work can support the feasibility of the use of recycled material for OS 3D printers. Nevertheless, it is necessary to take into account that the additional processes induce an increase in the material degradation.

Limits and perspectives of this research

It is well known that in a thesis project, it is difficult to deepen in each field that we have considered. This is why, we would like to highlight some limitations of our contributions, in order to put them into a larger perspective. Concerning the first contribution of the systematic literature review about material recycling in AM processes, we can highlight several considerations:

- The systematic literature approach used in this thesis tries to find the main insights about the material recycling processes intended for each type of AM techniques. Nevertheless, one limitation is that we have not found considerable studies concerning material recycling in *Liquid* or *Solid sheet* AM. It could be possible that the keywords used or the selected information source were not adequate for finding more information about the material recycling in these AM processes.
- In our analysis, we did not consider the manufacturing processes of the feedstock material (e.g. fabrication of powder material, or filament thermoplastic). It is necessary to understand this manufacturing processes in order to have an holistic vision of the material recycling processes for AM.

Concerning the second contribution of standard experimental protocol, several elements can be considered:

- From a methodological perspective, we defined only four type of dimensional accuracies in order to characterize the dimensional performance of the 3D printer. We acknowledge that one of the main advantages of the 3D printing is the fact that there is (practically) no restriction in terms of geometry. For that reason, we consider that a more robust reading grid, with more types of dimensional accuracies could be proposed in order to have a more complete evaluation of the 3D printer performance.
- From a experimental perspective, one of the first things that we noticed in the chapter 3 was about overall experimental time ($\sim 60h$) for the fabrication of the geometric benchmarking model. We could not perform an evaluation of other OS 3D printer in order to have a comparative with our case study. There is an intensive work in order to establish an multi-criteria analysis in order to compare the 3D printer performance, including factors such as price, easy-to-use, time of fabrication, among other aspects.
- Another point is related to the selection of the control factors used in our research. We only selected three parameters that we considered as been relevant from the literature. However, the Anova analysis showed that there are noise factors that had an important weight in the process for the selected accuracy parameters. Therefore, a more reliable process is necessary to understand the printing process and reduce these noise factors.

Concerning the limits of our second contribution, they can summarize the following elements:

- We based our research in the model represented in figure 6.1. As stated in the section 4.3, we started our analysis from *Virgin Material*. It is clear that in a real recycling process phases such as the collection of the wasted plastic, the sorting and the cleaning process, among others, are key elements that need to be clarified if a distributed recycling model would take place.
- Another element to consider in the phase of *Virgin Material* is concerning the use of additives. We simplified our case study using a virgin material without any additional components. An interesting path of research is to explore the use of additives in the recycling process in order to observe the evolution of the mechanical properties.
- The study of other commercial polymers (HDPE, PET, PET...) using this methodology is a important element, taking into account that these materials represent a greater contribution to waste than the bio-polymers such as PLA. Also, the study of composite materials would offer new possibilities to evaluate.
- One element that we have not considered is related to chemical issues. In this thesis, we explored the evolution of the mechanical properties. However, as stated in the section of polymer background (section 4.2), there is a set of additional methods that would describe in a integral manner the degradation of the material.
- We have developed our research in laboratory conditions, using certified laboratory machines for the fabrication of the filament material. It is interesting to study the performance of the open-source extruders found in the web literature (e.g. Lyman Filament Extruder [212], Filabot [213], Recyclebot [22], RepRap Recycle Add-on [214], Precious plastic [21]) in order to compare the quality material with respect to the laboratory systems. This evaluation could position the open-source systems with respect to the commercial options.

Future work

We can state the following elements regarding to the elements of our future work:

- A focus on the chemical characterization of the recycled material will be worked. We presented in this thesis the macro-properties of the recycled material. Now, the micro-structural changes such as thermal properties (e.g. glass transition, fusion temperature, the crystallization degree), rheological properties (e.g. changes in viscosity) could give an important understanding of the material changes and its influence on the macro-properties.
- From a global perspective, the study of the required elements for establishing a local recycling chain should be addressed, using the fablab as a recycling hub. Therefore, it necessary to establish the initial requirements in terms of machinery, quantity of material, type of plastics possible to recycle, and cleaning/sorting issues. Modelize the recycling chain and know stakeholders and observe the flux of material/information are essential elements to understand.

Annex A: Measurements of the Geometric Benchmarking Model

Résultats de l'expérimentation.

Analyse de la précision dans le plan XY							
Operations	Essai	Indice #1	Essai	Indice #2	Essai	Indice #3	
Ext	X	Essai 6	0,22923332	Essai 7	0,2548856	Essai 1	0,3262923
	Y	Essai 8	0,11532563	Essai 4	0,1261943	Essai 2	0,23259407
A1	X	Essai 4	0,06157651	Essai 2	0,15110703	Essai 6	0,16762433
	Y	Essai 8	0,05829165	Essai 1	0,14059398	Essai 2	0,14490658
A2	X	Essai 1	0,19424534	Essai 2	0,32364783	Essai 7	0,38359864
	Y	Essai 1	0,2136196	Essai 9	0,34496377	Essai 6	0,38578653
B1	X	Essai 8	0,05742749	Essai 6	0,07047458	Essai 1	0,10487095
	Y	Essai 8	0,090185	Essai 7	0,09218415	Essai 4	0,1030271
B2	X	Essai 6	0,04913841	Essai 2	0,10861822	Essai 3	0,11165423
	Y	Essai 7	0,06317964	Essai 8	0,10007289	Essai 4	0,10597759
B3	X	Essai 8	0,04795832	Essai 6	0,09712535	Essai 1	0,12602083
	Y	Essai 7	0,05649484	Essai 8	0,09451631	Essai 1	0,11873465
B4	X	Essai 7	0,07141428	Essai 6	0,0725718	Essai 1	0,11639552
	Y	Essai 1	0,05210166	Essai 8	0,07566373	Essai 6	0,16101242
K1	X	Essai 1	0,04966555	Essai 9	0,07112196	Essai 5	0,08385255
	Y	Essai 3	0,10161201	Essai 8	0,13288466	Essai 6	0,14059398
K2	X	Essai 1	0,02813657	Essai 5	0,10629166	Essai 2	0,16227549
	Y	Essai 6	0,10579067	Essai 2	0,12185203	Essai 3	0,15588457
K3	X	Essai 5	0,05757242	Essai 1	0,06606499	Essai 9	0,09201449
	Y	Essai 9	0,09547033	Essai 2	0,11444613	Essai 4	0,12724648
K4	X	Essai 5	0,04038874	Essai 9	0,06283245	Essai 1	0,07093131
	Y	Essai 9	0,0509902	Essai 2	0,06922187	Essai 4	0,1013965
K5	X	Essai 1	0,07787544	Essai 9	0,0848037	Essai 7	0,10123199
	Y	Essai 6	0,012829	Essai 2	0,03696846	Essai 9	0,03905125
L1	X	Essai 6	0,03913119	Essai 7	0,0624333	Essai 1	0,069267
	Y	Essai 2	0,10735455	Essai 3	0,11149552	Essai 9	0,13692303
L2	X	Essai 6	0,06656764	Essai 7	0,06904105	Essai 4	0,08060966
	Y	Essai 9	0,11625224	Essai 2	0,17915892	Essai 6	0,18193405
L3	X	Essai 8	0,06067331	Essai 1	0,1469623	Essai 7	0,16999387
	Y	Essai 4	0,06211548	Essai 6	0,0821457	Essai 8	0,09291573
L4	X	Essai 7	0,07593857	Essai 8	0,10583005	Essai 6	0,12698425
	Y	Essai 6	0,06067331	Essai 7	0,06780794	Essai 4	0,07874008
L5	X	Essai 6	0,13238202	Essai 7	0,21571586	Essai 9	0,22667433
	Y	Essai 6	0,03905125	Essai 2	0,07745967	Essai 9	0,08241157
M2	X	Essai 1	0,03730505	Essai 2	0,11305419	Essai 5	0,11596515
M3	X	Essai 6	0,10574143	Essai 2	0,18133188	Essai 5	0,2092845
M5	X	Essai 9	0,03511885	Essai 1	0,06067331	Essai 5	0,12798926
M6	X	Essai 5	0,1598958	Essai 4	0,16462078	Essai 8	0,20814658
M8	X	Essai 4	0,25779514	Essai 8	0,31315265	Essai 3	0,31527435

Analyse de la précision dans le Axe Z

		Essai	Indice #1	Essai	Indice #2	Essai	Indice #3
Ext	Z	Essai 5	0,09564474	Essai 7	0,10547512	Essai 4	0,13997024
A1	Z	Essai 5	0,1165833	Essai 1	0,13329166	Essai 2	0,14256577
A2	Z	Essai 3	0,0538323	Essai 6	0,11922493	Essai 2	0,18137783
B1	Z	Essai 6	0,04394599	Essai 3	0,05956439	Essai 5	0,17717694
B2	Z	Essai 3	0,06829776	Essai 6	0,09990621	Essai 2	0,15968067
B3	Z	Essai 6	0,08185353	Essai 4	0,1076646	Essai 2	0,12406316
B4	Z	Essai 6	0,04462809	Essai 7	0,076103	Essai 8	0,08321659
E1	Z	Essai 4	0,12987173	Essai 6	0,12999199	Essai 3	0,13152154
E2	Z	Essai 5	0,06626965	Essai 3	0,09201449	Essai 9	0,09587318
E3	Z	Essai 8	0,06890513	Essai 3	0,08827042	Essai 5	0,08933784
E4	Z	Essai 3	0,13303352	Essai 8	0,14311272	Essai 5	0,15096909
K1	Z	Essai 3	0,09388601	Essai 8	0,14387495	Essai 7	0,15132746
K2	Z	Essai 4	0,13891694	Essai 9	0,1832803	Essai 5	0,18527007
K3	Z	Essai 9	0,13801419	Essai 8	0,19764762	Essai 3	0,24413111
K4	Z	Essai 9	0,08484054	Essai 3	0,1285496	Essai 2	0,14888474
K5	Z	Essai 5	0,08133009	Essai 4	0,08474226	Essai 2	0,09263504
L1	Z	Essai 4	0,05823802	Essai 2	0,06189709	Essai 5	0,06474308
L2	Z	Essai 6	0,04451124	Essai 5	0,06922187	Essai 9	0,08385255
L3	Z	Essai 7	0,07342797	Essai 4	0,09309493	Essai 5	0,09379721
L4	Z	Essai 7	0,07697402	Essai 9	0,07851486	Essai 2	0,10048839
L5	Z	Essai 1	0,04279311	Essai 5	0,08519585	Essai 6	0,12325448
M2	Z	Essai 1	0,08660254	Essai 7	0,13490738	Essai 6	0,21924112
M3	Z	Essai 7	0,26219824	Essai 3	0,28213472	Essai 2	0,32351906
M5	Z	Essai 5	0,10294618	Essai 7	0,17228247	Essai 3	0,196956
M6	Z	Essai 7	0,1254907	Essai 6	0,13771952	Essai 3	0,2207374
M7	Z	Essai 7	0,11718042	Essai 4	0,2486589	Essai 6	0,38288107
N1	Z	Essai 2	0,10259142	Essai 3	0,11715375	Essai 4	0,1612387

Analyse de la précision dans Diametres

Operations		Essai	Indice #1	Essai	Indice #2	Essai	Indice #3
C1	D	Essai 1	0,04120578	Essai 5	0,18850287	Essai 9	0,196956
C2	D	Essai 1	0,04220486	Essai 9	0,0851347	Essai 5	0,17957705
D1	D	Essai 2	0,07967381	Essai 1	0,09398582	Essai 5	0,11051961
D2	D	Essai 1	0,03485087	Essai 2	0,06593873	Essai 5	0,08285278
D3	D	Essai 1	0,06768493	Essai 5	0,1197219	Essai 9	0,12489162
D4	D	Essai 1	0,04318082	Essai 5	0,04396969	Essai 9	0,09160604
D5	D	Essai 1	0,06375409	Essai 5	0,07381	Essai 4	0,09928914
G1	D	Essai 6	0,08036376	Essai 4	0,14865368	Essai 2	0,17406297
G2	D	Essai 8	0,1170381	Essai 4	0,13819521	Essai 6	0,14548769
G3	D	Essai 4	0,13735599	Essai 6	0,14650796	Essai 3	0,19006578

G4	D	Essai 4	0,13202746	Essai 7	0,16309506	Essai 6	0,18723871
H1	D	Essai 5	0,05408327	Essai 1	0,07659417	Essai 9	0,09432877
H2	D	Essai 9	0,06027714	Essai 5	0,08406347	Essai 1	0,08484054
H3	D	Essai 7	0,09928914	Essai 9	0,1038328	Essai 1	0,11715375
H4	D	Essai 1	0,03976493	Essai 5	0,06480741	Essai 9	0,11753546
H5	D	Essai 9	0,03532586	Essai 1	0,04462809	Essai 5	0,08205689
H6	D	Essai 2	0,05367728	Essai 7	0,0553022	Essai 9	0,05565893
I1	D	Essai 6	0,17106894	Essai 4	0,18397803	Essai 2	0,20403737
I2	D	Essai 7	0,04997916	Essai 3	0,14932487	Essai 6	0,17720045
I3	D	Essai 6	0,11743793	Essai 1	0,18119971	Essai 7	0,2486589
M1		Essai 7	0,02081666	Essai 1	0,13625956	Essai 6	0,1532971
M4		Essai 9	0,02883141	Essai 1	0,07958224	Essai 4	0,09599262

Analyse de la précision dans des épaisseurs de parois

Operations		Essai	Indice #1	Essai	Indice #2	Essai	Indice #3
F1	T	Essai 5	0,07448434	Essai 9	0,09622023	Essai 2	0,10270305
F2	T	Essai 2	0,03078826	Essai 5	0,06454972	Essai 9	0,07702813
F3	T	Essai 2	0,06309715	Essai 6	0,06986594	Essai 9	0,10188842
F4	T	Essai 2	0,07301541	Essai 4	0,08321659	Essai 6	0,12134661
F5	T	Essai 9	0,05823802	Essai 2	0,06362324	Essai 1	0,09469249
F6	T	Essai 9	0,06626965	Essai 2	0,09895285	Essai 1	0,11014195
J1	T	Essai 6	0,03041381	Essai 7	0,04320494	Essai 2	0,05627314
J2	T	Essai 3	0,03452053	Essai 6	0,06350853	Essai 4	0,07128289
J3	T	Essai 4	0,05090841	Essai 6	0,06440432	Essai 3	0,07481923
J4	T	Essai 2	0,14305448	Essai 7	0,17019597	Essai 8	0,17136705

Exemple d'analyse de la précision dans le plan XY.
Dimensions extérieures

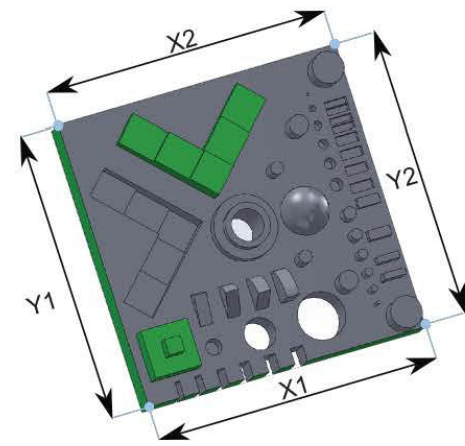

# Essai	Facteurs		
	L'épaisseur de couche [mm]	Largeur de route [mm]	Vitesse de mouvement de la Tête [mm/s]
1	0.127	0.54	25
2	0.127	0.62	50
3	0.127	0.71	75
4	0.178	0.54	75
5	0.178	0.62	25
6	0.178	0.71	50
7	0.254	0.54	50
8	0.254	0.62	75
9	0.254	0.71	25

Les données expérimentales sont les suivantes :

X Essais	Mesures X _{Ca0} = 90 mm				Résultats X _{Ca0} = 90 mm			Y Essais	Mesures Y _{Ca0} = 90 mm				Résultats Y _{Ca0} = 90 mm		
	Répétition 1		Répétition 2		Moyenne	Ecart Type	Déviation		Répétition 1		Répétition 2		Moyenne [mm]	Ecart Type [mm]	Déviation [mm]
	M1	M2	M1	M2					M1	M2	M1	M2			
1	90,27	90,26	90,38	90,37	90,32	0,06377042	0,32	90,45	90,36	90,33	90,34	90,37	0,05477226	0,37	
2	90,35	90,3	90,39	90,57	90,4025	0,11757976	0,4025	90,26	90,2	89,87	90,01	90,085	0,17860571	0,085	
3	90,34	90,97	90,18	90,56	90,5125	0,34247871	0,5125	90,5	90,28	89,81	90,01	90,15	0,30254476	0,15	
4	90,17	91	89,98	90,09	90,31	0,4665476	0,31	90,14	90,11	90,48	90,25	90,245	0,16782928	0,245	
5	90,46	90,37	90,58	90,57	90,495	0,09949874	0,495	90,33	90,3	90,11	89,99	90,1825	0,1611159	0,1825	
6	90,15	90,08	90,17	90,37	90,1925	0,12446552	0,1925	90,3	90,25	89,79	89,87	90,0525	0,25979158	0,0525	
7	90,24	90,22	89,95	90,35	90,19	0,16990193	0,19	90,31	90,32	89,78	90,23	90,16	0,25651511	0,16	
8	90,29	90,51	90,24	90,16	90,3	0,14988885	0,3	89,92	89,86	89,66	90,19	89,9075	0,21868928	0,0925	
9	90,39	90,26	90,33	90,55	90,3825	0,12365948	0,3825	90,15	90,3	89,96	89,95	90,09	0,16753109	0,09	

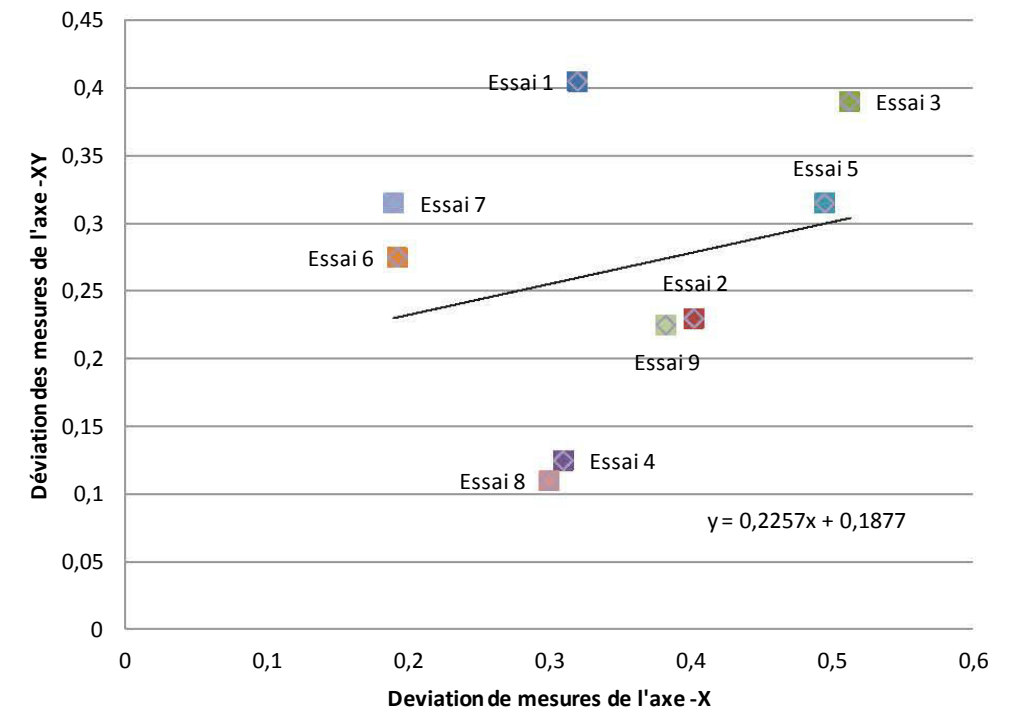
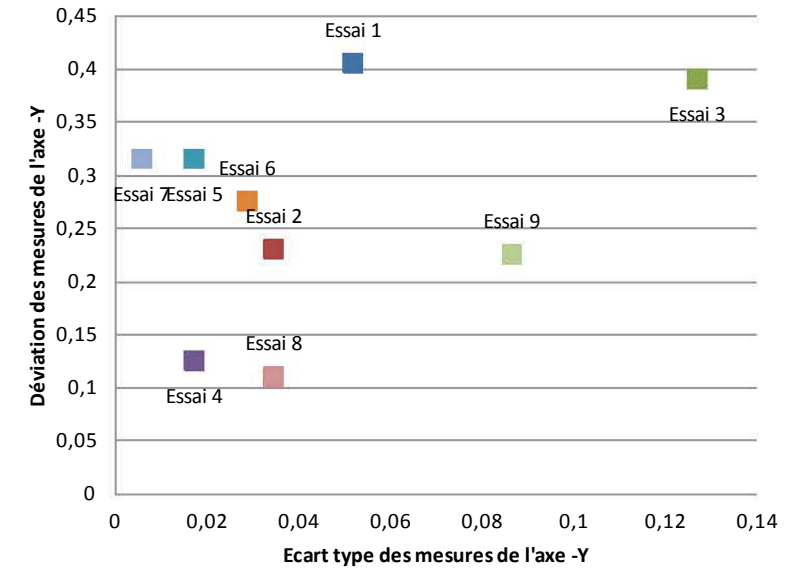
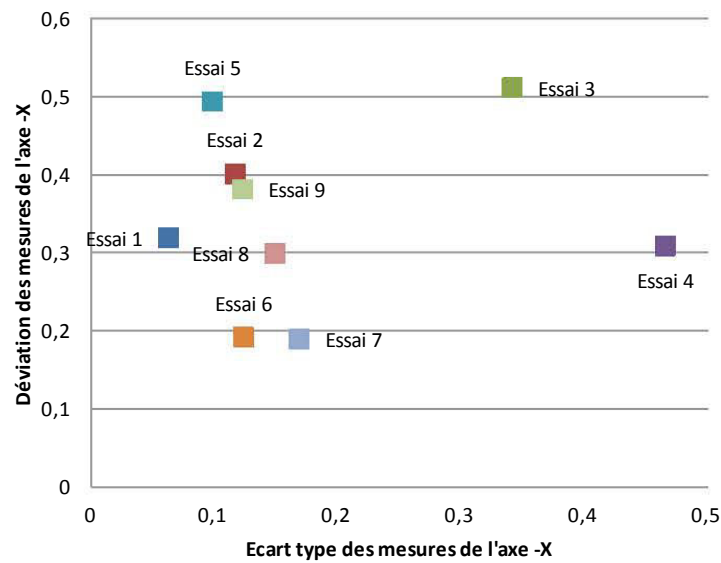

Exemple d'analyse de précision dans le plan XY

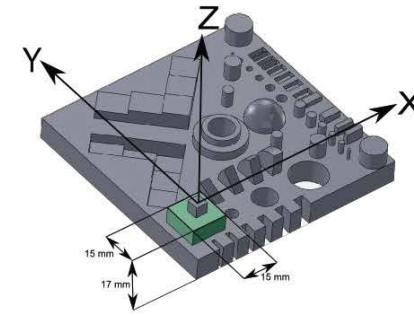

# Essai	Facteurs		
	L'épaisseur de couche [mm]	Largeur de route [mm]	Vitesse de mouvement de la Tête [mm/s]
1	0.127	0.54	25
2	0.127	0.62	50
3	0.127	0.71	75
4	0.178	0.54	75
5	0.178	0.62	25
6	0.178	0.71	50
7	0.254	0.54	50
8	0.254	0.62	75
9	0.254	0.71	25

Les données expérimentales sont les suivantes :

A1	Mesures				Résultats		
	X _{Ca0} = 10mm				X _{Ca0} = 10mm		
	Répétition 1		Répétition 2		Moyenne	Ecart Type	Déviations
Essais	M1	M2	M1	M2			
1	15,2	15,45	15,31	15,29	15,3125	0,10340052	0,3125
2	15,08	15,05	15,21	15,18	15,13	0,07702813	0,13
3	15,27	14,96	15,44	14,9	15,1425	0,25617377	0,1425
4	15	14,95	14,97	14,9	14,955	0,04203173	0,045
5	15,17	15,18	15,25	15,24	15,21	0,04082483	0,21
6	15,09	14,96	15,2	15,22	15,1175	0,11954776	0,1175
7	15,37	15,12	15,44	15,03	15,24	0,19612921	0,24
8	15,19	15,27	15,08	14,92	15,115	0,15154757	0,115
9	15,12	15,08	15,31	15,32	15,2075	0,12526638	0,2075

A1	Mesures				Résultats		
	Y _{Ca0} = 34 mm				Y _{Ca0} = 34 mm		
	Répétition 1		Répétition 2		Moyenne	Ecart Type	Déviations
Essais	M1	M2	M1	M2	[mm]	[mm]	[mm]
1	15,09	15,16	15,19	15,08	15,13	0,05354126	0,13
2	15	15,01	15,18	15,2	15,0975	0,10719919	0,0975
3	15,17	14,93	15,09	15,2	15,0975	0,12093387	0,0975
4	14,88	14,81	15,32	15,21	15,055	0,24826062	0,055
5	15,16	15,16	15,2	15,23	15,1875	0,0340343	0,1875
6	14,89	14,92	15,18	15,15	15,035	0,15110703	0,035
7	15,15	15,12	15,14	15,18	15,13	0,05354126	0,13
8	15,04	14,91	14,99	14,97	15,0975	0,10719919	0,0975
9	15,07	14,91	15,18	15,23	15,0975	0,12093387	0,0975

A2	Mesures				Résultats		
	X _{Ca0} = 10mm				X _{Ca0} = 10mm		
	Répétition 1		Répétition 2		Moyenne	Ecart Type	Déviations
Essais	M1	M2	M1	M2			
1	5,16	5,22	5,25	5,1	5,1825	0,06652067	0,1825
2	5,07	5,09	5,51	5,32	5,2475	0,20854656	0,2475
3	5,11	5,05	5,97	5,65	5,445	0,4419276	0,445
4	5,06	5,05	5,66	5,3	5,2675	0,28605069	0,2675
5	5,06	5,08	5,78	5,36	5,32	0,33585711	0,32
6	5,09	4,95	5,7	5,61	5,3375	0,37286056	0,3375
7	5,19	5,14	5,57	5,41	5,3275	0,19972898	0,3275
8	5,89	5,77	5,73	5,24	5,6575	0,28651643	0,6575
9	5,18	4,99	5,74	5,46	5,3425	0,32785922	0,3425

A2	Mesures				Résultats		
	Y _{Ca0} = 34 mm				Y _{Ca0} = 34 mm		
	Répétition 1		Répétition 2		Moyenne	Ecart Type	Déviations
Essais	M1	M2	M1	M2			
1	5,14	5,18	5,33	5,11	5,19	0,09763879	0,19
2	5,22	4,95	5,89	5,6	5,415	0,41396457	0,415
3	5,21	5,09	6,09	5,59	5,495	0,4502962	0,495
4	5,07	4,93	5,6	5,42	5,255	0,30881494	0,255
5	5,15	5,12	5,77	5,55	5,3975	0,31637267	0,3975
6	5,03	4,94	5,52	5,48	5,2425	0,30004166	0,2425
7	5,16	5,14	5,74	5,4	5,36	0,2795234	0,36
8	5,47	5,86	5,72	5,53	5,645	0,17860571	0,645
9	5,21	5,03	5,48	5,4	5,28	0,20149442	0,28

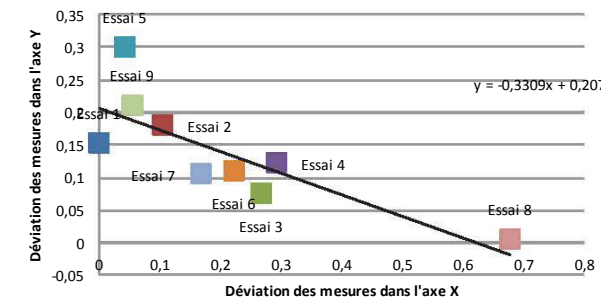
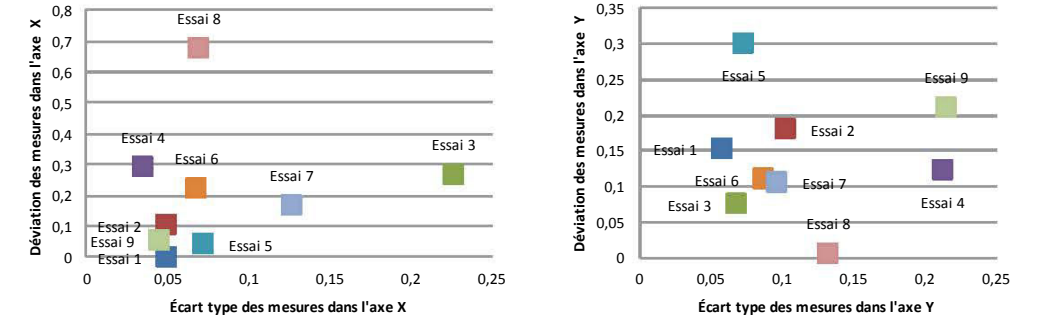

Figure 36. Analyse de la figure E1

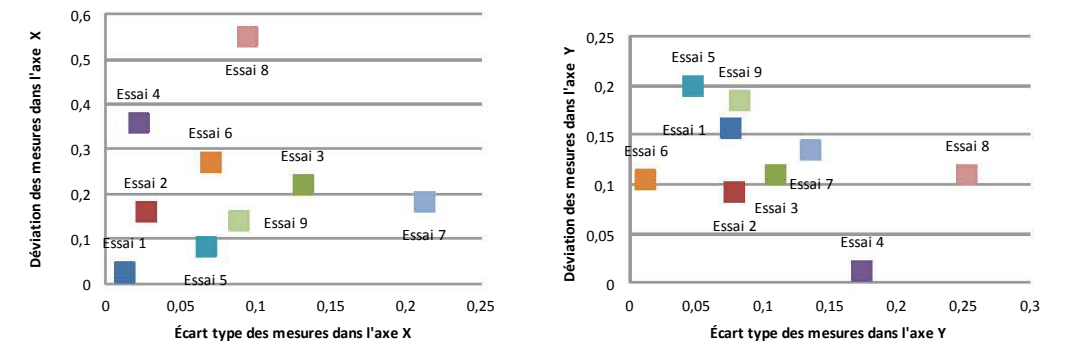
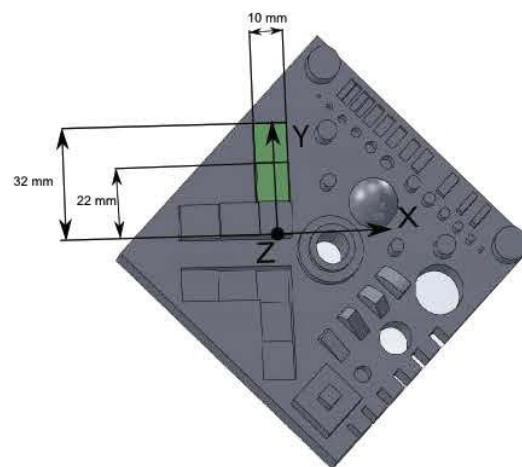

Figure 37. Analyse de la figure A2

# Essai	Facteurs		
	L'épaisseur de couche [mm]	Largeur de route [mm]	Vitesse de mouvement de la Tête [mm/s]
1	0.127	0.54	25
2	0.127	0.62	50
3	0.127	0.71	75
4	0.178	0.54	75
5	0.178	0.62	25
6	0.178	0.71	50
7	0.254	0.54	50
8	0.254	0.62	75
9	0.254	0.71	25



Les données expérimentales sont les suivantes :

Essai	Mesures $X_{Ca0} = 10\text{mm}$				Résultats $X_{Ca0} = 10\text{mm}$		
	Répétition 1		Répétition 2		Moyenne	Ecart Type	Déviation
	M1	M2	M1	M2			
1	9,97	9,96	10,07	10	10	0,04966555	0
2	9,87	9,84	9,92	9,95	9,895	0,04932883	0,105
3	9,98	9,83	9,67	9,45	9,7325	0,22691775	0,2675
4	9,75	9,72	9,67	9,69	9,7075	0,035	0,2925
5	10	10	9,98	9,85	9,9575	0,07228416	0,0425
6	9,85	9,82	9,71	9,73	9,7775	0,06800735	0,2225
7	9,96	9,92	9,7	9,75	9,8325	0,12685293	0,1675
8	9,36	9,25	9,4	9,28	9,3225	0,06946222	0,6775
9	10	9,95	9,94	9,89	9,945	0,0450925	0,055

Essai	Mesures $Y_{Ca0} = 34\text{mm}$				Résultats $Y_{Ca0} = 34\text{mm}$		
	Répétition 1		Répétition 2		Moyenne	Ecart Type	Déviation
	M1	M2	M1	M2			
1	34,18	34,22	34,12	34,09	34,1525	0,0585235	0,1525
2	34,08	34,11	34,3	34,23	34,18	0,1029563	0,18
3	34,14	34,05	34,12	33,99	34,075	0,06855655	0,075
4	33,97	33,91	34,28	34,33	34,1225	0,21313141	0,1225
5	34,21	34,27	34,36	34,36	34,3	0,07348469	0,3
6	34,1	33,99	34,18	34,17	34,11	0,0875595	0,11
7	34,05	34,05	34,07	34,25	34,105	0,09712535	0,105
8	34,12	33,93	34,09	33,84	33,995	0,13279056	0,005
9	34,03	34,02	34,43	34,36	34,21	0,21556128	0,21

Essai	Mesures $X_{Ca0} = 10\text{mm}$				Résultats $X_{Ca0} = 10\text{mm}$		
	Répétition 1		Répétition 2		Moyenne	Ecart Type	Déviation
	M1	M2	M1	M2			
1	9,98	9,99	9,96	9,97	9,975	0,01290994	0,025
2	9,88	9,83	9,82	9,83	9,84	0,02708013	0,16
3	9,86	9,92	9,7	9,64	9,78	0,13165612	0,22
4	9,65	9,67	9,62	9,63	9,6425	0,02217356	0,3575
5	9,98	9,97	9,85	9,87	9,9175	0,0670199	0,0825
6	9,8	9,78	9,68	9,66	9,73	0,07023769	0,27
7	10	10	9,6	9,67	9,8175	0,2126617	0,1825
8	9,38	9,38	9,46	9,58	9,45	0,09451631	0,55
9	9,93	9,94	9,81	9,76	9,86	0,08906926	0,14

Essai	Mesures $Y_{Ca0} = 22\text{mm}$				Résultats $Y_{Ca0} = 22\text{mm}$		
	Répétition 1		Répétition 2		Moyenne	Ecart Type	Déviation
	M1	M2	M1	M2			
1	22,12	22,14	22,27	22,1	22,1575	0,07675719	0,1575
2	22,01	22,04	22,15	22,17	22,0925	0,07932003	0,0925
3	21,95	22,2	22,16	22,13	22,11	0,11045361	0,11
4	21,87	21,85	22,23	22	21,9875	0,17480942	0,0125
5	22,21	22,22	22,24	22,13	22,2	0,04830459	0,2
6	22,09	22,11	22,1	22,12	22,105	0,01290994	0,105
7	22,21	22,2	22,2	21,93	22,135	0,13674794	0,135
8	22,06	21,93	21,52	22,05	21,89	0,25364017	0,11
9	22,07	22,18	22,23	22,26	22,185	0,08346656	0,185

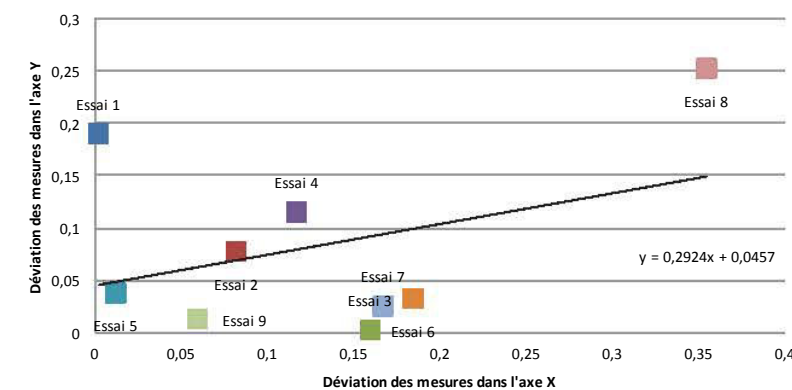
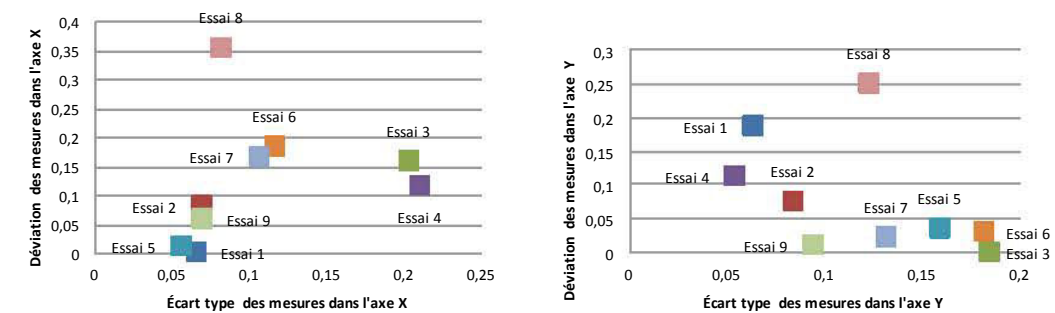

Figure 38. Analyse de la figure E1

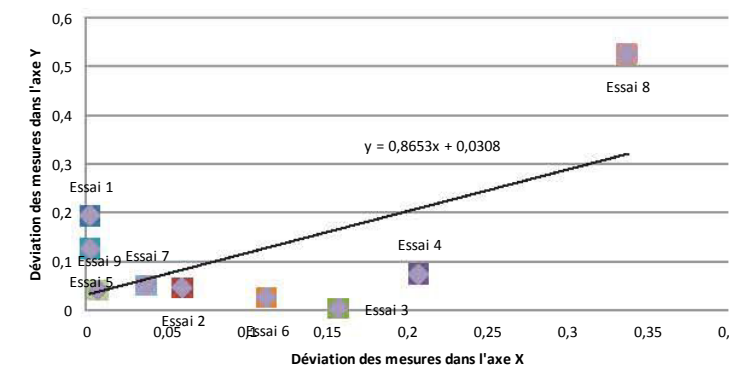
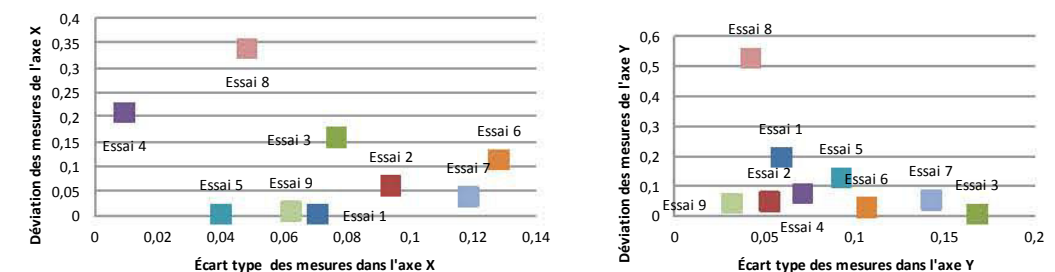
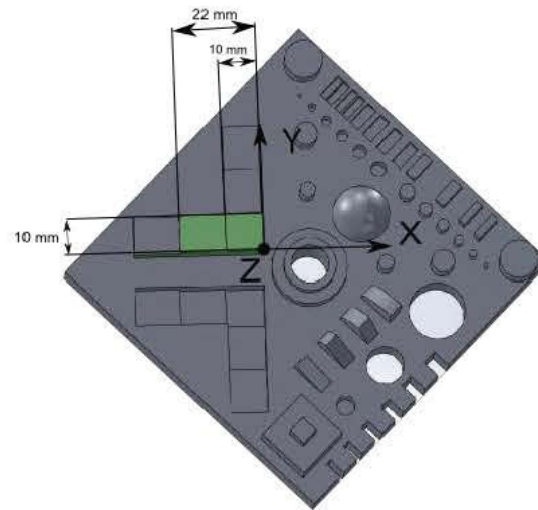

Figure 39. Analyse de la figure E2

# Essai	Facteurs		
	L'épaisseur de couche [mm]	Largeur de route [mm]	Vitesse de mouvement de la Tête [mm/s]
1	0.127	0.54	25
2	0.127	0.62	50
3	0.127	0.71	75
4	0.178	0.54	75
5	0.178	0.62	25
6	0.178	0.71	50
7	0.254	0.54	50
8	0.254	0.62	75
9	0.254	0.71	25



Les données expérimentales sont les suivantes :

Essais	Mesures X _{Ca0} = 10mm				Résultats X _{Ca0} = 10mm		
	Répétition 1		Répétition 2		Moyenne	Ecart Type	Déviation
	M1	M2	M1	M2			
1	9,97	9,92	10,07	10,03	9,9975	0,06601767	0,0025
2	9,84	9,88	9,99	9,96	9,9175	0,06946222	0,0825
3	9,99	10,04	9,65	9,68	9,84	0,2034699	0,16
4	9,71	9,7	10	10,12	9,8825	0,21077239	0,1175
5	10,04	10,07	9,94	10	10,0125	0,05619905	0,0125
6	9,9	9,93	9,73	9,7	9,815	0,11676187	0,185
7	9,82	9,97	9,83	9,71	9,8325	0,10657548	0,1675
8	9,59	9,57	9,75	9,67	9,645	0,08225975	0,355
9	10	10	9,89	9,87	9,94	0,0697615	0,06

Essais	Mesures Y _{Ca0} = 10mm				Résultats Y _{Ca0} = 10mm		
	Répétition 1		Répétition 2		Moyenne	Ecart Type	Déviation
	M1	M2	M1	M2			
1	10,13	10,14	10,24	10,25	10,19	0,06377042	0,19
2	10	9,99	9,86	9,84	9,9225	0,08421203	0,0775
3	10,2	10,12	9,85	9,84	10,0025	0,18481973	0,0025
4	9,9	9,95	9,82	9,87	9,885	0,05446712	0,115
5	10,19	10,16	9,91	9,89	10,0375	0,15945219	0,0375
6	10,13	10,12	9,8	9,82	9,9675	0,1820943	0,0325
7	10,18	9,96	9,88	10,08	10,025	0,13203535	0,025
8	9,7	9,7	9,66	9,93	9,7475	0,12311918	0,2525
9	10,12	10,03	9,89	10,01	10,0125	0,09464847	0,0125

Essais	Mesures X _{Ca0} = 22mm				Résultats X _{Ca0} = 22mm		
	Répétition 1		Répétition 2		Moyenne	Ecart Type	Déviation
	M1	M2	M1	M2			
1	21,93	21,99	22,1	21,99	22,0025	0,07088723	0,0025
2	21,84	21,88	22,01	22,03	21,94	0,09416298	0,06
3	21,93	21,88	21,8	21,76	21,8425	0,07675719	0,1575
4	21,8	21,78	21,79	21,8	21,7925	0,00957427	0,2075
5	21,98	22,05	22,02	21,96	22,0025	0,04031129	0,0025
6	22	21,99	21,82	21,74	21,8875	0,12841988	0,1125
7	22,03	22,05	21,98	21,79	21,9625	0,11870833	0,0375
8	21,69	21,6	21,71	21,65	21,6625	0,04856267	0,3375
9	21,93	21,95	22,06	22,03	21,9925	0,06238322	0,0075

Essais	Mesures Y _{Ca0} = 10mm				Résultats Y _{Ca0} = 10mm		
	Répétition 1		Répétition 2		Moyenne	Ecart Type	Déviation
	M1	M2	M1	M2			
1	10,15	10,17	10,28	10,17	10,1925	0,05909033	0,1925
2	10,09	10,01	10,09	9,99	10,045	0,05259911	0,045
3	10,1	10,18	9,84	9,87	9,9975	0,16820127	0,0025
4	9,98	9,99	9,84	9,9	9,9275	0,07088723	0,0725
5	10,21	10,2	10,05	10,04	10,125	0,09255629	0,125
6	10,06	10,05	9,83	9,96	9,975	0,10661457	0,025
7	10,18	10,16	9,89	9,97	10,05	0,142595	0,05
8	9,52	9,49	9,47	9,42	9,475	0,04203173	0,525
9	10,06	10,07	10,03	10	10,04	0,03162278	0,04

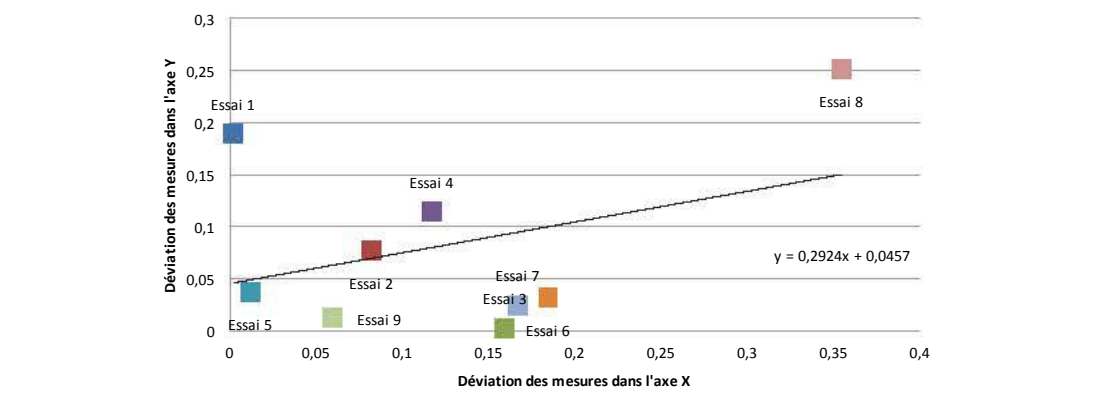
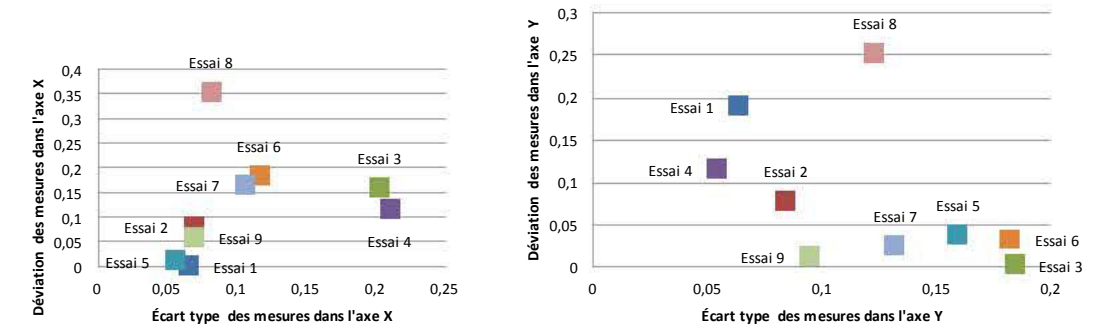

Figure 40. Analyse de la figure E3

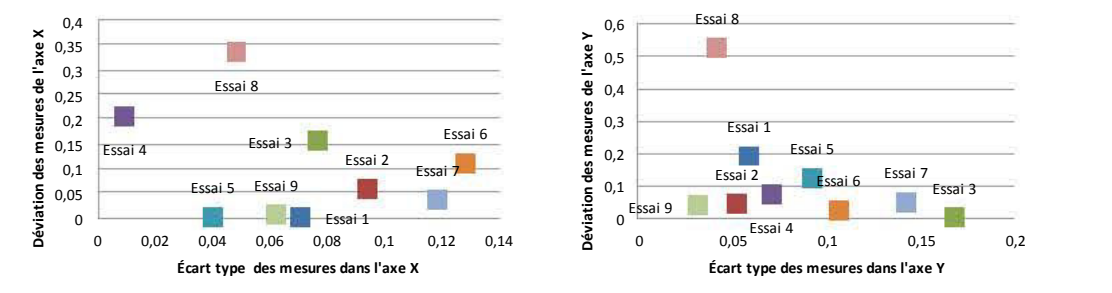

Figure 41. Analyse de la figure E3

Essai	Mesures $X_{Cao} = 34mm$				Résultats $X_{Cao} = 34mm$		
	Répétition 1		Répétition 2		Moyenne	Ecart Type	Déviation
	M1	M2	M1	M2			
1	34,01	34,03	34,13	34,06	34,0575	0,05251984	12,0575
2	33,87	33,87	34,16	34,02	33,98	0,13928388	11,98
3	33,85	33,88	34,03	33,9	33,915	0,07937254	11,915
4	33,88	33,84	33,95	33,94	33,9025	0,05188127	11,9025
5	33,99	34,1	34,26	34,1	34,1125	0,11116804	12,1125
6	33,9	34,09	33,95	33,89	33,9575	0,09215024	11,9575
7	34,06	34,01	34,17	33,97	34,0525	0,08655441	12,0525
8	33,8	33,69	33,67	33,86	33,755	0,09036961	11,755
9	33,96	33,98	34,12	34,08	34,035	0,0772442	12,035

Essai	Mesures $Y_{Cao} = 10mm$				Résultats $Y_{Cao} = 10mm$		
	Répétition 1		Répétition 2		Moyenne	Ecart Type	Déviation
	M1	M2	M1	M2			
1	10,2	10,23	10,17	10,19	10,1975	0,025	0,1975
2	10,03	10,06	10,01	10,02	10,03	0,02160247	0,03
3	10,05	10,06	9,91	9,92	9,985	0,08103497	0,015
4	9,91	9,9	10,02	9,87	9,925	0,06557439	0,075
5	10,19	10,18	10,08	10,12	10,1425	0,05188127	0,1425
6	10,02	10	10	9,99	10,0025	0,01258306	0,0025
7	14,13	14,13	9,84	9,9	12	2,45963412	2
8	9,63	10,01	9,81	9,85	9,825	0,15609826	0,175
9	9,94	10,03	10	10,01	9,995	0,03872983	0,005

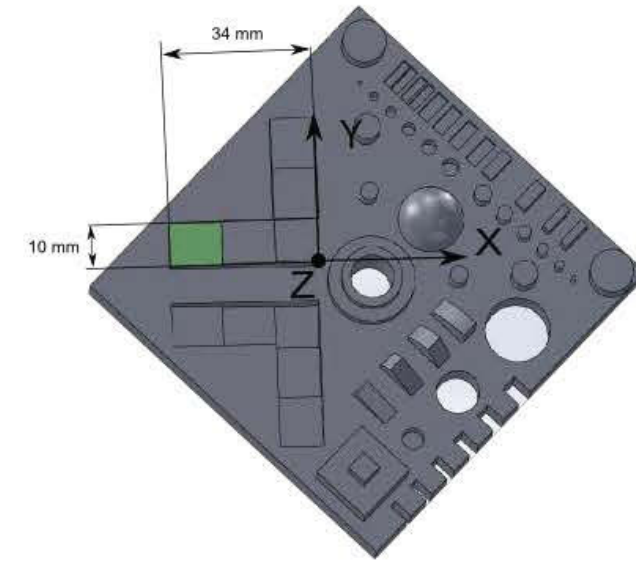
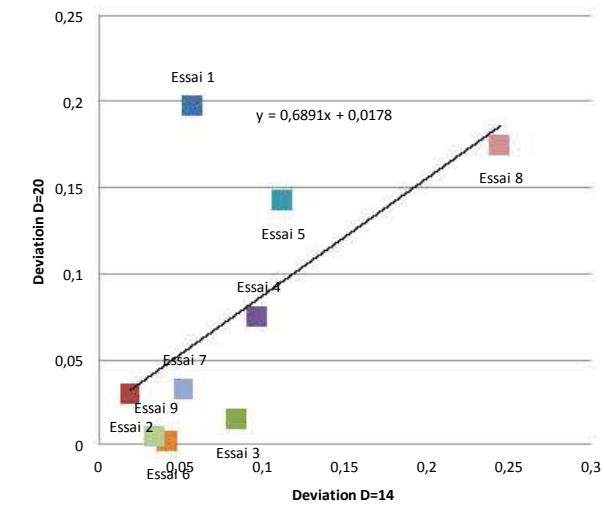
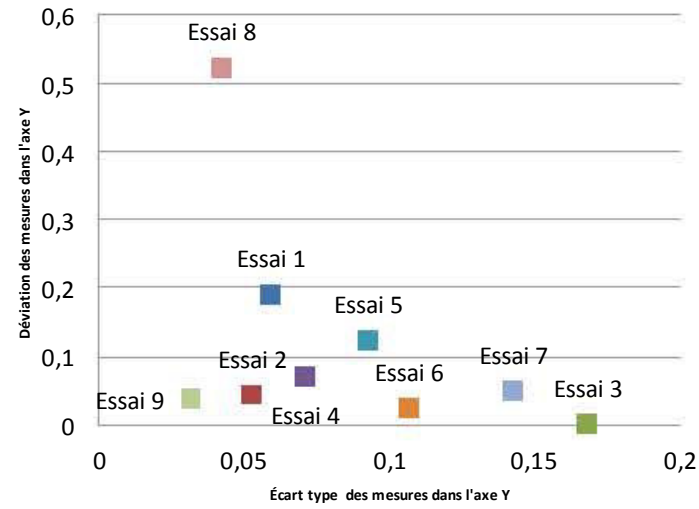
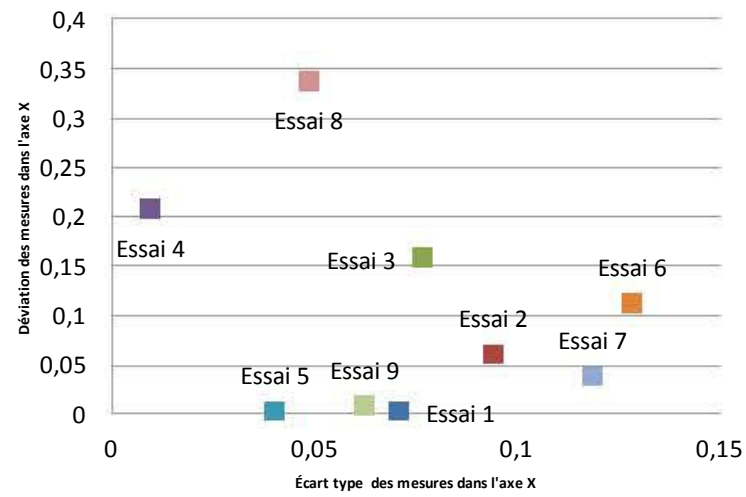
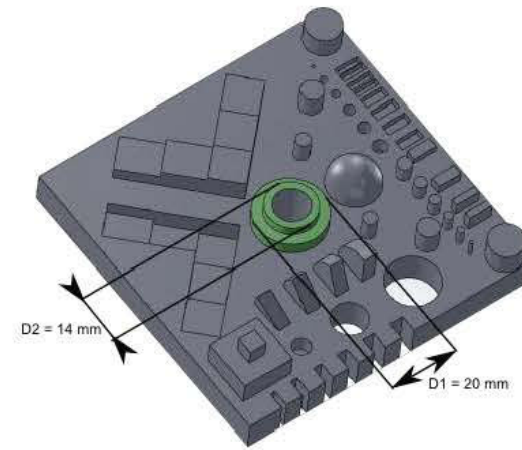

Figure 42. Analyse de la figure E5



Exemple d'analyse des Diamètres

# Essai	Facteurs			
	L'épaisseur de couche [mm]	Largeur de route [mm]	Vitesse de mouvement de la Tête [mm/s]	Temps de fabrication total
1	0.127	0.54	25	
2	0.127	0.62	50	
3	0.127	0.71	75	
4	0.178	0.54	75	
5	0.178	0.62	25	
6	0.178	0.71	50	
7	0.254	0.54	50	
8	0.254	0.62	75	
9	0.254	0.71	25	



Les données expérimentales sont les suivantes :

D1 /D2	Mesures				Résultats		
	D _{Ca0} = 20mm				D _{Ca0} = 20mm		
	Répétition 1		Répétition 2		Moyenne	Ecart Type	Déviation
M1	M2	M1	M2				
1	20	19,95	19,99	20,05	19,9975	0,04112988	0,0025
2	19,85	19,8	19,87	19,71	19,8075	0,07135592	0,1925
3	19,88	19,81	19,28	19,35	19,58	0,30865299	0,42
4	19,72	19,74	19,54	19,8	19,7	0,11195237	0,3
5	20	19,96	20,05	19,67	19,92	0,17068489	0,08
6	19,68	19,74	19,78	19,45	19,6625	0,14750706	0,3375
7	19,86	19,9	19,8	19,53	19,7725	0,16680827	0,2275
8	19,49	19,16	19,17	19,14	19,24	0,16713268	0,76
9	19,94	19,83	19,72	19,81	19,825	0,09036961	0,175

D1 /D2	Mesures				Résultats		
	D _{Ca0} = 14mm				D _{Ca0} = 14mm		
	Répétition 1		Répétition 2		Moyenne	Ecart Type	Déviation
M1	M2	M1	M2				
1	13,97	13,99	14,03	14,06	14,0125	0,04031129	0,0125
2	13,87	13,9	13,64	13,94	13,8375	0,13475286	0,1625
3	13,74	13,75	13,5	13,69	13,67	0,11633286	0,33
4	13,84	13,87	13,52	13,91	13,785	0,17897858	0,215
5	13,87	13,91	13,72	14,07	13,8925	0,14384598	0,1075
6	13,86	13,84	13,78	13,46	13,735	0,18645822	0,265
7	13,88	13,81	13,52	13,75	13,74	0,15599145	0,26
8	13,55	13,25	13,44	13,55	13,4475	0,14150972	0,5525
9	13,91	13,98	13,97	13,87	13,9325	0,05188127	0,0675

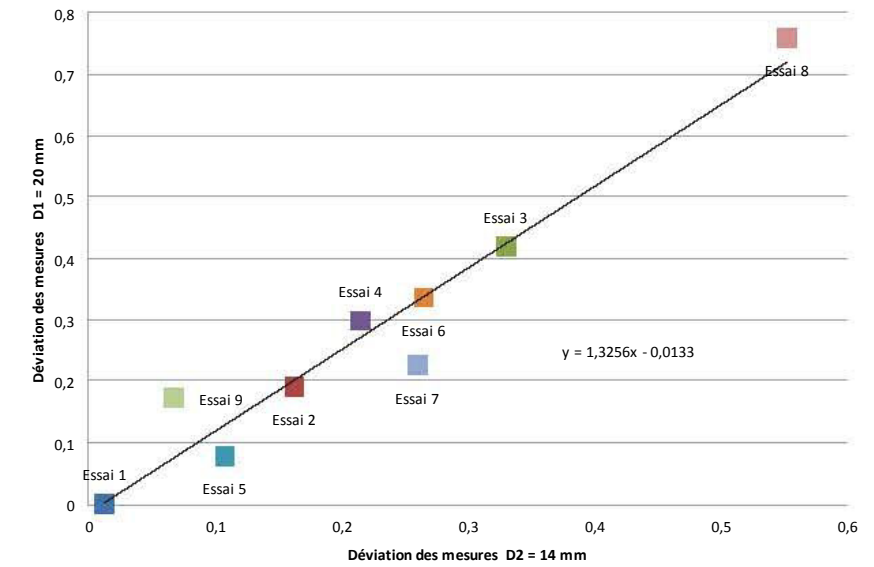
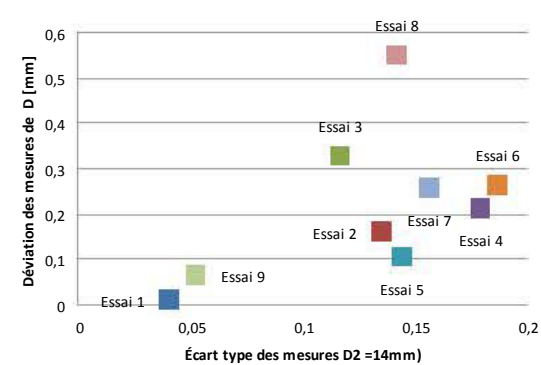
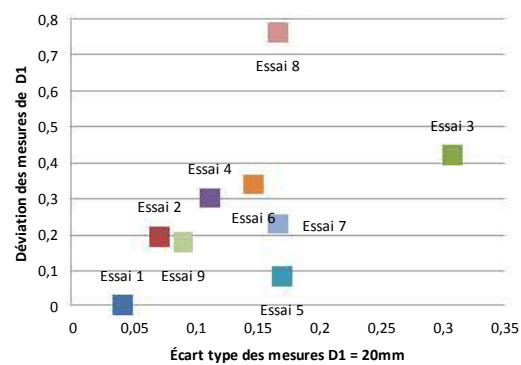
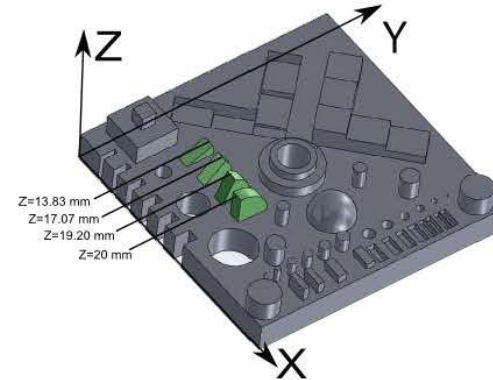

Figure 43. Analyse des figures D1 et D2



Exemple d'analyse des Planes Inclines

# Essai	Facteurs			
	L'épaisseur de couche [mm]	Largeur de route [mm]	Vitesse de mouvement de la Tête [mm/s]	Temps de fabrication total
1	0.127	0.54	25	
2	0.127	0.62	50	
3	0.127	0.71	75	
4	0.178	0.54	75	
5	0.178	0.62	25	
6	0.178	0.71	50	
7	0.254	0.54	50	
8	0.254	0.62	75	
9	0.254	0.71	25	



Les données expérimentales sont les suivantes :

Z1- Z2	Mesures				Résultats		
	$Z_{Cao} = 13.83\text{mm}$				$Z_{Cao} = 13.83\text{mm}$		
	Répétition 1	Répétition 2	Moyenne	Ecart Type	Déviaton		
Essai	M1	M2	M1	M2			
1	14,06	14,11	13,76	13,76	13,9225	0,18874586	0,0925
2	13,85	14,03	13,59	13,65	13,78	0,20033306	0,05
3	13,68	13,64	13,84	13,83	13,7475	0,10242884	0,0825
4	13,76	13,83	13,69	13,64	13,73	0,08286535	0,1
5	13,77	13,78	13,66	13,63	13,71	0,07615773	0,12
6	13,65	13,7	13,75	13,73	13,7075	0,04349329	0,1225
7	13,86	13,99	13,57	13,63	13,7625	0,19653244	0,0675
8	13,69	13,5	13,56	13,56	13,5775	0,0801561	0,2525
9	13,59	13,53	13,65	13,65	13,605	0,05744563	0,225

Z1- Z2	Mesures				Résultats		
	$Z_{Cao} = 17.07\text{mm}$				$Z_{Cao} = 17.07\text{mm}$		
	Répétition 1	Répétition 2	Moyenne	Ecart Type	Déviaton		
Essai	M1	M2	M1	M2			
1	17,34	17,26	17,13	17,13	17,215	0,1034408	0,145
2	17,41	17,28	17,12	17,02	17,2075	0,1723127	0,1375
3	17,03	17	17,14	17,19	17,09	0,08981462	0,02
4	17,3	17,29	17,12	17,24	17,2375	0,08261356	0,1675
5	17,15	17,12	17,13	17,14	17,135	0,01290994	0,065
6	17,28	17,22	17,48	17,37	17,3375	0,11324752	0,2675
7	17,37	17,4	17,06	16,99	17,205	0,21015867	0,135
8	16,88	16,87	17,06	17,09	16,975	0,1161895	0,095
9	16,96	16,93	17,07	17,06	17,005	0,07047458	0,065

Z3- Z4	Mesures				Résultats		
	$Z_{Cao} = 19.20\text{mm}$				$Z_{Cao} = 19.20\text{mm}$		
	Répétition 1	Répétition 2	Moyenne	Ecart Type	Déviaton		
Essai	M1	M2	M1	M2			
1	19,55	19,59	19,28	19,28	19,425	0,16822604	0,185
2	19,53	19,33	19,25	19,23	19,335	0,13699148	0,095
3	19,36	19,28	19,27	19,35	19,315	0,04654747	0,075
4	19,3	19,51	19,26	19,32	19,3475	0,11116804	0,1075
5	19,38	19,24	19,29	19,32	19,3075	0,0585235	0,0675
6	19,43	19,45	19,33	19,3	19,3775	0,0736546	0,1375
7	19,63	19,8	19,29	19,27	19,4975	0,26068819	0,2575
8	19,31	19,27	19,18	19,17	19,2325	0,06849574	0,0075
9	19,14	19,12	19,3	19,36	19,23	0,1183216	0,01

Z3- Z4	Mesures				Résultats		
	$Z_{Cao} = 20\text{mm}$				$Z_{Cao} = 20\text{mm}$		
	Répétition 1	Répétition 2	Moyenne	Ecart Type	Déviaton		
Essai	M1	M2	M1	M2			
1	20,44	20,36	20,22	20,28	20,325	0,09574271	0,325
2	20,4	20,38	20,21	20,12	20,2775	0,13524669	0,2775
3	20,2	20,08	19,91	19,98	20,0425	0,12606215	0,0425
4	2,2	20,23	20,08	20,02	15,6325	8,9554355	4,3675
5	20,15	20,2	20,1	20,13	20,145	0,04203173	0,145
6	20,34	20,23	20,15	20,13	20,2125	0,09535023	0,2125
7	20,4	20,39	20,16	20,18	20,2825	0,13022417	0,2825
8	20,13	20,1	19,89	19,85	19,9925	0,14291606	0,0075
9	19,93	19,9	20,16	20,19	20,045	0,15110703	0,045

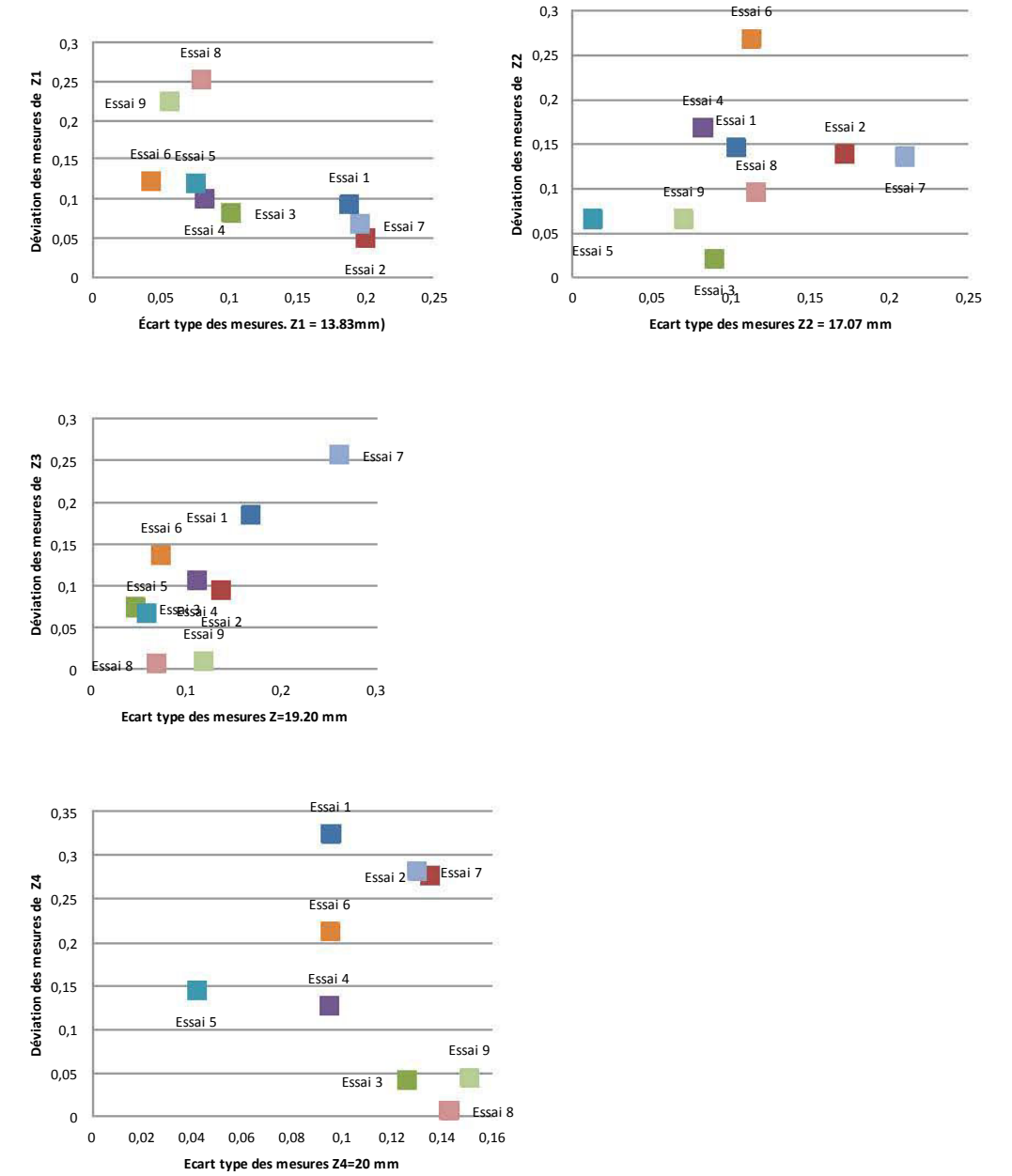
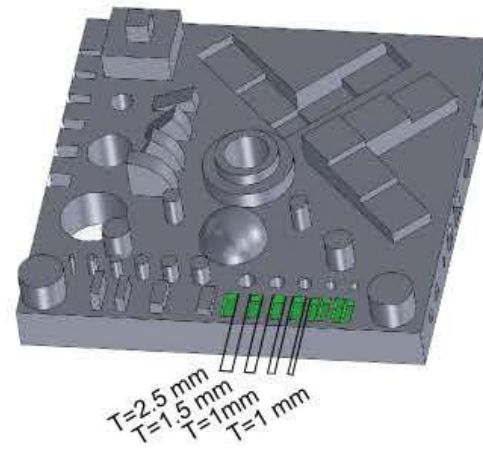

Figure 44. Analyse des figures Z1- Z4

Exemple d'analyse des figures de parois mince

# Essai	Facteurs			
	L'épaisseur de couche [mm]	Largeur de route [mm]	Vitesse de mouvement de la Tête [mm/s]	Temps de fabrication total
1	0.127	0.54	25	
2	0.127	0.62	50	
3	0.127	0.71	75	
4	0.178	0.54	75	
5	0.178	0.62	25	
6	0.178	0.71	50	
7	0.254	0.54	50	
8	0.254	0.62	75	
9	0.254	0.71	25	



Les données expérimentales sont les suivantes :

T1/T2	Mesures				Résultats		
	T _{Ca0} = 2.5mm				T _{Ca0} = 2.5mm		
	Répétition 1		Répétition 2		Moyenne	Ecart Type	Déviaton
Essais	M1	M2	M1	M2			
1	2,61	2,6	2,6	2,61	2,605	0,0057735	0,105
2	2,58	2,54	2,56	2,52	2,55	0,02581989	0,05
3	2,52	2,45	2,58	2,35	2,475	0,09882645	0,025
4	2,44	2,39	2,48	2,43	2,435	0,03696846	0,065
5	2,59	2,55	2,58	2,57	2,5725	0,01707825	0,0725
6	2,48	2,5	2,45	2,51	2,485	0,02645751	0,015
7	2,54	2,52	2,5	2,44	2,5	0,04320494	0
8	2,22	2,23	2,34	2,17	2,24	0,07164728	0,26
9	2,58	2,57	2,64	2,56	2,5875	0,03593976	0,0875

T1/T2	Mesures				Résultats		
	T _{Ca0} = 2mm				T _{Ca0} = 2mm		
	Répétition 1		Répétition 2		Moyenne	Ecart Type	Déviaton
Essais	M1	M2	M1	M2			
1	2,12	2,13	2,22	2,15	2,155	0,0450925	0,155
2	2,1	2,06	2,12	2,12	2,1	0,02828427	0,1
3	2,03	2,04	1,97	2,02	2,015	0,03109126	0,015
4	1,94	1,94	2,09	2	1,9925	0,07088723	0,0075
5	2,13	2,12	2,09	2,09	2,1075	0,02061553	0,1075
6	2,08	2,07	1,96	2,01	2,03	0,05597619	0,03
7	2,05	2,02	2,03	2,15	2,0625	0,05965177	0,0625
8	1,87	1,84	1,84	1,71	1,815	0,07141428	0,185
9	2,16	2,13	2,13	2,17	2,1475	0,02061553	0,1475

T3/T4	Mesures				Résultats		
	T _{Ca0} = 1.5mm				T _{Ca0} = 1.5mm		
	Répétition 1		Répétition 2		Moyenne	Ecart Type	Déviaton
Essais	M1	M2	M1	M2			
1	1,65	1,64	1,66	1,69	1,66	0,02160247	0,16
2	1,58	1,54	1,64	1,61	1,5925	0,04272002	0,0925
3	1,59	1,51	1,55	1,6	1,5625	0,04112988	0,0625
4	1,46	1,48	1,47	1,57	1,495	0,05066228	0,005
5	1,62	1,64	1,61	1,6	1,6175	0,01707825	0,1175
6	1,55	1,56	1,57	1,45	1,5325	0,05560276	0,0325
7	1,59	1,62	1,41	1,44	1,515	0,10535654	0,015
8	1,48	1,41	1,23	1,17	1,3225	0,14637281	0,1775
9	1,64	1,63	1,66	1,65	1,645	0,01290994	0,145

T3/T4	Mesures				Résultats		
	T _{Ca0} = 1mm				T _{Ca0} = 1mm		
	Répétition 1		Répétition 2		Moyenne	Ecart Type	Déviaton
Essais	M1	M2	M1	M2			
1	1,19	1,17	1,24	1,24	1,21	0,03559026	0,21
2	1,13	1,14	1,14	1,16	1,1425	0,01258306	0,1425
3	1,11	1,07	0,7	0,9	0,945	0,18699376	0,055
4	0,63	0,64	1,1	1,04	0,8525	0,25237208	0,1475
5	1,24	1,24	1,19	1,22	1,2225	0,02362908	0,2225
6	1	0,69	0,71	0,65	0,7625	0,1602862	0,2375
7	1,24	1,19	1,11	1,06	1,15	0,08041559	0,15
8	0,86	0,83	0,81	0,82	0,83	0,02160247	0,17
9	1,24	1,22	1,32	1,3	1,27	0,04760952	0,27

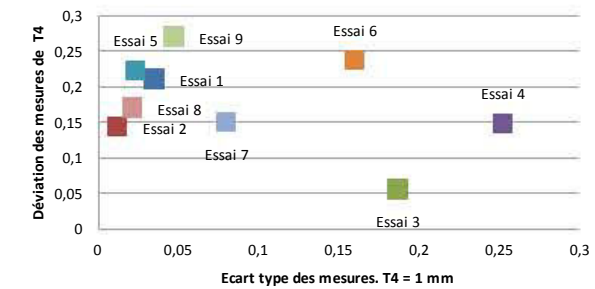
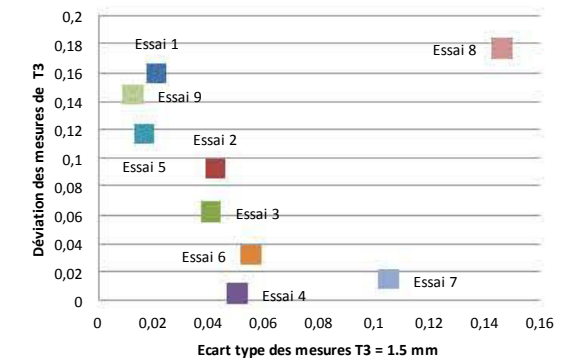
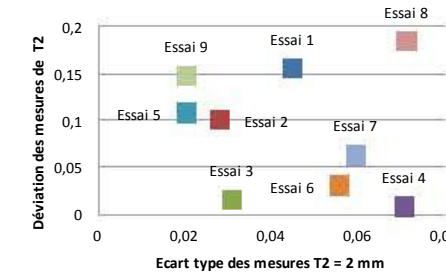
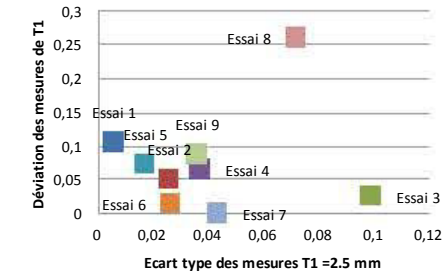
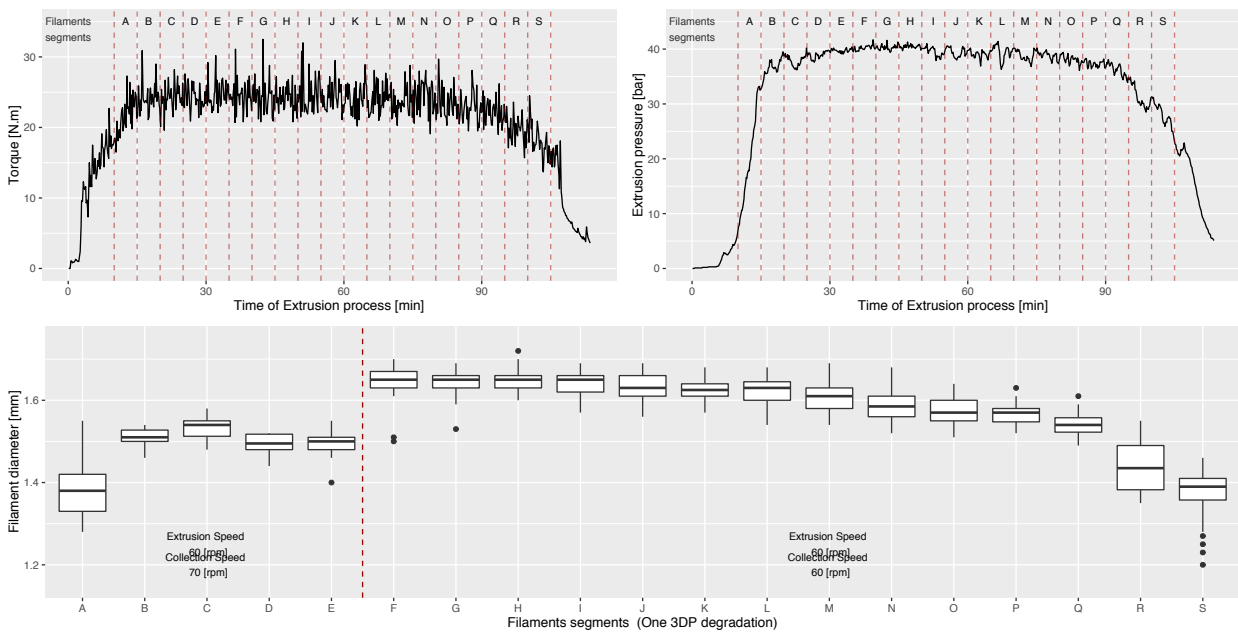

Figure 45. Analyse des figures T1-T4

Annex B: Feedstock quality for 3D printing process

Extrusion process after first cycle

Characteristical curves for filament of 'One 3DP'



(a) Filaments made from first recycling cycles (b) 3DP samples with a degradation of two 3D printing processes

Extrusion process after second cycle

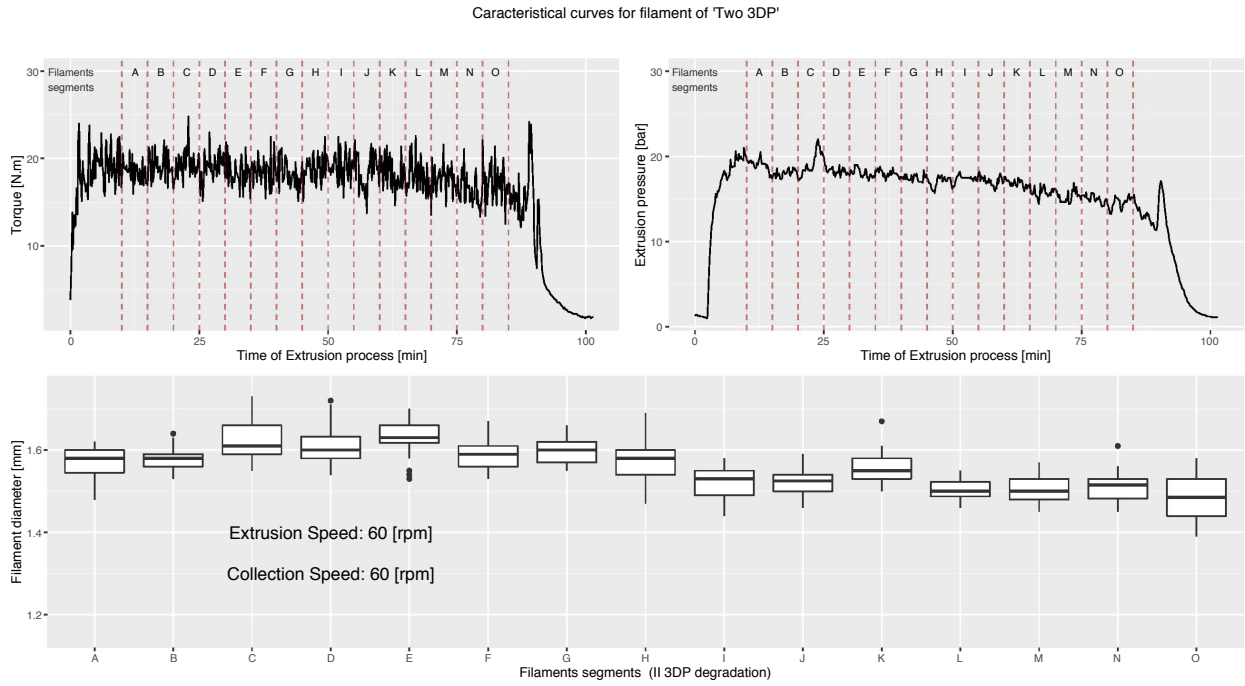

(a) Filaments made from the second recycling cycle



(b) 3DP samples with a degradation of three 3D printing processes

Extrusion process after third cycle

Characteristical curves for filament of 'Three 3DP'

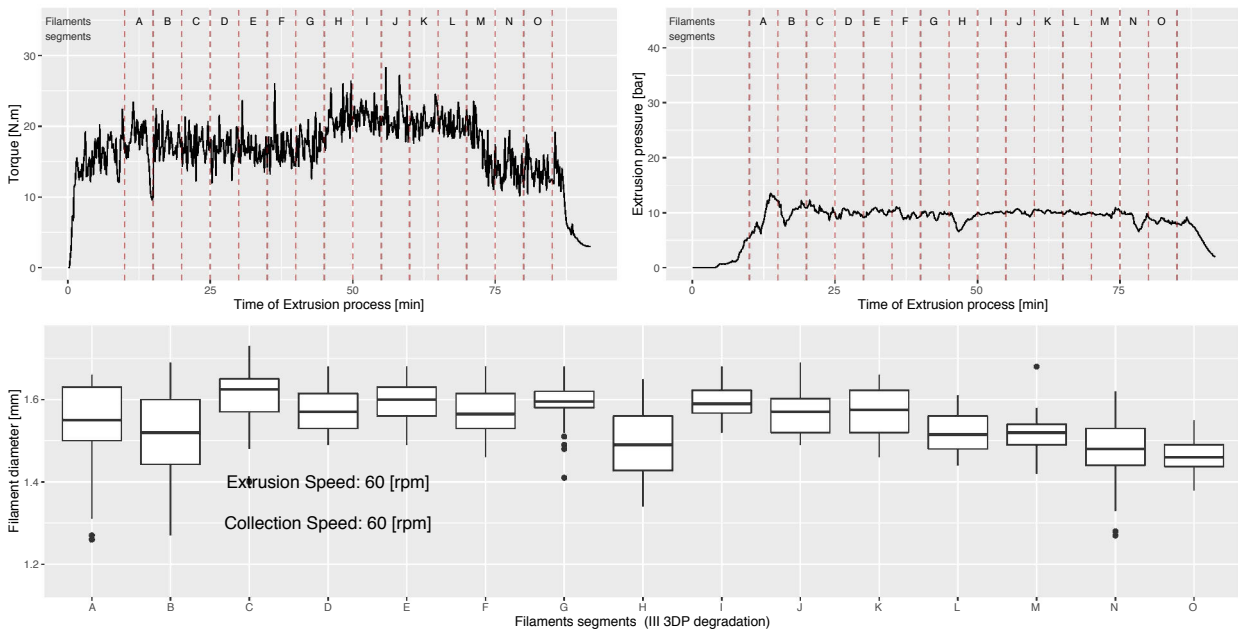

(a) Filaments made from the third recycling cycle

(b) 3DP samples with a degradation of four 3D printing processes

Extrusion process after fourth cycles

Characteristical curves for filament of 'Three 3DP'

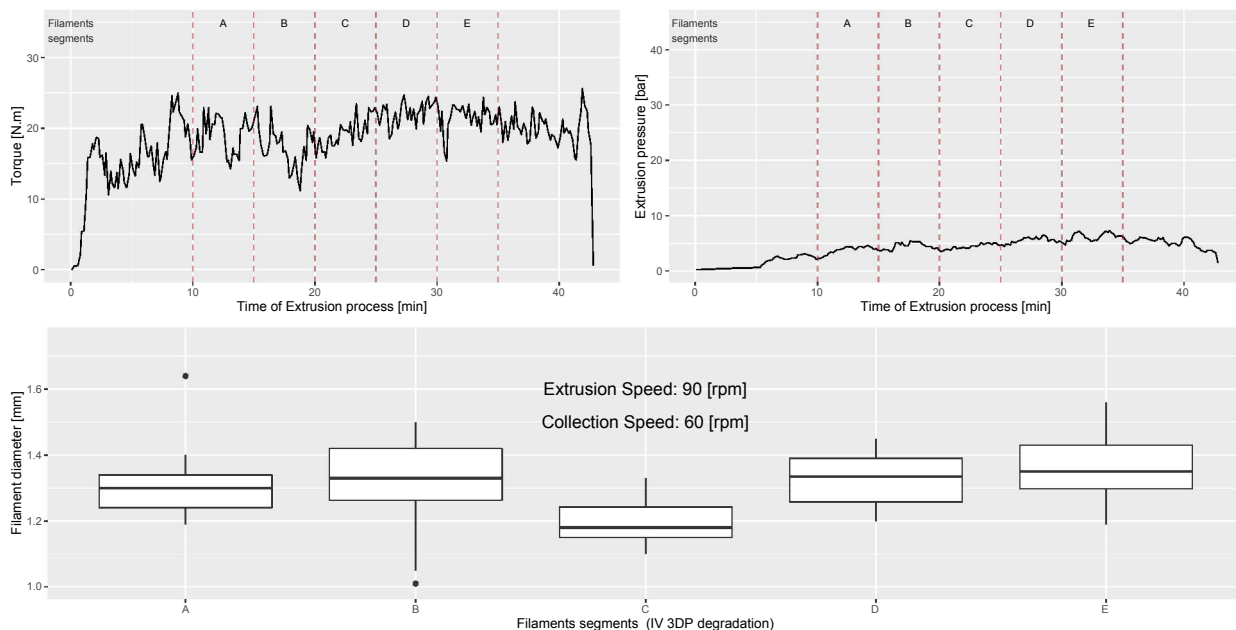

(a) Filaments made from the four recycling cycle

(b) 3DP samples with a degradation of five 3D printing processes

Résumé / Abstract

En ce début de XXI^{ème} siècle, l'époque où seul la technique transformait la société toute entière est clairement révolue. Certes, les révolutions techniques sont là: interconnexion des personnes, explosion de l'internet, apparition de nouvelles formes d'énergies, de nouveaux procédés de production, de nouveaux matériaux etc... mais l'homme n'est plus un simple consommateur sensible au prix et aux incitations de l'état. Il souhaite être acteur et participer à l'utilisation des nouvelles technologies mais de manière raisonnée et en intégrant les grands enjeux sociétaux tels que le partage et la sauvegarde des ressources et matières premières.

Cette thèse s'inscrit dans cette problématique globale: en effet tout au long du manuscrit nous réfléchissons à comment une révolution technique tel que la fabrication additive (FA) est prise en main par des citoyens dans des lieux de partage de la connaissance que sont les FabLabs, et plus précisément, s'il est possible et de quelle manière introduire de la durabilité dans le contexte open-source.

Nous voyons dans un premier temps, comment la problématique sociétale forte du recyclage des matériaux se développe dans le contexte de la FA en générale et plus particulièrement nous proposons une revue bibliographique systématique sur le sujet. Dans un second temps nous recentrons notre recherche sur la FA dans le contexte open source et nous montrons que les machines dans ce contexte, bien qu'à des coûts très faibles par rapport aux machines professionnelles, ont cependant des niveaux de reproductibilités suffisant pour que l'on les utilise dans le cadre d'une recherche poussée. Dans le troisième chapitre nous proposons une méthodologie générale fixant l'étude du recyclage de polymères thermoplastiques dans le contexte open-source. Dans le quatrième chapitre nous utilisons la méthodologie vu précédemment pour le recyclage de l'acide polylactique (PLA). Nous montrons le niveau de dégradation de la matière à travers l'ensemble du procédé et concluons qu'il est possible de recycler le PLA pour l'impression 3D mais dans une moindre mesure que pour les procédés d'injection. Enfin nous concluons et proposons en perspective d'étudier le recyclage en circuit court d'autres polymères thermoplastique.

Mot clés Recyclage des Polymères, Fabrication Additive, Open-Source, Impression 3D, Acide Polylactique (PLA), RepRap.

Since the beginning of the 21st century, we can recognize that several technical (r)evolutions have changed the way we conceived our world. New realities have appeared thanks to the information and communication technologies (e.g. Internet), peer-to-peer dynamics (e.g. open software/hardware, collaborative economy), new means of production (fablabs, hackerspaces), among others. One of the impacts of this technical ecosystem is the individual's empowerment that changes the relationship between consumer and producer. For instance, we observe an evolution of role passing from a *passive consumer* towards an *active prosumer*, where this latter considers not only economic aspects, but also social and environmental issues.

This thesis is integrated in this global issue; indeed, throughout the manuscript we analyze about the impact of open-source (OS) Additive Manufacturing (AM) (also as known as open-source 3D printing or just 3D printing) in the light of the sustainability issues. The democratization of OS AM and the creation of spaces for co-creation (e.g. FabLabs) proved the interest for changes in the established roles. Therefore, we are interested in how this OS technology could develop sustainable waste management option through a polymer recycling process.

In a first phase, we present the concept of additive manufacturing (AM) and its importance on sustainability issues. A systematic literature review related to the material recycling advances in the commercial and open-source (OS) AM is developed with a focus on thermoplastic polymer recycling. In a second phase, our aim is to validate open-source AM systems as a reliable manufacturing tool. We develop and test an experimental protocol in order to evaluate the dimensional performance using as case study a representative OS 3D printer: called *FoldaRap*. It was found that the International Standard Tolerance Grade of this machine is situated between IT14 and IT16. We conclude that the dimensional performance of this case study is comparable to the commercial AM systems, taking into account the important different in terms of machine cost. In a third phase, we center our attention on the recycling process and we propose a systematic methodology to evaluate the feasibility of the use of recycled thermoplastic polymer in OS 3D printers. A case study is developed with the evaluation of the recycling process using polylactid acid (PLA). The results allow us to conclude that the use of recycled PLA is technically feasible. Nevertheless, the degradation of the material is more important than in other traditional manufacturing systems (e.g. injection). Finally, we concludes and propose as perspectives, the study of a distributed recycling process for other type of polymers.

Keywords Polymer Recycling, Open-Source Additive Manufacturing, 3D printing, Polylactic Acid (PLA), RepRap.