



HAL
open science

Contributions to energy storage using hybrid systems from alternative energy sources

Alexandru Ciocan

► **To cite this version:**

Alexandru Ciocan. Contributions to energy storage using hybrid systems from alternative energy sources. Thermics [physics.class-ph]. Ecole nationale supérieure Mines-Télécom Atlantique, 2017. English. NNT : 2017IMTA0028 . tel-01668588

HAL Id: tel-01668588

<https://theses.hal.science/tel-01668588>

Submitted on 20 Dec 2017

HAL is a multi-disciplinary open access archive for the deposit and dissemination of scientific research documents, whether they are published or not. The documents may come from teaching and research institutions in France or abroad, or from public or private research centers.

L'archive ouverte pluridisciplinaire **HAL**, est destinée au dépôt et à la diffusion de documents scientifiques de niveau recherche, publiés ou non, émanant des établissements d'enseignement et de recherche français ou étrangers, des laboratoires publics ou privés.

Thèse de Doctorat

Alexandru CIOCAN

*Mémoire présenté en vue de l'obtention du
grade de Docteur de L'École nationale supérieure Mines-Télécom Atlantique Bretagne-
Pays de la Loire - IMT Atlantique
sous le sceau de l'Université Bretagne Loire*

École doctorale : Sciences pour l'ingénieur (SPI)

Discipline : Energétique, thermique

Spécialité : Génie des procédés

Unité de recherche : *Génie des Procédés-Environnement-Agroalimentaire (GEPEA)*

Soutenue le 17 octobre 2017

Thèse N° : 2017IMTA0028

Contributions aux systèmes de stockage d'énergie en utilisant des systèmes hybrides à partir de sources d'énergie alternatives

JURY

| | |
|-------------------------|---|
| Rapporteurs : | M. Liviu DRUGHEAN, Professeur d'Université Technique de Génie Civil Bucarest M. Said ABBOUDI, Professeur d'Université de Technologie de Belfort-Montbéliard |
| Examineurs : | M. Jean – Felix DURASTANTI, Professeur d'Université Paris Est Créteil M ^{me} Mariana-Florentina STEFANESCU, Professeur d'Université Politehnica de Bucarest |
| Invité(s) : | M. Valentin APOSTOL, Lecteur d'Université Politehnica de Bucarest |
| Directeur de Thèse : | M. Tudor PRISECARU, Professeur d'Université Politehnica de Bucarest |
| Co-directeur de Thèse : | M. Mohand TAZEROUT, Professeur d'École des Mines de Nantes |

Acknowledgment

There have been many people who have walked alongside me during all these last years. All of them had a special contribution in helping me to complete this Ph.D. thesis, so I would like to express the acknowledgment and to thank those who bear and support me in all this time.

First and foremost, I want to give a special thanks to prof. Tudor Prisecaru, from University Politehnica of Bucharest and to prof. Mohand Tazerout, from Ecole des Mines de Nantes, for accepting to be my scientific advisors, for guidance and encouragement all the time and give me a positive attitude and the right direction, without their suggestions and undertaking this project would not have been possible and for all of this, I am deeply grateful.

Next, I would like to express all my consideration to professors: Mariana Stefanescu, Liviu Drughean, Said Abboudi, Valentin Apostol and Jean-Felix Durastanti for having accepted to be members of the jury for the validation of my Ph.D. thesis and for all the remarks they did both in writing and during the presentation itself and a well for all the beautiful words said at the end.

I further extend my gratitude to all professors from the both University Politehnica of Bucharest and Ecole des Mines de Nantes with which I came into contact and helped me with suggestions during my formation. More than that I am hugely indebted to the staff of GEPEA Lab. from Ecole des Mines de Nantes / IMT Atlantique for receiving me in their laboratory and for the constant support that I received in the realization of the experimental part of my work.

My thankfulness goes also to The Embassy of French in Romania who offered the financial support and has done all their best that my internship in France to be in the best conditions.

Finally, I want to thank everyone from The National R&D Institute for Cryogenics and Isotopic Technologies - ICSI Ramnicu Valcea for believing in me and for the great work environment and as well for all the support that I have got.

Thank you all!

Alexandru

Work's Summary

The thesis entitled «Contributions to energy storage using hybrid systems from alternative energy sources» proposes a study of the energy storage technologies knowing the fact that these are considered one of the options that can facilitate a high penetration of renewable sources. In this context, the presented work aims to understand challenges in terms of energy storage and to develop a general studying model using compressed air as an energy storage medium.

The thesis is structured in ten chapters from which the first four are dedicated to the presentation of the renewable energy sources potential, to the energy sector evolution in the last decades and to the energy storage technologies, especially in the form of compressed air. The other six chapters are dealing with the theoretical thermodynamic calculations as far as that goes in investigating the performances of a hybrid energy storage system and presenting a mathematical model containing the steps taken into account in the renewable energy conversion into mechanical energy, stored in a form of compressed air and later reconverted into electricity. In addition these chapters present experimental data obtained on a laboratory installation which helped in validating the theoretical results obtained following a Matlab simulation, and finally a case study for a small scale application, 30 kWh of energy stored, where is aiming to find an optimal configuration of the whole system in terms of air working pressure, being analyzed from two points of view, technical and economic. The thesis ends with a chapter of general conclusions and indicates that there are still challenges that must be overcome in order to make the energy storage in a form of compressed air a feasible solution from an economic perspective.

Keywords:

RES, energy storage, CAES, TES, trigeneration, thermodynamic analysis

Contents

| | |
|---|----|
| Acknowledgment | 2 |
| Work's Summary | 3 |
| List of figures | 8 |
| List of tables | 12 |
| List of abbreviation | 13 |
| 1. Introduction | 14 |
| 1.1. Thesis context | 14 |
| 1.2. Climate changes | 15 |
| 1.3. Problematic of the thesis | 16 |
| 1.4. Aims and objectives | 17 |
| 2. Renewable Energy Sources overview | 20 |
| 2.1. Hydroelectric Power | 20 |
| 2.2. Solar Power | 21 |
| a. Advantages of solar energy | 23 |
| b. Disadvantages of solar energy | 24 |
| 2.3. Biomass | 24 |
| 2.4. Geothermal Power | 24 |
| 2.5. Wave and tidal energy | 25 |
| 2.6. Wind Power | 25 |
| a. Advantages of wind energy | 27 |
| b. Disadvantages of wind energy | 27 |
| 3. The energy sector evolution | 29 |
| 3.1. The energy sector evolution by country from 2002 to 2012 | 29 |
| 3.2. France energy context | 31 |
| 3.3. Romanian energy context | 33 |
| 3.4. Requests needed for a larger integration of RES | 34 |
| 3.6. Weather conditions | 36 |
| 3.7. Discussions and Perspectives | 42 |
| 4. Energy storage solutions overview | 44 |
| 4.1. Energy storage solutions | 44 |
| 4.1.1. Introduction | 44 |
| 4.2. Compressed air storage | 46 |

| | | |
|-----------|---|----|
| 4.2.1. | CAES technology _____ | 46 |
| 4.2.2. | Storage vessel characteristics and selections _____ | 47 |
| 4.2.2.1. | A sensitivity study in calculating the material required for an aboveground storage vessel, depending on the volume for certain storage pressure values _____ | 48 |
| 4.2.3. | Existing power plants _____ | 52 |
| 4.2.4. | Other projects in different stages of developing _____ | 54 |
| 4.3. | The principle of Compressed Air Energy Storage _____ | 55 |
| 4.4. | CAES process description _____ | 56 |
| 4.4.1. | Isothermal compression/expansion _____ | 57 |
| 4.4.2. | Adiabatic compression/expansion _____ | 57 |
| 4.4.3. | Polytropic compression/expansion _____ | 57 |
| 4.5. | Atmospheric air and its characteristic parameters _____ | 58 |
| a. | Temperature _____ | 58 |
| b. | Density _____ | 59 |
| c. | Humidity _____ | 59 |
| d. | Specific heat _____ | 60 |
| 5. | Mathematical modeling of a compressed air energy storage system _____ | 61 |
| 5.1. | CAES operating scenarios _____ | 61 |
| 5.1.1. | The charging process _____ | 62 |
| 5.1.1.1. | Compressor operation for a single stage compression _____ | 63 |
| 5.1.1.2. | The work consumed by an air compressor during compression process _____ | 64 |
| 5.1.1.3. | One stage isothermal compression _____ | 66 |
| 5.1.1.4. | One stage adiabatic compression _____ | 67 |
| 5.1.1.5. | One stage polytropic compression _____ | 68 |
| 5.1.1.6. | Multi-stage compression _____ | 70 |
| 5.1.1.7. | Isothermal multi-stage compression _____ | 71 |
| 5.1.1.8. | Adiabatic multi-stage compression _____ | 71 |
| 5.1.1.9. | Polytropic multi-stage compression _____ | 72 |
| 5.1.1.10. | Compressor features _____ | 72 |
| 5.1.2. | The storage process _____ | 76 |
| 5.1.3. | The discharging process _____ | 77 |
| 5.1.3.1. | Isothermal a single stage expansion _____ | 79 |
| 5.1.3.2. | Adiabatic a single stage expansion _____ | 79 |
| 5.1.3.3. | Polytropic single stage expansion _____ | 79 |
| 5.1.4. | Thermal energy storage _____ | 81 |

| | | |
|------------|---|-----|
| 5.1.4.1. | Thermal energy storage systems | 83 |
| 5.1.4.1.1. | Two – Tanks direct storage | 83 |
| 5.1.4.1.2. | Two – Tanks indirect storage | 83 |
| 5.1.4.2. | System efficiency | 84 |
| 6. | CAES system - simulation in Matlab | 87 |
| 6.1. | Simulation and optimization of a CAES system using Matlab tools | 87 |
| 7. | Experimental set-up representation | 102 |
| 7.1. | The air compressor characteristics | 106 |
| 7.2. | Charging//Discharging valve | 109 |
| 7.3. | Pressure regulator | 109 |
| 7.4. | Air engine description | 110 |
| 7.5. | The electric generator | 111 |
| 7.6. | Mass flow meter | 112 |
| 7.7. | Consumers | 112 |
| 7.8. | Pressure, temperature and humidity sensors | 112 |
| 7.9. | Power meter ProWatt-3 | 112 |
| 7.10. | Power AC analyzer Pm 1200 Voltech | 112 |
| 7.11. | Experimental results | 114 |
| 8. | A case study | 125 |
| 8.1. | CAES system pre-dimensioning | 125 |
| 8.2. | Chapter Conclusions | 145 |
| 8.3. | Storage vessel simulation in ANSYS | 147 |
| 9. | Energy price and consumption for householders | 151 |
| 9.1. | Energy market | 151 |
| 9.2. | Cost analysis | 153 |
| 9.3. | The optimization cost of production | 154 |
| 9.4. | Determining the objective function | 155 |
| 10. | Thesis conclusions and perspectives | 175 |
| | Limitations of the thesis | 178 |
| | Original contributions | 179 |
| | Bibliography | 180 |
| | List of relevant papers | 189 |
| | International and national conferences participation | 191 |
| | Annex 1 | 192 |

| | |
|---------|-----|
| Annex 2 | 193 |
| Annex 3 | 194 |

List of figures

| | |
|--|----|
| Figure 1 – Illustration of a pumped hydro energy storage system [13] | 21 |
| Figure 2 – CSP [Source: Concentrating Systems] | 22 |
| Figure 3 – Vertical axis wind turbine [22]..... | 26 |
| Figure 4 – Horizontal axis wind turbine [23]..... | 26 |
| Figure 5 – A snapshot for the share of energy from renewable sources for the year 2002 [26] | 29 |
| Figure 6 – A snapshot for the share of energy from renewable sources for the year 2012 [26] | 30 |
| Figure 7 – Electricity production from all energy sources: France case..... | 32 |
| Figure 8 – France interconnection energy sector [28] | 32 |
| Figure 9 – Electricity production from all energy sources: Romanian case | 34 |
| Figure 10 – Solar radiation and wind speed map illustration for France and Romania [34], [35]..... | 37 |
| Figure 11 – Wind speed illustration during the month of July 2015 | 38 |
| Figure 12 – Wind speed illustration during the month of February 2015 | 38 |
| Figure 13 – Solar radiation illustration during the month of July 2015 | 39 |
| Figure 14 – Solar radiation illustration during the month of February 2015..... | 39 |
| Figure 15 – Wind speed illustration for the first day of July 2015 | 40 |
| Figure 16 – Wind speed illustration for the first day of February 2015 | 40 |
| Figure 17 – Solar radiation illustration for the first day of July 2015 | 41 |
| Figure 18 – Solar radiation illustration for the first day of February 2015..... | 41 |
| Figure 19 – EST [12] | 44 |
| Figure 20 – Overview of electricity storage systems [12] | 45 |
| Figure 21 – Storage tank pre-dimensioning [42] | 49 |
| Figure 22 – Storage vessel wall thickness | 50 |
| Figure 23 – Storage vessel raw material required..... | 50 |
| Figure 24 – CAES Huntorf power plant with main components 1) compressor, 2) motor/generator, 3) turbine, 4) storage caverns [43], [44]..... | 52 |
| Figure 25 – CAES McIntosh power plant [47] | 53 |
| Figure 26 – Chart of compressor type..... | 62 |
| Figure 27 – P-V diagram for a theoretical compressor..... | 63 |
| Figure 28 – Ideal compression cycle | 65 |
| Figure 29 – Multi-stage compression with intercoolers P – V diagram | 70 |
| Figure 30 – Multi-stage compression with intercoolers T – S diagram..... | 70 |
| Figure 31 – A counter-flow heat exchanger illustration | 76 |
| Figure 32 – A single stage expansion process | 78 |
| Figure 33 – Multi-stage expansion process | 78 |
| Figure 34 – Thermal energy storage solutions [90]. | 83 |
| Figure 35 – Sensible and latent representation for different phase transition..... | 84 |
| Figure 36 – Diagram for 1 of 3 stages compression | 88 |

| | |
|--|-----|
| Figure 37 – Diagram for the heat transfer rate variation during a single stage compression - adiabatic process | 89 |
| Figure 38 – The total heat variation during a multi-stage compression for an adiabatic process | 90 |
| Figure 39 – The heat variation during a single stage adiabatic compression for a compressor with three identical stage compression | 90 |
| Figure 40 – Temperature variation for a multi-stage compression process | 91 |
| Figure 41 – Representation of specific work per unit mass function of pressure for a single stage compression | 92 |
| Figure 42 – Representation of specific work per unit mass function of pressure for multi-stage compression | 92 |
| Figure 43 – Energy required to fulfill the storage bootless in 1 and 3 stage compression | 93 |
| Figure 44 – Diagram for a single stages expansion | 94 |
| Figure 45 – Temperature variation for a single stage expansion | 95 |
| Figure 46 – Temperature variation for three-stage expansion | 96 |
| Figure 47 – Graphical representation of efficiency function of input expander pressure - adiabatic process | 97 |
| Figure 48 – The addition of the cycle efficiency by the compression ratio and the polytropic index..... | 98 |
| Figure 49 – Thermal energy storage system | 99 |
| Figure 50 – System efficiency for different scenarios | 100 |
| Figure 51 – The time required for charging the tank depending by the thermodynamic compression process | 100 |
| Figure 52 – Compression phase experimental set-up | 102 |
| Figure 53 – Expansion phase theoretical set-up | 103 |
| Figure 54 – Expansion phase experimental set-up | 103 |
| Figure 55 – The graphics interface in LabVIEW for the automatization part | 104 |
| Figure 56 – Compressor side view..... | 105 |
| Figure 57 – Storage vessel side view | 105 |
| Figure 58 – Air engine side view | 105 |
| Figure 59 – Compressor block IK120, front view [Source: user manual manufacturer] | 106 |
| Figure 60 – Pressure and temperature cylinder monitoring..... | 108 |
| Figure 61 – Compressor schematic representation [Scubaengineer.com] | 108 |
| Figure 62 – Illustration of a pressure regulator showing forces acting on the individual elements [93]..... | 109 |
| Figure 63 – The RM 110 air engine performance [Source GLOBE Airmotors] | 111 |
| Figure 64 –The air temperature into the tank variation during the charging process | 114 |
| Figure 65 – The air mass flow succeed variation during compression process..... | 114 |
| Figure 66 – The air pressure evolution after each stage of compression..... | 115 |
| Figure 67 – Experimental measurements of temperature before and after each stage of compression | 115 |
| Figure 68 –The power consumed by compressor during compression process..... | 116 |
| Figure 69 – The heat transfer rate resulted during compression process..... | 117 |

| | |
|---|-----|
| Figure 70 – Theoretical value for the energy unused by using the throttled valve in the case in which the air is not pre-heated before expansion process..... | 118 |
| Figure 71 – Theoretical value for the energy unused by using the throttled valve in the case in which the air is pre-heated before expansion process..... | 118 |
| Figure 72 – Specific work per unit mass variation during a single stage expansion | 119 |
| Figure 73 – Theoretical value for the energy unused by using the throttled valve in the case of Huntorf Power Plant | 120 |
| Figure 74 – The air temperature variation before and after the control valve | 120 |
| Figure 75 – The air temperature values at the output of the control valve and at the input air engine..... | 121 |
| Figure 76 – The air temperature before and after the air engine | 122 |
| Figure 77 – Pressure value before and after the air engine during expansion process | 122 |
| Figure 78 – Pressure and mass flow rate evolution during discharging process | 123 |
| Figure 79 – Power and pressure evolution in time during discharging process | 123 |
| Figure 80 – The value of the power generated and the cold resulted | 124 |
| Figure 81 – Figure representing a hybrid energy storage system from RES with the capabilities to supply energy in cogeneration | 126 |
| Figure 82 – Figure representing a hybrid energy storage system from RES with the capabilities to supply three types of energy | 127 |
| Figure 83 – Storage vessel volume required function of pressure: 1 stage compression – 1 stage expansion without preheated air | 131 |
| Figure 84 – Storage vessel volume required function of pressure: 2 stage compression – 1 stage expansion without preheated air | 132 |
| Figure 85 – Storage vessel volume required function of pressure: 1 stage compression – 1 stage expansion with preheated air | 133 |
| Figure 86 – The mass of air required to be stored function of the air engine inlet temperature | 134 |
| Figure 87 – The storage vessel volume required function of pressure: 2 stage compression – 1 stage expansion with preheated air | 135 |
| Figure 88 – The mass of air required to be stored function of the air engine inlet temperature | 136 |
| Figure 89 – The storage vessel volume required function of pressure: 2 stage compression – 2 stage expansion with preheated air | 137 |
| Figure 90 – The mass of air required to be stored function of air engine inlet temperature.. | 137 |
| Figure 91 – The storage vessel volume required function of pressure 1 stage compression – 1 stage expansion without preheated air | 139 |
| Figure 92 – The storage vessel volume required function of pressure: 2 stage compression – 1 stage expansion without preheated air | 140 |
| Figure 93 – The storage vessel volume required function of pressure 1 stage compression – 1 stage expansion with preheated air | 140 |
| Figure 94 – The mass of air required to be stored function of air engine inlet temperature.. | 141 |
| Figure 95 – The storage vessel volume required function of pressure: 2 stage compression – 1 stage expansion without preheated air | 142 |
| Figure 96 – The mass of air required to be stored function of air engine inlet temperature.. | 142 |

| | |
|---|-----|
| Figure 97 – The storage vessel volume required function of pressure: 2 stage compression – 2 stage expansion without preheated air | 143 |
| Figure 98 – The storage vessel volume required function of pressure | 144 |
| Figure 99 – Storage vessel ANSYS simulation | 149 |
| Figure 100 – Average electricity consumption per electrified households, data processed from [95]..... | 151 |
| Figure 101 – Electricity price households, data processed from [96]..... | 152 |
| Figure 102 – Price per kWh for natural gas, data processed from [96]..... | 152 |
| Figure 103 – Equipment costs in percentage for the pilot installation | 154 |
| Figure 104 – System primary efficiency..... | 160 |
| Figure 105 – Energy required from renewable sources | 160 |
| Figure 106 – Air temperature resulted after compression | 161 |
| Figure 107 – Heat resulted during air compression | 161 |
| Figure 108 – Outlet air engine temperature variation function of number of stages and the inlet air engine pressure | 162 |
| Figure 109 – Cold resulted during air expansion..... | 162 |
| Figure 110 – Cost for the equipment which converts renewable energy into electricity | 163 |
| Figure 111 – Compressors cost..... | 163 |
| Figure 112 – Storage vessel cost..... | 164 |
| Figure 113 – Storage vessel volume | 164 |
| Figure 114 – Expanders cost..... | 165 |
| Figure 115 – System capital cost | 165 |
| Figure 116 – Objective function determination to obtain 30 kWh energy with air stored a 300 bar and expanded from 30 bar function of number of stages | 172 |
| Figure 117 – Objective function determination to obtain 30 kWh energy with air stored a 300 bar and expanded from 60 bar function of number of stages | 172 |
| Figure 118 – Objective function determination to obtain 30 kWh energy with air stored a 60 bar and expanded from 30 bar function of number of stages | 173 |
| Figure 119 – Objective function determination to obtain 30 kWh energy with air stored a 120 bar and expanded from 60 bar function of number of stages | 173 |
| Figure 120 – System capital cost | 177 |

List of tables

| | |
|---|-----|
| Table 1 – List of the largest energy storage project at the level of 2015 [centralized data from Wikipedia]..... | 45 |
| Table 2 – Data summarizing table with existing power plants [43], [48]..... | 54 |
| Table 3 – Gaseous Composition of dry air [75]..... | 58 |
| Table 4 – A list of solid and liquid materials used for sensible heat storage [88]..... | 82 |
| Table 5 – Summary of processes for perfect gas | 86 |
| Table 6 – Initial conditions | 87 |
| Table 7 – Results obtained for polytropic experimental compression..... | 89 |
| Table 8 – The amount of energy consumed for a complete charge of the tank..... | 93 |
| Table 9 – Results obtained for isentropic expansion | 94 |
| Table 10 – Storage parameters function of the operating conditions | 128 |
| Table 11 – Storage parameters function of the operating conditions | 129 |
| Table 12 – Storage parameters function of the operating conditions | 130 |
| Table 13 – Comparison between CAES and AA-CAES system | 153 |
| Table 14 – Storage vessel dimension..... | 156 |
| Table 15 – System efficiency..... | 156 |
| Table 16 – Price for the equipment which convert into electricity renewable energy | 157 |
| Table 17 – Price for the air compressor | 157 |
| Table 18 – Price for the storage vessel | 158 |
| Table 19 – Price for the air expander..... | 158 |
| Table 20 – System capital cost..... | 159 |
| Table 21 – The objective function determination to obtain 30 kWh energy with 300 bar storage pressure and 30 bar air expanded inlet pressure..... | 168 |
| Table 22 – The objective function determination to obtain 30 kWh energy with 60 bar storage pressure and 30 bar air expanded inlet pressure | 169 |
| Table 23 – The objective function determination to obtain 30 kWh energy with 300 bar storage pressure and 60 bar air expanded inlet pressure..... | 170 |
| Table 24 – The objective function determination to obtain 30 kWh energy with 120 bar storage pressure and 60 bar air expanded inlet pressure..... | 171 |

List of abbreviation

| | |
|---------|--|
| AA-CAES | Adiabatic Advanced Compressed Air Energy Storage |
| ANRE | Romanian Energy Regulatory Authority |
| CAES | Compressed Air Energy Storage |
| CCGT | Combined-Cycle Gas Turbine |
| COP21 | The 21 st Conference of Parties |
| CSP | Concentrated Solar Power |
| DSM | Demand Side Management |
| EU | European Union |
| EST | Electricity Storage Technologies |
| GHG | Greenhouse Gas Emissions |
| GW | Gigawatt |
| HE | Heat Exchanger |
| HP | High Pressure |
| IEA | International Energy Agency |
| kJ | Kilojoule |
| kg | Kilogram |
| K | Kelvin |
| kWh | Kilowatt-hour |
| LP | Low Pressure |
| MW | Megawatt |
| PV | Photovoltaic Cells |
| PHES | Pumped Hydroelectric Energy Storage |
| RES | Renewable Energy Sources |
| TES | Thermal Energy Storage |

1. Introduction

1.1. Thesis context

In the last two decades, major changes have been seen in the way in which scientific community and the decision factors have seen the future of the energy sector. Over the years there have been several scenarios prediction for the main fossil fuel as is going to run out somewhere to the end of this century, considering the known reserves and the fact that is just a matter of time when they run out, not if [1]. Even if some new reserves will be found, and help to extend the deadline those reserves that will be discovered will be significantly smaller than that discovered in the past. Obviously, it's well known that fossil fuel doesn't represent a viable option and will be less and less used, and the fact that renewable energy sources will get an increasingly higher attention.

The interest in energy storage is currently increasing, especially in order to integrate the renewable energy sources to the grid and to satisfy consumers' demands directly. Renewable energy has great significance in the security of energy supply and can be used in the conservation of fuel, especially as raw materials in thermal power plants or for the road, rail, maritime and air transport.

The biggest challenge with renewable energy is represented by their intermittent nature. Referring only to solar and wind energy, those generate electric power only when the sun is shining or the wind is blowing. The ways of storing energy for use on windless or sunless periods must be found and must go up by the principle "you take when you can get it" [2]. How to manage the RES fluctuating problem is the key issue of the development and utilization of energy storage in the near future [3].

An important point underlying the integration and use of renewable sources is represented by the necessity of reducing greenhouse gas emissions, given the fact that an important part of contaminant released, represents the effect of the production processes of electricity and heat from the thermal power plants (SO₂, NO₂, CO₂, dust, slag, ash and thermal pollution).

A number of initiatives were taken globally with time thus in March 2007 the European Union adopted a new policy regarding renewable energy target setting to obtain at least 20% of EU energy needs from renewable sources by 2020. To achieve this goal the European Union

Commission has developed a series of new directives for the energy industry and public constructions and private procedures. Among them we can include here: reducing greenhouse emission (GHG) by 20% until 2020 in comparison with years '90, increasing the share of renewable energy (RES) to 20% of its energy sources by 2020, and reduction of the global primary consumption by 20% until 2020. Having these objectives summarized, the program was called 20-20-20% [4]. Later in 2012, a new directive comes to support the projection made in 2007 and to assume once more the targets for primary energy consumption by 2020 [5].

1.2. Climate changes

The global warming represents another starting point in which the renewable sources would be an ideal solution for reducing electricity consumption derived from fossil fuel. In literature, it was agreed that the greenhouse gas emission represents the main cause of the global warming.

To meet all these needs and to prevent the global warming the European Union launched a series of projects aimed to define a new direction in research and innovations, among other with the scope of reducing the global warming. The last big project launched in 2014 is “Horizon 2020”, and once with it, the purpose assumed by European Union Commission in 2007 that the global average temperature can grow up to a limited value of 2°C compared with the average of the pre-industrial era was reinforced. This could happen by limiting the concentration of greenhouse gases in the atmosphere to approximately 450 parts per million of CO₂ [6], [7], [8].

Later in 2015 European Union comes with a series of new policies to support the integration of RES, and at the same time to reduce the dependency of fossil fuel with the final target to reduce CO₂ emissions. A large number of countries signed in December 2015 at COP21 Summit, held in Paris, a new document which gives new directions in climate and energy policies, having the goal to reduce the greenhouse gas emissions and consequently the climate warming with 1.5°C until the end of 2030. Another target has been to reduce the oil imports from the Middle East.

Although earlier in 2010 a first document called “Energy 2020: A strategy for competitive, sustainable and secure energy” strengthened the same objectives imposed in 2007 a reduction of 20% of GHG and an increasing with 20% of the renewable source in the share of the energy mix. At the level of 2016, the results are encouraging being countries that reached already the

assumptions for the year 2020. Anyway, the new target of European Commission was fixed for Energy Roadmap 2030 where it is wanted to reduce GHG with 40% compared with the years '90, which means that renewable energy source has to represent at least 27% from the energy mix.

1.3. Problematic of the thesis

It is well known that the renewable energy presents two main characteristics which make them ideal as energy sources production, these are inexhaustible sources and are friendly with the environment as long as don't produce waste materials and are not polluting.

However there are some inconveniences in terms of renewable energy, particularly solar and wind energy depends on the weather conditions, their behavior varies not only hourly, but seasonally as well, and in this conditions, they are not always available when are needed. Taking into consideration the fluctuating nature of the renewable energy, storages systems are required to adapt the supply and demand and to increase their economic value. As an example, there are periods when wind turbines connected directly to the grid often produce power at off-peak times and sometimes their operation has to be managed in such way that there should not be a surplus of energy in the grid when it's not needed.

In the electricity systems, supply and demand have to be balanced in real time. To do that any electricity system requires enough power plants to meet the maximum electricity demand. Therefore the electricity demand has a fluctuating nature during a day, a week, or a year, and to avoid any difficulties that might appear for those periods then a flexible system with a faster response to the electricity system requires is mandatory. Pumped Hydroelectric Energy Storage (PHES), Compressed Air Energy Storage (CAES), the combined-cycle gas turbine (CCGT) have been used over the time to balance the electricity system, but once with the integration at a large scale and direct connection of the renewable sources to the electricity system these seem not being enough. A larger increase in the number of cycle starts-stops conducts in decreasing the efficiency of the conventional power plants and leads to a more rapid wear.

Why is energy storage important?

- For valorization of excess renewable energy with their intermittent nature.
- To meet energy supply with demand.
- To provide assured power capacity for difficult conditions of wind and sun.
- For non-optimal use of RES electricity and loss of value.
- To increase the grid stability if the system is connected to it.
- To provide energy to remote areas.
- From an economic perspective.

For the isolated locations of residence, energy storage may be easily obtained and could be more economical than grid extension, considering a long distance from the existing grid to the end users site.

Normally load leveling is initially based on the prediction of daily and seasonal needs, and the storage necessity appears when in any periods this production is not enough to satisfy the consumers' necessity. It is recognized that renewable sources connected directly to the grid have a significant impact due to their fluctuating nature, increasing then the difficulty in stabilizing network and playing an important role in predictions that follow to be done.

1.4. Aims and objectives

Energy storage is one of the main challenges in order to meet renewable energy technologies due to their intermittent nature. **So, the approach of the thesis is to realize contributions, to illustrate if the compressed air energy storage system can become a viable technical and economic solution or not in energy storage field.**

It should be mentioned from the very beginning that the theme imposed in the thesis was to address to the applications that propose small-scale energy storage systems, mainly focusing the attention on the energy stored in a form of compressed air.

CAES is not a simple energy storage system like batteries or super-capacitors because it involves during the process of converting electrical energy into mechanical form an important heat transfer. The global analysis of these systems should be realized taking into consideration all these aspects referring to the heat transfer.

Objectives:

- Developing a general model of study for a compressed air energy storage system.
- Understanding challenges in using compressed air as an energy storage medium.
- Achieving a comprehensive bibliographic study of the mathematical model in the domain of energy storage, especially as compressed air.
- Understanding the potential role of compressed air energy storage compared to other energy storage concepts.
- Understanding theoretical and practical involves of the thermodynamics of compressed air system.
- Finding of suitable heat storage solution.
- Developing an operable, safe and economic system.

CAES systems is the second major bulk energy storage technology, after pumped hydro energy storage (PHES), where a gas is compressed (usually air) to high pressure (tens maybe hundreds of bars) and injected into an underground structure (cavern, aquifer, abandoned mine and so on) discussing to a large scale, or to above ground tanks considering a smaller scale. In a CAES system to generate electricity the air is mixed with additional fuel, usually, natural gas burned and expanded through a conventional gas turbine which runs a generator. Besides this conventional technology called “diabatic CAES” there exist other advanced CAES concepts called “advanced adiabatic CAES”. The AA-CAES concept differs from the conventional CAES in that it functions without the combustion of natural gas. This solution requires that the thermal energy resulted from the compression process to be stored in a thermal energy storage system (TES) and used later during expansion process to re-heat the air before entering in the gas turbine. If the heat resulted from compression is used in other purposes, and not to re-heat the air during expansion, then a significant amount of cold will result, and three types of energy: electricity, hot and cold obtained can be considered, and the system became a “trigeneration” one, satisfying at the same time several consumers’ needs [9]. In order to avoid the fuel consumption which is a basic element in conventional CAES, known been the dependency of that, an alternative storage system free-fuel is presented in this work. Two scenarios are analyzed, first when the heat is used for purposes as: domestically water heating, heating of the buildings and so on, and the second scenario considered is when the heat is used to re-heat the compressed air before being expanded through an expander.

The main interest in this work is focused on the newest CAES technology which involves an advanced adiabatic system. Three types of energy could be obtained and the best solution for optimization and management of primary energy will be sought.

2. Renewable Energy Sources overview

The renewable energy development as a global and clean energy is one of the main objectives of worldwide energy policy which in the context of sustainable development aims to reduce the fossil fuel consumption, to reduce the greenhouse emissions and to develop new viable technologies in energy production [10], [11].

2.1. Hydroelectric Power

The hydroelectric power plant is the most mature technology used in energy storage and production from renewable energy sources. The process is simple and consists in a dam which is built across to a river to retain water in order to be used during the peak-on hours. The capacity of a hydroelectric power plant is incomparable with the capacity of any other powers plant which uses any other form of renewable energy. The biggest Power Plant in our days is Three Gorges Dam in China with a capacity of 22,500 MW. The operating principle consists in the fact that the captured water of rivers by hydro plants is transformed into mechanical energy of rotation through an impeller. The rotation speed being the result of the mass flow rate and the water intake.

The state-of-the-art for this technology is by far the method where a large amount of water is stored in an upper reservoir for later use. During the off-peak hours, usually during the night periods when the price is low or when there is a surplus of energy in the grid, the water from the lower reservoir is pumped into the upper reservoir. This kind of technology is economically attractive, the only constraint which makes it difficult for use at a wide scale is represented by the geological conditions for both reservoirs. According to Zach et al [12] pumped hydro energy storage can be classified into three types of systems:

- In a closed-loop when both reservoirs connected to the river are artificially built.
- In a semi open-loop when just one reservoir is artificially built, the other being built on the natural flow of the river.
- In an open system when both reservoirs are in the natural flow of the river.

Hydropower is the leading renewable electricity generation technology worldwide. In 2012 IEA presented a “Technology Roadmap: Hydropower” report where has been described that at

that moment of time Hydropower has the capacity to generate more electricity than all other renewables combined. Hydroelectricity's many advantages include reliability, proven technology, large-scale capacity, low operating cost.

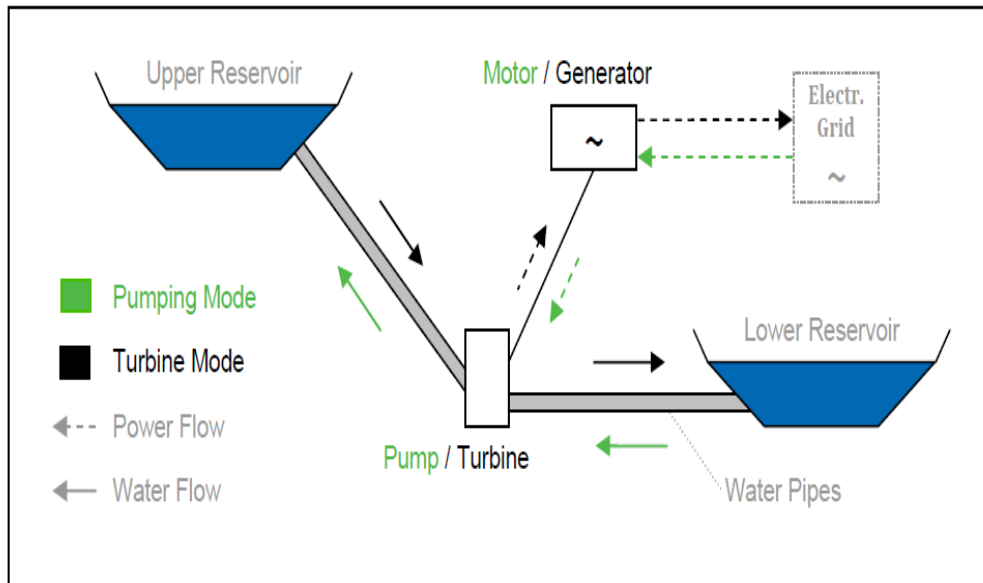


Figure 1 – Illustration of a pumped hydro energy storage system [13]

2.2. Solar Power

It is the power produced by collecting sunlight and converting into electricity. This thing can be done in two ways. By using solar panels made by many individual solar cells following the photoelectric effect or by using solar radiation to heat water capable of driving a steam turbine. It is well known that the sun provides enough energy in one minute to supply the world's energy needs for one year [14].

The photovoltaic panels allow the conversion of 10-15% of the solar power into electricity. The energy produced by such a panels vary once with the increase or decrease of solar radiation.

- **Photovoltaic cells**

Photovoltaic cells represent the most mature technology that converts solar energy into electricity. During the years The International Energy Agency has proposed several projects in order to understand the role of photovoltaic solar energy as a cornerstone in the transition to sustainable energy systems.

At the end of 2015 the global PV market measures at least 227.1 GW, 48.1 GW being installed all over the world only in 2015 compared to 38.7 GW in 2014 [15]. From this installed power just in 2015, China holds 15.2 GW, while Japan 11 GW and USA 7.3 GW, UK 3.51 GW, India 2 GW. Not less than 22 countries have passed at the end of 2015 over 1 GW of cumulative PV systems capacity. In the top 10 countries on the PV market, we can count countries like: China, Japan, India from Asia, Germany, Italy and France from Europe, the USA and Canada from North America, South Africa from Africa and Australia from Pacific zone [15].

- **Concentrated Solar Power**

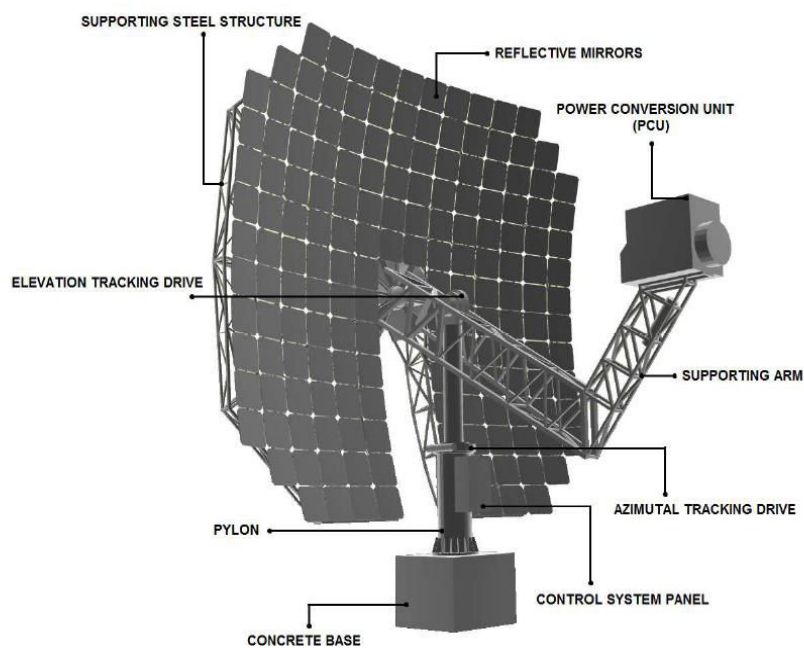


Figure 2 – CSP [Source: Concentrating Systems]

Concentrated solar power is one of the newest solutions used to convert solar energy first in thermal energy and later in electrical energy. Thermal energy generated by CSP produces no greenhouse gas emission, so it could be a key technology for minimizing climate changes.

In 2014 only United States and India added facilities to their grids while in Northern Africa's countries, Spain and South Africa have met stagnation. A year before, in 2013, the largest parabolic trough plant was committed in Arizona having the capacity to supply electricity for about 70,000 homes and use the equivalent of water for about 4,000 homes at a capacity of 280 MW. Also in the USA, it was committed in the same year, 2013, the largest solar Tower System – Ivanpah Plants in California with a capacity of 377 MW capable to supply enough energy to

140,000 homes during peak hours of the day. The project had the target to reduce carbon dioxide emissions by more than 400,000 tons annually [16].

Another technology used is dish Stirling Systems. These systems are using instead of water a small amount of gas to drive a piston of a Stirling engine to produce mechanical power. Until 2013 Infinia was one of the most important players on the market in the implementation of the solar concentrators [17], [18].

Anyway, during the course of the year 2014, the global capacity grew up with 27% to a value nearly 44 GW due to the implementation of four new projects.

There are several types of engines capable to transform thermal energy into mechanical energy. The most commune heat engines used are those with combustion, gas turbine, piston engines or installation based on Rankine cycle with steam water. Unfortunately, none of this engine is capable to valorize renewable energy sources (as solar or biomass). Meanwhile hot air engines, with external heat input, and engines which realize alternatively compression and expansion are capable to valorize renewable energy.

One of this hot air engines is Stirling engine invented by Robert Stirling and patented in 1816. In the sustainable development Stirling engine is considered a serious alternative and an efficient solution in the conversion of renewable energy into mechanical work, with a yield theoretic equal to that of Carnot cycle.

a. Advantages of solar energy

Like wind energy, solar energy is a clean and renewable source, which causes no pollution. However solar collectors and other additional equipment for solar systems are manufactured in factories that in change causes some pollution. Once a solar panel, a solar concentrator or a solar tower is installed, solar energy can be produced free of charge.

Solar systems are very attractive due to the fact that is needed a very little maintenance to keep them running and they don't produce any noise while wind turbines do.

Solar energy can be used in a remote area where is too expensive to extend the electricity power grid. As a particular example could help in the development of countries from the so-called 3rd world.

Solar power technology is in a continuous improvement in the last years, and people have begun to understand all the benefits offered by this. The decline of oil reserve forces them to turn their attention to alternative energy sources.

b. Disadvantages of solar energy

The main disadvantage of solar power is that it cannot be produced during the night, and the power generated is reduced during the clouds cover too. Electricity generation depends entirely by location that has been chosen in such way to have maximum exposure to sunlight.

As compared with wind turbines that need just a small piece of land for installation, solar cells or solar towers even solar concentrators require an important area of land to capture sun's energy.

From an economic point of view, the initial cost of purchasing a solar system is fairly high. Although many European countries have introduced some schemes for encouraging the adoption of renewable energy sources these still remain at a high price. Speaking only about photovoltaic cells these are in a constant development, so it is good to assume that the price will go down in the near future.

2.3. Biomass

It represents the fuel which is developed from organic materials as forest flow, certain crops, manure and some types of waste residues. The most used form to produce energy from biomass is by burning wood to produce steam which runs a turbine or it's burned to provide heat.

In the case of biomass should be mentioned that the renewable energy is not necessarily clean. By burning biomass, an important quantity of CO₂ is released into the environment, but this is significantly less than that produced by burning fossil fuel.

2.4. Geothermal Power

It represents the thermal energy contained in the earth. This heat can be used as an energy source in many ways, from large power stations to small pumping systems. In 2015 worldwide geothermal power capacity amounts 12.8 GW, of which 3.5 GW are installed in the United

States. At the end of 2020, the share of geothermal energy on the global market is expected to be somewhere between 14.5 GW and 17.6 GW. The value of 12.8 GW is spread across the world as 568 MW are installed in Asia, 563 MW in Central America, 15 MW in Caribbean, 563 MW in Central America, 2,178 MW in Europe, 611 MW in Middle East/Africa, 3,548 in North America, 364 MW in South America and 4,318 MW in South Pacific [19].

2.5. Wave and tidal energy

Wave energy is the power drawn by the waves. When the wind blows across the sea or the ocean surfaces its energy is transferred to the wave. The energy output is measured in function of wave speed, height, and length and water density. The ocean covers approximately 70% of Earth's surface and for sure could have a major contribution to the world's electricity needs. The same predictions say that once it becomes a mature technology, wave energy could meet 10% of the European Union power demand by 2050 [20]. Assessments of the global wave energy potential show that the most promising location for wave energy production is for countries like Australia, New Zealand, South Africa, Chile, Great Britain, Ireland and the USA having an average power density of 40 - 60 kW/m [21].

2.6. Wind Power

Wind turbines work by converting the kinetic energy of the wind first in the rotational kinetic energy in the turbine and then in electrical energy that can be supplied based on the final purpose. The energy available for conversion depends on the wind speed and the swept area of the wind turbine. When a wind turbine follows to be installed is important to be known the expected power and some maps for the wind speed should be considered in order to design a turbine capable to deliver the expected power.

The wind turbine can have different orientations, horizontal axis design or vertical axis design, but the way how the power is calculated remains the same.



Figure 3 – Vertical axis wind turbine
[22]



Figure 4 – Horizontal axis wind turbine [23]

The kinetic energy is the energy of motion, no matter, if it's horizontal or vertical motion an object which has motion has kinetic energy.

Wind energy is one of the most rapidly growing renewable sources of energy due to the fact that hasn't negatively impact on the environment. To meet an increasing demand wind turbines are being scaled up both in size and power rating. Over the years the size of wind turbines increases drastically from the level of watts at the beginning of 90' years until the level of megawatts in our days. In terms of size wind turbines can be divided into two categories as: small and large wind turbines. Small wind turbines have rotor diameter ranging up to 8 meters, and the power is up to 100 kW. Large wind turbines range from 100 kW up to units of MW. The largest wind turbine at the level of the 2014 year is V164 with a power of 8 MW a prototype at the Danish National Test Center for Large Wind Turbines in Osterild, having a diameter of 164 meter and a tower height of 140 meters [24].

Functional characteristics of the wind turbines:

All the wind turbines, regardless their constructive mode, follow the same functional characteristics in terms of starting, rated and cut-out speed and as well cut power generation.

- Starting speed (cut-in speed) – is the minimum speed of the wind at which the wind turbine starts to generate power. This value is usually located between 3 and 5 m/s.
- Rated speed – represents the minimum speed of the wind for which the wind turbine generates his rated power. This value is usually located between 10 and 15 m/s. For any values between the starting and the rated speed, it's generated a power proportional to

those values. Once the value of rated power is overrated the power cut is limited by its rated power.

- Cut-out speed – At high values of wind speed usually higher than 22 m/s, most of the wind turbines stop producing energy. The speed at which this thing happens is called cut-out speed and its role is to protect the integrity of the wind turbine. There are several ways in which the wind turbine can stop by an automatic brake which is activated by a sensor that detect the wind speed, by bringing the blades into a position that prevent them longer move, or by using same flaps on the rotor which are activated when a fixed limit is exceeded at high speed and repositions the wind turbine so as not being in the flow of wind.

a. Advantages of wind energy

The wind is a clean source of energy which has no impact on the air polluting. Wind turbines do not produce any atmospheric emissions, like power plants which consume fossil fuel and so emit a series of gasses with greenhouse emissions when producing electricity. The wind turbine construction can be very tall, and the land below can still be used, especially in the agricultural areas.

As well, represents a very good solution for remote areas that are not connected to the electrical power grid, and wind turbines can be used to produce their own supply. As long as wind turbines are available in a very large range of size starting from watts to megawatts making them usable for householders or businesses.

b. Disadvantages of wind energy

The main disadvantage is given by the intermittent nature of wind. The energy provided by a wind turbine depends by the wind blowing. The fact that the most of the time the wind turbine cannot generate energy when is needed, and in many other cases it generates energy when it's not really needed then a storage system makes the wind energy more valuable.

From an economic point of view sometimes wind power can be expensive due to the fact that the higher power demand is in the big cities and wind farms producing an important amount of energy are difficult to be built in such locations. Therefore the site of wind turbines has to be

outside of the cities and an important investment follows to be done into the line transmission of electricity.

Another obstacle that stays in the front of the building of wind turbines in the cities is due to the noise that their rotor blades produce. Many times wind turbines are suitable only for a private region with coastal regions or hilly areas. The location of a wind power system is crucial because has to determine the best weather conditions, best transmission ways and to offer the greatest possible comfort to the people nearby.

Taking a look at what is happening in France and Romania in the last years could be seen that the wind power production increased in France from the level of 3,577MW in 2008 to 10,200MW in 2015 while in Romania increased from 3MW in 2008 to 3,020MW in 2014 [25].

3. The energy sector evolution

3.1. The energy sector evolution by country from 2002 to 2012

If at the end of the 20th century the energy sector was almost covered by fossil fuel, in the last decade renewable energy started to have an increasing impact at its level all over the world. A report of U.S Energy Information Administration shows the penetration rate of non-carbon source incensement in European Union countries and the USA at the level of 2012 reporting their level at the year 2002. The same report said that eighteen countries from the European Union generate at least one-third of their generation power from non-carbon sources in 2002. Even if the wind turbine and photovoltaic panels had a fast development in the last years especially in countries like Germany or in Nordic countries their impact still remain at low level. However, almost all countries make that the intakes of energy from renewable energy sources to be one in constantly increasing.

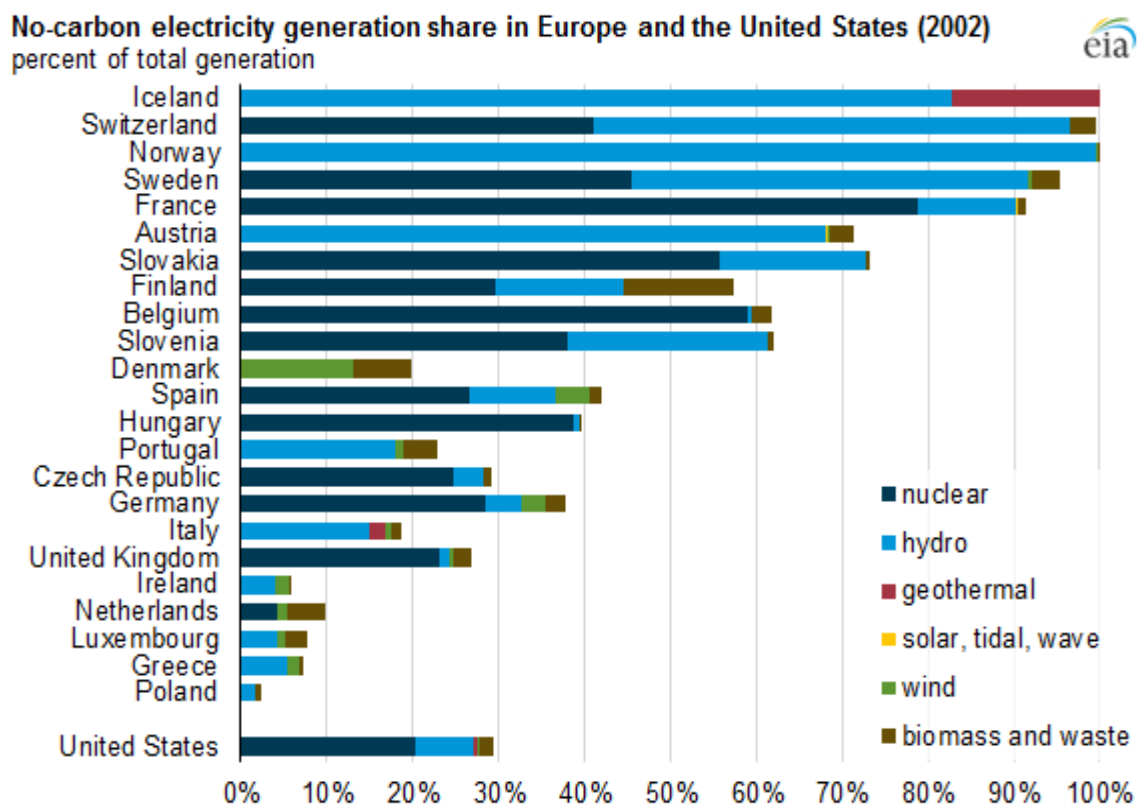


Figure 5 – A snapshot for the share of energy from renewable sources for the year 2002 [26]

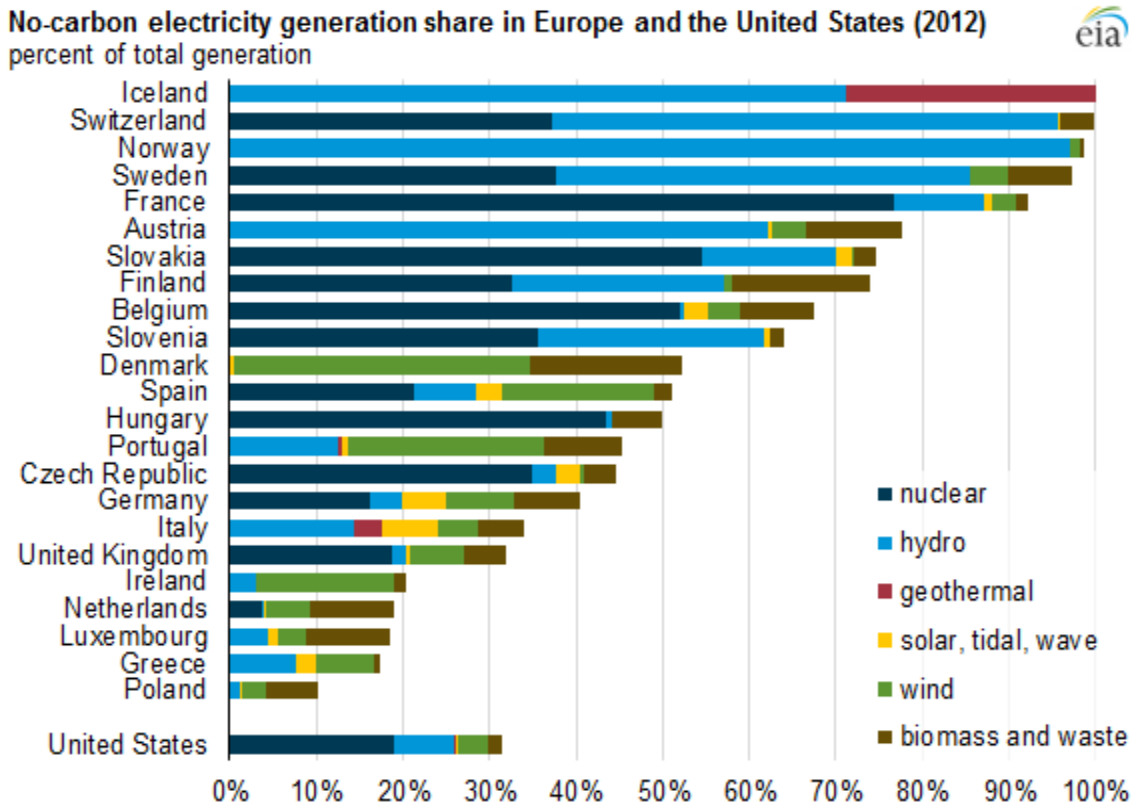


Figure 6 – A snapshot for the share of energy from renewable sources for the year 2012 [26]

Countries like Iceland, Switzerland, Norway, Sweden and France generate at least 90% of their net electricity from non-carbon source since 2002. Besides these Austria, Slovakia, Finland, Belgium, Slovenia, Denmark, Spain and Hungary accounted at least 50% of their generation.

According to the graphs, if in 2002 the most share of the renewable energy is covered by nuclear and hydroelectric sources at the level of the year 2012 wind energy and biomass succeeded in creating important portfolios.

The EU commitment in reducing greenhouse gas emission to 80-90% below 1990 level by 2050, so, purpose new directions to be followed for investors, governments and citizens in realizing a roadmap which will allow the movement to a competitive low-carbon economy in 2050. The investments represent a necessity and take time to produce results and for sure will imply major changes in energy prices, carbon prices, in realizing of new technologies, and networks.

3.2. France energy context

The French electricity sector is characterized by its high specificity when is compared with any other from worldwide countries. As a consequence of the oil crises in 1974 France decide to invest massively into the nuclear sector due to the fact that this energy is less dependent on the economic events [27]. Since years 90' nuclear energy in France represents more than 75% of the electricity consumption. Most of the investments have been driven from a political point of view in such way to encourage technologies based on this type of energy and leaving very little space to develop any other energy sources.

At present France is so addicted to the nuclear sector that the government decides that a new nuclear reactor will be started only when an old one will be shutting down. This decision comes immediately after Fukushima accident when the nuclear energy sector across the world was faced to reconsider its energy policy. Many countries decided to turn their faces towards the renewable energy sources and progressively to shut down their nuclear power plants. Germany was one of the countries who react immediately and by the voice of its canceler announced that all nuclear reactors would be closed until the end of 2022.

As well, the policies pursued by the European Union which imposed renewable energy targets to be reached by 2020 for each country finds France in a very difficult situation having at the end of 2014 only 9,100 MW power generation capacity from the wind and nearly 5,300 MW power generation capacity from photovoltaic panels [28].

As any market mechanism, the French power market is concentrated on: Electricity generation largely dominated by EDF which on its turn is controlled by the French state, Transmission and Distribution having as a system operator RTE and ERDF which are 100% owned by EDF. The retail market is liberalized since 1999 when industrial sites became eligible to choose their suppliers and in 2007 this option became possible as well for residential customers.

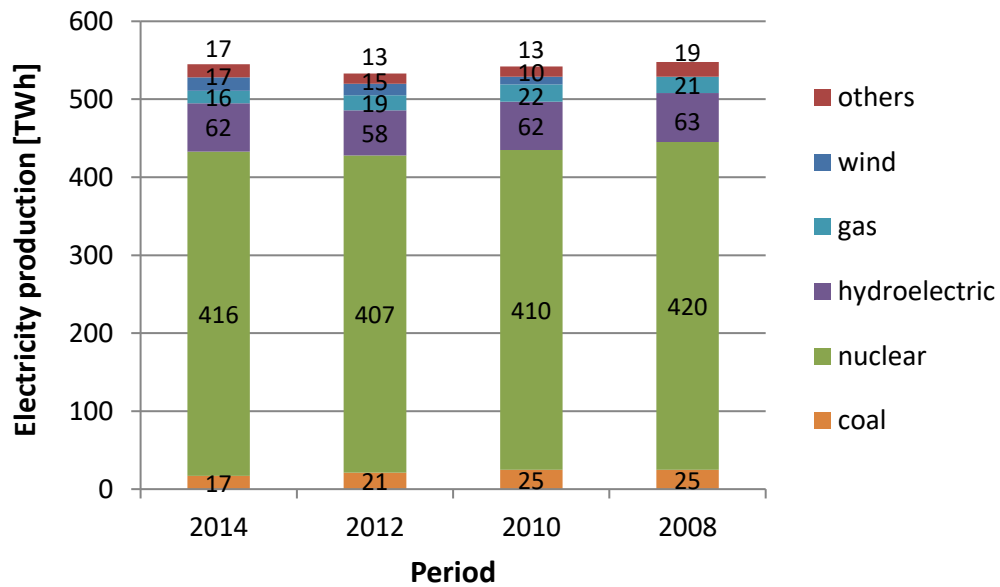


Figure 7 – Electricity production from all energy sources: France case

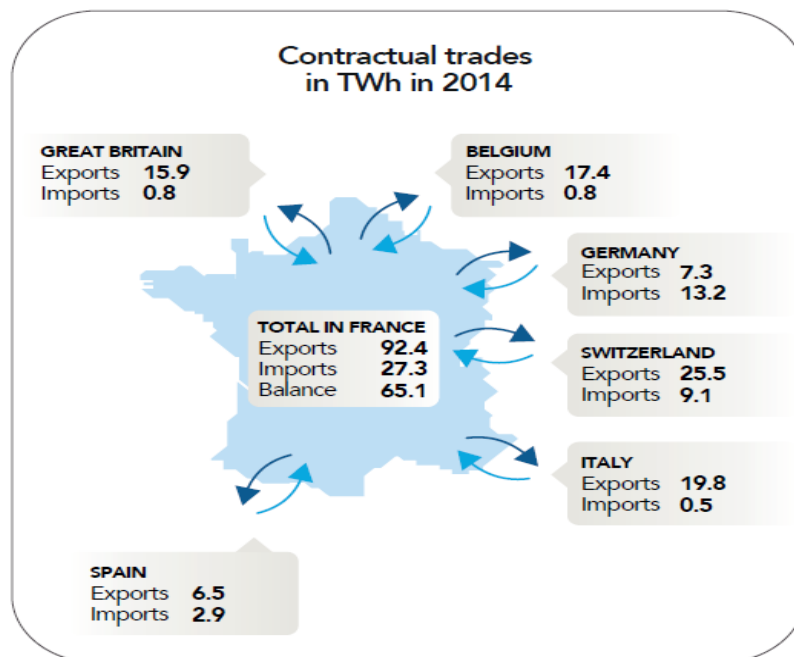


Figure 8 – France interconnection energy sector [28]

French energy sector is well interconnected with its neighbors. In figure 8 are presented exports and imports for the year 2014 in which France are involved. One can be noted that France exports electricity to Great Britain, Belgium, Switzerland Italy and Spain and mainly imports from Germany, Switzerland and Spain.

3.3. Romanian energy context

At the moment Romania disposes by a wide range, but reduced quantitatively, of primary fossil sources and minerals: oil, natural gas, coal, uranium and a potentially usable of renewable sources. At the same time can be said that Romania is placed in a relatively low dependency of energy import comparing with other European countries. In Europe, only Denmark and Estonia are better placed from this point of view. In the whole European Union, the primary energy demand is provided only in the proportion of 47% from own production, the difference being imported.

Looking back to the years 80' one can be seen that at the moment the primary energy demand has been almost halved due to the process of deindustrialization and due to the emergence of new technologies more effective from the energetic point of view.

The Romanian National Power Grid is a system both for production and distribution of electricity and it consists in all plants and distributions networks. Parts of Romanian National Grid are: Termoelectrica, Hidroelectrica, Nuclearelectrica, Electrica, Transelectrica. The first three companies have the role in energy production while Electrica has the role in energy distribution and supply and Transelectrica is a transport operator.

If we take a look at figure 9 easily can find that Romanian energy sector is much diversified being independent by one source of energy. For the year 2014, 27.5% of the total energy produced resulted from coal, 30% from hydro, 18% from the nuclear sector, 12.5% from natural gas and 12% from solar and wind. Relating to the year 2008 in 2014 energy coal production fell by almost 10%, the percentage covered by the renewable sources mostly by sun and wind energy.

At the end of 2015 in Romania, the installed power from renewable sources counts 4,662 MW according to ANRE [29] from which 2,931 MW from wind turbines, 1,296 from photovoltaic panels and 106.5 MW from biomass, biogas and waste fermentation gas and 327.8 MW from micro-hydro power plants with an installed power below 10 MW.

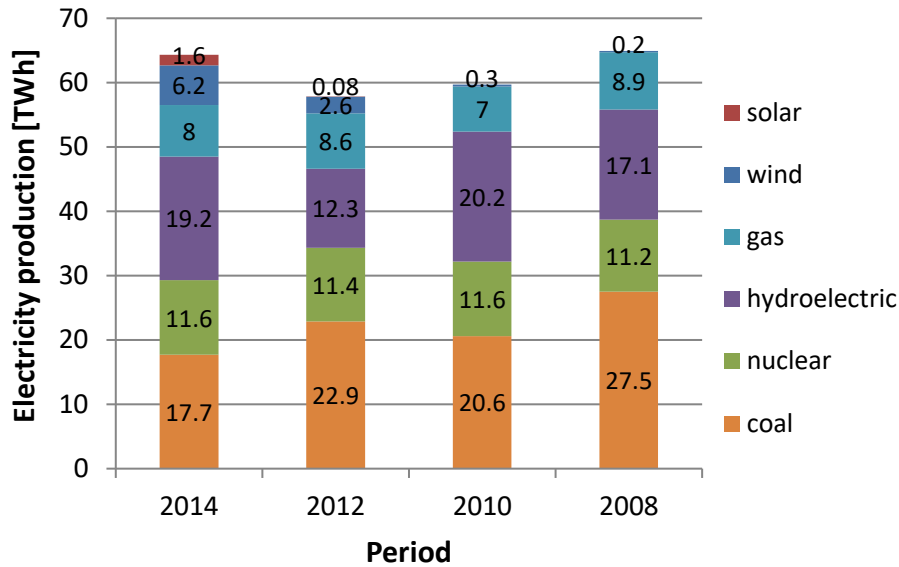


Figure 9 – Electricity production from all energy sources: Romanian case

3.4. Requests needed for a larger integration of RES

Taking into consideration all the constraints related to renewable sources and their fluctuating nature find that the actual energy system cannot integrate at a large scale these kinds of technologies without new investments into the transmission sector and definitely into the energy storage systems [30], [31], [32], [33].

- Grid expansion – should represent a priority in electric power grid capable of absorbing a growing share of renewable energy. The required technology is commercially available with few things that have to be improved in the field of security and flexibility of supply. However another problem which appears here is given by the public acceptance, but if the people want renewable energy they have to accept more grids in their neighborhoods.
- Energy storage – is by far the option which provides the highest level of flexibility for integration at a large scale renewable energy sources. Various technologies are presented by the scientific literature and most of them have been proven to be technically viable. Depending on the scale one can be mentioned: pumped hydro storage, compressed air, flywheels, batteries, fuel cell and supercapacitors. The problem

in the case of energy storage appears when we look at its costs, however, we take any storage technology is expensive at the moment. Anyway there are a lot of improvements regarding its efficiency and reliability and as well as if we look in their price which is in a constant decline, only if we consider Tesla which reports at the beginning of 2016 a price of 3500 USD for 10 kWh Li-Ion batteries, we can expect that in the future prices achieve an acceptable level.

- Demand side management – also known as energy demand management represents the modification of consumer demand for energy. The goal of DSM is to encourage the consumer to use less energy during the on-peak hours and to focus the time of energy use on off-peak periods such as nighttime and weekends. DSM doesn't have as objective to reduce the total energy consumption only the request at which the power grid is supposed. So, various beneficial effects are resulted, among this could be mentioned: mitigating electrical system emergencies, reducing the number of blackouts and increasing the system reliability, possible benefits could also include reducing the dependency on fossil fuel, reducing energy prices, reducing the investments in generation, transmission and distribution networks. A solution is to use energy storage units during off-peak periods and discharge them during on-peak periods. In DSM a significant role is played by the integration of communications technology with the power system and so in nowadays instead of DSM is more used the term of the smart grid. The aim of the smart grid is to lower energy costs and bring immediate benefits to the consumer.

3.6. Weather conditions

Not only for the experimental part of the work even in the theoretical part in order to have a better sizing of the system that follows to convert the renewable energy in usable energy it has been started from geographical conditions. As we already said in this work we are focused on renewable energy sources and particularly our attention turns to solar and wind energy.

Solar radiation and wind data help us to size the entire system function of the user needs. Thus a random location has been chosen having the following GPS coordinate $45^{\circ}02'09.2''\text{N}$ $24^{\circ}17'08.6''\text{E}$. which in this case coincides with the location of The National R&D Institute for Cryogenics and Isotopic Technologies – ICSI Ramnicu Valcea. The pictures below, figure 10, illustrates, first, a roadmap with the direct normal irradiation, global horizontal irradiation and average wind speed for countries like France and Romania. The other pictures, from figures 11 to 18, present a series of measurements data for both solar radiation and wind speed for the months of February and July, chosen as representative months for an entire year. For a better understanding of a solar radiation and wind nature, it has been shown their behavior daily.

All weather data has been measured with a weather station which involves a Solys2 Sun Tracker where is mounted a Pyrliometer for measurements of direct beam solar radiation. The working principle of a Pyrliometer is that the sunlight enters into the instrument through a window and is directed onto a stack of thermocouples which converts heat to an electrical signal. As well as a Pyranometer is mounted on the Sun Tracker and is used, like in many scientific applications, to measure sun's diffused energy. In solar energy research sun's diffused energy has a greater importance reason for which Pyranometer has greater significance than Pyrliometer which measures direct energy from the sun instead of diffused energy.

A WindSonic device is a wind sensor very robust used to measure wind speed and direction. This sensor measures the time taken for an ultrasonic pulse of sound to travel from the North transducer to the South transducer, and compare the resulted time with the time for another pulse required to travel from the South to the North transducer. The same principle is applied to measure the time between Western and Eastern transducers and vice-versa.

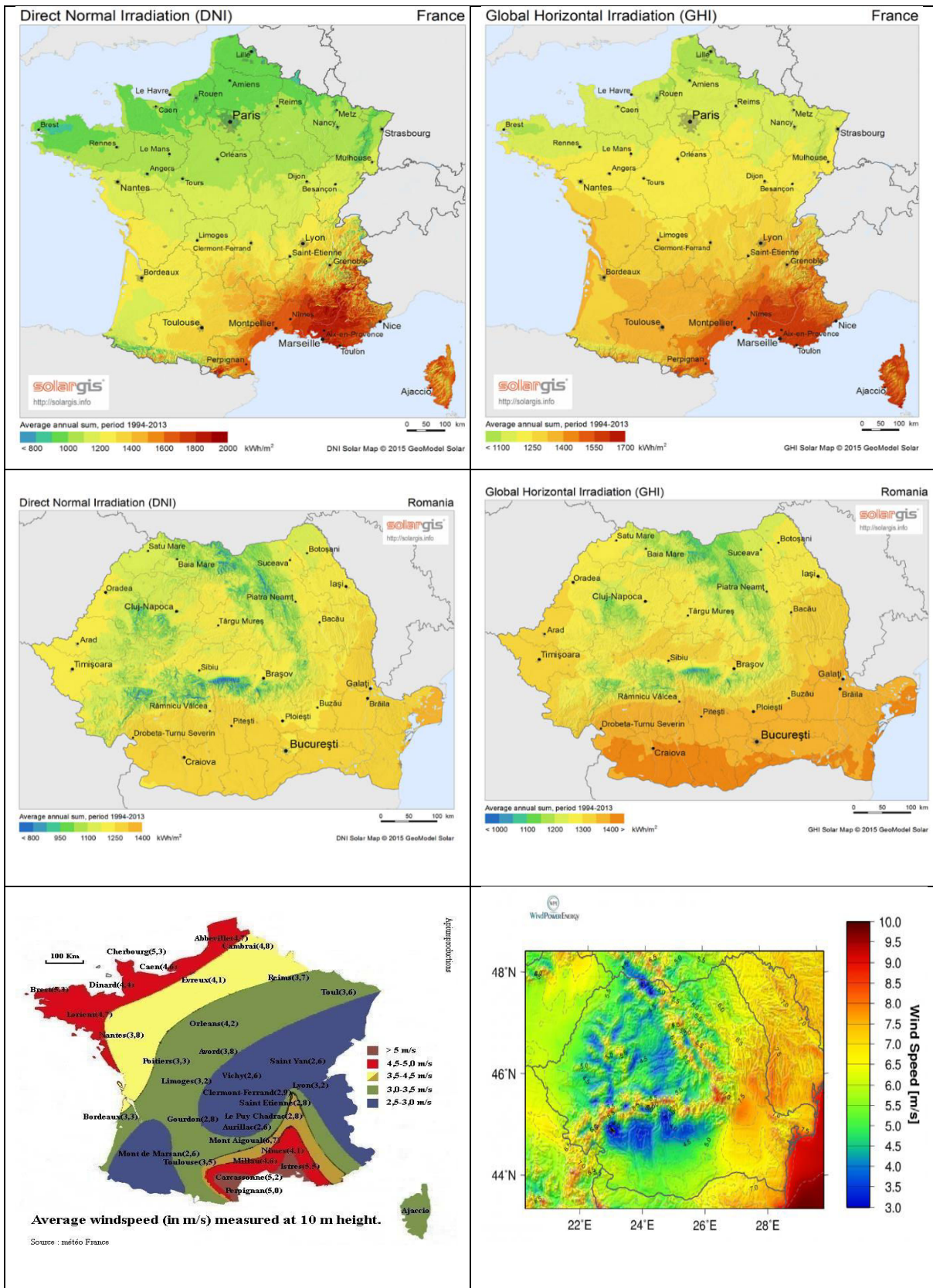


Figure 10 – Solar radiation and wind speed map illustration for France and Romania [34], [35]

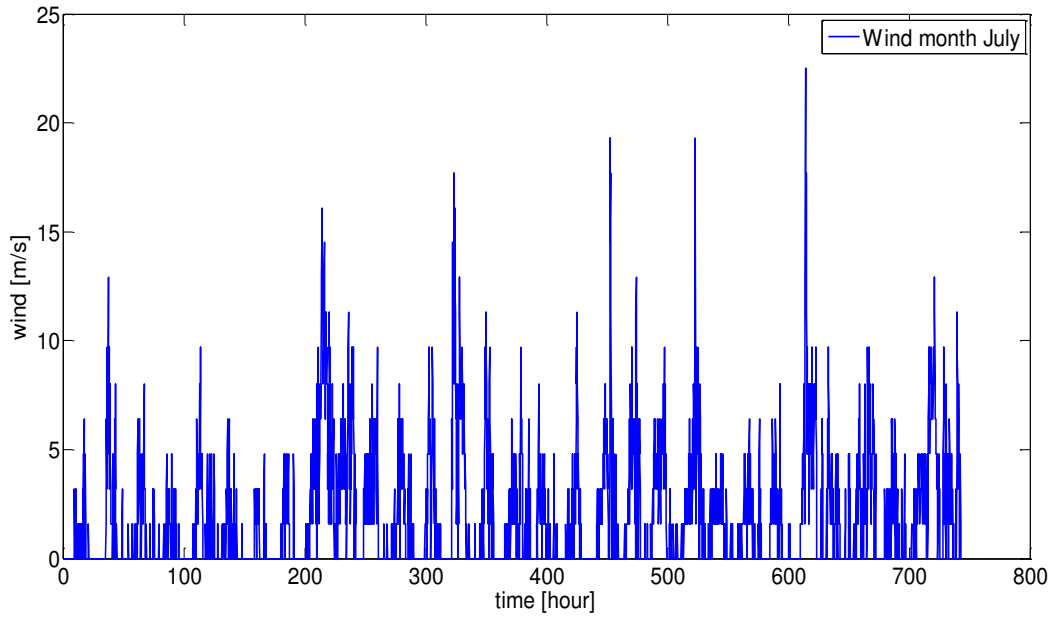


Figure 11 – Wind speed illustration during the month of July 2015

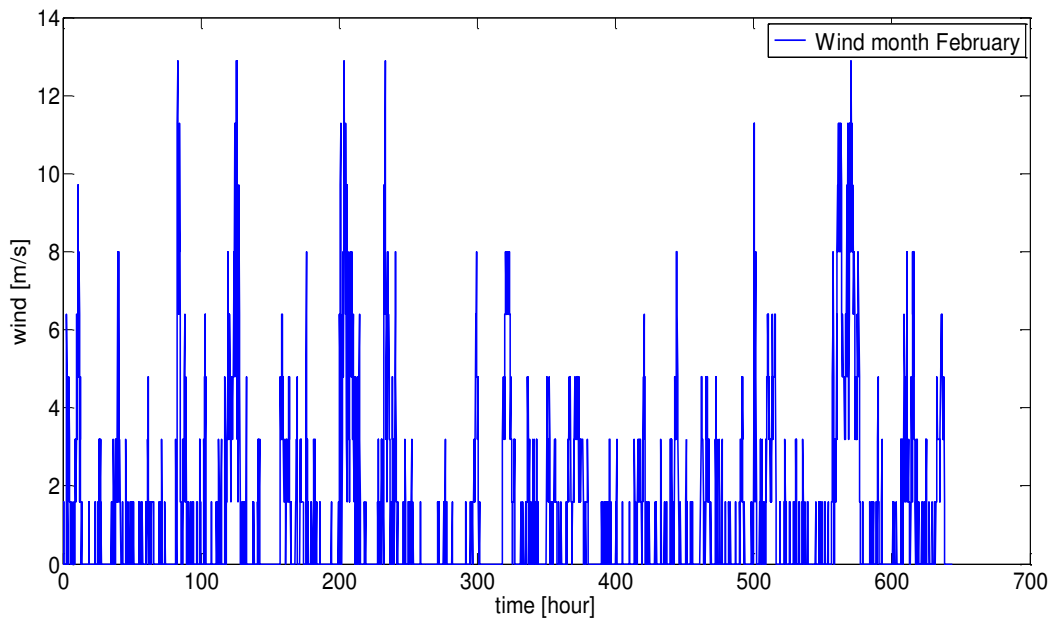


Figure 12 – Wind speed illustration during the month of February 2015

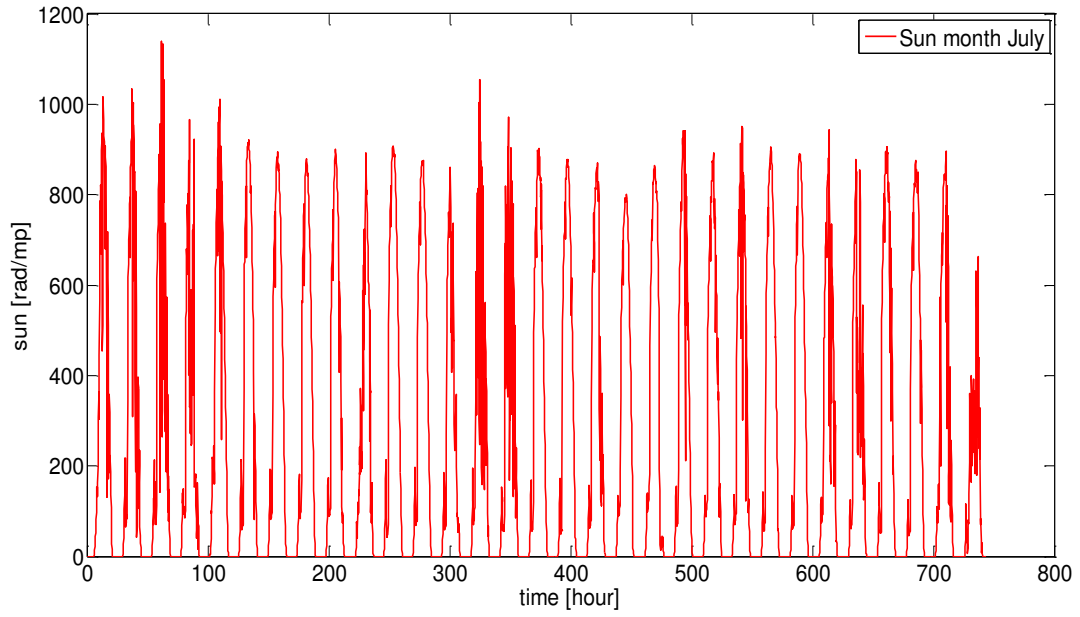


Figure 13 – Solar radiation illustration during the month of July 2015

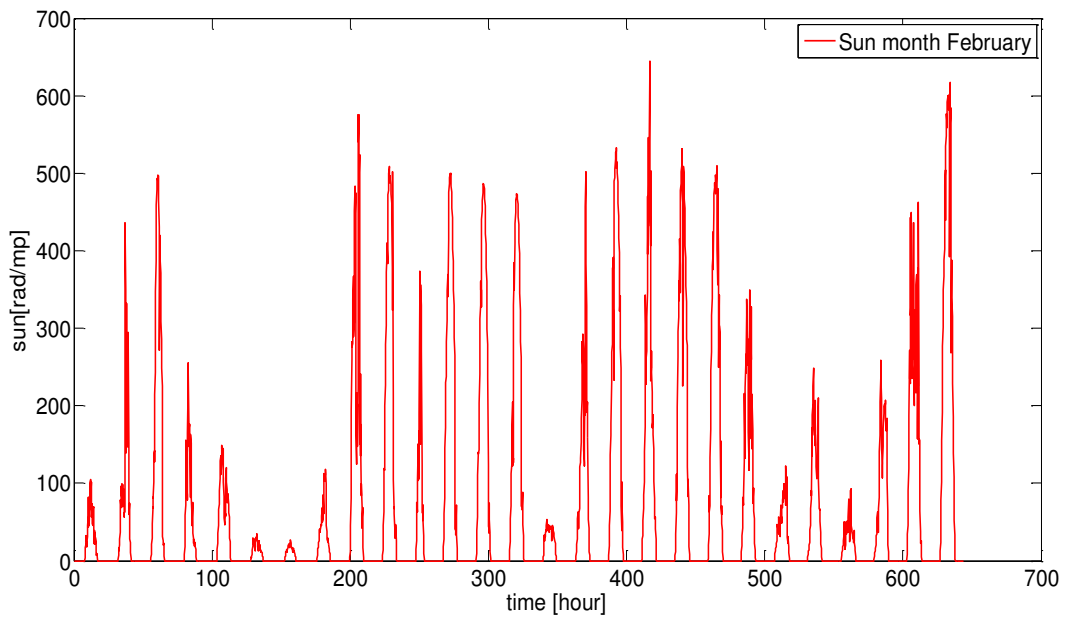


Figure 14 – Solar radiation illustration during the month of February 2015

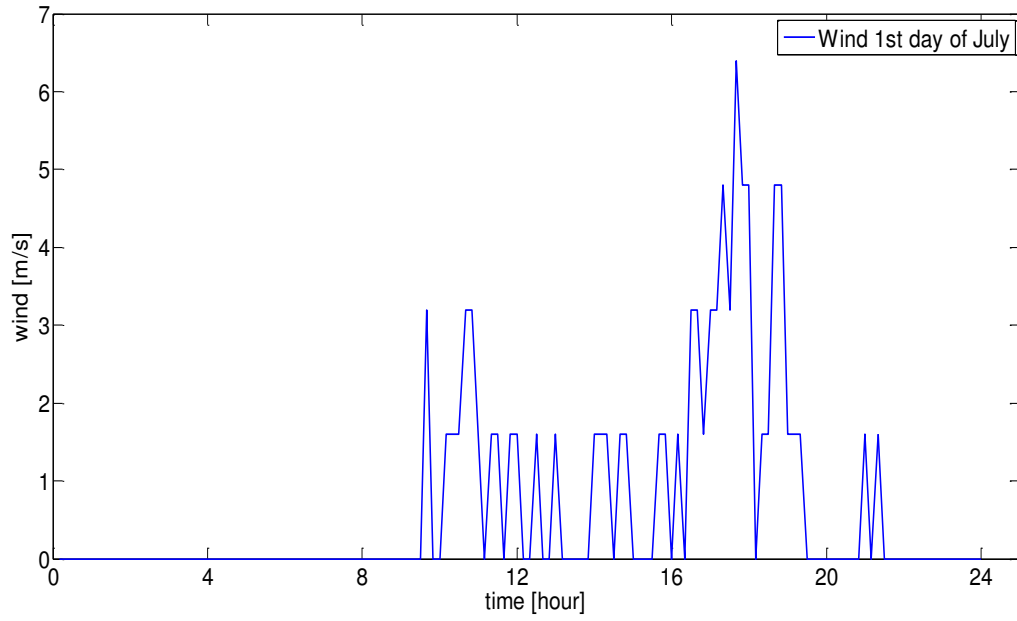


Figure 15 – Wind speed illustration for the first day of July 2015

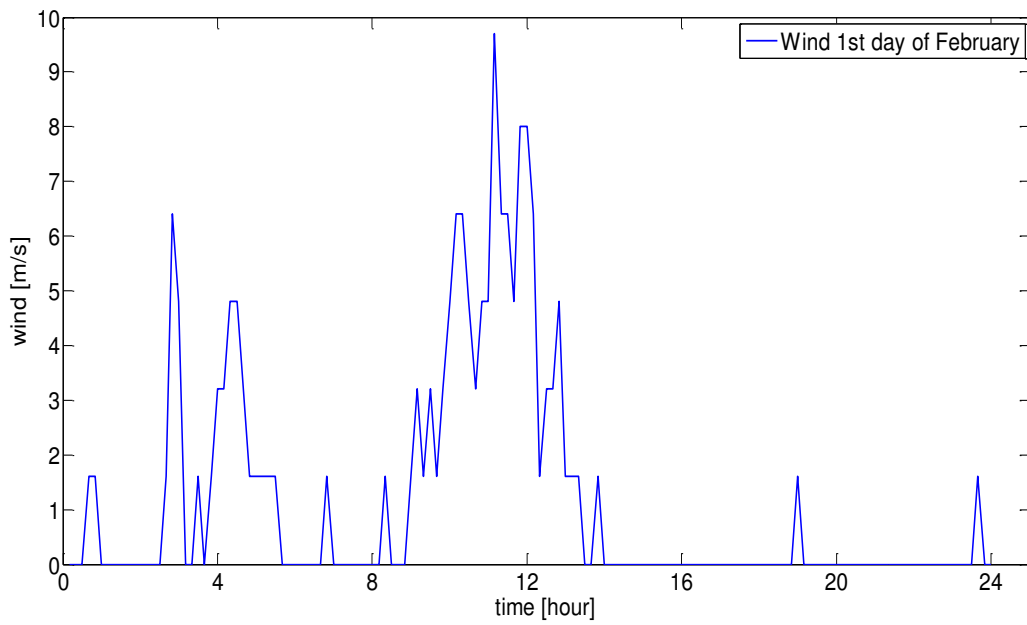


Figure 16 – Wind speed illustration for the first day of February 2015

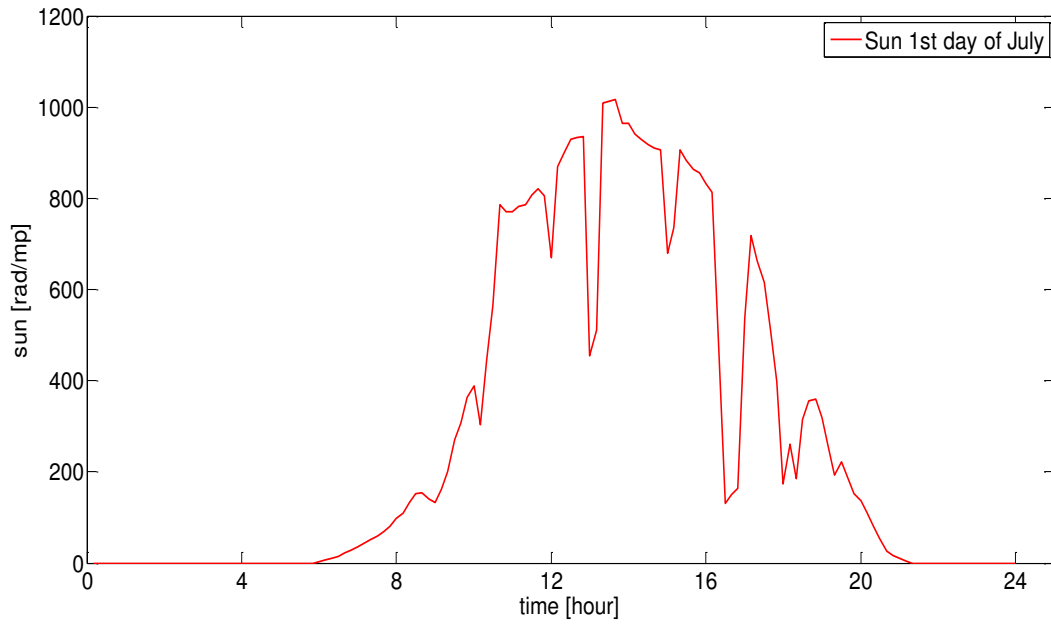


Figure 17 – Solar radiation illustration for the first day of July 2015

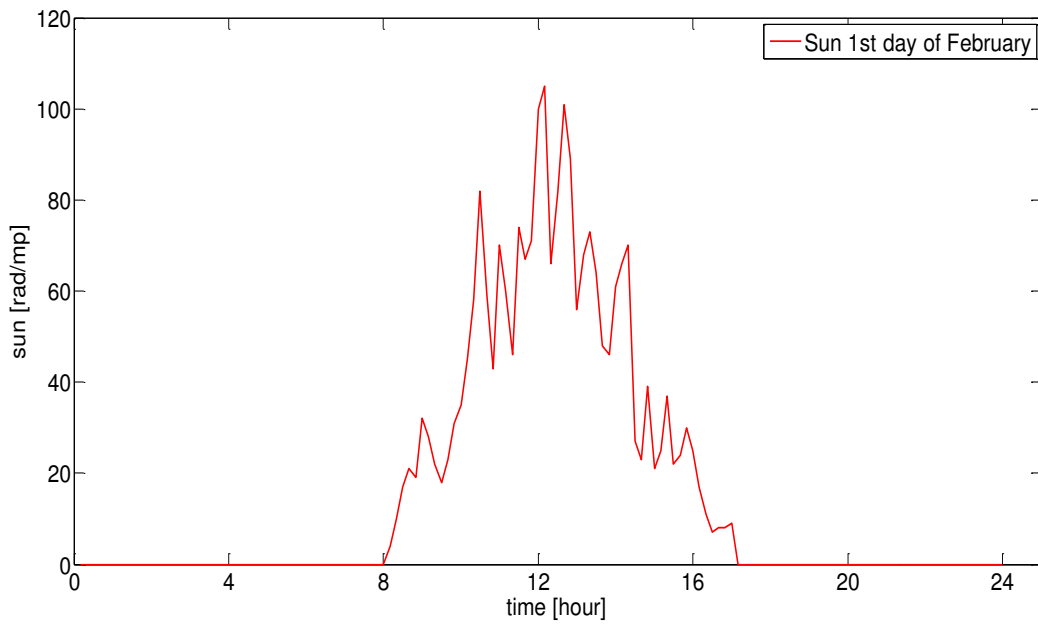


Figure 18 – Solar radiation illustration for the first day of February 2015

In the case of energy resulted from solar radiation it can be easily seen that this reaches a maximum value at the middle of the day, usually in each day if is not rainy or cloudy. Depending on the consumer profile some portion or even all the energy produced by the solar equipment could be stored. In the wind case, the situation is a little bit different, figure 16 shows that is some wind speed in the time frame 1 to 5 am, that usually is not needed. Almost all the energy produced in this frame should be stored for further use.

3.7. Discussions and Perspectives

At the moment all policy pursued in the energy sector is to focus more and more on renewable energy sources. Nevertheless, this transition to a green energy cannot be realized without the development of storage facilities mainly at a large scale. Fluctuating nature of renewable sources requires this with regard of having a balanced energy system.

Technically there are several storage technologies that have been proven their storage capabilities. Of course, there is space for further progress, especially regarding efficiency and lifetime. However, the big step that storage technologies have to cross is to achieve an economic feasibility.

Future progress in research and development of new solar concentrators and in the field of energy storage technologies is expected to help the price go down in the same manner in which happened in the case of photovoltaic cells and even in the case of wind turbines.

Renewables including wind and solar photovoltaic panels are increasingly competitive, even in a lower fossil price regime. Heat resulted from renewable source can be a cost-competitive option but not enjoy a sufficient policy attention. The policy should focus on creating the right market and regulatory frameworks. Market and regulatory measures can influence the expensive average and improve competitiveness.

A constant support for the market development and in the R&D sectors will reduce costs once a technology becomes mature. If we take a look at the technology trends, we can see that PV is extremely modular, easy and fast to install and accessible to everybody. The rapid cost reductions have confirmed the fast learning rate of PV which leads to an increase in confidence that sustained deployment will continue to reduce cost in the future.

Nowadays solar thermal energy based on concentrating solar power technologies can be used in locations where the sun is very shiny and the skies are clear and where long-range transmission lines are used for transport to connect different areas. Solar thermal electricity is usually used at large scale, but also small scale may find niche markets in isolated grids.

4. Energy storage solutions overview

4.1. Energy storage solutions

4.1.1. Introduction

There are three main pylons on which it's based the energy storage.

- Energy storage should have an important asset for enhancing renewable energy penetration.
- Energy storage should represent an option for regulators as an effective option to resolve issues regarding grid reliability.
- Energy storage should have a huge impact in realizing smart-grids, especially in developing of new electrical stations for transportation and for an optimal utilization of electrical consumption [36].

There is a variety of electricity storage technologies (EST) in use in our days.

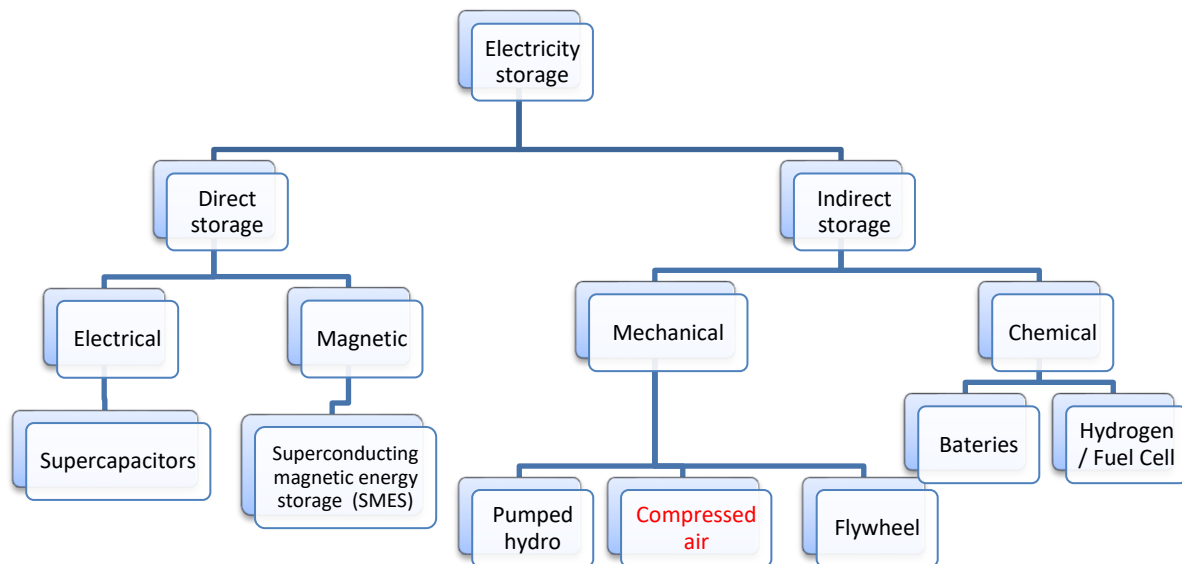


Figure 19 – EST [12]

There are two ways in which the electricity can be stored. One is in a form of direct storage which is divided in electrical storage (supercapacitors) and magnetic storage (superconducting magnetic energy storage - SMES) and for indirect storage in mechanical storage (compressed air, pumped hydro and flywheels) and in chemical storage (batteries, hydrogen and fuel cell).

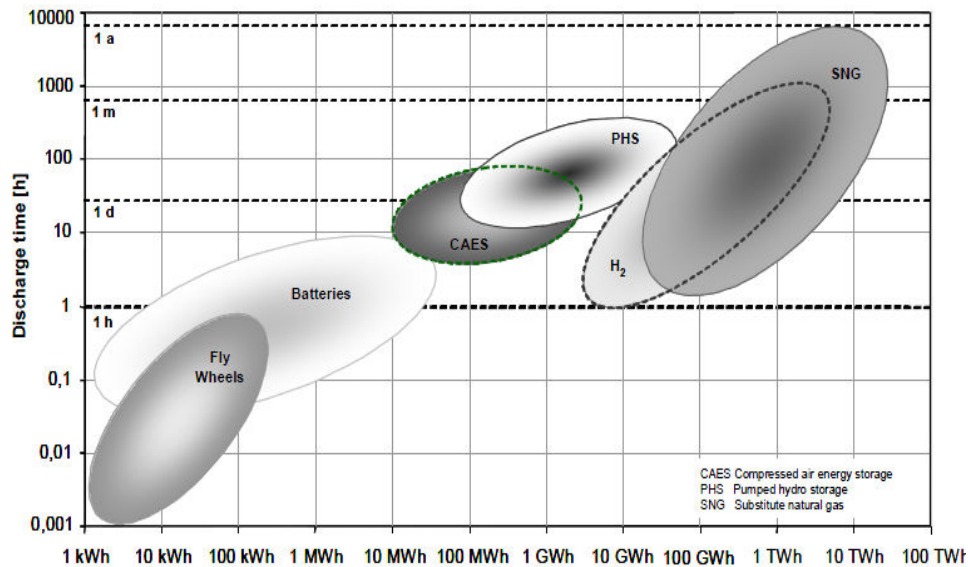


Figure 20 – Overview of electricity storage systems [12]

Figure 20 presents the range at which different storage technologies are usually used. Observing that for small-scale energy storage are preferred solutions based on flywheels or batteries while for large scale are preferred technologies based on compressed air storage, pumped hydro storage, hydrogen storage and substitute natural gas storage.

Table 1 – List of the largest energy storage project at the level of 2015 [centralized data from Wikipedia]

| Storage technologies | Name | Project/ Capacity | Year completion | Location |
|---|-----------------------------|----------------------|--------------------|--------------------|
| Hydro Power Plant | Three Gorges Dam | 22,500 MW | 2003 | China |
| Pumped storage hydroelectric power plant | Bad County | 3,003 MW | 1991 | USA Virginia |
| Compressed air energy storage | Huntorf | 321 MW | 1978 | Germany, Bremen |
| Biomass | Tilbury B | 750 MW | 1967 | UK Tilbury |
| Battery Li-Ion | Smart Network storage [UK] | 6 MW | | United Kingdom |
| Thermal Storage Molten salt | Andasol Solar Power Station | 1,030.5 MW | 2009 | Spain, Granada |
| Geothermal | The Geysers | 1,517 MW | 1921 | USA |

| | | | | |
|--------------------|--------------|----------|------|--------------|
| Solar Power | Topaz | 550 MW | 2014 | USA |
| Wind Farm | Jiuquan Wind | 7,965 MW | 2009 | China, Gansu |
| Onshore | Power Base | | | |
| Offshore | London Array | 630 MW | 2013 | UK |

4.2. Compressed air storage

There are mainly two kinds of air storage. One is in the underground solutions and the other is the aboveground storage solutions [37], [38], [39]. Currently, the underground storage reservoirs are more feasible for large-scale systems from the technical and economic point of view, while aboveground systems can work for small scale.

- Depleted natural gas caverns

Depleted natural gas caverns are very attractive since these already exist and can withstand the pressure. The only problem, in this case, is that so often the natural gas is stored at a low pressure and for a long period of time. Meanwhile, the CAES storage requires usually from daily to weekly variations of the pressure in the storage vessel, the fact that can produce a lot of stress in the cavern walls.

- Salt Mines

Salt mines are preferred because are formed by a homogeneous deposit of salt. Salt caverns are created by drilling a conventional well to pump fresh water into a salt dome. Then the salt is dissolved until the water is saturated, moment at which the water is extracted to the surface. The process is repeated till the storage volume is obtained. It is not difficult to build an underground gas cavern, though is a long process. From an economic point of view, this is one of the cheapest solutions to create reservoirs in which the compressed air follows to be stored.

- Aquifers

Aquifers are porous, permeable rock formations situated several hundred meters underground, naturally full of water. Storing compressed air in aquifers has as advantages, large storage capacity, geologically widespread availability and relatively low construction cost [40].

4.2.1. CAES technology

A CAES power plant works alternatively in two modes:

1. Charging mode – when the surplus of energy during off-peak hours is taken from renewable sources and used to compress air and store in a storage vessel. If the system is connected to the electrical grid it operates when there are off-peak hours and the price of electricity is low, usually in night periods.
2. Discharging mode – when the energy is required and there are no other sources of energy the compressed air is withdrawn from the storage reservoir and then expanded through an expander, to drive a generator and providing peak power to the grid, or providing energy to the final user.

The cycle efficiency of such a system is defined as the ratio between the energy delivered to the consumers during discharging mode and the energy consumed during charging mode.

$$\eta_{cycle} = \frac{\text{Power generated} \times \text{time of generation}}{\text{Power consumed} \times \text{time of consumption}}$$

The following CAES system configurations can be distinguished [41].

- CAES conventional cycle (eq. Huntorf Power Plant)
- CAES recuperated cycle (eq. McIntosh Power Plant)
- CAES combined cycle
- CAES adiabatic cycle (eq. ADELE Power Plant project)
- CAES steam injection
- CAES humid air

4.2.2. Storage vessel characteristics and selections

The storage vessel characteristics play a major role in defining the system operating conditions.

The most important parameters that should be considered by modeling the system are:

- Storage vessel volume.
- Maximum and minimum cavern operating pressures.
- Pipe connection length and diameter from the plant to the reservoir.

For the structural stability in the case of caverns just a small ratio of the pressure inside the cavern is permitted. The volume of the cavern and the operating pressure limits define the amount of the air stored.

4.2.2.1. A sensitivity study in calculating the material required for an aboveground storage vessel, depending on the volume for certain storage pressure values

Above storage devices used for compressed air can be classified into three types, according to their structures: air storage tanks, gas cylinders and gas storage pipelines [42]. The most common aboveground used storage devices are tanks usually with a cylindrical or spherical structure. To increase the storage capacity these can be connected in parallel or in series. The gas storage pipelines built from steel are usually used for large-scale operations.

Following the model presented by Liu et al. [42] an above ground air storage pre-dimensioning following EN 13445-3/2014 regulation of fixed pressure vessel is made by using equations eq 4.1 to eq 4.7.

$$\delta_1 = \frac{PD}{2\sigma\Phi - P} \quad (4.1)$$

$$\delta_2 = \frac{PD}{4\sigma\Phi - P} \quad (4.2)$$

Where δ_1 is the wall thickness of the cylindrical body, δ_2 is the wall thickness of the spherical head of the tank, P is the design pressure of the storage tank, which is often with 10% higher than the stored pressure, σ represents the allowable stress of the material and Φ is the weld efficiency, V_T is the total volume of the gas stored, meanwhile V_1 is the volume of the storage vessel, h is the storage vessel length and D is the inner diameter.

The theoretical raw metal material consumption of the cylindrical storage tank can be calculated by multiplying the material used for a single tank with the number of tanks.

$$M_T = M_1 n \quad (4.3)$$

$$M_1 = \rho\pi\delta_1(D + \delta_1)^3 h + \frac{\rho\pi}{6} + ((D + 2\delta_1)^3 - 2D^3) \quad (4.4)$$

$$V_1 = \frac{\pi}{4} D^2 h + \frac{\pi}{4} D^3 \quad (4.5)$$

$$V_T = \frac{mRT}{P} \quad (4.6)$$

$$n = \frac{V_T}{V_1} \quad (4.7)$$

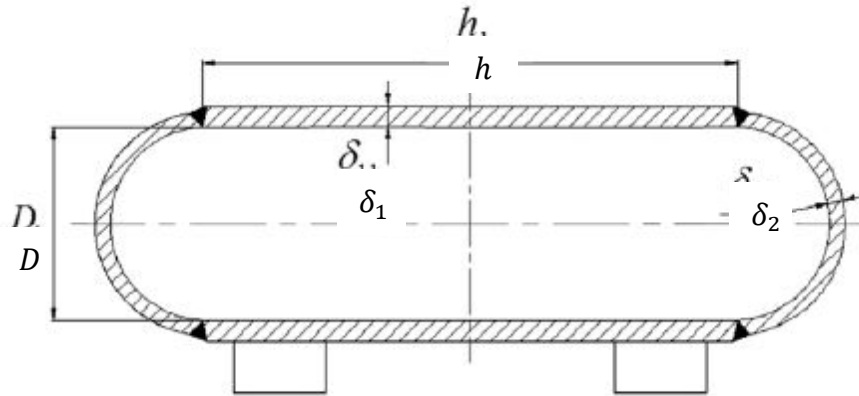
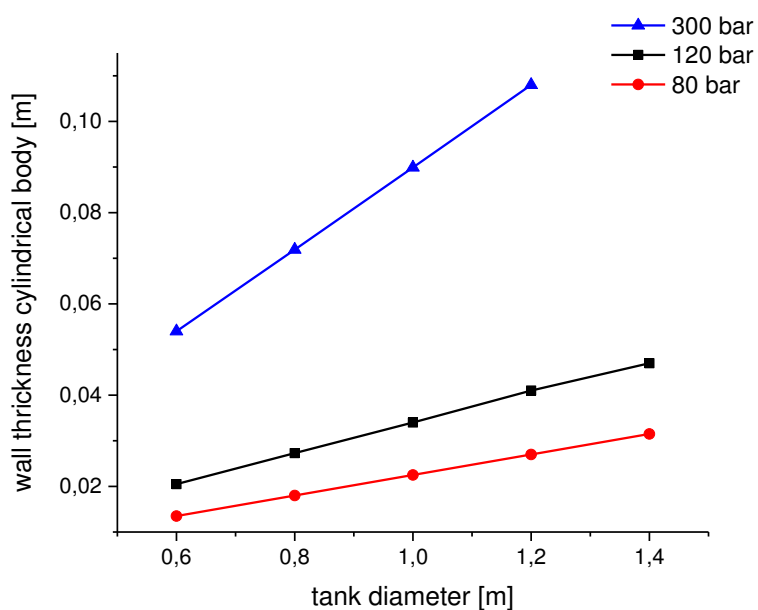


Figure 21 – Storage tank pre-dimensioning [42]

The figures 22 and 23 present the wall thickness and the raw material required to store a specific amount of energy at different pressures values and for different storage tank's diameters. These results will be developed and analyzed in an ANSYS modeling presented in a future subchapter. The “ n ” index from the figure 23 represents the storage vessel number of tanks.

For modeling, considered that the storage vessel is built of stainless steel. The storage vessel diameter has a huge impact on the quantity of the raw material required for its framework. The trend of the curves drawn in figure 22 shows that it's a linear dependency between the storage vessel diameter and the wall thickness and is less important the length of the vessel.



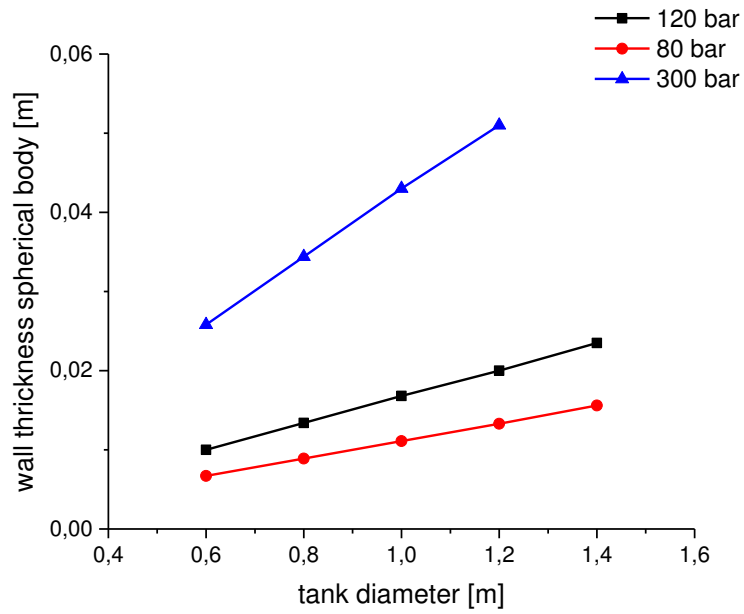


Figure 22 – Storage vessel wall thickness

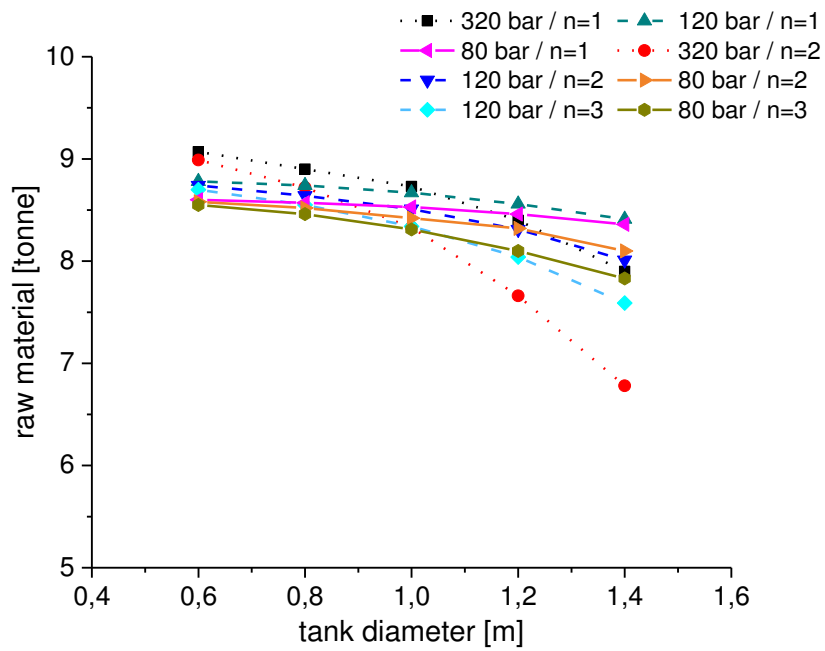


Figure 23 – Storage vessel raw material required

The number of the storage vessel is determined taking into consideration the tank storage pressure, length and inner diameter. A single storage vessel is limited as respects of pressure, volume and length, because of the practical manufacture and transport. Figure 23 presents the quantity of raw material required to build the storage vessel function of its diameter and the storage pressure for 1200 kg of air stored. To store the quantity of air mentioned before considering different storage pressures values, the tank volume has the following values: 3.12 m³ for air stored at 300 bar, 8.33 m³ for air stored at 120 bar and 12.5 m³ for air stored at 80 bar. This volume can be covered by using one or more tanks.

According to the graphs, it can be seen that the quantity of raw material required decreases once with the increasing of the tank diameter even if this suppose a bigger wall thickness. The quantity of raw material required to build the storage vessel has a fast increase once with the increase in the tank length. The cost of the quantity of the raw material required, the cost of manufacturing with the transportation and installation are deciding factors in a storage vessel building.

As we already mentioned before the results referring to the wall thickness of the storage vessel obtained using the equation from the model presented by Liu et al. will be validated by an ANSYS simulation in subchapter 6.4.

4.2.3. Existing power plants

The Huntorf Power Plant is the first storage station built, using an underground compressed air reservoir and has been in operation since November 1978. This station is located in Germany somewhere near Bremen. At the beginning the capacity of the system was of 290 MW, updated in 2006 to 321 MW and it can generate electricity for a period of approximately 2 hours at full capacity.

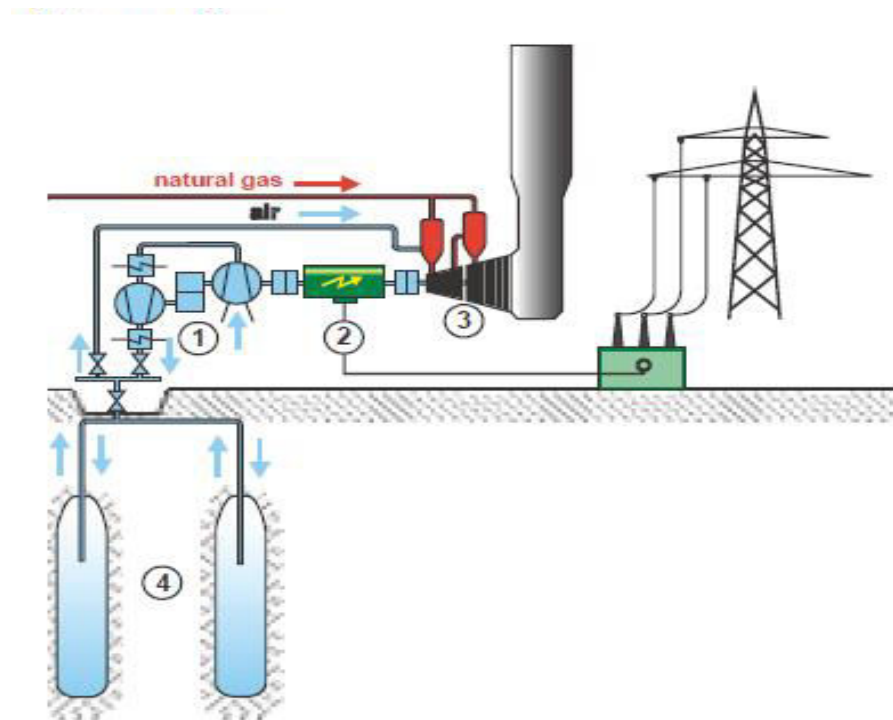


Figure 24 – CAES Huntorf power plant with main components 1) compressor, 2) motor/generator, 3) turbine, 4) storage caverns [43], [44]

The results reported for the Huntorf Power Plant are 42% efficiency, which means that for each 0.83 kWh electric energy and 1.56 kWh fossil energy input, the power plant is able to have an output of 1 kWh electricity.

McIntosh is an American installation built in McIntosh, Alabama in 1991, and its capacity is to deliver 110 MW of power for 26 hrs. The ambient air is compressed and stored at a pressure between 40 and 70 bar in a 2,555,000 m³ cavern located at 700 m deep in the ground [45], [46].

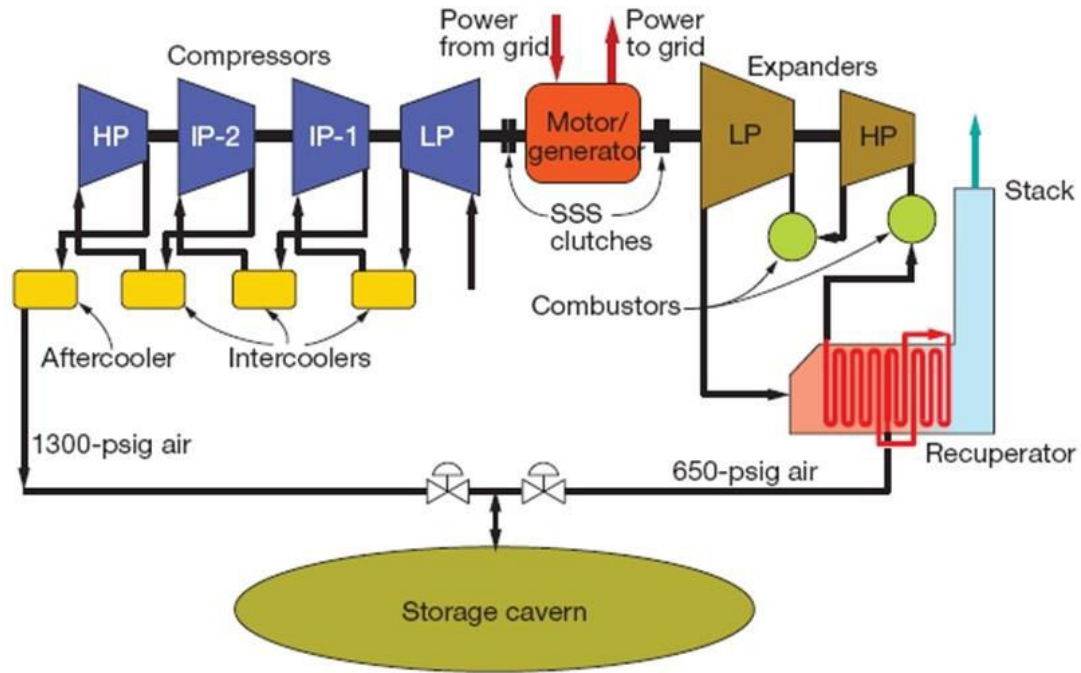


Figure 25 – CAES McIntosh power plant [47]

In the same way like for the Huntorf Power Plant the results reported for McIntosh are 54% efficiency which means that for each 0.69 kWh electric energy and 1.17 kWh fossil energy input, the power plant is able to have an output of 1 kWh electricity.

The two currently operating diabatic CAES power plants, Huntorf and McIntosh are unable to use the heat generated during the air compression which leads to using natural gas to heat air to increase the temperature during its withdrawal from the storage vessel. The advantages of using CAES compared with a pure gas power plant is the 40 to 60% lower consumption of natural gas.

A CAES power plant connected to the grid generally operates in turbine mode – electricity generation during peak-times while off-peak times, mainly in the night is used for storing energy – compression mode. The only impediments that in the encounter of new power plants are given that they are dependent on the availability of appropriate underground air storage capacities. However, any underground cavern used for storing of natural gas or CO₂ is a viable solution for compressed air storage without to require changes [12].

Table 2 – Data summarizing table with existing power plants [43], [48].

| Location | Huntorf, Bremen, Germany | McIntosh, Alabama, USA |
|---|-----------------------------------|-------------------------------------|
| Date commissioned | 1978 | 1991 |
| Storage volume | 310,000 m ³ | 540,000 m ³ |
| Input energy / compressor operation | 60 MW | 50 MW |
| Output energy / turbine operation | 290 MW upgraded to 321 MW in 2006 | 110 MW |
| Energy required for 1 kWh (electricity) | 0.8 kWh electricity + 1.6 kWh gas | 0.69 kWh electricity + 1.17 kWh gas |
| Cycle efficiency | 42% | 54% |
| Working cavern pressure | 43-70 bar | 45-76 bar |

4.2.4. Other projects in different stages of developing

The third commercial CAES is a 2,700 MW plant that is planned for construction in the USA, at Norton, Ohio [49]; [50]. The plant is supposed to consist in 9 units which pressurize the air at 100 bar in a cavern of about 120,000,000 m³.

Project Markham, Texas is a 540 MW project developed by Ridge Energy Services and El Paso Energy and the power plant will consist in 4 units with a salt dome used as the storage vessel [49].

Another project called Iowa was developed by Iowa Association of Municipal Utilities proposed to be located at Dallas Center, the plant configuration is for 270 MW of CAES generating capacity, with 100 MW of wind energy [49]. The project was terminated in 2011 due to geology reasons, the site proved not be suitable [50]; [51]; [52].

Dresser-Rand which supplied the turbo-expander turbines for the McIntosh CAES plant, working in partnership with Apex Compressed Air Energy Storage purposed the first big CAES project in the United States, known as the Bethel Energy Center, this is a 317 MW project having the location in Texas about 100 miles southeast of Dallas [53].

SustainX is constructing a 1.5 MW pilot system in Seatbrook, New Hampshire to demonstrate their isothermal compressed air energy storage system. The SustainX Inc. hope they are capable for commercial production in 2015 with an efficiency of 95% in both compression and expansion processes [48].

At the level of the year 2014 the first big project ADELE which involves the newest CAES technology the advanced adiabatic solution is in the phase of development in Germany. The project has been initiated by RWE, General Electric, Construction Company Zublin and German Aeronautics and Space Center. The study started in 2007, and the testing was purposed for 2013, but for an undisclosed reason, the data has been revised for 2016 [54].

The integration of renewable and energy storage has been to a large scale discussed in the existing literature. There are studies that includes technologies which are/or could be used, studies referring to the economic relevance and studies talking about greenhouse gas emission [55], [56], [57], [58], [59], [60], [61], [62], [63], [64].

An important aspect of a CAES technology is that it can deliver three types of energy: electricity, hot and cold. Wang et al. [65] described an air energy storage refrigerator system, while Li et al [66] examined a micro-trigeneration system based on compressed air and thermal energy storage, their results showed an efficiency of 50% for the winter season, when the system working in cogeneration, meanwhile an average of 35% can be reached in the summer season, when the cooling demand is higher.

4.3. The principle of Compressed Air Energy Storage

A simple way to see the electricity stored in a form of compressed air is like in a battery, which is charged and discharged according to the consumer's needs. When electricity is produced in excess the battery is charged, and when the demand is high the battery provides electricity.

A CAES connected to the grid is nothing else than a modification of the basic gas turbine technology in which low-cost electricity is used for storing compressed air in underground caverns. When the demand is high the air is heated and expanded in a gas turbine in order to produce electricity [67].

One of the disadvantages of the CAES systems is represented by its dependency on the gas combustion because the released gas must be heated before the air expansion process to increase the system's efficiency. To remove this inconvenience, and that given by the CO₂ emission during combustion a new technology AA-CAES has been developed [68]. An advanced adiabatic configuration for a CAES system is one of the most promising green solution, combined with renewable energy, offering a high efficiency of approximately 70% with no fuel consumption [67]; [69]. This happens due to the advances that have been done in

the study of thermal energy storage solutions, mainly in the molten salt solutions. Advancements in thermal energy storage systems have increased the feasibility of using heat exchangers in place of fossil fuel combustion to heat air before expansion process. The increase of clean energy, without NO_x emissions, has created the needs of studying systems less polluting, such as adiabatic advanced compressed air energy storage systems.

The simplest type of a compressed air energy storage system is that which follows an isentropic process, consisting only in a compressor, a storage vessel, an air turbine and a generator [70], [71]. The air is compressed and stored into a tank and expanded when electricity is required. In this kind of systems if the machine is a reversible one the theoretical efficiency of the system could be 100%. Now take into consideration materials from which the vessel was built, the fact that the air is cooled after compression make this system in practice to become a diabatic process. The cooling process involves exergy losses which mean a drop in the system's efficiency [72], [73].

The air temperature variation into the tank during compression or expansion processes is difficult to predict due to the heat exchanged with the environment. In the current literature according to [74] there are three ways taken into consideration with respect to the variation of the air temperature during these processes: 1) the temperature inside the tank remains constant, 2) the temperature follows an adiabatic process and 3) the temperature variation is so small that can be completely negligible.

4.4. CAES process description

A system that helps to store energy from renewable sources by means of compressed air and then producing electricity from the pressurized air can be described as a system where occurring three separate processes: the compression process, the storage process and the expansion process. And all the three processes can be analyzed one by one.

CAES systems may be classified as being:

- Diabatic CAES systems consisting in: a cooled compressor, a storage vessel, combustor, a turbine and a recovery system
- Adiabatic CAES systems consisting in: a compressor, a storage vessel, a turbine
- Advanced Adiabatic CAES systems consisting in: a cooled compressor, a storage vessel, a thermal energy storage system and a turbine

Both compression and expansion of the air can be considered as ideal processes, isothermal or adiabatic. From the best knowledge of the author was not been built yet an adiabatic or an isothermal compressor. Therefore for beginning are analyzed all three cases, the two listed above that are in fact the system limits and the polytropic process which is closer to the reality. It is very well known that an adiabatic or even one isothermal compression are impossible to build, because always will be some gasses' losses in temperature and some heat exchanged by surrounding.

4.4.1. Isothermal compression/expansion

In an isothermal compression/expansion process is assumed that the gas remains at a constant temperature throughout the compression or expansion process. In such a cycle internal energy is removed from the system as heat at the same rate that is added by the mechanical work of compression. A compressor that involves cooling between compression stages comes closest to achieve the isothermal compression. However, in the real world, perfect isothermal compression is not attainable.

4.4.2. Adiabatic compression/expansion

It assumes that no energy (heat) is transferred to or from the gas to the surrounding during compression or expansion process, and that all the mechanical work is added to the internal energy of the gas, results in increasing of temperature and pressure. In the case of an adiabatic storage the heat resulted during compression is also stored and returned to the air during the expansion process. Adiabatic compression can model real life when a compressor has good isolation. In practice, there will be always a certain amount of heat flowing out of the compressor.

4.4.3. Polytropic compression/expansion

Comparing with two other processes isothermal and adiabatic which are ideal solutions the polytropic process is a realistic model. This process assumes that heat may enter or leave the system, and then the input work can appear as an increase of pressure and temperature. For a draw representation, the polytropic curve is placed between the isothermal and the isentropic one.

4.5. Atmospheric air and its characteristic parameters

CAES operates by drawing ambient air from the atmosphere which usually varies in temperature, pressure and humidity. The atmospheric is normally the air we breathe and use in different systems of ventilation. It is compound by dry air and water vapors and in general is a moist air. The dry air is a mixture of gasses in different proportion as is showed in table 3.

Table 3 – Gaseous Composition of dry air [75].

| Constituent | Chemical Symbol | Mole percent |
|-------------------------|------------------------|---------------------|
| Nitrogen | N ₂ | 78.084 |
| Oxygen | O ₂ | 20.947 |
| Argon | Ar | 0.934 |
| Carbon dioxide | CO ₂ | 0.0350 |
| Neon | Ne | 0.001818 |
| Helium | He | 0.000524 |
| Methane | CH ₄ | 0.00017 |
| Krypton | Kr | 0.000114 |
| Hydrogen | H ₂ | 0.000053 |
| Nitrous oxide | N ₂ O | 0.000031 |
| Xenon | Xe | 0.0000087 |
| Ozone | O ₃ | traces |
| Carbon monoxide | CO | traces |
| Sulfur dioxide | SO ₂ | traces |
| Nitrogen dioxide | NO ₂ | traces |
| Ammonia | NH ₃ | traces |

The wet air contends water in different states of aggregation as: gaseous – vapors, liquids – drops, solid – ice particles. In function of the water, quantity contained the air can be saturated, unsaturated or oversaturated.

The parameters which characterize in general the air are: a) temperature; b) density; c) humidity; d) specific heat [76].

a. Temperature

It is well known that at a certain temperature and pressure the vapors of water content in 1 kilogram of atmospheric air cannot exceed a specified limit, which represents the vapors quantity what saturates the air. Once this limit is exceeded then the vapors of water content

condensate and pass to the liquid phase. At any given temperature, for a particular substance, there is a pressure at which the gas of that substance is in dynamic equilibrium with its liquid or solid forms. This is the vapor pressure of that substance at that temperature. The equilibrium vapor pressure is an indication of a liquid's evaporation rate. It relates to the tendency of molecules and atoms to escape from a liquid or a solid. A substance with a high vapor pressure at normal temperatures is often referred to as volatile. The Kelvin equation shows how equilibrium vapor pressure depends on droplet size.

b. Density

The density is expressed as a rapport between the mass and the volume of a substance, the unit measure in International System is $[g/m^3 \text{ or } kg/m^3]$. The density of a substance is changed once with temperature and pressure. This thing is more evident to gaseous as air and less visible to liquid or solid substances.

$$\rho = \frac{m}{V} \quad [kg/m^3] \quad (4.8)$$

c. Humidity

Absolute humidity – refers to the amount of water vapor present in a unit volume of air expressed in kilogram per cubic meter.

Relative humidity – refers to the ratio between the partial pressure of water vapors and air pressure or can be expressed as the ratio of the vapor density of the air to the saturation vapor density at the actual dry bulb density.

$$Rh = \frac{\text{vapor density}}{\text{vapor density at saturation at actual dry bulb density}} \quad (4.9)$$

Specific humidity – represents the weight of water vapors in wet air reported to 1 kilogram of dry air.

$$x = \frac{m_v}{m_a} = 622 * \frac{P_v}{P - P_v} \quad [g/kg] \quad (4.10)$$

$$P_v = RhP_{Sat(T)} \quad (4.11)$$

where:

- m_v – represents the water vapors mass
- m_a – represents the dry air mass
- Rh – represents the relative humidity
- $P_{sat(T)}$ – represents the water saturation pressure function of temperature

Perfect gas

According to the kinetic-molecular theory, the perfect gas is defined by the following assumptions:

- Gas molecules are perfectly spherical and perfectly elastic,
- Volume of the molecules is negligible compared to the total volume occupied,
- Intermolecular interaction forces are null.

As a result, the perfect gas is free from viscosity, no frictions occur in the perfect gas flow and it remains gaseous with the same properties unconcerned of the pressure, the temperature to which is subjected.

d. Specific heat

As a generally accepted formulation, the specific heat capacity represents the amount of heat energy required to raise the temperature of a body per unit of mass.

The specific heat capacities are not constant these vary once with the temperature variation.

$$c = \frac{q}{\Delta T} \quad (4.12)$$

In thermodynamics, there are two ways in which the temperature of a body is changed, for a substance which undergoing a process at a constant pressure, c_p , or for a substance which undergoing a process at a constant molar volume, c_v .

5. Mathematical modeling of a compressed air energy storage system

5.1. CAES operating scenarios

A CAES technology includes five main components: one or more compressors, several intercoolers, a storage vessel, one or more turbines, and one or more electric generators. During the air compression process compressor-motor consumes power from renewable sources or from the grid to run the air compressor. Ambient air is compressed to a high pressure, cooled and stored in a storage vessel for a certain period of time. When energy is needed the air is expanded through an air engine or a turbine which drives a generator to produce electricity.

For a thermodynamic point of view there are three possible compression and expansion cases, in which a CAES system can operate, under an isothermal, a polytropic or an adiabatic process. This involves several scenarios in function of the storage pressure ratio and volume variations [77], [78], [79]:

- Variable inlet turbine pressure which varies with the storage vessel pressure.
- Constant inlet turbine pressure by throttling the upstream air to a fixed pressure.
- Maintaining a constant pressure by using methods that allow this [80], [81].

Normally the first scenario where the inlet air turbine pressure varies with the storage vessel can be used just in very few applications due to the fact that the changes in the inlet air turbine pressure during discharging would lead to a constant reduction of the power, fact which will not be acceptable by the final user.

In the second scenario where the upstream air is throttled at a fixed pressure, the storage vessel works with an air buffer storage volume, and the power generated is easily controlled and the system efficiency is just a function of the storage vessel pressure ratio.

The third scenario is the most desirable but suffers the most constraints in terms of location. To maintain the pressure constant during both processes compression and expansion must be used storage vessels with variable volumes, like: aquifers, solutions with an underground cavern and an above ground water reservoir which can communicate with the cavern or underwater bags. So that the hydrostatic pressure of the water is used to maintain a constant pressure into the storage vessel during both processes compression and expansion.

5.1.1. The charging process

When the air at atmospheric pressure conditions is mechanically compressed by a compressor from 1 bar to a higher pressure, then the transformation of the air is determined by the laws of thermodynamics. In the charging process, the air is taken from the atmosphere and compressed by a compressor to a higher pressure. During a theoretical adiabatic or a more realistic polytropic compression once the pressure rises the temperature rises, too.

Once the temperature rises appear several phenomena that are less desirable:

- There is a decrease in compressor efficiency.
- The vessel storage walls are exposed to thermal stress.
- The gas density changes lead to a reduction in the amount of the gas stored.

To eliminate all these difficulties is important to cool the air before to store it in the reservoir through the use of the heat exchangers. The resulted heat from compression process can be used for other purposes or stored in a thermal energy storage system for later use.

In terms of working principle, compressors are divided into two categories: displacement compressors that can be reciprocating or rotating compressors and dynamic compressor, which in their turn can be centrifugal, turbo-compressors turbochargers, fans and axial.

The main types of the gas compressor are illustrated in figure 26.

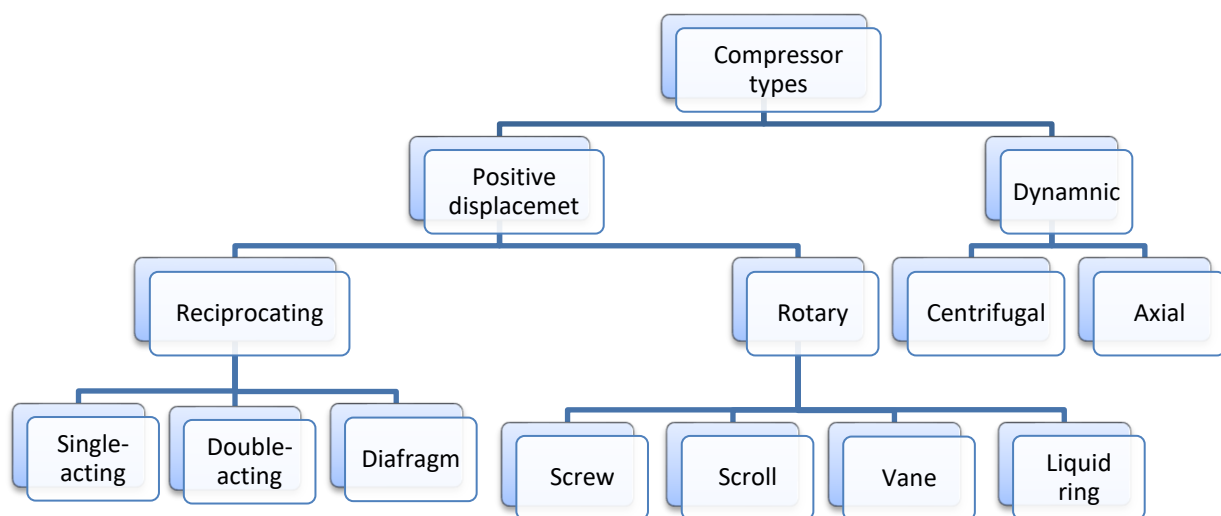


Figure 26 – Chart of compressor type

5.1.1.1. Compressor operation for a single stage compression

It should be noted that although we confine our attention in this work research to an example of a reciprocating compressor, single acting the same results will be found for any other type of compressor, because all compressors work based on the same working principle.

Theoretical compressor implies the absence of dead space that means the piston discharges all the gas from the working area. The stroke is realized between the top dead center (TDC) and the bottom dead center (BDC). Even if the theoretical compression process neglects the dead volume in actual compressors this cannot be negligible having an important role in preventing collision between piston and cylinder's head, also playing a significant role in controlling the opening or closing the two cylinder's valves, the suction and the discharging valve.

The P-V diagram for a theoretical compressor by means the entire cycle looks like that shown in figures 27 and 28. For each cycle the thermodynamic transformation is as follow:

- 4 → 1 isobaric process – suction
- 1 → 2 adiabatic/isothermal/polytropic process – compression
- 2 → 3 isobaric process – repression
- 3 → 4 isochoric process – relaxation

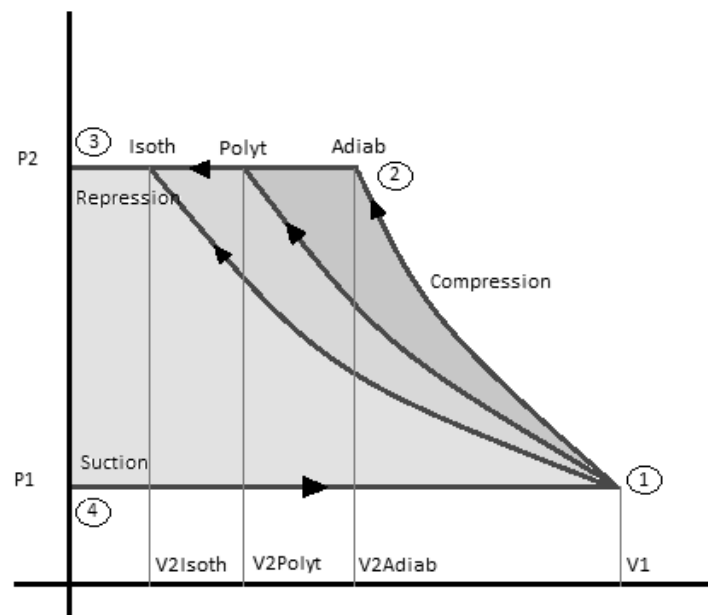


Figure 27 – P-V diagram for a theoretical compressor

5.1.1.2. The work consumed by an air compressor during compression process

The mechanical technical work consumed by the air compressor is proportional to the area described by the thermodynamic process of the cycle. In figure 27 is obviously that the minimum mechanical work consumed for the air compression is given by the isothermal transformation, while the maximum mechanical work required is for an adiabatic transformation. These two are boundary conditions because practically a real compressor follows a polytropic transformation.

In the following modeling, the air was considered an ideal gas governed by the ideal gas law.

$$PV = n\mathcal{R}T \quad (5.1)$$

- P is the pressure of the gas; V is the volume of the gas; n is the number of moles; \mathcal{R} is the ideal or universal gas constant; T is the temperature of the gas

An alternative to the ideal gas law which will be used extensively throughout this work looks written in the following form:

$$PV = mRT \quad (5.2)$$

Where the number of gas " n " is expressed as a rapport of the mass in grams, " m ", and the molar mass, " M ", in grams per mole, $n = \frac{m}{M}$ and subsequently R , is the specific gas constant, defined as the ratio between the universal gas constant and the molar mass, $R = \frac{\mathcal{R}}{M}$.

In compressors operation, the basic physical law of Gay-Lussac is applied saying that when the pressure rises in a cylinder due to the piston moves at the same time the temperature of the enclosed gas also rises. To define the calculus relation for the mechanical work consumed for compression, we have to sum the mechanical work for all four phases of compression: suction, compression, repression and relaxation.

$$\begin{aligned} w &= -(w_{Suction} + w_{Compression} + w_{Repression} + w_{Relaxation}) \\ &= -\left(\int_0^{v_1} p_1 dv + \int_{v_1}^{v_2} p dv + \int_{v_2}^{v_3} p_2 dv + \int_{v_3}^{v_4} p dv \right) \end{aligned} \quad (5.3)$$

The negative sign in the equation Eq. 5.3 appears because this represents a loss of energy for the machine which made the compression, said in a simpler form, when the volume decreases the work increase. Being a theoretical case, dead volume is neglected and then $v_3 = v_4 = 0$

$$w = - \left(p_1 v_1 + \int_{v_1}^{v_2} p dv - p_2 v_2 + 0 \right) \quad (5.4)$$

4 – 1, 2 – 3 - are isobaric processes, and 3 – 4 is an isochoric process (as long as the air volume is the same in the head points)

- then

$$p_2 v_2 - p_1 v_1 = \int_{p_1 v_1}^{p_2 v_2} d(pv) = \int_{v_1}^{v_2} p dv + \int_{p_1}^{p_2} v dp \quad (5.5)$$

- making changes in equation Eq. 5.4 then:

$$w = \int_{p_1}^{p_2} v dp \quad (5.6)$$

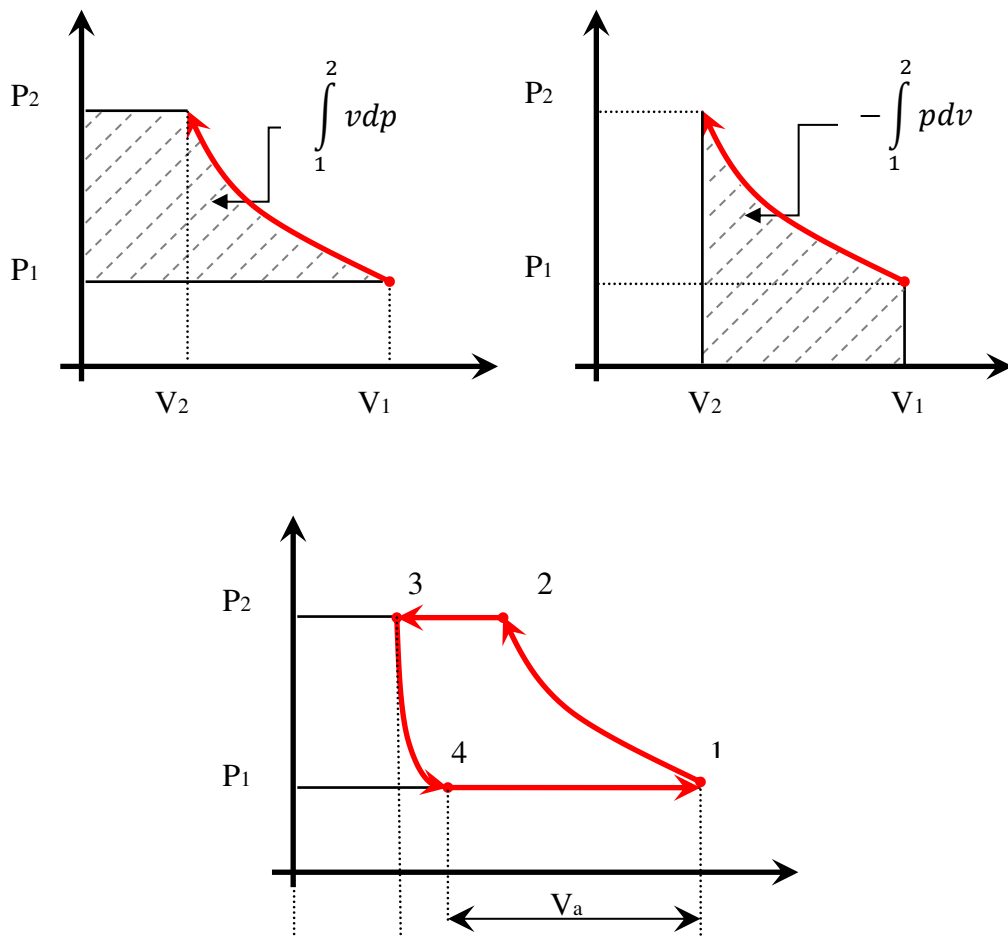


Figure 28 – Ideal compression cycle

At the top of figure 28 in the left corner is expressed the work done in flow process while in the right corner is expressed the work done in the non-flow process.

The cycle can be explained starting from point 1 which is the point when the piston is at the dead center position that gives the maximum cylinder volume. At this moment the gas inside the cylinder is at the suction pressure, and once the piston moves to decrease the cylinder volume the mass of the gas trapped in the cylinder is compressed and its pressure and temperature rise. If we considering an ideal case there are no frictions and no heat transfer from the gas or to the gas and in this condition the changes in pressure and temperature can be easily calculated from the well-known equation of an adiabatic process. At point 2 the pressure has increased till to that equal to the discharge pressure. In the case of an ideal compressor, the discharge vane will open when the pressure reaches this point and is assumed that there will not be pressure loss across the valve. Even if the piston continues to move further to decrease the cylinder volume the gas from the cylinder is discharged at a constant pressure. At point 3 the piston reaches the top dead center, the cylinder is at the minimum volume and the discharge valve is closed. Now, normally the gas remained inside the cylinder, trapped in the clearance volume, expands when the piston returns at the point 1, and its pressure and temperature decrease. At point 4 the pressure has decreased to the suction pressure point at which the valve opens and the piston moves further to increase the cylinder volume until it reaches the bottom dead center of the cylinder when the suction valve closes and the cycle restarts.

For all these processes the work consumed by the air compressor, and the temperature at the outlet of each stage of compression were calculated and presented below.

5.1.1.3. One stage isothermal compression

The mechanical work for an isothermal compression derives from Boyle's law:

$$pv = \text{constant}$$

$$p_1v_1 = p_2v_2$$

$$v = \frac{p_1v_1}{p} \quad (5.7)$$

$$w_{isoth} = \int_{p_1}^{p_2} p_1v_1 \frac{dp}{p} = p_1v_1 \ln\left(\frac{p_2}{p_1}\right) \quad (5.8)$$

- being an isothermal process the air temperature at the outlet of the air engine is equal with the temperature which enters in the air engine.

$$T_f = T_i$$

5.1.1.4. One stage adiabatic compression

The mechanical work for an adiabatic compression.

$$pv^k = \text{constant} \Rightarrow p_1 v_1^k = p_2 v_2^k \quad (5.9)$$

$$p_1^{\frac{1}{k}} v_1 = C^{\frac{1}{k}} \text{ or } v = \frac{p_1^{\frac{1}{k}} v_1}{p^{\frac{1}{k}}} \quad (5.10)$$

$$\begin{aligned} w_{\text{adiab}} &= \int_{p_1}^{p_2} v dp = C^{\frac{1}{k}} \int_{p_1}^{p_2} \frac{dp}{p^{\frac{1}{k}}} \\ &= C^{\frac{1}{k}} \frac{k}{k-1} p^{\frac{k}{k-1}} \Big|_{p_1}^{p_2} \\ &= \frac{k}{k-1} \left(p_2^{\frac{1}{k}} v_2 p_2^{\frac{k}{k-1}} - p_1^{\frac{1}{k}} v_1 p_1^{\frac{k}{k-1}} \right) \\ &= \frac{k}{k-1} (p_2 v_2 - p_1 v_1) \end{aligned} \quad (5.11)$$

Now if we put off in front $P_1 V_1$ in Eq. 5.11, then

$$W = \frac{k}{k-1} p_1 v_1 \left(\frac{p_2 v_2}{p_1 v_1} - 1 \right) \quad (5.12)$$

Rearranging equation, replacing $pv = RT$ and $\frac{v_2}{v_1} = \left(\frac{p_1}{p_2}\right)^{\frac{1}{k}}$

$$w_{\text{adiab}} = RT_1 \frac{k}{k-1} \left[\left(\frac{p_2}{p_1} \right)^{\frac{k-1}{k}} - 1 \right] \quad (5.13)$$

$$T_f = T_i \left(\frac{p_f}{p_i} \right)^{\frac{k-1}{k}} \quad (5.14)$$

– P_i, P_f are the initial (atmospheric) and the final storage vessel pressures, respectively T_i, T_f are the initial and the final temperature and k is the adiabatic exponent during the air compression process.

5.1.1.5. One stage polytropic compression

The mechanical work for a polytropic compression

$$pv^n = \text{constant or } p_1v_1^n = p_2v_2^n \quad (5.15)$$

$$v = \frac{p_1^{\frac{1}{n}}v_1}{p^{\frac{1}{n}}} \quad (5.16)$$

then

$$w_{polyt} = \int_{p_1}^{p_2} v dp = C^{\frac{1}{n}} \int_{p_1}^{p_2} \frac{dp}{p^{\frac{1}{n}}} = p_1v_1 \frac{n}{n-1} \left[\left(\frac{p_2}{p_1} \right)^{\frac{n-1}{n}} - 1 \right] \quad (5.17)$$

In thermodynamics there are two forms of energy transfer, one is work and the other is heat. Analog to the work, where we saw that the area under the graph gives the value of the work done on the gas or work done by the gas, a property called entropy has been chosen, so plotted against temperature to give the heat transfer.

- from $P - V$ diagram we have

$$w = \int_{v_1}^{v_2} v dp \quad (5.18)$$

- from $T - S$ graph we have

$$Q = \int_{S_1}^{S_2} T dS \quad (5.19)$$

Q – represents the quantity of heat resulted during compression process.

The polytropic compression follows the same equations as adiabatic compression, except that the adiabatic index " k " is replaced with the polytropic index " n "

$$w_{polyt} = p_1v_1 \frac{n}{n-1} \left[\left(\frac{p_2}{p_1} \right)^{\frac{n-1}{n}} - 1 \right] \quad (5.20)$$

The most known equation for the polytropic exponent is:

$$n = \frac{\ln\left(\frac{p_f}{p_i}\right)}{\ln\left(\frac{p_f}{p_i}\right) - \ln\left(\frac{T_f}{T_i}\right)} \quad (5.21)$$

Heat changed during the polytropic process with the environment can be calculated from the expression of the first principle of thermodynamics.

$$dq = du + dw \quad (5.22)$$

The equation for specific internal energy du for a perfect gas which has a constant specific heats is given by the following expression:

$$du = c_v(T_2 - T_1) \quad (5.23)$$

$$dq = c_v(T_2 - T_1) + \frac{R(T_1 - T_2)}{n - 1} \quad (5.24)$$

reordering the equation

$$dq = \frac{R(T_1 - T_2)}{n - 1} - c_v(T_1 - T_2) \quad (5.25)$$

but

$$c_v = \frac{R}{k - 1} \quad (5.26)$$

then

$$\begin{aligned} dq &= \frac{R(T_1 - T_2)}{n - 1} - \frac{R(T_1 - T_2)}{k - 1} \\ &= R(T_1 - T_2) \left(\frac{1}{n - 1} - \frac{1}{k - 1} \right) \\ &= R(T_1 - T_2) \left(\frac{k - 1 - n + 1}{(k - 1)(n - 1)} \right) \\ &= \frac{k - n}{k - 1} R \left(\frac{T_1 - T_2}{n - 1} \right) \end{aligned} \quad (5.27)$$

The second term represents the work then the equation gets the following form:

$$dq = \left(\frac{k - n}{k - 1} \right) w \quad (5.28)$$

The final temperature after the polytropic process can be calculated from the following equation, and its value is in the range from 1 to k.

$$T_f = T_i \left(\frac{p_f}{p_i} \right)^{\frac{n-1}{n}} \quad (5.29)$$

5.1.1.6. Multi-stage compression

A single-stage compression may result in relatively high temperature, requiring for high-pressure compressors built of materials that withstand high temperatures which imply a high cost.

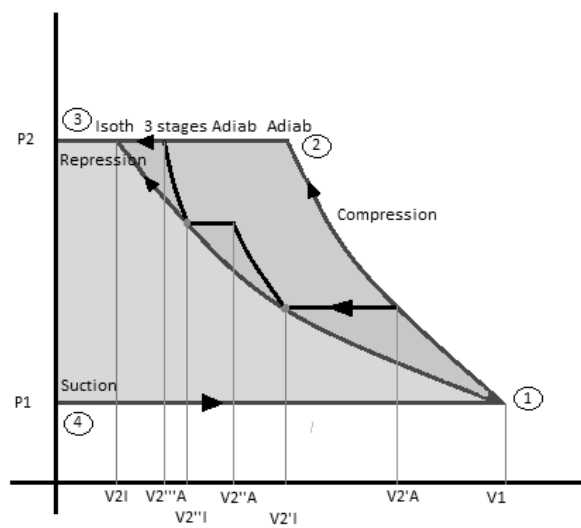


Figure 29 – Multi-stage compression with intercoolers P – V diagram

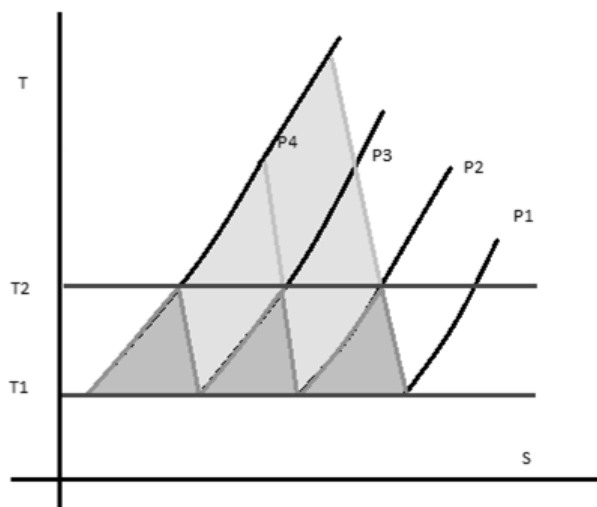


Figure 30 – Multi-stage compression with intercoolers T – S diagram

5.1.1.7. Isothermal multi-stage compression

$$W = mR \left[T_1 \ln \left(\frac{P_2}{P_1} \right) + T_2 \ln \left(\frac{P_3}{P_2} \right) + \dots + T_x \ln \left(\frac{P_{x+1}}{P_x} \right) \right] \quad (5.30)$$

- but being an isothermal compression with

$$T_1 = T_2 = \dots T_x \quad (5.31)$$

- then

$$W = mRT_1 \sum_1^x \ln \left(\frac{P_{x+1}}{P_n} \right) \quad (5.32)$$

$$W = mRT_1 \ln \left(\frac{P_{x+1}}{P_1} \right) \quad (5.33)$$

5.1.1.8. Adiabatic multi-stage compression

$$\begin{aligned} W_{adiab} = & P_1 V_1 \frac{k}{k-1} \left[\left(\frac{P_2}{P_1} \right)^{\frac{k-1}{k}} - 1 \right] \\ & + P_2 V_2 \frac{k}{k-1} \left[\left(\frac{P_3}{P_2} \right)^{\frac{k-1}{k}} - 1 \right] + \dots + P_x V_x \frac{k}{k-1} \left[\left(\frac{P_{x+1}}{P_x} \right)^{\frac{k-1}{k}} - 1 \right] \end{aligned} \quad (5.34)$$

$$T_{x+1} = T_x \left(\frac{p_{x+1}}{p_x} \right)^{\frac{k-1}{k}} \quad (5.35)$$

5.1.1.9. Polytropic multi-stage compression

$$W_{polyt} = P_1 V_1 \frac{n}{n-1} \left[\left(\frac{P_2}{P_1} \right)^{\frac{n-1}{n}} - 1 \right] + P_2 V_2 \frac{n}{n-1} \left[\left(\frac{P_3}{P_2} \right)^{\frac{n-1}{n}} - 1 \right] + \dots + P_x V_x \frac{n}{n-1} \left[\left(\frac{P_{x+1}}{P_x} \right)^{\frac{n-1}{n}} - 1 \right] \quad (5.36)$$

$$T_{x+1} = T_x \left(\frac{P_{x+1}}{P_x} \right)^{\frac{n-1}{n}} \quad (5.37)$$

From the ideal gas equation

$$PV = mRT \quad (5.38)$$

- if

$$\frac{P_2}{P_1} = \dots = \frac{P_{x+1}}{P_x} \quad (5.39)$$

- then

$$w_{polyt} = xRT \frac{n}{n-1} \left[\left(\frac{P_2}{P_1} \right)^{\frac{n-1}{n}} - 1 \right] \quad (5.40)$$

x – represents the number of compression stages

5.1.1.10. Compressor features

The volume described by the piston during movement from the BDC to TDC is called displacement or swept volume and is determined by the following relationship:

$$V_S = \frac{\pi D^2}{4} S \quad (5.41)$$

where:

D – represents the cylinder's diameter and S – represents the stroke of the piston.

The total displacement of the compressor is:

$$V_{S_{Total}} = \frac{\pi S}{4} \sum_1^x D^2 \quad (5.42)$$

Being a multistage compressor with several cylinders which have different diameters in order to maintain a close pressure ratio for all stages then the flow delivered by the compressor is determined by the following equation:

Free air delivery:

$$\dot{Q} = \frac{rpm}{60} V_s \quad (5.43)$$

Volumetric efficiency (VE) is defined as the deviation from the handling the compressor's capacity. Mathematically this deviation is given by the ratio between the aspirated volume of the air and the swept volume of the cylinder. In a case with multistage compression the swept volume considered is from the first cylinder. For a theoretical compressor the both volume are equal, but in a real compressor the existence of the clearance in favor of protecting the cylinder heads make that thing impossible. In function of the dead volume dimension the volumetric efficiency is higher or lower.

$$VE = \frac{\text{Volume of free air aspirated into cylinder}}{\text{swept volume of the first cylinder}} \quad (5.44)$$

Where x is the number of compressor's cylinders and rpm is the shaft speed.

Considering multistage compression and a cooling system after each stage of compression than the total power consumed is summed of powers consumed by each compression stage. A configuration with ' x ' identical stages with the same compression ratio give the minimum mechanical work required for compression.

When compressing the air in more stages, the compression takes place inside the compressor (cylinder) after that is isobaric cooled outside of the compressor (cylinder).

The heat extracted from the air before it reaches into the storage vessel is performed under an isobaric process and is given by the equation 5.45.

$$Q = mc_p \Delta T \quad (5.45)$$

The charging time represents the time taken to charge the storage reservoir to its full capacity, to the maximum pressure limit. This time depends on the storage volume and the pressure ratio.

$$t = \frac{m}{\dot{m}} \quad (5.46)$$

The thermodynamic efficiency of compression can be defined as the ratio of useful energy in the tank reported to the work required to fulfill the tank with pressurized air.

Isothermal efficiency

A mathematical parameter called isothermal efficiency is defined as quantifying of deviation from the polytropic work from the quasi-ideal isothermal compression process.

$$\eta = \frac{\textit{Isothermal work}}{\textit{Current polytropic work}} \quad (5.[47])$$

Adiabatic efficiency

It is represented as the ratio of adiabatic work of compression reported to the current polytropic work.

$$\eta = \frac{\textit{Isentropic work}}{\textit{Current polytropic work}} \quad (5.48)$$

$$\eta = \frac{\frac{k-1}{k}}{\frac{n-1}{n}} \quad (5.49)$$

As long as an ideally reciprocating compressor is defined as an adiabatic process and a reversible one, this makes it an isentropic process. Due to the speed of compression so fast inside the reciprocating compressor, their efficiency is reported moreover to the isentropic efficiency instead of isothermal efficiency. Another way to express the adiabatic efficiency is presented in equation Eq 5.49 where are taken into account the adiabatic and polytropic exponent.

Heat exchangers/ Intercoolers

In the present work, the heat exchanged throughout of the heat exchangers is modeled as an isobaric process. Air pressure remains constant as it passes through intercoolers, after-cooler and inter-heater. The heat transfer between the working fluid and the cooling or heating fluid provided by the heat exchangers is a function of effectiveness (ϵ).

The intercoolers which equip the compressor are mounted in counter-flow and are arranged so that after each step of compression the air to be cooled as close as to the ambient temperature.

$$Q = \varepsilon C_{min} \Delta T' \quad (5.50)$$

$$\Delta T' = T_{H,i} - T_{C,i} \quad (5.51)$$

- C_{min} is the minimum heat capacity flow rate and $T_{H,i}$ and $T_{C,i}$ are temperatures for the hot and cold fluids.

$$\varepsilon = \frac{c_p^{air} \dot{m}_{air} (T_{in}^{air} - T_{out}^{air})}{(c_p \dot{m})_{min} (T_{in}^{air} - T_{in}^{fluid})} = \frac{c_p^{fluid} \dot{m}_{fluid} (T_{out}^{fluid} - T_{in}^{fluid})}{(c_p \dot{m})_{min} (T_{in}^{air} - T_{in}^{fluid})} \quad (5.52)$$

Equation defined by Kays and London [3], [82].

Effectiveness equation for a counter-flow heat exchanger is the following:

$$\varepsilon = \frac{\text{heat transfer rate}}{\text{maximum possible heat transfer rate}} = \frac{\dot{Q}}{\dot{Q}_{max}} \quad (5.53)$$

- where “fluid” is the cold fluid used in a heat exchanger to drop the temperature of the air after compression stages.

Heat transfer:

$$\dot{Q} = c_p^{air} \dot{m}_{air} (T_{in}^{air} - T_{out}^{air}) = c_p^{fluid} \dot{m}_{fluid} (T_{out}^{fluid} - T_{in}^{fluid}) \quad (5.54)$$

$$\dot{Q}_{max} = (c_p \dot{m})_{min} (T_{in}^{air} - T_{in}^{fluid}) \quad (5.55)$$

$(c_p \dot{m})_{min}$ is the smaller value of $c_p^{air} \dot{m}_{air}$ and $c_p^{fluid} \dot{m}_{fluid}$

There are two scenarios from which the heat transfer reaches the maximum value

- If the cold fluid is heated by the inlet temperature of the hot fluid
- If the hot fluid is cooled by the inlet temperature of the cold fluid

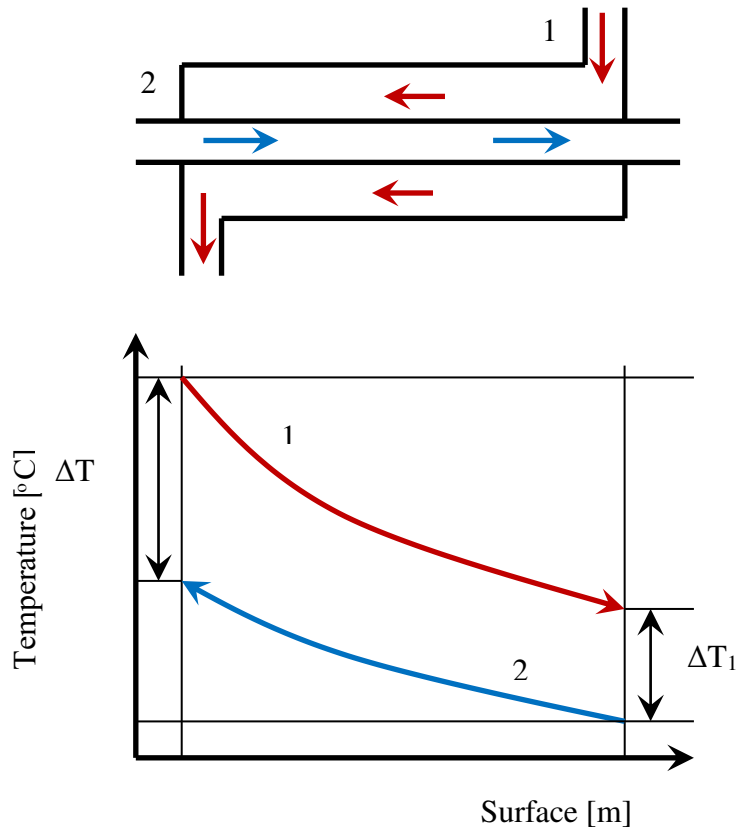


Figure 31 – A counter-flow heat exchanger illustration

The heat recovered through a heat exchanger by using a working fluid via an isobaric process is governed by the following equation:

$$Q_1 = m_{air} c_p^{air} \Delta T \quad (5.56)$$

$$Q_2 = m_{fluid} c_p^{fluid} \Delta T \quad (5.57)$$

Should be noted that a higher efficiency of compression is obtained when the air enters in the next compressor of a compression train or in the next stage of compression of a multi-stage compressor at a temperature closer to the ambient one. For this, a configuration where the heat exchangers are connected in parallel can be easily adapted and modeled.

5.1.2. The storage process

After compression, the pressurized air enters in the storage vessel at a high pressure P_f and temperature T_0 close to the environmental temperature. The pressurized air can be stored for indefinite period of time. The storage temperature is assumed to be constant.

The quantity of the air stored in the tank results from the ideal gas equation.

$$m = \frac{PV}{RT} \quad (5.58)$$

According to Kim et al. [81] the exergy of the air can be expressed as:

$$\dot{E}_a = \dot{m}[h - h_0 - T_0(s - s_0)] \quad (5.59)$$

- where h and s are the specific enthalpy and entropy of the gas.
- but in the case of perfect gas:

$$h - h_0 = c_p(T - T_0) \quad (5.60)$$

$$s - s_0 = c_p \ln\left(\frac{T}{T_0}\right) - R \ln\left(\frac{P}{P_0}\right) \quad (5.61)$$

- now the energy can be split between mechanical exergy and thermal exergy, and then:

$$\dot{E}_a = \dot{E}_{a(M)} + \dot{E}_{a(T)} \quad (5.62)$$

$$\dot{E}_{a(M)} = \dot{m}RT \ln\left(\frac{P}{P_0}\right) \quad (5.63)$$

$$\dot{E}_{a(T)} = \dot{m}c_p \left[T - T_0 - T_0 \ln\left(\frac{T}{T_0}\right) \right] \quad (5.64)$$

The exergy can be defined as the maximum useful work possible that can be obtained during a process that brings the system into equilibrium with the surrounding while interacting.

5.1.3. The discharging process

Similar to the compression process has been analyzed the expansion process, following, in the end, to compare all the obtained results in order to make an assessment of the global efficiency of the overall system.

An analysis for an isothermal, adiabatic and a polytropic expansion has been done for the discharging process. The compressed air is expanded through an air engine to a constant fixed inlet air engine pressure. The air engine consists in a reciprocating piston-cylinder arrangement in that way so the compressed air is admitted to the cylinder when the inlet valve is open for a limited period of time, then the air which enters in the cylinder causes piston movement and produce work shaft. The principle is relatively similar with that for compressors where the piston is moved to compress the air while to the air engine the gas (air) move (push) the piston to produce work.

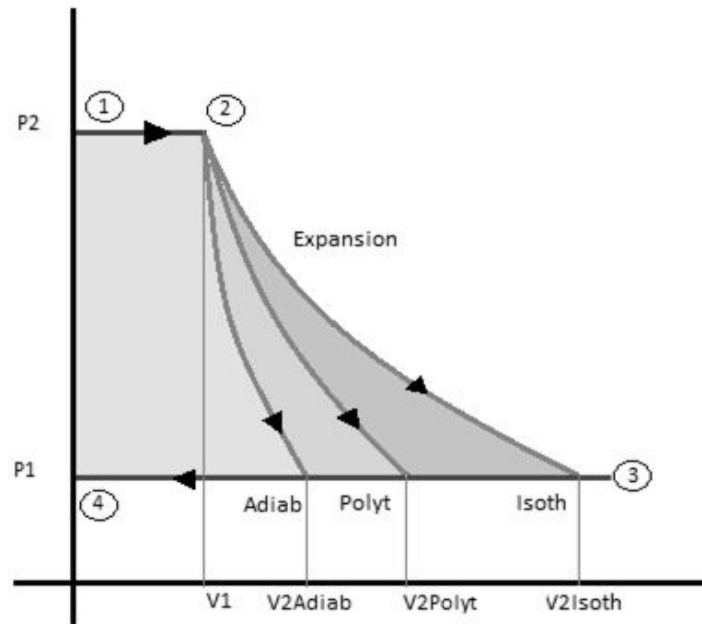


Figure 32 – A single stage expansion process

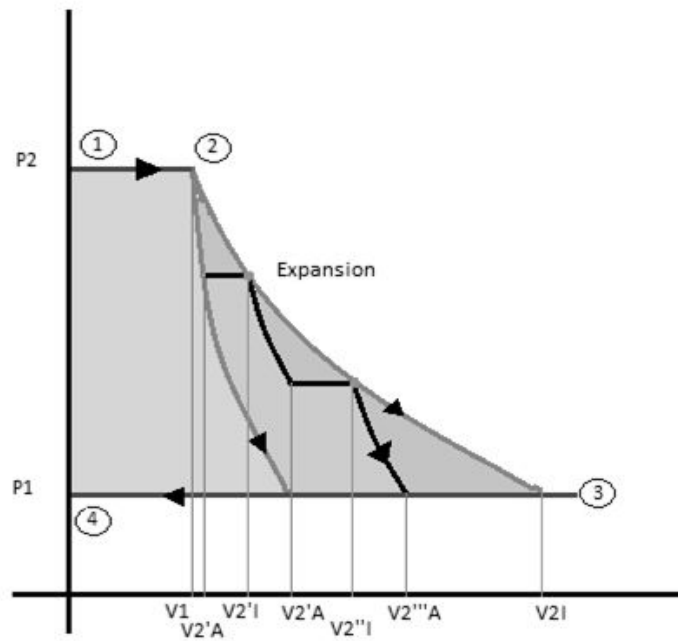


Figure 33 – Multi-stage expansion process

5.1.3.1. Isothermal a single stage expansion

For an isothermal expansion the specific work per unit mass is given by the following equation:

$$w_{isoth} = \int_{P_i}^{P_f} P_i V_i \frac{dP}{P} = RT_i \ln \frac{P_f}{P_i} \quad (5.65)$$

5.1.3.2. Adiabatic a single stage expansion

For an adiabatic expansion the specific work per unit mass is given by the equation 5.66:

$$w_{adiab} = \frac{k}{k-1} RT_i \left[1 - \left(\frac{P_f}{P_i} \right)^{\frac{k-1}{k}} \right] \quad (5.66)$$

$$T_f = T_i \left(\frac{p_f}{p_i} \right)^{\frac{k-1}{k}} \quad (5.67)$$

The above equation is for a single-stage expansion, considering our experimental set-up which will be presented in a next subchapter. For a multi-stage expansion the total specific work is a sum of works done for each stage.

5.1.3.3. Polytropic single stage expansion

$$w_{polyt} = \frac{n}{n-1} RT_i \left[1 - \left(\frac{P_f}{P_i} \right)^{\frac{n-1}{n}} \right] \quad (5.68)$$

$$\dot{W}_{polyt_engine} = \dot{m} \frac{n}{n-1} RT_i \left[1 - \left(\frac{P_f}{P_i} \right)^{\frac{n-1}{n}} \right] \quad (5.69)$$

$$\dot{W}_{generator} = \dot{W}_{polyt_engine} \eta_m \eta_g \quad (5.70)$$

In our calculus we assumed that the expander/air engine efficiency is 85% and the generator efficiency is also 85 % ($\eta_g = 0.85$, $\eta_{en} = 0.85$).

$$n = \frac{\ln \left(\frac{p_f}{p_i} \right)}{\ln \left(\frac{p_f}{p_i} \right) - \ln \left(\frac{T_f}{T_i} \right)} \quad (5.71)$$

$$T_f = T_i \left(\frac{p_f}{p_i} \right)^{\frac{n-1}{n}} \quad (5.72)$$

Heat added during a polytropic process:

$$dq = c_n dT \quad (5.73)$$

$$pv^n = \text{constant} \quad (5.74)$$

From the first law of thermodynamics:

$$dq = du + dW \quad (5.75)$$

$$\int_{T_1}^{T_2} c_n dT = \int_{T_1}^{T_2} c_v dT + \int_{v_1}^{v_2} p dv \quad (5.76)$$

We saw early that

$$\int_{v_1}^{v_2} p dv = -\frac{p_1 v_1}{-n+1} + \frac{p_2 v_2}{-n+1} \quad (5.77)$$

But $pv = RT$ and $\Delta T = T_2 - T_1$ then:

$$-\frac{p_1 v_1}{-n+1} + \frac{p_2 v_2}{-n+1} = \frac{R\Delta T}{-n+1} \quad (5.78)$$

so

$$c_n \Delta T = c_v \Delta T + \frac{R\Delta T}{-n+1} \quad (5.79)$$

Dividing equation by ΔT results that:

$$c_n = c_v + \frac{R}{1-n} \quad \text{or} \quad c_n = c_v \left(\frac{k-n}{1-n} \right) \quad (5.80)$$

Using the same principle as in the compression process, where the amount of heat is removed from the gas and stored for future use, after the expansion process the amount of heat which in this case is cold, can be recovered through the heat exchangers and as well stored for future use.

Adiabatic efficiency

It is represented as the ratio between the polytropic work of expansion and ideal adiabatic work of expansion.

$$\eta = \frac{\text{Current polytropic work}}{\text{Isentropic work}} \quad (5.81)$$

$$\eta = \frac{\frac{n-1}{k}}{\frac{n}{k-1}} \quad (5.82)$$

As long as an ideal expansion is defined as an adiabatic process and a reversible one, this makes it an isentropic process. Due to the speed of expansion so fast inside the air engines, their efficiency is reported moreover to the isentropic efficiency instead of isothermal efficiency. Similarly to the compression process, the adiabatic efficiency could be expressed function of the polytropic and the adiabatic exponent, eq. 5.82.

5.1.4. Thermal energy storage

Thermal energy storage is a thermal technology energy conservation by heating or cooling of a working medium, so it can be used later for heating, cooling or in energy production [83], [84]. In fact, the thermal energy storage is going to be a decisive factor for the problem of managing energy. At the moment are known two types of TES systems depending on the way in which the energy follow to be used, as sensible heat or as latent heat [85], [86].

The most common way of thermal energy storage is as sensible heat which represents the heat exchanged by a fluid/body increasing its temperature and remaining in the same phase of aggregation. This technology is cheap and used all over the world being less complicated compared with the latent heat or for certain applications with the chemical heat.

Typical sensible energy storage systems can involve or not a heat transfer fluid to transport heat from the hot source to the storage medium, usually if the medium is solid. Or even the working fluid can represent itself the storage medium, filling in the same time the role of the heat exchanger and thermal energy storage. So far there are used two tanks, one cold and one hot and the fluid is moved from one tank to the other passing through a heat exchanger.

Latent heat on the other way represents the amount of heat exchanged by a body which passes from one phase to another, from a gas to a liquid or a solid or vice versa at a constant temperature [87]. Compared to conventional sensible heat storage medium, PCM storage allows a high energy density at a constant operating temperature.

According to the temperature which is an important parameter by treating the heat and for this, there are two distinguished ways of storage heat as low-temperature storage or as high-temperature heat storage.

The storage of sensible energy from the thermodynamic point of view means an increasing of enthalpy in the storing material.

Table 4 – A list of solid and liquid materials used for sensible heat storage [88].

| Name | Cp [kJ/kgK] | Temperature [°C] |
|--|--------------------|-------------------------|
| Concrete (solid) | 0.916 | - |
| Rock | 0.879 | - |
| Brick | 0.84 | - |
| Granite | 0.8 | - |
| Sandstone | 0.72 | - |
| Salt hydrates | | Melting point |
| LiNO ₃ -3H ₂ O | - | 30 |
| K ₂ HPO ₄ -6H ₂ O | | 14 |
| FeBr ₃ -6H ₂ O | | 27 |
| Minerals oil | 1.97 | Up to 320 |
| Engine oil | 1.88 | Up to 160 |
| Caloria HT43 | 2.2 | Up to 260 |
| TherminolVP-1 | 2.48 | Up to 257 |
| Glycerol | 0.578 | Up to 297 |
| Propylene glycol | 1 | Up to 187 |
| Water at 16 bar | 4.41 | Up to 200 |

5.1.4.1. Thermal energy storage systems

5.1.4.1.1. Two – Tanks direct storage

In two-tank direct storage system, the fluid which is used to transfer the heat from the hot source is the same as the storage medium of the thermal energy. In such a system the fluid is stored in a cold tank and when a heat transfer is required the fluid is pumped from the cold tank, passes through a heat exchanger and in the end arrives in the hot tank, where the heat is stored till the system requires it. From the hot tank, the fluid flows to the cold tank pass through a heat exchanger where the fluid exchange heat with another fluid with a low temperature.

5.1.4.1.2. Two – Tanks indirect storage

In the two-tanks indirect storage the process is similar with that for direct storage by mean there are two tanks, one cold one hot, and the difference consists that the heat transfer fluid is different from the storage medium. This system is used in that situations when the heat transfer fluid from varies reasons cannot be used as a storage medium [89].

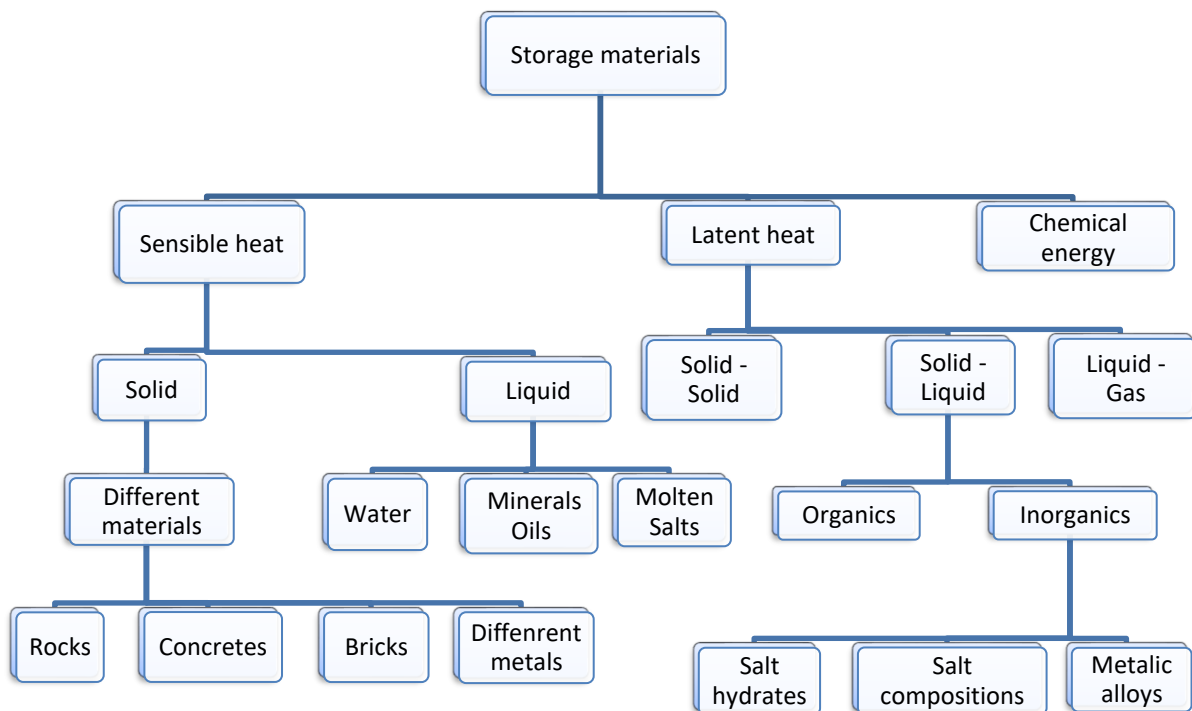


Figure 34 – Thermal energy storage solutions [90].

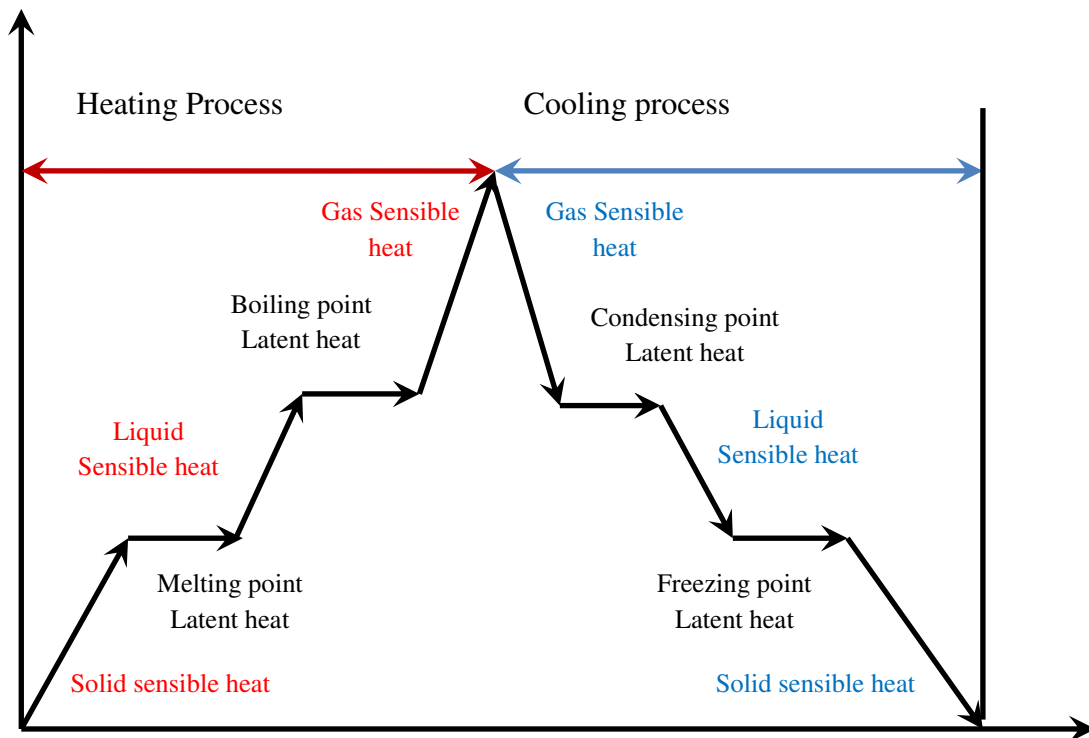


Figure 35 – Sensible and latent representation for different phase transition

Depending on the chosen solution for thermal energy storage the basic principle of storage is the same but the system is built differently. In a form of sensible heat thermal energy can be stored in solid materials (concrete, ceramic materials, brick) or in the liquid phase (by using mineral oils, molten salts or other storage fluids). While in the case of latent heat the thermal energy can be stored in materials which usually change its aggregation phase from solid to liquid. In this case, a heat transfer fluid is used as a medium to transport the heat between the heat exchangers and thermal energy storage system. Several suitable molten salts were presented in [90] and [91]. Storage thermal energy in concrete as storage material was presented by Jian et al. [92].

5.1.4.2. System efficiency

The electrical efficiency of the system is given by the report between the work required and the work done by the system.

$$\eta_{electricity} = \frac{w_e}{w_c} \quad (5.83)$$

In case that both the air compressor and the air engine have the same mass flow rate, then the electrical efficiency of the system can be expressed in the following form.

$$\eta_{electricity} = \frac{1 - \beta^{\frac{1-n}{n}}}{\beta^{\frac{n-1}{n}} - 1} \quad (5.84)$$

The global efficiency of the system is defined as the ratio between the total energy resulted and the electric energy consumed by the air compressor. The total resulted energy is the sum of the work produced by the air engine, the heat recovered by de coolant fluid and the cold resulted in the air expansion process.

$$\eta_{global} = \frac{w_e + q_h + |q_c|}{w_c} \quad (5.85)$$

Another approach for calculating the efficiency of each process can be considered as a ratio between the isothermal and the polytropic/adiabatic work produced or consumed.

For the compression process:

$$\begin{aligned} \eta &= \frac{W_{compression_isoth}}{W_{compression_polyt}} \\ &= \frac{P_i V_i \ln\left(\frac{P_f}{P_i}\right)}{\frac{n}{n-1} P_i V_i \left[\left(\frac{P_f}{P_i}\right)^{\frac{n-1}{n}} - 1 \right]} \end{aligned} \quad (5.86)$$

For the expansion process:

$$\begin{aligned} \eta &= \frac{W_{expansion_polyt}}{W_{expansion_isoth}} \\ &= \frac{\frac{n}{n-1} P_i V_i \left[1 - \left(\frac{P_f}{P_i}\right)^{\frac{n-1}{n}} \right]}{P_i V_i \ln\left(\frac{P_f}{P_i}\right)} \end{aligned} \quad (5.87)$$

n – being the polytropic index, and when $n = k$ the process is adiabatic, respectively when $n = 1$ the process is isothermal.

Table 5 – Summary of processes for perfect gas

| Process | index | Work | Heat added | P, V, T relations | Specific heat capacity |
|-----------------------------------|------------|-------------------------------|------------------------------|---|---|
| Isobaric (P=constant) | $n=0$ | $P\Delta V$ | $c_p\Delta T$ | $\frac{T_2}{T_1} = \frac{V_2}{V_1}$ | c_p |
| Isochoric (V=constant) | $n=\infty$ | 0 | $c_v\Delta T$ | $\frac{T_2}{T_1} = \frac{P_2}{P_1}$ | c_v |
| Isothermal (T=constant) | $n=1$ | $P_1V_1 \ln \frac{V_2}{V_1}$ | $P_1V_1 \ln \frac{V_2}{V_1}$ | $P_1V_1 = P_2V_2$ | ∞ |
| Adiabatic (Q=constant) | $n=k$ | $\frac{P_1V_1 - P_2V_2}{k-1}$ | 0 | $P_1V_1^k = P_2V_2^k$ $\frac{T_2}{T_1} = \left(\frac{P_2}{P_1}\right)^{\frac{k-1}{k}}$ $= \left(\frac{V_1}{V_2}\right)^{k-1}$ | 0 |
| Polytropic | n | $\frac{P_1V_1 - P_2V_2}{n-1}$ | $c_n\Delta T$ | $P_1V_1^n = P_2V_2^n$ $\frac{T_2}{T_1} = \left(\frac{P_2}{P_1}\right)^{\frac{n-1}{n}}$ $= \left(\frac{V_1}{V_2}\right)^{n-1}$ | c_n $= c_v \left(\frac{k-n}{1-n}\right)$ |

6. CAES system - simulation in Matlab

A Matlab code has been written according to the theoretical model presented in chapter 5. The modeling results obtained were validated on an experimental laboratory stand and all of these are shown in tables and graphs in the following chapter.

6.1. Simulation and optimization of a CAES system using Matlab tools

In this optimization method, we have tried to find optimum values for some parameters as pressure, temperature and volume in order to find an optimum set-up for the energy storage system. The initial and the boundary conditions are presented in Table 6.

Table 6 – Initial conditions

| Reference conditions | Initial condition |
|---|---|
| Normal pressure $P_0=1.0135$ bar | Ambient pressure $P_1=1.0135$ bar |
| Normal temperature $T_0=273.15$ K | Ambient temperature $T_1=288.15$ K |
| Air density at NTP $\rho=1.2922$ kg/m³ | Air density $\rho=1.2047$ kg/m ³ |
| | Storage vessel volume $V_1=0.3$ m ³ |
| Final conditions inside the filled tank | Final conditions after the expansion process |
| Pressure $P_2=330$ bar | Air pressure $P_4=1.0135$ bar |
| Temperature $T_2=288.15$ K | |

The assumptions listed below have been considered to simplify the analysis of the proposed AA-CAES system:

- The power provided by renewable energy sources through PV, CSP and/or wind turbine is at least equal to the power consumed by the air compressor.
- The compressed air is treated as an ideal gas.
- All the kinetic and the potential energy are negligible.
- The pressure drops in any of the system components are neglected.

- The polytropic exponent $n=1.2$ (the average polytropic exponent obtained during the experimental results varies between 1.18 and 1.2, at least 5 replies have been done, so we choose then 1.2 in the theoretical simulations).
- The temperature variation inside the storage vessel during both compression and expansion processes is modeled by following an isothermal process.
- The heat exchangers are modeled in such a way to bring the air temperature after each stage compression or expansion to a value close to the surrounding temperature.

In the adiabatic case, no heat is leaving the system, while in the polytropic case some heat is exchanged with the surrounding.

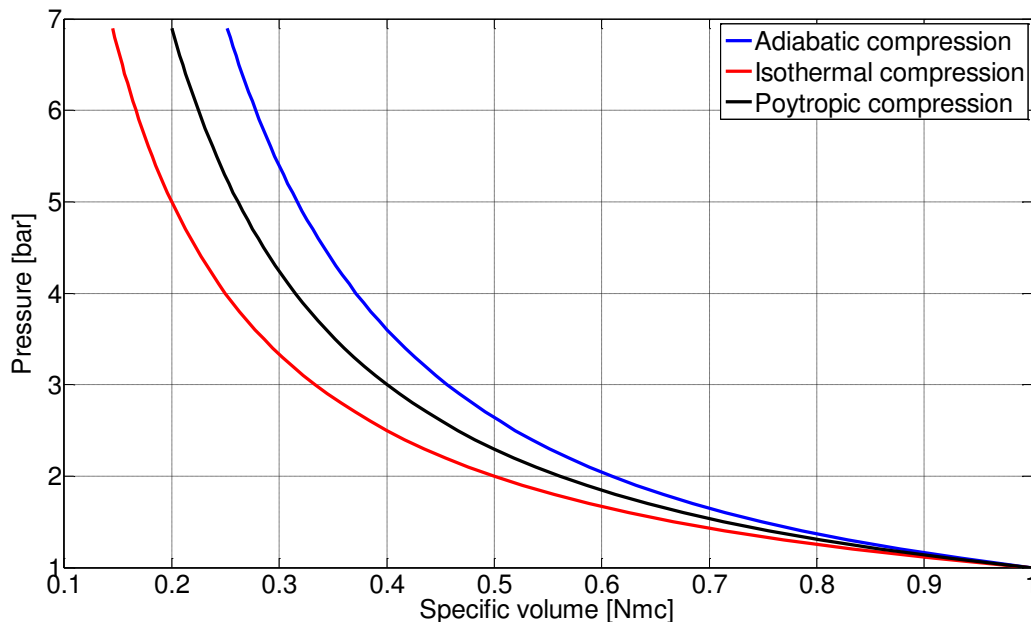


Figure 36 – Diagram for 1 of 3 stages compression

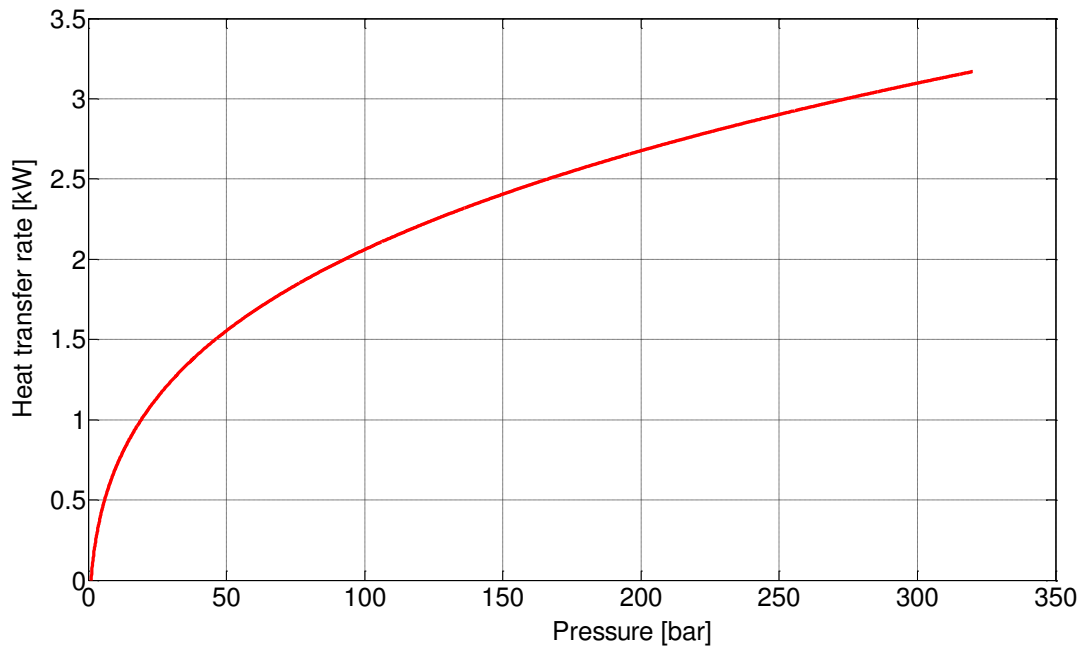
A theoretical simulation for the first stage of a multi-stage compressor to illustrate the specific volume variation during compression it's presented in figure 36. The area between the axis, abscissa and ordinate, and each curve in part represents the mechanical work required by the system to compress the air, taking into consideration the compression process, and in the case of expansion represents the mechanical work produced by the system.

The technical work required for filling the tank with compressed air under isothermal conditions has the minimum value of the mechanical work required that can be obtained.

Table 7 – Results obtained for polytropic experimental compression

| Three-stage compression | Units | I | II | III |
|--|-------------------|--------|--------|---------------|
| Inlet pressure | bar | 1 | 7.58 | 43.57 |
| Outlet pressure | bar | 7.58 | 43.57 | 320 |
| Inlet Temperature | K | 288.15 | 330.7 | 324.9 |
| Outlet Temperature | K | 389.9 | 465.14 | 413.67 |
| Inlet Air density | kg/m ³ | 1.2042 | 5.678 | 36.705 |
| Heat transfer rate recovered after each stage expansion | kW | 0.22 | 0.54 | 0.42 |

A polytropic three-stage compression has been summarized in table 7, having the average values for the intermediate pressure 7.58 bar, 43.57 bar and the final pressure 320 bar, respectively temperature after each stage compression 389.9 K for the 1st stage, 465.14 K for the 2nd stage and 413.67 K for the 3rd stage. As well it's presented the heat transfer rate recovered or dissipated between compression stages.

**Figure 37 – Diagram for the heat transfer rate variation during a single stage compression - adiabatic process**

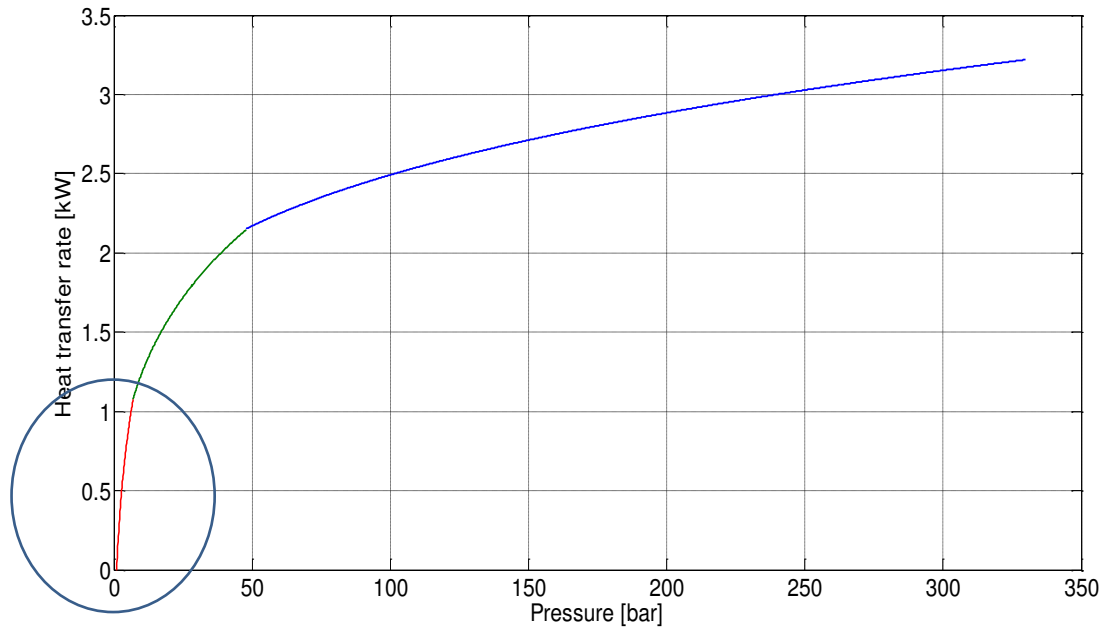


Figure 38 – The total heat variation during a multi-stage compression for an adiabatic process

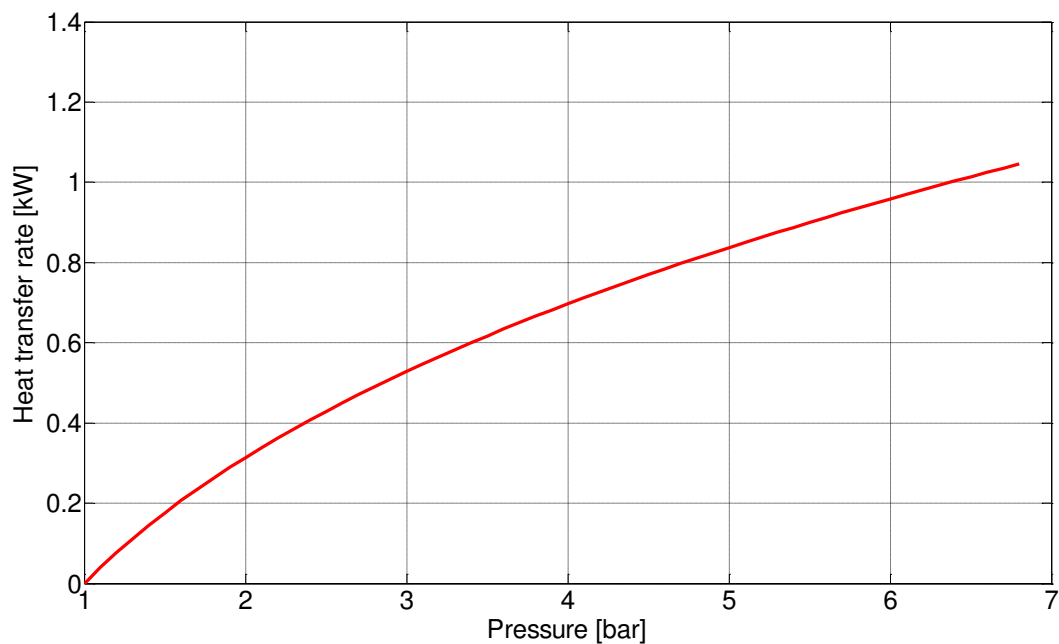


Figure 39 – The heat variation during a single stage adiabatic compression for a compressor with three identical stage compression

Taking a look at the figures 37 and 38 it can be observed that for a three-stage compression with the same ratio and using intercoolers after each stage compression to bring the air back to the initial temperature the quantity of heat recovered is identical with that obtained for a single-

stage compression. What should be mentioned is that even if the quantity of the heat is the same, the temperature at which this is stored is different, and a higher temperature is more valuable than that stored at a lower value. A detailed illustration of the first stage compression from figure 38 it's presented in figure 39.

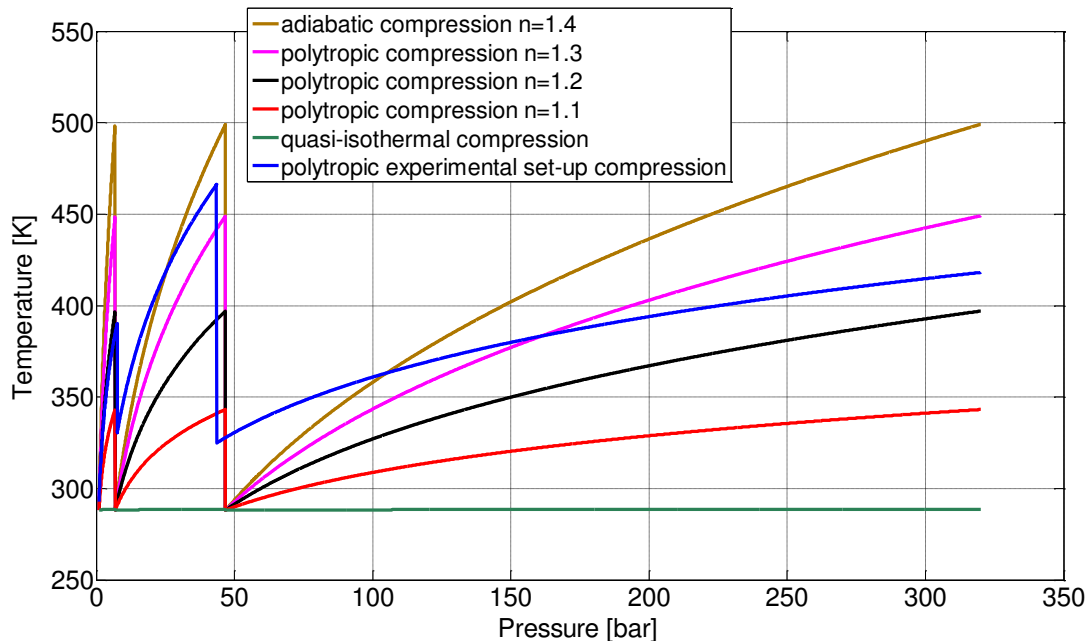


Figure 40 – Temperature variation for a multi-stage compression process

In figure 40 are shown the temperature evolution for a multistage compression with different compression ratio per stage and with intercoolers dimensioned to cool down the air to a temperature close to that from the initial conditions and as well the value of the temperature which leaves the last compression cylinder. The curves present: a theoretic three identical stage: an isothermal compression process (green curve), a theoretical three identical stage adiabatic compression process (brown curve), three identical stage polytropic compression with different polytropic index (red, black, magenta curves) and a scenario in which are used data from the experimental set-up (blue curve).

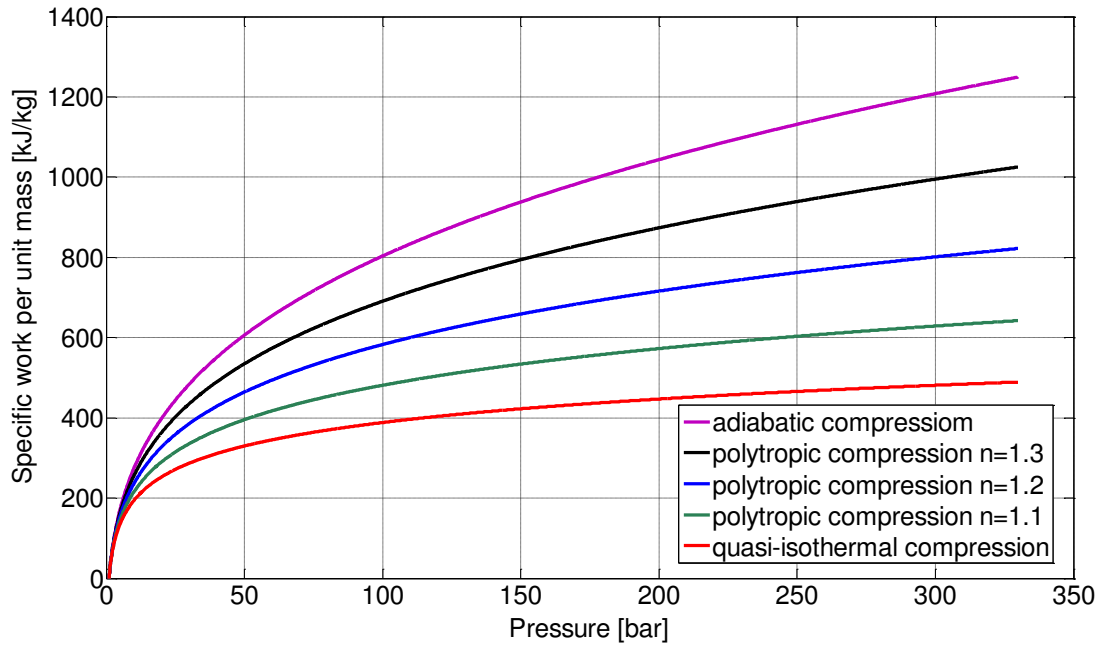


Figure 41 – Representation of specific work per unit mass function of pressure for a single stage compression

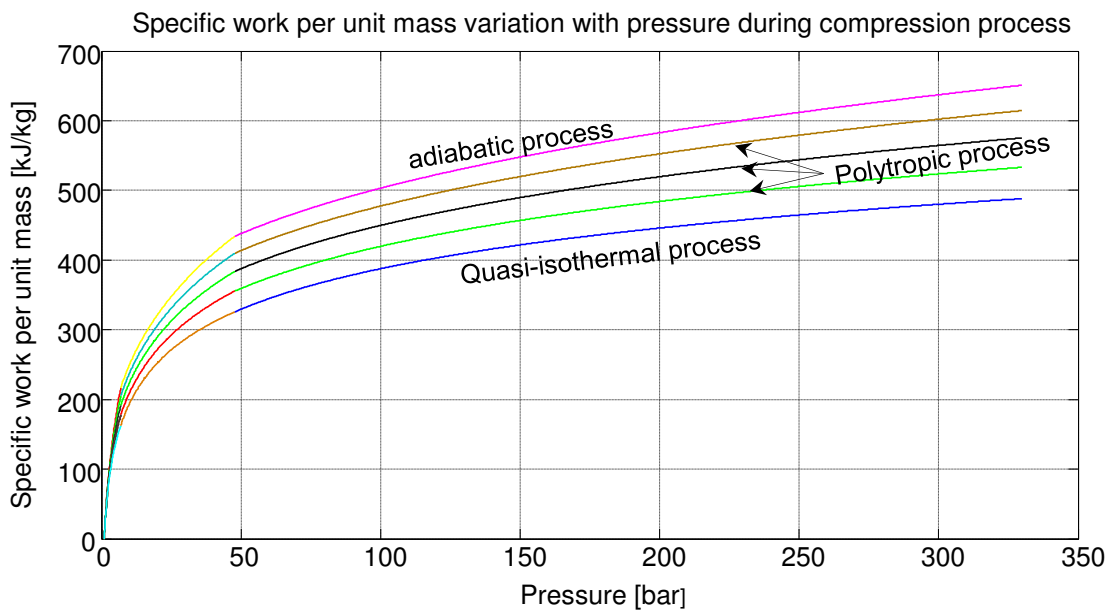


Figure 42 – Representation of specific work per unit mass function of pressure for multi-stage compression

The illustrated figure 41 and figure 42 show that using multi-stage compression then the compression work needed is significantly lower. The surface contents between two curves

represents the economy of work. According to the graphical representation, this economy is maximum when the amount of mechanical work of the 3 stages is minimal.

Table 8 – The amount of energy consumed for a complete charge of the tank

| Single stage | Units | Isothermal | Adiabatic | Polytropic n=1.3 | Polytropic n=1.2 | Polytropic n=1.1 |
|---|-------|------------|-----------|---------------------|---------------------|---------------------|
| Energy required to fill the tank | kWh | 21.5 | 55.01 | 45.18 | 36.2 | 28.3 |
| Three-stage Energy required to fill the tank | kWh | 21.5 | 28.5 | 27.09 | 25.3 | 23.5 |

In table 8 are summarized values of the energy consumed to fulfill the experimental storage vessel at 320 bar, in one or in multi-stage compression with intercoolers depending on what kind of compression process is followed. The storage vessel has 0.3 m³ volume and the air temperature inside the vessel is 300 K.

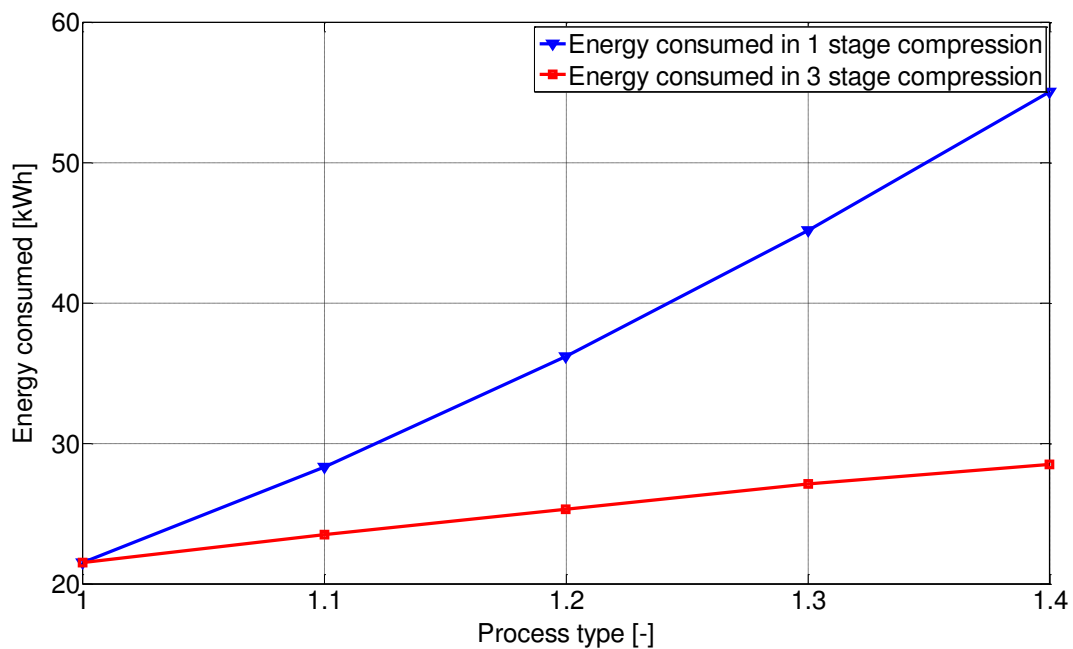


Figure 43 – Energy required to fulfill the storage bootless in 1 and 3 stage compression

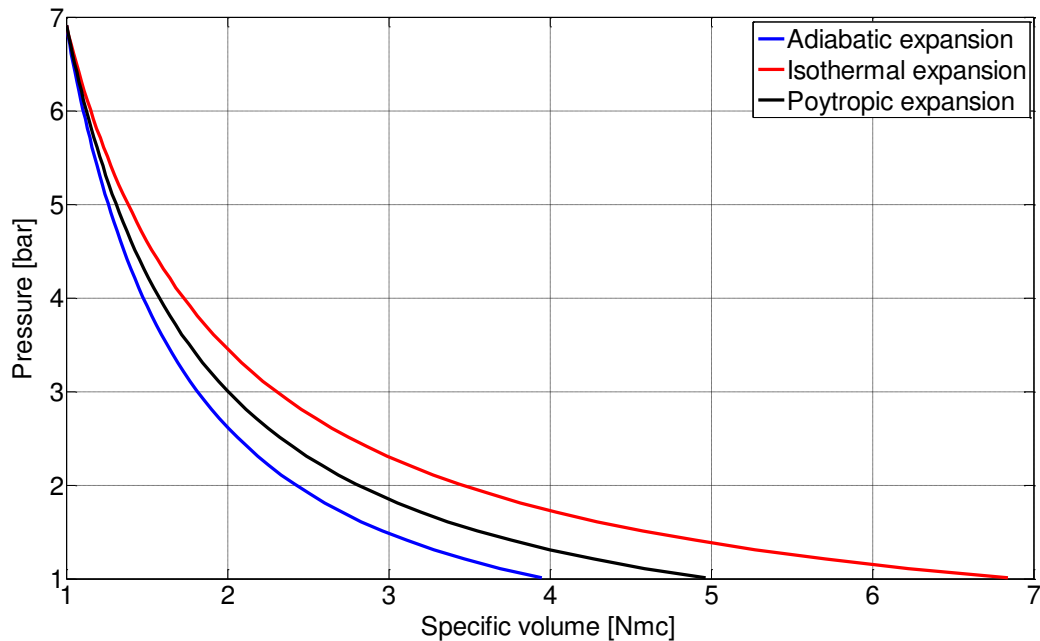


Figure 44 – Diagram for a single stages expansion

Figure 44 illustrates a single stage expansion process for a three-stage expander, all the stages having the same expansion ratio and the volume occupied by the gas. In the same time, table 9 presents the outlet temperature, outlet pressure, the air density and the heat recovered after each stage expansion. Easily can be observed that the contribution of surrounding which bring the air temperature after each stage expansion to the initial value by heating the air is essential.

Table 9 – Results obtained for isentropic expansion

| Three-stage expansion | Units | I | II | III | Single stage |
|------------------------------|-------------------|----------|--------------|------------|---------------------|
| Inlet pressure | Bar | 330 | 47.75 | 6.91 | 330 |
| Outlet pressure | Bar | 47.75 | 6.91 | 1 | 1 |
| Inlet Temperature | K | 300 | 300 | 300 | 300 |
| Outlet Temperature | K | 166 | 166 | 166 | 55.9 |
| Inlet Air density | kg/m ³ | 383.2 | 55.4 | 8.02 | 120.4 |
| Cold recovered | kWh | 3.96 | 3.96 | 3.96 | 7.55 |
| Electricity available | kWh | | 12.14 | | 7.72 |

For a single-stage expansion, the temperature drops to a very low level depending on the polytropic or isentropic process. The lowest temperature is reached for an adiabatic expansion when no heat is exchanged with the environment. Having a higher pressure from which is made

the expansion a lower value for the temperature which leaves the expander is obtained, this value could be closer to the melting point of the air or even exceeded. This very low value of temperature indicates that technical problem can occur and limit the extraction of mechanical work from the pressurized air.

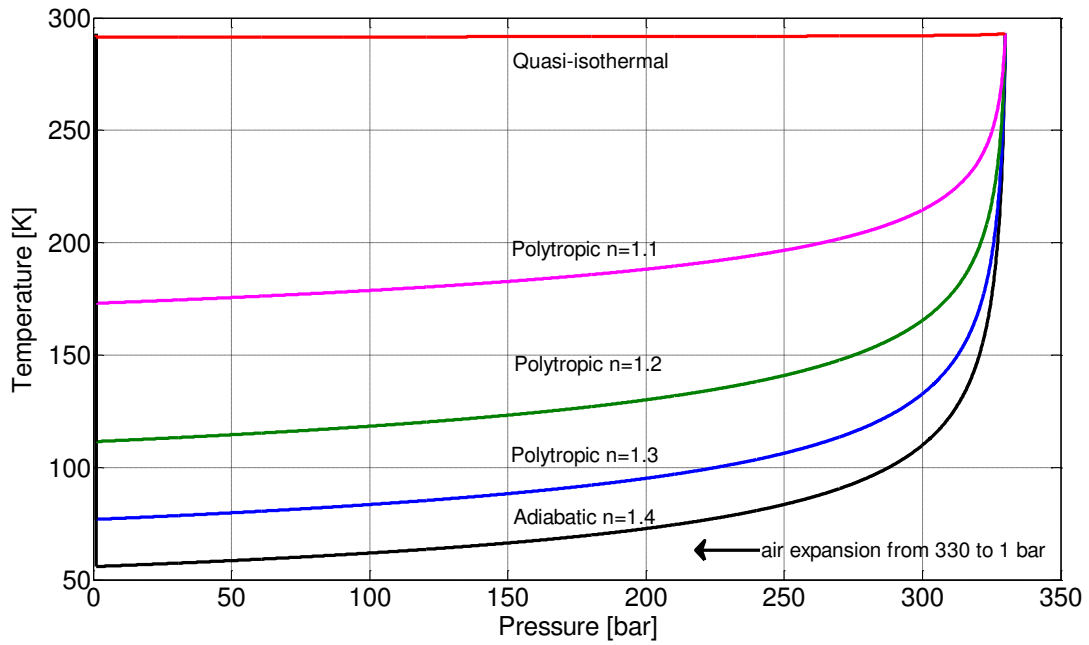
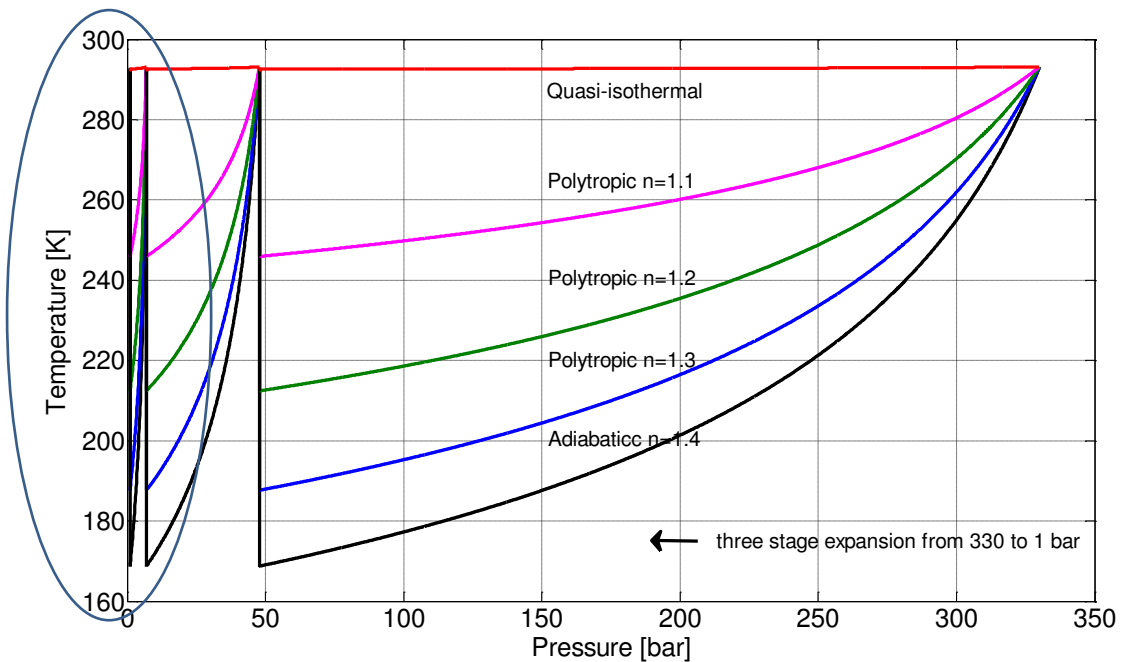


Figure 45 – Temperature variation for a single stage expansion



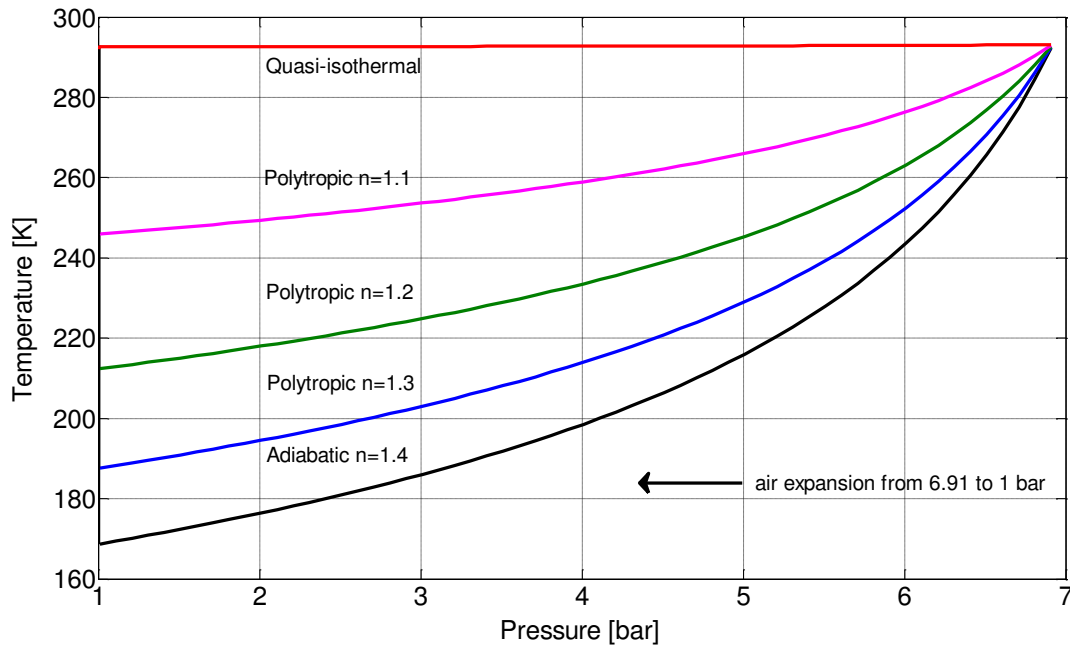


Figure 46 – Temperature variation for three-stage expansion

Figures 45 and 46 show that the temperature variation during expansion process depends only by the expansion ratio and the polytropic exponent. For an adiabatic expansion of the air no heat exchanged with the environment the predicted results for temperature after expansion are very low, less than -100 Celsius degree in the case of a three-stage expansion with air reheated up to the atmospheric condition between the expansion phases, and about -180 Celsius degree in the case of a single stage expansion when the temperature comes to be close to the melting point of the air. These very low values of temperature can significantly influence the operation of the equipment, appearing the possibility of the frost phenomenon of the bearings.

So, the first part of figure 46 illustrates a three-stage expansion process, while at the bottom, the second part is focused on the first of a three-stage compression train.

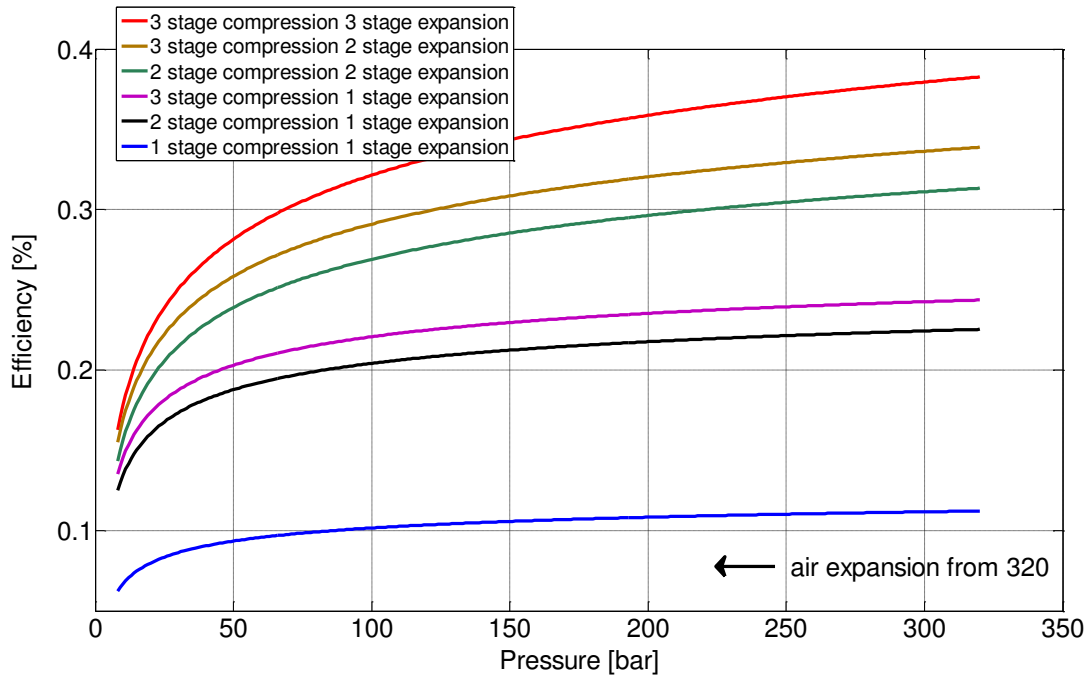


Figure 47 – Graphical representation of efficiency function of input expander pressure - adiabatic process

Throttling the upstream air to a fixed input expander pressure it could be seen which the efficiency of the system for that parameter is, and the dependency by the number of stages. Should be mentioned that when the air is released from the storage vessel it's at ambient temperature. The higher the pressure at which the air is throttled the higher obtained system efficiency is.

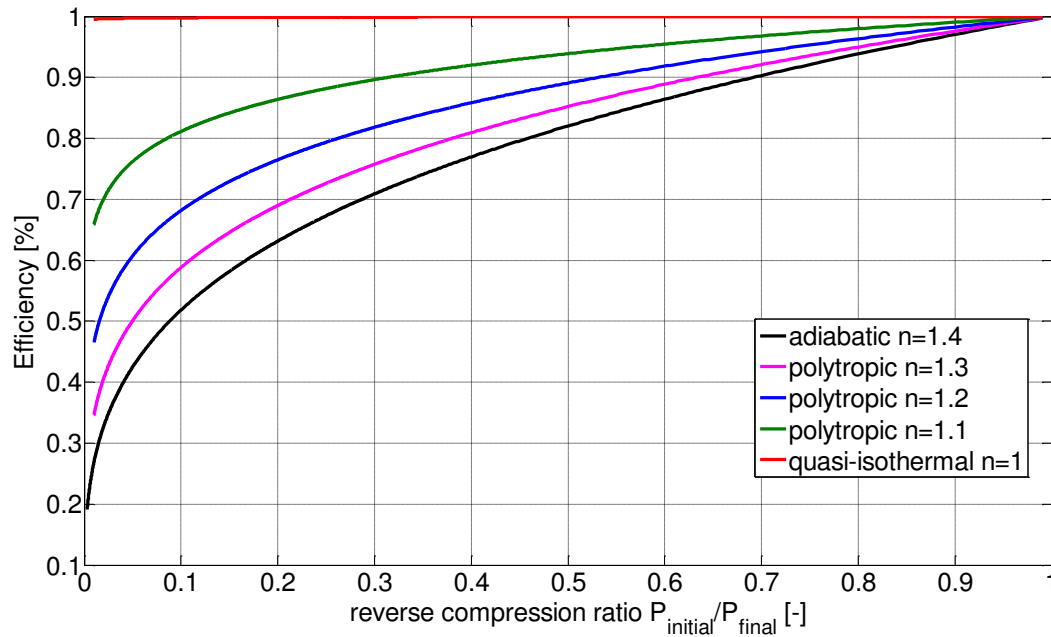


Figure 48 – The addition of the cycle efficiency by the compression ratio and the polytropic index

The current diagram shows that the efficiency of the cycle depends only by compression ratio and the isentropic or polytropic exponent. The efficiency is higher as long as the thermodynamic transformations are closer to an isothermal process and as well when the compression ratio is increasingly less.

Another scenario which was taken into consideration was that when the heat resulted during compression is stored in a thermal energy storage system and used later to reheat the air before the expansion process. In this case, the primary efficiency of the system increases considerably but eliminate the possibility of providing to the final user other form of energy, as heat and cold.

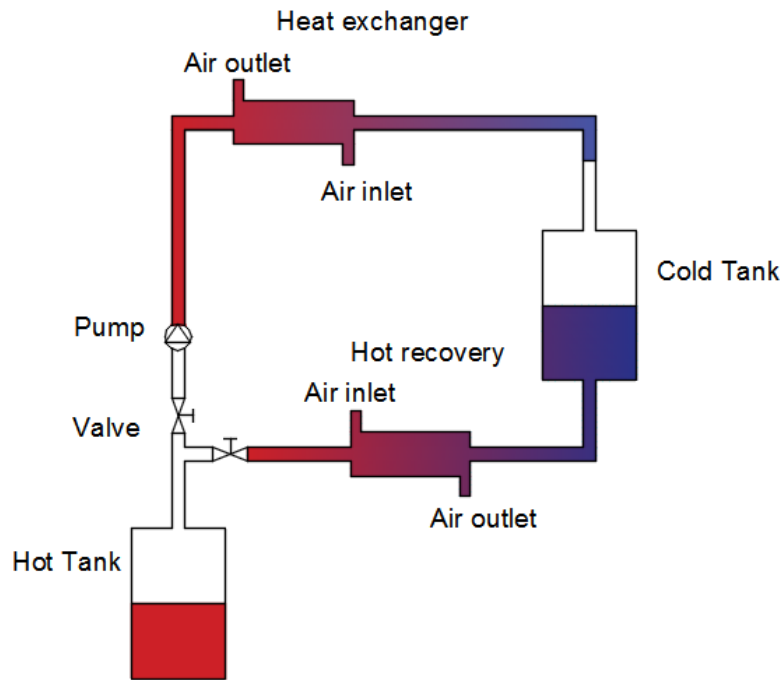


Figure 49 – Thermal energy storage system

For the thermal energy storage, the preferred solution consists in 2 tanks, one cold, and one hot and where the storing working fluid is pumped from one tank passing through two heat exchangers where is heated or cooled as needed and stored to the other. To obtain the perfect cooling or the imposed temperature to the inlet of the storage vessel is possible by controlling the mass flow rate of the cooling working fluid.

Considering a theoretical compression at 100 bars and expanding the air from 50 bars by throttling the inlet air engine pressure the following values presented below for the efficiency have been obtained. In order to obtain the same efficiency for different configurations with one, two or three stages for compression and one and two stages for expansion it was calculated the inlet air engine temperature.

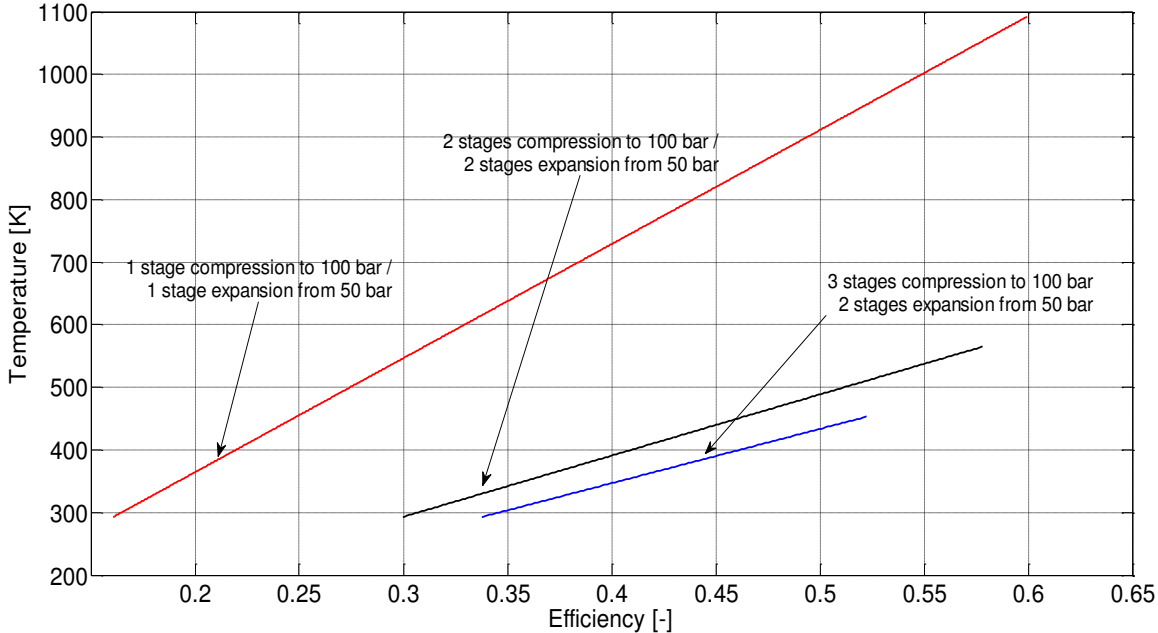


Figure 50 – System efficiency for different scenarios

In figure 50 is represented the dependency between the air inlet expander temperature and the system efficiency. Can be seen as air is heated to a higher temperature even higher efficiency is obtained.

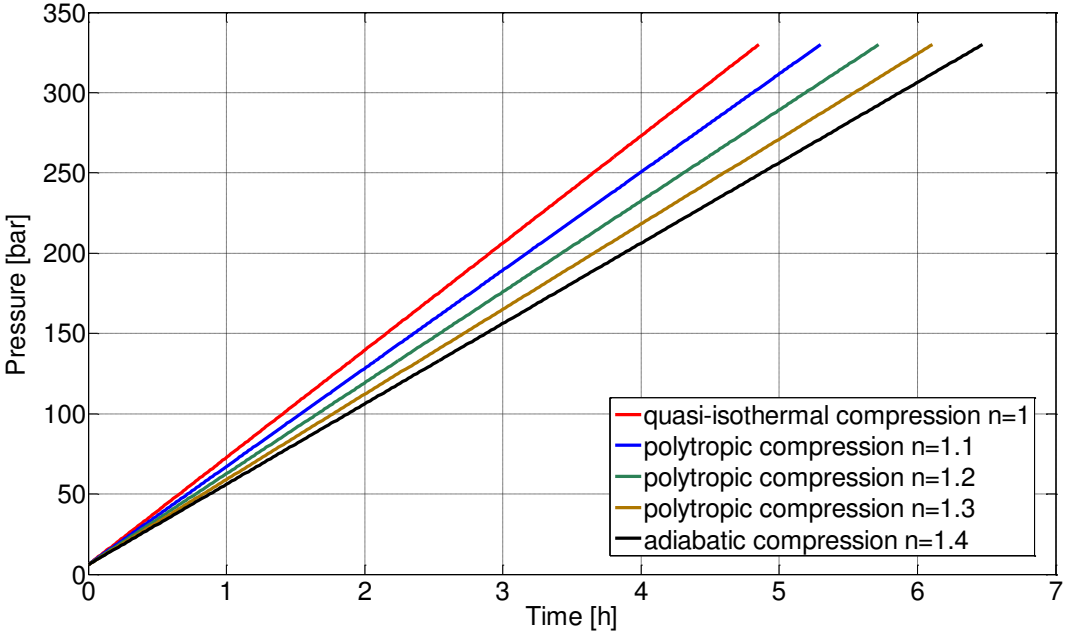


Figure 51 – The time required for charging the tank depending by the thermodynamic compression process

The storage vessel used for experimental set-up consists in a stack of 6 bottles of 50 liters each. The time required to fill the storage vessel knowing the maximum power consumed by the air compressor 4 kW and the fact that the pressurized air is stored at ambient temperature. In figure 51 is presented the time required to fill a storage vessel of 0.3 m³ in 3 stage compression at 330 bar function of the nature of the process.

7. Experimental set-up representation

In order to validate our assumptions, an experimental laboratory stand was built. The experimental stand configuration is presented in figures 52 and 54, however, in figure 53 an ideal configuration on the side of air expanding is illustrated.

- Compression – 3 stages compression process,
- Expansion – 1 (experimental) or 3 (theoretical) stage expansion process.

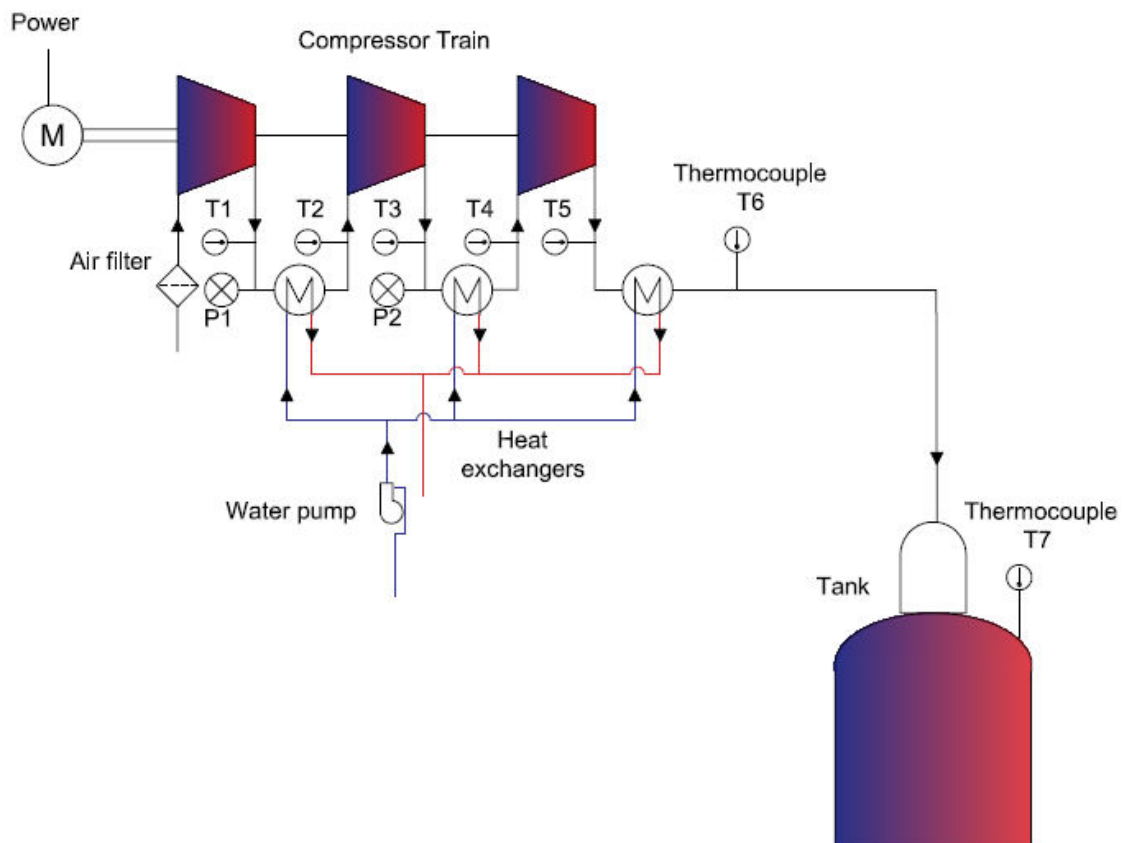


Figure 52 – Compression phase experimental set-up

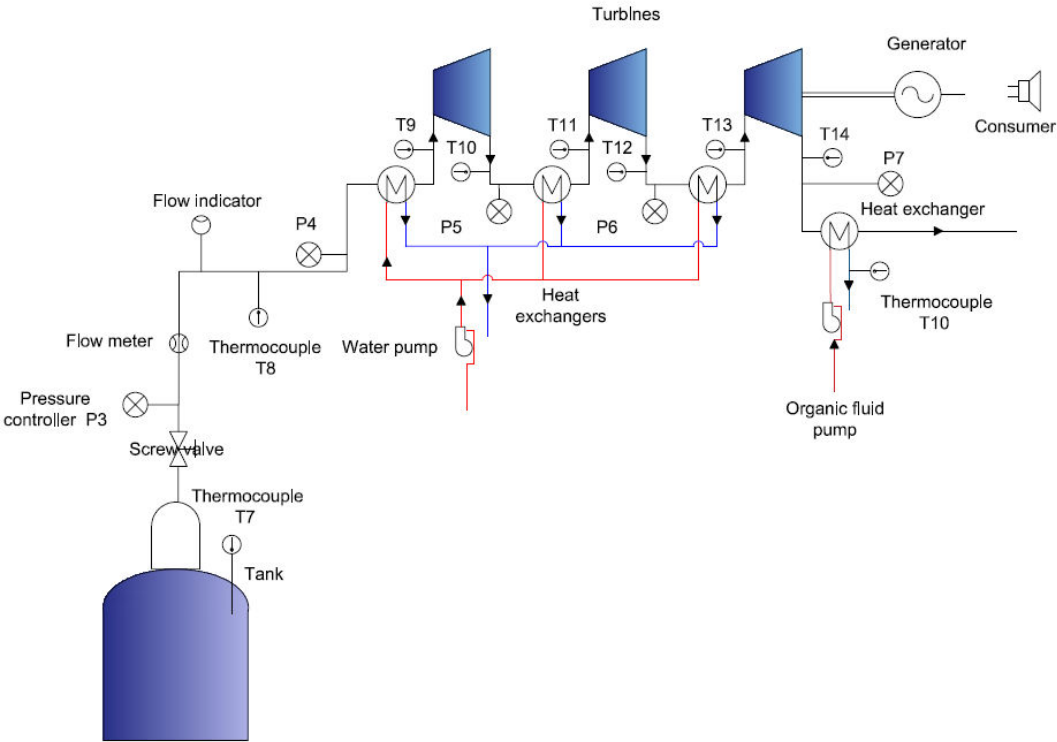


Figure 53 – Expansion phase theoretical set-up

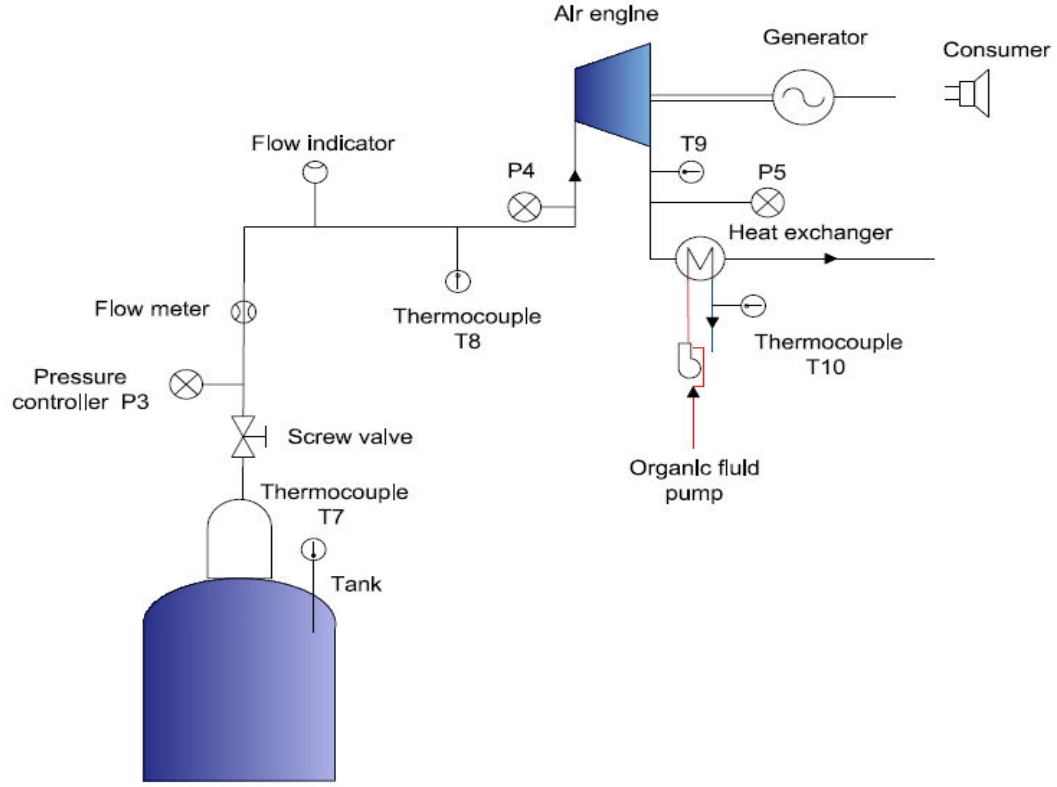


Figure 54 – Expansion phase experimental set-up

For the automatization and control part, it has been used the LabView software from the National Instruments. The program records values from different sensors and lets the user to interpret them subsequently. Through the measurements can be noted values during the charging process for: the room temperature, the air relative humidity, the air temperature into the storage vessel, the air temperature before and after each stage compression, the air pressure after each stage compression, the air mass flow rate, the compressor energy consumed; for the discharging process: the air temperature into the storage vessel, the air temperature before and after the control valve, the air temperature at the inlet of the air engine, the air temperature at the outlet of the air engine, the air pressure before and after the control valve, the air pressure at the outlet of the air engine, the air mass flow, the air engine revolutions per minutes, the power generated by the electric generator.

The software through the graphical interface offers to the final user the possibility to control the system functionality. Mostly the control refers to the consumer needs and to their power consumption requirements. By controlling the air engine pilot pressure is controlled the air mass flow which goes into the air engine.

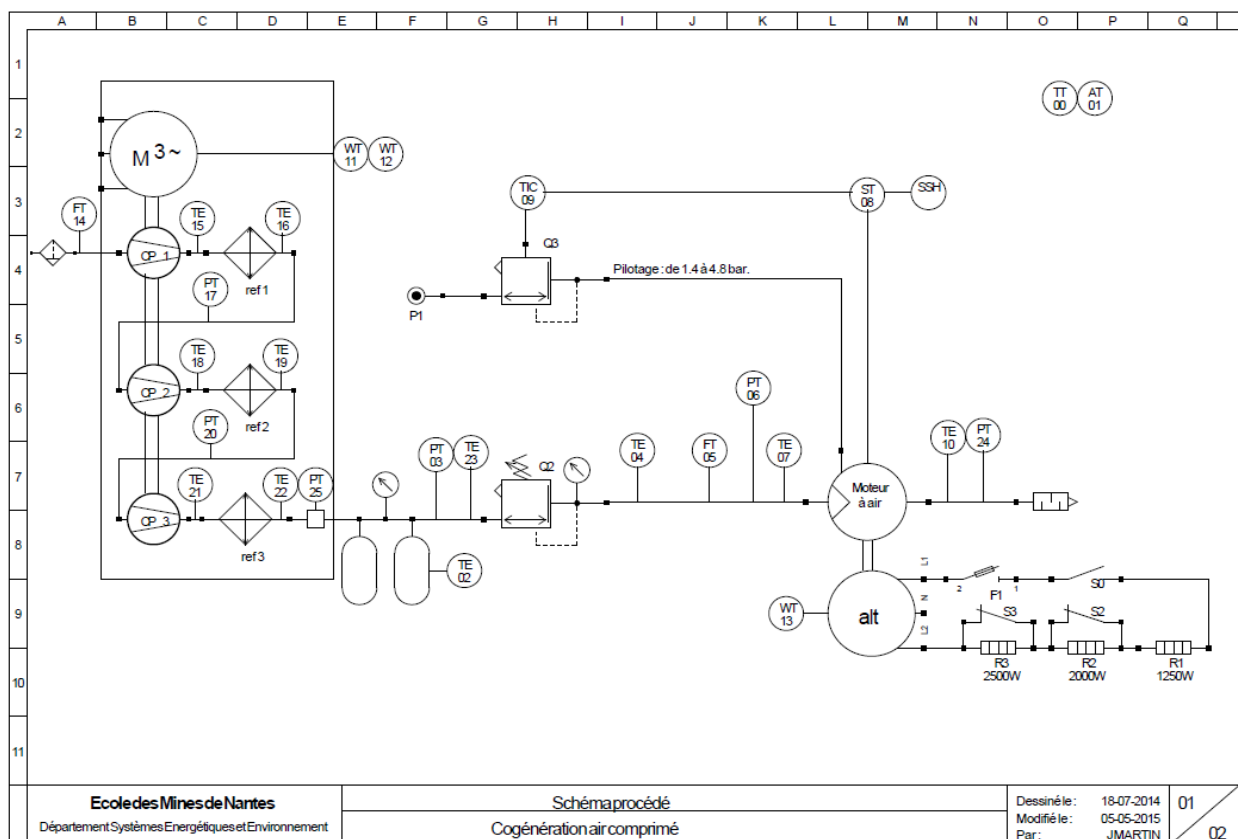


Figure 55 – The graphics interface in LabVIEW for the automatization part



Figure 56 – Compressor side view



Figure 57 – Storage vessel side view

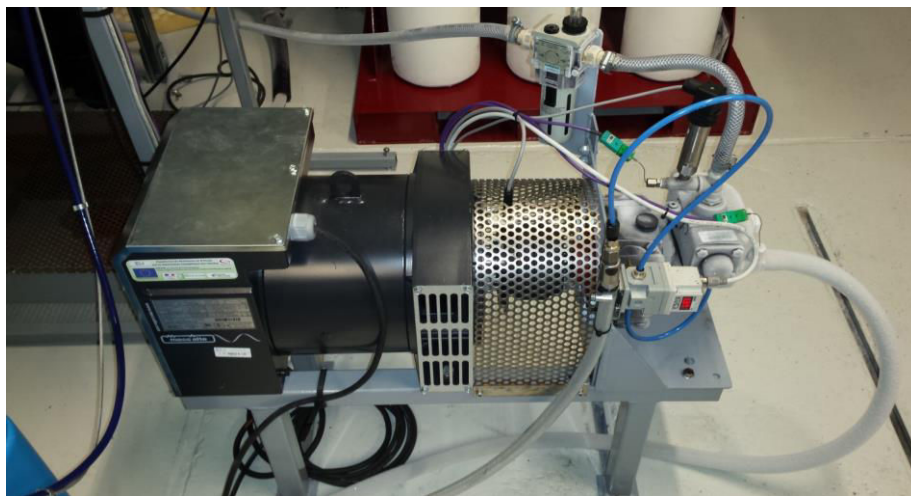


Figure 58 – Air engine side view

7.1. The air compressor characteristics

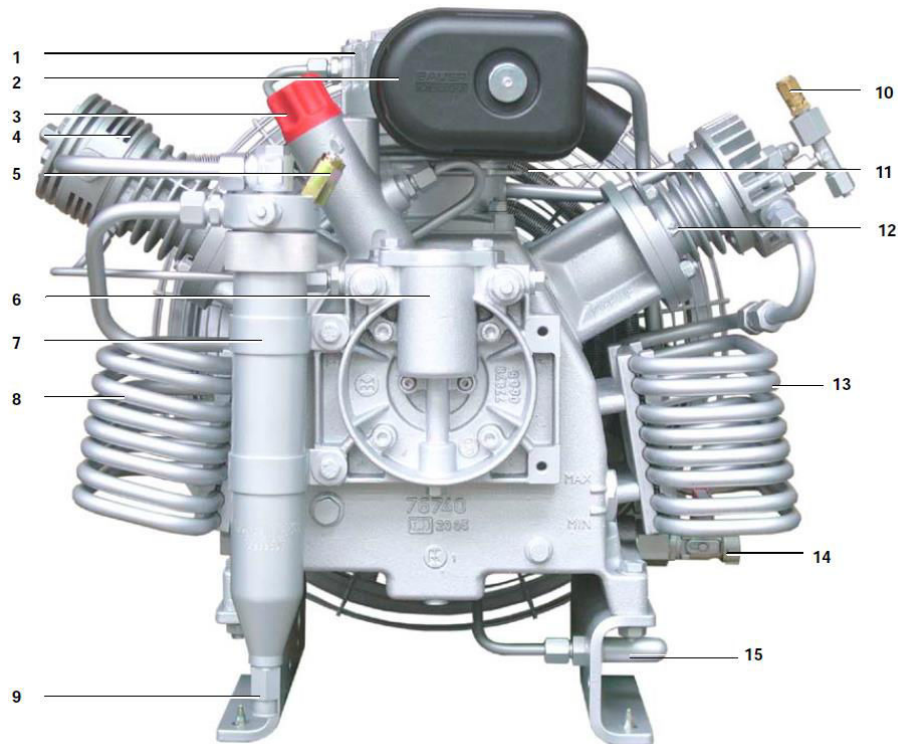


Figure 59 – Compressor block IK120, front view [Source: user manual manufacturer]

Cylinder 1st stage (1), Intake filter (2), Oil Filter neck (3), Cylinder 3rd stage (4), Safety valve 2nd stage (5), Oil filter housing (6), Intermediate separator 2nd stage (7), Inter-cooler 2nd stage (8), Condensate drain connector (9), Safety valve 1st stage (10), After-cooler (11), Cylinder 2nd stage (12), Inter-cooler 1st stage (13), Oil drain tap (14), Air outlet connector (15).

| Compressor block IK120 | |
|--|------------------------------|
| No. of stages | 3 |
| No. of cylinders | 3 |
| Cylinder bore 1st stage | 88 mm |
| Cylinder bore 2nd stage | 36 mm |
| Cylinder bore 3rd stage | 14 mm |
| Piston stroke | 40 mm |
| Direction of rotation – viewing at flywheel | Counter-clockwise |
| Intermediate pressure 1st stage | 6 to 6.5 bar |
| Adjustment, safety valve 1st stage | 8 bar |
| Intermediate pressure 2nd stage | 38 to 45 bar |
| Adjustment, safety valve 2nd stage | 60 bar |
| Compressor block capacity | 2.8 liter |
| Oil type | Synthetic oil or mineral oil |
| Oil pressure | 5 bar |

The air compressor used in the experimental part is a MV 3 Mini-Verticus model from Bauer manufacturer. The air compressor unit is designed for compression of industrial air in the high-pressure range. The maximum operating pressure of the compressor is 330 bar. The compressor block consists in three-stage compression and after each stage compression, the compressor is equipped with intercoolers to cool the air before entering in the next stage of compression. The air compressor not being designed express to be used in the field of energy storage the heat resulted during the air compression process is dissipated throughout a fan connected to the compressor shaft.

The current compressor still being an industrial one it is provided with three suction valves and three discharging valves, one for each stage of compression. Nevertheless, the principle they work is different. For the first two stages, the discharging valve is opening when the air inside the cylinder reaches a certain value of pressure. Meanwhile, the third discharging valve works function of a differential pressure. So this valve starts opening at 170 bar indifferent of the air pressure inside the tank, and this value increases once with the air pressure into the tank.

In the compressor compound is found a dry micro-filter used to filter the intake air. These kinds of cartridges are replaceable. However the compressor is also provided with two separators, an intermediate separator is mounted on the 2nd stage and is designed to remove the content of water and oil accumulating due to the cooling process after compression, a final separator is mounted after the 3rd stage compression to increase the degree of dryness air that goes to the storage vessel. According to the manufacturer the air that leaves the final stage of compression

is cooled in the after-cooler to a temperature of approximately 10 to 15 °C above ambient temperature.



Figure 60 – Pressure and temperature cylinder monitoring

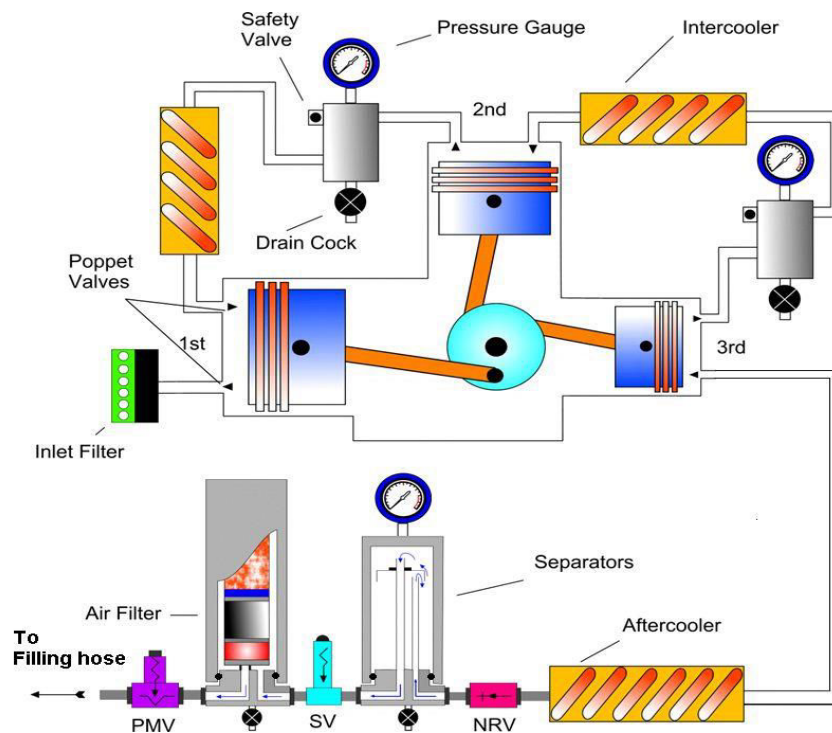


Figure 61 – Compressor schematic representation [copyright (c) C Stewart Meinert. The Association of Scuba Service Engineers and Technicians / www.scubaengineer.com]

NRV – non-return valve, SV- safety valve, PMV – pressure maintain valve

7.2. Charging//Discharging valve

For a rational design, the suction and the discharging valves of the reciprocating piston air compressor are designed to work in a way which could permit to work in optimum operating conditions, and to the power consumed by the compressor to be minimum. Usually, these are spring valves where a pressure is applied to a surface and holds it closed due to the spring in their mechanism. The suction valve is opened during the recession of the piston and provides the absorption of the air from outside into the cylinder. During all this process the delivery valve is closed. The discharging valve is opened when the piston moves forward and deliver all the air absorbed in the cylinder to the system. When this process happens the suction valve is closed.

7.3. Pressure regulator

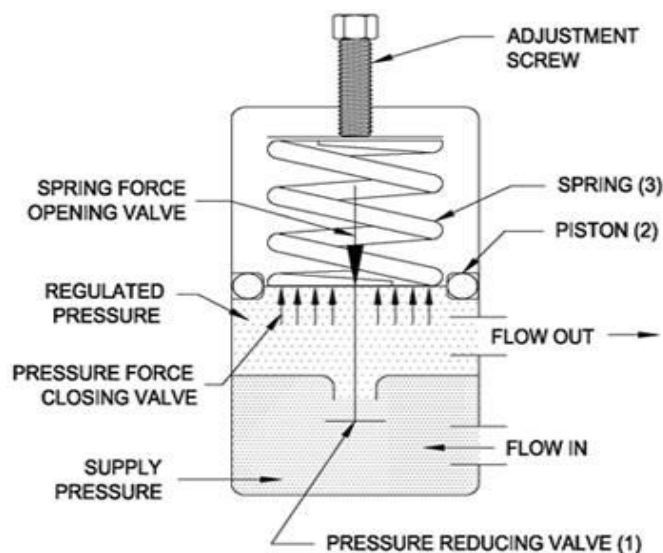


Figure 62 – Illustration of a pressure regulator showing forces acting on the individual elements [93]

A pressure regulator has used the control the air engine inlet pressure. Pressure regulators maintain the pressure at a constant value, prevent potential fluctuations and allow an easy control of the desired power. The main components of a pressure regulator are presented in figure 62: (1) the pressure reducing valve (the poppet), (2) the piston or diaphragm and (3) the spring. The most common regulators employ a spring loaded valve (poppet) as a restrict element. The poppet includes in its design a thermoplastic seal which has the role to seal the valve seat. When the spring force moves the seal away from the valve seat, fluid is allowed to flow from the inlet of the regulator to the outlet. Once the outlet pressure rises, the force

generated by the piston/diaphragm resists the force of the spring and the valve stay closed until these two forces reach a balance point at the set point of the pressure regulator. In the moment that the downstream pressure drops below the set-point the spring pushes the poppet away from the valve seat and allow to the additional fluid to flow from the inlet to the outlet until the force meets a balance again. The pressure set-point is adjusted through a knob which is turned clockwise to compress the spring and to exert a downward force on the piston, which pushes the valve to stay open. The reduced pressure in the valve chamber means a lesser upward force of the high-pressure gas in valve chamber acting on the valve. This force combined with the upward force exerted by the valve spring and the upward force of the high pressure gas in valve chamber acting on the valve becoming lesser than the downward force on the piston exerted by the spring making the piston to move down and letting the valve to open and allowing more gas to fill the low-pressure chamber resulting in an increase in the outlet pressure [93].

7.4. Air engine description

The air engine used in the experimental set-up is a Globe RM 110 radial piston air engine. The RM 110 motor has four cylinders, radial piston designs with oil bath lubrication. The air mass flow aspirated by the air engine is controlled by the remote control valve throughout a signal sent from a computer to the valve spool. Thus a pilot pressure ranged between 1.4 bar and 4.8 bar is applied to control the air engine rotation and direction.

Graphs from figure 67 show the operating parameters of the air engine function of the mass flow and the inlet pressure and the rotation motor speed. So, in order to produce a required power the air engine needs a specific speed and a certain mass flow rate for a fixed inlet pressure. Consequently, the power delivered by the air engine can be controlled by controlling the air mass flow rate or the air engine inlet pressure.

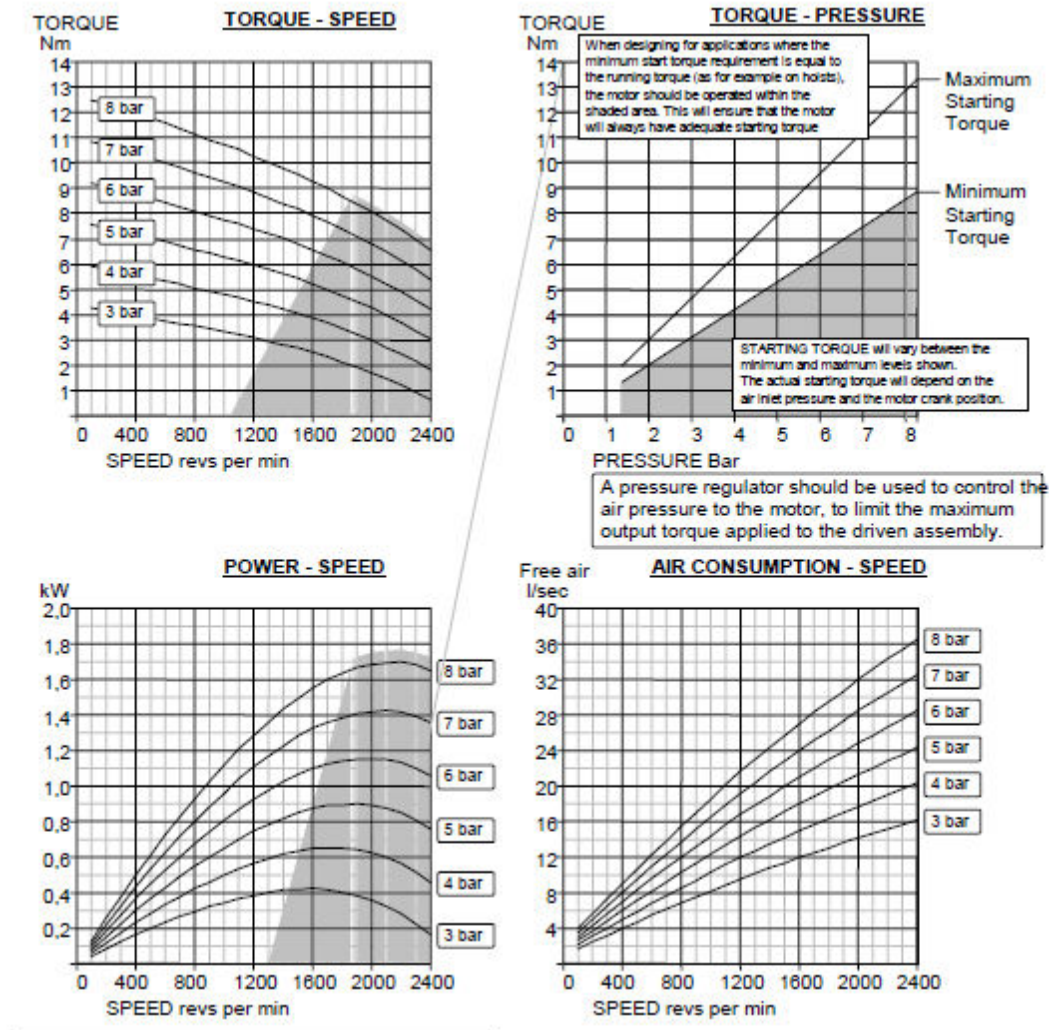


Figure 63 – The RM 110 air engine performance [Source GLOBE Airmotors]

7.5. The electric generator

The generator used in the experimental set-up is a ECP3-2S/4 model. ECP3 with two and four pole alternators are brushless, self-regulating and incorporate a rotating inductor and a fixed stator. This model is a 3 phase generator and it can be powered until 8 kVA (6.4 kW for $\cos\phi=0.8$). For 1 phase connection it can power until 5.5 kVA ($\cos\phi = 1$).

| Type | KVA - $\cos\phi = 0.8 \rightarrow$ 3 phase | KVA - $\cos\phi = 1$ or $\cos\phi = 0.8 \rightarrow$ 1 phase |
|-----------|--|--|
| ECP# 2S/P | 8 Efficiency 80.4% | 5.5 or 5 |

7.6. Mass flow meter

A mass flow meter manufactured by Brooks from Mf series is used to measure the mass flow that goes to the air engine. The mass flow meter can measure a mass flow rate in the range of 0 to 100 m³_N/h and can operate at any pressure lower than 50 bar. On the controlling part to fix a set point value means to control the valve that can be fully opened or closed via the valve override feature by simply providing a voltage signal through the interconnection wiring or through digital communications.

7.7. Consumers

Four different size resistors were chosen as consumers for the experimental study. The resistor with the highest value measures 1250 W, meanwhile, the resistance with the lowest value measures 585W. These had the objective to simulate scenarios as real as possible, taking into consideration that are periods when the consumer requires a larger amount of power and periods when just a small part of what the air engine can supply is necessary.

7.8. Pressure, temperature and humidity sensors

For the pressure measurements a series of floating piezo-resistive transducers were used in order to find the air pressure value along the entire route. Meanwhile, for the temperature, a series of thermocouples were mounted throughout the path of the air from when is sucked up until is discharged to the environment. All values were recorded on a PC with the help of the software LabView and a series of the interface cable.

7.9. Power meter ProWatt-3

ProWat-3 provides a comprehensive snapshot of power quality and energy consumption. Measures voltage, amps, power, energy, harmonics and more. However, the only parameters that we were interested are power and energy consumption of the air compressor.

7.10. Power AC analyzer Pm 1200 Voltech

The Voltech is a precision power analyzer designed to provide clear and accurate measurements of electrical power and energy. It can be used in both as a bench instruments or

as a programmable automatic interface via a RS232 or USB connection. It has the capabilities to measure Watts, Volts, Amps, Volt-Amperes and Power factor. The range of measurements for power is very wide from milli-watts to megawatts.

7.11. Experimental results

In the following subchapter are presented a couple of graphs where are illustrated all the variations of the involving parameters: powers, energies, pressures, temperatures, in the charging, storage and discharging processes.

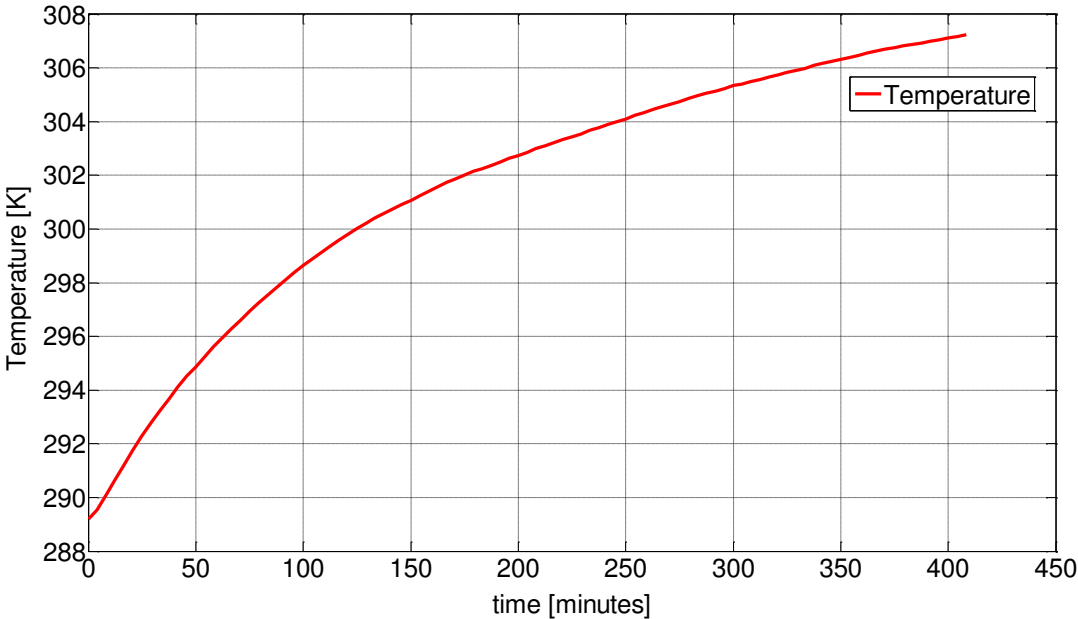


Figure 64 –The air temperature into the tank variation during the charging process

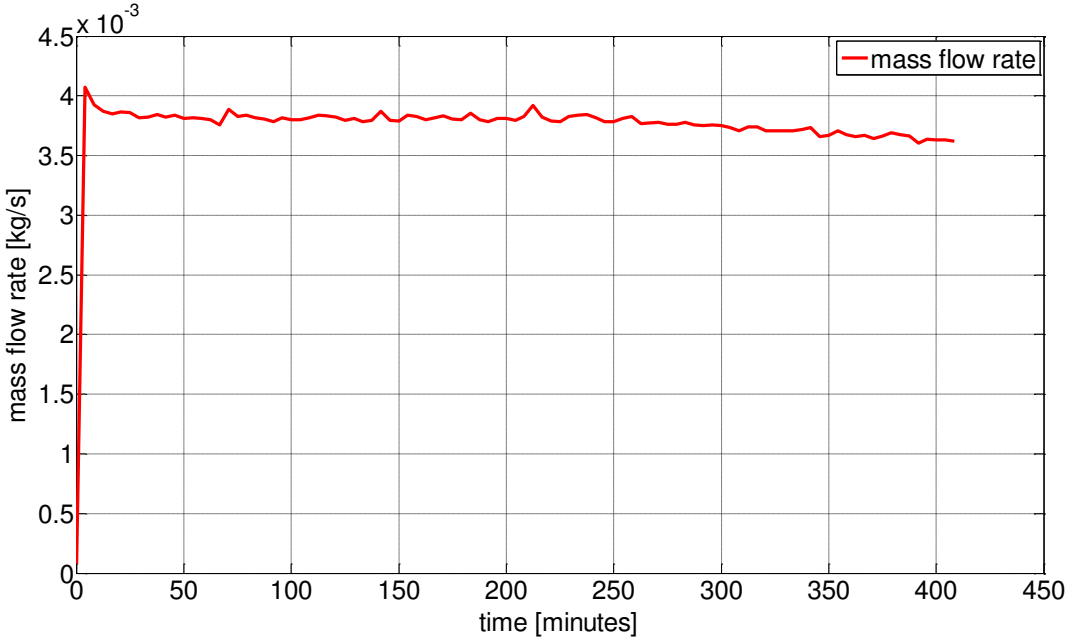


Figure 65 – The air mass flow succeed variation during compression process

In figures 64 and 65 are presented the air temperature variation into the tank where the air is stored and the mass flow of the air which comes from the compressor during the charging process. The upward sloping tending to stabilize the air temperature at the outlet value of the last heat exchanger.

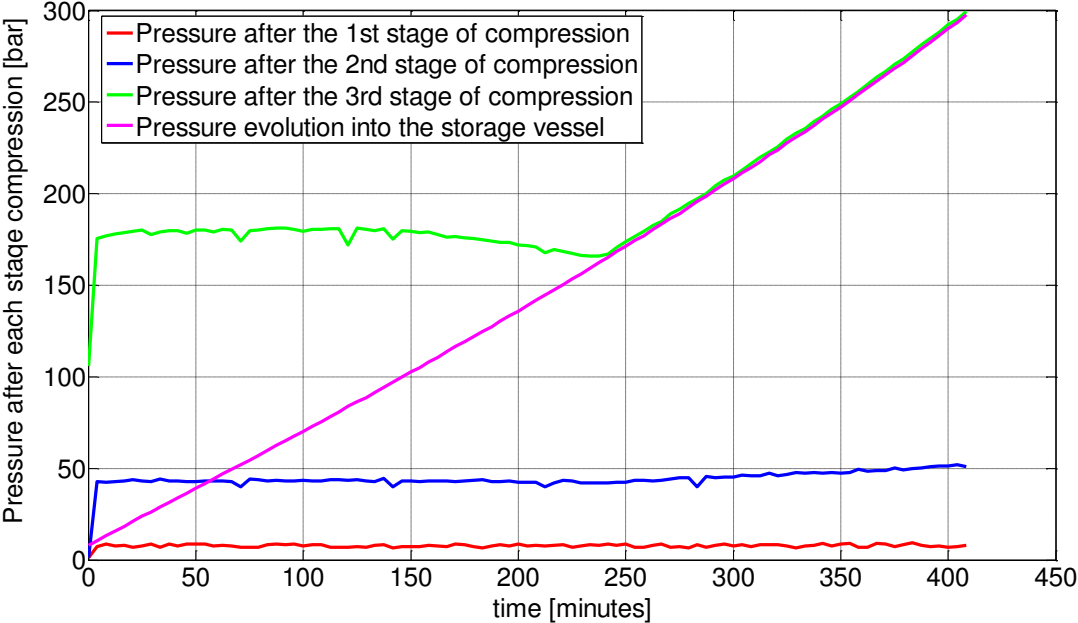


Figure 66 – The air pressure evolution after each stage of compression

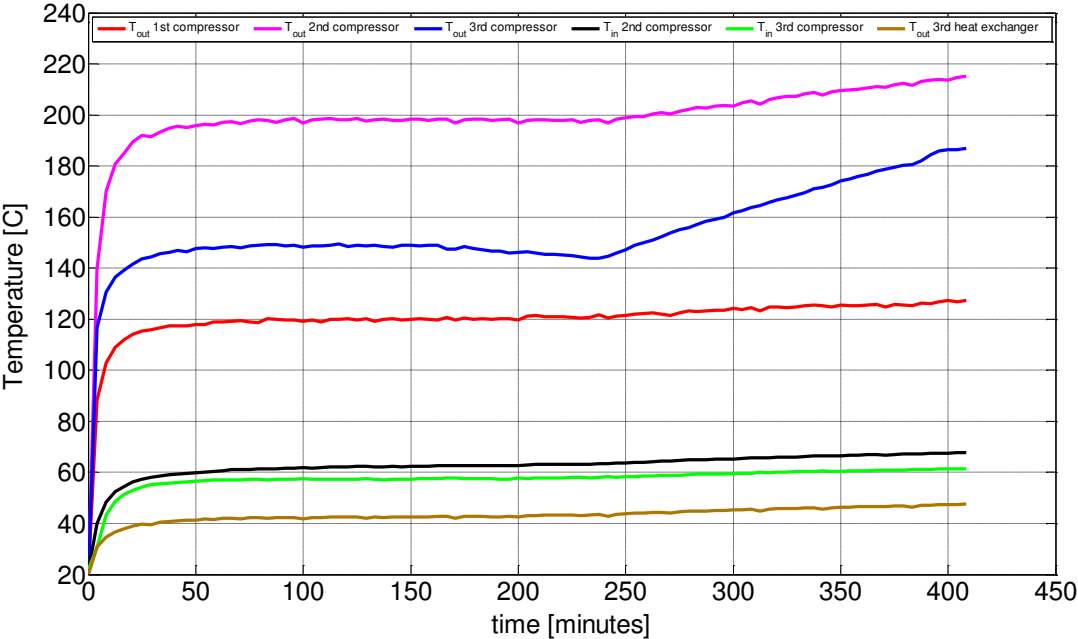


Figure 67 – Experimental measurements of temperature before and after each stage of compression

Figures 66 and 67 present the temperature and the pressure values after each stage of compression. Both figures show that the 3rd stage of compression has a different behavior comparing with the other two. If in the first two stages the discharging valves open at a constant value of pressure, in the 3rd stage the discharging valve opens first at a constant value of pressure at about 170 bar, then when the pressure into the storage vessel reaches this value the discharging valve starts to work based on a differential pressure.

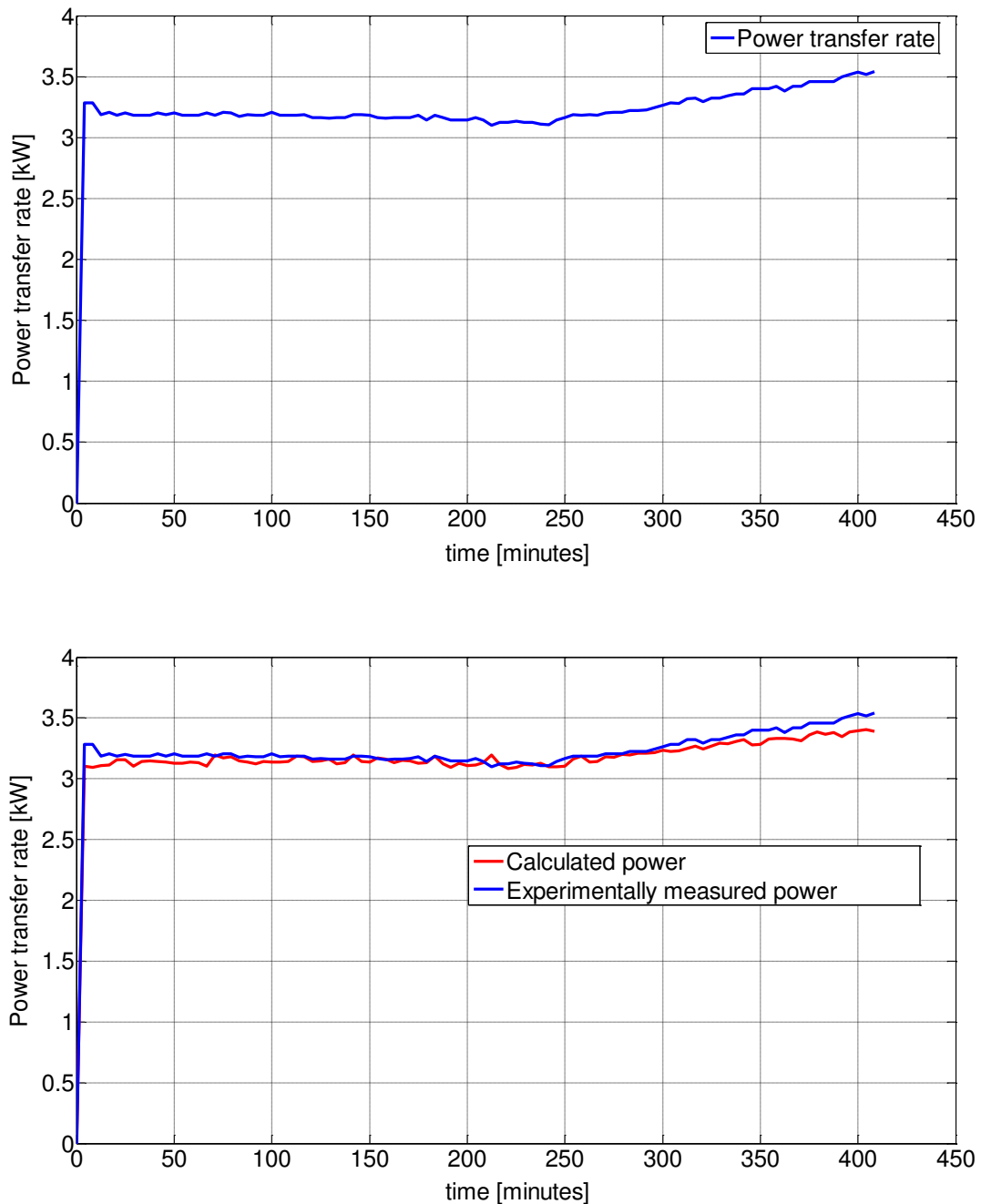


Figure 68 –The power consumed by compressor during compression process

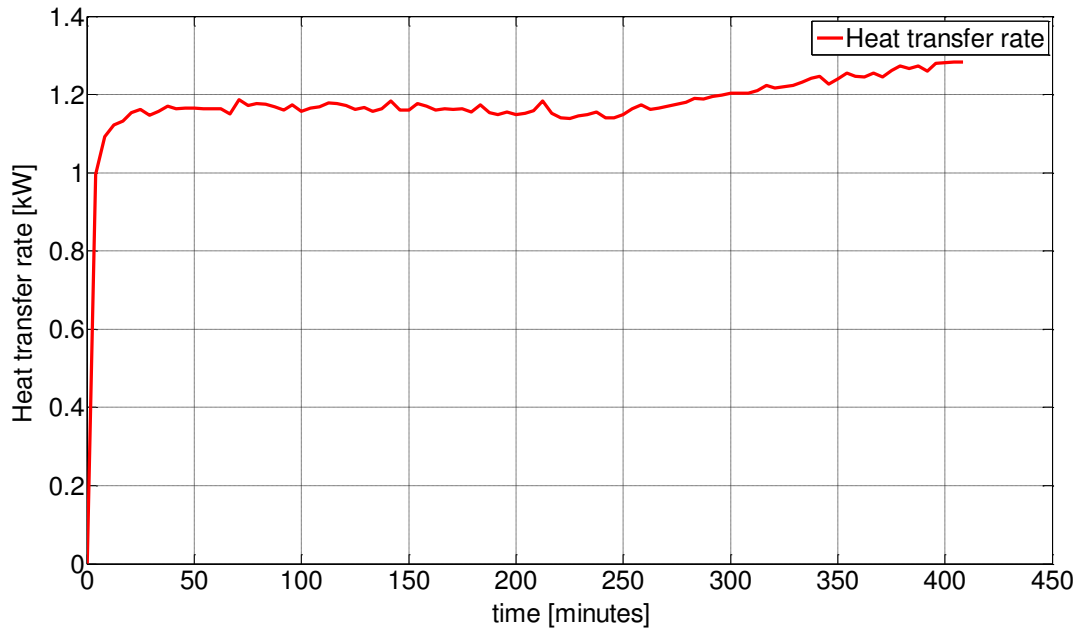


Figure 69 – The heat transfer rate resulted during compression process

Figure 68 illustrates at beginning the power consumed by the air compressor, obtained by experimental measurements, blue curve, meanwhile, the red curve represents the power consumed to compress the air obtained by calculations using equations Eq. 5.36 and Eq. 5.40, where all the other parameters used in the equations, like: mass flow rate, pressures, temperatures, and polytropic exponent are obtained from experimental measurements.

Figure 69 shows the amount of heat transfer variation resulted during the compression process. This energy can be stored for later use. In our experimental set-up, using an industrial compressor the resulted heat is dissipated through a fan connected to the compressor shaft, so, we can mention that the intercoolers and the aftercooler are cooled in air flux.

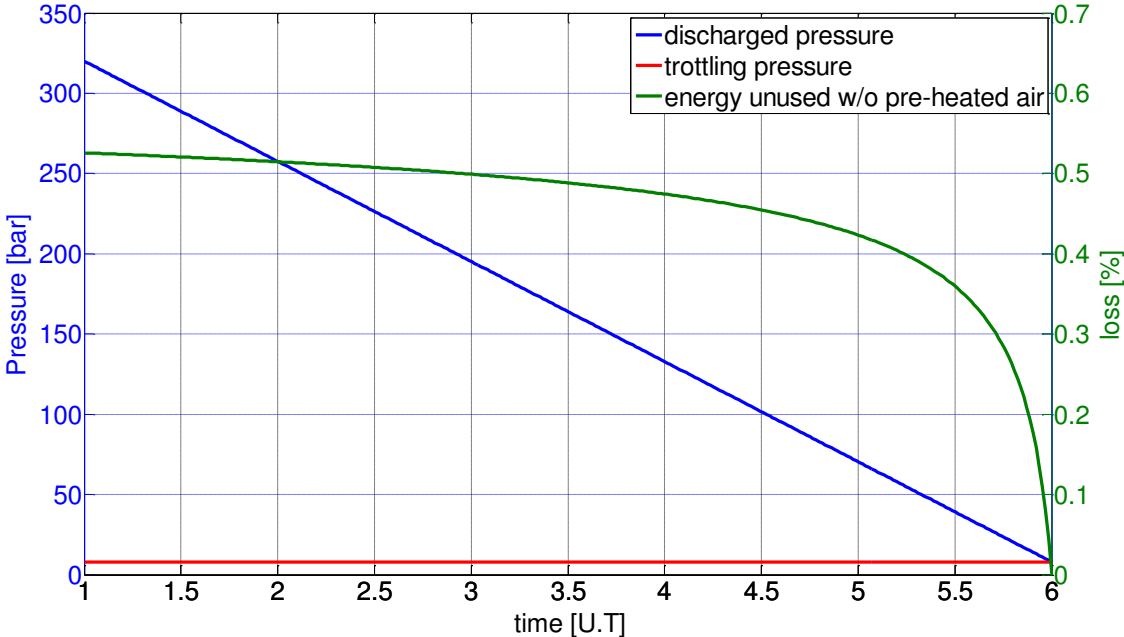


Figure 70 – Theoretical value for the energy unused by using the throttled valve in the case in which the air is not pre-heated before expansion process

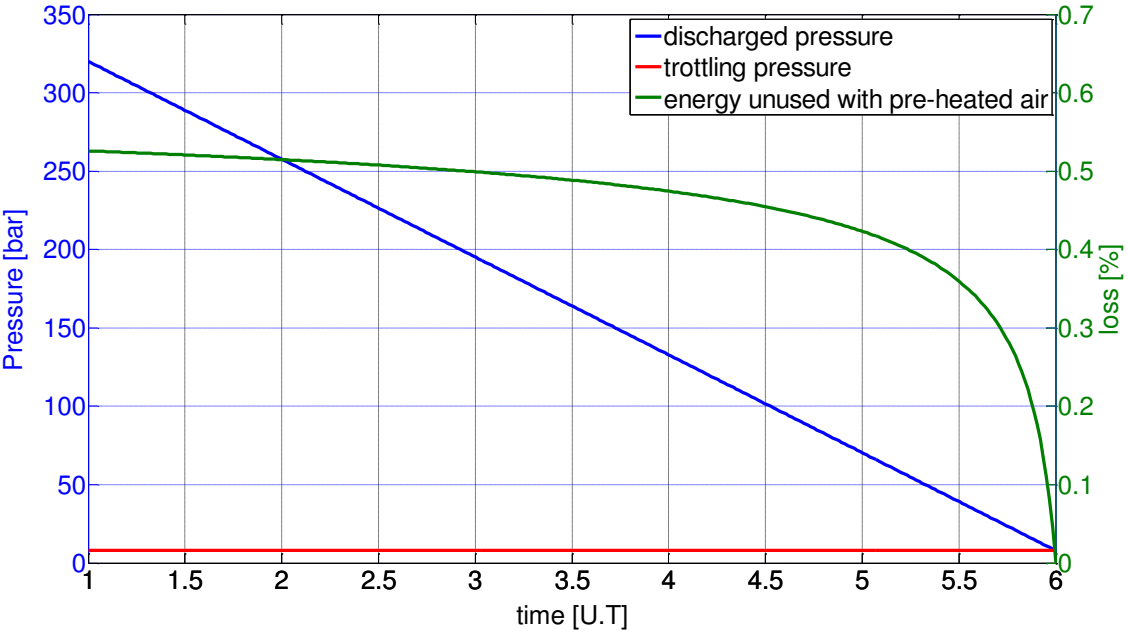


Figure 71 – Theoretical value for the energy unused by using the throttled valve in the case in which the air is pre-heated before expansion process

By throttling the upstream air to a constant pressure an important part of the energy is “destroyed”. This value of energy un-used depends on the storage pressure ratio. The above graphics figures 70 and 71 show this loss for a simplified hypothesis in which the air

temperature inside the tank remains constant during the expansion process, a fact which is almost impossible once with the increasing of the storage vessel pressure ratio and if the process is not a slow one. It's noted that these losses are not influenced by the air heating having the same values even if the air is heated or not, in fact, the maximum and minimum work done by the compressed air increase with the same ratio if the air is preheated before being expanded in the air engine

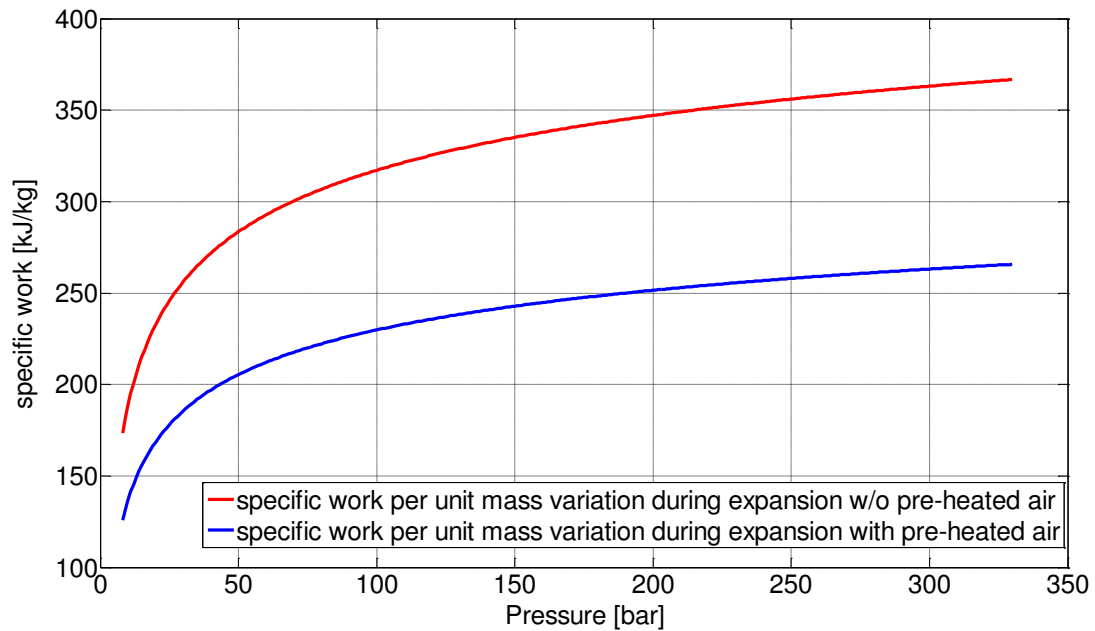


Figure 72 – Specific work per unit mass variation during a single stage expansion

In figure 72 are presented the specific work per unit mass values depending on the inlet air engine pressure. The expansion process was simulated in a single stage and the blue curve takes into consideration the inlet air engine temperature having a value equal to the surrounding's temperature. In the case of the red curve, a part of the heat resulted from compression is used to reheat the air before expansion process.

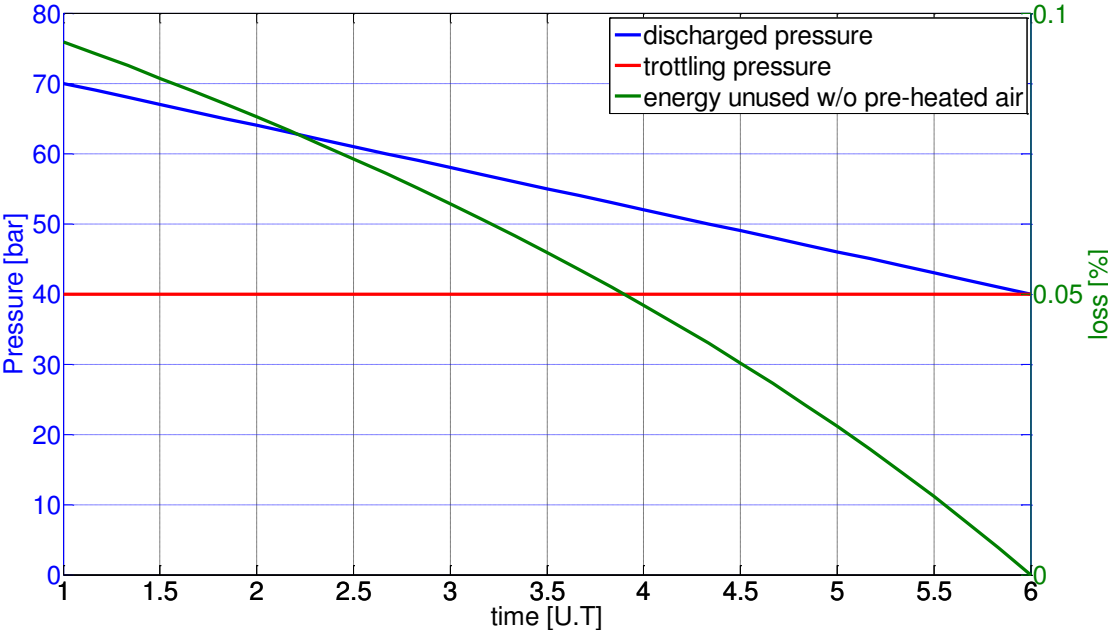


Figure 73 – Theoretical value for the energy unused by using the throttled valve in the case of Huntorf Power Plant

Figure 73 presents the quantity of un-used energy taking into consideration the actual operating parameters for the Huntorf power station and it can be seen that this value is less than 10% for a pressure storage vessel ration of 1.38.

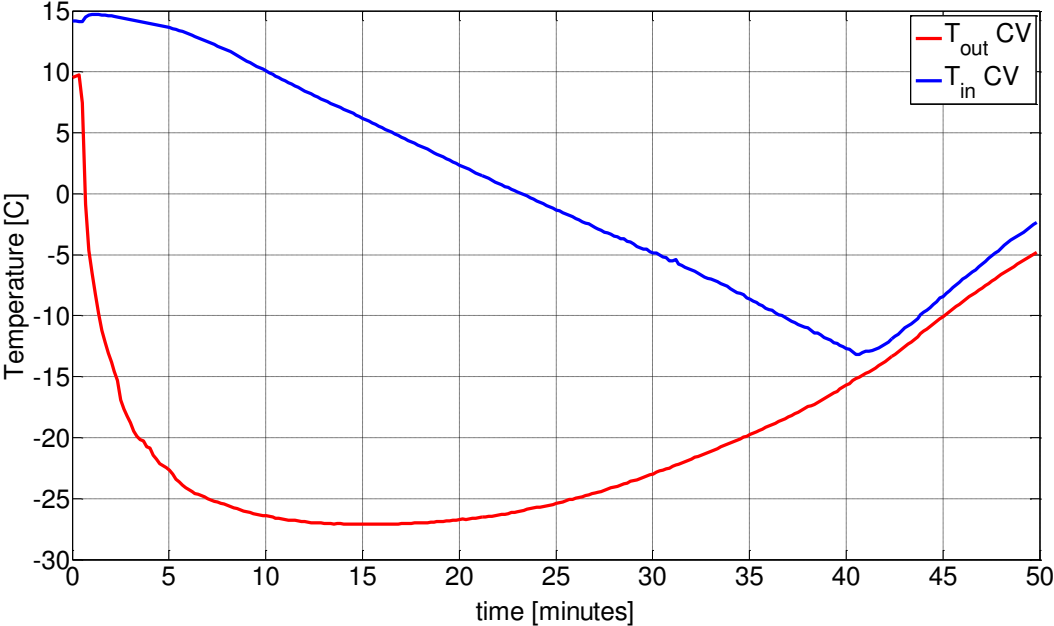


Figure 74 – The air temperature variation before and after the control valve

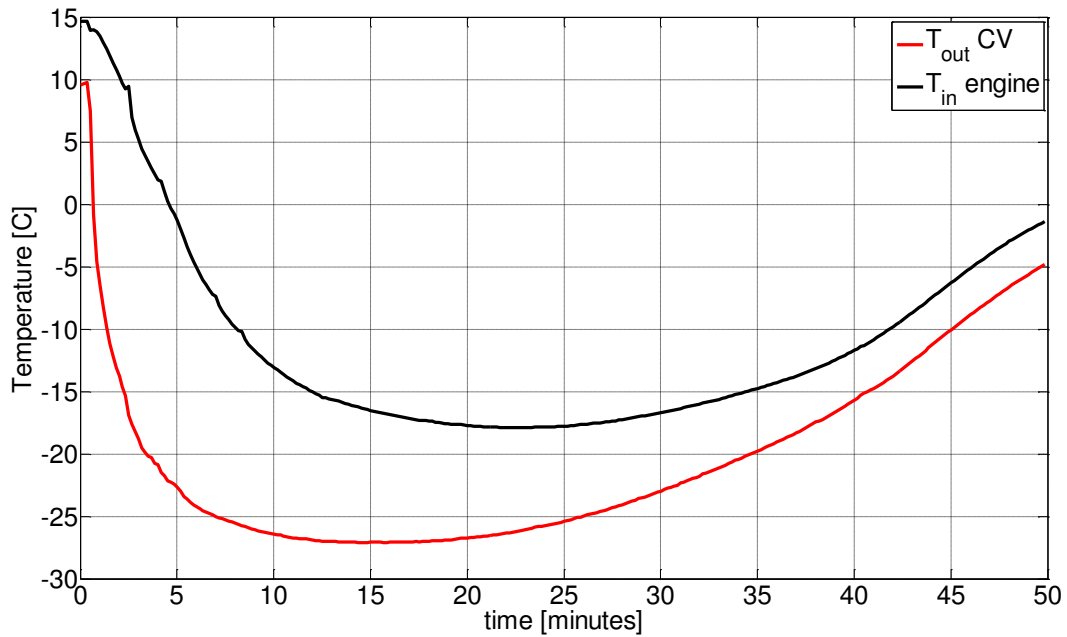


Figure 75 – The air temperature values at the output of the control valve and at the input air engine

During expansion process it has been observed that the air temperature into the tank somehow decreases due to the relaxation of the air, but as shown in graphs this reaches a minimum value and then starts to increase. This is easily explained by the fact that the amount of the air into the tank is becoming smaller and therefore the rate of the heat received the gas from surrounding is greater than the rate of the heat loss from the gas expansion. As the process is slower so the temperature difference into the storage vessel is smaller.

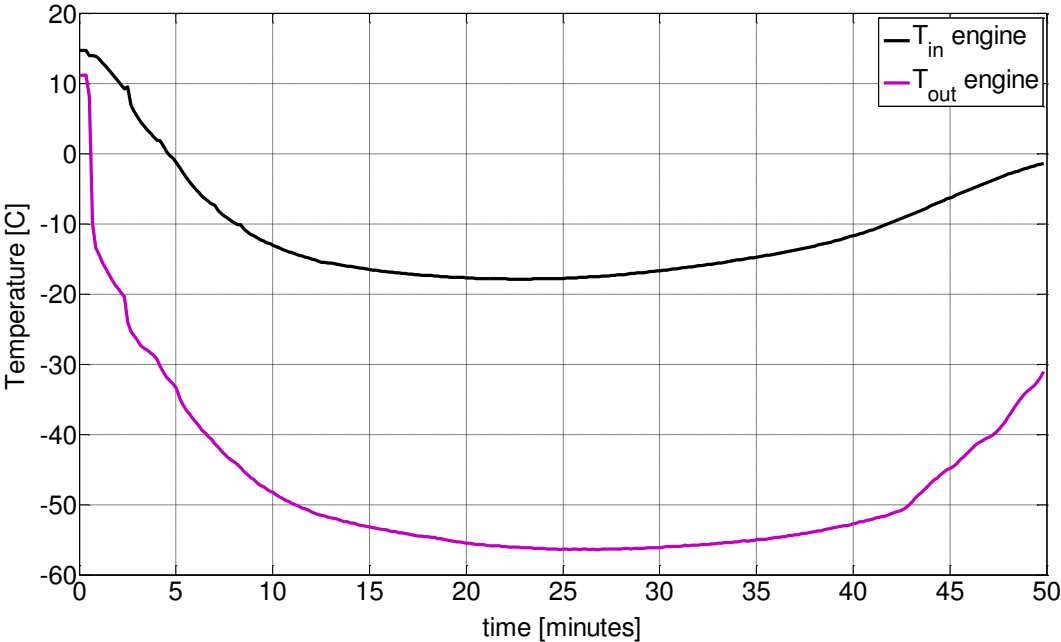


Figure 76 – The air temperature before and after the air engine

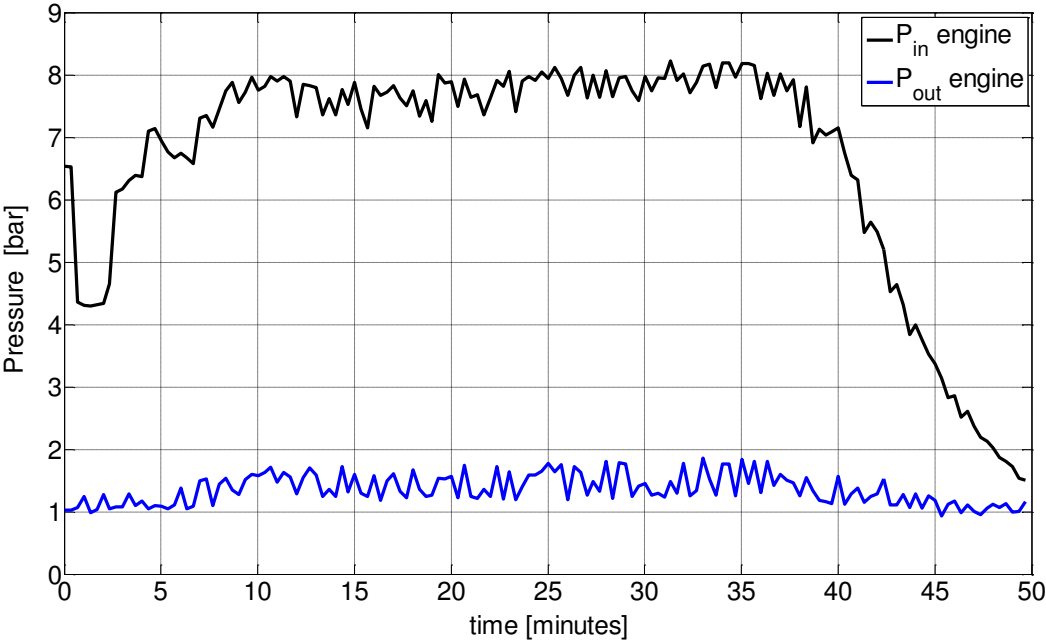


Figure 77 – Pressure value before and after the air engine during expansion process

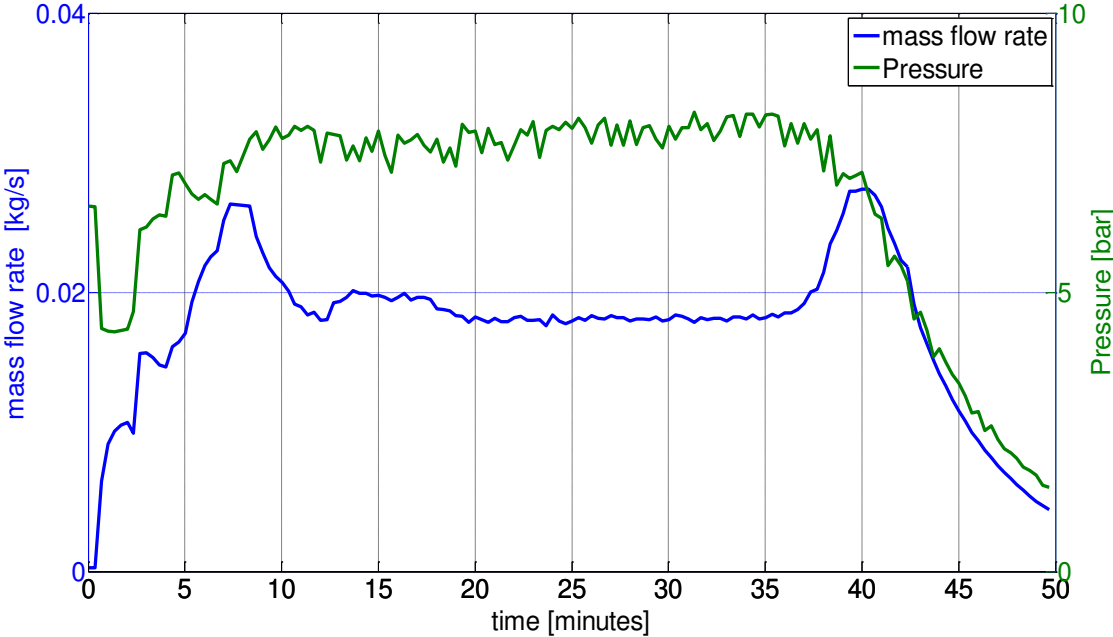


Figure 78 – Pressure and mass flow rate evolution during discharging process

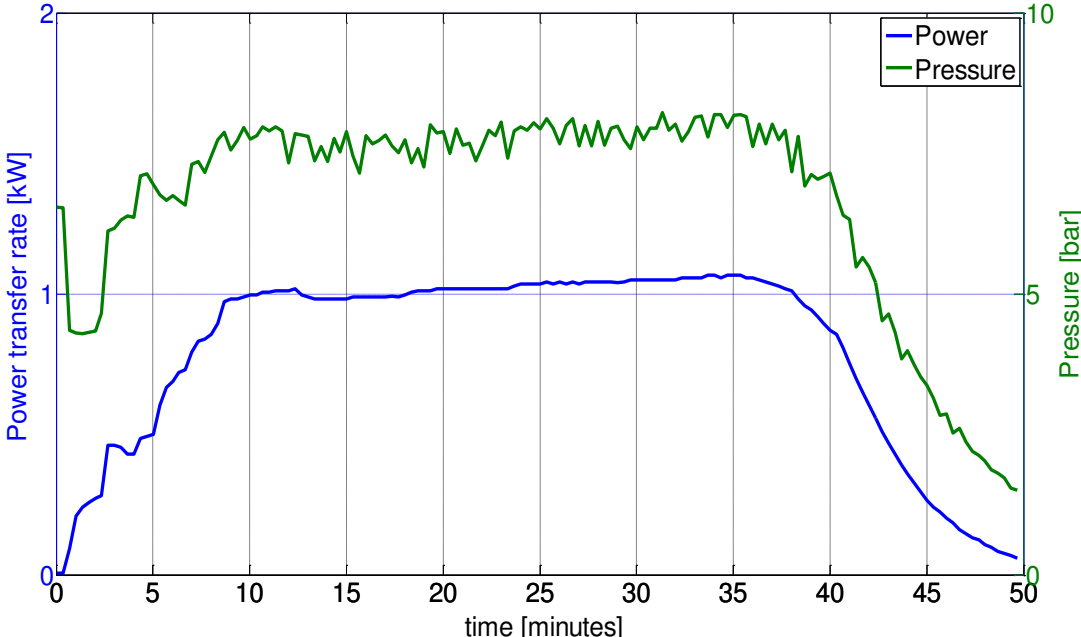


Figure 79 – Power and pressure evolution in time during discharging process

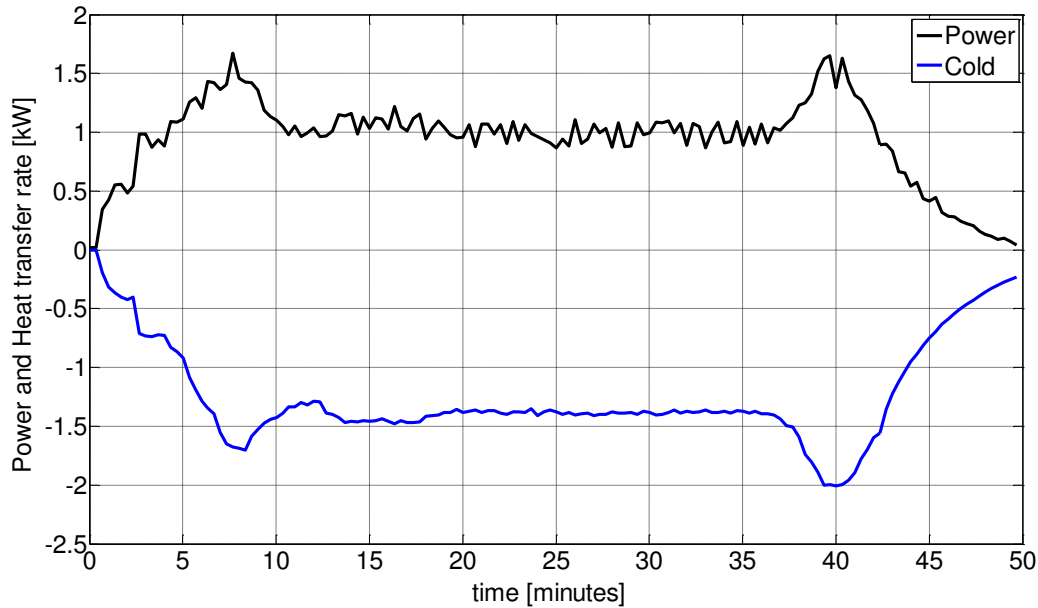


Figure 80 – The value of the power generated and the cold resulted

Expanding air from ambient temperature then the final temperature of the air at the outlet of the air engine is well below zero Celsius degree. Thus a significant amount of cold is resulted, this cold that could be recovered through heat exchangers and used for other purposes, as conditioning air or refrigerators. The peaks observed in the final part of the measurements in figures 77 to 80 are due to the pressure regulator operating principle explained in subchapter 6.2.2. As it was illustrated before when the control valve working principle was presented, once the pressure into the storage vessel drops then the pressure that acts on the piston is lower than the spring pressure. So, a pressure adjustment is required on the final part of the experiment in order to maintain as long as possible a constant pressure at the outlet of the pressure regulator until this value equalizes the inlet pressure of the pressure regulator. Obviously, this pressure variation involves changes in all the other parameters like: mass flow rate, power, cold and maybe others.

8. A case study

8.1. CAES system pre-dimensioning

Several theoretical scenarios have been taken into consideration with the goal to estimate the size of the system that could be used, at a small scale, for a given residence [94]. At the first onset, it is presumed that the system autonomy is well known.

A presentation of the needed parameters to generate an imposed power for a certain period of time is summarized in the following.

To evaluate some possible scenarios it has been assumed that during the discharging process the temperature of the air inside the storage vessel remains constant. In a previous chapter it has been seen that the temperature variation inside the storage vessel during expansion process for a storage pressure ratio ≤ 3 it is quite small as long as the process is not a fast one, fact which helps us to consider the relaxation process of the air inside the tank during discharging almost isothermal. Several values for the inlet pressure of the air engine have been evaluated with the purpose to determine an optimal value from an efficient perspective. Knowing the maximum pressure at the inlet of the air engine and also the power requested from the consumer then the mass flow rate has been calculated. An average value for the polytropic index has been chosen considering the results obtained experimentally in the laboratory at Ecole des Mines de Nantes. All these values have been centralized in the following tables, and a brief comparison between different operating conditions can be observed in table 10 to 12.

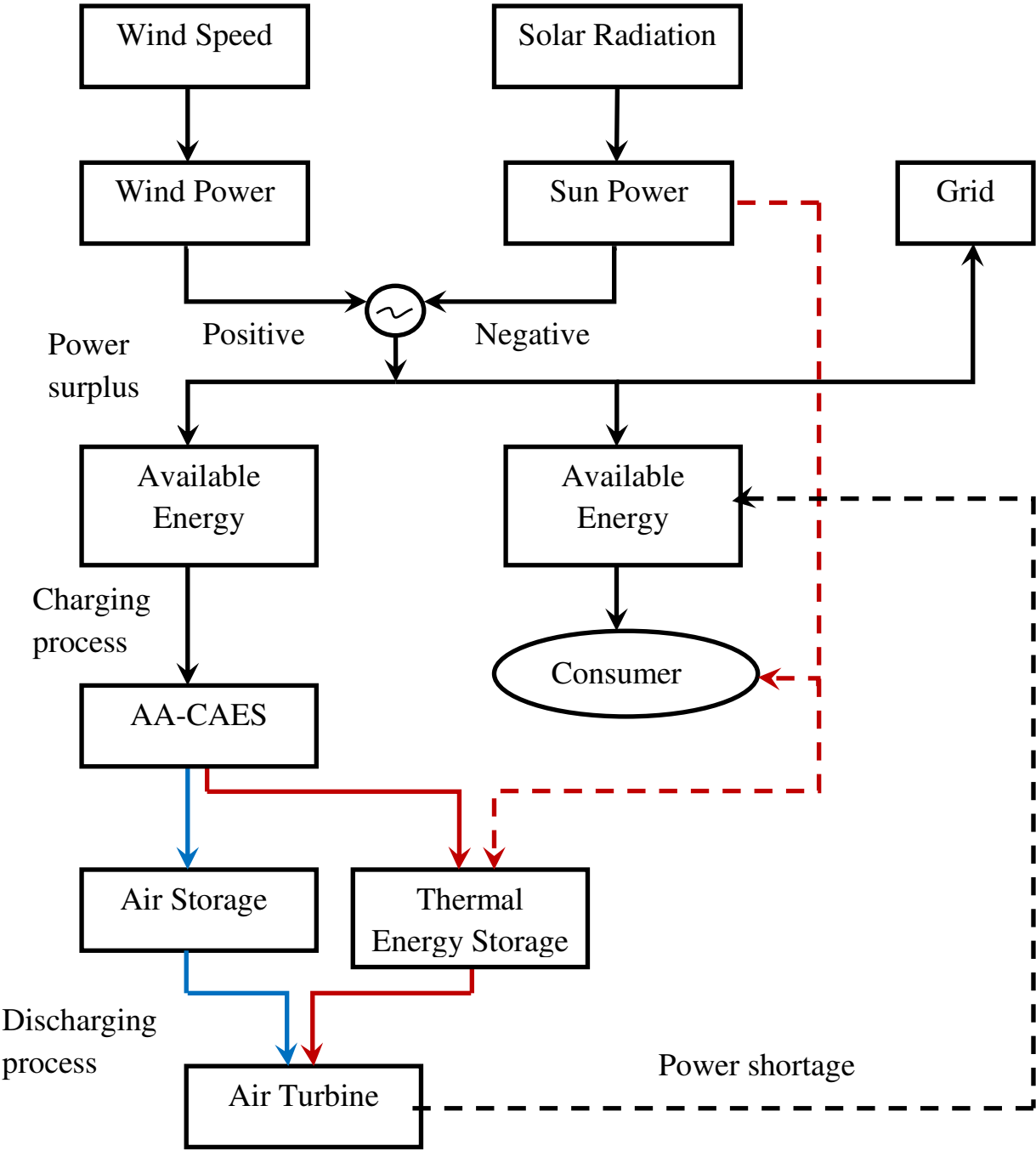


Figure 81 – Figure representing a hybrid energy storage system from RES with the capabilities to supply energy in cogeneration

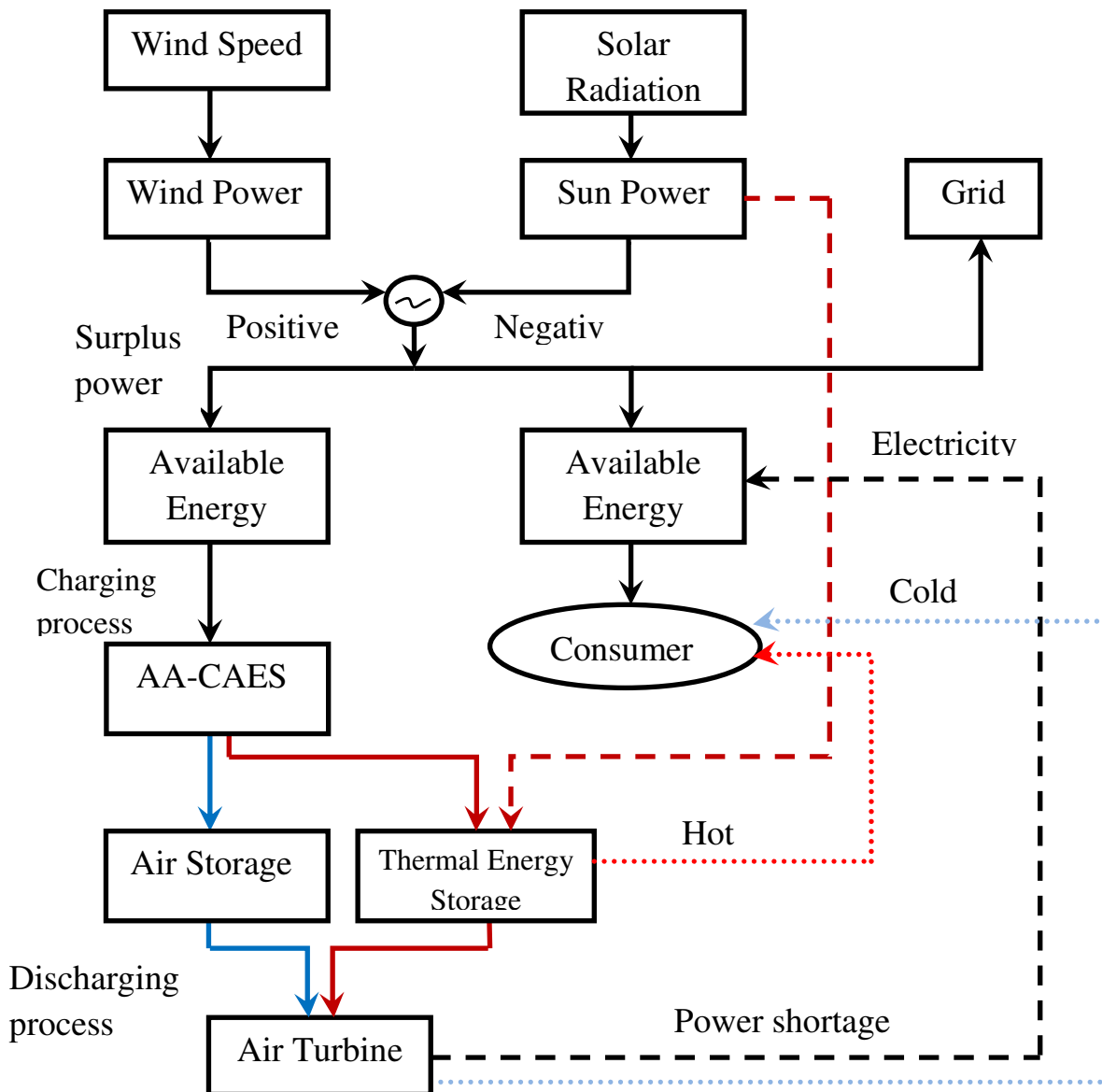


Figure 82 – Figure representing a hybrid energy storage system from RES with the capabilities to supply three types of energy

Figures 81 and 82 present a block diagram of a hybrid system which involves energy storage in form of compressed air and thermal energy storage in form of sensible heat. In this case the surplus of energy provided by renewable energy sources is stored as compressed air. The quantity of heat resulted during air compression is stored at its turn for further use. There are two possible scenarios considered, depending on the consumer's needs. One is if the consumer wants to use the heat as domestic hot water or for heating of the buildings case in which during the air expansion process an important quantity of cold results or a second scenario is if the heat resulted during compression is used to electrify it, case in which the whole system is thought to use only primary energy.

Table 10 – Storage parameters function of the operating conditions

| Power | Time | Storage vessel pressure ratio | Inlet air engine temperature | Compressor efficiency & engine efficiency | Inlet engine pressure | Storage vessel final pressure | Storage vessel volume configuration 1 stage compression | Storage vessel volume configuration 2 stage compression | Mass of air consumed for 1 stage compression | Mass of air consumed for 2 stage compression | System efficiency 1 stage compression | System efficiency 2 stage compression | Polytropic index compression & expansion | Average value for the energy unused by throttling the upstream pressure | |
|-------|------|---|------------------------------|---|-----------------------|-------------------------------|---|---|--|--|---------------------------------------|---------------------------------------|--|---|-------|
| kW | hs | - | K | % | bar | bar | mc | mc | kg | kg | % | % | n | % | |
| 5 | 6 | 3 | 293 | 85 | 20 | 60 | 13.4 | 13.4 | 640.7 | 640.7 | 29 | 34.9 | 1.2 | 13 | |
| | | 2.8 | | | | 56 | 14.9 | 14.9 | | | 29.7 | 35.6 | | 12.3 | |
| | | 2.5 | | | | 50 | 17.9 | 17.9 | | | 30.9 | 36.8 | | 11.05 | |
| | | 2.3 | | | | 46 | 20.7 | 20.7 | | | 31.8 | 37.7 | | 10.1 | |
| | | 2 | | | | 40 | 26.9 | 26.9 | | | 33.4 | 39.4 | | 8.4 | |
| | | 1.8 | | | | 36 | 33.6 | 33.6 | | | 34.7 | 40.8 | | 7.23 | |
| | | 1.5 | | | | 30 | 53.8 | 53.8 | | | 37.2 | 43.3 | | 5 | |
| | | 1.3 | | | | 26 | 89.7 | 89.7 | | | 39.6 | 45.5 | | 3.3 | |
| | | 0 | | | | 20 | 13.4 | 13.4 | | | 43.8 | 50 | | 0 | |
| | | Configuration in which the air is pre-heated before expansion with the heat recovered from compression | | | | | | | | | | | | | |
| 5 | 6 | 3 | 518.3 | 391.2 | 85 | 20 | 60 | 7.4 | 10.1 | 351.7 | 479.7 | 52.8 | 46.6 | 1.2 | 13 |
| | | 2.8 | 513 | 389.2 | | | 56 | 8.3 | 11.2 | 355.4 | 482.2 | 53.5 | 47.3 | | 12.3 |
| | | 2.5 | 504.5 | 386 | | | 50 | 10.1 | 13.6 | 361.7 | 486.3 | 54.7 | 48.5 | | 11.05 |
| | | 2.3 | 498.3 | 383.6 | | | 46 | 11.8 | 15.8 | 366.3 | 489.3 | 55.6 | 49.4 | | 10.1 |
| | | 2 | 488 | 379.6 | | | 40 | 15.7 | 20.8 | 374.3 | 494.4 | 57.3 | 51.1 | | 8.4 |
| | | 1.8 | 480.5 | 376.7 | | | 36 | 19.9 | 26.2 | 380.3 | 498.3 | 58.5 | 52.4 | | 7.23 |
| | | 1.5 | 467.7 | 371.6 | | | 30 | 32.8 | 42.4 | 391.1 | 505.1 | 60.9 | 54.9 | | 5 |
| | | 1.3 | 458 | 367.7 | | | 26 | 56 | 71.5 | 399.7 | 510.5 | 63.1 | 57.1 | | 3.3 |
| | | 0 | 440.8 | 360.6 | | | 20 | 17.4 | 21.9 | 425.8 | 520.5 | 65.9 | 61.6 | | 0 |

Table 11 – Storage parameters function of the operating conditions

| Power | Time | Storage vessel pressure ratio | Inlet air engine temperature | Compressor efficiency & engine efficiency | Inlet engine pressure | Storage vessel final pressure | Storage vessel volume configuration 1 stage compression | Storage vessel volume configuration 2 stage compression | Mass of air consumed for 1 stage compression | Mass of air consumed for 2 stage compression | System efficiency 1 stage compression | System efficiency 2 stage compression | Polytropic index compression & expansion | Average value for the energy unused by throttling the upstream pressure | |
|-------|------|---|------------------------------|---|-----------------------|-------------------------------|---|---|--|--|---------------------------------------|---------------------------------------|--|---|------|
| kW | hs | | K | % | bar | bar | mc | mc | kg | kg | % | % | n | % | |
| 5 | 6 | 3 | 293 | 85 | 30 | 90 | 8.1 | 8.1 | 582 | 582 | 28 | 34.3 | 1.2 | 11.4 | |
| | | 2.8 | | | | 84 | 9 | 9 | | | 28.6 | 35 | | 10.7 | |
| | | 2.5 | | | | 75 | 10.8 | 10.8 | | | 29.6 | 36.1 | | 9.6 | |
| | | 2.3 | | | | 69 | 12.5 | 12.5 | | | 30.5 | 36.9 | | 8.7 | |
| | | 2 | | | | 60 | 16.3 | 16.3 | | | 31.9 | 38.4 | | 7.3 | |
| | | 1.8 | | | | 54 | 20.3 | 20.4 | | | 33.1 | 39.6 | | 6.2 | |
| | | 1.5 | | | | 45 | 32.6 | 32.6 | | | 35.3 | 41.8 | | 4.3 | |
| | | 1.3 | | | | 39 | 54.3 | 54.3 | | | 37.1 | 43.7 | | 2.8 | |
| | | 0 | | | | 30 | 8.1 | 8.1 | | | 40.1 | 47.7 | | 0 | |
| | | Configuration in which the air is pre-heated before expansion with the heat recovered from compression | | | | | | | | | | | | | |
| 5 | 6 | 3 | 568.2 | 403.3 | 85 | 30 | 90 | 4.2 | 5.9 | 300.1 | 422.7 | 54.2 | 47.3 | 1.2 | 11.4 |
| | | 2.8 | 562.1 | 401.2 | | | 84 | 4.7 | 6.6 | 303.3 | 424.9 | 54.9 | 47.9 | | 10.7 |
| | | 2.5 | 552.4 | 397.8 | | | 75 | 5.7 | 8 | 308.6 | 428.6 | 55.9 | 49 | | 9.6 |
| | | 2.3 | 545.3 | 395.3 | | | 69 | 6.7 | 9.3 | 312.6 | 431.2 | 56.7 | 49.8 | | 8.7 |
| | | 2 | 533.7 | 391.2 | | | 60 | 8.9 | 12.2 | 319.4 | 435.7 | 58.2 | 51.3 | | 7.3 |
| | | 1.8 | 525.1 | 388.2 | | | 54 | 11.3 | 15.3 | 324.7 | 439.2 | 59.3 | 52.5 | | 6.2 |
| | | 1.5 | 510.6 | 382.9 | | | 45 | 18.7 | 24.9 | 333.9 | 445.2 | 61.5 | 54.7 | | 4.3 |
| | | 1.3 | 499.6 | 378.9 | | | 39 | 31.9 | 42 | 341.3 | 450 | 63.3 | 56.6 | | 2.8 |
| | | 0 | 479.8 | 371 | | | 30 | 9.9 | 12.8 | 355.2 | 458 | 67.1 | 60 | | 0 |

Table 12 – Storage parameters function of the operating conditions

| Power | Time | Storage vessel pressure ratio | Inlet air engine temperature | Compressor efficiency & engine efficiency | Inlet engine pressure | Storage vessel final pressure | Storage vessel volume configuration 1 stage compression | Storage vessel volume configuration 2 stage compression | Mass of air consumed for 1 stage compression | Mass of air consumed for 2 stage compression | System efficiency 1 stage compression | System efficiency 2 stage compression | Polytropic index compression & expansion | Average value for the energy unused by throttling the upstream pressure | |
|-------|------|---|------------------------------|---|-----------------------|-------------------------------|---|---|--|--|---------------------------------------|---------------------------------------|--|---|------|
| kW | hs | | K | % | bar | bar | mc | mc | kg | kg | % | % | n | % | |
| 10 | 3 | 3 | 293 | 85 | 30 | 90 | 8.1 | 8.1 | 582 | 582 | 28 | 34.3 | 1.2 | 11.4 | |
| | | 2.8 | | | | 84 | 9 | 9 | | | 28.6 | 35 | | 10.7 | |
| | | 2.5 | | | | 75 | 10.8 | 10.8 | | | 29.6 | 36.1 | | 9.6 | |
| | | 2.3 | | | | 69 | 12.5 | 12.5 | | | 30.5 | 36.9 | | 8.7 | |
| | | 2 | | | | 60 | 16.3 | 16.3 | | | 31.9 | 38.4 | | 7.3 | |
| | | 1.8 | | | | 54 | 20.3 | 20.4 | | | 33.1 | 39.6 | | 6.2 | |
| | | 1.5 | | | | 45 | 32.6 | 32.6 | | | 35.3 | 41.8 | | 4.3 | |
| | | 1.3 | | | | 39 | 54.3 | 54.3 | | | 37.1 | 43.7 | | 2.8 | |
| | | 0 | | | | 30 | 8.1 | 8.1 | | | 40.1 | 47.7 | | 0 | |
| | | Configuration in which the air is pre-heated before expansion with the heat recovered from compression | | | | | | | | | | | | | |
| 10 | 3 | 3 | 568.2 | 403.3 | 85 | 30 | 90 | 4.2 | 5.9 | 300.1 | 422.7 | 54.2 | 47.3 | 1.2 | 11.4 |
| | | 2.8 | 562.1 | 401.2 | | | 84 | 4.7 | 6.6 | 303.3 | 424.9 | 54.9 | 47.9 | | 10.7 |
| | | 2.5 | 552.4 | 397.8 | | | 75 | 5.7 | 8 | 308.6 | 428.6 | 55.9 | 49 | | 9.6 |
| | | 2.3 | 545.3 | 395.3 | | | 69 | 6.7 | 9.3 | 312.6 | 431.2 | 56.7 | 49.8 | | 8.7 |
| | | 2 | 533.7 | 391.2 | | | 60 | 8.9 | 12.2 | 319.4 | 435.7 | 58.2 | 51.3 | | 7.3 |
| | | 1.8 | 525.1 | 388.2 | | | 54 | 11.3 | 15.3 | 324.7 | 439.2 | 59.3 | 52.5 | | 6.2 |
| | | 1.5 | 510.6 | 382.9 | | | 45 | 18.7 | 24.9 | 333.9 | 445.2 | 61.5 | 54.7 | | 4.3 |
| | | 1.3 | 499.6 | 378.9 | | | 39 | 31.9 | 42 | 341.3 | 450 | 63.3 | 56.6 | | 2.8 |
| | | 0 | 479.8 | 371 | | | 30 | 9.9 | 12.8 | 355.2 | 458 | 67.1 | 60 | | 0 |

A theoretical simulation is presented in tables 10 to 12, and for a better understanding is figured out in figures 83 to 98. The simulations illustrate a small scale application, a residential one, where a consumer needs a certain amount of energy which can be used over a defined period of time.

For those scenarios where the heat recovered from compression is used to preheat the air before being expanded, the hypotheses which were taken into consideration consist that just 80% of this heat can be returned to the air. Said, in other words, the temperature of the air which enters in the air engine is with 80% lower than that resulted from the outlet of each compression stage (considered in Celsius degree).

Graphical representation of the theoretical results obtained from mathematical simulation, considering the required $Power = 5\text{ kW}$, supplied for a period of 6 hours, with the air expander inlet pressure $P_{in} = 20\text{ bar}$.

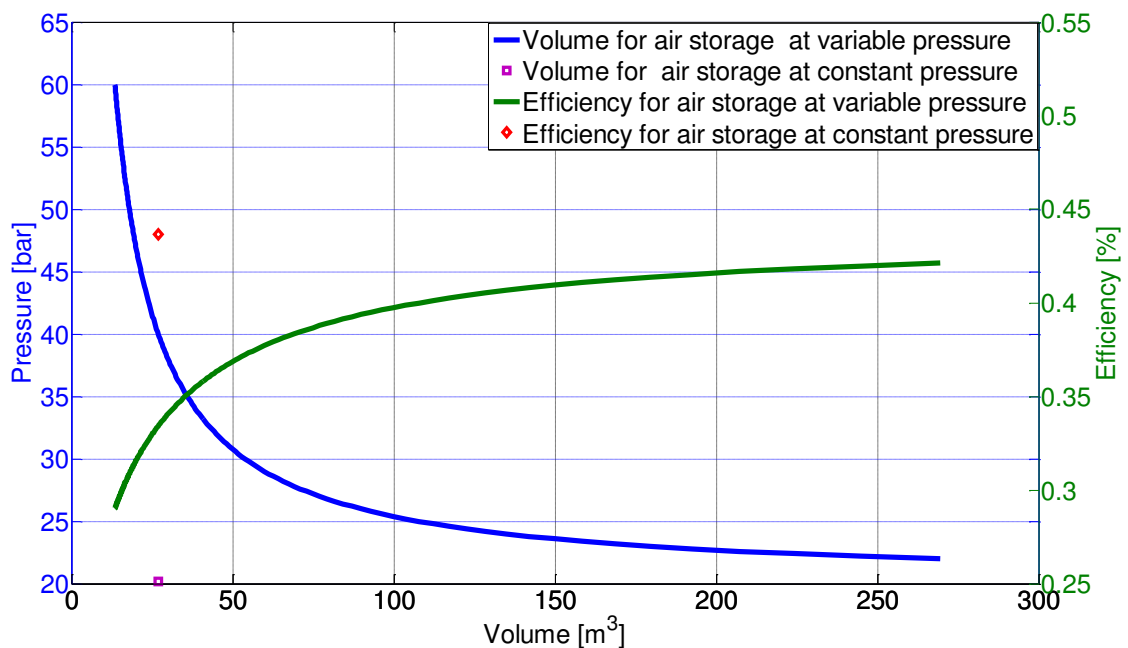


Figure 83 – Storage vessel volume required function of pressure: 1 stage compression – 1 stage expansion without preheated air

Figure 83 presents the storage vessel volume required to deliver to the final user a constant power, for a fixed period of time, at a constant inlet air engine pressure in function of the storage vessel pressure values (blue and magenta curves). Green and red curves show the system efficiency for a configuration with a single stage compression and a single stage

expansion in which the air is not preheated before being expanded through an air engine. Maximum efficiency is obtained for a reversible process, which means working with a variable vessel storage volume by using methods which allow this, as underwater bags, or any other solution which permits to maintain a constant pressure for both processes, compression and expansion, and is about 44% and could be reached in a configuration where the air is pressurized and expanded from 20 bar pressure and where the heat resulted from compression is used for other purposes.

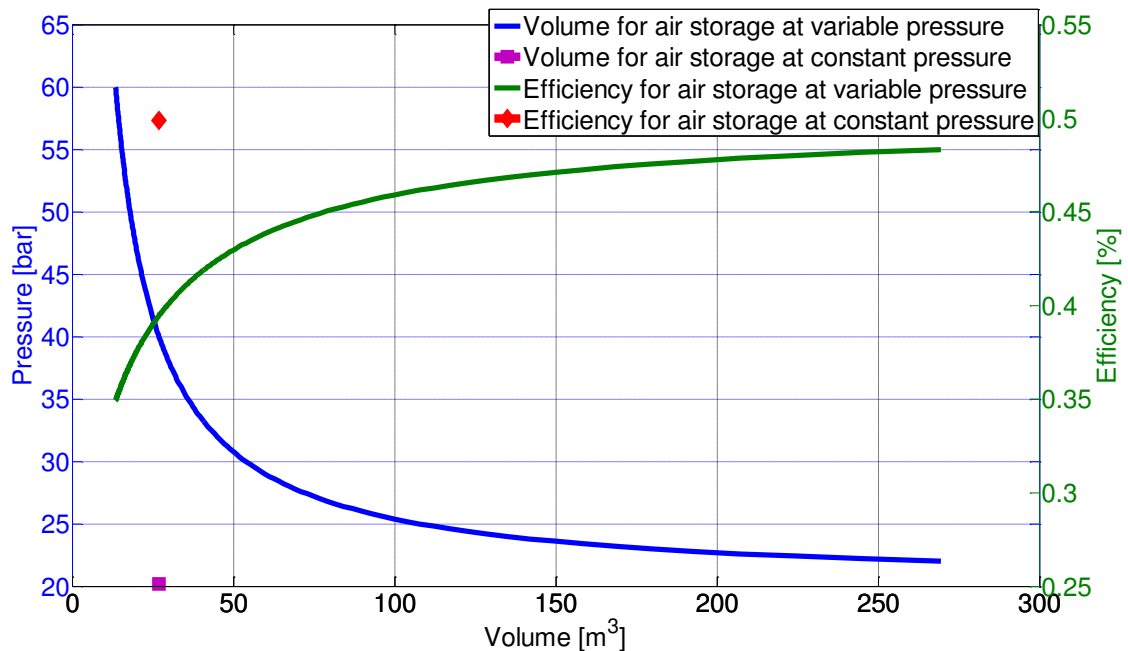


Figure 84 – Storage vessel volume required function of pressure: 2 stage compression – 1 stage expansion without preheated air

Like figure 83, figure 84 presents the storage vessel volume required to deliver to the final user a constant power for a fixed period of time at a constant inlet air engine pressure depending on the storage vessel ratio, in a configuration with two stage compression and a single stage expansion, in which the air is not preheated before being expanded. Having the same energy required and the same number of stages of expansion the volume of the storage vessel required is the same as in the case of a single stage compression single stage expansion. Anyway, the system efficiency is a little bit higher due to the fact that the power consumed by the compressor is lower. Maximum efficiency is obtained for a reversible process, which means working with a variable vessel storage volume and reaches a value about 50%.

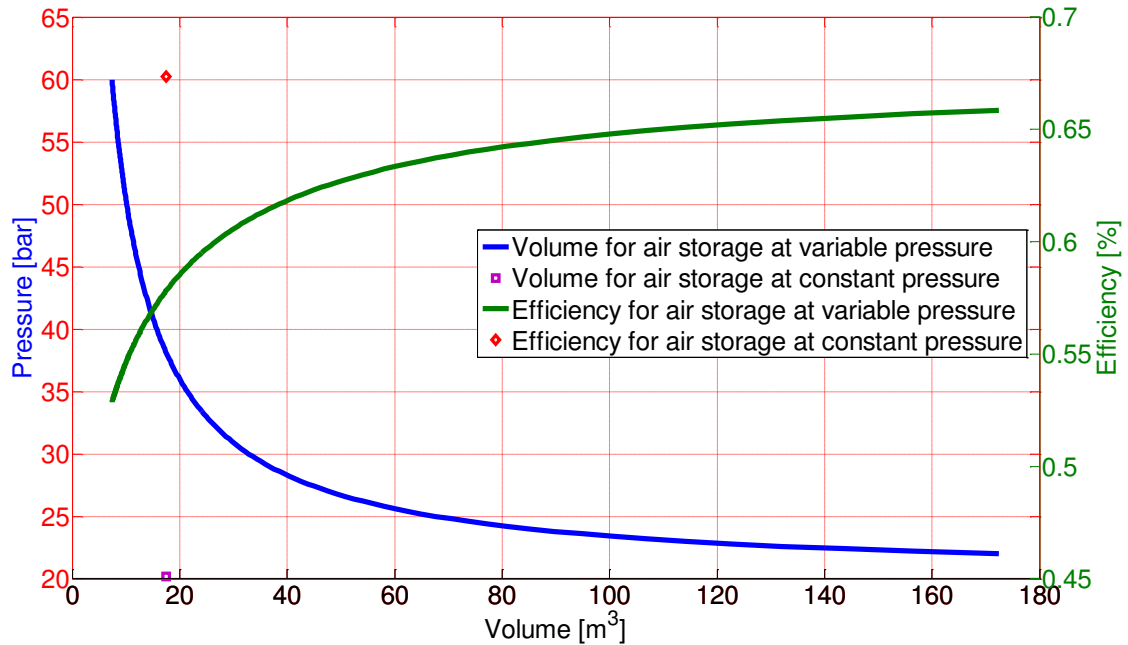


Figure 85 – Storage vessel volume required function of pressure: 1 stage compression – 1 stage expansion with preheated air

In figure 85 are presented the storage vessel volume required in order to deliver a constant power for a fixed period of time at a constant inlet air engine pressure depending on the storage vessel pressure ratio. In this scenario the heat resulted during air compression is stored and used to re-heat the air during the expansion process. So the system efficiency for a configuration with a single stage compression and a single stage expansion depends significant by the air temperature at the inlet of the air engine. The more the temperature is the more efficiency is. The red marker represents the maximum possible efficiency obtained for a reversible process, which means that the air is pressurized at 20 bar pressure and expanded from 20 bar pressure too, so, the magenta marker represents the volume required to store 30 kWh of energy at 20 bar pressure.

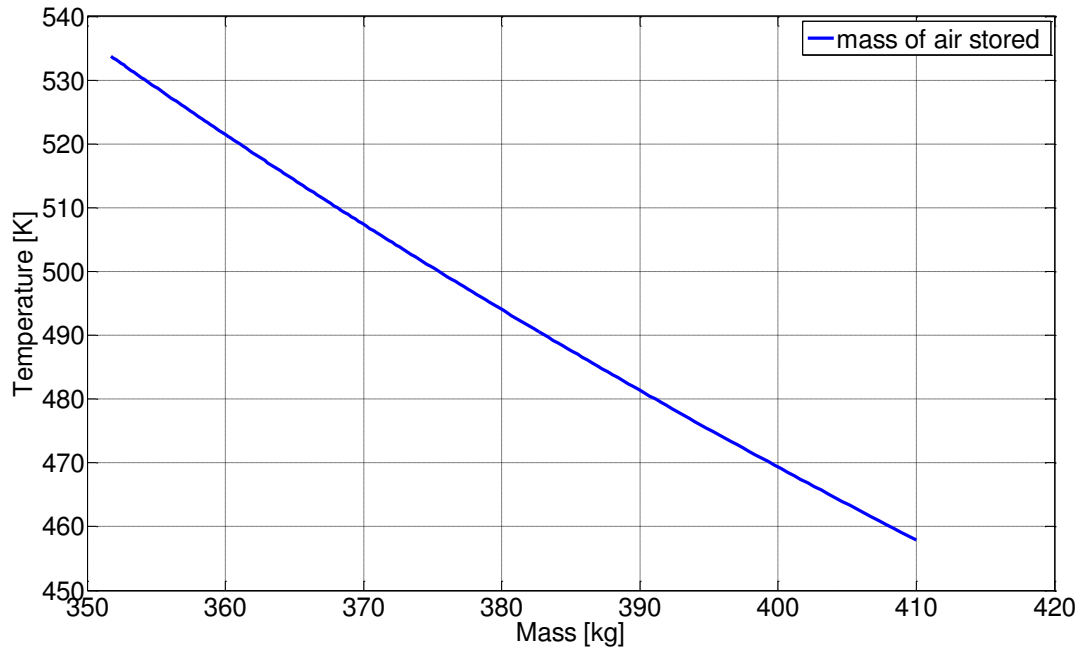


Figure 86 – The mass of air required to be stored function of the air engine inlet temperature

The mass of air required to be expanded is a linear function of the air inlet temperature of the air engine in order to obtain the desired power (see figure 86). The air is preheated using the heat recovered and stored during the compression process. The greater the compressed air pressure is then the higher the temperature at which the heat can be stored is. So, according to figure 86 to obtain 30 kWh of energy is required 410 kg of air if the air temperature at the inlet of the air engine is 458 K, while for 534 K is enough only 352 kg of air for an air engine inlet pressure of 20 bar.

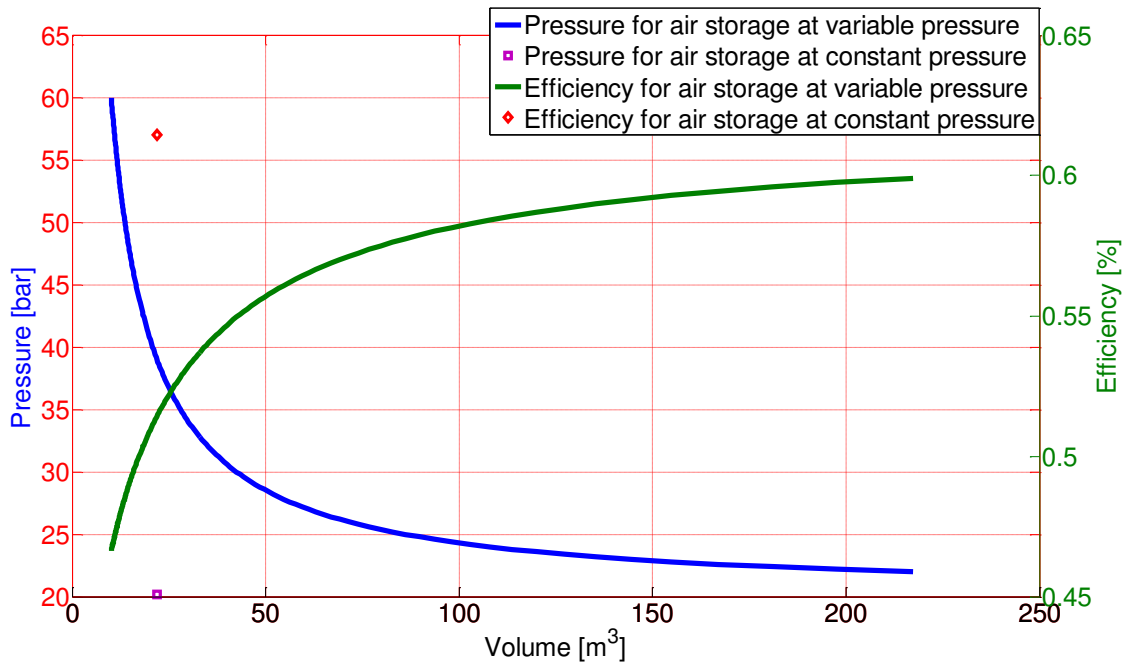


Figure 87 – The storage vessel volume required function of pressure: 2 stage compression – 1 stage expansion with preheated air

Figure 87 presents the storage vessel volume required to deliver a constant power for a fixed period of time at a constant inlet air engine pressure, depending on the storage vessel pressure ratio and the efficiency related too, for a configuration with two stages of compression and a single stage expansion in which the air is preheated before being expanded. Comparing with figure 86 could be seen that the system efficiency is lower due to the fact that if the efficiency of compression increase by using two-stage compression, and a single stage expansion the heat recovered and stored from compression can't be fully returned to the air, but only a certain part of it. Therefore the storage vessel required for a configuration of the system with two stages of compression and a single stage expansion is larger than for a configuration with a single stage compression and a single stage expansion in the case that the heat resulted during compression is used to reheat the air during expansion.

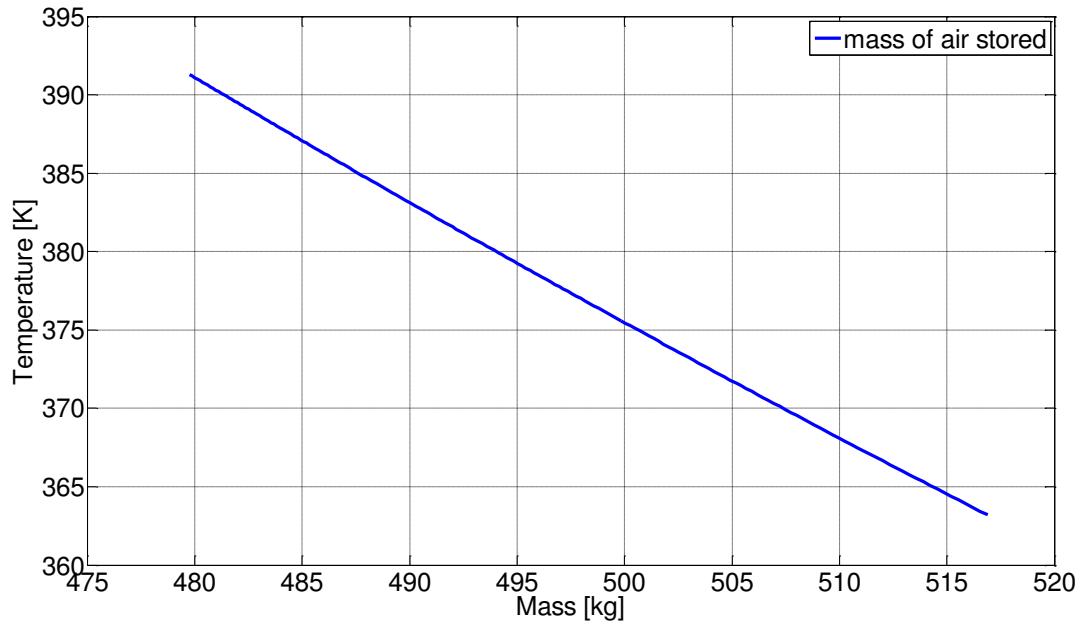


Figure 88 – The mass of air required to be stored function of the air engine inlet temperature

The mass of air required to be expanded function of the inlet temperature in order to obtain the wanted power it's illustrated in figure 88. The air is preheated using the heat recovered from two stages of compression. Having just a single stage expansion means that a part of the heat resulted from compression can't be returned to the air. So, according to figure 88 to obtain 30 kWh of energy is required 517 kg of air if the air temperature at the inlet of the air engine is 363 K, while for 391 K is enough only 480 kg of air for an air engine inlet pressure 20 bar.

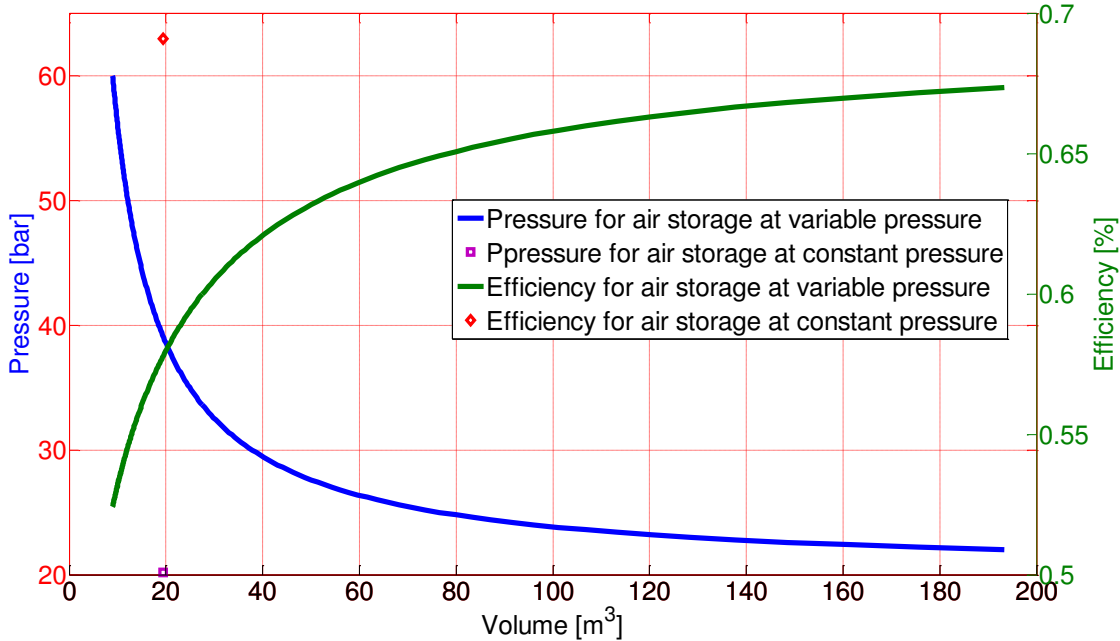


Figure 89 – The storage vessel volume required function of pressure: 2 stage compression – 2 stage expansion with preheated air

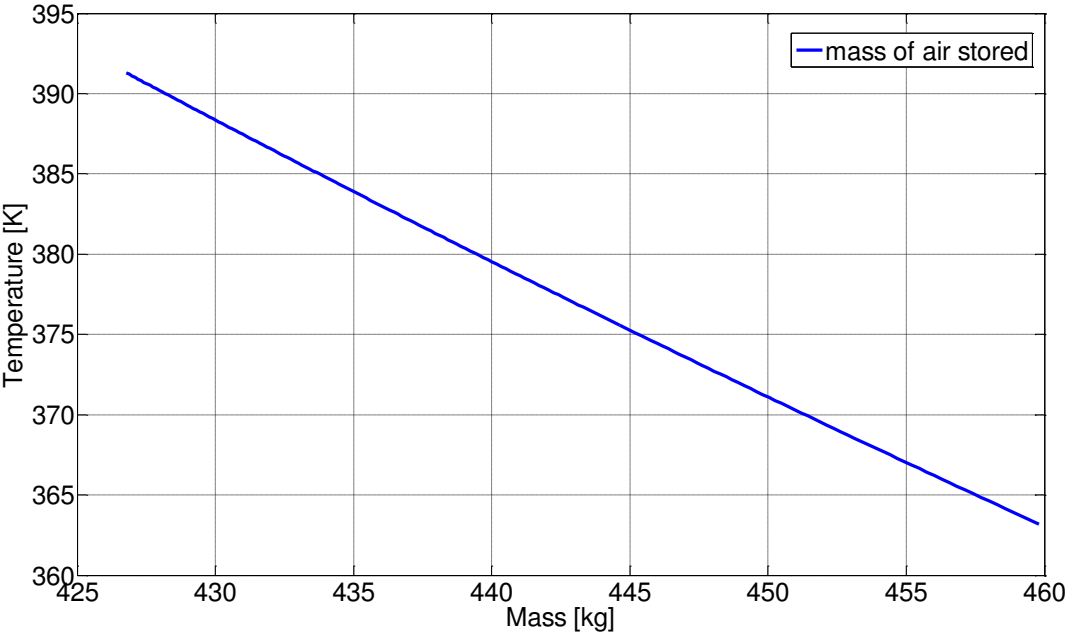


Figure 90 – The mass of air required to be stored function of air engine inlet temperature

Figure 89 presents the storage vessel volume required to deliver a constant power for a fixed period of time at a constant inlet air engine pressure depending on the storage vessel pressure

ratio and the efficiency related too, for a configuration with two stages of compression and two stages of expansion in which the air is preheated before being expanded. Maximum efficiency is obtained for a reversible process, which means working with a variable vessel storage volume and this value is almost 68%.

The mass of air required to be expanded is a linear function of the inlet temperature of the air engine in order to obtain the wanted power it's figured out in figure 90. The air is preheated using the heat recovered and stored after compression process. So, according to figure 90 to obtain 30 kWh of energy is required 460 kg of air if the air temperature at the inlet of the air engine is 363 K, while for 392 K is enough only 427 kg of air for an air engine inlet pressure 20 bar.

Graphical representation of the theoretical results obtained from mathematical simulation, considering the required $Power = 5 kW$, supplied for a period of $6 hours$, with the air expander inlet pressure $P_{in} = 30 bar$.

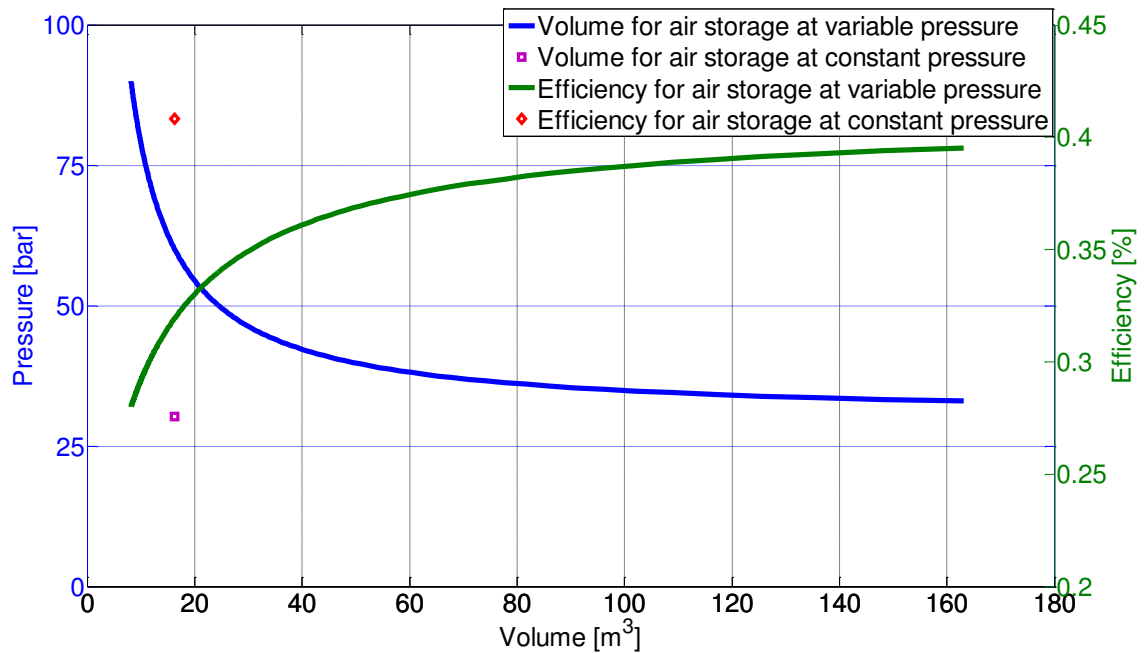


Figure 91 – The storage vessel volume required function of pressure 1 stage compression – 1 stage expansion without preheated air

Figure 91 presents the storage vessel volume required to deliver a constant power for a fixed period of time at a constant inlet air engine pressure depending on the storage vessel pressure ratio and the efficiency related too, for a configuration with a single stage compression and a single stage expansion in which the air is not preheated before being expanded through the air engine. Maximum efficiency is obtained for a reversible process, which means working with a variable vessel storage volume and is almost 42%. Those values are illustrated by the red marker in the case of efficiency and magenta for the storage vessel dimension.

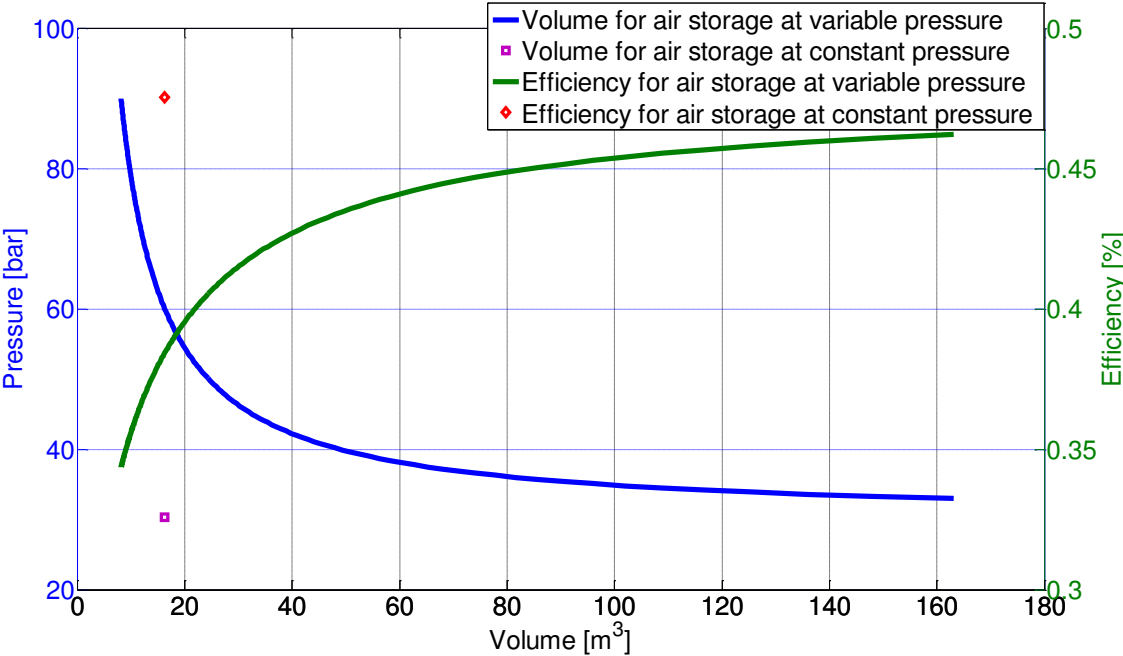


Figure 92 – The storage vessel volume required function of pressure: 2 stage compression – 1 stage expansion without preheated air

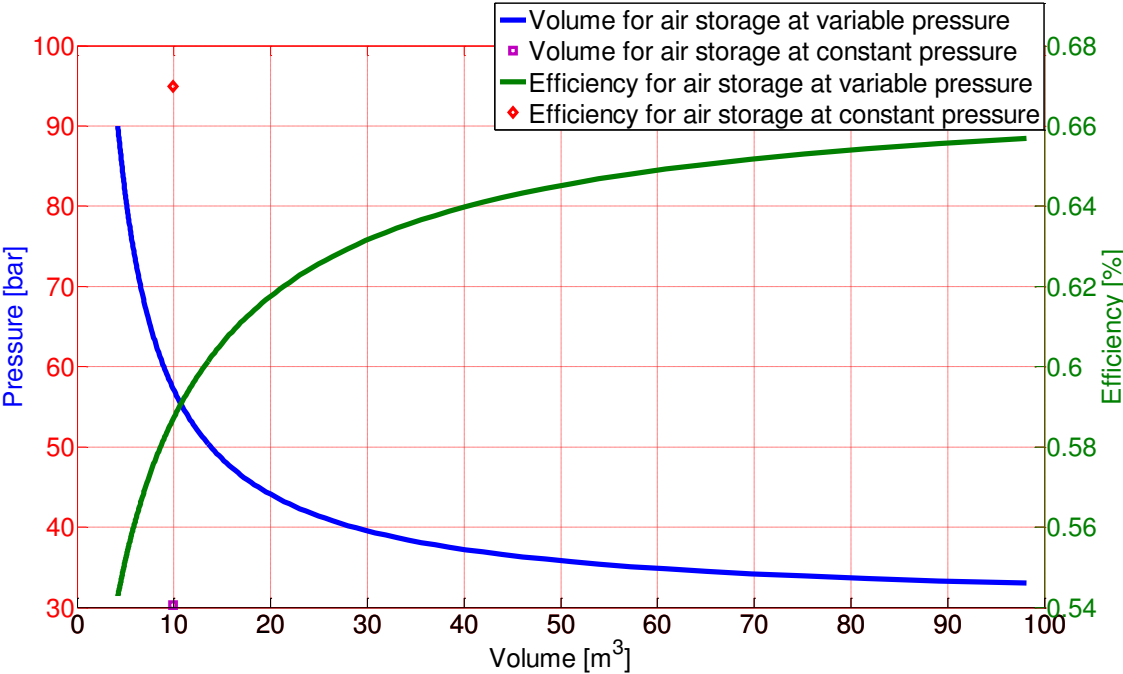


Figure 93 – The storage vessel volume required function of pressure 1 stage compression – 1 stage expansion with preheated air

Figure 92 presents the storage vessel volume required to deliver a constant power for a fixed period of time at a constant inlet air engine pressure depending on the storage vessel pressure ratio and efficiency related too, for a configuration with two stages of compression and a single stage expansion. Maximum efficiency is obtained for a reversible process, which means working with a variable vessel storage volume and is about 47%.

Figure 93 presents the storage vessel volume required to deliver a constant power for a fixed period of time at a constant inlet air engine pressure depending of the storage vessel pressure ratio and the efficiency related too, for a configuration with a single stage compression and a single stage expansion in which the air is preheated before being expanded. Maximum efficiency is obtained for a reversible process, which means working with a variable vessel storage volume and is almost 67%.

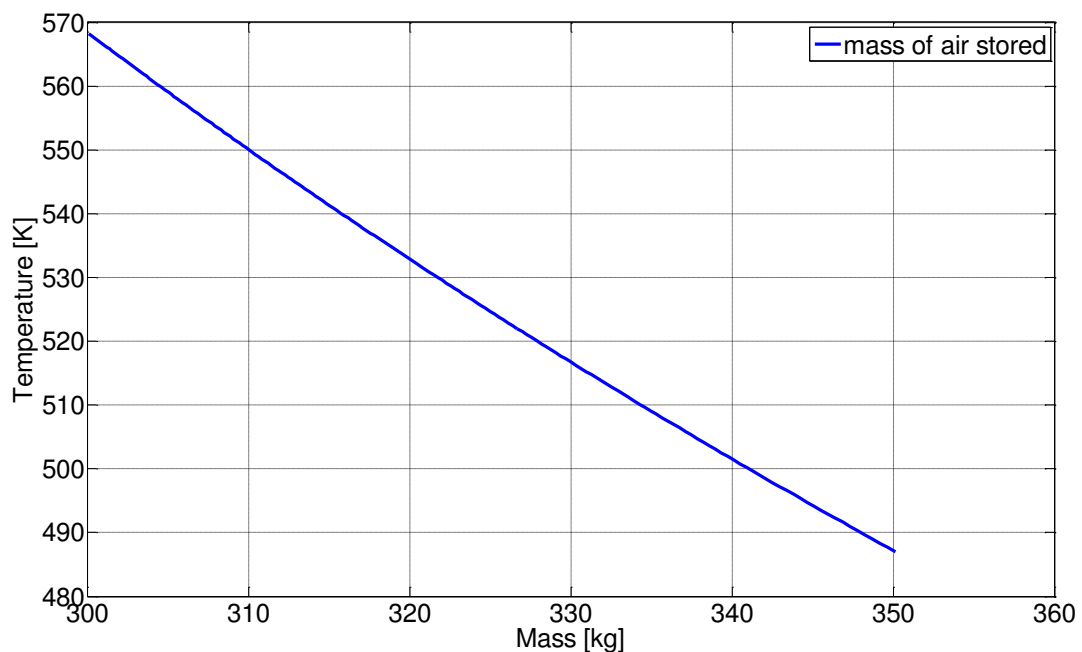


Figure 94 – The mass of air required to be stored function of air engine inlet temperature

In figure 94 it's represented the mass of air required to be expanded function of the inlet temperature in order to obtain the desired power. The air compressed is preheated using the heat recovered from a single stage compression. So, according to figure 94 to obtain 30 kWh of energy is required 350 kg of air, if the air temperature at the inlet of the air engine is 487 K, while for 569 K is enough only 300 kg of air for an air engine inlet pressure 30 bar.

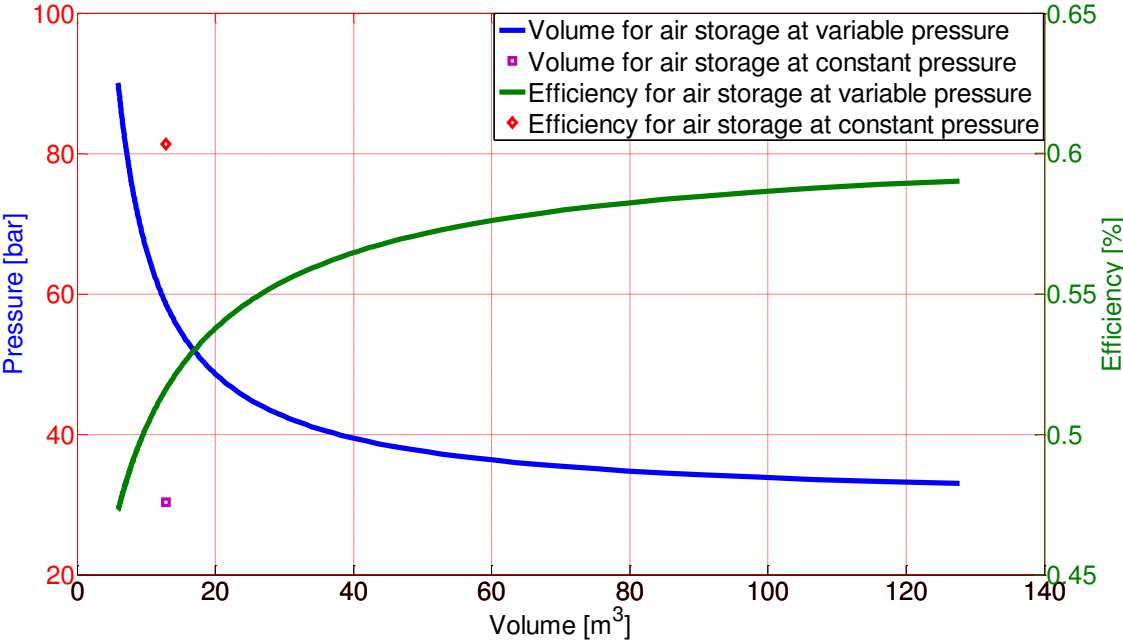


Figure 95 – The storage vessel volume required function of pressure: 2 stage compression – 1 stage expansion without preheated air

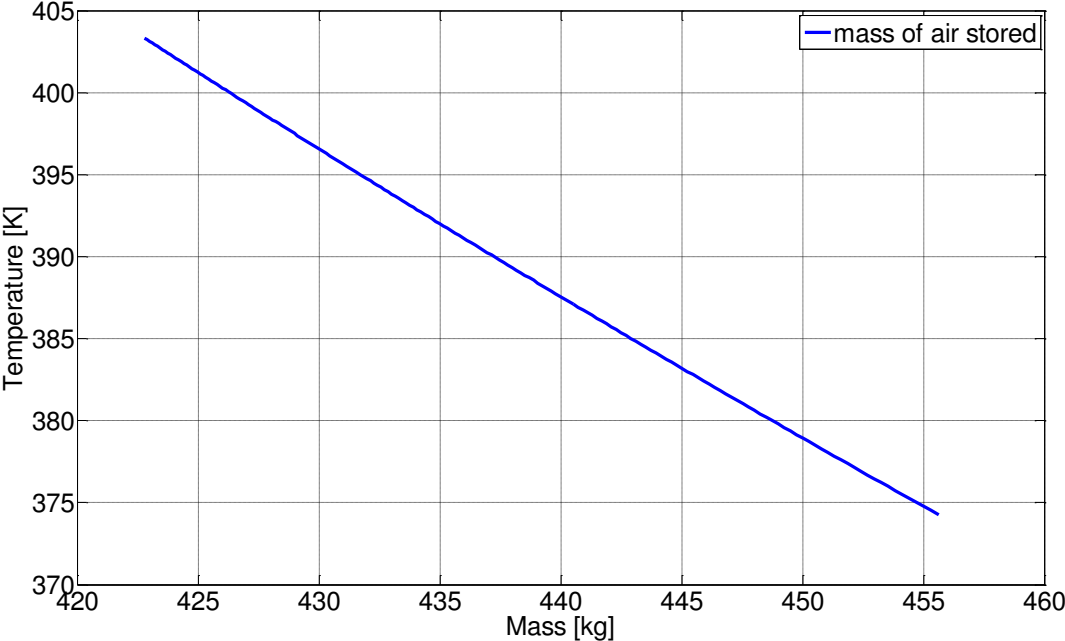


Figure 96 – The mass of air required to be stored function of air engine inlet temperature

Figure 95 presents the storage vessel volume required to deliver a constant power for a fixed period of time at a constant inlet air engine pressure depending on the storage vessel pressure ratio and the efficiency related too, for a configuration with two stage compression and a single stage expansion in which the air is preheated before being expanded. Maximum efficiency is obtained for a reversible process, which means working with a variable vessel storage volume and is almost 61%.

The mass of air required to be expanded function of the inlet temperature in order to obtain the wanted power in a configuration in which the air is preheated using the heat recovered from two stages of compression (see figure 96). So, according to figure 96 to obtain 30 kWh of energy is required 456 kg of air if the air temperature at the inlet of the air engine is 374 K, while for 403 K is enough only 423 kg of air for an air engine inlet pressure 30 bar.

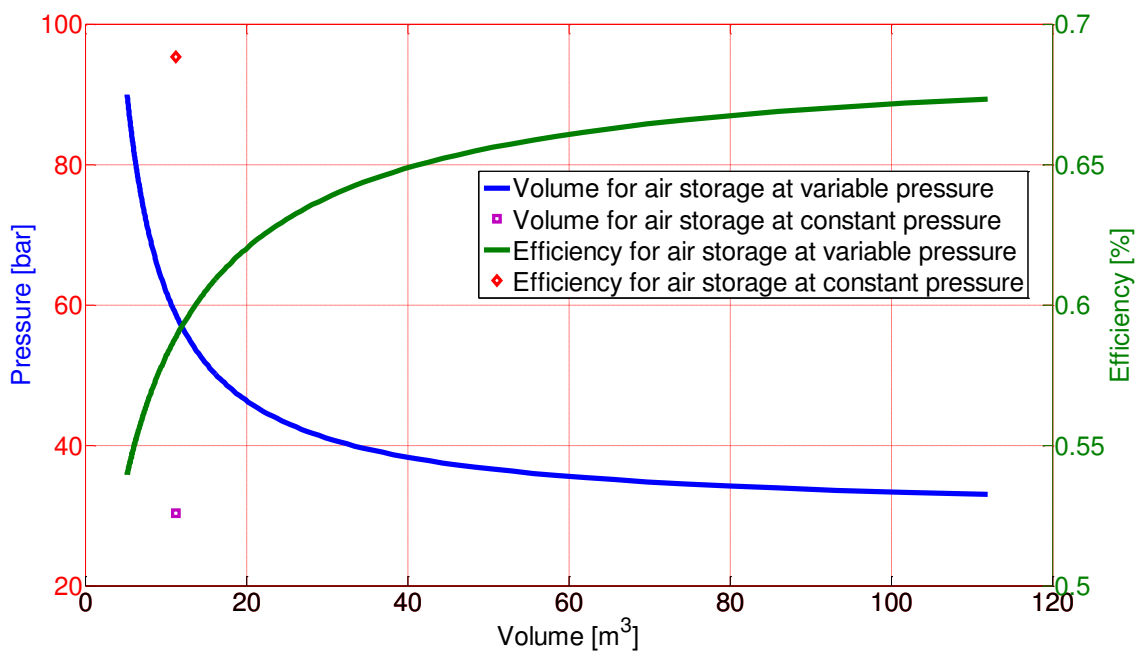


Figure 97 – The storage vessel volume required function of pressure: 2 stage compression – 2 stage expansion without preheated air

Figure 97 presents the storage vessel volume required to deliver a constant power for a fixed period of time at a constant inlet air engine pressure depending on the storage vessel pressure ratio and the efficiency related too, for a configuration with two stage of compression and two-stage expansion in which the air is preheated before being expanded. Maximum efficiency is

obtained for a reversible process, which means working with a variable vessel storage volume and is almost 68%.

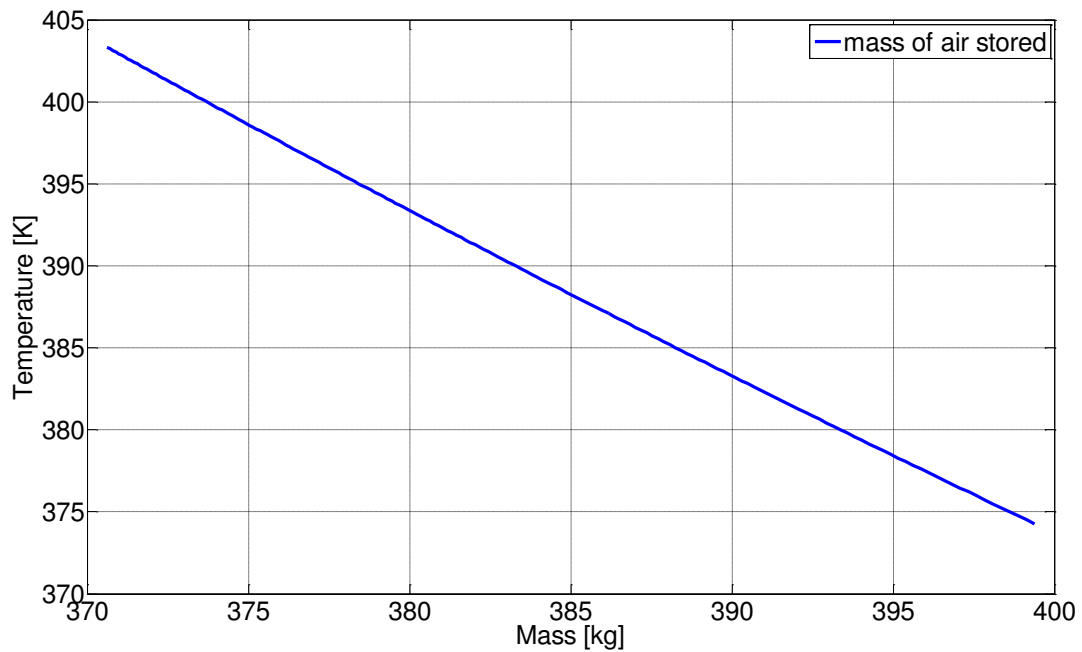


Figure 98 – The storage vessel volume required function of pressure

The mass of air required to be expanded function of inlet temperature in order to obtain the wanted power. The air is preheated using the heat recovered from two stages of compression. So, according to figure 98 to obtain 30 kWh of energy is required 399 kg of air if the air temperature at the inlet of the air engine is 374 K, while for 403 K is enough only 371 kg of air for an air engine inlet pressure 30 bar. Comparing figures 98 with 96 we notice that the importance of the second stage of expansion in terms of mass is about 13% less mass of air required.

8.2. Chapter Conclusions

The primary efficiency of the system depends by the operating system conditions, several scenarios are presented below:

- The highest primary efficiency is obtained if the number of compressors and expanders is the same.
- Once the number of compression stage increase and the intercoolers are used to cool down the air temperature after compression, the efficiency of compression increase too.
- If the air is expanded in a less number of expansion stages than compression, even if the work consumed to compress the air is lower comparing with that obtained in a single stage compression, also, the work produced by the pressurized air if the heat resulted from compression is used to preheated the air is lower comparing with a configuration in which are used the same number of compression and expansion stages. That happens because the heat recovered from compression cannot be integrally used to preheat the air during expansion process and only a certain part of it.
- Another important fact is that having a lower temperature of the air at the inlet of the air engine/expander/turbine this requires a higher mass flow amount in order to obtain the wanted power, which means, in fact, a larger quantity of air stored, what conclude to a larger storage vessel volume.
- Working with different storage vessel pressures an important part of the energy is unused because the air is throttled to a constant pressure at the inlet of the air engine. In function of this storage vessel pressure ratio an average value for this part of the energy, un-used, was centralized in the last column of the tables 10 to 12.
- As it was expected the minimum vessel storage volume required is that in a configuration where the pressure of the air remains constant inside the storage vessel during all the compression and expansion processes, that's possible only if the storage volume varies in time.
- As we already said the global efficiency of the system depends on the operating conditions. A theoretical primary efficiency close to 70% is possible only if both processes are reversible by mean compression and expansion are done from the same pressure, solution possible if as storage containers are used underwater bags or aquifers, and only if the air is re-heated with the heat recovered during the compression process.

- The smaller the difference between the minimum and the maximum storage pressure into the storage vessel is, then the greater primary efficiency system is. Taking into consideration scenarios in which the air is compressed to a pressure two times higher than the throttled pressure then a theoretical efficiency has been found of 52% and increase to 68% once with this ratio tends to 1, for scenarios in which the heat resulted in compression is returned to the air during the expansion process. Efficiency bounded by 37% to 51% was found for scenarios in which the heat resulted in compression is used for other purposes like: domestically water heating, heating of the buildings and so on.
- Using a buffer volume of air into the storage tank helps significantly in reducing the temperature variation during both processes compression and expansion. Sometimes this storage buffer of air involves a large storage vessel volume and if aboveground storage solutions are considered may not be a feasible one, being required a large amount of raw material in order to build the storage vessel, an affordable solution could consist in salt caverns or depleted mines which are already built.
- A deep analysis of this graph shows that for a configuration in which the compressed air is not preheated before expansion process, the system efficiency decreases once with the pressure at which the air is compressed and stored. This thing is explicable due to the fact that when the air is expanded to produce energy the power increase, but when the air is compressed to the same pressure also the consumed power increase and this ratio of consumed power increase faster than that of delivered power.
- In the case of preheated air, the system efficiency increase by increasing both compression pressure and expansion pressure but this increment of the efficiency is almost indistinguishable.

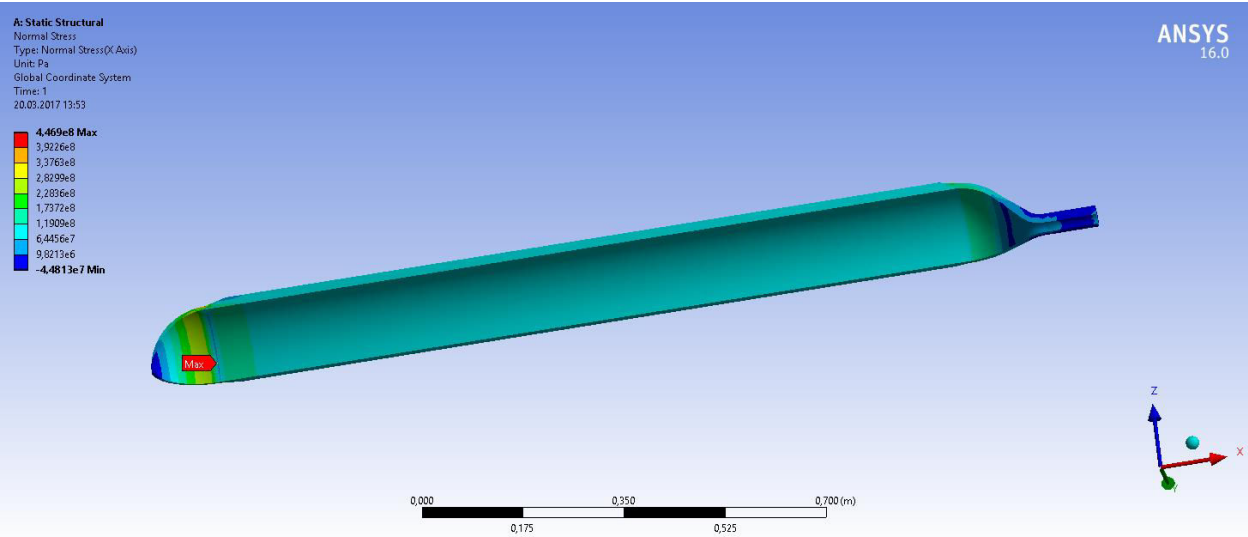
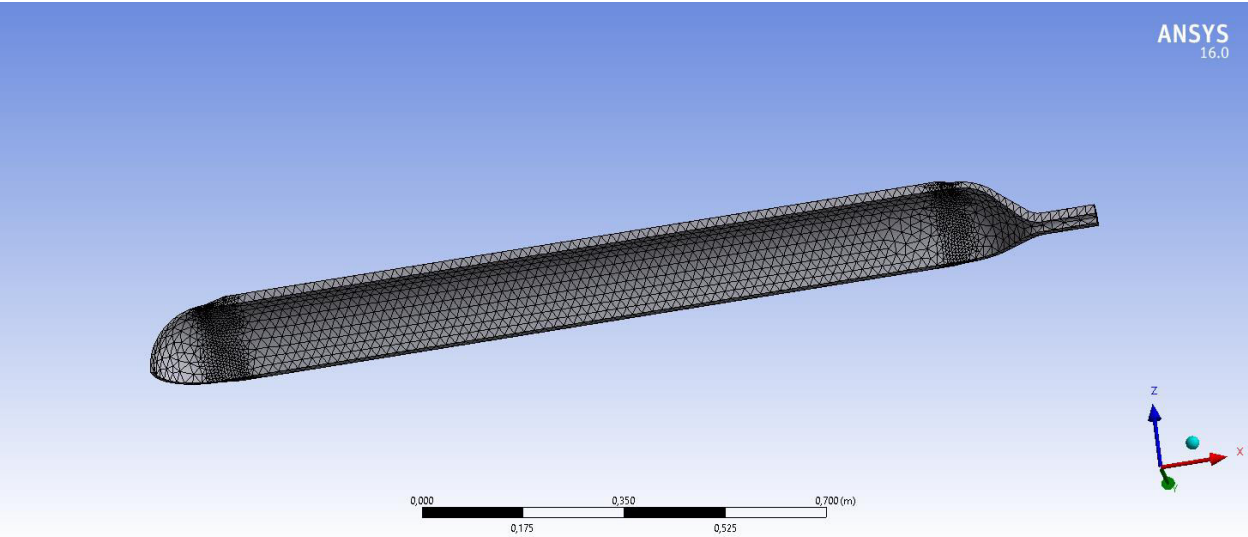
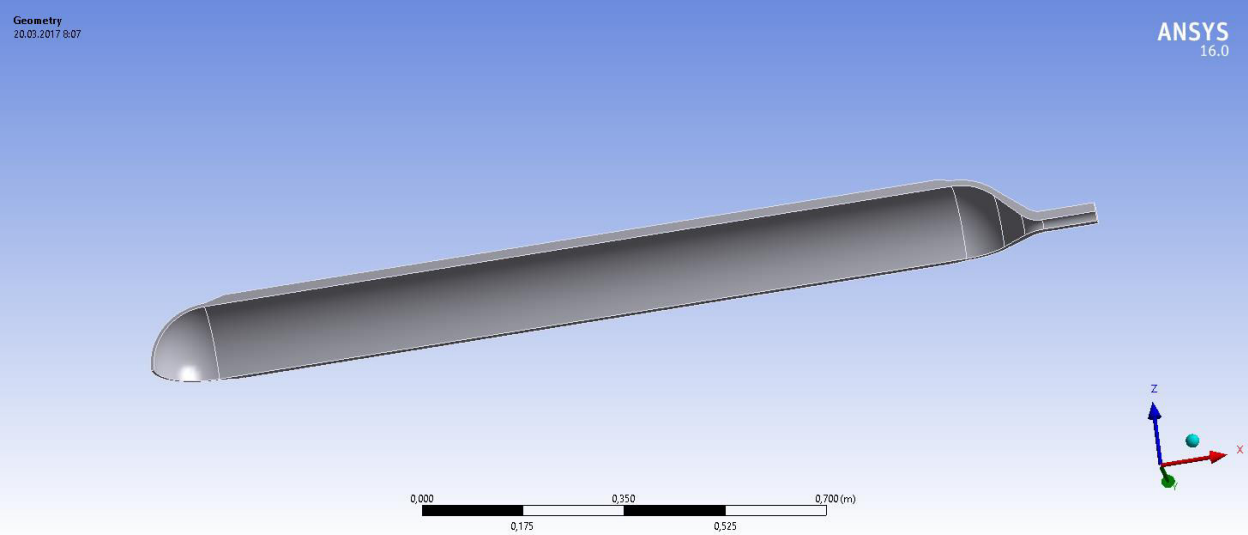
8.3. Storage vessel simulation in ANSYS

In a previous subchapter, 4.2.2.1, a pre-dimensioning for an above ground storage vessel has been presented. The obtained results show which should be the wall thickness and the entire quantity of raw material required for the construction of the storage vessel. So, it was observed which the most exposed areas at normal stress are and where the vessel will deform faster.

The pictures below are for a bottle of 50 liters capable of resisting at 350 bar. The wall thickness was chosen according to figure 22 from the subchapter 4.2.2. The raw material chosen is structural steel (12MoCr50) which has the tensile strength $\sigma_t = 690$ MPa and the proof strength $\sigma_c = 310$ MP.

Following the table 6-1 from EN 13445-3/2014 standards for the storage pressure vessel design, the dimensional equation for the design function $f_d = \min\left(\frac{\sigma_c}{1.5}; \frac{\sigma_t}{2.4}\right)$ and the testing equation $f_{test} = \frac{\sigma_c}{1.05}$ are used. So, $f_{test} = 295.2$ MPa and $f_d = \min(207; 287.9)$, which means 207 MPa. Now from equations 7.4-1 and 7.4-4 from EN 13445-3/2014 are checked the cylindrical body thickness δ_1 , and the spherical head thickness δ_2 using equation 4.1 and 4.2 from chapter 4. Then $\delta_1 = 15.63$ mm and $\delta_2 = 5.202$ mm. To see if this values are allowable the applicability condition is checked and it consists in verifying if $\frac{\delta_1}{D} < 0.16$, in the end is found that the condition is fulfilled.

The 50 liters bottle geometry is created and simulated within the ANSYS 16.0 software. Therefore after the geometry is designed it's passed to a finite element analysis. This involves dividing the model in a random number of elements having triangular form, and each element being considered as a freestanding piece. In the end the study of the real structure is replaced with the assembly finite element study obtained by meshing, which becomes an idealization of the original structure.



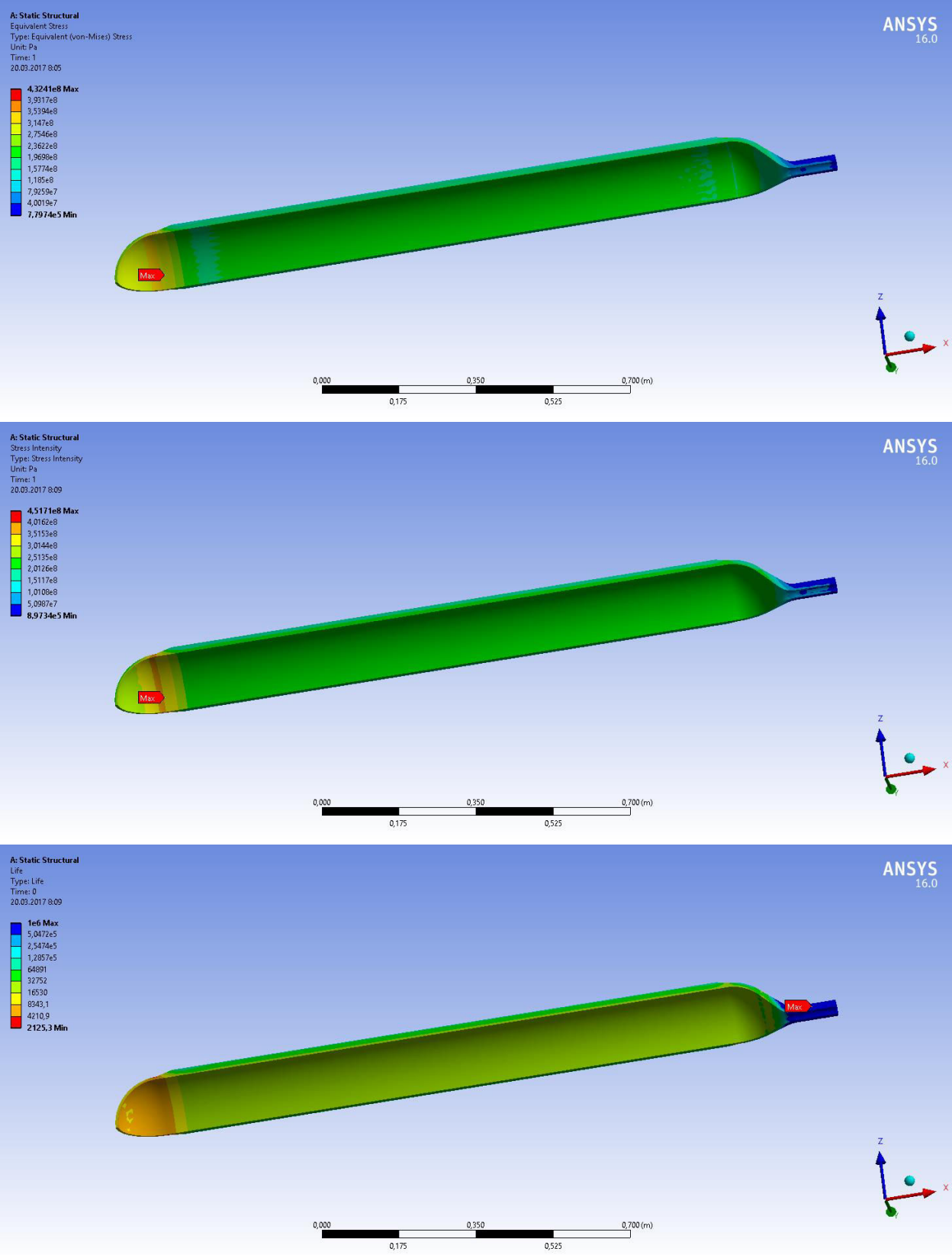


Figure 99 – Storage vessel ANSYS simulation

What interest us in the ANSYS simulation is the stress analysis where are proposed two methods (Tresca and von-Mises). Both methods let us see that the most exposed stress areas with the greatest values are at the bottom of the bottle, meanwhile, the smallest are at the top. Von-Mises and Tresca criterions are ways of determining when a material will fail due to multiaxial stress. In the components of both criterion's equations enter the normal stress which is used to evaluate the overall stress, and when the latest is greater than the material's yield strength, it will yield.

All these values obtained for each criterion are compared with the allowable stress of the used material, which in this case for the structural steel is equal to 207 MPa.

At the bottom of figure 99 is revealed a life cycle analysis and is illustrated that the drawn bottle support at least 3,000 cycles of charging-discharging.

9. Energy price and consumption for householders

9.1. Energy market

According to the World Energy Council in figure 100 are shown the average electricity consumption per electrified households. A consumption of 5,829.6 kWh/year for France and 1,935.5 kWh/year for Romania can be highlighted. While in figure 101 and figure 102 considering the data reported by Eurostat are presented electricity price for households for countries worldwide highlighting the price of 0.175 €/kWh in the case of France and 0.125 €/kWh for Romania and 0.076 €/kWh respectively 0.032 €/kWh for natural gas, too.

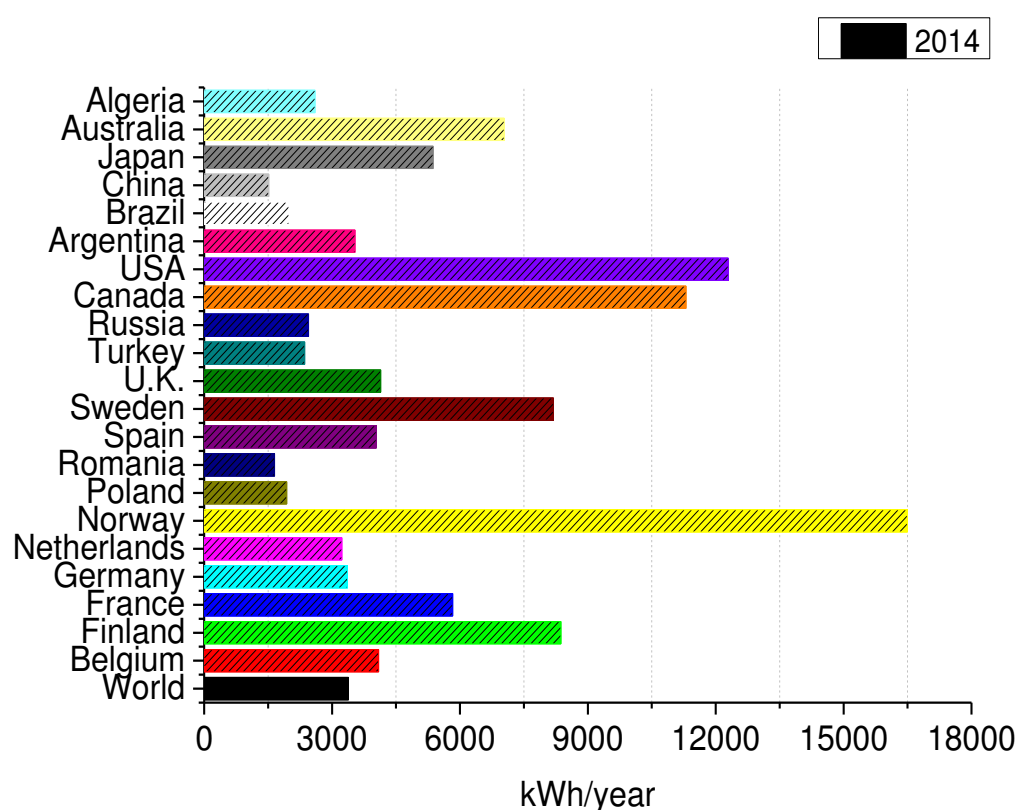


Figure 100 – Average electricity consumption per electrified households, data processed from [95]

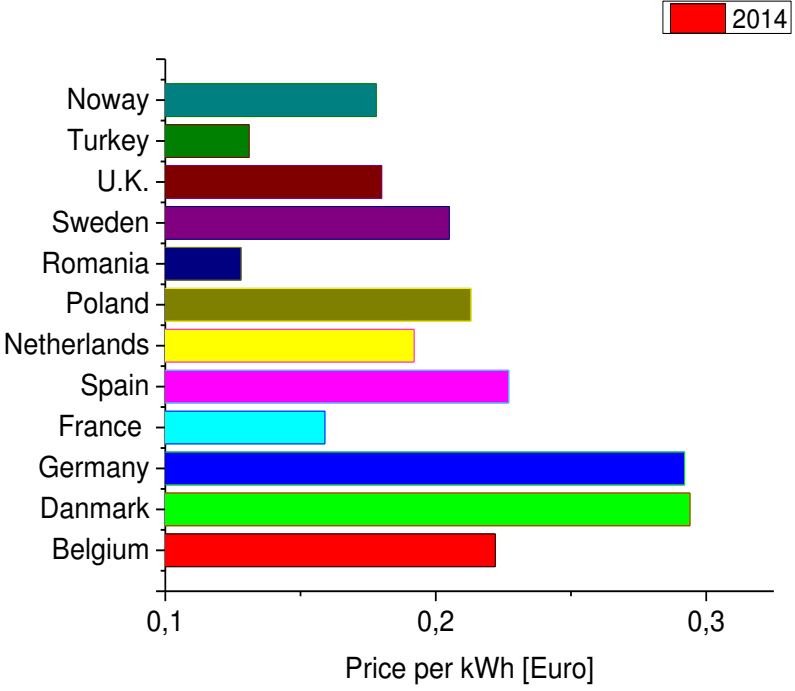


Figure 101 – Electricity price households, data processed from [96]

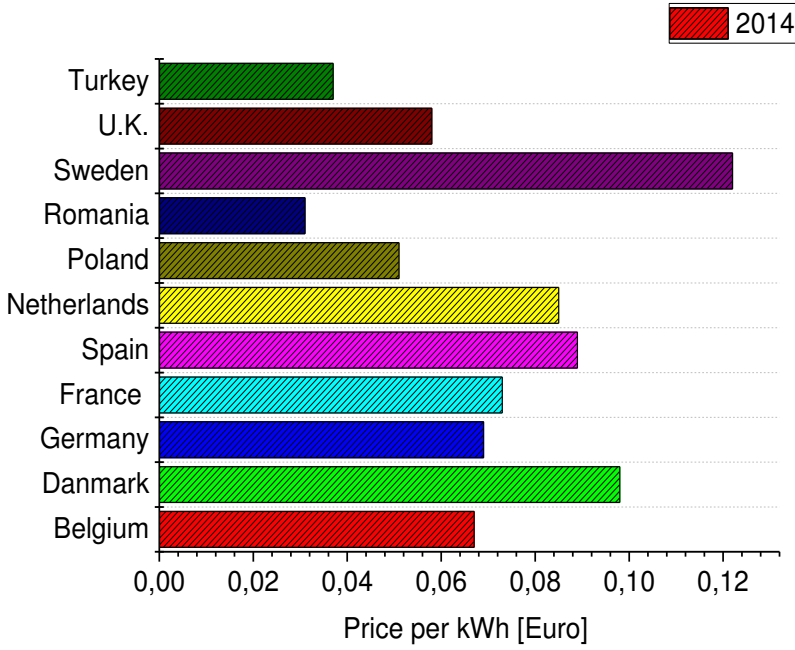


Figure 102 – Price per kWh for natural gas, data processed from [96]

Comparison and the advantages that adiabatically compressed air energy storage systems (AA-CAES) have in the front of conventional compressed air energy storage systems (CAES)

Table 13 – Comparison between CAES and AA-CAES system

| AA-CAES | CAES |
|---|---|
| Could achieve a round trip efficiency around 75%. | Nowadays conventional plants have an efficiency less than 60% (McIntosh 54% the highest efficiency) |
| Don't need natural gas consumption. | Use natural gas for combustion. |
| It is a “clean” solution. | Produce GHG emissions. |
| Require a new design of compressor. | The compressors are already commercially available on the market. |
| Require a new design of expander (turbine or air engine). | The expanders are already commercially available on the market. |
| Require a cooling system connected to the thermal energy storage system (TES). | Require a cooling system to cool the compressor. Thermal energy resulted is dissipated in the atmosphere. |
| Innovative solutions for the storage reservoir are still under research and development. | Innovative solutions for the storage reservoir are still under research and development. |

9.2. Cost analysis

The current existing power plants, Huntorf and McIntosh, had about the same specific investment cost of 400 €/kW. However, for nowadays, the investment costs are estimated between 400 – 1000 €/kW, having the strongest dependency by the structural conditions of the site. For an AA-CAES power plant since has been none realized, the estimation costs are uncertain, but for sure these are higher than for a conventional power plant, due to technological learning and could be estimated between 600 – 1200 €/kW [12], [97], [98], [99], [100], [101], [102], [103], [104].

Depending on the scale of the CAES system the charging cost can be seen from two points of view. Firstly can start from the point that the energy is taken from renewable sources, so the investment cost for the acquisition and installation of the conversion equipment of the wind and solar energy into electricity should be considered and is a consistent one. From another point of view can be considered that the energy is taken from the grid, so the charging cost, as well as the energy price, is a spread between charging and discharging. In order to make this system profitable, it works on the energy arbitrage market storing energy during off-peak hours and consumed or restoring to the grid in on-peak hours.

9.3. The optimization cost of production

We have to mention that the inlet pressure of the expander for the existing CAES high pressure (45 – 70 bar) is much higher than the equivalent for a gas turbine, so a conventional gas turbine can only be used as the low-pressure expander. Even on the market from the best knowledge of the author the gas expanders, air engines or turbines, operate at low values of pressure.

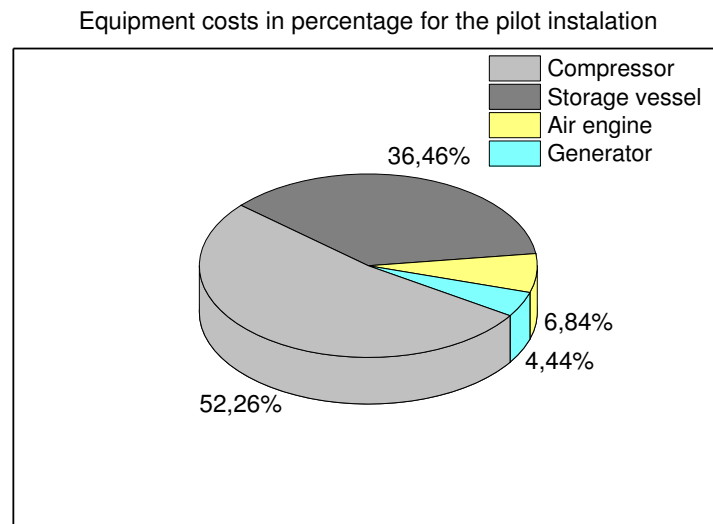


Figure 103 – Equipment costs in percentage for the pilot instalation

In figure 103 it is presented the cost in percentage of the equipment involved in the experimental set-up of the system and can be seen that the compressor cost together with the cost for the storage vessel count more than 88%. What should be mentioned is that in this figure has not been taken into consideration the cost with the automatization part of the system. Anyway, the cost of the automatization part is getting smaller once with the increasing range of the storage system.

9.4. Determining the objective function

For the economic evaluation is important to know at least for beginning the equipment capital cost. In literature and also on the market there is a lot of information which mention that for renewable energy, especially for photovoltaic panels the installation cost is 2 €/W, meanwhile, for wind turbines the cost varies between 2-3 €/W depending on the wind turbine scale. Regarding the other equipment namely compressors, storage vessel, expanders and generators the information are very few in relation with our requirements. In this situation for the economic analysis we considered an average price of the existing compressors on the market from Bauer and Kaesser manufacturer and we adapt a bit the price function of the number of compression stages, pressures and mass flow rate. We made the same thing in the case of expanders where we estimate an average price considering manufacturers like SPXFLOW Europe Ltd. or MacScott Bond Ltd.. For generators, we take into consideration the prices of the following manufacturers: Mafarlane Gerenators, MeccAlte, Stamford, Markon, Newage and Leroy Somer.

The objective function (F) which we define here as a mathematical equation which describes the output target that corresponds to the maximization of profit with respect to the cost of investment. The goal of an objective function is to maximize profits or to minimize losses based on a set of constraints and the relationship between the decision variables. The vast majority of constraints concern in limitations imposed by capacity, environmental conditions, working technology and so on.

$$F = F(n)$$

$$E_{ad}(n) = \frac{E(n)}{100}$$

$$C_{ad}(n) = \frac{C(n)}{C_{max}}$$

$$F = x \% / E_{ad}(n) + y \% C_{ad}(n) \rightarrow MIN$$

Where "n" is the number of stages, $E(n)$ and $C(n)$ are the efficiency and the economic cost related for n number of stages, C_{max} is the maximum cost and x and y are percentage from E_{ad} respectively C_{ad} for the objective function.

Table 14 – Storage vessel dimension

| Nr. of units | Storage vessel dimension – 60 bar air compression / 30 bar air expansion [in m ³] | Storage vessel dimension – 300 bar air compression / 30 bar air expansion [in m ³] | Storage vessel dimension – 120 bar air compression / 60 bar air expansion [in m ³] | Storage vessel dimension – 300 bar air compression / 60 bar air expansion [in m ³] |
|--------------|---|--|--|--|
| 1 | 16.3 | 1.81 | 7.13 | 1.78 |
| 2 | 14.3 | 1.58 | 6.1 | 1.52 |
| 3 | 13.67 | 1.51 | 5.78 | 1.445 |
| 4 | 13.35 | 1.48 | 5.62 | 1.4 |
| 5 | 13.17 | 1.46 | 5.51 | 1.38 |
| 6 | 13.06 | 1.45 | 5.47 | 1.368 |
| 7 | 12.96 | 1.44 | 5.42 | 1.357 |
| 8 | 12.9 | 1.43 | 5.4 | 1.78 |

Table 15 – System efficiency

| Nr. of units | System efficiency – 60 bar air compression / 30 bar air expansion [in %] | System efficiency – 300 bar air compression / 30 bar air expansion [in %] | System efficiency – 120 bar air compression / 60 bar air expansion [in %] | System efficiency – 300 bar air compression / 60 bar air expansion [in %] |
|--------------|--|---|---|---|
| 1 | 31.9 | 19.6 | 29.2 | 22.5 |
| 2 | 43.8 | 29.3 | 42.6 | 34.3 |
| 3 | 48.7 | 33.3 | 48.2 | 39.4 |
| 4 | 51.3 | 36 | 51.3 | 42.2 |
| 5 | 52.9 | 37 | 53.2 | 44 |
| 6 | 54 | 37.9 | 54.6 | 45.2 |
| 7 | 54.9 | 38.7 | 55.5 | 46.1 |
| 8 | 55.5 | 39.2 | 56.3 | 46.6 |

Table 16 – Price for the equipment which convert into electricity renewable energy

| Nr. of units | RES system price – 60 bar air compression / 30 bar air expansion [in €] | RES system price – 300 bar air compression / 30 bar air expansion [in €] | RES system price – 120 bar air compression / 60 bar air expansion [in €] | RES system price – 300 bar air compression / 60 bar air expansion [in €] |
|--------------|---|--|--|--|
| 1 | 62,695.92 | 102,040.8 | 68,493.15 | 88,888.89 |
| 2 | 45,662.1 | 68,259.39 | 46,948.36 | 58,309.04 |
| 3 | 41,067.76 | 60,060.06 | 41,493.78 | 50,761.42 |
| 4 | 38,986.35 | 55,555.56 | 38,986.35 | 47,393.36 |
| 5 | 37,807.18 | 54,054.05 | 37,593.98 | 45,454.55 |
| 6 | 37,037.04 | 52,770.45 | 36,630.04 | 44,247.79 |
| 7 | 36,429.87 | 51,679.59 | 36,036.04 | 43,383.95 |
| 8 | 36,036.04 | 51,020.41 | 35,523.98 | 42,918.45 |

Table 17 – Price for the air compressor

| Nr. of units | Compressor price – 60 bar air compression / 30 bar air expansion [in €] | Compressor price – 300 bar air compression / 30 bar air expansion [in €] | Compressor price – 120 bar air compression / 60 bar air expansion [in €] | Compressor price – 300 bar air compression / 60 bar air expansion [in €] |
|--------------|---|--|--|--|
| 1 | 30,000 | 40,000 | 34,500 | 46,000 |
| 2 | 35,000 | 50,000 | 40,250 | 57,500 |
| 3 | 40,000 | 55,000 | 46,000 | 63,250 |
| 4 | 47,000 | 65,000 | 54,050 | 74,750 |
| 5 | 55,000 | 75,000 | 63,250 | 86,250 |
| 6 | 60,000 | 85,000 | 69,000 | 97,750 |
| 7 | 70,000 | 95,000 | 80,500 | 109,250 |
| 8 | 80,000 | 105,000 | 92,000 | 120,750 |

Table 18 – Price for the storage vessel

| Nr. of units | Storage vessel price – 60 bar air compression / 30 bar air expansion [in €] | Storage vessel price – 300 bar air compression / 30 bar air expansion [in €] | Storage vessel price – 60 bar air compression / 120 bar air expansion [in €] | Storage vessel price – 60 bar air compression / 300 bar air expansion [in €] |
|--------------|---|--|--|--|
| 1 | 326,000 | 36,200 | 142,600 | 35,600 |
| 2 | 286,000 | 31,600 | 122,000 | 30,400 |
| 3 | 273,400 | 30,200 | 115,600 | 28,900 |
| 4 | 267,000 | 29,600 | 112,400 | 28,000 |
| 5 | 263,400 | 29,200 | 110,200 | 27,600 |
| 6 | 261,200 | 29,000 | 109,400 | 27,360 |
| 7 | 259,200 | 28,800 | 108,400 | 27,140 |
| 8 | 258,000 | 28,600 | 108,000 | 27,000 |

Table 19 – Price for the air expander

| Nr. of units | Expander price when the air is expanded from 30 bar and compressed at 60 bar [in €] | Expander price when the air is expanded from 30 bar and compressed at 300 bar [in €] | Expander price when the air is expanded from 60 bar and compressed at 120 bar [in €] | Expander price when the air is expanded from 60 bar and compressed at 300 bar [in €] |
|--------------|---|--|--|--|
| 1 | 10,000 | 10,000 | 10,500 | 10,500 |
| 2 | 13,600 | 13,600 | 14,280 | 14,280 |
| 3 | 16,500 | 16,500 | 17,325 | 17,325 |
| 4 | 19,400 | 19,400 | 20,370 | 20,370 |
| 5 | 22,150 | 22,150 | 22,785 | 22,785 |
| 6 | 24,000 | 24,000 | 25,100 | 25,100 |
| 7 | 26,000 | 26,000 | 27,050 | 27,050 |
| 8 | 28,000 | 28,000 | 29,125 | 29,125 |

Table 20 – System capital cost

| Nr. of units | Whole system capital cost – 60 bar air compression / 30 bar air expansion [in €] | Whole system capital cost – 300 bar air compression / 30 bar air expansion [in €] | Whole system capital cost – 120 bar air compression / 60 bar air expansion [in €] | Whole system capital cost – 300 bar air compression / 60 bar air expansion [in €] |
|---------------------|---|--|--|--|
| 1 | 233,095.9 | 188,240.8 | 199,053.1 | 163,988.8 |
| 2 | 208,662.1 | 163,459.4 | 174,678.3 | 160,489.0 |
| 3 | 206,927.7 | 161,760.1 | 174,178.7 | 160,236.4 |
| 4 | 212,186.3 | 169,555.6 | 180,846.3 | 170,513.3 |
| 5 | 220,317.1 | 180,404.1 | 189,748.9 | 182,089.5 |
| 6 | 225,517.1 | 190,770.4 | 196,370.0 | 194,457.7 |
| 7 | 236,109.8 | 201,479.6 | 208,626.0 | 206,823.9 |
| 8 | 247,236.1 | 212,620.4 | 221,448.9 | 219,793.4 |

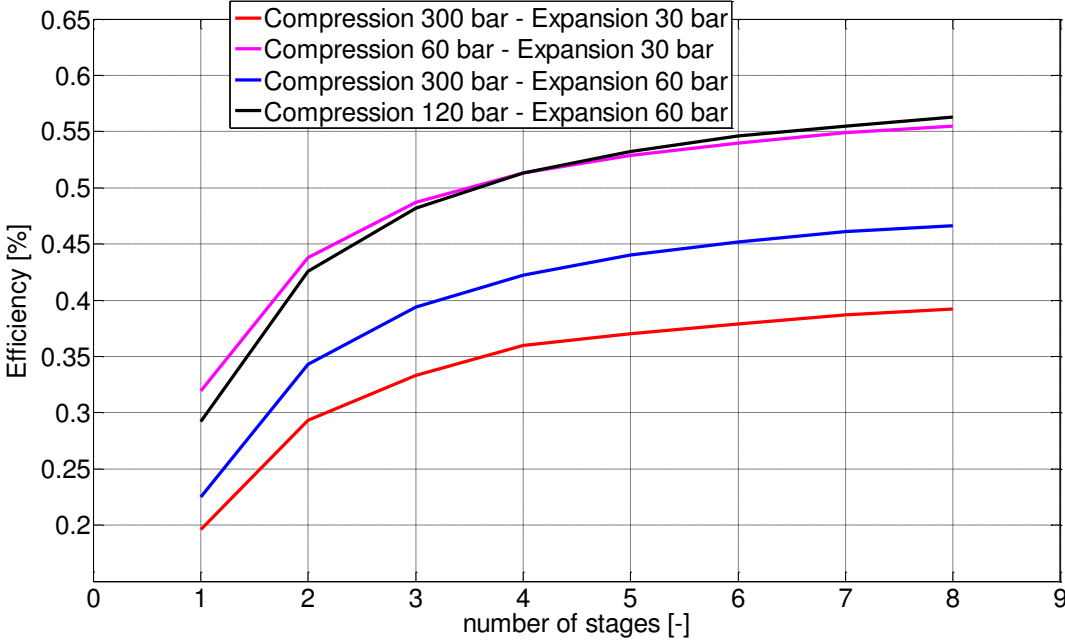


Figure 104 – System primary efficiency

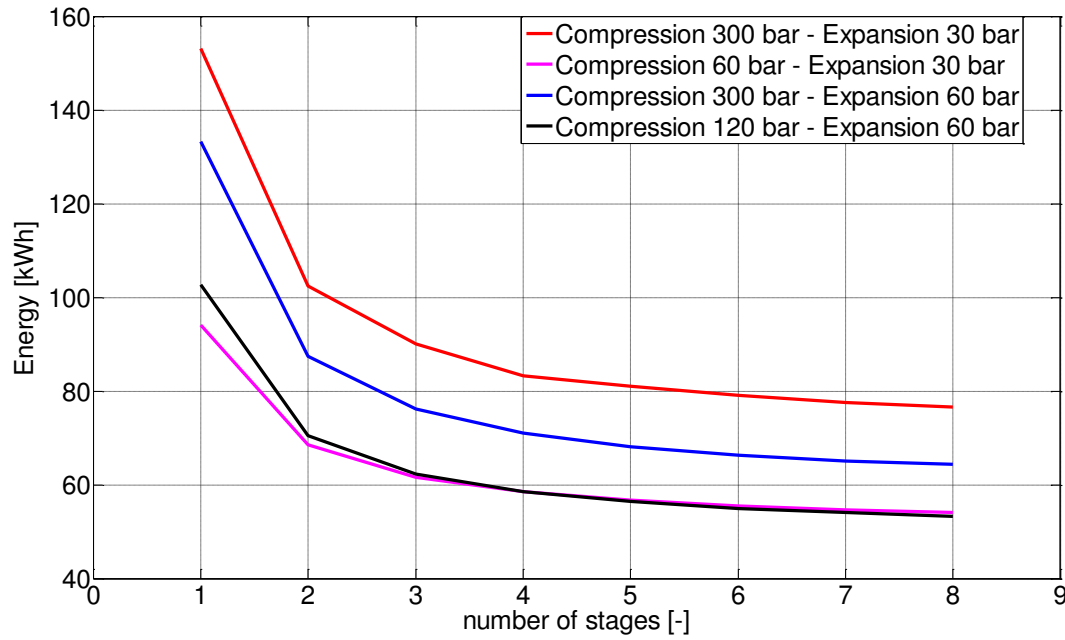


Figure 105 – Energy required from renewable sources

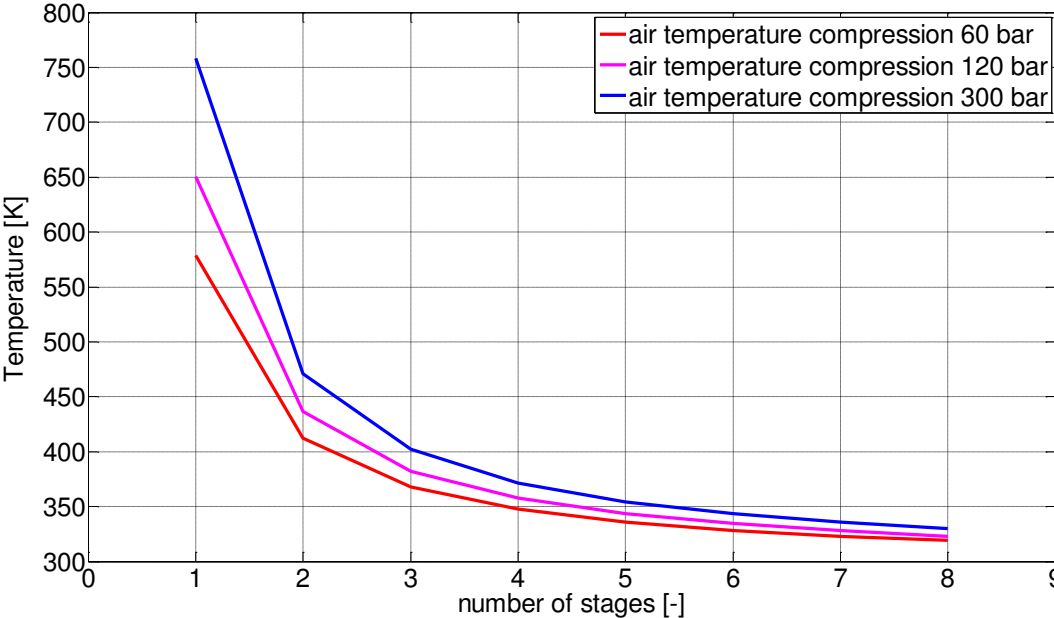


Figure 106 – Air temperature resulted after compression

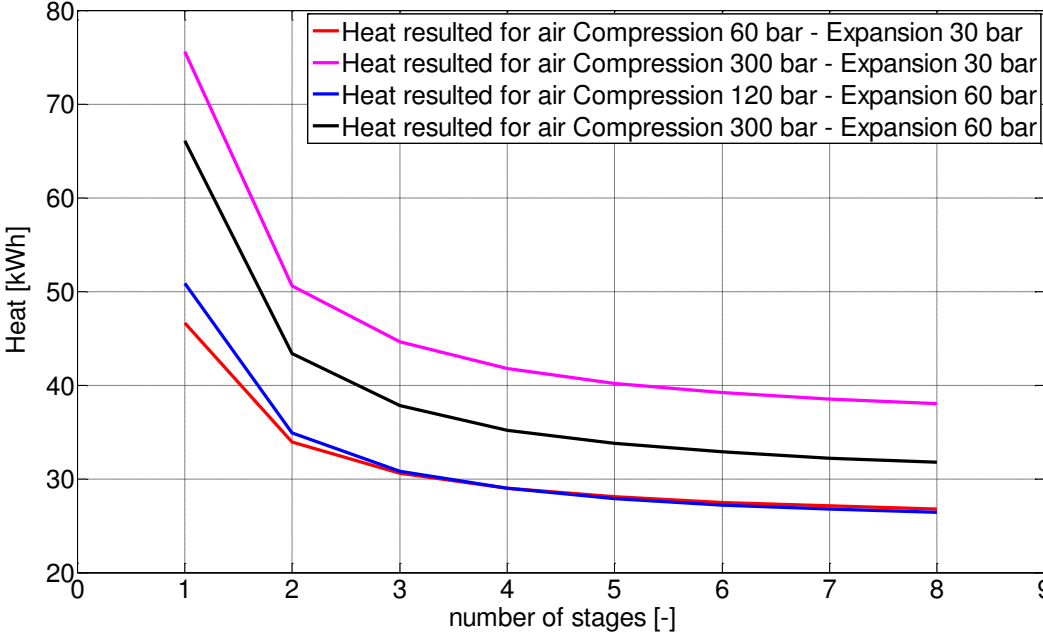


Figure 107 – Heat resulted during air compression

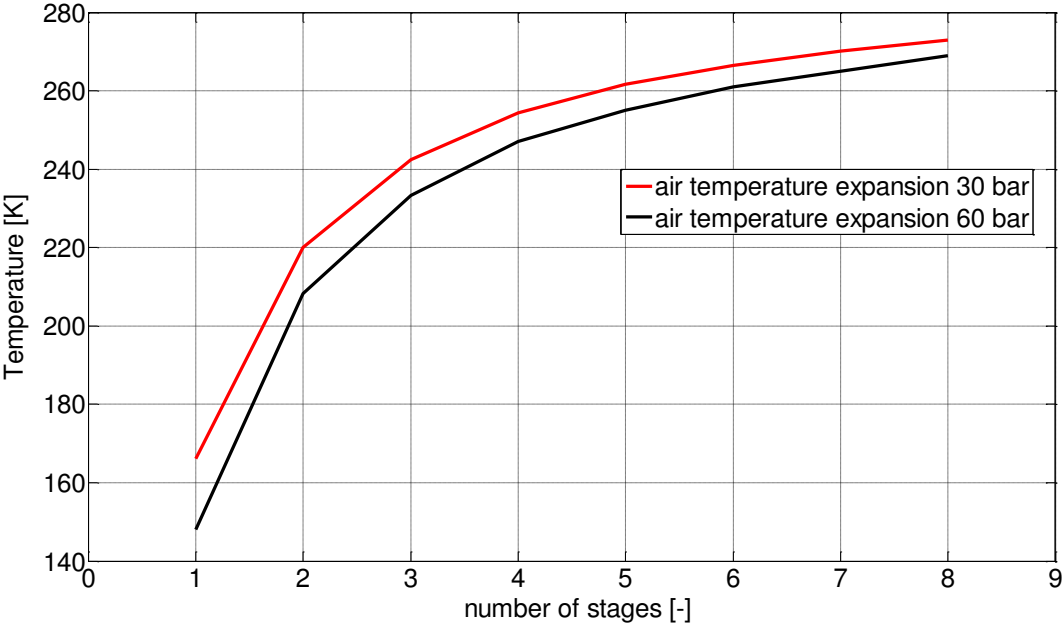


Figure 108 – Outlet air engine temperature variation function of number of stages and the inlet air engine pressure

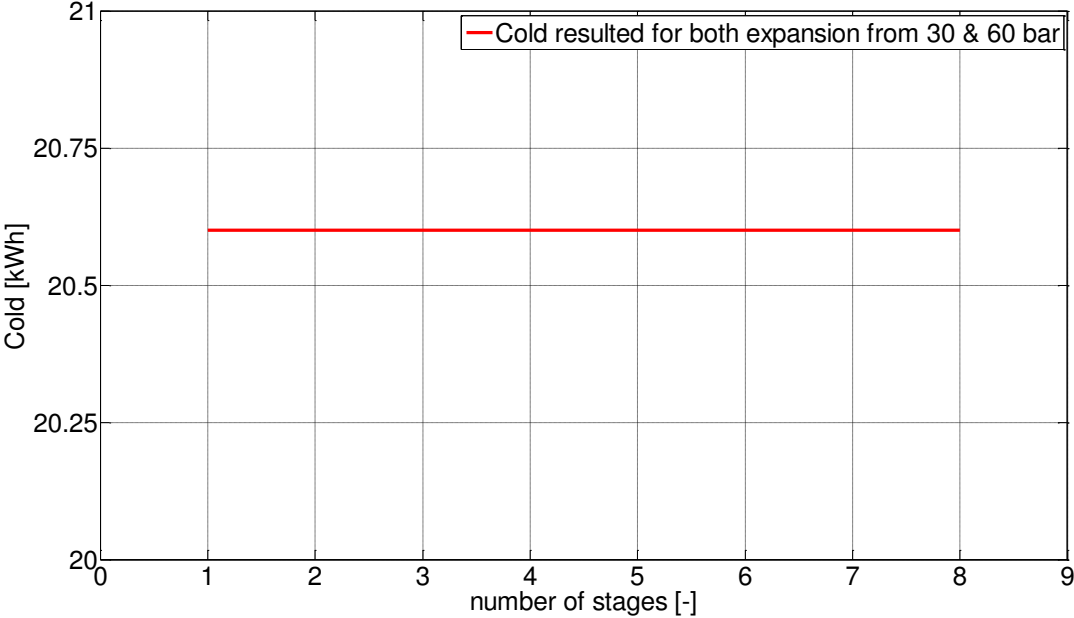


Figure 109 – Cold resulted during air expansion

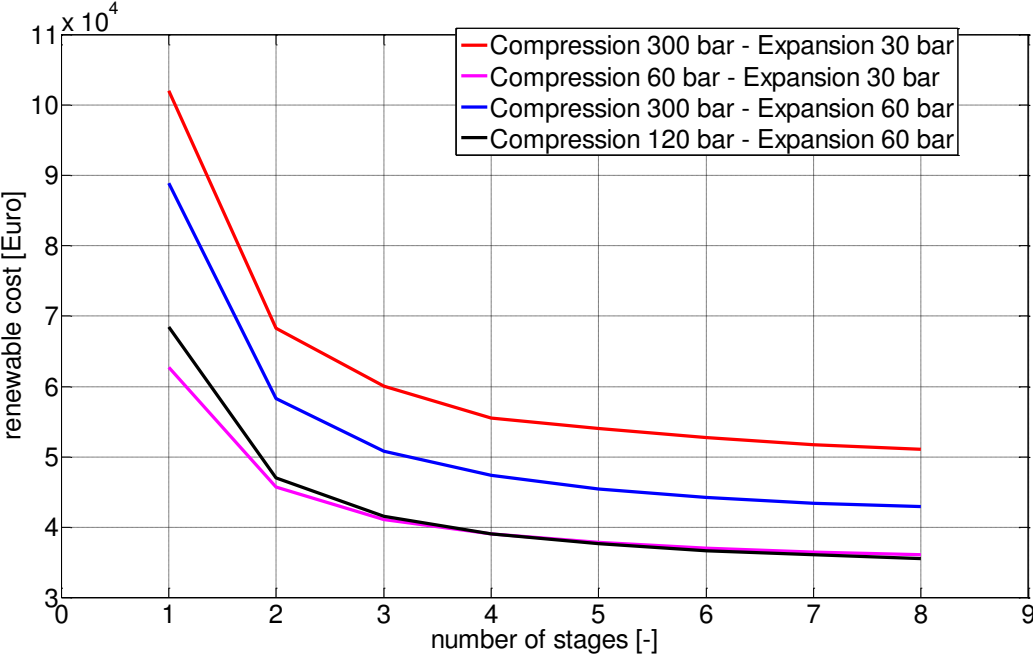


Figure 110 – Cost for the equipment which converts renewable energy into electricity

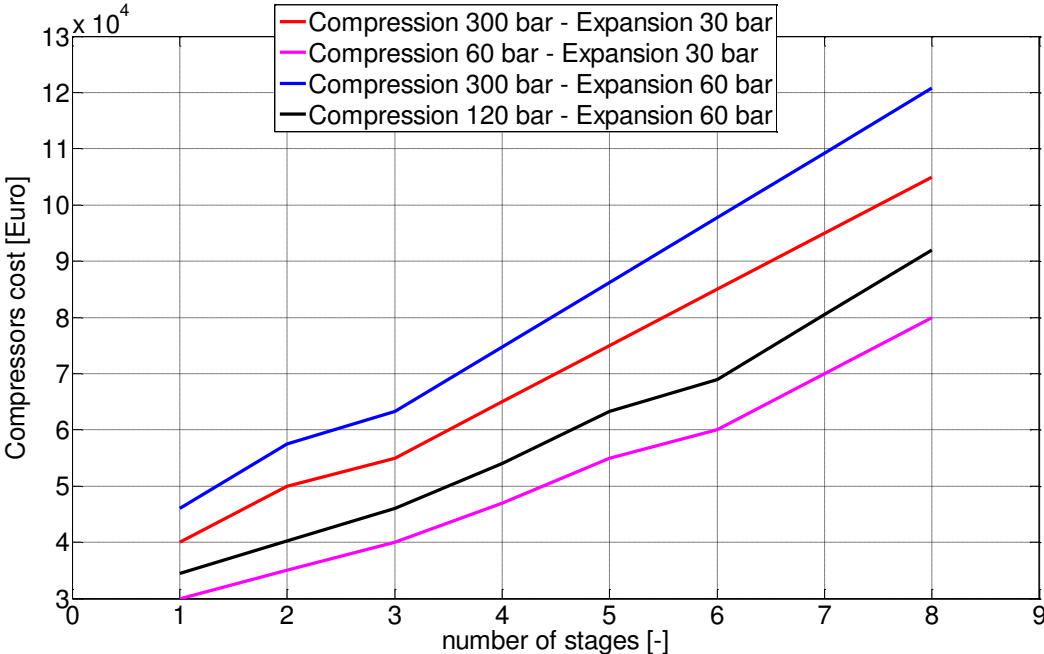


Figure 111 – Compressors cost

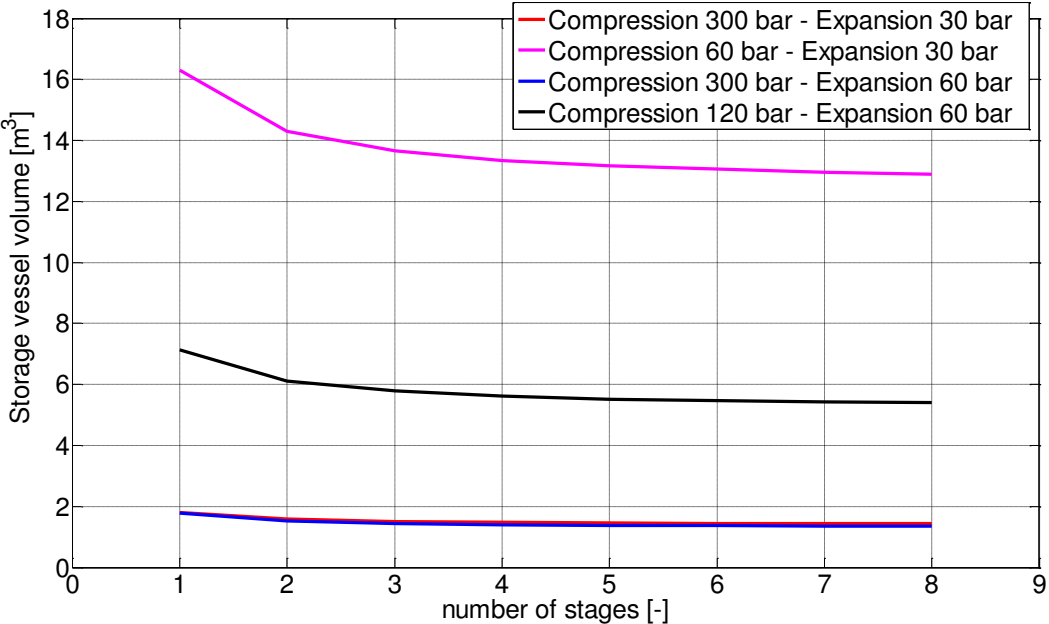


Figure 112 – Storage vessel cost

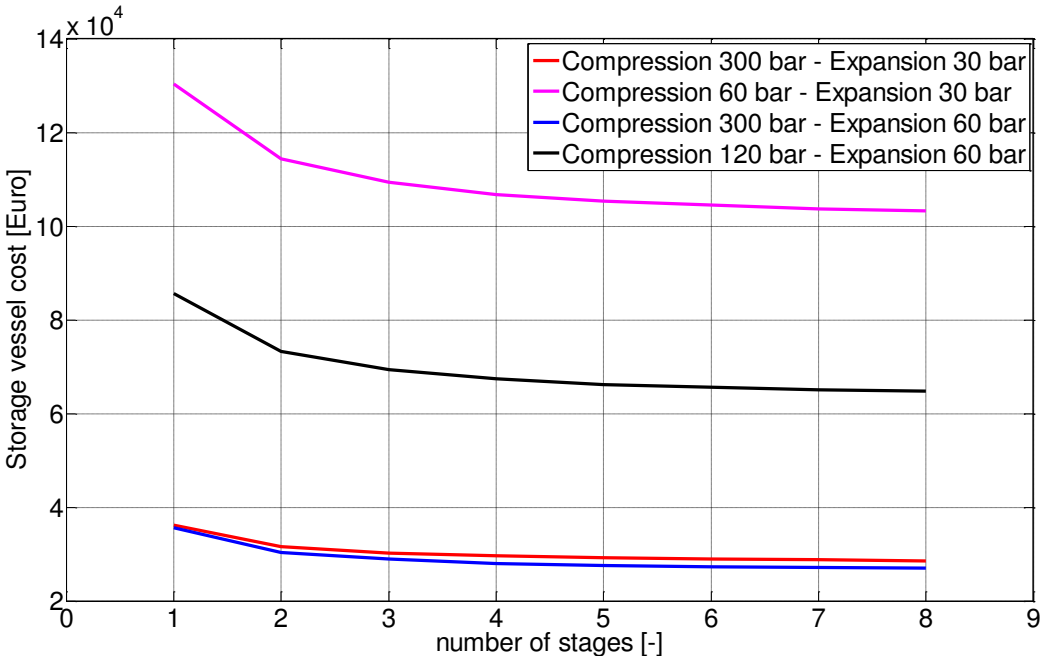


Figure 113 – Storage vessel volume

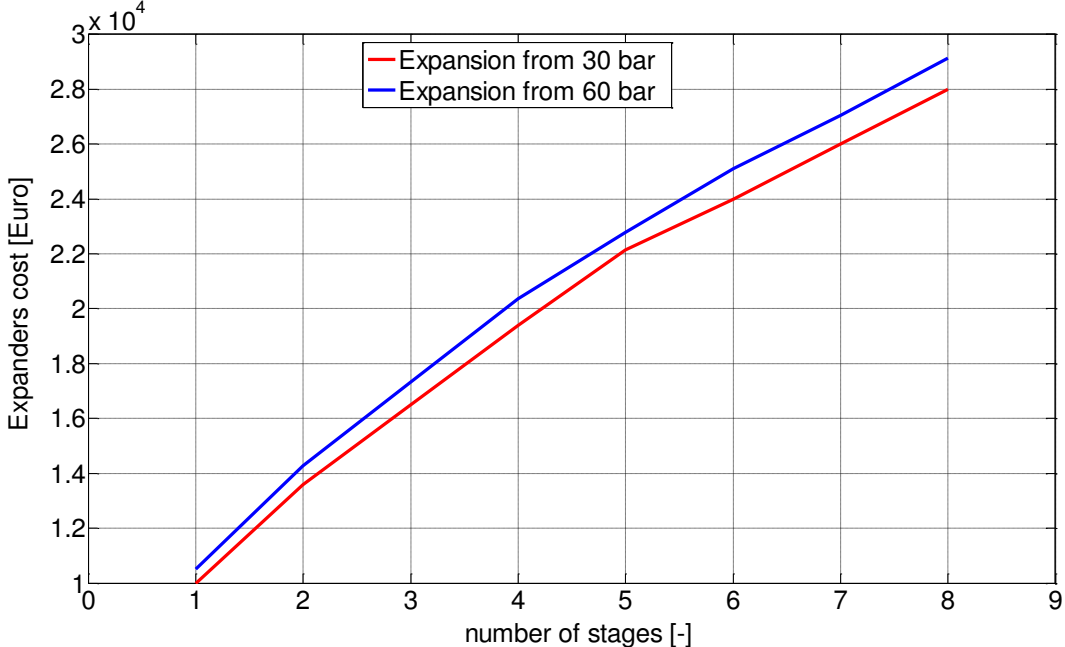


Figure 114 – Expanders cost

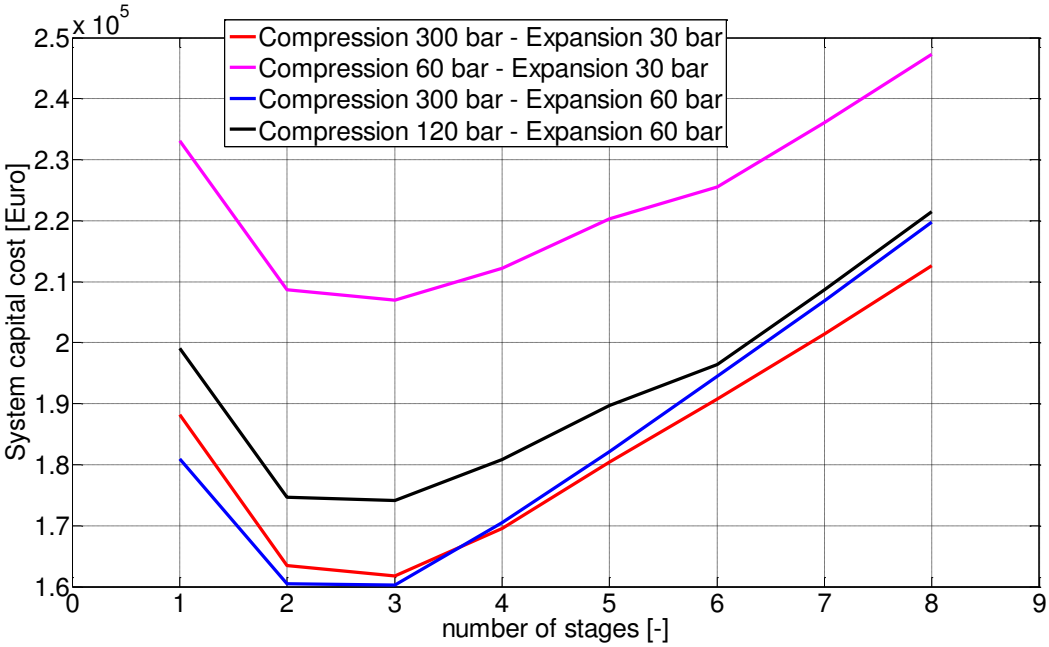


Figure 115 – System capital cost

In figures 105 to 110 are presented the quantity of energy which must be delivered from renewable energy sources in order to supply to the final user 5 kW of power during 6 hours, function of the storage pressure and inlet air engine temperature and pressure, the system primary efficiency, the heat resulted during the air compression and the cold resulted during the air expansion process.

Cost analysis includes the equipment purchase and installation costs, without to take into consideration the operation and the maintenance cost. In the above tables and figures are presented cost scenarios for cases in which the air is pressurized at 60 bar respectively at 300 bar when the air inlet expander pressure is throttled at 30 bar, and cases in which the air is pressurized at 120 bar respectively 300 bars when the air inlet expander pressure is throttled at 60 bar.

So, we tried to figure out which is the compression and expansion number of stages required to obtain the highest possible efficiency at minimum investment cost. As we already saw in the chapters before that the highest efficiency is obtained for the same number of stages in both processes, compression and expansion. Therefore it's evaluated the system efficiency involving from 1 to 8 stages for both processes. Having the value of the energy required to be stored and the pressure at which the air follows to be compressed and as well the air inlet expander pressure, we evaluate the system efficiency and the storage vessel dimension. Starting from this the investment costs for all the equipment including: wind turbine, photovoltaic cells, compressors, storage vessel, air turbines are shown in figures from 110 to 114.

Figure 112 shows that having a higher storage pressure for the same quantity of energy required by the consumer, the storage vessel dimension decrease considerably and so its cost too. As long as the storage vessel dimension increase the cost increase too, even if the storage pressure decrease.

As well as we already mentioned before have been seen that from a technical point of view for a higher efficiency must be increased the compression and expansion number of stages. This fact involves an incense in the purchasing cost of the compressors and expanders, but in the same time a reduction in the cost of the storage vessel, and our evaluation shows that the storage vessel cost has a faster increase comparing with the increment of compressors or the equipment for the renewable energy conversion into electricity.

According to the figure 115 considering that the storage vessel will be built aboveground, the storage in a larger vessel volume at a low pressure will involve a higher investment cost reported to a storage vessel at a higher pressure having a smaller dimension. A larger storage vessel imposes difficulties in terms of size and as well in the case of a higher number of stages of compression or expansion either if we consider multistage compressors/expanders or separate units.

From economic considerations figure 115 shows that the minimum investment will be done for three stages of compression/expansion followed then by two stages of compression/expansion.

Table 21 – The objective function determination to obtain 30 kWh energy with 300 bar storage pressure and 30 bar air expanded inlet pressure

| | | <i>n</i> | | | | | | | | | | | | | | | |
|----------|----------|-------------|------------|------------|------------|------------|------------|------------|------------|------------|------------|------------|------------|------------|------------|------------|------------|
| | | 1 | | 2 | | 3 | | 4 | | 5 | | 6 | | 7 | | 8 | |
| | | <i>Ead</i> | <i>Cad</i> | <i>Ead</i> | <i>Cad</i> | <i>Ead</i> | <i>Cad</i> | <i>Ead</i> | <i>Cad</i> | <i>Ead</i> | <i>Cad</i> | <i>Ead</i> | <i>Cad</i> | <i>Ead</i> | <i>Cad</i> | <i>Ead</i> | <i>Cad</i> |
| | | 0.319 | 0.943 | 0.438 | 0.844 | 0.487 | 0.837 | 0.513 | 0.858 | 0.529 | 0.891 | 0.540 | 0.912 | 0.549 | 0.955 | 0.555 | 1 |
| <i>%</i> | <i>%</i> | <i>%</i> | <i>%</i> | <i>%</i> | <i>%</i> | <i>%</i> | <i>%</i> | <i>%</i> | <i>%</i> | <i>%</i> | <i>%</i> | <i>%</i> | <i>%</i> | <i>%</i> | <i>%</i> | <i>%</i> | <i>%</i> |
| <i>x</i> | <i>y</i> | <i>F(n)</i> | | | | | | | | | | | | | | | |
| 0.1 | 0.9 | 1.162 | | 0.988 | | 0.959 | | 0.967 | | 0.991 | | 1.006 | | 1.042 | | 1.080 | |
| 0.2 | 0.8 | 1.381 | | 1.132 | | 1.080 | | 1.076 | | 1.091 | | 1.100 | | 1.128 | | 1.160 | |
| 0.3 | 0.7 | 1.600 | | 1.276 | | 1.202 | | 1.186 | | 1.191 | | 1.194 | | 1.215 | | 1.241 | |
| 0.4 | 0.6 | 1.820 | | 1.420 | | 1.324 | | 1.295 | | 1.291 | | 1.288 | | 1.302 | | 1.321 | |
| 0.5 | 0.5 | 2.039 | | 1.564 | | 1.445 | | 1.404 | | 1.391 | | 1.382 | | 1.388 | | 1.401 | |
| 0.6 | 0.4 | 2.258 | | 1.707 | | 1.567 | | 1.513 | | 1.491 | | 1.476 | | 1.475 | | 1.481 | |
| 0.7 | 0.3 | 2.477 | | 1.851 | | 1.688 | | 1.622 | | 1.591 | | 1.570 | | 1.562 | | 1.561 | |
| 0.8 | 0.2 | 2.696 | | 1.995 | | 1.810 | | 1.731 | | 1.691 | | 1.664 | | 1.648 | | 1.641 | |
| 0.9 | 0.1 | 2.916 | | 2.139 | | 1.932 | | 1.840 | | 1.790 | | 1.758 | | 1.735 | | 1.722 | |

Table 22 – The objective function determination to obtain 30 kWh energy with 60 bar storage pressure and 30 bar air expanded inlet pressure

| | | <i>n</i> | | | | | | | | | | | | | | | |
|----------|----------|-----------------------|-----------------------|-----------------------|-----------------------|-----------------------|-----------------------|-----------------------|-----------------------|-----------------------|-----------------------|-----------------------|-----------------------|-----------------------|-----------------------|-----------------------|-----------------------|
| | | 1 | | 2 | | 3 | | 4 | | 5 | | 6 | | 7 | | 8 | |
| | | <i>E_{ad}</i> | <i>C_{ad}</i> | <i>E_{ad}</i> | <i>C_{ad}</i> | <i>E_{ad}</i> | <i>C_{ad}</i> | <i>E_{ad}</i> | <i>C_{ad}</i> | <i>E_{ad}</i> | <i>C_{ad}</i> | <i>E_{ad}</i> | <i>C_{ad}</i> | <i>E_{ad}</i> | <i>C_{ad}</i> | <i>E_{ad}</i> | <i>C_{ad}</i> |
| | | 0.196 | 0.885 | 0.293 | 0.745 | 0.333 | 0.761 | 0.36 | 0.797 | 0.37 | 0.848 | 0.379 | 0.897 | 0.387 | 0.948 | 0.392 | 1 |
| % | % | % | % | % | % | % | % | % | % | % | % | % | % | % | % | % | % |
| <i>x</i> | <i>y</i> | <i>F(n)</i> | | | | | | | | | | | | | | | |
| 0.1 | 0.9 | 1.307 | | 1.012 | | 0.985 | | 0.995 | | 1.034 | | 1.071 | | 1.111 | | 1.155 | |
| 0.2 | 0.8 | 1.729 | | 1.279 | | 1.209 | | 1.194 | | 1.219 | | 1.245 | | 1.275 | | 1.310 | |
| 0.3 | 0.7 | 2.150 | | 1.546 | | 1.433 | | 1.392 | | 1.405 | | 1.420 | | 1.439 | | 1.465 | |
| 0.4 | 0.6 | 2.572 | | 1.812 | | 1.658 | | 1.590 | | 1.590 | | 1.594 | | 1.602 | | 1.620 | |
| 0.5 | 0.5 | 2.994 | | 2.079 | | 1.882 | | 1.788 | | 1.776 | | 1.768 | | 1.766 | | 1.776 | |
| 0.6 | 0.4 | 3.415 | | 2.346 | | 2.106 | | 1.986 | | 1.961 | | 1.942 | | 1.929 | | 1.931 | |
| 0.7 | 0.3 | 3.837 | | 2.613 | | 2.330 | | 2.184 | | 2.146 | | 2.116 | | 2.093 | | 2.086 | |
| 0.8 | 0.2 | 4.259 | | 2.879 | | 2.555 | | 2.382 | | 2.332 | | 2.290 | | 2.257 | | 2.241 | |
| 0.9 | 0.1 | 4.680 | | 3.146 | | 2.779 | | 2.580 | | 2.517 | | 2.464 | | 2.420 | | 2.396 | |

Table 23 – The objective function determination to obtain 30 kWh energy with 300 bar storage pressure and 60 bar air expanded inlet pressure

| | | <i>n</i> | | | | | | | | | | | | | | | |
|----------|----------|-----------------------|-----------------------|-----------------------|-----------------------|-----------------------|-----------------------|-----------------------|-----------------------|-----------------------|-----------------------|-----------------------|-----------------------|-----------------------|-----------------------|-----------------------|-----------------------|
| | | 1 | | 2 | | 3 | | 4 | | 5 | | 6 | | 7 | | 8 | |
| | | <i>E_{ad}</i> | <i>C_{ad}</i> | <i>E_{ad}</i> | <i>C_{ad}</i> | <i>E_{ad}</i> | <i>C_{ad}</i> | <i>E_{ad}</i> | <i>C_{ad}</i> | <i>E_{ad}</i> | <i>C_{ad}</i> | <i>E_{ad}</i> | <i>C_{ad}</i> | <i>E_{ad}</i> | <i>C_{ad}</i> | <i>E_{ad}</i> | <i>C_{ad}</i> |
| | | 0.225 | 0.823 | 0.343 | 0.704 | 0.394 | 0.729 | 0.422 | 0.775 | 0.44 | 0.828 | 0.452 | 0.884 | 0.461 | 0.94 | 0.466 | 1 |
| | | % | % | % | % | % | % | % | % | % | % | % | % | % | % | % | % |
| <i>x</i> | <i>y</i> | <i>F(n)</i> | | | | | | | | | | | | | | | |
| 0.1 | 0.9 | 1.186 | | 0.925 | | 0.910 | | 0.935 | | 0.973 | | 1.017 | | 1.064 | | 1.115 | |
| 0.2 | 0.8 | 1.548 | | 1.146 | | 1.091 | | 1.095 | | 1.117 | | 1.150 | | 1.187 | | 1.229 | |
| 0.3 | 0.7 | 1.910 | | 1.367 | | 1.272 | | 1.254 | | 1.262 | | 1.283 | | 1.309 | | 1.344 | |
| 0.4 | 0.6 | 2.272 | | 1.589 | | 1.453 | | 1.413 | | 1.406 | | 1.416 | | 1.432 | | 1.458 | |
| 0.5 | 0.5 | 2.634 | | 1.810 | | 1.634 | | 1.573 | | 1.551 | | 1.549 | | 1.555 | | 1.573 | |
| 0.6 | 0.4 | 2.996 | | 2.031 | | 1.814 | | 1.732 | | 1.695 | | 1.681 | | 1.678 | | 1.688 | |
| 0.7 | 0.3 | 3.358 | | 2.252 | | 1.995 | | 1.892 | | 1.839 | | 1.814 | | 1.801 | | 1.802 | |
| 0.8 | 0.2 | 3.720 | | 2.473 | | 2.176 | | 2.051 | | 1.984 | | 1.947 | | 1.924 | | 1.917 | |
| 0.9 | 0.1 | 4.082 | | 2.694 | | 2.357 | | 2.210 | | 2.128 | | 2.080 | | 2.046 | | 2.031 | |

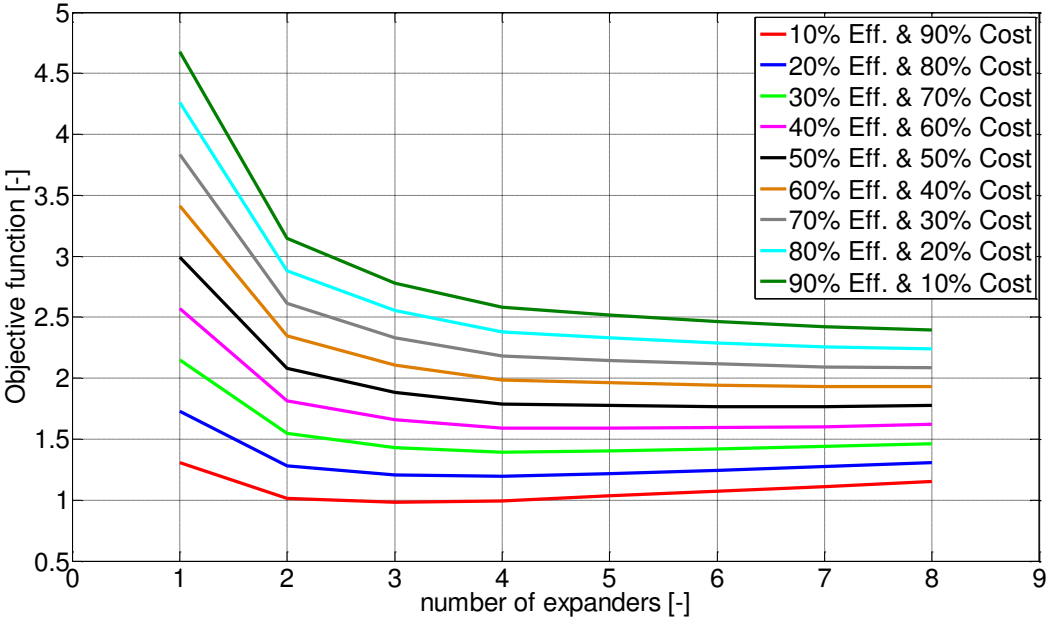


Figure 116 – Objective function determination to obtain 30 kWh energy with air stored a 300 bar and expanded from 30 bar function of number of stages

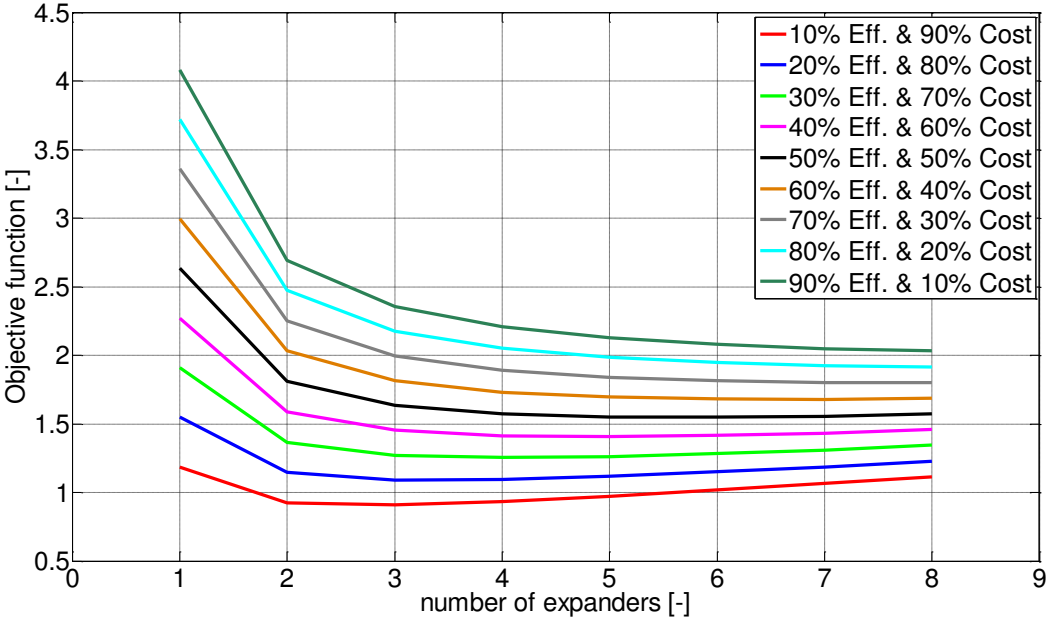


Figure 117 – Objective function determination to obtain 30 kWh energy with air stored a 300 bar and expanded from 60 bar function of number of stages

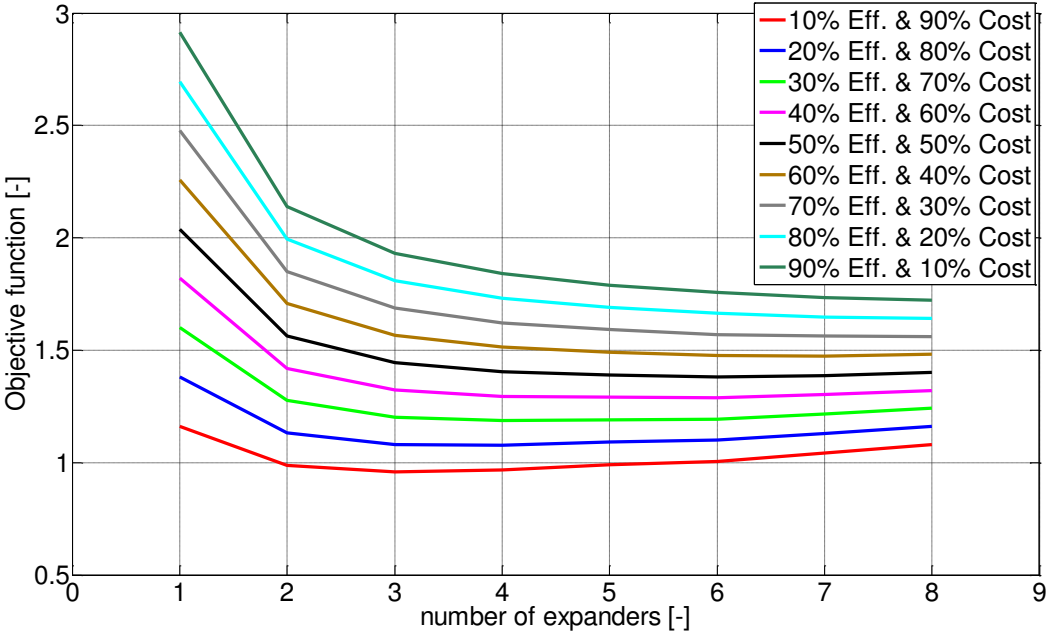


Figure 118 – Objective function determination to obtain 30 kWh energy with air stored a 60 bar and expanded from 30 bar function of number of stages

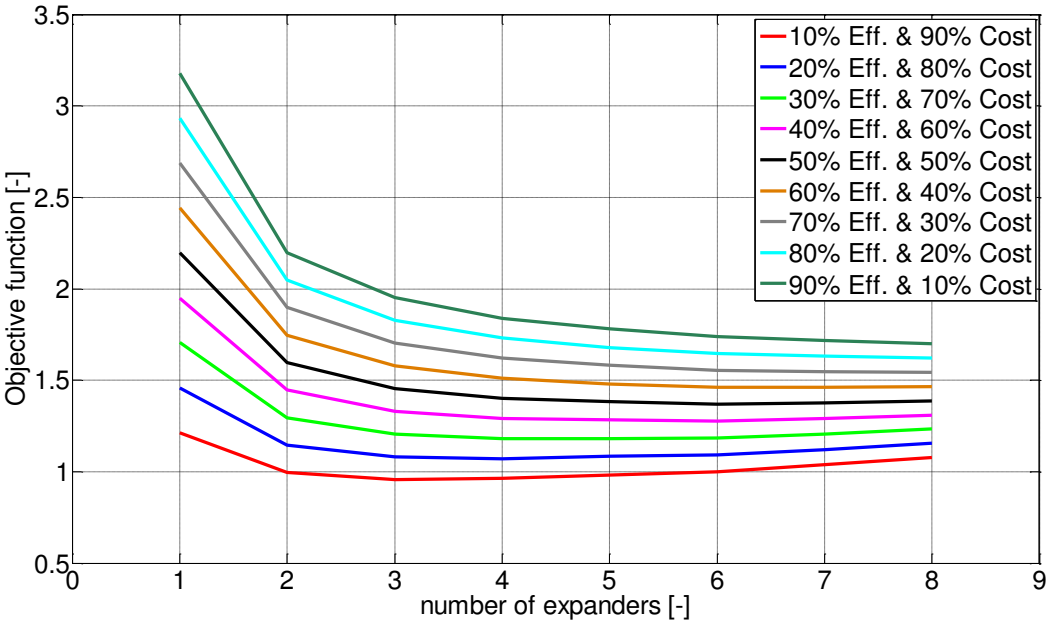


Figure 119 – Objective function determination to obtain 30 kWh energy with air stored a 120 bar and expanded from 60 bar function of number of stages

The objective function presented in tables 21 to 24 and figures 116 to 119 show that the minimum cost of the equipment is obtained when its value is minimum. In all the four tables are highlighted the first values from the third column, which means that for an expansion from 30 bar or from 60 bar with the air having the ambient temperature to the inlet of each stage expansion the minimum cost of investment it obtained for a process with three stages of compression and expansion as well. Should be also mentioned that the importance of the cold obtained during a lower number of expansion stages is higher due to the fact that the temperature at which this cold can be stored is very low. Once the number of expansion increase the temperature at which the cold can be stored increase too. Concluding the figures 116 to 119 let us see that considering more the investment in the equipment cost and less the efficiency's value represents a better option regarding the minimization of the investment cost.

10. Thesis conclusions and perspectives

Energy storage is one of the solutions which have the potential to help at the increasing share of renewable sources into the energy mix, having in the same time a major impact in reducing greenhouses gas emissions, offering a higher flexibility to the grid, mainly in the energy security of supply.

The main outcomes of the thesis comprehend to different fields of study, one is based on a thermodynamic analysis and another is focused to find an optimal control for the integration of renewable energy sources with the storage technologies.

Coupling hybrid renewable energy systems, wind and solar energy, with hybrid energy storage solutions can provide both electricity and heat for consumers use. However is essential that the system which makes the conversion from one kind of energy into another to be a modular one, smaller compressors could lead to the storage of a larger amount of energy than a big compressor due to the required starting power.

The main limitations that incurred for the use of a CAES system are when is taken into consideration the optimizations part. Even if the theoretical results show how the system efficiency can be improved and which is the direction that has to be followed we face technical limitations of the compressors, the heat exchangers, the storage vessel, the air engine in terms of pressure and temperature. The most of the caverns can withstand a certain pressure. Currently, the air engines or turbines operate at pressures of tens of bars, so, new designs are required in order to operate at higher pressures and temperatures values.

The complexity of hybrid systems that have the capability of generating several types of energy makes them desirable especially when the management system will be clearly defined.

Comparing with other storage technologies CAES is not a first time responding technology like batteries and ultracapacitors and doesn't have a low discharge time with high power rating, but it has the huge advantage that there's no degradation of capacity over time. Once the system is built it will continue to store the same quantity of energy as long as it exists.

As we already have seen the problem with CAES mostly is not represented by the technical challenges, it is represented by the storage vessel barriers. Underground caverns tend to be

porous enough but not impermeable enough to allow pressurization, underwater bags could be a suitable option as long as these don't involve a high cost.

From an economic point of view, definitely at the moment storage energy is expensive indifferent that we talk about thermal energy storage in the form of hot water, the cheapest ever solution, or if we talk about electricity storage using any of the existing technologies with all the advances made in the recent years. The current trend to have a much number of intermittent power sources make to have extra energy that can be wasted, so, if the electricity prices are high enough and this technology has lower cost and if the alternatives are too expensive, then storage energy in the form of compressed air might become more popular.

The results presented show the behavior of the CAES systems and how these evolve over time trying to find an optimum for energy storage from both technical and economic point of view. From economic considerations, we found that for the moment storage energy in the form of compressed air is not a viable investment taking into consideration either France or Romanian context and for sure others due to the fact that the technology cost is a considerable one.

From an environmental point of view, it's interested to observe that such a system which is able to supply energy in trigeneration could also provide environmental benefits, being a "clean" source of energy, playing an important role in integrating at a wide scale renewable energy sources.

At the final it is highlighted the figure 120 where is illustrated the cost needed to build a hybrid integrated system consisting in equipment to use RES to help in the energy storage in a form of compressed air and then to help to transform the mechanical energy of the air into electricity.

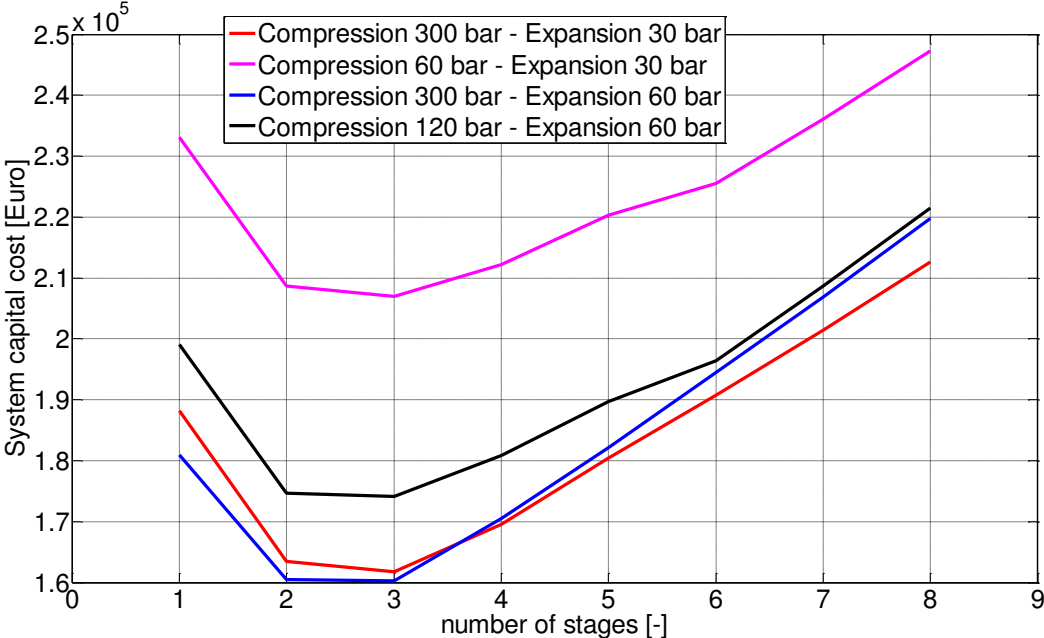


Figure 120 – System capital cost

Limitations of the thesis

The first limitation of the thesis consisted in the approach of the energy storage to a small scale application instead of having a wide overview on the opportunities of the energy storage by using compressed air energy storage systems and coupling them with renewable energy.

The second limitation was to use in the experimental set-up equipment which in their initial construction haven't been thought for applications which aim energy storage. The air compressor was an industrial one which has the objective to bottled air for other purposes not really for energy storage that would be later converted into electricity in an efficient way. Due to the fact that the experimental measurements were made on a laboratory bench, we had to use a small storage vessel and to work with high storage air pressure values. The air engine used in the experimental set-up has a maximum air inlet pressure 8 bar, while the air compressor compresses air at 320 bar, therefore the storage ratio being 40, we obtain a very low primary efficiency of the system.

Another limitation access the equipment prices. If for equipment like wind turbine, solar panels, electric generators we can find prices on the market for any size, with respect to air compressors, storage vessel, air turbine the prices are not so accessible, depending on the number of compression/expansion number of stages, inlet/outlet pressures and mass flow rate these requires a special construction, the same for the storage vessel, so we were forced to make several approximations for these prices starting from what we have now on the market. With more accurate values of prices for air compressors, storage vessel and air expanders the results from the economic analysis could look a bit different.

Original contributions

The thesis is among the first studies which connect the energy storage in a form of compressed air with the renewable energy sources and their intermittent nature.

In the thesis it has been developed a theoretical model for the energy storage which refers in converting the renewable energy into mechanical energy through compressors, storing it in a form of compressed air and later used in electricity production.

A weather station it has been installed in a location selected randomly, and where a series of data in terms of direct solar radiation, wind speed and direction has been collected.

In order to find an optimum for a system which involves the energy storage it's well known the fact that there are two optimum possible, one from energy point of view, also called technical optimum, and another from economic point of view, and both were analyzed in this thesis. As expected an energy optimum is hard to find it due to the fact that there are too many factors which interfere, as the storage vessel pressure ratio, the temperature, the compressor and expander number of stages, therefore must be found a compromise between both technical and economic optimum.

The experimental installation was designed and realized specifically with the objective in helping in the validation of the theoretical results obtained after mathematical modeling. The way how the automation part was thought, in terms of parameters monitoring and system controlling belong to the author.

A theoretical pre-sizing of the storage vessel volume of an energy storage system capable to supply to the consumer 30kWh depending by the operating parameters, pressure, and temperature has been realized in this thesis following a Matlab simulation.

Nowadays there are very few studies that deal with energy storage in a form of compressed air at a small scale. From the best knowledge of the author none of them doesn't deal with the economic analysis which proves to be a very important starting point in the implementing of such a systems.

Bibliography

- [1] "Forbes," [Online]. Available: <http://www.forbes.com/2009/07/24/peak-oil-production-business-energy-nelder.html>. [Accessed 9 April 2015].
- [2] S. Lemofouet-Gatsi, "Investigation and optimisation of hybrid electricity storage based on compressed air and supercapacitors," Ph.D. Thesis - Ecole Polytechnique de Lausanne, 2006.
- [3] Zhang Y, Yang K, Li X, Xu J, "The thermodynamic effect of air storage chamber model on advanced adiabatic compressed air energy storage system," *Renewable Energy*, no. 57, pp. 469-478, 2013.
- [4] 2009/548/EC, "Commission decision of 30 June 2009 - Establishing a template for national renewable energy action plans under Directive 2009/2/EC of the European Parliament and of the Council," 2009. [Online]. Available: <http://eur-lex.europa.eu>.
- [5] 2012/27/EC, "Directive 2012/27/EC of the European Parliament and the Council of 25 October 2012 on energy efficiency," 2012. [Online].
- [6] Syri S, Lehtila A, Ekholm T, Savolainen I, Holttinen H, Peltola E;, "Global energy and emissions scenarios for effective climate change mitigation - Deterministic and stochastic scenario with the TIAM model," *International Journal of Greenhouse Gas Control*, 2008.
- [7] "HORIZON 2020 // EUROPEAN COMMISSION," [Online]. Available: http://ec.europa.eu/research/participants/data/ref/h2020/wp/2014_2015/main/h2020-wp1415-energy_en.pdf. [Accessed November 2014].
- [8] "International Energy Agency," [Online]. Available: <http://www.iea.org/>. [Accessed December 2014].
- [9] Kim YM, Favrat D, "Energy and exergy analysis of a micro-compressed air energy storage and air cycle heating and cooling system," *Energy*, no. 35, pp. 213-220, 2010.
- [10] Evans A, Strezov V, Evans T.J, "Assessment of utility energy storage options for increased renewable energy penetration," *Renewable and Sustainable Energy Reviews*, no. 16, pp. 4141-4147, 2012.
- [11] Mahila T.M.I, Saktisahdan T.J, Jannifar A, Hasan M.H, Matseelar H.S.C, "A review of available methods and development on energy storage - technology update," *Renewable and Sustainable Energy Reviews*, no. 33, pp. 532-545, 2014.

- [12] Karl Zach, Hans Auer, Hans Lettner, Facilitating energy storage to allow high penetration of intermittent renewable energy - Report summarizing the current Status, Role and Costs of Energy Storage Technology, www.store-project.eu, 2012.
- [13] Wann A., Leahy P., McKeogh E., Reidy M., Doyle S., Dalton S. Barry P., "Facilitating energy storage to allow high penetration of intermittent renewable energy - Recommendations for furthering the Sustainable," 2013.
- [14] "Altenergy," [Online]. Available: <http://www.altenergy.org/renewables/solar.html>. [Accessed June 2015].
- [15] "http://www.iea-pvps.org/fileadmin/dam/public/report/statistics/IEA-PVPS_-_A_Snapshot_of_Global_PV_-_1992-2015_-_Final.pdf," [Online]. Available: http://www.iea-pvps.org/fileadmin/dam/public/report/statistics/IEA-PVPS_-_A_Snapshot_of_Global_PV_-_1992-2015_-_Final.pdf.
- [16] "Solarcell," [Online]. Available: http://solarcellcentral.com/csp_page.html. [Accessed June 2016].
- [17] [Online]. Available: <http://www.evwind.es/2015/06/23/concentrated-solar-power-csp-in-2014-grew-27-to-4-4-gw/52899..> [Accessed May 2016].
- [18] Andraka C.E, "Dish Stirling advanced latent storage feasibility," *Energy Procedia* 49, pp. 684-693, 2014.
- [19] "http://geo-energy.org/reports/2015/Int'lMarketataGlanceMay2015Final5_14_15.pdf," [Online].
- [20] O. E. Europe, "Draft Ocean Energy Strategic Roadmap, building ocean energy for Europe," 2015.
- [21] "Wave Energy Technology Brief2014. International Renewable Agency (IRENA), Ocean Energy Technology Brief 4," June 2014.
- [22] [Online]. Available: <http://www.quietrevolution.com/>. [Accessed June 2016].
- [23] [Online]. Available: <http://www.abb-conversations.com/2014/02/wind-power-transformed/>. [Accessed June 2016].
- [24] "Renewableenergyworld," [Online]. Available: <http://www.renewableenergyworld.com/articles/2014/02/meet-the-new-worlds-biggest-wind-turbine.html>. [Accessed MAy 2016].
- [25] "The wind power," [Online]. Available: www.thewindpower.net/statistics_en.php . [Accessed July 2016].

- [26] "EIA," [Online]. Available: http://www.eia.gov/todayinenergy/detail.cfm?id=18071#tabs_SpotPriceSlider-2. [Accessed June 2016].
- [27] "System dynamics," [Online]. Available: <http://www.systemdynamics.org/conferences/2013/proceed/papers/P1366.pdf>. [Accessed July 2016].
- [28] "RTE France," [Online]. Available: http://www.rte-france.com/sites/default/files/2015_01_27_pk_rte_2014_french_electricity_report.pdf. [Accessed June 2016].
- [29] "Agerpres," [Online]. Available: : <http://www.agerpres.ro/economie/2016/01/20/anre-a-acreditat-pana-la-31-decembrie-2015-capacitati-de-4-662-mw-de-energie-regenerabila-11-50-41>. [Accessed July 2016].
- [30] Wang S.Y, Yu J.L, "Optimal sizing of the CAES system in a power system with high wind power penetration," *Electrical Power and Energy Systems*, no. 37, pp. 117-125, 2012.
- [31] Marano V, Rizzo G, Tiano F.A, "Application of dynamic programming to the optimal management of a hybrid power plant with wind turbines, photovoltaic panels and compressed air energy storage," *Allied Energy*, no. 97, pp. 849-859.
- [32] Bullough C, Gatzen C, Jakiel C, Koller M, Nowi A, Zunft S, "Advanced adiabatic compressed air energy storage for the integration of wind energy," in *EWEC 2004*, London, November 2004.
- [33] Fiaschi D, Manfrida G, Secchi R, Tempesti, "A versatile system for offshore energy conversion including diversified storage," *Energy*, no. 48, pp. 566-576, 2012.
- [34] [Online]. Available: <http://energielive.ro/energie-eoliana-harta-de-vant-a-romaniei-potential-de-14-000-mw/harta-vant-romania/>. [Accessed July 2016].
- [35] "Solargis," [Online]. Available: <http://solargis.info/doc/free-solar-radiation-maps-GHI>.
- [36] *Grid Energy Storage U.S Department of Energy, December 2013*. [Performance].
- [37] Proczka J.J, Muralidharan K, Villela D, Simmons J.H, Frantziskonis G, "Guidelines for the pressure and efficiency sizing of pressure vessels for compressed air energy storage," *Energy Conversion and Management*, no. 65, pp. 597-605, 2013.

- [38] Park D, Kim H-M, Ryu D-W, Choi B-H, Han K-C, "Probability-based structural design of lined rock caverns to resist high internal gas pressure," *Engineering Geology*, no. 153, pp. 144-151, 2013.
- [39] van der Linden S, "Bulk energy storage potential in the USA, current developments and future prospects," *Energy*, no. 31, pp. 3446-3457, 2006.
- [40] Pei P, Korom S.F, He J, Gil A, "Thermodynamic impact of aquifer permeability on the performance of a compressed air energy storage plant," *Energy Conversion and Management*, vol. 97, pp. 340-350, 2015.
- [41] Sloterdik G, Timmers G, Magneschi G, CAES prefeasibility study, www.drenthe.nl, 2012.
- [42] Liu J, Zhang X, Xu Y, Chen Z, Chen H, Tan C, "Economic analysis of using above ground gas storage devices for a compressed air energy storage system," *Journal of Thermal Science*, vol. 23, no. 6, pp. 535-543, 2014.
- [43] Crotagino F, Huntorf CAES - More than 20 years of successful operation, Orlando, Florida: In SMRI Spring Meeting, April 2001.
- [44] Crotagino F, "Compressed air storage," in *at EUROSOLAR, International Conference "Energieautonomie durch Speicherung Erneuerbarer Energien"*, Gelsenkirchen, October 2006.
- [45] Kushnir P, Dayan A, Ullmann A, "Temperature and pressure variation within compressed air energy storage caverns," *International Journal of Heat and Mass Transfer*, no. 55, pp. 5616-5630, 2013.
- [46] Raju M, Khaitan S.K, "Modeling and simulation of compressed air energy storage: A case study of Huntorf plant," *Applied Energy*, no. 89, pp. 474-481, 2012.
- [47] Castellani B., Presciutti A., Morini E., Filipponi M., Nicolini A., Rossi F, "Experimental investigation on the effect of phase change materials on compressed air expansion in CAES plants," in *15th CIRIAF National Congress Environmental Footprint and Sustainable Development*, Perugia, 2015.
- [48] "DOE Global Energy Storage Database," [Online]. Available: <http://www.energystorageexchange.org/>. [Accessed November 2014].
- [49] Chen H, Zhang X, Liu J and Tan C, Compressed Air Energy Storage, Energy Storage - Technologies and Applications // <http://dx.doi.org/10.5772/52221>, 2013.

- [50] Mahila T.M.I, Saktisahdan T.J, Satkin M, Hoseinzadeh Lofti F, Noorollahi Y, a review of available methods and development on energy storage, technology update, *Renewable Energy* 51, 2013.
- [51] Abbaspour M, Satkin M, Ivatloo-Mohammadi B, Lofti Hoseinzadeh F, Noorollahi Y, "Optimal operation scheduling of wind power integrated with compressed air energy storage (CAES)," *Renewable Energy*, no. 51, pp. 53-59, 2013.
- [52] "North american WINDPOWER," [Online]. Available: http://www.nawindpower.com/e107_plugins/content/content.php?content.8322. [Accessed December 2014].
- [53] "Apex CAES," [Online]. Available: <http://www.apexcaes.com/project>. [Accessed December 2014].
- [54] RWE, "Project ADELE," [Online]. Available: <http://www.rwe.com/web/cms/en/365478/rwe/innovation/projects-technologies/energy-storage/project-adele-adele-ing/>. [Accessed June 2013].
- [55] Lund H, Salgi G, "The role of compressed air energy storage (CAES) in future sustainable energy systems," *Energy Conversion and Management*, no. 50, pp. 1172-1179, 2009.
- [56] Yucekaya A, "The operational economics of compressed air energy storage systems under uncertainty," *Renewable and Sustainable Energy Reviews*, no. 22, pp. 298-305, 2013.
- [57] Grazzini G, Milazzo A, "Exergy analysis of a CAES thermal energy storage," [Online]. Available: http://www.eurotherm2008.tue.nl/proceedings_eurotherm2008/papers/thermal_processes/thp_10.pdf. [Accessed 20 March 2015].
- [58] Mason J.E, Arher C.L, "Baseload electricity from wind via compressed air energy storage (CAES)," *Renewable and Sustainable Energy Reviews*, no. 16, pp. 1099-1109, 2012.
- [59] Arsie I, Marano V, Nappi G, Rizzo G, "A model of a hybrid power plant with wind turbine and compressed air energy storage," in *ASME Power*, Chicago, Illinois, April 2005.
- [60] Succar S, Denkenberger C.D, Williams H.R, "Optimization of specific rating for wind turbine arrays coupled to compressed air energy storage," *Applied Energy*, no. 96, pp. 222-234, 2012.

- [61] Sundaragavan S, Baker E, "Evaluating energy storage Technologies for wind power integration," *Solar Energy*, no. 86, pp. 2707-2717, 2012.
- [62] Elmegaard B, Brix W, "Efficiency of compressed air energy storage," in *24th International Conference on Efficiency, Cost, Optimization, Simulation and Environmental Impact of Energy Systems*, Serbia, 2011.
- [63] Hai Alami A, "Experimental assessment of compressed air energy storage (CAES) system and buoyancy work energy storage (BWES) as cellular wind energy storage options," *Journal of Energy Storage*, pp. 38-43, 2015.
- [64] Garvey S, "The dynamics of integrated compressed air renewable energy systems," *Renewable Energy*, no. 39, pp. 271-292, 2012.
- [65] Wang S, Chen G, Wang M.F.Q, "A new compressed air energy storage refrigeration system," *Energy Conversion and Management*, no. 47, pp. 3408-3416, 2006.
- [66] Li Y, Wang X, Li D, Ding Y, "A trigeneration system based on compressed air and thermal energy storage," *Applied Energy*, no. 99, pp. 316-323, 2012.
- [67] Jubeh N.M, Najar Y.S.H, "Green solution for power generation by adoption of adiabatic CAES system," *Applied Thermal Engineering*, no. 44, pp. 85-89, 2012.
- [68] Zhao P, Wang M, Wang J, Dai Y, "A preliminary dynamic behaviors analysis of a hybrid energy storage system based on adiabatic compressed air energy storage and flywheel energy storage system for wind power application," *Energy xxx*, 2015.
- [69] Hartmann N, Voheringer O, Kruck C, "Simulation and analysis of different adiabatic CAES plant configuration," *Applied Energy*, no. 93, pp. 541-548, 2012.
- [70] Dinfort R, "Estimating potential energy savings in compressed air systems," *Procedia Engineering*, no. 39, pp. 204-211, 2012.
- [71] J. Konrad, "Compressed Air Energy Storage - An Exergy-based Analysis of Turbomachinery Systems," 2011. [Online]. Available: <http://scholar.uwindsor.ca/cgi/viewcontent.cgi?article=1193&context=etd>. [Accessed 10 April 2015].
- [72] Gu W, Wu Z, Bo R, Liu W, Zhou G, Chen W, Wu Z, "Modeling, planning and optimal energy management of combined cooling heating and power microgrid: A review," *Electrical Power and Energy Systems*, no. 54, pp. 26-37, 2014.
- [73] Safaei H, Keith D. W, "Compressed air energy storage with waste heat export: An Alberta case study," *Energy Conversion and Management*, no. 78, pp. 114-124, 2014.

- [74] Xia C, Zhou Y, Zhou S, Zhang P, Wang F, "A simplified and unified analytical solution for temperature and pressure variation in compressed air energy storage cavern," *Renewable Energy*, no. 74, pp. 718-726, 2015.
- [75] "Coloumbia University," [Online]. Available: http://eesc.columbia.edu/courses/ees/slides/climate/table_1.html. [Accessed April 2015].
- [76] Bar-Meir G, Basics of fluid mechanics, 2013.
- [77] Zhang Y, Yang K, Li X, Xu J, "The thermodynamic effect of air storage chamber model on Advanced Adiabatic Compressed Air Energy Storage System," *Renewable Energy*, no. 57, pp. 469-478, 2013.
- [78] Kim YM, Shin DG, Favrat D, "Operating characteristics of constant-pressure compressed air energy storage (CAES) system combined with pumped hydro storage based on energy and exergy analysis," *Energy*, no. 36, pp. 6220-6233.
- [79] Budny C, Madlener R, Hilgers C, "Economic Feasibility of Pipe Storage and Underground Reservoir Storage Options for Power-to-Gas Load Balancing," *Energy Procedia* 61, pp. 2201-2205, 2014.
- [80] Pimm J. A, Garvery D. S, de Jong M, "Design and testing of energy bags for underwater compressed air energy storage," *Energy*, no. 66, pp. 496-508, 2014.
- [81] Kim YM, Lee JH, Kim SJ, Favrat D, "Potential and evolution of compressed air energy storage: energy and exergy analyses," *Entropy*, no. 14, pp. 1501-1521, 2012.
- [82] Yang K, Zhang Y, Li X, Xu J, "Theoretical evaluation on the impact of the exchanger in Advanced Adiabatic Compressed Air Energy Storage System," *Energy Conversion and Management*, no. 86, pp. 1031-1044, 2014.
- [83] Khushairi M.M, Abdullah H, Hazran H, "A study on the Optimization of Control Strategy of a Thermal Energy Storage System for Building Air-Conditioning," *Procedia Engineering*, no. 20, pp. 118-124, 2011.
- [84] Martins M, Villalabos U, Delclos T, Armstrong P, Bergan P, Calvet N, "New concentrating solar power facility for testing high temperature concrete thermal energy storage," *Energy Procedia* 75, pp. 2144-2149, 2015.
- [85] Ercan Ataer O, "Storage of thermal energy," [Online]. Available: <http://www.eolss.net/ebooks/sample%20chapters/c08/e3-14-02-00.pdf>. [Accessed 20 05 2015].

- [86] Hasnain S.M, "Review on sustainable thermal energy storage technologies, part II: cool thermal storage," *Energy Convers Mgmt*, no. 39, pp. 1139-1153, 1998.
- [87] Ibrahim H, Ilinca A, Perron J., "Energy storage systems - Characteristics and comparison," *Renewable and Sustainable Reviews*, vol. 12, 2008.
- [88] Ciocan A, Prisecaru T, Tazerout M, Durastanti J-F, "Thermodynamic evaluation for a small scale compressed air energy storage system by integrating renewable energy sources," in *ICRERA*, Palermo, 2015.
- [89] Barnes F.S, Levine J.G, Large energy storage systems Handbook, London, New York: CRC Press Taylor & Francis Group, 2011.
- [90] Cardenas B, Leon N, "High-temperature latent heat thermal energy storage: Phase change materials, design considerations and performance enhancement techniques," *Renewable and Sustainable Energy Reviews*, no. 27, pp. 724-737, 2013.
- [91] Farid M.M, Khudhair A.M, Razack S.A.K, Ali-Hallaj S, "A review on phase change energy storage: materials and applications," *Energy Conversion and Management*, no. 45, pp. 1597-1615, 2004.
- [92] Jian Y, Bai F, Falcoz Q, Wang Z, "Control strategy of the module concrete thermal energy storage for parabolic trough power plants," no. 69, 2015.
- [93] [Online]. Available: <http://www.beswick.com/basics-pressure-regulators>. [Accessed June 2016].
- [94] Jannelli E, Minutillo M, Lubrano Lavedera A, Falcucci G, "A small-scale CAES (compressed air energy storage) system for stand-alone renewable energy power plant for a radio base station: A sizing-design methodology," *Energy*, pp. 313-322, 2014.
- [95] [Online]. Available: <http://www.wec-indicators.enerdata.eu/electricity-use-per-capita.html#/household-electricity-use.html>. [Accessed June 2015].
- [96] "Eurostat," [Online]. Available: http://ec.europa.eu/eurostat/statistics-explained/images/6/6e/Half-yearly_electricity_and_gas_prices%2C_second_half_of_year%2C_2012%E2%80%93314_%28EUR_per_kWh%29_YB15.png. [Accessed 23 June 2015].
- [97] Drury E, Denholm P, Sioshansi R, "The value of compressed air energy storage in energy and reserve markets," *Energy*, no. 36, pp. 4959-4973, 2011.

- [98] Zafirakis D, Chalvatzis K.J, Baiocchi G, Daskalakis G, "Modeling of financial incentives for investments in energy storage systems that promote the large-scale integration energy," *Applied Energy*, no. 105, pp. 138-154, 2013.
- [99] Buffa F, Kemble S, Manfrida G, Milazzo A, "Exergy and Exergoeconomic Model of a Ground-Based CAES Plant for Peak-Load Energy Production," *Energies*, no. 6, 2013.
- [100] Bagdanavicius A, Jenkins N, "Exergy and economic analysis of a Compressed air energy storage combined with a district energy system," *Energy Conversion and Management*, no. 77, pp. 432-440, 2014.
- [101] Fertig E, Apt J, "Economics of compressed air energy storage to investigate wind power: A case study in ERCOT," *Energy Policy*, no. 39, pp. 2330-2342, 2011.
- [102] Gu Y, McCalley J, Ni M, Bo R, "Economic modeling of compressed air energy storage," *Energies*, no. 6, pp. 2221-2241, 2013.
- [103] Madlener R, Latz J, "Economics of centralized and decentralized compressed air energy storage for enhanced grid integration of wind power," *Applied Energy*, no. 101, pp. 299-309, 2013.
- [104] Vadasz P, "Compressed Air Energy Storage: Optimal Performance and Techno-Economical Indices," *Applied Thermodynamics*, 1999.
- [105] Saidur R, Rahim N, A, Hasanuzzaman M, "A review on compressed-air energy use and energy savings," *Renewable and Sustainable Energy Reviews*, no. 14, pp. 1135-1153, 2010.
- [106] "Scubaengineer," [Online]. Available: http://www.scubaengineer.com/high_pressure_compressor_filtrat.htm. [Accessed february 2015].
- [107] [Online]. Available: <http://www.boem.gov/Renewable-Energy-Program/Renewable-Energy-Guide/Offshore-Wind-Energy.aspx>. [Accessed April 2016].
- [108] "PVPS - Snapshot of Global PV Markets," Report IEA PVPS T1-29:2016.

List of relevant papers

Modeling an energy storage system based on a hybrid renewable energy system in stand-alone applications, Alexandru Ciocan, Ovidiu Mihai Balan, Mihaela-Ramona Buga, Tudor Prisecaru, Mohand Tazerout, accepted for publications REV.CHIM (68), No. 11/2017, ISSN 0034-7752

A hybrid energy storage system and control strategy for stand-alone applications using renewable energy sources, Alexandru Ciocan, Mihai Balan, Mihaela Pislaru, Alexandru RizoIU, Andrei Constantin, "Progress of Cryogenics and Isotopes Separation" volume 20, issue 1/2017, ISSN 1582-2575

Technical-economic analysis for an application where is aimed the energy storage supplied by a hybrid renewable energy sources system in a form of compressed air: Case study for a 30 kWh off-grid application, Alexandru Ciocan, Alexandru RizoIU, Conference Volume "Stiinta moderna si energia - Producerea, Transportul si utilizarea energiei", ISSN: 2066-4125, 2017, Cluj Napoca, Romania.

Power-to-Gas: development of analysis framework based on a Romanian case study, Mihai Balan, Adrian Badea, Mihaela Buga, Alexandru Ciocan, U.P.B. Sci. Bull., Series C, Vol. 78, Iss. 3, 2016

Implementing power-to-gas in the new energy context of Romania, Mihai Balan, Adrian Badea, Ioan Iordache, Mihaela Buga, Alexandru Ciocan, Conference Volume "Stiinta moderna si energia - Producerea, Transportul si utilizarea energiei", ISSN: 2066-4125, 2014, Cluj Napoca, Romania.

Elemente de comparatie privind sursele regenerabile in Romania, Mihaela Pislaru, Mihai Balan, Alexandru Ciocan, Conference volume "Stiinta moderna si energia - Producerea, Transportul si utilizarea energiei", ISSN: 2066-4125, 2016, Cluj Napoca, Romania.

Development of energy storage in link with renewable energy integration and new CO₂ reduction targets, Mihai Balan, Mihaela Buga, Alexandru Ciocan, Ioan Iordache, Adrian Badea, Conference Volume "Stiinta moderna si energia - Producerea, Transportul si utilizarea energiei", ISSN: 2066-4125, 2015, Cluj Napoca, Romania.

Comparative technical and economic assessment of Power-to-Gas in two scenarios: 2015 and 2030, Mihai Balan, Mihaela Buga, Aymeric Brunot, Adrian Badea, Alexandru Ciocan, Proceedings of WREC 2015, 14th World Renewable Energy Congress, Bucharest, 2015.

Hybrid energy storage systems for renewable energy sources: Applications and challenges, Alexandru Ciocan, Mihai Balan, Mihaela Buga, "Progress of Cryogenics and Isotopes Separation" volume 20, issue 2/2017, ISSN 1582-2575

Energia Hidrogenului in sectorul Transporturi, Aspecte din Romania, Ioan Iordache, Ioan Stefanescu, Gheorghe Badea, Alexandru Ciocan, Dorin Schitea, Mihaela Buga, Conference Volume "Stiinta moderna si energia - Producerea, Transportul si utilizarea energiei", ISSN: 2066-4125, 2015, Cluj Napoca, Romania.

Elemente de comparatie privind sursele regenerabile din Romania, Mihaela Pislaru, Mihai Balan, Alexandru Ciocan, Conference Volume "Stiinta moderna si energia - Producerea, Transportul si utilizarea energiei", ISSN: 2066-4125, 2016, Cluj Napoca, Romania.

Study of LiFePO₄ electrode morphology for Li-ion battery performance, Mihaela Buga, Constantin Bubulinca, Silviu Badea, Alexandru Rizoiu, Enache Stanica, Mihai Balan, Alexandru Ciocan, Mihai Varlam, under revision REV.CHIM (69), No. 3/2018, ISSN 0034-7752

International and national conferences participation

Various Solutions for Storage and Delivery of Renewable Energy – CAES Systems, Alexandru Ciocan, Proceeding the 6th National Workshop "Tritium Management", 21 June 2013, Ramnicu Valcea, Romania

A thermodynamic evaluation of a compressed air energy storage system, Alexandru Ciocan, Mohand Tazerout, Proceeding of 7th International Conference on Energy and Environment CIEM 2015, Iasi, Romania.

Thermodynamic evaluation for a small scale compressed air energy storage system by integrating the renewable energy sources, Alexandru Ciocan, Tudor, Prisecaru, Mohand Tazerout, Jean-Felix Durastanti, Proceeding of 4th International Conference on Renewable Energy Research and Applications, 23-25 November 2015, Palermo, Italy.

Comparative technical and economic assessment of Power-to-Gas in two scenarios: 2015 and 2030, Mihai Balan, Mihaela Buga, Aymeric Brunot, Adrian Badea, Alexandru Ciocan, Proceedings of WREC 2015, 14th World Renewable Energy Congress, Bucharest, 2015.

Modelling a Hybrid System consisting in Wind Turbines, Concentrated Solar Power and a Compressed Air Energy Storage System, Alexandru Ciocan, Mihai Balan, Mohand Tazerout, Proceeding of OSES 2016 13-15 July 2016, Valletta, Malta.

Hybrid energy storage systems for renewable energy sources: Applications and challenges, Alexandru Ciocan, Mihai Balan, Mihaela Buga, Proceeding of FOREN 2016, 12-16 June 2016, Costinesti, Romania.

Large-scale energy storage solutions comparison in the Romanian context – pumped hydro vs Battery storage and Power-to-Gas – Is Tarnita the only option?, Mihai Balan, Alexandru Ciocan, Mihaela Buga, Proceeding of FOREN 2016, 12-16 June 2016, Costinesti, Romania

Annex 1

Experimental data recorded for the charging process

| | Room temperature | Humidity | Tank temperature | P _{in_CV} | T _{out_CV} | Power compressor | Energy consumed | mass flow input comp. | mass flow in compressor | T _{out 1st stage comp} | T _{in 2nd stage comp} | P _{out 1st stage compression} | T _{out 2nd stage compression} | T _{in 3rd stage compression} | P _{out 2nd stage compression} | T _{out 3rd stage comp} | T _{out 3rd HE} | T _{in_CV} | P _{out 3rd stage compression} |
|------------|------------------|----------|------------------|--------------------|---------------------|------------------|-----------------|-----------------------|-------------------------|---------------------------------|--------------------------------|--|--|---------------------------------------|--|---------------------------------|-------------------------|--------------------|--|
| | C | %HR | C | bar abs | C | kW/s | kWh | kg/h | kg/s | C | C | bar abs | C | C | bar abs | C | C | C | bar abs |
| temps | TT00 | AT01 | TE2 | PT03 | TE04 | WT11 | WT12 | FT14 | FT | TE15 | TE16 | PT17 | TE18 | TE19 | PT20 | TE21 | TE22 | TE23 | PT25 |
| 14:14:15,5 | 21.15 | 63.72 | 16.04 | 8.15 | 17.52 | -0.01 | -0.24 | 0.282 | 0.0001 | 22.09 | 21.84 | 1.41 | 21.69 | 22.08 | 1.11 | 21.51 | 20.05 | 17.50 | 105.99 |
| 14:14:16,1 | 21.15 | 63.72 | 16.05 | 8.27 | 17.5 | -0.008 | -0.207 | 4.547 | 0.0013 | 22.11 | 21.87 | 3.65 | 21.70 | 22.08 | 3.13 | 21.53 | 20.07 | 17.53 | 105.49 |
| 14:14:17,1 | 21.15 | 63.72 | 16.05 | 7.92 | 17.53 | -0.008 | -0.248 | 10.851 | 0.0030 | 22.09 | 21.87 | 4.39 | 21.72 | 22.11 | 7.34 | 21.51 | 20.06 | 17.51 | 105.37 |
| 14:14:18,1 | 21.15 | 63.72 | 16.04 | 7.95 | 17.54 | -0.01 | -0.182 | 15.107 | 0.0042 | 22.07 | 21.87 | 5.97 | 21.94 | 22.14 | 10.66 | 21.50 | 20.06 | 17.51 | 105.35 |
| 14:14:19,1 | 21.15 | 63.72 | 16.04 | 8.3 | 17.54 | -0.008 | -0.334 | 16.51 | 0.0046 | 22.25 | 21.86 | 6.06 | 22.58 | 22.18 | 14.30 | 21.49 | 20.06 | 17.52 | 106.27 |
| 14:14:20,1 | 21.15 | 63.78 | 16.05 | 8.20 | 17.54 | -0.008 | -0.215 | 16.998 | 0.0047 | 22.7 | 21.83 | 6.66 | 23.54 | 22.21 | 17.19 | 21.52 | 20.09 | 17.51 | 105.99 |
| 14:14:21,1 | 21.14 | 63.77 | 16.05 | 8.04 | 17.53 | -0.007 | -0.215 | 17.013 | 0.0047 | 23.35 | 21.80 | 7.21 | 24.75 | 22.24 | 19.56 | 21.54 | 20.11 | 17.52 | 105.26 |
| 21:06:14,1 | 27.40 | 38.36 | 34.11 | 300.8 | 29.33 | 3.53 | 21.739 | 13.08 | 0.0036 | 126.85 | 67.67 | 8.329 | 214.05 | 61.66 | 51.83 | 187.64 | 46.63 | 30.26 | 302.90 |
| 21:06:15,1 | 27.40 | 38.34 | 34.11 | 300.7 | 29.32 | 3.56 | 21.689 | 13.05 | 0.0036 | 127.17 | 67.67 | 7.884 | 214.05 | 61.66 | 51.32 | 187.61 | 46.64 | 30.26 | 302.87 |
| 21:06:16,1 | 27.39 | 38.35 | 34.11 | 300.7 | 29.32 | 3.53 | 21.755 | 13.11 | 0.0036 | 127.42 | 67.66 | 8.147 | 214.09 | 61.66 | 51.20 | 187.60 | 46.64 | 30.26 | 302.85 |
| 21:06:17,2 | 27.41 | 38.34 | 34.12 | 300.3 | 29.33 | 3.53 | 21.681 | 13.10 | 0.0036 | 127.48 | 67.68 | 8.286 | 214.12 | 61.67 | 51.12 | 187.55 | 46.64 | 30.27 | 302.14 |
| 21:06:18,1 | 27.41 | 38.35 | 34.11 | 300.9 | 29.32 | 3.53 | 21.726 | 13.19 | 0.0037 | 127.13 | 67.66 | 7.354 | 214.11 | 61.66 | 51.98 | 187.61 | 46.63 | 30.26 | 302.90 |
| 21:06:19,1 | 27.40 | 38.34 | 34.11 | 300.6 | 29.31 | 3.54 | 21.776 | 13.04 | 0.0036 | 126.63 | 67.66 | 8.095 | 214.10 | 61.65 | 51.09 | 187.60 | 46.62 | 30.25 | 302.78 |
| 21:06:20,1 | 27.41 | 38.33 | 34.12 | 300.6 | 29.32 | 3.53 | 21.694 | 13.14 | 0.0037 | 126.54 | 67.66 | 8.054 | 214.12 | 61.66 | 51.04 | 187.62 | 46.62 | 30.25 | 302.55 |
| 21:06:21,1 | 27.40 | 38.34 | 34.11 | 300.8 | 29.32 | 3.53 | 21.772 | 13.04 | 0.0036 | 126.83 | 67.65 | 7.135 | 214.14 | 61.65 | 51.97 | 187.71 | 46.62 | 30.25 | 302.92 |

Annex 2

Experimental data recorded for the discharging process

| temps | Room temp. | Tank temp. | P _{in_CV} | T _{out_CV} | mass flow input engine | P _{in_engine} | T _{in_engine} | Shaft Speed | P _{control engine} | T _{out_ engine} | Power after generator | T _{in 3rd comp} | T _{out 3rd HE} | T _{in_CV} | P _{out engine} |
|--------------|------------|------------|--------------------|---------------------|---------------------------|------------------------|------------------------|----------------|---------------------------------|------------------------------|--------------------------|--------------------------|-------------------------|--------------------|-------------------------|
| | C | C | bar abs | C | kg/s | bar | C | trs/min | bar | C | kW | C | C | C | bar abs |
| 10:35:05,421 | 16.335 | 14.619 | 286.468 | 9.535 | 0.0003 | 6.54 | 14.686 | 1.758 | 1.446 | 11.059 | 0.006 | 15.027 | 14.944 | 14.195 | 1.026 |
| 10:35:06,421 | 16.331 | 14.608 | 285.985 | 9.542 | 0.0003 | 6.538 | 14.682 | 0.872 | 1.446 | 11.073 | 0.005 | 15.012 | 14.939 | 14.184 | 1.026 |
| 10:35:07,421 | 16.339 | 14.628 | 286.491 | 9.56 | 0.0003 | 6.54 | 14.692 | 0.97 | 1.437 | 11.067 | 0.005 | 15.018 | 14.941 | 14.181 | 1.026 |
| 10:35:08,421 | 16.327 | 14.62 | 286.514 | 9.575 | 0.0003 | 6.539 | 14.689 | 1.069 | 1.438 | 11.085 | 0.005 | 15.012 | 14.946 | 14.17 | 1.027 |
| 10:35:09,421 | 16.327 | 14.612 | 286.399 | 9.583 | 0.0003 | 6.536 | 14.687 | 1.266 | 1.437 | 11.093 | 0.005 | 15.016 | 14.937 | 14.167 | 1.027 |
| 10:35:10,421 | 16.343 | 14.621 | 286.445 | 9.599 | 0.0003 | 6.54 | 14.691 | 1.463 | 1.432 | 11.106 | 0.006 | 15.03 | 14.952 | 14.183 | 1.029 |
| 10:35:11,421 | 16.327 | 14.619 | 286.583 | 9.615 | 0.0003 | 6.545 | 14.69 | 0.576 | 1.434 | 11.106 | 0.006 | 15.022 | 14.94 | 14.168 | 1.027 |
| 10:35:12,421 | 16.327 | 14.619 | 286.491 | 9.615 | 0.0003 | 6.54 | 14.681 | 0.872 | 1.435 | 11.108 | 0.005 | 15.014 | 14.937 | 14.164 | 1.026 |

| | | | | | | | | | | | | | | | |
|--------------|--------|--------|-------|--------|--------|-------|--------|---------|-------|---------|-------|--------|--------|--------|-------|
| 11:24:51,421 | 16.654 | -8.317 | 4.41 | -4.866 | 0.0043 | 1.427 | -1.451 | 528.352 | 3.69 | -31.354 | 0.06 | 14.945 | 14.475 | -2.424 | 1.029 |
| 11:24:52,421 | 16.67 | -8.309 | 4.134 | -4.861 | 0.0043 | 1.495 | -1.434 | 532.193 | 3.677 | -31.276 | 0.06 | 14.939 | 14.471 | -2.404 | 1.068 |
| 11:24:53,421 | 16.654 | -8.288 | 4.134 | -4.849 | 0.0043 | 1.496 | -1.416 | 529.632 | 3.661 | -31.189 | 0.052 | 14.945 | 14.475 | -2.385 | 1.053 |
| 11:24:54,421 | 16.662 | -8.309 | 4.249 | -4.837 | 0.0043 | 1.377 | -1.426 | 527.17 | 3.634 | -31.138 | 0.052 | 14.93 | 14.467 | -2.382 | 1.046 |
| 11:24:55,421 | 16.654 | -8.294 | 4.226 | -4.824 | 0.0043 | 1.417 | -1.406 | 524.412 | 3.654 | -31.073 | 0.052 | 14.94 | 14.47 | -2.353 | 1.034 |
| 11:24:56,421 | 16.634 | -8.298 | 3.789 | -4.809 | 0.0042 | 1.424 | -1.404 | 525.791 | 3.618 | -30.996 | 0.053 | 14.925 | 14.465 | -2.314 | 1.049 |
| 11:24:57,421 | 16.65 | -8.287 | 4.341 | -4.794 | 0.0042 | 1.437 | -1.388 | 530.026 | 3.593 | -30.912 | 0.053 | 14.933 | 14.473 | -2.307 | 1.049 |

Annex 3

Temperature saturation table for water

| Tem- perature | .0 | .1 | .2 | .3 | .4 | .5 | .6 | .7 | .8 | .9 |
|------------------|--------|--------|--------|--------|--------|--------|--------|--------|--------|--------|
| °C | bar | bar | bar | bar | bar | bar | bar | bar | bar | bar |
| 10 | 0.0122 | 0.0123 | 0.0124 | 0.0125 | 0.0126 | 0.0126 | 0.0127 | 0.0128 | 0.0129 | 0.0130 |
| 11 | 0.0131 | 0.0132 | 0.0132 | 0.0138 | 0.0134 | 0.0135 | 0.0136 | 0.0137 | 0.0138 | 0.0139 |
| 12 | 0.0140 | 0.0141 | 0.0142 | 0.0142 | 0.0143 | 0.0144 | 0.0145 | 0.0146 | 0.0147 | 0.0148 |
| 13 | 0.0149 | 0.0150 | 0.0151 | 0.0152 | 0.0153 | 0.0154 | 0.0155 | 0.0156 | 0.0157 | 0.0158 |
| 14 | 0.0159 | 0.0160 | 0.0161 | 0.0162 | 0.0163 | 0.0165 | 0.0166 | 0.0167 | 0.0168 | 0.0169 |
| 15 | 0.0170 | 0.0171 | 0.0172 | 0.0173 | 0.0174 | 0.0176 | 0.0177 | 0.0178 | 0.0179 | 0.0180 |
| 16 | 0.0181 | 0.0182 | 0.0184 | 0.0184 | 0.0186 | 0.0187 | 0.0188 | 0.0190 | 0.0191 | 0.0192 |
| 17 | 0.0193 | 0.0194 | 0.0196 | 0.0196 | 0.0198 | 0.0199 | 0.0201 | 0.0202 | 0.0203 | 0.0205 |
| 18 | 0.0206 | 0.0207 | 0.0208 | 0.0208 | 0.0211 | 0.0212 | 0.0214 | 0.0215 | 0.0216 | 0.0218 |
| 19 | 0.0219 | 0.0221 | 0.0222 | 0.0222 | 0.0225 | 0.0226 | 0.0228 | 0.0229 | 0.0230 | 0.0232 |
| 20 | 0.0233 | 0.0235 | 0.0236 | 0.0238 | 0.0239 | 0.0241 | 0.0242 | 0.0244 | 0.0245 | 0.0247 |
| 21 | 0.0248 | 0.0250 | 0.0251 | 0.0253 | 0.0254 | 0.0256 | 0.0257 | 0.0259 | 0.0261 | 0.0262 |
| 22 | 0.0264 | 0.0265 | 0.0267 | 0.0269 | 0.0270 | 0.0272 | 0.0274 | 0.0275 | 0.0277 | 0.0279 |
| 23 | 0.0280 | 0.0282 | 0.0284 | 0.0286 | 0.0287 | 0.0289 | 0.0291 | 0.0292 | 0.0294 | 0.0296 |
| 24 | 0.0298 | 0.0300 | 0.0301 | 0.0303 | 0.0305 | 0.0307 | 0.0309 | 0.0311 | 0.0312 | 0.0314 |
| 25 | 0.0316 | 0.0318 | 0.0320 | 0.0322 | 0.0324 | 0.0326 | 0.0328 | 0.0330 | 0.0332 | 0.0334 |
| 26 | 0.0336 | 0.0338 | 0.0340 | 0.0342 | 0.0344 | 0.0346 | 0.0348 | 0.0350 | 0.0352 | 0.0354 |
| 27 | 0.0356 | 0.0358 | 0.0360 | 0.0362 | 0.0364 | 0.0367 | 0.0369 | 0.0371 | 0.0373 | 0.0375 |
| 28 | 0.0377 | 0.0380 | 0.0382 | 0.0384 | 0.0386 | 0.0389 | 0.0391 | 0.0393 | 0.0395 | 0.0398 |
| 29 | 0.0400 | 0.0402 | 0.0405 | 0.0407 | 0.0409 | 0.0412 | 0.0414 | 0.0417 | 0.0419 | 0.0421 |
| 30 | 0.0424 | 0.0426 | 0.0429 | 0.0431 | 0.0434 | 0.0436 | 0.0439 | 0.0441 | 0.0444 | 0.0446 |

Adapted from IST-90

Thèse de Doctorat

Alexandru CIOCAN

Contributions aux systèmes de stockage d'énergie en utilisant des systèmes hybrides à partir de sources d'énergie alternatives

Contributions to energy storage using hybrid systems from alternative energy sources

Résumé

La thèse intitulée «Contributions aux systèmes de stockage d'énergie en utilisant des systèmes à partir de sources d'énergie alternatives» propose une étude des technologies de stockage d'énergie en sachant qu'elles sont considérées comme l'une des options qui peuvent faciliter une forte pénétration de sources renouvelables. Dans ce contexte, le travail présenté vise à comprendre les défis liés au stockage de l'énergie et à développer un modèle général d'étude utilisant l'air comprimé comme moyen de stockage d'énergie.

La thèse est structurée dans dix chapitres dont les quatre premiers sont consacrés à la présentation potentielle des sources d'énergie renouvelables, à l'évolution du secteur de l'énergie au cours des dernières décennies et aux technologies de stockage d'énergie, notamment sous forme d'air comprimé. Les six autres chapitres concernent les calculs thermodynamiques théoriques dans la mesure où il s'agit d'étudier les performances d'un système de stockage d'énergie hybride et de présenter un modèle mathématique contenant les étapes prises en compte dans la conversion de l'énergie renouvelable en énergie mécanique, stockées dans une forme d'air comprimé et plus tard reconvertis en électricité. De plus, ces chapitres présentent des données expérimentales obtenues sur une installation de laboratoire qui ont contribué à la validation des résultats théoriques obtenus suite à une simulation Matlab, et enfin une étude de cas pour une application à petite échelle, 30 kWh d'énergie stockée, où vise à trouver une configuration optimale. De l'ensemble du système en termes de pression de travail de l'air, analysé sous deux points de vue, technique et économique. La thèse se termine par un chapitre de conclusions générales et nous constatons qu'il reste encore quelques défis à surmonter pour que le stockage de l'énergie sous forme d'air comprimé soit une solution possible d'une perspective économique.

Mots clés

RES, stockage d'énergie, CAES, TES, trigénération, analyse thermodynamique

Abstract

The thesis entitled «Contributions to energy storage using hybrid systems from alternative energy sources» proposes a study of the energy storage technologies knowing the fact that these are considered one of the options that can facilitate a high penetration of renewable sources. In this context, the presented work aims to understand challenges in terms of energy storage and to develop a general studying model using compressed air as an energy storage medium.

The thesis is structured in ten chapters from which the first four are dedicated to the presentation of the renewable energy sources potential, to the energy sector evolution in the last decades and to the energy storage technologies, especially in the form of compressed air. The other six chapters are dealing with the theoretical thermodynamic calculations as far as that goes in investigating the performances of a hybrid energy storage system and presenting a mathematical model containing the steps taken into account in the renewable energy conversion into mechanical energy, stored in a form of compressed air and later reconverted into electricity. In addition these chapters present experimental data obtained on a laboratory installation which helped in validating the theoretical results obtained following a Matlab simulation, and finally a case study for a small scale application, 30 kWh of energy stored, where is aiming to find an optimal configuration of the whole system in terms of air working pressure, being analyzed from two points of view, technical and economic. The thesis ends with a chapter of general conclusions and indicates that there are still challenges that must be overcome in order to make the energy storage in a form of compressed air a feasible solution from an economic perspective.

Keywords

RES, energy storage, CAES, TES, trigeneration, thermodynamic analysis

Thèse de Doctorat

Alexandru CIOCAN

*Mémoire présenté en vue de l'obtention du
grade de Docteur de L'École nationale supérieure Mines-Télécom Atlantique Bretagne-
Pays de la Loire - IMT Atlantique
sous le sceau de l'Université Bretagne Loire*

École doctorale : Sciences pour l'ingénieur (SPI)

Discipline : Energétique, thermique

Spécialité : Génie des procédés

Unité de recherche : *Génie des Procédés-Environnement-Agroalimentaire (GEPEA)*

Soutenue le 17 octobre 2017

Thèse N° : 2017IMTA0028

Contributions aux systèmes de stockage d'énergie en utilisant des systèmes hybrides à partir de sources d'énergie alternatives

Résumé de thèse

JURY

| | |
|-------------------------|---|
| Rapporteurs : | M. Liviu DRUGHEAN, Professeur d'Université Technique de Génie Civil Bucarest M. Said ABOUDI, Professeur d'Université de Technologie de Belfort-Montbéliard |
| Examineurs : | M. Jean – Felix DURASTANTI, Professeur d'Université Paris Est Créteil M ^{me} Mariana-Florentina STEFANESCU, Professeur d'Université Politehnica de Bucarest |
| Invité(s) : | M. Valentin APOSTOL, Lecteur d'Université Politehnica de Bucarest |
| Directeur de Thèse : | M. Tudor PRISECARU, Professeur d'Université Politehnica de Bucarest |
| Co-directeur de Thèse : | M. Mohand TAZEROUT, Professeur d'École des Mines de Nantes |

Contenu

| | |
|---|----|
| 1. Introduction..... | 3 |
| 2. Aperçu des sources d'énergie renouvelables..... | 5 |
| 3. L'évolution du secteur de l'énergie | 7 |
| 4. Aperçu des solutions de stockage d'énergie..... | 13 |
| 5. Modélisation mathématique d'un système de stockage par air comprimé..... | 14 |
| 6. Simulation du système CAES en Matlab..... | 16 |
| 7. Représentation de la configuration expérimentale..... | 20 |
| 8. Étude de cas | 28 |
| 9. Coût de production pour l'optimisation | 32 |
| 10. Conclusions de la thèse et perspectives | 35 |
| Contributions originales..... | 37 |
| Bibliographie..... | 37 |

1. Introduction

Au cours des deux dernières décennies, des changements majeurs ont été apportés à la façon dont la communauté scientifique et les décideurs ont perçu l'avenir du secteur de l'énergie. Au fil des ans, il y a eu plusieurs scénarios de prévisions pour les principaux combustibles fossiles, étant donné que, compte tenu des réserves connues, ils se termineront à la fin du siècle et que leur épuisement n'est qu'une question de temps et pas une incertitude [1]. Même s'il y a de nouvelles réserves qui seront trouvées et qui contribueront à prolonger le délai, les réserves qui seront découvertes seront nettement inférieures à celles trouvées dans le passé. Evidemment, il est bien connu que les combustibles fossiles ne sont pas une option viable et qu'ils seront de moins en moins utilisés, tout comme le fait que les sources d'énergie renouvelables seront de plus en plus sollicitées.

L'intérêt pour le stockage de l'énergie augmente actuellement, en particulier dans le but d'intégrer les énergies renouvelables dans le réseau et de répondre directement aux besoins des consommateurs. L'énergie renouvelable a une grande importance dans la sécurité de l'approvisionnement en énergie et peut être utilisée pour économiser le carburant, en particulier comme matières premières dans les centrales thermiques ou pour le transport routier, ferroviaire, maritime et aérien.

Le plus grand défi en matière d'énergies renouvelables est leur nature intermittente. En se référant uniquement à l'énergie solaire et éolienne, l'électricité n'est générée que lorsque le soleil brille ou que le vent souffle. Il faut trouver les moyens de stocker de l'énergie pour pouvoir l'utiliser pendant des périodes sans vent ni soleil, et il faut se guider par le principe de « la prendre quand on peut l'avoir » [2]. La gestion de la question des fluctuations des SER est la question clé dans le développement et l'utilisation du stockage de l'énergie dans un avenir proche [3].

Un point important sous-jacent à l'intégration et à l'utilisation des sources renouvelables est la nécessité de réduire les émissions de gaz à effet de serre, car une partie importante des contaminants libérés est l'effet des procédés de production de chaleur et d'électricité par les centrales thermiques (SO₂, NO₂, CO₂, poussière, scories, cendres et pollution thermique).

Au fil du temps, plusieurs initiatives ont été prises à l'échelle mondiale et en mars 2007, l'Union européenne a adopté une nouvelle politique pour fixer des objectifs en matière d'énergies renouvelables, afin qu'en 2020 au moins 20% l'énergie sera de sources renouvelables. Pour atteindre cet objectif, la Commission européenne a élaboré une série de nouvelles directives couvrant l'industrie de l'énergie, la construction publique et les procédures privées. Ceux-ci comprennent: réduire les émissions de gaz à effet de serre (GES) de 20% d'ici à 2020 en comparaison avec les années 1990, augmenter la quote-part des sources d'énergie renouvelable (SER) à 20% de ses sources d'énergie avant 2020 et réduire la consommation mondiale d'énergie primaire de 20% avant 2020. Avec ces objectifs résumés, le programme a été nommé 20-20-20% [4]. Plus tard, en 2012, une nouvelle directive est venue à appuyer la projection de

2007 et pour s'assumer une fois de plus les objectifs sur la consommation d'énergie primaire avant 2020 [5].

But et objectifs

Le stockage de l'énergie est l'un des principaux défis de la technologie des énergies renouvelables en raison de leur nature intermittente. **Ainsi, l'approche de la thèse est de contribuer et d'illustrer si le système de stockage par air comprimé peut devenir une solution viable de point de vue technique et économique dans le domaine du stockage d'énergie ou pas.**

Il convient de noter dès le départ que le thème de la thèse était de traiter les applications qui proposent des systèmes de stockage d'énergie à petite échelle, en se concentrant principalement sur l'énergie stockée par air comprimé.

Le stockage de l'énergie par air comprimé (CAES) n'est pas un simple système de stockage d'énergie, comme les batteries et les supercondensateurs, car il implique un transfert de chaleur important pendant le processus de transformation de l'énergie électrique en énergie mécanique. L'analyse globale de ces systèmes devrait être faite en tenant compte de tous ces aspects concernant le transfert de chaleur.

Objectifs :

- Développer un modèle général d'étude pour un système de stockage d'air comprimé.
- Comprendre les défis liés à l'utilisation de l'air comprimé comme support de stockage d'énergie.
- Effectuer une étude approfondie de la bibliographie sur le modèle mathématique dans le domaine du stockage de l'énergie, en particulier par air comprimé.
- Comprendre le rôle potentiel du stockage par air comprimé par rapport à d'autres concepts de stockage de l'énergie.
- Comprendre les implications théoriques et pratiques de la thermodynamique du système par air comprimé.
- Trouver une solution adéquate pour le stockage de chaleur.
- Développer un système opérationnel, sûr et économique.

Les systèmes CAES sont la deuxième plus grande technologie de stockage d'énergie en masse, après le pompage-turbinage (PHES), où un gaz (généralement de l'air) est comprimé à haute pression (des dizaines, voire des centaines de bar) et injecté dans une structure souterraine (caverne, aquifère, mine abandonnée et autres) s'il s'agit de grande taille, ou dans des réservoirs situés à la surface, s'il s'agit de petite échelle. Dans un système CAES, pour produire de l'électricité, l'air est mélangé à des carburants supplémentaires, habituellement du gaz naturel brûlé et détendu par une turbine à gaz conventionnelle qui entraîne un générateur. En plus de cette technologie conventionnelle appelée « CAES diabatique », il existe d'autres concepts avancés de CAES appelés « CAES adiabatiques avancé ». Le concept AA-CAES diffère des CAES classiques en ce sens qu'il fonctionne sans combustion du gaz naturel. Cette solution nécessite que l'énergie thermique résultant du processus de compression soit stockée dans un

système de stockage de l'énergie thermique (TES) et ensuite utilisée pendant le processus d'expansion pour réchauffer l'air avant d'entrer dans la turbine à gaz. Si la chaleur qui résulte de la compression est utilisée à d'autres fins et non pour réchauffer l'air pendant la dilatation, il se produit une quantité importante de froid et trois types d'énergie sont obtenus : électrique, thermique et froid ; le système est devenu une « trigénération », tout en satisfaisant les besoins de nombreux consommateurs [9]. Pour éviter la consommation de carburant, qui est un élément de base des CAES classiques, sachant leur dépendance, un système alternatif de stockage de carburant est présenté dans cette étude. Deux scénarios sont analysés, le premier dans lequel la chaleur est utilisée à des fins telles que le chauffage de l'eau domestique, le chauffage de l'immeuble etc. et le deuxième où la chaleur est utilisée pour réchauffer l'air comprimé avant le processus d'expansion.

2. Aperçu des sources d'énergie renouvelables

Le développement des énergies renouvelables en tant qu'énergies globales et propres est l'un des principaux objectifs de la politique énergétique globale qui vise à réduire la consommation des combustibles fossiles, à réduire les émissions de gaz à effet de serre et à développer de nouvelles technologies viables dans la production d'énergie [6], [7].

Aujourd'hui, nous utilisons principalement des combustibles fossiles pour chauffer nos maisons et alimenter nos voitures, même si de nombreux progrès ont été réalisés dans le secteur de la mobilité, en particulier dans les véhicules électriques et moins dans les véhicules à pile à combustible. Peut-être convient-il d'utiliser le charbon, le pétrole et le gaz naturel pour répondre à nos besoins énergétiques, mais ceux-ci sont limités et le temps de récupération est plus lent que la consommation. Cependant, même si l'approvisionnement en combustibles fossiles est illimité, l'utilisation d'énergie renouvelable est meilleure pour l'environnement et est généralement appelée énergie propre ou verte.

La centrale hydroélectrique est la technologie la plus mature utilisée pour le stockage et la production d'énergie à partir de sources d'énergie renouvelables. La capacité d'une centrale hydroélectrique est incomparable avec la capacité de toute autre centrale qui utilise toute autre forme d'énergie renouvelable. D'autres technologies de conversion des énergies renouvelables en électricité sont les cellules photovoltaïques et la concentration de l'énergie solaire en termes d'énergie solaire, les éoliennes en termes d'énergie éolienne et, à plus petite échelle mais avec un certain potentiel, ce sont les technologies basées sur la biomasse, l'énergie géothermique et l'énergie des vagues et des marées.

Le plus grand défi pour une grande partie des sources d'énergie renouvelables est leur nature intermittente. Les panneaux photovoltaïques et les éoliennes ne peuvent produire de l'énergie en cas de besoin, mais seulement lorsque le soleil brille et que le vent souffle. Pour cette raison, les sources d'énergie renouvelables ne peuvent pas remplacer les centrales électriques traditionnelles et les remplacent uniquement par des équivalents dans les éoliennes et les panneaux photovoltaïques. Comme l'énergie doit être produite aussi quand les sources d'énergie renouvelables ne peuvent pas répondre à la demande, les centrales électriques

traditionnelles doivent être maintenues en exploitation et l'inconvénient réside dans le fait que le fonctionnement de la centrale traditionnelle pendant des heures de forte demande détermine une faible efficacité économique, qui se reflète dans le coût. Cependant, une partie importante de l'énergie renouvelable produite par les panneaux photovoltaïques et les éoliennes dans le mix énergétique est une nécessité et cela ne peut se produire qu'en améliorant leur association à d'autres concepts techniques qui assureraient une alimentation sécurisée.

En 2015, la part de l'énergie provenant de sources renouvelables dans la consommation finale brute d'énergie a atteint 16,7% dans l'Union européenne et l'objectif à atteindre jusqu'à 2020 est de 20% pour les énergies renouvelables [source: Eurostat].

En 2016, la croissance de l'énergie éolienne a atteint jusqu'à 486 GW, l'énergie hydroélectrique jusqu'à 1064 GW, l'énergie solaire jusqu'à 303 GW, l'énergie issue de la biomasse jusqu'à 296 GW et l'énergie géothermique jusqu'à 13,2 GW.

3. L'évolution du secteur de l'énergie

Si, à la fin du XXe siècle, le secteur de l'énergie était presque couvert par les combustibles fossiles, l'énergie renouvelable a commencé, ces dix dernières années, à avoir un impact croissant sur ce secteur au niveau mondial. Un rapport de l'Agence américaine d'information sur l'énergie montre le taux de pénétration des sources sans carbone dans les pays de l'UE et des États-Unis au niveau de 2012, rapporté au niveau de 2002. Le même rapport indique qu'en 2002, dix-huit pays de l'Union européenne ont généré au moins un tiers de leur énergie des sources sans émission de carbone. Même si les éoliennes et les panneaux photovoltaïques ont connu un développement rapide ces dernières années, en particulier dans des pays comme l'Allemagne ou les pays nordiques, leur impact reste faible. Cependant, presque tous les pays contribuent régulièrement à ce que les apports d'énergie provenant de sources d'énergie renouvelables ne cessent d'augmenter.

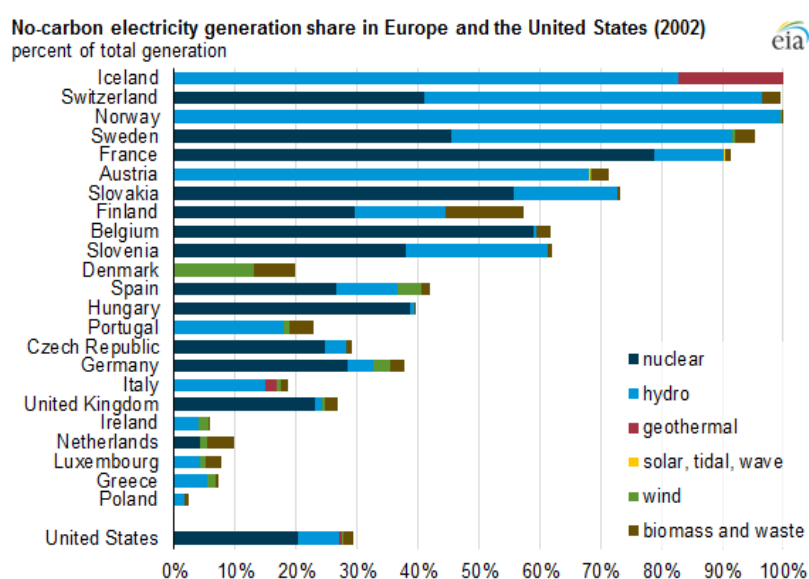


Figure 1 – Un aperçu sur la partie de l'énergie provenant de sources renouvelables pour l'année 2002 [8]

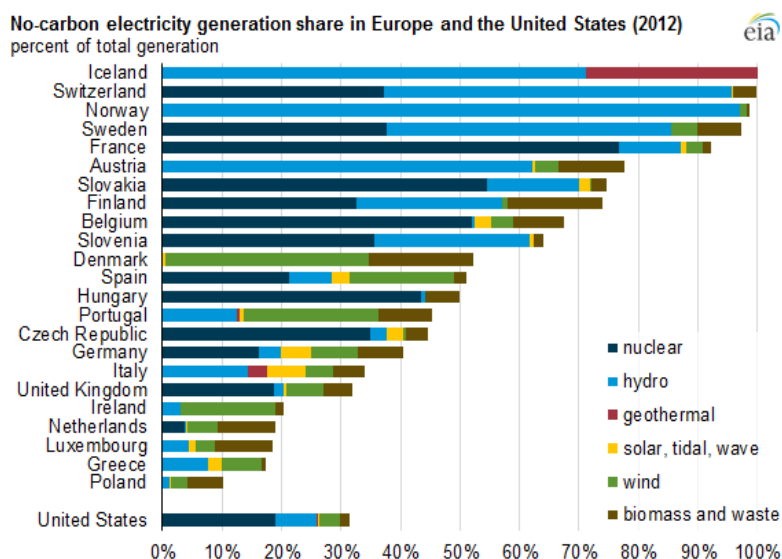


Figure 2 – Un aperçu sur la partie de l'énergie provenant de sources renouvelables pour l'année 2012 [8]

Le contexte énergétique en France

Le secteur de l'électricité en France se caractérise par sa spécificité élevée par rapport à tout autre pays du monde. Suite aux crises pétrolières de 1974, la France décide d'investir massivement dans le nucléaire à cause du fait que cette énergie est moins dépendante des événements économiques [9]. Depuis les années 1990, l'énergie nucléaire en France représente plus de 75% de la consommation d'électricité. La plupart des investissements ont été faits pour des raisons politiques afin d'encourager les technologies basées sur ce type d'énergie et laissant peu de place au développement d'autres sources d'énergie.

Actuellement, la France est tellement dépendante du secteur nucléaire que le gouvernement a décidé qu'un nouveau réacteur nucléaire ne serait lancé que lorsqu'un ancien réacteur s'arrêterait. Cette décision intervient immédiatement après l'accident de Fukushima, alors que le secteur de l'énergie nucléaire à travers le monde était confronté à la nécessité de reconsidérer sa politique énergétique. De nombreux pays ont décidé de se tourner vers les sources d'énergie renouvelables et de fermer progressivement leurs centrales nucléaires. L'Allemagne a été l'un des pays qui a réagi immédiatement et, à travers la voix de sa chancelière Merkel, a annoncé que tous les réacteurs nucléaires seraient fermés jusqu'à la fin de 2022.

De même, les politiques menées par l'Union européenne, qui ont exigé la réalisation de l'objectif d'énergie renouvelable pour chaque pays jusqu'en 2020, trouvent la France dans une situation très difficile, ayant à la fin de 2014 une capacité de production de seulement 9.100 MW d'énergie éolienne et une capacité de production d'environ 5.300 de panneaux photovoltaïques [10].

Comme tout mécanisme de marché, le marché français de l'énergie se concentre sur: La production d'électricité est majoritairement dominée par EDF, elle-même contrôlée par l'Etat français, Transport et Distribution tenant tant que gestionnaires de réseau RTE et ERDF, qui sont détenues à 100% par EDF. Le marché de détail a été libéralisé depuis 1999, lorsque les

sites industriels sont devenus éligibles de choisir leurs fournisseurs, et cette option est également devenue possible en 2007 pour les clients résidentiels.

Le secteur énergétique français est très interconnecté avec les pays voisins. La figure 8 montre les exportations et les importations pour 2014 concernant la France. On constate que la France exporte de l'électricité vers le Royaume-Uni, la Belgique, la Suisse, l'Italie et l'Espagne et qu'elle importe principalement d'Allemagne, de Suisse et d'Espagne.

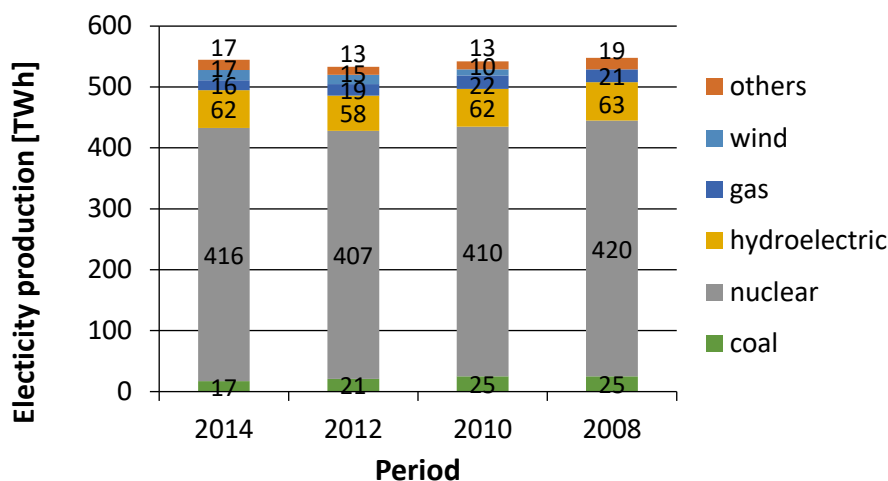


Figure 3 – Production d'électricité de toutes les sources d'énergie Le cas de la France

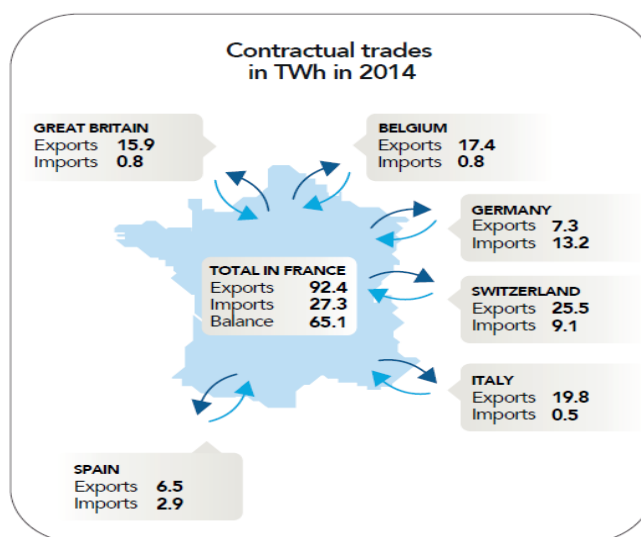


Figure 4 – L'interconnexion de la France dans le secteur de l'énergie [10]

Le contexte énergétique en Roumanie

À l'heure actuelle, la Roumanie dispose d'une gamme diverse, mais réduite de point de vue quantitatif, de sources fossiles primaires et de minéraux: le pétrole, le gaz naturel, le charbon, l'uranium, et d'un potentiel de sources renouvelable. Au même temps, on peut dire que la Roumanie est relativement peu dépendante des importations d'énergie, par rapport aux autres

pays européens. En Europe, seuls le Danemark et l'Estonie sont mieux placés de ce point de vue. Dans l'ensemble de l'Union européenne, la demande d'énergie primaire n'est fournie que dans une proportion de 47% de sa propre production, la différence étant importée.

En comparaison aux années 1980, on peut remarquer qu'aujourd'hui, la demande d'énergie primaire a été presque réduite de moitié en raison du processus de désindustrialisation et de l'émergence de nouvelles technologies économes en énergie.

Le réseau électrique national en Roumanie est un système de production et de distribution d'électricité, qui comprend tous les centrales électriques et tous réseaux de distribution. Les composantes du réseau national roumain sont: Termoelectrica, Hidroelectrica, Nuclearelectrica, Electrica, Transelectrica. Les trois premières sociétés ont un rôle dans la production d'énergie, tandis qu'Electrica joue le rôle de distribution et d'approvisionnement en électricité, et Transelectrica est un opérateur de transport.

Si nous regardons la figure 9, nous pouvons facilement voir que le secteur énergétique roumain est très diversifié, étant indépendant d'une seule source d'énergie. En 2014, 27,5% de l'énergie totale produite provenait du charbon, 30% de l'hydroélectricité, 18% du nucléaire, 12,5% du gaz naturel et 12% de l'énergie solaire et éolienne. Par rapport à 2008, la production d'énergie du charbon en 2014 a diminué de près de 10%, un pourcentage couvert par des sources renouvelables, principalement l'énergie solaire et éolienne.

À la fin 2015, l'énergie renouvelable installée en Roumanie est de 4,662 MW, d'après ANRE [11], dont 2,931 MW d'éoliennes, 1,296 de panneaux photovoltaïques, 106,5 MW de biomasse, de biogaz et de gaz de fermentation de déchets et 327,8 MW de micro-centrales hydroélectriques d'une puissance installée inférieure à 10 MW.

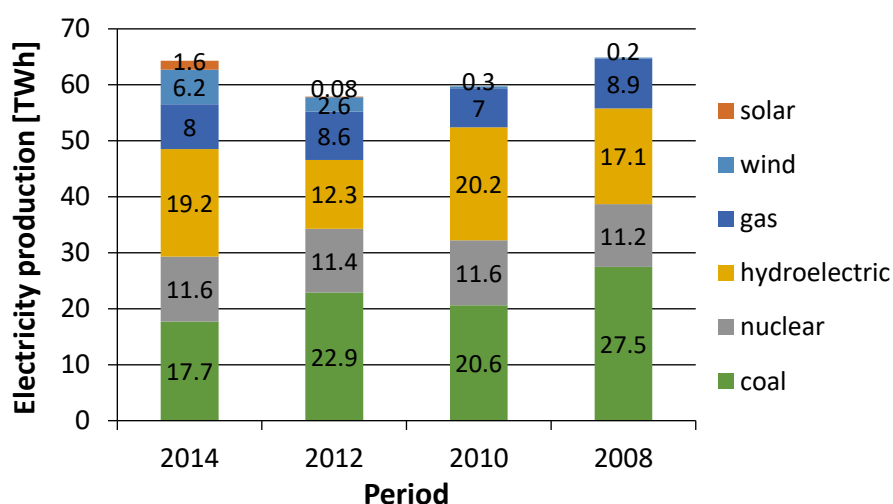


Figure 5 – La production d'électricité à partir de toutes les sources d'énergie : Le cas de la Roumanie

Tenant compte de toutes les contraintes en ce qui concerne les sources renouvelables de leur nature fluctuante, on remarque que le système énergétique actuel ne peut intégrer ces

technologies à grande échelle sans nouveaux investissements dans le secteur des transports et certainement dans les systèmes de stockage [12], [13], [14], [15].

- L'extension du réseau – devrait être une priorité dans un réseau électrique capable d'absorber une part croissante des énergies renouvelables. La technologie nécessaire est commercialement disponible, avec quelques éléments qui doivent être améliorés en ce qui concerne la sécurité et la flexibilité de l'approvisionnement. Cependant, une autre question qui apparaît ici est l'acceptation par le public, mais si les gens veulent de l'énergie renouvelable, ils doivent accepter plus de réseaux dans leur voisinage.
- Stockage d'énergie – est de loin l'option qui offre le plus haut niveau de flexibilité pour l'intégration généralisée des sources d'énergie renouvelables. Différentes technologies sont présentées dans la littérature scientifique et la plupart d'elles se sont avérées techniquement viables. En fonction de l'échelle, on peut citer le pompage-turbinage, l'air comprimé, le volant moteur, les batteries, les piles à combustible et les supercondensateurs. Le problème de stockage survient lorsque nous examinons ses coûts, mais nous considérons que toute technologie de stockage est coûteuse en ce moment. En tout cas, son efficacité et sa fiabilité s'améliorent considérablement, et si l'on regarde son prix, qui est en baisse constante, seulement si on considère Tesla, qui rapporte un prix de 3500 USD pour les batteries Li-Ion de 10 kWh au début de 2016, on peut s'attendre à ce que les prix futurs atteignent un niveau acceptable.
- Demand side management – également appelée maîtrise de la demande en énergie - correspond à l'évolution de la demande d'énergie des consommateurs. L'objectif du DSM est d'encourager le consommateur à consommer moins d'énergie pendant les heures de pointe et de se concentrer sur l'utilisation de l'énergie pour les périodes en dehors des heures de pointe, comme la nuit et la fin de semaine. DSM ne vise pas à réduire la consommation totale d'énergie, mais seulement la demande à laquelle le réseau électrique est soumis. Ainsi, divers effets bénéfiques peuvent survenir, tels que l'atténuation des urgences dans le système électrique, la réduction du nombre d'interruptions et l'augmentation de la fiabilité du système, les avantages possibles pouvant également consister à réduire la dépendance aux combustibles fossiles, à réduire les prix de l'énergie et à réduire les investissements dans les réseaux de production, de transport et de distribution. Une solution consiste à utiliser des unités de stockage d'énergie en dehors des heures de pointe et à les décharger pendant les périodes de pointe. Dans DSM, l'intégration de la technologie de communication avec le système d'alimentation joue un rôle important, et de nos jours, au lieu de DSM, le terme réseau intelligent est davantage utilisé. L'objectif du réseau intelligent est de réduire les coûts énergétiques et d'apporter des avantages immédiats au consommateur.

Discussions et perspectives

À l'heure actuelle, toutes les politiques menées dans le secteur de l'énergie se concentrent de plus en plus sur les sources d'énergie renouvelables. Cependant, cette transition vers l'énergie verte ne peut être réalisée sans le développement d'installations de stockage, principalement à

grande échelle. La nature fluctuante des sources renouvelables nécessite un système énergétique équilibré.

Du point de vue technique, il existe plusieurs technologies de stockage dont les capacités de stockage ont été démontrées. Il y a, bien sûr, de la place pour de nouveaux progrès, en particulier en termes d'efficacité et de durée de vie. Cependant, la grande étape que les technologies de stockage doivent surmonter est d'atteindre la faisabilité économique.

Les avancées futures dans la recherche et le développement de nouveaux concentrateurs solaires et de technologies de stockage d'énergie devraient contribuer à abaisser les prix de la même manière que ce qui est arrivé dans le cas des cellules photovoltaïques et même les éoliennes.

Les systèmes renouvelables, y compris les éoliennes et les panneaux photovoltaïques et solaires, deviennent de plus en plus compétitifs, même dans un régime de prix des combustibles fossiles bas. La chaleur renouvelable peut être une option compétitive en termes de coût, mais elle ne bénéficie pas d'une attention politique suffisante. Les politiques devraient être axées sur la création de marchés et de cadres réglementaires adéquats. Les mesures de marché et réglementaires peuvent influencer le coût moyen et améliorer la compétitivité.

Un soutien constant pour le développement du marché et la R&D réduira les coûts une fois la technologie mûrie. Si nous analysons les tendances technologiques, nous pouvons voir que le système photovoltaïque est extrêmement modulaire, facile et rapide à installer et accessible à tous. La baisse rapide des coûts a confirmé le rythme rapide de l'apprentissage en ce qui concerne les photovoltaïques, ce qui conduit à une augmentation de la confiance que la poursuite du développement continuera à réduire les coûts à l'avenir.

Aujourd'hui, l'énergie solaire thermique basée sur la technologie de l'énergie solaire peut être utilisée dans des endroits où le soleil est très lumineux et où le ciel est dégagé et où les lignes de transport longue distance sont utilisées pour le transport afin de relier différentes zones. L'électricité thermique solaire est généralement utilisée à grande échelle, mais la petite échelle peut également trouver des marchés de niche dans des réseaux isolés.

4. Aperçu des solutions de stockage d'énergie

Il y a trois principaux piliers sur lesquels repose le stockage de l'énergie.

- Le stockage d'énergie devrait avoir un avantage important dans l'augmentation de la pénétration des énergies renouvelables.
- Le stockage d'énergie devrait représenter pour les autorités réglementaires une option efficace pour résoudre les problèmes de fiabilité du réseau.
- Le stockage d'énergie devrait avoir un impact considérable sur les réseaux intelligents, en particulier dans le développement de nouvelles centrales électriques pour le transport et pour une utilisation optimale de la consommation d'électricité [16].

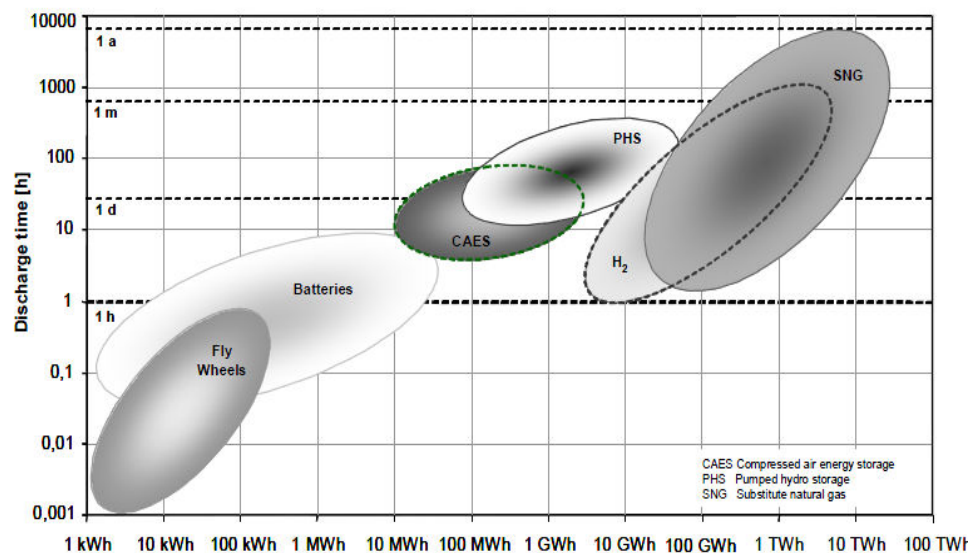


Figure 6 – Aperçu des systèmes de stockage d'énergie [17]

Quel que soit le support de stockage, qu'il s'agisse de batteries, de la pression du gaz, du déplacement d'eau etc., la plupart des technologies présentées dans la figure ci-dessus suivent le même principe de fonctionnement en ce qui concerne les processus de chargement, de stockage et de déchargement.

Mode de charge – Lorsque l'énergie excédentaire extraite des heures de pointe provient de sources renouvelables et est utilisée pour comprimer l'air et le stocker dans un réservoir de stockage. Si le système est connecté au réseau électrique, cela fonctionne quand il y a des heures qui ne sont pas de pointe, et le prix de l'électricité est bas, généralement la nuit.

Le mode de décharge – lorsque de l'énergie est nécessaire et il n'y a pas d'autres sources d'énergie, l'air comprimé est extrait du réservoir de stockage puis expansé par un détendeur pour entraîner un générateur et fournir la puissance maximale au réseau ou pour fournir l'énergie à l'utilisateur final.

5. Modélisation mathématique d'un système de stockage par air comprimé

Les scénarios de fonctionnement CAES

La technologie CAES comprend cinq composants principaux : un ou plusieurs compresseurs, plusieurs refroidisseurs intermédiaires, un réservoir de stockage, une ou plusieurs turbines et un ou plusieurs générateurs électriques. Pendant le processus de compression de l'air, le compresseur-moteur consomme de l'énergie provenant de sources renouvelables ou du réseau pour faire fonctionner le compresseur d'air. L'air ambiant est comprimé à haute pression, refroidi et stocké dans un récipient de stockage pendant un certain temps. Lorsque de l'énergie est nécessaire, l'air est expansé par un moteur pneumatique ou une turbine qui entraîne un générateur pour produire de l'électricité.

Du point de vue thermodynamique, il existe trois cas possibles de compression et d'expansion dans lesquels un système CAES peut fonctionner, dans un processus isotherme, polytropique ou adiabatique. Cela implique plusieurs scénarios, en fonction du coefficient de pression de stockage et des variations de volume [18], [19], [20] :

- La pression d'entrée de la turbine variable, qui varie avec la pression du réservoir de stockage.
- La pression d'entrée de la turbine constante, en ajustant le flux d'air en amont à une pression fixe.
- Maintenir une pression constante en utilisant les méthodes qui permettent cela [21], [22].

Certains de ces trois scénarios sont plus souhaitables que d'autres, selon les exigences de l'application. Il est bien connu que dans de nombreux cas, une puissance constante est nécessaire d'être fournie au consommateur.

Le processus de chargement

Lorsque l'air à la pression atmosphérique est comprimé mécaniquement par un compresseur à 1 bar à une pression plus élevée, la transformation de l'air est déterminée par les lois de la thermodynamique. Pendant le processus de chargement, l'air est extrait de l'atmosphère et est comprimé par un compresseur à une pression plus élevée. Lors d'une compression théorique adiabatique ou d'une compression polytrophe plus réaliste, une fois la pression augmentée, la température augmente également.

Avec l'augmentation de la température, il y a plus de phénomènes moins désirables:

- Il y a une diminution de l'efficacité du compresseur.
- Les parois du réservoir sont exposées à des contraintes thermiques.

- Les changements de densité du gaz entraînent une réduction de la quantité de gaz stocké.

Pour éliminer toutes ces difficultés, il est important de refroidir l'air avant de le stocker dans le réservoir, en utilisant des échangeurs de chaleur. La chaleur provenant du processus de compression peut être utilisée à d'autres fins ou stockée dans un système de stockage de l'énergie thermique pour une utilisation ultérieure.

En termes de principe de fonctionnement, les compresseurs sont divisés en deux catégories : les compresseurs volumétriques, qui peuvent être des compresseurs alternatifs ou rotatifs, et les compresseurs dynamiques, qui peuvent être des compresseurs centrifuges (turbocompresseurs, ventilateurs) et des compresseurs axiaux.

Le processus de stockage

Après compression, l'air sous pression pénètre dans le récipient de stockage à haute pression P_f et à une température T_0 proche de la température ambiante. L'air pressurisé peut être stocké pour une durée indéterminée. La température de stockage est supposée constante.

Le processus de déchargement

Comme pour le processus de compression, le processus d'expansion a été analysé en comparant tous les résultats obtenus pour évaluer l'efficacité globale du système dans son ensemble. Une analyse pour l'expansion isotherme, adiabatique et polytropique a été réalisée pour le processus de déchargement. L'air comprimé est dilaté par un moteur à air à une pression constante au moyen de l'entrée fixe du moteur pneumatique. Le moteur à air consiste dans un arrangement alternatif piston-cylindre, en ce que l'air comprimé est admis dans le cylindre quand la soupape d'admission est ouverte pour une période de temps limité ; après l'air qui entre le cylindre cause le mouvement du piston et de l'arbre de transmission. Le principe est relativement similaire à celui des compresseurs dans lesquels le piston est déplacé pour comprimer l'air, tandis que dans le cas du moteur à air, le gaz (air) déplace (pousse) le piston pour produire un travail mécanique.

Le stockage de l'énergie thermique

Le stockage de l'énergie thermique est une technologie permettant de conserver l'énergie thermique en chauffant ou en refroidissant un environnement de travail afin de pouvoir ensuite être utilisé pour le chauffage, le refroidissement ou la production d'énergie [23], [24]. En fait, le stockage de l'énergie thermique sera un facteur décisif dans le problème de la gestion de l'énergie. A l'heure actuelle, deux types de systèmes de stockage d'énergie thermique sont connus, selon la façon dont l'énergie est utilisée, comme chaleur sensible ou chaleur latente [25], [26].

La méthode la plus courante de stockage de l'énergie thermique est comme chaleur sensible, qui représente l'échange de chaleur d'un fluide / corps qui augmente sa température et reste dans la même phase d'agrégation. Cette technologie est peu coûteuse et utilisée dans le monde entier, ce qui la rend moins compliquée par rapport à la chaleur latente ou, pour certaines

applications, à la chaleur chimique. Des systèmes sensibles de stockage d'énergie typiques peuvent ou non impliquer un fluide de transfert de chaleur pour transporter la chaleur de la source chaude vers le support de stockage, typiquement si le milieu est solide. Ou même le fluide de travail peut représenter le support de stockage lui-même, tout en jouant le rôle de l'échangeur de chaleur et le stockage de l'énergie thermique. À ce jour, sont utilisés deux réservoirs, un froid et un chaud, et le fluide est déplacé d'un réservoir à l'autre, en passant par un échangeur de chaleur. Au contraire, la chaleur latente représente la quantité de chaleur échangée par un corps passant d'une phase à l'autre, d'un gaz à un liquide ou à un solide ou vice versa, à température constante [27]. Par rapport au stockage de chaleur conventionnel, le stockage basé sur des matériaux à changement de phase permet une haute densité d'énergie à une température de fonctionnement constante.

6. Simulation du système CAES en Matlab

Un code Matlab a été écrit conformément au modèle théorique présenté au chapitre 5. Les résultats de la modélisation obtenue ont été validés sur un stand de laboratoire expérimental, et tous sont présentés dans les tableaux et graphiques ci-dessous.

Les hypothèses énumérées ci-dessous ont été prises en compte pour simplifier l'analyse du système AA-CAES proposé :

- L'énergie fournie par les sources d'énergie renouvelables par les panneaux photovoltaïques, les concentrateurs d'énergie solaire et / ou les éoliennes est au moins égale à l'énergie consommée par le compresseur d'air.
- L'air comprimé est traité comme un gaz idéal.
- Toute l'énergie cinétique et potentielle est négligeable.
- La chute de pression dans l'un des composants du système est négligée.
- L'exposant polytropique $n = 1,2$ (l'exposant polytropique moyen obtenu au cours des résultats expérimentaux varie entre 1,18 et 1,2, au moins 5 réponses ont été faites, donc nous avons choisi 1,2 dans les simulations théoriques).
- La variation de température à l'intérieur du récipient de stockage pendant les processus de compression et d'expansion est modélisée à la suite d'un processus isotherme.
- Les échangeurs de chaleur sont modélisés pour amener la température de l'air après chaque compression ou expansion à une valeur proche de la température ambiante.

Les résultats théoriques présentés dans les figures ci-dessous ont été considérés comme respectant les caractéristiques techniques de l'équipement qui sera utilisé dans la partie expérimentale du papier, à savoir: un compresseur à 3 étages avec une pression maximale de 330 bar; un réservoir de stockage de $0,3 \text{ m}^3$ et un expanseur d'air.

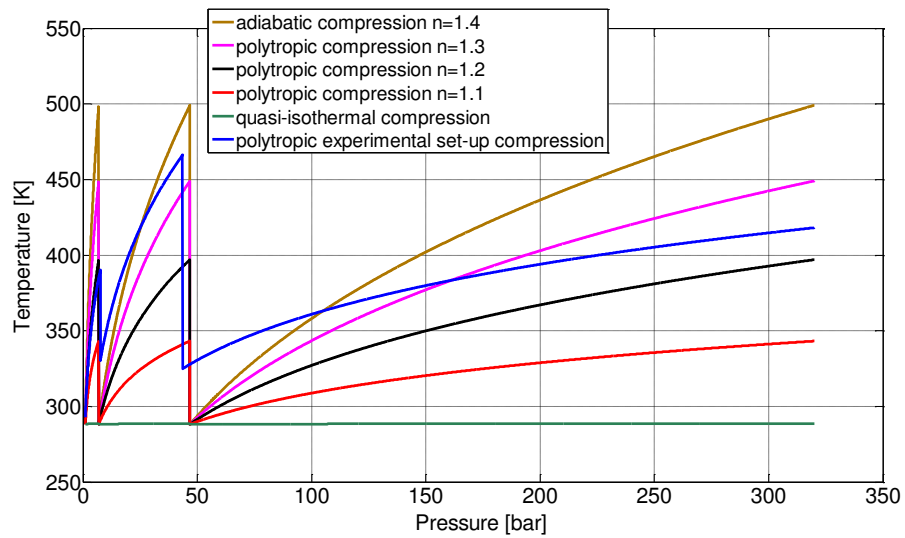


Figure 7 – Un processus de compression en plusieurs étapes

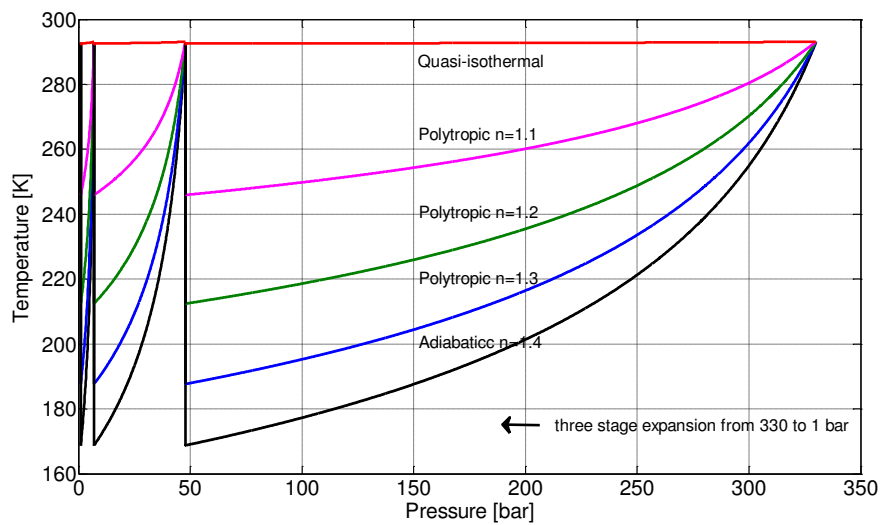


Figure 8 – Un processus d'expansion en plusieurs étapes

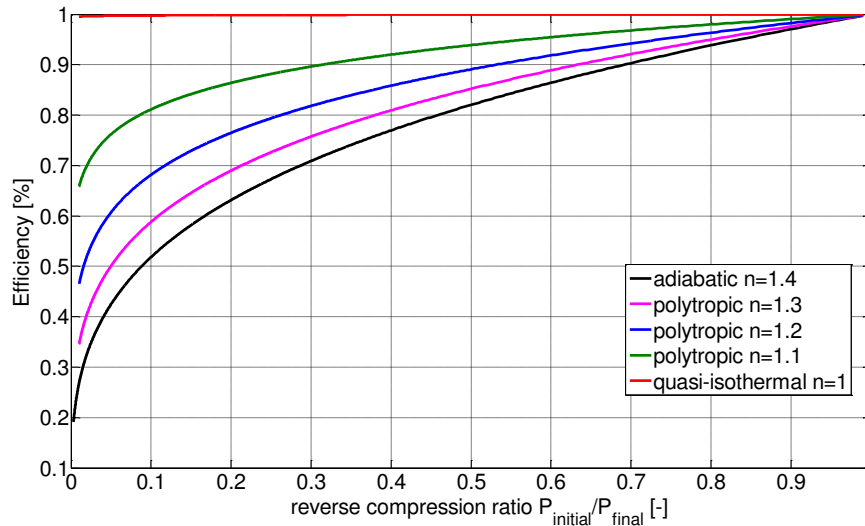


Figure 9 – Dépendance de l'efficacité du cycle sur le taux de compression et l'indice polytropique

Figure 9 montre que l'efficacité du cycle dépend uniquement du taux de compression et de l'exposant isentropique ou polytropique. L'efficacité est plus grande aussi longtemps que les transformations thermodynamiques sont plus proches d'un processus isotherme, et lorsque le taux de compression est de moins en moins.

Un autre scénario pris en compte a été celui où la chaleur générée pendant le processus de compression est stockée dans un système de stockage de chaleur puis utilisée pour réchauffer l'air avant le processus d'expansion. Dans ce cas, l'efficacité primaire du système augmente considérablement, mais élimine la possibilité de donner à l'utilisateur final une autre forme d'énergie telle que la chaleur et le froid.

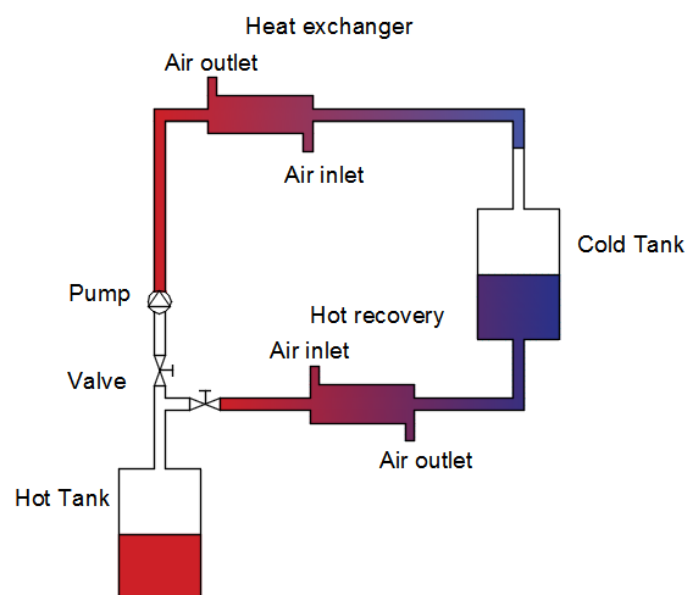


Figure 10 – Système de stockage de l'énergie thermique

Pour le stockage de l'énergie thermique, la solution la plus couramment utilisée consiste en 2 réservoirs, un froid et un chaud, dans lesquels le fluide de stockage est pompé d'un réservoir, traverse des échangeurs de chaleur où il est chauffé ou refroidi, tel que nécessaire, et puis stocké dans l'autre. L'obtention d'un refroidissement parfait ou de la température requise à l'entrée du récipient de stockage est possible en contrôlant le débit massique du fluide de travail de refroidissement.

Tableau 1 – Liste des matériaux solides et liquides utilisés pour stocker la chaleur sensible [28].

| Nom | Cp [kJ/kgK] | Température [°C] |
|--|--------------------|-------------------------|
| Béton (solide) | 0,916 | - |
| Pierre | 0,879 | - |
| Brique | 0,84 | - |
| Granit | 0,8 | - |
| Grès | 0,72 | - |
| Hydrates de sel | | Point de fusion |
| LiNO ₃ -3H ₂ O | - | 30 |
| K ₂ HPO ₄ -6H ₂ O | | 14 |
| FeBr ₃ -6H ₂ O | | 27 |
| Huiles minérales | 1,97 | Jusqu'à 320 |
| Huile moteur | 1,88 | Jusqu'à 160 |
| Caloria HT43 | 2,2 | Jusqu'à 260 |
| TherminolVP-1 | 2,48 | Jusqu'à 257 |
| Glycérol | 0,578 | Jusqu'à 297 |
| Propylène glycol | 1 | Jusqu'à 187 |
| Eau à 16 bar | 4,41 | Jusqu'à 200 |

7. Représentation de la configuration expérimentale

Pour valider toutes les hypothèses considérées dans le modèle théorique, un banc de laboratoire expérimental a été construit à IMT Atlantique – Nantes / France. La configuration du stand est représentée sur les figures 11 et 12, mais une configuration avec trois étages d'expansion a été considérée, mais seulement dans la partie théorique du papier.

- Compression – processus de compression en trois étapes,
- Expansion – processus d'expansion en 1 étape (expérimentale) ou 3 étapes (théorique).

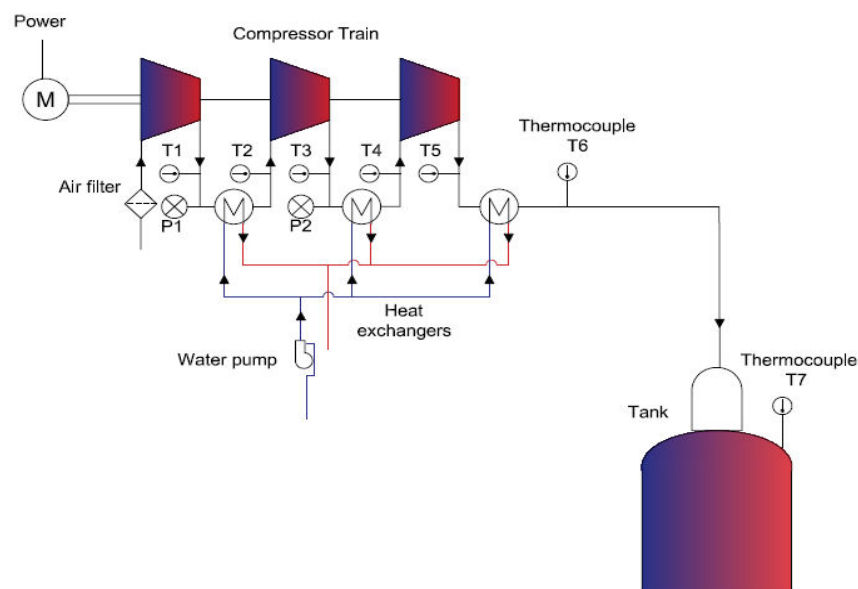


Figure 11 – Configuration expérimentale de la phase de compression

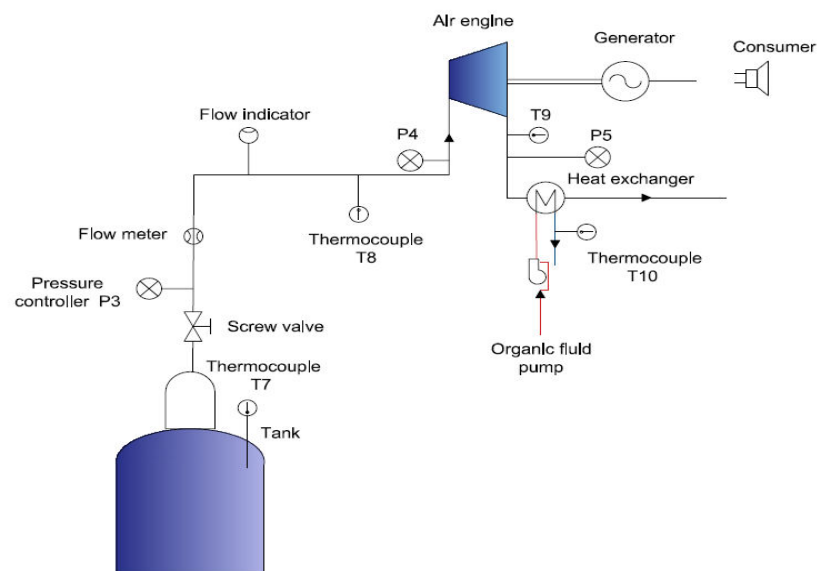


Figure 12 – Configuration expérimentale de la phase d'expansion



Figure 13 – La vue de côté du compresseur



Figure 14 – La vue de côté du réservoir de stockage

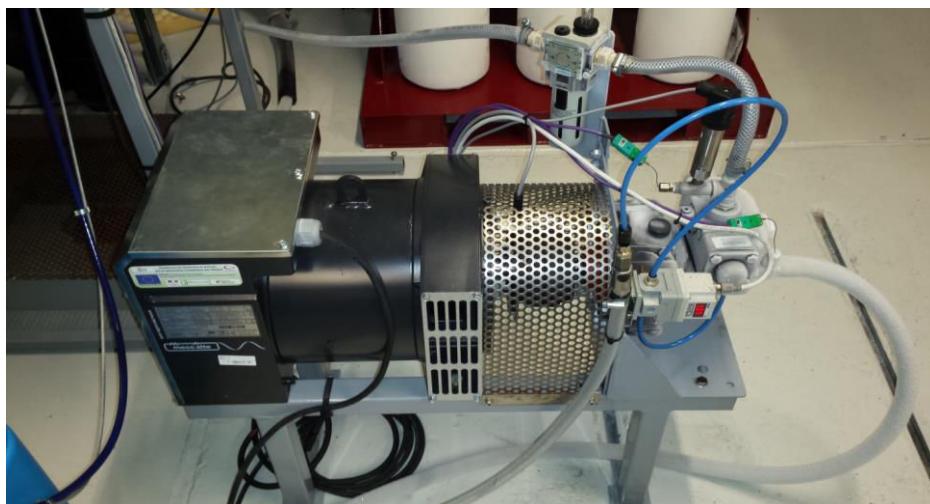


Figure 15 – La vue de côté du moteur à air

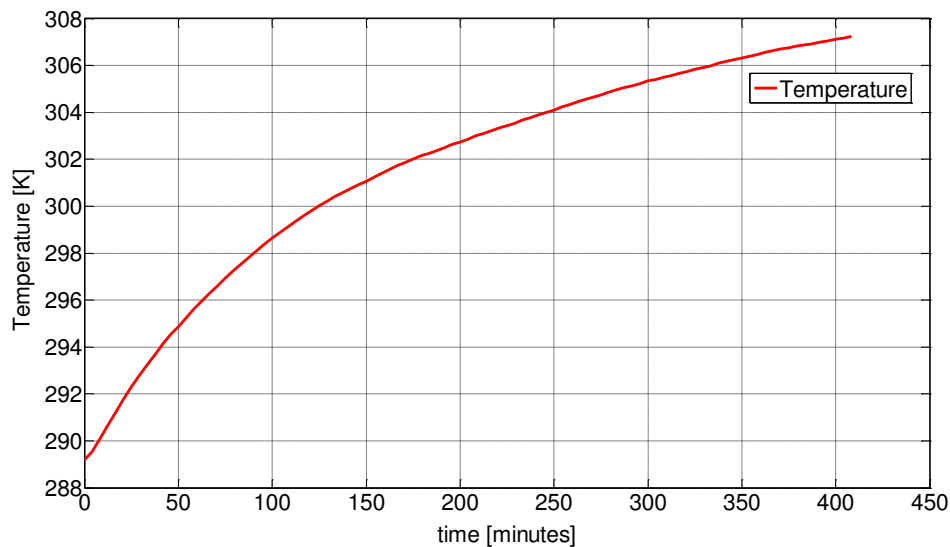


Figure 16 – Variation de la température de l'air dans le réservoir pendant le processus de changement

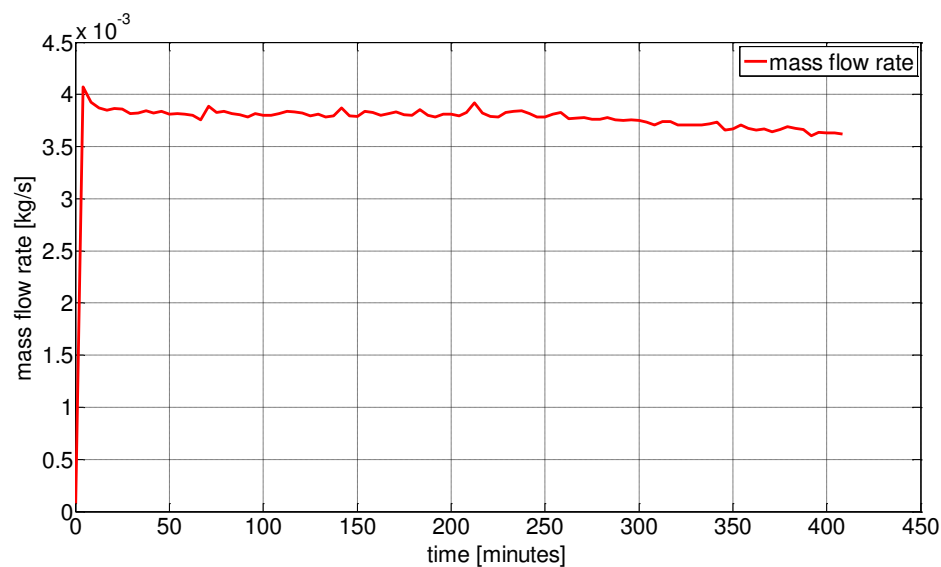


Figura 17 – Le débit massique d'air à variation succédée pendant le processus de compression

Les Figure 16 et Figura 17 montrent la variation de la température de l'air dans le réservoir dans laquelle l'air est stocké et le débit massique de l'air change pendant le processus de compression de l'air. La pente ascendante tend à stabiliser la température de l'air à la valeur de sortie du dernier échangeur de chaleur. En termes de débit massique, il est presque constant, avec une légère diminution au cours du processus de compression.

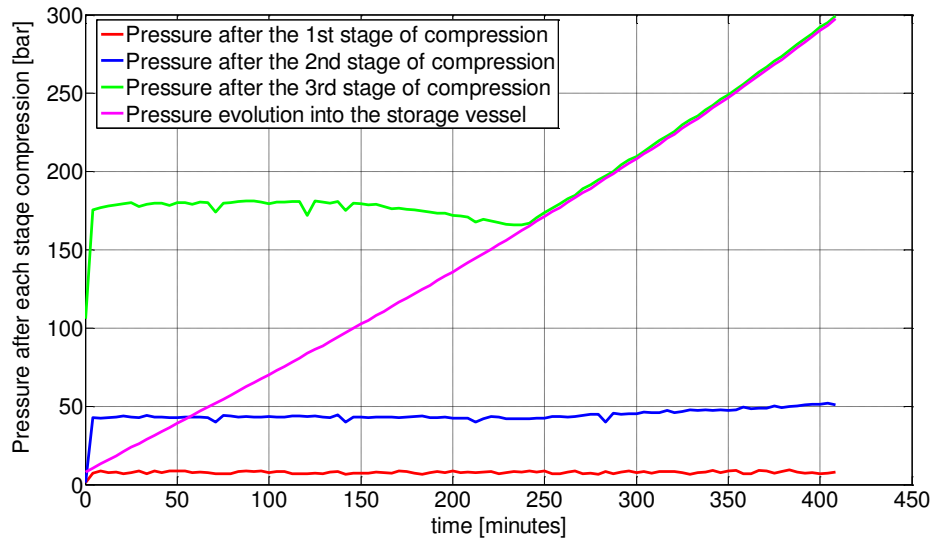


Figure 18 – Évolution de la pression d'air après chaque étape de compression

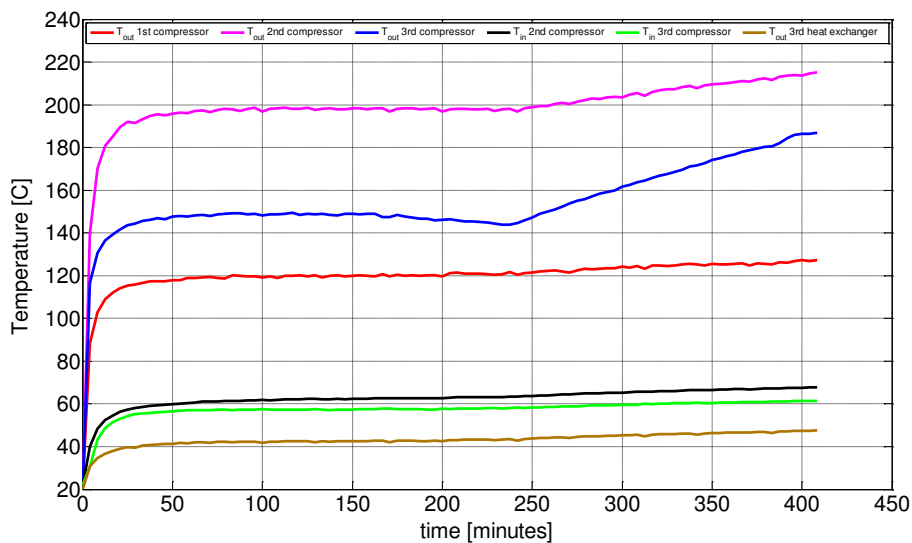


Figure 19 – Mesures expérimentales de température avant et après chaque étape de compression

Figure 18 et Figure 19 montrent les valeurs de température et de pression après chaque étape de compression. Les deux figures montrent que le troisième niveau de compression a un comportement différent des deux autres. Si, dans les deux premières étapes, les soupapes d'échappement s'ouvrent à une valeur de pression constante, dans la troisième étape la soupape d'échappement s'ouvre au début à une valeur de pression constante d'environ 170 bar et après, lorsque la pression dans le réservoir atteint cette valeur, alors les valeurs d'échappement fonctionnent sur la pression différentielle. En plus des valeurs de la pression montrées sur la figure 18, la figure 19 montre les valeurs de température à la fois à la sortie de chaque cylindre de compression et à la sortie de chaque échangeur de chaleur.

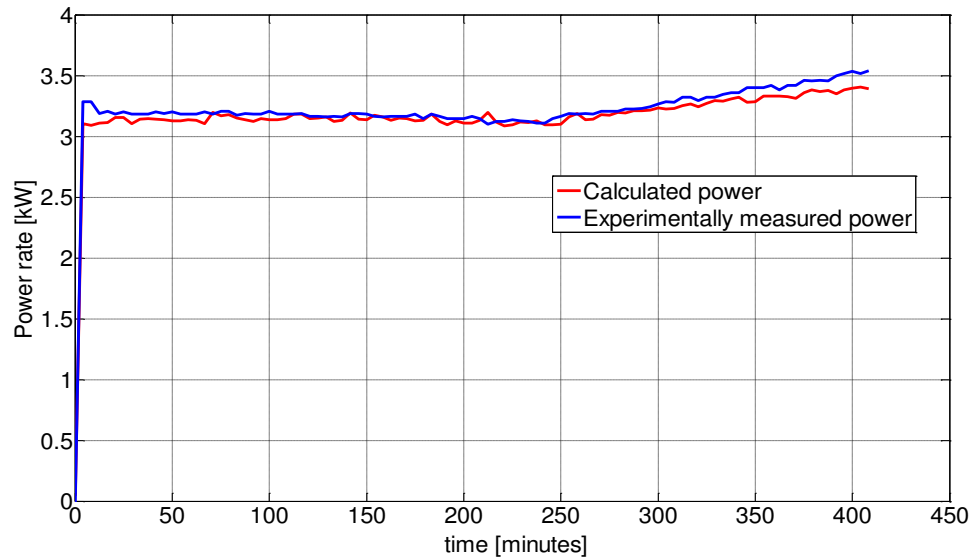


Figure 20 – L'énergie consommée par le compresseur pendant le processus de compression

La figure 20 illustre d'abord l'énergie consommée par l'air comprimé obtenu par des mesures expérimentales, la courbe bleue, tandis que la courbe rouge représente l'énergie consommée par l'air comprimé obtenue par les calculs 5.36 et 5.40, ou tous les autres paramètres utilisés dans les équations, comme : le débit massique, les pressions, les températures et l'exposant polytropique sont dérivés de mesures expérimentales.

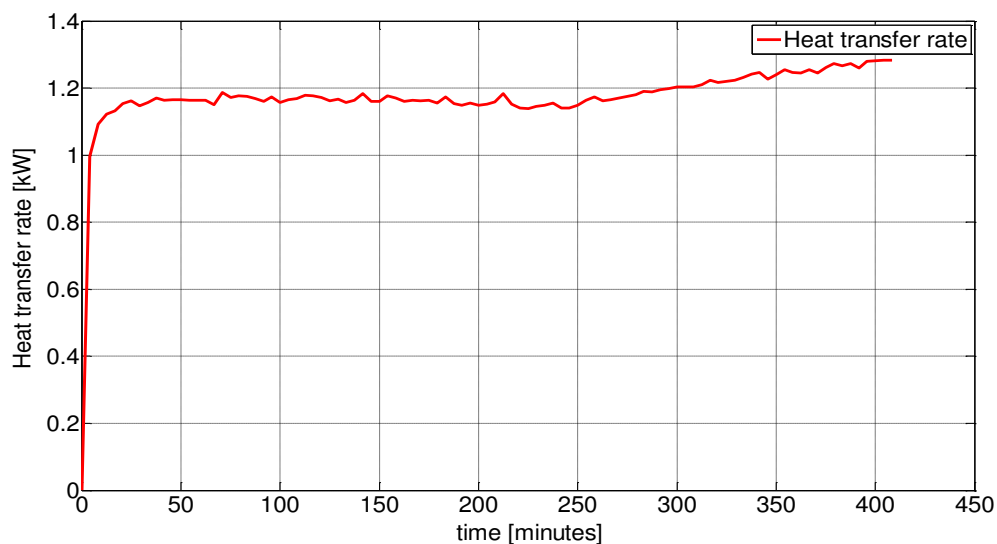


Figure 21 – Taux de transfert de chaleur résultant pendant le processus de compression

La figure 21 présente la variation quantitative du transfert de chaleur résultant du processus de compression. L'énergie résultante peut être stockée pour une utilisation ultérieure. Dans notre configuration expérimentale, en utilisant un compresseur industriel, la chaleur résultante est dissipée à travers un ventilateur relié à l'arbre du compresseur, de sorte que nous pouvons

mentionner que les refroidisseurs intermédiaires et le refroidisseur final sont refroidis dans le flux d'air.

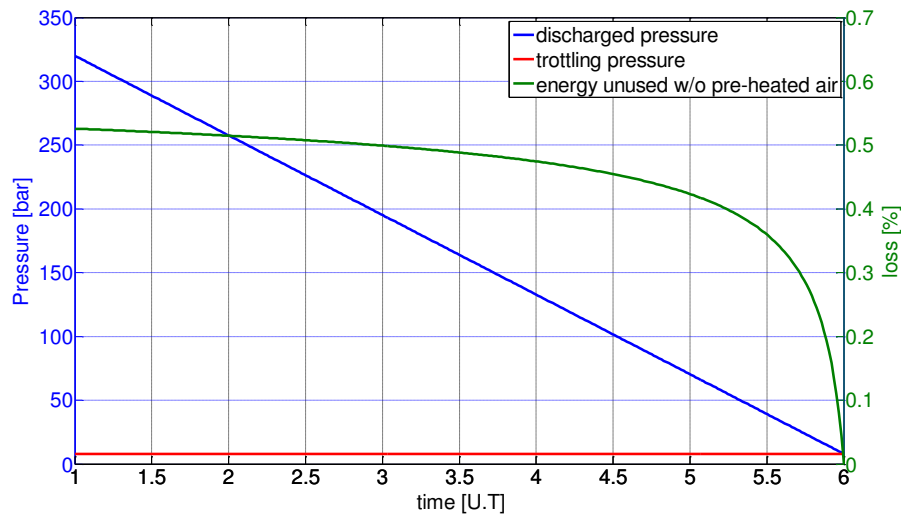


Figure 22 – Valeur théorique de l'énergie inutilisée à l'aide de la vanne de régulation si l'air n'est pas préchauffé avant l'expansion

En ajustant l'air en amont à une pression constante, une partie importante de l'énergie est «détruite». Cette valeur de l'énergie inutilisée dépend du coefficient de pression de stockage. Il est à noter que ces pertes ne sont pas influencées par le chauffage de l'air, même si l'air est chauffé ou pas. En effet, le travail mécanique maximum et minimum de l'air comprimé augmente dans la même proportion si l'air est préchauffé avant d'être dilaté à travers le moteur à air.

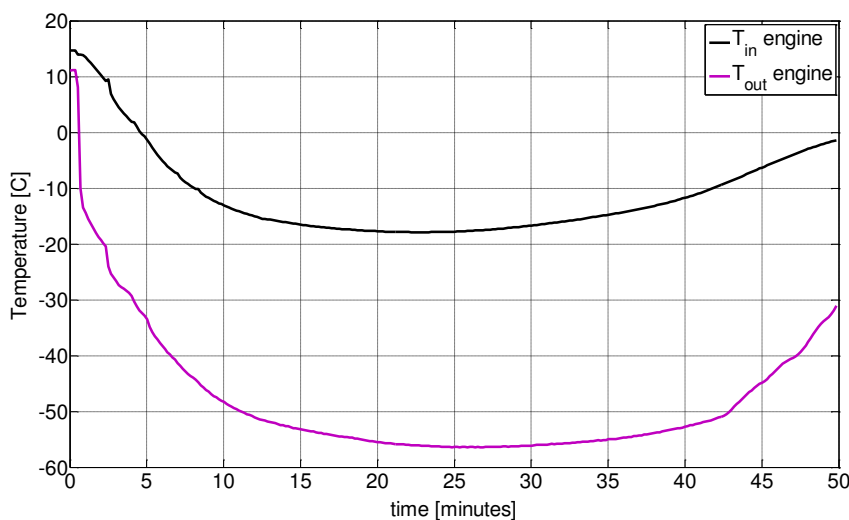


Figure 173 – Température de l'air avant et après le moteur à air

Pendant le processus d'expansion, on a remarqué que la température de l'air dans le réservoir a légèrement diminué en raison de la relaxation de l'air, mais comme le montrent les graphiques,

elle atteint une valeur minimale et commence à augmenter. Ceci est facile à expliquer car la quantité d'air dans le réservoir diminue et, par conséquent, la vitesse à laquelle le gaz reçoit la chaleur à proximité est supérieure au taux de perte de chaleur dû à l'expansion du gaz. A mesure que le processus est plus lent, la différence de température dans le réservoir de stockage est plus faible.

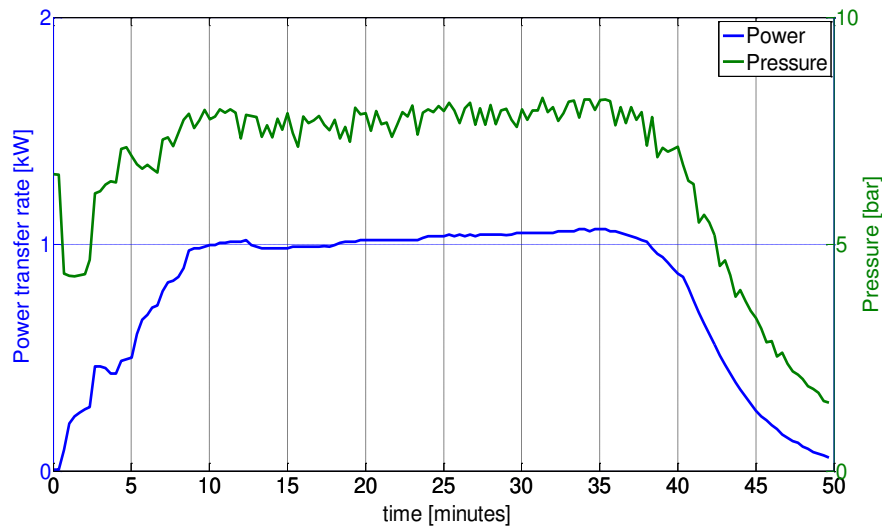


Figure 24 – Evolution en temps et de l'énergie et de la pression pendant le processus de décharge

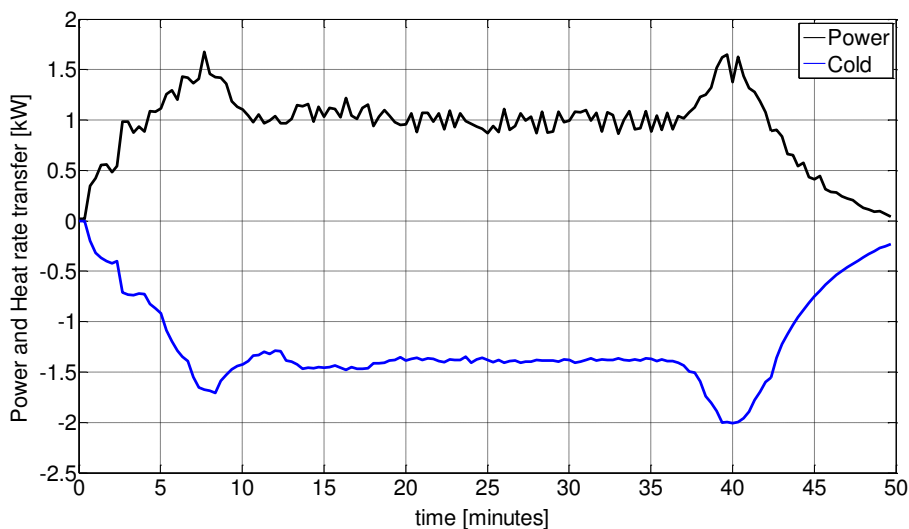


Figure 25 – Valeur de l'énergie produite et du froid résultant

L'air se dilate à la température ambiante et la température finale de l'air à la sortie du moteur est bien inférieure à zéro degré Celsius. Ainsi, il y a une quantité importante de froid qui résulte et qui peut être récupérée par les échangeurs de chaleur et utilisée à d'autres fins, comme la climatisation ou les réfrigérateurs. Les pics observés dans la partie finale de l'expérience de la figure 25 sont dus au principe de fonctionnement du régulateur de pression. Ainsi, pendant le processus d'expansion, une fois que la pression dans la cuve de stockage s'approche de la pression de l'admission du moteur à air, il est nécessaire d'ajuster la vanne de distribution dans

la partie finale de l'expérience afin de maintenir aussi longtemps que possible une pression constante à la sortie du régulateur de pression, jusqu'à ce que cette valeur soit égale à la pression d'entrée du régulateur de pression. Evidemment, cette variation de pression implique des variations dans tout autre paramètre, tels que: le débit massique, l'énergie, le froid et peut-être d'autres.

8. Étude de cas

Plusieurs scénarios théoriques ont été envisagés afin d'estimer la taille du système à petite échelle pour un logement particulier. Un schéma de principe de ces systèmes est illustré sur la figure 26. Comme on peut le voir, les systèmes de stockage d'énergie sous forme d'air comprimé ont la possibilité de fournir à l'utilisateur final de l'électricité ou de l'électricité, de la chaleur et du froid, en fonction des besoins des consommateurs.

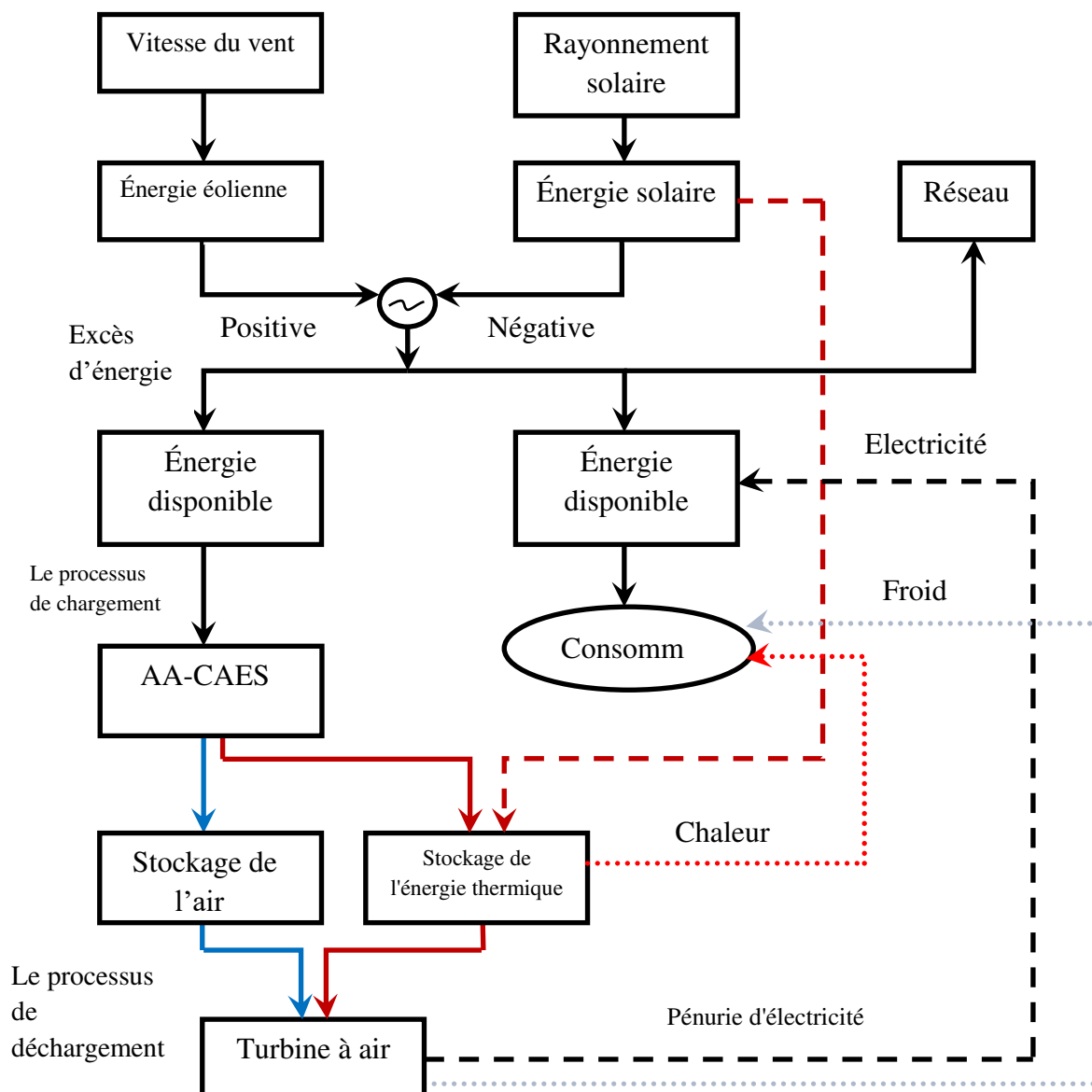


Figure 26 – Figure représentant un système de stockage d'énergie hybride dans les énergies renouvelables, capable de fournir trois types d'énergie

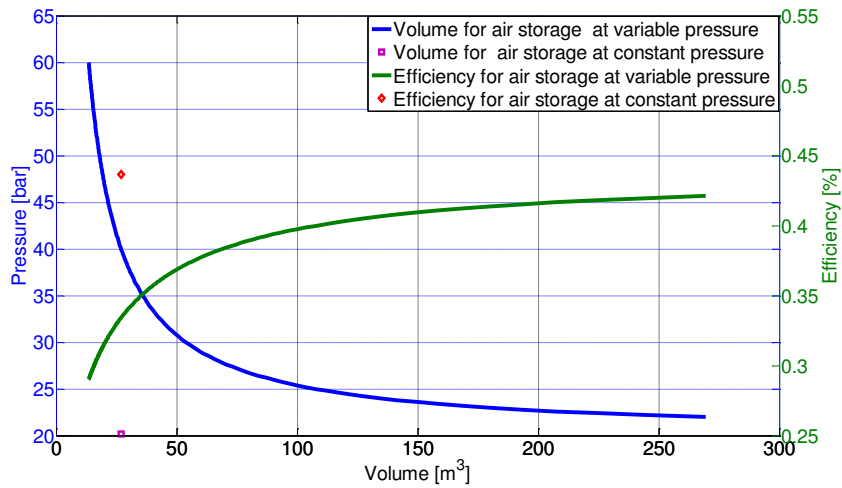


Figure 18 – Volume du réservoir de stockage requis par la pression: 1 étape compression – 1 étape expansion sans air préchauffé

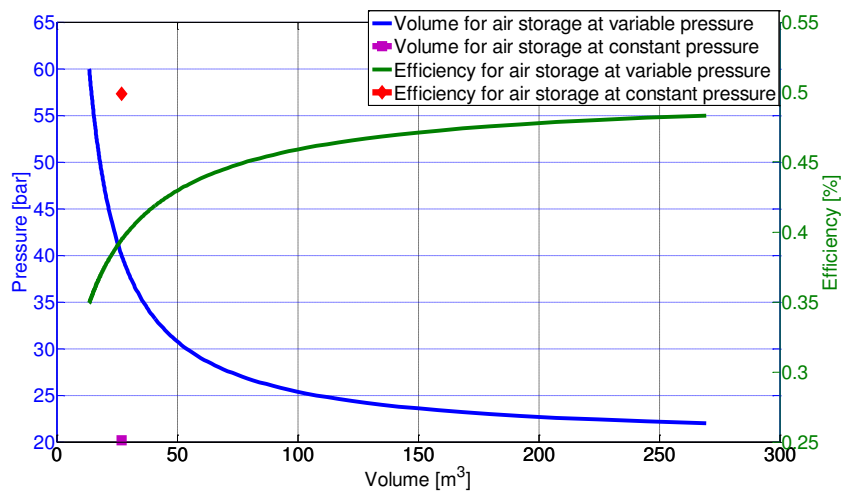


Figure 19 – Volume du réservoir de stockage requis par la pression: 2 étapes compression – 1 étape expansion sans air préchauffé

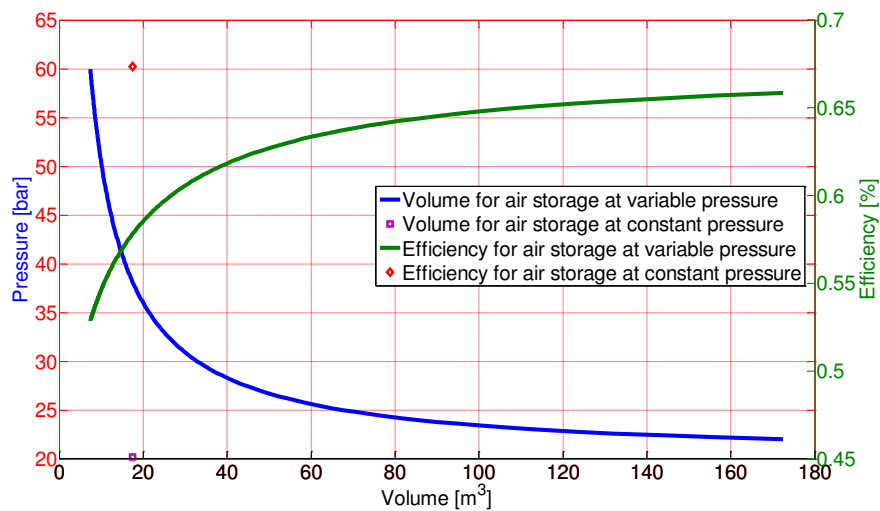


Figure 20 – Volume du réservoir de stockage requis par la pression: 1 étape compression – 1 étape expansion avec air préchauffé

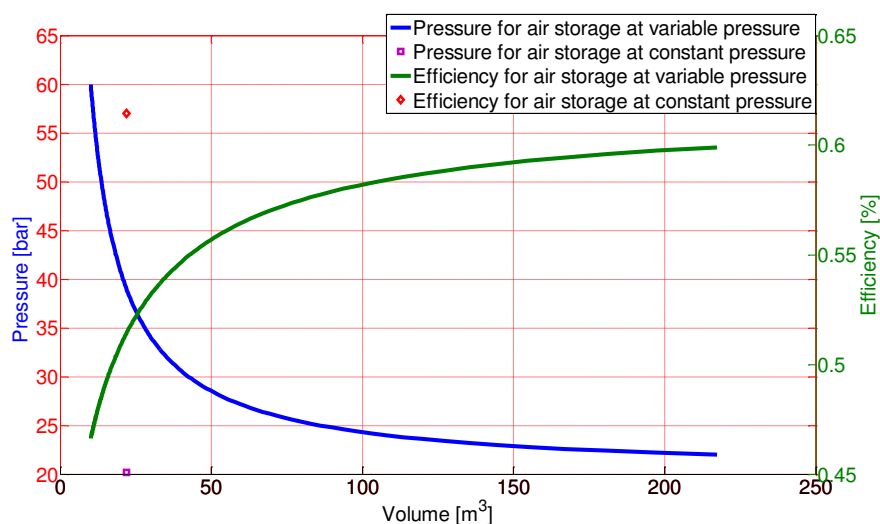


Figure 30 – Volume du réservoir de stockage requis par la pression: 2 étapes compression – 1 étape expansion avec air préchauffé

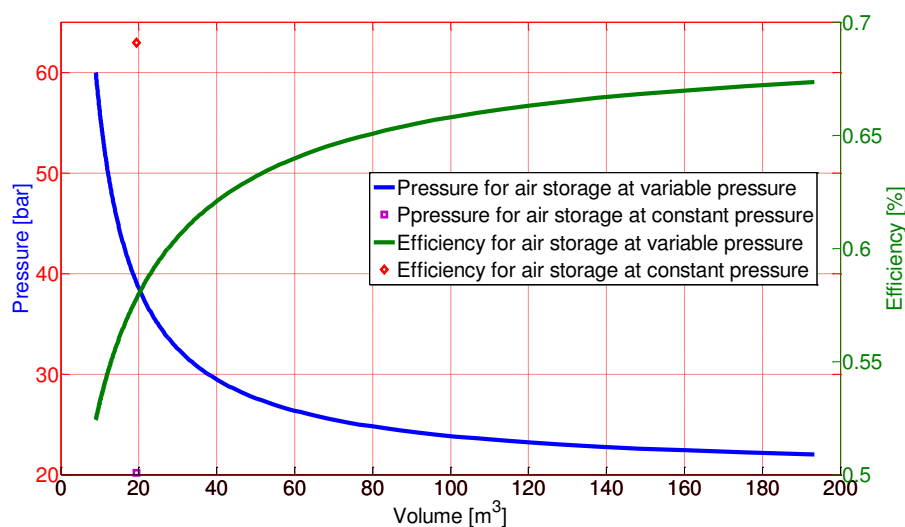


Figure 31 – Volume du réservoir de stockage requis par la pression: 2 étapes compression – 2 étapes expansion avec air préchauffé

Tous les figures ci-dessus, de 27 à 31, illustrent le volume des récipients de stockage requis et le rendement primaire du système, en fonction de la pression, de la température et du nombre d'étapes de compression / dilatation, compte tenu du fait que le système est capable de fournir à l'utilisateur final 30 kWh d'électricité à une puissance constante pendant 6 heures. Comme prévu, une meilleure efficacité est obtenue pour les scénarios où le taux de pression de stockage est aussi faible que possible, ce qui implique un plus grand réservoir de stockage. Cependant, la plus grande efficacité possible pourrait être obtenue si, pendant les deux processus de compression / expansion, la pression reste constante, ce qui peut être obtenu en utilisant la solution qui permet cela sous forme de sacs sous-marins.

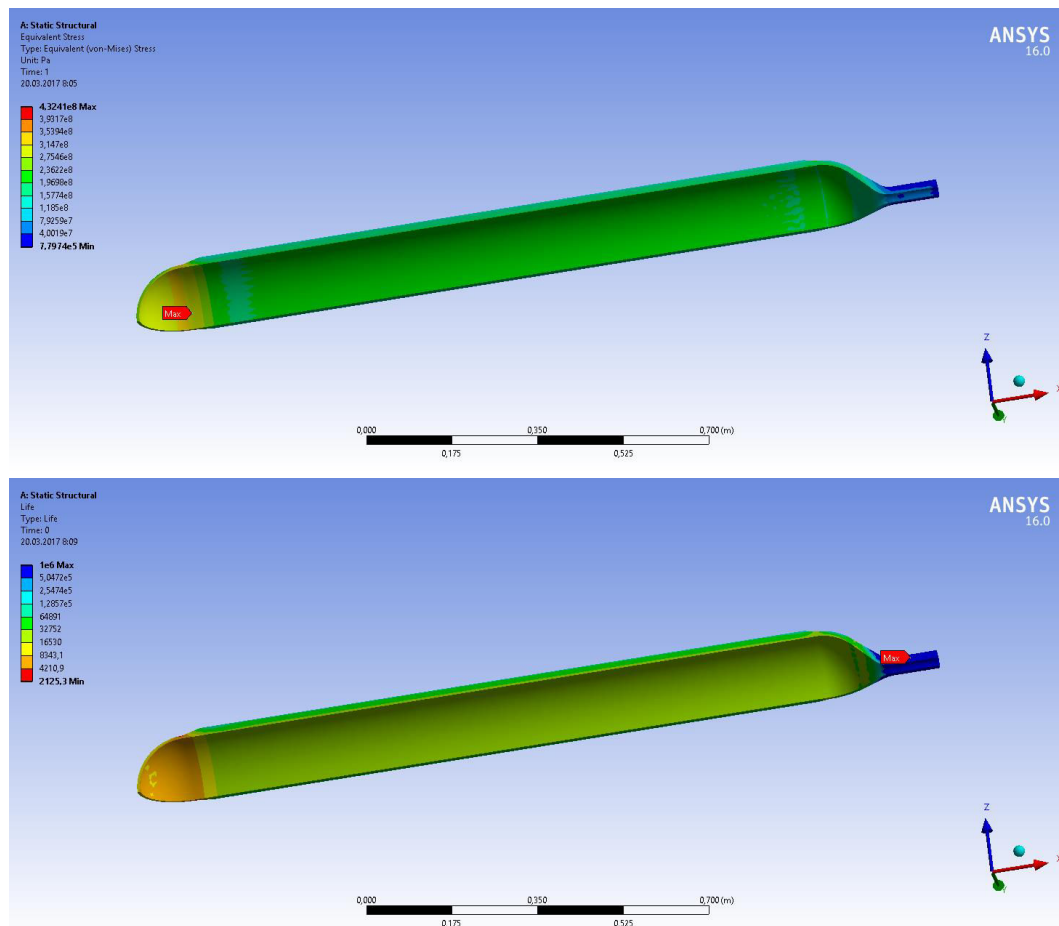


Figure 32 – Simulation dans ANSYS pour le réservoir de stockage

Ce qui nous intéresse dans la simulation ANSYS, c'est l'analyse de stress, dans laquelle deux méthodes sont proposées (Tresca et von-Mises, von Mises est illustré ci-dessus). Les deux méthodes permettent de voir que les zones de tension les plus exposées, avec les valeurs les plus élevées, se trouvent au bas du verre, tandis que les plus petites sont au sommet. Les critères Von-Mises et Tresca sont des moyens de déterminer quand un matériau va céder en raison d'une tension multiaxiale. Dans les composantes des deux équations du critère, entre la tension normale, qui est utilisée pour évaluer la tension globale, et quand celle-ci est supérieure à la résistance mécanique de l'allongement du matériau, elle cédera.

Toutes ces valeurs obtenues pour chaque critère sont comparées à la contrainte admissible du matériau utilisé, qui dans ce cas pour la structure en acier est égal à 207 MPa.

Une analyse du cycle de vie est présentée au bas de la figure 32, et il est illustré que la bouteille tendue soutient au moins 3.000 cycles de chargement / déchargement.

9. Coût de production pour l'optimisation

Il convient de noter que la pression d'admission de pour la pression CAE existante élevée (45-70 bar) est beaucoup plus élevée que l'équivalent pour une turbine à gaz, de sorte qu'une turbine à gaz classique ne peut être utilisée que comme un expasseur basse pression. Même sur le marché, d'après les connaissances de l'auteur, les turbines à gaz, les moteurs à gaz ou les turbines à air fonctionnent à de faibles pressions.

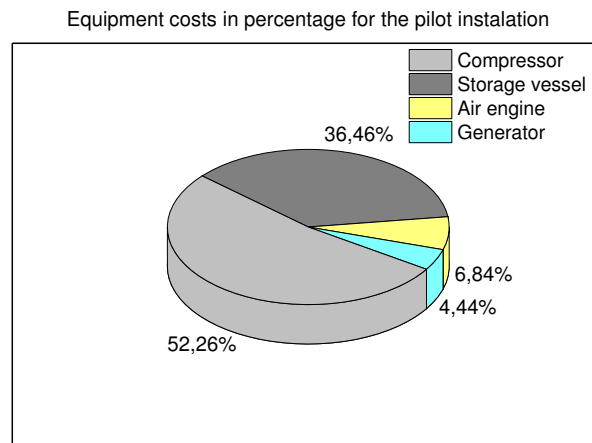


Figure 21 – Coûts de l'équipement de l'installation pilote, en pourcentages

Pour l'évaluation économique, il est important de savoir, au moins initialement, quels sont les coûts d'investissement de l'équipement. Dans la littérature et sur le marché, de nombreuses informations indiquent que pour les énergies renouvelables, en particulier pour les panneaux photovoltaïques, le coût d'installation est de 2 € / W, alors que pour les éoliennes le coût varie entre 2-3 € / W, en fonction de la taille de l'éolienne. En ce qui concerne les autres équipements, à savoir les compresseurs, les récipients de stockage, les expasseurs et les générateurs, l'information est très faible par rapport à nos besoins. Dans cette situation, pour l'analyse économique, nous avons considéré le prix moyen des compresseurs sur le marché des fabricants Bauer et Kaesser et nous avons adapté le prix dans une certaine mesure en fonction du nombre d'étapes de compression, de pression et de débit massique. Nous avons fait de même avec les expasseurs où nous estimons un prix moyen, en considérant des fabricants tels que SPX FLOW Europe Ltd. ou MacScott Bond Ltd. Pour les générateurs, nous prenons en considération les prix des fabricants suivants: Mafarlane Gerenators, MeccAlte, Stamford, Markon, Newage et Leroy Somer.

La fonction-objectif (F) que nous définissons ici comme une équation mathématique, décrit le rendement cible qui correspond à la maximisation du profit par rapport au coût de l'investissement. Le but d'une fonction-objectif est de maximiser les profits ou de minimiser les pertes en fonction d'un ensemble de contraintes et de la relation entre les variables de décision. La grande majorité des contraintes concernent les contraintes de capacité, les conditions environnementales, la technologie du travail etc.

$$F = x \% / E_{ad} (n) + y \% C_{Ad} (n) \rightarrow MIN$$

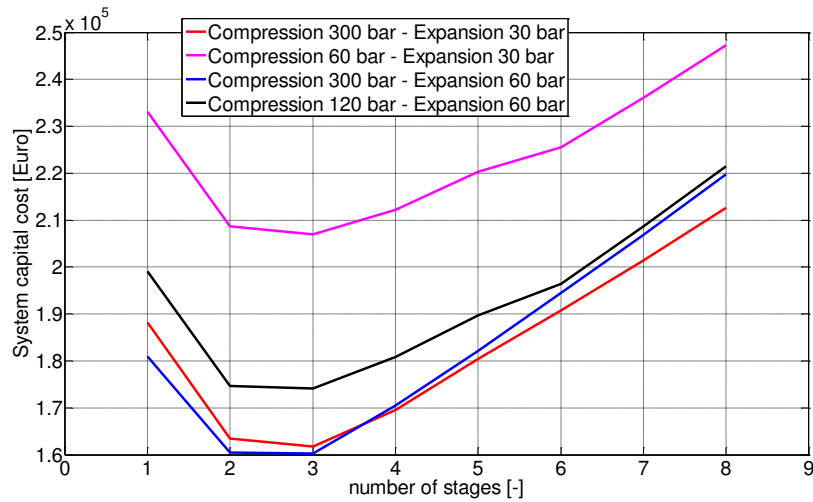


Figure 22 – Les coûts d'investissement du système

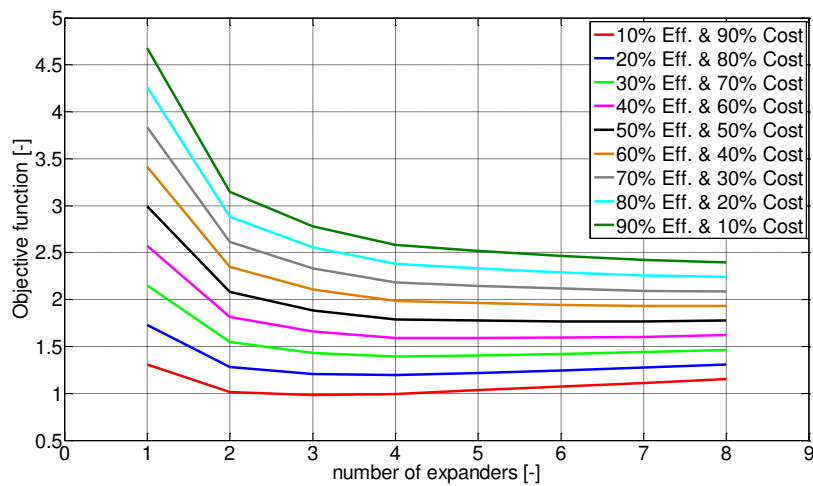


Figure 23 – Détermination de la fonction-objectif pour obtenir 30 KWh d'énergie d'air stockée à 300 bar et dilatée à partir de 30 bar, en fonction du nombre d'étapes

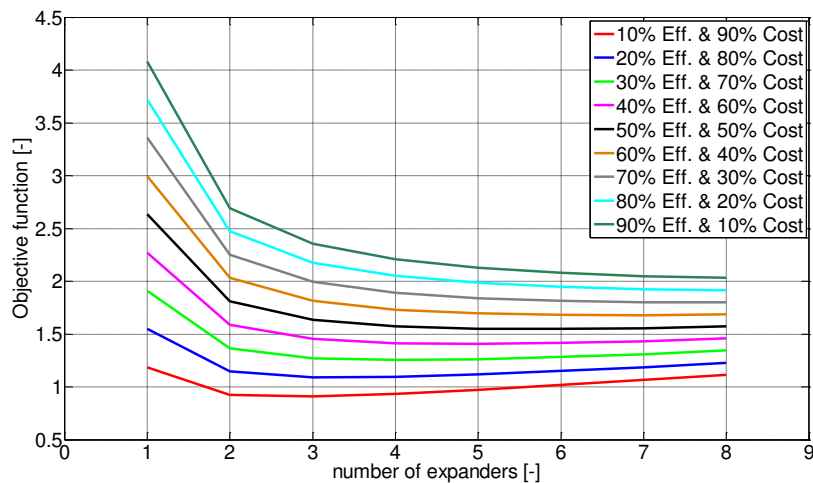


Figure 24 – Détermination de la fonction-objectif pour obtenir 30 KWh d'énergie d'air stockée à 300 bar et dilatée à partir de 60 bar, en fonction du nombre d'étapes

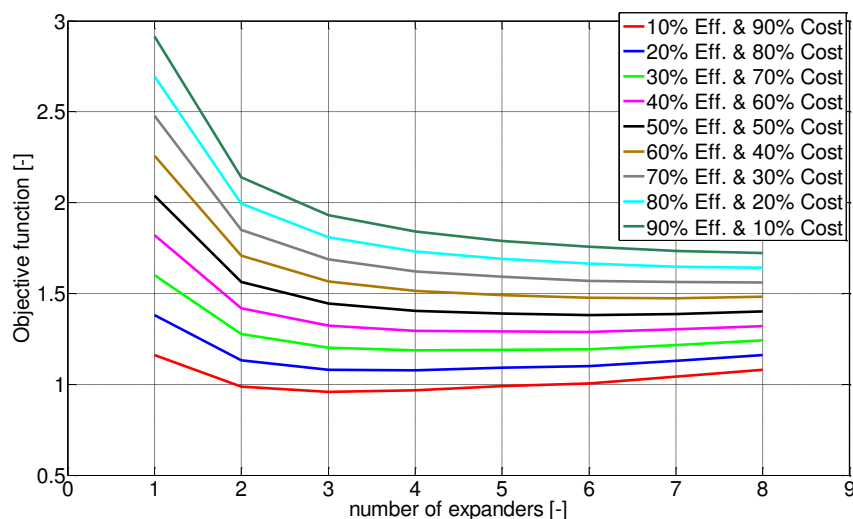


Figure 37 – Détermination de la fonction-objectif pour obtenir 30 KWh d'énergie d'air stockée à 60 bar et dilatée à partir de 30 bar, en fonction du nombre d'étapes

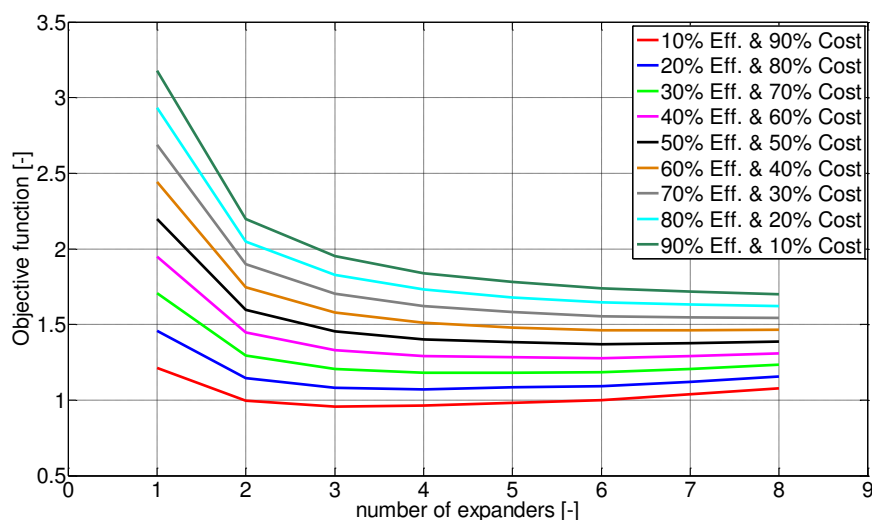


Figure 25 – Détermination de la fonction-objectif pour obtenir 30 KWh d'énergie d'air stockée à 120 bar et dilatée à partir de 60 bar, en fonction du nombre d'étapes

La fonction-objectif représentée sur les figures 35 à 38 montre que le coût minimal de l'équipement est obtenu lorsque sa valeur est minimale. On constate que pour une expansion de 30 bars ou de 60 bars à l'air à température ambiante jusqu'à l'entrée de chaque étape d'expansion, le coût d'investissement minimal est également atteint pour un processus de compression et d'expansion en trois étapes. Il convient également de noter que l'importance du froid obtenu lors d'un plus petit nombre d'étapes d'expansion est élevée du fait que la température à laquelle ce froid peut être stocké est très faible. Au fur et à mesure que le nombre augmente, la température à laquelle le froid peut être stocké augmente. En conclusion, les figures 35 à 38 montrent qu'investir davantage dans le coût de l'équipement et moins dans la valeur de l'efficacité est une meilleure option pour minimiser le coût de l'investissement.

10. Conclusions de la thèse et perspectives

Le stockage de l'énergie est l'une des solutions qui a le potentiel de contribuer à augmenter la partie des énergies renouvelables dans le mix énergétique, tout en ayant un impact majeur sur la réduction des émissions de gaz à effet de serre, en donnant plus de flexibilité au réseau, spécialement à la sécurité de l'approvisionnement énergétique.

Les principaux résultats de la thèse couvrent différents domaines d'étude, l'un basé sur une analyse thermodynamique et l'autre visant à trouver un contrôle optimal pour l'intégration des sources d'énergie renouvelables avec les technologies de stockage.

La combinaison de systèmes hybrides d'énergie renouvelable, d'énergie éolienne et solaire, avec des solutions de stockage d'énergie hybrides, peut fournir aux consommateurs de l'électricité et de la chaleur. Cependant, il est essentiel que le système qui assure la conversion d'un type d'énergie à un autre soit modulaire, les compresseurs plus petits peuvent stocker plus d'énergie qu'un grand compresseur, en raison de la puissance de démarrage requise.

Les principales limitations dans l'utilisation d'un système CAES se produisent lorsque la partie optimisation est prise en compte. Même si les résultats théoriques montrent comment l'efficacité du système peut être améliorée et la direction à suivre, nous sommes confrontés aux limitations techniques des compresseurs, des échangeurs de chaleur, du réservoir de stockage, de l'air et du moteur en termes de la pression et de la température. La plupart de la caverne peut résister à une certaine pression. À l'heure actuelle, les moteurs ou les turbines à air fonctionnent à des pressions de plusieurs dizaines de bars, de sorte que de nouveaux modèles sont nécessaires pour fonctionner à des pressions et des températures plus élevées.

La complexité des systèmes hybrides qui ont la capacité de générer plus de types d'énergie les rend souhaitables, en particulier lorsque le système de gestion est clairement défini.

Comparé à d'autres technologies de stockage, le CAES n'est pas une technologie de réponse immédiate, comme les batteries et les ultracondensateurs, et ne présente pas de temps d'arrêt bas avec une efficacité élevée, mais il a le grand avantage de ne pas dégrader la capacité au cours du temps. Une fois le système construit, il continuera à stocker la même quantité d'énergie aussi longtemps qu'il existe.

Comme nous l'avons déjà vu, le problème avec CAES n'est pas principalement représenté par des défis techniques, il est représenté par les barrières du récipient de stockage. Les cavités souterraines ont tendance à être plutôt poreuses, mais pas assez étanches pour permettre la pressurisation, les poches sous-marines peuvent être une bonne option, à condition qu'elles n'entraînent pas de coûts élevés.

D'un point de vue économique, le stockage d'énergie est actuellement coûteux, qu'il s'agisse du stockage d'énergie thermique sous forme d'eau chaude, de la solution la moins onéreuse possible ou de l'emmagasinage d'électricité à l'aide des technologies existantes, avec tous les progrès réalisés ces dernières années. La tendance actuelle d'avoir un grand nombre de sources

d'énergie intermittentes rend le gaspillage d'énergie supplémentaire, donc si les prix de l'électricité sont suffisamment élevés et que cette technologie a un coût moindre, et si les alternatives sont trop coûteuses, l'air comprimé pourrait devenir plus populaire.

Les résultats présentés montrent le comportement des systèmes CAES et leur évolution au fil du temps, en essayant de trouver une solution techniquement et économiquement optimale pour le stockage de l'énergie. Pour des raisons économiques, nous avons constaté que le stockage de l'énergie sous forme d'air comprimé n'est pas un investissement viable, compte tenu du contexte français ou roumain, et certainement d'autres parce que le coût technologique est important.

D'un point de vue environnemental, il est intéressant de noter qu'un tel système, capable de fournir de l'énergie grâce à la trigénération, pourrait apporter des avantages environnementaux en tant que source d'énergie «propre», jouant un rôle important dans l'intégration généralisée des sources énergie renouvelable.

Enfin, la figure 34 illustre le coût de la construction d'un système intégré hybride composé d'équipements pour l'utilisation des énergies renouvelables afin de stocker l'énergie sous forme d'air comprimé, puis de convertir l'énergie mécanique de l'air en électricité.

Contributions originales

La thèse est parmi les premières études liant le stockage de l'énergie sous une forme d'air comprimé avec des sources d'énergie renouvelables et leur nature intermittente.

Dans cet ouvrage, un modèle théorique de stockage de l'énergie a été développé, qui se réfère à la transformation des énergies renouvelables en énergie mécanique par les compresseurs, à leur stockage sous forme d'air comprimé puis à leur utilisation dans la production d'électricité.

Une station météorologique a été installée dans un endroit choisi au hasard où une série de données a été recueillie sur le rayonnement solaire direct et la vitesse et la direction du vent.

Afin de trouver une solution optimale pour un système impliquant le stockage d'énergie, il est bien connu qu'il existe deux solutions optimales possibles, l'une du point de vue énergétique, aussi appelée techniquement optimale, l'autre de point de vue économique, et les deux ont été analysées dans cette phrase. Comme on pouvait s'y attendre, un optimum énergétique est difficile à trouver car il y a trop de facteurs d'interférence tels que le coefficient de pression, la température, le compresseur et le nombre d'étapes de l'expanseur, ainsi qu'il faut trouver un compromis entre les deux optimaux, techniques et économiques.

L'installation expérimentale a été conçue et réalisée avec le but d'aider à valider les résultats théoriques obtenus après modélisation mathématique. La manière dont la partie d'automatisme a été conçue en termes de surveillance des paramètres et de contrôle du système appartient à l'auteur.

Dans cette thèse a été réalisé un prédimensionnement théorique du volume de stockage d'un système de stockage d'énergie capable de fournir 30 kWh au consommateur, en fonction des paramètres de fonctionnement, de pression et de température, suite à une simulation dans Matlab.

Actuellement, il existe très peu d'études portant sur le stockage d'énergie à petite échelle sous forme d'air comprimé. De la connaissance de l'auteur, aucun d'entre eux ne traite l'analyse économique, qui s'avère être un point de départ très important pour la mise en œuvre de tels systèmes.

Bibliography

- [1] "Forbes," [Online]. Available: <http://www.forbes.com/2009/07/24/peak-oil-production-business-energy-nelder.html>. [Accessed 9 April 2015].
- [2] S. Lemofouet-Gatsi, "Investigation and optimisation of hybrid electricity storage based on compressed air and supercapacitors," PhD Thesis - Ecole Polytechnique de Lausanne, 2006.
- [3] Zhang Y, Yang K, Li X, Xu J, "The thermodynamic effect of air storage chamber model on advanced adiabatic compressed air energy storage system," *Renewable Energy*, no. 57, pp. 469-478, 2013.
- [4] 2009/548/EC, "Commission decision of 30 June 2009 - Establishing a template for national renewable energy action plans under directive 2009/2/EC of the European Parliament and of the Council," 2009. [Online]. Available: <http://eur-lex.europa.eu>.
- [5] 2012/27/EC, "Directive 2012/27/EC of the European Parliament and the Council of 25 October 2012 on energy efficiency," 2012. [Online].
- [6] Evans A, Strezov V, Evans T.J, "Assessment of utility energy storage options for increased renewable energy penetration," *Renewable and Sustainable Energy Reviews*, no. 16, pp. 4141-4147, 2012.
- [7] Mahila T.M.I, Saktisahdan T.J, Jannifar A, Hasan M.H, Matseelar H.S.C, "A review of available methods and development on energy storage - technology update," *Renewable and Sustainable Energy Reviews*, no. 33, pp. 532-545, 2014.
- [8] "EIA," [Online]. Available: http://www.eia.gov/todayinenergy/detail.cfm?id=18071#tabs_SpotPriceSlider-2. [Accessed June 2016].
- [9] "System dynamics," [Online]. Available: <http://www.systemdynamics.org/conferences/2013/proceed/papers/P1366.pdf>. [Accessed July 2016].
- [10] "RTE France," [Online]. Available: http://www.rte-france.com/sites/default/files/2015_01_27_pk_rte_2014_french_electricity_report.pdf. [Accessed June 2016].
- [11] "Agerpres," [Online]. Available: : <http://www.agerpres.ro/economie/2016/01/20/anre-a-acreditat-pana-la-31-decembrie-2015-capacitati-de-4-662-mw-de-energie-regenerabila-11-50-41>. [Accessed July 2016].
- [12] Wang S.Y, Yu J.L, "Optimal sizing of the CAES system in a power system with high wind power penetration," *Electrical Power and Energy Systems*, no. 37, pp. 117-125, 2012.
- [13] Marano V, Rizzo G, Tiano F.A, "Application of dynamic programming to the optimal management of a hybrid power plant with wind turbines, photovoltaic panels and compressed air energy storage," *Allied Energy*, no. 97, pp. 849-859.
- [14] Bullough C, Gatzen C, Jakiel C, Koller M, Nowi A, Zunft S, "Advanced adiabatic compressed air energy storage for the integration of wind energy," in *EWEC 2004*, London, November 2004.

- [15] Fiaschi D, Manfrida G, Secchi R, Tempesti , "A versatile system for offshore energy conversion including diversified storage," *Energy*, no. 48, pp. 566-576, 2012.
- [16] *Grid Energy Storage U.S Department of Energy, December 2013.* [Performance].
- [17] Karl Zach, Hans Auer, Hans Lettner, Facilitating energy storage to allow high penetration of intermittent renewable energy - Report summarizing the current Status, Role and Costs of Energy Storage Technology, www.store-project.eu, 2012.
- [18] Zhang Y, Yang K, Li X, Xu J, "The thermodynamic effect of air storage chamber model on Advanced Adiabatic Compressed Air Energy Storage System," *Renewable Energy*, no. 57, pp. 469-478, 2013.
- [19] Kim YM, Shin DG, Favrat D, "Operating characteristics of constant-pressure compressed air energy storage (CAES) system combined with pumped hydro storage based on energy and exergy analysis," *Energy* , no. 36, pp. 6220-6233.
- [20] Budny C, Madlener R, Hilgers C, "Economic Feasibility of Pipe Storage and Underground Reservoir Storage Options for Power-to-Gas Load Balancing," *Energy Procedia 61*, pp. 2201-2205, 2014.
- [21] Pimm J. A, Garvery D. S, de Jong M, "Design and testing of energy bags for underwater compressed air energy storage," *Energy* , no. 66, pp. 496-508, 2014.
- [22] Kim YM, Lee JH, Kim SJ, Favrat D, "Potential and evolution of compressed air energy storage: energy and exergy analyses," *Entropy*, no. 14, pp. 1501-1521, 2012.
- [23] Khushairi M.M, Abdullah H, Hazran H, "A study on the Optimization of Control Strategy of a Thermal Energy Storage System for Building Air-Conditioning," *Procedia Engineering*, no. 20, pp. 118-124, 2011.
- [24] Martins M, Villalabos U, Delclos T, Armstrong P, Bergan P, Calvet N, "New concentrating solar power facility for testing high temperature concrete thermal energy storage," *Energy Procedia 75*, pp. 2144-2149, 2015.
- [25] Ercan Ataer O, "Storage of thermal energy," [Online]. Available: <http://www.eolss.net/ebooks/sample%20chapters/c08/e3-14-02-00.pdf>. [Accessed 20 05 2015].
- [26] Hasnain S.M, "Review on sustainable thermal energy storage technologies, part II: cool thermal storage," *Energy Convers Mgmt*, no. 39, pp. 1139-1153, 1998.
- [27] Ibrahim H, Ilinca A, Perron J., "Energy storage systems - Characteristics and comparison," *Renewable and Sustainable Reviews* , vol. 12, 2008.
- [28] Ciocan A, Prisecaru T, Tazerout M, Durastanti J-F, "Thermodynamic evaluation for a small scale compressed air energy storage system by integrating renewable energy sources," in *ICRERA*, Palermo, 2015.

Thèse de Doctorat

Alexandru CIOCAN

Contributions aux systèmes de stockage d'énergie en utilisant des systèmes hybrides à partir de sources d'énergie alternatives

Contributions to energy storage using hybrid systems from alternative energy sources

Résumé

La thèse intitulée « Contributions aux systèmes de stockage d'énergie en utilisant des systèmes à partir de sources d'énergie alternatives » propose une étude des technologies de stockage d'énergie, en sachant qu'elles sont considérées comme l'une des options qui peuvent faciliter une forte pénétration des sources renouvelables. Dans ce contexte, le travail présenté vise à comprendre les défis liés au stockage de l'énergie et à développer un modèle général d'étude utilisant l'air comprimé comme moyen de stockage d'énergie.

La thèse est structurée en dix chapitres, dont les premiers quatre sont consacrés à la présentation du potentiel des sources d'énergie renouvelable, à l'évolution du secteur de l'énergie au cours des dernières décennies et aux technologies de stockage d'énergie, notamment sous forme d'air comprimé. Les six autres chapitres concernent les calculs thermodynamiques théoriques, dans la mesure où il s'agit d'étudier les performances d'un système de stockage d'énergie hybride et de présenter un modèle mathématique contenant les étapes prises en compte dans la conversion de l'énergie renouvelable en énergie mécanique, stockée dans une forme d'air comprimé et plus tard reconvertie en électricité. De plus, ces chapitres présentent des données expérimentales obtenues sur une installation de laboratoire, qui ont contribué à la validation des résultats théoriques obtenus suite à une simulation Matlab, et enfin une étude de cas pour une application à petite échelle, 30 kWh d'énergie stockée, qui vise à trouver une configuration optimale de l'ensemble du système en termes de pression de travail de l'air, qui est analysée sous deux points de vue : technique et économique. La thèse finit par un chapitre de conclusions générales et nous constatons qu'il reste encore quelques défis à surmonter pour que le stockage de l'énergie sous forme d'air comprimé soit une solution possible d'une perspective économique.

Mots clés

RES, stockage d'énergie, CAES, TES, trigénération, analyse thermodynamique

Abstract

The thesis entitled «Contributions to energy storage using hybrid systems from alternative energy sources» proposes a study of the energy storage technologies knowing the fact that these are considered one of the options that can facilitate a high penetration of renewable sources. In this context, the presented work aims to understand challenges in terms of energy storage and to develop a general studying model using compressed air as an energy storage medium.

The thesis is structured in ten chapters from which the first four are dedicated to the presentation of the renewable energy sources potential, to the energy sector evolution in the last decades and to the energy storage technologies, especially in the form of compressed air. The other six chapters are dealing with the theoretical thermodynamic calculations as far as that goes in investigating the performances of a hybrid energy storage system and presenting a mathematical model containing the steps taken into account in the renewable energy conversion into mechanical energy, stored in a form of compressed air and later reconverted into electricity. In addition these chapters present experimental data obtained on a laboratory installation which helped in validating the theoretical results obtained following a Matlab simulation, and finally a case study for a small scale application, 30 kWh of energy stored, where is aiming to find an optimal configuration of the whole system in terms of air working pressure, being analyzed from two points of view, technical and economic. The thesis ends with a chapter of general conclusions and indicates that there are still challenges that must be overcome in order to make the energy storage in a form of compressed air a feasible solution from an economic perspective.

Keywords

RES, energy storage, CAES, TES, trigeneration, thermodynamic analysis