



HAL
open science

Specific and redundant roles of the Tead family of transcription factors in myogenic differentiation of C2C12 cells and primary myoblasts in vitro

Shilpy Joshi

► **To cite this version:**

Shilpy Joshi. Specific and redundant roles of the Tead family of transcription factors in myogenic differentiation of C2C12 cells and primary myoblasts in vitro. Embryology and Organogenesis. Université de Strasbourg, 2015. English. NNT : 2015STRAJ093 . tel-01673817v1

HAL Id: tel-01673817

<https://theses.hal.science/tel-01673817v1>

Submitted on 1 Jan 2018 (v1), last revised 11 Jan 2018 (v2)

HAL is a multi-disciplinary open access archive for the deposit and dissemination of scientific research documents, whether they are published or not. The documents may come from teaching and research institutions in France or abroad, or from public or private research centers.

L'archive ouverte pluridisciplinaire **HAL**, est destinée au dépôt et à la diffusion de documents scientifiques de niveau recherche, publiés ou non, émanant des établissements d'enseignement et de recherche français ou étrangers, des laboratoires publics ou privés.

ÉCOLE DOCTORALE des Sciences de la Vie et de la Santé

IGBMC - CNRS UMR 7104 - Inserm U 964

THÈSE présentée par :

Shilpy JOSHI

soutenue le : **26 novembre 2015**

pour obtenir le grade de : **Docteur de l'université de Strasbourg**

Discipline : Science de la vie de la santé

Spécialité : Aspects moléculaires et cellulaire de la Biologie

**Specific and redundant roles of the
Tead family of transcription factors in
myogenic differentiation of C2C12 cells
and primary myoblasts *in vitro***

THÈSE dirigée par :

Dr. DAVIDSON Irwin

DR, CNRS, IGBMC, Illkirch

RAPPORTEURS EXTERNES :

Dr. VANDEL Laurence

DR, CBD, Université Paul Sabatier, Toulouse

Dr. MAIRE Pascal

DR, Institut Cochin, Paris

RAPPORTEUR INTERNE :

Dr. METZGER Daniel

DR, CNRS, IGBMC, Illkirch

Acknowledgements

It is time to look back at the past four years of my life as a PhD student in Dr. Irwin Davidson's Lab at IGBMC (Illkirch). As much as I felt that time moves slowly during the thesis, looking back I feel, life in PhD just races through time. All that I acknowledge as an achievement or an accomplishment cannot start or end without expressing my gratitude to Dr. Irwin Davidson for accepting me as a PhD student in his lab, giving me an interesting project and for mentoring me. I would at the same time like to thank the IGBMC PhD programme committee for having selected me and giving me the esteemed opportunity to conduct my doctoral research at the IGBMC.

I would like to thank Dr. Laurence Vandell, Dr. Pascal Maire and Dr. Daniel Metzger for accepting my invitation to be the part of my PhD defense jury and for analyzing this work.

I reckon how important the role of our mentor and our colleagues can be. It can be life changing and career shaping. I am grateful to Diana Langer and Daniil Alpern for their timely technical and scientific advice. I wish to thank Isabelle Michel for her technical assistance and helping me locate any stocks very swiftly when I was new in lab. I want to thank Patrick Laurette for being the much-needed friend, colleague and motivator in the lab. My scientific, cultural, personal exchange of ideas with you is something I shall carry with me from here on. Your migration to 4039 was indeed an event. I learnt healthy co-operation and competition in your company, which are both key to success and sustainability in science.

Anas Fadloun, I find myself fortunate to have you as colleague. You have been a great supporter, critique, friend, mentor and a person I shall always admire. Thank you for your time to hear me out when I needed it the most. I believe I have grown as a person and as a scientist having you and Patrick around. I am fond of us three as a 4039 mini team that is quite functional. I wish to thank Gabrielle Mengus for her timely scientific and administrative advice and especially for taking on the huge task of helping with handling mice needed for my project. You have been immensely understanding and co-operative throughout. Marie, Sylvia, Dana, Mariam, Igor - thank you for your help from time to time.

I wish to thank my neighbours -Vanessa Ueberschlag-Pitiot and Gilles Laverny, for their very useful scientific advice especially in the *in vivo* part of my work and for "always there for trouble-shooting attitude". So much of our lives that we gave to CHIP *in vivo*, we should be

writing a rap song on CHIP by now. I also wish to express my gratitude to the scientist and friend Shankar Pattabhiraman for the great scientific advice and always being a message or call away in times of difficulty.

I am indebted enormously to my colleagues from the various technology platforms and facilities- cell culture (Betty, Patricia, Marie), sequencing and bioinformatics analysis team- Tao, Céline, Stéphanie, Guillaume – for their instant support at all times. Without their assistance, this work would not have been possible.

I would like to thank my corridor stress-busters, if they know who they are. Helena, Lena and Serena, ladies with their names ending in ‘na’, great girls, transmitters of positive attitude and hope. Thank you for the push! May be one day... I will cure cancer indeed or atleast we will party.

I want to thank all Indian friends and colleagues- Lavanya, Amita, Nisha, Manohar, Saurabh, Tripti for their wonderful company in this journey and for keeping me close to India. Lavanya, our long talks and walks, science and nonsense, love and lust- all made my journey possible. Ankit Gupta, my soul mate, I feel fortunate for getting the chance to acknowledge how your support and motivation, only made me stronger and a more balanced person. I learnt from you to keep my cool, stay focussed and keep going on, and how important it is to take breaks to keep performing.

Lastly and most importantly, words shall never be enough though, I thank my parents, my brother, my grandmother and my late grandfather, without whose long-standing and unconditional support, sacrifices and encouragement, I would not be able to live so far away from them and pursue my goals in life. I owe my thesis and accomplishments to my family.

Towards the end of my acknowledgements, I reckon how my thesis has been a learning process for me- full of lessons for life; nevertheless, I wish to also acknowledge myself for my conviction, courage and will to stand against all odds.

Shilpy.

Table of Contents

Abbreviations:	6
List of Figures and Tables	8
A. English Summary	9
B. Résumé en Français:	13
Introduction	
I.Skeletal muscle structure	26
I.1 Anatomy of skeletal muscle architecture:.....	26
I.2 Cellular organisation of skeletal muscle:	27
I.2.1 Myofibre:.....	27
I.2.2 Satellite cells:	27
I.3 Anatomical structure of myofibre:.....	28
I.3.1. Myofibrils:.....	28
I.3.2. Sarcomere:.....	28
I.3.3 Thick filaments:.....	30
I.3.4. Thin filaments:.....	30
I.3.5 Non-contractile cytoskeleton:	30
I.3.7 Neuromuscular junction:.....	33
II.Skeletal muscle formation:	34
II.1 Embryonic myogenesis:.....	34
II.1.1 Somitogenesis and myogenic compartmentalisation of somites:	34
II.1.2 Morphogenic Patterning and transcriptional control of embryonic myogenesis:.....	35
II.1.3 Transcriptional control of somitogenesis:.....	37
II.2 Adult myogenesis: muscle satellite cells.....	39
II.2.1 Embryonic origin of satellite cells:.....	39
II.2.2 Other Myogenic stem cells:.....	39
II.2.4 Extrinsic and intrinsic regulators of adult myogenesis:.....	41
II.2.5 Self-renewal of satellite cells:.....	42
III. Signalling pathways in Muscle plasticity:	43
III.1. Muscle fibre types:.....	43
III.2 Calcineurin/NFAT/MEF2 pathway	45
III.3 Calmodulin Kinase/HDAC/MEF2 signalling.....	46
III.4 The PGC-1 α co-activator	47
IV.Transcriptional and epigenetic blueprint of myogenesis	49
IV.1. Players in eukaryotic transcriptional regulation in a glimpse:	49
IV.1.1 Core Promoter	50
IV.2 Proximal and distal enhancers:	53
IV.3 Role of the Core/basal Transcription Machinery in Myogenesis:	54
IV.4 Transcription Factors and regulatory elements in myogenesis:	55
IV.5 Histone Modifications:.....	58
IV.6 ATP-dependent chromatin remodelling in myogenesis:.....	59
V. TEAD transcription factors	61
V.1 Identification and characterisation of TEAD/TEF family:.....	61

V.2 Tissue distribution:	62
V.4 Structure of TEAD proteins:	65
V.4.1 Functional domains in TEAD proteins:	65
V.4.2 The TEA/ATTS DNA binding domain:.....	65
V.4.3 The Trans-activation Domain (TAD):.....	67
V.4.4 The Proline-rich region	69
V.4.5 The N-terminal region	69
V.5 Mechanism of TEAD transcriptional activity via interaction with co-factors:	69
V.5.1 Yap/Taz co-activators:.....	70
V.5.2 Vgll proteins:.....	72
V.5.3 Physical interaction with other transcription factors:.....	73
V.6 Other Signalling pathways regulating the TEAD activity:	74
V.7 TEADs in embryonic development:.....	74
V.8 TEADs in heart development and hypertrophy:.....	78
V.9 TEADs in Cancer:	79
VI. TEADs in skeletal muscle differentiation:	79
VI.1 Embryonic skeletal muscle development:.....	80
VI.2 Satellite cells and regeneration:.....	81
VI.3 Adult muscle -Fibre-size and fibre-switch:	83
VII. A brief introduction to my thesis project.....	86
Results	
I. Specific and redundant roles of the TEAD family of transcription factors in C2C12 cell and primary myoblast differentiation.	89
II.Characterisation of the TEAD4 interactome: Identification of Ifi202 as a novel interaction partner.	139
III. Investigation of Tead4-function in muscle <i>in vivo</i>.	159
Global discussion and perspectives:	195
1. Tead1 and Tead4 are essential for <i>in vitro</i> myoblast differentiation: Redundancy, specificity and regulation of gene expression in myogenesis.....	195
2. Co-operation and synergy between Teads, MyoD and MyoG at muscle enhancers and epigenetic regulation of muscle enhancer function.....	196
3. TEADs function in vivo in muscle development, physiology and pathophysiology.....	197
A) Teads in embryonic myogenesis and adult muscle regeneration	197
B) Adult muscle plasticity.....	199
C) Disease and pathophysiology.....	200
Bibliography:	201

Abbreviations:

3D	three dimensional
ACh	Acetylcholin
AChE	Acetylcholinesterase
AChR	Acetylcholine receptor
AER	apical ectodermal ridge
AMPK	AMP activated protein kinase K
bHLH	basic helix loop helix
BMP	bone morphogenetic protein
Cadh15	M-Cadherin
CaMK	Calmodulin dependent kinase
CaN	Calcineurin
ChIP	chromatin immunoprecipitation
CHRNG	Acetylcholine receptor g
cTNT	cardiac Troponin T
CRMs	cis-regulatory modules
DBD	DNA binding domain
E	embryonic day
ECM	extracellular matrix
EMT	epithelial-mesenchymal transition
EOMES	Eomesodermin
ERR α	Estrogen-related receptor α
ES	embryonic stem
ESC	embryonic stem cell
FGF	fibroblast growth factor
HDAC	histone deacetylase protein
LCD	light chain domain
LPM	lateral plate mesoderm
MASC	muscle associated specific component
MCAT	muscle CAT
MCK	muscle creatine kinase
MEP	motor end plate
MEF2	myocyte enhancer factor 2
MHC	Myosin heavy chain
miRNA	microRNA
MLC	Myosin light chain
MRFs	myogenic regulatory factors
MTJ	myotendinous junction
MuSK	muscle skeletal receptor tyrosine kinase
Mustn1	muscle, skeletal, embryonic nuclear protein 1
MYF5	myogenic factor 5
MYOD1	myogenic differentiation factor 1
MYOG	Myogenin
NC	Notochord
NFAT	nuclear factor of activated T cells
NLS	nuclear localisation signal
NMJ	neuromuscular junction
NT	neural tube

PAX3	Paired box gene 3
PCR	polymerase chain reaction
PGC1-a	Peroxisome proliferator-activated receptor-g coactivator-1a
Pu/Py	polypurine/polypyrimidine
Pura	Purine-rich binding protein-a
Purb	Purine-rich binding protein-b
Pol II	RNA Polymerase II
qPCR	quantitative polymerase chain reaction
RLC	regulatory light chain
SE	surface ectoderm
shh	Sonic Hedgehog
siRNA	small interfering RNA
SM	smooth muscle
SNP	single nucleotide polymorphism
SR	sarcoplasmic reticulum
SRF	serum response factor
SSBP	single stranded DNA binding protein
SV40	simian virus 40
TA	tibialis anterior
TAZ	transcriptional coactivator with PDZ-binding motif
TAD	trans-activation domain
TEAD	TEA domain transcription factor
TEF	transcription enhancer factor
Tm	Tropomyosin
Tn	Troponin
TS	trophoblast stem
UTR	untranslated region
UTRN	Utrophin
VGCC	voltage-gated calcium channel
VGCC	voltage-gated calcium channel
VGKC	voltage-gated potassium channel
VGLL	Vestigial like
WWTR1	WW-domain containing transcription regulator 1
YAP1	Yes/src associated protein 1
YBD	YAP1 binding domain

List of Figures and Tables

Figure 1. Gross anatomy of skeletal muscle	26
Figure 2. Anatomy of a myofibril with detailed structure of sarcomere	28
Figure 3. Schematic of myosin molecule	29
Figure 4. Schematic showing non-contractile cytoskeleton in muscle	31
Figure 5. Triad organisation in skeletal muscle	32
Figure 6. Schematic showing neuromuscular junction	33
Figure 7. Somitogenesis and myogenic compartmentalisation	34
Figure 8. Myogenic patterning of somites by extracellular growth factors	36
Figure 9. Illustration of lineage progression and multiple waves of developmental myogenesis	38
Figure 10. Schematic showing transcriptional control of satellite cell activation, proliferation and differentiation	40
Figure 11. Adult myogenesis and self-renewal.	42
Figure 12. Sarcomeric MYH genes with corresponding protein products and their expression pattern in skeletal muscles	44
Figure 13. Ca ²⁺ / calcineurin/NFAT pathway	45
Figure 14. Schematic diagram of the Ca ²⁺ /CaMK/HDAC pathway for activation of slow fibre gene expression.	47
Figure 15. Regulation of PGC-1 α expression in skeletal muscle and mechanisms by which PGC-1 α stimulates mitochondrial gene expression	48
Figure 16. Schematic diagram showing structural elements in core promoter	50
Figure 17. Histone modification signature in different chromatin states and their association with transcription status.	53
Figure 18. Replacement of the canonical TFIID complex by a TRF3-TAF3-containing complex during terminal differentiation of myoblasts into myotubes.	54
Figure 19. Schematic showing major transcriptional regulatory network in myogenesis	55
Figure 20. Model for the coordinate assembly at active MyoD1 enhancers in muscle	57
Figure 21. Identification of TEADs or TEFs as GT-IIC and MCAT binding transcription factors.	61
Figure 22. Mutation in MCAT element caused delayed expression of SM α -actin in SMCs at early stages of embryonic development	64
Figure 23. Schematic representation of TEAD functional domains- DNA binding domain (DBD) and the trans-activation domain (TAD).	66
Figure 24. The 3D structure of Yap-binding domain	68
Figure 25. A comparison of the structure of Vgll1-TEAD4 complex with YAP-TEAD complex	68
Figure 26. Schematic representation of the various TEAD co-factors and their important conserved functional domains.	70
Figure 27. The Hippo signal transduction network and crosstalk with other signaling pathways	71
Figure 28. A model for cell position-dependent fate specification in pre-implantation embryos	76
Figure 29. TEAD4 mediated specification of TE and ICM lineages in a pre-implantation mammalian embryo.	77
Figure 30. Whole-mount immunohistochemistry (IHC) of TEAD proteins in 10.0 dpc embryos shows stronger TEAD4 expression in developing heart and somites.	80
Figure 31. Yap is highly expressed in activated satellite cells	82
Figure 32. A model for TEAD-YAP mediated fine-tuning of proliferation and differentiation	201
Table 1. MCAT elements found in muscle specific genes	63
Table 2. Amino acid sequence identity of various human TEADs compared to TEAD1	66

A. English Summary

Specific and redundant roles of the Tead family of transcription factors in myogenic differentiation of C2C12 cells and primary myoblasts *in vitro*

The Tead family of transcription factors comprises four members (Tead1-Tead4) that bind MCAT elements (5'-CATTCCA/T-3') with their highly conserved TEA/ATTS DNA binding domain (Anbanandam et al., 2006; Davidson et al., 1988; Xiao et al., 1991). The Tead proteins share a highly evolutionarily conserved DNA binding domain, called the TEA/ATTS domain (Andrianopoulos and Timberlake, 1991; Burglin, 1991). Mammalian Teads are expressed in almost all tissues with prominent Tead1 and Tead4 expression in skeletal muscle, lung and heart and nervous system. Several studies including ours, have reported that Tead factors bind to the MCAT elements present in promoters and enhancers of muscle specific genes such as *Myod1* and *Myogenin*. Tead1, Tead2 and Tead4 are expressed in proliferating C2C12s cells and Tead4 is upregulated during differentiation of both C2C12 cells and primary myoblasts. However, it is not clear how the different Teads co-operate to bring about skeletal muscle differentiation and whether they play specific or redundant roles. To address the role of Tead factors, I worked on the following four broad aspects of the problem:

1. What are the specific and redundant roles of various Tead factors in muscle differentiation?
2. Are Tead proteins also essential for primary myoblast differentiation *in vitro*?
3. How do Teads bring about transcriptional activation as well as repression during myogenesis i.e. which proteins or protein complexes modulate the transcriptional activity of Tead4?
4. Is Tead4 required for normal muscle function and muscle regeneration?

We showed previously that that Tead4 is upregulated and is required for C2C12 differentiation *in vitro* (Benhaddou et al., 2012). ShRNA-mediated stable knockdown of Tead4 led to formation of shortened myotubes compared to control C2C12 cells. CHIP-chip experiments in C2C12 overexpressing Flag-HA-Tead4 revealed that Tead4 occupies 867 promoters including *Myog*, *Cdkn1a* and *Cav3*. RNA-seq identified the set of genes downregulated upon Tead4 knockdown amongst which are muscle structural and regulatory proteins. We put forward a model in Benhaddou et al. showing that Tead4 induces expression of *Myog* and *Ankrd2* required for myoblast differentiation, but represses the expression of *Ctgf* and *Ccnd1* contributing to cell cycle exit. However, in this study we did not address the

role of other Teads in these cells.

During my PhD, I extended the study of Tead transcription factors to post natal primary myoblasts, where in contrast to C2C12 cells, I found that Tead4 siRNA silencing had no significant effect on differentiation. Also, siRNA knockdown of Tead1 or Tead2 had only marginal effects on differentiation. Knowing that Tead4 binds and regulates expression of several hundreds of genes, we reasoned that the absence of a strong phenotype upon Tead4 knockdown could be due to the potential redundancy between the different Teads owing to their highly conserved DNA binding domain. To address this question, we performed simultaneous siRNA based silencing of two or more Tead factors. We observed that simultaneous siRNA knockdown of Tead1 and Tead4 lead to a dramatic inhibition of differentiation. Collective knockdown of Tead1, Tead2 and Tead4 further aggravated the phenotype. These data indicate a functional redundancy between the Tead factors that is more pronounced in primary myoblasts than in C2C12 cells. Nevertheless similar experiments in C2C12 cells showed that simultaneous siRNA knockdown of Tead1 and Tead4 or of Tead1, Tead2 and Tead4 had a more dramatic effect than that of Tead4 alone. These differences can be accounted for by the fact that Tead1 expression is downregulated when Tead4 is knocked down in C2C12s but not in primary myoblasts. Thus, Tead1 expression in primary myoblasts might be able to compensate for diminished Tead4.

In order to define the redundant and specific roles of Tead factors we performed ChIP-seq on endogenous Tead1 and Tead4 in both undifferentiated and differentiated C2C12 cells. We found that Tead1 occupies a set of sites in undifferentiated cells, but few sites in differentiated cells where Tead4 expression is induced. Tead4 also occupies sites in undifferentiated cells, and upon differentiation the repertoire of target genes is altered towards those involved in differentiation. Comparison of Tead1 and Tead4 occupied sites in undifferentiated cells identified those that were occupied by both factors, but also a set of sites preferentially occupied by Tead1. Analysis of Tead binding sites indicated a strong association between Tead binding and that of the AP1 transcription factor and also with Myod1 and Myog in differentiated cells. Moreover, comparison of our Tead ChIP-seq data with publicly available Myod1 and Myog ChIP-seq data identified a substantial number of loci that were co-occupied by Tead4, Myod1 and Myog. We identify an enhancer signature of frequently co-occurring motifs at loci collectively bound by Tead4, Myod1 and Myog associated with genes activated during muscle differentiation. Further integration of the Tead ChIP-seq data with public data on histone modifications identified Tead binding

sites associated with active regulatory elements marked by H3K27 acetylation in both the differentiated and un-differentiated state. Together these results show that Tead4 and Tead1 bind both common and specific sites in undifferentiated C2C12 cells, but that upon its up-regulation Tead4 becomes the predominant factor bound to regulatory elements of genes induced upon differentiation.

We also used RNA-seq to profile gene expression of differentiating C2C12 and primary myoblasts with or without siRNA knockdown of Tead1 and Tead4. We identified distinct but overlapping sets of deregulated genes in C2C12 and primary myoblasts, which upon comparison with ChIP-seq data reveal genes that may be directly deregulated by Tead4.

Our previous (Benhaddou et al., 2012) and current results suggest that Tead4 functions both as a transcriptional activator as well as a repressor during myoblast differentiation. While the effectors of the Hippo pathway YAP and TAZ have been identified as coactivators for TEAD factors particularly in activating the expression of genes involved in proliferation and oncogenesis (Lamar et al., 2012; Vassilev et al., 2001), no co-repressors have been identified. Moreover, Vgl-family have been suggested to act as coactivators for Teads in differentiating myotubes (Chen et al., 2004b; Maeda et al., 2002a). Identification of Tead4 binding partners in differentiated C2C12 cells may therefore help to better understand the muscle and context-dependent function of Tead4 in gene expression. In a second project run in parallel with the above studies, we identified Tead4 binding partners in the differentiated C2C12 cells. For this, I generated a C2C12 cell line stably expressing F-HA-Tead4. These cells were differentiated and chromatin associated protein fractions were prepared and subjected to tandem affinity purification of the chromatin-associated Tead4 followed by mass-spectrometry analysis.

We identified known Tead4 binding partners such as Yap1, Vgl12 and Vgl14 and several novel partners amongst which was the Ifi202 protein. Co-expression and immunoprecipitation was performed to confirm that Ifi202 interacts with Tead4. Further, both siRNA knockdown and overexpression of Ifi202 lead to inhibition of differentiation. Hence, we show that Ifi202 is required for normal C2C12 cell differentiation.

Finally, to address the role of Tead4 in muscle physiology *in vivo*, we generated conditional Tead4 knockout mice using HSA-CreER^{T2} and Pax7-Cre-ER^{T2} transgenic driver lines to knockout Tead4 specifically in mature muscle fibres or Pax7+ satellite cells respectively. We are now in the process of characterising the phenotype of these animals,

although preliminary results suggest the role of Tead4 in fibre size and composition with no effect on muscle mass and muscle strength. Further experiments in these mice will help us conclude more specifically on the role of Tead4 in muscle physiology.

References:

Anbanandam, A., Albarado, D.C., Nguyen, C.T., Halder, G., Gao, X., and Veeraraghavan, S. (2006). Insights into transcription enhancer factor 1 (TEF-1) activity from the solution structure of the TEA domain. *Proc Natl Acad Sci U S A* *103*, 17225-17230.

Andrianopoulos, A., and Timberlake, W.E. (1991). ATTS, a new and conserved DNA binding domain. In *Plant Cell (United states)*, pp. 747-748.

Benhaddou, A., Keime, C., Ye, T., Morlon, A., Michel, I., Jost, B., Mengus, G., and Davidson, I. (2012). Transcription factor TEAD4 regulates expression of myogenin and the unfolded protein response genes during C2C12 cell differentiation. *Cell Death Differ* *19*, 220-231.

Burglin, T.R. (1991). The TEA domain: a novel, highly conserved DNA-binding motif. In *Cell (United states)*, pp. 11-12.

Chen, H.H., Maeda, T., Mullett, S.J., and Stewart, A.F. (2004). Transcription cofactor Vgl-2 is required for skeletal muscle differentiation. *Genesis* *39*, 273-279.

Davidson, I., Xiao, J.H., Rosales, R., Staub, A., and Chambon, P. (1988). The HeLa cell protein TEF-1 binds specifically and cooperatively to two SV40 enhancer motifs of unrelated sequence. *Cell* *54*, 931-942.

Lamar, J.M., Stern, P., Liu, H., Schindler, J.W., Jiang, Z.G., and Hynes, R.O. (2012). The Hippo pathway target, YAP, promotes metastasis through its TEAD-interaction domain. *Proc Natl Acad Sci U S A* *109*, E2441-2450.

Maeda, T., Chapman, D.L., and Stewart, A.F. (2002). Mammalian vestigial-like 2, a cofactor of TEF-1 and MEF2 transcription factors that promotes skeletal muscle differentiation. *J Biol Chem* *277*, 48889-48898.

Vassilev, A., Kaneko, K.J., Shu, H., Zhao, Y., and DePamphilis, M.L. (2001). TEAD/TEF transcription factors utilize the activation domain of YAP65, a Src/Yes-associated protein localized in the cytoplasm. *Genes Dev* *15*, 1229-1241.

Watt, K.I., Judson, R., Medlow, P., Reid, K., Kurth, T.B., Burniston, J.G., Ratkevicius, A., De Bari, C., and Wackerhage, H. (2010). Yap is a novel regulator of C2C12 myogenesis. *Biochem Biophys Res Commun* *393*, 619-624.

Xiao, J.H., Davidson, I., Matthes, H., Garnier, J.M., and Chambon, P. (1991). Cloning, expression, and transcriptional properties of the human enhancer factor TEF-1. *Cell* *65*, 551-568.

B. Résumé en Français:

Rôles spécifiques et redondants de la famille Tead de facteurs de transcription dans la différenciation des cellules C2C12 et myoblastes primaires in vitro

La famille Tead de facteurs de transcription comprend quatre membres (Tead1 à Tead4) qui ont été identifiées comme des protéines se liant spécifiquement à des motifs GTIIIC et Sph à l'enhancer SV40 (Figure 1) (Davidson et al, 1988; Xiao et al, 1991). Plus tard, ils étaient aussi identifiés chez les mammifères (Figure 1) comme des facteurs qui se lient à l'élément MCAT (5'-CATTCCA/T-3') grâce à leur domaine TEA/ATTS (Anbanandam et al., 2006; Davidson et al., 1988; Xiao et al., 1991). Ce domaine de liaison à l'ADN, partagé par toute la famille, est hautement conservé au cours de l'évolution (Andrianopoulos et Timberlake, 1991; Burglin, 1991).

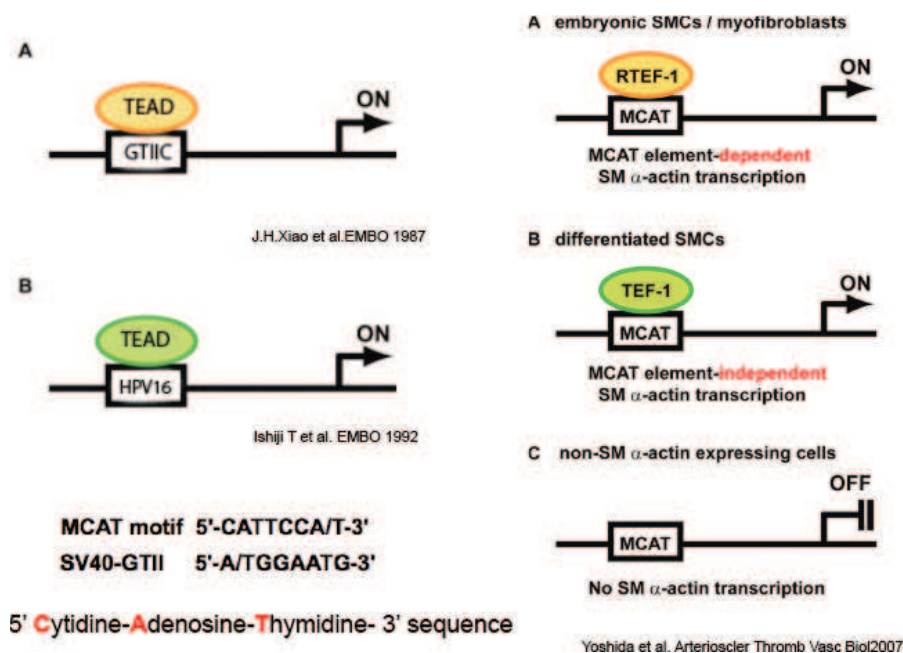


Figure 1. Identification des Teads or TEFs facteurs des transcription et leurs sites de liaison.

Chez les mammifères, les facteurs Tead sont exprimés de façon quasi ubiquitaire avec une expression plus importante de Tead1 et Tead4 dans le muscle squelettique, le poumon, le cœur et le système nerveux. Plusieurs études, y compris la nôtre, ont rapporté que les facteurs Tead se lient aux éléments MCAT présents dans les promoteurs et enhanceurs associés à des

gènes exprimés spécifiquement dans le muscle squelettique tels que MyoD1 et Myogenin. Tead1, Tead2 et Tead4 sont exprimés dans les cellules prolifératives C2C12s et Tead4 est régulée positivement au cours de la différenciation des cellules C2C12 et des myoblastes primaires de souris.

D'autres études parallèles ont décrit comment les facteurs Teads activent la transcription de plusieurs gènes eucaryote tels que la troponine T cardiaque, α -actine de muscle lisse, α -actine squelettique et Foxa-2 (Mar et Ordahl, 1988; Swartz et al, 1998) à travers un ou plusieurs motifs MCAT/GT-IIC (CAT musculaire) 5'-CATTCCT-3', qui ont été enrichis particulièrement dans les gènes exprimés spécifiquement en muscle (Karns et al., 1995; Pasquet et al., 2006; Rindt et al., 1993).

Les facteurs Teads partagent une homologie de séquence élevée dans les domaines fonctionnels conservés tels que le domaine de liaison à l'ADN à N-terminale et le domaine de trans-activation C-terminale (Table 1) (Yoshida, 2008)

Identité de séquence des acides aminés entre les Teads humains				
Name	Other names	% Identity with Tead1	% Identity within DBD	% Identity within TAD
Tead1	NTEF-1, TEF1	-	-	-
Tead2	ETEF-1, ETF, TEF-4	64%	100%	65%
Tead3	DTEF-1, ETFR-1, TEF-5	70%	99%	74%
Tead4	RTEF-1, ETFR-2, Tead4	74%	100%	82%

Table 1. Identité de séquence des acides aminés entre les Teads humains en les comparant avec Tead1 (modifié de Yoshida et al., 2008).

Cependant leur rôle exact, l'étendue de leur redondance –si elle existe- et dans quelle mesure ces facteurs coopèrent au cours de la différenciation du muscle squelettique ne sont pas clairement décrit à ce jour. Le doctorant précédente Attaillah Benhaddou a étudié spécifiquement le rôle de Tead4 dans la différenciation musculaire *in vitro* dans la lignées de

myoblastes C2C12. Il a démontré par la dérégulation d'expression de Tead4 en utilisant shARN que Tead4 est nécessaire à la différenciation normale des cellules C2C12. Il a réalisé des expériences CHIP-chip sur Flag-HA-Tead4 dans les cellules C2C12. Ce fut la première étude (Benhaddou et al., 2012) qui a identifié plusieurs nouvelles cibles Tead4 dans la différenciation musculaire en utilisant un stade précoce méthodes à haut débit.

Cette étude élégante conduit à plusieurs questions ouverts et durant ma thèse, je suis tenté de répondre aux questions suivantes. Ainsi pour caractériser le rôle de ces différents facteurs Tead j'ai abordé ce problème sous ces quatre aspects :

1. Quels sont les rôles spécifiques et redondants des facteurs Tead au cours de la différenciation musculaire?
2. Ces facteurs sont-ils essentiels pour la différenciation des myoblastes primaires *in vitro*?
3. Comment est régulée la capacité des facteurs Tead à activer ou à réprimer la transcription au cours de la myogenèse i.e. quelles protéines ou complexes protéiques associés à Tead4 permet de moduler sa activité transcriptionnelle en ce sens ?
4. Est-ce que Tead4 est requis pour la fonction musculaire normale et la régénération du muscle *in vivo* ?

Pour répondre aux premiers trois questions, on a utilisé les modèles de différenciation musculaire *in vitro*, qui comprends la lignée C2C12 des myoblastes et les myoblastes primaires isolée à partir de muscle des souris très jeune après la naissance. La lignée C2C12 est une lignée de myoblastes isolées des membres postérieurs des souris C3H et a été immortalisé en culture. Cette lignée est très proliférative et elle peut être induit à différencier dans les myotubes (les cellules longues et poly nucléées) en les traitant à milieu à faible quantité de sérum.

Les myoblastes primaires dérivés des cellules satellites (cellules souches musculaires adultes) peuvent être isolés du muscle squelettique par digestion enzymatique et être différenciées *in vitro* en myotubes. Les myoblastes primaires montrent une plus grande tendance à fusionner spontanément et se différencier en myotubes. Par conséquent, les myoblastes primaires deviennent un modèle de choix en raison de leur proximité à la situation *in vivo*. Par conséquent, dans cette étude, nous utilisons à la fois lignée cellulaire C2C12 et myoblastes primaires (PM) en parallèle pour comprendre le rôle des facteurs de transcription Tead dans la différenciation myogénique *in vitro*.

Comme indiqué, nous avons montré précédemment que l'expression de Tead4 est essentielle et augmente au cours de la différenciation de C2C12 *in vitro* (Benhaddou et al., 2012). Une suppression stable de Tead4 grâce à l'expression d'un shARN spécifique conduit à la formation de myotubes raccourcis par rapport à des C2C12 exprimant un shARN contrôle. Des expériences de chip-chip à partir de C2C12 surexprimant Flag-HA-Tead4 ont révélés que Tead4 occupe 867 promoteurs, y compris *Myog*, *Cdkn1A* et *Cav3*. Des analyses transcriptomiques ont identifié l'ensemble des gènes régulés à la baisse suite à la perte de Tead4 parmi lesquels figurent des protéines impliquées structurelles et régulatrices du muscle. Un modèle proposé par Benhaddou et al. situe Tead4 comme activateur de l'expression de *Myog* et *Ankrd2* requis pour la différenciation des myoblastes, mais répresseur de l'expression de *CTGF* et *Ccnd1* contribuant à la sortie du cycle cellulaire. Toutefois dans cette étude le rôle des autres Teads dans ce processus n'est pas abordé.

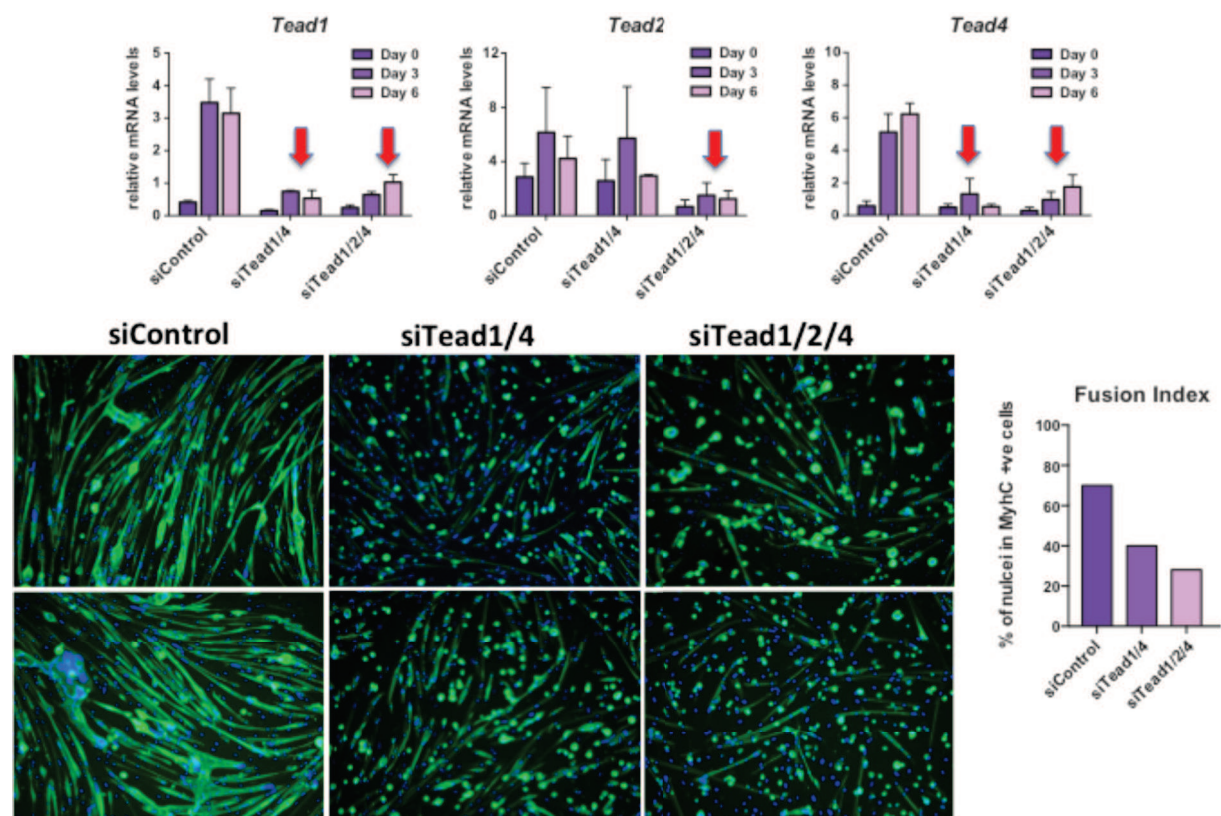


Figure 3. RT-PCR quantitative pour confirmer le knockdown par siRNA silencing des plusieurs facteurs Tead en combinaison de deux ou trois dans les myoblastes primaires (panneau supérieur). Immunofluorescence sur la marquer de différentiation –la myosine chaîne lourde (vert) et DAPI (bleu) dans les myotubes après knockdown combinatoire de Teads en myoblastes primaires (inférieure de gauche) et la quantification de l'indice de fusion (en bas à droite).

Au cours de ma thèse, j'ai approfondi l'étude des facteurs de transcription Tead à leur rôle dans les myoblastes primaires de souris post-natales, dans lesquelles contrairement aux cellules C2C12, la perte Tead4 par siARN n'a eu aucun effet significatif sur la différenciation. De même, la perte de Tead1 ou Tead2 n'a eu que des effets marginaux sur la différenciation. Sachant que Tead4 lie et régule l'expression de plusieurs centaines de gènes, nous avons pensé que l'absence d'un phénotype fort en son absence pourrait être due à la redondance potentielle entre les différents Teads grâce à leur domaine de liaison à l'ADN hautement conservé. Pour répondre à cette question, nous avons réalisé des pertes d'expression simultanées de deux ou plusieurs facteurs Tead par des combinaisons de siARN (Figure 3). Nous avons observé que la perte concomitante de Tead1 et Tead4 conduit à une inhibition dramatique de la différenciation. La perte collective de Tead1, Tead2 et Tead4 aggravent ce phénotype (Figure 3).

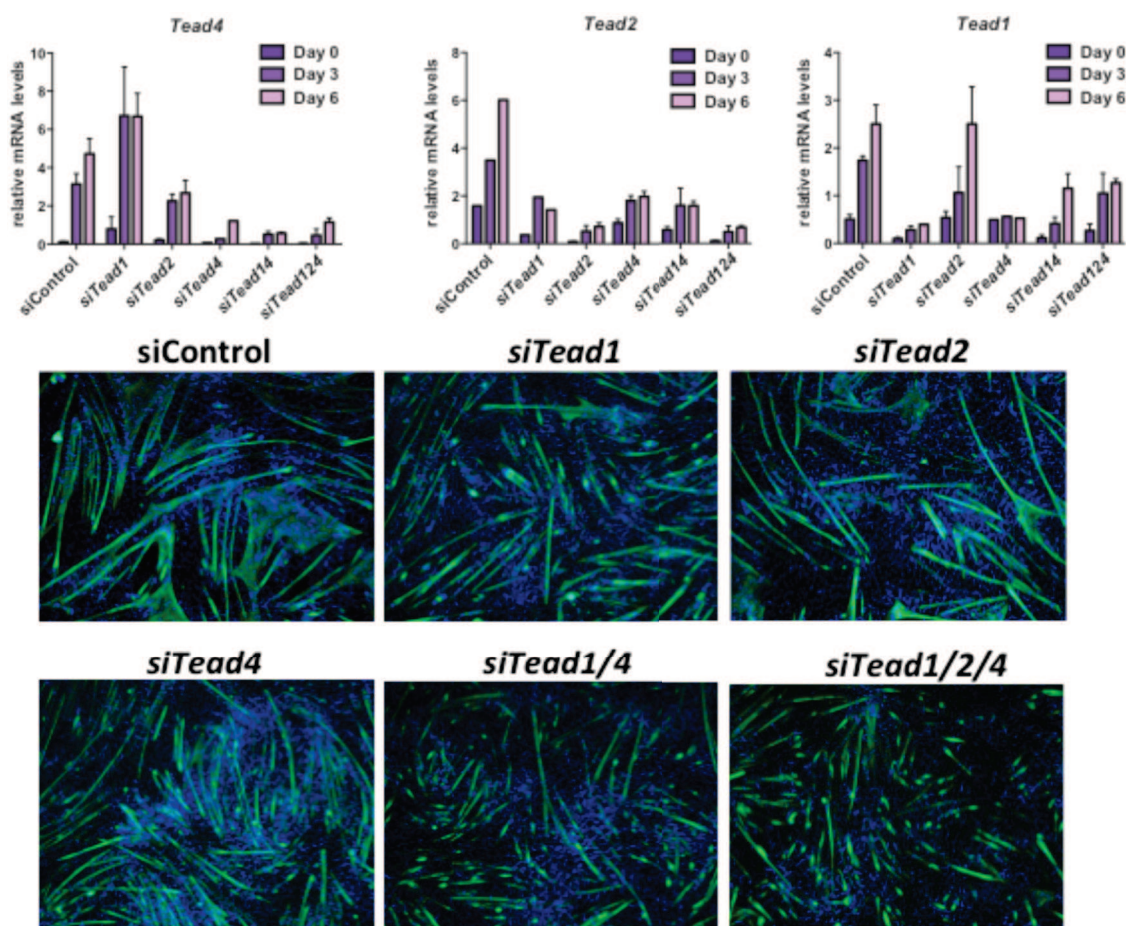


Figure 4. RT-PCR quantitative pour confirmer le knockdown par siRNA silencing des plusieurs facteurs Tead en combinaison de deux ou trois dans les cellules C2C12s (panneau supérieur). Immunofluorescence sur la marquer de différenciation –la myosine

chaîne lourde (vert) et DAPI (bleu) dans les myotubes après knockdown combinatoire de soit un facteur Tead à la fois soit plusieurs facteurs Teads simultanément (panneau inférieure) dans les cellules C2C12s.

Des expériences similaires dans les cellules C2C12 montrent que la perte simultanée de Tead1 et Tead4 ou de Tead1, Tead2 et Tead4 a un effet plus dramatique que celle de Tead4 seul (Figure 4). Ces données suggèrent fortement une redondance fonctionnelle entre les facteurs Tead, qui est plus prononcée dans les myoblastes primaires que dans les cellules C2C12. Ces différences peuvent être expliquées par le fait que l'expression de Tead1 fortement réduite par la perte de Tead4 dans les C2C12s mais pas dans les myoblastes primaires. Ainsi, dans les myoblastes primaires l'expression de Tead1 pourrait être en mesure de compenser la diminution Tead4.

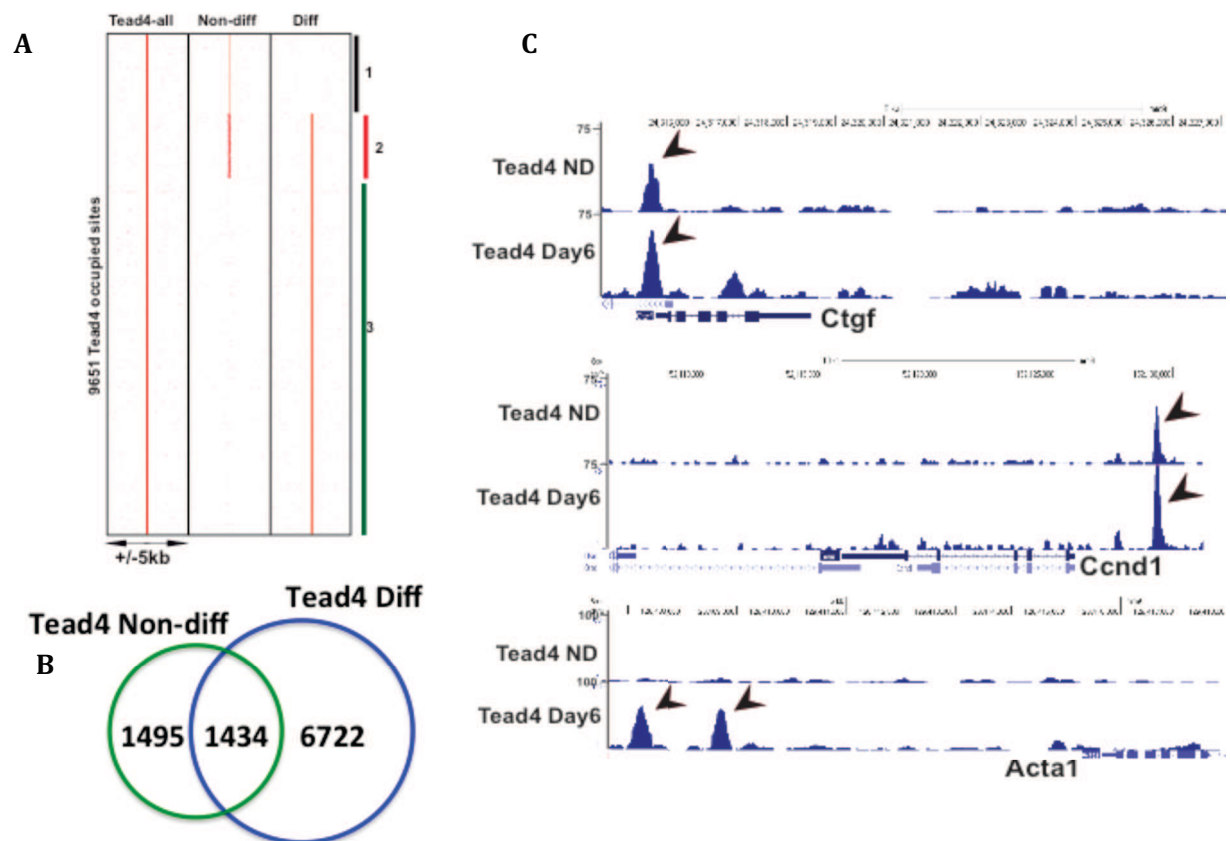


Figure 5. Comparaison d'occupation génomique Tead4 dans les cellules C2C12 non différenciées et différenciées. A. Clustering de sites cibles à la base de densité de reads en utilisant une liste non-redondant de tous les sites occupées par Tead4 dans les cellules non différenciées et différenciées B. Venn montrant le nombre de sites dans les différents groupes de clustering faites en schéma A C. Screenshots UCSC d'occupation Tead4 dans les cellules C2C12 non différenciées et différenciées aux loci des gènes indiqués.

Afin de définir les rôles redondants et spécifiques de facteurs Tead nous avons effectué des immunoprécipitations de la chromatine couplées à du séquençage haut-débit (ChIP-seq) sur les protéines Tead1 et Tead4 endogènes dans les deux cellules C2C12 indifférenciées et différenciées. Nous avons constaté que Tead1 occupe un ensemble de 1443 sites génomiques dans des cellules indifférenciées et un nombre réduit de 274 sites dans les cellules différenciées, dans lesquelles l'expression de Tead4 est induite. Tead4 occupe vers 3000 sites (Figure 5) dans les cellules indifférenciées, mais le répertoire des sites liés par Tead4 est augmenté à 8000 sites au cours myogenèse pour des gènes impliqués dans la différenciation (Figure 5).

La comparaison des données de liaisons génomiques pour les deux facteurs dans les cellules indifférenciées met en évidence des sites occupés par les deux facteurs, mais aussi un ensemble de sites occupés sélectivement par Tead1. On a observé que plupart des site occupé par Tead1 dans les cellules non-differentiées sont aussi liée par Tead4. Cependant, la repertoire des sites occupés par Tead4 dans les myotubes devient très important au cours de la différenciation.

Le contexte de séquence (motifs) autour des sites de liaison des Tead indique une forte association avec les facteurs de transcription AP1 mais aussi avec MYOD1 et Myog dans les cellules différenciées. Cette observation est confirmée par la comparaison de nos données ChIP-seq avec des données accessibles au public pour MYOD1 et Myog qui a mis en évidence un nombre important de loci co-occupé par Tead4, MYOD1 et Myog (données détaillés dans le partie « résultats »).

Ainsi nous avons pu déterminer une signature correspondant à sites constitués de motifs adjacents collectivement liés par leur facteur de transcription respectifs Tead4, MYOD1 et Myog et associée à des gènes activés lors de la différenciation musculaire. Une intégration des données de ChIP-seq des Tead avec des données publiques de modifications des histones permet en outre d'associer les sites de liaison avec des régions régulatrices actives marquées par H3K27 acétylé à la fois dans l'état différencié et non différencié.. Ensemble, ces résultats montrent que Tead4 et Tead1 se lient à la fois au niveau de sites communs et spécifiques dans des cellules C2C12 non différenciées, mais que, lors de sa régulation à la hausse Tead4 devient le facteur prédominant lié à des éléments régulateurs de gènes induits lors de la différenciation.

Ensuite, nous avons utilisé de l'ARN-seq pour étudier l'expression des gènes dans les cellules C2C12 et la différenciation des myoblastes primaires et comment ces programmes de régulation sont affectés par une perte de Tead1 et Tead4.

Nous avons d'abord fait une comparaison globale de l'expression génique dans le C2C12 et myoblastes primaires. Les gènes induits dans les deux modèles sont très riches en termes d'ontologie associés à la différenciation musculaire et les gènes réprimés sont souvent hautement enrichis en termes d'ontologie associés à cycle cellulaire, compatible avec le fait que la différenciation implique l'arrêt du cycle cellulaire. Ainsi, les programmes de l'expression des gènes similaires mais non identiques sont réprimés ou sont activés et au cours de la différenciation de ces deux types de cellules.

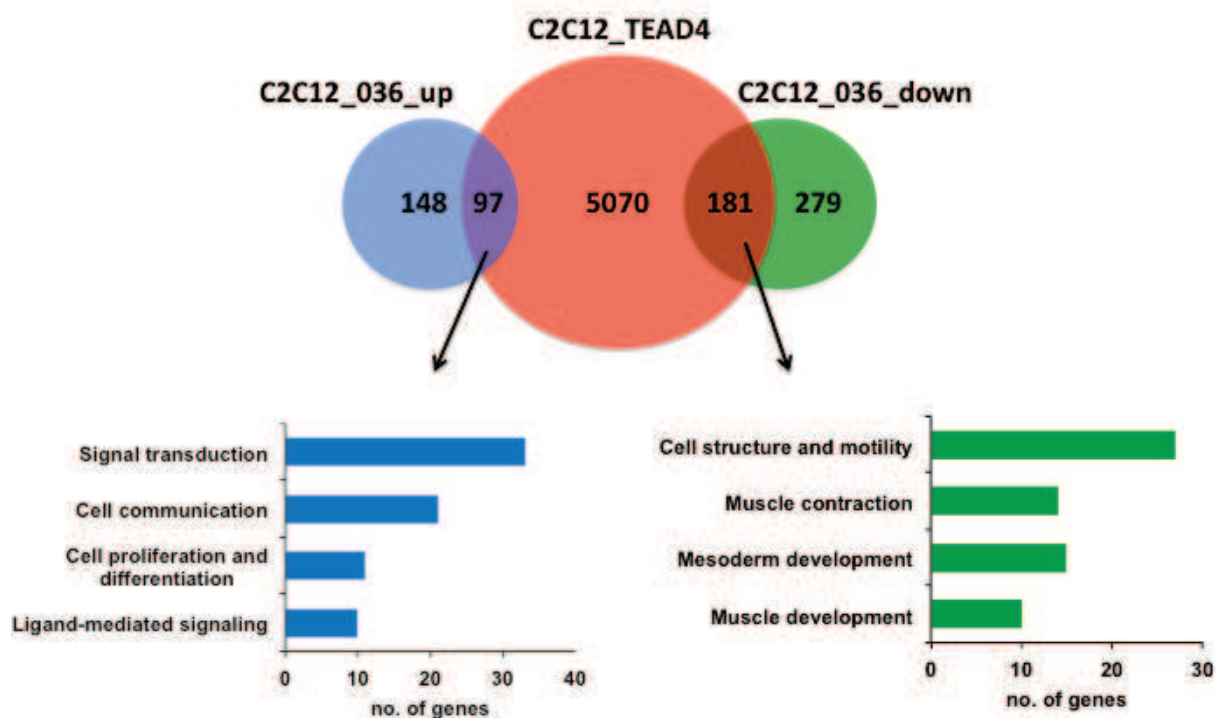


Figure 6. Identification des gènes cibles directs potentiellement régulés par Tead4 dans la différenciation des cellules C2C12. Les diagrammes de Venn illustrant le chevauchement entre les gènes associées avec site(s) de liaison de Tead4 et gènes dérégulé à la diminution d'expression de Tead1 and Tead4 par siTead 1/4 silencieux dans les cellules C2C12 (en haut). L'analyse de l'ontologie des gènes cibles potentiels et directs montré dans panneau inférieur.

La comparaison des données ChIP-seq et RNA-seq dans les cellules C2C12 a révélé que environ 5300 gènes ont été associés à au moins une Tead4 occupé site et parmi les 249 gènes qui étaient régulés à la hausse par siTead1 / 4 silence entre 0-6 jours, 97 étaient

associés à Tead4 sites (Figure 12A), tels que *Ccnd1* comme décrit précédemment occupé (Benhaddou et al., 2012) (Figure 12B) . Ces gènes présentent un faible enrichissement en termes d'ontologie associés à divers types de signalisation et de prolifération. Sur les 549 gènes qui ont été régulés à la baisse par siTead1 / 4 silence entre les jours 0-6, 181 ont été associés à Tead4 sites occupés, et ont été enrichis en termes d'ontologie associés au développement musculaire et comprennent une multitude de composants structurels. Ces données indiquent que près de 40% des gènes régulés à la baisse par la perte de Tead1 / 4 sont des cibles directs potentiels. Ensemble, les données ci-dessus confirment le rôle critique des facteurs Tead dans l'activation de la transcription de gènes impliqués dans la différenciation des myotubes et suggèrent qu'au moins certains gènes peuvent être réprimés par des facteurs Tead cours de ce processus.

En bref, la comparaison des sites de liaisons génomiques des Tead (ChIP-seq) avec les gènes effectivement dérégulés par leur perte (RNA-seq) a permis d'identifier un ensemble de gènes distinct mais chevauchant, liés et dérégulés dans les C2C12 et les myoblastes primaires et représentent des cibles directes de ces facteurs.

Nos résultats précédents (Benhaddou et al., 2012) et actuels suggèrent que Tead4 peut agir à la fois comme un activateur et un répresseur de la transcription au cours de la différenciation des myoblastes. Alors que les effecteurs de la voie Hippo -YAP et TAZ ont été décrits comme des co-activateurs pour les facteurs de Tead en particulier dans l'activation de l'expression de gènes impliqués dans la prolifération et l'oncogenèse (Lamar et al, 2012;.. Vassilev et al, 2001), aucun co-répresseurs n'a été identifié à ce jour. Par ailleurs, des membres de la famille Vgl semblent agir comme co-activateurs pour les Tead au cours de la différenciation des myotubes (Chen et al., 2004 ; Maeda et al., 2002). L'identification de partenaires de liaison de Tead4 dans les cellules C2C12 différenciés peut donc aider à mieux comprendre la fonction musculaire et le répertoire de gènes régulé par Tead4.

Dans un projet mené en parallèle avec les études ci-dessus, nous avons identifié des partenaires de liaison Tead4 dans les cellules C2C12 différenciées. Pour cela, je généré une lignée cellulaire C2C12 exprimant de façon stable F-HA-Tead4. Ces cellules ont été différenciées, la fraction associée à la chromatine a été préparée, puis F-HA-Tead4 purifié afin d'identifier ses partenaires par spectrométrie de masse.

Nous avons ainsi identifié des cofacteurs connus de Tead4 tels que Yap1, Vgl12 et Vgl14 et plusieurs nouveaux partenaires parmi lesquels la protéine était Ifi202. Des approches

de co-expression et d'immunoprécipitation de protéines ont confirmé que Ifi202 interagit avec Tead4. Par ailleurs nous avons pu observer qu'à la fois la perte et la surexpression de Ifi202 inhibent la différenciation et par conséquent Ifi202 est requis pour la différenciation des cellules C2C12.

Enfin, pour répondre à la dernière question concernant le rôle des Tead4 dans la physiologie normale du muscle et pendant la régénération musculaire *in vivo*, nous avons envisagé d'identifier les sites de liaisons de Tead4 dans le muscle adulte. Pour cela, on a optimisé un protocole de ChIP *in vivo* et par ChIP-seq, identifié les sites liés par Tead4 and ARN polymérase II. Donc, on a identifié les gènes liés par Tead4 and ceux qui montrent un association avec Pol II active et donc les gènes exprimés dans la muscles adulte restante.

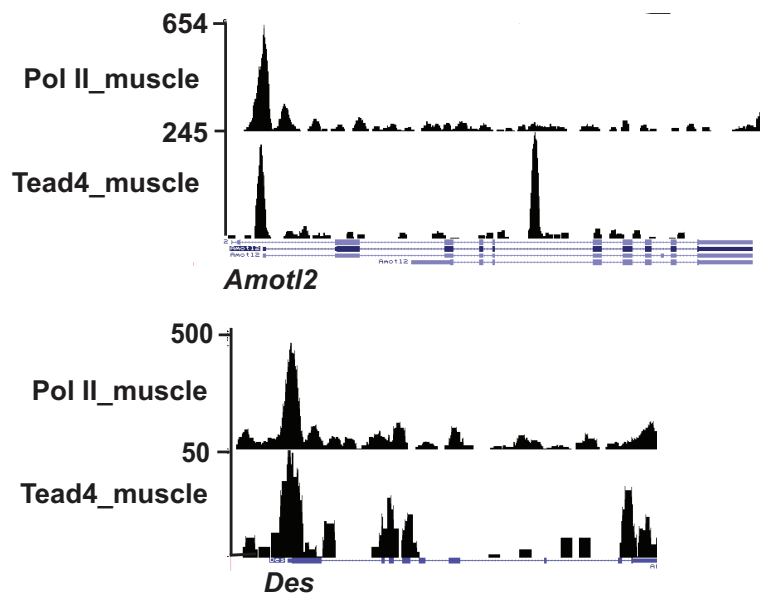


Figure 7. ChIP-seq *in vivo* : Capture de browser UCSC montrant le profil de liaison de Tead4 et Polymérase II au niveau des loci Amotl2 et Desmin dans le muscle chez souris l'adulte.

En parallèle, nous avons généré des souris transgénique permettant un knock-out conditionnel de Tead4 à l'aide des transgènes HSA-CreERT2 ou Pax7-Cre-ERT2 qui permettent de recombiner spécifiquement le locus et supprimer l'expression de Tead4 dans les fibres musculaires matures ou les cellules satellites Pax7+ respectivement. Nous caractérisons actuellement le phénotype de ces animaux, bien que les résultats préliminaires suggèrent un rôle de Tead4 dans la taille des fibres et leur composition mais sans effet sur la

masse et la force musculaire. D'autres expériences devraient nous aider à conclure plus spécifiquement sur le rôle de Tead4 dans la physiologie musculaire *in vivo*.

Bibliographie:

Anbanandam, A., Albarado, D.C., Nguyen, C.T., Halder, G., Gao, X., and Veeraraghavan, S. (2006). Insights into transcription enhancer factor 1 (TEF-1) activity from the solution structure of the TEA domain. *Proc Natl Acad Sci U S A* *103*, 17225-17230.

Andrianopoulos, A., and Timberlake, W.E. (1991). ATTS, a new and conserved DNA binding domain. In *Plant Cell (United states)*, pp. 747-748.

Benhaddou, A., Keime, C., Ye, T., Morlon, A., Michel, I., Jost, B., Mengus, G., and Davidson, I. (2012). Transcription factor Tead4 regulates expression of myogenin and the unfolded protein response genes during C2C12 cell differentiation. *Cell Death Differ* *19*, 220-231.

Burglin, T.R. (1991). The TEA domain: a novel, highly conserved DNA-binding motif. In *Cell (United states)*, pp. 11-12.

Chen, H.H., Maeda, T., Mullett, S.J., and Stewart, A.F. (2004). Transcription cofactor Vgl-2 is required for skeletal muscle differentiation. *Genesis* *39*, 273-279.

Davidson, I., Xiao, J.H., Rosales, R., Staub, A., and Chambon, P. (1988). The HeLa cell protein TEF-1 binds specifically and cooperatively to two SV40 enhancer motifs of unrelated sequence. *Cell* *54*, 931-942.

Karns, L.R., Kariya, K., and Simpson, P.C. (1995). M-CAT, CArG, and Sp1 elements are required for alpha 1-adrenergic induction of the skeletal alpha-actin promoter during cardiac myocyte hypertrophy.

Lamar, J.M., Stern, P., Liu, H., Schindler, J.W., Jiang, Z.G., and Hynes, R.O. (2012). The Hippo pathway target, YAP, promotes metastasis through its Tead-interaction domain. *Proc Natl Acad Sci U S A* *109*, E2441-2450.

Maeda, T., Chapman, D.L., and Stewart, A.F. (2002). Mammalian vestigial-like 2, a cofactor of TEF-1 and MEF2 transcription factors that promotes skeletal muscle differentiation. *J Biol Chem* *277*, 48889-48898.

Pasquet, S., Naye, F., Faucheux, C., Bronchain, O., Chesneau, A., Thiebaud, P., and Theze, N. (2006). Transcription enhancer factor-1-dependent expression of the alpha-tropomyosin gene in the three muscle cell types. *J Biol Chem* *281*, 34406-34420.

Rindt, H., Gulick, J., Knotts, S., Neumann, J., and Robbins, J. (1993). In vivo analysis of the murine beta-myosin heavy chain gene promoter. *J Biol Chem* *268*, 5332-5338.

Vassilev, A., Kaneko, K.J., Shu, H., Zhao, Y., and DePamphilis, M.L. (2001). Tead/TEF transcription factors utilize the activation domain of YAP65, a Src/Yes-associated protein localized in the cytoplasm. *Genes Dev* 15, 1229-1241.

Watt, K.I., Judson, R., Medlow, P., Reid, K., Kurth, T.B., Burniston, J.G., Ratkevicius, A., De Bari, C., and Wackerhage, H. (2010). Yap is a novel regulator of C2C12 myogenesis. *Biochem Biophys Res Commun* 393, 619-624.

Xiao, J.H., Davidson, I., Matthes, H., Garnier, J.M., and Chambon, P. (1991). Cloning, expression, and transcriptional properties of the human enhancer factor TEF-1. *Cell* 65, 551-568.

Yoshida, T. (2008). MCAT elements and the TEF-1 family of transcription factors in muscle development and disease. *Arterioscler Thromb Vasc Biol* 28, 8-17.

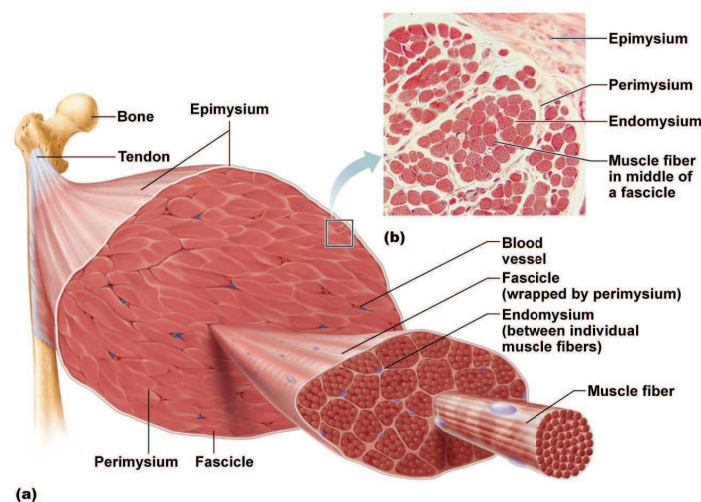
Introduction

I.Skeletal muscle structure

Skeletal muscle makes up for 40% of the body weight and 50-75% of the total protein content of the body. Locomotion, movement and maintenance of posture being its major functions, it also plays important role in storage of energy and maintaining whole-body metabolism. Right from the smallest structural and functional unit- myofiber or muscle cell to the whole muscle, the cytoskeletal structures are highly developed and organized in order to perform mechanical functions, utilize and store energy and provide endurance to the body.

I.1Anatomy of skeletal muscle architecture:

Skeletal muscle is made of compactly packed muscle fibres that are held together by a substantial amount of connective tissue. The outermost layer of connective tissue that covers the whole muscle is called the **epimysium (Figure 1)**. This layer of connective tissue extends at the ends of the muscle to form tendons that attach the muscle to the skeleton. The muscle can be divided into bundles of fibres called the **fascicles** that are enclosed in another layer of connective tissue called the **perimysium**. A fascicle consists of 10-100 muscle fibres depending upon the muscle in question. Eventually, each individual muscle fibre is surrounded by **endomysium (Figure 1)**.



© 2011 Pearson Education, Inc.

Figure 1. (a) Gross anatomy of skeletal muscle showing compact arrangement of muscle fibres that are held by connective tissue sheaths at many levels (b) Photomicrograph of a cross section of part of a skeletal muscle (cited from- A Brief Atlas of the Human Body, Plate 29).

Skeletal muscle is a highly vascularised and innervated tissue. The blood vessels and nerve endings penetrate through the epimysium with further branching of blood vessels and motor neurons into the peri- and endomysium. Each muscle fibre is innervated by a single axon near the middle of the fibre.

I.2 Cellular organisation of skeletal muscle:

I.2.1 Myofibre:

A myofibre or muscle cell is a long, cylindrical and multi-nucleated cell that runs along the entire length of the muscle. A muscle fibre can be up to 35 cm long and vary from 10-100 microns in diameter. Each muscle fibre is surrounded by a mesh-like **basal lamina** comprised of collagen and large glycoproteins. Basal lamina is present in the space between the endomysium and the plasma membrane or the **sarcolemma** of the muscle cell. The adult muscle stem cells or the satellite cells reside beneath the basal lamina in close contact with the sarcolemma. The basal lamina is known to provide a scaffold for muscle repair after injury. Each myofibre contains upto 1000 nuclei that result from the fusion of the embryonic and fetal myoblasts during natal and post-natal development. The nuclei are situated peripherally beneath the sarcolemma.

The myofibres have highly specialised sub-cellular structures such as myofibrils and cytoskeletal network that connects the myofibrils to the sarcolemma, thus, accounting for the contractile properties of the muscle as an organ.

I.2.2 Satellite cells:

They are the adult muscle stem cells that reside under the basal lamina next to the sarcolemma. Satellite cells are quiescent and get activated under conditions of repair and regeneration, followed by their proliferation and fusion into new or pre-existing fibres or self-renewal (discussed in details in the Chapter 2).

I.3 Anatomical structure of myofibre:

I.3.1. Myofibrils:

Each muscle fibre is made up of several hundred to thousand rod-like elements called myofibrils that run along the length of the fibre. They are 1-3 μm in diameter and occupy 80% of the cell volume (Huxley and Hanson, 1957). Each myofibril is composed of thin (actin) and thick (myosin) myofilaments. A myofibril can be further divided into sarcomeres that are lined end-to-end [Figure 2] (Craig and Padron, 2004).

I.3.2. Sarcomere:

Sarcomere is the smallest structural and functional unit of a muscle fibre and is made up of thick (myosin) and thin (actin) myofilaments (Figure 2). The arrangement of thick (myosin) and thin (actin) myofilaments of the sarcomere is largely responsible for the banding pattern observed under light and electron microscopy and thus the striated appearance in skeletal muscle in a longitudinal section (Gregorio et al., 1999).

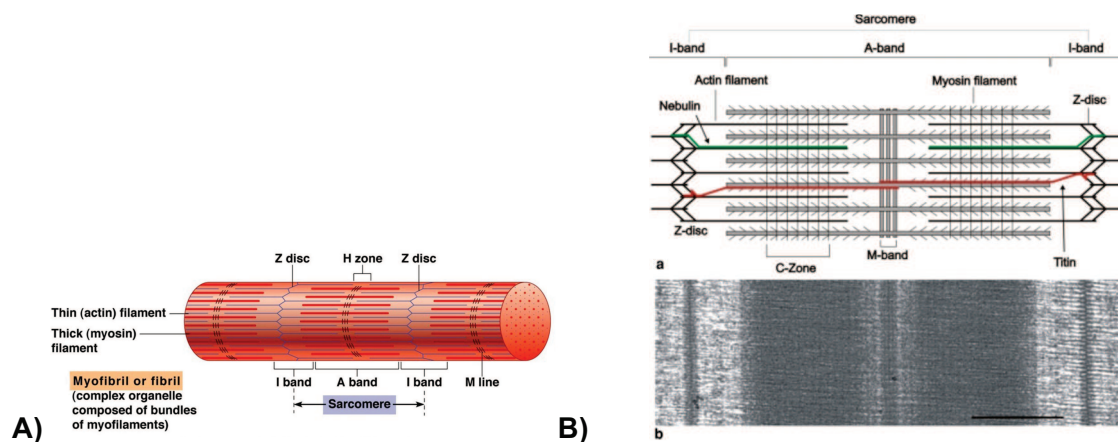


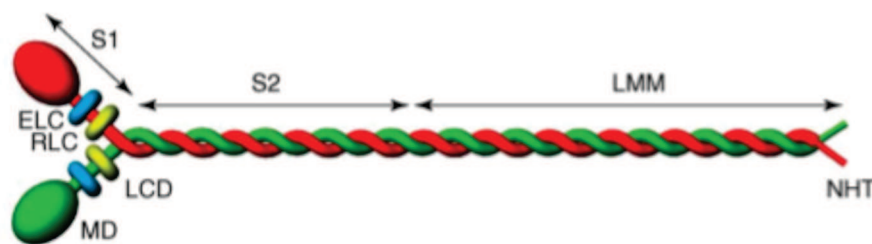
Figure 2. A) Schematic representation of the myofibril with B) a detailed molecular structure of a sarcomere and electron micrograph of a longitudinal section of muscle showing striated appearance of sarcomere [adapted from (Luther, 2009)].

Each sarcomere consists of a dark A- band (anisotropic band) and half a light band (I band) on either side flanked by z-discs on both sides. It is a 2 μm long region between two successive z-discs. The central thick filaments containing myosin extend the entire length of the A-band. The more lateral thin filaments containing actin extend across the I-band and partly into the A-band.

The actin filaments fit at trigonal positions in the hexagonal array of myosin filaments in the A-band (Squire, 1997). The H-zone in the middle of the A-band appears less dense because the thin filaments do not extend into this region. The M-line in the center of the H-zone is slightly darker because of the presence there of fine protein strands of myomesin that hold adjacent thick filaments together.

The myofilaments are connected to the sarcolemma and connected at the z-discs and M-lines transversally. For instance, the thin actin filaments of adjacent sarcomeres are joined together at the Z-discs by α -Actinin dimers (Luther, 2000). The thick filaments are also connected to giant Titin molecules (3000kDa) that cover half the sarcomere length. Titin helps regulate the sarcomere length after muscle contraction (Gautel et al., 1999). Nebulin (600-800Kda) associates with the thin filaments and regulates their length, contractility and z-disc structure (McElhinny et al., 2003).

A



B

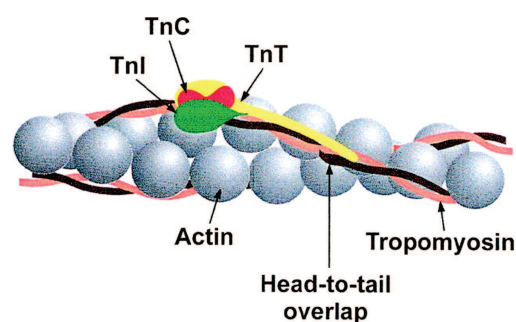


Figure 3. A) Schematic representation of myosin molecule. Heads (S1) comprise the motor domain (MD) and light chain domain (LCD), which contains the essential light chain (ELC, blue) and the regulatory light chain (RLC, yellow). The tail is a coiled-coil formed by the C-terminal halves of each heavy chain (Craig and Woodhead, 2006). B) Figure 14. A model of the molecular arrangement of Troponin (Tn), Tropomyosin (Tm), and Actin. TnC: Troponin C. Tn I: Troponin I. TnT: Troponin T. (Modified from Gordon et al. 2000).

I.3.3 Thick filaments:

The thick filaments are mainly made of Myosin II (conventional myosin). Myosin is a hexameric large molecule made of two heavy (200kDa) and two light (20kDa) chains. The structure can be divided into the two heads, neck and a long tail (Figure 3A). The N-terminal region of myosin (S1) folds into a globular head-like structure and consists of a motor domain that hydrolyses ATP and binds to actin (Craig and Woodhead, 2006). The C-terminal of the heavy chains form a long alpha-helical coiled-coil tail domain, that results from dimerization of the myosin heavy chains. The proximal S2 part of the tail is more soluble and flexible than the distal light meromyosin (LMM) part of the tail. The neck comprises of the two light chains, namely, the essential light chain (ELC) and a regulatory light chain (RLC). The phosphorylation of the RLC is responsible for the contractile activity of the myosin molecule.

I.3.4. Thin filaments:

The thin filaments are mainly comprised of Actin, along with two regulatory proteins: Troponin (Tn) and Tropomyosin (Tm) (Figure 3B). The globular actin (G-actin) polymerizes spontaneously to form a two-stranded helical structure called F-Actin, which constitutes the main body of the thin filament. Tropomyosin is rod-shaped coiled-coil homo or heterodimer protein that lies along the α -helical major groove of actin. It interferes with actin-myosin interaction in a Troponin-dependent manner. Troponin is composed of three subunits: Troponin C (Ca^{2+} -binding), Troponin T (Tropomyosin-binding) and Troponin I (Inhibits Acto-myosin interaction). When no Ca^{2+} binds Troponin C (TnC), Tropomyosin blocks the myosin binding sites of actin. Similarly, in the presence of Ca^{2+} binding to TnC, the conformational change in Tn-Tm complex shifts the complex and the myosin binding sites are exposed, hence, facilitating contraction of actin-myosin filaments (Gordon et al., 2000)

I.3.5 Non-contractile cytoskeleton:

A muscle fibre possesses a highly specialised cytoskeleton that not only supports the contractile apparatus and various organelles, but also mediates the inter-sarcomeric and intracellular co-ordination via the extracellular matrix (ECM). This is essential for proper mechanical co-ordination between adjacent myofibrils. The cytoskeleton can be broadly subdivided into – intra-sarcomeric, peri-sarcomeric and sub-sarcolemmal cytoskeleton (Berthier and Blaineau, 1997).

Titin and Nebulin, the thick and thin filament rulers respectively form the intra-sarcomeric cytoskeleton. Desmin along with Vimentin, Nestin constitute the intermediate filaments that form the peri-sarcomeric cytoskeleton (Clark KA 2015; Kathleen A. Clark et al., 2003). The intermediate filaments link the z-discs laterally and also with the sarcolemma. The sub-sarcolemmal cytoskeleton is crucial in providing a linkage between peripheral myofibrils via the sarcolemma and indirectly with the ECM. It is found mainly in myotendinous junctions (MTJ) and the neuromuscular junctions (NMJ) and the costameres. Costameres are structural protein complexes found all along the sarcolemma outside the MTJ and NMJ. There are three types of sub-sarcolemmal cytoskeleton (figure 4)-

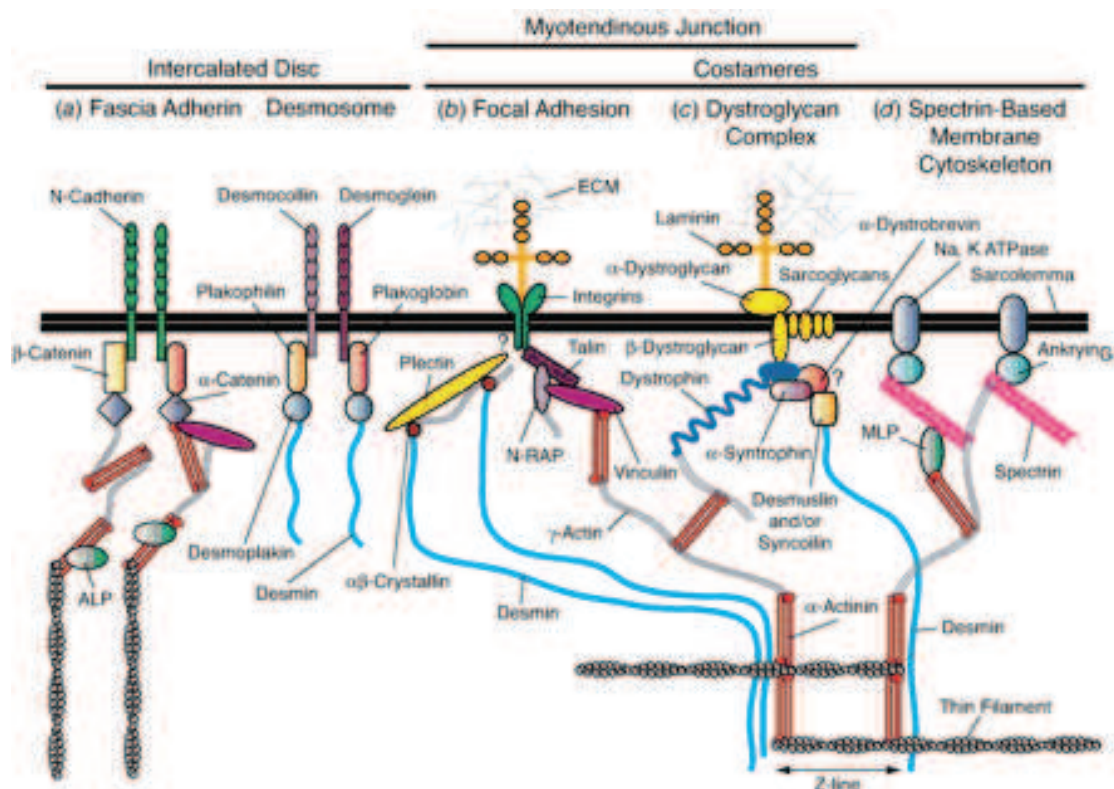


Figure 4. A schematic model of the cytoskeletal filament linkages at the sarcolemma of striated muscle. Four major cytoskeletal/membrane junctions are depicted: (a) cadherin-based linkages to actin and intermediate filaments (desmin); (b) integrin-based focal adhesions; (c) dystroglycan complex (DGC); and (d) spectrin-based membrane cytoskeleton. http://www.siumed.edu/~eniederhoffer/som_pbl/NMB/musc_bioch/musc_biochem.pdf

1. Integrin-based focal adhesion type cytoskeleton that is enriched in MTJ and NMJ in adult muscle. These are trans-membrane receptors interact with ECM proteins such as laminin, collagens and fibronectin (Berthier and Blaineau, 1997).

2. Dystrophin based cytoskeleton – Dystrophin along associated proteins such as Caveolin 3 are crucial in stabilising the sarcolemma and maintaining skeletal muscle integrity during contraction (Menke and Jockusch, 1991).

3. Spectrin-based cytoskeleton is found mainly in NMJs and costameres and is composed of Spectrins, Actin and Ankyrin. It plays a role in sarcomere integrity, proper neurotransmission and correct localisation of specific membrane proteins (Berthier and Blaineau, 1997).

I.3.6 Sarcoplasmic reticulum and T-tubules:

The skeletal muscle possesses a very specialised form of smooth endoplasmic reticulum called the sarcoplasmic reticulum (SR) that surrounds the myofibrils like a membranous sheath with sarcolemmal invaginations perpendicular to muscle length called the Transverse tubules (T-tubules). SR is specialised to store, release and reuptake Ca^{2+} and regulate intracellular Ca^{2+} levels when muscle fibre is stimulated. The calcium is stored in the terminal cisternae that are in close contact with the T-tubules. The contact point of T-tubules and the two cisternae on both sides of it form a structure known as a Triad.

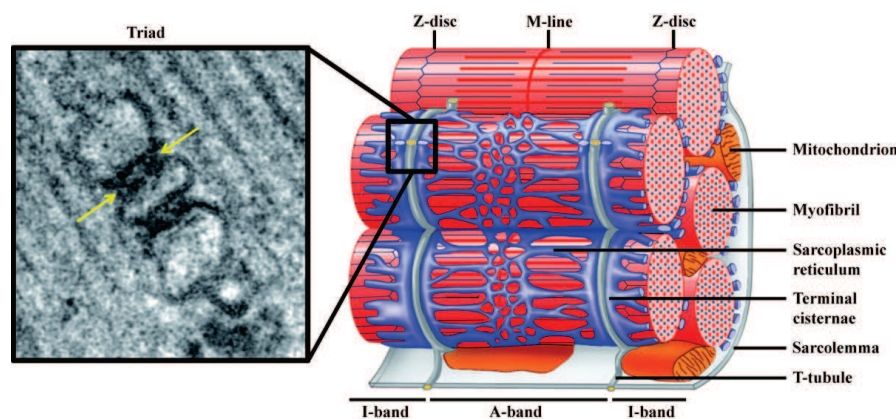


Figure 5. Triad organization in skeletal muscle. Left: Electron micrograph of a triad junction. A central T-tubule is flanked on both sides by a terminal cisternae element from the sarcoplasmic reticulum. Arrows indicate electron-dense junctional feet corresponding to the ryanodine receptor-dihydropyridine receptor complex. Right: Schematic representation of a mammalian muscle sarcomere and surrounding membranes. T-tubules shown in gray are specialized invaginations of the sarcolemma. The elaborated sarcoplasmic reticulum network is shown in blue (Al-Qusairi and Laporte, 2011).

I.3.7 Neuromuscular junction:

The neuromuscular junction is the site of the transmission of signals from motor neuron to a muscle fibre to contract. It is formed by the synapse of the terminal end of the axon of a motor neuron and a highly excitable region of the sarcolemma called the motor end plate (MEP) as shown in Figure 6. The pre-synaptic end of the axon bulges out into the synaptic cleft, an intermediate space 50 nm wide, formed by the invaginations of the sarcolemma in the post-synaptic membrane.

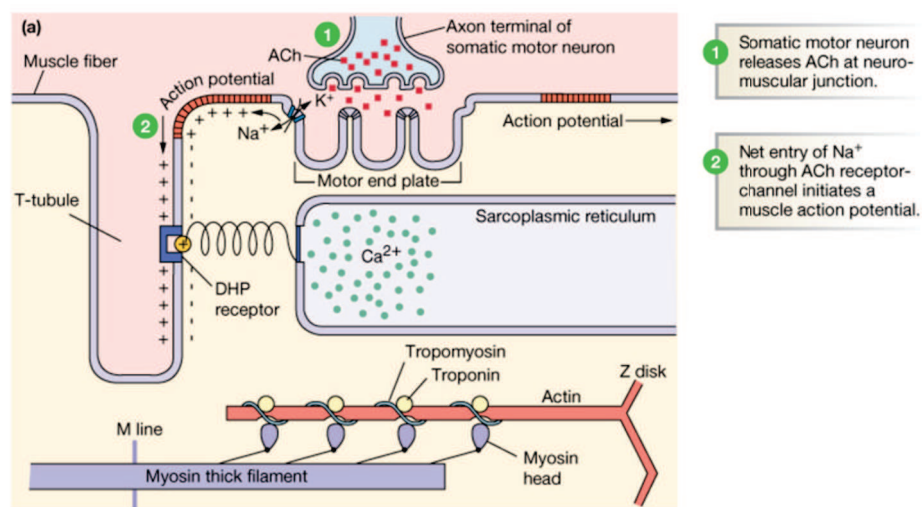


Figure 6. Schematic diagram of neuromuscular junction and conversion of action potential to muscle contraction via excitation-contraction coupling.

http://faculty.pasadena.edu/dkwon/chapt_11/textmostly/slide23.html

When an action potential reaches a terminal axon, it leads to activation of voltage-gated calcium channels (VGCC) in the presynaptic membrane and movement of Ca²⁺ ions into the axon cytosol. The influx of calcium ions facilitates fusion of the Acetylcholine (ACh) laden vesicles into the pre-synaptic membrane leading to release of ACh molecules into the synaptic cleft (Figure.) ACh then binds to the Acetylcholine receptors (AChR) in the post-synaptic membrane leading to influx of Na⁺ ions and depolarisation of the motor end plate (Hall and Sanes, 1993). The depolarisation potential extends along the muscle fibre into T-tubules, causing the release of calcium from the sarcoplasmic reticulum, thus initiating muscle contraction. This process is called excitation-contraction coupling (Campbell et al., 1987). Acetylcholine is hydrolysed in the synaptic cleft by the Acetylcholinesterase (AChE) enzyme and Choline is transported back into the pre-synaptic nerve terminal by a high-

affinity choline transporter. This facilitates recycling of Acetylcholine from choline by the help of Choline Acetyltransferase enzyme (Figure 6).

II. Skeletal muscle formation:

II.1 Embryonic myogenesis:

II.1.1 Somitogenesis and myogenic compartmentalisation of somites:

Embryonic myogenesis starts with formation of somites at day 8 p.c. in a mouse embryo. There are three key steps in embryonic myogenesis: somitogenesis, myogenic commitment, and delamination of committed cells to form limb and trunk muscle. At the time of establishment of the anterior to posterior body axis, the paraxial mesoderm i.e. the mesoderm surrounding the neural tube starts to get segmented on either side of the axis to form somites (Figure 7). The newly formed somites are epithelial in nature. The dorsal part of somites is called the dermomyotome (Figure 7), as it shall give rise to the skin and skeletal muscle of body proper and limbs, while the ventral part of the somite undergoes epithelial to mesenchymal transition and forms the sclerotome compartment (Ordahl et al. 1995).

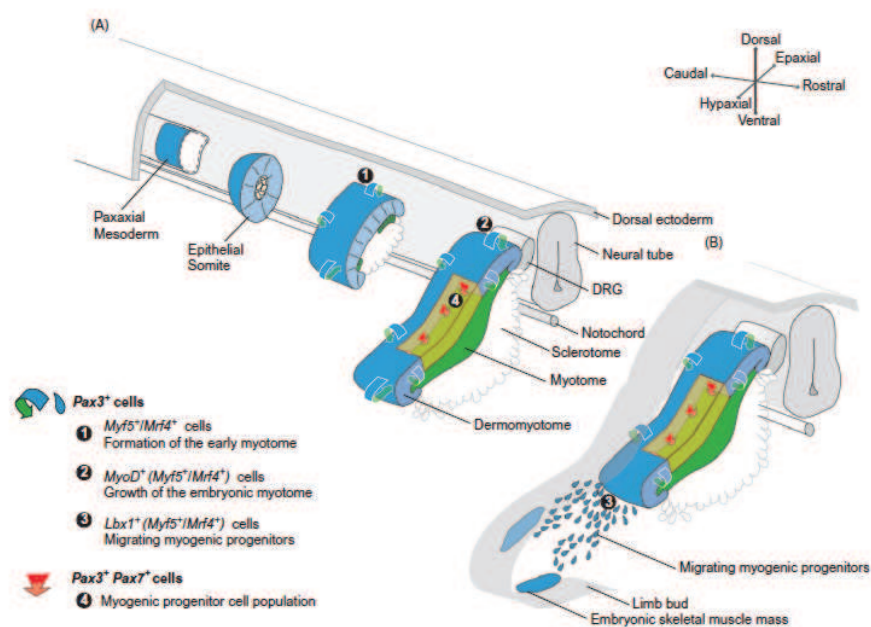


Figure 7. Embryonic origin of skeletal muscle of trunk and limbs – Somitogenesis and myogenic compartmentalisation. Cited from: *MUSCLE: Fundamental Biology and Mechanisms of disease* (Edited by Joseph A.Hill and Eric N.Olson)

The dermomyotome cells express *Pax3* and *Pax7*, are multipotent and would give rise to all the skeletal muscles of the body and dermis, while the sclerotome gives rise to bones and cartilage of vertebral column (Jostes et al. 1990; Goulding et al. 1991; Buckingham et al. 2003). The somites can be divided into two parts: epaxial and hypaxial mesoderm. The epaxial i.e. adjacent to neural tube gives rise to deep back muscles while the hypaxial extremity of dermomyotome gives rise to the limbs and the rest of the body musculature (Figure 7).

The first muscle to form is the myotome, located under the dermomyotome (Tajbakhsh & Buckingham, 2000). Morphogenic cues from the surrounding structures such as notochord, floor of neural tube and the surface ectoderm (Brand-Saberi et al., 1993; Fan and Tessier-Lavigne, 1994; Pourquie et al., 1993) result in myogenic determination and delamination of cells, mainly from dorsomedial lip (DML) of the epaxial mesoderm (Figure 7). The cells express myogenic regulatory factors such as *Myf5* and *Mrf4* and differentiate into myocytes upon leaving the dermomyotome. Some of the delaminated muscle progenitor cells also start to localise under the nascent basal lamina on muscle fibres. The satellite cells of postnatal muscle derive from this progenitor cell population (Gros et al. 2005).

At the level of limbs, cells delaminate from the ventrolateral lip (VLL) of the hypaxial dermomyotome and migrate into the early limb bud (Figure 8), where they proliferate extensively, start to express myogenic determination factors *Myf5* and *MyoD*, and subsequently differentiate into skeletal muscle (Vasyutina and Birchmeier 2006).

II.1.2 Morphogenic Patterning and transcriptional control of embryonic myogenesis:

The myogenic compartmentalization and specification of the somites is directed in a spatiotemporally controlled manner by morphogens released from several structures in vicinity of the somites.

Wnt and Sonic hedgehog:

Wnt and Shh family of proteins are of particular importance in guiding the muscle development. The neural tube secretes *Wnt1* and *Wnt3*, while the surface ectoderm releases *Wnt4*, *Wnt6* and *Wnt7a* (Parr et al 1993). *Wnt1* induces *Myf5* expression while *Wnt7a* or *Wnt6* have been shown to increase *MyoD* expression (Tajbakhsh et al. 1998). Sonic hedgehog (Shh) is released from the notochord and floor plate of the neural tube. It is required for the expression of *Myf5* in epaxial muscle precursors (Borycki et al. 1999). Absence of *Shh*

signaling in zebrafish increases the number of *Pax3*⁺/*Pax7*⁺ cells but prevents further progression of myogenesis. Further studies showed that *Shh* expression is required for dermomyotome to generate *MyoD*/*Myf5* positive committed cells that have downregulated *Pax3*/*Pax7* (Feng et al. 2006).

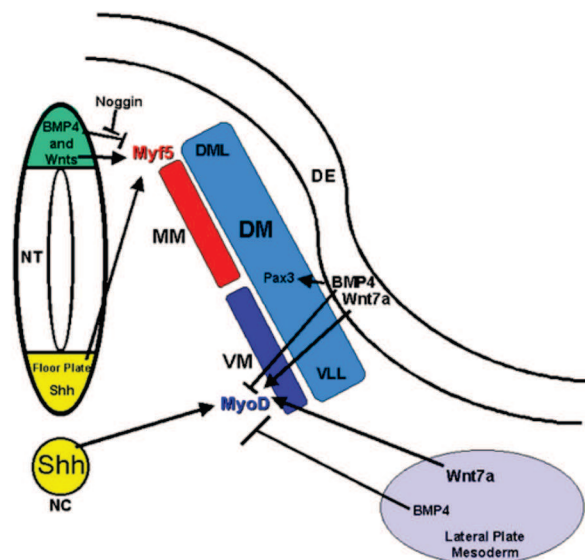


Figure 8. Myogenic patterning of somites by extracellular growth factors. Sonic hedgehog is secreted by both notochord and floor plate which serves to induce *Myf5* expression. *Wnts*, in particular *Wnt1*, secreted from the dorsal neural tube similarly induce *Myf5* expression in the epaxial myotome. By contrast, *Wnt7a* secreted from the dorsal ectoderm induces *MyoD* expression in the ventral myotome. *BMP4* secreted from the dorsal ectoderm and lateral plate mesoderm is important for repressing MRF activation and maintaining *Pax3* expression in cells of the dermomyotome and the migrating precursor population in the VLL. Both dorsal neural tube and the DML secrete *noggin*, inhibiting the repressive effects of *BMP4* on myogenesis. DML=dorsomedial lip; VLL=ventrolateral lip; DE=dorsal ectoderm; NT=neural tube; NC=notochord; MM=medial myotome; VM=ventral myotome; extracted from (Perry and Rudnick, 2000)

Bone morphogenetic proteins (BMPs) and Notch:

While *Wnts* and *Shh* positively regulate myogenesis, Bone morphogenetic proteins (BMPs) and Notch signalling inhibit the expression of certain myogenic genes. For instance, *Bmp2*, *Bmp4* and *Bmp7* secreted from the lateral plate mesoderm prevents commitment of certain muscle progenitors by positively regulating *Pax3* expression and delaying *Myf5* and *MyoD* expression. This suggests that BMP is required to maintain the muscle progenitor pool (Pourquie et al. 1995).

As Wnt and Shh antagonise BMP levels signals through increased expression of Noggin, MyoD gets upregulated and initiates myotome formation (Hirsinger et al. 1997; Marcelle et al. 1997).

Active Notch signaling has been shown to suppress MyoD in cooperation with DNA binding protein RBP-J and transcriptional repressor Hes1 (Jarriault et al., 1995; Kuroda et al., 1999). Loss-of-function mutations in Notch signaling proteins resulted in excessive myogenesis and decline in myogenic precursor population (Schuster-Gossler et al., 2007; Vasyutina et al., 2007). Together, these findings suggest that BMP and Notch act opposite to the myogenesis promoting Wnt and Shh pathways, thereby spatiotemporally fine tuning the myogenesis in the mouse embryo.

Hepatocyte growth factor (HGF):

Another important molecule required for delamination and migration of cells from the ventrolateral lip of the hypaxial mesoderm into early limb buds is the Hepatocyte growth factor (HGF), which works through its C-MET receptor on the progenitors. C-MET interacts with HGF, that is produced by the lateral plate mesoderm (Dietrich et al., 1999). Strikingly, C-MET mutant embryos displayed a lack of skeletal muscle formation in limbs (Bladt et al., 1995). Pax3 upregulates c-met expression and consistent with this, Pax3 mutant embryos also have no limb muscle (Tajbakhsh et al., 1997). In short, these morphogenic signals not only bring about the different steps of myogenic differentiation in a time and space controlled manner via expression of myogenic regulatory factors but also serve as commitment and stem cell maintenance checkpoints.

II.1.3 Transcriptional control of somitogenesis:

The myogenic progenitor specification starts with the expression of Pax3 and Pax7 in the dermomyotome cells (Goulding et al., 1994; Jostes et al., 1990). These cells proliferate extensively due to Pax3 dependent upregulation of FGF signalling (Lagha et al., 2008). Another homeodomain factor Six1 controls the proliferation of these progenitors in a complex with Eya1 and Dach through regulation of *c-myc* expression. *Six1: Eya1* double mutants display complete absence of limb musculature (Li et al., 2003). *Six1/4* and *Eya1/2* influence *Pax3* expression and *Myf5* is a direct transcriptional target of *Six1/4* (Giordani et al., 2007; Grifone et al., 2007; Grifone et al., 2005). Once the cells start expressing *Myf5*, whose expression is also directly controlled by Pax3, Six1 & Six4 (Sato et al., 2010) they

delaminate from the ventrolateral lip of the dermomyotome and commit to become myogenic precursors (Kiefer and Hauschka, 2001). Pax3/Pax7 also activate MyoD expression (Tajbakhsh et al., 1997). Myogenic precursors expressing Myf5 and MyoD possess long migratory capacity, which is aided by paracrine signals via HGF and c-met. It is the transcription factor Lbx1 that imparts migratory properties to these precursors (Mennerich and Braun, 2001). Myf5 and MyoD act redundantly and upstream of MyoG and mark the onset of myogenic commitment. In the absence of Myf5 and MyoD, cells would lose their myogenic commitment potential, are unable to localise correctly and adopt other cell fates (Tajbakhsh et al., 1996).

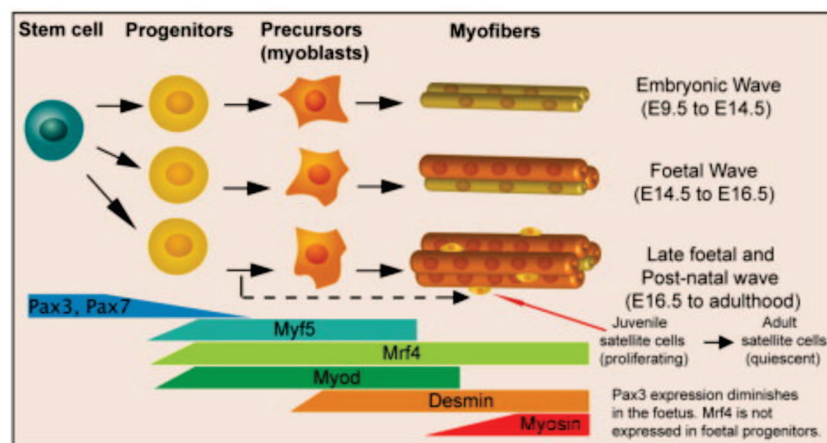


Figure 9. Illustration of lineage progression and multiple waves of developmental myogenesis. Extracted from Sambasivan and Tajbakhsh 2007

In addition, Myf5/MyoD null mutants lack skeletal muscle due to absence of myogenic precursor population (Rudnicki et al., 1993). The cells upon arriving in the limb bud switch off Pax3 and Lbx1 expression and express myogenic regulatory factors (MRFs). Myf5 controls the expression of MRF4 and MyoG, that start the final differentiation and fusion of precursors to form myotubes expressing slow or fast myosin heavy chain and hence, primary myofibres (Hasty et al., 1993; Nabeshima et al., 1993). The first myofibres are formed by E14.5 and will serve as a matrix for fusion of the second or foetal wave of myoblasts between E14.5 and E16.5. Following this the number of fibres does not change (Figure 9). The muscle growth happens via increase in cytoplasmic volume, production and incorporation of contractile machinery and fusion of the satellite cells to the pre-existing fibres (Sambasivan and Tajbakhsh 2007).

II.2 Adult myogenesis: muscle satellite cells

Adult skeletal muscle is a stable and post-mitotic tissue. Like any other tissue, it repairs itself or regenerates through stem cells, here called, satellite cells. Satellite cells lie under the basal lamina that surrounds each muscle fibre. The steady state muscle fibre turn over is in general low. However, injury and wear & tear caused by physical exercise or resistance training leads to the damage of muscle fibres which is recovered by activation of the quiescent satellite cells, rapid proliferation to committed myoblast state, and fusion with pre-existing or newly formed fibres.

II.2.1 Embryonic origin of satellite cells:

Satellite cells are Pax7⁺ and they lie in quiescent state adjacent to mature fibre under the basal lamina. They were identified for the first time in electron micrographs due to their unique anatomical position between basal lamina and the sarcolemma of mature fibre and, heterochromatin dense nuclei, which showed that these were mitotically quiescent cells (Mauro, 1961). They originate from the Pax3/Pax7⁺ cells in the dermomyotome during embryonic myogenesis. Many studies using lineage tracing experiments and classic chick-quail grafting experiments have shown that adult Pax7⁺ stem cells arise from the Pax3⁺/Pax7⁺ precursor cells in the dermomyotome (Manceau et al., 2005; Relaix et al., 2005). Pax7 expression is a hallmark of the resting adult muscle stem cells. Depletion of Pax7-expressing satellite cells showed complete lack of regeneration of adult skeletal muscles (Lepper et al., 2011; Relaix et al., 2005; von Maltzahn et al., 2013).

The three important aspects of the satellite cells behaviour are - their activation in response to intrinsic and extrinsic cues, proliferation and commitment to myogenic lineage and differentiation, and lastly self-renewal for the maintenance of the stem cell pool. There are about 0.2 to 1 million satellite cells per gram of muscle tissue that represents only 2-10% of total myonuclei (Hawke and Garry, 2001; White et al., 2010). Yet, the very small population of stem cells gives tremendous regenerative capacity to skeletal muscles.

II.2.2 Other Myogenic stem cells:

Several studies have elucidated the role of cells derived from other lineages in muscle regeneration. When co-cultured with myoblasts, muscle resident side populations and Bone marrow derived progenitors have shown myogenic potential (Asakura et al., 2002; Ferrari et al., 1998). Similarly, mesangioblasts, pericytes, CD133⁺ progenitors and PW1⁺ interstitial

cells are able to participate in formation of multinucleated myotubes (Dellavalle et al., 2011; Mitchell et al., 2010). These cells seem to co-operate or add to the myogenic potential of the satellite cells during regeneration but fail to elicit myogenic properties in the absence of Pax7⁺ satellite cells.

II.2.3 Satellite cell activation and myogenic differentiation:

Myogenic regulatory factors (MRFs) lay the blueprint of satellite cell myogenesis. These include Myf5, MyoD, MyoG and Mrf4 (Myf6). As shown in figure 10, Myf5, one of the MRFs, is highly expressed in quiescent satellite cells (Beauchamp et al., 2000; Zammit et al., 2004). This was demonstrated by using Myf5-driven expression of reporter in satellite cells. However, there are a small percentage of satellite cells that do not express Myf5. It has been proposed that Myf5⁻ cells may represent the stem cell pool that is meant to renew the satellite cell population (Day et al., 2007; Kuang et al., 2007).

Upon activation, the satellite cells continue to express Myf5 and proliferate rapidly. However, no Myf5 protein is detected in differentiated myotubes. In fact, the process of differentiation initiates with decline in Pax7 and Myf5 expression and simultaneous onset of MyoD followed by Myogenin (MyoG) expression. Eventually, MyoD is also downregulated and MyoG and MRF4 are upregulated. This leads to fusion of myoblasts to form multinucleated myotubes (Megency and Rudnicki, 1995).

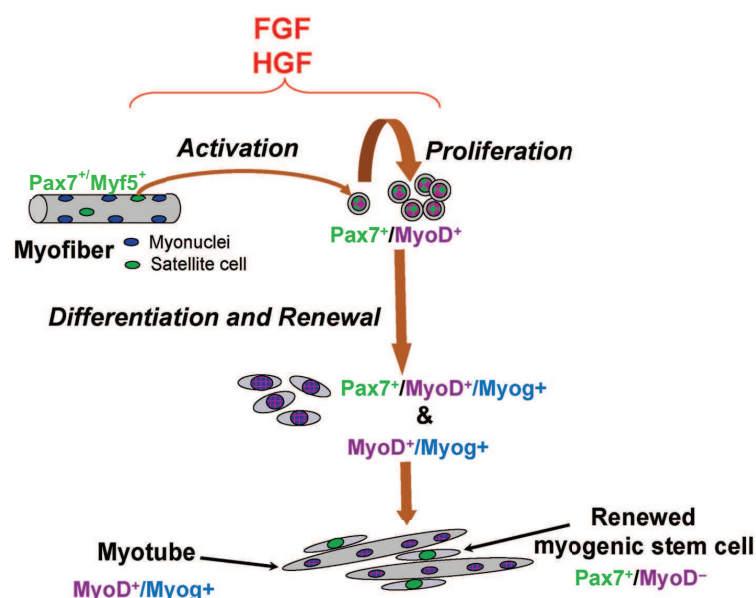


Figure 10. Schematic showing transcriptional control of satellite cell activation, proliferation and differentiation (Yablonka-Reuveni et al., 2008)

II.2.4 Extrinsic and intrinsic regulators of adult myogenesis:

Satellite cells express a variety of proteins that have also been used for their identification and purification, although none of these markers are unique to satellite cells but they facilitate isolation of populations enriched in cells with myogenic potential. These include CD34, M-cadherin, Pax-7, syndecan-3, syndecan-4, CXCR4 and c-met (Beauchamp et al., 2000; Cornelison et al., 2001; Seale et al., 2000).

The growth factors critically important in activation, proliferation and maintenance of satellite cells are HGF, FGFs and IGF-1 and GDF8/myostatin, respectively. Hepatocyte growth factor (HGF) is expressed in inactive form by the ECM and its receptor c-met is by expressed by quiescent satellite cells (Miller et al., 2000). Similarly, FGFs are released as a response to injury and FGF-R1 and FGF-R4 are expressed by quiescent satellite cells (Heszele and Price, 2004; Husmann et al., 1996). HGF and FGFs promote satellite cell activation and proliferation and delay differentiation partially by inhibiting MyoD expression (Maley et al., 1994). They require heparan sulphate proteoglycans (syndecan-3 and -4) for signalling via their receptors (Cornelison et al., 2001). Release of HGF at the site of injury activates mTOR in distant satellite cells rendering them ready for action (G_{Alert} state) (Rodgers et al., 2014). FGF2 is highly expressed in regenerating muscle and activates MAPK and ERK pathways in satellite cells (Yablonka-Reuveni et al., 1999). Inhibition of p38 α/β MAPK prevents satellite cells from entering cell cycle (Jones et al., 2005) and ERK activation is crucial for G1 to S phase transition (Jones et al., 2001). JNK/MAPK pathway was also shown to activate cyclin D1 and promote cell cycle progression (Perdiguero et al., 2007).

IGF-1 promotes myogenic differentiation by activating protein synthesis signalling pathways via 4E-BP translation factor and ribosomal protein S6 kinase and inhibiting muscle-specific E3 ligases involved in protein degradation (Heszele and Price, 2004).

On the other hand, Myostatin/GDF8, a muscle specific TGF- β family member prevents satellite cells from entering into cell cycle by induction of p21 and suppression of CDK25. Myostatin null mice have increased number of actively proliferating satellite cells (McCroskery et al., 2003; McPherron et al., 1997).

Interestingly, Notch signalling pathway plays an important role in timely expansion and differentiation of myogenic progenitors. This dual role is facilitated via upregulation of Notch ligand, Delta, on the satellite cells as well as adjacent damaged fibres. Delta marks the

intermediate step of transit amplifying cells. Inactivation of Notch via expression of Numb, an intracellular antagonist of Notch pushes the cells forward to differentiation (Conboy and Rando, 2002).

II.2.5 Self-renewal of satellite cells:

Self-renewal is a property intrinsic to stem cell populations and required for the sustenance of the stem cell pool for tissue repair and homeostasis. Satellite cells have been shown to undergo both symmetric and asymmetric cell divisions in order to produce sufficient myogenic progenitors as well as renewal of the satellite cell pool.

Lineage tracing experiments in *Myf-5Cre/ROSA26-YFP* mice revealed that there remains a minor population of YFP negative cells that is able to perform symmetric divisions that will help renew the satellite cell pool. The rest undergo asymmetric divisions to give a committed progenitor and a stem cell (Kuang et al., 2007).

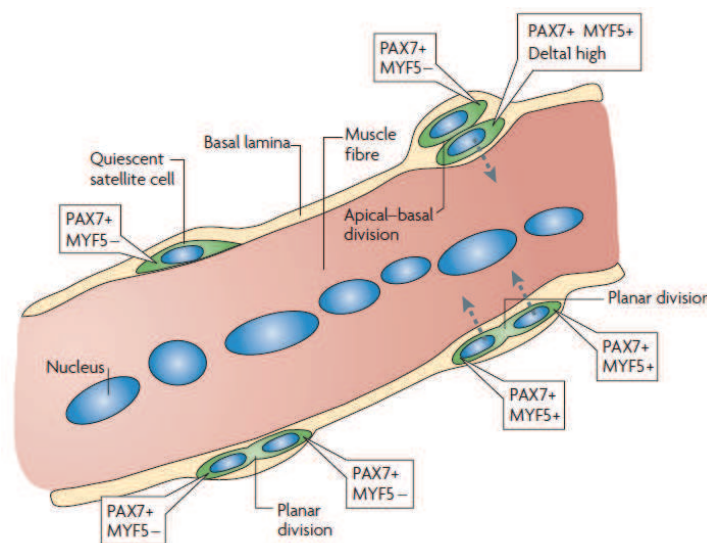


Figure 11. Adult myogenesis and self-renewal. Activated satellite cells may divide into fashions. Satellite cells dividing via planar divisions give rise to daughter cells with symmetric *Myf5* expression and those dividing in apical-basal plane have asymmetric *Myf5* expression, giving rise to *Myf5*⁺ committed progenitors and *Myf5*⁻ uncommitted satellite cells. (Bentzinger et al., 2012)

During asymmetric cell divisions, there is unequal segregation of cell fate determinants (Figure 11). While Notch3 receptor is expressed only in a *Myf5* negative cell, the *Myf5* positive daughter cell inherits Notch ligand, Delta1 (Kuang et al., 2007). Similarly, the Notch

antagonist Numb was expressed only in MyoG positive committed daughter cell (Conboy and Rando, 2002). Asymmetric division is also paralleled by asymmetric segregation of DNA. The daughter cell inheriting old DNA strand retains Pax7 expression, whereas the other receiving the new DNA strand becomes MyoG positive (Yennek et al., 2014). The symmetric divisions are planar while asymmetric divisions are apico-basal in polarity (Figure 11). It appears that the basal daughter cell may be receiving cues from the basal lamina, while the apical daughter cell is exposed to cues from the regenerating muscle fibres. The differential cues might be indeed leading to the apico-basal orientation of dividing cells, hence, asymmetric segregation of cell fate determinants. Thus, a balance between the symmetric and asymmetric divisions seems to be essential for muscle regeneration and satellite cell renewal.

III. Signalling pathways in Muscle plasticity:

Adult Skeletal muscle is a highly adaptive tissue. It plays an important role in whole-body metabolism and responds to environmental cues such as exercise, stress, glucose etc. It can adapt in two most important ways- regulation of muscle mass, which is dependant on fibre size & number and muscle function that depends on fibre type. It is via signalling pathways that environmental cues communicate and result into a specific muscle phenotype, having profound effects on contractile properties and metabolic state of the muscle fibres and hence their function.

III.1. Muscle fibre types:

The vertebrate body musculature is composed of several muscle groups and these muscle groups differ in different physiological properties depending on the functional needs. The myofiber diversity that comes from distinct muscle functional units, fibre type composition and motor units lends the body the ability to perform different functions that require strength, endurance, speed and fatigue resistance.

Muscle fibre types have been classified on the basis of myosin heavy chain (MyHC or MHC) isoform expression as: Type I, IIa, IIb and IIx fibres (Pette and Staron, 2000). Type I and IIa fibres exhibit oxidative metabolism, while type IIb and IIx are glycolytic in nature. Type I fibres are also called slow twitch fibres owing to their slower contraction due to Myosin I ATPase activity. They are rich in mitochondria, are oxidative, have slower velocity of shortening and high resistance to fatigue. While the Type II fibres are fast-twitch, contract

faster, have low mitochondrial content and get fatigued rapidly (Brooke and Kaiser, 1970; Guth and Samaha, 1969). Type I fibres are required for posture and endurance demanding tasks, while Type II are involved in movements requiring speed and strength. (Pette and Staron, 2000).

Interestingly, in small mammals like rat and mouse, the muscles are composed mostly of IIB and IIX fibres with abundant mitochondria and type I are mostly confined to rare muscles like soleus. In large mammals, including humans, muscles consist mainly of Type I and IIA fibres with relatively lesser mitochondrial content (Smerdu et al., 1994).

Muscle fibre composition changes from embryonic to neonatal to adult muscle development. Several myosin heavy chains are no more expressed in adult organism while others get upregulated during adult development. In mouse, before E16 all muscle fibres express both MyHC-emb and MyHC- β /slow and both fast & slow isoforms of myosin heavy chain (Condon et al., 1990). At E16, fibre diversification starts with loss of MyHC-slow expression and gain of MyHC-neo expression (Lyons et al., 1990). It is only after birth that MyHC-emb and MyHC-neo start to disappear overlapping with upregulation of fast-type 2A, 2B and 2X MyHC with complete transformation by week 4 (DeNardi et al., 1993). Figure 12 shows the various myosin heavy chains expressed at different times or different muscle groups.

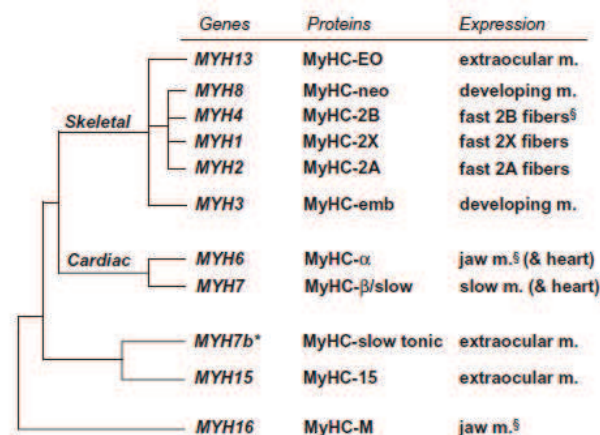
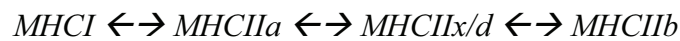


Figure 12. Sarcomeric MYH genes with corresponding protein products and their expression pattern in skeletal muscles. Scheme modified from (C, 2015; Schiaffino and Reggiani, 2011)

Muscle fibre transitions from fast-to-slow or vice-versa can occur as a result of changes in neuromuscular activity, mechanical stress, hormonal changes, and age. For example, denervation of a slow muscle leads to shift to fast-type fibres (Huey and Bodine, 1998). Also,

Glucocorticoids favour fast-to-slow transition while Thyroid favours slow-to-fast transition (Simonides and van Hardeveld, 2008)

The fibre-type transition is a reversible phenomenon that generally occurs in the following pattern:



Traditionally, the fibre types have been easily classified based on the myosin heavy chain composition. However, fibre-type differences are also observed in expression profiles of other muscle proteins such as tropomyosin, myosin light chain, parvalbumin and sarcoplasmic reticulum calcium ATPase (SERCA) (Pette and Staron, 1997; Schiaffino and Reggiani, 1996).

III.2 Calcineurin/NFAT/MEF2 pathway

Calcineurin or PP2B is a calcium/calmodulin regulated serine-threonine protein phosphatase that acts on NFAT (nuclear family of activated T cells) transcription factors, leading to their movement into the nucleus thereby facilitating their transcriptional activity. It comprises of a calmodulin binding catalytic A subunit and a calcium-binding regulatory B subunit (Crabtree, 1999). It is well known that skeletal muscle uses calcium as a second messenger to respond and adapt to environmental stimuli (Berchtold et al., 2000).

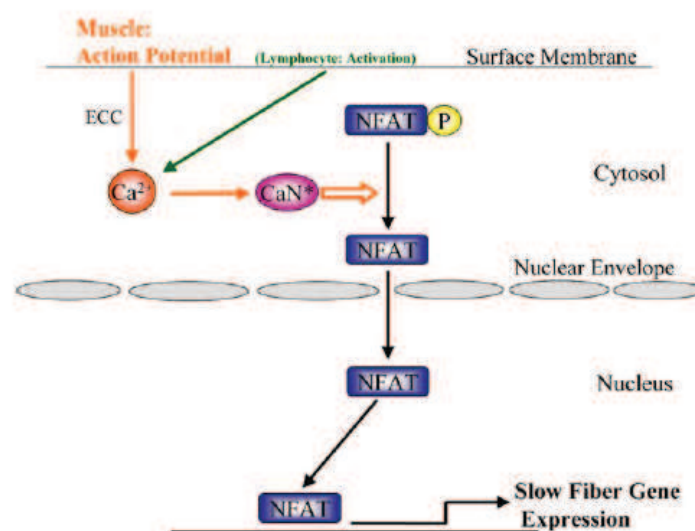


Figure 13. Schematic diagram for Ca^{2+} / calcineurin/NFAT pathway involved in slow-fibre type gene expression. Elevated cytosolic Ca^{2+} , produced in a muscle fibre during muscle contraction activates the cytoplasmic Ca^{2+} dependent phosphatase Calcineurin (CaN). CaN dephosphorylates cytoplasmic NFAT-P and NFAT then translocates to the nucleus where it activates genes implicated in slow muscle phenotype. (Modified from Liu et al, 2005)

Changes in the intracellular calcium levels regulate the contractile activity of muscle and also give rise to gene expression changes required for growth and remodelling. Elevation of intracellular calcium activates Calcineurin, thereby, dephosphorylating and translocating NFAT transcription factors to nucleus (Liu Y 2005).

Several *in vitro* and *in vivo* studies have confirmed the role of Calcineurin signalling in skeletal muscle remodelling. Ectopic expression of active form of calcineurin in C2C12s results in upregulation of slow-fibre type specific genes such as myoglobin, MHCI, slow troponin I via combined activity of NFAT and MEF2, while cyclosporine A mediated inhibition of calcineurin *in vivo* promotes slow-to-fast transition (Chin et al., 1998; Delling et al., 2000). Targeted mutagenesis of *cna α* and *cna β* in mice leads to a reduction in oxidative/slow fibers in several muscles (Parsons et al., 2003). Conversely, transgenic mice expressing activated calcineurin under the control of the MCK enhancer exhibited increased numbers of slow-type myofibers (Naya et al., 2000).

In addition to NFAT, MEF2 family members are also involved in calcineurin dependant reprogramming of muscle fibre-type specific gene expression. Calcineurin can directly interact with MEF2, dephosphorylate it and thereby indirectly upregulate MEF2 target genes during physiological adaptation of exercised muscle leading to conversion of a resting type IIb into contractile type I fibre (Wu et al., 2001). To further insist on the role NFAT in slow-fibre type gene expression, a recent study showed that muscle specific NFATc1 knockout mice have lower percentage of slow fibres in soleus muscle. NFATc1 KO mice also showed impairment in exercise-inducible fast-to-slow transition. The study also pointed to out to the negative regulation of MyoD activity by NFATc1, as MyoD is a promoter of fast-type gene expression program (Ehlers et al., 2014).

III.3 Calmodulin Kinase/HDAC/MEF2 signalling

MEF2 transcription factors have an important role both in muscle differentiation and fibre type switch. There are four genes in MEF family (MEF2a, MEF2b, MEF2c and MEF2d). Their expression increases during exercise or electrical stimulation/neural activity promoting fast-to-slow type transition. Both NFAT and MEF2 binding sites are present in the enhancer regions of the slow fibre type-specific genes (Chin et al., 1998). Class II histone deacetylases (HDAC4, 5,7 and 9) bind to MEF2 proteins in the nucleus and inhibit their transcriptional activity. The presence of HDACs in the nuclei is in turn regulated by Calcium/calmodulin dependant protein kinase (CaMK). Elevated intranuclear calcium activates the calmodulin

kinase, that then phosphorylates the HDACs, prevents formation of the HDAC-MEF2 complex and exports them out of the nucleus and hence, activating transcription of MEF2-dependant genes (McKinsey et al., 2000).

Upstream blocking of CaMK signalling via inhibitors blocked the translocation of HDAC4 from nucleus to cytoplasm in cultured muscle fibres (Liu et al., 2005a; Rodgers et al., 2014). Furthermore, *Hdac5* and *Hdac9* double knockouts showed increased number of slow fibres in soleus and increased levels of MHC I and MHC IIA transcripts in both soleus and plantaris (Potthoff et al., 2007). CaMK II, one of the Calmodulin dependent kinases is expressed in skeletal muscle and has been shown to be sensitive to differential calcium oscillations (De Koninck and Schulman, 1998). Moreover, constitutive overexpression of CaMKIV, not a traditional muscle CaM kinase, lead to increase in type I fibres, mitochondrial biogenesis and upregulation of oxidative enzymes (Wu et al., 2002).

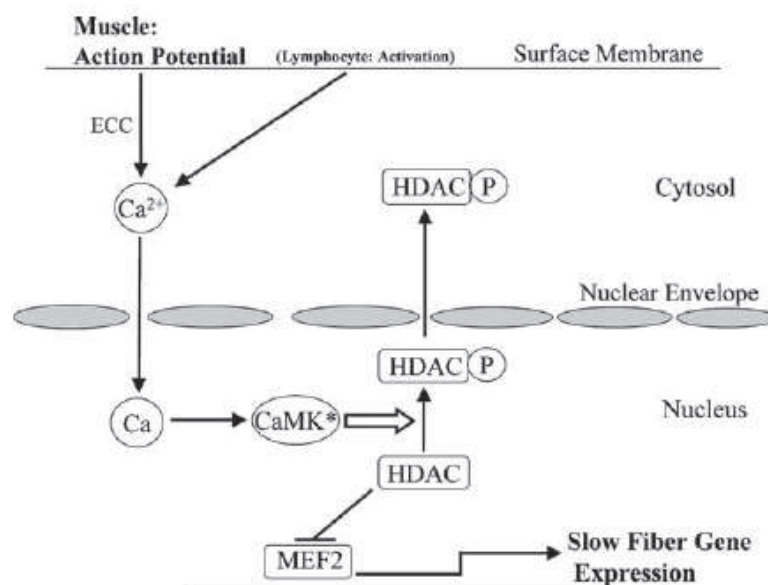


Figure 14. Schematic diagram of the Ca^{2+} /CaMK/HDAC pathway for activation of slow fibre gene expression. Elevated nuclear calcium leads to the activation of intranuclear CaM kinase. Activated nuclear CaMK phosphorylates HDAC in the nucleus, allowing HDAC to exit from the nucleus via the nuclear export system and thereby removing the HDAC repression of MEF2 activation of slow fibre type gene expression.

III.4 The PGC-1 α co-activator

Peroxisome proliferator-activated receptor gamma coactivator 1-alpha (PGC-1 α) is a transcriptional co-activator as well as a regulator of metabolism. On one hand, it plays a key

role in mitochondrial biogenesis and function (Wu et al., 1999) and on the other hand, it activates expression of slow, oxidative type-fibre genes in co-operation with MEF2. PGC-1 α is expressed at higher levels in the oxidative type I and type IIa muscle fibres. Moreover, skeletal muscle-specific overexpression of PGC-1 α lead to an increase in type I fibres in plantaris muscle (Lin et al., 2002). Similarly, inactivation of PGC-1 α in skeletal muscle resulted in a shift from oxidative type I and IIa to type IIb and IIx fibres with reduced endurance capacity and increased damage after endurance exercises (Handschin et al., 2007).

PGC-1 α interacts with several nuclear receptors and non-nuclear receptor type transcription factors (Figure 15). Nuclear receptors such as PPAR δ bind its N-terminus LXXL and LLXXL domains, which TFs like MEF2 interact with the C-terminus of PGC-1 α . It acts as a docking platform for the assembly of HAT, Mediator and SWI/SNF complexes (Li et al., 2008; Wallberg et al., 2003).

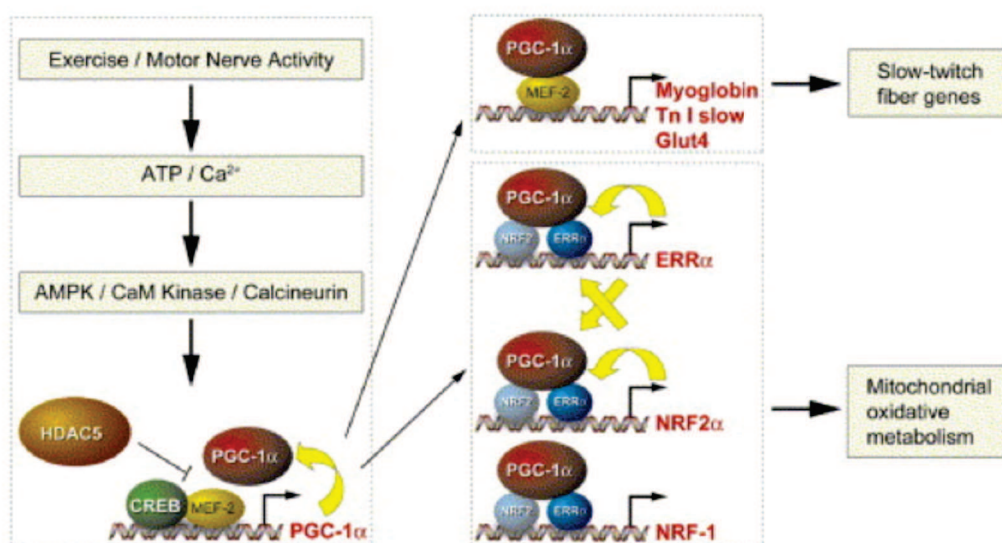


Figure 15. Regulation of PGC-1 α expression in skeletal muscle and mechanisms by which PGC-1 α stimulates mitochondrial gene expression. Coactivation of MEF2 by PGC-1 α provides a positive feed-forward signal to rapidly induce PGC-1 α expression following muscle contraction. PGC-1 α induces the expression of ERR α , which activates the expression of NRF-1, NRF-2, and ERR α itself. These molecular events lead to the stimulation of nuclear-encoded mitochondrial genes. PGC-1 α also simultaneously regulates the expression of slow-twitch muscle fiber genes through coactivation of MEF2. Extracted from (Lin et al., 2005)

Endurance exercise has been identified as one of the major extrinsic stimuli for PGC-1 α stimulation with resultant shift to oxidative metabolism. Motor neuron induced contractions

also activate PGC-1 α transcription via calcium signalling (Pilegaard et al., 2003; Wu et al., 2002). As a first response to exercise, the PGC-1 α protein is stabilised via phosphorylation by the activated p38 MAPK (Wright et al., 2007). Energy deprivation activates AMPK signalling which induces PGC-1 α expression (Zong et al., 2002). PGC-1 α induces the expression of ERR α (estrogen-related receptor alpha), which in turn activates NRF-1 and NRF-2 transcription factors. Together, ERR α and NRFs activate mitochondrial biogenesis genes and oxidative metabolism (Schreiber et al., 2004). In addition, as PGC-1 α is a direct MEF2 target, it regulates its expression via a positive autoregulatory loop by co-acting with MEF2 on its own promoter and slow-twitch fibre genes simultaneously (Handschin et al., 2003).

IV. Transcriptional and epigenetic blueprint of myogenesis

In last decade or so, many studies have come about describing the function and mechanism of transcriptional regulation of myogenesis. MRFs – MyoD, MyoG, Myf5, Mef2 along with some others have been shown to bind and regulate the gene expression changes in myogenesis. At the same time, last few years have seen a rise in the number of studies investigating chromatin modifications and remodelling during myogenesis. This chapter reviews briefly the mechanism of transcriptional and epigenetic regulation during myogenesis so as to better understand the muscle specific dynamic regulation of gene expression. The emphasis will be mainly on some general aspects of transcription, and then muscle-specific transcriptional regulation, including the role of enhancers and enhancer activation itself.

IV.1. Players in eukaryotic transcriptional regulation in a glimpse:

Transcription, i.e. the synthesis of messenger RNA (mRNA) molecules from a template DNA strand by RNA Polymerase II, is the fundamental step of gene expression in all living organisms. Not all protein coding genes are transcribed at all times, rather, specific biological functions in a living cell require specific set of genes to be expressed in a spatio-temporally controlled manner. This tight regulation of transcription mostly happens the step of transcription initiation and is facilitated either by *trans*-acting transcription factors (TFs) that regulate the activity or binding of Pol II to the gene promoters or recognise and directly bind

specific *cis*-acting transcriptional regulatory DNA elements. The *cis*-acting DNA elements contain recognition sites for *trans*-acting DNA-binding transcription factors, which either enhance or repress transcription (Maston et al., 2006). The *cis*-acting DNA elements include the core promoter, proximal and distal regulatory elements (enhancers, silencers and insulators). The presence of multiple regulatory elements provides for combinatorial regulation of transcription, which is essential for fine-tuning of gene expression in complex organisms.

IV.1.1 Core Promoter

The core promoter is the region at the start of the gene that defines the position of the transcription start site (TSS) as well as the site where the pre-initiation complex is formed. A typical focussed core promoter extends 40bp upstream and downstream the TSS (Figure 16) and comprises of certain DNA motifs such as the TATA box, BREu (the upstream TFIIB recognition element), INr (initiator), DPE (downstream promoter element), MTE (motif ten element), DCE (downstream core element), TCT motif (polypyrimidine initiator motif) and XCPE1 (X core promoter element 1), that are bound by the different TFs and that aid the assembly of the PIC.

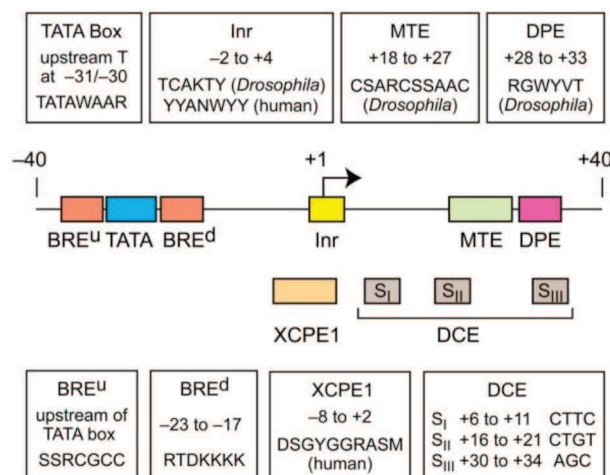


Figure 16. Some core promoter motifs for transcription by RNA polymerase II. This diagram is roughly to scale. These motifs are typically found in focused core promoters. There are no universal core promoter elements. It is likely that additional core promoter motifs remain to be discovered. The properties of any particular core promoter are dictated by the presence or absence of specific core promoter elements. For instance, as discussed in the text, a TATA-dependent core promoter with TATA + Inr motifs has different properties than a DPE-dependent core promoter with Inr + DPE motifs. Taken from (Juven-Gershon and Kadonaga, 2010)

There are no universal core promoter elements as all elements may not be present in the same gene promoter. For example, the TATA box is present only in one eighth of the promoters and BRE elements only in one fourth of the promoters (Gershenzon and Ioshikhes, 2005). This is mainly the case of the dispersed promoters, which may not comprise of all the elements and consist of a number of weak TSS distributed over a broad region of 50 to 100 bp and typically residing in the CpG islands in vertebrates. In coherence, the dispersed promoters were found to be more common than focused promoters in vertebrates. (Smale and Kadonaga, 2003). Figure 1 shows the various core promoter elements and roughly their location with respect to the TSS.

IV.1.1.1 TATA box

The TATA box was the first element of the core promoter to be identified (Goldberg, 1979). It consists of the consensus sequence TATATAA and is located 25-30 bp upstream of the TSS. A subunit of the TFIID complex hence named, the TATA binding protein (TBP), was identified to bind to the TATA box. It has now been established that only 10-15% of the mammalian core promoters actually consist of a TATA box (Carninci et al., 2006)

IV.1.1.2. Inr element

The initiator element marks the site of initiation of transcription (-2bp+4bp) and can function in synergy with the TATA box or independently to elicit basal transcription (Smale and Baltimore, 1989). It is the most common core promoter element as almost half the human promoters contain an Inr element (Gershenzon and Ioshikhes, 2005). The consensus sequence varies between species (YYANWYY in humans and TCAKTY in drosophila), however the nucleotide A is conserved as it represents the transcription initiation site. Several studies have shown that TFIID complex recognizes and binds the Inr element via two of its subunits – TAF1 and TAF2 (Chalkley and Verrijzer, 1999; Kaufmann and Smale, 1994).

IV.1.1.3 BRE elements

Initially, only one TFIIB recognition element upstream (BREu) of the TATA box was identified with the consensus sequence SSRGCC (Lagrange et al., 1998). Later, another BRE element (BREd), with the consensus sequence RTDKKK was identified downstream of the TATA box (Deng and Roberts, 2005). Both BREu and BREd can have a positive or negative effect on transcription in a promoter context dependent manner (Deng et al., 2009). Although, TFIIB is shown to bind BRE elements with strong affinity, more recent studies

have demonstrated using CHIP-chip experiments that the presence of BRE elements is not necessary for TFIIB binding to the core promoter (Albert et al., 2010).

IV.1.1.4 DPE and MTE motifs

The DPE is a core promoter element located downstream (+28 to +33) to the Inr element and was first identified as a recognition site for TFIID. It is conserved from *Drosophila* to humans (Burke and Kadonaga, 1996). More precisely, TAF6 and TAF9 dimeric complex shows DPE-binding specificity at least in *in vitro* assay. The DPE consensus sequence (A/G)G(A/T)CGTG is found in most TATA-less promoters and is analogous to a TATA box in function (Burke and Kadonaga, 1996).

Like DPE, the Motif ten element (MTE) is also a TFIID recognition site and is located upstream of the DPE from +18 to +27 relative to the TSS. This site is also conserved from *Drosophila* to humans. The MTE can also work in cooperation with the Inr element, independent of the DPE and TATA box (Lim et al., 2004; Ohler et al., 2002).

IV.1.1.5 The X core promoter element 1 (XCPE 1)

The XCPE 1 is a rare element of promoter located from -8 to +2 relative to TSS. The sequence of XPCE1 is DSGYGGRASM (Tokusumi, Ma et al. 2007) and is present in only 1% of the human core promoters, most of which are devoid of TATA-box. It does not function by itself, instead requires the sequence specific activators such as NRF1, NF-1 and Sp1.

IV.1.1.6 CpG islands and TATA-less promoters

CpG islands (CGIs) are, on average, 1000 base pairs long stretches of genomic DNA that show an elevated G+C base composition, little CpG depletion, and frequent absence of DNA methylation. Approximately 70% of annotated gene promoters are associated with a CGI, making it the most common promoter type in the vertebrate genome (Saxonov et al. 2006). CGI promoters include virtually all the housekeeping genes, as well as a proportion of tissue-specific genes and developmental regulator genes (Larsen et al. 1992; Zhu et al. 2008). Recent work has uncovered a large class of CGIs that are remote from annotated transcription start sites (TSSs), but nevertheless show evidence for promoter function (Illingworth et al. 2010; Maunakea et al. 2010). These promoters typically lack the canonical TATA-boxes, DPEs and the Inr motifs. Bioinformatics analysis suggests that BRE elements are frequently found in the CpG + DNA than in the CpG- DNA (Gershenson and Ioshikhes 2005). Transient

reporter gene assays examining the activity of about 5000 human promoters found that ubiquitously active CGI promoters tended to be enriched for Sp1, Nrf-1, E2F, and ETS transcription factor-binding motifs, each of which contains a CpG (Landolin et al. 2010).

IV.2 Proximal and distal enhancers:

The basal transcriptional machinery recognises the various promoter elements and help recruit Pol II by the formation of pre-initiation complex comprising of the basal transcription factors, mediator and Pol II. This is sufficient to start transcription, however, transcription is often weak in the absence of regulatory DNA regions that are more distant from the TSS; these regions are called enhancers or *cis*-regulatory modules (CRMs).

CRM consist of short DNA motifs that act as recognition sites for various other context and sequence-specific transcription factors that modulate the transcription at the promoter in question such that the combined regulatory cues of all CRM bound factors determine the activity of the enhancer.

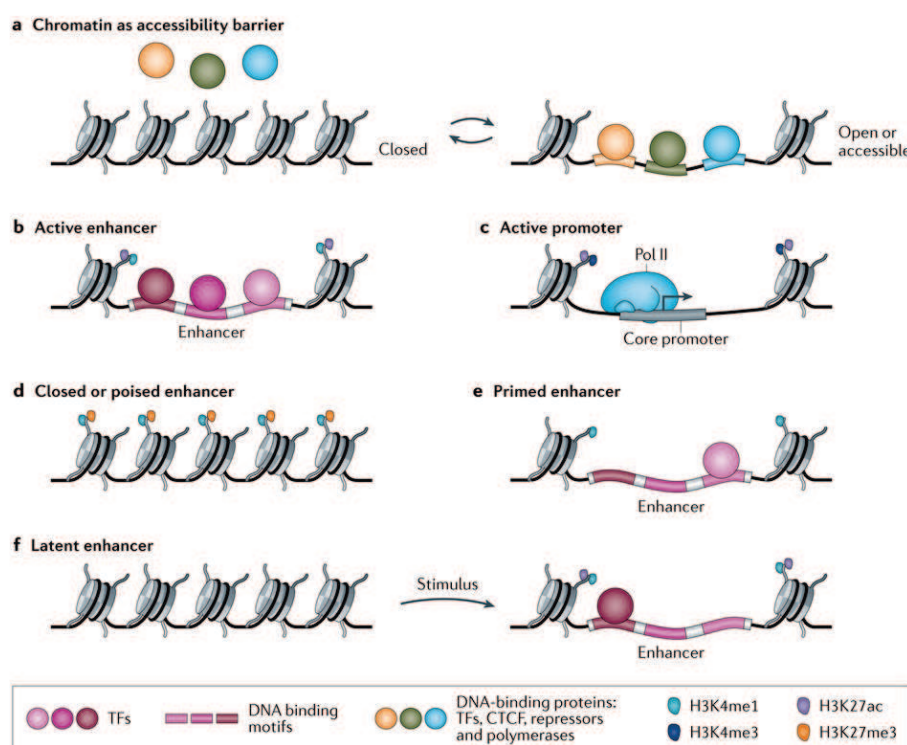


Figure 17. Histone modification signature in different chromatin states and their association with transcription status. Adapted from (Shlyueva et al., 2014).

In addition, enhancer activity has been shown to correlate with certain properties of chromatin. Active enhancers can be usually located in the nucleosome free regions so as to make the DNA accessible for transcription factors. The nucleosomes in the vicinity of active enhancers typically contain histones with characteristic post-translational modifications, such as histone H3 lysine 4 monomethylation (H3K4me1) and H3K27 acetylation (H3K27ac), at their amino termini, which the enhancers in the nucleosome-bound repressed chromatin state are characterised by histone modifications such as histone H3K9me3 and H3K27me3 (Shlyueva et al., 2014). Although H3K4me1 can be associated with both active or repressive marks, it generally defines a poised enhancer.

IV.3 Role of the Core/basal Transcription Machinery in Myogenesis:

Our knowledge on the role of the core transcription machinery in the regulation of muscle-specific gene expression is relatively less and this area of research has many open questions.

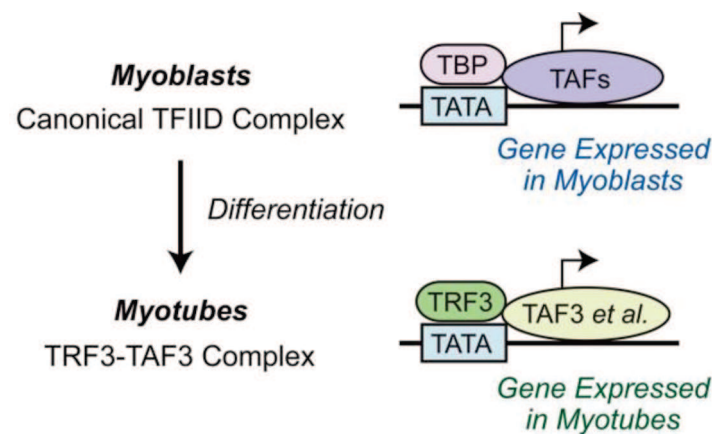


Figure 18. Replacement of the canonical TFIID complex by a TRF3-TAF3-containing complex during terminal differentiation of myoblasts into myotubes. Both complexes bind to TATA box motifs via the TBP or TRF3 subunits. Adapted from (Juven-Gershon and Kadonaga, 2010)

Until recently, muscle-specific transcription was primarily attributed to prototypic enhancer-binding factors, while the role of core promoter recognition complexes in directing myogenesis remained unknown. The general transcription factor TFIID is comprised of TBP (the TATA-box binding protein) and a number of TAFs. Deato and Tjian (2007) have reported that TFIID is degraded during the differentiation (Figure 18) of C2C12 cells and replaced by a simpler complex of TRF3 (a TBP-related factor) and TAF3 (Deato and Tjian,

2007). This new complex is required for MyoD to activate the MyoG promoter through a direct interaction of TAF3 and MyoD/E47 heterodimers (Deato et al., 2008) and knockdown of either component thus blocks differentiation. This may also imply that MyoD can communicate and direct transcription with two alternative core basal machineries. Moreover, the tissue-specific TAFs have been shown to counteract PcG proteins to promote terminal differentiation (Chen et al., 2005).

IV.4 Transcription Factors and regulatory elements in myogenesis:

The major transcriptional gene regulatory network involved in myogenesis is shown in Figure 19 (Buckingham and Rigby, 2014). Pax3/7, the upstream regulators of Myf5/MyoD have been shown to directly activate Id3, which encodes a HLH inhibitor of myogenic factor activity, potentially preventing, together with Id2, the onset of myogenesis in quiescent satellite cells (Kumar et al., 2009).

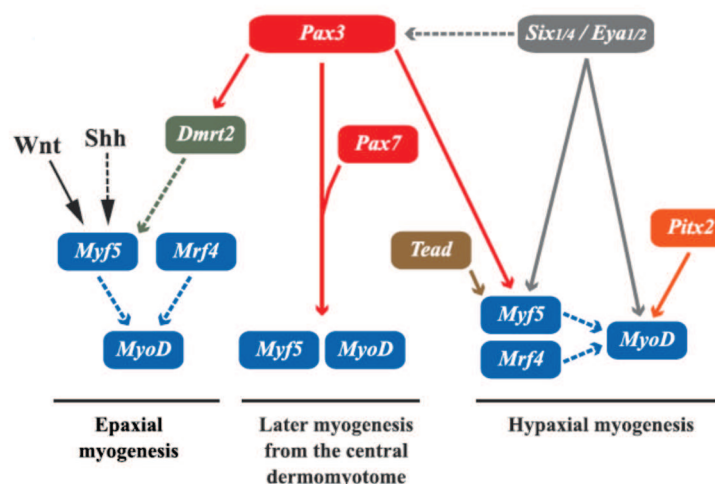


Figure 19. Schematic showing major transcriptional regulatory network in myogenesis. Adapted from (Buckingham and Rigby, 2014).

Prior to birth, Pax7 is not essential for myogenesis, presumably because Pax3 can compensate. After birth, on the other hand, Pax7 mutants lose their satellite cells and Pax3 cannot compensate even in trunk muscles such as the diaphragm, perhaps because the protein is present at too low a level or because of divergent Pax3 and Pax7 functions by this stage (Soleimani et al., 2012). Pax7-negative satellite cells can initiate differentiation, probably due to transcription of Myf5 in an increasing number of these cells from the perinatal period. Consistent with a role for Pax7 in the initiation of MyoD but not Myf5 transcription in most satellite cells in culture, introduction of dominant-negative Pax7 specifically abolishes MyoD

(Relaix et al., 2006) but not Myf5 expression or satellite cell differentiation. New insight into potential Pax7 targets in satellite cells comes from genome-wide ChIPseq and transcriptome analyses carried out on primary myoblasts derived from cultured satellite cells, in which a tagged Pax7 protein was expressed (Soleimani et al., 2012), shows that Pax7 targets many genes implicated in satellite cell function, including genes involved in cell growth, cell adhesion, and signaling pathways, whereas it represses genes involved in differentiation.

Six homeodomain transcription factors, with Eya and Dach cofactors (Kawakami et al., 2000), also play an important upstream role in myogenesis in regulation of Pax3 and other myogenic genes (Heanue et al., 1999). Eya function also involves recruitment of coactivators such as CBP to the Six complex (Jemc and Rebay, 2007). Six/Eya directly regulates enhancer elements of the Myf5 and MyoD genes (Giordani et al., 2007; Relaix et al., 2013). Six activation of MyoD is an important facet. Six1/Six4/Myf5 (Mrf4) compound mutants do not activate MyoD and do not form skeletal muscles in the trunk and limbs (Relaix et al., 2013).

The proximal regulatory region of Myogenin is also directly controlled by Six factors (Spitz et al., 1998) and again the double Six1/Six4 and Eya1/Eya2 mutant phenotypes indicate Six/Eya regulation of this myogenic differentiation gene. Six/Eya also controls downstream muscle genes, notably those associated with a fast glycolytic muscle phenotype that are downregulated in Six1/Six4 double mutants (Richard et al., 2011). Sox6, involved in suppressing the slow muscle phenotype in the mouse embryo, is not expressed in the Six1/Six4 double mutant. Six1 and Six4 bind to and trans-activate regulatory regions of fast muscle genes (Niro et al., 2010).

The MyoD family of myogenic regulatory factors (MRFs) controls the formation of skeletal muscle. These bHLH transcription factors act as obligate heterodimers with the ubiquitously expressed E proteins to activate the terminal differentiation program by regulating the transcription of many genes including those encoding the contractile proteins and muscle specific enzymes, as well as a number of miRNAs. The MRFs binds to E-boxes in promoters and enhancers in their target genes and act together with other transcriptional factors likes Mef2 and AP1 family of transcription factors and recruit co-regulators and Pol II.

MyoD preferentially binds to a VCASCTG sequence that resembles the in vitro-selected site for a MyoD:E-protein heterodimer, and MyoD binding increases during differentiation at many of the regulatory regions of genes expressed in skeletal muscle (Cao et al., 2010) Unanticipated findings were that MyoD was constitutively bound to thousands of additional

sites in both myoblasts and myotubes, and that the genome-wide binding of MyoD was associated with regional histone acetylation. Therefore, in addition to regulating muscle gene expression, MyoD binds genome wide and has the ability to broadly alter the epigenome in myoblasts and myotubes. Furthermore, Mousavi et al. (Mousavi et al., 2013) have identified 35k Myogenin (MyoG) sites in myotubes, the majority of which overlap with MyoD sites. MyoD also directs stem cells into the skeletal muscle lineage by binding and activating the expression of premyogenic mesoderm genes, prior to activating myoblast genes (Gianakopoulos et al., 2011). Blais et al. also showed that MyoD binds to several MyoG target genes before differentiation and sets the stage (Blais et al., 2005)

The ChIP-seq analysis by Fong et al. shows that MyoD binds to the CAGCTG E-box (shared with other bHLH proteins) but also a to a specific CAGGTG E box motif (Fong et al., 2012). Binding to the specific E-box sequences leads to activation of adjacent genes whereas binding to the common sequence correlates with regional epigenetic modification.

Considering the large number of sites bound by MyoD, it is clear that it extensively binds at the distal regulatory elements-which is indeed one of the mechanisms of tissue and stage specific gene expression regulation. A comparison of MyoD binding data with the histone marks that typify active and poised enhancers i.e. H3K27ac and H3K4me1 in myoblasts and myotubes reveals that MyoD binding essentially defines poised and active enhancers in myoblasts and myotubes (Blum et al., 2012).

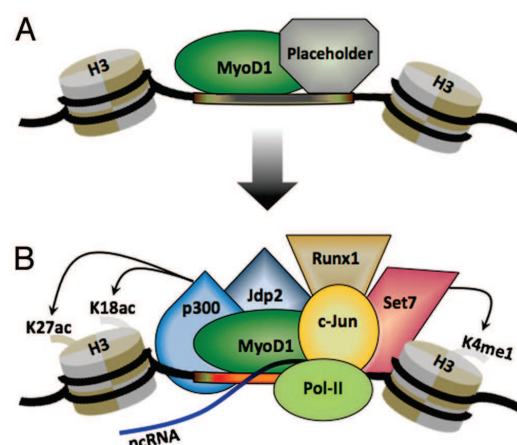


Figure 20. Model for the coordinate assembly at active MyoD1 enhancers in muscle. (A) MyoD1 co-binds to enhancers in conjunction with a putative pioneer factor (“placeholder”) that maintains them in a poised/inactive state. (B) Eviction (or inactivation) of enhancer-bound placeholder allows the recruitment of other transcription factors that positively regulate enhancer activity, leading to

acquisition of a transcriptionally active state, characterized by deposition of H3K4me1 and H3K27ac and often in non-coding transcription. Adapted from (Blum and Dynlacht, 2013)

In addition, Blum et al. also showed that approximately 10% of the context-specific enhancers were associated with non-coding transcripts, and ~60% of these enhancers displayed significant levels of RNA Pol II recruitment. These findings are in line with previous reports that suggest a cis-regulatory role for transcripts emanating from enhancers (De Santa et al., 2010; Kim et al., 2010). These enhancers also contain binding sites for AP-1 family and Runx1, Jdjp2 (Ostrovsky et al., 2002), Meis (Knoepfler et al., 1999) transcription factors that are recruited in a combinatorial manner in these enhancer sites to active transcription. This is inline with studies showing that MyoD plays a role in recruitment of various temporally controlled transcription factors (Figure 20) in myogenesis including c-Jun (Bengal et al., 1992), Fos (Li et al., 1992) and Runx1 (Umansky et al., 2015).

The differentiation programming requires a major change in chromatin landscape, as repressive marks at myogenic differentiation genes need to be erased and replaced with chromatin permissive histone modifications and nucleosome restructuring so as to enable Pol II recruitment and elongation. The major players in this process are the Histone acetyl transferases (HATs), ATP-dependent chromatin remodelling complexes, methyltransferases and demethylases.

IV.5 Histone Modifications:

The repressive mark of H3K27me3 is reduced at muscle specific regulatory regions by two distinct mechanisms. One is the suppression of Ezh2 expression by miR-26 and miR-214 (Juan et al., 2009; Wong and Tellam, 2008). Second, the active H3K27 demethylation by Six4-mediated recruitment of the UTX demethylase at Six4 and MyoD bound sites during myogenesis (Chakroun et al., 2015; Seenundun et al., 2010). Mixed lineage leukemia (MLL) proteins within the UTX complex provide a mechanism for replacement of a repressive mark with an active mark by the same protein complex (Rampalli et al., 2007).

Removal of HDACs from transcribed regions has been classically seen as a prerequisite for gene activation. Calcium-mediated activation of the calmodulin-dependent protein kinase (CaMK) stimulates MEF2 activity by dissociating it from class II HDACs (McKinsey et al., 2000). Class I HDACs are disengaged from MyoD via cell cycle-regulated events involving

pRb hypophosphorylation and thus promoting formation of pRb-HDAC1 complex in differentiated myotubes (Puri et al., 2001).

The HATs p300, PCAF are recruited at the muscle-activated genes by different transcription factors, including myogenic bHLH, MEF2 factors, SRF, six proteins, and ubiquitous transcriptional regulators [reviewed in (Sartorelli and Juan, 2011)]. Association of MyoD with the HATs p300 and PCAF (Puri et al., 1997) is promoted by AKT1 and 2 kinases via direct phosphorylation of p300 (Serra et al., 2007).

IV.6 ATP-dependent chromatin remodelling in myogenesis:

The nucleosome is the basic unit of eukaryotic chromatin, consisting of a histone core around which DNA is wrapped. The histone core contains two copies of each of the histone proteins H2A, H2B, H3 and H4 and is wrapped around by approximately 147 bp of DNA in a left-handed toroidal fashion. The polypeptide chains of the histone tails are subject to covalent modifications, including acetylation and methylation (as discussed in section above). At active genes or at genes that are poised for activation, histones H2A and H3 are replaced by the histone variants H2A.Z and H3.3. Beyond the nucleosome core is the linker histone, H1. Nucleosomes are arranged as a linear array along the DNA polymer as 'beads on a string'. The combination of nucleosome positions and their chemical and compositional modifications are key to genome regulation as the DNA inside each nucleosome is generally inaccessible to DNA-binding factors. Chromatin Remodelling complexes are thus necessary to provide access to the underlying DNA to enable transcription, DNA repair and other processes.

ATP-dependent chromatin-remodeling complexes regulate gene expression by either moving, ejecting or restructuring nucleosomes. These protein complexes have a common ATPase domain and energy from the hydrolysis of ATP allows these remodeling complexes to reposition (slide, twist or loop) nucleosomes along the DNA, expel histones away from DNA or facilitate exchange of histone variants, and thus creating nucleosome-free regions of DNA for gene activation.

In muscle-specific genome regulation, ATP-dependent SWI/SNF BRM and brahma-like 1 (BRG-1) chromatin remodeling complexes are recruited through their interaction with MyoD (de la Serna et al., 2001a; de la Serna et al., 2001b). This process is regulated via direct phosphorylation of the SWI/SNF BAF60c subunit mediated by the MAPK p38 (Simone et

al., 2004) and is required for binding of MyoD, myogenin, and MEF2d (de la Serna et al., 2005; Ohkawa et al., 2006). In mature myofibers, MyoG and Brg1 are preferentially co-localized to the myogenin promoter, to facilitate continued MyoG expression for the maintenance of the differentiated state.

More recently, it has been shown by 3C experiments that the spatial organization of late genes by MyoD-Brg1-mediated inter-chromosomal interactions between upstream sequences of late myogenic genes contributes in restricting late gene expression during the early stages of myogenesis (Harada et al., 2015).

Other major chromatin modifiers shown to be implicated in muscle differentiation are the arginine methyltransferases Prmt5 and Carn1/Prmt4. Prmt5 can symmetrically methylate arginine residues in a variety of cellular proteins, including histones (H3R8 and H4R3). Dacwag et al. showed that Prmt5 and dimethylated H3R8 (histone 3 arginine 8) localized at the myogenin promoter in differentiating cells and promote Brg1 ATPase-associated chromatin remodelling at myogenin promoter (Dacwag et al., 2007). Prmts are required for myogenic microRNA induction during differentiation. Mallappa et al. show that Prmt4 binds to the upstream regulatory regions of myogenic microRNAs and is required for dimethylation of the Prmt4 substrate, H3R17, at microRNA regulatory sequences. Absence of Prmt4 does not alter MyoD binding but prevents the binding of both MyoG and the Brg1 ATPase resulting in an inhibition of microRNA expression (Mallappa et al., 2011).

The FACT (Facilitates chromatin transcription) complex recognizes nucleosomes by acting as a histone chaperone that destabilizes the nucleosomal structure. It is composed of two subunits: SSRP1 and SPT16. Lolis et al. showed that the FACT complex promotes myogenin-dependent transcription at the onset of differentiation as it is specifically recruited to muscle-specific genes as differentiation initiates and then dissociates as differentiation proceeds (Lolis et al., 2013)

In this section, the transcription and epigenetic mechanisms involved in myogenic differentiation have been discussed. Some of relevant studies have been reviewed although this review is not exhaustive. But it gives an overall picture and incites thinking about the unknown and not yet described mechanisms that may be governing Tead-mediated transcriptional activation and repression of gene expression in myogenic program.

V. TEAD transcription factors

V.1 Identification and characterisation of TEAD/TEF family:

The TEAD transcription factors, previously also called TEFs (transcription enhancer factors) were first discovered during identification of SV40 enhancer binding proteins. SV40 is a cis-acting regulatory viral element that regulates transcription *in vivo* from RNA polII promoters via binding of various transcription activating proteins. TEF-1 or TEAD1 was first purified from HeLa extracts as a protein binding specifically to the GT-IIC and Sph motifs in the SV40 enhancer (Davidson et al., 1988; Xiao et al., 1991). Later, it was also shown to bind human papillomavirus-16 (HPV-16) enhancer and activate the E6 and E7 oncogenes (Ishiji et al., 1992).

Other Parallel studies described how TEADs were found to activate transcription of several mammalian genes like cardiac troponin T, smooth muscle α -actin, skeletal α -actin and Foxa-2 gene (Mar and Ordahl, 1988; Swartz et al., 1998) through a GT-IIC related MCAT (muscle CAT) conserved motif 5'-CATTCCCT-3', that was enriched particularly in muscle-specific genes such as cardiac troponin T, alpha-actins and beta-myosin heavy chain (Rindt et al., 1993) (Figure 21)

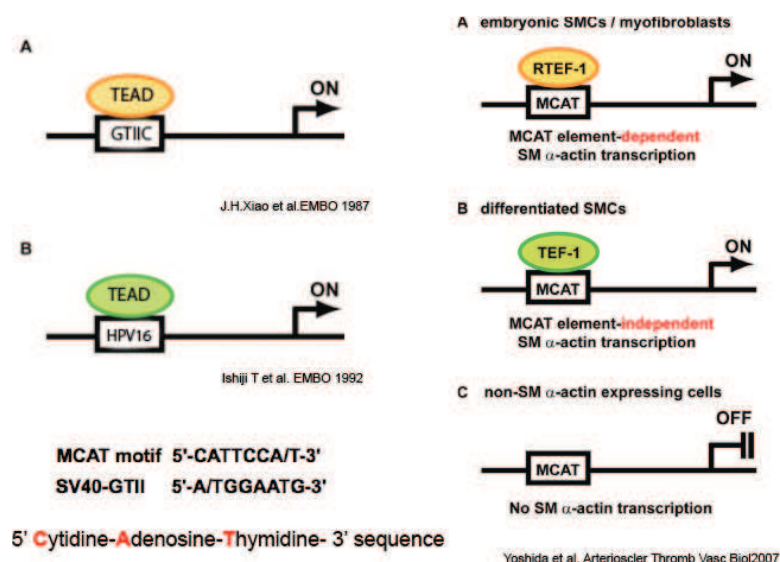


Figure 21. Identification of TEADs or TEFs as GT-IIC and MCAT binding transcription factors.

Four TEAD proteins have been identified so far in eukaryotes (TEAD1-4). Most tissues express at least one or more TEAD proteins. The four TEAD proteins share a highly

evolutionarily conserved DNA binding domain, called the TEA/ATTS domain, deriving the latter name from yeast, vertebrate, plant and fly transcription factors AbaA, TEC1, TEF-1 and Scalloped. AbaA regulates development of asexual spores (Andrianopoulos and Timberlake, 1994), TEC1 is required for filamentous growth in yeast *Saccharomyces cerevisiae* (Laloux et al., 1990) and Scalloped in *Drosophila melanogaster* is required for sensory neuronal development and wing development (Bray, 1999).

V.2 Tissue distribution:

Expression of TEADs at mRNA and protein levels has been widely studied and reported (Azakie et al., 2005; Jacquemin et al., 1996; Xiao et al., 1991; Yasunami et al., 1996). TEAD1 and TEAD4 are expressed in multiple tissues including skeletal muscle, lung and heart. While TEAD3 is lowly expressed in skeletal muscle, it is highly expressed in adult heart, placenta and other extra embryonic structures (Yasunami et al., 1996; (Azakie et al., 1996). TEAD2 is expressed in selected embryonic tissues such as distal portion of forelimb and hind limb buds, tail bud, cerebellum and testis (Yasunami et al., 1995). Kaneko et al., found that TEAD2 is one of the first proteins to be detected in a 2-cell embryo and is the only TEAD factor specifically expressed during first 7 days of embryonic development. It is absent in most adult tissues but is expressed in muscle, lung, heart and skin at low levels (Kaneko et al., 1997). However, later in 2008, it was shown that TEAD1, TEAD2 and TEAD4 were all detected in early embryos. TEAD4 was highest by E8 (Nishioka et al., 2008).

6.3 Transcriptional activation via MCAT element and the importance of its flanking sequences:

The MCAT (muscle-CAT) motif was first identified as a muscle specific regulatory element found in the distal promoter region of cardiac troponin T gene. Two copies of a conserved heptamer CATTCCCT sequence in the distal promoter element of cTNT gene were both required for the expression of cTNT in embryonic skeletal and cardiac development (Mar and Ordahl, 1988). Mutations in MCAT sequence disrupted TEAD binding and inactivated the cTNT expression (Mar and Ordahl, 1990). Since then, the MCAT element has been found in many other cardiac, smooth and skeletal muscle-specific genes, such as smooth muscle α -

actin (Swartz et al., 1998), skeletal α -actin (Karns et al., 1995), α -tropomyosin (Pasquet et al., 2006) and β -myosin heavy chain (Rindt et al., 1993), as shown in Table 1.

TEADs bind to tandemly arranged MCAT elements in promoter regions in a co-operative manner. Distance between the MCAT motifs is an important characteristic feature in the transcriptional activity of TEADs. In addition, TEADs bind only to the double stranded form of MCAT element and not to the single stranded form (Carlini et al., 2002). The sequences flanking the MCAT motif are found to be high in polypurine/polypyrimidine asymmetry and are in fact the binding sites for single-stranded DNA binding proteins such as Pur α , Pur β and MSY1 (Kelm et al., 1997; Sun et al., 1995). These proteins when bind to ssDNA flanking MCAT motif bring about local alterations that prevent the binding of TEAD1 protein to MCAT element and prevent activation of its target genes in tissue and context dependent manner. This was exemplified by a study regarding repression of the vascular smooth muscle α -actin gene that is normally activated in MCAT dependent manner in differentiating myoblasts (Cogan et al., 1995), while it is repressed in non differentiated myoblasts and fibroblasts due to binding of these tissue specific single stranded DNA binding proteins that prevented binding of TEAD factors to MCAT element (Kelm et al., 1999). Combinatorial interactions between the three single-stranded DNA-binding proteins may be important in regulating the differential expression patterns of many other MCAT containing genes during the process of myogenic differentiation.

<i>Gene</i>	<i>Species</i>	<i>Sequence and Position</i>	<i>Conserved in Human?</i>	<i>Reference</i>
Cardiac troponin T	Chicken	MCAT 1: CATTCT (-95/-89 bp) MCAT 2: CATTCT (-72/-66 bp)	Yes **	Mar and Ordahl., 1988
β -MHC	mouse	distal: CATTCCA (-275/-281 bp)* proximal: CATGCCA (-205/-211 bp)*	Yes	Rindt et al., 1993
SM α -actin	rat	MCAT2: CATTCT (-314/-320 bp)* MCAT1: CATTCT (-178/-184 bp)*	Yes	Swartz et al., 1998
Skeletal α -actin	mouse	CATTCT (-69/-63 bp)	Yes	Karns et al., 1995
α -MHC	rat	CATTCCA (-42/-48 bp)*	No	Gupta et al., 1994
β -acetylcholine receptor	rat	CATTCT (-49/-43)	Yes**	Berberich et al., 1993
Myocardin	mouse	CATTCCA (-30kb)	Yes	Creemers et al., 2006
α 1c-adrenergic receptor	mouse	CATGCCA (-916/-910 bp)	Yes	O'Connell et al., 2001
α -tropomyosin	frog	CATTCT (-59/-65 bp)*	No	Pasquet et al., 2006

* MCAT elements are located in reverse orientation.

**MCAT in human cardiac troponin T gene is CATCCCC and in human β -acetylcholine receptor is CATTCCC

Table 1. MCAT elements in muscle specific genes

Furthermore, the MCAT dependent expression of SM α -actin was studied in-vivo by following embryonic expression of SM α -actin in transgenic mice with LacZ reporter gene under the control of wild-type or mutated MCAT elements in the SM α -actin gene. Contrary to the wild-type, LacZ was not expressed in smooth, cardiac and skeletal muscles in transgenic embryos at E10.5 and E12.5 (Figure 22) and the transgene expression was completely restricted to only SMC-containing tissues by day 15.5 (Figure 22). This indicates that MCAT elements are required for SM α -actin expression in early smooth muscle, skeletal and cardiac muscle. While the expression of SM α -actin is independent of MCAT element in SM cells at later stages of embryonic development (Gan et al., 2007).

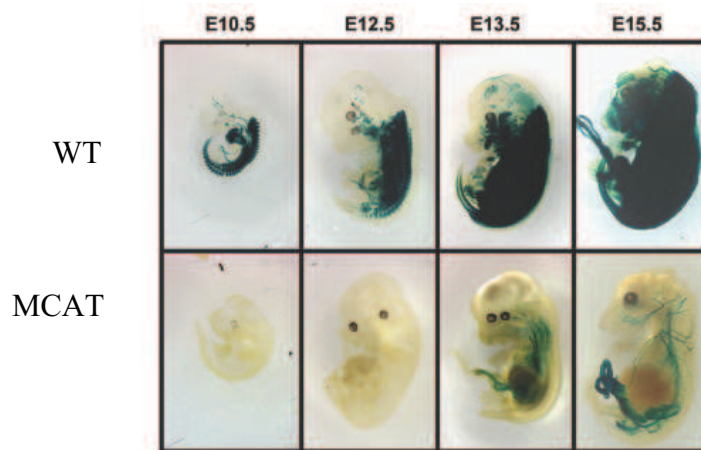


Figure 22. Mutation in MCAT element caused delayed expression of SM α -actin in SMCs at early stages of embryonic development, while completely abolished expression in skeletal and cardiac tissue upto the end of embryonic development.

Interestingly, this study also pointed out by siRNA mediated silencing of individual TEADs in rat aortic SM cells or RA-treated A404 cells (myofibroblast model) that TEAD4 is required for MCAT dependent expression of SM α -actin in embryonic SM cells or activated wound myofibroblasts in contrast to TEAD1 that was required in differentiated rat aortic or adult SM cells. Knockdown of TEAD1 in myofibroblasts had no effect on MCAT reporter gene expression (Gan et al., 2007).

It has been shown that α_1 -Adrenergic signals induce the expression of MCAT containing genes such as skeletal α -actin and β -myosin heavy chain in neonatal rat cardiomyocytes by potentiating TEAD4 binding to the MCAT motifs (Kariya et al., 1993; Kariya et al., 1994; Karns et al., 1995). Furthermore, Ueyama et al. demonstrated that phosphorylation of TEAD4

at Serine 322 is required for its binding to the MCAT element in the skeletal α -actin gene and its activation in cardiomyocytes. Interestingly, Serine 322 is one of the 8 serine residues that is present only in TEAD4 and not in TEAD1 and phosphorylation of Serine 322 is brought about by the α_1 -Adrenergic signal dependant kinases, that activate TEAD4 to bind to MCAT motif in skeletal α -actin gene (Ueyama et al., 2000).

On the other hand, protein kinase A mediated phosphorylation of TEAD1 at Serine 102 reduced the MCAT binding activity of TEAD1 at α -MHC gene in cardiomyocytes and increased the expression of α -MHC gene. In this case, phosphorylation acted to repress the TEAD1 activity in order to activate gene expression (Gupta et al., 2000).

As TEADs are expressed in most tissues, more studies would be required to understand how they elicit expression of muscle or any other tissue specific genes.

One of the possibilities that have been proposed and studied includes the important role of MCAT flanking sequences that might contain binding motifs for other transcriptional co-activators or repressors. The second possibility is the presence of tissue specific transcriptional co-activators or repressors that could be directly binding to TEAD factors and modulating their function in transcription. It appears to be the combination of these DNA binding and TEAD-binding protein factors that shall modulate the TEAD transcriptional activity in a tissue and stage dependent manner.

V.4 Structure of TEAD proteins:

V.4.1 Functional domains in TEAD proteins:

The TEAD proteins possess two major functional domains that are mostly conserved across the four family members, namely, the TEA DNA binding domain (DBD) in the N-terminal region and the C-terminal trans-activation domain (TAD) [Figure 23]. The extreme N-terminal part preceding the TEA DBD and the proline-rich domain following the TEA domain are more variable. The human TEAD factors are more than 99% identical in the DBD and the C-terminal TAD is nearly 70% conserved (Yoshida, 2008). [Table 2]

V.4.2 The TEA/ATTS DNA binding domain:

The first three-dimensional structure of a TEA DNA binding domain was worked out in 2006 by Anbanandam et al. It was shown that TEA domain comprises a three-helix bundle (Figure

23), with a homeodomain fold (Anbanandam et al., 2006). The TEA domain possessed a folded globular structure comprised of three α -helices- H1, H2 and H3. The H1 and H2 are nearly antiparallel and pack on either side of the H3. There are a total of 28 hydrophobic residues of which 12 reside in the core. Subsequently, the thermodynamic stability of the TEA domain is predicted to be low. This was verified with TEA domain unfolding irreversibly with a mid-point of urea denaturation of 2.5M (Anbanandam et al., 2006). The H1-H2 contact at I23, Y24, L46, Y50 and L53 creates a hydrophobic patch that is likely to be crucial in protein-protein interactions.

Amino acid identity between human TEADs

Name	Other names	% Identity with TEAD1	% Identity within DBD	% Identity within TAD
TEAD1	NTEF-1, TEF1	-	-	-
TEAD2	ETEF-1, ETF, TEF-4	64%	100%	65%
TEAD3	DTEF-1, ETFR-1, TEF-5	70%	99%	74%
TEAD4	RTEF-1, ETFR-2, Tead4	74%	100%	82%

Table 2. Amino acid sequence identity of various human TEADs compared to TEAD1 (Modified from Yoshida et al., 2008)

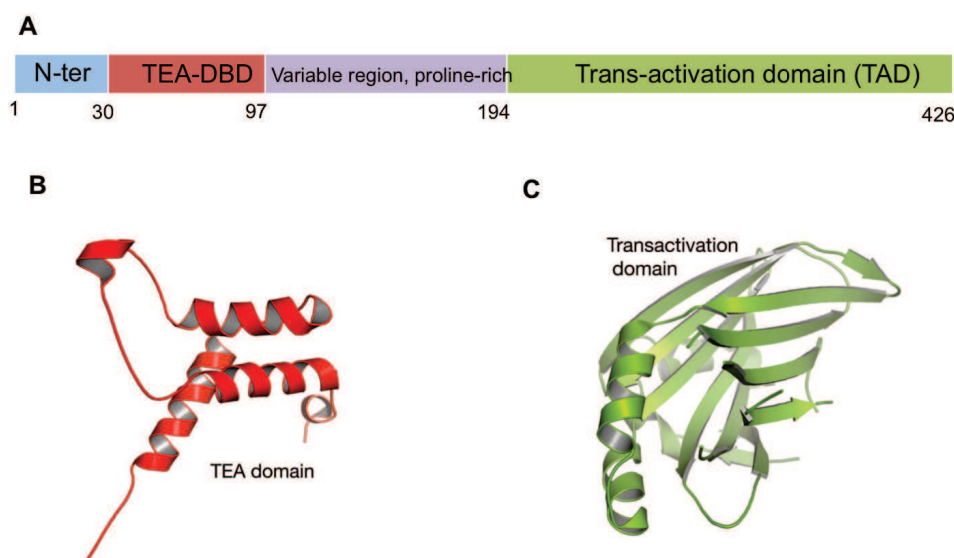


Figure 23. Schematic representation of TEAD proteins (A) and functional domains- DNA binding domain (DBD) and (B) the trans-activation domain (TAD).

The TEA domain binds a 1xGT sequence or a tandem 2xGT, 8-mer, 12-mer & 16-mer sequence cooperatively at nanomolar affinity. The consensus DNA sequence bound by the isolated TEA domain is N[A/T/G]G[AT/C]ATNT. Thus, six of eight nucleotides in the MCAT sequence confer binding selectivity. This suggests that other domains in a full-length TEAD protein may participate in binding specify perhaps by inducing conformational changes in the TEA domain. Consistent with this, Jiang et al. have shown that alternative splicing of TEAD1 mRNA in regions immediately after the TEA domain altered its DNA binding properties (Jiang et al., 2001).

The helix H3 and the L2 loop preceding it are identified as the DNA binding surface. The helix H3 contains three serines (Anbanandam et al., 2006). This is in agreement with biochemical data showing that phosphorylation of serine 102 by protein kinase A (Gupta et al., 2000) or of serine 91 by protein kinase C diminishes DNA binding activities (Jiang et al., 2001).

V.4.3 The Trans-activation Domain (TAD):

The trans-activation domain (TAD) situated in the C-terminal domain of TEAD proteins, was previously called YAP-binding domain (YBD) as it was first identified as the domain that interacts with the YAP protein that activates the TEAD transcriptional activity (Vassilev et al., 2001). Later, other studies described the use of the C-terminal domain to interact with other transcription co-factors such the VGLL proteins (Pobbati et al., 2012).

The TAD three-dimensional structure from human TEAD1, TEAD2 and mouse TEAD4 has been described (Chen et al., 2010; Li et al., 2010; Tian et al., 2010). The three structures are strikingly similar and reflect the conservation of the YBD through evolution. The YBD adopts an immunoglobulin-like sandwich fold structure and is composed of 12 β strands and four α helices (Figure 23,44)

The β strands form two β sheets that pack against each other to form a β sandwich with one β sheet composed of strands β 1, β 2, β 5, β 8, β 9 and the other consisting of β 3, β 4, β 6, β 7, β 10, β 11, β 12. The α helices form two helix-turn-helix motifs where each one connects two β strands. The vestigial-scalloped (Vg-Sd) complex was extensively studied in drosophila for its role in wing development (Halder et al., 1998; Simmonds et al., 1998). A short ~25aa motif in Vg is necessary and sufficient to interact with Sd. The motif is conserved in the four mammalian proteins (Vgll1-4) as well (Chen et al., 2004c; Maeda et al., 2002a).

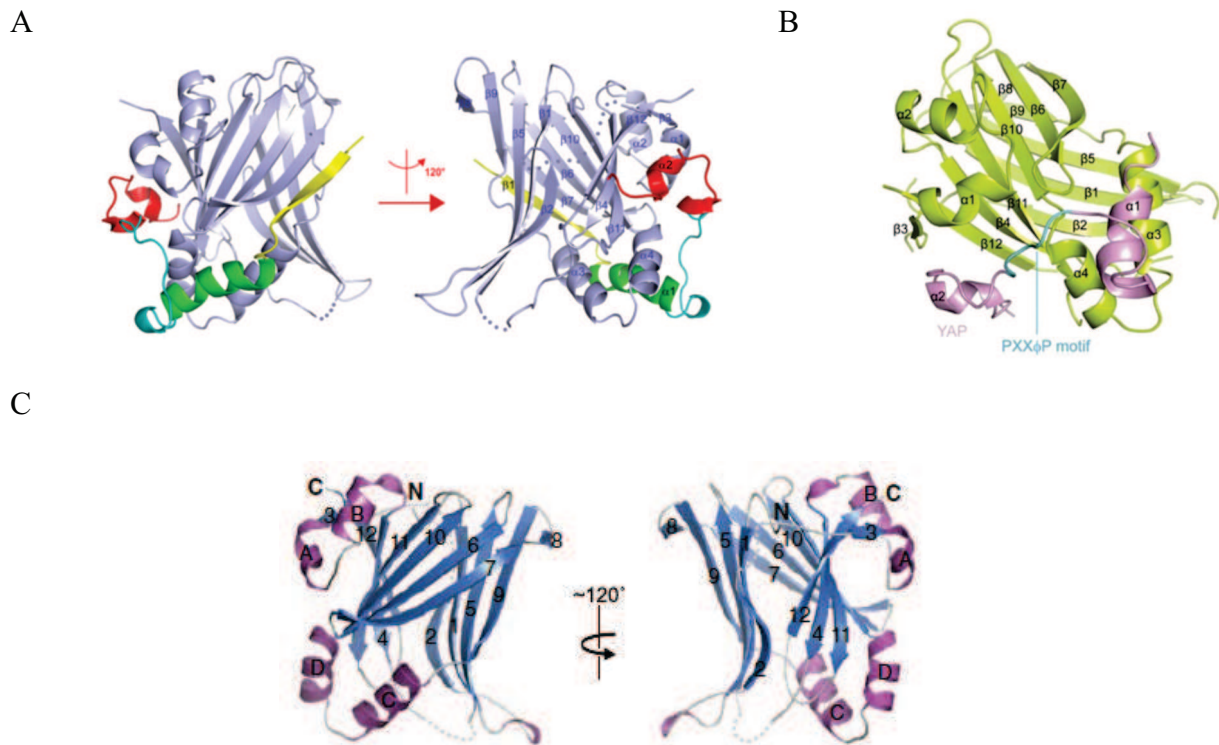


Figure 24. The 3D structure of YBD from (A) Li et al 2010 (B) Chen et al.2010. The YBD was crystallised together with the TEAD binding domain of YAP1 (C) Tian et al. 2010.

Interestingly, Pobbati et al. were able to co-crystallise the C-term TAD of TEAD4 with the TEAD-interacting region of Vgll1 rather easily. They showed that Vgll1 interacts with TEAD in a fashion very similar to YAP. Notably, YAP and Vgll1 share no similarity in the primary sequence yet they interact with TAD in a very similar manner and rather compete for binding the trans-activating domain of the TEAD proteins (Pobbati et al., 2012).

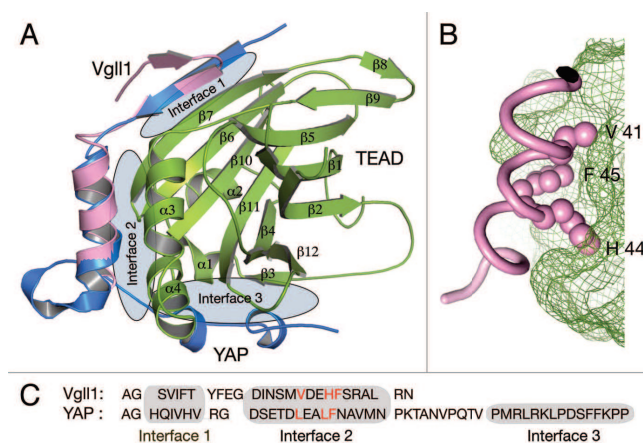


Figure 25. A) A comparison of the structure of Vgll1-TEAD4 complex with YAP-TEAD complex. Here Vgll1 is in blue, Yap in pink and TEAD in green. B) A closer look at the Interface 2 of Vgll1-TEAD complex. (Adapted from (Pobbati et al., 2012))

The TEAD-interacting region of Vgll1 comprises a β strand followed by a α -helix; they are roughly at right angles to each other and clasp the TEAD C-terminal domain. As shown in Figure 25, Yap (pink) interacts with TEAD by forming three interfaces while Vgll1 interacts with TEAD by forming two interfaces. The interfaces 1 and 2 are strikingly similar in both Vgll1 and Yap complex. Interface 1 is an antiparallel β -sheet formed between N ter of Vg or Yap and β 7 of TEAD. In interface 2, Vgll1 helix binds to the hydrophobic groove in TEAD and the crucial region in Vgll1 is the V⁴¹xxH⁴⁴F⁴⁵ motif. The side chains of these residues are shown as pink spheres and they bind to the complementary pockets in TEAD. Similar interaction is also seen in YAP but it has LxxLF motif. YAP makes a third interface where it adopts a twisted-coil structure and the residues of YAP fit into a groove in TEAD (Pobbati et al., 2012). Mutations in the third interface disrupt YAP-TEAD interactions. In fact, Sveinsson chorioretinal atrophy is a genetic disease that is caused due to Y406H point mutation in the interface 3 (Fossdal et al., 2004).

V.4.4 The Proline-rich region

Although the proline-rich region is not conserved at the primary sequence level, all TEAD family members are proline-rich (16-25%) in this region. The proline-rich region of rat TEAD1 is only 20% identical with rat TEAD4 (Mahoney et al., 2005). The proline-rich region is also required for full interaction with the YAP1 and related TAZ transcriptional coactivators (Vassilev et al., 2001). Therefore, the proline-rich region probably accounts for the differential interaction of the TEAD proteins with YAP/TAZ.

V.4.5 The N-terminal region

The N-terminal region of TEAD proteins is amongst the less conserved in the TEAD family. The TEAD1 N-terminal region has a net negative charge and contains a high concentration of serines that are potential sites of phosphorylation. The N-terminal region of TEAD1 is required for its interaction with the transcription factor MAX (Gupta et al., 2000). Furthermore, the full transcriptional activation by TEAD1 requires its N-terminal region to synergise with the proline rich-region and the YBD probably by forming a functional transactivation surface (Hwang et al., 1993).

V.5 Mechanism of TEAD transcriptional activity via interaction with co-factors:

TEAD transcription factors bind DNA directly but require a protein co-factor in order to bring about transcriptional activation or repression. Several co-factors of the TEAD family

have been identified so far. As described in the last section, YAP (Vassilev et al., 2001), its paralog TAZ (Mahoney et al., 2005) and vestigial-like (1-4) family of co-factors: VGLL-1 (TONDU) (Vaudin et al., 1999), VGLL-2 (VITO-1) (Maeda et al., 2002a),

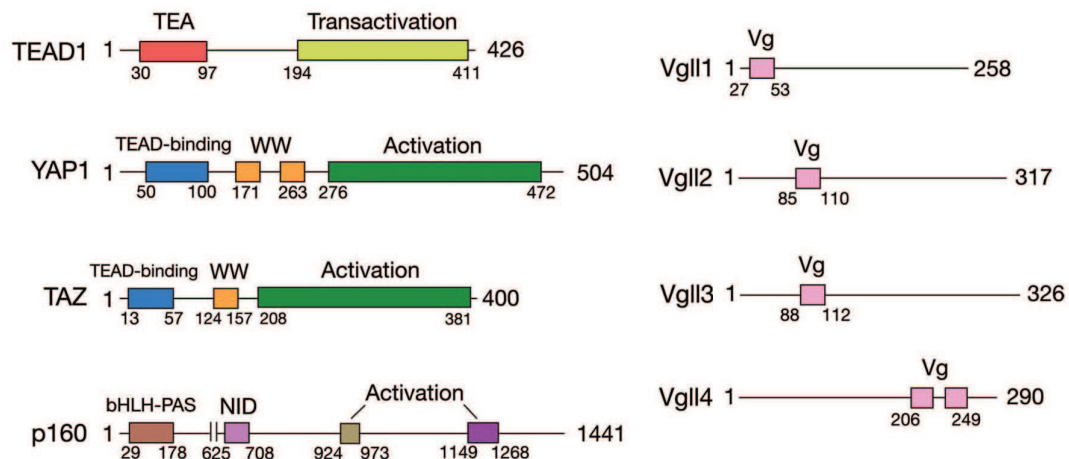


Figure 26. Schematic representation of the various TEAD co-factors and their important conserved functional domains. Modified from Pobbati et al., 2012.

VGLL-3 and VGLL-4 (Chen et al., 2004c) are the most well-known and characterised co-factors of TEAD family. Apart from them, p160 family of nuclear receptor co-activators (SRC1, TIF2, and RAC3) have also been found to interact with the TEAD proteins (Belandia and Parker, 2000).

V.5.1 Yap/Taz co-activators:

The Yes-associated protein (YAP) was first identified as a protein interacting with c-Yes tyrosine kinase (Sudol, 1994). Further studies demonstrated that YAP is a transcriptional coactivator as it possesses a trans-activation domain in its C-ter region (Yagi et al., 1999) and the N-terminal region is required for interaction with TEAD proteins (Vassilev et al., 2001). The central region has one or two WW domains that have been well characterised to bind the PPXY or PY (P = proline, x = any amino acid, Y = tyrosine) motifs found in other proteins (Sudol et al., 1995).

Yap is ubiquitous in expression and most tissues express at least one TEAD protein. Yap seems to bind all TEADs with similar affinity (Vassilev et al., 2001) while TAZ appears to have a preferential binding to TEAD1 with the highest affinity (Mahoney et al., 2005).

YAP is known its role in organ size and growth control. YAP overexpression in liver increases the size by 5 fold and the normal size is restored upon cessation of YAP overexpression (Camargo et al., 2007; Dong et al., 2007). YAP is an oncogene and its overexpression promotes cell growth and oncogenic transformation *in vitro* (Zhao et al., 2009) and also promotes epithelial-mesenchymal transition (EMT) (Zhang et al., 2008a), a property that is also characteristic of cancer metastasis. YAP is highly expressed in wide variety of cancers such as liver cancer (Xu et al., 2009), ovarian cancers (Zhang et al., 2011), oral squamous cell carcinoma (Snijders et al., 2005), embryonal rhabdomyosarcoma (Tremblay et al., 2014) etc. Amplification of YAP-containing 11q22 amplicon is frequently observed in many human cancers and it correlates with poor prognosis (Overholtzer et al., 2006).

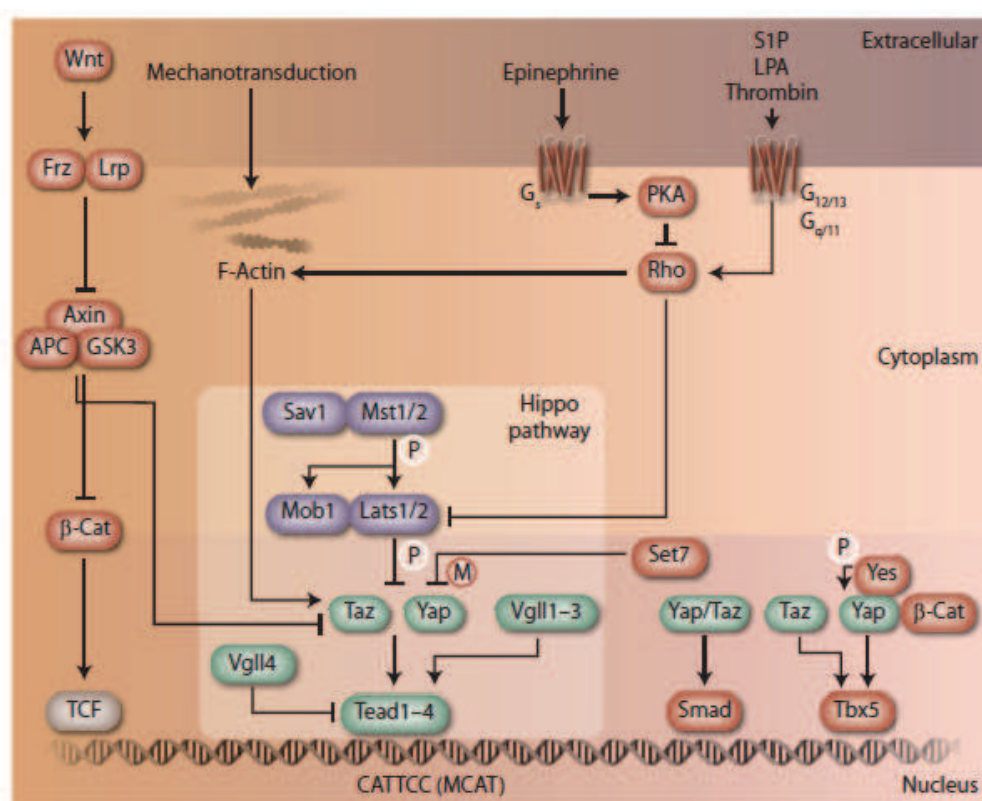


Figure 27. Schematic of key signaling modules within the Hippo signal transduction network and crosstalk with other signaling pathways. P, phosphorylation; M, methylation; LPA, lysophosphatidic acid; S1P, sphingosine 1-phosphate. Adapted from (Wackerhage et al., 2014)

YAP/TAZ are major downstream effectors of the Hippo tumour suppressor pathway (Figure 27). YAP activity is negatively regulated by Hippo pathway. LATS kinases are the key components of hippo pathway. They phosphorylate YAP leading to its retention in the cytoplasm. The nuclear-cytoplasmic shuttling of YAP is regulated by cell density (Zhao et al., 2007). For instance in low-cell density conditions, YAP and TAZ localise in the nucleus and thereby, act as coactivators for several transcription factors including the TEAD factors and promote cell proliferation (Huang et al., 2005). Upon confluence and cell-cell contact inhibition, hippo signalling is activated. The MST kinase (hippo in drosophila) phosphorylates (Figure 27) and activates the protein kinase LATS that subsequently phosphorylates YAP1 and TAZ to promote their binding to 14-3-3 transporter proteins and their translocation to the cytoplasm, thus inhibiting the downstream transcription co-activation (Chan et al., 2005; Zhang et al., 2008a; Zhao et al., 2007).

V.5.2 Vgll proteins:

Vestigial-like proteins got their name after *Drosophila* transcription coactivator vestigial (Vg), which a master regulator of wing development in *drosophila*. These proteins share a small domain of 25 amino acids that is only conserved part between the *drosophila* Vg and the mammalian Vgll proteins. There are four members in the Vgll family named Vgll1-4 (Figure 7).

Vgll1 or TONDU was the first to be identified and can compensate partially Vg loss in *Drosophila* (Vaudin et al., 1999). In humans, it is expressed in foetal lung, heart, kidney and placenta. Vgll1 also promotes cellular proliferation similar to Yap and has been implicated in some cancers such as bladder cancer, basal-like breast cancers (Blaveri et al., 2005; Richardson et al., 2006).

Vgll2 or VITO-1 is expressed in differentiating somites and branchial arches during embryogenesis and predominantly expressed in skeletal muscle in adult (Maeda et al., 2002a). Unlike Vgll1, Vgll2 plays role in cell differentiation. Its expression is upregulated during myogenic differentiation and the protein becomes localised to nucleus, where Vgll2 binds TEAD1 and TEAD4 and regulates their transcriptional activity (Chen et al., 2004b; Gunther et al., 2004). MCAT-dependent TEAD activity at promoters like that of myosin heavy chain or skeletal alpha actin, is enhanced in presence of Vgll2. Thus, Vgll2 appears to be muscle-specific coactivator for the TEAD proteins as it is expressed only in skeletal

muscle. In addition to TEADs, Vgll2 also interacts with MEF2 (myocytes enhancer factor-2) and activates MEF2-dependent gene expression (Maeda et al., 2002a).

Vgll3 or VITO-2 is predominantly expressed in placenta. It is also expressed in skeletal muscle, heart, brain and liver. It has been suggested to play a role in embryonic myogenesis (Mielcarek et al., 2009). Vgll3 is highly expressed and implicated in soft-tissue sarcomas (Helias-Rodzewicz et al., 2010). It has been shown to inhibit differentiation of adipocytes (Halperin et al., 2013).

Vgll4 is expressed in multiple tissues including heart, brain, lung and placenta. Like Vgll2, Vgll4 also interacts with both TEAD proteins and MEF2 and activates their transcriptional activity. However, it is the only Vgll protein that has two partially conserved Vg domains. It has been shown to activate TEAD dependent activation of VEGFA (vascular endothelial growth factor A) and IRF2BP2 (Interferon response factor 2 binding protein 2) (Teng et al., 2010). However, Vgll4 has been shown to suppress basal and α_1 -adrenergic agonist-induced activation of skeletal α -actin promoter in cardiac myocytes (Chen et al., 2004c). This suggests that Vgll4 can modulate TEAD transcriptional activity in context-dependent manner.

V.5.3 Physical interaction with other transcription factors:

TEAD family of transcription interact with several other transcription factors including SRF, MEF2 and the basic Helix-Loop-Helix zipper protein, MAX in order to elicit muscle-specific gene expression program (Azakie et al., 2005; Gupta et al., 2001; Maeda et al., 2002b).

SRF is a MADS box transcription factor that binds to CArG elements (Gupta et al.) found in the promoters of several serum-inducible and muscle specific genes. The MADS domain of SRF was shown to interact physically with the TEA domain of the TEAD1 (Gupta et al., 2001) and activate expression of SKA promoter synergistically. TEAD1 and MAX protein have also been shown to interact physically to activate expression of α -MHC. Overexpression of TEAD1 or MAX alone does not activate α -MHC expression (Gupta et al., 1997). Furthermore, TEAD3 has been shown to interact with MEF2 to activate transcription of cardiac Troponin T promoter in cardiac myocytes (Azakie et al., 2005)

V.6 Other Signalling pathways regulating the TEAD activity:

Apart from Hippo signalling pathway which mediates through Yap co-activator, there have been few studies exploring signalling pathways that could be upstream the TEAD and could be regulating its gene activation programs, namely, thyroid hormone signalling and glucocorticoid signalling.

Two studies suggest the role of thyroid hormone signalling in regulating TEAD transcription function. Iwaki et al. observed that thyroid hormone (T3) bound receptor inhibits TEAD-dependent activation of β -MHC chain expression in a T3 dose-dependent manner. Co-IP experiments showed that TR β 1 (T3 receptor) binds the TEA domain of TEAD1 via its DNA binding domain and interferes with trans-activation of β -MHC promoter by TEAD1 (Iwaki et al., 2014). The second study suggests the role of thyroid hormone in regulating the fibre-type composition of the fast-type muscles. It is demonstrated that thyroid hormone is involved in a more direct inhibition of TEAD1 via an epigenetic mechanism involving miR-133a-1. Since, TEAD1 expression favours slow contractile phenotype, TEAD1 expression is suppressed by T3 in fast-type muscles by direct upregulation of miR-133a-1 expression. Moreover, miR-133a-1 is enriched in fast-twitch muscle (Zhang et al., 2014)

It has been proposed that TEAD proteins may regulate Glucocorticoid receptor (GR)-dependent gene expression program. This is of interest in skeletal muscle where Glucocorticoid receptor signalling is implicated in atrophy and muscle mass regulation (Schakman et al., 2008). Starick et al. performed ChIP-exo for GR (Starick et al., 2015) in human fibroblasts and sarcoma cell lines, where they observed that only a few target gene promoters carried the classical GR response element (GRE) and while they could identify the GR binding peaks enriched with the classic TEAD binding MCAT motif or ETS transcription factor binding sites. Furthermore, knockdown of several TEAD proteins resulted in GR dependent decrease in expression. Hence, it is proposed that GR directs expression of many genes not via direct binding rather via interaction with other transcription factors such as ETS or TEAD proteins (Starick et al., 2015).

V.7 TEADs in embryonic development:

Several gene inactivation studies of various TEADs have contributed in elucidating their role in higher vertebrates. TEAD1 null mouse embryos show severe heart defects such as thin ventricular wall and dysfunction. They die by embryonic day 11 or 12 (E11 or E12) (Chen et al., 1994). TEAD2 null embryos exhibited defects in the closing of neural tube while in another

study *Tead2*^{-/-} embryos appeared normal. In addition, this study showed that TEAD1 and TEAD2 double mutant embryos have much severe defects compared to either TEAD1 or TEAD2 single mutant embryos (Kaneko et al., 2007; Sawada et al., 2008). At E8.5, TEAD1/TEAD2 double mutant embryos were smaller in size compared to their wild-type counterparts and characteristic embryonic structures such as a closed neural tube, a notochord, and somites were absent.

There have not been many studies on TEAD3 or TEF-5. The human TEAD3 cDNA was cloned in our laboratory in 1997. We found that TEAD3 or TEF-5 was highly expressed in placenta and that TEAD3 bound cooperatively to the MCAT tandem repeat motifs in the human chorionic somatomammotropin (hCS)-B gene enhancer and thus regulated the expression of the hCS-B gene (Jacquemin et al., 1997). Another study demonstrated that TEAD3 is required for the expression of 3beta-hydroxysteroid dehydrogenase/isomerase (3betaHSD-I), an enzyme that is specifically expressed in placenta and is critically required for biosynthesis of steroid hormones (Peng et al., 2004).

Several parallel studies on inactivation of TEAD4 in pre-implantation embryos demonstrated the TEAD4 is required for trophoctoderm (TE) development. Homozygous *Tead4*^{-/-} embryos died before implantation without forming the blastocoel (Nishioka et al., 2008; Yagi et al., 2007). *Tead4*^{-/-} embryos fail to express trophoctoderm markers such as *Cdx2* and its downstream actor *Eomes* (eomesodermin) but express normally the inner cell mass (ICM) specific genes such as *Oct4* and *Nanog*. Consequently, *Tead4*^{-/-} morulae lack TE and blastocoel cavity and thus, fail to implant into the uterine endometrium. Another transcription factor whose expression is regulated by TEAD4 during trophoctoderm formation is GATA3. GATA3 is expressed in the trophoblast lineage *in vivo* and its ectopic expression is sufficient to induce trophoblast genes in ES cells (Ma et al., 1997; Ralston et al., 2010). GATA3 expression in trophoctoderm was greatly reduced upon TEAD4 inactivation (Ralston et al., 2010).

Interestingly, TEAD4 expression was not restricted only to TE cells. So, this raised the question as to how TEAD4 plays a differential role in *Cdx2* activation in trophoctoderm lineage cells. Nishioka et al. showed in an elegant study that Hippo signalling is responsible for TE specific role of TEAD4 (Nishioka et al., 2009). YAP1, the downstream effector of hippo signalling is nuclear in localisation in the outside cells of the early embryo and therefore activates the transcription of TEAD4 target gene *Cdx2*. In contrast, YAP1 is phosphorylated by LATS kinase and localised in the cytoplasm. Thus, activated hippo

signalling prevents activation of TE markers in the inner cell mass (ICM). The study recapitulates this mechanism by LATS over-expression in embryos significantly reduced YAP1 accumulation in the nucleus of injected cells (Nishioka et al., 2009).

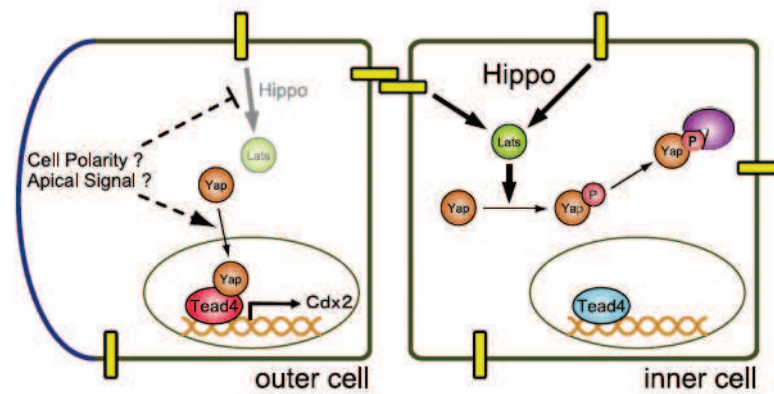


Figure 28. *A model for cell position-dependent fate specification in pre-implantation embryos (extracted from (Nishioka et al., 2009))*

This is coherent with the model proposed in cultured cells, where LATS2 phosphorylation of YAP1 leads to its cytoplasmic localisation (Zhang et al., 2008a; Zhao et al., 2007). On the basis of the above observations, Nishioka et al. proposed a model for TEAD4 differential role in trophectoderm specification, where activation of hippo pathway in ICM restricts YAP1 to cytoplasm and prevents activation of TEAD4 targets involved in TE development (Figure 28).

A recent study that examined the localisation of TEAD4 in pre-implantation embryos shows that TEAD4 is nuclear in trophectoderm (TE) cells while cytoplasmic in inner cell mass (ICM). This altered sub cellular localisation regulates cell fate in pre-implantation embryos (Home et al., 2012). TEAD4 being nuclear in localization in trophectoderm positively auto-regulates its own transcription and increases TEAD4 protein levels in the TE lineage, thereby facilitating TEAD-dependent transcription of GATA3 and Cdx2 specifically in the trophectoderm.

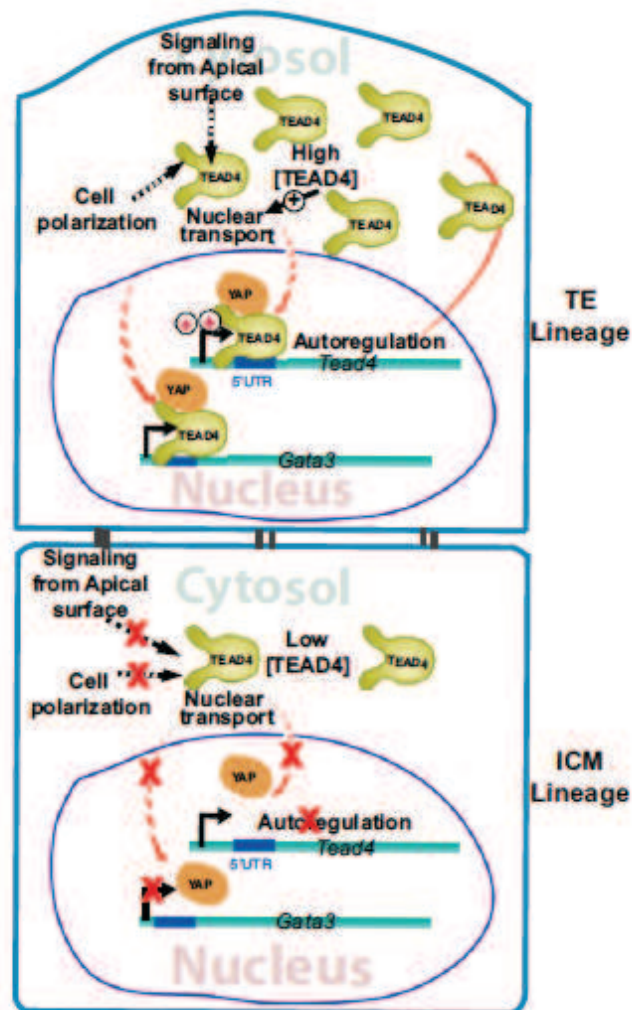


Figure 29. TEAD4 mediated specification of TE and ICM lineages in a pre-implantation mammalian embryo. The model illustrates that nuclear localization of TEAD4 in the outer TE lineage induces TE-specific genes like Gata3. TEAD4 nuclear localization positively auto-regulates its own transcription and increases TEAD4 protein levels in the TE lineage. Adapted from Home et al., 2012.

Further, they performed TEAD4 ChIP-seq on whole embryos as well as inner cell mass and showed that TE-marker genes were bound by TEAD4 in whole embryos and not in the inner cell mass. ChIP experiments further showed that several TE-specific genes such as Bmp4, Gata3, Cdx2, Fgfr2 and Eomes are bound and expressed specifically in TE-derived trophoblast stem cells (TSCs) and not in the ICM. Hence they proposed a new model for cell-fate specification. (Figure 29) The model also predicts that low TEAD4 impairs TEAD4 nuclear localization in the ICM lineage, thereby limiting TEAD4 transcription and abrogating expression of other TE-specific genes, such as Gata3 in the ICM (Home et al., 2012).

V.8 TEADs in heart development and hypertrophy:

As already mentioned above, *Tead1*^{-/-} mice generated by retroviral gene trap approach had several heart defects and died by day 12.5 of embryonic development (Chen et al., 1994). Histological examination revealed that *Tead1*^{-/-} mice possessed an abnormally thin ventricular wall with reduced number of trabeculae. This led to enlargement of the pericardial cavity, bradycardia (slower heart rate) and a consequent heart dysfunction. In addition these mice had a dilated fourth ventricle in brain. These results indicate that Tead1 is required for embryonic heart development and that other tead family members cannot compensate for the loss of TEAD1 function. Further studies are required to address the mechanism of the TEAD1 dependent heart development in order to decipher which genes are directly regulated by TEAD1 in heart development. This is in the light of the fact that known MCAT containing genes such as cardiac troponin T and MHC appear to be normally expressed in the transgenic mice heart. TEAD1 is also known to interact with SRF (serum response factor), another transcription factor that is essential for cardiac development (Carson et al., 1996).

TEAD3 is the only TEAD protein that is highly expressed in cardiac muscle but not in skeletal muscle. It starts to get expressed as early as 16h in chick embryogenesis and eventually becomes abundant in sinus venosus and trabeculated ventricular myocardium and ventricular outflow tracts (Azakie et al., 2005). TEAD3 binds the cTNT promoter in-vivo and it co-immunoprecipitates with MEF2 and trans-activates the CTNT promoter in cardiac myocytes (Azakie et al., 2005).

Transgenic mice with cardiac-specific overexpression of TEAD4 developed heart conduction defects associated with altered connexin phosphorylation (Chen et al., 2004a). These mice exhibited prolonged PR, QRS and AH intervals due to delayed conduction in the atrial and ventricular myocardium and the bundle of His, respectively. This led to atrial arrhythmias, atrial dilation accompanied by atrial tachycardia. To explain the molecular mechanism of conduction defects, the group examined expression and phosphorylation status of connexions that are involved in gap-junctions in heart. They found that protein phosphatase 1 β was up regulated that resulted in de-phosphorylation of connexin40 and connexin43 and this impaired gap-junction conduction in TEAD4 transgenic mice (Chen et al., 2004a).

Cardiac hypertrophy occurs in response to increased workload or injury. Increased cell size, protein synthesis and induction of foetal cardiac genes, such as β -MHC and skeletal α -actin (SKA) are hallmarks of cardiac hypertrophy. It has been shown that α_1 -adrenergic stimulation

leads to cardiac hypertrophy by induction of foetal cardiac genes like β -MHC and SKA. Interestingly, induction of these genes is MCAT-dependent as mutations in MCAT element within MHC and SKA promoters failed to elicit the α_1 -adrenergic response (Kariya et al., 1994). Moreover, TEAD4 overexpression could trans-activate both β -MHC and SKA minimal promoters while TEAD1 could trans-activate only the β -MHC minimal promoter under α_1 -adrenergic stimulation of cardiac myocytes. Hence, TEAD4 may be playing a specific role in mediating α_1 -adrenergic response during cardiac hypertrophy, and thus, this merits further in vivo studies in cardiac hypertrophy models.

V.9 TEADs in Cancer:

The TEAD (1-4) proteins as well as its co-factors YAP and Vgll (1-4) are deregulated in many kinds of cancers. TEADs are found to be responsible for mesothelin overexpression, a characteristic feature of pancreatic cancer (Hucl et al., 2007). High TEAD1 is a marker for prostate cancer and is correlated with poor patient survival (Knight et al., 2008). Likewise, TEAD1 expression is abnormally high in Kaposi sarcoma and basal-breast cancers, fallopian tube carcinoma and germ cell tumors (Han et al., 2008; Nowee et al., 2007; Richardson et al., 2006; Skotheim et al., 2006). Diepenbruck et al. employ genome wide association studies (GWAS) of TEAD2 in mammary gland epithelial cells and breast cancer cells to show that TEAD2 regulates the expression of genes required for epithelial-mesenchymal transition and metastasis (Diepenbruck et al., 2014). Consistent with this, another research group has recently demonstrated using GWAS coupled with transcriptomic data and DNA methylome data of human tumors that TEAD transcription factors are involved in transcriptional reprogramming of highly proliferative melanoma cells to invasive type as TEADs directly regulate expression of genes linked with invasive properties (Verfaillie et al., 2015).

VI. TEADs in skeletal muscle differentiation:

It is sufficiently clear from the above-discussed literature that TEAD family of transcription factors has a significant role in development, differentiation and cancer and maintenance of stem cells.

My thesis work concerns in particular the role of TEADs in skeletal muscle differentiation. Differentiation is a significant step in the process of embryonic as well as adult myogenesis. Therefore, it would be important for me to discuss in detail the known functions of TEAD

proteins in embryonic and adult myogenesis as well as in muscle plasticity. As it is often the case with most myogenic transcription factors that apart from their role in muscle development, they play also a role in responding to the environmental cues in adult muscle via fibre switch remodelling.

VI.1 Embryonic skeletal muscle development:

As previously discussed, TEAD1 and TEAD4 null mice die very early in embryonic development. In case of TEAD4, the post-implantation knockout mice appeared to be normal with no apparent changes in muscle weight and size and so, these mice were not subjected to further examination of muscle development and physiology (Yagi et al., 2007). There have been so far no studies on TEAD2 and TEAD3 in embryonic skeletal muscle development.

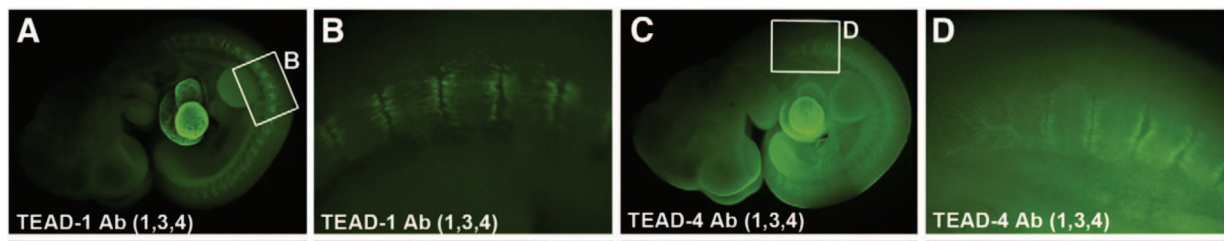


Figure 30. Whole-mount immunohistochemistry (IHC) of TEAD proteins in 10.0 dpc embryos shows stronger TEAD4 expression in developing heart and somites.

Ribas et al. showed that at least two TEAD transcription factors bind the MCAT element in the ECR111 (evolutionarily conserved region) and are required for Myf5 expression in ventral somatic compartments (Ribas et al., 2011). At E10.5, TEAD proteins localize to the developing heart and somites (Figure 30) with stronger staining in caudal and rostral regions of somites and deletion of ECR111 in mice completed abolished Myf5 expression at E10.5.

In short, absence of studies on TEADs in post-implantation embryos due to early embryonic death or severe birth defects in TEAD null mice coupled with the fact that MCAT elements are present in many embryonic muscle genes merit further research employing embryonic muscle specific knockouts of TEADs such as use of Pax7 or Myf5–driven overexpression or Pax7-Cre mediated knockout studies for a deeper understanding of the role of TEADs in somitogenesis and muscle development that ensues.

VI.2 Satellite cells and regeneration:

Muscle regeneration involves activation of the quiescent satellite cells, their amplification followed by differentiation resulting in formation of myotubes and then new muscle fibres. Myogenic differentiation *in vitro* has the following key steps: myoblast activation → proliferation → cell cycle exit → fusion (primary and secondary fusion events) → myotube formation. As a first line of evidence, *in vitro* studies in C2C12 myoblast differentiation have pointed towards the role of TEADs in skeletal muscle differentiation. For example, we have already discussed the role of TEADs in the expression of skeletal muscle-specific genes such as Myf5 (Ribas et al., 2011), cTnT, beta-MHC and alpha-actins (Mar and Ordahl, 1988; Swartz et al., 1998; Rindt et al., 1993).

The previous study from our own lab established that TEAD4 is required for C2C12 differentiation *in vitro* (Benhaddou et al., 2012). shRNA mediated stable knockdown of TEAD4 and ectopic overexpression of the DNA binding domain (TEAD-DBD) as a dominant negative repressor of TEAD4 led to formation of shortened myotubes compared to control C2C12 line. ChIP-chip experiments in C2C12s overexpressing Flag-HA-TEAD4 revealed that TEAD4 occupies 867 promoters including Myogenin, CDKN1A and Caveolin-3. RNA-seq identified the set of genes downregulated upon TEAD4 knockdown in C2C12s among which are muscle structural and regulatory proteins. The previous PhD student put forward a model in Benhaddou et al. showing that TEAD4 represses the expression of Ctgf required for cell cycle exit, induces proteins like caveolin-3 required for myoblast fusion and Myogenin for terminal differentiation of C2C12s.

Several studies have examined the role of Yap in differentiation, a transcriptional co-factor for the TEAD transcription factors. It has been shown that Yap is three-fold up-regulated in activated satellite cells, is actively transcribed in proliferating myoblasts and inhibits terminal differentiation into myotubes (Judson et al., 2012; Watt et al., 2010). In addition, Watt et al. also showed that overexpression of constitutively active YAP S127A in C2C12 cells increases Myf5 expression and reduced expression of late differentiation marker MyoG. Judson et al., (2012) showed that constitutive expression of Yap maintains Pax7+ and MyoD+ satellite cells and satellite cell-derived myoblasts, promotes proliferation but prevents differentiation (Figure 31). Lentiviral infection of satellite cell-derived myoblasts with anti-Yap shRNA significantly reduced proliferation of myoblasts. Consistently, Yap co-

immunoprecipitates with TEAD1 in C2C12 myoblasts and constitutively active Yap induces expression of the MCAT driven luciferase reporter (Judson et al., 2012).

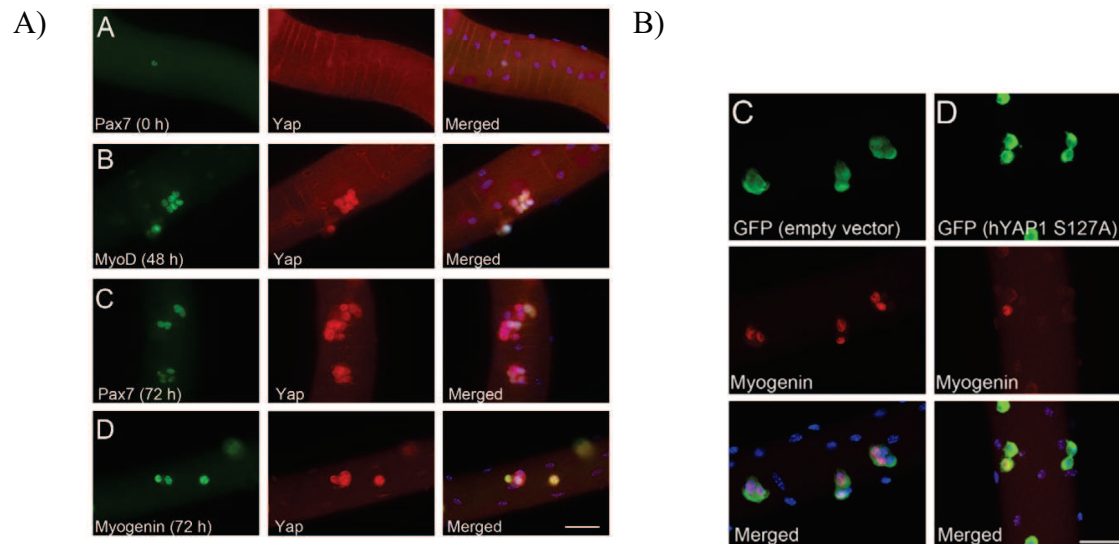


Figure 31. A) Yap is highly expressed in activated satellite cells until after the differentiation versus self-renewal decision is made. B) Effect of constitutively active hYAP1 S127A on the expression of myogenin in satellite cells cultured in their niche ex vivo (adapted from Judson et al., 2012).

There is more recent evidence about role of Yap in proliferation and differentiation of satellite cells. Satellite cell proliferation is promoted by Yap activation by GPCR signalling via S1P (sphingosine-1-phosphate) and Notch-signalling (Nagata et al., 2006; Rodgers et al., 2014). Yap also activates Bmp4 expression that promotes satellite cell proliferation and inhibits differentiation (Ono et al., 2011).

Yap1 null mutation in mice is embryonic lethal by E8.5 (Morin-Kensicki et al., 2006) whereas global knockout of Wwtr1 (Taz), another TEAD transcription co-factor does not exhibit an obvious skeletal muscle phenotype.

Above presented is a strong evidence for role of Yap in satellite cell proliferation and regeneration. Yet another indirect evidence for TEAD function in regeneration comes from the FGFR4 knockout mice that exhibit impaired regeneration upon cardiotoxin-based injury, with augmented fat and calcification in muscle, compared to their wild-type counterparts. FGFR4 expression is regulated by TEAD2 (Zhao et al., 2006). Given this, we will need more studies on the direct role of TEADs in muscle regeneration.

VI.3 Adult muscle -Fibre-size and fibre-switch:

Hypertrophy, such as induced by stretch-overload, is the increase in muscle size and mass due to increase in fibre size. It is characterised by enhanced mitochondrial biogenesis and changes in expression patterns of structural and metabolic proteins. TEADs regulate increased activation of skeletal α -actin (SKA) promoter in Stretch-overload induced muscle hypertrophy (Carson et al., 1996). Similarly, denervation-induced decrease in β -MHC expression in rat soleus muscle is mediated by loss of MCAT binding by TEAD factors (Huey KA 2003). Acute resistance exercise with high mechanical loading induces expression of *Cyr61* and *Ctgf* (Kivela et al., 2007). *Ctgf* has three MCAT elements in proximal promoter (Zhao et al., 2008) and our previous research shows that TEAD4 binds the MCAT elements in *Ctgf* promoter and regulates its expression (Benhaddou et al., 2012).

It may be suggested that TEAD proteins might function together with Yap in stretch-overload induced hypertrophy, consistent with the role of Yap in tissue growth. Surprisingly, Judson et al. showed that muscle-specific tet-off inducible overexpression of constitutively nuclear and active Yap (hYAP1 S127A) in adult mice resulted in atrophy, muscle degradation, loss of body weight and gait impairment rather than hypertrophy and increased muscle mass. The *tibialis anterior* (TA) muscle exhibited presence of myopathy associated centrally located nuclei, increased expression of markers of protein degradation (atrogin-1, MuRF1) and regeneration like embryonic myosin heavy chain, Myf5, Myogenin and Pax7. The phenotype could be mostly reversed by removal of Yap overexpression by doxycycline treatment (Judson et al., 2013)

Contrary to this, a recent study showed Yap expression is strongly induced in a mouse model of mechanical overload-induced hypertrophy and electroporation mediated overexpression of Flag-tagged Yap in TA muscle was sufficient to cause hypertrophy via an mTOR-independent mechanism that involved increased expression of cMyc and MyoD and decreased expression of MuRF1 (Goodman CA 2015). The contrasting observations in the above two studies were explained based on the fact that there could be differences between overexpression of a normal Yap or a mutated constitutively nuclear and active Yap where the Yap protein would perhaps normally elicit its function in hypertrophy and eventually be shuttled out of the nuclear whereas the hYAP1 S127A would stay nuclear, perhaps start the fibre growth process but would fail to fully culminate the terminal fibre maturation.

Further, Watt et al. demonstrate that YAP expression levels decline during maturation of skeletal fibres. This study elegantly illustrates and sums up the significant role of YAP in muscle fibre size control. To start with, they showed that AAV-mediated shRNA knockdown of Yap led to decrease in fibre size with reduced rates of protein synthesis, while, AAV-mediated overexpression of YAP led to hypertrophy in TA muscle with no effect on mTOR and ubiquitin proteasome system (UPS) activity (Watt et al., 2015). Ectopic expression of dominant negative TEAD2 (dnTEAD2) blunted YAP induced hypertrophy whereas overexpression of the mutant YAP S79A that does not bind to any of the TEAD proteins, displayed no difference in muscle mass and fibre size compared to contra-lateral muscle injected with control plasmid. Furthermore, they observed that YAP localises near the neuromuscular junctions (NMJ) at the membranes of adult muscle fibres. Similarly, another study established increased nuclear accumulation of Yap as a characteristic feature of muscles undergoing neurogenic atrophy in SOD1^{G93A} mice model of amyotrophic lateral sclerosis (ALS). In correlation with this, Watt et al. observed that YAP protein abundance increased dramatically in denervated muscle. Based on these findings, they suggest that induction of YAP expression in muscles undergoing neurogenic atrophy is a mechanism to promote growth, preserve muscle mass as a mechanism to compensate for poor nerve-muscle interaction (Watt et al., 2015). However, the above studies did not report any effect of YAP gain and loss-of-function as well as the functional mutants on fibre-type composition.

Tsika et al. provide evidence for the direct role of TEAD1 in fibre-type switch and muscle remodelling. They show that overexpression of MCK promoter driven HA-tagged TEAD1 resulted in fast-to-slow fibre-type switch in response to mechanical overload (Tsika et al., 2008). The overexpression of TEAD1 did not affect muscle growth or mass, rather led to increase in slow-type I MyHC expression consistent with sharp decrease in fast type IIX/d MyHC expression and slight decrease in fast type-IIb MyHC expression. The HA-TEAD1 muscle exhibited slower shortening velocity (V_{max}), and longer contraction and relaxation times in fast twitch EDL muscle. In addition, TEAD1 overexpression decreased expression of fast sarcoplasmic reticulum Ca^{2+} -ATPase (SERCA1) and increased expression of slow isoforms of Troponin T, I and C, and myoglobin that is highly expressed only in oxidative muscle fibres. Interestingly, TEAD1 overexpression resulted in the activation of glycogen synthase kinase (GSK)-3 α /3 β , decreased nuclear β -catenin and NFATc1/c3 protein. This suggests that transition toward slow fibre program occurred in NFAT-independent manner and that GSK-3 α /3 β regulates nuclear NFAT levels. Moreover, GSK-3 β phosphorylates β -

catenin leading to its degradation by ubiquitin proteasome, thereby controlling β -catenin nuclear levels and transcriptional activators of β -catenin/TCF/Lef-responsive promoters (Forde and Dale, 2007).

The expression pattern and direct function TEADs *in vivo* in muscle fibre growth and fibre type is an outstanding research question that requires further investigation. Another indirect evidence is the abnormally high Ctgf expression level in muscular dystrophy. TEADs are known to repress Ctgf expression during myogenesis. In light of the discussed literature, it can be suggested that TEADs have both Yap-dependent and independent functions in muscle physiology. Further studies in various hypertrophy, atrophy and disease models are needed to elucidate the precise mechanism of TEAD function in muscle mass regulation and in myopathic diseases.

VII. A brief introduction to my thesis project

My PhD thesis concerns the role of Tead family of transcription factors in skeletal muscle differentiation. This project is an extension on the study initiated by a previous PhD student Attaillah Benhaddou in our laboratory. Attaillah studied specifically the role of Tead4 in *in vitro* C2C12 differentiation by shRNA knockdown of Tead4 where it is shown that Tead4 is required for normal differentiation of C2C12 cells. He performed ChIP-chip experiments on ectopically expressed Flag-HA-Tead4 in C2C12 cells. This was the first study (Benhaddou et al., 2012) that identified many novel Tead4 targets in muscle differentiation using early stage high-throughput methods. He identified by microarray expression analysis that many of these target genes were deregulated in cells expressing shRNAs against Tead4. This elegant study leads to several outstanding questions to be addressed in present and near future. During my PhD I have tried to address the following questions:

1. What are the specific and redundant roles of various Tead factors in muscle differentiation?
2. Are Tead proteins also essential for primary myoblast differentiation *in vitro* ?
3. How do Teads bring about transcriptional activation as well as repression during myogenesis i.e. which proteins or protein complexes modulate the transcriptional activity of Tead4.
4. Is Tead4 required for normal muscle function and muscle regeneration?

Firstly, ChIP-chip experiments on ectopically expressed proteins, as performed by us previously, may identify more than the actual bonafide target genes in the context in question. To address this issue, we intended to perform ChIP-seq analysis on the endogenous Tead proteins. We have addressed this question quite successfully now. Secondly, several studies point out that at least three of the Teads- Tead1, Tead2 and Tead4 are expressed during muscle differentiation and their specific and redundant (if any) functions in muscle differentiation are not known as yet. We have combined our ChIP-seq data on individual Tead proteins with genome wide expression analysis of combined Tead1/Tead4 knockdown.

In addition, our study along existing data on the role of Yap/Tead in transcriptional activation raised the question as to how the Tead factors bring about activation and repression of gene transcription simultaneously. We decided to address this question by performing tandem-

affinity purification in Flag-HA-Tead4 expressing C2C12 cells and mass spectrometric identification of Tead4 binding partners. I have identified many novel Tead4 binding partners including Ifi202b and many members of transcription activating and repressing complexes. This part of my project opens up many questions for future investigation.

Thirdly, we wished to extend our study to the primary myoblasts, as it is an upcoming model to study differentiation in-vitro. I performed loss of function study of various Tead proteins both in C2C12 and in primary myoblasts. I try to address the similarities and differences in C2C12 and primary myoblasts gene regulation during differentiation. I established that Tead are equally essential in myoblast differentiation.

Finally, we envisaged studying the function of Tead proteins in-vivo. For this, we generated conditional knockout models of Tead4 deletion either in adult muscle fibre or in Pax7+ cells. Very few studies have addressed the role of Teads in vivo muscle development, function and regeneration. Although both these models will help us address these questions in a complementary manner, I have just begun to address this question and I will continue to undertake it as my post-doctoral research work.

Results

Part I

I. Specific and redundant roles of the TEAD family of transcription factors in C2C12 cell and primary myoblast differentiation.

Manuscript in preparation

Specific and redundant roles of the TEAD family of transcription factors in C2C12 cell and primary myoblast differentiation.

Shilpy Joshi, Guillaume Davidson, Stéphanie Le Gras and Irwin Davidson^{#, 4}

Department of Functional Genomics and Cancer, Institut de Génétique et de Biologie Moléculaire et Cellulaire, CNRS/INSERM/ULP, 1 Rue Laurent Fries, 67404 Illkirch Cédex, France. Equipe labélisée Ligue Contre le Cancer

To whom correspondence should be addressed:

E mail : irwin@igbmc.fr

Running Title: Tead factors are essential for muscle differentiation

Key words; C2C12, primary myoblasts, Tead1, Tead4, myogenesis

The authors declare no competing conflict of interest.

Abstract.

The TEAD family of transcription factors recognise the MCAT element found in the promoters of muscle-specific genes. Genetic analysis of their function in muscle differentiation has proved elusive likely due to redundancy amongst the family members. We previously used shRNA-mediated silencing to show that Tead4 plays an essential role in C2C12 cell differentiation. Tead4 silencing resulted in abnormal differentiation characterised by the formation of shortened myotubes. Integration of chromatin immunoprecipitation coupled to array hybridisation (ChIP-chip) and RNA-seq data identified a set of potential target genes that are either activated or repressed by Tead4 during differentiation. In this study, we have used siRNA-mediated silencing to address the role of the Tead factors in primary myoblast differentiation. In contrast to C2C12 cells where Tead4 plays a critical role, its silencing in primary myoblasts had little effect on their differentiation. Silencing of individual Tead factors had no significant effect on primary myoblast differentiation, whereas combinatorial silencing led to inhibition of their differentiation indicating redundancy amongst these factors. In C2C12 cells also, combinatorial Tead silencing had much more potent effects than silencing of Tead4 alone indicating a contribution of other Teads in this process. By integrating Tead1 and Tead4 ChIP-seq data with RNA-seq data following combinatorial Tead1/4 silencing, we identify distinct but overlapping sets of Tead regulated genes in both C2C12 cells and primary myoblasts. We also integrated the Tead1/4 ChIP-seq data with public data sets on Myog and Myod1 ChIP-seq and chromatin modifications to identify a series of active regulatory elements bound by Tead factors alone or together with Myog and Myod1. These data dissect the specific and combinatorial functions of these transcription factors in muscle differentiation regulatory networks.

Introduction

The Tead transcription factors, previously also called Tefs (transcription enhancer factors) bind to a consensus MCAT (5'-CATTCCA/T-3') element originally identified as the GT-II motif of the SV40 enhancer (Anbanandam et al., 2006; Davidson et al., 1988; Xiao et al., 1991). Tead family members (Tead1-4) share a highly evolutionarily conserved DNA binding domain, called the TEA/ATTS domain (Andrianopoulos and Timberlake, 1991; Burglin, 1991). Mammalian Teads are expressed in almost all tissues with prominent Tead1 and Tead4 expression in skeletal muscle, lung and heart and nervous system. Initially, only Tead4 was found expressed in developing skeletal muscle in mouse embryo (Jacquemin et al., 1996), however, later it was shown that both Tead1 and Tead4 are co-expressed and co-localise to somites in developing mouse embryos (Ribas et al., 2011). Several *in vitro* studies have established the role of Tead proteins in binding MCAT elements and activating expression of muscle-specific genes (Mar and Ordahl, 1988, 1990).

These findings have been extended *in vivo* where Teads have been shown to regulate increased activation of the *Acta1* promoter in stretch-overload induced muscle hypertrophy (Carson et al., 1995). Denervation-induced decrease in *Myh7* expression in rat soleus muscle is mediated by loss of MCAT binding by Tead factors (Huey KA 2003). Similarly, acute resistance exercise with high mechanical loading induces Tead-dependent expression of *Cyr61* and *Ctgf* (Kivela et al., 2007). Tsika et al. show that overexpression of HA-tagged Tead1 driven by the *Ckm* promoter resulted in fast-to-slow fibre-type switch in response to mechanical overload (Tsika et al., 2008).

Tead factors also act as mediators of the Hippo pathway in proliferation, oncogenesis, maintenance of stem cells and their differentiation as well as organ size via their interaction with the Yap and Wwtr1 (Taz) transcriptional co-activators (Cebola et al., 2015; Han et al., 2015; Watt et al., 2015; Zanconato et al., 2015; Zhao et al., 2008). In terms of muscle differentiation, constitutive expression of Yap maintains Pax7+ and Myod1+ satellite cells and satellite cell-derived myoblasts, promotes proliferation but prevents their differentiation. In C2C12 myoblasts, Yap co-immunoprecipitates with Tead1 and constitutively active Yap induces expression of the MCAT driven luciferase reporter (Judson et al., 2012). Moreover, it has been shown that Yap is upregulated in activated satellite cells, and is actively transcribed in proliferating myoblasts. In contrast, Yap is exported out of the nucleus during terminal differentiation into myotubes and expression of a constitutively nuclear form of Yap

inhibits differentiation (Judson et al., 2012; Watt et al., 2010). So far, no study has investigated the interaction of Yap and Tead4 in differentiating C2C12 cells.

Blais et al. showed by ChIP-chip experiments that both Myod1 and Myog transcription factors directly bind to the *Tead4* promoter in C2C12 cells (Blais et al., 2005). Subsequently, we showed that Tead4 is upregulated and is required for C2C12 differentiation *in vitro* (Benhaddou et al., 2012). ShRNA-mediated stable knockdown of Tead4 led to formation of shortened myotubes compared to control C2C12 cells. ChIP-chip experiments in C2C12 overexpressing Flag-HA-Tead4 revealed that Tead4 occupies 867 promoters including *Myog*, *Cdkn1a* and *Cav3*. RNA-seq identified the set of genes downregulated upon Tead4 knockdown amongst which are muscle structural and regulatory proteins. We put forward a model in Benhaddou et al. showing that Tead4 induces expression of *Myog* and *Ankrd2* required for myoblast differentiation, but represses the expression of *Ctgf* and *Ccnd1* contributing to cell cycle exit. However, in this study we did not address the role of other Teads in these cells.

Here, we show that siRNA mediated silencing of *Tead4* has no effect on primary myoblast differentiation. SiRNA silencing of either *Tead1*, *Tead2* or *Tead4* had no impact on differentiation of freshly isolated post-natal primary myoblasts while simultaneous knockdown of two or three of the Tead proteins resulted in strong impairment of differentiation in both primary myoblasts and C2C12 cells. By ChIP-seq, we identified sites commonly and preferentially bound by either Tead1 or Tead4 in non-differentiated C2C12 myoblasts, but that Tead1 genomic occupancy is strongly reduced in differentiated cells, where Tead4 binds to more than 8000 sites, many of which are associated with H3K27ac-marked active regulatory elements. RNA-seq identifies distinct but overlapping sets of deregulated genes in C2C12 and primary myoblasts, which upon comparison with ChIP-seq data reveal genes that may be directly deregulated by Tead4. We also identify an enhancer signature of frequently co-occurring motifs at loci collectively bound by Tead4, Myod1 and Myog associated with genes activated during muscle differentiation. We therefore describe for the first time in a comprehensive manner the regulatory roles of Tead factors in muscle cell differentiation.

Results

Tead family factors are essential for primary myoblast differentiation.

Our previous results showed that Tead4 plays an essential role in C2C12 cell differentiation (Benhaddou et al., 2012). We wished to extend the study of Tead4 function and address its role in the differentiation of primary murine myoblasts. Primary myoblasts were isolated from 3-4 week-old C57BL/6 mice and differentiated *in vitro* for 6 days (see Materials and methods). Quantitative RT-PCR analysis showed that *Tead4* mRNA expression was strongly induced at days 3 and 6 during differentiation (Figure 1A). Similarly, expression of *Tead1* was also strongly induced, whereas *Tead2* expression did not show strong variation during this process and *Tead3* is not significantly expressed in myoblasts (data not shown). Therefore similar to C2C12 cells, *Tead4* expression is induced during primary myoblast differentiation.

To address the function of Tead4 in this process, we used siRNA transfection to silence its expression. SiRNAs were transfected 24 hours before the initiation of differentiation. Compared to control siRNA, transfection of *siTead4* led to a potent reduction in *Tead4* expression (Figure 1B). Nevertheless, Tead4 silencing did not affect *Myog* and *Myod1* expression both of which remained expressed in the differentiating cells (Figure 1B). Staining of the transfected cells for myosin heavy chain expression (hereafter Myh) expression showed that *Tead4* silencing did not impair myoblast differentiation as the *Tead4*-silenced cells formed long multinucleate myotubes (Figure 1C). Calculation of the fusion index showed in fact that diminishing *Tead4* levels lead to a mild reduction in the number of shorter myotubes, but did not affect the generation of the longer tubes (Figure 1D). Thus, *Tead4* silencing in differentiating primary myoblasts does not have the same effect as in C2C12 cells where its reduction led to diminished *Myog* expression and impaired differentiation.

As *Tead1* expression is also induced in differentiating primary myoblasts, we investigated whether there could be functional redundancy amongst the Teads. We first used siRNAs to silence *Tead1*, *Tead2* or *Tead4* and examined how this affected the expression of the other family members. *Tead1* expression was strongly down-regulated by *siTead1*, less so by *siTead2*, but not by *siTead4* (Figure 1E). Similarly, *Tead4* expression was not affected by silencing of *Tead1* or *Tead2*. Expression of *Tead2* was reduced in the undifferentiated state upon silencing of either *Tead1* or *Tead2*, but its expression during differentiation was

minimally affected. Thus, expression of each of the Teads is rather independent of the others suggesting possible function redundancy.

To assess the function of Tead1 and Tead2 their expression was silenced using siRNAs. As seen above, *siTead4* silencing had only a mild effect on differentiation (Figure 1F). Similarly, silencing of *Tead1* or *Tead2* had little effect on differentiation (Figures 1F and G). These results show either that the Teads play redundant roles in differentiating primary myoblasts or alternatively no essential role in these cells. Examination of gene expression showed nevertheless that *Myh1* and *Myh2* were reduced by each knockdown (Figure 1H). In contrast, expression of *Cav3*, a well-defined Tead4 target gene in C2C12 cells, was reduced only by *Tead4* silencing. Similarly, *Myh7* expression was strongly and selectively diminished in the *siTead4* cells. This shows a specific requirement for Tead4 at these genes that cannot be compensated by the expression of the other Teads. Thus at least in the case of these genes, Teads are required and there is a specific non-redundant function for Tead4.

To address the possible redundancy, we next transfected primary myoblasts with combinations of siRNAs against *Tead1* and *Tead4*, the two Teads whose expression is strongly induced during differentiation, or Tead1, Tead2 and Tead4. The expression of the corresponding Teads was reduced in all cases (Figure 2A). In contrast to the individual *siTead1* and *siTead4* knockdowns the combinatorial knockdown of these two factors had a potent effect on differentiation, with the appearance of many cells expressing Myh, but no fusion and the prevalence of shorter myotubes than in the control siRNA cells (Figure 2B). Moreover, a larger number of cells failed to initiate Myh expression. Similar observations were made using the *Tead1*, *Tead2* and *Tead4* siRNA combination (Figure 2B). Calculation of the fusion index showed a marked reduction of the number of nuclei in myotubes expressing Myh and of the number of cells that initiated Myh expression (Figure 2C). Analysis of gene expression showed a strong reduction of *Myh1*, *Myh2*, *Myh7* and *Tnni1* in the *siTead1/Tead2/Tead4* cells (Figure 2D). Together, these observations showed that Teads do indeed play essential, but partially redundant functions in differentiating primary myoblasts.

Specific and redundant roles of Tead family factors in C2C12 cell differentiation.

The above observations showed partially redundant roles for Tead factors in differentiating primary myoblasts, whereas we showed a critical role for Tead4 in C2C12 cells. In our previous experiments, we used shRNA to make stable Tead4 knockdowns, but

Results

we did not investigate systematically the role of the other Teads in these cells. To investigate this more closely, we performed single and combinatorial siRNA knockdowns of the Teads in C2C12 cells.

As previously seen, *Tead4* expression was strongly induced during C2C12 cell differentiation (Figure 3A) and its induction was not diminished by *Tead1* silencing, but was somewhat reduced by *Tead2* silencing. *Tead2* expression was also induced albeit less strongly than *Tead1* or *Tead4*, but its activation was strongly diminished by *Tead1* or *Tead4* silencing. *Tead1* expression was induced during differentiation, but importantly its induction was strongly reduced when *Tead4* was silenced. This result was confirmed by Western blot, where induced expression of the Tead1 and Tead4 proteins was seen in the extracts from differentiated cells (Supplemental Figure 1A and B). While Tead4 induction was not reduced, but actually mildly increased in *siTead1* cells, Tead1 induction was reduced in the *siTead4* cells. This marks a fundamental difference with primary myoblasts where *Tead1* was strongly induced even in the absence of *Tead4* and thus could potentially compensate for *Tead4* silencing. In C2C12 cells this is not the case as *Tead4* is required for maximal *Tead1* activation during differentiation. In all situations, transfection with siRNAs against individual Teads or combinations of Teads had the potent and expected effects on their own expression. Moreover, *siTead1/Tead4* lead to reduced *Tead2* expression (Figure 3A).

Staining of control and siRNA transfected cells with Myh allowed assessment of the effects on differentiation. Compared to control cells, silencing of *Tead1* or *Tead4* lead to a reduction in myoblast fusion with the absence of longer and thicker fibres in favour of shorter and less developed fibres (Figure 3B). A similar, but less pronounced, effect was seen upon *Tead2* silencing. Combinatorial *Tead1/Tead4* silencing led to more dramatic effects with the appearance of fewer and shorter fibres, while silencing of all three Teads resulted in the formation of only a few elongated myotubes. A corresponding reduction of the fusion index upon combinatorial siTead silencing was observed (Figure 3C).

These results show that normal expression of each Tead is essential for full differentiation characterised by the generation of long and thick fibres and hence that all three factors contribute to this process.

Selective Tead1 and Tead4 genomic occupancy

Results

To better understand how individual Teads, in particular Tead1 and Tead4 contribute to gene expression in C2C12 cells, we used ChIP-seq to profile their genomic occupancy in un-differentiated and differentiated cells. Chromatin was prepared before differentiation and 6 days after differentiation and ChIP was performed with antibodies that selectively ChIP either Tead4 or Tead1.

Analysis of Tead4 occupancy in undifferentiated cells identified 2940 sites that were located mainly distant from the transcription start sites (TSS) (Figure 4A). In contrast with many other transcription factors, only little enrichment of Tead4 occupancy was seen close to the TSS. After differentiation, and consistent with the increase in Tead4 expression, more than 8100 sites were occupied, the majority of which were again located distant from the TSS (Figure 4B). Analysis of DNA motifs at the occupied sites in both undifferentiated and differentiated cells showed strong enrichment of the previously described MCAT motif (Figure 4C-D). Nevertheless, other motifs co-occurred with the MCAT motif at higher than expected frequency at these sites. In undifferentiated cells, a strong enrichment in motifs for the AP1-family of transcription factors was observed (Figure 4C). Enrichment for other factors such as Runx was also seen. In differentiated cells, AP1 family sites remained enriched, but other sites were now prominent such as the E-Box, recognition sequence for Myod1, Ctf3, and Tcf3 (Figure 4F). Thus during differentiation, Tead4 occupies a new repertoire of sites and associates with different transcription factors to activate the differentiation program.

As previously seen by ChIP-chip (Benhaddou et al., 2012), Tead4 constitutively occupied sites upstream of the *Ctgf* and *Ccnd1* genes (Figure 4G), whereas occupancy of sites at the *Acta1* locus is seen only during differentiation. A global comparison of the sites in undifferentiated and differentiated cells indicated that occupancy of 1400 sites was lost during differentiation, whereas that of more than 6700 sites was gained and that of 1400 sites was seen under both conditions (Figure 5A-B). Analysis of the DNA motifs at sites specifically occupied in undifferentiated and differentiated cells confirmed the analysis seen above with a prevalence of AP1 sites in the undifferentiated state and of Ctf3, Myod1, Myog and Tcf3 in differentiated cells (Figure 5C). We also found enrichment for Tcf12 at Tead4 sites in differentiated cells. Tcf12 has been shown to cooperate with Myod1 to promote myogenic differentiation (Parker et al., 2006).

Results

We next performed a similar analysis of Tead1 occupied sites. In undifferentiated cells, Tead1 occupied around 1400 sites, located far from the TSS, enriched in the MCAT motif as well as those of AP1 and Runx (Figures 6A, C and D). Strikingly however, Tead1 occupancy was strongly reduced in the differentiated state and only 274 sites were observed (Figure 6B). Sites occupied in both the undifferentiated and differentiated states, nevertheless showed lower expression in the differentiated states (Figure 6E). Thus, transition from the undifferentiated to the differentiated states involves a switch from Tead1 and Tead4 occupancy to predominantly Tead4 occupancy.

A comparison of Tead1 and Tead4 occupancy in the undifferentiated state revealed a large set of more than 900 sites occupied by both Tead1 and Tead4 as well as sites occupied almost exclusively by Tead4 (Figure 7A). A smaller set of sites also shows preferential occupancy by Tead1, although at most of these sites there is also a low level of Tead4 occupancy with few sites showing a selective Tead1 occupancy (Figure 7B). Thus despite the fact that these two proteins bind identical sequences and that Tead1 occupancy appears globally lower than that of Tead4, there are a set of sites that are preferentially occupied by Tead1.

We noted above that Tead4 regulated *Tead1* expression during differentiation. We therefore examined Tead4 occupancy at the *Tead1* locus. Two constitutive Tead1/Tead4 occupied sites were observed, one upstream of the promoter of the longest isoform and a second upstream of an alternative promoter giving rise to a shorter isoform (Figure 8A). Tead1 occupancy disappeared at this locus during differentiation, but Tead4 occupancy persisted and even increased suggesting that Tead4 directly regulates *Tead1* induction. Integration of the Tead1/4 ChIP-seq data with public data on histone modifications in undifferentiated and differentiated C2C12 cells revealed the presence of H3K27ac, a mark of active promoters and enhancers, at the *Tead1* promoter in undifferentiated cells overlapping with the Tead1/4 occupied sites. Interestingly, upon differentiation, H3K27ac increased at the Tead1/4 occupied sites and new regions marked by H3K27ac appeared upstream of and overlapping with the alternative promoter. Moreover, integration with ChIP-seq data for Myod1 and Myog indicated that these two factors bind immediately upstream of the alternative promoter at the regions that become enriched in H3K27ac. These observations suggest that Tead4 cooperates with Myog and Myod1 to activate *Tead1* expression during differentiation via constitutive and inducible enhancer and promoter elements and moreover

that an alternative *Tead1* isoform is expressed during differentiation under the control of Myog and Myod1.

An analogous examination of the *Tead4* locus showed that Tead4 occupied a site immediately upstream of its own promoter and that occupancy of this site was strongly increased upon differentiation (Figure 8B). In contrast, almost no Tead1 occupancy was seen at these sites. This Tead4-bound site coincided with H3K27ac, but upon differentiation, several regions in the *Tead4* gene body strongly acquired H3K27ac and several of these sites coincided with binding of Myod1 and Myog. This suggests that Tead4 positively regulates its own expression together with these factors that bind to differentiation-induced enhancer elements downstream of the Tead4 TSS.

These data help explain why Tead4 regulates *Tead1*, but not the inverse. At both genes, novel enhancers become active during differentiation and bind Myod1 and Myog to promote the up-regulated expression of these Teads during differentiation.

We made a more global analysis of Tead1 and Tead4 association with chromatin marks. We clustered Tead4-occupied sites in undifferentiated and differentiated cells with H3K4me3 a mark of active promoters, H3K4me1, a mark of active and poised enhancers as well as H3K27ac (Asp et al., 2011). Consistent with the fact that few Tead4 sites are at the TSS, only a limited overlap (280 of 2940) with H3K4me3 was observed (Figure 9A-B). In contrast, 1698 Tead4 sites in undifferentiated cells showed strong association with H3K4me1 and/or H3K27ac defining a set of sites at active and poised enhancer elements. A similar situation was seen with the sites occupied in differentiated cells where almost half were marked by with H3K4me1 and H3K27ac and up to 1500 sites associated with H3K4me3 (Figure 9A-B). Tead4 therefore occupies many functional regulatory elements in both undifferentiated and differentiated cells. A similar situation was seen in for Tead1 in undifferentiated cells (Supplemental Figure 2A). Due to their low number we did not analyse Tead1 sites in differentiated cells.

To better define the regulatory potential of Tead4, we identified the genes closest to the Tead4-occupied sites associated with active chromatin marks. In undifferentiated cells, 1262 genes were annotated and were found enriched in ontology terms such as cell structure and motility, developmental processes, oncogenesis and cell cycle control. Interesting KEGG pathway analysis revealed that Tead4 and Tead1, (Figure 9C and Supplemental Figure 2B) occupied sites associated with critical components of the Tgf β (*Smad2*, 3 6 and 7 as well as

Results

Tgfb2) and Wnt-signalling (*Fzd1*, *Fzd5*, *Tcf7l2*) pathways (Figure 9C). In addition, several effectors of the Hippo pathway such as *Amotl1*, *Amotl2* and *Lats2* are also associated with Tead1/4 occupied sites. In differentiated cells, more than 2000 genes were annotated and were found enriched in terms associated with cell structure and motility and developmental processes, but now also the terms muscle differentiation and contraction appear including the important regulatory genes *Myod1*, *Myog* and *Mef2a* as well as numerous structural genes of the muscle fibre. At many sites, Tead4 binding and H3K27ac is either enriched or acquired *de novo* at these genes during differentiation (see Supplemental Figure 2C).

As described above, we found that *Myod1* and *Myog* may co-regulate *Tead1* and *Tead4* expression during differentiation. Furthermore, we also found that *Myod1/Tcf12* binding motifs were enriched at *Tead4*-occupied sites in differentiated cells. We therefore analysed global co-localisation of *Tead4* with *Myod1* and *Myog*-occupied sites using previously published public data (Marinov et al., 2014). Comparison of *Myod1* and *Myog*-occupied sites in differentiated C2C12 cells with *Tead4* occupied sites showed a considerable overlap with more than 2000 loci with sites occupied by all three factors (Figure 10A). Analysis of the genes associated with these sites revealed as expected a collection of genes involved in myogenic differentiation (data not shown). As *Tead1* occupies sites essentially only in non-differentiated cells, a comparison with *Myod1* and *Myog*-occupied sites in differentiated cells revealed only a limited overlap of around 50 sites (Figure 10B). Analysis of the transcription factor binding motifs at the *Tead4-Myod1-Myog*-occupied sites showed enrichment not only in the recognition motifs for these factors, but also for *Tcf3*, *Tcf12*, *Runx*, and *Klf5*, whereas the AP1 family sites were less represented than in the overall *Tead4* profile (Figure 10C and see also Figure 4C).

This above analysis identified *Tead4*-occupied sites that are closely associated with *Myod1/Myog* sites. Nevertheless, as shown above at the *Tead1* and *Tead4* loci, *Tead4* may cooperate with *Myod1/Myog* to activate these genes despite the fact that binding sites are not closely spaced. We therefore generated a list of genes associated with *Tead4*-occupied sites and compared this to a list of genes associated with *Myog* and *Myod1* sites to identify genes that could be potential regulated by these factors despite the fact that they bind more distantly spaced promoter and/or enhancer elements. A large majority of all of the potential *Tead4* regulated genes are associated with *Myog/Myod1* whose potential target genes also show a strong overlap (Figure 10D).

Results

We also compared Tead1/4 occupancy with that of Mef2a, another myogenic factor for which a public data set is available (Wales et al., 2014). In this comparison, we also found a set of co-occupied sites in undifferentiated cells for both Tead1 and Tead4 (Figure 10E-F).

Together the above data indicate that Tead4 collaborates with Myod1 and/or Myog to activate a set of genes involved in myogenic differentiation and that Tead1/4 may collaborate with Mef2a to regulate gene expression in proliferating myoblasts.

Tead1/4-regulated gene expression in differentiating C2C12 cells.

We used RNA-seq to investigate gene expression in differentiating C2C12 cells and primary myoblasts and how these regulatory programs are affected by loss of Tead1 and Tead4. As the siRNA silencing of Tead4 or Tead1 individually had lesser effects on C2C12 differentiation, we chose to analyse the gene expression changes when both proteins were silenced simultaneously and differentiation was strongly impaired. Undifferentiated C2C12 cells were transfected with siRNAs and RNA was prepared 24 hours later (day 0) and then cells were moved to differentiation media and RNAs prepared 3 and 6 days later (Supplemental Figure 3A). Changes in gene expression in *siTead1/4* cells compared to the siControl cells were quantified to identify genes showing a greater than Log₂ fold change of 1 with adjusted p value <0,05.

We first made a global comparison of gene expression in the C2C12 and primary myoblasts. In C2C12 cells, 3137 genes are induced at day 3 and day 6 with respect to day 0, while in primary myoblasts 3626 genes are induced (Supplemental Figure 4A). Comparison showed that 1845 genes are commonly induced in both cell types. The commonly regulated genes are highly enriched in ontology terms associated with muscle differentiation. Similarly 2375 genes are repressed during C2C12 cell differentiation and 2799 genes repressed in primary myoblasts with 1495 common to both cell types (Supplemental Figure 4B). The commonly repressed genes are highly enriched in ontology terms associated with cell cycle, consistent with the fact that differentiation involves cell cycle arrest. Thus, similar but not identical, gene expression programs are activated and repressed during the differentiation of these two cell types.

Analysis of the 5512 genes regulated during differentiation of siControl C2C12 cells identified genes with different expression profiles that could be summarised in 6 clusters (Figure 11A). Genes in clusters 1, 3 and 4 are down-regulated during differentiation, but with

different kinetics, while those in clusters 2 and 5 are up-regulated with different kinetics, and those in cluster 6 are transiently induced at day 3 before returning to a lower level. Thus, gene expression during normal differentiation can be dissected into classes with different kinetics.

Following *siTead1/4* silencing, a set of both up and down-regulated genes were seen already at day 0 and the number of de-regulated genes increased at day 3 and then was somewhat reduced at day 6 (Figure 11B and Supplemental Figure 3B). In total, 249 genes were up-regulated by *siTead1/4* silencing between day 0-6, while 549 were repressed. Examples of genes whose expression was de-regulated are indicated in Figure 11C. Ontology analysis of the genes up-regulated by *Tead1/4* silencing at each day showed only low enrichment in various functions such as ectoderm and mesoderm development, proliferation, and signal transduction (Supplemental Figure 3C). On the other hand, ontology analyses of the down-regulated genes showed a strong enrichment in those involved in muscle differentiation particularly at days 3 and 6 (Supplemental Figure 3D).

To identify genes that may be directly regulated by Tead1/4, we integrated the genes identified as deregulated in the RNA-seq data with the list of genes associated with a Tead4 binding site. In total, around 5300 genes were associated with at least one Tead4 occupied site. Of the 249 genes that were up-regulated by *siTead1/4* silencing between days 0-6, 97 were associated with Tead4 occupied sites (Figure 12A), such as *Ccnd1* as previously described (Benhaddou et al., 2012) (Figure 12B). These genes show low enrichment in ontology terms associated with various types of signalling and proliferation. Of the 549 genes that were down-regulated by *siTead1/4* silencing between days 0-6, 181 were associated with Tead4 occupied sites, and were enriched in ontology terms associated with muscle development and include a plethora of structural components. These data indicate that almost 40% of the genes down-regulated by loss of Tead1/4 are potential direct targets.

Together the above data confirm the critical role of the Tead factors in the transcriptional activation of genes involved in myotube differentiation and suggest that at least some genes may be repressed by Tead factors during this process.

Tead1/4-regulated gene expression in differentiating primary myoblasts.

We performed a similar set of experiments in differentiating primary myoblasts. Again as Tead1 and Tead4 appear to have redundant roles in these cells, we chose to analyse

Results

the gene expression changes when both proteins were silenced simultaneously and differentiation was impaired. Triplicate samples were prepared at each time point and analysed to identify differentially regulated genes.

We analysed gene expression in control cells to organise the differentially expressed 6425 genes in 6 clusters (Figure 13A). As in C2C12 cells, this clustering identified genes up- or down regulated with different kinetics between days 0-6.

Following siTead1/4 silencing, up and down-regulated genes were seen already at day 0 and the number of de-regulated genes increased at day 3 and then was reduced at day 6 (Figure 13B and Supplemental Figure 5A). In total, 563 genes were up-regulated between day 0-6, while 377 were repressed. Selected genes whose expression was de-regulated are shown in Figure 13C. An unexpected observation was the large number of genes whose expression was up-regulated at day 3. In C2C12 cells, a majority of genes were down-regulated on each day (Figure 12B), whereas in primary myoblasts there were more genes up-regulated at each stage than down (Figure 13B). Ontology analysis of up-regulated genes showed enrichment in various aspects of signal transduction as well as ectoderm and mesoderm development, and proliferation (Supplemental Figure 5B). In contrast, ontology analyses of the down-regulated genes showed a strong enrichment in those involved in muscle differentiation (Supplemental Figure 5C). Thus, Tead factors are essential for activation of a set of genes involved in myotube differentiation in primary myoblasts.

We next compared the genes that are de-regulated by siTead1/4 silencing in C2C12 cells and in primary myoblasts. As the kinetics of their activation of repression may differ, we compared non-redundant lists of all genes deregulated between day 0-6 in each cell type. 249 genes are up-regulated in C2C12 cells compared with 563 in primary myoblasts, however only 65 are commonly up-regulated (Figure 14A). These genes are mainly involved in signalling and proliferation. 549 genes are down-regulated in C2C12 cells compared with 377 in primary myoblasts and only 119 are commonly down-regulated (Figure 14B). Amongst these are genes involved in myotube differentiation, including *Ankrd2* and several myosin genes. Remarkably therefore, Tead1/4 silencing had distinct effects on gene expression in C2C12 cells and primary myoblasts.

While we do not have Tead ChIP-seq data for primary myoblasts, we compared the genes whose expression was de-regulated in primary myoblasts with those associated with Tead4 in C2C12 cells. Of the 563 genes up-regulated by siTead1/4 silencing in primary

Results

myoblasts 160 were associated with Tead4 occupied sites (Figure 12B), again including *Ccnd1* and with enrichment in ontology terms associated with various types of signalling. Of the 377 genes that were down-regulated, 139 were associated with Tead4 occupied sites and were enriched in ontology terms associated with muscle development. Thus assuming that Tead4 genomic occupancy in primary myoblasts is comparable to that in C2C12 cells, 36% of the genes down-regulated by loss of Tead1/4 are potential direct targets. While confirmation of this will obviously require Tead4 ChIP-seq data from this line, Tead4 appears to directly regulate a significant fraction of these de-regulated genes.

Discussion.

Here we show that Tead factors play essential roles in primary myoblast differentiation. While silencing of each individual Tead had only a mild or no discernable effect at the cellular level, their loss specifically affected gene expression showing for example the critical role of Tead4 in expression of the *Myh7* and *Cav3* genes. In contrast, combinatorial *Tead1/4* or *Tead1/2/4* silencing strongly impaired primary myoblast differentiation indicating functional redundancy amongst these factors. Under these conditions, fewer cells initiated Myh expression and entered differentiation, and those that expressed Myh generated shorter myotubes.

Functional redundancy may be explained by the fact that both *Tead1* and *Tead4* expression, and to a lesser extent *Tead2*, was strongly up-regulated during differentiation. The expression of each Tead factor was largely independent of the silencing of the others such that loss of *Tead4* could be compensated by *Tead1* expression and *vice-versa*. These data show therefore for the first time the critical, but redundant roles that these factors play in primary myoblast differentiation.

The above data contrast with our previous observation that Tead4 plays a critical role in C2C12 cell differentiation (Benhaddou et al., 2012). We readdressed this using siRNA-mediated silencing and found that similar to what we previously reported, *Tead4* silencing by impaired C2C12 cell differentiation leading to the appearance of shorter myotubes. Nevertheless, this effect was less dramatic than that observed with shRNA-mediated silencing. Furthermore, we also found that *siTead1* or *siTead2* silencing also impaired differentiation. Normal activation of *Tead1* expression in C2C12 cells is down-regulated by loss of *Tead4*, at both the RNA and protein levels, whereas Tead4 induction is independent of Tead1. *Tead4* silencing also down-regulates *Tead2* expression in C2C12 cells. Thus, in

Results

contrast to what we observed in primary myoblasts, the expression of the Teads in C2C12 cells is strongly interconnected through a network of mutual regulation with a particularly important role for Tead4. Hence, the effects of silencing of a given Tead result not only from its loss, but also from the down-regulation of other Teads. Note however that the down-regulation of Tead1 and Tead2 expression by Tead4 silencing is less pronounced than that achieved by the specific siRNAs against these genes.

Further evidence for an important role of Tead4 in regulating Tead1 expression comes from the observation that it occupies sites around the TSS of the *Tead1* gene. Moreover, it also appears that an alternative isoform of *Tead1*, lacking the first exon, is induced from a downstream promoter during differentiation. This is suggested by the presence of Myod1 and Myog sites and by the appearance of H3K7ac upstream of and overlapping with this alternative TSS in differentiated cells. This will be confirmed by analysis of the splice junction sequences from the RNA-seq data.

There remains however some discrepancies with what we previously observed using shRNA silencing. For example, shRNA *Tead4* silencing strongly inhibited *Myog* expression, while this effect was much less pronounced upon *siTead4* silencing. Part of the explanation, may be explained by a less efficient silencing by the siRNA, however there is a second fundamental difference in the two approaches that may be more pertinent. In the shRNA experiments, cells were infected and selected for more than 10 days before differentiation. Thus, Tead4 was silenced during this period before differentiation was initiated. In the siRNA experiments, Tead4 is silenced immediately prior to differentiation. This difference takes on significance as we show that despite its low expression, Tead4 occupies more than 2800 binding sites in proliferating myoblasts, notably a site upstream of the *Myog* gene, previously identified in ChIP-chip, present in a region that strongly gains H3K27ac during differentiation. It is possible therefore that diminished Tead4 levels for several days prior to differentiation affects the subsequent activation of *Myog* expression. Perhaps Tead4 binding to this poised enhancer region is critical for *Myog* activation. A similar situation may also occur at other genes that are rapidly induced after differentiation. The finding that Tead4 extensively occupies the genome in proliferating C2C12 cells suggests that it may play a critical role in establishing the proper chromatin state permissive for activation of genes during differentiation. This hypothesis merits further investigation.

Results

As noted above, Tead4 occupies a large set of binding sites in proliferating C2C12 cells. Comparison with Tead1 occupancy showed that Tead4 occupied more sites than Tead1 despite its lower expression. This observation may have a biological significance, but also a technical explanation. It is possible that the ChIP-efficiency of the Tead1 antibody is much poorer than that of the Tead4 antibody, and thus it fails to detect Tead1 binding to many sites giving a lower overall signal. Nevertheless, there exists a set of sites that are preferentially occupied by Tead1 in undifferentiated cells rather suggesting that the otherwise lower binding of Tead1 has a biological relevance and is not due to technical problems related to the antibodies. It appears therefore that Tead1 binding is overall lower than Tead4, but there exist sets of sites selectively and/or preferentially occupied by Tead4 or Tead1. This preferential occupancy cannot be readily explained by differences in the DNA sequence at these sites as the DNA binding domains of the Teads are essentially identical as are the derived binding motifs from the ChIP-seq data. These data suggest that preferential occupancy is not only driven by relative abundance, but that other factors may contribute to the preferential occupancy by a given Tead.

Following differentiation and up-regulated Tead4 expression, Tead1 genomic occupancy is strongly reduced and Tead4 plays a dominant role. Examination of protein levels shows that Tead1 expression drops at day 6 when the ChIP-seq data were obtained. However as observed in undifferentiated cells, there is a preferential genomic binding of Tead4 and higher Tead4 expression therefore competes with Tead1 leading to an almost complete switch to Tead4 in differentiated cells. To test this idea it would be necessary to perform Tead1 ChIP-seq in Tead4 silenced cells as one would expect that under these conditions, Tead1 would be able to bind many sites in absence of Tead4, thus explaining the partial redundancy that is observed. We also attempted to perform Tead2 ChIP-seq using a previously published antibody, but were unable to obtain a meaningful profile.

Integration of the Tead4 ChIP-seq data with that of chromatin modifications showed that a large proportion of Tead4 occupied sites was associated with active H3K27ac-marked regulatory elements in both undifferentiated and differentiated cells. Moreover, many sites showed co-occupancy by Tead4 along with Myog and Myod1. These observations reinforce the idea that Tead4 in particular and Teads in general may cooperate with Myod1 and Myog to regulate gene expression during differentiation.

Results

It was previously reported that Myod1 binding orchestrates the activation of a compendium of muscle enhancer elements (Blum and Dynlacht, 2013; Blum et al., 2012). Analyses of the DNA sequences at these enhancers identified site for the AP1 and RUNX families, but did not revealed enrichment of the MCAT motif. In our analyses, we found that Tead4-occupied sites showed enrichment in AP1 family motifs in non-differentiated cells suggesting convergence of these two factors to drive proliferation. In differentiated cells, Myod1/Myog motifs and Runx motifs become enriched consistent with the observed colocalisation. Nevertheless, although a significant proportion of Tead4 occupied sites are co-occupied by Myod1/Myog, these sites constitute only a smaller subset of the total Myod1/Myog sites. This explains why the MCAT motif was not detected in the analyses of Blum et al., (Blum et al., 2012). It is also interesting to note that motifs for other factors such as Tcf3 and Ctfc are enriched at the Tead4 occupied sites, but were not generally detected at Myod1 sites suggesting that this subset comprises a slightly different signature from the more global population. It should also be noted that there is a large overlap between the Myod1 and Myog-bound sites as these two factors bind the same Ebox motifs. This result does not mean that these factors bind simultaneously, but that as transcription factor binding *in vivo* is very dynamic, the ChIP-seq data provides a snapshot of the relative occupancy of these sites by each factor at any given time. The same reasoning applies to Tead1 and Tead4 that also bind the same sites. Thus the preferential Tead4 occupancy seen in ChiP-seq reflects its higher occupancy time relative to Tead1.

The critical role of Tead factors in C2C12 cell and primary myoblast differentiation was confirmed by the results of RNA-seq showing that Tead1/4 silencing led to diminished activation of many muscle structural genes. A more intriguing observation is that Tead1/4 drive distinct but overlapping gene expression programs in the two cell types. This partly reflects the observation that the overall gene expression programs of differentiating C2C12 cells and primary myoblasts differ. Only a subset of genes are commonly activated and repressed in both cell types.

We previously suggested that Tead4 may also repress a set of genes during differentiation such as *Ccnd1* and *Ctgf* that are associated with Tead4-occupied sites, but whose expression increased upon Tead4 silencing. These data are partially confirmed in this study as we observed endogenous Tead4 binding to the *Ccnd1* and *Ctgf* loci and *Ccnd1* expression was up-regulated upon Tead4 silencing. In this case, we did not observe such

strong up-regulation of *Ctgf*, however we identified several other genes whose expression is up-regulated in both cell types and which are associated with Tead4 occupied sites. These data again raise the question of the ability of Tead4 to act as a transcriptional repressor. This prompted us to identify novel Tead4 interacting partners in a study described in the next section.

Materials and Methods

Mice.

Mice were kept in accordance with the institutional guidelines regarding the care and use of laboratory animals and in accordance with National Animal Care Guidelines (European Commission directive 86/609/CEE; French decree no.87–848). All procedures were approved by the French national ethics committee.

Cell culture, differentiation and transfections

C2C12 cells were grown in 20% foetal calf serum (FCS) containing DMEM medium and were differentiated for most experiments up to six days in 2% horse serum (HS) containing DMEM medium. Adult mouse primary myoblasts were isolated from C57BL/6 wild type 3-4 week old mice and plated on matrigel-coated dishes. The primary myoblasts were grown in 20% FCS containing IMDM GLUTAMAX-I medium and were differentiated in 2% HS containing IMDM GLUTAMAX-I medium. The siRNA transfection experiments were performed as per the Lipofectamine® RNAiMAX manufacturer's protocol and cells were harvested at indicated time points of differentiation after the siRNA transfection. ON-TARGET-plus SMARTpool siRNAs for Tead1, Tead2 and Tead4 knockdown were purchased from Dharmacon Inc. (Chicago, Il., USA). Control siRNA directed against luciferase was obtained from Eurogentec (Seraing, Belgium). The siRNA experiments were performed at least in triplicates. Phase contrast images were taken at 4x magnification using the EVOS digital microscope.

Immunoblotting

Whole cell extracts were prepared by the standard freeze-thaw technique using LSDB 500 buffer (500 mM KCl, 25 mM Tris at pH 7.9, 10% glycerol, 0.05% NP-40, 1 mM DTT, and protease inhibitor cocktail) and Immunoblotting was performed by the standard

procedure. The following antibodies were used: Tead4 (M01) from Abnova, Tead1 (BD Biosciences) and in-house beta-actin antibody.

Immunofluorescence and fusion index

1×10^5 cells were seeded on coverslips in 35mm dishes with matrigel for primary myoblasts and without matrigel for C2C12 cells and were transfected with siRNA 4 hours after seeding. Cells were refreshed 6 to 8 hours after the siRNA treatment and fixed on day 6 of differentiation with 4% formaldehyde for 10 mins. Cells were washed with PBS and permeabilized with 0.5% triton for 10 mins, washed twice with PBS-tween 0.2% and blocked with 5% BSA for 30 minutes. Cells were incubated overnight at 4°C with myosin heavy chain (fast) antibody (MY-32, sigma) followed by three PBS-tween 0.2% washes. Secondary antibody incubation was done for 30 minutes at room temperature. Cells were washed three times with PBS-tween 0,2% and stained with DAPI. Coverslips were mounted on superfrost glass slides using Vectashield®. Slides were visualised using an inverted fluorescence microscope at 10x magnification in all experiments.

Fusion index was calculated by two methods: 1) Only cells with more than 3 nuclei are considered as myotubes. Therefore, cells with 1-2 nuclei or more than 3 nuclei were counted and presented as a percentage of total cells in the field. 3 fields were counted per condition. 2) To quantify the fusion in double and triple knockdown experiments, we calculated the fusion index as the percentage of number of nuclei within the MHC-positive cells above total number of nuclei counted in a field. Nuclei in three such fields were counted and an average was represented. Note that Myh⁺ cells with only 3 or nuclei were taken for the counting of the nuclei.

RNA extraction, RTqPCR and RNA-sequencing

Total RNA was extracted using the GenElute™ Mammalian Total RNA Miniprep Kit from Sigma. cDNA was prepared with using SuperScript® II Reverse Transcriptase (RT) using the kit protocol and quantitative PCR was carried out with the SYBR® Green I (Qiagen) and monitored using the Roche Lightcycler® 480. Primer sequences were designed using Primer3plus software and b-actin was used as normalization control.

For RNA-sequencing, mRNA was prepared in two independent experiments and Messenger-RNA-seq was performed essentially as described (Herquel et al., 2013) with libraries of template molecules suitable for high throughput DNA sequencing prepared using

Results

the “TrueSeq™ RNA sample preparation kit” (Illumina). Reads were mapped onto the mm9 assembly of the mouse genome using Tophat v2.0.10 (Kim et al., 2013) and the bowtie2 v2.1.0 aligner (Langmead and Salzberg, 2012). Only uniquely aligned reads have been retained for further analyses. Quantification of gene expression was performed using HTSeq v0.6.1 (Anders et al., 2015) using gene annotations from Ensembl release 67. Read counts have been normalized across libraries with the method proposed by (Anders and Huber, 2010). Comparisons of interest were performed using the method proposed by (Love et al., 2014) and implemented in the DESeq2 Bioconductor library (DESeq2 v1.8.1), taking into account the batch, treatment and day effects. A likelihood ratio test where we remove the day specific differences was performed. Resulting p-values were adjusted for multiple testing by using the Benjamini and Hochberg (Benjamini and Hochberg, 2014). Significantly deregulated genes were selected using a log₂ fold change >1 and <1 and adjusted p-value cutoff of 0,05. Gene ontology analyses were performed using the DAVID functional annotation clustering tool available at the website- <https://david.ncifcrf.gov/>.

ChIP and ChIP-sequencing

For chromatin immunoprecipitation, cells were cross-linked with 1% formaldehyde at room temperature for 10 mins and the reaction was stopped by adding glycine to a final concentration of 125mM for 10 mins at room temperature. Fixed cells were rinsed twice with PBS and pelleted via centrifugation in the last wash. Wash was removed and pellet was re-suspended in lysis buffer (10mM EDTA pH 8, 50mM Tris-HCl pH 8, SDS 1%). Lysate was sonicated in the Covaris sonicator for 20 mins and centrifuged at 14000 rpm for 10 mins. The Clear supernatant chromatin was used immediately or stored in -80°C. 50-150ug of chromatin was diluted 10 times in ChIP dilution buffer, pre-cleared with initially blocked protein G sepharose beads for 1 hour at 4°C. Pre-cleared chromatin was incubated overnight with 1µg of TEAD1 or TEAD4 antibody per 15µg chromatin. Bound material was immunoprecipitated with blocked protein G beads for 2 hours at 4°C. The beads were washed twice for 10 mins with each of the following buffers – low salt buffer, high salt buffer, LiCl buffer and Tris-EDTA buffer. The ChIPed material was eluted by two 15-minute incubations at room temperature with 250µl of Elution buffer (1% SDS and 0.1M NaHCO₃). Chromatin was reverse cross-linked by adding 20µl of 5M NaCl and incubated at 65°C for at least 4 hours and then DNA was subjected to RNase and proteinase K digestion and extracted by phenol-chloroform extraction.

Results

ChIP-seq libraries were prepared as previously described and sequenced on the Illumina Hi-seq2500 as single-end 50-base reads (Herquel et al., 2013). After sequencing, peak detection was performed using the MACS software (Zhang et al., 2008b), (<http://liulab.dfci.harvard.edu/MACS/>). Peaks were then annotated with Homer (<http://homer.salk.edu/homer/ngs/annotation.html>) using a window of ± 10 kb (or as indicated in the figures) relative to the transcription start site of RefSeq transcripts. Global clustering analysis and quantitative comparisons were performed using seqMINER (Ye et al., 2011), (<http://bips.u-strasbg.fr/seqminer/>) and R (<http://www.r-project.org/>). The public data for H3K27ac and H3K4me3 data were taken from the GEO accession GSE25308. MYOD1 and MYOG ChIP-seq raw data were obtained from the GEO accession SRR768331 and SRR768333 respectively and re-analyzed in the similar way to the TEAD4 and TEAD1 ChIP-seq data.

Motif discovery and analysis

De novo motif discovery was performed on the 200 base pairs surrounding the top 600 Tead1 and Tead4 peaks using MEME-ChIP. Motif correlation matrix was calculated with in-house algorithms using JASPAR database. Individual motif occurrences were detected using FIMO within 200bp around peak summits. FIMO results were further processed to quantify occurrence and co-occurring motifs, using a custom Perl script which computes the frequency of occurrence of each motif. To assess the enrichment of motifs within the region of interest, the same analysis was done 100 times on randomly selected regions of the same size as that of the input bed file. Randomly selected regions were used to compute an expected distribution of motif occurrence or co-occurrence. The significance of the motif occurrence at the bound regions was estimated through the computation of a Z-score (z) with $z = (x - \mu) / \sigma$, where: x is the observed value (number of motif occurrence), μ is the mean of the number of occurrences (computed on randomly selected data), σ is the standard deviation of the number of occurrences of motifs (computed on randomly selected data). The source code is accessible at <https://github.com/slegras/motif-search-significance>.

Acknowledgements

We thank; C.Keime, B. Jost, and all the staff of the IGBMC high throughput sequencing facility, a member of “France Génomique” consortium (ANR10-INBS-09-08). This work was supported by

Results

grants from the CNRS, the INSERM, the AFM, the Ligue Nationale contre le Cancer (Région Alsace), the ANR-10-LABX-0030-INRT French state fund through the ANR under the programme Investissements d'Avenir labelled ANR-10-IDEX-0002-02 and the Labex INRT ANR-10-IDEX-0001-02. ID is an 'équipe labellisées' of the Ligue Nationale contre le Cancer. The funders had no role in study design, data collection and analysis, decision to publish, or preparation of the manuscript.

References.

- Anbanandam, A., Albarado, D.C., Nguyen, C.T., Halder, G., Gao, X., and Veeraraghavan, S. (2006). Insights into transcription enhancer factor 1 (TEF-1) activity from the solution structure of the TEA domain. *Proc Natl Acad Sci U S A* *103*, 17225-17230.
- Anders, S., and Huber, W. (2010). Differential expression analysis for sequence count data. *Genome Biol* *11*, R106.
- Anders, S., Pyl, P.T., and Huber, W. (2015). HTSeq--a Python framework to work with high-throughput sequencing data. *Bioinformatics* *31*, 166-169.
- Andrianopoulos, A., and Timberlake, W.E. (1991). ATTS, a new and conserved DNA binding domain. In *Plant Cell (United states)*, pp. 747-748.
- Asp, P., Blum, R., Vethantham, V., Parisi, F., Micsinai, M., Cheng, J., Bowman, C., Kluger, Y., and Dynlacht, B.D. (2011). Genome-wide remodeling of the epigenetic landscape during myogenic differentiation. *Proc Natl Acad Sci U S A* *108*, E149-158.
- Benhaddou, A., Keime, C., Ye, T., Morlon, A., Michel, I., Jost, B., Mengus, G., and Davidson, I. (2012). Transcription factor TEAD4 regulates expression of myogenin and the unfolded protein response genes during C2C12 cell differentiation. *Cell Death Differ* *19*, 220-231.
- Benjamini, Y., and Hochberg, Y. (2001). Discussion: An estimate of the science-wise false discovery rate and applications to top medical journals by Jager and Leek. *Biostatistics* *15*, 13-16; discussion 39-45.
- Blais, A., Tsikitis, M., Acosta-Alvear, D., Sharan, R., Kluger, Y., and Dynlacht, B.D. (2005). An initial blueprint for myogenic differentiation. *Genes Dev* *19*, 553-569.
- Blum, R., and Dynlacht, B.D. (2013). The role of MyoD1 and histone modifications in the activation of muscle enhancers. *Epigenetics* *8*, 778-784.
- Blum, R., Vethantham, V., Bowman, C., Rudnicki, M., and Dynlacht, B.D. (2012). Genome-wide identification of enhancers in skeletal muscle: the role of MyoD1. *Genes Dev* *26*, 2763-2779.

Results

- Burglin, T.R. (1991). The TEA domain: a novel, highly conserved DNA-binding motif. In *Cell (United states)*, pp. 11-12.
- Carson, J.A., Yan, Z., Booth, F.W., Coleman, M.E., Schwartz, R.J., and Stump, C.S. (1995). Regulation of skeletal alpha-actin promoter in young chickens during hypertrophy caused by stretch overload. *Am J Physiol* 268, C918-924.
- Cebola, I., Rodriguez-Segui, S.A., Cho, C.H., Bessa, J., Rovira, M., Luengo, M., Chhatriwala, M., Berry, A., Ponsa-Cobas, J., Maestro, M.A., *et al.* (2015). TEAD and YAP regulate the enhancer network of human embryonic pancreatic progenitors. *Nat Cell Biol* 17, 615-626.
- Davidson, I., Xiao, J.H., Rosales, R., Staub, A., and Chambon, P. (1988). The HeLa cell protein TEF-1 binds specifically and cooperatively to two SV40 enhancer motifs of unrelated sequence. *Cell* 54, 931-942.
- Han, D., Byun, S.H., Park, S., Kim, J., Kim, I., Ha, S., Kwon, M., and Yoon, K. (2015). YAP/TAZ enhance mammalian embryonic neural stem cell characteristics in a Tead-dependent manner. *Biochem Biophys Res Commun* 458, 110-116.
- Herquel, B., Ouararhni, K., Martianov, I., Le Gras, S., Ye, T., Keime, C., Lerouge, T., Jost, B., Cammas, F., Losson, R., *et al.* (2013). Trim24-repressed VL30 retrotransposons regulate gene expression by producing noncoding RNA. *Nat Struct Mol Biol* 20, 339-346.
- Huey KA , e.a. (2003). Transcriptional regulation of the type I myosin heavy chain gene in denervated rat soleus. - PubMed - NCBI.
- Jacquemin, P., Hwang, J.J., Martial, J.A., Dolle, P., and Davidson, I. (1996). A novel family of developmentally regulated mammalian transcription factors containing the TEA/ATTS DNA binding domain. *J Biol Chem* 271, 21775-21785.
- Judson, R.N., Tremblay, A.M., Knopp, P., White, R.B., Urcia, R., De Bari, C., Zammit, P.S., Camargo, F.D., and Wackerhage, H. (2012). The Hippo pathway member Yap plays a key role in influencing fate decisions in muscle satellite cells. *J Cell Sci* 125, 6009-6019.
- Kim, D., Pertea, G., Trapnell, C., Pimentel, H., Kelley, R., and Salzberg, S.L. (2013). TopHat2: accurate alignment of transcriptomes in the presence of insertions, deletions and gene fusions. *Genome Biol* 14, R36.
- Kivela, R., Kyrolainen, H., Selanne, H., Komi, P.V., Kainulainen, H., and Vihko, V. (2007). A single bout of exercise with high mechanical loading induces the expression of Cyr61/CCN1 and CTGF/CCN2 in human skeletal muscle. *J Appl Physiol* (1985) 103, 1395-1401.
- Langmead, B., and Salzberg, S.L. (2012). Fast gapped-read alignment with Bowtie 2. *Nat Methods* 9, 357-359.
- Love, M.I., Huber, W., and Anders, S. (2014). Moderated estimation of fold change and dispersion for RNA-seq data with DESeq2. *Genome Biol* 15, 550.

Results

- Mar, J.H., and Ordahl, C.P. (1988). A conserved CATTCT motif is required for skeletal muscle-specific activity of the cardiac troponin T gene promoter. *Proc Natl Acad Sci U S A* *85*, 6404-6408.
- Mar, J.H., and Ordahl, C.P. (1990). M-CAT binding factor, a novel trans-acting factor governing muscle-specific transcription. *Mol Cell Biol* *10*, 4271-4283.
- Marinov, G.K., Kundaje, A., Park, P.J., and Wold, B.J. (2014). Large-scale quality analysis of published CHIP-seq data. *G3 (Bethesda)* *4*, 209-223.
- Parker, M.H., Perry, R.L., Fauteux, M.C., Berkes, C.A., and Rudnicki, M.A. (2006). MyoD synergizes with the E-protein HEB beta to induce myogenic differentiation. *Mol Cell Biol* *26*, 5771-5783.
- Ribas, R., Moncaut, N., Siligan, C., Taylor, K., Cross, J.W., Rigby, P.W., and Carvajal, J.J. (2011). Members of the TEAD family of transcription factors regulate the expression of Myf5 in ventral somitic compartments. *Dev Biol* *355*, 372-380.
- Tsika, R.W., Schramm, C., Simmer, G., Fitzsimons, D.P., Moss, R.L., and Ji, J. (2008). Overexpression of TEAD-1 in transgenic mouse striated muscles produces a slower skeletal muscle contractile phenotype. *J Biol Chem* *283*, 36154-36167.
- Wales, S., Hashemi, S., Blais, A., and McDermott, J.C. (2014). Global MEF2 target gene analysis in cardiac and skeletal muscle reveals novel regulation of DUSP6 by p38MAPK-MEF2 signaling. *Nucleic Acids Res* *42*, 11349-11362.
- Watt, K.I., Judson, R., Medlow, P., Reid, K., Kurth, T.B., Burniston, J.G., Ratkevicius, A., De Bari, C., and Wackerhage, H. (2010). Yap is a novel regulator of C2C12 myogenesis. *Biochem Biophys Res Commun* *393*, 619-624.
- Watt, K.I., Turner, B.J., Hagg, A., Zhang, X., Davey, J.R., Qian, H., Beyer, C., Winbanks, C.E., Harvey, K.F., and Gregorevic, P. (2015). The Hippo pathway effector YAP is a critical regulator of skeletal muscle fibre size. *Nat Commun* *6*, 6048.
- Xiao, J.H., Davidson, I., Matthes, H., Garnier, J.M., and Chambon, P. (1991). Cloning, expression, and transcriptional properties of the human enhancer factor TEF-1. *Cell* *65*, 551-568.
- Ye, T., Krebs, A.R., Choukrallah, M.A., Keime, C., Plewniak, F., Davidson, I., and Tora, L. (2011). seqMINER: an integrated CHIP-seq data interpretation platform. *Nucleic Acids Res* *39*, e35.
- Zanconato, F., Forcato, M., Battilana, G., Azzolin, L., Quaranta, E., Bodega, B., Rosato, A., Bicciato, S., Cordenonsi, M., and Piccolo, S. (2015). Genome-wide association between YAP/TAZ/TEAD and AP-1 at enhancers drives oncogenic growth. *Nature Cell Biology* *17*, 1218-1227.
- Zhang, Y., Liu, T., Meyer, C.A., Eeckhoutte, J., Johnson, D.S., Bernstein, B.E., Nusbaum, C., Myers, R.M., Brown, M., Li, W., *et al.* (2008). Model-based analysis of CHIP-Seq (MACS). *Genome Biol* *9*, R137.

Zhao, B., Ye, X., Yu, J., Li, L., Li, W., Li, S., Lin, J.D., Wang, C.Y., Chinnaiyan, A.M., Lai, Z.C., *et al.* (2008). TEAD mediates YAP-dependent gene induction and growth control. *Genes Dev* 22, 1962-1971.

Figure legends.

Figure 1. Functions of Tead factors in differentiating primary myoblasts. **A-B.** Gene expression was quantified by RT-qPCR in differentiating primary myoblasts after transfection with the indicated siRNAs. **C.** Fluorescence microscopy images after 6 days of differentiation of primary myoblasts transfected with the indicated siRNAs. Green channel shows staining with Myosin heavy chain antibody, and blue Dapi-stained nuclei. 10X magnification. **D.** Fusion index of siControl and *siTead4* cells. **E.** Quantification of gene expression during primary myoblast differentiation after transfection with the indicated siRNAs. **F.** Bright field microscopy images after 6 days of differentiation of cells transfected with the indicated siRNAs. **G.** Fluorescence microscopy images after 6 days of differentiation following transfected with the indicated siRNAs. **H** Quantification of gene expression after transfection with the indicated siRNAs.

Figure 2. Redundant functions of Tead factors in differentiating primary myoblasts. **A.** Gene expression was quantified by RT-qPCR during primary myoblast differentiation after transfection with the indicated siRNAs. **B.** Fluorescence microscopy images after 6 days of differentiation of primary myoblasts transfected with the indicated siRNAs. Green channel shows staining with Myhc antibody, and blue Dapi-stained nuclei. **C.** Fusion index of siControl cells and cells following collective silencing of Tead1 and Tead4 or following collective silencing of Tead1, Tead2 and Tead4 **D.** Quantification of gene expression after transfection with the indicated siRNAs.

Figure 3. Specific and redundant functions of Tead factors in differentiating C2C12 cells. **A.** Gene expression was quantified by RT-qPCR during C2C12 cell differentiation after transfection with the indicated siRNAs. **B.** Fluorescence microscopy images after 6 days of C2C12 cell differentiation following transfection of the indicated siRNAs. Green channel shows staining with Myhc antibody **C.** Fusion index of siControl and following silencing of Tead factors alone or in combination, as indicated.

Figure 4. Tead4 genomic occupancy in non-differentiated and differentiated C2C12 cells. **A-B.** Localisation of Tead4 occupied sites in non-differentiated and differentiated C2C12 cells relative to genomic annotations (left panels) and the TSS (right panels). **C, E.** Frequency of occurrence of DNA binding motifs for the indicated transcription factors at Tead4 occupied sites in undifferentiated and differentiated C2C12 cells. **D, F.** Results of MEME analysis on the top 600 Tead4 occupied sites non-differentiated and differentiated C2C12 cells showing the high frequency of occurrence of the MCAT motif together with motifs for several other factors. **G.** UCSC screenshots of Tead4 occupancy in non-differentiated and differentiated C2C12 cells at the indicated gene loci.

Figure 5. Comparison of Tead4 genomic occupancy in non-differentiated and differentiated C2C12 cells. **A.** Read density cluster map using a non-redundant list of all Tead4-occupied sites to compare occupancy in non-differentiated and differentiated cells. **B.** Venn diagram showing the number of sites in the different clusters from the cluster map of panel A. **C.** analysis of transcription factor binding motifs at sites occupied by Tead4 in the differentiated and non-differentiated states as indicated.

Figure 6. Tead1 genomic occupancy in non-differentiated and differentiated C2C12 cells. **A-B.** Localisation of Tead1 occupied sites in non-differentiated and differentiated cells relative to genomic annotations (left panels) and the TSS (right panels). **C.** Frequency of occurrence of DNA binding motifs for the indicated transcription factors at Tead1 occupied sites in non-differentiated cells. **D.** Results of MEME analysis on the top 600 Tead1 occupied sites showing the high frequency of occurrence of the MCAT motif together with motifs for several other factors. **E.** UCSC screenshots of Tead1 occupancy in non-differentiated and differentiated C2C12 cells at the indicated gene loci.

Figure 7. Comparison of Tead1 and Tead4 genomic occupancy in non-differentiated C2C12 cells. **A.** Read density cluster map comparing Tead4 occupancy at Tead1-occupied sites. Right panel shows a Venn diagram with the number of common and shared sites. **B.** UCSC screenshots comparing Tead1 and Tead4 occupancy in non-differentiated C2C12 cells at the indicated gene loci.

Figure 8. Transcription factor occupancy and H3K27ac and the *Tead1* and *Tead4* gene loci. **A-B.** UCSC screenshots showing Tead4 and Tead1 occupancy and H3K27ac at *Tead1* and *Tead4* gene loci in non-differentiated and differentiated C2C12 cells along with Myog and Myod1 occupancy in differentiated cells.

Figure 9. Integration of Tead4 genomic occupancy with chromatin modifications during C2C12 cell differentiation. **A.** Read density cluster map showing chromatin modifications at Tead4-occupied sites in non-differentiated and differentiated cells. **B.** Venn diagrams illustrating the overlap of chromatin modifications with Tead4 genomic occupancy. **C.** Identification and ontology analysis of genes associated with Tead4 sites at active H3K27ac marked regulatory elements.

Figure 10. Identification of sites co-occupied by Tead4 with Myod1 and Myog. **A.** Read density cluster maps showing sites occupied by Myog, Myod1 and Tead4 in differentiated cells. The metaprofiles of selected clusters are shown to the right. **B.** Read density cluster map comparing sites occupied by Myog and Myod1 in differentiated cells with Tead1 in non-differentiated cells. Only a small collection of common sites was identified. **C.** Frequency of occurrence of transcription factor binding motifs at the commonly occupied sites from panel A. **D.** Venn diagrams illustrating the overlap of genes associated with Tead4, Myod1 and Myog bound sites. **E-F.** Read density cluster maps showing sites occupied by Tead4 or Tead1 and Mef2a. The metaprofiles of selected clusters are shown to the right.

Figure 11. Identification of Tead1/4-regulated genes in differentiating C2C12 cells. **A.** Classification of genes up- and down-regulated during differentiation of C2C12 cells transfected with control siRNA. **B.** Box plots showing gene expression changes during differentiation of cells transfected with *siTead1/4*. **C.** Examples of genes deregulated in *siTead1/4* cells compared to siControl.

Figure 12. Identification of potential direct Tead4-regulated genes in differentiating C2C12 cells. **A.** Venn diagrams illustrating the overlap between genes with associated Tead4 occupied sites and genes up or down-regulated by *siTead1/4* silencing in C2C12 cells. The ontology analysis of the potential direct target genes is shown. **B.** Venn diagrams illustrating the overlap between genes with associated Tead4 occupied sites in C2C12 cells and genes up or down-regulated by *siTead1/4* silencing in primary myoblasts. The ontology analysis of the potential direct target genes is shown.

Figure 13. Identification of Tead1/4-regulated genes in differentiating primary myoblasts. **A.** Classification of genes up- and down-regulated during differentiation of primary myoblasts transfected with control siRNA. **B.** Box plots showing gene expression changes

during differentiation of cells transfected with *siTead1/4*. **C.** Examples of genes deregulated in *siTead1/4* cells compared to siControl.

Figure 14. Identification of genes commonly regulated by Tead1/4 in differentiating primary myoblasts and C2C12 cells. **A-B.** Venn diagrams illustrating the overlap between genes up or down-regulated by *siTead1/4* silencing in differentiating primary myoblasts and C2C12 cells. The ontology analysis of the potential direct target genes is shown.

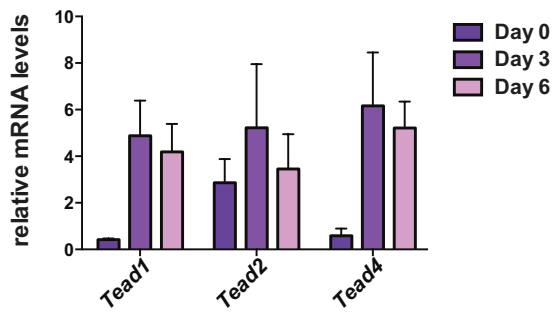
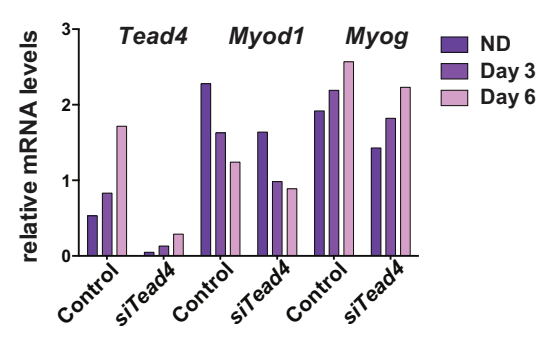
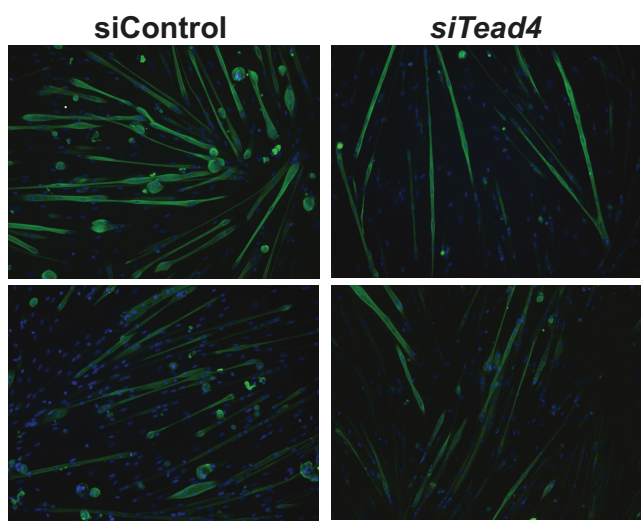
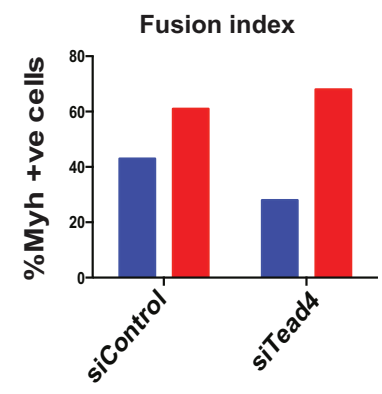
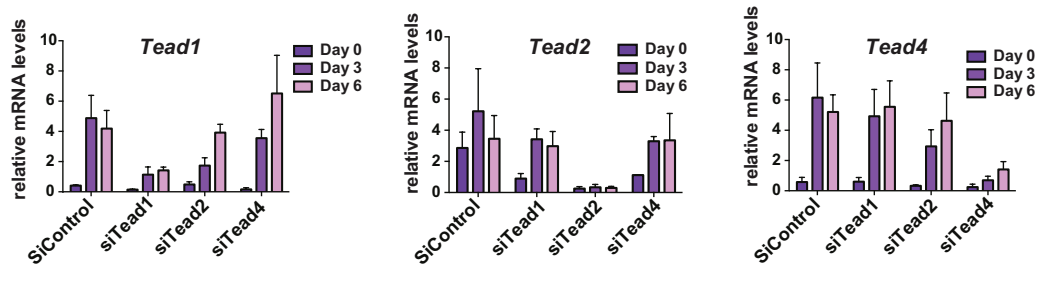
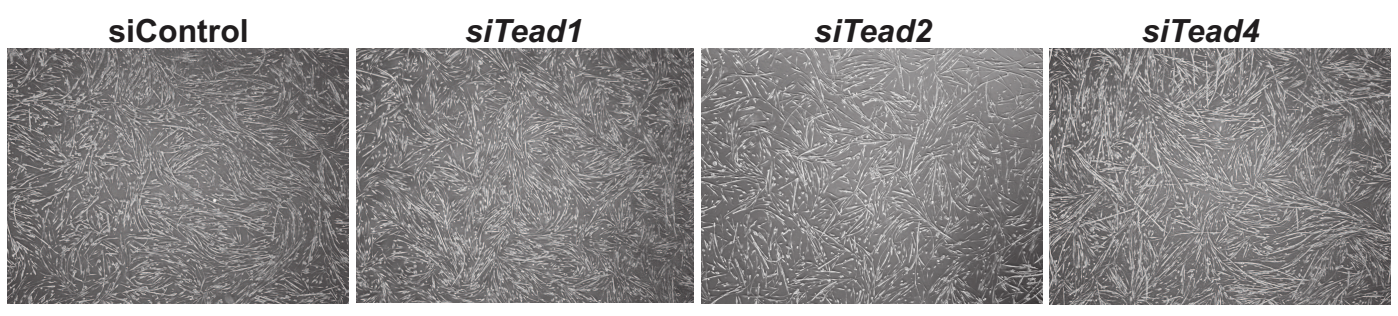
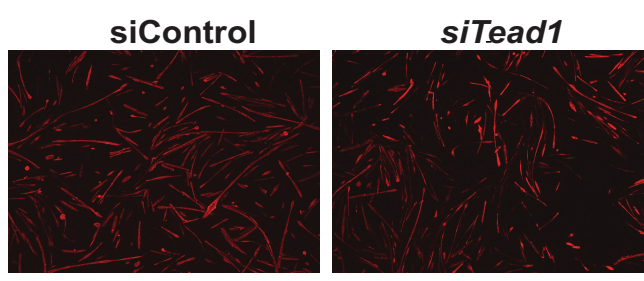
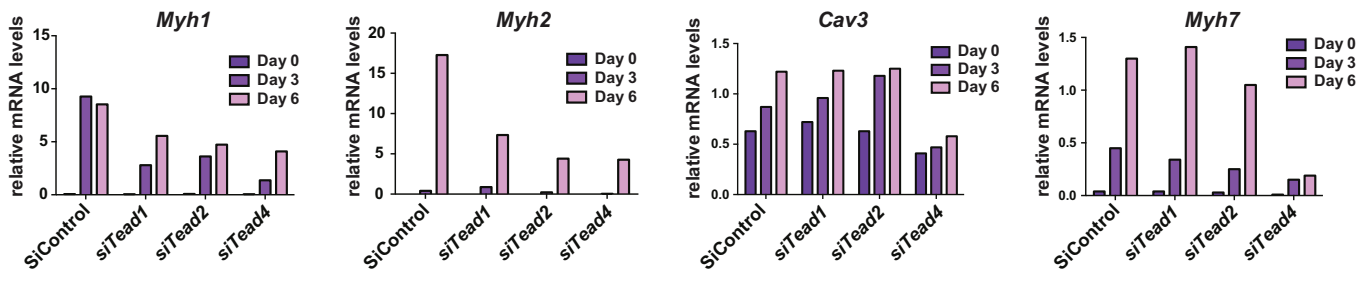
Supplemental Figure 1. Regulation of Tead1 expression by Tead4 in differentiating C2C12 cells. Immunoblots to detect Tead1 or Tead4 in differentiating cells transfected with the indicated siRNAs. Beta-actin is used as loading control.

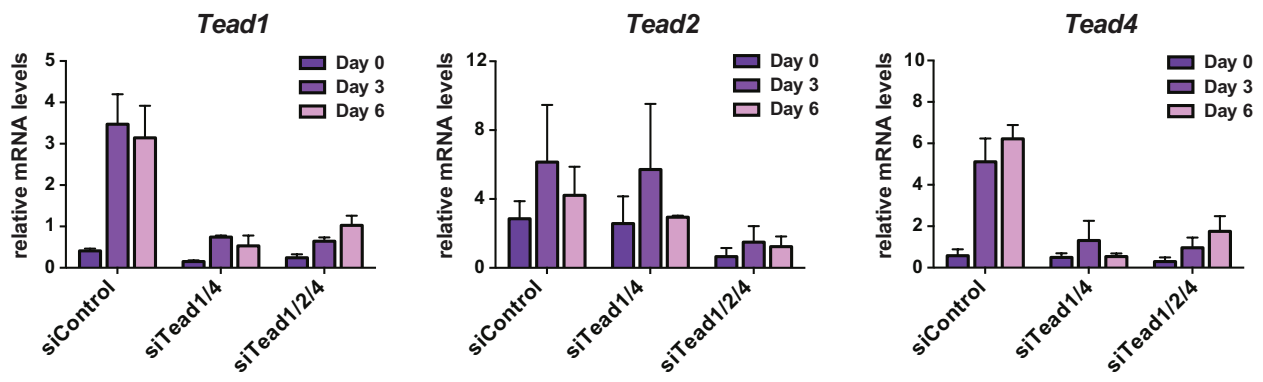
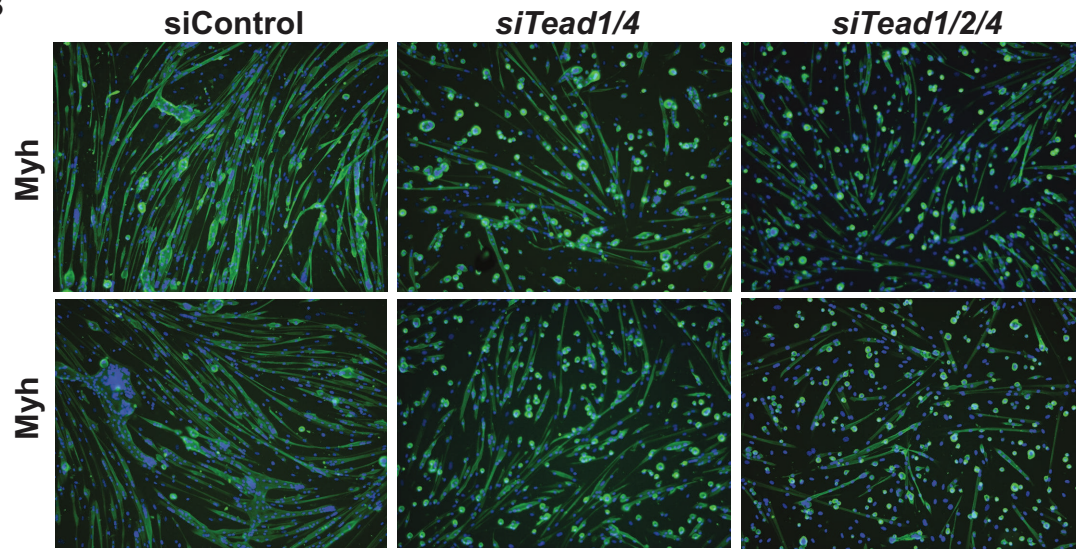
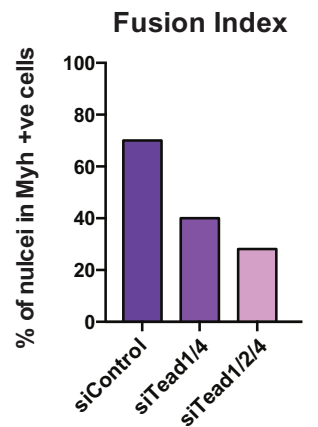
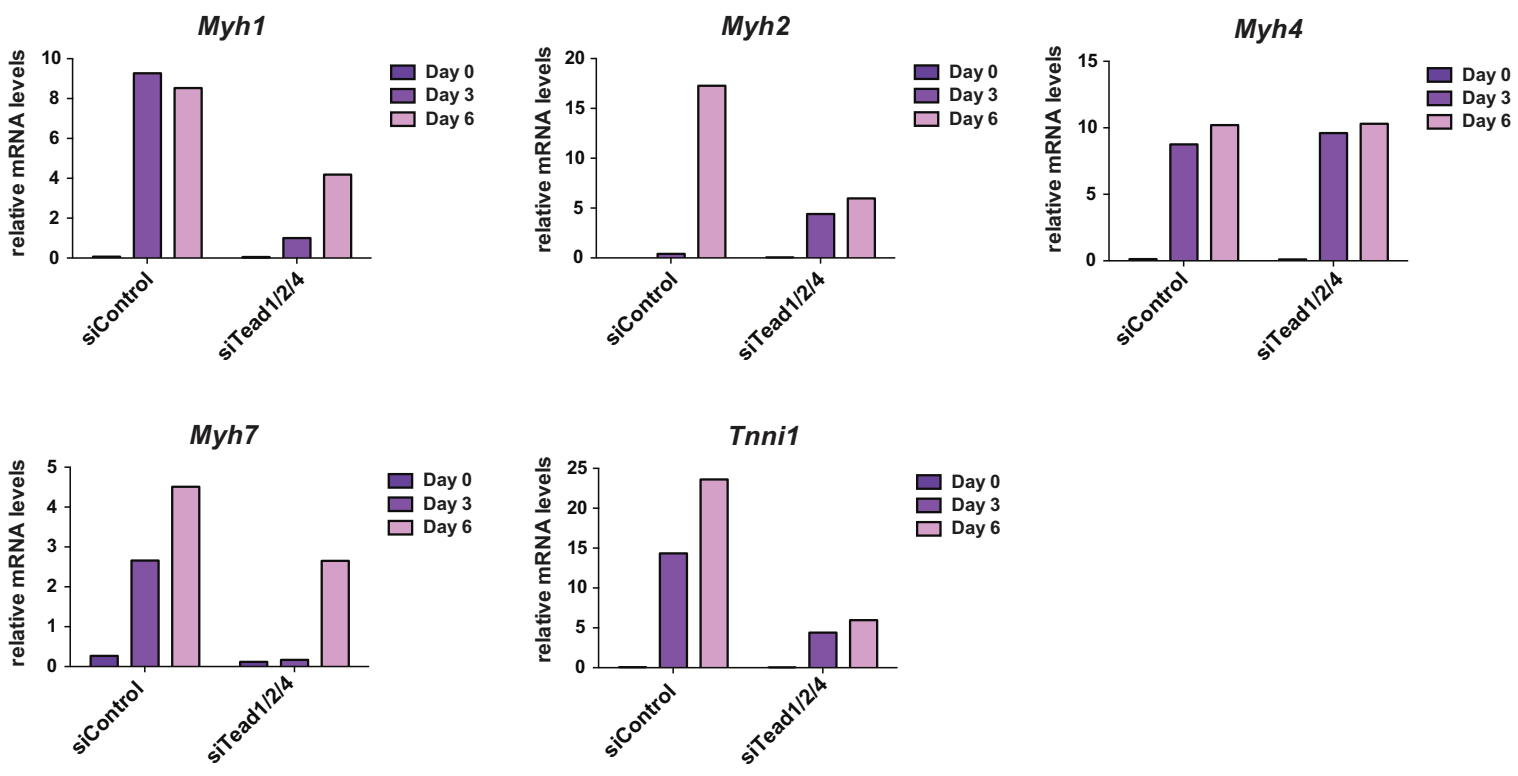
Supplemental Figure 2. Integration of Tead1 genomic occupancy with chromatin modifications in non-differentiated C2C12 cells. **A.** Read density cluster map showing chromatin modifications at Tead1-occupied sites in non-differentiated cells. **B.** Venn diagrams illustrating the overlap of chromatin modifications with Tead1 genomic occupancy. **C.** Identification and ontology analysis of genes associated with Tead4 sites at active H3K27ac marked regulatory elements. **D.** UCSC screenshots illustrating Tead1 and Tead4 occupancy along with H3K4me3 and H3K27ac chromatin modifications in differentiated and non-differentiated C2C12 cells at the indicated loci.

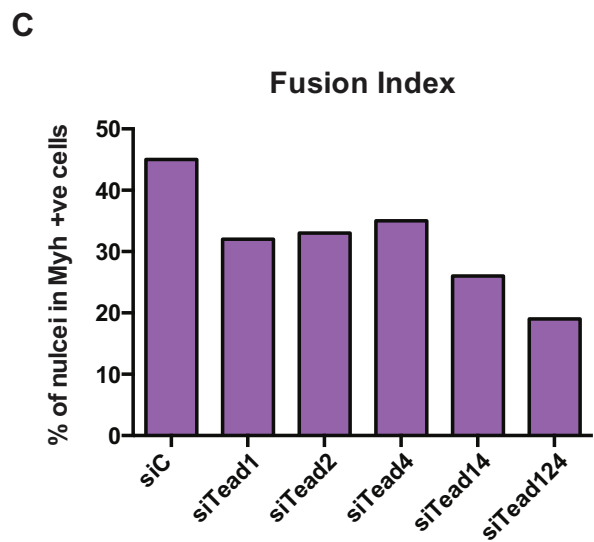
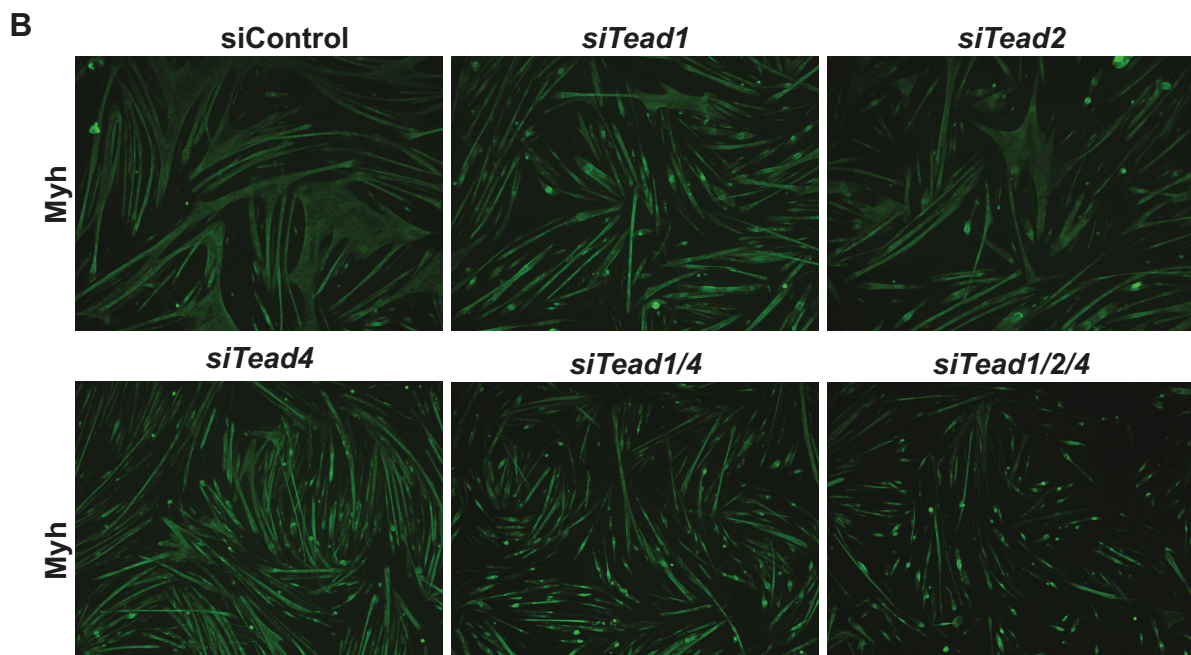
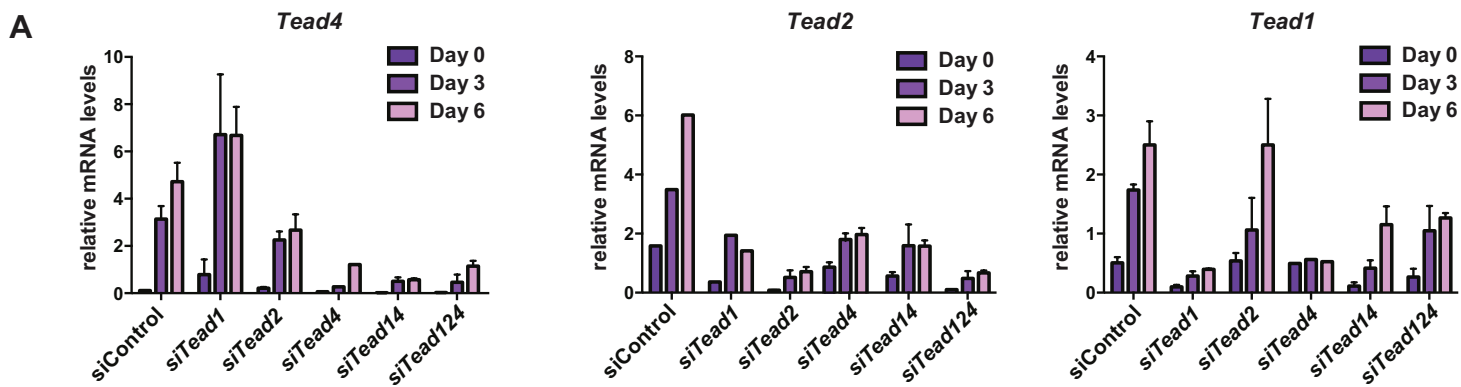
Supplemental Figure 3. Tead1/4 regulated gene expression in C2C12 cells. **A.** Schematic of the experimental workflow. **B.** Number of genes de-regulated by *siTead1/4* silencing at different days of differentiation. **C-D.** Ontology of genes de-regulated at the indicated days of differentiation.

Supplemental Figure 4. Comparative analysis of the gene expression programs of differentiating C2C12 cells and primary myoblasts. **A-B.** Venn diagrams illustrating the overlap of up and down-regulated genes in control differentiating C2C12 cells and primary myoblasts. The ontology analyses of the commonly regulated genes of both categories are shown.

Supplemental Figure 5. Tead1/4 regulated gene expression in primary myoblasts. **A.** Number of genes de-regulated by *siTead1/4* silencing at different days of differentiation. **B-C.** Ontology of genes de-regulated at the indicated days of differentiation.

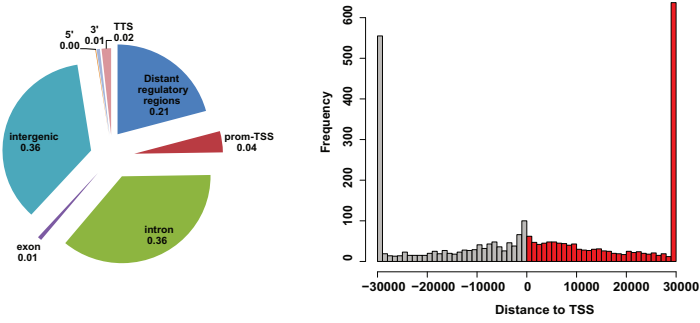
A**B****C****D****E****F****G****H**

A**B****C****D**



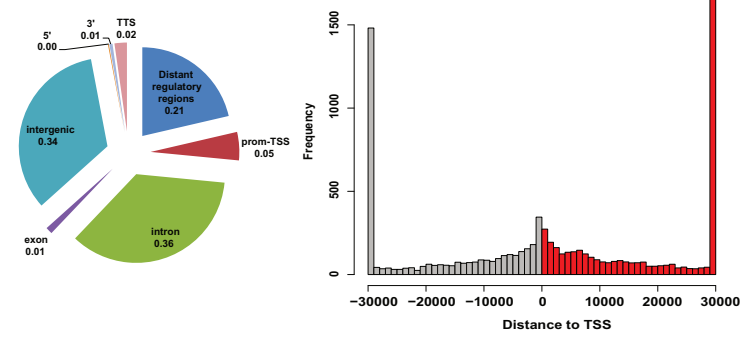
A

TEAD4_ND_2940 peaks



B

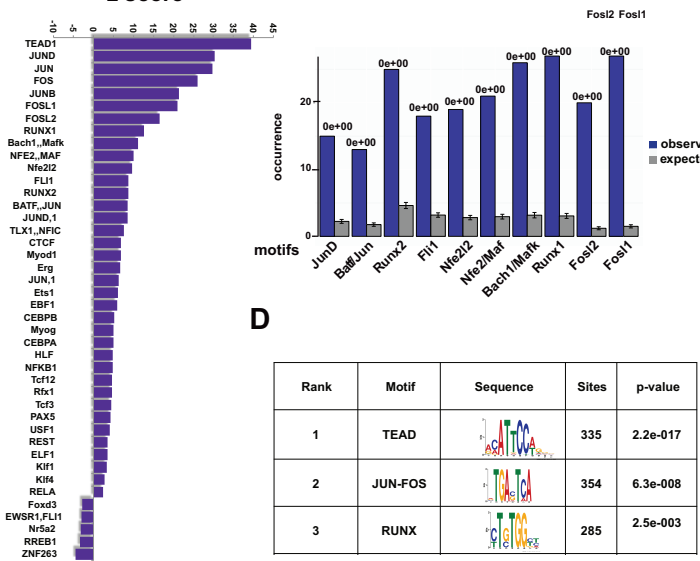
TEAD4_Day6_8156 peaks



C

z score

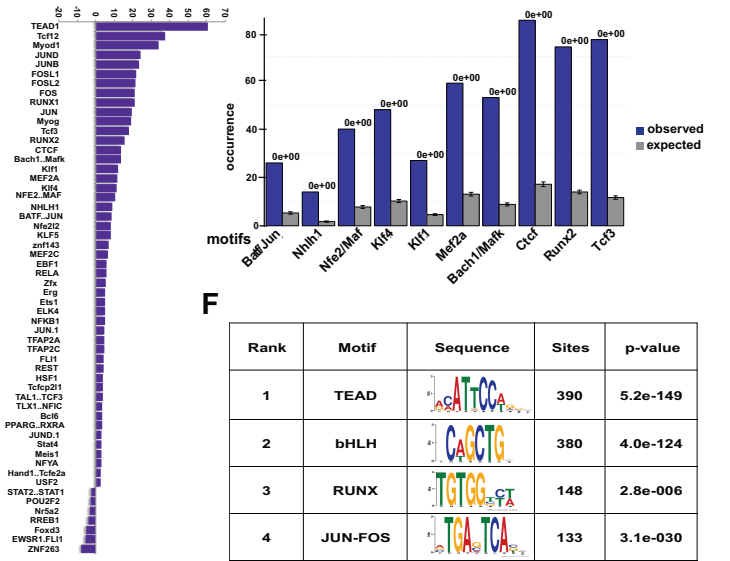
TEAD4_ND_2940 peaks



E

z score

TFAD4_Day6_8156 peaks



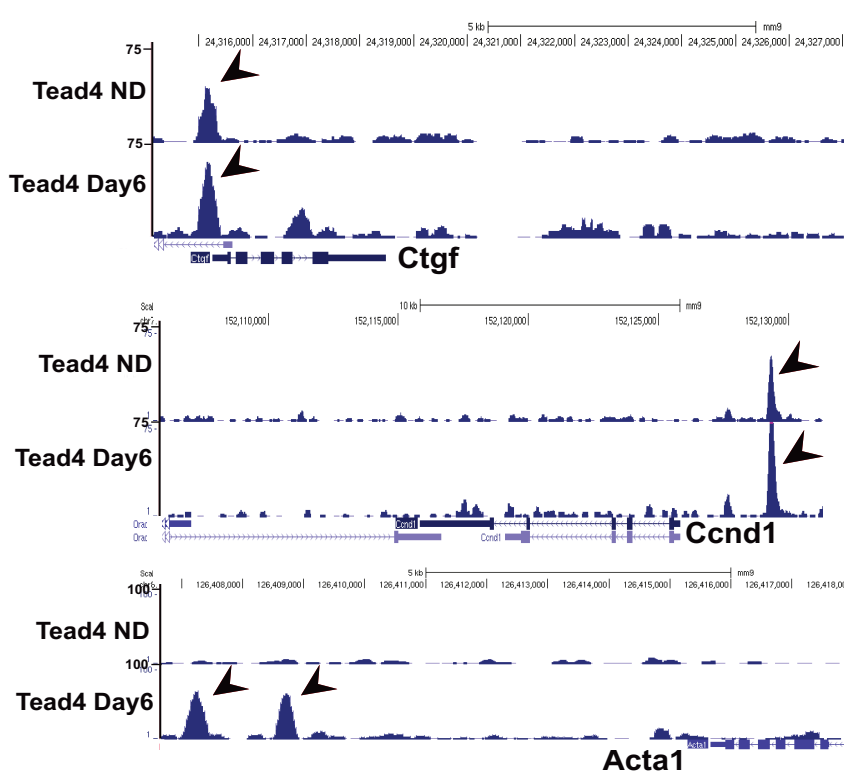
D

Rank	Motif	Sequence	Sites	p-value
1	TEAD		335	2.2e-017
2	JUN-FOS		354	6.3e-008
3	RUNX		285	2.5e-003

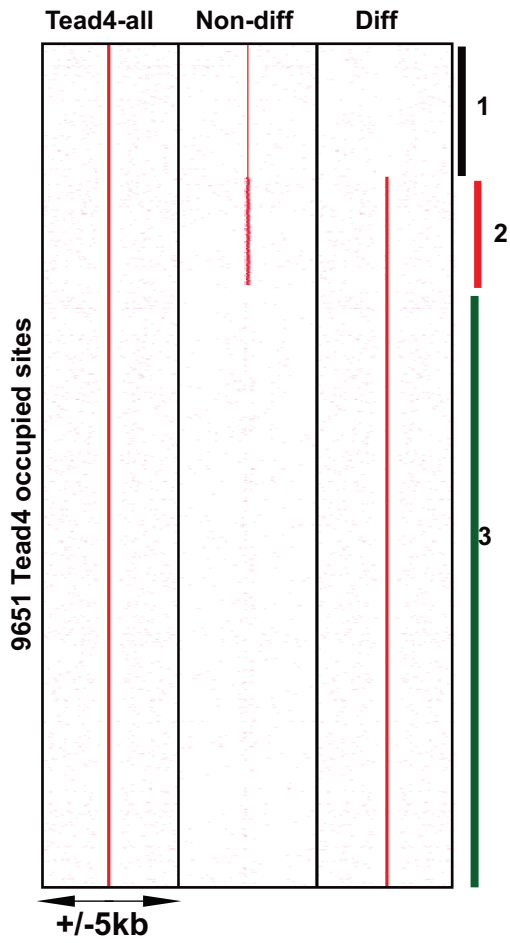
F

Rank	Motif	Sequence	Sites	p-value
1	TEAD		390	5.2e-149
2	bHLH		380	4.0e-124
3	RUNX		148	2.8e-006
4	JUN-FOS		133	3.1e-030

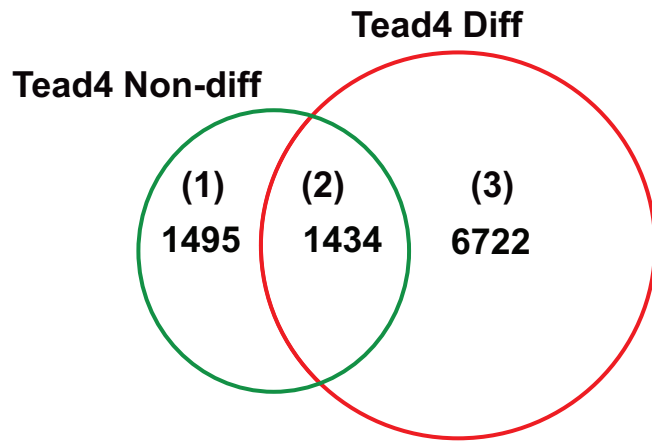
G



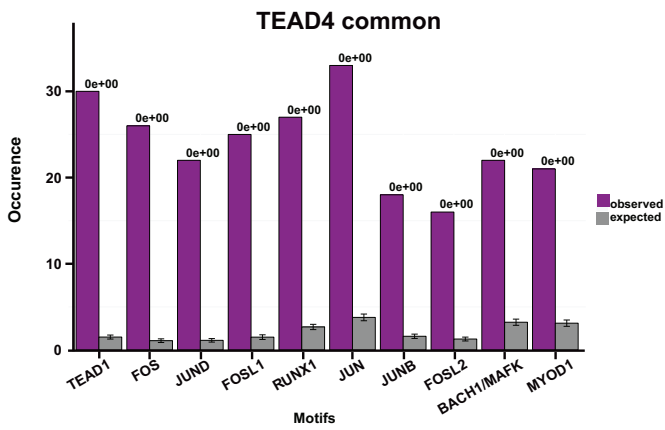
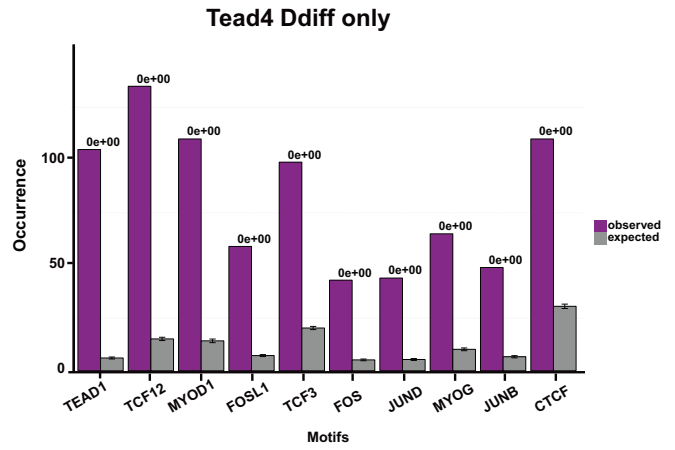
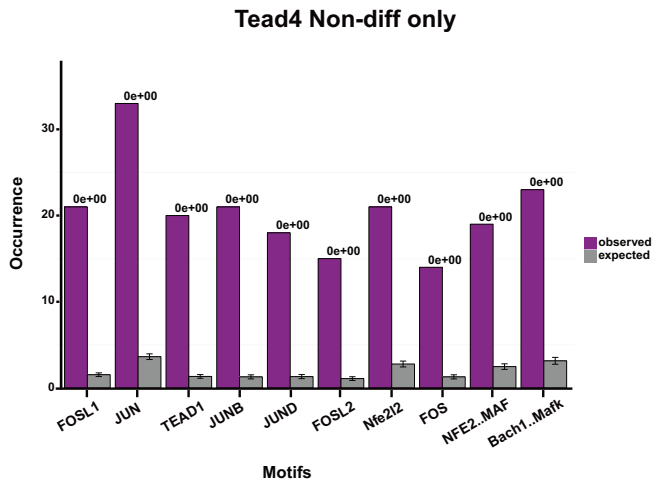
A

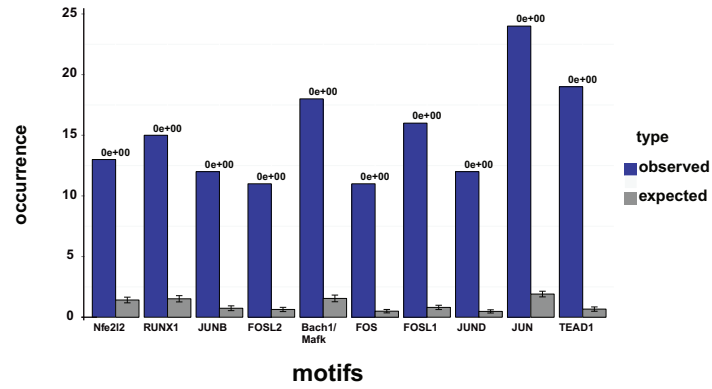
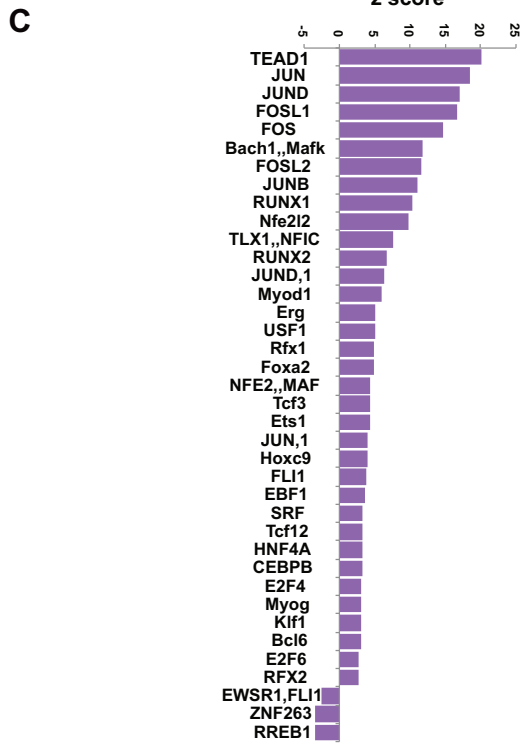
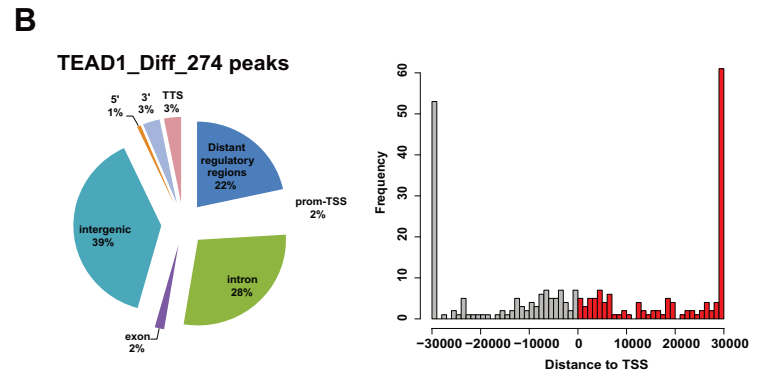
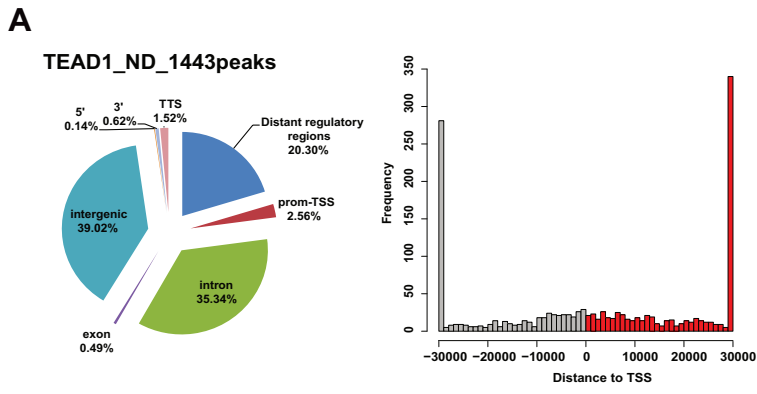


B



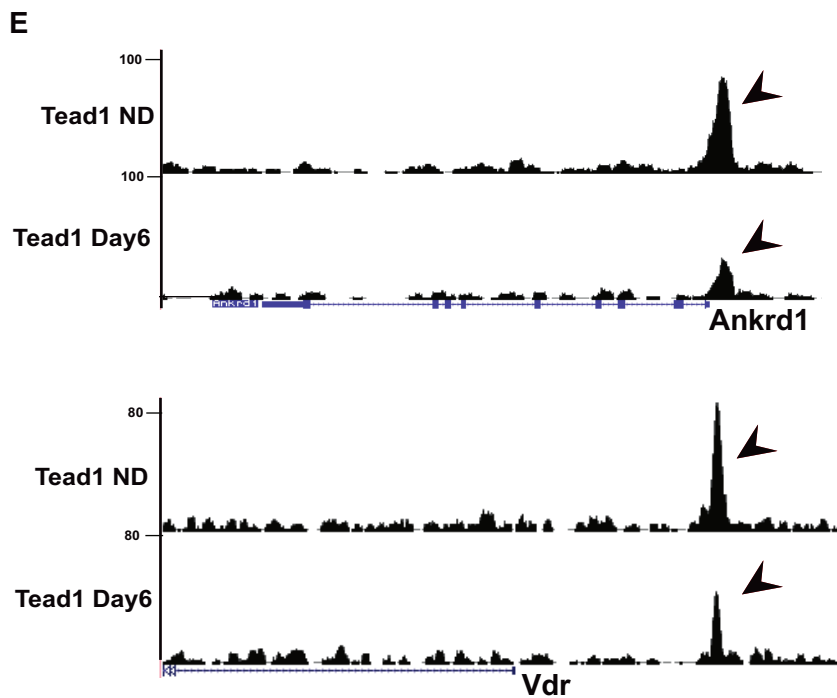
C

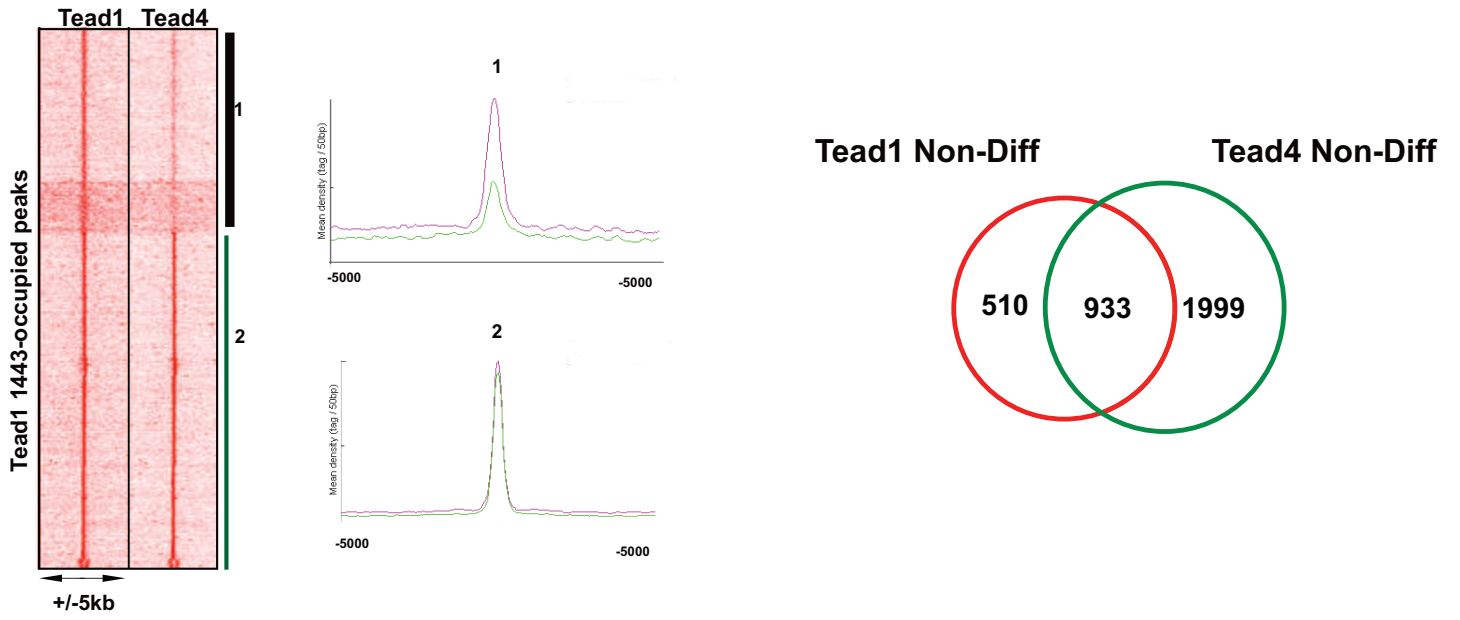
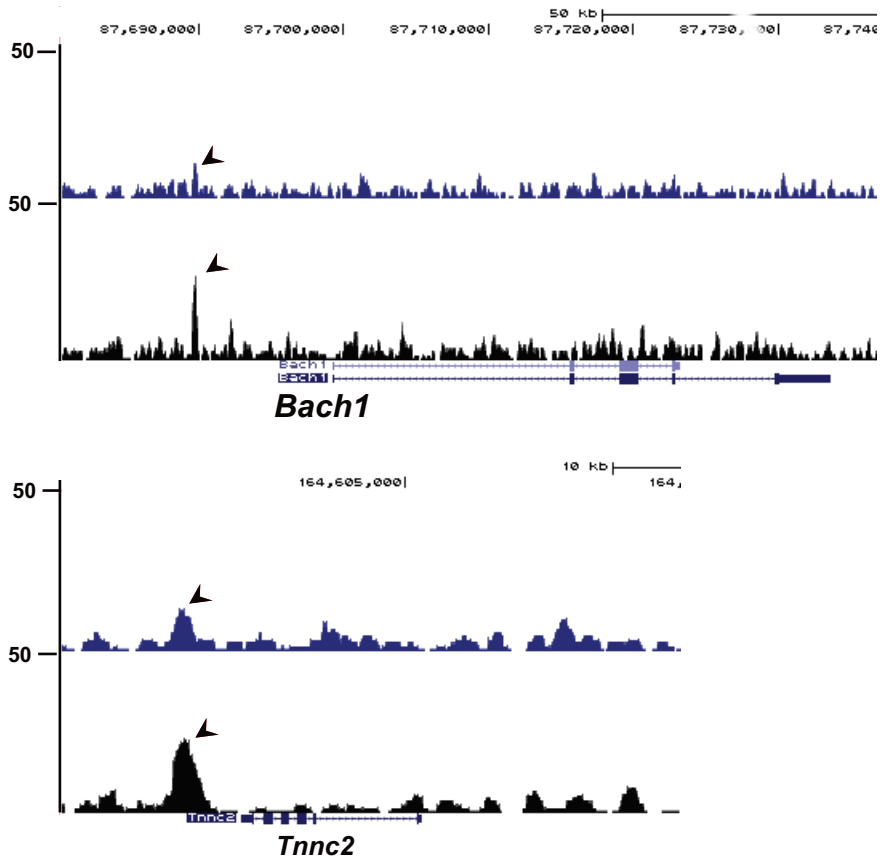




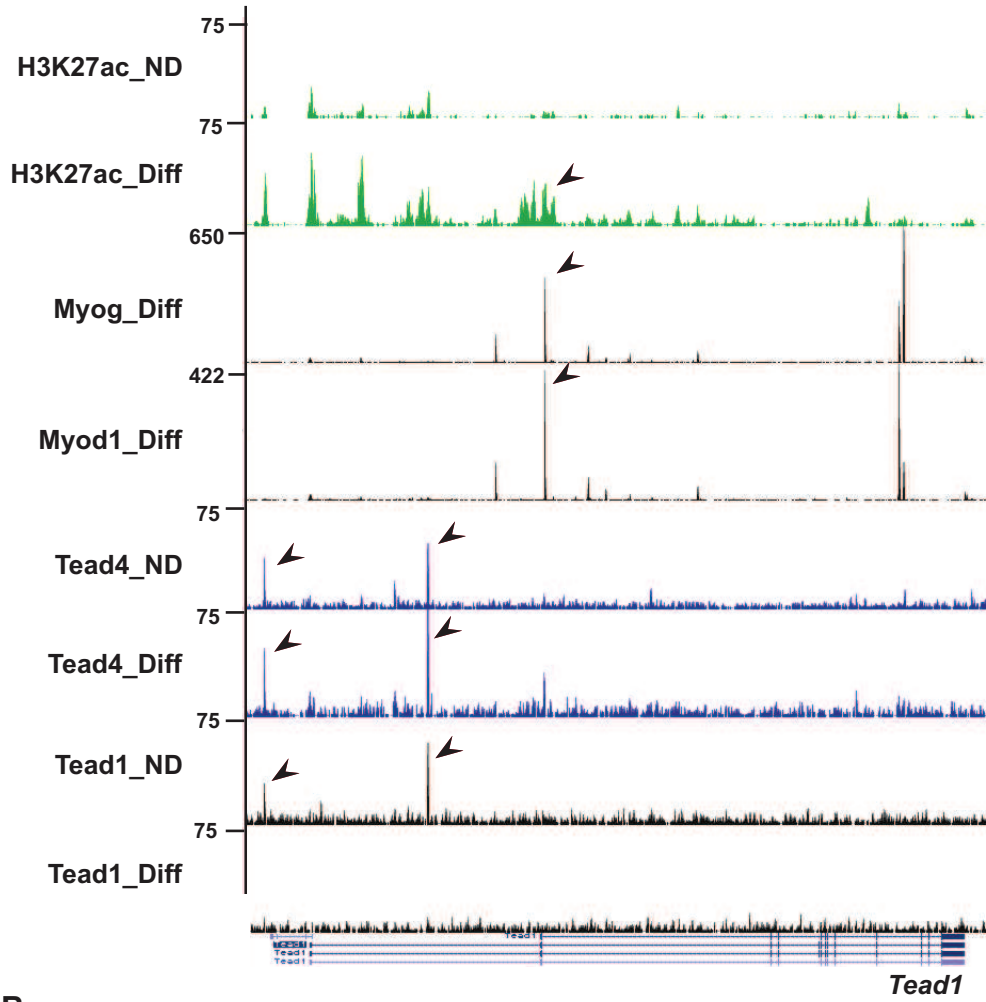
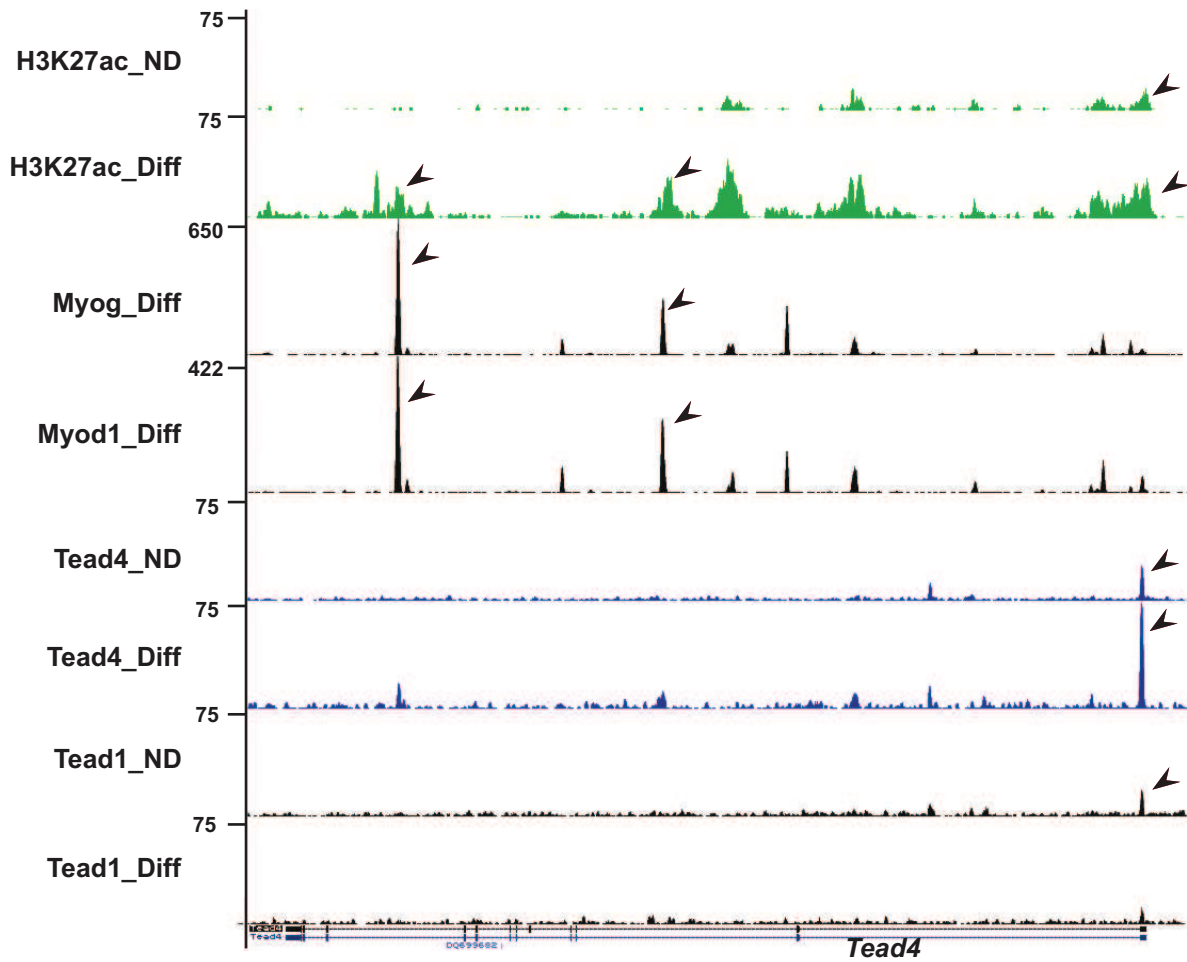
D

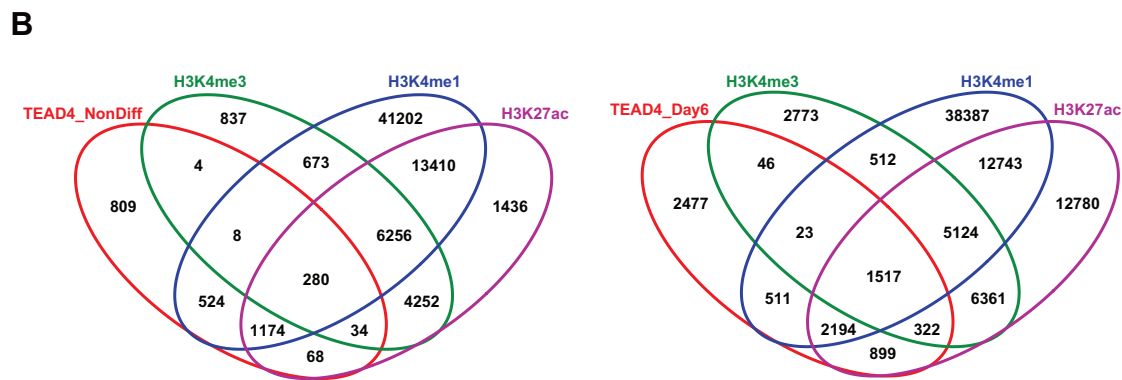
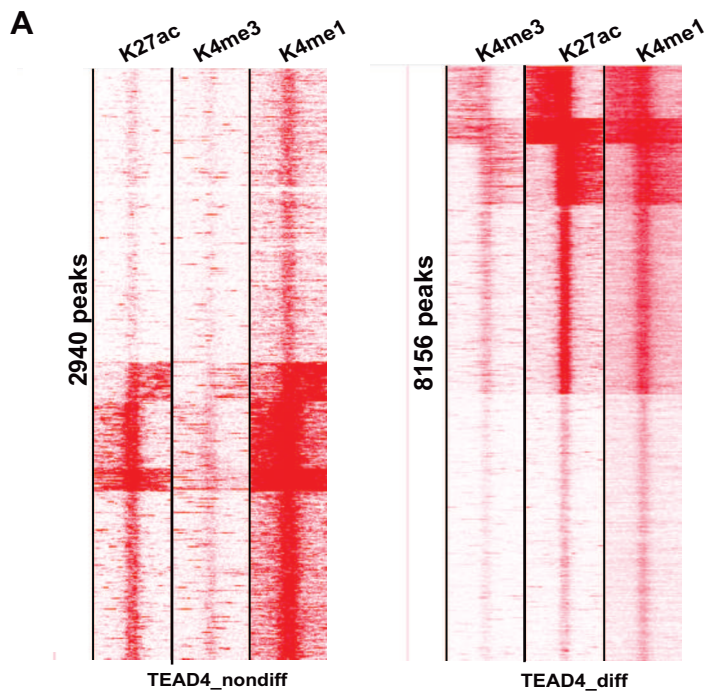
Rank	Motif	Sequence	Sites	p-value
1	TEAD		350	4.6e-103
2	JUN-FOS		273	1.6e-122
3	RUNX1		116	2.6e-016
4	BACH		134	1.5e-002



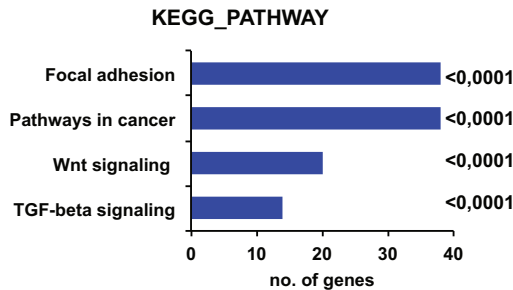
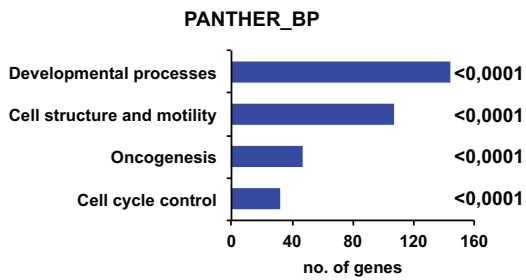
A**B**

Joshi et al., Fig. 7

A**B**

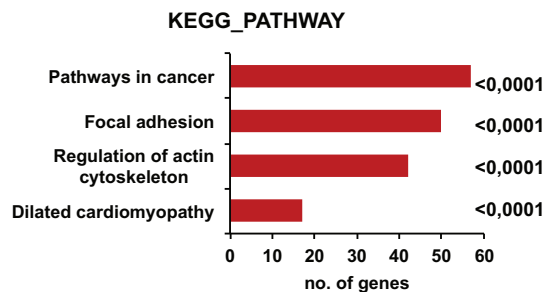
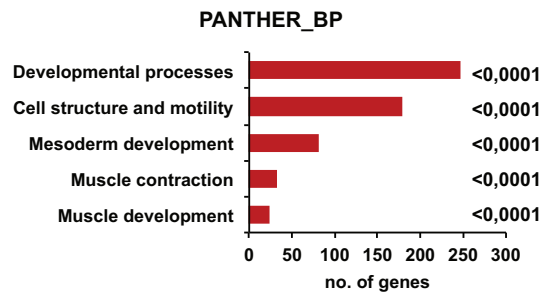


C NonDiff_TEAD4_H3K27ac_1262genes

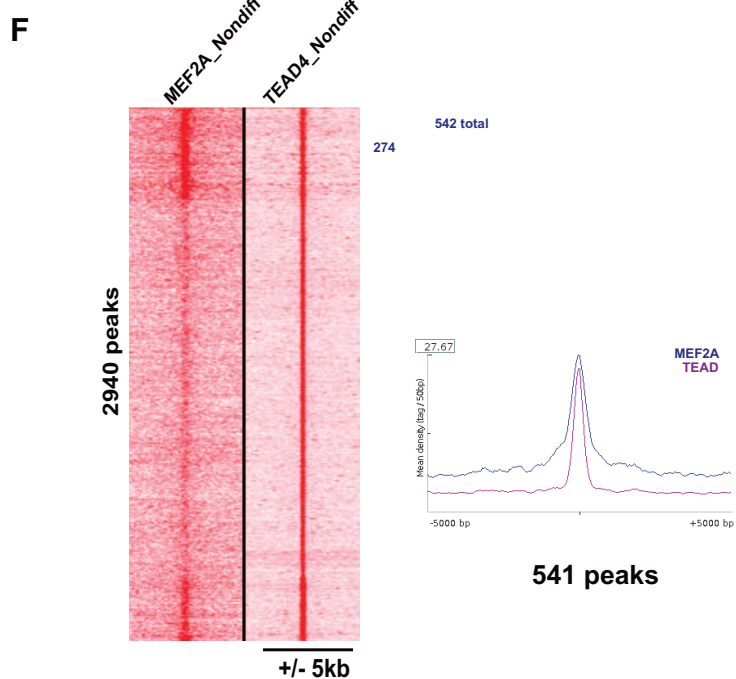
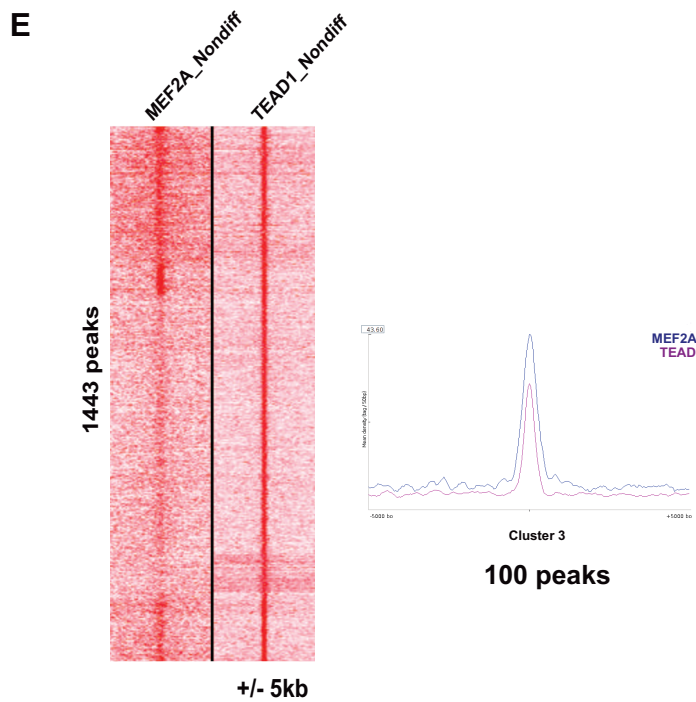
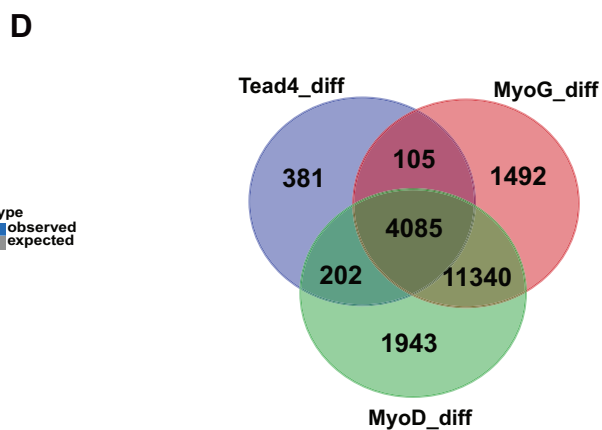
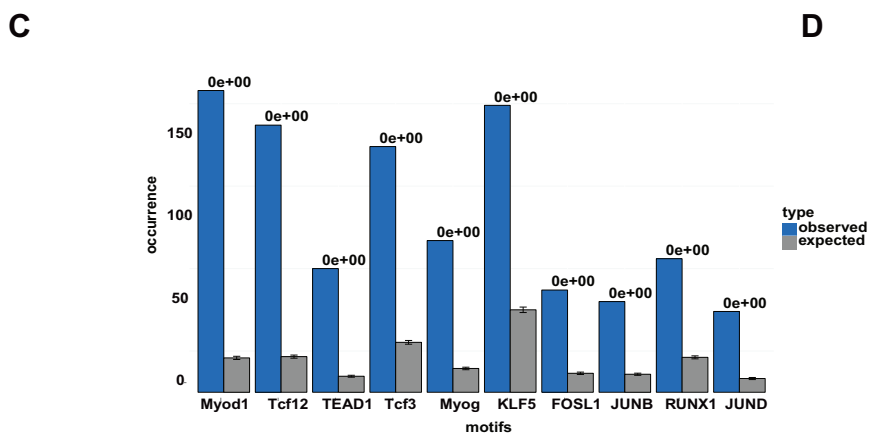
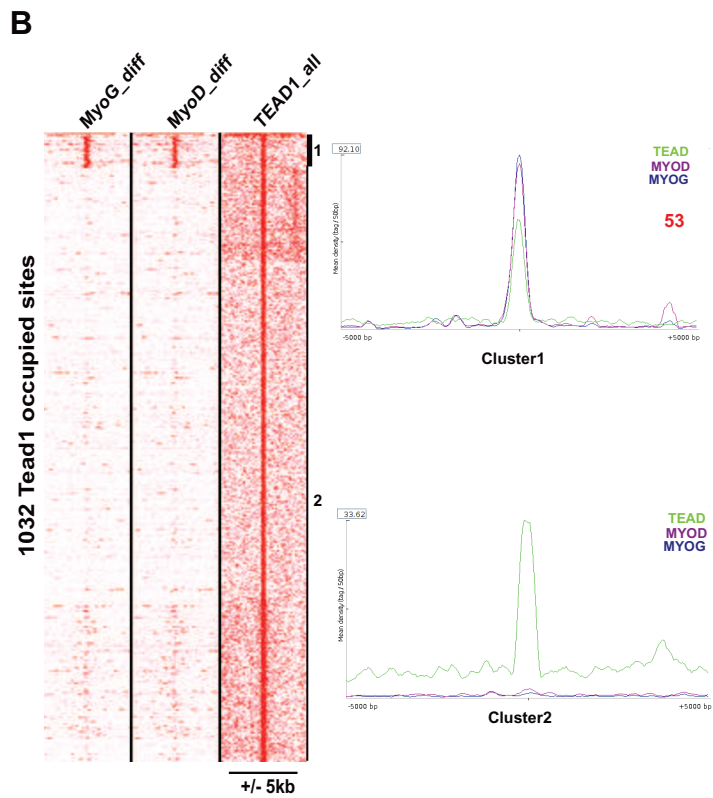
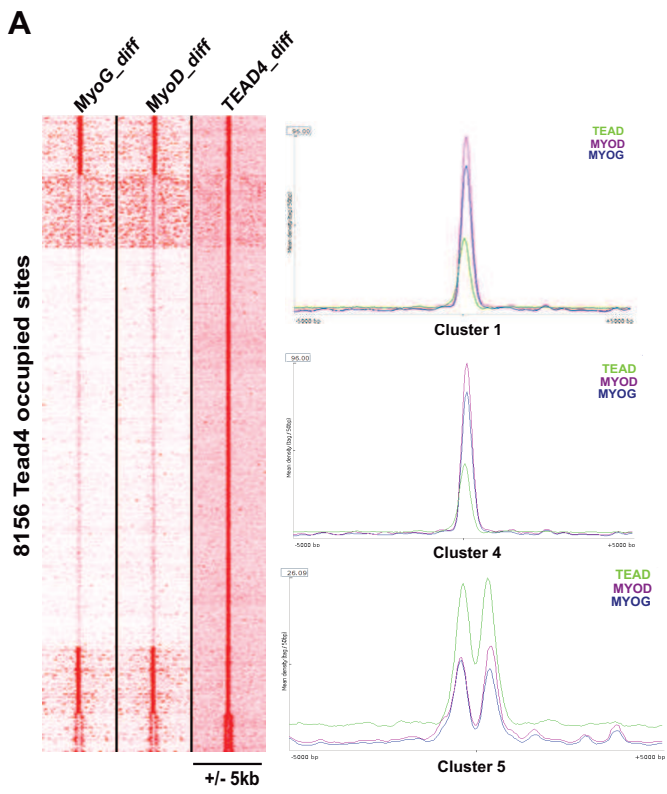


<i>Actn4</i>	<i>Fzd1</i>	<i>Pparg</i>	<i>Tgfr2</i>
<i>Akt2</i>	<i>Fzd5</i>	<i>Rac1</i>	<i>Thbs2</i>
<i>Cav1</i>	<i>Itgb5</i>	<i>Rock2</i>	<i>Tln2</i>
<i>Ccnd1</i>	<i>Lama3</i>	<i>Runx1</i>	<i>Vav3</i>
<i>Cdkn1b</i>	<i>Lamc3</i>	<i>Smad2</i>	
<i>Fadd</i>	<i>Nfatc2</i>	<i>Smad3</i>	
<i>Fgf7</i>	<i>Parva</i>	<i>Smad6</i>	
<i>Flnb</i>	<i>Pdgfb</i>	<i>Smad7</i>	
<i>Fosl1</i>	<i>Pik3r5</i>	<i>Tgfb2</i>	

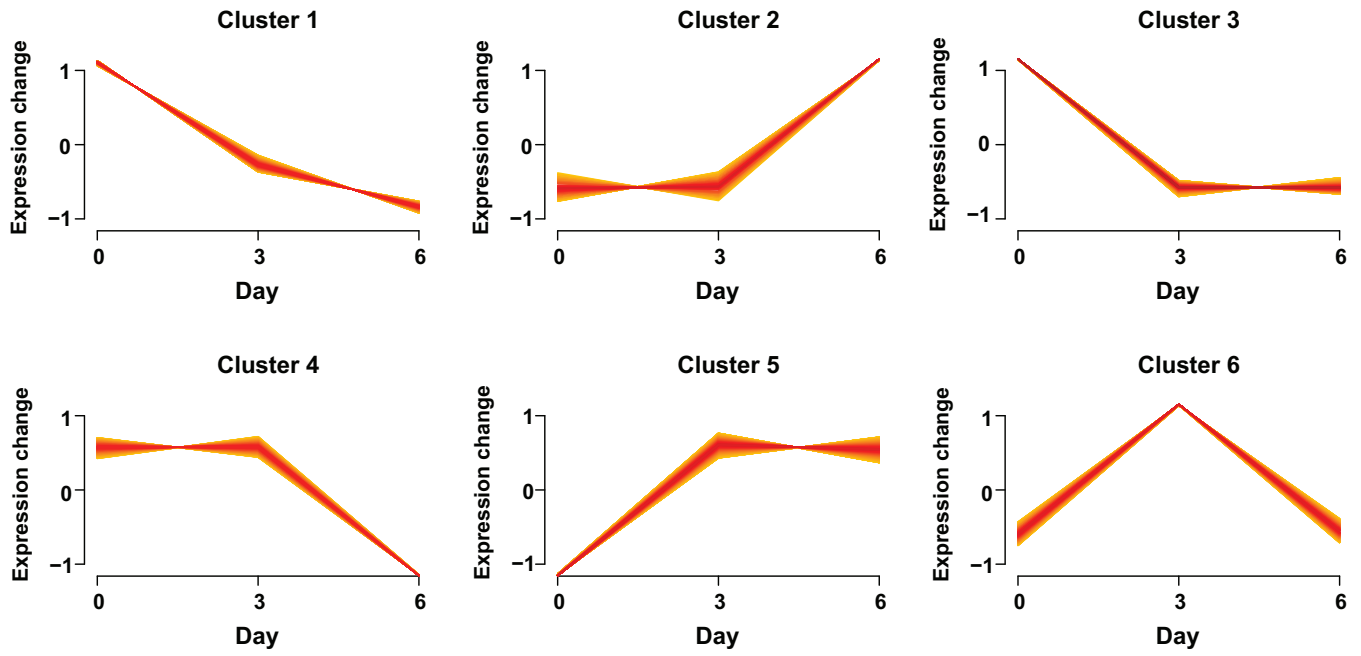
Diff_TEAD4_H3K27ac_2208



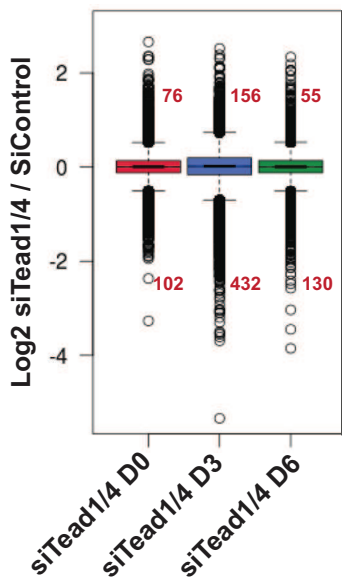
<i>Amotl1</i>	<i>Foxo3</i>	<i>Myof</i>	<i>Tgfb2</i>
<i>Amotl2</i>	<i>Mbn1</i>	<i>Myog</i>	<i>Tnnc2</i>
<i>Cacna1a</i>	<i>Mbn2</i>	<i>Myom1</i>	<i>Tnni1</i>
<i>Camk2d</i>	<i>Mef2a</i>	<i>Myom2</i>	<i>Tubb2b</i>
<i>Chrna1</i>	<i>Musk</i>	<i>Pdlim4</i>	<i>Utrn</i>
<i>Dbn1</i>	<i>Myh9</i>	<i>Pdlim5</i>	
<i>Dnm1</i>	<i>Mylk4</i>	<i>Rock2</i>	
<i>Dysf</i>	<i>Mylpf</i>	<i>Runx1</i>	
<i>Fhl2</i>	<i>Myod1</i>	<i>Runx2</i>	



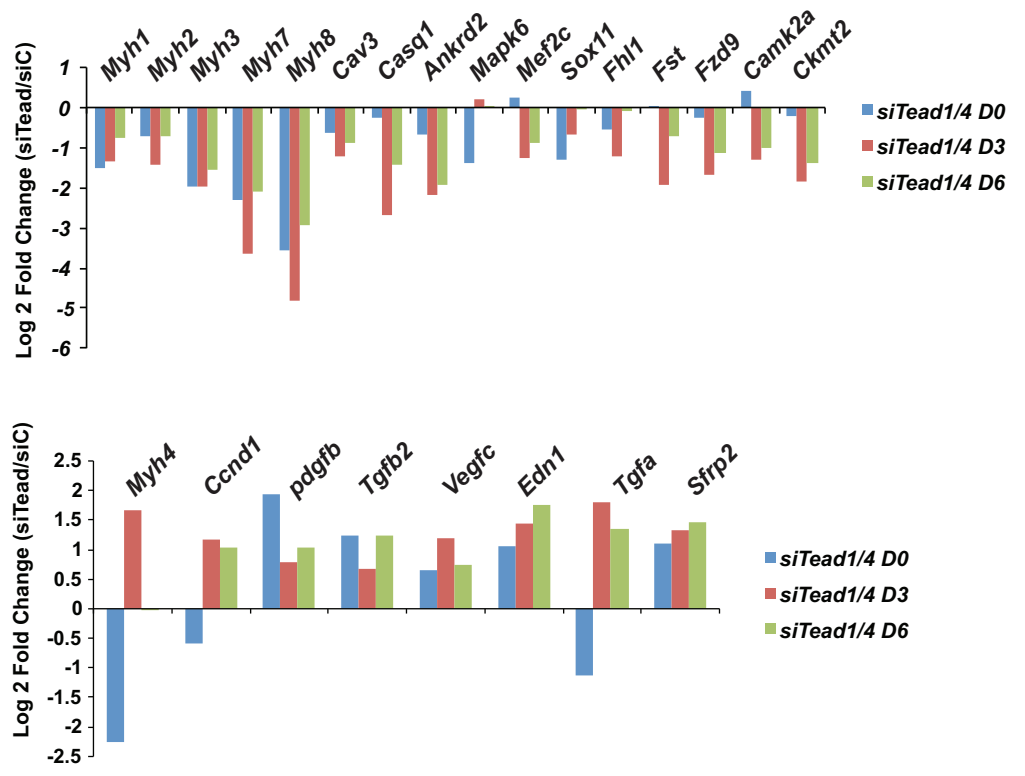
A



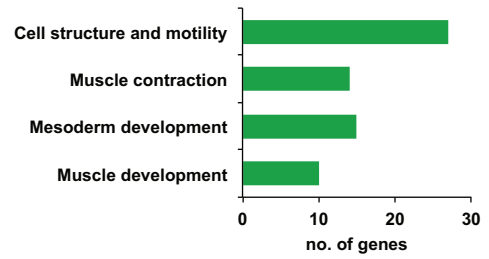
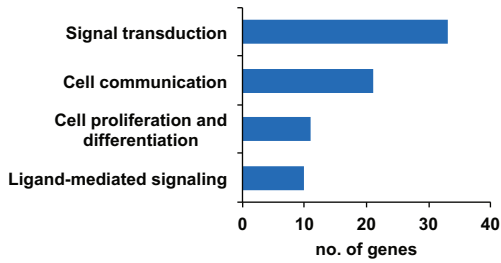
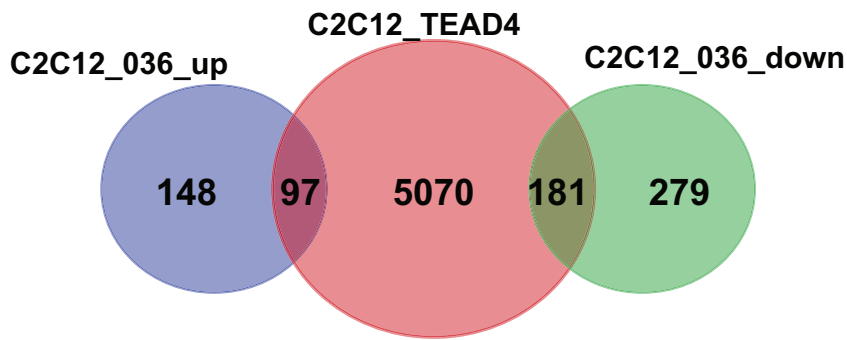
B



C

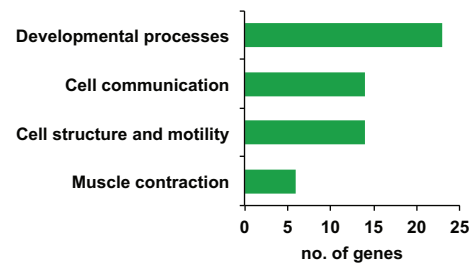
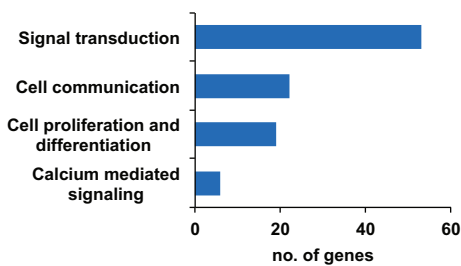
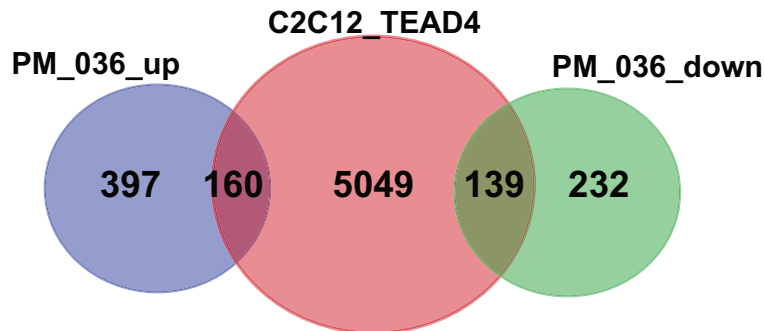


Joshi et al., Fig. 11



Adm Dusp4 Pdgfb
Atp10b Edn1 Ptx3
Cadm1 Elmo1 Rassf2
Cbx7 Fmod Rassf5
Ccl9 Gabrb2 Sema5a
Ccnd1 Gipc2 Tbxas1
Cdh1 Igf2bp1 Tgfa
Col14a1 Lyst Tgfb2
Cxcl1 Nfe2 Vegfc
Dusp27 Nrg1 Whrn
Pcsk6 Xdh

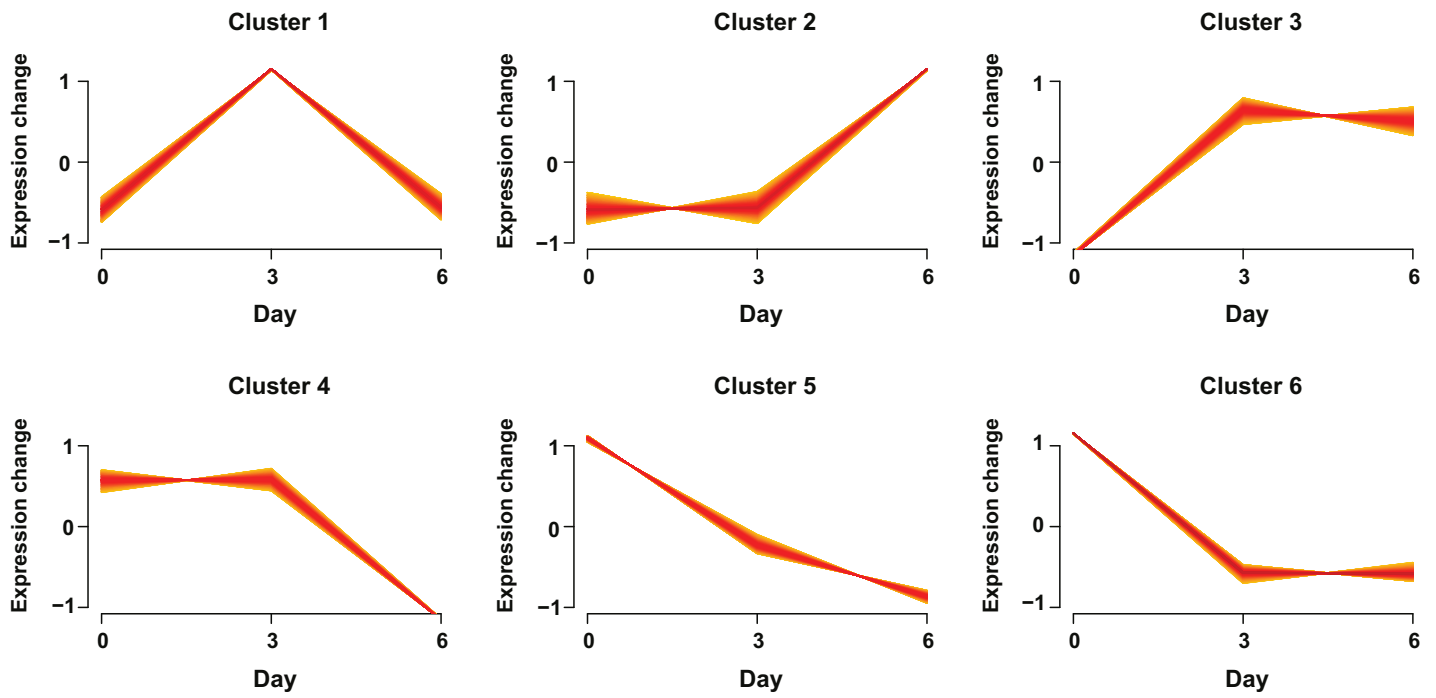
Actc1 Cyp26b1 Gja5 Mas1 Mylk3 Reep1 Tnnt2
Actn2 Dcn Grip2 Mb Myoz2 Rhoh Traf1
Aknad1 Dkk2 Hdac9 Mef2c Nav2 Rorb Txlnb
Ankmy1 Dusp8 Hfe2 Mfap4 Notch1 Rrad
Apo16 Dysf Inadl Murc Nrnx3 Sema4f
Atp6v1c2 E2f8 Kank1 Mybpc1 Pbx3 Serpinb1c
Camk2a Filip1 Ldb3 Myh2 Pdlim1 Slit1
Camk2b Fn3k Lgr6 Myh3 Pfkml Smyd1
Cav3 Foxo6 Lmod2 Myh8 Prrg4 Tmod1
Csrp3 Fst Lmod3 Myl2 Psd3 Tnni1



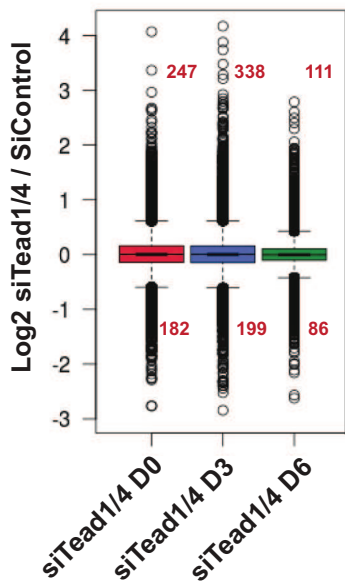
Abca1 Cxcl1 Gabrb2 Ryr2
Ankfn1 Cyp26b1 Grip2 Sema3d
Arc Dach1 Hgf Sphk1
Arid3b Dock10 Il12a Tceal7
Bach2 Dock11 Kif6 Tgfa
Btg1 Dusp7 Lsamp Tgfb2
Camk1g Egr2 Myzap Trib2
Cbx7 Fgf7 Nrg1 Tspan8
Ccnd1 Fmod Pbx1 Vegfc
Cntn1 Fos Pdgfb Vgll2
Col24a1 Fzd1 Rassf2

Ablim1 Dusp8 Mapk6 Pkhd1
Ablim2 Fbxl2 Mybpc1 Prg4
Capn2 Fgf2 Myh10 Ptpn3
Cav3 Fmn1 Myh2 Rassf7
Cdk14 Fmo2 Myh8 Reep1
Cdk18 Fn3k Myl2 Scn3a
Colq Gja5 Myoz2 Sgcd
Cyb5b Grem1 Ntn1 Sox11
Dcn Hmg20a Pdk1 Syt8
Dio2 Igfbp2 Pdlim1 Tcf23
Dkk3 Lman1 Pdlim2 Ugcg

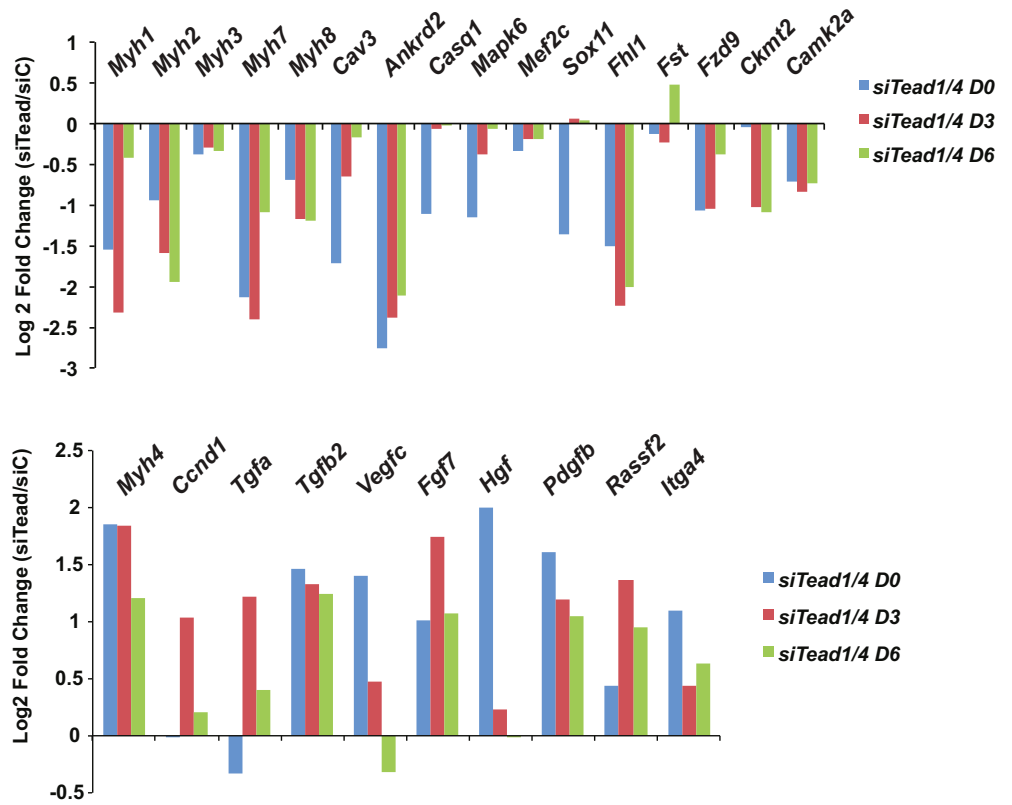
A



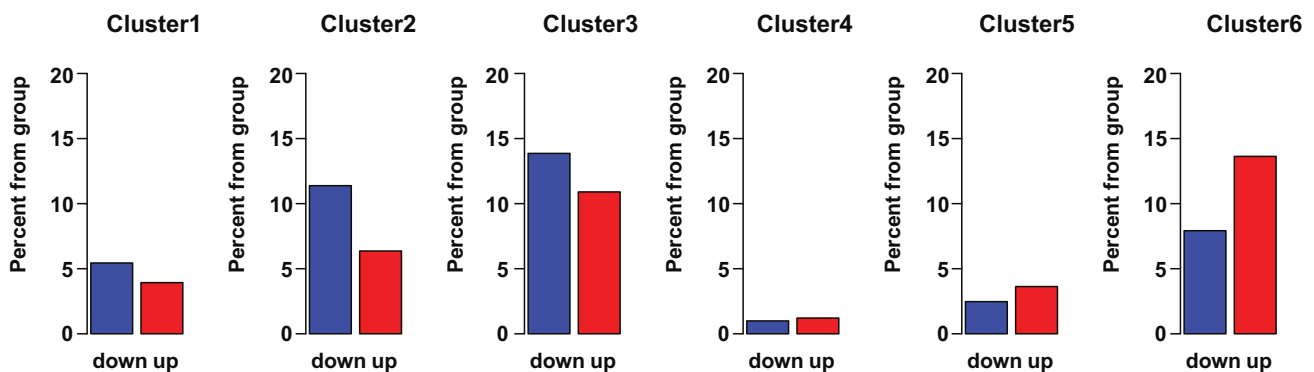
B



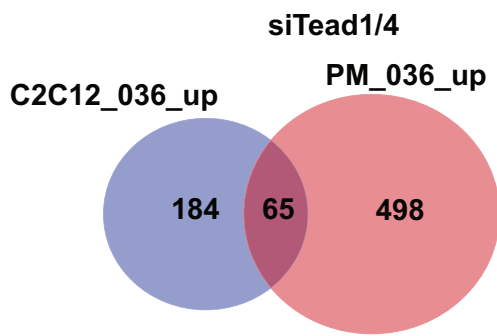
C



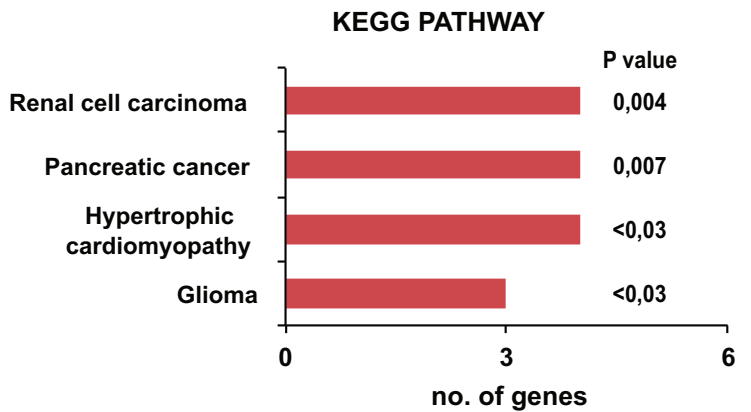
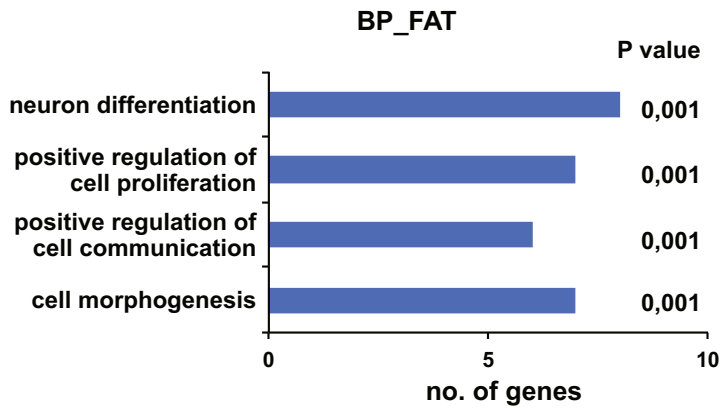
D



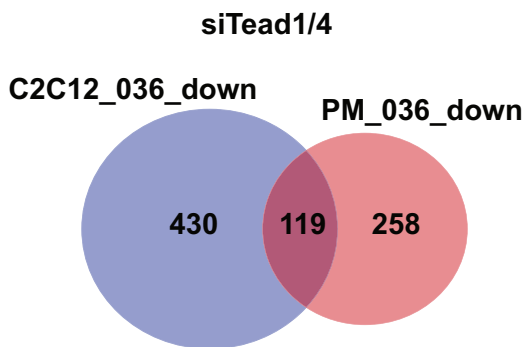
A



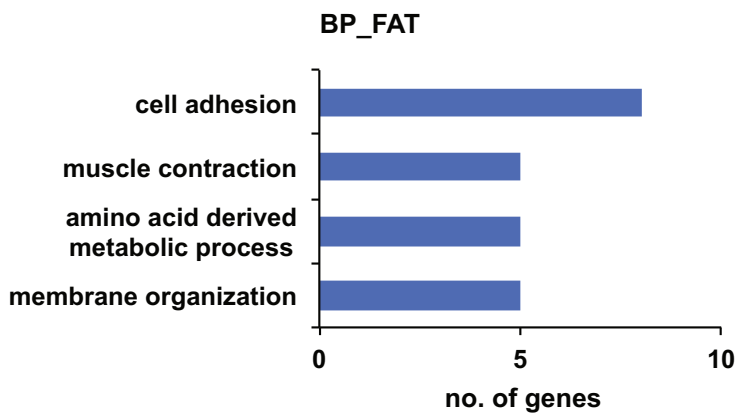
<i>Ace</i>	<i>Fmod</i>	<i>Pdgfb</i>
<i>Adh7</i>	<i>Gabrb2</i>	<i>Ppp2r2b</i>
<i>Cacna1h</i>	<i>Itga4</i>	<i>Rassf2</i>
<i>Cacna2d2</i>	<i>Kcnj12</i>	<i>Scn7a</i>
<i>Cbx7</i>	<i>Lingo1</i>	<i>Sema5a</i>
<i>Ccnd1</i>	<i>Mme</i>	<i>Sfrp2</i>
<i>Clu</i>	<i>Nhlh2</i>	<i>Tgfa</i>
<i>Cxcl1</i>	<i>Npr3</i>	<i>Tgfb2</i>
<i>Fgfbp1</i>	<i>Nrg1</i>	<i>Vegfc</i>

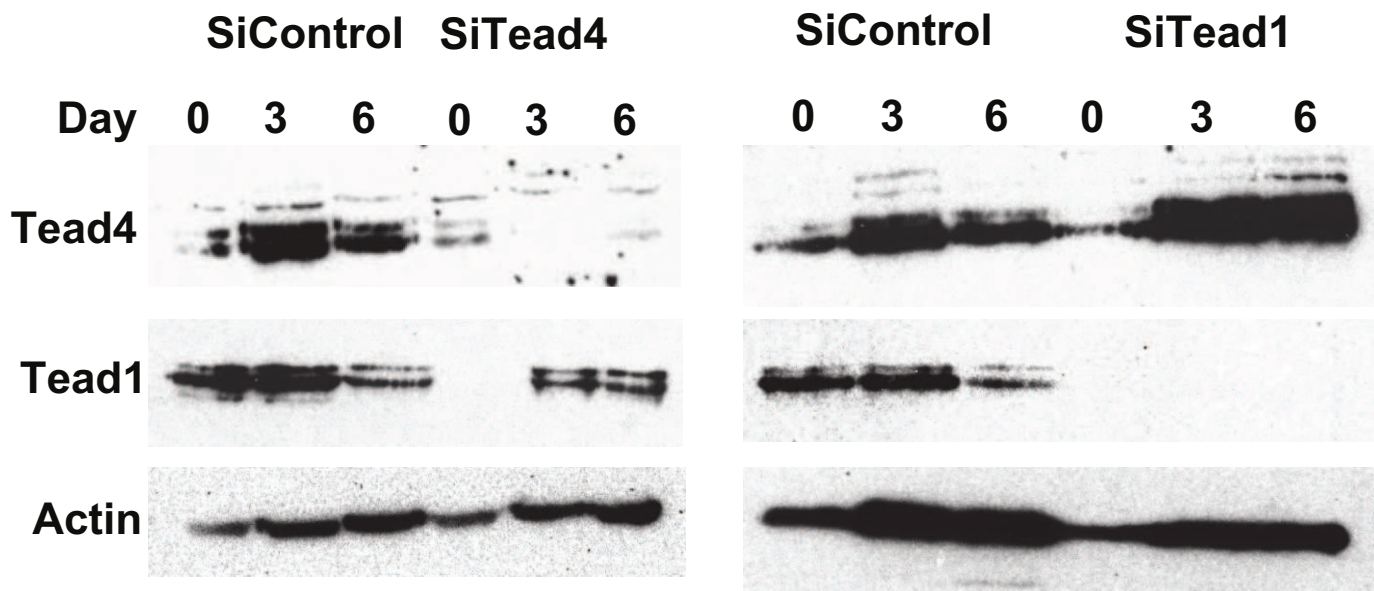


B

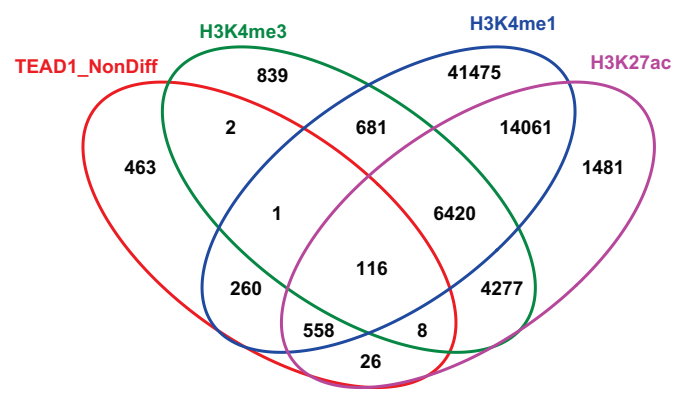
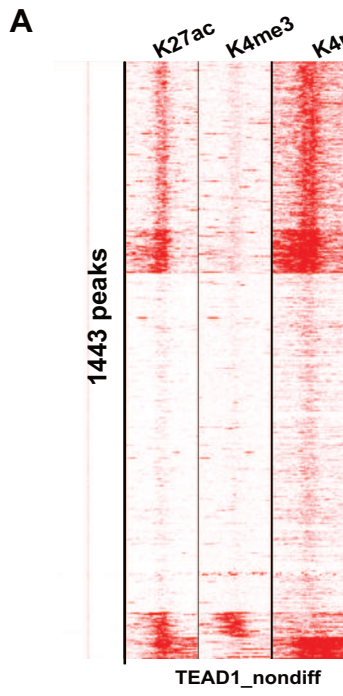


<i>Ankrd2</i>	<i>Fn3k</i>	<i>Myh7</i>	<i>Ugcg</i>
<i>Capn2</i>	<i>Fzd9</i>	<i>Myh8</i>	<i>Xrcc4</i>
<i>Casq1</i>	<i>Gja5</i>	<i>Myl2</i>	
<i>Cav3</i>	<i>Kcnb1</i>	<i>Myoz2</i>	
<i>Cdk14</i>	<i>Mapk6</i>	<i>Pacsin3</i>	
<i>Chn1</i>	<i>Msln</i>	<i>Pdk1</i>	
<i>Ckmt2</i>	<i>Mtmr12</i>	<i>Pdlim1</i>	
<i>Dusp8</i>	<i>Mybph</i>	<i>Plekha7</i>	
<i>Fgfr1</i>	<i>Myh1</i>	<i>Sox11</i>	
<i>Fhl1</i>	<i>Myh2</i>	<i>Spnb1</i>	

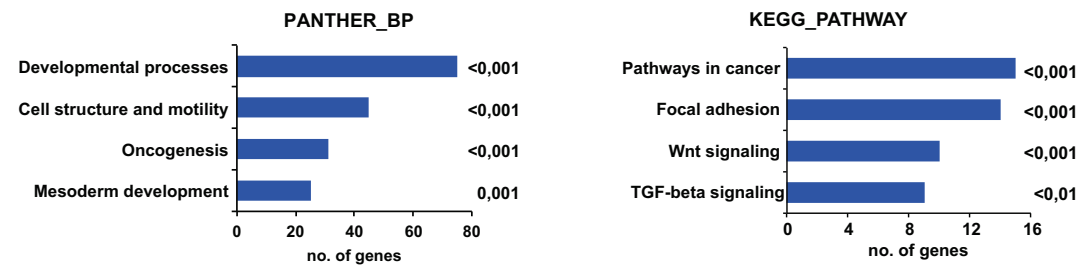




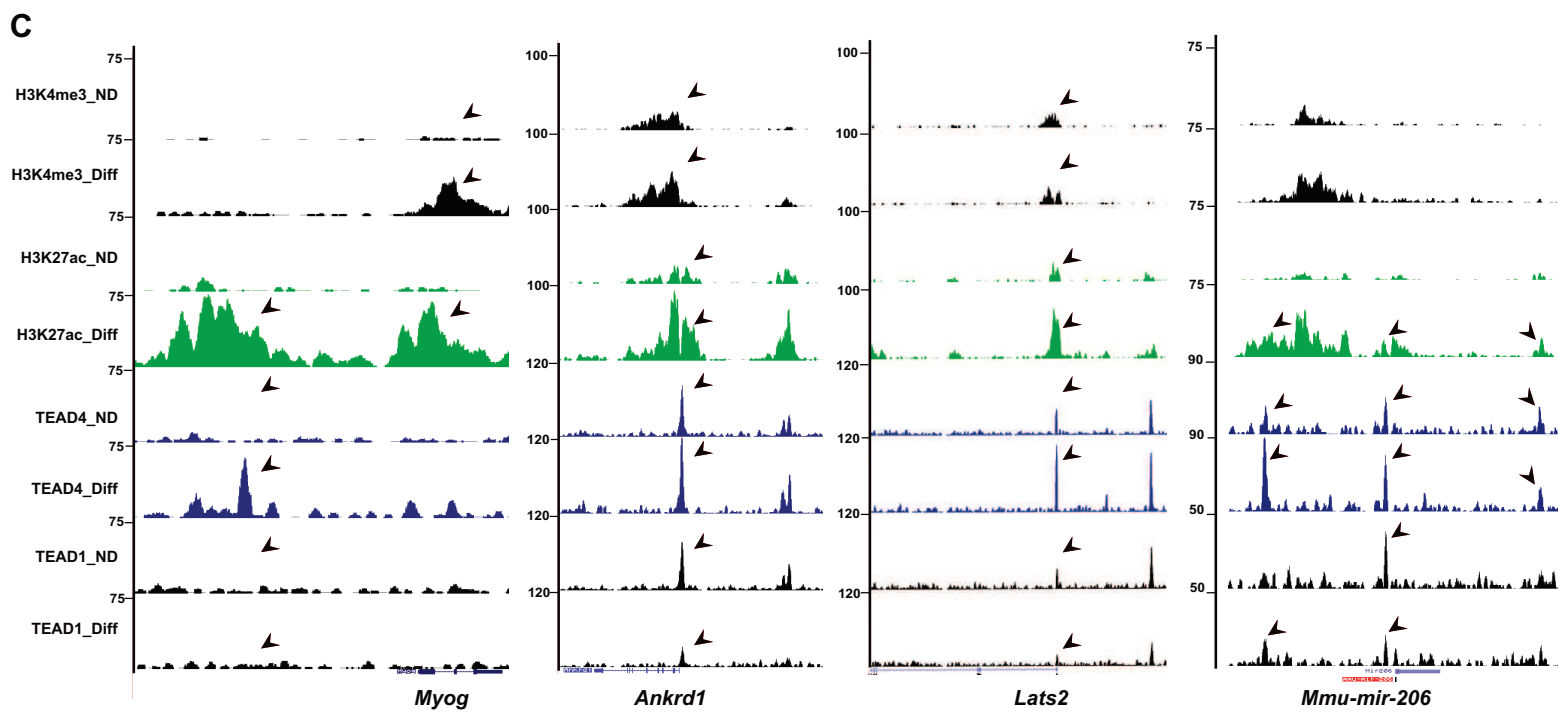
Joshi et al., Supplemental Fig. 1



B NonDiff_TEAD1_H3K27ac_604 genes

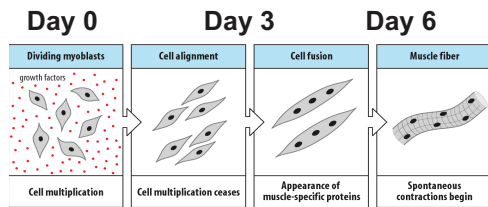


- | | | | | |
|---------------|---------------|---------------|---------------|--------------|
| <i>Ablim1</i> | <i>Col3a1</i> | <i>Mef2a</i> | <i>Ski</i> | <i>Thbs2</i> |
| <i>Amotl1</i> | <i>Fgf7</i> | <i>Meis1</i> | <i>Smad2</i> | <i>Tnnc2</i> |
| <i>Amotl2</i> | <i>Fhl2</i> | <i>Meis2</i> | <i>Smad3</i> | <i>Vav3</i> |
| <i>Btg1</i> | <i>Itgb3</i> | <i>Myom1</i> | <i>Smad6</i> | |
| <i>Cdk14</i> | <i>Lats2</i> | <i>Nfatc2</i> | <i>Smad7</i> | |
| <i>Cdkn1b</i> | <i>Lmnb1</i> | <i>Parva</i> | <i>Tcf7l2</i> | |
| <i>Cited2</i> | <i>Mbnl1</i> | <i>Rock2</i> | <i>Tgfbr2</i> | |



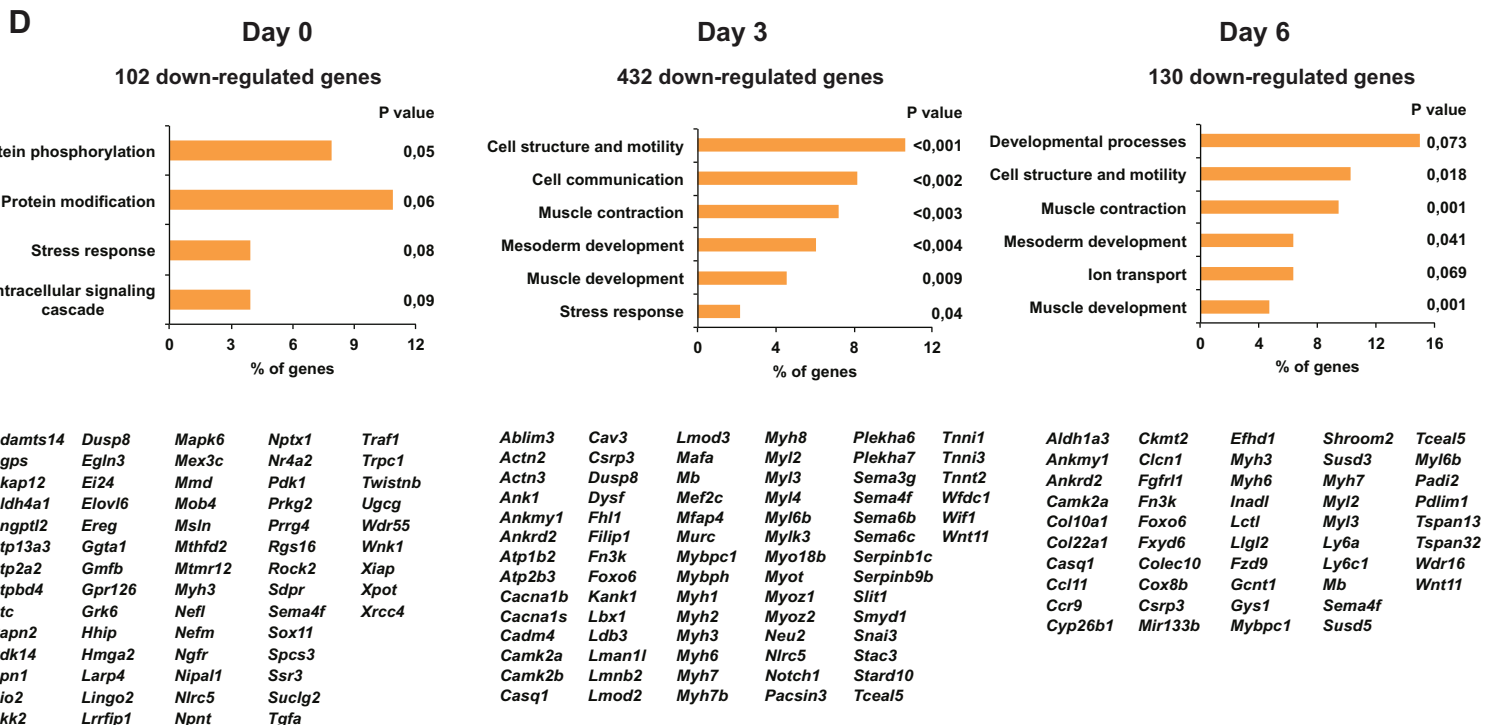
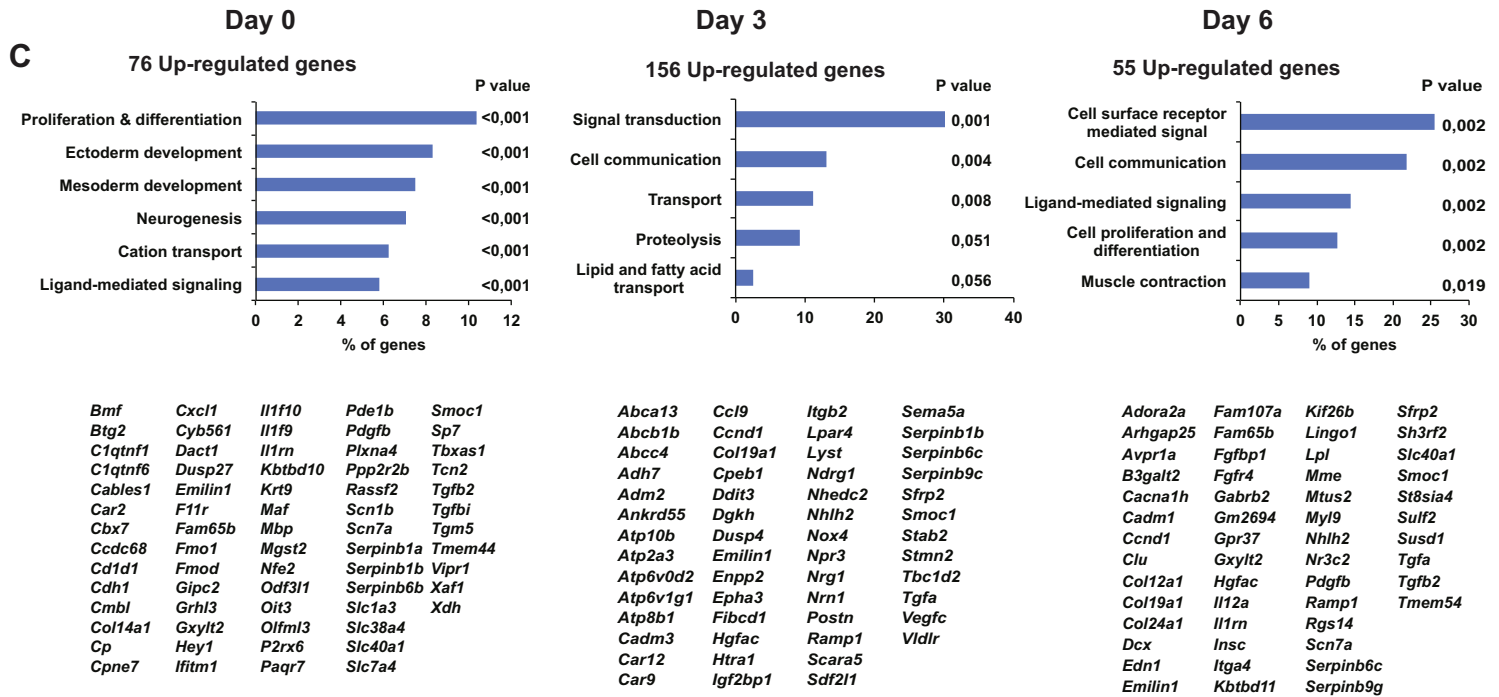
A

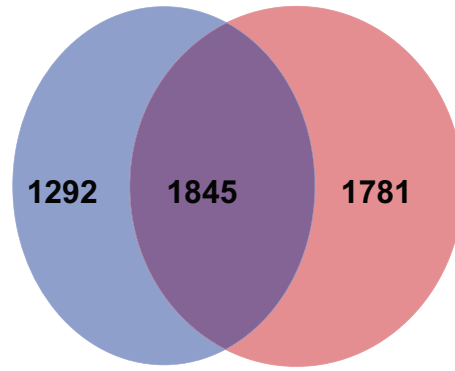
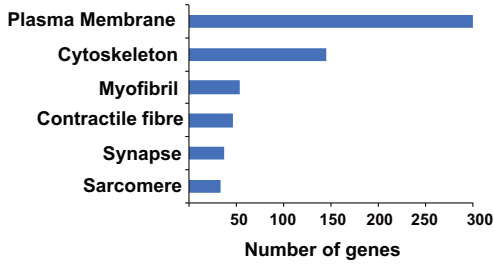
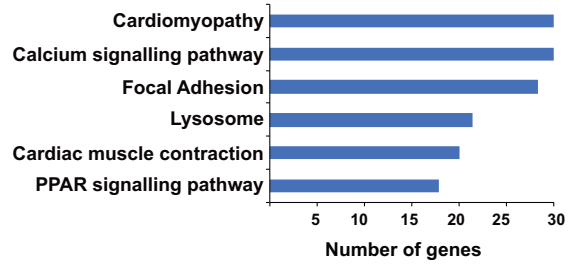
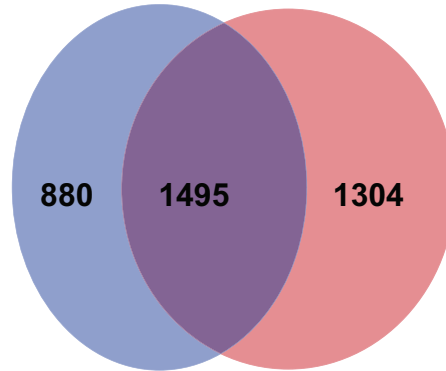
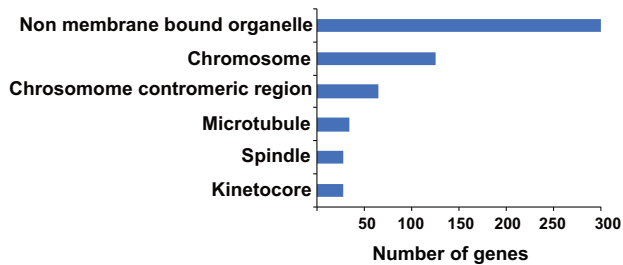
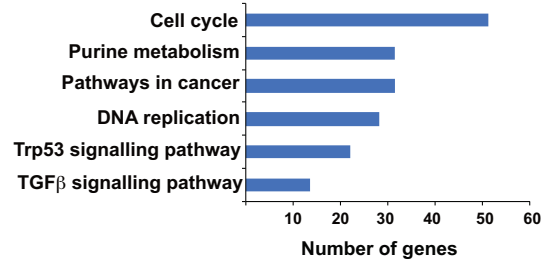
SiTead1/4 silencing in C2C12 cells



B

	siTead1/4		
	ND	Day 3	Day 6
Up-reg	76	156	55
down-reg	102	432	130



A**Genes up-regulated in C2C12 days 0-3-6****Genes up-regulated in PM days 0-3-6****CC-FAT Common up-regulated genes****KEGG pathway Common up-regulated genes****B****Genes down-regulated in C2C12 days 0-3-6****Genes down-regulated in PM days 0-3-6****CC-FAT Common down-regulated genes****KEGG pathway Common down-regulated genes**

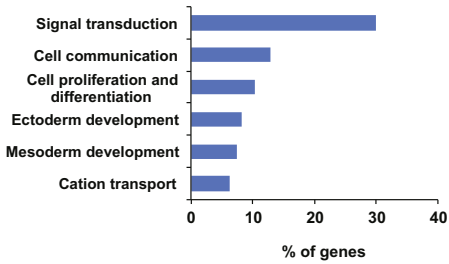
Primary Myoblasts- siTead1/4

	Day 0	Day 3	Day 6
Up	247	338	111
Down	182	199	86

B

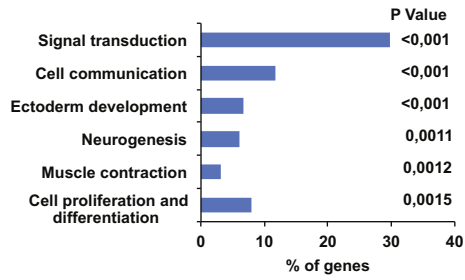
Day 0

247 Up-regulated genes



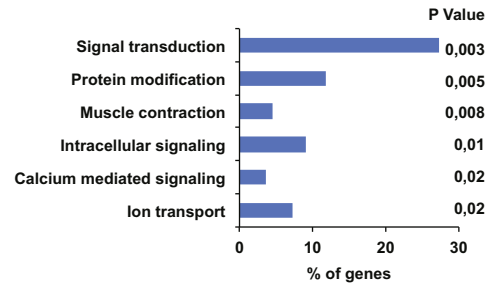
Day 3

338 Up-regulated genes



Day 6

111 Up-regulated genes



Abcd2 Cadm2 Ctnna2 Foxq1 Myh4 Pcdh9 Tgfb2
Acbd7 Card14 Diras2 Gabra1 Myo6 Pdgfb Tnni3
Adcy1 Casr Dock10 Gpr20 Myocd Plk3ip1 Vegfc
Adh7 Cbx7 Dusp2 Hgf Myzap Rgs2
Arid3b Chdh Ednra Hspa2 Ndst4 Rgs8
Art5 Ckmt1 Egr2 Id4 Neur13 Scn9a
Atf3 Cldn1 Esrrb Kcnh1 Nnat Sema5a
Atp1b2 Cldn21 Fgf7 Kcnh6 Pacsin1 Sfrp2
Atp9a Clu Fos Lin7a Pbx1 Snca
Batf3 Cntn1 Foxo1 Lmo2 Pcdh10 Sphk1
Btg1 Col24a1 Foxp2 Mdfi Pcdh17 Tbx2

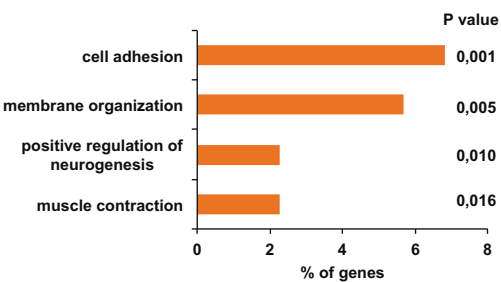
Adora2a Epha7 Nrg1 Rgs5 Tns4
Adra1d Ephb1 Olfml3 Rorc Tpbg
Ahrr Fgf7 Pacsin1 Ros1 Trib2
Alpk2 Flrt3 Palmd Rxfp1 Tspan8
Avpr1a Foxp2 Pdgfb Ryr2 Wnt10a
Calml3 Gabrb2 Penk Sag Wnt3
Cdh20 Htr2b Plk5 Sdk2
Cdh4 Igfbp4 Ptk2b Sema3d
Clstn2 Igsf1 Ptpzr1 Sema5a
Col10a1 Kcnip2 Pvr13 Sema6b
Col6a2 Lingo1 Pvr14 Sfrp2
Col9a1 Lingo3 Rasef Slc1a2
Dock11 Lphn2 Rasgef1a Tgfa
Dusp7 Mchr1 Rasgrp3 Tgfb2
Epha6 Mmel1 Rgs14 Thbd

Ache Ccdc64 Gabrb2 Myzap Sln
Adamts17 Col14a1 Galnt2 Nckap5 Smoc1
Aldh3b2 Col24a1 Gfra2 Ndst4 Tceal7
Alpk2 Col6a6 Golga7b Pdgfb Tgfb2
Ankfn1 Ctsx Gpr37 Pou2af1 Tpbg
Art3 Dcx Hpgd Ramp1 Tspan8
Astn2 Ephb1 Kcnj3 Rgs14 Vwc2
Atp1b4 Erbb4 Kcnmb1 Robo2 Wif1
Bmp2 Fgf7 Kif6 Rtnk2
C1ql3 Fgfbp1 Lingo1 Sema3d
Cacna1h Fhad1 Lmo2 Serpinb1b
Cacna2d2 Fmod Me3 Serpinb6b
Cadps Fras1 Mrc1 Sertad4
Calml3 Frmd3 Myh4 Slamf1
Camk1g Fut9 Mylk3 Slc1a2

C

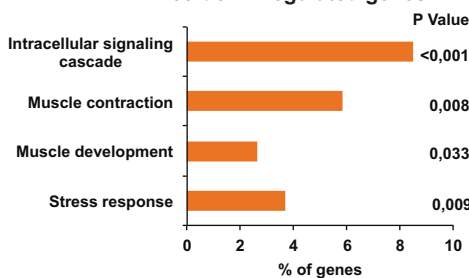
Day 0

182 down-regulated genes



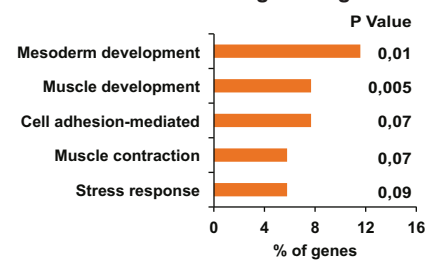
Day 3

199 down-regulated genes



Day 6

86 down-regulated genes



Ablim1 Cyb5b Itga3 Nctc1 Spnb1
Ablim2 Dkk3 Mapk6 Ngf Syt8
Adamts15 Dusp8 Mfap4 Nrcam Tagln
Adora1 Esrrg Msln Ntn1 Ugcg
Ak4 Fgf2 Mybpc1 Pacsin3 Xiap
Ankrd2 Fgf6 Mybph Pdk1 Xpo4
Ankrd23 Fhl1 Myh1 Pdlim2 Xrcc4
Casq1 Fzd9 Myh10 Plekha7
Cav3 Gja5 Myh7 Sgcd
Cdk14 Igfbp2 Myoz2 Sox11

Acacb Dgkg Jam2 Myoz2
Ak4 Dusp8 Lrrc2 Ndrp2
Ankrd2 Eef1a2 Mfap4 Parp3
Ankrd23 Esrrg Msln Pdk1
Atf3 Fgf2 Mybpc2 Pdlim1
Cdk18 Fhl1 Myh1 Plekha7
Cited4 Fzd9 Myh2 Ptpn3
Ckmt2 Gpr20 Myh7 Shroom3
Cnksr1 Heatr7b1 Myh8 Stac2
Crhr2 Hipk2 Myl2 Thrsp
Dchs1 Hspb7 Myl6b Wwc1

Xirp2
Xpo4
Aldoc Eps8l2 Pdgfra
Ankrd2 Fads6 Pln
Aspn Fhl1 Ppef1
Cd36 Gm3047 Ptpn3
Cd38 Gng13 Sim1
Cdk18 Kcne1 Slc10a4
Clip4 Lct1 Slc47a1
Cmb1 Lum Slc5a7
Cnksr1 Mlxipl Smoc2
Col23a1 Myh2 Sohlh2
Dchs1 Myh8 Syngn3
Dcn Myl2 Tlr5
Dupd1 Nos1 Xdh
Eef1a2 Nr4a3 Xirp2

Part 2

II.Characterisation of the TEAD4 interactome: Identification of Ifi202 as a novel interaction partner.

Introduction.

The results described in part 1 support our previous proposition that Tead factors in general and Tead4 in particular play a critical role of myoblast differentiation. We proposed that Tead4 could play a differential role in proliferating versus differentiating myoblasts (Benhaddou et al., 2012). It is required for expression of differentiation markers such as Cav3, Myh7b, and Acta1, but represses the expression of Ctgf and Ccnd1 during differentiation. This suggests that Tead4 functions both as a transcriptional activator as well as a repressor. While the effectors of the Hippo pathway YAP and TAZ have been identified as coactivators for TEAD factors particularly in activating the expression of genes involved in proliferation and oncogenesis (Lamar et al., 2012; Vassilev et al., 2001), no co-repressors have been identified. Moreover, it has been reported that YAP1 is exported from the nucleus during C2C12 cell differentiation (Watt et al., 2010) and it has been suggested that proteins of the Vgl-family are used as coactivators for Teads in differentiating myotubes (Chen et al., 2004b; Maeda et al., 2002a). Identification of Tead4 binding partners in differentiated C2C12 cells may therefore help to better understand the muscle and context-dependent function of Tead4 in gene expression.

Methods:

Tandem Affinity Purification:

Extracts were prepared essentially as previously described (Drane et al., 2010). Briefly, C2C12 cells were differentiated for 6 days and then resuspended in hypotonic buffer (10 mM Tris-HCl at pH 7.65, 1.5 mM MgCl₂, 10 mM KCl) and disrupted with a loose dounce homogenizer. The cytosolic fraction was separated from the cellular debris by centrifugation at 4°C. The nuclear-soluble fraction was obtained by incubation of the debris pellet in high-salt buffer (to get a final NaCl concentration of 300 mM) and separated from the pellet by centrifugation at 4°C. The insoluble chromatin fraction was obtained by treating the remaining pellet with micrococcal nuclease and subsequent sonication. The three extracts-cytoplasmic, soluble and chromatin-associated were then immunoprecipitated with anti-Flag M2-agarose (Sigma), eluted with Flag peptide (0.5 mg/mL), further affinity-purified with anti-HA antibody-conjugated agarose, and eluted with HA peptide (1 mg/mL). The HA and Flag peptides were first buffered with 50 mM Tris-Cl (pH 8.5), then diluted to 4 mg/mL in TGEN 150 buffer (20 mM Tris at pH 7.65, 150 mM NaCl, 3 mM MgCl₂, 0.1 mM EDTA, 10% glycerol, 0.01% NP40), and stored at -20°C until use. Between each step, beads were

washed in TGEN 150 buffer. Complexes were resolved by SDS-PAGE and stained using the Silver Quest kit (Invitrogen). The insoluble fractions were sent for mass-spectrometric analysis. Identification of proteins was carried out by the Taplin Biological Mass Spectrometry Facility at Harvard Medical School (Boston, MA).

Co-expression and Immunoprecipitation:

HEK cells were singly or co-transfected with 3 μ g each of Tead4 and HA- Ifi202b expression plasmids. Co-expression was verified by western blotting with Tead4 (Abnova) or HA (Sigma) antibodies respectively. Immunoprecipitation was performed as per standard protocols on 500 μ g of total cell extract using HA-Sepharose beads (Sigma). Beads were subjected to two high salt buffer and two low-salt buffer washes. The beads were then boiled in Laemmli 2X Sample Buffer and immuno-precipitated fractions were loaded onto SDS-PAGE gels.

Results.

1. Identification of TEAD4 binding partners by Tandem affinity purification-mass spectrometry (TAP-MS):

To identify Tead4 interacting proteins, C2C12 cells were infected with a lentivirus expressing F-HA-Tead4 or empty vector (EV) and selected with puromycin. F-HA-Tead4 expression was verified by blotting with Tead4 antibody showing expression of the tagged protein with slower electrophoretic mobility than the endogenous Tead4 protein (Figure 1A). Soluble nuclear and chromatin-associated fractions were prepared from these two cell lines differentiated for 6 days (Figure 1B) and subjected to tandem FLAG-HA immunoprecipitation followed by mass spectrometry.

SDS-PAGE and silver nitrate staining of the chromatin-associated fraction immunoprecipitate revealed the abundant presence of a protein of the molecular mass of tagged Tead4 only in the extracts from F-HA-Tead4 cells and not in the extracts from EV cells (Figure 1C). Several other proteins were observed only in the F-HA-Tead4 immunoprecipitates. These fractions were sent for analysis by mass-spectrometry that confirmed the presence of abundant peptides for Tead4 (Figure. 2A). Surprisingly, a protein of the molecular mass expected for Yap1 was also seen in these precipitates and abundant Yap1 peptides were identified (Figures 1C and 2A). Yap1 appeared to be close to stoichiometric with F-HA-Tead4 showing that it remained a major Tead4 partner on the

Results

chromatin of differentiated cells. Multiple peptides for Parp1, a previously described Tead4 partner (Butler and Ordahl, 1999), were also observed along with a protein of the expected molecular mass. Similar observations were made for Top1. In contrast, few peptides for Vgll2 and Vgll4 were observed (Figure 2A). More surprisingly, we identified abundant peptides specific for Tead2. Tead-family proteins are not known to form homo or heterodimers, so the reason for the presence of Tead2-specific peptides in the F-HA-Tead4 immunoprecipitate is not yet clear.

Peptides for other proteins were observed that could be classified in three major categories on the basis of their molecular function, as transcription co-regulators, direct DNA binders and chromatin modifiers (Figure 1D, and 2A-B). Chromatin modifiers and remodellers include Smarca1, Baf53a, Actl6a, Rbbp4, Ruvbl2, Ruvbl1, Hdac1 and Prmt5. Transcription co-factors included Yap1, Vgll2, Vgll4 and Wwtr1 (Taz). Surprisingly however, abundant peptides were found for a protein designated as Ifi202b and SDS-PAGE showed that a protein of this molecular mass was strongly represented in the Tead4 immunoprecipitate. 16 unique peptides for Ifi202b were found, comparable to 18 unique peptides for Tead4. This is the first time this protein has been found associated with Tead4 and appears to be a major interaction partner on the chromatin of differentiated C2C12 cells. Ifi202b has been shown previously to interact with several transcription factors such as Nf-kb, Jun, Fos, P53 and Myod1 and modulate their transcriptional activity (Datta et al., 1996; Datta et al., 1998; Min et al., 1996). We therefore investigated the potential function of Ifi202b as a Tead4 co-factor.

In order to validate the interaction of Tead4 with Ifi202b, HEK cells were transfected with either empty vector (EV) or expression vectors for Tead4 or HA-Ifi202b alone or in combination. Protein expression was checked by western blot in extracts from transfected cells (upper panel, Figure 1E). Immunoprecipitation was then performed using HA antibody showing that Tead4 coprecipitates with HA-Ifi202b when co-expressed in HEK cells. Interestingly, no endogenous HEK cell YAP or TAZ could be detected in the immunoprecipitation indicating that Ifi202b forms a complex with Tead4 independent of YAP1 and TAZ.

2. Both gain and loss of Ifi202b function inhibit C2C12 cell differentiation:

To begin to understand how Ifi202b may regulate Tead4 during C2C12 differentiation, we investigated its expression and function in differentiating cells. RT-qPCR

results showed that *Ifi202b* is lowly expressed at mRNA level, although it is induced during differentiation. We tried to check Ifi202b protein expression by western blot, however, none of the commercial antibodies could specifically detect Ifi202b in C2C12 cell extracts (data not shown).

To perform gain of function studies, we constitutively expressed HA-Ifi202b in C2C12 cells by lentiviral infection and differentiated the cells up to day 7. Expression of ectopic HA-Ifi202b was confirmed by RT-qPCR and by western blotting using HA antibody (Figure 3A and B). Differentiation of cells expressing ectopic HA-Ifi202b was severely impaired compared to that of wild-type cells (Figure 3C). Interestingly, Tead4 and Myod1 expression were significantly reduced in cells overexpressing HA-Ifi202b, perhaps contributing the reduced differentiation (Figure 3D).

Loss of Ifi202b function was performed using siRNA in parallel to siRNA against Tead4. Knockdown of *Ifi202b* and *Tead4* was confirmed by RT-qPCR (Figure 4A). Loss of Ifi202b expression also resulted in impaired C2C12 differentiation (Figure 4B). Tead4 knockdown resulted in a significant decrease in *Myhc* and *Cav3* mRNA levels, while despite the evident effect on differentiation, the expression of these genes showed only little change upon siIfi202b knockdown (Figure 4C). Expression of Titin and Dysferlin were reduced by siTead4 knockdown, whereas despite the impaired differentiation, expression of these genes was not significantly affected by siIfi202b knockdown (Figure 4C).

3. Ifi202 is required for normal elongation during differentiation of primary myoblasts.

We performed similar siRNA knockdown experiments in primary myoblasts isolated from adult mouse muscle. Knockdown of Tead4 and Ifi202b was verified by RT-qPCR (Figure 5A). While as described above, Tead4 knockdown had little effect on differentiation, Ifi202b knockdown had a potent effect compared to siControl (Figure 5B). Firstly, the number of Myhc expressing cells was strongly reduced. Secondly, the cells that did engage in differentiation generated only short myotubes. Nevertheless, despite the short length of the myotubes, calculation of the fusion index (Figure 5C) shows only a mild reduction in the number with more than three nuclei. The phenotype of Ifi202b silencing does not therefore arise from impaired fusion, but rather a defect in elongation, giving rise to shorter tubes with multiple nuclei.

Results

Given this specific phenotype, we were surprised to notice that there were no reads mapping to the *Ifi202b* gene in the RNA-seq data from undifferentiated and differentiated primary myoblasts suggesting that this gene is not expressed in these cells (Figure 6A). In contrast, reads mapping to *Ifi202b* were observed in the RNA-seq from C2C12 cells. The *Ifi200* locus is highly polymorphic amongst different mouse strains (Cridland et al., 2012). To investigate the difference in *Ifi202b* expression between C2C12 cells and primary myoblasts, we checked if these cells came from the same genetic background. C2C12 cells are derived from the C3H mouse strain, whereas we isolated primary myoblasts from C57BL/6. This is an important observation as *Ifi202b* belongs to a three-gene family of *Ifi202a*, *Ifi202b* and *Ifi202c*. *Ifi202b* and *Ifi202a* genes are highly homologous in their primary sequence with only 7 amino acid substitutions (Wang et al., 1999), while *Ifi202c* is a pseudogene. Wang et al., performed homologous recombination to delete the *Ifi202a* gene and showed that *Ifi202b* expression could still be detected in these mice. The *Ifi202a/b* genes are present at an obesity-linked locus and a strong decrease in obese phenotype was observed when the obese mice were crossed with BL/6 mice (Vogel et al., 2012). Further molecular characterisation led to the finding that BL/6 mice harbour a micro-deletion in the *Ifi202b/a* locus which leads to a loss of *Ifi202b* expression in BL/6 contrary to the C3H and 129Svj mice lines. This potentially explains the lack of *Ifi202b* expression in the primary myoblasts we prepared from the BL/6 background.

Nevertheless, given their high homology, RNA-seq reads from *Ifi202a* should map to the *Ifi202b* gene even when this gene is no longer expressed. To investigate this further, we looked up the annotation of *Ifi202b* in the NCBI gene database. The sequence and gene annotation in mm9 comes from C57BL/6 mice and the *Ifi202b* and *Ifi202a* gene annotations are merged and called *Ifi202b*, but the annotated sequence is that of *Ifi202a* as described by Wang et al, not 202b. Hence, it is unclear whether this is an annotation problem or whether independent *Ifi202a* and *Ifi202b* genes really exist.

If only one *Ifi202* gene exists, but is not expressed in primary myoblasts from BL/6 mice, then it is difficult to explain why *Ifi202b* knockdown has such a dramatic effect on their differentiation. To address this problem, we designed a common forward primer, but different reverse primers specific to either *Ifi202a* or *Ifi202b* based on the differences in sequence described by Wang et al (1999). We performed RT-PCR on both C2C12 and primary myoblast mRNA and loaded the samples on an agarose gel to check whether cDNAs for

Results

Ifi202a and *Ifi202b* gene were amplified in the two cell types. As shown in Figure 6B, concomitant with previous findings and RNA-seq data, *Ifi202a* was expressed in both C2C12 cells and primary myoblasts while *Ifi202b* was lowly expressed in C2C12, but could not be amplified at all in primary myoblasts. Moreover, *Ifi202a* expression is up-regulated during primary myoblast differentiation. In this respect it is interesting to note that, while there are no Tead-binding sites seen at this locus, *Myod1* and *Myog* occupy a site immediately upstream of the *Ifi202* gene (Figure 6C)

Together the above data support the contention of Wang et al for the existence at two distinct genes encoding *Ifi202a* and *Ifi202b* whose differential expression can be discriminated using specific primers. Both genes are expressed in C2C12 cells, while only *Ifi202a* is expressed in primary myoblasts where its expression is up-regulated during differentiation. The siRNA pool designed against *Ifi202b* cross reacts with *Ifi202a* as these two genes have highly homologous sequences, thus explaining the potent effect of the knockdown on primary myoblast differentiation. Moreover, the annotation of the *Ifi200* locus in public databases is confusing. Only *Ifi202b* is depicted, yet the sequence is that of *Ifi202a*, whereas no annotations for *Ifi202a* or *If202c* are shown. This locus is known to be highly polymorphic amongst mouse strains and its annotations show other anomalies. For example, Zhang et al., describe the *Mndal* gene and show it located between *Ifi202b* and *Ifi203* (Zhang et al., 2009), whereas it is annotated in UCSC/Ensembl as several independent transcripts located overlapping with *Ifi204*. Given these ambiguities, we re-examined the peptides that were identified in the mass spectrometry analysis to verify that they matched only the *Ifi202a/b* proteins and could not be confused with the closely related *Ifi203* and *Ifi204* proteins (Figure 6D). Only a single peptide was shared with *Ifi203/4*, all the others were specific to *Ifi102* demonstrating this protein is really expressed in C2C12 cells.

From this study, we therefore conclude that the gene designated previously as *Ifi202a* is expressed in primary myoblasts from BL/6 mice, is up-regulated perhaps through the action of *Myod1/Myog* during differentiation, and plays an important role in the elongation of myotubes.

Discussion and perspectives:**Ifi202 is a novel but enigmatic Tead4 interacting partner.**

Ifi202a and Ifi202b belong to a family of proteins containing HIN-domains (HIN-A and HIN-B) that has pleiotropic functions acting in the innate immune response and also as regulators of transcriptional activity in the nucleus through their binding to several transcription factors such as Trp53 (Xin et al., 2006). The HIN family in mouse is composed of 12 well-characterised genes while the human genome comprises only 4 genes (Cridland et al., 2012). There are two important functionally conserved domains in HIN proteins, the HIN domain that recognises exogenous cytosolic DNA during infection and the PYRIN/DAPIN domain that elicits the immune response via inflammasome complex formation. The transcriptional regulation function is mediated via the HIN-A and/or the HIN-B domains.

Interestingly, the Ifi202 proteins do not contain the PYRIN domain and possess only the two HIN domains. Ifi202 has been shown to interact with transcription factors such as NF- κ B and JUN/FOS both *in vitro* and *in vivo* (Min et al., 1996) and inhibit their transcriptional activity. In addition, overexpression of Ifi202b slowed cell proliferation. Another study from the same group showed that Ifi202 binding to Trp53bp1 also inhibited transcriptional activation of Trp53-dependent genes such *Cdkn1a* and *Mdm2* (Datta et al., 1996) and furthermore, knockdown of Ifi202 led to increased *Cdkn1a* expression showing that Ifi202b modulates growth and arrest of proliferation via Trp53bp1 binding activity. Datta et al. showed that transient overexpression of Ifi202 suppresses *Myod1* expression at mRNA level and also inhibits its transcriptional activity by directly binding the Myod1 protein (Datta et al., 1998). Further experiments showed that Ifi202 overexpression in C2C12 cells inhibited their differentiation, a result that we reproduced here. Similarly, the related Ifi204 protein is also induced during C2C12 differentiation where it is required for their differentiation by overcoming the inhibitory effect of ID proteins on Myod1 (Ding et al., 2006).

The above data on Ifi202 may help explain our observations that both gain and loss of its function inhibits C2C12 cell differentiation and provide a potential mechanism for these effects. Gain of Ifi202 inhibits both Myod1 expression and Myod1 activity resulting in impaired differentiation (Wang et al., 2002). However, as described for Ifi204, it is possible that Ifi202 is induced during differentiation to overcome the negative effects of ID-proteins on Myod1 and hence that loss of its function may lead to inhibition of Myod1 activity. This idea remains to be tested.

Results

In primary myoblasts, we found that Ifi202 silencing led to defective elongation, with the accumulation of shortened myotubes with multiple nuclei. As we did not yet carefully perform the analysis, we do not know whether this same defect is also seen in the C2C12 cells. Nevertheless, the phenotype of Ifi202 silencing differs from that of Tead4 silencing in primary myoblasts. Similarly, siTead1/4 silencing also does not result in a comparable elongation phenotype. There is therefore no evidence that the defects seen in either C2C12 cells or primary myoblasts can be directly attributed to inhibition of Tead activity by their interaction with Ifi202, rather than by inhibition of Myog and/or Myod1 function or by another as yet to be described mechanism. A more detailed analysis of gene expression under the different silencing conditions together with comparisons of the effects of siMyod1/Myog silencing may help to better understand the mechanism of Ifi202 action.

Tead4-interacting partners are primarily associated with transcription activation.

One of the objectives of this study was to identify novel Tead4 interacting proteins that could act as co-repressors and support the idea that Tead4 may repress a subset of genes in differentiating C2C12 cells. Analysis of the identified proteins has so far revealed mainly proteins associated with transcriptional activation. Surprisingly, one of the major Tead4 interactors in differentiated cells remains Yap1, despite the observation that it is exported from the nucleus during differentiation (Watt et al., 2010). This is an unexpected observation as it was reported that constitutive Yap1 localisation in the nucleus impairs C2C12 cell differentiation (Judson et al., 2012). Our data suggest that while the majority of Yap1 is exported from the nucleus a small fraction remains associated with Tead4 on chromatin perhaps participating in gene activation. In contrast, we found no evidence that the Vgl-family proteins are major Tead4 interaction partners on the chromatin of differentiated C2C12 cells.

In addition to Yap1 (and Ifi202b), the major partners of Tead4 are Parp1 and Top1. Both of these proteins are generally associated with the process of transcriptional activation. This is comforted by the additional finding of the subunits of FACT (Supt16h and Ssrp1), a complex associated with transcription through the chromatin environment (Belotserkovskaya et al., 2004). Nevertheless, in addition to Parp1, we also found macroH2A associated with Tead4 on chromatin. It has previously been shown that macroH2A can recruit Parp1 to chromatin and repress its enzymatic activity (Biterge and Schneider, 2014). Indeed, several studies have associated macroH2A with transcriptional repression although it has also been

Results

found on inducible genes, such as bivalent genes in ES cells where it remains associated with the chromatin after activation (Creppe et al., 2012). We found that Tead4 occupies sites at genes to be induced during differentiation already in myoblasts, for example at the *Myog* locus. Perhaps many of these promoters are bound by macroH2A poisoning them for activation during differentiation.

Interestingly, we also found that Tead4 associates with the histone arginine methylase Prmt5 that mediates H3R8 symmetric dimethylation. Prmt5 has been shown to be required for Myod1-driven myogenic differentiation of 3T3 cells (Dacwag et al., 2007). PRMT5 also plays an important role in myogenesis in Zebrafish where it regulates Myod, Myf5 and Myogenin expression and thereby slow and fast fibre formation (Batut et al., 2011). More recently, it has been shown that Prmt5 is required for muscle regeneration in the mouse, controlling proliferation and differentiation of the stem cells and is required for maintenance of the muscle stem cell population (Zhang et al., 2015). Moreover, Prmt5 appears to repress Cdkn1A expression in the muscle stem cell population. Based on these observations it would be pertinent to more closely examine recruitment of Prmt5 to Tead4 target genes, in particular those that are up-regulated upon Tead4 silencing, like *Ccnd1*, and to examine the presence of H3R8 dimethylation before and after differentiation to assess whether Tead4-driven Prmt5 recruitment to these genes may be a mechanism for Tead4-mediated transcriptional repression.

In summary, our identification of Tead4 associated proteins has identified both known and novel partners suggesting new avenues for future study. In particular, it will be important to better assess the role of Yap1 in differentiation, the role of macro2HA-Parp1 at promoters poised for activation during differentiation and the role of Prmt5 as a potential mediator of Tead4-driven transcriptional repression.

References.

- Batut, J., Duboe, C., and Vandel, L. (2011). The methyltransferases PRMT4/CARM1 and PRMT5 control differentially myogenesis in zebrafish. *PLoS One* 6, e25427.
- Belotserkovskaya, R., Saunders, A., Lis, J.T., and Reinberg, D. (2004). Transcription through chromatin: understanding a complex FACT. *Biochim Biophys Acta* 1677, 87-99.
- Benhaddou, A., Keime, C., Ye, T., Morlon, A., Michel, I., Jost, B., Mengus, G., and Davidson, I. (2012). Transcription factor TEAD4 regulates expression of myogenin and the

Results

unfolded protein response genes during C2C12 cell differentiation. *Cell Death Differ* 19, 220-231.

Biterge, B., and Schneider, R. (2014). Histone variants: key players of chromatin. *Cell Tissue Res* 356, 457-466.

Butler, A.J., and Ordahl, C.P. (1999). Poly(ADP-Ribose) Polymerase Binds with Transcription Enhancer Factor 1 to MCAT1 Elements To Regulate Muscle-Specific Transcription. In *Mol Cell Biol*, pp. 296-306.

Chen, H.H., Maeda, T., Mullett, S.J., and Stewart, A.F. (2004). Transcription cofactor Vgl-2 is required for skeletal muscle differentiation. *Genesis* 39, 273-279.

Creppe, C., Janich, P., Cantarino, N., Noguera, M., Valero, V., Musulen, E., Douet, J., Posavec, M., Martin-Caballero, J., Sumoy, L., *et al.* (2012). MacroH2A1 regulates the balance between self-renewal and differentiation commitment in embryonic and adult stem cells. *Mol Cell Biol* 32, 1442-1452.

Cridland, J.A., Curley, E.Z., Wykes, M.N., Schroder, K., Sweet, M.J., Roberts, T.L., Ragan, M.A., Kassahn, K.S., and Stacey, K.J. (2012). The mammalian PYHIN gene family: phylogeny, evolution and expression. *BMC Evol Biol* 12, 140.

Dacwag, C.S., Ohkawa, Y., Pal, S., Sif, S., and Imbalzano, A.N. (2007). The protein arginine methyltransferase Prmt5 is required for myogenesis because it facilitates ATP-dependent chromatin remodeling. *Mol Cell Biol* 27, 384-394.

Datta, B., Li, B., Choubey, D., Nallur, G., and Lengyel, P. (1996). p202, an interferon-inducible modulator of transcription, inhibits transcriptional activation by the p53 tumor suppressor protein, and a segment from the p53-binding protein 1 that binds to p202 overcomes this inhibition. *J Biol Chem* 271, 27544-27555.

Datta, B., Min, W., Burma, S., and Lengyel, P. (1998). Increase in p202 expression during skeletal muscle differentiation: inhibition of MyoD protein expression and activity by p202. *Mol Cell Biol* 18, 1074-1083.

Ding, B., Liu, C.J., Huang, Y., Hickey, R.P., Yu, J., Kong, W., and Lengyel, P. (2006). p204 is required for the differentiation of P19 murine embryonal carcinoma cells to beating cardiac myocytes: its expression is activated by the cardiac Gata4, Nkx2.5, and Tbx5 proteins. *J Biol Chem* 281, 14882-14892.

Drane, P., Ouararhni, K., Depaux, A., Shuaib, M., and Hamiche, A. (2010). The death-associated protein DAXX is a novel histone chaperone involved in the replication-independent deposition of H3.3. *Genes Dev* 24, 1253-1265.

Judson, R.N., Tremblay, A.M., Knopp, P., White, R.B., Urcia, R., De Bari, C., Zammit, P.S., Camargo, F.D., and Wackerhage, H. (2012). The Hippo pathway member Yap plays a key role in influencing fate decisions in muscle satellite cells. *J Cell Sci* 125, 6009-6019.

Lamar, J.M., Stern, P., Liu, H., Schindler, J.W., Jiang, Z.G., and Hynes, R.O. (2012). The Hippo pathway target, YAP, promotes metastasis through its TEAD-interaction domain. *Proc Natl Acad Sci U S A* 109, E2441-2450.

Results

Maeda, T., Chapman, D.L., and Stewart, A.F. (2002). Mammalian vestigial-like 2, a cofactor of TEF-1 and MEF2 transcription factors that promotes skeletal muscle differentiation. *J Biol Chem* 277, 48889-48898.

Min, W., Ghosh, S., and Lengyel, P. (1996). The interferon-inducible p202 protein as a modulator of transcription: inhibition of NF-kappa B, c-Fos, and c-Jun activities. *Mol Cell Biol* 16, 359-368.

Vassilev, A., Kaneko, K.J., Shu, H., Zhao, Y., and DePamphilis, M.L. (2001). TEAD/TEF transcription factors utilize the activation domain of YAP65, a Src/Yes-associated protein localized in the cytoplasm. *Genes Dev* 15, 1229-1241.

Vogel, H., Scherneck, S., Kanzleiter, T., Benz, V., Kluge, R., Stadion, M., Kryvykh, S., Bluher, M., Kloting, N., Joost, H.G., *et al.* (2012). Loss of function of *Ifi202b* by a microdeletion on chromosome 1 of C57BL/6J mice suppresses 11beta-hydroxysteroid dehydrogenase type 1 expression and development of obesity. *Hum Mol Genet* 21, 3845-3857.

Wang, H., Chatterjee, G., Meyer, J.J., Liu, C.J., Manjunath, N.A., Bray-Ward, P., and Lengyel, P. (1999). Characteristics of three homologous 202 genes (*Ifi202a*, *Ifi202b*, and *Ifi202c*) from the murine interferon-activatable gene 200 cluster. *Genomics* 60, 281-294.

Wang, H., Ding, B., Liu, C.J., Ma, X.Y., Deschamps, S., Roe, B.A., and Lengyel, P. (2002). The increase in levels of interferon-inducible proteins p202a and p202b and RNA-dependent protein kinase (PKR) during myoblast differentiation is due to transactivation by MyoD: their tissue distribution in uninfected mice does not depend on interferons. *J Interferon Cytokine Res* 22, 729-737.

Watt, K.I., Judson, R., Medlow, P., Reid, K., Kurth, T.B., Burniston, J.G., Ratkevicius, A., De Bari, C., and Wackerhage, H. (2010). Yap is a novel regulator of C2C12 myogenesis. *Biochem Biophys Res Commun* 393, 619-624.

Xin, H., D'Souza, S., Jorgensen, T.N., Vaughan, A.T., Lengyel, P., Kotzin, B.L., and Choubey, D. (2006). Increased expression of *Ifi202*, an IFN-activatable gene, in B6.Nba2 lupus susceptible mice inhibits p53-mediated apoptosis. *J Immunol* 176, 5863-5870.

Zhang, K., Kagan, D., DuBois, W., Robinson, R., Bliskovsky, V., Vass, W.C., Zhang, S., and Mock, B.A. (2009). *Mndal*, a new interferon-inducible family member, is highly polymorphic, suppresses cell growth, and may modify plasmacytoma susceptibility. *Blood* 114, 2952-2960.

Zhang, T., Gunther, S., Looso, M., Kunne, C., Kruger, M., Kim, J., Zhou, Y., and Braun, T. (2015). *Prmt5* is a regulator of muscle stem cell expansion in adult mice. *Nat Commun* 6, 7140.

Legends to Figures.

Figure 1. Identification of Tead4 binding partners by Tandem affinity purification-mass spectrometry (TAP-MS). **A.** Western blot confirming ectopic expression of Flag-HA-Tead4 in both non-differentiated and differentiated C2C12 cells. Upper panel is revealed with anti-Tead4 antibody and lower panel with anti-Actin. ND non-differentiated, EV empty vector, Diff 6 days of differentiation. **B.** Schematic description of pipeline for extract preparation and Tandem-affinity purifications performed for mass spectrometric analysis. **C.** SDS PAGE and silver-nitrate staining of immunopurified fractions from differentiated control (EV) and F-HA-Tead4 expressing C2C12 cells. The presumed locations of several of the major interactors are indicated on the right of the panel. **D.** Functional classification of the identified Tead4 binding partners. **E.** Co-expression of Tead4 and HA-Ifi202b in HEK-293T cells. The upper panel shows the presence of the ectopically expressed proteins in the transfected cell extracts. The lower panel shows the proteins present in the input fraction, the HA-immunoprecipitated fraction and the supernatant of the immunoprecipitation as indicated.

Figure 2. The Tead4 interactome. **A.** Table showing the various Tead4 binding partners identified in TAP-MS experiment along with the number of unique and total peptides indicated for each protein. **B.** DAVID ontology on the Tead4 binding partners identified with more than 3 unique peptides.

Figure 3. Gain of Ifi202b function impairs C2C12 cell differentiation. **A.** RT-qPCR quantification of endogenous and exogenous *Ifi202b* expression during C2C12 cell differentiation. **B.** Immunoblot with anti-HA antibody showing expression of HA-Ifi202b in C2C12 cells after infection and puromycin selection. First lane shows a control extract from HEK cells transfected with the HA-Ifi202b expression vector. **C.** Bright field microscopy images of C2C12 cells constitutively expressing HA-Ifi202b or cells infected with empty vector after 6 days of differentiation. **D.** RT-qPCR quantification of *Myod1* and *Tead4* expression in differentiating C2C12 cells with or without exogenous Ifi202b.

Figure 4. Loss of Ifi202b function impairs C2C12 cell differentiation. **A.** RT-qPCR quantification of *Tead4* and *Ifi202b* expression in differentiating C2C12 cells following transfection with the indicated siRNAs. **B.** Bright field microscopy images after 6 days of differentiation of C2C12 cells transfected with the indicated siRNAs. **C.** RT-qPCR

quantification of the expression of the indicated genes in differentiating C2C12 cells following transfection with the indicated siRNAs.

Figure 5. Loss of *Ifi202b* function impairs primary myoblast differentiation. **A.** RT-qPCR quantification of *Tead4* and *Ifi202b* expression in differentiating primary myoblasts following transfection with the indicated siRNAs. **B.** Fluorescence microscopy images after 6 days of differentiation of primary myoblasts transfected with the indicated siRNAs. Red channel shows staining with Myhc antibody, and blue Dapi-stained nuclei. Lower panels show blow-ups of cells to illustrate the presence of multiple nuclei in the shortened fibres after si*Ifi202b* knockdown. **C.** Fusion index of siControl and si*Ifi202b* cells. **D.** RT-qPCR quantification of *Myod1* expression in differentiating primary myoblasts following transfection with the indicated siRNAs.

Figure 6. Expression of *Ifi202a* in C2C12 cells and primary myoblasts. **A.** Table showing the number of reads in RNA-seq experiments from primary myoblasts (PM) or C2C12 cells. **B.** Agarose gel electrophoresis of products of semi-quantitative end point RT-qPCR performed on RNA from C2C12 cells differentiated for 0-7 days as indicated on primary myoblasts after 1 or 4 days of differentiation. **C.** UCSC screenshot illustrating the presence of a Myod1/Myog binding site immediately upstream of the *Ifi202a/b* gene. **D.** List of *Ifi202b* peptides found after tandem affinity purification of F-HA-Tead4. Blast alignment of the peptides showed they specifically matched to *Ifi202a/b*. Only a single peptide is shared with the closely related *Ifi203* and *Ifi204* proteins.

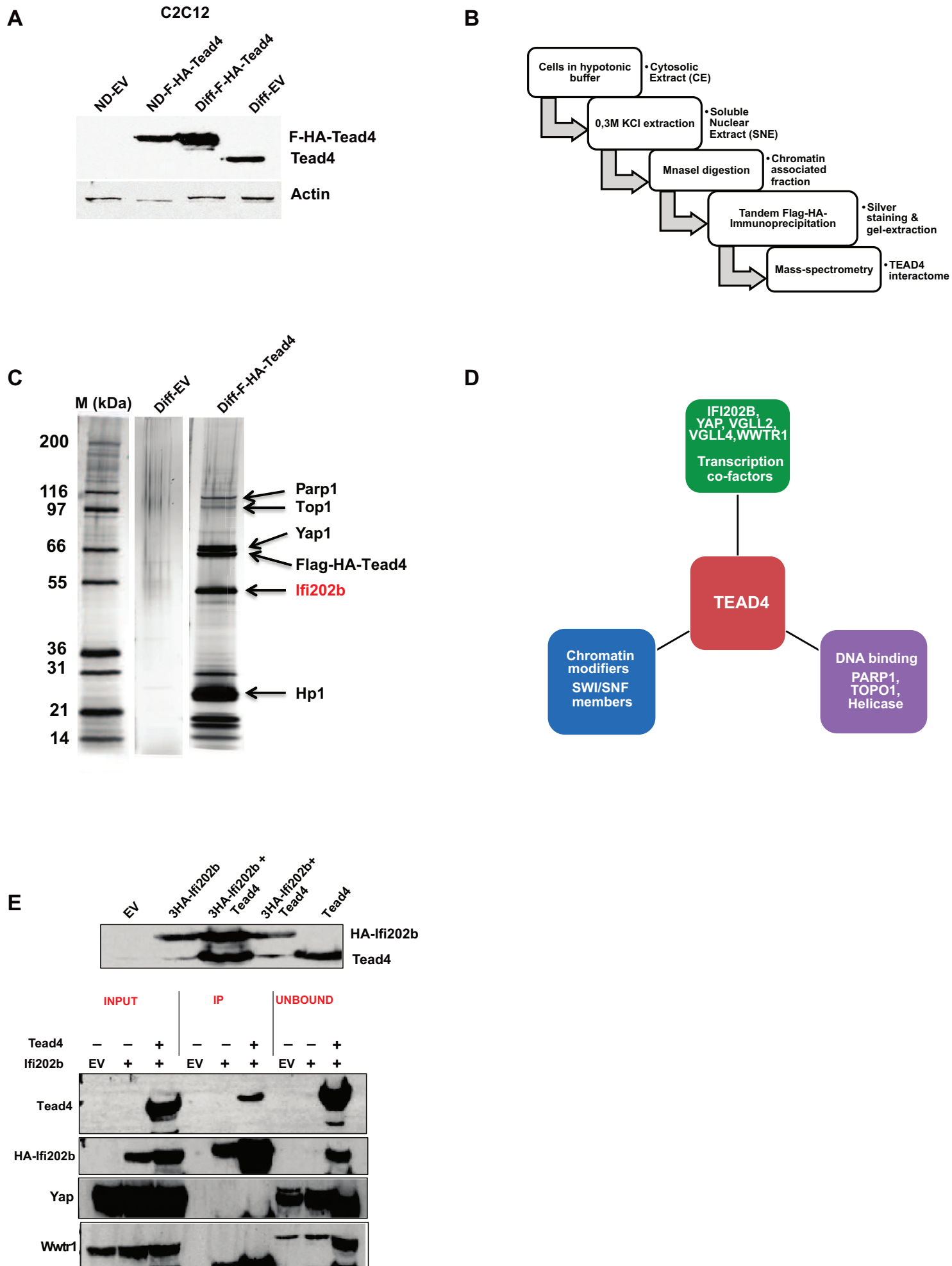


Figure 1

A

Protein	Unique peptides	Total peptides
Top1	24	36
Parp1	23	28
Tead4	18	209
Ifi202b	16	19
Yap1	12	27
Actl6a	10	13
Tead2	9	63
Rbbp4	8	9
Hnrnpc	7	7
Hnrnpu	7	10
Supt16h	7	8
Hist1h2bj	6	92
Ssbp1	6	10
H2af	6	38
Prmt5	6	6
Lmna	6	6
Ssrp1	6	6
Ruvbl1	5	5
Hdac1	5	5
Atp5a1	5	6
Hist1h1c	5	15
Hist1h2ba	5	11
Cbx1	4	4
Xrcc6	4	4
Cbx3	4	6
H2afy	4	6
Polr2e	4	4
Ruvbl2	4	4
H2afx	3	9
Atp5b	3	4
Hnrnpm	3	3
Hnrnph2	3	3
Cbx5	3	3
Hist1h2bp	3	8
Rpl4	3	3
Hist2h3b	3	6
Wwtr1	3	3
Smarca1	3	3

B

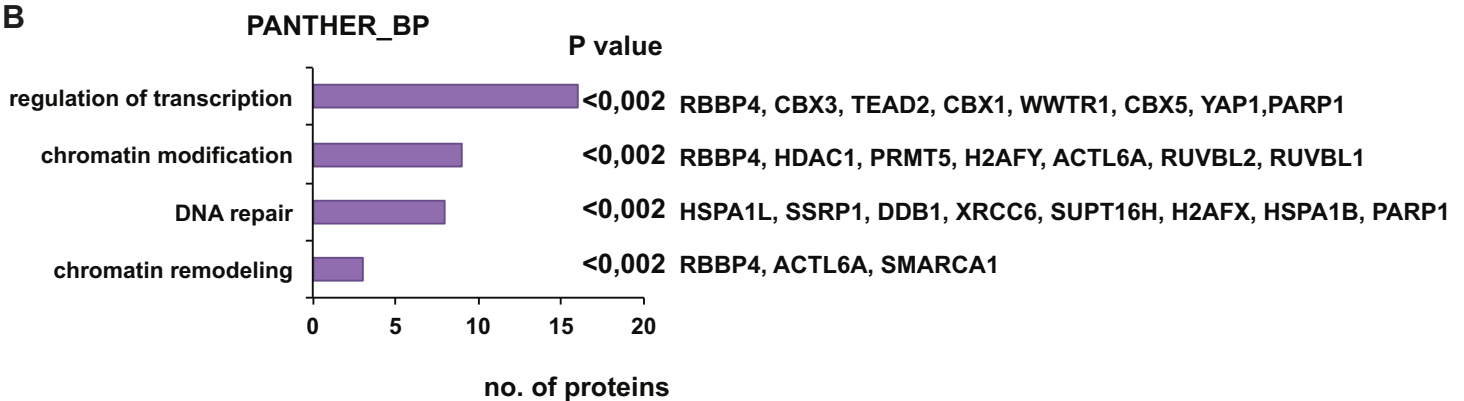


Figure 2

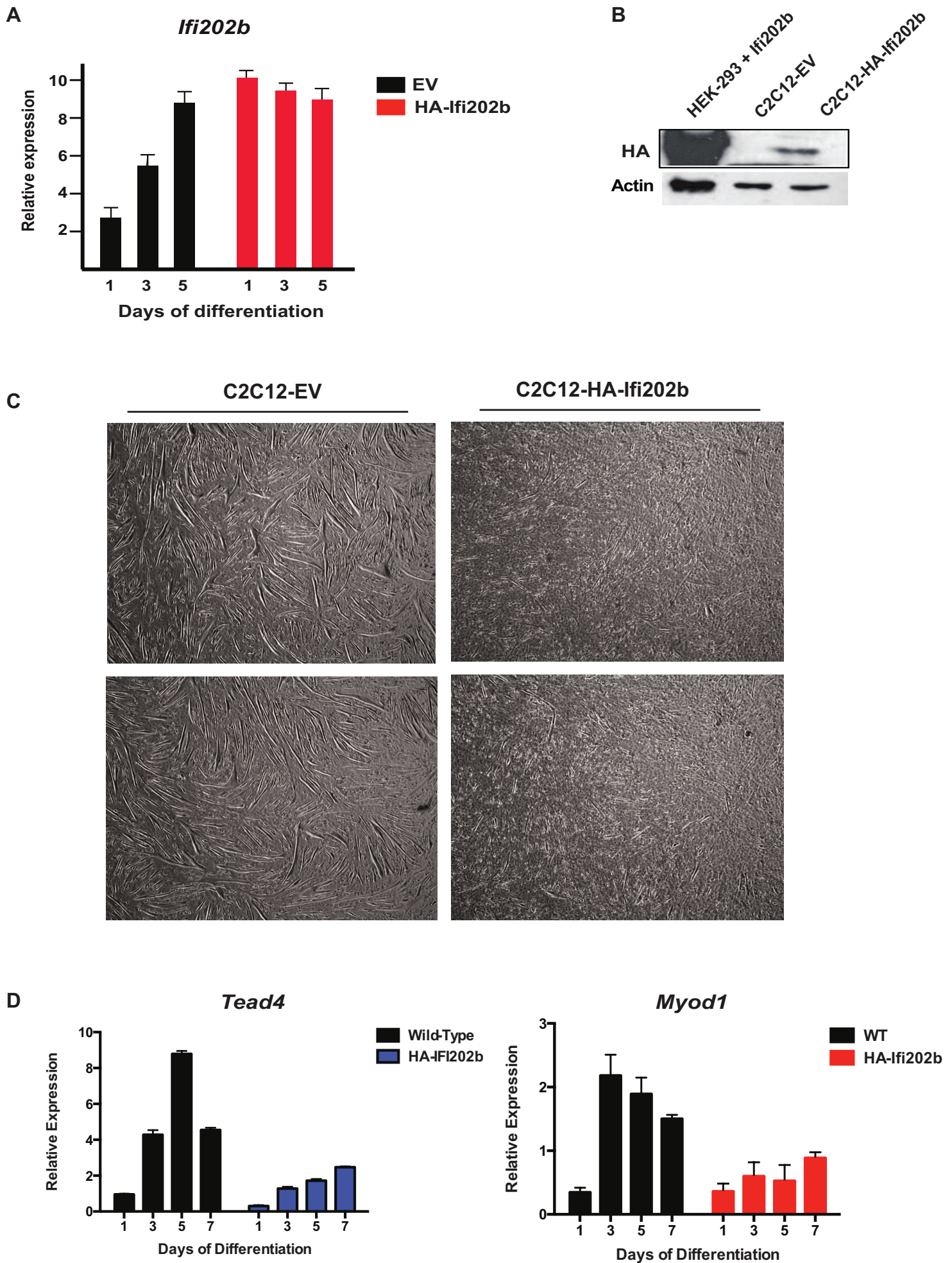
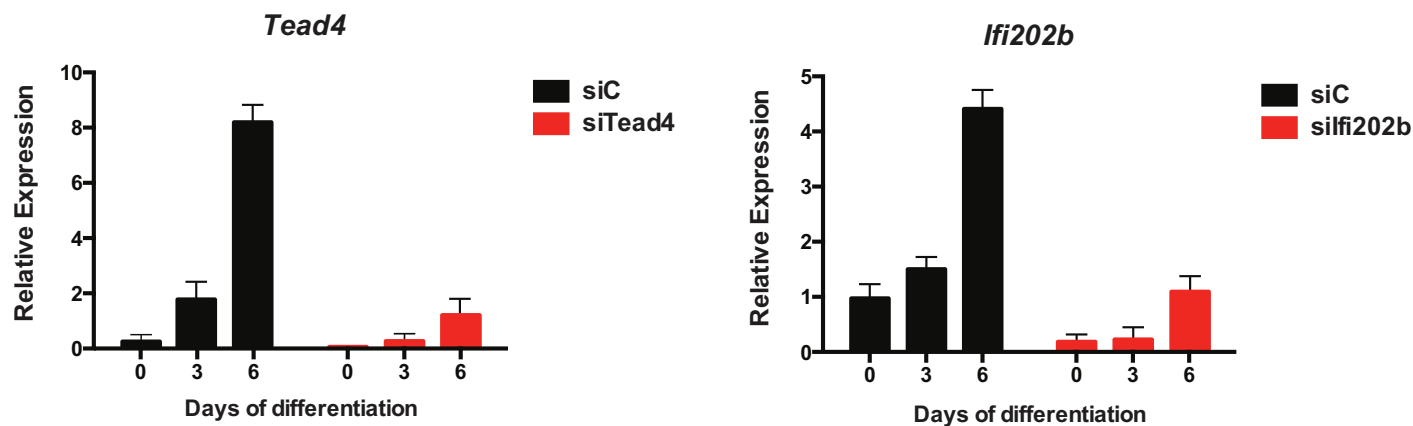
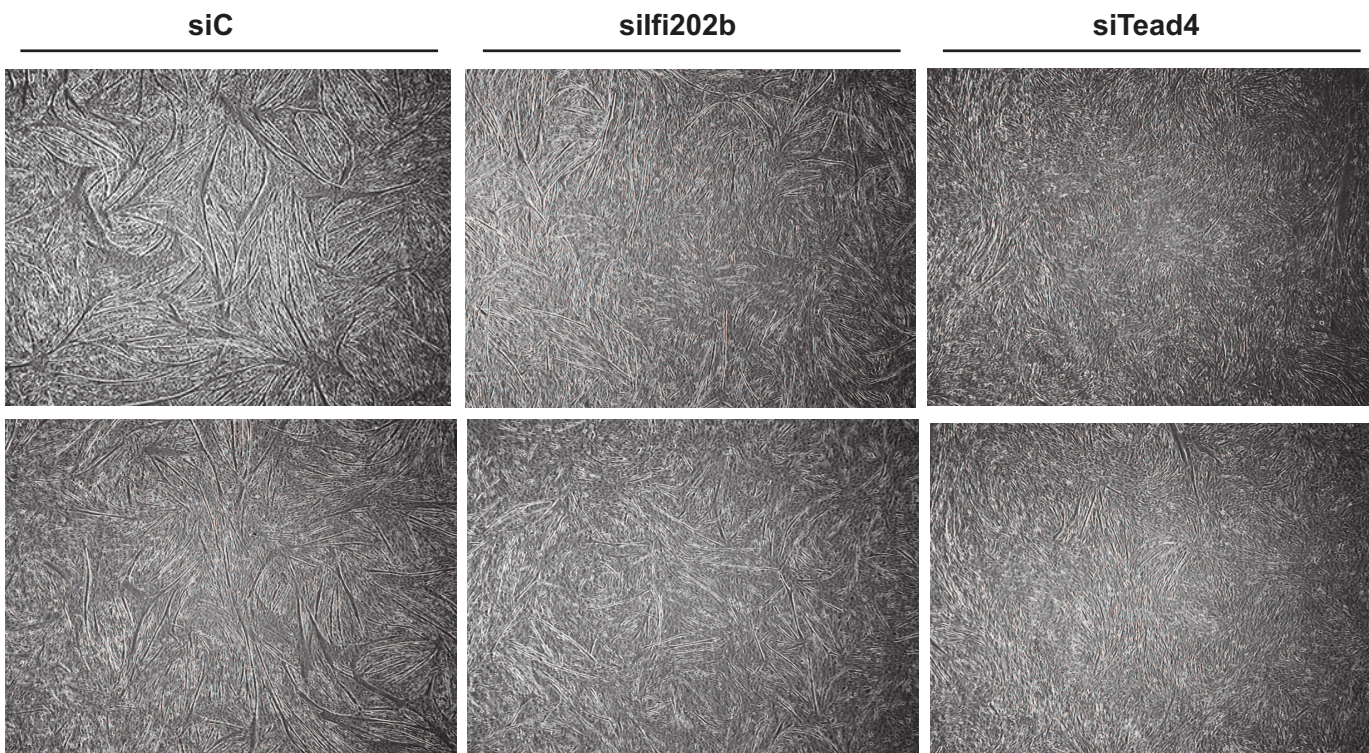


Figure 3

A



B



C

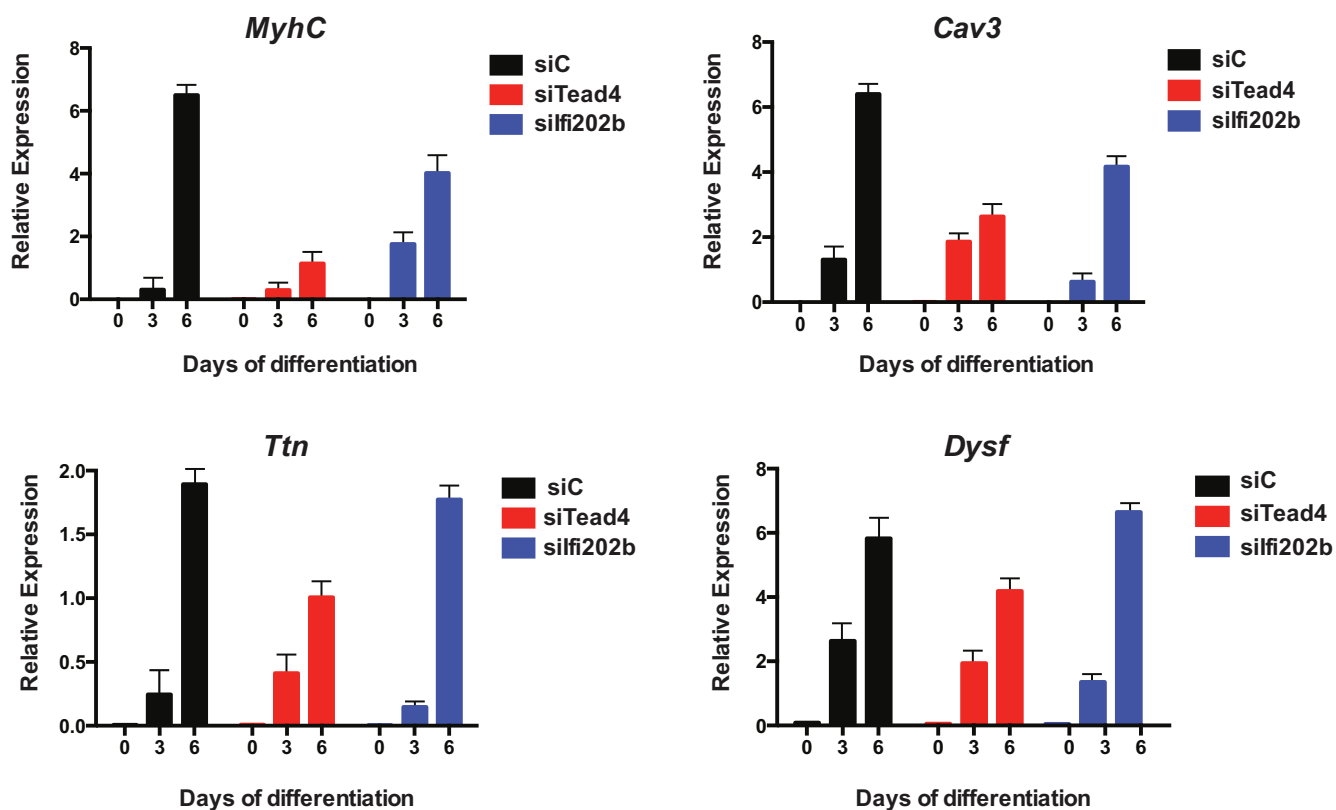


Figure 4

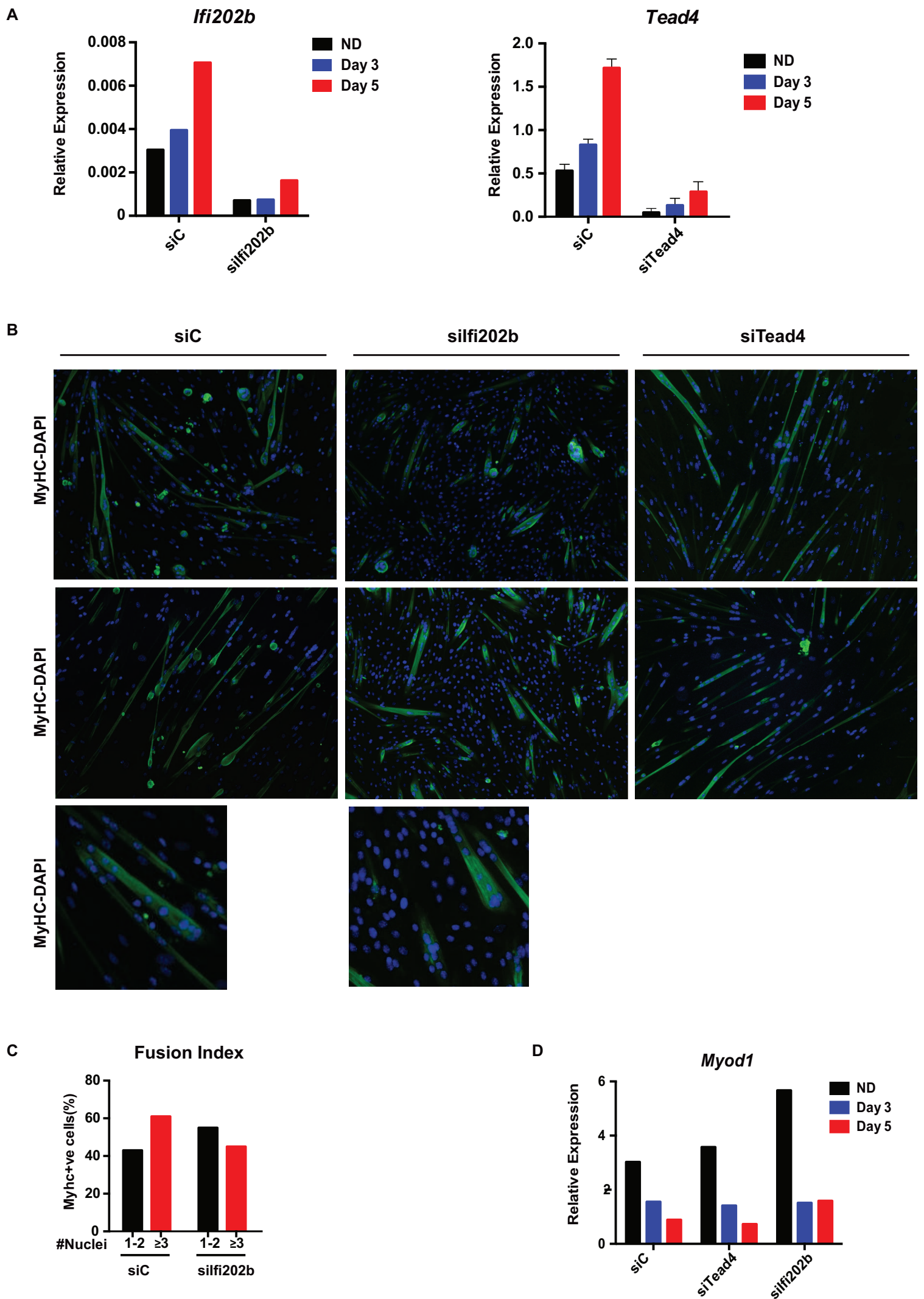
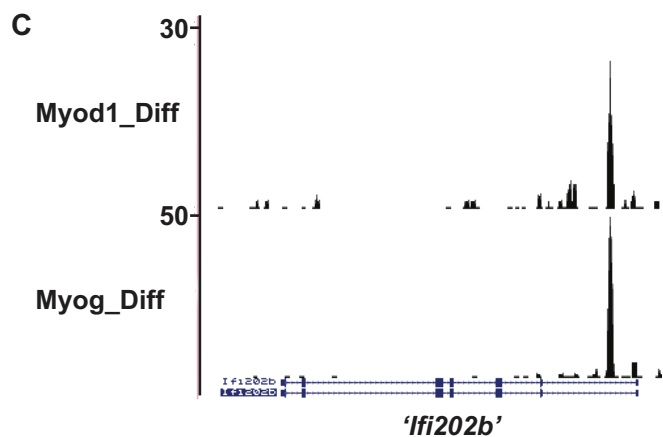
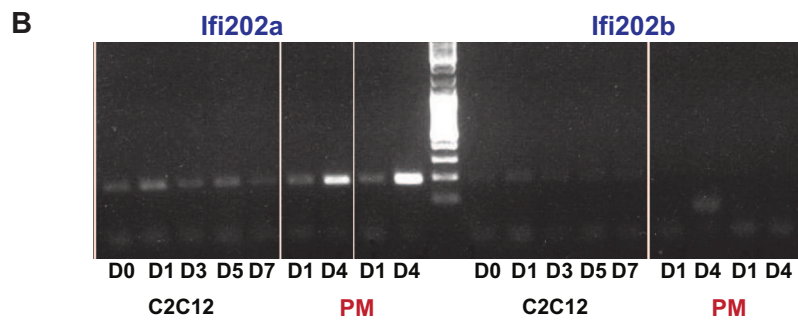


Figure 5

A

Cell type	Day 0 (raw read counts)	Day 3 (raw read counts)	Day 6 (raw read counts)
PM	1	0	0
C2C12	1536	1612	1960



D

Position	MH+	Sequence	Blast
98-104	867.0509	VFNMDLK	ifi202 like
270-277	987.1406	LFTYDSIK	ifi202 like
190-198	1089.1905	IKDNEDNIK	ifi202 like
248-257	1169.1926	ESFEGDGYHK	ifi202 like
295-304	1238.4414	VMVFEENLEK	ifi202 like
295-305	1366.6155	VMVFEENLEKK	ifi202 like
435-445	1390.6524	YSYMEVIMPEK	ifi202 like
281-294	1673.8838	MFHATVATDTEFFR	202,203,204
199-212	1802.9842	VVWDKEQHNINYEK	ifi202 like
161-178	1983.3123	IKELDSGTLIYGVFAVEK	ifi202 like
54-76	2578.0599	GAVLHEKPMTVMVLTATEPFNYK	ifi202 like

Figure 6

Part 3:

III. Investigation of Tead4-function in muscle *in vivo*.

Introduction

In the above study, we determined the genomic occupancy of Tead4 in differentiating C2C12 cells and its role in gene regulation during this process. We next sought to address the role of Tead4 in muscle physiology in mice *in vivo*. To do this we adopted several complementary approaches. We performed Tead4 ChIP-seq in muscle fibres to determine its genomic occupancy *in vivo*. In addition, we obtained mice with Floxed alleles of Tead4 from the laboratory of Dr Thomas Braun, and we crossed these mice with *Hsa::Cre-ER^{T2}* transgenics to inactivate Tead4 in mature muscle fibres and with *Pax7::Cre-ER^{T2}* mice to inactivate Tead4 in Pax7-positive satellite stem cells, addressing its role in their maintenance and their function during regeneration.

Results

Tead4 genomic occupancy in muscle *in vivo*.

In collaboration with the group of Dr Daniel Metzger at IGBMC, we developed a protocol to perform ChIP-seq directly from dissected hindlimb muscle (see Materials and methods). We used this protocol to perform ChIP-seq for Tead4 and as a positive control RNA polymerase II (Pol II). We first analysed the Pol II ChIP-seq to determine whether the protocol provides reliable data and in particular to determine whether the signal obtained results from Pol II occupancy in muscle, rather than any contaminating cells in the preparation. After sequencing, we first performed a standard peak calling procedure identifying more than 38000 peaks that as expected for Pol II localised at the TSS corresponding to engaged paused Pol II (Figure 1A).

It has previously been shown that transcribed genes can be separated into two major groups, those where Pol II is found paused at the promoter with few reads in the gene body and those where there is low pausing, but abundant elongating Pol II. The first class is the majority of genes that are transcribed in an intermittent fashion, whereas the second often corresponds to tissue identity genes controlled by so called “super enhancers” (Hnisz et al., 2013). We calculated the pausing index for the muscle Pol II ChIP-seq by calculating the ratio of reads at the TSS versus those in the gene body. We identified the 1000 loci with the lowest pausing index corresponding to the most highly transcribed genes. Analysis of the ontology of the associated genes identified numerous genes associated with muscle fibres (Figure 1B). For example, examination of the locus comprising *Myh2*, 1, 4, 8 and 13 revealed

Results

a high density of Pol II specifically over the *Myh4* gene with low density over the *Myh1* genes, but no transcription over the other myosin genes at this locus (Figure 1C). These results show that the Pol II ChIP-seq signal is highly enriched in muscle-expressed genes and that it is possible to determine the selectivity of myosin gene expression in the muscle fibre.

We next analysed the results of the Tead4 ChIP-seq by a standard peak calling procedure identifying around 28000 peaks of which only 10% of the peaks were localised at the TSS as previously observed for Tead4 in C2C12 cells (Figure 2A). There is however enrichment close to the TSS that is more pronounced than that seen in C2C12 cells. Analysis of the DNA sequence under the peaks revealed enrichment in the Tead-binding MCAT sequence, but also sequences for other transcription factors, notably Sp2, Nfr1, Runx and Klf5 (Figure 2B-C). Examples of Tead4 occupancy can be seen at the *Amotl2* and Desmin (*Des*) genes (Figure 2D).

We compared the Tead4 and Pol II data sets. As only a subset of Tead4 sites localised close to the TSS, we identified around 3000 loci where Tead4 was bound at an active TSS with a high pol II density (cluster 1 in Figure 3A). This can be clearly seen at the *Lats2* and *Ifrd1* loci (Figure 3B). This identifies loci where Tead4 is bound close to the TSS of actively transcribed genes. A more global analysis of all genes associated with Tead4 binding sites in muscle with those showing Pol II occupancy indicated a large overlap showing that a majority of genes associated with Tead4 binding are actively transcribed (Figure 3C). We also compared Tead4 genomic occupancy *in vivo* with that seen in C2C12 cells. Comparison of the Tead4 occupancy in differentiated C2C12 cells with the *in vivo* data showed that there was only a limited overlap of 1558 sites that showed strong occupancy in both situations. Thus, Tead4 genomic occupancy mature muscle fibres *in vivo* differs considerably from that in differentiated C2C12 cells. Ontology analysis of the genes associated with the commonly occupied showed enrichment in sites seen in a variety of functions including cell cycle control and muscle-related functions.

For example, Tead4 occupied several sites at the *Amotl2* locus in both C2C12 cells and muscle (Supplemental Figure 1A). In C2C12 cells, the Tead4 sites overlap with those of Myod1 and Myog. This gene also shows a strong peak of paused Pol II in muscle and the elongating pol II is also seen. In contrast, at the *Ccnd1* locus, little paused Pol II and no elongating Pol II is seen in muscle (Supplemental Figure 1B). Despite lack of expression,

Tead4 occupied the same site upstream of this locus as was seen in C2C12 cells. This site also showed strong occupancy by Myog in C2C12 cells.

Together these data show that it is possible to ChIP transcription factors and Pol II from muscle *in vivo*. This preliminary study identified Tead4 bound loci in muscle and showed that the repertoire of occupied sites is very different from that seen in C2C12 cells. It should be noted however that Tead4 occupancy is in general lower in muscle than in C2C12 cells. It remains to be determined whether this represents low expression of Tead4 in muscle and its low genomic occupancy, or whether it is a technical limitation of the experiment. This study nevertheless opens up new possibilities to investigate gene regulatory mechanisms in muscle *in vivo*.

Role of Tead4 in adult muscle physiology.

The above data together with the observations from the C2C12 cells and primary myoblasts all indicate that Tead4 plays a critical role in the expression of a subset of muscle genes. However, there is so far little data on the role that Tead factors may have *in vivo* in muscle. One reason for this is the potential for redundancy where knockout of one Tead factor has only limited effects due to compensation by the others. This was also revealed by our studies in the primary myoblasts. Nevertheless, we had the opportunity of acquiring mice with Floxed Tead4 alleles and this, together with the *in vivo* ChIP-seq data, prompted us to assess the role that Tead4 may play in the mature muscle fibre and in Pax7-expressing stem cells *in vivo*. The effects of such somatic knockouts have never been examined. In particular, we were also prompted to pursue this by the finding that Tead1 overexpression promotes transition from fast to slow fibre types *in vivo* (Tsika et al., 2008). Slow fibres are characterised by expression of Myh7 that is a preferential Tead4 target in primary myoblasts, whereas expression of fast-type Myh4 is up-regulated upon Tead4 silencing in cells. We thus hypothesised that Tead4 loss may affect muscle physiology in particular fibre type switching. To begin to address these questions we inactivated Tead4 in adult muscle.

The laboratory of Dr Thomas Braun provided us with mice harbouring Floxed *Tead4* alleles (Figure 5 upper panel) where exons 2 and 3 encoding the DNA-binding domain can be deleted. In order to generate tamoxifen-inducible muscle-specific *Tead4* knockout mice, *Tead4^{lox/lox}* mice were crossed with *Hsa::Cre-ER^{T2}* to obtain *Hsa::Cre-ER^{T2} ::Tead4^{lox/lox}* mice (Figure 6A). *Hsa::Cre-ER^{T2} ::Tead4^{wt/wt}* mice were used as controls in all experiments. Once generated, mice were injected intra-peritoneally (IP) with 100µl Tamoxifen (1mg/day) for

four consecutive days. Animals were observed for general health, movement and weight. Deletion of the *Tead4* was verified by PCR genotyping and mRNA levels were checked by RT-qPCR. Three weeks after tamoxifen treatment RT-qPCR from TA muscle showed nearly complete loss of *Tead4* expression in the muscle (Figure 6B).

Following *Tead4* inactivation, mutant (n=12) and control mice (n=9) were analysed for grip strength 1, 2 and 5 weeks after injection and muscles were harvested at 5 weeks after tamoxifen treatment. No significant change was observed in either the grip strength or the muscle mass (normalised to body weight) (Figure 6C). Thus, *Tead4* loss had no measurable effect on the muscle strength and mass over this time period. However, it will be important to repeat such analysis on larger numbers of animals over a longer period.

As indicated above, Tead4 plays a role in regulating expression of several muscle structural proteins, importantly, the MYH proteins. We therefore wished to address the effect of *Tead4* knockout on muscle fibre type and fibre size. For this, TA muscle was harvested five weeks after tamoxifen injection. H&E staining on muscle from 2 control and mutant mice showed an increase in the number of smaller fibres. (Figure 7A). We quantified the fibre cross-sectional area (CSA) with the Fiji imaging software after immunostaining for Dystrophin. Quantification of fibre CSA clearly indicates a decrease in fibre size in the TA muscle (n=3). However, the number of animals used for this analysis was limited and it will be important to repeat this analysis with more animals to improve the statistical significance.

The above data while preliminary, show that we have the resources to address and analyse the effects of Tead4 inactivation in muscle physiology *in vivo*.

Perspectives.

The *in vivo* Tead4 and Pol II ChIP-seq from adult muscle tissue clearly indicate that Tead4 binds a substantial number of genes in their enhancer and promoter regions in adult steady state muscle. Tead4 and Pol II co-localise in the promoters of around 3000 genes and overall Tead4 is bound in the distant regulatory regions of about 9000 genes that are bound by Pol II. This indicates that Tead4 may regulate expression of a substantial number of constitutively and transiently expressed genes in muscle. The role of Tead4 has not been so far studied in adult muscle physiology. While various studies have reported function of Tead1 in slow-fibre type expression of genes (Tsika et al., 2008) and Tead2 has been linked

to Yap induced hypertrophy (Watt et al., 2015), the expression and function of Tead4 across various muscle types is a largely untouched question.

Our preliminary data from muscle fibre-specific Tead4 inactivation in mice shows a decrease in fibre size or in other words, increase in the number of smaller fibres in TA muscle. The TA muscle in mouse is mainly composed of fast (Type IIb) fibres, while IIa, IIx and I are less abundant in TA (Schiaffino and Reggiani, 2011). Given that *in vitro*, Tead4 positively regulates the expression of slow type I (Myh7) and fast type IIx (Myh1) and IIa (Myh2) during differentiation and loss of Tead4 up-regulates fast type IIb (Myh4) expression, our choice of studying Myh gene expression in TA alone does not appear to be sufficient. Our preliminary data encourage us to include other muscle types such as Soleus (Sol) that is rich in Type 1 fibres and Gastrocnemius (Gas) that is more a mixed composition of all fibre types.

Therefore, we plan to perform a detailed analysis of fibre size and myosin composition along with different histochemical analyses (NADH and SDH staining) on different muscle types from the mice carrying deletion in Tead4 gene in adult muscle fibre. Subsequently, physiological tests such contraction potential, force generation and exercise induced changes shall be performed in order to better extrapolate our findings at molecular level to a change in physiological function.

Materials and Methods.

Chomatin Immunoprecipitation *in vivo*.

Muscles harvested from hind limbs of three adult mice were either snap frozen or immediately used for ChIP. The tissue was minced and quickly homogenised in cold hypotonic buffer (protease inhibitors and DTT) using Ultraturax homogeniser. The homogenised tissue lysate was fixed with 1% formaldehyde in fresh hypotonic buffer for 10 mins shaking at room temperature. Fixation was stopped by adding glycine at 0.15M concentration. Lysate was centrifuged at 3000 rpm in cooled centrifuge for 5 mins and pellet was resuspended in fresh hypotonic buffer. Lysate was filtered to get rid of the debris and obtain nuclei using cell strainer of 70 micrometer pore size. Filtrate was centrifuged for 5 mins at 3000 rpm to obtain nuclear pellet that was resuspended in 1%SDS sonication buffer and kept on ice for 10 mins and then sonicated using Covaris sonicator for 20 to 25 mins.

Results

Lysate was then centrifuged for 15 mins at 11000g at 4 °C to obtain clear chromatin. ChIP was performed as per standard procedure with 50 micrograms chromatin for ChIP qPCR and with 150 µg chromatin for ChIP-seq experiments. ChIP-seq libraries were prepared as previously described and sequenced on the Illumina Hi-seq2500 as single-end 50-base reads (Herquel et al., 2013). After sequencing, peak detection was performed using the MACS software ([Zhang et al., 2008] <http://liulab.dfci.harvard.edu/MACS/>). Peaks were then annotated with Homer (<http://homer.salk.edu/homer/ngs/annotation.html>) using a window of ±10 kb (or as indicated in the figures) relative to the transcription start site of RefSeq transcripts. Global clustering analysis and quantitative comparisons were performed using seqMINER ([Ye et al., 2011] <http://bips.u-strasbg.fr/seqminer/>) and R (<http://www.r-project.org/>).

References.

- Al-Qusairi, L., and Laporte, J. (2011). T-tubule biogenesis and triad formation in skeletal muscle and implication in human diseases. *Skelet Muscle* 1, 26.
- Albert, T.K., Grote, K., Boeing, S., and Meisterernst, M. (2010). Basal core promoters control the equilibrium between negative cofactor 2 and preinitiation complexes in human cells. *Genome Biol* 11, R33.
- Allen, R.E., and Boxhorn, L.K. (1987). Inhibition of skeletal muscle satellite cell differentiation by transforming growth factor-beta. *J Cell Physiol* 133, 567-572.
- Anbanandam, A., Albarado, D.C., Nguyen, C.T., Halder, G., Gao, X., and Veeraraghavan, S. (2006). Insights into transcription enhancer factor 1 (TEF-1) activity from the solution structure of the TEA domain. *Proc Natl Acad Sci U S A* 103, 17225-17230.
- Anders, S., and Huber, W. (2010). Differential expression analysis for sequence count data. *Genome Biol* 11, R106.
- Anders, S., Pyl, P.T., and Huber, W. (2015). HTSeq--a Python framework to work with high-throughput sequencing data. *Bioinformatics* 31, 166-169.
- Andrianopoulos, A., and Timberlake, W.E. (1991). ATTS, a new and conserved DNA binding domain. In *Plant Cell (United states)*, pp. 747-748.
- Andrianopoulos, A., and Timberlake, W.E. (1994). The *Aspergillus nidulans* *abaA* gene encodes a transcriptional activator that acts as a genetic switch to control development. *Mol Cell Biol* 14, 2503-2515.
- Asakura, A., Seale, P., Girgis-Gabardo, A., and Rudnicki, M.A. (2002). Myogenic specification of side population cells in skeletal muscle. *J Cell Biol* 159, 123-134.
- Asp, P., Blum, R., Vethantham, V., Parisi, F., Micsinai, M., Cheng, J., Bowman, C., Kluger, Y., and Dynlacht, B.D. (2011). Genome-wide remodeling of the epigenetic landscape during myogenic differentiation. *Proc Natl Acad Sci U S A* 108, E149-158.
- Azakie, A., Lamont, L., Fineman, J.R., and He, Y. (2005). Divergent transcriptional enhancer factor-1 regulates the cardiac troponin T promoter. *Am J Physiol Cell Physiol* 289, C1522-1534.
- Azakie, A., Larkin, S.B., Farrance, I.K., Grenningloh, G., and Ordahl, C.P. (1996). DTEF-1, a novel member of the transcription enhancer factor-1 (TEF-1) multigene family. *J Biol Chem* 271, 8260-8265.

- Batut, J., Duboe, C., and Vandel, L. (2011). The methyltransferases PRMT4/CARM1 and PRMT5 control differentially myogenesis in zebrafish. *PLoS One* *6*, e25427.
- Beauchamp, J.R., Heslop, L., Yu, D.S., Tajbakhsh, S., Kelly, R.G., Wernig, A., Buckingham, M.E., Partridge, T.A., and Zammit, P.S. (2000). Expression of CD34 and Myf5 defines the majority of quiescent adult skeletal muscle satellite cells. *J Cell Biol* *151*, 1221-1234.
- Belandia, B., and Parker, M.G. (2000). Functional interaction between the p160 coactivator proteins and the transcriptional enhancer factor family of transcription factors. *J Biol Chem* *275*, 30801-30805.
- Belotserkovskaya, R., Saunders, A., Lis, J.T., and Reinberg, D. (2004). Transcription through chromatin: understanding a complex FACT. *Biochim Biophys Acta* *1677*, 87-99.
- Bengal, E., Ransone, L., Scharfmann, R., Dwarki, V.J., Tapscott, S.J., Weintraub, H., and Verma, I.M. (1992). Functional antagonism between c-Jun and MyoD proteins: a direct physical association. *Cell* *68*, 507-519.
- Benhaddou, A., Keime, C., Ye, T., Morlon, A., Michel, I., Jost, B., Mengus, G., and Davidson, I. (2012). Transcription factor TEAD4 regulates expression of myogenin and the unfolded protein response genes during C2C12 cell differentiation. *Cell Death Differ* *19*, 220-231.
- Benjamini, Y., and Hochberg, Y. (2001). Discussion: An estimate of the science-wise false discovery rate and applications to top medical journals by Jager and Leek. *Biostatistics* *15*, 13-16; discussion 39-45.
- Bentzinger, C.F., Wang, Y.X., and Rudnicki, M.A. (2012). Building muscle: molecular regulation of myogenesis. *Cold Spring Harb Perspect Biol* *4*.
- Berchtold, M.W., Brinkmeier, H., and Müntener, M. (2000). Calcium Ion in Skeletal Muscle: Its Crucial Role for Muscle Function, Plasticity, and Disease.
- Berthier, C., and Blaineau, S. (1997). Supramolecular organization of the subsarcolemmal cytoskeleton of adult skeletal muscle fibers. A review. *Biol Cell* *89*, 413-434.
- Biressi, S., Miyabara, E.H., Gopinath, S.D., Carlig, P.M., and Rando, T.A. (2014). A Wnt-TGFbeta2 axis induces a fibrogenic program in muscle stem cells from dystrophic mice. *Sci Transl Med* *6*, 267ra176.
- Biterge, B., and Schneider, R. (2014). Histone variants: key players of chromatin. *Cell Tissue Res* *356*, 457-466.
- Bladt, F., Riethmacher, D., Isenmann, S., Aguzzi, A., and Birchmeier, C. (1995). Essential role for the c-met receptor in the migration of myogenic precursor cells into the limb bud. *Nature* *376*, 768-771.
- Blais, A., Tsikitis, M., Acosta-Alvear, D., Sharan, R., Kluger, Y., and Dynlacht, B.D. (2005). An initial blueprint for myogenic differentiation. *Genes Dev* *19*, 553-569.
- Blaveri, E., Simko, J.P., Korkola, J.E., Brewer, J.L., Baehner, F., Mehta, K., Devries, S., Koppie, T., Pejavar, S., Carroll, P., *et al.* (2005). Bladder cancer outcome and subtype classification by gene expression. *Clin Cancer Res* *11*, 4044-4055.
- Blum, R., and Dynlacht, B.D. (2013). The role of MyoD1 and histone modifications in the activation of muscle enhancers. *Epigenetics* *8*, 778-784.
- Blum, R., Vethanatham, V., Bowman, C., Rudnicki, M., and Dynlacht, B.D. (2012). Genome-wide identification of enhancers in skeletal muscle: the role of MyoD1. *Genes Dev* *26*, 2763-2779.
- Boettger, T., Wüst, S., Nolte, H., and Braun, T. (2014). The miR-206/133b cluster is dispensable for development, survival and regeneration of skeletal muscle. In *Skelet Muscle*.
- Brand-Saberi, B., Ebensperger, C., Wilting, J., Balling, R., and Christ, B. (1993). The ventralizing effect of the notochord on somite differentiation in chick embryos. *Anat Embryol (Berl)* *188*, 239-245.

Results

- Bray, S. (1999). *Drosophila* development: Scalloped and Vestigial take wing. *Curr Biol* 9, R245-247.
- Brooke, M.H., and Kaiser, K.K. (1970). Muscle fiber types: how many and what kind? *Arch Neurol* 23, 369-379.
- Buckingham, M., and Rigby, P.W. (2014). Gene regulatory networks and transcriptional mechanisms that control myogenesis. *Dev Cell* 28, 225-238.
- Burglin, T.R. (1991). The TEA domain: a novel, highly conserved DNA-binding motif. In *Cell* (United states), pp. 11-12.
- Burke, T.W., and Kadonaga, J.T. (1996). *Drosophila* TFIID binds to a conserved downstream basal promoter element that is present in many TATA-box-deficient promoters. *Genes Dev* 10, 711-724.
- Butler, A.J., and Ordahl, C.P. (1999). Poly(ADP-Ribose) Polymerase Binds with Transcription Enhancer Factor 1 to MCAT1 Elements To Regulate Muscle-Specific Transcription. In *Mol Cell Biol*, pp. 296-306.
- C, S.S.a.R. (2015). Fiber types in mammalian skeletal muscles. - PubMed - NCBI.
- Camargo, F.D., Gokhale, S., Johnnidis, J.B., Fu, D., Bell, G.W., Jaenisch, R., and Brummelkamp, T.R. (2007). YAP1 increases organ size and expands undifferentiated progenitor cells. *Curr Biol* 17, 2054-2060.
- Campbell, K.P., Knudson, C.M., Imagawa, T., Leung, A.T., Sutko, J.L., Kahl, S.D., Raab, C.R., and Madson, L. (1987). Identification and characterization of the high affinity [3H]ryanodine receptor of the junctional sarcoplasmic reticulum Ca²⁺ release channel. *J Biol Chem* 262, 6460-6463.
- Cao, Y., Yao, Z., Sarkar, D., Lawrence, M., Sanchez, G.J., Parker, M.H., MacQuarrie, K.L., Davison, J., Morgan, M.T., Ruzzo, W.L., *et al.* (2010). Genome-wide MyoD binding in skeletal muscle cells: a potential for broad cellular reprogramming. *Dev Cell* 18, 662-674.
- Carlini, L.E., Getz, M.J., Strauch, A.R., and Kelm, R.J., Jr. (2002). Cryptic MCAT enhancer regulation in fibroblasts and smooth muscle cells. Suppression of TEF-1 mediated activation by the single-stranded DNA-binding proteins, Pur alpha, Pur beta, and MSY1. *J Biol Chem* 277, 8682-8692.
- Carninci, P., Sandelin, A., Lenhard, B., Katayama, S., Shimokawa, K., Ponjavic, J., Semple, C.A., Taylor, M.S., Engstrom, P.G., Frith, M.C., *et al.* (2006). Genome-wide analysis of mammalian promoter architecture and evolution. *Nat Genet* 38, 626-635.
- Carson, J.A., Schwartz, R.J., and Booth, F.W. (1996). SRF and TEF-1 control of chicken skeletal alpha-actin gene during slow-muscle hypertrophy. *Am J Physiol* 270, C1624-1633.
- Carson, J.A., Yan, Z., Booth, F.W., Coleman, M.E., Schwartz, R.J., and Stump, C.S. (1995). Regulation of skeletal alpha-actin promoter in young chickens during hypertrophy caused by stretch overload. *Am J Physiol* 268, C918-924.
- Cebola, I., Rodriguez-Segui, S.A., Cho, C.H., Bessa, J., Rovira, M., Luengo, M., Chhatriwala, M., Berry, A., Ponsa-Cobas, J., Maestro, M.A., *et al.* (2015). TEAD and YAP regulate the enhancer network of human embryonic pancreatic progenitors. *Nat Cell Biol* 17, 615-626.
- Chakroun, I., Yang, D., Girgis, J., Gunasekharan, A., Phenix, H., Kaern, M., and Blais, A. (2015). Genome-wide association between Six4, MyoD and the histone demethylase Utx during myogenesis. *Faseb j*.
- Chalkley, G.E., and Verrijzer, C.P. (1999). DNA binding site selection by RNA polymerase II TAFs: a TAF(II)250-TAF(II)150 complex recognizes the initiator. *Embo j* 18, 4835-4845.
- Chan, E.H., Nousiainen, M., Chalamalasetty, R.B., Schafer, A., Nigg, E.A., and Sillje, H.H. (2005). The Ste20-like kinase Mst2 activates the human large tumor suppressor kinase Lats1. *Oncogene* 24, 2076-2086.

Results

- Chen, H.H., Baty, C.J., Maeda, T., Brooks, S., Baker, L.C., Ueyama, T., Gursoy, E., Saba, S., Salama, G., London, B., *et al.* (2004a). Transcription enhancer factor-1-related factor-transgenic mice develop cardiac conduction defects associated with altered connexin phosphorylation. *Circulation* *110*, 2980-2987.
- Chen, H.H., Maeda, T., Mullett, S.J., and Stewart, A.F. (2004b). Transcription cofactor Vgl-2 is required for skeletal muscle differentiation. *Genesis* *39*, 273-279.
- Chen, H.H., Mullett, S.J., and Stewart, A.F. (2004c). Vgl-4, a novel member of the vestigial-like family of transcription cofactors, regulates alpha1-adrenergic activation of gene expression in cardiac myocytes. *J Biol Chem* *279*, 30800-30806.
- Chen, L., Chan, S.W., Zhang, X., Walsh, M., Lim, C.J., Hong, W., and Song, H. (2010). Structural basis of YAP recognition by TEAD4 in the hippo pathway. *Genes Dev* *24*, 290-300.
- Chen, X., Hiller, M., Sancak, Y., and Fuller, M.T. (2005). Tissue-specific TAFs counteract Polycomb to turn on terminal differentiation. *Science* *310*, 869-872.
- Chen, Z., Friedrich, G.A., and Soriano, P. (1994). Transcriptional enhancer factor 1 disruption by a retroviral gene trap leads to heart defects and embryonic lethality in mice. *Genes Dev* *8*, 2293-2301.
- Chin, E.R., Olson, E.N., Richardson, J.A., Yang, Q., Humphries, C., Shelton, J.M., Wu, H., Zhu, W., Bassel-Duby, R., and Williams, R.S. (1998). A calcineurin-dependent transcriptional pathway controls skeletal muscle fiber type. *Genes Dev* *12*, 2499-2509.
- Clark KA , e.a. (2015). Striated muscle cytoarchitecture: an intricate web of form and function. - PubMed - NCBI.
- Cogan, J.G., Sun, S., Stoflet, E.S., Schmidt, L.J., Getz, M.J., and Strauch, A.R. (1995). Plasticity of vascular smooth muscle alpha-actin gene transcription. Characterization of multiple, single-, and double-strand specific DNA-binding proteins in myoblasts and fibroblasts. *J Biol Chem* *270*, 11310-11321.
- Cohen, T.J., Barrientos, T., Hartman, Z.C., Garvey, S.M., Cox, G.A., and Yao, T.P. (2009). The deacetylase HDAC4 controls myocyte enhancing factor-2-dependent structural gene expression in response to neural activity. *Faseb j* *23*, 99-106.
- Cohen, T.J., Choi, M.C., Kapur, M., Lira, V.A., Yan, Z., and Yao, T.P. (2015). HDAC4 regulates muscle fiber type-specific gene expression programs. *Mol Cells* *38*, 343-348.
- Conboy, I.M., and Rando, T.A. (2002). The regulation of Notch signaling controls satellite cell activation and cell fate determination in postnatal myogenesis. *Dev Cell* *3*, 397-409.
- Condon, K., Silberstein, L., Blau, H.M., and Thompson, W.J. (1990). Development of muscle fiber types in the prenatal rat hindlimb. *Dev Biol* *138*, 256-274.
- Cornelison, D.D., Filla, M.S., Stanley, H.M., Rapraeger, A.C., and Olwin, B.B. (2001). Syndecan-3 and syndecan-4 specifically mark skeletal muscle satellite cells and are implicated in satellite cell maintenance and muscle regeneration. *Dev Biol* *239*, 79-94.
- Crabtree, G.R. (1999). Generic signals and specific outcomes: signaling through Ca²⁺, calcineurin, and NF-AT. *Cell* *96*, 611-614.
- Craig, R., and Woodhead, J.L. (2006). Structure and function of myosin filaments. *Curr Opin Struct Biol* *16*, 204-212.
- Creppe, C., Janich, P., Cantarino, N., Noguera, M., Valero, V., Musulen, E., Douet, J., Posavec, M., Martin-Caballero, J., Sumoy, L., *et al.* (2012). MacroH2A1 regulates the balance between self-renewal and differentiation commitment in embryonic and adult stem cells. *Mol Cell Biol* *32*, 1442-1452.
- Cridland, J.A., Curley, E.Z., Wykes, M.N., Schroder, K., Sweet, M.J., Roberts, T.L., Ragan, M.A., Kassahn, K.S., and Stacey, K.J. (2012). The mammalian PYHIN gene family: phylogeny, evolution and expression. *BMC Evol Biol* *12*, 140.

Results

- Dacwag, C.S., Ohkawa, Y., Pal, S., Sif, S., and Imbalzano, A.N. (2007). The protein arginine methyltransferase Prmt5 is required for myogenesis because it facilitates ATP-dependent chromatin remodeling. *Mol Cell Biol* 27, 384-394.
- Datta, B., Li, B., Choubey, D., Nallur, G., and Lengyel, P. (1996). p202, an interferon-inducible modulator of transcription, inhibits transcriptional activation by the p53 tumor suppressor protein, and a segment from the p53-binding protein 1 that binds to p202 overcomes this inhibition. *J Biol Chem* 271, 27544-27555.
- Datta, B., Min, W., Burma, S., and Lengyel, P. (1998). Increase in p202 expression during skeletal muscle differentiation: inhibition of MyoD protein expression and activity by p202. *Mol Cell Biol* 18, 1074-1083.
- Davidson, I., Xiao, J.H., Rosales, R., Staub, A., and Chambon, P. (1988). The HeLa cell protein TEF-1 binds specifically and cooperatively to two SV40 enhancer motifs of unrelated sequence. *Cell* 54, 931-942.
- Day, K., Shefer, G., Richardson, J.B., Enikolopov, G., and Yablonka-Reuveni, Z. (2007). Nestin-GFP reporter expression defines the quiescent state of skeletal muscle satellite cells. *Dev Biol* 304, 246-259.
- De Koninck, P., and Schulman, H. (1998). Sensitivity of CaM kinase II to the frequency of Ca²⁺ oscillations. *Science* 279, 227-230.
- de la Serna, I.L., Carlson, K.A., and Imbalzano, A.N. (2001a). Mammalian SWI/SNF complexes promote MyoD-mediated muscle differentiation. *Nat Genet* 27, 187-190.
- de la Serna, I.L., Ohkawa, Y., Berkes, C.A., Bergstrom, D.A., Dacwag, C.S., Tapscott, S.J., and Imbalzano, A.N. (2005). MyoD targets chromatin remodeling complexes to the myogenin locus prior to forming a stable DNA-bound complex. *Mol Cell Biol* 25, 3997-4009.
- de la Serna, I.L., Roy, K., Carlson, K.A., and Imbalzano, A.N. (2001b). MyoD can induce cell cycle arrest but not muscle differentiation in the presence of dominant negative SWI/SNF chromatin remodeling enzymes. *J Biol Chem* 276, 41486-41491.
- De Santa, F., Barozzi, I., Mietton, F., Ghisletti, S., Polletti, S., Tusi, B.K., Muller, H., Ragoussis, J., Wei, C.L., and Natoli, G. (2010). A large fraction of extragenic RNA pol II transcription sites overlap enhancers. *PLoS Biol* 8, e1000384.
- Deato, M.D., Marr, M.T., Sottero, T., Inouye, C., Hu, P., and Tjian, R. (2008). MyoD targets TAF3/TRF3 to activate myogenin transcription. *Mol Cell* 32, 96-105.
- Deato, M.D., and Tjian, R. (2007). Switching of the core transcription machinery during myogenesis. *Genes Dev* 21, 2137-2149.
- Dellavalle, A., Maroli, G., Covarello, D., Azzoni, E., Innocenzi, A., Perani, L., Antonini, S., Sambasivan, R., Brunelli, S., Tajbakhsh, S., *et al.* (2011). Pericytes resident in postnatal skeletal muscle differentiate into muscle fibres and generate satellite cells. *Nat Commun* 2, 499.
- Delling, U., Tureckova, J., Lim, H.W., De Windt, L.J., Rotwein, P., and Molkenin, J.D. (2000). A calcineurin-NFATc3-dependent pathway regulates skeletal muscle differentiation and slow myosin heavy-chain expression. *Mol Cell Biol* 20, 6600-6611.
- DeNardi, C., Ausoni, S., Moretti, P., Gorza, L., Velleca, M., Buckingham, M., and Schiaffino, S. (1993). Type 2X-myosin heavy chain is coded by a muscle fiber type-specific and developmentally regulated gene. *J Cell Biol* 123, 823-835.
- Deng, W., Malecova, B., Oelgeschlager, T., and Roberts, S.G. (2009). TFIIB recognition elements control the TFIIA-NC2 axis in transcriptional regulation. *Mol Cell Biol* 29, 1389-1400.
- Deng, W., and Roberts, S.G. (2005). A core promoter element downstream of the TATA box that is recognized by TFIIB. *Genes Dev* 19, 2418-2423.

Results

- Diepenbruck, M., Waldmeier, L., Ivanek, R., Berninger, P., Arnold, P., van Nimwegen, E., and Christofori, G. (2014). Tead2 expression levels control the subcellular distribution of Yap and Taz, zyxin expression and epithelial-mesenchymal transition. *J Cell Sci* 127, 1523-1536.
- Dietrich, S., Abou-Rebyeh, F., Brohmann, H., Blatt, F., Sonnenberg-Riethmacher, E., Yamaai, T., Lumsden, A., Brand-Saberi, B., and Birchmeier, C. (1999). The role of SF/HGF and c-Met in the development of skeletal muscle. *Development* 126, 1621-1629.
- Ding, B., Liu, C.J., Huang, Y., Hickey, R.P., Yu, J., Kong, W., and Lengyel, P. (2006). p204 is required for the differentiation of P19 murine embryonal carcinoma cells to beating cardiac myocytes: its expression is activated by the cardiac Gata4, Nkx2.5, and Tbx5 proteins. *J Biol Chem* 281, 14882-14892.
- Dong, J., Feldmann, G., Huang, J., Wu, S., Zhang, N., Comerford, S.A., Gayyed, M.F., Anders, R.A., Maitra, A., and Pan, D. (2007). Elucidation of a universal size-control mechanism in *Drosophila* and mammals. *Cell* 130, 1120-1133.
- Drane, P., Ouararhni, K., Depaux, A., Shuaib, M., and Hamiche, A. (2010). The death-associated protein DAXX is a novel histone chaperone involved in the replication-independent deposition of H3.3. *Genes Dev* 24, 1253-1265.
- Du, C., Jin, Y.Q., Qi, J.J., Ji, Z.X., Li, S.Y., An, G.S., Jia, H.T., and Ni, J.H. (2012). Effects of myogenin on expression of late muscle genes through MyoD-dependent chromatin remodeling ability of myogenin. *Mol Cells* 34, 133-142.
- Ehlers, M.L., Celona, B., and Black, B.L. (2014). NFATc1 controls skeletal muscle fiber type and is a negative regulator of MyoD activity. *Cell Rep* 8, 1639-1648.
- Fan, C.M., and Tessier-Lavigne, M. (1994). Patterning of mammalian somites by surface ectoderm and notochord: evidence for sclerotome induction by a hedgehog homolog. *Cell* 79, 1175-1186.
- Ferrari, G., Cusella-De Angelis, G., Coletta, M., Paolucci, E., Stornaiuolo, A., Cossu, G., and Mavilio, F. (1998). Muscle regeneration by bone marrow-derived myogenic progenitors. *Science* 279, 1528-1530.
- Fong, A.P., Yao, Z., Zhong, J.W., Cao, Y., Ruzzo, W.L., Gentleman, R.C., and Tapscott, S.J. (2012). Genetic and epigenetic determinants of neurogenesis and myogenesis. *Dev Cell* 22, 721-735.
- Forde, J.E., and Dale, T.C. (2007). Glycogen synthase kinase 3: a key regulator of cellular fate. *Cell Mol Life Sci* 64, 1930-1944.
- Fossdal, R., Jonasson, F., Kristjansdottir, G.T., Kong, A., Stefansson, H., Gosh, S., Gulcher, J.R., and Stefansson, K. (2004). A novel TEAD1 mutation is the causative allele in Sveinsson's chorioretinal atrophy (helicoid peripapillary chorioretinal degeneration). *Hum Mol Genet* 13, 975-981.
- Gan, Q., Yoshida, T., Li, J., and Owens, G.K. (2007). Smooth muscle cells and myofibroblasts use distinct transcriptional mechanisms for smooth muscle alpha-actin expression. *Circ Res* 101, 883-892.
- Gautel, M., Mues, A., and Young, P. (1999). Control of sarcomeric assembly: the flow of information on titin. *Rev Physiol Biochem Pharmacol* 138, 97-137.
- Gershenson, N.I., and Ioshikhes, I.P. (2005). Synergy of human Pol II core promoter elements revealed by statistical sequence analysis. *Bioinformatics* 21, 1295-1300.
- Gianakopoulos, P.J., Mehta, V., Voronova, A., Cao, Y., Yao, Z., Coutu, J., Wang, X., Waddington, M.S., Tapscott, S.J., and Skerjanc, I.S. (2011). MyoD directly up-regulates premyogenic mesoderm factors during induction of skeletal myogenesis in stem cells. *J Biol Chem* 286, 2517-2525.

- Giordani, J., Bajard, L., Demignon, J., Daubas, P., Buckingham, M., and Maire, P. (2007). Six proteins regulate the activation of Myf5 expression in embryonic mouse limbs. *Proc Natl Acad Sci U S A* *104*, 11310-11315.
- Goodman CA , e.a. (2015). Yes-Associated Protein is up-regulated by mechanical overload and is sufficient to induce skeletal muscle hypertrophy. - PubMed - NCBI.
- Gordon, A.M., Homsher, E., and Regnier, M. (2000). Regulation of contraction in striated muscle. *Physiol Rev* *80*, 853-924.
- Goulding, M., Lumsden, A., and Paquette, A.J. (1994). Regulation of Pax-3 expression in the dermomyotome and its role in muscle development. *Development* *120*, 957-971.
- Gregorio, C.C., Granzier, H., Sorimachi, H., and Labeit, S. (1999). Muscle assembly: a titanic achievement? *Curr Opin Cell Biol* *11*, 18-25.
- Grifone, R., Demignon, J., Giordani, J., Niro, C., Souil, E., Bertin, F., Laclef, C., Xu, P.X., and Maire, P. (2007). Eya1 and Eya2 proteins are required for hypaxial somitic myogenesis in the mouse embryo. *Dev Biol* *302*, 602-616.
- Grifone, R., Demignon, J., Houbron, C., Souil, E., Niro, C., Seller, M.J., Hamard, G., and Maire, P. (2005). Six1 and Six4 homeoproteins are required for Pax3 and Mrf expression during myogenesis in the mouse embryo. *Development* *132*, 2235-2249.
- Gunther, S., Mielcarek, M., Kruger, M., and Braun, T. (2004). VITO-1 is an essential cofactor of TEF1-dependent muscle-specific gene regulation. *Nucleic Acids Res* *32*, 791-802.
- Gupta, M., Kogut, P., Davis, F.J., Belaguli, N.S., Schwartz, R.J., and Gupta, M.P. (2001). Physical interaction between the MADS box of serum response factor and the TEA/ATTS DNA-binding domain of transcription enhancer factor-1. *J Biol Chem* *276*, 10413-10422.
- Gupta, M.P., Amin, C.S., Gupta, M., Hay, N., and Zak, R. (1997). Transcription enhancer factor 1 interacts with a basic helix-loop-helix zipper protein, Max, for positive regulation of cardiac alpha-myosin heavy-chain gene expression. *Mol Cell Biol* *17*, 3924-3936.
- Gupta, M.P., Kogut, P., and Gupta, M. (2000). Protein kinase-A dependent phosphorylation of transcription enhancer factor-1 represses its DNA-binding activity but enhances its gene activation ability. *Nucleic Acids Res* *28*, 3168-3177.
- Guth, L., and Samaha, F.J. (1969). Qualitative differences between actomyosin ATPase of slow and fast mammalian muscle. *Exp Neurol* *25*, 138-152.
- Halder, G., Polaczyk, P., Kraus, M.E., Hudson, A., Kim, J., Laughon, A., and Carroll, S. (1998). The Vestigial and Scalloped proteins act together to directly regulate wing-specific gene expression in *Drosophila*. *Genes Dev* *12*, 3900-3909.
- Hall, Z.W., and Sanes, J.R. (1993). Synaptic structure and development: the neuromuscular junction. *Cell* *72 Suppl*, 99-121.
- Halperin, D.S., Pan, C., Lusic, A.J., and Tontonoz, P. (2013). Vestigial-like 3 is an inhibitor of adipocyte differentiation. *J Lipid Res* *54*, 473-481.
- Han, D., Byun, S.H., Park, S., Kim, J., Kim, I., Ha, S., Kwon, M., and Yoon, K. (2015). YAP/TAZ enhance mammalian embryonic neural stem cell characteristics in a Tead-dependent manner. *Biochem Biophys Res Commun* *458*, 110-116.
- Han, W., Jung, E.M., Cho, J., Lee, J.W., Hwang, K.T., Yang, S.J., Kang, J.J., Bae, J.Y., Jeon, Y.K., Park, I.A., *et al.* (2008). DNA copy number alterations and expression of relevant genes in triple-negative breast cancer. *Genes Chromosomes Cancer* *47*, 490-499.
- Handschin, C., Chin, S., Li, P., Liu, F., Maratos-Flier, E., Lebrasseur, N.K., Yan, Z., and Spiegelman, B.M. (2007). Skeletal muscle fiber-type switching, exercise intolerance, and myopathy in PGC-1alpha muscle-specific knock-out animals. *J Biol Chem* *282*, 30014-30021.
- Handschin, C., Rhee, J., Lin, J., Tarr, P.T., and Spiegelman, B.M. (2003). An autoregulatory loop controls peroxisome proliferator-activated receptor gamma coactivator 1alpha expression in muscle. *Proc Natl Acad Sci U S A* *100*, 7111-7116.

- Harada, A., Mallappa, C., Okada, S., Butler, J.T., Baker, S.P., Lawrence, J.B., Ohkawa, Y., and Imbalzano, A.N. (2015). Spatial re-organization of myogenic regulatory sequences temporally controls gene expression. *Nucleic Acids Res* *43*, 2008-2021.
- Hasty, P., Bradley, A., Morris, J.H., Edmondson, D.G., Venuti, J.M., Olson, E.N., and Klein, W.H. (1993). Muscle deficiency and neonatal death in mice with a targeted mutation in the myogenin gene. *Nature* *364*, 501-506.
- Hawke, T.J., and Garry, D.J. (2001). Myogenic satellite cells: physiology to molecular biology. *J Appl Physiol* (1985) *91*, 534-551.
- Heanue, T.A., Reshef, R., Davis, R.J., Mardon, G., Oliver, G., Tomarev, S., Lassar, A.B., and Tabin, C.J. (1999). Synergistic regulation of vertebrate muscle development by Dach2, Eya2, and Six1, homologs of genes required for Drosophila eye formation. *Genes Dev* *13*, 3231-3243.
- Helias-Rodzewicz, Z., Perot, G., Chibon, F., Ferreira, C., Lagarde, P., Terrier, P., Coindre, J.M., and Aurias, A. (2010). YAP1 and VGLL3, encoding two cofactors of TEAD transcription factors, are amplified and overexpressed in a subset of soft tissue sarcomas. *Genes Chromosomes Cancer* *49*, 1161-1171.
- Herquel, B., Ouararhni, K., Martianov, I., Le Gras, S., Ye, T., Keime, C., Lerouge, T., Jost, B., Cammas, F., Losson, R., *et al.* (2013). Trim24-repressed VL30 retrotransposons regulate gene expression by producing noncoding RNA. *Nat Struct Mol Biol* *20*, 339-346.
- Heszele, M.F., and Price, S.R. (2004). Insulin-like growth factor I: the yin and yang of muscle atrophy. *Endocrinology* *145*, 4803-4805.
- Hnisz, D., Abraham, B.J., Lee, T.I., Lau, A., Saint-Andre, V., Sigova, A.A., Hoke, H.A., and Young, R.A. (2013). Super-enhancers in the control of cell identity and disease. *Cell* *155*, 934-947.
- Home, P., Saha, B., Ray, S., Dutta, D., Gunewardena, S., Yoo, B., Pal, A., Vivian, J.L., Larson, M., Petroff, M., *et al.* (2012). Altered subcellular localization of transcription factor TEAD4 regulates first mammalian cell lineage commitment. *Proc Natl Acad Sci U S A* *109*, 7362-7367.
- Huang, J., Wu, S., Barrera, J., Matthews, K., and Pan, D. (2005). The Hippo signaling pathway coordinately regulates cell proliferation and apoptosis by inactivating Yorkie, the Drosophila Homolog of YAP. *Cell* *122*, 421-434.
- Hucl, T., Brody, J.R., Gallmeier, E., Iacobuzio-Donahue, C.A., Farrance, I.K., and Kern, S.E. (2007). High cancer-specific expression of mesothelin (MSLN) is attributable to an upstream enhancer containing a transcription enhancer factor dependent MCAT motif. *Cancer Res* *67*, 9055-9065.
- Huey, K.A., and Bodine, S.C. (1998). Changes in myosin mRNA and protein expression in denervated rat soleus and tibialis anterior. *Eur J Biochem* *256*, 45-50.
- Huey KA , e.a. (2003). Transcriptional regulation of the type I myosin heavy chain gene in denervated rat soleus. - PubMed - NCBI.
- Husmann, I., Soulet, L., Gautron, J., Martelly, I., and Barritault, D. (1996). Growth factors in skeletal muscle regeneration. *Cytokine Growth Factor Rev* *7*, 249-258.
- Huxley, H.E., and Hanson, J. (1957). Quantitative studies on the structure of cross-striated myofibrils. I. Investigations by interference microscopy. *Biochim Biophys Acta* *23*, 229-249.
- Ishiji, T., Lace, M.J., Parkkinen, S., Anderson, R.D., Haugen, T.H., Cripe, T.P., Xiao, J.H., Davidson, I., Chambon, P., and Turek, L.P. (1992). Transcriptional enhancer factor (TEF)-1 and its cell-specific co-activator activate human papillomavirus-16 E6 and E7 oncogene transcription in keratinocytes and cervical carcinoma cells. *Embo j* *11*, 2271-2281.
- Iwaki, H., Sasaki, S., Matsushita, A., Ohba, K., Matsunaga, H., Misawa, H., Oki, Y., Ishizuka, K., Nakamura, H., and Suda, T. (2014). Essential role of TEA domain transcription

- factors in the negative regulation of the MYH 7 gene by thyroid hormone and its receptors. *PLoS One* 9, e88610.
- Jacquemin, P., Hwang, J.J., Martial, J.A., Dolle, P., and Davidson, I. (1996). A novel family of developmentally regulated mammalian transcription factors containing the TEA/ATTS DNA binding domain. *J Biol Chem* 271, 21775-21785.
- Jacquemin, P., Martial, J.A., and Davidson, I. (1997). Human TEF-5 is preferentially expressed in placenta and binds to multiple functional elements of the human chorionic somatomammotropin-B gene enhancer. *J Biol Chem* 272, 12928-12937.
- Jarriault, S., Brou, C., Logeat, F., Schroeter, E.H., Kopan, R., and Israel, A. (1995). Signalling downstream of activated mammalian Notch. *Nature* 377, 355-358.
- Jemc, J., and Rebay, I. (2007). Identification of transcriptional targets of the dual-function transcription factor/phosphatase eyes absent. *Dev Biol* 310, 416-429.
- Jiang, S.W., Dong, M., Trujillo, M.A., Miller, L.J., and Eberhardt, N.L. (2001). DNA binding of TEA/ATTS domain factors is regulated by protein kinase C phosphorylation in human choriocarcinoma cells. *J Biol Chem* 276, 23464-23470.
- Jones, N.C., Fedorov, Y.V., Rosenthal, R.S., and Olwin, B.B. (2001). ERK1/2 is required for myoblast proliferation but is dispensable for muscle gene expression and cell fusion. *J Cell Physiol* 186, 104-115.
- Jones, N.C., Tyner, K.J., Nibarger, L., Stanley, H.M., Cornelison, D.D., Fedorov, Y.V., and Olwin, B.B. (2005). The p38alpha/beta MAPK functions as a molecular switch to activate the quiescent satellite cell. *J Cell Biol* 169, 105-116.
- Jostes, B., Walther, C., and Gruss, P. (1990). The murine paired box gene, Pax7, is expressed specifically during the development of the nervous and muscular system. *Mech Dev* 33, 27-37.
- Juan, A.H., Kumar, R.M., Marx, J.G., Young, R.A., and Sartorelli, V. (2009). Mir-214-dependent regulation of the polycomb protein Ezh2 in skeletal muscle and embryonic stem cells. *Mol Cell* 36, 61-74.
- Judson, R.N., Gray, S.R., Walker, C., Carroll, A.M., Itzstein, C., Lionikas, A., Zammit, P.S., De Bari, C., and Wackerhage, H. (2013). Constitutive expression of Yes-associated protein (Yap) in adult skeletal muscle fibres induces muscle atrophy and myopathy. *PLoS One* 8, e59622.
- Judson, R.N., Tremblay, A.M., Knopp, P., White, R.B., Urcia, R., De Bari, C., Zammit, P.S., Camargo, F.D., and Wackerhage, H. (2012). The Hippo pathway member Yap plays a key role in influencing fate decisions in muscle satellite cells. *J Cell Sci* 125, 6009-6019.
- Juven-Gershon, T., and Kadonaga, J.T. (2010). Regulation of Gene Expression via the Core Promoter and the Basal Transcriptional Machinery. *Dev Biol* 339, 225-229.
- Kaneko, K.J., Cullinan, E.B., Latham, K.E., and DePamphilis, M.L. (1997). Transcription factor mTEAD-2 is selectively expressed at the beginning of zygotic gene expression in the mouse. *Development* 124, 1963-1973.
- Kaneko, K.J., Kohn, M.J., Liu, C., and DePamphilis, M.L. (2007). Transcription factor TEAD2 is involved in neural tube closure. *Genesis* 45, 577-587.
- Kariya, K., Farrance, I.K., and Simpson, P.C. (1993). Transcriptional enhancer factor-1 in cardiac myocytes interacts with an alpha 1-adrenergic- and beta-protein kinase C-inducible element in the rat beta-myosin heavy chain promoter. *J Biol Chem* 268, 26658-26662.
- Kariya, K., Karns, L.R., and Simpson, P.C. (1994). An enhancer core element mediates stimulation of the rat beta-myosin heavy chain promoter by an alpha 1-adrenergic agonist and activated beta-protein kinase C in hypertrophy of cardiac myocytes. *J Biol Chem* 269, 3775-3782.
- Karns, L.R., Kariya, K., and Simpson, P.C. (1995). M-CAT, CArG, and Sp1 elements are required for alpha 1-adrenergic induction of the skeletal alpha-actin promoter during cardiac

- myocyte hypertrophy. Transcriptional enhancer factor-1 and protein kinase C as conserved transducers of the fetal program in cardiac growth. *J Biol Chem* 270, 410-417.
- Kathleen A. Clark, Abigail S. McElhinny, Mary C. Beckerle, and Gregorio, C.C. (2003). STRIATED MUSCLE CYTOARCHITECTURE: An Intricate Web of Form and Function. <http://dxdoiorg/101146/annurevcellbio18012502105840>.
- Kaufmann, J., and Smale, S.T. (1994). Direct recognition of initiator elements by a component of the transcription factor IID complex. *Genes Dev* 8, 821-829.
- Kelm, R.J., Jr., Cogan, J.G., Elder, P.K., Strauch, A.R., and Getz, M.J. (1999). Molecular interactions between single-stranded DNA-binding proteins associated with an essential MCAT element in the mouse smooth muscle alpha-actin promoter. *J Biol Chem* 274, 14238-14245.
- Kelm, R.J., Jr., Elder, P.K., Strauch, A.R., and Getz, M.J. (1997). Sequence of cDNAs encoding components of vascular actin single-stranded DNA-binding factor 2 establish identity to Puralpha and Purbeta. *J Biol Chem* 272, 26727-26733.
- Kiefer, J.C., and Hauschka, S.D. (2001). Myf-5 is transiently expressed in nonmuscle mesoderm and exhibits dynamic regional changes within the presegmented mesoderm and somites I-IV. *Dev Biol* 232, 77-90.
- Kim, D., Pertea, G., Trapnell, C., Pimentel, H., Kelley, R., and Salzberg, S.L. (2013). TopHat2: accurate alignment of transcriptomes in the presence of insertions, deletions and gene fusions. *Genome Biol* 14, R36.
- Kim, T.K., Hemberg, M., Gray, J.M., Costa, A.M., Bear, D.M., Wu, J., Harmin, D.A., Laptewicz, M., Barbara-Haley, K., Kuersten, S., *et al.* (2010). Widespread transcription at neuronal activity-regulated enhancers. *Nature* 465, 182-187.
- Kivela, R., Kyrolainen, H., Selanne, H., Komi, P.V., Kainulainen, H., and Vihko, V. (2007). A single bout of exercise with high mechanical loading induces the expression of Cyr61/CCN1 and CTGF/CCN2 in human skeletal muscle. *J Appl Physiol* (1985) 103, 1395-1401.
- Knight, J.F., Shepherd, C.J., Rizzo, S., Brewer, D., Jhavar, S., Dodson, A.R., Cooper, C.S., Eeles, R., Falconer, A., Kovacs, G., *et al.* (2008). TEAD1 and c-Cbl are novel prostate basal cell markers that correlate with poor clinical outcome in prostate cancer. *Br J Cancer* 99, 1849-1858.
- Knoepfler, P.S., Bergstrom, D.A., Uetsuki, T., Dac-Korytko, I., Sun, Y.H., Wright, W.E., Tapscott, S.J., and Kamps, M.P. (1999). A conserved motif N-terminal to the DNA-binding domains of myogenic bHLH transcription factors mediates cooperative DNA binding with pbx-Meis1/Prep1. *Nucleic Acids Res* 27, 3752-3761.
- Kuang, S., Kuroda, K., Le Grand, F., and Rudnicki, M.A. (2007). Asymmetric self-renewal and commitment of satellite stem cells in muscle. *Cell* 129, 999-1010.
- Kumar, D., Shadrach, J.L., Wagers, A.J., and Lassar, A.B. (2009). Id3 is a direct transcriptional target of Pax7 in quiescent satellite cells. *Mol Biol Cell* 20, 3170-3177.
- Kuroda, K., Tani, S., Tamura, K., Minoguchi, S., Kurooka, H., and Honjo, T. (1999). Delta-induced Notch signaling mediated by RBP-J inhibits MyoD expression and myogenesis. *J Biol Chem* 274, 7238-7244.
- Lagha, M., Kormish, J.D., Rocancourt, D., Manceau, M., Epstein, J.A., Zaret, K.S., Relaix, F., and Buckingham, M.E. (2008). Pax3 regulation of FGF signaling affects the progression of embryonic progenitor cells into the myogenic program. *Genes Dev* 22, 1828-1837.
- Lagrange, T., Kapanidis, A.N., Tang, H., Reinberg, D., and Ebright, R.H. (1998). New core promoter element in RNA polymerase II-dependent transcription: sequence-specific DNA binding by transcription factor IIB. *Genes Dev* 12, 34-44.

- Laloux, I., Dubois, E., Dewerchin, M., and Jacobs, E. (1990). TEC1, a gene involved in the activation of Ty1 and Ty1-mediated gene expression in *Saccharomyces cerevisiae*: cloning and molecular analysis. *Mol Cell Biol* *10*, 3541-3550.
- Lamar, J.M., Stern, P., Liu, H., Schindler, J.W., Jiang, Z.G., and Hynes, R.O. (2012). The Hippo pathway target, YAP, promotes metastasis through its TEAD-interaction domain. *Proc Natl Acad Sci U S A* *109*, E2441-2450.
- Langmead, B., and Salzberg, S.L. (2012). Fast gapped-read alignment with Bowtie 2. *Nat Methods* *9*, 357-359.
- Lepper, C., Partridge, T.A., and Fan, C.M. (2011). An absolute requirement for Pax7-positive satellite cells in acute injury-induced skeletal muscle regeneration. *Development* *138*, 3639-3646.
- Li, L., Chambard, J.C., Karin, M., and Olson, E.N. (1992). Fos and Jun repress transcriptional activation by myogenin and MyoD: the amino terminus of Jun can mediate repression. *Genes Dev* *6*, 676-689.
- Li, S., Liu, C., Li, N., Hao, T., Han, T., Hill, D.E., Vidal, M., and Lin, J.D. (2008). Genome-wide coactivation analysis of PGC-1alpha identifies BAF60a as a regulator of hepatic lipid metabolism. *Cell Metab* *8*, 105-117.
- Li, X., Oghi, K.A., Zhang, J., Krones, A., Bush, K.T., Glass, C.K., Nigam, S.K., Aggarwal, A.K., Maas, R., Rose, D.W., *et al.* (2003). Eya protein phosphatase activity regulates Six1-Dach-Eya transcriptional effects in mammalian organogenesis. *Nature* *426*, 247-254.
- Li, Z., Zhao, B., Wang, P., Chen, F., Dong, Z., Yang, H., Guan, K.L., and Xu, Y. (2010). Structural insights into the YAP and TEAD complex. *Genes Dev* *24*, 235-240.
- Lim, C.Y., Santoso, B., Boulay, T., Dong, E., Ohler, U., and Kadonaga, J.T. (2004). The MTE, a new core promoter element for transcription by RNA polymerase II. *Genes Dev* *18*, 1606-1617.
- Lin, J., Handschin, C., and Spiegelman, B.M. (2005). Metabolic control through the PGC-1 family of transcription coactivators. *Cell Metab* *1*, 361-370.
- Lin, J., Wu, H., Tarr, P.T., Zhang, C.Y., Wu, Z., Boss, O., Michael, L.F., Puigserver, P., Isotani, E., Olson, E.N., *et al.* (2002). Transcriptional co-activator PGC-1 alpha drives the formation of slow-twitch muscle fibres. *Nature* *418*, 797-801.
- Liu, N., Nelson, B.R., Bezprozvannaya, S., Shelton, J.M., Richardson, J.A., Bassel-Duby, R., and Olson, E.N. (2014). Requirement of MEF2A, C, and D for skeletal muscle regeneration. *Proc Natl Acad Sci U S A* *111*, 4109-4114.
- Liu Y , e.a. (2005). Signaling pathways in activity-dependent fiber type plasticity in adult skeletal muscle. - PubMed - NCBI.
- Liu, Y., Randall, W.R., and Schneider, M.F. (2005a). Activity-dependent and -independent nuclear fluxes of HDAC4 mediated by different kinases in adult skeletal muscle. *J Cell Biol* *168*, 887-897.
- Lolis, A.A., Londhe, P., Beggs, B.C., Byrum, S.D., Tackett, A.J., and Davie, J.K. (2013). Myogenin recruits the histone chaperone facilitates chromatin transcription (FACT) to promote nucleosome disassembly at muscle-specific genes. *J Biol Chem* *288*, 7676-7687.
- Love, M.I., Huber, W., and Anders, S. (2014). Moderated estimation of fold change and dispersion for RNA-seq data with DESeq2. *Genome Biol* *15*, 550.
- Luther, P.K. (2000). Three-dimensional structure of a vertebrate muscle Z-band: implications for titin and alpha-actinin binding. *J Struct Biol* *129*, 1-16.
- Luther, P.K. (2009). The vertebrate muscle Z-disc: sarcomere anchor for structure and signalling. In *J Muscle Res Cell Motil*, pp. 171-185.
- Lyons, G.E., Ontell, M., Cox, R., Sassoon, D., and Buckingham, M. (1990). The expression of myosin genes in developing skeletal muscle in the mouse embryo. *J Cell Biol* *111*, 1465-1476.

Results

- Ma, G.T., Roth, M.E., Groskopf, J.C., Tsai, F.Y., Orkin, S.H., Grosveld, F., Engel, J.D., and Linzer, D.I. (1997). GATA-2 and GATA-3 regulate trophoblast-specific gene expression in vivo. *Development* 124, 907-914.
- Maeda, T., Chapman, D.L., and Stewart, A.F. (2002a). Mammalian vestigial-like 2, a cofactor of TEF-1 and MEF2 transcription factors that promotes skeletal muscle differentiation. *J Biol Chem* 277, 48889-48898.
- Maeda, T., Gupta, M.P., and Stewart, A.F. (2002b). TEF-1 and MEF2 transcription factors interact to regulate muscle-specific promoters. *Biochem Biophys Res Commun* 294, 791-797.
- Mahoney, W.M., Jr., Hong, J.H., Yaffe, M.B., and Farrance, I.K. (2005). The transcriptional co-activator TAZ interacts differentially with transcriptional enhancer factor-1 (TEF-1) family members. *Biochem J* 388, 217-225.
- Maley, M.A., Fan, Y., Beilharz, M.W., and Grounds, M.D. (1994). Intrinsic differences in MyoD and myogenin expression between primary cultures of SJL/J and BALB/C skeletal muscle. *Exp Cell Res* 211, 99-107.
- Mallappa, C., Hu, Y.J., Shamulailatpam, P., Tae, S., Sif, S., and Imbalzano, A.N. (2011). The expression of myogenic microRNAs indirectly requires protein arginine methyltransferase (Prmt)5 but directly requires Prmt4. *Nucleic Acids Res* 39, 1243-1255.
- Manceau, M., Marcelle, C., and Gros, J. (2005). [A common somitic origin for embryonic muscle progenitors]. *Med Sci (Paris)* 21, 915-917.
- Mar, J.H., and Ordahl, C.P. (1988). A conserved CATTCT motif is required for skeletal muscle-specific activity of the cardiac troponin T gene promoter. *Proc Natl Acad Sci U S A* 85, 6404-6408.
- Mar, J.H., and Ordahl, C.P. (1990). M-CAT binding factor, a novel trans-acting factor governing muscle-specific transcription. *Mol Cell Biol* 10, 4271-4283.
- Marinov, G.K., Kundaje, A., Park, P.J., and Wold, B.J. (2014). Large-scale quality analysis of published ChIP-seq data. *G3 (Bethesda)* 4, 209-223.
- Maston, G.A., Evans, S.K., and Green, M.R. (2006). Transcriptional regulatory elements in the human genome. *Annu Rev Genomics Hum Genet* 7, 29-59.
- Mauro, A. (1961). SATELLITE CELL OF SKELETAL MUSCLE FIBERS. *The Journal of Biophysical and Biochemical Cytology* 9, 493-495.
- McCroskery, S., Thomas, M., Maxwell, L., Sharma, M., and Kambadur, R. (2003). Myostatin negatively regulates satellite cell activation and self-renewal. *J Cell Biol* 162, 1135-1147.
- McElhinny, A.S., Kazmierski, S.T., Labeit, S., and Gregorio, C.C. (2003). Nebulin: the nebulous, multifunctional giant of striated muscle. *Trends Cardiovasc Med* 13, 195-201.
- McKinsey, T.A., Zhang, C.L., Lu, J., and Olson, E.N. (2000). Signal-dependent nuclear export of a histone deacetylase regulates muscle differentiation. *Nature* 408, 106-111.
- McPherron, A.C., Lawler, A.M., and Lee, S.J. (1997). Regulation of skeletal muscle mass in mice by a new TGF-beta superfamily member. *Nature* 387, 83-90.
- Megeney, L.A., and Rudnicki, M.A. (1995). Determination versus differentiation and the MyoD family of transcription factors. *Biochem Cell Biol* 73, 723-732.
- Menke, A., and Jockusch, H. (1991). Decreased osmotic stability of dystrophin-less muscle cells from the mdx mouse. *Nature* 349, 69-71.
- Mennerich, D., and Braun, T. (2001). Activation of myogenesis by the homeobox gene Lbx1 requires cell proliferation. *Embo j* 20, 7174-7183.
- Mielcarek, M., Piotrowska, I., Schneider, A., Gunther, S., and Braun, T. (2009). VITO-2, a new SID domain protein, is expressed in the myogenic lineage during early mouse embryonic development. *Gene Expr Patterns* 9, 129-137.
- Miller, K.J., Thaloor, D., Matteson, S., and Pavlath, G.K. (2000). Hepatocyte growth factor affects satellite cell activation and differentiation in regenerating skeletal muscle. *Am J Physiol Cell Physiol* 278, C174-181.

- Min, W., Ghosh, S., and Lengyel, P. (1996). The interferon-inducible p202 protein as a modulator of transcription: inhibition of NF-kappa B, c-Fos, and c-Jun activities. *Mol Cell Biol* *16*, 359-368.
- Mitchell, K.J., Pannerec, A., Cadot, B., Parlakian, A., Besson, V., Gomes, E.R., Marazzi, G., and Sassoon, D.A. (2010). Identification and characterization of a non-satellite cell muscle resident progenitor during postnatal development. *Nat Cell Biol* *12*, 257-266.
- Molkentin, J.D., and Olson, E.N. (1996). Combinatorial control of muscle development by basic helix-loop-helix and MADS-box transcription factors. *Proc Natl Acad Sci U S A* *93*, 9366-9373.
- Morin-Kensicki, E.M., Boone, B.N., Howell, M., Stonebraker, J.R., Teed, J., Alb, J.G., Magnuson, T.R., O'Neal, W., and Milgram, S.L. (2006). Defects in yolk sac vasculogenesis, chorioallantoic fusion, and embryonic axis elongation in mice with targeted disruption of Yap65. *Mol Cell Biol* *26*, 77-87.
- Mousavi, K., Zare, H., Dell'orso, S., Grontved, L., Gutierrez-Cruz, G., Derfoul, A., Hager, G.L., and Sartorelli, V. (2013). eRNAs promote transcription by establishing chromatin accessibility at defined genomic loci. *Mol Cell* *51*, 606-617.
- Murphy, M.M., Keefe, A.C., Lawson, J.A., Flygare, S.D., Yandell, M., and Kardon, G. (2014). Transiently active Wnt/beta-catenin signaling is not required but must be silenced for stem cell function during muscle regeneration. *Stem Cell Reports* *3*, 475-488.
- Nabeshima, Y., Hanaoka, K., Hayasaka, M., Esumi, E., Li, S., and Nonaka, I. (1993). Myogenin gene disruption results in perinatal lethality because of severe muscle defect. *Nature* *364*, 532-535.
- Nagata, Y., Partridge, T.A., Matsuda, R., and Zammit, P.S. (2006). Entry of muscle satellite cells into the cell cycle requires sphingolipid signaling. *J Cell Biol* *174*, 245-253.
- Niro, C., Demignon, J., Vincent, S., Liu, Y., Giordani, J., Sgarioto, N., Favier, M., Guillet-Deniau, I., Blais, A., and Maire, P. (2010). Six1 and Six4 gene expression is necessary to activate the fast-type muscle gene program in the mouse primary myotome. *Dev Biol* *338*, 168-182.
- Nishimoto, N., Watanabe, M., Watanabe, S., Sugimoto, N., Yugawa, T., Ikura, T., Koiwai, O., Kiyono, T., and Fujita, M. (2012). Heterocomplex formation by Arp4 and beta-actin is involved in the integrity of the Brg1 chromatin remodeling complex. *J Cell Sci* *125*, 3870-3882.
- Nishioka, N., Inoue, K., Adachi, K., Kiyonari, H., Ota, M., Ralston, A., Yabuta, N., Hirahara, S., Stephenson, R.O., Ogonuki, N., *et al.* (2009). The Hippo signaling pathway components Lats and Yap pattern Tead4 activity to distinguish mouse trophectoderm from inner cell mass. *Dev Cell* *16*, 398-410.
- Nishioka, N., Yamamoto, S., Kiyonari, H., Sato, H., Sawada, A., Ota, M., Nakao, K., and Sasaki, H. (2008). Tead4 is required for specification of trophectoderm in pre-implantation mouse embryos. *Mech Dev* *125*, 270-283.
- Nowee, M.E., Snijders, A.M., Rockx, D.A., de Wit, R.M., Kosma, V.M., Hamalainen, K., Schouten, J.P., Verheijen, R.H., van Diest, P.J., Albertson, D.G., *et al.* (2007). DNA profiling of primary serous ovarian and fallopian tube carcinomas with array comparative genomic hybridization and multiplex ligation-dependent probe amplification. *J Pathol* *213*, 46-55.
- Ohkawa, Y., Marfella, C.G., and Imbalzano, A.N. (2006). Skeletal muscle specification by myogenin and Mef2D via the SWI/SNF ATPase Brg1. *Embo j* *25*, 490-501.
- Ohler, U., Liao, G.C., Niemann, H., and Rubin, G.M. (2002). Computational analysis of core promoters in the Drosophila genome. *Genome Biol* *3*, Research0087.
- Ono, Y., Calhabeu, F., Morgan, J.E., Katagiri, T., Amthor, H., and Zammit, P.S. (2011). BMP signalling permits population expansion by preventing premature myogenic differentiation in muscle satellite cells. *Cell Death Differ* *18*, 222-234.

- Ostrovsky, O., Bengal, E., and Aronheim, A. (2002). Induction of terminal differentiation by the c-Jun dimerization protein JDP2 in C2 myoblasts and rhabdomyosarcoma cells. *J Biol Chem* *277*, 40043-40054.
- Otto, A., Schmidt, C., Luke, G., Allen, S., Valasek, P., Muntoni, F., Lawrence-Watt, D., and Patel, K. (2008). Canonical Wnt signalling induces satellite-cell proliferation during adult skeletal muscle regeneration. *J Cell Sci* *121*, 2939-2950.
- Overholtzer, M., Zhang, J., Smolen, G.A., Muir, B., Li, W., Sgroi, D.C., Deng, C.X., Brugge, J.S., and Haber, D.A. (2006). Transforming properties of YAP, a candidate oncogene on the chromosome 11q22 amplicon. *Proc Natl Acad Sci U S A* *103*, 12405-12410.
- Paramasivam, M., Sarkeshik, A., Yates, J.R., 3rd, Fernandes, M.J., and McCollum, D. (2011). Angiomotin family proteins are novel activators of the LATS2 kinase tumor suppressor. *Mol Biol Cell* *22*, 3725-3733.
- Parker, M.H., Perry, R.L., Fauteux, M.C., Berkes, C.A., and Rudnicki, M.A. (2006). MyoD synergizes with the E-protein HEB beta to induce myogenic differentiation. *Mol Cell Biol* *26*, 5771-5783.
- Pasquet, S., Naye, F., Faucheux, C., Bronchain, O., Chesneau, A., Thiebaud, P., and Theze, N. (2006). Transcription enhancer factor-1-dependent expression of the alpha-tropomyosin gene in the three muscle cell types. *J Biol Chem* *281*, 34406-34420.
- Peng, L., Huang, Y., Jin, F., Jiang, S.W., and Payne, A.H. (2004). Transcription enhancer factor-5 and a GATA-like protein determine placental-specific expression of the Type I human 3beta-hydroxysteroid dehydrogenase gene, HSD3B1. *Mol Endocrinol* *18*, 2049-2060.
- Perdiguero, E., Ruiz-Bonilla, V., Serrano, A.L., and Munoz-Canoves, P. (2007). Genetic deficiency of p38alpha reveals its critical role in myoblast cell cycle exit: the p38alpha-JNK connection. *Cell Cycle* *6*, 1298-1303.
- Perry, R.L., and Rudnick, M.A. (2000). Molecular mechanisms regulating myogenic determination and differentiation. *Front Biosci* *5*, D750-767.
- Pette, D., and Staron, R.S. (1997). Mammalian skeletal muscle fiber type transitions. *Int Rev Cytol* *170*, 143-223.
- Pette, D., and Staron, R.S. (2000). Myosin isoforms, muscle fiber types, and transitions. *Microsc Res Tech* *50*, 500-509.
- Pilegaard, H., Saltin, B., and Neufer, P.D. (2003). Exercise induces transient transcriptional activation of the PGC-1alpha gene in human skeletal muscle. *J Physiol* *546*, 851-858.
- Pobbati, A.V., Chan, S.W., Lee, I., Song, H., and Hong, W. (2012). Structural and functional similarity between the Vgll1-TEAD and the YAP-TEAD complexes. *Structure* *20*, 1135-1140.
- Potthoff, M.J., Wu, H., Arnold, M.A., Shelton, J.M., Backs, J., McAnally, J., Richardson, J.A., Bassel-Duby, R., and Olson, E.N. (2007). Histone deacetylase degradation and MEF2 activation promote the formation of slow-twitch myofibers. *J Clin Invest* *117*, 2459-2467.
- Pourquie, O., Coltey, M., Teillet, M.A., Ordahl, C., and Le Douarin, N.M. (1993). Control of dorsoventral patterning of somitic derivatives by notochord and floor plate. *Proc Natl Acad Sci U S A* *90*, 5242-5246.
- Puri, P.L., Iezzi, S., Stiegler, P., Chen, T.T., Schiltz, R.L., Muscat, G.E., Giordano, A., Kedes, L., Wang, J.Y., and Sartorelli, V. (2001). Class I histone deacetylases sequentially interact with MyoD and pRb during skeletal myogenesis. *Mol Cell* *8*, 885-897.
- Puri, P.L., Sartorelli, V., Yang, X.J., Hamamori, Y., Ogryzko, V.V., Howard, B.H., Kedes, L., Wang, J.Y., Graessmann, A., Nakatani, Y., *et al.* (1997). Differential roles of p300 and PCAF acetyltransferases in muscle differentiation. *Mol Cell* *1*, 35-45.
- Ralston, A., Cox, B.J., Nishioka, N., Sasaki, H., Chea, E., Rugg-Gunn, P., Guo, G., Robson, P., Draper, J.S., and Rossant, J. (2010). Gata3 regulates trophoblast development downstream of Tead4 and in parallel to Cdx2. *Development* *137*, 395-403.

Results

- Rampalli, S., Li, L., Mak, E., Ge, K., Brand, M., Tapscott, S.J., and Dilworth, F.J. (2007). p38 MAPK signaling regulates recruitment of Ash2L-containing methyltransferase complexes to specific genes during differentiation. *Nat Struct Mol Biol* 14, 1150-1156.
- Relaix, F., Demignon, J., Laclef, C., Pujol, J., Santolini, M., Niro, C., Lagha, M., Rocancourt, D., Buckingham, M., and Maire, P. (2013). Six homeoproteins directly activate Myod expression in the gene regulatory networks that control early myogenesis. *PLoS Genet* 9, e1003425.
- Relaix, F., Montarras, D., Zaffran, S., Gayraud-Morel, B., Rocancourt, D., Tajbakhsh, S., Mansouri, A., Cumano, A., and Buckingham, M. (2006). Pax3 and Pax7 have distinct and overlapping functions in adult muscle progenitor cells. *J Cell Biol* 172, 91-102.
- Relaix, F., Rocancourt, D., Mansouri, A., and Buckingham, M. (2005). A Pax3/Pax7-dependent population of skeletal muscle progenitor cells. *Nature* 435, 948-953.
- Ribas, R., Moncaut, N., Siligan, C., Taylor, K., Cross, J.W., Rigby, P.W., and Carvajal, J.J. (2011). Members of the TEAD family of transcription factors regulate the expression of Myf5 in ventral somitic compartments. *Dev Biol* 355, 372-380.
- Richard, A.F., Demignon, J., Sakakibara, I., Pujol, J., Favier, M., Strohlic, L., Le Grand, F., Sgarloto, N., Guernec, A., Schmitt, A., *et al.* (2011). Genesis of muscle fiber-type diversity during mouse embryogenesis relies on Six1 and Six4 gene expression. *Dev Biol* 359, 303-320.
- Richardson, A.L., Wang, Z.C., De Nicolo, A., Lu, X., Brown, M., Miron, A., Liao, X., Iglehart, J.D., Livingston, D.M., and Ganesan, S. (2006). X chromosomal abnormalities in basal-like human breast cancer. *Cancer Cell* 9, 121-132.
- Rindt, H., Gulick, J., Knotts, S., Neumann, J., and Robbins, J. (1993). In vivo analysis of the murine beta-myosin heavy chain gene promoter. *J Biol Chem* 268, 5332-5338.
- Rodgers, J.T., King, K.Y., Brett, J.O., Cromie, M.J., Charville, G.W., Maguire, K.K., Brunson, C., Mastey, N., Liu, L., Tsai, C.R., *et al.* (2014). mTORC1 controls the adaptive transition of quiescent stem cells from G0 to G(Alert). *Nature* 510, 393-396.
- Rudnicki, M.A., Schnegelsberg, P.N., Stead, R.H., Braun, T., Arnold, H.H., and Jaenisch, R. (1993). MyoD or Myf-5 is required for the formation of skeletal muscle. *Cell* 75, 1351-1359.
- Sartorelli, V., and Juan, A.H. (2011). Sculpting chromatin beyond the double helix: epigenetic control of skeletal myogenesis. *Curr Top Dev Biol* 96, 57-83.
- Sato, T., Rocancourt, D., Marques, L., Thorsteinsdottir, S., and Buckingham, M. (2010). A Pax3/Dmrt2/Myf5 regulatory cascade functions at the onset of myogenesis. *PLoS Genet* 6, e1000897.
- Sawada, A., Kiyonari, H., Ukita, K., Nishioka, N., Imuta, Y., and Sasaki, H. (2008). Redundant roles of Tead1 and Tead2 in notochord development and the regulation of cell proliferation and survival. *Mol Cell Biol* 28, 3177-3189.
- Schakman, O., Gilson, H., and Thissen, J.P. (2008). Mechanisms of glucocorticoid-induced myopathy. *J Endocrinol* 197, 1-10.
- Schiaffino, S., and Reggiani, C. (1996). Molecular diversity of myofibrillar proteins: gene regulation and functional significance. *Physiol Rev* 76, 371-423.
- Schiaffino, S., and Reggiani, C. (2011). Fiber Types in Mammalian Skeletal Muscles.
- Schiaffino, S., Rossi, A.C., Smerdu, V., Leinwand, L.A., and Reggiani, C. (2015). Developmental myosins: expression patterns and functional significance. *Skelet Muscle* 5, 22.
- Schreiber, S.N., Emter, R., Hock, M.B., Knutti, D., Cardenas, J., Podvinec, M., Oakeley, E.J., and Kralli, A. (2004). The estrogen-related receptor alpha (ERRalpha) functions in PPARgamma coactivator 1alpha (PGC-1alpha)-induced mitochondrial biogenesis. *Proc Natl Acad Sci U S A* 101, 6472-6477.

Results

- Schuster-Gossler, K., Cordes, R., and Gossler, A. (2007). Premature myogenic differentiation and depletion of progenitor cells cause severe muscle hypotrophy in Delta1 mutants. *Proc Natl Acad Sci U S A* 104, 537-542.
- Seale, P., Sabourin, L.A., Girgis-Gabardo, A., Mansouri, A., Gruss, P., and Rudnicki, M.A. (2000). Pax7 is required for the specification of myogenic satellite cells. *Cell* 102, 777-786.
- Seenundun, S., Rampalli, S., Liu, Q.C., Aziz, A., Pali, C., Hong, S., Blais, A., Brand, M., Ge, K., and Dilworth, F.J. (2010). UTX mediates demethylation of H3K27me3 at muscle-specific genes during myogenesis. *Embo j* 29, 1401-1411.
- Serra, C., Palacios, D., Mozzetta, C., Forcales, S.V., Morante, I., Ripani, M., Jones, D.R., Du, K., Jhala, U.S., Simone, C., *et al.* (2007). Functional interdependence at the chromatin level between the MKK6/p38 and IGF1/PI3K/AKT pathways during muscle differentiation. *Mol Cell* 28, 200-213.
- Shlyueva, D., Stampfel, G., and Stark, A. (2014). Transcriptional enhancers: from properties to genome-wide predictions. *Nat Rev Genet* 15, 272-286.
- Simmonds, A.J., Liu, X., Soanes, K.H., Krause, H.M., Irvine, K.D., and Bell, J.B. (1998). Molecular interactions between Vestigial and Scalloped promote wing formation in *Drosophila*. *Genes Dev* 12, 3815-3820.
- Simone, C., Forcales, S.V., Hill, D.A., Imbalzano, A.N., Latella, L., and Puri, P.L. (2004). p38 pathway targets SWI-SNF chromatin-remodeling complex to muscle-specific loci. *Nat Genet* 36, 738-743.
- Simonides, W.S., and van Hardeveld, C. (2008). Thyroid hormone as a determinant of metabolic and contractile phenotype of skeletal muscle. *Thyroid* 18, 205-216.
- Skotheim, R.I., Autio, R., Lind, G.E., Kraggerud, S.M., Andrews, P.W., Monni, O., Kallioniemi, O., and Lothe, R.A. (2006). Novel genomic aberrations in testicular germ cell tumors by array-CGH, and associated gene expression changes. *Cell Oncol* 28, 315-326.
- Smale, S.T., and Baltimore, D. (1989). The "initiator" as a transcription control element. *Cell* 57, 103-113.
- Smale, S.T., and Kadonaga, J.T. (2003). The RNA polymerase II core promoter. *Annu Rev Biochem* 72, 449-479.
- Smerdu, V., Karsch-Mizrachi, I., Campione, M., Leinwand, L., and Schiaffino, S. (1994). Type IIx myosin heavy chain transcripts are expressed in type IIb fibers of human skeletal muscle. *Am J Physiol* 267, C1723-1728.
- Snijders, A.M., Schmidt, B.L., Fridlyand, J., Dekker, N., Pinkel, D., Jordan, R.C., and Albertson, D.G. (2005). Rare amplicons implicate frequent deregulation of cell fate specification pathways in oral squamous cell carcinoma. *Oncogene* 24, 4232-4242.
- Soleimani, V.D., Punch, V.G., Kawabe, Y., Jones, A.E., Palidwor, G.A., Porter, C.J., Cross, J.W., Carvajal, J.J., Kockx, C.E., van, I.W.F., *et al.* (2012). Transcriptional dominance of Pax7 in adult myogenesis is due to high-affinity recognition of homeodomain motifs. *Dev Cell* 22, 1208-1220.
- Spitz, F., Demignon, J., Porteu, A., Kahn, A., Concordet, J.P., Daegelen, D., and Maire, P. (1998). Expression of myogenin during embryogenesis is controlled by Six/sine oculis homeoproteins through a conserved MEF3 binding site. *Proc Natl Acad Sci U S A* 95, 14220-14225.
- Squire, J.M. (1997). Architecture and function in the muscle sarcomere. *Curr Opin Struct Biol* 7, 247-257.
- Starick, S.R., Ibn-Salem, J., Jurk, M., Hernandez, C., Love, M.I., Chung, H.R., Vingron, M., Thomas-Chollier, M., and Meijnsing, S.H. (2015). ChIP-exo signal associated with DNA-binding motifs provides insight into the genomic binding of the glucocorticoid receptor and cooperating transcription factors. *Genome Res* 25, 825-835.

Results

- Sudol, M. (1994). Yes-associated protein (YAP65) is a proline-rich phosphoprotein that binds to the SH3 domain of the Yes proto-oncogene product. *Oncogene* 9, 2145-2152.
- Sudol, M., Chen, H.I., Bougeret, C., Einbond, A., and Bork, P. (1995). Characterization of a novel protein-binding module--the WW domain. *FEBS Lett* 369, 67-71.
- Sun, S., Stoflet, E.S., Cogan, J.G., Strauch, A.R., and Getz, M.J. (1995). Negative regulation of the vascular smooth muscle alpha-actin gene in fibroblasts and myoblasts: disruption of enhancer function by sequence-specific single-stranded-DNA-binding proteins. *Mol Cell Biol* 15, 2429-2436.
- Swartz, E.A., Johnson, A.D., and Owens, G.K. (1998). Two MCAT elements of the SM alpha-actin promoter function differentially in SM vs. non-SM cells. *Am J Physiol* 275, C608-618.
- Tajbakhsh, S. (2009). Skeletal muscle stem cells in developmental versus regenerative myogenesis. *J Intern Med* 266, 372-389.
- Tajbakhsh, S., Rocancourt, D., and Buckingham, M. (1996). Muscle progenitor cells failing to respond to positional cues adopt non-myogenic fates in myf-5 null mice. *Nature* 384, 266-270.
- Tajbakhsh, S., Rocancourt, D., Cossu, G., and Buckingham, M. (1997). Redefining the genetic hierarchies controlling skeletal myogenesis: Pax-3 and Myf-5 act upstream of MyoD. *Cell* 89, 127-138.
- Teng, A.C., Kuraitis, D., Deeke, S.A., Ahmadi, A., Dugan, S.G., Cheng, B.L., Crowson, M.G., Burgon, P.G., Suuronen, E.J., Chen, H.H., *et al.* (2010). IRF2BP2 is a skeletal and cardiac muscle-enriched ischemia-inducible activator of VEGFA expression. *Faseb j* 24, 4825-4834.
- Tian, W., Yu, J., Tomchick, D.R., Pan, D., and Luo, X. (2010). Structural and functional analysis of the YAP-binding domain of human TEAD2. *Proc Natl Acad Sci U S A* 107, 7293-7298.
- Tremblay, A.M., Missiaglia, E., Galli, G.G., Hettmer, S., Urcia, R., Carrara, M., Judson, R.N., Thway, K., Nadal, G., Selfe, J.L., *et al.* (2014). The Hippo transducer YAP1 transforms activated satellite cells and is a potent effector of embryonal rhabdomyosarcoma formation. *Cancer Cell* 26, 273-287.
- Tsika, R.W., Schramm, C., Simmer, G., Fitzsimons, D.P., Moss, R.L., and Ji, J. (2008). Overexpression of TEAD-1 in transgenic mouse striated muscles produces a slower skeletal muscle contractile phenotype. *J Biol Chem* 283, 36154-36167.
- Ueyama, T., Zhu, C., Valenzuela, Y.M., Suzow, J.G., and Stewart, A.F. (2000). Identification of the functional domain in the transcription factor RTEF-1 that mediates alpha 1-adrenergic signaling in hypertrophied cardiac myocytes. *J Biol Chem* 275, 17476-17480.
- Umansky, K.B., Gruenbaum-Cohen, Y., Tsoory, M., Feldmesser, E., Goldenberg, D., Brenner, O., and Groner, Y. (2015). Runx1 Transcription Factor Is Required for Myoblasts Proliferation during Muscle Regeneration. *PLoS Genet* 11, e1005457.
- Vassilev, A., Kaneko, K.J., Shu, H., Zhao, Y., and DePamphilis, M.L. (2001). TEAD/TEF transcription factors utilize the activation domain of YAP65, a Src/Yes-associated protein localized in the cytoplasm. *Genes Dev* 15, 1229-1241.
- Vasyutina, E., Lenhard, D.C., Wende, H., Erdmann, B., Epstein, J.A., and Birchmeier, C. (2007). RBP-J (Rbpsi) is essential to maintain muscle progenitor cells and to generate satellite cells. *Proc Natl Acad Sci U S A* 104, 4443-4448.
- Vaudin, P., Delanoue, R., Davidson, I., Silber, J., and Zider, A. (1999). TONDU (TDU), a novel human protein related to the product of vestigial (vg) gene of *Drosophila melanogaster* interacts with vertebrate TEF factors and substitutes for Vg function in wing formation. *Development* 126, 4807-4816.

Results

- Verfaillie, A., Imrichova, H., Atak, Z.K., Dewaele, M., Rambow, F., Hulselmans, G., Christiaens, V., Svetlichnyy, D., Luciani, F., Van den Mooter, L., *et al.* (2015). Decoding the regulatory landscape of melanoma reveals TEADS as regulators of the invasive cell state. *Nat Commun* 6, 6683.
- Vogel, H., Scherneck, S., Kanzleiter, T., Benz, V., Kluge, R., Stadion, M., Kryvych, S., Bluher, M., Kloting, N., Joost, H.G., *et al.* (2012). Loss of function of *Ifi202b* by a microdeletion on chromosome 1 of C57BL/6J mice suppresses 11 β -hydroxysteroid dehydrogenase type 1 expression and development of obesity. *Hum Mol Genet* 21, 3845-3857.
- von Maltzahn, J., Jones, A.E., Parks, R.J., and Rudnicki, M.A. (2013). Pax7 is critical for the normal function of satellite cells in adult skeletal muscle. *Proc Natl Acad Sci U S A* 110, 16474-16479.
- Wackerhage, H., Del Re, D.P., Judson, R.N., Sudol, M., and Sadoshima, J. (2014). The Hippo signal transduction network in skeletal and cardiac muscle. *Sci Signal* 7, re4.
- Wales, S., Hashemi, S., Blais, A., and McDermott, J.C. (2014). Global MEF2 target gene analysis in cardiac and skeletal muscle reveals novel regulation of DUSP6 by p38MAPK-MEF2 signaling. *Nucleic Acids Res* 42, 11349-11362.
- Wallberg, A.E., Yamamura, S., Malik, S., Spiegelman, B.M., and Roeder, R.G. (2003). Coordination of p300-mediated chromatin remodeling and TRAP/mediator function through coactivator PGC-1 α . *Mol Cell* 12, 1137-1149.
- Wang, H., Chatterjee, G., Meyer, J.J., Liu, C.J., Manjunath, N.A., Bray-Ward, P., and Lengyel, P. (1999). Characteristics of three homologous 202 genes (*Ifi202a*, *Ifi202b*, and *Ifi202c*) from the murine interferon-activatable gene 200 cluster. *Genomics* 60, 281-294.
- Wang, H., Ding, B., Liu, C.J., Ma, X.Y., Deschamps, S., Roe, B.A., and Lengyel, P. (2002). The increase in levels of interferon-inducible proteins p202a and p202b and RNA-dependent protein kinase (PKR) during myoblast differentiation is due to transactivation by MyoD: their tissue distribution in uninfected mice does not depend on interferons. *J Interferon Cytokine Res* 22, 729-737.
- Watt, K.I., Judson, R., Medlow, P., Reid, K., Kurth, T.B., Burniston, J.G., Ratkevicius, A., De Bari, C., and Wackerhage, H. (2010). Yap is a novel regulator of C2C12 myogenesis. *Biochem Biophys Res Commun* 393, 619-624.
- Watt, K.I., Turner, B.J., Hagg, A., Zhang, X., Davey, J.R., Qian, H., Beyer, C., Winbanks, C.E., Harvey, K.F., and Gregorevic, P. (2015). The Hippo pathway effector YAP is a critical regulator of skeletal muscle fibre size. *Nat Commun* 6, 6048.
- White, R.B., Bierinx, A.S., Gnocchi, V.F., and Zammit, P.S. (2010). Dynamics of muscle fibre growth during postnatal mouse development. *BMC Dev Biol* 10, 21.
- Wong, C.F., and Tellam, R.L. (2008). MicroRNA-26a targets the histone methyltransferase Enhancer of Zeste homolog 2 during myogenesis. *J Biol Chem* 283, 9836-9843.
- Wright, D.C., Han, D.H., Garcia-Roves, P.M., Geiger, P.C., Jones, T.E., and Holloszy, J.O. (2007). Exercise-induced mitochondrial biogenesis begins before the increase in muscle PGC-1 α expression. *J Biol Chem* 282, 194-199.
- Wu, H., Kanatous, S.B., Thurmond, F.A., Gallardo, T., Isotani, E., Bassel-Duby, R., and Williams, R.S. (2002). Regulation of mitochondrial biogenesis in skeletal muscle by CaMK. *Science* 296, 349-352.
- Wu, H., Rothermel, B., Kanatous, S., Rosenberg, P., Naya, F.J., Shelton, J.M., Hutcheson, K.A., DiMaio, J., Olson, E.N., Bassel-Duby, R., *et al.* (2001). Activation of MEF2 by muscle activity is mediated through a calcineurin-dependent pathway. In *EMBO J*, pp. 6414-6423.
- Wu, Z., Puigserver, P., Andersson, U., Zhang, C., Adelmant, G., Mootha, V., Troy, A., Cinti, S., Lowell, B., Scarpulla, R.C., *et al.* (1999). Mechanisms controlling mitochondrial biogenesis and respiration through the thermogenic coactivator PGC-1. *Cell* 98, 115-124.

- Xiao, J.H., Davidson, I., Matthes, H., Garnier, J.M., and Chambon, P. (1991). Cloning, expression, and transcriptional properties of the human enhancer factor TEF-1. *Cell* *65*, 551-568.
- Xin, H., D'Souza, S., Jorgensen, T.N., Vaughan, A.T., Lengyel, P., Kotzin, B.L., and Choubey, D. (2006). Increased expression of Ifi202, an IFN-activatable gene, in B6.Nba2 lupus susceptible mice inhibits p53-mediated apoptosis. *J Immunol* *176*, 5863-5870.
- Xu, M.Z., Yao, T.J., Lee, N.P., Ng, I.O., Chan, Y.T., Zender, L., Lowe, S.W., Poon, R.T., and Luk, J.M. (2009). Yes-associated protein is an independent prognostic marker in hepatocellular carcinoma. *Cancer* *115*, 4576-4585.
- Yablonka-Reuveni, Z., Day, K., Vine, A., and Shefer, G. (2008). Defining the transcriptional signature of skeletal muscle stem cells. *J Anim Sci* *86*, E207-216.
- Yablonka-Reuveni, Z., Seger, R., and Rivera, A.J. (1999). Fibroblast growth factor promotes recruitment of skeletal muscle satellite cells in young and old rats. *J Histochem Cytochem* *47*, 23-42.
- Yagi, R., Chen, L.F., Shigesada, K., Murakami, Y., and Ito, Y. (1999). A WW domain-containing yes-associated protein (YAP) is a novel transcriptional co-activator. *Embo j* *18*, 2551-2562.
- Yagi, R., Kohn, M.J., Karavanova, I., Kaneko, K.J., Vullhorst, D., DePamphilis, M.L., and Buonanno, A. (2007). Transcription factor TEAD4 specifies the trophoctoderm lineage at the beginning of mammalian development. *Development* *134*, 3827-3836.
- Yasunami, M., Suzuki, K., Houtani, T., Sugimoto, T., and Ohkubo, H. (1995). Molecular characterization of cDNA encoding a novel protein related to transcriptional enhancer factor-1 from neural precursor cells. *J Biol Chem* *270*, 18649-18654.
- Yasunami, M., Suzuki, K., and Ohkubo, H. (1996). A novel family of TEA domain-containing transcription factors with distinct spatiotemporal expression patterns. *Biochem Biophys Res Commun* *228*, 365-370.
- Ye, T., Krebs, A.R., Choukrallah, M.A., Keime, C., Plewniak, F., Davidson, I., and Tora, L. (2011). seqMINER: an integrated ChIP-seq data interpretation platform. *Nucleic Acids Res* *39*, e35.
- Yennek, S., Burute, M., They, M., and Tajbakhsh, S. (2014). Cell adhesion geometry regulates non-random DNA segregation and asymmetric cell fates in mouse skeletal muscle stem cells. *Cell Rep* *7*, 961-970.
- Yoshida, T. (2008). MCAT elements and the TEF-1 family of transcription factors in muscle development and disease. *Arterioscler Thromb Vasc Biol* *28*, 8-17.
- Zammit, P.S., Carvajal, J.J., Golding, J.P., Morgan, J.E., Summerbell, D., Zolnerciks, J., Partridge, T.A., Rigby, P.W., and Beauchamp, J.R. (2004). Myf5 expression in satellite cells and spindles in adult muscle is controlled by separate genetic elements. *Dev Biol* *273*, 454-465.
- Zanconato, F., Forcato, M., Battilana, G., Azzolin, L., Quaranta, E., Bodega, B., Rosato, A., Bicciato, S., Cordenonsi, M., and Piccolo, S. (2015). Genome-wide association between YAP/TAZ/TEAD and AP-1 at enhancers drives oncogenic growth. *Nature Cell Biology* *17*, 1218-1227.
- Zhang, D., Wang, X., Li, Y., Zhao, L., Lu, M., Yao, X., Xia, H., Wang, Y.C., Liu, M.F., Jiang, J., *et al.* (2014). Thyroid hormone regulates muscle fiber type conversion via miR-133a1. *J Cell Biol* *207*, 753-766.
- Zhang, J., Smolen, G.A., and Haber, D.A. (2008a). Negative regulation of YAP by LATS1 underscores evolutionary conservation of the Drosophila Hippo pathway. *Cancer Res* *68*, 2789-2794.
- Zhang, K., Kagan, D., DuBois, W., Robinson, R., Bliskovsky, V., Vass, W.C., Zhang, S., and Mock, B.A. (2009). Mndal, a new interferon-inducible family member, is highly

polymorphic, suppresses cell growth, and may modify plasmacytoma susceptibility. *Blood* 114, 2952-2960.

Zhang, T., Gunther, S., Looso, M., Kunne, C., Kruger, M., Kim, J., Zhou, Y., and Braun, T. (2015). Prmt5 is a regulator of muscle stem cell expansion in adult mice. *Nat Commun* 6, 7140.

Zhang, X., George, J., Deb, S., Degoutin, J.L., Takano, E.A., Fox, S.B., Bowtell, D.D., and Harvey, K.F. (2011). The Hippo pathway transcriptional co-activator, YAP, is an ovarian cancer oncogene. *Oncogene* 30, 2810-2822.

Zhang, Y., Liu, T., Meyer, C.A., Eeckhoutte, J., Johnson, D.S., Bernstein, B.E., Nusbaum, C., Myers, R.M., Brown, M., Li, W., *et al.* (2008b). Model-based analysis of ChIP-Seq (MACS). *Genome Biol* 9, R137.

Zhao, B., Kim, J., Ye, X., Lai, Z.C., and Guan, K.L. (2009). Both TEAD-binding and WW domains are required for the growth stimulation and oncogenic transformation activity of yes-associated protein. *Cancer Res* 69, 1089-1098.

Zhao, B., Li, L., Lu, Q., Wang, L.H., Liu, C.Y., Lei, Q., and Guan, K.L. (2011). Angiomotin is a novel Hippo pathway component that inhibits YAP oncoprotein. *Genes Dev* 25, 51-63.

Zhao, B., Wei, X., Li, W., Udan, R.S., Yang, Q., Kim, J., Xie, J., Ikenoue, T., Yu, J., Li, L., *et al.* (2007). Inactivation of YAP oncoprotein by the Hippo pathway is involved in cell contact inhibition and tissue growth control. *Genes Dev* 21, 2747-2761.

Zhao, B., Ye, X., Yu, J., Li, L., Li, W., Li, S., Lin, J.D., Wang, C.Y., Chinnaiyan, A.M., Lai, Z.C., *et al.* (2008). TEAD mediates YAP-dependent gene induction and growth control. *Genes Dev* 22, 1962-1971.

Zhao, P., Caretti, G., Mitchell, S., McKeehan, W.L., Boskey, A.L., Pachman, L.M., Sartorelli, V., and Hoffman, E.P. (2006). Fgfr4 is required for effective muscle regeneration in vivo. Delineation of a MyoD-Tead2-Fgfr4 transcriptional pathway. *J Biol Chem* 281, 429-438.

Zong, H., Ren, J.M., Young, L.H., Pypaert, M., Mu, J., Birnbaum, M.J., and Shulman, G.I. (2002). AMP kinase is required for mitochondrial biogenesis in skeletal muscle in response to chronic energy deprivation. *Proc Natl Acad Sci U S A* 99, 15983-15987.

Legends to Figures.

Figure 1. Pol II genomic occupancy in muscle *in vivo*. **A.** Localisation of Pol II occupied sites relative to genomic annotations (left panel) and the TSS (right panel). **B.** Calculation of pausing index to identify the 100 most transcribed loci in muscle. The genes associated with these loci were annotated showing enrichment in the indicated ontology terms. The identities of several of these genes are indicated. **C.** UCSC screenshot of Pol II occupancy at the locus comprising *Myh4* together with several other myosin genes. High levels of elongating Pol II selectively at the *Myh4* gene can be seen. The lower panel shows a blow up of the *Myh4* gene.

Figure 2. Tead4 genomic occupancy in muscle *in vivo*. **A.** Localisation of Tead4 occupied sites relative to genomic annotations (left panel) and the TSS (right panel). **B.** Frequency of occurrence of DNA binding motifs for the indicated transcription factors at Tead4 occupied sites. **C.** Results of MEME analysis on top 600 Tead4 occupied sites showing the high frequency of occurrence of the

Results

MCAT motif together with motifs for several other factors. **D.** UCSC screenshot of Tead4 and Pol II occupancy at the *Amotl2* and *Des* loci.

Figure 3. Comparison of Pol II and Tead4 genomic occupancy in muscle *in vivo*. **A.** Read density cluster map showing Pol II occupancy at Tead4 occupied sites. Cluster A defines sites where Tead4 is bound close to actively transcribed promoters. **B.** Examples of promoters where Tead4 is bound close to the TSS occupied by high levels of paused Pol II.

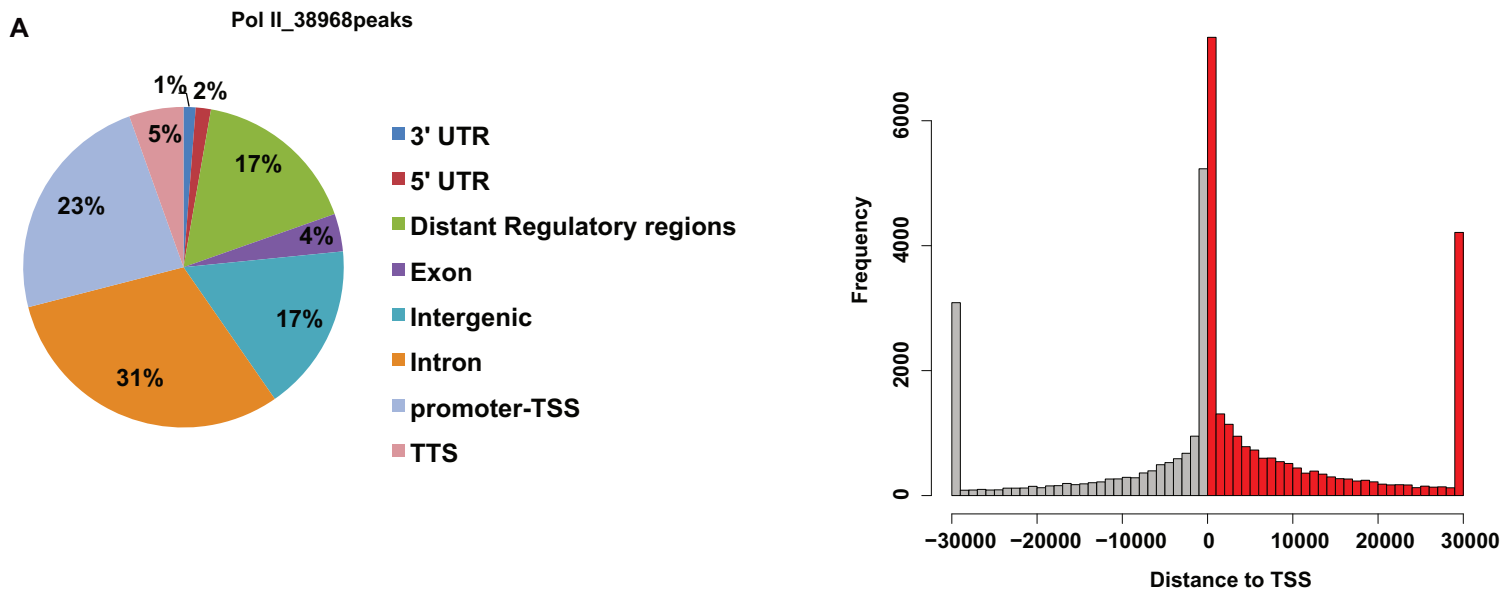
Figure 4. Comparison of Tead4 genomic occupancy in C2C12 cells and muscle *in vivo*. **A.** Read density cluster map showing comparing Tead4 occupancy in C2C12 cells and muscle. Cluster 3 defines sites with high occupancy in both conditions. **B-C.** Venn diagram and ontology analysis of the genes associated with the commonly occupied sites.

Figure 5. Mice with a modified *Tead4* locus. **A.** Schematic representation of the *Tead4* locus depicting location of the LoxP sites for Cre recombination, introns and exons of *Tead4*, location of forward and reverse primers used to identify and verify Cre-mediated deletion of exon 2 and 3, and useful restriction sites. **B.** Schematic organisation of Tead4 exons with respect to Tead4 protein domain structure before and after Cre-mediated deletion of exons 2 and 3.

Figure 6. Somatic inactivation of *Tead4* in muscle. **A.** Schematic representation crosses to generate *Hsa::Cre-ER^{T2}::Tead4^{lox/lox}* mice. **B.** RT-qPCR quantification of Tead4 expression in TA muscle of mice of the indicated genotype following Tamoxifen injection. **C.** Upper panel show a schematic timeline of the experimental strategy. Lower panel shows the results of grip strength tests and TA muscle mass after *Tead4* inactivation.

Figure 7. Measurement of fibre cross-sectional area (CSA). **A.** Images of H&E staining (10x, scale=250µm) on transverse sections of TA muscle from *Tead4^{+/+}* and *Tead4^{lox/lox}* mice. **B.** Histogram showing quantification of fibre cross-sectional area (micrometer sq.)

Supplemental Figure 1. Examples of Tead4 genomic occupancy in C2C12 cells and muscle *in vivo*. **A-B.** UCSC screenshots comparing Tead4 and Pol II occupancy at the *Amotl2* and *Ccnd1* loci *in vivo* with Tead4, Myod1 and Myog occupancy in C2C12 cells.



B Pausing index = $5' \text{ (read density)} / \text{Gene body (read density)} < 1 = 9828 \text{ loci}$
 1000 loci with the lowest pausing index

GO_CC_FAT	Count	PValue		
intrinsic to membrane	184	0,001	<i>Acta1</i>	<i>Myh1</i>
integral to membrane	178	0,045	<i>Actc1</i>	<i>Myh4</i>
extracellular region	69	0,053	<i>Amotl2</i>	<i>Neb</i>
extracellular space	22	0,057	<i>Ckm</i>	<i>Psen2</i>
myofibril	7	0,058	<i>Des</i>	<i>Tnni1</i>
contractile fiber	7	0,060	<i>Mbnl1</i>	<i>Tnni2</i>
sarcomere	6	0,063	<i>Mustn1</i>	
contractile fiber part	6	0,077		
I band	5	0,098		

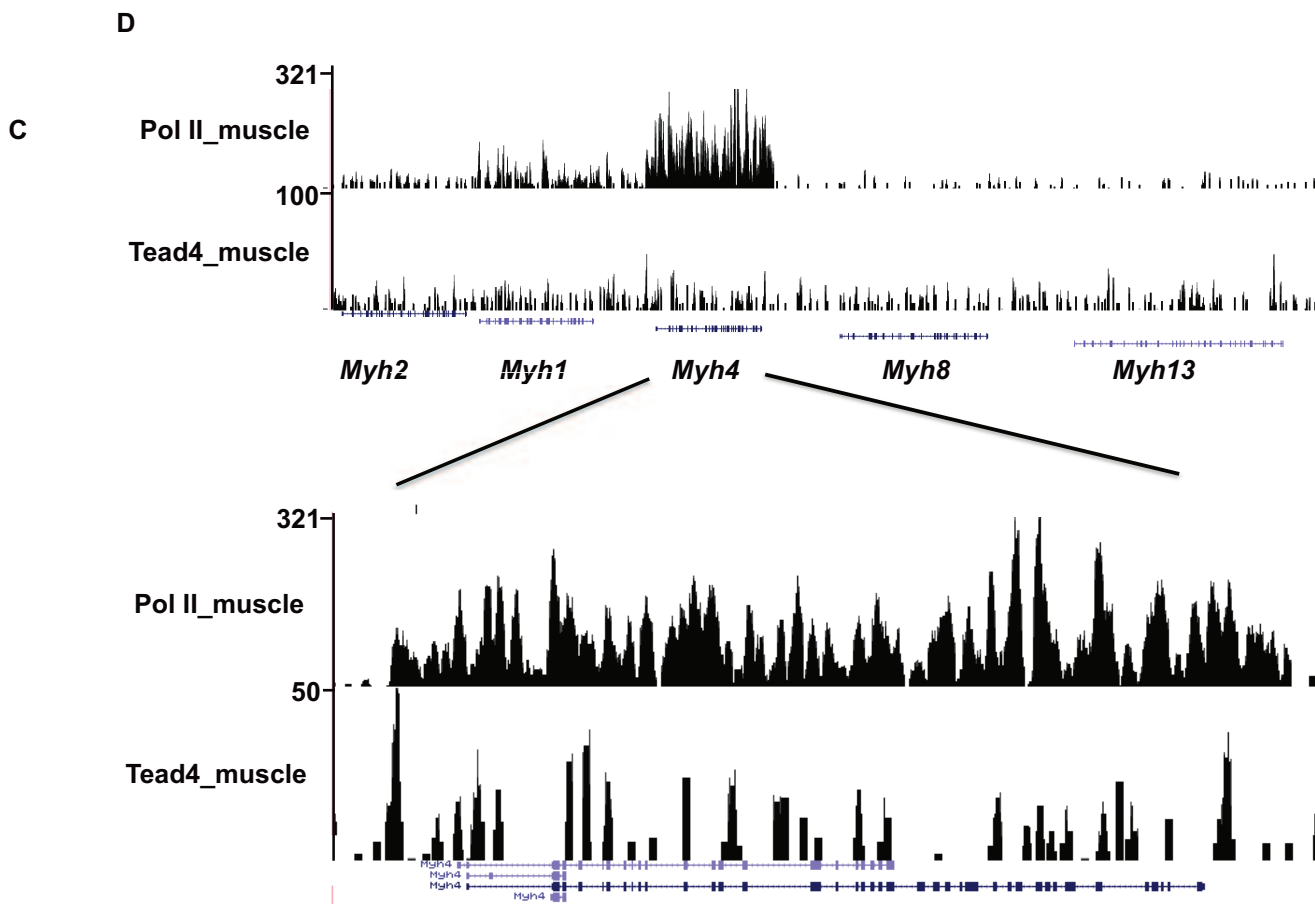
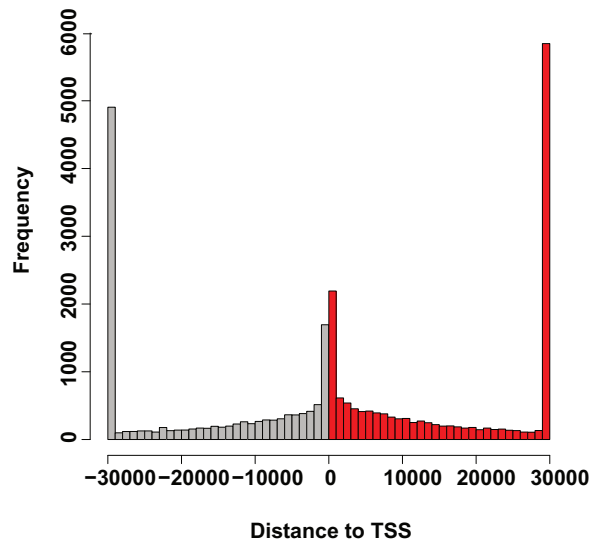
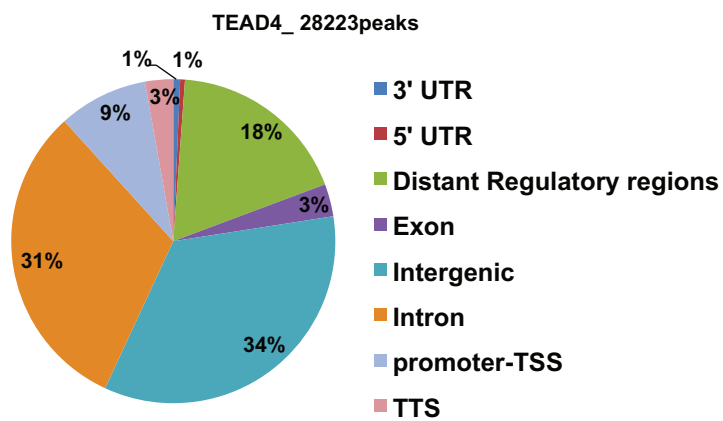
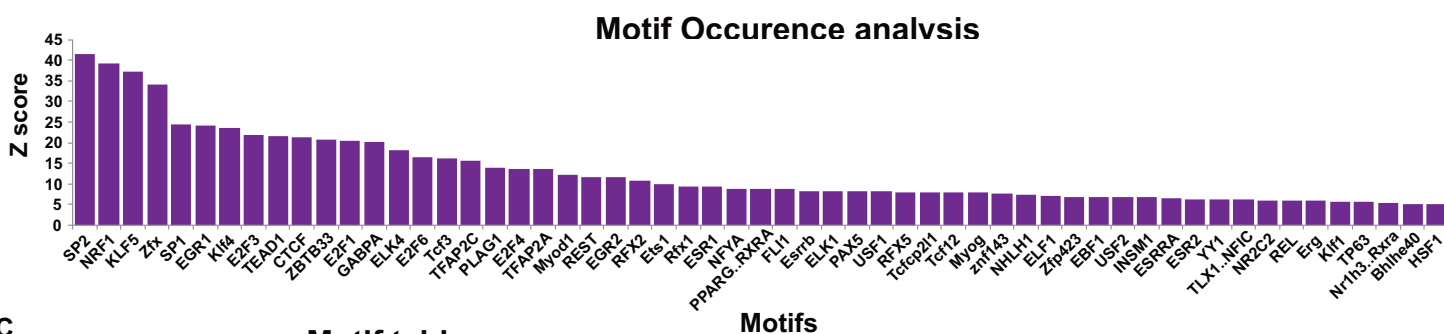


Figure 1

A



B



C

Motif table

Name	Motif	Sites	P Value
Tead		289	7.0e-101
Runx1/2		53	7.1e-068
Egr1		48	6.5e-024
Tcf12		30	7.5e-004

D

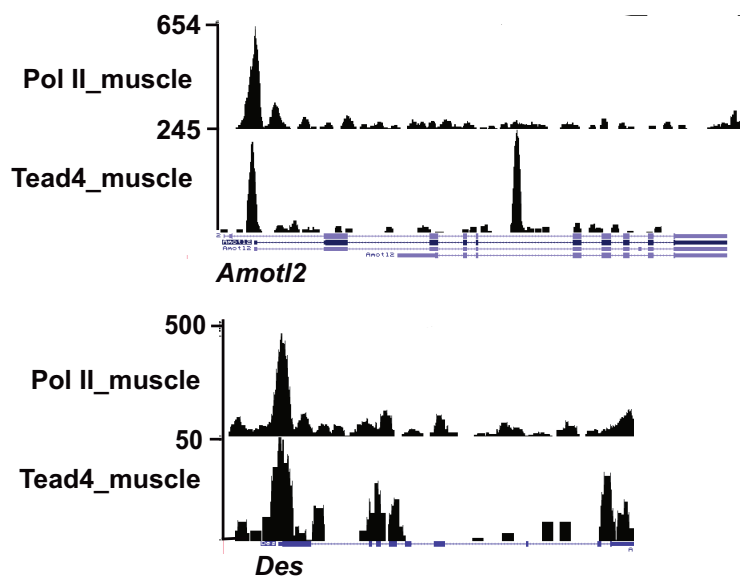


Figure 2

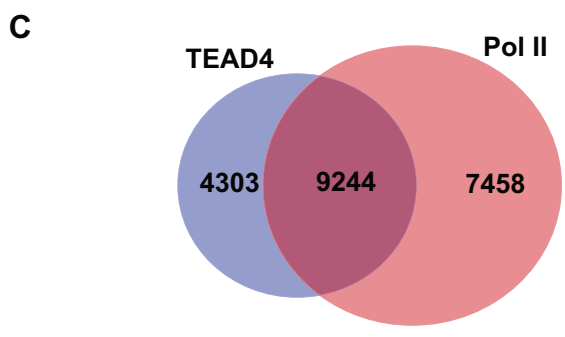
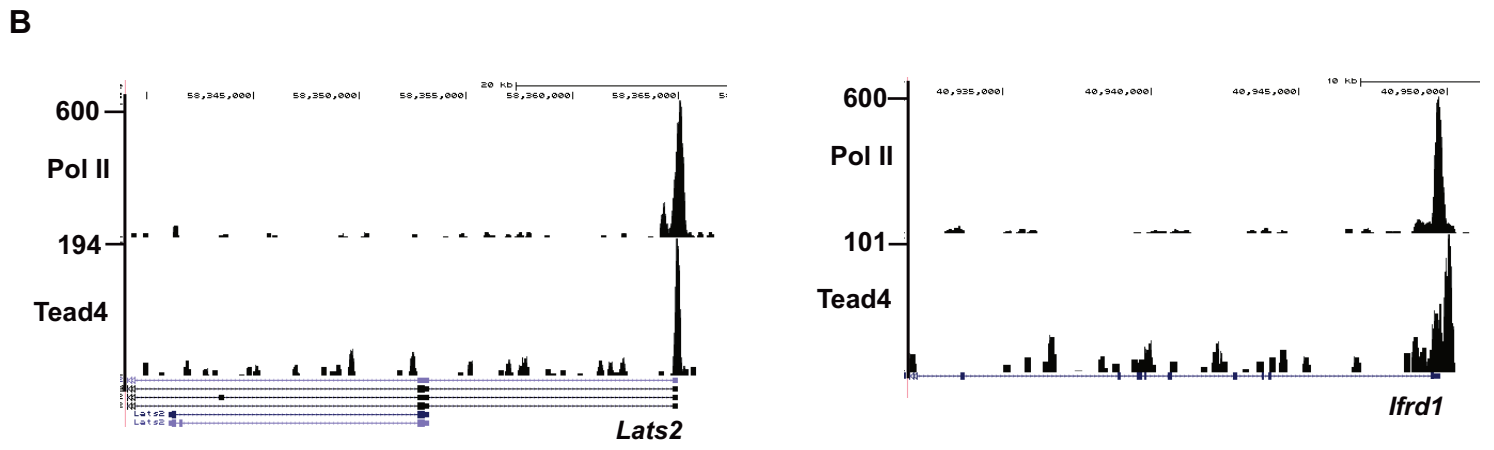
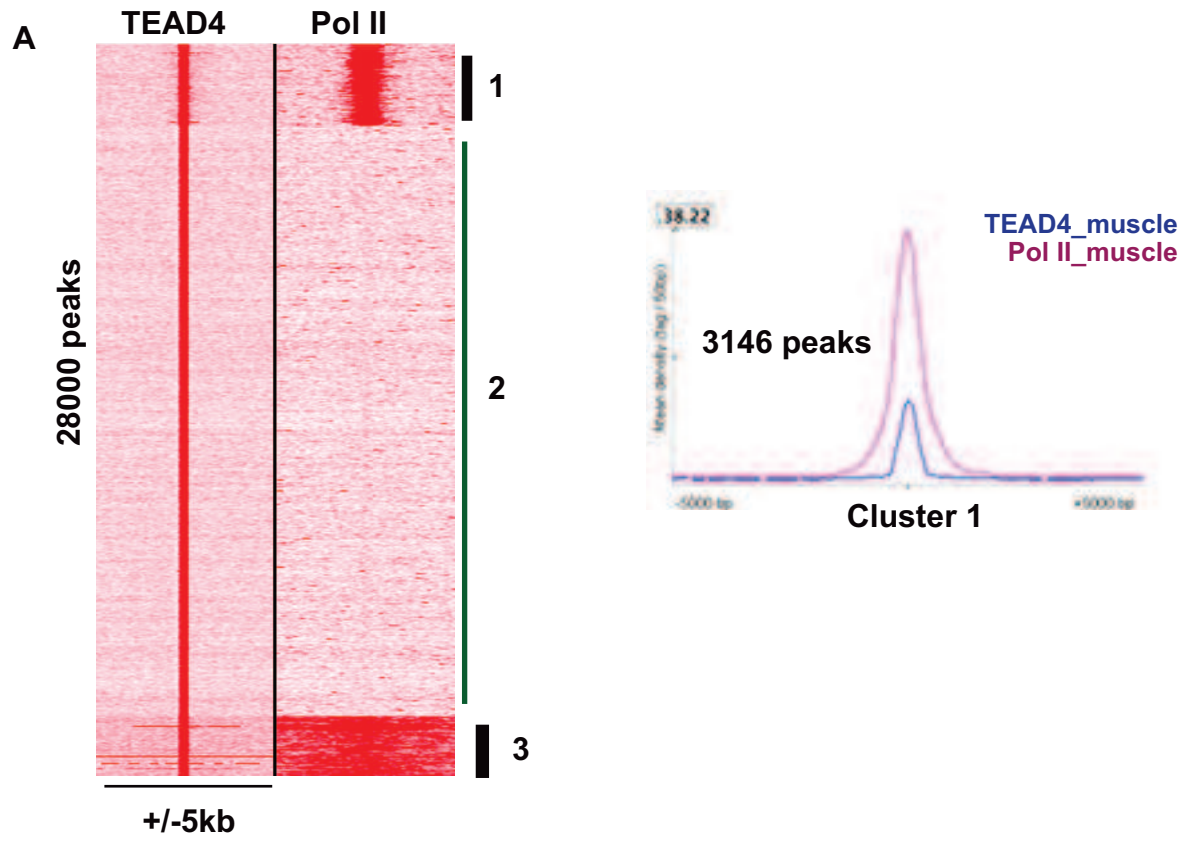
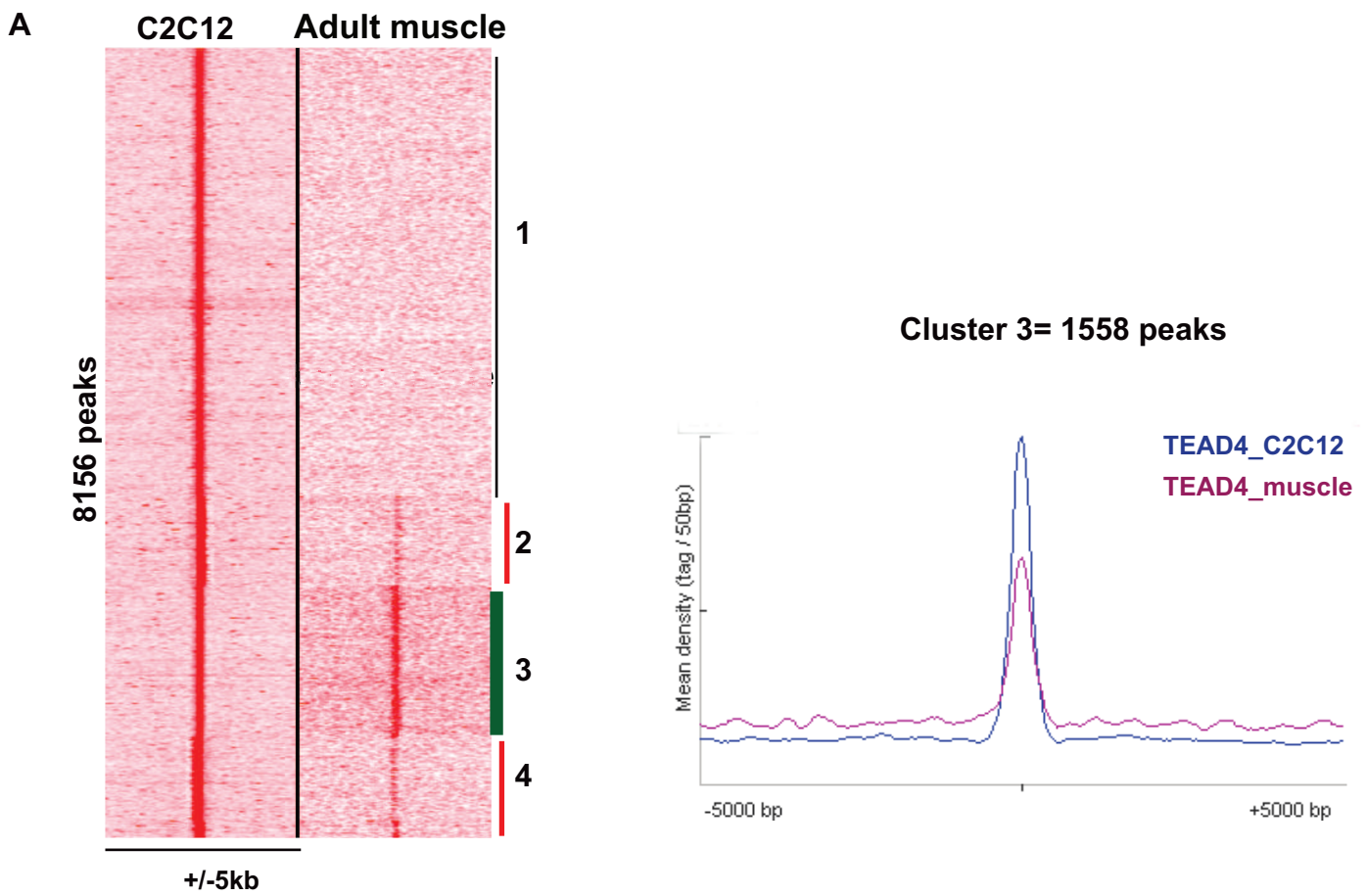
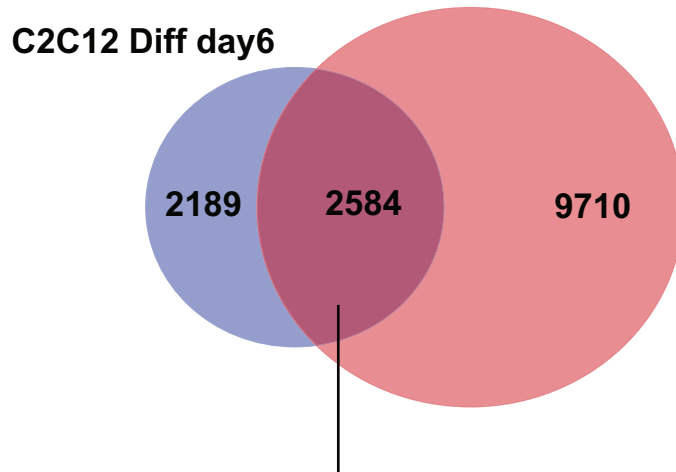


Figure 3



B Genes associated with Tead4-occupied sites

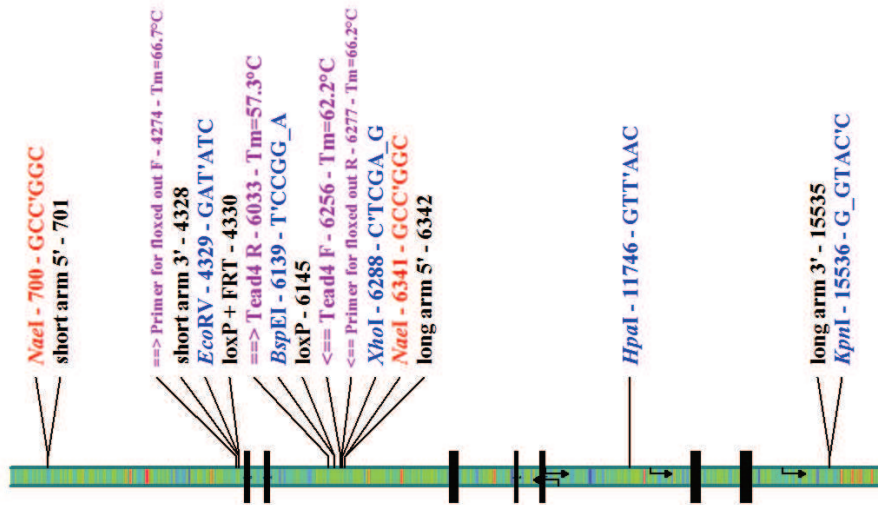


C

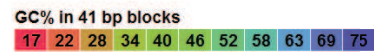
Category	Term		Count	PValue
PANTHER_BP_ALL	BP00285	Cell structure and motility	91	3,22E-10
PANTHER_BP_ALL	BP00248	Mesoderm development	50	1,67E-06
PANTHER_BP_ALL	BP00173	Muscle contraction	21	1,14E-04
PANTHER_BP_ALL	BP00108	Receptor protein tyrosine kinase signaling pathway	22	2,79E-04
PANTHER_BP_ALL	BP00281	Oncogenesis	35	6,05E-04
PANTHER_BP_ALL	BP00111	Intracellular signaling cascade	59	6,51E-04
PANTHER_BP_ALL	BP00064	Protein phosphorylation	49	6,66E-04
PANTHER_BP_ALL	BP00250	Muscle development	16	9,67E-04
PANTHER_BP_ALL	BP00124	Cell adhesion	41	0,00432
PANTHER_BP_ALL	BP00207	Cell cycle control	30	0,00580

Figure 4

A Schematic showing sites for Cre recombination and excision in *Tead4* leading to deletion in exon 2 and exon 3



Tead4 Flox after Cre-mediated deletion
1660 bp



(Provided by Thomas Braun Lab)

B

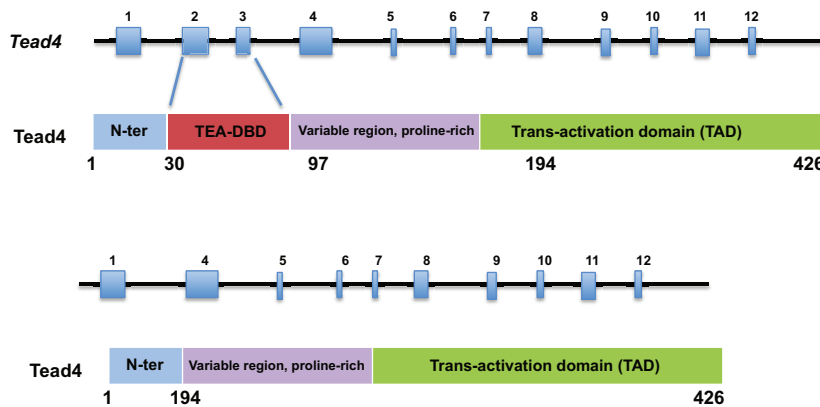


Figure 5

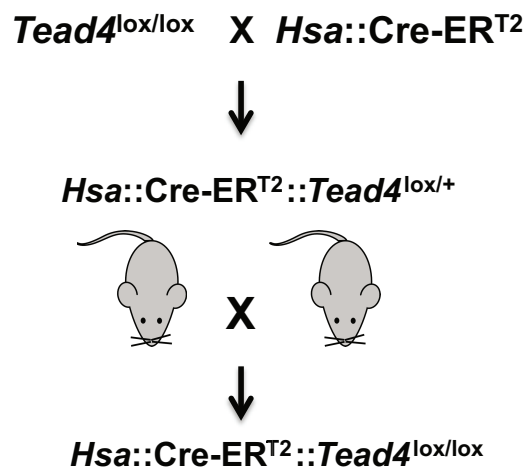
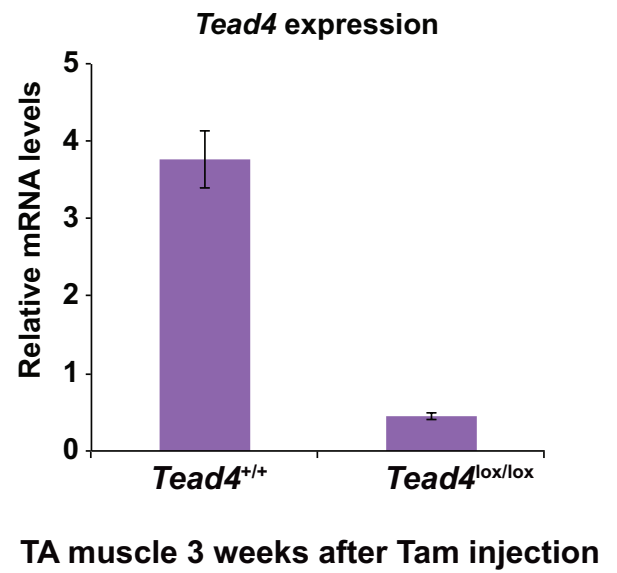
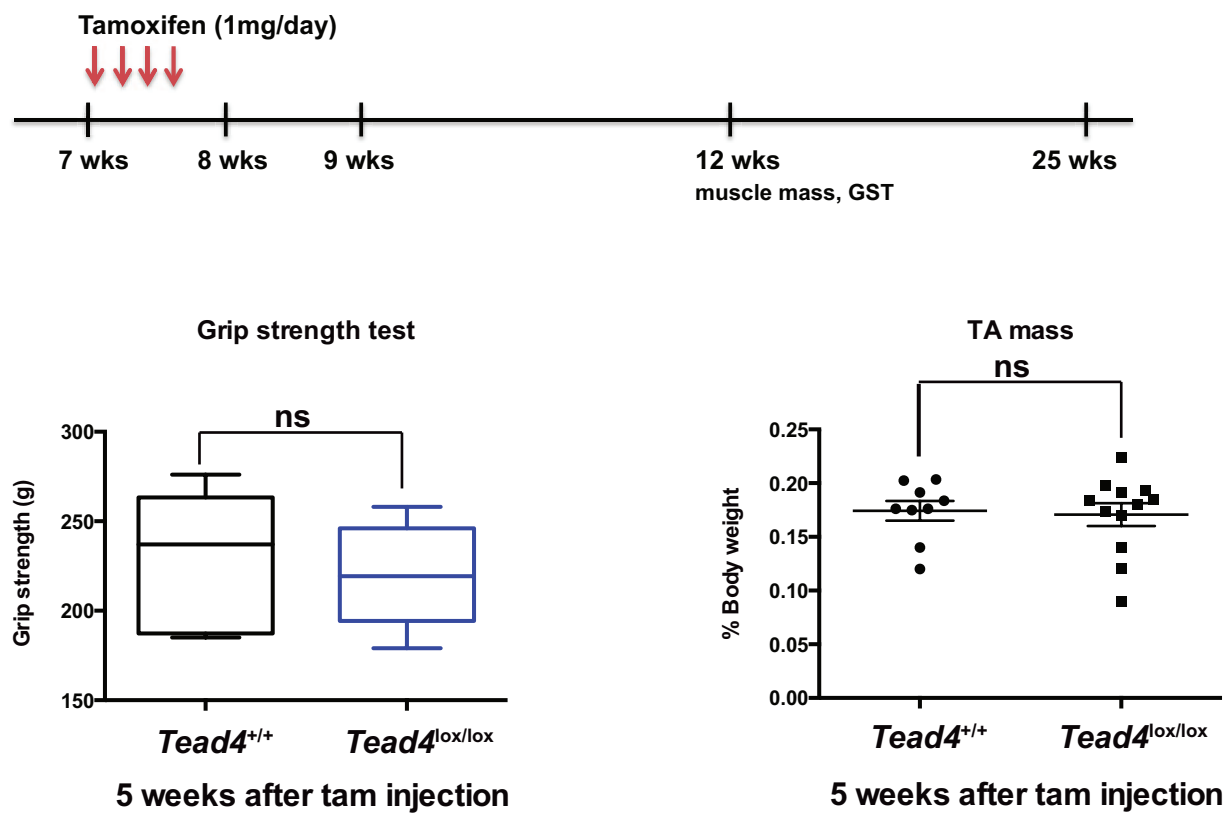
A**B****C**

Figure 6

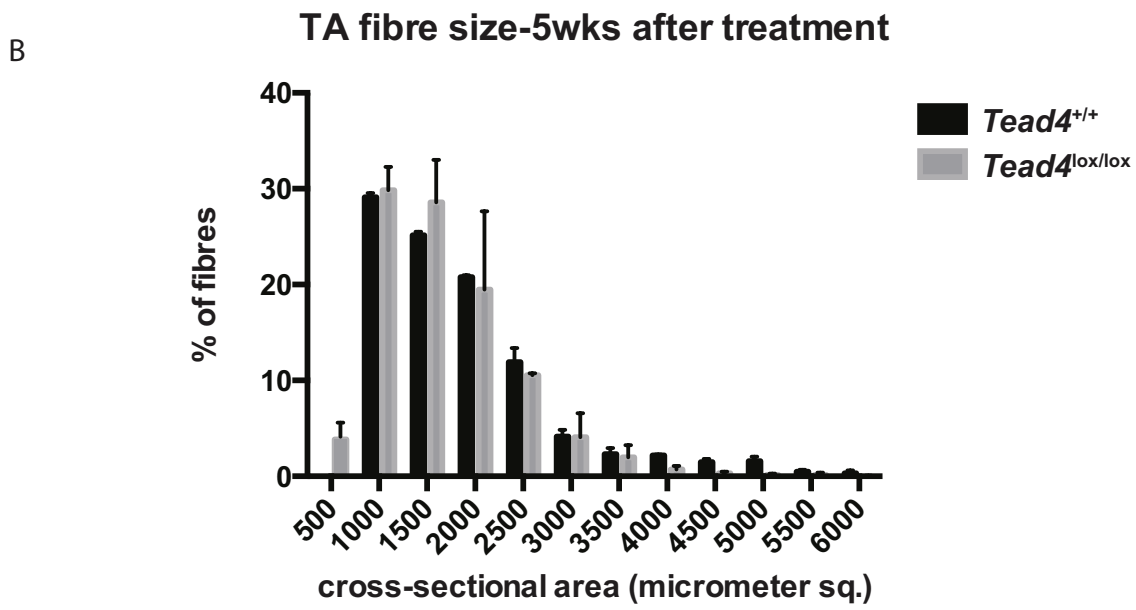
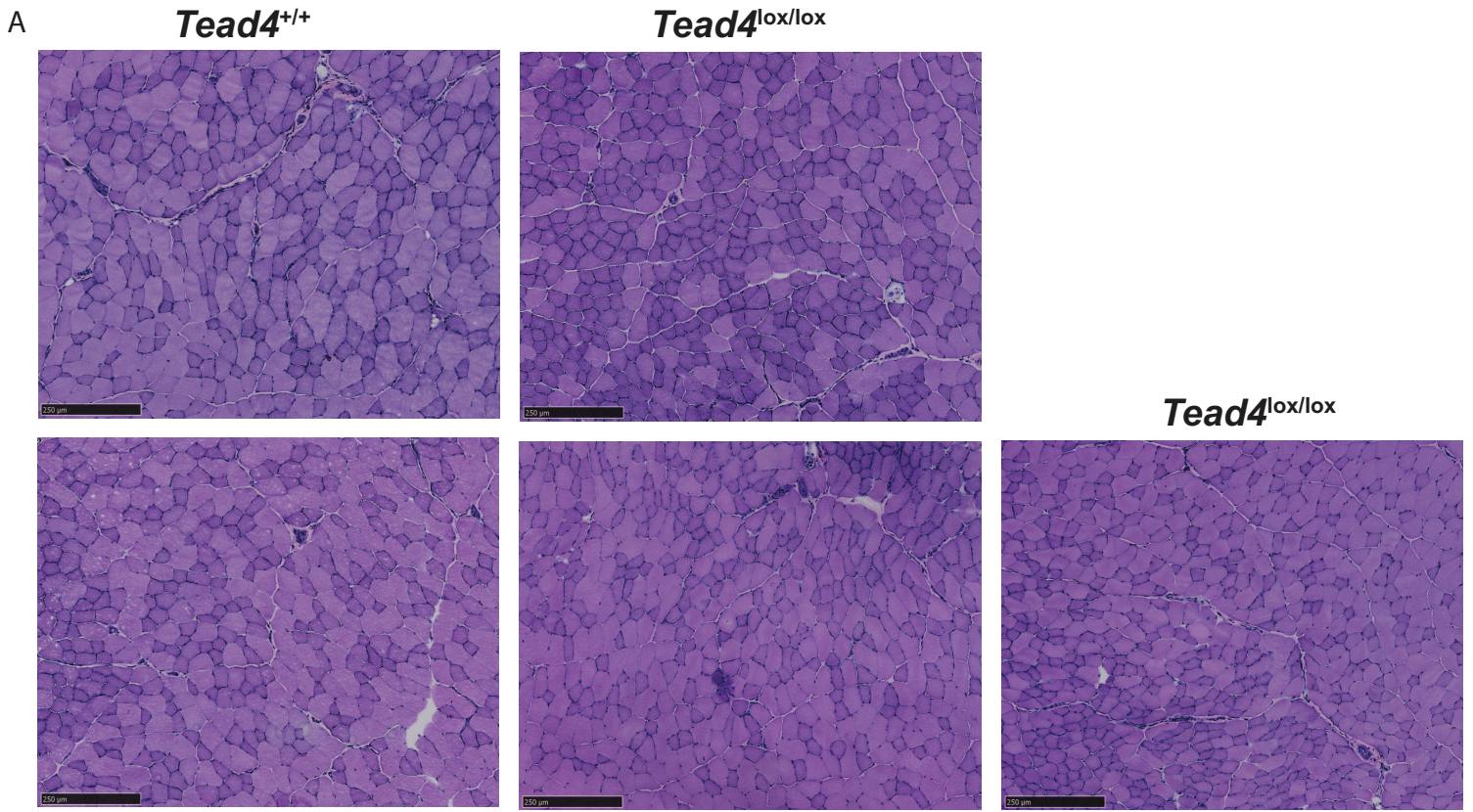
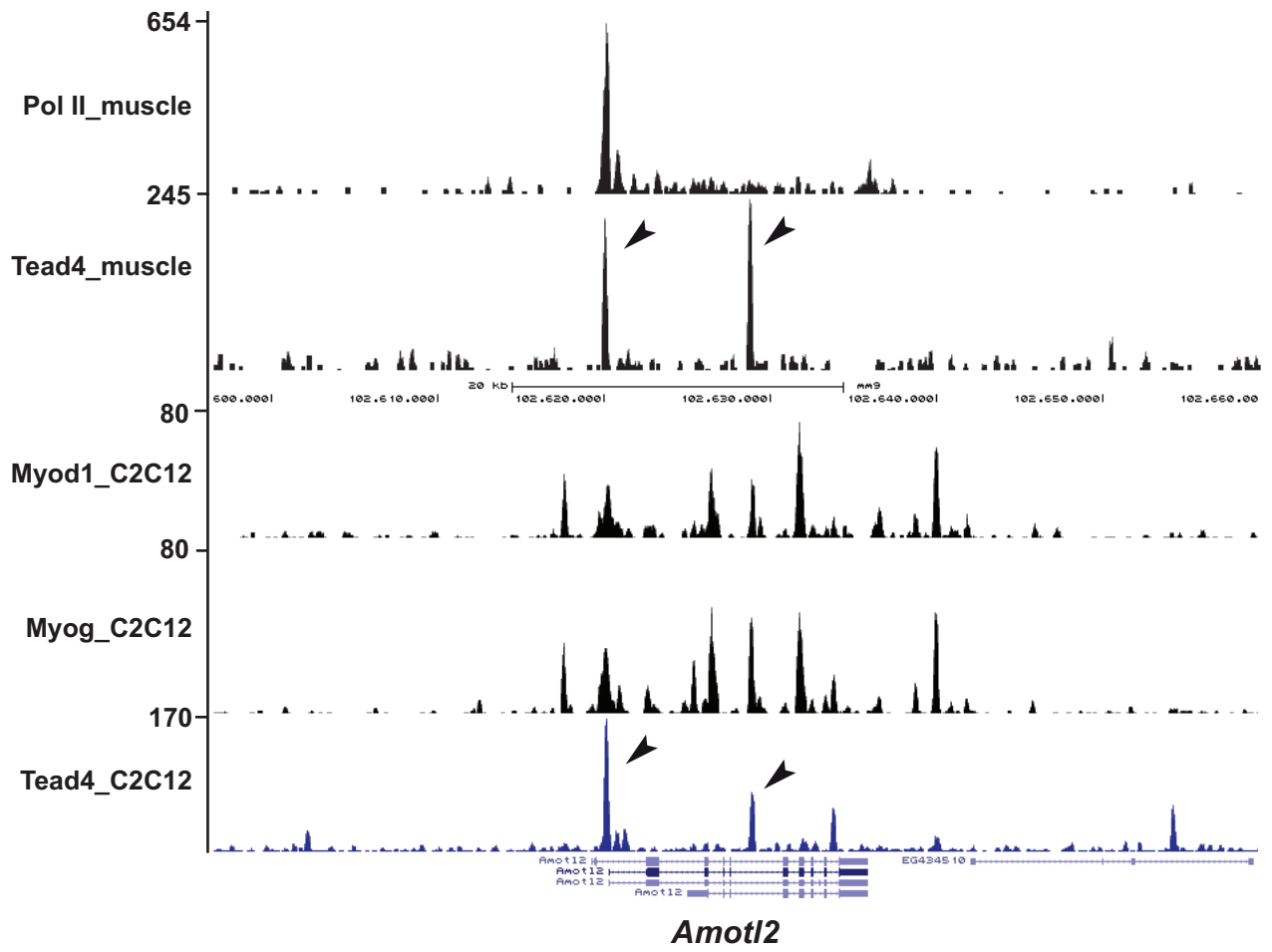
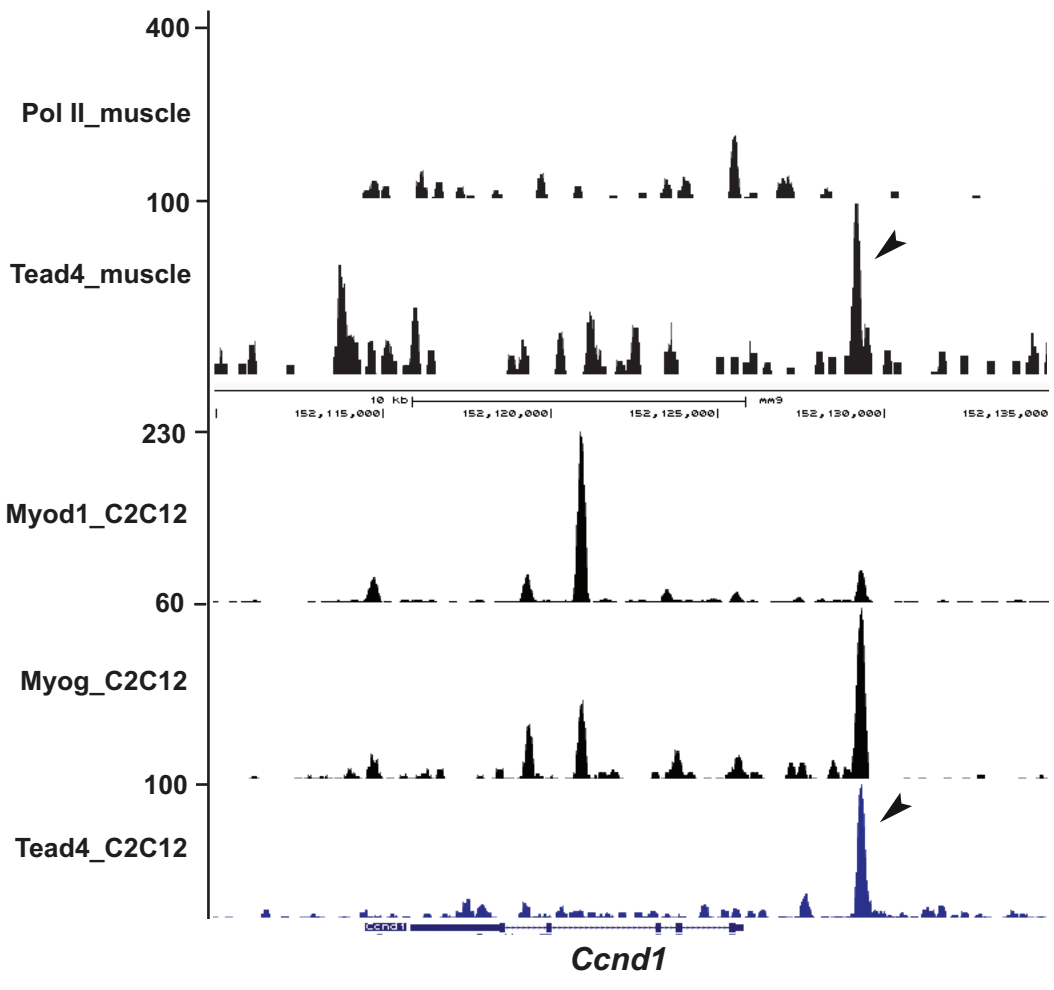


Figure 7

A**B**

Supplemental Fig. 1

Global Discussion and Perspectives

Global discussion and perspectives:

1. Tead1 and Tead4 are essential for *in vitro* myoblast differentiation: Redundancy, specificity and regulation of gene expression in myogenesis

The shRNA based stable knockdown of Tead4 in C2C12 cells resulted in formation of much shorter myotubes while overexpression of the highly conserved TEA-DBD led to inhibition of differentiation. However, C2C12 cells are an immortalised myoblast cell line and in order to get closer to *in vivo* myogenesis, we decided to extend our study to primary myoblasts isolated from young adult B6 mice. Freshly isolated primary myoblasts are highly pro-myogenic, spontaneously fuse to form myotubes, much more readily than C2C12 cells and have to be maintained in high serum, glutamine rich and growth factor enriched medium so as to keep them in state of proliferation. Since, these cells cannot be maintained as such for very long in cell culture conditions, if compared to the robust C2C12 cell line, it is difficult to perform lentiviral mediated stable knockdown and selection. This is why, we decided to perform siRNA-based knockdown of Tead4 in primary myoblasts.

To our surprise we observed that primary myoblasts rather differentiated normally upon siRNA silencing of Tead4, contrary to the shRNA silencing in C2C12 cells. We initially thought this could be because of the differences of silencing approach ie. shRNA or siRNA based silencing. To verify this, we performed siRNA-based knockdown of Tead4 in C2C12 cells as well. Here, siRNA silencing of Tead4 recapitulated the shRNA knockdown results in C2C12 cells. Hence, the difference in phenotype upon Tead4 knockdown could not be attributed to the silencing approach used. We confirmed by RT qPCR and western blotting the presence of knockdown up to the last day of differentiation.

We then hypothesised that this could probably be due to greater redundancy of function between the different Tead proteins in primary myoblast differentiation. Moreover, the functional redundancy between various Tead proteins has not been addressed in great detail, except that it is known that the Teads share great similarity in primary amino acid sequence and structure of the conserved function domains i.e. the DNA binding domain (DBD) and the transcriptional activation domain (TAD) (discussed in detail in chapter 6 of the introduction) and they can all bind with similar affinity to the MCAT motif. It appears that there is large redundancy in function and that their specific functions are controlled via a spatio-temporally controlled expression in a context-dependent manner.

Discussion

In this regard, we show that individual knockdown of either Tead1, Tead2 or Tead4 does not result in a significant defect in differentiation phenotype. However, Tead knockdowns in combinations of two or all three of them together resulted in severe inhibition of differentiation. This confirms that Tead factors are required in myogenic differentiation for activation or repression of MCAT-dependent transcription.

Chip-seq analysis combined with RNA-seq analysis of genome wide expression changes in Tead1/Tead4 double knockdown cells reveals that Teads bind and regulate expression of multiple genes in myoblast proliferation, cell cycle arrest, fusion, myotube formation, maturation and neuromuscular junction related proteins. Loss of Tead binding upregulated cell cycle genes such as *Ccnd1* and *Cdk14*, and also several components of TGF β signalling (Allen and Boxhorn, 1987) and Wnt signalling (Biressi et al., 2014; Murphy et al., 2014; Otto et al., 2008), both of which are critical regulators of *in vivo* proliferation of activated satellite cells and therefore progression of myogenesis. It appears that Tead proteins illicit repression of these pathways via a cross-talk at the onset of differentiation.

In addition, our data shows that Tead proteins also bind and activate critical Hippo cascade proteins such as Amotl2 and Lats2 during differentiation. Interestingly, Amotl2 and Lats2 are negative regulators of Yap function. Both Amotl2 and Lats2 can bind Yap at the tight junctions and promote contact mediated growth inhibition (Paramasivam et al., 2011; Zhao et al., 2011) by preventing nuclear localisation of Yap. This might be a negative feedback mechanism employed by Tead factors to progress from the state of proliferation to differentiation.

In brief, inhibition and cross-talk with TGF β signalling and Wnt signalling as well as negative feedback for Yap inhibition by Tead4 specifically, during myoblast differentiation open up areas of investigation of mechanisms of such cross-talk. It is interesting that Teads drive inhibition of three major pathways required for satellite cell proliferation and self-renewal thereby providing a check-point for the onset of differentiation.

2. Co-operation and synergy between Teads, MyoD and MyoG at muscle enhancers and epigenetic regulation of muscle enhancer function

We show that Tead1 co-localises with MyoD, MyoG and Mef2A at a number of enhancer sites in non-differentiated cells and Tead4 co-localises with MyoD and MyoG in a significant number of enhancer sites in differentiated C2C12 cells. It is well established that MyoD is

Discussion

expressed early and required for commitment to myoblast lineage (Rudnicki et al., 1993), which is subsequently followed by expression of Mef2 (Molkentin and Olson, 1996) and Myogenin (Hasty et al., 1993). It is clear now that Teads co-occupy many muscle enhancers along with MyoD and MyoG and both activate and repress genes to bring about differentiation (Blais et al., 2005). In fact, a detailed motif co-occurrence analysis at the sites commonly bound by Tead4, MyoD and MyoG reveal these muscle enhancers are often contain E-box, jun, fox, Tcf3, Runx1 and Klf5 binding motifs. This might perhaps represent a frequently active enhancer signature in differentiation. This is supported by the evidence that MyoD plays a role in recruitment of various temporally controlled transcription factors in myogenesis including c-Jun (Bengal et al., 1992), Fos (Li et al., 1992) and Runx1 (Umansky et al., 2015). MyoD is known to bind early in differentiation to active as well as poised enhancers (Blum et al., 2012) and remodels chromatin at MyoG and MyoG target genes at late stages of differentiation (de la Serna et al., 2005; Du et al., 2012). Both MyoD and MyoG act by recruiting Swi/Snf-Brg1 chromatin remodelling complexes to enhancers and promoters of these target genes. So, far no studies have identified how chromatin remodelling happens at Tead-bound promoters and enhancers. This could only partly be explained by the interaction of MyoG and MyoD with Brg1 (ATPase subunit) at the enhancers bound commonly by MyoD, MyoG and Tead factors, but would not explain how chromatin-remodelling factors are recruited at Tead-bound enhancers where there is no MyoD and Myog. Our proteomics data has also revealed that several members of FACT transcription activation complex can be found interacting with Tead4 in differentiated cells. This might be interesting as another study showed that MyoG interacts with and recruits FACT complex to its target genes (Lolis et al., 2013) We also identified peptides from Baf53a, a component of several chromatin remodelling complexes also shown to be required for maximal ATPase activity of BRG1 and for association of the BAF complex with chromatin (Nishimoto et al., 2012). Hence, epigenetic regulation at Tead factor occupied promoters and enhancers would be an important question to address in near future.

3. TEADs function in vivo in muscle development, physiology and pathophysiology

A) Teads in embryonic myogenesis and adult muscle regeneration

Embryonic myogenesis can be largely divided into the following sequential steps- limb bud migration of committed progenitors, proliferation, cell cycle arrest, myoblast fusion, myotube formation, maturation and eventually innervation (Perry and Rudnick, 2000). C2C12 or

Discussion

primary myoblast differentiation *in vitro* provide for a good model to study some of the critical steps including proliferation, cell cycle arrest, myoblast fusion, myotube formation, although the niche and environment of embryonic and regenerative myogenesis have their similarities and differences (Tajbakhsh, 2009), neither can be recapitulated *in vitro*. Given that our previous (Benhaddou et al., 2012) and current *in vitro* study on Tead4 and Tead1 clearly provide an indication for their implication in embryonic and regenerative myogenesis in co-operation with MyoD and MyoG. The induction of expression of the Tead factors, followed by Tead-mediated repression of *Ccnd1* and upregulation of their target genes such as *Cav3* and the embryonic (Myh3) and perinatal myosin (Myh8) heavy chains indicates that Teads may play an important role in terminal steps of embryonic myogenesis. Moreover, findings from Ribas et al (2011) strongly support this hypothesis as they showed that the Tead binding site is critical for the highly evolutionarily conserved ECR111 enhancer region to drive expression of *Mrf4/Myf5* in the ventral somites. Immunostaining showed that both Tead1 and Tead4 colocalise in the myotome at 10.5dpc and further they showed by ChIP experiments that both Tead1 and Tead4 can bind to ECR-111 MCAT element (Ribas et al., 2011). This is the first study to focus on expression and function of Teads in embryonic myogenesis. Further investigation on role of Teads can be performed by loss or gain of function mice transgenics specifically during embryonic myogenesis. While germ-line Tead4 KO is embryonic lethal (Yagi et al., 2007), we would like to take advantage of our in-house *Pax7::Cre-ER^{T2}::Tead4^{lox/lox}* mice to specifically induce deletion of *Tead4* in Pax7 +ve embryonic myogenic precursor cells and follow the embryonic and adult development of muscle. Embryonic myogenesis starts at 10.5dpc and Tead1 and Tead4 start to be expressed in somites from the start of embryonic myogenesis at 10.5dpc. For this, we plan to treat pregnant female mice with tamoxifen just prior to the start of somitogenesis and follow the expression of Tead4 and Tead1 and their target genes like the myosins during the embryonic muscle development and also here if Tead1 can compensate for the loss of Tead4.

Many of the Tead4 target genes like *Mef2c* (Liu et al., 2014), *Myh3*, *Myh8* and *Desmin* are also expressed during adult muscle regeneration (Schiaffino et al., 2015). Tead2 has been shown to act downstream of *Myod* in muscle regeneration (Zhao et al., 2006). We have also observed that Tead4 is induced in muscle regeneration following notexin injury (unpublished data). We will therefore employ *Pax7::Cre-ER^{T2}::Tead4^{lox/lox}* mice to study the effect of Tead4 loss in Pax7 +ve cell-mediated regeneration following Notexin injury. For this, Control and Mutant mice will be intraperitoneally injected with tamoxifen (1mg/day) for 4

consecutive days and 3 days later TA muscle will be subjected to notexin injury. Tissue will be harvested 3, 7, 14 and 28 days after injury in order to study the process of complete regeneration of muscle. Muscle cryosections will be stained for Myh3, Cav3 and other myogenic markers will be investigated at RNA and protein level.

B) Adult muscle plasticity

The adult skeletal muscle is a plastic tissue and plays an important function in the overall body metabolism. It mostly responds physiologically to changes in environmental and stress conditions by slow-to-fast or oxidative-to-glycolytic transition, which is elicited by major changes in gene expression program. Three important studies have shown that Tead1 positively regulates the slow-contractile type gene expression program. Tead1 expression is negatively regulated in fast-type fibres by thyroid hormone (TH) signalling via miR-133a1. The miR-133a1 is enriched in fast-twitch muscle and is responsible for inhibition of Tead1 expression in the fast-twitch muscle (Tsika et al., 2008). Interestingly, miR-133a1 specifically targeted only Tead1 mRNA for degradation. Tead4 mRNA levels were unaffected in C2C12 cells when treated with miR-133a1 mimics contrary to the strong decrease in expression of Tead1. In addition, Tead4 Chip-seq identified many muscle-specific microRNAs bound by Tead4, including miR-133b. This indicates that Tead1 and Tead4 may possess specific functions in context-dependent manner i.e. fibre-type dependent manner and their function may be regulated by miR133a and miR133b respectively. Although, miR133a/b have been shown to be dispensable for muscle development and regeneration (Boettger et al., 2014), they seem to have a role in fibre-type switch.

Another myomiR that is bound and regulated by Tead4 during C2C12 differentiation (Benhaddou et al., 2012), miR-206, was shown to be required for slow-fibre program and neuromuscular junction formation by suppressing HDAC4 that prevents MEF-2 dependent fast-to-slow-type remodelling (Cohen et al., 2009; Cohen et al., 2015).

In the light of above discussed literature, our preliminary data from *HSA::Cre-ER^{T2}::Tead4^{fllox/fllox}* mice indicates that Tead4 may be important in fibre-type or fibre-size at least in the TA muscle where Tead1 is not expressed due to inhibition by the mir-133/206 cluster and Tead4 might directly regulate expression of the several fibre-type specific genes. Therefore, we plan to perform a detailed analysis of fibre size and myosin composition along with different histochemical analyses (NADH and SDH staining) on different muscle types from the mice carrying deletion in Tead4 gene in adult muscle fibre.

C) Disease and pathophysiology

The function of Tead factors in muscle disease is a largely untouched question. No direct studies of loss or gain of function of Teads in muscle pathology in mouse disease models have been undertaken so far. Neither have there been any investigations of deregulation of Teads in human myopathic diseases. Indirect evidence like slow-fast type switch in mouse models of hypothyroidism via suppression of Tead1 may give clues of its role in denervation related myopathies (Iwaki et al., 2014).

Another elegant study recently showed that Tead co-factor Yap1 showed higher protein level and increased Yap1 copy number in human embryonal rhabdomyosarcoma (ERMS) and that inducible overexpression of constitutively active mutant Yap1 in mice lead to development of embryonal rhabdomyosarcoma in mouse skeletal muscle (Tremblay et al., 2014). Yap1 overexpression in ERMS lead to upregulation of many direct Tead1 targets that are usually down-regulated in differentiation including pro-proliferation genes such as *Ccnd1*, *Ctgf* and *Cyr61*, inhibitors of differentiation such as Id and twist proteins, while Yap1-Tead1 binding to the myogenic loci prevented Myod1 and Mef2c binding to the genes involved in cell cycle arrest and differentiation. This is concomitant with studies showing that during myogenic differentiation, Yap1 is required to be exported out of the nucleus (Watt et al., 2010), complemented with our finding that Tead1 binding to myogenic loci is lost or replaced by Tead4 binding that together with MyoG and MyoD regulates the expression of genes involved in early and late myogenic differentiation.

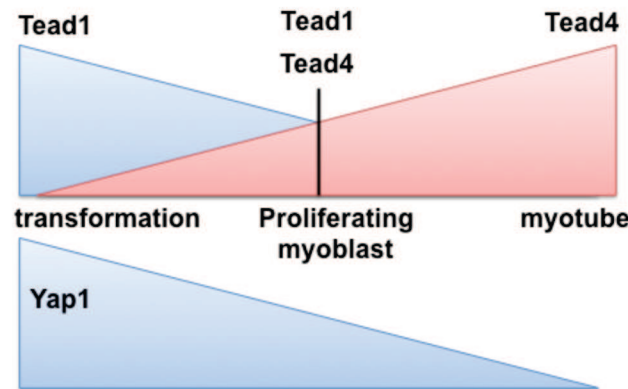


Figure 32. A model for TEAD-YAP mediated fine-tuning of proliferation and differentiation with Tead4 becoming the major positive regulator of myogenic differentiation while abrogation of YAP in co-operation with Tead1 function shifting the balance towards oncogenesis in muscle satellite cells.

Bibliography:

- Al-Qusairi, L. and Laporte, J. (2011). T-tubule biogenesis and triad formation in skeletal muscle and implication in human diseases. *Skelet Muscle* **1**, 26.
- Albert, T. K., Grote, K., Boeing, S. and Meisterernst, M. (2010). Basal core promoters control the equilibrium between negative cofactor 2 and preinitiation complexes in human cells. *Genome Biol* **11**, R33.
- Allen, R. E. and Boxhorn, L. K. (1987). Inhibition of skeletal muscle satellite cell differentiation by transforming growth factor-beta. *J Cell Physiol* **133**, 567-572.
- An, Y., Kang, Q., Zhao, Y., Hu, X. and Li, N. (2013). Lats2 modulates adipocyte proliferation and differentiation via hippo signaling. *PLoS One* **8**, e72042.
- Anbanandam, A., Albarado, D. C., Nguyen, C. T., Halder, G., Gao, X. and Veeraraghavan, S. (2006a). Insights into transcription enhancer factor 1 (TEF-1) activity from the solution structure of the TEA domain. *Proc Natl Acad Sci U S A* **103**, 17225-17230.
- Anders, S. and Huber, W. (2010). Differential expression analysis for sequence count data. *Genome Biol* **11**, R106.
- Anders, S., Pyl, P. T. and Huber, W. (2015). HTSeq--a Python framework to work with high-throughput sequencing data. *Bioinformatics* **31**, 166-169.
- Andrianopoulos, A. and Timberlake, W. E. (1991). ATTS, a new and conserved DNA binding domain. In *Plant Cell*, pp. 747-748. United states.
- (1994). The *Aspergillus nidulans* *abaA* gene encodes a transcriptional activator that acts as a genetic switch to control development. *Mol Cell Biol* **14**, 2503-2515.
- Asakura, A., Seale, P., Girgis-Gabardo, A. and Rudnicki, M. A. (2002). Myogenic specification of side population cells in skeletal muscle. *J Cell Biol* **159**, 123-134.
- Asaoka, Y., Hata, S., Namae, M., Furutani-Seiki, M. and Nishina, H. (2014). The Hippo pathway controls a switch between retinal progenitor cell proliferation and photoreceptor cell differentiation in zebrafish. *PLoS One* **9**, e97365.
- Asp, P., Blum, R., Vethantham, V., Parisi, F., Micsinai, M., Cheng, J., Bowman, C., Kluger, Y. and Dynlacht, B. D. (2011). Genome-wide remodeling of the epigenetic landscape during myogenic differentiation. *Proc Natl Acad Sci U S A* **108**, E149-158.
- Azaki, A., Lamont, L., Fineman, J. R. and He, Y. (2005). Divergent transcriptional enhancer factor-1 regulates the cardiac troponin T promoter. *Am J Physiol Cell Physiol* **289**, C1522-1534.

Bibliography

- Azakie, A., Larkin, S. B., Farrance, I. K., Grenningloh, G. and Ordahl, C. P. (1996a). DTEF-1, a novel member of the transcription enhancer factor-1 (TEF-1) multigene family. *J Biol Chem* **271**, 8260-8265.
- Batut, J., Duboe, C. and Vandell, L. (2011). The methyltransferases PRMT4/CARM1 and PRMT5 control differentially myogenesis in zebrafish. *PLoS One* **6**, e25427.
- Beauchamp, J. R., Heslop, L., Yu, D. S., Tajbakhsh, S., Kelly, R. G., Wernig, A., Buckingham, M. E., Partridge, T. A. and Zammit, P. S. (2000). Expression of CD34 and Myf5 defines the majority of quiescent adult skeletal muscle satellite cells. *J Cell Biol* **151**, 1221-1234.
- Belandia, B. and Parker, M. G. (2000). Functional interaction between the p160 coactivator proteins and the transcriptional enhancer factor family of transcription factors. *J Biol Chem* **275**, 30801-30805.
- Belotserkovskaya, R., Saunders, A., Lis, J. T. and Reinberg, D. (2004). Transcription through chromatin: understanding a complex FACT. *Biochim Biophys Acta* **1677**, 87-99.
- Bengal, E., Ransone, L., Scharfmann, R., Dwarki, V. J., Tapscott, S. J., Weintraub, H. and Verma, I. M. (1992). Functional antagonism between c-Jun and MyoD proteins: a direct physical association. *Cell* **68**, 507-519.
- Benhaddou, A., Keime, C., Ye, T., Morlon, A., Michel, I., Jost, B., Mengus, G. and Davidson, I. (2012). Transcription factor TEAD4 regulates expression of myogenin and the unfolded protein response genes during C2C12 cell differentiation. *Cell Death Differ* **19**, 220-231.
- Benjamini, Y. and Hechtlinger, Y. (2014). Discussion: An estimate of the science-wise false discovery rate and applications to top medical journals by Jager and Leek. *Biostatistics* **15**, 13-16; discussion 39-45.
- Berchtold, M. W., Brinkmeier, H. and Müntener, M. (2000). Calcium Ion in Skeletal Muscle: Its Crucial Role for Muscle Function, Plasticity, and Disease.
- Berthier, C. and Blaineau, S. (1997). Supramolecular organization of the subsarcolemmal cytoskeleton of adult skeletal muscle fibers. A review. *Biol Cell* **89**, 413-434.
- Biressi, S., Miyabara, E. H., Gopinath, S. D., Carlign, P. M. and Rando, T. A. (2014). A Wnt-TGFbeta2 axis induces a fibrogenic program in muscle stem cells from dystrophic mice. *Sci Transl Med* **6**, 267ra176.
- Biterge, B. and Schneider, R. (2014). Histone variants: key players of chromatin. *Cell Tissue Res* **356**, 457-466.
- Bladt, F., Riethmacher, D., Isenmann, S., Aguzzi, A. and Birchmeier, C. (1995). Essential role for the c-met receptor in the migration of myogenic precursor cells into the limb bud. *Nature* **376**, 768-771.
- Blais, A., Tsikitis, M., Acosta-Alvear, D., Sharan, R., Kluger, Y. and Dynlacht, B. D. (2005). An initial blueprint for myogenic differentiation. *Genes Dev* **19**, 553-569.
- Blaveri, E., Simko, J. P., Korkola, J. E., Brewer, J. L., Baehner, F., Mehta, K., Devries, S., Koppie, T., Pejavar, S., Carroll, P., et al. (2005). Bladder cancer outcome and subtype classification by gene expression. *Clin Cancer Res* **11**, 4044-4055.
- Blum, R. and Dynlacht, B. D. (2013). The role of MyoD1 and histone modifications in the activation of muscle enhancers. *Epigenetics* **8**, 778-784.
- Blum, R., Vethantham, V., Bowman, C., Rudnicki, M. and Dynlacht, B. D. (2012). Genome-wide identification of enhancers in skeletal muscle: the role of MyoD1. *Genes Dev* **26**, 2763-2779.
- Boettger, T., Wüst, S., Nolte, H. and Braun, T. (2014). The miR-206/133b cluster is dispensable for development, survival and regeneration of skeletal muscle. In *Skelet Muscle*.
- Brand-Saberi, B., Ebensperger, C., Wilting, J., Balling, R. and Christ, B. (1993). The ventralizing effect of the notochord on somite differentiation in chick embryos. *Anat Embryol (Berl)* **188**, 239-245.
- Bray, S. (1999). Drosophila development: Scalloped and Vestigial take wing. *Curr Biol* **9**, R245-247.
- Brooke, M. H. and Kaiser, K. K. (1970). Muscle fiber types: how many and what kind? *Arch Neurol* **23**, 369-379.
- Bryson-Richardson, R. J. and Currie, P. D. (2008). The genetics of vertebrate myogenesis. *Nat Rev Genet* **9**, 632-646.

Bibliography

- Buckingham, M. and Rigby, P. W.** (2014). Gene regulatory networks and transcriptional mechanisms that control myogenesis. *Dev Cell* **28**, 225-238.
- Burke, T. W. and Kadonaga, J. T.** (1996). Drosophila TFIID binds to a conserved downstream basal promoter element that is present in many TATA-box-deficient promoters. *Genes Dev* **10**, 711-724.
- Butler, A. J. and Ordahl, C. P.** (1999). Poly(ADP-Ribose) Polymerase Binds with Transcription Enhancer Factor 1 to MCAT1 Elements To Regulate Muscle-Specific Transcription. In *Mol Cell Biol*, pp. 296-306.
- Camargo, F. D., Gokhale, S., Johnnidis, J. B., Fu, D., Bell, G. W., Jaenisch, R. and Brummelkamp, T. R.** (2007). YAP1 increases organ size and expands undifferentiated progenitor cells. *Curr Biol* **17**, 2054-2060.
- Campbell, K. P., Knudson, C. M., Imagawa, T., Leung, A. T., Sutko, J. L., Kahl, S. D., Raab, C. R. and Madson, L.** (1987). Identification and characterization of the high affinity [3H]ryanodine receptor of the junctional sarcoplasmic reticulum Ca²⁺ release channel. *J Biol Chem* **262**, 6460-6463.
- Cao, Y., Yao, Z., Sarkar, D., Lawrence, M., Sanchez, G. J., Parker, M. H., MacQuarrie, K. L., Davison, J., Morgan, M. T., Ruzzo, W. L., et al.** (2010). Genome-wide MyoD binding in skeletal muscle cells: a potential for broad cellular reprogramming. *Dev Cell* **18**, 662-674.
- Carlini, L. E., Getz, M. J., Strauch, A. R. and Kelm, R. J., Jr.** (2002). Cryptic MCAT enhancer regulation in fibroblasts and smooth muscle cells. Suppression of TEF-1 mediated activation by the single-stranded DNA-binding proteins, Pur alpha, Pur beta, and MSY1. *J Biol Chem* **277**, 8682-8692.
- Carninci, P., Sandelin, A., Lenhard, B., Katayama, S., Shimokawa, K., Ponjavic, J., Semple, C. A., Taylor, M. S., Engstrom, P. G., Frith, M. C., et al.** (2006). Genome-wide analysis of mammalian promoter architecture and evolution. *Nat Genet* **38**, 626-635.
- Carson, J. A., Schwartz, R. J. and Booth, F. W.** (1996). SRF and TEF-1 control of chicken skeletal alpha-actin gene during slow-muscle hypertrophy. *Am J Physiol* **270**, C1624-1633.
- Carson, J. A., Yan, Z., Booth, F. W., Coleman, M. E., Schwartz, R. J. and Stump, C. S.** (1995). Regulation of skeletal alpha-actin promoter in young chickens during hypertrophy caused by stretch overload. *Am J Physiol* **268**, C918-924.
- Cebola, I., Rodriguez-Segui, S. A., Cho, C. H., Bessa, J., Rovira, M., Luengo, M., Chhatrivala, M., Berry, A., Ponsa-Cobas, J., Maestro, M. A., et al.** (2015a). TEAD and YAP regulate the enhancer network of human embryonic pancreatic progenitors. *Nat Cell Biol* **17**, 615-626.
- Chakroun, I., Yang, D., Girgis, J., Gunasekharan, A., Phenix, H., Kaern, M. and Blais, A.** (2015). Genome-wide association between Six4, MyoD and the histone demethylase Utx during myogenesis. *Faseb j.*
- Chalkley, G. E. and Verrijzer, C. P.** (1999). DNA binding site selection by RNA polymerase II TAFs: a TAF(II)250-TAF(II)150 complex recognizes the initiator. *Embo j* **18**, 4835-4845.
- Chan, E. H., Nousiainen, M., Chalamalasetty, R. B., Schafer, A., Nigg, E. A. and Sillje, H. H.** (2005). The Ste20-like kinase Mst2 activates the human large tumor suppressor kinase Lats1. *Oncogene* **24**, 2076-2086.
- Chen, H. H., Baty, C. J., Maeda, T., Brooks, S., Baker, L. C., Ueyama, T., Gursoy, E., Saba, S., Salama, G., London, B., et al.** (2004a). Transcription enhancer factor-1-related factor-transgenic mice develop cardiac conduction defects associated with altered connexin phosphorylation. *Circulation* **110**, 2980-2987.
- Chen, H. H., Maeda, T., Mullett, S. J. and Stewart, A. F.** (2004b). Transcription cofactor Vgl-2 is required for skeletal muscle differentiation. *Genesis* **39**, 273-279.
- Chen, H. H., Mullett, S. J. and Stewart, A. F.** (2004c). Vgl-4, a novel member of the vestigial-like family of transcription cofactors, regulates alpha1-adrenergic activation of gene expression in cardiac myocytes. *J Biol Chem* **279**, 30800-30806.
- Chen, L., Chan, S. W., Zhang, X., Walsh, M., Lim, C. J., Hong, W. and Song, H.** (2010). Structural basis of YAP recognition by TEAD4 in the hippo pathway. *Genes Dev* **24**, 290-300.

Bibliography

- Chen, X., Hiller, M., Sancak, Y. and Fuller, M. T.** (2005). Tissue-specific TAFs counteract Polycomb to turn on terminal differentiation. *Science* **310**, 869-872.
- Chen, Z., Friedrich, G. A. and Soriano, P.** (1994). Transcriptional enhancer factor 1 disruption by a retroviral gene trap leads to heart defects and embryonic lethality in mice. *Genes Dev* **8**, 2293-2301.
- Chin, E. R., Olson, E. N., Richardson, J. A., Yang, Q., Humphries, C., Shelton, J. M., Wu, H., Zhu, W., Bassel-Duby, R. and Williams, R. S.** (1998). A calcineurin-dependent transcriptional pathway controls skeletal muscle fiber type. *Genes Dev* **12**, 2499-2509.
- Clark KA , e. a.** (2015). Striated muscle cytoarchitecture: an intricate web of form and function. - PubMed - NCBI.
- Cogan, J. G., Sun, S., Stoflet, E. S., Schmidt, L. J., Getz, M. J. and Strauch, A. R.** (1995). Plasticity of vascular smooth muscle alpha-actin gene transcription. Characterization of multiple, single-, and double-strand specific DNA-binding proteins in myoblasts and fibroblasts. *J Biol Chem* **270**, 11310-11321.
- Cohen, T. J., Barrientos, T., Hartman, Z. C., Garvey, S. M., Cox, G. A. and Yao, T. P.** (2009). The deacetylase HDAC4 controls myocyte enhancing factor-2-dependent structural gene expression in response to neural activity. *Faseb j* **23**, 99-106.
- Cohen, T. J., Choi, M. C., Kapur, M., Lira, V. A., Yan, Z. and Yao, T. P.** (2015). HDAC4 regulates muscle fiber type-specific gene expression programs. *Mol Cells* **38**, 343-348.
- Conboy, I. M. and Rando, T. A.** (2002a). The regulation of Notch signaling controls satellite cell activation and cell fate determination in postnatal myogenesis. *Dev Cell* **3**, 397-409.
- Condon, K., Silberstein, L., Blau, H. M. and Thompson, W. J.** (1990). Development of muscle fiber types in the prenatal rat hindlimb. *Dev Biol* **138**, 256-274.
- Cornelison, D. D., Filla, M. S., Stanley, H. M., Rapraeger, A. C. and Olwin, B. B.** (2001). Syndecan-3 and syndecan-4 specifically mark skeletal muscle satellite cells and are implicated in satellite cell maintenance and muscle regeneration. *Dev Biol* **239**, 79-94.
- Crabtree, G. R.** (1999). Generic signals and specific outcomes: signaling through Ca²⁺, calcineurin, and NF-AT. *Cell* **96**, 611-614.
- Craig, R. and Woodhead, J. L.** (2006). Structure and function of myosin filaments. *Curr Opin Struct Biol* **16**, 204-212.
- Creppe, C., Janich, P., Cantarino, N., Noguera, M., Valero, V., Musulen, E., Douet, J., Posavec, M., Martin-Caballero, J., Sumoy, L., et al.** (2012). MacroH2A1 regulates the balance between self-renewal and differentiation commitment in embryonic and adult stem cells. *Mol Cell Biol* **32**, 1442-1452.
- Cridland, J. A., Curley, E. Z., Wykes, M. N., Schroder, K., Sweet, M. J., Roberts, T. L., Ragan, M. A., Kassahn, K. S. and Stacey, K. J.** (2012a). The mammalian PYHIN gene family: phylogeny, evolution and expression. *BMC Evol Biol* **12**, 140.
- Dacwag, C. S., Ohkawa, Y., Pal, S., Sif, S. and Imbalzano, A. N.** (2007). The protein arginine methyltransferase Prmt5 is required for myogenesis because it facilitates ATP-dependent chromatin remodeling. *Mol Cell Biol* **27**, 384-394.
- Datta, B., Min, W., Burma, S. and Lengyel, P.** (1998). Increase in p202 expression during skeletal muscle differentiation: inhibition of MyoD protein expression and activity by p202. *Mol Cell Biol* **18**, 1074-1083.
- Davidson, I., Xiao, J. H., Rosales, R., Staub, A. and Chambon, P.** (1988). The HeLa cell protein TEF-1 binds specifically and cooperatively to two SV40 enhancer motifs of unrelated sequence. *Cell* **54**, 931-942.
- Day, K., Shefer, G., Richardson, J. B., Enikolopov, G. and Yablonka-Reuveni, Z.** (2007). Nestin-GFP reporter expression defines the quiescent state of skeletal muscle satellite cells. *Dev Biol* **304**, 246-259.
- De Koninck, P. and Schulman, H.** (1998). Sensitivity of CaM kinase II to the frequency of Ca²⁺ oscillations. *Science* **279**, 227-230.
- de la Serna, I. L., Carlson, K. A. and Imbalzano, A. N.** (2001a). Mammalian SWI/SNF complexes promote MyoD-mediated muscle differentiation. *Nat Genet* **27**, 187-190.

Bibliography

- de la Serna, I. L., Ohkawa, Y., Berkes, C. A., Bergstrom, D. A., Dacwag, C. S., Tapscott, S. J. and Imbalzano, A. N. (2005). MyoD targets chromatin remodeling complexes to the myogenin locus prior to forming a stable DNA-bound complex. *Mol Cell Biol* **25**, 3997-4009.
- de la Serna, I. L., Roy, K., Carlson, K. A. and Imbalzano, A. N. (2001b). MyoD can induce cell cycle arrest but not muscle differentiation in the presence of dominant negative SWI/SNF chromatin remodeling enzymes. *J Biol Chem* **276**, 41486-41491.
- De Santa, F., Barozzi, I., Mietton, F., Ghisletti, S., Polletti, S., Tusi, B. K., Muller, H., Ragoussis, J., Wei, C. L. and Natoli, G. (2010). A large fraction of extragenic RNA pol II transcription sites overlap enhancers. *PLoS Biol* **8**, e1000384.
- Deato, M. D., Marr, M. T., Sottero, T., Inouye, C., Hu, P. and Tjian, R. (2008). MyoD targets TAF3/TRF3 to activate myogenin transcription. *Mol Cell* **32**, 96-105.
- Deato, M. D. and Tjian, R. (2007). Switching of the core transcription machinery during myogenesis. *Genes Dev* **21**, 2137-2149.
- Dekhuijzen, P. N., Gayan-Ramirez, G., Bisschop, A., De Bock, V., Dom, R. and Decramer, M. (1995). Corticosteroid treatment and nutritional deprivation cause a different pattern of atrophy in rat diaphragm. *J Appl Physiol* (1985) **78**, 629-637.
- Dellavalle, A., Maroli, G., Covarello, D., Azzoni, E., Innocenzi, A., Perani, L., Antonini, S., Sambasivan, R., Brunelli, S., Tajbakhsh, S., et al. (2011). Pericytes resident in postnatal skeletal muscle differentiate into muscle fibres and generate satellite cells. *Nat Commun* **2**, 499.
- Delling, U., Tureckova, J., Lim, H. W., De Windt, L. J., Rotwein, P. and Molkentin, J. D. (2000). A calcineurin-NFATc3-dependent pathway regulates skeletal muscle differentiation and slow myosin heavy-chain expression. *Mol Cell Biol* **20**, 6600-6611.
- DeNardi, C., Ausoni, S., Moretti, P., Gorza, L., Velleca, M., Buckingham, M. and Schiaffino, S. (1993). Type 2X-myosin heavy chain is coded by a muscle fiber type-specific and developmentally regulated gene. *J Cell Biol* **123**, 823-835.
- Deng, W., Malecova, B., Oelgeschlager, T. and Roberts, S. G. (2009). TFIIB recognition elements control the TFIIA-NC2 axis in transcriptional regulation. *Mol Cell Biol* **29**, 1389-1400.
- Deng, W. and Roberts, S. G. (2005). A core promoter element downstream of the TATA box that is recognized by TFIIB. *Genes Dev* **19**, 2418-2423.
- Diepenbruck, M., Waldmeier, L., Ivanek, R., Berninger, P., Arnold, P., van Nimwegen, E. and Christofori, G. (2014). Tead2 expression levels control the subcellular distribution of Yap and Taz, zyxin expression and epithelial-mesenchymal transition. *J Cell Sci* **127**, 1523-1536.
- Dietrich, S., Abou-Rebyeh, F., Brohmann, H., Bladt, F., Sonnenberg-Riethmacher, E., Yamaai, T., Lumsden, A., Brand-Saberi, B. and Birchmeier, C. (1999). The role of SF/HGF and c-Met in the development of skeletal muscle. *Development* **126**, 1621-1629.
- Ding, B., Liu, C. J., Huang, Y., Hickey, R. P., Yu, J., Kong, W. and Lengyel, P. (2006). p204 is required for the differentiation of P19 murine embryonal carcinoma cells to beating cardiac myocytes: its expression is activated by the cardiac Gata4, Nkx2.5, and Tbx5 proteins. *J Biol Chem* **281**, 14882-14892.
- Dong, J., Feldmann, G., Huang, J., Wu, S., Zhang, N., Comerford, S. A., Gayyed, M. F., Anders, R. A., Maitra, A. and Pan, D. (2007). Elucidation of a universal size-control mechanism in Drosophila and mammals. *Cell* **130**, 1120-1133.
- Drane, P., Ouararhni, K., Depaux, A., Shuaib, M. and Hamiche, A. (2010). The death-associated protein DAXX is a novel histone chaperone involved in the replication-independent deposition of H3.3. *Genes Dev* **24**, 1253-1265.
- Du, C., Jin, Y. Q., Qi, J. J., Ji, Z. X., Li, S. Y., An, G. S., Jia, H. T. and Ni, J. H. (2012). Effects of myogenin on expression of late muscle genes through MyoD-dependent chromatin remodeling ability of myogenin. *Mol Cells* **34**, 133-142.
- Ehlers, M. L., Celona, B. and Black, B. L. (2014). NFATc1 controls skeletal muscle fiber type and is a negative regulator of MyoD activity. *Cell Rep* **8**, 1639-1648.
- Emami, K. H., Jain, A. and Smale, S. T. (1997). Mechanism of synergy between TATA and initiator: synergistic binding of TFIID following a putative TFIIA-induced isomerization. *Genes Dev* **11**, 3007-3019.

Bibliography

- Fan, C. M. and Tessier-Lavigne, M.** (1994). Patterning of mammalian somites by surface ectoderm and notochord: evidence for sclerotome induction by a hedgehog homolog. *Cell* **79**, 1175-1186.
- Ferrari, G., Cusella-De Angelis, G., Coletta, M., Paolucci, E., Stornaiuolo, A., Cossu, G. and Mavilio, F.** (1998). Muscle regeneration by bone marrow-derived myogenic progenitors. *Science* **279**, 1528-1530.
- Fong, A. P., Yao, Z., Zhong, J. W., Cao, Y., Ruzzo, W. L., Gentleman, R. C. and Tapscott, S. J.** (2012). Genetic and epigenetic determinants of neurogenesis and myogenesis. *Dev Cell* **22**, 721-735.
- Forde, J. E. and Dale, T. C.** (2007). Glycogen synthase kinase 3: a key regulator of cellular fate. *Cell Mol Life Sci* **64**, 1930-1944.
- Fossdal, R., Jonasson, F., Kristjansdottir, G. T., Kong, A., Stefansson, H., Gosh, S., Gulcher, J. R. and Stefansson, K.** (2004). A novel TEAD1 mutation is the causative allele in Sveinsson's chorioretinal atrophy (helicoid peripapillary chorioretinal degeneration). *Hum Mol Genet* **13**, 975-981.
- Gan, Q., Yoshida, T., Li, J. and Owens, G. K.** (2007). Smooth muscle cells and myofibroblasts use distinct transcriptional mechanisms for smooth muscle alpha-actin expression. *Circ Res* **101**, 883-892.
- Gautel, M., Mues, A. and Young, P.** (1999). Control of sarcomeric assembly: the flow of information on titin. *Rev Physiol Biochem Pharmacol* **138**, 97-137.
- Gershenson, N. I. and Ioshikhes, I. P.** (2005). Synergy of human Pol II core promoter elements revealed by statistical sequence analysis. *Bioinformatics* **21**, 1295-1300.
- Gianakopoulos, P. J., Mehta, V., Voronova, A., Cao, Y., Yao, Z., Coutu, J., Wang, X., Waddington, M. S., Tapscott, S. J. and Skerjanc, I. S.** (2011). MyoD directly up-regulates premyogenic mesoderm factors during induction of skeletal myogenesis in stem cells. *J Biol Chem* **286**, 2517-2525.
- Giordani, J., Bajard, L., Demignon, J., Daubas, P., Buckingham, M. and Maire, P.** (2007a). Six proteins regulate the activation of Myf5 expression in embryonic mouse limbs. *Proc Natl Acad Sci U S A* **104**, 11310-11315.
- Goodman CA , e. a.** (2015). Yes-Associated Protein is up-regulated by mechanical overload and is sufficient to induce skeletal muscle hypertrophy. - PubMed - NCBI.
- Gordon, A. M., Homsher, E. and Regnier, M.** (2000). Regulation of contraction in striated muscle. *Physiol Rev* **80**, 853-924.
- Goulding, M., Lumsden, A. and Paquette, A. J.** (1994). Regulation of Pax-3 expression in the dermomyotome and its role in muscle development. *Development* **120**, 957-971.
- Gregorio, C. C., Granzier, H., Sorimachi, H. and Labeit, S.** (1999). Muscle assembly: a titanic achievement? *Curr Opin Cell Biol* **11**, 18-25.
- Grifone, R., Demignon, J., Giordani, J., Niro, C., Souil, E., Bertin, F., Laclef, C., Xu, P. X. and Maire, P.** (2007). Eya1 and Eya2 proteins are required for hypaxial somitic myogenesis in the mouse embryo. *Dev Biol* **302**, 602-616.
- Grifone, R., Demignon, J., Houbron, C., Souil, E., Niro, C., Seller, M. J., Hamard, G. and Maire, P.** (2005). Six1 and Six4 homeoproteins are required for Pax3 and Mrf expression during myogenesis in the mouse embryo. *Development* **132**, 2235-2249.
- Gunther, S., Mielcarek, M., Kruger, M. and Braun, T.** (2004). VITO-1 is an essential cofactor of TEF1-dependent muscle-specific gene regulation. *Nucleic Acids Res* **32**, 791-802.
- Gupta, M., Kogut, P., Davis, F. J., Belaguli, N. S., Schwartz, R. J. and Gupta, M. P.** (2001). Physical interaction between the MADS box of serum response factor and the TEA/ATTS DNA-binding domain of transcription enhancer factor-1. *J Biol Chem* **276**, 10413-10422.
- Gupta, M. P., Amin, C. S., Gupta, M., Hay, N. and Zak, R.** (1997). Transcription enhancer factor 1 interacts with a basic helix-loop-helix zipper protein, Max, for positive regulation of cardiac alpha-myosin heavy-chain gene expression. *Mol Cell Biol* **17**, 3924-3936.
- Gupta, M. P., Kogut, P. and Gupta, M.** (2000). Protein kinase-A dependent phosphorylation of transcription enhancer factor-1 represses its DNA-binding activity but enhances its gene activation ability. *Nucleic Acids Res* **28**, 3168-3177.

Bibliography

- Guth, L. and Samaha, F. J.** (1969). Qualitative differences between actomyosin ATPase of slow and fast mammalian muscle. *Exp Neurol* **25**, 138-152.
- Halder, G., Polaczyk, P., Kraus, M. E., Hudson, A., Kim, J., Laughon, A. and Carroll, S.** (1998). The Vestigial and Scalloped proteins act together to directly regulate wing-specific gene expression in *Drosophila*. *Genes Dev* **12**, 3900-3909.
- Hall, Z. W. and Sanes, J. R.** (1993). Synaptic structure and development: the neuromuscular junction. *Cell* **72 Suppl**, 99-121.
- Halperin, D. S., Pan, C., Lusic, A. J. and Tontonoz, P.** (2013). Vestigial-like 3 is an inhibitor of adipocyte differentiation. *J Lipid Res* **54**, 473-481.
- Han, D., Byun, S. H., Park, S., Kim, J., Kim, I., Ha, S., Kwon, M. and Yoon, K.** (2015). YAP/TAZ enhance mammalian embryonic neural stem cell characteristics in a Tead-dependent manner. *Biochem Biophys Res Commun* **458**, 110-116.
- Han, W., Jung, E. M., Cho, J., Lee, J. W., Hwang, K. T., Yang, S. J., Kang, J. J., Bae, J. Y., Jeon, Y. K., Park, I. A., et al.** (2008). DNA copy number alterations and expression of relevant genes in triple-negative breast cancer. *Genes Chromosomes Cancer* **47**, 490-499.
- Handschin, C., Chin, S., Li, P., Liu, F., Maratos-Flier, E., Lebrasseur, N. K., Yan, Z. and Spiegelman, B. M.** (2007). Skeletal muscle fiber-type switching, exercise intolerance, and myopathy in PGC-1 α muscle-specific knock-out animals. *J Biol Chem* **282**, 30014-30021.
- Handschin, C., Rhee, J., Lin, J., Tarr, P. T. and Spiegelman, B. M.** (2003). An autoregulatory loop controls peroxisome proliferator-activated receptor gamma coactivator 1 α expression in muscle. *Proc Natl Acad Sci U S A* **100**, 7111-7116.
- Harada, A., Mallappa, C., Okada, S., Butler, J. T., Baker, S. P., Lawrence, J. B., Ohkawa, Y. and Imbalzano, A. N.** (2015). Spatial re-organization of myogenic regulatory sequences temporally controls gene expression. *Nucleic Acids Res* **43**, 2008-2021.
- Hasty, P., Bradley, A., Morris, J. H., Edmondson, D. G., Venuti, J. M., Olson, E. N. and Klein, W. H.** (1993). Muscle deficiency and neonatal death in mice with a targeted mutation in the myogenin gene. *Nature* **364**, 501-506.
- Hawke, T. J. and Garry, D. J.** (2001). Myogenic satellite cells: physiology to molecular biology. *J Appl Physiol (1985)* **91**, 534-551.
- Heanue, T. A., Reshef, R., Davis, R. J., Mardon, G., Oliver, G., Tomarev, S., Lassar, A. B. and Tabin, C. J.** (1999). Synergistic regulation of vertebrate muscle development by Dach2, Eya2, and Six1, homologs of genes required for *Drosophila* eye formation. *Genes Dev* **13**, 3231-3243.
- Helias-Rodzewicz, Z., Perot, G., Chibon, F., Ferreira, C., Lagarde, P., Terrier, P., Coindre, J. M. and Aurias, A.** (2010). YAP1 and VGLL3, encoding two cofactors of TEAD transcription factors, are amplified and overexpressed in a subset of soft tissue sarcomas. *Genes Chromosomes Cancer* **49**, 1161-1171.
- Herquel, B., Ouararhni, K., Martianov, I., Le Gras, S., Ye, T., Keime, C., Lerouge, T., Jost, B., Cammas, F., Losson, R., et al.** (2013). Trim24-repressed VL30 retrotransposons regulate gene expression by producing noncoding RNA. *Nat Struct Mol Biol* **20**, 339-346.
- Heszele, M. F. and Price, S. R.** (2004). Insulin-like growth factor I: the yin and yang of muscle atrophy. *Endocrinology* **145**, 4803-4805.
- Hnisz, D., Abraham, B. J., Lee, T. I., Lau, A., Saint-Andre, V., Sigova, A. A., Hoke, H. A. and Young, R. A.** (2013). Super-enhancers in the control of cell identity and disease. *Cell* **155**, 934-947.
- Home, P., Saha, B., Ray, S., Dutta, D., Gunewardena, S., Yoo, B., Pal, A., Vivian, J. L., Larson, M., Petroff, M., et al.** (2012). Altered subcellular localization of transcription factor TEAD4 regulates first mammalian cell lineage commitment. *Proc Natl Acad Sci U S A* **109**, 7362-7367.
- Huang, J., Wu, S., Barrera, J., Matthews, K. and Pan, D.** (2005). The Hippo signaling pathway coordinately regulates cell proliferation and apoptosis by inactivating Yorkie, the *Drosophila* Homolog of YAP. *Cell* **122**, 421-434.
- Hucl, T., Brody, J. R., Gallmeier, E., Iacobuzio-Donahue, C. A., Farrance, I. K. and Kern, S. E.** (2007). High cancer-specific expression of mesothelin (MSLN) is attributable to an upstream

Bibliography

- enhancer containing a transcription enhancer factor dependent MCAT motif. *Cancer Res* **67**, 9055-9065.
- Huey, K. A. and Bodine, S. C.** (1998). Changes in myosin mRNA and protein expression in denervated rat soleus and tibialis anterior. *Eur J Biochem* **256**, 45-50.
- Huey KA , e. a.** (2003). Transcriptional regulation of the type I myosin heavy chain gene in denervated rat soleus. - PubMed - NCBI.
- Husmann, I., Soulet, L., Gautron, J., Martelly, I. and Barritault, D.** (1996). Growth factors in skeletal muscle regeneration. *Cytokine Growth Factor Rev* **7**, 249-258.
- Huxley, H. E. and Hanson, J.** (1957). Quantitative studies on the structure of cross-striated myofibrils. I. Investigations by interference microscopy. *Biochim Biophys Acta* **23**, 229-249.
- Ishiji, T., Lace, M. J., Parkkinen, S., Anderson, R. D., Haugen, T. H., Cripe, T. P., Xiao, J. H., Davidson, I., Chambon, P. and Turek, L. P.** (1992). Transcriptional enhancer factor (TEF)-1 and its cell-specific co-activator activate human papillomavirus-16 E6 and E7 oncogene transcription in keratinocytes and cervical carcinoma cells. *Embo j* **11**, 2271-2281.
- Iwaki, H., Sasaki, S., Matsushita, A., Ohba, K., Matsunaga, H., Misawa, H., Oki, Y., Ishizuka, K., Nakamura, H. and Suda, T.** (2014). Essential role of TEA domain transcription factors in the negative regulation of the MYH 7 gene by thyroid hormone and its receptors. *PLoS One* **9**, e88610.
- Jacquemin, P., Hwang, J. J., Martial, J. A., Dolle, P. and Davidson, I.** (1996). A novel family of developmentally regulated mammalian transcription factors containing the TEA/ATTS DNA binding domain. *J Biol Chem* **271**, 21775-21785.
- Jacquemin, P., Martial, J. A. and Davidson, I.** (1997). Human TEF-5 is preferentially expressed in placenta and binds to multiple functional elements of the human chorionic somatomammotropin-B gene enhancer. *J Biol Chem* **272**, 12928-12937.
- Jarriault, S., Brou, C., Logeat, F., Schroeter, E. H., Kopan, R. and Israel, A.** (1995). Signalling downstream of activated mammalian Notch. *Nature* **377**, 355-358.
- Jemc, J. and Rebay, I.** (2007). Identification of transcriptional targets of the dual-function transcription factor/phosphatase eyes absent. *Dev Biol* **310**, 416-429.
- Jiang, S. W., Dong, M., Trujillo, M. A., Miller, L. J. and Eberhardt, N. L.** (2001). DNA binding of TEA/ATTS domain factors is regulated by protein kinase C phosphorylation in human choriocarcinoma cells. *J Biol Chem* **276**, 23464-23470.
- Jones, N. C., Fedorov, Y. V., Rosenthal, R. S. and Olwin, B. B.** (2001). ERK1/2 is required for myoblast proliferation but is dispensable for muscle gene expression and cell fusion. *J Cell Physiol* **186**, 104-115.
- Jones, N. C., Tyner, K. J., Nibarger, L., Stanley, H. M., Cornelison, D. D., Fedorov, Y. V. and Olwin, B. B.** (2005). The p38alpha/beta MAPK functions as a molecular switch to activate the quiescent satellite cell. *J Cell Biol* **169**, 105-116.
- Jostes, B., Walther, C. and Gruss, P.** (1990). The murine paired box gene, Pax7, is expressed specifically during the development of the nervous and muscular system. *Mech Dev* **33**, 27-37.
- Juan, A. H., Kumar, R. M., Marx, J. G., Young, R. A. and Sartorelli, V.** (2009). Mir-214-dependent regulation of the polycomb protein Ezh2 in skeletal muscle and embryonic stem cells. *Mol Cell* **36**, 61-74.
- Judson, R. N., Gray, S. R., Walker, C., Carroll, A. M., Itzstein, C., Lionikas, A., Zammit, P. S., De Bari, C. and Wackerhage, H.** (2013). Constitutive expression of Yes-associated protein (Yap) in adult skeletal muscle fibres induces muscle atrophy and myopathy. *PLoS One* **8**, e59622.
- Judson, R. N., Tremblay, A. M., Knopp, P., White, R. B., Urcia, R., De Bari, C., Zammit, P. S., Camargo, F. D. and Wackerhage, H.** (2012). The Hippo pathway member Yap plays a key role in influencing fate decisions in muscle satellite cells. *J Cell Sci* **125**, 6009-6019.
- Juven-Gershon, T. and Kadonaga, J. T.** (2010). Regulation of Gene Expression via the Core Promoter and the Basal Transcriptional Machinery. *Dev Biol* **339**, 225-229.

Bibliography

- Kaneko, K. J., Cullinan, E. B., Latham, K. E. and DePamphilis, M. L.** (1997). Transcription factor mTEAD-2 is selectively expressed at the beginning of zygotic gene expression in the mouse. *Development* **124**, 1963-1973.
- Kaneko, K. J. and DePamphilis, M. L.** (2013). TEAD4 establishes the energy homeostasis essential for blastocoel formation. *Development* **140**, 3680-3690.
- Kaneko, K. J., Kohn, M. J., Liu, C. and DePamphilis, M. L.** (2007). Transcription factor TEAD2 is involved in neural tube closure. *Genesis* **45**, 577-587.
- Kariya, K., Karns, L. R. and Simpson, P. C.** (1994). An enhancer core element mediates stimulation of the rat beta-myosin heavy chain promoter by an alpha 1-adrenergic agonist and activated beta-protein kinase C in hypertrophy of cardiac myocytes. *J Biol Chem* **269**, 3775-3782.
- Karns, L. R., Kariya, K. and Simpson, P. C.** (1995). M-CAT, CArG, and Sp1 elements are required for alpha 1-adrenergic induction of the skeletal alpha-actin promoter during cardiac myocyte hypertrophy. Transcriptional enhancer factor-1 and protein kinase C as conserved transducers of the fetal program in cardiac growth. *J Biol Chem* **270**, 410-417.
- Kathleen A. Clark, Abigail S. McElhinny, Mary C. Beckerle and Gregorio, C. C.** (2003). STRIATED MUSCLE CYTOARCHITECTURE: An Intricate Web of Form and Function. <http://dx.doi.org/10.1146/annurev.cellbio.18.012502.105840>.
- Kaufmann, J. and Smale, S. T.** (1994). Direct recognition of initiator elements by a component of the transcription factor IID complex. *Genes Dev* **8**, 821-829.
- Kelm, R. J., Jr., Cogan, J. G., Elder, P. K., Strauch, A. R. and Getz, M. J.** (1999). Molecular interactions between single-stranded DNA-binding proteins associated with an essential MCAT element in the mouse smooth muscle alpha-actin promoter. *J Biol Chem* **274**, 14238-14245.
- Kelm, R. J., Jr., Elder, P. K., Strauch, A. R. and Getz, M. J.** (1997). Sequence of cDNAs encoding components of vascular actin single-stranded DNA-binding factor 2 establish identity to Puralpha and Purbeta. *J Biol Chem* **272**, 26727-26733.
- Kiefer, J. C. and Hauschka, S. D.** (2001). Myf-5 is transiently expressed in nonmuscle mesoderm and exhibits dynamic regional changes within the presegmented mesoderm and somites I-IV. *Dev Biol* **232**, 77-90.
- Kim, D., Pertea, G., Trapnell, C., Pimentel, H., Kelley, R. and Salzberg, S. L.** (2013). TopHat2: accurate alignment of transcriptomes in the presence of insertions, deletions and gene fusions. *Genome Biol* **14**, R36.
- Kim, T. K., Hemberg, M., Gray, J. M., Costa, A. M., Bear, D. M., Wu, J., Harmin, D. A., Laptewicz, M., Barbara-Haley, K., Kuersten, S., et al.** (2010). Widespread transcription at neuronal activity-regulated enhancers. *Nature* **465**, 182-187.
- Kivela, R., Kyrolainen, H., Selanne, H., Komi, P. V., Kainulainen, H. and Vihko, V.** (2007). A single bout of exercise with high mechanical loading induces the expression of Cyr61/CCN1 and CTGF/CCN2 in human skeletal muscle. *J Appl Physiol (1985)* **103**, 1395-1401.
- Knight, J. F., Shepherd, C. J., Rizzo, S., Brewer, D., Jhavar, S., Dodson, A. R., Cooper, C. S., Eeles, R., Falconer, A., Kovacs, G., et al.** (2008). TEAD1 and c-Cbl are novel prostate basal cell markers that correlate with poor clinical outcome in prostate cancer. *Br J Cancer* **99**, 1849-1858.
- Knoepfler, P. S., Bergstrom, D. A., Uetsuki, T., Dac-Korytko, I., Sun, Y. H., Wright, W. E., Tapscott, S. J. and Kamps, M. P.** (1999). A conserved motif N-terminal to the DNA-binding domains of myogenic bHLH transcription factors mediates cooperative DNA binding with pbx-Meis1/Prep1. *Nucleic Acids Res* **27**, 3752-3761.
- Kuang, S., Kuroda, K., Le Grand, F. and Rudnicki, M. A.** (2007). Asymmetric self-renewal and commitment of satellite stem cells in muscle. *Cell* **129**, 999-1010.
- Kumar, D., Shadrach, J. L., Wagers, A. J. and Lassar, A. B.** (2009). Id3 is a direct transcriptional target of Pax7 in quiescent satellite cells. *Mol Biol Cell* **20**, 3170-3177.
- Kuroda, K., Tani, S., Tamura, K., Minoguchi, S., Kurooka, H. and Honjo, T.** (1999). Delta-induced Notch signaling mediated by RBP-J inhibits MyoD expression and myogenesis. *J Biol Chem* **274**, 7238-7244.

Bibliography

- Lagha, M., Kormish, J. D., Rocancourt, D., Manceau, M., Epstein, J. A., Zaret, K. S., Relaix, F. and Buckingham, M. E. (2008). Pax3 regulation of FGF signaling affects the progression of embryonic progenitor cells into the myogenic program. *Genes Dev* **22**, 1828-1837.
- Lagrange, T., Kapanidis, A. N., Tang, H., Reinberg, D. and Ebright, R. H. (1998). New core promoter element in RNA polymerase II-dependent transcription: sequence-specific DNA binding by transcription factor IIB. *Genes Dev* **12**, 34-44.
- Laloux, I., Dubois, E., Dewerchin, M. and Jacobs, E. (1990). TEC1, a gene involved in the activation of Ty1 and Ty1-mediated gene expression in *Saccharomyces cerevisiae*: cloning and molecular analysis. *Mol Cell Biol* **10**, 3541-3550.
- Lamar, J. M., Stern, P., Liu, H., Schindler, J. W., Jiang, Z. G. and Hynes, R. O. (2012). The Hippo pathway target, YAP, promotes metastasis through its TEAD-interaction domain. *Proc Natl Acad Sci U S A* **109**, E2441-2450.
- Langmead, B. and Salzberg, S. L. (2012). Fast gapped-read alignment with Bowtie 2. *Nat Methods* **9**, 357-359.
- Lepper, C., Partridge, T. A. and Fan, C. M. (2011). An absolute requirement for Pax7-positive satellite cells in acute injury-induced skeletal muscle regeneration. *Development* **138**, 3639-3646.
- Li, L., Chambard, J. C., Karin, M. and Olson, E. N. (1992). Fos and Jun repress transcriptional activation by myogenin and MyoD: the amino terminus of Jun can mediate repression. *Genes Dev* **6**, 676-689.
- Li, S., Liu, C., Li, N., Hao, T., Han, T., Hill, D. E., Vidal, M. and Lin, J. D. (2008). Genome-wide coactivation analysis of PGC-1alpha identifies BAF60a as a regulator of hepatic lipid metabolism. *Cell Metab* **8**, 105-117.
- Li, X., Oghi, K. A., Zhang, J., Krones, A., Bush, K. T., Glass, C. K., Nigam, S. K., Aggarwal, A. K., Maas, R., Rose, D. W., et al. (2003). Eya protein phosphatase activity regulates Six1-Dach-Eya transcriptional effects in mammalian organogenesis. *Nature* **426**, 247-254.
- Li, Z., Zhao, B., Wang, P., Chen, F., Dong, Z., Yang, H., Guan, K. L. and Xu, Y. (2010a). Structural insights into the YAP and TEAD complex. *Genes Dev* **24**, 235-240.
- Lim, C. Y., Santoso, B., Boulay, T., Dong, E., Ohler, U. and Kadonaga, J. T. (2004). The MTE, a new core promoter element for transcription by RNA polymerase II. *Genes Dev* **18**, 1606-1617.
- Lin, J., Handschin, C. and Spiegelman, B. M. (2005). Metabolic control through the PGC-1 family of transcription coactivators. *Cell Metab* **1**, 361-370.
- Lin, J., Wu, H., Tarr, P. T., Zhang, C. Y., Wu, Z., Boss, O., Michael, L. F., Puigserver, P., Isotani, E., Olson, E. N., et al. (2002). Transcriptional co-activator PGC-1 alpha drives the formation of slow-twitch muscle fibres. *Nature* **418**, 797-801.
- Liu, D., Black, B. L. and Derynck, R. (2001). TGF-beta inhibits muscle differentiation through functional repression of myogenic transcription factors by Smad3. *Genes Dev* **15**, 2950-2966.
- Liu, D., Kang, J. S. and Derynck, R. (2004). TGF-beta-activated Smad3 represses MEF2-dependent transcription in myogenic differentiation. *Embo j* **23**, 1557-1566.
- Liu, N., Nelson, B. R., Bezprozvannaya, S., Shelton, J. M., Richardson, J. A., Bassel-Duby, R. and Olson, E. N. (2014). Requirement of MEF2A, C, and D for skeletal muscle regeneration. *Proc Natl Acad Sci U S A* **111**, 4109-4114.
- Liu Y , e. a. (2005). Signaling pathways in activity-dependent fiber type plasticity in adult skeletal muscle. - PubMed - NCBI.
- Liu, Y., Randall, W. R. and Schneider, M. F. (2005). Activity-dependent and -independent nuclear fluxes of HDAC4 mediated by different kinases in adult skeletal muscle. *J Cell Biol* **168**, 887-897.
- Lolis, A. A., Londhe, P., Beggs, B. C., Byrum, S. D., Tackett, A. J. and Davie, J. K. (2013). Myogenin recruits the histone chaperone facilitates chromatin transcription (FACT) to promote nucleosome disassembly at muscle-specific genes. *J Biol Chem* **288**, 7676-7687.
- Love, M. I., Huber, W. and Anders, S. (2014). Moderated estimation of fold change and dispersion for RNA-seq data with DESeq2. *Genome Biol* **15**, 550.

Bibliography

- Luther, P. K.** (2000). Three-dimensional structure of a vertebrate muscle Z-band: implications for titin and alpha-actinin binding. *J Struct Biol* **129**, 1-16.
- (2009). The vertebrate muscle Z-disc: sarcomere anchor for structure and signalling. In *J Muscle Res Cell Motil*, pp. 171-185.
- Lyons, G. E., Ontell, M., Cox, R., Sassoon, D. and Buckingham, M.** (1990). The expression of myosin genes in developing skeletal muscle in the mouse embryo. *J Cell Biol* **111**, 1465-1476.
- Ma, G. T., Roth, M. E., Groskopf, J. C., Tsai, F. Y., Orkin, S. H., Grosveld, F., Engel, J. D. and Linzer, D. I.** (1997). GATA-2 and GATA-3 regulate trophoblast-specific gene expression in vivo. *Development* **124**, 907-914.
- Maeda, T., Chapman, D. L. and Stewart, A. F.** (2002a). Mammalian vestigial-like 2, a cofactor of TEF-1 and MEF2 transcription factors that promotes skeletal muscle differentiation. *J Biol Chem* **277**, 48889-48898.
- Maeda, T., Gupta, M. P. and Stewart, A. F.** (2002b). TEF-1 and MEF2 transcription factors interact to regulate muscle-specific promoters. *Biochem Biophys Res Commun* **294**, 791-797.
- Mahoney, W. M., Jr., Hong, J. H., Yaffe, M. B. and Farrance, I. K.** (2005). The transcriptional co-activator TAZ interacts differentially with transcriptional enhancer factor-1 (TEF-1) family members. *Biochem J* **388**, 217-225.
- Maley, M. A., Fan, Y., Beilharz, M. W. and Grounds, M. D.** (1994). Intrinsic differences in MyoD and myogenin expression between primary cultures of SJL/J and BALB/C skeletal muscle. *Exp Cell Res* **211**, 99-107.
- Mallappa, C., Hu, Y. J., Shamulailatpam, P., Tae, S., Sif, S. and Imbalzano, A. N.** (2011). The expression of myogenic microRNAs indirectly requires protein arginine methyltransferase (Prmt)5 but directly requires Prmt4. *Nucleic Acids Res* **39**, 1243-1255.
- Manceau, M., Marcelle, C. and Gros, J.** (2005). [A common somitic origin for embryonic muscle progenitors]. *Med Sci (Paris)* **21**, 915-917.
- Manderfield, L. J., Aghajanian, H., Engleka, K. A., Lim, L. Y., Liu, F., Jain, R., Li, L., Olson, E. N. and Epstein, J. A.** (2015). Hippo signaling is required for Notch-dependent smooth muscle differentiation of neural crest. *Development* **142**, 2962-2971.
- Mar, J. H. and Ordahl, C. P.** (1988). A conserved CATTCCCT motif is required for skeletal muscle-specific activity of the cardiac troponin T gene promoter. *Proc Natl Acad Sci U S A* **85**, 6404-6408.
- (1990). M-CAT binding factor, a novel trans-acting factor governing muscle-specific transcription. *Mol Cell Biol* **10**, 4271-4283.
- Marinov, G. K., Kundaje, A., Park, P. J. and Wold, B. J.** (2014). Large-scale quality analysis of published ChIP-seq data. *G3 (Bethesda)* **4**, 209-223.
- Maston, G. A., Evans, S. K. and Green, M. R.** (2006). Transcriptional regulatory elements in the human genome. *Annu Rev Genomics Hum Genet* **7**, 29-59.
- Mauro, A.** (1961). SATELLITE CELL OF SKELETAL MUSCLE FIBERS. *The Journal of Biophysical and Biochemical Cytology* **9**, 493-495.
- McCroskery, S., Thomas, M., Maxwell, L., Sharma, M. and Kambadur, R.** (2003). Myostatin negatively regulates satellite cell activation and self-renewal. *J Cell Biol* **162**, 1135-1147.
- McElhinny, A. S., Kazmierski, S. T., Labeit, S. and Gregorio, C. C.** (2003). Nebulin: the nebulous, multifunctional giant of striated muscle. *Trends Cardiovasc Med* **13**, 195-201.
- McKinsey, T. A., Zhang, C. L., Lu, J. and Olson, E. N.** (2000). Signal-dependent nuclear export of a histone deacetylase regulates muscle differentiation. *Nature* **408**, 106-111.
- McPherron, A. C., Lawler, A. M. and Lee, S. J.** (1997). Regulation of skeletal muscle mass in mice by a new TGF-beta superfamily member. *Nature* **387**, 83-90.
- Megency, L. A. and Rudnicki, M. A.** (1995). Determination versus differentiation and the MyoD family of transcription factors. *Biochem Cell Biol* **73**, 723-732.
- Menke, A. and Jockusch, H.** (1991). Decreased osmotic stability of dystrophin-less muscle cells from the mdx mouse. *Nature* **349**, 69-71.
- Mennerich, D. and Braun, T.** (2001). Activation of myogenesis by the homeobox gene Lbx1 requires cell proliferation. *Embo j* **20**, 7174-7183.

Bibliography

- Mielcarek, M., Piotrowska, I., Schneider, A., Gunther, S. and Braun, T. (2009). VITO-2, a new SID domain protein, is expressed in the myogenic lineage during early mouse embryonic development. *Gene Expr Patterns* **9**, 129-137.
- Miller, K. J., Thaloor, D., Matteson, S. and Pavlath, G. K. (2000). Hepatocyte growth factor affects satellite cell activation and differentiation in regenerating skeletal muscle. *Am J Physiol Cell Physiol* **278**, C174-181.
- Min, W., Ghosh, S. and Lengyel, P. (1996). The interferon-inducible p202 protein as a modulator of transcription: inhibition of NF-kappa B, c-Fos, and c-Jun activities. *Mol Cell Biol* **16**, 359-368.
- Mitchell, K. J., Pannerec, A., Cadot, B., Parlakian, A., Besson, V., Gomes, E. R., Marazzi, G. and Sassoon, D. A. (2010). Identification and characterization of a non-satellite cell muscle resident progenitor during postnatal development. *Nat Cell Biol* **12**, 257-266.
- Molkentin, J. D. and Olson, E. N. (1996). Combinatorial control of muscle development by basic helix-loop-helix and MADS-box transcription factors. *Proc Natl Acad Sci U S A* **93**, 9366-9373.
- Morin-Kensicki, E. M., Boone, B. N., Howell, M., Stonebraker, J. R., Teed, J., Alb, J. G., Magnuson, T. R., O'Neal, W. and Milgram, S. L. (2006). Defects in yolk sac vasculogenesis, chorioallantoic fusion, and embryonic axis elongation in mice with targeted disruption of Yap65. *Mol Cell Biol* **26**, 77-87.
- Mousavi, K., Zare, H., Dell'orso, S., Grontved, L., Gutierrez-Cruz, G., Derfoul, A., Hager, G. L. and Sartorelli, V. (2013). eRNAs promote transcription by establishing chromatin accessibility at defined genomic loci. *Mol Cell* **51**, 606-617.
- Mu, X., Brown, L. D., Liu, Y. and Schneider, M. F. (2007). Roles of the calcineurin and CaMK signaling pathways in fast-to-slow fiber type transformation of cultured adult mouse skeletal muscle fibers.
- Murphy, M. M., Keefe, A. C., Lawson, J. A., Flygare, S. D., Yandell, M. and Kardon, G. (2014). Transiently active Wnt/beta-catenin signaling is not required but must be silenced for stem cell function during muscle regeneration. *Stem Cell Reports* **3**, 475-488.
- Nabeshima, Y., Hanaoka, K., Hayasaka, M., Esumi, E., Li, S. and Nonaka, I. (1993). Myogenin gene disruption results in perinatal lethality because of severe muscle defect. *Nature* **364**, 532-535.
- Nagata, Y., Partridge, T. A., Matsuda, R. and Zammit, P. S. (2006). Entry of muscle satellite cells into the cell cycle requires sphingolipid signaling. *J Cell Biol* **174**, 245-253.
- Niro, C., Demignon, J., Vincent, S., Liu, Y., Giordani, J., Sgarlato, N., Favier, M., Guillet-Deniau, I., Blais, A. and Maire, P. (2010). Six1 and Six4 gene expression is necessary to activate the fast-ty
- Nishimoto, N., Watanabe, M., Watanabe, S., Sugimoto, N., Yugawa, T., Ikura, T., Koiwai, O., Kiyono, T. and Fujita, M. (2012). Heterocomplex formation by Arp4 and beta-actin is involved in the integrity of the Brg1 chromatin remodeling complex. *J Cell Sci* **125**, 3870-3882.
- Nishioka, N., Inoue, K., Adachi, K., Kiyonari, H., Ota, M., Ralston, A., Yabuta, N., Hirahara, S., Stephenson, R. O., Ogonuki, N., et al. (2009). The Hippo signaling pathway components Lats and Yap pattern Tead4 activity to distinguish mouse trophectoderm from inner cell mass. *Dev Cell* **16**, 398-410.
- Nishioka, N., Yamamoto, S., Kiyonari, H., Sato, H., Sawada, A., Ota, M., Nakao, K. and Sasaki, H. (2008). Tead4 is required for specification of trophectoderm in pre-implantation mouse embryos. *Mech Dev* **125**, 270-283.
- Nowee, M. E., Snijders, A. M., Rockx, D. A., de Wit, R. M., Kosma, V. M., Hamalainen, K., Schouten, J. P., Verheijen, R. H., van Diest, P. J., Albertson, D. G., et al. (2007). DNA profiling of primary serous ovarian and fallopian tube carcinomas with array comparative genomic hybridization and multiplex ligation-dependent probe amplification. *J Pathol* **213**, 46-55.
- Ohkawa, Y., Marfella, C. G. and Imbalzano, A. N. (2006). Skeletal muscle specification by myogenin and Mef2D via the SWI/SNF ATPase Brg1. *Embo j* **25**, 490-501.

Bibliography

- Ohler, U., Liao, G. C., Niemann, H. and Rubin, G. M. (2002). Computational analysis of core promoters in the Drosophila genome. *Genome Biol* **3**, Research0087.
- Ono, Y., Calhabeu, F., Morgan, J. E., Katagiri, T., Amthor, H. and Zammit, P. S. (2011). BMP signalling permits population expansion by preventing premature myogenic differentiation in muscle satellite cells. *Cell Death Differ* **18**, 222-234.
- Ostrovsky, O., Bengal, E. and Aronheim, A. (2002). Induction of terminal differentiation by the c-Jun dimerization protein JDP2 in C2 myoblasts and rhabdomyosarcoma cells. *J Biol Chem* **277**, 40043-40054.
- Otto, A., Schmidt, C., Luke, G., Allen, S., Valasek, P., Muntoni, F., Lawrence-Watt, D. and Patel, K. (2008). Canonical Wnt signalling induces satellite-cell proliferation during adult skeletal muscle regeneration. *J Cell Sci* **121**, 2939-2950.
- Overholtzer, M., Zhang, J., Smolen, G. A., Muir, B., Li, W., Sgroi, D. C., Deng, C. X., Brugge, J. S. and Haber, D. A. (2006). Transforming properties of YAP, a candidate oncogene on the chromosome 11q22 amplicon. *Proc Natl Acad Sci U S A* **103**, 12405-12410.
- Paramasivam, M., Sarkeshik, A., Yates, J. R., 3rd, Fernandes, M. J. and McCollum, D. (2011). Angiotensin family proteins are novel activators of the LATS2 kinase tumor suppressor. *Mol Biol Cell* **22**, 3725-3733.
- Parker, M. H., Perry, R. L., Fauteux, M. C., Berkes, C. A. and Rudnicki, M. A. (2006). MyoD synergizes with the E-protein HEB beta to induce myogenic differentiation. *Mol Cell Biol* **26**, 5771-5783.
- Parker, M. H., Seale, P. and Rudnicki, M. A. (2003). Looking back to the embryo: defining transcriptional networks in adult myogenesis. *Nat Rev Genet* **4**, 497-507.
- Pasquet, S., Naye, F., Faucheux, C., Bronchain, O., Chesneau, A., Thiebaud, P. and Theze, N. (2006). Transcription enhancer factor-1-dependent expression of the alpha-tropomyosin gene in the three muscle cell types. *J Biol Chem* **281**, 34406-34420.
- Peng, L., Huang, Y., Jin, F., Jiang, S. W. and Payne, A. H. (2004). Transcription enhancer factor-5 and a GATA-like protein determine placental-specific expression of the Type I human 3beta-hydroxysteroid dehydrogenase gene, HSD3B1. *Mol Endocrinol* **18**, 2049-2060.
- Perdiguero, E., Ruiz-Bonilla, V., Serrano, A. L. and Munoz-Canoves, P. (2007a). Genetic deficiency of p38alpha reveals its critical role in myoblast cell cycle exit: the p38alpha-JNK connection. *Cell Cycle* **6**, 1298-1303.
- Perdiguero, E., Sousa-Victor, P., Ballestar, E. and Munoz-Canoves, P. (2009). Epigenetic regulation of myogenesis. *Epigenetics* **4**, 541-550.
- Perry, R. L. and Rudnick, M. A. (2000). Molecular mechanisms regulating myogenic determination and differentiation. *Front Biosci* **5**, D750-767.
- Pette, D. and Staron, R. S. (1997). Mammalian skeletal muscle fiber type transitions. *Int Rev Cytol* **170**, 143-223.
- (2000). Myosin isoforms, muscle fiber types, and transitions. *Microsc Res Tech* **50**, 500-509.
- Pilegaard, H., Saltin, B. and Neufer, P. D. (2003). Exercise induces transient transcriptional activation of the PGC-1alpha gene in human skeletal muscle. *J Physiol* **546**, 851-858.
- Pobbati, A. V., Chan, S. W., Lee, I., Song, H. and Hong, W. (2012a). Structural and functional similarity between the Vgll1-TEAD and the YAP-TEAD complexes. *Structure* **20**, 1135-1140.
- Potthoff, M. J., Wu, H., Arnold, M. A., Shelton, J. M., Backs, J., McAnally, J., Richardson, J. A., Bassel-Duby, R. and Olson, E. N. (2007). Histone deacetylase degradation and MEF2 activation promote the formation of slow-twitch myofibers. *J Clin Invest* **117**, 2459-2467.
- Pourquie, O., Coltey, M., Teillet, M. A., Ordahl, C. and Le Douarin, N. M. (1993). Control of dorsoventral patterning of somitic derivatives by notochord and floor plate. *Proc Natl Acad Sci U S A* **90**, 5242-5246.
- Puri, P. L., Iezzi, S., Stiegler, P., Chen, T. T., Schiltz, R. L., Muscat, G. E., Giordano, A., Kedes, L., Wang, J. Y. and Sartorelli, V. (2001). Class I histone deacetylases sequentially interact with MyoD and pRb during skeletal myogenesis. *Mol Cell* **8**, 885-897.

Bibliography

- Puri, P. L., Sartorelli, V., Yang, X. J., Hamamori, Y., Ogryzko, V. V., Howard, B. H., Kedes, L., Wang, J. Y., Graessmann, A., Nakatani, Y., et al. (1997). Differential roles of p300 and PCAF acetyltransferases in muscle differentiation. *Mol Cell* **1**, 35-45.
- Ralston, A., Cox, B. J., Nishioka, N., Sasaki, H., Chea, E., Rugg-Gunn, P., Guo, G., Robson, P., Draper, J. S. and Rossant, J. (2010). Gata3 regulates trophoblast development downstream of Tead4 and in parallel to Cdx2. *Development* **137**, 395-403.
- Rampalli, S., Li, L., Mak, E., Ge, K., Brand, M., Tapscott, S. J. and Dilworth, F. J. (2007). p38 MAPK signaling regulates recruitment of Ash2L-containing methyltransferase complexes to specific genes during differentiation. *Nat Struct Mol Biol* **14**, 1150-1156.
- Relaix, F., Demignon, J., Laclef, C., Pujol, J., Santolini, M., Niro, C., Lagha, M., Rocancourt, D., Buckingham, M. and Maire, P. (2013). Six homeoproteins directly activate Myod expression in the gene regulatory networks that control early myogenesis. *PLoS Genet* **9**, e1003425.
- Relaix, F., Montarras, D., Zaffran, S., Gayraud-Morel, B., Rocancourt, D., Tajbakhsh, S., Mansouri, A., Cumano, A. and Buckingham, M. (2006). Pax3 and Pax7 have distinct and overlapping functions in adult muscle progenitor cells. *J Cell Biol* **172**, 91-102.
- Relaix, F., Rocancourt, D., Mansouri, A. and Buckingham, M. (2005). A Pax3/Pax7-dependent population of skeletal muscle progenitor cells. *Nature* **435**, 948-953.
- Ribas, R., Moncaut, N., Siligan, C., Taylor, K., Cross, J. W., Rigby, P. W. and Carvajal, J. J. (2011). Members of the TEAD family of transcription factors regulate the expression of Myf5 in ventral somitic compartments. *Dev Biol* **355**, 372-380.
- Richard, A. F., Demignon, J., Sakakibara, I., Pujol, J., Favier, M., Strohlic, L., Le Grand, F., Sgarioto, N., Guernec, A., Schmitt, A., et al. (2011). Genesis of muscle fiber-type diversity during mouse embryogenesis relies on Six1 and Six4 gene expression. *Dev Biol* **359**, 303-320.
- Richardson, A. L., Wang, Z. C., De Nicolo, A., Lu, X., Brown, M., Miron, A., Liao, X., Iglehart, J. D., Livingston, D. M. and Ganesan, S. (2006). X chromosomal abnormalities in basal-like human breast cancer. *Cancer Cell* **9**, 121-132.
- Rindt, H., Gulick, J., Knotts, S., Neumann, J. and Robbins, J. (1993). In vivo analysis of the murine beta-myosin heavy chain gene promoter. *J Biol Chem* **268**, 5332-5338.
- Rodgers, J. T., King, K. Y., Brett, J. O., Cromie, M. J., Charville, G. W., Maguire, K. K., Brunson, C., Mastey, N., Liu, L., Tsai, C. R., et al. (2014). mTORC1 controls the adaptive transition of quiescent stem cells from G0 to G(Alert). *Nature* **510**, 393-396.
- Rudnicki, M. A., Schnegelsberg, P. N., Stead, R. H., Braun, T., Arnold, H. H. and Jaenisch, R. (1993). MyoD or Myf-5 is required for the formation of skeletal muscle. *Cell* **75**, 1351-1359.
- Sambasivan, R., Yao, R., Kissenpfennig, A., Van Wittenberghe, L., Paldi, A., Gayraud-Morel, B., Guenou, H., Malissen, B., Tajbakhsh, S. and Galy, A. (2011). Pax7-expressing satellite cells are indispensable for adult skeletal muscle regeneration. *Development* **138**, 3647-3656.
- Sartorelli, V. and Juan, A. H. (2011). Sculpting chromatin beyond the double helix: epigenetic control of skeletal myogenesis. *Curr Top Dev Biol* **96**, 57-83.
- Sato, T., Rocancourt, D., Marques, L., Thorsteinsdottir, S. and Buckingham, M. (2010). A Pax3/Dmrt2/Myf5 regulatory cascade functions at the onset of myogenesis. *PLoS Genet* **6**, e1000897.
- Sawada, A., Kiyonari, H., Ukita, K., Nishioka, N., Imuta, Y. and Sasaki, H. (2008). Redundant roles of Tead1 and Tead2 in notochord development and the regulation of cell proliferation and survival. *Mol Cell Biol* **28**, 3177-3189.
- Schakman, O., Gilson, H. and Thissen, J. P. (2008). Mechanisms of glucocorticoid-induced myopathy. *J Endocrinol* **197**, 1-10.
- Schakman, O., Kalista, S., Barbe, C., Loumaye, A. and Thissen, J. P. (2013). Glucocorticoid-induced skeletal muscle atrophy. *Int J Biochem Cell Biol* **45**, 2163-2172.
- Schiaffino, S. and Reggiani, C. (1996). Molecular diversity of myofibrillar proteins: gene regulation and functional significance. *Physiol Rev* **76**, 371-423.
- (2011). Fiber Types in Mammalian Skeletal Muscles.

Bibliography

- Schiaffino, S., Rossi, A. C., Smerdu, V., Leinwand, L. A. and Reggiani, C. (2015). Developmental myosins: expression patterns and functional significance. *Skelet Muscle* **5**, 22.
- Schreiber, S. N., Emter, R., Hock, M. B., Knutti, D., Cardenas, J., Podvinez, M., Oakeley, E. J. and Kralli, A. (2004). The estrogen-related receptor alpha (ERRalpha) functions in PPARgamma coactivator 1alpha (PGC-1alpha)-induced mitochondrial biogenesis. *Proc Natl Acad Sci U S A* **101**, 6472-6477.
- Schuster-Gossler, K., Cordes, R. and Gossler, A. (2007). Premature myogenic differentiation and depletion of progenitor cells cause severe muscle hypotrophy in Delta1 mutants. *Proc Natl Acad Sci U S A* **104**, 537-542.
- Seale, P., Sabourin, L. A., Girgis-Gabardo, A., Mansouri, A., Gruss, P. and Rudnicki, M. A. (2000). Pax7 is required for the specification of myogenic satellite cells. *Cell* **102**, 777-786.
- Seenundun, S., Rampalli, S., Liu, Q. C., Aziz, A., Palii, C., Hong, S., Blais, A., Brand, M., Ge, K. and Dilworth, F. J. (2010). UTX mediates demethylation of H3K27me3 at muscle-specific genes during myogenesis. *Embo j* **29**, 1401-1411.
- Segales, J., Perdiguero, E. and Munoz-Canoves, P. (2015). Epigenetic control of adult skeletal muscle stem cell functions. *Febs j* **282**, 1571-1588.
- Serra, C., Palacios, D., Mozzetta, C., Forcales, S. V., Morantte, I., Ripani, M., Jones, D. R., Du, K., Jhala, U. S., Simone, C., et al. (2007). Functional interdependence at the chromatin level between the MKK6/p38 and IGF1/PI3K/AKT pathways during muscle differentiation. *Mol Cell* **28**, 200-213.
- Shlyueva, D., Stampfel, G. and Stark, A. (2014). Transcriptional enhancers: from properties to genome-wide predictions. *Nat Rev Genet* **15**, 272-286.
- Simmonds, A. J., Liu, X., Soanes, K. H., Krause, H. M., Irvine, K. D. and Bell, J. B. (1998). Molecular interactions between Vestigial and Scalloped promote wing formation in *Drosophila*. *Genes Dev* **12**, 3815-3820.
- Simone, C., Forcales, S. V., Hill, D. A., Imbalzano, A. N., Latella, L. and Puri, P. L. (2004). p38 pathway targets SWI-SNF chromatin-remodeling complex to muscle-specific loci. *Nat Genet* **36**, 738-743.
- Simonides, W. S. and van Hardeveld, C. (2008). Thyroid hormone as a determinant of metabolic and contractile phenotype of skeletal muscle. *Thyroid* **18**, 205-216.
- Simpson, P. C., Kariya, K., Karns, L. R., Long, C. S. and Karliner, J. S. (1991). Adrenergic hormones and control of cardiac myocyte growth. *Mol Cell Biochem* **104**, 35-43.
- Sine, S. M. (2012). End-Plate Acetylcholine Receptor: Structure, Mechanism, Pharmacology, and Disease.
- Skotheim, R. I., Autio, R., Lind, G. E., Kraggerud, S. M., Andrews, P. W., Monni, O., Kallioniemi, O. and Lothe, R. A. (2006). Novel genomic aberrations in testicular germ cell tumors by array-CGH, and associated gene expression changes. *Cell Oncol* **28**, 315-326.
- Smale, S. T. and Baltimore, D. (1989). The "initiator" as a transcription control element. *Cell* **57**, 103-113.
- Smale, S. T. and Kadonaga, J. T. (2003). The RNA polymerase II core promoter. *Annu Rev Biochem* **72**, 449-479.
- Smerdu, V., Karsch-Mizrachi, I., Campione, M., Leinwand, L. and Schiaffino, S. (1994). Type Iix myosin heavy chain transcripts are expressed in type IIb fibers of human skeletal muscle. *Am J Physiol* **267**, C1723-1728.
- Snijders, A. M., Schmidt, B. L., Fridlyand, J., Dekker, N., Pinkel, D., Jordan, R. C. and Albertson, D. G. (2005). Rare amplicons implicate frequent deregulation of cell fate specification pathways in oral squamous cell carcinoma. *Oncogene* **24**, 4232-4242.
- Soleimani, V. D., Punch, V. G., Kawabe, Y., Jones, A. E., Palidwor, G. A., Porter, C. J., Cross, J. W., Carvajal, J. J., Kockx, C. E., van, I. W. F., et al. (2012). Transcriptional dominance of Pax7 in adult myogenesis is due to high-affinity recognition of homeodomain motifs. *Dev Cell* **22**, 1208-1220.
- Spitz, F., Demignon, J., Porteu, A., Kahn, A., Concordet, J. P., Daegelen, D. and Maire, P. (1998). Expression of myogenin during embryogenesis is controlled by Six/sine oculis

Bibliography

- homeoproteins through a conserved MEF3 binding site. *Proc Natl Acad Sci U S A* **95**, 14220-14225.
- Squire, J. M.** (1997). Architecture and function in the muscle sarcomere. *Curr Opin Struct Biol* **7**, 247-257.
- Starick, S. R., Ibn-Salem, J., Jurk, M., Hernandez, C., Love, M. I., Chung, H. R., Vingron, M., Thomas-Chollier, M. and Meijsing, S. H.** (2015). ChIP-exo signal associated with DNA-binding motifs provides insight into the genomic binding of the glucocorticoid receptor and cooperating transcription factors. *Genome Res* **25**, 825-835.
- Sudol, M.** (1994). Yes-associated protein (YAP65) is a proline-rich phosphoprotein that binds to the SH3 domain of the Yes proto-oncogene product. *Oncogene* **9**, 2145-2152.
- Sudol, M., Chen, H. I., Bougeret, C., Einbond, A. and Bork, P.** (1995). Characterization of a novel protein-binding module--the WW domain. *FEBS Lett* **369**, 67-71.
- Sun, S., Stoflet, E. S., Cogan, J. G., Strauch, A. R. and Getz, M. J.** (1995). Negative regulation of the vascular smooth muscle alpha-actin gene in fibroblasts and myoblasts: disruption of enhancer function by sequence-specific single-stranded-DNA-binding proteins. *Mol Cell Biol* **15**, 2429-2436.
- Swartz, E. A., Johnson, A. D. and Owens, G. K.** (1998). Two MCAT elements of the SM alpha-actin promoter function differentially in SM vs. non-SM cells. *Am J Physiol* **275**, C608-618.
- Tajbakhsh, S.** (2009). Skeletal muscle stem cells in developmental versus regenerative myogenesis. *J Intern Med* **266**, 372-389.
- Tajbakhsh, S., Rocancourt, D. and Buckingham, M.** (1996). Muscle progenitor cells failing to respond to positional cues adopt non-myogenic fates in myf-5 null mice. *Nature* **384**, 266-270.
- Tajbakhsh, S., Rocancourt, D., Cossu, G. and Buckingham, M.** (1997). Redefining the genetic hierarchies controlling skeletal myogenesis: Pax-3 and Myf-5 act upstream of MyoD. *Cell* **89**, 127-138.
- Teng, A. C., Kuraitis, D., Deeke, S. A., Ahmadi, A., Dugan, S. G., Cheng, B. L., Crowson, M. G., Burgon, P. G., Suuronen, E. J., Chen, H. H., et al.** (2010). IRF2BP2 is a skeletal and cardiac muscle-enriched ischemia-inducible activator of VEGFA expression. *Faseb j* **24**, 4825-4834.
- Tian, W., Yu, J., Tomchick, D. R., Pan, D. and Luo, X.** (2010). Structural and functional analysis of the YAP-binding domain of human TEAD2. *Proc Natl Acad Sci U S A* **107**, 7293-7298.
- Tremblay, A. M., Missiaglia, E., Galli, G. G., Hettmer, S., Urcia, R., Carrara, M., Judson, R. N., Thway, K., Nadal, G., Selfe, J. L., et al.** (2014). The Hippo transducer YAP1 transforms activated satellite cells and is a potent effector of embryonal rhabdomyosarcoma formation. *Cancer Cell* **26**, 273-287.
- Tsika, R. W., Schramm, C., Simmer, G., Fitzsimons, D. P., Moss, R. L. and Ji, J.** (2008). Overexpression of TEAD-1 in transgenic mouse striated muscles produces a slower skeletal muscle contractile phenotype. *J Biol Chem* **283**, 36154-36167.
- Ueyama, T., Zhu, C., Valenzuela, Y. M., Suzow, J. G. and Stewart, A. F.** (2000). Identification of the functional domain in the transcription factor RTEF-1 that mediates alpha 1-adrenergic signaling in hypertrophied cardiac myocytes. *J Biol Chem* **275**, 17476-17480.
- Umansky, K. B., Gruenbaum-Cohen, Y., Tsoory, M., Feldmesser, E., Goldenberg, D., Brenner, O. and Groner, Y.** (2015). Runx1 Transcription Factor Is Required for Myoblasts Proliferation during Muscle Regeneration. *PLoS Genet* **11**, e1005457.
- Vassilev, A., Kaneko, K. J., Shu, H., Zhao, Y. and DePamphilis, M. L.** (2001a). TEAD/TEF transcription factors utilize the activation domain of YAP65, a Src/Yes-associated protein localized in the cytoplasm. *Genes Dev* **15**, 1229-1241.
- Vasyutina, E., Lenhard, D. C., Wende, H., Erdmann, B., Epstein, J. A. and Birchmeier, C.** (2007). RBP-J (Rbpsi) is essential to maintain muscle progenitor cells and to generate satellite cells. *Proc Natl Acad Sci U S A* **104**, 4443-4448.
- Vaudin, P., Delanoue, R., Davidson, I., Silber, J. and Zider, A.** (1999). TONDU (TDU), a novel human protein related to the product of vestigial (vg) gene of *Drosophila melanogaster*

Bibliography

- interacts with vertebrate TEF factors and substitutes for Vg function in wing formation. *Development* **126**, 4807-4816.
- Verfaillie, A., Imrichova, H., Atak, Z. K., Dewaele, M., Rambow, F., Hulselmans, G., Christiaens, V., Svetlichnyy, D., Luciani, F., Van den Mooter, L., et al.** (2015). Decoding the regulatory landscape of melanoma reveals TEADS as regulators of the invasive cell state. *Nat Commun* **6**, 6683.
- Vogel, H., Scherneck, S., Kanzleiter, T., Benz, V., Kluge, R., Stadion, M., Kryvych, S., Blüher, M., Klöting, N., Joost, H. G., et al.** (2012). Loss of function of Ifi202b by a microdeletion on chromosome 1 of C57BL/6J mice suppresses 11beta-hydroxysteroid dehydrogenase type 1 expression and development of obesity. *Hum Mol Genet* **21**, 3845-3857.
- von Maltzahn, J., Jones, A. E., Parks, R. J. and Rudnicki, M. A.** (2013). Pax7 is critical for the normal function of satellite cells in adult skeletal muscle. *Proc Natl Acad Sci U S A* **110**, 16474-16479.
- Wackerhage, H., Del Re, D. P., Judson, R. N., Sudol, M. and Sadoshima, J.** (2014). The Hippo signal transduction network in skeletal and cardiac muscle. *Sci Signal* **7**, re4.
- Wales, S., Hashemi, S., Blais, A. and McDermott, J. C.** (2014). Global MEF2 target gene analysis in cardiac and skeletal muscle reveals novel regulation of DUSP6 by p38MAPK-MEF2 signaling. *Nucleic Acids Res* **42**, 11349-11362.
- Wallberg, A. E., Yamamura, S., Malik, S., Spiegelman, B. M. and Roeder, R. G.** (2003). Coordination of p300-mediated chromatin remodeling and TRAP/mediator function through coactivator PGC-1alpha. *Mol Cell* **12**, 1137-1149.
- Wang, H., Chatterjee, G., Meyer, J. J., Liu, C. J., Manjunath, N. A., Bray-Ward, P. and Lengyel, P.** (1999). Characteristics of three homologous 202 genes (Ifi202a, Ifi202b, and Ifi202c) from the murine interferon-activatable gene 200 cluster. *Genomics* **60**, 281-294.
- Wang, H., Ding, B., Liu, C. J., Ma, X. Y., Deschamps, S., Roe, B. A. and Lengyel, P.** (2002). The increase in levels of interferon-inducible proteins p202a and p202b and RNA-dependent protein kinase (PKR) during myoblast differentiation is due to transactivation by MyoD: their tissue distribution in uninfected mice does not depend on interferons. *J Interferon Cytokine Res* **22**, 729-737.
- Watt, K. I., Judson, R., Medlow, P., Reid, K., Kurth, T. B., Burniston, J. G., Ratkevicius, A., De Bari, C. and Wackerhage, H.** (2010). Yap is a novel regulator of C2C12 myogenesis. *Biochem Biophys Res Commun* **393**, 619-624.
- Watt, K. I., Turner, B. J., Hagg, A., Zhang, X., Davey, J. R., Qian, H., Beyer, C., Winbanks, C. E., Harvey, K. F. and Gregorevic, P.** (2015). The Hippo pathway effector YAP is a critical regulator of skeletal muscle fibre size. *Nat Commun* **6**, 6048.
- White, R. B., Bierinx, A. S., Gnocchi, V. F. and Zammit, P. S.** (2010). Dynamics of muscle fibre growth during postnatal mouse development. *BMC Dev Biol* **10**, 21.
- Wong, C. F. and Tellam, R. L.** (2008). MicroRNA-26a targets the histone methyltransferase Enhancer of Zeste homolog 2 during myogenesis. *J Biol Chem* **283**, 9836-9843.
- Wright, D. C., Han, D. H., Garcia-Roves, P. M., Geiger, P. C., Jones, T. E. and Holloszy, J. O.** (2007). Exercise-induced mitochondrial biogenesis begins before the increase in muscle PGC-1alpha expression. *J Biol Chem* **282**, 194-199.
- Wu, H., Kanatous, S. B., Thurmond, F. A., Gallardo, T., Isotani, E., Bassel-Duby, R. and Williams, R. S.** (2002). Regulation of mitochondrial biogenesis in skeletal muscle by CaMK. *Science* **296**, 349-352.
- Wu, H., Rothermel, B., Kanatous, S., Rosenberg, P., Naya, F. J., Shelton, J. M., Hutcheson, K. A., DiMaio, J., Olson, E. N., Bassel-Duby, R., et al.** (2001). Activation of MEF2 by muscle activity is mediated through a calcineurin-dependent pathway. In *EMBO J*, pp. 6414-6423.
- Wu, Z., Puigserver, P., Andersson, U., Zhang, C., Adelmant, G., Mootha, V., Troy, A., Cinti, S., Lowell, B., Scarpulla, R. C., et al.** (1999). Mechanisms controlling mitochondrial biogenesis and respiration through the thermogenic coactivator PGC-1. *Cell* **98**, 115-124.
- Xiao, J. H., Davidson, I., Matthes, H., Garnier, J. M. and Chambon, P.** (1991). Cloning, expression, and transcriptional properties of the human enhancer factor TEF-1. *Cell* **65**, 551-568.

Bibliography

- Xin, H., D'Souza, S., Jorgensen, T. N., Vaughan, A. T., Lengyel, P., Kotzin, B. L. and Choubey, D. (2006). Increased expression of Ifi202, an IFN-activatable gene, in B6.Nba2 lupus susceptible mice inhibits p53-mediated apoptosis. *J Immunol* **176**, 5863-5870.
- Xu, M. Z., Yao, T. J., Lee, N. P., Ng, I. O., Chan, Y. T., Zender, L., Lowe, S. W., Poon, R. T. and Luk, J. M. (2009). Yes-associated protein is an independent prognostic marker in hepatocellular carcinoma. *Cancer* **115**, 4576-4585.
- Yablonka-Reuveni, Z., Day, K., Vine, A. and Shefer, G. (2008). Defining the transcriptional signature of skeletal muscle stem cells. *J Anim Sci* **86**, E207-216.
- Yablonka-Reuveni, Z., Seger, R. and Rivera, A. J. (1999). Fibroblast growth factor promotes recruitment of skeletal muscle satellite cells in young and old rats. *J Histochem Cytochem* **47**, 23-42.
- Yagi, R., Chen, L. F., Shigesada, K., Murakami, Y. and Ito, Y. (1999). A WW domain-containing yes-associated protein (YAP) is a novel transcriptional co-activator. *Embo j* **18**, 2551-2562.
- Yagi, R., Kohn, M. J., Karavanova, I., Kaneko, K. J., Vullhorst, D., DePamphilis, M. L. and Buonanno, A. (2007). Transcription factor TEAD4 specifies the trophectoderm lineage at the beginning of mammalian development. *Development* **134**, 3827-3836.
- Yasunami, M., Suzuki, K., Houtani, T., Sugimoto, T. and Ohkubo, H. (1995). Molecular characterization of cDNA encoding a novel protein related to transcriptional enhancer factor-1 from neural precursor cells. *J Biol Chem* **270**, 18649-18654.
- Yasunami, M., Suzuki, K. and Ohkubo, H. (1996). A novel family of TEA domain-containing transcription factors with distinct spatiotemporal expression patterns. *Biochem Biophys Res Commun* **228**, 365-370.
- Ye, T., Krebs, A. R., Choukallah, M. A., Keime, C., Plewniak, F., Davidson, I. and Tora, L. (2011). seqMINER: an integrated ChIP-seq data interpretation platform. *Nucleic Acids Res* **39**, e35.
- Yennek, S., Burute, M., Thery, M. and Tajbakhsh, S. (2014). Cell adhesion geometry regulates non-random DNA segregation and asymmetric cell fates in mouse skeletal muscle stem cells. *Cell Rep* **7**, 961-970.
- Yoshida, T. (2008). MCAT elements and the TEF-1 family of transcription factors in muscle development and disease. *Arterioscler Thromb Vasc Biol* **28**, 8-17.
- Zammit, P. S., Carvajal, J. J., Golding, J. P., Morgan, J. E., Summerbell, D., Zolnerciks, J., Partridge, T. A., Rigby, P. W. and Beauchamp, J. R. (2004). Myf5 expression in satellite cells and spindles in adult muscle is controlled by separate genetic elements. *Dev Biol* **273**, 454-465.
- Zanconato, F., Forcato, M., Battilana, G., Azzolin, L., Quaranta, E., Bodega, B., Rosato, A., Bicciato, S., Cordenonsi, M. and Piccolo, S. (2015a). Genome-wide association between YAP/TAZ/TEAD and AP-1 at enhancers drives oncogenic growth. *Nature Cell Biology* **17**, 1218-1227.
- Zhang, D., Wang, X., Li, Y., Zhao, L., Lu, M., Yao, X., Xia, H., Wang, Y. C., Liu, M. F., Jiang, J., et al. (2014). Thyroid hormone regulates muscle fiber type conversion via miR-133a1. *J Cell Biol* **207**, 753-766.
- Zhang, J., Smolen, G. A. and Haber, D. A. (2008a). Negative regulation of YAP by LATS1 underscores evolutionary conservation of the Drosophila Hippo pathway. *Cancer Res* **68**, 2789-2794.
- Zhang, K., Kagan, D., DuBois, W., Robinson, R., Bliskovsky, V., Vass, W. C., Zhang, S. and Mock, B. A. (2009). Mndal, a new interferon-inducible family member, is highly polymorphic, suppresses cell growth, and may modify plasmacytoma susceptibility. *Blood* **114**, 2952-2960.
- Zhang, T., Gunther, S., Looso, M., Kunne, C., Kruger, M., Kim, J., Zhou, Y. and Braun, T. (2015). Prmt5 is a regulator of muscle stem cell expansion in adult mice. *Nat Commun* **6**, 7140.
- Zhang, X., George, J., Deb, S., Degoutin, J. L., Takano, E. A., Fox, S. B., Bowtell, D. D. and Harvey, K. F. (2011). The Hippo pathway transcriptional co-activator, YAP, is an ovarian cancer oncogene. *Oncogene* **30**, 2810-2822.

Bibliography

- Zhang, Y., Liu, T., Meyer, C. A., Eeckhoute, J., Johnson, D. S., Bernstein, B. E., Nusbaum, C., Myers, R. M., Brown, M., Li, W., et al. (2008b). Model-based analysis of ChIP-Seq (MACS). *Genome Biol* **9**, R137.
- Zhao, B., Kim, J., Ye, X., Lai, Z. C. and Guan, K. L. (2009). Both TEAD-binding and WW domains are required for the growth stimulation and oncogenic transformation activity of yes-associated protein. *Cancer Res* **69**, 1089-1098.
- Zhao, B., Li, L., Lu, Q., Wang, L. H., Liu, C. Y., Lei, Q. and Guan, K. L. (2011). Angiomotin is a novel Hippo pathway component that inhibits YAP oncoprotein. *Genes Dev* **25**, 51-63.
- Zhao, B., Wei, X., Li, W., Udan, R. S., Yang, Q., Kim, J., Xie, J., Ikenoue, T., Yu, J., Li, L., et al. (2007). Inactivation of YAP oncoprotein by the Hippo pathway is involved in cell contact inhibition and tissue growth control. *Genes Dev* **21**, 2747-2761.
- Zhao, B., Ye, X., Yu, J., Li, L., Li, W., Li, S., Lin, J. D., Wang, C. Y., Chinnaiyan, A. M., Lai, Z. C., et al. (2008). TEAD mediates YAP-dependent gene induction and growth control. *Genes Dev* **22**, 1962-1971.
- Zhao, P., Caretti, G., Mitchell, S., McKeehan, W. L., Boskey, A. L., Pachman, L. M., Sartorelli, V. and Hoffman, E. P. (2006). Fgfr4 is required for effective muscle regeneration in vivo. Delineation of a MyoD-Tead2-Fgfr4 transcriptional pathway. *J Biol Chem* **281**, 429-438.
- Zong, H., Ren, J. M., Young, L. H., Pypaert, M., Mu, J., Birnbaum, M. J. and Shulman, G. I. (2002). AMP kinase is required for mitochondrial biogenesis in skeletal muscle in response to chronic energy deprivation. *Proc Natl Acad Sci U S A* **99**, 15983-15987.

Specific and redundant roles of the Tead family of Transcription factors in myogenic differentiation of C2C12 cells and primary myoblasts *in vitro*

Résumé

La famille de facteurs de transcription Tead reconnaît l'élément MCAT présent dans le promoteur de gènes exprimés spécifiquement dans le muscle. L'analyse génétique de leur fonction dans la différenciation musculaire s'est révélée difficile vraisemblablement en raison d'une redondance entre les membres de cette famille. Dans cette étude, nous avons utilisé des approches de perte d'expression induite par siARN pour aborder le rôle des facteurs Tead dans la différenciation de myoblastes primaires de souris. Contrairement aux cellules C2C12 où Tead4 joue un rôle essentiel, sa suppression dans les myoblastes primaires n'a peu d'effet sur leur différenciation. De même, la perte individuelle des autres facteurs TEAD n'a aucun effet significatif sur la différenciation des myoblastes primaires. En revanche des combinaisons de siARN dirigés contre les facteurs Tead inhibent la différenciation de ces cellules attestant d'une certaine redondance fonctionnelle. De plus, la combinaison de siARN a des effets beaucoup plus drastiques que la perte de Tead4 seule aussi dans les cellules C2C12 appuyant une contribution des autres Teads dans cette lignée. La comparaison de données de ChIP-Seq pour Tead1 et Tead4 avec les données transcriptomiques suite à la perte d'expression de ces facteurs a permis d'identifier un ensemble distinct mais chevauchant de gènes qu'ils contrôlent dans les C2C12 et les myoblastes primaires. Enfin l'intégration de ces résultats avec des données de ChIP-Seq publiques pour Myog, MyoD1 et des modifications des histones nous a permis de définir une série d'éléments de régulation actifs liés par des facteurs TEAD seul ou avec Myog et MyoD1 nous permettant ainsi de disséquer les fonctions spécifiques et combinatoires de ces facteurs de transcription dans les réseaux de régulations impliqués au cours de la différenciation musculaire.

Mots-clés: différenciation musculaire, C2C12, myoblastes primaires, Tead1, Tead4

Summary

The Tead family of transcription factors recognises the MCAT element found in the promoters of genes specifically expressed in muscle. Genetic analysis of their function in muscle differentiation has proved elusive likely due to redundancy amongst the family members. We previously used shRNA-mediated silencing to show that loss of Tead4 function resulted in abnormal myogenic differentiation. ChIP-chip coupled to RNA-seq data identified a set of potential target genes that are either activated or repressed by Tead4 during differentiation. In this study, we have used siRNA-mediated silencing to address the role of the Tead factors in primary myoblast differentiation. In contrast to C2C12 cells where Tead4 plays a critical role, its silencing in primary myoblasts had little effect on their differentiation. Silencing of individual Tead factors had no significant effect on primary myoblast differentiation, whereas combinatorial silencing led to inhibition of their differentiation indicating redundancy amongst these factors. In C2C12 cells also, combinatorial Tead silencing had much more potent effects than silencing of Tead4 alone indicating a contribution of other Teads in this process. By integrating Tead1 and Tead4 ChIP-seq data with RNA-seq data following combinatorial Tead1/4 silencing, we identify distinct but overlapping sets of Tead regulated genes in both C2C12 cells and primary myoblasts. We also integrated the Tead1/4 ChIP-seq data with public data sets on Myog and MyoD1 ChIP-seq and chromatin modifications to identify a series of active regulatory elements bound by Tead factors alone or together with Myog and MyoD1. These data dissect the specific and combinatorial functions of these transcription factors in muscle differentiation regulatory networks.

Keywords: muscle differentiation, C2C12, primary myoblasts, Tead1, Tead4