



HAL
open science

Etude de l'influence du TNFSF11 (RANKL) sur le développement et homéostasie des organes lymphoïdes secondaires

Olga Cordeiro

► **To cite this version:**

Olga Cordeiro. Etude de l'influence du TNFSF11 (RANKL) sur le développement et homéostasie des organes lymphoïdes secondaires. Immunologie. Université de Strasbourg, 2015. Français. NNT : 2015STRAJ075 . tel-01674201

HAL Id: tel-01674201

<https://theses.hal.science/tel-01674201>

Submitted on 2 Jan 2018

HAL is a multi-disciplinary open access archive for the deposit and dissemination of scientific research documents, whether they are published or not. The documents may come from teaching and research institutions in France or abroad, or from public or private research centers.

L'archive ouverte pluridisciplinaire **HAL**, est destinée au dépôt et à la diffusion de documents scientifiques de niveau recherche, publiés ou non, émanant des établissements d'enseignement et de recherche français ou étrangers, des laboratoires publics ou privés.



UNIVERSITÉ DE
STRASBOURG



ÉCOLE DOCTORALE DES SCIENCES DE LA VIE ET DE LA SANTÉ

THÈSE présentée par :

Olga CORDEIRO

Soutenu le : **07 DECEMBRE 2015**

pour obtenir le grade de : **Docteur de l'université de Strasbourg**

Discipline/ Spécialité: Immunologie

**From lymph node embryogenesis to
homeostasis: New insights into the functions
of stromal RANKL (TNFSF11)**

Examineur:

Mme CHAN, Susan

Directrice de Recherche, INSERM U964/CNRS
UMR7104, IGBMC, Illkirch-Graffenstaden

RAPPORTEURS:

Mr CAAMAÑO, Jorge

Professeur, University of Birmingham, IBR-
College of Medical and Dental Sciences, UK

Mr STEIN Jens

Professeur, University of Bern, Theodor Kocher
Institute, Switzerland

THÈSE dirigée par:

Mr MUELLER Christopher

Directeur de Recherche, CNRS-UPR3572

ACKNOWLEDGEMENTS

To begin with I would like to acknowledge the members of my jury, Pr. Jorge Caamaño, Pr. Jens Stein and Pr. Susan Chan, for having kindly accepted to evaluate my PhD work.

I would like to acknowledge Dr Sylviane Muller, the director of the unit Immunologie et chimie thérapeutiques (UPR3572), for have received me in her laboratory.

I acknowledge Dr Christopher Mueller, my thesis director, for have chosen me for this project and for being always available during these three years. The best part of my thesis was the brainstorm sessions that we had during this PhD. Also for always trying to organize some social interaction between the team, for instance the garden dinner was a good one. I am also grateful for you concern regarding my health.

I am also grateful to Monique and Delphine for the hard work managing the mice lines, and the numerous experiments of injections they kindly performed for me. To Jean-Daniel for his availability in training me on microscopy and to help me whenever I needed. To Astrid for being always ready to help.

I am grateful to all the colleagues I have come across on this ICT family. To Benjamin, Maxime, Johan and Adrian for helping me on my moving and all the demoniac moments. To Carole, Diane and Lea for the first years of good parties and also the Luxembourg trip. To Dominique, the best student ever, I appreciated the long hours talking in front of the spinning disk. To Melanie for her hard work and for always being available to help. To Isabella, Melanie, Queen, Vincent, Cecile and Fenjuan for the lunch time, always a good break during the day. To Vincent for his positive vibe and its availability to discuss any issue. And all the other colleagues with whom I spend these three years.

I would like to thank the STROMA ITN which allowed me to do this 3 years of research replenished of nice trips and interesting courser and more important to have gave me the opportunity of creating a nice network and meeting amazing people, it was a pleasure to spend time with Monica, Ana, Bethania, Shubbam, Martina and all the other members.

I would like to acknowledge my parents and brother, first for having provided me the possibility of pursuing my studies abroad and then for having motivated me to accept this position. And of course for always being there during the time passed.

I am really grateful to the great friends I found here in Strasbourg and all the moments we spent together. The Tatrasteam, Gloria, Irene, Retana, Vanessa C., Albert, Mats, Julien S., François, Julien D. for the great moments we spent here. The trip to Belgium, the trip to Porto, the trip to Prague, all the movies sessions, the girls' nights, language exchange, parties, etc. All the other friends I spent time with and changed some point of views, Jorge, Bora, Orkan, Vanessa (Spanish).

Table of content

ACKNOWLEDGEMENTS.....	ii
Table of content	v
ABSTRACT	i
Resumé	ii
LIST OF FIGURES	xvi
LIST OF TABLES	xvii
LIST OF ABBREVIATIONS.....	xviii
INTRODUCTION.....	1
Chapter 1: RANK, RANKL and OPG	2
1.1 Members of TNF and TNFR superfamilies.....	2
1.2 RANK, RANKL and OPG discovery.....	4
1.3 RANK, RANKL and OPG: Structure and expression.....	5
1.3.1 OPG.....	5
1.3.2 RANK.....	7
1.3.3 RANKL	7
1.4 RANK signalling pathways.....	8
1.5 RANK, RANKL and OPG in the immune system	10
1.5.1 Dendritic cell biology	10
1.5.2 T and B cell development	12
1.5.3 Immune Tolerance.....	13
1.6 RANK, RANKL and OPG influence in other tissues.....	14
1.7 Conclusions.....	16
1.8 Bibliography.....	17
Chapter 2: Lymph Node development.....	21
2.1 The Lymphatic System	21
2.1.1 Lymphatic system development.....	21
2.1.2 Lymphatic specification, differentiation and maturation	22
2.1.3 Lymphatic vessels: Lymph and cell uptake and transport.....	23
2.1.4 Lymph filtration via the LNs.....	25
2.2 Lymph Node organogenesis	27
2.2.1 Lymphoid Tissue inducer cells (LTis).....	28
2.2.2 Lymphoid Tissue Organizer cells (LTos).....	28
2.2.3 LTo - LTi crosstalk during LN development.....	29
2.2.4 Involvement of TNFSF members in LN organogenesis.....	32
2.2.5 Cellular organization during lymph node development.....	38

2.3 Human Lymph node development	41
2.4 Conclusions	42
2.5 Bibliography	43
Chapter 3: Stromal and Hematopoietic cells within the LN	21
3.1 Lymph node stromal cells	48
3.1.1 Fibroblastic Reticular cells (FRCs)	51
3.1.2 Marginal Reticular Cells (MRCs)	53
3.1.3 Follicular Dendritic Cells (FDCs)	55
3.1.4 Lymphatic Endothelial Cells (LECs)	59
3.1.5 Blood endothelial Cells (BECs) and High endothelial cell venules (HEVs)	61
3.1.6 Double Negative stromal cells (DNC)	62
3.2 Lymph node macrophages	63
3.2.1 Lymph node macrophage development	64
3.2.2 Subcapsular Sinus Macrophages (SSMs)	64
3.2.3 Medullary Sinus Macrophages (MSMs) and Medullary Cord Macrophages (MCMs)	65
3.2.4 LN macrophages and their propensity to infection.....	66
3.3 Conclusions	67
3.4 Bibliography	68
Chapter 4: TNFSF and TNFRSF members in adult LNs	76
4.1 LT β R and TNFR	76
4.2 RANKL	77
4.3 Conclusions	81
4.4 Bibliography	82
Chapter 5: Integrins and the immune system	85
5.1 Integrin structure	86
5.2 Bidirectional integrin signalling	87
5.2.1 Inside-out signalling.....	88
5.2.2 Outside-in signalling	89
5.3 Biological relevance of integrins.....	90
5.3.1 Involvement in vasculature formation and functions	92
5.3.2 Integrins and immunity	93
5.3.3 α IIb β 3 integrin	97
5.4 Conclusions	98
5.5 Bibliography	99
Chapter 6: Tertiary Lymphoid Organs (TLOs)	104
6.1 TLO development	105
6.2 TLO functions	108

6.3 TLOs as a therapeutic approach	109
6.4 Conclusions	110
6.5 Bibliography	111
Results	115
1 Distinct and overlapping roles of RANKL and lymphotoxin in the regulation of CD169+ lymph node macrophages	116
1.1 Introduction	116
1.2 Article 1	117
1.3 Conclusions	145
2. Integrin-alpha IIb identifies murine lymph node lymphatic endothelial cells activated by receptor activator of NF-KB ligand	146
2.1 Introduction	146
2.2 Article 2	147
3.3 Conclusions	173
Preliminary results and Discussion	174
1- Preliminary Results	175
2- Thesis objectives	185
3- Thesis discussion and perspectives	186
4- Bibliography	195

ABSTRACT

RANKL and RANK are members of the TNF-superfamily and TNF-receptor superfamily, respectively. They are known to play an important role in the regulation of bone mass and in the development and the function of the immune system. However questions still remain. We have used genetically modified mice to address some of these questions, in particular by using a mouse whose lymph node marginal reticular stromal cells lack RANKL. The results obtained during this PhD provide important new insights into the positive impact of stromal RANKL on lymph node macrophages concomitant with enhanced B cell function and reduced viral pathogenicity. We found that stromal RANKL regulates lymphotoxin and CXCL13 expression, two key molecules for B cell homeostasis and secondary lymphoid organ cellular integrity. RANKL activity seems to follow a temporal hierarchy over lymphotoxin/TNF α , as the phenotype caused by stromal RANKL-deficiency has increased penetrance with age. Furthermore, we demonstrate that RANKL activates lymph node lymphatic endothelial cells and found that the integrin ITGA2b is a new indicator for activated lymphatic endothelial cells. Thus, together with MAdCAM-1, ITGA2b serves as a novel marker for those lymphatic endothelial cells that are constitutively activated by stromal RANKL. Altogether, the data reinforce the importance of RANKL for the lymph node homeostasis and uncover hereto unknown mechanisms of RANKL functions. In light of this and the fact that RANKL is responsive to female hormones, we studied the role of RANKL in the Sjögren's syndrome, a chronic inflammatory disease of salivary and lacrimal glands with a strong female sex bias. We provide evidence that RANKL neutralization reduces tertiary lymphoid organ size. On the perspective side, a possible crosstalk between lymph node lymphatic endothelial cells and macrophages or marginal reticular cells remains to be clarified. Furthermore, further work is required to elucidate the mechanism by which RANKL stimulates chronic inflammatory diseases presenting tertiary lymphoid structures, in order to make RANKL a new target for therapy.

Keywords: RANKL, RANK, lymph node, macrophages, lymphatic endothelial cells.

Resumé

RANKL (Receptor activator of nuclear factor- κ B ligand), une protéine membre de la superfamille du TNF (tumor necrosis factor) peut se présenter sous trois formes différentes, une protéine transmembranaire trimérique, un ectodomaine libéré de la forme membranaire par clivage enzymatique et une forme soluble primaire. Après engagement avec RANK, son récepteur, RANKL est capable d'induire l'activation de multiples voies de signalisation, y compris la voie NF- κ B, MAPK (Mitogen-activated protein kinase), la PKC (protéine kinase C), Ca^{2+} /Calcineurine/NFAT (nuclear factor activated T cells) et la PI3K (Figure 1). OPG (ostéoprotégérine), un autre récepteur soluble pour RANKL, permet d'inhiber l'interaction entre RANK et RANKL. Ces trois protéines forment une triade qui a principalement été décrite dans la maturation de l'ostéoclaste (macrophage spécialisée pour la résorption de la matrice osseuse). Mais ces molécules sont aussi impliquées dans la formation des glandes mammaires, dans les interactions entre cellules T et cellules dendritiques et de plus aussi dans l'organogenèse des ganglions lymphatiques et dans l'induction de la tolérance immune.

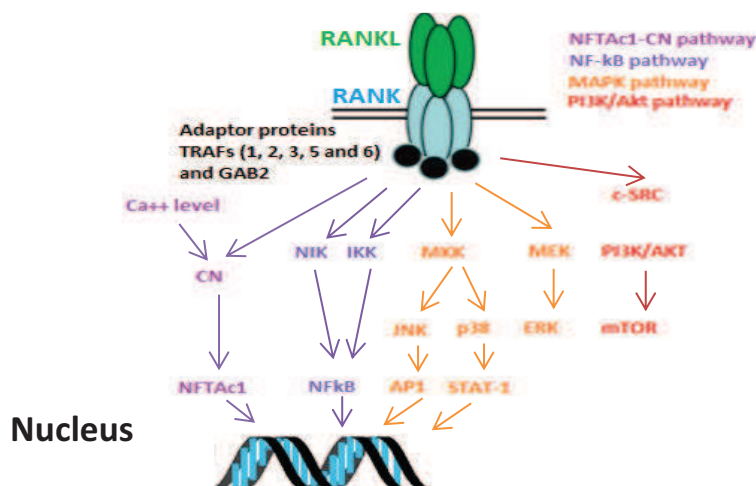

Figure 1 Voies de signalisation de RANK/RANKL

Durant mon doctorat j'ai dirigé mon intérêt au rôle de RANK et RANKL dans le développement des ganglions lymphatiques, dans l'homéostasie, pendant une réaction immunitaire et aussi dans le développement des structures lymphoïdes tertiaires. Il est déjà reconnu que durant l'organogenèse des organes lymphoïdes secondaires (ganglions lymphatiques, plaques de Peyer's) les LTis (lymphoid tissue inducer cells), cellules responsable de l'induction de la formation des tissus lymphoïdes, nécessitent RANKL pour la formation des ganglions. En fait, l'absence de RANK ou RANKL chez la souris se traduit par une absence complète des ganglions lymphatiques, qui a entravé l'étude de ces molécules dans les ganglions adultes. $LT\beta R$ ($LT\beta$ receptor) et $LT\alpha 1\beta 2$ (lymphotoxin $\alpha 1\beta 2$), deux autres membres des familles TNFR et TNF, respectivement, sont aussi très important pour l'organogenèse des ganglions lymphatiques. Les ganglions lymphatiques ne se développent pas quand les LTis ou la voie de signalisation $LT\beta R$ sont absents. La voie $LT\beta R$ est aussi très importante pour l'organisation des cellules B en follicules dans les ganglions. Parallèlement, le RANKL est aussi impliqué à l'organisation des cellules B, par exemple un modèle de souris surexprimant RANKL montre une augmentation du nombre de follicules de cellules B. En plus le blocage de RANKL pendant l'étape embryonnaire à 13.5E, mais pas à 14.5E-16.5, mène à une formation de follicules de cellules B altéré après la naissance. Il convient de noter, que dans les ganglions adultes, RANKL est exprimée par les cellules stromales MRC (marginal reticular cells) qui sont localisé juste au-dessus des follicules de cellules B, et dans le développement par les cellules stromales LTos (lymphoid tissue organizer cells). De plus amples recherches devraient être développées dans ce domaine afin de comprendre complètement l'influence de RANKL sur le développement et l'homéostasie des organes lymphoïdes secondaires en général et des follicules de cellules B en particulier.

Ainsi les objectifs de ma thèse ont été d'étudier les fonctions de RANKL dans le développement, l'homéostasie et la réponse immunitaire des organes lymphoïdes secondaires et aussi dans le développement des structures lymphoïdes tertiaires. Pour ce faire, j'ai utilisé un modèle murin déficiente de manière conditionnel pour le RANKL dans les cellules stromales sous le contrôle du promoteur codant la chimiokine

CCL19, qui sont les LTo, les FRC (fibroblastic reticular cells) et MRC (Figure 2). J'ai aussi bloqué RANKL en utilisant un anticorps anti-RANKL. Utilisant un nouvelle anticorps anti-RANK, qui á été fabriqué pour nous en collaboration avec MedImmune, on a pu identifier les cellules qui expriment RANK dans le ganglion. Pour obtenir mes résultats je effectuée des analyse en cryométrie de flux, immunohistochimie et qPCR (réaction en chaîne par polymérase en temps réel).

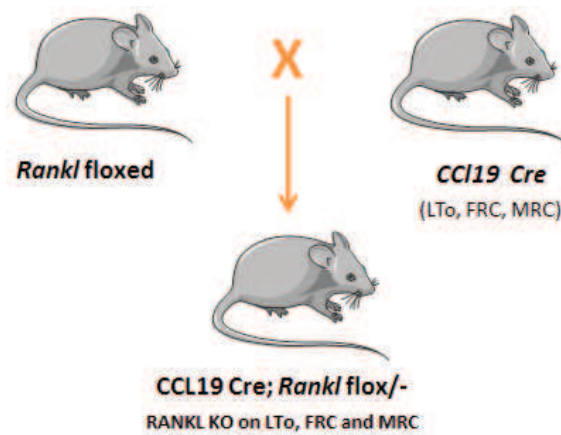

Figure 2 Modèle murin déficiente pour RANKL dans les cellules stromales

Résultats

1. Rôles distincts et concurrents de RANKL et lymphotoxine dans la régulation des macrophages CD169⁺ des ganglions lymphatiques

Les souris CCL19^{Cre+}RANKL^{ff} à l'âge adulte présentent une altération dans les macrophages des ganglions lymphatiques, tant sur les macrophages du sinus sous-capsulaire (SSMs) comme sur les macrophages médullaires (MSMs). Ces macrophages étaient toujours présents mais ils montrent une diminution d'expression du CD169 et du ligand du récepteur de mannose (MR-L) (Figure 3 a et b). Il est à noter que dans les souriceaux de 5 jours l'expression de CD169 est normale.

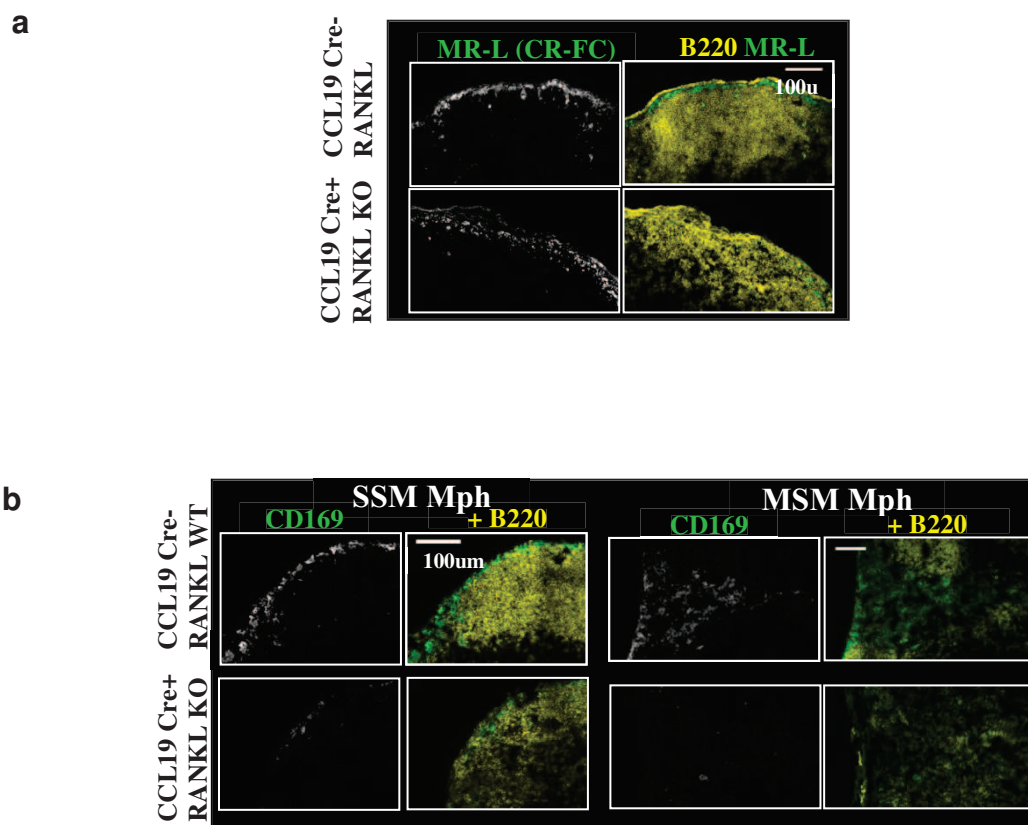

Figure 3 Réduction de l'expression de CD169 dans les SSM et MSM dans la souris KO.

Il a été montré précédemment que les SSM et les MSM sont sensibles à la LT produit par les cellules B. Par conséquent, nous avons comparé l'impact de la carence en LT par rapport à RANKL sur la différenciation des SSM et MSM. Les souris qui ont reçu

LTBR-Ig soluble pour 4 semaines ont montré une réduction supplémentaire des macrophages CD169⁺ (Figure 4). Ceci suggère que LT agit en aval de RANKL pour la différenciation des macrophages.

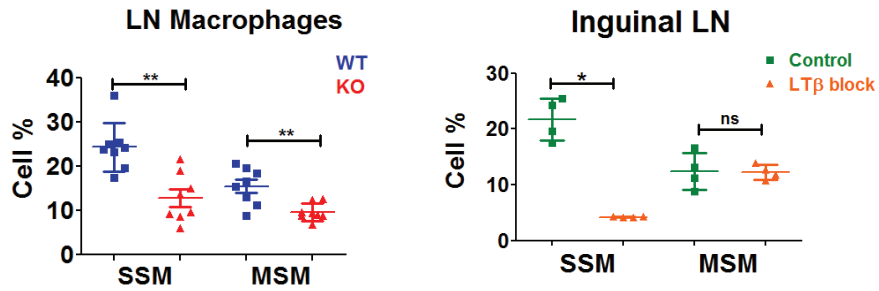

Figure 4 Réduction des macrophages dans les souris CCL19Cre⁺RANKL^{ff} KO et après le blocage de LT.

Étant donné que les macrophages sont connus pour capturer des antigènes issus du flux lymphatique et les transférer aux cellules B, nous avons analysé la capacité des souris KO de capturer des complexes immuns avec phycoérythrine (PE-IC) et de les transférer aux cellules B. Comme prévu les souris KO ont présenté une diminution de la capacité de transférer les PE-IC aux cellules B (Figure 5).

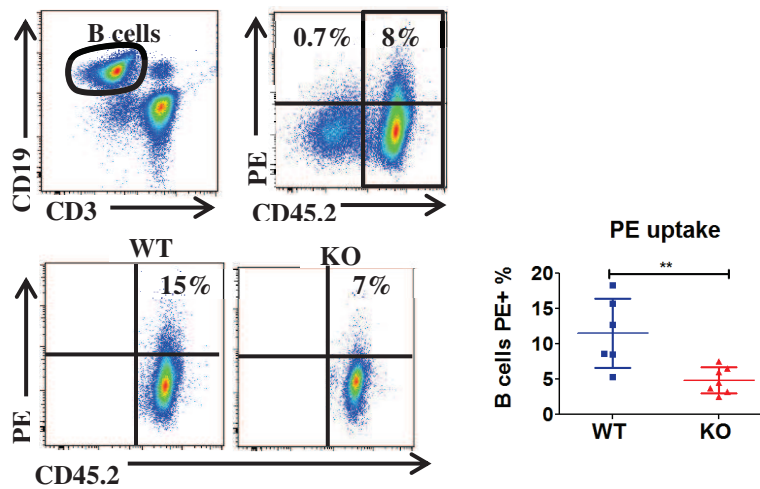

Figure 5 Diminution du transfert des PE-IC aux cellules B dans la souris KO.

En utilisant un nouvel anticorps anti-RANK nous avons observé que RANK n'est pas exprimé par les macrophages. Etant donné l'effet important de la LT sur les macrophages, RANKL pourrait influencer la production de LT. LT joue un rôle important dans la différenciation des FDCs (follicular dendritic cells) et dans la formation des follicules B à travers la production de CXCL13. Nous avons donc examiné les ganglions de la souris KO pour la formation normale des follicules de cellules B et pour la différenciation des FDCs. Les souris $CCL19^{Cre+}RANKL^{ff}$ ont présenté une diminution de la taille des ganglions, spécialement les ganglions inguinaux. Dans ces ganglions et aussi dans les ganglions brachiaux les proportions des cellules stromales étaient normales, par contre les proportions de cellules T et B étaient déséquilibrées, montrant plus de cellules T et moins de cellules B (Figure 6a). De plus, l'architecture des ganglions était désorganisée avec une faible ségrégation entre les cellules B et T (Figure 6b). Le problème organisationnel était dû à une diminution en nombre de cellules folliculaires dendritiques FDC et aussi une diminution de l'expression de CXCL13 par les MRC et FDC (Figure 6c).

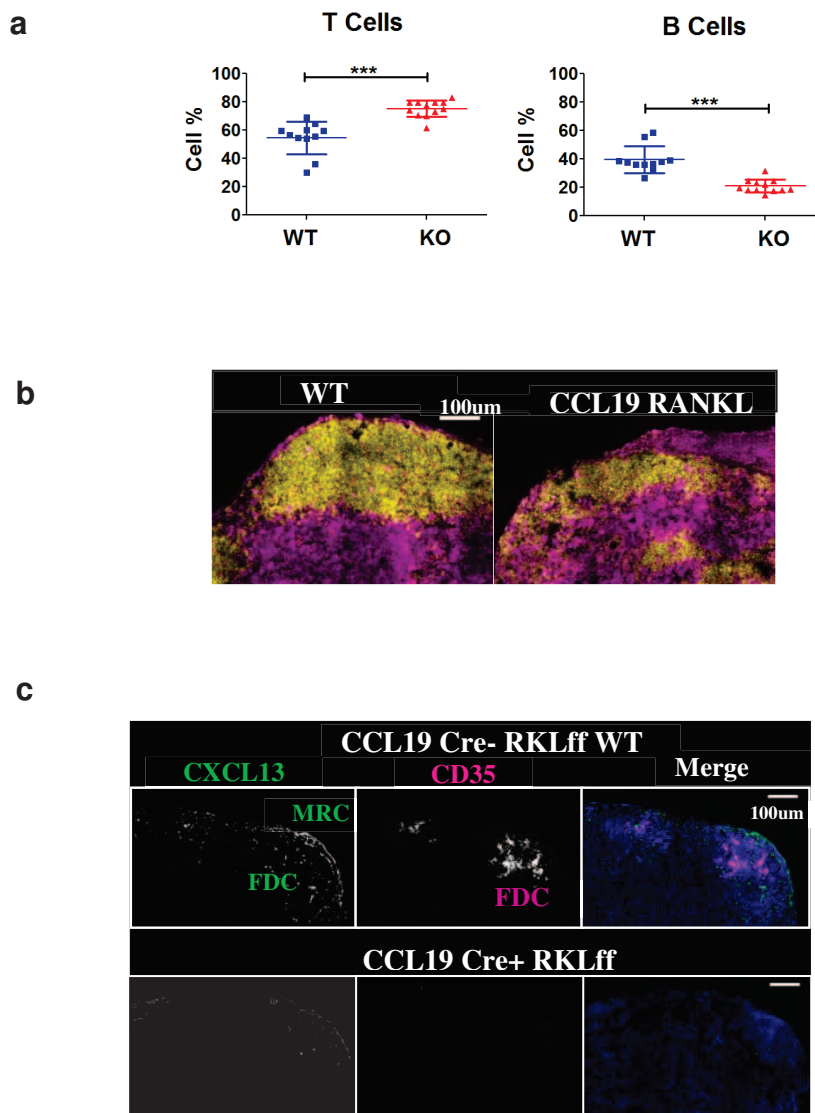

Figure 6 Les phénotypes dans les ganglions de la souris CCL19 RANKL KO. Proportion des cellules B et T dans les ganglions inguinaux et brachiaux (a). Image représentative de la désorganisation du ganglion inguinal chez la souris KO de 8 semaines (b). Images représentative de l'absence des FDC et de CXCL13 dans les ganglions inguinaux de la souris KO à 8 semaines (c).

Pour explorer les raisons sous-jacentes à l'expression de CXCL13 réduite, nous avons émis l'hypothèse que les événements embryonnaires requises pour l'homéostasie des ganglions peuvent être sous le contrôle du RANKL. L'expression de CXCL13 dépend de LT, et il a été montré que RANKL induit la production de LT par les LTi, ce qui suggère qu'une boucle de rétroaction positive peut être installée pour assurer une production

élevée et continue de LT, parce que LT à son tour active l'expression de RANKL par les LTo. Par conséquent nous avons évalué l'expression de LT par les LTi, dans les ganglions postnatals, qui semblaient inchangées (Figure 7a). Par contre, l'expression de LT à 8 semaines a été fortement diminuée chez les souris KO (Figure 7b).

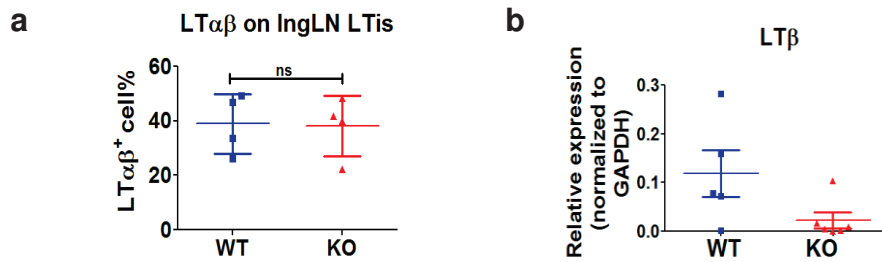

Figure 7 Expression de LT. Mesure par cryométrie en flux de LT exprimé à la surface par les LTi dans les ganglions inguinaux à 5 jours (a). Mesure par qRT-PCR du LT mRNA dans les ganglions inguinaux à 8 semaines (b).

Ainsi, il n'y avait aucune preuve d'un impact précoce de RANKL stromale sur la production de LT. Nous avons ensuite raisonnées qui RANKL ne pourrait affecter l'homéostasie des ganglions qu'après le développement initial. À cette fin, nous avons évalué la différenciation des SSM et des MSM avec l'âge. Nous avons constaté que les cellules étaient présentes après la naissance, mais ont commencé à disparaître quelques semaines plus tard. En plus, nous avons suivi aussi la taille des ganglions et les cellules B avec l'âge, comme une lecture pour la production défectueuse de CXCL13. Nous avons constaté que initialement le taille et la proportion de cellules B étais normal chez la souri KO, mais qui une différence commencé à devenir plus prononcée avec l'âge, parallèle au phénotype des SSM et MSM. Par conséquent, il y avait une hiérarchie temporelle de RANKL par rapport à LT/TNFα avec l'augmentation de l'influence de RANKL sur les événements de LT/ TNFα-dépendante avec l'âge des animaux.

En utilisant un anticorps anti-RANKL neutralisant, nous avons également analysé l'implication de RANKL dans la formation des organes lymphoïdes tertiaires (TLOs) dans un modèle de syndrome de Sjögren. Nous avons constaté que le blocage de RANKL conduit à une réduction de la taille des TLOs dans les glandes salivaires, tout comme le nombre de cellules lymphoïdes et stromales.

Ainsi, ce travail nous a permis de démontrer l'influence du RANKL, produit par les cellules stromales, sur le développement et l'homéostasie des ganglions lymphatiques et sur sa fonction.

2. RANKL active les cellules lymphatique endothélial (LEC)

Parallèlement, nous avons également analysé l'effet de RANKL sur les LEC basé sur le fait que des souris surexprimant RANKL (souris Tg) dans la peau présentent des ganglions hyperplasique, une activation des LECs (expression de marqueurs mesurée par qRT-PCR) et que certaines de ces souris présentaient aussi des lymphœdème en vieillissant.

Nous avons comparé les expressions de MAdCAM-1, VCAM-1 et ITGA2b entre les souris WT et Tg, et nous avons trouvé que la souris Tg présent une surexpression de ces marqueurs. Par ailleurs, chez les souris WT MAdCAM-1 est exprimée seulement par un petit sous-ensemble de LEC localisé sur «le plancher» du sinus sous-capsulaire (floor LEC). Ces floor LEC sont géographiquement proches des MRC, la source interne de RANKL. Ceci soulève la question de savoir si les expressions de MAdCAM-1, VCAM-1, et CD41 par les floor LEC est la conséquence de l'expression de RANKL par les MRC. Nous avons d'abord neutralisé RANKL à l'aide d'un anticorps chez la souris WT et constaté une diminution des niveaux des expressions de MAdCAM-1, VCAM et ITGA2b (Figure8).

Figure 8 Diminution des expressions de MAdCAM-1, VCAM-1 et ITGA2b après blocage de RANKL.

Pour tester si RANKL produit par les MRC est responsable de ces expressions nous avons analysé ces marqueurs comparant les souris WT et CCL19 Cre⁺ RANKL^{ff} KO (qui ne exprime pas de RANKL par les MRC). Les souris KO ont montré une diminution significative de ces marqueurs (Figure 9).

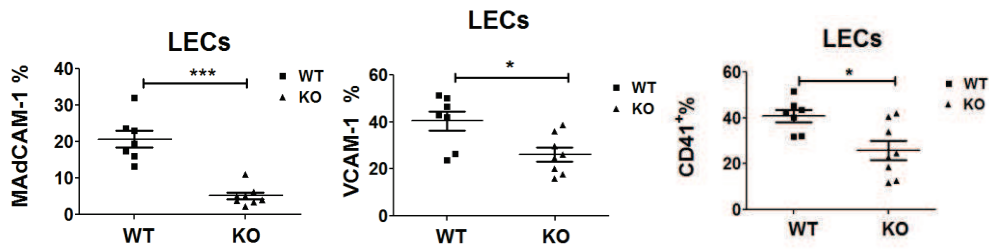

Figure 9 Diminution des expressions de MAdCAM-1, VCAM-1 et ITGA2B dans la souris KO

Nous avons aussi analysée l'expression de RANK par les LEC. En fait, une proportion non négligeable des LEC expriment RANK (Figure 10).

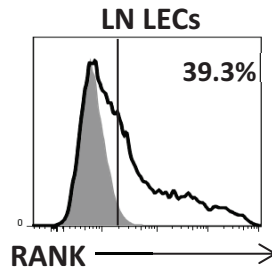

Figure 10 Les LEC expriment RANK

Ces résultats montrent que le RANKL produit par les MRC active les LEC, spécialement les floor LEC.

ITGA2b est un nouveau marqueur pour les LEC que nous avons trouvé et cette observation sera abordée ci-dessous.

3. Intégrine alpha IIb (ITGA2b) identifie les cellules lymphatiques endothéliales, des ganglions, activés par le RANKL

Nous avons analysé l'expression de ITGA2b dans les cellules stromales et avons observé que seulement les LECs l'expriment (Figure 11a). Les LEC qui expriment le ITGA2b sont les LEC sous-capsulaire (mais seulement la couche intérieure et pas la couche extérieure) et les LEC médullaires (Figure 11b). LEC humain à partir de ganglions lymphatiques mésentériques embryonnaires expriment également ITGA2b.

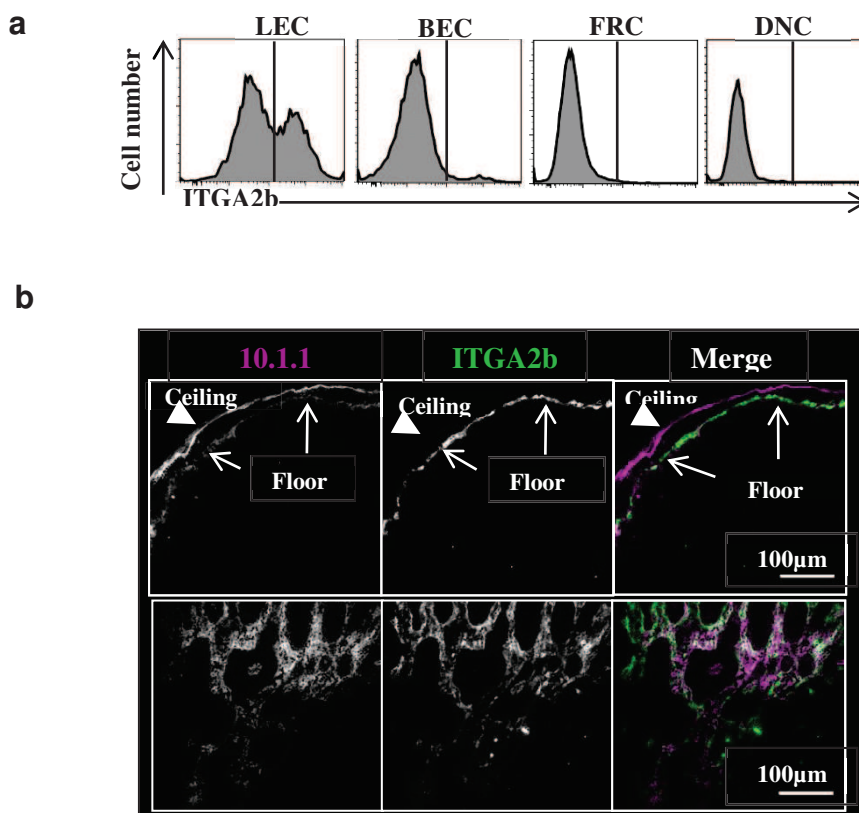

Figure 11 Expression de l'ITGA2b dans les LECs. Analyse en cytométrie de flux de l'expression de l'ITGA2b dans les cellules stromales (a). Image représentative de l'expression de l'ITGA2B par les LECs dans les ganglions lymphatiques (b).

Il est intéressant de noter que les LEC de la peau n'expriment pas ITGA2b, même pas après une inflammation. Nous avons évalué l'expression de RANK sur les LEC et les BEC

et l'a comparé entre le ganglion et la peau, les LEC de la peau expriment beaucoup moins RANK que les LEC des ganglions (Figure 12).

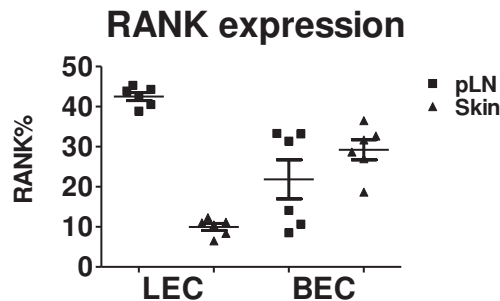

Figure 12 Expression de RANK dans les LEC et BEC du peau et des ganglions.

Les ganglions lymphatiques mésentériques (mesLN) des souris montrés une expression plus élevée de ITGA2b comparativement aux ganglions périphérique (pLN) (Figure 13a). Comme les ganglions mésentériques sont constamment stimulés par la microflore, nous nous demandons si l'augmentation d'ITGA2b était une conséquence de l'activation des LEC. Pour tester cette hypothèse nous avons immunisé des souris WT et cherché l'expression du ITGA2b sur les ganglions inguinaux, que nous avons trouvé augmenté (Figure 13a).

Pour tester si RANKL était responsable de l'expression d'ITGA2b par les LEC, nous avons utilisé la souris Tg (qui surexprime le RANKL) et avons trouvé une régulation positive d'ITGA2b (Figure 13b). Ensuite nous avons neutralisé RANKL dans des souris WT, à l'aide d'un anticorps, qui a conduit à une diminution de l'expression de ce marqueur (Figure 13b).

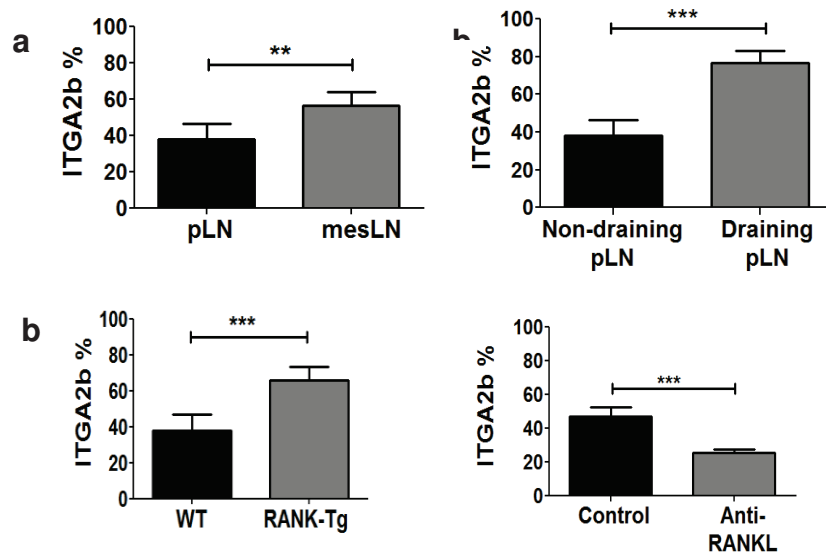

Figure 13 Expression augmenté d'ITGA2b dans les ganglions mésentériques et après immunisation (a). Expression augmenté dans la souris Tg et diminué après blocage de RANKL (b).

Ces résultats montrent qu'ITGA2b est un nouveau marqueur pour les LEC activées, et pourrait aider à identifier les différents sous-types de LEC avec des possibles fonctions différentes.

Conclusions et perspective

RANK et RANKL étaient déjà reconnus comme étant impliqués dans l'osté-immunologie et dans le système immunitaire, mais des informations détaillées manquaient encore. Les résultats obtenus lors de cette thèse ont recueilli des informations importantes concernant l'impact du RANKL stromal sur la différenciation des macrophages des ganglions lymphatiques qui affecte l'absorption de complexes immuns par les cellules B. Nous avons trouvé aussi un impact de RANKL sur la régulation de LT et CXCL13, affectant les follicules de cellule B et la formation de réseau FDC. Fait intéressant, cet effet semble suivre une hiérarchie temporelle de LT/TNF α et RANKL pendant l'homéostasie, avec influence de RANKL importante sur les événements de LT/TNF α -dépendante liées à l'âge. En outre, sachant que RANKL a un effet important sur les adultes et qu'il est influencé par les hormones féminines, nous concentrons notre attention sur le syndrome de Sjögren comme un modèle de TLO, puisque son incidence est de 90% sur les femmes. Nous fournissons un nouvel aperçu sur l'implication de RANKL sur le développement des TLO, montrant que le blocage de RANKL diminue la taille des TLO. Nous avons également démontré l'impact de RANKL sur les LEC et que le RANKL stromale est une source importante d'activation des LEC. Dans ce contexte, nous avons trouvé un nouveau marqueur pour l'activation des LEC, le ITGA2b, qui est également réglé par RANKL, et dépeint l'hétérogénéité des LEC dans le ganglion lymphatique. Au total, ces nouvelles données renforcent l'importance, déjà reconnue, du RANKL sur l'homéostasie des ganglions lymphatiques, mais dévoile une fonction du RANKL dans la régulation de la fonction des SLO (organes lymphatique secondaire). Sur perspective, il serait intéressant de vérifier possible l'influence des LEC sur les macrophages des ganglions. La caractérisation des différents sous-types de LEC ainsi que leurs fonctions serait également pertinent. En outre, il serait utile de savoir l'impact de la régulation du RANKL stromale, par exemple son blocus pourrait éventuellement être utilisé comme un moyen thérapeutique pour prévenir la formation de TLO.

LIST OF FIGURES

Figure 1- 1 TNF and TNFR superfamilies members.	3
Figure 1- 2 RANK/RANKL signalling pathways	8
Figure 2- 1 Lymphatic system development	23
Figure 2- 2 Lymphatic system organization	24
Figure 2- 3 Lymph Node architecture	26
Figure 2- 4 LN anlagen development	27
Figure 2- 5 LTi - LTo crosstalk drives LN organogenesis	31
Figure 2- 6 LTis generation	34
Figure 2- 7 LTis and LTo interaction through RANK-RANKL signalling during LN development	35
Figure 2- 8 TNF and TNFR superfamily, interactions between family members. Interactions between TNF, LT α and β and LIGHT and their receptors.....	36
Figure 2- 9 Homing specificity is determined by a multistep process coordinated by HEVs selective expression	39
Figure 2- 10 Lymph node organizations mediated by chemokines.....	40
Figure 3- 1 FRCs schematic view.....	51
Figure 3- 2 MRCs in different SLOs	54
Figure 3- 3 Germinal centre reaction	57
Figure 3- 4 Different macrophages subsets found within the LN	63
Figure 4- 1 RANKL effects on endothelial cells	79
Figure 5- 1 Integrin receptors	85
Figure 5- 2 Integrin subunit structure	87
Figure 5- 3 Bidirectional integrin signalling	89
Figure 5- 4 Leukocyte adhesion cascade	94
Figure 6- 1 Similarities between a LN and a salivary gland TLO.....	104
Figure 6- 2 TLO formation.....	107

LIST OF TABLES

Table 1- 1 RANK, RANKL and OPG names and chromosomal locations.....	5
Table 1- 2 Molecules that modify OPG, RANK and RANKL expression	6
Table 1- 3 RANKL impact on B cells	13
Table 2- 1 Molecules expressed by murine LTis and LTos.....	29
Table 2- 2 Mutant mice presenting defective SLO development.....	33
Table 3- 1 LN stromal subsets.....	51
Table 5- 1 Integrin KO phenotypes.....	92
Table 5- 2 Leukocytes integrins	97

LIST OF ABBREVIATIONS

ADAM	A disintegrin and metalloprotease domain
AP1	Activator protein 1
APCs	Antigen presenting cells
ARO	Autosomal recessive osteopetrosis
BAFF	B cell activator factor
BAFFR	BAFF Receptor
BALT	Bronchial-associated lymphoid tissue
BCMA	B-cell maturation antigen
BCR	B cell receptor
BECs	Blood endothelial cells
BMP-2	Bone morphogenic protein-2
Ca	Calcium
CCL	Chemokine (C-C motif) ligand
CCR	C-C chemokine receptor
CN	Calcineurin
CNS	Central nervous system
CP	Cryptopatches
CR	Complement Receptor
CRD	Cysteine rich domains
CSF1	Colony stimulating factor-1
CXCL	Chemokine (C-X-C motif) ligand
CXCR	Chemokine C-X-C motif receptor 5
c-SRC	Cellular-sarcoma
DCs	Dendritic cells
DDH	Death domains homologous
Deaf1	Deformed epidermal autoregulatory factor 1
DNCs	Double negative cells
ECM	Extracellular matrix
eNOS	Endothelial nitric oxide synthase
ERK	Extracellular-signal-regulated kinase
eTACs	Extra-thymic Aire-expressing cells
FADD	Fas-associated DD proteins
FAK	Focal adhesion kinase
FDCs	Follicular dendritic cells
FDC-M	Follicular dendritic cell marker

FRCs	Fibroblast reticular cells
GAB2	GRB2-associated binding protein
GC	Germinal centre
GFP	Green fluorescent protein
GI	Gastrointestinal
GRB2	Growth factor receptor-bound protein 2
HF	Hair follicle
HML-1	Human mucosal lymphocyte antigen-1
iBALT	Inducible BALT
IC	Immune complex
ICAM-1	Intercellular adhesion molecule 1
IGF-1	Insulin growth factor-1
IKK	I κ B kinases complex
IL	Interleukin
ILF	Isolated lymphoid follicles
JAK3	Janus kinase 3
JNK	c-Jun N-terminal kinase
KO	Knockout
LAD	Leukocyte Adhesion deficiency
LAP-TGF β	Latency-associated peptide- TGF β
LFA-1	Lymphocyte function-associated antigen-1
LECs	Lymphatic endothelial cells
LN	Lymph node
PLAM-1	Lymphocyte Peyer's patch adhesion molecule-1
LPS	Lipopolysaccharide
LT	Lymphotoxin
LTis	Lymphoid tissue inducer cells
LTos	Lymphoid tissue organizer cells
LV	Lymph vessel
LYVE-1	Lymphatic vessel endothelial hyaluronan receptor 1
Mac-1	Macrophage-1 antigen
MAdCAM-1	Mucosal vascular addressin cell adhesion molecule 1
MAPKs	Mitogen activated protein kinases
MCM	Medullary cord macrophages
MEC	Mammary epithelial cells
MEK	MAPK/ERK kinase
MHC	Major histocompatibility complex
mLN	Mesenteric lymph node

MKK	MAP kinase kinase
MR	Mannose receptor
MRCs	Marginal reticular cells
MR-L	MR-ligand
MSM	Medullary sinus macrophages
mTECs	Medullary-thymic epithelial cells
mTOR	Mammalian target of rapamycin
NALT	Nasal-associated lymphoid tissue
NF- κ B	Nuclear factor- κ B
NFTAc1	Nuclear factor of activated T cells 1
NIK	NF- κ B inducible kinase
NK	Natural killer
NO	Nitric oxide
OCIF	Oclastogenesis inhibitory factor
ODAR	Osteoclast differentiation and activation receptor
ODF	Osteoclast differentiation factor
ODFR	ODF receptor
OPG	Osteoprotegerin
OPGL	OPG Ligand
PC	Plasma cell
PCN	Protein-caged nanoparticles
PD-1	Programmed cell death-1
PD-L1	PD-ligand 1
PDGFR β	Platelet-derived growth factor receptor-beta
PE	Phycoerythrin
PECAM-1	Platelet-endothelial cell adhesion molecule-1
PI3K	Phosphoinositide 3-kinase
PLAD	Pre-ligand-binding assembly domain
pLN	Peripheral LN
PMA	Phorbol myristate acetate
PMN	Polymorphonuclear cells
PNAd	Peripheral LN adressin
PP	Peyer's patches
Prox1	Prospero homeobox protein 1
PTA	Peripheral tissue antigen
RA	Retinoic acid
RANK	Receptor activator of NF- κ B
RANKL	RANK ligand

RIP	Rat insulin promotor
RORyt	RA receptor-related orphan receptor
S1P	Sphingosine-1-phosphate
SAC	<i>Staphylococcus aureus</i> cell wall
SCID	Severe combined immunodeficiency
SCS	Subcapsular sinus
SF	Super family
SHM	Somatic hypermutation
SLO	Secondary lymphoid organs
SMA	Alpha smooth muscle actin
SMCs	Smooth muscle cells
SSM	SCS macrophages
STAT1	Signal transducer and activator of transcription 1
TACI	Transmembrane activator and cyclophilin ligand interactor
TCR	T cell receptor
TFH	T follicular helper
TGF- β	Transforming growth factor β
THD	TNF homology domain
TLN	Telencephalin
TLO	Tertiary lymphoid organ
TNF	Tumor necrosis factor
TNFR	TNF-receptor
TRADD	TNFR-associated DD proteins),
TRAF	TNFR-associated factor
TRAILR1	TNF-related apoptosis-inducing ligand receptor 1
TRANCE	TNF-related activation induced cytokine
TRANCER	TRANCE receptor
Treg	T regulatory cells
UV	Ultraviolet
VCAM-1	Vascular cell adhesion molecule-1
VE-cadherin	Vascular endothelial cadherin
VEGF-C	Vascular endothelial growth factor C
VEGFR-3	Vascular endothelial growth factor receptor 3
VEGI	Vascular endothelial cell-growth inhibitor
VLA-4	Very late antigen-4
vWF	Von Willebrand factor
XEDAR	X-linked EDA receptor

β -gal

β -galactosidase



INTRODUCTION



1 RANK, RANKL and OPG

1.1 Members of TNF and TNFR superfamilies

Lymphotoxin (LT) and tumor necrosis factor (TNF) were the first two members of TNF superfamily (SF) to be identified by their strong homologies [1-4]. Many other proteins were further discovered by large scale sequencing, and were referred as belonging to the TNFSF, including soluble and membrane-bound ligands. The receptors for these proteins also share strong homologies and therefore were also grouped into a SF, the TNF Receptor (TNFR) SF. TNFR1 and TNFR2 were the first receptors to be identified followed by several other receptors (Fig. 1-1) [5]. These TNF and TNFR members perform a great variety of functions in several different tissues, being involved in various biological processes ranging from hematopoiesis, morphogenesis, bone resorption, immune responses, viral replication, septic shock, tumorigenesis to immunity [5, 6]. Some of the ligands are able to bind to more than one receptor with high affinity, increasing, therefore, the regulatory flexibility and complexity (Figure 1-1). TNFSF members are all type II transmembrane proteins, except for the lymphotoxin- α (LT α) and the vascular endothelial cell-growth inhibitor (VEGI) that are soluble proteins. They have a carboxy-terminal extracellular domain, an amino-terminal intracellular domain and a single transmembrane domain. The 20-30% of homology between the members is mostly confined to the extracellular C-terminus, known as the TNF homology domain (THD), and this region is responsible for binding to the receptor [6]. The THD folds into an antiparallel β -sandwich which assembles into trimers. The individual selectivity of each ligand for its receptor is based on the length and composition of the loops connecting the THD β -strands [7], [8]. TNFR are mainly type I transmembrane proteins with extracellular N-terminus and intracellular C-terminus [5]. The intracellular domain is short and serves as docking site for signalling molecules. The TNFRSF can be divided into activating or death-inducing receptors based on their cytoplasmic adaptor proteins. Activating receptors like CD30, CD40 and TNFR2 are more numerous than death receptors and contain a TNFR-associated factor (TRAF) binding domain. TRAF proteins can induce several signalling pathways such as mitogen activated protein kinases (MAPKs) and nuclear factor- κ B (NF- κ B), leading to survival and cell growth [6]. Death receptors like TNFR1, FAS and TRAILR1 (TNF-related apoptosis-inducing ligand receptor 1) signal through a death domain (DD) which can associate with FADD (Fas-

associated DD proteins) and TRADD (TNFR-associated DD proteins), leading to cell death in a caspase-dependent manner (Locksley, Killeen et al. 2001).

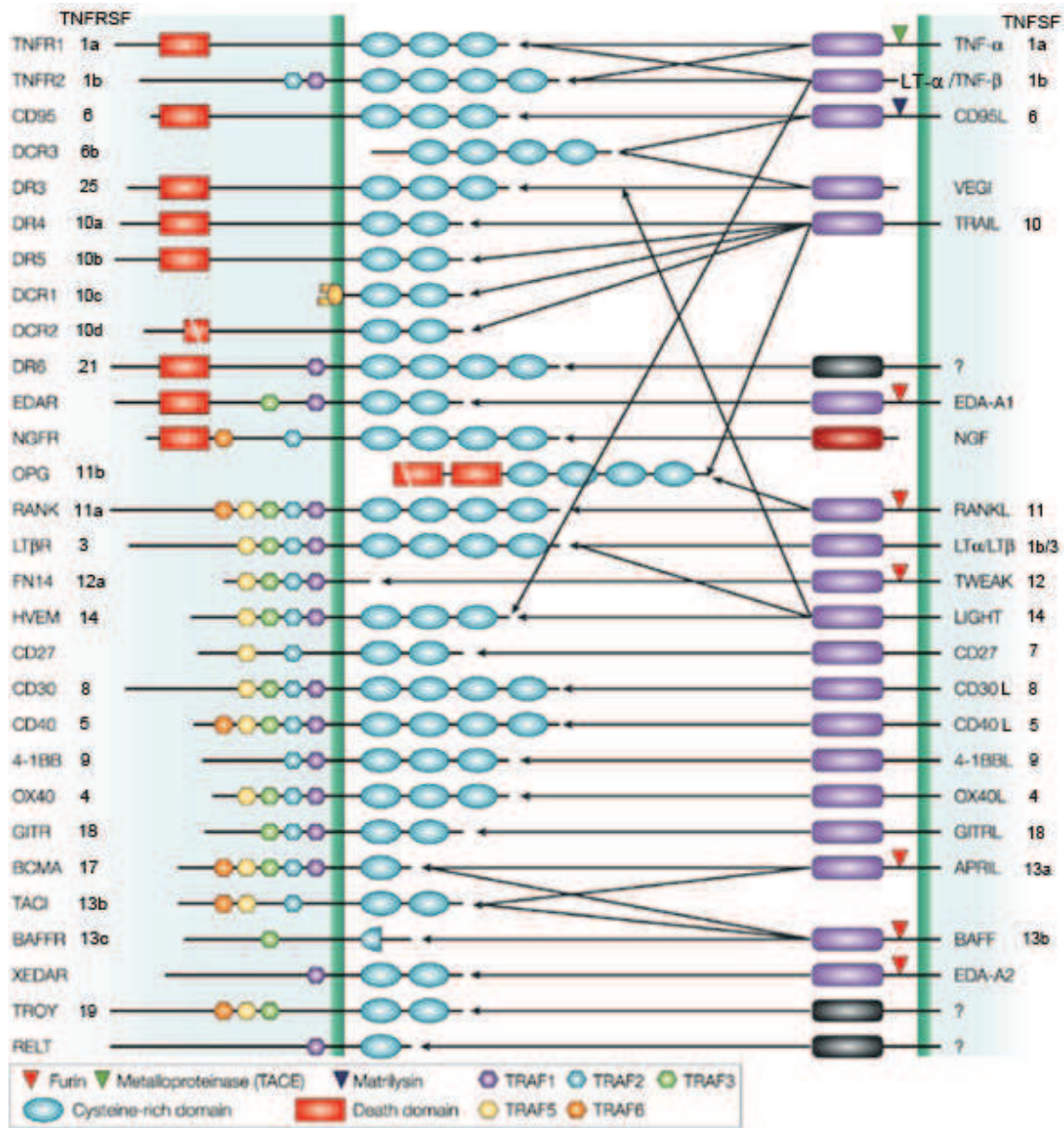

Figure 1- 1 TNF and TNFR superfamilies members. TNF members are all type II transmembrane proteins, except for the lymphotoxin-α (LTα) and the vascular endothelial cell-growth inhibitor (VEGI) which are soluble proteins without post-translational modifications such as protease-dependent membrane shedding. The TNFRs are type I transmembrane proteins, except the transmembrane activator and cyclophilin ligand interactor (TACI), the B-cell maturation antigen (BCMA), the X-linked EDA receptor (XEDAR) and BAFF receptor (BAFFR) which are type III transmembrane proteins. DCR3 and

osteoprotegerin (OPG) lack a transmembrane domain and are consequently soluble protein. Other receptors also have soluble forms [5].

1.2 RANK, RANKL and OPG discovery

In the 90s a study to identify new TNFR members for therapeutic use was designed by Amgen Inc. For that purpose several transgenic mice over-expressing different TNFRs were created, with one of them presenting osteopetrosis (increased bone density) due to a lack of osteoclasts. The protein overexpressed by these mice seemed to protect the bones by inhibiting bone resorption by osteoclasts, and so it was named osteoprotegerin (OPG) [9]. In Japan, an identical molecule was independently identified [10]. Tsuda and colleagues were searching for stimulatory and inhibitory factors of osteoclasts and they obtained a partial protein sequence called OCIF (osteoclastogenesis inhibitory factor) from human fibroblasts [10]. This OCIF protein turned out to be identical to OPG, previously identified by Amgen Inc. The OPG ligand (OPGL) was identified by both groups using expression cloning with OPG as a probe [9, 11]. OPGL turned out to be identical to a previously identified TNFSF member, the receptor activator of NF- κ B ligand (RANKL) [12] /TNF-related activation induced cytokine (TRANCE) [13]. Another receptor for OPGL/RANKL was soon discovered as the receptor activator of NF- κ B (RANK) previously found by sequencing cDNA from bone marrow-derived dendritic cells (DCs) [12]. The researchers described the partial homology between RANK and CD40 (TNFRSF5), and that RANK was involved in T cell activation [13]. After isolating RANKL, by direct expression cloning, they showed that T cell survival and proliferation was increased by RANK-RANKL interaction, which occurs through DC stimulation [12]. This is how a triad was discovered: a TNFSF member, RANKL, and their two receptors, the membrane-bounded RANK, and the soluble decoy receptor OPG. These molecules had different names attributed to, which are listed on Table 1-1 including also their human and mouse chromosomal locations. In this thesis these molecules will be referred as RANK, RANKL and OPG.

Another TNFSF member, TRAIL (TNF-related apoptosis-inducing ligand) was identified as an additional OPG ligand. This molecule induces apoptosis after engagement of its death domain-containing receptors, DR4 (death receptor 4) and DR5. Additionally, there were

more two receptors lacking functional death domains, DcR1 (decoy receptor 1) and DcR2, OPG was found to be the third decoy receptor [14].

Standard names	Other names	Human chromosome	Mouse chromosome
TNFRSF11A	RANK (receptor activator of NF-κB) ODFR (osteoclast differentiation factor receptor) TRANCER (TNF-related activation induced cytokine receptor) ODAR (Osteoclast differentiation and activation receptor)	18q22.1	1
TNFRSF11B	OPG (Osteoprotegerin) OCIF (Osteoclastogenesis inhibitory factor)	8q24	15
TNFSF11	RANKL (RANK ligand) OPGL (OPG ligand) TRANCE ODF	13q14	14

Table 1- 1 RANK, RANKL and OPG names and chromosomal locations.

1.3 RANK, RANKL and OPG: Structure and expression

1.3.1 OPG

Human OPG is a 44kDa protein, composed by 401 amino acids [9]. Its gene is highly conserved, presenting 85% and 94% homology between rat and mouse and human proteins, respectively [9]. Its N-terminus shares a high homology with CD40 and TNFR2, and has four characteristic TNFRSF cysteine rich domains [15]. Additionally, it displays two death domains homologous regions that are functionally active, however an apoptotic signal is unlikely to be induced by OPG since it has only been observed as a soluble protein. The C-terminal region comprises an amino acid residue for OPG dimerization (Cys-400) and a heparin binding site. The heparin binding site is involved in OPG binding to Syndecan-1, a transmembrane heparin sulfate proteoglycan implicated in various cell functions, such as cell adhesion and migration [16].

Different tissues produce OPG, such as the lungs, brain, spleen, skin, stomach, liver, kidneys, mammary tissue, bones, placenta, prostate and the heart arteries and veins [17, 18]. OPG production, alike RANK and RANKL, is controlled by several cytokines, hormones, peptides and drugs, listed in Table 1-2.

	OPG	RANK	RANKL
Hormones			
Vitamin-D3	+	+	+
Estradiol	+		NC
Testosterone	+		+
Prolactin	-		+
Parathyroid hormone	-		+
Growth factors			
TGF- β	+	-	-
TGF- β + α CD3 (T cells)		+	+
BMP-2	+		
IGF-1	-		
Cytokines			
IL-1 β	+		+
IL-4 + (CD3) (T cells)		+	+
IL-6	+	-	+
IL-11	+		+
IL-17			+
TNF- α	+		+
Oncostatin M		NC	+
Leukemia inhibitory cytokine	+	NC	+
CD40L (dendritic cells)	+	+	+
Immunosuppressive molecules			
Glucocorticoids	-		+
Rapamycin	-		+
Tacrolimus	-		+
Cyclosporine A	-		+
Others			
Prostaglandin E2	-	+	+
Calcium	+		+
LPS	-		+
Ionomycin (T cells)			+
PMA (T cells)			NC
Indian Hedgehog	+		+
Vasoactive intestinal peptide			-

Table 1- 2 Molecules that modify OPG, RANK and RANKL expression. All studies were performed on osteoblasts or osteoclast cell lines, except the ones stated in parenthesis. (+) increases expression, (-) decreases expression, (NC) not changed, blank not tested [19, 20].

1.3.2 RANK

Human RANK comprises 616 amino acids and shares around 85% homology with the murine RANK. It is a type I homotrimeric transmembrane protein, with four TNFRSF characteristic cysteine rich domain and a C-terminus with 383 residues, one of the largest cytoplasmic domains in the TNFRSF. In spite of its length, it lacks enzymatic activity, therefore the signal transduction is mediated by TRAF adaptor proteins. The TRAFs 1, 2, 3 and 5 interact with RANK at a membrane-distal region of the cytoplasmic tail, whereas TRAF6 at a membrane-proximal binding region [21]. CD40 is the TNFR member which shares the highest homology with RANK, around 40% [12]. It was shown that there is a truncated RANK protein, product of an alternative splicing, which was suggested as being a negative regulator for RANK-RANKL interactions, however its biological relevance remains elusive [22].

RANK expression has been found in several organs, such as bones, bone marrow, skin, lung, liver, kidney, heart, brain, skeletal muscles, spleen, LNs, mammary glands and cancer cells [17-19]. In Table 1-2 are listed the factors found to affect RANK expression.

1.3.3 RANKL

Human RANKL is a type II homotrimeric transmembrane glycoprotein composed of 316 amino acids of which 247 comprise the extracellular domain. Human and mouse RANKL share around 85% homology, and are closely related to TRAIL, FasL and TNF [12, 13]. RANKL exists in three molecular forms: (i) a trimeric transmembrane protein, (ii) a primary soluble form as produced by T cells and (iii) a truncated ectodomain enzymatically cleaved from the membrane-bound form [11, 23, 24]. RANKL enzymatic processing is carried out by ADAMs (A disintegrin and metalloprotease domain) and matrix metalloproteases [25, 26]. Originally, RANKL was associated to T lymphocytes, but latter on it was shown to be widely expressed. RANKL is expressed in LNs, spleen, mammary tissue, thyroid, thymus, liver, lungs, kidney, brain, heart, testes and placenta [12, 13, 18]. Several factors are known to influence RANKL expression, which are listed in Table 1-2.

1.4 RANK signalling pathways

RANK signalling is induced when RANKL binds to RANK leading to its trimerization [19]. Idriss and Naismith raised the hypothesis of RANK activation being alternatively achieved by a receptor network creation [27]. Hence, it was demonstrated that RANK can be found self-assembled at the cell membrane, through an intracellular domain different from the previously described PLAD (pre-ligand-binding assembly domain) domain [28, 29]. As previously described, RANK recruits TRAFs and downstream activation of intracellular molecules [30, 31]. TRAF6 appears to play a predominant role, since TRAF6-deficient mice presents a similar phenotype to RANK-KO mice, that is severe osteopetrosis and lack of LNs [32]. The main difference between TRAF6 and the other TRAFs consists in the presence of a different Pro-X-Glu-X-X-(aromatic/acid residue) binding motif, which is also present in its upstream activators, including RANK [33]. GRB2 (growth factor receptor-bound protein 2)-associated binding protein (GAB2) is another adaptor protein shown to be involved in RANK signal transduction [34]. The recruitment of adaptor molecules leads to the activation of numerous signalling pathways, summarized in Fig. 1-2. RANK/RANKL signalling has been shown to be mediated via several pathways, including NF- κ B, MAPK, protein kinase C (PKC), Ca²⁺/Calcineurin/nuclear factor activated T cells (NFAT) and PI3K [35].

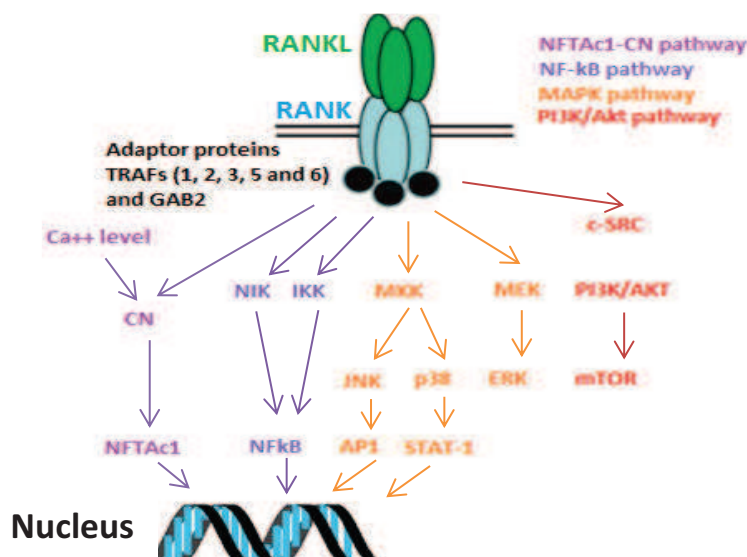

Figure 1- 2 RANK/RANKL signalling pathways. Abbreviations: Ca, calcium; CN, calcineurin; NFTAc1, nuclear factor of activated T cells 1; NIK, NF- κ B inducible kinase; IKK, I κ B kinases complex; MAPK, mitogen activated protein kinase; MKK, MAP kinase kinase; JNK, c-Jun N-terminal kinase;

AP1, activator protein 1; STAT1, signal transducer and activator of transcription 1; MEK, MAPK/ERK kinase; ERK, extracellular-signal-regulated kinase; c-SRC, cellular-sarcoma; PI3K, phosphoinositide 3-kinase; mTOR, mammalian target of rapamycin. Modified after reference [36].

- **NF- κ B pathway**

Mammals express five NF- κ B transcription factors including RelA (p65), RelB, c-Rel, NF- κ B1 (p50/p105) and NF- κ B2 (p52/p100). Both NF- κ B1 and NF- κ B2 are proteolytically processed into mature p50 and p52, respectively. Generally the NF- κ B dimers associate with I κ B inhibitor proteins, which retains them in the cytoplasm. Upon activation, I κ B is rapidly degraded by I κ B kinase (IKK), complex composed of two catalytic subunits, IKK α and IKK β and a regulatory subunit, IKK γ (NEMO, NF- κ B essential modulator) [37], [38]. NF- κ B activation and translocation into the nucleus is mediated by two pathways, the classical (canonical) and the alternative (non-canonical). Canonical pathway consists of p50:RelA and p50:c-Rel activation, that is dependent on IKK β activity. The non-canonical pathway depends on IKK α to initiate the processing of NF- κ B2/p100 complex with RelB which releases p52:RelB that are then translocate into the nucleus [34, 37, 38]. RANKL induces both canonical and non-canonical pathways upon binding to RANK, which leads to cell survival or differentiation.

- **MAPK pathway**

MAPKs are serine/threonine protein kinases and include the extracellular signal-regulated kinases (Erk1/2), p38-MAPKs ($\alpha/\beta/\gamma/\delta$), c-Jun N-terminal kinases (JNK1, 2, 3) and large MAPKs (Erk 5, 7, 8). RANK signalling activates the three conventional pathways, ERK, JNK and p38MAPKs to promote cell growth, differentiation but also, in some cases, apoptosis [38, 39].

- **Calcineurin/NFATc1 pathway**

NFAT comprises a family of 5 transcription factors, the NFATc1, c2, c3, c4 and NFATc5, which were previously identified in T cells. NFAT dephosphorylation allows their translocation into the nucleus. Cell differentiation by RANKL implicates the NFATc1 pathway [38, 40].

- **PKB/Akt pathway**

Three protein kinases B (PKB) are expressed by mammalian cells, Akt1/PKB α , Akt2/PKB β and Akt3/PK γ . Akt1 is ubiquitously expressed, Akt2 expression is restricted to insulin-sensitive tissues (liver, skeletal muscle and adipose tissue) and Akt3 is found in testis and brain. Their activation depends on PI3K, a heterodimeric lipid kinase, which phosphorylates PKB. PKT/Akt pathway leads to cell survival, cell cycle progress, glucose metabolism and protein synthesis, that may differ with cell type [38, 41].

1.5 RANK, RANKL and OPG in the immune system

RANKL was associated with the immune system since it was described as being expressed by T cells in order to stimulate dendritic cells (DCs) [12]. The involvement of RANK-stimulation in DCs biology has been further confirmed, but additional roles have been found. For instance, RANK- and RANKL-deficiency led to LN absence in mice, demonstrating the crucial roles of RANK and RANKL in LN organogenesis [42, 43]. This information will be further discussed in the following chapters. Other processes influenced by these molecules include immune tolerance as well as B and T cell development.

1.5.1 Dendritic cell biology

Dendritic cells (DCs) are antigen-presenting cells that process and present antigens to T cells, forming therefore the bridge between innate and adaptive immune systems. DCs from different tissues were found to express RANK, including mucosal DCs, mature bone marrow-derived DCs and freshly isolated LN and splenic DCs [13, 44]. RANK expression is upregulated in response to DC maturation [13]. RANKL was seen expressed by activated CD4⁺ and CD8⁺ T cells [45]. Activated T cell RANKL induces DC survival via anti-apoptotic protein Bcl-xL upregulation [13] which occurs through activation of the canonical NF- κ B pathway [46]. This survival effect was also corroborated *in vivo* by the finding that DC “vectors”, for immunotherapy purposes, lived longer when pre-incubated with RANKL [47]. Its survival effect was also demonstrated on Langerhans cells, the epidermis resident DCs [48]. Upon RANKL stimulation DCs produce pro-inflammatory molecules (IL-6 and IL-

1 β) and T cell differentiation factors (IL-12 and IL-15) [49]. CD40L, expressed by T cells, activates DCs and also induces survival and activation. However, unlike RANK, CD40 triggers an increase in MHC (major histocompatibility complex) class II or the costimulatory molecules CD80/86. Therefore, even though these two TNFR members share high homology, it seems that the final outcome of each pathway is slightly different [12, 45] [50]. Therefore RANK was postulated to provide an “adjuvant” effect, which was corroborated by increased longevity and adjuvant capacity of *ex vivo* transfer of RANKL pre-treated cDCs [51]. In spite of these findings, the phenotype of RANK or RANKL deficient mice was not found to concern DCs. Perhaps the strongest effect of RANK deficiency on DCs was shown by blocking RANKL in CD40-deficient mice, which led to a suppressed CD4⁺ T cell-mediated immune activation upon viral [52] and parasitic infections [53]. RANKL signalling involvement in immune responses was further investigated in an IL-2-deficiency model which presents a spontaneous autoimmune disease. Upon OPG administration the intestinal inflammation mediated by T cells was decreased in these mice and, in addition, there was a loss of activated DC numbers, providing *in vivo* evidence that RANKL mediates DC survival that can promote autoimmune inflammatory intestinal disease [53]. Hence, there is evidence that RANKL signalling promotes DC survival, which enhances T cell priming and activation, culminating in an activated immune response. Conversely, neither the innate nor the acquired immune responses were altered in an OPG overexpression model [54]. In contrast, RANKL immunosuppressive effects in the intestines were suggested by the increased IL-10 expression, an anti-inflammatory cytokine, and by the stimulation of Peyer’s patch-derived tolerogenic DC [44]. Moreover, mice challenged with ovalbumin presented an increased oral tolerance when treated with RANKL [44]. In a T cell-dependent autoimmune colitis model, the disease was mitigated when CD4⁺CD25⁺ T regulatory (Treg) cells were transferred, but when RANKL was blocked the Treg protective effect was no longer visible. This data suggests that CD4⁺CD25⁺ T regulatory cells function in the intestine is supported by RANKL [55]. Overall, it is probable that the immune response is only activated by RANKL in specific circumstances or that it occurs in redundancy with other molecules, such as CD40. RANKL may have a dominant effect in the intestine, possibly owing to high RANKL expression in this organ, suppressing autoimmunity and damaging immune responses against innocuous antigens from food and microbiome.

1.5.2 T and B cell development

RANKL was associated with T cell development when Kong and colleagues noted that the progression of CD4⁻CD8⁻CD44⁻CD25⁺ (DN3) precursors into CD4⁻CD8⁻CD44⁻CD25⁻ (DN4) thymocytes appeared arrested in RANKL-deficient mice [43]. Additionally, RANKL expression has been found on CD4⁻CD8⁻ thymocyte precursors [12]. Conversely, thymocytes development was not impaired in RANK-deficient mice, which was the only difference found between the RANK- and RANKL- deficient mice. This discrepancy evokes the possibility that RANKL could bind another receptor, or the phenotype was caused by other *in vivo* consequences of the RANKL-KO [42].

B cell development is also affected by RANK signalling, for instance, the RANK and RANKL-KO mice presented fewer mature B cells (B220⁺IgD⁺ and B220⁺IgM⁺ B cells) in the spleen [42, 43]. The reduced osteopetrosis-associated bone marrow cavities most probably explain the decreased cellularity, however, the progression of B220⁺CD43⁺CD25⁻ pro-B cell into B220⁺CD43⁻CD25⁺ pre B cell was also arrested on RANKL-KO mice [43]. Furthermore, the defective progression from pro-B to pre-B cell was maintained upon RANKL-KO bone marrow transfer into RAG-KO mice [43]. Normal bone marrow transfer into RANKL-KO mice led to normal B cell development and homing into the spleen [43]. Interestingly, B cells defects, including decreased serum Ig levels and hypogammaglobulinemia, were found in human patients with a RANK mutation [56]. Yun and colleagues showed that B cells express OPG and that its expression is regulated by CD40 stimulation. They isolated tonsillar B cells and stimulated them with anti-IgM and anti-CD40 which led to upregulated OPG transcription levels, additionally they stimulated tonsillar naïve B cells with either SAC (*Staphylococcus aureus* cell wall) or CD40L, and found that CD40 stimulation led to increased OPG upregulation compared to SAC stimulation alone [57]. OPG-deficient mice present an accumulation of type 1 transient B cells in the spleen, and when stimulated with IL-7, *in vitro*, their pro-B cells presented better proliferation when compared to wildtype pro-B cells, suggesting that OPG negatively regulates B cell maturation [12, 57-60]. Overall, the transition defect from pre-B to pro-B cells in RANK and RANKL-KO mice plus the increased numbers of transient B cells in OPG-KO mice suggest that this triad has an impact on the proliferative expansion of pro-B cells [42]. Even though, activated B cells can express RANK [12, 60] a conditional RANK-KO on B cells

showed no effect on B cell development nor B cell immune response [60], suggesting that this phenotype is due to non-B cells, but bone marrow or splenic stroma defects. Another study of RANKL blockade during embryonic development showed postnatally reduced B cell numbers and follicles [61]. Knoop and colleagues demonstrated that RANKL is essential for isolated lymphoid follicles (ILFs) development and normal cryptopatche (CP) formation, since they found no B cells on CPs and no ILF in RANKL-KO mice [62]. In TRAF-6 KO mice rescued with exogenous IL-7, the mice were able to form LNs however it lacked clearly defined B cell follicles [63] (Table 1-3). Overall, different studies have pointed out the influence of RANKL on B cells.

Organ (RANK[L] alteration)	Phenotype
LNs (KO)	Absent [43]
LNs (neutralisation)	B cell No/follicle reduced [61]
CP(KO)	B cells absent [62]
LN (TRAF-6 KO and IL-7 rescue)	Lack of defined B cell follicles. [63]

Table 1- 3 RANKL impact on B cells.

1.5.3 Immune Tolerance

As previously said, RANKL has been found to suppress autoimmunity in an oral tolerance model [55], and other studies have demonstrated its involvement in immune tolerance. A study in a TNF- α -inducible diabetes model, which is a CD8⁺ T cell mediated process, found that RANK/RANKL were necessary to prevent autoimmune reactions, since RANK pathway blockade led to fewer Treg cells, increased CD8⁺ T cells differentiation, and rapid diabetes onset [64]. In 2006, RANKL was found to be expressed by skin inflamed keratinocytes, this expression was found to activate Langerhans cells leading to an increased Treg cell number [65]. The same study found that ultraviolet-induced RANKL expression in the epidermis leads to immunosuppression, and that allergic contact hypersensitivity and systemic autoimmunity were suppressed in a RANKL-overexpression scenario in the

epidermis [65]. Later on, the same authors demonstrated that active vitamin D3 is produced in the skin, upon UV irradiation, which enhances RANKL expression (Table 1-2). Moreover, RANK⁺ Langerhans cell migration into the LNs appears enhanced by RANKL, which then induces Treg cell expansion [66]. Overall RANK and RANKL have been associated with peripheral tolerance, mediated by Treg cells, but they are also involved in central tolerance. Thymic medullary epithelial cells (mTECs) express AIRE (autoimmune regulator) and its expression was found to be under RANKL control [67]. The RANK pathway in thymic stromal cells seems to be required to promote immune tolerance since nude mice presented inflammatory cell infiltration and autoantibody production upon transplantation with RANK-KO fetal thymic stroma [68]. Furthermore, RANKL-deficient splenocyte transfer into nude mice led to a mild autoimmunity phenotype, and this phenotype was much more dramatic when the splenocytes originated from double deficient mice for RANKL and CD40 [68]. This severe phenotype was correlated to the impairment of mTECs in those mice [68].

1.6 RANK, RANKL and OPG influence in other tissues

RANK and RANKL affect other tissues apart from bone and the organs associated with the immune system, for instance the mammary glands, hair follicles, the skin and intestinal microfold (M) cell differentiation.

Mammary glands constitutively express RANK and mammary epithelial cells (MECs) express RANKL, induced by hormones, being detectable from mid pregnancy and with a peak at lactation onset [69]. Hence, RANKL-KO mice present mammary gland defects that can be reversed by recombinant RANKL administration [69]. RANKL ectopic expression in mammary epithelium led to alveologenesis and ductal side branching [47]. Overall, RANKL expression is hormonally regulated and is required to differentiate the mammary epithelium into a lactating organ.

Loser and colleagues described that mouse skin expresses low levels of RANKL under steady-state conditions whereas, under inflammatory conditions both mouse and human epidermis highly express RANKL [66]. Another group reported that human epidermis strongly expresses RANKL under steady-state conditions, with the suprabasal population

expressing the highest levels [70]. Regarding RANK expression it is detected on Langerhans cells [66, 70], and the basal-layer of keratinocytes [71]. Duheron and colleagues demonstrated that RANKL-KO mice display arrested epidermal homeostasis, and that RANKL overexpression or administration leads to epidermal growth [71]

RANK and RANKL were shown to regulate hair cycling in the hair follicle (HF). These molecules are not required for HF development, however, RANK stimulation is necessary for normal anagen occurrence, the HF growth phase [71]. A mice overexpressing RANK in the HF presented precocious hair cycles, which was normalized upon RANKL blockage. Furthermore, recombinant RANKL administration on WT mice induced anagen [71]. Intestinal microfold cells (M cells), a portal for Ag sampling from the intestinal lumen, are also influenced by RANKL. Mice administered with recombinant RANKL displayed synchronized M cell differentiation. RANKL-KO mice present fewer M cells, which can be normalized upon recombinant RANKL administration. Furthermore, WT mice treated with RANKL display ectopic M cells [72, 73].

1.7 Conclusions

The RANK/RANKL/OPG triad was discovered, by four independent groups, in a short period of time. RANKL binding to RANK recruits several adaptor molecules which can subsequently activate different pathways. The canonical and non-canonical NF- κ B, MAPK, NFATc1 and PKB/Akt pathways. The essential roles performed by RANK/RANKL *in vivo* were disclosed by their genetic ablation in mice. Osteopetrosis, absence of LNs and impaired mammary glands development were found in both RANK- and RANKL-deficient mice. Thus, these TNF(R)SF members are implicated in different biological processes. Additionally to its involvement in bone remodelling, RANK/RANKL/OPG participate in several immune processes, including interactions between T cells and DCs, T and B cell development and both central and peripheral immune tolerance. Furthermore, RANK and RANKL were also associated with hair follicle cycle, skin homeostasis, and M cell differentiation. The processes involved in the pathways activated upon RANK engagement are far more elaborated than how they were described, however it is beyond the scope of this thesis to go into detail of each signalling pathway. In my thesis I have been mainly focusing on the role of RANK and RANKL on LN development, homeostasis and immune reaction. I have also approached its relevance in tertiary lymphoid structure development, topics that will be furthered discussed in the following chapters.

1.8 Bibliography

1. Carswell, E.A., et al., *An endotoxin-induced serum factor that causes necrosis of tumors*. Proc Natl Acad Sci U S A, 1975. **72**(9): p. 3666-70.
2. Granger, G.A., et al., *Lymphocyte in vitro cytotoxicity: specific release of lymphotoxin-like materials from tuberculin-sensitive lymphoid cells*. Nature, 1969. **221**(5186): p. 1155-7.
3. Gray, P.W., et al., *Cloning and expression of cDNA for human lymphotoxin, a lymphokine with tumour necrosis activity*. Nature, 1984. **312**(5996): p. 721-4.
4. Pennica, D., et al., *Human tumour necrosis factor: precursor structure, expression and homology to lymphotoxin*. Nature, 1984. **312**(5996): p. 724-9.
5. Aggarwal, B.B., *Signalling pathways of the TNF superfamily: a double-edged sword*. Nat Rev Immunol, 2003. **3**(9): p. 745-56.
6. Locksley, R.M., N. Killeen, and M.J. Lenardo, *The TNF and TNF receptor superfamilies: integrating mammalian biology*. Cell, 2001. **104**(4): p. 487-501.
7. Bodmer, J.L., P. Schneider, and J. Tschopp, *The molecular architecture of the TNF superfamily*. Trends Biochem. Sci., 2002. **27**(1): p. 19-26.
8. Zhang, G., *Tumor necrosis factor family ligand-receptor binding*. Curr Opin Struct Biol, 2004. **14**(2): p. 154-60.
9. Simonet, W.S., et al., *Osteoprotegerin: a novel secreted protein involved in the regulation of bone density*. Cell, 1997. **89**(2): p. 309-19.
10. Tsuda, E., et al., *Isolation of a novel cytokine from human fibroblasts that specifically inhibits osteoclastogenesis*. Biochem. Biophys. Res. Commun., 1997. **234**(1): p. 137-42.
11. Lacey, D.L., et al., *Osteoprotegerin ligand is a cytokine that regulates osteoclast differentiation and activation*. Cell, 1998. **93**(2): p. 165-76.
12. Anderson, D.M., et al., *A homologue of the TNF receptor and its ligand enhance T-cell growth and dendritic-cell function*. Nature, 1997. **390**(6656): p. 175-9.
13. Wong, B.R., et al., *TRANCE (tumor necrosis factor [TNF]-related activation-induced cytokine), a new TNF family member predominantly expressed in T cells, is a dendritic cell-specific survival factor*. J. Exp. Med., 1997. **186**(12): p. 2075-80.
14. Emery, J.G., et al., *Osteoprotegerin is a receptor for the cytotoxic ligand TRAIL*. J. Biol. Chem., 1998. **273**(23): p. 14363-7.
15. Yamaguchi, K., et al., *Characterization of structural domains of human osteoclastogenesis inhibitory factor*. J. Biol. Chem., 1998. **273**(9): p. 5117-23.
16. Mosheimer, B.A., et al., *Syndecan-1 is involved in osteoprotegerin-induced chemotaxis in human peripheral blood monocytes*. J Clin Endocrinol Metab, 2005. **90**(5): p. 2964-71.
17. Schoppet, M., K.T. Preissner, and L.C. Hofbauer, *RANK ligand and osteoprotegerin: paracrine regulators of bone metabolism and vascular function*. Arterioscler Thromb Vasc Biol, 2002. **22**(4): p. 549-53.
18. Theoleyre, S., et al., *The molecular triad OPG/RANK/RANKL: involvement in the orchestration of pathophysiological bone remodeling*. Cytokine Growth Factor Rev, 2004. **15**(6): p. 457-75.
19. Walsh, M.C. and Y. Choi, *Biology of the TRANCE axis*. Cytokine Growth Factor Rev, 2003. **14**(3-4): p. 251-63.
20. Hanada, R., et al., *RANKL/RANK-beyond bones*. J Mol Med (Berl), 2011. **89**(7): p. 647-56.

21. Galibert, L., et al., *The involvement of multiple tumor necrosis factor receptor (TNFR)-associated factors in the signaling mechanisms of receptor activator of NF-kappaB, a member of the TNFR superfamily.* J. Biol. Chem., 1998. **273**(51): p. 34120-7.
22. Mukai, S., et al., *Identification and analysis of function of a novel splicing variant of mouse receptor activator of NF-kappaB.* Mol Cell Biochem, 2011. **350**(1-2): p. 29-38.
23. Findlay, D.M. and G.J. Atkins, *Relationship between serum RANKL and RANKL in bone.* Osteoporos Int, 2011. **22**(10): p. 2597-602.
24. Schramek, D., V. Sigl, and J.M. Penninger, *RANKL and RANK in sex hormone-induced breast cancer and breast cancer metastasis.* Trends Endocrinol Metab, 2011. **22**(5): p. 188-94.
25. Hikita, A., et al., *Negative regulation of osteoclastogenesis by ectodomain shedding of receptor activator of NF-kappaB ligand.* J Biol Chem, 2006. **281**(48): p. 36846-55.
26. Lynch, C.C., et al., *MMP-7 promotes prostate cancer-induced osteolysis via the solubilization of RANKL.* Cancer Cell, 2005. **7**(5): p. 485-96.
27. Idriss, H.T. and J.H. Naismith, *TNF alpha and the TNF receptor superfamily: structure-function relationship(s).* Microsc Res Tech, 2000. **50**(3): p. 184-95.
28. Chan, F.K., et al., *A domain in TNF receptors that mediates ligand-independent receptor assembly and signaling.* Science, 2000. **288**(5475): p. 2351-4.
29. Kanazawa, K. and A. Kudo, *Self-assembled RANK induces osteoclastogenesis ligand-independently.* J Bone Miner Res, 2005. **20**(11): p. 2053-60.
30. Boyle, W.J., W.S. Simonet, and D.L. Lacey, *Osteoclast differentiation and activation.* Nature, 2003. **423**(6937): p. 337-42.
31. Feng, X., *Regulatory roles and molecular signaling of TNF family members in osteoclasts.* Gene, 2005. **350**(1): p. 1-13.
32. Naito, A., et al., *Severe osteopetrosis, defective interleukin-1 signalling and lymph node organogenesis in TRAF6-deficient mice.* Genes Cells, 1999. **4**(6): p. 353-62.
33. Ye, H., et al., *Distinct molecular mechanism for initiating TRAF6 signalling.* Nature, 2002. **418**(6896): p. 443-7.
34. Wada, T., et al., *The molecular scaffold Gab2 is a crucial component of RANK signaling and osteoclastogenesis.* Nat Med, 2005. **11**(4): p. 394-9.
35. Raju, R., et al., *A comprehensive manually curated reaction map of RANKL/RANK-signaling pathway.* Database (Oxford), 2011. **2011**: p. bar021.
36. Baud'huin, M., et al., *RANKL, RANK, osteoprotegerin: key partners of osteoimmunology and vascular diseases.* Cell Mol Life Sci, 2007. **64**(18): p. 2334-50.
37. Bonizzi, G. and M. Karin, *The two NF-kappaB activation pathways and their role in innate and adaptive immunity.* Trends Immunol, 2004. **25**(6): p. 280-8.
38. Leibbrandt, A. and J.M. Penninger, *RANK/RANKL: regulators of immune responses and bone physiology.* Ann N Y Acad Sci, 2008. **1143**: p. 123-50.
39. Kyriakis, J.M. and J. Avruch, *Mammalian mitogen-activated protein kinase signal transduction pathways activated by stress and inflammation.* Physiol Rev, 2001. **81**(2): p. 807-69.
40. Takayanagi, H., et al., *Induction and activation of the transcription factor NFATc1 (NFAT2) integrate RANKL signaling in terminal differentiation of osteoclasts.* Dev Cell, 2002. **3**(6): p. 889-901.

41. Shiojima, I. and K. Walsh, *Role of Akt signaling in vascular homeostasis and angiogenesis*. *Circ Res*, 2002. **90**(12): p. 1243-50.
42. Dougall, W.C., et al., *RANK is essential for osteoclast and lymph node development*. *Genes. Dev.*, 1999. **13**(18): p. 2412-24.
43. Kong, Y.Y., et al., *OPGL is a key regulator of osteoclastogenesis, lymphocyte development and lymph-node organogenesis*. *Nature*, 1999. **397**(6717): p. 315-23.
44. Williamson, E., J.M. Bilborough, and J.L. Viney, *Regulation of Mucosal Dendritic Cell Function by Receptor Activator of NF-kappaB (RANK)/RANK Ligand Interactions: Impact on Tolerance Induction*. *J. Immunol.*, 2002. **169**(7): p. 3606-12.
45. Wong, B.R., et al., *TRANCE is a novel ligand of the tumor necrosis factor receptor family that activates c-Jun N-terminal kinase in T cells*. *J. Biol. Chem.*, 1997. **272**(40): p. 25190-4.
46. Ouaz, F., et al., *Dendritic cell development and survival require distinct NF-kappaB subunits*. *Immunity*, 2002. **16**(2): p. 257-70.
47. Zhong, L., et al., *Recombinant adenovirus is an efficient and non-perturbing genetic vector for human dendritic cells*. *Eur J Immunol*, 1999. **29**(3): p. 964-72.
48. Barbaroux, J.B., et al., *Epidermal receptor activator of NF-kB ligand controls Langerhans cell numbers and proliferation*. *J. Immunol.*, 2008. **181**(2): p. 1103-08.
49. Josien, R., et al., *TRANCE, a TNF family member, is differentially expressed on T cell subsets and induces cytokine production in dendritic cells*. *J Immunol*, 1999. **162**(5): p. 2562-8.
50. Akiyama, T., M. Shinzawa, and N. Akiyama, *RANKL-RANK interaction in immune regulatory systems*. *World J Orthop*, 2012. **3**(9): p. 142-50.
51. Bachmann, M.F., et al., *TRANCE, a tumor necrosis factor family member critical for CD40 ligand-independent T helper cell activation*. *J Exp Med*, 1999. **189**(7): p. 1025-31.
52. Ashcroft, A.J., et al., *Colonic dendritic cells, intestinal inflammation, and T cell-mediated bone destruction are modulated by recombinant osteoprotegerin*. *Immunity*, 2003. **19**(6): p. 849-61.
53. Padigel, U.M., et al., *TRANCE-RANK costimulation is required for IL-12 production and the initiation of a Th1-type response to Leishmania major infection in CD40L-deficient mice*. *J Immunol*, 2003. **171**(10): p. 5437-41.
54. Stolina, M., et al., *Continuous RANKL inhibition in osteoprotegerin transgenic mice and rats suppresses bone resorption without impairing lymphorganogenesis or functional immune responses*. *J. Immunol.*, 2007. **179**(11): p. 7497-7505.
55. Totsuka, T., et al., *RANK-RANKL signaling pathway is critically involved in the function of CD4+CD25+ regulatory T cells in chronic colitis*. *J Immunol*, 2009. **182**(10): p. 6079-87.
56. Guerrini, M.M., et al., *Human osteoclast-poor osteopetrosis with hypogammaglobulinemia due to TNFRSF11A (RANK) mutations*. *Am J Hum Genet*, 2008. **83**(1): p. 64-76.
57. Yun, T.J., et al., *Osteoprotegerin, a crucial regulator of bone metabolism, also regulates B cell development and function*. *J. Immunol.*, 2001. **166**(3): p. 1482-91.
58. Yun, T.J., et al., *OPG/FDCR-1, a TNF receptor family member, is expressed in lymphoid cells and is upregulated by ligating CD40*. *J. Immunol.*, 1998. **161**(11): p. 6113-21.
59. Senftleben, U., et al., *Activation by IKKalpha of a second, evolutionary conserved, NF-kappa B signaling pathway*. *Science*, 2001. **293**(5534): p. 1495-9.
60. Perlot, T. and J.M. Penninger, *Development and function of murine B cells lacking RANK*. *J. Immunol.*, 2012. **188**(3): p. 1201-1205.

- 61.Sugiyama, M., et al., *Expression pattern changes and function of RANKL during mouse lymph node microarchitecture development*. Int. Immunol., 2012. **2012**: p. 21.
- 62.Knoop, K.A., et al., *Distinct developmental requirements for isolated lymphoid follicle formation in the small and large intestine RANKL is essential only in the small intestine*. Am. J. Pathol., 2011. **179**(4): p. 1861-71.
- 63.Yoshida, H., et al., *Different cytokines induce surface lymphotoxin-alpha on IL-7 receptor-alpha cells that differentially engender lymph nodes and Peyer's patches*. Immunity, 2002. **17**(6): p. 823-33.
- 64.Green, E.A., Y. Choi, and R.A. Flavell, *Pancreatic lymph node-derived CD4(+)CD25(+) Treg cells: highly potent regulators of diabetes that require TRANCE-RANK signals*. Immunity, 2002. **16**(2): p. 183-91.
- 65.Loser, K., et al., *Epidermal RANKL controls regulatory T-cell numbers via activation of dendritic cells*. Nat Med, 2006. **12**(12): p. 1372-9.
- 66.Loser, K. and S. Beissert, *Regulation of cutaneous immunity by the environment: an important role for UV irradiation and vitamin D*. Int Immunopharmacol, 2009. **9**(5): p. 587-9.
- 67.Rossi, S.W., et al., *RANK signals from CD4(+)3(-) inducer cells regulate development of Aire-expressing epithelial cells in the thymic medulla*. J Exp Med, 2007. **204**(6): p. 1267-72.
- 68.Akiyama, T., et al., *The tumor necrosis factor family receptors RANK and CD40 cooperatively establish the thymic medullary microenvironment and self-tolerance*. Immunity, 2008. **29**(3): p. 423-37.
- 69.Wong, B.R., et al., *TRANCE, a TNF family member, activates Akt/PKB through a signaling complex involving TRAF6 and c-Src*. Mol. Cell, 1999. **4**(6): p. 1041-9.
- 70.Loser, K., et al., *Epidermal RANKL controls regulatory T-cell numbers via activation of dendritic cells*. Nat. Med., 2006. **12**(12): p. 1372-9.
- 71.Duheron, V., et al., *Receptor activator of NF-kappaB (RANK) stimulates the proliferation of epithelial cells of the epidermo-pilosebaceous unit*. Proc Natl Acad Sci U S A, 2011. **108**(13): p. 5342-7.
- 72.Knoop, K.A., et al., *RANKL is necessary and sufficient to initiate development of antigen-sampling M cells in the intestinal epithelium*. J. Immunol., 2009. **183**(9): p. 5738-47.
- 73.Kanaya, T., et al., *The Ets transcription factor Spi-B is essential for the differentiation of intestinal microfold cells*. Nat. Immunol., 2012. **13**(8): p. 729-736.

2 Lymph Node development

2.1 The Lymphatic System

The immune system comprises primary lymphoid organs such as the bone marrow and the thymus, secondary lymphoid organs (SLOs) such as lymph nodes (LNs) and spleen and mucosal associated lymphoid tissues such as Peyer's Patches (PPs), tonsils, nasal-associated lymphoid tissue (NALTs) and bronchial-associated lymphoid tissue (BALTs). The lymphatic system comprises a network of vessels which are responsible for the drainage of the lymph from peripheral tissues to the bloodstream. Drained by this system are the LNs and the mucosal-associated lymphoid organs. During my PhD I have been mainly focused on LNs, therefore this will be the SLO further explained.

2.1.1 Lymphatic system development

Lymph was first referenced by Hippocrates (460-377 B.C.) who described it as "white blood" and called it "chyle" (from the Greek *chylos*, meaning juice). Following Hippocrates not much more knowledge was gathered, until early in the 20th century, when two competing theories were raised. One hypothesis, proposed by Sabin, in 1902, argues that the lymphatics develop from the blood vascular system during early development, the so called "centrifugal model". This model was based on results obtained by ink injections into pig embryo veins, which demonstrated that the lymphatic system derives from the early embryonic vein [1, 2]. Furthermore, in this theory, the primary lymphatic sacs were formed by endothelial cells budding from veins, which centrifugally sprout towards the periphery, giving rise to capillaries [1-3]. In sharp contrast, Huntington and McClure, proposed an alternative theory, claiming that lymphatic endothelial cells (LECs) independently differentiate from mesenchymal-derived lymphangioblasts, and that only later the connections with the embryonic vein are reached, the "centripetal model" [3, 4]. Even though, experiments support Sabin's model, the existence of lymphangioblasts (lymphatic progenitor cells) and their significant roles have been further validated in non-mammals [5, 6] and in mammals, including humans and rodents, during postdevelopmental lymphangiogenesis [7]. Nevertheless, Sabin's model has been supported by later studies using LECs specific markers, including lymphatic vessel

endothelial hyaluronan receptor 1 (LYVE-1), Prox1 (Prospero homeobox protein 1) and vascular endothelial growth factor receptor 3 (VEGFR-3) [8].

2.1.2 Lymphatic specification, differentiation and maturation

Murine LECs in the anterior cardinal vein start to express LYVE-1 and VEGFR-3 at E8.5. The trigger for this initial lymphatic competent stage remains unknown. LYVE-1 is one of the first morphological signs of lymphatic differentiation, although it is not required for lymphatic competence, since Lyve-1-deficiency does not cause any impairment of the lymphatic system [9]. At E9.5 Prox1 starts to be expressed by these cells. Prox1 is considered a LEC signature and a key regulator for lymphatic development since *Prox1*^{-/-} mice fail to bud and sprout, which arrests lymphatic vasculature development [10]. The triggering signal for Prox1 onset remains unknown, however it is recognized that the transcription factor Sox18 (SRY (sex determining region Y) box 18) controls its expression [11]. At E10.5-11.5 Prox1/LYVE-1⁺ LECs bud and migrate from the central veins and start to form the jugular lymph sacs, in areas where lymphangiogenic growth factor VEGF-C is available (Fig. 2-1) [3]. This lymphatic differentiation gene set progressively down-regulates BEC-signature genes. *Vegfc*^{-/-} mice lack all lymphatic structures, rendering VEGF-C a crucial role in the lymphatic development [12, 13]. By this time additional lymphatic lineage markers start to be expressed, like the mucin-type transmembrane glycoprotein - podoplanin [14]. The lymphatic and blood systems become separated around E11.5-12.5 and the subsequent lymphatic and LN development takes place [3].

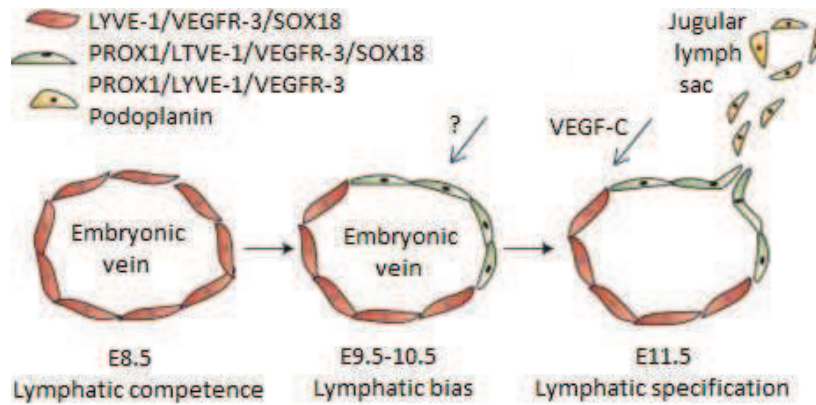

Figure 2- 1 Lymphatic system development. At mouse E8.5, endothelial cells in the vein start to express LYVE-1, VEGFR-3 and SOX18 and are lymphatic competent (potentially capable of lymphatic differentiation). Prox1, a key regulator for lymphatic development, is up-regulated by an inductive signal (lymphatic bias) at E9.5–E10.5. At E11.5 the Prox1-positive cells begin to migrate out and form the rudimentary lymphatic vessels (jugular lymph sacs), and start to express additional lymphatic molecules such as podoplanin (“lymphatic specification”). Modified after reference [3].

2.1.3 Lymphatic vessels: Lymph and cell uptake and transport

The lymphatic vasculature constitutes a parallel system to the blood vasculature and drains the excessive interstitial fluid (lymph leaking from blood capillaries), small molecules, resorbed fat, salts and cells and returns them into the blood flow, playing therefore an important role in tissue fluid homeostasis [15, 16]. The lymphatic system is also capable to initiate immune reactions due to migrating cells and soluble antigens transportation into SLOs [16-18]. The lymphatic system is present in most organs, except avascular tissues, and consists of a wide-meshed network of ducts and capillaries [10, 19]. This network begins with blind-ended small capillaries, which matures into pre-collecting and collecting vessels (Figure 2-2 A) [10]. Lymphatic vessels are formed by a continuous single layer of overlapping LECs with a unique junctional conformation. “Flap valves” are formed by cell edges anchored by discontinuous button-like junctions (Figure 2-2 B and C). These valves drain the lymph unidirectionally from the interstitium into the vessel under pressure gradients [10, 17, 18]. Anchoring filaments are the bridges between lymphatic capillaries and extracellular matrix, and prevent the capillaries from collapsing upon

increased interstitial pressure (Fig. 2-2 B) [10, 17, 18]. These junctions, distant by a 3 μ m range from each other, typically express platelet-endothelial cell adhesion molecule-1 (PECAM-1/CD31) and vascular endothelial cadherin (VE-cadherin). Lymph flow creates shear stress which in turn regulates junctional protein expression, up-regulates ICAM-1 (Intercellular adhesion molecule-1), VCAM-1 (Vascular cell adhesion molecule-1) and E-selectin (leukocyte adhesion molecules) and promotes CCL21 secretion, mediating DCs migration [10, 19, 20]. DCs use lymphatics to migrate from tissue to LNs. Firstly, DCs squeeze through pores in basement membrane and then reach the capillaries lumen through flap valves, being then drained into LNs [10, 21]. Therefore the transmural flow can regulate lymphatic endothelial function and might deliver early inflammatory signals for lymphatics, facilitating DC migration and soluble antigens delivery to LNs [19, 21].

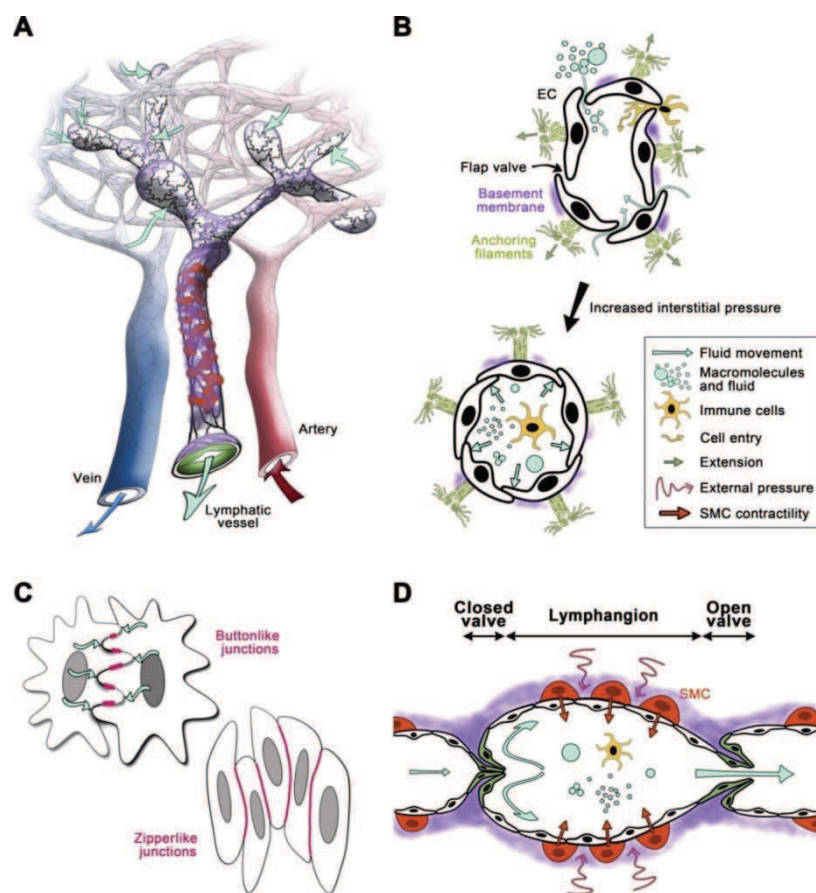

Figure 2- 2 Lymphatic system organization. (A) Interstitial fluid, macromolecules and cells are resorbed by the lymphatics. (B) Lymph formation mechanisms in capillaries. Openings between LECs enable interstitial components to penetrate the lymphatic capillaries. Lymph return is

prevented by specialized structures on such openings. LECs are attached to the extracellular matrix by anchoring filaments which prevent vessel collapse under increased interstitial pressure (black arrow). (C) LECs junctional organization, both “buttons” and “zippers” share a repertoire of adherens and tight junction–associated proteins (e.g., VE-cadherin, zonula occludens-1, occludin, and claudin-5). (D) Lymph propulsion mechanisms in collecting vessels. Efficient lymph transport is ensured by coordinated opening and closure of lymphatic valves. Each lymphangion is covered by smooth muscle cells which possess intrinsic contractile activity [10].

The lymph is drained from lymphatic capillaries into pre-collecting lymphatic vessels which present characteristics of both lymphatic capillaries and collecting lymphatic vessels. Functional units, the lymphangions, form the collecting vessels, are separated by intraluminal valves ensuring that way a unidirectional flow (Fig. 2-2 D) [10, 22]. Smooth muscle cells (SMCs) and basement membrane cover the collecting vessels, which are formed by elongated endothelial cells, connected by continuous zipperlike junctions (Fig. 2-2 C) [10]. Leakage is prevented by these junctions and by the presence of a basement membrane. The valves are opened by upstream lymph pressure, and closed by reverse flow pushing the leaflets against each other (Fig. 2-2 D) [10, 22]. Lymph propulsion is regulated by cyclical compression and expansion of lymphatic vessels and intrinsic pump forces [23].

2.1.4 Lymph filtration via the LNs

Before reaching the two lymph ducts, the lymph flows throughout the lymphatic system encountering several LNs on the way. LNs, as other SLOs, are specialized organs where immune responses can be initiated due to the encounter of B and T cells with antigen presenting cells (APCs) [24]. The LNs are populated by phagocytic macrophages that filter particles from the lymph and generate mature, antigen-primed B and T lymphocytes. Humans are believed to have around 450 LNs, around 250 in the abdomen and pelvis, 100 in the thorax and 100 in the head and neck. In mice, this number is much reduced, only 22 LNs are known, however the LNs are structurally similar among the different mammalian species [24, 25].

The LNs can be anatomically divided into different compartments: the sinuses, the superficial cortex, the paracortex and the medulla (Fig. 2-3).

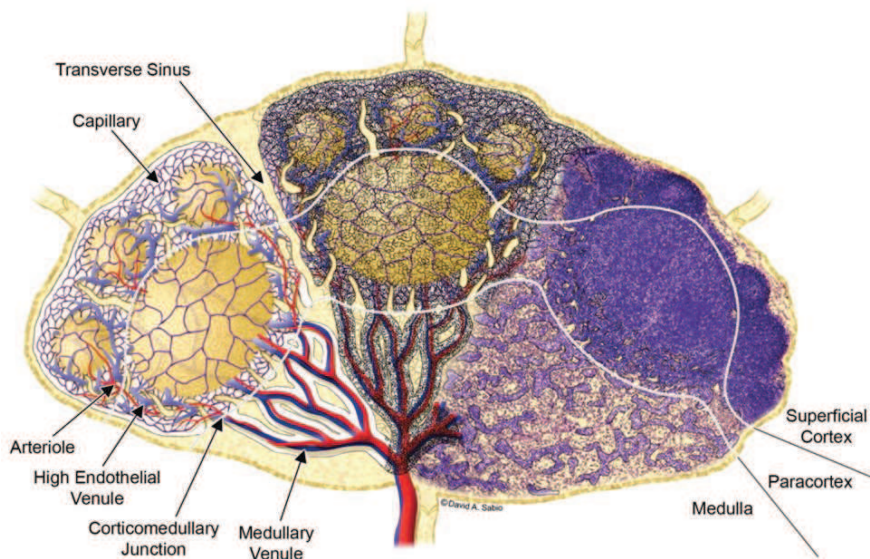

Figure 2- 3 Lymph Node architecture. Schematic view of a LN section with three lymphoid lobules. Each lobule lays beneath its own afferent lymphatic vessel. It is possible to visualise the different compartments, cortex, paracortex and medulla. LN blood suply is presented on the left lobule. The centre lobule shows the reticular meshwork, and finally the right one represents a rat mesenteric LN [26].

LNs have generally several afferent vessels, which enable the drainage of lymph from different areas, and have only one efferent vessel, through which the lymph leaves the LN. These organs comprise a convex surface where the lymphatic vessel gains access to the LN, and a concave area called hilum where veins and nerves reach the LN and the efferent lymphatic vessel leaves them. The draining lymph pours into the subcapsular sinus (SCS), which lies beneath the LN surrounding capsule. The SCS is connected to the medulla and its medullary sinus via transverse sinus. These sinuses are the remaining lumen of lymph vessels. The cortex lays underneath the SCS, and comprises the lymphoid follicles containing mainly B cells, some stromal follicular dendritic cells (FDCs) and few T cells and macrophages. Beneath the SCS and above the follicular region are localized other stromal subset, the marginal reticular cells (MRCs). The T cell zone or paracortex can be found between the follicles and the medulla, and as the name suggests it is filled with more than

95% of T cells and DCs and stromal fibroblastic reticular cells (FRCs). The medulla lays just beneath the paracortex, this area consists of medullary cords separated by medullary sinuses, and the main cell type found here are plasma B cells [24, 26]. Fully detailed information regarding LNs will be addressed later on this chapter.

2.2 Lymph Node organogenesis

Lymph node development is a highly laborious and organized process which starts during embryogenesis and continues for few weeks after birth [27]. Lymph node organogenesis has been divided in five distinct phases, based on molecular and histological studies [28]. The **initial step** of LN organogenesis in mice comprises the lymph sac formation at E10.5, even though it has been shown that LNs can still develop in mice lacking lymph sacs (Prox1-deficient mice) [17]. The **next step** occurs at E14.5-15.5 when the lymph sacs form sprouts that branch to create the lymphatic network [29]. The **third phase** takes place when mesenchymal connective tissue starts to prod into the lymph sacs forming the primary LN anlagen (Fig. 2-4) [27, 28]. The **fourth phase** is characterized by the recruitment and colonization of $CD45^+CD4^+CD3^-IL7R\alpha^+$ lymphoid tissue inducer cells (LTis). These LTis interact and cluster with resident stromal lymphoid tissue organizer cells (LTos) [28]. The **final step** during LN development consists in expansion of the LN anlagen with B and T cell recruitment.

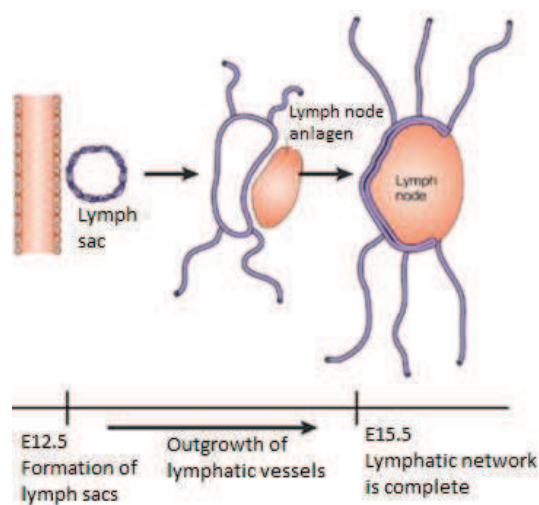

Figure 2- 4 LN anlagen development. Lymph sac formation is followed when mesenchymal tissue prods into the lymph sac, forming the primordial LN anlagen. Modified after reference [28].

2.2.1 Lymphoid Tissue inducer cells (LTis)

LTis are haematopoietic cells belonging to the innate lymphoid cell family, and are one of the first cells arriving at the lymph node anlagen [30-33]. These cells were firstly described, by Kelly and Scollay in 1992, as negative for lymphoid, myeloid and erythroid markers (excluding CD4) [34]. To be formed LTis require the negative regulator of basic helix-loop-helix (bHLH) protein signalling Id2, the nuclear retinoic acid (RA) receptor-related orphan receptor ROR γ t. The interleukin-7 (IL-7) is required for their survival and differentiation, and their function is secured by the lymphotoxin α 1 β 2 (LT α 1 β 2) [33, 35-39]. Defective function of the genes affecting LTi cells formation leads to their absence (Id2 and ROR γ t) or severe reduction (RANKL), which results in halted LN formation. It is accepted that these genes have a crucial influence on LTi cell formation and accumulation in LN anlagen, however the precise mechanism of their actions remains elusive [40]. LTi cell function is regulated by numerous genes, and most of them encode proteins involved in LT β R engagement on stromal cells. LT α 1 β 2 expression by LTis can be initiated by signalling via IL-7R or RANK, and LN development is severely compromised when either one of these pathways is impaired [41, 42]. Thus, LTis are required for LN, PP and NALT development and are characterized as CD45⁺CD3⁻CD4⁺IL7-R α ⁺ and they further express CD25 (IL-2R α), CD132 (IL-2R γ), CD44, CD90, CD117 (c-kit), MHC-II, integrins α 4 β 7 and α 4 β 1, RANK, RANKL and LT α 1 β 2 (Table 2-1) [28, 30, 36, 40, 42].

2.2.2 Lymphoid Tissue Organizer cells (LTos)

During secondary lymphoid organ development LTis interact with LTos, stromal cells of mesenchymal origin, therefore CD45-negative, which form the matrix of the developing lymphoid organ [28, 31, 33, 42]. These LTos were described by Cupedo *et al.*, in 2004 as being ICAM-1, VCAM-1 and MAdCAM-1 (Mucosal vascular addressin cell adhesion molecule 1) positive. In reality these LTos can further be divided into VCAM^{Int}ICAM^{Int} and VCAM^{Hi}ICAM^{Hi}, both populations can be found in mesenteric LNs (mLNs) and peripheral LNs (pLNs) however VCAM^{Int}ICAM^{Int} occurrence is highly reduced on pLNs [31]. Developing PPs and mLNs also present differences in these LTos populations, expressing different associated genes. LTos on PPs express higher levels of RANKL, IL-6, CCL1, CCL7 and CL11,

whereas mLN LTos express higher levels of TGF β and stem cell factor (c-kit ligand) [14, 42, 43]. It is acknowledged that different lymphoid organs require different growth factors and cytokines, e.g. IL-7 requirement for PPs and RANKL requirement for LNs, these variances might be explained by this different gene expression profile on LTos [42, 43].

In 2010, Bénézech *et al.*, showed that the first steps of LN development arise from mesenchymal VCAM⁻ICAM⁻ cells which localize around the lymph sacs. These cells mature into VCAM^{Int}ICAM^{Int}, in an LTi- and LT β R-independent manner. Finally these VCAM^{Int}ICAM^{Int} mature into VCAM^{Hi}ICAM^{Hi}MAdCAM⁺ LTos under the influence of LTis and LT β R signalling [44].

	Surface Antigens	Adhesion molecules	Chemokines and chemokines receptors	TNFSF and TNFRSF members
LTis	CD45, CD4, CD16/32, CD25 CD32, CD44, CD90, CD117 CD127, CD132, MHC-II (\pm 50%)	Integrins $\alpha\beta$ 7 and α 4 β 1 ICAM-1	CXCR4 CXCR5 CCR7	LT α 1 β 2 RANK RANKL
LTos		ICAM-1 MAdCAM-1 VCAM-1	CXCL13 CCL19 CCL21	RANKL LT β R

Table 2- 1 Molecules expressed by murine LTis and LTos [28, 30, 33, 40, 42]

2.2.3 LTo - LTi crosstalk during LN development

LNs originate consistently at specific places, for instance around large veins and blood vessels branching sites. It is from LTi and LTo interactions that the successful formation of LNs depends, however the origin and identity of the first triggering signals remain mostly unknown. The first LTi clustering occurs near endothelial cells where developing LNs take place, and it does not occur when CXCL13 (chemokine C-X-C motif ligand 13) or its

receptor CXCR5 (chemokine C-X-C motif receptor 5) are missing, which invokes a link between locally produced CXCL13 by LTos and CXCR5-expressing LTi cell recruitment [11]. The initiation of CXCL13 expression by LTos seems to be triggered by retinoic acid (RA). In fact, the enzymes (RALDHs) responsible for the conversion of vitamin A into RA have been found, in developing LNs, expressed by adjacent nerve fibres [11]. Moreover, van de Pavert *et al.*, in 2009 showed that CXCL13 expression can be triggered by vagal nerve stimulation and that CXCL13 can mediate LTi migration [45] reinforcing the idea that LN development is initiated by RA production, which triggers CXCL13 expression by LTos and then attracts LTis [45, 46].

LT α 1 β 2, expressed by LTis, stimulates LTo maturation through LT β R signalling [40, 41], and it is crucial for LN development since mice lacking LT α 1 β 2 or LT β R show absence of most LNs [41, 47, 48]. Conversely, the early LTis seem to express RANKL rather than LT α 1 β 2, moreover, LTi cell clustering is still less severely affected in LT α -deficient or LT β R-deficient mouse embryos compared to RANKL mutant mice [39, 47, 49]. Consequently, LTis clustering might activate RANK signalling that, in an autocrine manner, then leads to LT α 1 β 2 expression and LTo maturation. This process initiates VCAM-1, ICAM-1 and MADCAM-1 expression and CXCL13, CCL19 and CCL21 production by LTos [47, 48]. Subsequently, circulating LTis are attracted and retained in the LN anlagen. LT β R signalling induces RANKL and IL-7 expression by LTos, which further stimulate LT α 1 β 2 production by the immature arriving LTis [39, 47, 48]. In a positive feedback manner the LT α 1 β 2 would further stimulate the LTos (Fig. 2-5) [47]. Noteworthy is that VEGF-C (vascular endothelial growth factor C) expression by LTos is induced by LT α 1 β 2, this promotes the connection between lymphatic vasculature and the developing LN [47]. The LN development final stage consists in expansion of the LN anlagen with B and T cell recruitment secondary to the differentiation of blood vessels into HEVs (High Endothelial Cells), specialized vessels which allow efficient blood circulating cell income [27]. B and T cells express LT α 1 β 2 and therefore take over from LTis in the maintenance and differentiation of stromal cells [28, 48]. Noteworthy is the involvement of lymphatic endothelium derived CCL21 in LTi cell recruitment. CCL21 Ser is an isoform expressed by LN stromal cells and HEVs, whereas CCL21 Leu is expressed by the lymphatic endothelium. Lack of both CXCR5 and CCR7 (C-C chemokine receptor 7 – the CCL21 receptor) leads to LN absence, though mice lacking

CXCL13 but expressing the CCL21 Leu isoform develop cervical LNs [47, 50]. An *in vitro* study showed that the CCL21 Leu (lymphatic endothelium) influences the initial attraction of LTis into LN anlagen, since both CXCL13 and CCL21 can mediate LTi migration, and that both chemokines are expressed during LN development [45].

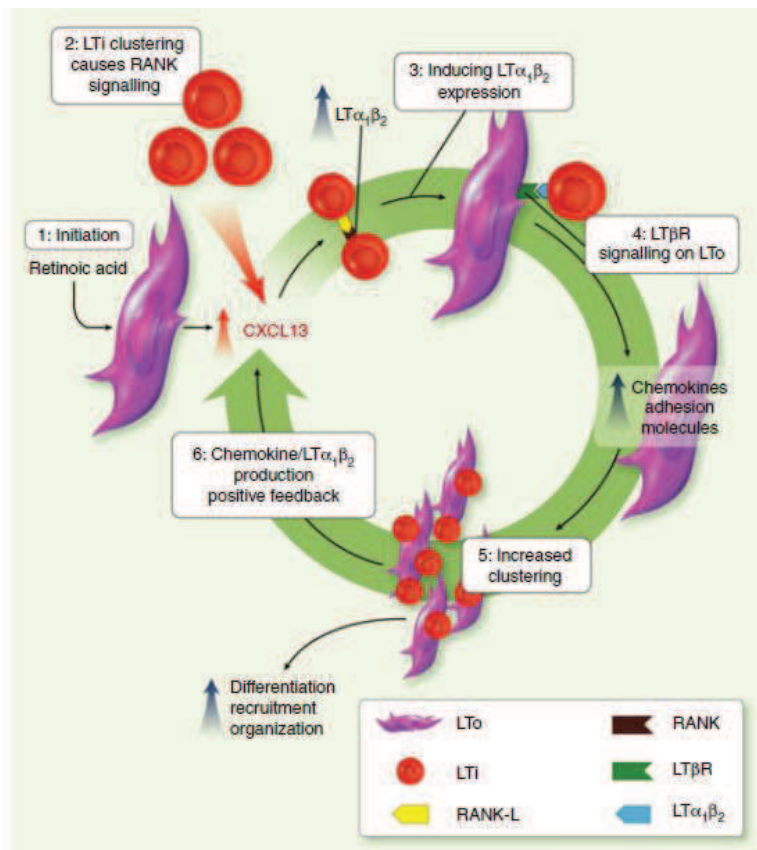

Figure 2- 5 LTi - LTo crosstalk drives LN organogenesis. Retinoic acid acts on LToS inducing CXCL13 expression therefore initiating LN development (1). CXCR5⁺ LTis are attracted by CXCL13 and cluster in the LN anlagen. During a short period the LTis express both RANK and RANKL, stimulating themselves in an autocrine manner, inducing $LT\alpha_1\beta_2$ expression (2 and 3). $LT\alpha_1\beta_2$ stimulates the $LT\beta R$ ⁺ LTo leading to maturation and chemokines and adhesion molecules expression (4), resulting in further attraction and clustering on LTis (5). This creates a positive feedback loop with chemokines and $LT\alpha_1\beta_2$ production and consequently leads to LN expansion [46].

2.2.4 Involvement of TNFSF members in LN organogenesis

The bulk of information collected regarding the molecular actors involved in LN development stems from a collection of genetic studies performed in mice. For instance, this knowledge was initiated by the study of the LT α -deficient mice in 1994 [51]. Subsequently, other molecules involved in LN development were reported, including RANK, RANKL and LT α 1 β 2 (Table 2-2).

Mutation	Signalling Pathway	Affected Cells	LNs	PPs	NALTs
LT α ^{-/-} , LT β r ^{-/-} , Nik ^{-/-} , Aly/aly, Rela x Tnfr ^{-/-}	LT β R	Stromal	-	-	-
Nfkb2 ^{-/-} , Relb ^{-/-}	LT β R	Stromal	\pm^*	-	ND
LT β ^{-/-}	LT β R	Stromal	CLNs, mLNs	-	+
Light ^{-/-}	LT β R	Stromal	+	+	+
Light/LT β ^{-/-}	LT β R	Stromal	<mLNs than LT β ^{-/-}	-	ND
Ikka ^{-/-}	LT β R	Stromal	-	-	+
Tnfr1 ^{-/-}	TNFR1	Stromal	+	Reduced number	+
Tnf ^{-/-}	TNFR1 AND 2	Stromal	+	Reduced number	+
IL7 α ^{-/-} , Jak3 ^{-/-} , γ c ^{-/-}	IL-7R	LTis	bLN, aLN, mLN	-	+
IL7 ^{-/-}	IL-7R	LTis	mLN?	-	-
RANK ^{-/-} , RANKL ^{-/-} , Traf6 ^{-/-}	RANK	LTis	-	Smaller	+

Rorc ^{-/-}		LTis	-	-	+
Id2 ^{-/-}		LTis	-	-	-
Ikaros ^{-/-}		LTis	-	-	ND
Cxcl13 ^{-/-} , Cxcr5 ^{-/-}	CXCR5	LTis	cLN, fLN, mLN	Reduced number	-
Plt/plt, Ccr7 ^{-/-}	CCR7	LTis	+	+	+
Cxcr5x Ccr7 ^{-/-}	CXCR5/CCR7	LTis	+	-	ND
Plt/plt/Cxcl13 ^{-/-}	CXCR5/CCR7	LTis	-	-	-

Table 2- 2 Mutant mice presenting defective SLO development. Symbols and abbreviations: + lymphoid organ is developed; - impaired development; ND not determined; * development was reported normal at day P0 but at P10 lymphoid depletion was observed; aLN, axillary LN; bLN brachial LN, cLN, cervical LN, fLN, facial LN; mLN mesenteric LN; NALT, nasal-associated lymphoid tissue; PPs, Peyer's Patches; aly, alymphoplasia; γ c, common cytokine receptor γ -chain; CCR7, chemokine receptor for CCL19 and CCL21; CXCL13, chemokine (C-X-C motif) ligand 13; CXCR5, CXCL13 receptor; IKK, inhibitor of κ b kinase; IL-7, interleukine-7; Jak3, Janus kinase 3; LT, lymphotoxin; NIK, nuclear-factor- κ b-inducing kinase; Plt, paucity of LN T cells; ROR γ , retinoid-related orphan receptor γ ; TNF, tumo-necrosis factor; Traf6, TNF-receptor-associated factor 6 [28, 50-52].

RANK pathway involvement in lymph node development

The RANK signalling pathway was originally linked to LN development in 1999 when Kong *et al.*, unpredictably observed that RANKL-deficient mice presented no LNs, but normal spleen and smaller but still normal PPs and NALTs [53]. Studies of RANK- [38] and TRAF6-deficient mice [53] corroborate this link by showing similar phenotypes. Furthermore, RANK-RANKL signalling may also be involved in human LN development, since it was shown that patients with osteoclast-poor autosomal recessive osteopetrosis (ARO)

presented no palpable LNs [54]. LN absence in RANKL-deficient mice is not caused by defective cell homing, since RANKL-deficient B and T cells transfer into RAG1-knockout mice efficiently populate the LNs. Moreover, LN formation is not rescued in RANKL-deficient mice transferred with normal bone marrow cells [53]. Kim *et al.*, demonstrated, in 2000, that RANKL-deficient mice have considerably fewer LTis in the LN anlagen, and the rare ones were not able to cluster and interact with the LTos, explaining that way the lack of LNs [39]. Furthermore, RANK-Fc antagonist experiments showed partially reduced LTis numbers, with the mLNs presenting a more prominent effect [32]. Despite the reduced number of LTis on RANKL- and TRAF6-deficient mice, they are still present which rules out the requirement of RANK signalling for the generation of LTis [39, 55]. In addition, RANKL-transgenic overexpression in T and B cells of RANKL-deficient mice partly restores LTi numbers and LN development [39]. Together these data suggests that the LTi number is a limiting factor of LN development and RANKL, even though not involved in their generation, appears involved in their survival and/or proliferation. Importantly, RANKL is also known to induce $LT\alpha 1\beta 2$ expression by LTis (Fig. 2-6) [41].

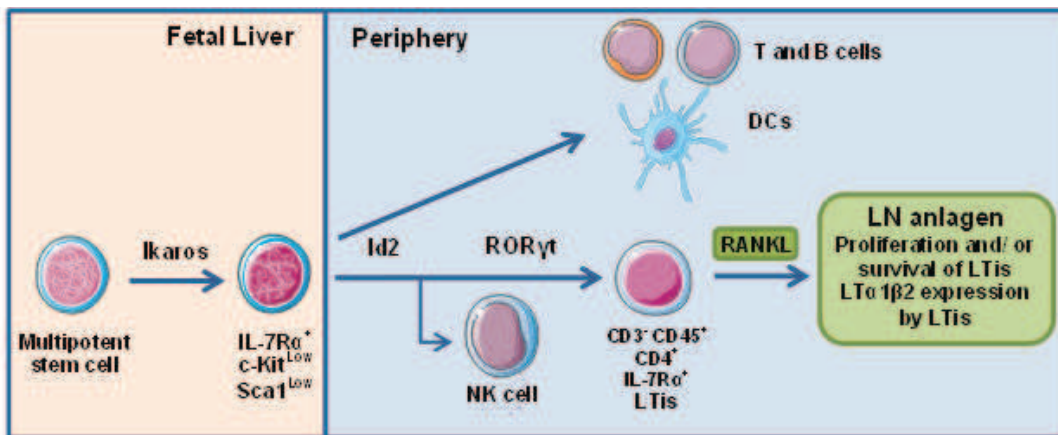

Figure 2- 6 LTi cells generation. Multipotent stem cells, under the control of the transcription factor Ikaros, give rise to LTi precursors. These precursors are localized in the fetal liver and express IL-7R α and low levels of c-kit and Sca-1, they are also precursors for NK, T and B cells and DCs. In order to differentiate into LTis these cells require Id2 and ROR γ t. Finally, in the LN anlagen, RANKL is involved in LTi proliferation/survival and induces $LT\alpha 1\beta 2$ expression by these cells. Modified after [28, 41, 49].

As LTis express RANK and were shown to also express RANKL in early stages (E14.5 – E15.5) of LN anlage [36] their clustering could lead to autocrine activation, promoting the expression of $LT\alpha1\beta2$, which then acts on $LT\beta R^+$ LTos (Fig. 2-7) [47, 56]. Additionally to RANKL, IL-7 is also an important element affecting LTi numbers and their $LT\alpha1\beta2$ expression, however IL-7 is mainly required for PPs **and not for LNs development**. Conversely, TRAF6-deficient embryos (impaired RANK signalling cascade among other TNFRSF members that use this TRAF protein) were able to present early stage of LN development and rudimentary mLNs when ectopic IL-7 was administered [41]. IL-7 requirement for LN development was de-emphasized since IL-7-deficient mice present LNs, nevertheless, the combined CXCL13 and IL-7R α deficiency leads to complete LNs absence, including mLNs, normally present in CXCL13-deficient mice [50]. Moreover, overexpression of IL-7 leads to ectopic LN formation, resulting from increased LTi numbers [37]. Despite RANKL predominance for LN development, IL-7 contribution cannot be discarded.

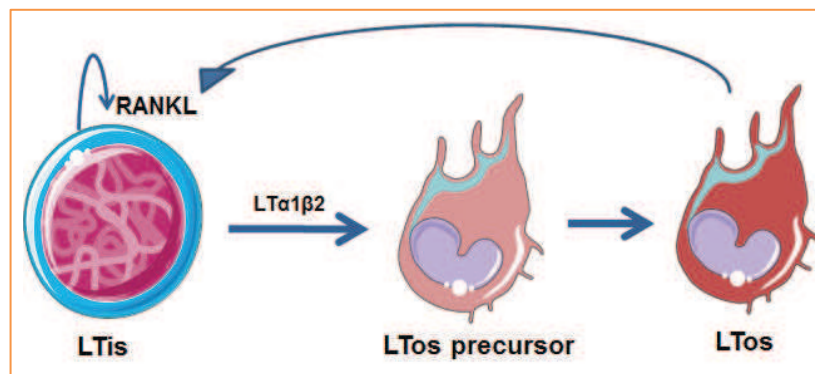

Figure 2- 7 LTi and LTo interaction through RANK-LT β R signalling during LN development. LTis are recruited to LN anlage which is already populated by mesenchymal stromal cells (LTo precursors). Then a cross-talk between LTis, expressing RANKL, RANK and $LT\alpha1\beta2$, and LTos, that express $LT\beta R$, takes place. $LT\beta R$ engagement leads to LTo maturation and consequent RANKL and chemokine expression to attract more LTis. The newly arrived LTis cluster with LTos and therefore LN organogenesis occurs [56].

LT α 1 β 2 pathway in lymph node development

The lymphotoxin signalling pathway is indispensable for LN organogenesis, it has a crucial role stimulating the LTos to express numerous cytokines, chemokines and adhesion molecules (Table 2-1). PPs and LNs are absent in LT α -deficient mice, however rudimentary mLNs sporadically appear in some mice (<5%) [51, 56]. LT α shares similar structure and functions with TNF α , and it is able to bind the same receptors, such as TNFR1 and TNFR2, therefore it was expected that TNF α and its receptors could play a comparable role in LN development [57]. However, *Tnfa*, *Tnfr1* or *Tnfr2* mutation did not lead to impaired LNs or PPs development, even if B cell follicles structure was altered [58-60]. This discrepancy in functions was clarified by the fact that LT α can dimerize with LT β and form the LT α 1 β 2 which engages specifically the LT β receptor (Fig. 2-8) [61-63].

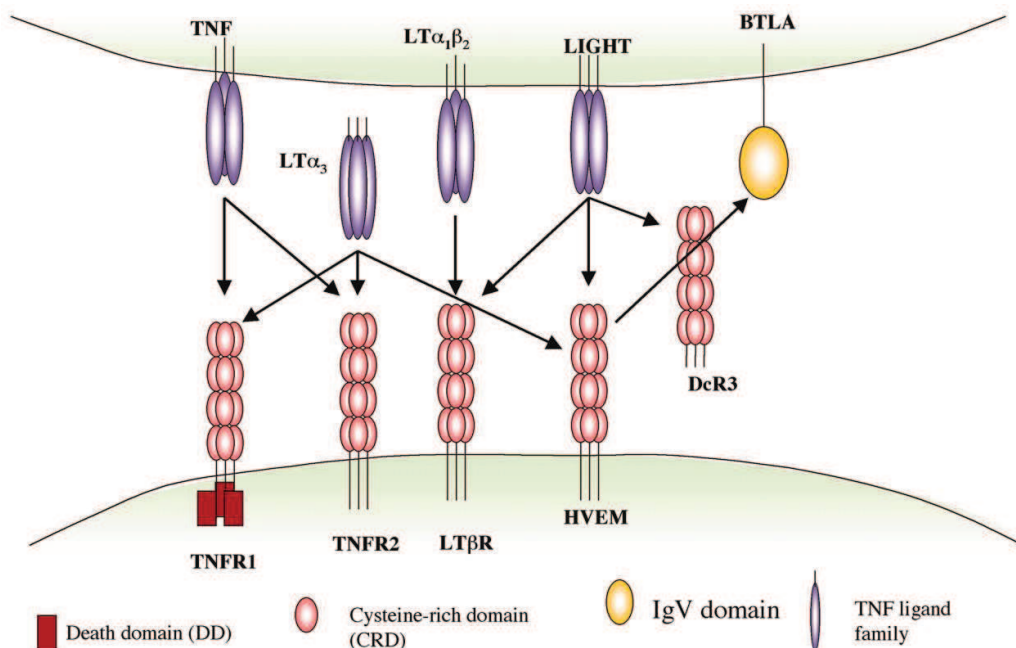

Figure 2- 8 TNF and TNFR superfamily, interactions between family members. Interactions between TNF, LT α and β and LIGHT and their receptors. Abbreviations: TNF, tumor necrosis factor; LT, lymphotoxin; TNFR, TNF receptor; LT β R, LT β receptor; HVEM, herpes virus entry mediator; DcR3, decoy receptor 3; BTLA, B and T Lymphocyte Attenuator [64].

LT α 1 β 2 was shown as being essential for SLO development, since LT β - and LT β R-KO mice presented disrupted SLO organogenesis [65, 66]. Despite the minor contribution of TNF α to SLOs development, it is still involved. For instance, mice embryos treated with soluble

LT β R-Ig presented cervical and mLNs, however when a TNF-Ig was added the mice no longer developed these LNs [36]. Moreover, even though Light $^{-/-}$ and Lt $\beta^{-/-}$ mice display mLNs, Light $^{-/-}$ and Lt $\beta^{-/-}$ double KO mice presented a markedly reduced number of these organs [67]. Therefore, even though LT α 1 β 2-LT β R signalling is the main pathway involved in LN development, TNF α and LIGHT still give their contributions. It was shown that LT α -deficient mice are able to develop LNs after being administered in utero with agonistic anti-LT β R antibody, however the administration of this antibody into ROR γ -deficient mice (lacking LTis) did not rescue LN formation. These findings reinforce the importance of LTis in delivering and extra signal to LTos [36].

Both RANK also LT β R are capable of activating both the NF- κ B classical and alternative pathways, and each pathway is responsible for the expression of different genes [68]. LT β R engagement activates the classical NF- κ B pathway which promotes inflammatory protein expression, including VCAM-1, CXCL1 and CCL4, and also increases the NF- κ B p100 production [69]. Alternative pathway activation induces the expression of CCL19, CCL21 and CXCL13, molecules known to be involved in SLO development and homeostasis [69]. Mice deficient for the alternative pathway NF- κ B inducing kinase (NIK) present neither LNs nor PPs [68, 70, 71]. Moreover, the classical pathway RelA protein is also crucial, as its deficiency is lethal during embryogenesis. RelA-KO mice, bred onto a TNFR1-null background (to protect them from uncontrolled TNFR1 induced apoptosis) display neither LNs nor PPs [72]. Therefore it is acknowledged that both classical and alternative pathways play an important role in lymphoid organ development. LT α 1 β 2 was also shown to induce adhesion molecule expression by HEVs, involved in lymphocyte transmigration into the LN [73]. Moreover, LT β R signalling is required for HEV development, since a mouse model with conditional deletion of LT β R on endothelial lineages showed reduced number of LNs and the rudimentary LN which developed presented impaired HEVs network [74]. Additionally, LT β R influences B cell follicle micro-architecture. Even though the administration, *in utero*, of an agonist anti-LT β R antibody is able to rescue LNs in LT α -deficient mice, it is not sufficient to generate and maintain a normal LN micro-architecture [36]. Another study was performed on mice lacking LT β R expression by FRCs-like cells using a CCL19-Cre mouse. Surprisingly, the LNs were normally formed as well as FRCs conduits, however CCL19, CCL21 and podoplanin expressions appeared decreased.

Moreover, these mice did not respond well to a murine herpes virus infection, demonstrating the importance of LT β R signalling on FRCs during a viral infection [75].

2.2.5 Cellular organization during lymph node development

During LN development LTis and LTos are known to cluster, when a certain degree of clustering is reached endothelial cells start to differentiate into HEVs [28]. HEVs are specialized endothelial cells which express PNAd (peripheral LN addressin) and are responsible for lymphocyte transmigration into lymphoid organs. These cells keep some plasticity during adulthood since they can be reverted to PNAd-negative endothelial cells after ligation of the LN afferent lymphatic vessels [76]. After B and T cell recruitment, these cells allocate into their specific areas and the B cell follicles formation starts. In mice, these last steps of LN development occur just after birth. Soon after birth, HEVs undergo maturation, which is noticed by a switch in addressin expression. From development until day one after birth, HEVs express mainly MAdCAM-1, which attracts $\alpha 4\beta 7$ expressing-cells, such as LTis. After day one HEVs start to express PNAd, allowing the recruitment of L-selectin⁺ leukocytes. The blockade of LT β R signalling, using a soluble decoy receptor, revealed decreased LN cellularity in adult mice concomitant with lower levels of PNAd and MAdCAM-1 on HEVs, thus elucidating the crucial role of LT β R [73]. Leukocyte homing into LNs and transmigration through HEVs depends on different molecular steps (Fig. 2-9), for instance L-selectin expression alone does not suffice for leukocytes to cross HEVs, CCR7 and CXCR4 also play an important role by inducing integrin activation and therefore adhesion. Consequently the main cells entering the LNs through HEVs are naïve B cells, naïve and central memory T cells [27]. CXCL13 has been reported as another arrest chemokine on HEVs, influencing B cells [77].

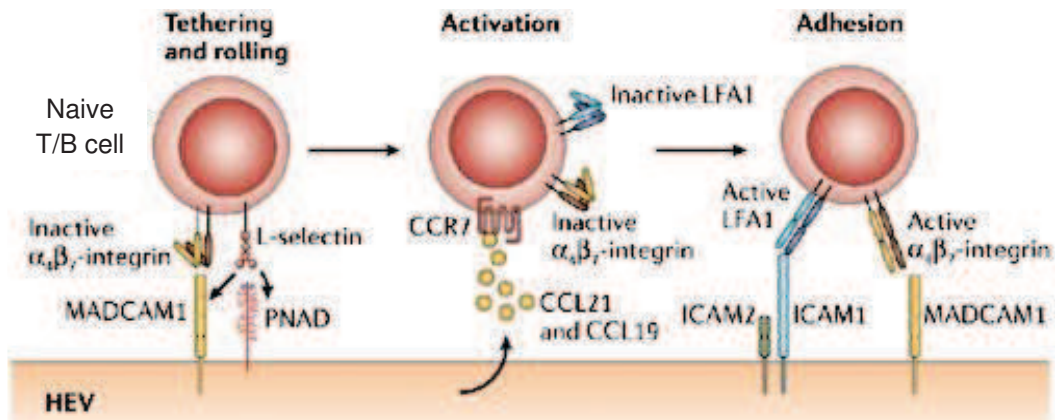

Figure 2- 9 Homing specificity is determined by a multistep process coordinated by HEVs selective expression. Naïve B and T cell and central memory T cells initiate rolling and tethering through L-selectin and PNA^d interactions. Selectin-independent rolling can also occur on intestinal vessels and early after birth on other SLO vessels due to MAdCAM-1 expression that interact with $\alpha_4\beta_7$ -integrin. CCL21 and CCL19 on HEVs bind CCR7 on the rolling cells, leading to integrin activation. Activated LFA1 (lymphoid function-associated antigen 1) and $\alpha_4\beta_7$ bind to ICAM1 and ICAM2 and MAdCAM-1, respectively, resulting in cell adhesion. B cells can also activate LFA1 following CXCL12 stimulation on CXCR4. After adhesion the cells transmigrate through the HEVs. Recruitment selectivity is ensured by a restricted pattern of traffic molecules on HEVs. L-selectin and LFA1 are expressed by numerous myeloid cells, however CCR7 and CXCR4 are not, therefore these cells can roll but are unable to arrest. L-selectin negative cells, e.g. activated effector T cells or effector memory cells, are not able to initiate the rolling step. Modified after references [27, 78].

MAdCAM-1 expression is found on adult vessels of mucosal LNs and until around 4 weeks after birth on peripheral LNs. Through its capacity to interact with $\alpha_4\beta_7$ -integrin expressed on T and B cells, MAdCAM-1 is involved in cell homing (Figure 2-9). Noteworthy, β_7 deficiency has no effect on pLNs homing but leads to reduced homing in mLNs [73].

After extravasation, lymphocytes migrate to their specific regions, forming the B and T-cell areas, this process is orchestrated by CCL19, CCL21, CXCL12 and CXCL13 expression [79]. Lymphoid organ compartmentalization is defective when these chemokines or their receptors are compromised [79]. B cell follicles are absent in mice lacking CXCR5 on recirculating B cells [80], or when deficient in CXCL13, normally expressed by FDCs [81]. Mice

deficient for CCR7, expressed by T cells and DCs, or CCL19/CCL21, expressed by stromal cells in T area, present impaired T cell areas [82-84]. The expression of these homing chemokines by stromal cells is dependent on LT α 1 β 2 and TNF α [85]. During LN development, the first B cells do not respond to CXCL13, due to low CCR5 expression, and do not express LT α 1 β 2, yet these B cells are able to form a ring-like pattern in the outer cortex at postnatal day 4 (P4). Therefore, B cell migration into the outer cortex occurs independently of CXCL13 [86]. At this time CXCL13 expression depends on LT α 1 β 2, however B cells just start to express it at P2, therefore LTis are its main source and the only cells responding to CXCL13, due to its CXCR5 expression [86]. B cells start to respond to CXCL13 after P4, thus B cell organization becomes CXCL13-dependent, and LTis are progressively replaced by B cells in LN architecture maintenance (Fig. 2-10) [86]. Corroborating the notion that LT α 1 β 2 expressing B cells replace LTis in their functions is the fact that mice lacking NK, B and T cells develop the initial LN anlage but this structure does not develop after birth [87].

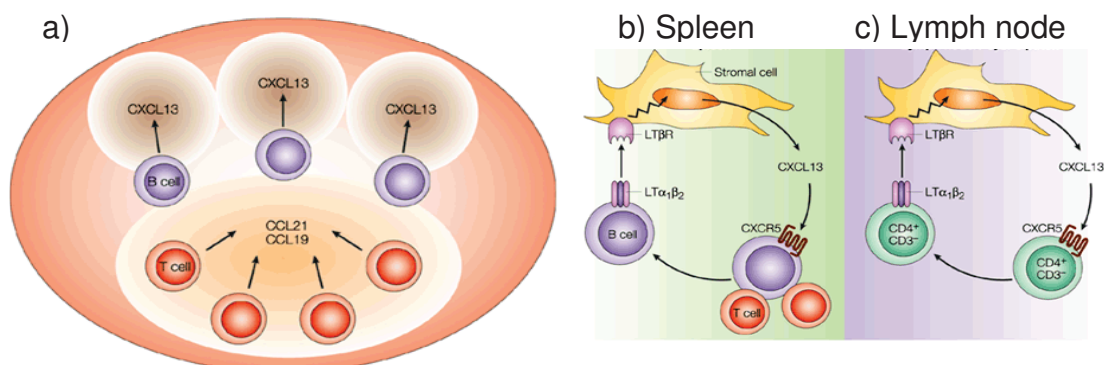

Figure 2- 10 Lymph node organizations mediated by chemokines. a. CXCL13 is expressed in the B cell area and attracts B cells which express the receptor CXCR5, establishing this way the B cell follicles. CCL19 and CCL21 are expressed in the T cell area, attracting T and dendritic cells, that express CCR7. B cell follicle formation in the spleen (b) and in the lymph nodes (c) [28].

2.3 Human Lymph node development

All the information gathered regarding LN organogenesis in mice raised the curiosity to know if the same would apply to human LNs. It was in the 1970s and 1980s that the majority of the knowledge on human lymphoid organ development was acquired, based on microscopic analysis. The first LN development phases overlap between mice and humans, starting with the lymph sac formation after budding from cardinal and jugular veins, followed by a LN development around 8 to 11 weeks of gestation [88-90]. Human LNs develop in a temporally-regulated manner, and similar to mice they develop in sequence, from head to feet. Whether this process is dependent on $LT\beta R$ signalling or not remains to be elucidated [91]. Lymphocyte colonization starts as early as 12 weeks of gestation, and B and T cell segregation occurs during the 14th week [91, 92]. HEVs can be detected during the 15th week, and in opposite to mice, both peripheral and mesenteric HEVs express MAdCAM-1 and PNA^d throughout fetal development [93]. As in mice MAdCAM-1 expression eventually disappears from the peripheral LNs during the first years [93]. During weeks 15 and 17 the subcapsular sinus becomes apparent [94]. Some genetic defects have been associated with LN absence in humans, for instance three patients with SCID (severe combined immunodeficiency) disorders linked to mutation in the $IL-7R\alpha$ gene lack palpable LNs [95, 96]. LNs were also absent or rather small when JAK3 (janus kinase 3) and the common γ chain (γc) ($IL-7R\alpha$ signalling cascade molecules) are defective [97, 98]. Moreover, LNs were also not palpable in patients with autosomal recessive osteopetrosis (ARO) linked to a RANK-RANKL mutation [54, 99]. Ultimately, the major difference between mouse and human lies is that in humans the lymphoid architecture is formed prenatally, whereas in mice it occurs postnatally. Further studies are necessary to deepen the knowledge regarding cellular and molecular mechanisms involved in LN organogenesis [89].

2.4 Conclusions

The lymphatic system collects the interstitial fluid leaking from blood capillaries and from the surrounding tissues into the collecting ducts. Before being returned to the blood circulation the lymph crosses the lymphatic system passing through the LNs where it is filtered. LN development was firstly described, over 100 years ago, by Sabin, who proposed a model where the lymph sac is developed through the sprouting of blood endothelial cells. After the lymph sac formation, the subsequent LN development is dependent on close interactions between LTis and LTos. The molecular players known so far to be involved in these interactions were disclosed by genetic studies in mice. After the finding that $LT\alpha$ -deficient mice lack LNs, other TNFSF members were found as playing a role in LN development. LTo maturation and chemokine expression highly depends on $LT\alpha 1\beta 2$ - $LT\beta R$. RANK and RANKL are indispensable for LTi numbers and clustering, and also for their $LT\alpha 1\beta 2$ expression. The several genetic mouse models were crucial in disclosing the molecular players in these cellular interactions. Different TNF(R)SF members have been described as fundamental for LN development, since the description of the $LT\alpha$ importance in 1994. LTo maturation and chemokine expression is dependent on $LT\alpha 1\beta 2$ - $LT\beta R$ signalling.

Lymph nodes are secondary lymphoid organs, which play a crucial role by enabling the encounter of B and T cells with antigen or antigen presenting cells (APCs) arriving from the periphery. Consequently, LNs are strategic points located throughout the body where immune responses can be mounted. In the next chapter the stromal and hematopoietic cells within the LNs will be furthered described.

2.5 Bibliography

1. Sabin, F.R., *On the origin of the lymphatic system from the veins and the development of lymph hearts and thoracic duct in the pig*. Am J of Anat, 1902. **1**(2): p. 367-89.
2. Sabin, F.R., *On the development of the superficial lymphatics in the skin of the pig*. Am J Anat, 1904. **1**(2): p. 183-195.
3. Choi, I., S. Lee, and Y.K. Hong, *The new era of the lymphatic system: no longer secondary to the blood vascular system*. Cold Spring Harb Perspect Med, 2012. **2**(4): p. a006445.
4. Huntington, G.S.a.C.F.W.M., *The anatomy and development of the jugular lymph sac in the domestic cat*. Am J of Anat, 1910. **10**: p. 177-311.
5. Wilting, J., et al., *Lymphangioblasts in embryonic lymphangiogenesis*. Lymphat Res Biol, 2003. **1**(1): p. 33-40.
6. Wilting, J., et al., *Dual origin of avian lymphatics*. Dev Biol, 2006. **292**(1): p. 165-73.
7. Lee, J.Y., et al., *Podoplanin-expressing cells derived from bone marrow play a crucial role in postnatal lymphatic neovascularization*. Circulation, 2010. **122**(14): p. 1413-25.
8. Srinivasan, R.S., et al., *Lineage tracing demonstrates the venous origin of the mammalian lymphatic vasculature*. Genes Dev, 2007. **21**(19): p. 2422-32.
9. Gale, N.W., et al., *Normal lymphatic development and function in mice deficient for the lymphatic hyaluronan receptor LYVE-1*. Mol Cell Biol, 2007. **27**(2): p. 595-604.
10. Schulte-Merker, S., A. Sabine, and T.V. Petrova, *Lymphatic vascular morphogenesis in development, physiology, and disease*. J Cell Biol, 2011. **193**(4): p. 607-18.
11. Francois, M., et al., *Sox18 induces development of the lymphatic vasculature in mice*. Nature, 2008. **456**(7222): p. 643-7.
12. Wigle, J.T., et al., *An essential role for Prox1 in the induction of the lymphatic endothelial cell phenotype*. EMBO J, 2002. **21**(7): p. 1505-13.
13. Karkkainen, M.J., et al., *Vascular endothelial growth factor C is required for sprouting of the first lymphatic vessels from embryonic veins*. Nat Immunol, 2004. **5**(1): p. 74-80.
14. Schacht, V., et al., *T1alpha/podoplanin deficiency disrupts normal lymphatic vasculature formation and causes lymphedema*. EMBO J, 2003. **22**(14): p. 3546-56.
15. von Andrian, U.H. and T.R. Mempel, *Homing and cellular traffic in lymph nodes*. Nat Rev Immunol, 2003. **3**(11): p. 867-78.
16. Kerjaschki, D., *The lymphatic vasculature revisited*. J Clin Invest, 2014. **124**(3): p. 874-7.
17. Oliver, G., *Lymphatic vasculature development*. Nat Rev Immunol, 2004. **4**(1): p. 35-45.
18. Hong, Y.K., J.W. Shin, and M. Detmar, *Development of the lymphatic vascular system: a mystery unravels*. Dev Dyn, 2004. **231**(3): p. 462-73.
19. Miteva, D.O., et al., *Transmural flow modulates cell and fluid transport functions of lymphatic endothelium*. Circ Res, 2010. **106**(5): p. 920-31.

20. Johnson, L.A. and D.G. Jackson, *Cell traffic and the lymphatic endothelium*. Ann N Y Acad Sci, 2008. **1131**: p. 119-33.
21. Johnson, L.A. and D.G. Jackson, *Inflammation-induced secretion of CCL21 in lymphatic endothelium is a key regulator of integrin-mediated dendritic cell transmigration*. Int Immunol, 2010. **22**(10): p. 839-49.
22. Wang, Y. and M. Simons, *Flow-regulated lymphatic vasculature development and signaling*. Vasc Cell, 2014. **6**: p. 14.
23. Zawieja, D.C., *Contractile physiology of lymphatics*. Lymphat Res Biol, 2009. **7**(2): p. 87-96.
24. Standring, S., ed. *Gray's Anatomy: The Anatomical Basis of Clinical Practice*. Churchill-Livingstone, Elsevier, 2008. **40ed**: p. 1576.
25. Van den Broeck, W., A. Derore, and P. Simoons, *Anatomy and nomenclature of murine lymph nodes: Descriptive study and nomenclatory standardization in BALB/cAnNCrI mice*. J Immunol Methods, 2006. **312**(1-2): p. 12-9.
26. Willard-Mack, C.L., *Normal structure, function, and histology of lymph nodes*. Toxicol Pathol, 2006. **34**(5): p. 409-24.
27. Eikelenboom, P., et al., *The histogenesis of lymph nodes in rat and rabbit*. Anat Rec, 1978. **190**(2): p. 201-15.
28. Mebius, R.E., *Organogenesis of lymphoid tissues*. Nat Rev Immunol, 2003. **3**(4): p. 292-303.
29. Vondenhoff, M.F.e.a., *Lymph sacs are not required for the initiation of lymph node formation*. Development, 2009. **136**(1): p. 29-34.
30. Mebius, R.E., P. Rennert, and I.L. Weissman, *Developing lymph nodes collect CD4+CD3- LTbeta+ cells that can differentiate to APC, NK cells, and follicular cells but not T or B cells*. Immunity, 1997. **7**(4): p. 493-504.
31. Cupedo, T., et al., *Presumptive lymph node organizers are differentially represented in developing mesenteric and peripheral nodes*. J Immunol, 2004. **173**(5): p. 2968-75.
32. Eberl, G., et al., *An essential function for the nuclear receptor RORgamma(t) in the generation of fetal lymphoid tissue inducer cells*. Nat Immunol, 2004. **5**(1): p. 64-73.
33. Brendolan, A. and J.H. Caamano, *Mesenchymal cell differentiation during lymph node organogenesis*. Front Immunol, 2012. **3**: p. 381.
34. Kelly, K.A. and R. Scollay, *Seeding of neonatal lymph nodes by T cells and identification of a novel population of CD3-CD4+ cells*. Eur J Immunol, 1992. **22**(2): p. 329-34.
35. Boos, M.D., et al., *Mature natural killer cell and lymphoid tissue-inducing cell development requires Id2-mediated suppression of E protein activity*. J Exp Med, 2007. **204**(5): p. 1119-30.
36. Rennert, P.D., et al., *Lymph node genesis is induced by signaling through the lymphotoxin beta receptor*. Immunity, 1998. **9**(1): p. 71-9.
37. Meier, D., et al., *Ectopic lymphoid-organ development occurs through interleukin 7-mediated enhanced survival of lymphoid-tissue-inducer cells*. Immunity, 2007. **26**(5): p. 643-54.
38. Dougall, W.C., et al., *RANK is essential for osteoclast and lymph node development*. Genes Dev, 1999. **13**(18): p. 2412-24.

39. Kim, D., et al., *Regulation of peripheral lymph node genesis by the tumor necrosis factor family member TRANCE*. J Exp Med, 2000. **192**(10): p. 1467-78.
40. Cupedo, T. and R.E. Mebius, *Cellular interactions in lymph node development*. J Immunol, 2005. **174**(1): p. 21-5.
41. Yoshida, H., et al., *Different cytokines induce surface lymphotoxin-alpha on IL-7 receptor-alpha cells that differentially engender lymph nodes and Peyer's patches*. Immunity, 2002. **17**(6): p. 823-33.
42. Randall, T.D., D.M. Carragher, and J. Rangel-Moreno, *Development of secondary lymphoid organs*. Annu Rev Immunol, 2008. **26**: p. 627-50.
43. Okuda, M., et al., *Distinct activities of stromal cells involved in the organogenesis of lymph nodes and Peyer's patches*. J. Immunol., 2007. **179**(2): p. 804-811.
44. Benezech, C., et al., *Ontogeny of stromal organizer cells during lymph node development*. J. Immunol., 2011. **184**(8): p. 4521-30.
45. van de Pavert, S.A., et al., *Chemokine CXCL13 is essential for lymph node initiation and is induced by retinoic acid and neuronal stimulation*. Nat Immunol, 2009. **10**(11): p. 1193-9.
46. Kain, M.J. and B.M. Owens, *Stromal cell regulation of homeostatic and inflammatory lymphoid organogenesis*. Immunology, 2013. **140**(1): p. 12-21.
47. Vondenhoff, M.F., et al., *LTbetaR signaling induces cytokine expression and up-regulates lymphangiogenic factors in lymph node anlagen*. J. Immunol., 2009. **182**(9): p. 5439-45.
48. van de Pavert, S.A. and R.E. Mebius, *New insights into the development of lymphoid tissues*. Nat Rev Immunol, 2010. **10**(9): p. 664-74.
49. Sugiyama, M., et al., *Expression pattern changes and function of RANKL during mouse lymph node microarchitecture development*. Int. Immunol., 2012. **2012**: p. 21.
50. Luther, S.A., K.M. Ansel, and J.G. Cyster, *Overlapping roles of CXCL13, interleukin 7 receptor alpha, and CCR7 ligands in lymph node development*. J Exp Med, 2003. **197**(9): p. 1191-8.
51. De Togni, P., et al., *Abnormal development of peripheral lymphoid organs in mice deficient in lymphotoxin*. Science, 1994. **264**(5159): p. 703-7.
52. Foster, R.e.a., *Abnormal development of peripheral lymphoid organs in mice deficient in lymphotoxin*. Science, 1994. **264**(5159): p. 703-707.
53. Kong, Y.Y., et al., *OPGL is a key regulator of osteoclastogenesis, lymphocyte development and lymph-node organogenesis*. Nature, 1999. **397**(6717): p. 315-23.
54. Sobacchi, C., et al., *Osteoclast-poor human osteopetrosis due to mutations in the gene encoding RANKL*. Nat. Genet., 2007. **39**(8): p. 960-2.
55. Finke, D., *Fate and function of lymphoid tissue inducer cells*. Curr Opin Immunol, 2005. **17**(2): p. 144-50.
56. Mueller, C.G. and E. Hess, *Emerging Functions of RANKL in Lymphoid Tissues*. Frontiers in Immunology, 2012. **3**: p. 261-7.
57. Aggarwal, B.B., T.E. Eessalu, and P.E. Hass, *Characterization of receptors for human tumour necrosis factor and their regulation by gamma-interferon*. Nature, 1985. **318**(6047): p. 665-7.

58. Erickson, S.L., et al., *Decreased sensitivity to tumour-necrosis factor but normal T-cell development in TNF receptor-2-deficient mice*. *Nature*, 1994. **372**(6506): p. 560-3.
59. Pasparakis, M., et al., *Immune and inflammatory responses in TNF alpha-deficient mice: a critical requirement for TNF alpha in the formation of primary B cell follicles, follicular dendritic cell networks and germinal centers, and in the maturation of the humoral immune response*. *J Exp Med*, 1996. **184**(4): p. 1397-411.
60. Pasparakis, M., et al., *Peyer's patch organogenesis is intact yet formation of B lymphocyte follicles is defective in peripheral lymphoid organs of mice deficient for tumor necrosis factor and its 55-kDa receptor*. *Proc Natl Acad Sci U S A*, 1997. **94**(12): p. 6319-23.
61. Locksley, R.M., N. Killeen, and M.J. Lenardo, *The TNF and TNF receptor superfamilies: integrating mammalian biology*. *Cell*, 2001. **104**(4): p. 487-501.
62. Browning, J.L., et al., *Lymphotoxin beta, a novel member of the TNF family that forms a heteromeric complex with lymphotoxin on the cell surface*. *Cell*, 1993. **72**(6): p. 847-56.
63. Crowe, P.D., et al., *A lymphotoxin-beta-specific receptor*. *Science*, 1994. **264**(5159): p. 707-10.
64. Watts, T.H. and J.L. Gommerman, *The LIGHT and DARC sides of herpesvirus entry mediator*. *Proc Natl Acad Sci U S A*, 2005. **102**(38): p. 13365-6.
65. Futterer, A., et al., *The lymphotoxin beta receptor controls organogenesis and affinity maturation in peripheral lymphoid tissues*. *Immunity*, 1998. **9**(1): p. 59-70.
66. Koni, P.A., et al., *Distinct roles in lymphoid organogenesis for lymphotoxins alpha and beta revealed in lymphotoxin beta-deficient mice*. *Immunity*, 1997. **6**(4): p. 491-500.
67. Scheu, S., et al., *Targeted disruption of LIGHT causes defects in costimulatory T cell activation and reveals cooperation with lymphotoxin beta in mesenteric lymph node genesis*. *J. Exp. Med.*, 2002. **195**(12): p. 1613-24.
68. Miyawaki, S., et al., *A new mutation, aly, that induces a generalized lack of lymph nodes accompanied by immunodeficiency in mice*. *Eur J Immunol*, 1994. **24**(2): p. 429-34.
69. DeJardin, E., et al., *The lymphotoxin-beta receptor induces different patterns of gene expression via two NF-kappaB pathways*. *Immunity*, 2002. **17**(4): p. 525-35.
70. Shinkura, R., et al., *Allymphoplasia is caused by a point mutation in the mouse gene encoding Nf-kappa b-inducing kinase*. *Nat Genet*, 1999. **22**(1): p. 74-7.
71. Fagarasan, S., et al., *Allymphoplasia (aly)-type nuclear factor kappaB-inducing kinase (NIK) causes defects in secondary lymphoid tissue chemokine receptor signaling and homing of peritoneal cells to the gut-associated lymphatic tissue system*. *J Exp Med*, 2000. **191**(9): p. 1477-86.
72. Alcamo, E., et al., *Requirement for the NF-kappaB family member RelA in the development of secondary lymphoid organs*. *J Exp Med*, 2002. **195**(2): p. 233-44.
73. Browning, J.L., et al., *Lymphotoxin-beta receptor signaling is required for the homeostatic control of HEV differentiation and function*. *Immunity*, 2005. **23**(5): p. 539-50.
74. Onder, L., et al., *Endothelial cell-specific lymphotoxin-beta receptor signaling is critical for lymph node and high endothelial venule formation*. *J Exp Med*, 2013. **210**(3): p. 465-73.
75. Chai, Q., et al., *Maturation of lymph node fibroblastic reticular cells from myofibroblastic precursors is critical for antiviral immunity*. *Immunity*, 2013. **38**(5): p. 1013-24.

76. Mebius, R.E., et al., *The influence of afferent lymphatic vessel interruption on vascular addressin expression*. J. Cell. Biol., 1991. **115**(1): p. 85-95.
77. Kanemitsu, N., et al., *CXCL13 is an arrest chemokine for B cells in high endothelial venules*. Blood, 2005. **106**(8): p. 2613-8.
78. Agace, W.W., *Tissue-tropic effector T cells: generation and targeting opportunities*. Nat Rev Immunol, 2006. **6**(9): p. 682-92.
79. Cyster, J.G., *Chemokines and cell migration in secondary lymphoid organs*. Science, 1999. **286**(5447): p. 2098-102.
80. Forster, R., et al., *A putative chemokine receptor, BLR1, directs B cell migration to defined lymphoid organs and specific anatomic compartments of the spleen*. Cell, 1996. **87**(6): p. 1037-47.
81. Legler, D.F., et al., *B cell-attracting chemokine 1, a human CXC chemokine expressed in lymphoid tissues, selectively attracts B lymphocytes via BLR1/CXCR5*. J Exp Med, 1998. **187**(4): p. 655-60.
82. Forster, R., et al., *CCR7 coordinates the primary immune response by establishing functional microenvironments in secondary lymphoid organs*. Cell, 1999. **99**(1): p. 23-33.
83. Gunn, M.D., et al., *Mice lacking expression of secondary lymphoid organ chemokine have defects in lymphocyte homing and dendritic cell localization*. J Exp Med, 1999. **189**(3): p. 451-60.
84. Mori, S., et al., *Mice lacking expression of the chemokines CCL21-ser and CCL19 (plt mice) demonstrate delayed but enhanced T cell immune responses*. J Exp Med, 2001. **193**(2): p. 207-18.
85. Ngo, V.N., et al., *Lymphotoxin alpha/beta and tumor necrosis factor are required for stromal cell expression of homing chemokines in B and T cell areas of the spleen*. J Exp Med, 1999. **189**(2): p. 403-12.
86. Cupedo, T., et al., *Initiation of cellular organization in lymph nodes is regulated by non-B cell-derived signals and is not dependent on CXC chemokine ligand 13*. J Immunol, 2004. **173**(8): p. 4889-96.
87. Coles, M.C., et al., *Role of T and NK cells and IL7/IL7r interactions during neonatal maturation of lymph nodes*. Proc Natl Acad Sci U S A, 2006. **103**(36): p. 13457-62.
88. Bailey, R.P. and L. Weiss, *Ontogeny of human fetal lymph nodes*. Am J Anat, 1975. **142**(1): p. 15-27.
89. Hoorweg, K. and T. Cupedo, *Development of human lymph nodes and Peyer's patches*. Semin Immunol, 2008. **20**(3): p. 164-70.
90. Markgraf, R., B. von Gaudecker, and H.K. Muller-Hermelink, *The development of the human lymph node*. Cell Tissue Res, 1982. **225**(2): p. 387-413.
91. Kyriazis, A.A. and J.R. Esterly, *Development of lymphoid tissues in the human embryo and early fetus*. Arch Pathol, 1970. **90**(4): p. 348-53.
92. Asano, S., et al., *Immunohistologic detection of the primary follicle (PF) in human fetal and newborn lymph node anlagen*. Pathol Res Pract, 1993. **189**(8): p. 921-7.
93. Salmi, M., et al., *Immune cell trafficking in uterus and early life is dominated by the mucosal addressin MAdCAM-1 in humans*. Gastroenterology, 2001. **121**(4): p. 853-64.

94. Dubey, A.e.a., *Development of the Human Lymph*

Nodes- A Histological Study. Journal of Clinical and Diagnostic Research, 2012. **6**(7): p. 1155-1157.

95. Cunningham-Rundles, C. and P.P. Ponda, *Molecular defects in T- and B-cell primary immunodeficiency diseases*. Nat Rev Immunol, 2005. **5**(11): p. 880-92.

96. Roifman, C.M., et al., *A partial deficiency of interleukin-7R alpha is sufficient to abrogate T-cell development and cause severe combined immunodeficiency*. Blood, 2000. **96**(8): p. 2803-7.

97. Buckley, R.H., *Molecular defects in human severe combined immunodeficiency and approaches to immune reconstitution*. Annu Rev Immunol, 2004. **22**: p. 625-55.

98. Russell, S.M., et al., *Mutation of Jak3 in a patient with SCID: essential role of Jak3 in lymphoid development*. Science, 1995. **270**(5237): p. 797-800.

99. Leibbrandt, A. and J.M. Penninger, *Novel functions of RANK(L) signaling in the immune system*. Adv Exp Med Biol, 2010. **658**: p. 77-94.

3 Stromal and Hematopoietic cells within the LN

The LN is composed of numerous types of stromal and hematopoietic cells, and most probably there are still cells to be found and described. Therefore, in this chapter only stromal and hematopoietic cells with relevance for this thesis will be discussed.

3.1 Lymph node stromal cells

For many years stromal cells have been defined as cells which provide support within an organ, however its involvement in immune responses is now starting to be considered. As LNs are the organs where immune responses are initiated, it is the LN stromal cells that form the cellular structures necessary for those processes. During an immune response the LN expands and lymphocyte numbers increase exponentially and these processes are supported by local stromal cells [1, 2]. Therefore LN organization and immune responses are deeply interconnected. Despite this interdependency, stromal cells from LNs and from other lymphoid organs, are not clearly defined. For instance, stromal cell is a general term applied to a heterogeneous group of non-hematopoietic cells [3, 4]. The previously

described LN stromal subsets are listed in Table 3-1. They can be grossly divided into BECs (including HEVs), LECs and non-endothelial cells derived from mesenchymal progenitors. According to their location, mesenchymal stromal cells are subdivided into FRC (T-cell zone), FDCs (B-cell zone) and MRCs [4-7]. The MRCs are situated beneath the SCS in the outer edge of B cell follicles. The stromal subsets can be identified as CD45-negative cells and based on their differential expression of podoplanin (gp38) and CD31 [8]. Lymphatic endothelial cells express CD31 and gp38 while BECs carry only CD31. Mesenchymal stromal cells all lack CD31 expression, with FRC being gp38 positive and another population lacking both CD31 and gp38, the double negative cells (DNCs) [2]. FRCs can be further characterized by ICAM-1, VCAM-1 and production of CCL19, CCL21 and IL-7, whereas MRCs express MAdCAM-1 and RANKL in addition to ICAM-1, VCAM-1, and produce CXCL13 [9]. On the other hand, FDCs have their own specific markers such as follicular dendritic cell marker (FDC-M1 and FDC-M2), and like MRCs produce CXCL13 and BAFF (B cell survival factor) [10]. Although LTo are believed to function as their precursors, their contributions and the signals involved in differentiation of the different mesenchymal cells are not fully understood [11]. Regarding FDCs, some researchers have proposed its origin in bone marrow stromal cells or myeloid cells [12]. However, Cupedo and colleagues showed, in 2004, that neonatal LTo could differentiate into mature FRCs and FDCs, since transplantation of neonatal LN cells under the adult mouse skin gave rise to stromal cell networks [13]. Moreover, MRCs are thought to be the LTo adult counterpart, as they share similar markers and a $LT\beta R$ -dependent expression of ICAM-1, VCAM-1, MAdCAM-1 and CXCL13 [9]. Further studies are required to determine if different stromal subsets originate from a single mesenchymal progenitor, such as the LTo, or whether intermediate cell types are implicated.

Stromal cell type	Surface markers	Description
Lymphoid Tissue organizer	gp38 ⁺ CD31 ⁻ MAdCAM ⁺ RANKL ⁺ ER- TR7 ⁺	LTo differentiate from mesenchymal cells upon $LT\beta R$ signalling by interaction with $LT\alpha 1\beta 2^+$ LTi during LN development. LTo recruit and retain hematopoietic cells into the LN anlagen and are believed to give rise to adult stromal cells such as FRCs and

(LTo)		MRCs.
Follicular Dendritic cell (FDC)	gp38 ⁺ CD31 ⁻ ER-TR7 ⁻ CD35 ⁺ FDC-M1 ⁺ FDC-M2 ⁺	FDCs localize in the B cell area, and are key players in B cell organization into follicles through CXCL13 expression. These cells also provide BAFF and APRIL (B cell survival factors). Capable to acquire and retain antigens for prolonged times, FDCs are an important constituent off germinal centres.
Fibroblastic Reticular cell (FRC)	gp38 ⁺ CD31 ⁻ ER-TR7 ⁺ LTβR ⁺ ICAM-1 ⁺ VCAM-1 ⁺	Found within the T cell area, where they produce and ensheath extracellular matrix, creating a fibroptic-like reticular structure. The LN parenchyma is permeated by a large and interconnected reticular network, which facilitates the lymph flow and the transport of small molecules. As heterogeneous populations, they fulfil distinct functions according to their location, including HEV integrity support, T cell recruitment and survival, and B cell survival.
Marginal Reticular cell (MRC)	gp38 ⁺ CD31 ⁻ MAdCAM ⁺ RANKL ⁺ ER-TR7 ⁺	MRCs, a recently identified subset, are localized at the outer edge of B cell follicles beneath the subcapsular sinus. MRCs constitutively produce CXCL13 and maintain several LTo characteristics, although its precise immunological function is not clear yet.
Integrin α7 pericytes (IAP)	gp38 ⁻ CD31 ⁻ ITGA7 ⁺	IAPs, a newly identified subset, are localized around blood vessels in the cortex and medulla. Information about these cells is still lacking, although transcriptional data suggests that they are highly contractile and similar to FRCs.
Blood Endothelial cell (BEC)	gp38 ⁻ CD31 ⁺ RANK ⁺ VCAM-1 ⁺	BECs line the LN blood vessels, they express leukocyte adressins and/or integrins to attract and allow their entry into the organ (see HEVs).
High Endothelial Venule (HEV)	gp38 ⁻ CD31 ⁺ MECA-79 ⁺ (PNAd ⁺)	HEVs are a specialized BEC subset of the post-capillary venules. HEVs actively promote lymphocyte egress into the LN
Lymphatic Endothelial cell (LEC)	gp38 ⁻ CD31 ⁺ LYVE-1 ⁺ , mCLCA1	LECs line the afferent, efferent lymphatic vessels and the trabecular sinuses. They are involved in the transport of material and cells into, through and out of the LN

	MAdCAM-1 ^{+/-} ITGA2b ^{+/-}	
--	--	--

Table 3- 1 LN stromal subsets. A list of LN stromal cells with their surface markers and description [1, 5, 6, 14].

3.1.1 Fibroblastic Reticular cells (FRCs)

FRCs can be found in the medullary and cortical areas of the LN, and depending on their location they can be fusiform, stellate or highly elongated [15, 16]. Its cytoplasm contains intertwined tubules and cisterns that form cytoplasmic channels where antigens can be delivered to antigen-presenting cells (Fig. 3-1). FRCs are in close contact with each other as well as with other cells, including lymphocytes, dendritic cells and plasma B cells [16]. Side-by-side FRCs create an intercellular channel through which soluble molecules smaller than 60kDa can be transported, forming a conduit system called reticular fibre network. This structure enables the delivery of soluble antigens, arising from the afferent lymph, to dendritic cells in the T cell area. Cortical FRCs, residing close to the SCS, are polarized cells which collect soluble molecules at the side close to the SCS lumen and release them to reach lymphocytes, dendritic cells and possibly FDCs [17, 18].

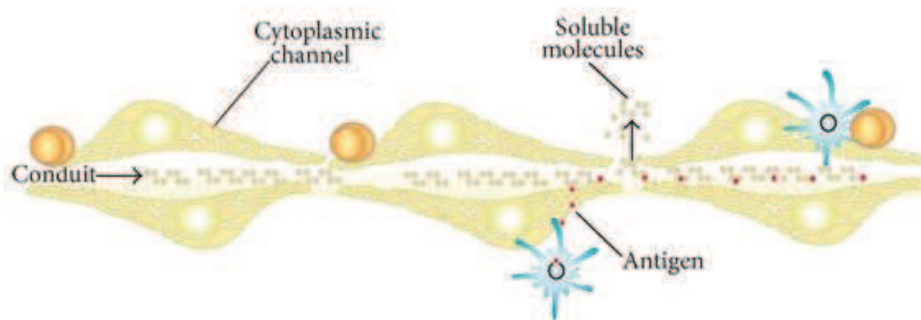

Figure 3- 1 FRCs schematic view. FRCs present cytoplasmic channels, where antigens can be delivered to antigen-presenting cells. These cells are localized next to each other in order to create a conduit channel for small soluble molecules [17].

FRCs, as all stromal cells, were initially considered as supporting cells, however this does not correspond to reality and these cells display additional roles such as a support for lymphocyte migration and survival, immune response activation and control, and are also involved in peripheral tolerance [19].

Regarding cell migration and survival, the FRC network regulates T cell access to the paracortex and also supports and delimits T cell movements within this area [20]. FRCs engage CLEC-2 on DCs, supporting their spreading and migration and inducing membrane protrusions [21]. CCL19 and CCL21 (lymphocyte homing molecules) are expressed by FRCs, and are required for T cell movements within the LN [22-24]. For instance, FRCs surrounding HEVs produce CCL21, promoting the transmigration of lymphocytes [1]. CCL19 and CCL21 support antigen-induced cell death in activated T cells, and it has been shown that T cell function, activation and proliferation is inhibited by constant stimulation or high doses of CCL19 and CCL21 [25]. FRCs are also an important source of IL-7, a survival factor for naïve T cells, B cells, DCs and NK cells. IL-7 maintains the B and T cell repertoire and immune system homeostasis [22, 26].

FRCs are also involved in cell recruitment and activation. Several data suggest that FRCs play a role in the immune response through cell traffic regulation, lymphocyte survival and providing superior antigen presentation. Hence, antigens entering the SCS are actively selected by these cells, high molecular weight molecules cannot enter the conduits whereas small molecular weight molecules are delivered to APCs via the conduits, and can activate Ag-specific T cells. Furthermore, this conduit network contains CXCL13 which can be a guiding pathway for B cells to their cognate antigen in the follicular area [27]. FRCs produce IL-7 which stimulates APC functions, and produce CCL19 and CCL21 which promote DC-T cell interactions, and enhances endocytosis and DC antigen presentation. CCL3 and CCL4 are then secreted by activated DCs, which recruit T cells and support immune priming [1, 22, 25]. It was shown, by Chai and colleagues, that resistance to viral infection is impaired in FRC-deficient mice, and moreover that FRC maturation through LT β R signalling is indispensable for the maintenance of immunocompetence [28]. Yang *et al.*, showed a correlation between antigen-specific T cell response and FRC numbers, phenotype and function. The researchers also showed that DC-induced trapping of naïve lymphocytes activates FRCs [29].

Peripheral tolerance is also performed by FRCs, as some of these cells express peripheral tissue antigens (PTAs) and maintain peripheral tolerance through self-reactive T cell deletion. A study using a transgenic model of truncated ovalbumin expression showed that after ovalbumin-specific CD8⁺ T cell transfer, these cells were activated in LNs even when hematopoietic cells (including DCs) were prevented from presenting antigens. These cells were, therefore, not kept in the peripheral T cell pool, which resulted in tolerance [30]. Another study reported that CD8⁺ T cells interacting with self-antigen expressing stromal cells were deleted in a model consisting of mice expressing AIRE with GFP (green fluorescent protein) which enabled the identification of AIRE⁺ FRCs [31]. Another player in peripheral tolerance, highly expressed by FRCs, is the deformed epidermal autoregulatory factor 1 (Deaf1), responsible for PTA expression [5, 32-35]. Besides PTA expression, FRCs can also block T cell activation when IFN- γ increases FRC nitrite production, which can interfere with the cell cycle [35]. The PD-1 (programmed cell death-1) and PD-L1 (PD-ligand 1) seem also to be involved, since PD-L1 blockade led to autoimmune enteritis [36]. Moreover, PD-L1 expression can be induced by IFN- γ , and the PD-L1 involvement in regulatory T cells (Treg) and myeloid suppressor cells development is already acknowledged. This information raises a connection between FRCs and regulatory cell production, maintenance and activation [35].

RANKL plays a role in the thymus, inducing AIRE expression by mTECs, therefore a possible role in peripheral tolerance cannot be ruled out, as described in the first chapter, however it still remains to be further investigated.

FRCs also play a role in the regulation of LN vasculature. It was shown that FRCs are an important source of VEGF (vascular endothelial growth factor) to stimulate endothelial cell proliferation. During immune responses, the increased LN vascularity may be attributable to an increased production of VEGF by FRCs [37].

3.1.2 Marginal Reticular Cells (MRCs)

In the SCS region there is a layer of reticular stromal cells just underneath the floor LECs which correspond to MRCs in the LN, but these cells can be found in all secondary lymphoid organs (Fig.3-2). These cells were recently described as expressing CXCL13 and

MAdCAM-1 but no CCL21 which differentiate them from T zone FRCs. The FDC marker CR1/CD35 is also absent or weakly expressed by these cells, making them distinct from FDCs. However, the MRCs express RANKL [9].

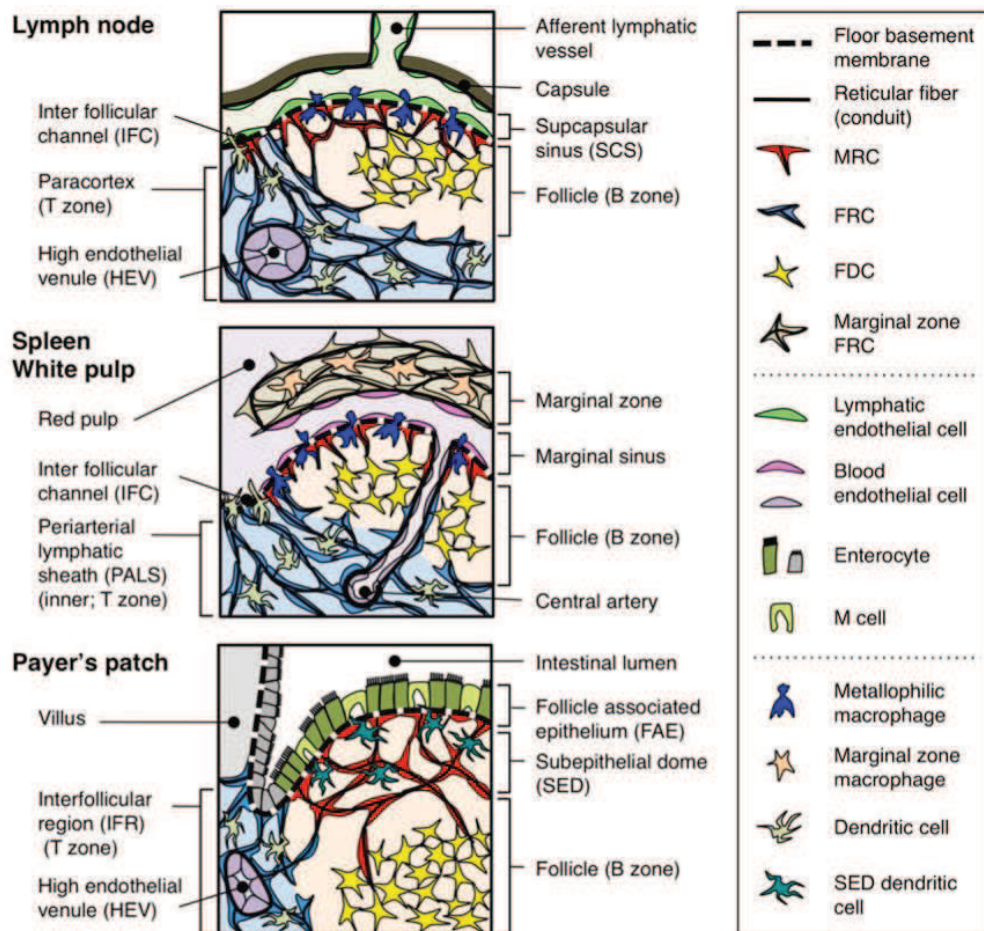

Figure 3- 2 MRCs in different SLOs. MRCs localize within LN, spleen and Peyer's patches, as part of the antigen-transporting apparatus. Reference [38] .

LT β R and/or TNFR-1 pathways are believed to be required for MRC differentiation since LT α -deficient mice no longer comprise splenic MRCs [39]. MRC analysis in the LN is not possible in this model since LNs are absent, however, LT β R blockade led to disappearance of MAdCAM-1 and CXCL13 expressions in the SCS area, but RANKL was still detectable. Hence, it appears that MRCs may persist after LT β R blockade as RANKL⁺MAdCAM-1⁻CXCL13⁻ cells [6, 9]. MRC development remains elusive, however the contribution does not

appear to come from T or B lymphocytes since SCID (severe combined immunodeficiency) mice present this cell population [40]. An important candidate are the LTis themselves express themselves $LT\alpha\beta$ and postnatally these cells accumulate in the SLO outer cortex, where MRCs are localized [9, 40]. Due to their localization underneath the SCSs, where lymph-borne antigens and antigen-carrying DCs arrive from the periphery, MRCs may support the antigen-transporting frontline. Furthermore, it was demonstrated that the conduit network, possibly made of MRCs, is able to transport small molecules from the SCS into B cell follicles [27, 41]. The SCS floor is also highly populated by SCS macrophages ($CD169^+$) which directly deliver antigens to Ag-specific B cells in the follicle, and MRCs express high levels of ICAM-1, VCAM-1 and CXCL13, which can support the interstitial migration of B cells, suggesting a possible role of MRCs in this interaction between SCS macrophages and B cells [42, 43].

A relationship between LTos and MRCs is suggested by a similar expression profile. During LN development LTos localize frequently at the lymphatic sinus where the SCS will form. As the anlage grows this layer expands and thus possible give rise to the MRC layer [9, 44]. SLOs have Ag collecting structures which are created during development and need to be maintained after birth. For this an organizer-like stromal cell, as MRCs, may be required [9]. MRCs share many characteristics with FRCs and FDCs, and if indeed they retain LTos features it is reasonable to question if whether MRCs may differentiate into FRCs and FDCs, which would provide MRCs with stem cell characteristics [9].

3.1.3 Follicular Dendritic Cells (FDCs)

FDCs can be found in the centre of B cell follicles, and are involved in B cell homing, migration, survival and proliferation. They also play a role in antigen presentation and in T cell-dependent Ab response, and are essential for efficient germinal centre (GC) formation. In order to keep functional B cell follicles, FDCs and B cells must influence each other.

FDCs have been shown to originate from mesenchymal precursors [45]. However it is still elusive if they arise from one single precursor or distinct ones. For instance a cell lineage tracing study showed that splenic FDC precursors express $PDGFR\beta$ (platelet-derived

growth factor receptor-beta) and SMA (alpha smooth muscle actin), molecules associated with vascular mural cells, and these precursors were found in the perivascular space [46, 47]. It was shown that stromal vascular areas in the white adipose tissue contain undifferentiated preadipocytes [48, 49]. Another lineage-tracing experiment in the spleen showed that FDCs, FRCs and MRCs originate from precursors which express homeobox protein NKX2-5 and insulin gene enhancer protein ISL1. These precursor cells were implanted under the kidney capsule and gave rise to lymphoid structures [50]. However, LN FDCs did not derive from $Nkx2-5^+$ $Isl1-1^+$ mesenchymal lineage. Alternatively, LN FDCs might originate from a local stromal population that can also give rise to FRCs. A multicolour fate mapping study suggested that LN FDCs can differentiate from MRCs both in the steady state and upon an inflammatory stimulus [51].

FDCs are critically involved in B cells homing and migration. Lymphoid organs can have two types of B cell follicles, either primary follicles, found in a quiescent state composed basically of naïve B cells, or secondary follicles in an activated state, composed of germinal centre B and T cells and tingible body macrophages. Regarding primary follicle maintenance, FDCs produce CXCL13 which signals through CXCR5 and attracts B cells and specific T cell subsets into the follicles [52]. These features are necessary to keep an organized follicle structure, since the selective ablation of FDCs leads to the loss of follicles and results in unorganized B cells distribution [53]. On the other hand, FDC development and maintenance is guaranteed by TNF and $LT\alpha 1\beta 2$ signals coming from B cells. FDCs are absent in SLOs lacking B cells, $LT\alpha$, $LT\beta$ or $TNF\alpha$ [10, 54]. B cells are known to migrate extensively within the follicle which is important for B cell Ag survey.

FDCs play an indispensable role in the germinal centre reaction. Secondary follicles have a germinal centre composed mainly of B cell blasts. The GC has two distinct regions, the dark and light zones. The dark zone is localized near the T cell area and is rich in centroblasts, proliferating B cells with low Ig expression. The light zone has fewer B cells which are not proliferating and express surface Ig [55]. The dark zone presents a dense FDC network, whereas this network is rather sparse in the light zone. FDCs have the ability to retain immune complexes (IC) for long periods, and this is required for germinal centre (GC) maintenance, B cell somatic hypermutation (SHM) and also for long-term immune memory [56]. During a GC reaction B cells interact with Ag on FDC surface, which gives

them survival signals and leads to affinity maturation, forming therefore memory B cell pools [55]. When a GC reaction takes place, activated B cells migrate to the T-B cell border, in order to present Ag to T helper cells and receive co-stimulation. Stimulated B cells migrate into the follicle centre, in the dark zone, where a cycle of proliferation and hypermutation is initiated. Then, already in the light zone, these B cells undergo Ag-driven selection by FDCs. The selected B cells can re-enter the GC or, helped by T follicular helper (T_{FH}) cells, they can exit the GC and give rise to plasma or memory B cells (Fig. 3-3) [10, 47, 55, 57].

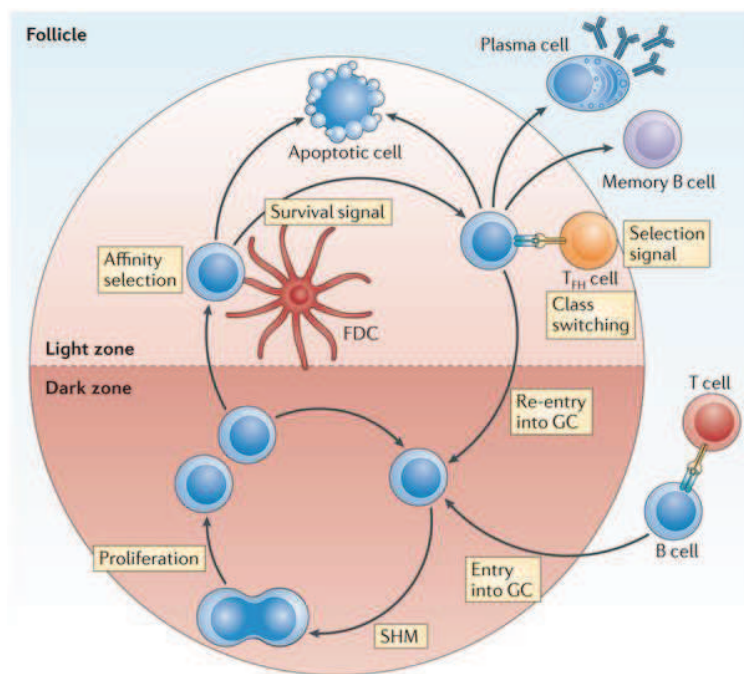

Nature Reviews | Immunology

Figure 3- 3 Germinal centre reaction. Schematic view of affinity maturation in the GC. The B cells present Ag to T helper cells at the T-B cell border, and receive co-stimulatory signals. After selection B cells enter the dark zone and undergo hypermutation. Then, B cells migrate into the light zone, where they are exposed to Ag on FDCs. If there is low affinity the B cells will not survive, on the other hand, high affinity B cells receive survival signals. The selected B cells can achieve higher affinity maturation if they re-enter the dark zone or they can exit the GC as memory B cells or plasma cells [55].

FDCs induce survival and proliferation of both naïve and activated B cells. FDCs are known to be an important source of BAFF, and this cytokine is required for B cell homeostasis in developing as well as mature B cells. Therefore FDCs may impact this way on the survival of follicular and GC B cells [58, 59]. BAFF or BAFF-receptor deficient mice are unable to sustain GCs [60]. IL-6 is expressed by FDCs and it was shown that IL-6 deficiency leads to reduced GCs in mice [61]. Additionally, FDCs express IL-15 which supports GC B cell proliferation [62]. Due to their cytokine expression FDCs provide survival and proliferative signals to B cells and help maintain GCs, however the precise mechanism involved remains poorly understood [47].

FDCs display immune complexes (ICs) and present them to B cells. ICs are rapidly transported and deposited on FDCs both in primary and secondary follicles. Some studies suggest that B cells are involved in IC transport to FDCs [63], whereas others suggest a DC involvement [64]. It was shown by videomicroscopy that ICs can be transported from the SCS by naïve B cells to FDCs [65]. Another possibility of IC delivery to FDCs can be through the conduit system [41]. FDCs within the GC display ICs which may provide a depot of Ag for which mutated B cells can compete during the Ab affinity maturation process [66]. FDCs are able to display ICs in a multivalent way, some ICs may stimulate B cells by clustering with the B cell receptors (BCRs) and CD21, or inhibit B cells by binding the FcγRIIb [67, 68]. This can be a possible mode of B cell selection in the GCs. The signalling of high affinity BCR promotes survival, whereas, FcγRIIb signals promote apoptosis on low affinity and/or autoreactive cells [68, 69]. Another hypothesis is that the interaction between the FC regions in ICs with FcγRIIb on GC B cells can be prevented by high expression of FcγRIIb by FDCs, which would allow ICs to be highly stimulatory for GC B cells [70]. It could be easily invoked that ICs on FDCs play a role in memory cell maintenance and recall responses, since FDCs can retain antigens for long periods of time. However further studies are still necessary, as well as to confirm the importance of ICs on FDCs in B cell responses initiation, GC function, and memory responses [10, 67].

3.1.4 Lymphatic Endothelial Cells (LECs)

The specification, differentiation and maturation of LECs were already discussed in the previous chapter, however these cells display important roles in LN homeostasis and immune responses and for that reason their functions are further discussed in this chapter.

LECs control DC and lymphocyte migration into and out of the LNs by expressing CCL21, sphingosine-1-phosphate (S1P) and adhesion molecules. DCs enter the lymphatic vasculature through portals in the basement membrane, and T cells are supposed to follow the same route [71, 72]. The lymphatics outside the LN express CCL21-Leu and CXCL12 which are responsible for DC entry through CCR7 and CXCR4 engagement, respectively [73, 74]. Differential expression of the chemokine receptor CCLR1 has recently highlighted structural and functional specialization of the two LEC layers on the SCS. CCLR1 is expressed by the outer layer and functions as a guide for DC trafficking across the sinus floor [75]. It was demonstrated that CLEC-2 binding to gp38 (expressed by LECs and FRCs) is also required for DC migration into lymphatic vessels and migration into the LN T cell area [21]. The scavenger receptor CLEVER-1 has been implicated in T cell transmigration into the lumen of lymphatic vessels [76]. Cell entry into the LN relies on CCL19 and CCL21-Ser both expressed by LECs [73]. CCL1 can also facilitate cell entry and it is expressed by SCS LECs [74, 77]. DCs immediately enter the LN through the LN cortex, whereas T cells enter the paracortex through medullary lymphatic sinuses. How these migration paths are regulated remains elusive and suggests that cellular trafficking might be based on distinct LEC subpopulations that may perform different functions [78]. Recent data shows that SCS and medullary LECs differentially express MAdCAM-1, suggesting that cell trafficking is based on anatomically and molecularly distinct LEC subpopulations. Of interest, MAdCAM-1⁺ LECs express low level of LTβR expression [14, 77]. Lymphocytes egress is regulated by their adherence to LECs. LN LECs express higher levels of CLCA1 and mannose receptor (MR) than tissue LECs, making them good candidates for lymphocyte adhesion [77]. LECs also express mineralocorticoid receptor that binds to L-selectin (CD62L) on lymphocytes promoting their adhesion. Lymphocyte egress is promoted by S1P1 binding to S1P, only produced by LECs in the LN [79]. It is established that DC and

lymphocyte migration into and within the LN is controlled by chemokines and sphingolipid ligands produced by LECs, however further studies are necessary to evaluate the possible role of integrins and adhesion molecules in this process. Even though LECs express several chemokines and adhesion molecules, specific markers are still rare (Table 3-1) with Lyve-1 and mCLCA1 being the most specific, however some macrophages can also express Lyve-1. Therefore further research must be performed in order to identify new markers, and to further differentiate the different LEC subtypes and their functions.

LN LECs are specialized antigen presenting cells. LN LECs, but not tissue LECs, express major histocompatibility complex class II (MHC-II) molecules, evoking a different immunological role between these two subpopulations [77, 80]. Lund and colleagues showed that LECs can also process MHC-I molecules however less efficiently than other APCs [81]. Costimulatory molecules such as CD80, CD86, OX40L or 4-1BBL are not expressed by LECs [82]. Onder *et al.*, showed, in 2011, that β -galactosidase (β -gal) specific CD4 T cells proliferate after adoptive transfer into mice whose LECs and FRCs express β -gal [83]. However it was not investigated if this effect was due to direct Ag presentation by LECs/FRCs or to antigen endocytosis and presentation by hematopoietic cells. Hence, most probably, LN LECs are able to express MHC-II, activate naïve T cells and cross-present Ag, but lack costimulatory molecules, which would make them tolerance promoting cells [77]. It was also shown that LECs can provide Ag to DCs for MHC-II presentation, the same way as medullary thymic epithelial cells (mTEC) transfer Ag to thymic DCs [84]. Ag presentation by LECs to CD8 T cells was shown to induce abortive apoptosis in vitro [81]. Other models provided evidence that CD8 T cell anergy or deletion is determined by Ag level [85].

LN LECs express peripheral tissue antigens. Several studies showed that CD8 T cell abortive proliferation and deletion was promoted by antigen derived from LEC PTAs [19, 30-32, 86, 87]. Of note, PTA expression of LECs is Aire-independent, in contrast to mTECs, thus the mechanisms controlling this PTA expression remain elusive [77]. It was shown that upon PD-L1 blockade or exogenous costimulation Ag presentation by LECs leads to autoimmune disease development [82]. Taking into account that LECs express several

PTAs [19, 87], this evokes the hypothesis that a dysregulation of LEC tolerance-inducing competence might influence the onset and severity of autoimmune diseases.

LN LECs during inflammation upregulate ICAM-1 and VCAM-1, which are involved in DC entry into the LN, under inflammatory conditions [88-90]. Lymphangiogenesis is promoted under inflammatory conditions by ligands for VegfR2 (Vascular endothelial growth factor receptore-2), VegfR3 and LT β R [91-93]. Upon skin inflammation, lymphangiogenesis increases lymph flow and cell migration into the LN helping in inflammation resolution. In contrast, lymphangiogenesis following peritoneal inflammation reduces the lymph drainage [91]. During prolonged inflammation the lymphocyte egress is promoted by lymphangiogenesis [94]. Hence, LECs under inflammatory condition play an important role in attracting immune cells into the LN. Interestingly, it has been shown that lymphoangiogenesis during inflammation is highly modulated by macrophages which secrete lymphangiogenic growth factors [95, 96]. This crosstalk has been demonstrated in several models, such as dermal wound healing [97], lipopolysaccharide (LPS)-induced dermal and peritoneal inflammation [91, 98].

3.1.5 Blood endothelial Cells (BECs) and High endothelial cell venules (HEVs)

BECs play a crucial role in lymphocyte trafficking in the LN. At the LN hilus, one or two arteries enter the LN, branch and pass through the medullary area, enter the cortex and sometimes reached the SCS area. The branching capillaries become arteriovenous communications which give place to HEVs (high endothelial cells) [99]. HEVs create then a specialized network which plays a critical role in lymphocyte trafficking.

HEV phenotypical characteristics differ from BECs, the former having an almost cuboidal appearance whereas BECs are flat [100]. HEVs have an intense biosynthetic activity, as evidenced by a prominent Golgi complex and several polyribosomes, which differs from BECs. HEVs present discontinuous “spot-welded” junctions between cells, which differ from the characteristic tight junctions between BECs. These junctions facilitate lymphocyte egress through HEVs [101]. Only HEVs express PNA_d (peripheral node addressin), recognized by the MECA-79 Ab [102]. PNA_d, a L-selectin ligand, is composed of different glycoproteins such as GlyCAM-1, CD34, podocalyxin and Sgp200, which must be

sialylated, sulphated and fucosylated to become functionally capable to bind L-selectin [99]. Several enzymes perform these posttranslational modifications such as FucT-IV, FucT-VII and GlcNac6ST2 (also called HEC-6ST) [101, 102]. HEVs express PNAd and therefore interact with lymphocytes through L-selectin. PNAd slows down (tethers) naïve lymphocytes along HEVs walls [101-104]. Lymphocyte entry via HEVs was already described on the previous chapter, see Figure 2-9.

HEVs mediate other immune cell entry, including plasmacytoid DCs (pDCs) [105] and conventional DCs precursors (pre-cDCs) [106]. pDCs numbers were found decreased in CCR7-deficient mice [105] and L-selectin⁺ pre-cDCs accumulation was prevented after L-selectin blockade [106], however the chemokines and their receptors involved remain uncharacterized. Furthermore, natural killer (NK) cell migration into LNs was found decreased in mice deficient for L-selectin or L-selectin ligands [107].

3.1.6 Double Negative stromal cells (DNC)

Finally there is a fibroblastic stromal subset in the LNs, which is called double negative stromal cells (DNCs). Their name is based on the lack of both CD31 and podoplanin (gp38) expression. It is a highly heterogeneous population, and not much information is gathered so far. In 2008, cells expressing AIRE were found among this subset. This population were then termed extra-thymic Aire-expressing cells (eTACs), and were characteristically different from FRCs since they lack UEA1 and gp38 expressions, and they shared some similarities with mTECs such as MHC class I and EpCAM expression [31]. However the existence of eTACS among the DNCs remained inconclusive. In 2010, Fletcher *et al.*, demonstrated that DNCs highly express AIRE, but EpCAM expression was not found within LNs [32]. In 2012, the DNC population was described as smooth muscle-like cells with contractile activity, and were found surrounding some LN vessels. This finding led to the concept that pericytes are the main cells found in the DNC population [108]. Further research is required in order to disclose all the subpopulations within the DNCs, as well as their different roles.

3.2 Lymph node macrophages

Macrophages are highly phagocytic and capable of internalizing and degrading pathogens and particles, they are also an important source of alerting signals to the adaptive immune system. These cells develop from the bone marrow and require stimulation by the colony stimulating factor-1 (CSF1) [109, 110]. Macrophages can be found in all tissues, presenting different specializations adapted to each tissue. Therefore, LN macrophages are specialized in providing support to the LN and to general immune functions. LN macrophages can be classified according to their locations. SCS macrophages (SSMs) reside in the SCS area between the sinus and the B cell follicle and can capture lymph-borne molecules, however they are poorly phagocytic [15, 111]. Medullary sinus macrophages (MSMs) can be found in the medullary sinuses and are capable of capturing material which rapidly localizes on phagolysosomes [111, 112]. There are also macrophages residing in the medullary cords (MCMs), (Fig. 3-4). Some macrophages can be found in the interfollicular area, sometimes the SSMs can migrate to these regions, but MSMs can also be found there [43, 113].

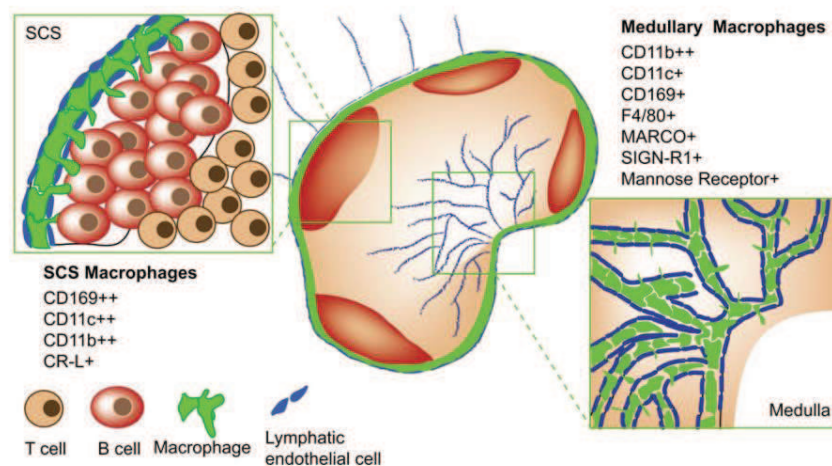

Figure 3- 4 Different macrophages subsets found within the LN. Left box shows the SCS, green represents the macrophages. Right box shows the medullary region. SSM, and MSM are shown in their respective localizations with their different surface markers. [114]

3.2.1 Lymph node macrophage development

The cues for LN macrophages development are starting to be understood. For example, CSF1 is required for CD169⁺ SSMs since they are absent on CSF1 deficient mice, whereas F4/80⁺ MSMs and MCMs appear unaffected [115, 116]. LT α 1 β 2 was also found to be essential for SSMs, since LT β R blockade led to a decrease in CD169⁺F4/80⁻ cells within the LN [42]. Furthermore, it was shown that LT α 1 β 2 transgenic overexpression by B cells generates more CD169⁺ cells [42]. TNF α seems to be necessary for spleen macrophage development but its involvement in LN macrophages remains elusive [117]. The signals for MSMs and MCMs development are unclear, for instance CSF1-deficient mice or LT β R blockade did not show an effect on these populations [42]. However, a study of CSF1R blocking showed a greater loss of macrophages than CSF1-deficient mice, which could be due to IL34 (another CSF1R ligand). Nevertheless, it must be evaluated if MSM development depends on CSF1R [118]. Further studies are necessary to determine if the different LN macrophages subsets originate from different precursors and depend on different molecular signals.

3.2.2 Subcapsular Sinus Macrophages (SSMs)

SSMs are localized to the SCS floor, overlaying the B cell follicles to where they extend cytoplasmic protrusions. In fact, these macrophages present a “head” localized in the sinus, and a long “tail” (the protrusions) which extends into the follicle. The region between the head and the tail, here called “neck” is tightly inserted across the LEC layer, (Figure 3-4) [43, 65, 119]. Imagining the signals involved in their positioning is challenging. However, lymph-derived factors seem to be implicated in their positioning since afferent lymphatics occlusion leads to SSM migration and disappearance [120, 121]. Several studies demonstrated their capacity to capture lymph-borne viruses and Ag particles by their heads and to transfer them to Ag-specific B cells [43, 65, 119]. Further studies showed the importance of complement receptor 1 and 2 expressed by B cells for capturing immune complexes from SSM and delivery them to FDCs [119, 120]. SSMs seem to retain ICs on their surface, since real-time imaging experiments with phycoerythrin-(PE) ICs showed them moving along the cell processes surface from the lymph-facing

extremity of the cell to the opposite side [119]. Of note, ICAM-1 and VCAM-1 expression by SSMs may facilitate their interaction with B cells [119, 122]. Mouse SSMs are characterized as CD169^{hi}, CD11b⁺, CD11c^{lo} and lack F4/80 expression [43, 65, 119, 123]. CD169, a feature of LN macrophages, also expressed by the MSM, strongly binds sialic acids and might also be involved in cell-cell interactions and Ag uptake [124]. In contrast to MSMs, the SSMs do not express the mannose receptor (MR) [124]. The mannose receptor (MR) has three different extracellular domains, one of them is the cysteine rich (CR) domain, which binds sulphated carbohydrates, particularly, galactose or GalNAc sulphated [124-126]. The CR-ligands (CR-L) can be recognized by a CR-Fc fusion protein, and were found on the SSMs [124]. One of the CR-Ls is CD169 (also known sialoadhesin) as well as CD45, these molecules undergo post-translational modifications gaining sulphated N-linked glycans, which can be recognized by the CR domain. SSMs are recognized by this CR-Fc protein [127{Martinez-Pomares, 1996 #157}. SSMs may express other sulphated glycans which function as MR ligands (MR-L) [128].

3.2.3 Medullary Sinus Macrophages (MSMs) and Medullary Cord Macrophages (MCMs)

MSMs can be found attached to the medullary sinus walls and reticular fibres in the lumen, which are lined by LECs. On the other hand, MCMs can be found associated with the medullary cords. The MSMs express CD11b and CD169 as the SSMs whereas MCMs lack CD169. Additionally MSMs and MCMs express F4/80. Other general markers for these macrophages are SIGNR1 [129, 130] and MARCO [131], thought to be involved in Ag uptake and pathogen capture [3]. MR [131-133] and Lyve-1 [134].

Labelled Ags accumulate in the medullary area upon subcutaneous injection, therefore the major Ag capture is performed by lymph-exposed MSMs. These macrophages are highly phagocytic since they contain large lysosomes and vesicles and they internalize significant amounts of labelled Ags [135]. In contrast, MCMs present small lysosomes and vesicles, being less phagocytic than MSMs [135]. Another functional difference is that MCMs frequently contain apoptotic plasma cells, whereas MSMs contain mainly apoptotic polymorphonuclear cells [135]. Medullary macrophages may also play a role in taking up and sensing lipids, like other macrophages [136]. Furthermore, it was demonstrated that

medullary macrophages can interact with plasma cells during immune responses, influencing their survival and differentiation [137]. Medullary macrophages were also associated with apoptotic cell uptake, coming through the lymph, and subsequent cross-presentation to CD8⁺ T cells [138].

3.2.4 LN macrophages and their propensity to infection

Several studies have demonstrated that SSMs present some permissivity to viral infections [130, 139-141]. The benefits from this are becoming clear, since viral replication in SSMs increases LN immune response in different ways. It was demonstrated that, during vesicular stomatitis virus (VSV) infection, viral replication in SSMs is necessary for sufficient IFN-I production which is required to protect from intranodal nerve infection. The IFN-I sources were the SSMs themselves and plasmacytoid DCs [139]. Of note, the VSV rapidly replicates on SSMs but not on MSMs [139, 142]. This different permissivity to VSV infection of SSMs and MSMs may be explained by phenotypically differences. MSMs are more phagocytic than SSMs, and SSMs seem to be less sensitive to IFN than MSMs [42, 120]. It was demonstrated that VSV infection and IFN protective response is dependent on LT [142]. SSMs assume a medullary phenotype when LT levels are low, and VSV replication is no longer supported [120, 142]. Raising the question if constant exposure to LT from the B cells to the SSMs attenuates their responsiveness to autocrine IFN, thus when LT levels are lower SSMs may gain IFN responsiveness leading to VSV resistance [114, 139]. Viral replication on SSMs may also be important to generate intact viral particles in order to promote Ab responses, since B cell activation is more effectively achieved by viral particles than by free Ags [143]. Effector CD8 T cell responses may benefit from SSM viral replication, either directly, by Ag presentation to T cells, or indirectly, by transferring Ags to local DCs [111, 144]. SSM permissivity may not be restricted to viruses, Chtanova *et al.*, showed that *Toxoplasma gondii* preferentially infects and replicates on SSMs [145]. Furthermore, *T. gondii* growth in monocyte-derived macrophages was inhibited by IFN-I [144].

3.3 Conclusions

The LN is an efficient site for lymphocytes to encounter Ags and APCs. In order to perform this function the LN microarchitecture needs to be maintained. The main responsible for keeping the LN architecture are the stromal cells. The stromal cells have long been ignored by immunologists, and have been seen as cells that play supportive roles, and as not participating in immunity. Lately this erroneous idea has been corrected and stromal cells are now starting to be recognised as important players in immunology. FRCs form a reticular meshwork which is considered as the infrastructure of the LN. Besides creating this infrastructure, the meshwork also forms an efficient circulating system where the lymph moves through the conduits, from the SCS to the HEVs. FRCs express CCL19 and CCL21 while FDCs and MRCs express CXCL13, these expression profiles makes them critical players for lymphocyte homing and segregation into specific areas within the LN, *i.e.*, LN compartmentalization. Additionally, FRCs and FDCs play important immunological function, such as promoting lymphocyte survival, proliferation and activation, and are also involved in immune peripheral tolerance. LECs are important cells within the LNs, these cells form the vessels where the lymph can circulate into, within and leave the LNs. Besides this structural role, LECs also perform important functions, for instance they control DC and lymphocyte migration into and out of the LNs. LECs can also function as specialized APCs and can express PTAs, participating in peripheral tolerance. BECs form the blood vasculature and therefore are important in lymphocyte trafficking into the LN. Specialized BECs, the HEVs, create a network and express several molecules which interact with lymphocytes, promoting its income into the LN. Besides lymphocyte trafficking, HEVs also mediate pDCs and pre-DCs entry into the LN. LN macrophages play an important role in providing support and helping in general immune functions. These cells can be divided in three main groups according to their localizations, surface markers and antigen uptake, they are the SSMs, the MCMs and MSMs. Noteworthy is the fact that SSMs present some permissivity to infection, which paradoxically is beneficial in that it increases the immune response.

3.4 Bibliography

1. Mueller, S.N. and R.N. Germain, *Stromal cell contributions to the homeostasis and functionality of the immune system*. Nat. Rev. Immunol., 2009. **9**(9): p. 618-29.
2. Roozendaal, R. and R.E. Mebius, *Stromal cell-immune cell interactions*. Annu Rev Immunol, 2011. **29**: p. 23-43.
3. Junt, T., E. Scandella, and B. Ludewig, *Form follows function: lymphoid tissue microarchitecture in antimicrobial immune defence*. Nat Rev Immunol, 2008. **8**(10): p. 764-75.
4. Collier, A.Y., J.W. Lee, and S.J. Turley, *Self-encounters of the third kind: lymph node stroma promotes tolerance to peripheral tissue antigens*. Mucosal Immunol, 2008. **1**(4): p. 248-51.
5. Chang, J.E. and S.J. Turley, *Stromal infrastructure of the lymph node and coordination of immunity*. Trends Immunol, 2015. **36**(1): p. 30-9.
6. Koning, J.J. and R.E. Mebius, *Interdependence of stromal and immune cells for lymph node function*. Trends Immunol, 2012. **33**(6): p. 264-70.
7. Lammermann, T. and M. Sixt, *The microanatomy of T-cell responses*. Immunol. Rev., 2008. **221**: p. 26-43.
8. Link, A., et al., *Fibroblastic reticular cells in lymph nodes regulate the homeostasis of naive T cells*. Nat. Immunol., 2007. **8**(11): p. 1255-65.
9. Katakai, T., et al., *Organizer-like reticular stromal cell layer common to adult secondary lymphoid organs*. J. Immunol., 2008. **181**(9): p. 6189-200.
10. Allen, C.D. and J.G. Cyster, *Follicular dendritic cell networks of primary follicles and germinal centers: phenotype and function*. Semin Immunol, 2008. **20**(1): p. 14-25.
11. Brendolan, A. and J.H. Caamano, *Mesenchymal cell differentiation during lymph node organogenesis*. Front Immunol, 2012. **3**: p. 381.
12. Munoz-Fernandez, R., et al., *Follicular dendritic cells are related to bone marrow stromal cell progenitors and to myofibroblasts*. J. Immunol., 2006. **177**(1): p. 280-289.
13. Cupedo, T., et al., *Induction of secondary and tertiary lymphoid structures in the skin*. Immunity, 2004. **21**(5): p. 655-67.
14. Cohen, J.N., et al., *Tolerogenic properties of lymphatic endothelial cells are controlled by the lymph node microenvironment*. PLoS ONE., 2014. **9**(2): p. e87740. doi: 10.1371/journal.pone.0087740. eCollection 2014.
15. Clark, S.L., Jr., *The reticulum of lymph nodes in mice studied with the electron microscope*. Am J Anat, 1962. **110**: p. 217-57.
16. Crivellato, E. and F. Mallardi, *Stromal cell organisation in the mouse lymph node. A light and electron microscopic investigation using the zinc iodide-osmium technique*. J Anat, 1997. **190 (Pt 1)**: p. 85-92.
17. Alvarenga, H.G. and L. Marti, *Multifunctional roles of reticular fibroblastic cells: more than meets the eye?* J Immunol Res, 2014. **2014**: p. 402038.
18. Sixt, M., et al., *The conduit system transports soluble antigens from the afferent lymph to resident dendritic cells in the T cell area of the lymph node*. Immunity, 2005. **22**(1): p. 19-29.
19. Fletcher, A.L., D. Malhotra, and S.J. Turley, *Lymph node stroma broaden the peripheral tolerance paradigm*. Trends Immunol., 2011. **32**(1): p. 12-8.

20. Bajenoff, M., et al., *Stromal cell networks regulate lymphocyte entry, migration, and territoriality in lymph nodes*. *Immunity*, 2006. **25**(6): p. 989-1001.
21. Acton, S.E., et al., *Podoplanin-rich stromal networks induce dendritic cell motility via activation of the C-type lectin receptor CLEC-2*. *Immunity*, 2012. **37**(2): p. 276-89.
22. Luther, S.A., T.K. Vogt, and S. Siegert, *Guiding blind T cells and dendritic cells: A closer look at fibroblastic reticular cells found within lymph node T zones*. *Immunol. Lett.*, 2011: p. in press.
23. Zeng, M., et al., *Critical role of CD4 T cells in maintaining lymphoid tissue structure for immune cell homeostasis and reconstitution*. *Blood*, 2012. **120**(9): p. 1856-67.
24. Graw, F. and R.R. Regoes, *Influence of the fibroblastic reticular network on cell-cell interactions in lymphoid organs*. *PLoS Comput Biol*, 2012. **8**(3): p. e1002436.
25. Mueller, S.N. and R. Ahmed, *Lymphoid stroma in the initiation and control of immune responses*. *Immunol Rev*, 2008. **224**: p. 284-94.
26. Onder, L., et al., *IL-7-producing stromal cells are critical for lymph node remodeling*. *Blood*, 2012. **120**(24): p. 4675-4683.
27. Roozendaal, R., et al., *Conduits mediate transport of low-molecular-weight antigen to lymph node follicles*. *Immunity*, 2009. **30**(2): p. 264-76.
28. Chai, Q., et al., *Maturation of lymph node fibroblastic reticular cells from myofibroblastic precursors is critical for antiviral immunity*. *Immunity*, 2013. **38**(5): p. 1013-24.
29. Yang, C.Y., et al., *Trapping of naive lymphocytes triggers rapid growth and remodeling of the fibroblast network in reactive murine lymph nodes*. *Proc Natl Acad Sci U S A.*, 2014. **111**(1): p. E109-18. doi: 10.1073/pnas.1312585111. Epub 2013 Dec 23.
30. Lee, J.W., et al., *Peripheral antigen display by lymph node stroma promotes T cell tolerance to intestinal self*. *Nat. Immunol.*, 2007. **8**(2): p. 181-90.
31. Gardner, J.M., et al., *Deletional tolerance mediated by extrathymic Aire-expressing cells*. *Science*, 2008. **321**(5890): p. 843-7.
32. Fletcher, A.L., et al., *Lymph node fibroblastic reticular cells directly present peripheral tissue antigen under steady-state and inflammatory conditions*. *J Exp Med*, 2010. **207**(4): p. 689-97.
33. Fletcher, A.L., S.E. Acton, and K. Knoblich, *Lymph node fibroblastic reticular cells in health and disease*. *Nat Rev Immunol*, 2015.
34. Turley, S.J., A.L. Fletcher, and K.G. Elpek, *The stromal and haematopoietic antigen-presenting cells that reside in secondary lymphoid organs*. *Nat Rev Immunol*, 2010. **10**(12): p. 813-25.
35. Siegert, S. and S.A. Luther, *Positive and negative regulation of T cell responses by fibroblastic reticular cells within paracortical regions of lymph nodes*. *Front Immunol.*, 2012. **3**:285.(doi): p. 10.3389/fimmu.2012.00285. eCollection 2012.
36. Reynoso, E.D., et al., *Intestinal tolerance is converted to autoimmune enteritis upon PD-1 ligand blockade*. *J Immunol*, 2009. **182**(4): p. 2102-12.
37. Thomazy, V.A., et al., *Phenotypic modulation of the stromal reticular network in normal and neoplastic lymph nodes: tissue transglutaminase reveals coordinate regulation of multiple cell types*. *Am J Pathol*, 2003. **163**(1): p. 165-74.
38. Katakai, T., *Marginal reticular cells: a stromal subset directly descended from the lymphoid tissue organizer*. *Frontiers in Immunology*, 2012. **3**: p. 200-6.
39. Mebius, R.E. and G. Kraal, *Structure and function of the spleen*. *Nat Rev Immunol*, 2005. **5**(8): p. 606-16.

40. Cupedo, T. et al., *Initiation of cellular organization in lymph nodes is regulated by non-B cell derived signals and is not dependent on CXC chemokine ligand 13*. *J. Immunol*, 2004. **173**: p. 4889-96.
41. Bajenoff, M. and R.N. Germain, *B-cell follicle development remodels the conduit system and allows soluble antigen delivery to follicular dendritic cells*. *Blood*, 2009. **114**(24): p. 4989-97.
42. Phan, T.G., et al., *Immune complex relay by subcapsular sinus macrophages and noncognate B cells drives antibody affinity maturation*. *Nat Immunol*, 2009. **10**(7): p. 786-93.
43. Carrasco, Y.R. and F.D. Batista, *B cells acquire particulate antigen in a macrophage-rich area at the boundary between the follicle and the subcapsular sinus of the lymph node*. *Immunity*, 2007. **27**(1): p. 160-71. Epub 2007 Jul 19.
44. Cupedo, T., et al., *Presumptive lymph node organizers are differentially represented in developing mesenteric and peripheral nodes*. *J. Immunol.*, 2004. **173**(5): p. 2968-75.
45. Cyster, J.G., et al., *Follicular stromal cells and lymphocyte homing to follicles*. *Immunol Rev*, 2000. **176**: p. 181-93.
46. Krautler, N.J., et al., *Follicular dendritic cells emerge from ubiquitous perivascular precursors*. *Cell*, 2012. **150**(1): p. 194-206.
47. Aguzzi, A., J. Kranich, and N.J. Krautler, *Follicular dendritic cells: origin, phenotype, and function in health and disease*. *Trends Immunol*, 2014. **35**(3): p. 105-13.
48. Tang, W., et al., *White fat progenitor cells reside in the adipose vasculature*. *Science*, 2008. **322**(5901): p. 583-6.
49. Benezech, C., et al., *Lymphotoxin-beta receptor signaling through NF-kappaB2-RelB pathway reprograms adipocyte precursors as lymph node stromal cells*. *Immunity*, 2012. **37**(4): p. 721-34.
50. Castagnaro, L., et al., *Nkx2-5(+)/islet1(+) mesenchymal precursors generate distinct spleen stromal cell subsets and participate in restoring stromal network integrity*. *Immunity*, 2013. **38**(4): p. 782-91. doi: 10.1016/j.immuni.2012.12.005.
51. Jarjour, M., et al., *Fate mapping reveals origin and dynamics of lymph node follicular dendritic cells*. *J Exp Med*, 2014. **211**(6): p. 1109-22.
52. Ansel, K.M., et al., *A chemokine-driven positive feedback loop organizes lymphoid follicles*. *Nature*, 2000. **406**(6793): p. 309-14.
53. Wang, X., et al., *Follicular dendritic cells help establish follicle identity and promote B cell retention in germinal centers*. *J Exp Med.*, 2011. **208**(12): p. 2497-510. doi: 10.1084/jem.20111449. Epub 2011 Oct 31.
54. Ware, C.F., *Network communications: lymphotoxins, LIGHT, and TNF*. *Annu Rev Immunol*, 2005. **23**: p. 787-819.
55. Kelsoe, G., *Life and death in germinal centers (redux)*. *Immunity*, 1996. **4**(2): p. 107-11.
56. Mandel, T.E., et al., *The follicular dendritic cell: long term antigen retention during immunity*. *Immunol Rev*, 1980. **53**: p. 29-59.
57. Heesters, B.A., R.C. Myers, and M.C. Carroll, *Follicular dendritic cells: dynamic antigen libraries*. *Nat Rev Immunol*, 2014. **14**(7): p. 495-504.
58. Suzuki, K., et al., *The sensing of environmental stimuli by follicular dendritic cells promotes immunoglobulin A generation in the gut*. *Immunity*, 2010. **33**(1): p. 71-83.
59. Schneider, P., et al., *BAFF, a novel ligand of the tumor necrosis factor family, stimulates B cell growth*. *J Exp Med*, 1999. **189**(11): p. 1747-56.

- 60.Vora, K.A., et al., *Cutting edge: germinal centers formed in the absence of B cell-activating factor belonging to the TNF family exhibit impaired maturation and function*. J Immunol, 2003. **171**(2): p. 547-51.
- 61.Deng, C., et al., *Resistance to experimental autoimmune myasthenia gravis in IL-6-deficient mice is associated with reduced germinal center formation and C3 production*. J Immunol, 2002. **169**(2): p. 1077-83.
- 62.Park, C.S., et al., *Follicular dendritic cells produce IL-15 that enhances germinal center B cell proliferation in membrane-bound form*. J Immunol, 2004. **173**(11): p. 6676-83.
- 63.Heinen, E., et al., *Transfer of immune complexes from lymphocytes to follicular dendritic cells*. Eur J Immunol, 1986. **16**(2): p. 167-72.
- 64.Martinez-Pomares, L., et al., *Fc chimeric protein containing the cysteine-rich domain of the murine mannose receptor binds to macrophages from splenic marginal zone and lymph node subcapsular sinus and to germinal centers*. J Exp Med, 1996. **184**(5): p. 1927-37.
- 65.Phan, T.G., et al., *Subcapsular encounter and complement-dependent transport of immune complexes by lymph node B cells*. Nat Immunol., 2007. **8**(9): p. 992-1000. Epub 2007 Jul 29.
- 66.MacLennan, I.C., *Germinal centers*. Annu Rev Immunol, 1994. **12**: p. 117-39.
- 67.Tew, J.G., et al., *Follicular dendritic cells and presentation of antigen and costimulatory signals to B cells*. Immunol. Rev., 1997. **156**: p. 39-52.
- 68.Ravetch, J.V. and L.L. Lanier, *Immune inhibitory receptors*. Science, 2000. **290**(5489): p. 84-9.
- 69.Ravetch, J.V.a.N., M., *Killing some to make way for others*. Nat Immunol, 2000. **8**: p. 338-339.
- 70.Qin, D., et al., *Fc gamma receptor IIB on follicular dendritic cells regulates the B cell recall response*. J. Immunol., 2000. **164**(12): p. 6268-75.
- 71.Lammermann, T., et al., *Rapid leukocyte migration by integrin-independent flowing and squeezing*. Nature, 2008. **453**(7191): p. 51-5.
- 72.Pflicke, H. and M. Sixt, *Preformed portals facilitate dendritic cell entry into afferent lymphatic vessels*. J Exp Med, 2009. **206**(13): p. 2925-35.
- 73.Nakano, H. and M.D. Gunn, *Gene duplications at the chemokine locus on mouse chromosome 4: multiple strain-specific haplotypes and the deletion of secondary lymphoid-organ chemokine and EBI-1 ligand chemokine genes in the plt mutation*. J Immunol, 2001. **166**(1): p. 361-9.
- 74.Kabashima, K., et al., *CXCL12-CXCR4 engagement is required for migration of cutaneous dendritic cells*. Am J Pathol, 2007. **171**(4): p. 1249-57.
- 75.Ulvmar, M.H., et al., *The atypical chemokine receptor CCRL1 shapes functional CCL21 gradients in lymph nodes*. Nat Immunol., 2014. **15**(7): p. 623-30. doi: 10.1038/ni.2889. Epub 2014 May 11.
- 76.Salmi, M., et al., *CLEVER-1 mediates lymphocyte transmigration through vascular and lymphatic endothelium*. Blood, 2004. **104**(13): p. 3849-57.
- 77.Tewalt, E.F., et al., *Lymphatic endothelial cells - key players in regulation of tolerance and immunity*. Front Immunol, 2012. **3**: p. 305.
- 78.Braun, A., et al., *Afferent lymph-derived T cells and DCs use different chemokine receptor CCR7-dependent routes for entry into the lymph node and intranodal migration*. Nat Immunol, 2011. **12**(9): p. 879-87.
- 79.Cyster, J.G. and S.R. Schwab, *Sphingosine-1-phosphate and lymphocyte egress from lymphoid organs*. Annu Rev Immunol, 2012. **30**: p. 69-94.

80. Tripp, C.H., et al., *The lymph vessel network in mouse skin visualised with antibodies against the hyaluronan receptor LYVE-1*. Immunobiology., 2008. **213**(9-10): p. 715-28. .
81. Lund, A.W., et al., *VEGF-C promotes immune tolerance in B16 melanomas and cross-presentation of tumor antigen by lymph node lymphatics*. Cell Rep, 2012. **1**(3): p. 191-9.
82. Tewalt, E.F., et al., *Lymphatic endothelial cells induce tolerance via PD-L1 and lack of costimulation leading to high-level PD-1 expression on CD8 T cells*. Blood, 2012. **120**(24): p. 4772-82.
83. Onder, L., et al., *A novel bacterial artificial chromosome-transgenic podoplanin-cre mouse targets lymphoid organ stromal cells in vivo*. Front Immunol, 2011. **2**: p. 50.
84. Koble, C. and B. Kyewski, *The thymic medulla: a unique microenvironment for intercellular self-antigen transfer*. J Exp Med, 2009. **206**(7): p. 1505-13.
85. Redmond, W.L., B.C. Marincek, and L.A. Sherman, *Distinct requirements for deletion versus anergy during CD8 T cell peripheral tolerance in vivo*. J Immunol, 2005. **174**(4): p. 2046-53.
86. Nichols, L.A., et al., *Deletional self-tolerance to a melanocyte/melanoma antigen derived from tyrosinase is mediated by a radio-resistant cell in peripheral and mesenteric lymph nodes*. J Immunol, 2007. **179**(2): p. 993-1003.
87. Cohen, J.N., et al., *Lymph node-resident lymphatic endothelial cells mediate peripheral tolerance via Aire-independent direct antigen presentation*. J. Exp. Med., 2010. **207**(4): p. 681-8.
88. Johnson, L.A., et al., *An inflammation-induced mechanism for leukocyte transmigration across lymphatic vessel endothelium*. J Exp Med, 2006. **203**(12): p. 2763-77.
89. Fiorentini, S., et al., *Human cytomegalovirus productively infects lymphatic endothelial cells and induces a secretome that promotes angiogenesis and lymphangiogenesis through interleukin-6 and granulocyte-macrophage colony-stimulating factor*. J Gen Virol, 2011. **92**(Pt 3): p. 650-60.
90. Sawa, Y., et al., *LPS-induced IL-6, IL-8, VCAM-1, and ICAM-1 expression in human lymphatic endothelium*. J Histochem Cytochem, 2008. **56**(2): p. 97-109.
91. Kim, K.E., et al., *Role of CD11b+ macrophages in intraperitoneal lipopolysaccharide-induced aberrant lymphangiogenesis and lymphatic function in the diaphragm*. Am J Pathol, 2009. **175**(4): p. 1733-45.
92. Flister, M.J., et al., *Inflammation induces lymphangiogenesis through up-regulation of VEGFR-3 mediated by NF-kappaB and Prox1*. Blood, 2010. **115**(2): p. 418-29.
93. Mounzer, R.H., et al., *Lymphotoxin-alpha contributes to lymphangiogenesis*. Blood, 2010. **116**(12): p. 2173-82.
94. Tan, K.W., et al., *Expansion of cortical and medullary sinuses restrains lymph node hypertrophy during prolonged inflammation*. J Immunol, 2012. **188**(8): p. 4065-80.
95. Ji, R.C., *Macrophages are important mediators of either tumor- or inflammation-induced lymphangiogenesis*. Cell Mol Life Sci, 2012. **69**(6): p. 897-914.
96. Kim, H., R.P. Kataru, and G.Y. Koh, *Regulation and implications of inflammatory lymphangiogenesis*. Trends Immunol, 2012. **33**(7): p. 350-6.
97. Maruyama, K., et al., *Decreased macrophage number and activation lead to reduced lymphatic vessel formation and contribute to impaired diabetic wound healing*. Am J Pathol, 2007. **170**(4): p. 1178-91.

98. Kataru, R.P., et al., *Critical role of CD11b+ macrophages and VEGF in inflammatory lymphangiogenesis, antigen clearance, and inflammation resolution*. *Blood*, 2009. **113**(22): p. 5650-9.
99. William, E.P., *Fundamental Immunology*. Lippincott Williams & Wilkins, a Wolters Kluwer business, 2013. **3**(7th Edition): p. 55-57.
100. Streeter, P.R., B.T. Rouse, and E.C. Butcher, *Immunohistologic and functional characterization of a vascular addressin involved in lymphocyte homing into peripheral lymph nodes*. *J Cell Biol*, 1988. **107**(5): p. 1853-62.
101. Kawashima, H., et al., *N-acetylglucosamine-6-O-sulfotransferases 1 and 2 cooperatively control lymphocyte homing through L-selectin ligand biosynthesis in high endothelial venules*. *Nat Immunol*, 2005. **6**(11): p. 1096-104.
102. Girard, J.P., C. Moussion, and R. Forster, *HEVs, lymphatics and homeostatic immune cell trafficking in lymph nodes*. *Nat Rev Immunol*, 2012. **12**(11): p. 762-73.
103. Miyasaka, M. and T. Tanaka, *Lymphocyte trafficking across high endothelial venules: dogmas and enigmas*. *Nat Rev Immunol*, 2004. **4**(5): p. 360-70.
104. Umemoto, E., et al., *Novel regulators of lymphocyte trafficking across high endothelial venules*. *Crit Rev Immunol*, 2011. **31**(2): p. 147-69.
105. Seth, S., et al., *CCR7 essentially contributes to the homing of plasmacytoid dendritic cells to lymph nodes under steady-state as well as inflammatory conditions*. *J Immunol*, 2011. **186**(6): p. 3364-72.
106. Liu, K., et al., *In vivo analysis of dendritic cell development and homeostasis*. *Science*, 2009. **324**(5925): p. 392-7.
107. Chen, S., et al., *Suppression of tumor formation in lymph nodes by L-selectin-mediated natural killer cell recruitment*. *J Exp Med*, 2005. **202**(12): p. 1679-89.
108. Malhotra, D., et al., *Transcriptional profiling of stroma from inflamed and resting lymph nodes defines immunological hallmarks*. *Nat. Immunol.*, 2012. **2012**(1): p. 2262.
109. Gordon, S. and P.R. Taylor, *Monocyte and macrophage heterogeneity*. *Nat. Rev. Immunol.*, 2005. **5**(12): p. 953-64.
110. Gordon, S., *The macrophage: past, present and future*. *Eur J Immunol*, 2007. **37 Suppl 1**: p. S9-17.
111. Gray, E.E. and J.G. Cyster, *Lymph node macrophages*. *J Innate Immun.*, 2012. **4**(5-6): p. 424-36. doi: 10.1159/000337007. Epub 2012 Apr 4.
112. Delemarre, F.G., et al., *Repopulation of macrophages in popliteal lymph nodes of mice after liposome-mediated depletion*. *J Leukoc Biol*, 1990. **47**(3): p. 251-7.
113. Mebius, R.E., et al., *Macrophages and the activity of high endothelial venules. The effect of interferon-gamma*. *Eur J Immunol*, 1990. **20**(7): p. 1615-8.
114. Kuka, M. and M. Iannacone, *The role of lymph node sinus macrophages in host defense*. *Ann N Y Acad Sci*, 2014. **1319**: p. 38-46.
115. Witmer-Pack, M.D., et al., *Identification of macrophages and dendritic cells in the osteopetrotic (op/op) mouse*. *J. Cell. Sci.*, 1993. **104**(Pt 4): p. 1021-1029.
116. Cecchini, M.G., et al., *Role of colony stimulating factor-1 in the establishment and regulation of tissue macrophages during postnatal development of the mouse*. *Development*, 1994. **120**(6): p. 1357-72.

117. Pasparakis, M., et al., *Tumor necrosis factor and the p55TNF receptor are required for optimal development of the marginal sinus and for migration of follicular dendritic cell precursors into splenic follicles*. *Cell. Immunol.*, 2000. **201**(1): p. 33-41.
118. MacDonald, K.P., et al., *An antibody against the colony-stimulating factor 1 receptor depletes the resident subset of monocytes and tissue- and tumor-associated macrophages but does not inhibit inflammation*. *Blood*, 2010. **116**(19): p. 3955-63.
119. Junt, T., et al., *Subcapsular sinus macrophages in lymph nodes clear lymph-borne viruses and present them to antiviral B cells*. *Nature.*, 2007. **450**(7166): p. 110-4. Epub 2007 Oct 14.
120. Phan, T.G., et al., *Immune complex relay by subcapsular sinus macrophages and noncognate B cells drives antibody affinity maturation*. *Nat Immunol.*, 2009. **10**(7): p. 786-93. doi: 10.1038/ni.1745.
121. Pasparakis, M., et al., *Tumour necrosis factors in immune regulation: everything that's interesting is...new!* *Cytokine Growth Factor Rev*, 1996. **7**(3): p. 223-9.
122. Fleire, S.J., et al., *B cell ligand discrimination through a spreading and contraction response*. *Science*, 2006. **312**(5774): p. 738-41.
123. Mebius, R.E., et al., *The influence of afferent lymphatic vessel interruption on vascular addressin expression*. *J. Cell. Biol.*, 1991. **115**(1): p. 85-95.
124. Taylor, P.R., S. Gordon, and L. Martinez-Pomares, *The mannose receptor: linking homeostasis and immunity through sugar recognition*. *Trends Immunol*, 2005. **26**(2): p. 104-10.
125. East, L. and C.M. Isacke, *The mannose receptor family*. *Biochim Biophys Acta*, 2002. **1572**(2-3): p. 364-86.
126. Leteux, C., et al., *The cysteine-rich domain of the macrophage mannose receptor is a multispecific lectin that recognizes chondroitin sulfates A and B and sulfated oligosaccharides of blood group Lewis(a) and Lewis(x) types in addition to the sulfated N-glycans of lutropin*. *J Exp Med*, 2000. **191**(7): p. 1117-26.
127. Martinez-Pomares, L., et al., *Cell-specific glycoforms of sialoadhesin and CD45 are counter-receptors for the cysteine-rich domain of the mannose receptor*. *J Biol Chem*, 1999. **274**(49): p. 35211-8.
128. Martinez-Pomares, L., *The mannose receptor*. *J Leukoc Biol*, 2012. **92**(6): p. 1177-86.
129. Geijtenbeek, T.B., et al., *Marginal zone macrophages express a murine homologue of DC-SIGN that captures blood-borne antigens in vivo*. *Blood*, 2002. **100**(8): p. 2908-16.
130. Gonzalez, S.F., et al., *Capture of influenza by medullary dendritic cells via SIGN-R1 is essential for humoral immunity in draining lymph nodes*. *Nat Immunol*, 2010. **11**(5): p. 427-34.
131. Gomes, I.N., et al., *The scavenger receptor MARCO is involved in Leishmania major infection by CBA/J macrophages*. *Parasite Immunol*, 2009. **31**(4): p. 188-98.
132. Linehan, S.A., et al., *Mannose receptor and its putative ligands in normal murine lymphoid and nonlymphoid organs: In situ expression of mannose receptor by selected macrophages, endothelial cells, perivascular microglia, and mesangial cells, but not dendritic cells*. *J Exp Med*, 1999. **189**(12): p. 1961-72.
133. Linehan, S.A., et al., *Endogenous ligands of carbohydrate recognition domains of the mannose receptor in murine macrophages, endothelial cells and secretory cells; potential relevance to inflammation and immunity*. *Eur J Immunol*, 2001. **31**(6): p. 1857-66.
134. Schledzewski, K., et al., *Lymphatic endothelium-specific hyaluronan receptor LYVE-1 is expressed by stabilin-1+, F4/80+, CD11b+ macrophages in malignant tumours and wound healing*

tissue in vivo and in bone marrow cultures in vitro: implications for the assessment of lymphangiogenesis. *J Pathol*, 2006. **209**(1): p. 67-77.

135. Steer, H.W. and R.A. Foot, *Changes in the medulla of the parathyroid lymph nodes of the rat during acute gastro-intestinal inflammation*. *J Anat*, 1987. **152**: p. 23-36.

136. Lichtenstein, L., et al., *Angptl4 protects against severe proinflammatory effects of saturated fat by inhibiting fatty acid uptake into mesenteric lymph node macrophages*. *Cell Metab*, 2010. **12**(6): p. 580-92.

137. Mohr, E., et al., *Dendritic cells and monocyte/macrophages that create the IL-6/APRIL-rich lymph node microenvironments where plasmablasts mature*. *J Immunol*, 2009. **182**(4): p. 2113-23.

138. Asano, K., et al., *CD169-positive macrophages dominate antitumor immunity by crosspresenting dead cell-associated antigens*. *Immunity*, 2011. **34**(1): p. 85-95.

139. Iannacone, M., et al., *Subcapsular sinus macrophages prevent CNS invasion on peripheral infection with a neurotropic virus*. *Nature*, 2010. **465**(7301): p. 1079-83. doi: 10.1038/nature09118.

140. Norbury, C.C., et al., *Visualizing priming of virus-specific CD8+ T cells by infected dendritic cells in vivo*. *Nat Immunol*, 2002. **3**(3): p. 265-71.

141. Hsu, K.M., et al., *Murine cytomegalovirus displays selective infection of cells within hours after systemic administration*. *J Gen Virol*, 2009. **90**(Pt 1): p. 33-43.

142. Moseman, E.A., et al., *B cell maintenance of subcapsular sinus macrophages protects against a fatal viral infection independent of adaptive immunity*. *Immunity*, 2012. **36**(3): p. 415-26. doi: 10.1016/j.immuni.2012.01.013. Epub 2012 Mar 1.

143. Bachmann, M.F., et al., *The influence of antigen organization on B cell responsiveness*. *Science*, 1993. **262**(5138): p. 1448-51.

144. Hickman, H.D., et al., *Chemokines control naive CD8+ T cell selection of optimal lymph node antigen presenting cells*. *J Exp Med*, 2011. **208**(12): p. 2511-24.

145. Chtanova, T., et al., *Dynamics of neutrophil migration in lymph nodes during infection*. *Immunity*, 2008. **29**(3): p. 487-96.

4 TNFSF and TNFRSF members in adult LNs

In an earlier chapter, TNFSF members involvement in LN development were described, but these molecules also play an important role during adult stages, including stromal cell maintenance and control of chemokine expression, which will now be further discussed in this chapter.

4.1 LT β R and TNFR

LT β R was thought to be important for LN architecture maintenance since its ligand (LT - lymphotoxin) is expressed by various cells in the adult LNs, including B, T and NK cells. LT β R knockout mice lack all LNs, therefore, information regarding its function during adulthood was mainly gathered through LT β R blockade experiments. Multiple FDCs markers (FDC-M1, FDC-M2, MAdCAM-1 and CR35) disappear upon LT β R blockade [1]. Furthermore, the trapping of newly formed immune complexes was prevented and the trapped ones were eliminated after LT β R inhibition, CXCL13 expression was also found to be decreased [2]. TNFR blockade also affected the FDC network, but only in the absence of a strong immune response, since its blockade associated with immunization with sheep red blood cells did not affect FDCs [1]. Besides FDCs, also FRCs are influenced by lymphocytes and their TNF α /LT expression [3]. T and B cell expression of TNF α was found to be required for LN microarchitecture maintenance [3]. LT β R is necessary to maintain PNA β and MAdCAM-1 homeostatic levels on HEVs, to ensure proper lymphocyte recruitment into the LNs, since it was shown that LT β R blockade led to a decreased cellularity in the LN due to impaired lymphocyte entry [2, 4]. CCL21 expression did not appear altered after LT β R or TNFR blockade, whereas CCL19 was slightly decreased [2]. During a viral infection the LT β influences LN growth. Even though anti-viral B cell response was not altered on conditional or complete LT β -deficient mice, the response against non-replicating Ag was impaired [5, 6]. LT β R blockade also led to impaired Ab maturation, CD4 $^+$ and CD8 $^+$ T cell responses [7]. The involvement of LT β R signalling on lymphatic function is not yet clear, however LT-deficient mice presented defects in lymphatic function [8]. Although, resting FRC maintenance is not obviously under LT β R control, a recent study clearly demonstrated that reactive FRCs depend on LT/LIGHT

signal. Luther and colleagues immunized mice, previously transferred with ovalbumin (OVA) specific T cells, with OVA in Montanide adjuvant, and analysed FRC network changes. The FRCs were found proliferating and expanding, however in RAG2-deficient mice (lack mature lymphocytes) this expansion was abrogated. LT β R blockade also led to reduced FRC expansion. This study suggests a role for LT $\alpha\beta$ expressed by lymphocytes in reactive FRCs [9, 10]. During an immune reaction the medullary region swells and is filled with lymphocytes, it was demonstrated that LT β R is also involved in this process, since its blockade reduces the medullary remodelling [11].

4.2 RANKL

Several studies demonstrated the importance of LT β R signalling in development and maintenance of B cell follicles. Even though RANK involvement is less studied, there is some evidence regarding its importance in this process. The RANKL-KO mice model helped address this issue by showing that B cell follicle integrity was impaired, despite B and T cell segregation in the spleen [12]. However, in the same study, it was shown that RANKL contributes to but it is not essential for proper B cell follicle formation in the spleen, since normal splenic germinal centres were formed in the RANKL-KO mice upon T cell dependent Ag immunization [12]. Furthermore, in the RANKL-KO mice it was reported that some occasional cervical LNs formed but were small and comprised few B cells unable to form follicles [12]. Another study performed on TRAF-6-deficient embryos, in which there is an impairment of RANK signalling via TRAF6, demonstrated that discrete mLNs can be recovered upon ectopic IL-7 application but that B cell follicles and FDCs were absent in those LNs [13]. LNs can be restored in the RANKL-KO mice by RANKL transgenic expression of B and T cells, nevertheless, these LNs presented few B cells and defective B cell follicles [12]. Additionally, the RANKL-KO mice lack B cells in the small intestine cryptopatches (CPs) that did not show VCAM-1 and CXCL13 expression on stromal cells [14]. A study of RANKL blockade during the different stages of embryonic development demonstrated that B cell follicle formation was impaired after birth, accompanied by misplaced FDCs, and reduced VCAM-1 staining [15]. Hess *et al.*, demonstrated that postnatal RANKL overexpression led to an increase in smaller but clearly defined B cell follicles, all

comprising FDCs [16]. Altogether these studies evoke the possible involvement of RANKL in B cell follicle formation, as was discussed in chapter 1. Noteworthy, in the adult LN, RANKL is expressed by the MRCs which are localized just above the B cell follicles, further research should be developed in this field in order to completely understand its influence on LN B cell homeostasis and organization [17].

Several studies have been showing suggested an involvement of RANKL in secondary lymphoid organ (SLO) growth [18]. Upon embryonic RANKL-blockade, the LNs that developed appeared smaller [15, 19]. The RANKL-KO mice presented smaller PPs, CPs and isolated lymphoid follicles (ILFs) [13], and massive LN hyperplasia was found on mice overexpressing RANK postnatal [16]. A possible regulatory mechanism of SLO growth is immune cell recruitment and stromal cell division. For instance the maturation of LTos, and consequent production of chemokines and cell adhesion molecules, coincides with lymphocyte recruitment into SLO anlage [20-25]. Moreover, postnatal RANKL overexpression leads to an upregulated gene expression of CXCL13, CCL19, VCAM-1 and MAdCAM-1 on FRCs and vascular cells [16]. Since these chemokines and adhesion molecules are known to attract immune cells, RANKL could therefore directly increase immune cell accumulation. RANKL was also found to stimulate FRC and endothelial cell proliferation [16].

Numerous observations elucidate the influence of RANK signalling on endothelial cells. These cells, whether lymphatic or blood, are part of the LN stromal populations, and are crucial for LN homeostasis as being the gates for cell entry and egress. During inflammation, both blood and lymphatic vasculatures grow, lymphocyte egress is interrupted and more immune cells are recruited, leading to LN hypertrophy [26, 27]. LN hypertrophy mechanisms remain elusive, but TNFSF members are known to be involved in this process. HEVs homeostasis and function as well as lymphoangiogenesis depend on LT β R signalling [2, 28]. Initially it was thought that LT was the ligand triggering LT β R signalling in this context, but lately LIGHT was also found to be required for LN hypertrophy during inflammation [29]. In 2002, Kim and colleagues showed that both *in vitro* and *in vivo* blood vessels angiogenesis was induced by RANKL [30]. In 2003, another study demonstrated that the endothelial cells in those vessels express RANK [31]. In the same study, LPS- and TNF α -induced apoptosis on endothelial cells, *in vitro*, was prevented

by RANKL, this process occurred through PI3K/Akt pathway activation [31]. Endothelial cell survival was also associated with OPG through the neutralization of pro-apoptotic TRAIL. Moreover, endothelial cells beside expressing RANK were found to express also RANKL and OPG, and smooth muscle cells surrounding endothelial cells also express OPG [32-34]. ICAM-1 and VCAM-1 expression on endothelial cells was found to be induced by RANKL, this mechanism was dependent on NF- κ B, PLC, PI3K and PKC [30]. Thus, RANKL increases leukocyte adhesion to endothelial cells, Figure 4-1. Furthermore, Min and colleagues demonstrated that RANKL increases vascular permeability, and this process is mediated by eNOs (endothelial nitric oxide synthase) and NO (nitric oxide) (Fig. 4-1) [30, 35].

The possible functions of RANK and RANKL in the function of lymphatic endothelial cells remain elusive, nevertheless, osteoclasts stimulated by RANKL release lymphangiogenic mediators, for instance VEGF-C is expressed by RANKL activated osteoclasts [36]. Additionally, RANKL also triggers VEGF-A expression by osteoclasts [37]. A postnatal RANKL overexpression led to lymphedema in the LNs of old mice, suggesting an impairment of lymphatic endothelial cells [16]. The influence of RANKL on LECs requires further investigations.

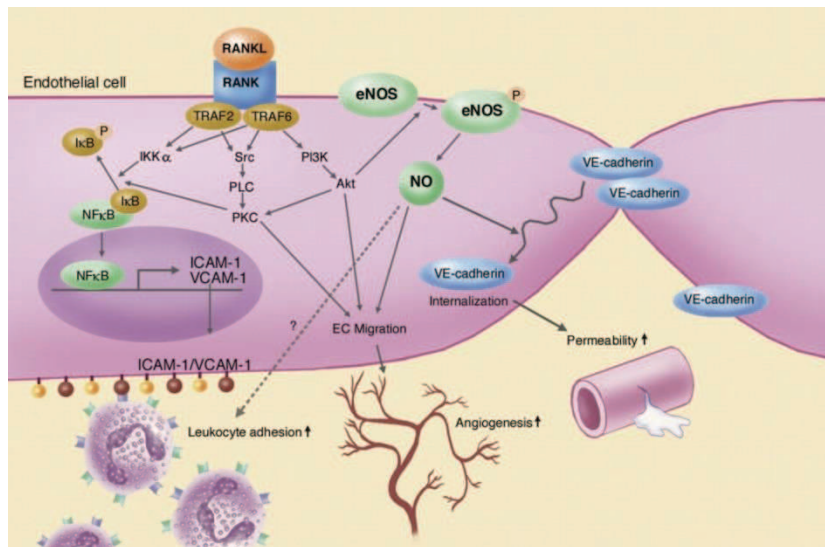

Figure 4- 1 RANKL effects on endothelial cells. RANKL induces ICAM-1 and VCAM-1 expressions on endothelial cells, which increases leukocyte adhesiveness. Angiogenesis and permeability are increased by RANK signalling on endothelial cells [35].

RANK and RANKL also play a role in adaptive immune responses. Activated CD4 and CD8 T cells express both surface and soluble RANKL [38, 39]. DCs express RANK, and it was shown, *in vitro*, that RANKL confers a better survival to DCs [40-43]. RANKL stimulated DCs produce pro-inflammatory cytokines and T cell differentiation factors [38]. Conversely, RANKL activation of DCs, in an oral tolerance model, was associated with tolerance [43]. Moreover, RANKL stimulation on Langerhans cells and macrophages triggered anti-inflammatory effects [44, 45]. This topic was already discussed on the first chapter.

4.3 Conclusions

The TNFRSF member LT β R was found to be involved in the maintenance of FDC network and consequently B cell follicle microarchitecture. TNFR1 was also found important in these processes, however only under specific conditions. A similar role played by RANK has been highlighted by several studies, but further research remains necessary. LT β R involvement on HEVs and FRCs homeostasis has also been evoked. Furthermore, its involvement during an immune response was demonstrated. Regarding RANK, several studies demonstrated its involvement in SLO growth and endothelial cells function. Despite the good progress achieved so far, the role of RANK and RANKL in adult LN homeostasis remains elusive, and that is what I have been addressing during my PhD.

4.4 Bibliography

1. Mackay, F. and J.L. Browning, *Turning off follicular dendritic cells*. Nature, 1998. **395**(6697): p. 26-7.
2. Browning, J.L., et al., *Lymphotoxin-beta receptor signaling is required for the homeostatic control of HEV differentiation and function*. Immunity, 2005. **23**(5): p. 539-50.
3. Tumanov, A.V., et al., *Cellular source and molecular form of TNF specify its distinct functions in organization of secondary lymphoid organs*. Blood, 2010. **116**(18): p. 3456-64.
4. Girard, J.P., C. Moussion, and R. Forster, *HEVs, lymphatics and homeostatic immune cell trafficking in lymph nodes*. Nat Rev Immunol, 2012. **12**(11): p. 762-73.
5. Kumar, V., et al., *Global lymphoid tissue remodeling during a viral infection is orchestrated by a B cell-lymphotoxin-dependent pathway*. Blood., 2010. **115**(23): p. 4725-33. .
6. Junt, T., et al., *Expression of lymphotoxin beta governs immunity at two distinct levels*. Eur J Immunol, 2006. **36**(8): p. 2061-75.
7. McCarthy, D.D., et al., *The lymphotoxin pathway: beyond lymph node development*. Immunol Res, 2006. **35**(1-2): p. 41-54.
8. Mounzer, R.H., et al., *Lymphotoxin-alpha contributes to lymphangiogenesis*. Blood, 2010. **116**(12): p. 2173-82.
9. Yang, C.Y., et al., *Trapping of naive lymphocytes triggers rapid growth and remodeling of the fibroblast network in reactive murine lymph nodes*. Proc Natl Acad Sci U S A, 2014. **111**(1): p. E109-18.
10. Lu, T.T. and J.L. Browning, *Role of the Lymphotoxin/LIGHT System in the Development and Maintenance of Reticular Networks and Vasculature in Lymphoid Tissues*. Front Immunol, 2014. **5**: p. 47.
11. Abe, J., et al., *B cells regulate antibody responses through the medullary remodeling of inflamed lymph nodes*. Int Immunol, 2012. **24**(1): p. 17-27.
12. Kim, D., et al., *Regulation of peripheral lymph node genesis by the tumor necrosis factor family member TRANCE*. J. Exp. Med., 2000. **192**(10): p. 1467-78.
13. Knoop, K.A., et al., *Distinct developmental requirements for isolated lymphoid follicle formation in the small and large intestine RANKL is essential only in the small intestine*. Am. J. Pathol., 2011. **179**(4): p. 1861-71.
14. Yoshida, H., et al., *Different cytokines induce surface lymphotoxin-alpha on IL-7 receptor-alpha cells that differentially engender lymph nodes and Peyer's patches*. Immunity, 2002. **17**(6): p. 823-33.
15. Sugiyama, M., et al., *Expression pattern changes and function of RANKL during mouse lymph node microarchitecture development*. Int. Immunol., 2012. **2012**: p. 21.
16. Hess, E., et al., *RANKL induces organized lymph node growth by stromal cell proliferation*. J. Immunol., 2012. **188**: p. 1245-54.
17. Katakai, T., et al., *Organizer-like reticular stromal cell layer common to adult secondary lymphoid organs*. J. Immunol., 2008. **181**(9): p. 6189-200.
18. Mueller, C.G. and E. Hess, *Emerging Functions of RANKL in Lymphoid Tissues*. Frontiers in Immunology, 2012. **3**: p. 261-7.
19. Eberl, G., et al., *An essential function for the nuclear receptor RORgamma(t) in the generation of fetal lymphoid tissue inducer cells*. Nat. Immunol., 2004. **5**(1): p. 64-73.

20. Benezech, C., et al., *Ontogeny of stromal organizer cells during lymph node development*. J. Immunol., 2011. **184**(8): p. 4521-30.
21. Cupedo, T., et al., *Presumptive lymph node organizers are differentially represented in developing mesenteric and peripheral nodes*. J. Immunol., 2004. **173**(5): p. 2968-75.
22. Finke, D., et al., *CD4⁺CD3⁻ cells induce Peyer's patch development: role of alpha4beta1 integrin activation by CXCR5*. Immunity, 2002. **17**(3): p. 363-373.
23. Honda, K., et al., *Molecular basis for hematopoietic/mesenchymal interaction during initiation of Peyer's patch organogenesis*. J. Exp. Med., 2001. **193**(5): p. 621-30.
24. Luther, S.A., K.M. Ansel, and J.G. Cyster, *Overlapping roles of CXCL13, interleukin 7 receptor alpha, and CCR7 ligands in lymph node development*. J. Exp. Med., 2003. **197**(9): p. 1191-8.
25. White, A., et al., *Lymphotoxin α -dependent and -independent signals regulate stromal organizer cell homeostasis during lymph node organogenesis*. Blood, 2007. **110**(6): p. 1950-9.
26. Soderberg, K.A., et al., *Innate control of adaptive immunity via remodeling of lymph node feed arteriole*. Proc Natl Acad Sci U S A, 2005. **102**(45): p. 16315-20.
27. Schwab, S.R. and J.G. Cyster, *Finding a way out: lymphocyte egress from lymphoid organs*. Nat Immunol, 2007. **8**(12): p. 1295-301.
28. Chyou, S., et al., *Fibroblast-type reticular stromal cells regulate the lymph node vasculature*. J Immunol, 2008. **181**(6): p. 3887-96.
29. Zhu, M., et al., *LIGHT regulates inflamed draining lymph node hypertrophy*. J Immunol, 2011. **186**(12): p. 7156-63.
30. Min, J.K., et al., *TNF-related activation-induced cytokine enhances leukocyte adhesiveness: induction of ICAM-1 and VCAM-1 via TNF receptor-associated factor and protein kinase C-dependent NF-kappaB activation in endothelial cells*. J. Immunol., 2005. **175**(1): p. 531-40.
31. Kim, H.H., et al., *RANKL regulates endothelial cell survival through the phosphatidylinositol 3'-kinase/Akt signal transduction pathway*. Faseb J., 2003. **17**(14): p. 2163-5.
32. Pritzker, L.B., M. Scatena, and C.M. Giachelli, *The role of osteoprotegerin and tumor necrosis factor-related apoptosis-inducing ligand in human microvascular endothelial cell survival*. Mol Biol Cell, 2004. **15**(6): p. 2834-41.
33. Collin-Osdoby, P., *Regulation of vascular calcification by osteoclast regulatory factors RANKL and osteoprotegerin*. Circ Res, 2004. **95**(11): p. 1046-57.
34. McGonigle, J.S., C.M. Giachelli, and M. Scatena, *Osteoprotegerin and RANKL differentially regulate angiogenesis and endothelial cell function*. Angiogenesis, 2009. **12**(1): p. 35-46.
35. Fukumura, D.a.J., R.K., *Novel function of RANKL: eNOS activator*. Blood 2007. **109**(4): p. 1339-1340.
36. Zhang, Q., et al., *VEGF-C, a lymphatic growth factor, is a RANKL target gene in osteoclasts that enhances osteoclastic bone resorption through an autocrine mechanism*. J Biol Chem, 2008. **283**(19): p. 13491-9.
37. Trebec-Reynolds, D.P., et al., *VEGF-A expression in osteoclasts is regulated by NF-kappaB induction of HIF-1alpha*. J Cell Biochem, 2010. **110**(2): p. 343-51.
38. Josien, R., et al., *TRANCE, a TNF family member, is differentially expressed on T cell subsets and induces cytokine production in dendritic cells*. J Immunol, 1999. **162**(5): p. 2562-8.
39. Wang, R., et al., *Regulation of activation-induced receptor activator of NF-kappaB ligand (RANKL) expression in T cells*. Eur J Immunol, 2002. **32**(4): p. 1090-8.

40. Wong, B.R., et al., *TRANCE (tumor necrosis factor [TNF]-related activation-induced cytokine), a new TNF family member predominantly expressed in T cells, is a dendritic cell-specific survival factor.* J Exp Med, 1997. **186**(12): p. 2075-80.
41. Dougall, W.C., et al., *RANK is essential for osteoclast and lymph node development.* Genes. Dev., 1999. **13**(18): p. 2412-24.
42. Josien, R., et al., *TRANCE, a tumor necrosis factor family member, enhances the longevity and adjuvant properties of dendritic cells in vivo.* J. Exp. Med., 2000. **191**(3): p. 495-502.
43. Williamson, E., J.M. Billsborough, and J.L. Viney, *Regulation of Mucosal Dendritic Cell Function by Receptor Activator of NF-kappaB (RANK)/RANK Ligand Interactions: Impact on Tolerance Induction.* J. Immunol., 2002. **169**(7): p. 3606-12.
44. Maruyama, K., et al., *Receptor activator of NF-kappa B ligand and osteoprotegerin regulate proinflammatory cytokine production in mice.* J Immunol., 2006. **177**(6): p. 3799-805.
45. Yoshiki, R., et al., *IL-10-producing Langerhans cells and regulatory T cells are responsible for depressed contact hypersensitivity in grafted skin.* J. Invest. Dermatol., 2009. **129**(3): p. 705-13.

5 Integrins and the immune system

Immune response efficiency depends on the capacity of immune cells to migrate within the body, penetrate into tissues and make contact with other cells. Integrins form a large family of homologous transmembrane molecules and are the main receptors to most extracellular matrix proteins such as fibronectin, collagens and laminins, and cellular receptors such as VCAM-1, and the ICAM family [1-3]. Integrins can be activated and induce signalling pathways which are involved in cell adhesion and migration, thrombosis, T and B cell help [4]. Integrins on immune cells, such as lymphocytes and APCs, and their receptors on the endothelium are responsible for trafficking into SLOs and tissues. They also play an important role in the regulation of development, homeostasis, immunity, inflammation and are also involved in some disease processes such as in autoimmunity, cancer and atherothrombosis [2]. An important feature of integrins, like other cell adhesion molecules, is that when compared to other cell surface receptors they present much lower affinity to their ligands and are present at much higher concentrations on the cell surface, creating a strong interaction but avoiding a permanent engagement [1, 5]. Integrins are a family of $\alpha\beta$ heterodimeric cell surface receptors comprising 8 β and 18 α subunits which can form 24 different heterodimer pairs (Fig. 5-1) [5, 6].

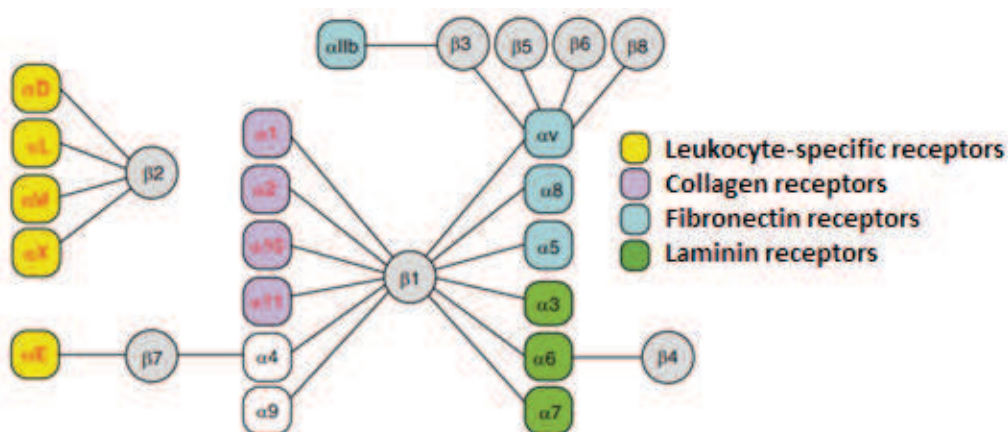

Figure 5- 1 Integrin receptors. 18 α and 8 β subunits forming 24 different integrins. Adapted from [7].

5.1 Integrin structure

Two transmembrane glycoproteins subunits, α and β , associate noncovalently to form an integrin dimer (Figure 5-2). Each subunit presents a large extracellular domain, a single-spanning transmembrane domain and a short unstructured cytoplasmic tail. Subunit sizes differ but generally the α and β subunits contain around 1000 and 750 amino acids, respectively [7-9]. Integrins can be found in three major states: inactive (low affinity), primed or active (high affinity) and ligand occupied. Information regarding these three states was mainly gathered by crystallography studies, however this approach remains controversial [10-12]. The “switchable” model, the most widely accepted, states that the three conformations correspond to a **bent**, **extended** and **extended with an open headpiece** forms [13-15]. Nevertheless, there is evidence that even in a bent (or partially unbent) form integrins can still bind their ligands with low affinity [8]. Interactions between integrins and their ligands depend on divalent cations such as Ca^{2+} or Mg^{2+} therefore the extracellular domains of each subunit are equipped with divalent-cation-binding domains (Fig. 5-2). The specificity and affinity of binding can be influenced by the type of divalent cation [16, 17]. Several integrins are able to bind to many matrix proteins, for instance fibronectin is recognized by 8 different integrins and laminin by 5 different integrins. The $\beta 1$ subunit can dimerize with at least 12 different α subunits (Figure 5-1), almost all vertebrate cells form these dimers. The $\beta 2$ subunit interacts with at least 4 α subunits, and these dimers are exclusively found on leukocytes, playing a role in the immune response, and therefore mediating mainly cell-cell interactions rather than cell-matrix interactions. The $\beta 3$ chain undergoes dimerization only with αIIb and αV subunits and can be found on several cells, including platelets where it binds to fibrinogen to help in the clotting process [1].

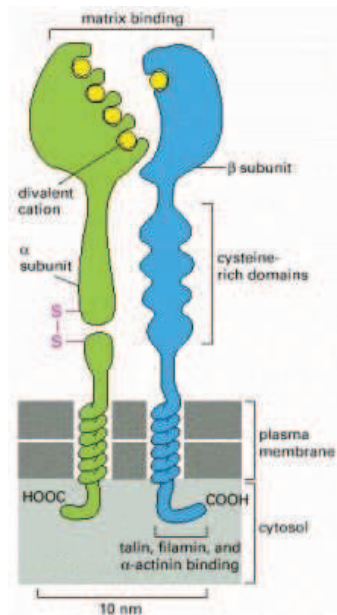

Figure 5- 2 Integrin subunit structure. Each subunit presents a globular head distancing around 20nm from the lipid bilayer. Noncovalent bonds hold the two subunits together. The α subunit in this receptor (fibronectin receptor) presents two domains, a small transmembrane and a large extracellular domain with four divalent-cation-binding sites, the two domains are held together by a disulphide bond. One divalent-cation-binding site is present on the β subunit [1].

5.2 Bidirectional integrin signalling

Integrins can transduce intracellular signals upon ligand binding, so called “outside-in” signalling. Interestingly, they can also produce “inside-out” signalling, by shifting between high and low affinity conformations. These features influence processes such as cytoskeletal arrangement and signalling for gene transcription [18]. Integrins can either be basally activated or inactivated, the first occurs in most adherent cells when attached to the basal membrane, and the second with platelets and leukocytes that circulate until activated to undergo platelet aggregation or mediate an inflammatory response, respectively. There is no kinase activity associated with integrins, however, integrins create a link between extracellular matrix (ECM) and the actin cytoskeleton, which allows the regulation of cell motility, cytoskeletal organization, and many intracellular signalling pathways such as survival, cell shape and proliferation and angiogenesis. The intracellular domain anchors cytoskeletal proteins whereas the extracellular can bind several ligands, it

is this connection between intra and extracellular environment that allows bidirectional signalling [7, 19].

5.2.1 Inside-out signalling

Before activation integrins are in a resting state with their extracellular domains in a bent conformation unbound to any ligand. Activation, or inside-out signalling, leads to the binding of an intracellular activator, talin or kindlins, to the tail of the β subunit. Consequently, the α tail is displaced from its complex with the β tail, generating conformational changes that unclasp the integrin from its bent 'closed' conformation, to its extended 'open' conformation. This process leads to an increased affinity for extracellular ligands by exposing the extracellular ligand-binding site (Fig. 5-3) [14, 19-23]. Inside-out signalling controls the adhesion strength, as well as the efficiency of interactions between integrins and ECM, playing a crucial role in cell migration and ECM remodelling. Inside-out signalling is crucial in platelets and leukocytes, because integrins must be activated in order to mediate adhesion, in other cells integrins are generally in an adhesion-competent state. This regulation of integrins activation allows leukocytes to circulate in the blood, where they are continuously close to their ligands, without adhesion. Adhesion only occurs upon an appropriated stimulus, such as inflammation or vasculature injury or physiological signal molecules [1, 24]. When a blood vessel is damaged platelets become activated by intracellular signalling pathways that turn $\beta 3$ integrin into its activated conformation, enabling the platelet to bind to fibrinogen with high affinity and therefore to form a platelet plug and to stop the haemorrhage. When a T cell binds a specific antigen, on an APC surface for instance, an intracellular signalling pathway is triggered and leads to the activation of $\beta 2$ integrins. This activation on $\beta 2$ integrins allows the T cell to strongly adhere to the APC, which sufficiently prolong the contact to fully stimulate the T cell. Then in order to allow the T cell to disengage the integrins return to their inactive state [1].

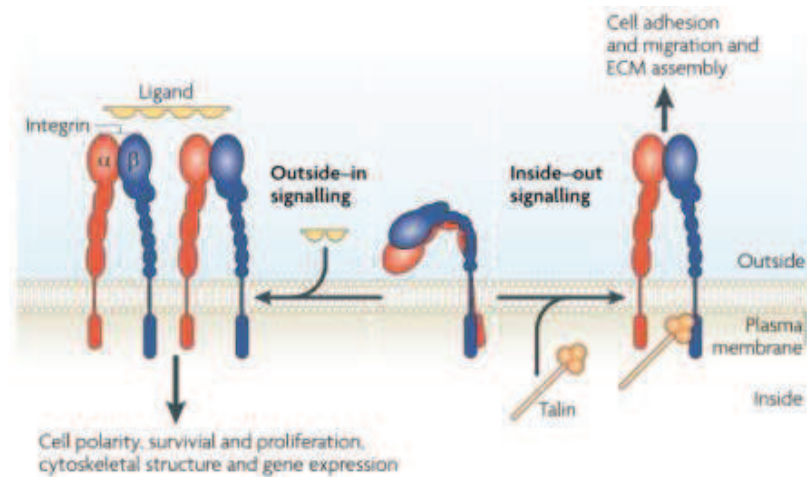

Figure 5- 3 Bidirectional integrin signalling. Inside-out signalling or activation leads to talin binding to the β subunit, generating conformational changes culminating in an active form with higher affinity for its ligands. Outside-in signalling occurs upon ligand binding to integrins and triggers several signalling pathways.

5.2.2 Outside-in signalling

Like traditional receptors, integrins are also able to transmit information into cells by outside-in signalling. Upon ligand-binding integrins undergo conformational changes that generally contribute to integrin clustering with other bound integrins (Figure 5-3). This clustering leads to highly organized intracellular complexes, the focal adhesion complexes, which enables a tight anchoring to the cytoskeleton [25]. These focal adhesions consist of cytoskeletal proteins, the integrins cytoplasmic domains, and signalling molecules. Focal adhesion kinase (FAK) is a cytoplasmic kinase responsible for the majority of integrin signalling functions. Upon integrin clustering of anchor proteins, such as talin or paxillin, it recruits FAK to focal adhesions. Then FAKs phosphorylate themselves on tyrosines creating docking sites for different intracellular signalling proteins, allowing the communication of the signal to the cell [1, 7]. These processes generate intracellular signalling pathways involved in cytoskeletal structure, cell polarity, gene expression, cell survival and proliferation [2, 4, 25]. Noteworthy is that conceptually these two signalling processes are generally separated, however, biologically they are often interconnected. For example, ligand binding is able to generate signals that lead to inside-out signalling,

and on the other hand integrin activation can also increase ligand binding, resulting in outside-in signalling.

5.3 Biological relevance of integrins

Integrins are involved in different important biological processes. The generation of integrin-deficient-mouse models provided an important insight into the specific roles of each gene. Genes for each β and each α (except α_X and α_D) subunits have been deleted, the phenotype and outcome for each KO is summarized in Table 6-1. Several studies have shown that integrins play key roles during development, for instance, α_3 KO mice show severe abnormalities in lung development and leads to perinatal mortality [26]. α_5 KO mice present vascular defects [27] and α_4 KO mice show impaired cardiac development [28]. The α_6 KO mice present severe skin blistering [29].

The data of integrin deficiency corroborate the concept of high redundancy and compensation amongst the collagen receptor integrins ($\alpha_1\beta_1$, $\alpha_2\beta_1$, $\alpha_{10}\beta_1$ and $\alpha_{11}\beta_1$), whereas the deletion of laminin ($\alpha_3\beta_1$, $\alpha_6\beta_1/\alpha_6\beta_4$, $\alpha_4\beta_7$) and the fibronectin ($\alpha_5\beta_1$, $\alpha_8\beta_1$, α_V and $\alpha_{IIb}\beta_3$) receptor integrins leads to more severe phenotypes, which suggests less redundancy and compensation [7, 30]. Besides their crucial role during organ development, integrins also play a role in wound healing, immune responses, autoimmunity and cancer [30].

In humans, three recessive autosomal diseases related to integrin subunits mutations are well described. The Glanzmann's thrombasthenia, associated with α_{IIb} and β_3 subunits, is characterized by platelet dysfunction and bleeding disorders [31]. Leukocyte adhesion deficiency (LAD) is associated with β_2 mutations and gene deletion [31, 32]. Mutations in α_6 and β_4 subunits lead to junction epidermolysis bulbosa and skin blistering [33-35]. As stated before integrins are involved in several different biological processes and their involvement in vasculature and immunity is relevant to this thesis therefore it will be furthered discussed.

Gene	Phenotype	Outcome
$\alpha 1$	Increased collagen synthesis, reduced tumor vascularization	V, F
$\alpha 2$	Few developmental defects. Delayed platelet aggregation	V, F
$\alpha 3$	Kidney, lungs and cerebral cortex defects. Skin blistering	L, birth
$\alpha 4$	Chorioallantois fusion and cardiac development defects	L, E11-E14
$\alpha 5$	Embryonic and extraembryonic vascular development defects	L, E10
$\alpha 6$	Cerebral cortex and retina defects. Skin blistering	L, birth
$\alpha 7$	Muscular dystrophy	V, F
$\alpha 8$	Small or absent kidneys. Inner ear defects	L+V/F
$\alpha 9$	Bilateral chylothorax	L, perinatal
$\alpha 10$	Growth plate chondrocytes dysfunction	V, F
$\alpha 11$	Dwarfism resulting from severely defective incisors	V, F
α_v	Placenta, CNS and GI blood vessels defects. Cleft palate	L, E12-birth
α_D	Not available	
α_L	Impaired leukocyte recruitment and tumor rejection	V, F
α_M	Obesity. Impaired phagocytosis and PMN apoptosis.	V, F
α_x	Not available	
α_E	Inflammatory skin lesions	V, F
α_{IIb}	Platelet aggregation defects	V, F
$\beta 1$	Inner cell mass deterioration	L, E5.5

$\beta 2$	Defective leukocyte recruitment. Skin infections	V, F
$\beta 3$	Platelet aggregation defects. Osteosclerosis	V, F
$\beta 4$	Skin blistering	L, perinatal
$\beta 5$	No apparent phenotype	V, F
$\beta 6$	Skin and lung inflammation. Impaired lung fibrosis	V, F
$\beta 7$	Peyer's patches defects. Fewer intraepithelial lymphocytes	V, F
$\beta 8$	Placenta, CNS and GI blood vessels defects. Cleft palate	L, E12-birth

Table 5- 1 Integrin KO phenotypes. V, viable; F, fertile; L, lethal, L+V/F, disrupted development in some but survival in others; GI, gastrointestinal; PMN, polymorphonuclear cells. Adapted from [7, 26-29, 36]

5.3.1 Involvement in vasculature formation and functions

Several integrins are involved in vasculature formation during development as well as in vasculature integrity during homeostasis [37]. Integrins can bind different growth factors, including VEGFs, which are essential for vasculature development. Furthermore, they bind ECM proteins generating outside-in signals to guide the endothelial precursor cells during vascular branching. During pathologic angiogenesis integrins also play a role by mediating adhesion events [18]. The $\alpha 5\beta 1$ integrin pair and its ligand, fibronectin, are absolutely crucial for vasculogenesis as $\alpha 5$ deficiency leads to severely impaired vascularization and mesodermal defects culminating in embryogenic death [27, 38]. Mice lacking fibronectin present a similar phenotype but even more severe [39]. Since the $\beta 1$ subunit is part of many integrins, its deficiency leads to a severe phenotype with gastrulation defects and pre-implantation lethality [40]. The $\beta 1$ integrin, binding to $\alpha 5$, is expressed by endothelial cells and seems to be the dominant integrin recognizing fibronectin during angiogenesis, since a conditional $\beta 1$ -KO restricted to endothelial cells presents a phenotype similar to the full $\alpha 5$ KO [41].

The development of lymphatic vasculature is also dependent on integrins. The $\alpha 9$ deficiency leads to disorganized lymphatic development and lymph accumulation in the thorax, culminating in perinatal death [42]. Moreover, a conditional KO of $\alpha 9$ on endothelial cells (VE-cadherin-Cre) showed the crucial role of $\alpha 9\beta 1$ in fibronectin bundle assembly during lymphatic valve morphogenesis, which normally prevents lymph leakage [42]. This phenotype can be attributed to loss of VEGF-C and VEGF-D signalling in lymphatic precursors, since $\alpha 9\beta 1$ is the major binding protein for these growth factors [43].

Mice with αv deficiency present haemorrhage and vascular defects leading to embryonic death. However, mice with specific deletion of αv on endothelial cells show no vascular defects during development, whereas deletion on neural cells leads to brain haemorrhage, suggesting that αv is relatively absent in the microvasculature and plays a role more in organizing the parenchyma surrounding the vasculature [44, 45]. The $\alpha 4$ subunit is also involved in angiogenesis since its deficiency arrests allantois and chorion fusion during placentation and leads to cardiac developmental defects [28, 46]. VCAM-1 is most likely the ligand involved since its deficiency results in a similar phenotype [47].

5.3.2 Integrins and immunity

Integrin involvement in immunity has been extensively addressed. $\alpha 4\beta 1$, $\alpha 4\beta 7$ $\alpha 5\beta 1$, all of the $\beta 2$ integrins, $\alpha v\beta 3$ and $\alpha E\beta 7$ are the primary integrins found on immune cells (Table 5-2) and $\alpha IIb\beta 3$ is the primary platelet integrin. The counter-receptors of integrins expressed by leukocytes include members of IgG superfamily such as ICAMs, VCAM-1 and MAdCAM-1, and also the E-cadherin protein. These counter-receptors are mainly present on blood and lymphatic endothelial cells. Some plasma proteins, such as fibrinogen and iC3b complement component can also be recognized by leukocyte integrins [18]. Integrins are crucial in leukocyte diapedesis, *i.e.*, to guide leukocytes from the vasculature into the tissues and the lymphoid organs. Selectins, chemokines and integrins are the main molecules involved in leukocyte diapedesis also called adhesion cascade [48]. The initial tethering is achieved via selectin interactions, both on leukocytes and endothelium, resulting in leukocyte rolling along the vascular wall. Meanwhile, chemokines induce

inside-out signalling on leukocytes resulting in integrin binding to the endothelium, promoting cell arrest. Local egress is then facilitated by chemokines in the tissue (Fig. 5-4) [18]. This is a simplistic view, since many other steps following adhesion and implicating alterations in leukocyte shape are required for diapedesis, all processes in which integrins are be involved [49]. Without going into these details, the overt consequences of integrin deficiency on leukocytes emigration highlight their general involvement in the leukocyte adhesion cascade. Blood cells deficient in $\beta 1$ subunit present migratory defects, which prevents foetal liver and spleen colonization by hematopoietic stem cells [50]. Mature lymphocytes lacking $\beta 1$ present impaired migration into the skin, liver, lung and peritoneum, mainly due to the lack of $\alpha 4\beta 1$ integrin [51]. $\beta 2$ deficient mice show immunodeficiency due to impaired leukocyte migration, which generates profound T cell defects and compromised neutrophil recruitment upon infection [32]. Consequently, these mice are protected from tissue damage mediated by immune cells, and on the other hand show an impaired response to inflammatory stimuli [52]. In the absence of the $\beta 3$ integrin, platelet function is lost resulting in haemorrhage, due to the lack of $\alpha IIb\beta 3$ integrin [53].

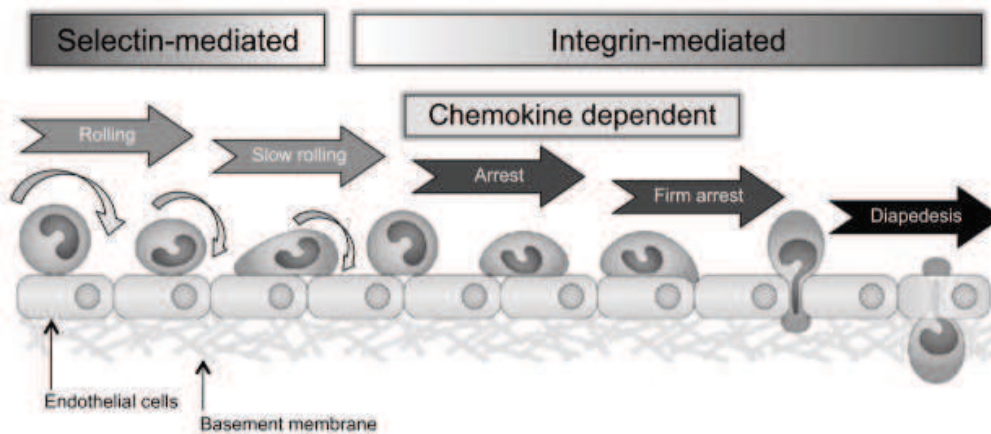

Figure 5- 4 Leukocyte adhesion cascade. Initial rolling is largely mediated by selectins, however some integrins can also contribute (eg. $\alpha 4\beta 1$). Cellular activation by chemokines facilitates leukocyte adherence mediated by integrins, culminating in diapedesis into the tissue through the endothelium [18].

Although it is already acknowledged that integrins play an important role in recruiting immune cells during inflammation or disease, this happens mainly with leukocytes and cannot be extrapolated to all immune cells. For instance dendritic cells lacking $\beta 1$, $\beta 2$, $\beta 7$ and αV integrins were able to migrate normally into the LNs, suggesting that migration through interstitial spaces is not so dependent on integrins [52].

An important feature of leukocyte integrins is their ability to activate effector functions through outside-in signalling, which sometimes works in synergy with other leukocyte receptors [49]. T cell proliferative responses are more robust when the TCR (T cell receptor) is co-stimulated in parallel with integrin activation (cells plated on matrix-coated surface), than just the TCR alone [5]. Similar results were found for neutrophils when simultaneously stimulated with chemokines and integrins [54]. Some integrin deficiency does not affect leukocyte migration but rather cell function. For instance, in a thrombohemorrhagic vasculitis model, neutrophils deficient for $\alpha M\beta 2$ integrin can migrate to the inflammation site, but, once in place, they do not recognize the complement deposits. Therefore, the neutrophils cannot produce the proteases that cause the vascular damage and haemorrhage [55].

Noteworthy is that LTis express integrins $\alpha 4\beta 7$ and $\alpha 4\beta 1$ and that HEVs, LECs and stromal cells express their ligands MAdCAM-1 and VCAM-1. During development, LTis are attracted and migrate into the LNs anlage via the blood stream where, $\alpha 4\beta 7$ and most probably $\alpha 4\beta 1$ play an important role [56]. After entering the tissue where the future LN will form, LTis establish contact with stromal cells expressing MAdCAM-1 ($\alpha 4\beta 7$ ligand) [57]. LTis in adult LN are mainly found at the B cell-T cell interface, interacting with VCAM-1 positive stromal cells, most probably via $\alpha 4\beta 1$ integrin [58], and in the SCS area they appear to be associated with MAdCAM-1 positive cells [59]. Interestingly, MAdCAM-1 is expressed by different cell types in the SCS area, including the LECs [60] and the MRCs [61] which evokes a possible interaction between these cells and the LTis.

Integrin names	Ligands	Cells	Functions
$\alpha_L\beta_2$ (LFA-1, CD11a/CD18)	ICAM-1-5; TLN; Type I collagen	T and B cells, DCs, NK cells, monocyte/macrophages, neutrophils, eosinophils	T cell migration; monocyte, neutrophil and eosinophil activation; DC, B and T cell activation and adhesion; NK cell and CTL T cell toxicity [62-64]
$\alpha_M\beta_2$ (Mac-1, CR3, CD11b/CD18)	ICAM-1,2,4; iC3b; fibrinogen; factor X; heparin; laminin; LPS; zymosan; collagen; elastase; oligodeoxynucleotide	DCs, monocyte/macrophages, NK cells, neutrophil, basophil and eosinophils	Adhesion, activation and phagocytosis [65, 66]
$\alpha_X\beta_2$ (p150/95, CR4, CD11c/CD18)	C3bi; collagen; fibrinogen; LPS; CD23 heparin;	NK cells, neutrophils, monocyte/macrophage	NK cell adhesion; neutrophil and monocyte/macrophage adhesion and phagocytosis [65, 67]
$\alpha_D\beta_2$ (CD11d/CD18)	ICAM-2; VCAM-1	NK cells, eosinophils, T cells and macrophages	T cell adhesion; eosinophil and macrophage adhesion and migration [68]
$\alpha_4\beta_1$ (VLA-4, CD49d/CD29)	VCAM-1, MAdCAM-1, thrombospondin, pro-vWF, fibrinogen, fibronectin, chondroitin, osteopontin	Basophils, neutrophils, eosinophils, DCs, T, B and NK cells, monocyte/macrophage	T and B cell development and migration; DC, eosinophil and monocyte/macrophage migration; NK cell and neutrophil adhesion [69-71]
$\alpha_4\beta_7$ (LPAM-1, CD49d/ITGB7)	MAdCAM-1, VCAM-1, fibronectin, fibrinogen, osteopontin	DCs, T, B and NK cells, eosinophils, basophils, monocyte/macrophages, LTis	DC, NK cell, eosinophil, monocyte/macrophage migration; T and B cell development and migration [70, 72]
$\alpha_E\beta_7$ (HML-1, CD103/ITGB7)	E-cadherin	DCs, macrophages, NK, Treg and T cells	DC and T cell adhesion and activation; Treg suppressive function; macrophage and NK cell recruitment; T cell cytotoxicity [73-75]
$\alpha_V\beta_3$ (CD51/CD61)	Vitronectin, ICAM-1, VCAM-1, PECAM-1, fibrinogen,	Monocytes, macrophages, DC,	Monocyte, macrophages and neutrophil migration; macrophage and

	fibronectin, vWF, LAP-TGF- β , thrombospondin	neutrophils	DC phagocytosis [76, 77]
--	---	-------------	--------------------------

Table 5- 2 Leukocytes integrins. CR3, complement receptor-3; DC, dendritic cell; HML-1, human mucosal lymphocyte antigen-1; ICAM-1, intercellular adhesion molecule-1; LAP-TGF- β , latency-associated peptide-transforming growth factor- β complex; LFA-1, lymphocyte function-associated antigen-1; LPS, lipopolysaccharide; LPAM-1, lymphocyte Peyer’s patch adhesion molecule-1; Mac-1, Macrophage-1 antigen; MAdCAM-1, mucosal addressin cell adhesion molecule-1; NK cell, natural killer cell; PECAM-1, platelet endothelial cell adhesion molecule-1; TLN, telencephalin; Treg, regulatory T cell; VCAM-1, vascular cell adhesion molecule-1; VLA-4, very late antigen-4; vWF, von Willebrand factor.

5.3.3 α IIb β 3 integrin

the α IIb β 3 integrin will be further discussed given its implication in my work. The integrin α IIb (ITGA2b, CD41 or glycoprotein IIb) pairs exclusively with integrin β 3 (ITGB3, CD61 or glycoprotein IIIa), while the later can also form a heterodimer with integrin α V (CD51). Integrin α IIb β 3 is well known for its role in blood clotting through its expression by megakaryocytes and platelets [78]. Upon platelet stimulation, α IIb β 3 integrin becomes activated (inside-out signaling), conveying it a high affinity for fibrinogen and von Willebrand factor, which results in platelet aggregation. Drugs targeting specifically the α IIb β 3 integrin have been developed for the treatment and prevention of cardiovascular diseases [79]. Autoantibodies against α IIb β 3 lead to platelet elimination (thrombocytopenia-ITP) and bleeding [80]. α IIb and β 3 integrins can also be found in embryonic erythroid and hematopoietic progenitor cells arising from the homogenic endothelium of the conceptus and embryo [81-83]. Even though, the homogenic endothelium does not express α IIb integrin itself, these cells generate α IIb⁺ hematopoietic progenitors [81]. Nevertheless, endothelial cells express a wide range of integrins, both in the abluminal space to adhere to the basement membrane and in the lumen to recruit leukocytes, as discusses above [18].

5.4 Conclusions

Integrins, a large family of several $\alpha\beta$ heterodimeric cell surface receptors, can bind ECM proteins and cellular receptors. They play an important role in cell migration and ECM remodelling. Integrins are special receptors that typically transduce intracellular signals “outside-in” but can also produce “inside-out” signalling, changing their affinity for ligand binding. These molecules are involved in different biological processes such as development regulation, homeostasis, immunity, inflammation and are also involved in some diseases such as autoimmunity, cancer and atherothrombosis. In humans, three recessive autosomal diseases related to integrin subunits mutations are well described, Glanzmann’s thrombasthenia, associated to α IIb and β 3 subunits, Leukocyte Adhesion Deficiency (LAD) associated with β 2 mutation and gene deletion and mutations in α 6 and β 4 subunits which lead to junction epidermolysis bulbosa and skin blistering.

5.5 Bibliography

1. Alberts B, J.A., Lewis J, et al. , *Molecular Biology of the Cell. 4th edition*. New York: Garland Science, 2002.
2. Hynes, R.O., *Integrins: bidirectional, allosteric signaling machines*. Cell, 2002. **110**(6): p. 673-87.
3. Plow, E.F., et al., *Ligand binding to integrins*. J Biol Chem, 2000. **275**(29): p. 21785-8.
4. Schwartz, M.A., M.D. Schaller, and M.H. Ginsberg, *Integrins: emerging paradigms of signal transduction*. Annu Rev Cell Dev Biol, 1995. **11**: p. 549-99.
5. Pribila, J.T., et al., *Integrins and T cell-mediated immunity*. Annu Rev Immunol, 2004. **22**: p. 157-80.
6. Shimizu, Y., D.M. Rose, and M.H. Ginsberg, *Integrins in the immune system*. Adv Immunol, 1999. **72**: p. 325-80.
7. Zent, M.B.S.a.R., *Integrin Structure and Function*. Springer Science+Business Media, LLC, 2010. **Cell-Extracellular Matrix Interactions in Cancer**.
8. Arnaout, M.A., S.L. Goodman, and J.P. Xiong, *Structure and mechanics of integrin-based cell adhesion*. Curr Opin Cell Biol, 2007. **19**(5): p. 495-507.
9. Bennett, J.S., B.W. Berger, and P.C. Billings, *The structure and function of platelet integrins*. J Thromb Haemost, 2009. **7 Suppl 1**: p. 200-5.
10. Xiao, T., et al., *Structural basis for allostery in integrins and binding to fibrinogen-mimetic therapeutics*. Nature, 2004. **432**(7013): p. 59-67.
11. Xiong, J.P., et al., *Crystal structure of the extracellular segment of integrin alpha Vbeta3*. Science, 2001. **294**(5541): p. 339-45.
12. Xiong, J.P., et al., *Crystal structure of the extracellular segment of integrin alpha Vbeta3 in complex with an Arg-Gly-Asp ligand*. Science, 2002. **296**(5565): p. 151-5.
13. Shimaoka, M., J. Takagi, and T.A. Springer, *Conformational regulation of integrin structure and function*. Annu Rev Biophys Biomol Struct, 2002. **31**: p. 485-516.
14. Nishida, N., et al., *Activation of leukocyte beta2 integrins by conversion from bent to extended conformations*. Immunity, 2006. **25**(4): p. 583-94.
15. Beglova, N., et al., *Cysteine-rich module structure reveals a fulcrum for integrin rearrangement upon activation*. Nat Struct Biol, 2002. **9**(4): p. 282-7.
16. Humphries, M.J., *Integrin structure*. Biochem Soc Trans, 2000. **28**(4): p. 311-39.
17. Campbell, I.D. and M.J. Humphries, *Integrin structure, activation, and interactions*. Cold Spring Harb Perspect Biol, 2011. **3**(3).
18. Lowell, C.A. and T.N. Mayadas, *Overview: studying integrins in vivo*. Methods Mol Biol, 2012. **757**: p. 369-97.
19. Shattil, S.J., C. Kim, and M.H. Ginsberg, *The final steps of integrin activation: the end game*. Nat Rev Mol Cell Biol, 2010. **11**(4): p. 288-300.
20. Watanabe, N., et al., *Mechanisms and consequences of agonist-induced talin recruitment to platelet integrin alphallbbeta3*. J Cell Biol, 2008. **181**(7): p. 1211-22.
21. Qin, J., O. Vinogradova, and E.F. Plow, *Integrin bidirectional signaling: a molecular view*. PLoS Biol, 2004. **2**(6): p. e169.

22. Kim, M., C.V. Carman, and T.A. Springer, *Bidirectional transmembrane signaling by cytoplasmic domain separation in integrins*. Science, 2003. **301**(5640): p. 1720-5.
23. Tadokoro, S., et al., *Talin binding to integrin beta tails: a final common step in integrin activation*. Science, 2003. **302**(5642): p. 103-6.
24. Ratnikov, B.I., A.W. Partridge, and M.H. Ginsberg, *Integrin activation by talin*. J Thromb Haemost, 2005. **3**(8): p. 1783-90.
25. Giancotti, F.G. and E. Ruoslahti, *Integrin signaling*. Science, 1999. **285**(5430): p. 1028-32.
26. Kreidberg, J.A., et al., *Alpha 3 beta 1 integrin has a crucial role in kidney and lung organogenesis*. Development, 1996. **122**(11): p. 3537-47.
27. Yang, J.T., H. Rayburn, and R.O. Hynes, *Embryonic mesodermal defects in alpha 5 integrin-deficient mice*. Development, 1993. **119**(4): p. 1093-105.
28. Yang, J.T., H. Rayburn, and R.O. Hynes, *Cell adhesion events mediated by alpha 4 integrins are essential in placental and cardiac development*. Development, 1995. **121**(2): p. 549-60.
29. Georges-Labouesse, E., et al., *Absence of integrin alpha 6 leads to epidermolysis bullosa and neonatal death in mice*. Nat Genet, 1996. **13**(3): p. 370-3.
30. Zhang, Y. and H. Wang, *Integrin signalling and function in immune cells*. Immunology, 2012. **135**(4): p. 268-75.
31. Hogg, N. and P.A. Bates, *Genetic analysis of integrin function in man: LAD-1 and other syndromes*. Matrix Biol, 2000. **19**(3): p. 211-22.
32. Scharffetter-Kochanek, K., et al., *Spontaneous skin ulceration and defective T cell function in CD18 null mice*. J Exp Med, 1998. **188**(1): p. 119-31.
33. Pulkkinen, L., D.U. Kim, and J. Uitto, *Epidermolysis bullosa with pyloric atresia: novel mutations in the beta4 integrin gene (ITGB4)*. Am J Pathol, 1998. **152**(1): p. 157-66.
34. Ruzzi, L., et al., *A homozygous mutation in the integrin alpha6 gene in junctional epidermolysis bullosa with pyloric atresia*. J Clin Invest, 1997. **99**(12): p. 2826-31.
35. Pulkkinen, L., et al., *Homozygous alpha6 integrin mutation in junctional epidermolysis bullosa with congenital duodenal atresia*. Hum Mol Genet, 1997. **6**(5): p. 669-74.
36. Sheppard, D., *In vivo functions of integrins: lessons from null mutations in mice*. Matrix Biol, 2000. **19**(3): p. 203-9.
37. Weis, S.M., *Evaluating integrin function in models of angiogenesis and vascular permeability*. Methods Enzymol, 2007. **426**: p. 505-28.
38. Astrof, S. and R.O. Hynes, *Fibronectins in vascular morphogenesis*. Angiogenesis, 2009. **12**(2): p. 165-75.
39. Hynes, R.O., *Cell-matrix adhesion in vascular development*. J Thromb Haemost, 2007. **5 Suppl 1**: p. 32-40.
40. Stephens, L.E., et al., *Deletion of beta 1 integrins in mice results in inner cell mass failure and peri-implantation lethality*. Genes Dev, 1995. **9**(15): p. 1883-95.
41. Carlson, T.R., et al., *Cell-autonomous requirement for beta1 integrin in endothelial cell adhesion, migration and survival during angiogenesis in mice*. Development, 2008. **135**(12): p. 2193-202.
42. Huang, X.Z., et al., *Fatal bilateral chylothorax in mice lacking the integrin alpha9beta1*. Mol Cell Biol, 2000. **20**(14): p. 5208-15.

43. Vlahakis, N.E., et al., *The lymphangiogenic vascular endothelial growth factors VEGF-C and -D are ligands for the integrin alpha9beta1*. J Biol Chem, 2005. **280**(6): p. 4544-52.
44. Bader, B.L., et al., *Extensive vasculogenesis, angiogenesis, and organogenesis precede lethality in mice lacking all alpha v integrins*. Cell, 1998. **95**(4): p. 507-19.
45. McCarty, J.H., et al., *Defective associations between blood vessels and brain parenchyma lead to cerebral hemorrhage in mice lacking alphav integrins*. Mol Cell Biol, 2002. **22**(21): p. 7667-77.
46. Grazioli, A., et al., *Defective blood vessel development and pericyte/pvSMC distribution in alpha 4 integrin-deficient mouse embryos*. Dev Biol, 2006. **293**(1): p. 165-77.
47. Kwee, L., et al., *Defective development of the embryonic and extraembryonic circulatory systems in vascular cell adhesion molecule (VCAM-1) deficient mice*. Development, 1995. **121**(2): p. 489-503.
48. Ley, K., et al., *Getting to the site of inflammation: the leukocyte adhesion cascade updated*. Nat Rev Immunol, 2007. **7**(9): p. 678-89.
49. Abram, C.L. and C.A. Lowell, *The ins and outs of leukocyte integrin signaling*. Annu Rev Immunol, 2009. **27**: p. 339-62.
50. Potocnik, A.J., C. Brakebusch, and R. Fassler, *Fetal and adult hematopoietic stem cells require beta1 integrin function for colonizing fetal liver, spleen, and bone marrow*. Immunity, 2000. **12**(6): p. 653-63.
51. Sixt, M., et al., *Beta1 integrins: zip codes and signaling relay for blood cells*. Curr Opin Cell Biol, 2006. **18**(5): p. 482-90.
52. Kakkar, A.K. and D.J. Lefler, *Leukocyte and endothelial adhesion molecule studies in knockout mice*. Curr Opin Pharmacol, 2004. **4**(2): p. 154-8.
53. Hodivala-Dilke, K.M., et al., *Beta3-integrin-deficient mice are a model for Glanzmann thrombasthenia showing placental defects and reduced survival*. J Clin Invest, 1999. **103**(2): p. 229-38.
54. Berton, G., et al., *Neutrophil activation by adhesion: mechanisms and pathophysiological implications*. Int J Clin Lab Res, 1996. **26**(3): p. 160-77.
55. Hirahashi, J., et al., *Mac-1 signaling via Src-family and Syk kinases results in elastase-dependent thrombohemorrhagic vasculopathy*. Immunity, 2006. **25**(2): p. 271-83.
56. Wang, C., et al., *Alpha4beta7/MAdCAM-1 interactions play an essential role in transitioning cryptopatches into isolated lymphoid follicles and a nonessential role in cryptopatch formation*. J Immunol, 2008. **181**(6): p. 4052-61.
57. Mebius, R.E., P. Rennert, and I.L. Weissman, *Developing lymph nodes collect CD4+CD3-LTbeta+ cells that can differentiate to APC, NK cells, and follicular cells but not T or B cells*. Immunity, 1997. **7**(4): p. 493-504.
58. Kim, M.Y., et al., *Heterogeneity of lymphoid tissue inducer cell populations present in embryonic and adult mouse lymphoid tissues*. Immunology, 2008. **124**(2): p. 166-74.
59. Lane, P.J., et al., *Lymphoid tissue inducer cells: pivotal cells in the evolution of CD4 immunity and tolerance?* Front Immunol, 2012. **3**: p. 24.
60. Cohen, J.N., et al., *Tolerogenic properties of lymphatic endothelial cells are controlled by the lymph node microenvironment*. PLoS One, 2014. **9**(2): p. e87740.
61. Katakai, T., *Marginal reticular cells: a stromal subset directly descended from the lymphoid tissue organizer*. Front Immunol, 2012. **3**: p. 200.

62. Balkow, S., et al., *LFA-1 activity state on dendritic cells regulates contact duration with T cells and promotes T-cell priming*. *Blood*, 2010. **116**(11): p. 1885-94.
63. Carrasco, Y.R., et al., *LFA-1/ICAM-1 interaction lowers the threshold of B cell activation by facilitating B cell adhesion and synapse formation*. *Immunity*, 2004. **20**(5): p. 589-99.
64. Humphries MJ, H.J., Byron A. , *Integrin ligands at a glance*. *J Cell Sci*, 2006. **3**: p. 119:3901.
65. Plow, E.F. and L. Zhang, *A MAC-1 attack: integrin functions directly challenged in knockout mice*. *J Clin Invest*, 1997. **99**(6): p. 1145-6.
66. Han, C., et al., *Integrin CD11b negatively regulates TLR-triggered inflammatory responses by activating Syk and promoting degradation of MyD88 and TRIF via Cbl-b*. *Nat Immunol*, 2010. **11**(8): p. 734-42.
67. Luo, B.H., C.V. Carman, and T.A. Springer, *Structural basis of integrin regulation and signaling*. *Annu Rev Immunol*, 2007. **25**: p. 619-47.
68. Yakubenko, V.P., et al., *The role of integrin alpha D beta2 (CD11d/CD18) in monocyte/macrophage migration*. *Exp Cell Res*, 2008. **314**(14): p. 2569-78.
69. Jin, H., et al., *Integrin alpha4beta1 promotes monocyte trafficking and angiogenesis in tumors*. *Cancer Res*, 2006. **66**(4): p. 2146-52.
70. Arroyo, A.G., et al., *Differential requirements for alpha4 integrins during fetal and adult hematopoiesis*. *Cell*, 1996. **85**(7): p. 997-1008.
71. Randolph, G.J., J. Ochoa, and S. Partida-Sanchez, *Migration of dendritic cell subsets and their precursors*. *Annu Rev Immunol*, 2008. **26**: p. 293-316.
72. Walsh, G.M., et al., *Integrin alpha 4 beta 7 mediates human eosinophil interaction with MAdCAM-1, VCAM-1 and fibronectin*. *Immunology*, 1996. **89**(1): p. 112-9.
73. Hori, S., T. Nomura, and S. Sakaguchi, *Control of regulatory T cell development by the transcription factor Foxp3*. *Science*, 2003. **299**(5609): p. 1057-61.
74. Le Floch, A., et al., *Alpha E beta 7 integrin interaction with E-cadherin promotes antitumor CTL activity by triggering lytic granule polarization and exocytosis*. *J Exp Med*, 2007. **204**(3): p. 559-70.
75. Tiisala, S., T. Paavonen, and R. Renkonen, *Alpha E beta 7 and alpha 4 beta 7 integrins associated with intraepithelial and mucosal homing, are expressed on macrophages*. *Eur J Immunol*, 1995. **25**(2): p. 411-7.
76. Bishop, G.G., et al., *Selective alpha(v)beta(3)-receptor blockade reduces macrophage infiltration and restenosis after balloon angioplasty in the atherosclerotic rabbit*. *Circulation*, 2001. **103**(14): p. 1906-11.
77. Guermonprez, P., et al., *Antigen presentation and T cell stimulation by dendritic cells*. *Annu Rev Immunol*, 2002. **20**: p. 621-67.
78. Lefkovits, J., E.F. Plow, and E.J. Topol, *Platelet glycoprotein IIb/IIIa receptors in cardiovascular medicine*. *N Engl J Med*, 1995. **332**(23): p. 1553-9.
79. Nurden, A.T., et al., *Platelet glycoprotein IIb/IIIa inhibitors: basic and clinical aspects*. *Arterioscler Thromb Vasc Biol*, 1999. **19**(12): p. 2835-40.
80. Cines, D.B., A. Cuker, and J.W. Semple, *Pathogenesis of immune thrombocytopenia*. *Presse Med*, 2014. **43**(4 Pt 2): p. e49-59.
81. Mitjavila-Garcia, M.T., et al., *Expression of CD41 on hematopoietic progenitors derived from embryonic hematopoietic cells*. *Development*, 2002. **129**(8): p. 2003-13.

82. Emambokus, N.R. and J. Frampton, *The glycoprotein IIb molecule is expressed on early murine hematopoietic progenitors and regulates their numbers in sites of hematopoiesis*. *Immunity*, 2003. **19**(1): p. 33-45.
83. Ferkowicz, M.J., et al., *CD41 expression defines the onset of primitive and definitive hematopoiesis in the murine embryo*. *Development*, 2003. **130**(18): p. 4393-403.

6 Tertiary Lymphoid Organs (TLOs)

TLOs can be formed during chronic inflammation. They consist of accumulations of cells in a semi-organized lymphoid structure that can be found in several non-lymphoid organs, including, skin, joints, glands, vasculature, lungs, kidneys, intestines, central nervous system (CNS), stomach and heart [1, 2]. TLOs share organizational, cellular and vascular characteristics with SLOs, such as LNs. TLOs, present B and T cell distinct areas, they comprise stromal cells and APCs, including DCs, organized HEVs and lymph vessels (LVs) and also conduits, (Fig. 6-1) [3-5]. One of the main differences between SLOs and TLOs is that the latter generally lack a capsule, with some exceptions, such as some TLOs found in the kidney [6]. This absence of a capsule may influence T cell and DC trafficking, which in the LN occurs through the peripheral medullary sinus to the parenchyma [7].

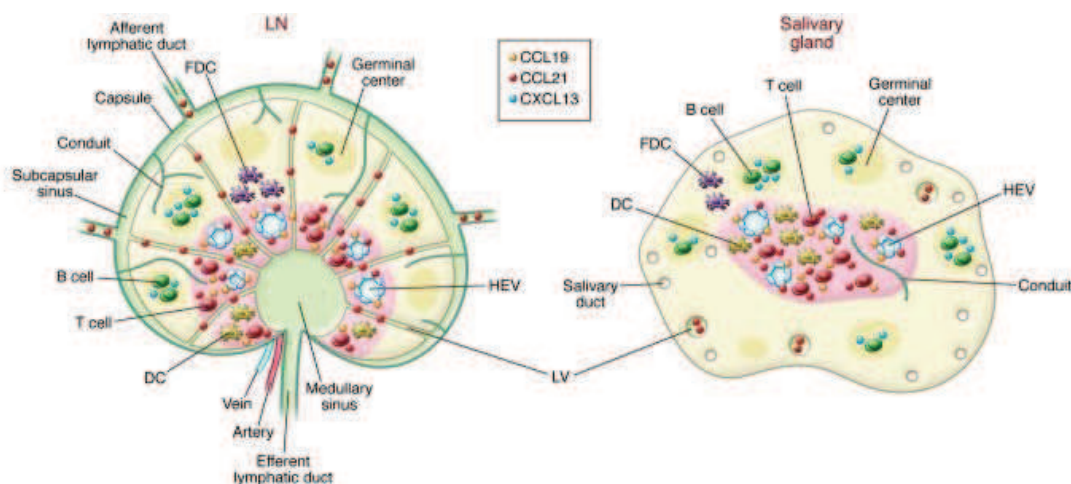

Figure 6- 1 Similarities between a LN and a salivary gland TLO. T and B cell compartmentalization, stromal cells, APCs, HEVs, LVs, conduits and chemokines are similar between a LN and a TLO, whereas the main difference is the lack of capsule in the TLO. It is not clear if the LVs in the TLOs are afferent and/or efferent [8].

TLOs have been found in autoimmune diseases, chronic allograft rejection, chronic inflammation [1], atherosclerosis [9], cancer [10, 11], and even in the endometrium during menstrual cycle [12]. TLOs were also found in several transgenic models of inflammatory cytokines or lymphoid chemokines, including lymphotoxin family members [13, 14].

Lymphocyte and DC trafficking into and within the LN is regulated by chemokines, and one of the TLOs defining criteria is ectopic expression of chemokines [1, 15]. The chemokines CCL19, CCL21 and CXCL13 play similar roles in secondary lymphoid organs and TLOs, by attracting CCR7⁺ T cells and DCs and CXCR5⁺ B cells, respectively. It has been demonstrated that antigen presentation and lymphocyte activation, with somatic hypermutation and B cell class switch, occurs in TLOs [16], suggesting a role in autoimmune exacerbation, antimicrobial responses and epitope spreading [17, 18].

6.1 TLO development

The development of TLOs during chronic inflammation has been one of the most challenging issues in the lymphoid neogenesis field. Several studies of the past years have aimed to elucidate this process, and have proposed that TLO development occurs following the same molecular and cellular processes that govern SLO development [14]. However, the exact events that trigger TLO formation still remain incompletely understood. Transgenic and KO mice as well as clinical observations have made important contributions to the understanding of the role of TRNF family members and lymphoid chemokines in this process. Several studies have demonstrated that LT α or LT β induce TLO formation [1, 19, 20]. TLO formation depends at least on three critical events: inflammatory cytokine expression (TNF-LT), stromal cell production of lymphoid chemokines, and HEVs development. The requirement of LTis for TLOs development remains unclear, for instance, LTis were found in the pancreas of RIP-BLC mice (with pancreatic TLOs and CXCL13 expression under control of the rat insulin promoter [RIP]) [21]. Influenza A virus infection leads to inducible bronchus-associated lymphoid tissues (iBALTs) formation, and it was shown that this process does not depend on LTis [22, 23]. Therefore, it remains to be determined if LTis are a TLO common feature and if they play an inductive role. Another elusive question is if the LVs are a common feature of TLOs, as they are in SLOs. Independently of the stimulus, LT β R signalling appears essential for mature TLO development, and, when the signal is not present TLOs are rather small and unorganized [24-26]. The blocking of LT β R signalling in non-obese diabetic (NOD) mice led to an amelioration of Sjogren's syndrome in the salivary glands [27]. Another study in the

same model showed that $LT\beta R$ blockade reduced CXCL13 expression in the lacrimal glands and improved corneal integrity [28]. In a different TLO model it was shown that inhibition of the $LT\beta R$ signalling pathway dissociates pancreatic TLOs [4]. This raises the question which cells provide $LT\alpha\beta$ in TLOs where LTis were shown to be redundant. This signal has been proposed to originate in B, T or dendritic cells. It was shown that maturation of TLOs is dependent on $LT\alpha\beta$ expression by B cells, (Fig. 6-2) [29]. Another study demonstrated that activated T cells, through interactions with DCs, can act as LTis and induce TLO formation in the thyroid [30]. Other studies suggest the involvement of activated Th17-producing cells in TLO formation in the iBALT model [31] and in an autoimmune encephalomyelitis model [32, 33]. Furthermore, LIGHT can also trigger $LT\beta R$ signalling and its expression by T cells was also shown to be important in TLO development and maintenance in a NOD model [34]. The fact that DCs activate T cells raised the question whether DCs were sufficient for TLO induction. Indeed, iBALT structures were formed upon repeated DC injections into the lungs [35, 36]. Moreover, DCs seem to be required for TLO maintenance since DCs depletion led to TLO disappearance [35]. Therefore, it is probable that LTis are not a requisite for TLO induction, since DCs, T and B cells appear to be good substitutes. Chemokines such as CCL21 or CXCL13 also play crucial role in inducing TLO formation. As previously mentioned, ectopic expression of CXCL13 but also CCL21 under the RIP promotor control induces TLO formation [21, 25, 30, 37]. Moreover, TLO formation was arrested in several infection and autoimmune models when either CCL19 [38], CCL21 [38], CXCR5 [39, 40], or CCR7 [39] were neutralized or absent. Overall, it seems that $LT\alpha$ induces stromal cells development and that CCL19 and CCL21 are instrumental for T zone organization [22, 38, 39]. IL-7 may also be involved in TLO induction, since it is overexpressed in the synovial tissue of rheumatoid arthritis patients [41]. It was also found strongly expressed in perivascular TLOs of idiopathic pulmonary hypertension patients [42].

TLO formation

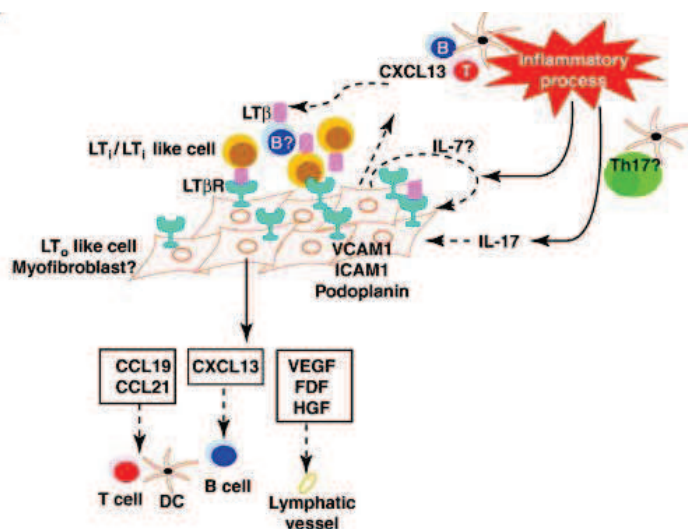

Figure 6- 2 TLO formation. DCs repeatedly present antigens to B and T cells during chronic inflammation or transplant rejection. LT β is expressed by activated B cells and stimulates LTO differentiation from local myofibroblasts. It is also possible that the continuous antigen presentation may lead to a Th17 T cell response, which is maintained on site via interactions with podoplanin⁺ fibroblasts. The mechanism behind TLO formation through Th17 cells remains elusive. Stromal cells, then, produce chemokines and growth factors which further attract DCs, T and B cells, and stimulate LV formation. Modified after reference [24].

The nature of the LTOs in TLOs remains unclear. However, it has been suggested that the LTO-like cells arise from local myofibroblasts, since LTOs and FRCs express α -smooth muscle actin and desmin, alike myofibroblasts [43], and also it was shown that upon inflammation the myofibroblasts differentiate to produce CXCL13, CCL21 and lymphangiogenic cytokines [44]. It was demonstrated that aorta smooth muscle cells can differentiate into LTO-like cells in an atherosclerosis model [9, 45]. Furthermore, myofibroblasts are generally found on scarring and fibrotic tissues, which may be the reason for TLO appearance in lung fibrosis and chronic obstructive pulmonary disease [46, 47]. LT β signalling on LTOs induces the expression of chemokines and adhesion molecules to attract lymphocytes. The cytokines promote lymphocyte viability and leads to differentiation into FRCs and FDCs [24]. Interestingly, transplantation of newborn LN cells

also triggered TLO formation [48]. Cupedo and colleagues injected single-cell suspensions of newborn mLNs into abdominal skin of adult mice. Two weeks later the mice presented LN-like structures in the abdomen, with T and B cells, HEVs some DCs and lymphatic endothelium [48].

6.2 TLO functions

TLOs appear to be an adaptation to a situation when a localized immune response is required. Therefore, TLO function as immune inductive sites, since they allow lymphocyte activation and GC formation. It was shown that iBALTs induce T cell differentiation upon DC interaction [49]. It was demonstrated that B cell class switching and GC reaction occur in TLOs generating memory B cells that become active upon reinfection [23, 35, 42]. Plasma cells are also found in TLOs and are capable of secreting antibodies [35]. Moyron-Quiroz and colleagues demonstrated that mice lacking SLOs but with iBALTs can resist a higher virus inoculation, and present memory CD8⁺ T cells during influenza infection, in opposite to mice without SLOs nor iBALTs [22, 23]. TLOs can be formed during *Helicobacter pylori* infections, but when the antigen is eradicated the TLOs degrade, probably because they have already performed their function and are no longer needed [40]. This supports the notion that TLOs play a protective role by generating a local immune response. In spite of this, it is also known that TLOs can induce or exacerbate autoimmune responses and chronic transplant rejections. TLOs in NOD mice generate insulin-specific plasma cells and T cells that destroy the islets [34, 50]. It was demonstrated that the presence of TLOs in autoimmune encephalomyelitis correlates with disease severity [18, 51]. TLOs are generated during chronic transplant rejections, and they might positively influence the rejection since mice lacking SLOs rejected skin harbouring TLOs transplants but did not rejected the skin when it lacked TLOs [52]. Furthermore, rheumatoid arthritis patients have B cells in TLOs in the lung that produce rheumatoid factor [53]. Overall, TLOs can be of important help to defend the host against infectious diseases, but it can also cause harm in chronic diseases and transplants.

6.3 TLOs as a therapeutic approach

One therapeutic approach is to induce TLOs by vaccination in order to create a long-lasting local immunity, and this could work both for lung and gut immunity [54]. It was demonstrated that mice becomes protected against lethal and sublethal doses of influenza viruses upon treatment with protein-caged nanoparticles (PCN) adjuvants without any viral antigen. These mice presented increased survival, viral clearance, and decreased morbidity and lung damage. These features were associated with presence of pre-established iBALTs [55]. Further research is necessary to fully understand the mechanisms behind these outcomes.

As previously discussed TLOs are found in several chronic diseases and are associated with autoimmunity and transplant rejection, which raises the question whether targeting TLOs could be a novel therapeutic approach. Since it is acknowledged that $LT\beta R$ signalling positively affects TLOs, $LT\alpha\beta$ or their receptors could be targets. Hence, it was demonstrated that blocking the LIGHT pathway, led to a disruption of TLOs in NOD mice with autoimmune diabetes, and inhibits autoaggressive T cells and diabetes progression [34]. Salivary function was partially restored upon $LT\beta R$ blockage in a NOD model of Sjögren's disease [27]. Since chemokines are also important players in TLO formation, targeting them or their receptors could be another therapeutic approach. A *Cxcr5* KO in a rheumatoid arthritis model led to reduced joint destruction [38]. CXCL13 blockade in a NOD mice model with diabetes led to disorganized TLOs, however there was no impact in disease incidence [56]. Further research is required to better understand the potential of TLOs as therapeutic targets.

6.4 Conclusions

TLOs are formed during chronic inflammation, and have been found in several clinical conditions, including autoimmunity, cancer and chronic transplant rejection. TLOs are organized structures similar to SLOs, and the mechanisms behind their formation are also thought similar to those involved in SLO development. For instance, $LT\beta R$ plays a crucial role as well as chemokines. TLO functions can be helpful to the host providing a localized immune response in the case of infectious diseases, but can also represent harm and lead to autoimmunity, poor disease outcome and chronic transplant rejections.

Due to its similarities with SLOs, and knowing the involvement of RANKL during development, homeostasis and immune response in SLOs, it would be of great interest to study the RANKL function in TLO induction and/or maintenance. This question has been addressed during my thesis.

6.5 Bibliography

1. Drayton, D.L., et al., *Lymphoid organ development: from ontogeny to neogenesis*. Nat. Immunol., 2006. **7**(4): p. 344-53.
2. Aloisi, F. and R. Pujol-Borrell, *Lymphoid neogenesis in chronic inflammatory diseases*. Nat Rev Immunol., 2006. **6**(3): p. 205-17.
3. Stranford, S. and N.H. Ruddle, *Follicular dendritic cells, conduits, lymphatic vessels, and high endothelial venules in tertiary lymphoid organs: Parallels with lymph node stroma*. Front Immunol, 2012. **3**: p. 350.
4. Link, A., et al., *Association of T-zone reticular networks and conduits with ectopic lymphoid tissues in mice and humans*. Am J Pathol, 2011. **178**(4): p. 1662-75.
5. Penaranda, C., et al., *Prevention of diabetes by FTY720-mediated stabilization of peri-islet tertiary lymphoid organs*. Diabetes, 2010. **59**(6): p. 1461-8.
6. Mandache, E. and M. Penescu, *Renal subcapsular tertiary lymphoid aggregates in chronic kidney diseases*. Rom J Morphol Embryol, 2011. **52**(4): p. 1219-25.
7. Braun, A., et al., *Afferent lymph-derived T cells and DCs use different chemokine receptor CCR7-dependent routes for entry into the lymph node and intranodal migration*. Nat Immunol, 2011. **12**(9): p. 879-87.
8. Ruddle, N.H., *Lymphatic vessels and tertiary lymphoid organs*. J Clin Invest, 2014. **124**(3): p. 953-9.
9. Grabner, R., et al., *Lymphotoxin beta receptor signaling promotes tertiary lymphoid organogenesis in the aorta adventitia of aged ApoE^{-/-} mice*. J Exp Med, 2009. **206**(1): p. 233-48.
10. Cipponi, A., et al., *Neogenesis of lymphoid structures and antibody responses occur in human melanoma metastases*. Cancer Res, 2012. **72**(16): p. 3997-4007.
11. Bergomas, F., et al., *Tertiary intratumor lymphoid tissue in colo-rectal cancer*. Cancers (Basel), 2011. **4**(1): p. 1-10.
12. Yeaman, G.R., et al., *Unique CD8⁺ T cell-rich lymphoid aggregates in human uterine endometrium*. J Leukoc Biol, 1997. **61**(4): p. 427-35.
13. Drayton, D.L., et al., *Ectopic LT alpha beta directs lymphoid organ neogenesis with concomitant expression of peripheral node addressin and a HEV-restricted sulfotransferase*. J Exp Med, 2003. **197**(9): p. 1153-63.
14. Kratz, A., et al., *Chronic inflammation caused by lymphotoxin is lymphoid neogenesis*. J. Exp. Med., 1996. **183**(4): p. 1461-72.
15. Hjelmstrom, P., et al., *Lymphoid tissue homing chemokines are expressed in chronic inflammation*. Am J Pathol, 2000. **156**(4): p. 1133-8.
16. Schroder, A.E., et al., *Differentiation of B cells in the nonlymphoid tissue of the synovial membrane of patients with rheumatoid arthritis*. Proc Natl Acad Sci U S A, 1996. **93**(1): p. 221-5.
17. McMahan, E.J., et al., *Epitope spreading initiates in the CNS in two mouse models of multiple sclerosis*. Nat Med, 2005. **11**(3): p. 335-9.
18. Kuerten, S., et al., *Tertiary lymphoid organ development coincides with determinant spreading of the myelin-specific T cell response*. Acta Neuropathol, 2012. **124**(6): p. 861-73.
19. Haybaeck, J., et al., *A lymphotoxin-driven pathway to hepatocellular carcinoma*. Cancer Cell, 2009. **16**(4): p. 295-308.

20. Seleznik, G.M., et al., *Lymphotoxin beta receptor signaling promotes development of autoimmune pancreatitis*. *Gastroenterology*, 2012. **143**(5): p. 1361-74.
21. Luther, S.A., K.M. Ansel, and J.G. Cyster, *Overlapping roles of CXCL13, interleukin 7 receptor alpha, and CCR7 ligands in lymph node development*. *J Exp Med*, 2003. **197**(9): p. 1191-8.
22. Moyron-Quiroz, J.E., et al., *Role of inducible bronchus associated lymphoid tissue (iBALT) in respiratory immunity*. *Nat Med*, 2004. **10**(9): p. 927-34.
23. Moyron-Quiroz, J.E., et al., *Persistence and responsiveness of immunologic memory in the absence of secondary lymphoid organs*. *Immunity*, 2006. **25**(4): p. 643-54.
24. Neyt, K., et al., *Tertiary lymphoid organs in infection and autoimmunity*. *Trends Immunol*, 2012. **33**(6): p. 297-305.
25. Luther, S.A., et al., *BLC expression in pancreatic islets causes B cell recruitment and lymphotoxin-dependent lymphoid neogenesis*. *Immunity*, 2000. **12**(5): p. 471-81.
26. Browning, J.L., *Inhibition of the lymphotoxin pathway as a therapy for autoimmune disease*. *Immunol Rev*, 2008. **223**: p. 202-20.
27. Gatumu, M.K., et al., *Blockade of lymphotoxin-beta receptor signaling reduces aspects of Sjogren's syndrome in salivary glands of non-obese diabetic mice*. *Arthritis Res Ther*, 2009. **11**(1): p. R24.
28. Fava, R.A., et al., *Lymphotoxin-beta receptor blockade reduces CXCL13 in lacrimal glands and improves corneal integrity in the NOD model of Sjogren's syndrome*. *Arthritis Res Ther*, 2011. **13**(6): p. R182.
29. McDonald, K.G., J.S. McDonough, and R.D. Newberry, *Adaptive immune responses are dispensable for isolated lymphoid follicle formation: antigen-naive, lymphotoxin-sufficient B lymphocytes drive the formation of mature isolated lymphoid follicles*. *J Immunol*, 2005. **174**(9): p. 5720-8.
30. Marinkovic, T., et al., *Interaction of mature CD3+CD4+ T cells with dendritic cells triggers the development of tertiary lymphoid structures in the thyroid*. *J Clin Invest*, 2006. **116**(10): p. 2622-32.
31. Rangel-Moreno, J., et al., *The development of inducible bronchus-associated lymphoid tissue depends on IL-17*. *Nat Immunol*, 2011. **12**(7): p. 639-46.
32. Peters, A., et al., *Th17 cells induce ectopic lymphoid follicles in central nervous system tissue inflammation*. *Immunity*, 2011. **35**(6): p. 986-96.
33. Grogan, J.L. and W. Ouyang, *A role for Th17 cells in the regulation of tertiary lymphoid follicles*. *Eur J Immunol*, 2012. **42**(9): p. 2255-62.
34. Lee, Y., et al., *Recruitment and activation of naive T cells in the islets by lymphotoxin beta receptor-dependent tertiary lymphoid structure*. *Immunity*, 2006. **25**(3): p. 499-509.
35. GeurtsvanKessel, C.H., et al., *Dendritic cells are crucial for maintenance of tertiary lymphoid structures in the lung of influenza virus-infected mice*. *J Exp Med*, 2009. **206**(11): p. 2339-49.
36. van Rijt, L.S., et al., *Persistent activation of dendritic cells after resolution of allergic airway inflammation breaks tolerance to inhaled allergens in mice*. *Am J Respir Crit Care Med*, 2011. **184**(3): p. 303-11.
37. Chen, S.C., et al., *Ectopic expression of the murine chemokines CCL21a and CCL21b induces the formation of lymph node-like structures in pancreas, but not skin, of transgenic mice*. *J Immunol*, 2002. **168**(3): p. 1001-8.

38. Rangel-Moreno, J., et al., *Pulmonary expression of CXC chemokine ligand 13, CC chemokine ligand 19, and CC chemokine ligand 21 is essential for local immunity to influenza*. Proc Natl Acad Sci U S A, 2007. **104**(25): p. 10577-82.
39. Wengner, A.M., et al., *CXCR5- and CCR7-dependent lymphoid neogenesis in a murine model of chronic antigen-induced arthritis*. Arthritis Rheum, 2007. **56**(10): p. 3271-83.
40. Winter, S., et al., *The chemokine receptor CXCR5 is pivotal for ectopic mucosa-associated lymphoid tissue neogenesis in chronic Helicobacter pylori-induced inflammation*. J Mol Med (Berl), 2010. **88**(11): p. 1169-80.
41. Timmer, T.C., et al., *Inflammation and ectopic lymphoid structures in rheumatoid arthritis synovial tissues dissected by genomics technology: identification of the interleukin-7 signaling pathway in tissues with lymphoid neogenesis*. Arthritis Rheum, 2007. **56**(8): p. 2492-502.
42. Perros, F., et al., *Pulmonary lymphoid neogenesis in idiopathic pulmonary arterial hypertension*. Am J Respir Crit Care Med, 2012. **185**(3): p. 311-21.
43. Link, A., et al., *Fibroblastic reticular cells in lymph nodes regulate the homeostasis of naive T cells*. Nat. Immunol., 2007. **8**(11): p. 1255-65.
44. Peduto, L., et al., *Inflammation recapitulates the ontogeny of lymphoid stromal cells*. J Immunol, 2009. **182**(9): p. 5789-99.
45. Lotzer, K., et al., *Mouse aorta smooth muscle cells differentiate into lymphoid tissue organizer-like cells on combined tumor necrosis factor receptor-1/lymphotoxin beta-receptor NF-kappaB signaling*. Arterioscler Thromb Vasc Biol, 2010. **30**(3): p. 395-402.
46. Hogg, J.C., et al., *The nature of small-airway obstruction in chronic obstructive pulmonary disease*. N Engl J Med, 2004. **350**(26): p. 2645-53.
47. Marchal-Somme, J., et al., *Dendritic cells accumulate in human fibrotic interstitial lung disease*. Am J Respir Crit Care Med, 2007. **176**(10): p. 1007-14.
48. Cupedo, T., et al., *Induction of secondary and tertiary lymphoid structures in the skin*. Immunity, 2004. **21**(5): p. 655-67.
49. Halle, S., et al., *Induced bronchus-associated lymphoid tissue serves as a general priming site for T cells and is maintained by dendritic cells*. J Exp Med, 2009. **206**(12): p. 2593-601.
50. Astorri, E., et al., *Evolution of ectopic lymphoid neogenesis and in situ autoantibody production in autoimmune nonobese diabetic mice: cellular and molecular characterization of tertiary lymphoid structures in pancreatic islets*. J. Immunol., 2010. **185**(6): p. 3359-68.
51. Magliozzi, R., et al., *Meningeal B-cell follicles in secondary progressive multiple sclerosis associate with early onset of disease and severe cortical pathology*. Brain, 2007. **130**(Pt 4): p. 1089-104.
52. Nasr, I.W., et al., *Tertiary lymphoid tissues generate effector and memory T cells that lead to allograft rejection*. Am J Transplant, 2007. **7**(5): p. 1071-9.
53. Rangel-Moreno, J., et al., *Inducible bronchus-associated lymphoid tissue (iBALT) in patients with pulmonary complications of rheumatoid arthritis*. J Clin Invest, 2006. **116**(12): p. 3183-94.
54. Chiavolini, D., et al., *Bronchus-associated lymphoid tissue (BALT) and survival in a vaccine mouse model of tularemia*. PLoS One, 2010. **5**(6): p. e11156.
55. Wiley, J.A., et al., *Inducible bronchus-associated lymphoid tissue elicited by a protein cage nanoparticle enhances protection in mice against diverse respiratory viruses*. PLoS One, 2009. **4**(9): p. e7142.

56. Henry, R.A. and P.L. Kendall, *CXCL13 blockade disrupts B lymphocyte organization in tertiary lymphoid structures without altering B cell receptor bias or preventing diabetes in nonobese diabetic mice*. J Immunol, 2010. **185**(3): p. 1460-5.



Results



1 Distinct and overlapping roles of RANKL and lymphotoxin in the regulation of CD169+ lymph node macrophages

1.1 Introduction

RANKL, expressed by bone-residing mesenchymal cells, is known for its role in the differentiation of osteoclasts, specialized bone resorbing macrophages. Moreover, RANKL is also involved in the immune system, being required for lymph node development. However, its function in regulating other macrophage subsets, for example the lymph node residing macrophages, has not been addressed. During my PhD we aimed to address this question and unveil the impact of RANKL on the CD169⁺ lymph node macrophages. Using a murine model, conditionally deficient for stromal RANKL, we were able to show that RANKL has an impact on CD169⁺ lymph node macrophages leading to reduced antigen transport to B cells and reduced permissivity to VSV infection. Furthermore, in view of RANKL requirement on LN development, a role on TLO development would be expectable, therefore we used a RANKL neutralizing antibody in a Sjögren Syndrome model, and confirmed RANKL importance on TLO formation.

1.2 Article 1

Distinct and overlapping roles of RANKL and lymphotoxin in the regulation of CD169+ lymph node macrophages

Olga Cordeiro, Saba Nayar, Mohamed Habbeddine, Farouk Alloush, Mélanie Chypre, Dominik Vonficht, Monique Duval, Burkhard Ludewig, Toby Lawrence, Christopher Buckley, Francesca Barone, Christopher G. Mueller

Distinct and overlapping roles of RANKL and lymphotoxin in the regulation of CD169+ lymph node macrophages

Olga Cordeiro¹, Saba Nayar³, Mohamed Habbeddine⁴, Farouk Alloush¹, Mélanie Chypre^{1,2}, Dominik Vonficht¹, Monique Duval¹, Burkhard Ludewig⁵, Toby Lawrence⁴, Christopher Buckley³, Francesca Barone³, Christopher G. Mueller^{1,6}

¹ CNRS UPR 3572, Laboratory of Immunopathology and Therapeutic Chemistry / Laboratory of Excellence MEDALIS, Institut de Biologie Moléculaire et Cellulaire, Université de Strasbourg, Strasbourg, France

² Prestwick Chemical, **Blvd Gonthier d'Andernach, Parc d'innovation, 67400 Illkirch, France**

⁶ Corresponding author: Tel: +33 (0)3 88 41 71 14, Fax. +33 (0)3 88 61 06 80

c.mueller@ibmc-cnrs.unistra.fr

Abstract

The TNF superfamily member RANKL functions in osteoclastogenesis. However, whether it also plays a role in the differentiation of other macrophage subsets is not known. We addressed this question by conditionally deleting RANKL from marginal reticular stromal cells that constitutively express RANKL in the lymph node (LN). We observed impaired differentiation of both the subcapsular sinus macrophages (SSMs) and the medullary sinus macrophages. As a consequence, antigen transport to B cells and viral infection was reduced. Moreover, there was a reduced expression of CXCL13 by marginal reticular cells, compromised formation of follicular dendritic cells and fewer B cells leading to lower lymphotoxin- β mRNA expression. In the absence of RANK expression by the CD169⁺ macrophages, and in light of the sensitivity of SSMs to lymphotoxin- β , this suggests that RANKL regulates SSMs by altering B cell homeostasis and lymphotoxin production. Penetrance of the phenotypes occurs postnatally, showing that RANKL regulates LN integrity in the adult but not in the embryo. Because RANKL is under female sex hormonal control, it was neutralized in a model of Sjögren syndrome, an inflammatory disease with a strong female bias. It resulted in diminished lymphoid tissue formation. Thus, RANKL shares with lymphotoxin- β the regulation of B cell homeostasis and SSM differentiation but distinguishes itself for its action on medullary sinus macrophages. These functions make RANKL a potential target in the treatment of inflammatory diseases characterized by ectopic lymphoid structures. (232)

Introduction

Sinuses of lymph nodes (LNs) and spleen in mouse and human are lined by macrophages that play an important role in the initiation and regulation of innate and adaptive immunity. The CD169⁺ subcapsular sinus macrophages (SSMs), localized between the B cell follicles and the floor subcapsular lymphatic endothelial cells constitute an early target cell for pathogen replication and a key player for a rapid innate immune defense (Coombes et al., 2012; Garcia et al., 2012; Iannacone et al., 2010; Moseman et al., 2012). SSMs also capture non-infectious antigen, otherwise too large to drain through the conduit system into the organ (Carrasco and Batista, 2007; Moalli et al., 2015; Phan et al., 2007). Their position together with their lower lysosomal enzymatic activity, favors antigen relay to activate B cells and subsequent transfer of native antigen to the stromal follicular dendritic cells (FDCs) for germinal center formation and memory (Phan et al., 2007). The CD169⁺ medullary sinus macrophages (MSMs) are associated with the medullary lymphatics that collect lymph before its exit through efferent lymphatics. MSMs also capture viral pathogens (Gonzalez et al., 2010; Moseman et al., 2012) but are more mature macrophages as indicated by expression of the F4/80 and SIGN-R1 markers and by their active proteolytic machinery (Phan et al., 2009). Thus, while MSMs are also equipped to recognize pathogens they are likely to be more active in their elimination.

The SSMs and possibly also MSMs require CSF-1 (Wiktor-Jedrzejczak and Gordon, 1996). In addition, and similar to the splenic CD169⁺ macrophages (Tumanov et al., 2002), SSM differentiation is regulated by lymphotoxin $\alpha\beta$ (LT) produced by B cells. LT-deficient B cells or LTR blocking leads to their conversion into macrophages with MSM phenotype (Moseman et al., 2012; Phan et al., 2009). Although MSMs appear to express LT β R, the impact of LT signal depletion is limited (Moseman et al., 2012; Phan et al., 2009), and the identity of the molecular signals that regulate MSM differentiation is unclear.

The TNFSF member RANKL (TNFSF11) is required for the formation of osteoclasts, specialized bone-resorbing macrophages, by activating the signaling receptor RANK (Receptor activator of NF- κ B, TNFRSR11a) (Dougall et al., 1999; Kong et al., 1999; Walsh and Choi, 2014). The Langerhans-type dendritic cells are also under RANKL regulatory control, as their number decreases in mice lacking RANKL (Barbaroux et al., 2008). Mature

dendritic cells also carry the receptor, yet, so far no function for RANKL in dendritic cell biology has been defined *in vivo* (Dougall et al., 1999; Kong et al., 1999).

RANKL shares with LT and TNF α , yet without complete overlap, the control over secondary lymphoid organogenesis (Dougall et al., 1999; Kong et al., 1999; Mueller and Hess, 2012). Mice deficient in RANKL or RANK lack LNs and have smaller Peyer's patches (Dougall et al., 1999; Kong et al., 1999). Critical for the formation of lymphoid organs is the interaction between the hematopoietic lymphoid tissue inducer (LTi) cells and the stromal lymphoid tissue organizers (LTOs) (Mebius, 2003). LTi cells activate LTOs through LT β receptor (R) leading to expression of RANKL. RANK is carried by LTi cells and because RANK stimulates expression of LT, an amplification loop may arise to ensure lymphoid organ formation (Roosendaal and Mebius, 2011; Yoshida et al., 2002). In adult secondary lymphoid organs RANKL is constitutively expressed by the marginal zone reticular cells (MRCs) (Katakai et al., 2008). This, together with other markers such as MAdCAM-1 and the ability of MRC-like cell lines to produce CXCL13 indicated that MRC constitute the adult counterpart of LTOs (Katakai, 2012). While there is evidence that MRCs function as precursors for FDCs (Jarjour et al., 2014), the role of RANKL produced by MRCs remains unexplored.

Despite the lack of LNs in RANKL-deficient mice that hampers the investigation into its role for the immune system, there is support for the idea that RANKL imprints on B cell homeostasis. Cryptopatches of *Rankl*^{-/-} mice are devoid of B cells and lack CXCL13 expression (Knoop et al., 2011), and RANKL overexpression or the deficiency for soluble RANKL decoy receptor osteoprotegerin (OPG) results in increased B cell numbers (Hess et al., 2012; Yun et al., 2001). Because B cell-specific RANK knock out mice do not phenocopy these changes (Perlot and Penninger, 2012), RANKL is likely to regulate B cell homeostasis indirectly.

In the light of the dual impact of RANKL on the myeloid lineage and on lymphoid organs, we asked whether these two elements are united in the regulation of LN macrophages. Using a conditional knock-out of RANKL in MRCs, we show that RANKL regulates both SSMs and MSMs. Antigen transfer to B cells and viral infection are compromised. The shared activity of LT and RANKL is demonstrated by cooperativity in the differentiation of SSMs, while RANKL solely affects MSMs. Neither macrophage subsets express RANK, and the control over SSMs likely occurs via the regulation of B cell homeostatic mechanisms

implicating the expression of CXCL13 by MRCs and the formation of the FDC network. The impact of stromal RANKL deficiency on LN macrophages occurs in the adult suggesting that the decline in LT and/or TNF α levels allow RANKL to surpass redundancy with the other TNFSF members. RANKL neutralization reduces tertiary lymphoid organ formation illustrating a therapeutic interest in RANKL for the treatment of chronic inflammatory diseases.

Material and Methods

Mice

C57BL/6 (Charles River Laboratories France), RANKL^{-/-} (Kim et al., 2000), Ly5.1 (CD45.1) and RANKL ^{Δ Ccl19} were bred and kept in specific pathogen-free conditions. All experiments were carried out in conformity with the animal bioethics legislation and institutional guidelines. To generate mice with conditional RANKL deficiency in marginal reticular cells (RANKL ^{Δ Ccl19}), mice containing a single copy of the *Ccl19-cre* BAC transgene (Chai et al., 2013) were crossed with RANKL^{*fl/fl*} (B6.129-Tnfsf11tm1.1Caob/J) mice (Xiong et al., 2011). Unless otherwise indicated all mice were 8 weeks old. To inhibit LT β R mice received 20 μ g of LT β R-mulgG1 or its isotype control MOPC-21 isotype (kindly provided by Biogen, Cambridge, MA, USA) i.v. twice a week for 4 weeks. *In vivo* generation of immune complexes was performed as described (Phan et al., 2009). In brief, mice were injected i.p. with 2 mg rabbit IgG anti-PE (Rocklands) 12-16 h before s.c. administration of 10 μ g PE (Invitrogen Molecular Probes) into hind legs to drain into the inguinal and popliteal LNs. Mice were sacrificed 8 h later. For VSV infection, mice received subcutaneously at the base of the tail 10⁷ pfu of VSV-eGFP (Iannacone et al., 2010). Twelve hours later, skin draining inguinal LNs were harvested and fixed for 4 h in Antigenfix (DiaPath, MM France), washed in PBS for one hour, dehydrated in 30 % sucrose overnight at 4°C, and then embedded in OCT freezing media (Tissue-Tek). VSV-eGFP were propagated at a multiplicity of infection of 0.01 on BHK cells, purified and infectivity of VSV preparation was quantified by plaque assay on BHK cells as described (Junt et al., 2007).

Isolation and analysis of LN cells

Stromal cells (MRCs) from peripheral LNs were prepared as published (Fletcher et al., 2011; Link et al., 2007). LN macrophages were isolated following the same protocol as for stromal cells omitting the CD45⁺ cell depletion step. Lymphocytes were isolated by crushing the LN in PBS with a glass pestle and mortar followed by filtering the cells through a 40 µm cell strainer (BD Biosciences).

Salivary gland cannulation.

Under ketamine/ domitor anaesthesia, the submandibular glands of female C57BL/6 (8-12 weeks old) were intraductally cannulated with 10⁸-10⁹ p.f.u. of luciferase-encoding replication-defective adenovirus (Ad5) to induce formation of tertiary lymphoid organs (TLOs), as previously described (Barone et al., 2015). A group of mice were administered via subcutaneous injections 50 µg of either anti-RANKL (IK22-5) antibody or control Ig2a isotype antibody prophylactically (i.e. day 0) and then subsequent injections were done every two days until mice were culled by terminal anesthesia at various time points (day 2, 5 and 15) post cannulation to harvest salivary glands. The salivary glands were processed for FACS or immunofluorescence analysis, as described (Barone et al., 2015).

Flow cytometry and immunofluorescence

Primary and secondary antibodies used are listed in Supplemental Table. Flow cytometry was performed on a Gallios (Beckman-Coulter) and analyzed with FlowJo software (Treestar). Eight µm LN and spleen sections were cut on a cryostat (Leica), fixed in cold acetone and blocked with 2% BSA. After immunolabelling, sections were mounted in Fluomount (Dako) and images acquired on a spinning disk inverted microscope (Carl Zeiss) with a confocal head (Yokogawa CSU) and the appropriate software (Metamorph). Images were analyzed using the open source imageJ software.

Quantitative reverse transcription coupled polymerase chain reaction (qRT-PCR)

RNA from total LNs was extracted using the RNeasy kit (Qiagen) and cDNA was synthesized with Maxima First Strand cDNA Synthesis Kit (Thermo Scientific) and Improm-II (Promega) using oligo(dT)15 primers. RT-PCR was performed using Luminaris color HiGreen qPCR Master Mix (Thermo Scientific) using the following primers to amplify

CXCL13 (Forward 5'- GTATTCTGGAAGCCCATTACAC and Reverse 5' - CATTGGCAGGAGGATTCACAC), LT β (Forward 5' - CTGCCACCTCATAGGCGC and Reverse 5' - CGTCCTGCCCTGTACC) and GAPDH (Forward 5'-TGACGTGCCGCCTGGAGAAA and Reverse 5'-AGTGTAGCCCAAGATGCCCTTCAG). Quantitative RT-PCR was run on a Bio-Rad CFX96 thermal cycler, and threshold values (Ct) of the target genes (X) were normalized to GAPDH (Δ Ct = CtX – CtGAPDH). The relative quantification was performed as $2^{-\Delta$ Ct.

Statistical analysis

Unpaired two-tailed Student t-test and Mann Whitney were used on GraphPad Prism version 5 for Windows (GraphPad software). The p values <0.05 were considered statistically significant.

Results

RANKL regulates CD169⁺ macrophage differentiation in spleen and lymph node

It has previously been reported that the spleen of RANK-deficient mice displays reduced labelling by the Moma-1 monoclonal antibody that recognizes the CD169 antigen of marginal metallophilic macrophages (MMMs) (Dougall et al., 1999). We therefore examined the spleen of *Rankl*^{-/-} mice for the expression of CD169 as well as SIGNR1, a marker of the closely related marginal zone macrophages (MZMs). Although the periarteriolar lymphoid sheaths (PALS) were smaller, likely owing to reduced bone marrow hematopoiesis (Dougall et al., 1999; Kong et al., 1999), B and T cell zones were present and normally separated. Yet, there was a reduction in CD169 expression while the expression of SIGN-R1 was normal (Fig. 1A). To extend this finding to LNs, we generated mice with a conditional *Rankl* knock-out under control of the CCL19 promoter (Chai et al., 2013), because unconditional RANKL-knock out mice lack LNs and bear defects in Peyer's patches (Kong et al., 1999). CCL19 is active in LTOs that give rise to the lymphoid stromal compartment including the MRCs that are the main constitutive source of RANKL in the adult (Benezech et al., 2011; Katakai et al., 2008). RANKL ^{Δ CCL19} mice developed LNs and had normal-sized splenic PALS and Peyer's patches. Immunolabelling for RANKL in the inguinal LNs revealed a strong reduction in embryo (**Fig. S1A**) and a complete absence in

the adult (**Fig. S1B**). RANKL expression was not disturbed in mesenteric LNs or in Peyer's patches (**Fig. S1C, D**), probably due to incomplete penetrance of the *cre* transgene in these organs, as indicated by the presence of eYFP⁻ stroma in Peyer's patches of *CCL19 cre x ROSA26 eYFP* fate mapping mice (Chai et al., 2013). In the inguinal LN of RANKL^{ΔCCL19} mice there was a clear reduction in the expression of CD169, both in the subcapsular and in the medullary sinus (**Fig. 1B**). Furthermore, the mannose receptor ligand (MR-L) carried by the SSMs (Linehan et al., 1999) was lost (**Fig. 1C**). We then assessed the reduction of SSMs and MSMs by flow cytometry, using a previously established cell gating strategy (Phan et al., 2009). There was a 2-fold reduction in the SSM population and a significant drop in MSMs (**Fig. 1D**). The expression of MR-L was also strongly diminished (**Fig. 1D**). We next probed for the functional consequences by determining the relay of immune complexes to B cells. Passive immunization with phycoerythrin (PE)-specific antibodies followed by subcutaneous administration of PE led to the capture of PE-labeled immune complexes by B cells via SSMs (Phan et al., 2007). However, fewer B cells captured the fluorochrome in RANKL^{ΔCCL19} mice (**Fig. 1E**). SSMs have also been implicated in early viral infection by acting as an infectious cell target (Iannacone et al., 2010; Junt et al., 2007; Moseman et al., 2012). Therefore, we determined the consequences of stromal RANKL deficiency for infection of GFP-encoding VSV and observed greatly reduced GFP foci in the LNs of the mutant animals (**Fig. 1F**). Taken together, normal LN function in response to immune complex formation or viral infection is dependent on stromal RANKL by regulating SSM and MSM differentiation.

LT-distinct and overlapping control of LN macrophage populations by RANKL

It has previously been shown that SSMs are sensitive to B cell-produced LT (Moseman et al., 2012; Phan et al., 2009). Therefore, we first assessed the impact of LTβR inhibition on the two CD169⁺ LN macrophage subsets in inguinal LNs. Mice received soluble LTβR-Ig and the differentiation of SSMs and MSMs was assessed by flow cytometry, using the same identification procedure as before. Inhibition of LTβR signalling resulted in a pronounced defect in the differentiation of CD169⁺ MRL⁺ SSMs, however, it had no impact on MSMs (**Fig. 2A**). To assess more precisely RANKL-LT overlapping and RANKL-distinct activities, we

assessed SSM and MSM formation in RANKL^{ΔCCL19} and control mice, treated or not with LTβR-Ig in inguinal, axillary and brachial LNs (**Fig. 2B**). In axillary LNs the loss of LTβR or RANK signalling led to an equally strong reduction in SSMs, while in brachial and in inguinal LNs the effect of LTβ block was marginally superior. As can be expected from a shared activity, a cooperative effect of RANKL-deficiency and LTβ block was seen in all three LNs. The abrogation of LTβR signalling did not result in a loss of MSMs, rather, in axillary and brachial LNs, there was even an accumulation of this population. In agreement with a LT-distinct function, RANKL deficiency led to a reduction in MSMs in WT mice and in mice treated with LTβR-Ig. Therefore, RANKL operates independently of LT to regulate MSM differentiation.

Stromal RANKL dually controls SSM differentiation and B cell homeostasis

To understand the mechanisms underlying the regulation of SSMs and MSMs by stromal RANKL, we asked whether the cells expressed RANK. To this end, we used two monoclonal antibodies validated for its high specificity and affinity (Kamijo et al., 2006) (manuscript in preparation), but found none on either macrophage types (**Fig. S2A**). The absence of RANK is supported by a transcriptome analysis of SSMs and MSMs that detected negligible amounts of *Rank* mRNA (Phan et al., 2009). In view of the shared impact of LT and RANKL on SSMs, we asked whether RANKL could exert its regulatory activity on LN macrophages indirectly, by controlling B cell numbers and LT production. We therefore determined the numbers of B cells in inguinal LNs of WT and RANKL^{ΔCCL19} mice and found reduced proportions of B cells but, reciprocally, increased percentages of T cells (**Fig. 3A**). Immunolabelling of section showed that B cell follicles were smaller and less clearly segregated from the T cell zone (**Fig. 3D**). We can rule out an impaired B cell development, because all the splenic subsets were present (**Fig. S2B**), and Peyer's patches and mesenteric LNs where stromal RANKL was not silenced displayed normal B cell numbers (**Fig. S2C**). We therefore investigated the presence of FDCs by labelling sections for the FDC marker CR1/CD35. Expression of CD35 was almost undetectable in the RANKL-deficient mice (**Fig. 3C**). This is confirmed by absent MR-L expression in the B cell follicles of knock-out mice (**Fig. 1C**). Moreover, CXCL13, likewise synthesized by FDCs, was strongly

reduced, both on the protein and mRNA level (**Fig. 3C,D**). CXCL13 was not only greatly diminished in FDCs but also in MRCs, a B cell associated stromal cell of the marginal zone (Katakai et al., 2008; Roozendaal and Mebius, 2011). Reduced B cell numbers and CXCL13 would imply a downregulation of LT production (Ansel et al., 2000). However, surface LT expression by B cells, as detected by LT β R-Ig, was low and unchanged between mutant and control mice, probably owing to the low sensitivity of the reagent (Luther et al., 2002) (data not shown). However, there was a markedly diminished *LT β* transcriptional activity in the RANKL-deficient LNs (**Fig. 3D**). The loss of CXCL13 from MRCs suggested that RANKL either regulates MRC differentiation, which may subsequently affect FDC formation (Jarjour et al., 2014), or that CXCL13 expression is RANKL sensitive. We therefore determined the presence of MRCs by FACS by labelling the gp38⁺ stromal cells for expression of MAdCAM-1 and VCAM-1. This strategy to visualize MRCs in the absence of RANKL as marker showed no difference between mutant and control mice (**Fig. S2D**). We interpret these data as indicating that RANKL positively regulates B cell numbers through CXCL13 production by MRCs and FDCs, which in turn activates LT expression to stimulate SSM differentiation.

Stromal RANKL operates postnatally

We next explored the possibility that altered B cell homeostasis had its origin in LN development. It has been shown that RANKL induces LT production by LT_i cells (Yoshida et al., 2002), which in turn activates RANKL expression by LTOs (Vondenhoff et al., 2009). This suggests the setup of a positive feedback loop in development to assure a high and continuous LT production by LT_i cells. Since LT is required for CXCL13 synthesis and FDC differentiation (Allen et al., 2008; Ansel et al., 2000; Endres et al., 1999; Huber et al., 2005), it is possible that the impact of RANKL on B cells occurs during LN development. To address this question, we determined the expression of LT by LT_is in LNs of newborn RANKL ^{Δ CC19} and control mice, a stage in development when B cells are recruited to form primary lymphoid follicles (Cupedo et al., 2004). We found that LT_i cells were present in normal numbers (**Fig. 4A**) and that the expression surface LT was unchanged (**Fig. 4B**). We next assessed the production of LT functionally, by measuring the replacement of α 4 β 7⁺

cells by L-selectin⁺ cells, since a critical role of LT in the postnatal LN is the maturation of blood vessels by replacing the $\alpha 4\beta 7^+$ ligand MAdCAM-1 with peripheral node addressins to allow the entry of L-selectin⁺ lymphocytes (Berlin et al., 1993; Mebius et al., 1996). This analysis revealed no difference in the ratio of $\alpha 4\beta 7^+$ versus L-selectin⁺ lymphocytes (**Fig. 4C**). Thus, we found no evidence of an early impact of stromal RANKL on LT production.

Intriguingly, RANKL neutralization has an impact on neonatal B cell follicle formation when injected at E13.5 but not post E16.5 (Sugiyama et al., 2012). Yet, mice deficient for LT α show a phenotype post E16.5 but not at E13.5 (Rennert et al., 1996; Vondenhoff et al., 2009; White et al., 2007), suggesting that RANKL and LT are redundant for LN ontogeny. Because stromal RANKL is expressed post E16.5 (Sugiyama et al., 2012), it was therefore reasonable to assume that stromal RANKL may affect LN homeostasis only after LN development. Therefore, we assessed B cell loss, and CD169⁺ macrophage differentiation in RANKL-deficient neonatal and juvenile mice. In neonatal LNs, the B/T cell ratio and the presence of CD169⁺ macrophages was normal (**Fig. 4D**). At three weeks of age, there was a slight but not yet statistically significant change in B/T cell proportions but CD169⁺ expression were already reduced (**Fig. 4E**). At 8 weeks, as shown previously the B/T cell proportion was significantly different and SSM and MSM differentiation was impaired. Thus, the data show that stromal RANKL is dispensable for LN development but plays a functionally important role postnatally.

RANKL neutralization reduces tertiary lymphoid tissue formation

In light of LT-RANKL overlapping activities in secondary lymph node organogenesis, B cell homeostasis and macrophage differentiation, we investigated whether RANKL neutralization would limit tertiary lymphoid tissue formation. Such ectopic lymphoid structures occur in adult mice in response to chronic inflammation leading to autoimmune affectations, such as Sjögren's syndrome. To this end, we used a model of Sjögren's syndrome characterized by tertiary lymphoid tissue formation in salivary and lacrimal glands induced by the retrograde cannulation of replication-deficient adenovirus (Barone et al., 2015; Bombardieri et al., 2012). Sjögren's syndrome mostly affects post-menopausal women, a condition characterized by changes in RANKL/OPG levels (Nagy and Penninger,

2015). At the onset of tertiary lymphoid organ induction, mice received the RANKL-neutralizing antibody IK22-5 (Kamijo et al., 2006) or its isotype control. At different times, lymphocyte infiltration and the development of the lymphoid stromal compartment was characterized. We found that RANKL neutralization significantly reduced tertiary lymphoid tissue size, affecting equally T and B cells (**Fig. 5A**). The accumulation of CD45⁺ hematopoietic cells was significantly diminished at early and late time points (**Fig. 5B**), and the formation of lymphoid tissue stromal cells was significantly reduced at 2 and 5 days post cannulation (**Fig. 5C**). Therefore, RANKL supports tertiary lymphoid tissue formation in a model of Sjögren's syndrome. These data suggest that through its action on lymphoid tissue stroma and macrophages, RANKL may make a therapeutic target to treat tertiary lymphoid structures arising in chronically inflamed tissues.

Discussion

Here we have shown that stromal RANKL is required for the maintenance of both the subcapsular and the medullary sinus macrophages. Moreover, we found that deficiency in stromal RANKL leads to disturbed B cell homeostasis attributed to reduction in CXCL13 production and in FDC formation. This results in lower LT β production, which negatively affects SSM differentiation. These alterations are apparent only in the adult suggesting that stromal RANKL is part of safeguard mechanisms to assure LN integrity when the levels of redundant TNFSF members fall. The data also support RANKL-neutralization as treatment of tertiary lymphoid tissue.

In the LN, RANKL is constitutively expressed by MRCs and by activated T cells during an immune response (Anderson et al., 1997; Katakai et al., 2008). To assess the role of RANKL in the resting LN we silenced its expression in the embryonic LTOs that give rise to adult stromal subsets, inclusive the MRCs. We observed a reduction in CD169⁺ macrophages and B cells concomitant with disruption of primary B cell follicle formation. SSMs capture antigen in the form of particulate antigen, virus or dead cells, and present it to the B cells that lie underneath (Carrasco and Batista, 2007; Moalli et al., 2015; Phan et al., 2007). They also act as an early infectious target cells for virus and other pathogens (Coombes et al., 2012; Garcia et al., 2012; Iannacone et al., 2010; Moseman et al., 2012).

Thus, mice with stromal RANKL deficiency display lower B cell uptake of immune complexes and impaired VSV replication. The function of MSMs is less clearly defined. After capturing antigen or pathogens, they may relay native antigen to those B cells attracted to the medullary sinus (Junt et al., 2007), process it to present peptides to T cells (Asano et al., 2011), or finally degrade it. A greater proteolytic activity of MSMs is supported by expression of the more mature macrophage markers F4/80 and SIGN-R1. The understanding of MSM function is complicated by the possible existence of a DC-type subset, competent in crosspresentation of tumor antigens to CD8⁺ T cells (Asano et al., 2011), but which may be the result of the uptake of CD169⁺ membrane fragments by conventional DCs (Gray et al., 2012). The dissection of SSM versus MSM function has not been completed, and further insight into the molecular requirements for SSM and MSM formation should open the way to specifically delete MSMs before assessing LN functions. The impact of RANKL on MSMs is unlikely to be the result of altered B cell homeostasis, since these macrophages are insensitive to B cell numbers and LT levels (Moseman et al., 2012; Phan et al., 2009). On the contrary, we found that the inhibition of LT led to a compensatory increase in MSMs. Whether present in normal numbers or in increased numbers following LT-inhibition, stromal RANKL deficiency led to a marked loss of MSMs. Because the cells failed to display a convincing RANK expression, RANKL is likely to control MSMs indirectly. The underlying mechanism is open to conjecture. We have previously shown that LN lymphatic endothelial cells are activated by RANKL (Hess et al., 2012), raising the possibility that lymphatic endothelial cells that are in direct contact with the macrophages may regulate MSMs. Further work is required to address this possibility.

In keeping with the idea that the macrophage - B cell interaction occurs primarily through SSMs, this subset is sensitive to B cell produced LT (Moseman et al., 2012; Phan et al., 2009). In mice deficient for LN stromal RANKL, we observed both the reduction of SSMs and B cells, as well as lower levels of CXCL13 and LT. In the absence of RANK expression by SSMs, we attribute the macrophage defect to the deregulation of B cell homeostasis. Further, we interpret the cooperative action of RANKL deficiency with LT-inhibition as the increased efficiency of LT blocking in an environment impoverished in LT. Because LT expression, B cell numbers and CXCL13 production are mutually dependent (Ansel et al., 2000), the question of the precise action of RANKL on B cell homeostasis arises. In taking

into consideration the following elements, we favour the scenario that RANKL affects primarily CXCL13 production. First, B cell hematopoiesis and B cell entry into inguinal LNs was not perturbed. Second, we found no evidence that stromal RANKL deficiency affected LT production by LT_i cells, which could have been expected given the likelihood of a LT-RANKL feedback loop operating in the embryonic LN (Vondenhoff et al., 2009). It is unlikely that the incomplete embryonic RANKL silencing accounts for normal LT expression by LT_i cells, because even if the LT β R reagent were insensitive to minor LT expression changes, the functional assay based on the proportion of $\alpha 4\beta 7^+$ versus L-selectin⁺ B and T cells should have revealed the difference. Third, there is cooperativity between LT β R signalling and TNF α , that, alike RANKL, stimulates the canonical NF- κ B pathway, to maximize CXCL13 gene transcription (Katakai et al., 2008; White et al., 2007). Interestingly, the splenic equivalent of SSMs, express CXCR5 and that the transfer of CXCR5-deficient bone marrow led to reduced MMM numbers (Yu et al., 2002), suggesting that SSMs themselves may be sensitive to CXCL13. Redundancies between RANKL, TNF α and LT may also explain the belated penetrance of the RANKL knock-out phenotypes. The notion of redundancy is supported by the observation that deficiencies in RANKL and LT are only consequential for LN development when temporally distinct (Sugiyama et al., 2012). Hence, stromal RANKL may function as a safeguard mechanisms operating to assure LN integrity should the level of TNFSF members fall below a critical threshold. Interestingly, FDC ablation led to a reorganization of B cells within the LNs but their number and the level of CXCL13 remained constant (Wang et al., 2011). This suggests that FDCs are probably not the main RANKL target cell to control CXCL13 levels.

Taken together, we propose the following model (**Fig. 6**). Stromal cells expressing RANK, TNFRs and LT β R are activated by their respective ligands to produce RANKL and CXCL13. Embryonic LN development does not require stromal RANKL because of redundancy with LT or other TNF family members, such as TNF α . Postnatally, and in the absence of immune stimulation, LT and/or TNF α levels decline and the maintenance of CXCL13 production and the retention and activation of B cells relies on stromal RANKL. These stromal cells are likely to be LTO in the embryo and FDC precursors, such as MRCs, in the adult (Cremasco et al., 2014; Jarjour et al., 2014). However this model does not exclude the existence of different types of FDC precursors expressing distinct TNFRSF

members. Stromal RANKL assures SSMs and MSMs differentiation through a B cell dependent and independent pathway, respectively.

Other than a possible age-related natural decline in LT and/or TNF α production, an imbalance may be created by changes in female sex hormones that regulate RANKL and OPG expression (Schramek et al., 2010). This is particularly relevant for chronic inflammatory diseases such as the Sjögren's syndrome or lupus erythematosus that are characterized by tertiary lymphoid structures and a predominant female bias (Buckley et al., 2015; Pennell et al., 2012). The finding that RANKL neutralization reduces tertiary lymphoid tissue in a mouse model of Sjögren's syndrome supports a role of RANKL in the formation of these structures and encourages further studies into the role of RANKL in the etiology of inflammatory diseases and as a therapeutic target.

In conclusion, the analysis of stromal RANKL requirement for LN macrophages sheds new light on its function in lymphoid tissue formation and calls for further investigation into the effects of age and gender on chronic inflammatory diseases.

Acknowledgements

We thank Biogen (Cambridge, MA, USA) for generously providing reagents, Jennifer Gommerman and Jorge Camaano for critical reading of the manuscript, Jean-Daniel Fauny for help in microscopy, and lab members for discussion. OGC was supported by FP7-MC-ITN 289720 "Stroma", MC by a convention between Prestwick Chemical and Centre National pour la Recherche Scientifique, F.A. by Idex and CGM by l'Agence Nationale pour la Recherche (Program "Investissements d'Avenir", ANR-10-LABX-0034 MEDALIS; ANR-11-EQPX-022).

References

- Allen, C.D., Cyster, J.G., Pasparakis, M., Kousteni, S., Peschon, J., Kollias, G., Alexopoulou, L., Pasparakis, M., and Kollias, G. (2008). Follicular dendritic cell networks of primary follicles and germinal centers: phenotype and function. *Semin Immunol.* *20*, 14-25.
- Anderson, D.M., Maraskovsky, E., Billingsley, W.L., Dougall, W.C., Tometsko, M.E., Roux, E.R., Teepe, M.C., DuBose, R.F., Cosman, D., and Galibert, L. (1997). A homologue of the TNF receptor and its ligand enhance T-cell growth and dendritic-cell function. *Nature* *390*, 175-179.
- Ansel, K.M., Ngo, V.N., Hyman, P.L., Luther, S.A., Forster, R., Sedgwick, J.D., Browning, J.L., Lipp, M., and Cyster, J.G. (2000). A chemokine-driven positive feedback loop organizes lymphoid follicles. *Nature* *406*, 309-314.
- Asano, K., Nabeyama, A., Miyake, Y., Qiu, C.H., Kurita, A., Tomura, M., Kanagawa, O., Fujii, S., and Tanaka, M. (2011). CD169-positive macrophages dominate antitumor immunity by crosspresenting dead cell-associated antigens. *Immunity.* *34*, 85-95.
- Barbaroux, J.B., Beleut, M., Briskin, C., Mueller, C.G., and Groves, R. (2008). Epidermal receptor activator of NF- κ B ligand controls Langerhans cell numbers and proliferation. *J. Immunol.* *181*, 1103-1108.
- Barone, F., Nayar, S., Campos, J., Cloake, T., Withers, D.R., Toellner, K.M., Zhang, Y., Fouser, L., Fisher, B., Bowman, S., *et al.* (2015). IL-22 regulates lymphoid chemokine production and assembly of tertiary lymphoid organs. *Proc Natl Acad Sci U S A.* *112*, 11024-11029.
- Benezech, C., White, A., Mader, E., Serre, K., Parnell, S., Pfeffer, K., Ware, C.F., Anderson, G., and Caamano, J.H. (2011). Ontogeny of stromal organizer cells during lymph node development. *J. Immunol.* *184*, 4521-4530.
- Berlin, C., Berg, E.L., Briskin, M.J., Andrew, D.P., Kilshaw, P.J., Holzmann, B., Weissman, I.L., Hamann, A., and Butcher, E.C. (1993). Alpha 4 beta 7 integrin mediates lymphocyte binding to the mucosal vascular addressin MAdCAM-1. *Cell.* *74*, 185-195.
- Bombardieri, M., Barone, F., Lucchesi, D., Nayar, S., van den Berg, W.B., Proctor, G., Buckley, C.D., and Pitzalis, C. (2012). Inducible tertiary lymphoid structures, autoimmunity, and exocrine dysfunction in a novel model of salivary gland inflammation in C57BL/6 mice. *J. Immunol.* *189*, 3767-3776.
- Buckley, C.D., Barone, F., Nayar, S., Benezech, C., and Caamano, J. (2015). Stromal cells in chronic inflammation and tertiary lymphoid organ formation. *Annu Rev Immunol.* *33*:715-45., 10.1146/annurev-immunol-032713-120252.
- Carrasco, Y.R., and Batista, F.D. (2007). B cells acquire particulate antigen in a macrophage-rich area at the boundary between the follicle and the subcapsular sinus of the lymph node. *Immunity.* *27*, 160-171.
- Chai, Q., Onder, L., Scandella, E., Gil-Cruz, C., Perez-Shibayama, C., Cupovic, J., Danuser, R., Sparwasser, T., Luther, S.A., Thiel, V., *et al.* (2013). Maturation of lymph node fibroblastic reticular cells from myofibroblastic precursors is critical for antiviral immunity. *Immunity.* *38*, 1013-1024.
- Coombes, J.L., Han, S.J., van Rooijen, N., Raulet, D.H., and Robey, E.A. (2012). Infection-induced regulation of natural killer cells by macrophages and collagen at the lymph node subcapsular sinus. *Cell Rep.* *2*, 124-135.
- Cremasco, V., Woodruff, M.C., Onder, L., Cupovic, J., Nieves-Bonilla, J.M., Schildberg, F.A., Chang, J., Cremasco, F., Harvey, C.J., Wucherpfennig, K., *et al.* (2014). B cell homeostasis and follicle confines are governed by fibroblastic reticular cells. *Nat Immunol* *24*.

- Cupedo, T., Lund, F.E., Ngo, V.N., Randall, T.D., Jansen, W., Greuter, M.J., de Waal-Malefyt, R., Kraal, G., Cyster, J.G., and Mebius, R.E. (2004). Initiation of cellular organization in lymph nodes is regulated by non-B cell-derived signals and is not dependent on CXC chemokine ligand 13. *J. Immunol.* *173*, 4889-4896.
- Dougall, W.C., Glaccum, M., Charrier, K., Rohrbach, K., Brasel, K., De Smedt, T., Daro, E., Smith, J., Tometsko, M.E., Maliszewski, C.R., *et al.* (1999). RANK is essential for osteoclast and lymph node development. *Genes. Dev.* *13*, 2412-2424.
- Endres, R., Alimzhanov, M.B., Plitz, T., Futterer, A., Kosco-Vilbois, M.H., Nedospasov, S.A., Rajewsky, K., and Pfeffer, K. (1999). Mature follicular dendritic cell networks depend on expression of lymphotoxin beta receptor by radioresistant stromal cells and of lymphotoxin beta and tumor necrosis factor by B cells. *J. Exp. Med.* *189*, 159-168.
- Fletcher, A.L., Malhotra, D., Acton, S.E., Lukacs-Kornek, V., Bellemare-Pelletier, A., Curry, M., Armant, M., and Turley, S.J. (2011). Reproducible isolation of lymph node stromal cells reveals site-dependent differences in fibroblastic reticular cells. *Frontiers in Immunology* *2*, 1-15.
- Garcia, Z., Lemaitre, F., van Rooijen, N., Albert, M.L., Levy, Y., Schwartz, O., and Bousso, P. (2012). Subcapsular sinus macrophages promote NK cell accumulation and activation in response to lymph-borne viral particles. *Blood.* *120*, 4744-4750.
- Gonzalez, S.F., Lukacs-Kornek, V., Kuligowski, M.P., Pitcher, L.A., Degen, S.E., Kim, Y.A., Cloninger, M.J., Martinez-Pomares, L., Gordon, S., Turley, S.J., and Carroll, M.C. (2010). Capture of influenza by medullary dendritic cells via SIGN-R1 is essential for humoral immunity in draining lymph nodes. *Nat Immunol.* *11*, 427-434.
- Gray, E.E., Friend, S., Suzuki, K., Phan, T.G., and Cyster, J.G. (2012). Subcapsular sinus macrophage fragmentation and CD169+ bleb acquisition by closely associated IL-17-committed innate-like lymphocytes. *PLoS ONE.* *7*, e38258.
- Hess, E., Duheron, V., Decossas, M., Lézot, F., Berdal, A., Chea, S., Golub, R., Bosisio, M.R., Bridal, S.L., Choi, Y., *et al.* (2012). RANKL induces organized lymph node growth by stromal cell proliferation. *J. Immunol.* *188*, 1245-1254.
- Huber, C., Thielen, C., Seeger, H., Schwarz, P., Montrasio, F., Wilson, M.R., Heinen, E., Fu, Y.X., Miele, G., and Aguzzi, A. (2005). Lymphotoxin-beta receptor-dependent genes in lymph node and follicular dendritic cell transcriptomes. *J. Immunol.* *174*, 5526-5536.
- Iannacone, M., Moseman, E.A., Tonti, E., Bosurgi, L., Junt, T., Henrickson, S.E., Whelan, S.P., Guidotti, L.G., and von Andrian, U.H. (2010). Subcapsular sinus macrophages prevent CNS invasion on peripheral infection with a neurotropic virus. *Nature.* *465*, 1079-1083.
- Jarjour, M., Jorquera, A., Mondor, I., Wienert, S., Narang, P., Coles, M.C., Klauschen, F., and Bajenoff, M. (2014). Fate mapping reveals origin and dynamics of lymph node follicular dendritic cells. *J Exp Med.* *211*, 1109-1122. .
- Junt, T., Moseman, E.A., Iannacone, M., Massberg, S., Lang, P.A., Boes, M., Fink, K., Henrickson, S.E., Shayakhmetov, D.M., Di Paolo, N.C., *et al.* (2007). Subcapsular sinus macrophages in lymph nodes clear lymph-borne viruses and present them to antiviral B cells. *Nature.* *450*, 110-114.
- Kamijo, S., Nakajima, A., Ikeda, K., Aoki, K., Ohya, K., Akiba, H., Yagita, H., and Okumura, K. (2006). Amelioration of bone loss in collagen-induced arthritis by neutralizing anti-RANKL monoclonal antibody. *Biochem. Biophys. Res. Commun.* *347*, 124-132.
- Katakai, T. (2012). Marginal reticular cells: a stromal subset directly descended from the lymphoid tissue organizer. *Frontiers in Immunology* *3*, 200-206.

- Katakai, T., Suto, H., Sugai, M., Gonda, H., Togawa, A., Suematsu, S., Ebisuno, Y., Katagiri, K., Kinashi, T., and Shimizu, A. (2008). Organizer-like reticular stromal cell layer common to adult secondary lymphoid organs. *J. Immunol.* *181*, 6189-6200.
- Kim, N., Odgren, P.R., Kim, D.K., Marks, S.C., Jr., and Choi, Y. (2000). Diverse roles of the tumor necrosis factor family member TRANCE in skeletal physiology revealed by TRANCE deficiency and partial rescue by a lymphocyte-expressed TRANCE transgene. *Proc. Natl. Acad. Sci. USA* *97*, 10905-10910.
- Knoop, K.A., Butler, B.R., Kumar, N., Newberry, R.D., and Williams, I.R. (2011). Distinct developmental requirements for isolated lymphoid follicle formation in the small and large intestine RANKL is essential only in the small intestine. *Am. J. Pathol.* *179*, 1861-1871.
- Kong, Y.Y., Yoshida, H., Sarosi, I., Tan, H.L., Timms, E., Capparelli, C., Morony, S., Oliveira-dos-Santos, A.J., Van, G., Itie, A., *et al.* (1999). OPGL is a key regulator of osteoclastogenesis, lymphocyte development and lymph-node organogenesis. *Nature* *397*, 315-323.
- Linehan, S.A., Martinez-Pomares, L., Stahl, P.D., and Gordon, S. (1999). Mannose receptor and its putative ligands in normal murine lymphoid and nonlymphoid organs: In situ expression of mannose receptor by selected macrophages, endothelial cells, perivascular microglia, and mesangial cells, but not dendritic cells. *J. Exp. Med.* *189*, 1961-1972.
- Link, A., Vogt, T.K., Favre, S., Britschgi, M.R., Acha-Orbea, H., Hinz, B., Cyster, J.G., and Luther, S.A. (2007). Fibroblastic reticular cells in lymph nodes regulate the homeostasis of naive T cells. *Nat. Immunol.* *8*, 1255-1265.
- Luther, S.A., Bidgol, A., Hargreaves, D.C., Schmidt, A., Xu, Y., Paniyadi, J., Matloubian, M., and Cyster, J.G. (2002). Differing activities of homeostatic chemokines CCL19, CCL21, and CXCL12 in lymphocyte and dendritic cell recruitment and lymphoid neogenesis. *J. Immunol.* *169*, 424-433.
- Mebius, R.E. (2003). Organogenesis of lymphoid tissues. *Nat. Rev. Immunol.* *3*, 292-303.
- Mebius, R.E., Streeter, P.R., Michie, S., Butcher, E.C., and Weissman, I.L. (1996). A developmental switch in lymphocyte homing receptor and endothelial vascular addressin expression regulates lymphocyte homing and permits CD4⁺ CD3⁻ cells to colonize lymph nodes. *Proc. Natl. Acad. Sci. USA* *93*, 11019-11024.
- Moalli, F., Proulx, S.T., Schwendener, R., Detmar, M., Schlapbach, C., and Stein, J.V. (2015). Intravital and whole-organ imaging reveals capture of melanoma-derived antigen by lymph node subcapsular macrophages leading to widespread deposition on follicular dendritic cells. *Front Immunol.* *6*:114., 10.3389/fimmu.2015.00114. eCollection 02015.
- Moseman, E.A., Iannaccone, M., Bosurgi, L., Tonti, E., Chevrier, N., Tumanov, A., Fu, Y.X., Hacohen, N., and von Andrian, U.H. (2012). B cell maintenance of subcapsular sinus macrophages protects against a fatal viral infection independent of adaptive immunity. *Immunity* *36*, 415-426.
- Mueller, C.G., and Hess, E. (2012). Emerging Functions of RANKL in Lymphoid Tissues. *Frontiers in Immunology* *3*, 261-267.
- Nagy, V., and Penninger, J.M. (2015). The RANKL-RANK Story. *Gerontology* *14*, 14.
- Pennell, L.M., Galligan, C.L., and Fish, E.N. (2012). Sex affects immunity. *J Autoimmun.* *38*, 282-291.
- Perlot, T., and Penninger, J.M. (2012). Development and function of murine B cells lacking RANK. *J. Immunol.* *188*, 1201-1205.
- Phan, T.G., Green, J.A., Gray, E.E., Xu, Y., and Cyster, J.G. (2009). Immune complex relay by subcapsular sinus macrophages and noncognate B cells drives antibody affinity maturation. *Nat Immunol.* *10*, 786-793.

- Phan, T.G., Grigorova, I., Okada, T., and Cyster, J.G. (2007). Subcapsular encounter and complement-dependent transport of immune complexes by lymph node B cells. *Nat Immunol.* **8**, 992-1000.
- Rennert, P.D., Browning, J.L., Mebius, R., Mackay, F., and Hochman, P.S. (1996). Surface lymphotoxin alpha/beta complex is required for the development of peripheral lymphoid organs. *J Exp Med.* **184**, 1999-2006.
- Roozendaal, R., and Mebius, R.E. (2011). Stromal cell-immune cell interactions. *Annu. Rev. Immunol.* **29**, 23-43.
- Schramek, D., Leibbrandt, A., Sigl, V., Kenner, L., Pospisilik, J.A., Lee, H.J., Hanada, R., Joshi, P.A., Aliprantis, A., Glimcher, L., *et al.* (2010). Osteoclast differentiation factor RANKL controls development of progesterin-driven mammary cancer. *Nature* **468**, 98-102.
- Sugiyama, M., Nakato, G., Jinnohara, T., Akiba, H., Okumura, K., Ohno, H., and Yoshida, H. (2012). Expression pattern changes and function of RANKL during mouse lymph node microarchitecture development. *Int. Immunol.* **2012**, 21.
- Tumanov, A., Kuprash, D., Lagarkova, M., Grivennikov, S., Abe, K., Shakhov, A., Drutskaya, L., Stewart, C., Chervonsky, A., and Nedospasov, S. (2002). Distinct role of surface lymphotoxin expressed by B cells in the organization of secondary lymphoid tissues. *Immunity* **17**, 239-250.
- Vondenhoff, M.F., Greuter, M., Goverse, G., Elewaut, D., Dewint, P., Ware, C.F., Hoorweg, K., Kraal, G., and Mebius, R.E. (2009). LTbetaR signaling induces cytokine expression and up-regulates lymphangiogenic factors in lymph node anlagen. *J. Immunol.* **182**, 5439-5445.
- Walsh, M.C., and Choi, Y. (2014). Biology of the RANKL-RANK-OPG System in Immunity, Bone, and Beyond. *Front Immunol.* **5**:511.
- Wang, X., Cho, B., Suzuki, K., Xu, Y., Green, J.A., An, J., and Cyster, J.G. (2011). Follicular dendritic cells help establish follicle identity and promote B cell retention in germinal centers. *J Exp Med.* **208**, 2497-2510.
- White, A., Carragher, D., Parnell, S., Msaki, A., Perkins, N., Lane, P., Jenkinson, E., Anderson, G., and Caamano, J.H. (2007). Lymphotoxin a-dependent and -independent signals regulate stromal organizer cell homeostasis during lymph node organogenesis. *Blood* **110**, 1950-1959.
- Wiktor-Jedrzejczak, W., and Gordon, S. (1996). Cytokine regulation of the macrophage (M phi) system studied using the colony stimulating factor-1-deficient op/op mouse. *Physiol. Rev.* **76**, 927-947.
- Xiong, J., Onal, M., Jilka, R.L., Weinstein, R.S., Manolagas, S.C., and O'Brien, C.A. (2011). Matrix-embedded cells control osteoclast formation. *Nat. Med.* **17**, 1235-1241.
- Yoshida, H., Naito, A., Inoue, J., Satoh, M., Santee-Cooper, S.M., Ware, C.F., Togawa, A., and Nishikawa, S. (2002). Different cytokines induce surface lymphotoxin-alpha on IL-7 receptor-alpha cells that differentially engender lymph nodes and Peyer's patches. *Immunity* **17**, 823-833.
- Yu, P., Wang, Y., Chin, R.K., Martinez-Pomares, L., Gordon, S., Kosco-Vibois, M.H., Cyster, J., and Fu, Y.X. (2002). B cells control the migration of a subset of dendritic cells into B cell follicles via CXC chemokine ligand 13 in a lymphotoxin-dependent fashion. *J. Immunol.* **168**, 5117-5123.
- Yun, T.J., Tallquist, M.D., Aicher, A., Rafferty, K.L., Marshall, A.J., Moon, J.J., Ewings, M.E., Mohaupt, M., Herring, S.W., and Clark, E.A. (2001). Osteoprotegerin, a crucial regulator of bone metabolism, also regulates B cell development and function. *J. Immunol.* **166**, 1482-1491.

Figures

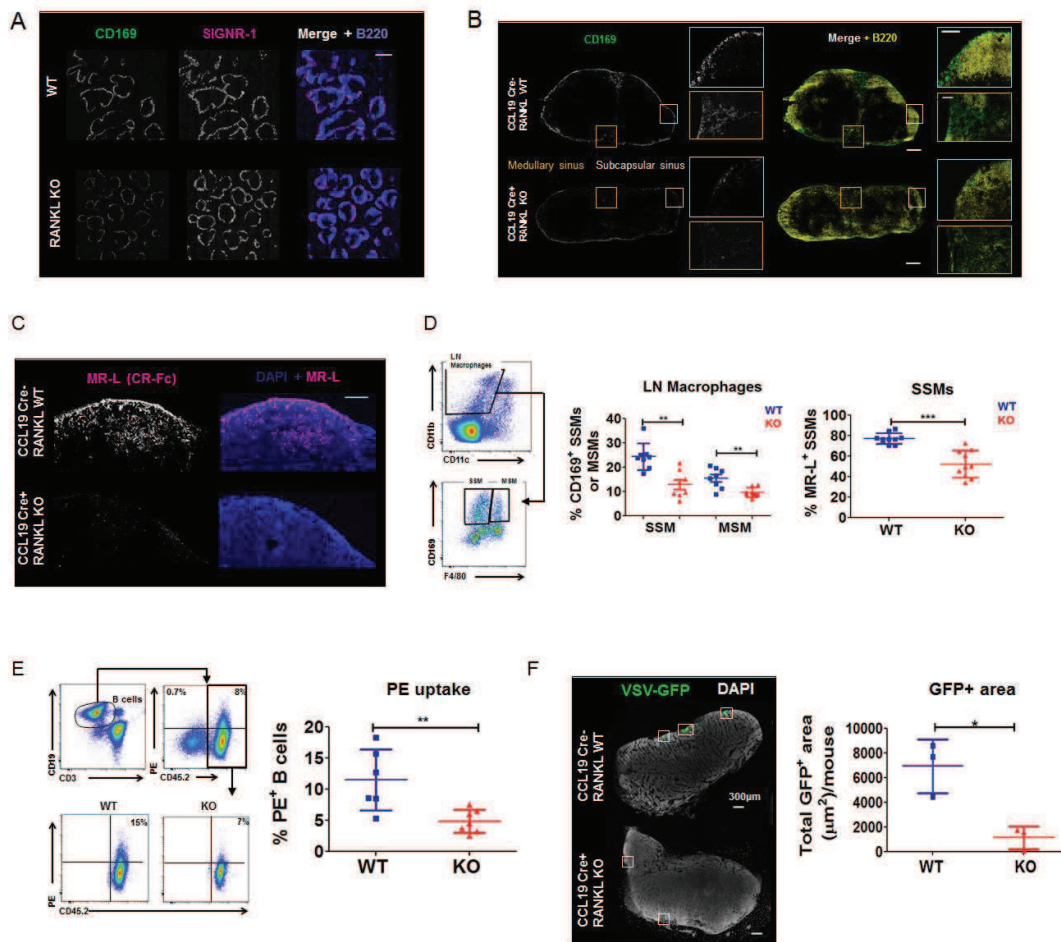

Figure 1. RANKL regulates CD169⁺ macrophage differentiation. **(A)** Confocal microscopy images of CD169 and SIGNR-1 expressions in spleens of WT and RANKL^{-/-} mice. Scale bar = 500 μm. Data is representative of 3 mice each. **(B)** Confocal microscopy imaging of RANKL^{ΔCcl19} and Cre⁻ littermates (WT) showing CD169 expression by SSMs of the subcapsular sinus (white writing) and by MSMs of the medullary regions (orange writing). B220 marks B cells. Scale bars = 300 μm and 100 μm of insets. Data is representative of 5 mice of each genotype. **(C)** Confocal microscopy imaging for MR-L expression by SSMs and FDCs in RANKL^{ΔCcl19} KO and Cre⁻ littermates (WT). Scale bar = 100 μm. Data is representative of 3 mice of each genotype. **(D)** Left: Dot plots showing the gating strategy to identify SSMs and MSM by flow cytometry. Upper panel shows LN macrophages gated as CD11b⁺CD11c^{low} cells that are divided into SSM (CD169⁺ F4/80⁻) and MSM (CD169⁺ F4/80⁺) in the lower panel. Right: Graph depicts the mean percentage ± SD of SSMs and MSMs in RANKL^{ΔCcl19} and Cre⁻ littermates (WT). The second graph shows the mean percentage of MR-L⁺ SSMs in either mice. **(E)** Dot plots showing the gating strategy and the percentage of PE⁺ B cells of CD45.2 RANKL^{ΔCcl19} KO and control littermates after delivery of PE-immune complexes. To assure that B cells were not

labelled *ex vivo*, lymphocytes from CD45.1 (Ly5.1) mice were added to the cell suspension. The second panel shows that PE⁺ B cells originated from the PE-recipient CD45.2 mice. The percentage PE⁺ B cells were determined and shown in the graph (mean ± SD). **(F)** LNs from mice administered s.c. GFP-expressing VSV were analysed for viral replication in the SSMs by determining the area of GFP expression. On the left is shown an image of GFP expression in LNs from RANKL^{ΔCcl19} and Cre⁻ littermates (WT). On the right, the graph depicts the mean ± SD of total VSV-GFP⁺ area in μm²/mouse. Data is from 3 mice, 2 LN/mouse and 13 sections/LN. *p < 0.05, **p < 0.01, ***p < 0.001.

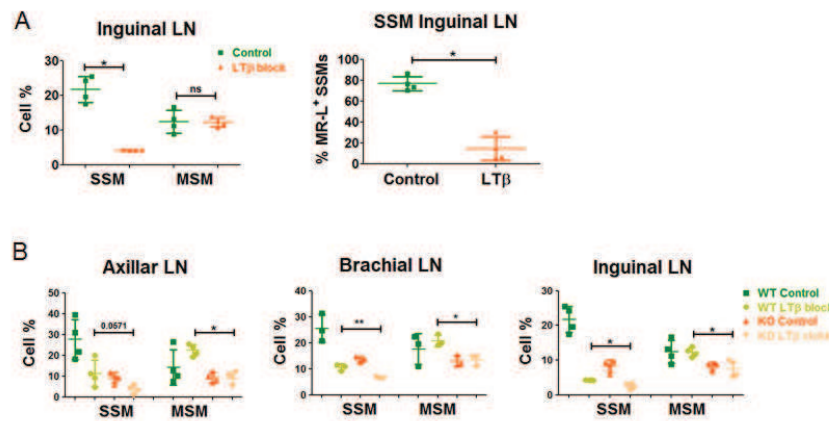

Figure 2. LT-distinct and overlapping control of LN macrophage populations by RANKL. (A) Mean percentages ± SD of SSMs and MSMs in inguinal LNs of control or LTβR-Ig injected mice. The macrophages were identified by FACS as in Fig.1D. Right hand graph shows the mean percentage ± SD of MR-L⁺ SSMs in inguinal LNs of control or LTβR-Ig injected mice. **(B)** Mean percentage ± SD of SSMs and MSMs identified by FACS as in Fig. 1D of different LNs (axillary, inguinal and brachial) in RANKL^{ΔCcl19} and Cre⁻ littermates (WT) having received isotype control antibody or LTβR-Ig. Data is representative of 4 mice in 4 different experiments. *p < 0.05, **p < 0.01, ***p < 0.001.

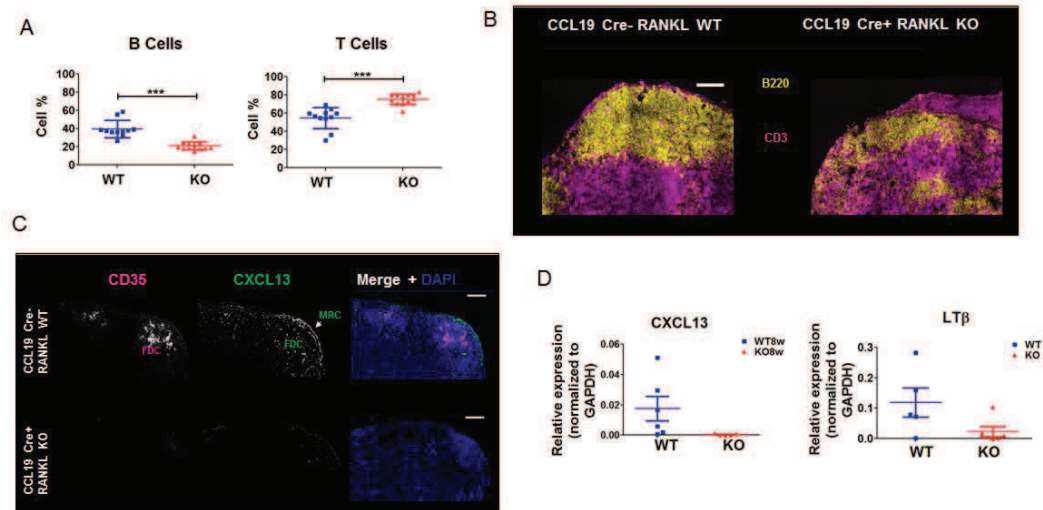

Figure 3. Stromal RANKL regulates CXCL13 and LT expression. (A) Mean percentage \pm SD of B and T cells in inguinal LNs of RANKL ^{Δ Ccl19} and Cre⁻ littermates (WT). (B) Confocal microscopy of B cells (B220) and T cells (CD3) in RANKL ^{Δ Ccl19} and Cre⁻ littermates (WT). Scale bar = 100 μ m. Image is representative of 4 mice of each genotype. (C) Confocal microscopy CD35⁺ FDCs and CXCL13 expression by FDCs and MRCs, alone or merged with DAPI nuclear counterstain. Images are representative of 4 mice of each genotype. Scale bars = 100 μ m. (D) Mean transcriptional activity of CXCL13 and LT β \pm SEM (n=6) in total LNs of RANKL ^{Δ Ccl19} and Cre⁻ littermates (WT). ***p < 0.001.

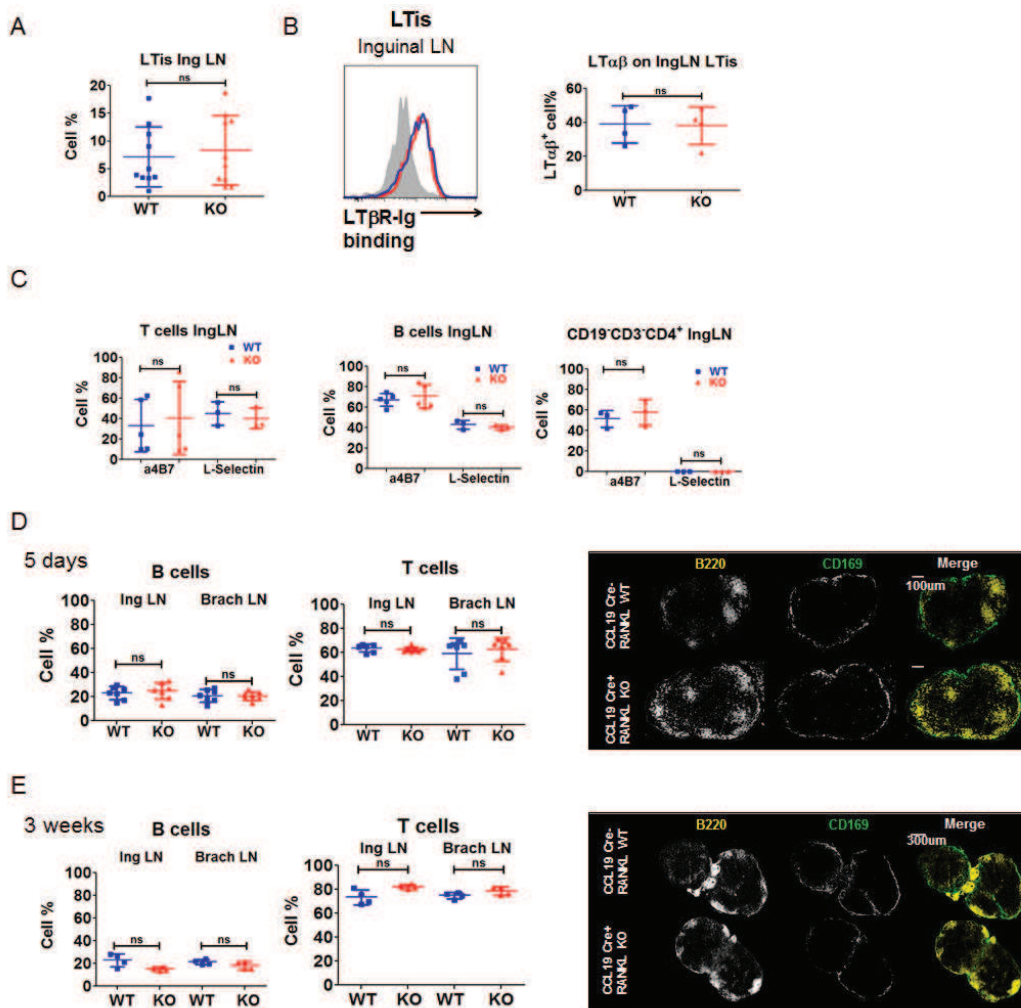

Figure 4. Stromal RANKL functions to maintain macrophage differentiation and B cell homeostasis. (A) Mean percentage \pm SD of LTi cells ($CD19^+CD3^+CD4^+IL7R\alpha^+$) in inguinal LNs of 5-day old $RANKL^{\Delta Ccl19}$ KO and littermates (WT) controls. **(B)** Histograms display the expression of $LT\alpha_2\beta_1$ by LTi cells from inguinal and brachial LNs recognized by $LT\beta R-Ig$. In black is expression from $RANKL^{\Delta Ccl19}$ KO mice and in blue from control mice. The graph depicts the mean percentage of $LT\alpha_2\beta_1^+$ LTi cells \pm SD in inguinal LNs of 5-day old $RANKL^{\Delta Ccl19}$ KO and littermates (WT) controls. **(C)** Mean percentage \pm SD of $\alpha 4\beta 7^+$ and L-selectin⁺ T, B and LTi cells in of 5-day old $RANKL^{\Delta Ccl19}$ KO and littermates (WT) mice. **(D, E)** Mean percentage \pm SD of B and T cells in inguinal and brachial LNs, and confocal imaging of $CD169^+$ macrophages and B cells ($B220^+$) in inguinal LNs in mice aged 5 days **(D)** and 3 weeks **(E)**. Scale bar = 100 μm in panel D, 300 μm in panel E. Images are representative of 5 mice of each genotype. ns= not significant, * $p < 0.05$ **, $p < 0.01$ ***.

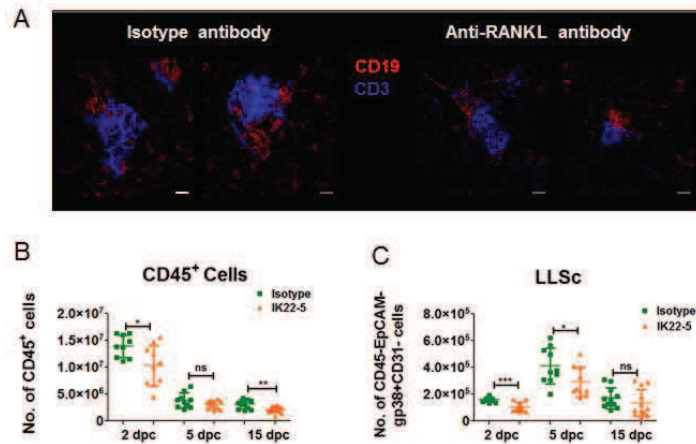

Figure 5. RANKL supports tertiary lymphoid tissue formation. (A) Confocal microscopy images of salivary glands 15 days post cannulation showing ectopic lymphoid structures in isotype-administrated control mice and anti-RANKL-treated mice. T cells are labelled with CD3 (blue) and B cells with CD19 (red). The images are representative of 5 mice. Scale bar = 100 μ m. (B) Mean number \pm SD of CD45⁺ cells in salivary glands of control and in mice treated with RANKL-neutralizing antibody IK22-5, at day 2, 5 and 15 post cannulation. (C) Mean number \pm SD of lymphoid tissue stromal cells in salivary glands of control and anti-RANKL-treated mice, at day 2, 5 and 15 post cannulation. ns=not significant, * $p < 0.05$, ** $p < 0.01$, *** $p < 0.001$.

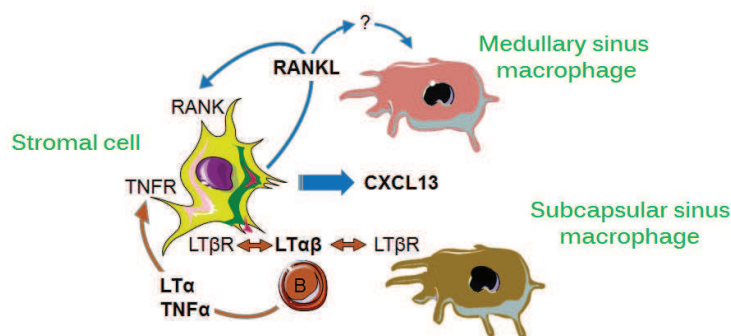
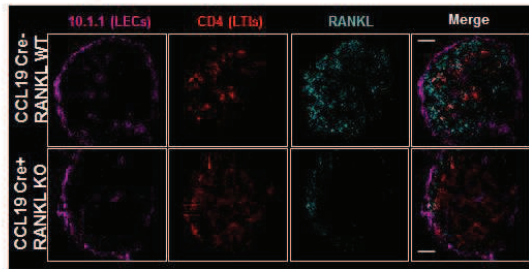
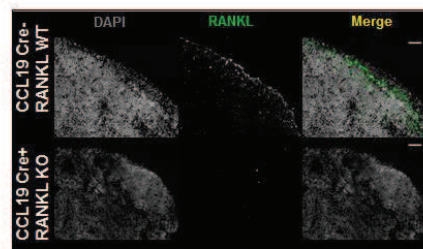

Figure 6. Model of stromal RANKL action on LN CD169⁺ macrophage types. Stromal cells express RANK, TNFRs and LT β R are activated by their respective ligands to produce RANKL and CXCL13. This chemokine attracts B cells which supplant early LT_i cells for the provision of cell surface-bound LT $\alpha_1\beta_2$ to drive SSM differentiation. In young animals RANKL is dispensable, however, when TNF α , LT α and LT $\alpha_1\beta_2$ levels wane, such as in unstimulated LNs of adult mice, autocrine RANKL is required to maintain B cell homeostasis. RANKL also regulates MSMs independently of B cell LT $\alpha_1\beta_2$.

A E18 inguinal LN



B Adult inguinal LN



C E18 mesenteric LN

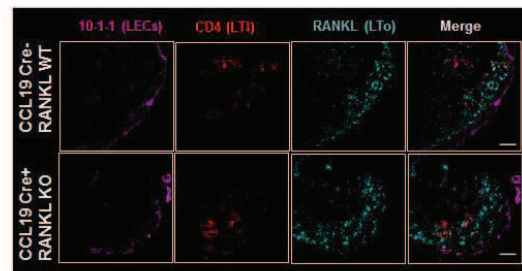

D Adult Peyer's Patches

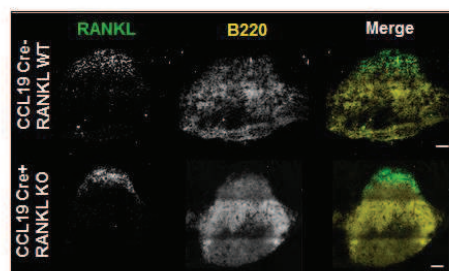

Supplementary Fig. 1. RANKL deficiency in $RANKL^{\Delta Ccl19}$ mice. **(A)** Confocal microscopy images of inguinal LN anlagen of $RANKL^{\Delta Ccl19}$ and Cre^- littermate controls at E18, labelled for lymphatic endothelial cells (LECs) (using monoclonal antibody 10.1.1), for LTI cells (CD4) and RANKL (expressed by LTOs). Images are representative of 4 mice. Scale bar = 50 μ m. **(B)** Confocal microscopy images of inguinal LNs of $RANKL^{\Delta Ccl19}$ KO and Cre^- littermates at 8 weeks of age, labelled for RANKL with DAPI nuclear counterstaining. Images are representative of 4 mice. Scale

bar = 50 μ m. **(C)** Confocal microscopy images of E18 mesenteric LN anlagen of RANKL Δ Ccl19 KO and Cre $^{-}$ littermates, labelled as in panel A. Scale bar = 50 μ m. **(D)** Confocal microscopy images of Peyer's patches of RANKL Δ Ccl19 KO and Cre $^{-}$ littermates at 8 weeks of age, labelled for RANKL and B cells (B220). The image is representative of 4 mice. Scale bar = 100 μ m.

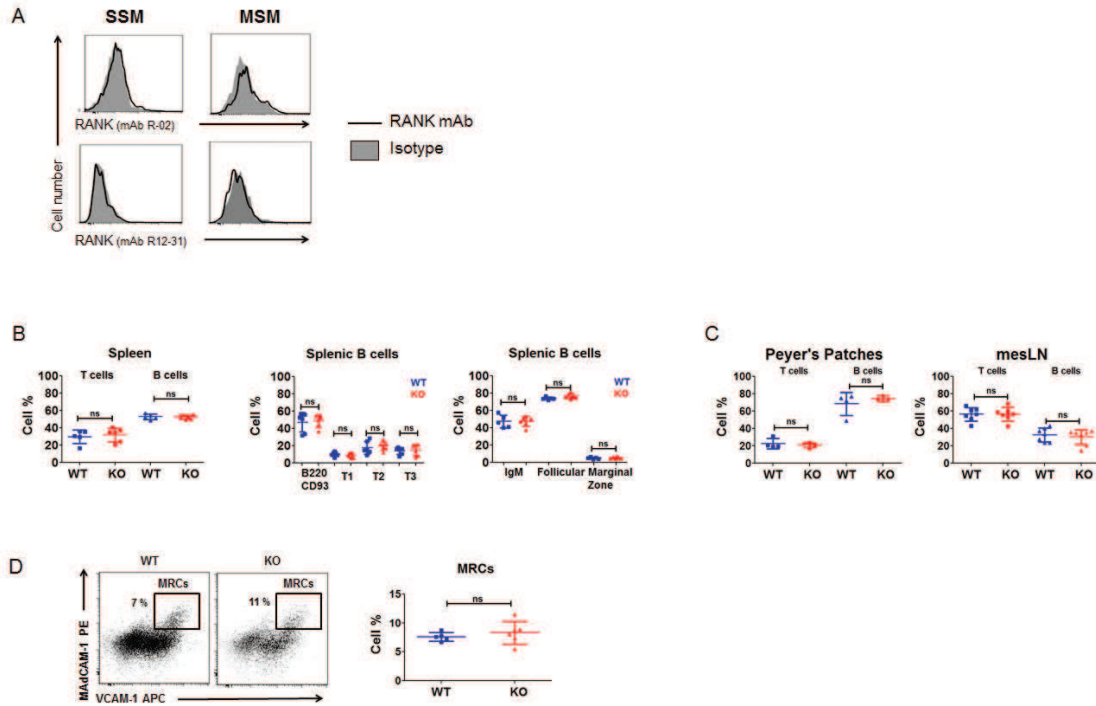

Supplementary Fig. 2. **(A)** SSMs and MSMs were labelled for RANK expression using the monoclonal antibodies RANK-02 and R12-31. Histograms depict flow cytometry profile with anti-RANK antibodies versus isotype control antibodies. The data is representative of 6 mice. **(B)** First panel shows the mean percentage \pm SD of T and B cells in the spleen of RANKL Δ Ccl19 KO and Cre $^{-}$ littermates at 8 weeks. Second panel shows mean percentage \pm SD of splenic B220 $^{+}$ CD93 $^{+}$ and T1 (B220 $^{+}$ CD93 $^{+}$ IgM hi CD23 $^{-}$), T2 (B220 $^{+}$ CD93 $^{+}$ IgM hi CD23 $^{+}$) and T3 (B220 $^{+}$ CD93 $^{+}$ IgM lo CD23 $^{+}$) transition-type B cells. Third panel shows the mean percentage \pm SD of splenic IgM $^{+}$, follicular and marginal zone B cells. Data is representative of 6 mice in 3 different experiments. **(C)** Mean percentage \pm SD of T and B cells in the Peyer's patches and the mesenteric LN of 8 week-old RANKL Δ Ccl19 KO and Cre $^{-}$ littermates (WT). Data is representative >4 mice in 3 different experiments. **(D)** FACS dot plots showing MRCs (MAAdCAM-1 $^{+}$ VCAM-1 $^{+}$ among gp38 $^{+}$ CD31 $^{-}$ FRCs) of RANKL Δ Ccl19 KO and Cre $^{-}$ littermates (WT) at 8 weeks. Graphs depicts the mean percentage \pm SD of MRCs in RANKL Δ Ccl19 KO and Cre $^{-}$ littermates (WT). ns = not significant.

Supplemental Table.

Antibodies used in the study.

Target	Species	Clone	Conjugation	Supplier
CD45	Rat IgG2a	30-F11	APC-CY7	Biologend
CD45	Rat IgG2b	30-F11	APC	BD
Ter-119	Rat IgG2b	TER-119	APC-CY7	Biologend
CD31	Rat IgG2a	390	PercP eF710	eBioscience
Gp38	Syrian Hamster IgG	8.1.1	A488	eBioscience
MAdCAM-1	Rat IgG2a	MECA-367	Purified	BD Pharmingen
VCAM-1	Rat IgG2a	429	APC	Biologend
CXCL13	Goat IgG	Polyclonal	Purified	R&D
CD35	Rat IgG2a	8C12	Biotine	BD
B220	Rat IgG2a	RA3-6B2	Biotine	eBioscience
RANKL	Rat IgG2a	IK22.5	Purified	Hideo Yagita
RANK	Rat IgG1	R12-31	Purified	Hideo Yagita
RANK	Human FC	RANK-02	Purified	MedImmune
LPAM-1(a4B7)	Rat IgG2a	DATK32	Biotine/PE	eBioscience
CD16/32	Rat IgG2b	2.4G2	Purified	BD Pharmingen
CD11c	Armenian hamster	N418	PE/Cy7	eBioscience
CD11b	Rat IgG2b	M1/70	PerCP CY5.5	BD
CD169	Rat IgG2a	Moma-1	FITC	ABd Serotec
F4/80	Rat IgG2a	BM8	APC	eBioscience
CD3	Armenian hamster IgG1, k	145-2C11	FITC; PE	BD
CD19	Rat IgG2a	RA3-6B2	PE, PerCPCy5.5; APC	BD
CD45.1	Mouse IgG2a	A20	APC	eBioscience
CD45.2	mouse IgG2a	104	APC	eBioscience
CD4	Rat IgG2a	RM4-5	PerCPCy5.5; APC	BD
IL7-R α	Rat IgG2a	A7R34	PE	eBioscience
L-selectin (CD62L)	Rat IgG2a	MEL-14	PE	BD
IgMb	Mouse IgG1	AF6-78	Biotine	BD
CD21/35	Rat IgG2b	7G6	APC	BD
CD23	Rat IgG2a	B3B4	PE	BD
CD93	Rat IgG2b,	AA4.1	APC	eBioscience
LT β R-Fc	Mouse IgG1			Biogen
mCLCA1	Syrian Hamster IgG	10.1.1	Purified	Andy Farr {Hara, 2012 #2602}
SIGN-R1	Armenian Hamster IgG	22D1	Purified	eBioscience
MR-L	CR-hIgG1-Fc		Purified	Luisa Martinez-

				Pomarez
eYFP	Rabbit	Polyclonal	Purified	Clonetech
Hamster IgG	Goat	Polyclonal	A488; A546	Molecular probes
Mouse	Donkey	Polyclonal	A647	Life Technologies
Rat	Donkey	Polyclonal	Cy3	Jackson
Human IgG	Mouse	IgG	Biotine-SP	Jackson
Streptavidin			PerCP	eBioscience
Streptavidin			PE/Cy7; APC	BD

1.3 Conclusions

In this work we have shown for the first time that stromal RANKL is required for CD169⁺ lymph node macrophages differentiation leading to impaired antigen transfer to B cells and VSV infection. Despite the strong effect of RANKL, these macrophages do not express RANK which raised the hypothesis of an indirect effect. LT came out as the logical intermediary since it is required for lymph node macrophages formation. Indeed we found a loss of B cells, probably due to reduced CXCL13 levels, and impaired FDC network, culminating in decreased LT production. The fact that the phenotype was gradually penetrating with aging establishes a temporal hierarchy for RANKL over other TNFSF members (LT/TNF α). Invoking the hypothesis that at early stages TNFSF members levels are high which remits RANKL to a redundant role, whereas, with aging, these levels decrease rendering RANKL essential for FDC development/maintenance. Furthermore, we also demonstrated RANKL involvement on tertiary lymphoid organ development, since its neutralization led to diminished lymphoid tissue formation with decreased numbers of hematopoietic and stromal cells on a Sjögren syndrome model.

Taken together, these data provides new insights of RANKL involvement on secondary and tertiary lymphoid tissue formation by regulating lymphoid and myeloid cell homeostatic mechanisms.

2. Integrin-alpha IIb identifies murine lymph node lymphatic endothelial cells activated by receptor activator of NF- κ B ligand

2.1 Introduction

Integrins form a large family of transmembrane receptors composed by α and β subunits. These molecules play an important role on structural and functional integrity, on mediating cell trafficking into tissues and organs and on cell activation. The integrin ITGA2b pairs exclusively with ITGB3, while the later can also form a dimer with ITGV. ITGA2b integrin is well known by being expressed in megakaryocytes and platelets, and therefore being implicated on blood clotting. Lymphatic endothelial cells (LECs) within the LN can be found on the SCS area, where they form two layers, an outermost (ceiling-lining) and an inner (floor-lining) layer and on the medullary and cortical sinuses. LECs play an important structural and functional role by mediating lymph drainage and cellular organization, regulating the immune response and controlling lymph exit. LECs are known to express some integrins, such as $\alpha 5\beta 1$ and $\alpha 9\beta 1$, which help in the connection to the extracellular matrix. Furthermore our team have previously demonstrated that these cells are activated by RANKL.

In this study (Article 2, under revision for *Blood*) we found that LECs express other integrins including ITGA2b, ITGB3 and ITGV. ITGA2b is restrictedly expressed by LECs of the subcapsular, cortical and medullary sinuses in a heterogeneous way. In addition, ITGA2b appeared as an activation marker influenced by RANKL and lymphotoxin.

2.2 Article 2

Integrin-alpha IIb identifies murine lymph node lymphatic endothelial cells activated by receptor activator of NF- κ B ligand

Olga G. Cordeiro, Melanie Chypre, Nathalie Brouard, Simon Rauber, Farrouk Alloush, Monica Romera-Hernandez, Cécile Benezech, Zhi Li, Mark Coles, Hideo Yagita, Catherine Léon, Burkhard Ludewig, Tom Cupedo, François Lanza and Christopher G. Mueller

Blood, under revision.

Integrin- α IIb identifies murine lymph node lymphatic endothelial cells activated by receptor activator of NF- κ B ligand

Olga G. Cordeiro¹, Mélanie Chypre^{1,2}, Nathalie Brouard³, Simon Rauber¹, Farouk Alloush¹, Monica Romera-Hernandez⁴, Cécile Bénézech⁵, Zhi Li⁶, Mark Coles⁶, Antal Rot⁶, Hideo Yagita⁷, Catherine Léon³, Burkhard Ludewig⁸, Tom Cupedo⁴, François Lanza³ and Christopher G. Mueller^{1*}

¹CNRS UPR 3572, University of Strasbourg, Laboratory of Immunopathology and Therapeutic Chemistry/Laboratory of Excellence MEDALIS, Institut de Biologie Moléculaire et Cellulaire, Strasbourg, France.

²Prestwick Chemical, Blvd Gonthier d'Andernach, Parc d'innovation, 67400 Illkirch, France

³INSERM, UMR_S949, Etablissement Français du Sang-Alsace, Faculté de Médecine, Fédération de Médecine Translationnelle, Université de Strasbourg, Strasbourg, France

⁴Department of Hematology, Erasmus University Medical Center, Rotterdam, The Netherlands

⁵BHF Centre for Cardiovascular Science, Queens Medical Research Institute, University of Edinburgh, Edinburgh, UK

⁶Center for Immunology and Infection, Department of Biology, University of York, York, UK

⁷Department of Immunology, Juntendo University School of Medicine, Tokyo 113-8421, Japan

⁸Institute of Immunobiology, Kantonspital St. Gallen, 9007 St. Gallen, Switzerland

*Corresponding author: Tel: +33 (0)3 88 41 71 14, Fax. +33 (0)3 88 61 06 80

c.mueller@cns-ibmc.unistra.fr

RUNNING TITLE: RANKL activates lymphatic integrin- α IIb expression

(Text word count: 4730, Abstract 200, 4 Figures, 3 supplemental Figures, 1 supplemental Table; 38 references)

Key points

- Integrin alpha IIb is a marker for activated lymph node lymphatic endothelial cells
- RANKL stimulates lymphatic endothelial cell subsets

Abstract

Microenvironment and activation signals likely imprint heterogeneity in the lymphatic endothelial cell (LEC) population. Particularly LECs of secondary lymphoid organs are exposed to different cell types and immune stimuli. However, our understanding of the nature of LEC activation signals and their cell target within the secondary lymphoid organ in the steady state remains incomplete. Here we show that ITGA2b, previously known to be carried by platelets, megakaryocytes and hematopoietic progenitors, is expressed by subsets of LECs of non-immunized murine and human lymph nodes, residing in medullary, cortical and subcapsular sinuses. ITGA2b expression increases in response to immunization, raising the possibility that heterogeneous ITGA2b levels reflect variation in exposure to activation signals. Because LECs respond to the ligand of receptor activator of NF- κ B (RANKL), and marginal reticular cells express RANKL in the lymph node, we determined the impact of RANKL on LECs. We showed that alterations of the level of RANKL, by overexpression, neutralization or deletion from marginal reticular cells, affected the proportion of ITGA2b⁺ LECs. In addition, we found that lymphotoxin- β signaling likewise regulated ITGA2b expression. These findings provide evidence that ITGA2b is a novel marker for LN LECs and shed new light on the nature of LEC activation signals. (200)

Introduction

Molecules, cells and pathogens carried by the lymph flow are filtered by lymph nodes (LNs). In these specialized organs, resident immune cells recognize, eliminate and mount an immune response against pathogens. The LECs provide an important structural and functional support to this process by mediating lymph drainage, organizing cellular compartments, regulating the immune response and controlling lymph exit¹. Lymph first drains into the subcapsular sinus, which comprises an outermost (ceiling-lining) and an inner (floor-lining) lymphatic endothelial layer. Differential expression of the chemokine

ACKR4 (also called CCRL1) has recently highlighted structural and functional specialization of these layers². LECs also form the cortical and medullary sinuses that allow distribution of cells and large molecules within different LN compartments and the exit from the organ into the efferent lymph³. Platelet adhesion to lymphatic endothelium mediates blood and lymphatic vessel separation during embryonic development⁴.

Integrins play an important role in a variety of biological processes ranging from development, cancer, and inflammation⁵. The large family of transmembrane receptors, composed of α and β subunits, provides structural and functional integrity to connective tissues and organs, mediates cell extravasation from blood and contributes to cell activation. The integrin $\alpha 2b$ (ITGA2b, CD41 or glycoprotein IIb) pairs exclusively with integrin $\beta 3$ (ITGB3, CD61 or glycoprotein IIIa), while the latter can also form a heterodimer with integrin αV (ITGAV, CD51). ITGA2b/ITGb3 is well known for its role in blood clotting through its expression by megakaryocytes and platelets⁶. Upon platelet stimulation, the surface integrin heterodimer becomes activated, binds fibrinogen and von Willebrand factor resulting in platelet aggregation. ITGA2b and ITGB3 are also expressed by embryonic erythroid and hematopoietic progenitor cells arising from the hemogenic endothelium of the conceptus and embryo⁷⁻⁹. Although hemogenic endothelium generates ITGA2b⁺ hematopoietic progenitor cells, these special endothelial cells themselves lack the integrin⁷. Otherwise, blood endothelial cells express a number of integrins, both in the abluminal space to adhere to the basement membrane and in the lumen to recruit leucocytes⁵.

The TNF family member RANKL (TNFSF11), alike other member of the protein family such as lymphotoxin- α and β , plays an important role in LN development¹⁰. It is expressed in the embryo by the hematopoietic lymphoid tissue inducing cells and triggers lymphotoxin production¹¹. In a second phase RANKL is expressed by the lymphoid organizer cells of mesenchymal origin¹², which are thought to persist as marginal reticular cells (MRCs) in the adult¹³. The role of RANKL produced by MRCs remains unknown. In a model of skin RANKL overexpression, we have recently shown that RANKL activates LN lymphatic and blood endothelial cells as well as fibroblastic reticular cells raising the possibility that RANKL of MRCs functions as internal activator of these cells¹⁴.

In this study, we show that a subset of LECs of mouse and human LNs express ITGA2b. In the murine LN the ITGA2b⁺ LECs are heterogeneously distributed in the medullary and cortical areas as well as in the subcapsular sinus, where only the floor-lining cells carry the integrin. ITGA2b could potentially heterodimerize with ITGB3 to bind ligands, such as fibronectin, but the alternative α -chain, ITGAV, is also present to pair with ITGB3 to anchor the cells to matrix components. In mice overexpressing RANKL the level of ITGA2b increases, while its neutralization or its genetic deletion from MRCs reduce the integrin expression. Similarly, inhibition of lymphotoxin- $\alpha\beta$ signaling negatively affects the proportion of ITGA2b⁺ LECs. Therefore, ITGA2b is a novel marker for LN LECs constitutively activated by TNF-family members RANKL and lymphotoxin- $\alpha\beta$.

Material and Methods

Mice

C57BL/6, *Itga2b*^{-/-} ¹⁵, ACKR4-eGFP transgenic mice (otherwise known as CCRL-1-eGFP) ², RANK-transgenic ¹⁴, and RANKL ^{Δ Ccl19} mice were bred and kept in specific pathogen-free conditions, and all experiments were carried out in conformity to the animal bioethics legislation. To generate mice with conditional RANKL deficiency in marginal reticular cells (*RANKL* ^{Δ Ccl19}), mice containing a single copy of the *Ccl19-cre* BAC transgene ¹⁶ were crossed with RANKL^{*ff*} (B6.129-Tnfsf11tm1.1Caob/J) mice ¹⁷.

Preparation of LN stromal cells

Stromal cells were prepared from murine peripheral (inguinal, axil and brachial) or mesenteric LNs as previously described ¹⁸. CD45⁺ and TER119⁺ cells were depleted using anti-TER119 and anti-CD45 coupled magnetic beads (Miltenyi Biotec). Use of all human tissues was approved by the Medical Ethical Commission of the Erasmus University Medical Center Rotterdam and was contingent on informed consent. Stromal cells from human LNs were obtained as described ¹⁹.

Flow cytometry and cell sorting

All reactions were performed at 4°C for 20 min in PBS supplemented with 2% FCS and 2.5 mM EDTA. The following antibodies were used for flow cytometry (see **supplemental Table**): CD45-APC/CY7 (30-F11, Biolegend), Ter119-APC/CY7 (Ter119, Biolegend),

gp38/podoplanin-A488 (8.1.1, Biolegend), CD31-PcPeF710 (390, eBioscience), ITGA2b (APC-conjugated MWRReg30, Biolegend, A647-conjugated RAM-2), ITGB3-PE (2C9.G2, Biolegend), glycoprotein subunit IB β -A647 (RAM-1²⁰), ITGAV-PE (RMV-7, eBioscience), CD3-FITC (145-2C11, BD), CD19-APC (1D3, BD), CD103-PerCP-Cy5.5 (M290, BD), CD11c-PerCP-Cy5.5 (N418, BD), or their isotype controls. Integrin α IIb β 3-PE (JON/A, EMFRET analytics GmbH, Eibelstadt, Germany) was used to stain for the active integrin conformation in tyrode-albumin buffer pH 7.3 (137 mM NaCl, 2,7mM KCl, 12mM NaHCO₃, 0.36 mM NaH₂PO₄, 1mM MgCl₂, 2mM CaCl₂, 5mM Hepes, 0,35% albumin, 5.55 mM Glucose). To label skin-derived DCs, cells were fixed, permeabilized (Cytofix/Cytoperm, BD) and incubated with anti-Langerin-FITC (929F3.01, Dendritics, Lyon, France). Flow cytometry was performed on a Gallios (Beckman-Coulter, Fullerton, CA, USA) or a Fortessa X-20 SORP (BD) and analyzed with FlowJo software (Treestar, Ashland, OR, USA). For flow cytometric analysis of human fetal LNs the following antibodies were used: gp38/podoplanin A488 (NC-08, Biolegend), CD31 Pacific-blue (WM59, Biolegend), CD45 PE-Cy7 (HI30, Biolegend), and mouse anti-Donkey A647 (Life technologies). Primary antibodies were added to the cells for 30 min at 4°C. Then, cells were stained with secondary antibodies for 20 min at 4 °C.

Lymphatic endothelial cell culture

LECs were cell-sorted and cultured in a single drop of endothelial cell growth medium (Lonza) in culture slides (Corning) pre-coated with 5 μ g/cm² of fibronectin and collagen (Sigma-Aldrich) over-night at 37°C 5% CO₂. The next day, 300 μ l of endothelial cell growth medium were added. Cells were fixed in 4% formaldehyde and then stained for ITGA2b and mCLCA1 with DAPI nuclear counterstain. Images were acquired on a Microscope Zeiss Axio Observer Z1 Confocal LSM780 (Carl Zeiss) with the Carl Zeiss proprietary software Zen and on a spinning disk inverted microscope (Carl Zeiss) with a confocal head Yokogawa CSU and a Metamorph software (Metamorph). Analysis of all microscopic images was done using the open source imageJ-based Fiji distribution.

Immunofluorescence

LNs were embedded in Tissue-Tek O.C.T Compound (Electron Microscopy Science) and frozen in liquid nitrogen. Six to 8 μ m sections were cut, fixed in cold acetone and then blocked with 2% BSA. The following antibodies were used: mCLCA1 (10.1.1, Hamster, a

kind gift from Andrew Farr), Lyve-1-A488 (ALY7, eBioscience), ITGA2b-APC (MWRReg30, Biolegend), Langerin-FITC (929F3.01, Dendritics, Lyon, France), CD3 (polyclonal/A0452, Dako), B220-biotin (RA3-6B2, BD-Pharmingen), MAdCAM-1 (MECA-367, BD-Pharmingen), fibronectin (Rabbit polyclonal, Patricia Simon-Assmann), RANKL (IK22.5, Rat IgG2a, ²¹), goat anti-rabbit-A488 (Molecular Probes), goat anti-hamster-A488/A546 (Molecular Probes), donkey anti-rat-Cy3 (Jackson) or streptavidin A546 or A647 (Molecular Probes). Sections were mounted using DAKO mounting medium (Dako, Hamburg, Germany). Images were acquired and treated as noted above.

Quantitative reverse transcription coupled polymerase chain reaction (qRT-PCR)

RNA from total LNs and from sorted LECs were extracted with RNeasy kits (Qiagen) and cDNA was synthesized with Maxima First Strand cDNA Synthesis Kit (Thermo Scientific) and Improm-II (Promega) using oligo(dT)₁₅ primers. RT-PCR was performed using Luminaris color HiGreen qPCR Master Mix (Thermo Scientific) using the following primers to amplify ITGA2b: Forward 5'-ATTCCTGTTTAGGACGTTTGGG and Reverse: 5'-TCTTGACTTGCGTTTAGGGC ²² with the housekeeping gene coding for GAPDH (Forward 5'-TGACGTGCCGCTGGAGAAA and Reverse 5'-AGTGTAGCCCAAGATGCCCTTCAG). Quantitative RT-PCR was run on a Bio-Rad CFX96 thermal cycler, and threshold values (Ct) of the target gene were normalized to GAPDH ($\Delta Ct = Ct_{ITGA2b} - Ct_{GAPDH}$). The relative expression was calculated for each sample versus the mean of total 5 day LN ΔCt : $\Delta \Delta Ct = \Delta Ct_{sample} - \Delta Ct_{total LN at 5 days}$; and relative quantification was performed as $2^{-\Delta \Delta Ct}$.

Immunization

Six-week-old mice were injected in both posterior limbs with 70 μ g of chicken ovalbumin, 600 μ g aluminium hydroxide (Sigma-Aldrich) and 6×10^8 heat inactivated *B. pertussis* ml⁻¹. A boost was administrated 2 weeks later. Inguinal and popliteal LN were sampled 4 days later.

Imiquimod treatment

Adult mice were anesthetized by intraperitoneal injection of ketamine and xylazine (100 μ g/g body weight and 10 μ g/g body weight, respectively). Back skin or ear skin received 12.5 μ g/g (0.1mg/kg body weight) of Toll-like receptor (TLR)-7 agonist imiquimod (Aldara), diluted in neutral cream (Diprobase) ²³. Back skin hair was trimmed before hair removal with cold wax (Klorane, France). The animals were sacrificed 12h after.

RANKL and lymphotoxin α/β neutralization

The neutralizing anti-RANKL mAb IK22-5²¹ or the rat IgG2a isotype control (Bio Ex) were administrated s.c. into 6-week old C57BL/6 mice every 3 days (50 μ g/ mouse in sterile saline) for two weeks and for 3 consecutive days for the third week. The lymphotoxin β receptor -Ig fusion protein or mIgG1 isotype control (Biogen) (20 μ g/mouse in sterile saline) were administrated s.c. into 6-week old mice every 3 days for four weeks.

Statistical analysis

An unpaired two-tailed Student *t*-test and ANOVA with the Bonferroni method were used to determine statistically significant differences. The *p* values <0.05 were considered statistically significant. GraphPad Prism version 5 for Windows (GraphPad software) was used for the analysis.

Results

LN LECs express ITGA2b

Microarray gene expression analysis of murine LN stromal cells had revealed transcription of *Itga2b* by LECs but by no other stromal or hematopoietic cells²⁴. To study ITGA2b expression by LECs, we prepared stromal cells from peripheral LNs following the same procedure as used in the microarray study. LECs (gp38⁺CD31⁺), fibroblastic reticular cells (FRCs, gp38⁺CD31⁻), blood endothelial cells (BECs, gp38⁻CD31⁺), and pericyte-containing double-negative cells (DNCs, gp38⁻CD31⁻) were identified in the cell suspension (**supplemental Figure 1A**). ITGA2b-specific mAbs (MWRReg30 and RAM-2), validated on platelets (**supplemental Figure 1B**), recognized a major subset of LECs and a minor subset of BECs (**Figure 1A**). To verify whether the labelling was due to platelets bound to the cells, we exposed them to an antibody specific for glycoprotein subunit GPIIb β (CD42c) that is exclusively carried by megakaryocytes and platelets²⁰ (**supplemental Figure 1B**). The antibody recognized the minor fraction of BECs but did not interact with LECs (**Figure 1B**). A comparison between LECs and platelets disclosed that platelets expressed the ITGA2b integrin at higher levels than LECs (mean fluorescence index (MFI) \pm SD: platelets 5,113 \pm 196 (n=4) versus LECs 3,750 \pm 994 (n=4)). To confirm ITGA2b expression, LECs were prepared from mice deficient for ITGA2b¹⁵. As shown in **Figure 1C**, LECs from heterozygous mice expressed reduced levels of the integrin and LECs from mice with the

homozygous deletion fully lacked ITGA2b. We tested whether the integrin could be detected on LECs grown in culture. To this end, murine gp38⁺CD31⁺ LECs were FACS-sorted and grown on a fibronectin/collagen-coated surface. After fixation, the cells were labelled for ITGA2b and the pan-LEC marker mCLCA1 (recognized by mAb 10.1.1, ^{25,26}). LECs expressing ITGA2b could be seen, which was found distributed throughout the cell and concentrated at cell-cell junctions (see arrows) (**Figure 1D**). Finally, to extend this finding to man, human embryonic mesenteric LNs were processed in a similar fashion to obtain the four stromal subsets (**supplemental Figure 1C**). An ITGA2b-reactive mAb that recognized platelets from healthy donors but not from an ITGA2b-deficient Glanzmann donor (**supplemental Figure 1D**) labelled LECs but not the other stromal subsets (**Figure 1E**). Taken together, these findings demonstrated that LN LECs, but not other stromal cells, express the ITGA2b integrin.

ITGA2B is restricted to LN LEC subsets

Because only a subset of LN LECs expressed ITGA2b, we next wished to localize the ITGA2b⁺ LECs in the mouse LN. ITGA2b immunofluorescence on cross-sections together with LEC marker mCLCA1 (10.1.1 mAb) revealed that LECs of the medullary and the cortical area expressed ITGA2b in a heterogeneous manner (**Figure 2A**). Remarkably, the subcapsular sinus ceiling LECs were totally devoid of ITGA2, while its floor counterpart uniformly expressed the integrin. We repeated the immunofluorescence with the lymphatic vessel endothelial hyaluronan receptor (Lyve)-1 and observed again a restricted expression of ITGA2b to a subset of LECs (**supplemental Figure 2A**). At E18.5, the subcapsular sinus of the embryonic inguinal LNs were not yet formed and was constituted of a single layer of Lyve-1⁺ LECs expressing the integrin to different extents (**Figure 2B**). To verify its exclusion from the subcapsular sinus ceiling-lining cells, LECs of mice that express GFP exclusively in this subset ² were labelled for ITGA2b. Indeed, the GFP⁺ LECs lacked the integrin (**Figure 2C**). To verify ITGA2b expression in the floor-lining cells, we sorted LECs based on gp38/CD31 and MAdCAM-1 expression for qRT-PCR analysis. MAdCAM-1 is uniformly carried by the floor-lining subcapsular sinus LECs but not the ceiling counterpart (**supplemental Figure 2B**). Quantitative RT-PCR revealed that the highest level of *Itga2b* mRNA was amplified from MAdCAM-1⁺ cells; it was also detectable in LECs lacking MAdCAM-1 and in neonatal total LNs. In whole adult LN RNA the message was barely

detectable (**Figure 2D**). Sorted LN BECs were devoid of the mRNA (data not shown). This supports its restricted expression in LECs, and in particular the floor-lining MAdCAM-1⁺ cells. To determine if ITGA2 is also expressed by non-LN LECs, we assessed whether skin LECs also carried this integrin. Skin was processed into a cell suspension and LECs were identified as CD45⁻F4/80⁻gp38⁺CD31⁺ cells. However, we saw no ITGA2b expression by FACS or qRT-PCR, neither in LECs from resting skin, after activation with imiquimod²³ or from RANK-transgenic mice overexpressing RANKL from hair follicles^{14,27} (**supplemental Figure 2C and data not shown**). Taken together, the data show that ITGA2b is restricted to subsets of LN LECs.

LEC ITGA2b is not required for residence in fibronectin-rich environments

To explore the function of ITGA2b for LECs, we first asked whether ITGA2b could heterodimerize with ITGB3 to interact with ligands, such as fibronectin. Indeed, ITGB3 was uniformly expressed by LECs and BECs, while there was little of the β -chain found on FRCs and DNCs (**Figure 3A**). We next assessed whether there was a correlation between ITGA2b expression and residence in a fibronectin-containing environment. To this end, we stained the LN subcapsular area that contained the ITGA2b⁺ floor-lining and the ITGA2b⁻ ceiling-lining LECs for fibronectin. It was apparent that this extracellular matrix component was present in both sites, demonstrating that the absence of ITGA2b does not prevent LECs to take up position in the fibronectin-containing ceiling (**Figure 3B**). To explore whether a functional ITGA2b/ITGB3 complex was indeed formed, LECs and, as controls unstimulated and thrombin-activated platelets, were incubated with the phycoerythrin (PE)-conjugated JON/A mAb, which recognizes only the ITGA2b/ITGB3 complex in its activated state, as found on platelets^{28,29}. While agonist stimulated platelets were labelled with this mAb, LECs were not recognized (**Figure 3C**). This suggests that if an ITGA2b/ITGB3 heterodimer is formed on LECs, it is not in a configuration recognized by PE-JON/A and may present a low affinity for its ligands. We therefore asked whether ITGA2b could be substituted by ITGAV to pair with ITGB3. LECs, alike all other stromal cells, expressed ITGAV, suggesting that they could anchor to matrix proteins through ITGAV/ITGB3 (**Figure 3D**). In platelets (**supplemental Figure 1B**) but not in embryonic hematopoietic stem cells or mast cells^{22,30}, ITGA2b is required to translocate ITGB3 to the cell surface^{15,31}, raising the question of whether, in the absence of ITGA2b, ITGB3 would be available to heterodimerize with

ITGAV on the cell surface. To assess this issue, we labelled LECs from mice deficient for ITGA2 and observed that cell surface expression of the ITGB3 was maintained in *Itga2b*^{-/-} mice (**Figure 3E**). We also measured the levels of both alpha chains at the cell surface and determined their mean fluorescence index. In comparison with ITGA2b (3,750 ± 994 (n=4)), ITGAV is expressed at similar levels (4,125 ± 463 (n=4)) making it likely that ITGB3 forms a complex with either alpha chains. Taken together, ITGA2b is not required for residence of the ceiling LECs in its fibronectin-containing environment, most probably by the formation of an ITGAV/ITGB3 complex that binds with high affinity to this matrix protein.

ITGA2b is an LEC-specific RANKL activation marker

We noted that in comparison to peripheral LNs, the proportion of ITGA2b⁺ LECs was higher in mesenteric LNs (**Figure 4A**). Because mesenteric LNs are stimulated by the intestinal microflora, this evoked the possibility that the heterogenous LN ITGA2b expression reflects differences in cell activation. To test this hypothesis, we administered heat-inactivated *Bordetella pertussis* subcutaneously, and after a secondary immunization, compared ITGA2b expression in draining and non-draining LNs. The proportion of ITGA2b⁺ LECs was markedly increased in response to immunization (**Figure 4B**), while the other stromal cells remained devoid of the integrin (**Figure 4C**). The upregulation was not due to platelet adherence to LECs because there was no recognition of LECs by the GPIIb/IIIa-specific mAb (**Figure 3D**). We also tested whether the innate immune stimulus imiquimod (TLR7 ligand) resulted in a similar upregulation. LECs from auricular LNs draining imiquimod or mock-treated ears were analyzed, however, the proportion of ITGA2b⁺ LECs did not rise after application of the TLR-7 ligand (**supplemental Figure 3A**). We have previously observed that RANKL activates LN LECs in a transgenic model of cutaneous RANKL overproduction¹⁴. Therefore, we determined in these mice whether RANKL affected ITGA2b levels and indeed found that ITGA2b expression was positively regulated by this TNF-family member (**Figure 4E**). We addressed the question of whether integrin upregulation was due to its externalization to the cell surface. In WT controls, immunolabelling of permeabilized cells revealed a stronger signal compared with the cell surface, however, the signal was identical in the LECs isolated from the transgenic mice (**supplemental Figure 3B**). This suggests that the increased expression of ITGA2b by RANKL

stimulation likely involves its translocation from the cytoplasm to the cell membrane. We tested whether the upregulation was accompanied by a rise in transcriptional activity. In comparison with WT controls, there was no major increase in mRNA synthesis in the LEC subsets isolated from the mutant mice (**supplemental Figure 3C**). However, because the proportion of MAdCAM-1⁺ LECs greatly augmented in the transgenic mice (**supplemental Figure 3C**), the increase in ITGA2b expression in these mice is principally the result of an expansion of the MAdCAM-1⁺ subset that naturally expresses more ITGA2b. We next determined if neutralizing RANKL in WT mice led to a downregulation of ITGA2b. Administration of RANKL-blocking mAb caused a significant decrease in ITGA2b expression by LECs in comparison to isotype injected controls (**Figure 4F**). Immunofluorescence on sections confirmed the strong decline of ITGA2b in subcapsular and medullary sinuses (**Figure 4G**). Because in the LN, RANKL is principally produced by MRCs¹³, this raised the possibility that MRC RANKL activates LECs resulting in ITGA2b expression. To address this question, we generated mice conditionally deficient for RANKL in MRCs by crossing *Ccl19-cre* mice¹⁶ with *RANKL^{ff}* mice¹⁷. These mice were devoid of RANKL expression by MRCs (**supplemental Figure 3D**). Analysis of *RANKL^{ΔCcl19}* mice showed that the disappearance of MRC RANKL strongly compromised ITGA2b expression (**Figure 4H**) supporting a role of RANKL in LEC activation. However, because there was not a complete loss of ITGA2b other factors could contribute to LEC activation. Indeed, approximately 15 % of LECs were double positive for RANK and ITGA2b, suggesting that a proportion of LECs react to other stimulatory factors (**supplemental Figure 3E**). On the other hand, cutaneous LECs that do not respond to RANKL do not carry any RANK (**supplemental Figure 3F**). In light of similar activities of RANKL and lymphotoxin αβ (LT)^{10,32} and the expression of the LTβ receptor by LECs³³, we asked whether also LT regulated ITGA2b expression. Therefore, mice were treated with soluble LTβR-Ig to inhibit LTβR signaling³⁴. We found that this treatment likewise reduced ITGA2b (**Figure 4I**). Therefore, both RANKL and LTβ signaling activate LECs resulting in ITGA2b expression. Taken together, ITGA2b is a novel marker for subsets of LN LECs constitutively activated by TNF-family members RANKL and LT.

Discussion

In this study we show that ITGA2b is expressed by a subset of LN LECs, in particular the subcapsular floor-lining cells. ITGA2b is dispensable for LN formation and is expressed in response to RANKL and LT-stimulation.

ITGA2b is known to be carried by megakaryocytes and platelets as well as by hematopoietic stem and progenitor cells in the embryo and the adult^{7-9,35}. Here we show for the first time that LN LECs also carry this integrin. A number of studies had analyzed ITGA2b expression using different experimental approaches, including a genetic reporter system to mark ITGA2b-expressing cells by β -galactosidase⁷⁻⁹. However, these reports, which investigated whole embryos, the embryonic aorta-gonad-mesonephros region, spleen, thymus and bone marrow, identified hematopoietic precursor cells as well as megakaryocytes and platelets, did not study LNs. Although platelets interact with endothelial cells in the embryo during separation of blood and lymphatic systems⁴, the following observations exclude the possibility that ITGA2b expression by LEC is the result of platelet contamination: (i) the platelet glycoprotein subunit I β is not detected on LECs, (ii) ITGA2b-deficient platelets lack surface ITGB3, yet the β -chain is expressed by LECs of *Itga2b*^{-/-} mice and (iii) *Itga2b* mRNA can be amplified from sorted LECs. The related BECs were devoid of the integrin, irrespective of the site of residence or the presence of stimulatory signals. This is supported by an early report noting the absence of ITGA2b in the blood endothelial cell line bEnd3³⁶.

LN LECs and BECs uniformly express ITGB3 and ITGAV, while a subset of LECs also carries ITGA2b. Both α -chains pair with ITGB3 and recognize similar matrix proteins, such as fibronectin, fibrinogen, von Willebrand factor and vitronectin, which raises the question of the necessity of the ITGA2b chain. This is in contrast to platelets that predominantly express ITGA2b to ensure platelet aggregation. Indeed, although ITGA2b is expressed by LECs in embryonic LNs, its absence has no discernible impact on LN development. In addition, those LECs that naturally lack ITGA2b are still capable of taking up residence in the fibronectin-rich subcapsular sinus. It is very likely that LECs rendered genetically deficient for ITGA2b function normally, since the migration of tissue-derived dendritic cells to the LN cortex of ITGA2b-deficient mice was unperturbed (data not shown). Although we observed a reduction in the number of B cells, it cannot be excluded that this defect was

the result of a loss of ITGA2b from platelets (data not shown). Indeed, a minor defect in LN structuring during development was seen in mice lacking platelet CLEC-2³⁷. Further investigation into the role of ITGA2b for LEC function will await the generation of mice with conditional deletion of ITGA2b in LECs. Inside-out signaling of platelets results in a conformation change of ITGA2b/ITGB3 to increase affinity for its ligands. This conformation is detected by the PE-conjugated JON/A mAb. LECs were not recognized by the antibody indicating either that ITGA2b does not pair with ITGB3 or that the complex is not in the same configuration as that found on platelets. On the other hand, to our knowledge, this mAb has only been used successfully on activated platelets and may not be a suitable reagent to probe for the ITGA2b/ITGB3 heterodimer on other cells. It is also noteworthy that although bone marrow-derived mast cells express ITGA2b and ITGB3, no binding to fibrinogen was seen, and, paradoxically, cell adhesion to fibronectin increased in ITGA2b-deficient cells²². It should also be noted that the densities of the α and β chains are at least 10-fold higher on platelets owing to their approximately 10-fold smaller size with roughly equal mean fluorescence intensities, resulting in greatly increasing the avidity.

ITGA2b was carried by the subcapsular floor-lining LECs but absent from its ceiling equivalent. Interestingly, this expression pattern was shared with MAdCAM-1. Hence, MAdCAM-1⁺ LECs displayed the highest *Itga2b* transcriptional activity. In addition, there was a heterogeneous expression of ITGA2b in the medullary and the cortical sinuses, cells that lack MAdCAM-1 in the resting LN. Skin LECs were devoid of the integrin on protein and mRNA levels in all conditions tested. Difference in tissue versus secondary lymphoid organ LECs is supported by other examples, such as Sphingosine-1-phosphate³, found expressed by LN LECs, or ITGA9³⁸ that is carried exclusively by vessel LECs. In view of its uniform expression by the subcapsular floor-lining LECs, their juxtaposition to the RANKL-expressing MRCs, and the finding that RANKL upregulates MAdCAM-1 expression¹⁴, we reasoned that RANKL may control ITGA2b synthesis. Indeed, our findings support this notion. Using overexpression and neutralization / genetic deletion, we showed that RANKL positively regulates the proportion of ITGA2b⁺ LECs. The finding that conditional deficiency of RANKL from MRCs lowers ITGA2b expression to the same extent as RANKL neutralization concurs with the idea that MRC RANKL is the main LN RANKL source and

identifies a cellular target for the stromal cell-produced RANKL. However, two elements suggested that RANKL is not the exclusive ITGA2b regulatory factor: (i) RANKL neutralization or genetic deletion do not eliminate its expression and (ii) only a proportion of ITGA2b⁺ LECs express RANK. Lymphotoxin and RANKL share not only biological functions (requirement for secondary lymphoid organ formation), signaling (canonical and non-canonical NF- κ B pathways) but also receptor expression by LECs, so that it appeared rational to investigate the impact of LT β R blockage. Indeed, administration of LT β R-Ig also led to reduced ITGA2b expression. It is therefore likely that both RANKL and LT are responsible for expression of this integrin by LECs and that upregulation of ITGA2b expression in response to immunization is the result of the combined actions of RANKL produced by primed T cells and LT expressed by activated B and T cells. The finding that imiquimod had no effect on ITGA2b may therefore reflect a failure to stimulate RANKL and LT synthesis. Further work is necessary to determine whether other stimuli such as TNF- α or T and B cell-released cytokines also impact on ITGA2b expression by LN LECs. Beyond the question of its function for LN LECs, the ITGA2b integrin sheds a new light on the heterogeneity of LECs and their response to activation signals.

Acknowledgements

The authors would like to thank Monique Duval and Delphine Lamon for mouse care, and Andy Farr (Seattle, USA) for mAb 10.1.1, the Biogen Idec Inc. for lymphotoxin reagents, the IGBMC microarray / sequencing and the cell sorting facilities and Sophie Guillot (Institut Pasteur, Paris) for *B. pertussis*. O.C. and M. R.-H. were supported by FP7-MC-ITN No. 289720 "Stroma", M.C. by Prestwick Chemical, S.R. by the German-French University program and F.A. by the IDEX-University of Strasbourg international PhD program. The study has received financial support by the Centre National pour la Recherche Scientifique and the Agence Nationale pour la Recherche (Program "Investissements d'Avenir", ANR-10-LABX-0034 MEDALIS; ANR-11-EQPX-022) to C.G.M.

Authorship Contribution

O.C., M.C., N.B., S.R., F.A., M.R-H, C.B. and Z.L. performed research and analyzed the data, M.C., A.R., H.Y., C.L., B.L., T.C. and F.L. contributed material, F.L. edited the paper and C.G.M. directed the study and wrote the paper. There is no conflict of interest.

References

1. Tewalt EF, Cohen JN, Rouhani SJ, Engelhard VH. Lymphatic endothelial cells - key players in regulation of tolerance and immunity. *Front Immunol*. 2012;3:305-1-6.
2. Ulvmar MH, Werth K, Braun A, et al. The atypical chemokine receptor CCRL1 shapes functional CCL21 gradients in lymph nodes. *Nat Immunol*. 2014;15(7):623-630.
3. Schwab SR, Cyster JG. Finding a way out: lymphocyte egress from lymphoid organs. *Nat Immunol*. 2007;8(12):1295-1301.
4. Bertozzi CC, Schmaier AA, Mericko P, et al. Platelets regulate lymphatic vascular development through CLEC-2-SLP-76 signaling. *Blood*. 2010;116(4):661-670.
5. Lowell CA, Mayadas TN. Overview: studying integrins in vivo. *Methods Mol Biol*. 2012;757:369-397.
6. Lefkovits J, Plow EF, Topol EJ. Platelet glycoprotein IIb/IIIa receptors in cardiovascular medicine. *N Engl J Med*. 1995;332(23):1553-1559.
7. Mitjavila-Garcia MT, Cailleret M, Godin I, et al. Expression of CD41 on hematopoietic progenitors derived from embryonic hematopoietic cells. *Development*. 2002;129(8):2003-2013.
8. Emambokus NR, Frampton J. The glycoprotein IIb molecule is expressed on early murine hematopoietic progenitors and regulates their numbers in sites of hematopoiesis. *Immunity*. 2003;19(1):33-45.
9. Ferkowicz MJ, Starr M, Xie X, et al. CD41 expression defines the onset of primitive and definitive hematopoiesis in the murine embryo. *Development*. 2003;130(18):4393-4403.
10. Mueller CG, Hess E. Emerging Functions of RANKL in Lymphoid Tissues. *Frontiers in Immunology*. 2012;3:261-267.
11. Yoshida H, Naito A, Inoue J, et al. Different cytokines induce surface lymphotoxin-alpha on IL-7 receptor-alpha cells that differentially engender lymph nodes and Peyer's patches. *Immunity*. 2002;17(6):823-833.
12. Sugiyama M, Nakato G, Jinnohara T, et al. Expression pattern changes and function of RANKL during mouse lymph node microarchitecture development. *Int Immunol*. 2012;2012:21.
13. Katakai T, Suto H, Sugai M, et al. Organizer-like reticular stromal cell layer common to adult secondary lymphoid organs. *J Immunol*. 2008;181(9):6189-6200.
14. Hess E, Duheron V, Decossas M, et al. RANKL induces organized lymph node growth by stromal cell proliferation. *J Immunol*. 2012;188:1245-1254.
15. Zhang J, Varas F, Stadtfeld M, Heck S, Faust N, Graf T. CD41-YFP mice allow in vivo labeling of megakaryocytic cells and reveal a subset of platelets hyperreactive to thrombin stimulation. *Exp Hematol*. 2007;35(3):490-499.
16. Chai Q, Onder L, Scandella E, et al. Maturation of lymph node fibroblastic reticular cells from myofibroblastic precursors is critical for antiviral immunity. *Immunity*. 2013;38(5):1013-1024.
17. Xiong J, Onal M, Jilka RL, Weinstein RS, Manolagas SC, O'Brien CA. Matrix-embedded cells control osteoclast formation. *Nat Med*. 2011;17(10):1235-1241.
18. Link A, Vogt TK, Favre S, et al. Fibroblastic reticular cells in lymph nodes regulate the homeostasis of naive T cells. *Nat Immunol*. 2007;8(11):1255-1265.
19. Onder L, Narang P, Scandella E, et al. IL-7-producing stromal cells are critical for lymph node remodeling. *Blood*. 2012;120(24):4675-4683.
20. Perrault C, Moog S, Rubinstein E, et al. A novel monoclonal antibody against the extracellular domain of GPIIb/IIIa modulates vWF mediated platelet adhesion. *Thromb Haemost*. 2001;86(5):1238-1248.
21. Kamijo S, Nakajima A, Ikeda K, et al. Amelioration of bone loss in collagen-induced arthritis by neutralizing anti-RANKL monoclonal antibody. *Biochem Biophys Res Commun*. 2006;347(1):124-132.
22. Berlanga O, Emambokus N, Frampton J. GPIIb (CD41) integrin is expressed on mast cells and influences their adhesion properties. *Exp Hematol*. 2005;33(4):403-412.

23. Voisin B, Mairhofer DG, Chen S, Stoitzner P, Mueller CG, Flacher V. Anatomical distribution analysis reveals lack of Langerin+ dermal dendritic cells in footpads and tail of C57BL/6 mice. *Exp Dermatol*. 2014;23:354-356.
24. Malhotra D, Fletcher AL, Astarita J, et al. Transcriptional profiling of stroma from inflamed and resting lymph nodes defines immunological hallmarks. *Nat Immunol*. 2012;2012(1):2262.
25. Ruddell A, Mezquita P, Brandvold KA, Farr A, Iritani BM. B lymphocyte-specific c-Myc expression stimulates early and functional expansion of the vasculature and lymphatics during lymphomagenesis. *Am J Pathol*. 2003;163(6):2233-2245.
26. Furuya M, Kirschbaum SB, Paulovich A, et al. Lymphatic endothelial murine chloride channel calcium-activated 1 is a ligand for leukocyte LFA-1 and Mac-1. *J Immunol*. 2010;185(10):5769-5777.
27. Duheron V, Hess E, Duval M, et al. Receptor Activator of NF-kB (RANK) stimulates the proliferation of epithelial cells of the epidermo-pilosebaceous unit. *Proc Natl Acad Sci USA*. 2011;108(13):5342-5347.
28. Bergmeier W, Schulte V, Brockhoff G, Bier U, Zirngibl H, Nieswandt B. Flow cytometric detection of activated mouse integrin alphaIIb beta3 with a novel monoclonal antibody. *Cytometry*. 2002;48(2):80-86.
29. Wang Y, Jobe SM, Ding X, et al. Platelet biogenesis and functions require correct protein O-glycosylation. *Proc Natl Acad Sci U S A*. 2012;109(40):16143-16148.
30. Boisset JC, Clapes T, Van Der Linden R, Dzierzak E, Robin C. Integrin alphaIIb (CD41) plays a role in the maintenance of hematopoietic stem cell activity in the mouse embryonic aorta. *Biol Open*. 2013;2(5):525-532.
31. Hodivala-Dilke KM, McHugh KP, Tsakiris DA, et al. Beta3-integrin-deficient mice are a model for Glanzmann thrombasthenia showing placental defects and reduced survival. *J Clin Invest*. 1999;103(2):229-238.
32. Kong YY, Yoshida H, Sarosi I, et al. OPG is a key regulator of osteoclastogenesis, lymphocyte development and lymph-node organogenesis. *Nature*. 1999;397(6717):315-323.
33. Cohen JN, Tewalt EF, Rouhani SJ, et al. Tolerogenic properties of lymphatic endothelial cells are controlled by the lymph node microenvironment. *PLoS ONE*. 2014;9(2):e87740.
34. Ettinger R, Browning JL, Michie SA, van Ewijk W, McDevitt HO. Disrupted splenic architecture, but normal lymph node development in mice expressing a soluble lymphotoxin-beta receptor-IgG1 fusion protein. *Proc Natl Acad Sci USA*. 1996;93(23):13102-13107.
35. Gekas C, Graf T. CD41 expression marks myeloid-biased adult hematopoietic stem cells and increases with age. *Blood*. 2013;121(22):4463-4472. .
36. Nieswandt B, Echtenacher B, Wachs FP, et al. Acute systemic reaction and lung alterations induced by an antiplatelet integrin gpIIb/IIIa antibody in mice. *Blood*. 1999;94(2):684-693.
37. Benezech C, Nayar S, Finney BA, et al. CLEC-2 is required for development and maintenance of lymph nodes. *Blood*. 2014;123(20):3200-3207. .
38. Bazigou E, Xie S, Chen C, et al. Integrin-alpha9 is required for fibronectin matrix assembly during lymphatic valve morphogenesis. *Dev Cell*. 2009;17(2):175-186.

Figures

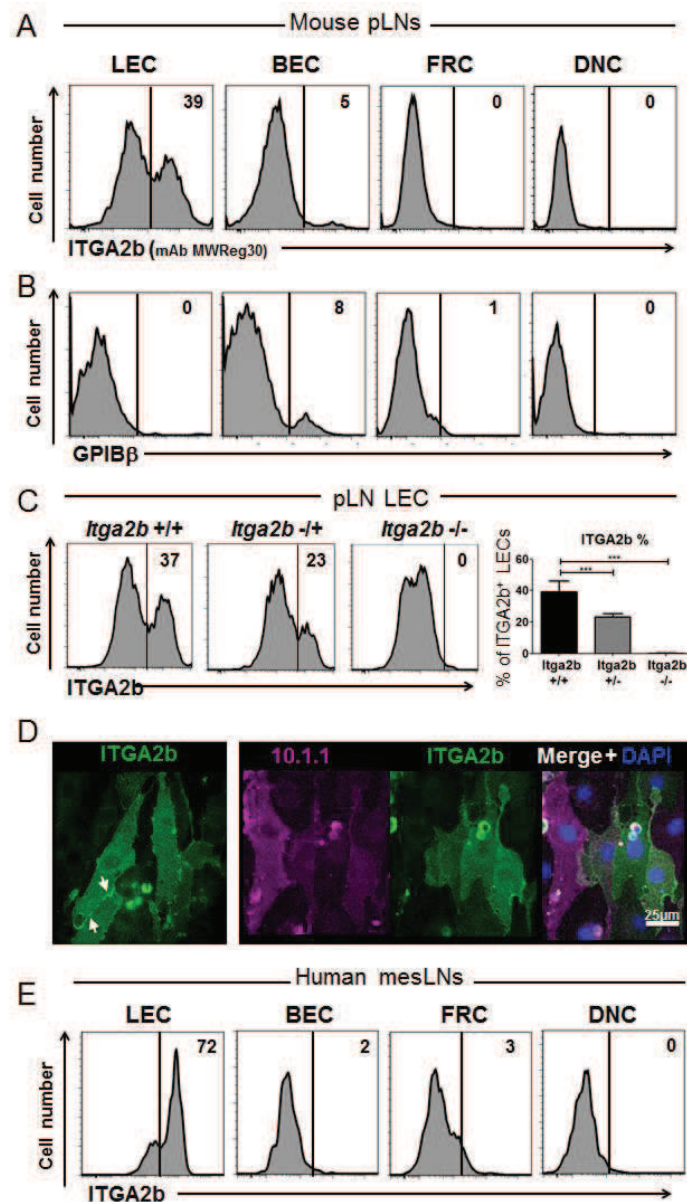

Figure 1. LN LECs express ITGA2b. (A) Flow cytometry histograms display ITGA2b expression by peripheral (p)LN stromal subsets, lymphatic endothelial cells (LEC), blood endothelial cells (BEC), fibroblastic reticular cells (FRC) and the pericyte-containing gp38⁺CD31⁻ double negative cells (DNC). Peripheral LNs are inguinal, brachial and axial LNs. The percentage of cells labelled by the mAb is indicated. The data is representative of 18 mice. (B) Histograms of the four stromal cell types incubated with a mAb specific for platelet-restricted GPIIb/IIIa. The percentage of cells labelled by the antibody is indicated. The data is representative of 11 mice in 5 different experiments. (C) Histograms show ITGA2b expression by WT control LECs, but reduced and no expression by LECs isolated from mice heterozygous or homozygous for *Itga2b* genetic deletion. The graph depicts the mean \pm SD (n=9) percentage of ITGA2b⁺ LECs in WT controls and in mice heterozygous or

homozygous for the *Itga2b* genetic deletion. (D) Confocal fluorescence microscopy images of cell-sorted LECs in culture showing mCLCA1 (mAb 10.1.1) (magenta) and ITGA2b (green) expression. The images are representative of 2 different experiments with 4 mice pooled per experiment. (E) Flow cytometry histograms display ITGA2b expression within the four stromal subsets of human embryonic mesenteric LN. The data is representative of two different specimens. *** $p < 0.001$.

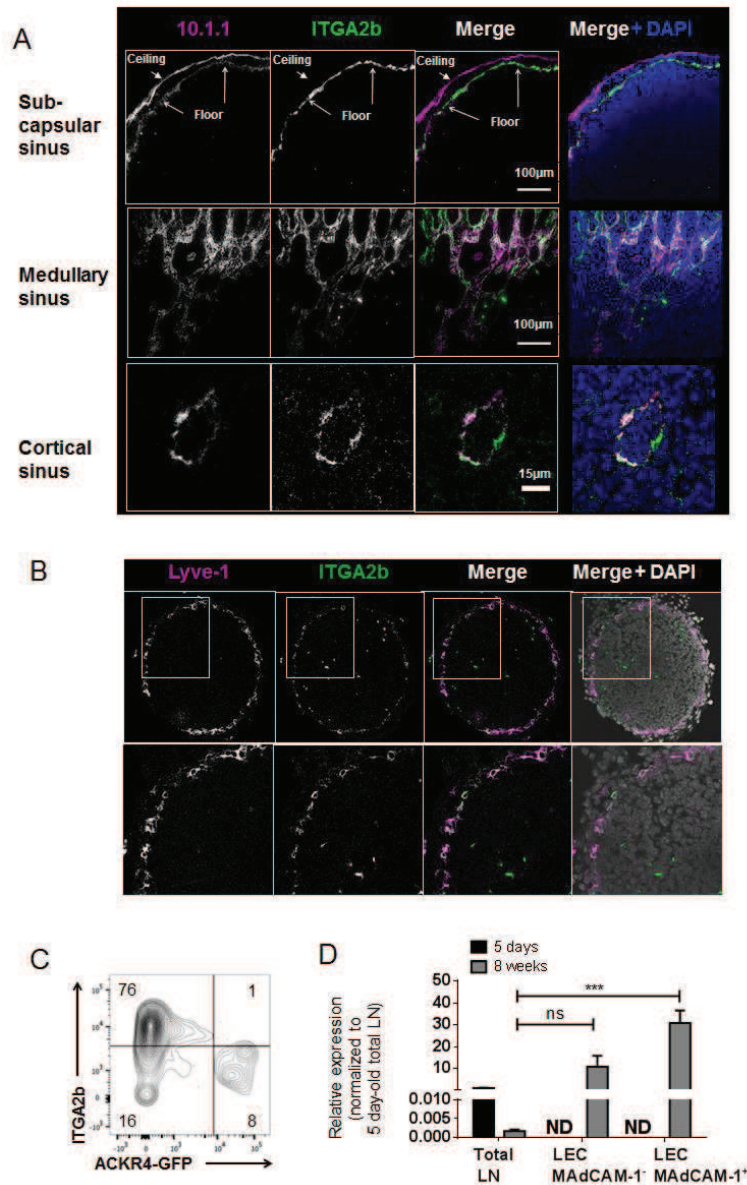

Figure 2. ITGA2b is heterogeneously expressed in the adult and embryonic LN. (A) Confocal microscopy images of an adult inguinal LN probed for ITGA2b together with LEC marker mCLCA1 (mAb 10.1.1) in the subcapsular, the medullary and the cortical sinus. Scale bars are indicated. The images are representative of 7 mice. (B) Confocal microscopy images of an embryonic (E18.5) inguinal LN of ITGA2b and LEC marker Lyve-1. Higher magnification of boxed area is shown below.

The image is representative of 3 mice. (C) Flow cytometry counterplot of ITGA2b versus ACKR4 expression by LN LECs of ACKR4-GFP transgenic mice. Data is representative from 3 mice. (D) Mean \pm SEM *Itga2b* mRNA expression of total LN from mice aged 5 days and 8 weeks, and of MAdCAM-1⁺ and MAdCAM-1⁻ cell-sorted LECs from mice aged 8 weeks (n=6). Statistical analysis: ***p<0.001, ns= non-significant by one way Anova with the Bonferroni method.

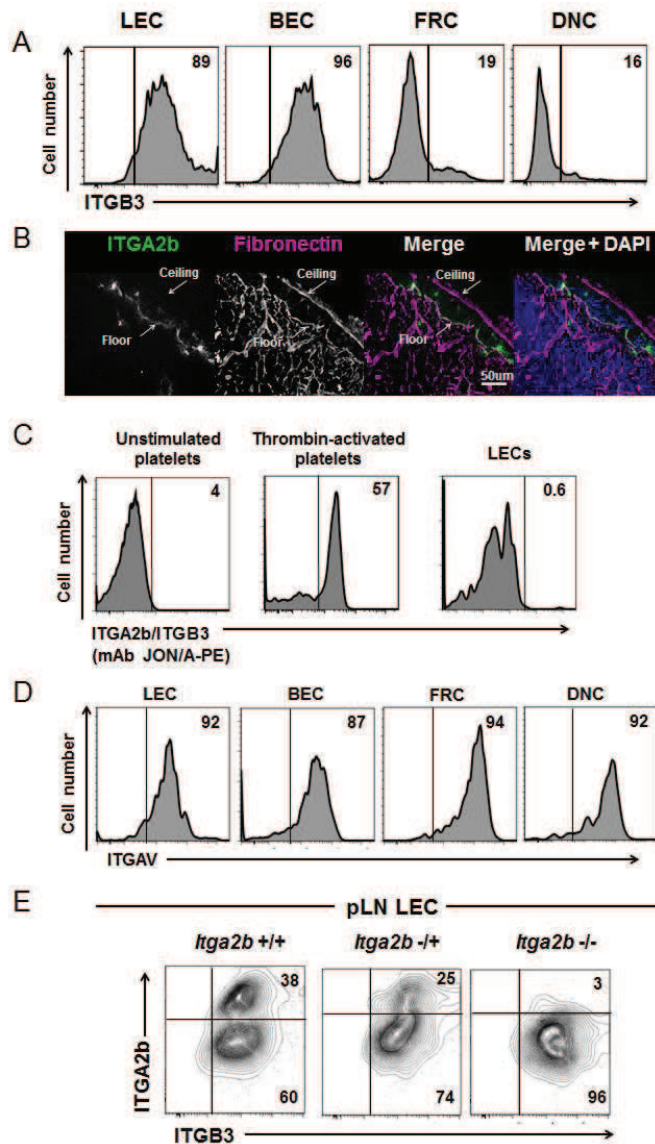

Figure 3. LEC ITGA2b is not required for residence in fibronectin-rich environments. (A) Flow cytometry histograms show the percentage of LECs expressing ITGB3 by the four stromal subsets. (B) Confocal microscopic images of an inguinal LN labelled for fibronectin (magenta) and ITGA2b (green). Nuclear coloration was with DAPI. The images are representative of two mice. (C) Histograms show recognition of the active conformation of the ITGA2b/ITGB3 complex on

activated platelets but not on LECs or unstimulated platelets by the PE-conjugated JON/A mAb. Data are representative of 3 mice. (D) Histograms display ITGA2b expression on the stromal subsets and are representative of 4 mice. (E) Flow cytometry counterplots of LECs probed for expression of ITGA2b and ITGB3 in *Itga2b*^{+/+}, *Itga2b*^{+/-} and *Itga2b*^{-/-} mice. Data are from 9 mice in 4 different experiments.

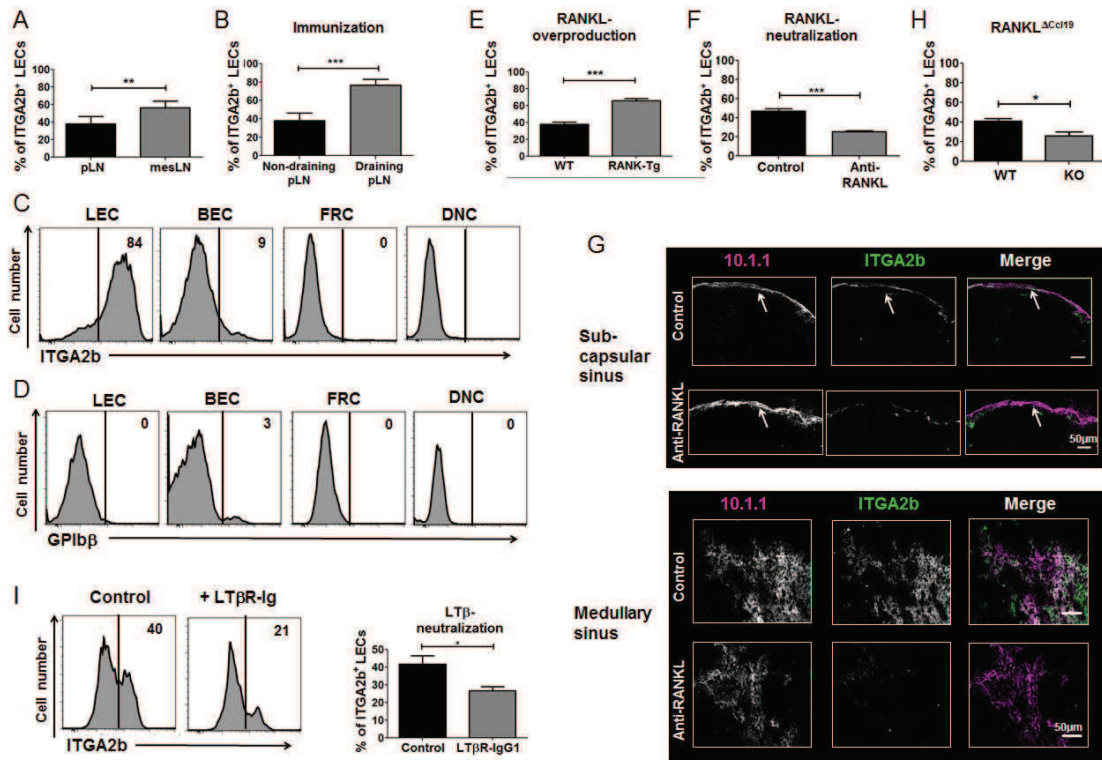
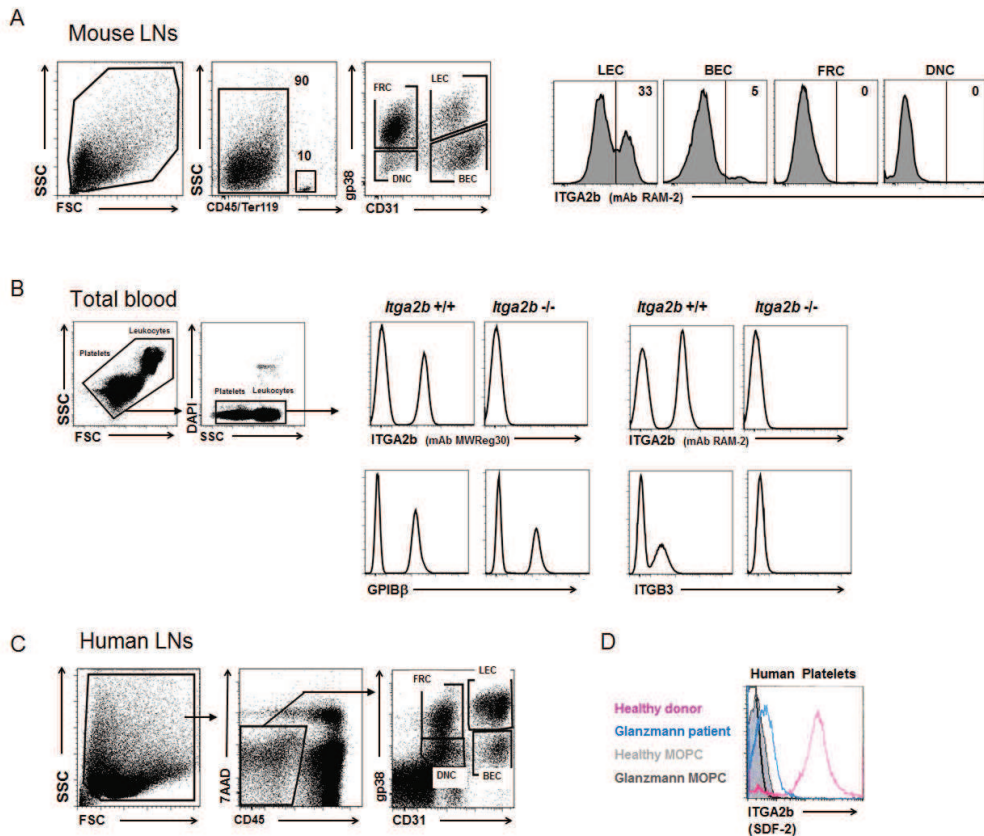
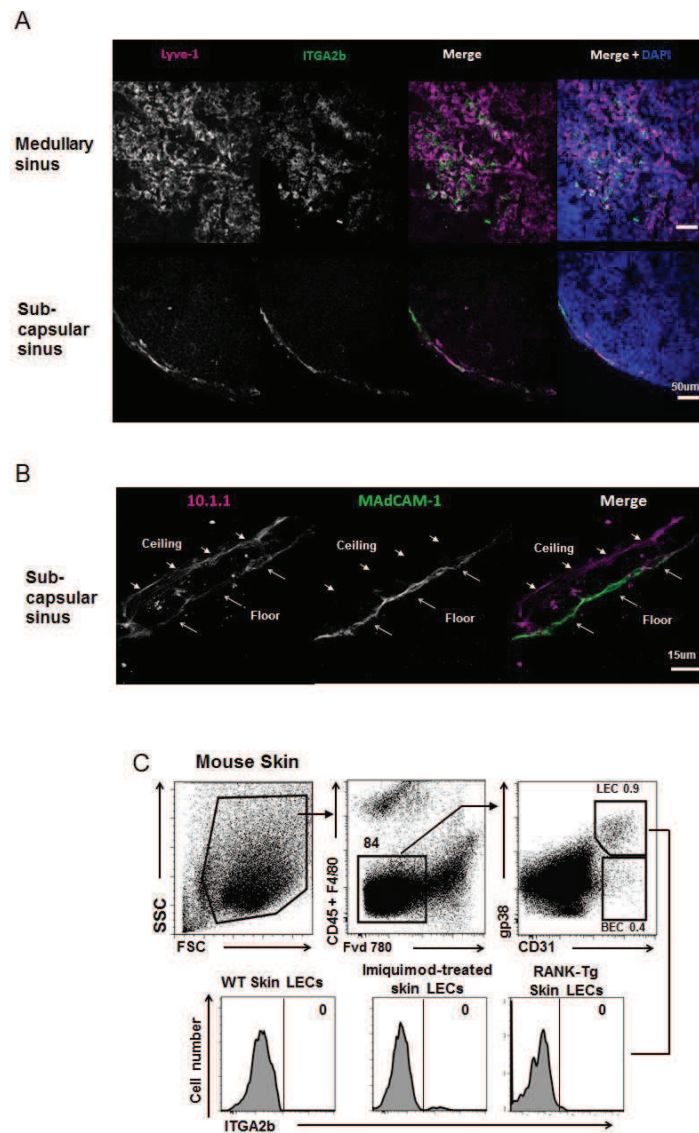

Figure 4. ITGA2b is an LEC-specific activation marker responsive to RANKL. (A) Mean \pm SD (n=17) percentage of ITGA2b⁺ LECs of peripheral (p)LN (inguinal, axil and brachial) versus mesenteric (mes) LNs. (B) Mice were immunized with heat-inactivated *B. pertussis* and LEC ITGA2b expression of draining and non-draining LNs was compared. The graph shows the mean \pm SD (n=13) percentage of ITGA2b⁺ LECs, revealing increased ITGA2b proportions in response to immunization. (C) Flow cytometry histograms display representative ITGA2b expression by stromal subsets of inguinal and popliteal LNs draining the immunization site. The percentage of cells labelled by the antibody is indicated. (D) Histograms show reactivity to anti-GPIIb/3 labelling of stromal subsets of inguinal and popliteal LNs draining the immunization site. The percentage of cells labelled by the antibody is indicated. (E) The increase in the proportion of ITGA2b⁺ pLN LECs from RANK-Tg mice (overproducing soluble RANKL in the skin) compared with LECs of WT controls is shown as mean \pm SD (n=21). (F) Graph shows reduction in the percentage of ITGA2b⁺ LECs upon RANKL neutralization (mean \pm SD, n=10). (G) Confocal microscopy imaging in inguinal LN subcapsular and medullary sinuses of ITGA2b expression (green) by LECs (10.1.1, magenta) after RANKL-

neutralization or after administration of isotype-control antibody. (H) Mean \pm SD (n=15) percentage of ITGA2b⁺ LECs from mice with conditional deficiency of RANKL in marginal reticular cells (KO) versus WT littermate controls. (I) Histograms of ITGA2b expression of LECs from mice treated with LT β R-Ig or IgG1 control. The graph depicts the mean \pm SD (n=8) percentage of ITGA2b⁺ LECs. *p<0.5, **p < 0.01, ***p < 0.001.



Supplemental Figure 1. (A) Left: Flow cytometry dot plot profiles displaying the gating strategy for stromal cell identification in CD45/Ter119-depleted LN cell suspensions. Right: Flow cytometry histograms show ITGA2b expression by the four stromal subsets using the RAM-2 mAb. The percentage of cells labelled by the antibody is indicated. The data is representative of 11 mice in 5 different experiments. (B) Validation of MWRReg30 and RAM.2 (anti-ITGA2b antibodies), RAM.1 (anti-GPIIb β antibody) and 2C9.G2 (anti-ITGB3 antibody) in WT and knock-out animals. ITGA2b and ITGB3 were seen on platelets from *Itgab2*^{+/+} mice but not on platelets from *Itgab2*^{-/-} mice. GPIIb β was present on platelets of both mice. (C) Flow cytometry dot plot profiles displaying the gating strategy for stromal cell identification from human embryonic mesenteric LN. (D) The histogram displays ITGA2b expression (SDF.2 mAb) on human healthy donor platelets but not on platelets from a patient with Glanzmann's thrombasthenia. Representative image of over 10 donors.



Supplemental Figure 2. (A) Confocal microscopy images of an inguinal LN, showing the medullary and the subcapsular sinus LECs labelled with anti-Lyve-1 and anti-ITGA2b mAbs. Scale bar = 50µm. Images are representative of 2 different experiments with 2 different mice. Counter coloration was with DAPI. (B) Confocal microscopy images of a LN subcapsular sinus showing MAdCAM-1 (green) expression by the floor-lining but not the ceiling-lining LECs marked with the 10.1.1 mAb. (C) Flow cytometry of mouse skin: upper dot blot panels depict the gating strategy for skin LECs; lower panels show the histograms for ITGA2b expression of skin LECs from control mice, imiquimod-treated skin and from RANK-transgenic skin (overexpressing RANKL in the hair follicles).

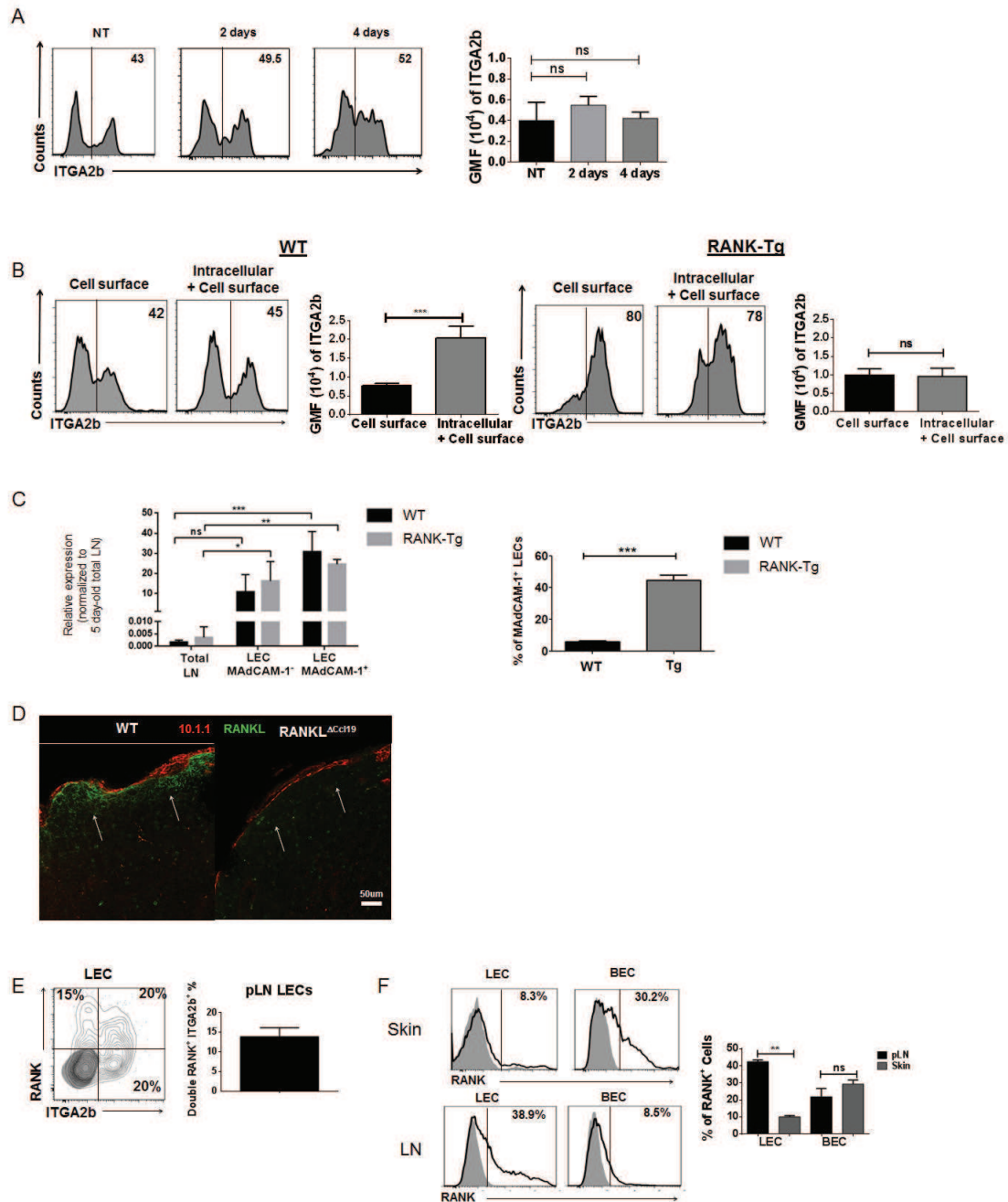

Supplemental Figure 3. (A) Histograms show ITGA2b expression of auricular LN LECs from mice non-treated or after 2 or 4 day topical application of imiquimod on ears. Bar graph depicts the levels (geometric mean of fluorescence) of ITGA2b expression (n=6 mice of 3 different experiments). (B) Histograms show LEC ITGA2b expression on the cell surface or on the cell surface and within the cytoplasm for WT and RANK-Tg mice. The graphs show the expression levels of the integrin in LECs after cell surface or intracellular/cell surface labelling. The data for WT mice are of 8 mice and for Tg mice are of 4 mice. (C) Graphs show mean \pm SEM (n=6) *Itga2b* mRNA expression of total LN, MAdCAM-1⁺ and MAdCAM-1⁻ LECs from WT and RANK-Tg mice (left) normalized with respect to WT 5 day LNs. Right: Graph shows the mean \pm SD (n=10) percentage of MAdCAM-1⁺

LECs in WT and RANK-Tg mice measured by flow cytometry. (D) Confocal microscopy images of WT and RANKL^{ΔCcl19} inguinal LNs, showing the subcapsular sinus area labelled for mCLCA1 (green) and RANKL (red). The RANKL^{ΔCcl19} LN is devoid of RANKL expression. Representative of 4 mice. (E) Counterplot of LN LECs double stained for ITGA2b and RANK expression. Graph bar (n=6) shows the percentage of LECs expressing both ITGA2b and RANK. (F) Histograms show RANK expression by LECs and BECs from skin and LNs. The percentage of ITGA2b⁺ cells is indicated. Graph shows their mean ± SD (n=6) percentages. ns= not significant, *p<0.5, **p < 0.01, ***p < 0.001.

Supplemental Table. Antibodies used in the study

Target	Species	Clone	Conjugation	Supplier
CD3	Rabbit	Polyclonal	Purified	DAKO
CD3	Armenian hamster IgG1	145-2C11	FITC; PE	BD
CD11c	Armenian hamster	N418	PE/Cy7	eBioscience
CD19	Rat IgG2a	RA3-6B2	PE, PerCPCy5.5; APC	BD
B220	Rat IgG2a	RA3-6B2	Biotine	eBioscience
CD45	Rat IgG2a	30-F11	APC-CY7	Biolegend
CD45	Rat IgG2b	30-F11	APC	BD
CD197 (CCR7)	Rat IgG2a	4B12	PE	eBioscience
Ter-119	Rat IgG2b	TER-119	APC-CY7	Biolegend
CD31	Rat IgG2a	390	PercP eF710	eBioscience
Gp38	Syrian Hamster IgG	8.1.1	A488	eBioscience
mITGA2b	Rat IgG1	MWReg30	APC	Biolegend
mITGA2b	Rat IgG1	RAM.2	A647	Own production
hITGA2b	IgG1	SDF.2	purified	Own production
ITGB3	Armenian hamster IgG	2C9.G2 (HMβ3-1)	PE	Biolegend
GPIIbβ	Rat IgG1	RAM.1	A647	Own production ¹
ITGA2b/ITGB3	Rat IgG2b	JON/A	PE	Emfret analytics
ITGAV	Rat IgG2a, k	RMV-7	PE	eBioscience
Langerin	Rat IgG2a	929F3.01	A488	Dendritics
F4/80	Rat IgG2a	BM8	APC	eBioscience
mCLCA1	Syrian Hamster IgG	10.1.1	Purified	Andy Farr ²
Lyve-1	Rat IgG1	ALY7	Purified	eBioscience
Fibronectin	Rabbit polyclonal		Purified	Patricia Simon-Assmann ³
MAdCAM-1	Rat IgG2a	MECA-367	Purified	BD Pharmingen
RANK	Human FC	O2	Purified	MedImmune

RANKL	Rat IgG2a	IK22.5	Purified	Hideo
Hamster IgG	Goat	Polyclonal	A488	Molecular probes
Mouse	Donkey	Polyclonal	A647	Life Technologies
hGp38	Rat IgG2a	NC-08	A488	Biolegend
hCD31	Mouse IgG1	WM59	Pacific-blue	Biolegend
hCD45	Mouse IgG1	HI30	PE-Cy7	Biolegend

References

1. Perrault C, Moog S, Rubinstein E, et al. A novel monoclonal antibody against the extracellular domain of GPIIb/IIIa modulates vWF mediated platelet adhesion. *Thromb Haemost.* 2001;86(5):1238-1248.
2. Ruddell A, Mezquita P, Brandvold KA, Farr A, Iritani BM. B lymphocyte-specific c-Myc expression stimulates early and functional expansion of the vasculature and lymphatics during lymphomagenesis. *Am J Pathol.* 2003;163(6):2233-2245.
3. Simon-Assmann P, Kedinger M, Haffen K. Immunocytochemical localization of extracellular-matrix proteins in relation to rat intestinal morphogenesis. *Differentiation.* 1986; 32(1): 59-66.

3.3 Conclusions

LECs are a heterogeneous population due to its exposure to different cell types and stimuli. However, specific subpopulations of LECs are not yet well understood. Here we demonstrate for the first time that ITGA2b is expressed by a subset of LECs on mice and human lymph nodes, where they can be heterogeneously found on the subcapsular, cortical and medullary sinuses. Immunization greatly increased ITGA2b expression which raised the hypothesis of this molecule as being an activation marker, and that its heterogeneity on non-immunized mice was a reflection of different exposure to activation signals. As we had previously demonstrated that RANKL activates LECs, we used that knowledge to verify this hypothesis. We found that RANKL over expression leads to ITGA2b upregulation and, on the other hand, RANKL blockage or conditional KO (on marginal reticular cells) leads to ITGA2b decreased expression. Since RANKL and lymphotoxin (LT) share similar roles on LN development and homeostasis we also verified its influence. We found that neutralization of LT also leads to decreased ITGA2b expression.

Overall, we described ITGA2b as a novel marker for a subset of lymph node LECs, particularly the SCS floor-lining cells. ITGA2b is not required for LN formation and is expressed in response to RANKL and LT-stimulation. Beyond the question of its function for LN LECs, the ITGA2b integrin sheds a new light on the heterogeneity of LN LECs and their response to activation signals.



Preliminary results and Discussion



1- Preliminary Results

LN LECs are RANKL sensitive - possible interaction with LN macrophages

Lymphatic endothelial cells (LECs) form the lymphatic system and help drain the lymph through the lymph nodes (LNs). Within the LN, LECs form the subcapsular, cortical and medullary sinuses, keeping close contact with local and transitory cells. This microenvironment and its different activation signals imprint heterogeneity on LECs, yet, the nature of the signals and the emissary cells remain elusive. Here we present evidence that RANKL (ligand of receptor activator of NF- κ B) activates LECs to express MAdCAM-1, VCAM-1 and ITGA2b. We show that RANKL overexpression, neutralization or deletion from marginal reticular cells (MRCs) affected the proportion of activated LECs. Based on marker expression, the data suggest that the SCS floor-lining LECs, which reside next to the RANKL-expressing MRCs, are constitutively activated by RANKL. However, this subpopulation did not express higher levels of RANK mRNA suggesting that sensitivity of RANKL activation cannot be attributed to restricted RANK expression. We have previously shown that conditional KO of RANKL from MRCs leads to B cell and FDC disturbances, lower CXCL13 and LT β levels, and impaired LN macrophages development. Here we show that RANKL neutralization in adults only affects LECs and macrophages but not B cell homeostasis. Since the LN macrophages do not express RANK these findings unveil a possible crosstalk between LECs and LN macrophages.

Results

RANKL activates LECs

To better understand the impact of RANKL on LN stromal cells, first we scrutinized the LNs of RANKL-overproducing mice [1]. These mice overexpress RANK in the skin and by an autocrine loop RANK stimulates the production of soluble RANKL leading to postnatal cutaneous LN hyperplasia with more B cells organized into distinct and smaller B cell follicles. In these mice LN, LECs stand out from the other non-hematopoietic cells by showing the most gene expression changes [1]. This suggests that among the non-hematopoietic cells, LECs appear to be the most affected by RANKL. Indeed, with age the mice develop lymphedema without overt disruption of the LN B-T cell architecture (**Supp Fig. 1-1A**), supporting their sensitivity to RANKL. To test the activation of LECs

by RANKL, we determined MAdCAM-1 and VCAM-1 expressions, which we knew being upregulated on the mRNA level in RANK-Tg mice [1]. In addition, we verified the level of ITGA2b, also a RANKL-sensitive cell activation marker. In the WT mouse, LECs express these markers to variable levels but in the Tg mouse the markers were all upregulated (**Fig. 1-1A**). MAdCAM-1 is known to be restrictedly expressed by a subset of LECs [2]. In order to see where this subset localizes, we stained WT and Tg LN sections for MAdCAM-1. We confirmed that MAdCAM-1 is expressed by the subcapsular sinus LECs in WT and Tg mice (**Fig. 1-1B**). Detailed analysis of the SCS disclosed that the floor LECs but not the ceiling LECs were MAdCAM-1⁺ in both WT and Tg mice. In addition, the Tg mice presented MAdCAM-1 expression on the medullary LECs (**Fig. 1-1B**). In order to confirm that the overexpression of MAdCAM-1 and VCAM-1 markers on Tg LECs was caused by excess of RANKL we neutralized RANKL in adult Tg mice. This blockade led to a decrease of MAdCAM-1 and VCAM-1 expressions to a WT level, confirming the RANKL activation effect on LECs (**Fig. 1-1C**). The findings that MAdCAM-1, VCAM-1 and ITGA2b are upregulated on LECs in RANK-Tg mice supports the idea that LECs are RANKL sensitive.

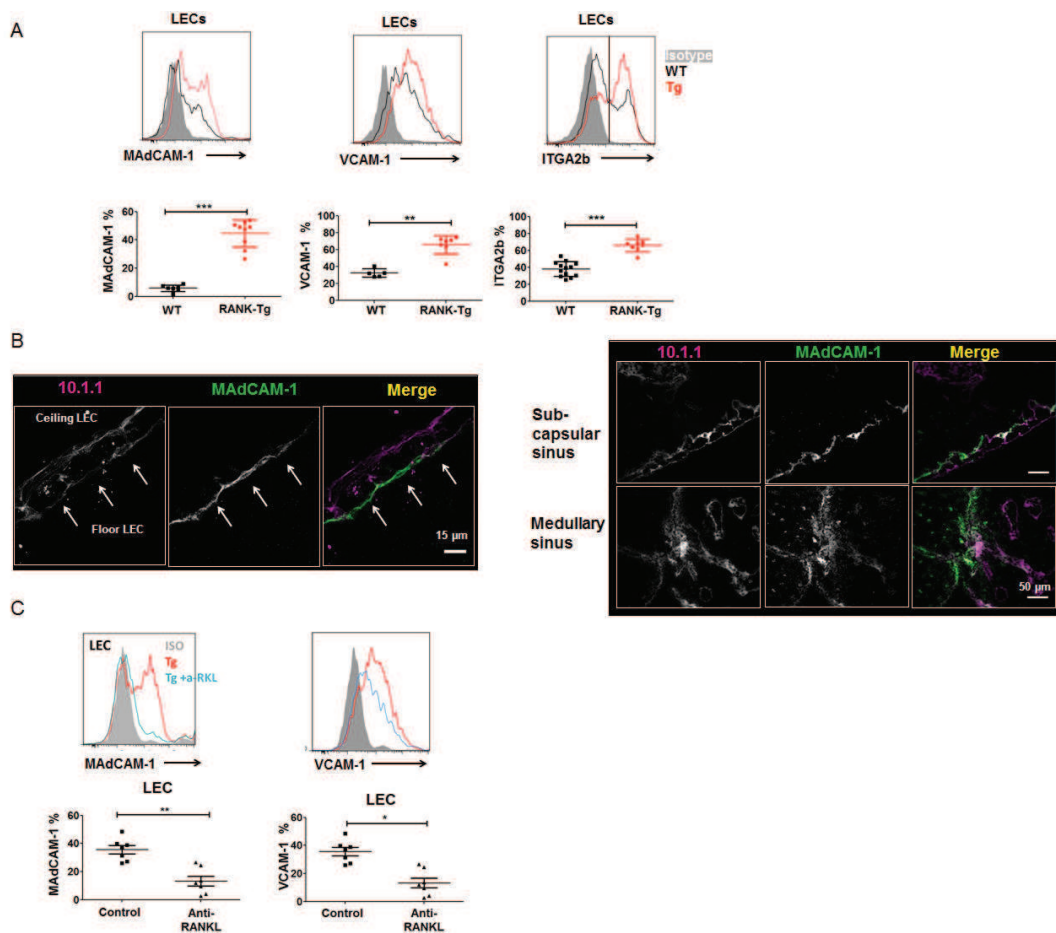

Figure 3-1 RANKL activates LN LECs. (A) Histograms show increased expressions of MAdCAM-1, VCAM-1 and ITGA2b in RANK-Tg mice. Mean \pm SD these markers between WT and Tg mice. Data is

representative of 10 different experiments. (B) Confocal microscopy images of inguinal LN from WT (left) and RANK-Tg (right) mice showing MAdCAM-1 expression on SCS on WT and Tg mice and also on medullary sinus on Tg mice. Scale bars are displayed. Data is representative of 10 mice on 10 different experiments. (C) Histograms show decreased expressions of MAdCAM-1 and VCAM-1 on Tg mice upon RANKL-neutralization. The graphs show the mean \pm SD of these markers on Tg and Tg with RANKL-neutralization. Data is representative of 6 mice on 4 experiments *p < 0.05 **p < 0.01 ***p < 0.001

RANKL from MRCs activates the LECs

Floor SCS LECs seem to be the most RANKL sensitive LECs and they reside close to an internal RANKL source, the MRCs (**Suppl Fig. 1-1B**). To address the importance of MRC RANKL, we first administrated the RANKL-blocking mAb to WT mice and monitored MAdCAM-1, VCAM-1 and ITGA2b expressions on LECs. As shown in **Fig. 1-2A**, we observed reduced expression of all three markers after RANKL neutralization. Indeed, there was a profound effect on LECs with almost full disappearance of SCS MAdCAM-1 staining (**Fig. 1-2B**). To address the question of the source of RANKL, we then genetically deleted *Rankl* from MRCs by generating RANKL ^{Δ CC19} mice. We determined MAdCAM-1, VCAM-1 and ITGA2b expressions on LECs in these mice and found that all the three molecules were markedly decreased on the KO mice (**Fig. 1-2C**), with clear absence of MAdCAM-1 from the floor SCS LECs (**Fig. 1-2D**). Interestingly, RANKL ^{Δ CC19} mice also presented smaller LNs (**Suppl Fig. 1-1C**). These data show that RANKL from MRCs activates SCS floor LECs to express MAdCAM-1.

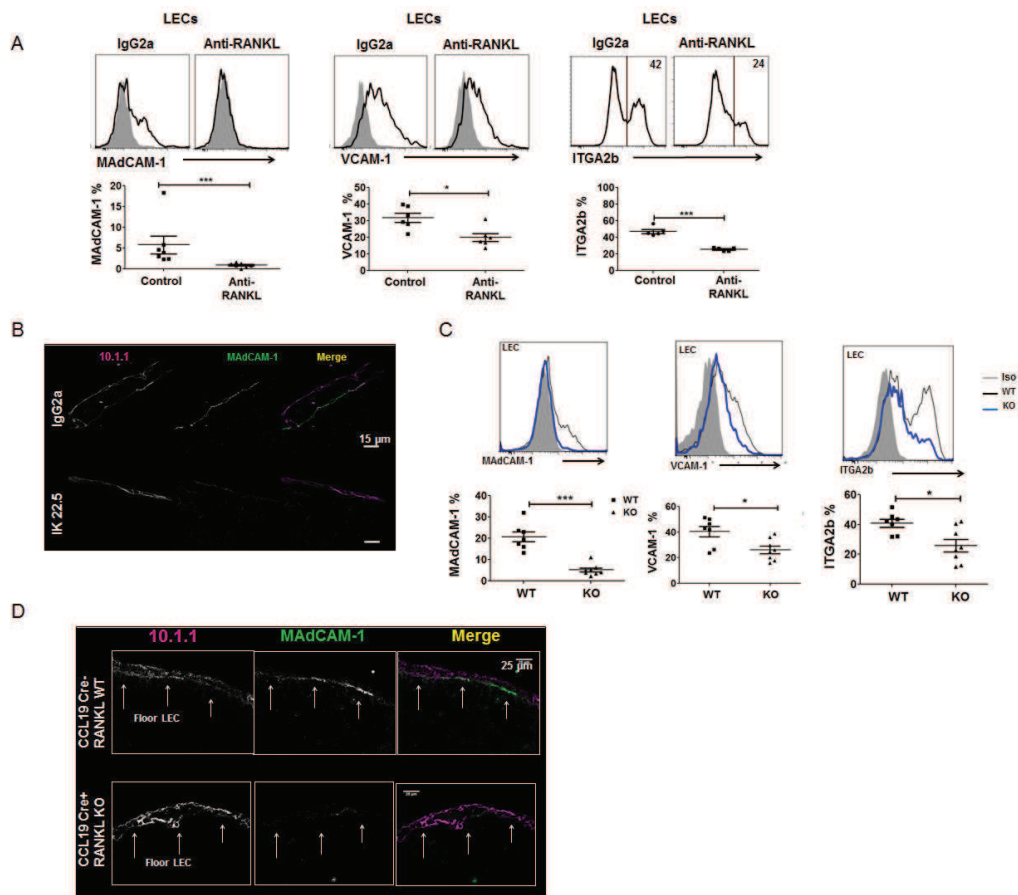

Figure 1-4 RANKL from MRCs activates the LECs. (A) Histograms show decreased expression of MADCAM-1, VCAM-1 and ITGA2b on RANKL-neutralized mice. Mean \pm SD of these markers from control and RANKL neutralized mice. Data is representative of 6 mice in 5 different experiments. (B) Confocal microscopy images of LN showing MADCAM-1 disappearance from the SCS area of RANKL neutralized mice. Data is representative of 5 mice in 5 different experiments. (C) Histograms show decreased expressions of MADCAM-1, VCAM-1 and ITGA2b in RANKL ^{Δ CCL19} mice. Mean \pm SD these markers from RANKL ^{Δ CCL19} mice and WT littermates. Data is representative of 7 mice in 5 different experiments. (D) Confocal microscopy images of LN showing MADCAM-1 disappearance from the SCS area of RANKL ^{Δ CCL19} mice. Data is representative of 5 mice in 5 different experiments. Scale bars are showed.

LECs express RANK, LT β R but low levels of OPG

SCS floor LECs appeared as the most RANKL sensitive subset, being physically close to MRCs and expressing MADCAM-1 and ITGA2b, markers regulated by RANKL. In order to disclose the reason for this higher sensitivity we performed a careful measure of RANK mRNA expression as well as

that of the RANKL-decoy receptor OPG. We hypothesized that SCS floor LECs would express higher levels of RANK and lower OPG levels. We used the expression of MAdCAM-1 and VCAM-1 to sort out SCS LECs and performed qRT-PCR analysis (**Suppl Fig. 1-1D**). Comparison between MAdCAM-1/VCAM-1⁺ and MAdCAM-1/VCAM-1⁻ LECs showed that both populations express similar levels of RANK mRNA. As for OPG mRNA, both LEC populations expressed very similar and low levels (**Fig 1-3A**). This suggests that the higher RANKL sensitivity of LN LECs may be related to an advantageous RANK/OPG level favouring RANKL activation. However, the higher sensitivity of floor LECs is probably not a cell-inherent feature, but may be the reflection of physical proximity to MRCs (**Suppl Fig. 1-1B**). We next used a newly generated anti-RANK antibody [3] to assess RANK expression on the protein level by flow cytometry on LECs. We found that a subset (39 %) of the LECs expressed cell surface RANK (**Fig. 1-3B**). The RANK expression on LECs shows that they can be directly activated by RANKL, however it was not possible to double label with MAdCAM-1. We analysed skin LECs and found virtually no RANK expression (**Fig. 1-3B**). Finally, in view of the finding that MAdCAM-1 is also regulated by LT $\alpha\beta$, we performed qPCR on MAdCAM-1/VCAM-1⁺ versus MAdCAM-1/VCAM-1⁻ LECs for LT β R and found that the level of LT β R mRNA was again similar between the two populations. Interestingly LT β R transcripts were more abundant in LECs than the RANK transcripts. FACS analysis revealed that LECs express LT β R on the protein level (**Fig. 1-3C**), however not a level higher than RANK. Double labelling for MAdCAM-1 and LT β R showed that only few MAdCAM-1⁺ cells (SCS floor LECs) expressed the LT β R (**Fig. 1-3C**).

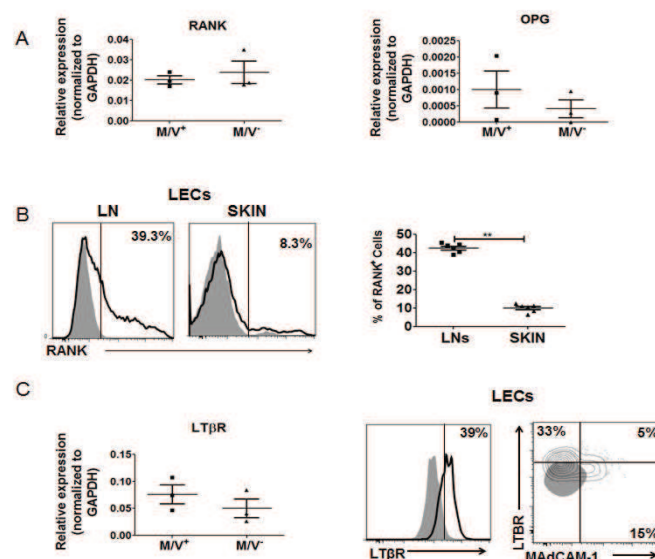

Figure 1-5 LECs express RANK, LT β R but low levels of OPG. (A) Mean \pm SEM of *Rank* and *Opg* mRNA expression in sorted MAdCAM-1/VCAM-1⁺ LECs and MAdCAM-1/VCAM-1⁻ LECs from WT mice, normalized to GAPDH. Data is representative of 4 different experiments, CT values higher

than 34 were discarded. (B) Histograms show RANK expression on LN and Skin LECs. Data is representative of 6 mice on 4 different experiments. Mean \pm SD of RANK expression on skin and LN LECs. Data is representative of 6 mice in 6 different experiments. (C) Mean \pm SEM of *Lt β r* mRNA expression in sorted MAdCAM-1/VCAM-1⁺ LECs and MAdCAM-1/VCAM-1⁻ LECs, from WT mice, normalized to GAPDH. Histogram shows LT β R expression on LECs. Counterplot shows double staining of MAdCAM-1 and LT β R on LECs Data is representative of 4 mice on 4 different experiments.

RANKL neutralization affects LN macrophages but not FDCs, B or T cells

We have previously showed that the loss of RANKL expression by MRCs on the RANKL ^{Δ CC119} mice led to impaired FDC network with decreased CXCL13 expression. This led to fewer and misplaced B cells and to lower LT α β levels. LN macrophage development was also affected. Knowing this we wanted to verify if RANKL blockade on adult mice would give similar results. Interestingly, the RANKL neutralization did not mimic the phenotype completely. The proportion of SSMs was decreased, whereas MSM were not affected. Furthermore, SSM presented only slightly lower levels of MR-L expression upon RANKL neutralization (**Fig. 1-4A**). However, CD169 staining on LN section showed decreased expression on both SSM and MSM on RANKL neutralized mice (**Fig. 1-4A**), meaning that CD169 expression on MSM was affected but the RANKL neutralization was not enough to change the cell percentage. In contrast to what was observed in the RANKL KO mice, RANKL blockade had no effect on LT β levels, or on B and T cell proportions (**Fig. 1-4B**). Moreover, the FDC network remained normal upon RANKL neutralization (**Fig. 1-4C**). The fact that LN macrophages do not express RANK raised the question of which other cells stimulated by RANKL could then affect the macrophages. Because of RANKL neutralization clearly affected LECs, a cell type closely associated with the SSMs and MSMs, it appears probable that LECs influence the differentiation of LN sinus-associated macrophages.

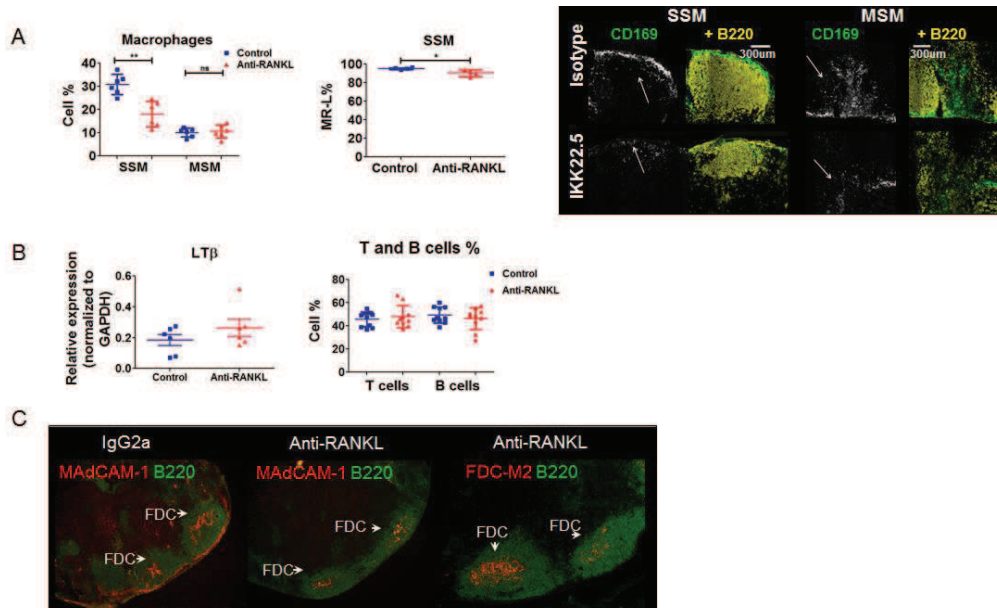
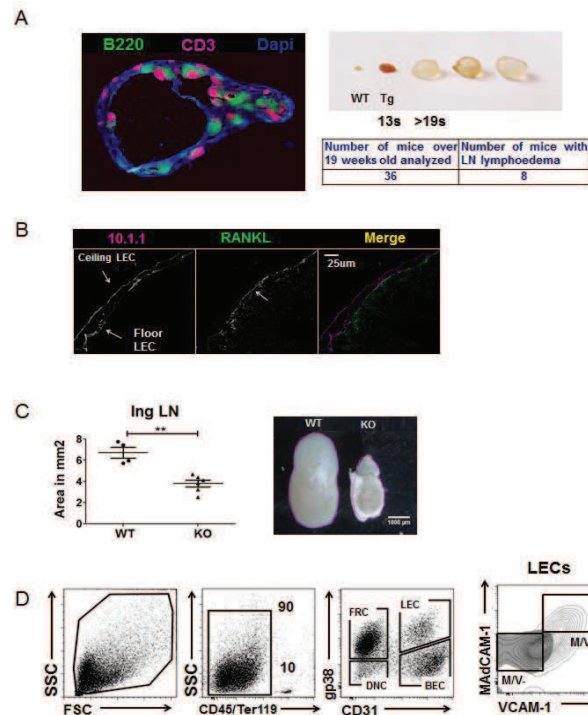

Figure 1-4 RANKL neutralization affects LN macrophages. (A) Mean \pm SD of SSM and MSM percentages between control and RANKL-neutralized mice. Mean \pm SD of MR-L expression on SSM between control and RANKL neutralized mice. Confocal microscopy images of an inguinal LN of control and RANKL-neutralized mice stained with CD169 (green) and B220 (yellow). Data is representative of 4 mice in 3 different experiments. (B) Mean \pm SEM of *Lt β* mRNA from control and RANKL neutralized mice. Data is representative of 4 mice in 3 different experiments. Mean \pm SD of T and B cell percentages between control and RANKL neutralized mice. Data is representative of 8 mice in 5 different experiments. (C) Confocal microscopy images of LN showing MAdCAM-1 disappearance on RANKL neutralized mice, but the presence of FDCs in the same mice.



Supplemental Figure 1-1 (A) Confocal microscopy images of cervical LN with lymphedema of RANK-Tg mice, showing B and T cells. Photography of LNs from WT and RANK-Tg mice with different stages of lymphedema. Data is representative of 5 mice in 5 different experiments. (B) Confocal microscopy images of LN showing RANKL expression close to the floor SCS LECs. Data is representative of 14 mice in 10 different experiments. (C) Mean \pm SD of IngLN size of RANKL ^{Δ Ccl19} KO and WT littermates. Photography of IngLNs from RANKL ^{Δ Ccl19} KO and WT littermates. Data is representative of 6 mice in 3 different experiments. (D) Dot plots showing gating strategy for sorting LN stromal cells. Data is representative of 20 mice in 20 different experiments.

DISCUSSION

These data suggests that LN LECs are RANKL sensitive, which in the case of constantly increased RANKL levels in the afferent lymph leads to an unbalanced LEC activation generating increased LN size [1] and age related lymphedema. On the other hand, RANKL deletion from LN stromal cells of the RANKL ^{Δ CCL19} mice led to smaller LN size. This effect on LN size was not observed on other TNF members, as mice with a transgenic overexpression of TNFR-Fc fusion protein (neutralization of TNF and LT α 3) presented normal LN size [4] as well as mice with transgenic overexpression of LT β R-Fc fusion protein (neutralization of LT $\alpha\beta$) [5]. Moreover, the depletion of LT β R expression on stromal cells (LT β R ^{Δ CCL19}) did not present any alteration on LN size [6]. Therefore, the

impact of RANKL on LN size may occur via LEC activation. Within the LN LECs, the floor SCS subpopulation seems to be the most RANKL sensitive, however this RANKL responsiveness was not due to a greater RANK expression but most probably due to a constant contact with a RANKL source, the MRCs, since conditional RANKL-KO on MRCs clearly affected MAdCAM-1 and ITGA2b expression by this LEC subset. The fact that by FACS only a proportion of LECs appeared RANK⁺ may be explained by a constant RANKL stimulation which could lead to RANK internalization, and hence undetectable by flow cytometry for cell surface RANK. We tried to perform intracellular staining but for some reason the staining did not work, providing a high background. It is also possible that some LECs express RANK on the mRNA level but not on the protein level. Skin LECs do not express RANK, therefore RANK expression on LECs appears to be a feature of LN LECs. It would be interesting to verify if LECs in other organs express RANK, for example on Peyer's patches, and how would RANKL affect them. It would also be of interest to verify if the ceiling SCS LECs express RANK, which can be easily accessed due to the fact that ACKR4 (CCRL1) is selectively expressed by this population [7].

MAdCAM-1 depicted a specific subpopulation that is probably in constant contact with RANKL, and MAdCAM-1 expression is directly correlated with RANKL levels, suggesting that this molecule could be a valuable LEC activation marker. Interestingly, MAdCAM-1⁺ LECs have been described as expressing low levels of LTβR, but still when LTβR-Ig was administered this population was drastically reduced [2].

In order to verify the direct effect of RANKL on LECs it would be of value to generate a RANK-KO on LECs and expect to find a similar phenotype to the one found by RANKL neutralization.

The RANKL^{ΔCCL19} mice presented additional phenotypes including a strong effect on LN macrophages, FDC network, B cell numbers and CXCL13 and LTβ levels. However, RANKL neutralization only affected LECs and macrophages, this may be due to the fact that RANKL blocking experiment was performed for 3 weeks, at adult stage, which may not be sufficient to affect the FDC network, whereas in the RANKL^{ΔCCL19} mice RANKL is deleted in the embryo, which would continuously exert an impact on FDC network. Therefore the normal FDC network on neutralized mice enables a normal CXCL13 expression, normal B

cells numbers and therefore normal $LT\beta$ levels. Alternatively, because the neutralizing RANKL mAb is of rat origin and complexes cell surface and soluble RANKL, immune complexes may be formed that will then activate B cells leading to increased $LT\alpha\beta$ and/or $TNF\alpha$ production. $LT\alpha\beta$ was already described as being extremely important for LN macrophages, and these macrophages express the $LT\beta R$ [8]. We have previously showed that LN macrophages do not express RANK, and interestingly, despite the normal $LT\beta$ levels on the RANKL-neutralized mice, the SSMs were still affected by RANKL neutralization. This finding raises the hypothesis that an extra signal, located downstream of RANK activation, is able to affect the macrophages. Furthermore, $LT\alpha\beta$ does not seem to affect the MSM whereas RANKL had an effect on this subset [8]. It appears reasonable to invoke the hypothesis of LECs being the cells responsible for providing that extra signal. It was shown by microarray that LN LECs can produce CSF-1 [9], and human LECs infected with HCMV (human cytomegalovirus) produce GM-CSF [10]. Therefore, MRC RANKL could activate LECs to produce CSF-1/GM-CSF and stimulate macrophage differentiation. As future work, it would be important to verify this possible crosstalk between LECs and macrophages by co-culturing these two populations.

2- Thesis objectives

The role of RANK-RANKL in LN development is well recognized, mainly due to the fact that unconditional KO of these molecules leads to the absence of LNs. LN development depends on the crosstalk between lymphoid tissue organizer cells (LTos) that express RANKL, and lymphoid tissue inducer cells (LTis) that express $LT\alpha1\beta2$ and RANKL. RANK signaling is believed to be required for LTi proliferation and/or survival, whereas $LT\beta R$ signaling is necessary for proper LTo maturation and chemokine expression (Fig. 2-1). The maintenance of the B cell follicle microarchitecture also depends on $LT\beta R$ signal, while previous studies [11-14] and our work point out a similar role for RANK, although not yet clearly verified. In adult LNs the major RANKL source is the marginal reticular cells (MRCs), localized between the SCS area and the B cell follicles. In view of its importance for secondary lymphoid organ development, a RANKL involvement for tertiary lymphoid organ (TLO) development/maintenance would be expectable, however this has so far been studied. Furthermore, RANKL also plays a role on endothelial cell proliferation and survival and influences the expression of their adhesion molecules. As part of the LN stroma, endothelial cells are important players during steady state and inflammation. For these reasons we aimed to address the importance of stromal RANKL from development to LN homeostasis, its impact on LN LECs and on TLO development and maintenance. To address these issues different tools were used: two murine models, a RANK-Tg mouse with RANKL overexpression in the skin and a model with RANKL conditional deletion on MRCs ($RANKL^{\Delta CCL19}$); as well as RANKL- and $LT\alpha1\beta2$ -neutralizing reagents.

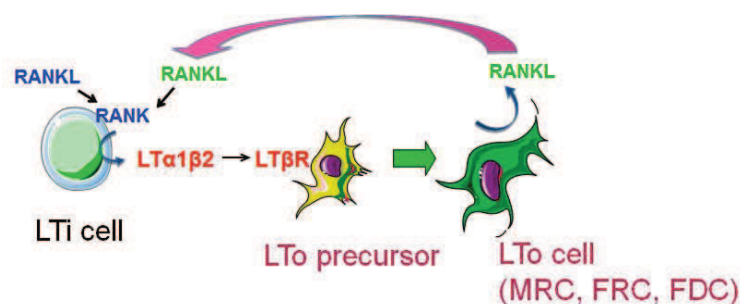

Figure 2-1 Crosstalk between LTis and LTos

3- Thesis discussion and perspectives

Stromal RANKL is not required for LN development

Regarding the RANKL^{ΔCCL19} mouse model, the first finding was that the mice develop all LNs, which contrasts with the total RANKL-KO mice. We demonstrated that RANKL was almost completely absent from LTos at E18, so the LNs presence may be explained by two hypotheses. The first hypothesis is that stromal RANKL would not be required for LN development because the LTis express RANKL from day E13.5 until E15.5 inclusive [12]. Furthermore, LTi clustering is less severely affected in LTα-deficient or LTβR-deficient mouse embryos compared to RANKL mutant mice [12, 15, 16]. Reinforcing the idea of a RANKL autocrine stimulation on LTis, being sufficient for LN anlagen initiation. Interestingly, the conditional KO of LTβR on the same cells (LTβR^{ΔCCL19}) showed that LTβR is not required for LN formation [6], suggesting a redundancy of RANKL and LT for LN development. On the other hand, we know that LTos express high levels of CCL19 (the promoter) at day E18 [17] and that RANKL was highly decreased but still present at E18, however we do not have data proving that RANKL was reduced previously and also the small amount of RANKL still present at E18 might be sufficient.

Stromal RANKL influence on LN cells (CD169⁺ macrophages, FDCs, B cells and LECs)

We demonstrated that the RANK-RANKL axis plays a crucial role beyond LN development. In our model the RANKL-KO on MRCs results in decreased CD169⁺ (MOMA-1) LN macrophages, both the SSM and the MSM, which is in agreement with the phenotype described by Phan *et al.*, [8] where upon LTαβ neutralization the LN macrophages appeared reduced, especially the SSM. Koni and colleagues also reported an important MOMA-1 reduction on SSM from mesLNs of LTβ deficient mice [18]. On the other hand, we performed LTαβ neutralization and found that while the SSM were highly affected there was no difference on the MSM. Moreover, Cyster and colleagues performed bone marrow transfer of LTβR-deficient mice into WT and found a slight decrease of SSM numbers and no effect on MSM numbers, corroborating our results [8]. Thus the phenotype of LTαβ blockade is much stronger than the phenotype of bone marrow transfer from LTβR-deficient mice, raising the hypothesis that LTα1β2 indeed influences

these macrophages, probably not only directly but also via other molecules. From our results, the $LT\alpha\beta$ neutralization in $RANKL^{\Delta CCL19}$ produced a greater phenotype on SSMs than on littermates, reinforcing the idea that RANKL has an impact on those cells, beyond LT. We should also take into consideration that RANKL neutralization by blocking mAb IK22-5 showed an effect on SSMs despite of normal B cell homeostasis and apparent normal $LT\beta$ levels. This is a further indication that RANKL can affect SSMs beyond LT. We tried to determine RANK expression by LN macrophages, however the results were not coherent, sometimes those cells seemed to slightly express RANK other times not, thus it remains unclear if these cells express the receptor. Therefore, if considering that the cells do not express RANK, there must be an intermediary in between RANK stimulation and LN macrophages, other than LT. Macrophages in general are highly responsive to $TNF\alpha$ [19] however the $CD169^+$ macrophages in LNs and spleen are not affected by TNFR signalling [4, 20], excluding this TNFSF member as the possible signal. The intermediary signal for LN macrophages probably comes from an accessory cell, which could be the RANKL-activated LECs, since these two populations (LECs and macrophages) were the ones affected both on the $RANKL^{\Delta CCL19}$ and RANKL neutralization models. We have shown that LECs express RANK and are activated by RANKL. Furthermore, it was demonstrated by microarray that LN LECs can produce CSF-1 [9], and human LECs infected with HCMV (human cytomegalovirus) are able to produce GM-CSF [10]. Afferent lymphatics occlusion led to SSM migration and disappearance, reinforcing the idea of an LEC involvement [21]. One could infer that RANKL produced by MRCs stimulates the LECs that would then provide a signal to macrophages. Thus, as we demonstrated, when RANKL is conditionally deleted from MRCs or neutralized the activity of LECs is downregulated, which would then negatively affect the macrophages, despite normal LT levels. Interestingly, CSF-1 deficient mice showed that CSF-1 is required for SSMs but not for MSMs [22]. Additionally, a study on CSF-1R blocking experiment showed a greater phenotype on body macrophages, which could be explained by an additional ligand for CSF-1R, the IL-34, however MSM were still not affected. The signals orchestrating MSMs thus remain unclear, but RANKL appears to have an indirect impact on this population (**Fig. 3-1**) [23].

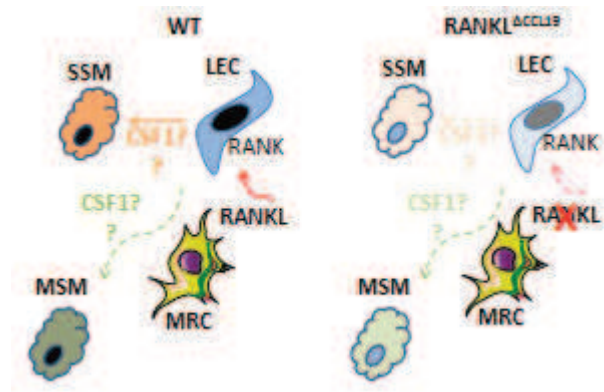

Figure 3-1 RANKL impact on SSM via LECs. RANKL expression by MRCs activates SCS floor LECs which then provide a signal (CSF1?) to SSMs, and eventually some soluble signal from LECs capable of influencing MSMs.

Interestingly, in the RANKL^{ΔCCL19} model, the RANKL influence on LNs appeared to be temporal, *i.e.*, the LNs showed normal phenotypes at day 5, with normal LT levels, T and B cell proportions and LN macrophages. Then, at 3 weeks the phenotype was still mild with slight but not significant differences on B and T cells, and less macrophages. At 8 weeks, the phenotype was already well established. This gradual phenotype penetrance occurred despite the RANKL-absence at least from E18 onward. Moreover, not all the LNs presented the same impairments, the mesenteric and the axillar LNs did not appear affected, regarding the B cell loss, whereas the brachial and the inguinal LNs showed defects, with the inguinal being the most affected one. This is not surprising since it has been demonstrated that different LNs require different molecules. In LT β -KO some cervical and mesenteric LN are formed whereas all the other LNs are absent. [24, 25]. The phenotype of CXCL13 and IL-7R α deficiency was partial with certain peripheral LNs present [26, 27].

The gradual phenotype penetrance may be explained by a gradual decrease of one or more homeostatic molecules, responsible for FDC development/differentiation. Several studies have demonstrated that both LT and TNF α are required for FDC development/maintenance. Mice deficient for these molecules or their receptors fail to form proper FDC networks [28-30]. LT α 1 β 2 seems to play an important role in FDC development/maintenance, since LT β - and LT β R-KO mice showed a high defect on FDCs,

similar results were found in LT α 1 β 2 blocking experiments [31, 32]. FDCs are known to be stimulated by TNF α [33] and to express TNFR [34]. Ruuls *et al.*, showed that a mice without the soluble form of TNF α failed to form primary B cell follicles and FDC networks, however GCs were formed upon immunization [35]. TNFR1 deficient mice presented no FDC network, but it showed FDC-like cells on the splenic marginal sinus, evoking the hypothesis that FDC precursors fail to migrate into the follicle areas, similar results were found in TNF α KO mice [36, 37]. A TNFR1 specific KO on FDCs (CD21/35) demonstrated that stimulation via TNFR1 is required for FDC development, meaning that TNF α and/or LT α 3 act directly on FDC precursors [34]. Therefore we hypothesised that possibly one of these molecules or both could be gradually reduced with aging, thus, the impact of RANKL deficiency on LNs occurs in the adult stages suggesting that a decline in LT/TNF α levels allow RANKL to surpass redundancy with the other TNFSF members. At early stages, RANKL is redundant since the other TNFSF members are available at high levels and suffice for FDC network formation and LN development, whereas at later stages these molecules decrease and RANKL role becomes essential for the FDC recycling and maintenance. The high levels of those homeostatic molecules enable normal FDC differentiation, which occurs around day 7, as well as normal CXCL13 levels [38]. This normal FDC network and CXCL13 levels allow proper B cell follicle formation, allowing CD169⁺ macrophages differentiation and maintenance. Then, at some point those levels start to gradually decrease and it is at this stage that RANKL is needed the most to differentiate/stimulate FDC precursors. So, at this point, if RANKL is missing, the FDCs gradually start to disappear, decreasing CXCL13 expression. This affects B cell numbers and organization, which consequently leads to lower LT levels. The LT lower levels will further affect FDC differentiation and macrophages, functioning as a vicious cycle. MRCs are thought to be the FDC precursors in LNs [39, 40]. Furthermore, Jarjour *et al.*, demonstrated that B cells are not required for MRC proliferation since they proliferate before B cell colonization and proliferative MRCs were found on RAG-2 KO mice [39], meaning that another signal may influence MRC differentiation. RANKL effect on MRCs could be direct in the scenario of MRCs expressing RANK, besides expressing LT β R and TNFR1 [41]. In that case RANKL could be the extra stimulus for MRC differentiation into FDCs or it is also possible that RANKL autocrine stimulation is required for MRCs to express LT β R and/or TNFR1 (**Fig. 3-2**).

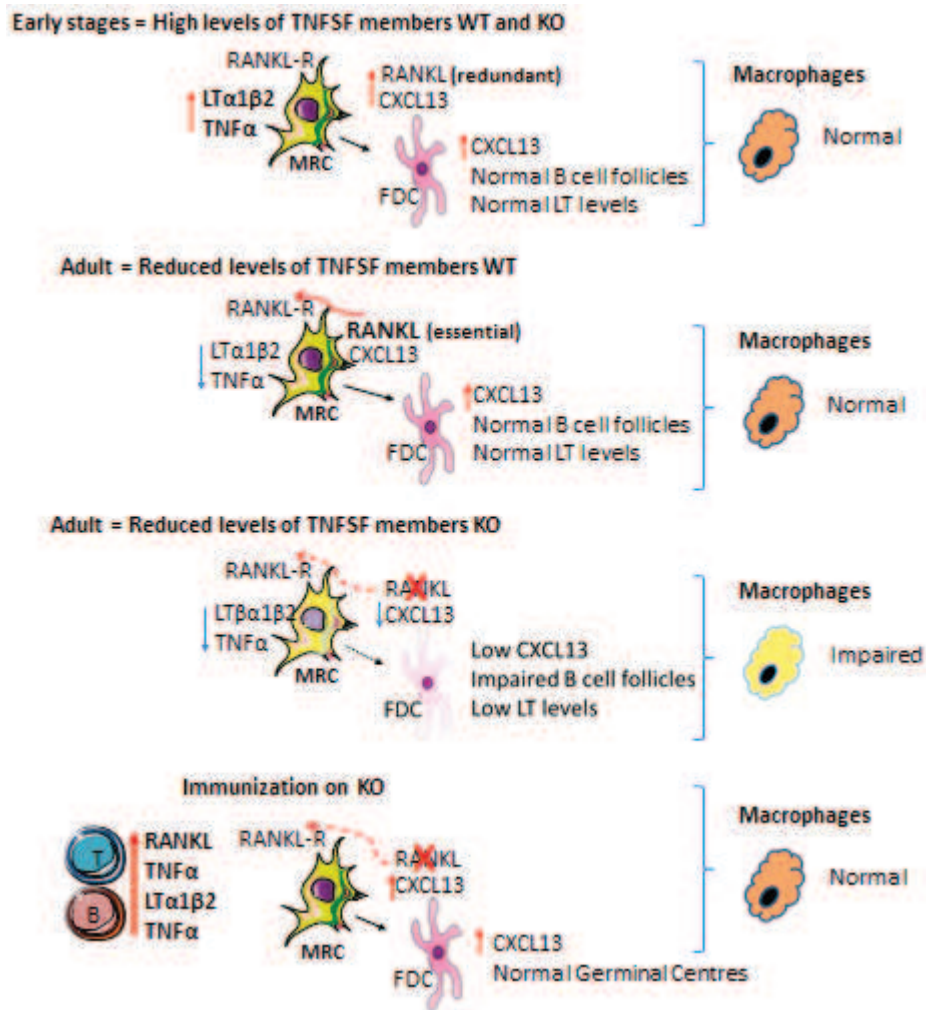

Figure 3-2 RANKL autocrine stimulation on FDC precursor (MRCs) is required for FDC development/maintenance. At early stages, LT/TNF α levels are high and sufficient for FDC development/maintenance, and RANKL role is redundant, however with aging these levels decrease and RANKL becomes essential to stimulate MRCs in an autocrine manner, enabling FDC development/maintenance. At this stage if RANKL is no longer present (RANKL^{ACCL19}) FDC recycling is not assured, CXCL13 levels decrease, B cell numbers and localization are affected which leads to LT lower levels and impaired macrophages. This would predict that when the RANKL^{ACCL19} mice are immunized, there is a restoration of FDC network and macrophages and germinal centres as normally formed, which may be due to an upregulation of RANKL, TNF α and LT from activated T and B cells.

The second hypothesis is that if MRCs do not express RANK the signal for its differentiation comes from accessory cells. We have demonstrated that RANKL from MRCs

stimulates the SCS floor LECs, therefore it could be possible that RANKL stimulated LECs would provide an extra feedback signal to MRCs. This signal could be TNF α , since it was shown by microarray that LECs can produce it [9], and we also found TNF α mRNA on LECs by qPCR. Interestingly the levels were higher on SCS floor LECs than on other LECs (data not shown). These signals would then differentiate/maintain MRCs/FDCs. When RANKL is KO on MRCs (RANKL ^{Δ CCL19}) LECs are downregulated and these signals are missing, therefore FDC maintenance is impaired. Alternatively, if LECs are not the cells providing the signal, it could be possible that it comes from the SSM macrophages, since activated macrophages are known to produce TNF α [9, 19]. The macrophages would be stimulated by an extra signal coming from activated LECs as previously proposed (**Fig. 3-3**). These hypotheses are not incompatible, *i.e.*, it is also reasonable that all the hypotheses occur simultaneously. Preliminary data show that upon immunisation, the RANKL ^{Δ CCL19} mice presented a normal phenotype, with regular germinal centre formation, comprising FDCs (data not shown). This restoration may be explained by the fact that an immune reaction activates T cells which start to produce RANKL and TNF α , and also activates B cells which start to produce LT and TNF α . When those molecules are present at higher levels the FDC precursor can be stimulated and can differentiate, generating a normal FDC network and normal germinal centres.

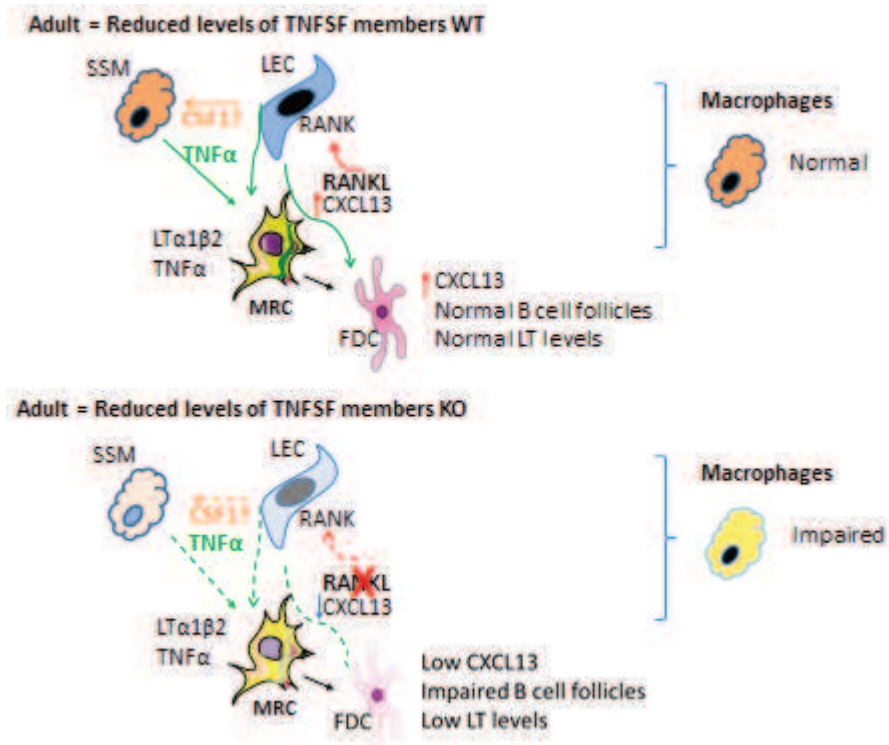

Figure 3-3 RANKL stimulated LECs and/or SSMs provide a signal to MRC differentiation. When the levels of homeostatic molecules are low, MRCs need a direct/local signal (TNFα?) which can come either by RANKL stimulated LECs or by SSM. When RANKL is KO on MRCs, LECs are no longer activated, not providing the feedback signal to MRCs. Alternatively, RANKL stimulated LECs provide a signal (CSF1?) to SSM. SSM then produce TNFα that further stimulates MRCs and FDCs, keeping normal CXCL13 levels, B cell numbers and therefore LT levels.

The discrepancy between the RANKL^{ΔCCL19} and the RANKL neutralization models may be explained by the fact that the antibody injected was from rat origin, and we found immune complex deposition on FDCs, which could generate some immune response increasing the levels of LT/TNFα and therefore FDC differentiation would be assured. Alternatively, it could be possible that RANKL neutralization during only three weeks is too short for normal FDC turnover. Therefore, this short period of time does not impact on FDC network, whereas on the RANKL^{ΔCCL19} model RANKL was absent since embryonic stages, and the FDC turnover gradually became impaired.

As future work it would be interesting to block RANKL since early stages, around 5 days after birth until 8 weeks of age, but it would be important to do it with a mouse antibody

in order to avoid any immune reaction. On the other hand it could be valuable to block RANKL, LT and TNF α , from 6 to 9 weeks in order to confirm that the differences in phenotype found between RANKL ^{Δ CCL19} and RANKL blocking were due to normal levels of LT and TNF α on the latest, due to the presence of immune complexes. Therefore it would be expectable that by blocking these three molecules a phenotype similar to the one found on RANKL ^{Δ CCL19} would emerge. Other possible approach could be to try to keep normal LT/TNF α levels on the RANKL ^{Δ CCL19}, by an exogenous source, to verify if this arrests the phenotype penetrance. It would also be interesting to confirm the LT/TNF α levels on the RANKL neutralized model and at different time points during aging.

The generation of a conditional KO for RANK on LECs would be of great value, allowing the confirmation of a RANKL direct effect, and also the verification if some phenotypical characteristics found on the RANKL ^{Δ CCL19} were present. If macrophages were affected it would mean that RANKL-activated LECs provide a signal to macrophages. If, on the other hand, MRCs and FDCs would be affected, this would reinforce the idea of a feedback signal from LECs to MRCs. Cell culture of LECs with these different populations, macrophages, MRCs and FDCs, could provide direct information regarding the possible crosstalks. However, we have been trying to culture LECs, and we found it extremely demanding, LECs are present in a really small number on LNs and they are extraordinarily difficult to culture and exhibit strong propensity to apoptosis. MRCs and FDCs are also challenging cell types to culture. Further information can be gathered from an RNAseq experiment, that we are currently developing, with two different LEC populations, the MAdCAM-1⁺/VCAM-1⁺ (SCS floor) versus the MAdCAM-1⁻/VCAM-1⁻. This would provide information regarding the different specialization of each population, and would give us some clues of possible molecules produced by LECs, able to affect MRCs/FDCs/Macrophages. Furthermore it would be of value to investigate the molecular cues behind MSM regulation, which still remain elusive.

RANKL involvement on TLOs formation

Since RANKL involvement on SLOs development was already acknowledged, it would be expectable that RANKL could play a role in TLO development as well, given that the

development of these two structures share similar molecular cues [42]. We showed here for the first time that RANKL neutralization on a tertiary lymphoid organ model leads to smaller TLOs with fewer CD45⁺ cells and Lymphoid Like Stromal Cells (LLSCs). TLOs appear during chronic inflammation under several conditions, including cancer, atherosclerosis, persistent infection, chronic graft rejection and autoimmunity [43]. TLOs can be beneficial, however they also easily progress to a destructive phase. Interestingly, several molecules have been already identified as playing a crucial role, such as IL-23/IL-17 [44] and recently IL-22 [45]. Hence, other molecules can be involved, which is what we state here, that RANKL is also important for TLO formation in a Sjogren's syndrome model. As perspective and future work, it would be of great value to investigate if RANKL also has an impact on TLOs from other disease models. Moreover, it would be interesting to verify if RANKL blockade leads to reduced autoantibody levels, since, in the light of our data and the literature, it is probable that RANKL has an important impact on B cells. Thus targeting RANKL could be an effective way of preventing TLO formation. If this is confirmed it would then be of value to translate this information into a clinical context.

Interestingly RANKL is under female sex hormonal control and diminishes post-menopausally. We have shown here that stromal RANKL deficiency perturbs LN integrity, one could infer that decreased RANKL levels in post-menopausal women could have the same effect. In that scenario, the increased viral pathogenicity in elderly humans, frequently presenting LN impairments, could be explained [46]. On the other hand, women receiving hormonal replacement therapy present higher RANKL levels [47]. As we showed here, RANKL blockade impairs TLOs development, therefore it is possible to evoke a possible connection between high RANKL levels in women under hormonal replacement therapy and TLO formation in chronic inflammatory conditions, which can present a strong female bias, *e.g.*, the Sjögren's syndrome. Overall, RANKL should be considered as novel therapeutic target for chronic inflammatory diseases presenting TLOs.

4- Bibliography

1. Hess, E., et al., *RANKL induces organized lymph node growth by stromal cell proliferation*. J. Immunol., 2012. **188**: p. 1245-54.
2. Cohen, J.N., et al., *Tolerogenic properties of lymphatic endothelial cells are controlled by the lymph node microenvironment*. PLoS ONE., 2014. **9**(2): p. e87740. doi: 10.1371/journal.pone.0087740. eCollection 2014.
3. Newa, M., et al., *Expression, characterization, and evaluation of a RANK-binding single chain fraction variable: an osteoclast targeting drug delivery strategy*. Mol Pharm., 2014. **11**(1): p. 81-9. doi: 10.1021/mp400188r. Epub 2013 Dec 3.
4. Ettinger, R., et al., *Effects of tumor necrosis factor and lymphotoxin on peripheral lymphoid tissue development*. Int. Immunol., 1998. **10**(6): p. 727-41.
5. Ettinger, R., et al., *Disrupted splenic architecture, but normal lymph node development in mice expressing a soluble lymphotoxin-beta receptor-IgG1 fusion protein*. Proc. Natl. Acad. Sci. USA, 1996. **93**(23): p. 13102-7.
6. Chai, Q., et al., *Maturation of lymph node fibroblastic reticular cells from myofibroblastic precursors is critical for antiviral immunity*. Immunity., 2013. **38**(5): p. 1013-24.
7. Ulvmar, M.H., et al., *The atypical chemokine receptor CCRL1 shapes functional CCL21 gradients in lymph nodes*. Nat Immunol., 2014. **15**(7): p. 623-30. doi: 10.1038/ni.2889. Epub 2014 May 11.
8. Phan, T.G., et al., *Immune complex relay by subcapsular sinus macrophages and noncognate B cells drives antibody affinity maturation*. Nat Immunol, 2009. **10**(7): p. 786-93.
9. Malhotra, D., et al., *Transcriptional profiling of stroma from inflamed and resting lymph nodes defines immunological hallmarks*. Nat Immunol, 2012. **13**(5): p. 499-510.
10. Fiorentini, S., et al., *Human cytomegalovirus productively infects lymphatic endothelial cells and induces a secretome that promotes angiogenesis and lymphangiogenesis through interleukin-6 and granulocyte-macrophage colony-stimulating factor*. J Gen Virol, 2011. **92**(Pt 3): p. 650-60.
11. Kong, Y.Y., et al., *OPGL is a key regulator of osteoclastogenesis, lymphocyte development and lymph-node organogenesis*. Nature, 1999. **397**(6717): p. 315-23.
12. Sugiyama, M., et al., *Expression pattern changes and function of RANKL during mouse lymph node microarchitecture development*. Int. Immunol., 2012. **2012**: p. 21.
13. Knoop, K.A., et al., *Distinct developmental requirements for isolated lymphoid follicle formation in the small and large intestine RANKL is essential only in the small intestine*. Am. J. Pathol., 2011. **179**(4): p. 1861-71.
14. Yoshida, H., et al., *Different cytokines induce surface lymphotoxin-alpha on IL-7 receptor-alpha cells that differentially engender lymph nodes and Peyer's patches*. Immunity, 2002. **17**(6): p. 823-33.
15. Kim, D., et al., *Regulation of peripheral lymph node genesis by the tumor necrosis factor family member TRANCE*. J Exp Med, 2000. **192**(10): p. 1467-78.
16. Vondenhoff, M.F., et al., *LTbetaR signaling induces cytokine expression and up-regulates lymphangiogenic factors in lymph node anlagen*. J. Immunol., 2009. **182**(9): p. 5439-45.
17. Benezech, C., et al., *Ontogeny of stromal organizer cells during lymph node development*. J. Immunol., 2011. **184**(8): p. 4521-30.

18. Koni, P.A., et al., *Distinct roles in lymphoid organogenesis for lymphotoxins alpha and beta revealed in lymphotoxin beta-deficient mice*. Immunity, 1997. **6**(4): p. 491-500.
19. Parameswaran, N. and S. Patial, *Tumor necrosis factor-alpha signaling in macrophages*. Crit Rev Eukaryot Gene Expr, 2010. **20**(2): p. 87-103.
20. Mebius, R.E., P. Rennert, and I.L. Weissman, *Developing lymph nodes collect CD4+CD3-LTbeta+ cells that can differentiate to APC, NK cells, and follicular cells but not T or B cells*. Immunity, 1997. **7**(4): p. 493-504.
21. Mebius, R.E., et al., *The influence of afferent lymphatic vessel interruption on vascular addressin expression*. J. Cell. Biol., 1991. **115**(1): p. 85-95.
22. Cecchini, M.G., et al., *Role of colony stimulating factor-1 in the establishment and regulation of tissue macrophages during postnatal development of the mouse*. Development, 1994. **120**(6): p. 1357-72.
23. MacDonald, K.P., et al., *An antibody against the colony-stimulating factor 1 receptor depletes the resident subset of monocytes and tissue- and tumor-associated macrophages but does not inhibit inflammation*. Blood, 2010. **116**(19): p. 3955-63.
24. Koni, P.A., et al., *Distinct roles in lymphoid organogenesis for lymphotoxins alpha and beta revealed in lymphotoxin beta-deficient mice*. Immunity, 1997. **6**(4): p. 491-500.
25. Alimzhanov, M.B., et al., *Abnormal development of secondary lymphoid tissues in lymphotoxin beta-deficient mice*. Proc Natl Acad Sci U S A, 1997. **94**(17): p. 9302-7.
26. Luther, S.A., K.M. Ansel, and J.G. Cyster, *Overlapping roles of CXCL13, interleukin 7 receptor alpha, and CCR7 ligands in lymph node development*. J Exp Med, 2003. **197**(9): p. 1191-8.
27. Cupedo, T. and R.E. Mebius, *Cellular interactions in lymph node development*. J. Immunol., 2005. **174**(1): p. 21-5.
28. Tumanov, A.V., D.V. Kuprash, and S.A. Nedospasov, *The role of lymphotoxin in development and maintenance of secondary lymphoid tissues*. Cytokine. Growth. Factor. Rev., 2003. **14**(3-4): p. 275-88.
29. Fu, Y.X. and D.D. Chaplin, *Development and maturation of secondary lymphoid tissues*. Annu. Rev. Immunol., 1999. **17**: p. 399-433.
30. Endres, R., et al., *Mature follicular dendritic cell networks depend on expression of lymphotoxin beta receptor by radioresistant stromal cells and of lymphotoxin beta and tumor necrosis factor by B cells*. J. Exp. Med., 1999. **189**(1): p. 159-68.
31. Allen, C.D. and J.G. Cyster, *Follicular dendritic cell networks of primary follicles and germinal centers: phenotype and function*. Semin Immunol, 2008. **20**(1): p. 14-25.
32. Alimzhanov, M.B., et al., *Abnormal development of secondary lymphoid tissues in lymphotoxin beta-deficient mice*. Proc. Natl. Acad. Sci. USA, 1997. **94**(17): p. 9302-7.
33. Husson, H., et al., *Functional effects of TNF and lymphotoxin alpha1beta2 on FDC-like cells*. Cell Immunol, 2000. **203**(2): p. 134-43.
34. Victoratos, P., et al., *FDC-specific functions of p55TNFR and IKK2 in the development of FDC networks and of antibody responses*. Immunity, 2006. **24**(1): p. 65-77.
35. Ruuls, S.R., et al., *Membrane-bound TNF supports secondary lymphoid organ structure but is subservient to secreted TNF in driving autoimmune inflammation*. Immunity, 2001. **15**(4): p. 533-43.

36. Pasparakis, M., et al., *Tumor necrosis factor and the p55TNF receptor are required for optimal development of the marginal sinus and for migration of follicular dendritic cell precursors into splenic follicles.* Cell Immunol, 2000. **201**(1): p. 33-41.
37. Le Hir, M., et al., *Differentiation of follicular dendritic cells and full antibody responses require tumor necrosis factor receptor-1 signaling.* J. Exp. Med., 1996. **183**(5): p. 2367-72.
38. Cupedo, T., et al., *Initiation of cellular organization in lymph nodes is regulated by non-B cell-derived signals and is not dependent on CXC chemokine ligand 13.* J Immunol, 2004. **173**(8): p. 4889-96.
39. Jarjour, M., et al., *Fate mapping reveals origin and dynamics of lymph node follicular dendritic cells.* J Exp Med, 2014. **211**(6): p. 1109-22.
40. Heesters, B.A., R.C. Myers, and M.C. Carroll, *Follicular dendritic cells: dynamic antigen libraries.* Nat Rev Immunol, 2014. **14**(7): p. 495-504.
41. Katakai, T., et al., *Organizer-like reticular stromal cell layer common to adult secondary lymphoid organs.* J. Immunol., 2008. **181**(9): p. 6189-200.
42. Stranford, S. and N.H. Ruddle, *Follicular dendritic cells, conduits, lymphatic vessels, and high endothelial venules in tertiary lymphoid organs: Parallels with lymph node stroma.* Front Immunol, 2012. **3**: p. 350.
43. Ruddle, N.H., *Lymphatic vessels and tertiary lymphoid organs.* J Clin Invest, 2014. **124**(3): p. 953-9.
44. Rangel-Moreno, J., et al., *The development of inducible bronchus-associated lymphoid tissue depends on IL-17.* Nat Immunol, 2011. **12**(7): p. 639-46.
45. Barone, F., et al., *IL-22 regulates lymphoid chemokine production and assembly of tertiary lymphoid organs.* Proc Natl Acad Sci U S A, 2015. **112**(35): p. 11024-9.
46. Hadamitzky, C., et al., *Age-dependent histoarchitectural changes in human lymph nodes: an underestimated process with clinical relevance?* J Anat, 2010. **216**(5): p. 556-62.
47. Schramek, D., et al., *Osteoclast differentiation factor RANKL controls development of progesterin-driven mammary cancer.* Nature, 2010. **468**(7320): p. 98-102.

Résumé

RANKL et RANK sont membres de la superfamille des TNF et de la superfamille des TNF-récepteurs, respectivement. Ils sont connus pour jouer un rôle important dans la régulation de la masse osseuse et dans le développement et la fonction du système immunitaire. Cependant des questions restent. Nous avons utilisé des souris génétiquement modifiées pour répondre à certaines de ces questions, en particulier en utilisant une souris dont les cellules stromales réticulaires marginales manquent RANKL dans les ganglions lymphatiques. Les résultats obtenus lors de cette thèse fournissent de nouvelles informations importantes sur l'impact positif de RANKL stromal sur les macrophages des ganglions lymphatiques concomitantes avec une fonction des cellules B améliorée et une pathogénicité virale réduite. Nous avons constaté que RANKL stromal régule l'expression de lymphotoxine et CXCL13, deux molécules clés de l'homéostasie des cellules B et de l'intégrité cellulaire des organes lymphoïdes secondaires. L'activité du RANKL semble suivre une hiérarchie temporelle sur lymphotoxine/TNF α , vu que le phénotype causé par le déficit en RANKL a une pénétrance augmentée avec l'âge. De plus, nous démontrons que RANKL active les cellules endothéliales lymphatiques des ganglions lymphatiques et on a trouvé que l'intégrine ITGA2b est un nouvel indicateur pour les cellules endothéliales lymphatiques activées. Ainsi, avec MAdCAM-1, ITGA2b sert comme un nouveau marqueur pour les cellules endothéliales lymphatiques qui sont constitutivement activées par le RANKL stromal. Au total, les données confirment l'importance de RANKL pour l'homéostasie des ganglions lymphatiques et dévoile les mécanismes ci-inconnus des fonctions de RANKL. À la lumière de cela et le fait que RANKL est sensible aux hormones féminines, nous avons étudié le rôle de RANKL dans le syndrome de Sjögren, une maladie inflammatoire chronique des glandes salivaires et lacrymales avec une forte polarisation de sexe féminin. Nous apportons la preuve que la neutralisation du RANKL réduit la taille des organes lymphoïdes tertiaire. En perspective, une éventuelle diaphonie entre les cellules endothéliales lymphatiques et les macrophages ou les cellules réticulaires marginales reste à clarifier. En outre, d'autres travaux sont nécessaires pour élucider le mécanisme par lequel RANKL stimule les maladies inflammatoires chroniques présentant des structures lymphoïdes tertiaires, afin de faire RANKL une nouvelle cible pour la thérapie.

Résumé en anglais

RANKL and RANK are members of the TNF-superfamily and TNF-receptor superfamily, respectively. They are known to play an important role in the regulation of bone mass and in the development and the function of the immune system. However questions still remain. We have used genetically modified mice to address some of these questions, in particular by using a mouse whose lymph node marginal reticular stromal cells lack RANKL. The results obtained during this PhD provide important new insights into the positive impact of stromal RANKL on lymph node macrophages concomitant with enhanced B cell function and reduced viral pathogenicity. We found that stromal RANKL regulates lymphotoxin and CXCL13 expression, two key molecules for B cell homeostasis and secondary lymphoid organ cellular integrity. RANKL activity seems to follow a temporal hierarchy over lymphotoxin/TNF α , as the phenotype caused by stromal RANKL-deficiency has increased penetrance with age. Furthermore, we demonstrate that RANKL activates lymph node lymphatic endothelial cells and found that the integrin ITGA2b is a new indicator for activated lymphatic endothelial cells. Thus, together with MAdCAM-1, ITGA2b serves as a novel marker for those lymphatic endothelial cells that are constitutively activated by stromal RANKL. Altogether, the data reinforce the importance of RANKL for the lymph node homeostasis and uncover hereto unknown mechanisms of RANKL functions. In light of this and the fact that RANKL is responsive to female hormones, we studied the role of RANKL in the Sjögrens syndrome, a chronic inflammatory disease of salivary and lacrimal glands with a strong female sex bias. We provide evidence that RANKL neutralization reduces tertiary lymphoid organ size. On the perspective side, a possible crosstalk between lymph node lymphatic endothelial cells and macrophages or marginal reticular cells remains to be clarified. Furthermore, further work is required to elucidate the mechanism by which RANKL stimulates chronic inflammatory diseases presenting tertiary lymphoid structures, in order to make RANKL a new target for therapy.

Keywords: RANKL, RANK, LN, macrophages, LECs