



HAL
open science

Role of the central serotonin subscript 2B receptor in the regulation of ascending dopaminergic pathways : relevance for the treatment of schizophrenia and drug addiction

Celine Devroye

► **To cite this version:**

Celine Devroye. Role of the central serotonin subscript 2B receptor in the regulation of ascending dopaminergic pathways : relevance for the treatment of schizophrenia and drug addiction. Human health and pathology. Université de Bordeaux; Università degli studi (Catane, Italie), 2016. English. NNT : 2016BORD0462 . tel-01676942

HAL Id: tel-01676942

<https://theses.hal.science/tel-01676942>

Submitted on 7 Jan 2018

HAL is a multi-disciplinary open access archive for the deposit and dissemination of scientific research documents, whether they are published or not. The documents may come from teaching and research institutions in France or abroad, or from public or private research centers.

L'archive ouverte pluridisciplinaire **HAL**, est destinée au dépôt et à la diffusion de documents scientifiques de niveau recherche, publiés ou non, émanant des établissements d'enseignement et de recherche français ou étrangers, des laboratoires publics ou privés.



université
de BORDEAUX

UNIVERSITY OF CATANIA - MEDICAL SCHOOL,
INTERNATIONAL PHD PROGRAM IN NEUROPHARMACOLOGY, XXVIIIth EDITION
UNIVERSITY OF BORDEAUX - DOCTORAL SCHOOL OF LIFE AND HEALTH SCIENCES,
SPECIALITY NEUROSCIENCE

**ROLE OF THE CENTRAL SEROTONIN_{2B} RECEPTOR IN THE REGULATION OF
ASCENDING DOPAMINERGIC PATHWAYS:
RELEVANCE FOR THE TREATMENT OF SCHIZOPHRENIA AND
DRUG ADDICTION**

PHD THESIS

CÉLINE DEVROYE

THESIS DIRECTOR (BORDEAUX): PR UMBERTO SPAMPINATO

THESIS CO-DIRECTOR (CATANIA): PR FILIPPO DRAGO

COORDINATOR : PR SALOMONE SALVATORE

DECEMBER 20th, 2016

The present work was carried out in the Team of Physiopathology of Addiction and Traumatic Memory, directed by Dr Pier-Vincenzo Piazza (INSERM U1215, Neurocenter Magendie, Bordeaux, France), and was supported by a fellowship from the International Ph.D. program in Neuropharmacology of the University of Catania, Medical School (Catania, Italy).

COMPOSITION OF THE JURY

Pr Marina Ziche (examiner). *Dpt Life Sciences, University of Siena, via A. Moro 2, 53100 Siena, Italy*

Pr Marco Andrea Riva (examiner). *Dpt Pharmacological and Biomolecular Sciences, University of Milan, via Balzaretti 9, 20133 Milan, Italy*

Pr Gianni Sava. *Dpt Life Sciences, University of Trieste, via L. Giorgieri 5, 34127 Trieste, Italy*

Pr Umberto Spampinato. *University of Bordeaux, 146 rue Léo Saignat, 33077 Bordeaux, France*

REMERCIEMENTS

Je dois tout d'abord remercier mon directeur de thèse, le professeur Umberto Spampinato, aux côtés duquel j'ai beaucoup appris au cours des six dernières années. Merci à lui pour sa présence et pour son indéfectible persévérance dans l'enseignement de l'écriture et de la rigueur. Je lui suis reconnaissante de m'avoir accompagnée tout au long du chemin et de m'avoir inculqué non seulement l'opiniâtreté mais aussi la confiance en mon propre jugement. Au-delà de toute considération scientifique, cette expérience m'a surtout permis de mieux me connaître moi-même.

Je remercie évidemment Adeline Cathala, avec qui j'ai partagé nombre d'expériences techniques et humaines. Merci pour son soutien, son écoute et son aide indispensable. Avec elle, il va sans dire qu'au souvenir des longues heures passées à faire la guerre à la chromatographie, lesquelles m'auront enseigné la patience dans son sens le plus abouti, s'ajoutent ceux des voyages, de la course aux buffets, et bien d'autres encore.

J'exprime ma gratitude au docteur Pier-Vincenzo Piazza pour m'avoir accueillie au sein de son laboratoire, me permettant ainsi de travailler dans d'excellentes conditions. A cet égard, je remercie tous les membres de l'équipe pour leur disponibilité et leur bienveillance. Merci à Jean-François pour nos réunions (entre deux portes de l'animalerie) portant sur nos vellétés de collaboration scientifique (un jour peut-être !), à Monique et Guillaume pour leurs précieux conseils, à Jess, Miguel, Agnès, Prisca, Lucie, Cédric pour leur bonne humeur, inaltérable... Bref, je serai plus exhaustive en remerciant l'ensemble du rez-de-chaussée, que j'ai rejoint bien tard d'un point de vue géographique, mais qui a souvent contribué à rendre ces journées au laboratoire plus légères.

Je remercie également l'Université de Catane d'avoir financé cette thèse. Je suis en particulier reconnaissante envers mon cotuteur, le professeur Filippo Drago, ainsi que le coordinateur du programme international de PhD en

Neuropharmacologie, le professeur Salvatore Salomone, de m'avoir accordé leur confiance pour mener à bien ce travail. Je remercie également les professeurs Ziche, Riva et Sava, d'avoir accepté d'assister à la présentation de ce travail. Merci au professeur Filippo Caraci pour son aide lors de mes échanges avec l'Université de Catane, et à Barbara Di Marco, avec qui j'ai eu le plaisir de travailler et de partager des moments à la fois bordelais et siciliens pendant six mois.

Il est bien évident que, sans le soutien de mes proches, cette expérience de vie aurait été tout autre. Aussi, j'ai bien conscience que les mots ne suffiront pas pour remercier mes parents, et leur exprimer combien je suis chanceuse de les compter parmi mes soutiens les plus assidus, et les plus infaillibles. Pourtant, je suppose qu'ils ont souffert, au même titre que d'autres, de supporter le récit interminable de mes semaines passées au labo. Je remercie également ma sœur, pour la fréquence de nos échanges à propos de tout et de rien, pour sa présence, tout simplement. Merci évidemment à ma grand-mère, ma tante, mon oncle, toute ma famille, pour ces précieux moments passés ensemble, qui m'ont rappelé combien le travail n'est qu'un moyen, et que bien d'autres choses sont fondamentales.

Je ne trouverai pas non plus les mots justes pour faire honneur au soutien de mes amis. Alors, simplement, un immense merci à Marion, Mathieu, Laurie, Maude, Simon, Marine et ma zoude. Sans vous, je n'ose pas imaginer de quelle manière j'aurais traversé ces quelques années. Nos moments de partage, les rires tout comme les violents coups de cafard, font partie de mes souvenirs les plus marquants et les plus enrichissants de cette période. Merci d'avoir su quoi dire lorsque j'en avais besoin, et surtout merci d'avoir été là. Un grand merci également à Eric, pour nos pauses café toujours trop courtes, et pour sa mise à l'épreuve de mon pessimisme récurrent. Merci aussi à Marie et Yvan, pour tous ces moments précieux passés en leur compagnie à des années lumières de tout le reste.

Enfin, il peut dorénavant croire que je m'emploie toujours à garder le meilleur pour la fin, je tiens à remercier celui qui m'a plus que quiconque aidée au cours des quatre dernières années. Merci, infiniment, à toi qui a dû absorber les moindres détails du récit de ma vie au labo, chaque soir, sans jamais céder à l'impulsion de les réduire à de simples détails. A toi qui m'a portée, avec ton humour, ton optimisme et la justesse de tes réflexions. Merci pour ta patience, ta force, et ta présence, toujours indispensables dans les meilleurs comme dans les mauvais instants. Grandir à tes côtés est sans détour la meilleure expérience de ma vie.

TABLE OF CONTENTS

LIST OF PUBLICATIONS AND SCIENTIFIC COMMUNICATIONS	11
LIST OF FIGURES AND TABLES	13
LIST OF ABBREVIATIONS	15
ABSTRACT	17
RESUME	19
INTRODUCTION	21
I. Anatomy of central dopaminergic and serotonergic systems	23
II. Therapeutic relevance of the interaction between central dopaminergic and serotonergic systems	27
A. Schizophrenia	27
B. Drug addiction: focus on cocaine	33
III. The serotonin _{2B} receptor	39
A. Localization	39
B. Molecular properties	40
C. Pharmacology	45
D. Functional aspects	49
1. Regulation of cell differentiation and proliferation	49
2. Regulation of the gastrointestinal tract	49
3. Regulation of the vascular function	50
4. Regulation of the pulmonary function	51
5. Regulation of the cardiac function	52

6. Regulation of the central nervous system	53
6.1. Regulation of serotonin transport	53
6.2. Regulation of astrocytes	54
6.3. Regulation of the dopaminergic network	54
6.3.1. Neurochemical aspects	54
6.3.2. Behavioral aspects	56
6.4. Therapeutic implications	58
6.4.1. Schizophrenia	58
6.4.2. Drug addiction	60
6.4.3. Depression	61
IV. Aims	63
PUBLICATIONS	67
I. Article 1: Differential control of dopamine ascending pathways by serotonin _{2B} receptor antagonists: new opportunities for the treatment of schizophrenia. <i>Devroye et al., 2016, Neuropharmacology 109, 59-68.</i>	69
II. Article 2: A functional interplay with serotonin _{1A} receptors drives central serotonin _{2B} receptor-opposite controls of mesocortical and mesoaccumbal dopaminergic pathways. <i>To be submitted.</i>	111
III. Article 3: Central serotonin _{2B} receptor blockade inhibits cocaine-induced hyperlocomotion independently of changes of subcortical dopamine outflow. <i>Devroye et al., 2015, Neuropharmacology 97, 329-337.</i>	141
DISCUSSION	181
CONCLUSIONS	193
REFERENCES	197

LIST OF PUBLICATIONS AND SCIENTIFIC COMMUNICATIONS

Publications

***Devroye**, C., Filip, M., Przegaliński, E., McCreary, A.C., Spampinato, U., 2013. Serotonin_{2C} receptors and drug addiction: focus on cocaine. *Exp. Brain Res.* 230, 537-545.

*Cathala, A., **Devroye**, C., Maitre, M., Piazza, P.V., Abrous, D.N., Revest, J.M., Spampinato, U., 2014. Serotonin_{2C} receptors modulate dopamine transmission in the nucleus accumbens independently of dopamine release: behavioral, neurochemical and molecular studies with cocaine. *Addict. Biol.* 20, 445-457.

***Devroye**, C., Cathala, A., Maitre, M., Piazza, P.V., Abrous, D.N., Revest, J.M., Spampinato, U., 2015. Serotonin_{2C} receptor stimulation inhibits cocaine-induced Fos expression and DARPP-32 phosphorylation in the rat striatum independently of dopamine outflow. *Neuropharmacology* 89, 375-381.

Devroye, C., Cathala, A., Di Marco, B., Caraci, F., Drago, F., Piazza, P.V., Spampinato, U., 2015. Central serotonin(2B) receptor blockade inhibits cocaine-induced hyperlocomotion independently of changes of subcortical dopamine outflow. *Neuropharmacology* 97, 329-337.

Devroye, C., Cathala, A., Haddjeri, N., Rovera, R., Vallée, M., Drago, F., Piazza, P.V., Spampinato, U., 2016. Differential control of dopamine ascending pathways by serotonin_{2B} receptor antagonists: new opportunities for the treatment of schizophrenia. *Neuropharmacology* 109, 59-68.

Devroye, C., Haddjeri, N., Cathala, A., Rovera, R., Drago, F., Piazza, P. V., Spampinato, U. A functional interplay with serotonin_{1A} receptors drives central serotonin_{2B} receptor-mediated opposite controls of mesocortical and mesoaccumbal dopaminergic pathways. *To be submitted.*

**These publications do not belong to the present study.*

Scientific communications

Oral communications

Devroye, C., Cathala, A., Maitre, M., Piazza, P.V., Abrous, D.N., Revest, J.M., Spampinato, U. 5-HT_{2C} receptors modulate DA transmission in the nucleus accumbens and the striatum: studies with cocaine. Neuropathology and Neuropharmacology of monoaminergic systems, CM1103 Action annual conference, October, 8-10th, 2014, Bordeaux, France.

Devroye, C., Cathala, A., Drago, F., Piazza, P.V., Spampinato, U. Serotonin_{2B} receptor-dopamine interaction: new opportunities for improved treatment of schizophrenia. Mediterranean Neuroscience Society - MNS 2015, June, 12-15th, 2015, Cagliari, Italy.

Poster communications

Devroye, C., Cathala, A., Drago, F., Piazza, P.V., Spampinato, U. Blockade of central serotonin_{2B} receptors reduces cocaine-induced hyperlocomotion independently of subcortical DA outflow. European College of Neuropsychopharmacology - ECNP 2014, October, 18-21st, 2014, Berlin, Germany.

Cathala, A., **Devroye, C., Maitre, M., Piazza, P.V., Abrous, D.N., Revest, J.M., Spampinato, U.** Serotonin_{2C} receptor stimulation inhibits dopamine transmission in the nucleus accumbens independently of dopamine release: studies with cocaine. ECNP 2014, October, 18-21st, 2014, Berlin, Germany.

Devroye, C., Cathala, A., Drago, F., Piazza, P.V., Spampinato, U. Serotonin_{2B} receptor antagonists reduce cocaine-induced hyperlocomotion: a possible post-synaptic interaction. ECNP workshop for junior scientists, March, 12-15th, 2015, Nice, France.

LIST OF FIGURES AND TABLES

Figures

Figure 1: Distribution of DA neuron cell groups in the adult rodent brain	24
Figure 2: Distribution of noradrenergic and adrenergic neurons and their major projections in the rat brain	25
Figure 3: Distribution of 5-HT neuron cell groups in the adult rat brain	26
Figure 4: Anatomical circuits proposed by Pierce and Vanderschuren (2010) to underlie the progressive recruitment of more dorsal regions of the striatum during the transition from casual cocaine use to habitual cocaine seeking and taking	37
Figure 5: Prototypical signaling enzyme linkages of the G-protein-coupled 5-HT receptors	44
Figure 6: Schematic representation of the differential regulation of ascending DA pathways by 5-HT _{2B} R	184
Figure 7: Schematic representation of the functional interplay between the 5-HT _{2B} R and the 5-HT _{1A} R controlling mesocorticolimbic DA pathways	187
Figure 8: Time course effect of the administration of 5-HT _{2B} R antagonists on cocaine-induced increase in DA outflow in the mPFC	191
Figure 9: Schematic representation of the possible circuits underlying 5-HT _{2B} R-mediated control of cocaine-induced hyperlocomotion	192

Tables

Table 1: Criteria for schizophrenia in the Diagnostic and Statistical Manual of Mental Disorders	31
Table 2: Behavioral models classically used to assess the efficacy of APDs against positive, negative and cognitive symptoms of schizophrenia, as well as their propensity to induce EPS	32
Table 3: Signaling characteristics of human 5-HT receptors	43
Table 4: Binding affinities of some antagonist ligands at human recombinant 5-HT ₂ receptors	46
Table 5: Binding affinities of some agonist ligands at human recombinant 5-HT ₂ receptors	47

LIST OF ABBREVIATIONS

5-HT	serotonin
APD	antipsychotic drug
DA	dopamine
DAG	diacyl glycerol
DARPP-32	DA and cyclic 3'-5' adenosine monophosphate-regulated phosphoprotein
DAT	dopamine transporter
DRN	dorsal raphe nucleus
DSM	diagnostic & statistical manual of mental disorders
EPS	extrapyramidal side effect
GI	gastrointestinal
ICC	interstitial cells of cajal
IP3	inositol 1,4,5-trisphosphate
MAPK	mitogen-activated protein kinase
MDMA	4-methylenedioxymethamphetamine
mPFC	medial prefrontal cortex
NAc	nucleus accumbens
NAD	nicotinamide adenine dinucleotide
NET	noradrenaline transporter
NMDA	N-methyl-D-aspartate
NO	nitric oxide
NOR	novel object recognition
PAH	pulmonary arterial hypertension
PIP2	phosphatidylinositol 4,5-bisphosphate
PKC	protein kinase C
PLA ₂	phospholipase A ₂
PLC	phospholipase C
PCP	phencyclidine
ROS	reactive oxygen species
SERT	serotonin transporter

SNc substantia nigra pars compacta
SSRI selective serotonin reuptake inhibitors
VIC valvular interstitial cells
VTA ventral tegmental area

ABSTRACT

Four years ago, at the beginning of my thesis in Neuropharmacology, the functional role of the central serotonin_{2B} receptor (5-HT_{2B}R) remained poorly investigated. Indeed, in light of the relatively recent discovery of its presence in the mammalian brain, as compared to other 5-HT receptors, only few studies had explored its impact within the central nervous system. Interestingly, it had been shown that 5-HT_{2B}Rs, while having no effect at the level of the nigrostriatal dopaminergic (DA) pathway, afford a tonic excitatory control on the activity of the mesoaccumbal DA tract. This differential influence on subcortical DA brain regions had led to the proposal that 5-HT_{2B}R antagonists may be a useful tool for improved treatment of DA-related disorders requiring an independent modulation of the activity of ascending DA pathways, such as schizophrenia. However, the effect of 5-HT_{2B}R blockade at the level of the mesocortical DA pathway, which plays a pivotal role in the therapeutic benefit of atypical antipsychotic drugs (APDs), had never been studied. In addition, analysis of the literature revealed that 5-HT_{2B}R blockade suppresses amphetamine and 3,4-methylenedioxymethamphetamine-induced neurochemical and behavioral responses, suggesting that this receptor may also be a relevant pharmacological target for treating drug addiction. Nevertheless, its possible implication in the effects induced by cocaine, one of the most worldwide abused drugs, remained unknown.

Thus, the aim of the present thesis was to study the regulatory control exerted by the 5-HT_{2B}R on both basal and cocaine-induced stimulation of DA activity, in order to evaluate its therapeutic relevance for improved treatment of schizophrenia and drug abuse and dependence. To this purpose, we assessed the effects of potent and selective 5-HT_{2B}R antagonists (RS 127445 and LY 266097) on DA activity, by using biochemical, electrophysiological and behavioral approaches in rats.

In a first group of experiments, we found that 5-HT_{2B}Rs exert a tonic inhibitory control on DA outflow in the medial prefrontal cortex (mPFC). This finding, by showing that 5-HT_{2B}Rs afford differential controls over the three ascending DA pathways, indicates that 5-HT_{2B}R antagonists display an ideal pattern of effects to restore normal DA function in schizophrenia. Accordingly, 5-HT_{2B}R antagonists were efficient in several behavioral models aimed at predicting APD efficacy, and had no effect in a behavioral task reflecting APD propensity to induce motor side effects. In a second group of experiments performed to determine the mechanisms underlying the differential control exerted by 5-HT_{2B}Rs on DA activity, we demonstrated that 5-HT_{2B}R antagonist-induced opposite effects on DA outflow in the mPFC and the nucleus accumbens (NAc) involve a functional interplay with 5-HT_{1A}Rs expressed in the mPFC. Finally, we found that 5-HT_{2B}R blockade suppresses cocaine-induced hyperlocomotion. This effect, which occurs independently from changes of DA outflow in the NAc and the striatum, where DA activity is tightly related to cocaine-induced behavioral responses, likely involves a post-synaptic interaction in subcortical DA brain regions.

To conclude, the work accomplished over the past four years provides substantial information with regards to the functional role of 5-HT_{2B}Rs in the regulation of the activity of ascending DA pathways. In addition, while improving the understanding of the interaction between DA and 5-HT systems, the present findings altogether highlight the therapeutic potential of 5-HT_{2B}R antagonists for treating schizophrenia and cocaine addiction.

RESUME

Il y a quatre ans, lorsque j'ai commencé ma thèse en Neuropharmacologie, le rôle fonctionnel du récepteur serotoninergique_{2B} (5-HT_{2B}) central n'était guère connu. En effet, compte tenu de la mise en évidence de son expression dans le cerveau relativement récente par rapport aux autres récepteurs à la 5-HT, peu d'études avaient porté sur son impact au sein du système nerveux central. En particulier, il était établi que les récepteurs 5-HT_{2B}, sans effet au niveau de la voie dopaminergique (DA) nigrostriée, sont capables d'exercer un contrôle tonique excitateur sur l'activité de la voie DA mésoaccumbale. Sur la base de cette régulation différentielle des voies DA sous-corticales, il avait été proposé que les antagonistes du récepteur 5-HT_{2B} pourraient constituer des outils pharmacologiques pertinents pour le traitement des pathologies liées à une dysfonction du système DA et requérant une modulation indépendante des voies DA ascendantes, telles que la schizophrénie. Cependant, l'effet du blocage des récepteurs 5-HT_{2B} au niveau de la voie DA mésocorticale, laquelle joue un rôle pivot dans le bénéfice thérapeutique des antipsychotiques (APs) atypiques, n'avait jamais été exploré. De plus, l'analyse de la littérature avait révélé que le blocage du récepteur 5-HT_{2B} réduit les réponses neurochimiques et comportementales induites par l'amphétamine et la 3,4-méthylènedioxyméthamphétamine, suggérant que ce récepteur pourrait également représenter une cible pharmacologique intéressante pour le traitement de l'addiction. Néanmoins, la possible implication de ce récepteur dans les effets de la cocaïne, l'une des drogues les plus consommées au monde, restait alors inconnue.

Ainsi, l'objectif de cette thèse était d'étudier l'influence exercée par le récepteur 5-HT_{2B} sur l'activité DA basale et activée par la cocaïne, afin de mieux évaluer le potentiel thérapeutique de ce récepteur dans le traitement de la schizophrénie et de l'addiction. A cette fin, nous avons étudié les effets de deux antagonistes puissants et sélectifs du récepteur 5-HT_{2B} (RS 127445 et LY 266097) sur

l'activité DA, en utilisant des approches biochimiques, électrophysiologiques et comportementales chez le rat.

Un premier groupe d'expériences a mis en évidence l'existence d'un contrôle tonique inhibiteur exercé par le récepteur 5-HT_{2B} sur la libération de DA dans le cortex préfrontal médian (CPFm). Ce résultat, démontrant que les récepteurs 5-HT_{2B} régulent de manière différentielle les trois voies DA ascendantes, indique que les antagonistes du récepteur 5-HT_{2B} présentent un profil d'action idéale pour restaurer une fonction DA normale chez les patients schizophrènes. En accord avec cette proposition, les antagonistes 5-HT_{2B} se révèlent efficaces dans plusieurs modèles classiquement utilisés pour prédire l'efficacité des APs, alors qu'ils n'ont pas d'effet dans une tâche comportementale prédisant la tendance des APs à induire des effets secondaires moteurs. Un second groupe d'expériences visant à étudier les mécanismes sous-tendant le contrôle différentiel exercé par le récepteur 5-HT_{2B} sur l'activité DA montre que les effets opposés induits par les antagonistes 5-HT_{2B} sur la libération de DA dans le CPFm et le noyau accumbens (NAc) résultent d'une interaction fonctionnelle avec les récepteurs 5-HT_{1A} exprimés dans le CPFm. Enfin, nous avons également démontré que le blocage du récepteur 5-HT_{2B} supprime l'hyperlocomotion provoquée par la cocaïne. Cet effet, qui se produit indépendamment de la libération de DA dans le NAc et le striatum, où l'activité DA est étroitement liée aux effets comportementaux induits par la cocaïne, implique une interaction post-synaptique dans les régions DA sous-corticales.

En conclusion, le travail accompli au cours des quatre années passées apporte des informations substantielles quant au rôle fonctionnel du récepteur 5-HT_{2B} dans la régulation des voies DA ascendantes. En outre, l'ensemble de nos résultats permet non seulement d'améliorer la compréhension de l'interaction des systèmes DA et 5-HT, mais aussi de mettre en avant le potentiel thérapeutique des antagonistes du récepteur 5-HT_{2B} pour le traitement de la schizophrénie et de l'addiction à la cocaïne.

INTRODUCTION

I. Anatomy of central dopaminergic and serotonergic systems

Following the first demonstration by Arvid Carlsson (awarded with the Nobel Prize in 2000 for his work in the field) of the existence of catecholamine-containing neurons in the late 1950s (Carlsson *et al.*, 1958), the possible immunochemical identification of dopamine (DA) neurons in the central nervous system has permitted the localization and subsequent classification of mesotelencephalic DA cells into 10 distinct groups, reconciled into three main systems (Dahlström and Fuxe, 1964; Figure 1):

- the mesencephalic DA system, involving areas A8, A9 and A10 (areas A1 to A7 being noradrenergic nuclei; Figure 2)
- the diencephalic DA system, involving areas A11, A12, A13, A14 and A15
- the retinal DA tract, involving areas A16 and A17

The majority of central DA neurons originates in the mesencephalic DA system. While the substantia nigra pars compacta (SNc, A9) and the retro-rubral area (A8) mainly project to the dorsal striatum (caudate nucleus and putamen), most of the DA neurons emerging from the ventral tegmental area (VTA, A10) innervate the olfactory tubercle, the ventral striatum (namely the nucleus accumbens, NAc) and the frontal cortex, thereby indicating the existence of two sub-systems, the nigrostriatal and the mesocorticolimbic DA tracts (Fallon and Moore, 1978). This classification is of course a simplistic one, considering the substantial overlap of DA fibers in the mesencephalic DA complex (Björklund and Dunnett, 2007). However, on the basis of the most representative DA projection sites and their distinct functional properties, it is generally considered that the DA network falls out into three major ascending pathways: the nigrostriatal, the mesocortical and the mesoaccumbal DA tracts (Tzschentke, 2001; Björklund and Dunnett, 2007). In addition, for the sake of clarity, the terms “dorsal striatum” and “ventral striatum” are usually replaced by “striatum” and “NAc”, respectively.

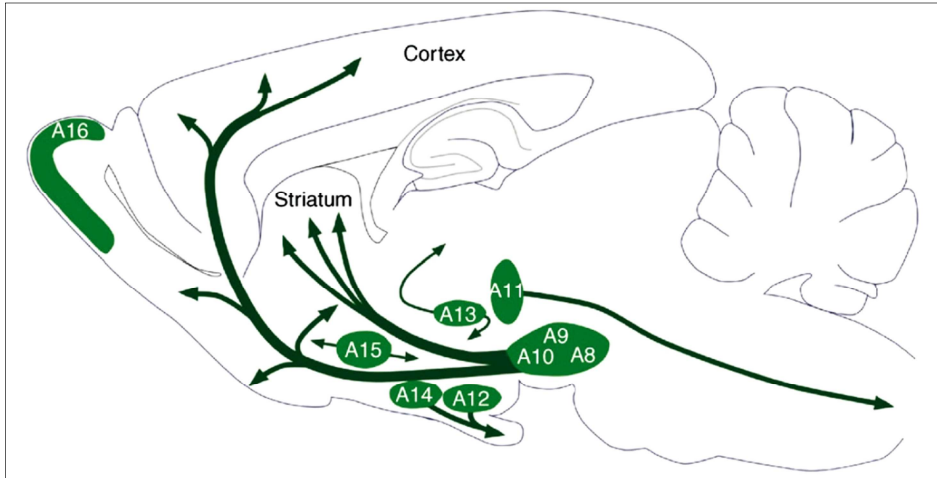

Figure 1: Distribution of DA neuron cell groups in the adult rodent brain. The DA neurons in the mammalian brain are localized in nine distinctive cell groups, distributed from the mesencephalon to the olfactory bulb, as illustrated schematically, in a sagittal view, in the adult rat brain. The principal projections of DA cell groups are illustrated by arrows. DA, dopamine. *Drawing adapted from Björklund and Dunnett, 2007.*

The mid-twentieth century has also witnessed the discovery of serotonin (5-HT) in significant amounts in the central nervous system (Amin *et al.*, 1954). Histochemical fluorescence, radioautography and immunocytochemistry studies led to the classification of 5-HT neurons in 9 clusters designated as B1 to B9, all present in the brain stem (Azmitia and Segal, 1978; Jacobs and Azmitia, 1992; Figure 3):

- the nuclei B1 to B4 form the inferior group (descending pathways)
- the nuclei B5 to B9 form the superior group (ascending pathways)

The superior group includes the dorsal raphe nucleus (DRN; the largest nucleus of this group, containing half of its 5-HT neurons), the median raphe nucleus, the caudal linear nucleus and the prosuprlemniscus nucleus. In keeping with the extensive branching of 5-HT neuronal processes, these structures provide a widespread innervation of the forebrain (hippocampus, hypothalamus, SNC,

medial mammillary nucleus, lateral septum, thalamus, amygdala, cortex...), via different fiber tracts, of which the medial forebrain bundle is the most prominent (Azmitia and Segal, 1978).

Interestingly, DA brain regions (SNc, VTA) as well as their terminal fields (striatum, NAc and frontal cortex; see above) are intensively innervated by the 5-HT system (Azmitia and Segal, 1978). This anatomical promiscuity of DA and 5-HT neurons, along with the importance of DA ascending pathways in several pathological conditions (see section II), has raised and maintained, over the past 40 years, the interest of neuroscience researchers for the potential role of the fourteen 5-HT receptor subtypes in the regulation of the DA network activity.

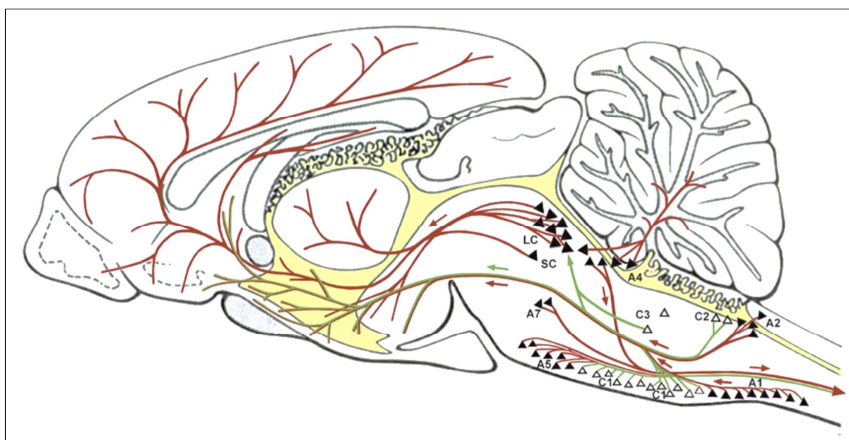

Figure 2: Distribution of noradrenergic and adrenergic neurons and their major projections in the rat brain (drawing on the midsagittal plane of the brain). The noradrenaline system is represented by solid triangles and lines in red, and the adrenaline system is represented by open triangles and lines in green. A1, A2, A4, A5, and A7 are noradrenergic neurons; C1, C2, and C3, are adrenergic neurons; LC, locus coeruleus; SC, subcoeruleus area. *Drawing adapted from Kvetnansky et al., 2009.*

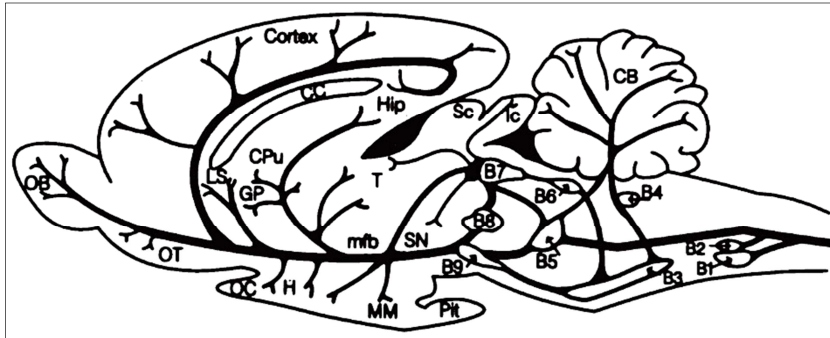

Figure 3: Distribution of 5-HT neuron cell groups in the adult rat brain. A longitudinal view of rat brain with a schematic representation of the localization of the 5-HT cell bodies in the raphe nuclei and in the brain stem reticular formation, and the corresponding classification into B-groups and their projections. CB, cerebellum; mfb, medial forebrain bundle; CC, corpus callosum; OB, olfactory bulb; Cpu, caudate putamen; OC, optic chiasma; GP, globus pallidus; OT, olfactory tubercle; H, hypothalamus; Pit, pituitary gland; Hip, hippocampal region; Sc, superior colliculus; Ic, locus coeruleus; SN, substantia nigra; LS, lateral septal nucleus; T, thalamus; MM, medial mammillary nucleus. *Drawing from Waldinger et al., 1998.*

II. Therapeutic relevance of the interaction between central dopaminergic and serotonergic systems

A. Schizophrenia

The word "schizophrenia", introduced for the first time in 1911 by a Swiss psychiatrist, Eugen Bleuler, comes from the Greek roots "schizo" (split) and "phrene" (mind), to describe the fragmented thinking of people suffering from this neuropsychiatric disorder. Schizophrenia is a chronic, severe, and disabling mental disorder characterized by deficits in thought processes, perceptions, and emotional responsiveness. The illness occurs in less than 1 percent of the general population, and is favoured by genetic and environmental factors as well as specific brain chemistry or substance use (van Os and Kapur, 2009). Although the definitions and diagnosis criteria are constantly evolving along the different versions of the Diagnostic and Statistical Manual of Mental Disorders (DSM; Table 1), three core features emerge in the etiology of schizophrenia: positive (i.e. hallucinations, delusions), negative (i.e. social interaction deficits, blunted affect) and cognitive (i.e. working and reference memory deficits, executive function impairments, decreased vigilance) symptoms (Newman-Tancredi and Kleven, 2011; Meltzer, 2013).

Several hypothesis have been advanced with regards to the implication of specific neurotransmitters, such as DA, glutamate or 5-HT (Rastogi *et al.*, 1981; Carlsson *et al.*, 1999; Svensson, 2003; Moghaddam and Javitt, 2012; Halberstadt and Geyer, 2013), in the pathophysiology of schizophrenia. Although there may be a shared responsibility of several neuronal networks, in view of their close interactions in the brain (Azmitia and Segal, 1978; Carlsson *et al.*, 2000; Delille *et al.*, 2013), we will focus our attention on the DA hypothesis of schizophrenia, which remains one of the most prominent theory in the field. The first clues supporting this hypothesis were brought by the discovery that the DA-D₂ receptor (DA-D₂R) antagonist chlorpromazine achieves antipsychotic effects in schizophrenic patients and that drugs which

Introduction

increase DA (such as amphetamine and methylphenidate) provoke and/or exacerbate psychotic episodes in humans (Delay *et al.*, 1952; Smith and Davis, 1977; Lieberman *et al.*, 1984, 1987; Kollins *et al.*, 2001). Today, it is generally accepted that this multimodal symptomatology results, at least in part, from an imbalance in central DA neurotransmission. Specifically, a DA hyperfunction of the mesoaccumbal pathway would lead to positive symptoms, while a DA hypofunction of the mesocortical pathway could be responsible for the expression of negative and cognitive symptoms (Svensson, 2000; Newman-Tancredi and Kleven, 2011).

The advent of schizophrenia pharmacotherapy coincides with the ability of chlorpromazine and haloperidol (another DA-D₂R antagonist) to alleviate positive symptoms. However, these treatments (later renamed “typical” antipsychotics drugs, APDs) fail to alleviate negative and cognitive symptoms (Newman-Tancredi and Kleven, 2011). In addition, they exhibit a marked propensity to induce extrapyramidal side effects (EPS), related to their blockade of DA activity in the nigrostriatal DA ascending pathway (Shapira *et al.*, 2006). Thus, the need for treatments with a larger therapeutic window and reduced EPS risk gave birth to a second generation pharmacotherapy, the atypical APDs, of which clozapine is the prototype. These compounds are “selectively nonselective drugs” (Roth *et al.*, 2004; Csermely *et al.*, 2005; Wong *et al.*, 2010), displaying antagonist properties towards the DA-D₂R (as this feature appears fundamental to alleviate positive symptoms), together with agonist or antagonist properties towards other pharmacological targets, such as 5-HT, adrenergic, muscarinic or histaminergic receptors (Newman-Tancredi and Kleven, 2011).

Noteworthy, most of atypical APDs target the 5-HT_{1A}R, 5-HT_{2A}R, 5-HT_{2B}R and the 5-HT_{2C}R, and sometimes interact with the 5-HT₆R and the 5-HT₇R (Newman-Tancredi and Kleven, 2011). Previous studies have shown that the atypicality of APDs (low EPS incidence and improved therapeutic effect with regards to typical APDs) would be related to their low affinity towards DA-

D₂Rs together with high 5-HT_{2A}R antagonist properties (Newman-Tancredi and Kleven, 2011). It is also well-established that 5-HT_{1A}Rs are key targets for the therapeutic benefit of atypical APDs. Indeed, microdialysis and knock-out studies have shown that activation of this receptor is necessary for the increase in cortical DA outflow induced by atypical APDs (Ichikawa *et al.*, 2001; Díaz-Mataix *et al.*, 2005), an effect which could be related to their ability to alleviate the cognitive and negative symptoms of schizophrenia. Actually, several findings suggest that the therapeutic benefit of atypical APDs partly results from a cooperation between 5-HT_{2A}Rs and 5-HT_{1A}Rs. As a matter of fact, administration of a 5-HT_{2A}R antagonist, at a dose which has no effect by itself, potentiates 5-HT_{1A}R agonist-induced increase in DA outflow in the medial prefrontal cortex (mPFC, Ichikawa *et al.*, 2001).

That 5-HT receptors could be interesting targets for the improved treatment of schizophrenia is strengthened by previous findings supporting the involvement of the 5-HT system in the pathophysiology of schizophrenia. First, in schizophrenic patients, many 5-HT receptors, as well as the 5-HT transporter (SERT), tryptophan hydroxylase and monoamine oxidase proteins show alterations in terms of mRNA or protein levels in different brain regions, as well as specific protein sequences (single nucleotide polymorphisms; Bennett *et al.*, 1979; Baou *et al.*, 2015). In addition, low cortical 5-HT levels have been associated with positive symptoms (Rasmussen *et al.*, 2010). Whether these alterations are the cause or the consequence of a DA imbalance in the central nervous system remains unclear. However, it is noteworthy that both the DA and the 5-HT systems may be involved in both the treatment and the development of schizophrenia.

It must be borne in mind that it is crucial to develop new APDs. Indeed, although it is better tolerated with regards to typical APDs, the treatment of schizophrenia with the available atypical APDs is often associated with important side effects (as sedation, weight gain, and metabolic disturbances), related to their multitarget properties, in particular their affinity for

Introduction

histaminergic and muscarinic receptors, as well as 5-HT_{2C}Rs (Nasrallah, 2008). Also, a substantial number of patients fail to respond to this pharmacotherapy, especially in terms of negative and cognitive symptoms, which may be due at least in part to the heterogeneity of the disease. From a preclinical point of view, developing behavioral models can be difficult because of the typical human nature of some of the symptoms observed in schizophrenia (for example flattened affect). In addition, it is, at the moment, impossible to reconcile all the features of schizophrenia in a unique animal model, because of the multimodal nature of schizophrenia. Instead, numerous behavioral models in the primate or the rodent have been developed to predict the ability of a given compound to alleviate either the positive, cognitive or negative symptoms of schizophrenia, or their propensity to induce EPS (Table 2). On the basis of these limitations, the only strategy to identify a potential candidate for treating schizophrenia would be to assess its effects in numerous models of the different symptom clusters of schizophrenia.

Criterion A. Characteristic symptoms

Two (or more) of the following, each present for a significant portion of time during a 1-month period (or less if successfully treated)

- (1) Delusions
- (2) Hallucinations
- (3) Disorganized speech
- (4) Grossly disorganized or catatonic behavior
- (5) Negative symptoms, i.e., affective flattening, alogia, or avolition

Note: Only one Criterion A symptom is required if delusions are bizarre or hallucinations consist of a voice keeping up a running commentary on the person's behavior or thoughts, or two or more voices conversing with each other

Criterion B. Social/occupational dysfunction: For a significant portion of the time since the onset of the disturbance, one or more major areas of functioning, such as work, interpersonal relations, or self-care, are markedly below the level achieved prior to the onset (or when the onset is in childhood or adolescence, failure to achieve expected level of interpersonal, academic, or occupational achievement).

Criterion C. Duration: Continuous signs of the disturbance persist for at least 6 months. This 6-month period must include at least 1 month of symptoms (or less if successfully treated) that meet Criterion A (i.e., active-phase symptoms) and may include periods of prodromal or residual symptoms. During these prodromal or residual periods, the signs of the disturbance may be manifested by only negative symptoms or by two or more symptoms listed in Criterion A present in an attenuated form (e.g., odd beliefs, unusual perceptual experiences).

Criterion D. Schizoaffective and major mood disorder exclusion

Schizoaffective disorder and depressive or bipolar disorder with psychotic features have been ruled out because either (1) no major depressive or manic episodes have occurred concurrently with the active phase symptoms; or (2) if mood episodes have occurred during active-phase symptoms, their total duration has been brief relative to the duration of the active and residual periods.

Criterion E. Substance/general mood condition exclusion

Substance/general medical condition exclusion: The disturbance is not attributed to the direct physiological effects of a substance (e.g., a drug of abuse, a medication) or another medical condition.

Criterion F. Relationship to Global Developmental Delay or Autism Spectrum Disorder:

If there is a history of autism spectrum disorder, the additional diagnosis of schizophrenia is made only if prominent delusions or hallucinations are also present for at least 1 month (or less if successfully treated).

Table 1: Criteria for schizophrenia in the Diagnostic and Statistical Manual of Mental Disorders (DSM), 4th edition. *Adapted from Tandon et al., 2013.*

Symptom cluster or side effect	Behavioral models
Positive symptoms	<p>Stereotyped behaviors or hyperlocomotion elicited by DA releasers (methylphenidate, amphetamine), DA agonists (apomorphine), or noncompetitive NMDA receptor antagonists (PCP, ketamine, MK-801)</p> <p>Conditioned avoidance behavior</p> <p>Apomorphine-induced climbing behaviors</p>
Negative & Cognitive symptoms	<p>PCP-induced deficits in the social interaction test</p> <p>Scopolamine-induced deficit in social recognition test</p> <p>PCP-induced working memory deficit in hole-board test</p> <p>PCP-induced cognitive flexibility deficit in reversal learning task</p> <p>PCP-induced working memory deficit in delayed nonmatching to position</p> <p>PCP-induced deficits in novel object recognition</p>
EPS liability	<p>Catalepsy duration</p> <p>Inhibition of spontaneous locomotion</p> <p>Induction of basal prepulse inhibition deficit</p> <p>Induction of attentional deficit</p>

Table 2: Behavioral models classically used to assess the efficacy of APDs against positive, negative and cognitive symptoms of schizophrenia, as well as their propensity to induce EPS. APD, antipsychotic drug; DA, dopamine; NMDA, N-methyl-D-aspartate; PCP, phencyclidine; EPS, extrapyramidal side effect. *Adapted from Newman-Tancredi and Kleven, 2011.*

B. Drug addiction: focus on cocaine

Substance use disorders (drug abuse and dependence) are classically defined as chronically relapsing disorders characterized by the compulsion to seek and take a drug, loss of control in limiting intake, and emergence of a negative emotional state reflecting a motivational withdrawal syndrome when access to the drug is prevented (Koob and Volkow, 2010).

As opportunities to use and abuse drugs have increased dramatically during the past 50 years, so has the research on addiction. A first step in the understanding of the neurobiological substrates of drug addiction was taken with the identification of a reward circuitry (a reward being a class of unconditioned motivational stimuli provided with hedonic properties that can act as positive reinforcers), which drives the reinforcing effects of drugs of abuse (Koob and Volkow, 2010). In particular, previous intracranial brain stimulation or self-administration studies have shown that the most sensitive sites of this network belong to the mesocorticolimbic tracts (Olds and Milner, 1954; Crow, 1973; Wise, 1978; Kornetsky and Esposito, 1979). Also, increased DA in the NAc is the hallmark of all drugs abused by humans (Di Chiara and Imperato, 1988), and has been suggested to be the starting point of psychostimulant drug-induced rewarding effects (Koob and Volkow, 2010). Altogether, these findings demonstrate that the DA ascending pathways play a critical role in the behavioral and neurochemical effects of psychostimulant drugs. Noteworthy, this network can be critical not only for the acute reward properties of psychostimulant drugs but also for the long-term neuroadaptive changes in the brain responsible for the ingrained behaviors characterizing drug addiction (Grüsser *et al.*, 2004; Bossert *et al.*, 2009; McClernon *et al.*, 2009; Pierce and Vanderschuren, 2010). Indeed, several studies have shown that the transition from goal-directed (occasional and controlled drug use) to habitual forms of cocaine seeking/taking and chronic relapse is mediated by the gradual

Introduction

recruitment of ventromedial-to-dorsolateral striatal DA regions with prolonged drug self-administration (Pierce and Vanderschuren, 2010; Figure 4).

Cocaine has become one of the most commonly used drugs in the world. It is a severe public health problem, with major somatic, psychological, psychiatric, socio-economic and legal implications. However, there is no approved medication for the treatment of cocaine abuse and dependence. As a member of the psychostimulant drug class [with nicotine, amphetamine, methamphetamine, and 4-methylenedioxymethamphetamine, (MDMA)], cocaine-induced short-term effects include mental alertness, energy, euphoria, mood elevation, decreased appetite, dilated pupils, and increased body temperature, heart rate and blood pressure. Following chronic exposure, tolerance to the feeling of energy and euphoria occurs, and cocaine use leads to addiction, paranoia, irritability, restlessness, auditory hallucinations and mood disturbances (Filip *et al.*, 2010). From an experimental point of view, there are several behavioral responses induced by cocaine in laboratory animals that partly resemble some of the symptoms seen in humans (acute or chronic psychomotor stimulation, subjective effects, rewarding/reinforcing properties, and relapse). Thus, over the past 20 years, numerous behavioral models have been developed, the most frequently used including evoked locomotor hyperactivity, conditioned locomotion, sensitization, drug discrimination and reinstatement of seeking behavior (Filip *et al.*, 2012).

It is well-established that cocaine blocks the DA transporter (DAT) and the SERT, as well as the norepinephrine transporter (NET) to a lesser extent (Koe, 1976). Several findings suggest that DAT blockade is required for the reinforcing effects of cocaine. Indeed, cocaine self-administration is inhibited in DAT knock-out mice (Thomsen *et al.*, 2009), while it is not disrupted by the systemic administration of 5-HT (Porrino *et al.*, 1989; Peltier and Schenk, 1991) or noradrenergic antagonists (De Wit and Wise, 1977). In addition, it has been shown that genetic ablation of SERT in both rats and mice fails to reduce cocaine-induced place preference (Sora *et al.*, 1998; Homberg *et al.*, 2008).

Nevertheless, other findings question the importance of DAT blockade in the expression of cocaine-induced behaviors. Thus, in DAT knock-out mice, cocaine-conditioned place preference is maintained (Sora *et al.*, 1998) and cocaine self-administration remains unaltered (Rocha *et al.*, 1998), which contrasts with other findings (Thomsen *et al.*, 2009). Interestingly, the ability of cocaine to target the SERT could be a key factor in the expression of its behavioral effects. Indeed, 5-HT outflow is increased in the NAc of rats during cocaine-induced hyperlocomotion (Broderick *et al.*, 2004), and reduced during withdrawal from cocaine self-administration (Parsons *et al.*, 1996). Furthermore, it has been shown that cocaine-conditioned place preference is decreased in SERT knock-out mice (Hall *et al.*, 2009), which also contrasts with previous reports (Sora *et al.*, 1998; Homberg *et al.*, 2008). Thus, no clear conclusion can be drawn with regards to the relative contribution of each transporter to the behavioral effects of cocaine. However, it should be emphasized that compensatory mechanisms may be triggered by the chronic absence of a given transporter. In this regard, Di Chiara and coworkers have shown that despite the genetic ablation of the DAT, cocaine is able to increase NAc DA outflow by blocking the NET (Carboni *et al.*, 2001), which acts as an alternative site for DA clearance from the extracellular compartment (Carboni *et al.*, 1990; Tanda *et al.*, 1997). These findings provide an explanation for the persistence of cocaine reinforcement in DAT knock-out mice. Finally, a previous study has shown that the DAT, the SERT and the NET all participate to cocaine-induced conditioned locomotion in mice, albeit to a different degree and at different stages of the development of this behavior, thereby suggesting the polygenic nature of cocaine reward mechanisms (Hall *et al.*, 2009). Whatever the neurochemical effects underlying the behavioral effects of cocaine may be, the present observations altogether suggest the tight cooperation of DA and 5-HT systems in the control of cocaine rewarding properties. Accordingly, numerous studies have shown that 5-HT receptors are

Introduction

able to control cocaine-induced neurochemical and behavioral effects (Bubar and Cunningham, 2008; Howell and Cunningham, 2015).

Although the 5-HT system appears to play a key role in the neurochemical and behavioral responses of cocaine, clinical tests have failed to demonstrate a clear therapeutic effect of SERT antagonists (Howell and Cunningham, 2015). This may be due to the fact that blockade of the SERT, by increasing 5-HT outflow, triggers the modulation of all 5-HT receptors regardless of their subtype and different implications in the behavioral effects of cocaine. When investigating the impact of specific 5-HT subtypes in behavioral models of drug dependence, preclinical studies have permitted to identify the 5-HT_{1B}R (antagonists), 5-HT_{2A}R (antagonists), 5-HT_{2C}R (agonists) and 5-HT₃R (antagonists) as promising candidates for improved treatment of cocaine addiction (Filip *et al.*, 2010). Finally, a recent paper, demonstrating the existence of a synergistic efficacy of a 5-HT_{2A}R antagonist plus a 5-HT_{2C}R agonist to attenuate relapse factors (impulsivity and cue reactivity), suggests the therapeutic relevance of a bifunctional ligand as an anti-addiction pharmacotherapy, with improved efficacy, potency and selectivity over individual molecules (Cunningham *et al.*, 2013).

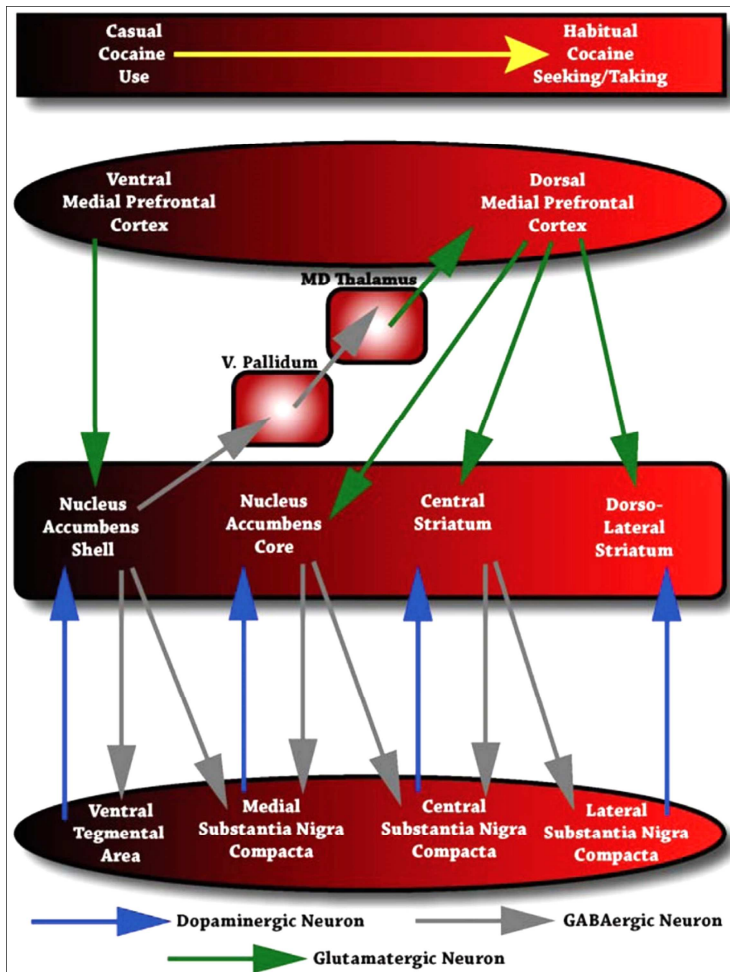

Figure 4: Anatomical circuits proposed by Pierce and Vanderschuren (2010) to underlie the progressive recruitment of more dorsal regions of the striatum during the transition from casual cocaine use to habitual cocaine seeking and taking.

III. The serotonin_{2B} receptor

The 5-HT receptors encompass fourteen subtypes, reconciled into seven receptor families (5-HT₁₋₇) on the basis of their molecular properties (Table 3 and Figure 5). All 5-HT receptors belong to the seven transmembrane spanning receptor family, more commonly referred to as G-protein-coupled receptors, except the 5-HT₃R subtype which is a ligand-gated ion channel (Hannon and Hoyer, 2008). The 5-HT_{2B}R is the most recent addition to the 5-HT₂R family (Foguet *et al.*, 1992; Kursar *et al.*, 1992), which includes the 5-HT_{2A} and the 5-HT_{2C} subtypes.

A. Localization

The 5-HT_{2B}R (formerly called 5-HT_{2F}R) was first cloned and characterized in the rat stomach fundus (Foguet *et al.*, 1992; Kursar *et al.*, 1992), then in the mouse (Loric *et al.*, 1992) and in the human (Kursar *et al.*, 1994; Schmuck *et al.*, 1994; Bonhaus *et al.*, 1995). Its presence has been demonstrated in various peripheral tissues, such as the liver, kidney, heart, uterus, trachea and small intestine (Foguet *et al.*, 1992a, 1992b; Kursar *et al.*, 1994; Schmuck *et al.*, 1994; Bonhaus *et al.*, 1995; Fiorica-Howells *et al.*, 2000). Specifically, several studies have shown that it is expressed in rat and pig blood vessels (Ullmer *et al.*, 1995; Watts and Thompson, 2004), in pig heart valves (Fitzgerald *et al.*, 2000) and in the smooth muscle cells of the stomach fundus and myenteric neurons of the intestine of mouse and rat (Fiorica-Howells *et al.*, 2000). In humans, it has been found in endothelial and smooth muscle cells of the pulmonary vasculature (Ullmer *et al.*, 1995), in liver Kupffer cells and tumor-associated macrophages (de Las Casas-Engel *et al.*, 2013), in heart valves (Fitzgerald *et al.*, 2000) and in the longitudinal and circular smooth muscles as well as in the myenteric nerve plexus of the colon (Borman *et al.*, 2002).

Introduction

The first studies investigating 5-HT_{2B}R expression in the mammalian brain have failed to detect the presence of these receptors (Foguet *et al.*, 1992; Kursar *et al.*, 1992; Pompeiano *et al.*, 1994), probably because of the low sensitivity of the employed techniques at that time. Later, several mRNA expression and *in-situ* hybridization studies have shown that the 5-HT_{2B}R is actually expressed in the spinal cord (Helton *et al.*, 1994) as well as in several regions of the central nervous system, such as the frontal cortex, lateral septum, dorsal hypothalamus, medial amygdala, DRN, locus coeruleus, hippocampus and cerebellum (Duxon *et al.*, 1997a; Bonaventure *et al.*, 2002). However, there is a paucity of information regarding its cellular localization in the central nervous system. What is known so far is that 5-HT_{2B}Rs are expressed in primary astrocyte cultures from mouse neocortex (Li *et al.*, 2008) and from rat cortex, hippocampus and brainstem (Hirst *et al.*, 1998; Sandén *et al.*, 2000), although a previous study has failed to detect them in rat brain astrocytes (Duxon *et al.*, 1997a). In addition, their presence has been detected in SERT-expressing primary neurons from mouse embryonic raphe nuclei (Launay *et al.*, 2006), and in mouse post-natal microglia (Kolodziejczak *et al.*, 2015).

B. Molecular properties

Studies in cells expressing 5-HT_{2B}Rs have shown that this receptor is functionally coupled to the protein G_{q/11} (Kursar, 1992; Wainscott *et al.*, 1993; Kursar *et al.*, 1994; Schmuck *et al.*, 1994; Cox and Cohen, 1995; Ellis *et al.*, 1995; Loric *et al.*, 1995; Launay *et al.*, 1996; Cussac *et al.*, 2002, 2008). Activation of G_{q/11} stimulates phospholipase C (PLC), which cleaves the phosphatidylinositol 4,5-bisphosphate (PIP₂) into diacyl glycerol (DAG) and inositol 1,4,5-trisphosphate (IP₃). Thereafter, IP₃ activates its receptors, in particular calcium channels of the endoplasmic reticulum (Figure 5). The resulting increase in intracellular calcium combined with the activation of protein kinase C (PKC, by DAG and its translocation to the membrane) triggers

various intracellular changes (i.e. apoptosis, regulation of enzyme activity, permeability of ion channels, regulation of the activity of ion pumps and components of the cytoskeleton), leading to numerous physiological responses (such as fertilization, cell growth, transformation, secretion, smooth muscle contraction, sensory perception and neuronal signaling; Berridge, 1993). However, studies in tissue preparations, demonstrating that 5-HT_{2B}R stimulation-induced responses in the stomach fundus (contraction) or the jugular vein (relaxation) occur independently from PIP₂ hydrolysis, have suggested that other signalization pathways may be responsible for 5-HT_{2B}R-mediated increased intracellular calcium (Cox and Cohen, 1995; Ellis *et al.*, 1995). For instance, as suggested by Cox and Cohen (1995), this effect could involve the second messenger cyclic ADP-ribose (a metabolite of NAD⁺), which is able to mobilize intracellular calcium stores (Galione, 1992). However, there is no data in the literature with regards to a possible interaction between cyclic ADP-ribose and 5-HT_{2B}Rs. A more plausible mechanism could involve a direct effect of PKC, which can be activated independently of PIP₂ hydrolysis (Whetton *et al.*, 1988), without translocation to the membrane (Heidenreich *et al.*, 1990; Deisher *et al.*, 1993), and has been shown to participate to the 5-HT_{2B}R-mediated contractile effect of the rat stomach fundus (Cox and Cohen, 1995). Finally, it should be noted that the 5-HT_{2B}R is also able to stimulate L-type voltage dependent calcium channels, thereby suggesting the role of extracellular calcium in its functional effects (Cox and Cohen, 1995). Further studies are needed to clarify the exact mechanisms involved in the 5-HT_{2B}R-induced increase of intracellular calcium.

Additional intracellular signalization pathways recruited by the 5-HT_{2B}R have been reported in the literature, although these couplings, observed in cell lines expressing 5-HT_{2B}Rs, need to be further confirmed in tissue preparations. Thus, nitric oxide (NO), which induces the relaxation of various blood vessels, has been shown to behave as a signaling effector of the 5-HT_{2B}R in LMTK⁻ fibroblasts (Manivet *et al.*, 2000). In addition, in 1C11 cells (endowed with the

Introduction

capacity to differentiate into neuronal 5-HT cells expressing the 5-HT_{2B}R), 5-HT activates the ras protein which in turn stimulates the mitogen-activated protein kinase (MAPK) pathway (Launay *et al.*, 1996), responsible for the regulation of the expression of genes involved in proliferation, differentiation, apoptosis, and synaptic plasticity (Girault, 2007). Finally, previous studies in 1C11 cell lines or in mesoblastic cells converting into osteocytes have demonstrated that the 5-HT_{2B}R can control arachidonic acid release through the activation of phospholipase A₂ (PLA₂; Tournois *et al.*, 1998; Locker *et al.*, 2006). Activation of PLA₂ by 5-HT_{2B}Rs can also lead to reactive oxygen species (ROS) production through NADPH oxidase activation in 1C11 cells, an effect which could trigger the degradation of 5-HT (Pierce *et al.*, 2005; Schneider *et al.*, 2006).

Receptor	Common signaling linkages	Other signaling linkages	G-protein coupling
5-HT _{1A}	Inhibits AC Activates K ⁺ channels Stimulates ERK Inhibits Ca ²⁺ conductances	Activates PLC Activates NOS Activates NAD(P)H oxidase Activates NHE-1	$G_{i\alpha3} > G_{i\alpha2} \geq G_{i\alpha1} \geq G_{o\alpha} > G_{z\alpha}$
5-HT _{1B}	Inhibits AC Stimulates ERK	Activates PLC Activates NOS Activates AC2 Activates K ⁺ channels Inhibits Ca ²⁺ conductances Activates K ⁺ channels	$G_{i\alpha3} > G_{i\alpha1} \geq G_{i\alpha2} \geq G_{o\alpha}$
5-HT _{1D}	Inhibits AC	Inhibits Ca ²⁺ conductances Activates K ⁺ channels	$G_{i\alpha} \& G_{o\alpha}$
5-HT _{1E}	Inhibits AC		$G_{i\alpha} \& G_{o\alpha}$
5-HT _{1F}	Inhibits AC	Activates PLC	$G_{i\alpha} \& G_{o\alpha}$
5-HT _{2A}	Activates PLC Activates PKC Stimulates ERK Activates PLA ₂	Activates NHE-1 Activates AC Inhibits AC Activates Jak2/STAT3 Activates Ca ²⁺ channels Activates cell cycle	$G_{q\alpha} \& G_{11\alpha} \geq G_{i\alpha}$
5-HT _{2B}	Activates PLC Activates ERK Activates PLA ₂	Activates iNOS Activates cNOS	$G_{q\alpha} \& G_{11\alpha}$
5-HT _{2C}	Activates PLC Activates PKC Activates PLA ₂	Activates Na ⁺ /Ca ²⁺ exchanger PDZ motif signals?	$G_{q\alpha} \& G_{11\alpha}$
5-HT ₄	Activates AC Activates PKA	Regulates various channels	$G_{s\alpha}$
5-HT _{5a}	Unknown	Unknown	Unidentified
5-HT _{5B}	Unknown	Unknown	Unidentified
5-HT ₆	Activates AC Activates PKA		$G_{s\alpha}$
5-HT ₇	Activates AC Activates PKA	Activates ERK	$G_{s\alpha}$

Table 3: Signaling characteristics of human 5-HT receptors. The table is not all-encompassing. 5-HT, serotonin; AC, adenylyl cyclase; cNOS, constitutive NOS; ERK, extracellular signal-regulated kinases; iNOS, inducible NOS; Jak, Janus kinase; NHE, Na⁺/H⁺ exchange; NOS, nitric oxide synthase; PDZ, PS-95 discs-large ZO-1; PKA, protein kinase A; PLC, phospholipase C; PKC, protein kinase C; PLA₂, phospholipase A₂; STAT, signal transducers and activators of transcription. *Adapted from Raymond et al., 2001.*

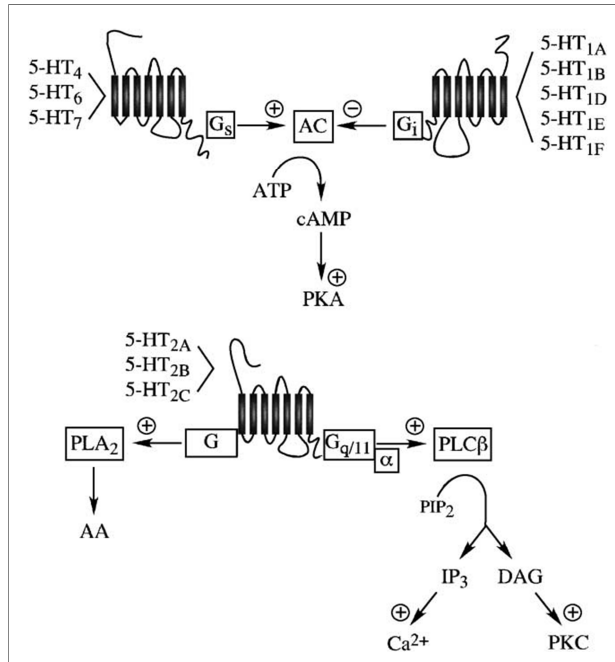

Figure 5: Prototypical signaling enzyme linkages of the G-protein-coupled 5-HT receptors. 5-HT₁Rs typically inhibit AC through pertussis toxin-sensitive G-proteins of the G_i family, whereas 5-HT₄Rs, 5-HT₆Rs, and 5-HT₇Rs typically stimulate AC through G_s family G-proteins. Activation of AC results in increased production of cAMP, leading to activation of PKA. 5-HT₂Rs activate PLC-β through G_{q/11} family G-proteins, resulting in accumulation of PIP₂ to IP₃ and DAG. Generation of IP₃ results in elevation of intracellular Ca²⁺ levels, whereas DAG activates the Ca²⁺ and phospholipid-dependent protein kinase (PKC). 5-HT₂Rs also typically activate PLA₂ through G-proteins to increase the accumulation of AA. 5-HT, serotonin; AC, adenylyl cyclase; cAMP, cyclic AMP; PKA, protein kinase A; PLC, phospholipase C; PIP₂, phosphatidylinositol 4,5-bisphosphate; IP₃, inositol trisphosphate; DAG, diacylglycerol; PKC, protein kinase C; PLA₂, phospholipase A₂; AA, arachidonic acid. *Drawing from Raymond et al., 2001.*

C. Pharmacology

The first efforts aimed at exploring the role of 5-HT_{2B}R in physiological or pathological states have been hampered by the lack of selective and potent ligands. Indeed, most agents initially failed to discriminate the 5-HT_{2B}R from the 5-HT_{2A}R and the 5-HT_{2C}R, especially the latter, with which it shares a high degree of sequence homology and very similar pharmacology (Foguet *et al.*, 1992a, 1992b; Kursar *et al.*, 1992; Wainscott *et al.*, 1993). Thus, in keeping with the first belief that 5-HT_{2B}R were absent in the central nervous system (see above), it is noteworthy that several central functions may have been illegitimately ascribed to the 5-HT_{2C}R in the past.

In the mid-1990s, SB 204741 [N-(1-Methyl-5-indolyl)-N'-(3-methyl-5-isothiazoly1)urea] was introduced as a 5-HT_{2B}R antagonist (Forbes *et al.*, 1995). This compound, while displaying a higher selectivity for the 5-HT_{2B}R over the 5-HT_{2C}R, the 5-HT_{2A}R and numerous other receptors, has a relatively low affinity for the 5-HT_{2B}R (Bonhaus *et al.*, 1995; Forbes *et al.*, 1995; Baxter, 1996). Thereafter, two studies identified LY 266097 [1-[(2-Chloro-3,4-dimethoxyphenyl)methyl]-2,3,4,9-tetrahydro-6-methyl-1H-pyrido[3,4-b]indole] and RS 127445 [2-amino-4-(4-fluoronaphth-1-yl)-6-isopropylpyrimidine] as potent and high-affinity antagonists (pK_i = 9.8 for LY 266097 and 9.5 for RS 127445), with more than 100-fold and 1000-fold selectivity for the 5-HT_{2B}R over the other 5-HT₂R subtypes, respectively (Audia *et al.*, 1996; Bonhaus *et al.*, 1999). These compounds are at the moment the best 5-HT_{2B}R antagonists available (Table 4).

Identifying a proper 5-HT_{2B}R agonist is still a challenge today (Table 5). The compound BW 723C86 [(α -methyl-5-(2-thienylmethoxy)-1H-indole-3-ethanamine] is classically used to assess the effects of 5-HT_{2B}R stimulation (Gobert *et al.*, 2000; Auclair *et al.*, 2010), but it is only a preferential agonist. Indeed, this compound displays a poor affinity and low selectivity for the 5-HT_{2B}R (Baxter, 1996; Kennett *et al.*, 1997, 1998). In addition, there are

Introduction

substantial differences in BW 723C86 affinities for 5-HT receptors depending on the species or tissue preparations in which its binding properties are assessed (Baxter, 1996). Finally, it should be borne in mind that Ro 60-0175 [(α S-6-chloro-5-fluoro- α -methyl-1H-indole-1-ethanamine)], initially characterized as a highly selective 5-HT_{2C}R agonist (Martin *et al.*, 1998), could be a good 5-HT_{2B}R agonist. Indeed, Ro 60-0175 was discovered to be a potent (pEC50 = 9.05) and high efficacy agonist (79%) at 5-HT_{2B}Rs (Porter *et al.*, 1999), with better affinity and functional selectivity over the 5-HT_{2C}R (Cussac *et al.*, 2002). Once again (see above), it is therefore possible that several effects of Ro 60-0175 reported in the literature and attributed to the 5-HT_{2C}R may actually result from 5-HT_{2B}R stimulation.

Antagonists	5-HT _{2A} pKi	5-HT _{2B} pKi	5-HT _{2C} pKi	References
RS 127445	6.30	9.5	6.4	Bonhaus et al., 1999
	6.03	8.97	6.33	Knight et al., 2004
	6.16	9.23	6.36	Mean value
LY 266097		9.70	7.17	Cussac et al., 2002
	7.71	9.80	7.61	Audia et al., 1996
	7.71	9.75	7.39	Mean value
SB 204741	< 5	6.90	5.56	Knight et al., 2004
		7.29	5.67	Cussac et al., 2002
	< 5	7.09	5.61	Mean value

Table 4: Binding affinities (pKi) of some antagonist ligands at human recombinant 5-HT₂ receptors.

Agonists	5-HT _{2A} pKi	5-HT _{2B} pKi	5-HT _{2C} pKi	References
5-HT	7.2	9.1	6.8	Bonhaus et al., 1995
		8.55	7.74	Cussac et al., 2002
	7.79	7.87	8.24	Knight et al., 2004
	7.18	8.38	7.79	Cussac et al., 2008
	7.39	8.47	7.64	Mean value
mCPP		7.92	7.07	Cussac et al., 2002
	7.26	7.39	7.84	Knight et al., 2004
	7.39	8.05	7.59	Cussac et al., 2008
	7.32	7.79	7.50	Mean value
DOI		8.15	7.73	Cussac et al., 2002
	9.03	7.55	8.08	Knight et al., 2004
	8.04	7.78	7.73	Cussac et al., 2008
	8.53	7.83	7.85	Mean value
BW 723C86		8.50	6.94	Cussac et al., 2002
	7.20	7.33	7.11	Knight et al., 2004
	6.63	7.85	7.11	Cussac et al., 2008
	6.91	7.89	7.05	Mean value
Ro 60-0175		9.26	7.57	Cussac et al., 2002
	7.44	8.27	8.22	Knight et al., 2004
	6.80	8.66	7.67	Cussac et al., 2008
	7.12	8.73	7.82	Mean value

Table 5: Binding affinities (pKi) of some agonist ligands at human recombinant 5-HT₂ receptors.

D. Functional aspects

1. Regulation of cell differentiation and proliferation

Interestingly, the 5-HT_{2B}R is involved in the proper development or the modulation of the number of various cell subtypes in the body, thereby suggesting that this receptor may play important roles in the onset of peripheral functions or in their regulation during adulthood. In particular, pharmacological and knock-out studies have shown that 5-HT_{2B}R modulation impacts on the differentiation and/or proliferation of mouse enteric neurons (Fiorica-Howells *et al.*, 2000), hepatocytes (Lesurtel *et al.*, 2006) and cardiomyocytes (Nebigil *et al.*, 2000, 2003), as well as on the number of retinal cells in the *Xenopus* (De Lucchini *et al.*, 2003, 2005). In addition, 5-HT_{2B}Rs may participate to the proper wiring of neuronal networks by regulating the motility of microglial processes in the postnatal mouse (Kolodziejczak *et al.*, 2015).

2. Regulation of the gastrointestinal tract

Since the discovery and characterization of 5-HT_{2B}Rs in the rat stomach fundus, several studies have attempted to determine the exact role of these receptors in the regulation of the gastrointestinal (GI) tract. Thus, it was found that stimulation of 5-HT_{2B}Rs triggers a contractile effect on smooth muscle preparations isolated from the rat stomach fundus and maintained in organic bath solutions (Baxter *et al.*, 1994; Cox and Cohen, 1995), as well as on intestinal smooth muscles in humans (Borman and Burleigh, 1995). Another substantial aspect of the involvement of 5-HT_{2B}Rs in the regulation of the GI function relies on their ability to modulate the proliferation of the interstitial cells of cajal (ICC), which are expressed all along the GI tract and determine the frequency of contraction of its smooth muscle cells (Tharayil *et al.*, 2010). Specifically, in mice, 5-HT_{2B}Rs promote the ICC turnover both *in vitro* and *in vivo*, and are required for the maintenance of ICC network (Wouters *et al.*,

Introduction

2007; Tharayil *et al.*, 2010). Interestingly, these findings have shed light on the therapeutic potential of 5-HT_{2B}R ligands in pathological conditions depending on a decreased number of ICCs or a disrupted ICC network, such as slow transit constipation, diabetic gastroparesis, or pseudo obstruction (Kenny *et al.*, 1998; He *et al.*, 2000; Lyford *et al.*, 2002; Forster *et al.*, 2005). Finally, it is noteworthy that 5-HT_{2B}Rs may participate to the maturation of the GI tract, as suggested by a previous study showing that 5-HT promotes the *in vitro* development of enteric neurons through 5-HT_{2B}R stimulation (Fiorica-Howells *et al.*, 2000).

3. Regulation of the vascular function

The involvement of 5-HT_{2B}Rs in the control of vascular function was introduced with the discovery of its relaxing effect on the jugular vein (Ellis *et al.*, 1995). This effect has been subsequently attributed to the ability of 5-HT_{2B}Rs to trigger the release of NO, although this signalization pathway has been observed only *in vitro* (Manivet *et al.*, 2000). In this context, it is noteworthy that 5-HT_{2B}Rs may play an important role in migraine headache. Indeed, a previous study has suggested that migraine headache would result, at least in part, from the formation of NO triggered by the activation of 5-HT_{2B}Rs located on the endothelial cells of human meningeal blood vessels (Schmuck *et al.*, 1996). Specifically, the release of NO, which by itself induces migraine headaches in susceptible humans (Olesen *et al.*, 1994), would stimulate the trigeminal nerve (Wei *et al.*, 1992). Stimulation of this nerve would provoke blood vessel dilatation and protein leakage, leading to inflammation within the dural vasculature (Moskowitz, 1993). On the other hand, 5-HT_{2B}R stimulation has been shown to induce a contractile effect on the renal artery isolated from the rat and maintained in an organic bath (Watts and Thompson, 2004), suggesting that 5-HT_{2B}Rs may play an important role in the regulation of blood pressure. This hypothesis is further supported by the observation that central 5-

HT_{2B}Rs control renal sympathoexcitation and sympathoinhibition in the *in vivo* rat (Knowles and Ramage, 1999, 2000).

4. Regulation of the pulmonary function

Pulmonary arterial hypertension (PAH) is a progressive disease, characterized by sustained elevation of pulmonary arterial pressure associated with abnormal vascular proliferation, neomuscularization of small pulmonary arteries with intimal thickening, leading to right ventricle failure and death (Rhodes *et al.*, 2009). Interestingly, it has been shown that 5-HT_{2B}R activation is critical for the development of PAH in mice. Specifically, 5-HT_{2B}Rs regulate the differentiation and proliferation of bone-marrow stem cells, which are known to participate in the development of PAH and pulmonary vascular remodeling (Launay *et al.*, 2012). In line with these results, 5-HT_{2B}R expression is increased in pulmonary arteries of both humans and mice suffering from PAH (Launay *et al.*, 2002). In addition, it has been demonstrated that all the physiological features of the chronic-hypoxic-mouse model of PAH (i.e. increase in pulmonary blood pressure and in lung remodeling, associated with an increase in vascular proliferation, elastase activity and transforming growth factor-beta levels) are no longer observed in the 5-HT_{2B}R knock-out mouse (Launay *et al.*, 2002). Similarly, pharmacological blockade of 5-HT_{2B}Rs with selective antagonists counteracts monocrotaline-induced muscularization of pulmonary arterioles and perivascular fibrosis in the rat lung (Zopf *et al.*, 2011), as well as the increase in pulmonary arterial pressure in mice challenged with hypoxia (Dumitrascu *et al.*, 2011). Altogether, these findings suggest that the use of 5-HT_{2B}R antagonists may be a valuable therapeutic approach for the treatment of PAH.

5. Regulation of the cardiac function

Heart valves encompass two cellular subtypes: valvular endothelial and valvular interstitial cells (VICs). It is well-established that VICs maintain the integrity of heart valves and participate to the repair processes occurring during disease and following valve injury, by regulating the organization of the valvular extracellular matrix. A disruption in this matrix can lead to severe valvulopathies, a main cause of morbidity and mortality in humans worldwide, requiring valve replacement surgery (Elangbam, 2010). Thus, drug-induced valvulopathies are serious obstacles to the development of new treatments or to the use of drugs already marketed. In particular, it is currently admitted that the pathogenesis of valvulopathy by several drugs with 5-HT_{2B}R agonist properties (i.e. fenfluramine, pergolide, MDMA, ergotamine...) likely results from an “off-target” effect of the activation of 5-HT_{2B}Rs, which are expressed on heart valve leaflets (Fitzgerald *et al.*, 2000; Elangbam, 2010). Indeed, while these compounds also display some affinity for the other members of the 5-HT₂R family, drugs which are selective agonists towards the 5-HT_{2A}R and 5-HT_{2C}R (i.e. lisuride and terguride) do not induce valvulopathies (Jähnichen *et al.*, 2005; Roth, 2007). In addition, it has been shown that 5-HT exerts an inappropriate mitogenic effect on VICs through 5-HT_{2B}R activation (Fitzgerald *et al.*, 2000), which could lead to their proliferation and subsequent disruption of their ability to regulate the valvular extracellular matrix (Elangbam, 2010). Finally, it should be noted that genetic inactivation of 5-HT_{2B}Rs in mice leads to embryonic and neonatal death caused by heart defects (Nebigil *et al.*, 2000), which provides an additional argument to the prevalence of 5-HT_{2B}Rs in the regulation and development of the heart. Altogether these observations indicate that it is crucial to characterize the 5-HT_{2B}R functional selectivity of drugs being developed or currently on the market to avoid valvulopathy liability. Nevertheless, conversely to 5-HT_{2B}R stimulation, no evidence of a deleterious impact of 5-HT_{2B}R blockade on cardiac function has been provided in the literature to date. Instead,

recent findings rather suggest a protective effect of 5-HT_{2B}R antagonists in cardiac disorders (Janssen *et al.*, 2015).

6. Regulation of the central nervous system

6.1. Regulation of serotonin transport

Several studies suggest that the 5-HT_{2B}R plays a key role in the regulation of the 5-HT system. First, it has been shown that 5-HT_{2B}R stimulation promotes the phosphorylation of the SERT and the Na⁺, K⁺-ATPase pump (the energy source of the SERT) in 1C11 cells and primary neurons from the raphe. These effects, which would involve couplings to the PKC and protein kinase G/NO signalization pathways, suggest that 5-HT_{2B}Rs govern the overall 5-HT transport (Launay *et al.*, 2006). Although it has been demonstrated only *in vitro*, the authors have shown that there are two distinct and contrasting 5-HT_{2B}R-mediated controls of 5-HT transport. Thus, 5-HT_{2B}Rs promote the basal phosphorylation of SERT allowing the maximal 5-HT uptake capacities and antidepressant drug (SERT inhibitors) binding. On the other side, in the presence of 5-HT, they further phosphorylate the SERT as well as the Na⁺, K⁺-ATPase pump, leading to reduced 5-HT transport efficiency and decreased antidepressant efficacy.

Interestingly, a study performed in the freely-moving mouse has confirmed that 5-HT_{2B}Rs participate to the control of the 5-HT system. Specifically, reverse-dialysis of the 5-HT_{2B}R preferential agonist BW 723C86 into the DRN induces an increase in local 5-HT outflow. This excitatory influence is suppressed by pretreatment with the antagonist RS 127445, which has no effect by itself, thereby confirming the selective involvement of 5-HT_{2B}Rs in this response (Doly *et al.*, 2008). However, the authors conclude that BW 723C86-induced effect does not result from an inhibition of 5-HT reuptake, as suggested by *in vitro* studies (Launay *et al.*, 2006), but could involve a SERT-mediated 5-HT

release. Additional investigations are warranted to address the mechanisms underlying 5-HT_{2B}R-mediated control of 5-HT transport.

6.2. Regulation of astrocytes

Previous results have shown that 5-HT_{2B}Rs may be key players in the regulation of astrocytes activity. Indeed, stimulation of 5-HT_{2B}Rs produces a transient increase in intracellular calcium (resulting from the mobilization of intracellular stores) in cultured astrocytes from cerebral cortex, hippocampus, and brain stem (Sandén *et al.*, 2000). This effect presumably results from the activation of the PLC signalization pathway, although other sources of intracellular calcium cannot be excluded (see section III.B). Importantly, in the study by Sandén and coworkers, the increase in intracellular calcium was observed only in a minority of 5-HT_{2B}R-expressing astrocytes. In keeping with the numerous signalization cascades recruited by 5-HT_{2B}Rs (see section III.B), it is possible that 5-HT_{2B}Rs could trigger various cellular changes in astrocytes in addition to calcium mobilization. For instance, 5-HT_{2B}Rs could participate to the regulation of gap junction permeability, which is known to be altered following 5-HT stimulation of cultured astrocytes (Rörig and Sutor, 1996; Blomstrand *et al.*, 1999). Considering the importance of astrocytes in the migration of neurons (Rakic, 1981) and synaptogenesis (Perlmutter *et al.*, 1984; Meshul *et al.*, 1987), as well as the role of 5-HT_{2B}Rs in cell proliferation and differentiation (see section III.D.1), additional studies are warranted to address the involvement of astrocytic 5-HT_{2B}Rs in brain development.

6.3. Regulation of the dopaminergic network

6.3.1. Neurochemical aspects

Intracerebral microdialysis studies in anesthetized or freely moving rats have failed to detect an effect of 5-HT_{2B}R stimulation on DA activity. Indeed, the 5-

HT_{2B}R agonist BW 723C86 does not modulate basal DA outflow in the mPFC, the NAc and the striatum (Di Matteo *et al.*, 2000; Gobert *et al.*, 2000; Auclair *et al.*, 2010). In addition, BW 723C86 has no effect on the firing rate of VTA DA neurons (Di Matteo *et al.*, 2000), supporting the insensitivity of mesocortical and mesoaccumbal DA pathways to 5-HT_{2B}R stimulation. Furthermore, haloperidol-induced increase in DA outflow in the NAc and the striatum remains unaltered by BW 723C86 administration (Auclair *et al.*, 2010). Thus, both basal and “activated” DA outflow are insensitive to 5-HT_{2B}R stimulation. However, this conclusion should be further confirmed with agonists more selective than BW 723C86, or by using DA-activating drugs with different mechanisms of action than haloperidol. Indeed, the ability of 5-HT receptors to control DA outflow is known to depend on the specific mechanism of action of a given drug to activate DA neurons (Porrás *et al.*, 2002a, 2002b, 2003; Navailles *et al.*, 2004; De Deurwaerdère *et al.*, 2005), and sometimes also on the degree to which it activates DA neurons (Schmidt *et al.*, 1992; Gudelsky *et al.*, 1994).

With regards to 5-HT_{2B}R blockade, neurochemical data obtained from the anesthetized rat indicate that the highly potent and selective 5-HT_{2B}R antagonists RS 127445 and LY 266097 have no effect on DA outflow in the striatum. Also, it has been shown that both RS 127445 and LY 266097 reduce DA outflow in the shell subdivision of the NAc, whereas they have no effect in its core part (Auclair *et al.*, 2010). As discussed elsewhere (Auclair *et al.*, 2010), this preferential effect at the level of the shell is in line with previous studies showing different DA responsiveness and regulatory controls between the shell and the core subdivisions of the NAc (Di Chiara, 2002). Noteworthy, that 5-HT_{2B}Rs can exert a tonic excitatory control on the mesoaccumbal DA pathway contrasts with previous findings. Indeed, it had been previously shown that the 5-HT_{2B}R antagonist SB 204741 has no effect on DA outflow in the NAc, as well as in the striatum, of freely moving rats (Gobert *et al.*, 2000). Nevertheless, differences in microdialysis probe placements could be

Introduction

responsible for the discrepancies observed between both studies. Indeed, in the study by Gobert and coworkers, the cannula aimed at monitoring accumbal DA outflow was implanted at the interface between the striatum and the core subregion of the NAc. In the same study, it has been shown that DA outflow in the PFC remains unaltered by the peripheral administration of SB 240741. However, in keeping with the poor affinity of SB 204741 for 5-HT_{2B}Rs (see section III.C), and considering that SB 204741 was administered at a dose much higher than the efficient doses used in other studies (Knowles and Ramage, 1999; Yonezawa *et al.*, 2008), further experiments are needed to confirm or reject the hypothesis of an insensitive mesocortical DA pathway to 5-HT_{2B}R modulation. Interestingly, several studies have shown that 5-HT_{2B}R blockade not only impacts on basal DA outflow but also on DA outflow when it is increased by drugs with different mechanisms of action. Thus, in the anesthetized rat, LY 266097, with no effect at the level of the striatum, suppresses amphetamine and haloperidol-induced DA outflow in the NAc, thereby confirming the region-dependent 5-HT_{2B}R control of subcortical DA pathways (Auclair *et al.*, 2010). Similarly, in freely-moving mice, either pharmacological blockade with RS 127445 or genetic ablation of the 5-HT_{2B}R reverses MDMA-induced increase in NAc DA outflow (Doly *et al.*, 2008). However, it should be considered that this suppressive effect, at difference with amphetamine and haloperidol, may be directly related to the ability of MDMA to behave as a 5-HT_{2B}R agonist (Setola *et al.*, 2003).

6.3.2. Behavioral aspects

Several studies have investigated the impact of 5-HT_{2B}R modulation on the behavioral responses induced by drugs targeting the DA system. Thus, RS 127445, with no effect by itself on spontaneous locomotor activity, reduces amphetamine-induced hyperlocomotion in rats (Auclair *et al.*, 2010). As previously suggested, the ability of 5-HT_{2B}R antagonists to block amphetamine-

evoked hyperactivity may result from their suppressant effect on amphetamine-induced DA outflow in the NAc (Auclair *et al.*, 2010). Indeed, although amphetamine is able to block the DAT and the NET, and to a lesser extent the SERT (Ritz and Kuhar, 1989), knock-out studies in mice have shown that blockade of the DAT is necessary to cause the robust hyperactivity induced by this drug (Spielewoy *et al.*, 2007), while lesion investigations in rats have demonstrated that NAc DA activity is tightly related to amphetamine-induced motor effects (Kelly et Iversen, 1976; Joyce and Iversen, 1984; Dunnett and Robbins, 1992). In addition, selective 5-HT reuptake inhibitors (SSRIs), which prevent the binding of amphetamine to the SERT, do not suppress amphetamine-induced hyperlocomotion (Callaway *et al.*, 1990). Whether the NET may also participate to this effect remains an open question.

It has been previously shown that 5-HT_{2B}Rs can also control the behavioral effects of MDMA. Specifically, MDMA-induced hyperlocomotion, locomotor sensitization and conditioned place preference are no longer observed in 5-HT_{2B}R knock-out mice or in wild-type mice following the systemic administration of RS 127445 (Doly *et al.*, 2008, 2009). Once again, it is tempting to suggest that 5-HT_{2B}R blockade may inhibit MDMA-induced hyperlocomotion by suppressing MDMA-induced DA outflow in the NAc (Doly *et al.*, 2008). However, RS 127445 has also been shown to block MDMA-induced increased 5-HT outflow in the NAc and the VTA (Doly *et al.*, 2008), and the relative contributions of DA and 5-HT in the behaviors evoked by this drug are far from clear (Bankson and Cunningham, 2001). Indeed, it is well-established that MDMA targets the SERT, DAT and NET with comparable potencies (Rothman *et al.*, 2001; Verrico *et al.*, 2007), but, at difference with amphetamine, its impact on locomotor activity cannot be ascribed to a single transporter. Indeed, microdialysis studies have shown that MDMA-induced ambulation is positively correlated both with DA and 5-HT outflow in several DA brain regions (Baumann *et al.*, 2008). In addition, previous reports have shown that the SERT plays a crucial role in the expression of MDMA responses

(Bengel *et al.*, 1998; Bankson and Cunningham, 2001; Trigo *et al.*, 2007). A more global interpretation of the literature reveals that both the SERT and the DAT would participate to MDMA-evoked behaviors. Indeed, as discussed elsewhere (Bankson and Cunningham, 2001), MDMA-induced increased DA outflow may result from two concurrent mechanisms: 1) the reversal of DAT leading to increased extracellular DA levels; 2) the reversal of SERT increasing extracellular 5-HT levels, which in turn stimulate 5-HT receptors responsible for the increase in vesicular DA release (Yamamoto *et al.*, 1995; Gudelsky and Nash, 1996). Thus, additional studies are needed to assess whether the 5-HT_{2B}R-mediated control of MDMA-induced hyperlocomotion relies on an interaction with the DA or the 5-HT system. Whatever this interaction may be, 5-HT_{2B}R-induced suppression of MDMA hyperactivity would rather result from the inhibition of NAc DA outflow, and not that of 5-HT outflow. Indeed, while it is well-established that NAc activity is crucial for the expression of behaviors induced by psychostimulant drugs (Dunnett and Robbins, 1992), MDMA-induced ambulation has been positively correlated with DA outflow, but not with 5-HT outflow, in the rat NAc (Baumann *et al.*, 2008).

6.4. Therapeutic implications

The ability of the 5-HT_{2B}R to control DA outflow in the mesocorticolimbic network, as well as DA-dependent behaviors, suggests that this receptor could be an interesting pharmacological target for improved treatments of DA-related disorders. In particular, its potential interest for schizophrenia, drug addiction and depression is discussed below.

6.4.1. Schizophrenia

The particular pattern of effects of 5-HT_{2B}R blockade on the DA ascending pathways may represent a valuable tool for improved treatment of

schizophrenia. Indeed, the ability of 5-HT_{2B}R antagonists to decrease DA outflow, whereas they have no effect at the level of the striatum (Auclair *et al.*, 2010), suggests that these compounds may be able to alleviate the positive symptoms of schizophrenia, without inducing EPS. However, the impact of 5-HT_{2B}R blockade on DA outflow in the PFC remains an open question. In keeping with the role of cortical DA function in the physiopathology of schizophrenia (see section II.A), and considering that numerous atypical APDs (clozapine, amisulpride, asenapine, aripiprazole, cariprazine) display high affinity and potent antagonist properties at the 5-HT_{2B}R (Shapiro *et al.*, 2003; Abbas *et al.*, 2009; Shahid *et al.*, 2009; Kiss *et al.*, 2010), the need for neurochemical studies assessing this issue is obvious. Noteworthy, a recent study performed in mice has suggested the role of 5-HT_{2B}R in the neurodevelopmental mechanisms of schizophrenia. Specifically, genetic ablation of 5-HT_{2B}R leads to several antipsychotic-sensitive schizophrenic-like behaviors in mice (Pitychoutis *et al.*, 2015). At first sight, these findings do not favor the hypothesis that the 5-HT_{2B}R antagonist properties of atypical APDs may contribute to their therapeutic benefit. Nevertheless, it should be borne in mind that knock-out models do not reflect the physiological role of a given receptor expressed in a specific locus but rather the developmental adaptations triggered by the total and chronic suppression of this receptor. Accordingly, in 5-HT_{2B}R knock-out mice, NAc DA levels are unaltered as compared to wild-type animals, whereas RS 127445 decreases accumbal DA outflow in rats. On the other hand, striatal DA levels are lower in 5-HT_{2B}R knock-out mice as compared to controls, whereas RS 127445 has no effect on DA outflow in the rat striatum (Doly *et al.*, 2009, Auclair *et al.*, 2010; Pitychoutis *et al.*, 2015). Whether these discrepancies result from species-related differences or total *versus* acute inactivation of 5-HT_{2B}R remains to be determined.

6.4.2. Drug addiction

In keeping with the key role of the mesoaccumbal DA pathway in drug addiction (see section II.B), the ability of 5-HT_{2B}Rs to exert an excitatory control on amphetamine and MDMA-induced increased NAc DA outflow suggests that these receptors may be useful to control drugs of abuse-induced behavioral responses (Doly *et al.*, 2008; Auclair *et al.*, 2010). It is therefore not surprising that pharmacological blockade or genetic inhibition of 5-HT_{2B}Rs suppresses amphetamine and MDMA-induced hyperlocomotion, a behavior which is highly dependent on the stimulation of the reward pathway (Hedou *et al.*, 1999; Heidbreder *et al.*, 1999; Filip and Siwanowicz, 2001). Although the acute hyperactivity resulting from the administration of drugs of abuse does not reflect the physiological and behavioral features of repeated drug exposure, these findings provide a first clue to correlate the behavioral outcome of 5-HT_{2B}R blockade with its impact on amphetamine and MDMA-induced neurochemical effects (see section III.D.6.3.1). In addition, a study published by Doly and coworkers indicates that the 5-HT_{2B}R participates in the reinforcing effects of MDMA, as its genetic inactivation or pharmacological blockade suppresses MDMA-induced locomotor sensitization and conditioned place preference in mice (Doly *et al.*, 2009). However, the effect of 5-HT_{2B}Rs on behavioral paradigms more relevant to drug addiction (i.e. self-administration, relapse) has never been studied to date. Finally, the possibility that 5-HT_{2B}Rs may participate to the expression of addictive-like behaviors in rodents is supported by previous findings showing that 5-HT_{2B}Rs are involved in impulsivity, defined as the tendency to act without foresight (Bevilacqua and Goldman, 2013). Indeed, 5-HT_{2B}R knock-out mice display increased delayed discounting, high novelty seeking and high reactivity to novelty, which are all markers of impulsivity in rodent models (Bevilacqua and Goldman, 2013). In addition, a functional stop codon of the gene encoding the 5-HT_{2B}R has been identified in a population of incarcerated Finnish males selected on the basis of

their violent past (homicides, batteries, assaults and arsons), thereby suggesting that the 5-HT_{2B}R also predisposes to severe impulsivity in humans (Bevilacqua *et al.*, 2010). Considering that a shift from impulsivity to compulsivity occurs during the onset of addictive behaviors (Belin *et al.*, 2008), these observations altogether support the hypothesis that 5-HT_{2B}R may participate to the development of drug dependence.

6.4.3. Depression

Depression, with bipolar disorder, belongs to the class of “depressive syndromes”, characterized by several symptoms such as long-lasting depressed mood, feelings of guilt, anxiety, and recurrent thoughts of death and suicide (Nestler *et al.*, 2002). Previous findings suggest a role of DA in the neurobiology of depression (Zangen *et al.*, 2001; Nestler and Carlezon, 2006; Leggio *et al.*, 2013). In particular, DA hypoactivity in the mesolimbic pathway is involved in the anhedonia associated with depression (Nestler and Carlezon, 2006). In addition, several symptoms of depression which resemble the negative symptoms of schizophrenia (i.e. apathy, psychomotor retardation) may reflect a DA dysfunction in the PFC (Alex and Pehek, 2007). However, the pathophysiology of depression is more classically related to 5-HT and noradrenaline dysfunction, in keeping with the ability of drugs blocking the SERT or the NET to alleviate depressive symptoms (Alex and Pehek, 2007). In this context, it has been shown that 5-HT_{2B}R activation is required for the therapeutic actions of SSRIs. Thus, the acute and long-term behavioral effects of SSRIs, as well as their neurogenic effects, are abolished by both genetic inactivation and pharmacological blockade of 5-HT_{2B}R in mice, while 5-HT_{2B}R stimulation induces SSRI-like effects (Diaz *et al.*, 2012). Also, as previously mentioned, 5-HT_{2B}R may be involved in impulsivity, a trait which is tightly related to suicidality (Bevilacqua *et al.*, 2010). In addition, previous findings suggest the therapeutic benefit of 5-HT_{2B}R agonists in anxiety disorder,

Introduction

which is known to overlap to some extent with depression (Nestler *et al.*, 2002). Specifically, the 5-HT_{2B}R agonist BW 723C86 causes anxiolysis in the social interaction test following its systemic (Kennett *et al.*, 1996) or local administration in the amygdala (Duxon *et al.*, 1997b), which is known to play a key role in the acquisition and expression of anxiety and the action of anxiolytic drugs (Kuhar, 1986; Kahn *et al.*, 1988; Aggleton, 1993). Other findings suggest that 5-HT_{2B}Rs could have a protective role in the 5-HT syndrome, which results from antidepressant drug overdose or combination of drugs inducing a massive increase in extracellular 5-HT levels (Diaz and Maroteaux, 2011). Altogether these observations demonstrate that 5-HT_{2B}R agonists could represent a useful therapeutic tool for improved treatment of depression. However, this prospect needs to be qualified, with regards to the important side-effects associated with the use of treatments with 5-HT_{2B}R agonist properties (see section III.D.5).

IV. Aims

At the beginning of the present thesis, the analysis of the literature revealed that the role of 5-HT_{2B}Rs in the control of the central nervous system had been poorly explored. This observation was not surprising when considering the relatively recent interest of the scientific community in the functional role of central 5-HT_{2B}Rs. Indeed, while neurochemical studies had shown that the 5-HT_{2B}R exerts opposite controls on the mesoaccumbal and nigrostriatal DA pathways, its impact on cortical DA outflow had never been studied. In keeping with the key role of the mesocortical DA pathway in the pathophysiology of several neuropsychiatric disorders, additional investigations were therefore crucial to fill this gap of the literature, and provide a more complete overview of the pattern of effects of 5-HT_{2B}Rs on the whole DA network. In particular, such investigations would permit to explore the therapeutic potential of 5-HT_{2B}R antagonists for improved treatment of cognitive and negative symptoms observed in schizophrenic patients (see section II.A). On the other hand, several studies had provided the first clues of the involvement of 5-HT_{2B}Rs in the control of the neurochemical and behavioral effects of drugs of abuse. However, their participation to the effects of cocaine, one of the most worldwide abused drug, whose behavioral responses are tightly related to DA activity, remained unknown. Finally, as discussed in the present introduction, the literature had provided some contradictory data, likely because of the use of different species or pharmacological ligands with poor selectivity for the 5-HT_{2B}R.

Thus, the general objective of the present thesis was to clarify and complete the available data related to the role of the 5-HT_{2B}R in the control of basal and stimulated activity of ascending DA pathways (Auclair *et al.*, 2010), in order to provide a deeper insight into its therapeutic potential for the treatment of DA-dependent neuropsychiatric disorders. Considering the deleterious side effects associated with the use of 5-HT_{2B}R agonists (i.e. valvulopathies; see section III.D.5), we focused our investigations on the changes in DA function resulting

Introduction

from 5-HT_{2B}R blockade, which, as previously discussed (see sections III.D.6.4.1 and III.D.6.4.2), could be a key strategy for improved treatment of schizophrenia and drug addiction. To this purpose, we used the most selective and potent 5-HT_{2B}R antagonists available on the market, RS 127445 and LY 266097. Several aspects of 5-HT_{2B}R-modulation of DA activity were explored in the rat, by using biochemical, electrophysiological and behavioral approaches. In particular, we monitored *in vivo* DA and 5-HT outflow in discrete brain regions (by using intracerebral microdialysis in both anesthetized and freely moving animals), as well as basal DA firing rate, and we used various DA-related behavioral models, to address the following main questions:

1- Do 5-HT_{2B}R antagonists provide an interesting pharmacological tool for improved treatment of schizophrenia?

To address this question, we studied the effects of 5-HT_{2B}R antagonists on basal DA outflow in DA-innervated brain regions (mPFC, NAc shell, NAc core, striatum) of freely moving rats, as well as on the firing activity of VTA and SNc DA neurons. In addition, we assessed the impact of 5-HT_{2B}R blockade on several behavioral tasks classically used to predict the ability of APDs to alleviate the different symptoms of schizophrenia, or their propensity to induce motor side effects.

2- Which are the mechanisms underlying the differential control of 5-HT_{2B}R antagonists on the mesocorticolimbic DA system?

The first group of experiments (see above) provided evidence that the 5-HT_{2B}R exerts a tonic inhibitory control on the mesocortical DA pathway, at difference with the mesoaccumbal DA pathway which undergoes a tonic excitatory control. Thus, our following experiments aimed at determining the mechanisms underlying these opposite effects. Specifically, we investigated the possible existence of a functional interplay between 5-HT_{2B}Rs and mPFC 5-HT_{1A}Rs. Such an interaction was suggested by the fact that 5-HT_{2B}R blockade increases mPFC

5-HT outflow (preliminary results), and that 5-HT_{1A}R agonists induce opposite effects on mPFC and NAc DA outflow, likely via the stimulation of 5-HT_{1A}Rs expressed in the mPFC (Ichikawa and Meltzer, 2000; Ichikawa *et al.*, 2001; Assié *et al.*, 2005; Díaz-Mataix *et al.*, 2005; Lladó-Pelfort *et al.*, 2012).

3- Do 5-HT_{2B}Rs participate to the neurochemical and behavioral responses elicited by cocaine?

First, we assessed the impact of 5-HT_{2B}R antagonists on cocaine-induced hyperlocomotion, one of the most frequently used screening tests in drug abuse and dependence research (Filip *et al.*, 2010). Then, considering the tight relationship between locomotor activity and subcortical DA activity, we investigated the effect of 5-HT_{2B}R blockade on DA outflow in the NAc core, the NAc shell and the striatum, in an attempt to correlate the behavioral and neurochemical interactions of 5-HT_{2B}Rs with cocaine.

PUBLICATIONS

Article 1

Devroye *et al.*, 2016, Neuropharmacology 109, 59-68

Adapted from the PDF version of our manuscript



Contents lists available at ScienceDirect

Neuropharmacology

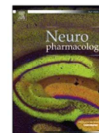
journal homepage: www.elsevier.com/locate/neuropharm

Differential control of dopamine ascending pathways by serotonin_{2B} receptor antagonists: New opportunities for the treatment of schizophrenia



Céline Devroye^{a, b}, Adeline Cathala^{a, b, 1}, Nasser Haddjeri^{c, d, 1}, Renaud Rovera^{c, d},
Monique Vallée^{a, b}, Filippo Drago^e, Pier Vincenzo Piazza^{a, b}, Umberto Spampinato^{a, b, *}

^a Inserm U1215, Neurocentre Magendie, Physiopathology of Addiction Group, Bordeaux, F-33000, France

^b Université de Bordeaux, Bordeaux, F-33000, France

^c Inserm U1208, Stem Cell and Brain Research Institute, 69500, Bron, France

^d Université Lyon 1, 69373, Lyon, France

^e Department of Biomedical and Biotechnological Sciences, Section of Pharmacology, University of Catania, Catania, 95125, Italy

ARTICLE INFO

Article history:

Received 17 February 2016

Received in revised form

18 May 2016

Accepted 30 May 2016

Available online 31 May 2016

Keywords:

5-HT_{2B} receptor

Dopamine release

Dopamine firing

Locomotion

Novel object recognition

Catalepsy

ABSTRACT

Recent studies suggest that the central serotonin_{2B} receptor (5-HT_{2B}R) could be an interesting pharmacological target for treating neuropsychiatric disorders related to dopamine (DA) dysfunction, such as schizophrenia. Thus, the present study was aimed at characterizing the role of 5-HT_{2B}Rs in the control of ascending DA pathway activity. Using neurochemical, electrophysiological and behavioral approaches, we assessed the effects of two selective 5-HT_{2B}R antagonists, RS 127445 and LY 266097, on *in vivo* DA outflow in DA-innervated regions, on mesencephalic DA neuronal firing, as well as in behavioral tests predictive of antipsychotic efficacy and tolerability, such as phencyclidine (PCP)-induced deficit in novel object recognition (NOR) test, PCP-induced hyperlocomotion and catalepsy. Both RS 127445 (0.16 mg/kg, *i.p.*) and LY 266097 (0.63 mg/kg, *i.p.*) increased DA outflow in the medial prefrontal cortex (mPFC). RS 127445, devoid of effect in the striatum, decreased DA outflow in the nucleus accumbens, and potentiated haloperidol (0.1 mg/kg, *s.c.*)-induced increase in mPFC DA outflow. Also, RS 127445 decreased the firing rate of DA neurons in the ventral tegmental area, but had no effect in the substantia nigra pars compacta. Finally, both RS 127445 and LY 266097 reversed PCP-induced deficit in NOR test, and reduced PCP-induced hyperlocomotion, without inducing catalepsy. These results demonstrate that 5-HT_{2B}Rs exert a differential control on DA pathway activity, and suggest that 5-HT_{2B}R antagonists could represent a new class of drugs for improved treatment of schizophrenia, with an ideal profile of effects expected to alleviate cognitive and positive symptoms, without eliciting extrapyramidal symptoms.

© 2016 Elsevier Ltd. All rights reserved.

1. Introduction

Schizophrenia is a major neuropsychiatric disorder characterized by three main groups of symptoms: positive (i.e. hallucinations, delusions), negative (i.e. social interaction deficits, blunted

affect) and cognitive (i.e. working and reference memory deficits, executive function impairments, decreased vigilance) (Meltzer, 2013; Newman-Tancredi and Kleven, 2011). This multimodal symptomatology is classically related to an imbalance in central dopamine (DA) neurotransmission: positive symptoms would result from DA hyperfunction in the nucleus accumbens (NAc), whereas negative and cognitive symptoms would involve DA hypofunction in the frontal cortex (Newman-Tancredi and Kleven, 2011; Svensson, 2000). The pharmacological treatment of schizophrenia relies on the use of DA-D₂ receptor antagonists classified as typical and atypical antipsychotic drugs (APDs; Meltzer and Massey, 2011). Typical APDs, such as haloperidol and chlorpromazine, while effective in controlling positive symptoms, exhibit a

* Corresponding author. Université de Bordeaux, Neurocentre Magendie, Inserm U1215, 146 rue Léo Saignat, 33077, Bordeaux Cedex, France.

E-mail addresses: celine.devroye@inserm.fr (C. Devroye), adeline.cathala@inserm.fr (A. Cathala), nasser.haddjeri@inserm.fr (N. Haddjeri), renaud.rovera@wanadoo.fr (R. Rovera), monique.vallee@inserm.fr (M. Vallée), fdrago@tin.it (F. Drago), pier-vincenzo.piazza@inserm.fr (P.V. Piazza), umberto.spampinato@inserm.fr (U. Spampinato).

¹ Contributed equally to this work.

Abstract

Recent studies suggest that the central serotonin_{2B} receptor (5-HT_{2B}R) could be an interesting pharmacological target for treating neuropsychiatric disorders related to dopamine (DA) dysfunction, such as schizophrenia. Thus, the present study was aimed at characterizing the role of 5-HT_{2B}Rs in the control of ascending DA pathway activity. Using neurochemical, electrophysiological and behavioral approaches, we assessed the effects of two selective 5-HT_{2B}R antagonists, RS 127445 and LY 266097, on *in vivo* DA outflow in DA-innervated regions, on mesencephalic DA neuronal firing, as well as in behavioral tests predictive of antipsychotic efficacy and tolerability, such as phencyclidine (PCP)-induced deficit in novel object recognition (NOR) test, PCP-induced hyperlocomotion and catalepsy. Both RS 127445 (0.16 mg/kg, i.p.) and LY 266097 (0.63 mg/kg, i.p.) increased DA outflow in the medial prefrontal cortex (mPFC). RS 127445, devoid of effect in the striatum, decreased DA outflow in the nucleus accumbens, and potentiated haloperidol (0.1 mg/kg, s.c.)-induced increase in mPFC DA outflow. Also, RS 127445 decreased the firing rate of DA neurons in the ventral tegmental area, but had no effect in the substantia nigra pars compacta. Finally, both RS 127445 and LY 266097 reversed PCP-induced deficit in NOR test, and reduced PCP-induced hyperlocomotion, without inducing catalepsy. These results demonstrate that 5-HT_{2B}Rs exert a differential control on DA pathway activity, and suggest that 5-HT_{2B}R antagonists could represent a new class of drugs for improved treatment of schizophrenia, with an ideal profile of effects expected to alleviate cognitive and positive symptoms, without eliciting extrapyramidal symptoms.

1. Introduction

Schizophrenia is a major neuropsychiatric disorder characterized by three main groups of symptoms: positive (i.e. hallucinations, delusions), negative (i.e. social interaction deficits, blunted affect) and cognitive (i.e. working and reference memory deficits, executive function impairments, decreased vigilance) (Meltzer, 2013; Newman-Tancredi and Kleven, 2011). This multimodal symptomatology is classically related to an imbalance in central dopamine (DA) neurotransmission: positive symptoms would result from DA hyperfunction in the nucleus accumbens (NAc), whereas negative and cognitive symptoms would involve DA hypofunction in the frontal cortex (Newman-Tancredi and Kleven, 2011; Svensson, 2000). The pharmacological treatment of schizophrenia relies on the use of DA-D₂ receptor antagonists classified as typical and atypical antipsychotic drugs (APDs; Meltzer and Massey, 2011). Typical APDs, such as haloperidol and chlorpromazine, while effective in controlling positive symptoms, exhibit a marked propensity to induce extrapyramidal side effects (EPS), related to altered striatal DA activity (Schapira *et al.*, 2006). Conversely, atypical APDs, of which clozapine is the prototype, display limited propensity to induce EPS along with a wider therapeutic spectrum covering positive, and to some extent, negative and cognitive symptoms (Meltzer and Massey, 2011).

It is well established that the therapeutic benefit of atypical APDs is related to their multi-target properties towards various neurotransmitter systems, involving, in particular, direct or indirect effects on various serotonin receptors (5-HTRs), especially 5-HT_{2A}Rs and 5-HT_{1A}Rs (Meltzer and Massey, 2011; Newman-Tancredi and Kleven, 2011). Interestingly, several atypical APDs display antagonist properties towards the central 5-HT_{2B}R (Abbas *et al.*, 2009; Kiss *et al.*, 2010; Shahid *et al.*, 2009; Shapiro *et al.*, 2003), which has been recently shown to participate in the control of DA neuron activity (Auclair *et al.*, 2010; Devroye *et al.*, 2015; Doly *et al.*, 2008, 2009). Also, microdialysis

studies in anesthetized rats, showing that 5-HT_{2B}R blockade decreases DA outflow in the NAc but has no effect in the striatum, suggested that 5-HT_{2B}Rs could contribute to the therapeutic benefit of atypical APDs, by achieving a differential control of subcortical DA pathway activity (Auclair *et al.*, 2010). However, the functional significance of this interaction, as well as the possible role of 5-HT_{2B}Rs in the control of DA outflow in the medial prefrontal cortex (mPFC), remain unknown to date.

Thus, the present study, encompassing neurochemical, electrophysiological and behavioral approaches, aimed at assessing the functional role of 5-HT_{2B}Rs in the control of DA ascending pathways, by using two selective, potent and brain-penetrant 5-HT_{2B}R antagonists, RS 127445 and LY 266097 (Audia *et al.*, 1996; Bonhaus *et al.*, 1999). First, using intracerebral microdialysis in freely moving rats, we investigated the effect of 5-HT_{2B}R blockade on basal DA outflow in the NAc, the striatum and the mPFC. Second, using single unit extracellular recordings, we examined the influence of 5-HT_{2B}R blockade on the basal firing rate of DA neurons located in the ventral tegmental area (VTA) and the substantia nigra pars compacta (SNc). Third, the effects of 5-HT_{2B}R antagonists were assessed in behavioral models classically used to predict APDs ability to induce EPS (catalepsy test), and to alleviate positive [phencyclidine (PCP)-induced hyperlocomotion] and cognitive [PCP-induced deficit in novel object recognition (NOR)] symptoms of schizophrenia (Newman-Tancredi and Kleven, 2011). Finally, to provide a deeper insight into the pro-cognitive potential of 5-HT_{2B}R antagonists, the effect of RS 127445 on haloperidol-induced DA outflow in the mPFC was also assessed.

2. Materials and methods

2.1. Animals

Male Sprague-Dawley rats (IFFA CREDO, Lyon, France) weighing 280-350 g were used. Animals, housed in individual plastic cages were kept at constant

room temperature ($21 \pm 2^\circ\text{C}$) and relative humidity (60%) with a 12h light/dark cycle (dark from 20:00 h) and had free access to water and food. For electrophysiological experiments, rats were housed two per cage and kept under standard laboratory conditions as above. Animals were acclimated to the housing conditions for at least one week prior to the start of the experiments. All experiments were conducted during the light phase of the light-dark cycle. Animals use procedures conformed to the International European Ethical Standards (86/609-EEC) and the French National Committee (décret 87/848) for the care and use of laboratory animals. All efforts were made to minimize animal suffering and to reduce the number of animals used.

2.2. Drugs

The following compounds were used: the 5-HT_{2B}R antagonists RS 127445.HCl (2-amino-4-(4-fluoronaphth-1-yl)-6-isopropylpyrimidine hydrochloride) and LY 266097.HCl (1-[(2-Chloro-3,4-dimethoxyphenyl) methyl]-2,3,4,9-tetrahydro-6-methyl-1*H*-pyrido[3,4-*b*] indole hydrochloride), the atypical antipsychotic clozapine (8-Chloro-11-(4-methyl-1-piperazinyl)-5*H*-dibenzo[*b,e*][1,4]diazepine), purchased from R&D Systems (Abingdon, UK); the non-competitive N-methyl-D-aspartate (NMDA)-R antagonist phencyclidine (PCP).HCl (1-(1-Phenylcyclohexyl)piperidine hydrochloride), purchased from Sigma-Aldrich (Saint-Quentin Fallavier, France), and the DA-D₂R antagonist haloperidol (4-[4-(*p*-chlorophenyl)-4hydroxypiperidino]-4'-fluorobutyrophenone) as the commercially available solution (Haldol 5 mg/ml, Janssen Pharmaceutica, Bersee, Belgium). All other chemicals and reagents were the purest commercially available (VWR, Strasbourg, France; Sigma-Aldrich).

2.3. Pharmacological treatments

RS 127445 was dissolved in a 0.3% Tween 80 distilled water solution or in a 20% hydroxypropyl- β -cyclodextrin distilled water solution for electrophysiological experiments; when administered locally (see Supplementary Fig. S1), it was first dissolved in a 0.3% Tween 80 distilled water solution to obtain a 500 μ M concentration, and then further diluted to the required concentration with artificial cerebrospinal fluid just before use. LY 266097, PCP and clozapine were dissolved in distilled water. Haloperidol was diluted in distilled water. All drugs were administered intraperitoneally (i.p.), except haloperidol which was injected subcutaneously (s.c.).

In microdialysis experiments, when assessing DA outflow, dose-response studies were performed in the mPFC with increasing doses of RS 127445 (0.08 - 0.16 mg/kg) or LY 266097 (0.16 - 0.63 mg/kg). In the NAc and the striatum, the effect of a single dose of RS 127445 (0.16 mg/kg) was assessed. In an additional experiment, 0.16 mg/kg RS 127445 was administered 15 min before 0.1 mg/kg haloperidol. When assessing serotonin (5-HT) outflow in the mPFC (see Supplementary Fig. S2), the effect of a single dose of RS 127445 (0.16 mg/kg) or LY 266097 (0.63 mg/kg) was tested. Finally, in reverse microdialysis experiments (see Supplementary Fig. S1), RS 127445 was perfused, during the entire experimental period (120 min), *via* the dialysis probe into the NAc and the mPFC at increasing concentrations (0.1 - 1 μ M). In electrophysiological experiments, 0.16 mg/kg RS 127445 was administered 5 min after vehicle injection. In catalepsy experiments, animals were treated with 0.16 mg/kg RS 127445, 0.63 mg/kg LY 266097 or 1 mg/kg haloperidol. In locomotor activity experiments, 0.16 mg/kg RS 127445 or 0.63 mg/kg LY 266097 were administered respectively 15 or 30 min before 5 mg/kg PCP. In NOR experiments, rats were treated with 2 mg/kg PCP twice daily for 7 days. On the testing day, after a 7-day washout period, RS 127445 was administered at 0.16 mg/kg, LY 266097 at 0.63 mg/kg and clozapine at 1 mg/kg.

Doses and pretreatment administration time of 5-HT_{2B}R antagonists were chosen according to previous studies reporting their efficacy to modulate DA outflow and DA-dependent behaviors (Auclair *et al.*, 2010; Devroye *et al.*, 2015). The doses of haloperidol were selected on the basis of previous studies reporting their ability to block central DA-D₂Rs in the rat brain (Lucas *et al.*, 1997) and to induce an increase in mPFC DA outflow or catalepsy (Li *et al.*, 2005; Lucas *et al.*, 2000). The doses and injection procedures (acute or subchronic administration) of PCP were selected according to previous studies reporting its ability to induce hyperlocomotion or a strong deficit in the NOR test (Adams and Moghaddam, 1998; Horiguchi and Meltzer, 2012; Schlumberger *et al.*, 2010). Finally, the dose of clozapine was chosen according to previous studies reporting its ability to reverse PCP-induced deficit in the NOR test (Grayson *et al.*, 2007).

All drug doses were calculated as the free base and injected in a volume of 1 ml/kg. In each experimental group, animals received either drugs or their appropriate vehicle, according to a randomized design.

2.4. Microdialysis and chromatographic analysis

Surgery and perfusion procedures were performed as previously described (Devroye *et al.*, 2015) with minor modifications. Briefly, rats were anesthetized with 3% isoflurane (CSP, Cournon-d'Auvergne, France) and placed in a stereotaxic frame. A siliconized stainless guide-cannula (Carnegie Medicin, Phymep, Paris, France) was stereotaxically implanted, according to the atlas of Paxinos and Watson (2005), just above the right NAc shell (coordinates of the lower extremity of the guide, in mm, relative to the interaural point: anteroposterior (AP) = 10.7, lateral (L) = 1.0, ventral (V) = 4.0), the right striatum (AP = 9.7, L = 2.8, V = 6.6), or the right mPFC (AP = 11.7, L = 0.5, V = 7.7), so that the tip of the probe (CMA/11, cuprophane, 240 µm outer diameter, 2 mm length for the NAc or 4 mm length for the striatum and the mPFC,

Publications

Carnegie Medicin, Phymep) once lowered through the guide-cannula on the day of the experiment, reached a depth value of 2 mm (NAc), 2.6 mm (striatum), or 3.7 mm (mPFC) above the interaural point.

Experiments were performed in freely moving rats 5 to 7 days after surgery. The probe was inserted in the guide-cannula and perfused at a constant flow rate (2 μ l/min for the NAc and the striatum, 1 μ l/min for the mPFC), by means of a microperfusion pump (CMA 111, Carnegie Medicin, Phymep) with artificial cerebrospinal fluid containing (in mM): 147 NaCl, 4 KCl, 2.2 CaCl₂, pH 7.4.

Pharmacological treatments (see section 2.3. for details) were performed 120 min after the beginning of the perfusion (stabilization period), and DA outflow was monitored during 120 min (dose-response experiments) or 180 min (RS 127445-haloperidol interaction experiment) after the last drug injection. Dialysates were collected in a refrigerated fraction collector (MAB 85 Microbiotech, Phymep) every 15 min.

At the end of each experiment, the animal was deeply anesthetized with a pentobarbital overdose (100 mg/kg, CEVA, Libourne, France), and its brain was removed and fixed in NaCl (0.9%)/paraformaldehyde solution (10%). Probe location into the targeted region was determined histologically on serial coronal sections (60 μ m) stained with cresyl violet, and only data obtained from rats with correctly implanted probes were included in the results.

After collection, dialysate samples were immediately analyzed with a high-performance liquid chromatography apparatus (Alexys UHPLC/ECD Neurotransmitter Analyzer, Antec, The Netherlands), equipped with an autosampler (AS 110 UHPLC cool 6-PV, Antec). The mobile phase [containing (in mM) 100 phosphoric acid, 100 citric acid, 0.1 EDTA.2H₂O, 4.6 octanesulfonic acid.NaCl plus 4.5% acetonitrile, adjusted to pH 6.0 with NaOH solution (50%)] was delivered at 0.075 ml/min flow rate with a LC 110S pump (Antec) through an Acquity UPLC BEH column (C₁₈; 1 x 100 mm, particle size 1.7 μ m; Waters, Saint-Quentin en Yvelynes, France). Detection of DA was carried out with an electrochemical detector (DECADE II, Antec) with a VT-03

glassy carbon electrode (Antec) set at +460 mV *versus* Ag/AgCl. Output signals were recorded on a computer (Clarity, Antec). Under these conditions, the retention time for DA was 4-4.5 min, and the sensitivity was 50 pM with a signal/noise ratio of 3:1.

When measuring 5-HT extracellular levels in the mPFC (see Supplementary Fig. S2), its quantification in dialysates was performed under the same chromatographic conditions described above. The retention time for 5-HT was 10-10.5 min.

DA and 5-HT content in each sample was expressed as the percentage of the average baseline level calculated from the three fractions preceding the first drug administration. Data correspond to the mean \pm S.E.M. of the percentage obtained in each experimental group.

2.5. Extracellular recordings of VTA and SNc DA neurons

Surgery and extracellular recording procedures were performed as previously described (Dahan *et al.*, 2009) with minor modifications. Rats were anesthetized with chloral hydrate (400 mg/kg, i.p.) and placed in a stereotaxic apparatus. Extracellular recordings were performed with single-barreled glass micropipettes preloaded with fiberglass filaments in order to facilitate filling. The tip was broken back to 2 to 4 μ m and filled with a 2M NaCl solution saturated with blue Chicago dye to verify the electrode position in the recorded nuclei. Only one neuron was recorded in each rat. The electrode was stereotaxically implanted, according to the atlas of Paxinos and Watson (2005), in the right VTA (5.2 mm posterior to the bregma, 0.9 mm lateral to the midline and 7.5-8.5 mm ventral to the cortical surface) or the right SNc (5 mm posterior to the bregma, 2 mm lateral to the midline and 7.2-8.2 mm ventral to the cortical surface). During the recording sessions, a neuron encountered in the VTA or the SNc was considered dopaminergic if it fulfilled the following characteristics: 1) a triphasic and wide action potential (>2.5 ms), 2) a characteristic low-pitch

Publications

sound when monitored through an audio-amplifier and 3) a slow spontaneous firing rate ranging between 2 and 9 Hz (Bunney and Aghajanian, 1977; Ungless *et al.*, 2004; White and Wang, 1983). The first injection (see section 2.3. for details) was performed once the baseline firing of the presumed DA neuron was stable.

At the end of each experiment, the animal was deeply anesthetized with a pentobarbital overdose (100 mg/kg, CEVA, Libourne, France), and its brain was removed, snap-frozen in isopentane (Sigma-Aldrich) and stored at -40°C. Electrode location into the targeted region was determined histologically on serial coronal sections (60 µm), and only data obtained from rats with correctly implanted electrodes were included in the results.

Changes in neuronal firing (% of baseline) were calculated by comparing the mean baseline firing (obtained from a 1-2 min interval prior to vehicle injection) with the mean cell firing rate obtained from a 1-2 min interval 3 min after vehicle injection or 15 min after RS 127445 injection. Data correspond to the mean \pm S.E.M. of the percentage of baseline firing obtained following vehicle or RS 127445 administration.

2.6. Catalepsy test

Experiments were carried out in a sound-attenuated room. The animals were brought from the vivarium to the testing room 1 h before the experiment to allow habituation to the new environment. Catalepsy was measured 30, 60 and 120 min after drug injections (see section 2.3. for details) by gently placing both forepaws of the rat on the top of a wooden parallelepiped block (height = 9 cm) with the hind limbs abducted (Lucas *et al.*, 1997). The intensity of catalepsy was assessed by counting the time the animal remained in this position with a maximal “cut-off” of 300 s. Catalepsy measurement was performed by an observer blind to the drug schedule administration. Data are presented as mean \pm S.E.M. duration of catalepsy.

2.7. Locomotor activity test

As described previously (Devroye *et al.*, 2015; Piazza *et al.*, 1989), locomotor activity was measured in a circular corridor equipped with four photoelectric cells placed at the two perpendicular axes of the apparatus to automatically record horizontal locomotion. The apparatus were placed in a light- and sound-attenuated chamber. All rats were habituated to the test environment for 1 h on the day before the experiment. Drug injections (see section 2.3. for details) were performed outside the testing room. After the last injection, rats were placed into the circular corridor, and locomotor activity was recorded during 60 min. Data are presented as mean \pm S.E.M. total horizontal activity counts.

2.8. NOR test

NOR testing was performed as previously described (Horiguchi and Meltzer, 2012) with minor modifications. Rats were treated with 2 mg/kg PCP or vehicle twice daily for 7 days. Subchronically PCP-treated rats were randomly assigned to four groups (vehicle, RS 127445, LY 266097 and clozapine group). Subsequently, animals were given a 7-day washout period prior to NOR testing. On the day of the experiment, PCP- and vehicle-treated rats were habituated for 15 min to the test environment and NOR arena (a 50 cm x 50 cm open field placed in a light- and sound-attenuated chamber). After the 15-min habituation period, rats were given two 5-min trials (acquisition and retention trials), separated by a 2-min intertrial return to their home cage. During the acquisition trial, the animals were allowed to explore two identical objects placed at two opposite corners of the NOR arena (“left” or “right” placement). During the retention trial, the animals explored a familiar object from the acquisition trial and a novel object. Behavior was recorded on video for blind scoring of objects exploration. Object exploration was defined by animal’s licking, sniffing, or touching the object with the forepaws while sniffing. The exploration time of each object in each trial was recorded manually by the use of two stopwatches.

Publications

The discrimination index [(time spent exploring the novel object - time spent exploring the familiar object) / total exploration time] was calculated. If a rat did not explore at least 5 s in either of the acquisition or retention phases, its data were excluded from analysis. This rarely occurred and did not affect the ability to complete the analysis using data from the remaining animals of that group.

On the testing day, drugs (see section 2.3. for details) were administered immediately (RS 127445) or 15 min before (LY 266097 or clozapine) the habituation to the test environment and NOR arena. Data are presented as mean \pm S.E.M. exploration time or discrimination index.

2.9. Statistics

Statistical analysis was carried out by Statistica 8.0 for Windows (Statsoft, Maisons-Alfort, France).

In microdialysis experiments, the effect of 5-HT_{2B}R antagonists (treatment) on basal DA or 5-HT outflow was analyzed by a multifactorial ANOVA with treatment as the between-subject factor, and time as the within-subject factor (time fractions 0-120 min). The ability of RS 127445 (pretreatment) to modulate the effect of haloperidol (treatment) on DA outflow was analyzed by a multifactorial ANOVA with pretreatment and treatment as the between-subject factors, and time as the within-subject factor (including values from time -15 to time 180 min). Finally, in each experiment, statistical differences in basal DA values among groups were assessed by a one-way ANOVA using group as a main factor.

In electrophysiological experiments, the effect of RS 127445 (treatment) on DA neuronal firing was analyzed by a one-way ANOVA (using group as a main factor).

In behavioral experiments, the ability of RS 127445, LY 266097 or haloperidol to induce catalepsy was analyzed for each time point (30, 60 and 120 min after

drug injections) by a one-way ANOVA (using group as a main factor). The ability of RS 127445, or LY 266097 (pretreatment) to modify the effect of PCP (treatment) on locomotor activity was analyzed by a multifactorial ANOVA with pretreatment and treatment as the between-subject factors. In NOR experiments, exploration data in the acquisition trial were analyzed by a one-way ANOVA (using object or treatment as a main factor). Exploration data in the retention trial were analyzed by a one-way ANOVA (using object as a main factor). Discrimination indexes were analyzed by a one-way ANOVA (using group as a main factor).

Finally, in all experiments, when multifactorial ANOVA results were significant ($p < 0.05$), the Dunnett (for dose-responses studies) or the Newman-Keuls *post-hoc* test was performed to allow adequate multiple comparisons between groups.

3. Results

3.1. Effect of RS 127445 and LY 266097 on DA outflow in the NAc, the striatum and the mPFC

Fig. 1 illustrates the effect of RS 127445 on DA outflow in the NAc (Figure 1A), the striatum (Fig. 1B) and the mPFC (Fig. 1C), as well as the effect of LY 266097 on mPFC DA outflow (Fig. 1D). In the NAc (Fig. 1A), RS 127445 elicited a time-dependent decrease in DA outflow ($F_{RS(1,7)} = 14.90$, $p < 0.01$; $F_{RS \times time(8,56)} = 2.24$, $p < 0.05$), without altering striatal DA outflow (Figure 1B; $F_{RS(1,6)} = 0.12$, NS; $F_{RS \times time(8,48)} = 0.37$, NS). As regards the effect of RS 127445 in the mPFC (Fig. 1C), we found a significant main effect of treatment ($F_{RS(2,12)} = 44.88$, $p < 0.001$) and a significant treatment by time interaction ($F_{RS \times time(16,96)} = 3.98$, $p < 0.001$). *Post-hoc* analysis revealed that 0.16 mg/kg RS 127445 elicited an overall increase in DA outflow ($p < 0.001$, *versus* the vehicle group), whereas the dose of 0.08 mg/kg had no effect ($p > 0.05$, *versus* the vehicle group). Finally, when looking at the effect of LY 266097 (Fig. 1D), we found a

Publications

significant main effect of treatment ($F_{LY (2,14)} = 5.83$, $p < 0.05$) and a significant treatment by time interaction ($F_{LY \times time (16,112)} = 1.78$, $p < 0.05$). *Post-hoc* analysis revealed that 0.63 mg/kg LY 266097 elicited an overall increase in DA outflow ($p < 0.05$, *versus* the vehicle group), whereas the dose of 0.16 mg/kg had no effect ($p > 0.05$, *versus* the vehicle group).

3.2. Effect of RS 127445 on DA neuronal firing in the VTA and the SNc

Fig. 2 illustrates the effect of RS 127445 on the discharge of presumed DA cells in the VTA (Fig. 2A,C) and the SNc (Fig. 2B,D). The basal firing rate of DA neurons was 7.3 ± 0.7 spike/s ($n = 6$ animals/group) and 4.1 ± 0.3 ($n = 8$ animals/group) in the VTA and the SNc, respectively. In the VTA (Fig. 2C), RS 127445 decreased the firing activity of presumed DA neurons ($F_{RS (1,10)} = 10.78$, $p < 0.01$), whereas it had no effect in the SNc (Fig. 2D, $F_{RS (1,14)} = 0.04$, NS).

3.3. Effect of RS 127445 and LY 266097 in behavioral tests

Fig. 3 illustrates the effects of RS 127445 and LY 266097 in behavioral tests used to predict antipsychotic efficacy.

In the catalepsy test (Fig. 3A), we found a significant effect of treatment at all the time points studied (30 min: $F_{treatment (3,20)} = 14.45$, $p < 0.001$; 60 min: $F_{treatment (3,20)} = 10.29$, $p < 0.001$; 120 min: $F_{treatment (3,20)} = 14.93$, $p < 0.001$). *Post-hoc* analysis revealed that haloperidol induced a strong cataleptic state at each time point (30 min: $p < 0.001$; 60 min: $p < 0.01$; 120 min: $p < 0.001$, *versus* the vehicle group). Conversely, RS 127445- and LY 266097-treated rats did not display catalepsy ($p > 0.05$, *versus* the vehicle group).

When assessing the effect of RS 127445 on PCP-induced hyperlocomotion (Fig. 3B), we found a significant main effect of pretreatment ($F_{RS (1,25)} = 5.51$, $p < 0.05$) and treatment ($F_{PCP (1,25)} = 9.60$, $p < 0.01$), as well as a significant pretreatment \times treatment interaction ($F_{RS \times PCP (1,25)} = 6.51$, $p < 0.05$). *Post-hoc* analysis revealed that PCP increased locomotor activity ($p < 0.01$, *versus* the vehicle/vehicle

group). PCP-induced hyperlocomotion was significantly reduced by RS 127445 pretreatment ($p < 0.01$, *versus* the vehicle/PCP group), which *per se* did not alter basal locomotor activity ($p > 0.05$, *versus* the vehicle/vehicle group). Similar results were obtained with LY 266097 (Fig. 3C). Indeed, there was a significant main effect of pretreatment ($F_{LY (1,22)} = 5.56$, $p < 0.05$) and treatment ($F_{PCP (1,22)} = 7.87$, $p < 0.01$), as well as a significant pretreatment x treatment interaction ($F_{LY \times PCP (1,22)} = 5.98$, $p < 0.05$). *Post-hoc* analysis revealed that PCP increased locomotor activity ($p < 0.01$, *versus* the vehicle/vehicle group). PCP-induced hyperlocomotion was significantly reduced by LY 266097 pretreatment ($p < 0.01$, *versus* the vehicle/PCP group), which *per se* did not alter basal locomotor activity ($p > 0.05$, *versus* the vehicle/vehicle group).

The results obtained from the acquisition trial in the NOR test are reported in Fig. 3D. Statistical analysis revealed no significant differences in the time spent exploring the two identical objects (right or left corners of the NOR arena) in any group (vehicle/vehicle group: $F_{object (1,16)} = 0.16$, NS; PCP/vehicle: $F_{object (1,12)} = 0.26$, NS; PCP/clozapine: $F_{object (1,16)} = 2.56$, NS; PCP/RS 127445: $F_{object (1,12)} = 0.00$, NS; PCP/LY 266097: $F_{object (1,14)} = 0.27$, NS). Also, there was no significant main effect of treatment during this period ($F_{treatment (4,75)} = 2.38$, NS). In the retention trial (Fig. 3E), rats explored the novel object significantly longer than the familiar objects in the vehicle/vehicle ($F_{object (1,16)} = 16.75$, $p < 0.001$), PCP/clozapine ($F_{object (1,16)} = 9.27$, $p < 0.01$), PCP/RS 127445 ($F_{object (1,12)} = 26.91$, $p < 0.001$) and PCP/LY 266097 ($F_{object (1,14)} = 18.31$, $p < 0.001$) groups. This ability to discriminate novel and familiar objects was abolished in the PCP/vehicle group ($F_{object (1,12)} = 0.06$, NS). Finally, when analyzing the discrimination index (Fig. 3F), we found a significant main effect of treatment ($F_{treatment (4,35)} = 9.36$, $p < 0.001$). *Post-hoc* analysis revealed that PCP decreased the discrimination index ($p < 0.001$, *versus* the vehicle/vehicle group), and that this effect was reversed by clozapine, RS 127445 and LY 266097 ($p < 0.001$, *versus* the PCP/vehicle group).

3.4. Effect of RS 127445 on haloperidol-induced DA outflow in the mPFC

Fig. 4 illustrates the effect of RS 127445 on haloperidol-induced increase in DA outflow in the mPFC. We found a significant main effect of pretreatment ($F_{RS(1,15)} = 23.13$, $p < 0.001$) and treatment ($F_{hal(1,15)} = 46.52$, $p < 0.001$), as well as a significant pretreatment \times treatment interaction ($F_{RS \times hal(1,15)} = 5.02$, $p < 0.05$). Moreover, these effects were dependent on time ($F_{RS \times time(13,195)} = 7.17$, $p < 0.001$; $F_{hal \times time(13,195)} = 10.52$, $p < 0.001$; $F_{RS \times hal \times time(13,195)} = 2.01$, $p < 0.05$). *Post-hoc* analysis revealed that haloperidol increased DA outflow ($p < 0.05$, *versus* the vehicle/vehicle group). RS 127445, with no effect on basal DA outflow ($p > 0.05$, *versus* the vehicle/vehicle group), potentiated haloperidol-induced DA outflow ($p < 0.001$, *versus* the vehicle/haloperidol group).

3.5. Effect of intra-NAc and intra-mPFC administration of RS 127445 on accumbal and cortical DA outflow

The effect of the intra-NAc and intra-mPFC infusion of RS 127445 on accumbal and cortical DA outflow is illustrated in the Supplementary Fig. S1 (S1A and S1B, respectively). In both brain regions, basal DA outflow remained unaltered by the local infusion of RS 127445 (NAc: $F_{RS(2,12)} = 2.40$, NS; $F_{RS \times time(16,96)} = 1.04$, NS; mPFC: $F_{RS(2,12)} = 1.58$, NS; $F_{RS \times time(16,96)} = 0.59$, NS).

3.6. Effect of RS 127445 and LY 266097 on 5-HT outflow in the mPFC

The effect of the peripheral administration of RS 127445 and LY 266097 on basal 5-HT outflow in the mPFC is illustrated in the Supplementary Fig. S2 (S2A and S2B, respectively). We found that RS 127445 elicited a time-dependent increase in 5-HT outflow ($F_{RS(1,11)} = 34.10$, $p < 0.001$; $F_{RS \times time(8,88)} = 2.68$, $p < 0.05$). A similar effect was observed following LY 266097 administration ($F_{LY(1,9)} = 50.92$, $p < 0.001$; $F_{LY \times time(8,72)} = 3.74$, $p < 0.01$).

4. Discussion

The present study provides the first evidence that 5-HT_{2B}R antagonists exert a differential control on ascending DA pathway activity, resulting in increased, decreased and unaltered DA function in the mPFC, the NAc and the striatum, respectively. In keeping with the role of DA pathways in the multimodal symptomatology of schizophrenia (Newman-Tancredi and Kleven, 2011), 5-HT_{2B}R antagonists are also able to restore normal functional output in behavioral models predictive of APDs efficiency (PCP-induced deficit in NOR and PCP-induced hyperlocomotion) and have no effect in a behavioral paradigm predictive of APDs propensity to induce EPS (catalepsy test) (Newman-Tancredi and Kleven, 2011). Altogether, our findings, showing that the profile of effects of 5-HT_{2B}R antagonists corresponds to that of an ideal APD, suggest that 5-HT_{2B}R antagonists could be an interesting pharmacological tool for the treatment of schizophrenia.

In the present study, the role of 5-HT_{2B}Rs in the control of DA pathway activity was assessed using two selective, brain penetrant and potent 5-HT_{2B}R antagonists, RS 127445 and LY 266097, which have been well characterized *in vitro* and *in vivo* (Auclair *et al.*, 2010; Audia *et al.*, 1996; Bonhaus *et al.*, 1999; Devroye *et al.*, 2015; Doly *et al.*, 2008, 2009). Both compounds possess similar high affinity for the 5-HT_{2B}R (pK_i = 9.5 for RS 127445 and pK_i = 9.3 for LY 266097), and at least 1000-fold (RS 127445) and 100-fold (LY 266097) selectivity over the 5-HT_{2A}R and the 5-HT_{2C}R, as well as over numerous other receptors (Audia *et al.*, 1996; Bonhaus *et al.*, 1999). Thus, in keeping with their *in vitro* pharmacological properties, the fact that both 5-HT_{2B}R antagonists were administered at very low doses known to target selectively 5-HT_{2B}Rs *in vivo* (Auclair *et al.*, 2010) strongly supports the specificity of the effects observed in the present study.

In a first group of experiments, we performed microdialysis studies in freely moving rats to assess the impact of 5-HT_{2B}R blockade on DA outflow in

terminal regions of ascending DA pathways. We found that 0.16 mg/kg RS 127445, with no effect in the striatum, decreased DA outflow in the NAc. These findings confirm a previous study performed in halothane-anesthetized rats demonstrating that 5-HT_{2B}Rs exert a tonic excitatory control on mesoaccumbal DA pathway activity (Auclair *et al.*, 2010). At variance with the mesoaccumbens DA pathway, we found that 5-HT_{2B}Rs exert a tonic inhibitory control on mesocortical DA pathway. Indeed, 0.16 mg/kg RS 127445 increased DA outflow in the mPFC. A similar effect was observed following the administration of 0.63 mg/kg LY 266097, a dose which has been previously shown to reduce accumbal DA outflow without altering it in the striatum (Auclair *et al.*, 2010). Altogether, these results demonstrate that 5-HT_{2B}Rs do not modulate the nigrostriatal DA pathway, and exert opposite controls on the mesocortical and mesoaccumbal DA pathways, this profile of effects remaining unequaled by any other 5-HTR subtype. In line with this conclusion, electrophysiological experiments showed that 5-HT_{2B}Rs exert a differential control on midbrain DA neuron activity. Indeed, we found that 0.16 mg/kg RS 127445 had no effect on the firing rate of DA neurons in the SNc, but reduced it in the VTA. Despite the difficulties in directly relating data from *in vivo* microdialysis in freely moving rats and single unit recording in anesthetized rats, it is tempting to suggest that 5-HT_{2B}R antagonism reduces accumbal DA outflow *via* an inhibitory modulation of mesoaccumbal DA neuronal firing. Nevertheless, considering the cellular heterogeneity of the VTA (Carr and Sesack, 2000; Beier *et al.*, 2015; Ikemoto, 2007; Lammel *et al.*, 2014), further studies are needed to clearly identify DA neurons projecting to the NAc or to the mPFC.

In keeping with the role of the DA network in the symptomatology of schizophrenia (Newman-Tancredi and Kleven, 2011), 5-HT_{2B}R antagonists could represent a useful pharmacological tool to alleviate cognitive and positive symptoms, which are respectively related to DA hypofunction in the mPFC and DA hyperfunction in the NAc (Newman-Tancredi and Kleven, 2011). In

addition, the lack of effect of 5-HT_{2B}R antagonists on the nigrostriatal DA pathway would predict a low propensity of these compounds to elicit EPS (Schapira *et al.*, 2006). To further assess this hypothesis, we investigated the functional significance of the 5-HT_{2B}R-DA interaction in behavioral models classically used to explore the therapeutic potential of putative APDs for treating the different symptom clusters of schizophrenia: PCP-induced hyperlocomotion (predictive of APDs ability to alleviate positive symptoms), PCP-induced deficit in the NOR test (predictive of APDs ability to alleviate cognitive symptoms), and catalepsy (predictive of APDs propensity to induce EPS) (Newman-Tancredi and Kleven, 2011). We found that both RS 127445 and LY 266097 reduced PCP-induced hyperlocomotion. These results are consistent with previous findings showing that 5-HT_{2B}R blockade reduces amphetamine-induced hyperlocomotion (Auclair *et al.*, 2010), another behavioral model used to investigate the potential of APDs to restore normal accumbal DA function (Newman-Tancredi and Kleven, 2011). Also, both RS 127445 and LY 266097 were able to reverse PCP-induced NOR deficit to a similar extent as clozapine. Finally, we found that, at difference with haloperidol, neither RS 127445 nor LY 266097 produced a cataleptic state. Altogether, these results, along with our biochemical and electrophysiological findings, demonstrate that 5-HT_{2B}R antagonists could represent an interesting pharmacological tool to alleviate cognitive and positive symptoms of schizophrenia, with low risk of EPS. Nevertheless, considering the complexity and multifactorial nature of schizophrenia, as well as the lack of experimental procedures with clear translational validity, the prediction of the efficacy of a drug to alleviate a given symptom cluster cannot rely on a single behavioral procedure (Newman-Tancredi and Kleven, 2011). Thus, future studies aimed at profiling the acute or chronic effects of 5-HT_{2B}R antagonists in a palette of other behavioral experiments predictive of therapeutic efficacy or side effects are needed (Porsolt *et al.*, 2010; Newman-Tancredi and Kleven, 2011).

Publications

In keeping with the therapeutic potential of 5-HT_{2B}R antagonists, it is noteworthy that several atypical APDs (clozapine, amisulpride, asenapine, aripiprazole, cariprazine) possess high affinity and potent antagonist properties at the 5-HT_{2B}R (Abbas *et al.*, 2009; Kiss *et al.*, 2010; Shahid *et al.*, 2009; Shapiro *et al.*, 2003), which could contribute to their therapeutic benefit. In line with this hypothesis, we found that RS 127445 potentiates haloperidol-induced DA outflow in the mPFC. This result, together with the finding that 5-HT_{2B}R blockade inhibits haloperidol-induced DA outflow in the NAc but not in the striatum (Auclair *et al.*, 2010), suggests that it may be possible to generate a clozapine-like neurochemical profile when combining 5-HT_{2B}R and DA-D₂R antagonisms, as previously observed with other 5-HT receptors, such as the 5-HT_{2A}R (Ichikawa and Meltzer, 2000; Meltzer *et al.*, 2003). Furthermore, that 5-HT_{2B}R could play a role in the neurobiology of schizophrenia has been recently suggested by a study performed in the constitutive 5-HT_{2B}R knock-out mice (Pitychoutis *et al.*, 2015). At variance with the present findings, this study concluded that the genetic ablation of the 5-HT_{2B}R leads to a schizophrenic-like phenotype. In agreement with the role of 5-HT_{2B}R in brain maturation (Kolodziejczak *et al.*, 2015), it is conceivable that the observed phenotype could result from profound neural adaptations triggered by the permanent lack of this receptor. However, the fact that acute pharmacological blockade of 5-HT_{2B}R phenocopied some behavioral responses observed in knock-out mice (Pitychoutis *et al.*, 2015), points out that additional factors, such as the use of different species, may account for the different conclusion offered by the present study. Future investigations in animals chronically treated with 5-HT_{2B}R antagonists as well as in advanced genetic models, such as conditional 5-HT_{2B}R knock-out animals, are warranted to address this issue.

Finally, although the present study does not permit to determine the mechanisms and/or the neuronal circuits underlying the effects of 5-HT_{2B}R antagonists on DA pathway activity, several hypothesis can be discussed on the basis of preliminary findings from our laboratory and the few data available in

the literature with regards to the cellular and regional expression of 5-HT_{2B}Rs in the mammalian brain (Bonaventure *et al.*, 2002; Doly *et al.*, 2008; Duxon *et al.*, 1997; Kolodziejczak *et al.*, 2015). A first mechanism could rely on a local control of DA outflow, especially in the mPFC where 5-HT_{2B}Rs have been shown to be expressed (Bonaventure *et al.*, 2002; Duxon *et al.*, 1997). However, we found that mPFC DA outflow, as well as NAc DA outflow, are unaltered by the local perfusion (0.1–1 μM) of RS 127445 (see Supplementary Fig. S1). These findings, while discarding the hypothesis of a local control, suggest the involvement of 5-HT_{2B}R populations expressed in other brain regions which could control mPFC and NAc DA outflow, through direct or polysynaptic pathways afferent to the mesocorticolimbic DA system. In this context, a possible mechanism could involve a 5-HT_{1A}R-mediated control of mPFC glutamate-containing pyramidal neurons, which exert opposite controls on the mesocortical and the mesoaccumbens DA pathway activity (Sesack *et al.*, 2003; Svensson, 2000). Specifically, stimulation of 5-HT_{1A}Rs localized to mPFC GABA interneurons leads to the disinhibition of mPFC pyramidal neurons (Lladó-Pelfort *et al.*, 2012), which provide a direct and a GABA-mediated input on mesocortical and mesoaccumbal DA pathways, respectively (Sesack *et al.*, 2003). Interestingly, we found that peripheral administration of 5-HT_{2B}R antagonists increases 5-HT extracellular levels in the mPFC (see Supplementary Fig. S2), an effect which could result from blockade of 5-HT_{2B}Rs expressed in the dorsal raphe nucleus (DRN) (Bonaventure *et al.*, 2002; Duxon *et al.*, 1997), which sends 5-HT projections to numerous brain regions including the mPFC (Azmitia and Segal, 1978). Thus, it is tempting to suggest that the increase in mPFC 5-HT outflow induced by 5-HT_{2B}R antagonists, activating the circuits described above, could account for their opposite effects on mPFC and NAc DA outflow. An additional step of complexity is provided by the fact that, in the mPFC, DA is mainly released by noradrenergic terminals issued from the locus coeruleus (LC) (Devoto *et al.*, 2008; Masana *et al.*, 2011; Tanda *et al.*, 1997). This mechanism has also to be considered, as 5-HT_{2B}Rs are

Publications

expressed in the LC (Bonaventure *et al.*, 2002), which, in addition, is anatomico-functionally linked to the mPFC, the VTA and the DRN (Lu *et al.*, 2012; Uematsu *et al.*, 2015; Weinshenker and Holmes, 2015). Additional studies are needed to unravel the polysynaptic circuits involved in the 5-HT_{2B}R regulatory control of DA network.

In conclusion, the present study shows that 5-HT_{2B}Rs exert a differential modulation of ascending DA pathway activity, affording inhibitory and excitatory controls on the mesocortical and the mesoaccumbal pathways, respectively, and no effect on the nigrostriatal one. Furthermore, our findings, demonstrating the efficacy of 5-HT_{2B}R antagonists in different behavioral models predictive of the therapeutic potential of putative APDs, suggest that these compounds could represent a new class of drugs to alleviate positive and cognitive symptoms of schizophrenia, without risk of EPS. Furthermore, as discussed previously (Auclair *et al.*, 2010), 5-HT_{2B}R antagonists would be expected to reduce DA-dependent psychosis in Parkinson's disease without impairing motor function (Meltzer and Roth, 2013).-Additional investigations are warranted to further explore the therapeutic potential of 5-HT_{2B}R antagonists.

Acknowledgements

This work was supported by grants from the Institut National de la Recherche et de la Santé (INSERM) and Bordeaux University. C. Devroye was a fellowship recipient from the International Ph.D. program in Neuropharmacology, University of Catania Medical School, Catania, Italy, during the course of this study. The authors wish to thank Cédric Dupuy for providing excellent care to animals and Dr Adrian Newman-Tancredi for fruitful discussions during the accomplishment of this study.

References

- Abbas, A.I., Hedlund, P.B., Huang, X.P., Tran, T.B., Meltzer, H.Y., Roth, B.L., 2009. Amisulpride is a potent 5-HT₇ antagonist: relevance for antidepressant actions in vivo. *Psychopharmacology* 205, 119-128.
- Adams, B., Moghaddam, B., 1998. Corticolimbic dopamine neurotransmission is temporally dissociated from the cognitive and locomotor effects of phencyclidine. *J. Neurosci.* 18, 5545-5554.
- Auclair, A.L., Cathala, A., Sarrazin, F., Depoortère, R., Piazza, P.V., Newman-Tancredi, A., Spampinato, U., 2010. The central serotonin 2B receptor: a new pharmacological target to modulate the mesoaccumbens dopaminergic pathway activity. *J. Neurochem.* 114, 1323-1332.
- Audia, J.E., Evrard, D.A., Murdoch, G.R., Droste, J.J., Nissen, J.S., Schenck, K.W., Fludzinski, P., Lucaites, V.L., Nelson, D.L., Cohen, M.L., 1996. Potent, selective tetrahydro-beta-carboline antagonists of the serotonin 2B (5HT_{2B}) contractile receptor in the rat stomach fundus. *J. Med. Chem.* 39, 2773-2780.
- Azmitia, E.C., Segal, M., 1978. An autoradiographic analysis of the differential ascending projections of the dorsal and median raphe nuclei in the rat. *J. Comp. Neurol.* 179, 641-668.
- Beier, K.T., Steinberg, E.E., DeLoach, K.E., Xie, S., Miyamichi, K., Schwarz, L., Gao, X.J., Kremer, E.J., Malenka, R.C., Luo, L., 2015. Circuit architecture of VTA dopamine neurons revealed by systematic input-output mapping. *Cell* 162, 622-634.
- Bonaventure, P., Guo, H., Tian, B., Liu, X., Bittner, A., Roland, B., Salunga, R., Ma, X.J., Kamme, F., Meurers, B., Bakker, M., Jurzak, M., Leysen, J.E., Erlander, M.G., 2002. Nuclei and subnuclei gene expression profiling in mammalian brain. *Brain Res.* 943, 38-47.
- Bonhaus, D.W., Flippin, L.A., Greenhouse, R.J., Jaime, S., Rocha, C., Dawson, M., Van Natta, K., Chang, L.K., Pulido-Rios, T., Webber, A., Leung, E., Eglen, R.M., Martin, G.R., 1999. RS-127445: a selective, high affinity, orally bioavailable 5-HT_{2B} receptor antagonist. *Br. J. Pharmacol.* 127, 1075-1082.
- Bunney, B.S., Aghajanian, G.K., 1977. D-Amphetamine-induced inhibition of central dopaminergic neurons: direct effect or mediated by a striatonigral feedback pathway? *Adv. Biochem. Psychopharmacol.* 16, 577-582.

Publications

- Carr, D.B., Sesack, S.R., 2000. Projections from the rat prefrontal cortex to the ventral tegmental area: target specificity in the synaptic associations with mesoaccumbens and mesocortical neurons. *J. Neurosci.* 20, 3864-3873.
- Dahan, L., Husum, H., Mnie-Filali, O., Arnt, J., Hertel, P., Haddjeri, N., 2009. Effects of bifeprunox and aripiprazole on rat serotonin and dopamine neuronal activity and anxiolytic behaviour. *J. Psychopharmacol.* 23, 177-189.
- Devoto, P., Flore, G., Saba, P., Castelli, M.P., Piras, A.P., Luesu, W., Viaggi, M.C., Ennas, M.G., Gessa, G.L., 2008. 6-Hydroxydopamine lesion in the ventral tegmental area fails to reduce extracellular dopamine in the cerebral cortex. *J. Neurosci. Res.* 86, 1647-1658.
- Devroye, C., Cathala, A., Di Marco, B., Caraci, F., Drago, F., Piazza, P.V., Spampinato, U., 2015. Central serotonin(2B) receptor blockade inhibits cocaine-induced hyperlocomotion independently of changes of subcortical dopamine outflow. *Neuropharmacology* 97, 329-337.
- Doly, S., Bertran-Gonzalez, J., Callebert, J., Bruneau, A., Banas, S.M., Belmer, A., Boutourlinsky, K., Hervé, D., Launay, J.M., Maroteaux, L., 2009. Role of serotonin via 5-HT_{2B} receptors in the reinforcing effects of MDMA in mice. *PLoS ONE* 4, e7952.
- Doly, S., Valjent, E., Setola, V., Callebert, J., Hervé, D., Launay, J.M., Maroteaux, L., 2008. Serotonin 5-HT_{2B} receptors are required for 3,4-methylenedioxymethamphetamine-induced hyperlocomotion and 5-HT release *in vivo* and *in vitro*. *J. Neurosci.* 28, 2933-2940.
- Duxon, M.S., Flanigan, T.P., Reavley, A.C., Baxter, G.S., Blackburn, T.P., Fone, K.C., 1997. Evidence for expression of the 5-hydroxytryptamine-2B receptor protein in the rat central nervous system. *Neuroscience* 76, 323-329.
- Grayson, B., Idris, N.F., Neill, J.C., 2007. Atypical antipsychotics attenuate a sub-chronic PCP-induced cognitive deficit in the novel object recognition task in the rat. *Behav. Brain Res.* 184, 31-38.
- Horiguchi, M., Meltzer, H.Y., 2012. The role of 5-HT_{1A} receptors in phencyclidine (PCP)-induced novel object recognition (NOR) deficit in rats. *Psychopharmacology* 221, 205-215.
- Ichikawa, J., Meltzer, H.Y., 2000. The effect of serotonin_{1A} receptor agonism on antipsychotic drug-induced dopamine release in rat striatum and nucleus accumbens. *Brain Res.* 858, 252-263.

- Ikemoto, S., 2007. Dopamine reward circuitry: two projection systems from the ventral midbrain to the nucleus accumbens-olfactory tubercle complex. *Brain Res. Rev.* 56, 27-78.
- Kiss, B., Horváth, A., Némethy, Z., Schmidt, E., Laszlovszky, I., Bugovics, G., Fazekas, K., Hornok, K., Orosz, S., Gyertyán, I., Agai-Csongor, E., Domány, G., Tihanyi, K., Adham, N., Szombathelyi, Z., 2010. Cariprazine (RGH-188), a dopamine D(3) receptor-preferring, D(3)/D(2) dopamine receptor antagonist-partial agonist antipsychotic candidate: in vitro and neurochemical profile. *J. Pharmacol. Exp. Ther.* 333, 328-340.
- Kolodziejczak, M., Béchade, C., Gervasi, N., Irinopoulou, T., Banas, S.M., Cordier, C., Rebsam, A., Roumier, A., Maroteaux, L., 2015. Serotonin Modulates Developmental Microglia via 5-HT_{2B} Receptors: Potential Implication during Synaptic Refinement of Retinogeniculate Projections. *ACS Chem. Neurosci.* 6, 1219-1230.
- Lammel, S., Lim, B.K., Malenka, R.C., 2014. Reward and aversion in a heterogeneous midbrain dopamine system. *Neuropharmacology* 76, 351-359.
- Li, Z., Ichikawa, J., Huang, M., Prus, A.J., Dai, J., Meltzer, H.Y., 2005. ACP-103, a 5-HT_{2A/2C} inverse agonist, potentiates haloperidol-induced dopamine release in rat medial prefrontal cortex and nucleus accumbens. *Psychopharmacology* 183, 144-153.
- Lladó-Pelfort, L., Santana, N., Ghisi, V., Artigas, F., Celada, P., 2012. 5-HT_{1A} receptor agonists enhance pyramidal cell firing in prefrontal cortex through a preferential action on GABA interneurons. *Cereb. Cortex* 22, 1487-1497.
- Lu, Y., Simpson, K.L., Weaver, K.J., Lin, R.C., 2012. Differential distribution patterns from medial prefrontal cortex and dorsal raphe to the locus coeruleus in rats. *Anat. Rec. (Hoboken)* 295, 1192-1201.
- Lucas, G., Bonhomme, N., De Deurwaerdère, P., Le Moal, M., Spampinato, U., 1997. 8-OH-DPAT, a 5-HT_{1A} agonist and ritanserin, a 5-HT_{2A/C} antagonist, reverse haloperidol-induced catalepsy in rats independently of striatal dopamine release. *Psychopharmacology* 131, 57-63.
- Lucas, G., De Deurwaerdère, P., Caccia, S., Spampinato, U., 2000. The effect of serotonergic agents on haloperidol-induced striatal dopamine release in vivo: opposite role of 5-HT_{2A} and 5-HT_{2C} receptor subtypes and significance of the haloperidol dose used. *Neuropharmacology* 39, 1053-1063.

Publications

- Masana, M., Bortolozzi, A., Artigas, F., 2011. Selective enhancement of mesocortical dopaminergic transmission by noradrenergic drugs: therapeutic opportunities in schizophrenia. *Int. J. Neuropsychopharmacol.* 14, 53-68.
- Meltzer, H.Y., Li, Z., Kaneda, Y., Ichikawa, J., 2003. Serotonin receptors: their key role in drugs to treat schizophrenia. *Prog. Neuropsychopharmacol. Biol. Psychiatry* 27, 1159-1172.
- Meltzer, H.Y., 2013. Update on typical and atypical antipsychotic drugs. *Annu. Rev. Med.* 64, 393-406.
- Meltzer, H.Y., Massey, B.W., 2011. The role of serotonin receptors in the action of atypical antipsychotic drugs. *Curr. Opin. Pharmacol.* 11, 59-67.
- Meltzer, H.Y., Roth, B.L., 2013. Lorcaserin and pimavanserin: emerging selectivity of serotonin receptor subtype-targeted drugs. *J. Clin. Invest.* 123, 4986-4991.
- Newman-Tancredi, A., Kleven, M.S., 2011. Comparative pharmacology of antipsychotics possessing combined dopamine D2 and serotonin 5-HT1A receptor properties. *Psychopharmacology* 216, 451-473.
- Paxinos, G., Watson, C., 2005. *The rat brain in stereotaxic coordinates*, 6th ed. Academic Press.
- Piazza, P.V., Deminière, J.M., Le Moal, M., Simon, H., 1989. Factors that predict individual vulnerability to amphetamine self-administration. *Science* 24, 1511-1513.
- Pitychoutis, P.M., Belmer, A., Moutkine, I., Adrien, J., Maroteaux, L., 2015. Mice Lacking the Serotonin Htr2B Receptor Gene Present an Antipsychotic-Sensitive Schizophrenic-Like Phenotype. *Neuropsychopharmacology* 40, 2764-2773.
- Porsolt, R.D., Moser, P.C., Castagné, V., 2010. Behavioral indices in antipsychotic drug discovery. *J. Pharmacol. Exp. Ther.* 333, 632-638.
- Schapira, A.H., Bezard, E., Brotchie, J., Calon, F., Collingridge, G.L., Ferger, B., Rebsam, A., Roumier, A., Maroteaux, L., 2006. Novel pharmacological targets for the treatment of Parkinson's disease. *Nat. Rev. Drug Discov.* 5, 845-854.
- Schlumberger, C., Pietraszek, M., Gravius, A., Danysz, W., 2010. Effects of a positive allosteric modulator of mGluR5 ADX47273 on conditioned avoidance response and PCP-induced hyperlocomotion in the rat as models for schizophrenia. *Pharmacol. Biochem. Behav.* 95, 23-30.
- Sesack, S.R., Carr, D.B., Omelchenko, N., Pinto, A., 2003. Anatomical substrates for glutamate-dopamine interactions: evidence for specificity of connections and extrasynaptic actions. *Ann. N. Y. Acad. Sci.* 1003, 36-52.

- Shahid, M., Walker, G.B., Zorn, S.H., Wong, E.H., 2009. Asenapine: a novel psychopharmacologic agent with a unique human receptor signature. *J. Psychopharmacol.* 23, 65-73.
- Shapiro, D.A., Renock, S., Arrington, E., Chiodo, L.A., Liu, L.X., Sibley, D.R., Roth, B.L., Mailman, R., 2003. Aripiprazole, a novel atypical antipsychotic drug with a unique and robust pharmacology. *Neuropsychopharmacology* 28, 1400-1411.
- Svensson, T.H., 2000. Dysfunctional brain dopamine systems induced by psychotomimetic NMDA-receptor antagonists and the effects of antipsychotic drugs. *Brain Res. Brain Res. Rev.* 31, 320-329.
- Tanda, G., Pontieri, F.E., Frau, R., Di Chiara, G., 1997. Contribution of blockade of the noradrenaline carrier to the increase of extracellular dopamine in the rat prefrontal cortex by amphetamine and cocaine. *Eur. J. Neurosci.* 9, 2077-2085.
- Uematsu, A., Tan, B.Z., Johansen, J.P., 2015. Projection specificity in heterogeneous locus coeruleus cell populations: implications for learning and memory. *Learn Mem.* 22, 444-451.
- Ungless, M.A., Magill, P.J., Bolam, J.P., 2004. Uniform inhibition of dopamine neurons in the ventral tegmental area by aversive stimuli. *Science* 303, 2040-2042.
- Weinshenker, D., Holmes, P.V., 2015. Regulation of neurological and neuropsychiatric phenotypes by locus coeruleus-derived galanin. *Brain Res.* <http://dx.doi.org/10.1016/j.brainres.2015.11.025>.
- White, F.J., Wang, R.Y., 1983. Differential effects of classical and atypical antipsychotic drugs on A9 and A10 dopamine neurons. *Science* 221, 1054-1057.

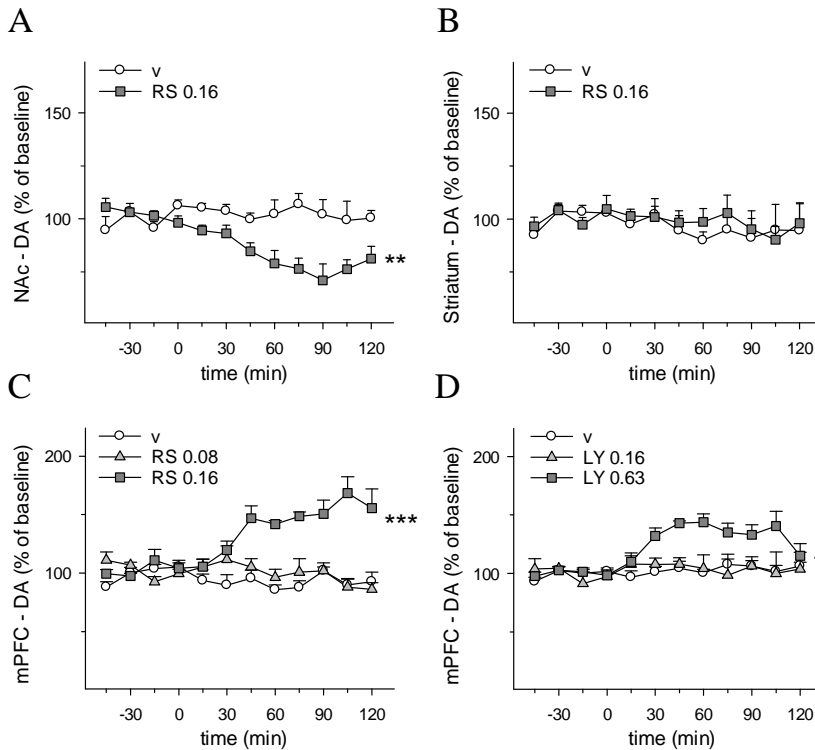

Fig. 1. Time course effect of the administration of RS 127445 and LY 266097 on dopamine (DA) outflow in the nucleus accumbens (NAc), the striatum and the medial prefrontal cortex (mPFC). (A,B) Effect of the intraperitoneal (i.p.) administration (time zero) of 0.16 mg/kg RS 127445 (RS) on DA outflow in the NAc (A) and the striatum (B). (C) Effect of RS (0.08-0.16 mg/kg, i.p.) administration (time zero) on DA outflow in the mPFC. (D) Effect of LY 266097 (LY, 0.16-0.63 mg/kg, i.p.) administration (time zero) on DA outflow in the mPFC. Data are represented as the mean \pm SEM percentages of the baseline calculated from the three samples preceding drug administration ($n = 4-6$ animals/group). Absolute basal levels of DA in dialysates collected in each brain region did not differ across the different experimental groups (A: $F_{(1,7)} = 0.48$, NS; B: $F_{(1,6)} = 1.08$, NS; C: $F_{(2,12)} = 3.37$, NS; D: $F_{(2,14)} = 0.62$, NS, ANOVA) and were (mean \pm SEM): 1.02 ± 0.12 nM ($n = 9$) for A, 4.96 ± 0.46 nM ($n = 8$) for B, 0.32 ± 0.04 nM ($n = 15$) for C, and 0.41 ± 0.05 nM ($n = 17$) for D. ** $p < 0.01$ versus the v group (ANOVA, A and B); * $p < 0.05$ and *** $p < 0.001$ versus the v group (Dunnett test, C and D).

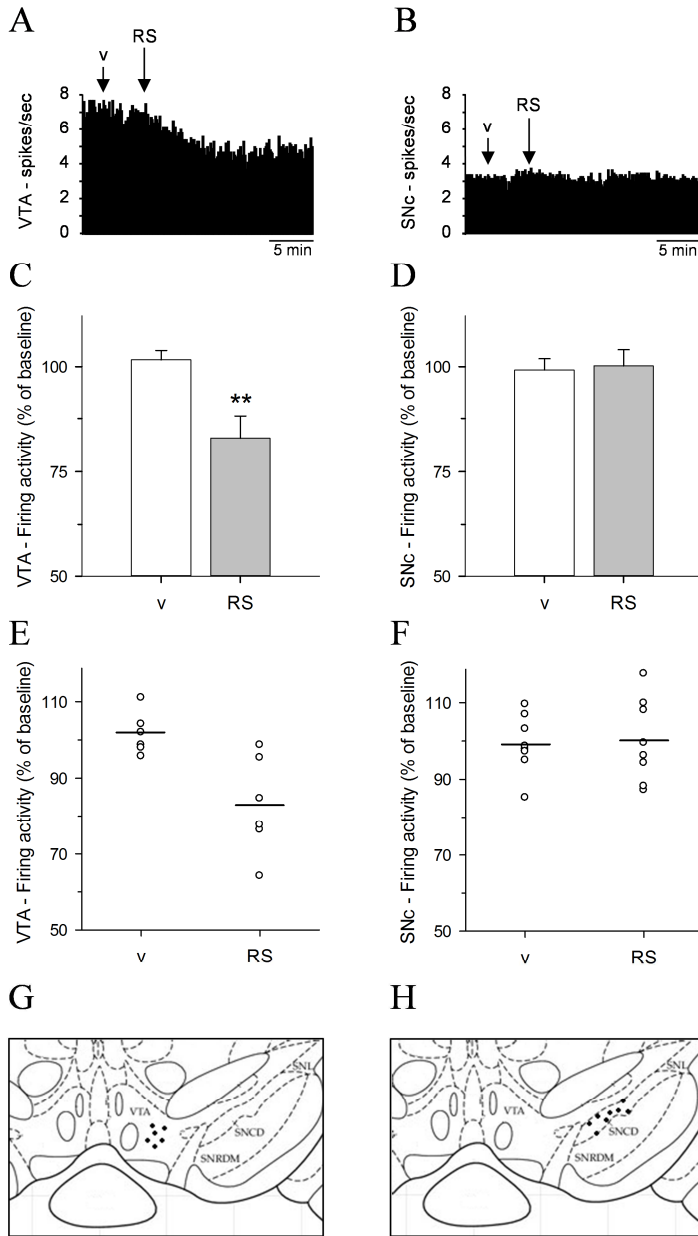

Fig. 2. Effect of RS 127445 on dopamine (DA) neuronal firing in the ventral tegmental area (VTA) and the substantia nigra pars compacta (SNc). (A,B) Integrative firing rate histograms showing the effect of the intraperitoneal (i.p.) administration of vehicle (v) and RS 127445 (RS) on DA neuronal firing rate in the VTA (A) and the SNc (B). RS (0.16 mg/kg) was administered 5 min after v (vertical arrows). (C,D) Histograms

represent the mean \pm SEM percentages of the basal firing rate of DA neurons recorded in the VTA (C) and the SNc (D), after v or RS injection (n= 6 and 8 animals/group for VTA and SNc recordings, respectively). Percentages are calculated by comparing the mean baseline firing (obtained from a 1-2 min interval prior to injection of v with the mean cell firing rate obtained from a 1-2 min interval 3 min after v injection or 15 min after RS injection. (E,F) Open circles represent individual neurons recorded in the VTA (E) and the SNc (F) and the horizontal bars represent the mean of each group (G,H) Schematic diagrams, taken from the Paxinos and Watson atlas (2005), show (black points) the anatomical localization of DA neurons recorded in the VTA (G, 5.2 mm posterior to the bregma) and the SNc (H, 5 mm posterior to the bregma). SNCD: substantia nigra, compacta part, dorsal tier; SNL: substantia nigra, lateral part; SNRDM: substantia nigra, reticular part, dorsomedial tier. **p<0.01 *versus* the vehicle (v) group (ANOVA).

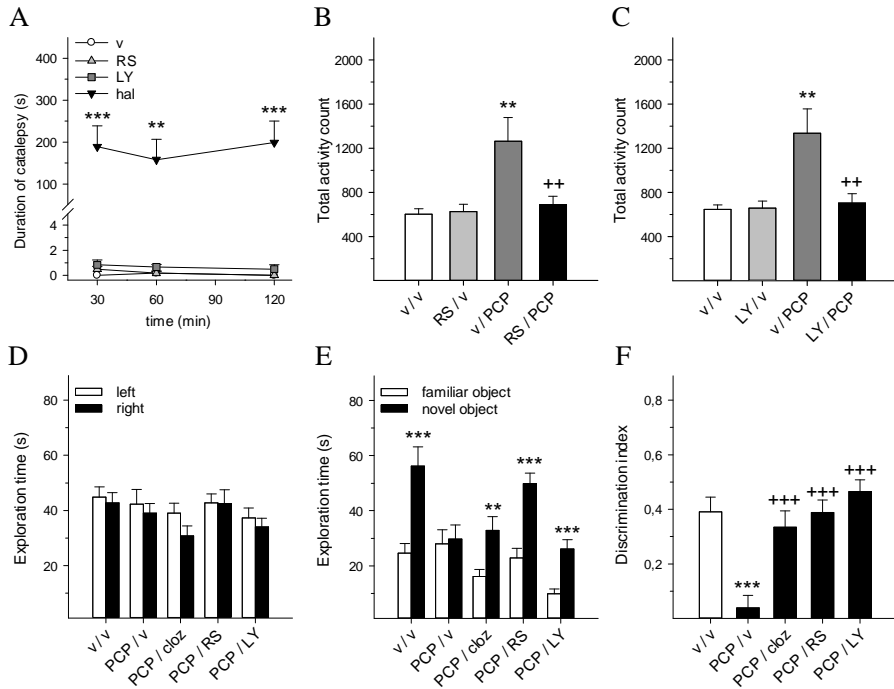

Fig. 3. Effect of RS 127445 and LY 266097 in behavioral testing. (A) Catalepsy test. RS 127445 (RS, 0.16 mg/kg) or LY 266097 (LY, 0.63 mg/kg) was intraperitoneally (i.p.) injected, whereas haloperidol (hal, 1 mg/kg) was subcutaneously (s.c.) administered. Data are represented as the mean \pm SEM duration of catalepsy state 30, 60 and 120 min after drug injection ($n = 6$ animals/group). ** $p < 0.01$, *** $p < 0.001$ versus the vehicle (v) group (ANOVA). (B,C) Locomotor activity test. RS (0.16 mg/kg, i.p., B) or LY 266097 (LY, 0.63 mg/kg, i.p., C) were respectively injected 15 or 30 min before the administration of PCP (5 mg/kg, i.p.). Histograms represent the mean \pm SEM horizontal activity counts over a 60-min test period ($n = 7-8$ and $n = 5-7$ animals/group for experiments with RS and LY, respectively). ** $p < 0.01$ versus the vehicle/vehicle (v/v) group and ++ $p < 0.01$ versus the vehicle/PCP (v/PCP) group (Newman-Keuls test). (D-F) Effect of clozapine (cloz), RS or LY in the novel object recognition (NOR) test. Rats were treated with 2 mg/kg PCP or vehicle (v) twice daily for 7 days. NOR test was performed after a 7-day washout period. Cloz (1 mg/kg, i.p.) or LY (0.63 mg/kg, i.p.) were injected 30 min before the acquisition trial; RS (0.16 mg/kg, i.p.) was injected 15 min before the acquisition trial ($n = 7-9$ animals/group). (D) Acquisition trial. Data are represented as the mean \pm SEM exploration time of two identical objects placed at left or right corners of the NOR arena. (E) Retention trial. Data are represented as the mean \pm SEM exploration time of the familiar and novel objects. ** $p < 0.01$, *** $p < 0.001$ versus familiar object (ANOVA). (F) Discrimination index, calculated from the retention trial.

Data are represented as the mean \pm SEM [(time spent exploring the novel object - time spent exploring the familiar object during the retention trial) / total exploration time].
*** $p < 0.001$, *versus* the vehicle/vehicle (v/v) group and ⁺⁺⁺ $p < 0.001$ *versus* the PCP/vehicle (PCP/v) group (Newman-Keuls test).

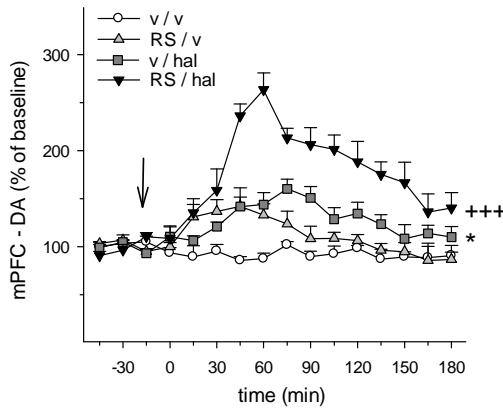

Fig. 4. Effect of RS 127445 on haloperidol-induced dopamine (DA) outflow in the medial prefrontal cortex (mPFC). RS 127445 (RS, 0.16 mg/kg) was intraperitoneally (i.p.) injected 15 min (vertical arrow) before the subcutaneous (s.c.) administration of haloperidol (hal, 0.1 mg/kg, time zero). Data are represented as the mean \pm SEM percentages of the baseline calculated from the three samples preceding the first drug administration ($n = 4-5$ animals/group). Absolute basal levels of DA in dialysates collected in the mPFC did not differ across the different experimental groups ($F_{(3,15)} = 1.74$, NS, ANOVA) and were: 0.28 ± 0.03 nM (mean \pm SEM, $n = 19$ rats). * $p < 0.05$ versus the vehicle/vehicle (v/v) group and $^{+++}p < 0.001$ versus the vehicle/haloperidol (v/hal) group (Newman-Keuls test).

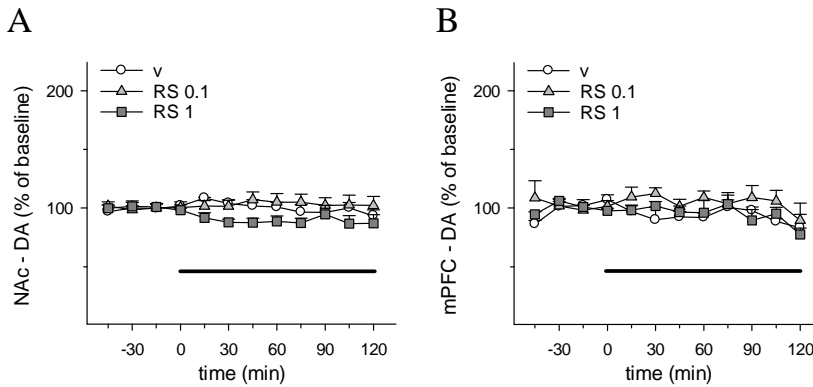

Fig. S1. Time course effect of the intra-nucleus accumbens (NAc) and intra-medial prefrontal cortex (mPFC) administration of RS 127445 on local dopamine (DA) outflow. (A) Effect of the intra-NAc perfusion (from time zero until the end of the experiment, horizontal bar) of 0.1 and 1 μ M RS 127445 (RS) on DA outflow in the NAc. (B) Effect of the intra-mPFC perfusion (from time zero until the end of the experiment, horizontal bar) of 0.1 and 1 μ M RS on DA outflow in the mPFC. Data are represented as the mean \pm SEM percentages of the baseline calculated from the three samples preceding the perfusion ($n= 4-6$ animals/group). Absolute basal levels of DA in dialysates collected in each brain region did not differ across the different experimental groups (A: $F_{(2,12)} = 0.26$, NS; B: $F_{(2,12)} = 1.08$, NS, ANOVA) and were (mean \pm SEM): 1.07 ± 0.11 nM ($n= 15$) for A, and 0.32 ± 0.03 nM ($n= 15$) for B. In both brain regions, basal DA outflow remained unaltered by the local infusion of RS 127445 (A: $F_{RS(2,12)} = 2.40$, NS; $F_{RS \times time(16,96)} = 1.04$, NS; B: $F_{RS(2,12)} = 1.58$, NS; $F_{RS \times time(16,96)} = 0.59$, NS, ANOVA).

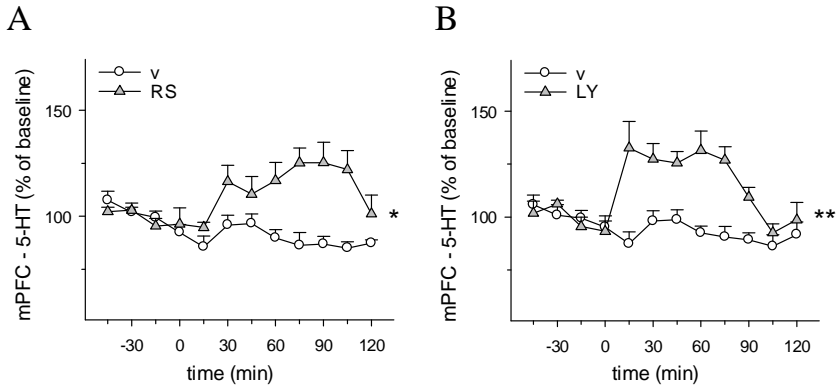

Fig. S2. Time course effect of the administration of RS 127445 and LY 266097 on serotonin (5-HT) outflow in the medial prefrontal cortex (mPFC). (A) RS 127445 (RS, 0.16 mg/kg) was intraperitoneally injected at time zero. (B) LY 266097 (LY, 0.63 mg/kg) was intraperitoneally injected at time zero. Data are represented as the mean \pm SEM percentages of the baseline calculated from the three samples preceding the perfusion ($n= 5-7$ animals/group). Absolute basal levels of DA in dialysates collected in the mPFC did not differ across the different experimental groups (A: $F_{(1,11)} = 0.23$, NS; B: $F_{(1,9)} = 1.42$, NS, ANOVA) and were (mean \pm SEM): 0.54 ± 0.05 nM ($n= 13$) for A and 0.53 ± 0.05 nM for B ($n= 11$). Both RS 127445 and LY 266097 elicited a time-dependent increase in 5-HT outflow (A: $F_{RS (1,11)} = 34.10$, $p<0.001$; $F_{RS \times time (8,88)} = 2.68$, $p<0.05$; B: $F_{LY (1,9)} = 50.92$, $p<0.001$; $F_{LY \times time (8,72)} = 3.74$, $p<0.01$, ANOVA). * $p<0.05$, ** $p<0.01$ versus the vehicle (v) group.

Article 2
To be submitted

A functional interplay with serotonin_{1A} receptors drives central serotonin_{2B} receptor-opposite controls of mesocortical and mesoaccumbal dopaminergic pathways

Céline Devroye^{a,b}, Nasser Haddjeri^{c,d}, Adeline Cathala^{a,b}, Renaud Rovera^{c,d},
Filippo Drago^e, Pier Vincenzo Piazza^{a,b}, Umberto Spampinato^{a,b*}

^aInserm U1215, Neurocentre Magendie, Physiopathology of Addiction group, Bordeaux, F-33000, France

^bUniversité de Bordeaux, Bordeaux, F-33000, France

^cInserm U1208, Stem Cell and Brain Research Institute, 69500 Bron, France

^dUniversité Lyon 1, 69373 Lyon, France

^eDepartment of Biomedical and Biotechnological Sciences, Section of Pharmacology, University of Catania, Catania, 95125, Italy

***Corresponding author:** Pr. U. Spampinato, Université de Bordeaux – Neurocentre Magendie, Inserm U1215, 146 rue Léo Saignat, 33077 Bordeaux Cedex, France. Tel. +33 (0) 557 57 37 57; Fax +33 (0) 557 57 36 69; e-mail: umberto.spampinato@inserm.fr

Abstract

Recent studies have shown that serotonin_{2B} receptor (5-HT_{2B}R) antagonists exert a differential control on ascending DA pathways, resulting in increased, decreased and unaltered DA release in the medial prefrontal cortex (mPFC), the nucleus accumbens (NAc) and the striatum, respectively. In keeping with the role of DA pathways in the symptomatology of schizophrenia, these findings led to the suggestion that 5-HT_{2B}R antagonists could be an interesting pharmacological tool for treating schizophrenia.

The present study, using *in vivo* microdialysis in freely-moving and anesthetized rats, aimed at assessing the role of the central 5-HT_{1A}R, known to play a key role in the therapeutic benefit of atypical antipsychotic drugs, in the opposite controls exerted by 5-HT_{2B}R antagonists on the mesocorticolimbic DA pathway. To this purpose, we used two selective 5-HT_{1A}R (WAY 100635) and 5-HT_{2B}R (RS 127445) antagonists.

RS 127445, administered either peripherally (0.16 mg/kg, i.p.) or locally into the dorsal raphe nucleus (DRN, 0.032 µg/0.2 µl), increased 5-HT outflow in the mPFC. Also, the opposite changes of mPFC and the NAc DA release induced by the intraperitoneal injection of RS 127445 were blocked by the peripheral (0.16 mg/kg, s.c) or the intra-mPFC (0.1 µM) administration of WAY 100635.

These results demonstrate the existence of a functional interplay between mPFC 5-HT_{1A}Rs and DRN 5-HT_{2B}Rs in the control of DA mesocorticolimbic system, and highlight the clinical interest of this interaction, as both receptors represent an important pharmacological target for the treatment of schizophrenia.

1. Introduction

The central serotonin_{2B} receptor (5-HT_{2B}R) is now well-established as a modulator of dopamine (DA) neuron function in the mammalian brain (Auclair *et al.*, 2010; Devroye *et al.*, 2015; Doly *et al.*, 2008, 2009). Interestingly, recent findings have pointed out this receptor as a new pharmacological target for treating schizophrenia (Devroye *et al.*, 2016). Indeed, 5-HT_{2B}R blockade reverses the cognitive deficit induced by phencyclidine (PCP) in the novel object recognition test and suppresses PCP-induced hyperlocomotion, two behavioral models classically used to predict the ability of antipsychotic drugs (APDs) to alleviate cognitive and positive symptoms of schizophrenia, respectively (Newman-Tancredi and Kleven, 2011). In keeping with the classical hypothesis that the cognitive and positive symptoms of schizophrenia result from a DA hypoactivity in the medial prefrontal cortex (mPFC) and a DA hyperactivity in the nucleus accumbens (NAc), respectively (Newman-Tancredi and Kleven, 2011; Svensson, 2000), the efficacy of 5-HT_{2B}R antagonists in these behavioral trials could be related to their ability to increase DA outflow in the mPFC and decrease it in the NAc (Auclair *et al.*, 2010; Devroye *et al.*, 2016).

However, the mechanisms underlying the 5-HT_{2B}R modulation of DA outflow remain unknown to date. The possibility of a local control has already been discarded, by recent findings showing that intra-mPFC or intra-NAc perfusion of 5-HT_{2B}R antagonists does not alter DA outflow in these brain regions (Devroye *et al.*, 2016). On the other hand, the fact that 5-HT_{2B}R blockade increases mPFC 5-HT outflow (Devroye *et al.*, 2016) raises the possibility that 5-HT_{2B}R antagonist-induced changes of DA outflow could involve polysynaptic cortico-subcortical circuits driven by the stimulation of 5-HT_{1A}Rs located in the mPFC. Indeed, agonists of the 5-HT_{1A}R, a key pharmacological target in the therapeutic benefit of atypical APDs (Meltzer and Massey, 2011; Newman-Tancredi and Kleven, 2011), are known to increase mPFC DA outflow and

decrease it in the NAc (Assié *et al.*, 2005; Ichikawa and Meltzer, 2000; Ichikawa *et al.*, 2001). As discussed elsewhere, these opposite effects could result from the stimulation of mPFC 5-HT_{1A}Rs (Devroye *et al.*, 2016; Lladó-Pelfort *et al.*, 2012).

Thus, the present study, using *in vivo* intracerebral microdialysis, was aimed at assessing the role of mPFC 5-HT_{1A}Rs in mediating the opposite effects of 5-HT_{2B}R antagonists on NAc and mPFC DA outflow, by using two selective 5-HT_{2B}R and 5-HT_{1A}R antagonists, RS 127445 and WAY 100635, respectively (Bonhaus *et al.*, 1999; Müller *et al.*, 2007). First, we assessed the influence of the peripheral and intra-mPFC administration of WAY 100635 on RS 127445-induced changes of DA outflow in the mPFC and the NAc. Thereafter, as 5-HT_{2B}Rs are expressed in the dorsal raphe nucleus (DRN; Bonaventure *et al.*, 2002; Duxon *et al.*, 1997), which contains 5-HT neurons projecting to the mPFC (Azmitia and Segal, 1978), we investigated the effect of the intra-DRN injection of RS 127445 on mPFC 5-HT outflow. Microdialysis experiments were performed in freely moving or isoflurane-anesthetized rats, this latter experimental procedure being used when simultaneously monitoring DA outflow in the NAc and mPFC or when monitoring 5-HT outflow after drug microinjection into the DRN.

2. Materials and methods

2.1. Animals

Male Sprague-Dawley rats (IFFA CREDO, Lyon, France) weighing 280-350 g were used. Animals, housed in individual plastic cages were kept at constant room temperature ($21 \pm 2^\circ\text{C}$) and relative humidity (60%) with a 12h light/dark cycle (dark from 20:00 h) and had free access to water and food. For electrophysiological experiments, rats were housed two per cage and kept under standard laboratory conditions as above. Animals were acclimated to the housing conditions for at least one week prior to the start of the experiments.

All experiments were conducted during the light phase of the light-dark cycle. Animals use procedures conformed to the International European Ethical Standards (86/609-EEC) and the French National Committee (décret 87/848) for the care and use of laboratory animals. All efforts were made to minimize animal suffering and to reduce the number of animals used.

2.2. Drugs

The following compounds were used: the 5-HT_{1A}R antagonist WAY 100635.C₄H₄O₄ (*N*-[2-[4-(2-Methoxyphenyl)-1-piperazinyl]ethyl]-*N*-2-pyridinylcyclohexanecarboxamide maleate), and the 5-HT_{2B}R antagonist RS 127445.HCl (2-amino-4-(4-fluoronaphth-1-yl)-6-isopropylpyrimidine hydrochloride), purchased from R&D Systems (Abingdon, UK). All other chemicals and reagents were the purest commercially available (VWR, Strasbourg, France; Sigma-Aldrich).

2.3. Pharmacological treatments

WAY 100635 was dissolved in distilled water and administered subcutaneously (s.c.) at 0.16 mg/kg in a volume of 1 ml/kg; when administered locally into the mPFC by reverse dialysis, it was first dissolved in distilled water to obtain a 500 mM concentration, and then further diluted to the required concentration (0.1 μM) with artificial cerebrospinal fluid just before use.

RS 127445 was dissolved in a 0.3% Tween 80 distilled water solution, and administered intraperitoneally (i.p.) at 0.16 mg/kg in a volume of 1 ml/kg, or locally injected into the DRN at 0.016 or 0.032 μg/0.2 μl. When studying their interaction, RS 127445 was administered systemically 30 min after the systemic injection of WAY 100635 or the beginning of its perfusion in the mPFC.

Doses and pretreatment administration time of WAY 100635 and RS 127445 were chosen according to their pharmacodynamic properties (Bonhaus *et al.*, 1999; Laporte *et al.*, 1994) and on the basis of previous studies reporting their

Publications

efficacy to selectively block 5-HT_{1A}Rs and 5-HT_{2B}Rs, respectively (Assié *et al.*, 2005; Ichikawa and Meltzer, 2000; Auclair *et al.*, 2010; Devroye *et al.*, 2016).

All drug doses were calculated as the free base. In each experimental group, animals received either drugs or their appropriate vehicle, according to a randomized design.

2.4. Microdialysis

Surgery and perfusion procedures were performed as previously described (Auclair *et al.*, 2010; Devroye *et al.*, 2016) with minor modifications. In all experiments, microdialysis probes (CMA/11, cuprophan, 240 µm outer diameter, Carnegie Medicin, Phymep) were 4 mm length for the mPFC and 2 mm length for the NAc. Stereotaxic coordinates were chosen according to the atlas of Paxinos and Watson (2005).

For experiments performed in freely moving animals (see Fig. 1), rats were anesthetized with 3% isoflurane (CSP, Cournon-d'Auvergne, France) and placed in a stereotaxic frame. A siliconized stainless guide-cannula (Carnegie Medicin, Phymep, Paris, France) was stereotaxically implanted, just above the right mPFC (coordinates of the lower extremity of the guide, in mm, relative to the interaural point: anteroposterior (AP) = 11.7, lateral (L) = 0.5, ventral (V) = 7.7) or the right NAc shell (AP = 10.7, L = 1.0, V = 4.0), so that the tip of the probe, once lowered through the guide-cannula, could reach a depth value of 3.7 mm (mPFC) or 2 mm (NAc shell) above the interaural point. The probe was inserted in the guide-cannula on the day of the experiment (5 to 7 days after surgery).

For experiments performed in anesthetized animals, rats were anesthetized with 3% isoflurane, and placed in a stereotaxic frame. When assessing DA outflow (see Fig 2), two microdialysis probes were simultaneously implanted in the right mPFC (coordinates, in mm, relative to the interaural point: 10° anterior from vertical, AP = 11.2, L = 0.5, V = 3.6) and the right NAc shell (AP = 10.7,

L = 1, V = 2). When assessing 5-HT outflow (Fig. 3), one microdialysis probe was implanted in the right mPFC (coordinates, in mm, relative to the interaural point: AP = 11.7, L = 0.5, V = 3.7). After the surgery, the percentage of isoflurane was adjusted to 1.5% until the end of the experiment.

In all experiments, probes were perfused at a constant flow rate (1 $\mu\text{l}/\text{min}$), by means of a microperfusion pump (CMA 111, Carnegie Medicin, Phymep), with artificial cerebrospinal fluid containing (in mM): 147 NaCl, 4 KCl, 2.2 CaCl₂, pH 7.4.

Pharmacological treatments (see section 2.3 for details), were performed 120 min after the beginning of the perfusion (stabilization period). DA outflow was monitored during 180 min (120 min when measuring DA outflow in the NAc of freely moving rats) after the last drug injection; 5-HT outflow was monitored during 120 min after the last drug injection. Dialysates were collected in a refrigerated fraction collector (MAB 85 Microbiotech, Phymep) every 15 min.

2.5. Surgical implantation of cannulae and microinjection protocol

In the experiment reported in Fig. 3, drug applications were performed after the stabilization of 5-HT levels in the perfusate (see section 2.3), as described previously (Leggio *et al.*, 2009).

Briefly, a stainless steel cannula (30 G) was stereotaxically lowered into the DRN through a previously drilled hole, just before drug injections, according to the atlas of Paxinos and Watson (2005) (coordinates, in mm, relative to the interaural point, 20° lateral from vertical, AP = 1.0, L = -1.6, V = 4.3). Drug or corresponding vehicle was delivered into the DRN (see section 2.3 for details) in a final volume of 0.2 μl at a constant flow rate of 0.1 $\mu\text{l}/\text{min}$ by a 5 μl Hamilton syringe (Sigma-Aldrich) and a syringe pump (Pico plus elite, Phymep). After completion of the microinjection, the injection cannula was left in place for an additional 5 min before withdrawal to allow diffusion from the tip and prevent reflux of the solution injected.

2.6. Histology

At the end of each experiment, the animal was deeply anesthetized with a pentobarbital overdose (100 mg/kg, CEVA, Libourne, France), and its brain was removed and fixed in NaCl (0.9%)/paraformaldehyde solution (10%). Probe or injection cannula location into the targeted region was determined histologically on serial coronal sections (60 μ m) stained with cresyl violet, and only data obtained from rats with correctly implanted probes were included in the results.

2.7. Chromatographic analysis

After collection, dialysate samples were immediately analyzed with a high-performance liquid chromatography apparatus (Alexys UHPLC/ECD Neurotransmitter Analyzer, Antec, The Netherlands), equipped with an autosampler (AS 110 UHPLC cool 6-PV, Antec), as described previously (Devroye *et al.*, 2016). The mobile phase [containing (in mM) 100 phosphoric acid, 100 citric acid, 0.1 EDTA.2H₂O, 4.6 octanesulfonic acid.NaCl plus 4.5% or 6% acetonitrile for the measurement of DA or 5-HT, respectively, adjusted to pH 6.0 with NaOH solution (50%)] was delivered at 0.065 ml/min flow rate with a LC 110S pump (Antec) through an Acquity UPLC BEH column (C₁₈; 1 x 100 mm, particle size 1.7 μ m; Waters, Saint-Quentin en Yvelynes, France). Detection of DA or 5-HT was carried out with an electrochemical detector (DECADE II, Antec) with a VT-03 glassy carbon electrode (Antec) set at +460 mV *versus* Ag/AgCl. Output signals were recorded on a computer (Clarity, Antec). Under these conditions, the retention times for DA and 5-HT were 4-4.5 and 8-8.5 min, respectively, and the sensitivity was 50 pM with a signal/noise ratio of 3:1.

DA and 5-HT content in each sample was expressed as the percentage of the average baseline level calculated from the three fractions preceding the first

drug administration. Data correspond to the mean \pm S.E.M. of the percentage obtained in each experimental group.

2.9. Statistics

Statistical analysis was carried out by Statistica 8.0 for Windows (Statsoft, Maisons-Alfort, France).

In microdialysis experiments, the ability of WAY 100635 (pretreatment) to modulate the effect of RS 127445 (treatment) on DA outflow was analyzed by a multifactorial ANOVA with pretreatment and treatment as the between-subject factors, and time as the within-subject factor (including values from time -15 to time 120 or 180 min). The effect of the intra-DRN administration of RS 127445 (treatment) on mPFC 5-HT outflow was analyzed by a multifactorial ANOVA with treatment as the between-subject factor, and time as the within-subject factor (including values from time -15 to time 120 min). In each experiment, statistical differences in basal DA or 5-HT values among groups were assessed by a one-way ANOVA using group as a main factor.

Finally, in all experiments, when multifactorial ANOVA results were significant ($p < 0.05$), the Newman-Keuls or the Dunnett (for dose-response studies) *post-hoc* test was performed to allow adequate multiple comparisons between groups.

3. Results

3.1. Effect of WAY 100635 on RS 127445-induced effects on mPFC and NAc DA outflow

Fig. 1 illustrates the effect of WAY 100635 on RS 127445-induced effects on DA outflow in the mPFC (Fig. 1A) and the NAc (Fig. 1B).

In the mPFC (Fig. 1A), statistical analysis revealed significant and time-dependent effects of pretreatment ($F_{\text{WAY} \times \text{time}} (14,182) = 3.26, p < 0.001$), treatment ($F_{\text{RS} \times \text{time}} (14,182) = 2.47, p < 0.01$), and pretreatment \times treatment interaction ($F_{\text{WAY} \times$

$F_{RS \times time (14,182)} = 2.43, p < 0.01$). Post-hoc analysis revealed that, as reported previously (Auclair *et al.*, 2010; Devroye *et al.*, 2016), RS 127445 produced an overall significant increase in DA outflow ($p < 0.05$, *versus* the vehicle/vehicle group), reaching 155% of baseline. WAY 100635, with no effect on basal DA outflow ($p > 0.05$, *versus* the vehicle/vehicle group), reduced RS 127445-induced increased DA outflow ($p < 0.01$, *versus* the vehicle/RS group).

In the NAc (Fig. 1B), statistical analysis revealed significant and time-dependent effects of pretreatment ($F_{WAY \times time (10,180)} = 7.72, p < 0.001$), treatment ($F_{RS \times time (10,180)} = 1.95, p < 0.05$), and pretreatment x treatment interaction ($F_{WAY \times RS \times time (10,180)} = 2.82, p < 0.01$). Post-hoc analysis revealed that, as reported previously (Auclair *et al.*, 2010; Devroye *et al.*, 2016), RS 127445 produced an overall significant decrease in DA outflow ($p < 0.01$, *versus* the vehicle/vehicle group), reaching 76% of baseline. WAY 100635, with no effect on basal DA outflow ($p > 0.05$, *versus* the vehicle/vehicle group), reversed RS 127445-induced decreased DA outflow ($p < 0.01$, *versus* the vehicle/RS group).

3.2. Effect of the intra-mPFC administration of WAY 100635 on RS 127445-induced effects on mPFC and NAc DA outflow

Fig. 2 illustrates the effect of WAY 100635 on RS 127445-induced effects on DA outflow in the mPFC (Fig.2A) and the NAc (Fig.2B).

In the mPFC (Fig. 2A), statistical analysis revealed no significant effect of pretreatment ($F_{WAY \times time (14,238)} = 1.22, NS$) but significant and time-dependent effects of treatment ($F_{RS \times time (14,238)} = 2.26, p < 0.01$) and pretreatment x treatment interaction ($F_{WAY \times RS \times time (14,238)} = 2.54, p < 0.01$). Post-hoc analysis revealed that, as previously observed (Auclair *et al.*, 2010; Devroye *et al.*, 2016), RS 127445 produced an overall significant increase in DA outflow ($p < 0.001$, *versus* the vehicle/vehicle group), reaching 146% of baseline. Intra-mPFC perfusion of WAY 100635, with no effect on basal DA outflow ($p > 0.05$, *versus* the

vehicle/vehicle group), reduced RS 127445-induced increased DA outflow ($p < 0.001$, *versus* the vehicle/RS group).

In the NAc (Fig. 2B), statistical analysis revealed a significant time-dependent effect of pretreatment ($F_{\text{WAY} \times \text{time}} (14,224) = 3.04$, $p < 0.001$), no significant effect of treatment ($F_{\text{RS} \times \text{time}} (14,224) = 0.99$, NS), and a significant time-dependent pretreatment x treatment interaction ($F_{\text{WAY} \times \text{RS} \times \text{time}} (14,224) = 2.35$, $p < 0.01$). Post-hoc analysis revealed that, as reported previously (Auclair *et al.*, 2010; Devroye *et al.*, 2016), RS 127445 produced an overall significant decrease in DA outflow ($p < 0.01$, *versus* the vehicle/vehicle group), reaching 61% of baseline. WAY 100635, with no effect on basal DA outflow ($p > 0.05$, *versus* the vehicle/vehicle group), reversed RS 127445-induced decreased DA outflow ($p < 0.01$, *versus* the vehicle/RS group).

3.3. Effect of the intra-DRN administration of RS 127445 on mPFC 5-HT outflow

Fig. 3 illustrates the effect of the intra-DRN administration of RS 127445 on 5-HT outflow in the mPFC.

Statistical analysis revealed a significant time-dependent effect of treatment ($F_{\text{RS} \times \text{time}} (16,88) = 2.02$, $p < 0.05$). Post-hoc analysis revealed that the dose of 0.032 $\mu\text{g}/0.2 \mu\text{l}$ of RS 127445 (but not 0.016 $\mu\text{g}/0.2 \mu\text{l}$) produced an overall significant increase in 5-HT outflow, reaching 164% of baseline ($p < 0.001$, *versus* the vehicle group).

4. Discussion

The present study provides the first evidence that 5-HT_{1A}Rs participate to the 5-HT_{2B}R-mediated control of the mesocortical and mesoaccumbal DA pathway activity. Specifically, the ability of 5-HT_{2B}R antagonists to increase and decrease DA outflow in the mPFC and the NAc, respectively, is consequent to the activation of mPFC 5-HT_{1A}Rs, likely triggered by increased mPFC 5-HT outflow induced by DRN 5-HT_{2B}R blockade. These findings demonstrate the existence of a functional interplay between 5-HT_{2B}Rs and 5-HT_{1A}Rs, and highlight its interest for the development of new atypical APDs.

In the present study, the effects of 5-HT_{2B}R and 5-HT_{1A}R blockade were assessed by using two potent and selective antagonists, RS 127445 and WAY 100635, respectively, which have been well-characterized *in vitro* and *in vivo* (Auclair *et al.*, 2010; Devroye *et al.*, 2016; Müller *et al.*, 2007). Both compounds possess high affinity for the corresponding receptor (pKi for RS 127445 = 9.50 and pKi for WAY 100635 = 9.02) and at least 1000-fold (RS 127445) and 100-fold (WAY 100635) selectivity for the 5-HT_{2B}R and the 5-HT_{1A}R, respectively, over other receptors (Bonhaus *et al.*, 1996; Fletcher *et al.*, 1996).

In a first group of experiments, using microdialysis in freely moving rats, we assessed the effect of WAY 100635 on RS 127445-induced changes of mPFC and NAc DA outflow, following their peripheral administration. In agreement with previous studies (Auclair *et al.*, 2010; Devroye *et al.*, 2016), RS 127445 was able to increase and decrease DA outflow in the mPFC and the NAc, respectively. WAY 100635 pretreatment had no effect by itself, as previously shown (Assié *et al.*, 2005; Ichikawa and Meltzer, 2000), but suppressed both responses of RS 127445. These findings demonstrate that 5-HT_{1A}Rs participate to the 5-HT_{2B}R-mediated control of mesocorticolimbic DA pathways.

A second group of experiments aimed at exploring the specific involvement of 5-HT_{1A}Rs located in the mPFC, where they are expressed on GABA

interneurons and on glutamate containing-pyramidal neurons (Lladó-Pelfort *et al.*, 2012; Santana *et al.*, 2004). Also, it has been shown that the stimulation of GABA-5-HT_{1A}Rs inhibits the activity of these interneurons, leading to the disinhibition of mPFC glutamatergic neurons, which in turn send excitatory projections to the VTA (Lladó-Pelfort *et al.*, 2012) where they provide a direct and a GABA-mediated input to DA neurons projecting to the mPFC and the NAc, respectively (Sesack *et al.*, 2003; Svensson, 2000). Interestingly, we found that intra-mPFC perfusion of WAY 100635 reversed the changes in mPFC and NAc DA outflow elicited by the peripheral administration of RS 127445, thereby confirming the specific involvement of mPFC 5-HT_{1A}Rs in the 5-HT_{2B}R-mediated effects on DA outflow. It is tempting to suggest that the opposite effects induced 5-HT_{2B}R blockade on mPFC and NAc DA outflow could result from the stimulation of 5-HT_{1A}Rs localized to mPFC GABA interneurons. Indeed, the fact that 5-HT_{2B}R antagonists increase mPFC 5-HT outflow makes unlikely the involvement of the 5-HT_{1A}Rs expressed on glutamatergic neurons, whose contribution to the observed effects on DA outflow would have required a suppression of mPFC 5-HT endogenous tone, leading to the disinhibition of pyramidal neurons. Our conclusion is in line with previous studies suggesting the role of GABA interneurons in the 5-HT_{1A}R agonist-induced increase in mPFC DA outflow (Díaz-Mataix *et al.*, 2005; Lladó-Pelfort *et al.*, 2012), and suggest that this receptor population may also participate to the 5-HT_{1A}R agonist-induced decrease in DA outflow in the NAc (Ichikawa and Meltzer, 2000).

The next step of our investigations aimed at determining the site of action of 5-HT_{2B}R antagonists. Considering that 5-HT_{2B}Rs are expressed in the DRN (Bonaventure *et al.*, 2002; Duxon *et al.*, 1997), which is known to send 5-HT projections to the mPFC (Azmitia and Segal, 1978), we further explored the role of the DRN in the 5-HT_{2B}R antagonist-induced increase in mPFC 5-HT outflow. We found that, as following its systemic administration (Devroye *et al.*, 2016), intra-DRN microinjection of RS 127445 induced a dose-dependent

increase in 5-HT outflow in the mPFC. Thus, altogether our findings suggest that 5-HT_{2B}R blockade in the DRN, by increasing 5-HT outflow in the mPFC, triggers the stimulation of mPFC 5-HT_{1A}Rs located onto GABAergic interneurons, leading to the activation of pyramidal glutamatergic neurons projecting to the VTA, thereby driving opposite changes in mPFC and NAc DA outflow. Additional intracranial microinjection studies are warranted to confirm the functional interplay between DRN 5-HT_{2B}Rs and mPFC 5-HT_{1A}Rs. Noteworthy, the present findings provide the first evidence of an effect exerted by a specific 5-HT_{2B}R population in the central nervous system. As regards the mechanisms involved in the 5-HT_{2B}R-mediated control of 5-HT neurons, it is noteworthy that previous *in vitro* studies in primary neurons of mouse DRN have suggested that these receptors may govern the activity of the 5-HT transporter (Launay *et al.*, 2006). The involvement of such an interaction remains to be established in the living rat.

Finally, the present findings deserve some considerations from a therapeutic point of view. It has been recently shown that 5-HT_{2B}R antagonists induce a suppressive effect in behavioral models classically used to reflect the cognitive and positive symptoms of schizophrenia, suggesting that they could be useful for the development of new atypical APDs (Devroye *et al.*, 2016; Newman-Tancredi and Kleven, 2011; Svensson, 2000). Cognitive and positive symptoms being related to a hypoDA and hyperDA activity in the mesocortical and mesoaccumbal DA pathways, respectively (Newman-Tancredi and Kleven, 2011; Svensson, 2000), 5-HT_{2B}R antagonist ability to alleviate these symptoms may result from their differential control of mPFC and NAc DA outflow. Thus, it is tempting to suggest that 5-HT_{1A}Rs would enable the efficacy of 5-HT_{2B}R antagonists in these behavioral paradigms. Also, the existence of a functional interplay between 5-HT_{2B}Rs and 5-HT_{1A}Rs suggests that drugs exhibiting both antagonist and agonist properties towards the 5-HT_{2B}Rs and the 5-HT_{1A}Rs, respectively, would represent a useful pharmacological tool for improved treatments of schizophrenia. In line with this hypothesis, many atypical APDs

already combine these two pharmacological features (Abbas *et al.*, 2009; Kiss *et al.*, 2010; Shahid *et al.*, 2009; Shapiro *et al.*, 2003). Furthermore, the 5-HT_{1A}R is known to play a critical role in the therapeutic benefit of atypical APDs (Meltzer and Massey, 2011; Newman-Tancredi and Kleven, 2011). In this context, additional investigations are needed to evaluate the significance of the functional interplay between 5-HT_{1A}Rs and 5-HT_{2B}Rs in the therapeutic benefit of atypical APDs.

To conclude, the present study provides the first evidence of a functional interplay between 5-HT_{2B}Rs and 5-HT_{1A}Rs, which accounts for the differential effects exerted by 5-HT_{2B}Rs antagonists on DA outflow in the mPFC and the NAc. Specifically, the tonic inhibitory and excitatory controls of mesocortical and mesoaccumbal DA pathways resulting from 5-HT_{2B}R blockade would involve a DRN-5-HT_{2B}R-dependent increase of mPFC 5-HT outflow leading to the stimulation of mPFC 5-HT_{1A}Rs. Finally, our findings support the therapeutic relevance of atypical APDs combining 5-HT_{2B}R antagonist and 5-HT_{1A}R agonist properties for the improved treatment of schizophrenia.

Acknowledgements

This work was supported by grants from the Institut National de la Recherche et de la Santé (INSERM) and Bordeaux University. C. Devroye was a fellowship recipient from the International Ph.D. program in Neuropharmacology, University of Catania Medical School, Catania, Italy, during the course of this study. The authors wish to thank Cédric Dupuy for providing excellent care to animals and Dr Adrian Newman-Tancredi for fruitful discussions during the accomplishment of this study.

References

- Abbas, A.I., Hedlund, P.B., Huang, X.P., Tran, T.B., Meltzer, H.Y., Roth, B.L., 2009. Amisulpride is a potent 5-HT₇ antagonist: relevance for antidepressant actions in vivo. *Psychopharmacology* 205, 119-128.
- Assié, M.B., Ravailhe, V., Faucillon, V., Newman-Tancredi, A., 2005. Contrasting contribution of 5-hydroxytryptamine 1A receptor activation to neurochemical profile of novel antipsychotics: frontocortical dopamine and hippocampal serotonin release in rat brain. *J. Pharmacol. Exp. Ther.* 315, 265-272.
- Auclair, A.L., Cathala, A., Sarrazin, F., Depoortère, R., Piazza, P.V., Newman-Tancredi, A., Spampinato, U., 2010. The central serotonin 2B receptor: a new pharmacological target to modulate the mesoaccumbens dopaminergic pathway activity. *J. Neurochem.* 114, 1323-1332.
- Azmitia, E.C., Segal, M., 1978. An autoradiographic analysis of the differential ascending projections of the dorsal and median raphe nuclei in the rat. *J. Comp. Neurol.* 179, 641-668.
- Beier, K.T., Steinberg, E.E., DeLoach, K.E., Xie, S., Miyamichi, K., Schwarz, L., Gao, X.J., Kremer, E.J., Malenka, R.C., Luo, L., 2015. Circuit architecture of VTA dopamine neurons revealed by systematic input-output mapping. *Cell* 162, 622-634.
- Bonaventure, P., Guo, H., Tian, B., Liu, X., Bittner, A., Roland, B., Salunga, R., Ma, X.J., Kamme, F., Meurers, B., Bakker, M., Jurzak, M., Leysen, J.E., Erlander, M.G., 2002. Nuclei and subnuclei gene expression profiling in mammalian brain. *Brain. Res.* 943, 38-47.
- Bonhaus, D.W., Flippin, L.A., Greenhouse, R.J., Jaime, S., Rocha, C., Dawson, M., Van Natta, K., Chang, L.K., Pulido-Rios, T., Webber, A., Leung, E., Eglen, R.M., Martin, G.R., 1999. RS-127445: a selective, high affinity, orally bioavailable 5-HT_{2B} receptor antagonist. *Br. J. Pharmacol.* 127, 1075-1082.
- Carr, D.B., Sesack, S.R., 2000. Projections from the rat prefrontal cortex to the ventral tegmental area: target specificity in the synaptic associations with mesoaccumbens and mesocortical neurons. *J. Neurosci.* 20, 3864-3873.
- Devroye, C., Cathala, A., Di Marco, B., Caraci, F., Drago, F., Piazza, P.V., Spampinato, U., 2015. Central serotonin(2B) receptor blockade inhibits cocaine-induced hyperlocomotion independently of changes of subcortical dopamine outflow. *Neuropharmacology* 97, 329-337.

Publications

- Devroye, C., Cathala, A., Haddjeri, N., Rovera, R., Vallée, M., Drago, F., Piazza, P.V., Spampinato, U., 2016. Differential control of dopamine ascending pathways by serotonin_{2B} receptor antagonists: New opportunities for the treatment of schizophrenia. *Neuropharmacology* 109, 59-68.
- Díaz-Mataix, L., Scorza, M.C., Bortolozzi, A., Toth, M., Celada, P., Artigas, F., 2005. Involvement of 5-HT_{1A} receptors in prefrontal cortex in the modulation of dopaminergic activity: role in atypical antipsychotic action. *J. Neurosci.* 25, 10831-10843.
- Doly, S., Bertran-Gonzalez, J., Callebert, J., Bruneau, A., Banas, S.M., Belmer, A., Boutourlinsky, K., Hervé, D., Launay, J.M., Maroteaux, L., 2009. Role of serotonin via 5-HT_{2B} receptors in the reinforcing effects of MDMA in mice. *PLoS ONE* 4, e7952.
- Doly, S., Valjent, E., Setola, V., Callebert, J., Hervé, D., Launay, J.M., Maroteaux, L., 2008. Serotonin 5-HT_{2B} receptors are required for 3,4-methylenedioxymethamphetamine-induced hyperlocomotion and 5-HT release *in vivo* and *in vitro*. *J. Neurosci.* 28, 2933-2940.
- Duxon, M.S., Flanigan, T.P., Reavley, A.C., Baxter, G.S., Blackburn, T.P., Fone, K.C., 1997. Evidence for expression of the 5-hydroxytryptamine-2B receptor protein in the rat central nervous system. *Neuroscience* 76, 323-329.
- Fletcher, A., Forster, E.A., Bill, D.J., Brown, G., Cliffe, I.A., Hartley, J.E., Jones, D.E., McLenachan, A., Stanhope, K.J., Critchley, D.J., Childs, K.J., Middlefell, V.C., Lanfumey, L., Corradetti, R., Laporte, A.M., Gozlan, H., Hamon, M., Dourish, C.T., 1996. Electrophysiological, biochemical, neurohormonal and behavioural studies with WAY-100635, a potent, selective and silent 5-HT_{1A} receptor antagonist. *Behav. Brain Res.* 73, 337-353.
- Ichikawa, J., Meltzer, H.Y., 2000. The effect of serotonin_{1A} receptor agonism on antipsychotic drug-induced dopamine release in rat striatum and nucleus accumbens. *Brain Res.* 858, 252-263.
- Ichikawa, J., Ishii, H., Bonaccorso, S., Fowler, W.L., O'Laughlin, I.A., Meltzer, H.Y., 2001. 5-HT_{2A} and D₂ receptor blockade increases cortical DA release via 5-HT_{1A} receptor activation: a possible mechanism of atypical antipsychotic-induced cortical dopamine release. *J. Neurochem.* 76, 1521-1531.
- Ikemoto, S., 2007. Dopamine reward circuitry: two projection systems from the ventral midbrain to the nucleus accumbens-olfactory tubercle complex. *Brain Res. Rev.* 56, 27-78.

- Kiss, B., Horváth, A., Némethy, Z., Schmidt, E., Laszlovszky, I., Bugovics, G., Fazekas, K., Hornok, K., Orosz, S., Gyertyán, I., Agai-Csongor, E., Domány, G., Tihanyi, K., Adham, N., Szombathelyi, Z., 2010. Cariprazine (RGH-188), a dopamine D(3) receptor-preferring, D(3)/D(2) dopamine receptor antagonist-partial agonist antipsychotic candidate: in vitro and neurochemical profile. *J. Pharmacol. Exp. Ther.* 333, 328-340.
- Lammel, S., Lim, B.K., Malenka, R.C., 2014. Reward and aversion in a heterogeneous midbrain dopamine system. *Neuropharmacology* 76, 351-359.
- Laporte, A.M., Lima, L., Gozlan, H., Hamon, M., 1994. Selective in vivo labelling of brain 5-HT1A receptors by [3H]WAY 100635 in the mouse. *Eur. J. Pharmacol.* 271, 505-514.
- Leggio, G.M., Cathala, A., Neny, M., Rouge-Pont, F., Drago, F., Piazza, P.V., Spampinato, U., 2009. In vivo evidence that constitutive activity of serotonin_{2C} receptors in the medial prefrontal cortex participates in the control of dopamine release in the rat nucleus accumbens: differential effects of inverse agonist versus antagonist. *J. Neurochem.* 111, 614-623.
- Lladó-Pelfort, L., Santana, N., Ghisi, V., Artigas, F., Celada, P., 2012. 5-HT1A receptor agonists enhance pyramidal cell firing in prefrontal cortex through a preferential action on GABA interneurons. *Cereb. Cortex* 22, 1487-1497.
- Meltzer, H.Y., Massey, B.W., 2011. The role of serotonin receptors in the action of atypical antipsychotic drugs. *Curr. Opin. Pharmacol.* 11, 59-67.
- Müller, C.P., Carey, R.J., Huston, J.P., De Souza Silva, M.A., 2007. Serotonin and psychostimulant addiction: focus on 5-HT1A-receptors. *Prog. Neurobiol.* 81, 133-178.
- Newman-Tancredi, A., Kleven, M.S., 2011. Comparative pharmacology of antipsychotics possessing combined dopamine D2 and serotonin 5-HT1A receptor properties. *Psychopharmacology* 216, 451-473.
- Paxinos, G., Watson, C., 2005. *The rat brain in stereotaxic coordinates*, 6th ed. Academic Press.
- Santana, N., Bortolozzi, A., Serrats, J., Mengod, G., Artigas, F., 2004. Expression of serotonin_{1A} and serotonin_{2A} receptors in pyramidal and GABAergic neurons of the rat prefrontal cortex. *Cereb. Cortex* 14, 1100-1109.
- Schapira, A.H., Bezard, E., Brotchie, J., Calon, F., Collingridge, G.L., Ferger, B., Rebsam, A., Roumier, A., Maroteaux, L., 2006. Novel pharmacological targets for the treatment of Parkinson's disease. *Nat. Rev. Drug Discov.* 5, 845-854.

Publications

- Sesack, S.R., Carr, D.B., Omelchenko, N., Pinto, A., 2003. Anatomical substrates for glutamate-dopamine interactions: evidence for specificity of connections and extrasynaptic actions. *Ann. N. Y. Acad. Sci.* 1003, 36-52.
- Shahid, M., Walker, G.B., Zorn, S.H., Wong, E.H., 2009. Asenapine: a novel psychopharmacologic agent with a unique human receptor signature. *J. Psychopharmacol.* 23, 65-73.
- Shapiro, D.A., Renock, S., Arrington, E., Chiodo, L.A., Liu, L.X., Sibley, D.R., Roth, B.L., Mailman, R., 2003. Aripiprazole, a novel atypical antipsychotic drug with a unique and robust pharmacology. *Neuropsychopharmacology* 28, 1400-1411.
- Svensson, T.H., 2000. Dysfunctional brain dopamine systems induced by psychotomimetic NMDA-receptor antagonists and the effects of antipsychotic drugs. *Brain Res. Brain Res. Rev.* 31, 320-329.

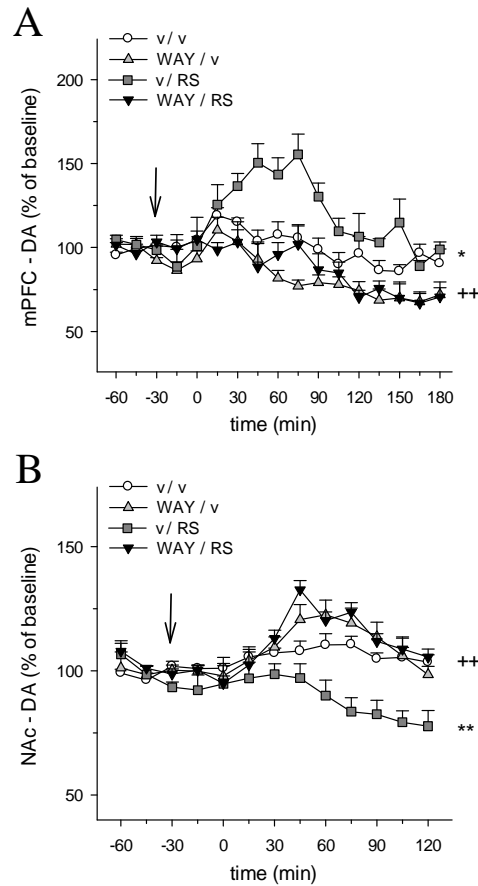

Fig. 1. Time course effect of the peripheral administration of WAY 100635 on RS 127445-induced changes of dopamine (DA) outflow in the medial prefrontal cortex (mPFC) and the nucleus accumbens (NAc). Effect of the subcutaneous (s.c.) administration (vertical arrow) of 0.16 mg/kg WAY 100635 (WAY) on the changes in DA outflow induced by the intraperitoneal administration (time zero) of RS 127445 (RS, 0.16 mg/kg), in the mPFC (A) and the NAc (B). Data are represented as the mean \pm SEM percentages of the baseline calculated from the three samples preceding drug administration ($n= 4-6$ and $5-6$ animals/group for the mPFC and the NAc, respectively). Absolute basal levels of DA in dialysates collected in each brain region did not differ across the different experimental groups (mPFC: $F(1,15) = 2.65$, NS; NAc: $F(1,18) = 1.63$, NS, ANOVA) and were (mean \pm SEM): 0.25 ± 0.03 nM for the mPFC ($n= 19$) and 1.28 ± 0.12 nM for the NAc ($n= 22$). * $p < 0.05$, ** $p < 0.01$ versus the corresponding v/v group and ++ $p < 0.01$ versus the corresponding v/RS group (Newman-Keuls test).

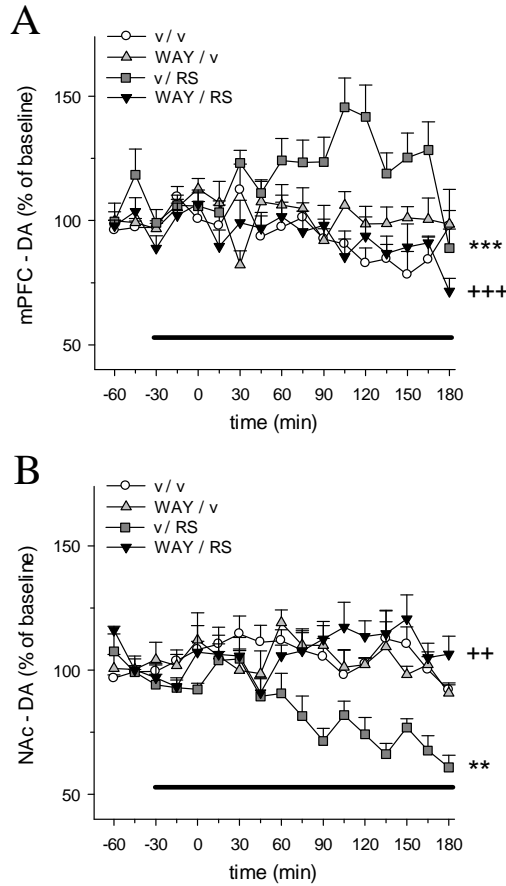

Fig. 2. Time course effect of the intra-mPFC administration of WAY 100635 on RS 127445-induced changes of dopamine (DA) outflow in the medial prefrontal cortex (mPFC) and the nucleus accumbens (NAc). Effect of the intra-mPFC administration (horizontal bars) of 0.1 μ M WAY 100635 (WAY) on the changes in DA outflow induced by the intraperitoneal administration (time zero) of RS 127445 (RS, 0.16 mg/kg), in the mPFC (A) and the NAc (B). Data are represented as the mean \pm SEM percentages of the baseline calculated from the three samples preceding drug administration ($n = 4-7$ and $4-6$ animals/group for the mPFC and the NAc, respectively). Absolute basal levels of DA in dialysates collected in each brain region did not differ across the different experimental groups (mPFC: $F(1,17) = 1.36$, NS; NAc: $F(1,16) = 0.21$, NS, ANOVA) and were (mean \pm SEM): 0.26 ± 0.02 nM for the mPFC ($n = 21$) and 0.70 ± 0.09 nM for the NAc ($n = 20$). ** $p < 0.01$, *** $p < 0.001$ versus the corresponding v/v group and ++ $p < 0.01$, +++ $p < 0.001$ versus the corresponding v/RS group (Newman-Keuls test).

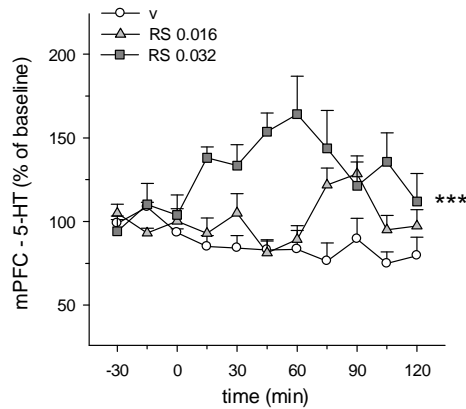

Fig. 3. Time course effect of the intra-dorsal raphe nucleus (DRN) administration of RS 127445 on serotonin (5-HT) outflow in the medial prefrontal cortex (mPFC). RS 127445 (RS) was administered (0.016 or 0.032 $\mu\text{g}/0.2 \mu\text{l}$) into the DRN at time zero. Data are represented as the mean \pm SEM percentages of the baseline calculated from the three samples preceding drug administration ($n=4$ animals/group). Absolute basal levels of 5-HT in dialysates collected in the DRN did not differ across the different experimental groups ($F_{(1,6)} = 1.33$, NS; ANOVA) and were (mean \pm SEM): 0.24 ± 0.03 nM ($n=8$). *** $p < 0.001$ versus the corresponding v group (Dunnett test).

Article 3

Devroye *et al.*, 2015, *Neuropharmacology* 97, 329-337

Adapted from the PDF version of our manuscript



Contents lists available at ScienceDirect

Neuropharmacology

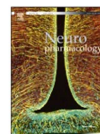
journal homepage: www.elsevier.com/locate/neuropharm

Central serotonin_{2B} receptor blockade inhibits cocaine-induced hyperlocomotion independently of changes of subcortical dopamine outflow



Céline Devroye^{a,b}, Adeline Cathala^{a,b}, Barbara Di Marco^{a,1}, Filippo Caraci^{a,c,2},
Filippo Drago^d, Pier Vincenzo Piazza^{a,b}, Umberto Spampinato^{a,b,*}

^a Inserm, U862, Neurocentre Magendie, Physiopathology of Addiction Group, Bordeaux, F-33000, France

^b Université de Bordeaux, Bordeaux, F-33000, France

^c Department of Drug Sciences, University of Catania, Catania, 95125, Italy

^d Department of Biomedical and Biotechnological Sciences, Section of Pharmacology, University of Catania, Catania, 95125, Italy

ARTICLE INFO

Article history:

Received 25 March 2015

Received in revised form

10 June 2015

Accepted 16 June 2015

Available online 25 June 2015

Keywords:

5-HT_{2B} receptor

Dopamine

Cocaine

Dorsal striatum

Nucleus accumbens

Rat

ABSTRACT

The central serotonin_{2B} receptor (5-HT_{2B}R) is currently considered as an interesting pharmacological target for improved treatment of drug addiction. In the present study, we assessed the effect of two selective 5-HT_{2B}R antagonists, RS 127445 and LY 266097, on cocaine-induced hyperlocomotion and dopamine (DA) outflow in the nucleus accumbens (NAc) and the dorsal striatum of freely moving rats. The peripheral administration of RS 127445 (0.16 mg/kg, i.p.) or LY 266097 (0.63 mg/kg, i.p.) significantly reduced basal DA outflow in the NAc shell, but had no effect on cocaine (10 mg/kg, i.p.)-induced DA outflow in this brain region. Also, RS 127445 failed to modify both basal and cocaine-induced DA outflow in the NAc core and the dorsal striatum. Conversely, both 5-HT_{2B}R antagonists reduced cocaine-induced hyperlocomotion. Furthermore, RS 127445 as well as the DA-R antagonist haloperidol (0.1 mg/kg, i.p.) reduced significantly the late-onset hyperlocomotion induced by the DA-R agonist quinpirole (0.5 mg/kg, s.c.). Altogether, these results demonstrate that 5-HT_{2B}R blockade inhibits cocaine-induced hyperlocomotion independently of changes of subcortical DA outflow. This interaction takes place downstream to DA neurons and could involve an action at the level of dorsostriatal and/or NAc DA transmission, in keeping with the importance of these brain regions in the behavioural responses of cocaine. Overall, this study affords additional knowledge into the regulatory control exerted by the 5-HT_{2B}R on ascending DA pathways, and provides additional support to the proposed role of 5-HT_{2B}Rs as a new pharmacological target in drug addiction.

© 2015 Elsevier Ltd. All rights reserved.

1. Introduction

The serotonin_{2B} receptor (5-HT_{2B}R), a member of the G-protein coupled receptor superfamily was first cloned and characterized in

the rat stomach fundus (McCorvy and Roth, 2015). Subsequent mRNA expression and *in-situ* hybridization studies showed its presence in various peripheral tissues (liver, kidney, heart) (McCorvy and Roth, 2015), as well as in several regions of the mammalian brain, such as the frontal cortex, lateral septum, dorsal hypothalamus, medial amygdala, dorsal raphe nucleus, locus coeruleus, hippocampus and cerebellum (Bonaventure et al., 2002; Duxon et al., 1997). During the last decade, the 5-HT_{2B}R has been shown to modulate dopamine (DA) neuron activity in the mammalian brain (Auclair et al., 2010; Doly et al., 2008, 2009). In keeping with the key role of the DA ascending pathways in the effects of drugs of abuse (Di Chiara and Bassareo, 2007; Pierce and Vanderschuren, 2010), the 5-HT_{2B}R has been suggested as a new pharmacological target for improved treatment of drug addiction

* Corresponding author. Université de Bordeaux, Inserm U862, 146 rue Léo Saigant, 33077, Bordeaux Cedex, France.

E-mail addresses: celine.devroye@inserm.fr (C. Devroye), adeline.cathala@inserm.fr (A. Cathala), bbr.dimarco@gmail.com (B. Di Marco), filippo.caraci@inserm.fr (F. Caraci), fdrago@tin.it (F. Drago), pier-vincenzo.piazza@inserm.fr (P.V. Piazza), umberto.spampinato@inserm.fr (U. Spampinato).

¹ Present address: Institute of Neurological Sciences, National Research Council (CNR), Catania, Italy.

² On leave the absence from Department of Drug Sciences, University of Catania, Catania, Italy.

Abstract

The central serotonin_{2B} receptor (5-HT_{2B}R) is currently considered as an interesting pharmacological target for improved treatment of drug addiction. In the present study, we assessed the effect of two selective 5-HT_{2B}R antagonists, RS 127445 and LY 266097, on cocaine-induced hyperlocomotion and dopamine (DA) outflow in the nucleus accumbens (NAc) and the dorsal striatum of freely moving rats. The peripheral administration of RS 127445 (0.16 mg/kg, i.p.) or LY 266097 (0.63 mg/kg, i.p.) significantly reduced basal DA outflow in the NAc shell, but had no effect on cocaine (10 mg/kg, i.p.)-induced DA outflow in this brain region. Also, RS 127445 failed to modify both basal and cocaine-induced DA outflow in the NAc core and the dorsal striatum. Conversely, both 5-HT_{2B}R antagonists reduced cocaine-induced hyperlocomotion. Furthermore, RS 127445 as well as the DA-R antagonist haloperidol (0.1 mg/kg, i.p.) reduced significantly the late-onset hyperlocomotion induced by the DA-R agonist quinpirole (0.5 mg/kg, s.c.). Altogether, these results demonstrate that 5-HT_{2B}R blockade inhibits cocaine-induced hyperlocomotion independently of changes of subcortical DA outflow. This interaction takes place downstream to DA neurons and could involve an action at the level of dorsostriatal and/or NAc DA transmission, in keeping with the importance of these brain regions in the behavioural responses of cocaine. Overall, this study affords additional knowledge into the regulatory control exerted by the 5-HT_{2B}R on ascending DA pathways, and provides additional support to the proposed role of 5-HT_{2B}Rs as a new pharmacological target in drug addiction.

1. Introduction

The serotonin_{2B} receptor (5-HT_{2B}R), a member of the G-protein coupled receptors superfamily was first cloned and characterized in the rat stomach fundus (McCorvy and Roth 2015). Subsequent mRNA expression and *in-situ* hybridization studies showed its presence in various peripheral tissues (liver, kidney, heart) (McCorvy and Roth 2015), as well as in several regions of the mammalian brain, such as the frontal cortex, lateral septum, dorsal hypothalamus, medial amygdala, dorsal raphe nucleus, locus coeruleus, hippocampus and cerebellum (Bonaventure *et al.*, 2002; Duxon *et al.*, 1997). During the last decade, the 5-HT_{2B}R has been shown to modulate dopamine (DA) neuron activity in the mammalian brain (Auclair *et al.*, 2010; Doly *et al.*, 2008, 2009). In keeping with the key role of the DA ascending pathways in the effects of drugs of abuse (Di Chiara and Bassareo, 2007; Pierce and Vanderschuren, 2010), the 5-HT_{2B}R has been suggested as a new pharmacological target for improved treatment of drug addiction (Auclair *et al.*, 2010). Indeed, peripheral administration of selective 5-HT_{2B}R antagonists revealed that 5-HT_{2B}Rs exert a tonic excitatory control on DA release in the shell subregion of the nucleus accumbens (NAc, Auclair *et al.*, 2010), accumbal DA release being the hallmark of all drugs abused by humans (Carboni *et al.*, 1989; Di Chiara and Imperato, 1988). In addition, several studies have indicated that 5-HT_{2B}Rs participate in the neurochemical and behavioural effects of methylenedioxymetamphetamine (MDMA) and amphetamine. Indeed, pharmacological blockade or genetic inactivation of 5-HT_{2B}Rs suppresses the hyperlocomotion, locomotor sensitization and conditioned place preference as well as the increase in accumbal DA outflow induced by MDMA (Doly *et al.*, 2008, 2009). Furthermore, 5-HT_{2B}R blockade reduces amphetamine-induced hyperlocomotion and increased DA outflow in the NAc shell (Auclair *et al.*, 2010). However, the impact of 5-HT_{2B}Rs on the neurochemical and behavioural

responses induced by cocaine, one of the most worldwide abused drugs, remains unknown to date.

Thus, the present study was aimed at addressing this issue by studying the effect of 5-HT_{2B}R blockade on cocaine-induced hyperlocomotion and DA outflow in subcortical brain regions. To this purpose, we used two selective, potent and brain-penetrant 5-HT_{2B}R antagonists, RS 127445 and LY 266097 (Audia *et al.*, 1996; Bonhaus *et al.*, 1999). First we investigated the effect of 5-HT_{2B}R blockade on cocaine-induced DA outflow using intracerebral microdialysis in freely moving rats. Specifically, we monitored DA outflow in the NAc shell and core subregions and in the dorsal striatum, these regions being known to play a key role in mediating the behavioural responses of drugs of abuse (Koob and Volkow, 2010; Pierce and Vanderschuren, 2010; Wise, 2009). Secondly, we assessed the effect of 5-HT_{2B}R blockade on cocaine-induced hyperlocomotion, a response typically related to DA function (Beeler *et al.*, 2009; Dunnett and Robbins, 1992). Finally, to provide a deeper insight into the role of 5-HT_{2B}R in the control of stimulated locomotor activity, we assessed the effect of 5-HT_{2B}R blockade on the late-onset hyperlocomotion induced by the DA-D₂R agonist quinpirole. This effect, which has been well characterized in the literature (Benaliouad *et al.*, 2009 ; Cathala *et al.*, 2015 ; Eilam and Szechtman, 1989 ; Koeltzow *et al.*, 2003), occurs independently of DA outflow and, at variance with cocaine-induced hyperlocomotion, is related to direct stimulation of post-synaptic DA-Rs.

2. Materials and Methods

2.1. Animals

Male Sprague-Dawley rats (IFFA CREDO, Lyon, France) weighing 320-350 g were used. Animals, housed in individual plastic cages, were kept at constant room temperature (21±2°C) and relative humidity (60%) with a 12h light/dark cycle (dark from 20:00 h) and had free access to water and food. Animals were

acclimated to the housing conditions for at least one week prior to the start of the experiments. All experiments were conducted during the light phase of the light-dark cycle. Animals use procedures conformed to the International European Ethical Standards (86/609-EEC) and the French National Committee (décret 87/848) for the care and use of laboratory animals. All efforts were made to minimize animal suffering and to reduce the number of animals used.

2.2. Drugs

The following compounds were used: RS 127445.HCl (2-amino-4-(4-fluoronaphth-1-yl)-6-isopropylpyrimidine hydrochloride), LY 266097.HCl (1-[(2-Chloro-3,4-dimethoxyphenyl) methyl]-2,3,4,9-tetrahydro-6-methyl-1*H*-pyrido[3,4-*b*] indole hydrochloride) and quinpirole.HCl (trans(-)-4aR-4,4a,5,6,7,8,8a,9-octahydro-5-propyl-1*H*-pyrazolo[3,4-*g*] quinoline hydrochloride) purchased from R&D Systems (Abingdon, UK); cocaine.HCl purchased from Cooper (Melun, France), and haloperidol (4-[4-(*p*-chlorophenyl)-4hydroxypiperidino]-4'-fluorobutyrophenone) as the commercially available solution (Haldol 5 mg/mL, Janssen Pharmaceutica, Bersee, Belgium). All other chemicals and reagents were the purest commercially available (VWR, Strasbourg, France; Sigma-Aldrich, Saint-Quentin Fallavier, France).

2.3. Pharmacological treatments

Cocaine was dissolved in NaCl 0.9%, and administered intraperitoneally (i.p.) at 10 mg/kg. Quinpirole was dissolved in NaCl 0.9 %, and injected subcutaneously (s.c.) at 0.1, 0.25 or 0.5 mg/kg. Haloperidol, diluted in NaCl 0.9%, was administered at 0.1 mg/kg i.p. immediately before quinpirole. RS 127445, dissolved in a 99:1 mixture of water and lactic acid, was injected at 0.16 mg/kg i.p. 15 min prior to cocaine or immediately before quinpirole

Publications

administration. LY 266097, dissolved in distilled H₂O, was injected at 0.63 mg/kg i.p. 30 min prior to cocaine.

The dose of cocaine was selected on the basis of previous studies reporting its ability to increase locomotor activity and *in vivo* DA release in the rat NAc and dorsal striatum (Cadoni *et al.*, 2003; Fletcher *et al.*, 2002; Porras *et al.*, 2003). Dose and pretreatment administration time of RS 127445 and LY 266097 were chosen according to previous dose-response studies reporting their efficacy to modulate basal and activated DA outflow in the NAc shell subregion through selective blockade of central 5-HT_{2B}Rs (Auclair *et al.*, 2010). The dose range of quinpirole was chosen on the basis of previous studies showing its ability to induce a robust late-onset hyperlocomotion (Benaliouad *et al.*, 2009; Koeltzow *et al.*, 2003). Finally, the dose of haloperidol was selected on the basis of previous studies reporting its ability to block central DA-D₂Rs in the rat brain (Lucas *et al.*, 2000; Schotte *et al.*, 1993).

All drug doses were calculated as the free base and injected in a volume of 1 ml/kg. In each experimental group, animals received either drugs or their appropriate vehicle, according to a randomised design.

2.4. Microdialysis and DA assay

2.4.1. Surgery and perfusion procedures

Surgery and perfusion procedures were performed as previously described (Cathala *et al.*, 2015) with minor modifications. Briefly, rats were anaesthetised with 3% isoflurane (CSP, Cournon-d'Auvergne, France) and placed in a stereotaxic frame. A siliconized stainless guide-cannula (Carnegie Medicin, Phymep, Paris, France) was stereotaxically implanted just above the shell or the core subregion of the right NAc (coordinates of the lower extremity of the guide, in mm, relative to the interaural point: NAc shell: anteroposterior (AP) = 10.7, lateral (L) = 1.0, ventral (V) = 4.0; core: AP = 10.7, L = 1.4, V = 3.8, Paxinos and Watson, 1986), or above the right dorsal striatum (AP = 9.7, L =

2.8, $V = 6.6$, Paxinos and Watson, 1986), so that the tip of the probe (CMA/11, cuprophane, 240 μm outer diameter, 2 mm or 4 mm length for the NAc and the dorsal striatum respectively, Carnegie Medicin, Phymep) once lowered through the guide-cannula on the day of the experiment, reached a depth value of 2 mm (NAc shell and core) or 2.6 mm (dorsal striatum) above the interaural point.

Experiments were performed in freely moving rats 5 to 7 days after surgery. The probe was inserted in the guide-cannula and perfused at a constant flow rate (2 $\mu\text{l}/\text{min}$), by means of a microperfusion pump (CMA 111, Carnegie Medicin, Phymep) with artificial cerebrospinal fluid containing (in mM): 147 NaCl, 4 KCl, 2.2 CaCl_2 , pH 7.4.

Pharmacological treatments (see section 2.3.) were performed 120 min after the beginning of the perfusion (stabilisation period), and DA outflow was monitored during 120 min after the last drug injection. Dialysates (30 μl) were collected in a refrigerated fraction collector (MAB 85 Microbiotech, Phymep) every 15 min.

At the end of each experiment, the animal was deeply anaesthetised with a pentobarbital overdose (100 mg/kg, CEVA, Libourne, France), and its brain was removed and fixed in NaCl (0.9%)/paraformaldehyde solution (10%). Probe location into the targeted region was determined histologically on serial coronal sections (60 μm) stained with cresyl violet, and only data obtained from rats with correctly implanted probes were included in the results.

2.4.2. Chromatographic analysis

After collection, dialysate samples were immediately analysed with a high-performance liquid chromatography apparatus (Antec Alexys UHPLC/ECD, WynSep, Labège-Innopole, France), equipped with an autosampler (Antec AS 110 UHPLC cool 6-PV, WynSep). The mobile phase [containing (in mM) 100 phosphoric acid, 100 citric acid, 0.1 EDTA.2H₂O, 4.6 octanesulfonic acid.NaCl plus 4.5% acetonitrile, adjusted to pH 6.0 with NaOH solution (50%)] was

Publications

delivered at 0.075 ml/min flow rate with a LC 110S pump (Antec, WynSep) through an Acquity UPLC BEH column (C₁₈; 1 x 100 mm, particle size 1.7 µm; Waters, Saint-Quentin en Yvelynes, France).

Detection of DA was carried out with an amperometric detector (Antec DECADE II, WynSep) with a glassy carbon electrode set at +460 mV *versus* Ag/AgCl. Output signals were recorded on a computer (Clarity, WynSep). Under these conditions, the retention time for DA was 4-4.5 min, and the sensitivity was 50 pM with a signal/noise ratio of 3:1.

2.5. Measurement of locomotor activity

As described previously (Cathala *et al.*, 2015; Piazza *et al.*, 1989), locomotor activity was measured in a circular corridor equipped with four photoelectric cells placed at the two perpendicular axes of the apparatus to automatically record horizontal locomotion. The apparatus were placed in a light- and sound-attenuated chamber. All rats were habituated to the test environment for 3 h/day on each of the three days before the start of the experiment. In quinpirole experiments, 1 h habituation was additionally performed on the test day before drug administration. Drug injections (see section 2.3.) were performed outside the testing room. After the last injection, rats were placed into the circular corridor, and locomotor activity was recorded for 10 min intervals over a period of 120 min (cocaine experiments) or 180 min (quinpirole experiments).

2.6. Statistics

Statistical analysis was carried out by Statistica 8.0 for Windows (Statsoft, Maisons-Alfort, France).

In microdialysis experiments, DA content in each sample was expressed as the percentage of the average baseline level calculated from the three fractions preceding the first drug administration. Data correspond to the mean ± S.E.M. of the percentage obtained in each experimental group. The ability of 5-HT_{2B}R

antagonists (pretreatment) to modulate the effects of cocaine (treatment) on DA outflow (see Fig. 1-2) was analysed by a multifactorial ANOVA with pretreatment and treatment as the between-subject factors, and time as the within-subject factor (including values from time -15 to time 120 min or time -30 to 120 min for experiments with RS 127445 and LY 266097, respectively). In addition, the effect of 5-HT_{2B}R antagonists alone (treatment) on basal DA outflow (see insets in Fig. 1-2) was analysed by a multifactorial ANOVA with treatment as the between-subject factor, and time as the within-subject factor (time fractions 0-120 min). Finally, in each experiment, statistical differences in basal DA values among groups were assessed by a one-way ANOVA using group as a main factor.

In behavioural experiments, locomotor activity data are presented as mean \pm S.E.M. horizontal activity counts in each 10-minute period of the test session or averaged over 0-120 min (cocaine), 0-60 min and 61-180 min (quinpirole) monitoring. The ability of RS 127445, LY 266097 or haloperidol (pretreatment) to modify the effect of cocaine or quinpirole (treatment) on locomotor activity was analysed by a multifactorial ANOVA with pretreatment and treatment as the between-subject factors (see Fig. 3, Fig. 4C and 4D). The effect of quinpirole on locomotor activity was analysed by a multifactorial ANOVA with treatment as the between-subject factor, and time as the within-subject factor (including values from time 10 to time 180 min) (see Fig. 4A), as well as by a one-way ANOVA (using group as a main factor) when analysing its effect on activity counts averaged over 0-60 min and 61-180 min (see Fig. 4B).

Finally, in both neurochemical and behavioural experiments, when ANOVA results were significant ($p < 0.05$), the *post-hoc* Newman-Keuls test was performed to allow adequate multiple comparisons between groups.

3. Results

3.1. Effect of RS 127445 and LY 266097 on cocaine-induced increase in DA outflow

Fig. 1 illustrates the effect of the 5-HT_{2B}R antagonist RS 127445 on cocaine-induced DA outflow in the shell (Fig. 1A) and core (Fig. 1B) subregions of the NAc and in the dorsal striatum (Fig. 1C). In the three brain regions studied, statistical analysis revealed a significant main effect of treatment (NAc shell: $F_{\text{coc}} (1,14) = 108.73$, $p < 0.001$; NAc core: $F_{\text{coc}} (1,15) = 50.13$, $p < 0.001$; dorsal striatum: $F_{\text{coc}} (1,14) = 33.49$, $p < 0.001$) and a significant treatment by time interaction (NAc shell: $F_{\text{coc} \times \text{time}} (9,126) = 97.73$, $p < 0.001$; NAc core: $F_{\text{coc} \times \text{time}} (9,135) = 25.16$, $p < 0.001$; dorsal striatum: $F_{\text{coc} \times \text{time}} (9,126) = 17.91$, $p < 0.001$). As expected (Cadoni *et al.*, 2003; Porrás *et al.*, 2003), cocaine elicited an overall significant increase in DA outflow (NAc shell: time points 15-120 min, at least $p < 0.05$; NAc core: time points 15-105 min, at least $p < 0.05$; dorsal striatum: time points 30-75 min, at least $p < 0.01$, *versus* the corresponding cocaine-untreated groups). In the three brain regions, there was no significant main effect of pretreatment (NAc shell: $F_{\text{RS}} (1,14) = 0.72$, NS; NAc core: $F_{\text{RS}} (1,15) = 0.05$, NS; dorsal striatum: $F_{\text{RS}} (1,14) = 0.43$, NS), and no significant pretreatment \times treatment interaction (NAc shell: $F_{\text{RS} \times \text{coc}} (1,14) = 0.12$, NS; NAc core: $F_{\text{RS} \times \text{coc}} (1,15) = 0.02$, NS; dorsal striatum: $F_{\text{RS} \times \text{coc}} (1,14) = 0.01$, NS). The effect of RS 127445 on basal DA outflow is illustrated in the insets of Fig. 1A-C. According to a previous study (Auclair *et al.*, 2010), RS 127445 *per se* did not alter basal DA outflow in the NAc core and the dorsal striatum (see insets in Fig. 1B and 1C), but elicited a progressive decrease in DA efflux in the NAc shell, reaching approximately 20 % below basal values 75 min after its injection (see inset in Fig. 1A). This effect, because of its small magnitude, did not reach statistical significance in the context of the statistical analysis of the interaction between RS 127445 and cocaine. However, a significant effect of RS 127445 on basal DA outflow was found in the NAc shell ($F_{\text{RS}} (1,7) = 23.88$, $p < 0.01$), but not in the NAc core (F_{RS}

(1,7) = 0.20, NS) and the dorsal striatum ($F_{RS (1,6)} = 0.41$, NS), when directly comparing the RS 127445/vehicle group to the vehicle/vehicle group.

Fig. 2 reports the effect of the 5-HT_{2B}R antagonist LY 266097 on cocaine-induced DA outflow in the NAc shell. Statistical analysis revealed a significant main effect of treatment ($F_{coc (1,15)} = 63.10$, $p < 0.001$) and a significant treatment by time interaction ($F_{coc \times time (10,150)} = 18.52$, $p < 0.001$). As expected (Cadoni *et al.*, 2003), cocaine elicited an overall significant increase in DA outflow (time points 15-90 min, at least $p < 0.05$, *versus* cocaine-untreated groups). There was no significant main effect of pretreatment ($F_{LY (1,15)} = 1.45$, NS), and no significant pretreatment x treatment interaction ($F_{LY \times coc (1,15)} = 0.19$, NS). The inset of Fig. 2 illustrates the effect of LY 266097 on basal DA outflow. In agreement with previous findings (Auclair *et al.*, 2010), LY 266097 elicited a progressive decrease in DA efflux in the NAc shell, reaching approximately 35 % below basal values 105 min after its injection. As in the case of RS 127445 (see Fig. 1A), this effect reached significance only when directly comparing the LY 266097/vehicle group to the vehicle/vehicle group ($F_{LY (1,7)} = 20.47$, $p < 0.01$).

Finally, in a separate experiment, we have also assessed the effect of RS 127445 on the increase in DA outflow induced by 15 mg/kg cocaine in the NAc shell. As in the case of 10 mg/kg cocaine, RS 127445 failed to modify 15 mg/kg cocaine-increased DA outflow. Indeed, statistical analysis revealed a significant main effect of treatment ($F_{coc (1,12)} = 56.44$, $p < 0.001$) and a significant treatment by time interaction ($F_{coc \times time (9,108)} = 31.71$, $p < 0.001$). As expected (Cathala *et al.*, 2015), cocaine elicited an overall significant increase in DA outflow (time points 30-90 min, at least $p < 0.05$, *versus* cocaine-untreated groups). There was no significant main effect of pretreatment ($F_{RS (1,12)} = 0.31$, NS), and no significant pretreatment x treatment interaction ($F_{RS \times coc (1,12)} = 0.03$, NS) (data not shown).

3.2. Effect of RS 127445 and LY 266097 on cocaine-induced hyperlocomotion

Fig. 3 illustrates the effect of the 5-HT_{2B}R antagonists RS 127445 (Fig. 3A) and LY 266097 (Fig. 3B) on the increase in locomotor activity induced by cocaine. As regards the effect of RS 127445 (Fig. 3A), statistical analysis revealed a significant main effect of pretreatment ($F_{RS (1,26)} = 9.76$, $p < 0.01$) and treatment ($F_{coc (1,26)} = 43.62$, $p < 0.001$), as well as a significant pretreatment x treatment interaction ($F_{RS \times coc (1,26)} = 17.86$, $p < 0.001$). *Post-hoc* analysis revealed that, as reported previously (Filip *et al.*, 2004; Fletcher *et al.*, 2002), cocaine produced a significant increase in total locomotor counts recorded over the 120 min test session, reaching about 325% of basal activity ($p < 0.001$, *versus* the vehicle/vehicle group). Cocaine-induced hyperlocomotion was significantly reduced by about 50% by RS 127445 pretreatment ($p < 0.001$, *versus* the vehicle/cocaine group). Finally, administration of RS 127445 alone did not significantly alter basal locomotor activity ($p > 0.05$, *versus* the vehicle/vehicle group). As regards the effect of LY 266097 (Fig. 3B), statistical analysis revealed no significant main effect of pretreatment ($F_{LY (1,20)} = 2.10$, NS), but a significant main effect of treatment ($F_{coc (1,20)} = 20.79$, $p < 0.001$), as well as a significant pretreatment x treatment interaction ($F_{LY \times coc (1,20)} = 15.18$, $p < 0.001$). *Post-hoc* analysis revealed that, as reported previously (Filip *et al.*, 2004; Fletcher *et al.*, 2002), cocaine produced a significant increase in total locomotor counts recorded over the 120 min test session, reaching about 284% of basal activity ($p < 0.001$, *versus* the vehicle/vehicle group). Cocaine-induced hyperlocomotion was significantly reduced by about 41% by LY 266097 pretreatment ($p < 0.01$, *versus* the vehicle/cocaine group). Finally, administration of LY 266097 alone did not significantly alter basal locomotor activity ($p > 0.05$, *versus* the vehicle/vehicle group).

3.3. Effect of haloperidol and RS 127445 on quinpirole-induced changes of locomotor activity

The time-course effect of quinpirole on spontaneous locomotor activity is illustrated in Fig. 4A. As reported previously (Basso *et al.*, 2005; Benaliouad *et al.*, 2009), quinpirole produced time-dependent changes of spontaneous locomotion, encompassing first a reduction, and then a moderate and sustained increase in locomotor activity ($F_{Q \times \text{time} (51,425)} = 6.89$, $p < 0.001$ *versus* quinpirole-untreated groups). To analyse the influence of its different doses (0.1, 0.25 and 0.5 mg/kg) over time, the effect of quinpirole was studied on total horizontal activity counts recorded from 0 to 60 min (Fig. 4B, upper panel) and from 61 to 180 min (Fig. 4B, lower panel) following its injection. During the first 60 min post-injection, at a time when spontaneous locomotion is maximal in vehicle-treated rats, statistical analysis revealed a significant main effect of treatment ($F_{Q (3,25)} = 32.36$, $p < 0.001$). *Post-hoc* analysis revealed that, in line with previous reports (Benaliouad *et al.*, 2009; Cathala *et al.*, 2015), basal locomotor activity was significantly reduced by about 60% by all the tested doses of quinpirole ($p < 0.001$, *versus* the vehicle group). Analysis performed at a later time post-injection (61-180 min) also revealed a significant main effect of treatment ($F_{Q (3,25)} = 19.10$, $p < 0.001$). *Post-hoc* analysis revealed that, in agreement with previous studies (Cathala *et al.*, 2015; Koeltzow *et al.*, 2003), only 0.5 mg/kg quinpirole elicited a significant increase in locomotor activity reaching about 634% of basal activity ($p < 0.001$, *versus* the vehicle group).

Fig. 4C illustrates the effect of the DA-D₂R antagonist haloperidol on 0.5 mg/kg quinpirole-induced changes of locomotor activity counts, averaged over 0-60 min and 61-180 min monitoring. During the first 60 min post-injection, statistical analysis revealed a significant main effect of treatment ($F_{Q (1,26)} = 44.35$, $p < 0.001$). As expected (Cathala *et al.*, 2015; Eilam and Szechtman, 1989; Koeltzow *et al.*, 2003; present study), 0.5 mg/kg quinpirole elicited a significant decrease in locomotor activity ($p < 0.001$, *versus* quinpirole-untreated

groups). There was no significant main effect of pretreatment ($F_{\text{Hal (1,26)}} = 0.09$, NS), and no significant pretreatment x treatment interaction ($F_{\text{Hal x Q (1,26)}} = 2.74$, NS). Statistical analysis performed at a later time post-injection (61-180 min) revealed a significant main effect of pretreatment ($F_{\text{Hal (1,26)}} = 10.52$, $p < 0.01$) and treatment ($F_{\text{Q (1,26)}} = 13.47$, $p < 0.01$), as well as a significant pretreatment x treatment interaction ($F_{\text{Hal x Q (1,26)}} = 15.77$, $p < 0.001$). *Post-hoc* analysis revealed that, in agreement with previous studies (Basso *et al.*, 2005; Cathala *et al.*, 2015; Koeltzow *et al.*, 2003), 0.5 mg/kg quinpirole elicited a significant increase in locomotor activity reaching about 562% of basal activity ($p < 0.001$, *versus* the vehicle/vehicle group). In line with previous studies (Basso *et al.*, 2005; Benaliouad *et al.*, 2009), quinpirole-induced hyperlocomotion was significantly reduced by about 82% by haloperidol pretreatment ($p < 0.001$, *versus* the vehicle/quinpirole group). Finally, as reported previously (Adams *et al.*, 2001), haloperidol alone did not significantly alter basal locomotor activity ($p > 0.05$, *versus* the vehicle/vehicle group).

Finally, Fig. 4D illustrates the effect of RS 127445 on 0.5 mg/kg quinpirole-induced changes of locomotor activity counts, averaged over 0-60 min and 61-180 min monitoring. During the first 60 min post-injection, statistical analysis revealed a significant main effect of treatment ($F_{\text{Q (1,41)}} = 24.58$, $p < 0.001$). As expected (Cathala *et al.*, 2015; Eilam and Szechtman, 1989; Koeltzow *et al.*, 2003; present study), 0.5 mg/kg quinpirole elicited a significant decrease in locomotor activity ($p < 0.001$, *versus* quinpirole-untreated groups). There was no significant main effect of pretreatment ($F_{\text{RS (1,41)}} = 1.98$, NS), and no significant pretreatment x treatment interaction ($F_{\text{RS x Q (1,41)}} = 0.22$, NS). Statistical analysis performed at a later time post-injection (61-180 min) revealed a significant main effect of pretreatment ($F_{\text{RS (1,41)}} = 7.94$, $p < 0.01$), treatment ($F_{\text{Q (1,41)}} = 40.63$, $p < 0.001$), and a significant pretreatment x treatment interaction ($F_{\text{RS x Q (1,41)}} = 7.43$, $p < 0.01$). *Post-hoc* analysis revealed that quinpirole induced a significant increase in locomotor activity reaching about 563% of basal activity ($p < 0.001$, *versus* the vehicle/vehicle group). RS 127445, with no effect on basal

locomotion ($p > 0.05$, *versus* the vehicle/vehicle group), significantly diminished (overall reduction of approximately 50%) quinpirole-induced locomotor activity ($p < 0.001$, *versus* the vehicle/quinpirole group).

4. Discussion

The present study shows that 5-HT_{2B}R blockade reduces cocaine-induced hyperlocomotion independently of accumbal and striatal DA outflow. Furthermore, 5-HT_{2B}R antagonism suppresses quinpirole-induced late-onset hyperlocomotion, a response which happens independently of DA release and is related to direct stimulation of post-synaptic DA-D₂Rs (Benaliouad *et al.*, 2009). Thus, in keeping with the tight relationship between subcortical DA pathway activity and locomotion (Beeler *et al.*, 2009; Dunnett and Robbins, 1992), our findings altogether demonstrate that 5-HT_{2B}R control of cocaine-induced hyperlocomotion occurs downstream from DA neurons, and could involve an action at the level of DA transmission.

In the present study, the functional role of 5-HT_{2B}Rs in the control of cocaine responses was assessed using two selective, brain penetrant and potent 5-HT_{2B}R antagonists, RS 127445 and LY 266097, which have been well characterised *in vitro* and *in vivo* (Auclair *et al.*, 2010; Audia *et al.*, 1996; Bonhaus *et al.*, 1999; Doly *et al.*, 2008, 2009).

We found that peripheral administration of RS 127445 reduced basal DA outflow in the NAc shell but had no effect on basal DA outflow in the NAc core subregion and the dorsal striatum. Basal DA outflow in the NAc shell was also decreased by the peripheral administration of LY 266097. These results, in agreement with previous findings in halothane-anaesthetised rats (Auclair *et al.*, 2010), confirm that 5-HT_{2B}Rs exert a tonic facilitatory control on mesoaccumbens DA pathway restrained to the shell subregion of the NAc. Although the 5-HT_{2B}R antagonists used in the present study possess some affinity for the other members of the 5-HT₂R family (Audia *et al.*, 1996; Bonhaus *et al.*, 1999), the obtained results permit to discard a possible involvement of 5-HT_{2A} or 5-HT_{2C}Rs in the observed effect, as their blockade is known to have no effect or to increase basal DA outflow in the NAc, respectively (Auclair *et al.*, 2010).

As previously reported (Cadoni *et al.*, 2003; Fletcher *et al.*, 2002; Porrás *et al.*, 2003), we found that peripheral administration of 10 mg/kg cocaine elicited a significant increase in DA outflow in both the shell and core subregions of the NAc, as well as in the dorsal striatum. RS 127445 pretreatment failed to modulate the effect of cocaine in these brain regions. Also, cocaine-increased DA outflow in the NAc shell remained unaltered by LY 266097 pretreatment.

It is unlikely that the absence of effect of 5-HT_{2B}R blockade on cocaine-increased DA outflow is related to the dose of 5-HT_{2B}R antagonists used. Indeed, 0.16 mg/kg RS 127445 and 0.63 mg/kg LY 266097 have been shown to be effective in reducing both basal (present study; Auclair *et al.*, 2010) and stimulated DA outflow in the NAc shell (Auclair *et al.*, 2010). Furthermore, although the ability of 5-HT_{2B}R antagonists to modulate cocaine-increased DA outflow could be dependent on the inherent tone of the 5-HT system, which is subject to modification by the 5-HT reuptake inhibiting properties of cocaine (Bradberry *et al.*, 1993; Koe, 1976), the observed results are unlikely dependent on the dose of cocaine (10 mg/kg) used in the present study. Indeed, we found that the increase in NAc shell DA outflow induced by a higher dose of cocaine (15 mg/kg), despite its ability to evoke a larger increase in 5-HT extracellular levels in various brain regions (Müller *et al.*, 2007), was also unaltered by RS 127445 pretreatment (data not shown). More likely, the failure of RS 127445 and LY 266097 to affect cocaine-induced DA outflow is related to the cellular mechanisms underlying their interaction on DA neurons. Indeed, the ability of 5-HT receptors to control DA outflow is known to be dependent on the specific mechanism of action of a given drug to activate DA neurons (De Deurwaerdère *et al.*, 2005; Navailles *et al.*, 2004; Porrás *et al.*, 2002a, 2002b, 2003). A previous study assessing the effect of 5-HT_{2B}Rs on amphetamine- and haloperidol-evoked DA release led to the suggestion that 5-HT_{2B}Rs could control DA outflow by modulating DA synthesis and/or DA neuronal firing rate (Auclair *et al.*, 2010). Thus, it is tempting to suggest that the inhibitory effect of cocaine on DA synthesis and DA neuronal firing rate (Nielsen *et al.*, 1983; Pitts

and Marwah, 1988) could preclude the action of 5-HT_{2B}R antagonists on cocaine-induced DA outflow. Additional experiments are warranted to address this hypothesis.

Interestingly, we found that blockade of 5-HT_{2B}Rs by RS 127445 or LY 266097 reduced cocaine-evoked hyperlocomotion to a similar extent. Of note, it is known that cocaine-induced hyperlocomotion is also reduced by selective 5-HT_{2A}R antagonists (Fletcher *et al.*, 2002). However, both 5-HT_{2B}R antagonists used in the present study possess similar high affinity for the 5-HT_{2B}R (pKi= 9.3 for LY 266097 and pKi= 9.5 for RS 127445), and at least 100-fold (LY 266097) and 1000-fold (RS 127445) selectivity over the 5-HT_{2A}R and numerous other receptors (Audia *et al.*, 1996; Bonhaus *et al.*, 1999). Thus, in keeping with the *in vitro* pharmacological properties of RS 127445 and LY 266097, and considering that both 5-HT_{2B}R antagonists were administered at very low doses, which have been shown to target selectively 5-HT_{2B}Rs *in vivo* (Auclair *et al.*, 2010), it is likely that the effects observed in the present study result from their selective blockade of 5-HT_{2B}Rs. Nevertheless, this issue will deserve future investigations in advanced genetic models, such as conditional 5-HT_{2B}R knock-out animals, to bypass the limits (lethal phenotype, neurodevelopmental-like disorders) of the currently available constitutive 5-HT_{2B}R knock-out mice (Bevilacqua *et al.*, 2010; McCorvy and Roth, 2015).

Altogether, our neurochemical and behavioural findings demonstrate that the suppressant effect of 5-HT_{2B}R antagonists on cocaine-induced hyperlocomotion occurs independently of changes of accumbal and/or striatal DA outflow. Thus, as already shown for the 5-HT_{2C}R and the 5-HT_{1A}R (Cathala *et al.*, 2015; Devroye *et al.*, 2015; Müller *et al.*, 2007), it appears that 5-HT_{2B}Rs could control cocaine hyperactivity by a mechanism which bypasses DA release itself. To have a deeper insight into this hypothesis, we assessed the effect of 5-HT_{2B}R antagonists in the presence of quinpirole, a useful pharmacological tool to explore possible post-synaptic interactions. Indeed, quinpirole is known to induce a late-onset hyperlocomotion resulting from direct stimulation of post-

synaptic DA-D₂Rs (Benaliouad *et al.*, 2009; Cathala *et al.*, 2015). In agreement with previous findings (Cathala *et al.*, 2015), we found that 0.5 mg/kg quinpirole increased locomotor activity 60 minutes following its injection, this effect being blocked by both haloperidol and RS 127445. These results confirm that the suppressant effect of 5-HT_{2B}R blockade on cocaine-induced hyperlocomotion occurs downstream to DA neurons, and suggest a possible action at the level of DA transmission. Thus, as already shown for the 5-HT_{2C}Rs (Cathala *et al.*, 2015; Devroye *et al.*, 2015), 5-HT_{2B}Rs could participate to the regulatory control of the phosphorylation of the DA and cyclic 3'-5' adenosine monophosphate-regulated phosphoprotein (DARPP-32), a protein located in dopaminergic neurons and involved in the mediation of the behavioural effects of cocaine by processes acting independently from changes of DA outflow (Svenningsson *et al.*, 2005; Zachariou *et al.*, 2002). Interestingly, the results obtained with quinpirole raise an additional question concerning a possible role of 5-HT_{2B}Rs in the control of DA-D₁R-mediated hyperlocomotion (Sakanoue *et al.*, 2002). Indeed, DA-D₁R agonist-induced behaviors, including hyperlocomotion, are known to undergo modulatory controls by several 5-HT receptors (Bishop *et al.*, 2005; Dupre *et al.*, 2013; Fox and Brotchie, 2000; Jaunarajs *et al.*, 2009; Scalzitti *et al.*, 1999), and can be differentially regulated compared to DA-D₂R agonist-evoked behavioral responses (Bishop *et al.*, 2005; Cathala *et al.*, 2015; Sakanoue *et al.*, 2002). Thus it will be interesting in the future to assess whether 5-HT_{2B}R antagonists are also able to modulate DA-D₁R-mediated hyperactivity, to determine whether 5-HT_{2B}Rs might differentially control DA-D₂R *versus* DA-D₁R-mediated hyperlocomotion.

Finally, the data available in the literature do not permit to precise the mechanisms and/or the neuronal circuits underlying the inhibitory effects of 5-HT_{2B}R antagonists on cocaine-induced hyperlocomotion. Indeed, in this context, a critical point is the lack of information concerning the regional and/or cellular distribution of 5-HT_{2B}Rs in the mammalian brain, as only few studies explored this issue (Bonaventure *et al.*, 2002; Doly *et al.*, 2008; Duxon *et al.*,

1997; Kolodziejczak *et al.*, 2015). On the one hand, 5-HT_{2B}Rs are not expressed in the NAc and the dorsal striatum (Duxon *et al.*, 1997), thereby suggesting that the effects observed in the present study could involve extra-accumbal and extra-striatal regulations. Conversely, 5-HT_{2B}Rs have been shown to be expressed in the frontal cortex (Bonaventure *et al.*, 2002; Duxon *et al.*, 1997). In keeping with the key role of this brain region in the regulation of subcortical DA activity and cocaine-induced DA-dependent behaviours (Filip and Cunningham, 2003; Leggio *et al.*, 2009; Tzschentke, 2001), it is possible that cortical 5-HT_{2B}Rs may participate to the suppressant effect of 5-HT_{2B}R antagonists on cocaine hyperactivity through glutamatergic and/or GABAergic polysynaptic cortico-subcortical pathways afferent to the NAc and/or the dorsal striatum. Indeed, anatomical studies have shown that GABAergic neurons located in the NAc and the dorsal striatum receive direct monosynaptic input from prefrontal cortex (PFC) glutamate-containing pyramidal cells (Sesack *et al.*, 2003), as well as afferents from several regions which receive projections from the PFC pyramidal neurons (Azmitia and Segal, 1978; Gabbott *et al.*, 2005; Sesack *et al.*, 2003). An additional mechanism could rely on the fact that 5-HT_{2B}Rs could exert a direct control on 5-HT neuron activity, as suggested by their ability to regulate the phosphorylation of the 5-HT transporter (SERT) *in vitro* (Launay *et al.*, 2006). Thus, in keeping with the ability of cocaine to block the SERT (Bradberry *et al.*, 1993; Koe, 1976), it is possible that 5-HT_{2B}Rs antagonists could modulate cocaine-induced changes of extracellular 5-HT levels, which in turn would impact on other 5-HT receptor subtypes participating to the control of cocaine-induced hyperlocomotion, such as 5-HT_{2A}Rs, 5-HT_{2C}Rs, 5-HT₃Rs or 5-HT₄Rs (Cathala *et al.*, 2015, Fletcher *et al.*, 2002; McMahon and Cunningham, 1999; Svingos and Hitzemann, 1992). Additional studies, including intracranial microinjections, are needed to unravel the mechanisms and circuitry underlying this interaction.

In conclusion, this study provides the first evidence that central 5-HT_{2B}Rs are able to control cocaine-induced hyperlocomotion independently of changes of

Publications

subcortical DA outflow. This regulatory control appears to occur downstream to DA neurons and could involve an indirect action at the level of striatal and/or accumbal DA transmission. Altogether the present results afford additional knowledge into the regulatory neurochemistry of ascending DA pathways, and provide new information supporting the therapeutic potential of 5-HT_{2B}R antagonists in drug addiction (Auclair *et al.*, 2010; Doly *et al.*, 2008, 2009).

Acknowledgements

This work was supported by grants from the Institut National de la Recherche et de la Santé (INSERM) and Bordeaux University. C. Devroye and B. Di Marco were fellowship recipients from the International Ph.D. program in Neuropharmacology, University of Catania Medical School, Catania, Italy, during the course of this study.

References

- Adams, J.U., Careri, J.M., Efferen, T.R., Rotrosen, J., 2001. Differential effects of dopamine antagonists on locomotor activity, conditioned activity and conditioned place preference induced by cocaine in rats. *Behav. Pharmacol.* 12, 603-611.
- Auclair, A.L., Cathala, A., Sarrazin, F., Depoortère, R., Piazza, P.V., Newman-Tancredi, A., Spampinato, U., 2010. The central serotonin 2B receptor: a new pharmacological target to modulate the mesoaccumbens dopaminergic pathway activity. *J. Neurochem.* 114, 1323-1332.
- Audia, J.E., Evrard, D.A., Murdoch, G.R., Droste, J.J., Nissen, J.S., Schenck, K.W., Fludzinski, P., Lucaites, V.L., Nelson, D.L., Cohen, M.L., 1996. Potent, selective tetrahydro-beta-carboline antagonists of the serotonin 2B (5HT2B) contractile receptor in the rat stomach fundus. *J. Med. Chem.* 39, 2773-2780.
- Azmitia, E.C., Segal, M., 1978. An autoradiographic analysis of the differential ascending projections of the dorsal and median raphe nuclei in the rat. *J. Comp. Neurol.* 179, 641-668.
- Basso, A.M., Gallagher, K.B., Bratcher, N.A., Brioni, J.D., Moreland, R.B., Hsieh, G.C., Drescher, K., Fox, G.B., Decker, M.W., Rueter, L.E., 2005. Antidepressant-like effect of D(2/3) receptor-, but not D(4) receptor-activation in the rat forced swim test. *Neuropsychopharmacology* 30, 1257-1268.
- Beeler, J.A., Cao, Z.F., Kheirbek, M.A., Zhuang, X., 2009. Loss of cocaine locomotor response in Pitx3-deficient mice lacking a nigrostriatal pathway. *Neuropsychopharmacology* 34, 1149-1161.
- Benaliouad, F., Kapur, S., Natesan, S., Rompré, P.P., 2009. Effects of the dopamine stabilizer, OSU-6162, on brain stimulation reward and on quinpirole-induced changes in reward and locomotion. *Eur. Neuropsychopharmacol.* 19, 416-430.
- Bevilacqua, L., Doly, S., Kaprio, J., Yuan, Q., Tikkanen, R., Paunio, T., Zhou, Z., Wedenoja, J., Maroteaux, L., Diaz, S., Belmer, A., Hodgkinson, C.A., Dell'osso, L., Suvisaari, J., Coccaro, E., Rose, R.J., Peltonen, L., Virkkunen, M., Goldman, D., 2010. A population-specific HTR2B stop codon predisposes to severe impulsivity. *Nature* 468, 1061-1066.
- Bishop, C., Daut, G.S., Walker P.D., 2005. Serotonin 5-HT2A but not 5-HT2C receptor antagonism reduces hyperlocomotor activity induced in dopamine-depleted rats by striatal administration of the D1 agonist SKF 82958. *Neuropharmacology* 49, 350-358.

Publications

- Bonaventure, P., Guo, H., Tian, B., Liu, X., Bittner, A., Roland, B., Salunga, R., Ma, X.J., Kamme, F., Meurers, B., Bakker, M., Jurzak, M., Leysen, J.E., Erlander, M.G., 2002. Nuclei and subnuclei gene expression profiling in mammalian brain. *Brain Res.* 943, 38-47.
- Bonhaus, D.W., Flippin, L.A., Greenhouse, R.J., Jaime, S., Rocha, C., Dawson, M., Van Natta, K., Chang, L.K., Pulido-Rios, T., Webber, A., Leung, E., Eglen, R.M., Martin, G.R., 1999. RS-127445: a selective, high affinity, orally bioavailable 5-HT_{2B} receptor antagonist. *Br. J. Pharmacol.* 127, 1075-1082.
- Bradberry, C.W., Nobiletti, J.B., Elsworth, J.D., Murphy, B., Jatlow, P., Roth, R.H., 1993. Cocaine and cocaethylene: microdialysis comparison of brain drug levels and effects on dopamine and serotonin. *J. Neurochem.* 60, 1429-1435.
- Cadoni, C., Solinas, M., Valentini, V., Di Chiara, G., 2003. Selective psychostimulant sensitization by food restriction: differential changes in accumbens shell and core dopamine. *Eur. J. Neurosci.* 18, 2326-2334.
- Carboni, E., Imperato, A., Perezzi, L., Di Chiara, G., 1989. Amphetamine, cocaine, phencyclidine and nomifensine increase extracellular dopamine concentrations preferentially in the nucleus accumbens of freely moving rats. *Neuroscience* 28, 653-661.
- Cathala, A., Devroye, C., Maitre, M., Piazza, P.V., Abrous, D.N., Revest, J.M., Spampinato, U., 2015. Serotonin_{2C} receptors modulate dopamine transmission in the nucleus accumbens independently of dopamine release: behavioral, neurochemical and molecular studies with cocaine. *Addict. Biol.* 20, 445-457.
- De Deurwaerdère, P., Moison, D., Navailles, S., Porrás, G., Spampinato, U., 2005. Regionally and functionally distinct serotonin₃ receptors control *in vivo* dopamine outflow in the rat nucleus accumbens. *J. Neurochem.* 94, 140-149.
- Devroye, C., Cathala, A., Maitre, M., Piazza, P.V., Abrous, D.N., Revest, J.M., Spampinato, U., 2015. Serotonin_{2C} receptor stimulation inhibits cocaine-induced Fos expression and DARPP-32 phosphorylation in the rat striatum independently of dopamine outflow. *Neuropharmacology* 89, 375-381.
- Di Chiara, G., Bassareo, V., 2007. Reward system and addiction: what dopamine does and doesn't do. *Curr. Opin. Pharmacol.* 7, 69-76.
- Di Chiara, G., Imperato, A., 1988. Drugs abused by humans preferentially increase synaptic dopamine concentrations in the mesolimbic system of freely moving rats. *Proc. Natl. Acad. Sci. U. S. A.* 85, 5274-5278.
- Doly, S., Bertran-Gonzalez, J., Callebert, J., Bruneau, A., Banas, S.M., Belmer, A., Boutourlinsky, K., Hervé, D., Launay, J.M., Maroteaux, L., 2009. Role of serotonin

- via 5-HT_{2B} receptors in the reinforcing effects of MDMA in mice. *PLoS ONE* 4, e7952.
- Doly, S., Valjent, E., Setola, V., Callebert, J., Hervé, D., Launay, J.M., Maroteaux L., 2008. Serotonin 5-HT_{2B} receptors are required for 3,4-methylenedioxymethamphetamine-induced hyperlocomotion and 5-HT release *in vivo* and *in vitro*. *J. Neurosci.* 28, 2933-2940.
- Dunnett, S.B., Robbins, T.W., 1992. The functional role of mesotelencephalic dopamine systems. *Biol. Rev. Camb. Philos. Soc.* 67, 491-518.
- Dupre, K.B., Ostock, C.Y., George, J.A., Eskow Jaunarajs, K.L., Hueston, C.M., Bishop, C., 2013. Effects of 5-HT_{1A} receptor stimulation on D1 receptor agonist-induced striatonigral activity and dyskinesia in hemiparkinsonian rats. *ACS Chem. Neurosci.* 4, 747-760.
- Duxon, M.S., Flanigan, T.P., Reavley, A.C., Baxter, G.S., Blackburn, T.P., Fone, K.C., 1997. Evidence for expression of the 5-hydroxytryptamine-2B receptor protein in the rat central nervous system. *Neuroscience* 76, 323-329.
- Eilam, D., Szechtman, H., 1989. Biphasic effect of D-2 agonist quinpirole on locomotion and movements. *Eur. J. Pharmacol.* 161, 151-157.
- Filip, M., Bubar, M.J., Cunningham, K.A., 2004. Contribution of serotonin (5-hydroxytryptamine; 5-HT) 5-HT₂ receptor subtypes to the hyperlocomotor effects of cocaine: acute and chronic pharmacological analyses. *J. Pharmacol. Exp. Ther.* 310, 1246-1254.
- Filip, M., Cunningham, K.A., 2003. Hyperlocomotive and discriminative stimulus effects of cocaine are under the control of serotonin(2C) (5-HT(2C)) receptors in rat prefrontal cortex. *J. Pharmacol. Exp. Ther.* 306, 734-743.
- Fletcher, P.J., Grottick, A.J., Higgins, G.A., 2002. Differential effects of the 5-HT(2A) receptor antagonist M100907 and the 5-HT(2C) receptor antagonist SB242084 on cocaine-induced locomotor activity, cocaine self-administration and cocaine-induced reinstatement of responding. *Neuropsychopharmacology* 27, 576-586.
- Fox, S.H., Brotchie, J.M., 2000. 5-HT(2C) receptor antagonists enhance the behavioural response to dopamine D(1) receptor agonists in the 6-hydroxydopamine-lesioned rat. *Eur. J. Pharmacol.* 398, 59-64.
- Gabbott, P.L., Warner, T.A., Jays, P.R., Salway, P., Busby, S.J., 2005. Prefrontal cortex in the rat: projections to subcortical autonomic, motor, and limbic centers. *J. Comp. Neurol.* 492, 145-77.

Publications

- Jaunaraajs, K.L., Dupre, K.B., Steiniger, A., Klioueva, A., Moore, A., Kelly, C., Bishop, C., 2009. Serotonin 1B receptor stimulation reduces D1 receptor agonist-induced dyskinesia. *Neuroreport* 20, 1265-1269.
- Koe, B.K., 1976. Molecular geometry of inhibitors of the uptake of catecholamines and serotonin in synaptosomal preparations of rat brain. *J. Pharmacol. Exp. Ther.* 199, 649-661.
- Koeltzow, T.E., Austin, J.D., Vezina, P., 2003. Behavioral sensitization to quinpirole is not associated with increased nucleus accumbens dopamine overflow. *Neuropharmacology* 44, 102-110.
- Kolodziejczak, M., Béchade, C., Gervasi, N., Irinopoulou, T., Banas, S.M., Cordier, C., Rebsam, A., Roumier, A., Maroteaux, L., 2015. Serotonin modulates developmental microglia via 5-HT2B receptors: potential implication during synaptic refinement of retinogeniculate projections. *ACS Chem. Neurosci.* <http://dx.doi.org/10.1021/cn5003489>.
- Koob, G.F., Volkow, N.D., 2010. Neurocircuitry of addiction. *Neuropsychopharmacology* 35, 217-238.
- Launay, J.M., Schneider, B., Loric, S., Da Prada, M., Kellermann, O., 2006. Serotonin transport and serotonin transporter-mediated antidepressant recognition are controlled by 5-HT2B receptor signaling in serotonergic neuronal cells. *FASEB J.* 20, 1843-1854.
- Leggio, G.M., Cathala, A., Moison, D., Cunningham, K.A., Piazza, P.V., Spampinato, U., 2009. Serotonin(2C) receptors in the medial prefrontal cortex facilitate cocaine-induced dopamine release in the rat nucleus accumbens. *Neuropharmacology* 56, 507-513.
- Lucas, G., De Deurwaerdère, P., Caccia, S., Spampinato, U., 2000. The effect of serotonergic agents on haloperidol-induced striatal dopamine release in vivo: opposite role of 5-HT2A and 5-HT2C receptor subtypes and significance of the haloperidol dose used. *Neuropharmacology* 39, 1053-1063.
- McCorvy, J.D., Roth, B.L., 2015. Structure and function of serotonin G protein-coupled receptors. *Pharmacol. Ther.* 150, 129-142.
- McMahon, L.R., Cunningham, K.A., 1999. Antagonism of 5-hydroxytryptamine4 receptors attenuates hyperactivity induced by cocaine: putative role for 5-hydroxytryptamine4 receptors in the nucleus accumbens shell. *J. Pharmacol. Exp. Ther.* 291, 300-307.

- Müller, C.P., Carey, R.J., Huston, J.P., De Souza Silva, M.A., 2007. Serotonin and psychostimulant addiction: focus on 5-HT_{1A}-receptors. *Prog. Neurobiol.* 81, 133-178.
- Navailles, S., De Deurwaerdère, P., Porras, G., Spampinato, U., 2004. *In vivo* evidence that 5-HT_{2C} receptor antagonist but not agonist modulates cocaine-induced dopamine outflow in the rat nucleus accumbens and striatum. *Neuropsychopharmacology* 29, 319-326.
- Nielsen, J.A., Chapin, D.S., Moore, K.E., 1983. Differential effects of d-amphetamine, beta-phenylethylamine, cocaine and methylphenidate on the rate of dopamine synthesis in terminals of nigrostriatal and mesolimbic neurons and on the efflux of dopamine metabolites into cerebroventricular perfusates of rats. *Life Sci.* 33, 1899-1907.
- Paxinos, G., Watson, C., 1986. *The rat brain in stereotaxic coordinates*. Academic Press, New York.
- Piazza, P.V., Deminière, J.M., Le Moal, M., Simon, H., 1989. Factors that predict individual vulnerability to amphetamine self-administration. *Science* 245, 1511-1513.
- Pierce, R.C., Vanderschuren, L.J., 2010. Kicking the habit: the neural basis of ingrained behaviors in cocaine addiction. *Neurosci. Biobehav. Rev.* 35, 212-219.
- Pitts, D.K., Marwah, J., 1988. Cocaine and central monoaminergic neurotransmission: a review of electrophysiological studies and comparison to amphetamine and antidepressants. *Life Sci.* 42, 949-968.
- Porras, G., De Deurwaerdère, P., Moison, D., Spampinato U., 2003. Conditional involvement of striatal serotonin₃ receptors in the control of *in vivo* dopamine outflow in the rat striatum. *Eur. J. Neurosci.* 17, 771-781.
- Porras, G., Di Matteo, V., De Deurwaerdère, P., Esposito, E., Spampinato, U., 2002a. Central serotonin₄ receptors selectively regulate the impulse-dependent exocytosis of dopamine in the rat striatum: *in vivo* studies with morphine, amphetamine and cocaine. *Neuropharmacology* 43, 1099-1109.
- Porras, G., Di Matteo, V., Fracasso, C., Lucas, G., De Deurwaerdère, P., Caccia, S., Esposito, E., Spampinato, U., 2002b. 5-HT_{2A} and 5-HT_{2C/2B} receptor subtypes modulate dopamine release induced *in vivo* by amphetamine and morphine in both the rat nucleus accumbens and striatum. *Neuropsychopharmacology* 26, 311-324.
- Sakanoue, M., Mori, N., Takei, N., Kawai, M., Tani, K., Suzuki, K., Iwata, Y., Sekine, Y., Ashby, C.R. Jr., Minabe, Y., 2002. Tacrolimus, a specific inhibitor of

Publications

- calcineurin, modifies the locomotor activity of quinpirole, but not that of SKF82958, in male rats. *Eur. J. Pharmacol.* 438, 93-97.
- Scalzitti, J.M., Cervera, L.S., Smith, C., Hensler, J.G., 1999. Serotonin 2A receptor modulation of D1 dopamine receptor-mediated grooming behavior. *Pharmacol. Biochem. Behav.* 63, 279-284.
- Schotte, A., Janssen, P.F., Megens, A.A., Leysen, J.E., 1993. Occupancy of central neurotransmitter receptors by risperidone, clozapine and haloperidol, measured *ex vivo* by quantitative autoradiography. *Brain. Res.* 631, 191-202.
- Sesack, S.R., Carr, D.B., Omelchenko, N., Pinto, A., 2003. Anatomical substrates for glutamate-dopamine interactions: evidence for specificity of connections and extrasynaptic actions. *Ann. N. Y. Acad. Sci.* 1003, 36-52.
- Svenningsson, P., Nairn, A.C., Greengard, P., 2005. DARPP-32 mediates the actions of multiple drugs of abuse. *AAPS journal* 7, 353-360.
- Svingos, A.L., Hitzemann, R., 1992. 5-HT₃ receptor antagonists block cocaine-induced locomotion via a PCPA-sensitive mechanism. *Pharmacol. Biochem. Behav.* 43, 871-879.
- Tzschentke, T.M., 2001. Pharmacology and behavioral pharmacology of the mesocortical dopamine system. *Prog. Neurobiol.* 63, 241-320.
- Wise, R.A., 2009. Roles for nigrostriatal-not just mesocorticolimbic-dopamine in reward and addiction. *Trends Neurosci.* 32, 517-524.
- Zachariou, V., Benoit-Marand, M., Allen, P.B., Ingrassia, P., Fienberg, A.A., Gonon, F., Greengard, P., Picciotto, M.R., 2002. Reduction of cocaine place preference in mice lacking the protein phosphatase 1 inhibitors DARPP 32 or Inhibitor 1. *Biol. Psychiatry* 51, 612-620.

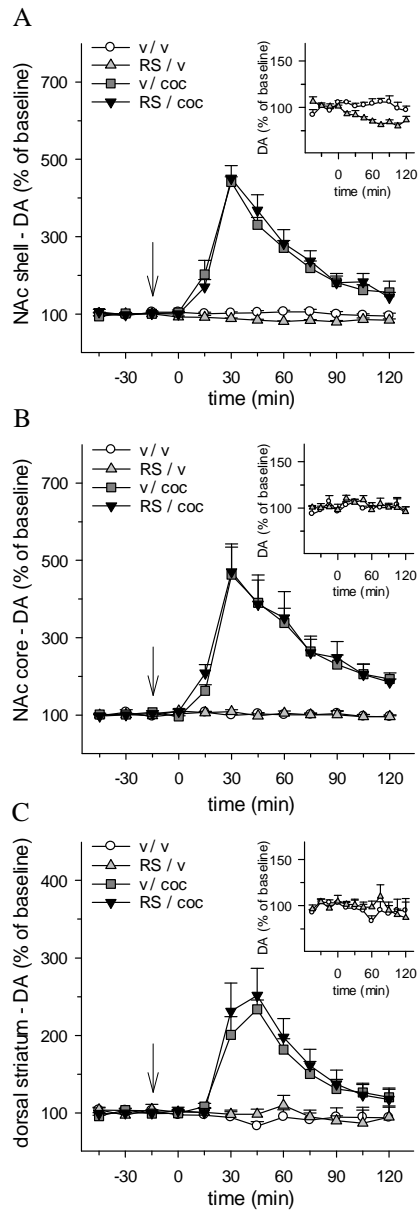

Fig. 1. Time course effect of the administration of RS 127445 on cocaine-induced increase in dopamine (DA) outflow in the shell (A) and core (B) subregions of the nucleus accumbens (NAc), and in the dorsal striatum (C). RS 127445 (RS, 0.16 mg/kg) was intraperitoneally (i.p.) injected (vertical arrow) 15 min before the administration of cocaine (coc, 10 mg/kg, i.p., time zero). Data are represented as the mean \pm SEM percentages of the baseline calculated from the three samples preceding the first drug

Publications

administration (n= 4-5 animals/group). Absolute basal levels of DA in dialysates collected in each brain region did not differ across the different experimental groups (NAc shell: $F_{(3,14)} = 2.32$, NS; NAc core: $F_{(3,15)} = 2.42$, NS; dorsal striatum: $F_{(3,14)} = 0.65$, NS, ANOVA) and were: 1.02 ± 0.06 nM (NAc shell), 0.82 ± 0.08 nM (NAc core), and 4.88 ± 0.27 nM (dorsal striatum) (mean \pm SEM, n= 18 rats for the NAc shell and the dorsal striatum, and 19 rats for the NAc core). **Insets:** time-course of the effect of RS 127445 on basal DA outflow in the NAc shell (A), the NAc core (B) and the dorsal striatum (C), see Results section for statistical details.

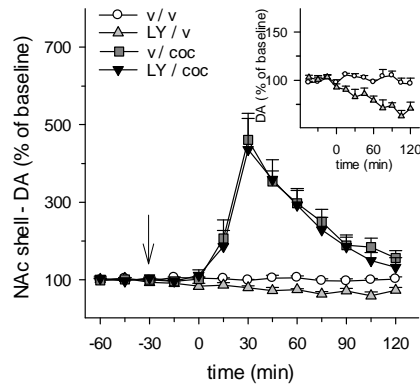

Fig. 2. Time course effect of the administration of LY 266097 on cocaine-induced increase in dopamine (DA) outflow in the shell subregion of the nucleus accumbens (NAc). LY 266097 (LY, 0.63 mg/kg) was intraperitoneally (i.p.) injected (vertical arrow) 30 min before the administration of cocaine (coc, 10 mg/kg, i.p., time zero). Data are represented as the mean \pm SEM percentages of the baseline calculated from the three samples preceding the first drug administration ($n = 4-5$ animals/group). Absolute basal levels of DA in dialysates did not differ across the different experimental groups ($F_{(3,15)} = 1.18$, NS, ANOVA) and were 0.67 ± 0.09 nM (mean \pm SEM, $n = 19$ rats). **Inset:** time-course of the effect of LY 266097 on basal DA outflow, see Results section for statistical details.

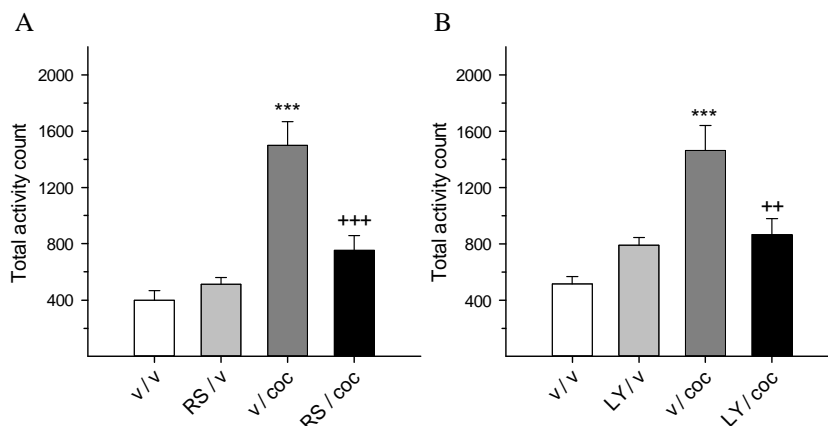

Fig. 3. Effect of RS 127445 (A) and LY 266097 (B) on cocaine-induced hyperlocomotion. RS 127445 (RS, 0.16 mg/kg) or LY 266097 (LY, 0.63 mg/kg) was intraperitoneally (i.p.) injected 15 or 30 min before the administration of cocaine (coc, 10 mg/kg, i.p., time zero), respectively. Histograms represent the mean \pm SEM horizontal activity counts over a 2-hour test period ($n= 7-8$ and $n= 6$ animals/group for experiments with RS 127445 and LY 266097, respectively). *** $p<0.001$ versus the corresponding vehicle/vehicle (v/v) group and +++ $p<0.001$, ++ $p<0.01$ versus the corresponding v/coc group (Newman-Keuls test).

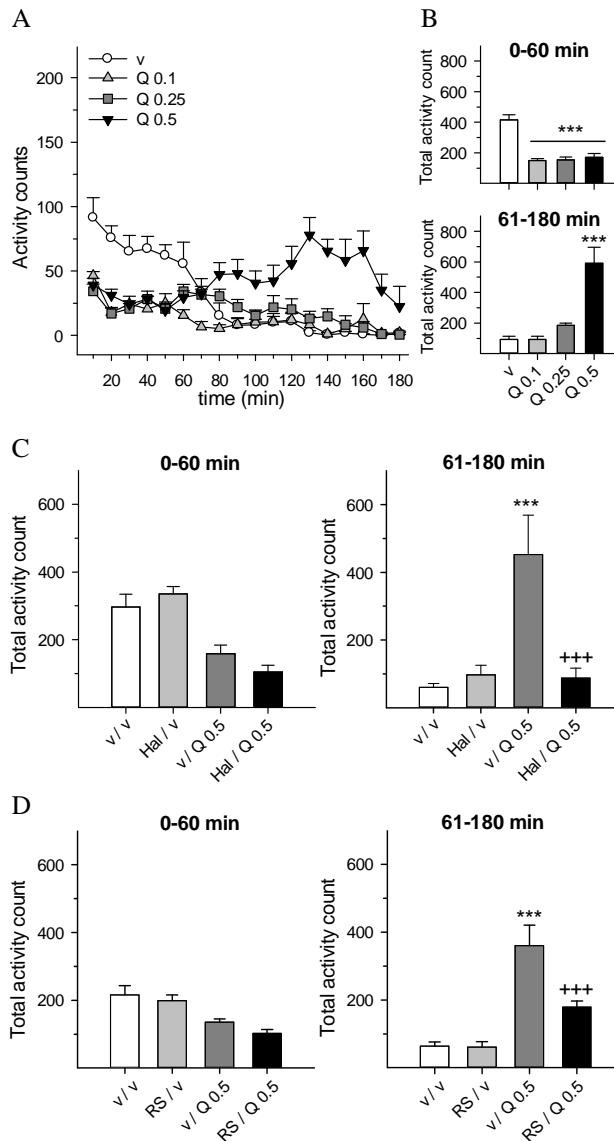

Fig. 4. Effect of haloperidol and RS 127445 on quinpirole-induced changes of spontaneous locomotor activity. (A) Time-course effect of different doses of quinpirole on spontaneous locomotor activity. Quinpirole (Q) was subcutaneously (s.c.) injected (time zero) at the doses of 0.1, 0.25 or 0.5 mg/kg. Data represent the mean \pm SEM horizontal activity counts in each 10-minute period of the 3-hour test ($n = 7-8$ animals/group). (B) Histograms represent the mean \pm SEM horizontal activity counts of quinpirole-induced locomotor activity changes averaged over 0-60 minutes and 61-180

Publications

minutes monitoring. (C) Effect of haloperidol on quinpirole-induced changes of locomotor activity. Haloperidol (Hal, 0.1 mg/kg, i.p.) was injected immediately before Q (0.5 mg/kg, s.c.). Data represent the mean \pm SEM horizontal activity counts averaged over 0-60 minutes and 61-180 minutes monitoring (n= 6-8 animals/group). (D) Effect of RS 127445 on quinpirole-induced changes of locomotor activity. RS 127445 (RS, 0.16 mg/kg) was intraperitoneally (i.p.) injected immediately before the administration of quinpirole (Q, 0.5 mg/kg, s.c.). Histograms represent the mean \pm SEM horizontal activity counts averaged over 0-60 minutes and 61-180 minutes monitoring (n= 11-12 animals/group). ***p<0.001 *versus* the vehicle (v) group or v/v group and +++p<0.001 *versus* the v/Q group (Newman-Keuls test).

DISCUSSION

The work accomplished over the past four years has provided interesting information on the regulatory control of DA function by central 5-HT_{2B}Rs. Specifically, altogether our findings have permitted to successfully address the three main objectives of the present thesis, by showing that:

1- 5-HT_{2B}R antagonists could be an interesting pharmacological tool for improved treatment of schizophrenia

For the first time, a complete overview of the pattern of action of 5-HT_{2B}Rs on DA outflow is afforded by the discovery of a 5-HT_{2B}R-mediated tonic inhibitory control of the mesocortical DA pathway (Figure 6; Devroye *et al.*, 2016). This finding, which contrasts with the impact of 5-HT_{2B}Rs at the level of the NAc (tonic excitatory control) and the striatum (no effect), allows the identification of the 5-HT_{2B}R as the only 5-HT receptor, to date, capable of exerting independent controls on the three ascending DA pathways. In keeping with the role of DA activity in the pathophysiology of schizophrenia (see section II.A), the control exerted by the 5-HT_{2B}R on DA outflow correlates with its impact in behavioral models predicting the ability of APDs to alleviate cognitive and positive symptoms, or APD propensity to induce motor side effects (Devroye *et al.*, 2016). Thus, in addition to a possible contribution to the therapeutic benefit of atypical APDs (Devroye *et al.*, 2016), the “ideal” antipsychotic profile of 5-HT_{2B}R antagonists could offer an alternative to the use of current “selective non-selective” treatments, whose side effects are related to their multi-target properties (see section II.A). However, this conclusion should be nuanced. First, the ability of 5-HT_{2B}R antagonists to exert their neurochemical and behavioral effects must be confirmed following chronic administration. Second, additional experiments are needed to explore the possible side effects concomitant with the acute and chronic administration of 5-HT_{2B}R antagonists. Specifically, the involvement of 5-HT_{2B}Rs in metabolism, body mass and diabetic disorders (commonly referred to as “metabolic syndrome”; Newman-Tancredi and Kleven, 2011) should be investigated.

Discussion

Finally, further behavioral experiments are also warranted to explore the potential of 5-HT_{2B}R antagonists to alleviate the different symptoms of schizophrenia. Indeed, as previously discussed (see section II.A and Porsolt *et al.*, 2010), the efficacy of a potential APD should be explored in a palette of diverse experiments reflecting the individual symptoms of schizophrenia. In particular, the ability of 5-HT_{2B}R antagonists to alleviate negative symptoms remains unknown, and deserves additional investigations.

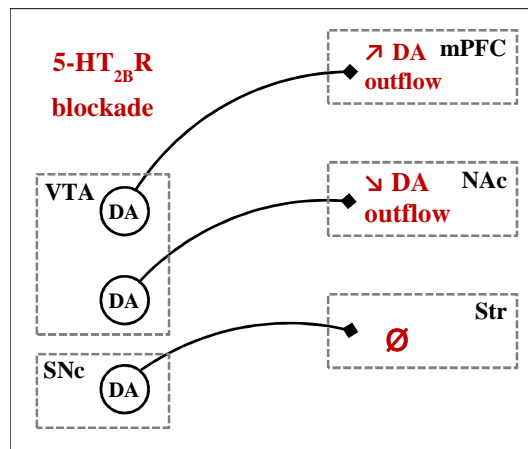

Figure 6: Schematic representation of the differential regulation of ascending DA pathways by 5-HT_{2B}Rs. Blockade of 5-HT_{2B}Rs reveals a tonic inhibitory and excitatory control on the mesocortical and mesoaccumbal DA pathways, respectively, and no effect on the nigrostriatal DA pathway activity. DA, dopamine; NAc, nucleus accumbens; mPFC, medial prefrontal cortex; SNc, substantia nigra pars compacta; Str, striatum; VTA, ventral tegmental area. *Auclair et al., 2010; Devroye et al., 2016.*

2- The 5-HT_{2B}R exerts its differential control on mesocorticolimbic DA pathways via the stimulation of mPFC 5-HT_{1A}Rs

This work, by showing that intra-DRN injection of RS 127445 increases 5-HT outflow in the mPFC, offers the first evidence of an effect triggered by the blockade of a specific 5-HT_{2B}R population in the central nervous system. Several findings suggest that the ability of 5-HT_{2B}R antagonists to increase mPFC 5-HT outflow may result from the modulation of SERT-mediated 5-HT transport in the DRN. Indeed, as discussed elsewhere (see section III.D.6.1), previous *in vitro* studies have shown that 5-HT_{2B}Rs govern the overall 5-HT transport by modulating the phosphorylation of the SERT in the DRN (Launay *et al.*, 2006). In addition, intra-DRN administration of the 5-HT_{2B}R preferential agonist BW 723C86 increases local 5-HT outflow (Doly *et al.*, 2008). Thus, it is tempting to suggest that 5-HT_{2B}R antagonists, by promoting SERT-dependent 5-HT transport in the DRN, would be able to reduce the 5-HT endogenous tone at DRN 5-HT_{1A}Rs, thereby leading to a disinhibition of 5-HT neurons projecting to the mPFC. Further experiments are warranted to assess this hypothesis. Interestingly, when considering the widespread innervation of the whole brain by DRN 5-HT projections (see section I), the ability of 5-HT_{2B}Rs to control DRN 5-HT neuron activity provides crucial information to explore the role of these receptors in various central functions. In addition, the existence of a functional interplay between 5-HT_{2B}Rs and 5-HT_{1A}Rs (Figure 7) raises the possibility that mPFC 5-HT_{1A}Rs may contribute not only to the impact of 5-HT_{2B}R antagonists on basal DA outflow, but also to their effects on “activated” DA outflow and DA-related behaviors. For instance, the suppressive influence of 5-HT_{2B}R blockade on amphetamine, MDMA and haloperidol-induced accumbal DA outflow (Doly *et al.*, 2008, 2009; Auclair *et al.*, 2010) may depend on the stimulation of mPFC 5-HT_{1A}Rs. As previously discussed (Auclair *et al.*, 2010), the ability of 5-HT_{2B}Rs to control exocytotic (haloperidol-induced) and non exocytotic (amphetamine-induced) DA outflow

Discussion

suggests that these receptors may be able to regulate DA neuronal firing and/or DA synthesis. In line with this proposal, we have shown that 5-HT_{2B}R blockade reduces VTA DA neuronal firing (Devroye *et al.*, 2016). Thus, the suppressive effect of 5-HT_{2B}R antagonists on haloperidol and amphetamine-induced accumbal DA outflow may involve a 5-HT_{1A}R-dependent inhibition of DA neuronal firing and/or DA synthesis in VTA DA neurons projecting to the NAc. On the other hand, in keeping with the tight relationship between NAc DA activity and locomotion (see section II.B), the ability of 5-HT_{2B}R antagonists to decrease amphetamine and MDMA-induced hyperlocomotion may also result from the stimulation of mPFC 5-HT_{1A}Rs. This hypothesis is supported by previous findings showing that 5-HT_{1A}R stimulation inhibits both amphetamine and MDMA-induced hyperlocomotion (Kehne *et al.*, 1996; Przegaliński and Filip, 1997). Additional experiments are needed to specifically address the involvement of mPFC 5-HT_{1A}Rs and DRN 5-HT_{2B}Rs in the control of these behavioral responses. Finally, as suggested in the present work, the discovery of an interaction between 5-HT_{2B}Rs and 5-HT_{1A}Rs provides interesting information with regards to the development of atypical APDs. Similarly, previous findings have described a functional crosstalk between 5-HT_{1A}Rs and 5-HT_{2A}Rs. Indeed, pretreatment with a 5-HT_{2A}R antagonist, which has no effect by itself, potentiates the increase in mPFC DA outflow induced by 5-HT_{1A}R stimulation (Ichikawa *et al.*, 2001). Thus, atypical APDs displaying antagonist properties towards both the 5-HT_{2B}R and the 5-HT_{2A}R, together with 5-HT_{1A}R agonist properties, could be the pharmacological key for improved treatment of schizophrenia.

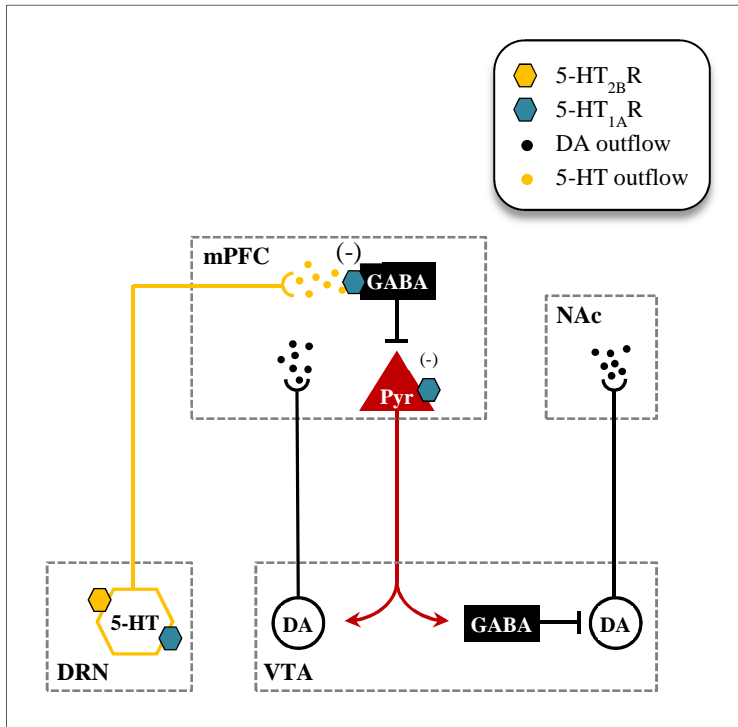

Figure 7: Schematic representation of the functional interplay between the 5-HT_{2B}R and the 5-HT_{1A}R controlling mesocorticolimbic DA pathways. Blockade of DRN 5-HT_{2B}Rs increases 5-HT outflow in the mPFC. It is possible that 5-HT_{2B}Rs may be expressed on DRN 5-HT neurons, as previously suggested by *in vitro* studies in primary neurons from mouse DRN (Launay *et al.*, 2006). However, additional investigations are needed to confirm 5-HT_{2B}R expression in rat DRN. Stimulation of GABAergic 5-HT_{1A}Rs by increased mPFC 5-HT levels leads to the disinhibition of glutamatergic pyramidal neurons, which send direct and GABA-mediated projections to VTA DA neurons innervating the mPFC and the NAc, respectively, thereby increasing mPFC DA outflow and decreasing NAc DA outflow. 5-HT, serotonin; DA, dopamine; DRN, dorsal raphe nucleus; GABA, γ -aminobutyric acid; mPFC, medial prefrontal cortex; NAc, nucleus accumbens; Pyr, glutamatergic pyramidal neurons; VTA, ventral tegmental area. Devroye *et al.*, 2016.

3- 5-HT_{2B}R antagonists suppress cocaine-induced hyperlocomotion independently of subcortical DA outflow

This work provides the first evidence that, as previously suggested for amphetamine and MDMA (Doly *et al.*, 2008, 2009; Auclair *et al.*, 2010), 5-HT_{2B}Rs may represent interesting pharmacological targets for improved treatment of cocaine abuse and dependence. Specifically, our findings demonstrate that 5-HT_{2B}Rs are able to control cocaine-induced hyperlocomotion (Devroye *et al.*, 2015), a behavioral model which is classically used to predict the reinforcing properties of drugs of abuse (Bubar and Cunningham, 2008). This interaction, which occurs independently from accumbal and striatal DA outflow, likely results from a post-synaptic interaction leading to changes of DA transmission in subcortical DA brain regions (Devroye *et al.*, 2015). This hypothesis is supported by the finding that 5-HT_{2B}R blockade suppresses the late-onset hyperactivity induced by quinpirole, a behavioral responses which is related to the direct activation of post-synaptic DA-D₂Rs (Benaliouad *et al.*, 2009; Devroye *et al.*, 2015). Thus, it is unlikely that the ability of mPFC 5-HT_{1A}Rs to activate glutamatergic neurons projecting to the VTA could be involved in 5-HT_{2B}R-mediated control of cocaine-induced hyperlocomotion (Devroye *et al.*, 2016). On the other hand, as previously suggested, the mPFC may be of particular relevance in the 5-HT_{2B}R control of post-synaptic DA activity in subcortical DA brain regions (Devroye *et al.*, 2015). Indeed, the mPFC is anatomically and functionally linked to the NAc and the striatum, and is known to participate to cocaine-induced behavioral responses (Tzschentke, 2001; Filip and Cunningham, 2003; Leggio *et al.*, 2009). Interestingly, we found that 5-HT_{2B}R blockade potentiates cocaine-induced mPFC DA outflow (unpublished results; Figure 8). Although the mechanisms underlying this potentiation remain to be determined, it is tempting to suggest that this excitatory effect may account for 5-HT_{2B}R antagonist-evoked suppressive effect on cocaine-induced hyperlocomotion. Indeed, several

Discussion

studies have shown that mPFC DA activity exerts an inhibitory control on subcortical DA transmission (Loulot *et al.*, 1989; Jaskiw *et al.*, 1991; Kolachana *et al.*, 1995) and on behaviors depending on subcortical DA transmission (Vezina *et al.*, 1991; Broersen *et al.* 1999; Lacroix *et al.* 2000). Thus, in addition to an action at pre-synaptic level, possibly resulting from mPFC 5-HT_{1A}R-mediated regulation of DA neuronal firing and/or DA synthesis (see above), 5-HT_{2B}Rs may modulate DA activity by a mPFC DA-dependent control of subcortical DA transmission, involving direct or indirect projections from the mPFC to dopaminergic neurons in the NAc and the striatum (Figure 9; Tzschentke, 2001). Importantly, similar effects have already been described in the literature. Indeed, the ability of 5-HT_{2C}Rs to regulate cocaine-induced phosphorylation of the DA and c-AMP-regulated phosphoproteins Mr 32 kDa (DARPP-32, a marker of DA neurotransmission; Nishi *et al.*, 2000) in the NAc and the striatum, independently of subcortical DA outflow, could account for the suppressive effect of the systemic administration of 5-HT_{2C}R agonists on cocaine-induced hyperlocomotion (Cathala *et al.*, 2014; Devroye *et al.*, 2015). Furthermore, these changes of NAc and striatal DA transmission could result from an action at the level of the mPFC, as cocaine-induced hyperactivity is also suppressed following intra-mPFC administration of 5-HT_{2C}R agonists (Filip and Cunningham, 2003). Thus, it is possible that 5-HT_{2B}Rs and 5-HT_{2C}Rs may share a common cortico-subcortical circuitry to control cocaine-induced hyperlocomotion. Nevertheless, this hypothesis should be assessed with further investigations aimed at determining the specific population of 5-HT_{2B}Rs involved in cocaine-induced neurochemical and behavioral responses, as well as the impact of 5-HT_{2B}R antagonists on cocaine-induced phosphorylation of DARPP-32 in subcortical DA regions. Finally, although the ability of 5-HT_{2B}R antagonists to affect the neurochemical and behavioral effects of cocaine provides useful clues to predict their potential to control cocaine rewarding properties, additional experiments are needed to

assess the influence of 5-HT_{2B}Rs in behavioral models more relevant to cocaine addiction, such as self-administration (Filip *et al.*, 2012).

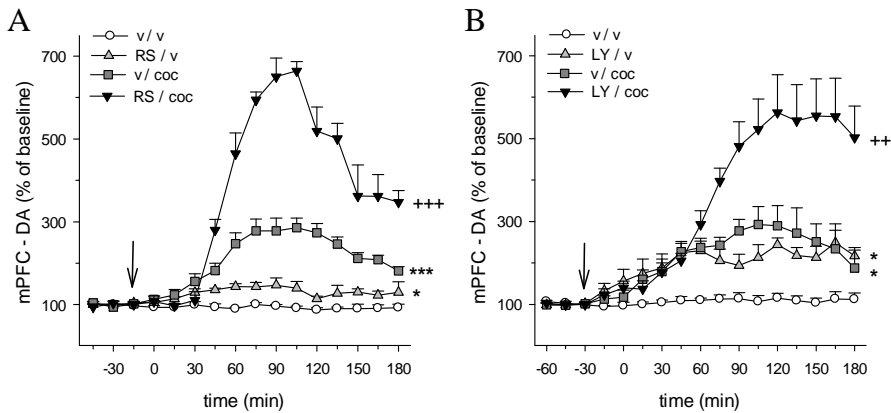

Figure 8: Time course effect of the administration of 5-HT_{2B}R antagonists on cocaine-induced increase in DA outflow in the mPFC. (A) RS 127445 (RS, 0.16 mg/kg) was intraperitoneally (i.p.) injected (vertical arrow) 15 min before the administration of cocaine (coc, 10 mg/kg, i.p., time zero). (B) LY 266097 (LY, 0.63 mg/kg) was intraperitoneally (i.p.) injected (vertical arrow) 30 min before the administration of cocaine (coc, 10 mg/kg, i.p., time zero). Data are represented as the mean \pm SEM percentages of the baseline calculated from the three samples preceding the first drug administration ($n = 4-7$ and 5 animals/group for A and B, respectively). Absolute basal levels of DA in dialysates collected in each brain region did not differ across the different experimental groups (A: $F_{(3,17)} = 0.34$, NS; B: $F_{(3,16)} = 0.75$, NS, ANOVA) and were: 0.25 ± 0.02 nM (A) and 0.25 ± 0.03 nM (B) (mean \pm SEM, $n = 21$ and 20 rats for A and B, respectively). A: statistical analysis revealed significant and time-dependent effects of pretreatment ($F_{RS \times time (13,221)} = 18.10$, $p < 0.001$), treatment ($F_{coc \times time (13,221)} = 51.02$, $p < 0.001$), and pretreatment \times treatment interaction ($F_{RS \times coc \times time (13,221)} = 13.59$, $p < 0.001$). Post-hoc analysis revealed that both RS and cocaine produced an overall significant increase in DA outflow ($p < 0.05$ and $p < 0.001$, *versus* the v/v group, respectively for RS and cocaine). Cocaine-induced DA outflow was significantly reduced by RS pretreatment ($p < 0.001$, *versus* the v/coc group). B: statistical analysis revealed significant and time-dependent effects of pretreatment ($F_{LY \times time (14,224)} = 10.99$, $p < 0.001$), treatment ($F_{coc \times time (14,224)} = 18.24$, $p < 0.001$), and pretreatment \times treatment interaction ($F_{LY \times coc \times time (14,224)} = 5.99$, $p < 0.001$). Post-hoc analysis revealed that both LY and cocaine produced an overall significant increase in DA outflow ($p < 0.05$, *versus* the v/v group). Cocaine-induced DA outflow was significantly reduced by LY pretreatment ($p < 0.01$, *versus* the v/coc group). DA, dopamine; mPFC, medial prefrontal cortex.

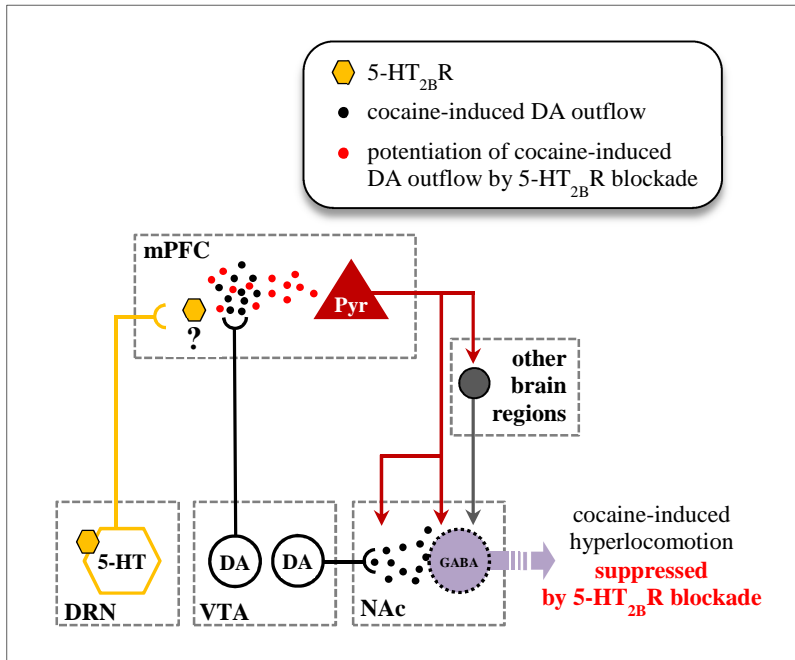

Figure 9: Schematic representation of the possible circuits underlying 5-HT_{2B}R-mediated control of cocaine-induced hyperlocomotion. Blockade of 5-HT_{2B}Rs potentiates cocaine-induced mPFC DA outflow, but has no effect at subcortical level, where DA activity is positively related to cocaine-induced hyperlocomotion. The potentiation of cocaine-induced mPFC DA outflow may inhibit, via direct or indirect inputs of the mPFC to dopaminergic cells (GABAergic medium spiny neurons; *Tzschentke, 2001; Sesack et al., 2003; Gabbott et al., 2005*), DA transmission in the NAc, leading to a decrease in cocaine-induced hyperlocomotion. The 5-HT_{2B}R population involved in the control of cocaine-induced neurochemical and behavioral responses remains to be determined. Additional investigations aimed at precisizing the expression of 5-HT_{2B}Rs in the cortex (*Bonaventure et al., 2002*) may help to address this issue, although the observed effects could also involve 5-HT_{2B}Rs in the DRN (*Launay et al., 2006*) or other brain regions (*Duxon et al., 1997a; Bonaventure et al., 2002*). 5-HT, serotonin; DA, dopamine; DRN, dorsal raphe nucleus; GABA, γ -aminobutyric acid; mPFC, medial prefrontal cortex; NAc, nucleus accumbens; VTA, ventral tegmental area. *Devroye et al., 2015* and unpublished data.

CONCLUSIONS

To conclude, the present study provides substantial advances to the understanding of the physiological role of the central 5-HT_{2B}R, whose importance in the central nervous system had been neglected for a long time. Thus, the 5-HT_{2B}R, with its unique pattern of effects within the 5-HT receptor family, appears to be a key player in the regulation of the DA network. In particular, the present work demonstrates that 5-HT_{2B}Rs are able to regulate both DA release and DA transmission via complex polysynaptic processes. Indeed, we have shown that 5-HT_{2B}R-mediated control of basal DA outflow results from a functional interplay with mPFC 5-HT_{1A}Rs, leading to the regulation of VTA DA neurons projecting to the mPFC and to the NAc (Devroye *et al.*, 2016). On the other hand, as demonstrated by our study with cocaine, 5-HT_{2B}Rs are able to control DA transmission independently of their pre-synaptic effect on DA release, likely by regulating mPFC DA-dependent inhibitory control of subcortical DA activity (Devroye *et al.*, 2015; Figure 8). Of note, the involvement of these distinct circuits in the effects of drugs modulating DA system activity (i.e. haloperidol, MDMA, amphetamine, cocaine) may depend upon the cellular mechanisms underlying the interaction of these drugs with DA neurons (Porras *et al.*, 2002a, 2002b, 2003; Navailles *et al.*, 2004; De Deurwaerdère *et al.*, 2005). Overall, regulation of both DA outflow and DA neurotransmission by 5-HT_{2B}Rs may account for the effects of 5-HT_{2B}R antagonists on DA-related behaviors. From a clinical point of view, the present work offers new insights into the therapeutic relevance of 5-HT_{2B}R agents, which was shadowed by the poor reputation of treatments with 5-HT_{2B}R agonist properties (Elangbam, 2010). Specifically, the ability of 5-HT_{2B}Rs to afford differential controls on the DA network indicates that 5-HT_{2B}R antagonists may represent a useful tool for improved treatment of pathological conditions requiring an independent modulation of the activity of ascending DA pathways, in particular schizophrenia and levodopa-induced psychosis in Parkinson's disease (Meltzer and Huang, 2008; Auclair *et al.*, 2010; Newman-Tancredi and Kleven, 2011). In addition, the involvement of 5-HT_{2B}Rs in the

Conclusions

control of cocaine-induced hyperlocomotion strengthens the therapeutic potential of 5-HT_{2B}R antagonists for treating drug addiction, as suggested by previous studies with amphetamine and MDMA (Doly *et al.*, 2008, 2009; Auclair *et al.*, 2010). Finally, our results altogether provide additional knowledge to the regulation of ascending DA pathways by the central 5-HT system, and demonstrate the legitimacy of 5-HT_{2B}Rs amongst the key modulators of the activity of the central DA network.

REFERENCES

A

- Abbas, A.I., Hedlund, P.B., Huang, X.P., Tran, T.B., Meltzer, H.Y., Roth, B.L., 2009. Amisulpride is a potent 5-HT₇ antagonist: relevance for antidepressant actions in vivo. *Psychopharmacology* 205, 119-128.
- Aggleton, J.P., 1993. The contribution of the amygdala to normal and abnormal emotional states. *Trends Neurosci.* 16, 328-333.
- Alex, K.D., Pehek, E.A., 2007. Pharmacologic mechanisms of serotonergic regulation of dopamine neurotransmission. *Pharmacol. Ther.* 113, 296-320.
- Amin, A.H., Crawford, T.B., Gaddum, J.H., 1954. The distribution of substance P and 5-hydroxytryptamine in the central nervous system of the dog. *J. Physiol.* 126, 596-618.
- Assié, M.B., Ravailhe, V., Faucillon, V., Newman-Tancredi, A., 2005. Contrasting contribution of 5-hydroxytryptamine 1A receptor activation to neurochemical profile of novel antipsychotics: frontocortical dopamine and hippocampal serotonin release in rat brain. *J. Pharmacol. Exp. Ther.* 315, 265-272.
- Auclair, A.L., Cathala, A., Sarrazin, F., Depoortère, R., Piazza, P.V., Newman-Tancredi, A., Spampinato, U., 2010. The central serotonin 2B receptor: a new pharmacological target to modulate the mesoaccumbens dopaminergic pathway activity. *J. Neurochem.* 114, 1323-1332.
- Audia, J.E., Evrard, D.A., Murdoch, G.R., Droste, J.J., Nissen, J.S., Schenck, K.W., Fludzinski, P., Lucaites, V.L., Nelson, D.L., Cohen, M.L., 1996. Potent, selective tetrahydro-beta-carboline antagonists of the serotonin 2B (5HT_{2B}) contractile receptor in the rat stomach fundus. *J. Med. Chem.* 39, 2773-2780.
- Azmitia, E.C., Segal, M., 1978. An autoradiographic analysis of the differential ascending projections of the dorsal and median raphe nuclei in the rat. *J. Comp. Neurol.* 179, 641-667.

B

- Bankson, M.G., Cunningham, K.A., 2001. 3,4-Methylenedioxymethamphetamine (MDMA) as a unique model of serotonin receptor function and serotonin-dopamine interactions. *J. Pharmacol. Exp. Ther.* 297, 846-852.
- Baou, M., Boumba, V.A., Petrikis, P., Rallis, G., Vougiouklakis, T., Mavreas, V., 2015. A review of genetic alterations in the serotonin pathway and their correlation with psychotic diseases and response to atypical antipsychotics. *Schizophr. Res.* 170, 18-29.
- Baumann, M.H., Clark, R.D., Rothman, R.B., 2008. Locomotor stimulation produced by 3,4-methylenedioxymethamphetamine (MDMA) is correlated with dialysate levels of serotonin and dopamine in rat brain. *Pharmacol. Biochem. Behav.* 90, 208-217.

References

- Baxter, G.S., 1996. Novel discriminatory ligands for 5-HT_{2B} receptors. *Behav. Brain Res.* 73, 149-152.
- Baxter, G.S., Murphy, O.E., Blackburn, T.P., 1994. Further characterization of 5-hydroxytryptamine receptors (putative 5-HT_{2B}) in rat stomach fundus longitudinal muscle. *Br. J. Pharmacol.* 112, 323-331.
- Belin, D., Mar, A.C., Dalley, J.W., Robbins, T.W., Everitt, B.J., 2008. High impulsivity predicts the switch to compulsive cocaine-taking. *Science* 320, 1352-1355.
- Benaliouad, F., Kapur, S., Natesan, S., Rompré, P.P., 2009. Effects of the dopamine stabilizer, OSU-6162, on brain stimulation reward and on quinpirole-induced changes in reward and locomotion. *Eur. Neuropsychopharmacol.* 19, 416-430.
- Bengel, D., Murphy, D.L., Andrews, A.M., Wichems, C.H., Feltner, D., Heils, A., Mössner, R., Westphal, H., Lesch, K.P., 1998. Altered brain serotonin homeostasis and locomotor insensitivity to 3, 4-methylenedioxymethamphetamine ("Ecstasy") in serotonin transporter-deficient mice. *Mol. Pharmacol.* 53, 649-655.
- Bennett, J.P.Jr, Enna, S.J., Bylund, D.B., Gillin, J.C., Wyatt, R.J., Snyder, S.H., 1979. Neurotransmitter receptors in frontal cortex of schizophrenics. *Arch. Gen. Psychiatry* 36, 927-934.
- Berridge M.J., 1993. Inositol trisphosphate and calcium signalling. *Nature* 361, 315-325.
- Bevilacqua, L., Doly, S., Kaprio, J., Yuan, Q., Tikkanen, R., Paunio, T., Zhou, Z., Wedenoja, J., Maroteaux, L., Diaz, S., Belmer, A., Hodgkinson, C.A., Dell'osso, L., Suvisaari, J., Coccaro, E., Rose, R.J., Peltonen, L., Virkkunen, M., Goldman, D., 2010. A population-specific HTR2B stop codon predisposes to severe impulsivity. *Nature* 468, 1061-1066.
- Bevilacqua, L., Goldman, D., 2013. Genetics of impulsive behaviour. *Philos. Trans. R. Soc. Lond. B. Biol. Sci.* 368, 20120380.
- Björklund, A., Dunnett, S.B., 2007. Dopamine neuron systems in the brain: an update. *Trends Neurosci.* 30, 194-202.
- Blomstrand, F., Åberg, N.D., Eriksson, P.S., Hansson, E., Rönnbäck, L., 1999. Extent of intercellular calcium wave propagation is related to gap junction permeability and level of connexin-43 expression in astrocytes in primary cultures from four brain regions. *Neurosci.* 92, 255-265.
- Bonaventure, P., Guo, H., Tian, B., Liu, X., Bittner, A., Roland, B., Salunga, R., Ma, X.J., Kamme, F., Meurers, B., Bakker, M., Jurzak, M., Leysen, J.E., Erlander, M.G., 2002. Nuclei and subnuclei gene expression profiling in mammalian brain. *Brain Res.* 943, 38-47.
- Bonhaus, D.W., Bach, C., DeSouza, A., Salazar, F.H., Matsuoka, B.D., Zuppan, P., Chan, H.W., Eglén, R.M., 1995. The pharmacology and distribution of human 5-hydroxytryptamine_{2B} (5-HT_{2B}) receptor gene products: comparison with 5-HT_{2A} and 5-HT_{2C} receptors. *Br. J. Pharmacol.* 115, 622-628.
- Bonhaus, D.W., Flippin, L.A., Greenhouse, R.J., Jaime, S., Rocha, C., Dawson, M., Van Natta, K., Chang, L.K., Pulido-Rios, T., Webber, A., Leung, E., Eglén, R.M.,

- Martin, G.R., 1999. RS-127445: a selective, high affinity, orally bioavailable 5-HT_{2B} receptor antagonist. *Br. J. Pharmacol.* 127, 1075-1082.
- Borman, R.A., Burleigh, D.E., 1995. Functional evidence for a 5-HT_{2B} receptor mediating contraction of longitudinal muscle in human small intestine. *Br. J. Pharmacol.* 114, 1525-1527.
- Borman, R.A., Tilford, N.S., Harmer, D.W., Day, N., Ellis, E.S., Sheldrick, R.L., Carey, J., Coleman, R.A., Baxter, G.S., 2002. 5-HT(2B) receptors play a key role in mediating the excitatory effects of 5-HT in human colon in vitro. *Br. J. Pharmacol.* 135, 1144-1151.
- Bossert, J.M., Wihbey, K.A., Pickens, C.L., Nair, S.G., Shaham Y., 2009. Role of dopamine D(1)-family receptors in dorsolateral striatum in context-induced reinstatement of heroin seeking in rats. *Psychopharmacology* 206, 51-60.
- Broderick, P.A., Hope, O., Okonji, C., Rahni, D.N., Zhou, Y., 2004. Clozapine and cocaine effects on dopamine and serotonin release in nucleus accumbens during psychostimulant behavior and withdrawal. *Prog. Neuropsychopharmacol. Biol. Psychiatry* 28, 157-171.
- Bubar, M.J., Cunningham, K.A., 2008. Prospects for serotonin 5-HT_{2R} pharmacotherapy in psychostimulant abuse. *Prog. Brain Res.* 172, 319-346.

C

- Callaway, C.W., Wing, L.L., Geyer, M.A., 1990. Serotonin release contributes to the locomotor stimulant effects of 3,4-methylenedioxymethamphetamine in rats. *J. Pharmacol. Exp. Ther.* 254, 456-464.
- Carboni, E., Spiewoy, C., Vacca, C., Nosten-Bertrand, M., Giros, B., Di Chiara G., 2001. Cocaine and amphetamine increase extracellular dopamine in the nucleus accumbens of mice lacking the dopamine transporter gene. *J. Neurosci.* 21, RC141, 1-4.
- Carboni, E., Tanda, G.L., Frau, R., Di Chiara, G., 1990. Blockade of the noradrenaline carrier increases extracellular dopamine concentrations in the prefrontal cortex: evidence that dopamine is taken up in vivo by noradrenergic terminals. *J. Neurochem.* 55, 1067-1070.
- Carlsson, A., Lindqvist, M., Magnusson, T., Waldeck, B., 1958. On the presence of 3-hydroxytyramine in brain. *Science* 127, 471.
- Carlsson, A., Waters, N., Carlsson, M.L., 1999. Neurotransmitter interactions in schizophrenia--therapeutic implications. *Biol. Psychiatry* 46, 1388-1395.
- Carlsson, A., Waters, N., Waters, S., Carlsson, M.L., 2000. Network interactions in schizophrenia - therapeutic implications. *Brain Res. Rev.* 31, 342-349.
- Cox, D.A., Cohen, M.L., 1995. 5-Hydroxytryptamine_{2B} receptor signaling in rat stomach fundus: role of voltage-dependent calcium channels, intracellular calcium release and protein kinase C. *J. Pharmacol. Exp. Ther.* 272, 143-150.

References

- Crow, T.J., 1973. Catecholamine-containing neurones and electrical self-stimulation. 2. A theoretical interpretation and some psychiatric implications. *Psychol. Med.* 3, 66-73.
- Csermely, P., Agoston, V., Pongor, S., 2005. The efficiency of multitarget drugs: the network approach might help drug design. *Trends Pharmacol. Sci.* 26, 178-182.
- Cunningham, K.A., Anastasio, N.C., Fox, R.G., Stutz, S.J., Bubar, M.J., Swinford, S.E., Watson, C.S., Gilbertson, S.R., Rice, K.C., Rosenzweig-Lipson, S., Moeller, F.G., 2013. Synergism between a serotonin 5-HT_{2A} receptor (5-HT_{2AR}) antagonist and 5-HT_{2CR} agonist suggests new pharmacotherapeutics for cocaine addiction. *ACS Chem. Neurosci.* 4, 110-121.
- Cussac, D., Boutet-Robinet, E., Ailhaud, M.C., Newman-Tancredi, A., Martel, J.C., Danty, N., Raully-Lestienne, I., 2008. Agonist-directed trafficking of signalling at serotonin 5-HT_{2A}, 5-HT_{2B} and 5-HT_{2C}-VSV receptors mediated Gq/11 activation and calcium mobilisation in CHO cells. *Eur. J. Pharmacol.* 594, 32-38.
- Cussac, D., Newman-Tancredi, A., Quentric, Y., Carpentier, N., Poissonnet, G., Parmentier, J.G., Goldstein, S., Millan, M.J., 2002. Characterization of phospholipase C activity at h5-HT_{2C} compared with h5-HT_{2B} receptors: influence of novel ligands upon membrane-bound levels of [3H]phosphatidylinositols. *Naunyn Schmiedebergs Arch. Pharmacol.* 365, 242-252.

D

- Dahlström, A., Fuxe, K., 1964. Localization of monoamines in the lower brain stem. *Experientia* 20, 398-399.
- De Deurwaerdère, P., Moison, D., Navailles, S., Porras, G., Spampinato, U., 2005. Regionally and functionally distinct serotonin₃ receptors control in vivo dopamine outflow in the rat nucleus accumbens. *J. Neurochem.* 94, 140-149.
- de las Casas-Engel, M., Domínguez-Soto, A., Sierra-Filardi, E., Bragado, R., Nieto, C., Puig-Kroger, A., Samaniego, R., Loza, M., Corcuera, M.T., Gómez-Aguado, F., Bustos, M., Sánchez-Mateos, P., Corbí, A.L., 2013. Serotonin skews human macrophage polarization through HTR_{2B} and HTR₇. *J. Immunol.* 190, 2301-2310.
- De Lucchini, S., Ori, M., Cremisi, F., Nardini, M., Nardi, I., 2005. 5-HT_{2B}-mediated serotonin signaling is required for eye morphogenesis in *Xenopus*. *Mol. Cell Neurosci.* 29, 299-312.
- De Lucchini, S., Ori, M., Nardini, M., Marracci, S., Nardi, I., 2003. Expression of 5-HT_{2B} and 5-HT_{2C} receptor genes is associated with proliferative regions of *Xenopus* developing brain and eye. *Mol. Brain Res.* 115, 196-201.
- De Wit, H., Wise, R.A., 1977. Blockade of cocaine reinforcement in rats with the dopamine receptor blocker pimozide, but not with the noradrenergic blockers phentolamine or phenoxybenzamine. *Can. J. Psychol.* 31, 195-203.
- Deisher, T.A., Sato, T.T., Pohlman, T.H., Harlan, J.M., 1993. A protein kinase C agonist, selective for the beta I isozyme, induces E-selectin and VCAM-1 expression

- on HUVEC but does not translocate PKC. *Biochem. Biophys. Res. Commun.* 193, 1283-1290.
- Delay, J., Deniker, P., Harl, J.M., 1952. Utilisation en thérapeutique psychiatrique d'une phénothiazine d'action centrale élective (4560 RP). *Ann. Med. Psychol. (Paris)* 110, 112-117.
- Delille, H.K., Mezler, M., Marek, G.J., 2013. The two faces of the pharmacological interaction of mGlu2 and 5-HT_{2A} - relevance of receptor heterocomplexes and interaction through functional brain pathways. *Neuropharmacology* 70, 296-305.
- Devroye, C., Cathala, A., Maitre, M., Piazza, P.V., Abrous, D.N., Revest, J.M., Spampinato, U., 2015. Serotonin_{2C} receptor stimulation inhibits cocaine-induced Fos expression and DARPP-32 phosphorylation in the rat striatum independently of dopamine outflow. *Neuropharmacology* 89, 375-381.
- Di Chiara, G., 2002. Nucleus accumbens shell and core dopamine: differential role in behavior and addiction. *Behav. Brain Res.* 137, 75-114.
- Di Chiara, G., Imperato, A., 1988. Drugs abused by humans preferentially increase synaptic dopamine concentrations in the mesolimbic system of freely moving rats. *Proc. Natl. Acad. Sci. U. S. A.* 85, 5274-5278.
- Di Matteo, V., Di Giovanni, G., Di Mascio, M., Esposito, E., 2000. Biochemical and electrophysiological evidence that RO 60-0175 inhibits mesolimbic dopaminergic function through serotonin_{2C} receptors. *Brain Res.* 865, 85-90.
- Diaz, S.L., Doly, S., Narboux-Nême, N., Fernández, S., Mazot, P., Banas, S.M., Boutourlinsky, K., Moutkine, I., Belmer, A., Roumier, A., Maroteaux, L., 2012. 5-HT_{2B} receptors are required for serotonin-selective antidepressant actions. *Mol. Psychiatry* 17, 154-63.
- Diaz, S.L., Maroteaux, L., 2011. Implication of 5-HT_{2B} receptors in the serotonin syndrome. *Neuropharmacology* 61, 495-502.
- Díaz-Mataix, L., Scorza, M.C., Bortolozzi, A., Toth, M., Celada, P., Artigas, F., 2005. Involvement of 5-HT_{1A} receptors in prefrontal cortex in the modulation of dopaminergic activity: role in atypical antipsychotic action. *J. Neurosci.* 25, 10831-10843.
- Doly, S., Bertran-Gonzalez, J., Callebert, J., Bruneau, A., Banas, S.M., Belmer, A., Boutourlinsky, K., Herve, D., Launay, J.M., Maroteaux, L., 2009. Role of serotonin via 5-HT_{2B} receptors in the reinforcing effects of MDMA in mice. *PLoS ONE* 4, e7952.
- Doly, S., Valjent, E., Setola, V., Callebert, J., Herve, D., Launay, J.M., Maroteaux, L., 2008. Serotonin 5-HT_{2B} receptors are required for 3,4-methylenedioxymethamphetamine-induced hyperlocomotion and 5-HT release in vivo and in vitro. *J. Neurosci.* 28, 2933-2940.
- Dumitrescu, R., Kulcke, C., Königshoff, M., Kouri, F., Yang, X., Morrell, N., Ghofrani, H.A., Weissmann, N., Reiter, R., Seeger, W., Grimminger, F., Eickelberg, O., Schermuly, R.T., Pullamsetti, S.S., 2011. Terguride ameliorates monocrotaline-induced pulmonary hypertension in rats. *Eur. Respir. J.* 37, 1104-1118.

References

- Dunnett, S.B., Robbins, T.W., 1992. The functional role of mesotelencephalic dopamine systems. *Biol. Rev. Camb. Philos. Soc.* 67, 491-518.
- Duxon, M.S., Flanigan, T.P., Reavley, A.C., Baxter, G.S., Blackburn, T.P., Fone, K.C., 1997a. Evidence for expression of the 5-hydroxytryptamine-2B receptor protein in the rat central nervous system. *Neuroscience* 76, 323-329.
- Duxon, M.S., Kennett, G.A., Lightowler, S., Blackburn, T.P., Fone, K.C., 1997b. Activation of 5-HT_{2B} receptors in the medial amygdala causes anxiolysis in the social interaction test in the rat. *Neuropharmacology* 36, 601-608.

E

- Elangbam, C.S., 2010. Drug-induced valvulopathy: an update. *Toxicol. Pathol.* 38, 837-848.
- Ellis, E.S., Byrne, C., Murphy, O.E., Tilford, N.S., Baxter, G.S., 1995. Mediation by 5-hydroxytryptamine_{2B} receptors of endothelium-dependent relaxation in rat jugular vein. *Br. J. Pharmacol.* 114, 400-404.

F

- Fallon, J.H., Moore, R.Y., 1978. Catecholamine innervation of the basal forebrain. IV. Topography of the dopamine projection to the basal forebrain and neostriatum. *J. Comp. Neurol.* 180, 545-580.
- Filip, M., Alenina, N., Bader, M., Przegaliński, E., 2010. Behavioral evidence for the significance of serotonergic (5-HT) receptors in cocaine addiction. *Addict. Biol.* 15, 227-249.
- Filip, M., Siwanowicz, J., 2001. Implication of the nucleus accumbens shell, but not core, in the acute and sensitizing effects of cocaine in rats. *Pol. J. Pharmacol.* 53, 459-466.
- Filip, M., Spampinato, U., McCreary, A.C., Przegaliński, E., 2012. Pharmacological and genetic interventions in serotonin (5-HT)_{2C} receptors to alter drug abuse and dependence processes. *Brain Res.* 1476, 132-153.
- Fiorica-Howells, E., Maroteaux, L., Gershon, M.D., 2000. Serotonin and the 5-HT_{2B} receptor in the development of enteric neurons. *J. Neurosci.* 20, 294-305.
- Fitzgerald, L.W., Burn, T.C., Brown, B.S., Patterson, J.P., Corjay, M.H., Valentine, P.A., Sun, J.H., Link, J.R., Abbaszade, I., Hollis, J.M., Largent, B.L., Hartig, P.R., Hollis, G.F., Meunier, P.C., Robichaud, A.J., Robertson, D.W., 2000. Possible role of valvular serotonin 5-HT_{2B} receptors in the cardiopathy associated with fenfluramine. *Mol. Pharmacol.* 57, 75-81.
- Foguet, M., Hoyer, D., Pardo, L.A., Parekh, A., Kluxen, F.W., Kalkman, H.O., Stühmer, W., Lübbert, H., 1992. Cloning and functional characterization of the rat stomach fundus serotonin receptor. *EMBO J.* 11, 3481-3487.

- Forbes, I.T., Jones, G.E., Murphy, O.E., Holland, V., Baxter, G.S., 1995. N-(1-methyl-5-indolyl)-N'-(3-methyl-5-isothiazolyl)urea: a novel, high-affinity 5-HT_{2B} receptor antagonist. *J. Med. Chem.* 38, 855-857.
- Forster, J., Damjanov, I., Lin, Z., Sarosiek, I., Wetzel, P., McCallum, R.W., 2005. Absence of the interstitial cells of Cajal in patients with gastroparesis and correlation with clinical findings. *J. Gastrointest. Surg.* 9, 102-108.

G

- Galione, A., 1992. Ca²⁺-induced Ca²⁺ release and its modulation by cyclic ADP-ribose. *Trends Pharmacol. Sci.* 13, 304-306.
- Girault, J.A., 2007. Signaling in striatal neurons: the phosphoproteins of reward, addiction, and dyskinesia. *Prog. Mol. Biol. Transl. Sci.* 106, 33-62.
- Gobert, A., Rivet, J.M., Lejeune, F., Newman-Tancredi, A., Adhumeau-Auclair, A., Nicolas, J.P., Cistarelli, L., Melon, C., Millan, M.J., 2000. Serotonin(2C) receptors tonically suppress the activity of mesocortical dopaminergic and adrenergic, but not serotonergic, pathways: a combined dialysis and electrophysiological analysis in the rat. *Synapse* 36, 205-221.
- Grüsser, S.M., Wrase, J., Klein, S., Hermann, D., Smolka, M.N., Ruf, M., Weber-Fahr, W., Flor, H., Mann, K., Braus, D.F., Heinz, A., 2004. Cue-induced activation of the striatum and medial prefrontal cortex is associated with subsequent relapse in abstinent alcoholics. *Psychopharmacology* 175, 296-302.
- Gudelsky, G.A., Nash, J.F., 1996. Carrier-mediated release of serotonin by 3,4-methylenedioxymethamphetamine: implications for serotonin-dopamine interactions. *J. Neurochem.* 66, 243-249.
- Gudelsky, G.A., Yamamoto, B.K., Nash, J.F., 1994. Potentiation of 3,4-methylenedioxymethamphetamine-induced dopamine release and serotonin neurotoxicity by 5-HT₂ agonists. *Eur. J. Pharmacology* 264, 325-330.

H

- Halberstadt, A.L., Geyer, M.A., 2013. Serotonergic hallucinogens as translational models relevant to schizophrenia. *Int. J. Neuropsychopharmacol.* 16, 2165-2180.
- Hall, F.S., Li, X.F., Randall-Thompson, J., Sora, I., Murphy, D.L., Lesch, K.P., Caron, M., Uhl, G.R., 2009. Cocaine-conditioned locomotion in dopamine transporter, norepinephrine transporter and 5-HT transporter knockout mice. *Neuroscience* 162, 870-880.
- Hannon, J., Hoyer, D., 2008. Molecular biology of 5-HT receptors. *Behav. Brain Res.* 195, 198-213.
- He, C.L., Burgart, L., Wang, L., Pemberton, J., Young-Fadok, T., Szurszewski, J., Farrugia, G., 2000. Decreased interstitial cell of cajal volume in patients with slow-transit constipation. *Gastroenterology* 118, 14-21.

References

- Hedou G., Feldon J., Heidbreder C.A. 1999. Effects of cocaine on dopamine in subregions of the rat prefrontal cortex and their efferents to subterritories of the nucleus accumbens. *Eur. J. Pharmacol.* 372, 143-155.
- Heidbreder C.A., Hedou G., Feldon J. 1999. Behavioral neurochemistry reveals a new functional dichotomy in the shell subregion of the nucleus accumbens. *Prog. Neuropsychopharmacol. Biol. Psychiatry* 23, 99-132.
- Heidenreich K.A., Toledo S.P., Brunton L.L., Watson M.J., Daniel-Issakani S., Strulovici B. 1990. Insulin stimulates the activity of a novel protein kinase C, PKC-epsilon, in cultured fetal chick neurons. *J. Biol. Chem.* 265, 15076-15082.
- Helton, L.A., Thor, K.B., Baez, M., 1994. 5-hydroxytryptamine2A, 5-hydroxytryptamine2B, and 5-hydroxytryptamine2C receptor mRNA expression in the spinal cord of rat, cat, monkey and human. *Neuroreport* 5, 2617-2620.
- Hirst, W.D., Cheung, N.Y., Rattray, M., Price, G.W., Wilkin, G.P., 1998. Cultured astrocytes express messenger RNA for multiple serotonin receptor subtypes, without functional coupling of 5-HT1 receptor subtypes to adenylyl cyclase. *Brain Res. Mol. Brain Res.* 61, 90-99.
- Homberg J.R., De Boer S.F., Raasø H.S., Olivier J.D., Verheul M., Ronken E., Cools A.R., Ellenbroek B.A., Schoffelmeer A.N., Vanderschuren L.J., De Vries T.J., Cuppen E. 2008. Adaptations in pre- and postsynaptic 5-HT1A receptor function and cocaine supersensitivity in serotonin transporter knockout rats. *Psychopharmacology* 200, 367-380.
- Howell, L.L., Cunningham, K.A., 2015. Serotonin 5-HT2 receptor interactions with dopamine function: implications for therapeutics in cocaine use disorder. *Pharmacol. Rev.* 67, 176-197.

I

- Ichikawa J., Ishii H., Bonaccorso S., Fowler W.L., O'Laughlin I.A., Meltzer H.Y. 2001. 5-HT(2A) and D(2) receptor blockade increases cortical DA release via 5-HT(1A) receptor activation: a possible mechanism of atypical antipsychotic-induced cortical dopamine release. *J. Neurochem.* 76, 1521-1531.
- Ichikawa, J., Meltzer, H.Y., 2000. The effect of serotonin1A receptor agonism on antipsychotic drug-induced dopamine release in rat striatum and nucleus accumbens. *Brain Res.* 858, 252-263.

J

- Jacobs, B.L., Azmitia, E.C., 1992. Structure and function of the brain serotonin system. *Physiol. Rev.* 72, 165-229.
- Jähnichen, S., Horowski, R., Pertz, H. H., 2005. Agonism at 5HT2B receptors is not a class effect of the ergolines. *Eur. J. Pharmacol.* 513, 225-28.
- Janssen, W., Schymura, Y., Novoyatleva, T., Kojonazarov, B., Boehm, M., Wietelmann, A., Luitel, H., Murmann, K., Krompiec, D.R., Tretyn, A., Pullamsetti,

- S.S., Weissmann, N., Seeger, W., Ghofrani, H.A., Schermuly, R.T., 2015. 5-HT_{2B} receptor antagonists inhibit fibrosis and protect from RV heart failure. *Biomed. Res. Int.* 2015, 438403.
- Joyce, E.M., Iversen, S.D., 1984. Dissociable effects of 6-OHDA-induced lesions of neostriatum on anorexia, locomotor activity and stereotypy: the role of behavioural competition. *Psychopharmacology* 83, 363-366.
- ## K
- Kahn, R. S., Van Praag, H. M., Wetzler, S., Asnis, G. M., Barr, G., 1988. Serotonin and anxiety revisited. *Biol. Psychiatry* 23, 189-208.
- Kelly, P.H., Iversen, S.D., 1976. Selective 6-OHDA-induced destruction of mesolimbic dopamine neurons: Abolition of psychostimulant-induced locomotor activity in rats. *Eur. J. Pharmacol.* 40, 45-56.
- Kennett, G.A., Ainsworth, K., Trail, B., Blackburn, T.P., 1997. BW 723C86, a 5-HT_{2B} receptor agonist, causes hyperphagia and reduced grooming in rats. *Neuropharmacology* 36, 233-239.
- Kennett, G.A., Bright, F., Trail, B., Baxter, G.S., Blackburn, T.P., 1996. Effects of the 5-HT_{2B} receptor agonist, BW 723C86, on three rat models of anxiety. *Br. J. Pharmacol.* 117, 1443-1448.
- Kennett, G.A., Trail, B., Bright, F., 1998. Anxiolytic-like actions of BW 723C86 in the rat Vogel conflict test are 5-HT_{2B} receptor mediated. *Neuropharmacology* 37, 1603-1610.
- Kenny, S.E., Vanderwinden, J.M., Rintala, R.J., Connell, M.G., Lloyd, D.A., Vanderhaegen, J.J., De Laet, M.H., 1998. Delayed maturation of the interstitial cells of Cajal: a new diagnosis for transient neonatal pseudoobstruction. Report of two cases. *J. Pediatr. Surg.* 33, 94-98.
- Kiss, B., Horváth, A., Némethy, Z., Schmidt, E., Laszlovszky, I., Bugovics, G., Fazekas, K., Hornok, K., Orosz, S., Gyertyán, I., Agai-Csongor, E., Domány, G., Tihanyi, K., Adham, N., Szombathelyi, Z., 2010. Cariprazine (RGH-188), a dopamine D(3) receptor-preferring, D(3)/D(2) dopamine receptor antagonist-partial agonist antipsychotic candidate: in vitro and neurochemical profile. *J. Pharmacol. Exp. Ther.* 333, 328-340.
- Knowles, I.D., Ramage, A.G., 1999. Evidence for a role for central 5-HT_{2B} as well as 5-HT_{2A} receptors in cardiovascular regulation in anaesthetized rats. *Br. J. Pharmacol.* 128, 530-542.
- Knowles, I.D., Ramage, A.G., 2000. Evidence that activation of central 5-HT(2B) receptors causes renal sympathoexcitation in anaesthetized rats. *Br. J. Pharmacol.* 129, 177-183.
- Koe, B.K., 1976. Molecular geometry of inhibitors of the uptake of catecholamines and serotonin in synaptosomal preparations of rat brain. *J. Pharmacol. Exp. Ther.* 199, 649-661.

References

- Kollins, S.H., MacDonald, E.K., Rush, C.R., 2001. Assessing the abuse potential of methylphenidate in nonhuman and human subjects: a review. *Pharmacol. Biochem. Behav.* 68, 611-627.
- Koob, G.F., Volkow, N.D., 2010. Neurocircuitry of addiction. *Neuropsychopharmacol.* 35, 217-238.
- Kornetsky, C., Esposito, R.U., 1979. Euphorogenic drugs: effects on the reward pathways of the brain. *Fed. Proc.* 38, 2473-2476.
- Kuhar, M. J., 1986. Neuroanatomical substrates of anxiety: a brief survey. *Trends in Neuroscience* 9, 307-312.
- Kursar, J.D., Nelson, D.L., Wainscott, D.B., Baez M., 1994. Molecular cloning, functional expression, and mRNA tissue distribution of the human 5-hydroxytryptamine_{2B} receptor. *Mol. Pharmacol.* 46, 227-234.
- Kursar, J.D., Nelson, D.L., Wainscott, D.B., Cohen, M.L., Baez, M. 1992. Molecular cloning, functional expression, and pharmacological characterization of a novel serotonin receptor (5-hydroxytryptamine_{2F}) from rat stomach fundus. *Mol. Pharmacol.* 42, 549-557.
- Kvetnansky, R., Sabban, E.L., Palkovits, M., 2009. Catecholaminergic systems in stress: structural and molecular genetic approaches. *Physiol. Rev.* 89, 535-606.

L

- Launay, J.M., Birraux, G., Bondoux, D., Callebert, J., Choi, D.S., Loric, S., Maroteaux, L., 1996. Ras involvement in signal transduction by the serotonin 5-HT_{2B} receptor. *J. Biol. Chem.* 271, 3141-3147.
- Launay, J.M., Hervé, P., Callebert, J., Mallat, Z., Collet, C., Doly, S., Belmer, A., Diaz, S.L., Hatia, S., Côté, F., Humbert, M., Maroteaux, L., 2012. Serotonin 5-HT_{2B} receptors are required for bone-marrow contribution to pulmonary arterial hypertension. *Blood* 119, 1772-1780.
- Launay, J.M., Hervé, P., Peoc'h, K., Tournois, C., Callebert, J., Nebigil, C.G., Etienne, N., Drouet, L., Humbert, M., Simonneau, G., Maroteaux, L., 2002. Function of the serotonin 5-hydroxytryptamine 2B receptor in pulmonary hypertension. *Nat. Med.* 8, 1129-1135.
- Launay, J.M., Schneider, B., Loric, S., Da Prada, M., Kellermann, O., 2006. Serotonin transport and serotonin transporter-mediated antidepressant recognition are controlled by 5-HT_{2B} receptor signaling in serotonergic neuronal cells. *FASEB J.* 20, 1843-1854.
- Leggio, G.M., Salomone, S., Bucolo, C., Platania, C., Micale, V., Caraci, F., Drago, F., 2013. Dopamine D(3) receptor as a new pharmacological target for the treatment of depression. *Eur. J. Pharmacol.* 719, 25-33.
- Lesurtel, M., Graf, R., Aleil, B., Walther, D.J., Tian, Y., Jochum, W., Gachet, C., Bader, M., Clavien, P.A., 2006. Platelet-derived serotonin mediates liver regeneration. *Science* 312, 104-107.

- Li B., Zhang S., Zhang H., Nu W., Cai L., Hertz L., Peng L. 2008. Fluoxetine-mediated 5-HT_{2B} receptor stimulation in astrocytes causes EGF receptor transactivation and ERK phosphorylation. *Psychopharmacology* 201, 443-458.
- Lieberman, J.A., Kane, J.M., Alvir, J., 1987. Provocative tests with psychostimulant drugs in schizophrenia. *Psychopharmacology* 91, 415-433.
- Lieberman, J.A., Kane, J.M., Gadaleta, D., Brenner, R., Lesser, M.S., Kinon, B., 1984. Methylphenidate challenge as a predictor of relapse in schizophrenia. *Am. J. Psychiatry* 141, 633-638.
- Lladó-Pelfort, L., Santana, N., Ghisi, V., Artigas, F., Celada, P., 2012. 5-HT_{1A} receptor agonists enhance pyramidal cell firing in prefrontal cortex through a preferential action on GABA interneurons. *Cereb. Cortex* 22, 1487-1497.
- Locker, M., Bitard, J., Collet, C., Poliard, A., Mutel, V., Launay, J.M., Kellermann, O., 2006. Stepwise control of osteogenic differentiation by 5-HT(2B) receptor signaling: nitric oxide production and phospholipase A2 activation. *Cell Signal* 18, 628-639.
- Loric, S., Launay, J.M., Colas, J.F., Maroteaux, L., 1992. New mouse 5-HT₂-like receptor. Expression in brain, heart and intestine. *FEBS Lett.* 312, 203-207.
- Lyford G.L., He C.L., Soffer E., Hull T.L., Strong S.A., Senagore A.J., Burgart L.J., Young-Fadok T., Szurszewski J.H., Farrugia G. 2002. Pan-colonic decrease in interstitial cells of Cajal in patients with slow transit constipation. *Gut* 51, 496-501.

M

- Manivet, P., Mouillet-Richard, S., Callebert, J., Nebigil, C.G., Maroteaux, L., Hosoda, S., Kellermann, O., Launay, J.M., 2000. PDZ-dependent activation of nitric-oxide synthases by the serotonin 2B receptor. *J. Biol. Chem.* 275, 9324-9331.
- Martin, J.R., Bös, M., Jenck, F., Moreau, J., Mutel, V., Sleight, A.J., Wichmann, J., Andrews, J.S., Berendsen, H.H., Broekkamp, C.L., Ruigt, G.S., Köhler, C., Delft, A.M., 1998. 5-HT_{2C} receptor agonists: pharmacological characteristics and therapeutic potential. *J. Pharmacol. Exp. Ther.* 286, 913-924.
- McCleron, F.J., Kozink, R.V., Lutz, A.M., Rose, J.E., 2009. 24-h smoking abstinence potentiates fMRI-BOLD activation to smoking cues in cerebral cortex and dorsal striatum. *Psychopharmacology* 204, 25-35.
- Meltzer, H.Y., 2013. Update on typical and atypical antipsychotic drugs. *Annu. Rev. Med.* 64, 393-406.
- Meltzer, H.Y., Huang, M., 2008. In vivo actions of atypical antipsychotic drug on serotonergic and dopaminergic systems. *Prog. Brain Res.* 172, 177-197.
- Meshul, C.K., Seil, F.J., Herndon, R.M., 1987. Astrocytes play a role in regulation of synaptic density. *Brain Res.* 402, 139-145.
- Moghaddam, B., Javitt, D., 2012. From revolution to evolution: the glutamate hypothesis of schizophrenia and its implication for treatment. *Neuropsychopharmacol.* 37, 4-15.

References

Moskowitz, M.A., 1993. Neurogenic inflammation in the pathophysiology and treatment of migraine. *Neurology* 43, S16-20.

N

Nasrallah, H.A., 2008. Atypical antipsychotic-induced metabolic side effects: insights from receptor-binding profiles. *Mol. Psychiatry* 13, 27-35.

Navailles, S., De Deurwaerdère, P., Porras, G., Spampinato, U., 2004. In vivo evidence that 5-HT_{2C} receptor antagonist but not agonist modulates cocaine-induced dopamine outflow in the rat nucleus accumbens and striatum. *Neuropsychopharmacol.* 29, 319-326.

Nebigil, C.G., Choi, D.S., Dierich, A., Hickel, P., Le Meur, M., Messaddeq, N., Launay, J.M., Maroteaux, L., 2000. Serotonin 2B receptor is required for heart development. *Proc. Natl. Acad. Sci. U. S. A.* 97, 9508-9513.

Nebigil, C.G., Jaffré, F., Messaddeq, N., Hickel, P., Monassier, L., Launay, J.M., Maroteaux, L., 2003. Overexpression of the serotonin 5-HT_{2B} receptor in heart leads to abnormal mitochondrial function and cardiac hypertrophy. *Circulation* 107, 3223-3229.

Nestler, E.J., Barrot, M., DiLeone, R.J., Eisch, A.J., Gold, S.J., Monteggia, L.M., 2002. Neurobiology of depression. *Neuron* 34, 13-25.

Nestler, E.J., Carlezon, W.A.Jr., 2006. The mesolimbic dopamine reward circuit in depression. *Biol. Psychiatry* 59, 1151-1159.

Newman-Tancredi, A., Kleven, M.S., 2011. Comparative pharmacology of antipsychotics possessing combined dopamine D₂ and serotonin 5-HT_{1A} receptor properties. *Psychopharmacology* 216, 451-473.

Nishi, A., Bibb, J.A., Snyder, G.L., Higashi, H., Nairn, A.C., Greengard, P., 2000. Amplification of dopaminergic signaling by a positive feedback loop. *Proc. Natl. Acad. Sci. U. S. A.* 97, 12840-12845.

O

Olds, J., Milner, P., 1954. Positive reinforcement produced by electrical stimulation of septal area and other regions of rat brain. *J. Comp. Physiol. Psychol.* 47, 419-427.

Olesen, J., Thomsen, L.L., Iversen, H., 1994. Nitric oxide is a key molecule in migraine and other vascular headaches. *Trends Pharmacol. Sci.* 15, 149-153.

P

Parsons, L.H., Koob, G.F., Weiss, F., 1996. Extracellular serotonin is decreased in the nucleus accumbens during withdrawal from cocaine self-administration. *Behav. Brain Res.* 73, 225-228.

Peltier, R., Schenk, S., 1991. GR38032F, a serotonin 5-HT₃ antagonist, fails to alter cocaine self-administration in rats. *Pharmacol. Biochem. Behav.* 39, 133-136.

- Perlmutter, L.S., Tweedle, C.D., Hatton, G.I., 1984. Neuronal/glial plasticity in the supraoptic dendritic zone: dendritic bundling and double synapse formation at parturition. *Neurosci.* 13, 769-779.
- Pierce, R.C., Vanderschuren, L.J., 2010. Kicking the habit: the neural basis of ingrained behaviors in cocaine addiction. *Neurosci. Biobehav. Rev.* 35, 212-219.
- Pietri, M., Schneider, B., Mouillet-Richard, S., Ermonval, M., Mutel, V., Launay, J.M., Kellermann, O., 2005. Reactive oxygen species-dependent TNF-alpha converting enzyme activation through stimulation of 5-HT2B and alpha1D autoreceptors in neuronal cells. *FASEB J.* 19, 1078-1087.
- Pitychoutis, P.M., Belmer, A., Moutkine, I., Adrien, J., Maroteaux, L., 2015. Mice Lacking the Serotonin Htr2B Receptor Gene Present an Antipsychotic-Sensitive Schizophrenic-Like Phenotype. *Neuropsychopharmacol.* 40, 2764-2773.
- Pompeiano, M., Palacios, J.M., Mengod, G., 1994. Distribution of the serotonin 5-HT2 receptor family mRNAs: comparison between 5-HT2A and 5-HT2C receptors. *Brain Res. Mol. Brain Res.* 23, 163-178.
- Porras, G., De Deurwaerdère, P., Moison, D., Spampinato, U., 2003. Conditional involvement of striatal serotonin3 receptors in the control of in vivo dopamine outflow in the rat striatum. *Eur. J. Neurosci.* 17, 771-781.
- Porras, G., Di Matteo, V., De Deurwaerdère, P., Esposito, E., Spampinato, U., 2002a. Central serotonin4 receptors selectively regulate the impulse-dependent exocytosis of dopamine in the rat striatum: in vivo studies with morphine, amphetamine and cocaine. *Neuropharmacology* 43, 1099-1109.
- Porras, G., Di Matteo, V., Fracasso, C., Lucas, G., De Deurwaerdère, P., Caccia, S., Esposito, E., Spampinato, U., 2002b. 5-HT2A and 5-HT2C/2B receptor subtypes modulate dopamine release induced in vivo by amphetamine and morphine in both the rat nucleus accumbens and striatum. *Neuropsychopharmacol.* 26, 311-324.
- Porrino, L.J., Ritz, M.C., Goodman, N.L., Sharpe, L.G., Kuhar, M.J., Goldberg, S.R., 1989. Differential effects of the pharmacological manipulation of serotonin systems on cocaine and amphetamine self-administration in rats. *Life Sci.* 45, 1529-1535.
- Porter R.H., Benwell K.R., Lamb H., Malcolm C.S., Allen N.H., Revell D.F., Adams D.R., Sheardown M.J. 1999. Functional characterization of agonists at recombinant human 5-HT2A, 5-HT2B and 5-HT2C receptors in CHO-K1 cells. *Br. J. Pharmacol.* 128, 13-20.

R

- Rakic, P., 1981. Neuronal-glial interactions during brain development. *Trends Neurosci.* 4, 184-187.
- Rasmussen, H., Erritzoe, D., Andersen, R., Ebdrup, B.H., Aggernaes, B., Oranje, B., Kalbitzer, J., Madsen, J., Pinborg, L.H., Baaré, W., Svarer, C., Lublin, H., Knudsen, G.M., Glenthøj, B., 2010. Decreased frontal serotonin2a receptor binding in antipsychotic-naïve patients with first-episode schizophrenia. *Arch. Gen. Psychiatry* 67, 9-16.

References

- Rastogi, R.B., Singhal, R.L., Lapierre, Y.D., 1981. Effects of short- and long-term neuroleptic treatment on brain serotonin synthesis and turnover: focus on the serotonin hypothesis of schizophrenia. *Life Sci.* 29, 735-741.
- Raymond J.R., Mukhin Y.V., Gelasco A., Turner J., Collinsworth G., Gettys T.W., Grewal J.S., Garnovskaya M.N. 2001. Multiplicity of mechanisms of serotonin receptor signal transduction. *Pharmacol. Ther.* 92, 179-212.
- Rhodes, C.J., Davidson, A., Gibbs, J.S., Wharton, J., Wilkins, M.R., 2009. Therapeutic targets in pulmonary arterial hypertension. *Pharmacol. Ther.* 121, 69-88.
- Ritz, M.C., Kuhar, M.J., 1989. Relationship between self-administration of amphetamine and monoamine receptors in brain: comparison with cocaine. *J. Pharmacol. Exp. Ther.* 248, 1010-1017.
- Rocha, B.A., Fumagalli, F., Gainetdinov, R.R., Jones, S.R., Ator, R., Giros, B., Miller, G.W., Caron, M.G., 1998. Cocaine self-administration in dopamine-transporter knockout mice. *Nat. Neurosci.* 1, 132-137.
- Rörig, B., Sutor, B., 1996. Serotonin regulates gap junction coupling in the developing rat somatosensory cortex. *Eur. J. Neurosci.* 8, 1685-1695.
- Roth, B.L., 2007. Drugs and valvular heart disease. *N. Engl. J. Med.* 356, 6-9.
- Roth, B.L., Sheffler, D.J., Kroeze, W.K., 2004. Magic shotguns versus magic bullets: selectively non-selective drugs for mood disorders and schizophrenia. *Nat. Rev. Drug Discov.* 3, 353-359.
- Rothman, R.B., Baumann, M.H., Dersch, C.M., Romero, D.V., Rice, K.C., Carroll, F.I., Partilla, J.S., 2001. Amphetamine-type central nervous system stimulants release norepinephrine more potently than they release dopamine and serotonin. *Synapse* 39, 32-41.

S

- Sandén, N., Thorlin, T., Blomstrand, F., Persson, P.A., Hansson, E., 2000. 5-Hydroxytryptamine_{2B} receptors stimulate Ca²⁺ increases in cultured astrocytes from three different brain regions. *Neurochem. Int.* 36, 427-434.
- Schapira, A.H., Bezard, E., Brotchie, J., Calon, F., Collingridge, G.L., Ferger, B., Rebsam, A., Roumier, A., Maroteaux, L., 2006. Novel pharmacological targets for the treatment of Parkinson's disease. *Nat. Rev. Drug Discov.* 5, 845-854.
- Schmidt, C.J., Fadayel, G.M., Sullivan, C.K., Taylor, V.L., 1992. Serotonin 2 receptors exert a state-dependent regulation of dopaminergic function: studies with MDL 100,907 and the amphetamine analogue, 3,4-methylenedioxymethamphetamine. *Eur. J. Pharmacol.* 223, 65-74.
- Schmuck, K., Ullmer, C., Engels, P., Lübbert, H., 1994. Cloning and functional characterization of the human 5-HT_{2B} serotonin receptor. *FEBS Lett.* 342, 85-90.
- Schmuck, K., Ullmer, C., Kalkman, H.O., Probst, A., Lübbert, H., 1996. Activation of meningeal 5-HT_{2B} receptors: an early step in the generation of migraine headache? *Eur. J. Neurosci.* 8, 959-967.

- Schneider, B., Pietri, M., Mouillet-Richard, S., Ermonval, M., Mutel, V., Launay, J.M., Kellermann, O., 2006. Control of bioamine metabolism by 5-HT_{2B} and alpha 1D autoreceptors through reactive oxygen species and tumor necrosis factor-alpha signaling in neuronal cells. *Ann. N. Y. Acad. Sci.* 1091, 123-141.
- Setola, V., Hufeisen, S.J., Grande-Allen, K.J., Vesely, I., Glennon, R.A., Blough, B., Rothman, R.B., Roth, B.L., 2003. 3,4-methylenedioxymethamphetamine (MDMA, "Ecstasy") induces fenfluramine-like proliferative actions on human cardiac valvular interstitial cells in vitro. *Mol. Pharmacol.* 63, 1223-1229.
- Shahid, M., Walker, G.B., Zorn, S.H., Wong, E.H., 2009. Asenapine: a novel psychopharmacologic agent with a unique human receptor signature. *J. Psychopharmacol.* 23, 65-73.
- Shapiro, D.A., Renock, S., Arrington, E., Chiodo, L.A., Liu, L.X., Sibley, D.R., Roth, B.L., Mailman, R., 2003. Aripiprazole, a novel atypical antipsychotic drug with a unique and robust pharmacology. *Neuropsychopharmacol.* 28, 1400-1411.
- Smith, R.C., Davis, J.M., 1977. Comparative effects of d-amphetamine, l-amphetamine, and methylphenidate on mood in man. *Psychopharmacology* 53, 1-12.
- Sora, I., Wichems, C., Takahashi, N., Li, X.F., Zeng, Z., Revay, R., Lesch, K.P., Murphy, D.L., Uhl, G.R., 1998. Cocaine reward models: conditioned place preference can be established in dopamine- and in serotonin-transporter knockout mice. *Proc. Natl. Acad. Sci. U. S. A.* 95, 7699-7704.
- Spielewoy, C., Biala, G., Roubert, C., Hamon, M., Betancur, C., Giros B., 2007. Hypolocomotor effects of acute and daily d-amphetamine in mice lacking the dopamine transporter. *Psychopharmacology* 159, 2-9.
- Svensson, T.H., 2000. Dysfunctional brain dopamine systems induced by psychotomimetic NMDA-receptor antagonists and the effects of antipsychotic drugs. *Brain Res. Rev.* 31, 320-329.
- Svensson, T.H., 2003. Alpha-adrenoceptor modulation hypothesis of antipsychotic atypicality. *Prog. Neuropsychopharmacol. Biol. Psychiatry.* 27, 1145-1158.

T

- Tanda G., Pontieri F.E., Frau R., Di Chiara G. 1997. Contribution of blockade of the noradrenaline carrier to the increase of extracellular dopamine in the rat prefrontal cortex by amphetamine and cocaine. *Eur. J. Neurosci.* 9, 2077-2085.
- Tandon, R., Gaebel, W., Barch, D.M., Bustillo, J., Gur, R.E., Heckers, S., Malaspina, D., Owen, M.J., Schultz, S., Tsuang, M., Van Os, J., Carpenter, W., 2013. Definition and description of schizophrenia in the DSM-5. *Schizophr. Res.* 150, 3-10.
- Tharayil, V.S., Wouters, M.M., Stanich, J.E., Roeder, J.L., Lei, S., Beyder, A., Gomez-Pinilla, P.J., Gershon, M.D., Maroteaux, L., Gibbons, S.J., Farrugia, G., 2010. Lack of serotonin 5-HT_{2B} receptor alters proliferation and network volume of interstitial cells of Cajal in vivo. *Neurogastroenterol. Motil.* 22, 462-469, e109-110.

References

- Thomsen, M., Hall, F.S., Uhl, G.R., Caine, S.B., 2009. Dramatically decreased cocaine self-administration in dopamine but not serotonin transporter knock-out mice. *J. Neurosci.* 29, 1087-1092.
- Tournois, C., Mutel, V., Manivet, P., Launay, J.M., Kellermann, O., 1998. Cross-talk between 5-hydroxytryptamine receptors in a serotonergic cell line. Involvement of arachidonic acid metabolism. *J. Biol. Chem.* 273, 17498-17503.
- Trigo, J.M., Renoir, T., Lanfumey, L., Hamon, M., Lesch, K.P., Robledo, P., Maldonado, R., 2007. 3,4-methylenedioxymethamphetamine self-administration is abolished in serotonin transporter knockout mice. *Biol. Psychiatry* 62, 669-679.
- Tzschentke, T.M., 2001. Pharmacology and behavioral pharmacology of the mesocortical dopamine system. *Prog. Neurobiol.* 63, 241-320.

U

- Ullmer C., Schmuck K., Kalkman H.O., Lübbert H. 1995. Expression of serotonin receptor mRNAs in blood vessels. *FEBS Lett.* 370, 215-221.

V

- van Os, J., Kapur, S., 2009. Schizophrenia. *Lancet* 374, 635-645.
- Verrico, C.D., Miller, G.M., Madras, B.K., 2007. MDMA (Ecstasy) and human dopamine, norepinephrine, and serotonin transporters: implications for MDMA-induced neurotoxicity and treatment. *Psychopharmacology* 189, 489-503.

W

- Wainscott, D.B., Cohen, M.L., Schenck, K.W., Audia, J.E., Nissen, J.S., Baez, M., Kursar, J.D., Lucaites, V.L., Nelson, D.L., 1993. Pharmacological characteristics of the newly cloned rat 5-hydroxytryptamine_{2F} receptor. *Mol. Pharmacol.* 43, 419-426.
- Waldinger, M.D., Berendsen, H.H., Blok, B.F., Olivier, B., Holstege, G., 1998. Premature ejaculation and serotonergic antidepressants-induced delayed ejaculation: the involvement of the serotonergic system. *Behav. Brain Res.* 92, 111-118.
- Watts, S.W., Thompson, J.M., 2004. Characterization of the contractile 5-hydroxytryptamine receptor in the renal artery of the normotensive rat. *J. Pharmacol. Exp. Ther.* 309, 165-172.
- Wei, E. P., Moskowitz, M. A., Boccalini, P. and Kontos, H. A., 1992. Calcitonin gene-related peptide mediates nitro-glycerine and sodium nitroprusside-induced vasodilation in feline cerebral arterioles. *Circ. Res.* 70, 1313-1319.
- Whetton, A.D., Monk, P.N., Consalvey, S.D., Huang, S.J., Dexter, T.M., Downes, C.P., 1988. Interleukin 3 stimulates proliferation via protein kinase C activation without increasing inositol lipid turnover. *Proc. Natl. Acad. Sci. U. S. A.* 85, 3284-3288.
- Wise, R.A., 1978. Catecholamine theories of reward: a critical review. *Brain Res.* 152, 215-247.

- Wong, E.H., Yocca, F., Smith, M.A., Lee, C.M., 2010. Challenges and opportunities for drug discovery in psychiatric disorders: the drug hunters' perspective. *Int. J. Neuropsychopharmacol.* 13, 1269-1284.
- Wouters, M.M., Gibbons, S.J., Roeder, J.L., Distad, M., Ou, Y., Strege, P.R., Szurszewski, J.H., Farrugia, G., 2007. Exogenous serotonin regulates proliferation of interstitial cells of Cajal in mouse jejunum through 5-HT_{2B} receptors. *Gastroenterology* 133, 897-906.

Y

- Yamamoto, B.K., Nash, J.F., Gudelsky, G.A., 1995. Modulation of methylenedioxymethamphetamine-induced striatal dopamine release by the interaction between serotonin and gamma-aminobutyric acid in the substantia nigra. *J. Pharmacol. Exp. Ther.* 273, 1063-1070.
- Yonezawa, A., Yoshizumi, M., Ebiko, M., Ise, S.N., Watanabe, C., Mizoguchi, H., Kimura, Y., Sakurada, S., 2008. Ejaculatory response induced by a 5-HT₂ receptor agonist m-CPP in rats: differential roles of 5-HT₂ receptor subtypes. *Pharmacol. Biochem. Behav.* 88, 367-373.

Z

- Zangen, A., Nakash, R., Overstreet, D.H., Yadid, G., 2001. Association between depressive behavior and absence of serotonin-dopamine interaction in the nucleus accumbens. *Psychopharmacology* 155, 434-439.
- Zopf, D.A., das Neves, L.A., Nikula, K.J., Huang, J., Senese, P.B., Gralinski, M.R., 2011. C-122, a novel antagonist of serotonin receptor 5-HT_{2B}, prevents monocrotaline-induced pulmonary arterial hypertension in rats. *Eur. J. Pharmacol.* 670, 195-203.

