



HAL
open science

Internal Reshetikhin-Turaev Topological Quantum Field Theories

Mickaël Lallouche

► **To cite this version:**

Mickaël Lallouche. Internal Reshetikhin-Turaev Topological Quantum Field Theories. General Topology [math.GN]. Université Montpellier, 2016. English. NNT : 2016MONT015 . tel-01681854v1

HAL Id: tel-01681854

<https://theses.hal.science/tel-01681854v1>

Submitted on 11 Jan 2018 (v1), last revised 12 Jan 2018 (v2)

HAL is a multi-disciplinary open access archive for the deposit and dissemination of scientific research documents, whether they are published or not. The documents may come from teaching and research institutions in France or abroad, or from public or private research centers.

L'archive ouverte pluridisciplinaire **HAL**, est destinée au dépôt et à la diffusion de documents scientifiques de niveau recherche, publiés ou non, émanant des établissements d'enseignement et de recherche français ou étrangers, des laboratoires publics ou privés.

THÈSE

Pour obtenir le grade de
Docteur

Délivré par l'Université de Montpellier

Préparée au sein de l'école doctorale
Information Structures Systèmes
et de l'unité de recherche
Institut Montpelliérain Alexander Grothendieck

Spécialité: **Mathématiques et modélisation**

Présentée par **Mickaël Lallouche**

**Théories des champs quantiques
topologiques internes de type
Reshetikhin-Turaev**

Soutenue le 31 octobre 2016 devant le jury composé de

M. Stéphane BASEILHAC	Université de Montpellier	Président du jury
M. Christian BLANCHET	UP7D / UMPC	Rapporteur (absent)
M. Alain BRUGUIERES	Université de Montpellier	Directeur de thèse
M. Louis FUNAR	Université Grenoble Alpes	Examineur
M. Gwénaél MASSUYEAU	Université de Strasbourg	Examineur
M. Christoph SCHWEIGERT	Universität Hamburg	Rapporteur
M. Alexis VIRELIZIER	Université de Lille I	Co-directeur de thèse



Remerciements

À chaque fois que je me mets à écrire, c'est à 1 000 mains. L'occasion m'est donnée ici de toutes les serrer.

Aux oubliés : merci, vous êtes indispensables !

À mes deux directeurs de thèse, Alain Bruguières et Alexis Virelizier, pour m'avoir gentiment accueilli en stage, puis avoir accepté de superviser ma thèse. Vous m'avez emmené avec vous dans le joli monde caché des Théories des Champs Quantiques Topologiques (l'ordre de ces mots est toujours un mystère !) et pour ça, je vous suis reconnaissant. Alain, merci pour ta patience et ton calme sans limites : même après t'avoir posé la même question 2 503 fois tu y réponds comme à la première, avec un point de vue toujours plus simple et élégant. Merci pour ton soutien quotidien, ta bonne humeur contagieuse, pour les repas du mardi, pour avoir partagé tes expériences d'enseignement et pour m'avoir presque donné envie d'apprendre l'allemand (peut-être un jour) ! Alexis, malgré l'éloignement, merci d'avoir été présent, d'avoir pris du temps pour m'expliquer en détails des points délicats (« c'est juste des petits calculs »), pour m'avoir reçu plusieurs fois à Lille, et pour tes relectures scrupuleuses – ce qui reste un euphémisme – qui m'ont plusieurs fois fait douter de la langue dans laquelle je m'exprime !

Aux membres de mon jury : à mes deux rapporteurs Christian Blanchet et Christoph Schweigert pour leur relecture attentive et leurs différents conseils pour améliorer significativement le contenu de ce manuscrit. Merci à Stéphane Baseilhac pour l'intérêt porté à ce travail, pour tes remarques et pour le temps que tu as pris pour en discuter avec moi. Merci également à MM. Louis Funar et Gwénaél Massuyeau d'avoir accepté de faire partie de mon jury deux fois d'affilée : une fois avant la pluie et une fois après !

À ceux qui font en sorte que la vie au laboratoire soit un long fleuve tranquille. Merci à Gemma pour ton sourire quotidien et les discussions qui facilitent grandement la transition entre l'oreiller et le bureau à des heures bien trop matinales pour qu'un être humain normalement constitué garde le sourire ! Qu'il est reposant pour l'angoissé que je suis de savoir qu'aussi saugrenue soit la question administrative, matérielle, technique, hors-catégorie (« où est passée la machine à blattes d'Elsa ? ») que je puisse me poser, la réponse se trouve toujours au deuxième étage : merci à Baptiste, Bernadette, Carmela, Eric, Laurence, Myriam, Nathalie, Sophie. Eric, merci pour les escapades sportives dans les derniers moments de la rédaction de ce manuscrit.

À ceux qui à un moment ou un autre vous apporte un regain d'énergie. Merci à Hoel pour les échanges, pour ta gentillesse et pour essayer de catégorifier le monde. Merci à Damien Calaque pour les divers conseils, merci à Philippe Roche pour m'avoir donné envie de plonger au-delà de 6m, merci à M. Vershinine pour votre cours de théorie des nœuds et votre gentillesse, merci à M. Boyom pour les nombreuses discussions, votre considération et pour l'introduction au monde du vin (avec modération), merci à Viviane Durand-Guerrier et Thomas Hausberger pour les expositions mathématiques dans lesquelles je me suis amusé comme un enfant, merci à Nicolas Saby pour m'avoir fait comprendre qu'un peu de maths s'échange parfois contre un repas gastronomique (!), merci à David Théret, Marc Herzlich, Gaëtan Planchon et Jérémie Brieussel pour m'avoir fait entrer dans le monde de l'enseignement, merci à Julien St. avec qui j'ai pris un malin plaisir à harceler les gens pour passer en Semdoc, merci à Olivier G. pour ton talent à détruire le sérieux

de chaque conférence.

À mes co-bureaux du bureau 115 pour m'avoir supporté durant mes pérégrinations et doutes mathématiques : Guillaume (t'as failli me faire aimer l'Analyse), Marco, David et Francesco (cette dernière année fut studieuse et agréable).

Aux résidents du bureau du fond de couloir du premier : merci d'avoir accepté contraints et forcés que j'occupe une place dans votre bureau (#incruste #parasitage) sans (presque) jamais vous plaindre (mais aussi, doit y'avoir une substance dans ce bureau qui attire à la fois les blattes et moi...).

Gautier : je pense que je peux doubler la taille de ce manuscrit rien qu'en te remerciant pour chaque chose que je te dois. Je vais n'en citer que quelques-unes : merci pour nos engrainages mathématiques (j'ai raison), nos conversations mathématico-scientifico-philosophico-osso-bucco sur la vie, pour avoir partagé les trois premiers jours de ton périple vers le bout de l'Espagne, les cinémas (très mauvais choix à chaque fois), les théâtres (boire un verre avec la comédienne !), pour m'avoir parlé de tant de bouquins que je ne lirai jamais, pour le goût du sang dans la bouche à chaque fois qu'on va courir, pour me réciter des poèmes ennuyants à mourir y compris quand on court, pour ton goût immodéré pour les poneys (?!)...

Elsaaaaa ! Faudra qu'on remette un peu de café dans les plantes : elles poussent de mieux en mieux. A Metz ou au bout du monde, un parasite n'a aucune notion de distance quand il s'agit de retrouver son hôte de légende.

Tutu : merci d'être aussi Chinois en Vietnamien.

Anis : t'es retourné au Liban en juif ! Tu me dois un café, non ?... Avec les intérêts, tu m'en dois 4000 aujourd'hui.

Rodrigo : nooon, une pizza n'est pas un bon carburant pour la course (« oh purée »). Merci à ton frère pour l'intérêt porté à ce travail et pour l'invitation au mariage !

Stéphanie : merci pour les pizzas-maison (mais n'en donne plus à Rodrigo) !

Coralie : merci de m'avoir relayé pour le parasitage de ce bureau. Et non, le rose n'est pas la plus belle des couleurs (c'est pas pour rien que c'est la couleur dominante près des toilettes).

Merci à tous les doctorants du laboratoire I3M puis IMAG pour l'ambiance, pour les gâteaux, pour les bières, les goûters, les bières, les séminaires, les bières.

Les vieux : Alaeddine, Angelina, Anthony, Arnaud, Benjamin, Björn, Boushra, Damien, Christian, Christophe, Claudia, Daniel, Jean, Lounès, Nahla, Pierre, Thomas, Vanessa (t'es plus doctorante mais on te compte), Vincent, Yousri (The King), Walid.

Les moins vieux : Alexandre, Amina, Antoine, Emmanuelle, Etienne, Jérémie F., Joubine, Julien Si., Myriam, Nejib, Paul, Quentin, Samuel, Théo, Wenran.

Et les jeunes plein d'énergie : Abel, Jérémie, Jocelyn, Mario, Paul.

À mon petit groupe d'Orcéens physiciens (une espèce rare), Adrien, Jérémie, Louis, Maxime et Nicolas pour les repas toujours plus gras, les geekages intempestifs et les discussions scientifiques interminables. Merci Nico de me faire découvrir toutes les séries du monde, tous les plats du monde et de voyager un peu partout dans le monde en me laissant m'y incruster à chaque fois (si ta prochaine destination est la Nouvelle-Zélande, ça me va :).

À l'équipe nîmoise (la secte ?!), toujours prête à faire la fête, qui m'a accompagné de la meilleure des façons dans la dernière ligne droite : Alicia, Lisa, Maeva, Marion et Rémi.

À ceux qui sont toujours là, même quand ils sont loin, quoi qu'on fasse et quoi qu'on devienne, à mes parasites, ceux que j'aime soûler même quand il n'y a pas d'alcool, ceux avec qui je voyagerais au bout du monde ou que j'écouterais comparer la taille de leurs mollets pendant des heures (ça n'est heureusement jamais arrivé) :

Brice (le petit Ku), Claire (la meuf), Dimitri (le boudoir), Ludovic (le canard), Maxime (le Noir), Pierre (l'enfant), Thibaud (le papa), Yamine (l'Arabe).

Clin d'œil particulier à Thibaud pour ces dernières années ; entre fêtes, courses et marathon, l'étincelle ne s'éteint jamais ! Je profite de l'occasion pour saluer à nouveau la performance de Pedrolito au Marvejols-Mende 2015 : merci, on n'oubliera jamais.

Et qui serait-on sans le soutien inconditionnel de sa famille ? Merci à ma sœur, mon beau-frère, mon père et ma nièce démoniaque.

Mes derniers remerciements sont pour celle qui est là depuis le tout début, qui me traite aussi souvent que nécessaire « d'abruti » et qui me soutient dans tous mes choix, aussi débiles soient-ils : à ma maman.

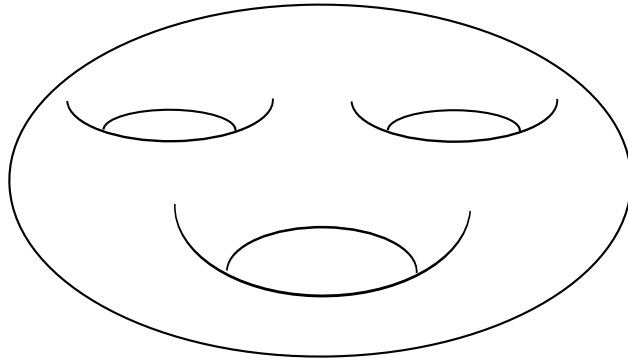

Résumé

Théories des Champs Quantiques Topologiques internes de type Reshetikhin-Turaev

Une théorie des champs quantique topologique (TQFT) en dimension 3 est un foncteur monoïdal symétrique de la catégorie des cobordismes de dimension 3 vers celle des espaces vectoriels. Une TQFT fournit en particulier un invariant scalaire des variétés fermées de dimension 3 comme ceux définis par Reshetikhin et Turaev ainsi que des représentations du groupe de difféotopie des surfaces fermées. A partir d'une catégorie modulaire, Turaev explique en 1994 comment construire une TQFT.

Dans cette thèse, nous généralisons cette construction à l'aide d'une catégorie \mathcal{C} en ruban avec coend. On représente un cobordisme par un type d'enchevêtrement et on associe à celui-ci un morphisme défini entre puissances tensorielles de la coend comme décrit par Lyubashenko en 1995. A l'aide de l'extension du calcul de Kirby sur les cobordismes en dimension 3, ce morphisme nous permet de construire un invariant de cobordisme puis une TQFT à valeurs dans la sous-catégorie monoïdale symétrique des objets transparents de \mathcal{C} . Dans le cas où \mathcal{C} est une catégorie modulaire, cette catégorie est équivalente à celle des espaces vectoriels. Dans le cas où \mathcal{C} est une catégorie prémodulaire normalisable et de dimension inversible, notre TQFT est un relèvement de la TQFT de Turaev associée à la modularisée de \mathcal{C} .

Abstract

Internal Reshetikhin-Turaev Topological Quantum Field Theories

A 3-dimensional topological quantum field theory (TQFT) is a symmetric monoidal functor from the category of 3-cobordisms to the category of vector spaces. Such TQFTs provide in particular numerical invariants of closed 3-manifolds such as the Reshetikhin-Turaev invariants or representations of the mapping class group of closed surfaces. In 1994, using a modular category, Turaev explains how to construct a TQFT.

In this thesis, we describe a generalization of this construction starting from a ribbon category \mathcal{C} with coend. We present a cobordism by a certain type of tangle and we associate to the latter a morphism defined between tensorial products of the coend as described by Lyubashenko in 1994. Using extension of the Kirby calculus on 3-cobordisms, this morphism gives rise to an invariant of cobordism and a TQFT which takes values in the symmetric monoidal subcategory of transparent objects of \mathcal{C} . When the category \mathcal{C} is modular, this subcategory is equivalent to the category of vector spaces. When the category \mathcal{C} is premodular, normalizable with invertible dimension, our TQFT is a lift of Turaev's one associated to the modularization of \mathcal{C} .

Contents

Remerciements	3
Introduction	9
1 Categorical preliminaries	15
1.1 Categories	15
1.1.1 Monoidal category	15
1.1.2 Rigid category	17
1.1.3 Pivotal category	17
1.1.4 Braided category	17
1.1.5 Symmetric category	18
1.1.6 The subcategory of transparent objects of a braided category	18
1.1.7 Balanced category	18
1.1.8 Ribbon category	19
1.1.9 Linear category	19
1.1.10 Fusion category	20
1.1.11 Premodular category and S -matrix	20
1.1.12 Modular category	20
1.1.13 Modularization and modularizable category	20
1.1.14 Category with split idempotents	20
1.1.15 Graphical calculus in a ribbon category	21
1.2 Coend and universal morphism	22
1.2.1 Hopf algebras, pairing and integrals in a ribbon category	22
1.2.2 Dinatural transformations and coends	23
1.2.3 Coend of a ribbon category	24
1.2.4 Universal morphism	27
2 TQFT with anomaly	29
2.1 Functor with anomaly	29
2.1.1 Basic definitions	29
2.1.2 Unitalization of a functor with anomaly	30
2.2 Natural transformation between functors with the same anomaly	30
2.3 Monoidal functor with anomaly	31
2.4 Braided and symmetric functor with anomaly	35
2.5 Cobordism category and TQFT with anomaly	36
2.6 Anomaly lifting	36

3	Presentation of 3-cobordisms by cobordism tangles	39
3.1	Topological and combinatorial preliminaries	39
3.1.1	Ribbon graphs	39
3.1.2	Ribbon (g, n, \underline{h}) -graphs	40
3.1.3	Ribbon cobordism tangles	41
3.1.4	Ribbon opentangles	42
3.2	Presentation of 3-cobordisms by cobordism tangles	45
3.2.1	Categories of 3-cobordisms	45
3.2.2	Surgery of 3-manifolds and presentation by links	45
3.2.3	Surgery of 3-cobordisms and presentation by ribbon cobordism tangles	45
	Presentation by ribbon cobordism tangles	45
	Extended Kirby calculus	46
3.2.4	Two operations on cobordism tangles	48
	Encircling composition	48
	Hallowed tangles	49
4	Construction of the internal 3-dimensional TQFT	51
4.1	Isotopy invariant of opentangles	51
4.2	Isotopy invariant of cobordism tangles	52
4.3	Homeomorphism invariant of 3-cobordisms	53
4.3.1	Admissible element	53
4.3.2	Homeomorphism invariant of 3-cobordisms	53
4.4	Internal TQFT	55
4.4.1	A useful morphism	55
4.4.2	The idempotent $\Pi_{\alpha, n}$	56
4.4.3	The internal TQFT	56
4.5	Proofs	60
4.5.1	Proof of Lemma 4.2.1	60
4.5.2	Proof of Lemma 4.2.3	64
4.5.3	Proof of Lemma 4.3.4	65
4.5.4	Proof of Lemma 4.3.5	71
4.5.5	Proof of the Lemma 4.4.1	74
4.5.6	Proof of the first main Theorem 4.4.4	84
4.5.7	Proof of the second main Theorem 4.4.6	86
5	The modular and premodular cases	89
5.1	Preliminaries	89
5.2	The modular case : on the Reshetikhin-Turaev TQFTs	90
5.3	Functoriality of the construction	94
5.4	The modularizable case	97
	Index	98
	Bibliography	101

Introduction

Contexte

La notion de *théorie des champs quantique topologique* (c'est la théorie qui est quantique par contraste avec la théorie classique des champs), abrégée en TQFT, fut introduite en 1988 par Witten [Wit89] avec pour exemple phare la théorie de Chern-Simons, avant d'être formalisée comme objet mathématique en 1989 par Atiyah [Ati89]. Une TQFT de dimension n associe à chaque variété sans bord de dimension $n - 1$ un espace vectoriel et à chaque cobordisme de dimension n une application linéaire entre les espaces vectoriels associés respectivement au bord entrant et au bord sortant. Formellement, il s'agit d'un foncteur monoïdal symétrique de la catégorie des cobordismes de dimension n vers celles des espaces vectoriels (ou des modules). Une TQFT de dimension 1 est équivalente à la donnée d'un espace vectoriel de dimension finie. Une TQFT de dimension 2 correspond à la donnée d'une algèbre de Frobenius commutative (voir [Koc03]). Dans le cas de la dimension 3, il n'existe pas à notre connaissance de classification des TQFTs.

Il existe cependant plusieurs constructions en dimension 3. Une telle TQFT fournit en particulier un invariant des variétés fermées de dimension 3 (vues comme variétés du bord vide vers le bord vide) appelés *invariants quantiques*. En 1991, Reshetikhin et Turaev [RT91] donnent la première construction rigoureuse d'un tel invariant en dimension 3. Leur construction est fondée sur la chirurgie de 3-variétés le long d'entrelacs en ruban et sur l'usage d'invariants de noeuds. Par la suite, Blanchet, Habegger, Masbaum et Vogel [BHMV95] construisent la TQFT associée à l'invariant scalaire de Reshetikhin et Turaev à l'aide du crochet de Kauffman. Un peu plus tard, Turaev [Tur94] énonce plus généralement que la donnée d'une catégorie dite *modulaire* donne une TQFT de dimension 3 dans ce type de constructions. Il s'agit d'une catégorie prémodulaire (i. e. en ruban, semi-simple avec un nombre fini de classes d'isomorphismes de simples) dont la *S-matrice* est inversible (hypothèse de modularité). Dans [Bru00], Bruguières montre que sous l'hypothèse de *modularisabilité*, les catégories prémodulaires se plongent dans une catégorie modulaire et fournissent donc une TQFT. En parallèle de la construction de Turaev, en 1994, Lyubashenko [Lyu95a] généralise la construction de l'invariant scalaire de Reshetikhin et Turaev grâce à une approche par les *groupes quantiques* et les *algèbres de Hopf* dont les catégories de représentations associées ne sont donc pas nécessairement semi-simples. L'ingrédient essentiel de son travail est la coend d'une catégorie en ruban : il s'agit d'un objet de la catégorie vérifiant une certaine propriété universelle et muni d'une structure d'algèbre de Hopf. Une catégorie en ruban avec coend munie d'un certain morphisme, une *intégrale* de la coend, fournit un invariant de 3-variété fermée. Une catégorie \mathcal{C} modulaire en est un exemple. En effet, si l'on note $\Lambda_{\mathcal{C}}$ un ensemble de représentants de classe d'isomorphismes d'objets simples de \mathcal{C} , la coend de \mathcal{C} est donnée par :

$$C = \sum_{X \in \Lambda_{\mathcal{C}}} X^* \otimes X,$$

et l'intégrale $\alpha: \mathbb{1} \rightarrow C$, où $\mathbb{1}$ est l'unité monoïdale de \mathcal{C} , est le morphisme de \mathcal{C} correspondant à

l'élément de l'algèbre de fusion de \mathcal{C} :

$$\Omega = \frac{1}{\dim(\mathcal{C})} \sum_{X \in \Lambda_{\mathcal{C}}} \dim_q(X) X.$$

En 2002, Virelizier [Vir06] montre qu'une catégorie avec coend munie d'un *élément de Kirby*, un morphisme plus général qu'une intégrale, donne un invariant de 3-variété fermée. Une première construction de TQFTs à partir de la donnée d'une catégorie en ruban avec coend est faite par Kerler et Lyubashenko dans [KL01] au début des années 2000. Pour cela, ils modifient la catégorie de départ des cobordismes : les bords sont connexes et le produit monoïdal est la somme connexe.

Dans cette thèse, nous proposons de construire des TQFTs à partir de catégories en ruban avec coend en conservant une catégorie de cobordismes « classique » mais en modifiant la catégorie d'arrivée des espaces vectoriels. Par analogie avec une théorie homologique (see [Ati89]), le changement de catégorie cible peut s'interpréter comme un changement de « coefficients ». On montre qu'une catégorie \mathcal{C} avec coend C munie d'un certain *élément admissible* α fournit une TQFT en dimension 3 à valeurs dans une sous-catégorie de \mathcal{C} monoïdale symétrique, la sous-catégorie des *objets transparents*. Dans le cas où \mathcal{C} est une catégorie prémodulaire, les objets transparents représentent précisément l'obstruction à la modularité de \mathcal{C} (see [Bru00]).

Principaux résultats

Soit Cob_3^p la catégorie des 3-cobordismes dont les objets sont les surfaces orientées fermées paramétrées par les surfaces canoniques et les morphismes sont les 3-cobordismes entre deux telles surfaces. Fixons une catégorie en ruban \mathcal{C} (dont les idempotents se scindent) et possédant une coend C associée au foncteur $(X, Y) \in \mathcal{C}^{op} \times \mathcal{C} \mapsto X^* \otimes X \in \mathcal{C}$. Soit $\alpha : \mathbb{1} \rightarrow C$ un morphisme de \mathcal{C} . Notre but est de construire une TQFT avec anomalie (voir Section 2.5)

$$V_{\mathcal{C}}(\ ; \alpha) : Cob_3^p \rightarrow \mathcal{T},$$

où \mathcal{T} est la sous-catégorie monoïdale symétrique pleine de \mathcal{C} des objets transparents. Un objet X de \mathcal{C} est transparent si pour tout objet Y , $\tau_{Y, X} \tau_{X, Y} = \text{id}_{X \otimes Y}$ où τ désigne le tressage de \mathcal{C} (voir Section 1.1.6).

Enchevêtrements de cobordisme et invariant d'enchevêtrements

Par chirurgie, nous représentons un cobordisme connexe

$$M : \Sigma_{\underline{g}} \rightarrow \Sigma_{\underline{h}}$$

entre deux surfaces $\Sigma_{\underline{g}}$ et $\Sigma_{\underline{h}}$ de multigenres respectifs $\underline{g} = (g_1, \dots, g_r)$ et $\underline{h} = (h_1, \dots, h_s)$ (voir Section 3.2.1) par un $(\underline{g}, n, \underline{h})$ -*enchevêtrement de cobordisme* où n est un entier naturel (voir Section 3.1.3). Un tel enchevêtrement T et le choix d'un morphisme $\alpha : \mathbb{1} \rightarrow C$ fournissent un invariant d'isotopie d'enchevêtrement [Lemme 4.2.1] :

$$|T|_{\mathcal{C}, \alpha} : C^{\otimes g_1} \otimes \dots \otimes C^{\otimes g_r} \rightarrow C^{\otimes h_1} \otimes \dots \otimes C^{\otimes h_s}.$$

Cette construction repose sur deux propriétés. La première est le théorème de Shum-Turaev (voir [Shu94] et [[Tur94], Theorem 2.5]) qui représente chaque enchevêtrement en ruban coloré par les objets d'une catégorie en ruban par un morphisme de \mathcal{C} . La seconde est la propriété universelle de la coend C . Pour la construction et le calcul de cet invariant, nous définissons l'ensemble des $(\underline{g}, n, \underline{h})$ -*enchevêtrements ouverts* (voir Section 3.1.4) ; un tel enchevêtrement O fournit un invariant d'isotopie [Lemme 4.1.1] :

$$|O|_{\mathcal{C}} : C^{\otimes g_1} \otimes \dots \otimes C^{\otimes g_r} \rightarrow C^{\otimes h_1} \otimes \dots \otimes C^{\otimes h_s}.$$

Calcul de Kirby et invariant de 3-cobordismes

Afin de définir un invariant d'homéomorphisme de 3-cobordismes, nous utilisons une extension du calcul de Kirby [Lemme 3.2.1]. Ce dernier nous permet de définir un invariant de 3-cobordismes à partir de l'invariant d'isotopie $|T|_{C,\alpha}$ défini dans la partie précédente en imposant certaines conditions sur le morphisme $\alpha: \mathbb{1} \rightarrow C$. Un morphisme α est ainsi un *élément admissible* s'il vérifie les 5 conditions suivantes (Ad1)-(Ad5) où interviennent certains morphismes de structure de la coend que sont le produit $m: C \otimes C \rightarrow C$, le coproduit $\Delta: C \rightarrow C \otimes C$, la co-unité $\varepsilon: \mathbb{1} \rightarrow C$, l'antipode $S: C \rightarrow C$, le pairing de Hopf $\omega: C \otimes C \rightarrow \mathbb{1}$ associé à l'enchevêtrement $\left(\begin{array}{c} \text{---} \\ \text{---} \end{array}\right)$, les formes linéaires $\theta_{\pm}: C \rightarrow \mathbb{1}$ qui proviennent des enchevêtrements $\left(\begin{array}{c} \text{---} \\ \text{---} \end{array}\right)$ et $\left(\begin{array}{c} \text{---} \\ \text{---} \end{array}\right)$, et la coaction naturelle de la coend sur ses puissances tensorielles $\bigcup_{C^{\otimes n}}^C$ (voir Section 1.2.3) :

- (Ad1) $\varepsilon\alpha = \text{id}_{\mathbb{1}}$; (Ad2) $S\alpha = \alpha$; (Ad3) $\theta_+\alpha, \theta_-\alpha \in \text{End}_C(\mathbb{1})^\times$;

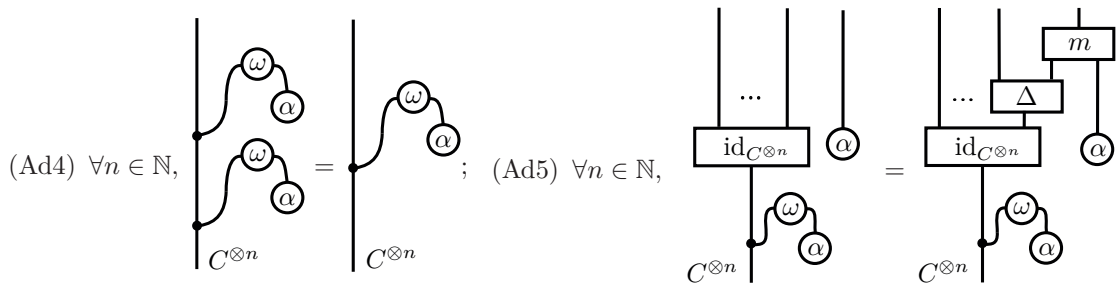

Par exemple, une intégrale de la coend satisfaisant les conditions (Ad1), (Ad2) and (Ad3) est un élément admissible.

A présent, désignons par M_T le 3-cobordisme représenté par le $(\underline{g}, n, \underline{h})$ -enchevêtrement de cobordisme T où $\underline{g} = (g_1, \dots, g_r)$ et $\underline{h} = (h_1, \dots, h_s)$. Définissons le $(\underline{g}, r + s, \underline{h})$ -enchevêtrement de cobordismes $\overset{\circ}{T}$ suivant:

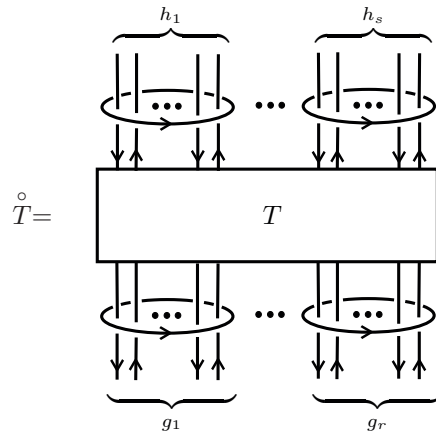

Etant donné un élément admissible α , on pose :

$$W_C(M_T; \alpha) = \nu_\alpha(T) |T|_{C,\alpha} : C^{\otimes g_1} \otimes \dots \otimes C^{\otimes g_r} \rightarrow C^{\otimes h_1} \otimes \dots \otimes C^{\otimes h_s},$$

où $\nu_\alpha(T) = (\theta_+\alpha)^{-b_+(T)}(\theta_-\alpha)^{-b_-(T)}$ est un coefficient de normalisation. Ici, $b_+(T)$ (respectively $b_-(T)$) désigne le nombre de valeurs propres strictement positives (respectivement négatives) de la

matrice d'entrelacement de l'entrelacs en ruban défini par les composantes fermées de T tandis que θ_{\pm} sont les deux formes linéaires sur la coend C associées aux balancements (twists) de la coend. On montre que $W_C(M_T; \alpha)$ est un invariant topologique de 3-cobordismes [Lemme 4.3.5].

TQFT interne avec anomalie

L'opération topologique qui consiste à rajouter des composantes fermées pour passer de T à $\overset{\circ}{T}$ correspond algébriquement à effectuer certaines projections (voir Section 4.4.2 ; il s'agit en particulier de la projection sur la composante $\mathbb{1}$ -isotypique chez Turaev). On montre alors que le morphisme $W_C(M_T; \alpha)$ restreint aux images de ces projecteurs (voir Section 1.1.14) définit un foncteur avec anomalie monoïdal tressé [Lemme 4.4.1] ce qui constitue un résultat clé dans la construction de la TQFT. Le morphisme

$$\Pi_g := \omega(\alpha \otimes \alpha)^{-g} W_C(\Sigma_g \times [0, 1]; \alpha),$$

où Σ_g est une surface de genre g , $\omega: C \otimes C \rightarrow \mathbb{1}$ est le pairing de Hopf de la coend C et α est un élément admissible, est lui-même un projecteur (voir Section 2.1.2). Pour toute surface Σ_g de genre g , posons :

$$V_C(\Sigma_g; \alpha) = \text{Im}(\Pi_g)$$

et pour tout cobordisme connexe $M_T: \Sigma_g \rightarrow \Sigma_h$, définissons par $V_C(M_T; \alpha)$ le morphisme restreint aux images des projecteurs Π_g et Π_h induit par $W_C(M_T; \alpha)$ noté abusivement (voir Section 1.1.14) :

$$V_C(M_T; \alpha) = \nu_{\alpha}(T)|\overset{\circ}{T}|_{C, \alpha}.$$

Cette construction définit la TQFT interne avec anomalie [Théorème 4.4.4].

Théorème 1 — *Soit α un élément admissible. Alors le foncteur avec anomalie $V_C(\ ; \alpha): \text{Cob}_3^p \rightarrow \mathcal{T}$ défini par :*

$$\begin{aligned} V_C(\Sigma_g; \alpha) &= \text{Im}(\Pi_g) \\ V_C(M_T; \alpha) &= \nu_{\alpha}(T)|\overset{\circ}{T}|_{C, \alpha} \end{aligned}$$

est une TQFT avec anomalie où \mathcal{T} est la sous-catégorie de \mathcal{C} des objets transparents.

L'espace $V_C(\Sigma_g; \alpha)$ est l'image du projecteur $\Pi_g = \omega(\alpha \otimes \alpha)^{-g}|\overset{\circ}{\Sigma_g \times [0, 1]}|_{C, \alpha}$ donné par

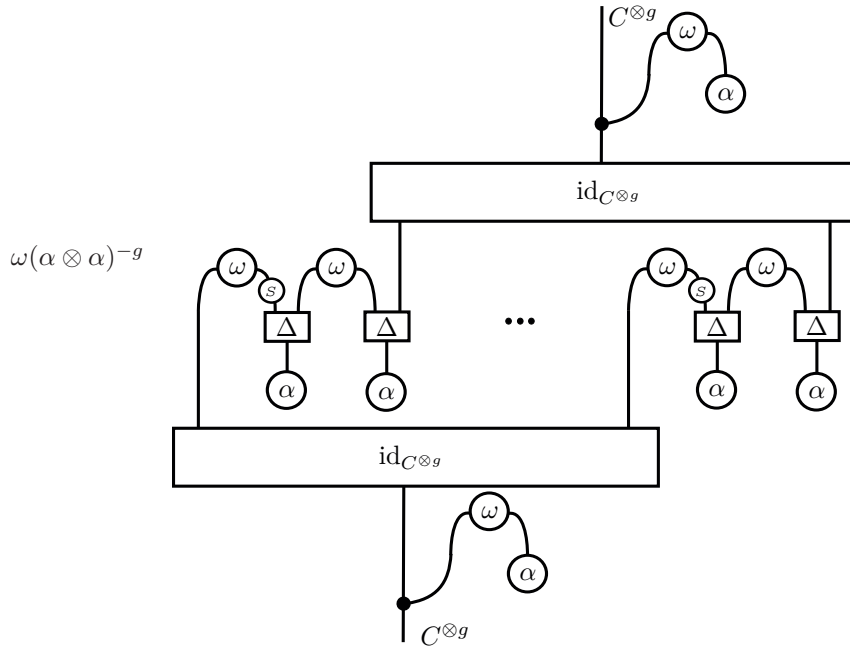

Nous montrons ensuite, en utilisant les résultats de Bruguières et Virelizier [BV07], que la TQFT $V_{\mathcal{C}}(\ ; \alpha)$ s'exprime seulement à l'aide des morphismes de structure de la coend C [Théorème 4.4.6].

Théorème 2 — *Soit α un élément admissible et M un cobordisme. Alors les morphismes $V_{\mathcal{C}}(M; \alpha)$ sont obtenus par tensorisation et composition de α et des morphismes de structures de la coend C .*

Les cas modulaire et modularisable

Dans le cas où \mathcal{C} est modulaire et α est l'élément de Kirby de \mathcal{C} (voir Chapitre 5), nous comparons notre TQFT $V_{\mathcal{C}}(\ ; \alpha)$ à celle de Turaev notée $RT_{\mathcal{C}}$ [Théorème 5.2.1] à l'aide de l'équivalence symétrique monoïdale

$$\mathrm{Hom}_{\mathcal{C}}(\mathbb{1}, -) : \mathcal{T} \xrightarrow{\sim} \mathrm{Mod}_{\mathbb{k}}^f,$$

où $\mathrm{Mod}_{\mathbb{k}}^f$ est la catégorie des \mathbb{k} -espaces vectoriels de dimension finie sur le corps \mathbb{k} .

Théorème 3 — *A normalisation près, le diagramme suivant commute :*

$$\begin{array}{ccc} \mathrm{Cob}_3^p & \xrightarrow{V_{\mathcal{C}}(\ ; \alpha_K)} & \mathcal{T} \\ & \searrow RT_{\mathcal{C}} & \downarrow \wr \mathrm{Hom}_{\mathcal{C}}(\mathbb{1}, -) \\ & & \mathrm{Mod}_{\mathbb{k}}^f \end{array} \tag{0.0.1}$$

Enfin, dans le cas où \mathcal{C} est une catégorie prémodulaire normalisable modularisable de dimension inversible (voir Chapitre 5), notre TQFT est un relèvement de la TQFT $RT_{\tilde{\mathcal{C}}}$ associée à la catégorie modularisée $\tilde{\mathcal{C}}$ de \mathcal{C} à valeurs dans la catégorie des objets transparents de \mathcal{C} [Théorème 5.4.1].

Théorème 4 — *Soit \mathcal{C} une catégorie prémodulaire normalisable de dimension inversible et α_K son élément de Kirby.*

Si \mathcal{C} est modularisable, avec modularisation $F : \mathcal{C} \rightarrow \tilde{\mathcal{C}}$, alors $F(\mathcal{T})$ est une sous-catégorie de la catégorie $\tilde{\mathcal{T}}$ des objets transparents de $\tilde{\mathcal{C}}$ et il existe un isomorphisme naturel ζ entre les foncteurs

avec anomalie $\text{RT}_{\tilde{\mathcal{C}}}$ et $\text{FV}_{\mathcal{C}}(\ ; \alpha_K)$.

$$\begin{array}{ccc}
 \text{Cob}_3 & \xrightarrow{\text{V}_{\mathcal{C}}(\ ; \alpha_K)} & \mathcal{T} \\
 & \searrow \text{RT}_{\tilde{\mathcal{C}}} & \downarrow \text{F}_{|\mathcal{T}} \\
 & & \tilde{\mathcal{T}} \\
 & & \downarrow \wr \text{Hom}_{\tilde{\mathcal{C}}}(\mathbf{1}, -) \\
 & & \text{Mod}_{\mathbb{k}}^f
 \end{array} \tag{0.0.2}$$

Plan

Le chapitre 1 est constitué de rappels sur les catégories en rubans, les catégories (pré)modulaires et les coends.

Le chapitre 2 a pour but de donner la définition d'une TQFT avec anomalie.

Le chapitre 3 définit d'abord les objets combinatoires de type enchevêtrement dont nous avons besoin pour la construction de la TQFT (on y trouvera notamment la définition d'un enchevêtrement de cobordisme) et rappelle l'extension des résultats de chirurgie et du calcul de Kirby aux cobordismes de dimension 3.

Le chapitre 4 est le coeur de cette thèse et détaille les résultats nécessaires à la construction de la TQFT interne à partir d'un enchevêtrement de cobordisme. On y trouvera les deux premiers résultats principaux de cette thèse (Théorèmes 4.4.4 et 4.4.6) qui indiquent respectivement qu'un élément admissible d'une catégorie en ruban avec coend fournit une TQFT et que cette TQFT ne dépend que des morphismes de structures de la coend.

Le chapitre 5 est un chapitre de comparaison et d'application des résultats du chapitre 4. On y trouvera les deux derniers résultats principaux de cette thèse (Théorèmes 5.2.1 et 5.4.1) qui comparent respectivement nos TQFTs internes à celles de Turaev dans les cas modulaire et modularisable.

Chapter 1

Categorical preliminaries

In this chapter, we recall basic definitions on monoidal, braided and ribbon categories. We introduce one of the main tools of this thesis: that is the coend of a ribbon category, when it exists, which is a special object of the category. This object leads to the construction of some quantum invariants as done by Lyubashenko. We recall that this object has a Hopf algebra structure and is equipped with a pairing and two linear forms encoding respectively the double braiding and the twists of the ribbon category.

1.1 Categories

1.1.1 Monoidal category

A *monoidal category* is a quintuplet $(\mathcal{C}, \otimes, \mathbb{1}, a, l, r)$ where \mathcal{C} is a category, $\otimes: \mathcal{C} \times \mathcal{C} \rightarrow \mathcal{C}$ is a functor called *tensor product* or *monoidal product*, $\mathbb{1}$ is an object of \mathcal{C} called the *unit object*, a is a natural isomorphism $\{a_{X,Y,Z}: (X \otimes Y) \otimes Z \rightarrow X \otimes (Y \otimes Z)\}_{X,Y,Z \in \mathcal{C}}$, l is a natural isomorphism $\{l_X: \mathbb{1} \otimes X \rightarrow X\}_{X \in \mathcal{C}}$, and r is a natural isomorphism $\{r_X: X \otimes \mathbb{1} \rightarrow X\}_{X \in \mathcal{C}}$ such that, for any objects W, X, Y, Z of \mathcal{C} , the following diagrams 1.1.1 and 1.1.2 commute:

$$\begin{array}{ccc}
 & ((W \otimes X) \otimes Y) \otimes Z & \\
 a_{W \otimes X, Y, Z} \swarrow & & \searrow a_{W, X, Y} \otimes \text{id}_Z \\
 (W \otimes X) \otimes (Y \otimes Z) & & (W \otimes (X \otimes Y)) \otimes Z \\
 a_{W, X, Y \otimes Z} \downarrow & & \downarrow a_{W, X \otimes Y, Z} \\
 W \otimes (X \otimes (Y \otimes Z)) & \xleftarrow{\text{id}_W \otimes a_{X, Y, Z}} & W \otimes ((X \otimes Y) \otimes Z)
 \end{array} \tag{1.1.1}$$

$$\begin{array}{ccc}
 (X \otimes \mathbb{1}) \otimes Y & \xrightarrow{a_{X, \mathbb{1}, Y}} & X \otimes (\mathbb{1} \otimes Y) \\
 r_X \otimes \text{id}_Y \searrow & & \swarrow \text{id}_X \otimes l_Y \\
 & X \otimes Y &
 \end{array} \tag{1.1.2}$$

Example 1.1.1 : The category $\text{Mod}_{\mathbb{k}}$ of \mathbb{k} -vector spaces equipped with the usual tensor product $\otimes_{\mathbb{k}}$, the unit object \mathbb{k} , and for X, Y , and Z three vector spaces, the natural isomorphisms given

by $a_{X,Y,Z}((x \otimes y) \otimes z) = x \otimes (y \otimes z)$, $l_X(\lambda \otimes x) = \lambda x$ and $r_X(x \otimes \lambda) = \lambda x$ where $x \in X$, $y \in Y$ and $z \in Z$ is a monoidal category.

A *strict monoidal category* is a monoidal category $(\mathcal{C}, \otimes, \mathbb{1}, a, l, r)$ where the natural isomorphisms a , l and r are identities. Then we just note $(\mathcal{C}, \otimes, \mathbb{1})$ for a strict monoidal category. According to a result of Mac Lane (see [ML98]), every monoidal category is equivalent in a canonical way to a strict monoidal category. **In the sequel, we suppose that all monoidal categories are strict.**

Let $(\mathcal{C}, \otimes, \mathbb{1})$ and $(\mathcal{D}, \otimes, \mathbb{1})$ be two monoidal categories. A *monoidal functor* from \mathcal{C} to \mathcal{D} is a triplet (F, F_2, F_0) where F is a functor from \mathcal{C} to \mathcal{D} ,

$$F_2 = \{F_2(X, Y): F(X) \otimes F(Y) \rightarrow F(X \otimes Y)\}_{X, Y \in \mathcal{C}},$$

is a natural transformation between functors $F \otimes F$ and $F \otimes$ and $F_0: \mathbb{1} \rightarrow F(\mathbb{1})$ is a morphism of \mathcal{D} such that, for every objects X , Y and Z of \mathcal{C} , the following diagrams 1.1.3, 1.1.4 and 1.1.5 commute:

$$\begin{array}{ccc} F(X) \otimes F(Y) \otimes F(Z) & \xrightarrow{F_2(X, Y) \otimes \text{id}_{F(Z)}} & F(X \otimes Y) \otimes F(Z) \\ \text{id}_{F(X)} \otimes F_2(Y, Z) \downarrow & & \downarrow F_2(X \otimes Y, Z) \\ F(X) \otimes F(Y \otimes Z) & \xrightarrow{F_2(X, Y \otimes Z)} & F(X \otimes Y \otimes Z) \end{array} \quad (1.1.3)$$

$$\begin{array}{ccc} F(X) \otimes \mathbb{1} & \xrightarrow{\text{id}_{F(X)} \otimes F_0} & F(X) \otimes F(\mathbb{1}) \\ \text{id}_{F(X)} \searrow & & \swarrow F_2(X, \mathbb{1}) \\ & F(X) & \end{array}$$

(1.1.4)

$$\begin{array}{ccc} \mathbb{1} \otimes F(X) & \xrightarrow{F_0 \otimes \text{id}_{F(X)}} & F(\mathbb{1}) \otimes F(X) \\ \text{id}_{F(X)} \searrow & & \swarrow F_2(\mathbb{1}, X) \\ & F(X) & \end{array}$$

(1.1.5)

If F_2 and F_0 are isomorphisms, the monoidal functor F is *strong*. If F_2 and F_0 are identities, the monoidal functor F is *strict*.

Let $(\mathcal{C}, \otimes, \mathbb{1})$ and $(\mathcal{D}, \otimes, \mathbb{1})$ be two monoidal categories and $F = (F, F_2, F_0)$ and $G = (G, G_2, G_0)$ be two monoidal functors from \mathcal{C} to \mathcal{D} . A monoidal natural transformation β from F to G is a natural transformation from F to G , $\beta = \{\beta_X: F(X) \rightarrow G(X)\}_{X \in \mathcal{C}}$, such that for every objects X and Y of \mathcal{C} , the following diagrams 1.1.6 and 1.1.7 commute:

$$\begin{array}{ccc} F(X) \otimes F(Y) & \xrightarrow{\beta_X \otimes \beta_Y} & G(X) \otimes G(Y) \\ F_2(X, Y) \downarrow & & \downarrow G_2(X, Y) \\ F(X \otimes Y) & \xrightarrow{\beta_{X \otimes Y}} & G(X \otimes Y) \end{array} \quad (1.1.6)$$

$$\begin{array}{ccc} & \mathbb{1} & \\ F_0 \swarrow & & \searrow G_0 \\ F(\mathbb{1}) & \xrightarrow{\beta_{\mathbb{1}}} & G(\mathbb{1}) \end{array} \quad (1.1.7)$$

A *monoidal natural isomorphism* from the monoidal functor $F = (F, F_2, F_0)$ to the monoidal functor $G = (G, G_2, G_0)$ is a monoidal natural transformation which is a natural isomorphism from F to G .

1.1.2 Rigid category

Let $\mathcal{C} = (\mathcal{C}, \otimes, \mathbb{1})$ a monoidal category. A *left dual* of an object X of \mathcal{C} is an object ${}^\vee X$ of \mathcal{C} together with morphisms $\text{ev}_X: {}^\vee X \otimes X \rightarrow \mathbb{1}$, called *left evaluation*, and $\text{coev}_X: \mathbb{1} \rightarrow X \otimes {}^\vee X$, called *left coevaluation*, such that

$$(\text{id}_X \otimes \text{ev}_X) \circ (\text{coev}_X \otimes \text{id}_X) = \text{id}_X \text{ and } (\text{ev}_X \otimes \text{id}_{{}^\vee X}) \circ (\text{id}_{{}^\vee X} \otimes \text{coev}_X) = \text{id}_{{}^\vee X}.$$

Similarly, a *right dual* of an object X of \mathcal{C} is an object X^\vee of \mathcal{C} together with morphisms $\widetilde{\text{ev}}_X: X \otimes X^\vee \rightarrow \mathbb{1}$, called *right evaluation*, and $\widetilde{\text{coev}}_X: \mathbb{1} \rightarrow X^\vee \otimes X$, called *right coevaluation*, such that

$$(\text{id}_{X^\vee} \otimes \widetilde{\text{ev}}_X) \circ (\widetilde{\text{coev}}_X \otimes \text{id}_{X^\vee}) = \text{id}_{X^\vee} \text{ and } (\widetilde{\text{ev}}_X \otimes \text{id}_X) \circ (\text{id}_X \otimes \widetilde{\text{coev}}_X) = \text{id}_X.$$

A *rigid category* (or *autonomous category*) is a monoidal category in which every object of \mathcal{C} has a left dual and a right dual. The left and right duals of an object of \mathcal{C} are unique up to an isomorphism preserving the evaluation and coevaluation morphisms. The choice of left duals and right duals define a *left dual functor* ${}^\vee?: \mathcal{C}^{op} \rightarrow \mathcal{C}$ and a *right dual functor* $?^\vee: \mathcal{C}^{op} \rightarrow \mathcal{C}$ where \mathcal{C}^{op} is the opposite category to \mathcal{C} endowed with the opposite monoidal structure. The image of a morphism $f: X \rightarrow Y$ of \mathcal{C} by the left dual functor is the morphism ${}^\vee f: {}^\vee Y \rightarrow {}^\vee X$ of \mathcal{C} defined by

$${}^\vee f = (\text{ev}_Y \otimes \text{id}_{{}^\vee X}) \circ (\text{id}_{{}^\vee Y} \otimes f \otimes \text{id}_{{}^\vee X}) \circ (\text{id}_{{}^\vee Y} \otimes \text{coev}_X),$$

and the image of $f: X \rightarrow Y$ by the right dual functor is the morphism $f^\vee: Y^\vee \rightarrow X^\vee$ of \mathcal{C} defined by

$$f^\vee = (\text{id}_{X^\vee} \otimes \widetilde{\text{ev}}_Y) \circ (\text{id}_{X^\vee} \otimes f \otimes \text{id}_{Y^\vee}) \circ (\widetilde{\text{coev}}_X \otimes \text{id}_{Y^\vee}).$$

The left and right dual functors are strong monoidal functors. In particular, for any objects X and Y of \mathcal{C} , we have natural isomorphisms ${}^\vee X \otimes {}^\vee Y \simeq {}^\vee (Y \otimes X)$, $X^\vee \otimes Y^\vee \simeq (Y \otimes X)^\vee$ and isomorphisms ${}^\vee \mathbb{1} \simeq \mathbb{1} \simeq \mathbb{1}^\vee$. Note that a strong monoidal functor preserves left and right duality.

1.1.3 Pivotal category

A rigid category \mathcal{C} is *pivotal* if it is endowed with a monoidal natural isomorphism between left and right dual functors. Without loss of generality we can assume that this isomorphism is the identity, that is, for every object X of \mathcal{C} , there exist a *dual object* X^* in \mathcal{C} and four morphisms

$$\text{ev}_X: X^* \otimes X \rightarrow \mathbb{1}, \text{coev}_X: \mathbb{1} \rightarrow X \otimes X^*, \widetilde{\text{ev}}_X: X \otimes X^* \rightarrow \mathbb{1}, \widetilde{\text{coev}}_X: \mathbb{1} \rightarrow X^* \otimes X,$$

such that $(X^*, \text{ev}_X, \text{coev}_X)$ is a left dual of X , $(X^*, \widetilde{\text{ev}}_X, \widetilde{\text{coev}}_X)$ is a right dual of X , and the left and right dual functors coincide as monoidal functors. The *dual morphism* of any morphism $f: X \rightarrow Y$ of \mathcal{C} is defined by $f^* = {}^\vee f = f^\vee: Y^* \rightarrow X^*$.

1.1.4 Braided category

A monoidal category is *braided* if it is endowed with a *braiding*, that is, a system of isomorphisms $\tau = \{\tau_{X,Y}: X \otimes Y \rightarrow Y \otimes X\}_{X,Y \in \mathcal{C}}$, natural in X and Y , satisfying

$$\tau_{X \otimes Y, Z} = (\tau_{X,Z} \otimes \text{id}_Y)(\text{id}_X \otimes \tau_{Y,Z}) \text{ and } \tau_{X, Y \otimes Z} = (\text{id}_Y \otimes \tau_{X,Z})(\tau_{X,Y} \otimes \text{id}_Z)$$

for all objects $X, Y, Z \in \mathcal{C}$. Note that these conditions imply that $\tau_{X, \mathbb{1}} = \tau_{\mathbb{1}, X} = \text{id}_X$.

Let \mathcal{C} and \mathcal{D} be two braided categories. A *braided functor* from \mathcal{C} to \mathcal{D} is a monoidal functor (F, F_2, F_0) such that the following diagram 1.1.8 commutes for every objects $X, Y \in \mathcal{C}$:

$$\begin{array}{ccc}
 F(X) \otimes F(Y) & \xrightarrow{\tau_{F(X), F(Y)}} & F(Y) \otimes F(X) \\
 F_2(X, Y) \downarrow & & \downarrow F_2(Y, X) \\
 F(X \otimes Y) & \xrightarrow{F(\tau_{X, Y})} & F(Y \otimes X)
 \end{array} \tag{1.1.8}$$

1.1.5 Symmetric category

A braiding τ of a monoidal category \mathcal{C} is *symmetric* if

$$\tau_{Y, X} \tau_{X, Y} = \text{id}_{X \otimes Y}$$

for all objects X, Y of \mathcal{C} . A *symmetric category* is a monoidal category endowed with a symmetric braiding. A *symmetric monoidal functor* is a braided functor between symmetric categories.

Example 1.1.2 : Let X, Y be two \mathbb{k} -vector spaces and for $x \in X, y \in Y$, define the \mathbb{k} -linear map $\tau_{X, Y}: X \otimes_{\mathbb{k}} Y \rightarrow Y \otimes_{\mathbb{k}} X$ setting $\tau_{X, Y}(x \otimes y) = y \otimes x$. The category $\text{Mod}_{\mathbb{k}}$ equipped with τ is a symmetric category.

1.1.6 The subcategory of transparent objects of a braided category

Let \mathcal{C} be a braided category with braiding $\tau = \{\tau_{X, Y}: X \otimes Y \rightarrow Y \otimes X\}_{X, Y \in \mathcal{C}}$. An object X of \mathcal{C} is *transparent* if for every object Y of \mathcal{C} ,

$$\tau_{Y, X} \tau_{X, Y} = \text{id}_{X \otimes Y}.$$

The *full subcategory* \mathcal{T} of \mathcal{C} of *transparent objects* is a symmetric monoidal subcategory of \mathcal{C} .

1.1.7 Balanced category

A *balanced category* is a braided category \mathcal{C} endowed with a *twist* (or *balancing*), that is, a natural isomorphism $\theta = \{\theta_X: X \rightarrow X\}_{X \in \mathcal{C}}$ such that

$$\theta_{X \otimes Y} = \tau_{Y, X} \tau_{X, Y} (\theta_X \otimes \theta_Y)$$

for all objects $X, Y \in \mathcal{C}$.

Let \mathcal{C} and \mathcal{D} be two balanced categories. A *balanced functor* from \mathcal{C} to \mathcal{D} is a braided functor $F: \mathcal{C} \rightarrow \mathcal{D}$ such that for all objects $X \in \mathcal{C}$, $F(\theta_X) = \theta_{F(X)}$.

A braided pivotal category \mathcal{C} has two canonical balanced structures. The *left twist* on an object X of \mathcal{C} is defined by

$$\theta_X^l = (\text{id}_X \otimes \tilde{\text{ev}}_X)(\tau_{X, X} \otimes \text{id}_{X^*})(\text{id}_X \otimes \text{coev}_X): X \rightarrow X$$

whereas the *right twist* is defined by

$$\theta_X^r = (\text{ev}_X \otimes \text{id}_X)(\text{id}_X \otimes \tau_{X, X})(\widetilde{\text{coev}}_X \otimes \text{id}_X): X \rightarrow X.$$

The left and right twists are invertible, with inverses

$$(\theta_X^l)^{-1} = (\text{ev}_X \otimes \text{id}_X)(\text{id}_{X^*} \otimes \tau_{X, X}^{-1})(\widetilde{\text{coev}}_X \otimes \text{id}_X): X \rightarrow X$$

and

$$(\theta_X^r)^{-1} = (\text{id}_X \otimes \tilde{\text{ev}}_X)(\tau_{X, X}^{-1} \otimes \text{id}_{X^*})(\text{id}_X \otimes \text{coev}_X): X \rightarrow X.$$

Note that $\theta_{\mathbb{1}}^l = \text{id}_{\mathbb{1}} = \theta_{\mathbb{1}}^r$.

1.1.8 Ribbon category

A *ribbon category* \mathcal{C} is a braided pivotal category such that for all objects X of \mathcal{C}

$$\theta_X^l = \theta_X^r.$$

The last condition is equivalent to ask that the left twist (respectively the right twist) is self-dual that means for all objects X of \mathcal{C}

$$\theta_{X^*}^l = (\theta_X^l)^*$$

(respectively $\theta_{X^*}^r = (\theta_X^r)^*$). This axiom of self-duality is equivalent to the axiom

$$(\theta_X^l \otimes \text{id}_{X^*})\text{coev}_X = (\text{id}_X \otimes \theta_{X^*}^l)\text{coev}_X$$

(respectively $(\theta_X^r \otimes \text{id}_{X^*})\text{coev}_X = (\text{id}_X \otimes \theta_{X^*}^r)\text{coev}_X$).

For an endomorphism $f: X \rightarrow X$ of a ribbon category, the *trace* of f is defined as:

$$\text{tr}(f) = \text{ev}_X(\text{id}_{X^*} \otimes f)\widetilde{\text{coev}}_X = \widetilde{\text{ev}}_X(f \otimes \text{id}_{X^*})\text{coev}_X \in \text{Hom}_{\mathcal{C}}(\mathbb{1}, \mathbb{1}).$$

Let $f: X \rightarrow X$, $g: Y \rightarrow Y$, $h: X \rightarrow Y$, and $i: Y \rightarrow X$. Then $\text{tr}(f^*) = \text{tr}(f)$, $\text{tr}(gh) = \text{tr}(hg)$, $\text{tr}(f \otimes g) = \text{tr}(f) \otimes \text{tr}(g)$. The *dimension* of an object X of \mathcal{C} is defined as:

$$\dim_q(X) = \text{tr}(\text{id}_X) \in \text{Hom}_{\mathcal{C}}(\mathbb{1}, \mathbb{1}).$$

Note that isomorphic objects have the same dimension, $\dim_q(X^*) = \dim_q(X)$, and $\dim_q(X \otimes Y) = \dim_q(X)\dim_q(Y)$.

Examples 1.1.3 :

- The category of finite-dimensional \mathbb{k} -vector spaces $\text{Mod}_{\mathbb{k}}^f$ endowed with the trivial braiding $\theta_X = \text{id}_X$ is ribbon.
- More generally, the category Rep_H of representations of a finite-dimensional ribbon Hopf algebra H is ribbon (see [KRT97] and [Tur94]).

A *ribbon functor* is a braided and balanced functor between ribbon categories.

1.1.9 Linear category

Recall that a finite set $\{X_1, \dots, X_n\}$ of objects of a category \mathcal{C} has a *direct sum* if there exist an object X and morphisms $p_i: X \rightarrow X_i$, $q_i: X_i \rightarrow X$ satisfying $p_i \circ q_k = \delta_{i,k}\text{id}_{X_i}$ for $1 \leq i, k \leq n$, such that, for any object Y and any morphisms $f_i: Y \rightarrow X_i$ and $g_i: X_i \rightarrow Y$ for $1 \leq i \leq n$, there is a unique morphism $f: Y \rightarrow X$ and a unique morphism $g: X \rightarrow Y$ with $p_i \circ f = f_i$ and $g \circ q_i = g_i$ for all $1 \leq i \leq n$. The object X is then unique up to isomorphism and X is called direct sum of *direct factors* X_1, \dots, X_n . We write $X = \bigoplus_i X_i$, $f = \bigoplus_i f_i$ and $g = \bigoplus_i g_i$.

Let \mathbb{k} be a commutative ring. A *\mathbb{k} -linear category* \mathcal{C} is a category where Hom -sets are \mathbb{k} -modules, the composition of morphisms is \mathbb{k} -bilinear, and any finite family of objects has a direct sum. In particular, such a category \mathcal{C} has a zero object. An object X of \mathcal{C} is *scalar* if the map $\mathbb{k} \rightarrow \text{End}_{\mathcal{C}}(X)$, $\lambda \mapsto \lambda \text{id}_X$ is bijective.

Let \mathcal{C} and \mathcal{D} be two \mathbb{k} -additive category. A *\mathbb{k} -linear functor* from \mathcal{C} to \mathcal{D} is a functor which defines a \mathbb{k} -linear map between the \mathbb{k} -modules $\text{Hom}_{\mathcal{C}}(X, Y)$ and $\text{Hom}_{\mathcal{D}}(F(X), F(Y))$ for every objects $X, Y \in \mathcal{C}$.

A *\mathbb{k} -linear monoidal category* is a monoidal category which is \mathbb{k} -linear in such a way that the monoidal product is \mathbb{k} -bilinear.

1.1.10 Fusion category

Let \mathbb{k} be a commutative ring. A *fusion category over \mathbb{k}* is a \mathbb{k} -linear rigid category \mathcal{C} such that

- each object of \mathcal{C} is a finite direct sum of scalar objects;
- for any non-isomorphic scalar objects i and j of \mathcal{C} , $\text{Hom}_{\mathcal{C}}(i, j) = 0$;
- the isomorphism classes of scalar objects of \mathcal{C} form a finite set;
- the unit object $\mathbb{1}$ is scalar.

The Hom-spaces in \mathcal{C} are free \mathbb{k} -modules of finite rank. Given a scalar object i of \mathcal{C} , the *i -isotypical component* $X^{(i)}$ of an object X is the largest direct factor of X isomorphic to a direct sum of copies of i . The number of copies of i in the direct sum decomposition of X is equal to the rank of the \mathbb{k} -module $\text{Hom}_{\mathcal{C}}(i, X)$ which is the same of the rank of $\text{Hom}_{\mathcal{C}}(X, i)$.

An *i -decomposition of an object X* is an explicit direct sum decomposition of $X^{(i)}$ into copies of i , that is, a family of pairs of morphisms in \mathcal{C} $(p_a: X \rightarrow i, q_a: i \rightarrow X)_{a \in A}$ such that the set A has $\text{rank}(\text{Hom}_{\mathcal{C}}(i, X))$ elements and for all $a, b \in A$, $p_a q_a = \delta_{a,b} \text{id}_i$ where $\delta_{a,b}$ is the Kronecker symbol.

A *representative set of scalar objects* of \mathcal{C} is a set I of scalar objects such that $\mathbb{1} \in I$ and every scalar object of \mathcal{C} is isomorphic to exactly one element of I . Note that if \mathbb{k} is a field, a fusion category over \mathbb{k} is abelian and semisimple. Recall that an abelian category is semisimple if its objects are direct sums of simple objects.

1.1.11 Premodular category and S -matrix

Let \mathbb{k} be a commutative ring. A *premodular category \mathcal{C} over \mathbb{k}* is a ribbon and fusion category over \mathbb{k} . Pick a representative set I of scalar objects of \mathcal{C} . For $i, j \in I$, set

$$S_{i,j} = (\text{ev}_i \otimes \widetilde{\text{ev}}_j)(\text{id}_{i^*} \otimes \tau_{j,i} \tau_{i,j} \otimes \text{id}_{j^*})(\widetilde{\text{coev}}_i \otimes \text{coev}_j) \in \mathbb{k},$$

where τ is the braiding of \mathcal{C} . The matrix $S = [S_{i,j}]_{i,j \in I}$ is called the *S -matrix* of \mathcal{C} .

1.1.12 Modular category

Let \mathbb{k} be a commutative ring. A *modular category over \mathbb{k}* is a premodular category over \mathbb{k} for which the S -matrix is invertible.

1.1.13 Modularization and modularizable category

Let \mathcal{C} and \mathcal{D} be two categories. For X and Y two objects of \mathcal{C} , the object X is a *retract* of the object Y if there exist two morphisms $i: X \rightarrow Y$ and $p: Y \rightarrow X$ such that $p \circ i = \text{id}_X$. A functor $F: \mathcal{C} \rightarrow \mathcal{D}$ is *dominant* if for every object $Z \in \mathcal{D}$, there exists an object $X \in \mathcal{C}$ such that Z is a retract of $F(X)$ in \mathcal{D} .

A *modularization* of a premodular category \mathcal{C} over \mathbb{k} is a dominant strong monoidal ribbon \mathbb{k} -linear functor $F: \mathcal{C} \rightarrow \widetilde{\mathcal{C}}$, where $\widetilde{\mathcal{C}}$ is a modular category. A premodular category \mathcal{C} is *modularizable* if it admits a modularization. See [Bru00] for details on modularization.

1.1.14 Category with split idempotents

An *idempotent* of a category \mathcal{C} is an endomorphism Π of an object of \mathcal{C} such that $\Pi^2 = \Pi$. A *split decomposition* of an idempotent Π of an object X of \mathcal{C} is a triple (A, p, q) where A is an object of \mathcal{C} and $p: X \rightarrow A$ and $q: A \rightarrow X$ are two morphisms of \mathcal{C} satisfying:

$$pq = \text{id}_A \quad \text{and} \quad qp = \Pi.$$

Such a splitting, if it exists, is unique up to unique isomorphism, that is, given a second splitting (A', p', q') of Π , there exists a unique isomorphism $\eta: A \xrightarrow{\sim} A'$ such that $\eta p = p'$ and $q' \eta = q$. Note that the object A is called the *image* of Π . We say that \mathcal{C} is a *category with split idempotents* if any idempotent of \mathcal{C} admits a split decomposition. We will always assume that in a category with split idempotents, for each idempotent Π , a splitting $(\text{Im}(\Pi), p_\Pi, q_\Pi)$ has been chosen.

Lemma 1.1.4 — *Let \mathcal{C} be category with split idempotents. Let X, X' be two objects of \mathcal{C} and Π, Π' be idempotents of X and X' respectively.*

(i) *If $f: X \rightarrow Y$ is a morphism such that $\Pi' f = f \Pi$, there exists a unique morphism $g: \text{Im}(\Pi) \rightarrow \text{Im}(\Pi')$ such that the following diagram 1.1.9 commutes:*

$$\begin{array}{ccccc}
 X & \xrightarrow{p_\Pi} & \text{Im}(\Pi) & \xrightarrow{q_\Pi} & X \\
 f \downarrow & & \downarrow g & & \downarrow f \\
 Y & \xrightarrow{p_{\Pi'}} & \text{Im}(\Pi') & \xrightarrow{q_{\Pi'}} & Y
 \end{array} \tag{1.1.9}$$

The morphism g is given by $p_{\Pi'} f q_\Pi$. We call g the restriction of f to the images of the idempotents Π and Π' .

(ii) *This construction induces a bijection*

$$\{f \in \text{Hom}_{\mathcal{C}}(X, X') \mid \Pi' f \Pi = f\} \rightarrow \text{Hom}_{\mathcal{C}}(\text{Im}(\Pi), \text{Im}(\Pi'))$$

by sending f to its restriction.

(iii) *If X'' is a third object and Π'' an idempotent of X'' , and if $f: X \rightarrow X'$ and $f': X' \rightarrow X''$ satisfy $\Pi'' f' = f' \Pi$ then the restriction of $f' f$ is the compositum of the restrictions of f and f' .*

In this way, when $\Pi' f \Pi = f$, a morphism between images of idempotents $\text{Im}(\Pi)$ and $\text{Im}(\Pi')$ can be represented by a morphism between X and X' . We will often use this representation in the sequel.

1.1.15 Graphical calculus in a ribbon category

Let \mathcal{C} be a ribbon category. Using Penrose graphical calculus, we represent morphisms of \mathcal{C} by drawings as in Figure 1.1.

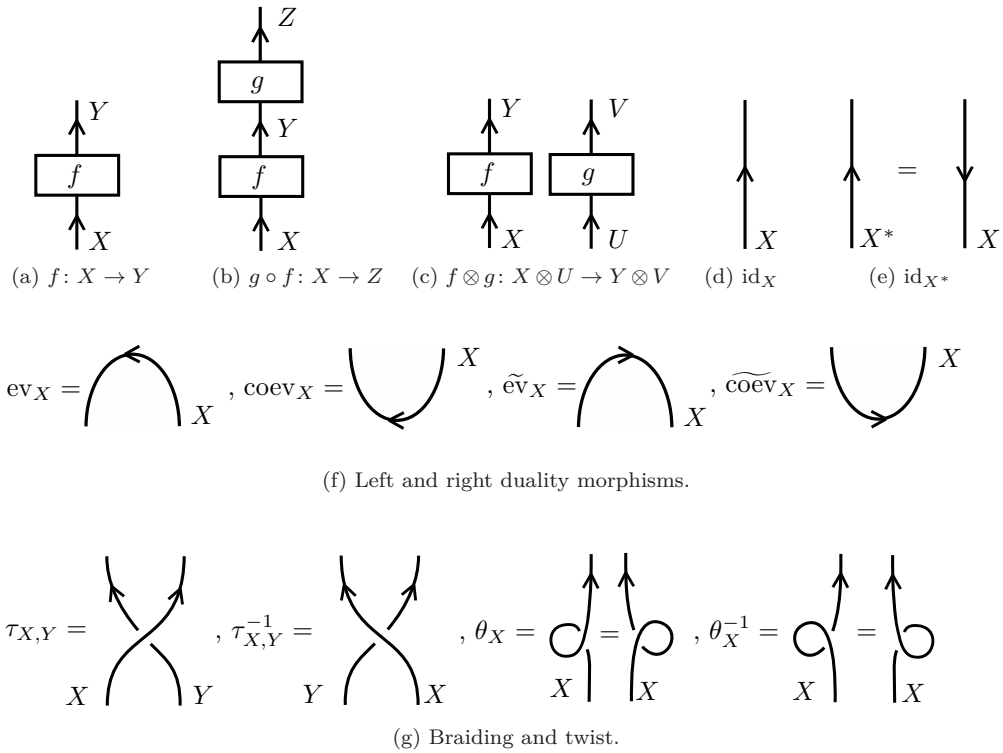
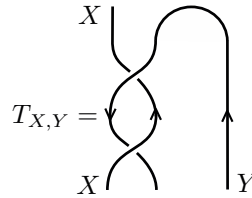

Figure 1.1 – Diagrammatic representation of morphisms in a ribbon category.

The category of oriented ribbon tangles satisfies a universal property (see [Shu94]), which means in particular that any oriented ribbon tangle T colored by objects of \mathcal{C} defines a morphism $\langle T \rangle$ in \mathcal{C} . For example, to the colored ribbon tangle



is associated the morphism

$$\langle T_{X,Y} \rangle = (\text{id}_X \otimes \text{ev}_Y)(\tau_{Y^*,X} \tau_{X,Y^*} \otimes \text{id}_{Y^*}): X \otimes Y^* \otimes Y \rightarrow X.$$

1.2 Coend and universal morphism

1.2.1 Hopf algebras, pairing and integrals in a ribbon category

See [Kas95] or [Rad12] for details on classical bialgebras and Hopf algebras.

Let \mathcal{C} be a ribbon category, with braiding τ . An object A of \mathcal{C} is a *bialgebra in \mathcal{C}* if it is endowed with four morphisms,

$$m: A \otimes A \rightarrow A, \quad u: \mathbb{1} \rightarrow A, \quad \Delta: A \rightarrow A \otimes A, \quad \text{and} \quad \varepsilon: A \rightarrow \mathbb{1}$$

called respectively *product*, *unit*, *coproduct*, and *counit* such that

$$\begin{aligned} m(m \otimes \text{id}_A) &= m(\text{id}_A \otimes m), \quad m(\text{id}_A \otimes u) = \text{id}_A = m(u \otimes \text{id}_A), \\ (\Delta \otimes \text{id}_A)\Delta &= (\text{id}_A \otimes \Delta)\Delta, \quad (\text{id}_A \otimes \varepsilon)\Delta = \text{id}_A = (\varepsilon \otimes \text{id}_A)\Delta, \\ \Delta m &= (m \otimes m)(\text{id}_A \otimes \tau_{A,A} \otimes \text{id}_A)(\Delta \otimes \Delta), \quad \Delta u = u \otimes u, \quad \varepsilon m = \varepsilon \otimes \varepsilon, \quad \varepsilon u = \text{id}_{\mathbb{1}}. \end{aligned}$$

A morphism $S: A \rightarrow A$ is an *antipode* for a bialgebra A if it satisfies

$$m(S \otimes \text{id}_A)\Delta = u\varepsilon = m(\text{id}_A \otimes S)\Delta.$$

If it exists, an antipode is unique. A *Hopf algebra in \mathcal{C}* is a bialgebra in \mathcal{C} which admits an invertible antipode.

Let H be a Hopf algebra in \mathcal{C} . A *Hopf pairing* for H is a morphism $\omega: H \otimes H \rightarrow \mathbb{1}$ such that

$$\begin{aligned} \omega(m \otimes \text{id}_H) &= \omega(\text{id}_H \otimes \omega \otimes \text{id}_H)(\text{id}_{H \otimes H} \otimes \Delta), \quad \omega(u \otimes \text{id}_H) = \varepsilon, \\ \omega(\text{id}_H \otimes m) &= \omega(\text{id}_H \otimes \omega \otimes \text{id}_H)(\Delta \otimes \text{id}_{H \otimes H}), \quad \omega(\text{id}_H \otimes u) = \varepsilon. \end{aligned}$$

These axioms imply that $\omega(S \otimes \text{id}_H) = \omega(\text{id}_H \otimes S)$.

A Hopf pairing ω for H is nondegenerate if there exists a morphism $\Omega: \mathbb{1} \rightarrow H \otimes H$ such that

$$(\omega \otimes \text{id}_H)(\text{id}_H \otimes \Omega) = \text{id}_H = (\text{id}_H \otimes \omega)(\Omega \otimes \text{id}_H).$$

If such is the case, the morphism Ω is unique and called the *inverse* of ω .

A *left* (respectively, *right*) *integral* for H is a morphism $\alpha: \mathbb{1} \rightarrow H$ such that

$$m(\text{id}_H \otimes \alpha) = \alpha\varepsilon \quad (\text{respectively, } m(\alpha \otimes \text{id}_H) = \alpha\varepsilon).$$

A *left* (respectively, *right*) *cointegral* for H is a morphism $\lambda: H \rightarrow \mathbb{1}$ such that

$$(\text{id}_H \otimes \lambda)\Delta = u\lambda \quad (\text{respectively, } (\lambda \otimes \text{id}_H)\Delta = u\lambda).$$

A (co)integral is *two-sided* if it is both a left and a right (co)integral.

If $\alpha: \mathbb{1} \rightarrow H$ is a left (respectively, right) integral for H , then $S\alpha$ is a right (respectively, left) integral for H . If λ is a left (respectively, right) cointegral for H , then λS is a right (respectively, left) cointegral for H . A left (respectively, right) integral α is *S-invariant* if it satisfies $S\alpha = \alpha$ and a left (respectively, right) cointegral λ is *S-invariant* if it satisfies $\lambda S = \lambda$. A *S-invariant* (co)integral is then two-sided.

Let ω be a Hopf pairing for H and $\alpha: \mathbb{1} \rightarrow H$ be a morphism in \mathcal{C} . Assume ω is nondegenerate. Then α is a left integral for H if and only if $\lambda = \omega(\text{id}_H \otimes \alpha)$ is a right cointegral for H , and α is a right integral for H if and only if $\lambda = \omega(\alpha \otimes \text{id}_H)$ is a left cointegral for H .

1.2.2 Dinatural transformations and coends

Let \mathcal{C} and \mathcal{D} be two categories and consider a functor $F: \mathcal{C}^{op} \times \mathcal{C} \rightarrow \mathcal{D}$ where \mathcal{C}^{op} is the opposite category. A *dinatural transformation* between the functor F and an object $D \in \mathcal{D}$ is a function d which assigns to every object X of \mathcal{C} , a morphism $d_X: F(X, X) \rightarrow D$ of \mathcal{D} such that, for every morphism $f: X \rightarrow Y$ of \mathcal{C} , the following diagram 1.2.10 commutes:

$$\begin{array}{ccc} F(Y, X) & \xrightarrow{F(f, \text{id}_X)} & F(X, X) \\ F(\text{id}_Y, f) \downarrow & & \downarrow d_X \\ F(Y, Y) & \xrightarrow{d_Y} & D \end{array} \quad (1.2.10)$$

A *coend* of the functor F is a pair (C, ι) consisting of an object C of \mathcal{C} and a dinatural transformation between F and C which is *universal* among the dinatural transformations from the functor F to a constant, that is, for every pair (A, d) where A is an object of \mathcal{C} and d is a dinatural transformation from F to A , there exists a unique morphism $r: C \rightarrow A$ such that for every object X of \mathcal{C} , the following diagram 1.2.11 commutes:

$$\begin{array}{ccc}
 & F(X, X) & \\
 \iota_X \swarrow & & \searrow d_X \\
 C & \xrightarrow{r} & A
 \end{array} \tag{1.2.11}$$

Since the coend (C, ι) satisfies a universal property, then it is unique up to a unique isomorphism so we would be able to talk about the coend of a category. Furthermore, depending on the context, the coend will only refer to the object C instead of the pair (C, ι) .

1.2.3 Coend of a ribbon category

Let \mathcal{C} be a ribbon category. Consider the functor $F: \mathcal{C}^{op} \times \mathcal{C} \rightarrow \mathcal{C}$ defined by

$$F(X, Y) = X^* \otimes Y \quad \text{and} \quad F(f, g) = f^* \otimes g \tag{1.2.12}$$

for all objects $X, Y \in \mathcal{C}$ and all morphisms $f, g \in \mathcal{C}$. The *coend of a ribbon category*, when it exists, is the coend of the functor F defined just above (1.2.12). For example, the category $\mathcal{R}ep_H$ of left H -modules of a finite-dimensional Hopf algebra H over a field \mathbb{k} possesses a coend (C, ι) where $C = H^* = \text{Hom}_{\mathbb{k}}(H, \mathbb{k})$ and is endowed with the coadjoint left H -action given by

$$(h \otimes f) \in H \otimes H^* \rightarrow f(S(h_{(1)})_h_{(2)}) \in H^*$$

and, for a left H -module M , the dinatural map $\iota_M: M^* \otimes M \rightarrow H^*$ is given by

$$(l \otimes m) \in M^* \otimes M \rightarrow l(_m) \in H^*.$$

Theorem 1.2.1 — *Let \mathcal{C} be a ribbon category with a coend (C, ι) . Then \mathcal{C} is a Hopf algebra in the category \mathcal{C} .*

See [Lyu95b] for a proof of Theorem 1.2.1.

In order to explicit structural morphisms of \mathcal{C} , recall fundamental consequences of the universal property of the coend C and of the Fubini theorem (see [ML98]) in the case of a ribbon category:

Theorem 1.2.2 — *Let \mathcal{C} be a ribbon category with coend (C, ι) , A be an object of \mathcal{C} and*

$$d = \{d_{X_1, \dots, X_n}: X_1^* \otimes X_1 \otimes \dots \otimes X_n^* \otimes X_n \rightarrow A\}_{X_1, \dots, X_n \in \mathcal{C}}$$

be a system of morphisms of \mathcal{C} which is dinatural in every X_i for $1 \leq i \leq n$. Then there exists a unique morphism $\phi: C^{\otimes n} \rightarrow A$ such that

$$d_{X_1, \dots, X_n} = \phi \circ (\iota_{X_1} \otimes \dots \otimes \iota_{X_n})$$

Lemma 1.2.3 — *Let \mathcal{C} be a ribbon category with coend (C, ι) , A be an object of \mathcal{C} and $\phi: C^{\otimes n} \rightarrow A$ and $\psi: C^{\otimes n} \rightarrow A$ be two morphisms of \mathcal{C} . Suppose that for all set of objects X_1, \dots, X_n of \mathcal{C} ,*

$$\phi \circ (\iota_{X_1} \otimes \dots \otimes \iota_{X_n}) = \psi \circ (\iota_{X_1} \otimes \dots \otimes \iota_{X_n}).$$

Then $\phi = \psi$.

All structural morphisms of C are defined using Theorem 1.2.2. Let us define the product m , the coproduct Δ , the unit u , the counit ε and the antipode S by:

$$\iota_{Y \otimes X}(\zeta_{X,Y} \otimes \text{id}_{Y \otimes X})(\text{id}_{X^*} \otimes \tau_{X,Y^* \otimes Y}) = m(\iota_X \otimes \iota_Y): X^* \otimes X \otimes Y^* \otimes Y \rightarrow C \quad (1.2.13)$$

$$\iota_{\mathbb{1}} = u: \mathbb{1} = \mathbb{1}^* \otimes \mathbb{1} \rightarrow \mathbb{1} \quad (1.2.14)$$

$$(\iota_X \otimes \iota_X)(\text{id}_{X^*} \otimes \text{coev}_X \otimes \text{id}_X) = \Delta \iota_X: X^* \otimes X \rightarrow C \otimes C \quad (1.2.15)$$

$$\text{ev}_X = \varepsilon \iota_X: X^* \otimes X \rightarrow \mathbb{1} \quad (1.2.16)$$

$$(\text{ev}_X \otimes \iota_{X^*})(\text{id}_{X^*} \otimes \tau_{X^*,X} \otimes \text{id}_{X^*})(\text{coev}_{X^*} \otimes \tau_{X^*,X}) = S \iota_X: X^* \otimes X \rightarrow C \quad (1.2.17)$$

where equalities are satisfied for every objects X, Y of \mathcal{C} and $\zeta_{X,Y}: X^* \otimes Y^* \xrightarrow{\sim} (Y \otimes X)^*$ is the isomorphism defined by $\zeta_{X,Y} = (\text{ev}_X(\text{id}_{X^*} \otimes \text{ev}_Y \otimes \text{id}_X) \otimes \text{id}_{(Y \otimes X)^*})(\text{id}_{X^* \otimes Y^*} \otimes \text{coev}_{Y \otimes X})$. The antipode S is invertible, with inverse defined via:

$$(\text{ev}_X \otimes \iota_{X^*})(\text{id}_{X^*} \otimes \tau_{X^*,X}^{-1} \otimes \text{id}_{X^*})(\text{coev}_{X^*} \otimes \tau_{X^*,X}^{-1}) = S^{-1} \iota_X: X^* \otimes X \rightarrow C \quad (1.2.18)$$

and it can be shown that $S^2 = \theta_C$. The coend C is equipped with three additional structural morphisms, $\theta_+: C \rightarrow \mathbb{1}$, $\theta_-: C \rightarrow \mathbb{1}$ and $\omega: C \otimes C \rightarrow \mathbb{1}$ defined using the universal property of the coend:

$$\text{ev}_X(\text{id}_{X^*} \otimes \theta_C) = \theta_+ \iota_X: X^* \otimes X \rightarrow \mathbb{1} \quad (1.2.19)$$

$$\text{ev}_X(\text{id}_{X^*} \otimes \theta_C^{-1}) = \theta_- \iota_X: X^* \otimes X \rightarrow \mathbb{1} \quad (1.2.20)$$

$$(\text{ev}_X \otimes \text{ev}_Y)(\text{id}_{X^*} \otimes \tau_{Y^*,X} \tau_{X,Y^*} \otimes \text{id}_Y) = \omega(\iota_X \otimes \iota_Y): X^* \otimes X \otimes Y^* \otimes Y \rightarrow \mathbb{1} \quad (1.2.21)$$

The morphism $\omega: C \otimes C \rightarrow \mathbb{1}$ is a Hopf pairing. Recall that a pairing ω is said to be non-degenerate if there exists a morphism $\Omega: \mathbb{1} \rightarrow C \otimes C$ such that $(\omega \otimes \text{id}_C)(\text{id}_C \otimes \Omega) = \text{id}_C = (\text{id}_C \otimes \omega)(\Omega \otimes \text{id}_C)$. This is equivalent to say that $(\omega \otimes \text{id}_{C^*})(\text{id}_C \otimes \text{coev}_C): C \rightarrow C^*$ and $(\text{id}_{C^*} \otimes \omega)(\widetilde{\text{coev}}_C \otimes \text{id}_C): C \rightarrow C^*$ are isomorphisms. The *universal dinatural transformation* of the coend C on an object X , $\iota_X: X^* \otimes X \rightarrow \mathbb{1}$, is depicted as in Figure 1.2.

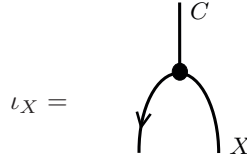

Figure 1.2 – The universal dinatural transformation of the coend.

Using the graphical calculus defined in Section 1.1.15, we depict all equalities defining the structural morphisms of C in Figure 1.3.

There is a natural version of all this equalities. It uses the *universal coaction* of C on the objects of \mathcal{C} defined by

$$\delta_X = (\text{id}_X \otimes \iota_X) \circ (\text{coev}_X \otimes \text{id}_X): X \rightarrow X \otimes C,$$

and depicted as in Figure 1.4.

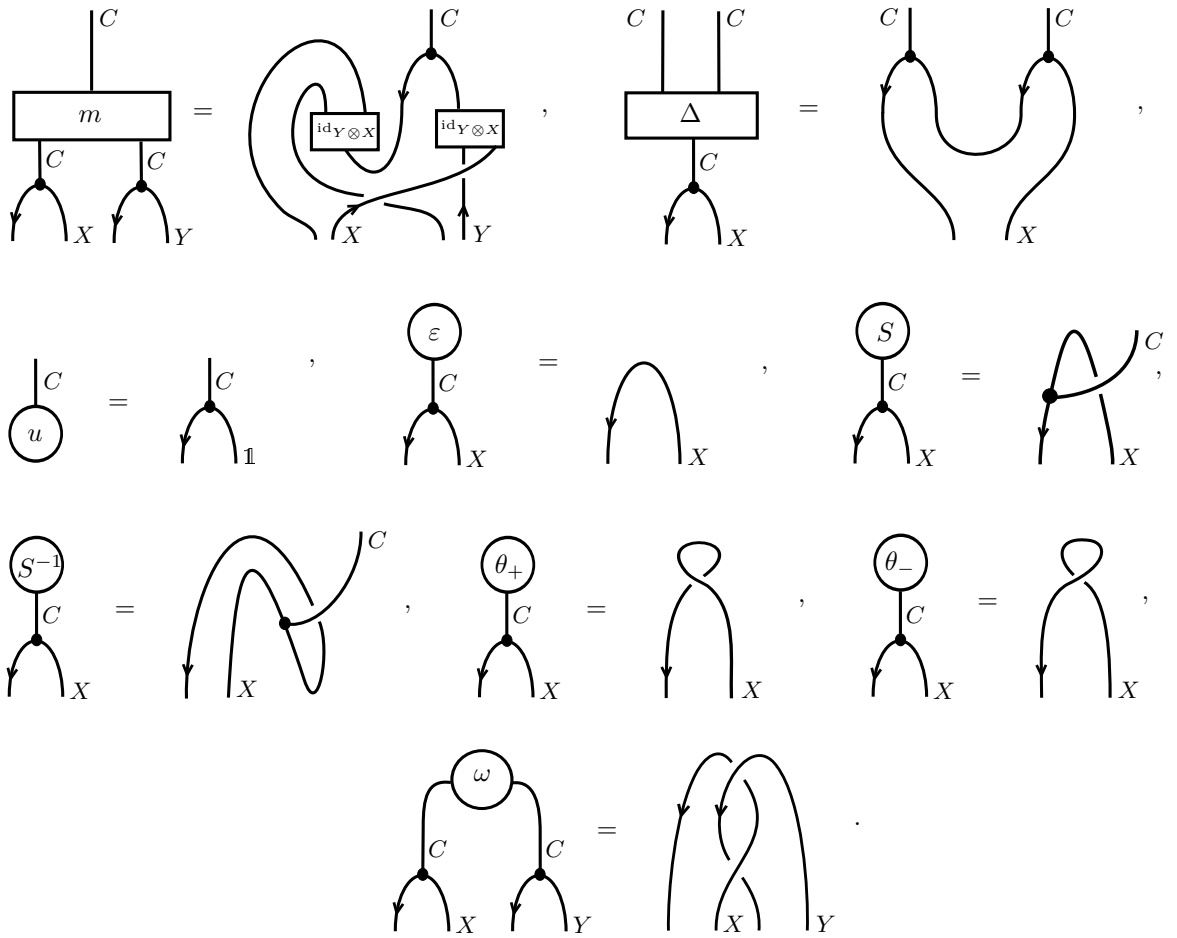

Figure 1.3 – Structural morphisms of C .

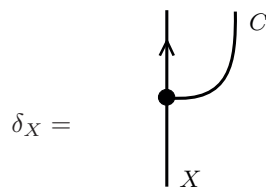

Figure 1.4 – The universal natural transformation of the coend.

Using the universal coaction, equalities defining the structural morphisms of C are depicted in Figure 1.5.

The product m and the coproduct Δ are depicted as in Figure 1.6.

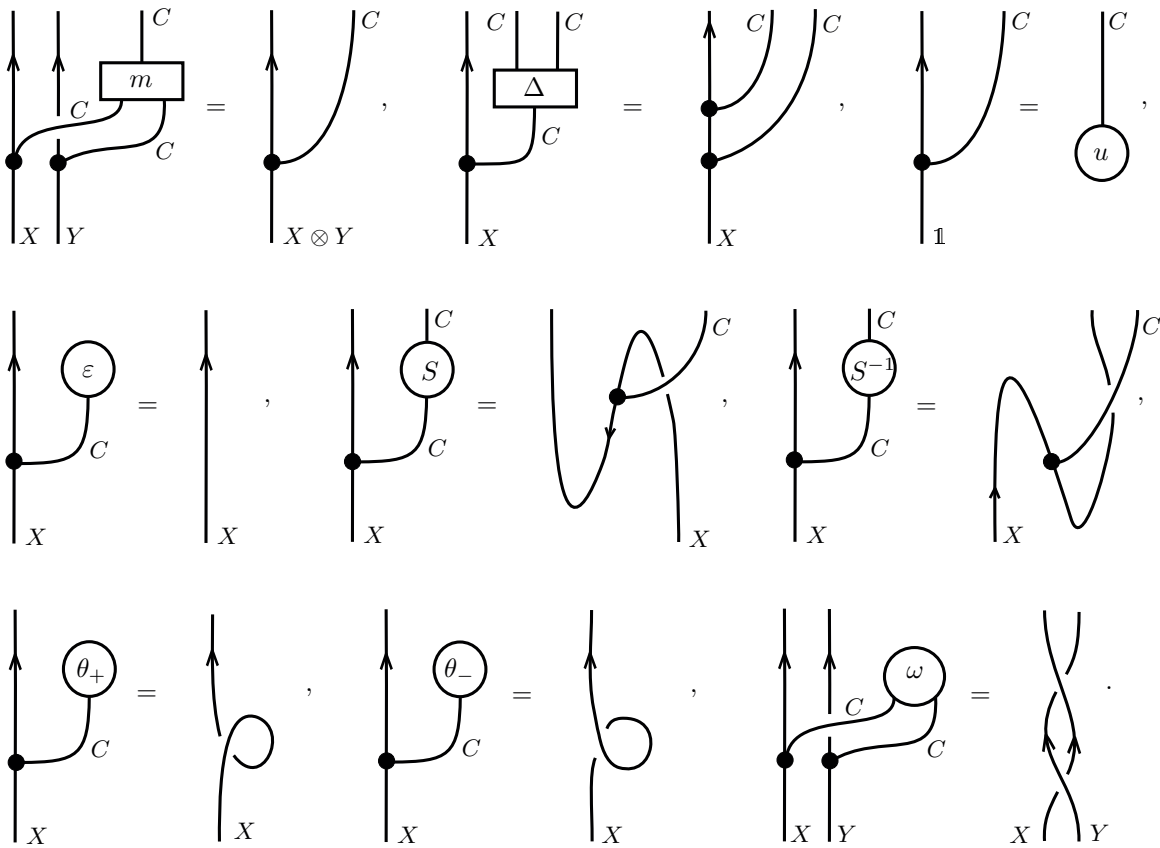

Figure 1.5 – Structural morphisms of C .

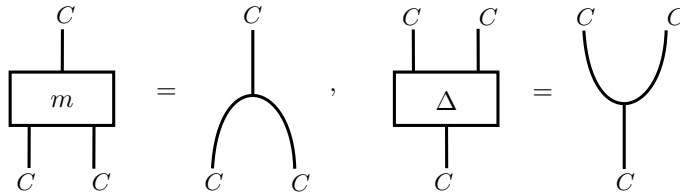

Figure 1.6 – The product and the coproduct of C .

1.2.4 Universal morphism

We present in the next Lemma a fundamental result which will allow us to start our construction of TQFTs.

Lemma 1.2.4 — *Let \mathcal{C} be a ribbon category with a coend (C, ι) . Consider a system of morphisms of \mathcal{C}*

$$f = \left\{ f_{X_1, \dots, X_n, Y_1, \dots, Y_{2m}} : \bigotimes_{i=1}^n (X_i^* \otimes X_i) \otimes \bigotimes_{j=1}^{2m} Y_j \rightarrow \bigotimes_{j=1}^{2m} Y_j \right\}_{X_1, \dots, X_n, Y_1, \dots, Y_{2m} \in \mathcal{C}}$$

which is dinatural for the functor $(X, Y) \mapsto X^* \otimes Y$ in every X_i for $1 \leq i \leq n$ and natural for the

functor $Id_{\mathcal{C}}$ in every Y_j for $1 \leq j \leq 2m$. Then there exists a unique morphism

$$|f|: C^{\otimes n+m} \rightarrow C^{\otimes m}$$

such that $\forall X_1, \dots, X_n \in \mathcal{C}, \forall Y_1, \dots, Y_m \in \mathcal{C}$,

$$(\iota_{Y_1} \otimes \dots \otimes \iota_{Y_m})f_{X_1, \dots, X_n, Y_1^*, Y_1, \dots, Y_m^*, Y_m} = |f| \circ (\iota_{X_1} \otimes \dots \otimes \iota_{X_n} \otimes \iota_{Y_1} \otimes \dots \otimes \iota_{Y_m}).$$

depicted as:

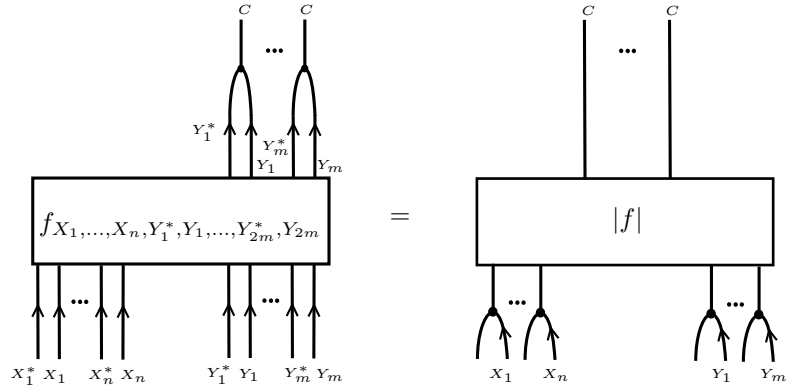

The morphism $|f|$ is called the *universal morphism* associated to the system of morphisms f .

Proof. The system of morphisms $(\iota_{Y_1} \otimes \dots \otimes \iota_{Y_m})f_{X_1, \dots, X_n, Y_1^*, Y_1, \dots, Y_m^*, Y_m}$ is dinatural in every X_i and in every Y_j . The result is then the consequence of parameter theorems and Fubini theorem for coends. For details of the proof, see [ML98] and [FS]. \square

Chapter 2

TQFT with anomaly

In this chapter, we define all things with anomaly. First, we give the definition of a functor with anomaly and recall that images of identities are idempotents. Taking the restrictions on images of these idempotents, we define a unitalized functor with anomaly where identities are now sent to identities, up to a scalar. After extending definitions of a braided monoidal functor to functor with anomalies, we give the main definition of this chapter, that is, the definition of a TQFT with anomaly.

In this chapter, let \mathcal{C} be a category and \mathcal{D} be a \mathbb{k} -linear category.

2.1 Functor with anomaly

2.1.1 Basic definitions

A pair of morphisms (g, f) of the category \mathcal{C} is *composable* if the source of f is the target of g . A *2-cocycle* γ for the category \mathcal{C} associates to all pairs (g, f) of composable morphisms of \mathcal{C} a scalar $\gamma_{g,f} \in \mathbb{k}^\times$ such that for all composable pairs of morphisms (h, g) and (g, f) ,

$$\gamma_{hg,f}\gamma_{h,g} = \gamma_{h,gf}\gamma_{g,f}.$$

For every object $X \in \mathcal{C}$, denote by $\gamma_{X,X}$ the scalar $\gamma_{\text{id}_X, \text{id}_X}$.

Lemma 2.1.1 — *Let γ be a 2-cocycle of \mathcal{C} and $f \in \text{Hom}_{\mathcal{C}}(X, Y)$. Then*

$$\gamma_{f, \text{id}_X} = \gamma_{X,X} \text{ and } \gamma_{\text{id}_Y, f} = \gamma_{Y,Y}.$$

Proof. We have, $\gamma_{f \text{id}_X, \text{id}_X} \gamma_{f, \text{id}_X} = \gamma_{f, \text{id}_X \text{id}_X} \gamma_{X,X}$, and as γ_{f, id_X} is invertible, $\gamma_{f, \text{id}_X} = \gamma_{X,X}$. In the same way, $\gamma_{\text{id}_Y \text{id}_Y, f} \gamma_{\text{id}_Y, \text{id}_Y} = \gamma_{\text{id}_Y, \text{id}_Y} \gamma_{\text{id}_Y, f}$ and, as $\gamma_{\text{id}_Y, f}$ is invertible, $\gamma_{Y,Y} = \gamma_{\text{id}_Y, f}$. \square

A *functor with anomaly* from the category \mathcal{C} to the category \mathcal{D} is a pair (F, γ) where:

- F associates to each object X of \mathcal{C} an object $F(X)$ of \mathcal{D} and to each morphism $f \in \text{Hom}_{\mathcal{C}}(X, Y)$ a morphism of \mathcal{D} in $\text{Hom}_{\mathcal{D}}(F(X), F(Y))$;
- γ is a 2-cocycle of \mathcal{C} called the *anomaly*;

such that for all pairs (g, f) of composable morphisms of \mathcal{C} ,

$$F(g \circ f) = \gamma_{g,f} F(g) \circ F(f).$$

When the anomaly is the constant function equal to 1, we recover the definition of a functor. For every object $X \in \mathcal{C}$, denote by Π_X the morphism $\gamma_{X,X} F(\text{id}_X)$ of \mathcal{D} .

Lemma 2.1.2 — For every object $X \in \mathcal{C}$, the morphism Π_X is an idempotent of \mathcal{D} .

Proof. We have $\Pi_X^2 = \gamma_{X,X}(\gamma_{X,X}F(\text{id}_X) \circ F(\text{id}_X)) = \gamma_{X,X}F(\text{id}_X \circ \text{id}_X) = \gamma_{X,X}F(\text{id}_X) = \Pi_X$. \square

A functor with anomaly $(F, \gamma): \mathcal{C} \rightarrow \mathcal{D}$ is *unital* if for all $X \in \text{Ob}(\mathcal{C})$,

$$\Pi_X = \text{id}_{F(X)}.$$

A unital functor with anomaly is *strict* if $\gamma_{X,X} = 1$.

Let (F, γ) be a functor with anomaly between \mathcal{C} and \mathcal{D} and let $G: \mathcal{B} \rightarrow \mathcal{C}$ and $H: \mathcal{D} \rightarrow \mathcal{E}$ be two functors where the category \mathcal{E} and the functor H are supposed to be \mathbb{k} -linear. The *left composed functor with anomaly* is the functor with anomaly $(H \circ F, \gamma)$ which associates to any object $X \in \mathcal{C}$ the object $H(F(X)) \in \mathcal{E}$ and to any morphism $f: X \rightarrow Y$ of \mathcal{C} the morphism $H(F(f)): H(F(X)) \rightarrow H(F(Y))$ of \mathcal{E} . The *right composed functor with anomaly* is the functor with anomaly $(F \circ G, \gamma_{G(), G()})$ which associates to any object $X \in \mathcal{B}$ the object $F(G(X)) \in \mathcal{D}$ and to any morphism $f: X \rightarrow Y$ of \mathcal{B} the morphism $F(G(f)): F(G(X)) \rightarrow F(G(Y))$ of \mathcal{D} .

2.1.2 Unitalization of a functor with anomaly

Suppose that the category \mathcal{D} has splitting idempotents and let $(F, \gamma): \mathcal{C} \rightarrow \mathcal{D}$ be a functor with anomaly. Then for all $X \in \text{Ob}(\mathcal{C})$, since $\Pi_X = \gamma_{X,X}F(\text{id}_X)$ is an idempotent (see Lemma 2.1.1), there exist an object $\text{Im}(\Pi_X) \in \mathcal{D}$ and two morphisms $p_X: F(X) \rightarrow \text{Im}(\Pi_X)$ and $q_X: \text{Im}(\Pi_X) \rightarrow F(X)$ such that $p_X q_X = \text{id}_{\text{Im}(\Pi_X)}$ and $q_X p_X = \Pi_X$. Define the *unitalized functor with anomaly* $(\tilde{F}, \gamma): \mathcal{C} \rightarrow \mathcal{D}$ of (F, γ) by:

- for all $X \in \text{Ob}(\mathcal{C})$, $\tilde{F}(X) = \text{Im}(\Pi_X)$;
- for all $f \in \text{Hom}_{\mathcal{C}}(X, Y)$, $\tilde{F}(f) = p_Y \circ F(f) \circ q_X$.

Lemma 2.1.3 — Let $(F, \gamma): \mathcal{C} \rightarrow \mathcal{D}$ a functor with anomaly. Then the unitalized functor with anomaly (\tilde{F}, γ) is a unital functor with anomaly.

Proof. First, for $X \in \mathcal{C}$, compute $\gamma_{X,X}\tilde{F}(f)$:

$$\gamma_{X,X}\tilde{F}(\text{id}_X) = \gamma_{X,X}p_X F(\text{id}_X)q_X = p_X(q_X p_X)q_X = (p_X q_X)(p_X q_X) = \text{id}_{\text{Im}(\Pi_X)}\text{id}_{\text{Im}(\Pi_X)} = \text{id}_{\tilde{F}(X)}$$

so the unitary condition is satisfied for \tilde{F} .

Next, for $f: X \rightarrow Y$ and $g: Y \rightarrow Z$, compute $\tilde{F}(gf)$:

$$\tilde{F}(gf) = p_Z F(gf)q_X = \gamma_{g,f}F(g)F(f)q_X = \gamma_{g,f}F(g)F(\text{id}_Y f)q_X = \gamma_{g,f}p_Z F(g)(\gamma_{\text{id}_Y, f}F(\text{id}_Y)F(f))q_X$$

But, as γ is a 2-cocycle and according to the Lemma 2.1.1, $\gamma_{\text{id}_Y, f} = \gamma_{Y,Y}$. Thus:

$$\begin{aligned} \gamma_{g,f}p_Z F(g)(\gamma_{\text{id}_Y, f}F(\text{id}_Y)F(f))q_X &= \gamma_{g,f}p_Z F(g)(\gamma_{Y,Y}F(\text{id}_Y)F(f))q_X \\ &= \gamma_{g,f}p_Z F(g)\Pi_Y F(f)q_X = \gamma_{g,f}p_Z F(g)q_Y p_Y F(f)q_X \\ &= \gamma_{g,f}(p_Z F(g)q_Y)(p_Y F(f)q_X) = \gamma_{g,f}\tilde{F}(g)\tilde{F}(f) \end{aligned}$$

Then $\tilde{F}(gf) = \gamma_{g,f}\tilde{F}(g)\tilde{F}(f)$. \square

2.2 Natural transformation between functors with the same anomaly

Let (F, γ) and (G, γ) be two functors with anomaly from \mathcal{C} to \mathcal{D} having the same anomaly. A *natural transformation* from (F, γ) to (G, γ) is a family of morphisms $\rho = \{\rho_X: F(X) \rightarrow G(X)\}_{X \in \mathcal{C}}$ such that, for every objects X of \mathcal{C} , the following diagram 2.2.1 commutes:

$$\begin{array}{ccc}
F(X) & \xrightarrow{\rho_X} & G(X) \\
F(f) \downarrow & & \downarrow G(f) \\
F(Y) & \xrightarrow{\rho_Y} & G(Y)
\end{array} \tag{2.2.1}$$

Remark 2.2.1 – There is a more general notion of natural transformation with anomaly when the functors F and G have different anomalies: a *natural transformation with anomaly* from (F, γ) to (G, η) is a pair (ρ, ω) where $\rho = \{\rho_X: F(X) \rightarrow G(X)\}_{X \in \mathcal{C}}$ is a family of morphisms of \mathcal{D} indexed by objects of \mathcal{C} and ω is a map which assigns to every morphism f of \mathcal{C} an element $\omega_f \in \mathbb{k}^\times$ such that for every pair of composable morphisms $f: X \rightarrow Y$ and $g: Y \rightarrow Z$ of \mathcal{C} ,

$$\omega_{gf} \eta_{g,f} = \omega_g \omega_f \gamma_{g,f}$$

and for every morphism $f: X \rightarrow Y$ of \mathcal{C} ,

$$\omega_f G(f) \rho_X = \rho_Y F(f).$$

The map ω is the *anomaly* of the natural transformation with anomaly (ρ, ω) . When the anomaly is the constant map equal to 1, we recover our definition of a natural transformation between functors with the same anomaly.

Now, recall the unitalized functor (\tilde{F}, γ) of a functor with anomaly (F, γ) (see 2.1.2). Note that $p_X: F(X) \rightarrow \tilde{F}(X)$ and $q_X: \tilde{F}(X) \rightarrow F(X)$ define two natural transformations $p: (F, \gamma) \rightarrow (\tilde{F}, \gamma)$ and $q: (\tilde{F}, \gamma) \rightarrow (F, \gamma)$. Then Π_X defines also a natural transformation $\Pi: (F, \gamma) \rightarrow (F, \gamma)$. The next Lemma 2.2.2 claims that the unitalized functor (\tilde{F}, γ) equipped with natural transformations (p, q) is universal among the unital functors with anomaly $(G, \gamma): \mathcal{C} \rightarrow \mathcal{D}$ equipped with two natural transformations $\alpha: (F, \gamma) \rightarrow (G, \gamma)$ and $\beta: (G, \gamma) \rightarrow (F, \gamma)$ such that $\alpha\beta = \text{id}_G$ and $\beta\alpha = \Pi$.

Lemma 2.2.2 — *Let $(F, \gamma): \mathcal{C} \rightarrow \mathcal{D}$ be a functor with anomaly. Then for any functor with anomaly $(G, \gamma): \mathcal{C} \rightarrow \mathcal{D}$ equipped with two natural transformations $\alpha: (F, \gamma) \rightarrow (G, \gamma)$ and $\beta: (G, \gamma) \rightarrow (F, \gamma)$ such that $\alpha\beta = \text{id}_G$ and $\beta\alpha = \Pi$, there exists a unique natural isomorphism*

$$\eta = \{\eta_X: \tilde{F}(X) \rightarrow G(X)\}_{X \in \mathcal{C}}$$

such that the following diagram commutes for all objects $X \in \mathcal{C}$:

$$\begin{array}{ccccc}
F(X) & \xrightarrow{p_X} & \tilde{F}(X) & \xrightarrow{q_X} & F(X) \\
& \searrow \alpha_X & \downarrow \eta_X & \nearrow \beta_X & \\
& & G(X) & &
\end{array}$$

Proof. Let us define $\eta = \alpha q$. Then η is a natural isomorphism that satisfies the conditions (its inverse is $p\beta$). □

2.3 Monoidal functor with anomaly

Suppose that the category \mathcal{C} and \mathcal{D} are monoidal in this section. Let (F, γ) be a functor with anomaly from \mathcal{C} to \mathcal{D} . The anomaly γ is *monoidal* if for all morphisms $f: X \rightarrow Y$, $g: Y \rightarrow Z$, $f': X' \rightarrow Y'$, $g': Y' \rightarrow Z'$ of \mathcal{C} ,

$$\gamma_{g \otimes g', f \otimes f'} = \gamma_{g, f} \gamma_{g', f'}.$$

A *monoidal functor with anomaly* from the category \mathcal{C} to the category \mathcal{D} is a quadruplet (F, F_2, F_0, γ) where (F, γ) is a functor with monoidal anomaly γ from \mathcal{C} to \mathcal{D} , F_2 is a natural transformation between $(F \otimes F, \gamma_{g,f} \gamma_{g',f'})$ and $(F \otimes, \gamma_{g \otimes g', f \otimes f'})$ denoted by

$$F_2 = \{F_2(X, Y): F(X) \otimes F(Y) \rightarrow F(X \otimes Y)\}_{X, Y \in \mathcal{C}}$$

and $F_0: \mathbf{1} \rightarrow F(\mathbf{1})$ is a morphism of \mathcal{D} such that, for every objects X, Y and Z of \mathcal{C} , the following diagrams 2.3.2, 2.3.3 and 2.3.4 commute:

$$\begin{array}{ccc} F(X) \otimes F(Y) \otimes F(Z) & \xrightarrow{F_2(X, Y) \otimes \text{id}_{F(Z)}} & F(X \otimes Y) \otimes F(Z) \\ \text{id}_{F(X)} \otimes F_2(Y, Z) \downarrow & & \downarrow F_2(X \otimes Y, Z) \\ F(X) \otimes F(Y \otimes Z) & \xrightarrow{F_2(X, Y \otimes Z)} & F(X \otimes Y \otimes Z) \end{array} \quad (2.3.2)$$

$$\begin{array}{ccc} F(X) \otimes \mathbf{1} & \xrightarrow{\text{id}_{F(X)} \otimes F_0} & F(X) \otimes F(\mathbf{1}) \\ \text{id}_{F(X)} \searrow & & \swarrow F_2(X, \mathbf{1}) \\ & F(X) & \end{array}$$

(2.3.3)

$$\begin{array}{ccc} \mathbf{1} \otimes F(X) & \xrightarrow{F_0 \otimes \text{id}_{F(X)}} & F(\mathbf{1}) \otimes F(X) \\ \text{id}_{F(X)} \searrow & & \swarrow F_2(\mathbf{1}, X) \\ & F(X) & \end{array}$$

(2.3.4)

If F_2 and F_0 are isomorphisms, the monoidal functor with anomaly F is *strong*. If F_2 and F_0 are identities, the monoidal functor F is *strict*.

Let (F, F_2, F_0, γ) and (G, G_2, G_0, γ) be two monoidal functors with anomaly. A *monoidal natural transformation* from F to G is a natural transformation $\rho = \{\rho_X: F(X) \rightarrow G(X)\}_{X \in \mathcal{C}}$ such that for all objects $X, Y \in \mathcal{C}$, the following diagrams 2.3.5 and 2.3.6 commute:

$$\begin{array}{ccc} F(X) \otimes F(Y) & \xrightarrow{\rho_X \otimes \rho_Y} & G(X) \otimes G(Y) \\ F_2(X, Y) \downarrow & & \downarrow G_2(X, Y) \\ F(X \otimes Y) & \xrightarrow{\rho_{X \otimes Y}} & G(X \otimes Y) \end{array} \quad (2.3.5)$$

$$\begin{array}{ccc} & \mathbf{1} & \\ F_0 \swarrow & & \searrow G_0 \\ F(\mathbf{1}) & \xrightarrow{\rho_{\mathbf{1}}} & G(\mathbf{1}) \end{array} \quad (2.3.6)$$

Lemma 2.3.1 — *Let $F = (F, F_2, F_0, \gamma): \mathcal{C} \rightarrow \mathcal{D}$ be a monoidal functor with anomaly. Then*

- (i) *The unitalized functor (\tilde{F}, γ) admits a unique structure of monoidal functor with anomaly such that the natural transformations $p: F \rightarrow \tilde{F}$ and $q: \tilde{F} \rightarrow F$ (see section 2.1.2) are monoidal.*
- (ii) *If (F, γ) is strict (respectively strong) then (\tilde{F}, γ) is strict (respectively strong).*

Proof. First, we show result (i). Define the monoidal structure of $\widetilde{F} = (\widetilde{F}, \widetilde{F}_2, \widetilde{F}_0, \gamma)$ by

$$\widetilde{F}_2(X, Y) = p_{X \otimes Y} F_2(X, Y)(q_X \otimes q_Y): \widetilde{F}(X) \otimes \widetilde{F}(Y) \rightarrow \widetilde{F}(X \otimes Y)$$

and

$$\widetilde{F}_0 = p_{\mathbb{1}} F_0: \mathbb{1} \rightarrow \widetilde{F}(\mathbb{1})$$

where X, Y are objects of \mathcal{C} , $q_X p_X = \Pi_X = \gamma_{X, X} F(\text{id}_X)$, $\widetilde{F}(X) = \text{Im}(\Pi_X)$ and $p_X q_X = \text{id}_{\widetilde{F}(X)}$.

Impose that p and q are monoidal transformations means that for every objects $X, Y \in \mathcal{C}$,

$$\widetilde{F}_2(X, Y)(p_X \otimes p_Y) = p_{X \otimes Y} F_2(X, Y)$$

and

$$q_{X \otimes Y} \widetilde{F}_2(X, Y) = F_2(X, Y)(q_X \otimes q_Y)$$

so the choice of \widetilde{F}_2 is uniquely determined. Moreover, it means that $\widetilde{F}_0 = p_{\mathbb{1}} F_0$ and $q_{\mathbb{1}} \widetilde{F}_0 = F_0$ so the choice of \widetilde{F}_0 is uniquely determined.

First, we check the naturality of \widetilde{F}_2 :

Let $f: X \rightarrow X'$ and $g: Y \rightarrow Y'$ be two morphisms of \mathcal{C} . We compute $\widetilde{F}_2(X', Y')(\widetilde{F}(f) \otimes \widetilde{F}(g))$:

$$\begin{aligned} \widetilde{F}_2(X', Y')(\widetilde{F}(f) \otimes \widetilde{F}(g)) &= p_{X' \otimes Y'} F_2(X', Y')(q_{X'} \otimes q_{Y'})(p_{X'} F(f) q_X \otimes p_{Y'} F(g) q_Y) \\ &= p_{X' \otimes Y'} F_2(X', Y')(q_{X'} p_{X'} F(f) q_X \otimes q_{Y'} p_{Y'} F(g) q_Y) \\ &\stackrel{(3)}{=} p_{X' \otimes Y'} F_2(X', Y')(\gamma_{X', X'} F(\text{id}_{X'}) F(f) q_X \otimes \gamma_{Y', Y'} F(\text{id}_{Y'}) p_{Y'} F(g) q_Y) \\ &\stackrel{(4)}{=} p_{X' \otimes Y'} F_2(X', Y')(\gamma_{\text{id}_{X'}, f} F(\text{id}_{X'}) F(f) q_X \otimes \gamma_{\text{id}_{Y'}, g} F(\text{id}_{Y'}) F(g) q_Y) \\ &= p_{X' \otimes Y'} F_2(X', Y')(F(f) \otimes F(g))(q_X \otimes q_Y) \\ &\stackrel{(6)}{=} p_{X' \otimes Y'} F(f \otimes g) F_2(X, Y)(q_X \otimes q_Y) \\ &= p_{X' \otimes Y'} F((f \otimes g) \text{id}_{X \otimes Y}) F_2(X, Y)(q_X \otimes q_Y) \\ &= p_{X' \otimes Y'} (\gamma_{f \otimes g, \text{id}_{X \otimes Y}} F(f \otimes g) F(\text{id}_{X \otimes Y})) F_2(X, Y)(q_X \otimes q_Y) \\ &\stackrel{(9)}{=} p_{X' \otimes Y'} (F(f \otimes g) \Pi_{X \otimes Y}) F_2(X, Y)(q_X \otimes q_Y) \\ &\stackrel{(10)}{=} p_{X' \otimes Y'} F(f \otimes g) q_{X \otimes Y} p_{X \otimes Y} F_2(X, Y)(q_X \otimes q_Y) \\ &= \widetilde{F}(f \otimes g) \widetilde{F}_2(X, Y) \end{aligned}$$

Equalities (3) and (10) follow from the definitions of idempotents $\Pi_{X'} = q_{X'} p_{X'}$, $\Pi_{Y'} = q_{Y'} p_{Y'}$ and $\Pi_{X \otimes Y} = q_{X \otimes Y} p_{X \otimes Y}$.

As γ is a 2-cocycle, $\gamma_{X', X'} = \gamma_{\text{id}_{X'}, f}$, $\gamma_{Y', Y'} = \gamma_{\text{id}_{Y'}, g}$ and $\gamma_{X \otimes Y, X \otimes Y} = \gamma_{f \otimes g, \text{id}_{X \otimes Y}}$ which imply equality (4) and (9).

Equality (6) comes from the naturality of $F_2: F \otimes F \rightarrow F \otimes$.

Next, we have to check the coherence axioms of the definition of a monoidal functor with anomaly. We first compute $\widetilde{F}_2(X, Y \otimes Z)(\text{id}_{\widetilde{F}(X)} \otimes \widetilde{F}_2(Y, Z))$ for any objects X, Y of \mathcal{C} and show

that the axiom 2.3.2 is satisfied for \widetilde{F} :

$$\begin{aligned}
& \widetilde{F}_2(X, Y \otimes Z)(\text{id}_{\widetilde{F}(X)} \otimes \widetilde{F}_2(Y, Z)) \\
&= p_{X \otimes Y \otimes Z} \widetilde{F}_2(X, Y \otimes Z)(q_X \otimes q_{Y \otimes Z})(\text{id}_{\widetilde{F}(X)} \otimes (p_{Y \otimes Z} F_2(Y, Z)(q_Y \otimes q_Z))) \\
&= p_{X \otimes Y \otimes Z} F_2(X, Y \otimes Z)(q_X \otimes (q_{Y \otimes Z} p_{Y \otimes Z} F_2(Y, Z)(q_Y \otimes q_Z))) \\
&= p_{X \otimes Y \otimes Z} F_2(X, Y \otimes Z)(q_X \otimes (\Pi_{Y \otimes Z} F_2(Y, Z)(q_Y \otimes q_Z))) \\
&\stackrel{(4)}{=} p_{X \otimes Y \otimes Z} F_2(X, Y \otimes Z)(q_X \otimes (F_2(Y \otimes Z)(\Pi_Y \otimes \Pi_Z)(q_Y \otimes q_Z))) \\
&= p_{X \otimes Y \otimes Z} F_2(X, Y \otimes Z)(\text{id}_{F(X)} \otimes F_2(Y \otimes Z))(q_X \otimes (\Pi_Y \otimes \Pi_Z)(q_Y \otimes q_Z)) \\
&\stackrel{(6)}{=} p_{X \otimes Y \otimes Z} F_2(X \otimes Y, Z)(F_2(X \otimes Y) \otimes \text{id}_{F(Z)})(q_X \otimes (\Pi_Y \otimes \Pi_Z)(q_Y \otimes q_Z)) \\
&= p_{X \otimes Y \otimes Z} F_2(X \otimes Y, Z)(F_2(X \otimes Y) \otimes \text{id}_{F(Z)})(q_X \otimes \Pi_Y q_Y \otimes \Pi_Z q_Z) \\
&\stackrel{(8)}{=} p_{X \otimes Y \otimes Z} F_2(X \otimes Y, Z)(F_2(X \otimes Y) \otimes \text{id}_{F(Z)})(q_X \otimes q_Y \otimes q_Z) \\
&\stackrel{(9)}{=} p_{X \otimes Y \otimes Z} F_2(X \otimes Y, Z)(F_2(X \otimes Y) \otimes \text{id}_{F(Z)})(\Pi_X q_X \otimes \Pi_Y q_Y \otimes q_Z) \\
&= p_{X \otimes Y \otimes Z} F_2(X \otimes Y, Z)(F_2(X \otimes Y)(\Pi_X \otimes \Pi_Y) \otimes q_Z)(q_X \otimes q_Y \otimes \text{id}_{\widetilde{F}(Z)}) \\
&\stackrel{(11)}{=} p_{X \otimes Y \otimes Z} F_2(X \otimes Y, Z)(\Pi_{X \otimes Y} F_2(X \otimes Y) \otimes q_Z)(q_X \otimes q_Y \otimes \text{id}_{\widetilde{F}(Z)}) \\
&\stackrel{(12)}{=} p_{X \otimes Y \otimes Z} F_2(X \otimes Y, Z)(q_{X \otimes Y} p_{X \otimes Y} F_2(X \otimes Y) \otimes q_Z)(q_X \otimes q_Y \otimes \text{id}_{\widetilde{F}(Z)}) \\
&= (p_{X \otimes Y \otimes Z} F_2(X \otimes Y, Z)(q_{X \otimes Y} \otimes q_Z))(p_{X \otimes Y} F_2(X \otimes Y) \otimes \text{id}_{\widetilde{F}(Z)})(q_X \otimes q_Y \otimes \text{id}_{\widetilde{F}(Z)}) \\
&= (p_{X \otimes Y \otimes Z} F_2(X \otimes Y, Z)(q_{X \otimes Y} \otimes q_Z))((p_{X \otimes Y} F_2(X \otimes Y)(q_X \otimes q_Y)) \otimes \text{id}_{\widetilde{F}(Z)}) \\
&= \widetilde{F}_2(X \otimes Y, Z)(\widetilde{F}_2(X, Y) \otimes \text{id}_{\widetilde{F}(Z)})
\end{aligned}$$

Equalities (4) and (11) are due to the naturality of $F_2: F \otimes F \rightarrow F \otimes$ and the monoidal property of γ . Equality (6) follows from the axiom 2.4.7 satisfied by F . Equalities (8), (9), (11) and (12) are due to the definition of Π , p and q .

Now, we show that \widetilde{F} the axiom 2.3.3 is satisfied. For every object $X \in \mathcal{C}$,

$$\begin{aligned}
\widetilde{F}(X, \mathbf{1})(\text{id}_{\widetilde{F}(X)} \otimes \widetilde{F}_0) &= p_{X \otimes \mathbf{1}} F_2(X, \mathbf{1})(q_X \otimes q_{\mathbf{1}})(\text{id}_{\widetilde{F}(X)} \otimes p_{\mathbf{1}} F_0) \\
&\stackrel{(2)}{=} p_X F_2(X, \mathbf{1})(q_X \otimes q_{\mathbf{1}})(p_X q_X \otimes p_{\mathbf{1}} F_0) \\
&= p_X F_2(X, \mathbf{1})(\Pi_X \otimes \Pi_{\mathbf{1}})(q_X \otimes F_0) \\
&\stackrel{(4)}{=} p_X \Pi_{X \otimes \mathbf{1}} F_2(X, \mathbf{1})(q_X \otimes F_0) \\
&= p_X \Pi_X F_2(X, \mathbf{1})(\text{id}_{F(X)} \otimes F_0) q_X \\
&\stackrel{(6)}{=} p_X \Pi_X \text{id}_{F(X)} q_X \\
&\stackrel{(7)}{=} p_X q_X p_X \text{id}_{F(X)} q_X \\
&\stackrel{(8)}{=} \text{id}_{\widetilde{F}(X)}
\end{aligned}$$

Equality (2), (3), (7) and (8) are due to the equality $p_X q_X = \text{id}_{\text{Im}(F(X))}$ and Π_X . Equality (4) follows from the identity $F_2(X, Y)(\Pi_X \otimes \Pi_Y) = \Pi_{X \otimes Y} F_2(X, Y)$ which follows from the naturality of $F_2: F \otimes F \rightarrow F \otimes$ and the fact that γ is monoidal. Equality (6) follows from the axiom 2.3.3 which is satisfied by F .

In the same way, the axiom 2.3.4 is satisfied by \widetilde{F} . \square

2.4 Braided and symmetric functor with anomaly

Suppose that the categories \mathcal{C} and \mathcal{D} are braided and denote indifferently by τ the braiding of the two categories. A *braided functor with anomaly* is a monoidal functor with anomaly (F, F_2, F_0, γ) such that for all objects X and Y of \mathcal{C} , the following diagram commutes:

$$\begin{array}{ccc}
 F(X) \otimes F(Y) & \xrightarrow{(F(\text{id}_Y) \otimes F(\text{id}_X))\tau_{F(X), F(Y)}} & F(Y) \otimes F(X) \\
 F_2(X, Y) \downarrow & & \downarrow F_2(Y, X) \\
 F(X \otimes Y) & \xrightarrow{F(\tau_{X, Y})} & F(Y \otimes X)
 \end{array} \tag{2.4.7}$$

A *symmetric monoidal functor with anomaly* is a braided functor with anomaly between symmetric categories.

Remark 2.4.1 – This lax definition of a braided functor allows us to consider braided functors with anomaly which don't send isomorphisms on isomorphisms.

Lemma 2.4.2 — *Let $F = (F, F_2, F_0, \gamma)$ be a braided functor with anomaly. Then the unitalized functor \widetilde{F} is a braided functor with anomaly.*

Proof. Recall the monoidal structure of the unitalized monoidal functor with anomaly $\widetilde{F} = (F, F_2, F_0, \gamma)$:

$$\text{for } X, Y \in \mathcal{C}, \quad \widetilde{F}_2(X, Y) = p_{X \otimes Y} F_2(X, Y) q_X \otimes q_Y,$$

and, as p and q are monoidal natural transformations,

$$\widetilde{F}_2(X, Y) p_X \otimes p_Y = p_{X \otimes Y} F_2(X, Y) \quad \text{and} \quad q_{X \otimes Y} \widetilde{F}_2(X, Y) = F_2(X, Y) q_X \otimes q_Y.$$

Now, we can compute $\widetilde{F}(\tau_{X, Y}) \widetilde{F}_2(X, Y)$:

$$\begin{aligned}
 \widetilde{F}(\tau_{X, Y}) \widetilde{F}_2(X, Y) &= p_{Y \otimes X} F(\tau_{X, Y}) q_{X \otimes Y} p_{X \otimes Y} F_2(X, Y) q_X \otimes q_Y \\
 &= p_{Y \otimes X} F(\tau_{X, Y}) q_{X \otimes Y} \widetilde{F}_2(X, Y) (p_X \otimes p_Y) (q_X \otimes q_Y) \\
 &= p_{Y \otimes X} F(\tau_{X, Y}) F_2(X, Y) (q_X \otimes q_Y) (p_X \otimes p_Y) (q_X \otimes q_Y) \\
 &= p_{Y \otimes X} F(\tau_{X, Y}) (q_X \otimes q_Y) \\
 &= p_{Y \otimes X} F_2(Y, X) (F(\text{id}_Y) \otimes F(\text{id}_X)) \tau_{F(X), F(Y)} (q_X \otimes q_Y) \\
 &\stackrel{(5)}{=} \gamma_{X, X}^{-1} \gamma_{Y, Y}^{-1} p_{Y \otimes X} F_2(Y, X) (q_Y p_Y \otimes q_X p_X) \tau_{F(X), F(Y)} (q_X \otimes q_Y) \\
 &= \gamma_{X, X}^{-1} \gamma_{Y, Y}^{-1} p_{Y \otimes X} F_2(Y, X) (q_Y \otimes q_X) (p_Y \otimes p_X) \tau_{F(X), F(Y)} (q_X \otimes q_Y) \\
 &= \gamma_{X, X}^{-1} \gamma_{Y, Y}^{-1} p_{Y \otimes X} F_2(Y, X) (q_Y \otimes q_X) (p_Y \otimes p_X) (q_Y \otimes q_X) \tau_{\widetilde{F}(X), \widetilde{F}(Y)} \\
 &= p_{Y \otimes X} F_2(Y, X) (q_Y \otimes q_X) \tau_{\widetilde{F}(X), \widetilde{F}(Y)} \\
 &= p_{Y \otimes X} F_2(Y, X) (q_Y \otimes q_X) (\gamma_{Y, Y}^{-1} \text{id}_Y \otimes \gamma_{X, X}^{-1} \text{id}_X) \tau_{\widetilde{F}(X), \widetilde{F}(Y)} \\
 &= \widetilde{F}_2(Y, X) (\widetilde{F}(\text{id}_Y) \otimes \widetilde{F}(\text{id}_X)) \tau_{\widetilde{F}(X), \widetilde{F}(Y)}
 \end{aligned}$$

using that $F(\text{id}_X) = \gamma_{X, X}^{-1} q_X p_X$, $p_X q_X = \text{id}_{\widetilde{F}(X)}$, the braiding is natural and that F is a braided functor with anomaly in equality (5). \square

2.5 Cobordism category and TQFT with anomaly

Let n be a non-negative integer. A n -manifold means a topological manifold of dimension n and the empty set \emptyset is a n -manifold for any n . The category of n -dimensional cobordisms Cob_n is defined as follows. The objects of Cob_n are closed oriented $(n-1)$ -manifolds as objects. A morphism from a $(n-1)$ -manifold Σ to a $(n-1)$ -manifold Σ' is represented by a pair (M, h) where M is a compact oriented n -manifold and h is a orientation preserving homeomorphism between $\bar{\Sigma} \sqcup \Sigma'$ and ∂M where $\bar{\Sigma}$ represents the manifold Σ with the opposite orientation. Two such pairs $(M, h: \bar{\Sigma} \sqcup \Sigma' \rightarrow \partial M)$ and $(N, k: \bar{\Sigma} \sqcup \Sigma' \rightarrow \partial N)$ represent the same morphism in Cob_n if there exists a preserving-orientation homeomorphism $f: M \rightarrow N$ such that $k = fh$. The composition in the category Cob_n is given by the gluing of two n -cobordisms: the composition of the two morphisms $(M, h): (\Sigma, \phi_\Sigma) \rightarrow (\Sigma', \phi_{\Sigma'})$ and $(N, k): (\Sigma', \phi_{\Sigma'}) \rightarrow (\Sigma'', \phi_{\Sigma''})$ is represented by the morphism (L, g) where L is the gluing of M on N along Σ' given by the gluing homeomorphism $kh^{-1}: h(\Sigma') \rightarrow k(\Sigma')$ and g is the homeomorphism $h_\Sigma \sqcup k_{\Sigma''}$. The identity morphism of the $(n-1)$ -manifold Σ is represented by the n -cobordism $(\Sigma \times [0, 1], c: \bar{\Sigma} \sqcup \Sigma \rightarrow \Sigma \times \{0\} \sqcup \Sigma \times \{1\})$ where $c|_{\bar{\Sigma}}(x) = (x, 0)$ and $c|_{\Sigma}(x) = (x, 1)$. The category Cob_n is a symmetric monoidal category with tensor product given by disjoint union, unit object is the empty $(n-1)$ -manifold and the symmetric braiding $\tau_{\Sigma, \Sigma'}$ between two $(n-1)$ -manifolds Σ and Σ' is represented by the n -cobordism $((\Sigma \sqcup \Sigma') \times [0, 1], d: \bar{\Sigma} \sqcup \bar{\Sigma}' \sqcup \Sigma' \sqcup \Sigma \rightarrow (\Sigma \sqcup \Sigma') \times \{0\} \sqcup (\Sigma' \sqcup \Sigma) \times \{1\})$ where $d|_{\bar{\Sigma} \sqcup \bar{\Sigma}'}(x) = (x, 0)$ and $d|_{\Sigma' \sqcup \Sigma}(x) = (x, 1)$.

A n -dimensional Topological Quantum Field Theory with anomaly (TQFT with anomaly) with values in a symmetric monoidal category \mathcal{S} is a symmetric monoidal unital functor with anomaly from Cob_n to the symmetric monoidal category \mathcal{S} .

Remark 2.5.1 – A classical n -dimensional TQFT is a particular case of a TQFT with anomaly where $\mathcal{S} = Mod_{\mathbb{k}}$ and anomaly equal to $1_{\mathbb{k}}$.

2.6 Anomaly lifting

Let (F, γ) be a functor with anomaly from a category \mathcal{C} to a category \mathcal{D} and let ω be a map that associates to any morphism f of \mathcal{C} an invertible scalar $\omega_f \in \mathbb{k}$. Define a new functor with anomaly $(F^\omega, \gamma^\omega)$ called the ω -rescaling of (F, γ) by:

$$F^\omega(X) = X \text{ and } F^\omega(f) = \omega_f F(f),$$

for any objects X of \mathcal{C} and any morphism f of \mathcal{C} . The anomaly γ^ω is then given by $\frac{\omega_{gf}}{\omega_f \omega_g} \gamma_{g,f}$ on a pair of composable morphisms (g, f) of \mathcal{C} .

Let (F, γ) be a functor with anomaly from \mathcal{C} to \mathcal{D} . There is a canonical way to "suppress" the anomaly by modifying less as possible the category \mathcal{C} . Define by $\bar{\mathcal{C}}$ the category:

- whose objects are the same than those of \mathcal{C} ;
- a morphism of $\text{Hom}_{\bar{\mathcal{C}}}(X, Y)$ is a pair (f, x) where $f \in \text{Hom}_{\mathcal{C}}(X, Y)$ and $x \in \mathbb{k}^\times$;
- the composition between $(f, x): X \rightarrow Y$ and $(g, y): Y \rightarrow Z$ is given by $(g \circ_{\mathcal{C}} f, \gamma_{g,f}^{-1} xy)$.

If $U: \bar{\mathcal{C}} \rightarrow \mathcal{C}$ is the forgetful functor between $\bar{\mathcal{C}}$ and \mathcal{C} , then define the functor $\bar{F}: \bar{\mathcal{C}} \rightarrow \mathcal{D}$ by:

$$\bar{F}(X) = F(X) \text{ and } \bar{F}(f, x) = xF(f)$$

where X is any object of $\bar{\mathcal{C}}$ and (f, x) is any morphism of $\bar{\mathcal{C}}$. Now, if (f, x) is a morphism of $\bar{\mathcal{C}}$, set

$\omega_{(f,x)} = x$. Then we have the following commutative diagram of functors with anomaly:

$$\begin{array}{ccc}
 \bar{\mathcal{C}} & & \\
 U \downarrow & \searrow \bar{F}^\omega & \\
 \mathcal{C} & \xrightarrow{(F, \gamma)} & \mathcal{D}
 \end{array} \tag{2.6.8}$$

Note that the triplet $(\mathcal{C}^\omega, U, \bar{F}^\omega)$ has the following property: for all triplets $(\tilde{\mathcal{C}}, E, G^\alpha)$ such that $E: \tilde{\mathcal{C}} \rightarrow \mathcal{C}$ is an equivalence of category, G^α is a functor with anomaly which is the α -rescaling of a functor $G: \tilde{\mathcal{C}} \rightarrow \mathcal{D}$ and $FE = G^\alpha$, there exists an equivalence of category H such that the following diagram 2.6.9 commutes

$$\begin{array}{ccc}
 & \bar{\mathcal{C}} & \\
 & \downarrow H & \\
 U \swarrow & \tilde{\mathcal{C}} & \searrow \bar{F}^\omega \\
 E \swarrow & & \searrow G^\alpha \\
 \mathcal{C} & \xrightarrow{(F, \gamma)} & \mathcal{D}
 \end{array} \tag{2.6.9}$$

Chapter 3

Presentation of 3-cobordisms by cobordism tangles

In this chapter, we define all ribbon things. We first recall the definition of Turaev [Tur94] of a ribbon graph before defining the main combinatorial object of this thesis, that is, the ribbon cobordism tangles. Another set of tangles is defined called opentangles. It will be useful in the construction of an isotopy invariant of cobordism tangles. The end of this chapter gives the relationship between 3-cobordisms and cobordism tangles: every 3-cobordism is represented by surgery by a cobordism tangle and two cobordisms are homeomorphic if and only if their cobordism tangles are separated by certain moves defined at the end of the chapter.

In this chapter, for any tuple of integers (g_1, \dots, g_r) , denote by $|g| = \sum_{i=1}^r g_i$.

3.1 Topological and combinatorial preliminaries

3.1.1 Ribbon graphs

An *arc* is an embedding of the square $[0, 1] \times [0, 1]$ in \mathbb{R}^3 . The image of $[0, 1] \times \{0\}$ and of $[0, 1] \times \{1\}$ are called *bases* of the arc whereas the image of $[0, 1] \times \{\frac{1}{2}\}$ is called the *core* of the arc. A *coupon* is an arc with a distinguished base called the *bottom base* (the other base is the *top base*). A *closed component* is an embedding of the the surface $\mathbb{S}^1 \times [0, 1]$ in \mathbb{R}^3 . The image of $\mathbb{S}^1 \times \{\frac{1}{2}\}$ is the *core* of the closed component.

A *ribbon graph with k bottom endpoints and l top endpoints* is an oriented surface G embedded in $\mathbb{R}^2 \times [0, 1]$ which is a finite disjoint union of arcs, coupons, and closed components such that

- the set $G \cap \mathbb{R}^2 \times \{0\}$ (respectively $G \cap \mathbb{R}^2 \times \{1\}$) is the union of the k (respectively l) disjoint segments $[(1, 1, 0), (1, 2, 0)], \dots, [(1, 2k-1, 0), (1, 2k, 0)]$ (respectively $[(1, 1, 1), (1, 2, 1)], \dots, [(1, 2l-1, 1), (1, 2l, 1)]$) which belong to some arcs of G and the orientation of G near these segments is given by the normal vector $(1, 0, 0)$;
- all other bases of arcs lie on bases of coupons;
- the core of arcs and closed components are oriented.

For more details on ribbon graphs, see [Tur94].

A *ribbon tangle* is a ribbon graph with k bottom endpoints and l top endpoints without coupons.

A *diagram* of a ribbon graph G is a projection of the coupons and the core of arcs and closed components of G in the plane $\{0\} \times \mathbb{R} \times \mathbb{R}$ such that the crossing have only double points and the orientation of a coupon is the orientation of $\{0\} \times \mathbb{R} \times \mathbb{R}$; we distinguish the overcrossing and the undercrossing in such a case. Except on Figure 3.2, the bottom base of a coupon is parallel to the

line $\{0\} \times \mathbb{R} \times \{0\}$ and is lower than the top base. An example of a projection of a ribbon graph is given in Figure 3.1.

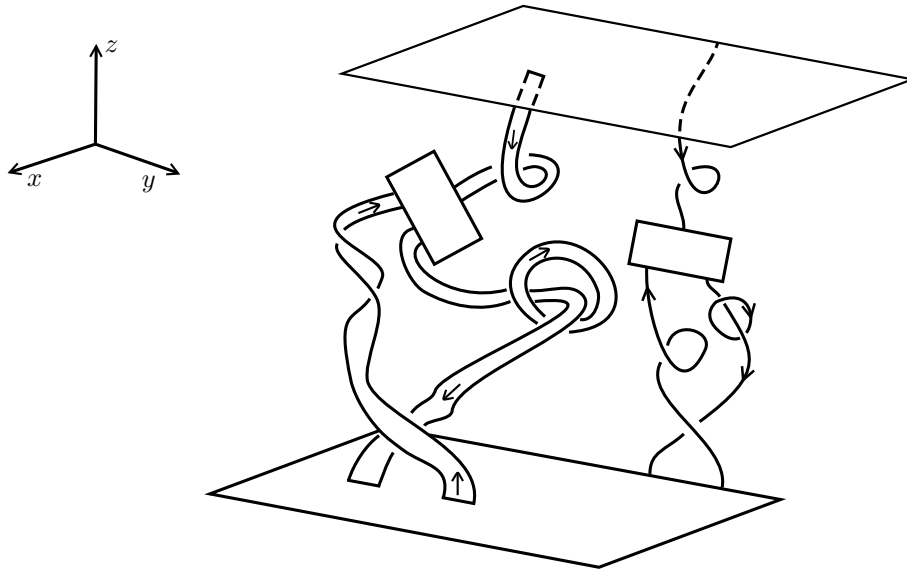

Figure 3.1 – A ribbon graph and one of its diagrams in the plane $\{0\} \times \mathbb{R} \times \mathbb{R}$.

To rebuild the ribbon graph starting from one of its diagrams, just thicken the cores of arcs and closed components of the diagram in the plane $\{0\} \times \mathbb{R} \times \mathbb{R}$. We say that diagrams are represented with convention of *blackboard framing*.

By an *isotopy of ribbon graphs*, we mean an orientation preserving isotopy in $\mathbb{R}^2 \times [0, 1]$ constant on the boundary segments and preserving the splitting into arcs, coupons and annulus as well as the orientation of cores. Recall that two diagrams represent the same isotopy class of a ribbon tangle if and only if one can be obtained from the other by deformation (planar isotopies) and a finite sequence of ribbon Reidemeister moves (see [Tur94] for details on isotopies and ribbon Reidemeister moves).

Finally, remember that you can compose two isotopy classes of ribbon graphs by juxtaposing them when the number of top endpoints of the first coincides with the number of bottom endpoints of the second. Moreover, you can obtain a new ribbon graph by putting two ribbon graphs side by side. These operations turn the set of isotopy class of ribbon graphs into a monoidal category (see [Tur94]).

In the sequel, when there is no confusion, we identify a ribbon tangle and its isotopy class.

3.1.2 Ribbon $(\underline{g}, n, \underline{h})$ -graphs

Let $\underline{g} = (g_1, \dots, g_r)$ and $\underline{h} = (h_1, \dots, h_s)$ be two tuples of non-negative integers, n be a non-negative integer, and denote by $|\underline{g}| = \sum_{i=1}^r g_i$. By a *ribbon $(\underline{g}, n, \underline{h})$ -graph*, we shall mean a ribbon graph $G \subset \mathbb{R}^2 \times [0, 1]$ consisting of n closed components, s ordered coupons called *entrance coupons*, r ordered coupons called *exit coupons*, and $|\underline{g}| + |\underline{h}|$ arcs based on coupons such that for all $1 \leq i \leq r$ and all $1 \leq j \leq s$ the i th entrance coupon has $2g_i$ top endpoints and no bottom endpoints and the j th exit coupon has $2h_j$ bottom endpoints and no top endpoints such that:

- for $1 \leq k \leq g_i$, an arc joins the $(2k - 1)$ th and the $2k$ th top endpoints of the i th entrance coupon and its core is oriented from the $2k$ th top endpoint to the $(2k - 1)$ th top endpoint;

- for $1 \leq k \leq h_j$, an arc joins the $(2k - 1)$ th and the $2k$ th bottom endpoints of the j th exit coupon and its core is oriented from the $(2k - 1)$ th bottom endpoint to the $2k$ th bottom endpoint.

A closed component of a ribbon $(\underline{g}, n, \underline{h})$ -graph is called a *surgery component*. An arc based on an entrance coupon (respectively exit coupon) is an *entrance component* (respectively *exit component*). A connected component of an entrance (resp. exit) coupon constitutes an *entrance boundary component* (resp. *exit boundary component*). A ribbon $(\underline{g}, n, \underline{h})$ -graph is represented by a diagram with blackboard framing.

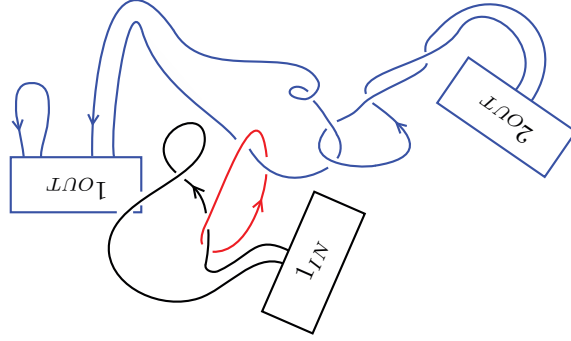

Figure 3.2 – A ribbon $((1), 1, (2, 1))$ -graph.

For an example, see Figure 3.2 where there is one surgery component (red), one entrance component which is a part of the unique entrance boundary component (black), and three exit components separated on the two exit boundary components (blue).

We denote by $GRAPH(\underline{g}, n, \underline{h})$ the set of all $(\underline{g}, n, \underline{h})$ -graphs, by

$$GRAPH = \bigsqcup_{(\underline{g}, n, \underline{h})} GRAPH(\underline{g}, n, \underline{h}),$$

by $Graph(\underline{g}, n, \underline{h})$ the set of all isotopy classes of $(\underline{g}, n, \underline{h})$ -graphs, and by

$$Graph = \bigsqcup_{(\underline{g}, n, \underline{h})} Graph(\underline{g}, n, \underline{h}).$$

3.1.3 Ribbon cobordism tangles

Let $\underline{g} = (g_1, \dots, g_r)$ and $\underline{h} = (h_1, \dots, h_s)$ be two tuples of non-negative integers and n be a non-negative integer. By a *ribbon $(\underline{g}, n, \underline{h})$ -cobordism tangle*, we shall mean a ribbon tangle $T \subset \mathbb{R}^2 \times [0, 1]$ with $2|\underline{g}|$ bottom endpoints and $2|\underline{h}|$ top endpoints consisting of n closed oriented components called *surgery components*, $|\underline{g}|$ arcs called *entrance components* and $|\underline{h}|$ arcs called *exit components* such that:

- for $1 \leq k \leq |\underline{g}|$, the k th entrance component joins the $(2k - 1)$ th and the $2k$ th bottom endpoints and its core is oriented from the $2k$ th bottom endpoint to the $(2k - 1)$ th bottom endpoint;
- for $1 \leq k \leq |\underline{h}|$, the k th exit component joins the $(2k - 1)$ th and the $2k$ th top endpoints and its core is oriented from the $(2k - 1)$ th top endpoint to the $2k$ th top endpoint.

For every $1 \leq i \leq r$, the disjoint union of the k th entrance component for $\left(\sum_{j=1}^{i-1} g_j\right) + 1 \leq k \leq \sum_{j=1}^i g_j$ is called the i th *entrance boundary component* of the cobordism tangle. For every $1 \leq i \leq s$, the

disjoint union of the k th top arcs for $\left(\sum_{j=1}^{i-1} h_j\right) + 1 \leq k \leq \left(\sum_{j=1}^i h_j\right)$ is called the i th *exit boundary component* of the cobordism tangle.

A ribbon cobordism tangle is represented by a diagram with blackboard framing.

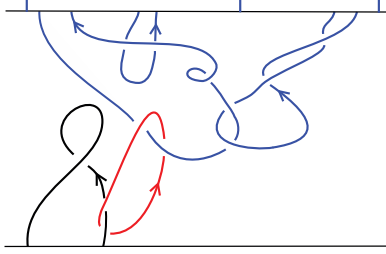

Figure 3.3 – A ribbon $((1), 1, (2, 1))$ -cobordism tangle.

For an example, see Figure 3.3 where there is one surgery component (red), one entrance component which forms the only one entrance boundary component (black) and three exit components separated on two exit boundary components materialized by vertical little segments (blue).

We denote by $TANG^{Cob}(\underline{g}, n, \underline{h})$ the set of all $(\underline{g}, n, \underline{h})$ -cobordism tangles, by

$$TANG^{Cob} = \bigsqcup_{(\underline{g}, n, \underline{h})} TANG^{Cob}(\underline{g}, n, \underline{h}),$$

by $Tang^{Cob}(\underline{g}, n, \underline{h})$ the set of all isotopy classes of $(\underline{g}, n, \underline{h})$ -cobordism tangles, and by

$$Tang^{Cob} = \bigsqcup_{(\underline{g}, n, \underline{h})} Tang^{Cob}(\underline{g}, n, \underline{h}).$$

There is a surjective map $Gr: Tang^{Cob} \rightarrow Graph$ defined on an isotopy class T of a $(\underline{g}, n, \underline{h})$ -cobordism tangle where $\underline{g} = (g_1, \dots, g_r)$ and $\underline{h} = (h_1, \dots, h_s)$ by:

$$Gr(T) = \left(\begin{array}{|c|} \hline h_1 \\ \hline \updownarrow \dots \updownarrow \\ \hline \end{array} \otimes \dots \otimes \begin{array}{|c|} \hline h_s \\ \hline \updownarrow \dots \updownarrow \\ \hline \end{array} \right) \circ T \circ \left(\begin{array}{|c|} \hline \updownarrow \dots \updownarrow \\ \hline g_1 \\ \hline \end{array} \otimes \dots \otimes \begin{array}{|c|} \hline \updownarrow \dots \updownarrow \\ \hline g_r \\ \hline \end{array} \right) \quad (3.1.1)$$

where a coupon colored by a positive integer m means that there is m couples of oriented arrows attached on the coupon as specified in the definition 3.1.1 of the map Gr .

3.1.4 Ribbon opentangles

Let $\underline{g} = (g_1, \dots, g_r)$ and $\underline{h} = (h_1, \dots, h_s)$ be two tuples of non-negative integers and n be a non-negative integer. By a *ribbon $(\underline{g}, n, \underline{h})$ -opentangle*, we shall mean a ribbon tangle $T \subset \mathbb{R}^2 \times [0, 1]$ with $2(|\underline{g}| + n + |\underline{h}|)$ bottom endpoints and $2|\underline{h}|$ top endpoints, consisting of $N = |\underline{g}| + n + 2|\underline{h}|$ arcs components without any closed component, such that:

- for $1 \leq k \leq |\underline{g}| + n$, the k th arc joins the $(2k - 1)$ th and the $2k$ th bottom endpoints and its core is oriented from the $(2k - 1)$ th bottom endpoint to the $2k$ th bottom endpoint;
- for $|\underline{g}| + n + 1 \leq k \leq N$, the k th arc joins the $(k + |\underline{g}| + n)$ th bottom endpoint with the $(k - |\underline{g}| - n)$ th top endpoint and its core is oriented upwards if $k - |\underline{g}| - n$ is odd and downwards if not.

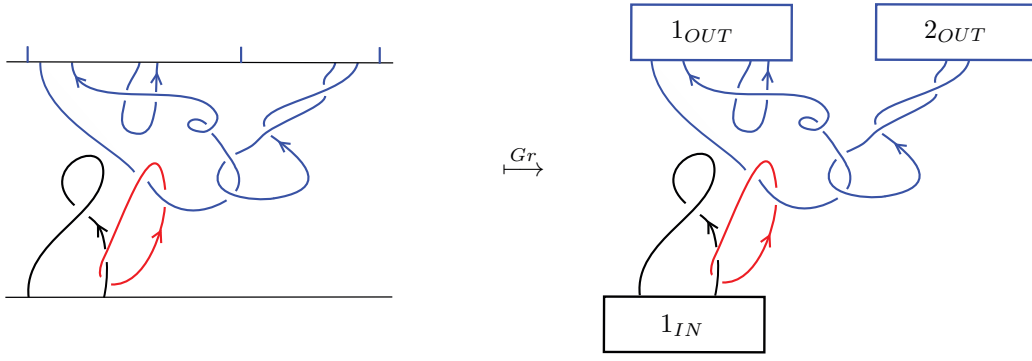

Figure 3.4 – The map Gr from $Tang^{Cob}$ to $Graph$.

The $|g|$ first arcs are the *entrance components*, the n following arcs are the *surgery components* and the last $|h|$ couples of consecutive arcs are the *exit components*. For every $1 \leq i \leq r$, the disjoint union of the k th arcs for $\left(\sum_{j=1}^{i-1} g_j\right) + 1 \leq k \leq \sum_{j=1}^i g_j$ is called the i th *entrance boundary component* of the opentangle. For every $1 \leq i \leq s$, the disjoint union of the k th arcs for $\left(|g| + n + \sum_{j=1}^{i-1} h_j\right) + 1 \leq k \leq |g| + n + 2 \left(\sum_{j=1}^i h_j\right)$ is called the i th *exit boundary component* of the opentangle.

A ribbon opentangle is represented by a diagram with blackboard framing.

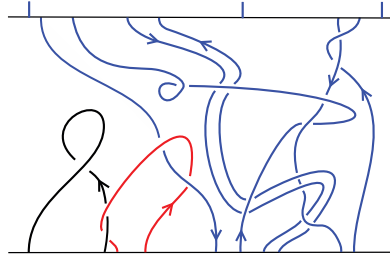

Figure 3.5 – A ribbon $((1), 1, (2, 1))$ -opentangle.

For an example, see Figure 3.5 where there is one surgery component (red), one entrance component which forms the only entrance boundary component (black) and three exit components separated on two exit boundary components materialized by vertical little segments (blue).

We denote by $OTANG(\underline{g}, n, \underline{h})$ the set of all $(\underline{g}, n, \underline{h})$ -opentangles, by

$$OTANG = \bigsqcup_{(\underline{g}, n, \underline{h})} OTANG(\underline{g}, n, \underline{h}),$$

by $Otang(\underline{g}, n, \underline{h})$ the set of all isotopy classes of $(\underline{g}, n, \underline{h})$ -opentangles, and by

$$Otang = \bigsqcup_{(\underline{g}, n, \underline{h})} Otang(\underline{g}, n, \underline{h}).$$

There is a surjective map $U: Otang \rightarrow Tang^{Cob}$ whose restriction on $Otang(\underline{g}, n, \underline{h}) \rightarrow Tang^{Cob}(\underline{g}, n, \underline{h})$ is also surjective and is given by the closure of surgery components and the bottom closure of exit

components of a class of opentangles, that is,

$$U(O) = O \circ (\downarrow \uparrow^{\otimes |g|} \otimes \vee^{\otimes n+|\underline{h}|}) \tag{3.1.2}$$

where O is an isotopy class of a (g, n, \underline{h}) -opentangle.

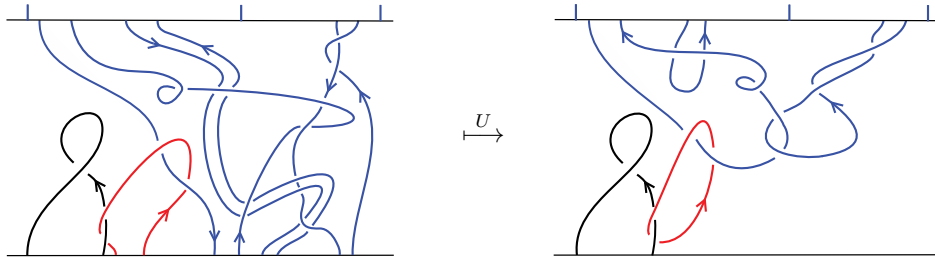
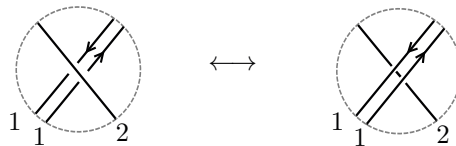

Figure 3.6 – The map U from $Otang$ to $Tang^{Cob}$.

Since the map U is surjective, it induces a bijection between the set $Tang^{Cob}(g, n, \underline{h})$ and the quotient set $Otang(g, n, \underline{h}) / \sim$ where two isotopy classes of opentangles are equivalent if and only if they have the same image under U . There is a diagrammatical characterization of this equivalence relation: two isotopy classes of opentangles O_1 and O_2 are equivalent if and only if a diagram of O_1 and a diagram of O_2 are related by a finite sequence of planar isotopies, ribbon Reidemeister moves (see [Tur94]) and three additional moves (see [Lyu95a]): moves of type BA ("below-above") defined on Figure 3.7, moves of type ESC ("exchange-surgery-components") defined on Figure 3.8 and moves of type "ROT" ("rotation") defined on Figure 3.9.



The two arcs 1 belong to the same surgery or exit component.
Arc 2 belongs to any component and can be oriented in the two ways.

Figure 3.7 – The move BA on diagrams of opentangles.

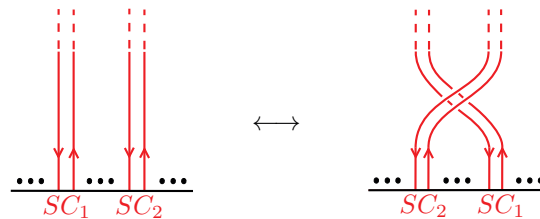
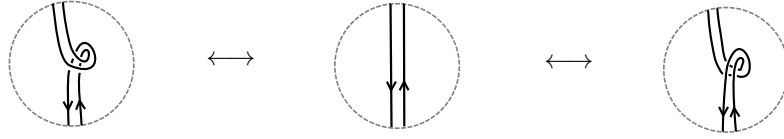

Figure 3.8 – The move ESC on diagrams of opentangles.



The two arcs belong to the same surgery or exit component.

Figure 3.9 – The move *ROT* on diagrams of opentangles.

3.2 Presentation of 3-cobordisms by cobordism tangles

3.2.1 Categories of 3-cobordisms

For the definition of the category of 3-cobordisms Cob_3 , see Section 2.5. Let $\underline{g} = (g_1, \dots, g_r)$ be a r -tuple of non-negative integers and g be a non-negative integer. If $\Sigma_{g_1}, \dots, \Sigma_{g_r}$ are r connected surfaces of respective genus g_1, \dots, g_r , the *multigenus* of the surface $\Sigma_{\underline{g}} := \bigsqcup_{i=1}^r \Sigma_{g_i}$ is \underline{g} . Denote by $S_{\underline{g}}$ the canonical oriented connected and closed surface of genus \underline{g} and by $S_{\underline{g}}$ the ordered disjoint union of connected canonical surfaces $\bigsqcup_{i=1}^r S_{g_i}$. Then we define the *category of 3-dimensional parametrized cobordisms* Cob_3^p which contains parametrized surfaces as objects that are pairs $(\Sigma, \phi_{\Sigma}: \Sigma \rightarrow S_{\underline{g}})$ with Σ a closed oriented surface of multigenus \underline{g} and ϕ_{Σ} a orientation preserving homeomorphism. Morphisms and composition are defined exactly in the same way that in Cob_3 and there exists an equivalence of category given by the forgetful functor $Cob_3^p \rightarrow Cob_3$.

We denote by $Cob_3^p(\underline{g}, \underline{h})$ the set of all parametrized cobordisms from a surface of multigenus \underline{g} to a surface of genus \underline{h} and by $Cob_3^{p,cd}(\underline{g}, \underline{h})$ the subset of $Cob_3^p(\underline{g}, \underline{h})$ of connected parametrized cobordisms.

A closed 3-manifold can be presented by a framed link. Using this result, we describe how to generalize this combinatorial presentation to 3-cobordisms as it is explained in [Tur94].

3.2.2 Surgery of 3-manifolds and presentation by links

Let L be a n -components framed link embedded in \mathbb{S}^3 and denote by $V(L)$ a tubular neighborhood of L in \mathbb{S}^3 . The boundary of the 3-manifold $\mathbb{S}^3 \setminus V(L)$ is then homeomorphic to n disjoint canonical tori (or handlebodies) $\mathbb{D}^2 \times \mathbb{S}^1$. We define the 3-manifold \mathbb{S}_L^3 obtained by surgery of \mathbb{S}^3 along the link L by:

$$\mathbb{S}_L^3 = (\mathbb{S}^3 \setminus V(L)) \bigsqcup_{\phi: \partial(\mathbb{S}^3 \setminus V(L)) \rightarrow \bigsqcup_{i=1}^n (\mathbb{S}^1 \times \mathbb{S}^1)_i} \bigsqcup_{i=1}^n (\mathbb{D}^2 \times \mathbb{S}^1)_i$$

where ϕ is a homeomorphism between tori that exchanges meridian and parallel and for every $1 \leq i \leq n$, the 3-manifold $(\mathbb{D}^2 \times \mathbb{S}^1)_i$ is a copy of the canonical torus $\mathbb{D}^2 \times \mathbb{S}^1$. A result of Lickorish which is proved in [Lic97] claims that if M be a closed oriented connected 3-manifold, then there exists a framed link L in \mathbb{S}^3 such that M is homeomorphic to \mathbb{S}_L^3 .

This last result will allow us to present 3-cobordisms by ribbon graphs and tangles in the sequel.

3.2.3 Surgery of 3-cobordisms and presentation by ribbon cobordism tangles

Presentation by ribbon cobordism tangles

Let $(M, h: \overline{\Sigma} \bigsqcup \Sigma' \rightarrow \partial M)$ be a connected 3-cobordism between the parametrized surfaces $(\Sigma, \phi_{\Sigma}: \Sigma \rightarrow S_{\underline{g}})$ and $(\Sigma', \phi_{\Sigma'}: \Sigma' \rightarrow S_{\underline{k}})$ where \underline{g} and \underline{k} are respectively a r -tuple and a s -tuple of nonnegative integers. Denote by $H_{\underline{g}}$ the 3-dimensional handlebody of genus \underline{g} bounded by the canonical closed

surface S_g and when \underline{g} is a r -tuple of nonnegative integers, denote by $H_{\underline{g}}$ the ordered disjoint union of handlebodies H_{g_1}, \dots, H_{g_r} . Then, define by \widetilde{M} the closed 3-manifold:

$$\widetilde{M} = H_{\underline{g}} \bigsqcup_{h_- \circ \phi_{\Sigma}^{-1}} M \bigsqcup_{\phi_{\Sigma'} \circ h_+} H_{\underline{k}}$$

where $h_- = h|_{\overline{\Sigma}}$ and $h_+ = h|_{\Sigma'}$. Now, according to the surgery theorem of Lickorish recalled in Section 3.2.2, there exist a n -component framed link L and a homeomorphism f between \widetilde{M} and \mathbb{S}_L^3 . Moreover, every canonical handlebody H_g of genus g is the tubular neighborhood of an oriented surface which is a ribbon graph G_g composed by one coupon and g handles based on the same side of the coupon. We can suppose that, for every $1 \leq i \leq r$ and every $1 \leq j \leq s$, $f(G_{g_i}) \cap L = \emptyset$ and $f(G_{k_j}) \cap L = \emptyset$ because the ribbon link L and the image by f of graphs G_{g_i} and G_{k_j} are objects of codimension 1 in \mathbb{S}^3 . Consider the ribbon graph in \mathbb{S}^3

$$G_{\underline{g}, n, \underline{k}} = G_{g_1} \sqcup \dots \sqcup G_{g_r} \bigsqcup L \bigsqcup G_{k_1} \sqcup \dots \sqcup G_{k_s}.$$

By isotopy, pull down the graphs G_{g_1}, \dots, G_{g_r} and pull up the graphs G_{k_1}, \dots, G_{k_s} and then cut them : the obtained ribbon $(\underline{g}, n, \underline{k})$ -cobordism is a presentation of the 3-cobordism $(M, h: \overline{\Sigma} \sqcup \Sigma' \rightarrow \partial M)$.

For example, the cylinder $\text{id}_{\Sigma_g} = (\Sigma_g \times [0, 1], \text{id}_{\overline{\Sigma_g} \sqcup \Sigma_g})$ over a surface Σ_g of genus g is presented by the ribbon (g, g, g) -cobordism tangle given on Figure 3.10.

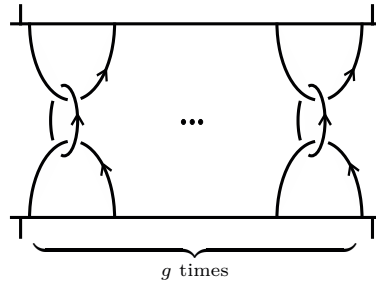



Figure 3.10 – A cobordism tangle which presents the cylinder of a surface of genus g .

Extended Kirby calculus

Let T be a $(\underline{g}, n, \underline{h})$ -cobordism tangle in \mathbb{S}^3 with $\underline{g} = (g_1, \dots, g_r)$ and $\underline{h} = (h_1, \dots, h_s)$ and denote by L the link defined by the disjoint union of the n surgery components of T . Consider the ribbon $(\underline{g}, n, \underline{h})$ -graph $G = Gr(T)$ as defined in 3.1.1 where $r + s$ coupons have been attached to entrance and exit components of T . Then do the surgery on \mathbb{S}^3 along L to obtain a closed connected oriented 3-manifold \mathbb{S}_L^3 with $r + s$ disjoint embedded ribbon graphs of type . Take tubular neighborhoods N_1, \dots, N_r of the r entrance boundary components of G and tubular neighborhoods N_{r+1}, \dots, N_{r+s} of the s exit boundary components of G in \mathbb{S}_L^3 . Then we obtain a 3-cobordism

$$M_T = \mathbb{S}_L^3 \setminus (N_1 \sqcup \dots \sqcup N_{r+s})$$

from $\partial(N_1 \sqcup \dots \sqcup N_r)$ to $\partial(N_{s+1} \sqcup \dots \sqcup N_{r+s})$ with a parametrization of these two boundary components by canonical surfaces.

This construction gives a surjective map N (for "neighborhood") from $\bigsqcup_{n \in \mathbb{N}} \text{Tang}^{Cob}(\underline{g}, n, \underline{h})$ to $\text{Cob}_3^{p, cd}(\underline{g}, \underline{h})$ defined on an isotopy class T of a $(\underline{g}, n, \underline{h})$ -cobordism tangle by:

$$N(T) = M_T \tag{3.2.3}$$

The surjectivity of the map N comes from the existence of a presentation for any connected 3-cobordism by a ribbon (g, n, \underline{h}) -cobordism tangle. Since N is surjective, it defines a bijection between the set $Cob_3^{p,cd}(\underline{g}, \underline{h})$ and the quotient set of $\left(\bigsqcup_{n \in \mathbb{N}} Tang^{Cob}(\underline{g}, n, \underline{h}) \right) / \sim$ where two cobordism tangles T_1 and T_2 are equivalent if and only if $M_{T_1} = M_{T_2}$. In order to give a characterization in terms of cobordism tangles diagrams, we define the moves SO ("surgery orientation"), KI (Kirby I), KII^g ("generalized Kirby II"), $COUPON$ and $TWIST$ illustrated respectively in Figures 3.11, 3.12, 3.13, 3.14, and 3.15.

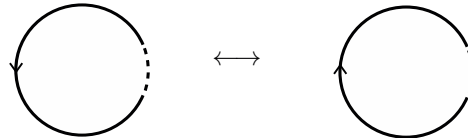

Figure 3.11 – The move SO on cobordism tangles.

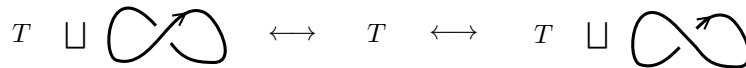
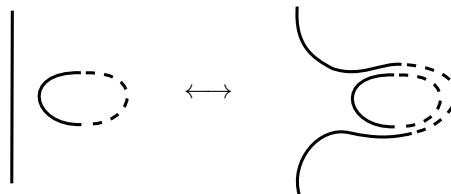
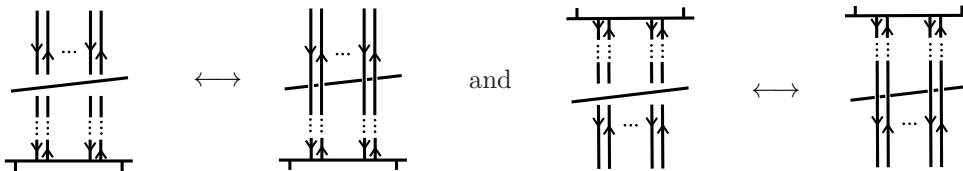

Figure 3.12 – The move KI on cobordism tangles.



Any component can slides over a surgery component.
Figure 3.13 – The move KII^g on cobordism tangles.



All components of the same entrance or exit boundary component can cross any component.

Figure 3.14 – The move $COUPON$ on cobordism tangles.

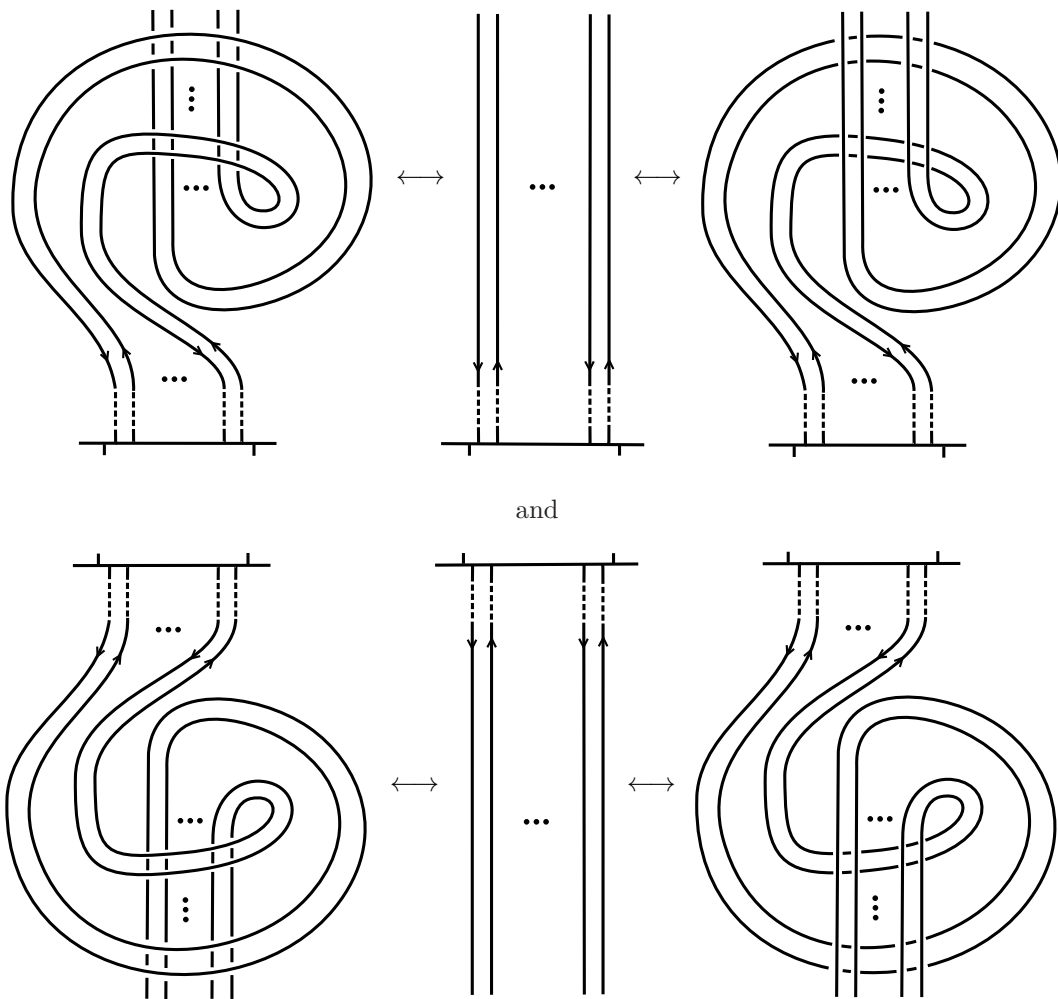

The simultaneous twist of all components of the same entrance or exit boundary component is considered as nothing happened.

Figure 3.15 – The move *TWIST* on cobordism tangles.

Theorem 3.2.1 — *Two isotopy classes of cobordism tangles T_1 and T_2 are equivalent if and only if a diagram of T_1 and a diagram of T_2 differ only by a finite sequence of planar isotopies, ribbon Reidemeister moves, and moves of type *SO*, *KI*, *KII*⁹, *COUPON*, and *TWIST*.*

For details concerning extended Kirby calculus, see [Section 3.1, Chapter II, [Tur94]] and for a proof of Theorem 3.2.1, see [Section 7.2, [RT91]].

3.2.4 Two operations on cobordism tangles

Encircling composition

Let $\underline{g} = (g_1, \dots, g_r)$, $\underline{h} = (h_1, \dots, h_s)$ and $\underline{k} = (k_1, \dots, k_t)$ be three tuples of positive integers.

Let $M_S \in \text{Cob}_3^{p,cd}(\underline{g}, \underline{h})$ and $M_T \in \text{Cob}_3^{p,cd}(\underline{h}, \underline{k})$ two cobordisms represented respectively by a $(\underline{g}, n, \underline{h})$ -cobordism tangle S and a $(\underline{h}, m, \underline{k})$ -cobordism tangle T . Then, according to Turaev (see [Tur94]), the connected parametrized 3-cobordism $M_T \circ M_S \in \text{Cob}_3^{p,cd}(\underline{g}, \underline{k})$ is represented by a

tangle $T \star S$ obtained by adding $s - 1$ trivial knots respectively surrounded the $s - 1$ first boundary components of T and juxtaposing this new tangle over S as it is illustrated on Figure 3.16:

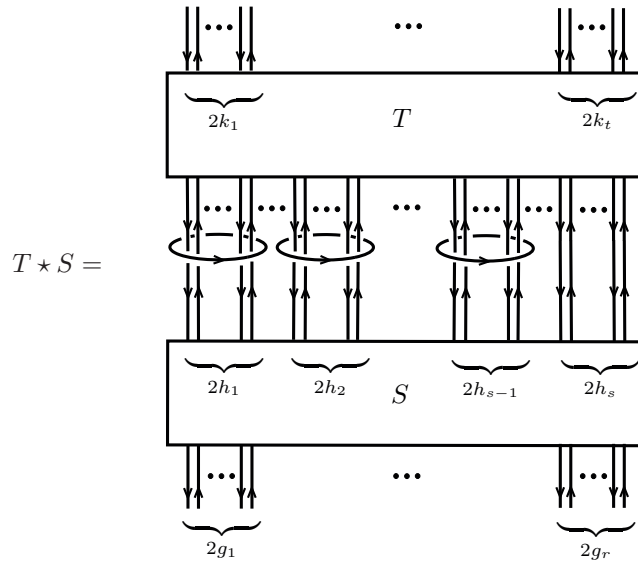

Figure 3.16 – Operation \star on cobordism tangles.

Hallowed tangles

Let T be a $(\underline{g}, n, \underline{h})$ -cobordism tangle T . We define the *hallowed cobordism tangle* $\overset{\circ}{T}$ by:

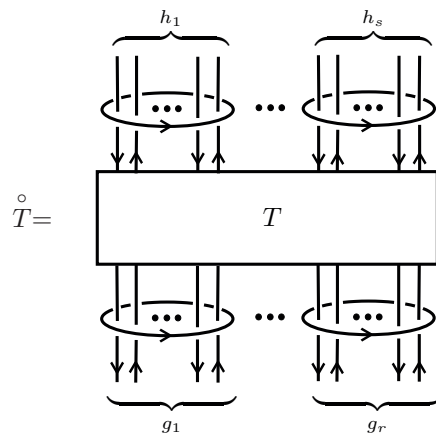

Figure 3.17 – Hallowed cobordism tangle $\overset{\circ}{T}$.

Chapter 4

Construction of the internal 3-dimensional TQFT

In this chapter, we give all the steps to define the internal TQFT. First, we define isotopy invariants of opentangles and cobordism tangles. Then we give sufficient conditions on a morphism α to obtain a topological cobordism invariant. After explaining projections that emerge in the construction, we give the main result of this thesis, that is, the construction of the internal TQFT. We remark that all the TQFT depends only on the structure of the coend.

In this chapter, the category \mathcal{C} is a ribbon category admitting a coend (C, ι) and with split idempotents. If $\underline{g} = (g_1, \dots, g_r)$ is a r -tuple of integers, denote by $|\underline{g}| = \sum_{i=1}^r g_i$.

4.1 Isotopy invariant of opentangles

Let O be a ribbon $(\underline{g}, n, \underline{h})$ -opentangle (see Section 3.1.4). If $X_1, \dots, X_{|\underline{g}|+n}, Y_1, \dots, Y_{2|\underline{h}|}$ are objects of \mathcal{C} , denote by

$$O_{X_1, \dots, X_{|\underline{g}|+n}, Y_1, \dots, Y_{2|\underline{h}|}} : \bigotimes_{i=1}^{|\underline{g}|+n} (X_i^* \otimes X_i) \otimes \bigotimes_{j=1}^{2|\underline{h}|} Y_j \rightarrow \bigotimes_{j=1}^{2|\underline{h}|} Y_j$$

the morphism of \mathcal{C} graphically represented by a diagram of O as illustrated on Figure 4.1.

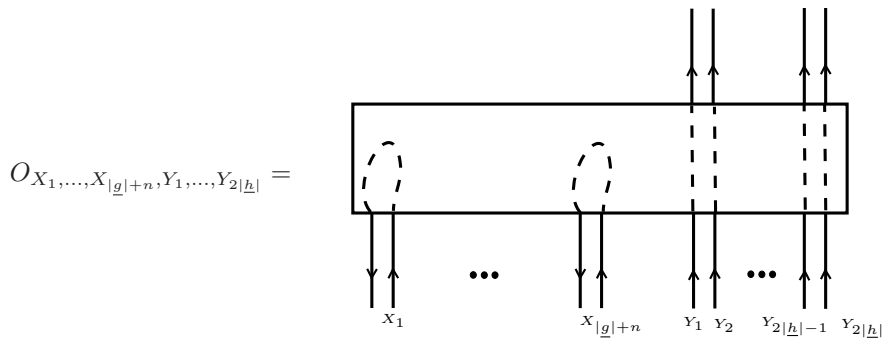

Figure 4.1 – Morphism graphically represented by an opentangle.

Then the following system, also denoted by O ,

$$O = \left\{ O_{X_1, \dots, X_{|g|+n}, Y_1, \dots, Y_{2|\underline{h}|}} : \bigotimes_{i=1}^{|\underline{g}|+n} (X_i^* \otimes X_i) \otimes \bigotimes_{j=1}^{2|\underline{h}|} Y_j \rightarrow \bigotimes_{j=1}^{2|\underline{h}|} Y_j \right\}_{X_1, \dots, X_{|g|+n}, Y_1, \dots, Y_{2|\underline{h}|} \in \mathcal{C}}$$

satisfies the conditions of Lemma 1.2.4 and denote by

$$|O|_{\mathcal{C}} : C^{\otimes |g|+n+|\underline{h}|} \rightarrow C^{\otimes |g|}$$

the universal morphism associated to the system O . This construction provides us an invariant of opentangles.

Lemma 4.1.1 — *The universal morphism associated to an opentangle defines a map*

$$| \cdot |_{\mathcal{C}} : \text{Otang} \rightarrow \text{Hom}_{\mathcal{C}}$$

such that every isotopy class of $(\underline{g}, n, \underline{h})$ -opentangle O is mapped to the morphism of \mathcal{C} :

$$|O|_{\mathcal{C}} : C^{\otimes |g|} \otimes C^{\otimes n} \otimes C^{\otimes |\underline{h}|} \rightarrow C^{|\underline{h}|}.$$

Proof. Choosing a $(\underline{g}, n, \underline{h})$ -opentangle O , the construction of the universal morphism is well-defined by the universal property of the coend of the category \mathcal{C} . Moreover, the construction does not depend on the choice of an element in the isotopy class of O because of Shum's result (see [Shu94]): two isotopic opentangles define the same morphism in the ribbon category \mathcal{C} . \square

4.2 Isotopy invariant of cobordism tangles

Using the isotopy invariant of opentangles of Lemma 4.1.1, we define an isotopy invariant of cobordism tangles.

Lemma 4.2.1 — *Let α be a morphism of $\text{Hom}_{\mathcal{C}}(\mathbb{1}, C)$. There is a map*

$$| \cdot |_{\mathcal{C}, \alpha} : \text{Tang}^{Cob}(\underline{g}, n, \underline{h}) \rightarrow \text{Hom}_{\mathcal{C}}$$

defined on every isotopy class of $(\underline{g}, n, \underline{h})$ -cobordism tangle T by

$$|T|_{\mathcal{C}, \alpha} = |O|_{\mathcal{C}} \circ (\text{id}_{C^{\otimes |g|}} \otimes \alpha^{\otimes n+|\underline{h}|})$$

where O is any preimage of T by the map $U : \text{Otang} \rightarrow \text{Tang}^{Cob}$ defined in 3.1.2.

Proof. See Section 4.5.1. \square

Remark 4.2.2 — This result could be obviously generalized by coloring the n surgery components and the $|\underline{h}|$ exit components of a $(\underline{g}, n, \underline{h})$ -cobordism tangle by any different morphisms $\alpha_1, \dots, \alpha_{n+|\underline{h}|}$ of $\text{Hom}_{\mathcal{C}}(\mathbb{1}, C)$.

Note that the isotopy invariant of cobordism tangles $| \cdot |_{\mathcal{C}, \alpha}$ is multiplicative for the disjoint union as claimed in the following Lemma.

Lemma 4.2.3 — *Let $\alpha \in \text{Hom}_{\mathcal{C}}(\mathbb{1}, C)$ and T_1, T_2 be two cobordism tangles. Then*

$$|T_1 \sqcup T_2|_{\mathcal{C}, \alpha} = |T_1|_{\mathcal{C}, \alpha} \otimes |T_2|_{\mathcal{C}, \alpha}.$$

Proof. See Section 4.5.2. \square

4.3 Homeomorphism invariant of 3-cobordisms

In order to define a topological invariant of 3-cobordisms using the isotopy invariant $|\cdot|_{C,\alpha}$, we need to make some assumptions on α .

4.3.1 Admissible element

Let $\alpha \in \text{Hom}_C(\mathbb{1}, C)$. The morphism α is an *admissible element* if it satisfies the following conditions, where $m, \Delta, \varepsilon, S, \omega$, and θ_{\pm} denote respectively the multiplication, the comultiplication, the counit, the antipode, the pairing and the linear form coming from twists of the coend C :

$$(Ad1) \quad \varepsilon\alpha = \text{id}_{\mathbb{1}};$$

$$(Ad2) \quad S\alpha = \alpha;$$

$$(Ad3) \quad \theta_+\alpha, \theta_-\alpha \in \text{End}_C(\mathbb{1})^\times;$$

$$(Ad4) \quad \forall n \in \mathbb{N}, \quad \begin{array}{c} \text{Diagram 1: } n \text{ strands of } C^{\otimes n} \text{ with } \omega \text{ and } \alpha \text{ nodes} \\ \text{Diagram 2: } n \text{ strands of } C^{\otimes n} \text{ with } \omega \text{ and } \alpha \text{ nodes} \end{array} = ; \quad (Ad5) \quad \forall n \in \mathbb{N}, \quad \begin{array}{c} \text{Diagram 3: } n \text{ strands of } C^{\otimes n} \text{ with } \text{id}_{C^{\otimes n}} \text{ and } \alpha \text{ nodes} \\ \text{Diagram 4: } n \text{ strands of } C^{\otimes n} \text{ with } \text{id}_{C^{\otimes n}}, \Delta, m \text{ and } \alpha \text{ nodes} \end{array} = .$$

Remark 4.3.1 – For example, every integral $\alpha: \mathbb{1} \rightarrow C$ of the coend C satisfying (Ad1), (Ad2) and (Ad3) is an admissible element.

4.3.2 Homeomorphism invariant of 3-cobordisms

Before we formulate the main result of this section (Lemma 4.3.5), we need some intermediate results.

Lemma 4.3.2 —

If (Ad5) holds, then for any $n \in \mathbb{N}$,

$$\begin{array}{c} \text{Diagram 5: } n \text{ strands of } C^{\otimes n} \text{ with } \text{id}_{C^{\otimes n}}, \Delta, m \text{ and } \alpha \text{ nodes} \\ \text{Diagram 6: } n \text{ strands of } C^{\otimes n} \text{ with } \text{id}_{C^{\otimes n}} \text{ and } \alpha \text{ nodes} \end{array} = .$$

Proof. Set $\Pi_n = [\text{id}_{C^{\otimes n}} \otimes \omega(\text{id}_C \otimes \alpha)]\delta_{C^{\otimes n}}$. We have:

$$\begin{aligned} & (\text{id}_{C^{\otimes n}} \otimes m(\text{id}_C \otimes \alpha))(\text{id}_{C^{\otimes n-1}} \otimes \tau_{C,C})(\text{id}_C \otimes \tau_{C,C^{\otimes n-2}} \otimes \text{id}_C)\Pi_n \\ &= (\tau_{C,C^{\otimes n-2}} \otimes \text{id}_{C^{\otimes 2}})(\text{id}_C \otimes \tau_{C^{\otimes n-2},C} \otimes m(\text{id}_C \otimes \alpha))(\text{id}_{C^{\otimes n-1}} \otimes \Delta)(\text{id}_C \otimes \tau_{C^{\otimes n-2},C})(\tau_{C,C^{\otimes n-2}} \otimes \text{id}_C)\Pi_n \\ &\stackrel{(2)}{=} (\tau_{C,C^{\otimes n-2}} \otimes \text{id}_{C^{\otimes 2}})(\text{id}_C \otimes \tau_{C^{\otimes n-2},C} \otimes m(\text{id}_C \otimes \alpha))(\text{id}_{C^{\otimes n-1}} \otimes \Delta)\Pi_n(\text{id}_C \otimes \tau_{C^{\otimes n-2},C})(\tau_{C,C^{\otimes n-2}} \otimes \text{id}_C) \\ &\stackrel{(3)}{=} (\tau_{C,C^{\otimes n-2}} \otimes \text{id}_C \otimes \alpha)(\text{id}_C \otimes \tau_{C^{\otimes n-2},C})\Pi_n(\text{id}_C \otimes \tau_{C^{\otimes n-2},C})(\tau_{C,C^{\otimes n-2}} \otimes \text{id}_C) \\ &\stackrel{(4)}{=} (\tau_{C,C^{\otimes n-2}} \otimes \text{id}_C \otimes \alpha)(\text{id}_C \otimes \tau_{C^{\otimes n-2},C})(\text{id}_C \otimes \tau_{C^{\otimes n-2},C})(\tau_{C,C^{\otimes n-2}} \otimes \text{id}_C)\Pi_n \\ &= \Pi_n \otimes \alpha \end{aligned}$$

Equalities (2) and (4) are due to the naturality of Π_n between Identity functors whereas equality (3) comes from the "If" part of the lemma. \square

For any $\alpha \in \text{Hom}_{\mathcal{C}}(\mathbb{1}, C)$, define the morphism

$$\Pi_{\alpha, n} = [\text{id}_{C^{\otimes n}} \otimes \omega(\text{id}_C \otimes \alpha)] \delta_{C^{\otimes n}} : C^{\otimes n} \rightarrow C^{\otimes n}.$$

For any tuples $\underline{g} = (g_1, \dots, g_r)$ of integers, set

$$C^{\otimes \underline{g}} = C^{\otimes g_1} \otimes \dots \otimes C^{\otimes g_r}$$

and

$$\Pi_{\alpha, \underline{g}} = \Pi_{g_1, \alpha} \otimes \dots \otimes \Pi_{g_r, \alpha}.$$

When T is a cobordism tangle, recall the construction of the tangle $\overset{\circ}{T}$ (see Section 3.2.4). The next Lemma compares the two invariants $|T|_{\mathcal{C}, \alpha}$ and $|\overset{\circ}{T}|_{\mathcal{C}, \alpha}$.

Lemma 4.3.3 — *Let $\alpha : \mathbb{1} \rightarrow C$ and T be a $(\underline{g}, n, \underline{h})$ -cobordism tangle. Then*

$$\Pi_{\alpha, \underline{h}} |T|_{\mathcal{C}, \alpha} \Pi_{\alpha, \underline{g}} = |\overset{\circ}{T}|_{\mathcal{C}, \alpha} \quad (4.3.1)$$

To construct an invariant of cobordism, we construct an invariant of generalized Kirby II move KII^g (see Figure 3.13).

Lemma 4.3.4 — *Let $\alpha : \mathbb{1} \rightarrow C$ that satisfy (Ad1), (Ad2) and (Ad5) and T be a $(\underline{g}, n, \underline{h})$ -cobordism tangle. Then the morphism*

$$|\overset{\circ}{T}|_{\mathcal{C}, \alpha} : C^{\otimes \underline{g}} \rightarrow C^{\otimes \underline{h}}$$

is invariant by the generalized Kirby move KII^g on cobordism tangle T .

Proof. See Section 4.5.3. \square

We are equipped now with an invariant of generalized Kirby move. We have to normalize this invariant to obtain an invariant of Kirby I move (see Figure 3.12). Let T be a $(\underline{g}, n, \underline{h})$ -cobordism tangle and $\alpha : \mathbb{1} \rightarrow C$ be a morphism of \mathcal{C} that satisfies (Ad3). Denote by $b_+(T)$ (respectively $b_-(T)$) the number of positive (respectively negative) eigenvalues of the linking matrix of the link composed by all the surgery components of T and set

$$\nu_{\alpha}(T) = (\theta_+ \alpha)^{-b_+(T)} (\theta_- \alpha)^{-b_-(T)} \in \text{End}_{\mathcal{C}}(\mathbb{1}). \quad (4.3.2)$$

Clearly, ν_{α} is multiplicative for disjoint union of tangles:

$$\nu_{\alpha}(T \sqcup T') = \nu_{\alpha}(T) \nu_{\alpha}(T').$$

Lemma 4.3.5 — *Let $\alpha \in \text{Hom}_{\mathcal{C}}(\mathbb{1}, C)$ satisfying (Ad1), (Ad2), (Ad3) and (Ad5) and let M_T be a connected cobordism represented by a cobordism tangle T . Then*

$$W_{\mathcal{C}}(M_T; \alpha) = \nu_{\alpha}(T) |\overset{\circ}{T}|_{\mathcal{C}, \alpha}$$

is a topological 3-cobordism invariant.

Proof. See Section 4.5.1. \square

We extend the invariant $W_{\mathcal{C}}(\ ; \alpha)$ to non-connected cobordisms. If M is a 3-cobordism of $\text{Cob}_3^p(\underline{g}, \underline{h})$, denote by $M^{\#}$ the 3-cobordism of $\text{Cob}_3^p(\underline{g}, \underline{h})$ obtained as the connected sum of connected components of M .

Lemma 4.3.6 — Let $\alpha \in \text{Hom}_{\mathcal{C}}(\mathbf{1}, C)$ satisfying (Ad1), (Ad2), (Ad3) and (Ad5) and let M be a cobordism. Then

$$W_{\mathcal{C}}(M; \alpha) = W_{\mathcal{C}}(M^{\#}; \alpha).$$

is a topological 3-cobordism invariant.

Remarks 4.3.7 –

- If M is a connected cobordism, then $M^{\#} = M$.
- Suppose that M has n connected components represented by cobordism tangles T_1, \dots, T_n . Then there exist two braids b_{in} and b_{out} such that the cobordism $M^{\#}$ is represented by the cobordism tangle $b_{out} \circ (T_1 \sqcup \dots \sqcup T_n) \circ b_{in}$. Then

$$W_{\mathcal{C}}(M^{\#}; \alpha) = \prod_{i=1}^n \nu_{\alpha}(T_i) \left(b_{out, \mathcal{C}}(|\overset{\circ}{T}_1|_{\mathcal{C}, \alpha} \otimes \dots \otimes |\overset{\circ}{T}_n|_{\mathcal{C}, \alpha}) b_{in, \mathcal{C}} \right)$$

where $b_{in, \mathcal{C}}$ and $b_{out, \mathcal{C}}$ are morphisms of the ribbon category \mathcal{C} encoded by braids b_{in} and b_{out} whose every strand has been colored by the coend C .

4.4 Internal TQFT

In previous section, we have defined a 3-cobordism invariant $W_{\mathcal{C}}(\ ; \alpha)$ under assumptions on α . We will use it to define the TQFT. For that, we have to understand what is going on for the composition of cobordisms. Recall that the cobordism tangle which encodes the compositum of two cobordisms is not the compositum of the tangles: we have to add several closed components (see Section 3.2.4).

4.4.1 A useful morphism

Let X, Y be any objects of \mathcal{C} and consider the morphism $\Pi_{X, Y}$ defined in Figure 4.2:

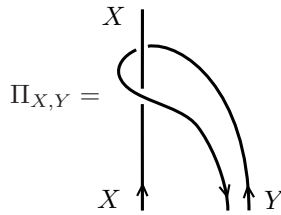
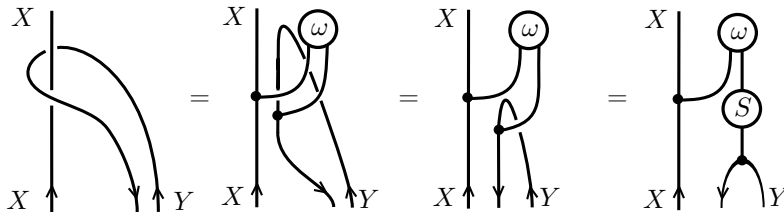

Figure 4.2 – A useful morphism

Let us express this morphism $\Pi_{X, Y}$ using structural morphisms of the coend C of \mathcal{C} :



4.4.2 The idempotent $\Pi_{\alpha,n}$

Suppose that $\alpha: \mathbb{1} \rightarrow C$ satisfies admissibility condition (Ad4) this means that for all $n \in \mathbb{N}$, the morphism

$$\Pi_{\alpha,n} = [\text{id}_C \otimes \omega(\text{id}_C \otimes \alpha)]\delta_{C^{\otimes n}}: C^{\otimes n} \rightarrow C^{\otimes n}$$

is an idempotent of C . As C has splitting idempotents then $\Pi_{\alpha,n}$ has a split decomposition, that is, there are an object $(C^{\otimes n})_\alpha \in C$ and two morphisms $p_{\alpha,n}: C^{\otimes n} \rightarrow (C^{\otimes n})_\alpha$, $q_{\alpha,n}: (C^{\otimes n})_\alpha \rightarrow C^{\otimes n}$ such that

$$p_{\alpha,n}q_{\alpha,n} = \text{id}_{(C^{\otimes n})_\alpha}$$

and

$$q_{\alpha,n}p_{\alpha,n} = \Pi_{\alpha,n}.$$

For any tuple $\underline{g} = (g_1, \dots, g_r)$ of integers, set

$$\Pi_{\alpha,\underline{g}} = \Pi_{\alpha,g_1} \otimes \dots \otimes \Pi_{\alpha,g_r},$$

$$p_{\alpha,\underline{g}} = p_{\alpha,g_1} \otimes \dots \otimes p_{\alpha,g_r},$$

and

$$q_{\alpha,\underline{g}} = q_{\alpha,g_1} \otimes \dots \otimes q_{\alpha,g_r}.$$

4.4.3 The internal TQFT

Suppose that α satisfies (Ad4) and let T be a $(\underline{g}, n, \underline{h})$ -cobordism tangle where $\underline{g} = (g_1, \dots, g_r)$ and $\underline{h} = (h_1, \dots, h_s)$. As $\Pi_{\alpha,\underline{h}}|T|_{C,\alpha}\Pi_{\alpha,\underline{g}} = \overset{\circ}{|T|}_{C,\alpha}$ (see Lemma 4.3.3), remark that the restriction to the images of $\Pi_{\alpha,\underline{g}}$ and $\Pi_{\alpha,\underline{h}}$ (see Section 1.1.14) of these two morphisms are the same that means the morphism

$$p_{\alpha,\underline{h}}|T|_{C,\alpha}q_{\alpha,\underline{g}}: \text{Im}(\Pi_{\alpha,\underline{g}}) = (C^{\otimes g_1})_\alpha \otimes \dots \otimes (C^{\otimes g_r})_\alpha \rightarrow \text{Im}(\Pi_{\alpha,\underline{h}}) = (C^{\otimes h_1})_\alpha \otimes \dots \otimes (C^{\otimes h_s})_\alpha$$

is the the same that the morphism

$$p_{\alpha,\underline{h}}|\overset{\circ}{T}|_{C,\alpha}q_{\alpha,\underline{g}}: \text{Im}(\Pi_{\alpha,\underline{g}}) = (C^{\otimes g_1})_\alpha \otimes \dots \otimes (C^{\otimes g_r})_\alpha \rightarrow \text{Im}(\Pi_{\alpha,\underline{h}}) = (C^{\otimes h_1})_\alpha \otimes \dots \otimes (C^{\otimes h_s})_\alpha.$$

It could be useful in the sequel.

Recall that every connected 3-parametrized cobordism of $\text{Cob}_3^{p,cd}(\underline{g}, \underline{h})$ can be represented by a $(\underline{g}, n, \underline{h})$ -cobordism tangle (see Section 3.2.3) and denote by $b_+(T)$ (respectively $b_-(T)$) the number of positive (respectively negative) eigenvalues of the linking matrix of the closed components of the tangle T . Moreover, the compositum $M_T \circ M_{T'}$ of two cobordisms represented by T and T' is encoded by the cobordism tangle $T \star T'$ (see 3.2.4). Before constructing the internal TQFT, the next Lemma makes the invariant of 3-cobordisms $W_C(\ ; \alpha)$ into a braided functor with anomaly.

Lemma 4.4.1 — *Let $\alpha \in \text{Hom}_C(\mathbb{1}, C)$ be an admissible element. Then for every connected parametrized surface Σ_g of genus g and for every connected 3-cobordism M_T of $\text{Cob}_3^p(\underline{g}, \underline{h})$ represented by a $(\underline{g}, n, \underline{h})$ -cobordism tangle T , the assignment:*

$$W_C(\Sigma_g; \alpha) = (C^{\otimes g})_\alpha \tag{4.4.3}$$

$$W_C(M_T; \alpha) = \nu_\alpha(T) (p_{\alpha,\underline{h}}|T|_{C,\alpha}q_{\alpha,\underline{g}}) \tag{4.4.4}$$

defines a braided monoidal functor with anomaly (W, γ) between the category Cob_3^p and C where the anomaly γ is given by:

$$\gamma_{M_T, M_{T'}} = (\theta_+ \alpha)^{b_+(T)+b_+(T')-b_+(T \star T')} (\theta_- \alpha)^{b_-(T)+b_-(T')-b_-(T \star T')},$$

Remark 4.4.2 – For any 3-cobordism, we set $\gamma_{M,N} := \gamma_{M\#,N\#}$.

Proof. See Section 4.5.5. □

The following Lemma gives a characterization of the transparency of the image of an idempotent. We will use it to show that the internal TQFT takes values in the subcategory of \mathcal{C} of transparent objects.

Lemma 4.4.3 — *Let $\Pi: X \rightarrow X$ be an idempotent of a ribbon category \mathcal{C} with coend. Then $\text{Im}(\Pi)$ is transparent if and only if*

$$\Pi(\text{id}_X \otimes \omega(\text{id}_C \otimes S))\delta_X = \Pi \otimes \varepsilon.$$

Proof. Let $(\text{Im}(\Pi), p, q)$ a decomposition of the idempotent Π that means $pq = \text{id}_{\text{Im}(\Pi)}$ and $qp = \Pi$. $\text{Im}(\Pi)$ is transparent if and only if

$$\begin{aligned} \forall Y \in \mathcal{C}, (\text{id}_{\text{Im}(\Pi)} \otimes \text{coev}_Y)(\tau_{\text{Im}(\Pi), Y}^{-1} \tau_{Y, \text{Im}(\Pi)}^{-1} \otimes \text{id}_Y) &= \text{id}_{\text{Im}(\Pi)} \otimes \text{coev}_Y \\ \iff \forall Y \in \mathcal{C}, (\text{id}_{\text{Im}(\Pi)} \otimes \omega(\text{id}_C \otimes S))\delta_{\text{Im}(\Pi)}(\text{id}_{\text{Im}(\Pi)} \otimes \iota_Y) &= \text{id}_{\text{Im}(\Pi)} \otimes \text{coev}_Y \\ \stackrel{(2)}{\iff} (\text{id}_{\text{Im}(\Pi)} \otimes \omega(\text{id}_C \otimes S))\delta_{\text{Im}(\Pi)} &= \text{id}_{\text{Im}(\Pi)} \otimes \varepsilon \\ \stackrel{(3)}{\iff} q(\text{id}_{\text{Im}(\Pi)} \otimes \omega(\text{id}_C \otimes S))\delta_{\text{Im}(\Pi)}p &= \Pi \otimes \varepsilon \\ \stackrel{(4)}{\iff} qp(\text{id}_{\text{Im}(\Pi)} \otimes \omega(\text{id}_C \otimes S))\delta_X &= \Pi \otimes \varepsilon \\ \iff \Pi(\text{id}_X \otimes \omega(\text{id}_C \otimes S))\delta_X &= \Pi \otimes \varepsilon \end{aligned}$$

Equivalence (2) is due to the universal property of the coend, equivalence (3) comes from the identities $pq = \text{id}_{\text{Im}(\Pi)}$ et $qp = \Pi$ and equivalence (4) is the consequence of naturality of δ . □

As $W_{\mathcal{C}}(\cdot; \alpha)$ is a functor with anomaly, for every surface Σ_g of genus g , the morphism

$$\Pi_g = \omega(\alpha \otimes \alpha)^{-g} W_{\mathcal{C}}(\Sigma_g \times [0, 1]; \alpha) =$$

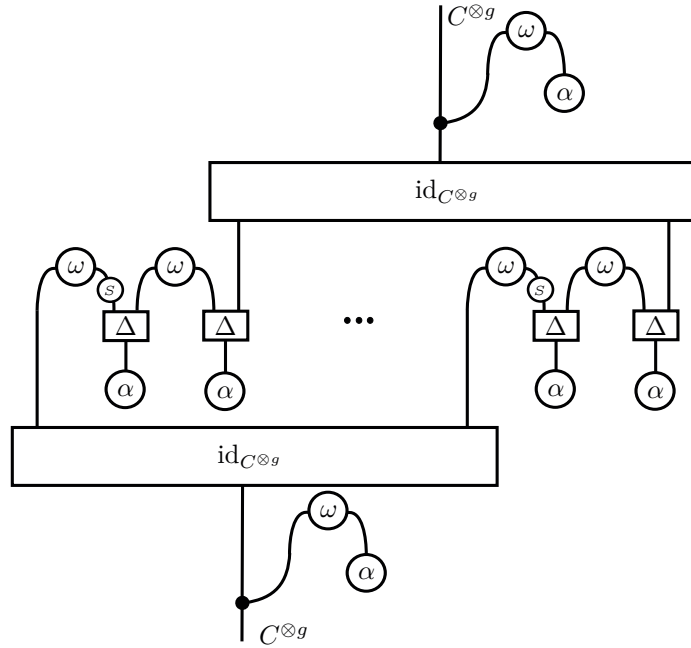

is an idempotent of \mathcal{C} and then splits: there exist two morphisms p_g and q_g such that $p_g q_g = \text{id}_{\text{Im}(\Pi_g)}$ and $q_g p_g = \Pi_g$. For $\underline{g} = (g_1, \dots, g_r)$ a tuple of integers, denote $p_{\underline{g}} = p_{g_1} \otimes \dots \otimes p_{g_r}$ and $q_{\underline{g}} = q_{g_1} \otimes \dots \otimes q_{g_r}$. We are ready now to give the two main results of this chapter: Theorem 4.4.4 and Theorem 4.4.6.

Theorem 4.4.4 — Let $\alpha \in \text{Hom}_{\mathcal{C}}(\mathbb{1}, C)$ be an admissible element. Then for every connected parametrized surface Σ_g of genus g and for every connected 3-cobordism M_T of $\text{Cob}_3^p(g, \underline{h})$ represented by a (g, n, \underline{h}) -cobordism tangle T , the assignment:

$$V_{\mathcal{C}}(\Sigma_g; \alpha) = \text{Im}(\omega(\alpha \otimes \alpha)^{-g} W_{\mathcal{C}}(\Sigma_g \times [0, 1]; \alpha)) \tag{4.4.5}$$

$$V_{\mathcal{C}}(M_T; \alpha) = \nu_{\alpha} p_{\underline{h}}(T) (p_{\mathcal{C}, \alpha} q_{\alpha, g}) q_g \tag{4.4.6}$$

defines a TQFT with anomaly (V, γ) between the category Cob_3^p and the subcategory of transparent objects \mathcal{T} of \mathcal{C} where the anomaly γ is given by:

$$\gamma_{M_T, M_{T'}} = (\theta_+ \alpha)^{b_+(T) + b_+(T') - b_+(T \star T')} (\theta_- \alpha)^{b_-(T) + b_-(T') - b_-(T \star T')},$$

Proof. See Section 4.5.6 □

Remarks 4.4.5 –

- The space $V_{\mathcal{C}}(\Sigma_g; \alpha)$ is the image of the projector $\omega(\alpha \otimes \alpha)^{-g} |\Sigma_g \times [0, 1]|_{\mathcal{C}, \alpha} =$

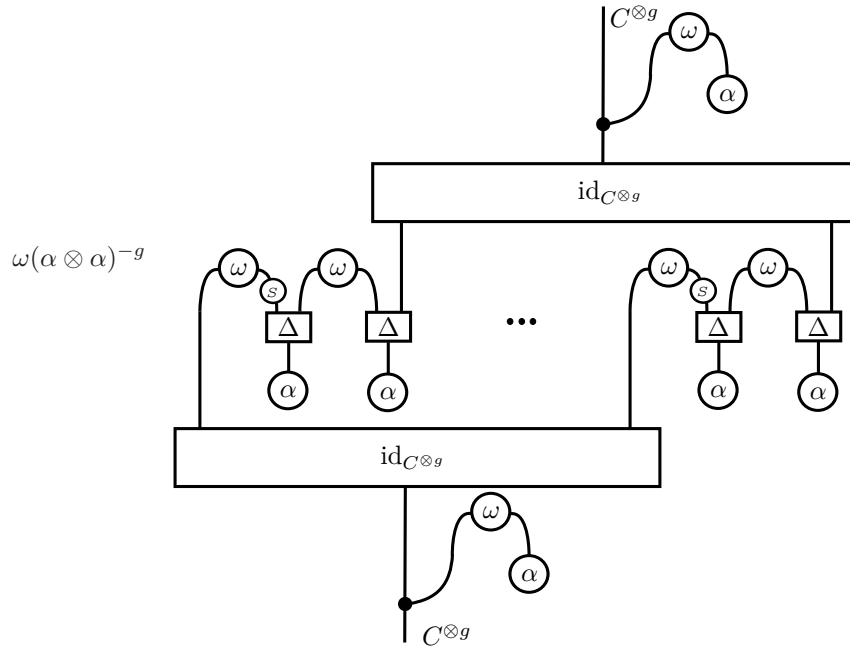

- If \mathcal{C} is modular, we recover the Reshetikhin-Turaev TQFT as it is explained in Chapter 5.

Theorem 4.4.6 — Let $\alpha: \mathbb{1} \rightarrow C$ be an admissible element. The TQFT $V_{\mathcal{C}}(\ ; \alpha)$ can be expressed entirely in terms of α and the structural morphisms

$$m, \Delta, \varepsilon, u, S, S^{-1}, \theta_+, \theta_-, \omega, \tau_{C, C}, \tau_{C, C}^{-1}, \text{id}_C$$

of the coend C .

Remark 4.4.7 – To compute the TQFT, note that the product m of the coend C is only used to express the universal coaction on tensorial products of the coend C (see Figure 4.3).

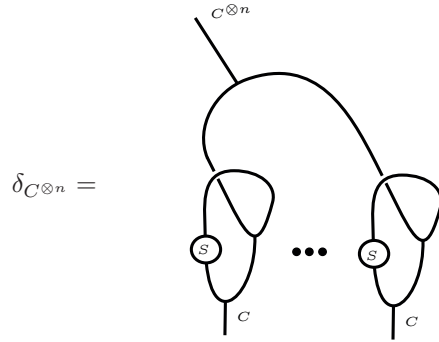
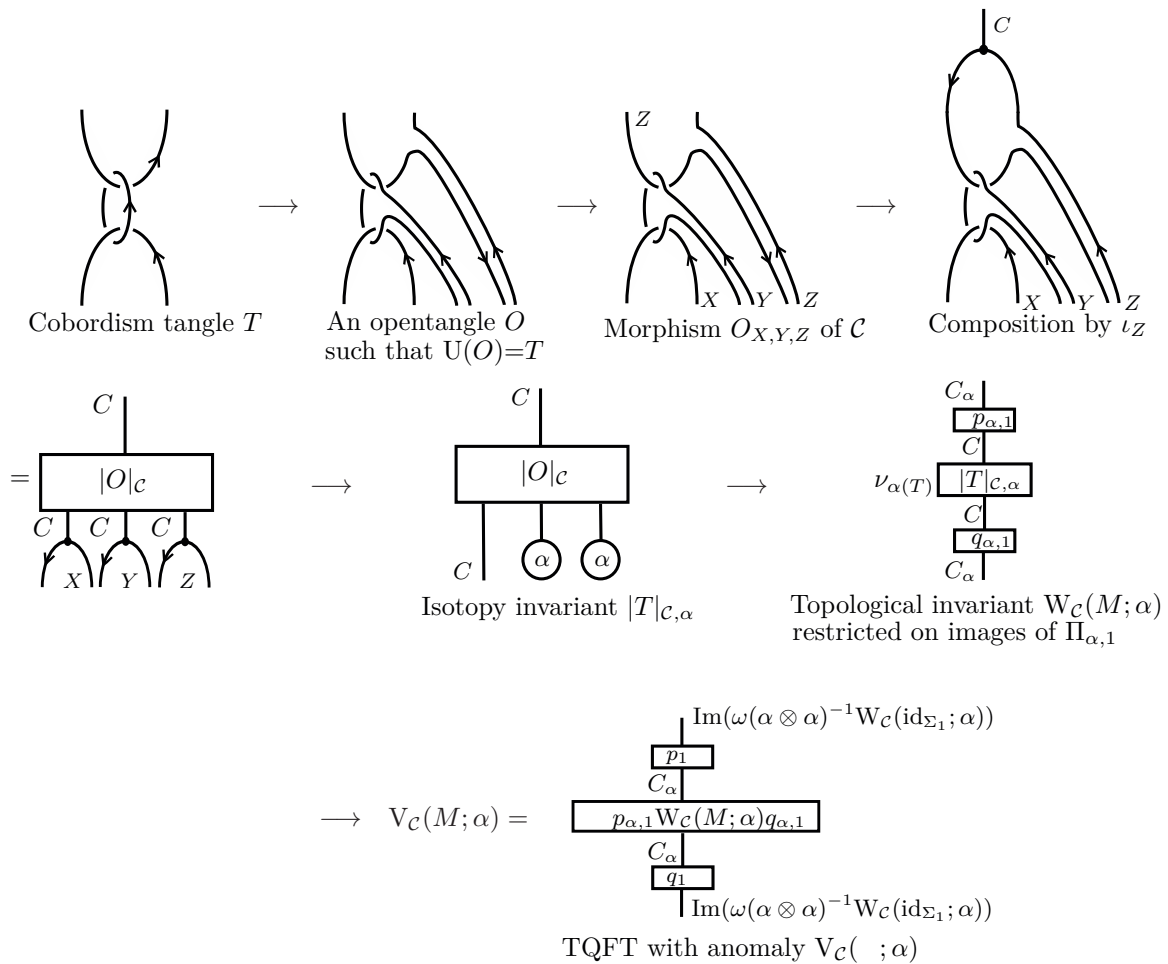

Figure 4.3 – The morphism $\delta_{C^{\otimes n}}$.

Before starting proofs of the different results of this chapter, we illustrate the steps of the construction on the example of the cylinder $M_T = \Sigma_1 \times [0, 1]$ on the surface Σ_1 of genus 1:



where

$$\begin{aligned} \Pi_{\alpha,1} &= q_{\alpha,1} p_{\alpha,1}, \\ p_{\alpha,1} q_{\alpha,1} &= \text{id}_{C_\alpha}, \quad (\text{see Section 4.4.2}) \end{aligned}$$

$$\omega(\alpha \otimes \alpha)^{-1} W_{\mathcal{C}}(\text{id}_{\Sigma_1}; \alpha) = q_1 p_1,$$

and

$$p_1 q_1 = \text{id}_{\text{Im}(\omega(\alpha \otimes \alpha)^{-1} W_{\mathcal{C}}(\text{id}_{\Sigma_1}; \alpha))}.$$

4.5 Proofs

4.5.1 Proof of Lemma 4.2.1

Proof. Consider an isotopy class T of a (g, n, \underline{h}) -cobordism tangle and two (g, n, \underline{h}) -opentangles T_1^o and T_2^o such that $U(T_1^o) = T = U(T_2^o)$ where the map U is defined in 3.1.2. Then, as it is explained in Section 3.1.4, there exists a finite sequence of planar isotopies and ribbon Reidemeister moves, moves BA (see Figure 3.7), moves ESC (see Figure 3.8), and moves ROT (see Figure 3.9) between diagrams of T_1^o and T_2^o . We have to show that

$$|T_1^o|_{\mathcal{C}}(\text{id}_{\mathcal{C}^{\otimes |g|}} \otimes \alpha^{\otimes n + |\underline{h}|}) = |T_2^o|_{\mathcal{C}}(\text{id}_{\mathcal{C}^{\otimes |g|}} \otimes \alpha^{\otimes n + |\underline{h}|}). \quad (4.5.7)$$

If T_1^o and T_2^o differ by planar isotopies and ribbon Reidemeister moves, the equality 4.5.7 is obvious because $|\cdot|_{\mathcal{C}}$ is an isotopy invariant of opentangles (see Lemma 4.1.1). Suppose now that T_1^o and T_2^o , considered as diagrams, differ only from one move BA as it is illustrated in Figure 4.4.

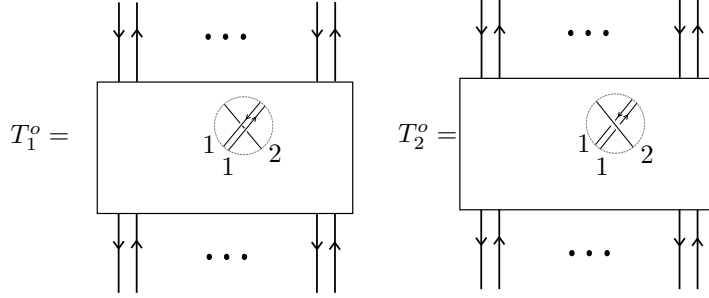

Figure 4.4 – One different crossing between T_1^o and T_2^o .

By isotopy, we modify the diagrams of opentangles T_1^o and T_2^o such that the difference of crossings is at the bottom of the diagram as shown in Figure 4.5.

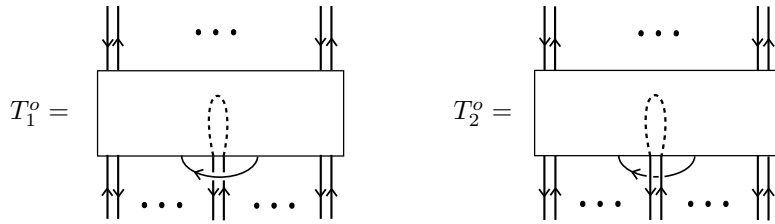

Figure 4.5 – One different bottom crossing between T_1^o and T_2^o .

Now, let $\underline{X} = X_1, \dots, X_{|g|+n+|\underline{h}|}$ be objects of \mathcal{C} and color T_1^o and T_2^o by those objects to obtain morphisms of \mathcal{C} , $T_{1,\underline{X}}^o$ and $T_{2,\underline{X}}^o$. Suppose that the crossing which is different between T_1^o and T_2^o affects the i th component such that $|g| + 1 \leq i \leq |g| + n + |\underline{h}|$ (a surgery component or an exit component) and denote by Y the color of the other component in the crossing and by

$$f: X_1^* \otimes X_1 \otimes \dots \otimes Y^* \otimes X_i^* \otimes X_i \otimes Y \otimes \dots \otimes X_{|g|+n+|\underline{h}|}^* \otimes X_{|g|+n+|\underline{h}|} \rightarrow X_{|g|+n+1}^* \otimes X_{|g|+n+1} \otimes \dots \otimes X_{|g|+n+|\underline{h}|}^* \otimes X_{|g|+n+|\underline{h}|}$$

the morphism of \mathcal{C} defined in Figure 4.6.

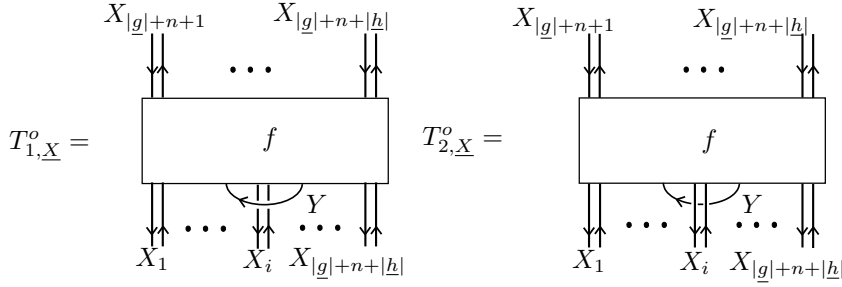

Figure 4.6 – The morphisms $T_{1,\underline{X}}^o$ and $T_{2,\underline{X}}^o$ of \mathcal{C} associated to tangles T_1^o and T_2^o .

Note that there exists $j \in \mathbb{N}$ such that $Y = X_j$.

Suppose that $j \neq i$ and without loss of generality that $j = |g| + n + |h|$. Using dinaturality of $(\iota_{X_{|g|+n+1}} \otimes \dots \otimes \iota_{X_{|g|+n+|h|}}) \circ f$ in $X_1, \dots, X_{|g|+n+|h|-1}$ and using Fubini theorem (see [ML98] and see Lemma 1.2.4) with parameters Y^* and Y , by universal property of the coend \mathcal{C} , there exists a unique morphism

$$\psi_f: \mathcal{C}^{\otimes i-1} \otimes Y^* \otimes \mathcal{C} \otimes Y \otimes \mathcal{C}^{\otimes |g|+n+|h|-i-1} \otimes Y^* \otimes Y \rightarrow \mathcal{C}^{\otimes |h|}$$

such that, for all objects $X_1, \dots, X_{|g|+n+|h|-1}$ of \mathcal{C} ,

$$(\iota_{X_{|g|+n+1}} \otimes \dots \otimes \iota_{X_{|g|+n+|h|}}) \circ f = \psi_f \circ (\iota_{X_1} \otimes \dots \otimes \text{id}_{Y^*} \otimes \iota_{X_i} \otimes \text{id}_Y \otimes \iota_{X_{i+1}} \otimes \dots \otimes \iota_{X_{|g|+n+|h|-1}} \otimes \text{id}_{Y^* \otimes Y})$$

Moreover, we know by Lemma 4.1.1 that

$$(\iota_{X_{|g|+n+1}} \otimes \dots \otimes \iota_{X_{|g|+n+|h|}}) \circ T_{1,\underline{X}}^o = |T_1^o|_{\mathcal{C}} \circ (\iota_{X_1} \otimes \dots \otimes \iota_{X_{|g|+n+|h|}})$$

and

$$(\iota_{X_{|g|+n+1}} \otimes \dots \otimes \iota_{X_{|g|+n+|h|}}) \circ T_{2,\underline{X}}^o = |T_2^o|_{\mathcal{C}} \circ (\iota_{X_1} \otimes \dots \otimes \iota_{X_{|g|+n+|h|}}).$$

Thus we have the two identities showed on Figure 4.7.

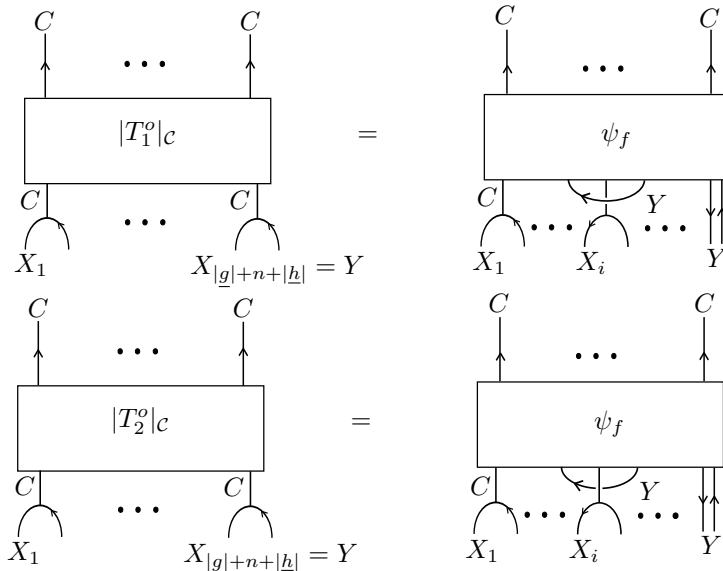

Figure 4.7 – Two factorizations of $(\iota_{X_{|g|+n+1}} \otimes \dots \otimes \iota_{X_{|g|+n+|h|}})T_{1,\underline{X}}^o$ (resp. $T_{2,\underline{X}}^o$)

Remark that in one hand, we have for all objects Y of \mathcal{C}

$$|T_1^o|_{\mathcal{C}} \circ (\text{id}_{C^{\otimes |g|+n+|h|-1}} \otimes \iota_Y) = \psi_f \circ (\text{id}_{C^{\otimes i-1}} \otimes \bigcup_C Y \otimes \text{id}_{C^{\otimes |g|+n+|h|-i-1}} \otimes \text{id}_{Y^* \otimes Y}) \quad (4.5.8)$$

and in the other hand, we have

$$|T_2^o|_{\mathcal{C}} \circ (\text{id}_{C^{\otimes |g|+n+|h|-1}} \otimes \iota_Y) = \psi_f \circ (\text{id}_{C^{\otimes i-1}} \otimes \bigcup_C Y \otimes \text{id}_{C^{\otimes |g|+n+|h|-i-1}} \otimes \text{id}_{Y^* \otimes Y}) \quad (4.5.9)$$

Indeed, as the right member of the equation 4.5.8 is dinatural in Y with parameters C , there exists a unique morphism $\phi: C^{\otimes |g|+n+|h|} \rightarrow C^{\otimes |h|}$ such that, for all $Y \in \mathcal{C}$,

$$\psi_f \circ (\text{id}_{C^{\otimes i-1}} \otimes \bigcup_C Y \otimes \text{id}_{C^{\otimes |g|+n+|h|-i-1}} \otimes \text{id}_{Y^* \otimes Y}) = \phi \circ (\text{id}_{C^{\otimes |g|+n+|h|-1}} \otimes \iota_Y)$$

and composing with morphism $\iota_{X_1} \otimes \dots \otimes \iota_{X_{|g|+n+|h|-1}}$,

$$\psi_f \circ (\iota_{X_1} \otimes \dots \otimes \bigcup_C Y \circ \iota_{X_i} \otimes \dots \otimes \iota_{X_{|g|+n+|h|-1}} \otimes \text{id}_{Y^* \otimes Y}) = \phi \circ (\iota_{X_1} \otimes \dots \otimes \iota_{X_{|g|+n+|h|-1}} \otimes \iota_Y)$$

so, using the first equality of Figure 4.7,

$$|T_1^o|_{\mathcal{C}} \circ (\iota_{X_1} \otimes \dots \otimes \iota_{X_{|g|+n+|h|}}) = \phi \circ (\iota_{X_1} \otimes \dots \otimes \iota_{X_{|g|+n+|h|}})$$

and by unicity of this factorization

$$|T_1^o|_{\mathcal{C}} = \phi.$$

And now, we compute the invariant $|T|_{\mathcal{C}, \alpha}$ using T_1^o and T_2^o . Using the opentangle T_1^o , we have equality showed on Figure 4.8.

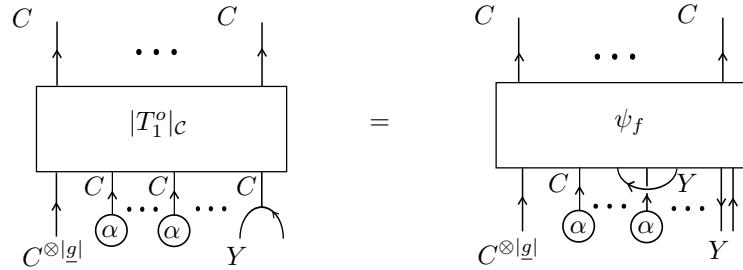

Figure 4.8 – Toward the computation of the invariant $|T|_{\mathcal{C}, \alpha}$ using T_1^o .

In the same way, using the opentangle T_2^o , we have equality showed on Figure 4.9.

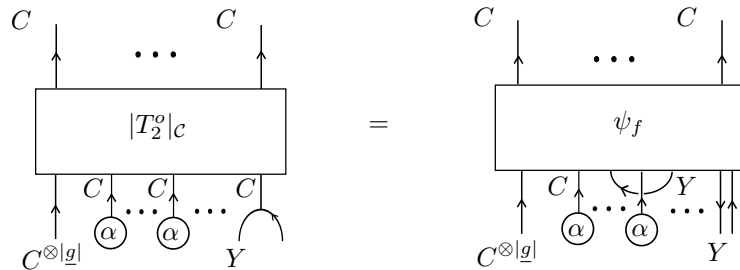

Figure 4.9 – The invariant $|T|_{\mathcal{C}, \alpha}$ using T_2^o .

But the braiding of C is natural and $c_{Y, \mathbb{1}} = \text{id}_{\mathbb{1}}$ as shown in Figure 4.10

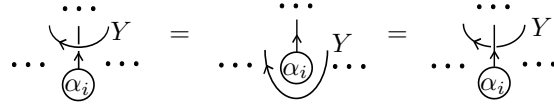

Figure 4.10 – Naturality of the braiding and trivial braiding on $\mathbb{1}$.

Thus we have identities of Figure 4.11

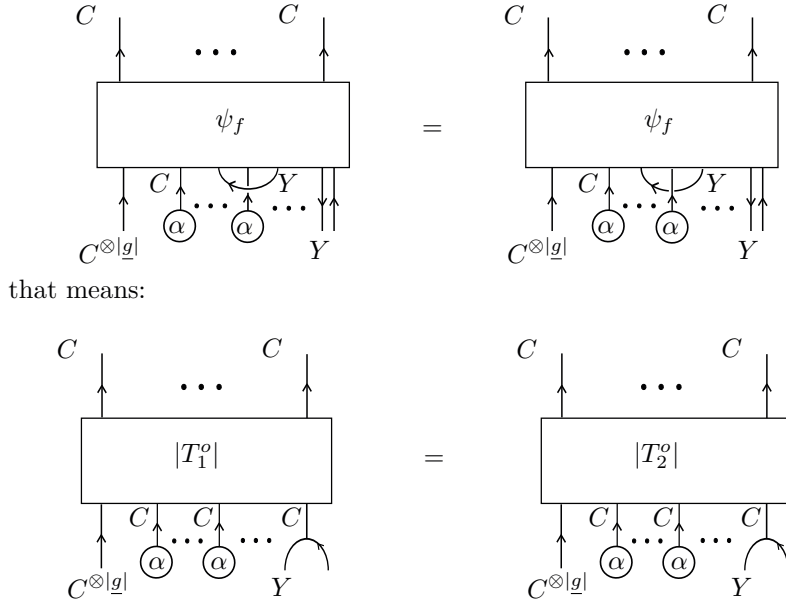

Figure 4.11 – Equal invariants.

and then by the factorization property of the coend C ,

$$|T_1^o|_c(\text{id}_{C^{\otimes |g|}} \otimes \alpha^{\otimes n+|h|-1} \otimes \text{id}_C) = |T_2^o|_c(\text{id}_{C^{\otimes |g|}} \otimes \alpha^{\otimes n+|h|-1} \otimes \text{id}_C)$$

so composing with the missing α ,

$$|T_1|_{c,\alpha} = |T_2|_{c,\alpha}.$$

Secondly, suppose that diagrams of opentangles T_1^o and T_2^o differ only by one move ESC (see Figure 3.8) as it is illustrated in Figure 4.12. where T is a (g, n, h) -opentangle. Applying Lemma 1.2.4 to the (g, n, h) -opentangle T , there exists a morphism $|T|_c: C^{\otimes |g|+n+|h|} \rightarrow C^{|h|}$ such that we have identities of Figure 4.13.

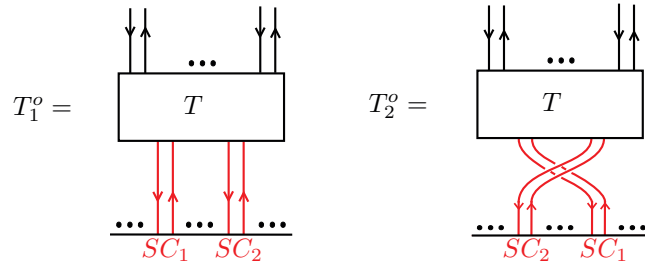

Figure 4.12 – One permutation in the ordered surgery components of an opentangle.

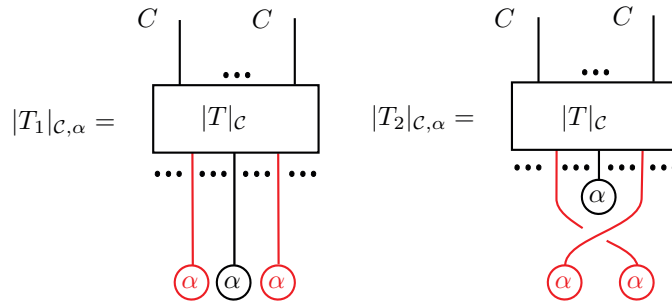

Figure 4.13 – Computation of the invariant $|c, \alpha$ with T_1^o and T_2^o .

As the braiding τ is natural and $\tau_{\mathbb{1}, \mathbb{1}} = \text{id}_{\mathbb{1}} = \text{id}_{\mathbb{1} \otimes \mathbb{1}}$, we have equalities of Figure 4.14. And so

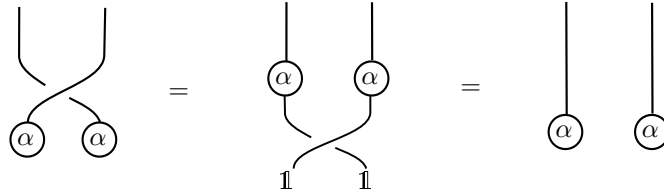

Figure 4.14 – Natural braiding and transparent object $\mathbb{1}$

$$|T_1|c, \alpha = |T_2|c, \alpha.$$

Lastly, suppose that diagrams of opentangles T_1^o and T_2^o differ only by one move *ROT* (see Figure 3.9). The invariance by this last move comes from naturality of θ . Indeed we have then $\theta_{\pm C} \alpha = \alpha \theta_{\mathbb{1}} = \alpha$ since $\theta_{\mathbb{1}} = \text{id}_{\mathbb{1}}$. \square

4.5.2 Proof of Lemma 4.2.3

Proof. Let us give the idea of the proof on simple cobordism tangles. Suppose that T_1 is a $((1), 2, (1))$ -cobordism tangle, T_2 is a $((1), 1, (1, 1))$ -cobordism tangle. Denote by T_1^o a $((1), 2, (1))$ -opentangle and by T_2^o a $((1), 1, (1, 1))$ -opentangle such that $U(T_1^o) = T_1$ and $U(T_2^o) = T_2$ (see 3.1.2) that means we have equalities of Figure 4.15.

Choose the following $((1, 1), 3, (1, 2))$ -opentangle O drawn on Figure 4.16.

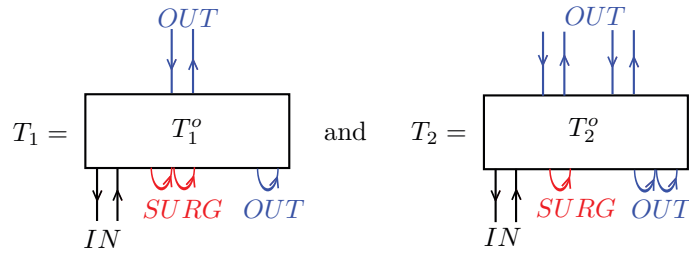

Figure 4.15 – Opentangles T_1^o and T_2^o such that $T_1 = U(T_1^o)$ and $T_2 = U(T_2^o)$.

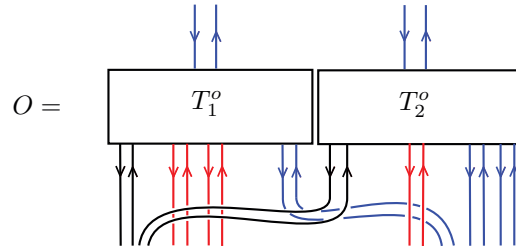

Figure 4.16 – Opentangle O such that $T_1 \sqcup T_2 = U(O)$.

Remark that the universal morphism $|O|_C$ is equal to the morphism

$$(|T_1^o|_C \otimes |T_2^o|_C) \left(\begin{array}{c} \text{diagram with crossings} \\ \text{CCCCCCCC} \end{array} \right)$$

and then

$$|T_1 \sqcup T_2|_{C,\alpha} = (|T_1^o|_C \otimes |T_2^o|_C) \left(\begin{array}{c} \text{diagram with crossings} \\ \text{CCCCCCCC} \end{array} \right) (\text{id}_{C^{\otimes 2}} \otimes \alpha^{\otimes 6}) = |T^o|$$

As the braiding τ is natural, $C \otimes \mathbb{1} = \mathbb{1} \otimes C = C$, $\tau_{\mathbb{1},C} = \text{id}_C$ and $\tau_{C,\mathbb{1}} = \text{id}_{\mathbb{1}}$,

$$(|T_1^o|_C \otimes |T_2^o|_C) \left(\begin{array}{c} \text{diagram with crossings} \\ \text{CCCCCCCC} \end{array} \right) (\text{id}_{C^{\otimes 2}} \otimes \alpha^{\otimes 6}) = |T_1^o|_C(\text{id}_C \otimes \alpha^{\otimes 3}) \otimes |T_2^o|_C(\text{id}_C \otimes \alpha^{\otimes 3})$$

and we get the expected result. □

4.5.3 Proof of Lemma 4.3.4

Proof. Let T_1 and T_2 be two (g, n, \hbar) -cobordism tangles that differ by one move KII^g . Let us compute $|T_1^o|_{C,\alpha}$ and $|T_2^o|_{C,\alpha}$.

- First, suppose that an entrance component slides over a surgery component and without loss of generality, we suppose that the entrance component and the surgery component are the first ones as illustrated on the following picture:

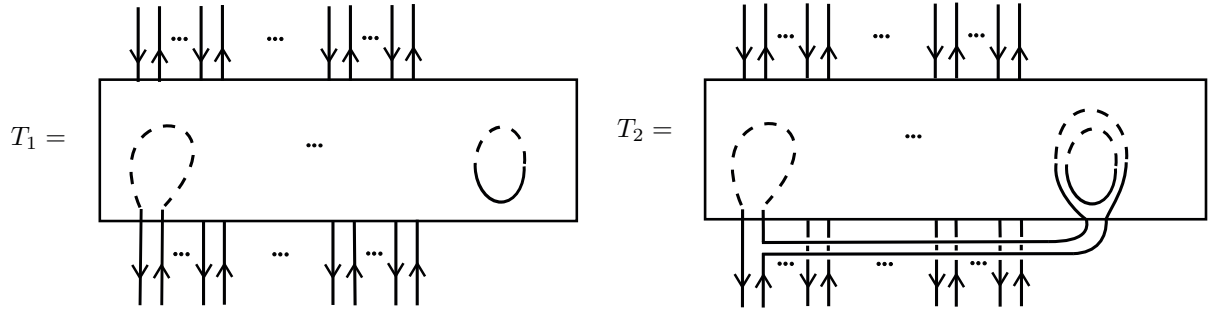

Note that we can always suppose that the "sliding" part of the entrance component is located on the bottom of the picture (if not, you could "transport" by isotopy the little piece of the entrance component of T_2 that had slid over the surgery component to the bottom of the tangle T_2). We choose two opentangles O_1 and O_2 coming respectively from T_1 and T_2 (that means $U(O_1) = T_1$ and $U(O_2) = T_2$) as shown just below:

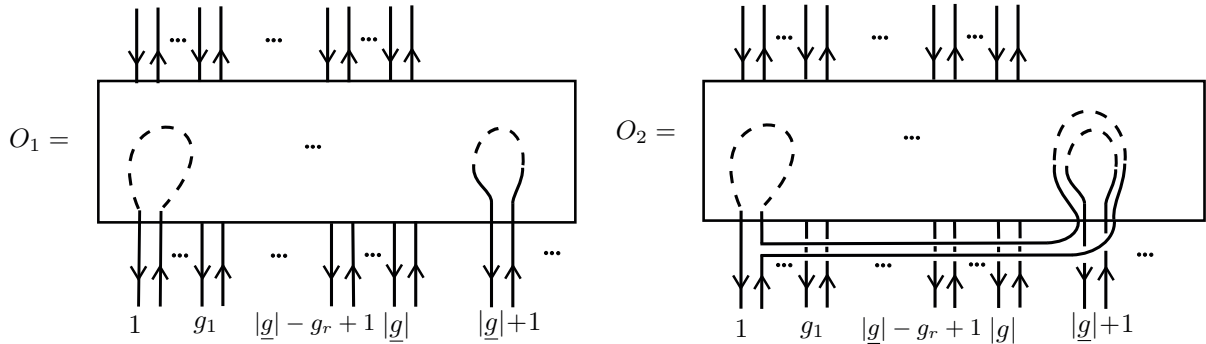

After coloring O_1 and O_2 by objects of \mathcal{C} (we only particularize the color X corresponding to the first entrance component of O_1 and O_2 and the color Y on the first surgery component of O_1 and O_2) and composing this morphism of \mathcal{C} with the universal dinatural action ι of the coend tensored as many times as the number of exit components $|\underline{h}|$, we obtain a dinatural transformation $d_{X,\dots,Y,\dots}$ which is dinatural in every entrance pairs:

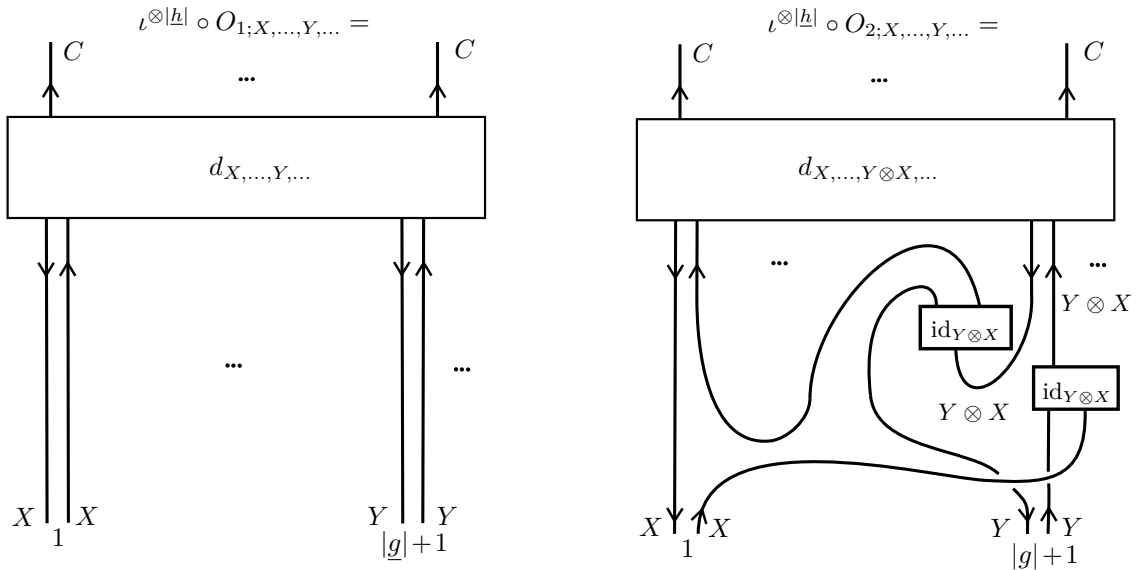

By universal property of the coend, there exists a unique morphism $\phi: C^{\otimes |\underline{g}|+n+|\underline{h}|} \rightarrow C^{|\underline{h}|}$ such that $\forall X \in \mathcal{C}, \dots, \forall Y \in \mathcal{C}, \dots,$

$$d_{X,\dots,Y,\dots} = \phi(\iota_X \otimes \dots \otimes \iota_Y \otimes \dots)$$

and then, we can factorize the two last diagrams using the morphism ϕ and the universal action ι :

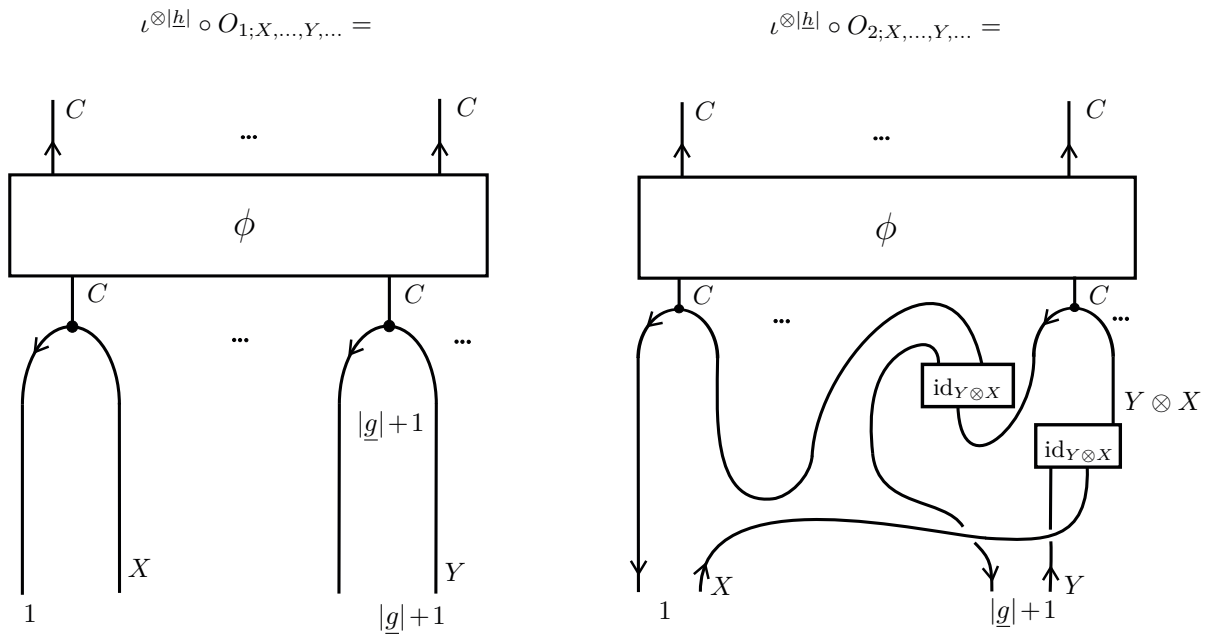

Using the definition of Δ , the morphism $\iota^{\otimes |\underline{h}|} \circ O_{2;X,\dots,Y,\dots}$ is equal to

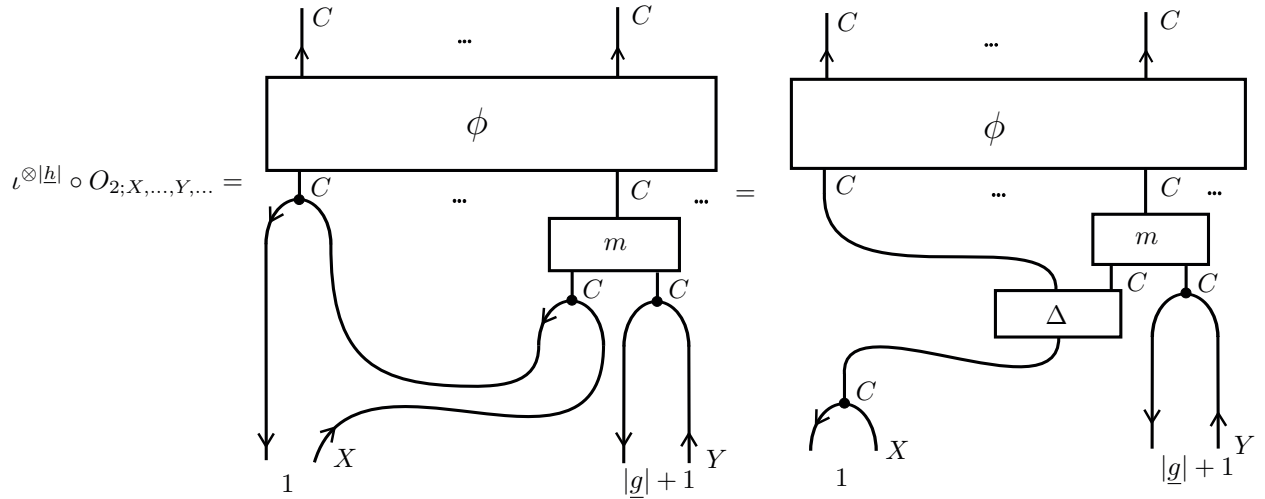

Consequently, the morphism $|T_2|_{C,\alpha}$ is given by:

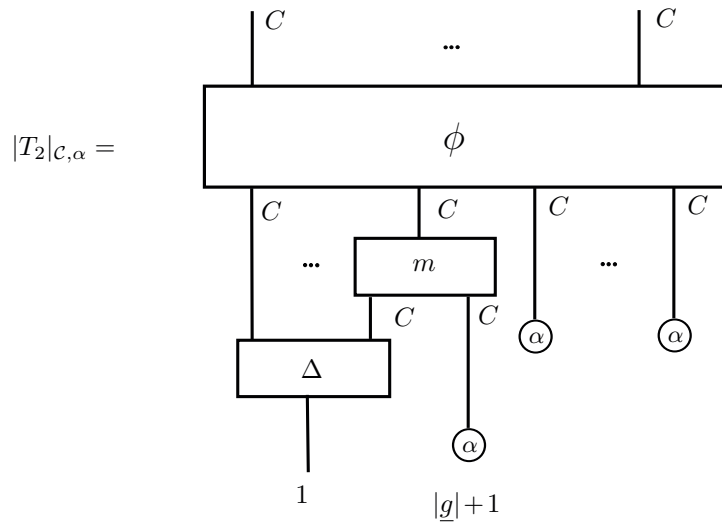

so, according to lemma 4.3.3, the morphism $|\mathring{T}_{C,\alpha}|$ is given by:

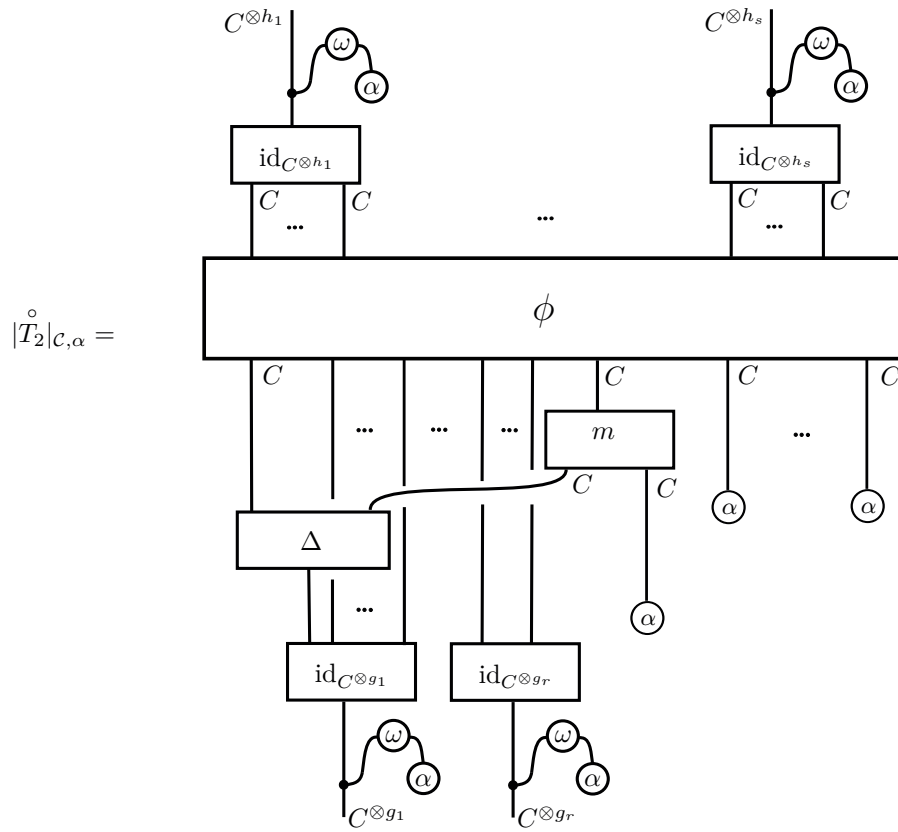

and since α satisfies (Ad5) and using the result of lemma 4.3.2:

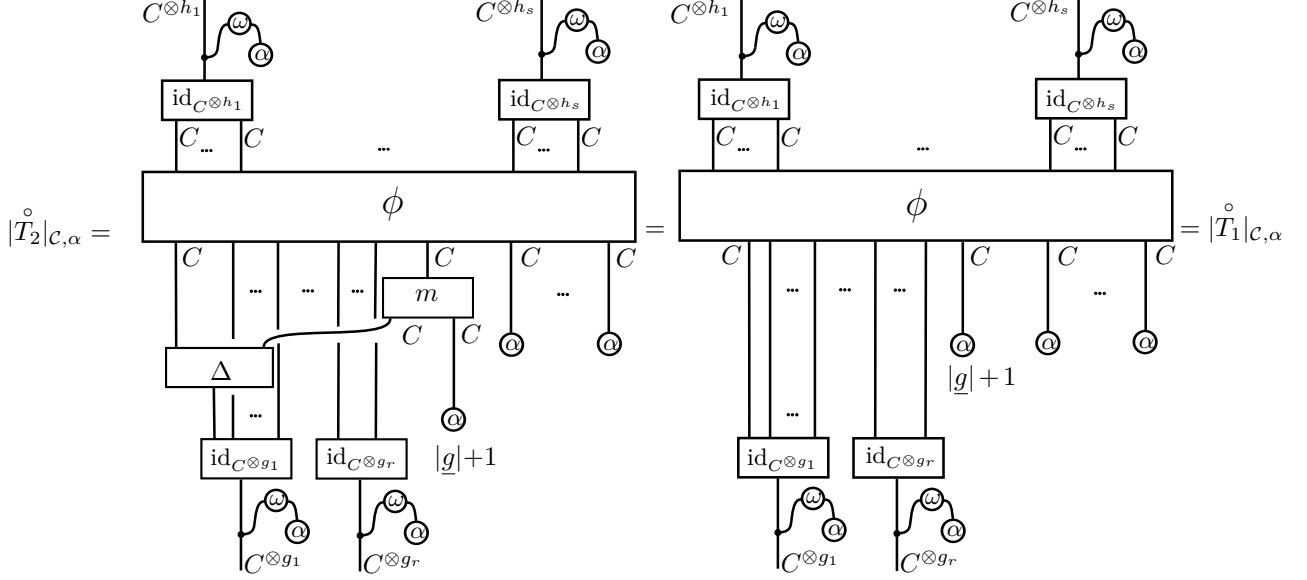

Then $|\overset{\circ}{T}_1|_{C, \alpha} = |\overset{\circ}{T}_2|_{C, \alpha}$.

- Secondly, suppose that a surgery component slides over another (or itself) surgery component. The topological proof is essentially the same than previously. As there is two surgery components, to assure that we have an invariant by the classical move KII , this time we only need to satisfy the axiom

$$(\text{id}_C \otimes m)(\Delta \otimes \text{id}_C)(\alpha \otimes \alpha) = \alpha \otimes \alpha \quad (4.5.10)$$

The latter is a consequence of axiom (Ad1) and (Ad5). Indeed, as the we suppose (Ad5), we have

$$(\text{id}_C \otimes m)(\Delta \otimes \text{id}_C)(\text{id}_C \otimes \alpha)(\text{id}_C \otimes \omega(\text{id}_C \otimes \alpha))\delta_C = [(\text{id}_C \otimes \omega(\text{id}_C \otimes \alpha))\delta_C] \otimes \alpha.$$

Composing the last equality by α , we obtain

$$(\varepsilon\alpha)(\text{id}_C \otimes m)(\Delta \otimes \text{id}_C)(\alpha \otimes \alpha) = (\varepsilon\alpha)(\alpha \otimes \alpha)$$

because the transformation $\delta = \{\delta_X : X \rightarrow X \otimes C\}$ is natural, $u = \delta_{\mathbb{1}}$, $\omega(u \otimes \text{id}_C) = \varepsilon$ (properties of the Hopf pairing ω) and $\varepsilon\alpha$ is invertible by (Ad1). Consequently, the identity 4.5.10 is true.

- Thirdly, suppose that an exit component slides over a surgery component and without loss of generality that the first exit component slides over the first surgery component. Moreover, we can assume that the "sliding part" of the exit component is located at the top of the exit component as it is drawn of the following picture:

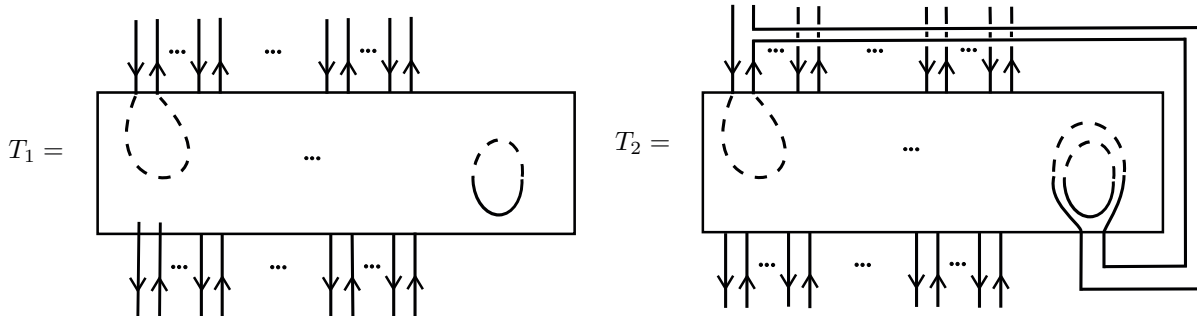

We choose two opentangles P_1 and P_2 associated respectively to T_1 and T_2 as shown on the picture:

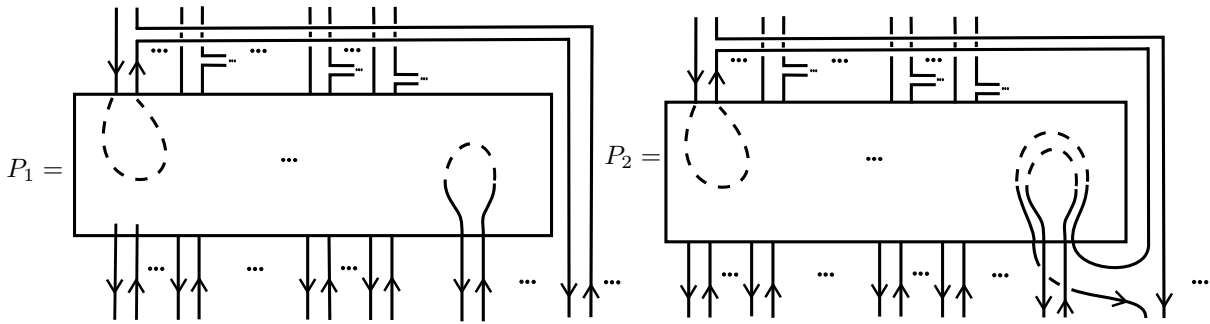

The sequel of the reasoning is the same as in the first case. As ι is dinatural, note that multiplication m of the coend could be defined graphically by the two following forms:

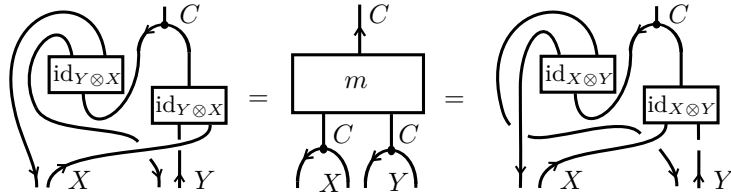

We use the second form in this case and to conclude, we observe that we only need to satisfy the axiom:

$$(m \otimes \text{id}_C)(\text{id}_C \otimes \Delta)(\alpha \otimes \alpha) = \alpha \otimes \alpha \tag{4.5.11}$$

Note that in the case where (Ad 2) is satisfied, the two identities 4.5.10 and 4.5.10 are equivalent as it is proved in [Vir06] (just using elementary axioms of m , Δ and S). As we have proved in the second case that 4.5.10 is true, 4.5.11 is satisfied and the third and last case is proved. \square

4.5.4 Proof of Lemma 4.3.5

Recall that

$$\nu_\alpha(T) = (\theta_+ \alpha)^{-b_+(T)} (\theta_- \alpha)^{-b_-(T)} \in \text{End}_C(\mathbf{1}).$$

and

$$W_C(T; \alpha) = \nu_\alpha(T) |T|_{C, \alpha}^\circ.$$

Proof. Let M be a connected 3-cobordism of $Cob_3^p(\underline{g}, \underline{h})$ and let $[T_1]$ and $[T_2]$ be two cobordism tangles of $\bigsqcup_{n \in \mathbb{N}} Tang^{Cob}(\underline{g}, n, \underline{h})$ which represent the cobordism M that is $N([T_1]) = M = N([T_2])$ where the map N is defined in Section 3.2.3. Our goal is to prove that $W_C(M_{T_1}; \alpha) = W_C(M_{T_2}; \alpha)$.

As indicated in section 3.2.3, $[T_1]$ and $[T_2]$ are equivalent if and only if a diagram of $[T_1]$ and a diagram of $[T_2]$ are related by a planar isotopy and a finite sequence of moves of type SO , KI , KII^g , $COUPON$, and $TWIST$. In the sequel, we denote indifferently by T_1 and T_2 the tangles and their diagrams. We can suppose without loss of generality that T_1 and T_2 are only isotopic or only differ by only one of the four moves SO , KI , KII^g , $COUPON$, and $TWIST$.

- If T_1 and T_2 are (planar) isotopic, then $\nu_\alpha(T_1) = \nu_\alpha(T_2)$ cause it is well-known that the linking number is an isotopy invariant and so it is the linking matrix. Moreover, if T_1 and T_2 are isotopic then $\overset{\circ}{T}_1$ and $\overset{\circ}{T}_2$ are obviously isotopic too by construction. We have already shown that $| \cdot |_{C, \alpha}$ is an isotopy invariant (see Lemma 4.2.1) and as a consequence, $W_C(M_{T_1}; \alpha) = W_C(M_{T_2}; \alpha)$.

- If one surgery component of T_1 and T_2 differs by its orientation:
In order to simplify notations on the proof, we assume that the surgery component is isolated from others components of the tangle. The general case is a direct rewriting of this particular case. Suppose that $T_1 = T \sqcup L$ and $T_2 = T \sqcup \bar{L}$ where T is a tangle of cobordism and L and \bar{L} are respectively the surgery components of T_1 and T_2 that differ by their orientation. Cause L and \bar{L} are links, $\overset{\circ}{T}_1 = \overset{\circ}{T} \sqcup L$ and $\overset{\circ}{T}_2 = \overset{\circ}{T} \sqcup \bar{L}$. As $|\overset{\circ}{T}_1|_{C, \alpha} = |\overset{\circ}{T} \sqcup L|_{C, \alpha} = |\overset{\circ}{T}|_{C, \alpha} \otimes |L|_{C, \alpha}$ and $|\overset{\circ}{T}_2|_{C, \alpha} = |\overset{\circ}{T} \sqcup \bar{L}|_{C, \alpha} = |\overset{\circ}{T}|_{C, \alpha} \otimes |\bar{L}|_{C, \alpha}$ by Lemma 4.2.3, it is sufficient to prove that $|L|_{C, \alpha} = |\bar{L}|_{C, \alpha}$.

First, compute $|L|_{C, \alpha} = \left| \begin{array}{c} \boxed{\text{---}} \\ \downarrow \text{---} \\ \downarrow \end{array} \right|_{C, \alpha}$. By the factorization property of the coend C of \mathcal{C} , there exists a unique morphism $\phi: C \rightarrow \mathbb{1}$ such that for all objects X of \mathcal{C} ,

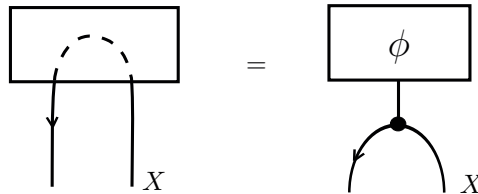

and $|L|_{C, \alpha} = \phi \alpha$.

Then, compute $|\bar{L}|_{C, \alpha} = \left| \begin{array}{c} \boxed{\text{---}} \\ \uparrow \text{---} \\ \uparrow \end{array} \right|_{C, \alpha}$. Since $\begin{array}{c} \boxed{\text{---}} \\ \uparrow \end{array} = \begin{array}{c} \boxed{\text{---}} \\ \uparrow \downarrow \end{array}$, compute $|\bar{L}|_{C, \alpha}$ using this second diagram of \bar{L} . For all objects X of \mathcal{C} ,

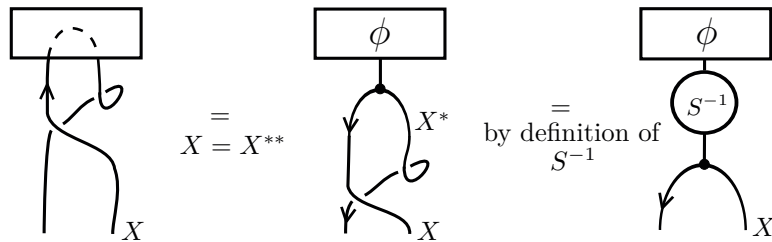

and by the factorization property of the coend, we have $|\overline{L}|_{\mathcal{C},\alpha} = \phi S^{-1}\alpha$. Thus, as $S\alpha = \alpha$ (the morphism α satisfies (Ad2)), we have $S^{-1}\alpha = \alpha$ too so $|\overline{L}|_{\mathcal{C},\alpha} = \phi\alpha$ and we conclude that $|L|_{\mathcal{C},\alpha} = |\overline{L}|_{\mathcal{C},\alpha}$. The number of positive (respectively negative) eigenvalues is invariant by changing the orientation of a link component : indeed, changing the orientation of one component goes back to change the sign of exactly the k th-line and the k th-column for a certain integer k of the linking matrix and this new matrix is similar to the first one. Then we get that $W_{\mathcal{C}}(M_{T_1};\alpha) = W_{\mathcal{C}}(M_{T_2};\alpha)$.

- If $T_1 = T_2 \sqcup \infty$, we have $|\overset{\circ}{T}_1|_{\mathcal{C},\alpha} = |\overset{\circ}{T}_2|_{\mathcal{C},\alpha} \otimes |\infty|_{\mathcal{C},\alpha}$ by Lemma 4.2.3. Compute $|\infty|_{\mathcal{C},\alpha}$: by definition of $\theta_+ : \mathcal{C} \rightarrow \mathbb{1}$ (see ??), for all objects $X \in \mathcal{C}$,

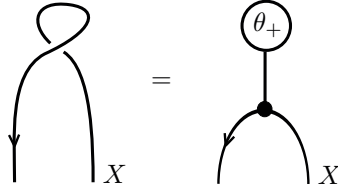

then $|\infty|_{\mathcal{C},\alpha} = \theta_+\alpha$. Since $\nu_{\alpha}(T_1) = \nu_{\alpha}(T_2 \sqcup \infty) = \nu_{\alpha}(T_2)(\theta_+\alpha)^{-1}$,

$$\nu_{\alpha}(T_1)|\overset{\circ}{T}_1|_{\mathcal{C},\alpha} = \nu_{\alpha}(T_2)(\theta_+\alpha)^{-1} \left(|\overset{\circ}{T}_2|_{\mathcal{C},\alpha} \otimes \theta_+\alpha \right) = \nu_{\alpha}(T_2)|\overset{\circ}{T}_2|_{\mathcal{C},\alpha}$$

that is $W_{\mathcal{C}}(M_{T_1};\alpha) = W_{\mathcal{C}}(M_{T_2};\alpha)$. The case where $T_1 = T_2 \sqcup \infty$ is similar.

- If T_1 and T_2 differ by one move KII^g , since α satisfies conditions (Ad1) et (Ad5), the result is the consequence of Lemma 4.3.4 and the fact that $b_{\pm}(T)$ is invariant by classical Kirby move II (handle sliding).

- If T_1 and T_2 differ by one move *COUPON*, without loss of generality, suppose that the move *COUPON* concerns the first boundary component of T_1 and T_2 as shown on the following diagram

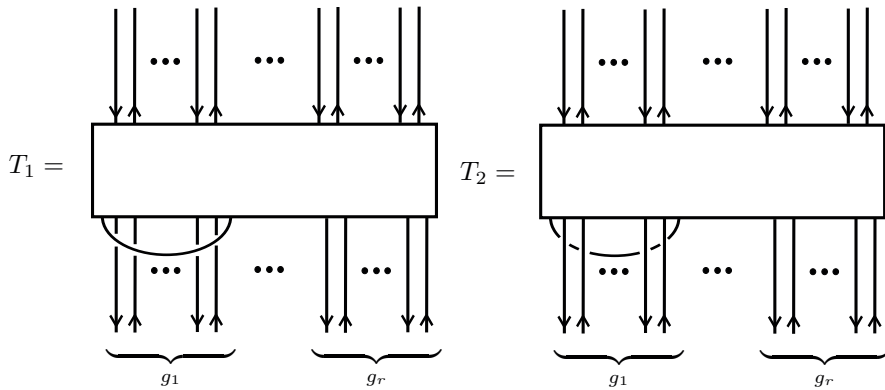

where T_1 and T_2 are (g, n, h) -cobordism tangles and $g = (g_1, \dots, g_r)$. Then $\overset{\circ}{T}_1$ and $\overset{\circ}{T}_2$ are given by:

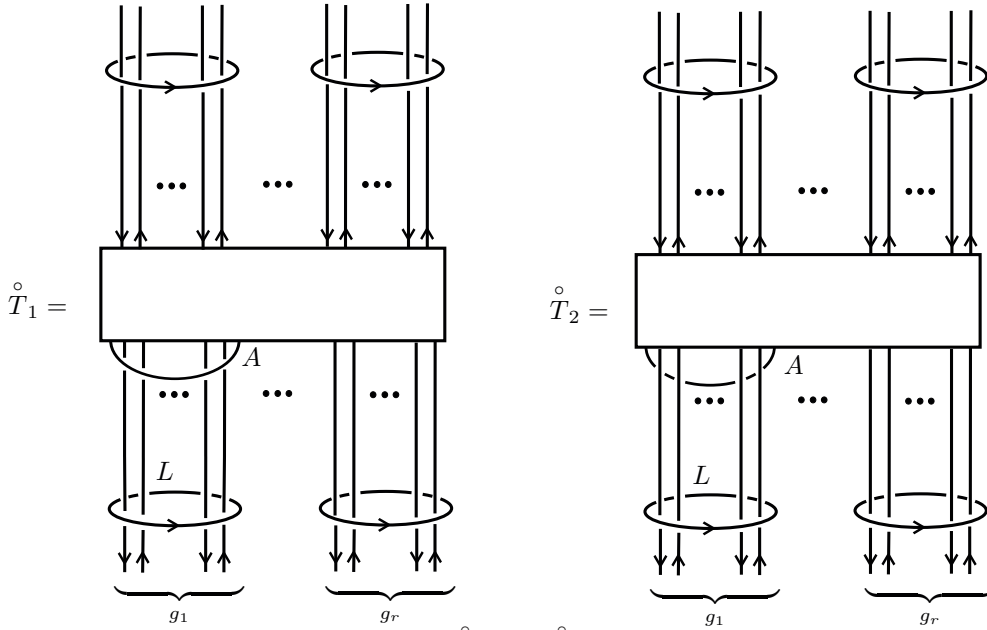

Just remark that you can transform $\overset{\circ}{T}_1$ into $\overset{\circ}{T}_2$ by a move KII^g considering that the arc A slides on the link L as indicated on the diagram just above. We have already shown that $|_{\mathcal{C}, \alpha}$ is invariant by move KII^g when α verifies (Ad1) and (Ad5) (see Lemma 4.3.4) so $|\overset{\circ}{T}_1|_{\mathcal{C}, \alpha} = |\overset{\circ}{T}_2|_{\mathcal{C}, \alpha}$ and since the move *COUPON* doesn't affect the normalization coefficient $\nu_\alpha(T)$, we conclude that $W_{\mathcal{C}}(M_{T_1}; \alpha) = W_{\mathcal{C}}(M_{T_2}; \alpha)$.

- If T_1 and T_2 differ by one move *TWIST*, then, thanks to Fenn and Rourke moves (see [FR79]), note that you can eliminate a twist of a boundary component adding an encircling closed twisted component. So add such a surgery component and remark that it could slides on halo of $\overset{\circ}{T}_1$ or $\overset{\circ}{T}_2$. Since $\theta_{\pm}\alpha$ is invertible (Ad3), we get easily the result. \square

4.5.5 Proof of the Lemma 4.4.1

Recall that for any 3-cobordism, we set $\gamma_{M,N} := \gamma_{M\#, N\#}$.

Proof. First, let us check that $(W_{\mathcal{C}}, \gamma)$ is a functor with anomaly.

- Let us see what's going on objects of Cob_3^p . Let (g_1, \dots, g_r) be a r -tuple of integers and denote by $\Sigma_{\underline{g}}$ a surface of multigenus \underline{g} that means there exists, for $1 \leq i \leq r$, a connected surface Σ_{g_i} of genus g_i such that

$$\Sigma_{\underline{g}} = \Sigma_{g_1} \sqcup \dots \sqcup \Sigma_{g_r}.$$

Note that we will forget parametrizations of surfaces in this proof. For a surface of multigenus $\underline{g} = (g_1, \dots, g_r)$, set:

$$W_{\mathcal{C}}(\Sigma_{\underline{g}}; \alpha) := (C^{\otimes g_1})_{\alpha} \otimes \dots \otimes (C^{\otimes g_r})_{\alpha}.$$

Thus we have a canonical identification $W_2(\Sigma_{\underline{g}}, \Sigma_{\underline{h}}): W_{\mathcal{C}}(\Sigma_{\underline{g}}) \otimes W_{\mathcal{C}}(\Sigma_{\underline{h}}) \xrightarrow{\sim} W_{\mathcal{C}}(\Sigma_{\underline{h}} \otimes \Sigma_{\underline{h}})$. Moreover, we set $W_{\mathcal{C}}(\emptyset; \alpha) = \mathbb{1}$.

Pay attention that on a connected 3-cobordism M_T represented by a $(\underline{g}, n, \underline{h})$ -cobordism tangle T , the formula:

$$W_{\mathcal{C}}(M_T; \alpha) = \nu_{\alpha}(T)(p_{\alpha, \underline{h}} |T|_{\mathcal{C}, \alpha} q_{\alpha, \underline{g}})$$

is obtained by the formula defined in Lemmas 4.3.5 and 4.3.6 by composing on the left by $p_{\alpha, \underline{h}}$ and on the right by $q_{\alpha, \underline{g}}$ (we have chosen a splitting of idempotents $\Pi_{\alpha, \underline{h}}$ and $\Pi_{\alpha, \underline{g}}$).

- Suppose that $M_T \in \mathcal{Cob}_3^p(\underline{g}, \underline{h})$ and $M_{T'} \in \mathcal{Cob}_3^p(\underline{h}, \underline{k})$ are two connected 3-cobordisms represented respectively by a $(\underline{g}, n, \underline{h})$ -cobordism tangle T and by a $(\underline{h}, m, \underline{k})$ -cobordism tangle T' . We want to compare $W_C(M_{T'} \circ M_T; \alpha)$ and $W_C(M_{T'}; \alpha) \circ W_C(M_T; \alpha)$.

According to Turaev (see [Tur94]), the cobordism tangle $T' \star T$ (defined in ?) encodes the compositum of 3-cobordisms $M_{T'} \circ M_T$ that means $M_{T'} \circ M_T$ is homeomorphic (as 3-cobordisms) to $M_{T' \star T}$. Recall that the tangle $T' \star T$ is defined by

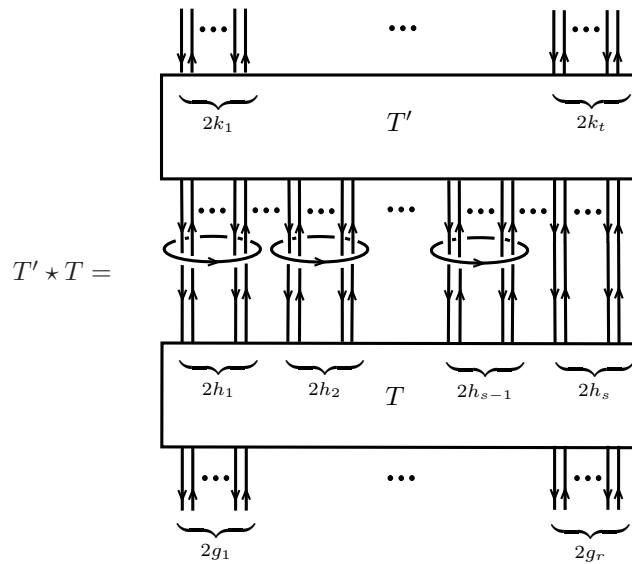

We want to show that $|T' \star T|_{\mathcal{C}, \alpha} = |T'|_{\mathcal{C}, \alpha} \circ |T|_{\mathcal{C}, \alpha}$. To be more symmetric, we define a new operation \square on cobordism tangles T' and T by

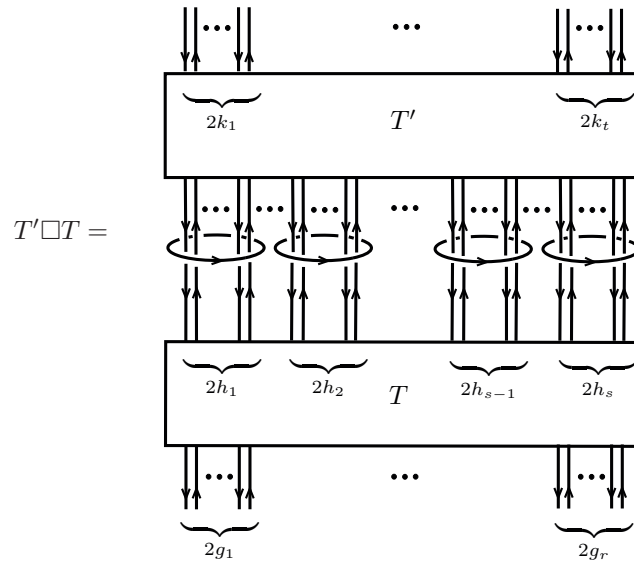

Note that $|T' \square T|_{\mathcal{C}, \alpha} = |T' \star T|_{\mathcal{C}, \alpha}$. Indeed, observe that

$$\begin{aligned}
 |T' \overset{\circ}{\square} T|_{\mathcal{C}, \alpha} &= \left| \begin{array}{c} \text{Diagram 1} \\ \text{Diagram 2} \end{array} \right|_{\mathcal{C}, \alpha} \stackrel{(2)}{=} \left| \begin{array}{c} \text{Diagram 3} \\ \text{Diagram 4} \end{array} \right|_{\mathcal{C}, \alpha} \\
 &\stackrel{(3)}{=} \left| \begin{array}{c} \text{Diagram 5} \\ \text{Diagram 6} \end{array} \right|_{\mathcal{C}, \alpha} \stackrel{(4)}{=} \left| \begin{array}{c} \text{Diagram 7} \\ \text{Diagram 8} \end{array} \right|_{\mathcal{C}, \alpha} \\
 &= |T' \star T|_{\mathcal{C}, \alpha} \otimes | \bigcirc |_{\mathcal{C}, \alpha} = |T' \star T|_{\mathcal{C}, \alpha} \otimes \varepsilon \alpha \stackrel{(7)}{=} |T' \star T|_{\mathcal{C}, \alpha}
 \end{aligned}$$

Since α is admissible, equalities (2) and (4) are due to Lemma 4.3.4 which guarantees that $| \cdot |_{\mathcal{C}, \alpha}$ is invariant by generalized Kirby move KII^g whereas the third equality is due to Lemma 4.2.1

which assures that $|\cdot|_{\mathcal{C},\alpha}$ is an isotopy invariant. Finally, equality (7) is the consequence of the first admissibility condition (Ad 1). Then we compute $|T' \star T|_{\mathcal{C},\alpha}$ using the $(g, n + m + |\underline{h}| + s, \underline{k})$ -cobordism tangle $T' \square T$. We choose an opentangle Q such that $U(Q) = T' \square T$ as shown on the following diagram:

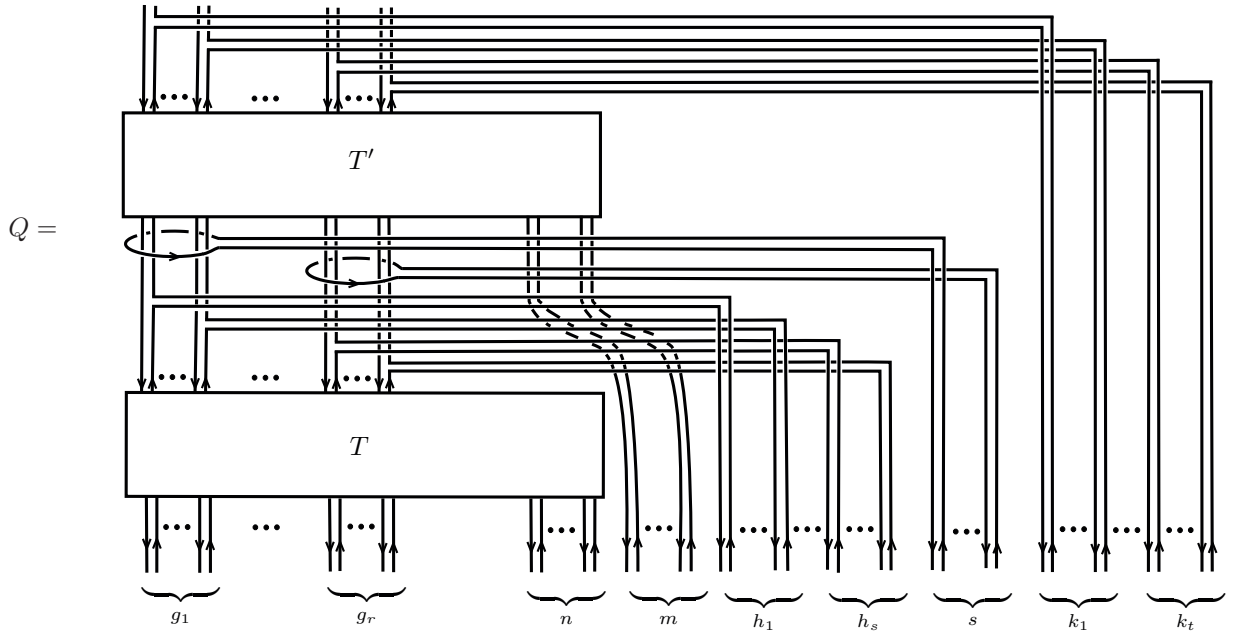

Let $X_1, \dots, X_{|g|}, Y_1, \dots, Y_n, Z_1, \dots, Z_m, A_1, \dots, A_{|\underline{h}|}, B_1, \dots, B_s, D_1, \dots, D_{|\underline{k}|}$ be any objects of \mathcal{C} and color the opentangle Q thanks to these objects:

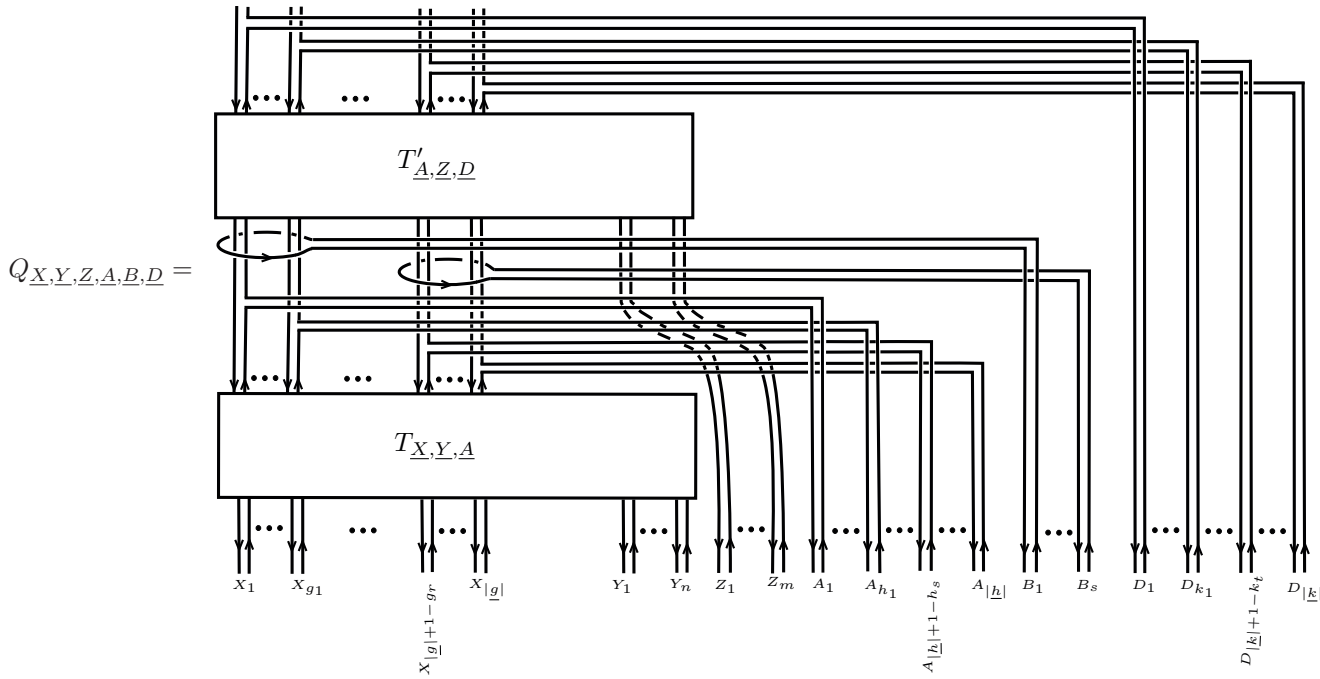

We are going to factorize this morphism "by part". First, consider one opentangle O' associated to the cobordism tangle T' defined by:

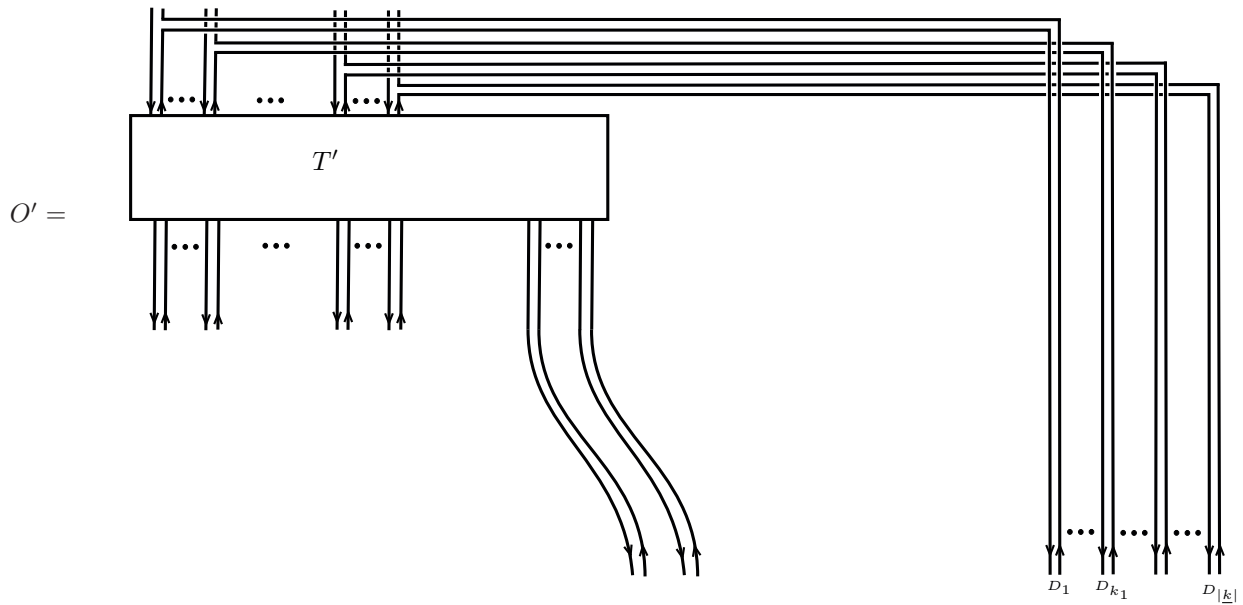

Then applying Lemma 4.1.1 to the opentangle O' , the universal morphism

$$|O'|_c: C^{|\underline{h}|+m+|\underline{k}|} \rightarrow C^{\otimes |\underline{k}|}$$

is such that for all $\underline{X}, \underline{Y}, \underline{Z}, \underline{A}, \underline{B}, \underline{D}$ tuples of objects of \mathcal{C} , the morphism $\iota_{D_1 \otimes \dots \otimes D_{|\underline{k}|}} Q_{\underline{X}, \underline{Y}, \underline{Z}, \underline{A}, \underline{B}, \underline{D}} =$

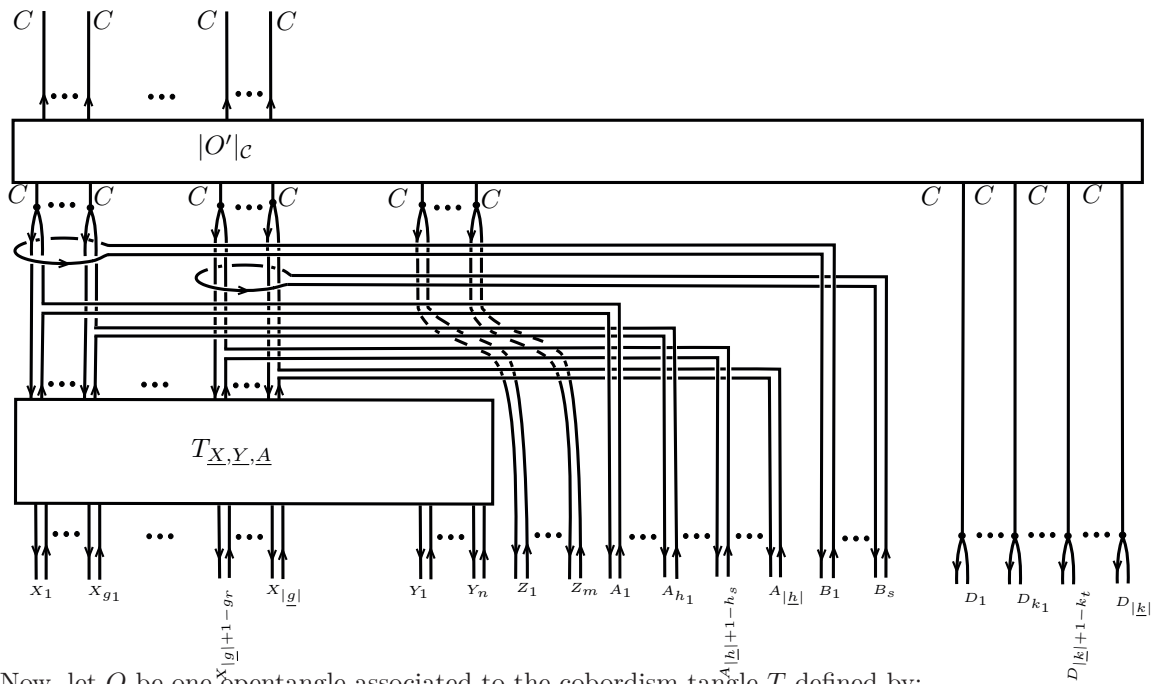

Now, let O be one opentangle associated to the cobordism tangle T defined by:

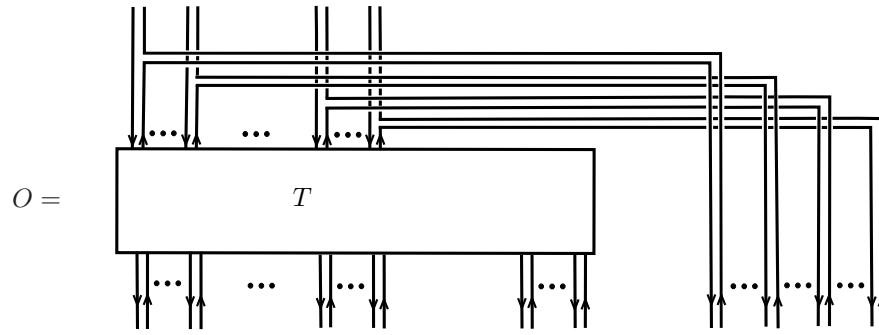

Applying Lemma 4.1.1 on the opentangle O , the universal morphism $|O|_{\mathcal{C}}: C^{|\underline{g}|+n+|\underline{h}|} \rightarrow C^{|\underline{h}|}$ is such that for all $\underline{X}, \underline{Y}, \underline{Z}, \underline{A}, \underline{B}, \underline{D}$ tuples of objects of \mathcal{C} , the morphism $\iota_{D_1 \otimes \dots \otimes D_{|\underline{k}|}} Q_{\underline{X}, \underline{Y}, \underline{Z}, \underline{A}, \underline{B}, \underline{D}} =$

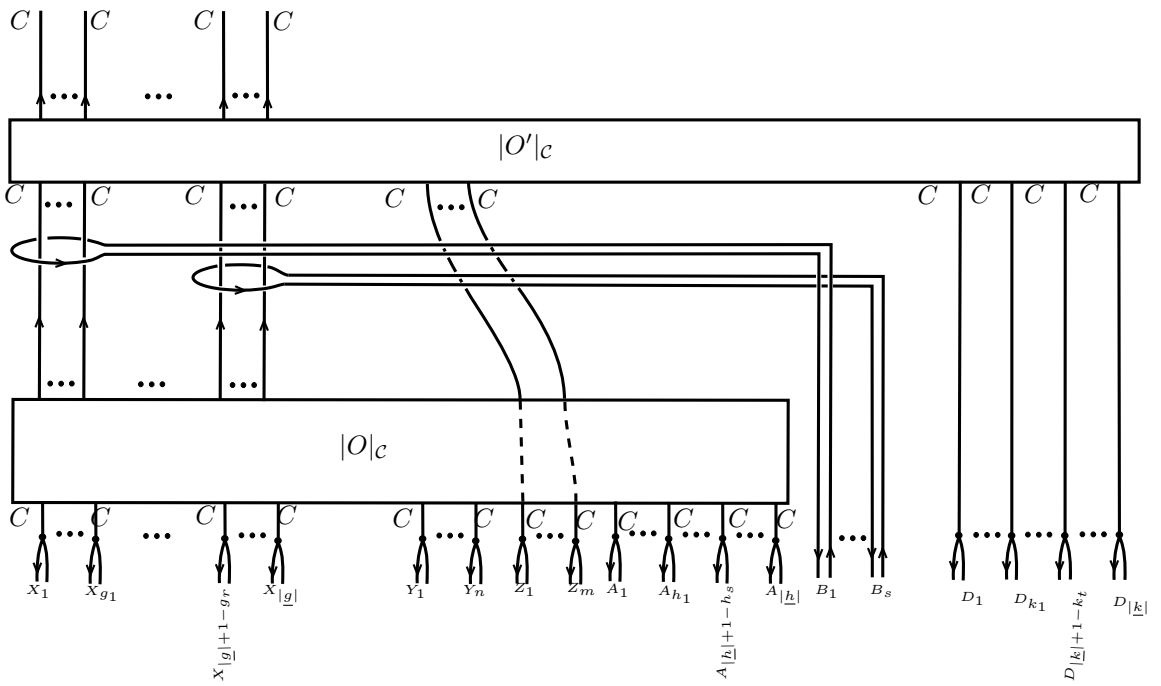

Note that the mid part of the diagram correspond to morphisms of type 4.2 and for all $\underline{X}, \underline{Y}, \underline{Z}, \underline{A}, \underline{B}, \underline{D}, \iota_{D_1 \otimes \dots \otimes D_{|\underline{k}|}} Q_{\underline{X}, \underline{Y}, \underline{Z}, \underline{A}, \underline{B}, \underline{D}} =$

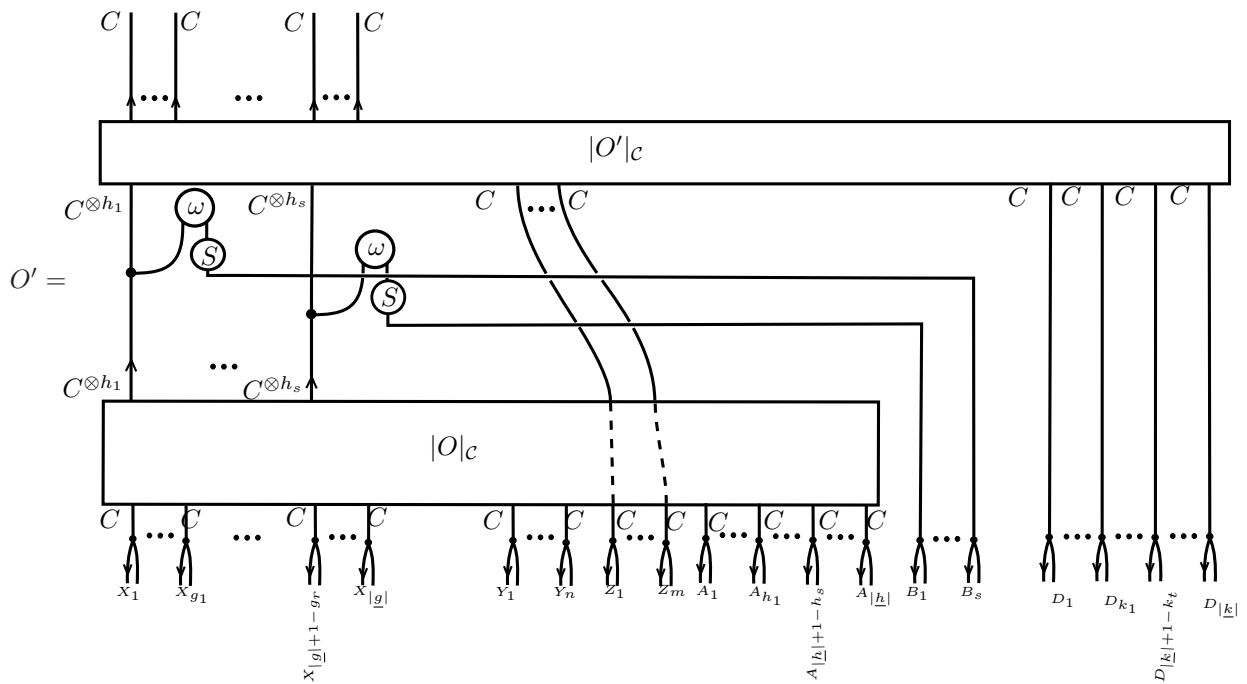

Thus, we have found the universal morphism $|Q|_c: C^{\otimes |g|+n+m+|h|+s+|k|}$. As a consequence, and using that $S\alpha = \alpha$, the morphism $|T' \square T|_{c,\alpha}$ is given by:

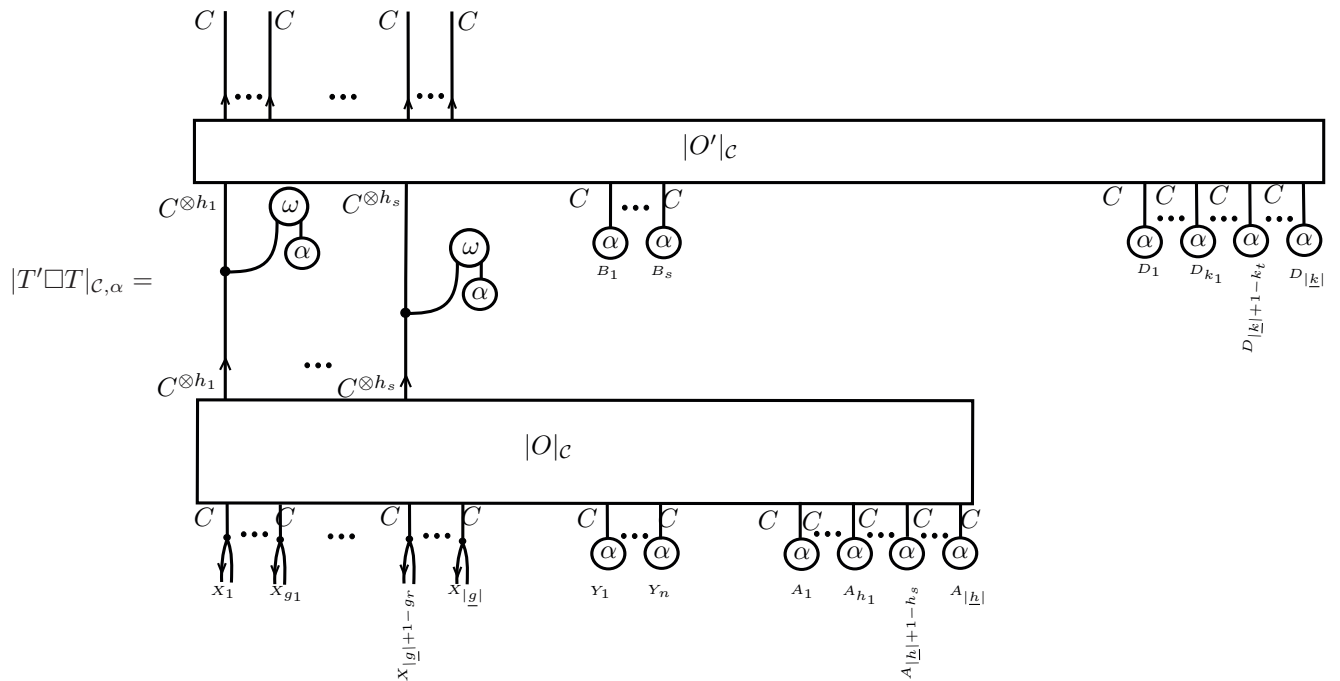

$$= |T'|_{c,\alpha} \Pi_{\alpha, \underline{h}} |T|_{c,\alpha}$$

So $p_{\alpha, \underline{k}} |T' \square T|_{c,\alpha} q_{\alpha, \underline{g}} = p_{\alpha, \underline{k}} |T'|_{c,\alpha} \Pi_{\alpha, \underline{h}} |T|_{c,\alpha} q_{\alpha, \underline{g}}$ but we have

$$p_{\alpha, \underline{k}} |T' \square T|_{c,\alpha} q_{\alpha, \underline{g}} = p_{\alpha, \underline{k}} |T' \star T|_{c,\alpha} q_{\alpha, \underline{g}}.$$

Indeed,

$$\begin{aligned}
p_{\alpha, \underline{k}} |T' \square T|_{\mathcal{C}, \alpha} q_{\alpha, \underline{g}} &= p_{\alpha, \underline{k}} q_{\alpha, \underline{k}} p_{\alpha, \underline{k}} |T' \square T|_{\mathcal{C}, \alpha} p_{\alpha, \underline{g}} q_{\alpha, \underline{g}} p_{\alpha, \underline{g}} \\
&= p_{\alpha, \underline{k}} \Pi_{\alpha, \underline{k}} |T' \square T|_{\mathcal{C}, \alpha} \Pi_{\alpha, \underline{g}} p_{\alpha, \underline{g}} \\
&= p_{\alpha, \underline{k}} \Pi_{\alpha, \underline{k}} |T' \square T|_{\mathcal{C}, \alpha} \Pi_{\alpha, \underline{g}} p_{\alpha, \underline{g}} \\
&= p_{\alpha, \underline{k}} |T' \square T|_{\mathcal{C}, \alpha} p_{\alpha, \underline{g}} \\
&= p_{\alpha, \underline{k}} |T' \square T|_{\mathcal{C}, \alpha} p_{\alpha, \underline{g}} \\
&= p_{\alpha, \underline{k}} |T' \star T|_{\mathcal{C}, \alpha} p_{\alpha, \underline{g}} \\
&= p_{\alpha, \underline{k}} \Pi_{\alpha, \underline{k}} |T' \star T|_{\mathcal{C}, \alpha} \Pi_{\alpha, \underline{g}} p_{\alpha, \underline{g}} \\
&= p_{\alpha, \underline{k}} |T' \star T|_{\mathcal{C}, \alpha} q_{\alpha, \underline{g}}
\end{aligned}$$

Thus,

$$p_{\alpha, \underline{k}} |T' \star T|_{\mathcal{C}, \alpha} q_{\alpha, \underline{g}} = p_{\alpha, \underline{k}} |T'|_{\mathcal{C}, \alpha} \Pi_{\alpha, \underline{h}} |T|_{\mathcal{C}, \alpha} q_{\alpha, \underline{g}} = (p_{\alpha, \underline{k}} |T'|_{\mathcal{C}, \alpha} q_{\alpha, \underline{h}}) (p_{\alpha, \underline{h}} |T|_{\mathcal{C}, \alpha} q_{\alpha, \underline{g}}).$$

Moreover, $\gamma_{M_{T'}, M_T} = \frac{\nu_{\alpha}(T' \star T)}{\nu_{\alpha}(T') \nu_{\alpha}(T)}$ so

$$W_{\mathcal{C}}(M_{T'} \circ M_T; \alpha) = \gamma_{M_{T'}, M_T} W_{\mathcal{C}}(M_T; \alpha) W_{\mathcal{C}}(M_{T'}; \alpha).$$

Now, we have to prove this formula for non-connected 3-cobordisms using the connected case. Let M and N be two composable 3-cobordisms. Note that the cobordism $(M \circ N)^{\#}$ can differ from the cobordism $M^{\#} \circ N^{\#}$ only by adding a finite number of handles of type $\mathbb{S}^2 \times [0, 1]$. If M_T is a cobordism represented by the cobordism tangle T , the cobordism $M_T \# (\mathbb{S}^2 \times \mathbb{S}^1)$ is represented by the cobordism tangle $T \sqcup \bigcirc$ and $|T \sqcup \bigcirc|_{\mathcal{C}, \alpha} = |T|_{\mathcal{C}, \alpha} \otimes |\bigcirc|_{\mathcal{C}, \alpha} = |T|_{\mathcal{C}, \alpha} \otimes \varepsilon \alpha = |T|_{\mathcal{C}, \alpha}$ since $\varepsilon \alpha = 1$ so $W_{\mathcal{C}}(M_T \# (\mathbb{S}^2 \times \mathbb{S}^1); \alpha) = W_{\mathcal{C}}(M_T; \alpha)$. Then

$$\begin{aligned}
W_{\mathcal{C}}(M \circ N; \alpha) &\stackrel{(1)}{=} W_{\mathcal{C}}((M \circ N)^{\#}; \alpha) \\
&\stackrel{(2)}{=} W_{\mathcal{C}}(M^{\#} \circ N^{\#}; \alpha) \\
&\stackrel{(3)}{=} \gamma_{M^{\#}, N^{\#}} W_{\mathcal{C}}(M^{\#}; \alpha) \circ W_{\mathcal{C}}(N^{\#}; \alpha) \\
&\stackrel{(4)}{=} \gamma_{M, N} W_{\mathcal{C}}(M; \alpha) \circ W_{\mathcal{C}}(N; \alpha)
\end{aligned}$$

Equalities (1) et (4) come from the definition of the invariant $W_{\mathcal{C}}(\ ; \alpha)$ on any cobordisms, equality (3) is based on the fact that cobordisms $(M \circ N)^{\#}$ and $M^{\#} \circ N^{\#}$ could differ only by adding or suppress handles $\mathbb{S}^2 \times [0, 1]$, operation that is not detected by the invariant W , and equality (4) is true because we have proved it on connected cobordisms. To conclude that $W_{\mathcal{C}}(\ ; \alpha)$ is a functor with anomaly, we have to check that γ is a 2-cocycle. We have already explained the difference between the two cobordisms $(M \circ N)^{\#}$ and $M^{\#} \circ N^{\#}$: they could differ only by handles of type $\mathbb{S}^2 \times [0, 1]$. And as $\nu_{\alpha}(\bigcirc) = 1$, then $\nu_{\alpha}(T \sqcup \bigcirc) = \nu_{\alpha}(T) \nu_{\alpha}(\bigcirc) = \nu_{\alpha}(T)$, it is straightforward to check that γ is a 2-cocycle.

- We show that $W_{\mathcal{C}}(\ ; \alpha)$ is a strong monoidal functor with anomaly.

Let $\Sigma_{\underline{g}}$ and $\Sigma_{\underline{h}}$ be two surfaces of multigenus \underline{g} and \underline{h} . We have already seen that we have a canonical identification $W_2(\Sigma_{\underline{g}}, \Sigma_{\underline{h}}) : W_2(\Sigma_{\underline{g}}) \otimes W_2(\Sigma_{\underline{h}}) \rightarrow W_2(\Sigma_{\underline{g}} \sqcup \Sigma_{\underline{h}})$ and an identity $W_0 : \mathbb{1} \rightarrow W_{\mathcal{C}}(\emptyset; \alpha)$. It remains to be seen if the anomaly of the functor with anomaly $W_{\mathcal{C}}(\ ; \alpha)$ is monoidal. Let

(M, N) and (M', N') be two pairs of composable cobordisms and suppose that there exist 3-cobordisms $B_{in}^M, B_{out}^M, B_{in}^{M'}, B_{out}^{M'}, B_{in}^N, B_{out}^N, B_{in}^{N'}, B_{out}^{N'}$ obtained by composition and juxtaposition of the braiding and its inverse in Cob_3^p such that

$$\begin{aligned} M &= B_{out}^M \circ (M_{T_1} \sqcup \dots \sqcup M_{T_m}) \circ B_{in}^M, \\ M' &= B_{out}^{M'} \circ (M'_{S_1} \sqcup \dots \sqcup M'_{S_n}) \circ B_{in}^{M'}, \\ N &= B_{out}^N \circ (N_{R_1} \sqcup \dots \sqcup N_{R_k}) \circ B_{in}^N, \\ N' &= B_{out}^{N'} \circ (N'_{O_1} \sqcup \dots \sqcup N'_{O_l}) \circ B_{in}^{N'}. \end{aligned}$$

where $T_1, \dots, T_m, S_1, \dots, S_n, R_1, \dots, R_p, O_1, \dots, O_l$ are cobordism tangles. We have

$$\begin{aligned} \gamma_{M \sqcup M', N \sqcup N'} &= \gamma_{(M \sqcup M')^\#, (N \sqcup N')^\#} \\ &= \frac{\nu_\alpha((T_1 \sqcup \dots \sqcup T_m \sqcup S_1 \sqcup \dots \sqcup S_n) \star (R_1 \sqcup \dots \sqcup R_k \sqcup O_1 \sqcup \dots \sqcup O_l))}{\nu_\alpha(T_1 \sqcup \dots \sqcup T_m \sqcup S_1 \sqcup \dots \sqcup S_n) \nu_\alpha(R_1 \sqcup \dots \sqcup R_k \sqcup O_1 \sqcup \dots \sqcup O_l)} \\ &\stackrel{(3)}{=} \frac{\nu_\alpha((T_1 \sqcup \dots \sqcup T_m) \square (R_1 \sqcup \dots \sqcup R_l)) \nu_\alpha((S_1 \sqcup \dots \sqcup S_n) \star (O_1 \sqcup \dots \sqcup O_l))}{\nu_\alpha(T_1 \sqcup \dots \sqcup T_m \sqcup S_1 \sqcup \dots \sqcup S_n) \nu_\alpha(R_1 \sqcup \dots \sqcup R_k \sqcup O_1 \sqcup \dots \sqcup O_l)} \\ &= \frac{\nu_\alpha((T_1 \sqcup \dots \sqcup T_m) \star (R_1 \sqcup \dots \sqcup R_k)) \nu_\alpha((S_1 \sqcup \dots \sqcup S_n) \star (O_1 \sqcup \dots \sqcup O_l))}{\nu_\alpha(T_1 \sqcup \dots \sqcup T_m \sqcup S_1 \sqcup \dots \sqcup S_n) \nu_\alpha(R_1 \sqcup \dots \sqcup R_k \sqcup O_1 \sqcup \dots \sqcup O_l)} \\ &= \frac{\nu_\alpha((T_1 \sqcup \dots \sqcup T_m) \star (R_1 \sqcup \dots \sqcup R_k)) \nu_\alpha((S_1 \sqcup \dots \sqcup S_n) \star (O_1 \sqcup \dots \sqcup O_l))}{\nu_\alpha(T_1 \sqcup \dots \sqcup T_m) \nu_\alpha(S_1 \sqcup \dots \sqcup S_n) \nu_\alpha(R_1 \sqcup \dots \sqcup R_k) \nu_\alpha(O_1 \sqcup \dots \sqcup O_l)} \\ &= \gamma_{M^\#, N^\#} \gamma_{M', N'^\#} \\ &= \gamma_{M, N} \gamma_{M', N'} \end{aligned}$$

Remember the operation \square on cobordism tangles which is defined above in this proof (see 4.5.5) and remark that if T, T' are two cobordism tangles, the number of positive (respectively negative) eigenvalues $b_+(T \star T') = b_+(T \square T')$ (respectively $b_-(T \star T') = b_-(T \square T')$). Indeed, the operation \square only add a circle which just encircles closed components so this circle is not linked with other components. Then we conclude that γ is a monoidal anomaly and then (W, W_2, W_0, γ) is a monoidal functor with anomaly.

• We show that $W_C(\ ; \alpha)$ is a braided functor with anomaly. Let us show this result on connected surfaces Σ_g of and Σ_h respectively of genus g and h . The general case is analogous. Denote by $T_{g,h}$ the following cobordism tangle

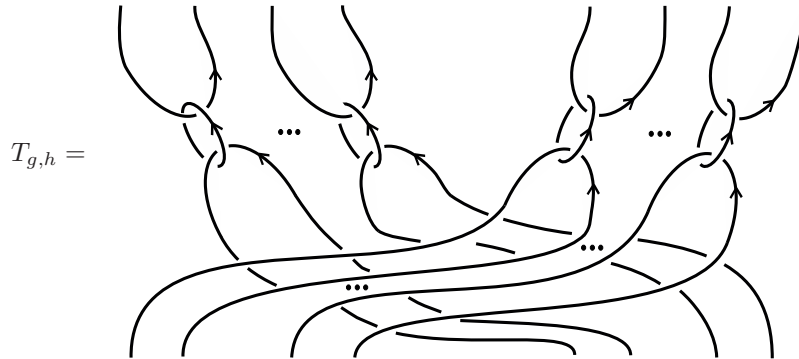

and remark that $\nu_\alpha(T_{g,h}) = 1$ since its closed components are not linked. We have

$$\begin{aligned}
 W_{\mathcal{C}}\left(\begin{array}{c} \text{Z} \\ \Sigma_g \Sigma_h \end{array}; \alpha\right) &= (p_{\alpha,h} \otimes p_{\alpha,g})|T_{g,h}|_{\mathcal{C},\alpha}(q_{\alpha,g} \otimes q_{\alpha,h}) \\
 &= (p_{\alpha,h} \otimes p_{\alpha,g})\left(\underbrace{\left| \begin{array}{c} \text{Y} \\ \mathcal{C},\alpha \end{array} \right|}_{h \text{ times}} \otimes \underbrace{\left| \begin{array}{c} \text{Y} \\ \mathcal{C},\alpha \end{array} \right|}_{g \text{ times}}\right) \tau_{\mathcal{C}^{\otimes g}, \mathcal{C}^{\otimes h}}(q_{\alpha,g} \otimes q_{\alpha,h}) \\
 &= (p_{\alpha,h} \underbrace{\left| \begin{array}{c} \text{Y} \\ \mathcal{C},\alpha \end{array} \right|}_{h \text{ times}} q_{\alpha,g} \otimes p_{\alpha,g} \underbrace{\left| \begin{array}{c} \text{Y} \\ \mathcal{C},\alpha \end{array} \right|}_{g \text{ times}} q_{\alpha,h}) \tau_{(\mathcal{C}^{\otimes g})_\alpha, (\mathcal{C}^{\otimes h})_\alpha} \\
 &= (W_{\mathcal{C}}(\text{id}_{\Sigma_h}; \alpha) \otimes W_{\mathcal{C}}(\text{id}_{\Sigma_g}; \alpha)) \tau_{W_{\mathcal{C}}(\Sigma_g; \alpha), W_{\mathcal{C}}(\Sigma_h; \alpha)}
 \end{aligned}$$

and $W_{\mathcal{C}}(\ ; \alpha)$ is then a braided functor with anomaly. □

4.5.6 Proof of the first main Theorem 4.4.4

Proof. Recall the braided monoidal functor with anomaly $(W_{\mathcal{C}}(\ ; \alpha), \gamma)$ (see Lemma 4.4.1). Then the unitalized functor $(V_{\mathcal{C}}(\ ; \alpha), \gamma)$ is a braided monoidal unital functor with anomaly (see ??). We just have to prove that objects associated to surfaces are transparent. Let Σ_g be the canonical surface of genus g . Recall that $\Sigma_g \times [0, 1]$ is encoded by the (g, g, g) -cobordism tangle:

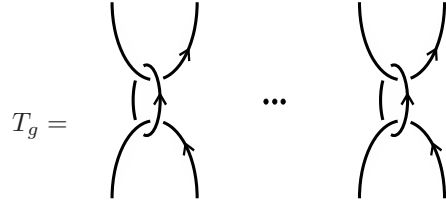

Denote by

$$\Pi_g = \omega(\alpha \otimes \alpha)^{-g} W_{\mathcal{C}}(\Sigma_g \times [0, 1]; \alpha)$$

the unique endomorphism of $\text{Im}(\Pi_{\alpha,g})$ induced by the morphism

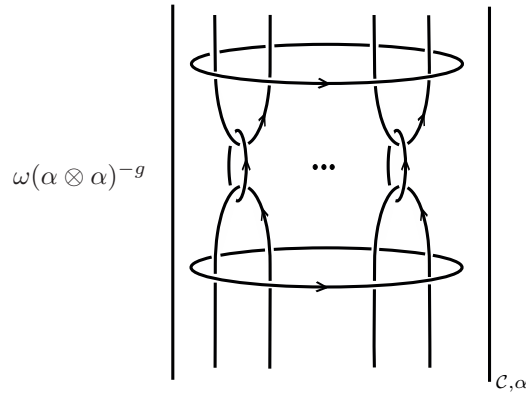

As image of an identity by a functor with anomaly, Π_g is an idempotent of \mathcal{C} .

In order to show that $\text{Im}(\Pi_g)$ is transparent, we compute the following morphism:

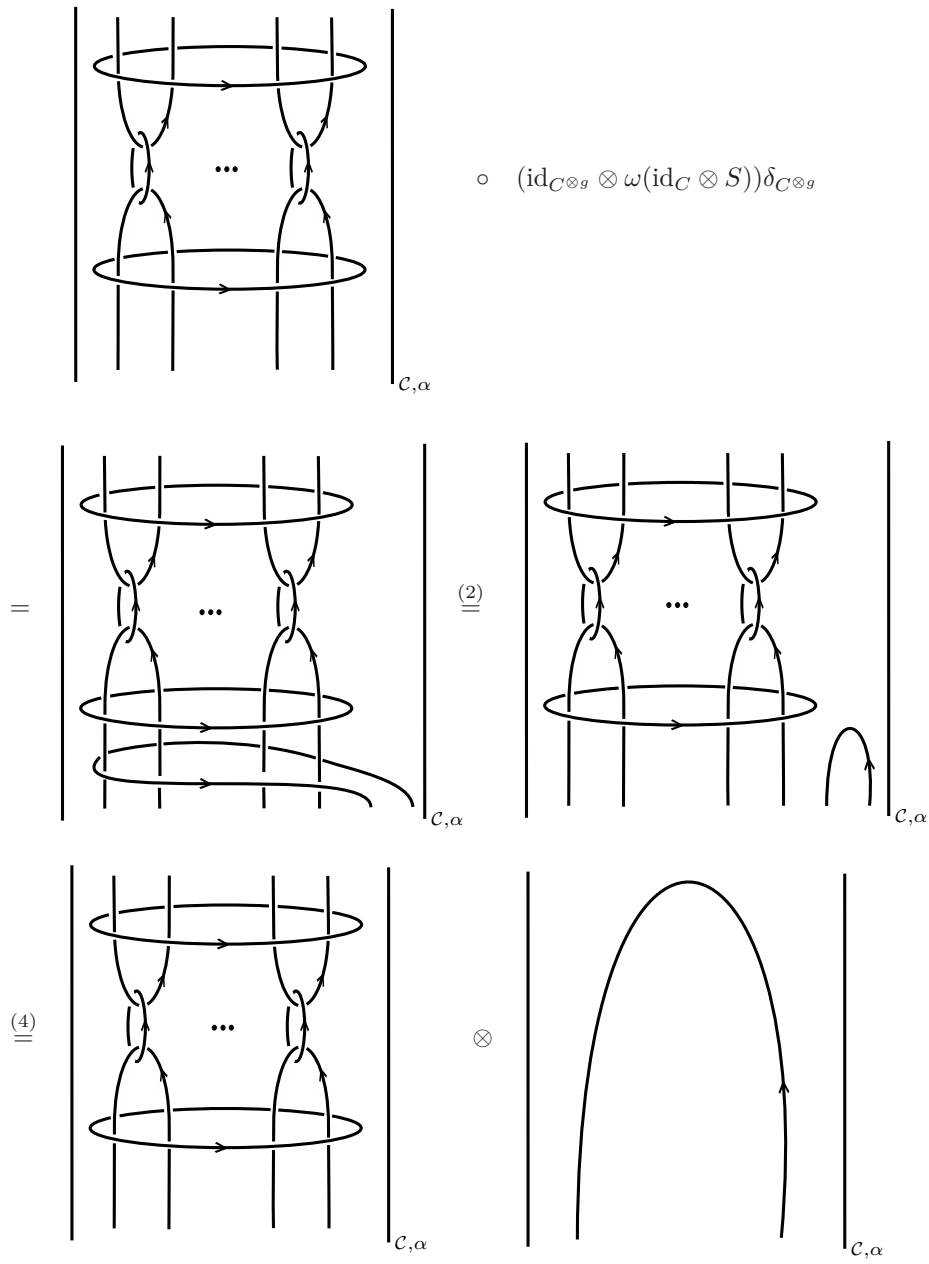

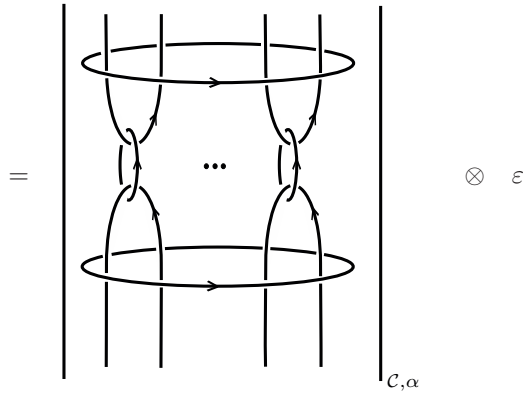

Equality (2) uses the fact that α is an admissible element so $|_{C, \alpha}$ is invariant by the generalized Kirby move KII^g . Equality (4) is based on the multiplicativity of $|_{C, \alpha}$ on a cobordism tangle seen as the disjoint union of a $(g, g + 2, g)$ -cobordism tangle and a $(1, 0, 0)$ -cobordism tangle. This calculus implies that $\Pi_g \circ (\text{id}_{C^{\otimes g}} \otimes \omega(\text{id}_C \otimes S)) = \Pi_g \otimes \varepsilon$. Applying Lemma 4.4.3 to Π_g , we get the result. \square

4.5.7 Proof of the second main Theorem 4.4.6

Proof. In [BV05], Bruguières and Virelizier show that one $(|g|, n, 0)$ -cobordism tangle without exit components (called *ribbon handles*) gives a morphism $|T|_{C, \alpha} : C^{|g|} \rightarrow \mathbb{1}$ which is expressed entirely in terms of structural morphisms (except m) of the coend C and α . We want to show that it is still the case for any (g, n, \underline{h}) -cobordism tangle. The product m is needed only to express $\delta_{C^{\otimes n}}$. Let T be a (g, n, \underline{h}) -cobordism tangle. We pull down the exit components before pull them up as shown of the following diagram we denote by T' the $(g, \underline{h}, n, 0)$ -cobordism tangle defined just below:

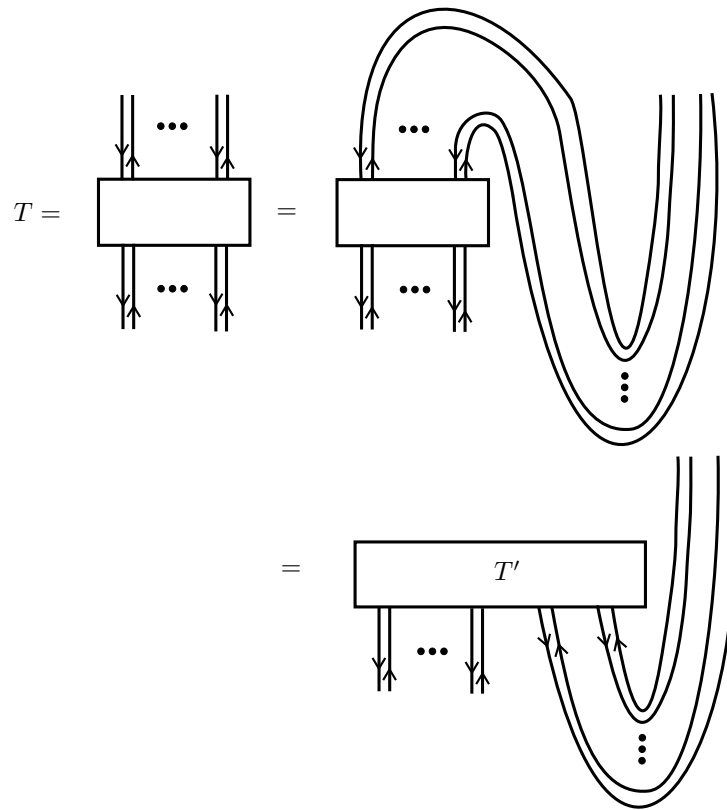

where $\underline{g} = (g_1, \dots, g_r)$, $\underline{h} = (h_1, \dots, h_s)$ and $\underline{g}.\underline{h} = (g_1, \dots, g_r, h_1, \dots, h_s)$. Then just remark that

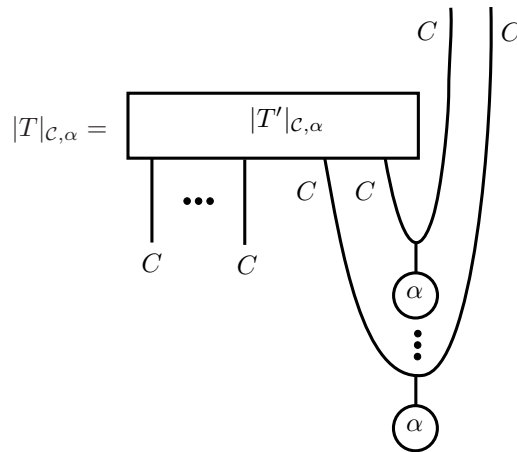

According to the result of Bruguières and Virelizier, $|T'|_{C, \alpha}$ can be expressed only thanks to structural morphisms of C (except m) and α . So is $|T|_{C, \alpha}$ and then so is the TQFT V (the normalization coefficient ν_α of the TQFT is expressed using only morphisms θ_+ , θ_- , and α ; see 4.3.2). \square

Chapter 5

The modular and premodular cases

In this chapter, we compare our internal TQFTs with those of Turaev in the modular case and the modularizable case. After recalling some properties of premodular categories, we give one of the main results of this thesis, that is, our TQFT is a transparent lift of Turaev's one. We study the dependence of our TQFT $V_{\mathcal{C}}$ with the category \mathcal{C} and we conclude the chapter with the last main result of this thesis that compares our TQFT and Turaev's one in the modularizable case.

In this chapter, assume that \mathbb{k} is a field.

5.1 Preliminaries

Let \mathcal{C} be a premodular category and denote by $\Lambda_{\mathcal{C}}$ a representative set of simple objects of \mathcal{C} . Recall that the category \mathcal{C} has a coend

$$C = \bigoplus_{\lambda \in \Lambda_{\mathcal{C}}} \lambda^* \otimes \lambda.$$

Assume that the category \mathcal{C} is *normalizable*, that is, for all transparent objects X of \mathcal{C} ,

$$\theta_X = \text{id}_X$$

and suppose that \mathcal{C} has invertible dimension

$$\dim(\mathcal{C}) := \sum_{\lambda \in \Lambda_{\mathcal{C}}} \dim_q^2(\lambda).$$

The category \mathcal{C} has a Kirby element

$$\alpha_K := \frac{1}{\dim(\mathcal{C})} \sum_{\lambda \in \Lambda_{\mathcal{C}}} \dim_q(\lambda) e_{\lambda}$$

where $e_{\lambda} = \iota_{\lambda} \widetilde{\text{coev}}_{\lambda}$ is a S -invariant integral of C such that $\varepsilon \alpha_K = 1$ and $\theta_+ \alpha_K, \theta_- \alpha_K$ are invertible. Then the morphism α_K is an admissible element (see [Vir06]) and the TQFT with anomaly $V_{\mathcal{C}}(\ ; \alpha_K)$ is well-defined. Denote by \mathcal{T} the subcategory of transparent objects of \mathcal{C} . Let X be an object of \mathcal{C} and decomposed as direct sum of n simple objects:

$$X := \bigoplus_{i=1}^n S_i$$

The transparent part $X_{\mathcal{T}}$ of X is defined as:

$$X_{\mathcal{T}} := \bigoplus_{i \in \{k \mid S_k \in \mathcal{T}\}} S_i.$$

The next Lemma identifies the natural transformation $\Pi_{\alpha_K, X} = [\text{id}_X \otimes \omega(\text{id}_C \otimes \alpha_K)]\delta_X$ with the projector on the transparent part of the object X .

Lemma 5.1.1 — *Let \mathcal{C} be a premodular category with invertible dimension. Then, for all objects X of \mathcal{C} :*

- i) *The morphism $[\text{id}_X \otimes \omega(\text{id}_C \otimes \alpha_K)]\delta_X$ is an idempotent of \mathcal{C} .*
- ii) *If X is a transparent object of \mathcal{C} , $\Pi_{\alpha_K, X} = \text{id}_X$.*
- iii) *If X is simple and not transparent, $\Pi_{\alpha_K, X} = 0$.*

Proof. For all objects X of \mathcal{C} ,

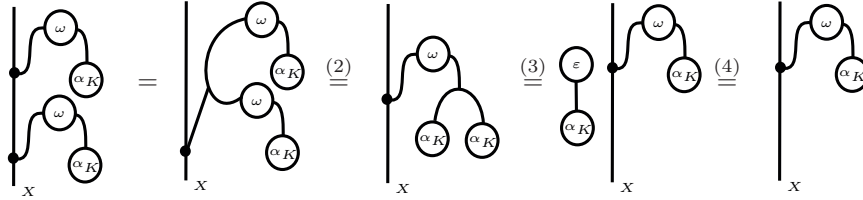

Equality (2) uses the axiomatic of the Hopf pairing ω (see Section 1.2.1), equalities (3) and (4) hold because α_K is an admissible element (α_K is an integral) so the *i*-part of the Lemma is proved. Now, assume that X is a transparent object. Then for all objects Y ,

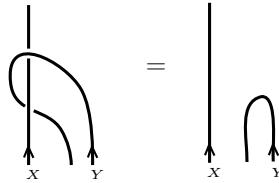

so $\Pi_{\alpha_K, X} = \text{id}_X \otimes \varepsilon \alpha_K = \text{id}_X$. If X is not transparent and simple, remark that $\text{Im}(\Pi_{\alpha_K, X})$ is transparent : see [Bru00] for details. Then, as $\text{Im}(\Pi_{\alpha_K, X})$ is a direct factor of X , $\text{Im}(\Pi_{\alpha_K, X}) = 0$. \square

5.2 The modular case : on the Reshetikhin-Turaev TQFTs

Let \mathcal{C} be a modular category. We have the following comparison result between the TQFT $\text{RT}_{\mathcal{C}}$ of Reshetikhin-Turaev and our TQFT.

Theorem 5.2.1 — *Let \mathcal{C} be a modular category and denote by α_K its Kirby element and by \mathcal{T} its subcategory of transparent objects. Then, up to normalization, the following diagram commutes*

$$\begin{array}{ccc}
 \text{Cob}_3^p & \xrightarrow{\text{Vc}(\cdot; \alpha_K)} & \mathcal{T} \\
 & \searrow \text{RT}_{\mathcal{C}} & \downarrow \text{Hom}_{\mathcal{C}}(\mathbb{1}, -) \\
 & & \text{Mod}_{\mathbb{k}}^f
 \end{array} \tag{5.2.1}$$

where $\text{Mod}_{\mathbb{k}}^f$ is the category of finite dimensional \mathbb{k} -vector spaces.

Before proving this theorem, we need some tools. First, recall that the subcategory of transparent objects of a modular category is identified with the category $\text{Mod}_{\mathbb{k}}^f$ of finite dimensional vector spaces. If \mathcal{C} is a \mathbb{k} -fusion category and X is an object of \mathcal{C} , we denote by $\langle X \rangle$ the smallest monoidal rigid subcategory of \mathcal{C} containing X and stable under direct sums and direct factors. The subcategory $\langle X \rangle$ is a fusion subcategory of \mathcal{C} such that the simple objects are the direct factors of tensorial products of X and X^* .

Lemma 5.2.2 — *Let \mathcal{C} be a modular category. The subcategory $\langle \mathbb{1} \rangle$ of transparent objects of \mathcal{C} is monoidally equivalent to the category $\text{Mod}_{\mathbb{k}}^f$.*

Proof. In a modular category, the only simple and transparent object is the monoidal unit $\mathbb{1}$. Indeed, if we denote by S a simple and transparent object of \mathcal{C} , it satisfies for all simple objects X of \mathcal{C} ,

$$\text{tr}_q(\tau_{S,X}\tau_{X,S}) = \dim_q(S)\dim_q(X)$$

so the line of the object S in the S -matrix is colinear to the line of the object $\mathbb{1}$. As the S -matrix is invertible, we have

$$S = \mathbb{1}.$$

Then every transparent object of a modular category is a direct sum of copies of $\mathbb{1}$ and the functor defined by $\mathbb{k} \in \text{Mod}_{\mathbb{k}}^f \mapsto \mathbb{1} \in \langle \mathbb{1} \rangle$ is a \mathbb{k} -linear monoidal equivalence of category. \square

Secondly, recall that the cylinder $\Sigma_g \times [0, 1]$ on a surface of genus g is represented by the (g, g, g) -cobordism tangle T_g :

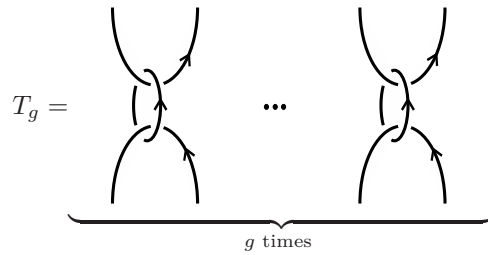

Lemma 5.2.3 — *Suppose that \mathcal{C} is a modular category and α_K its Kirby element. Then*

$$|T_g|_{\mathcal{C}, \alpha_K} = \omega(\alpha_K \otimes \alpha_K)^g \text{id}_{\mathcal{C}^{\otimes g}}.$$

Proof. Let us show that $|T_1|_{\mathcal{C}, \alpha_K} = \text{id}_{\mathcal{C}}$; the general result comes from tensorization. Remark that

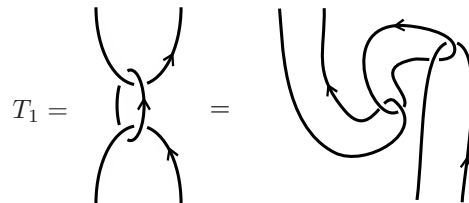

We choose the following opentangle O coming from T_1 :

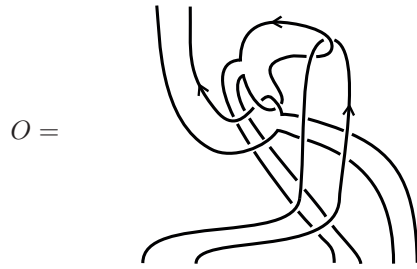

Then compute $|O|_{\mathcal{C}}$. For X_1, X_2, X_3 objects of \mathcal{C} ,

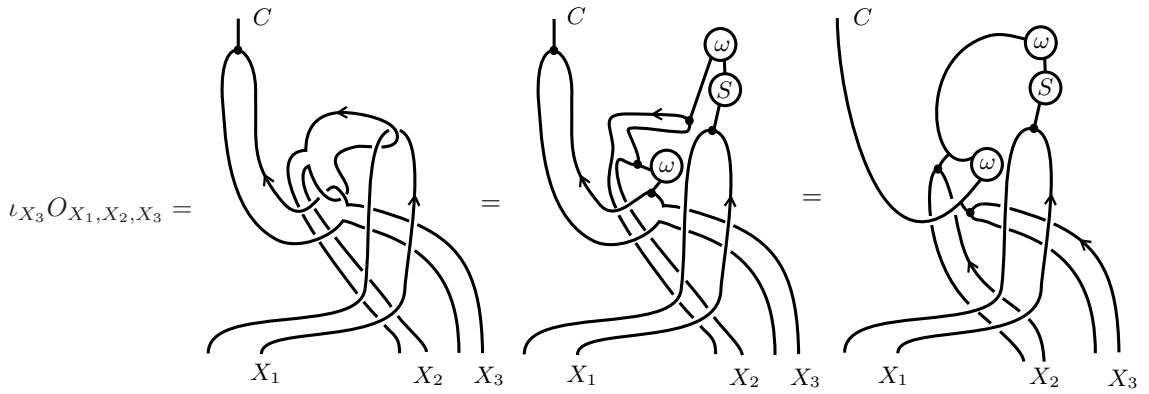

so the invariant is

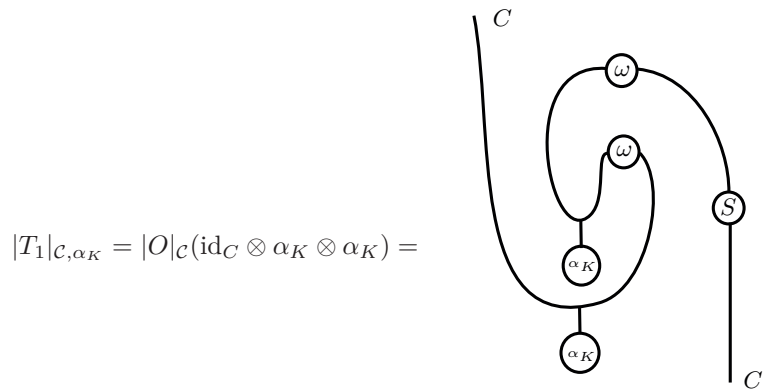

As ω is nondegenerate and α_K is an integral of \mathcal{C} , as shown in [[BV13], Lemma 3.1], we have the following identity:

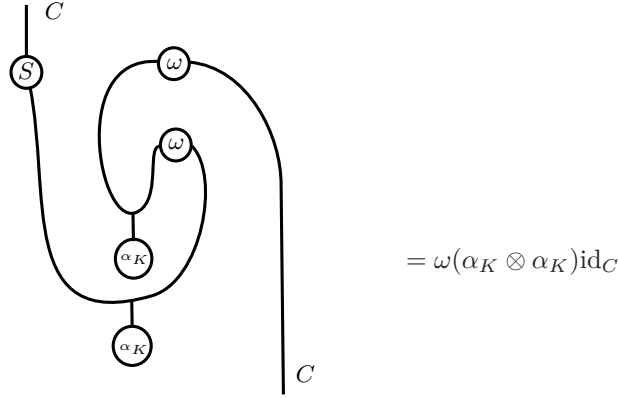

so $|T_1|_{\mathcal{C}, \alpha} = \omega(\alpha_K \otimes \alpha_K)\text{id}_C$. \square

Thus, in our construction, if \mathcal{C} is modular and α_K is the Kirby element of \mathcal{C} :

$$W_{\mathcal{C}}(\Sigma_g \times [0, 1]; \alpha_K) = \text{id}_{(C^{\otimes g})\alpha_K}.$$

Then, in this case, the functor with anomaly $W_{\mathcal{C}}(\ ; \alpha)$ is already unitalized and $W_{\mathcal{C}}(\ ; \alpha_k) = V_{\mathcal{C}}(\ ; \alpha_k)$. Now we are ready to prove Theorem 5.2.1.

Proof. • On a connected surface Σ_g (we forget the parametrization of the surface) of genus g ,

$$\text{RT}_{\mathcal{C}}(\Sigma_g) = \text{Hom}_{\mathcal{C}} \left(\mathbb{1}, \bigoplus_{(\lambda_1, \dots, \lambda_g) \in \Lambda_{\mathcal{C}}^g} \lambda_1^* \otimes \lambda_1 \otimes \dots \otimes \lambda_g^* \otimes \lambda_g \right)$$

and

$$V_{\mathcal{C}}(\Sigma_g; \alpha_K) = \left(\left(\bigoplus_{\lambda \in \Lambda_{\mathcal{C}}} \lambda^* \otimes \lambda \right)^{\otimes g} \right)_{\alpha_K} = \left(\left(\bigoplus_{\lambda \in \Lambda_{\mathcal{C}}} \lambda^* \otimes \lambda \right)^{\otimes g} \right)_{\mathcal{T}}$$

according to Lemmas 5.2.3 and 5.1.1. Moreover, for every object $X \in \mathcal{C}$, we have $\text{Hom}_{\mathcal{C}}(\mathbb{1}, X) = \text{Hom}_{\mathcal{C}}(\mathbb{1}, X_{\mathcal{T}})$ by Schur lemma. Then we have the result on surfaces.

• We show the result now on a connected cobordism $M: \Sigma \rightarrow \Sigma'$. For simplicity of notations, assume that Σ and Σ' have genus 1. Let T be a $(1, n, 1)$ -cobordism tangle representing M and denote by L_1, \dots, L_n the n surgery components of T . Colore by $k \in \Lambda_{\mathcal{C}}$ and by $l \in \Lambda_{\mathcal{C}}$ the boundary components of T corresponding respectively to Σ and Σ' defining a morphism $T_k^l: k^* \otimes k \rightarrow l^* \otimes l$. Let $c: \{L_1, \dots, L_n\} \rightarrow \Lambda_{\mathcal{C}}$ and denote by F the Shum-Turaev functor from colored ribbon tangles to \mathcal{C} (see [Shu94] and [Tur94]) and by $e_{\lambda} = \iota_{\lambda} \widehat{\text{coev}}_{\lambda}$. Choose an opentangle O such that $T = U(O)$. Then we have:

$$F(T_k^l, c) = p_l \circ |O|_{\mathcal{C}} \circ (\iota_k \otimes e_{c(1)} \otimes \dots \otimes e_{c(n)} \otimes e_l)$$

where for all $\lambda \in \Lambda_{\mathcal{C}}$, $p_{\lambda}: C \rightarrow l^* \otimes l$ is such that $\text{id}_C = \sum_{\lambda \in \Lambda_{\mathcal{C}}} \iota_{\lambda} p_{\lambda}$ and $p_{\lambda} \iota_{\mu} = \delta_{\lambda, \mu} \text{id}_{\lambda^* \otimes \lambda}$. Then

$$\frac{1}{\dim(\mathcal{C})^n} \sum_c \dim_q(c) F(T_k^l, c) = p_l \circ |O|_{\mathcal{C}} \circ (\iota_k \otimes \alpha_K^{\otimes n} \otimes e_l)$$

where $\dim_q(c) := \prod_{i=1}^n \dim_q(c(i))$ and so

$$\frac{\dim_q(l)}{\dim(\mathcal{C})^n} \sum_c \dim_q(c) F(T_k^l, c) = p_l \circ |O|_{\mathcal{C}} \circ (\iota_k \otimes \alpha_K^{\otimes n} \otimes \dim_q(l) e_l) \stackrel{(2)}{=} p_l \circ |O|_{\mathcal{C}} \circ (\iota_k \otimes \alpha_K^{\otimes n} \otimes \alpha_K)$$

The last equality (2) holds because:

$$\begin{aligned}
\dim(\mathcal{C})^n(p_l \circ |O|_{\mathcal{C}} \circ (\iota_k \otimes \alpha_K^{\otimes n} \otimes \alpha_{RT})) &= \sum_{\gamma \in \Lambda_{\mathcal{C}}} \dim_q(\gamma) p_l \circ |O|_{\mathcal{C}} \circ (\iota_k \otimes \alpha_K^{\otimes n} \otimes e_{\gamma}) \\
&= \sum_{\gamma \in \Lambda_{\mathcal{C}}} \dim_q(\gamma) p_l \circ \iota_{\gamma} p_{\gamma} |O|_{\mathcal{C}} (\iota_k \otimes \alpha_K^{\otimes n} \otimes e_{\gamma}) \\
&= \sum_{\gamma \in \Lambda} \dim_q(\gamma) \delta_{l, \gamma} \text{id}_{l^* \otimes l} \circ p_{\gamma} |O|_{\mathcal{C}} (\iota_k \otimes \alpha_K^{\otimes n} \otimes e_{\gamma}) \\
&= \dim_q(l) p_l \circ |O|_{\mathcal{C}} \circ (\iota_k \otimes \alpha_K^{\otimes n} \otimes e_{\gamma})
\end{aligned}$$

Thus we have shown that

$$\frac{\dim_q(l)}{\dim(\mathcal{C})^n} \sum_c \dim_q(c) F(T_k^l, c) = p_l \circ |T|_{\mathcal{C}, \alpha} \circ \iota_k.$$

The default of normalization between the two TQFTs is given by $\mathcal{D}^{-b_0(T) - g' - 2n}$, where \mathcal{D} is a square root of $\dim(\mathcal{C})$, $b_0(T)$ is the number of null eigenvalues of the linking matrix of the surgery components of T and g' is the genus of exit boundary Σ' of M .

Adding projections and injections, we recover exactly

$$\text{RT}_{\mathcal{C}}(M) = \mathcal{D}^{-b_0(T) - g' - 2n} \text{Hom}_{\mathcal{C}}(\mathbf{1}, -) \mathbf{V}_{\mathcal{C}}(\ ; \alpha_K).$$

□

5.3 Functoriality of the construction

Let \mathcal{C} and \mathcal{D} be two ribbon categories with coend respectively denoted by (\mathcal{C}, ι) and (\mathcal{D}, j) . Let $\alpha: \mathbf{1} \rightarrow \mathcal{C}$ and $\beta: \mathbf{1} \rightarrow \mathcal{D}$. Suppose that $F: \mathcal{C} \rightarrow \mathcal{D}$ is a strong monoidal functor which is ribbon such that $(F(\mathcal{C}), F(\iota))$ is the coend of the functor $F: \mathcal{C}^{op} \otimes \mathcal{C} \rightarrow \mathcal{D}$ defined by

$$F(X \otimes Y) = F(X^* \otimes Y) \quad \text{and} \quad F(f, g) = F(f^* \otimes g) \quad (5.3.2)$$

As F is a strong monoidal functor, we have a natural isomorphism $F(X^* \otimes Y) \simeq F(X)^* \otimes F(Y)$. Then, by the factorization property of the coend $(F(\mathcal{C}), F(\iota))$, there exists a unique morphism $\zeta: F(\mathcal{C}) \rightarrow D$ of \mathcal{D} such that, for every object X of \mathcal{C} , the following 5.3.3 diagram commutes:

$$\begin{array}{ccc}
& F(X)^* \otimes F(X) & \\
F(\iota_X) \swarrow & & \searrow j_{F(X)} \\
F(\mathcal{C}) & \xrightarrow{\zeta} & D
\end{array} \quad (5.3.3)$$

If $\alpha \in \text{Hom}_{\mathcal{C}}(\mathbf{1}, \mathcal{C})$, denote by $F_! \alpha = \zeta F(\alpha): F(\mathbf{1}) \simeq \mathbf{1} \rightarrow D$.

Lemma 5.3.1 — *Let T be a $(\underline{g}, n, \underline{h})$ -cobordism and $\alpha \in \text{Hom}_{\mathcal{C}}(\mathbf{1}, \mathcal{C})$. Then the following diagram commutes:*

$$\begin{array}{ccc}
F(\mathcal{C}^{\otimes |\underline{g}|}) & \xrightarrow{\zeta^{\otimes |\underline{g}|}} & D^{\otimes |\underline{g}|} \\
F(|T|_{\mathcal{C}, \alpha}) \downarrow & & \downarrow |T|_{\mathcal{D}, F_! \alpha} \\
F(\mathcal{C}^{\otimes |\underline{h}|}) & \xrightarrow{\zeta^{\otimes |\underline{h}|}} & D^{\otimes |\underline{h}|}
\end{array}$$

Proof. For simplicity of notations, assume that T is a (g, n, h) -cobordism tangle where g and h are integers. The case where T is a $(\underline{g}, n, \underline{h})$ -cobordism tangle with multigenus \underline{g} and \underline{h} is similar. Let O be a $(\underline{g}, n, \underline{h})$ -opentangle such that $U(O) = T$. Colore the components of the opentangle O by objects of \mathcal{C} : the entrance components are colored by X_1, \dots, X_g , the surgery components are colored by X_{g+1}, \dots, X_{g+n} , the exit components are colored by $X_{g+n+1}, \dots, X_{g+n+h}$.

Remark that, since F is ribbon, that:

$$\begin{aligned} F((\iota_{X_{g+n+1}} \otimes \dots \otimes \iota_{X_{g+n+h}}) \circ O_{X_1, \dots, X_{g+n+h}}) &= F(\iota_{X_{g+n+1}} \otimes \dots \otimes \iota_{X_{g+n+h}}) F(O_{X_1, \dots, X_{g+n+h}}) \\ &= F(\iota_{X_{g+n+1}} \otimes \dots \otimes \iota_{X_{g+n+h}}) O_{F(X_1), \dots, F(X_{g+n+h})} \end{aligned}$$

$$\text{And, as } (\iota_{X_{g+n+1}} \otimes \dots \otimes \iota_{X_{g+n+h}}) \circ O_{X_1, \dots, X_{g+n+h}} = |O|_{\mathcal{C}}(\iota_{X_1} \otimes \dots \otimes \iota_{X_{g+n+h}}),$$

$$F(|O|_{\mathcal{C}}(\iota_{X_1} \otimes \dots \otimes \iota_{X_{g+n+h}})) = F(\iota_{X_{g+n+1}} \otimes \dots \otimes \iota_{X_{g+n+h}}) O_{F(X_1), \dots, F(X_{g+n+h})}.$$

so, multiplying by $\zeta^{\otimes h}$,

$$\begin{aligned} &\zeta^{\otimes h} F(|O|_{\mathcal{C}}(\iota_{X_1} \otimes \dots \otimes \iota_{X_{g+n+h}})) \\ &= (j_{F(X_{g+n+1})} \otimes \dots \otimes j_{F(X_{g+n+h})}) F(\iota_{X_{g+n+1}} \otimes \dots \otimes \iota_{X_{g+n+h}}) O_{F(X_1), \dots, F(X_{g+n+h})} \\ &= |O|_{\mathcal{D}}(j_{F(X_1)} \otimes \dots \otimes j_{F(X_{g+n+h})}) \\ &= |O|_{\mathcal{D}} \zeta^{\otimes g+n+h}(F(\iota_{X_1}) \otimes \dots \otimes F(\iota_{X_{g+n+h}})). \end{aligned}$$

We have

$$\zeta^{\otimes h} F(|O|_{\mathcal{C}}(F(\iota_{X_1}) \otimes \dots \otimes F(\iota_{X_{g+n+h}}))) = |O|_{\mathcal{D}} \zeta^{\otimes g+n+h}(F(\iota_{X_1}) \otimes \dots \otimes F(\iota_{X_{g+n+h}}))$$

so as $(F(\mathcal{C}), F(\iota))$ is a coend,

$$\zeta^{\otimes h} F(|O|_{\mathcal{C}}) = |O|_{\mathcal{D}} \zeta^{\otimes g+n+h}$$

thus

$$\zeta^{\otimes h} F(|O|_{\mathcal{C}}) F(\text{id}_{\mathcal{C}^{\otimes g}} \otimes \alpha^{\otimes n+h}) = |O|_{\mathcal{D}} \zeta^{\otimes g+n+h} F(\text{id}_{\mathcal{C}^{\otimes g}} \otimes \alpha^{\otimes n+h})$$

so

$$\zeta^{\otimes h} F(|T|_{\mathcal{C}, \alpha}) = F(|T|_{\mathcal{D}, F_1 \alpha}) \zeta^{\otimes g}.$$

□

If α is an admissible element of \mathcal{C} and g is a positive integer, then define the following idempotent of \mathcal{C}

$$\Pi_{\alpha, g}^{\mathcal{C}} = \left(\begin{array}{c} \text{Diagram of } \Pi_{\alpha, g}^{\mathcal{C}} \text{ showing } g \text{ strands with } g \text{ crossings and } h \text{ horizontal bands} \\ \text{--- } \mathcal{C}, \alpha \end{array} \right),$$

and if $\underline{g} = (g_1, \dots, g_r)$ is a r -tuple of positive integers, denote by $\Pi_{\alpha, \underline{g}}^{\mathcal{C}} = \Pi_{\alpha, g_1}^{\mathcal{C}} \otimes \dots \otimes \Pi_{\alpha, g_r}^{\mathcal{C}}$.

Lemma 5.3.2 — Let $\alpha: \mathbb{1} \rightarrow C$ be an admissible element of C and suppose that $F_!\alpha$ is an admissible element of \mathcal{D} . Then the following diagram commutes:

$$\begin{array}{ccc} F(C^{\otimes |g|}) & \xrightarrow{\zeta^{\otimes |g|}} & D^{\otimes |g|} \\ F(\Pi_{\alpha, g}^C) \downarrow & & \downarrow \Pi_{F_!\alpha, g}^D \\ F(C^{\otimes |g|}) & \xrightarrow{\zeta^{\otimes |g|}} & D^{\otimes |g|} \end{array}$$

Proof. The result is just the consequence of Lemma 5.3.1 applied on the special $(\underline{g}, n, \underline{g})$ -cobordism tangle

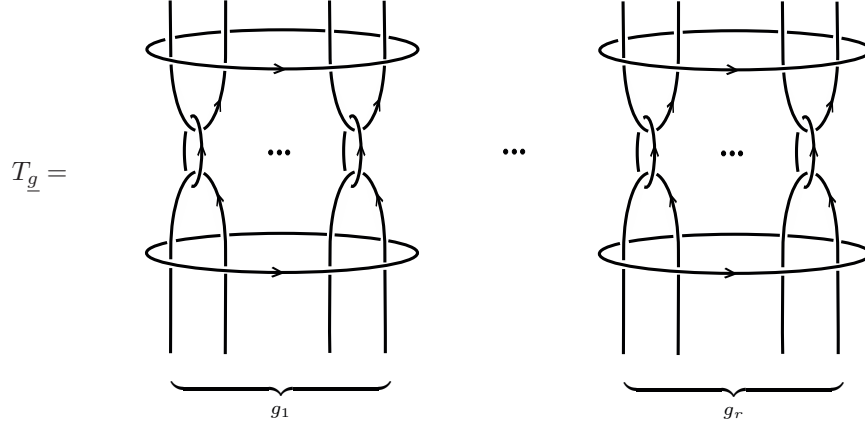

where $\underline{g} = (g_1, \dots, g_r)$. □

Recall that if α is admissible, we have defined a braided functor with anomaly $(W_C(\ ; \alpha), \gamma)$ and then a TQFT with anomaly $(V_C(\ ; \alpha), \gamma)$. The space associated to the surface of multigenus $\Sigma_{\underline{g}}$ is the image of the idempotent $W_C(\text{id}_{\Sigma_{\underline{g}}}; \alpha)$ denoted by Π_{α}^C .

Lemma 5.3.3 — Let $F = (F, F_2, F_0, \gamma)$ and $G = (G, G_2, G_0, \gamma)$ be two strong monoidal functors with the same anomaly between categories \mathcal{C} and \mathcal{D} where \mathcal{C} is supposed to be rigid. Then a monoidal natural transformation between F and G with the same anomaly is a natural isomorphism.

Proof. Let

$$\zeta = \{\zeta_X: F(X) \rightarrow G(X)\}_{X \in \mathcal{C}}$$

be a monoidal natural transformation. For X an object of \mathcal{C} , set

$$\beta_X = (G_0 G(\tilde{e}v_X) G_2(X, X^*) \otimes \text{id}_{F(X)}) (\text{id}_{G(X)} \otimes \zeta_{X^*} \otimes \text{id}_{F(X)}) (\text{id}_{G(X)} \otimes F_2^{-1}(X^*, X) F(\widetilde{\text{co}e}v_X) F_0^{-1})$$

and remark that $\zeta_X \beta_X$ and $\beta_X \zeta_X$ are identities up to an invertible scalar. □

Lemma 5.3.4 — Let α be a morphism of $\text{Hom}_{\mathcal{C}}(\mathbb{1}, C)$. If α and $F_!\alpha$ are admissible elements then ζ induces a system of natural isomorphisms

$$\underline{\zeta} = \{\underline{\zeta}: FV_{\mathcal{C}}(\Sigma; \alpha) \rightarrow V_{\mathcal{D}}(\Sigma; F_!\alpha)\}_{\Sigma \in \text{Cob}_3^p}$$

between functors with anomaly $FV_{\mathcal{C}}(\ ; \alpha)$ and $V_{\mathcal{D}}(\ ; F_!\alpha)$.

Proof. First, note that the two functors $FV_C(\ ; \alpha)$ and $V_D(\ ; F_! \alpha)$ have the same anomaly. Indeed, the anomaly of $V_C(\ ; \alpha)$ is given by a product of inverse of $\theta_{\pm} \alpha$ which are morphisms of the form $|T_{\pm}|_{C, \alpha}$ for some $(0, 1, 0)$ -cobordim tangles T_{\pm} (see Figure 1.5) so, applying the result of Lemma 5.3.1, $F(\theta_{\pm}^C \alpha) = \theta_{\pm}^D F_! \alpha$.

Let $M_T: \Sigma_{\underline{g}} \rightarrow \Sigma_{\underline{h}}$ be a cobordism represented by the $(\underline{g}, n, \underline{h})$ -cobordism tangle T . As $FV_C(\Sigma_{\underline{u}ng}; \alpha)$ is a direct factor of $F(C^{\otimes |\underline{g}|})$ and using the commutative diagram of Lemma 5.3.2, we have the following commutative diagram:

$$\begin{array}{ccccc}
 F(C^{\otimes |\underline{g}|}) & \xrightarrow{\zeta^{\otimes |\underline{g}|}} & & & D^{\otimes |\underline{g}|} \\
 \downarrow F(W_C(M_T; \alpha)) & \swarrow & FV_C(\Sigma_{\underline{g}}; \alpha) \xrightarrow{\quad} & V_D(\Sigma_{\underline{g}}; F_! \alpha) & \searrow \\
 & & \downarrow FV_C(M_T; \alpha) & \downarrow FV_D(M_T; F_! \alpha) & \\
 & & FV_C(\Sigma_{\underline{h}}; \alpha) \xrightarrow{\quad} & V_D(\Sigma_{\underline{h}}; F_! \alpha) & \\
 & \swarrow & & & \searrow \\
 F(C^{\otimes |\underline{g}|}) & \xrightarrow{\zeta^{\otimes |\underline{h}|}} & & & D^{\otimes |\underline{g}|} \\
 & & & & \downarrow W_D(M_T; F_! \alpha)
 \end{array}$$

The induced natural transformation $\zeta: FV_C \rightarrow V_D$ is monoidal by construction. Finally, we can conclude applying Lemma 5.3.3. \square

Remark 5.3.5 – If $\zeta: F(C) \rightarrow D$ is an epimorphism then $F_! \alpha$ is an admissible element.

5.4 The modularizable case

Theorem 5.4.1 — *Let \mathcal{C} be a normalizable premodular category with Kirby element α_K . Assume that \mathcal{C} is modularizable, with modularization $F: \mathcal{C} \rightarrow \tilde{\mathcal{C}}$. Then $F(\mathcal{T})$ is a subcategory of the category $\tilde{\mathcal{T}}$ of transparent objects of $\tilde{\mathcal{C}}$ and there exists a natural isomorphism ζ such that*

$$\begin{array}{ccc}
 Cob_3 & \xrightarrow{V_{\mathcal{C}, \alpha_K}} & \mathcal{T} \\
 & \searrow & \downarrow F_! \tau \\
 & & \tilde{\mathcal{T}} \\
 & \searrow RT_{\tilde{\mathcal{C}}} & \downarrow \text{Hom}_{\tilde{\mathcal{C}}}(\mathbb{1}, -) \\
 & & Mod_{\mathbb{k}}^f
 \end{array}$$

ζ is indicated by a double line between \mathcal{T} and $\tilde{\mathcal{T}}$.

Proof. Apply the result of Lemma 5.3.4 on the modularization functor $F: \mathcal{C} \rightarrow \tilde{\mathcal{C}}$ which is ribbon and preserves coends (and so preserves coends). In this case, $F_!(\alpha_K)$ is the Kirby element of \mathcal{C} so is admissible. For details, see [[Bru00], Section 2]. \square

Index

- BA , 44
- $COUPON$, 47
- ESC , 44
- $Graph(\underline{g}, n, \underline{h})$, 41
- KI , 47
- KII^g , 47
- $Otang(\underline{g}, n, \underline{h})$, 43
- ROT , 45
- S , 23
- SO , 47
- $TWIST$, 47
- $Tang^{Cob}(\underline{g}, n, \underline{h})$, 42
- Π_g , 57
- $\Pi_{X,Y}$, 55
- $\Pi_{\alpha, \underline{g}}$, 54
- $\Pi_{\alpha, n}$, 54
- \mathbb{S}_L^3 , 45
- $Mod_{\mathbb{k}}$, 15
- $W_C(M_T; \alpha)$, 54
- α_K , 89
- δ_X , 25
- $\gamma_{g,f}$, 29
- $\overset{\circ}{T}$, 49
- ι_X , 25
- $|O|_C$, 51
- $|T|_{C, \alpha}$, 52
- $|f|$, 28
- $|\underline{g}|$, 39
- $Mod_{\mathbb{k}}^f$, 19
- RT_C , 90
- $V_C(M_T; \alpha)$, 58
- $V_C(\Sigma_g; \alpha)$, 58
- $W_C(M_T; \alpha)$, 56
- $W_C(\Sigma_g; \alpha)$, 56
- $\dim(C)$, 89
- $\nu_{\alpha}(T)$, 54
- ω , 23
- \star , 48
- $\tau_{X,Y}$, 17
- θ_+ , 25
- θ_- , 25
- ζ , 94
- $b_+(T)$, 54
- $b_-(T)$, 54
- (C, ι) , 24
- S -invariant cointegral, 23
- S -invariant integral, 23
- S_g , 45
- $X_{\mathcal{T}}$, 90
- Cob_n , 36
- $Cob_3^p(\underline{g}, \underline{h})$, 45
- Cob_3^b , 45
- Δ , 22
- $\Pi_{X,Y}$, 55
- $\Pi_{\alpha, \underline{g}}$, 56
- $\Pi_{\alpha, n}$, 56
- \mathbb{k} -linear category, 19
- \mathbb{k} -linear functor, 19
- \mathbb{k} -linear monoidal category, 19
- ω , 25
- ω rescaling of a functor with anomaly, 36
- ε , 22
- i -decomposition, 20
- m , 22
- u , 22
- 2-cocycle, 29
- anomaly, 29
- anomaly of a natural transformation, 31
- antipode, 23
- autonomous category, 17
- balanced category, 18
- balanced functor, 18
- balancing, 18
- bialgebra in a ribbon category, 22
- braided category, 17
- braided functor, 18
- braided functor with anomaly, 35
- braiding, 17
- category of 3-dimensional parametrized cobor-disms, 45

- category of n -dimensional cobordisms, 36
- category of transparent objects, 18
- category with split idempotents, 21
- cobordism tangle
 - entrance boundary component, 41
 - exit boundary component, 42
- coend, 24
 - of a ribbon category, 24
- composable pair of morphisms, 29
- coproduct, 23
- counit, 23
- coupon, 39

- dimension, 19
- dimension of a premodular category, 89
- dinatural transformation, 23
- direct factor, 19
- direct sum, 19
- dominant, 20
- dual morphism, 17
- dual object, 17

- functor with anomaly, 29
- fusion category, 20

- hallowed cobordism tangle, 49
- Hopf algebra in a ribbon category, 23
- Hopf pairing, 23

- idempotent, 20
- image, 21
- inverse of a Hopf pairing, 23
- isotopy, 40
- isotypical component, 20

- Kirby element in a premodular category, 89

- left coevaluation, 17
- left composed functor with anomaly, 30
- left dual, 17
- left dual functor, 17
- left evaluation, 17
- left integral, 23
- left twist, 18

- manifold, 36
- modularizable category, 20
- modularization, 20
- monoidal anomaly, 31
- monoidal category, 15
 - strict, 16
- monoidal functor, 16
 - strict, 16
 - strong, 16
- monoidal functor with anomaly, 32
 - strict, 32
 - strong, 32
- monoidal natural isomorphism, 17
- monoidal natural transformation between functors with the same anomaly, 32
- multigenus, 45

- natural transformation on functors with anomaly, 30
- normalizable, 89

- pivotal category, 17
- premodular category, 20
- product, 23

- retract, 20
- representative set of scalar objects, 20
- restriction to the image of idempotents, 21
- ribbon (g, n, \underline{h}) -graph, 40
 - exit coupon, 40
 - entrance boundary component, 41
 - entrance component, 41
 - entrance coupon, 40
 - exit boundary component, 41
 - exit component, 41
- ribbon category, 19
- ribbon cobordism tangle, 41
 - surgery component, 41
- ribbon cobordism tangle
 - entrance component, 41
 - exit component, 41
- ribbon functor, 19
- ribbon graph, 39
 - arc
 - base, 39
 - core, 39
 - closed component, 39
 - core, 39
 - arc, 39
 - coupon
 - top base, 39
 - diagram, 39
 - blackboard framing, 40
 - ribbon tangle with k bottom endpoints and l top endpoints, 39
 - surgery component, 41
- ribbon opentangle, 42
 - entrance boundary component, 43
 - exit boundary component, 43
- ribbon opentangle
 - entrance component, 43

- exit component, 43
- surgery component, 43
- right coevaluation, 17
- right composed functor with anomaly, 30
- right dual, 17
- right dual functor, 17
- right evaluation, 17
- right integral, 23
- right twist, 18
- rigid category, 17

- scalar object, 19
- split decomposition, 20
- symmetric braiding, 18
- symmetric category, 18
- symmetric monoidal functor, 18
- symmetric monoidal functor with anomaly, 35

- TQFT with anomaly, 36
- trace, 19
- transparent object, 18
- transparent part, 90
- twist, 18
- two-sided cointegral, 23
- two-sided integral, 23

- unit, 23
- unital functor with anomaly, 30
 - strict, 30
- unitalized functor with anomaly, 30
- universal coaction, 25
- universal dinatural transformation, 25
- universal morphism, 28

Bibliography

- [Ati89] M. Atiyah, *Topological quantum field theories*, Publications Mathématiques de l’IHÉS **68** (1989), 175–186.
- [BCGPM16] C. Blanchet, F. Constantino, N. Geer, and B. Patureau-Mirand, *Non semi-simple TQFTs, Reidemeister torsion and Kashaev’s invariants*, Advances in Mathematics **301** (2016), 1–78.
- [BHMV95] C. Blanchet, N. Habegger, G. Masbaum, and P. Vogel, *Topological quantum field theories derived from the kauffman bracket*, Topology **34**, No 4 (1995), 883–927.
- [Bru00] A. Bruguières, *Catégories prémodulaires, modularisations et invariants des variétés de dimension 3*, Mathematische Annalen **316** (2) (2000), 215–236.
- [BV05] A. Bruguières and A. Virelizier, *Hopf diagrams and quantum invariants*, Algebraic and Geometric Topology **5** (2005), 1677–1710.
- [BV07] ———, *Hopf monads*, Advances in Mathematics **215** (2007), 679–733.
- [BV13] ———, *On the center of fusion categories*, Pacific Journals of Mathematics **264**, No.1 (2013), 1–30.
- [FR79] R. Fenn and C. Rourke, *On Kirby’s calculus of links*, Topology **18** (1979), 1–15.
- [FS] J. Fuchs and C. Schweigert, *Coends in conformal field theory*, ZMP-HH/16-6, Hamburger Beiträge zur Mathematik **589**, preprint, arXiv:1604.01670.
- [Kas95] C. Kassel, *Quantum Groups*, Graduate Texts in Mathematics, vol. 155, Springer, 1995.
- [Kir78] K. Kirby, *A calculus of framed links in S^3* , Inventiones mathematicae **45** (1978), 35–56.
- [KL01] T. Kerler and V. Lyubashenko, *Non-Semisimple Topological Quantum Field Theories for 3-Manifolds with Corners*, Lecture Notes in Mathematics, vol. 1765, Springer, 2001.
- [Koc03] J. Kock, *Frobenius algebras and 2D topological quantum field theories*, London Mathematical Society Student Texts, vol. 59, Cambridge University Press, 2003.
- [KRT97] C. Kassel, M. Rosso, and V. Turaev, *Quantum groups and knot invariants*, Panoramas et Synthèses de la S.M.F., vol. 5, Société Mathématique de France, 1997.
- [Lic97] W. B. R. Lickorish, *An introduction to knot theory*, Springer, 1997.
- [Lyu95a] V. Lyubashenko, *Invariants of 3-manifolds and projective representations of mapping class groups via quantum groups at roots of unity*, Communications in Mathematical Physics **172** (1995), 467–516.

- [Lyu95b] ———, *Tangles and Hopf algebras in braided categories*, Journal of Pure and Applied Algebra **98** (1995), 245–278.
- [ML98] S. Mac Lane, *Categories for the working mathematician*, 2nd edition, 1998.
- [Rad12] D. E. Radford, *Hopf Algebras*, Series on Knots and Everything, vol. 49, World Scientific, 2012.
- [RT91] N. Reshetikhin and V. Turaev, *Invariants of 3-manifolds via link polynomials and quantum groups*, Inventiones mathematicae **103** (1991), 547–598.
- [Shu94] M. C. Shum, *Tortile Tensor Categories*, Journal of Pure and Applied Algebra **93** (1) (1994), 57–110.
- [Tur94] V. Turaev, *Quantum Invariants of Knots and 3-Manifolds*, Studies in Mathematics, vol. 18, W. de Gruyter, 1994.
- [Vir06] A. Virelizier, *Kirby elements and quantum invariants*, Proc. London Math. Soc. **93** (2006), 474–514.
- [Wit89] E. Witten, *Quantum field theory and the Jones polynomial*, Communications in Mathematical Physics **121**, No. **3** (1989), 351–399.