



**HAL**  
open science

# Generating a new vaccine for protecting poultry from Newcastle disease and controlling viral shedding

Haijin Liu

► **To cite this version:**

Haijin Liu. Generating a new vaccine for protecting poultry from Newcastle disease and controlling viral shedding. Veterinary medicine and animal Health. Université Montpellier, 2017. English. NNT : 2017MONTT025 . tel-01684253

**HAL Id: tel-01684253**

**<https://theses.hal.science/tel-01684253>**

Submitted on 15 Jan 2018

**HAL** is a multi-disciplinary open access archive for the deposit and dissemination of scientific research documents, whether they are published or not. The documents may come from teaching and research institutions in France or abroad, or from public or private research centers.

L'archive ouverte pluridisciplinaire **HAL**, est destinée au dépôt et à la diffusion de documents scientifiques de niveau recherche, publiés ou non, émanant des établissements d'enseignement et de recherche français ou étrangers, des laboratoires publics ou privés.

# THÈSE POUR OBTENIR LE GRADE DE DOCTEUR DE L'UNIVERSITÉ DE MONTPELLIER

En: Biologie-Santé

École doctorale: Sciences Chimiques et Biologiques pour la Santé]

Unité de recherche: ASTRE, CIRAD

## **Génération d'un nouveau vaccin pour protéger les volailles contre la maladie de Newcastle et l'excrétion virale (Generating a new vaccine for protecting poultry from Newcastle disease and controlling viral shedding)**

Présentée par HAIJIN LIU  
Le 28 Septembre 2017

Sous la direction de Emmanuel Albina

Devant le jury composé de

Emmanuel Albina, Docteur, CIRAD

Nicolas Etteradossi, Docteur, ANSES

Natàlia Majo Masferrer, Docteur, IRTA CRESA Barcelone

Stéphane Bertagnoli, Professeur, Ecole Vétérinaire de Toulouse

Yannick Simonin, Docteur, CNRS-Université de Montpellier

Directeur de thèse

Rapporteur

Rapporteur

Président; Examineur

Examineur



UNIVERSITÉ  
DE MONTPELLIER



## **Acknowledgement**

I very appreciate Chinese government who offers me four years' scholarship to study in France and University of Montpellier, CBS2 and CIRAD who provide a great platform for me to open horizons, improve skills and accomplish the thesis.

During processes of my thesis, there are many persons in my unit (Cirad, UMR ASTRE) giving me a help hand. Firstly, I want to thank my supervisor, Emmanuel Albina who spends so many time to guide me, to find funding and cooperation for animal experiments of my thesis, to assist me in thesis writing and publication. I cannot forget you decided to be my supervisor four years ago, which makes my dream come true to study in abroad. Secondly, I am very appreciative for Renata Servan de Almeida. I cannot speak French. Without you, I cannot image how my life will be like in Cirad. Thanks for your patience, your help in registration, suggestion and modification in paper and thesis writing. Thirdly, I deeply appreciate Patricia Gil for your help in doing experiments and advice in writing. You are the first person I met in France. I was moved by your warm welcome. You invited me to your home to celebrate Christmas, which makes me not fell alone in Montpellier. Last but not least, Cécile, Genevieve, Lucia, Valérie, Aurélie, Sylvain, Nadège, Denise, Tiffany, Serafin, Olivier, Philippe and other members of ASTRE unit, please receive my sincere acknowledgement. Without your help, it is impossible for me to finish my thesis so smooth.

I also want to thank persons from other units who give me help in the thesis. Firstly, I quite appreciate Natàlia Majo Masferrer who helps me a lot to do animal experiments, to review my manuscript of thesis and to be one of members of jury. Secondly, my great thanks belong to Patti J. Miller and Bénédicte Lambrecht who kindly afford viruses for my thesis. Furthermore, it is my honor that Nicolas Eterradossi, Yannick Simonin and Stéphane Bertagnoli are members of my jury.

My parents are quite important for me during my study. They don't be educated in university and even in high school, but they totally believe education is necessary for a person. Thus, they are always doing their best to encourage me to get bachelor and master degrees. Without their support, I don't think I have chance to pursue PhD degree.

My wife is another quite important person for me. She is like the lighthouse to light roads for my study career. She always encourages me to insist when I want to give up. I never forget

she got up so early to practice English with me. In recent 4 years, I spend so little time with her. However, she never complains and always supports me to get PhD degree.

Finally, I also want to thank my parents in law, my little brother and my friends. Without you help, I cannot focus on my PhD study.

## Contents

<b>Acknowledgements.....</b>	<b>1</b>
<b>Summary in French.....</b>	<b>4</b>
<b>Introduction.....</b>	<b>14</b>
<b>Chapter 1.....</b>	<b>47</b>
<b>Development and Efficiency Comparison of Newcastle Disease Virus Reverse Genetics Systems with Different Number of Plasmids.....</b>	<b>47</b>
<b>Chapter 2.....</b>	<b>61</b>
<b>Two-Plasmid System to Increase the Rescue Efficiency of Paramyxoviruses by Reverse Genetics: the example of rescuing Newcastle Disease Virus....</b>	<b>61</b>
<b>Chapter 3.....</b>	<b>82</b>
<b>Newcastle disease virus uses cell-to-cell transmission to maintain persistent infection, resist superinfection exclusion and enhance co-infection.....</b>	<b>82</b>
<b>Chapter 4.....</b>	<b>114</b>
<b>Generation of a Recombinant Attenuated Vaccine to Protect Chickens from Newcastle Disease and Block Viral Shedding.....</b>	<b>114</b>
<b>General discussion.....</b>	<b>134</b>

# **Génération d'un nouveau vaccin pour protéger les volailles contre la maladie de Newcastle et l'excrétion virale**

## **RESUME EN FRANÇAIS**

Par

**LIU Haijin**

La maladie de Newcastle est, avec l'influenza aviaire, une des deux pestes aviaires impactant fortement la santé des oiseaux d'élevage. Au-delà de l'impact sanitaire, ce sont les conséquences liées aux restrictions des mouvements d'animaux et aux mesures de contrôle de l'infection qui désorganisent les filières et fragilisent l'équilibre économique des éleveurs et des pays, en particulier au sud. La maladie de Newcastle est très largement répandue à l'échelle du globe et si elle semble relativement bien contrôlée au nord par l'association de vaccinations ciblées de populations d'oiseaux domestiques à risques (exemple des pigeons d'élevage en France) et de la surveillance événementielle, elle reste une des premières causes de mortalité dans les élevages au sud, en dépit d'un large usage de vaccins.

La maladie est provoquée par un virus enveloppé à ARN négatif d'environ 80-100 nm, appartenant au genre *Avulavirus* dans la famille *Paramyxoviridae*. Le génome viral d'un peu plus de 15 kilobases, code pour 6 protéines structurales (Figure 1). Trois, la nucléoprotéine (N), la phosphoprotéine (P) et la large protéine (L), entrent dans la composition du complexe ribonucléoprotéique (RNP) qui est la structure minimale du virus permettant la réplication du génome et la synthèse des protéines virales. C'est cette RNP qui doit être reconstituée dans le cytoplasme de la cellule pour générer des virus modifiés par génétique inverse. La protéine de membrane (M) sert à la formation de la particule virale par son interaction avec la membrane cellulaire et les protéines de surface du virion. Les protéines de surface, l'hémagglutinine (HN) et la protéine de fusion (F), servent à l'interaction avec un récepteur cellulaire et la fusion des

membranes virales et cellulaires pour la libération du génome viral dans le cytoplasme cellulaire.

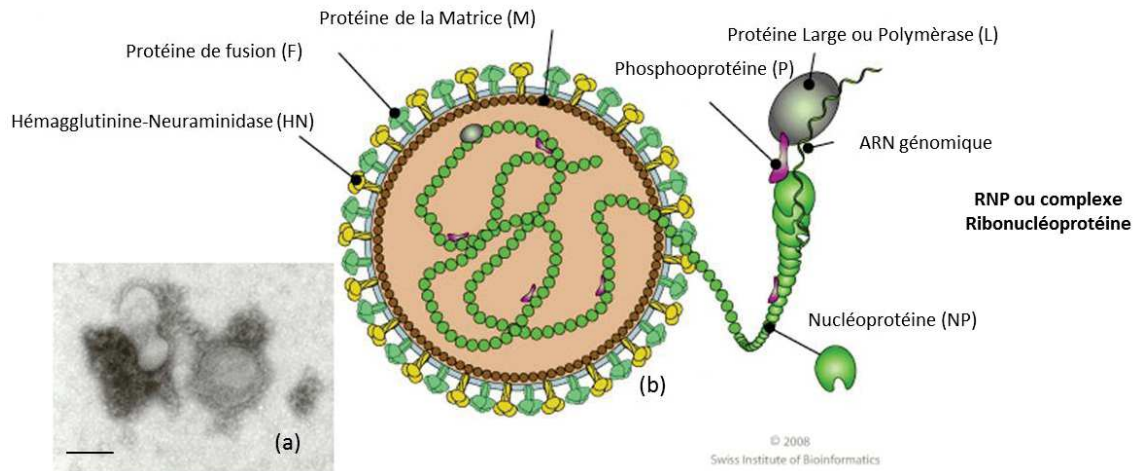
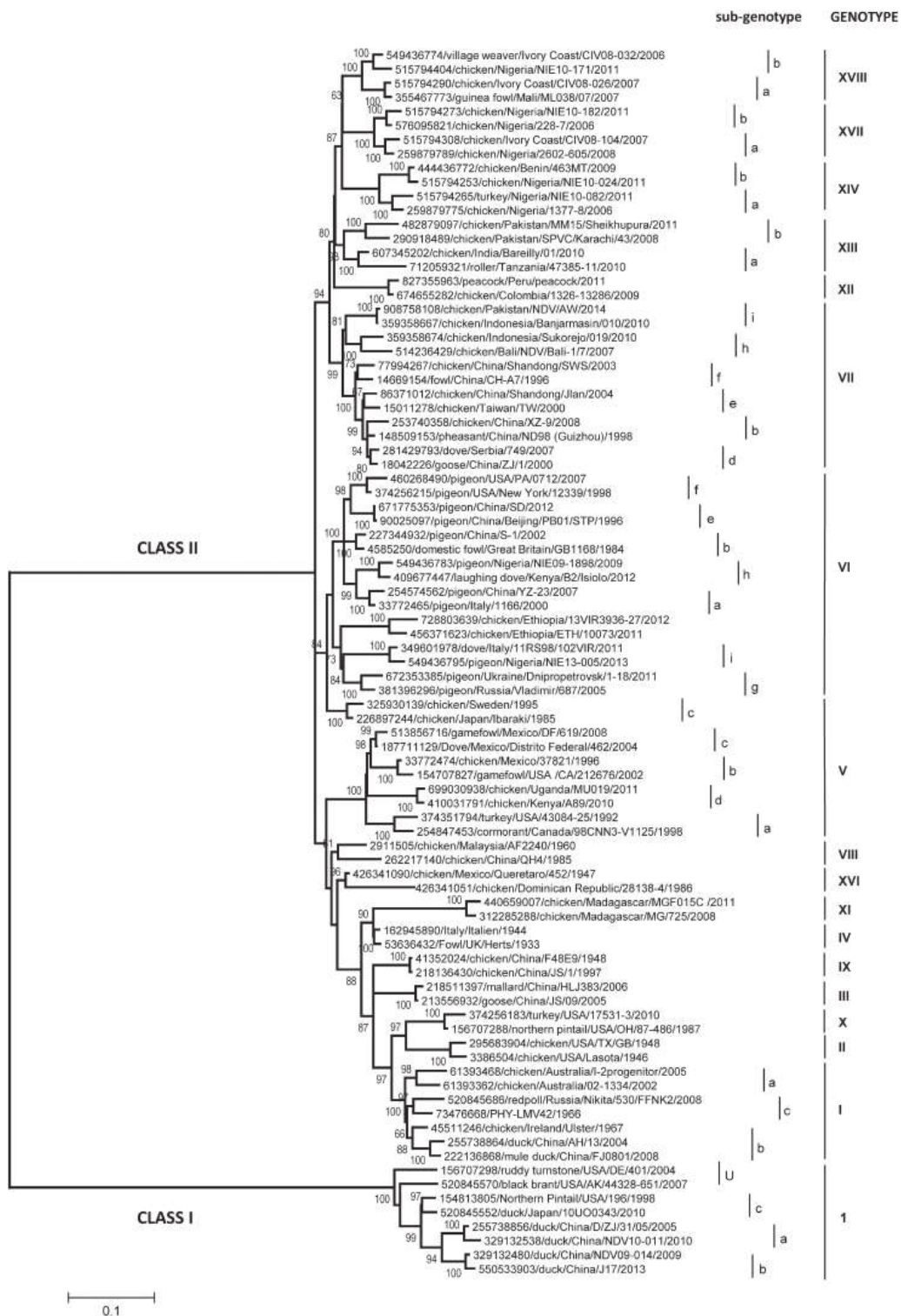

**Figure 1.** Représentation schématique de la structure et de la composition du virus de la maladie de Newcastle. Le génome de 15 186 à 15 198 bases selon les virus, code pour 6 protéines structurales et deux protéines non structurales

Il existe une grande variabilité de pouvoir pathogène chez les oiseaux, liée aux propriétés intrinsèques du virus. Si les déterminants de la virulence semblent multiples et répartis sur l'ensemble du génome, il existe toutefois un mécanisme bien décrit qui conditionne à lui seul le pouvoir pathogène du virus. Il s'agit du clivage de la protéine de fusion. Dans son état natif, la protéine F est un monomère F0 inactif qui pour devenir actif doit être clivé en deux sous-unités F1 et F2 liées par un pont disulfure. Cette activation est réalisée par les enzymes cellulaires qui reconnaissent un motif situé en positions 112-117. Le type d'enzymes capables de faire ce clivage dépend du motif présent. Plus le motif contient des acides aminés basiques plus il est facilement clivé par des enzymes ubiquitaires de type furine. Inversement, les motifs avec peu d'acides aminés basiques sont essentiellement clivés par des enzymes de type trypsine. Or, chez l'animal, ces dernières sont abondantes au niveau des muqueuses alors que les furines sont répandues en profondeur dans les organes et tissus : ce qui explique que les virus à motif basique, très virulents ou dits vélogènes, ont la capacité à envahir les tissus et produire une maladie sévère alors que les virus à motif moins basique, atténués ou lentogènes, seront moins invasifs.



A ce jour, il n'existe qu'un seul sérotype du virus de la maladie de Newcastle. Autrement dit, un animal protégé contre un virus l'est contre tous les autres. Cependant, il existe une grande variabilité génétique parmi les virus Newcastle, avec près d'une vingtaine de génotypes décrits (Figure 2). Tous les vaccins courants sont dérivés de génotypes anciens (I, II, III ou IV), identifiés il y a près de 70 ans. Pour autant, la dérive génétique accumulée depuis lors amène à des taux de substitution en nucléotides par site de l'ordre de 20% entre les protéines F des anciens et des nouveaux génotypes. Un tel niveau de variation peut interroger en terme d'efficacité des vaccins basés sur des anciens génotypes pour lutter contre les souches virulentes circulant actuellement. Cette interrogation a été le point de départ de notre travail de thèse. Fin des années 2000, le CIRAD a reçu des informations d'Afrique de l'ouest et de Madagascar tendant à accréditer l'idée que les vaccins actuels ne seraient que partiellement efficaces dans les élevages faisant l'objet d'une vaccination bien conduite. Cette perte d'efficacité se manifestait par l'apparition de signes atténués de maladie de Newcastle chez des volailles régulièrement vaccinées. Pour confirmer que cette observation pouvait être réellement attribuée à une perte d'efficacité du vaccin, le CIRAD en collaboration avec l'ANSES a mis en œuvre un essai expérimental sous condition contrôlée visant à évaluer l'efficacité d'un vaccin actuel contre un nouveau génotype virulent isolé à Madagascar en 2008.



**Figure 2.** Arbre phylogénétique de virus Newcastle établi sur la base de la séquence complète du gène F. Les virus responsables de la maladie de Newcastle sont principalement regroupés dans la classe II. Les vaccins actuels sont à base de souches dérivées des anciens génotypes I, II, III et IV.

L'essai réalisé à l'ANSES a permis de vérifier que le vaccin protégeait toujours cliniquement les animaux mais qu'en revanche il contrôlait beaucoup moins bien la réplication et la ré-excrétion du virus malgache (Figure 3).

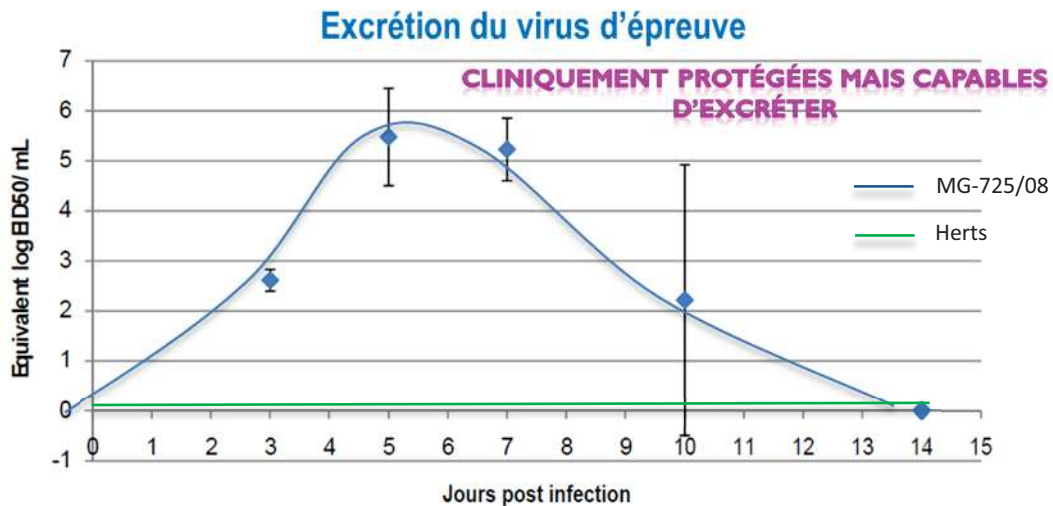

Vaccination mixte (HB-vivant-vivant /La Sota Clone-30-inactive) sur des poussins EOPS d'1 jour  
 Souche d'épreuve MG-725/08 (génétype XI)/  
 Souche d'épreuve de contrôle Herts

**Figure 3.** Des poulets vaccinés par voie oculonasale et intramusculaire avec deux vaccins commerciaux à base de souches de génotype II ont été éprouvés soit avec une souche virulente ancienne de génotype IV (Herts), soit avec une souche virulente récente de génotype XI, isolée en collaboration par le CIRAD et le FOFIFA-DRZV. Dans le premier cas, aucune excrétion virale n'est observée après épreuve avec la souche Herts. En revanche, la souche malgache de génotype XI est excrétée plusieurs jours par les animaux vaccinés alors qu'ils ne présentent aucune symptomatologie.

L'objectif initial de cette thèse était de produire un vaccin vivant modifié permettant de contrôler l'excrétion virale de plusieurs génotypes virulents, anciens et récents. Pour ce faire, nous sommes partis d'un vaccin vivant déjà connu et très largement répandu à l'échelle du globe : le vaccin à base de la souche LaSota de génotype II. Puis nous avons envisagé de modifier les antigènes immunoprotecteurs HN et F de cette souche par des antigènes provenant d'une souche plus récente. Notre choix s'est porté sur une souche de Madagascar isolée en 2008 par notre groupe. Cette souche est particulière dans le sens où elle est issue d'un génotype IV ancien et porte des motifs antigéniques sur HN et F, intermédiaires entre génotypes anciens et nouveaux (Maminiaina et al., 2010). Elle présentait donc à nos yeux un profil intéressant pour l'objectif visé.

Dans un premier temps, nous avons adopté la technique de génétique inverse pour générer toute une série de virus modifiés. Cette technique est classiquement basée sur l'utilisation de 4 plasmides permettant de reconstituer une RNP virale dans une cellule sensible à l'infection. Un des plasmides comprends le génome complet du virus. Les trois autres plasmides fournissent la N, la P et la L. Utilisant cette technologie classique, nous n'avons eu aucun problème à générer des virus virulents. En revanche, nous avons été confrontés à des échecs pour générer certains virus atténués modifiés. Pour contourner cet obstacle, nous avons dû innover et développer un système plus efficace. Nous avons développé un système de génétique inverse basé sur 2 plasmides : un contenant le génome complet et un second contenant les trois cassettes exprimant N, P et L. Nous démontrons que ce système est plus efficace que le système conventionnel pour générer des virus atténués (Figure 4, Liu et al., 2017)

Viruses	Rescuing with:			
	4-plasmid		2-plasmid	
	A <sup>a</sup>	B <sup>b</sup>	A	B
MG-725	+ <sup>c</sup>	+	+	+
MG-725/EGFP	- <sup>d</sup>	+	+	+
MG-725/Fmu	-	+	+	+
MG-725/Fmu/EGFP	-	-	+	+
MG-725/Fmu/Cherry	-	+	+	+
LaSota	-	+	-	+
LaSota/Cherry	-	-	-	+
LaSota/M-Fmu	-	-	-	+
LaSota/M-HN	-	+	-	+

<sup>a</sup> The condition for the rescue was 2 µg plasmids, one day after transfection.

<sup>b</sup> The condition for the rescue was 3 µg plasmids, 3 days after transfection.

<sup>c</sup> Viruses were considered as successfully rescued after confirmation by HA and qRT-PCR.

<sup>d</sup> Viruses were not rescued after three independent tries.

**Figure 4.** Efficacité comparative du système conventionnel de génétique inverse et de celui mis au point dans le cadre de cette thèse sur neuf virus modifiés (reproduction du tableau 5 de l'article Liu et al., 2017)

Par ailleurs, nous avons comparé différentes associations à 4, 3, 2 ou 1 plasmides en termes d'efficacité en génétique inverse. Nous montrons que c'est le système à 2 plasmides qui est le plus efficace (Figure 5)

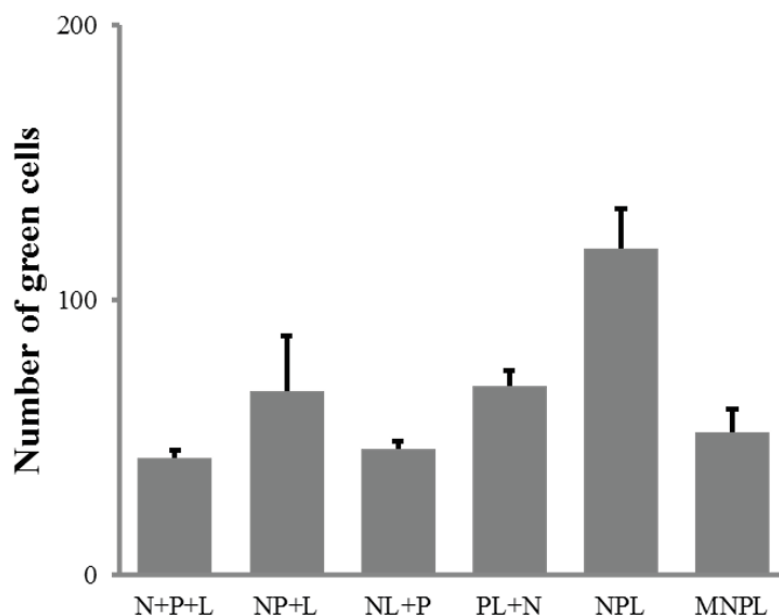

**Figure 5.** Efficacité comparée de différentes associations de plasmides sur l'expression d'un minigénome EGFP. N+P+L = 4 plasmides (minigénome, N, P et L) ; NP+L = 3 plasmides (minigénome, NP, L) ; NL+P = 3 plasmides (minigénome, NL, P) ; PL+N = 3 plasmides (minigénome, PL, N) ; NPL = 2 plasmides (minigénome, NPL) ; MNPL = 1 plasmide (minigénome-NPL). Toutes les associations testées font au moins jeu égal avec le système conventionnel à 4 plasmides. Toutefois, c'est le système à 2 plasmides qui détient le meilleur rendement.

Dans un second temps, nous nous sommes intéressés à étudier les propriétés des virus modifiés produits. En particulier, nous avons évalué la capacité de ces virus à établir des infections persistantes *in vitro* et à générer des co-infections qui pourraient dans l'absolu conduire à des événements de recombinaison indésirables notamment entre souches vaccinales et souches virulentes. Pour faciliter ces études, certains de nos virus d'intérêts ont été équipés d'une cassette d'expression d'un marqueur fluorescent, soit EGFP, soit mCherry. Nous montrons que tous les virus vélogènes ou lentogènes sont capables d'établir des infections persistantes en culture cellulaire *in vitro*. En revanche, une cellule infectée par un premier virus ne peut être infectée directement par une seconde particule virale, probablement parce que les récepteurs membranaires sont indisponibles : il s'agit d'un mécanisme d'exclusion de la surinfection. Toutefois, nous démontrons que les virus établis de façon persistante sont capables de gagner une autre cellule, infectée ou non, en guidant la formation de connexions cytoplasmiques parfois de longue dimension. Par ce mécanisme, la co-infection devient alors possible (Figure 6).

C.

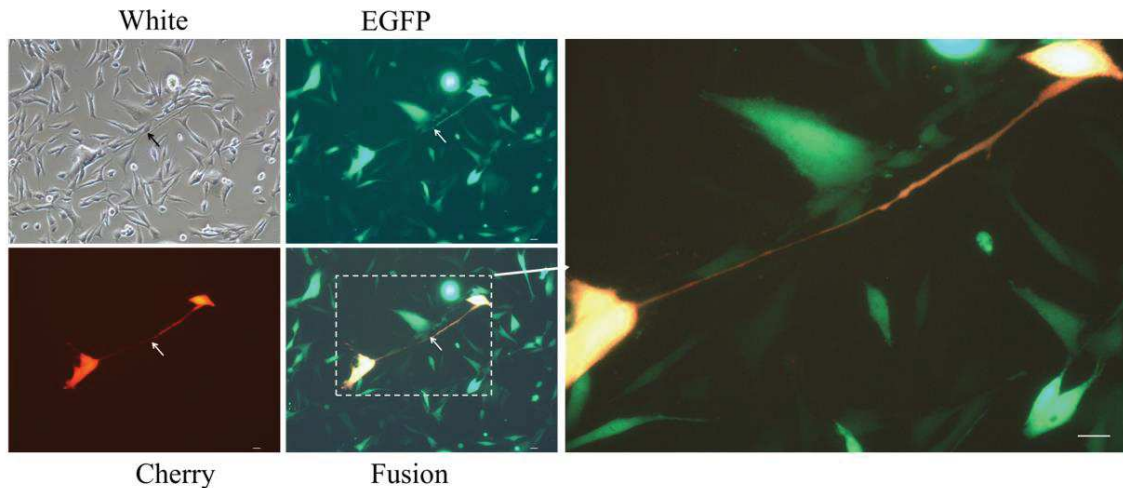

**Figure 6.** Des cellules BHK21 ont été co-infectées par un virus vélogène fluorescent vert (EGFP) et par un virus lentogène fluorescent rouge (Cherry). Alors qu’une surinfection directe d’une cellule déjà infectée n’est pas possible, nous observons ici qu’une co-infection a été possible entre deux cellules et que celle-ci s’est opérée par la formation d’une connexion entre cellules à longue distance permettant le trafic des deux virus (fluorescence verte et rouge).

Ces observations permettent d’expliquer pourquoi les analyses de séquences d’isolats de terrain identifient régulièrement des événements de recombinaison entre souches virulentes et souches vaccinales. Notre hypothèse est que par le biais d’infections persistantes chez l’animal, des surinfections par ce mécanisme de connexions intercellulaire distantes pourraient créer les conditions de recombinaisons entre virus.

Dans la dernière partie de ce travail de thèse, nous nous sommes attachés à vérifier si notre prototype vaccinal était capable de contrôler la ré-excrétion après épreuve infectieuse. Le vaccin correspond à la souche LaSota dans laquelle les gènes HN et F ont été remplacés par ceux de la souche Madagascar MG-725 : il s’agit donc d’une souche hybride génotype II – génotype XI. Le gène F de la souche Madagascar ayant à l’origine un motif de site de clivage vélogène, nous l’avons modifié en motif lentogène avant insertion dans le vaccin. Dans un essai en condition contrôlée, des poulets ont été vaccinés soit avec la souche LaSota conventionnelle soit avec notre prototype vaccinal recombinant entre LaSota et MG-725 (rLaSota/M-Fmu-HN). Trois semaines après vaccination, les animaux ont été éprouvés soit avec une souche virulente de génotype II, soit la souche de génotype XI MG-725, soit une souche virulente de génotype VII. Nous montrons que les deux vaccins confèrent le même niveau de protection clinique contre les trois souches virulentes. En revanche, le prototype vaccinal rLaSota/M-Fmu-HN contrôle mieux la réplication des trois souches virulentes. En



effet, nous observons sur des poulets sacrifiés trois jours après épreuve que les poulets vaccinés LaSota présentent plus de virus génotype II et génotype XI dans le système respiratoire que des poulets vaccinés rLaSota/M-Fmu-HN (Figure 7). Par ailleurs, le vaccin LaSota a empêché l'excrétion virale dans tous les écouvillons trachéaux et cloacaux de poulets à 3, 5, 7 et 10 jours après infection par la souche de génotype VII. Aucun écouvillon n'a été trouvé positif chez les poulets vaccinés rLaSota/M-Fmu-HN quelle que soit la souche d'épreuve.

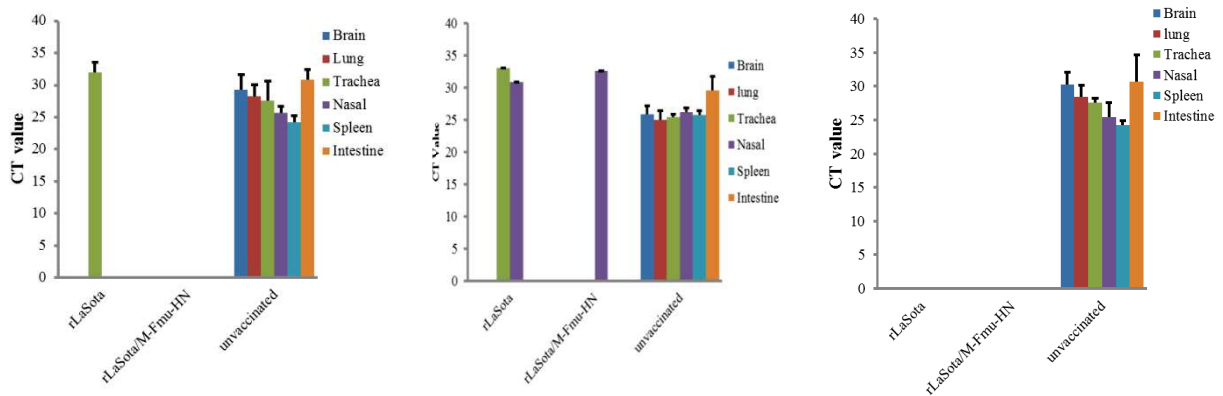

**Figure 7.** Recherche de virus dans les prélèvements de poulets vaccinés par LaSota, rLaSota/M-Fmu-HN ou non vaccinés et éropvés trois semaines plus tard par un virus de génotype XI (graphe de gauche), de génotype II (graphe du milieu) ou de génotype VII (graphe de droite). On observe plus de prélèvements positifs chez les poulets vaccinés avec LaSota. A noter, qu'aucune présence de virus n'est observée avec l'un ou l'autre des vaccins après épreuve infectieuse avec le génotype VII, génotype actuellement dominant, en particulier en Asie.

## Conclusion :

Dans ce travail de thèse, nous proposons un système de génétique inverse du virus de la maladie de Newcastle optimisé pour générer des virus atténués modifiés. Nous pensons que ce système peut également améliorer la génétique inverse d'autres virus à ARN négatif. Grâce à ce système nous avons pu générer divers virus atténués dont certains équipés d'un traceur fluorescent afin de caractériser le comportement de ces virus en culture cellulaire in vitro. Après avoir vérifié que le mécanisme d'exclusion de la surinfection existe bien chez le virus Newcastle, nous identifions une propriété originale de ce virus consistant à diffuser de cellule en cellule par l'établissement de connexions membranaires de longue distance. Par ces connexions, le virus est capable de surinfecter une cellule infectée de manière persistante par un autre virus, ouvrant la voie à de possibles évènements de recombinaison. Un candidat vaccin comprenant l'essentiel du génome de la souche LaSota mais les gènes HN et F d'une

souche malgache a été testée in vivo contre trois souches virulentes de génotype II, VII et XI. Cette souche s'est montrée moins réplivative que la souche LaSota d'origine mais tout autant protectrice. Ces propriétés en font un prototype vaccinal pertinent pour les animaux vaccinés et l'environnement.



## **Introduction**

## 1. Newcastle disease

Newcastle disease (ND) is caused by velogenic strains of Newcastle disease virus (NDV) and has large economic impacts in the poultry industry due to its high pathogenicity and animal movement bans imposed for the control of the infection (1-3). Chickens infected by virulent NDV can show serious clinical signs like diarrhea, nervous and respiratory illnesses, egg laying reduction, generation of deformed eggs and mortality (4-6). NDV also causes haemorrhagic lesions in the trachea, intestine and proventriculus (5, 7-12).

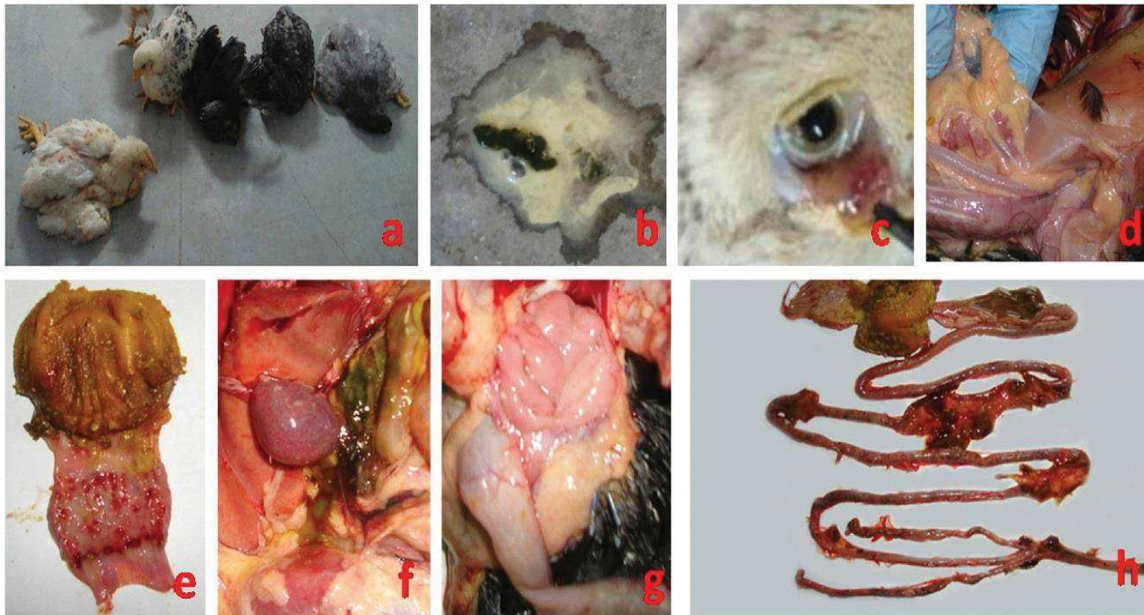

**Fig. 1.1.** Clinical signs and haemorrhagic lesions in chickens infected by virulent NDV. a) Infected chickens; b) Feces; c) Eyelid; d) Thymus; e) Proventricular glands; f) Spleen; g) Cloacal bursa; h) Intestine (5).

Newcastle disease was first described in 1926, in Indonesia and one year later in England in Newcastle and then gradually spreads worldwide through bird trade, movement of human and wild bird (13-15). However, an outbreak of this disease was probably observed in 1897 based on Macpherson's report and this date of first occurrence is more in agreement with the results of molecular dating performed by Yee et al., estimating the time to the most recent common ancestor (TMRCA) of NDV between 1868-1891 (13, 16). Since its description, three main ND panzootics have successively occurred in the world. The first one started in 1926 and vanished in 1960 (1). The second one lasted from 1970 to 1974 and the third one was during 1980s (1). ND outbreaks have been confirmed in many countries up to now (17).

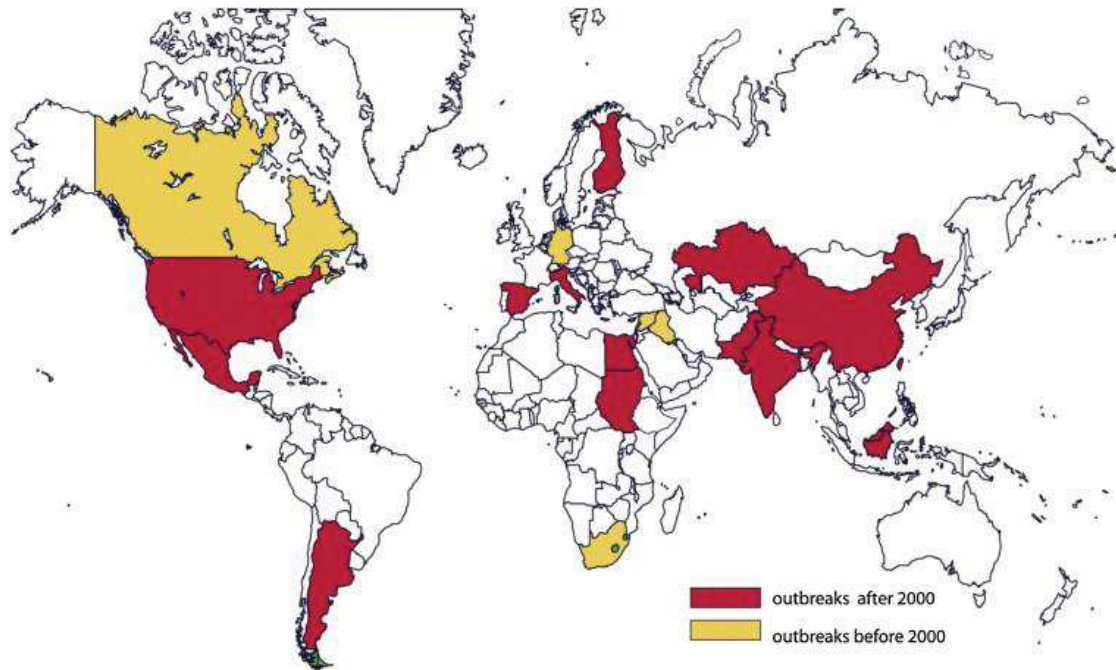

**Fig. 1.2.** ND outbreaks among the world (15).

## 2. Newcastle disease virus (NDV)

Birds are the main hosts of NDV with at least 234 susceptible species described (18), but the virus can also infrequently be isolated from other animals like mink and pig (19, 20). NDV belongs to the *Avulavirus* genus in the *Paramyxoviridae* family (21). The virion of NDV is enveloped and pleiomorphic, ranging from 100 nm to 500 nm in diameter (22, 23). The size of viral particle relates to copies of the genome packaged into the particles. Usually, each NDV virion only wraps one genome, but some particles can tolerate more than one copy of the genome (24, 25).

The genome of NDV is composed by a non-segmented RNA, negative sense with 15,186, 15,192 or 15198 bases (26-28). The size of the genome of NDV respects the rule of 6: the number of nucleotides in the genome has to be divided by 6 as a consequence of the stoichiometric interaction between the viral nucleoprotein and the genome (29).

The genome consists of six gene segments (3'-NP-P-M-F-HN-L-5') and inserted between the Leader and Trailer regions at the 3' and 5' terminus which act as promoters for RNA transcription and replication. Each gene unit, surrounded by a gene start (GS, 3'-UGCCCAUCUU-5') and gene end (GE, 3'-AAUCUUUUUU-5') regions, is separated by inter-genic residues (30, 31). These genes encode six structural proteins – Nucleocapsid (NP)

protein, Phosphoprotein (P), Matrix (M) protein, Fusion (F) protein, Hemagglutinin-Neuraminidase (HN) protein, Large (L) protein, and two nonstructural proteins, V and W due to P gene editing (32, 33). NP protein encapsidates viral RNA to be a template for transcription and replication by RNA-dependent RNA polymerase (RdRP) consisting of P and L protein. The complex containing viral RNA, NP, P and L proteins is named ribonucleoprotein complex (RNP) (34-36). Through the direct interactions with RNP and HN, M protein plays a pivotal role in the viral assembly (37, 38). On the surface of viral envelope, F and HN proteins are in charge of the virus-receptor interactions and virus entry (39-41). Both F and HN are glycoproteins that cause immunity reaction of hosts, notably to generate NDV neutralizing antibodies (42-46).

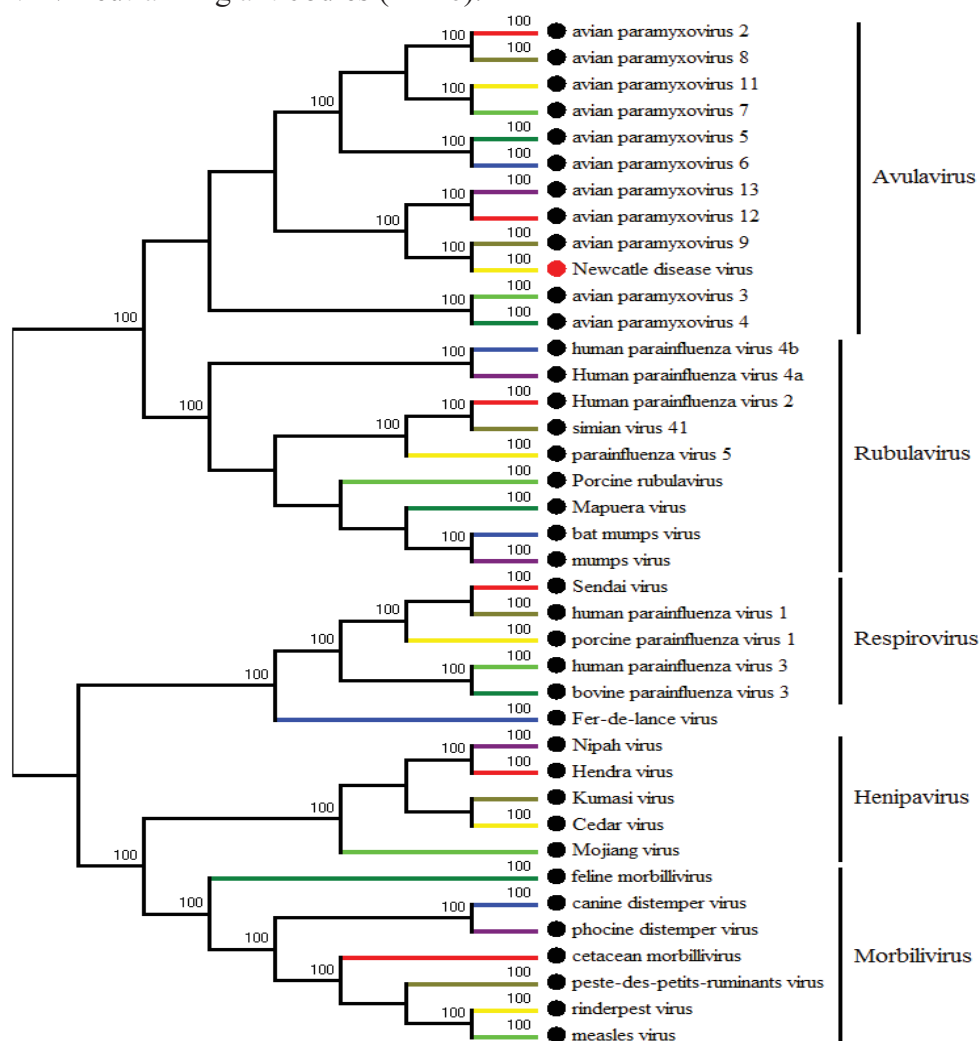

**Fig. 1.3.** Phylogenetic tree of paramyxovirus was built by MEGA6 based on L genes of different virus from paramyxovirus family.

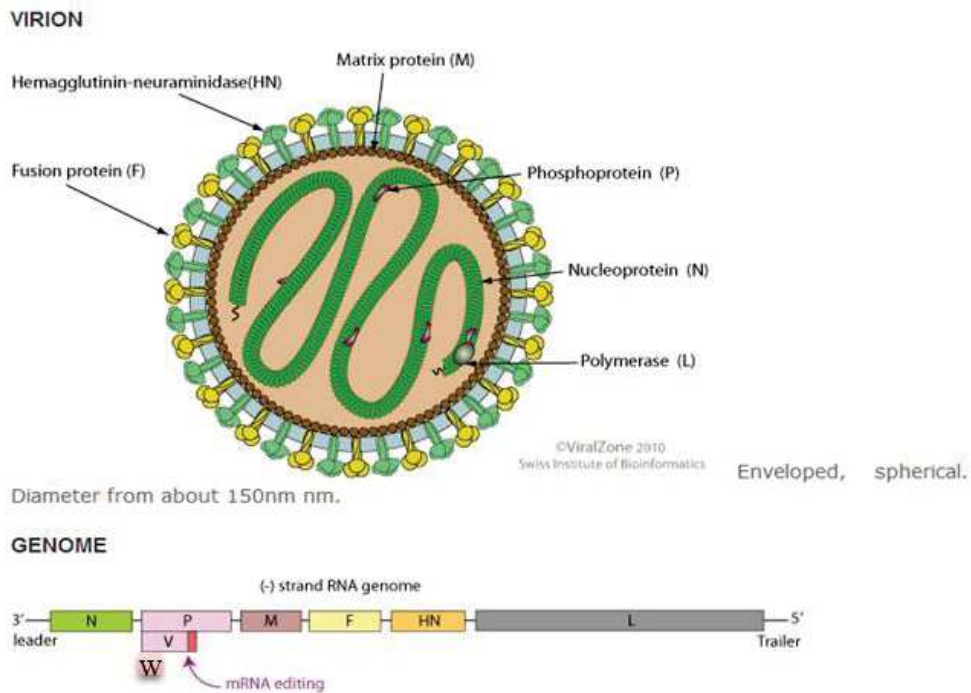

**Fig. 1.4.** Virions of NDV and its genome structure (Viral zone: [http://viralzone.expasy.org/84?outline=all\\_by\\_protein](http://viralzone.expasy.org/84?outline=all_by_protein)).

3. Newcastle disease virus life cycle.

NDV life cycle processes start at receptor binding and end at viral budding (15, 47).

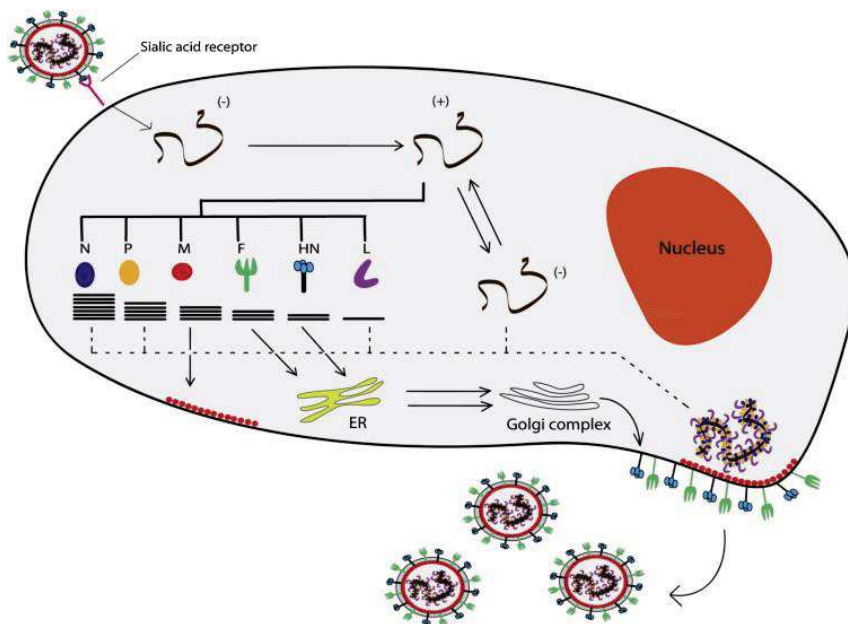

**Fig. 1.5.** NDV life cycle (15)



The NDV HN protein interacts with the cell receptor. HN protein is divided into three regions based on its structure—one is N-terminal transmembrane domain, another is stalk and the last one is C-terminal head (41, 48). On the head of HN, there are two receptor binding sites that recognize sialic acids on the cellular membrane (49-51). After binding to its receptor, HN initiates a series of changes from “Head-down” to “Head-up” conformation followed by the exposure of the F protein stalk region which contains the active fusion sites (52-55). When activated, the F protein insert its fusion peptide into the cell membrane and also start conformational changes from a pre-fusion to post-fusion structure, which close membranes of cell and virus and then fuse them in a pH-dependent manner (56-58).

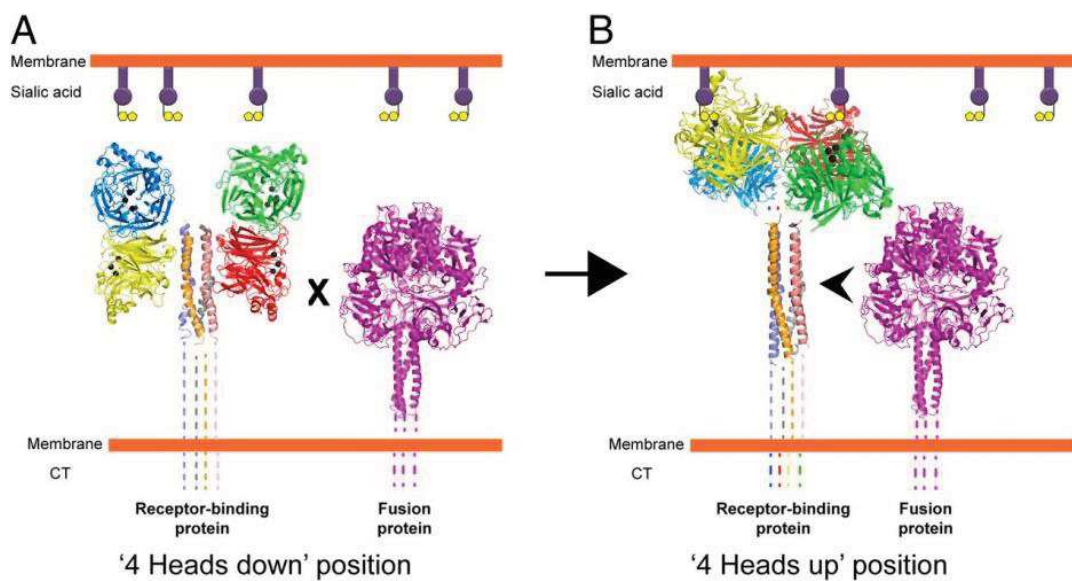

**Fig. 1.6.** HN protein conformation before and after receptor recognition (54).

The RNP is released into cytoplasm when fusion is achieved (56). After releasing, RdRp complex uses encapsidated RNA as the template to transcribe viral RNA in a “stop-start” mode to produce viral proteins from NP to L into the cytoplasm according to a decreasing gradient (59-65). P protein, as chaperone, interacts with NP to prevent its oligomerization until the virus genome RNA is encapsidated (66, 67). After post-translational modifications, M protein is transported to the inner layer of cell membrane, while F and HN proteins display on the cell surface (37, 68). RdRp changes its role from transcription to generate viral negative RNA using the positive RNA strand as template, followed by viral RNA and NP protein encapsidation (61, 62). Finally, RNP complexes move to the plasma membrane to be assembled with the other viral proteins under the guidance of M for viral budding (15, 47, 68).

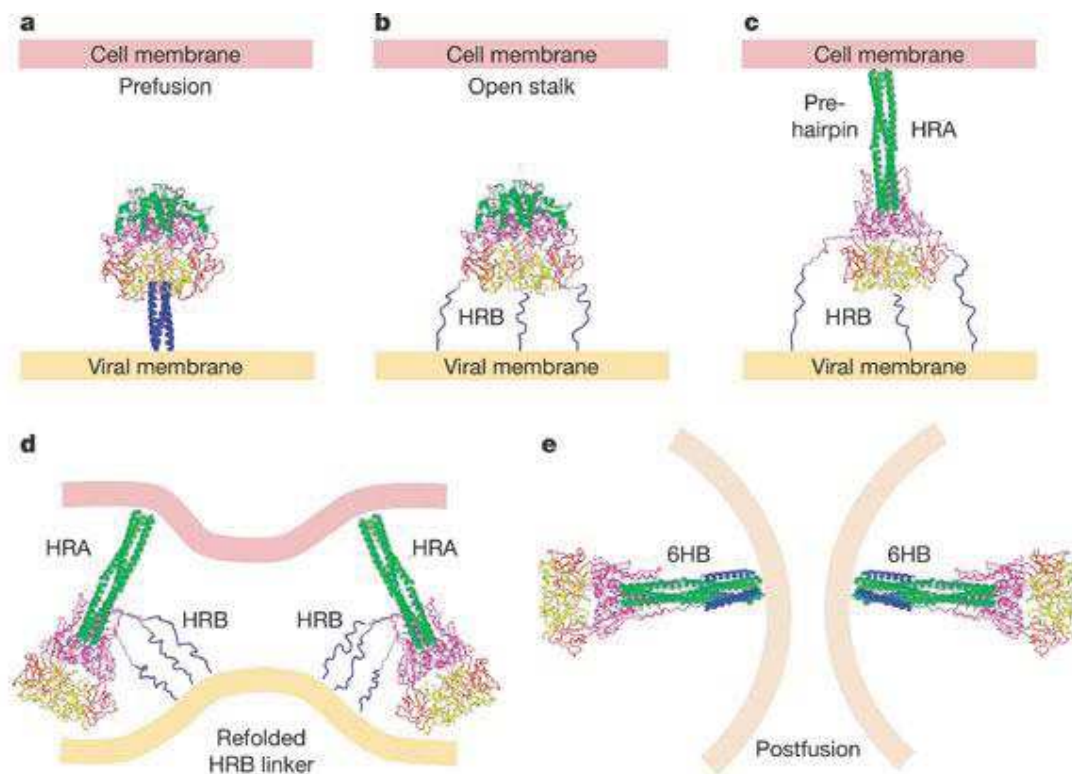

**Fig. 1.7.** F protein conformation during fusion steps (56).

#### 4. Newcastle disease virus virulence

Based on mortality of chicken embryo and clinical signs observed in chickens, NDV is divided into three pathotypes: velogenic, mesogenic (pathogenic strains) and lentogenic (apathogenic strain). Usually, the mean death time (MDT) of embryonated chicken eggs and the intracerebral pathogenicity index (ICPI) in one-day-old chickens are used to assess NDV virulence. Velogenic strains have MDT lower than 60 hours (<60 h) and ICPI around 2.0, while MDT is beyond 90 hours (>90h) and ICPI approaches 0.0 for lentogenic strains (69).

The cleavage site of F protein plays a major role for the NDV virulence (31, 70, 71). F protein is synthesized and glycosylated in the endoplasmic reticulum as an inactive F<sub>0</sub> precursor shifted to an active F protein after cleavage by cellular proteases resulting into a disulfide-linked F<sub>1</sub> and F<sub>2</sub> sub-units. F<sub>1</sub> and F<sub>2</sub> are necessary for viral infection (72, 73). The lentogenic strains usually own a cleavage motif with dual-basic amino acids which can be only cleaved by trypsin-like proteases located in the respiratory and intestinal tract. In contrast, the cleavage site of velogenic strains has multi-basic amino acids which are recognized by ubiquitous furin-like proteases (74). Consequently, virulent strains are fatal for chickens due

to systemic infection. Modifications of the cleavage motif of velogenic viruses to that of lentogenic strains significantly attenuate the virus virulence (31). In addition, the replication of lentogenic viruses in chickens, often leads to the emergence of velogenic variants by the accumulation of multi-basic amino-acids in the cleavage site (75-77).

Despite the fact that the F protein cleavage site is considered as the primary determinant of NDV virulence, significant differences in virulence can exist between strains having the same velogenic F cleavage site. In addition, some NDV strain from pigeon or dove (PPMV-1) with multi-basic amino acids can be lentogenic on chickens (78-80). These observations indicate that other factors can be also involved in NDV virulence (81). Replacement of whole F protein of a mesogenic strain by that of a velogenic PPMV-1 strain decrease ICPI from 1.36 to 0.60, even though both F proteins contain polybasic amino acids (82). Exchange or modification of NP, P, L, M or HN proteins between velogenic and lentogenic strains can decrease or increase the pathogenicity of viruses (33-36, 83-88). V protein antagonizes the host interferon response induced by viral infection. Consequently, the inactivation of the expression of V protein decreases the viral virulence while the restoration of its expression results in reversion to virulence (89-92). Interestingly, non-coding inter-genic regions of viral genome can also affect viral pathogenicity (28, 93-95).

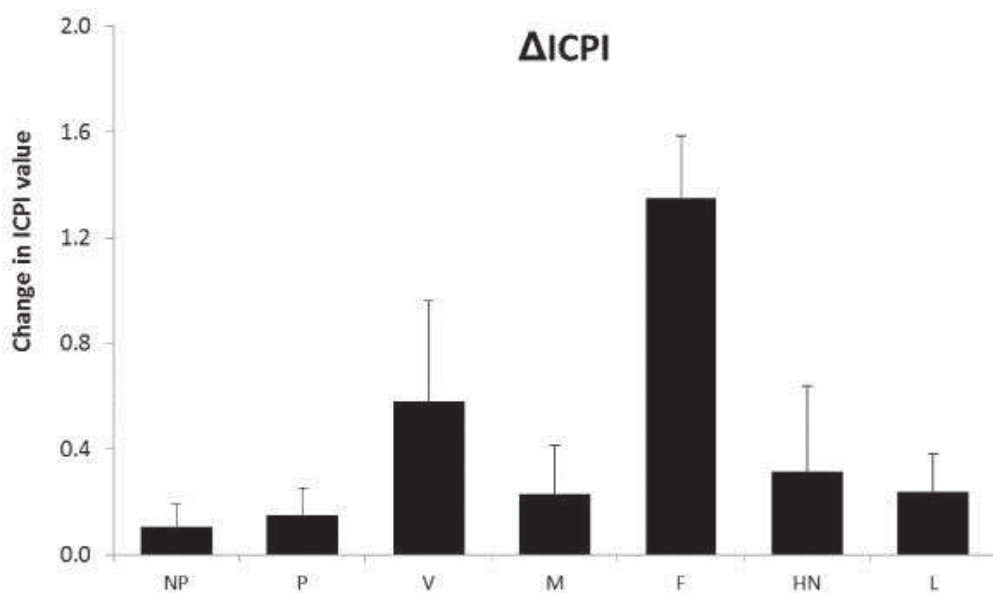

Fig. 1.8. Impacts of each protein on NDV virulence (81).

## 5. Newcastle disease virus transmission



## 5.1 Transmission between hosts

Since infected birds excrete NDV in feces and oculo-nasal secretions, NDV transmits mainly horizontally by direct contact between infected and uninfected birds within the same flock (7, 96-98). Furthermore, NDV can transmit to offspring via chicken embryos and is able to transmit from parental to descendant cells in persistently infected (PI) cells (99-103). Even if NDV easily loses its infectivity under exposure to high temperatures and irradiation of sunlight, the high virus load and relative persistence of the virus in birds' bodily discharges, feathers and other materials can be source of distant spread of the infection by human activities between different flocks (98, 104-107). Contacts between wild and yard birds is another route for viral transmission (108, 109). Some infected exotic birds shed NDV without clinical symptoms and spread virus to other birds located in remote areas (110, 111).

## 5.2 Transmission between cells

Virus can spread among cells through two ways. One is the cell-free virus-cell route that requires an initial complete virus life cycle releasing progeny viruses into the cell-medium capable of infecting new susceptible cells. The second transmission route is a direct cell-cell spread without the release of virus particles into the culture medium (112-114). Since cultured cells lack trypsin-like proteases, the F protein cleavage motif with dual-basic amino acids cannot be activated. Consequently, lentogenic strains transmit and amplify much lower than velogenic strains in cultured cells (31, 115). Cells infected by virulent strains release a high number of viral particles outside the cells (115). These suggest that NDV, in favorable conditions, spreads primarily through the route of cell-free virus-cell among cells.

NDV can also take a cell-cell route for spreading, notably through the constitution of cell syncytia (116). Syncytia are resulting from the virus infection that induces the fusion of different cells and forms giant cells containing several nuclei (55). The formation of syncytium requires the activation of F protein and allows virus transmission to surrounding connecting cells (117).

In addition to syncytia, some viruses use cell connections to spread from one cell to another one (113). These cell connections can be preexisting cell appendices like for instance the axons and neurological synapses used by the measles virus to transmit between neuronal cells (118, 119). In other cases, viral proteins are required to shape cell connections for viral spread. The murine leukemia virus, for example, expresses viral envelope protein to build cell-cell

contact for virus transmission (120). Furthermore, due to actin rearrangement, cells can be induced in the production of cell extensions after infection by some viruses, such as respiratory syncytial virus, human metapneumovirus, influenza virus and parainfluenza virus 5 (121-123). However, for NDV and at the beginning of this work, it was still unclear whether the virus could spread via a direct cell-to-cell route.

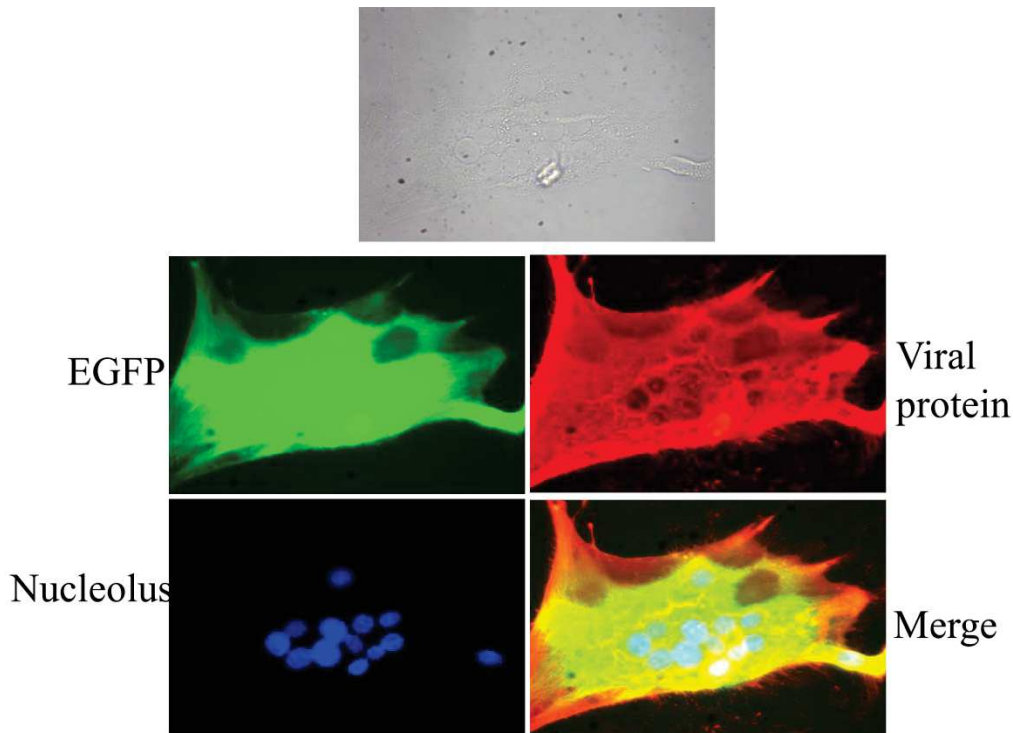

**Fig. 1.9.** Syncytium formed on BHK-21 cells persistently infected with the recombinant NDV – MG\_725 strain expressing EGFP (From this thesis).

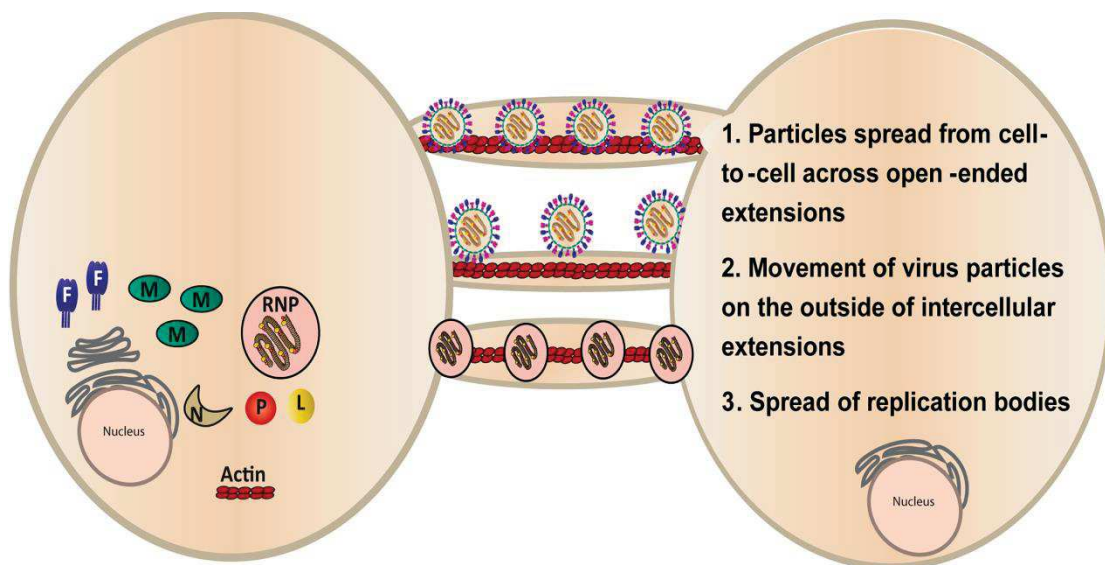

**Fig. 1.10.** Model for virus transmission among cells via the cell-to-cell route (121).

### 5.3 Assets of the cell-cell transmission route for the virus.

Since the cell-cell transmission can maintain an infection without the release of viral particles, it assists the virus in escaping the host immune response based on neutralizing antibodies (124). In addition, the cell-cell route can allow the transmission of incomplete viruses, thus saving the time and costs for a full virus cycle to release free particles (125).

Another possibly interesting feature for the virus is the capacity of the cell-cell transmission to circumvent the superinfection exclusion and promote co-infection and evolution by recombination events. Indeed, recombination events have been detected by sequence comparisons in NDV (13, 126). Whether this is resulting from a natural biological process remains to be established and at least requires that the two parental viruses infect the same cell at the same time. However, co-infection is inhibited by the superinfection exclusion due to receptor destroyed or taken up by the first virus infection (127, 128). Since virus can be directly transmitted from infected cells to others through the cell-cell route, virus infection bypasses the step of receptor interaction. Thus, super-infection or co-infection could occur under the condition of cell-cell transmission.

Furthermore, birds can shed NDV for a long time (sometimes up to 3 weeks) after initial infection, even if the host has generated NDV neutralizing antibodies against viral re-infection (7, 129). NDV strains antigenically distinct from the first infecting virus can still successfully infect and replicate in chickens without inducing morbidity (130, 131). If the second strain can spread among cells of the immunized chicken via the cell-cell route, it may encounter a cell already infected by the first virus and then create a condition which may allow NDV recombination.

### 6. Genotyping and evolution of Newcastle disease viruses.

Based on sequence analyses of the F gene (position 47 to 421), NDV strains have been split into two clades - Class I and II (1, 132). Class I strains are mostly lentogenic viruses isolated from water birds, while Class II strains consist of viruses of different virulence, affecting different avian hosts and being responsible for the ND outbreaks (133). Although the purifying selection has been considered as the main driving force in the evolution of NDV, the evolutionary rate of Class II virus genome is around  $10^{-3}$  (per site per year) that is similar to other RNA viruses (13, 132). Under this evolution rate, Class II NDV strains have involved into multiple genotypes in the last 100 years. The current genotyping is based on the F gene sequences (134).

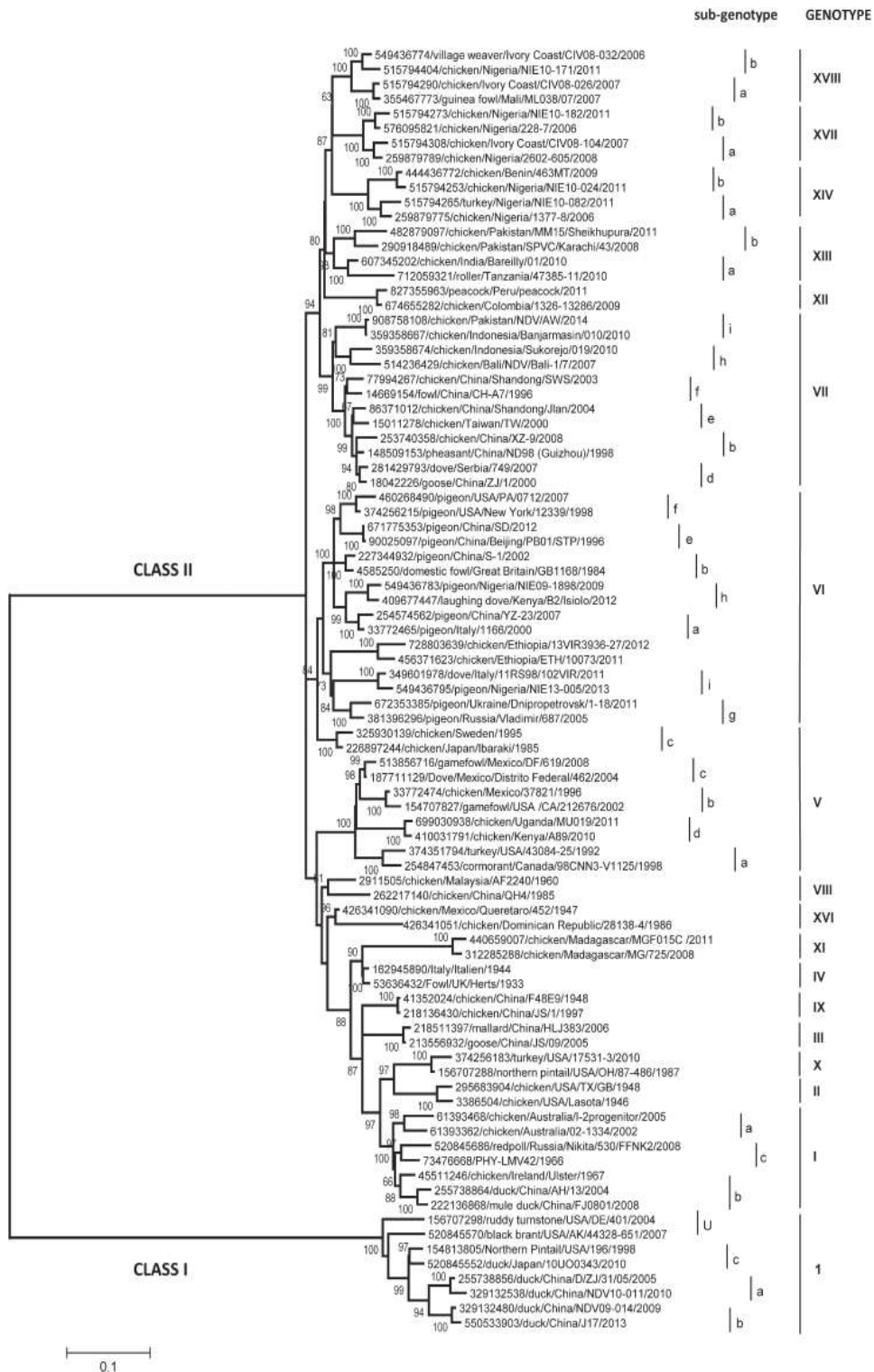

**Fig. 1.11.** NDV genotypes based on F gene (133).

From 1920s to 1960s, only genotypes I-IV (considered as the old genotypes) and IX were identified and virulent strains from these genotypes were responsible for the first ND panzootics (1). Since 1960s, genotypes V- XVIII (recent genotypes) have been isolated (133). Genotypes V and VI caused the second and the third panzootics, respectively (135).

Nowadays, most ND outbreaks, particularly in Asia, are due to genotype VII (133). Besides differences in the F gene sequences, an obvious difference between old and recent genotypes lays in the genome size. The genome of old genotypes has 15,186 bases whereas new genotypes have an insertion of 6 nucleotides into the 5' un-translated region of NP gene (136). Some recent isolates of genotype VII strains also show another insertion of a stretch of 6 nucleotides into the inter-genic region between HN and L (26).

Among NDV strains, the genotype XI was recently identified in Madagascar Island. This genotype is interesting since it is present only in Madagascar, probably at least from 1992 and is currently responsible for most ND outbreaks in the island even though genotype VII is also present (136). Based on phylogenetic and evolutionary analyses, genotype XI is very distant from currently circulating genotypes and is presumed to have emerged from the old genotype IV that has now vanished from the planet (136). Furthermore, genotype XI viruses has unique amino acid motifs exposed at the globular head of the F and HN proteins, which suggests this genotype has evolved in a specific direction under the pressure of the host immune system in a context of vaccination in domestic poultry with attenuated old-genotype strains (136, 137).

#### 7. Newcastle disease vaccines

Vaccination is currently the most effective mean to control ND (138). Currently, live and inactivated ND vaccines are used around the world. Inactivated vaccines are safe for the animals and environment, but the administration is not suitable for large flocks since it requires intramuscular injections with adjuvant and the cell immunogenicity is weak (139). Live vaccines are much more efficient since they can be easily administrated though spray and drinking water, and also induce stronger immune responses (17). Even if they are produced from highly attenuated strains, they still represent a risk of release into the environment (140). However, live vaccines are widely applied in commercial poultry farms. The first live ND vaccine was licensed in 1950s. Currently, ND vaccines are based on lentogenic viruses from genotype I (V4 and Ulster strains) and also genotype II (LaSota, B1, VG/GA and Clone 30 strains) One live vaccine, was generated from the mesogenic Mukteswar strain (genotype III) but it still has a residual risk in younger birds, causing morbidity, and is only recommended in chickens of at least four-weeks of age. Even if live vaccines contribute a lot to prevent NDV, there are still many ND outbreaks around the world, suggesting that ND vaccination and/or vaccine efficacy still needs to be improved (17).



### 7.1 Increasing vaccine's thermal stability.

One of the reasons why the ND vaccination may partly fail in the field could be related to the thermal susceptibility of the attenuated strains and the difficulty to maintain a cold chain in tropical and sub-tropical countries. For these reasons, the thermostability of NDV vaccine strains has been improved and then used in licensed live vaccines (141). Derived from the parental V4 strain, the I-2 strain has a better thermostability and is now licensed in Australia (142, 143). Other thermostable NDV strains have been identified showing stable infective titers after heating at 56 °C for one hour (144). Furthermore, one thermostable strain has been proved to 100% protect chicken from virulent challenge (145). In addition, replacing the HN gene of thermolabile Lasota strain by the one of thermostable TS09-C strain (derived from passaging V4 strain in BHK-21 cells at high temperature) increased the virus thermal stability with virus activity maintained up to 16 days at 30°C (146-148). In addition, this modified strain also prevents chicken from ND in in vivo tests.

### 7.2 Inducing earlier protection in commercial flocks.

After vaccination, chickens need days to mount a full protective immunity to prevent NDV infection (149). In blood, antibodies are detected starting at six days and peaks around 21 days after vaccination (150-152). During this period, vaccinated chickens remain susceptible and can be infected. In order to reduce the period into which chickens are not protected, *in ovo* vaccination using live vaccines has been proposed (153, 154). The vaccine is directly injected into embryos to allow the immune system to develop a protective immunity in the early days after hatching. The in-ovo vaccination is already in place against Marek's disease in the USA (155, 156). A hurdle to use *in ovo* vaccination against ND is the residual virulence of attenuated vaccine strains for the embryos. At the moment, several commercialized ND live vaccines can cause morbidity in chicken embryos and also significantly affect hatch ability and survival rate after hatch (157, 158). However, attenuated strains suitable for *in ovo* vaccine have been developed. One of them is a recombinant NDV strain that keeps a high hatchability and global survival rate after injection into 18-day old chicken embryos. It also protects 100% of chickens against a lethal NDV challenge (158). Furthermore, after *in ovo* vaccination with 5.7 Log<sub>10</sub> EID<sub>50</sub> dose, the modified NDV-P1 strain was able to down-regulate the V protein expression, maintains 90% and 85% hatchability and survival rate, respectively, and also blocks the virulent NDV infection at two-week after hatch (157). Recently, another improved strain named TS09-C not only showed the same capabilities than

the NDV-P1 strain, but also prevented histopathologic lesions in vaccinated chickens compared to the parental V4 strain (159). Another possibility to prevent undesirable side effects of *in ovo* vaccination is to mix the live vaccine and antibodies to obtain antigen-antibody complexes that enhance hatch ability and protect chickens from virulent strain challenge (160).

### 7.3 Resisting maternal antibody.

Another option to improve vaccination in the field is to circumvent the interference of maternal antibodies on the replication of attenuated vaccine strains (161). Chickens have three isotypes of antibodies, IgY, IgA and IgM. In the chicken plasma, IgY is the predominant antibody that is transferred from hens to chicken embryos via the egg yolk and then to chicks through the embryo (162). Even if the transfer efficiency is approximate 30%, chicks can maintain NDV maternal antibodies for around 30 days (162, 163). Live vaccines delivered into host by nanoparticles are able to escape neutralizing by maternal antibodies (164). Chitosan with very low toxicity is used as the material of nanoparticles carriers and can be administered by multiple routes including oral, intranasal-drop (165, 166). One-day old chicks immunized by attenuated NDV encapsulated in chitosan generate more NDV specific IgY and IgA antibodies in serum and show better protection level than those of commercial live vaccine (167). Beyond nanoparticles, some cytokines also can help virus in resisting maternal antibodies. The granulocyte-macrophage colony-stimulating factor (GM-CSF) improves vaccine immunogenicity by recruiting more dendritic and B cells (168). A recombinant lentogenic NDV, expressing GM-CSF, induced higher antibodies in the vaccinees compared to the parent Clone 30 strain, regardless the presence of maternal antibodies before the vaccination (169).

### 7.4 Matching antigens of vaccine strains with circulating strains.

NDV is described as a single serotype, which suggests that any vaccine strain can protect chickens against any virulent virus. This is currently what is observed in terms of clinical protection (170). However, a clinical protection does not mean that current commercial vaccines are able to totally prevent virus infection and subsequent viral shedding by vaccinated chickens. Extents of viral shedding vary among birds and virulent strains (26, 130, 131, 171). In case that chickens produce enough NDV neutralizing antibodies, protection against viral shedding properly relates to the extent of antigenic community between the vaccine and virulent challenge strains (172). The F protein is the most immunogenic antigen

of NDV and is able to induce neutralizing antibodies (45, 46). Consequently, the cross-protection mainly depends on the F gene diversity between strains. In Class II, the diversity of F gene ranges from 8% to 29% among the 18 genotypes currently described (133). To date, all commercial attenuated live vaccines are generated based on old genotypes (I and II) strains (isolated 70 years ago). The F gene diversity between currently circulating virulent strains (genotypes V – VII, XI – XVIII) and vaccine strains is beyond 16% (133). Consequently, current commercial live vaccines cannot prevent current virulent strains from viral shedding even in optimized conditions of vaccination.

Genotype (number of analyzed sequences)	No. of base substitutions per site (SE) <sup>3</sup>																	
	I	II	III	IV	V	VI	VII	VIII	IX	X	XI	XII	XIII	XIV	XVI	XVII	XVIII	
I (n=136)																		
II (n=154)	0.129																	
III (n=8)	0.115	0.144																
IV (n=4)	0.102	0.131	0.082															
V (n=87)	0.192	0.211	0.181	0.147														
VI (n=222)	0.189	0.210	0.184	0.140	0.165													
VII (n=460)	0.187	0.218	0.179	0.143	0.164	0.139												
VIII (n=5)	0.145	0.169	0.136	0.097	0.131	0.124	0.129											
CLASS II IX (n=25)	0.107	0.132	0.094	0.078	0.173	0.177	0.173	0.127										
X (n=11)	0.119	0.122	0.143	0.129	0.212	0.207	0.209	0.167	0.129									
XI (n=14)	0.202	0.231	0.192	0.128	0.232	0.240	0.248	0.200	0.173	0.227								
XII (n=8)	0.197	0.234	0.189	0.155	0.171	0.136	0.125	0.132	0.187	0.216	0.254							
XIII (n=40)	0.186	0.218	0.184	0.144	0.166	0.144	0.122	0.129	0.171	0.208	0.237	0.116						
XIV (n=50)	0.226	0.266	0.229	0.185	0.195	0.177	0.153	0.161	0.224	0.240	0.289	0.143	0.142					
XVI (n=4)	0.164	0.194	0.159	0.117	0.161	0.158	0.166	0.117	0.152	0.184	0.224	0.168	0.159	0.195				
XVII (n=48)	0.183	0.225	0.190	0.153	0.171	0.156	0.137	0.143	0.177	0.216	0.235	0.127	0.120	0.135	0.176			
XVIII (n=16)	0.191	0.220	0.186	0.149	0.170	0.142	0.129	0.137	0.176	0.211	0.238	0.123	0.116	0.137	0.168	0.108		
CLASS I genotype 1 (n=199)	0.412	0.441	0.423	0.429	0.448	0.444	0.451	0.431	0.439	0.410	0.463	0.440	0.436	0.450	0.432	0.437	0.412	

**Fig. 1.12.** Diversity of F gene of different genotypes (133).

It is also suggested that a strong herd immunity can only be achieved if a high proportion of birds (>85%) have a high antibody titre (log<sub>2</sub> haemagglutination inhibition titre  $\geq 3$ ) after vaccination (96, 173). The viral shedding allows virulent strains circulating in immunized flocks. When the herd immunity decreases, and circulating strains are distant from the vaccine strain, then ND outbreaks may occur, which may be one of the reasons why farmers complain about vaccine failure in some countries (17). Therefore, generation of antigenically matched and improved vaccines is quite important to inhibit the viral shedding by currently circulating virulent strains and then properly control ND outbreaks.

Several homologous live vaccines made of a recent genotype have been developed. All of them not only fully protect chickens from ND, but also block the viral shedding after lethal challenge with genotype matched strains. According to our knowledge, all these live vaccines



were generated from genotype VII strains and their protection ability against viral shedding was only tested using a virulent strain from the same genotypes (115, 174, 175). It is unclear whether those vaccines have efficiency to prevent virus shedding against the most recent circulating NDV genotypes including genotypes XI, XIV, XVII and XVIII. In Madagascar, genotype XI strains have been responsible for outbreaks for at least 25 years (133). Based on F gene, the diversity between genotypes XI and I, II and VII is up to 20%, 23% and 25%, respectively, which suggests that the current commercial living vaccines cannot prevent viral shedding from genotype XI strains. Similarly, vaccines based on genotype VII strains may experience similar problem, ie they are not able to prevent an excretion of a virulent strain of genotype XI. Consequently, generating a live vaccine based on genotype XI strain may be important to control ND outbreaks due to virulent genotype XI viruses. However, all isolated genotypes XI are velogenic strains with five basic amino acids at the cleavage motif of F protein and cannot be directly used as candidate live vaccines (133, 137). Thus, the first step is to attenuate virus by modifying the cleavage motif into a lentogenic-like motif by reverse genetics.

## 8. Reverse genetics.

Reverse genetics has been used for decades to rescue RNA viruses (176). The systems vary according to the virus genome characters (177). Rescuing positive-sense-non-segment virus is simple, because the genome is an RNA molecule directly translated into proteins by the cell (178, 179). Consequently, a genomic cDNA is sufficient to generate infectious viruses. In contrast, rescuing negative-sense-non-segmented virus (NSNSV), such as NDV, is more complex. The cDNA derived from the genome has to be designed to produce both the viral proteins and the negative-sense RNA virus genome. The basic principle of the technology to be used with negative RNA viruses lies on the generation of a copy of the virus genome and a ribonucleoprotein (RNP) complex, consisting of the viral RNA dependent RNA polymerase or RdRP which is the large (L) protein, and two others protein, the nucleoprotein N and the phosphoprotein P (179). The first NDV strain was rescued in 1999. Since then, a large number of modified strains have been rescued by reverse genetics (31).

### 8.1 NDV reverse genetics system

The conventional system consists of four plasmids and one eukaryotic cell line. The four plasmids consist of a plasmid with the full viral genome in a positive orientation (pFull-genome) and three plasmids pN, pP and pL which encode NP, P and L, respectively

(31). Due to the size of NDV genome, around 15 Kb, the generation of the pFull-genome plasmid remains tricky. So far, there are three methods used for the generation of this plasmid (180). The first one is based on the use of restriction enzymes (RE). The viral full genome is amplified in different fragments by RT-PCR, which are successively assembled with RE between the promoter and terminator of the virus into a plasmid backbone (31). The disadvantage of this strategy is the need of selecting unique RE sites that are not already present in the virus genome. Some viral genomes have to be modified to generate unique RE sites for cloning and multi-cloning steps and this requires intensive and time-consuming laboratory work. However, its high success rate and reliable operation, RE method remains the most popular way for the construction of a pFull-genome plasmid. The second approach depends on *In-Fusion PCR* technology (181). Using this method, the viral genome is usually divided into three fragments by RT-PCR. There are 20 bp overlapping regions between those fragments based on genome order, which are ligated based on these 20 bp overlap regions into competent cells to get the pFull-genome plasmid. Even though this method does not require any modifications on the viral genome and saves time, the success rate of getting a correct pFull-genome is low due to recurrent rearrangements occurring in competent cells (182, 183). The third approach is based on the generation of a full DNA copy of the viral genome by chemical synthesis (180). This copy is then cloned into a plasmid via RE. This technology is more expensive and must be repeated for each strain. In contrast to the generation of a pFull-genome plasmid, the construction of pN, pP and pL is much easier. NP, P and L gene are amplified from viral RNA by RT-PCR and then cloned by RE into the plasmid, between the promoter and terminator. For the final rescue of the virus, the four plasmids generated are co-transfected into eukaryotic cells with different weight ratios.

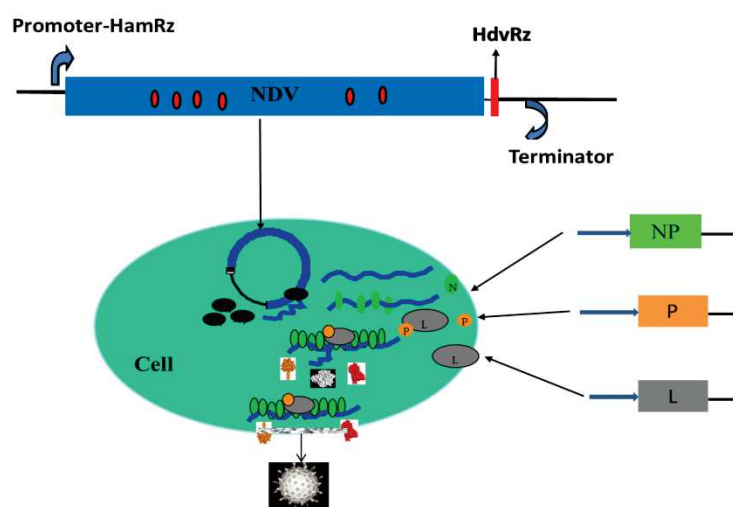

**Fig 1.13.** NDV reverse genetics system.

## 8.2 Application of NDV reverse genetics

Reverse genetics allow modifying viral genomes and generating recombinant viruses. Therefore, it has been widely used to explore NDV virulence related factors (184, 185). By reverse genetics, the F protein cleavage site, V protein, L protein and RNP complex, have been confirmed as playing roles in NDV virulence (31, 36, 91). From this information, velogenic strains were attenuated by reverse genetics to produce antigenic matching ND vaccines (115). In addition, the NDV genome can afford an insertion of exogenous sequence with a size higher than 3kb (25). Via reverse genetic, recombinant NDV strains have been generated to serve as vectors to express foreign antigens. Thus, multivalent vaccines were produced like rNDV-influenza or NDV-human immunodeficiency virus (186-189). Since some NDV strains exhibit oncolytic activity, modified viruses with improved anti-tumoral capacities have been produced by reverse genetics with a long-term objective to be used in anti-cancer therapy (190, 191).

## 8.3 Improvement of NDV reverse genetics

### 8.3.1 Improvement of promoter from T7 to CMV.

In the first approach for NDV reverse genetics, the full genome of NDV was assembled directly downstream to the T7 promoter that is specifically recognized by T7 RNA polymerase (T7poly). In order to increase the transcription efficiency, three G nucleotides are added before the 3'-end promoter of the viral full genome, which results in the extension of the genome size by three additional nucleotides at the 3'-end of the genome (31). Those extra nucleotides can be eliminated by the hammerhead ribozyme which is inserted before the viral full genome in the plasmids. Even if this hammerhead ribozyme does not improve the rescuing efficiency for NDV, it has been shown to enhance the rescuing virus titer for other paramyxoviruses (192, 193). The use of the T7 promoter requires the expression of T7 polymerase into the eukaryotic cells used for the virus rescue. To do so, the T7 polymerase has to be provided by other expression systems-a recombinant virus, plasmid transfected cells or T7 gene transgenic cells (31, 194, 195). This expression system has made more complex the reverse genetics and has probably impacted the throughput of the technology. Therefore, alternative systems to express the virus genome have been developed. Alternative promoters, like the promoter of human cytomegalovirus (CMV), have been successfully proposed (196). Under the CMV promoter, several NDVs have been rescued, including lentogenic and velogenic strains (195, 197, 198).

### 8.3.2 Improving the rescuing efficiency of NDV

A high rescuing efficiency system is necessary as long as the NDV reverse genetics is broadly used in many fields. However, since its first development in the 90's, there has not been a generally acknowledged improvement of NDV reverse genetics with obvious higher rescuing yield. Furthermore, the number of plasmids to be used in reverse genetics varies according to the virus. For example, reverse genetics developed for classical swine fever virus only uses one plasmid, while for the influenza virus it may consist of up to twelve (179, 199). The key point for successful rescuing of the virus is the efficient co-transfection of the plasmids into the same cell. However, the co-transfection of different plasmids with different sizes into the same cell is really tricky. Therefore, the decrease of the number of plasmids to be used is supposed to enhance the efficacy of reverse genetics. For the influenza virus, the reduction of plasmids from 12 to 8, 8 to 3, or 3 to 1 has resulted in an enhancement in terms of the rescued virus titer and the overall rescuing yield (199-201). Furthermore, decreasing plasmids number from 10 to 4 in the reverse genetics of orthoreovirus also increased the titer of the rescued virus of about 2 Log<sub>10</sub> (202). Decreasing the number of plasmids was also useful for generating a plant negative-strand RNA virus (203). In that case, the 2-plasmid strategy increases the rescuing efficiency from 5.3 to 12.4% compared to the conventional 4-plasmid system. Before we started this study, reverse genetics system included four plasmids, which had failed in rescuing some strains (204).

### References

1. Miller PJ, Decanini EL, Afonso CL. 2010. Newcastle disease: evolution of genotypes and the related diagnostic challenges. *Infect Genet Evol* 10:26-35.
2. Nagai Y, Yoshida T, Hamaguchi M, Naruse H, Iinuma M, Maeno K, Matsumoto T. 1980. The pathogenicity of Newcastle disease virus isolated from migrating and domestic ducks and the susceptibility of the viral glycoproteins to proteolytic cleavage. *Microbiol Immunol* 24:173-177.
3. Alexander DJ. 1988. Newcastle disease diagnosis, p 147-160, Newcastle disease. Springer.
4. Biancifiori F, Fioroni A. 1983. An occurrence of Newcastle disease in pigeons: virological and serological studies on the isolates. *Comp Immunol Microbiol Infect Dis* 6:247-252.
5. Desingu P, Singh S, Dhama K, Kumar OV, Malik Y, Singh R. 2017. Clinicopathological characterization of experimental infection in chickens with sub-genotype VIIi Newcastle disease virus isolated from peafowl. *Microb Pathog* 105:8-12.
6. Liu M, Qu Y, Wang F, Liu S, Sun H. 2015. Genotypic and pathotypic characterization of Newcastle disease virus isolated from racing pigeons in China. *Poult Sci* 94:1476-1482.

7. Guo H, Liu X, Xu Y, Han Z, Shao Y, Kong X, Liu S. 2014. A comparative study of pigeons and chickens experimentally infected with PPMV-1 to determine antigenic relationships between PPMV-1 and NDV strains. *Vet Microbiol* 168:88-97.
8. Ecco R, Susta L, Afonso CL, Miller PJ, Brown C. 2011. Neurological lesions in chickens experimentally infected with virulent Newcastle disease virus isolates. *Avian Pathol* 40:145-152.
9. Xu X, Yin R, Qian J, Sun Y, Wang C, Ding C, Yu S, Hu S, Liu X, Cong Y. 2017. Identification and pathotypical analysis of a novel VIk sub-genotype Newcastle disease virus obtained from pigeon in China. *Virus Res*.
10. Desingu PA, Singh SD, Dhama K, Vinodhkumar OR, Barathidasan R, Malik YS, Singh R, Singh RK. 2016. Molecular characterization, isolation, pathology and pathotyping of peafowl (*Pavo cristatus*) origin Newcastle disease virus isolates recovered from disease outbreaks in three states of India. *Avian Pathol* 45:674-682.
11. Jaganathan S, Ooi PT, Phang LY, Allaudin ZNB, Yip LS, Choo PY, Lim BK, Lemiere S, Audonnet J-C. 2015. Observation of risk factors, clinical manifestations and genetic characterization of recent Newcastle Disease Virus outbreak in West Malaysia. *BMC Vet Res* 11:219.
12. Diel DG, Susta L, Garcia SC, Killian ML, Brown CC, Miller PJ, Afonso CL. 2012. Complete genome and clinicopathological characterization of a virulent Newcastle disease virus isolate from South America. *J Clin Microbiol* 50:378-387.
13. Chong YL, Padhi A, Hudson PJ, Poss M. 2010. The effect of vaccination on the evolution and population dynamics of avian paramyxovirus-1. *PLoS Pathog* 6:e1000872.
14. Edwards J. 1928. A new fowl disease. *Ann Rep Inst Vet Sci, Muktheswar*:14-18.
15. Ganar K, Das M, Sinha S, Kumar S. 2014. Newcastle disease virus: current status and our understanding. *Virus Res* 184:71-81.
16. Macpherson L. 1956. Some observations on the epizootiology of Newcastle disease. *Can J Comp Med Vet Sci* 20:155.
17. Dimitrov KM, Afonso CL, Yu Q, Miller PJ. 2016. Newcastle disease vaccines—A solved problem or a continuous challenge? *Vet Microbiol*.
18. Kaleta EF, Baldauf C. 1988. Newcastle disease in free-living and pet birds, p 197-246, *Newcastle disease*. Springer.
19. Zhao P, Sun L, Sun X, Li S, Zhang W, Pulscher LA, Chai H, Xing M. 2017. Newcastle disease virus from domestic mink, China, 2014. *Vet Microbiol* 198:104-107.
20. Chen S, Hao H, Wang X, Du E, Liu H, Yang T, Liu Y, Fu X, Zhang P, Yang Z. 2013. Genomic characterisation of a lentogenic Newcastle disease virus strain HX01 isolated from sick pigs in China. *Virus Genes* 46:264-270.
21. Amarasinghe GK, Bào Y, Basler CF, Bavari S, Beer M, Bejerman N, Blasdell KR, Bochnowski A, Briese T, Bukreyev A. 2017. Taxonomy of the order Mononegavirales: update 2017. *Arch Virol*:1-12.
22. Alexander D, Calnek B, Barnes H, Beard C, Reid W, Yoder Jr H. 1991. Newcastle disease and other paramyxovirus infections, chapt. 19. *Diseases of poultry*, 9th ed Iowa State University Press, Ames, IA.
23. DiNapoli JM, Yang L, Suguitan A, Elankumaran S, Dorward DW, Murphy BR, Samal SK, Collins PL, Bukreyev A. 2007. Immunization of primates with a Newcastle disease virus-vectored vaccine via the

- respiratory tract induces a high titer of serum neutralizing antibodies against highly pathogenic avian influenza virus. *J Virol* 81:11560-11568.
24. Goff PH, Gao Q, Palese P. 2012. A majority of infectious Newcastle disease virus particles contain a single genome, while a minority contain multiple genomes. *J Virol* 86:10852-10856.
  25. Gao Q, Park M-S, Palese P. 2008. Expression of transgenes from Newcastle disease virus with a segmented genome. *J Virol* 82:2692-2698.
  26. Samuel A, Nayak B, Paldurai A, Xiao S, Aplogan GL, Awoume KA, Webby RJ, Ducatez MF, Collins PL, Samal SK. 2013. Phylogenetic and pathotypic characterization of Newcastle disease viruses circulating in west Africa and efficacy of a current vaccine. *J Clin Microbiol* 51:771-781.
  27. Czeglédi A, Ujvári D, Somogyi E, Wehmann E, Werner O, Lomniczi B. 2006. Third genome size category of avian paramyxovirus serotype 1 (Newcastle disease virus) and evolutionary implications. *Virus Res* 120:36-48.
  28. Paldurai A, Xiao S, Kim S-H, Kumar S, Nayak B, Samal S, Collins PL, Samal SK. 2014. Effects of naturally occurring six-and twelve-nucleotide inserts on Newcastle disease virus replication and pathogenesis. *PLoS One* 9:e103951.
  29. Phillips R, Samson A, Emmerson P. 1998. Nucleotide sequence of the 5'-terminus of Newcastle disease virus and assembly of the complete genomic sequence: agreement with the "rule of six". *Arch Virol* 143:1993-2002.
  30. de Leeuw O, Peeters B. 1999. Complete nucleotide sequence of Newcastle disease virus: evidence for the existence of a new genus within the subfamily Paramyxovirinae. *J Gen Virol* 80:131-136.
  31. Peeters BP, de Leeuw OS, Koch G, Gielkens AL. 1999. Rescue of Newcastle disease virus from cloned cDNA: evidence that cleavability of the fusion protein is a major determinant for virulence. *J Virol* 73:5001-5009.
  32. Steward M, Vipond IB, Millar NS, Emmerson PT. 1993. RNA editing in Newcastle disease virus. *J Gen Virol* 74:2539-2547.
  33. Paldurai A, Kim S-H, Nayak B, Xiao S, Shive H, Collins PL, Samal SK. 2014. Evaluation of the contributions of individual viral genes to newcastle disease virus virulence and pathogenesis. *J Virol* 88:8579-8596.
  34. Rout SN, Samal SK. 2008. The large polymerase protein is associated with the virulence of Newcastle disease virus. *J Virol* 82:7828-7836.
  35. Yu X-h, Cheng J-l, Xue J, Jin J-h, Song Y, Zhao J, Zhang G-z. 2017. Roles of the polymerase-associated protein genes in Newcastle disease virus virulence. *Front Microbiol* 8.
  36. Dortmans J, Rottier P, Koch G, Peeters B. 2010. The viral replication complex is associated with the virulence of Newcastle disease virus. *J Virol* 84:10113-10120.
  37. Battisti AJ, Meng G, Winkler DC, McGinnes LW, Plevka P, Steven AC, Morrison TG, Rossmann MG. 2012. Structure and assembly of a paramyxovirus matrix protein. *Proc Natl Acad Sci U S A* 109:13996-14000.
  38. Pantua HD, McGinnes LW, Peeples ME, Morrison TG. 2006. Requirements for the assembly and release of Newcastle disease virus-like particles. *J Virol* 80:11062-11073.



39. Swanson K, Wen X, Leser GP, Paterson RG, Lamb RA, Jardetzky TS. 2010. Structure of the Newcastle disease virus F protein in the post-fusion conformation. *Virology* 402:372-379.
40. Chen L, Gorman JJ, McKimm-Breschkin J, Lawrence LJ, Tulloch PA, Smith BJ, Colman PM, Lawrence MC. 2001. The structure of the fusion glycoprotein of Newcastle disease virus suggests a novel paradigm for the molecular mechanism of membrane fusion. *Structure* 9:255-266.
41. Yuan P, Swanson KA, Leser GP, Paterson RG, Lamb RA, Jardetzky TS. 2011. Structure of the Newcastle disease virus hemagglutinin-neuraminidase (HN) ectodomain reveals a four-helix bundle stalk. *Proc Natl Acad Sci U S A* 108:14920-14925.
42. Bournsnel M, Green P, Samson A, Campbell J, Deuter A, Peters R, Millar N, Emmerson P, Binns M. 1990. A recombinant fowlpox virus expressing the hemagglutinin-neuraminidase gene of Newcastle disease virus (NDV) protects chickens against challenge NDV. *Virology* 178:297-300.
43. Cosset F-l, Bouquet J-F, Drynda A, Chebloune Y, Rey-Senelonge A, Kohen G, Nigon VM, Desmettre P, Verdier G. 1991. Newcastle disease virus (NDV) vaccine based on immunization with avian cells expressing the NDV hemagglutinin-neuraminidase glycoprotein. *Virology* 185:862-866.
44. Karaca K, Sharma JM, Winslow BJ, Junker DE, Reddy S, Cochran M, McMillen J. 1998. Recombinant fowlpox viruses coexpressing chicken type I IFN and Newcastle disease virus HN and F genes: influence of IFN on protective efficacy and humoral responses of chickens following in ovo or post-hatch administration of recombinant viruses. *Vaccine* 16:1496-1503.
45. Meulemans G, Letellier C, Gonze M, Carlier M, Burny A. 1988. Newcastle disease virus f glycoprotein expressed from a recombinant vaccinia virus vector protects chickens against live - virus challenge. *Avian Pathol* 17:821-827.
46. Kumar S, Nayak B, Collins PL, Samal SK. 2011. Evaluation of the Newcastle disease virus F and HN proteins in protective immunity by using a recombinant avian paramyxovirus type 3 vector in chickens. *J Virol* 85:6521-6534.
47. Takimoto T, Portner A. 2004. Molecular mechanism of paramyxovirus budding. *Virus Res* 106:133-145.
48. Crennell S, Takimoto T, Portner A, Taylor G. 2000. Crystal structure of the multifunctional paramyxovirus hemagglutinin-neuraminidase. *Nat Struct Mol Biol* 7:1068-1074.
49. Porotto M, Fornabaio M, Greengard O, Murrell MT, Kellogg GE, Moscona A. 2006. Paramyxovirus receptor-binding molecules: engagement of one site on the hemagglutinin-neuraminidase protein modulates activity at the second site. *J Virol* 80:1204-1213.
50. Connaris H, Takimoto T, Russell R, Crennell S, Moustafa I, Portner A, Taylor G. 2002. Probing the sialic acid binding site of the hemagglutinin-neuraminidase of Newcastle disease virus: identification of key amino acids involved in cell binding, catalysis, and fusion. *J Virol* 76:1816-1824.
51. Zaitsev V, von Itzstein M, Groves D, Kiefel M, Takimoto T, Portner A, Taylor G. 2004. Second sialic acid binding site in Newcastle disease virus hemagglutinin-neuraminidase: implications for fusion. *J Virol* 78:3733-3741.
52. Brindley MA, Suter R, Schestak I, Kiss G, Wright ER, Plemper RK. 2013. A stabilized headless measles virus attachment protein stalk efficiently triggers membrane fusion. *J Virol* 87:11693-11703.

53. Liu Q, Stone JA, Bradel-Tretheway B, Dabundo J, Montano JAB, Santos-Montanez J, Biering SB, Nicola AV, Iorio RM, Lu X. 2013. Unraveling a three-step spatiotemporal mechanism of triggering of receptor-induced Nipah virus fusion and cell entry. *PLoS Pathog* 9:e1003770.
54. Bose S, Zokarkar A, Welch BD, Leser GP, Jardetzky TS, Lamb RA. 2012. Fusion activation by a headless parainfluenza virus 5 hemagglutinin-neuraminidase stalk suggests a modular mechanism for triggering. *Proc Natl Acad Sci U S A* 109:E2625-E2634.
55. Bose S, Song AS, Jardetzky TS, Lamb RA. 2014. Fusion activation through attachment protein stalk domains indicates a conserved core mechanism of paramyxovirus entry into cells. *J Virol* 88:3925-3941.
56. Yin H-S, Wen X, Paterson RG, Lamb RA, Jardetzky TS. 2006. Structure of the parainfluenza virus 5 F protein in its metastable, prefusion conformation. *Nature* 439:38-44.
57. Poor TA, Jones LM, Sood A, Leser GP, Plasencia MD, Rempel DL, Jardetzky TS, Woods RJ, Gross ML, Lamb RA. 2014. Probing the paramyxovirus fusion (F) protein-refolding event from pre-to postfusion by oxidative footprinting. *Proc Natl Acad Sci U S A* 111:E2596-E2605.
58. Kim YH, Donald JE, Grigoryan G, Leser GP, Fadeev AY, Lamb RA, DeGrado WF. 2011. Capture and imaging of a prehairpin fusion intermediate of the paramyxovirus PIV5. *Proc Natl Acad Sci U S A* 108:20992-20997.
59. Peeters B, Gruijthuisen Y, De Leeuw O, Gielkens A. 2000. Genome replication of Newcastle disease virus: involvement of the rule-of-six. *Arch Virol* 145:1829-1845.
60. Zhang Z, Zhao W, Li D, Yang J, Zsak L, Yu Q. 2015. Development of a Newcastle disease virus vector expressing a foreign gene through an internal ribosomal entry site provides direct proof for a sequential transcription mechanism. *J Gen Virol* 96:2028-2035.
61. Gutsche I, Desfosses A, Effantin G, Ling WL, Haupt M, Ruigrok RW, Sachse C, Schoehn G. 2015. Near-atomic cryo-EM structure of the helical measles virus nucleocapsid. *Science* 348:704-707.
62. Alayyoubi M, Leser GP, Kors CA, Lamb RA. 2015. Structure of the paramyxovirus parainfluenza virus 5 nucleoprotein-RNA complex. *Proc Natl Acad Sci U S A* 112:E1792-E1799.
63. Cox R, Pickar A, Qiu S, Tsao J, Rodenburg C, Dokland T, Elson A, He B, Luo M. 2014. Structural studies on the authentic mumps virus nucleocapsid showing uncoiling by the phosphoprotein. *Proc Natl Acad Sci U S A* 111:15208-15213.
64. Reich S, Guilligay D, Pflug A, Malet H, Berger I, Crépin T, Hart D, Lunardi T, Nanao M, Ruigrok RW. 2014. Structural insight into cap-snatching and RNA synthesis by influenza polymerase. *Nature* 516:361-366.
65. Lukarska M, Fournier G, Pflug A, Resa-Infante P, Reich S, Naffakh N, Cusack S. 2017. Structural basis of an essential interaction between influenza polymerase and Pol II CTD. *Nature* 541:117-121.
66. Errington W, Emmerson PT. 1997. Assembly of recombinant Newcastle disease virus nucleocapsid protein into nucleocapsid-like structures is inhibited by the phosphoprotein. *J Gen Virol* 78:2335-2339.
67. Kho CL, Tan WS, Tey BT, Yusoff K. 2003. Newcastle disease virus nucleocapsid protein: self-assembly and length-determination domains. *J Gen Virol* 84:2163-2168.
68. Liljeroos L, Krzyzaniak MA, Helenius A, Butcher SJ. 2013. Architecture of respiratory syncytial virus revealed by electron cryotomography. *Proc Natl Acad Sci U S A* 110:11133-11138.



69. Vallat B, Allen G. 2004. Manual of diagnostic tests and vaccines for terrestrial animals (mammals, birds and bees). Paris: Office International Des Epizooties.
70. Panda A, Huang Z, Elankumaran S, Rockemann DD, Samal SK. 2004. Role of fusion protein cleavage site in the virulence of Newcastle disease virus. *Microb Pathog* 36:1-10.
71. Samal S, Kumar S, Khattar SK, Samal SK. 2011. A single amino acid change, Q114R, in the cleavage-site sequence of Newcastle disease virus fusion protein attenuates viral replication and pathogenicity. *J Gen Virol* 92:2333-2338.
72. Young JK, Li D, Abramowitz MC, Morrison TG. 1999. Interaction of peptides with sequences from the Newcastle disease virus fusion protein heptad repeat regions. *J Virol* 73:5945-5956.
73. Sergel-Germano T, McQUAIN C, Morrison T. 1994. Mutations in the fusion peptide and heptad repeat regions of the Newcastle disease virus fusion protein block fusion. *J Virol* 68:7654-7658.
74. Glickman RL, Syddall RJ, Iorio RM, Sheehan JP, Bratt MA. 1988. Quantitative basic residue requirements in the cleavage-activation site of the fusion glycoprotein as a determinant of virulence for Newcastle disease virus. *J Virol* 62:354-356.
75. Meng C, Qiu X, Yu S, Li C, Sun Y, Chen Z, Liu K, Zhang X, Tan L, Song C. 2016. Evolution of Newcastle disease virus quasispecies diversity and enhanced virulence after passage through chicken air sacs. *J Virol* 90:2052-2063.
76. Shengqing Y, Kishida N, Ito H, Kida H, Otsuki K, Kawaoka Y, Ito T. 2002. Generation of velogenic Newcastle disease viruses from a nonpathogenic waterfowl isolate by passaging in chickens. *Virology* 301:206-211.
77. de Leeuw OS, Hartog L, Koch G, Peeters BP. 2003. Effect of fusion protein cleavage site mutations on virulence of Newcastle disease virus: non-virulent cleavage site mutants revert to virulence after one passage in chicken brain. *J Gen Virol* 84:475-484.
78. Dortmans JC, Fuller CM, Aldous EW, Rottier PJ, Peeters BP. 2010. Two genetically closely related pigeon paramyxovirus type 1 (PPMV-1) variants with identical velogenic fusion protein cleavage sites but with strongly contrasting virulence. *Vet Microbiol* 143:139-144.
79. Liu H, Zhang P, Wu P, Chen S, Mu G, Duan X, Hao H, Du E, Wang X, Yang Z. 2013. Phylogenetic characterization and virulence of two Newcastle disease viruses isolated from wild birds in China. *Infect Genet Evol* 20:215-224.
80. Dortmans J, Koch G, Rottier P, Peeters B. 2009. Virulence of pigeon paramyxovirus type 1 does not always correlate with the cleavability of its fusion protein. *J Gen Virol* 90:2746-2750.
81. Dortmans JC, Koch G, Rottier PJ, Peeters BP. 2011. Virulence of Newcastle disease virus: what is known so far? *Vet Res* 42:122.
82. Heiden S, Grund C, Röder A, Granzow H, Kühnel D, Mettenleiter TC, Römer-Oberdörfer A. 2014. Different regions of the newcastle disease virus fusion protein modulate pathogenicity. *PLoS One* 9:e113344.
83. Liu J, Cong Y, Yin R, Ding C, Yu S, Liu X, Wang C, Ding Z. 2014. The deletion of an extra six nucleotides in the 5'-untranslated region of the nucleoprotein gene of Newcastle disease virus NA-1 decreases virulence. *BMC Vet Res* 10:964.

84. Huang Z, Panda A, Elankumaran S, Govindarajan D, Rockemann DD, Samal SK. 2004. The hemagglutinin-neuraminidase protein of Newcastle disease virus determines tropism and virulence. *J Virol* 78:4176-4184.
85. de Leeuw OS, Koch G, Hartog L, Ravenshorst N, Peeters BP. 2005. Virulence of Newcastle disease virus is determined by the cleavage site of the fusion protein and by both the stem region and globular head of the haemagglutinin–neuraminidase protein. *J Gen Virol* 86:1759-1769.
86. Duan Z, Li J, Zhu J, Chen J, Xu H, Wang Y, Liu H, Hu S, Liu X. 2014. A single amino acid mutation, R42A, in the Newcastle disease virus matrix protein abrogates its nuclear localization and attenuates viral replication and pathogenicity. *J Gen Virol* 95:1067-1073.
87. Xu H, Song Q, Zhu J, Liu J, Cheng X, Hu S, Wu S, Wang X, Liu X, Liu X. 2016. A single R36Q mutation in the matrix protein of pigeon paramyxovirus type 1 reduces virus replication and shedding in pigeons. *Arch Virol* 161:1949-1955.
88. Xu H, Duan Z, Chen Y, Liu J, Cheng X, Liu J, Zhu J, Wang X, Liu X, Hu S. 2016. Simultaneous mutation of G275A and P276A in the matrix protein of Newcastle disease virus decreases virus replication and budding. *Arch Virol* 161:3527-3533.
89. Park M-S, Shaw ML, Muñoz-Jordan J, Cros JF, Nakaya T, Bouvier N, Palese P, García-Sastre A, Basler CF. 2003. Newcastle disease virus (NDV)-based assay demonstrates interferon-antagonist activity for the NDV V protein and the Nipah virus V, W, and C proteins. *J Virol* 77:1501-1511.
90. Park M-S, García-Sastre A, Cros JF, Basler CF, Palese P. 2003. Newcastle disease virus V protein is a determinant of host range restriction. *J Virol* 77:9522-9532.
91. Huang Z, Krishnamurthy S, Panda A, Samal SK. 2003. Newcastle disease virus V protein is associated with viral pathogenesis and functions as an alpha interferon antagonist. *J Virol* 77:8676-8685.
92. Qiu X, Fu Q, Meng C, Yu S, Zhan Y, Dong L, Song C, Sun Y, Tan L, Hu S. 2016. Newcastle Disease Virus V Protein Targets Phosphorylated STAT1 to Block IFN-I Signaling. *PLoS One* 11:e0148560.
93. Yan Y, Samal SK. 2008. Role of intergenic sequences in Newcastle disease virus RNA transcription and pathogenesis. *J Virol* 82:1323-1331.
94. Yan Y, Rout SN, Kim S-H, Samal SK. 2009. Role of untranslated regions of the hemagglutinin-neuraminidase gene in replication and pathogenicity of newcastle disease virus. *J Virol* 83:5943-5946.
95. Oh S-W, Onomoto K, Wakimoto M, Onoguchi K, Ishidate F, Fujiwara T, Yoneyama M, Kato H, Fujita T. 2016. Leader-containing uncapped viral transcript activates RIG-I in antiviral stress granules. *PLoS Pathog* 12:e1005444.
96. Van Boven M, Bouma A, Fabri TH, Katsma E, Hartog L, Koch G. 2008. Herd immunity to Newcastle disease virus in poultry by vaccination. *Avian Pathol* 37:1-5.
97. Onapa MO, Christensen H, Mukiibi G, Bisgaard M. 2006. A preliminary study of the role of ducks in the transmission of Newcastle disease virus to in-contact rural free-range chickens. *Trop Anim Health Prod* 38:285-289.
98. Hugh-Jones M, Allan W, Dark F, Harper G. 1973. The evidence for the airborne spread of Newcastle disease. *Epidemiol Infect* 71:325-339.

99. Capua I, Scacchia M, Toscani T, Caporale V. 1993. Unexpected isolation of virulent Newcastle disease virus from commercial embryonated fowls' eggs. *Zoonoses Public Health* 40:609-612.
100. Chen J-P, Wang C-H. 2002. Clinical epidemiologic and experimental evidence for the transmission of Newcastle disease virus through eggs. *Avian Dis* 46:461-465.
101. Thacore H, Youngner JS. 1969. Cells Persistently Infected with Newcastle Disease Virus I. Properties of Mutants Isolated from Persistently Infected L Cells. *J Virol* 4:244-251.
102. Chia S-L, Yusoff K, Shafee N. 2014. Viral persistence in colorectal cancer cells infected by Newcastle disease virus. *Virology* 11:91.
103. Rangaswamy US, Wang W, Cheng X, McTamney P, Carroll D, Jin H. 2017. Newcastle disease virus establishes persistent infection in tumor cells in vitro: contribution of the cleavage site of fusion protein and second sialic acid binding site of hemagglutinin-neuraminidase. *J Virol*:JVI. 00770-00717.
104. Voss-Rech D, Trevisol IM, Brentano L, Silva VS, Rebelatto R, Jaenisch FRF, Okino CH, Mores MAZ, Coldebella A, de Avila Botton S. 2017. Impact of treatments for recycled broiler litter on the viability and infectivity of microorganisms. *Vet Microbiol* 203:308-314.
105. Alexander D, Parsons G, Marshall R. 1984. Infection of fowls with Newcastle disease virus by food contaminated with pigeon faeces. *Vet Rec* 115:601-602.
106. Alexander DJ. 1988. Newcastle disease: methods of spread, p 256-272, Newcastle disease. Springer.
107. Burrige M, Riemann H, Utterback W. 1975. Methods of spread of velogenic viscerotropic Newcastle disease virus in the southern Californian epidemic of 1971-1973. *Avian Dis*:666-678.
108. Kim LM, King DJ, Curry PE, Suarez DL, Swayne DE, Stallknecht DE, Slemons RD, Pedersen JC, Senne DA, Winker K. 2007. Phylogenetic diversity among low-virulence Newcastle disease viruses from waterfowl and shorebirds and comparison of genotype distributions to those of poultry-origin isolates. *J Virol* 81:12641-12653.
109. Kim B-Y, Lee D-H, Kim M-S, Jang J-H, Lee Y-N, Park J-K, Yuk S-S, Lee J-B, Park S-Y, Choi I-S. 2012. Exchange of Newcastle disease viruses in Korea: the relatedness of isolates between wild birds, live bird markets, poultry farms and neighboring countries. *Infect Genet Evol* 12:478-482.
110. Erickson G, Brugh M, Beard C. 1980. Viscerotropic velogenic Newcastle disease in pigeons: clinical disease and immunization. *Avian Dis*:257-267.
111. Kang Y, Xiang B, Yuan R, Zhao X, Feng M, Gao P, Li Y, Li Y, Ning Z, Ren T. 2016. Phylogenetic and pathotypic characterization of Newcastle disease viruses circulating in South China and transmission in different birds. *Front Microbiol* 7.
112. Sattentau Q. 2008. Avoiding the void: cell-to-cell spread of human viruses. *Nat Rev Microbiol* 6:815-826.
113. Zhong P, Agosto LM, Munro JB, Mothes W. 2013. Cell-to-cell transmission of viruses. *Curr Opin Virol* 3:44-50.
114. Mothes W, Sherer NM, Jin J, Zhong P. 2010. Virus cell-to-cell transmission. *J Virol* 84:8360-8368.
115. Xiao S, Nayak B, Samuel A, Paldurai A, Kanabagattebasavarajappa M, Prajitno TY, Bharoto EE, Collins PL, Samal SK. 2012. Generation by reverse genetics of an effective, stable, live-attenuated Newcastle disease virus vaccine based on a currently circulating, highly virulent Indonesian strain. *PLoS One* 7:e52751.

116. Johnson CF, Scott AD. 1964. Cytological Studies of Newcastle Disease Virus (NDV) in HEp-2 Cells. *Proc Soc Exp Biol Med* 115:281-286.
117. Horvath C, Paterson R, Shaughnessy M, Wood R, Lamb R. 1992. Biological activity of paramyxovirus fusion proteins: factors influencing formation of syncytia. *J Virol* 66:4564-4569.
118. Makhortova NR, Askovich P, Patterson CE, Gechman LA, Gerard NP, Rall GF. 2007. Neurokinin-1 enables measles virus trans-synaptic spread in neurons. *Virology* 362:235-244.
119. Lawrence DM, Patterson CE, Gales TL, D'Orazio JL, Vaughn MM, Rall GF. 2000. Measles virus spread between neurons requires cell contact but not CD46 expression, syncytium formation, or extracellular virus production. *J Virol* 74:1908-1918.
120. Jin J, Sherer NM, Heidecker G, Derse D, Mothes W. 2009. Assembly of the murine leukemia virus is directed towards sites of cell–cell contact. *PLoS Biol* 7:e1000163.
121. El Najjar F, Cifuentes-Muñoz N, Chen J, Zhu H, Buchholz UJ, Moncman CL, Dutch RE. 2016. Human metapneumovirus Induces Reorganization of the Actin Cytoskeleton for Direct Cell-to-Cell Spread. *PLoS Pathog* 12:e1005922.
122. Mehedi M, McCarty T, Martin SE, Le Nouën C, Buehler E, Chen Y-C, Smelkinson M, Ganesan S, Fischer ER, Brock LG. 2016. Actin-Related Protein 2 (ARP2) and Virus-Induced Filopodia Facilitate Human Respiratory Syncytial Virus Spread. *PLoS Pathog* 12:e1006062.
123. Roberts KL, Manicassamy B, Lamb RA. 2015. Influenza A virus uses intercellular connections to spread to neighboring cells. *J Virol* 89:1537-1549.
124. Xiao F, Fofana I, Heydmann L, Barth H, Soulier E, Habersetzer F, Doffoël M, Bukh J, Patel AH, Zeisel MB. 2014. Hepatitis C virus cell-cell transmission and resistance to direct-acting antiviral agents. *PLoS Pathog* 10:e1004128.
125. Iwami S, Takeuchi JS, Nakaoka S, Mammano F, Clavel F, Inaba H, Kobayashi T, Misawa N, Aihara K, Koyanagi Y. 2015. Cell-to-cell infection by HIV contributes over half of virus infection. *Elife* 4:e08150.
126. Qin Z, Sun L, Ma B, Cui Z, Zhu Y, Kitamura Y, Liu W. 2008. F gene recombination between genotype II and VII Newcastle disease virus. *Virus Res* 131:299-303.
127. Baumann CA, Neubert WJ. 2010. Neuraminidase-deficient Sendai virus HN mutants provide protection from homologous superinfection. *Arch Virol* 155:217-227.
128. Huang I-C, Li W, Sui J, Marasco W, Choe H, Farzan M. 2008. Influenza A virus neuraminidase limits viral superinfection. *J Virol* 82:4834-4843.
129. Dortmans J, Koch G, Rottier P, Peeters B. 2011. A comparative infection study of pigeon and avian paramyxovirus type 1 viruses in pigeons: evaluation of clinical signs, virus shedding and seroconversion. *Avian Pathol* 40:125-130.
130. Kapczynski DR, King DJ. 2005. Protection of chickens against overt clinical disease and determination of viral shedding following vaccination with commercially available Newcastle disease virus vaccines upon challenge with highly virulent virus from the California 2002 exotic Newcastle disease outbreak. *Vaccine* 23:3424-3433.

131. Jeon W-J, Lee E-K, Lee Y-J, Jeong O-M, Kim Y-J, Kwon J-H, Choi K-S. 2008. Protective efficacy of commercial inactivated Newcastle disease virus vaccines in chickens against a recent Korean epizootic strain. *J Vet Sci* 9:295-300.
132. Miller PJ, Kim LM, Ip HS, Afonso CL. 2009. Evolutionary dynamics of Newcastle disease virus. *Virology* 391:64-72.
133. Dimitrov KM, Ramey AM, Qiu X, Bahl J, Afonso CL. 2016. Temporal, geographic, and host distribution of avian paramyxovirus 1 (Newcastle disease virus). *Infect Genet Evol* 39:22-34.
134. Miller PJ, Haddas R, Simanov L, Lublin A, Rehmani SF, Wajid A, Bibi T, Khan TA, Yaqub T, Setiyaningsih S. 2015. Identification of new sub-genotypes of virulent Newcastle disease virus with potential panzootic features. *Infect Genet Evol* 29:216-229.
135. Wehmann E, Czeglédi A, Werner O, Kaleta E, Lomniczi B. 2003. Occurrence of genotypes IV, V, VI and VIIa in Newcastle disease outbreaks in Germany between 1939 and 1995. *Avian Pathol* 32:157-163.
136. Maminaiina OF, Gil P, Briand F-X, Albina E, Keita D, Andriamanivo HR, Chevalier V, Lancelot R, Martinez D, Rakotondrao R. 2010. Newcastle disease virus in Madagascar: identification of an original genotype possibly deriving from a died out ancestor of genotype IV. *PLoS One* 5:e13987.
137. Servan de Almeida R, Hammoumi S, Gil P, Briand F-X, Molia S, Gaidet N, Cappelle J, Chevalier V, Balanca G, Traore A. 2013. New avian paramyxoviruses type I strains identified in Africa provide new outcomes for phylogeny reconstruction and genotype classification. *Plos One* 10 (8),(2013).
138. Gallili GE, Ben-Nathan D. 1998. Newcastle disease vaccines. *Biotechnol Adv* 16:343-366.
139. Keeble S, Wade J. 1963. Inactivated Newcastle disease vaccine. *J Comp Pathol Ther* 73:186-200.
140. Dimitrov KM, Lee D-H, Williams-Coplin D, Olivier TL, Miller PJ, Afonso CL. 2016. Newcastle Disease Viruses Causing Recent Outbreaks Worldwide Show Unexpectedly High Genetic Similarity to Historical Virulent Isolates from the 1940s. *J Clin Microbiol* 54:1228-1235.
141. Lomniczi B. 1975. Thermostability of Newcastle disease virus strains of different virulence. *Arch Virol* 47:249-255.
142. Alders RG. 2014. Making Newcastle disease vaccines available at village level. *Vet Rec* 174:502-503.
143. Nyaupane S, Pokharel BB, Acharya MP. 2016. A Study to Estimate Longevity of Thermostable Newcastle Disease Vaccine (strain I-2) in Village Chickens of Nepal. *Advances in Life Sciences* 6:45-48.
144. Omony JB, Wanyana A, Mugimba KK, Kirunda H, Nakavuma JL, Otim-Onapa M, Byarugaba DK. 2016. Disparate thermostability profiles and HN gene domains of field isolates of Newcastle disease virus from live bird markets and waterfowl in Uganda. *Virol J* 13:103.
145. Jeong S-H, Lee D-H, Kim B-Y, Choi S-W, Lee J-B, Park S-Y, Choi I-S, Song C-S. 2013. Immunization with a thermostable Newcastle disease virus K148/08 strain originated from wild mallard duck confers protection against lethal viscerotropic velogenic Newcastle disease virus infection in chickens. *PLoS One* 8:e83161.
146. Wen G, Hu X, Zhao K, Wang H, Zhang Z, Zhang T, Yang J, Luo Q, Zhang R, Pan Z. 2016. Molecular basis for the thermostability of Newcastle disease virus. *Sci Rep* 6:22492.

147. Wen G, Chen C, Guo J, Zhang Z, Shang Y, Shao H, Luo Q, Yang J, Wang H, Wang H. 2015. Development of a novel thermostable Newcastle disease virus vaccine vector for expression of a heterologous gene. *J Gen Virol* 96:1219-1228.
148. Wen G, Shang Y, Guo J, Chen C, Shao H, Luo Q, Yang J, Wang H, Cheng G. 2013. Complete genome sequence and molecular characterization of thermostable Newcastle disease virus strain TS09-C. *Virus Genes* 46:542-545.
149. Dalgaard T, Norup LR, Pedersen AR, Handberg K, Jørgensen PH, Juul-Madsen HR. 2010. Flow cytometric assessment of chicken T cell-mediated immune responses after Newcastle disease virus vaccination and challenge. *Vaccine* 28:4506-4514.
150. Yongola M, MUHAIRA A, MTAMBO M, Minga M, Minja M. 2006. Immunogenicity and protection ability of candidate Newcastle disease virus isolated for vaccine production. *Livestock Research and Rural Development* 18.
151. Pleidrup J, Dalgaard TS, Norup LR, Permin A, Schou TW, Skovgaard K, Vadekær DF, Jungersen G, Sørensen P, Juul-Madsen HR. 2014. *Ascaridia galli* infection influences the development of both humoral and cell-mediated immunity after Newcastle Disease vaccination in chickens. *Vaccine* 32:383-392.
152. Al-Garib S, Gielkens ALJ, Gruys E, Hartog L, Koch G. 2003. Immunoglobulin class distribution of systemic and mucosal antibody responses to Newcastle disease in chickens. *Avian Dis* 47:32-40.
153. Ge J, Wang X, Tian M, Wen Z, Feng Q, Qi X, Gao H, Wang X, Bu Z. 2014. Novel in-ovo chimeric recombinant Newcastle disease vaccine protects against both Newcastle disease and infectious bursal disease. *Vaccine* 32:1514-1521.
154. Yosipovich R, Aizenshtein E, Shadmon R, Krispel S, Shuster E, Pitcovski J. 2015. Overcoming the susceptibility gap between maternal antibody disappearance and auto-antibody production. *Vaccine* 33:472-478.
155. Johnston P, Liu H, O'Connell T, Phelps P, Bland M, Tyczkowski J, Kemper A, Harding T, Avakian A, Haddad E. 1997. Applications in in ovo technology. *Poult Sci* 76:165-178.
156. Williams C, Zedek A. 2010. Comparative field evaluations of in ovo applied technology. *Poult Sci* 89:189-193.
157. Mebatsion T, Verstegen S, De Vaan LT, Römer-Oberdörfer A, Schrier CC. 2001. A recombinant Newcastle disease virus with low-level V protein expression is immunogenic and lacks pathogenicity for chicken embryos. *J Virol* 75:420-428.
158. Ramp K, Topfstedt E, Wäckerlin R, Höper D, Ziller M, Mettenleiter TC, Grund C, Römer-Oberdörfer A. 2012. Pathogenicity and immunogenicity of different recombinant Newcastle disease virus clone 30 variants after in ovo vaccination. *Avian Dis* 56:208-217.
159. Wen G, Li L, Yu Q, Wang H, Luo Q, Zhang T, Zhang R, Zhang W, Shao H. 2017. Evaluation of a thermostable Newcastle disease virus strain TS09-C as an in-ovo vaccine for chickens. *PLoS One* 12:e0172812.
160. Kapczynski DR, Martin A, Haddad EE, King DJ. 2012. Protection from clinical disease against three highly virulent strains of Newcastle disease virus after in ovo application of an antibody–antigen complex vaccine in maternal antibody–positive chickens. *Avian Dis* 56:555-560.



161. Rauw F, Gardin Y, Palya V, Van Borm S, Gonze M, Lemaire S, van den Berg T, Lambrecht B. 2009. Humoral, cell-mediated and mucosal immunity induced by oculo-nasal vaccination of one-day-old SPF and conventional layer chicks with two different live Newcastle disease vaccines. *Vaccine* 27:3631-3642.
162. Hamal KR, Burgess S, Pevzner I, Erf G. 2006. Maternal antibody transfer from dams to their egg yolks, egg whites, and chicks in meat lines of chickens. *Poult Sci* 85:1364-1372.
163. Gharaibeh S, Mahmoud K. 2013. Decay of maternal antibodies in broiler chickens. *Poult Sci* 92:2333-2336.
164. Zhao K, Rong G, Hao Y, Yu L, Kang H, Wang X, Wang X, Jin Z, Ren Z, Li Z. 2016. IgA response and protection following nasal vaccination of chickens with Newcastle disease virus DNA vaccine nanoencapsulated with Ag@ SiO<sub>2</sub> hollow nanoparticles. *Sci Rep* 6.
165. Dai C, Kang H, Yang W, Sun J, Liu C, Cheng G, Rong G, Wang X, Wang X, Jin Z. 2015. O-2'-Hydroxypropyltrimethyl ammonium chloride chitosan nanoparticles for the delivery of live Newcastle disease vaccine. *Carbohydr Polym* 130:280-289.
166. Zhao K, Chen G, Shi X-m, Gao T-t, Li W, Zhao Y, Zhang F-q, Wu J, Cui X, Wang Y-F. 2012. Preparation and efficacy of a live newcastle disease virus vaccine encapsulated in chitosan nanoparticles. *PLoS One* 7:e53314.
167. Zhao K, Sun Y, Chen G, Rong G, Kang H, Jin Z, Wang X. 2016. Biological evaluation of N-2-hydroxypropyl trimethyl ammonium chloride chitosan as a carrier for the delivery of live Newcastle disease vaccine. *Carbohydr Polym* 149:28-39.
168. Zhou M, Zhang G, Ren G, Gnanadurai CW, Li Z, Chai Q, Yang Y, Leyson CM, Wu W, Cui M. 2013. Recombinant rabies viruses expressing GM-CSF or flagellin are effective vaccines for both intramuscular and oral immunizations. *PLoS One* 8:e63384.
169. Zhang T, Liu Y, Wang H, Zhang X, Zhu S, Xu P, Yin J, Ren G, Liu J, Li D. 2016. Recombinant NDV expressing cytokines or fliC confers a quick immune response against NDV challenge and resistance to maternal antibody. *Vet Microbiol* 196:107-117.
170. Alexander D. 1988. Newcastle disease virus—An avian paramyxovirus, p 11-22, Newcastle disease. Springer.
171. Miller PJ, Estevez C, Yu Q, Suarez DL, King DJ. 2009. Comparison of viral shedding following vaccination with inactivated and live Newcastle disease vaccines formulated with wild-type and recombinant viruses. *Avian Dis* 53:39-49.
172. Miller PJ, King DJ, Afonso CL, Suarez DL. 2007. Antigenic differences among Newcastle disease virus strains of different genotypes used in vaccine formulation affect viral shedding after a virulent challenge. *Vaccine* 25:7238-7246.
173. Hossain KMM, Ali MY, Yamato I. 2010. Antibody levels against Newcastle Disease Virus in chickens in Rajshahi and surrounding districts of Bangladesh. *Int J Biol* 2:102.
174. Hu S, Ma H, Wu Y, Liu W, Wang X, Liu Y, Liu X. 2009. A vaccine candidate of attenuated genotype VII Newcastle disease virus generated by reverse genetics. *Vaccine* 27:904-910.

175. Liu M-M, Cheng J-L, Yu X-H, Qin Z-M, Tian F-L, Zhang G-Z. 2015. Generation by reverse genetics of an effective attenuated Newcastle disease virus vaccine based on a prevalent highly virulent Chinese strain. *Biotechnol Lett* 37:1287.
176. Schnell MJ, Mebatsion T, Conzelmann K-K. 1994. Infectious rabies viruses from cloned cDNA. *EMBO J* 13:4195.
177. Conzelmann K. 2004. Reverse genetics of mononegavirales, p 1-41, *Biology of negative strand RNA viruses: The power of reverse genetics*. Springer.
178. Siridechadilok B, Gomutsukhavadee M, Sawaengpol T, Sangiambut S, Puttikhunt C, Chin-inmanu K, Suriyaphol P, Malasit P, Sreaton G, Mongkolsapaya J. 2013. A simplified positive-sense-RNA virus construction approach that enhances analysis throughput. *J Virol* 87:12667-12674.
179. Li C, Huang J, Li Y, He F, Li D, Sun Y, Han W, Li S, Qiu H-J. 2013. Efficient and stable rescue of classical swine fever virus from cloned cDNA using an RNA polymerase II system. *Arch Virol* 158:901-907.
180. Molouki A, Peeters B. 2017. Rescue of recombinant Newcastle disease virus: current cloning strategies and RNA polymerase provision systems. *Arch Virol* 162:1-12.
181. Zhao W, Hu H, Zsak L, Yu Q, Yang Z. 2013. Application of the ligation-independent cloning (LIC) method for rapid construction of a minigenome rescue system for Newcastle disease virus VG/GA strain. *Plasmid* 70:314-320.
182. Zhao W, Zhang Z, Zsak L, Yu Q. 2015. P and M gene junction is the optimal insertion site in Newcastle disease virus vaccine vector for foreign gene expression. *J Gen Virol* 96:40-45.
183. Zhao W, Spatz S, Zhang Z, Wen G, Garcia M, Zsak L, Yu Q. 2014. Newcastle disease virus (NDV) recombinants expressing infectious laryngotracheitis virus (ILTV) glycoproteins gB and gD protect chickens against ILTV and NDV challenges. *J Virol* 88:8397-8406.
184. Pfaller CK, Cattaneo R, Schnell MJ. 2015. Reverse genetics of Mononegavirales: How they work, new vaccines, and new cancer therapeutics. *Virology* 479:331-344.
185. Walpita P, Flick R. 2005. Reverse genetics of negative-stranded RNA viruses: a global perspective. *FEMS Microbiol Lett* 244:9-18.
186. Nakaya T, Cros J, Park M-S, Nakaya Y, Zheng H, Sagrera A, Villar E, García-Sastre A, Palese P. 2001. Recombinant Newcastle disease virus as a vaccine vector. *J Virol* 75:11868-11873.
187. DiNapoli JM, Nayak B, Yang L, Finneyfrock BW, Cook A, Andersen H, Torres-Velez F, Murphy BR, Samal SK, Collins PL. 2010. Newcastle disease virus-vectored vaccines expressing the hemagglutinin or neuraminidase protein of H5N1 highly pathogenic avian influenza virus protect against virus challenge in monkeys. *J Virol* 84:1489-1503.
188. Bukreyev A, Skiadopoulos MH, Murphy BR, Collins PL. 2006. Nonsegmented negative-strand viruses as vaccine vectors. *J Virol* 80:10293-10306.
189. Maamary J, Gao Q, García-Sastre A, Steinman RM, Palese P, Nchinda G. 2011. Newcastle disease virus expressing a dendritic cell-targeted HIV gag protein induces a potent gag-specific immune response in mice. *J Virol* 85:2235-2246.
190. Shobana R, Samal SK, Elankumaran S. 2013. Prostate-specific antigen-retargeted recombinant newcastle disease virus for prostate cancer virotherapy. *J Virol* 87:3792-3800.

191. Zamarin D, Holmgaard RB, Ricca J, Plitt T, Palese P, Sharma P, Merghoub T, Wolchok JD, Allison JP. 2017. Intratumoral modulation of the inducible co-stimulator ICOS by recombinant oncolytic virus promotes systemic anti-tumour immunity. *Nat Commun* 8.
192. Le Mercier P, Jacob Y, Tanner K, Tordo N. 2002. A novel expression cassette of lyssavirus shows that the distantly related Mokola virus can rescue a defective rabies virus genome. *J Virol* 76:2024-2027.
193. Yun T, Park A, Hill TE, Pernet O, Beaty SM, Juelich TL, Smith JK, Zhang L, Wang YE, Vigant F. 2015. Efficient reverse genetics reveals genetic determinants of budding and fusogenic differences between Nipah and Hendra viruses and enables real-time monitoring of viral spread in small animal models of henipavirus infection. *J Virol* 89:1242-1253.
194. Römer-Oberdörfer A, Mundt E, Mebatsion T, Buchholz UJ, Mettenleiter TC. 1999. Generation of recombinant lentogenic Newcastle disease virus from cDNA. *J Gen Virol* 80:2987-2995.
195. Zhang X, Liu H, Liu P, Peeters BP, Zhao C, Kong X. 2013. Recovery of avirulent, thermostable Newcastle disease virus strain NDV4-C from cloned cDNA and stable expression of an inserted foreign gene. *Arch Virol* 158:2115-2120.
196. Martin A, Staeheli P, Schneider U. 2006. RNA polymerase II-controlled expression of antigenomic RNA enhances the rescue efficacies of two different members of the Mononegavirales independently of the site of viral genome replication. *J Virol* 80:5708-5715.
197. Li B-y, Li X-r, Lan X, Yin X-p, Li Z-y, Yang B, Liu J-x. 2011. Rescue of Newcastle disease virus from cloned cDNA using an RNA polymerase II promoter. *Arch Virol* 156:979-986.
198. Wang J, Wang C, Feng N, Wang H, Zheng X, Yang S, Gao Y, Xia X, Yin R, Liu X. 2015. Development of a reverse genetics system based on RNA polymerase II for Newcastle disease virus genotype VII. *Virus Genes* 50:152-155.
199. Neumann G, Fujii K, Kino Y, Kawaoka Y. 2005. An improved reverse genetics system for influenza A virus generation and its implications for vaccine production. *Proc Natl Acad Sci U S A* 102:16825-16829.
200. Zhang X, Kong W, Ashraf S, Curtiss R. 2009. A one-plasmid system to generate influenza virus in cultured chicken cells for potential use in influenza vaccine. *J Virol* 83:9296-9303.
201. Zhang X, Curtiss R. 2015. Efficient generation of influenza virus with a mouse RNA polymerase I-driven all-in-one plasmid. *Virol J* 12:95.
202. Kobayashi T, Ooms LS, Ikizler M, Chappell JD, Dermody TS. 2010. An improved reverse genetics system for mammalian orthoreoviruses. *Virology* 398:194-200.
203. Wang Q, Ma X, Qian S, Zhou X, Sun K, Chen X, Zhou X, Jackson AO, Li Z. 2015. Rescue of a plant negative-strand RNA virus from cloned cDNA: insights into enveloped plant virus movement and morphogenesis. *PLoS Pathog* 11:e1005223.
204. Adu-Gyamfi E, Kim LS, Jardetzky TS, Lamb RA. 2016. Flexibility of the head-stalk linker domain of paramyxovirus HN glycoprotein is essential for triggering virus fusion. *J Virol* 90:9172-9181.

## **Chapter 1**

### **Development and Efficiency Comparison of Newcastle Disease Virus Reverse Genetics Systems with Different Number of Plasmids**

## **Abstract**

Viruses from different families have been rescued by reverse genetics which usually consist of the transfection of cells with plasmids containing virus cDNA sequences that initiate the first minimum steps to achieve a complete cycle of virus replication. The number of initial steps to achieve and consequently the number of plasmids to be used depend on the viral genome. For positive single-strand RNA virus, the rescuing system uses only one plasmid that convert cDNA into a viral RNA genome expressed and replicated by the cell. In contrast, the number of plasmids can be high up to twelve, for segmented negative--RNA viruses like influenza. Some authors have shown that the lower plasmid number, the higher efficiency of the reverse genetics for segmented RNA or DNA viruses. However, it is unclear if the number of plasmids affects the efficiency of reverse genetics for negative--single-strand RNA viruses, such as Newcastle disease virus (NDV). To address this issue, six variants of NDV reverse genetic systems have been established, based on one, two, three or four plasmids, and compared in cell culture. In terms of mini-genome and full-genome rescue, we show that only the 2-plasmid system was able to improve the rescue efficiency compared to the conventional 4-plasmid system. These results may contribute to establish and improve reverse genetics for other mononegaviruses.

## **Introduction**

The genetic material of *Mononegavirales* consists of a negative-sense single-stranded RNA (1). Replication of this viral genome requires an intermediate molecule of positive-sense RNA that can only be generated by a viral RNA-dependent RNA polymerase (RdRp) (2-6). RdRp includes different viral proteins which varies within the order *Mononegavirales*. It usually contains P and L proteins for paramyxoviruses (7-10) but more proteins are required for some viruses, such as VP30 and VP35 for Ebolavirus and M2-1 for human metapneumovirus (11, 12). The reverse genetics system must mimic viral transcription and replication to generate viral particles from genome, so it has to reproduce a ribonucleoprotein complex (RNP) which is the minimal molecular complex of the virus that can replicate virus particles into the cell. The RNP is made of a viral genome enwrapped by the nucleocapsid (N) and the RdRp proteins, as well. Consequently, the rescue system of *Mononegavirales* is far more complex than that of positive-sense single-stranded RNA viruses (13).

Reverse genetics has been extensively used in virology since it allows genome editing, including insertions, deletions, mutations, which are essential manipulations in vaccinology, virus vectorization, biology and pathogenesis studies, etc. (13-15). Generating modified mononegaviruses which can re-infect and grow on cells has been achieved for long by current systems with high efficiency (13, 15). However, these systems can fail in rescuing defective virus particles (16). Furthermore, the current reverse genetics systems have low efficiency for mini-genome expression, which may induces discrepant results in experiments based on mini-genome compared to experiments with full-genomes (17-19). Xiao-hui Yu reported that the replacement of L protein significantly decreased the performances of RdRp in mini-genome expression, while it did not decrease the replication ability of Newcastle disease virus (NDV) strain bearing this L protein (20). In another study, the outcome was the opposite, one NDV strain's RdRp working well on the mini-genome expression, but was bad in terms of viral replication (21). All these observations suggest that there is space for improving the performances of the current reverse genetics systems for mononegavirus rescue.

Since the first mononegavirus rescue, achieved in 1994 on the rabies virus (22), many other viruses from different have been recovered by using the same or a very similar strategy (13). Some improvements have been introduced in the reverse genetics technology in the last twenty years. Firstly, the T7 promoter has substituted by other promoters, such as the human cytomegalovirus promoter (CMV), which are directly recognized by Eukaryotic RNA polymerases. This overcomes the constraint of the introduction of a T7 RNA polymerase in the system to initiate the initial expression of the viral genome. Usually, the T7 polymerase was provided either by the addition of a recombinant virus, the transfection a an additional plasmid of the development and T7 gene transgenic cell lines (23, 24). Another improvement consisted in the introduction of a hammer-head ribozyme derived from the human Hepatitis C virus, placed immediately upstream of the 5'-end of the viral anti-genome in order to generate an exact 5'-end. This modification increased the rescue efficiency for some viruses, such as Nipah virus (25). For segmented RNA viruses, number of plasmids has starkly affected the rescuing efficiency. Accordingly, decreasing the number of plasmids from 12 to 3 has enhanced the titer of a rescued influenza virus from less than  $10^4$  TCID<sub>50</sub>/ml up to  $3.7 \times 10^4$  on Vero cells (26). Similarly, one-plasmid improved the rescued of an influenza virus by 6-fold on CEF cells compared to 8 plasmids (27). Another study confirmed that the system based on one-plasmid allowed the rescue of an influenza virus with high titer on MDCK cells, while the 3-plasmid system just failed (28). A mammalian orthoreovirus, which is a double-stranded



RNA virus, was also recovered one day earlier with the use of 4 instead of 10 plasmids (29). It is surprising that the reduction of the number of plasmids used in the rescue of animal mononegaviruses was never tried before. In this study, we developed and compared several reverse genetics systems based on different numbers of plasmids to rescue NDV strains as models for mononegaviruses. We conclude that the method based on 2-plasmids provide the best performances in in viral rescue, while other systems have similar rescuing efficiency as the conventional 4-plasmid system.

## **Materials and Methods**

### **1. Cells**

Baby hamster kidney (BHK-21) cells were grown in Eagle's minimum essential medium (Gibco) with 10% fetal bovine serum (PAN-Biotch) and cultured at 37°C with 5% CO<sub>2</sub>. Chemically competent cells, E.coli 10-beta strains, were purchased from New England Biolabs (NEB).

### **2. Plasmid constructions.**

In total, 11 constructions were made either with a single cassette, various combinations of cassettes expressing the viral proteins NP, P and L, a mini-genome or a full-genome, all placed downstream a human cytomegalovirus promoter (pCMV). The mini-genome consisting of a pCMV placed upstream of EGFP reporter gene flanked by the NDV leader and trailer, all in reverse orientation. The leader, the trailer, the NP, P and L sequences and the full-genome were all derived from a Madagascar NDV strain (MG-725) (Fig. 2.1). All these plasmids were purified with the Quick Plasmid Miniprep kit (Invitrogen) and the EndoFree plasmid Maxi kit (QIAGEN), aliquoted and stored at -20°C.

To ease the cloning step of the plasmid constructs, a quick and convenient method was also adopted and validated to screen clones after transformation (Fig. 2.2A). Single bacterium clones were picked into 500 µL liquid Luria-Bertani (LB) medium containing ampicillin (100µg/ml) and cultured overnight at 30°C, 200 rpm. Then, 40 µL of the cultured medium were mixed with 10 µL of distilled water, 10 µL of 10× Gel Loading Buffer and 40 µL of Phenol:Chloroform:Isoamyl Alcohol (25:24:1) (SIGMA) , vortexed for 10 seconds and finally centrifuged at 16,000g for 5 minutes. Twenty µL of the supernatants were loaded on gel for electrophoresis (Fig. 2.2A) (30).

### 3. Assessment of the performances of the different reverse genetics systems.

#### 3.1. Assessment based on the mini-genome expression.

BHK-21 cells were seeded in 6-well plates at a concentration of  $2 \times 10^5$  cells/well and incubated overnight at  $37^\circ\text{C}$  with 5%  $\text{CO}_2$ . A total of 2.5  $\mu\text{g}$  of plasmid mixes consisting of either 4-, 3-, 2- or 1-plasmid systems with mini-genome were transfected into the cells by Lipofectamine 3000 (Invitrogen). The ratios of these vectors varied as follows: [5: 2: 2: 1 for pMini-genome: pNn: pP: pL], [2: 1: 1 for pMini-genome : pN-P: pL], [2: 1: 1 for pMini-genome: pN-L: pP], [2: 1: 1 for pMini-genome: pP-L: pN], [1: 1 for pMini-genome: pNPL], [2.5  $\mu\text{g}$  pMini-genome-NPL] and [5: 2: 2: 1 for pMini-genome: pN: pP: pCI-neo (Clontech)] as control . Two days after transfection, green fluorescence was checked and imaged by microscope. In order to quantitate and compare the efficiency of the different systems, 0.5  $\mu\text{g}$  of each system with the same ratios were transfected into  $1 \times 10^5$  BHK-21 cells seeded in 24-well plates. Then, cells expressing EGFP were enumerated two days after transfection under the fluorescent microscope.

#### 3.2. Assessment based on the rescue of rMG-725/EGFP strain.

BHK-21 cells were seeded in 6-well plates at a concentration of  $4 \times 10^5$  cells/well and incubated at  $37^\circ\text{C}$  with 5%  $\text{CO}_2$ . Plasmid mixes consisting of various combination single, dual or triple cassettes in the pCMV vector to provide N, P and L were transfected into cells exactly as described in the previous section with the exception that pMini-genome was replaced by pMG-725/EGFP. Three days post-transfection, cells expressing EGFP were imaged under the fluorescent microscope. In addition, 100  $\mu\text{L}$  of supernatants were collected daily for six days to titer the rescued viruses on BHK-21 cells by the  $\text{TCID}_{50}$  method.

## Results

### 1. The modified pCMV plasmid can accommodate an insertion of up to 30kb.

To develop the 1-plasmid system, all sequences for the NDV reverse genetics had to be inserted into the same vector. It is a rather complex construction since it involves more steps and much bigger insertions than that of the 4-plasmid system (Fig. 2.1). Using the quicker clone screening approach as described in methods section, it was faster, easier and cheaper to screen positive clones compared to the conventional PCR screening method. This screening method was applied for all cloning steps in this study (Fig. 2.2A), such as 2.8 kilobases (kb)

of NP cassette and 7.9 kb of L cassette cloned into 4.3 kb pCMV and 9.1 kb of pCMV-N-P-SgrAI vector, respectively (Fig. 2.2B). All of 11 clones containing NP cassette insertion were positives, while only 7 of 11 clones containing L cassette insertion were positive, which indicated the bigger the fragment is, the more difficult to insert it (Fig. 2.2B). However, the 13kb fragment, including NP, P and L cassettes, was successfully inserted into a 20 kb NDV full-genome pMG-725/EGFP-SgrAI vector, even though there were only two positive clones out of thirty tested clones (Fig. 2.2C). However, bacteria transformed with this big plasmid grew very slowly. The 600 wavelength optical density (OD600) value of the bacterium culture was still 0.00 at 13 h after incubation in LB. In contrast, OD600 value was 0.29 and 1.01 for pMG-725/EGFP and pCMV, respectively. After 24h of culture, the OD600 values of bacteria containing pMG-725/EGFP-NPL, pMG-725/EGFP or pCMV plasmids were 0.67, 0.91 and 1.34, respectively (Fig. 2.2D). In addition, this 33kb pMG-725/EGFP-NPL plasmid was unstable due to its size. It could not be re-amplified after the transfer of cultured bacteria into a fresh medium. The pMG-725/EGFP-NPL plasmid was lost and instead, other unknown small plasmids were generated (Fig. 2.2C). These results show that a big exogenous fragment of around 30 kb can be cloned into a pCMV vector, but it affects the bacterium growth and the plasmid has a reduced stability.

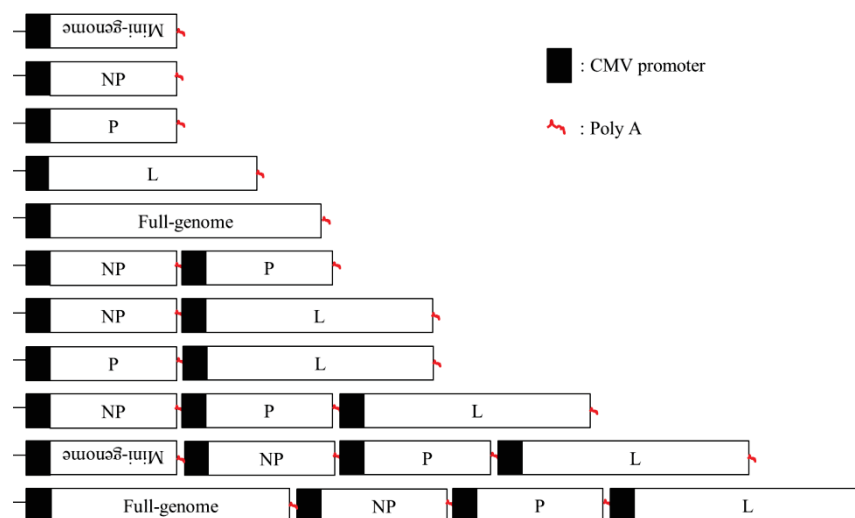

**Fig. 2.1.** Different reverse genetics systems were constructed and used in this study. The conventional 4-plasmids system, named thereafter as N+P+L, consists of pMini-genome (Mini-genome cassette) or pFull-genome (rMG725-EGFP strain's Full-genome), pN (NP cassette), pP (P cassette) and pL (L cassette). In contrast, the 1-plasmid system, named as MNPL, consists of pMini-minigenome-NPL (Mini-genome, NP, P and L cassettes) or pFull-genome-NPL (Full-genome, NP, P and L cassettes). The 3- and 2-plasmids systems correspond to various combinations of the constructions described in this figure.

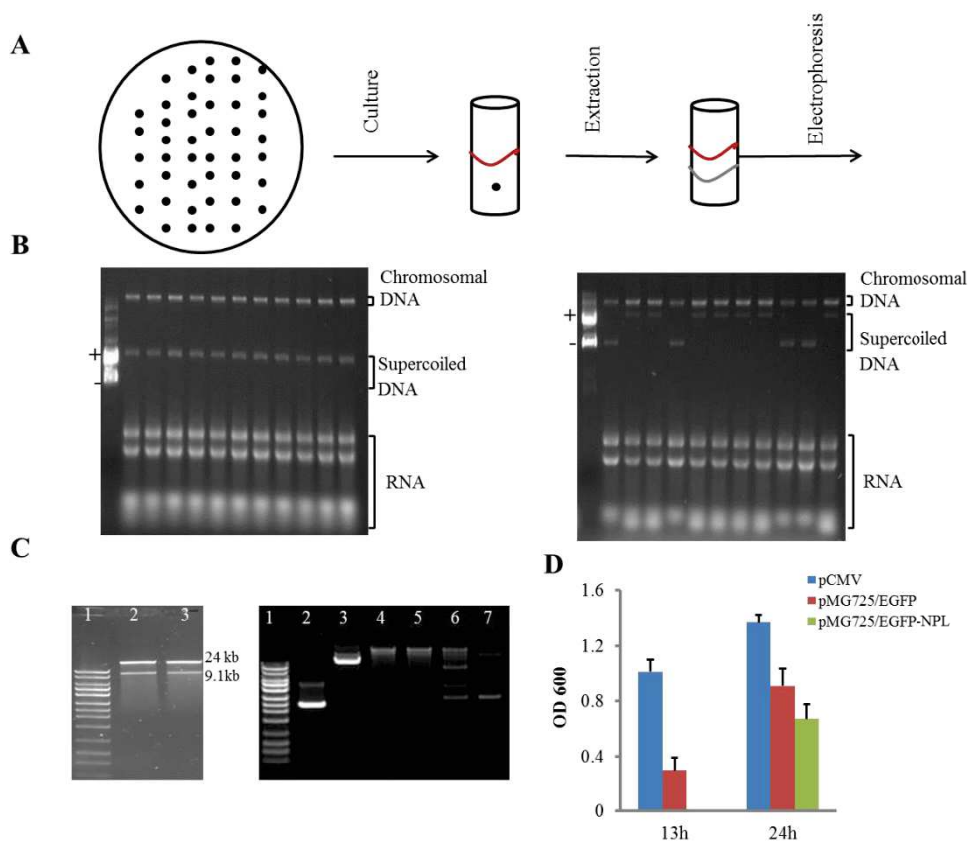

**Fig. 2.2.** Fast screening of the clones after transformation. (A) The strategy of clone screening as described in material & method. (B) Confirmation of positive clones during the pCMV-NPL-SgrAI construction: the left picture showed that the NP cassette (2.8 kb) was inserted into pCMV vector (4.3 kb) to get pCMV-N-SgrAI (6.6 kb). All the 11 clones were detected as positive since the size of clones was the same as for pCMV-N-SgrAI (+) and bigger than empty pCMV(-). The right image indicated L cassette (7.9 kb) was added to pCMV-N-P-SgrAI vector (9.1 kb; -) to generate pNPL (15.9 kb; +). Seven out of 11 clones were found with the L insertion. (C) pMG-725/EGFP-NPL plasmid. The left picture showed that two positive clones (out of thirty tested, data not shown). 1: 1 kb DNA marker; 2-3: positive clones were cut by PacI to generate 9.1 kb and 24 kb bands. The right picture showed the instability of the pMG-725/EGFP-NPL plasmid. 1: 1 kb DNA marker; 2: pCMV vector; 3: pMG-725/EGFP plasmid; 3-4: pMG-725/EGFP-NPL plasmid; 5-6: re-amplification of pMG-725/EGFP-NPL plasmids could generate unknown small plasmids. (D) The growth ability of E.coli with plasmids. The pMG-725/EGFP-NPL plasmid attenuated the growth of E.coli which OD600 still null after 13 hours of culture in Ampicillin liquid medium.

2. The 2-plasmids system increased efficiency of reverse genetic based on mini-genome expression.

Since the mini-genome containing EGFP ORF was cloned into the pCMV vector in the reverse direction, EGFP expression relies on the generation of an antisense EGFP-RNA taken over by NP, P and L protein of NDV (Fig. 2.3A). Accordingly, cells transfected with plasmids encoding those proteins, developed green fluorescence (Fig. 2.3B). However, the number of EGFP positive cells differed according to the system. The NP+L and PL+N systems generated 1.5 times fluorescent cells as the 4-plasmids system, while the NL+P system did not show any improvement. In contrast, the 2-plasmids system increased the fluorescent cells by 2.5 fold compared to the 4-plasmids system. However, when the mini-genome, NP, P and L cassettes were all assembled in the same vector, the number of EGFP positive cells was unchanged compared to the 4-plasmids system (Fig. 2.3C). These results show that the 2-plasmids system is the optimized condition for mini-genome rescue.

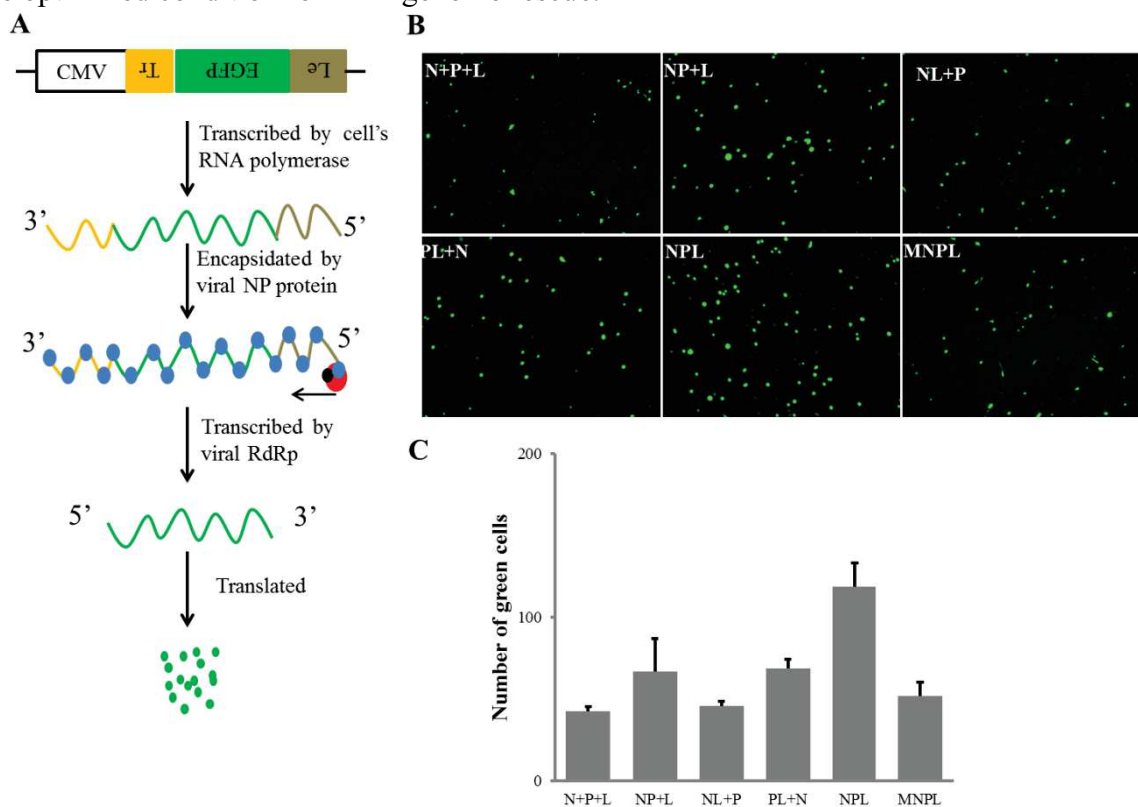
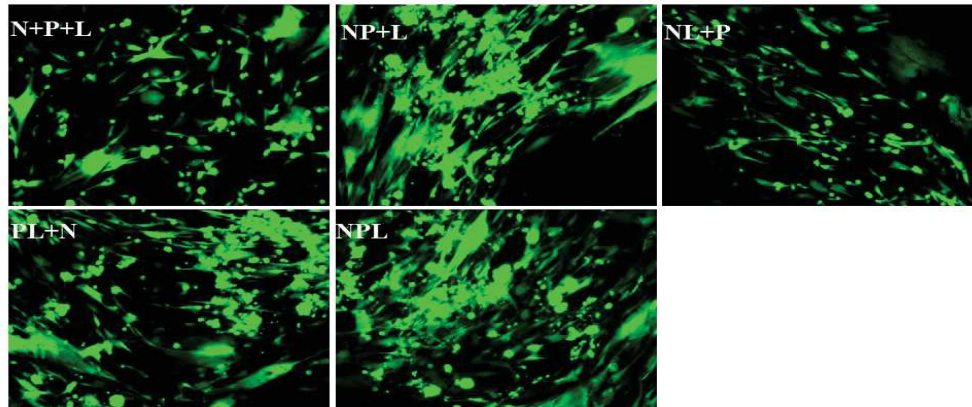

**Fig. 2.3.** Efficiency of the different systems on Mini-genome expression. (A) The strategy of EGFP expression from Mini-genome. Due to Mini-genome, including viral Leader (Le), Trailer (Tr) and EGFP gene, inserted in pCMV vector with a reverse direction, the EGFP expression requires both the cell's RNA polymerase II, and the viral NP, P and L proteins as well. (B) All of the 4-, 3-, 2- and 1- plasmid systems induced cell expressing EGFP. Images were taken two days after transfection, magnification  $2.5 \times$ . (C) The 2-plasmid system increased efficiency. Two days after transfection, green fluorescent cells were counted under the microscope. The number of green cells of the 2-plasmid system was around 2.5 times as that of the 4- plasmid systems. Histograms show the average and bars are the SD of the number of cells expressing EGFP in triplicate wells of 24-well plates in the same assay.

3. The 2-plasmid system generated virus in a shorter time with a higher titer.

The different constructions made for the expression of NP, P and L were then tested to rescue one NDV strain, the recombinant virulent rMG-725/EGFP. Since we failed in getting the pMG-725/EGFP-NPL plasmid by Maxiprep, the 1-plasmid system could not be tested. The MG-725/EGFP strain was successfully rescued by all the systems, by three days post-transfection (Fig. 2.4A).

**A**



**B**

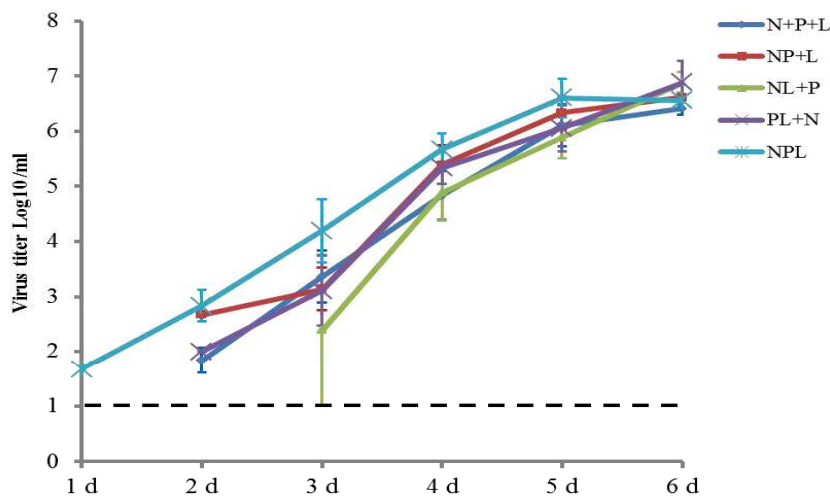

**Fig. 2.4.** Performances of the different systems in rescuing the recombinant NDV strain, rMG-725/EGFP. (A) All the systems could rescue rMG-725/EGFP strain. The 2-plasmid system generated more viruses based on EGFP expression. Images were taken three days after transfection, at magnification 10 $\times$ . (B) The 2-plasmid system could rescue the virus in a shorter time and with higher titers. In supernatants, viral particles were detected as soon as one day post-transfection when using the 2-plasmid system. In the first three days, the viral titer obtained with the 2-plasmid was 1 Log<sub>10</sub> higher than the titer obtained with the 4-plasmid system. The dashed line indicated the minimum viral titer could be detected. Values showed the average and bars were the SD in triplicate wells of 6-well plates in the same assay.



One day after transfection, the green fluorescence was already detected in the cells transfected with the 2- and one of 3-plasmid (NP+L) systems. However, virus titers of the rescued virus differed according to the system used. Compared to the 4-plasmids system, the 3-plasmids systems, NP+L or PL+N, generated similar titers while NL+P system was less performant, confirming the observation on the mini-genome. The 2-plasmids system was the best, with an increase of the rescued virus titer of one log<sub>10</sub> compared to the 4-plasmids system. The differences observed between all the systems were essentially seen in the early days after transfection, the virus titers reaching the same climax in the late stages of infection (Fig. 2.4B).

## **Discussion**

In this study, six reverse genetics systems, including different number of plasmids, were constructed. The efficiencies of these systems were compared. The 2-plasmids system where NP, P and L genes are cloned in a unique vector showed the highest efficiency based on mini-genome expression and one recombinant NDV strain rescue.

As many cloning steps were required to construct these systems, a faster and more economic method for clone screening was adopted and validated (30). The theory of this screening method is based on the size difference between the empty and ligated plasmids observed in gel electrophoresis (31). We successfully used this method as an alternative of the conventional restriction fragment length pattern or PCR methods. In this study, the 30 kb fragment, including viral full-genome, L, P and NP genes cassettes, was cloned into pCMV vector by many steps to get pMG-725/EGFP-NPL plasmid. The size of this plasmid was around 33kb, which results in a big instability of this plasmid and the impossibility to re-amplify this plasmid into bacteria. We believe that this difficulty was also partly resulting from the pMG-725/EGFP-NPL plasmid has a pBluscript backbone which is a high copy plasmid that may not accommodate a large insertion of 30 kb bases and re-arrange in bacteria (32, 33). A low copy plasmid or even a Bacterial Artificial Chromosome (BAC) vector could possibly solve this problem (34, 35). For instance, the respiratory syncytial virus was successfully rescued from a BAC vector (36).

For rescuing viruses, it is necessary to achieve the transfection of all plasmids in the same cells. Consequently, systems containing less plasmids should work better than those with more plasmids as already observed with segmented RNA viruses, such as influenza virus

(37-39). Thus, we initially hypothesized that the less plasmid used the better the system would be to rescue mononegaviruses. In this study, we found that the 2-plasmids system enhanced the efficiency of the mini-genome expression and virus rescue compared to the 4-plasmids system, while the other systems did not. Surprisingly, the 1-plasmid system did not increase efficiency of mini-genome rescue compared to the 4-plasmids system. Some authors have suggested that although each gene is expressed from an independent cassette including a promoter and a terminator, the quantity of each gene expression from the same vector may not be always balanced (40). The pMini-NPL plasmid requires the expression of four genes - mini-genome, NP, P and L - to make the system functional. After transfection into cells, the efficiency of expression of mini-genome, NP, P or L can vary and can also be low, and it can explain why the 1-plasmid failed in increasing the efficiency based on mini-genome testing.

Mononegavirus replication depends on the ribonucleoprotein complex (RNP) that contains encapsidated RNA and RdRp (2). How to generate much RNP by reverse genetics may be the key point to increase efficiency. For some mononegaviruses, such as NDV, the transcription of viral gene follows the 3'- to -5' attenuation rule (41, 42). The replication of NDV is affected when this attenuation rule is disturbed (43). Since the pNL plasmid (13 kb) is bigger than the pP plasmid (6.6 kb), cells transfected with the same amount of both plasmids will probably express more P protein than NP. This imbalance compared to the normal gradient of NP/P expression in natural infection may be responsible for the decreased rescue efficiency of the NL+P system. In contrast, the NP+L and PL+N systems had higher efficiency than the 4-plasmids system based on mini-genome, but the efficiency was not really different when applied to the rescue of the full-genome, which indicate other factors, such as efficiency of RNA polymerase transcribing long RNA, may influence virus rescuing.

## References

1. Amarasinghe GK, Bào Y, Basler CF, Bavari S, Beer M, Bejerman N, Blasdel KR, Bochnowski A, Briese T, Bukreyev A. 2017. Taxonomy of the order Mononegavirales: update 2017. *Arch Virol*:1-12.
2. Whelan S, Barr J, Wertz G. 2004. Transcription and replication of nonsegmented negative-strand RNA viruses, p 61-119, *Biology of Negative Strand RNA Viruses: The Power of Reverse Genetics*. Springer.
3. Kingston RL, Hamel DJ, Gay LS, Dahlquist FW, Matthews BW. 2004. Structural basis for the attachment of a paramyxoviral polymerase to its template. *Proc Natl Acad Sci U S A* 101:8301-8306.
4. Green TJ, Rowse M, Tsao J, Kang J, Ge P, Zhou ZH, Luo M. 2011. Access to RNA encapsidated in the nucleocapsid of vesicular stomatitis virus. *J Virol* 85:2714-2722.

5. Raymond DD, Piper ME, Gerrard SR, Skiniotis G, Smith JL. 2012. Phleboviruses encapsidate their genomes by sequestering RNA bases. *Proc Natl Acad Sci U S A* 109:19208-19213.
6. Gutsche I, Desfosses A, Effantin G, Ling WL, Haupt M, Ruigrok RW, Sachse C, Schoehn G. 2015. Near-atomic cryo-EM structure of the helical measles virus nucleocapsid. *Science* 348:704-707.
7. Radecke F, Spielhofer P, Schneider H, Kaelin K, Huber M, Dötsch C, Christiansen G, Billeter M. 1995. Rescue of measles viruses from cloned DNA. *EMBO J* 14:5773.
8. Yoneda M, Guillaume V, Ikeda F, Sakuma Y, Sato H, Wild TF, Kai C. 2006. Establishment of a Nipah virus rescue system. *Proc Natl Acad Sci U S A* 103:16508-16513.
9. Garcin D, Pelet T, Calain P, Roux L, Curran J, Kolakofsky D. 1995. A highly recombinogenic system for the recovery of infectious Sendai paramyxovirus from cDNA: generation of a novel copy-back nondefective interfering virus. *EMBO J* 14:6087.
10. He B, Paterson RG, Ward CD, Lamb RA. 1997. Recovery of infectious SV5 from cloned DNA and expression of a foreign gene. *Virology* 237:249-260.
11. Volchkov VE, Volchkova VA, Mühlberger E, Kolesnikova LV, Weik M, Dolnik O, Klenk H-D. 2001. Recovery of infectious Ebola virus from complementary DNA: RNA editing of the GP gene and viral cytotoxicity. *Science* 291:1965-1969.
12. Biacchesi S, Skiadopoulos MH, Tran KC, Murphy BR, Collins PL, Buchholz UJ. 2004. Recovery of human metapneumovirus from cDNA: optimization of growth in vitro and expression of additional genes. *Virology* 321:247-259.
13. Pfaller CK, Cattaneo R, Schnell MJ. 2015. Reverse genetics of Mononegavirales: How they work, new vaccines, and new cancer therapeutics. *Virology* 479:331-344.
14. Stobart CC, Moore ML. 2014. RNA virus reverse genetics and vaccine design. *Viruses* 6:2531-2550.
15. Walpita P, Flick R. 2005. Reverse genetics of negative-stranded RNA viruses: a global perspective. *FEMS Microbiol Lett* 244:9-18.
16. Adu-Gyamfi E, Kim LS, Jardetzky TS, Lamb RA. 2016. Flexibility of the head-stalk linker domain of paramyxovirus HN glycoprotein is essential for triggering virus fusion. *J Virol* 90:9172-9181.
17. Qiu X, Zhan Y, Meng C, Wang J, Dong L, Sun Y, Tan L, Song C, Yu S, Ding C. 2016. Identification and functional analysis of phosphorylation in Newcastle disease virus phosphoprotein. *Arch Virol* 161:2103-2116.
18. Zhao W, Hu H, Zsak L, Yu Q, Yang Z. 2013. Application of the ligation-independent cloning (LIC) method for rapid construction of a minigenome rescue system for Newcastle disease virus VG/GA strain. *Plasmid* 70:314-320.
19. Su J, Dou Y, You Y, Cai X. 2015. Application of minigenome technology in virology research of the Paramyxoviridae family. *J Microbiol Immunol Infect* 48:123-129.
20. Yu X-h, Cheng J-l, Xue J, Jin J-h, Song Y, Zhao J, Zhang G-z. 2017. Roles of the polymerase-associated protein genes in Newcastle disease virus virulence. *Front Microbiol* 8.
21. Dortmans J, Rottier P, Koch G, Peeters B. 2010. The viral replication complex is associated with the virulence of Newcastle disease virus. *J Virol* 84:10113-10120.
22. Schnell MJ, Mebatsion T, Conzelmann K-K. 1994. Infectious rabies viruses from cloned cDNA. *EMBO J* 13:4195.

23. Martin A, Staeheli P, Schneider U. 2006. RNA polymerase II-controlled expression of antigenomic RNA enhances the rescue efficacies of two different members of the Mononegavirales independently of the site of viral genome replication. *J Virol* 80:5708-5715.
24. Li B-y, Li X-r, Lan X, Yin X-p, Li Z-y, Yang B, Liu J-x. 2011. Rescue of Newcastle disease virus from cloned cDNA using an RNA polymerase II promoter. *Arch Virol* 156:979-986.
25. Yun T, Park A, Hill TE, Pernet O, Beaty SM, Juelich TL, Smith JK, Zhang L, Wang YE, Vigant F. 2015. Efficient reverse genetics reveals genetic determinants of budding and fusogenic differences between Nipah and Hendra viruses and enables real-time monitoring of viral spread in small animal models of henipavirus infection. *J Virol* 89:1242-1253.
26. Neumann G, Fujii K, Kino Y, Kawaoka Y. 2005. An improved reverse genetics system for influenza A virus generation and its implications for vaccine production. *Proc Natl Acad Sci U S A* 102:16825-16829.
27. Zhang X, Kong W, Ashraf S, Curtiss R. 2009. A one-plasmid system to generate influenza virus in cultured chicken cells for potential use in influenza vaccine. *J Virol* 83:9296-9303.
28. Zhang X, Curtiss R. 2015. Efficient generation of influenza virus with a mouse RNA polymerase I-driven all-in-one plasmid. *Virology* 529:12-19.
29. Kobayashi T, Ooms LS, Ikizler M, Chappell JD, Dermody TS. 2010. An improved reverse genetics system for mammalian orthoreoviruses. *Virology* 398:194-200.
30. Xu-Dong G, Shu-Yan M, Dong-Xia H, Shorgan B. 2007. A rapid method for preparation of plasmid DNA for screening recombinant clones. *Chin J Biotechnol* 23:176-178.
31. Bimboim H, Doly J. 1979. A rapid alkaline extraction procedure for screening recombinant plasmid DNA. *Nucleic Acids Res* 7:1513-1523.
32. Alting-Mees M, Short J. 1989. pBluescript II: gene mapping vectors. *Nucleic Acids Res* 17:9494.
33. Nakano Y, Yoshida Y, Yamashita Y, Koga T. 1995. Construction of a series of pACYC-derived plasmid vectors. *Gene* 162:157-158.
34. She K. 2003. So you want to work with giants: the BAC vector. *BioTech J* 1:69-74.
35. Shizuya H, Birren B, Kim U-J, Mancino V, Slepak T, Tachiiri Y, Simon M. 1992. Cloning and stable maintenance of 300-kilobase-pair fragments of human DNA in *Escherichia coli* using an F-factor-based vector. *Proc Natl Acad Sci U S A* 89:8794-8797.
36. Hotard AL, Shaikh FY, Lee S, Yan D, Teng MN, Plemper RK, Crowe JE, Moore ML. 2012. A stabilized respiratory syncytial virus reverse genetics system amenable to recombination-mediated mutagenesis. *Virology* 434:129-136.
37. Chen H, Angel M, Li W, Finch C, Gonzalez AS, Sutton T, Santos J, Perez DR. 2014. All-in-one bacmids: an efficient reverse genetics strategy for influenza A virus vaccines. *J Virol* 88:10013-10025.
38. Wang Q, Ma X, Qian S, Zhou X, Sun K, Chen X, Zhou X, Jackson AO, Li Z. 2015. Rescue of a plant negative-strand RNA virus from cloned cDNA: insights into enveloped plant virus movement and morphogenesis. *PLoS Pathog* 11:e1005223.
39. Molouki A, Peeters B. 2017. Rescue of recombinant Newcastle disease virus: current cloning strategies and RNA polymerase provision systems. *Arch Virol* 162:1-12.

40. Kim KJ, Kim HE, Lee KH, Han W, Yi MJ, Jeong J, Oh BH. 2004. Two - promoter vector is highly efficient for overproduction of protein complexes. *Protein Sci* 13:1698-1703.
41. Zhao W, Zhang Z, Zsak L, Yu Q. 2015. P and M gene junction is the optimal insertion site in Newcastle disease virus vaccine vector for foreign gene expression. *J Gen Virol* 96:40-45.
42. Zhang Z, Zhao W, Li D, Yang J, Zsak L, Yu Q. 2015. Development of a Newcastle disease virus vector expressing a foreign gene through an internal ribosomal entry site provides direct proof for a sequential transcription mechanism. *J Gen Virol* 96:2028-2035.
43. Gao Q, Park M-S, Palese P. 2008. Expression of transgenes from Newcastle disease virus with a segmented genome. *J Virol* 82:2692-2698.

## **Chapter 2**

### **Two-Plasmid System to Increase the Rescue Efficiency of Paramyxoviruses by Reverse Genetics: the example of rescuing Newcastle Disease Virus**

Virology, 2017; 509: 42-15.

DOI: 10.1016/j.virol.2017.06.003



## **Abstract**

Within paramyxoviruses, conventional reverse genetics require the transfection of a minimum of four plasmids: three to reconstruct the viral polymerase complex that replicates and expresses the virus genome delivered by a fourth plasmid. The successful transfection of four or more plasmids of different sizes into one cell and the subsequent generation of at least one viable and replicable viral particle is a rare event, which explains the low rescue efficiency, especially of low virulent viruses with reduced replication efficiency in cell lines. In this study, we report on an improved reverse genetics system developed for an avian paramyxovirus, Newcastle Disease Virus (NDV), in which the number of plasmids was reduced from four to two. Compared to the conventional method, the 2-plasmid system enables earlier and increased production of rescued viruses and, in addition, makes it possible to rescue viruses that it was not possible to rescue using the 4-plasmid system.

## **Introduction**

Reverse genetics of negative RNA viruses is widely used in research (1). The general scheme for this method relies on the cloning of the complete viral genome, segmented or not, in one or several plasmids under promoters that will generate positive-sense RNAs. Complementary plasmids are produced to express viral proteins that will take over the transcribed viral genome (1). Since the transfection of a high number of plasmids of different size into one cell is tricky but indispensable for successful virus rescue, several groups have tried to improve the system either by reducing the number of plasmids to be used (2, 3) or by generating cells that constitutively express the viral polymerase complex. However, the latter is a more complicated and time-consuming process.

Our laboratory is currently working with an avian paramyxovirus, the Newcastle Disease Virus (NDV), to learn more about its virulence and immunogenicity. NDV belongs to the *Avulavirus* genus in the *Paramyxoviridae* family (4, 5). The genome is composed of a 15 kb negative-sense single-stranded RNA molecule with six coding segments surrounded by the leader and trailer viral polymerase promoters (6-8). This genome structure (3'-Leader-NP-P-M-F-HN-L-Trailer-5') encodes six structural viral proteins: nucleocapsid protein (NP), phosphoprotein (P), matrix protein (M), fusion protein (F), hemagglutinin-neuraminidase (HN), large protein (L), and two nonstructural proteins - V and W proteins, respectively (9, 10). Among these proteins, N, P and L form the viral

polymerase complex replicates and transcribes the viral genome (10). These three proteins play a crucial role in virus rescue by reverse genetics (11-13).

Reverse genetics have long been used in research on NDV virulence, vaccine generation, oncolytic applications, virion assembly, etc. (13-16). The conventional reverse genetics of NDV involves four different plasmids (13). The complete genome and the NP, P and L genes are cloned into plasmids downstream from the most commonly used T7 polymerase promoter or alternatively the CMV promoter. These plasmids are co-transfected into eukaryotic cells and transcribed by an exogenous source of T7 RNA polymerase (virus or transgenic cell line) or the cell RNA polymerase II, respectively (17, 18). Although, widely used to rescue viruses, the T7 polymerase system requires the use of a recombinant virus or a specific cell line constitutively expressing the enzyme. These materials are not easily available for most laboratories tempted by the reverse genetics, in contrast to plasmids using CMV promoters.

Accordingly, we started to set up a conventional reverse genetics system based on the CMV promoter to generate 10 different modified viruses for virulence studies. However, two of these viruses, although correct in their genome sequences, could not be rescued. They all were attenuated virus strains and we consequently concluded that the system was not efficient enough for low virulent strains, probably because of the complexity of the system involving a large number of different size plasmids and the reduced capacity of low virulent strains to be rescued from very rare events, as already shown for segmented influenza viruses (2). We therefore developed an alternative system based on only two plasmids of similar size. Here, we demonstrate that this system was able to rescue all our viruses in a shorter time and with a higher yield.

## **Materials and Methods**

### **1. Cells and Viruses**

Baby hamster kidney BHK-21 cells were used for NDV rescuing, because these cells are easily transfected with plasmids, susceptible to NDV infection and often used in the past for efficient NDV rescue. They were grown in Eagle's minimum essential medium (Gibco) with 10% fetal bovine serum (PAN-Biotch) and cultured at 37 °C with 5% CO<sub>2</sub>. Chemically competent cells, E.coli 10-beta, were purchased from New England Biolabs (NEB). NDV chicken/Madagascar/2008 (MG-725) strain, isolated from chicken in Madagascar (19), was

amplified in 10 day-old specific pathogen free (SPF) chicken embryos (Couvoir de Cerveloup, France). After two days of infection, allantoic liquid was harvested and stored at -80 °C. NDV LaSota strain, kindly provided by ISZVe, Italy, was amplified and stored in the same way as the MG-725 strain.

## 2. Plasmid constructions

RNA of MG-725 was extracted using the NucleoSpin RNA virus kit (MACHEREY-NAGEL) according to the manufacturer's instructions. RNA was used to generate cDNA with the Super Script III First-Strand kit (Invitrogen). Pfu Ultra Fusion HS DNA polymerase (Agilent) was used to amplify the NP, P and L genes of MG-725 from cDNA and the three genes were cloned into the pCI-neo (Clontech) to get pN, pP and pL plasmids by restriction enzymes (NEB).

PolyA was amplified from pCI-neo by PolyA-F and PolyA-R-SapI primers. With Ribo-F and Ribo-R primers, the hepatitis delta virus ribozyme (HDVrbz: 5' GGGTCGGCATGGCATCTCCACCTCCTCGCGGTCCGACCTGGGCATCCGAAGGAGG ACGTCGTCCTCACTCGGATGGCTAAGGGAGAGTGAGCAATAA 3') was amplified from pBS-RiboT7terminator plasmid (gift from M. Brémont, INRA, Jouy-en Josas, France). PolyA and HDVrbz were assembled by overlapping PCR and then cloned into pBluescript II Ks (+) (pKS; In house) by ClaI and SapI restriction enzymes to get pKS-HDVrbz-PolyA. CMV promoter with part of Hammerhead ribozyme (HHrbz: 5'TGTTAAGCGTCTGATGAGTCCGTGAGGACGAAACTATAGGAAAGGAATTCCTA TAGTC3') was amplified from pCI-neo by CMV-F-BssHIII and CMV-R primers then cloned into pKS-HDVrbz-PolyA by BssHIII and EcoRI to generate pKS-CMV-HHrbz-HDVrbz-PolyA. Then, the fragment was amplified by 1-F and 1-R primers with multi-clone sites (MCS) and inserted into pKS-CMV-HHrbz-HDVrbz-PolyA by EcoRI and ClaI to get pCMV vector (Table 3.1, Fig.3.1).

NP, P and L gene cassettes were amplified from pN, pP and pL plasmids with CMV-F-ClaI and PolyA-R-SapI, CMV-F-FseI and PolyA-R-ClaI, CMV-F-BssHIII and PolyA-R-FseI primers, respectively. Then, these cassettes were gradually cloned into pCMV to get pCMV-N, pCMV-N-P and final pNPL plasmid by the restriction enzymes shown in Table 3.1 and Fig.3.1.

A mini-genome plasmid was also prepared to assess the usefulness of the helper plasmids. In this plasmid, the enhanced green fluorescence protein (EGFP) gene was flanked by the leader and trailer strains of MG-725 by overlap PCR and then cloned into pCMV vector, between ribozymes, in the reverse direction to get the pMini-genome (Fig. 3.1).

**Table 3.1.** Primers for pCMV and pNPL plasmids construction

Primer name	Primer sequence (5'---3')
PolyA-F	TGAGCAATAACAGACATGATAAGATACA
PolyA-R-SapI	GAGCGAGGAAGCGGAAGAGCTACCACATTTGTAGAGGTT
Ribo-F	CC <u>ATCGAT</u> GGGTCGGCATGGCATCTC <i>Clal</i>
Ribo-R	ATCATGTCTGTTATTGCTCACTCTCCCTTAG
CMV-F-BssHII	TTGGCGCGCTCAATATTGGCCATTAGCCAT <i>BssHII</i>
CMV-R	GgaattccttctctatagtctcctcagactcatcagacgctaacAGATCTGACG <i>EcoRI</i> GTTCACTAA
1-F	CGGAATTCGGTACCCCTTAGTTTCCGCGGGTATGGTGCAC <i>EcoRI KpnI SacII</i> TCTCAGTACAAT
1-R	CC <u>ATCGATACTTAATTAAGCCGGCCTTATTGAAGCATTTA</u> <i>Clal PacI FseI</i> TCAGGGT
CMV-F-Clal	CC <u>ATCGATT</u> CAATATTGGCCATTAGCCAT <i>Clal</i>
CMV-F-FseI	ATTGGCCGGCCTCAATATTGGCCATTAGCCAT <i>FseI</i>
PolyA-R-Clal	CC <u>ATCGATT</u> ACCACATTTGTAGAGGTT <i>Clal</i>
PolyA-R-FseI	ATTGGCCGGCCTACCACATTTGTAGAGGTT <i>FseI</i>

Underlines indicate sequences of restriction enzymes; Lower-case shows part of HHrbz sequence

The complete MG-725 genome was divided into eight fragments with overlap regions. These fragments were amplified from viral RNA and were assembled into pCMV vector, between two ribozymes, to generate pMG-725 plasmid according to the order of virus genome (Leader-NP-P-M-F-HN-L-Trailer) and restriction sites (Fig. 3.1). F gene of MG-725 was modified by overlap PCR to obtain a lentogenic cleavage site identical to that of the LaSota strain (hereafter called Fmu). The Fmu gene replaced that of pMG-725 plasmid to obtain pMG-725/Fmu by KpnI and SacII. The EGFP or mcherry fluorescent gene with gene start (GS) and gene end (GE) of MG-725 strain's M gene was amplified from pEGFP-C1 or pmCherry-N1 (Clontech) and then cloned into pMG-725 and pMG-725/Fmu plasmids,

between the P and M genes, to get pMG-725/EGFP, pMG-725/Cherry, pMG-725/Fmu/EGFP, and pMG-725/Fmu/Cherry plasmids. The detailed information is provided in Fig.3.1.

The complete genome of the LaSota strain was divided into seven fragments. These seven fragments were amplified and assembled into pCMV to get pLaSota. The F and HN genes of pLaSota were replaced individually with those of pMG-725/Fmu to get pLaSota/M-Fmu, pLaSota/M-HN. The mcherry fluorescent gene with GS and GE of LaSota' M gene was inserted between the P and M genes of pLaSota to generate pLaSota/Cherry (Fig.3.1). All these plasmids were purified with the Quick Plasmid Miniprep kit (Invitrogen) and the EndoFree plasmid Maxi kit (QIAGEN), aliquoted and stored at -20 °C. The total number of plasmids produced with the complete viral genome was 10 (Table 3.2).

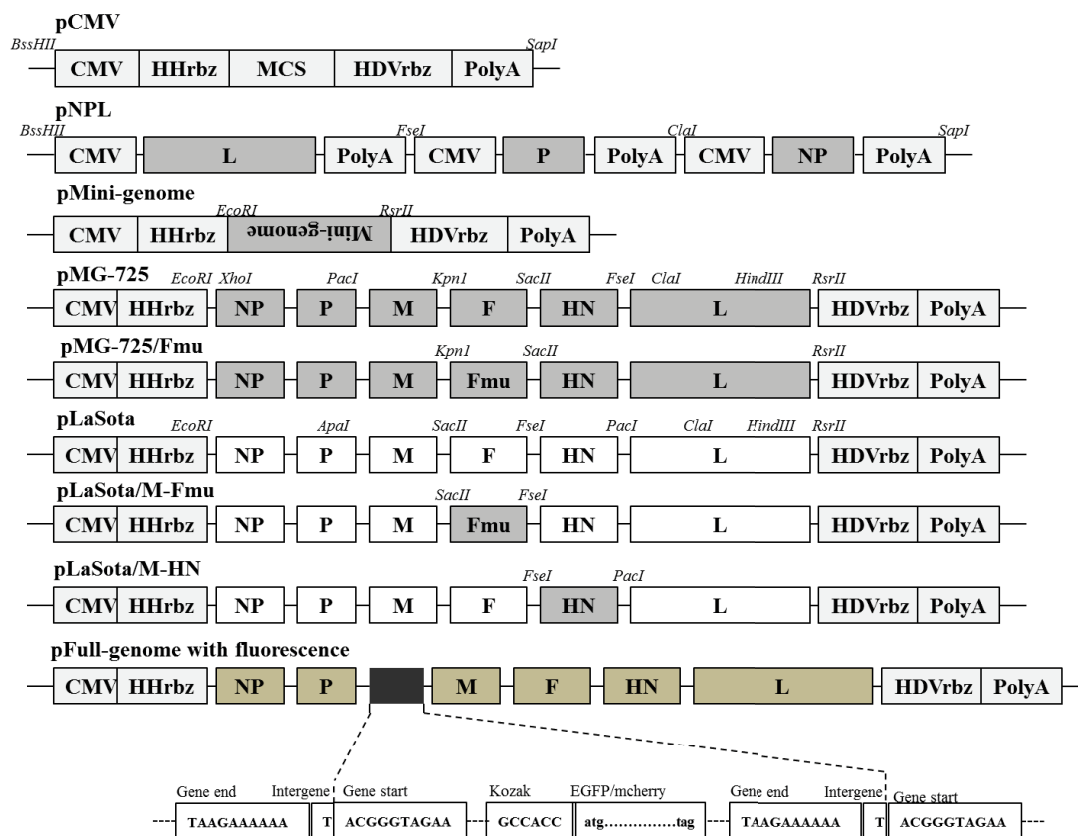

**Fig. 3.1.** Plasmid constructions made in this study. T7 promoter and terminator of pKS vector were replaced by CMV and PloyA of pCI-neo and the two ribozymes and multi-clone sites were cloned between CMV and PolyA to get pCMV vector. In the pNPL plasmid, three expression cassettes consisting of pCMV and polyA tail flanking the NP, P or L gene from MG-725 were cloned into the same pCMV vector. Downstream, the pMini-genome plasmid includes the promoter pCMV, the leader and trailer of MG-725 flanking the EGFP gene placed in antisense direction. Complete genomes of original or recombinant NDV were assembled by RT-PCR and restriction enzymes into pCMV vector, between the two ribozymes.

**Table 3.2** Information of all plasmids used in this study

Plasmids	Backbone of complete genome or gene	Properties	F protein cleavage sites
pN	MG-725	NP gene of MG-725	-
pP	MG-725	P gene of MG-725	-
pL	MG-725	L gene of MG-725	-
pNPL	MG-725	NP, P and L genes of MG-725	-
pMini-genome	MG-725	Leader and trailer of MG-725, EGFP from pEGFP-C1	-
pMG-725	MG-725	Complete genome of MG-725	Velogenic-like <sup>a</sup>
pMG-725/EGFP	MG-725	EGFP gene was inserted between P and M genes of the complete MG-725 genome	Velogenic-like
pMG-725/Cherry	MG-725	mCherry gene was inserted between P and M genes of the complete MG-725 genome	Velogenic-like
pMG-725/Fmu	MG-725	Cleavage site of the F protein in MG-725 was modified to that of LaSota	Lentogenic-like <sup>b</sup>
pMG-725/Fmu/EGFP	MG-725	Cleavage site of the F protein in MG-725 /EGFP was modified to that of LaSota.	Lentogenic-like
pMG-725/Fmu/Cherry	MG-725	Cleavage site of the F protein inMG-725 /Cherry was modified to that of LaSota.	Lentogenic-like
pLaSota	LaSota	The complete genome of LaSota	Lentogenic-like
pLaSota/Cherry	LaSota	Cherry gene was inserted between P and M genes of LaSota	Lentogenic-like
pLaSota/M-Fmu	LaSota	The F gene of LaSota was replaced by that of MG-725/Fmu	Lentogenic-like
pLaSota/M-HN	LaSota	The HN gene of LaSota was replaced by that of MG-725	Lentogenic-like

a: F protein cleavage sites are <sup>112</sup>RRRRRF<sup>117</sup>. b: F protein cleavage sites are <sup>112</sup>GRQGRL<sup>117</sup>.

### 3. Validation of 4-plasmid and 2-plasmid systems on the EGFP mini-genome

4×10<sup>5</sup> BHK-21 cells were seeded in 6-well plates one day before transfection. A total of 5 µg of plasmids were transfected into the cells using Lipofectamine 2000 (Invitrogen). Two µL of Lipofectamine 2000 were used with 1 µg of DNA. Different plasmid cocktails were tested: [pMini-genome, pN, pP and pL, ratio 5:2:2:1], [pMini-genome, pN, pP and pCI-neo, ratio 5:2:2:1], [pMini-genome and pNPL, ratio, 1:1] and [pMini-genome and pCI-neo, ratio, 1:1]. After six hours, the transfection media were replaced by 2 ml of MEM medium containing 10% FBS. Cells expressing EGFP were checked daily for 3 days after transfection. EGFP positive cells were enumerated in 10 different fields under the fluorescent microscope 2 days after

transfection. To optimize the 4-plasmid system,  $1 \times 10^5$  BHK-21 cells were seeded on 24-well plates one day before transfection. A mixture of 0.5  $\mu\text{g}$  pMini-genome, 0.1  $\mu\text{g}$  pL and 0.4  $\mu\text{g}$  of [pN and pP, with ratios ranging from 9:1 to 1:9] was then transfected into cells. The number of cells expressing EGFP was determined under the fluorescent microscope two days after transfection. To optimize the 2-plasmid system, 2.5  $\mu\text{g}$  of pMini-genome and pNPL with ratios ranging from 9:1 to 1:9 were transfected into BHK-21 cells seeded on 6-well plates. EGFP positive cells were enumerated in 10 fields under the microscope two days after transfection.

### 3.1. Virus rescue with the 4-plasmid system

$4 \times 10^5$  BHK-21 cells were seeded on 6-well plates the day before transfection. Each of the 10 complete viral genome plasmids (Table 3.2) was mixed with three other plasmids, pN, pP and pL, to obtain a total quantity of 10  $\mu\text{g}$  with a ratio of 5:2:2:1. These mixtures were transfected into the cells and three days later, images were taken for fluorescent viruses and cell supernatants were collected. Attached cells were removed by incubation in presence of trypsin, centrifuged for 5 min at 1,000 g and suspended again in 200  $\mu\text{L}$  of the previously collected media. These cell samples were injected into 10 day old SPF chicken embryos for virus amplification.

### 3.2. Generation of the M-725/Fmu/EGFP strain with the 4-plasmid and the 2-plasmid systems

Based on the results obtained using the method described in the previous section, we decided to develop an improved reverse genetics system based on the transfection of only two plasmids. We then compared the rescue viral titers of the 4-plasmid and 2-plasmid systems. To this end, either [5  $\mu\text{g}$  of pMG-725/Fmu/EGFP, 2  $\mu\text{g}$  pN, 2  $\mu\text{g}$  pP and 1  $\mu\text{g}$  pL] or [5  $\mu\text{g}$  pMG-725/Fmu/EGFP and 5  $\mu\text{g}$  pNPL] were transfected into  $4 \times 10^5$  BHK-21 cells seeded in a 6-well plate. Three days after transfection, the EGFP expression of cells was checked. Next, cell supernatants were collected and diluted 2, 4, 6, 8, 10, 12, 14, 16, 18 and 20 times in MEM. 200  $\mu\text{L}$  of these dilutions were injected into chicken embryos for virus titration.

To test the quantity of plasmids and the time taken by the 2-plasmid system to rescue virus, the different amounts of pMG-725/Fmu/EGFP and pNPL to be transfected into  $4 \times 10^5$  BHK-21 cells seeded in a 6-well plate and collected at different times were assessed. The total amount of these plasmids ranged from 1  $\mu\text{g}$  to 10  $\mu\text{g}$  with a ratio of 1:1. The cells with 200  $\mu\text{L}$  of their supernatants were collected three days after transfection, except the cells transfected



with 10 µg of plasmids, which were collected one, two and three days after transfection with 200 µl of their supernatant. These samples were injected into chicken embryos.

### 3.3. Comparison of the two systems with a set of complete genomes including virulent and attenuated phenotypes

Nine different complete genomes comprising two virulent phenotypes (pMG-725, pMG-725/EGFP) and seven attenuated strains (pMG-725/Fmu, pMG-725/Fmu/EGFP, pMG-725/Fmu/Cherry, pLaSota, pLaSota/Cherry, pLaSota/M-Fmu or pLaSota/M-HN) were transfected with either pN, pP and pL or pNPL, into  $4 \times 10^5$  BHK-21 cells plated on 6-well plates. Based on the results obtained in the previous section, the total amount of the plasmids delivered to the cells was set at 2 and 3 µg with a ratio of 5:2:2:1 or 1:1. As described in the previous section, one or three days after transfection, fluorescence was checked under the microscope and cells and their supernatants were collected and used for virus amplification in eggs.

### 3.4. Confirmation of rescued virus

Dead chicken embryos and chicken embryos that were still alive three days after inoculation at 37 °C were left overnight at 4 °C. Allantoic fluids were collected and used to perform a hemagglutination assay (HA) and a real-time PCR (qRT-PCR). After extraction, RNAs were first digested with TURBO DNase enzyme (Ambion) to prevent DNA contamination. The qRT-PCR used F259 (5'-ACAYTGACYACTTTGCTCA-3') as forward primer and F488 (5'-TGCACAGCYTCATTGGTTGC-3') as reverse primer. These primers were designed by us based on the alignment of different strains' F genes and matched the F NDV gene. The Brilliant III Ultra-Fast SYBR Green QRT-PCR Master mix kit (Agilent) was used. Only samples showing positive results in both HA and qRT-PCR were considered successfully rescued. Negative allantoic fluids were passaged twice in chicken embryos and tested again by HA and qRT-PCR.

## Results

1. The rescue performance of the 4-plasmid system was lower in the case of attenuated NDV strains.

Since the mini-genome includes an EGFP ORF inserted in reverse direction (Fig. 3.1), EGFP expression requires the expression of NDV NP, P and L proteins to wrap and generate EGFP mRNA in forward direction. Therefore, we used this mini-genome to validate all our

constructions and the functionality of the reverse genetics system. After transfection of BHK-21 with the mini-genome expressing EGFP in the 4-plasmid system, green fluorescence was observed in the cells (Fig. 3.2A). As expected, this fluorescence was not seen in the absence of pL (Fig. 3.2B). The pMini-genome and pL were transfected into BHK-21 cells with different quantity ratios for pN and pP to achieve the best performance. The best quantity ratio for pN and pP was 1:1 (Fig. 3.2C).

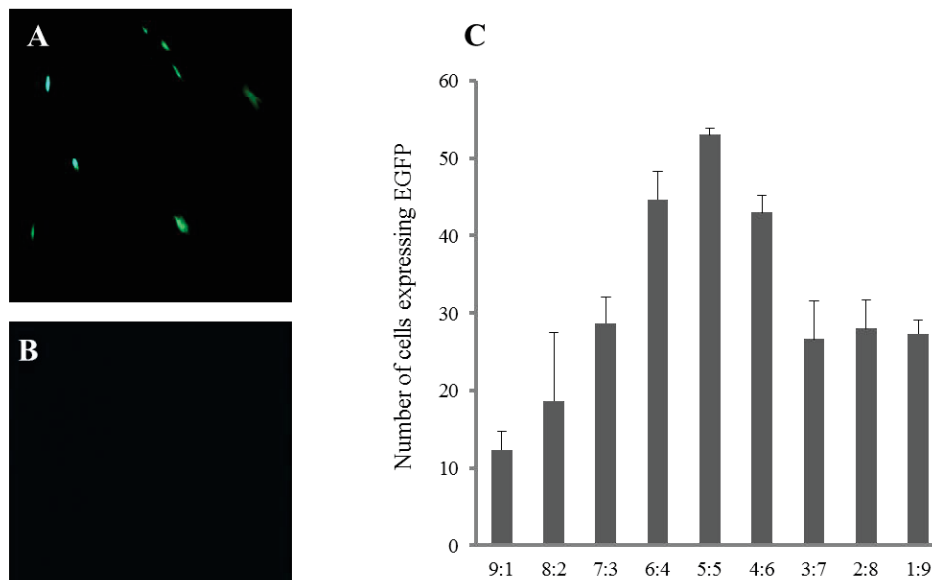

**Fig. 3.2.** Mini-genome assay with the 4-plasmid system. (A) Fluorescence appeared after transfection of BHK21 with the mini-genome expressing EGFP and pN, pP and pL. (B) Fluorescence did not appear when pL was not included in the plasmid cocktail used for transfection. Pictures were taken two days after transfection at 10× magnification. (C) Optimization of the 4-plasmid system. Histograms show the average and bars are the SD of the number of cells expressing EGFP in triplicate wells of 24-well plates in the same assay.

This optimized 4-plasmid system was then used to rescue 10 different viruses, three of which were expected to be velogenic (virulent), while the seven others were lentogenic (attenuated) (Table 3.2). This distinction is based on the amino acid motif found at the F protein cleavage site. The velogenic strains have five basic amino acids, while the lentogenic strains have two basic amino acids (Fig. 3.3). This difference makes the F protein of virulent strains more prone to be cleaved by various proteases present in various tissues and the virus is then activated to amplify whereas the F protein of attenuated strains is only cleaved in environments like the digestive and respiratory tracts or *in vitro*, in cell culture medium containing trypsin (13). Using the 4-plasmid system, particles of velogenic strains were clearly more efficiently generated than lentogenic strains with the same backbone but only

differing by their lentogenic-like cleavage site (Fig. 3.4A to D). In addition, two lentogenic strains out of the 10 strains could not be rescued after inoculation of the egg, additional blind passages in eggs and HA test and qRT-PCR (Fig. 3.4E, Table 3.3). This resulted in a rescue efficiency of only 71% with attenuated strains, whereas for velogenic viruses, the efficiency was 100% (Fig. 3.4F). These results suggest that the 4-plasmid reverse genetics system is less efficient for the rescue of viruses with lentogenic-like F protein cleavage sites.

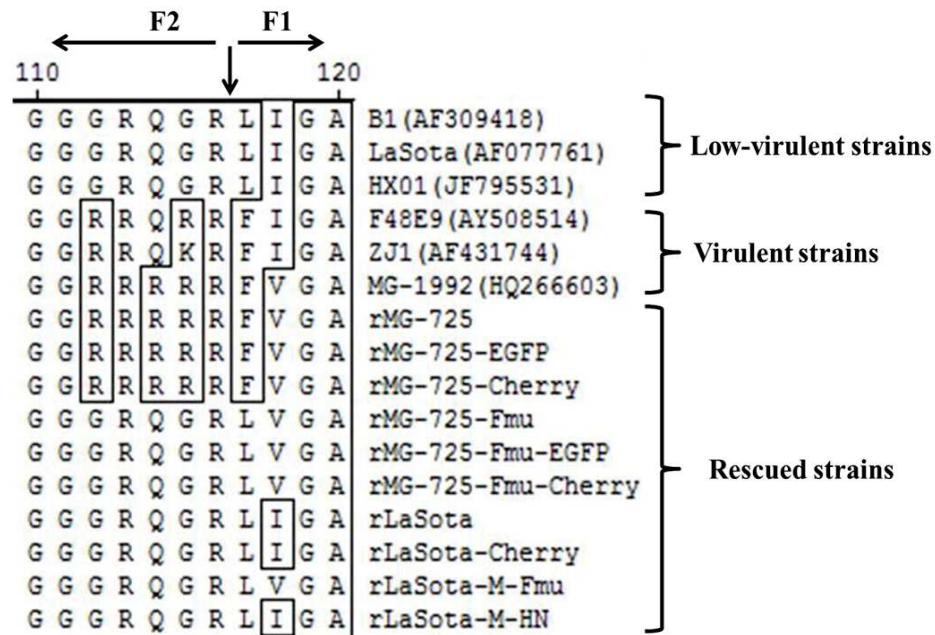

**Fig. 3.3.** Alignment of F protein cleavage sites from the rescued strains in this study and in other strains retrieved from GenBank. Multiple alignments performed done using the Clustal W method in the DNA star software. The different amino acids in the low-virulent, virulent and rescued strains in the region encompassing residues 110-120 are framed. The vertical arrow indicates the trypsin cleavage site.

**Table 3.3** Viruses used in the 4-plasmid system

Viruses	Rescuing <sup>a</sup>
MG-725	+ <sup>b</sup>
MG-725/EGFP	+
MG-725/Cherry	+
MG-725/Fmu	+
MG-725/Fmu/EGFP	+
MG-725/Fmu/Cherry	+
LaSota	+
LaSota/Cherry	- <sup>c</sup>
LaSota/M-Fmu	-
LaSota/M-HN	+

a :The condition for the rescue of the virus was 10 µg plasmids, 3 days after transfection.b:

Viruses were successfully rescued after confirmation by HA and qRT-PCR.c: Viruses were not

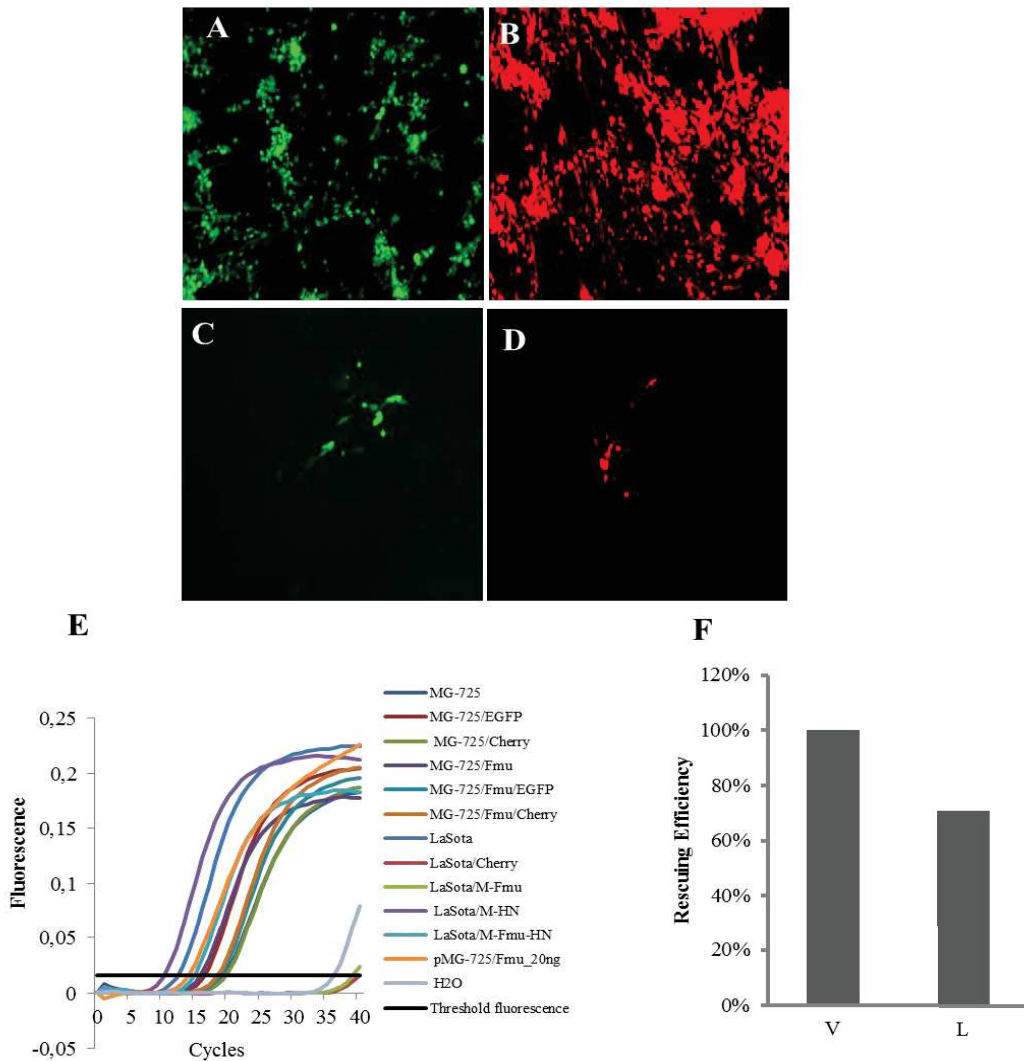

**Fig. 3.4.** Rescue efficiency of the 4-plasmid system. (A to D) Three days after transfection with pMG-725/EGFP (A), pMG-725/Cherry (B), pMG-725/Fmu/EGFP (C) and pMG-725/Fmu/Cherry (D), cells were observed under a fluorescent microscope at magnification 10 $\times$ . The two velogenic strains (A and B) show a clear enhancement of the fluorescent cells compared to the lentogenic strains (C and D). (E) Three days after transfection, viruses were recovered and passaged in eggs for three days then tested by qRT-PCR as detailed in ‘Materials and Methods’. The pMG-725/Fmu plasmid and H<sub>2</sub>O were used as positive and negative controls of the qRT-PCR. Only two attenuated strains (LaSota/M Fmu and LaSota/Cherry) were not rescued. (F) Allantoic fluids showing HA and qRT-PCR positive results were considered as successfully rescued (V and L stand for strains with velogenic-like and lentogenic-like F protein cleavage site, respectively). All three velogenic strains (100%) were rescued, versus 5 out 7 lentogenic strains (71%).

2. The 2-plasmid system outperformed the 4-plasmid system in the replication of the EGFP mini-genome.

To test the 2-plasmid system, another plasmid, pNPL, was produced in which the NP, P and L genes are inserted downstream from the CMV promoters (Fig. 3.1). The 2-plasmid system was the most efficient with a pMini-genome:pNPL ratio of 1:1 (Fig. 3.5A). In comparison to the 4-plasmid system, the 2-plasmid system showed double the number of cells expressing the EGFP (Fig. 3.5B to D). Based on EGFP mini-genome testing, these findings suggest that the 2-plasmid reverse genetics system is more effective than the 4-plasmid system.

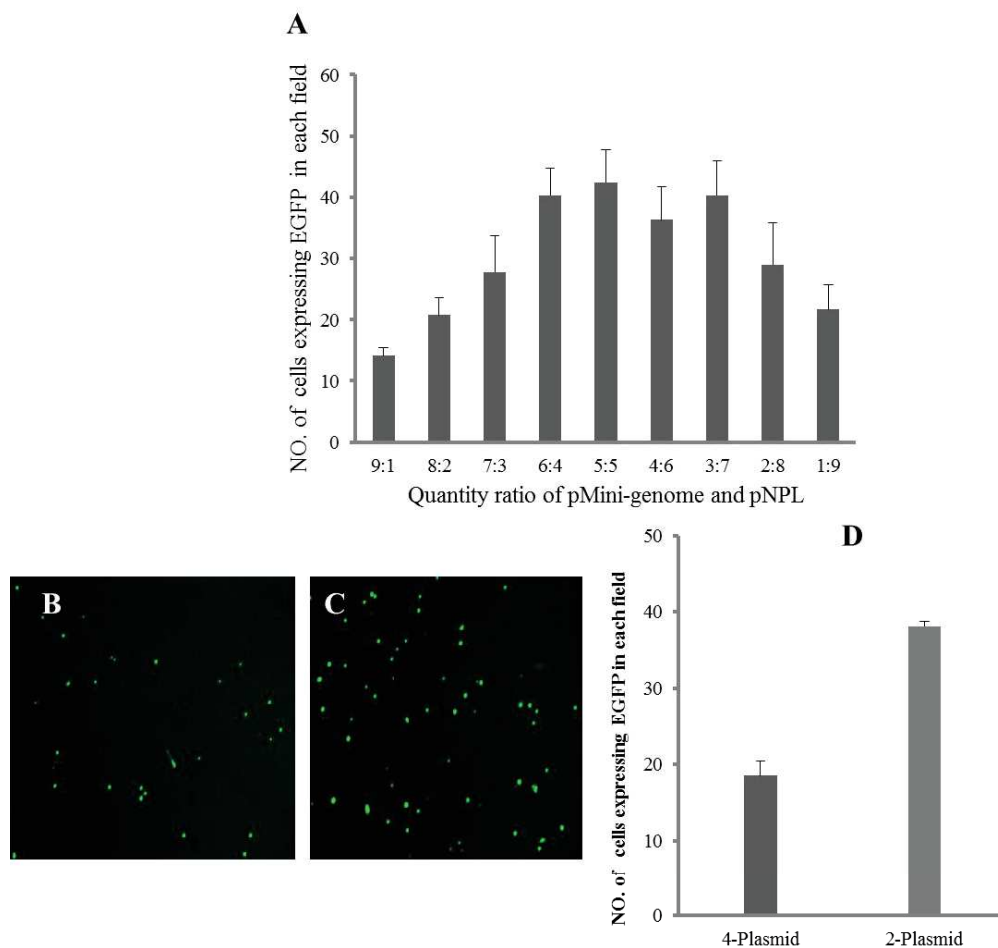

**Fig. 3.5.** Optimization of the 2-plasmid system on EGFP mini-genome assay and comparison with the 4-plasmid assay. (A) The 2-plasmid system was optimized by changing the quantitative ratio of pMini-genome and pNPL from 9:1 to 1:9 as shown on the X-axis. EGFP positive cells were then enumerated under a fluorescent microscope at magnification 2.5 $\times$ , in 10 fields of one well of 6-well plates. (B and C) Comparative EGFP mini-genome performance between the 4- and 2-plasmid systems. The pictures were taken 2 days after transfection and suggest a higher number of fluorescent cells with the 2-plasmid systems (Magnification, 2.5 $\times$ ). (D) The improved performance was quantified by enumerating EGFP positive cells in 10 fields at magnification 2.5 $\times$  of one well of 6-well plates. Data show the average and SD of triplicate wells.

3. The 2-plasmid system generates more viruses with lentogenic-like F protein cleavage sites.

To test whether a 2-plasmid system would circumvent the reduced rescuing efficiency observed with our lentogenic viruses, pMG-725/Fmu/EGFP plasmid containing the full genome of an attenuated green fluorescent recombinant virus was transfected into BHK-21 cells either with pN, pP and pL or pNPL. Based on the EGFP expression of transfected cells, the 2-plasmid system clearly outperformed the 4-plasmid system for the rescue of this lentogenic virus (Fig. 3.6A and B). In addition, the supernatant of transfected cells using the 2-plasmid system had a viral titer about 4.5 times higher than the titer achieved by the 4-plasmid system (Fig. 3.6C). These results demonstrate that the 2-plasmid system is more suitable for the rescue of lentogenic viruses.

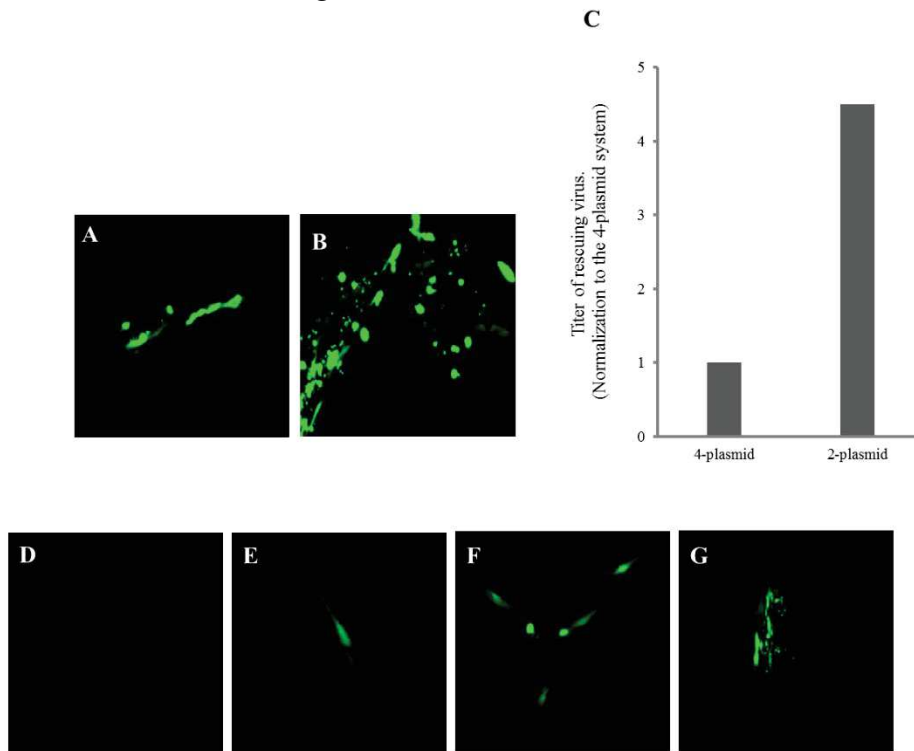

**Fig. 3.6.** Comparative performance of 2- and 4-plasmid systems in rescuing one fluorescent lentogenic-like NDV strain. (A and B) BHK-21 cells were transfected with pMG-725/Fmu/EGFP (feature of lentogenic strain) and either pN, pP and pL (A) or pNPL (B). After three days, pictures were taken under the fluorescent microscope at magnification 20 $\times$ . The 2-plasmid system shows a higher number of cells expressing EGFP. (C) The resulting viral titers were then determined on chicken embryos. The histograms show a 4.5-fold increase in the titer with the 2-plasmid system after standardization of the titer achieved with the 4-plasmid system. (D to G) For the evaluation of the limiting conditions for the 2-plasmid system, the quantities of the plasmid cocktail pMG-725/Fmu/EGFP and pNPL (quantitative ratio 1:1) ranged from 1 to 4  $\mu$ g, tested in virus rescue assays. Three days after transfection, pictures were taken under the fluorescent microscope at magnification 10 $\times$ . Rescue was successful with as little as 2  $\mu$ g of plasmids.

In order to identify the conditions that limit the efficacy of the 2-plasmid system, rescue of the MG-725/Fmu/EGFP strain was tested at different plasmid concentrations for transfection of  $4 \times 10^5$  BHK-21 cells seeded in 6-well plates and at different intervals after transfection for virus recovery. It was possible to reduce the total quantity of plasmids to be delivered to the cells with the 2-plasmid system to 2  $\mu$ g and still successfully rescue the virus three days after transfection (Fig. 3.6D to G, Table 3.4). Rescue was also possible as soon as 24 h after cell transfection when 10  $\mu$ g of plasmids was used for transfection (Table 3.4). These results indicate that rescuing a virus with only 2 plasmids can still be effective and rapid even with a small quantity of plasmids.

**Table 3.4** Optimization of the 2-plasmid system on the rescue of the MG-725/Fmu/EGFP strain.

Virus	Rescue with 10 $\mu$ g of plasmids and recovery 1 to 3 days after transfection			Rescue with 1 to 10 $\mu$ g of plasmids and recovery 3 days after transfection									
	Day 1	Day 2	Day 3	1	2	3	4	5	6	7	8	9	10
MG-725/Fmu/EGFP	+ <sup>a</sup>	+	+	- <sup>b</sup>	+	+	+	+	+	+	+	+	+

a: Viruses were considered as successfully rescued after confirmation by HA and qRT-PCR.

b: Viruses were not rescued.

**Table 3.5** Rescue efficiencies of 4- and 2-plasmid systems under two conditions on a set of 9 different viruses.

Viruses	Rescuing with:			
	4-plasmid		2-plasmid	
	A <sup>a</sup>	B <sup>b</sup>	A	B
MG-725	+ <sup>c</sup>	+	+	+
MG-725/EGFP	- <sup>d</sup>	+	+	+
MG-725/Fmu	-	+	+	+
MG-725/Fmu/EGFP	-	-	+	+
MG-725/Fmu/Cherry	-	+	+	+
LaSota	-	+	-	+
LaSota/Cherry	-	-	-	+
LaSota/M-Fmu	-	-	-	+
LaSota/M-HN	-	+	-	+

a: The condition for the rescue was 2  $\mu$ g plasmids, one day after transfection.

b: The condition for the rescue was 3  $\mu$ g plasmids, 3 days after transfection.

c: Viruses were considered as successfully rescued after confirmation by HA and qRT-PCR.

d: Viruses were not rescued.



4. The 2-plasmid system performs better than the 4-plasmid system under two different conditions.

To confirm the superiority of the 2-plasmid system, different viruses were rescued under two different limiting conditions. Under the first condition (2  $\mu\text{g}$  plasmids, collection one day after transfection), the 4-plasmid system successfully rescued only one velogenic virus (MG-725) from 9 complete genome plasmids (Table 3.5).

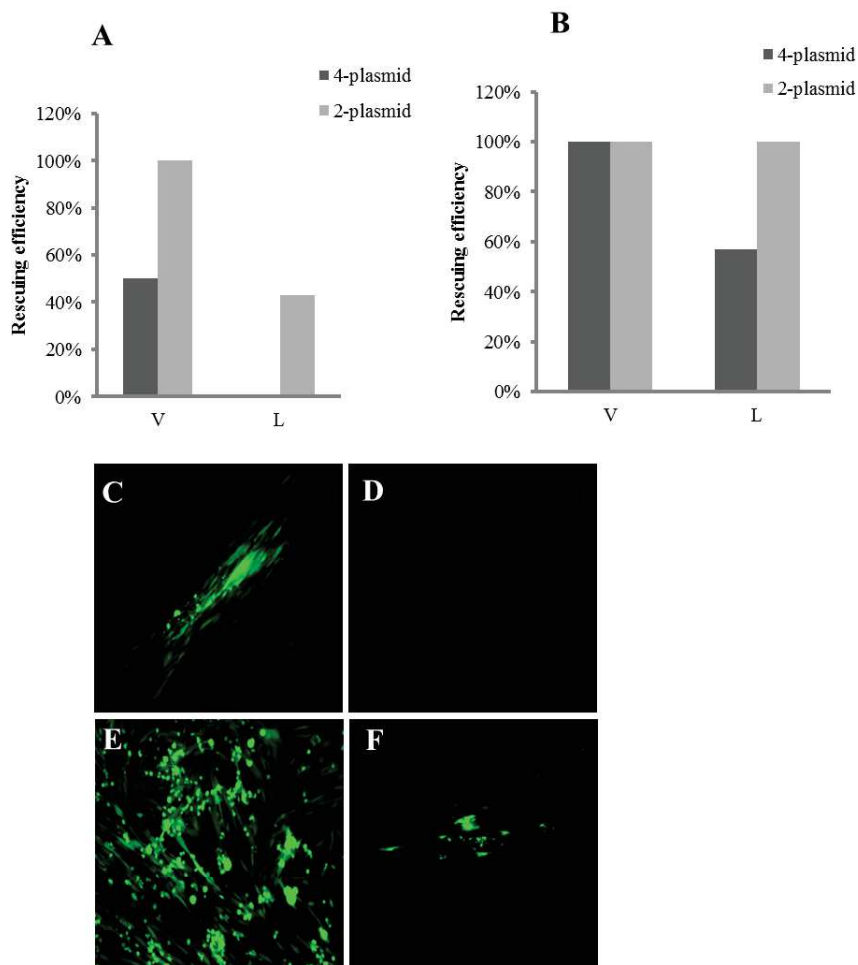

**Fig. 3.7.** Efficiency of the 2- and 4-plasmid system on 9 NDV strains. (A and B) The rescue of two velogenic-like (V) and seven lentogenic-like (L) strains was tested in the two systems. The 2-plasmid system outperformed the 4-plasmid system under the limiting recovery 1 day after transfection conditions of use consisting of 2  $\mu\text{g}$  plasmids for transfection and virus (A). Under the conditions of 3  $\mu\text{g}$  of plasmids and recovery 3 days after transfection, the 2-plasmid system performed better than the other for the lentogenic strains. In addition, under these conditions, more fluorescent cells were generated after transfection pMG-725/EGFP (C, E), pMG-725/Fmu/EGFP (D, F) with the 2-plasmid system (E, F) than with the 4-plasmid system (C, D). The pictures were taken at magnification 10 $\times$ .

In contrast, the 2-plasmid system was able to rescue five viruses, including three lentogenic viruses (Fig. 3.7A, Table 3.5). Under the second condition (3 µg plasmids, three days after transfection), the rescue efficiency increased to 67% for the 4-plasmid system, but three viruses with lentogenic-like F protein cleavage sites were still not rescued. In contrast, rescue efficiency was 100% with the 2-plasmid system (Fig. 3.7B, Table 3.5). Moreover, three days after transfection, the titers of both velogenic and lentogenic viruses were higher in the 2-plasmid system than in the 4-plasmid system, as evidenced by the number of cells expressing the EGFP (Fig. 3.7C to 3.7F). These results demonstrate the better performance of the 2-plasmid system whatever the conditions of use and the virulence of rescued viruses.

## **Discussion**

Since NDV reverse genetics was first developed in the 1990s, the technology has been extensively used in research (13). For example, virulent factors of the virus have been identified and some gene functions have been clarified (10, 13, 20, 21). Different modified vaccine candidates have also been generated (14, 22). Other pathogen genes have been inserted into the full genome of NDV and recombinant strains rescued using this technique as vaccine candidates for other diseases (23, 24). Last but not least, the genome of the NDV virus has been engineered by reverse genetics to enhance the oncolytic ability of the virus (16). In this context, virus rescue has been a quite important issue. Different modifications were proposed to improve NDV reverse genetics from its very beginning (1). For instance, in reverse genetics based on the T7 polymerase promoter for RNA transcription and protein expression, T7 RNA polymerase (T7pol) transgenic cell lines were generated to replace the use of a recombinant T7pol-fowlpox virus, thus eliminating the risk of contamination of the rescued virus by the fowlpox virus (18). Other authors used an additional plasmid to express T7pol (25). In other systems, the T7pol promoter was replaced by the CMV promoter, which renders the reverse genetics independent of the T7pol, simplifies the molecular constructions and extends the types of cell lines that can be used to rescue the viruses (17). However, before the present study, reverse genetics systems were all based on the use of four different plasmids to deliver the minimum elements of the replicative form of the virus: the complete genome and the NP, P, and L proteins of the virus. Although generally successful, this 4-plasmid system has to get round the difficulty of sending four different size plasmids into the same cell to be able to generate an infectious clone. This difficulty is increased by the fact that the plasmid containing the complete genome is large and its transfection efficiency can be

affected. When we first began our study of the virulence of new strains from Africa, we used a 4-plasmid strategy to generate various infectious clones. However, the system was not efficient enough to rescue attenuated strains. To get round this difficulty, we tried to improve the system by reducing the number of plasmids to be used for NDV reverse genetics, as has previously been successfully achieved in other studies, mainly for segmented viruses (2, 3, 26-28). Here, three plasmids were combined into one to express the NP, P and L proteins.

An antisense fluorescent mini-genome placed under the control of pCMV was constructed for comparative assays as previously described (11, 12). With the 2-plasmid system, we observed increased EGFP expression as early as one day after transfection and double the number of fluorescent cells the following day, compared to the conventional 4-plasmid system. This suggested that the 2-plasmid system would be more efficient than the 4-plasmid system for the rescue of NDV viruses.

Indeed, we observed that it was possible to rescue our two lentogenic strains with the 2-plasmid system. The conditions for viral rescue with the 4-plasmid system were then refined, including optimization of the plasmid concentrations and ratios, using homologous NP, P and L genes from the LaSota strain, extension of the period of incubation before cell collection or addition of exogenous trypsin to cleave the F protein and promote BHK-21 cell viral infection and replication (13, 18). However, none of these improvements allowed the rescue of the two missing lentogenic viruses (data not shown). In contrast, the 2-plasmid system was able to rescue all our 10 viruses including the two lentogenic strains, even when the total quantity of plasmids was reduced to 3  $\mu$ g. More viral particles were generated by the transfected cells, thereby increasing the chance of rescuing the virus in fresh cells or chicken embryos. In this study, the 2-plasmid system generated more viruses than the 4-plasmid system, whatever the velogenic or lentogenic feature of the F protein cleavage site. Reducing the number of plasmids used in reverse genetics also increased the efficiency of the rescue of other viruses (2, 3, 29). The number of plasmids used to rescue influenza viruses was reduced from eight to one to generate more viral particles in transfected cells (26, 27). Similarly, two plasmids instead of four improved rescue efficiency for a plant Negative-Strand RNA virus (28). However, it was also possible to successfully rescue the viruses used in those studies using the conventional reverse genetics system with more plasmids (eight plasmids or four plasmids) (27, 28). In our case, it was only possible to rescue all of our attenuated viruses using the 2-plasmid system.

The usual time required to collect rescued viruses from cells is three days after transfection (13). In this study, with the 2-plasmid system, it was possible to rescue viruses as early as one day post-transfection. Even if the rescue efficiency of the 2-plasmid system was not 100% under the minimal conditions tested (2 µg plasmids, recovery one day after transfection), it is still competitive for most viruses in comparison with either optimized 4-plasmid system, because the 2-plasmid system reduces the time and cost of generating infectious clones. Interestingly, under limiting conditions (2 µg plasmids and recovery one day after transfection), the 2-plasmid system was unable to rescue four strains with the same LaSota backbone (LaSota, LaSota/Cherry, LaSota/M-Fmu, LaSota/M-HN). Whether the use of heterologous NP, P and L genes from MG-725 in the 2-plasmid system reduced the rescuing efficiency on these viruses with a LaSota backbone, remains to be investigated in depth, for instance, by comparing the outcomes when homologous NP, P and L genes are used.

In conclusion, the 2-plasmid system developed here for NDV reverse genetics not only simplifies the transfection procedure, reduces the number of plasmids to be transfected and requires less time to achieve successful rescue, but also increases the efficiency for lentogenic-type viruses compared to the conventional 4-plasmid system. Using this improvement in reverse genetics for other viruses may be equally successful.

## References

1. Neumann G, Whitt MA, Kawaoka Y. 2002. A decade after the generation of a negative-sense RNA virus from cloned cDNA—what have we learned? *J Gen Virol*83:2635-2662.
2. Neumann G, Fujii K, Kino Y, Kawaoka Y. 2005. An improved reverse genetics system for influenza A virus generation and its implications for vaccine production. *Proc Natl Acad Sci U S A* 102:16825-16829.
3. Kobayashi T, Ooms LS, Ikizler M, Chappell JD, Dermody TS. 2010. An improved reverse genetics system for mammalian orthoreoviruses. *Virology* 398:194-200.
4. Mayo M. 2002. A summary of taxonomic changes recently approved by ICTV. *Arch Virol*147:1655-1656.
5. Mayo M. 2002. Virus taxonomy-Houston 2002. *Arch Virol*147:1071-1076.
6. de Leeuw O, Peeters B. 1999. Complete nucleotide sequence of Newcastle disease virus: evidence for the existence of a new genus within the subfamily Paramyxovirinae. *J Gen Virol*80:131-136.
7. Phillips R, Samson A, Emmerson P. 1998. Nucleotide sequence of the 5'-terminus of Newcastle disease virus and assembly of the complete genomic sequence: agreement with the "rule of six". *Arch Virol*143:1993-2002.
8. Krishnamurthy S, Samal SK. 1998. Nucleotide sequences of the trailer, nucleocapsid protein gene and intergenic regions of Newcastle disease virus strain Beaudette C and completion of the entire genome sequence. *J Gen Virol*79:2419-2424.

9. Steward M, Vipond IB, Millar NS, Emmerson PT. 1993. RNA editing in Newcastle disease virus. *J Gen Virol*74:2539-2547.
10. Dortmans J, Rottier P, Koch G, Peeters B. 2010. The viral replication complex is associated with the virulence of Newcastle disease virus. *J Virol* 84:10113-10120.
11. Zhao W, Hu H, Zsak L, Yu Q, Yang Z. 2013. Application of the ligation-independent cloning (LIC) method for rapid construction of a minigenome rescue system for Newcastle disease virus VG/GA strain. *Plasmid* 70:314-320.
12. Qiu X, Zhan Y, Meng C, Wang J, Dong L, Sun Y, Tan L, Song C, Yu S, Ding C. 2016. Identification and functional analysis of phosphorylation in Newcastle disease virus phosphoprotein. *Archives of virology*:1-14.
13. Peeters BP, de Leeuw OS, Koch G, Gielkens AL. 1999. Rescue of Newcastle disease virus from cloned cDNA: evidence that cleavability of the fusion protein is a major determinant for virulence. *J Virol* 73:5001-5009.
14. Xiao S, Nayak B, Samuel A, Paldurai A, Kanabagattebasavarajappa M, Prajitno TY, Bharoto EE, Collins PL, Samal SK. 2012. Generation by reverse genetics of an effective, stable, live-attenuated Newcastle disease virus vaccine based on a currently circulating, highly virulent Indonesian strain. *PLoS One* 7:e52751.
15. Goff PH, Gao Q, Palese P. 2012. A majority of infectious Newcastle disease virus particles contain a single genome, while a minority contain multiple genomes. *J Virol* 86:10852-10856.
16. Shobana R, Samal S, Elankumaran S. 2013. Prostate-specific antigen-retargeted recombinant newcastle disease virus for prostate cancer virotherapy. *J Virol* 87:3792-3800.
17. Wang J, Wang C, Feng N, Wang H, Zheng X, Yang S, Gao Y, Xia X, Yin R, Liu X, Hu S, Ding C, Yu S, Cong Y, Ding Z. 2015. Development of a reverse genetics system based on RNA polymerase II for Newcastle disease virus genotype VII. *Virus Genes* 50:152-155.
18. Römer-Oberdörfer A, Mundt E, Mebatsion T, Buchholz UJ, Mettenleiter TC. 1999. Generation of recombinant lentogenic Newcastle disease virus from cDNA. *J Gen Virol*80:2987-2995.
19. Maminiaina OF, Gil P, Briand F-X, Albina E, Keita D, Andriamanivo HR, Chevalier V, Lancelot R, Martinez D, Rakotondravao R. 2010. Newcastle disease virus in Madagascar: identification of an original genotype possibly deriving from a died out ancestor of genotype IV. *PLoS One* 5:e13987.
20. Dortmans J, Rottier P, Koch G, Peeters B. 2011. Passaging of a Newcastle disease virus pigeon variant in chickens results in selection of viruses with mutations in the polymerase complex enhancing virus replication and virulence. *J Gen Virol*92:336-345.
21. Mebatsion T, Verstegen S, De Vaan LT, Römer-Oberdörfer A, Schrier CC. 2001. A recombinant Newcastle disease virus with low-level V protein expression is immunogenic and lacks pathogenicity for chicken embryos. *J Virol* 75:420-428.
22. Hu S, Ma H, Wu Y, Liu W, Wang X, Liu Y, Liu X. 2009. A vaccine candidate of attenuated genotype VII Newcastle disease virus generated by reverse genetics. *Vaccine* 27:904-910.
23. Park M-S, Steel J, García-Sastre A, Swayne D, Palese P. 2006. Engineered viral vaccine constructs with dual specificity: avian influenza and Newcastle disease *Proc Natl Acad Sci U S A* 103:8203-8208.

24. Krishnamurthy S, Huang Z, Samal SK. 2000. Recovery of a virulent strain of Newcastle disease virus from cloned cDNA: expression of a foreign gene results in growth retardation and attenuation. *Virology* 278:168-182.
25. Jiang Y, Liu H, Liu P, Kong X. 2009. Plasmids driven minigenome rescue system for Newcastle disease virus V4 strain. *Mol Biol Rep* 36:1909-1914.
26. Chen H, Angel M, Li W, Finch C, Gonzalez AS, Sutton T, Santos J, Perez DR. 2014. All-in-one bacmids: an efficient reverse genetics strategy for influenza A virus vaccines. *J Virol* 88:10013-10025.
27. Zhang X, Kong W, Ashraf S, Curtiss R. 2009. A one-plasmid system to generate influenza virus in cultured chicken cells for potential use in influenza vaccine. *J Virol* 83:9296-9303.
28. Wang Q, Ma X, Qian S, Zhou X, Sun K, Chen X, Zhou X, Jackson AO, Li Z. 2015. Rescue of a plant negative-strand RNA virus from cloned cDNA: insights into enveloped plant virus movement and morphogenesis. *PLoS Pathog* 11:e1005223.
29. Zhang X, Curtiss R. 2015. Efficient generation of influenza virus with a mouse RNA polymerase I-driven all-in-one plasmid. *Virolo J* 12:1.

## **Chapter 3**

**Newcastle disease virus uses cell-to-cell transmission to maintain persistent infection, resist superinfection exclusion and enhance co-infection**



## **Abstract**

The cell-to-cell route is an alternative way for viral spread among cells. For some viruses, cell-to-cell dissemination is even more efficient since it helps viruses escape circulating neutralizing antibodies. However, except for this obvious beneficial effect, it is not clear whether the cell-to-cell route plays other roles for viruses. The situation is further complicated by the fact that viruses mainly spread using cell-free virus-cell transmission, which significantly disturbs our ability to establish the existence and identify the roles of cell-to-cell transmission. Newcastle disease virus (NDV) uses the cell-free virus-cell route to spread and virulent or velogenic strains consequently spread much better than attenuated or lentogenic strains. Here, we show that the cell-free virus-cell route is blocked when cells are persistently infected (PI). We also found that NDV used cell extensions to spread from one cell to another one in PI cells, even over relatively long distances. Although direct cell-to-cell spread was not as fast as the cell-free virus-cell route for NDV, this route was required to maintain PI cells, resist superinfection exclusion and to enhance co-infection by either lentogenic or velogenic viruses.

## **Introduction**

Viruses can spread among cells in two different ways: cell-free virus-cell and cell-to-cell (1-3). Almost all viruses use cell-free virus-cell transmission, as long as infected cells produce mature virus progenies. Viable particles can be released into the extracellular space and remain stable until they reach new target cells (2). Cell-to-cell transmission requires a connection between donor and receiving cells (1-3). Viruses can use existing connections between cells to spread. For example, measles virus and herpesviruses are transmitted between neuronal cells via neurological synapses (4-7). When there are no preexisting contacts between cells, new connections can be formed, driven by the viral infection. The murine leukemia virus, for example, expresses viral envelope (Env) protein to build cell-cell contact for transmission of the virus (8-10). Another example is the human metapneumovirus, which induces cell reshaping that consists in long cell extensions linking infected and uninfected cells to enable viral spread (11).

Cell-to-cell dissemination can be very effective, since the virus does not need to complete all the steps to generate a free viable particle. Indeed, incomplete viral particles or even genomic materials can be transferred through connections between infected and uninfected cells,

resulting in more rapid transmission of the virus (1-3). For example, cell-to-cell spread is more efficient for human immunodeficiency virus (HIV) and hepatitis C virus (HCV) than transmission via cell free virus, resulting in a shorter progeny generation time (12, 13). In addition, the cell-to-cell mode can help the virus to circumvent barriers imposed on cell free viruses like neutralizing antibodies or antiviral drugs (14). In contrast, some viruses mainly use the cell-free virus-cell route to spread but may switch to cell-to-cell transmission under adverse circumstances (3). However, neither the mechanisms that underline the switch from the cell-free virus-cell to the cell-to-cell route, nor the impacts of the switch on the virus spread are currently well understood.

Newcastle disease virus (NDV) belongs to the genus *Avulavirus*, family *Paramyxoviridae* with a single negative RNA strand (15). Cell-to-cell transmission of some viruses has been already identified in the order *Mononegavirales*, e.g. for parainfluenza virus 5, respiratory syncytia virus, measles virus and human metapneumovirus (5, 11, 16, 17). NDV infections initially depend on the interaction of the Hemagglutinin-Neuraminidase (HN) protein with sialic acid receptors on the cells (18-20). After this interaction, the fusion (F) protein starts a series of conformational changes from a pre-fusion to a post-fusion structure to merge the virus and cell envelopes and then releases viral RNA and proteins inside the cell for replication (21-25). The cleavage site of the F protein can have different motifs targeted by different types and localizations of proteases. If there are at least three basic amino acids at the cleavage site, the F protein can be cleaved by proteases that are widely distributed in the host, thus allowing the virus to cause a systemic infection, which is one of the characteristics of velogenic strains. In contrast, a cleavage site with fewer basic amino acids can only be cut by trypsin-like proteases, which are usually restricted to the respiratory and digestive tracts (26-28). Consequently, velogenic NDV strains are easier to amplify in cell cultures because their cleavage site (virulent-like cleavage site: VCS) can be activated by cell proteases, whereas attenuated strains cannot, since trypsin-like proteases are not excreted by cultured cells (28-30). Viral spread can also be influenced by HN protein expression, because the neuraminidase component of this protein destroys the viral receptors on the surface of the infected cell surface thereby preventing superinfection during virus replication and self-reassociation of the newly released free virus particles (31-33). Some cells can be persistently infected by NDV and these cells continuously express HN protein (34-37). We thus hypothesized that the establishment of PI cells would be a good way to study NDV switching from the cell-free virus-cell spread way to the cell-to-cell route.

To this end, we generated fluorescent NDV strains by reverse genetics and used them to establish persistently infected (PI) BHK-21 cells. The PI cells were maintained and passaged as normal cells. Here we show that NDV transmission is switched from the conventional cell-free virus-cell to the unusual cell-to-cell spread route in PI BHK-21 cells. The switch is driven by an interference state in PI cells associated with consistent HN protein expression and possibly with the presence of defective interfering particles (DIPs) in these cells. We also show that the cell-free virus-cell transmission can be restored and virus replication can rebound in PI cells when interference is reduced. We also observed that cell-to-cell transmission helps the virus overcome superinfection exclusion and consequently improves the co-infection ratio in PI cells.

## **Materials and Methods**

### **1. Viruses and cells**

NDV MG-725 (hereafter referred to as the M strain) is a velogenic strain isolated from chickens in Madagascar (38). MG-725/Cherry (M-R strain), MG-725/EGFP (M-E strain), MG-725/Fmu/Cherry (M-F-R strain), MG-725/Fmu/EGFP (M-F-E strain) were generated by reverse genetics based on the M strain and incorporated either a Cherry or an EGFP cassette expressing red or green fluorescence protein, respectively (39). M-F-R and M-F-E strains had their fusion cleavage site modified to become attenuated. All these strains were amplified in 10 day-old specific pathogen free (SPF) chicken embryos (Couvoir de Cerveloup, France). After three days of infection or death of the chicken embryo, allantoic liquids were harvested and stored at  $-80^{\circ}\text{C}$ . Baby hamster kidney cells (BHK-21) persistently infected with M-F-R, M-F-E, M-E strains were named B-MFR, B-MFE and B-ME, respectively. B-MFR-ME cells were persistently co-infected by M-F-R and M-E strains. All these cells were grown in Eagle's Minimum Essential Medium (Gibco) with 10% fetal bovine serum (FBS) (PAN-Biotch) and cultured at  $37^{\circ}\text{C}$ , with 5%  $\text{CO}_2$ .

### **2. Construction and overexpression of plasmids**

EGFP, Cherry and MG-725 strain HN genes were amplified from pEGFP-C1 (Clontech, France), pmCherry-N1 (Clontech, France) and pMG-725 (in house) plasmids and cloned into pCI-neo (Clontech, France) between CMV promoter and PolyA to obtain pCI-neo-EGFP, pCI-neo-Cherry, pCI-neo-HN, respectively. The EGFP cassette was then inserted into pCMV

(in house) plasmid to obtain pEGFP. The Cherry and HN cassettes were cloned into pEGFP to obtain pCherry-EGFP and pHN-EGFP plasmids, respectively. All these plasmids were purified with Quik Plasmid Miniprep kit (Invitrogen) and stored at -20°C.

The pEGFP-C1, pHN-EGFP and pHN-EGFP (0.5 µg each) were transfected into BHK-21 cells by Lipofectamine 2000 (Invitrogen). One day after transfection, EGFP or Cherry expressions were checked under a fluorescent microscope. The cells were then collected, the RNA was extracted (RNasy Mini Kit; QIAGEN) and then digested by TURBO DNase enzyme (Ambion). The mRNA from these digested RNA (Oligotex mRNA Mini Kit; QIAGEN) was purified and used to check EGFP, Cherry or HN mRNA expression by RT-PCR.

### 3. Transfection and infection

$1 \times 10^5$  BHK-21 cells were seeded in 24-well plates overnight; 0.5 µg pEGFP-C1 or pHN-EGFP plasmids were transfected into BHK-21 cells using Lipofectamine 2000 (Invitrogen). After 5 h, the media were replaced by MEM with 2% FBS. One day after transfection, the cells were infected with 10 M.O.I. of M-R strain. The fluorescent microscope was used to check EGFP and Cherry protein expression one day after infection.

### 4. Establishment of persistently infected cell lines

BHK-21 cells were seeded in 24-well plates ( $1 \times 10^5$ /well) overnight and then infected with 10 M.O.I of each virus strain. When the infected cells again became confluent, they were transferred into 25 cm<sup>2</sup> cell flasks (T25) to obtain the B-MFR (PI cells with MG-725/Fmu/Cherry strain), B-MFE (PI cells with MG-725/Fmu/EGFP strain), B-ME (PI cells with MG-725/EGFP strain) and B-MFR-ME PI (PI cells with both MG-725/Fmu/Cherry and MG-725/EGFP strains) cell lines. Cells were subsequently passaged to new T25 flasks at 3-day intervals. Supernatants and  $5 \times 10^5$  cells of each cell passage were harvested and stored at -80°C. Flow cytometry was used to check the condition of EGFP expression of B-MFE and B-ME cell lines over passages.

### 5. Viral virulence, replication and transmission

The mean time of death of the chicken embryos (MDT) of viruses and the replication ability of virus strains were evaluated on 10 day old SPF embryos (40). In brief, 1000 50% tissue

culture infective doses (TCID<sub>50</sub>) of virus suspensions were injected into chicken embryos and allantoic liquids were harvested three days after infection or upon embryo death. The viral titer was then checked by hemagglutination assay (HA) (40) and with the TCID<sub>50</sub> method on BHK-21 cells (41). Viral replication was performed on BHK-21 cells as follows: cells were seeded in 24-well plates overnight and then infected with 0.01 M.O.I of virus. Next, 100 µl of supernatants were collected at 24 hour intervals over three days to determine viral titers by TCID<sub>50</sub> on BHK-21 cells. Fluorescent images of infected cells were taken every day to monitor viral transmission in normal cells. For M-E and M-F-E strains, the relative numbers of cells infected by the virus were also determined by flow cytometry.

To check viral transmission in PI cells,  $5 \times 10^4$  B-MFE cells from the 23<sup>rd</sup> and 25<sup>th</sup> passages and  $5 \times 10^4$  B-ME cells from the 19<sup>th</sup> and 21<sup>st</sup> passages were seeded in 24-well plates and harvested every day over three days for EGFP cell enumeration by flow cytometry. These different passages were selected to achieve between 60% and 80% of EGFP positive cells with more spaces between the cells to enable monitoring of the spread of the virus from infected to uninfected cells.

## 6. Infection of PI cells

PI cells were seeded in 24-well plates ( $1 \times 10^5$ /well) overnight. B-MFR cells were infected with 10 M.O.I of either the M-F-E or the M-E strain. In parallel, B-MFE and B-ME cells were infected with 10 M.O.I of either the M-F-R or the M-R strain. The progress of the infection was monitored using a fluorescent microscope. The relative numbers of EGFP positive B-MFE and B-ME cells were measured by flow cytometry.

## 7. Viral titration in PI cells

Infective virus titers in the supernatants of B-MFE, B-ME and B-MFR-ME cells were determined using the TCID<sub>50</sub> method on BHK-21 cells. Infective virus titers inside B-MFR-ME cells were determined as follows: during each passage,  $5 \times 10^5$  B-MFR-ME cells were collected and re-suspended in 200 µl of MEM, frozen and thawed 4 times, after which the clarified supernatants were used for viral titration.

For gene expression quantification, total RNA was extracted from supernatants and cells of the B-MFR-ME cultures using the NucleoSpin RNA virus kit (MACHEREY-NAGEL) and RNasy Mini kit (QIAGEN), respectively. Next, viral NP, EGFP and Cherry RNAs were

quantified by real time RT-PCR (qRT-PCR) using Brilliant III Ultra-Fast SYBR Green QRT-PCR Master mix kit (Agilent) with NP-F (5'-CGACTCATACATCAGAAACACC-'3) and NP-R (5'-GGAGTAAAGTTGTGCGTATTCA-'3), EGFP-F(5'-CGACCACTACCAGCAGAAC-'3) and EGFP-R (5'-GGTACCGTCGACTGCAGAAT-'3), Cherry-F (5'-CCTACGAGGGCACCCAGAC-'3) and Cherry-R (5'-AAGTAGTCGGGGATGTCGGC-'3) primers, respectively.

#### 8. Cell enumeration

To compare the growth ability of PI cells,  $5 \times 10^4$  B-MFE and B-ME cells were seeded in 24-well plates and stained with AlamarBlue (Thermo Fisher Scientific) every 24 hours for three days. Cells were enumerated under the microscope using the cell counting plate. Also under the microscope, 10 fields of B-MFR-ME cells (the first day after passage) were randomly selected from each passage and white, red fluorescent and green fluorescent images were taken of these fields and enumerated using ImageJ software (42).

#### 9. Indirect immunofluorescence

NDV proteins were detected by indirect immunofluorescence (IFA) using a polyclonal chicken antiserum. Briefly, B-MFE or B-ME cells grown in 24-well plates were washed three times with PBS and then fixed in 4% PFA at room temperature (RT) for 20 min, incubated with 0.2% Triton-X100 at RT for 5 min, blocked with 1% BSA at RT for 20 min and incubated with 1/100 dilution of NDV polyclonal chicken antiserum (ID-Vet, France) at RT for 1 h, each step being separated by three washes in PBS. The chicken antiserum was finally removed and the cells were washed five times for 5 min in PBS. Next, a 1/1000 dilution of a goat anti-chicken IgY TRITC conjugate antibody (Life technologies) was added for 1h at RT. Cells were washed as before, then incubated with 1/5000 dilution of Hoechst (Life technologies) at RT for 15 min and finally washed three times in PBS. The fluorescent microscope was used to view the cells.

#### 10. Interference capacity of PI cell supernatants

Supernatants of PI or normal cells were inactivated by 30 W UV irradiation for 30 min. After irradiation, the supernatants were used to infect BHK-21 cells to confirm the complete inactivation of the viral suspensions. Normal BHK-21 cells were seeded in 96-well plates ( $1 \times 10^4$ /well). The cell medium was removed one day later and the cells were incubated at

37 °C, with 5% CO<sub>2</sub> for 20 h with 100 µl of irradiated supernatants from PI or normal cells, either undiluted or diluted 1/10 in MEM. The cell supernatants were then discarded and the cells were washed twice in MEM and infected by 1 M.O.I. of M-E strain. One day after infection, EGFP expression was checked by microscopy and flow cytometry. In addition, 100 µl of the supernatant of these cells were injected into 10 day old SPF embryonated eggs, which were then incubated at 37 °C for three days. After incubation, the egg's allantoic liquids were harvested and the viral titer determined by HA and TCID<sub>50</sub>.

## Results

1. NDV replication and transmission in naïve BHK-21 cells depend on the nature of the cleavage site of the F protein.

NDV virulence can be affected by many factors (43). Here, two fluorescent genes (EGFP and Cherry) were inserted between the P and M genes of the virulent MG-725 strains to obtain M-E and M-R strains. Insertion resulted in an extended virus MDT in the eggs from 48 hours to 72 hours, providing evidence for reduced virulence. The F protein cleavage site of M-E and M-R strains consists of five basic amino acids (<sup>112</sup>RRRRRF<sup>117</sup>). When changed to <sup>112</sup>GRQGRL<sup>117</sup> by reverse genetics, the MDT of M-E and M-R strains (hence named M-F-E and M-F-R) was delayed from 72 hours to more than 120 hours, which is characteristic of attenuated lentogenic viruses. (Fig. 4.1A, Table 4.1).

Although the insertion of a gene between P and M genes and modification of the cleavage site affected the kinetics of embryo death induced by the different viruses, the virus titers in the allantoic fluids did not differ significantly between the viruses (around 9log<sub>2</sub> HA and 13log<sub>10</sub> TCID<sub>50</sub>/ml, Table 4.1). This is probably because the allantoic fluid contains trypsin-like proteases that allow efficient cleavage of the F protein of both lentogenic and velogenic strains. In contrast, growth ability differed significantly between velogenic (virus with VCS) and lentogenic (virus without VCS) viruses in the BHK-21 cells. For M, M-E and M-R strains, the cell-free viral titer increased from around 5 to 9.5log<sub>10</sub> TCID<sub>50</sub>/ml from the 1<sup>st</sup> to the 3<sup>rd</sup> day of infection, while M-F-E and M-F-R strains were unable to replicate in BHK-21 cells (Fig. 4.1B).

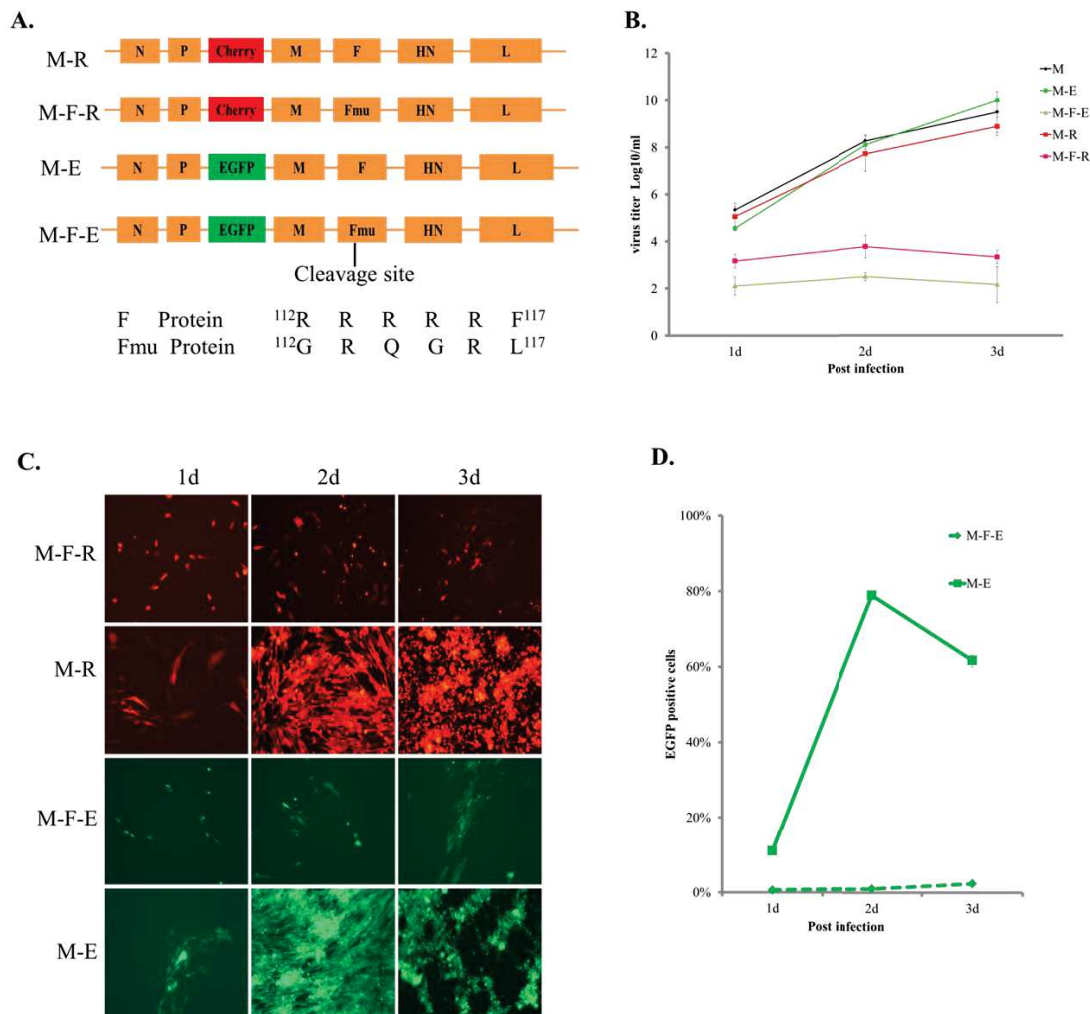

**Table 4.1** Properties of the viruses produced and used in this study

Viruses	Virus titer		Chicken embryo mortality
	HA <sup>a</sup> (Log2)	TCID50 <sup>b</sup> (Log10/ml)	MDT <sup>c</sup> (Hours)
M	8.67±1.53	13.55±1.83	48
M-F-E	9±0	13.22±1.38	>120
M-E	9.33±0.58	13.78±0.19	72
M-F-R	9±0	13.33±1.34	>120
M-R	8.67±0.58	13±1.67	72

a: Hemagglutination assay. b: Tissue culture infective doses. c: Mean time of death.

In addition, many more cells showed fluorescence two and three days after infection with M-R and M-E strains than after infection with M-F-R and M-F-E strains (Fig. 4.1C). This result was confirmed by flow cytometry. EGFP positive cells increased from 11% to 79% from one to two days after infection with M-E strains, whereas they remained between 0.6% and 1% with M-F-E strains (Fig. 4.1D). Furthermore, M-E and M-F strains produced cell syncytia in culture whereas M-F-E and M-F-R strains did not (Fig. 4.1C). Altogether, these results indicate that NDV with and without VCS showed different amplification and transmission efficiency in BHK-21 cells due to difference in their F protein cleavage site and ability to spread via the cell-free virus-cell and syncytia pathways.

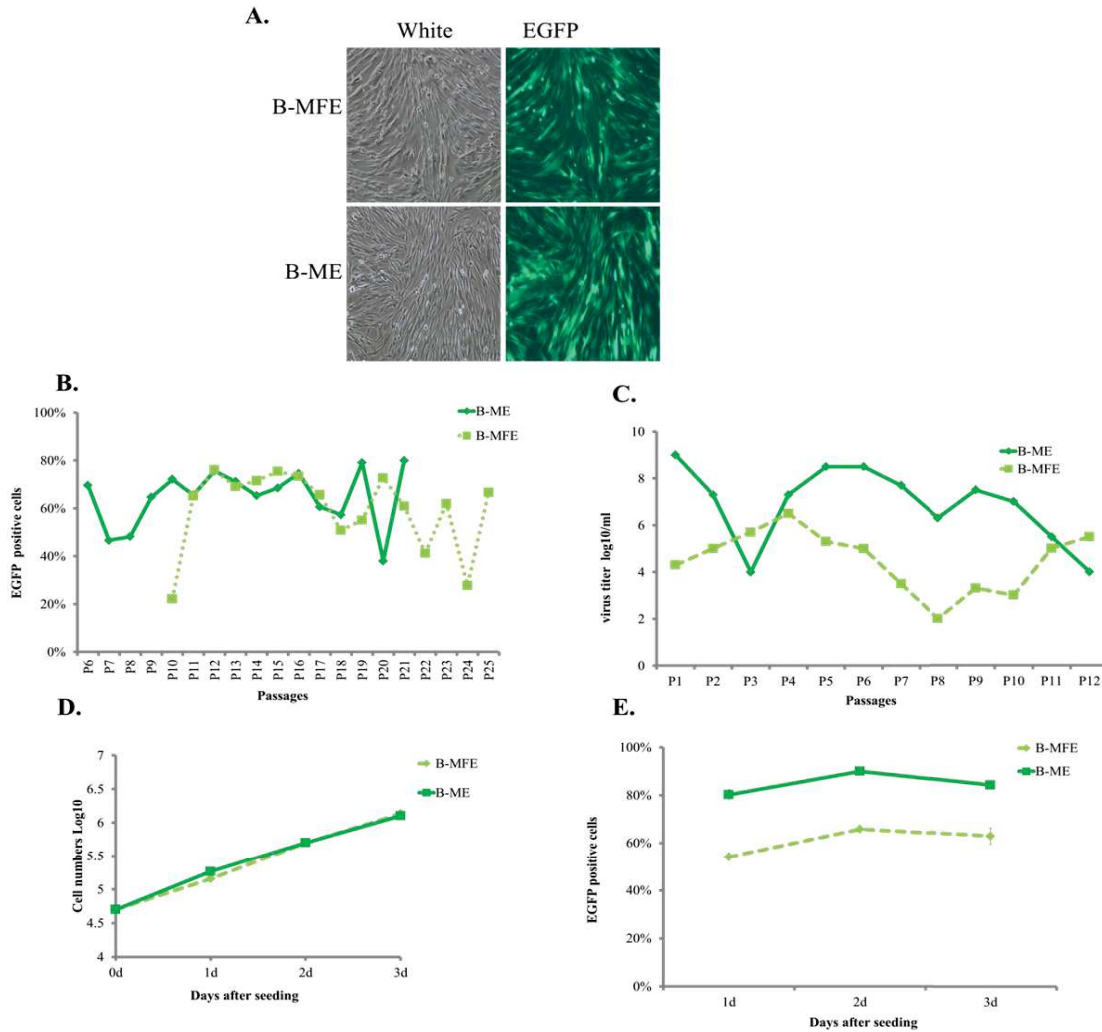

**Fig. 4.1. The cleavage site of the F protein determines NDV transmission in naïve cells. (A)** Genome structure of the four fluorescent NDV strains generated and used in this study. These viruses differ in the fluorescent marker inserted between the P and M genes and the motif of the cleavage site of the F protein. <sup>112</sup>RRRRRF<sup>117</sup> represents the virulent or velogenic-like cleavage site and <sup>112</sup>GRQGRL<sup>117</sup> is the attenuated or lentogenic-like cleavage site. **(B)** BHK-21 cells were infected with the four different viruses at M.O.I of 0.01. Virus titers in the cell supernatant were determined daily over three days post-infection as described in the Material and Methods section. Only the strains with the virulent-like cleavages site were able to grow in BHK-21 cells. **(C)** Images of BHK-21 cells used for virus titrations in the supernatants as described in (B) taken with a fluorescent microscope at magnification 10×. Only the two virulent strains developed lots of red or green fluorescence, with no apparent difference according to the marker. **(D)** The transmission of M-F-E and M-E strains in BHK21 was estimated by flow cytometry. Only the virulent strain increased the proportion of EGFP positive cells at 2 and 3 days post-infection. Dots and associated bars represent means±standard deviation (SD) of triplicates.

2. Establishment of persistent infection in BHK-21 and virus transmission in persistently infected cells is independent of the F cleavage site.

Persistent infection with NDV has been already described in some cells but to our knowledge, only viruses with VCS have been shown to establish persistent infection with viral RNA and protein expression and even excretion of viral particles (34-37). Here, we show that velogenic as well as lentogenic NDV can persistently infect BHK-21 cells. After infection with the M-E strain, marked cytopathic effects (CPE) were observed 24 h after infection with 10 M.O.I. The surviving cells and cells that remained attached required around 12 days to refill the wells: these persistently infected BHK-21 cells are referred to as B-ME. B-ME cells were passaged serially with continuous fluorescence expression and production of infective viral particles. The ratio of EGFP positive cells (infected cells) in B-ME cells ranged from 38% to 80% between the 6<sup>th</sup> and 21<sup>st</sup> passages and viral titers in the supernatants ranged from 4 to 9log<sub>10</sub> between the 1<sup>st</sup> and 12<sup>th</sup> passages (Fig. 4.2A to C). Interestingly, a viral rebound characterized by a marked increase in the virus titer in the cell supernatant was observed at passages 4-5 in B-ME cells (Fig. 4.2C).

With the attenuated M-F-E strain, although CPE was not observed and EGFP positive cells were limited in number at M.O.I = 0.01, as described previously, CPE were clearly visible one day after infection with 10 M.O.I of virus. However, over a period of 6 days, attached cells gradually filled up the surface of the well, some cells still expressing EGFP. These attached cells (named B-MFE cells) were passaged and maintained as the B-ME cells with continuous expression of EGFP and production of infective viral particles. Like B-ME cells, EGFP positive B-MFE cells ranged from 22% to 76% between the 10<sup>th</sup> and 25<sup>th</sup> passages. However, viral titers in the supernatants of the B-MFE cells decreased compared to those in the supernatants of the B-ME cells, reaching 2 to 6.5log<sub>10</sub> TCID<sub>50</sub>/ml between the 1<sup>st</sup> and 12<sup>th</sup> passages (Fig. 4.2A to C). These results suggest that the cleavage site of NDV does not determine the establishment of persistent infection in BHK-21 cells but modulates the production of the virus, velogenic viruses maintaining persistent infection with higher titers than lentogenic viruses.



**Fig 4.2. NDV spread in persistently infected cells occurs independent of the F protein cleavage site. (A)** Image (magnification 10×) of persistently infected B-MFE and B-ME cells at the 21<sup>st</sup> cell passage. No significant difference in fluorescence development between virulent and attenuated strains is visible. **(B)** This was confirmed by the relative proportion of EGFP positive cells enumerated by flow cytometry. At the 10<sup>th</sup> passage, the percentage of EGFP positive cells in B-MFE cells was much lower than that in B-ME cells. Between the 11<sup>th</sup> and 18<sup>th</sup> passage, there was no longer any difference in the percentages of green cells between the two types of cells. Beyond the 18<sup>th</sup> passage, the percentage of EGFP positive cells in B-ME and B-MFE cells oscillated around 60% and 50%, respectively. **(C)** In contrast, virus titers in the supernatants of the B-ME cells was 2 Log<sub>10</sub> higher than in the B-MFE cells between the 5<sup>th</sup> and 10<sup>th</sup> passages, whereas thereafter, the titer in B-ME cells decreased to the level of that in the B-MFE cells. **(D)** B-MFE and B-ME cell growth abilities measured by cell enumeration after AlamarBlue staining (see Materials & Methods), did not differ over the first three days of culture at two different passages. **(E)** M-F-E and M-E virus transmission in PI cells was checked at the 19<sup>th</sup> and 21<sup>st</sup> passages for B-ME and at the 23<sup>rd</sup> and 25<sup>th</sup> passages for B-MFE, respectively. These passages were selected because EGFP negative cells were more abundant in the previous passage which made it easier to monitor virus transmission. Every 24 hours for 3 days, EGFP positive cells were enumerated by flow cytometry. Although there were more positive cells in B-ME cells, virus transmission in both B-ME and B-MFE cells was similar with a 10-11% increase on the second day and a 3-6% decrease thereafter. These results were reproduced in 10 replications of two independent experiments. Error bars represent SDs.

In contrast, the growth ability of PI cells was similar whatever the virulence of the strain used for infection (M-E or M-F-E strain, Fig. 4.2D). Viral transmission dynamics were not affected in PI cells infected with lentogenic or velogenic viruses, as evidenced by the dynamics of EGFP positive cells. Indeed, from the 1<sup>st</sup> to the 3<sup>rd</sup> day of culture, the ratio of EGFP positive cells first increased by 10% and 11% and then decreased by 6% and 3% in B-ME and B-MFE cells, respectively (Fig. 4.2E). These results confirm that NDV transmission occurs in PI cells independently of the cleavage site, suggesting a different transmission pathway in PI cells than in naïve cells, in which velogenic strains spread faster and have a higher yield than lentogenic strains.

### 3. Superinfection exclusion prevents cell-free virus-cell transmission in PI cells.

One of the reasons viral transmission in PI cells differs from that in naïve cells could be the superinfection exclusion that can block the cell-free virus infection in PI cells. To test this hypothesis, 10 M.O.I of the M-R strain were used to infect naïve BHK21, B-MFE and B-ME cells. Upon infection with the M-R strain, B-MFE and B-ME cells showed only 60% of EGFP-positive cells (Fig. 4.3A). However, in the other 40% of cells, only rare cells became infected by M-R strain whereas almost all naïve BHK21 cells were infected 24 h post-infection (Fig. 4.3B). Nonetheless, no CPE developed in B-MFE and B-ME cells unlike in naïve BHK-21 cells, evidence that superinfection exclusion blocked infection by the virus in these cells (Fig. 4.3B).

To check if this superinfection exclusion is linked to the inaccessibility of the virus receptor promoted by HN protein activity, BHK-21 cells were transfected to overexpress the HN protein with pHN-EGFP and secondarily infected with the M-R strain. One day after infection with the M-R strain, only 27% of the cells expressing HN protein (EGFP positive), were successfully infected and expressed Cherry protein in contrast to 97% of the control cells (Fig. 4.3C and D), showing that HN can account for superinfection exclusion. Nevertheless, only 60% of B-ME and B-MFE cells expressed the virus EGFP marker (Fig. 4.3A), and most of the EGFP negative cells were not infected by the M-R strain (Fig. 4.3A and 3B). These results suggest that other mechanisms than HN expression are behind superinfection exclusion. To test this hypothesis, normal BHK-21 cells were cultured with UV inactivated supernatants of B-ME or B-MFE for 20 hours and then challenged with 1 M.O.I of the M-E strain. Interestingly, there was almost no infection of BHK-21 cells pre-incubated with inactivated supernatants of B-ME cells and limited infection after pre-incubation with supernatants of B-

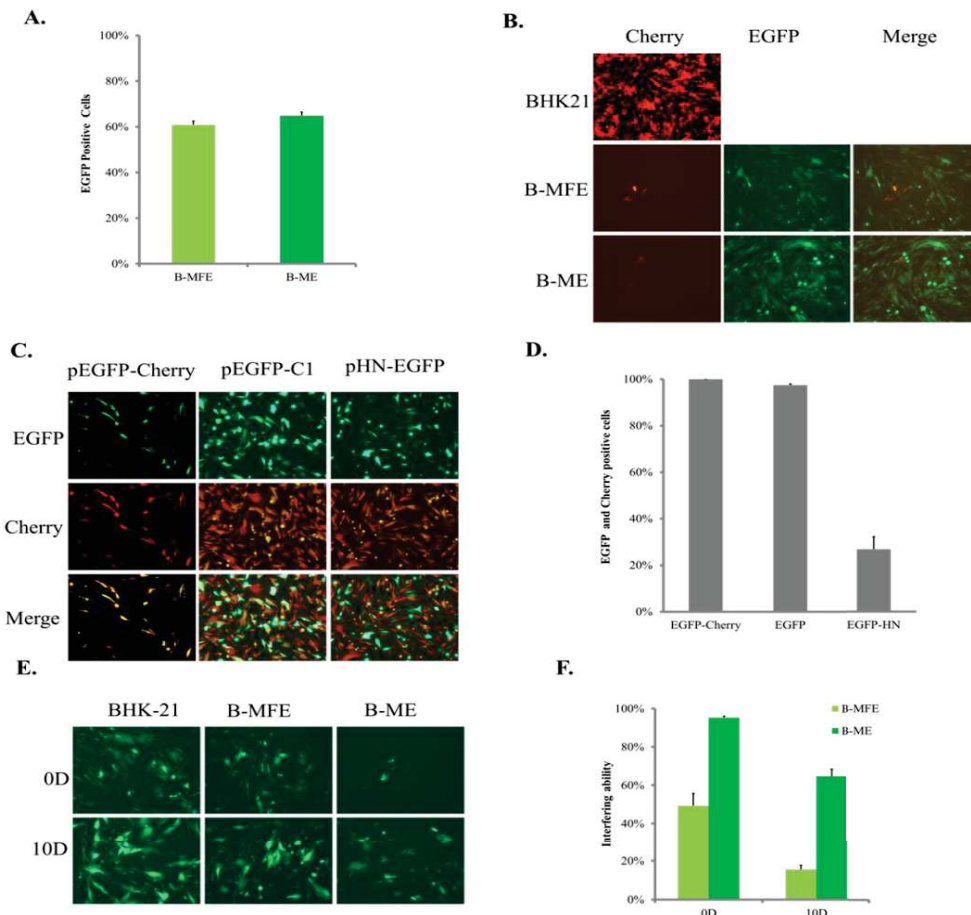

**Fig 4.3.** The cell-free infection is blocked in PI cells. (A) For superinfection assays, B-ME and B-MFE were selected at passages with percentages of EGFP positive cells around 60%. (B) These cells and control BHK-21 cells were infected with the M-R strain at a M.O.I of 10. Images (magnification 10 $\times$ ) were taken one day post infection. The results show that M-R strain has more difficulty infecting and replicating in PI cells than in naïve BHK21 cells. (C) BHK-21 cells were transfected with plasmids pCherry-EGFP, pEGFP-C1 or pHN-EGFP. EGFP, Cherry or HN mRNA were detected one day after transfection. pEGFP-C1 and pHN-EGFP transfected cells were infected with M-R strains at a M.O.I of 10. Images (magnification 10 $\times$ ) were taken of all cells the day after infection. Control pCherry-EGFP transfected cells show double fluorescence. Similarly, almost all pEGFP-C1-transfected cells show double fluorescence after infection by M-R virus at a high MOI. In contrast, only a small proportion of the pHN-EGFP-transfected cells show double fluorescence after infection with the M-R virus. (D) Inhibition of M-R virus infection in cells expressing the HN virus protein was further quantified by enumerating Cherry-positive cells with ImageJ software in more than 400 randomly selected green cells. (E) Undiluted and tenfold diluted UV-inactivated supernatants of BHK-21, B-MFE and B-ME cells were incubated with BHK-21 cells for 20 hours. The media were then removed and the cells infected with M-E strain at a M.O.I of 1. Image of cells (magnification 10 $\times$ ) one day later. A strong inhibiting effect of the inactivated undiluted and tenfold diluted supernatant of B-ME cells was observed on M-E infection and development. (F) This effect was further quantified by flow cytometry. The interference capacity of the B-MFE or B-ME supernatants was calculated and expressed in percentage as follows: (% of BHK-21 EGFP-positive cells – % of B-MFE (or B-ME) EGFP-positive cells) / % of BHK-21 EGFP-positive cells. The undiluted B-ME supernatant induced almost complete inhibition, while the undiluted B-MFE supernatant induced half inhibition. Interestingly, the tenfold diluted B-ME supernatant was still able to achieve up to 60% inhibition, whereas the diluted B-MFE supernatant only achieved 20% inhibition. Data were generated from triplicates in one experiment. Error bars represent SDs.



MFE cells. This interference was also dose-dependent (Fig. 4.3E). The interference capacity of undiluted and 1/10 diluted B-ME cell irradiated supernatants was 95% and 65%, respectively, whereas that of the B-MFE cell supernatant was 49% and 15%, respectively (Fig. 4.3F).

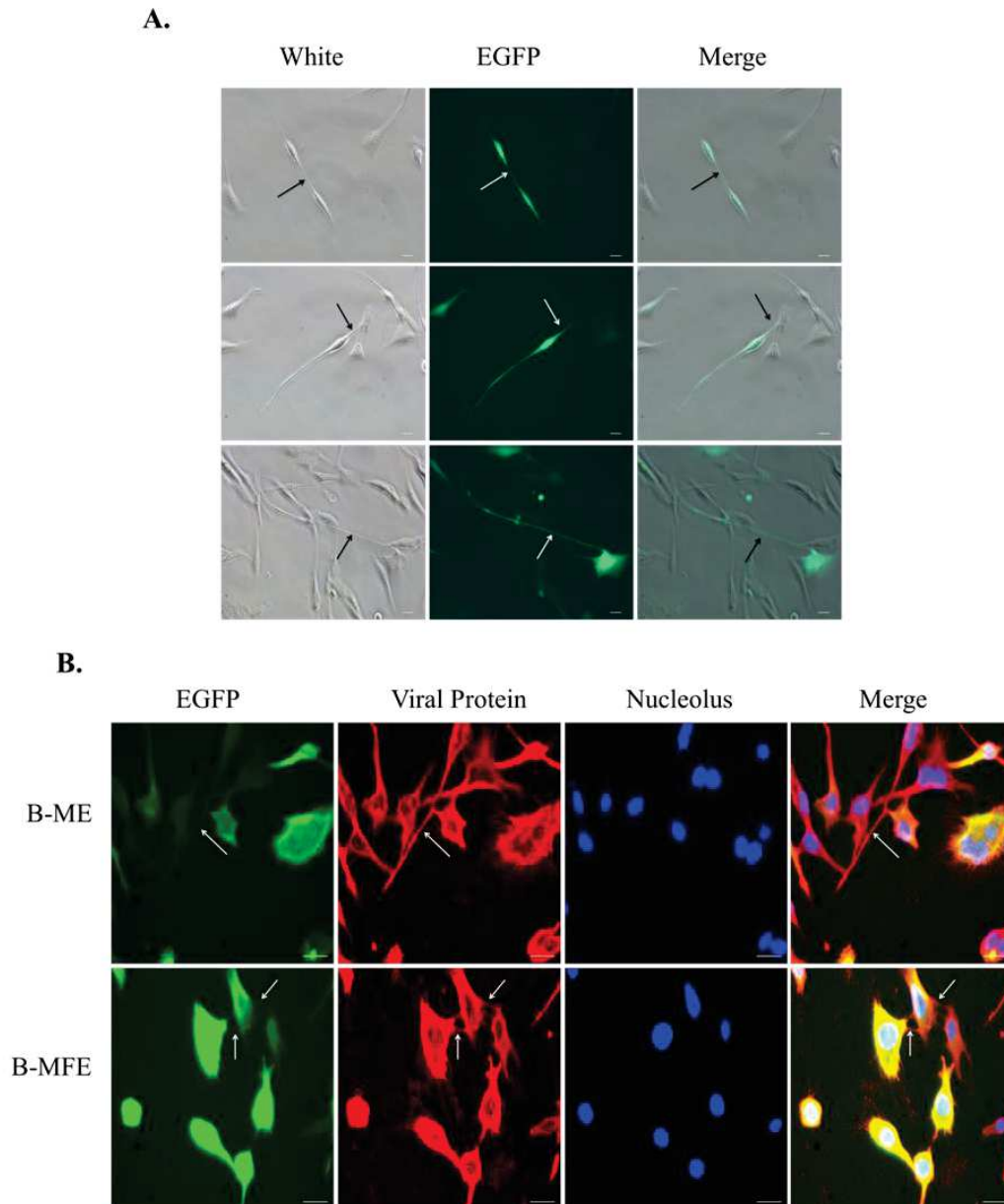

**Fig 4.4.** PI cells are connected by cell extensions containing viral materials. (A) Infected and uninfected cells in PI B-ME cells can be seen to connect to each other through cell extensions containing EGFP, magnification 20×. These cell extensions can be very long, up to 1.3 millimeter, connecting very distant cells, based on ImageJ estimation. (B) Cell extensions in both B-ME and B-MFE cells contained EGFP and viral proteins (red immune staining as described in the Materials & Methods section, arrows identify connections), magnification 40×. The scale bar represents 100 μm.

#### 4. The spread of NDV in PI cells occurs through cell-to-cell connections



In the previous sections, we showed that free virus particles could not infect PI cells that were either positive (infected) or negative (uninfected). We also showed that persisting virus can still spread in PI cells and infect new cells even though these cells are mostly resistant to infection by free virus particles. Thus, persisting virus transmission in these PI cells cannot rely on cell-free virus-cell spread. Paramyxoviruses like measles virus can use cell syncytia to spread between cells (4). The formation of syncytium depends on activation of the F protein (44). Consequently, the transmission of viruses with VCS would be expected to be more efficient than that of lentogenic viruses. However, this was not the case in the present study (Fig. 4.2E). This can only be explained by other cell-to-cell spread mechanisms than cell syncytia. It is known that some viruses can use cell physical connections to direct the transport of viral particles, RNA or proteins from one cell to another (1-3). In our PI cells, long cell extensions emerging from cell membranes were detected. Furthermore, some infected cells connected with each other or with uninfected cells through these cell extensions (Fig.4.4A). EGFP and viral proteins were observed in these cell extensions (Fig. 4.4B). These results suggest that, in addition to cell syncytia for virulent NDV strains, cell extensions can be used by virulent and attenuated viruses for cell-to-cell transmission when cell-virus free-cell transmission is inhibited.

5. Velogenic NDV enables to infect cells already expressing or being invaded by lentogenic virus.

Cell extensions are bridges that connect different cells thereby allowing direct transmission of the virus from one cell to another. Hence, we hypothesized that NDV spread would not be prevented by the expression of HN and the resulting destruction of the virus receptor. To test this hypothesis, BHK-21 cells were transfected with pHN-EGFP plasmid and infected with the M-R strain one day later. The expression of Cherry protein in EGFP-HN positive cells increased from 27% (Fig. 4.3C) to 86% (Fig. 4.5B) from the 1<sup>st</sup> to the 2<sup>nd</sup> day after infection with the M-R strain, showing that the virus was transmitted to cells overexpressing the HN protein. In addition, cell extensions and connections between double EGFP and Cherry positive cells were clearly visible at 2 days post-infection (Fig. 4.5A), suggesting that these formations were used by the virus to spread. We already showed (Fig. 4.3B) that B-ME cells were not permissive to M-R strain one day post-infection. This superinfection exclusion was extended up to 5 days post-infection (Fig. 4.5.C). In contrast, in B-MFR cells infected with 10 M.O.I of the M-E strain, superinfection exclusion was observed one day post-infection as

expected (data not shown) but was progressively circumvented by the M-E strain, with a clear increase in green cells from the 3<sup>rd</sup> to the 5<sup>th</sup> day post-infection (Fig. 4.5D). On the 5<sup>th</sup> day after infection, a large proportion of Cherry positive cells also expressed EGFP, but CPE did not develop, and the extent of M-E strain infection was less than that normally observed in naïve cells infected with this virus. In other experiments, we observed that velogenic strains exclude superinfection by lentogenic strains (data not shown). Furthermore, the M-F-E strain was unable to infect B-MFR cells (data not shown). Altogether, these results show that only velogenic strains can overcome superinfection exclusion when the cell-free virus-cell pathway is blocked by HN protein expression or avirulent strain infection in advance.

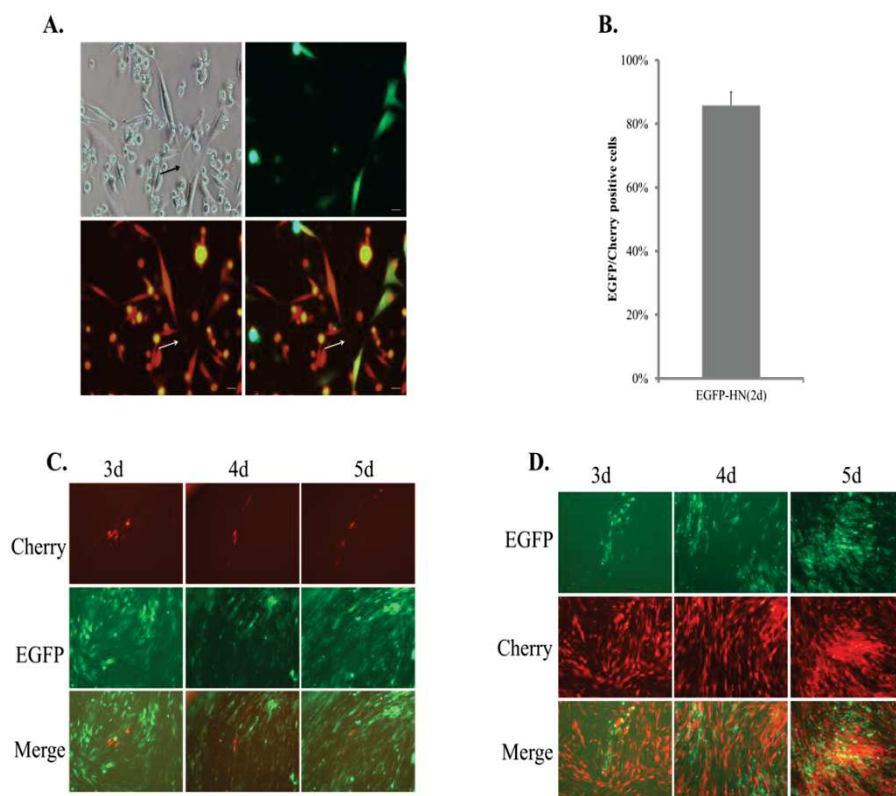

**Fig. 4.5.** NDV can circumvent the inhibition pressure on infection and superinfection. (A) BHK-21 cells transfected with pHN-EGFP as described in Fig. 3C, show an increased proportion of double positive cells under the fluorescence microscope, 2 days after infection compared to 1 day (see Fig. 4.3C). In addition, cell extensions are visible (see arrows) at magnification 20 $\times$ . (B) This was further confirmed by around 300 EGFP cells counting by ImageJ software, with more than 80% of the cells expressing green fluorescence (due to pHN-EGFP transfection), and were also red 2 days after M-R infection, versus 20-30% 1 day after infection (see Fig. 4.3D). (C) B-ME cells infected with the M-R strain as described in Fig. 3B, were monitored 3 to 5 days post-infection to show that superinfection exclusion persisted, magnification 10 $\times$ . (D) In contrast, B-MFR cells could be infected by M-E strain, suggesting that velogenic strains have the capacity to circumvent superinfection exclusion. The scale bar represents 100  $\mu$ m.

6. Uninfected cells between persistently infected cells play a pivotal role in superinfection.

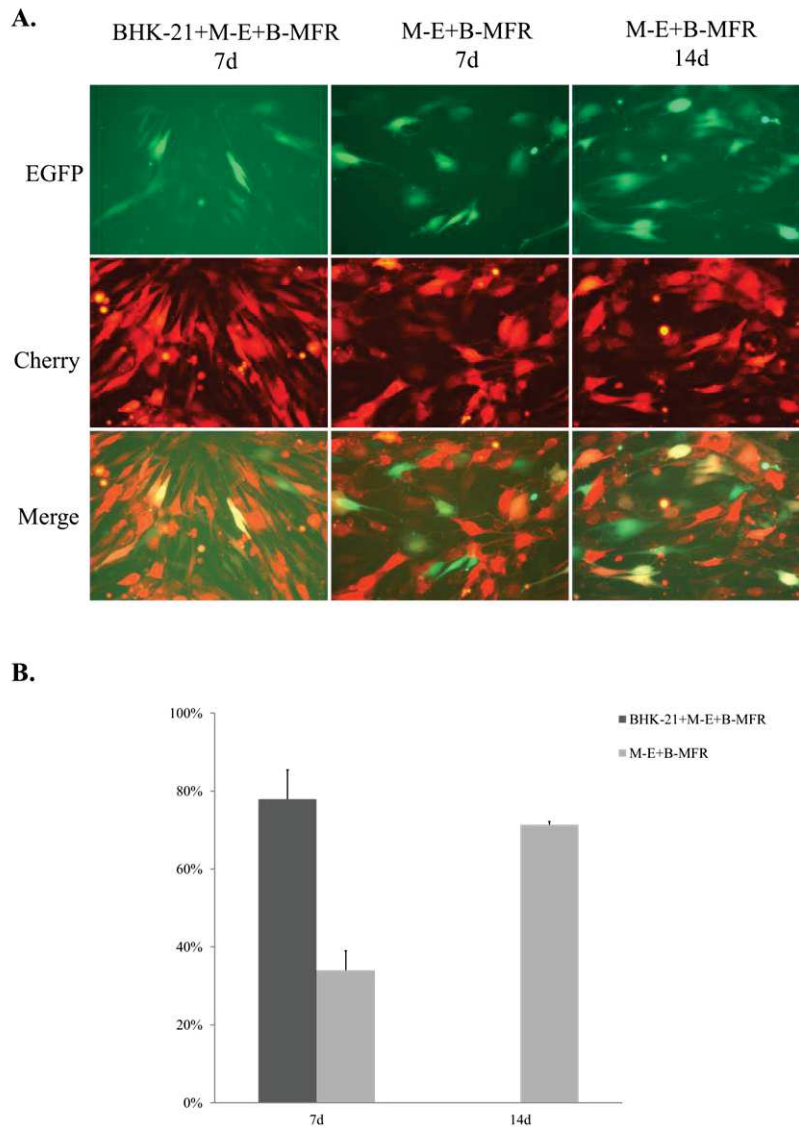

**Fig. 4.6.** Naïve cells improve superinfection of infected cells. (A) BHK-21 cells were infected with the M-E strain and then, 4 hours later, B-MFR cells were added in the culture, named BHK-21+M-E+B-MFR. B-MFR cells were also directly inoculated with the M-E strain, named M-E+B-MFR. Green or red fluorescent images (magnification 20×), were taken 7 and 14 days post-infection as indicated in the figure. (B) More than 300 EGFP cells, described in (A), were randomly selected to check the expression of red fluorescence with ImageJ software. Results show that the more M-E infected cells in the population, the more double fluorescent (co-infected) cells. Data were generated from three independent experiments. Error bars represent SDs.

In the previous section, we showed that the M-E strain preferred to infect Cherry-negative cells of B-MFR and then gradually invade cells already expressing red fluorescence, which suggested that uninfected cells contribute to superinfection. To test the hypothesis, we

co-cultivated BHK21 cells infected with the M-E strain and B-MFR cells. Naïve BHK21 cells were seeded in a T25 cell culture flask ( $2.5 \times 10^5$  cells) and infected with 10 M.O.I of the M-E strain. Cells were washed twice 1 h post-infection and  $2.5 \times 10^5$  B-MFR cells were added 4 h post-infection. Under this protocol and after 7 days of co-culture, 78% of M-E infected cells also became infected by M-F-R strain, as evidenced by double red-green fluorescence. In contrast, double fluorescent/infected cells peaked at only 34% 7 days after B-MFR cells were infected with 10 M.O.I of M-E strain. This percentage increased to 71% 14 days post-infection (Fig. 4.6A and B). These observations suggest that superinfection may result from cell-to-cell transfer of infection from cells primarily infected with the M-E strain to cells infected by M-F-R strain.

7. Cell extensions linked to significant improvement in co-infection of cells by velogenic and lentogenic viruses.

If the M-E strain can superinfect cells previously infected with M-F-R virus through cell extensions, then normal cells challenged simultaneously by M-E and M-F-R should also be able to develop connections between EGFP and Cherry-positive cells by cell extensions. To confirm this hypothesis, BHK-21 cells were simultaneously co-infected with 10 M.O.I of the M-F-R strain and 10 M.O.I of the M-E strain to generate double PI cells denominated B-MFR-ME. Cells showed CPE on the first day following the combined challenge. The remaining attached cells were then able to refill the well and express EGFP and Cherry proteins around 11 days after infection (Fig. 4.7A). These persistently co-infected cells (B-MFR-ME) were subsequently passaged and maintained as normal BHK-21 cells (Fig. 4.7B).

The dynamics of the ME virus in B-MFR-ME cells and in the supernatants were similar to those observed in the single persistently infected B-ME cells in terms of virus RNA expression and virus titers (Fig. 4.7C to F). In contrast, the M-F-R virus maintained itself at almost undetectable levels after the 6-7<sup>th</sup> passage (virus RNA expression was still detected) while it persisted in B-MFR cells. Like in single infection, the M-E virus displayed a rebound phase around the 5<sup>th</sup> passage in B-MFR-ME cells. The M-F-R virus also showed a rebound phase in these cells, but much more limited in magnitude. The rebound phase of the ME strain was linked to an increase in the percentage of EGFP fluorescent cells between the 1<sup>st</sup> and 2<sup>nd</sup> day of the 5<sup>th</sup> passage (Fig. 4.7G). The ratio of EGFP positive cells increased from 41% to

81%, whereas it only increased by 4% in Cherry-positive cells (Fig. 4.7G and H), suggesting cell-free virus-cell transmission at this passage. These results suggest that the viral rebound seen in persistently infected BHK-21 cells after 4 consecutive passages is probably linked to the transient recovery of a cell-free virus-cell transmission pathway.

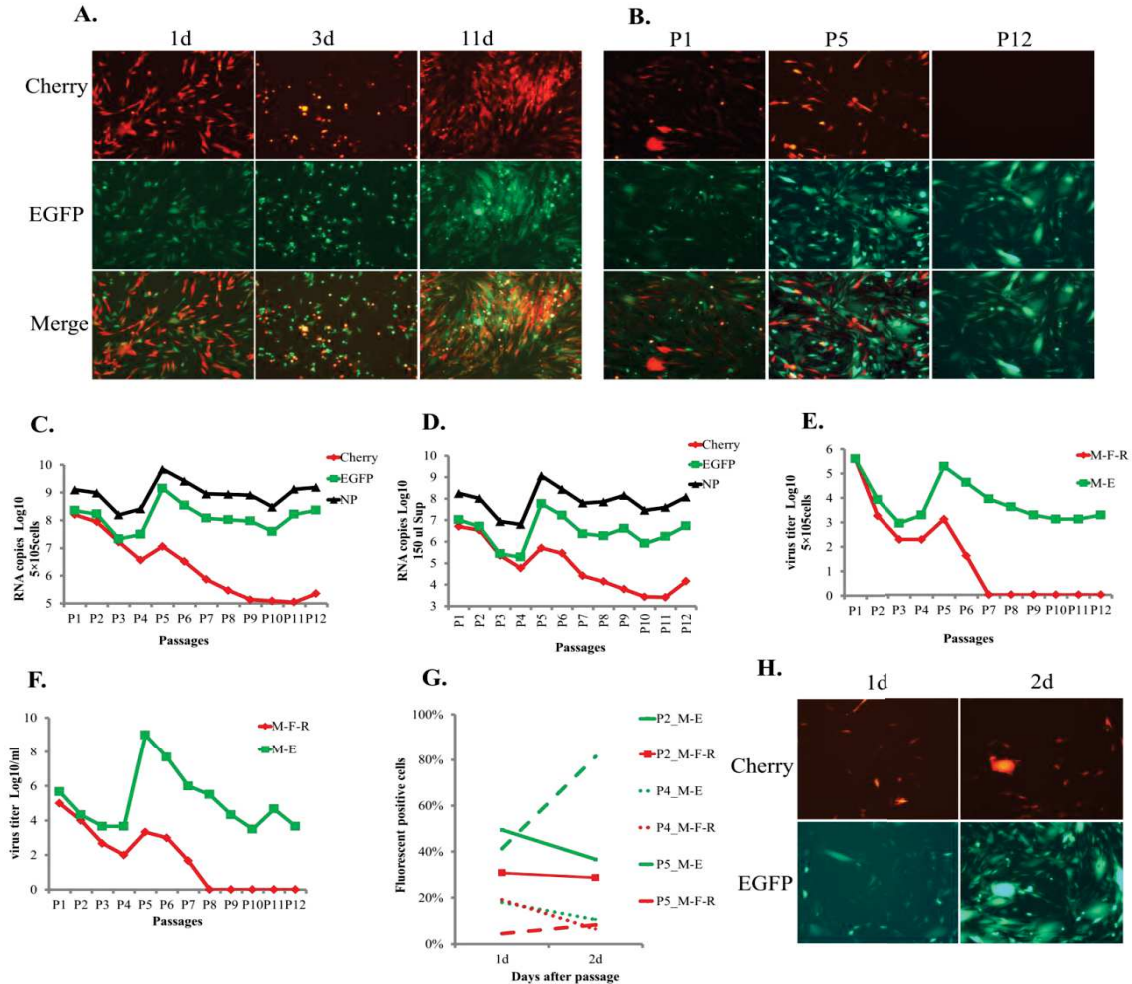

**Fig. 4.7.** Velogenic NDV strains can rebound in persistently co-infected BHK-21 cells. (A) BHK-21 cells were infected with 10 M.O.I of both M-F-R and M-E strains at the same time. Images (magnification 10 $\times$ ) of cells taken 1, 3 and 11 days after infection, After a marked CPE developed 1 day post-infection, cells recovered by the 11<sup>th</sup> day post-infection. (B) At 11 days post-infection, cells were passaged 12 times and images (magnification 10 $\times$ ) were taken on the 3<sup>rd</sup> day of each of the 1<sup>st</sup>, 5<sup>th</sup> and 12<sup>th</sup> passages. Results show that the attenuated M-F-R strain progressively vanished while M-E persisted. (C and D)  $5 \times 10^5$  cells and their supernatants were collected on the 3<sup>rd</sup> day of each passage from the 1<sup>st</sup> to 12<sup>th</sup> passage. The viral NP, Cherry and EGFP RNAs in these cells and their supernatants were quantified by qRT-PCR. In agreement with the previous fluorescence microscopy observations, M-E RNA remained at a high level, while M-F-R RNA progressively decreased by 3 Log<sub>10</sub>. A noticeable rebound effect was observed at the 5<sup>th</sup> and 6<sup>th</sup> passages mainly for the M-E virus, but also for M-F-R strain. (E and F) M-F-R and M-E viruses in cells or in their supernatants were titrated in BHK-21 cells. Again, a viral rebound was confirmed at the 5<sup>th</sup> and 6<sup>th</sup> passages, but of different magnitudes for the M-F-R and M-E strains, followed by a decline in virus titers for both strains, and the M-F-R virus became undetectable after the 7<sup>th</sup> passage. (G and H) Viral transmission in B-MFR-ME cells. Cells were enumerated by ImageJ on the 1<sup>st</sup> and 2<sup>nd</sup> days of the 2<sup>nd</sup>, 4<sup>th</sup> and 5<sup>th</sup> passages. The viral rebound is clearly visible between the 1<sup>st</sup> and 2<sup>nd</sup> second day of the 5<sup>th</sup> passage of M-E. Images (magnification 10 $\times$ ) confirm the rebound effect for M-E at the 5<sup>th</sup> passage.



The dynamics of M-E infection in B-MFR-ME cells already infected by M-F-R was followed by normalization versus the ratio of Cherry-positive cells. M-F-R and M-E double-infected cells fluctuated at around 15% during the first five passages, and suddenly increased to 62% and 76% at 6<sup>th</sup> and 7<sup>th</sup> passage, respectively. Even if Cherry-positive cells were scarce from the 9<sup>th</sup> to the 19<sup>th</sup> passage and suddenly increased at the 20<sup>th</sup> passage for unknown reasons (Fig. 4.8A and B), these cells always expressed EGFP. The expansion of co-infection across the passages appeared to be related to cell-to-cell transmission of the virus via a cell extension, because Cherry and EGFP double-positive cells had long connecting cell extensions, some up to 1.4 mm in length, that were easy to see at the 6<sup>th</sup> passage, but were less clear at other passages (Fig. 4.8C).

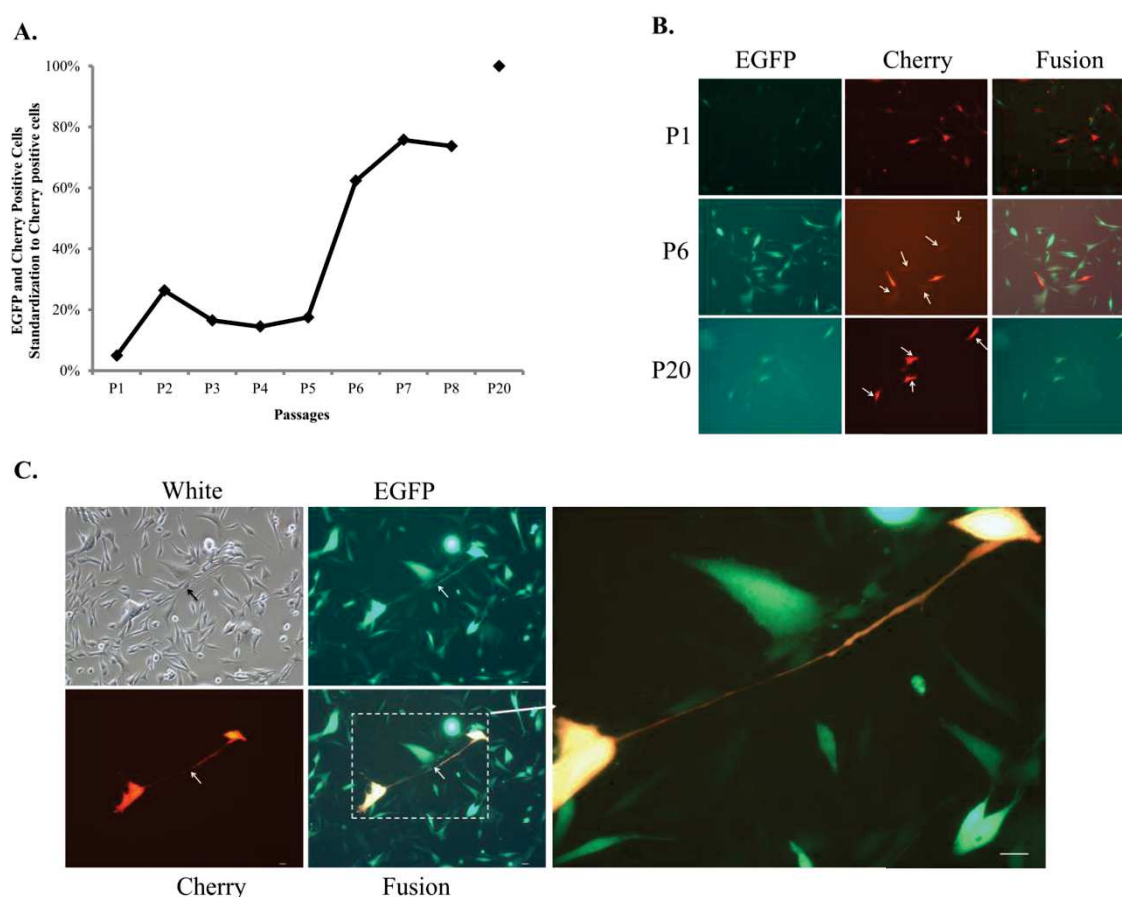

**Fig. 4. 8.** Dual infection of cells improved in PI cells co-infected by M-E and M-F-R strains. (A) From the 1<sup>st</sup> to 8<sup>th</sup> passage, the number of red cells (infected by M-F-R strain) also showing green fluorescence (infection by M-E strain) increased at the 6<sup>th</sup> passage and reached 100% at the 20<sup>th</sup> passage. (B) Images (magnification 10×) showing dual infection on the 1<sup>st</sup> day of the 1<sup>st</sup>, 6<sup>th</sup> and 20<sup>th</sup> passage of B-MFR-ME cells. Arrows indicate cells co-expressing EGFP and Cherry proteins. (C) Dual infected cells can connect via cell extensions (see arrows) as shown in the images (magnification 10× or 20×) taken on the second day of culture of the 6<sup>th</sup> passage. The scale bar represents 100 μm.

8. Cell-free virus-cell transmission and virus rebound inversely correlates with the interference capacity of PI cells.

The interference capacity of PI cell supernatants was quantified during the successive B-MFR-ME cell passages. As already shown in the previous sections, a viral rebound was evidenced by an increase in the percentage of fluorescent cells at the 5<sup>th</sup> passage (Fig. 4.9A). This rebound was attributed to the ME virus alone, since the fluorescence generated by the M-F-R virus was almost lost at the 7<sup>th</sup> passage. Interestingly, at the 4<sup>th</sup> passage preceding the virus rebound, the ratio of infected cells was the lowest and supernatants were less able to interfere in the virus infection than at any other passages in B-MFR-ME cells (Fig. 4.9A and B). Similarly, the weakest interference capacity of cells or cell supernatants coincided with the rebound of ME virus titers (Fig. 4.9C).

Since BHK-21 cells are interferon ( $\alpha/\beta$ ) defective (45-47), interference in NDV PI cells cannot be ascribed to an interferon-mediated antiviral response. During passages of B-MFR-ME cells, the RNA of the M-F-R strain was always detected up to the 12<sup>th</sup> passage, whereas no more infective M-F-R particles were detected after the 7<sup>th</sup> passage. In addition, M-E virus titers decreased continuously from the 7<sup>th</sup> to the 12<sup>th</sup> passage whereas the number of viral RNA copies remained high (Fig.4.7C to D). This apparent discrepancy could be explained by the generation of defective virus particles (DIPs) over time (47). This hypothesis is supported by the fact that UV-treated PI cell supernatants retained their interference capacity (Fig. 4.9B). The interference observed in cell culture was further confirmed in another more sensitive amplification system using chicken embryos. Three days after inoculation with supernatants from different passages of B-MFR-ME cells, viral titers in the allantoic fluids of chicken embryos gradually decreased over successive passages, as evidenced by HA and TCID50 titers (results not shown). B-MFR and B-ME cell supernatants also revealed this interfering phenomenon. Interestingly, the supernatant of the 12<sup>th</sup> passage of B-ME cells almost totally blocked viral growth in chicken embryos, because after three days of incubation, the virus titer in the allantoic fluid remained unchanged at 4 Log<sub>10</sub> TCID50/ml. These results are also compatible with the increased presence of DIPs in these PI cell supernatants over successive cell passages.



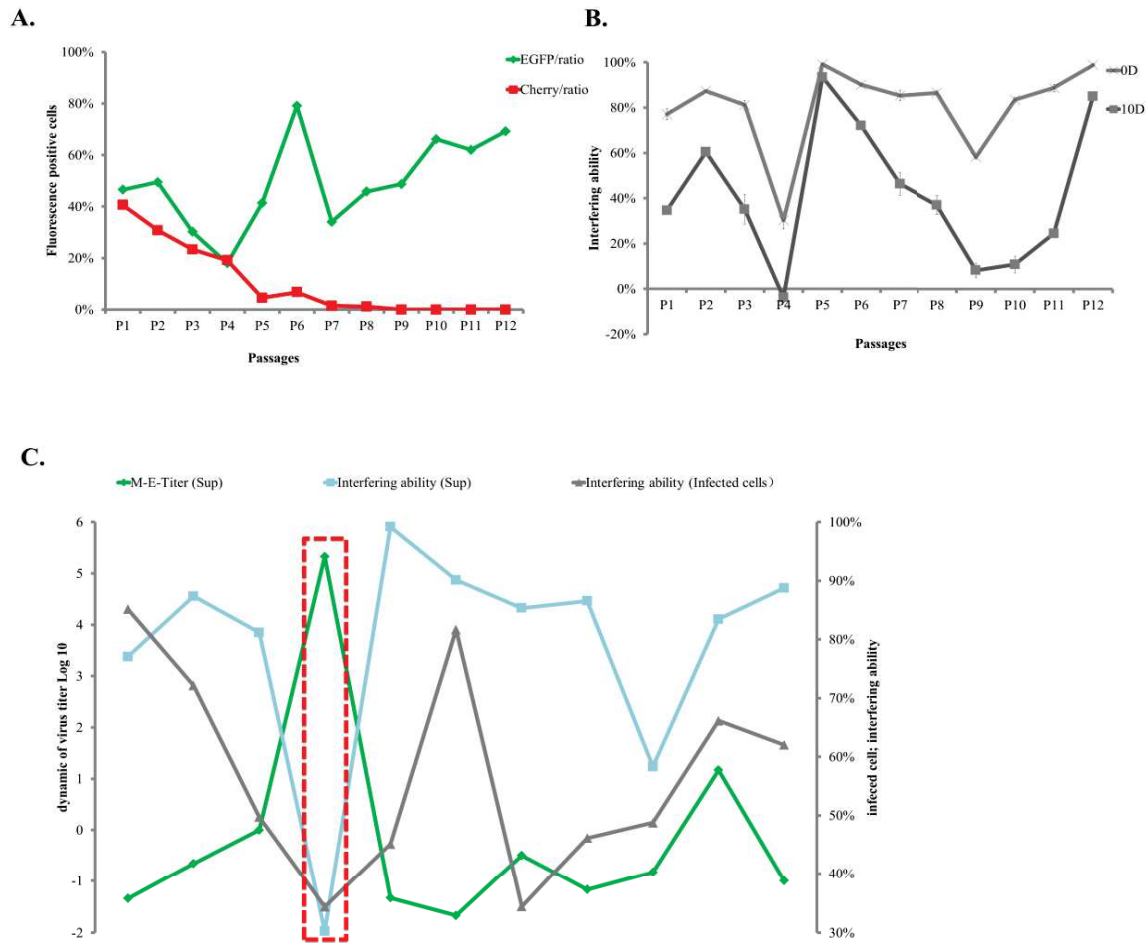

**Fig. 4.9.** Viral rebounds coincide with a reduction in the capability of PI cells and their supernatants to interfere with the infection. (A) The dynamics of infected B-MFR-ME cells was reproduced in this assay. From the 1<sup>st</sup> to the 12<sup>th</sup> passages of B-MFR-ME cells, 10 fields were randomly chosen to take pictures on the 1<sup>st</sup> day of culture. Fluorescent cells were counted with ImageJ software based on fluorescent protein expression. A clear reduction in EGFP-positive cells (infected by M-E strain) was observed at the 3<sup>rd</sup> and 4<sup>th</sup> passages followed by a rebound at the 5<sup>th</sup> – 6<sup>th</sup> passages, in agreement with the results of the assay presented in Fig. 7. In contrast, Cherry-positive cells infected with the M-F-R strain progressively declined and became almost undetectable from the 7<sup>th</sup> passage on. (B) The dynamics of interference in B-MFR-ME cell supernatants was also monitored. Supernatants were collected after 3 days of culture at each passage. The interference capacity of each medium was checked as described in Fig. 3. Data are from three replications of one experiment. Error bars are SDs. (C) The relationship between the dynamics of the M-E virus titer and the interference capacity in the supernatants of B-MFR-ME cells. For easier visibility, the dynamics of the M-E virus titers in supernatants is shown as differences between the current passage and the previous one. The dashed red rectangle indicates the point of viral rebound on B-MFR-ME cells.

## Discussion

To obtain evidence for a cell-to-cell transmission pathway for virus spread, the cell-free virus-cell transmission pathway first has to be blocked. This can be achieved in different ways. Viral budding and release of viable particles can be prevented by modifying or deleting the viral matrix (M) protein. Deleting the M protein in the Sendai, Measles and Nipah viruses was shown to reduce the release of viable particles and concomitantly to promote the spread of the virus by cell-to-cell transmission through syncytia (48-50). Neutralizing antibodies can also block cell infection by free virus particles. For example, cells infected by the hepatitis C virus and then cultured in the presence of neutralizing antibodies showed efficient cell-to-cell virus transmission (12). Increasing the viscosity of the cell medium can also slow down the virus spread by reducing the cell-free virus-cell transmission and favoring cell-to-cell transmission (11). In this study, we show that the destruction of cell receptors for NDV by overexpression of the viral HN protein or pretreatment of cells with inactivated supernatants of persistently infected cells can also reduce the cell-free virus-cell infection in PI cells. Interestingly, the effect was obtained with an unmodified virus (no genome editing) and with no extraneous additives. In fact, many viruses, including NDV, the measles virus, Tacaribe virus, Junin virus, Japanese encephalitis virus, and respiratory syncytial virus, develop persistent infection after acute infection and persistently infected cells can be maintained for a long period resisting from further free-virus infection (34, 51-55). Therefore, the options we chose in this study to block cell-free virus-cell infection could be used to obtain more information about cell-to-cell transmission in a wide range of viruses, especially viruses that usually spread using the cell-free virus-cell pathway.

Persistent infections do not only depend on the infecting virus. Interactions between cells and viruses, and between infected and susceptible cells, certainly play a role. Consequently, the mechanisms involved in PI may vary according to the type of virus and the type of cell. Up to now, two main mechanisms have been described as underlying persistent infections, the production of defective interfering particles or DIPs, and fine-tuned regulation through the interferon system. For instance, it has been shown that DIPs help Japanese encephalitis virus to establish PI in BHK-21 cells (56), while interferon  $\gamma$  promotes PI for Adenovirus 5 in human HDF-TERT cells (57). In our model, interferon cannot account for NDV PI in BHK21 because these cells are defective for interferons. Our results also show that when infective viral particles are not detected in PI cells, a relatively high level of NDV RNA can

nevertheless be detected. In addition, inactivated supernatants from PI cells transfer the property of superinfection exclusion to naïve cells. Taken together, these observations strongly suggest the presence of DIPs in our model. In our model, we cannot rule out the possibility that uninfected cells from PI cells are actually tolerant to NDV acute infection, as previously shown using chicken induced pluripotent stem cells (58). Indeed, in this study, we did not clone uninfected cells to evaluate their susceptibility to cell-free virus-cell infection from PI cells.

To establish and maintain PI *in vitro* or *in vivo*, cells or hosts have to control virus replication and keep the generation of new infective viral particles below a threshold that would jeopardize the survival of the cell or host. A range of control measures are used, including naturally derived countermeasures like virus receptor disruption, DIPs, innate or acquired antiviral immune responses, or artificial measures based on antiviral biochemicals. However, measures need to be sustained to prevent viral rebounds when the pressure declines. In HIV, the duration of the viral RNA rebound is indeed inversely related to the host's ability to activate antiviral immunity (59). Similarly, antiviral drugs contain HIV replication in a limited number of tissues in the host, but rebounds are observed in a wide range of tissues when antiretroviral therapy ceases (60, 61). The quantity of measles virus RNA peaks when antibodies reach their lowest level (62). With the Ebola virus, infective virus particles rebound when the Ras/MAPK pathway is activated in PI cells (63). With the Junin virus, rebounds always appear after the drop of DIPs in PI BHK-21 cells (47). Our results suggest that HN protein expression and DIP production in PI cells may be responsible for reducing the generation of infective viral particles. HN protein expression can limit virus infection by destroying the receptors, as previously demonstrated (33), but it is not clear how DIPs achieve the same. Whether it happens on receptor recognition, virus entry, viral transcription or replication requires further analyses.

In this study, we provide evidence that the interference capacity of PI cells in viral rebound and cell-free virus-cell spread, force the virus to select an alternative route based on the less efficient cell-to-cell transmission. The formation of syncytia is one way for the virus to spread from cell-to-cell (48-50). Many viruses can force cells to fuse to generate syncytia. With NDV, only membranes expressing activated F protein can form syncytia, although the size of syncytia is also affected by deleting or modifying some amino acids of the HN protein (19, 32, 64-66). However, although the formation of syncytia is one type of cytopathic effect mainly

observed with NDV containing VCS, it only allows the virus to spread into surrounding cells (16). In normal conditions, NDV mainly spread using the cell-free virus-cell pathway. The transmission of virus with VCS is thus much more efficient than that of virus without VCS. In contrast, when the cell-free virus-cell transmission is blocked, both velogenic and lentogenic viruses use the cell-to-cell transmission route with similar efficiency. These viruses are able to spread to remote cells through cell extensions that connect cells over long distances, in contrast to syncytia. It is not clear how these cell extensions are formed. In other viruses, actin rearrangements are involved in the formation of cell extensions (11, 16). Knockdown of actin-related protein 2 could affect the transmission of the respiratory syncytia virus (RSV) via cell extensions, while the spread through syncytia is not influenced (16). NDV entry also induces cellular actin rearrangement (67) which could also be involved in the formation of cell extensions. The nature of the trafficking in these cell extensions induced by NDV is not yet known. It could involve nucleocapsids or viral replication bodies, as is the case in human metapneumovirus infections (11) or viral particles, as in RSV infections (16).

Viral recombination or reassortment occur when at least two different viruses co-infect the same cell (68). In the case of the influenza virus, the proportion of reassortants is related to the frequency of co-infection (69) which itself depends on the virus charges and time lags between infection by different viruses. Small virus charges and longtime lags significantly decrease the co-infection frequency due to superinfection exclusion (69, 70). Superinfection exclusion is quite common for viruses, especially for viruses that are able to destroy the cell receptor to prevent self-attachment and virus sequestration (33, 51, 71). NDV is one of these viruses and the pressure of superinfection exclusion may strongly limit the possibility to generate recombined viruses in nature. Even if recombination in nature is probably not so easy for NDV, there are still few viruses claimed as recombinant strains (72, 73). In addition, more and more NDV genome information is provided with deep sequencing, which resulted in more and more strains identified as recombinants (85). However, other publications suggest that recombination could be artificial due to sequencing based on PCR contamination or mixed isolated strains (86). This issue could be dealt if there was model that can be used to test NDV recombinant under laboratory conditions. Here, we showed *in vitro* that the NDV velogenic M-E strain successfully infected cells already persistently infected with a lentogenic M-F-R virus, opening the opportunity for recombination events. This infection did not generate syncytia and infection was very slow compared to infected naïve cells.

Superinfection at the level of a population does not necessarily imply an increase in co-infection, since only uninfected cells may catch the second infection (74-77). However, in our system, co-infection was significantly enhanced and linked to cell extensions from the 6<sup>th</sup> passage of B-MFR-ME cells. Co-infection even reached 100% in the late passages of PI cells. Influenza virus can also spread via cell extensions (17). For those viruses, ours and possibly others, superinfection through cell extensions in a context of persistent infection may support the possible occurrence of viral recombination or reassortments (72, 73, 78-84).

## References

1. Sattentau Q. 2008. Avoiding the void: cell-to-cell spread of human viruses. *Nat Rev Microbiol* 6:815-826.
2. Zhong P, Agosto LM, Munro JB, Mothes W. 2013. Cell-to-cell transmission of viruses. *Curr Opin Virol* 3:44-50.
3. Mothes W, Sherer NM, Jin J, Zhong P. 2010. Virus cell-to-cell transmission. *J Virol* 84:8360-8368.
4. Zinke M, Kendl S, Singethan K, Fehrholz M, Reuter D, Rennick L, Herold MJ, Schneider-Schaulies J. 2009. Clearance of measles virus from persistently infected cells by short hairpin RNA. *J Virol* 83:9423-9431.
5. Lawrence DM, Patterson CE, Gales TL, D'Orazio JL, Vaughn MM, Rall GF. 2000. Measles virus spread between neurons requires cell contact but not CD46 expression, syncytium formation, or extracellular virus production. *J Virol* 74:1908-1918.
6. Makhortova NR, Askovich P, Patterson CE, Gechman LA, Gerard NP, Rall GF. 2007. Neurokinin-1 enables measles virus trans-synaptic spread in neurons. *Virology* 362:235-244.
7. Smith GA, Gross SP, Enquist LW. 2001. Herpesviruses use bidirectional fast-axonal transport to spread in sensory neurons. *Proc Natl Acad Sci U S A* 98:3466-3470.
8. Sherer NM, Lehmann MJ, Jimenez-Soto LF, Horensavitz C, Pypaert M, Mothes W. 2007. Retroviruses can establish filopodial bridges for efficient cell-to-cell transmission. *Nat Cell Biol* 9:310-315.
9. Jin J, Sherer NM, Heidecker G, Derse D, Mothes W. 2009. Assembly of the murine leukemia virus is directed towards sites of cell-cell contact. *PLoS Biol* 7:e1000163.
10. Sherer NM, Jin J, Mothes W. 2010. Directional spread of surface-associated retroviruses regulated by differential virus-cell interactions. *J Virol* 84:3248-3258.
11. El Najjar F, Cifuentes-Muñoz N, Chen J, Zhu H, Buchholz UJ, Moncman CL, Dutch RE. 2016. Human metapneumovirus Induces Reorganization of the Actin Cytoskeleton for Direct Cell-to-Cell Spread. *PLoS Pathog* 12:e1005922.
12. Xiao F, Fofana I, Heydmann L, Barth H, Soulier E, Habersetzer F, Doffoël M, Bukh J, Patel AH, Zeisel MB. 2014. Hepatitis C virus cell-cell transmission and resistance to direct-acting antiviral agents. *PLoS Pathog* 10:e1004128.
13. Iwami S, Takeuchi JS, Nakaoka S, Mammano F, Clavel F, Inaba H, Kobayashi T, Misawa N, Aihara K, Koyanagi Y. 2015. Cell-to-cell infection by HIV contributes over half of virus infection. *Elife* 4:e08150.

14. Zhong P, Agosto LM, Ilinskaya A, Dorjbal B, Truong R, Derse D, Uchil PD, Heidecker G, Mothes W. 2013. Cell-to-cell transmission can overcome multiple donor and target cell barriers imposed on cell-free HIV. *PloS one* 8:e53138.
15. Mayo M. 2002. A summary of taxonomic changes recently approved by ICTV. *Arch Virol* 147:1655-1656.
16. Mehedi M, McCarty T, Martin SE, Le Nouën C, Buehler E, Chen Y-C, Smelkinson M, Ganesan S, Fischer ER, Brock LG. 2016. Actin-Related Protein 2 (ARP2) and Virus-Induced Filopodia Facilitate Human Respiratory Syncytial Virus Spread. *PLoS Pathog* 12:e1006062.
17. Roberts KL, Manicassamy B, Lamb RA. 2015. Influenza A virus uses intercellular connections to spread to neighboring cells. *J Virol* 89:1537-1549.
18. Crennell S, Takimoto T, Portner A, Taylor G. 2000. Crystal structure of the multifunctional paramyxovirus hemagglutinin-neuraminidase. *Nat Struct Mol Biol* 7:1068-1074.
19. Yuan P, Swanson KA, Leser GP, Paterson RG, Lamb RA, Jardetzky TS. 2011. Structure of the Newcastle disease virus hemagglutinin-neuraminidase (HN) ectodomain reveals a four-helix bundle stalk. *Proc Natl Acad Sci U S A* 108:14920-14925.
20. Yuan P, Paterson RG, Leser GP, Lamb RA, Jardetzky TS. 2012. Structure of the ulster strain newcastle disease virus hemagglutinin-neuraminidase reveals auto-inhibitory interactions associated with low virulence. *PLoS Pathog* 8:e1002855.
21. Swanson K, Wen X, Leser GP, Paterson RG, Lamb RA, Jardetzky TS. 2010. Structure of the Newcastle disease virus F protein in the post-fusion conformation. *Virology* 402:372-379.
22. Yin H-S, Wen X, Paterson RG, Lamb RA, Jardetzky TS. 2006. Structure of the parainfluenza virus 5 F protein in its metastable, prefusion conformation. *Nature* 439:38-44.
23. McGinnes LW, Gravel K, Morrison TG. 2002. Newcastle disease virus HN protein alters the conformation of the F protein at cell surfaces. *J Virol* 76:12622-12633.
24. Porotto M, Salah Z, DeVito I, Talekar A, Palmer SG, Xu R, Wilson IA, Moscona A. 2012. The second receptor binding site of the globular head of the Newcastle disease virus hemagglutinin-neuraminidase activates the stalk of multiple paramyxovirus receptor binding proteins to trigger fusion. *J Virol* 86:5730-5741.
25. Takimoto T, Portner A. 2004. Molecular mechanism of paramyxovirus budding. *Virus Res* 106:133-145.
26. Meng C, Qiu X, Yu S, Li C, Sun Y, Chen Z, Liu K, Zhang X, Tan L, Song C. 2016. Evolution of Newcastle disease virus quasispecies diversity and enhanced virulence after passage through chicken air sacs. *J Virol* 90:2052-2063.
27. Glickman RL, Syddall RJ, Iorio RM, Sheehan JP, Bratt MA. 1988. Quantitative basic residue requirements in the cleavage-activation site of the fusion glycoprotein as a determinant of virulence for Newcastle disease virus. *J Virol* 62:354-356.
28. Peeters BP, de Leeuw OS, Koch G, Gielkens AL. 1999. Rescue of Newcastle disease virus from cloned cDNA: evidence that cleavability of the fusion protein is a major determinant for virulence. *J Virol* 73:5001-5009.
29. Panda A, Huang Z, Elankumaran S, Rockemann DD, Samal SK. 2004. Role of fusion protein cleavage site in the virulence of Newcastle disease virus. *Microbial pathogenesis* 36:1-10.



30. Welch BD, Liu Y, Kors CA, Leser GP, Jardetzky TS, Lamb RA. 2012. Structure of the cleavage-activated prefusion form of the parainfluenza virus 5 fusion protein. *Proc Natl Acad Sci U S A* 109:16672-16677.
31. Morrison TG, McGinnes LW. 1989. Avian cells expressing the Newcastle disease virus hemagglutinin-neuraminidase protein are resistant to Newcastle disease virus infection. *Virology* 171:10-17.
32. Bousse TL, Taylor G, Krishnamurthy S, Portner A, Samal SK, Takimoto T. 2004. Biological significance of the second receptor binding site of Newcastle disease virus hemagglutinin-neuraminidase protein. *J Virol* 78:13351-13355.
33. Baumann CA, Neubert WJ. 2010. Neuraminidase-deficient Sendai virus HN mutants provide protection from homologous superinfection. *Arch Virol* 155:217-227.
34. Sato M, Urade M, Yoshida H, Maeda N, Yura Y, Shirasuna K, Miyazaki T. 1978. Evidence for phenotypic mixing between Newcastle disease virus (NDV) and a latent virus of BHK21/WI-2 cells in the early passaged BHK21/WI-2 cells persistently infected with NDV. *Arch Virol* 56:157-162.
35. Cumiskey J, Hallum J, Skinner M, Leslie G. 1973. Persistent Newcastle disease virus infection in embryonic chicken tracheal organ cultures. *Infect Immun* 8:657-664.
36. Preble OT, Youngner JS. 1973. Selection of temperature-sensitive mutants during persistent infection: role in maintenance of persistent Newcastle disease virus infections of L cells. *J Virol* 12:481-491.
37. Chia S-L, Yusoff K, Shafee N. 2014. Viral persistence in colorectal cancer cells infected by Newcastle disease virus. *Virol J* 11:91.
38. Maminiaina OF, Gil P, Briand F-X, Albina E, Keita D, Andriamanivo HR, Chevalier V, Lancelot R, Martinez D, Rakotondraivo R. 2010. Newcastle disease virus in Madagascar: identification of an original genotype possibly deriving from a died out ancestor of genotype IV. *PLoS One* 5:e13987.
39. Liu H, Albina E, Gil P, Minet C, de Almeida RS. 2017. Two-plasmid system to increase the rescue efficiency of paramyxoviruses by reverse genetics: The example of rescuing Newcastle Disease Virus. *Virology* 509:42-51.
40. Vallat B, Allen G. 2004. *Manual of diagnostic tests and vaccines for terrestrial animals (mammals, birds and bees)*. Paris: Office International Des Epizooties.
41. Reed LJ, Muench H. 1938. A simple method of estimating fifty per cent endpoints. *Am J Epidemiol* 27:493-497.
42. Schneider CA, Rasband WS, Eliceiri KW. 2012. NIH Image to ImageJ: 25 years of image analysis. *Nat Methods* 9:671.
43. Dortmans JC, Koch G, Rottier PJ, Peeters BP. 2011. Virulence of Newcastle disease virus: what is known so far? *Vet Res* 42:122.
44. Li Z, Sergel T, Razvi E, Morrison T. 1998. Effect of cleavage mutants on syncytium formation directed by the wild-type fusion protein of Newcastle disease virus. *J Virol* 72:3789-3795.
45. Liu WJ, Wang XJ, Clark DC, Lobigs M, Hall RA, Khromykh AA. 2006. A single amino acid substitution in the West Nile virus nonstructural protein NS2A disables its ability to inhibit alpha/beta interferon induction and attenuates virus virulence in mice. *J Virol* 80:2396-2404.
46. Otsuki K, Yamamoto H, Tsubokura M. 1979. Studies on avian infectious bronchitis virus (IBV). *Arch*



- Virology 60:25-32.
47. Ellenberg P, Linero FN, Scolaro LA. 2007. Superinfection exclusion in BHK-21 cells persistently infected with Junin virus. *J Gen Virol* 88:2730-2739.
  48. Inoue M, Tokusumi Y, Ban H, Kanaya T, Shirakura M, Tokusumi T, Hirata T, Nagai Y, Iida A, Hasegawa M. 2003. A new Sendai virus vector deficient in the matrix gene does not form virus particles and shows extensive cell-to-cell spreading. *J Virol* 77:6419-6429.
  49. Cathomen T, Mrkic B, Spehner D, Drillien R, Naef R, Pavlovic J, Aguzzi A, Billeter MA, Cattaneo R. 1998. A matrix - less measles virus is infectious and elicits extensive cell fusion: consequences for propagation in the brain. *EMBO J* 17:3899-3908.
  50. Dietzel E, Kolesnikova L, Sawatsky B, Heiner A, Weis M, Kobinger GP, Becker S, Von Messling V, Maisner A. 2016. Nipah virus matrix protein influences fusogenicity and is essential for particle infectivity and stability. *J Virol* 90:2514-2522.
  51. Ludlow M, McQuaid S, Cosby SL, Cattaneo R, Rima BK, Duprex WP. 2005. Measles virus superinfection immunity and receptor redistribution in persistently infected NT2 cells. *J Gen Virol* 86:2291-2303.
  52. D'Aiutolo AC, Coto CE. 1986. Vero cells persistently infected with Tacaribe virus: role of interfering particles in the establishment of the infection. *Virus Res* 6:235-244.
  53. Ellenberg P, Edreira M, Scolaro L. 2004. Resistance to superinfection of Vero cells persistently infected with Junin virus. *Arch Virol* 149:507-522.
  54. Yoon SW, Lee S-Y, Won S-Y, Park S-H, Park S-Y, Jeong YS. 2006. Characterization of homologous defective interfering RNA during persistent infection of Vero cells with Japanese encephalitis virus. *Mol Cells* 21.
  55. Sarmiento RE, Tirado Ro, Gómez Bz. 2002. Characteristics of a respiratory syncytial virus persistently infected macrophage-like culture. *Virus Res* 84:45-58.
  56. Park SY, Choi E, Jeong YS. 2013. Integrative effect of defective interfering RNA accumulation and helper virus attenuation is responsible for the persistent infection of Japanese encephalitis virus in BHK - 21 cells. *J Med Virol* 85:1990-2000.
  57. Zheng Y, Stamminger T, Hearing P. 2016. E2F/Rb family proteins mediate interferon induced repression of adenovirus immediate early transcription to promote persistent viral infection. *PLoS Pathog* 12:e1005415.
  58. Susta L, He Y, Hutcheson JM, Lu Y, West FD, Stice SL, Yu P, Abdo Z, Afonso CL. 2016. Derivation of chicken induced pluripotent stem cells tolerant to Newcastle disease virus-induced lysis through multiple rounds of infection. *Virology* 533:205.
  59. Borducchi EN, Cabral C, Stephenson KE, Liu J, Abbink P, Nkolola JP, Brinkman AL, Peter L, Lee BC, Jimenez J. 2016. Ad26/MVA therapeutic vaccination with TLR7 stimulation in SIV-infected rhesus monkeys. *Nature* 540:284-287.
  60. Fletcher CV, Staskus K, Wietgreffe SW, Rothenberger M, Reilly C, Chipman JG, Beilman GJ, Khoruts A, Thorkelson A, Schmidt TE. 2014. Persistent HIV-1 replication is associated with lower antiretroviral drug concentrations in lymphatic tissues. *Proc Natl Acad Sci U S A* 111:2307-2312.
  61. Lorenzo-Redondo R, Fryer HR, Bedford T, Kim E-Y, Archer J, Pond SLK, Chung Y-S, Penugonda S,

- Chipman JG, Fletcher CV. 2016. Persistent HIV-1 replication maintains the tissue reservoir during therapy. *Nature* 530:51-56.
62. Lin W-HW, Kouyos RD, Adams RJ, Grenfell BT, Griffin DE. 2012. Prolonged persistence of measles virus RNA is characteristic of primary infection dynamics. *Proc Natl Acad Sci U S A* 109:14989-14994.
  63. Strong JE, Wong G, Jones SE, Grolla A, Theriault S, Kobinger GP, Feldmann H. 2008. Stimulation of Ebola virus production from persistent infection through activation of the Ras/MAPK pathway. *Proc Natl Acad Sci U S A* 105:17982-17987.
  64. Bose S, Song AS, Jardetzky TS, Lamb RA. 2014. Fusion activation through attachment protein stalk domains indicates a conserved core mechanism of paramyxovirus entry into cells. *J Virol* 88:3925-3941.
  65. Takimoto T, Taylor GL, Connaris HC, Crennell SJ, Portner A. 2002. Role of the hemagglutinin-neuraminidase protein in the mechanism of paramyxovirus-cell membrane fusion. *J Virol* 76:13028-13033.
  66. Connaris H, Takimoto T, Russell R, Crennell S, Moustafa I, Portner A, Taylor G. 2002. Probing the sialic acid binding site of the hemagglutinin-neuraminidase of Newcastle disease virus: identification of key amino acids involved in cell binding, catalysis, and fusion. *J Virol* 76:1816-1824.
  67. Tan L, Zhang Y, Zhan Y, Yuan Y, Sun Y, Qiu X, Meng C, Song C, Liao Y, Ding C. 2016. Newcastle disease virus employs macropinocytosis and Rab5a-dependent intracellular trafficking to infect DF-1 cells. *Oncotarget*.
  68. Simon-Loriere E, Holmes EC. 2011. Why do RNA viruses recombine? *Nat Rev Microbiol* 9:617-626.
  69. Marshall N, Priyamvada L, Ende Z, Steel J, Lowen AC. 2013. Influenza virus reassortment occurs with high frequency in the absence of segment mismatch. *PLoS Pathog* 9:e1003421.
  70. Li J, Hu H, Yu Q, Diel DG, Li D-s, Miller PJ. 2012. Generation and characterization of a recombinant Newcastle disease virus expressing the red fluorescent protein for use in co-infection studies. *Virol J* 9:227.
  71. Huang I-C, Li W, Sui J, Marasco W, Choe H, Farzan M. 2008. Influenza A virus neuraminidase limits viral superinfection. *J Virol* 82:4834-4843.
  72. Qin Z, Sun L, Ma B, Cui Z, Zhu Y, Kitamura Y, Liu W. 2008. F gene recombination between genotype II and VII Newcastle disease virus. *Virus Res* 131:299-303.
  73. Chong YL, Padhi A, Hudson PJ, Poss M. 2010. The effect of vaccination on the evolution and population dynamics of avian paramyxovirus-1. *PLoS Pathog* 6:e1000872.
  74. Bergua M, Zwart MP, El-Mohtar C, Shilts T, Elena SF, Folimonova SY. 2014. A viral protein mediates superinfection exclusion at the whole-organism level but is not required for exclusion at the cellular level. *J Virol* 88:11327-11338.
  75. Atallah OO, Kang S-H, El-Mohtar CA, Shilts T, Bergua M, Folimonova SY. 2016. A 5'-proximal region of the Citrus tristeza virus genome encoding two leader proteases is involved in virus superinfection exclusion. *Virology* 489:108-115.
  76. Beperet I, Irons SL, Simón O, King LA, Williams T, Possee RD, López-Ferber M, Caballero P. 2014. Superinfection exclusion in alphabaculovirus infections is concomitant with actin reorganization. *J Virol* 88:3548-3556.

77. Gaudin R, Kirchhausen T. 2014. Superinfection exclusion is absent during acute Junin virus infection of Vero and A549 cells. *Sci Rep* 5:15990-15990.
78. Vijaykrishna D, Poon L, Zhu H, Ma S, Li O, Cheung C, Smith G, Peiris J, Guan Y. 2010. Reassortment of pandemic H1N1/2009 influenza A virus in swine. *Science* 328:1529-1529.
79. Holmes EC, Ghedin E, Miller N, Taylor J, Bao Y, St George K, Grenfell BT, Salzberg SL, Fraser CM, Lipman DJ. 2005. Whole-genome analysis of human influenza A virus reveals multiple persistent lineages and reassortment among recent H3N2 viruses. *PLoS Biol* 3:e300.
80. Nelson MI, Viboud C, Simonsen L, Bennett RT, Griesemer SB, George KS, Taylor J, Spiro DJ, Sengamalay NA, Ghedin E. 2008. Multiple reassortment events in the evolutionary history of H1N1 influenza A virus since 1918. *PLoS Pathog* 4:e1000012.
81. Li C, Hatta M, Nidom CA, Muramoto Y, Watanabe S, Neumann G, Kawaoka Y. 2010. Reassortment between avian H5N1 and human H3N2 influenza viruses creates hybrid viruses with substantial virulence. *Proc Natl Acad Sci U S A* 107:4687-4692.
82. Cui L, Liu D, Shi W, Pan J, Qi X, Li X, Guo X, Zhou M, Li W, Li J. 2014. Dynamic reassortments and genetic heterogeneity of the human-infecting influenza A (H7N9) virus. *Nat Commun* 5.
83. Han G-Z, He C-Q, Ding N-Z, Ma L-Y. 2008. Identification of a natural multi-recombinant of Newcastle disease virus. *Virology* 371:54-60.
84. Lam TT-Y, Wang J, Shen Y, Zhou B, Duan L, Cheung C-L, Ma C, Lycett SJ, Leung CY-H, Chen X. 2013. The genesis and source of the H7N9 influenza viruses causing human infections in China. *Nature* 502:241-244.
85. Satharasinghe, D.A., Murulitharan, K., Tan, S.W., Yeap, S.K., Munir, M., Ideris, A., Omar, A.R., 2016. Detection of inter-lineage natural recombination in avian paramyxovirus serotype 1 using simplified deep sequencing platform. *Front Microbiol* 7.
86. Song, Q., Cao, Y., Li, Q., Gu, M., Zhong, L., Hu, S., Wan, H., Liu, X., 2011. Artificial recombination may influence the evolutionary analysis of Newcastle disease virus. *J Virol* 85: 10409-10414.

## **Chapter 4**

### **Generation of a Recombinant Attenuated Vaccine to Protect Chickens from Newcastle Disease and Block Viral Shedding**

## **Abstract**

Newcastle disease (ND) is a high threat for the poultry industry. Live vaccines are widely used to prevent this disease all over the world. They were originally derived from lentogenic Newcastle disease virus (NDV) strains isolated 70 years ago. Since then, the viral evolution has resulted in extended genetic distance between recent NDV isolates and vaccine strains, especially on the fusion (F) and hemagglutinin-neuraminidase (HN) genes that are encoding the protective antigens. There are a number of published data showing that the immunoprotection conferred by the current commercial ND living vaccines provides protection against disease but cannot prevent viral shedding when immunized chickens are challenged by a recent virulent genotype strain. To deal with this issue, some new vaccines homologous to recent genotypes have been generated, but those vaccines have been showed to prevent viral shedding only for the same genotype. Our group has described in 2008 the recent virulent genotype XI responsible for ND outbreaks in Madagascar. In spite of the established virulence of the genotype XI, it was recovered both from cloacal and tracheal swabs from an unvaccinated and apparently healthy chicken suggesting genotype XI strains can escape the immune responses conferred by current commercial vaccines. Our group in collaboration with ANSES Ploufragan has previously performed an experimental trial in poultry where the animals were vaccinated using a vaccine strain of the genotype II and challenged with a genotype XI strain. This trial enabled us to confirm that the current vaccine clinically protected the animals, but that failed to control the replication and re-excretion of the Malagasy virus. Consequently, in this study, we hypothesized that a recombinant virus wisely mixing genes from ancient and recent strains could provide larger protection against viral shedding of different genotypes. Therefore, a recombinant lentogenic NDV strain, rLaSota/M-Fmu-HN, was constructed using reverse genetics strategy, based on a backbone of the worldwide used LaSota vaccine strain (genotype II) containing the F and HN genes of a strain belonging to genotype XI (MG-725 strain). Animal experiments showed that this recombinant strain not only protected chickens from ND caused by virulent strains pertaining to genotypes II, VII and XI, but also blocked shedding of these viruses.

## **Introduction**

Newcastle disease (ND) is one the most fatal diseases of birds, representing a high threat for the poultry industry owing to its sanitary and economic impacts around the world (1, 2). The causative agent is a virulent Newcastle disease virus (NDV), an enveloped virus that belongs

to the *Avulavirus* genus, *Paramyxoviridae* family (3). The genome of NDV is a 15 kilobases (Kb) negative-sense single-strand RNA molecule structured as 3'-Leader-NP-P-M-F-HN-L-Trailer-5' (4-6). This genome encodes six structural proteins, nucleocapsid (NP), phosphoprotein (P), matrix (M), fusion (F), hemagglutinin-neuraminidase (HN), large protein (L) and two nonstructural proteins, V and W protein, from P gene editing (7, 8). HN protein recognizes sialic acids as receptors to activate F protein for fusion of cell plasma and viral membranes (9, 10). After fusion, the viral ribonucleotide polymerase complex (RNP), made of the genome encapsidated in NP and associated to a RNA-dependent RNA polymerase (RdRP) which are polymers of P and L proteins (7), is released into the cell cytoplasm. The RNP generates progeny viral RNA and proteins that are assembled under the guidance of M protein to produce new viral particles via budding (11-13).

Since F and HN are transmembrane glycoproteins exposed to the immune system, both proteins induce neutralizing antibody responses and are consequently protective antigens (14, 15). F or HN proteins from NDV expressed by other virus vectors have been shown to protect chickens from virulent NDV infection (16-19). Live attenuated vaccines are frequently utilized in commercial flocks and backyard birds to prevent ND because of the strong immunity induced and easy delivery operation (20). The current commercial vaccines derived from strains, such as V4 and LaSota, isolated 70 years ago and belonging to genotype I or II (old genotypes). However, recent ND outbreaks are due to strains from genotypes V-VII, XI-XIV and XVI-XVIII (new genotypes) (21). Nucleotide identity between the ancient vaccine strains and recent isolates are only around 80% on the F gene (21). So far, this genetic variation has not questioned the clinical protection conferred by the vaccines, probably because still, there is only one single serotype based on in vitro neutralizing tests and in vivo cross-protective trials (22). However, different levels of cross-protection have been observed in chickens vaccinated with current vaccines and challenged with different wild-type strains (39). This could result in partial vaccination coverage and the possibility for duly vaccinated poultry to become infected and healthy shedder (23-27). Moreover, virulent strains circulating among seemingly healthy backyard chickens have been reported. (A persisting worldwide problem. 2016. International Poultry Production: [www.positiveaction.info/digital/Supplements/NewcastleDisease/](http://www.positiveaction.info/digital/Supplements/NewcastleDisease/)). This scenario can potentially contribute to the emergence of highly pathogenic variant strains out of vaccine control.

To deal with this issue, some candidates of live ND vaccine have been generated from strains of genotype V or VII (20, 23, 24, 26). These candidate vaccines not only prevent immunized chickens from ND, but also stopped viral shedding after a challenge with the homologous strain or a genotype II virulent strain. However, it is not clear whether the vaccine produced from new genotypes strains can also prevent virus excretion from current heterologous virulent strains.

Previously, our group has confirmed, in an experimental trial of protection, that chickens vaccinated with vaccines based on genotype II strains widely used in the field and challenged with a virulent genotype XI strain (MG-725) have excreted the virus challenge by ocular and tracheal routes. These animals were vaccinated by oculonasal and intramuscular routes with two commercial vaccines based on genotype II strains. Three weeks later, the animals were challenged using either an old virulent strain of genotype IV (Herts/33) or the MG-725 strain of genotype XI. No animals developed clinical signs related with ND regardless of the vaccine strain used. Moreover, no viral excretion was observed after challenge with the Herts/33 strain. On the other hand, the genotype XI strain was excreted during several days by the vaccinated animals while they present no symptomatology (Fig. 5.1).

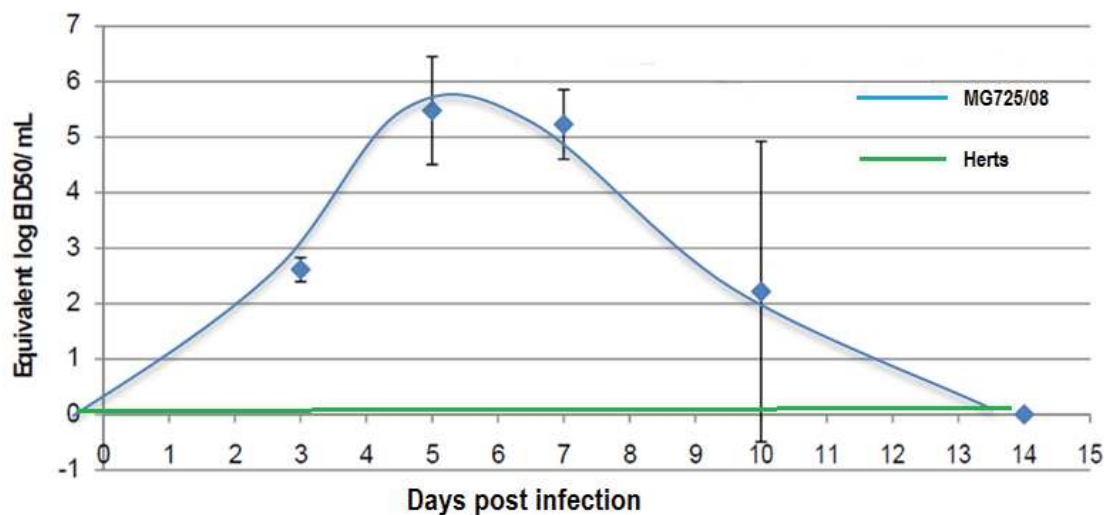

**Fig. 5.1.** Experimental protection essay realized previously to that study. The graph show the virus challenge excretion by vaccinated animals in cloacal swabs tested using qRT-PCR.

MG-725 strain was selected to generate a live vaccine candidate in this study. This strain was isolated from poultry in Madagascar, in 2008 and classified into genotype XI (28). To date, this genotype is unique because it has an original F1/F2 cleavage site motif formed by five basic amino acid (R)  $^{112}\text{R-R-R-R-R}^{116}$  which is consistent with character of NDV velogenic



strain (29, 30). Moreover, based on *in silico* analyses of F and HN protein structures, viruses from genotype XI have amino acid motifs shared by ancient and recent genotypes and also some unique mutations on the surface of the F and HN head (28, 31). Some of these mutations are supposed to play a role in the interaction with NDV neutralizing antibodies, potentially involved in the protection against viral shedding (data not shown).

In order to address the issues related to the protection given by current NDV vaccines as explained before, a new attenuated vaccine against virulent strains circulating worldwide has been generated by reverse genetics. This recombinant vaccine is based on the worldwide used LaSota strain in which the F and HN genes have been replaced by those of MG-725 strain. In order to modify the virulence, the F cleavage site was mutated in lentogenic motif (RRRRRF to GRQGRL). This vaccine candidate was tested in comparison to the parental LaSota strain in a vaccine/challenge experiment in chickens involving different ND genotypes.

## **Materials and Method**

### **1. Cells and virus**

Baby hamster kidney cells (BHK-21) were cultured in Eagle's minimum essential medium (Gibco) with 10% fetal bovine serum (PAN-Biotech) at 37 °C, 5% CO<sub>2</sub>. Chemically competent cells, *E.coli* 10-beta, were purchased from New England Biolabs (NEB). The rMG-725 strain was produced by reverse genetics based on the full genome of the NDV/chicken/Madagascar/2008 strain (MG-725), a virulent strain isolate from Madagascar and belonging to genotype XI (32). The virulent NDV/EG/CK/104/12 strain belonging to genotype VII was kindly provided by Patti J. Miller from Southeast Poultry Research Laboratory, United States. The GB Texas strain, kindly provided by Bénédicte Lambrecht from CODA-CERVA, Belgium, is a virulent strain of genotype II. The rLaSota strain was rescued based on the full genome of the LaSota strain. All of these viruses were grown in 10 day-old specific pathogen free (SPF) chicken embryos (Couvoir de Cerveloup, France). After three days of infection or egg death, allantoic liquid was harvested, filtered through 0.22 µm and stored at -80 °C.

### **2. Construction of rLaSota/M-Fmu-HN strain.**

For the cloning strategy, the Fmu gene (cleavage site of MG-725 strain's F gene was mutated to the LaSota (32)) was first amplified from pMG-725/Fmu plasmid by M-F-change-F (5'-TCCCCGCGGGCAAGATGGGCTCTAAATCTTCTAC-3') and M-F-change-R (5'-

ACCGGCCGGCCTCATCTGTGTTTCATATTCTTGTGGTGGCTC-‘3) primers. After, the F gene of pLaSota plasmid was replaced by Fmu gene using SacII and FseI restriction enzymes to obtain pLaSota/M-Fmu plasmid. The HN gene of MG-725 strain was amplified from pMG-715/Fmu plasmid using M-HN-change-F (5'- ACCGACAACAGTCCTCAATCATGG ACCATGTAGTTAGCAG-‘3) and M-HN-change-R (5'-CCTTAATTAATCAAGTCCTGCCATCCTTGAGAATCTCCACT-‘3) primers. The non-coding region between F and HN genes of LaSota strain was generated by M-HN-change-L-F (5'-GCACATCTGCTCTCATTACCT-‘3) and M-HN-change-L-R (5'-GATTGAGGAC TGTTGTCGGT-‘3) primers. The two fragments were then assembled by over-lap PCR and inserted in the place of the corresponding region in pLaSota/M-Fmu by FseI and PacI enzymes to finally get the pLaSota/M-Fmu-HN plasmid. Fragments bearing NP, P and L gene of LaSota strain were generated from wild LaSota strain by RT-PCR using LaSo-NP-F (5'- CCGCTCGAGATGTCTTCCGTATTTGATGAGTA-‘3) and LaSo-NP-R(5'- ATTTGCGGCCGCTCAATACCCCAAGTCG-‘3), LaSo-P-F (5'- CCGCTCGAGATGGCCACCTTTAC AGATGC-‘3) and LaSo-P-R(5'- ATTTGCGGCCGCTTAGCCATTTAGAGCAAG-‘3), and LaSo-L-F (5'- GGA TAGTATGGCGAGCTCCGGTCCTG-‘3) and LaSo-L-R (5'- ATTTGCGGCCGCTTAAGAGTCACAGTTACTG-‘3) primers, respectively. The NP and P genes were inserted into pCI-neo plasmid between XhoII and NotI sites to obtain pLaSo-NP and pLaSo-P, while the L gene was cloned in this vector by SpeI and NotI enzymes to generate pLaSo-L. All these plasmids were purified by EndoFree plasmid Maxi kit (QIAGEN), aliquoted, stored at -20 °C and sequenced.

### 3. Recovery of rLaSota/M-Fmu-HN strain.

Recombinant rLaSota/M-Fmu-HN strain was generated by reverse genetics as previously described (32). Briefly,  $4 \times 10^5$  BHK-21 cells were grown overnight in 6-well plates. Supernatants were discarded and cells were washed twice with Opti-MEM (Gibco). Then, 5 µg of pLaSota/M-Fmu-HN, 2 µg of pLaSo-NP, 2 µg of pLaSo-P and 1 µg of pLaSo-L were cotransfected with 20 µL Lipofectamine 2000 (Invitrogen). After 6 h, the transfection mixture was replaced by MEM medium with 10% FBS. Three days after transfection, the cells with 200 µL supernatants were collected and injected into 10-day-old SFP embryonated chicken eggs to amplify the rescued virus. The allantoic liquid was harvested at 3 days post-infection and tested for the virus presence by the hemagglutination test (HA). Viral RNA were extracted from HA positive samples and digested with TURBO DNase enzyme (Ambion) to prevent DNA contamination followed by confirmation with qRT-PCR based on F gene (32).

Finally, the recovered virus was passaged once again in SPF embryonated eggs, aliquoted and stored at -80 °C.

#### 4. Growth ability and pathogenicity index tests

The growth characteristics of rLaSota and rLaSota/M-Fmu-HN strain were checked on embryonated chicken eggs. One hundred 50% egg infective doses (EID<sub>50</sub>) of both strains were injected into allantoic cavity of 10-day-old SPF eggs and incubated at 37 °C. Three days after injection, allantoic liquids were harvested and viruses titrated by the EID<sub>50</sub> method. To test pathogenicity of strains, the mean death time index (MDT) in 9-day-old embryonated SPF chicken eggs and the intracerebral pathogenicity index (ICPI) in 1-day-old SPF chickens were used. To determine MDT, 10-fold serial dilutions of the infective allantoic liquid were prepared in sterile phosphate-buffered saline (PBS). One hundred microliters of 10<sup>-6</sup> to 10<sup>-12</sup> diluted liquids were injected into allantoic cavity of eggs, five eggs per each dilution. The eggs were observed daily, in the morning and afternoon, for six days and the times (in hour) of egg deaths were recorded. MDT is defined as the mean time to achieve 100% of egg death at the highest dilution of the allantoic fluid. The ICPI was tested by the standard procedure. Briefly, Fresh infective allantoic fluids with HA titres >2<sup>4</sup> were diluted 1/10 in sterile isotonic saline without antibiotics and used as inoculum. Fifty µl of the diluted virus was injected intracerebrally into each one-day-old SPF chick, 10 chicks per strain, using a 30-gauge needle attached to a 1 ml syringe. The inoculum was injected into the left rear quadrant of the cranium. The birds were examined daily for 8 days. At each observation, the birds were scored: 0 if normal, 1 if sick, and 2 if dead (Birds that were alive but unable to eat or drink were killed humanely and scored as dead at the next observation. Dead individuals were scored as 2 at each of the remaining daily observations after death.). The ICPI is the mean score of 10 chicks over 8 days.

#### 5. Immunization and challenge

Two groups of 39 SPF chickens of 2-weeks of age were vaccinated by rLaSota and rLaSota/M-Fmu-HN strains, respectively. Each chicken was vaccinated with 10<sup>6</sup> EID<sub>50</sub> (50% egg infective dose) of the corresponding vaccine strain through the intranasal and eye routes. Vaccine strains were diluted in PBS. Chickens from another group received 100 µL sterile PBS without virus through the same route and were used as control group. Oral and Cloacal swabs were collected from all chickens in 1ml of PBS with antibiotics at 3, 5 and 7 days after vaccination to measure the vaccine virus shedding. Blood were collected from all chicken

three weeks after immunization, to study the serum NDV antibody response. Then, the two vaccinated groups were randomly split into three subgroups (n=13 per subgroup) and challenges. Virulent challenges occurred three weeks post vaccination and each chicken received  $10^5$  ELD<sub>50</sub> (50% egg lethal dose) of either virulent genotype II strain (GB Texas), virulent genotype VII strain (EG/CK/104/12), or virulent genotype XI (rMG-725) though the intramuscular route. Three chickens of each subgroup were sacrificed 3 days post-challenge and tissues, including brain, lung, trachea, nasal turbinate, spleen, and small intestine, were collected to measure challenge virus replication in the organs. The tissue samples were homogenized in cell culture medium (1 g/10 ml) and clarified by centrifugation. The oral and cloacal swabs were collected from all surviving chickens 3, 5, 7 and 10 days post-challenge for the evaluation of challenge viral shedding. Chickens clinical signs and mortality were recorded daily for 10 days. At each observation, the birds were scored: 0 if normal, 1 if sick, and 2 if dead. Birds that were alive but unable to eat or drink were killed humanely and scored as dead at the next observation. Dead individuals were scored as 2 at each of the remaining daily observations after death. All surviving birds were euthanized at 10 days post-infection.

All experimental challenges were performed according to the European Directive 2010/63/UE on the protection of animals used for scientific purposes and approved by the Ethical committee of Animal Experimentation (CEEA) of the Institution (IRTA).

#### 6. Serological analysis.

Serum antibodies were analyzed by enzyme-linked immunosorbent assay (ELISA) and Hemagglutination Inhibition assay (HI) assays. For ELISA assay, the commercial kit ID Screen Newcastle Disease Indirect Conventional Vaccines kit from ID-Vet was used on serial 2-fold dilutions of the serum to determine the antibody titers. To test antibodies by HI, five viruses were utilized. Briefly, 2-fold serial dilutions of the serum (25  $\mu$ L) were mixed with 4 HA units of rLaSota, rLaSota/M-Fmu-HN, GB Texas, EG/CK/104/12 or rMG-725 (25  $\mu$ L). After 1h, 25  $\mu$ L of 1% chicken red blood cells (RBC) were added. The mixture was then incubated at room temperature for 30 min and hemagglutination was recorded.

#### 7. Virological analysis

Two methods, qRT-PCR and egg incubation, were used to check virus shedding from swabs or virus replication in tissues. Briefly, total RNA using Biomek robot was extracted from swabs and tissues by NucleoSpin RNA virus core kit (MACHEREY-NAGEL). Viral RNA was quantified by qRT-PCR based on the F gene detection with primers F259

(5'-ACAYTGACYACTTTGCTCA-3') and F488 (5'-TGCACAGCYTCATTGGTTGC-3') according to Brilliant III Ultra-Fast SYBR Green QRT-PCR Master mix kit (Agilent). Then 200 µl of the cloacal and tracheal swabs and tissue homogenization were inoculated into SPF embryonated eggs. Five days later, samples, showing hemagglutination of allantoic fluids, were considered as virus positives (33).

## Results

### 1. Recovery of rLaSota/M-Fmu-HN strain by reverse genetics.

In order to replace F and HN genes in the LaSota strain, the virus genome was modified to introduce three restriction enzyme sites, SacII, FseI and PacI, before F, between F and HN and behind HN genes, respectively (Fig. 5.2).

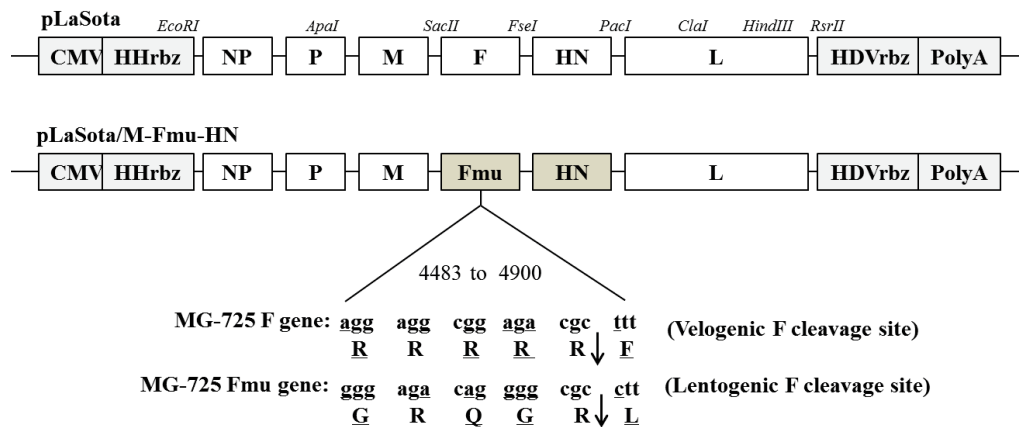

**Fig. 5.2.** Construction of pLaSota/M-Fmu-HN plasmid. The pLaSota/M-Fmu-HN was generated from pLaSota plasmid which contained the full-genome of LaSota. Three unique restriction enzymes sites (SacII, FseI and PacI) were introduced into the LaSota genome for further manipulations of F and HN genes. The cleavage site of the F protein of the MG-725 strain was first modified from “RRRRRF” to “GRQGRL” by overlap PCR as described (32). The modified nucleotides or amino acids are underlined and the modified F gene was thereafter named Fmu. Then, the F gene of LaSota was replaced by the one of MG-725 strains with the modified cleavage site Fmu, using SacII and FseI enzymes. Immediately after, the HN gene from LaSota was replaced by the one of MG-725 strain using FseI and PacI enzymes.

All these modifications were done in non-coding region of F and HN gene. The cleavage site of MG-725 strain’s F gene was mutated to that of LaSota by overlap PCR and named as Fmu gene (Fig. 5.2). The MG-725 Fmu and HN genes were replaced in pLaSota (In house) plasmid to get pLaSota/M-Fmu-HN. With the helper plasmids containing the NP, P, and L genes from LaSota strain, the rLaSota/M-Fmu-HN strain was rescued on BHK-21 cells according to a method developed in our laboratory (32). The rescued strain was amplified once in 10-days old SPF chicken embryos and virus genome sequenced.

## 2. Properties of rescued NDV strains.

The growth ability of rescued strains was verified on eggs. The F and HN genes replacement did not affect the viral growth. The titers of rLaSota and rLaSota/M-Fmu-HN, after three days of amplification, were up to  $3.16 \times 10^9$  and  $3.98 \times 10^9$  EID<sub>50</sub>/ml, respectively. These titers were around 2 Log<sub>10</sub> less than the rescued virulent rMG-725 strain (Table 5.1), supporting the attenuation of the rLaSota/M-Fmu-HN strain.

The virulence of rLaSota, rLaSota/M-Fmu-HN and rMG-725 was then confirmed by MDT in chicken embryos. The MDT values of these rescued strains were 96 h, 113 h and 49 h, respectively. In addition, the pathogenicity of these viruses was also checked by ICPI in 1-day old chicks. The ICPI values were 0.00 for rLaSota and rLaSota/M-Fmu-HN strains and 1.825 for rMG-725 similar to the wild type MG-725 strains (Table 5.1). Based on the World Organization for Animal Health (OIE) guidelines (34), a NDV strain with MDT value higher than 90 h and ICPI value close to 0.00 is considered as a lentogenic strain, while a strain with MDT value less than 60 h and ICPI approaching 2.00 is considered as a velogenic strain. Consequently, rLaSota and rLaSota/M-Fmu-HN strains were confirmed as avirulent strains whilst rMG-725 is virulent. These results suggest that the replacement of the F and HN genes of LaSota by the Fmu and HN genes of MG-725 strain did not increase the viral virulence of the vaccine strain.

**Table 5.1.** Properties of rescued strains.

	HA	EID <sub>50</sub>	MDT	ICPI
rLaSota	$2^9$	$3.16 \times 10^9$	96 h	0.00
rLaSota/M-Fmu-HN	$2^9$	$3.98 \times 10^9$	113 h	0.00
rMG-725	$2^{10}$	$3.16 \times 10^{11}$	49 h	1.825

## 3. Evaluation of viral replication and immunity response after vaccination.

To test the vaccine virus shedding after immunization, oral and cloacal swabs from chickens vaccinated with rLaSota or rLaSota/M-Fmu-HN strains were collected at 3, 5 and 7 days after vaccination. The presence of viral RNA in swabs was confirmed by qRT-PCR on 21 oral and 21 cloacal swabs randomly selected from 39 of each. In the group vaccinated with rLaSota, the number of positive oral swabs and their viral RNA charge as measured by a reduction of the CT values were higher than in the group vaccinated with rLaSota/M-Fmu-HN at days 3, 5 and 7 post vaccination (Table 5.2). In contrast, the viral shedding in cloacal swabs was limited

for the two groups, with only 1 positive cloacal swab 3 days after vaccination for the group rLaSota. These results suggest that the lentogenic rLaSota/M-Fmu-HN strain is less replicative in vivo than the rLaSota.

**Table 5.2.** Viral shedding of vaccine strains after immunization.

	3 days		5 days		7days	
	Oral	Cloacal	Oral	Cloacal	Oral	Cloacal
rLaSota	18/21 <sup>a</sup>	1/21	11/21	0/21	2/21	0/21
CT values±SD	34.52±1.48	33.99±0	33.8±0.94	-	35.42±0.35	-
rLaSota/M-Fmu-HN	3/20	0/20	9/20	0/20	0/20	0/20
CT values±SD	37.32±1.55	-	35.63±0.84	-	-	-

a: Positive/ total analysis numbers.

To evaluate the antibody response in immunized chickens, serums were collected 21 days after vaccination and analyzed by HI and ELISA tests. HI and ELISA titers in the animals vaccinated with both strains were higher than 6 log<sub>2</sub> and 6000, respectively (Table 5.3). Interestingly, HI titers were always higher when the vaccine and HI test strains used were of the same genotype. In contrast, there was no difference between the two vaccine groups when the HI test strain was of genotype VII and HI titers against this genotype were lower than with the others (Table 5.3).

**Table 5.3.** Evaluation of the antibody response after vaccination.

	HI (Log2)					ELISA
	rLaSota	GB Texas	rLaSota/ M-Fmu-HN	rMG-725	NDV/EG/ CK/104/12	
rLaSota	8±0	7.5 ± 0.55	6.67 ± 0.52	6.83 ± 0.75	6.5 ±0.55	8728±2280
rLaSota/ M-Fmu-HN	7±0	7 ± 0	7.33 ± 0.52	7.67±0.52	6.5 ±0.55	9154±790
Unvaccine	0	0	0	0	0	40.78±21.80

4. The rLaSota/M-Fmu-HN strain protects chickens from virulent homologous challenge. Chickens immunized with rLaSota/M-Fmu-HN or rLaSota strain were challenged with 10<sup>5</sup> ELD<sub>50</sub> of rMG-725 strain via the intramuscular route, 21 days after vaccination. To check viral shedding, oral and cloacal swabs were collected at 3 days, 5 days, 7 days and 10 days



after challenge. The viral RNA could not be detected in any swabs from chicken vaccinated with rLaSota/M-Fmu-HN or rLaSota (Table 5.4A). In contrast, there were eight oral and twelve cloacal positive swabs in unvaccinated birds 3 days after the challenge (Table 5.4A). Three days post-challenge, three chickens of each group were sacrificed and tissue samples from nervous system (brain), respiratory system (lung, trachea and nasal turbinate), lymphoid system (spleen) and digestive tract (small intestine) were tested by qRT-PCR. All the unvaccinated birds had virus in their tissues. The viral RNA load was the highest in spleen followed by the respiratory tract (Fig. 5.3A). Viral RNA was detected in trachea of two chickens of the group LaSota whereas none of the chickens of group rLaSota/M-Fmu-HN had positive tissues (Fig. 5.3A). The challenge virus was not isolated from any samples of rLaSota/M-Fmu-HN or rLaSota vaccinated chickens, while it was isolated from almost all samples of unvaccinated chickens. Chickens were observed daily for 10 days clinical signs and death were scored. After challenge, none of the immunized chickens showed any clinical signs, but all unvaccinated chickens became sick from the third day after the challenge and died 5 days post-challenge (Fig. 5.3B and C).

5. The rLaSota/M-Fmu-HN strain protected chickens against heterologous virulent genotypes II and VII strains.

To test the heterologous protection conferred by rLaSota/M-Fmu-HN, immunized chickens were infected by the virulent GB Texas (genotype II) or NDV/EG/CK/104/12 (genotype VII) strains. The two groups of vaccinated chickens challenged with these two strains, had no detectable viral RNA by qRT-PCR in their oral or cloacal swabs, except one cloacal swab from chicken immunized by rLaSota and challenged with genotype VII. In contrast, almost all swabs from unvaccinated birds had viral RNA (Table 5.4B and 5.4C). One animal vaccinated with rLaSota/M-Fmu-HN strain and two with rLaSota strain showed viral RNA in their respiratory tract three days after the challenge with GB Texas, while all tissues from unvaccinated birds were detected with high viral RNA loads as measured by lower CT values with the highest load in the spleen (Fig. 5.3A). None of the vaccinated chickens did show any virus positive detection after challenge with NDV/EG/CK/104/12. Nevertheless, no virus was isolated in eggs from any samples of immunized chickens. All unvaccinated birds died 3 and 4 days after challenge with GB Texas or NDV/EG/CK/104/12 strains, respectively, which is one to two days earlier than with the strain rMG-725 (Fig. 5.3B and C).

**Table 5.4.** Viral shedding in oral and cloacal swabs collected from chickens after challenges with genotype XI, genotype II and genotype VII strains.

A. rMG-725 (genotype XI)									
	3 days		5 days		7days		10 days		
	Oral	Cloacal	Oral	Cloacal	Oral	Cloacal	Oral	Cloacal	
rLaSota	0/13 <sup>a</sup>	0/13	0/10	0/10	0/10	0/10	0/10	0/10	
rLaSota/M-Fmu-HN	0/13	0/13	0/10	0/10	0/10	0/10	0/10	0/10	
Unvaccinated	8 <sup>c</sup> /13	12 <sup>c</sup> /13	2 <sup>c</sup> /2	2 <sup>c</sup> /2	-	-	-	-	
B. GB Texas (genotype II)									
	3 days		5 days		7days		10 days		
	Oral	Cloacal	Oral	Cloacal	Oral	Cloacal	Oral	Cloacal	
rLaSota	0/13 <sup>a</sup>	0/13	0/10	0/10	0/10	0/10	0/10	0/10	
rLaSota/M-Fmu-HN	0/13	0/13	0/10	0/10	0/10	0/10	0/10	0/10	
Unvaccinated	13 <sup>c</sup> /13	12 <sup>c</sup> /13	-	-	-	-	-	-	
C. NDV/EG/CK/104/12 (genotype VII)									
	3 days		5 days		7days		10 days		
	Oral	Cloacal	Oral	Cloacal	Oral	Cloacal	Oral	Cloacal	
rLaSota	0/13 <sup>a</sup>	0/13	0/10	0/10	0/10	1 <sup>b</sup> /10	0/10	0/10	
rLaSota/M-Fmu-HN	0/13	0/13	0/10	0/10	0/10	0/10	0/10	0/10	
Unvaccinated	13 <sup>c</sup> /13	12 <sup>c</sup> /13	-	-	-	-	-	-	

a: Positive number/total number; b: viral shedding was detected by qRT-PCR; c: viral shedding was detected by qRT-PCR and egg inoculation.

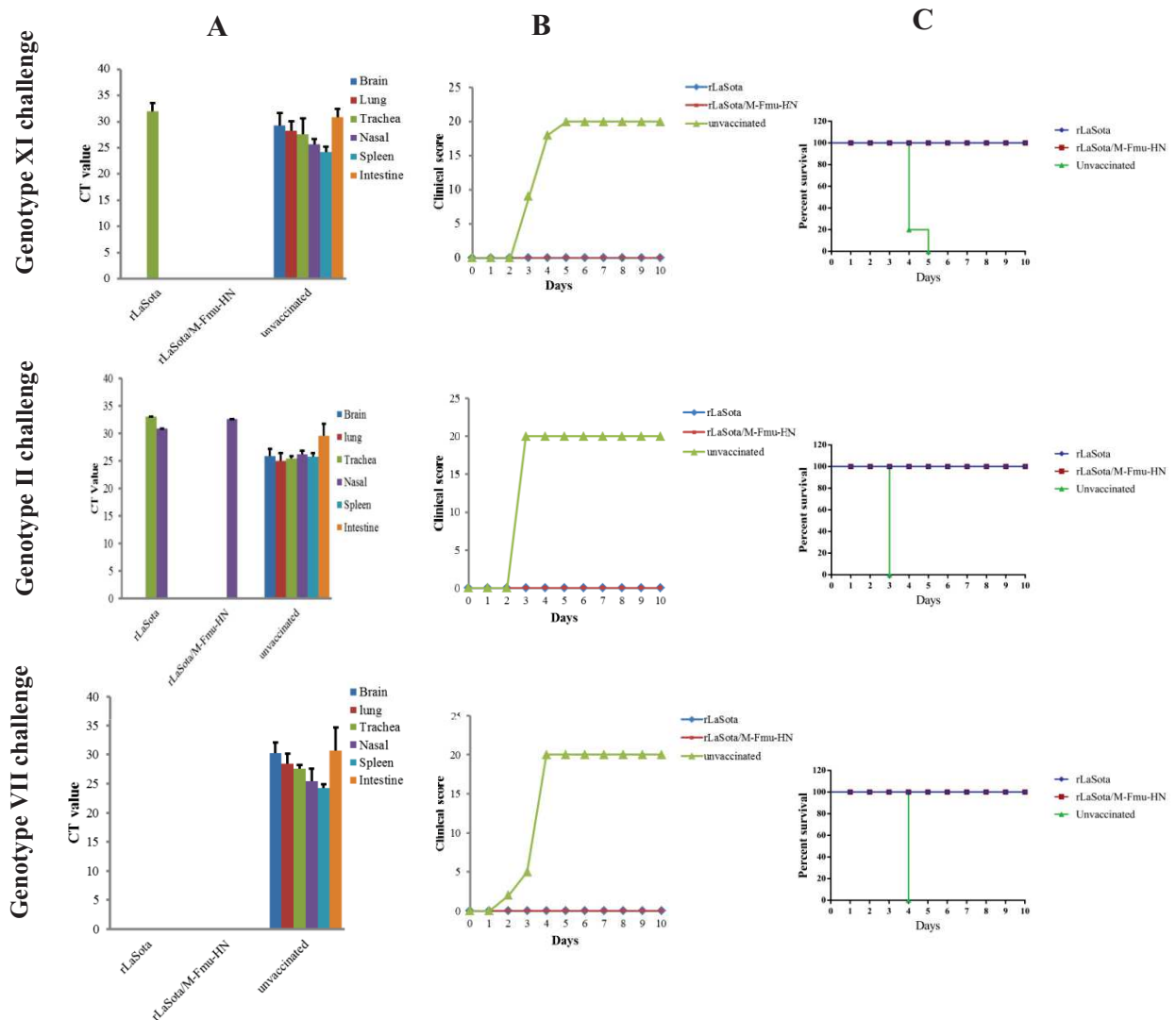

**Fig. 5.3.** Protection conferred by the rLaSota and rLaSota/M-Fmu-HN vaccines against rMG-725 (Genotype XI), GB Texas (genotype II) and NDV/EG/CK/104/12 (Genotype VII) challenges by intramuscular route. (A) Two of three sacrificed chickens vaccinated with rLaSota strain showed genotype XI strain RNA in trachea, but no viral RNA could be detected in tissues from bird vaccinated with the rLaSota/M-Fmu-HN strain. Two of three sacrificed chickens vaccinated with the rLaSota had genotype II RNA in the tracheal and nasal. After challenge with the genotype VII, none of the vaccinated showed virus RNA in their tissues. In contrast, all tissues of unvaccinated birds had viral RNA and the spleen followed by the respiratory tract had the highest loads. (B and C) Vaccinated chickens never showed clinical signs and mortality. All unvaccinated chickens suffered from disease and died within 3 to 5 days after challenge. It seems that the challenge with the genotype II was more serious in terms of clinical signs and survival curve.

## Discussion

ND causes very important sanitary and economic losses in the poultry industry (2). Lentogenic NDV strains, such as LaSota, are widely used as live attenuated vaccines to control this disease all around the world (20). However, irregular usage of vaccines over decades has probably contributed to the emergence of new virulent variants. Several reports show that recent strains are much less controlled than before by attenuated vaccines made of ancient viruses. Since this would lead ultimately to the emergence of escape mutants, new generation vaccines more adapted to the current circulating NDV strain are needed. In this study, an avirulent strain, rLaSota/M-Fmu-HN, was generated by reverse genetics as a candidate ND vaccine. This strain is a recombinant virus based on the genome of the LaSota strain in which the F and HN genes were replaced by ones of the virulent genotype XI strain, MG-725. The cleavage site of the F gene was modified to generate an attenuated motif similar to that of LaSota strain. Compared to the parental LaSota strain, the growth ability and virulence of this recombinant virus is not modified. Based on MDT value the pathogenicity is even slightly reduced (gain of 17 hours in the survival).

One of the shortcomings of live vaccines is their spread into the environment and its associated risks of reversion to virulence (35). Actually, some lentogenic NDV strains have been found to be able to become velogenic after several passages in chickens, just by the addition of mutations to basic amino acids in the cleavage site of the F protein (30, 36, 37). After being released into the environment, the vaccine strain can also contribute to NDV recombination (38). Some natural recombinant strains have emerged from vaccine strains (39-41). In this study, we found that chickens vaccinated with rLaSota/M-Fmu-HN strain do not excrete the vaccine strain as much as chickens vaccinated with the rLaSota strain. Consequently, the risks for the rLaSota/M-Fmu-HN of being released into the environment is reduced compared to the rLaSota strain. The better replication ability of NDV is thought to induce the stronger immune response (23). However, based on ELISA results, we found that rLaSota/M-Fmu-HN strain could induce an immune response as strong as the one induced by the rLaSota strain. In addition, we show that protection against challenge and virus excretion is at least as high as the one conferred by the LaSota vaccine.

Current ND live vaccines were generated from NDV strains isolated 70 years ago (20). These vaccines can still prevent chickens from disease, but hardly block viral shedding when infected by recent isolates (23-27). Even if it is widely accepted that NDV exists as in only one single serotype, mutations often happened in F and HN generating some antigenic

diversity (21). Here, we demonstrate that antibodies from immunized chickens react better with the homologous HI test virus. We believe that this antigenic diversity of F and HN proteins accounts for the sub-optimal cross-reactions with heterologous test strains. This also could be the main reason why current live vaccines cannot fully block shedding from new genotypes strains, such as genotype VII (24, 26, 42) when the animals are vaccinated with old genotypes. However, even if the HI titers of sera obtained after vaccination with rLaSota or rLaSota/M-Fmu-HN were lower against heterologous test strains, the two vaccines totally protected chickens and stopped viral shedding from homologous and heterologous virulent strains.

Even if no virus could be isolated in this study, viral RNA was detected in five samples from vaccinated birds and challenged with heterologous virulent strains. Four of them were from chickens vaccinated with the rLaSota strain and one from chickens vaccinated with the rLaSota/M-Fmu-HN strain. We do not know exactly what would be the consequences in the field of such a slight difference observed under controlled experimental conditions. However, we consider that in a particular epidemiological context in the field (poor immunity, high animal density, secondary infections, etc.) an impact cannot be ruled out.

Other authors and we in a previous experiment have shown a more pronounced virus shedding after heterologous virulent challenges (23-27, 46, 47, this paper introduction). The reasons for these discordant results are not known. However, in this study we used two-week-old SPF chickens which had no NDV antibodies. This immunization process was different from previous studies where SPF chickens were vaccinated at the age of 1 day and boosted at 3 weeks of age (43-45). This difference may produce distinct immunization conditions of chickens between two *in vivo* tests, possibly inducing different responses in terms of virus shedding in previous (Fig. 5.1) and current studies (Table 5.4A), respectively. In addition, different experimental conditions including animal care and handling, environmental conditions and swab collection may affect the result outcome. Another reason could be the use of the intramuscular route for the virulent challenge. Some authors have suggested that the viral shedding is more important if chickens are challenged with NDV virulent strain via the oculonasal route than by the intramuscular route (48). However, the question of the challenge dose standardization by the oculonasal route is more sensitive compared to the intramuscular route.

Nonetheless, we establish here that our modified rLaSota strain, embedding the F and HN viral proteins of a genotype XI strain from Madagascar, has excellent vaccine properties with potentially a reduced excretion post-vaccination and an improved control on virus shedding after challenge with recent field strains. In order to confirm whether the rLaSota/M-Fmu-HN strain has significant benefits in terms of preventing viral shedding from different virulent virus challenge, more experiments are required. For example, the use of suboptimal vaccine dosage to immunize chickens or a challenge via the oculonasal route could provide final conclusion.

## References

1. Alexander DJ. 1988. Newcastle disease diagnosis, p 147-160, Newcastle disease. Springer.
2. Miller PJ, Decanini EL, Afonso CL. 2010. Newcastle disease: evolution of genotypes and the related diagnostic challenges. *Infect Genet Evol* 10:26-35.
3. Amarasinghe GK, Bào Y, Basler CF, Bavari S, Beer M, Bejerman N, Blasdel KR, Bochnowski A, Briese T, Bukreyev A. 2017. Taxonomy of the order Mononegavirales: update 2017. *Arch Virol*:1-12.
4. de Leeuw O, Peeters B. 1999. Complete nucleotide sequence of Newcastle disease virus: evidence for the existence of a new genus within the subfamily Paramyxovirinae. *J Gen Virol* 80:131-136.
5. Krishnamurthy S, Samal SK. 1998. Nucleotide sequences of the trailer, nucleocapsid protein gene and intergenic regions of Newcastle disease virus strain Beaudette C and completion of the entire genome sequence. *J Gen Virol* 79:2419-2424.
6. Phillips R, Samson A, Emmerson P. 1998. Nucleotide sequence of the 5'-terminus of Newcastle disease virus and assembly of the complete genomic sequence: agreement with the "rule of six". *Arch Virol* 143:1993-2002.
7. Dortmans J, Rottier P, Koch G, Peeters B. 2010. The viral replication complex is associated with the virulence of Newcastle disease virus. *J Virol* 84:10113-10120.
8. Steward M, Vipond IB, Millar NS, Emmerson PT. 1993. RNA editing in Newcastle disease virus. *J Gen Virol* 74:2539-2547.
9. Crennell S, Takimoto T, Portner A, Taylor G. 2000. Crystal structure of the multifunctional paramyxovirus hemagglutinin-neuraminidase. *Nat Struct Mol Biol* 7:1068-1074.
10. Bose S, Song AS, Jardetzky TS, Lamb RA. 2014. Fusion activation through attachment protein stalk domains indicates a conserved core mechanism of paramyxovirus entry into cells. *J Virol* 88:3925-3941.
11. Ganar K, Das M, Sinha S, Kumar S. 2014. Newcastle disease virus: current status and our understanding. *Virus Res* 184:71-81.
12. Takimoto T, Portner A. 2004. Molecular mechanism of paramyxovirus budding. *Virus Res* 106:133-145.
13. Pantua HD, McGinnes LW, Peeples ME, Morrison TG. 2006. Requirements for the assembly and release of Newcastle disease virus-like particles. *J Virol* 80:11062-11073.

14. Chen L, Gorman JJ, McKimm-Breschkin J, Lawrence LJ, Tulloch PA, Smith BJ, Colman PM, Lawrence MC. 2001. The structure of the fusion glycoprotein of Newcastle disease virus suggests a novel paradigm for the molecular mechanism of membrane fusion. *Structure* 9:255-266.
15. Yuan P, Swanson KA, Leser GP, Paterson RG, Lamb RA, Jardetzky TS. 2011. Structure of the Newcastle disease virus hemagglutinin-neuraminidase (HN) ectodomain reveals a four-helix bundle stalk. *Proc Natl Acad Sci U S A* 108:14920-14925.
16. Boursnell M, Green P, Samson A, Campbell J, Deuter A, Peters R, Millar N, Emmerson P, Binns M. 1990. A recombinant fowlpox virus expressing the hemagglutinin-neuraminidase gene of Newcastle disease virus (NDV) protects chickens against challenge NDV. *Virology* 178:297-300.
17. Cosset F-I, Bouquet J-F, Drynda A, Chebloune Y, Rey-Senelonge A, Kohen G, Nigon VM, Desmettre P, Verdier G. 1991. Newcastle disease virus (NDV) vaccine based on immunization with avian cells expressing the NDV hemagglutinin-neuraminidase glycoprotein. *Virology* 185:862-866.
18. Meulemans G, Letellier C, Gonze M, Carlier M, Burny A. 1988. Newcastle disease virus glycoprotein expressed from a recombinant vaccinia virus vector protects chickens against live - virus challenge. *Avian Pathol* 17:821-827.
19. Nagy E, Krell P, Dulac G, Derbyshire J. 1991. Vaccination against Newcastle disease with a recombinant baculovirus hemagglutinin-neuraminidase subunit vaccine. *Avian Dis*:585-590.
20. Dimitrov KM, Afonso CL, Yu Q, Miller PJ. 2016. Newcastle disease vaccines—A solved problem or a continuous challenge? *Vet Microbiol*.
21. Dimitrov KM, Ramey AM, Qiu X, Bahl J, Afonso CL. 2016. Temporal, geographic, and host distribution of avian paramyxovirus 1 (Newcastle disease virus). *Infect Genet Evol* 39:22-34.
22. Alexander D, Manvell R, Lowings J, Frost K, Collins M, Russell P, Smith J. 1997. Antigenic diversity and similarities detected in avian paramyxovirus type 1 (Newcastle disease virus) isolates using monoclonal antibodies. *Avian Pathol* 26:399-418.
23. Xiao S, Nayak B, Samuel A, Paldurai A, Kanabagattebasavarajappa M, Prajitno TY, Bharoto EE, Collins PL, Samal SK. 2012. Generation by reverse genetics of an effective, stable, live-attenuated Newcastle disease virus vaccine based on a currently circulating, highly virulent Indonesian strain. *PLoS One* 7:e52751.
24. Liu M-M, Cheng J-L, Yu X-H, Qin Z-M, Tian F-L, Zhang G-Z. 2015. Generation by reverse genetics of an effective attenuated Newcastle disease virus vaccine based on a prevalent highly virulent Chinese strain. *Biotechnol Lett* 37:1287.
25. Hu S, Ma H, Wu Y, Liu W, Wang X, Liu Y, Liu X. 2009. A vaccine candidate of attenuated genotype VII Newcastle disease virus generated by reverse genetics. *Vaccine* 27:904-910.
26. Kim S-H, Wanasen N, Paldurai A, Xiao S, Collins PL, Samal SK. 2013. Newcastle disease virus fusion protein is the major contributor to protective immunity of genotype-matched vaccine. *PLoS One* 8:e74022.
27. Samuel A, Nayak B, Paldurai A, Xiao S, Aplogan GL, Awoume KA, Webby RJ, Ducatez MF, Collins PL, Samal SK. 2013. Phylogenetic and pathotypic characterization of Newcastle disease viruses circulating in west Africa and efficacy of a current vaccine. *J Clin Microbiol* 51:771-781.



28. Maminiaina OF, Gil P, Briand F-X, Albina E, Keita D, Andriamanivo HR, Chevalier V, Lancelot R, Martinez D, Rakotondraivo R. 2010. Newcastle disease virus in Madagascar: identification of an original genotype possibly deriving from a died out ancestor of genotype IV. *PLoS One* 5:e13987.
29. Peeters BP, de Leeuw OS, Koch G, Gielkens AL. 1999. Rescue of Newcastle disease virus from cloned cDNA: evidence that cleavability of the fusion protein is a major determinant for virulence. *J Virol* 73:5001-5009.
30. Meng C, Qiu X, Yu S, Li C, Sun Y, Chen Z, Liu K, Zhang X, Tan L, Song C. 2016. Evolution of Newcastle disease virus quasispecies diversity and enhanced virulence after passage through chicken air sacs. *J Virol* 90:2052-2063.
31. Servan de Almeida R, Hammoumi S, Gil P, Briand F-X, Molia S, Gaidet N, Cappelle J, Chevalier V, Balanca G, Traore A. 2013. New avian paramyxoviruses type I strains identified in Africa provide new outcomes for phylogeny reconstruction and genotype classification. *Plos One* 10 (8),(2013).
32. Liu H, Albina E, Gil P, Minet C, de Almeida RS. 2017. Two-plasmid system to increase the rescue efficiency of paramyxoviruses by reverse genetics: The example of rescuing Newcastle Disease Virus. *Virology* 509:42-51.
33. Reed LJ, Muench H. 1938. A simple method of estimating fifty per cent endpoints. *Am J Epidemiol* 27:493-497.
34. Vallat B, Allen G. 2004. *Manual of diagnostic tests and vaccines for terrestrial animals (mammals, birds and bees)*. Paris: Office International Des Epizooties.
35. Dimitrov KM, Lee D-H, Williams-Coplin D, Olivier TL, Miller PJ, Afonso CL. 2016. Newcastle Disease Viruses Causing Recent Outbreaks Worldwide Show Unexpectedly High Genetic Similarity to Historical Virulent Isolates from the 1940s. *J Clin Microbiol* 54:1228-1235.
36. Shengqing Y, Kishida N, Ito H, Kida H, Otsuki K, Kawaoka Y, Ito T. 2002. Generation of velogenic Newcastle disease viruses from a nonpathogenic waterfowl isolate by passaging in chickens. *Virology* 301:206-211.
37. de Leeuw OS, Hartog L, Koch G, Peeters BP. 2003. Effect of fusion protein cleavage site mutations on virulence of Newcastle disease virus: non-virulent cleavage site mutants revert to virulence after one passage in chicken brain. *J Gen Virol* 84:475-484.
38. Chong YL, Padhi A, Hudson PJ, Poss M. 2010. The effect of vaccination on the evolution and population dynamics of avian paramyxovirus-1. *PLoS Pathog* 6:e1000872.
39. Han G-Z, He C-Q, Ding N-Z, Ma L-Y. 2008. Identification of a natural multi-recombinant of Newcastle disease virus. *Virology* 371:54-60.
40. Satharasinghe DA, Murulitharan K, Tan SW, Yeap SK, Munir M, Ideris A, Omar AR. 2016. Detection of inter-lineage natural recombination in avian paramyxovirus serotype 1 using simplified deep sequencing platform. *Front Microbiol* 7.
41. Qin Z, Sun L, Ma B, Cui Z, Zhu Y, Kitamura Y, Liu W. 2008. F gene recombination between genotype II and VII Newcastle disease virus. *Virus Res* 131:299-303.
42. Miller PJ, King DJ, Afonso CL, Suarez DL. 2007. Antigenic differences among Newcastle disease virus strains of different genotypes used in vaccine formulation affect viral shedding after a virulent challenge. *Vaccine* 25:7238-7246.

43. Fellah JS, Jaffredo T, Dunon D. 2008. Development of the Avian Immune System. *Avian Immunology*. 4:51-66.
44. Kapczynski DR, Afonso CL, Miller PJ. 2013. Immune responses of poultry to Newcastle disease virus. *Dev Comp Immunol* 41: 447-453.
45. Wang X, Wang X, Jia Y, Wang C, Han Q, Lu Z, Yang Z. 2017. Adenoviral-expressed recombinant granulocyte monocyte colony-stimulating factor (GM-CSF) enhances protective immunity induced by inactivated Newcastle Disease Virus (NDV) vaccine. *Antiviral Res* 144: 322-329.
46. Dortmans JC, Peeters BP, Koch G. 2012. Newcastle disease virus outbreaks: vaccine mismatch or inadequate application?. *Vet Microbiol* 160: 17-22.
47. Cardenas-Garcia S, Diel DG, Susta L, Lucio-Decanini E, Yu Q, Brown CC, Miller PJ, Afonso CL. 2015. Development of an improved vaccine evaluation protocol to compare the efficacy of Newcastle disease vaccines. *Biologicals* 43: 136-145.
48. Kumar S, Nayak B, Collins PL, Samal SK. 2011. Evaluation of the Newcastle disease virus F and HN proteins in protective immunity by using a recombinant avian paramyxovirus type 3 vector in chickens. *J Virol* 85:6521-6534.

## **General discussion**

## **Contribution to a better control of recent genotypes of Newcastle disease viruses**

Newcastle disease (ND) and Influenza are the two poultry plagues. Since influenza is a zoonotic disease, it has received much attention in the last decades, especially when H5N1 emerged in the late 90's and was announced as the fourth and probably the most devastating human pandemics (1). Fortunately, the predicted disaster did not occur but regular outbreaks in the poultry and swine industries worldwide and the emergence of the pandemics H1N1 in 2009 in humans remind us that the threat still exists (2). In contrast, ND is a minor zoonotic disease (transient and confined conjunctivitis) but a serious disease of birds (3). Countries in the north have succeeded in the management of the disease in their poultry sector. The success relied on the existence of effective veterinary authorities, adapted surveillance programs and targeted vaccinations. In this context, any new introduction of the virus is costly but effectively contained in a timely manner. The situation is more contrasted in the south (4). In the worst conditions, the disease is largely uncontrolled with regular waves of mortality (5). However, in most countries, vaccination is widely used to control Newcastle disease (ND) (6). There are three types of vaccines against ND, inactivated, vectored and live vaccines (5, 7, 8). Inactivated vaccines can be generated from on any strain and have no risks of virus releasing into the environment (9). In order to generate a strong immune response, adjuvants are usually necessary for inactivated vaccines, which increases the costs of the vaccine (10, 11). Furthermore, inactivated vaccines have to be injected into chickens via the intramuscular route, which is not so convenient for the poultry industry. These disadvantages prevent inactivated vaccines being widely used in the field. Since F and HN proteins are the protective antigens of NDV, viral vectors bearing F or HN genes can protect chickens from virulent strain challenges (12-16). However, application of vectored vaccines is affected by maternal antibodies against the virus vector (17-19). Due to easy operation and strong immune response, live NDV vaccines are the most frequently used.

Despite the effectiveness of vaccines in providing clinical protection against ND, ND outbreaks still occur around the world (5, 20). According to OIE reports, there were around 56 countries affected by ND outbreaks from 2006 to 2009 (5). Based on epidemic data, virulent NDV strains circulate among birds in countries where ND outbreaks frequently happens in spite of vaccination (21-24). NDV infection has been confirmed in more than 234 avian species (25). Except of poultry, virulent and non-virulent NDV strains can be isolated from other birds, such as pigeon, dove, peacock and water birds (26-30). In some cases, viruses

isolated from wild birds are nearly closed to virus from poultry, suggesting an epidemiological link between poultry and wild birds (31, 32).

The rapid genetic evolution of NDV has generated important genetic distances between currently circulating genotypes and commercial vaccines that are all made from old genotypes (I and II) (33-36). Although the impact of this divergence on the vaccine efficacy is still debated, the genetic diversity of F and HN genes between old and new genotypes can reach 20%, which could be one the reasons why virulent strains of new genotypes are less controlled by chickens immunized with genotype I or II vaccines (4). Even if there is only one single serotype for NDV, vaccines better reduce virus shedding after a homologous genotype challenge than after a heterologous genotype challenge (37, 38). It was demonstrated that under controlled conditions, current living vaccines are able to prevent chickens from clinical signs caused by new genotype virulent strains, but cannot block viral shedding (11, 39, 40). This situation may be worse in the field because other factors, such as bad herd immunity level, lack of nutrition, stress and immunity suppression, can affect the efficiency of vaccines (41-45). The viral shedding improves virulent strain to spillover from vaccinated birds to unvaccinated or bad immunized birds and generates new virulent variants of NDV with outbreak potential. The lack of effective control on the virus excretion also promotes virus persistence in ND endemic areas (46, 47). Thus, generation of antigenically matched vaccines may contribute to better control the current situation about ND. One possibility to achieve this objective is the attenuation of a circulating strain. Since factors determining the NDV virulence have been revealed (48-51), the attenuation can be simply done by modifying the genome of the virulent strain by reverse genetics. Any new virulent genotype can be attenuated by the modification of the cleavage site of F gene (48). At the beginning of this thesis, only attenuated strains from the recent genotype VII were available (52-54). To date, another candidate vaccine has been produced using a similar approach to us, consisting in the substitution of the F and HN genes of a current vaccine strain old genotype, by those of a new genotype strain (38). Both types of vaccines were able not only to protect chickens from ND, but also to decrease the viral shedding of chickens challenged by recent virulent strains (38, 55). However, the second type of live vaccine may be safer than the first. Indeed, the backbone of the vaccine is still from a vaccine strain that has been used for decades in the field with no records of change to virulence (5, 6). The first type of vaccine can be much more risky since only one or two amino acids mutations in the cleavage site of the F protein can reverse the attenuation (48, 56, 57).

This consideration led us to generate by reverse genetics an antigenically matched vaccine combining a LaSota strain backbone and the F and HN genes from one recently isolated genotype XI strain (34). The F gene was modified to contain a lentogenic-like cleavage site. This recombinant candidate vaccine grew well in chicken embryos and showed highly attenuated phenotype based on pathogenicity indexes. Recently, some genetic matched vaccines are already produced, but all of them just show blocking viral shedding from same genotype challenge (53, 55, 58). It is quite unclear whether they are able to block viral secretion from other genotypes. We also tested how our candidate vaccine could control different genotypes (II, VII and XI), compared to the current LaSota vaccine. Based on clinical signs, both LaSota and our candidate vaccines protected chickens from ND caused by the three virulent strains.

### **Development of an optimized system for the rescue of attenuated strains**

During the process of generating and validating our candidate vaccine, we had to produce by reverse genetics a series of different viruses to check different features. We first cloned the conventional LaSota vaccine from a live vaccine batch that appeared to be a mixture of different viruses and then any recombination of the cloned LaSota strain with different genes of the Madagascar genotype XI strain (F alone, HN alone, F and HN together). We had also to clone the virulent Madagascar strain and generate an attenuated version of this strain. At last, to study the in vitro behavior of the virulent and attenuated strains, we also produced recombinant viruses incorporating a cassette expressing a fluorescent marker (EGFP or mCherry). In all, we generated 11 different strains by reverse genetics. We initially started to work with a conventional method of reverse genetics close to the first method developed for the rabies virus in 1994 (59). The system consists of four plasmids bearing viral full-length cDNA, N, P and L genes under T7 promoter, a recombinant vaccinia virus providing T7 RNA polymerase and BHK-21 cells and. Since then, the reverse genetics has become a classical system to rescue many viruses with negative-sense single band RNA from different viral families (48, 60-71).

However, this conventional method has two major disadvantages. Firstly, three G nucleotides are introduced between T7 promoter and 5' end of the anti-genome to increase transcription efficiency of T7 RNA polymerase, which can alter the rescuing efficiency, because these three G must be eliminated from the viral genomic transcript to maintain the rule of six and the appropriate terminal sequence (59). To deal with this problem, sequences of self-cleaving

hammerhead ribozyme are cloned immediately before of 5' end of the anti-genome to generate exact viral termination after T7 RNA polymerase transcription, which improves virus rescuing efficiency (72, 73). Secondly, in order to provide T7 RNA polymerase for transcription, recombinant vaccinia virus infection contaminates rescuing virus (59). To avoid contamination, the exogenous gene is cloned into cells or a plasmid containing T7 RNA polymerase gene is transfected into cells to express T7 RNA polymerase (74, 75).

To overcome the limitation of T7 RNA polymerase, T7 promoter can be replaced by other promoters, such as CMV promoter, which are recognized by naive cellular RNA polymerase. Although RNA II polymerase transcribes RNA under CMV promoter in nucleus, the rescue efficiency is still better than the one offered by the T7 promoters (76). Many viruses have been rescued with the CMV promoter (75, 77, 78).

Other systems have been proposed for improving the virus rescue. For measles virus, a cell line, 293-3-46, was built from 293 cells to continuously express the viral N and P proteins and T7 RNA polymerase. Using this 293-3-46 cell line, a plasmid bearing the measles virus full-length cDNA and another plasmid harbouring the viral L gene were co-transfected to rescue infectious viral particles (79). Nevertheless, the establishment of a transformed cell line like the 293-3-46 can be cumbersome.

In this study, the first reverse genetics we used included four plasmids under CMV promoter, one expressing the viral anti-genome and the other three expressing NP, P and L proteins. The cDNA of the full-length NDV was assembled between hammerhead ribozyme and hepatitis delta virus ribozyme, which generate exact terminations of viral anti-genome. However, by using this system, we were only able to recover 8 out of 10 NDV strains (see Chapter 2). The two strains that were not rescued were lentogenic strains that cannot replicate in BHK-21 cells without trypsin-like protease. We hypothesized that the probability of transfecting a relatively high number of plasmids into the same cell in order to produce a live self-replicating virus was probably not high enough for successfully rescuing an attenuated strain compared to a virulent strain. Since the conventional reverse genetics for mononegavirus include at least four plasmids, the efficiency of transfection all these plasmids into the same cell may influence rescuing efficiency. Some authors have demonstrated that decreasing the number of plasmids can improve the rescuing efficiency of segmented viruses (80-83). However, to the best of our knowledge, the influence of the number of plasmids in the rescuing efficiency of mononegaviruses has never been evaluated before. Consequently, we established different



NDV reverse genetic systems with varying numbers of plasmids from 1 to 4. The efficiency of these systems was compared on a mini-genome expression or a virus rescue. All of these systems worked, but only the 2-plasmids system really increased the mini-genome expression and rescuing efficiency. Unexpectedly, the 1-plasmid system did not improve the mini-genome expression, which suggested that the number of plasmids is not the only factor affecting the rescuing efficiency.

The higher efficiency of the 2-plasmids system was confirmed in the chapter 2 by rescuing different strains. This 2-plasmids system was able to rescue two strains which were not recovered with the 4-plasmids system. Not only the number of strain rescued, the 2-plasmids system generates strains 1 to 2 days earlier than the conventional system and required less DNA material to produce (2  $\mu$ g for transfection instead of 10  $\mu$ g). This important achievement is now available to the scientific community for research purposes. Any commercial use of this improvement will require prior agreement with CIRAD.

### **In vitro virus transmission and superinfection, lessons for recombination events**

Some of our viruses were equipped with a cassette expressing a fluorescent dye (EGFP or mCherry). This allowed us to study their behavior in cell culture, focusing on persisting infection, transmission and superinfection.

Animal or plant tissues consist of individual cells with a complex organization. The cell-to-cell communications play a pivotal role in this organization. Mechanisms of cell-to-cell communications vary among different types of cells, but cell extensions are frequently involved (84, 85). The cell extension is the general term of cellular protrusions which include synapsis, tunneling nanotube, filopodia, cell-associated filaments etc (86-89). Donor and target cells are directly or indirectly connected by cell extensions, which maintain a route for transporting signal and molecules between cells (84). A good example is the nervous system in which axons and dendrites of neurons are linked by synapses (86, 90). The cell extension is not only important for cell-to-cell communication, but also for viral dissemination between cells (86). For example, measles virus transmits between neurons through synapses in the nervous system (91, 92). In some cases, cells are forced by the virus to make cellular protrusions to enable viral spread from infected to uninfected cells (93-95). The formation of unnatural cellular extensions often relates to reorganization of cell cytoskeleton. Vaccinia virus infection induces cells to generate tails which are rich in actin

and improve viral spread via the cell-to-cell route (96, 97). Influenza A virus and parainfluenza virus 5 stimulate cells to produce intercellular extensions that contain actin and viral proteins and transport viral proteins from one cell to another (98). Similarly, the human metapneumovirus and respiratory syncytial virus induce cells to form filopodia which can be blocked by the action of some drugs or by silencing of the actin gene (93-95). Furthermore, the expression of some viral proteins is sufficient to induce cell extensions, such as the P protein of the human metapneumovirus, the F protein of the respiratory syncytial virus and the A33 and A36 proteins of vaccinia virus (93, 94, 96).

In this study, we first showed that both virulent and attenuated NDV strain could establish persistent infection in BHK21 cells. In addition, rather long cell extensions were detected in NDV persistently infected BHK-21 cells compared to non-infected BHK21 that form short bridges to connect between themselves. In contrast, cell extensions in persistently infected BHK21 could reach up to 1.4 millimeter, suggesting a viral intervention. It is unclear whether the actin is involved in these extensions because we did not check it.

It is obscure how virus spread from cell-to-cell via cellular extensions. The structure of cell extensions can be “open-ended” or “close-ended” (84, 87, 99). The “open-ended” cellular extensions directly connects two cells (84). Consequently, viral replication bodies or viral particles can be transmitted from one cell to another cell across “open-ended” extensions (93). For influenza virus, viral proteins are spread in a single-direction between two cells linked by “open-ended” extensions (98). The “close-ended” extensions do not link two cells together, but viral particles are detected at the extensions’ tips where are close to another cell, which short the viral dissemination distance from infected to uninfected cells (94). In the present study, cell extensions were observed between two NDV infected cells. We cannot make sure these extensions are “open-ended” or “close-ended” due to low resolution of microscope. However, viral proteins were detected in the cell extensions suggesting NDV can be transmitted between cells via these cell extensions.

Among the benefits for viruses to spread by the cell-to-cell route, are the increased speed of virus dissemination (100), to the escape from neutralizing antibodies (101) and the infection of cells in the absence of viral receptors (93). The latter allows circumventing the mechanism of superinfection exclusion. Superinfection exclusion is a widely observed phenomenon during virus infections where infected cells become refractory to re-infection by the same or a homologous virus (102-114). For some viruses, such as NDV, the literature suggests that

superinfection exclusion is due to viral HN protein that breaks the viral receptors made of sialic acid by its neuraminidase activity (115-118). In chapter 4, we showed that NDV is able to infect cells expressing HN proteins and also to superinfect persistently infected cells. Shortly after infection, NDV preferred to invade HN- or virus-negative cells among the population of persistently NDV-infected cells. In the late stages of infection, the virus is then able to infect HN- or virus-positive cells. This timeline suggest that superinfection was actually promoted by a cell-to-cell route between the first infected cells and the second ones. We also show that superinfection is induced in two directions when cells are co-infected by two strains. In persistently infected cells, we found that cells co-infected with the two viruses were connected by cell extensions also containing materials from both strains. In this situation, one can easily imagine that recombination events could occur. Because of a lack of time, we could not investigate this issue but this is certainly an interesting point to look at. Nonetheless, this in vitro observation gives an explanation to reconcile on one hand, the well-established superinfection exclusion mechanism with NDV and on the other hand, the detection of recombination events between vaccine and virulent strains in the genome of some field isolates. The occurrence of cell-to-cell transmission of viruses in vivo could also result in cells co-infected by two viruses and thus provides a condition for recombination events. The reason why recombination is mainly detected between vaccine and virulent strains remains unclear (119-122).

## References

1. Yuen K, Chan P, Peiris M, Tsang D, Que T, Shortridge K, Cheung P, To W, Ho E, Sung R. 1998. Clinical features and rapid viral diagnosis of human disease associated with avian influenza A H5N1 virus. *Lancet* 351:467-471.
2. Smith GJ, Vijaykrishna D, Bahl J, Lycett SJ, Worobey M, Pybus OG, Ma SK, Cheung CL, Raghwani J, Bhatt S. 2009. Origins and evolutionary genomics of the 2009 swine-origin H1N1 influenza A epidemic. *Nature* 459:1122.
3. Bukreyev A, Collins PL. 2008. Newcastle disease virus as a vaccine vector for humans. *Curr Opin Mol Ther* 10:46-55.
4. Dimitrov KM, Ramey AM, Qiu X, Bahl J, Afonso CL. 2016. Temporal, geographic, and host distribution of avian paramyxovirus 1 (Newcastle disease virus). *Infect Genet Evol* 39:22-34.
5. Dimitrov KM, Afonso CL, Yu Q, Miller PJ. 2016. Newcastle disease vaccines—A solved problem or a continuous challenge? *Vet Microbiol*.
6. Gallili GE, Ben-Nathan D. 1998. Newcastle disease vaccines. *Biotechnol Adv* 16:343-366.
7. Bournsnel M, Green P, Campbell J, Deuter A, Peters R, Tomley F, Samson A, Chambers P, Emmerson P, Binns M. 1990. Insertion of the fusion gene from Newcastle disease virus into a non-essential region

- in the terminal repeats of fowlpox virus and demonstration of protective immunity induced by the recombinant. *J Gen Virol* 71:621-628.
8. Morgan RW, Gelb Jr J, Schreurs CS, Lütticken D, Rosenberger JK, Sondermeijer PJ. 1992. Protection of chickens from Newcastle and Marek's diseases with a recombinant herpesvirus of turkeys vaccine expressing the Newcastle disease virus fusion protein. *Avian Dis*:858-870.
  9. Keeble S, Wade J. 1963. Inactivated Newcastle disease vaccine. *J Comp Pathol Ther* 73:186-200.
  10. Maas R, Komen M, Van Diepen M, Oei H, Claassen I. 2003. Correlation of haemagglutinin-neuraminidase and fusion protein content with protective antibody response after immunisation with inactivated Newcastle disease vaccines. *Vaccine* 21:3137-3142.
  11. Miller PJ, Estevez C, Yu Q, Suarez DL, King DJ. 2009. Comparison of viral shedding following vaccination with inactivated and live Newcastle disease vaccines formulated with wild-type and recombinant viruses. *Avian Dis* 53:39-49.
  12. Boursnell M, Green P, Samson A, Campbell J, Deuter A, Peters R, Millar N, Emmerson P, Binns M. 1990. A recombinant fowlpox virus expressing the hemagglutinin-neuraminidase gene of Newcastle disease virus (NDV) protects chickens against challenge NDV. *Virology* 178:297-300.
  13. Cosset F-I, Bouquet J-F, Drynda A, Chebloune Y, Rey-Senelonge A, Kohen G, Nigon VM, Desmettre P, Verdier G. 1991. Newcastle disease virus (NDV) vaccine based on immunization with avian cells expressing the NDV hemagglutinin-neuraminidase glycoprotein. *Virology* 185:862-866.
  14. Meulemans G, Letellier C, Gonze M, Carlier M, Burny A. 1988. Newcastle disease virus f glycoprotein expressed from a recombinant vaccinia virus vector protects chickens against live-virus challenge. *Avian Pathol* 17:821-827.
  15. Nagy E, Krell P, Dulac G, Derbyshire J. 1991. Vaccination against Newcastle disease with a recombinant baculovirus hemagglutinin-neuraminidase subunit vaccine. *Avian Dis*:585-590.
  16. Kumar S, Nayak B, Collins PL, Samal SK. 2011. Evaluation of the Newcastle disease virus F and HN proteins in protective immunity by using a recombinant avian paramyxovirus type 3 vector in chickens. *J Virol* 85:6521-6534.
  17. Le Gros F, Dancer A, Giacomini C, Pizzoni L, Bublot M, Graziani M, Prandini F. 2009. Field efficacy trial of a novel HVT-IBD vector vaccine for 1-day-old broilers. *Vaccine* 27:592-596.
  18. Faulkner OB, Estevez C, Yu Q, Suarez DL. 2013. Passive antibody transfer in chickens to model maternal antibody after avian influenza vaccination. *Vet Immunol Immunopathol* 152:341-347.
  19. Bublot M, Pritchard N, Swayne DE, Selleck P, Karaca K, Suarez DL, AUDONNET JC, Mickle TR. 2006. Development and use of fowlpox vectored vaccines for avian influenza. *Ann N Y Acad Sci* 1081:193-201.
  20. Ganar K, Das M, Sinha S, Kumar S. 2014. Newcastle disease virus: current status and our understanding. *Virus Res* 184:71-81.
  21. Zhang P, Xie G, Liu X, Ai L, Chen Y, Meng X, Bi Y, Chen J, Sun Y, Stoeger T. 2016. High genetic diversity of newcastle disease virus in wild and domestic birds in Northeastern China from 2013 to 2015 reveals potential epidemic trends. *Appl Environ Microbiol* 82:1530-1536.

22. Zhang Y-y, Shao M-y, Yu X-h, Zhao J, Zhang G-z. 2014. Molecular characterization of chicken-derived genotype VIIId Newcastle disease virus isolates in China during 2005–2012 reveals a new length in hemagglutinin–neuraminidase. *Infect Genet Evol* 21:359-366.
23. Siddique N, Naeem K, Abbas MA, Malik AA, Rashid F, Rafique S, Ghafar A, Rehman A. 2013. Sequence and phylogenetic analysis of virulent Newcastle disease virus isolates from Pakistan during 2009–2013 reveals circulation of new sub genotype. *Virology* 444:37-40.
24. Shabbir MZ, Zohari S, Yaqub T, Nazir J, Shabbir MAB, Mukhtar N, Shafee M, Sajid M, Anees M, Abbas M. 2013. Genetic diversity of Newcastle disease virus in Pakistan: a countrywide perspective. *Virol J* 10:170.
25. Kaleta EF, Baldauf C. 1988. Newcastle disease in free-living and pet birds, p 197-246, Newcastle disease. Springer.
26. Wang J, Liu H, Liu W, Zheng D, Zhao Y, Li Y, Wang Y, Ge S, Lv Y, Zuo Y. 2015. Genomic characterizations of six pigeon paramyxovirus type 1 viruses isolated from live bird markets in China during 2011 to 2013. *PLoS One* 10:e0124261.
27. Liu H, Zhang P, Wu P, Chen S, Mu G, Duan X, Hao H, Du E, Wang X, Yang Z. 2013. Phylogenetic characterization and virulence of two Newcastle disease viruses isolated from wild birds in China. *Infect Genet Evol* 20:215-224.
28. Munir M, Shabbir MZ, Yaqub T, Shabbir MA, Mukhtar N, Khan MR, Berg M. 2012. Complete genome sequence of a velogenic neurotropic avian paramyxovirus 1 isolated from peacocks (*Pavo cristatus*) in a wildlife park in Pakistan. *J Virol* 86:13113-13114.
29. Wobeser G, Leighton FA, Norman R, Myers DJ, Onderka D, Pybus MJ, Neufeld JL, Fox GA, Alexander DJ. 1993. Newcastle disease in wild water birds in western Canada, 1990. *Can Vet J* 34:353.
30. Napp S, Alba A, Rocha AI, Sánchez A, Rivas R, Majó N, Perarnau M, Massot C, Miguel ES, Soler M. 2017. Six-year surveillance of Newcastle disease virus in wild birds in north-eastern Spain (Catalonia). *Avian Pathol* 46:59-67.
31. Kim LM, King DJ, Curry PE, Suarez DL, Swayne DE, Stallknecht DE, Slemmons RD, Pedersen JC, Senne DA, Winker K. 2007. Phylogenetic diversity among low-virulence Newcastle disease viruses from waterfowl and shorebirds and comparison of genotype distributions to those of poultry-origin isolates. *J Virol* 81:12641-12653.
32. Usachev E, Fediakina I, Shchelkanov M, L'vov D, Prilipov A, Iamnikova S. 2005. Molecular genetic characteristics of the Newcastle Sterna/Astrakhan/Z275/2001 virus isolated in Russia. *Mol Gen Mikrobiol Virusol*:14-20.
33. Diel DG, Susta L, Garcia SC, Killian ML, Brown CC, Miller PJ, Afonso CL. 2012. Complete genome and clinicopathological characterization of a virulent Newcastle disease virus isolate from South America. *J Clin Microbiol* 50:378-387.
34. Maminiaina OF, Gil P, Briand F-X, Albina E, Keita D, Andriamanivo HR, Chevalier V, Lancelot R, Martinez D, Rakotondravao R. 2010. Newcastle disease virus in Madagascar: identification of an original genotype possibly deriving from a died out ancestor of genotype IV. *PLoS One* 5:e13987.

35. Servan de Almeida R, Hammoumi S, Gil P, Briand F-X, Molia S, Gaidet N, Cappelle J, Chevalier V, Balanca G, Traore A. 2013. New avian paramyxoviruses type I strains identified in Africa provide new outcomes for phylogeny reconstruction and genotype classification. *Plos One* 10 (8),(2013).
36. Cattoli G, Fusaro A, Monne I, Molia S, Le Menach A, Maregeya B, Nchare A, Bangana I, Maina AG, Koffi J-NG. 2010. Emergence of a new genetic lineage of Newcastle disease virus in West and Central Africa—implications for diagnosis and control. *Vet Microbiol* 142:168-176.
37. Miller PJ, King DJ, Afonso CL, Suarez DL. 2007. Antigenic differences among Newcastle disease virus strains of different genotypes used in vaccine formulation affect viral shedding after a virulent challenge. *Vaccine* 25:7238-7246.
38. Kim S-H, Wanasen N, Paldurai A, Xiao S, Collins PL, Samal SK. 2013. Newcastle disease virus fusion protein is the major contributor to protective immunity of genotype-matched vaccine. *PLoS One* 8:e74022.
39. Kapczynski DR, King DJ. 2005. Protection of chickens against overt clinical disease and determination of viral shedding following vaccination with commercially available Newcastle disease virus vaccines upon challenge with highly virulent virus from the California 2002 exotic Newcastle disease outbreak. *Vaccine* 23:3424-3433.
40. Jeon W-J, Lee E-K, Lee Y-J, Jeong O-M, Kim Y-J, Kwon J-H, Choi K-S. 2008. Protective efficacy of commercial inactivated Newcastle disease virus vaccines in chickens against a recent Korean epizootic strain. *J Vet Sci* 9:295-300.
41. Van Boven M, Bouma A, Fabri TH, Katsma E, Hartog L, Koch G. 2008. Herd immunity to Newcastle disease virus in poultry by vaccination. *Avian Pathol* 37:1-5.
42. Dortmans JC, Peeters BP, Koch G. 2012. Newcastle disease virus outbreaks: vaccine mismatch or inadequate application? *Vet Microbiol* 160:17-22.
43. Cornax I, Miller PJ, Afonso CL. 2012. Characterization of live LaSota vaccine strain–induced protection in chickens upon early challenge with a virulent Newcastle disease virus of heterologous genotype. *Avian Dis* 56:464-470.
44. Meulemans G. 1988. Control by vaccination, p 318-332, Newcastle disease. Springer.
45. Perozo F, Marcano R, Afonso CL. 2012. Biological and phylogenetic characterization of a genotype VII Newcastle disease virus from Venezuela: efficacy of field vaccination. *J Clin Microbiol* 50:1204-1208.
46. Zhu J, Hu S, Xu H, Liu J, Zhao Z, Wang X, Liu X. 2016. Characterization of virulent Newcastle disease viruses from vaccinated chicken flocks in Eastern China. *BMC Vet Res* 12:113.
47. Rehmani SF, Wajid A, Bibi T, Nazir B, Mukhtar N, Hussain A, Lone NA, Yaqub T, Afonso CL. 2015. Presence of Virulent Newcastle Disease Virus in Vaccinated Chickens Farms In Pakistan. *J Clin Microbiol*: 02818-02814.
48. Peeters BP, de Leeuw OS, Koch G, Gielkens AL. 1999. Rescue of Newcastle disease virus from cloned cDNA: evidence that cleavability of the fusion protein is a major determinant for virulence. *J Virol* 73:5001-5009.
49. Panda A, Huang Z, Elankumaran S, Rockemann DD, Samal SK. 2004. Role of fusion protein cleavage site in the virulence of Newcastle disease virus. *Microb Pathog* 36:1-10.



50. de Leeuw OS, Koch G, Hartog L, Ravenshorst N, Peeters BP. 2005. Virulence of Newcastle disease virus is determined by the cleavage site of the fusion protein and by both the stem region and globular head of the haemagglutinin–neuraminidase protein. *J Gen Virol* 86:1759-1769.
51. Dortmans JC, Koch G, Rottier PJ, Peeters BP. 2011. Virulence of Newcastle disease virus: what is known so far? *Vet Res* 42:122.
52. Liu M-M, Cheng J-L, Yu X-H, Qin Z-M, Tian F-L, Zhang G-Z. 2015. Generation by reverse genetics of an effective attenuated Newcastle disease virus vaccine based on a prevalent highly virulent Chinese strain. *Biotechnol Lett* 37:1287.
53. Hu S, Ma H, Wu Y, Liu W, Wang X, Liu Y, Liu X. 2009. A vaccine candidate of attenuated genotype VII Newcastle disease virus generated by reverse genetics. *Vaccine* 27:904-910.
54. Hu Z, Hu S, Meng C, Wang X, Zhu J, Liu X. 2011. Generation of a genotype VII Newcastle disease virus vaccine candidate with high yield in embryonated chicken eggs. *Avian Dis* 55:391-397.
55. Xiao S, Nayak B, Samuel A, Paldurai A, Kanabagattebasavarajappa M, Prajitno TY, Bharoto EE, Collins PL, Samal SK. 2012. Generation by reverse genetics of an effective, stable, live-attenuated Newcastle disease virus vaccine based on a currently circulating, highly virulent Indonesian strain. *PLoS One* 7:e52751.
56. Meng C, Qiu X, Yu S, Li C, Sun Y, Chen Z, Liu K, Zhang X, Tan L, Song C. 2016. Evolution of Newcastle disease virus quasispecies diversity and enhanced virulence after passage through chicken air sacs. *J Virol* 90:2052-2063.
57. Shengqing Y, Kishida N, Ito H, Kida H, Otsuki K, Kawaoka Y, Ito T. 2002. Generation of velogenic Newcastle disease viruses from a nonpathogenic waterfowl isolate by passaging in chickens. *Virology* 301:206-211.
58. Liu M-M, Cheng J-L, Yu X-H, Qin Z-M, Tian F-L, Zhang G-Z. 2015. Generation by reverse genetics of an effective attenuated Newcastle disease virus vaccine based on a prevalent highly virulent Chinese strain. *Biotechnol Lett* 37:1287-1296.
59. Schnell MJ, Mebatsion T, Conzelmann K-K. 1994. Infectious rabies viruses from cloned cDNA. *EMBO J* 13:4195.
60. Schneider U, Schwemmle M, Staeheli P. 2005. Genome trimming: a unique strategy for replication control employed by Borna disease virus. *Proc Natl Acad Sci U S A* 102:3441-3446.
61. Volchkov VE, Volchkova VA, Mühlberger E, Kolesnikova LV, Weik M, Dolnik O, Klenk H-D. 2001. Recovery of infectious Ebola virus from complementary DNA: RNA editing of the GP gene and viral cytotoxicity. *Science* 291:1965-1969.
62. Herrel M, Haag L, Nilsson J, Staeheli P, Schneider U. 2013. Reverse genetics identifies the product of open reading frame 4 as an essential particle assembly factor of Nyamanini virus. *J Virol* 87:8257-8260.
63. Yoneda M, Guillaume V, Ikeda F, Sakuma Y, Sato H, Wild TF, Kai C. 2006. Establishment of a Nipah virus rescue system. *Proc Natl Acad Sci U S A* 103:16508-16513.
64. Baron MD, Barrett T. 1997. Rescue of rinderpest virus from cloned cDNA. *J Virol* 71:1265-1271.
65. Garcin D, Pelet T, Calain P, Roux L, Curran J, Kolakofsky D. 1995. A highly recombinogenic system for the recovery of infectious Sendai paramyxovirus from cDNA: generation of a novel copy-back nondefective interfering virus. *EMBO J* 14:6087.



66. He B, Paterson RG, Ward CD, Lamb RA. 1997. Recovery of infectious SV5 from cloned DNA and expression of a foreign gene. *Virology* 237:249-260.
67. Biacchesi S, Skiadopoulos MH, Tran KC, Murphy BR, Collins PL, Buchholz UJ. 2004. Recovery of human metapneumovirus from cDNA: optimization of growth in vitro and expression of additional genes. *Virology* 321:247-259.
68. Collins PL, Hill MG, Camargo E, Grosfeld H, Chanock RM, Murphy BR. 1995. Production of infectious human respiratory syncytial virus from cloned cDNA confirms an essential role for the transcription elongation factor from the 5'proximal open reading frame of the M2 mRNA in gene expression and provides a capability for vaccine development. *Proc Natl Acad Sci U S A* 92:11563-11567.
69. Kormelink R, Garcia ML, Goodin M, Sasaya T, Haenni A-L. 2011. Negative-strand RNA viruses: the plant-infecting counterparts. *Virus Res* 162:184-202.
70. Biacchesi S, Thoulouze M-I, Béarzotti M, Yu Y-X, Brémont M. 2000. Recovery of NV knockout infectious hematopoietic necrosis virus expressing foreign genes. *J Virol* 74:11247-11253.
71. Lawson ND, Stillman EA, Whitt MA, Rose JK. 1995. Recombinant vesicular stomatitis viruses from DNA. *Proc Natl Acad Sci U S A* 92:4477-4481.
72. Le Mercier P, Jacob Y, Tanner K, Tordo N. 2002. A novel expression cassette of lyssavirus shows that the distantly related Mokola virus can rescue a defective rabies virus genome. *J Virol* 76:2024-2027.
73. Yun T, Park A, Hill TE, Pernet O, Beaty SM, Juelich TL, Smith JK, Zhang L, Wang YE, Vigant F. 2015. Efficient reverse genetics reveals genetic determinants of budding and fusogenic differences between Nipah and Hendra viruses and enables real-time monitoring of viral spread in small animal models of henipavirus infection. *J Virol* 89:1242-1253.
74. Römer-Oberdörfer A, Mundt E, Mebatsion T, Buchholz UJ, Mettenleiter TC. 1999. Generation of recombinant lentogenic Newcastle disease virus from cDNA. *J Gen Virol* 80:2987-2995.
75. Zhang X, Liu H, Liu P, Peeters BP, Zhao C, Kong X. 2013. Recovery of avirulent, thermostable Newcastle disease virus strain NDV4-C from cloned cDNA and stable expression of an inserted foreign gene. *Arch Virol* 158:2115-2120.
76. Martin A, Staeheli P, Schneider U. 2006. RNA polymerase II-controlled expression of antigenomic RNA enhances the rescue efficacies of two different members of the Mononegavirales independently of the site of viral genome replication. *J Virol* 80:5708-5715.
77. Wang J, Wang C, Feng N, Wang H, Zheng X, Yang S, Gao Y, Xia X, Yin R, Liu X. 2015. Development of a reverse genetics system based on RNA polymerase II for Newcastle disease virus genotype VII. *Virus Genes* 50:152-155.
78. Li B-y, Li X-r, Lan X, Yin X-p, Li Z-y, Yang B, Liu J-x. 2011. Rescue of Newcastle disease virus from cloned cDNA using an RNA polymerase II promoter. *Arch Virol* 156:979-986.
79. Radecke F, Spielhofer P, Schneider H, Kaelin K, Huber M, Dötsch C, Christiansen G, Billeter M. 1995. Rescue of measles viruses from cloned DNA. *EMBO J* 14:5773.
80. Neumann G, Fujii K, Kino Y, Kawaoka Y. 2005. An improved reverse genetics system for influenza A virus generation and its implications for vaccine production. *Proc Natl Acad Sci U S A* 102:16825-16829.

81. Zhang X, Kong W, Ashraf S, Curtiss R. 2009. A one-plasmid system to generate influenza virus in cultured chicken cells for potential use in influenza vaccine. *J Virol* 83:9296-9303.
82. Zhang X, Curtiss R. 2015. Efficient generation of influenza virus with a mouse RNA polymerase I-driven all-in-one plasmid. *Virol J* 12:95.
83. Kobayashi T, Ooms LS, Ikizler M, Chappell JD, Dermody TS. 2010. An improved reverse genetics system for mammalian orthoreoviruses. *Virology* 398:194-200.
84. Gurke S, Barroso JF, Gerdes H-H. 2008. The art of cellular communication: tunneling nanotubes bridge the divide. *Histochem Cell Biol* 129:539-550.
85. Rørth P. 2003. Communication by touch: role of cellular extensions in complex animals. *Cell* 112:595-598.
86. Fink RP, Heimer L. 1967. Two methods for selective silver impregnation of degenerating axons and their synaptic endings in the central nervous system. *Brain Res* 4:369-374.
87. Rustom A, Saffrich R, Markovic I, Walther P, Gerdes H-H. 2004. Nanotubular highways for intercellular organelle transport. *Science* 303:1007-1010.
88. Nobes CD, Hall A. 1995. Rho, rac, and cdc42 GTPases regulate the assembly of multimolecular focal complexes associated with actin stress fibers, lamellipodia, and filopodia. *Cell* 81:53-62.
89. Zhang J-G, Czabotar PE, Policheni AN, Caminschi I, San Wan S, Kitsoulis S, Tullett KM, Robin AY, Brammananth R, van Delft MF. 2012. The dendritic cell receptor Clec9A binds damaged cells via exposed actin filaments. *Immunity* 36:646-657.
90. Edwards FA, Gibb AJ, Colquhoun D. 1992. ATP receptor-mediated synaptic currents in the central nervous system. *Nature* 359:144-147.
91. Makhortova NR, Askovich P, Patterson CE, Gechman LA, Gerard NP, Rall GF. 2007. Neurokinin-1 enables measles virus trans-synaptic spread in neurons. *Virology* 362:235-244.
92. Lawrence DM, Patterson CE, Gales TL, D'Orazio JL, Vaughn MM, Rall GF. 2000. Measles virus spread between neurons requires cell contact but not CD46 expression, syncytium formation, or extracellular virus production. *J Virol* 74:1908-1918.
93. El Najjar F, Cifuentes-Muñoz N, Chen J, Zhu H, Buchholz UJ, Moncman CL, Dutch RE. 2016. Human metapneumovirus Induces Reorganization of the Actin Cytoskeleton for Direct Cell-to-Cell Spread. *PLoS Pathog* 12:e1005922.
94. Mehedi M, McCarty T, Martin SE, Le Nouën C, Buehler E, Chen Y-C, Smelkinson M, Ganesan S, Fischer ER, Brock LG. 2016. Actin-Related Protein 2 (ARP2) and Virus-Induced Filopodia Facilitate Human Respiratory Syncytial Virus Spread. *PLoS Pathog* 12:e1006062.
95. Martinez MG, Kielian M. 2016. Intercellular Extensions Are Induced by the Alphavirus Structural Proteins and Mediate Virus Transmission. *PLoS Pathog* 12:e1006061.
96. Doceul V, Hollinshead M, van der Linden L, Smith GL. 2010. Repulsion of superinfecting virions: a mechanism for rapid virus spread. *Science* 327:873-876.
97. Frischknecht F, Moreau V, Röttger S, Gonfloni S, Reckmann I, Superti-Furga G, Way M. 1999. Actin-based motility of vaccinia virus mimics receptor tyrosine kinase signalling. *Nature* 401:926-929.
98. Roberts KL, Manicassamy B, Lamb RA. 2015. Influenza A virus uses intercellular connections to spread to neighboring cells. *J Virol* 89:1537-1549.

99. Sowinski S, Jolly C, Berninghausen O, Purbhoo MA, Chauveau A, Köhler K, Oddos S, Eissmann P, Brodsky FM, Hopkins C. 2008. Membrane nanotubes physically connect T cells over long distances presenting a novel route for HIV-1 transmission. *Nat Cell Biol* 10:211-219.
100. Iwami S, Takeuchi JS, Nakaoka S, Mammano F, Clavel F, Inaba H, Kobayashi T, Misawa N, Aihara K, Koyanagi Y. 2015. Cell-to-cell infection by HIV contributes over half of virus infection. *Elife* 4:e08150.
101. Xiao F, Fofana I, Heydmann L, Barth H, Soulier E, Habersetzer F, Doffoël M, Bukh J, Patel AH, Zeisel MB. 2014. Hepatitis C virus cell-cell transmission and resistance to direct-acting antiviral agents. *PLoS Pathogens* 10:e1004128.
102. Tscherne DM, Evans MJ, von Hahn T, Jones CT, Stamatakis Z, McKeating JA, Lindenbach BD, Rice CM. 2007. Superinfection exclusion in cells infected with hepatitis C virus. *J Virol* 81:3693-3703.
103. Karpf AR, Lenches E, Strauss EG, Strauss JH, Brown DT. 1997. Superinfection exclusion of alphaviruses in three mosquito cell lines persistently infected with Sindbis virus. *J Virol* 71:7119-7123.
104. Lee Y-M, Tscherne DM, Yun S-I, Frolov I, Rice CM. 2005. Dual mechanisms of pestiviral superinfection exclusion at entry and RNA replication. *J Virol* 79:3231-3242.
105. Folimonova SY. 2012. Superinfection exclusion is an active virus-controlled function that requires a specific viral protein. *J Virol* 86:5554-5561.
106. Whitaker-Dowling P, Ungner JS, Widnell CC, Wilcox DK. 1983. Superinfection exclusion by vesicular stomatitis virus. *Virology* 131:137-143.
107. Simon KO, Cardamone JJ, Whitaker-Dowling PA, Youngner JS, Widnell CC. 1990. Cellular mechanisms in the superinfection exclusion of vesicular stomatitis virus. *Virology* 177:375-379.
108. Bergua M, Zwart MP, El-Mohtar C, Shilts T, Elena SF, Folimonova SY. 2014. A viral protein mediates superinfection exclusion at the whole-organism level but is not required for exclusion at the cellular level. *J Virol* 88:11327-11338.
109. Laliberte JP, Moss B. 2014. A novel mode of poxvirus superinfection exclusion that prevents fusion of the lipid bilayers of viral and cellular membranes. *J Virol* 88:9751-9768.
110. Atallah OO, Kang S-H, El-Mohtar CA, Shilts T, Bergua M, Folimonova SY. 2016. A 5'-proximal region of the Citrus tristeza virus genome encoding two leader proteases is involved in virus superinfection exclusion. *Virology* 489:108-115.
111. Campbell CL, Smith DR, Sanchez-Vargas I, Zhang B, Shi P-Y, Ebel GD. 2014. A positively selected mutation in the WNV 2K peptide confers resistance to superinfection exclusion in vivo. *Virology* 464:228-232.
112. Folimonova SY, Harper SJ, Leonard MT, Triplett EW, Shilts T. 2014. Superinfection exclusion by Citrus tristeza virus does not correlate with the production of viral small RNAs. *Virology* 468:462-471.
113. Beperet I, Irons SL, Simón O, King LA, Williams T, Possee RD, López-Ferber M, Caballero P. 2014. Superinfection exclusion in alphabaculovirus infections is concomitant with actin reorganization. *J Virol* 88:3548-3556.
114. Zhang X-F, Sun R, Guo Q, Zhang S, Meulia T, Halfmann R, Li D, Qu F. 2017. A self-perpetuating repressive state of a viral replication protein blocks superinfection by the same virus. *PLoS Pathog* 13:e1006253.

115. Baumann CA, Neubert WJ. 2010. Neuraminidase-deficient Sendai virus HN mutants provide protection from homologous superinfection. *Arch Virol* 155:217-227.
116. Ludlow M, McQuaid S, Cosby SL, Cattaneo R, Rima BK, Duprex WP. 2005. Measles virus superinfection immunity and receptor redistribution in persistently infected NT2 cells. *J Gen Virol* 86:2291-2303.
117. Huang I-C, Li W, Sui J, Marasco W, Choe H, Farzan M. 2008. Influenza A virus neuraminidase limits viral superinfection. *J Virol* 82:4834-4843.
118. Morrison TG, McGinnes LW. 1989. Avian cells expressing the Newcastle disease virus hemagglutinin-neuraminidase protein are resistant to Newcastle disease virus infection. *Virology* 171:10-17.
119. Han G-Z, He C-Q, Ding N-Z, Ma L-Y. 2008. Identification of a natural multi-recombinant of Newcastle disease virus. *Virology* 371:54-60.
120. Satharasinghe DA, Murulitharan K, Tan SW, Yeap SK, Munir M, Ideris A, Omar AR. 2016. Detection of inter-lineage natural recombination in avian paramyxovirus serotype 1 using simplified deep sequencing platform. *Front Microbiol* 7.
121. Qin Z, Sun L, Ma B, Cui Z, Zhu Y, Kitamura Y, Liu W. 2008. F gene recombination between genotype II and VII Newcastle disease virus. *Virus Res* 131:299-303.
122. Chong YL, Padhi A, Hudson PJ, Poss M. 2010. The effect of vaccination on the evolution and population dynamics of avian paramyxovirus-1. *PLoS Pathog* 6:e1000872.



---

## **Génération d'un nouveau vaccin pour protéger les volailles contre la maladie de Newcastle et l'excrétion virale**

---

### **Résumé**

La maladie de Newcastle est une de deux pestes aviaires qui, comme l'influenza, impactent fortement les élevages d'oiseaux domestiques par leur incidence clinique et leurs conséquences économiques sur la filière (contrôle des mouvements d'animaux, abattages sanitaires et préventifs). Des vaccins contre cette maladie ont été développés il y a plusieurs décennies à base de souches virales isolées dans les années 60. Ils assurent normalement une excellente protection clinique. Toutefois, depuis une dizaine d'années, des observations de terrain, principalement en Afrique et en Asie, font état d'échecs partiels de vaccination avec occurrence de foyers réduits dans des élevages a priori correctement vaccinés. En parallèle, des essais in vivo en conditions contrôlées ont établi que les vaccins actuels protégeaient bien cliniquement contre une épreuve avec des souches virulentes récentes mais n'empêchaient pas leur excrétion par les animaux vaccinés. Pour résoudre cette problématique, l'objectif de ce travail a été de générer une souche vaccinale plus efficace contre les souches virulentes circulant actuellement à l'échelle du globe. Pour générer des virus atténués modifiés, nous avons dû dans un premier temps améliorer le système conventionnel de génétique inverse. Nous montrons que la réduction du nombre de plasmides à 2 dans le système, permet de générer plus de virus atténués que le système conventionnel basé sur 4 plasmides. Dans un second temps, nous nous sommes intéressés à étudier le comportement in vitro de virus atténués et virulents équipés de marqueurs fluorescents. Nous montrons que seuls les virus virulents induisent un effet cytopathique in vitro. En revanche, les deux types de virus induisent une infection persistante à long terme sans effet cytopathique. Les cellules infectées de façon persistante résistent à une surinfection par un autre virus. En revanche, lors de co-infections simultanées, nous établissons qu'une cellule infectée par un premier virus peut s'infecter par un second virus lors d'un transfert direct de matériel viral d'une cellule à une autre par des extensions membranaires. Cette observation est remise en perspective par rapport à la capacité de ces virus à se recombiner chez l'animal telle qu'identifiée par des analyses bioinformatiques comparatives de différents isolats. En effet, nous montrons que des cellules peuvent s'infecter avec plusieurs virus par contact direct. Dans un dernier travail, une nouvelle souche vaccinale a été générée consistant à insérer des antigènes immunoprotecteurs d'un virus original isolé à Madagascar en 2008, dans un génome d'une souche vaccinale conventionnelle utilisée depuis plus de 50 ans. Nous montrons que cette nouvelle souche protège efficacement contre trois génotypes viraux dont deux circulant actuellement en Afrique et en Asie.

---

## **Generating a new vaccine for protecting poultry from Newcastle disease and controlling viral shedding**

---

### **Summary**

In addition to influenza, Newcastle disease is one of the two major diseases of poultry that strongly impact the animal health and farming owing to animal bans and depopulations. Vaccines against Newcastle disease are available. They have been developed some decades ago from isolates collected in the 60's. They usually provide an excellent clinical protection. However, field reports of the last decade, mainly from Africa and Asia, suggest partial vaccination failures in some farms despite proper vaccination. In parallel, in vivo trials have shown that current vaccines provide a good clinical protection against a challenge with recent field strains, but do not prevent shedding of the challenge virus from vaccinated birds. To address this issue, one of the objectives of this study was to generate a new vaccine prototype with improved efficacy against virulent strains circulating worldwide. To generate new engineered attenuated viruses, we first developed an improved reverse genetics system. We demonstrate that the reduction of the number of plasmids to 2 compared to the conventional system based on 4 plasmids does not affect the performances of reverse genetics for virulent strains but significantly increases the yield of attenuated viruses. In a second step, we focused on the behavior of the attenuated and virulent viruses generated by reverse genetics. The viruses were tagged with fluorescent reporter genes to make easier they follow up in cell culture. We show that only virulent strains produce cytopathic effects in vitro. However, both attenuated and virulent strains are able to establish persistent infection in cells without cytopathic effects. Persistently infected cells resist to a super-infection by another virus. In contrast, after co-infection by two different viruses, we show that a cell infected by one virus can be infected by a second one by direct virus trafficking between the cells through cell membrane extensions. This observation supports the possibility of recombination events in the field which are sometime claim in the literature from comparative bioinformatics of field isolates and vaccine strains. Indeed, we show that cells can be infected by multiple viruses through direct contacts between cells. In a last step, a new vaccine prototype has been produced consisting in the substitution of immune-protective antigens in the conventional LaSota vaccine by their homologues derived from an original isolate of Madagascar (2008). We show that this prototype is protective against challenges with three different viruses, including two recent isolates from Africa and Asia.