



HAL
open science

Fab-Cell: Aided-design tool for non-standard timber walls

Oscar Gámez Bohórquez

► **To cite this version:**

Oscar Gámez Bohórquez. Fab-Cell: Aided-design tool for non-standard timber walls. Architecture, space management. Université de Lorraine, 2017. English. NNT : 2017LORR0053 . tel-01686715

HAL Id: tel-01686715

<https://theses.hal.science/tel-01686715v1>

Submitted on 17 Jan 2018

HAL is a multi-disciplinary open access archive for the deposit and dissemination of scientific research documents, whether they are published or not. The documents may come from teaching and research institutions in France or abroad, or from public or private research centers.

L'archive ouverte pluridisciplinaire **HAL**, est destinée au dépôt et à la diffusion de documents scientifiques de niveau recherche, publiés ou non, émanant des établissements d'enseignement et de recherche français ou étrangers, des laboratoires publics ou privés.



AVERTISSEMENT

Ce document est le fruit d'un long travail approuvé par le jury de soutenance et mis à disposition de l'ensemble de la communauté universitaire élargie.

Il est soumis à la propriété intellectuelle de l'auteur. Ceci implique une obligation de citation et de référencement lors de l'utilisation de ce document.

D'autre part, toute contrefaçon, plagiat, reproduction illicite encourt une poursuite pénale.

Contact : ddoc-theses-contact@univ-lorraine.fr

LIENS

Code de la Propriété Intellectuelle. articles L 122. 4

Code de la Propriété Intellectuelle. articles L 335.2- L 335.10

http://www.cfcopies.com/V2/leg/leg_droi.php

<http://www.culture.gouv.fr/culture/infos-pratiques/droits/protection.htm>



UNIVERSITÉ
DE LORRAINE



École doctorale IAEM Lorraine

Fab-Cell

Outil d'aide à la conception de parois non standards en bois

THÈSE

Présentée et soutenue publiquement le 24 mars 2017

pour l'obtention du

Doctorat de l'Université de Lorraine

Discipline Sciences de l'Architecture

par

Oscar GAMEZ BOHORQUEZ

Composition du jury

Président:	Mme. Nadia HOYET	LéaV École nationale supérieure d'architecture de Versailles
Rapporteurs:	Mme. Gabriela CELANI	Universidade Estadual de Campinas - São Paulo - BRESIL
	M. Pierre LECLERCQ	LUCID - Lab for User Cognition & Innovative Design. University of Liege- Belgium
Examineur:	Mme. Nadia HOYET	LéaV Laboratoire de recherche de l'École nationale supérieure d'architecture de Versailles
Directeur de thèse	M. Jean-Claude BIGNON	Centre de Recherche en Architecture et Ingénierie, ENSA Nancy
Co-directeur de thèse	M. Gilles DUCHANOIS	Centre de Recherche en Architecture et Ingénierie, ENSA

Fab-Cell

Aided-design tool for non-standard timber walls

By

Oscar Gámez Bohórquez

Submitted to the IAEM graduate school on November the 28th 2016

Defended the 24 March 2017

In partial fulfillment for the degree of

Doctor in Architectural Sciences

“Université de Lorraine”

Map CRAI – School of Architecture of Nancy

ACKNOWLEDGEMENTS

To begin, I am very grateful with Prof. Jean-Claude Bignon for his support, guidance and knowledge that made possible achieving the research and experimentation described in this dissertation. Thanks also to the principals and personnel at C.R.A.I, the School of Architecture of Nancy, and the ENSTIB whom have helped accomplishing this challenge. Furthermore, I acknowledge the Ministry of Culture, the Lorraine region and the School of Architecture of Nancy for partially funding this work.

A very special mention goes to prof. Gilles Duchanois as well as to students Guillaume Ginefri and Thomas Erhardt who contributed in accelerating the achievement of the results shown by the end of Chapter 7.

My most profound (if not infinite) gratitude goes to my close family and those friends who unconditionally supported me ever since I came to France and never gave up on cheering me up or giving me a hand when I needed it: María José Cabezas, Paula M. Jaramillo, Juliana Herrera, Karina Quiroz, Manuela de la Torre, Lika Kovaleva, Dinín Vargas, Elodie Hoschheid and Robert Valverde. Blessings to you all.

As for those who I might have forgotten to mention, you people know who you are!

Last but not least, thanks to God: Omnipotent energy that rules the universe...

Dedicated to María Ana and Leonor, for they have made the most to help me be what I am.

To Claudia Díaz for being an ever present light, even when things have turned so blurry for the light to be there.

“It takes a gentleman to suffer ignorance and smile”

G.M. Thomas Sumner

ABSTRACT

Keywords: Non-standard walls; CNC fabrication; Mass customization; Timber construction; Aided-Conception Parametric Tools; Geometric patterns.

The integration of computing language into architecture and engineering has been present since the 1960s but it only proved practical by the 1990s when modeling tools started to participate in an architectural shift that has conceptually mutated through the years. By then, the trend was called “blob architecture” and thirteen years ago, trends succeeding “blobism” were named as non-standard architecture.

In the last ten years, academicians like Mario Carpo and practitioners such as Patrick Schumacher nested the terms parametricism, mass customization, and non-standard architecture to define those complex –not necessarily complicated- architectures created by using of digital tools and aided-manufacturing methods.

This thesis is underpinned on the fact that using the non-standard approach in any architectural project needs more than just a plastic or functional intention but the means to translate that intention into actual buildable objects. The aims of this study are therefore oriented towards architectural elements using cellular-like patterns as morphologic resource.

This work brings up an Aided-Conception Parametric Tool (ACPT) that actually helps designers to explore non-standard solutions to specific architectural problems regarding timber-built walls and envelopes.

This ACPT is meant then to succeed architectural intentions in which geometric patterns –as morphologic modifiers- are used to provide walls and envelopes with a particular language (a cellular structure) that might require morphologic form-searching (Carpo, 2015a) and topologic optimization by means of parametric-generative modeling.

The previously mentioned aims were validated by means of a full-scale prototyping exercise in which the first version of the ACPT is tested. Furthermore A series of modeling improvements regarding pattern generation, jointing calculation and fabrication simulation, helped fixing the difficulties found during the first validation stage in order to produce a set of Rhinoceros-Grasshopper (RGH) functional clusters that embody the early operational state of this ACPT called Fab-Cell.

RESUMÉ

Mots clés: Parois non-standards; Fabrication CNC; Customisation de masse; Construction bois; Outils Paramétriques d'Aide à la Conception; Motifs géométriques.

L'intégration du langage informatique dans l'architecture et l'ingénierie a commencé dès les années 1960, mais a connu un réel essor dans les années 1990. Les outils de modélisation ont alors progressivement fait émerger une nouvelle architecture. Tout d'abord baptisée « architecture blob », on lui a ensuite attribué le nom de « blobisme » et ses dérivés sont aujourd'hui appelés « architecture non standard ».

Au cours de la dernière décennie, certains chercheurs comme Mario Carpo ou praticiens comme Patrick Schumacher ont introduit les termes de « paramétrisme », « customisation de masse », et « architecture non standard » pour définir ces nouvelles constructions complexes. Elles ne sont pas nécessairement savantes, mais ont été conçues grâce à des outils numériques et réalisées avec des méthodes de fabrication digitales.

Cette thèse prend appui sur le postulat qu'une approche non standard dans un projet est loin de se résumer à une démarche purement plastique ou fonctionnelle : elle est destinée à produire des objets constructibles.

Le domaine d'étude est celui des murs et enveloppes construites en bois et plus particulièrement les parois de type cellulaire.

Ce travail inclut donc un outil paramétrique d'aide à la conception (ACPT, Aided-Conception Parametric Tool) et à la fabrication qui peut accompagner les concepteurs dans l'exploration de solutions non-standards pour des problèmes architecturaux spécifiques

Cet outil paramétrique et intégré s'appuie sur une modélisation géométrique et technique des parois murales et des différents dispositifs cellulaires qui les composent. L'approche paramétrique autorise le développement de nombreuses variantes morphologiques. Sa dimension intégrée permet la production et l'optimisation des données tant topologiques que constructives.

La production grandeur nature d'une paroi réalisée par un robot de coupe a servi de cadre expérimental pour démontrer les potentialités de notre approche mais aussi en identifier les difficultés.

Les améliorations effectuées ont conduit à produire une série de clusters (groupes de fonctions) pour Rhinoceros-Grasshopper (RGH) qui ont permis de mettre en œuvre la première version opérationnelle de cet outil, baptisée Fab-Cell.

RELATED PUBLICATIONS

Gámez Oscar. 2017. "N-sWArm. Outil d'aide à la conception de parois non-standards en bois" In "Actes du 7^{ème} Forum Internatinoal Bois Construction FBC 2017" Épinal- Nancy, France, April 5-7, 2017. Pg 291–308. Forumholzbois

Gámez, Oscar, Jean Claude Bignon, and Gilles Duchanois. 2015. "Assisted Construction of Non-Standard Wooden Walls and Envelope Structures by Parametric Modeling." In 16th International Conference, CAAD Futures 2015, São Paulo, Brazil, July 8-10, 2015. Selected Papers, 527:291–308. 1865-0929. Sao Paulo, Brazil: Springer Berlin Heidelberg.

Gámez, Oscar; Jean-Claude Bignon and Gilles Duchanois. 2015. "Assisted Construction of Non-Standard Wooden Walls and Envelope Structures by Parametric Modeling." In Proceedings of the 20th International Conference of the Association for Computer-Aided Architectural Design Research in Asia (CAADRIA 2015). Daegu: 653-662. http://cumincad.scix.net/cgi-bin/works/Show?id=caadria2015_010&sort=DEFAULT&search=G%e1mez&hits=1.

Gámez, Oscar, Julien Meyer, Jean-Claude Bignon, and Gilles Duchanois. 2015. "Interaction of Analogic and Digital Workflows for Architectural Design and Production." In Project Information for Interaction. Florianopolis, Brazil.

RÉSUMÉ GÉNÉRAL DE LA THÈSE.

Depuis les années 1960, architectes et ingénieurs en calcul tentent d'intégrer l'automatisation dans les tâches de conception et de production (Illustration Fr. 1). Il ne s'agit cependant pas d'automatisation dans le sens où elle remplacerait la créativité ou l'artisanat, mais serait un support pour aider les architectes à résoudre des problèmes architecturaux complexes et faciliter l'intégration de solutions formelles complexes qui caractérisent l'architecture et le design contemporains.

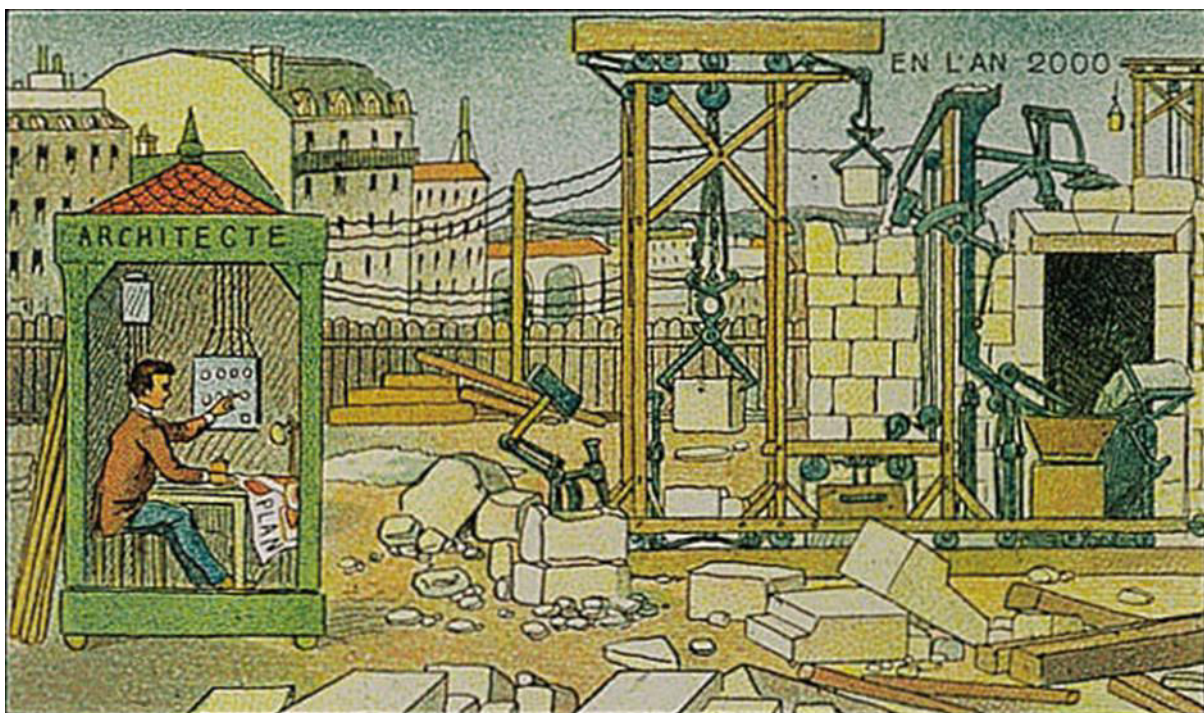

Illustration Fr. 1. La vision de Villemard à l'égard du rôle des robots et leur interaction avec l'architecte dans le site de chantier. 1910. En : expositions.bnf.fr/utopie/grand/3_95a2.htm.

Les travaux dans ce domaine sont nombreux, mais citons en particulier ceux de Nicholas Negroponte (1970), Paul Quinrand (1985) ou John Frazer (Frazer, 1995), qui ont fait figure de précurseurs et ont en partie ouvert la voie à notre vision contemporaine de l'architecture. Celle-ci s'est affirmée au fil des années, mais est loin d'être universelle. En effet, de toutes les activités humaines, l'architecture semble être l'une des plus résistantes au changement (Kolarevic, 2015), même si quelques exceptions existent.

Dans les années 1980 et 1990, des architectes tenaces tels que Frazer lui-même, Lars Spuybroek, Norman Foster, Daniel Libeskind, Frank Gehry ou Greg Lynn ont exploré la conception architecturale avec des solutions logicielles utilisées dans l'industrie automobile et aéronautique (Celedón, 2014; Lynn, 1998). Leur travail a abouti à de nouvelles tendances et productions architecturales telles que le déconstructivisme, l'architecture blob, l'architecture non-standard et le paramétrisme de Schumacher. Il n'est donc pas surprenant que des solutions logicielles destinées à l'industrie aient été préférées à des logiciels pour l'architecture dans le cadre de certains projets complexes comme la Sagrada Familia ou le Peix de Frank Gehry à Barcelone (Burry, 2002; Davis, 2013; Halabi, 2016)¹

Depuis que nous explorons des solutions architecturales et formelles complexes, la conception intègre de nouvelles problématiques comme la gestion de données et d'informations numériques pour la visualisation et la fabrication. Aucun projet architectural contemporain ne peut se soustraire à cette réalité, quelle que soit l'approche plastique et spatiale dont il a fait l'objet.

La matérialisation de murs et enveloppes basés sur des formes libres est devenue possible grâce à la généralisation de la customisation de masse, et donc à la possibilité de produire des ensembles sur-mesure (Anzalone et al., 2009; Carpo, 2005). Les formes libres et la customisation de masse sont les concepts de base de ce que l'on appelle « architecture non-standard ».

La filière de la construction bois est devenue un champ d'expérimentation privilégié de ce type d'architecture. En effet, le bois est un matériau qui allie propriétés mécaniques et esthétiques intéressantes, qui lui confèrent à la fois charme et performance structurelle. Il est également l'un des premiers matériaux travaillés et sculptés par l'homme. En d'autres termes, la fabrication soustractive est inhérente au travail du bois.

¹ Les géométries complexes que l'on retrouve dans ces deux exemples ont nécessité une approche numérique qui est courante pour la conception et modélisation industrielle, mais rare dans le cadre de la modélisation architecturale. On pense notamment aux surfaces réglées (ruled surfaces) des colonnes de la Sagrada Familia et aux éléments de façade du Peix de F. Gehry qui sont relativement similaires mais pas identiques (Davis Burry). Dans les deux cas, des solutions logicielles comme CAADS5 ou Catia ont été utilisés pour traduire des formes complexes en données de fabrication

Sa valeur esthétique, ses propriétés mécaniques et sa maniabilité sont probablement ce qui fait du bois un élément essentiel dans la construction, qu'elle soit traditionnelle ou contemporaine. En outre, dans de nombreux pays industrialisés, les filières du bois d'œuvre et de la construction intègrent les aspects de durabilité, d'économies d'énergie et la prise en compte du cycle de vie des produits pour limiter leurs émissions de CO2.

Les outils numériques permettent donc aujourd'hui de travailler une architecture contemporaine en bois qui use de parois et d'enveloppes fonctionnelles qui se détache des paradigmes de l'orthogonalité et du parallélisme. C'est dans ce contexte que s'inscrit ce travail de thèse (Illustration Fr. 2).



Illustration Fr. 2. Un ensemble d'architectures non-standard réalisées en bois. Un domaine d'expérimentation dans lequel les formes et les approches architecturales peuvent être testées grâce aux propriétés physiques et esthétiques offertes par le bois.

Les parois et enveloppes non standard (en particulier celles qui ont une morphologie cellulaire) sont généralement utilisées pour des architectures d'exposition ou des structures éphémères. Et si les qualités de l'approche non-standard et les avantages de la production dé-sérialisée étaient exploitées pour l'architecture « de tous les jours » ?

Ce travail de thèse fut l'occasion de développer un ACPT (Aided-Conception Parametric Tool, outil paramétrique d'aide à la conception) qui fournit une aide à la décision destinée aux concepteurs qui ont déjà entamé la conception et qui ont besoin dont le travail nécessite une optimisation du langage architectural, des détails et de l'espace.

Cet ACPT est constitué d'un ensemble de fonctions qui permettent de travailler différentes variantes de projet et accompagne le concepteur jusqu'aux phases de fabrication : il s'agit d'un outil de CAO et de FAO. À partir d'un design existant représenté par des surfaces, il permet dans un premier temps de générer des variantes de projet en utilisant des processus de calcul itératifs basés sur des variables d'entrée. Ensuite, il permet de générer des données de fabrication qui sont lisibles par des machines à Commande Numérique (Illustration Fr. 3). Alors, de quelle manière cet ACPT peut-il aider les concepteurs dans leur démarche ?

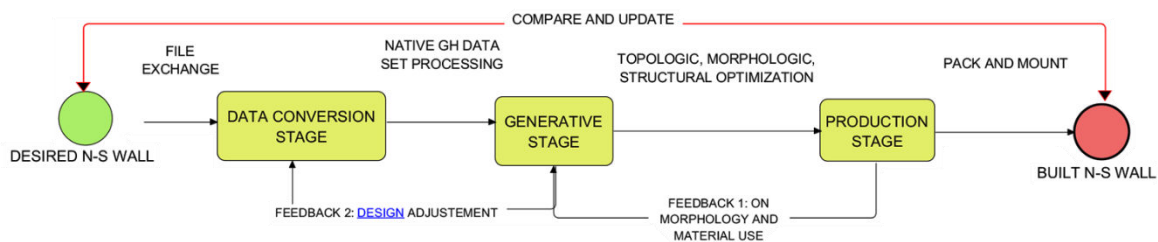

Illustration Fr. 3. Modèle de données de l'outil Fab-Cell summarized data model. Phases = noyaux de l'outil.

En phase de conception, les architectes commencent généralement par définir des espaces qui répondent à des usages, puis les hiérarchisent en utilisant des cloisons et des murs.

Pour caractériser un espace, il faut également travailler les aspects structurels et esthétiques des parois qui le définissent (murs et enveloppes).

L'ACPT proposé, intitulé Fab-Cell ², intègre les problématiques évoquées précédemment et permet de : **a)** Générer des parois composées de cellules construites sur des motifs géométriques (le concepteur peut explorer différentes solutions morphologiques grâce à l'aspect paramétrique de l'outil). **b)** Appliquer des transformations directement à des surfaces issues de l'esquisse initiale du concepteur. **c)** Visualiser ces transformations dans une interface et d'interagir avec les composants de l'outil qui sont interconnectés. **d)** Traduire les entités (parois) retravaillées et détaillées en informations de construction pour des machines à commande numérique (CNC) (Illustration Fr. 4).

² Fab-Cell est l'acronyme de "Non-Standard Wall Maker". (Outil de conception de murs et enveloppes non-standards). Merci de vous référer à la section 6.4.3 pour plus de détails.

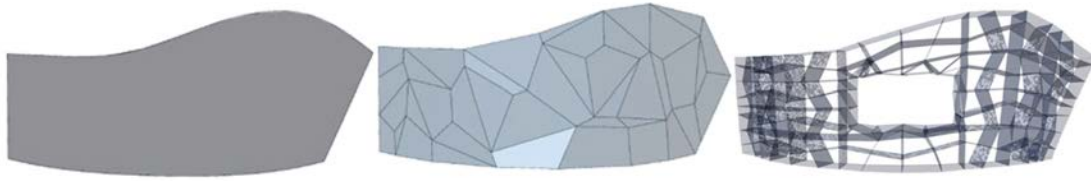

Illustration Fr. 4. Étapes de traitement des informations dans Fab-Cell. De gauche à droite : géométrie du design initial ; redéfinition morphologique et topologique ; modèle détaillé en cellules.

Pour cela, l'ACPT offre une interface de calepinage qui permet d'exporter les éléments usinables réorganisés et numérotés pour la fabrication numérique. Durant une étape supplémentaire, Fab-Cell intègre sa propre interface de FAO qui permet de générer des informations exploitables par les machines CNC. Actuellement, Fab-Cell est capable de simuler les routines de fabrication et de produire les données de fabrication pour les robots KUKA. Cette partie est basée sur les capacités offertes par le plugin de RGH Kuka|PRC (Braumann and Brell-Cokcan, 2012) (Illustration Fr. 5).

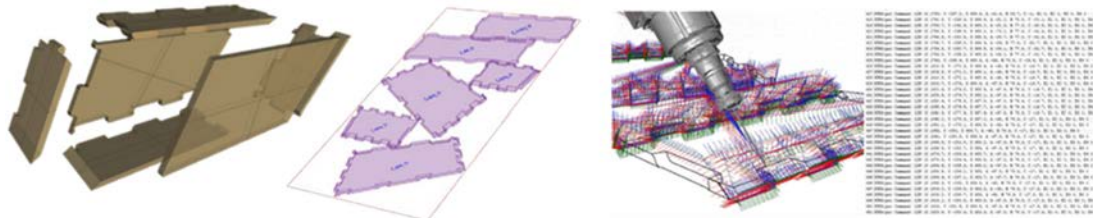

Illustration Fr. 5. Étapes de production de Fab-Cell. De gauche à droite : calcul d'assemblages de chaque cellule (caisson) ; nesting du caisson ; programmation CNC et simulation d'usinage.

L'ensemble des possibilités qu'offre Fab-Cell permet aux concepteurs de travailler avec des parois porteuses et non porteuses dans des projets en neuf et en rénovation. Dans les projets neufs, l'outil peut intervenir dans les premières phases de conception, notamment pour la recherche de forme et pour valider ou invalider des options de projet.

Pour les projets de rénovation, l'ACPT permet de travailler des cloisons ou des enveloppes de façade pour lesquelles la couche extérieure serait peu sollicitée structurellement.³ Cette approche peut être particulièrement utile dans le cadre de rénovations énergétiques ou de constructions passives pour lesquelles la diminution

³ C.f. parties 5.7 et 6.2

des déperditions thermiques et l'optimisation de la consommation d'énergie sont indispensables.

Les principes architecturaux, structurels, conceptuels et technologiques sur lesquels nous nous sommes appuyés pour créer Fab-Cell ainsi qu'une expérimentation menée pour réaliser cet outil sont détaillés dans le document qui suit, résumé dans le sommaire ci-dessous.

SOMMAIRE

Ce manuscrit de thèse comporte huit chapitres regroupés en trois parties. La première partie regroupe les parties une à trois ; la seconde partie les chapitres quatre à six, la troisième partie est composée des chapitres sept et huit.

Le 1^{er} chapitre présente un résumé des évolutions des pratiques et théories architecturales, du modernisme à ce qui est aujourd'hui appelé « architecture non-standard ». Nous évoquons également l'évolution des moyens de production qui ont amené à explorer de nouveaux langages architecturaux qui ont indubitablement fait évoluer la manière dont l'architecture est conçue et construite.

Le chapitre 2 est constitué d'un état de l'art de l'utilisation des calculs numériques pour la conception architecturale et la manière dont cela a influencé l'émergence d'outils numériques qui permettent d'explorer des formes architecturales en dehors d'un environnement papier. Il montre l'évolution des outils de conception numériques dans la pratique architecturale. Une partie sur les motifs et la tessellation expose la manière dont les approches informatiques, géométriques et biomimétiques (cellulaires) ont évolué dans la conception architecturale pour rendre possible le travail du non-standard.

Le chapitre 3 décrit les différentes étapes de la fabrication numérique et la manière dont elle a participé à la conception en architecture et ingénierie. Il contient une partie sur le prototypage rapide (RP), la fabrication digitale (RM) et les transferts de données utilisés dans les environnements CAO et FAO. Un inventaire des différents modeleurs itératifs permet d'évoquer les possibilités qu'ils offrent pour le design architectural et l'ingénierie.

Le chapitre 4 est une vue d'ensemble sur le bois comme ressource et matière première de l'industrie de la construction. Ce chapitre décrit les différents produits dérivés réalisés à partir de bois les plus couramment utilisés dans la construction. Il se termine par une section dédiée aux assemblages, dont la fabrication a été révolutionnée par l'utilisation des machines CNC et de robots dans la construction en bois.

Le chapitre 5 décrit l'utilisation du bois dans l'architecture non-standard. Un ensemble de projets y sont analysés pour étudier la manière dont les évolutions

contemporaines ont été utilisées. Ces projets font en effet appel à des méthodes paramétriques et génératives, à la fabrication automatisée principalement réalisée avec des machines CNC multi-axes et des manipulateurs industriels.

Le chapitre 6 établit le modèle de données qui a guidé l'implémentation de Fab-Cell. Celui-ci est divisé en trois groupes de tâches (ou noyaux) qui sont respectivement chargés de la conversion de données, de la recherche de forme, et de la génération de données pour la fabrication.

Le chapitre 7 décrit l'expérimentation et les différentes étapes au travers desquelles le projet a évolué. Les résultats exposés dans ce chapitre sont le fruit des évolutions successives du modèle proposé dans le chapitre 6 et de l'expérimentation à l'échelle 1 par fabrication digitale. L'optimisation de la programmation et de la modélisation sont supportées par trois étapes supplémentaires qui consistent à : **a)** déboguer la génération des assemblages. **b)** Améliorer la génération des patterns. **c)** Générer les informations de simulation et de fabrication CNC.

Le chapitre 8 expose les conclusions générales de ce travail, comme les perspectives de recherche qu'il a fait émerger. On note par exemple que les murs non-standards sont des entités architecturales qui peuvent être mise en œuvre dans d'autres matériaux que le bois. Il est montré également que l'utilisation de Fab-Cell peut être étendue au domaine de la fabrication additive et à la fabrication de coffrages pour les murs et enveloppes non-standards.

TABLE OF CONTENTS

GENERAL INTRODUCTION	i
PART 1: NON-STANDARD ARCHITECTURE, ARCHITECTURAL COMPUTING AND DIGITAL FABRICATION	1
Chapter 1. Towards Non-Standard Architecture.	1
1.1. The Modernist Awakening. Habitat, Politics, Industry, and Academy as Ingredients of Architecture.	2
1.1.1. Modernism and modernity.....	8
1.1.2. Modernist outcome.....	11
1.1.3. Summarizing.....	14
1.2. Modernism's Breakpoint	15
1.3. Form No Longer Follows Function And Vice-Versa.	24
1.4. The Blob-Boom Theory.....	30
1.5. From Simply Digital To High Complexity = Non-Standard.....	39
1.5.1. Non-Standard Mathematics.....	39
1.5.2. Architectural Non-Standard	40
1.5.3. Mass Customization and the organic approach.	42
1.5.4. Non-Standard Shape and contemporary production means.	45
1.5.5. Architecture's Post-Machinist Age.....	47
1.5.6. Conceptual Approach	48
Chapter 2. Digital morphogenesis: machines, Patterns and architecture.	55
2.1. Early Architectural Computing: From Negroponte (1970s) To Frazer (1990s)	56
2.1.1. The architecture machine "utopia"......	57
2.1.2. Evolutionary design.	59
2.2. Digitally-Conceived Form	63
2.2.1. Modeling Data Retrieving Techniques: Lasergrammetry	64
2.2.2. Modeling Data retriving techniques: Photogrammetry.....	66
2.2.3. Parametric-generative modeling.....	67
2.3. Patterns.	75
2.3.1. Categorizing patterns.....	76
2.3.1.1. Computational patterns.	77
2.3.1.2. Functional patterns	78
2.3.1.3. Morphologic Patterns and Biomimetics.....	79
2.3.2. Patterns as Geometric Entities.	82
2.3.3. Working with tessellations.	85

2.3.4.	Stochastic Tessellations by Collision and Triangulation. Voronoi diagrams and Delaunay tessellations.-----	89
2.4.	Chapter Conclusions-----	94
Chapter 3.	Non-standard fabrication: when challenging the digital to go physical completes the loop. 96	
3.1.	The Robot and the Architect. From Industrial To Post-Industrial Usage -----	97
3.1.1.	The Japanese case -----	98
3.1.2.	The advent and flourishing of mass customization.-----	100
3.2.	Improving Design Through Fabrication-----	105
3.2.1.	Additive Fabrication-----	107
3.2.2.	Subtractive Fabrication-----	111
3.2.3.	Two axis cutting-----	112
3.2.4.	Multi-axis subtraction -----	113
3.2.5.	Formative Fabrication -----	116
3.2.6.	In the Threshold -----	119
3.3.	Workflows for Digital Fabrication-----	122
3.3.1.	Digital design-to-fabrication environments -----	122
3.3.2.	File formats -----	124
3.3.3.	Object Modeling (OM) tools-----	126
3.3.4.	Associative Modeling (AM) Tools-----	128
3.3.5.	Dataflow Modeling (DFM) Tools. -----	131
3.3.6.	Procedural Modeling (PM) tools -----	133
3.4.	Why CAD/CAM? A closer look on CAD/CAM interfaces. -----	134
3.5.	Fabrication-to-Design Feedback-----	138
3.5.1.	Material and Design Itself.-----	139
3.5.2.	Production Environment Capabilities -----	140
3.5.3.	When Materials and Know-How Try to Speak.-----	142
3.6.	Closing the loop. -----	144
	PART 2. NON-STANDARD TIMBER CONSTRUCTION AND PROPOSITION OF AN A.C.P.T.-----	146
Chapter 4.	Wood construction: materials, building systems and jointing methods. -----	147
4.1.	Wood as it is. -----	148
4.2.	Wood Availability, Exploitation and Sustainability.-----	149
4.3.	Hardwoods, Softwoods and Wood Anatomy. -----	151
4.3.1.	Wood anatomy -----	155
4.4.	Wood as product.-----	157
4.4.1.	Structural Composite Lumber -----	158
4.4.2.	Glulam and Cross Laminated Timber (CLT)-----	159
4.4.3.	Composite panels -----	160

4.5.	Wood-based building systems.	162
4.6.	Timber joinery	165
4.6.1.	Basic principles for joint-choice and use.	167
4.6.2.	Frictional Joint types	169
4.7.	Chapter conclusions	172
Chapter 5.	Non-standard approaches in wood construction.	175
5.1.	Glam pod	176
5.2.	Swissbau Pavilion - ETH Zurich, and Kreod Pavilion - London.	178
5.3.	Eureka Pavilion, London.	181
5.4.	Vacation Cottages at Xertigny - France	182
5.5.	Solar energy house, Toul rosières - France.	184
5.6.	Nursery facility at Guebwiller – France	186
5.7.	Jules Ferry Social Dwellings, Épinal – France.	188
5.8.	Chapter Conclusions	190
Chapter 6.	A digital morphogenetic model for non-standard timber walls and envelopes.	192
6.1.	Concepts.	193
6.1.1.	Parameter.	193
6.1.2.	Walls	194
6.1.3.	Cells, Patterns and Framed Structures	196
6.1.4.	Joints	199
6.2.	Goals, Boundaries and Research Context	201
6.2.1.	Tackling individual architectural elements to create design sensations and experiences.	201
6.2.2.	Setting the aim	202
6.3.	Goal Considerations	204
6.3.1.	Development environment.	204
6.3.2.	Data retrieving.	205
6.3.3.	Form-Searching.	205
6.3.4.	Design span.	205
6.3.5.	Expected Outcome.	206
6.4.	Design of a Model for an Aided-Conception Parametric Tool. Stage 1: general approach	207
6.4.1.	Wall Characterization	208
6.4.2.	Standard Wall Definitions and adaptation to the ACPT's aim.	209
6.4.3.	Setting the model	211
6.5.	Design of a Model for an Aided-Conception Parametric Tool. Stage 2: detailed approach.	214
6.5.1.	Data conversion kernel function range.	214
6.6.	Chapter conclusions	218
PART 3.	ACPT VALIDATION AND IMPROVEMENT	220
Chapter 7.	Model evolution and validation	221

7.1.	First evolution and validation stage. The “désis du bois” 2014 case.	221
7.1.1.	Bulding Fab-Cell. First Generative Approach	222
7.1.2.	Building Fab-Cell: Progressive Enhancement.	223
7.1.3.	Digital chain from modeling to execution. The modeling environment	225
7.1.4.	Getting Into Context: The wood challenges 2014	227
7.1.5.	Modeling prototypes	229
7.1.6.	CNC programming, fabrication, and mounting.	232
7.1.7.	After production evaluation.	237
7.2.	Second Evolution and Validation Stage. Improving Parametric Generation Processes for Cellular Subdivision and Joint Setup.	240
7.2.1.	Interface Optimization.	240
7.2.2.	Improving pattern creation. First Stage	241
7.2.3.	Improving pattern creation. Second Stage	245
7.2.3.1.	Building patterns with Mesh+	246
7.2.3.2.	Building Patterns with Starfish	247
7.2.4.	Working With Planar Items	247
7.2.5.	Openings management	251
7.2.6.	Cell-set extrusion.	253
7.2.7.	Cell-jointing optimization. First stage.	254
7.2.7.1.	Creation of finger joints and dovetails.	255
7.2.7.2.	Output	257
7.3.	Cell-jointing optimization. Second stage.	258
7.4.	Nesting utility.	260
7.5.	CAM Integration.	261
7.5.1.	Setting up fabrication paths	263
7.5.2.	Output.	263
7.6.	Chapter conclusion and results.	264
Chapter 8.	General Conclusion, Research Perspectives, and Related Publications.	266
8.1.	General conclusion	266
8.2.	Research Perspectives	269
8.3.	Related Publications.	271
APPENDIXES		273
Appendix 1.	DESIGN STRATEGIES DEFINING POST-MODERN ARCHITECTURE, AS STATED BY ROBERT STERN	274
Appendix 2.	ENGELBART’S EARLY APPROACH TO CONTEMPORARY DESIGN AND BIM METHODS. ON: (Engelbart, 1962)	276
Appendix 3.	FOREST GAINS AND LOSSES OVER A 14 YEAR PERIOD.	279
Appendix 4.	EUREKA PAVILION STRUCTURE MANUFACTURING INFORMATION.	281

Appendix 5.	STANDARD ELEMENTS FOR NON- STANDARD ARCHITECTURE AFTER CIBLAC (2011)	284
Appendix 6.	FAB-CELL DATA MODEL ACTIVITY DIAGRAM. -----	286
Appendix 7.	FAB-CELL OBJECT CLASS DATA MODEL. -----	289
Appendix 8.	FAB-CELL'S FIRST VALIDATION STAGE PROTOTYPES.-----	291
Appendix 9.	FAB-CELL'S PATTERN COLLECTION FIRST OPTIMIZATION-----	293
Appendix 10.	FAB-CELL'S PLANARIZATION PROCESS -----	296
Appendix 11.	FAB-CELL GENERATIVE KERNEL AS GH USER COMPONENT SET -----	298
Appendix 12.	FAB-CELL DATA MODEL. EVOLVED ACTIVITY DIAGRAM -----	300
Appendix 13.	DIGITAL TOOLS USED FOR DEVELOPMENT AND TESTING.-----	303
	REFERENCES-----	306
	LIST OF FIGURES-----	320
	LIST OF TABLES-----	332
	INDEX -----	333

GENERAL INTRODUCTION

Ever since the 1960s, architects along with computing engineers have been searching for the way to introduce automation into design and production tasks (Figure 1). However, this is not automation in the sense of replacing creativity or workmanship, but automation in the sense of helping architects to find solutions to complex architectural problems and facilitate the making of the complex formal approaches characterizing contemporary architecture and design.

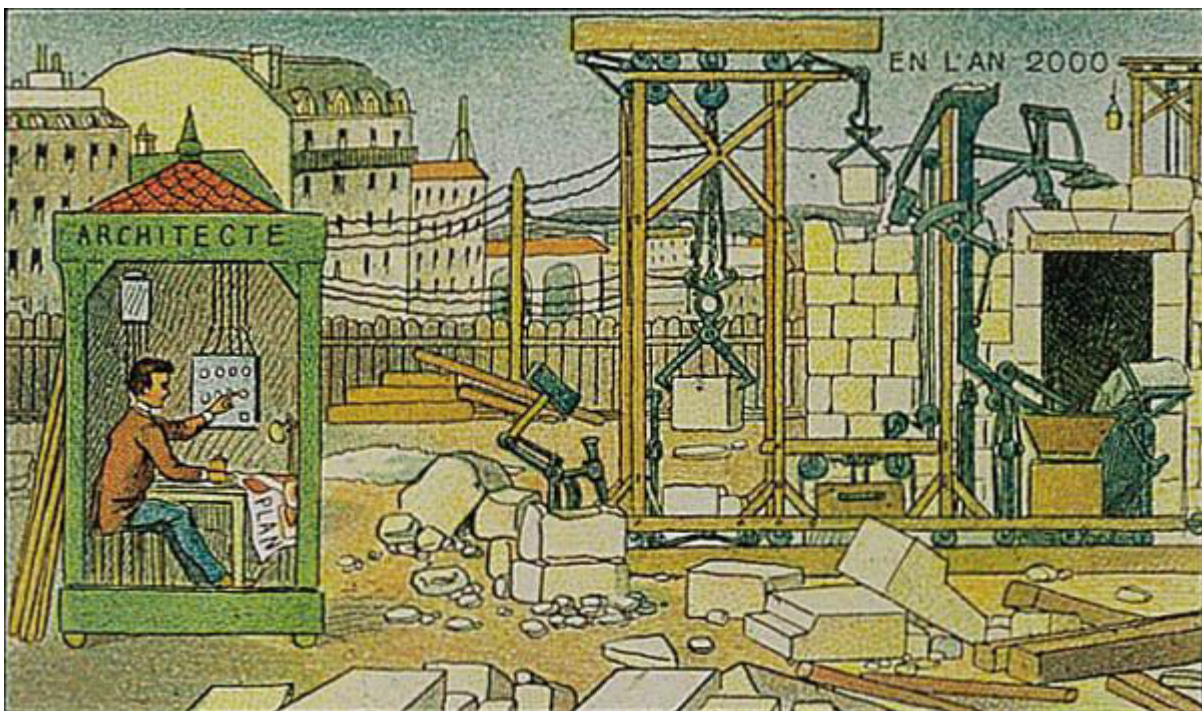

*Figure 1. Villenard's vision of the role of robots and the interaction with the architect in the worksite. 1910.
On: expositions.bnf.fr/utopie/grand/3_95a2.htm*

Efforts on the topic are numerous, but we will here underline those of Nicholas Negroponte (1970), Paul Quinrand (1985) or John Frazer (1995), which opened the way towards our contemporary vision of architecture. A vision not necessarily shared by everyone, but an outlook that has gained strength because perhaps of a single fact: of all the human activities, architecture might be one of the most reluctant ones to move forward (Kolarevic 2015), although exceptions might well exist.

Back in the 1980s and 1990s some relentless architects such as Frazer himself Lars Spuybroek, Norman Foster, Daniel Libeskind, Frank Gehry or Greg Lynn gave

the battle to explore with design software not intended for architecture but for industrial or automotive design (Celedón 2014; Lynn 1998). Their effort proved to be in the right direction not only because of the results they achieved but because the methods they developed, as the shift slowly took place, encouraged the architectural production of trends such as deconstructivism, blob architecture, non-standard architecture and Schumacher's parametricism. Not surprisingly, complex projects such as the Sagrada Familia or F.O. Gehry's Barcelona Fish have preferred to make use of industrial-aimed software instead than of architectural-intended software (Burry, 2002; Davis, 2013; Halabi, 2016)⁴.

To such extent, making architecture is no more a question of space on its own but a problem of data management since complex architectural arrangements demand for intricate solutions for data treatment, visualization, and production so, as one can imagine, no contemporary architectural endeavor -regardless of its plastic approach- escapes to that reality.

Such is the case of walls and envelopes whose morphologic features are free-form based. The materialization of such components has become possible thanks to mass customization and the freedom it gives to produce non-serial aggregates (Anzalone, Vidich, and Draper 2009; Carpo 2005). Both concepts, free-form and mass customization are the grounding concepts of what is known as non-standard architecture.

Within such context, the world of timber construction has become a primary experimentation field in which wood, as material, fulfills highly desirable mechanical and aesthetical properties that confer it with both beauty and structural performance. Furthermore, wood is also a material that has been carved ever since it started being used by man, in other words, subtractive manufacturing is inherent to the processing of wood.

Aesthetical value, mechanical performance and workability, are perhaps part of the main reasons why timber is so essential in construction, be it made the traditional

⁴ These two examples are to show that complex geometries such as the ruled surfaces found in the Sagrada Familia's columns, or the façade components of the Barcelona Fish, needed a digital approach common in industrial – not architectural- modeling. In both cases, environments such as CAADS5 or Catia have helped those projects' complex shapes to be translated into fabrication data. Notice that, as documented by Burry and Davis, columns of the Sagrada Familia share close genera but are not the same, nor are the envelope components of the Barcelona's fish either.

or the contemporary way, however, a fourth aspect is essential to be considered. In many industrialized countries, wood industry has taken a step forward in which concerns product renewability, construction sustainability, energy saving, and material reclaiming; making the cycle to be oriented towards achieving zero carbon emissions concerning wood-building activities.

Given these facts, contemporary timber architectural language has found in digital modeling tools the way to make walls and envelopes to fulfill their function without being bonded by paradigms of orthogonality or parallelism. It is precisely within this framework that this thesis finds its research environment (Figure 2).



Figure 2. A collection of non-standard timber architectures proves that timber construction, or timber-related construction techniques, continuously provide an experimentation field in which new formal and building approaches can be tested because of the aesthetical and mechanical features wood offers. See details in Figure 157

Non-standard walls and envelopes, specially featuring cellular morphologies, are usually seen in showcase or ephemeral architectures; but, how to translate the qualities and advantages de-serialized production offers into day-to-day architecture?

That is precisely the gap this thesis takes on by proposing a model whose aim is to further designing an Aided-Conception Parametric Tool (ACPT) capable of helping designers in taking decisions on already-launched design processes requiring language optimization, as well as space characterization and detailing. The aforesaid ACPT's function range includes tasks such as retrieving raw design data, transform it into form-searching modeling, create iterative solutions based on parameterized

inputs, and generate fabrication and CAM data for aided-manufacturing (Figure 3). However, how will this so-called ACPT help designers in achieving such purposes?

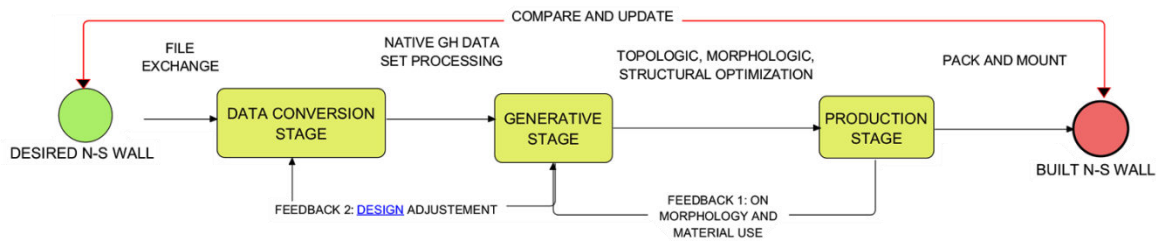

Figure 3. Fab-Cell's summarized data model. Stages = processing kernels

The problem of solving space oftentimes has a lot to do with the way it is structured, and walls are -perhaps- the key element that helps the most in doing so.

Furthermore, characterizing space and detailing its definers and/or modifiers (walls and envelopes) requires adding stability and aesthetic value to such entities. Fab-Cell, as the ACPT herein proposed is named⁵, aims to fulfill this goal by means of: **a)** Providing walls with cellular-like morphologies (based on geometric patterns) that will facilitate the designer to explore among a range of parametric morphological possibilities. **b)** Allowing the designer to follow the morphologic and/or topologic effects of the transformations applied on chosen entities. **c)** Furnishing an interface in which the designer can visualize and parameterize the means by which a component's aggregates are interconnected and assembled. **d)** Facilitating a mechanism to translate redefined entities into buildable data (Figure 4).

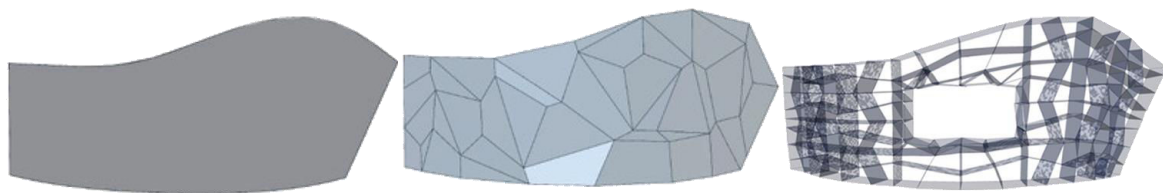

Figure 4. Fab-Cell's Data conversion and generative stages summarized. Left to right: Retrieved geometry; morphologic and topologic redefinition; buildable cellular-like set.

For that purpose, the ACPT is designed to offer a nesting interface that allows exporting buildable items nested and numbered for digital fabrication. In a further step, Fab-Cell integrates its own CAM interface in order to generate CNC machining data. At the present time, Fab-Cell is capable of simulating fabrication routines and

⁵ Fab-Cell is an acronym for "Non-Standard Wall Maker". Please refer to section 6.4.3 for further details.

produce fabrication data for KUKA robots, based on the capabilities offered by the Kuka|PRC plugin for RGH (Braumann and Brell-Cokcan 2012) (Figure 5).

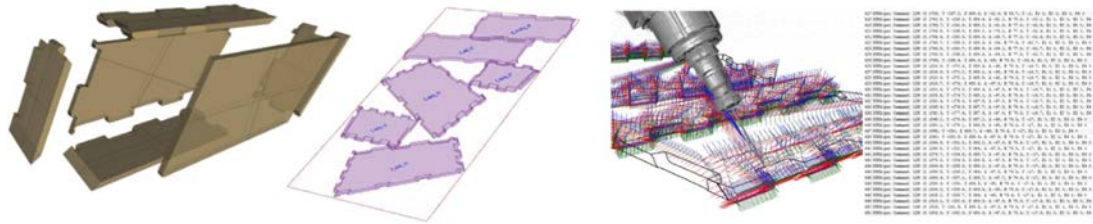

Figure 5. Fab-Cell's production stage summarized. Left to right: Item (cells) splitting and jointing calculation; Item nesting; item CNC programming and simulation.

This set of capabilities Fab-Cell offers allows designers to tackle conception tasks for bearing and non-bearing walls and envelopes in brand-new and renovation projects. In new designs, the aim is to intervene at early stages by using form-searching as a means to facilitate and assessment on design decisions.

As for Renovation projects, the ACPT helps performing design tasks involving partition walls and façade envelopes in which the exterior insulating layer might have a reduced structural involvement⁶. This approach should be particularly useful in passive-aimed projects for which energy consumption optimization is a main concern.

The architectural, material, conceptual, and technologic grounds on which Fab-Cell is underpinned, as well as the methods and experimentation stages that have helped defining it are stated and analyzed throughout this dissertation as the following outline describes.

⁶ Please refer to sections 5.7 and 6.2.

THESIS OUTLINE

The structure of this dissertation is divided into eight chapters grouped in three parts each. Part one groups chapters one to three; part two, chapters four to six, and part three contains chapters seven and eight.

Chapter 1 presents a summary on the evolution of architectural practice and theory, from modernism to what is known nowadays as non-standard architecture. It also refers to the evolution of production means for construction that led to exploring new architectural languages that undoubtedly shifted the way architecture is conceived and built.

Chapter 2 shows a state of the art on digital computing applied to architectural design and the way it influences design by means of digital tools that allow for exploring architectural shapes out of the paper-driven environment. It shows the evolution of digital design tools from the 1960s up to our time, and the way computing language has been integrated into architectural practice. A section on patterns and tessellations shows how computing, geometric and biomimetic (cellular) approaches are involved in architectural conception to render non-standard design conceivable.

Chapter 3 shows the current state of digital manufacturing and the way it participates from architectural design and engineering. Topics gradually flow towards a description of most used techniques in Rapid Prototyping (RP), Rapid Manufacturing (RM) and data exchange as used in CAD/CAM environments. Moreover, a state on current iterative modelers depicts their capabilities as well as the advantages they give to architectural design and engineering.

Chapter 4 makes an overview on wood as resource and prime material for the construction industry. The chapter describes the most common lumber derivatives used in current construction practices and building systems. It ends with a section dedicated to joinery, in which friction joints play an important role as their making has taken a second air since the introduction of CNC and robotic machining in timber construction.

Chapter 5 continues the discussion on timber construction from the non-standard point of view. A group of projects is analyzed to see the way contemporary trends

have taken over timber construction by means of parametric-generative design methods, as well as with automated fabrication approaches mainly performed via CNC multi-axis machines and industrial manipulators.

Chapter 6 establishes the data model guiding the building of Fab-Cell, as the ACPT is named from this chapter forth. The data model is divided into three processing task groups (or kernels) which individually carry on specific functions such as design geometry insertion, data conversion, form searching and production data generation.

Chapter 7 describes the experimentation and development stages the project underwent. The results shown in this chapter are obtained from the evolution of the model proposed in Chapter 6 by means of full-scale prototyping via RM. Programming and modeling optimization is carried on in three more stages: **a)** in-cell joint generation debugging **b)** pattern generation improvement and **c)** fabrication simulation and CNC data generation.

Chapter 8 will state the general conclusions as well as the research perspectives that emerge from this work. Furthermore, it will state that Non-standard walls are likely to be architectural entities that can embody different material dimensions not necessarily restrained to the timber construction field. It also shows that Fab-Cell's design span can be well extended towards the realms of additive fabrication and formwork manufacturing for non-standard walls and envelopes.

***PART 1: NON-STANDARD
ARCHITECTURE, ARCHITECTURAL
COMPUTING AND DIGITAL FABRICATION***

Chapter 1. TOWARDS NON-STANDARD ARCHITECTURE.

One of the most representative samples of what contemporary architecture embodies when being referred to as Non-Standard, was presented at the Pompidou Center in Paris in 2003, opening a vivid discussion that involves the use of digital tools in architectural conception to a point in which the concept itself was mistaken or misunderstood even at high publication levels. At least that is what Greg Lynn claims when he states that, in some manner, the Non-Standard concept was reduced to a matter of “variety.” At some point digital tools became a way for finding stylistic expression in architecture, and for Lynn, digital expressionism was frequently a consequence of using digital tools without having a consideration about architectural typology, which degenerated in the use of “variety for the sake of variety” (Celedón, 2014) to emulate Non-Standard forms in architecture.

It becomes ambiguous to find out at which point, when conceiving through digital tools, a designer stops working in Non-Standard types and starts just adding style to an object with the intention to make it look as contemporary as possible.

This first chapter’s aim is to help improve the comprehension of what is today known as digital architecture and its participation regarding the architectural trends that appeared since digital tools became an inexorable part of the architectural praxis so that computational reasoning became a relevant variable in the cognitive process of designing spaces. Such mental endeavor is often accompanied by a profound knowledge in the use of complex modeling-software and building processes so that the resulting outcome is not a cold consequence of just using a computer.

Forthcoming sections in this chapter will try to expose the way architecture evolved in terms of complexity (Comment 1) and style (from modernism to blob architecture – and beyond-) as to define the so-called Non-Standard concept and the way it is applied to wider knowledge and practical architectural fields other than the mere conception one.

1.1. THE MODERNIST AWAKENING. HABITAT, POLITICS, INDUSTRY, AND ACADEMY AS INGREDIENTS OF ARCHITECTURE.

Architectural and philosophical movements previous to our present time tried, in different ways, to break the paradigms imposed by modernism along with the serial and materialist trends that came with it (Jencks, 2010). In a way, modernism was the consequence of Taylorism, Fordism and serial production as applied to architecture and engineering, (among many other industrial, political and economic, even artistic, fields) (Comment 2). The very existence of the concept made most architects (and construction firms) to adopt the use of repetitive components with the aim to accelerate building processes therefore increasing profit in construction and time gain in execution (Figure 6). Something uneasy to achieve when dealing with complex ornaments and shapes⁷, as shown in the Sagrada Familia approach, whose morphologic complexity boosted the development of innovating building technologies (Burry, 2002)⁸.

The concept of complexity will be discussed at different levels, inasmuch as architectural objects are seen from different outlooks that change in function of detail. To start this dissertation, the term will be attached to mathematical concepts such as organized and disorganized complexities, which are related to the way data, in the form of solved and unsolved problems, are treated (see section 1.5.6). Problems can be solved through statistical or specific approaches depending on the intricacies of the problem itself.

Architectural complexity embodies both approaches, Statistical (disorganized) and specific (organized). Statistic approaches are used to solve generic problems containing a wide number of variables for which a generic solution is found, yet it does not solve all variables. Specific approaches tackle the problem of space and technical feasibility. This kind of complexity, that of solving specificities arisen from a generic approach, is the one that comes into our attention.

Comment 1. The basic, not simple, concept of complexity as seen through this dissertation's outlook

From the Bauhaus to the international style and even through post-modernism, serial production has been a key tool in the architecture, engineering, and construction industries. Even if it is true that much of the modern movement was not born from industrial production, its conceptual and formal grounds were based on standardization as a means to propagate the design avant-garde that emerged from schools (like the Bauhaus) and later (or

⁷ It happens to be the main difference regarding what we will try to define in forthcoming chapters as Non - standard architecture and mass customization.

⁸ See also section 3.1.2.



Figure 6. Steel workers mounting a pre-assembled girder for the Consolidated Gas Company Building. N.Y 1913. Source: etsy.com

It must be understood that modernism, even Taylorism or Fordism did not emerge spontaneously. Abstractionism, as tool for simplifying problems, was not only present in arts but in science and economics as well.

Economical-mathematical abstraction is what probably led to production optimization and quality control as a model to obtain repetition-based profit. On these grounds, abstraction on Taylorism and Fordism resulted in workforce de-skilling inasmuch as repetitive tasks needed only a few instructions to be performed, ergo skilled personnel would not be needed anymore. This fact would be contradicted later by the apparition of mass customization in which skill is replaced by complex mathematical and computational emulated processes (section 4.6.)

Comment 2. Abstractionism in the arising of Taylorism and Fordism. (Gartman, 1998; Naruse, 1991)

before?), applied not only to architectural but to industrial design. In fact, most standardization processes used for construction and architecture are born from an industrial environment so that construction and architectural design seemed to be obliged to adapt themselves to the premises of industrial production in order to become competitive as economical activities (Girmscheid, 2005).

Serial industrialization came along with constructive systems⁹ whose goal was to increase the speed with which buildings were made (Figure 7) allowing to speed-up most construction tasks from the very sketch of a project, not without adding a degree of coldness to the resulting outcome.

Such “coldness”, supported on the cubist form’s simplicity and abstraction, is what brought to modernism an amount of detractors that argued on the fact that architecture had become an instrument of industrialization and generalization of the aesthetically acceptable in function of the economically profitable, which led to a total absence of symbolism (Urban, 2012).

As stated before, modernism in architecture does not entirely emerge from the prevailing industrial wave of the early 20th century, no at least concerning the material spirit of what the modern movement wanted to represent. Industrialization came along with social phenomena that mutated according to particular geographic locations to which the modernist trend is referred to.

⁹ Such as pre-cast concrete walls, pre-cast beams (even columns), modular metallic formwork systems for concrete walls, tilt-up systems, standardized windowing and door systems among many other alternatives.

On the European side, the start of the 20th century comes with the emergence of a series of geo-political tensions preceded by an industrial boom that turned out into urban and architectural exceptional needs that should be resolved from within architecture (and urbanism) itself.

Human settlements around industrial facilities generated dwelling and infrastructure availability challenges in order to satisfy the needs of the families whose life revolved around industrial activities, so that the plans aiming to satisfy such needs had to be conceived not only from the planning point of view but from the essence of the dwelling itself... How to create a dignifying and healthy habitat for a constantly-growing population as consequence of an industrial activity, governed by politic and economic interests? During the years the Bauhaus was active, the discussion about the minimum spatial requirements for a decent and healthy dwelling (Corbusier and Sert, 1973) was taken to the field of the C.I.A.M¹⁰. It returned results in which class-working dwelling -that environment capable of satisfying the essential needs of non bourgeoisie families- diminished its size as a means to avoid the waste of living space in the cities by subduing vital space to an extreme optimization (Figure 8), which came to feed the “dwelling machine” model proposed by Le Corbusier (Diaz C., 2007).

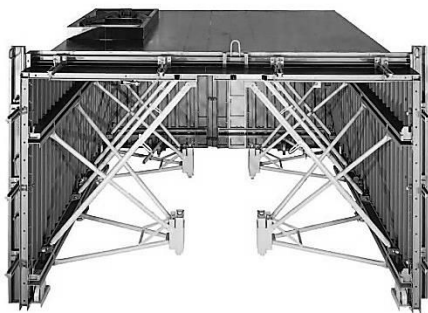

Figure 7. Outinord System. In use since 1955, was conceived to improve construction times and optimize concrete consumption. On: outinord.fr

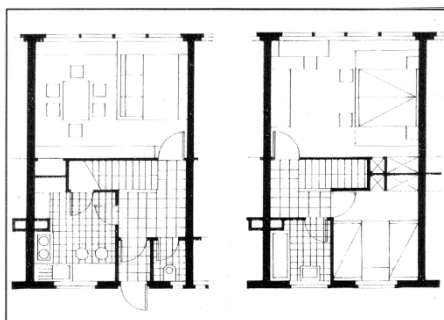

Figure 8. The existenzminimum. CIAM 1919. On: *Estado, Ciudad y Vivienda[...]* 1996.

¹⁰ French acronym for “International Congresses of Modern Architecture”

The precedent fact allows for making a review about the theoretical framework around classical modernism (modernism at its beginnings). Bauhaus director, Walter Gropius, stated that the machine in which man dwells should meet the requirements of the “new mentality” (Jacobs, 1993), which means the conceptual ground stated by Le Corbusier in his Athens Charter (Figure 9)¹¹.

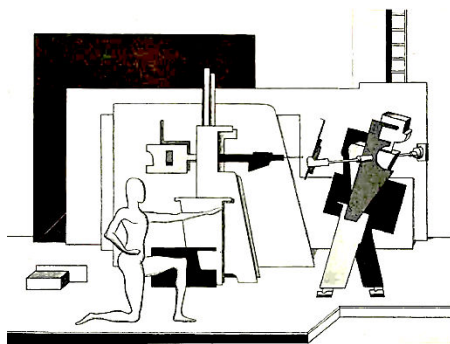

Figure 9. *Man + Machine*, by Kurt Schmidt. On: *Die Bühne im Bauhaus*, 1925.

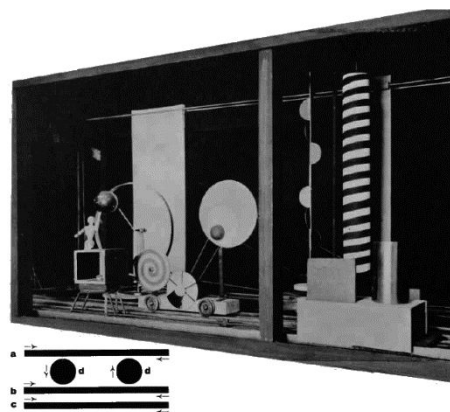

Figure 10. *This Model for a mechanical stage*, by Heinz Loew, leads to an idea of how the interactive machine-house should work. On: *Die Bühne im Bauhaus*, 1925.

However, Gropius was not the only one in stating postulates that later would come to put the concepts of the modernist paradigm together. Oskar Schlemmer, on his side, defended the idea of a dwelling machine in which walls could move in such way that they would adjust the dwelling to its inhabitants specific needs and surrounding weather conditions¹² thus creating, along with Gropius, the concept of space as representation of a system of dynamic elements (Jacobs, 1993, p. 58) (Figure 10). This kind of thinking fits in what Sara Goldhagen defined as the second period of Modernism (Goldhagen, 2005). A period in which protomodernist thinking¹³ stops being relevant to give way to the modernist paradigm which grows up to be, perhaps, the only clear alternative whose technologic and theoretical approaches prevailed as the sole ones capable of representing a modernity (Younés, 2004).

By 1924 the principles ruling the School (the Bauhaus) turned towards social and technical approaches. At this point not only the problem of

¹¹ Figure #4 shows an academic research representation of how the interaction between man and technology (machine) was supposed to be.

¹² In forthcoming chapters, it will be seen that Schlemmer's thinking was not utopic at all, in regard to the topics this dissertation deals with.

¹³ Victor Horta, Frank Lloyd Wright, Otto Wagner, Adolf Loos, Louis Sullivan, among others.

space and the requirements to make it optimally inhabitable were under discussion but also the dimension of material and industrialized production systems that emerged as to substitute all kind of handcrafted construction items¹⁴ (Jacobs, 1993, p. 58).

This crucial period of the modern movement witnesses the consolidation of concepts that were later transformed into a monism, defined by Samir Younés, as the “inevitable pinnacle that prevails over any other architecture, past or present” (Younés, 2004, p. 539). This statement means that much of the ideas featured by the modernist trend, which are gestated during the existence of the Bauhaus, aim to impose their postulates as absolute facts in an attempt of defending its formal (plastic) propositions. Such practice is still permanently used up until our days in professional and academic environments: the lyrical and literary argument as justification of form in which the argued evidence is not necessarily the real origin of the proposed architectural object. A fact indirectly linked to a statement by Oskar Schlemmer who affirmed that the space produced by man is defined by abstract laws regarding stereometric and planimetric relationships. In other words, the inhabitable space should paradoxically be cubic for the sake of human comfort (Jacobs, 1993, p. 59).

Proto-modernist architecture is yielded by a thinking that, despite considering the problem of space in terms of comfort and functionality, does not neglect ornament. The works of Wright, Loos or Kunstler show that spatial quality is possible, though aesthetics do not need to be sacrificed.

However, a certain distance from modernist postulates is tangible inasmuch as spatial over-optimization was not in the scope of proto-modernist thinking. Unlike modernist thinking, its right predecessor is less monistic and more pluralist in the sense that elements composing architecture change from one architect to another. A thing that did not happen in modernist architecture as the essential elements of space: point, line, plane and volume were consistently used in the most purist possible way.

Proto-modernism couples industrialist resources with an architectural approach that privileges spatiality rather than rationality and/or abstractionism.

Comment 3. Assertions on proto-modernism Vs modernist architecture. As adapted from (Goldhagen, 2005; Silva et al., 2009; Younés, 2004)

Then comes the modernism’s third stage (early 1930s). By that time, Mies Van der Rohe assumes the direction of the Bauhaus giving it a more technical and perhaps materialist approach and, by

¹⁴ Which is the opposite to what we will further define as “mass customization”

the same time, the international style boom came in the shape of a viral style applied to corporate architecture (Goldhagen, 2005, p. 151).

Parallely, the modernist avant-garde is exported out of the countries where it originally emerged, spreading to other continents to find reinterpretations that tried to keep loyal to the grounding principles of modernism but that were enriched by cultural and geographic contexts (Latin America and Spain for example)¹⁵ that differed from the German-French environment in which the movement was born.



Figure 11. The Fagus Factory. On: germany.travel

By the early 1940s, whilst war takes over Europe, Latin America welcomes an influx of exiled architects that came to reinforce the education of local ones, hence facilitating the modernist paradigm's expansion. In a context heavily marked by social inequity and a remarkable technological backwardness, the modernist practice is carried out more or less in the same way as it was in Europe but with a delay of about 10 years in the best of cases. White buildings appear supported over concrete structures that evoke projects like the Fagus factory (1911-1925), designed by Walter Gropius (Figure 11).

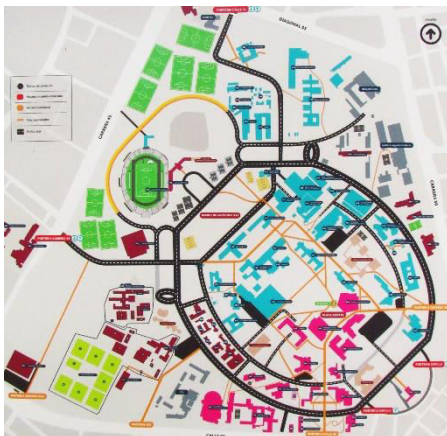

Figure 12. National University of Colombia. 1934-1941. Karl Brunner. Photo O.GÁMEZ

At this point we could cite the campus of the National University of Colombia (Figure 12), whose urban planning is the work of German-born architect Karl Brunner and whose buildings are conceived from within the knowledge of a diverse group of national and foreign architects (Figure 13).

¹⁵ In other European countries, architects like Alvar Aalto gave a particular touch to modern architecture thus creating a particular, even eclectic, style.

The campus, most of it dressed in white, masterly emulates the paradigms that emerged in Europe during the 1920s and 1930s, becoming a sample that reiterates the fact that most of the modernist production is funded by social poles, public or private, holding economic power (Guillén, 2004, p. 24).

1.1.1. MODERNISM AND MODERNITY

In the middle of this summary about the asymmetric evolution of the modernist paradigm, it might be important to keep in mind the following fact. The emergence of the first working-class settlements designed under the modernist principles of appropriate spaces for building housing projects (Corbusier and Sert, 1973, p. 55) was favored by an scenario in which state, religious and private funding privileged such thing (Corporacion Colegio de Villa de Leyva, 1996).

This is mainly caused by the fact that such countries had what is known as modernity: A cultural state not only implying modernist thinking transcending from philosophical and political fields towards economic and industrial environments, but the existence of technological and technical means to materialize such modernity.

That is precisely what did not happen in contexts such as Spain or Latin America. For the first, the country was hit by a civil war followed by a complex dictatorship that made it to lag behind more nearby-developed countries. Nonetheless, war had no devastating effect on Spain (it was already devastated) but allowed for the country to catch up



*Figure 13. Museum of Architecture.
National University of Colombia.
Leopoldo Rother, 1945. Photo
O.GÁMEZ.*

so that urban planning and modernist architectural ideas found ground once the country overcame the effects of civil war and dictatorship. This way, after 36 years of dictatorship (1939-1975), the modern movement made it into Spain¹⁶ once the economy found a break to recover and the country itself could match its neighbors' technology, industry, and production means, as to favor the availability of prime materials (glass, steel, concrete, brick) facilitating the modernist machine's development.

On another scenario parallel to the French-German machinist-rationalist modernism, Spanish modernism from the early 20th century finds a welcoming environment in the Catalan context, accompanied by an eclecticism that characterizes most of the Catalan architecture of that time a bit more oriented towards Art Nouveau. This so-called Spanish modernism *per se*, marks the 19th century's architecture end, represented by the works of Domenech & Montaner (Figure 14) or Gaudí, which followed a different philosophical approach in comparison to the modern movement (Navascués Palacio, 1988).

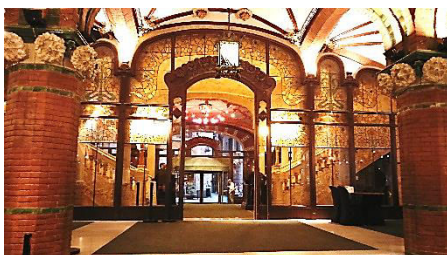

Figure 14. *Palau de la Música Catalana*. 1908, Domenech & Montaner. Photo O.GÁMEZ

Subsequently, socio-political connotations of the Spanish context would cause the first samples of Spanish modern architecture to preserve their eclecticism concerning the buildings' material and language, as is the case of the "Casa Sindical" building, In Madrid (Figure 15), or the dwellings created years later in areas like Villaverde – Madrid (Figure 16).

¹⁶ The international trend widely diffused by the C.I.A.M

Latin America, on its side, served as destination for exiled European architects who had been educated in the whereabouts of the modernist paradigm, which in the end came to feed Faculties, schools and praxis itself with works that kept loyal to the modernist model.

Modern architecture theories found in Latin America (by the 1940s and 1950s) a favorable industrial and economic context that allowed to build complex steel and concrete structures throughout the region¹⁷. The presence of steel factories and aggregate sources for concrete production, made it easy to spread social programs for working-class dwellings integrating vernacular-like elements to their architectural language (Figure 17). In other cases, the use of materials not frequently used (even absent) in the European context took a main participation in the aesthetics of buildings and houses turning Latin American architecture into a discipline that did not constrain itself to just copying the European model (Figure 18).



Figure 15. Syndical house of Madrid. Cabrero and Aburto 1951. Photo O.G.



Figure 16. Villaverde Housing project. Rafael Aburto 1954. On: taller 4 Blogspot

Said so, whilst a part of western Europe called for modernist principles to rebuild itself and generate new homes for the people of devastated areas by war, Spain¹⁸ and Latin America experienced a modernism in absence of modernity (Guillén, 2004, p. 7), which accelerated local economies and industries at the same time that enriched the local architectural know-how.

¹⁷ In some countries more than others, however most countries have a wide sample of modernist realizations.

¹⁸ Spain had to be reconstructed in the aftermath of the civil war that finished in 1939 followed by a dictatorship that endured up until 1975.

The absence of modernity explains the fact that, between the 1930s and the 1950s, the intellectual resources of the Spanish and Latin American communities were well ahead the technological tools available for mass production, which takes us back to the discussion about modernism in architecture being linked not only to a socio-political context but to an industry as well. As such, it makes part of an economic scheme in which the application of Taylorist and Fordist theories led it to behave as a business during the whole process from component production to building erection, which satisfied the demand for low-cost dwellings (Guillén, 2004, p. 22). At the same time, it covered a social need generating employment at all social scales.



Figure 17. Working-class housing. Acevedo Tejada Neighborhood. Bogotá-Colombia, 1940s. Photo: Andrés Rojas, andresrojasgb.blogspot.com.co

1.1.2. MODERNIST OUTCOME

By the 1960s decade, modernist postulates were widely spread around the western world and, as described in precedent paragraphs, they adapted themselves to cultures and environments different from the European one, which leads now this discussion towards the United States field.



Figure 18. Vermillion granite façade at the Blumenau Cathedral by Gottfried Boehm. 1958, Photo O.GÁMEZ

As well as in Latin America or Spain, the United States welcomed not only the modern movement's ideas but, during the 1920s and 1930s (with the advantage of possessing a philosophic and technologic modernity) the country acted as place of exile for architects of the category of Mies Van der Rohe or Gropius himself.

It is precisely Mies Van der Rohe, one of the architects that will come to profess what was known

then as international style. Along with the north American industrial power, the international style found the proper environment to conjugate the principles of formal simplification of the modernist paradigm with the industrial model that allowed to build skyscrapers long before any modernist postulate was stated in Europe (Figure 19).

The international style, already gestated by the 1930s, gets repeatedly used not only for individual housing projects but for representing the corporate image of companies that could afford to invest in a built representation of themselves. This way, the international style adopts two dimensions. a) the familiar dimension represented by works like the Barcelona Pavilion (Figure 20) or the Villa Savoye (1931) by Le Corbusier whereby geometric simplicity and the absence of ornament are the formal determinants of the style. b) the corporate dimension that encourages the erection of glazed towers repeated throughout all western culture nodes with almost no consideration of history, place or culture (Younés, 2004, p. 540), since their aspect hardly obeys to any of these circumstances (Figure 21).

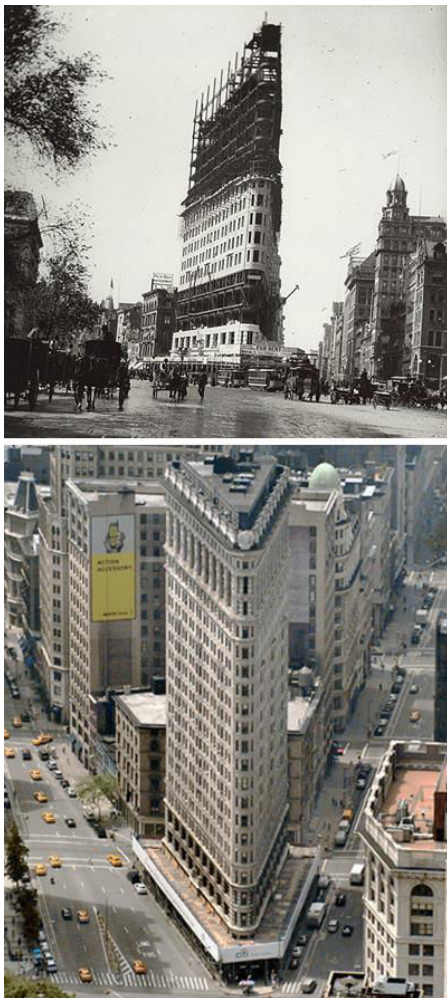

Figure 19. Chicago School-style Flatiron Building by Daniel Burnham, NY, 1902. On: nyc-architecture.com.

Based on the stated premises and returning to the 1960s decade, modernism in North America reaches a formal and functional climax in which, apparently, everything has been seen. As modernism's critics were not few, some architects - not seduced by the modernist trend- found a favorable market in reproducing neoclassicist styles that saw a renewed purpose when post-modernism

emerged¹⁹.

The late 1950s and the early 1960s opened up the door to formal propositions like those of John Hejduk, Peter Eisenmann or Richard Meier (Figure 22). In such, the dimension of place and material, reinterpreted through non-necessarily cubic geometric compositions, gave place to an architecture that would want to reformulate, in a given way, the grounding postulates of the modern movement.



Figure 20. Barcelona Pavilion by Mies van Der Rohe, 1929. Photo O.GÁMEZ

In this field, North American architecture schools not only did receive the contribution of modernism's expatriated masters²⁰, but the country's industrial and cultural muscle which allowed to open a discussion leading to proposing teaching methods that searched for enriching the way to create architecture. In that sense, schools like the Illinois Institute of technology or the Cooper union ²¹, in different times, could establish teaching strategies that turned into the appearing of architectures that marked a trend prior to the appearance of post-modernism ²².



Figure 21. International Style. Lever House Building by Gordon Bunshaft, 1952. On: michaelminn.net

1.1.3. SUMMARIZING.

As a conclusion on this discussion about modernism, it is clear that architectural modernism is a social consequence of industrialization regarding social, technic, politic and plastic aspects ²³. It is also a result of the theories and productive

¹⁹ See 1.2. Modernism's breakpoint.

²⁰ As it was the case of Mies Van der Rohe at the Illinois Institute of Technology.

²¹ See: Education of an Architect: The Cooper Union School of Art and Architecture, 1964-1971. Exhibition at the Museum of Modern Art -New York 1971.

²² We talk about the whites, as it will be further described in this dissertation.

²³ Which is one of the premises that gave birth to the modern movement.

practices (Taylorism, Fordism, Serialism) that appeared by the end of the 19th century and beginnings of the 20th dealing with means of production linked to human habitat generation. Such environment led to optimizing of the latter as response to the growing densification of cities as consequence of the industrialist boom; response that emerged from the discussions of practitioners and academicians for as long as four decades²⁴.

On the other hand, the appearance and development of modernism as style and model would not have been possible without the following factors:

Politics and economics: Architectural and urban planning works require capital investment therefore a sponsorship coming from either a private source or a public-administrative project with politic connotations as sponsoring model (Guillén, 2004).

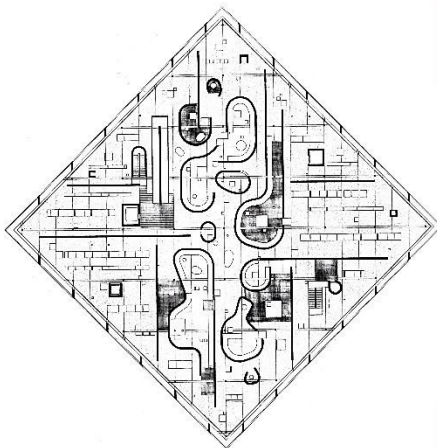

Figure 22. Organic and orthogonal shapes in the Diamond Museum by John Hejduk, 1967. On: Mask of Medusa.

Infrastructure: As stated before, one of the main interests of modern urban postulates was to dignify the working-class housing. To do so, a group of architects and artists among whom we can cite Walter Gropius, Oskar Schlemmer, and Le Corbusier, defined the minimum requirements for a healthy and worthy dwelling. Such postulates were reaffirmed at C.I.A.M (Corporacion Colegio de Villa de Leyva, 1996, p. 21).

In contexts alien to the European one (such as Latin America and Spain), the modernist concept of

²⁴ Bauhaus, C.I.A.M and consequently architecture schools in which architects were formed under these precepts.



Figure 23. Social Housing in Buenos Aires -Argentina. Simon Bolívar Neighborhood, 1953. On: bocio.blogspot.com.co

housing acquires another dimension, not only because the contributions of local materials and know-how, but because some projects incorporated eclectic or vernacular elements²⁵ that gave them a different character compared to their European equals; however, that was not necessarily the rule (Figure 23).

It is finally at this level where modernism calls at the common citizen's door: through social dwelling programs (from public or private origins) that tend, as well as in Europe, to dignify and create a healthy human habitat.

1.2. MODERNISM'S BREAKPOINT

When Modern architecture emerged, it was ruled by principles that were not entirely shared by the architectural community of its time and, as any other trend, it needed an answer either philosophical or morphological that came in the form of postmodernism. Unlike modernism, postmodern form in architecture takes elements from different times in the history of the discipline that span from classic to vernacular styles, mixing them and trying to find a common language that is never to be found since theoreticians think differently and it seems that, even up to our days, everybody seems to be right yet no one might be.

Postmodernism is complex to define in terms of time, language and above all, style, since stylistic pluralism is the main concept to deal with when discussing this architectural trend (Goldhagen,

²⁵ Which happens to be the case in Latin-American countries such as Argentina, Colombia, Mexico or Brazil.

2005, p. 151). The postmodern era in architecture can be located between the 1960s and the 1990s assuming a concretization of the concept by the 1970s (Luigi, 1982), however, it is not merely time but language which defines a trend in architecture.

Account taken of the fact that some of the key values of modernism were the absence of ornament along with the simplicity of form, which became the minimalist trend represented by the New York Five (NYF) post-functionalism phenomenon (Stern, 1998), some postmodern architects turned to criticize what late modernists were doing arguing that architecture should not be confined to the mere concept of space as a clean abstract entity dressed in black and white.

Because of their links to the grounding principles of modernism along with the permanent reference of their work to the Corbusian style, the NYF were also known as "*the whites*" (Watson, 2005). On their side the whites were, given their way, preservers of the modernist paradigm but on the research for new boundaries nonetheless, as they knew that evolution was needed for the modern paradigm to prevail.

An exposition organized in 1969 by the New York Museum of Modern Art (MoMA) called "the New York Five" promoted the work of five architects that were earlier part of the Independent Conference of Architects for the Study of Environment (CASE), henceforth, they were known as the New York Five (Watson, 2005)²⁶.

²⁶ The exposition followed the publication of a book by George Wittenborn, in 1973, entitled *Five Architects*.

From the five, the work of Hejduk's is remarkably interesting since he started exploring with disruptions in a particular way. Several of Hejduk's works dealt with the problem of decomposing cubic shapes into more basic elements as a means of exploration, in the same way, he introduced curvy shapes as to define spaces in a differently more sensual way (Diamond house²⁷).

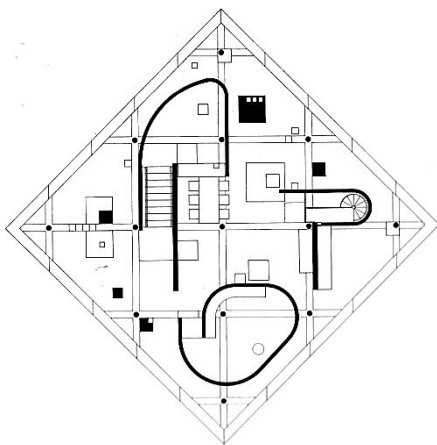

Figure 24. Exploration with curved walls. Diamond house by John Hejduk, 1962-1967. On: Mask of Medusa

The wall, beyond its physical condition, is capable of transmitting sensations and transforming the inner dimension of the space in which one dwells (Figure 24) (Chapter 6). This is what one should perceive when inhabiting one of Hejduk's houses in which double-curved walls marked a contrast against the regularity of the grid and, why not, the exteriority that marked modernism (Hillier, 2010).

Hejduk's work is an example that represents what architects, from the 1960s and 1970s, were trying to do by either pushing modernism up to its boundaries or even denying it. The semantic discussion modernists and their opponents had, derived into two movements: the grays and the whites.

A critical essay entitled "Five on Five", published in the May 1973 issue of Architectural Forum started the discussion, not entirely polarized (Stern, 1998), between two architectural currents with different epistemological approaches. The so-

²⁷ The diamond concept consisted of rotating a cube and designing inner space preserving the cube's original grid as if the cube was not rotated. In other words, the building's skin could revolve around an axis and take any position whilst the grid, from which space is derived, remains immobile.

called “grays”, composed by Robert Stern, Jacquelin Robertson, Charles Moore, Ronaldo Giurgola and Allan Greenberg (Bletter, 1979), rejected the prevalent purism in which “late modernism”²⁸, incarnated by the whites, treated architecture as if it was a kind of plastic art, a “high art”²⁹ (Watson, 2005). However, the “Gray” thinking was not uniform as it was split through different paths according to each architects’ philosophical and formal convictions. In an article published in 1982 by the *Neuf* magazine; G.Luigi identifies two well-defined tendencies in the postmodernist architectural discourse: Eclecticism and vernacularism.



Figure 25. The News Building. Allan Greenberg -1992. On: allangreenberg.com.

As for the first one, it calls for baroque and renaissance as design bases underpinned on new classicism as theoretical argument. Allan Greenberg makes a fine example of new classicism adapted to modern, even contemporary needs. In works like the *News Building* (Athens GA, 1992), the presence of classic elements is everywhere as it is mixed with colors allegoric to Greek culture (Figure 25), reaffirming a statement made in the presentation of his selected works declaring the “*continuing significance of classical architecture in our contemporary way of life*” (Greenberg, 1995) as a means of becoming truly modern by finding a balance between human values and contemporary demands instead of moving towards the fashioned trends of the moment. Classic architecture has an undeniable

²⁸ Understood as the farthest tip of modernism. The final trend that extended its power over the 1990s reaching the 21st century by sharing its place in time and history along with postmodernism.

²⁹ Watson recalls this postulate made by Jacqueline Robertson and Charles Moore.

weight in history that made it an unavoidable tool for proportioning spaces and creating buildings with a certain aesthetics quality in which function follows form.

Nowadays several architects and construction companies are still interested in perpetuating the classic style through neoclassicism as a business and architectural practice in which contemporary needs are reinterpreted and satisfied through the basic elements defined by classic architecture. Even more interesting, is the fact that a segment of the public shows a particular attraction for Non - contemporary or modern shapes when they can afford to hire an architect. At some point such approach is more welcomed by commercial practices since the common subconscious tends to better appreciate traditional or regional styles over the audacious and abstract languages of contemporary architecture (Figure 26).



Figure 26. Style-Mixed commercial house featuring an eclectic exterior language. On: builderhouseplans.com

The vernacular sub-trend, defines the type of architecture fed by local practices as defining elements of an architectural language applied to contemporary needs so that it can be considered regional or even nationalist (Luigi, 1982) in opposition to the international approach professed by modernism. By using local materials, architectural rhythms and arrangements typical to a region or culture, traditionalism is maybe the word that defines the best this architectural tendency.

Several realizations matching this principle are represented by housing projects whose architectural qualities are more developed on the inside rather than the outside dealing, in many cases, with the modernist principle of free plan in which a clean room serves as an environment for freely distributing furniture and fixtures that give character to space (Figure 27).

Approaches on describing post-modernism (PoMo) were heterogeneous as they not only depended on the philosophical backgrounds and personal experiences of whom was making the description but on the ambiguity and irony characterizing the period (Jencks, 2010), which is already complicated to understand. By the 1970s there was a lot of writing about the subject. The apparent “polarized” discussion between two architectural points of view was on every specialized journal and magazine as they were representing the “seism” that was about to mark the end of absolute modernism. At this point, it seems very much that the architectural avant-garde, once led by Europeans, was no longer in Europe so that the eyes of the architectural world were put on America.



Figure 27. Vernacular approach. Lakeside Residence. Stanley Tigerman, 1982? On: tigerman-mccurry.com

A deeper exploration on the matter made by Charles Jencks, identified post-modern architecture as a representation of a hybrid language particular only to architecture rather than to other arts. Since today’s architectural language mixes manifold formal approaches and constructive techniques, in which case formal eclecticism is better accepted than formal

abstraction, the concept of double-coding (Jencks, 2010, p. 21) arises as to describe the kind of architecture that gathers architectural traces belonging to different times to create formal unity (Figure 28). Such architectural understanding fits in the concept of being eclectic, stated by Domenech & Montaner: “[...] *If caring for the practice of all good doctrines... is to be eclectic, if to believe that all generations did let us something new to learn from, study it and apply it is to commit that fault, then we declare ourselves guilty of eclecticism..*” (Navascués Palacio, 1988, p. 10).

Post-functionalist and post-modern trends had both the goal of giving back to architecture, “the vitality” that became “lost” with the modern movement. That spirit led to seek the way to make architecture more attractive not only to the architect’s but to the user’s eye, both trends had clients that felt identified with them thus proving none was right or wrong. Nonetheless, it did not deter the grays from defining modern and functionalist architecture as narcissist, selfish or narrow when talking about the excess of minimalism the latter used to employ (Stern, 1998).

In the end, postmodern architecture has no defined language but design strategies for defining it, as stated by Robert Stern³⁰ (Stern, 1998), such strategies are:



Figure 28. A mix of international style along with concrete brutalism and big cornices as ornament on the roof are found at The Colón Towers by Antonio Lamela, Madrid 1976. Photo O.GÁMEZ

“The use of ornament. [...]

The manipulation of forms to introduce an explicit historical reference. [...]

The conscious and eclectic utilization of the formal strategies of orthodox Modernism, [...]

³⁰ See full citation in Appendix 1

The emphasis on intermediate spaces, [...]

The configuration of spaces [...]

The adjustment of specific images charged with carrying the ideas of the building. [...].”

A common point between modernist and post-modernist trends, except perhaps for those oriented towards utopia, is that materiality –as means for expression- is regarded differently despite the fact that materials have more or less the same origin (which is culturally dependent). Namely, the window used for a modernist or a post-modernist project might be the same. The question is not the window itself but the way it is used and the elements accompanying it.

As seen in afore-shown projects, a column is still a column regardless of how it looks like. It might still be concrete-made, however, putting a set of fancy neoclassic ornaments change the way it communicates with space and the user and, of course, the character it gives to space too.

The problem is not material itself; it is how it is used. Forthcoming chapters and sections will show that, even if some new materials have been introduced into the architectural scenario, the basic ones: lumber, steel, concrete, brick, glass, still shape buildings as they are intended to.

Comment 4. Material as means of architectural expression in post-modernist trends.

Stern's statements became complementary to Jencks's double-coding definition as Post-modernism opened the door for questioning the serial cost-saving model on which modernism relied. Nevertheless, making it disappear might not be enough since the modernist approach was constantly used by commercial-architectural practices linked to construction industry ³¹. Nonetheless, the post-modernist paradigm, even at industrial levels, could bring forth equally-acceptable aesthetic results the way modernism did (Figure 29) thus proving, as Jencks would put it: *“Post-modernism is not a total break with Modernism, but rather its combination with other things”* (Jencks, 2010, p. 16) -Comment 4-.

This section ends with a reflection about alternative architectural outlooks that surely were considered utopic by their time. The 1960s counter-culture gave way to propositions defying the reigning stasis on which architectural thinking was grounded, such as B.Fuller's Triton City (1967), preceded by other no less revolutionary inventions such as the Dymaxion Deployment Unit -DDU- (1944).

³¹ The paradox is that, despite post-modern arguments, post-modernism uses serial production, and industrialization as source for building (thus architectural) components.

Such projects explored aspects like building and densifying mobility, in which appeared to be an effort to displace human settlements out of the cities and giving buildings the ability to be place-detached. Any question about, how useful could this be? Imagine a post-Katrina scenario, no doubt a series of DDU's would have been the right mechanism to counter-attack the devastation the hurricane left over new Orleans back in 2005 (Rappaport, 2008).

Not for nothing, Fuller defended the idea of the floating city of Triton as a living set containing its own infrastructure. Namely, the city should be able to produce its own energetic resources as well as to manage the waste it produces in a renewable way – perhaps-. This kind of post-modernism lies not so far from today's environmental and sustainable postulates in which passiveness seems to be a goal in which not only energy is saved and renewed, but waste is used in generating energy or soil nutrients for reducing carbon emissions.

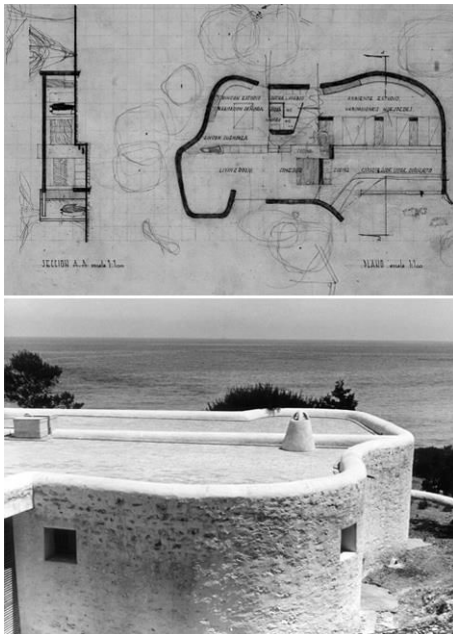

Figure 29. Vernacular and simple. Family House in Ibiza by Ricardo Bofill, 1960. On: ricardobofill.com

But, was B.fuller the only one in giving thoughts and actually patenting utopic visions? The answer is no. Ideal cities and homes were also in the mind of other architects who made connections between architecture and natural phenomena as it was perhaps the case of Paolo Soleri's propositions (Collins, 1979).

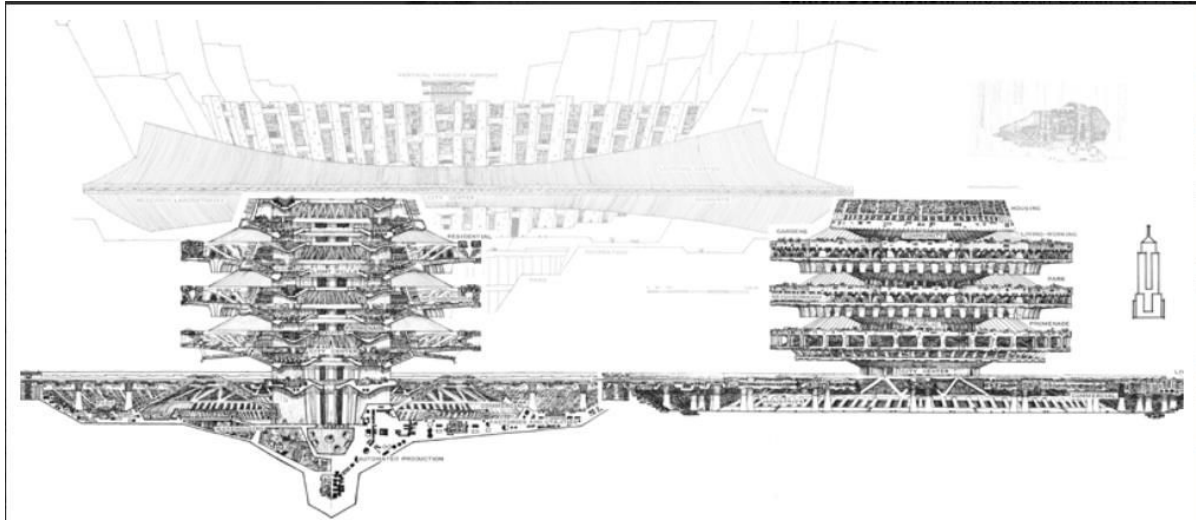

Figure 30. Arcology - City in the Image of Man by Paolo Solari, 1969, the MIT press.

1.3. FORM NO LONGER FOLLOWS FUNCTION AND VICE-VERSA.

Whilst classical architecture was characterized for its rich ornamental content and concern for proportion and aesthetics, the modern movement called for a machinist approach and mass production as to create an aesthetics and building grammar based on repetition, rhythm, and formal simplification.

Years Later, the post-modern school eternalized the dilemma between form and function along with the denial of modern trends for considering them simplistic because of the absence of ornament and the abuse of abstraction and formal lightness. In the middle of the discussion between modernism and postmodernism along with a wide range of nuances and philosophical parties pretending to change architecture from a semantic point of view; another tendency in architecture turned towards more challenging forms characterized by

disruption, noise and constant negation of the classic ornaments, serialism and parallelism characterizing the aforementioned architectural movements (Comment 5). That disturbance came with a denial in the relationship between form and function.

This stance should not be taken as an absolute inasmuch as, somehow, deconstructivism (and maybe all postmodern isms) still make use of standardized components for achieving buildings. In his work entitled "Simply complex [...]" , Kas Oosterhuis sets a posture against deconstructivism by arguing that the use it makes of standardized doors, windows, girders, columns and all construction-related items, is a fallacy against the meaning of what deconstructivism should be, against what post-modernities should mean, as to evolve towards a new architectural level or style.

Though his reasoning is valid, it might miss the fact that architecture, engineering and construction, outside academic and research fields, must fit into legislative constraints that somehow require things to be the way they are. It is possible of course to propose new approaches to make the exception to the rule and render them valid, in the meantime, things have to be done according to regulations and schedules. In sight of the contemporary architectural context, a stance criticizing his work is valid too. The Al Nassar building, in Dubai, makes use of standardized structural steel-frame circular sections. So, is it a Non-Standard building?

Comment 5. A brief critic on Kas Oosterhuis paper, "Simply complex, toward a new kind of building" (Oosterhuis, 2012)

From this moment forth form is in some way free, only conditioned by geometric paradigms that call for distorted Euclidean forms disposed differently; parallelism is not the rule to follow anymore and the continuity of form is also (somehow) denied (Figure 31). It is the time of deconstructivism.

As well as the exposition that unveiled the works of the NYF, years later there was another one named "*Deconstructivist Architecture*"³² that boosted the discussion about deconstructivism and deconstructivist architects, the goals of their architectural thinking and the "*why's*" of a trend that would not want to become a style or paradigm.

According to the homonym publication's introduction made by Phillip Johnson, this trend would not represent a style, movement or creed, neither would it have rules of compliance to be followed. From the exhibition's (and Johnson's) outlook, the so-called deconstructivist architecture was an approach taken by several architects with different visions about architecture, though the general outcome was similar somehow. The exhibition's organizers made a thorough selection of architects and projects which they considered

³² The exposition was held at the MoMa in 1988, organized by Phillip Johnson and Mark Wigley.

top samples of this tendency during the period from 1980 to 1988 (Figure 32).

According to the exhibition's fact sheet (MoMa, 1988), the sample included:

"[...] drawings, models, and site plans for recent projects by Coop Himmelblau, Peter Eisenman, Frank Gehry, Zaha M. Hadid, Rem Koolhaas, Daniel Libeskind, and Bernard Tschumi (list of projects attached). Their works are preceded by an introductory section of Constructivist paintings and sculptures drawn from the Museum's collection. [...]"

By taking into account the impact that Russian constructivism had on deconstructivist thinking, the exposition made clear that much of the inspiration if not the concept of what deconstructivism is about, emerges long ago in the past from the works of Malevich, Tatlin or Popova (among others) (Figure 33 Figure 34). As well as its akin *"-ism"*, deconstructivist architecture is characterized by compositions of overlapping diagonals, trapezoidal geometries and intersecting bars which appear as volumes and plans so that similarities arise when comparing constructivist and deconstructivist works, as is the case for Hadid and Tatlin or Rodchenko and Gehry (Johnson and Wigley, 1988). Russian constructivism broke the classical harmonious rules of composition; pure forms were then disturbed to produce impure geometries dressed in basic colors to mark hierarchies.



Figure 31. Skewed geometry of the Kio Towers by Phillip Johnson, 1989-1996. Photo O.GÁMEZ.

Through the eyes of constructivist thinking, architecture could be seen as a high art that could be used in achieving revolutionary goals (Johnson and Wigley, 1988) so that no social revolution was

possible without an architectural one. Painting soon transcended into architectural intention (Figure 35) and some of the early constructivist outcome used to represent ideally deconstructed buildings from which some were later aligned and obliged to preserve the common sense of form purity and order (Johnson and Wigley, 1988, p. 14).



Figure 32, Rooftop remodeling by Coop Himmelblau. Photo by John Hill, On: archidose.blogspot.com.co

In some way, deconstructivism could have emerged in the 1920s or 1930s right after constructivism promoted dissonance in plastic arts. If it was not because architectural tectonics were affected by limitations in engineering, maybe the modernist movement would have turned into something less functionalist and (perhaps) more complex, distorted and why not, organic. Who could tell what architecture would have been thirty years later?. It did not happen that way.



Figure 33. Tatlin tower. Photo JC Bignon.

Back into historical reality, postmodernism (which happens to be still present when deconstructivism arises), incarnated the denial of modernist ideals of geometric purity, minimalism and most of all, functionalism. Deconstructivism on its side, as stated by Daniel Libeskind, is maybe (back in the 1980s) the beginning of what modern architecture really is and not its ending as postmodernism intended to show (MichaelBlackwoodProd, 2011).

Deconstructivism demonstrated to have a different sensibility concerning space and form which is contrary to the prevalent paradigms of form purity, order and visual (not necessarily



Figure 34. Zhivopiskaya arkhitektonika by L. Popova, 1918. On: Russian Constructivism. C. Lodder

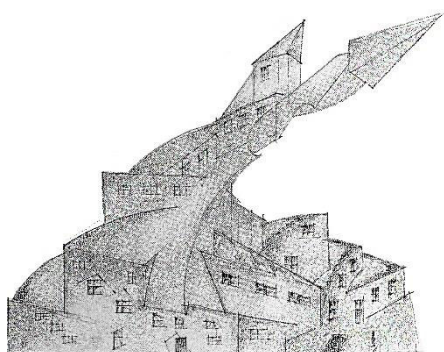

Figure 35. Project for a neighborhood-house by Ladovski, 1920. On: Constructivismo Ruso. C. Cooke.



Figure 36. Bearing and façade structures for the Confluences Museum at Lyon-France, by Coop Himmelblau. Photo 2012, O. GAMEZ.

structural) stability professed if not stubbornly defended by precedent trends.

By pushing form and structural stability to its boundaries, deconstructivist architects redefine morphological stability so that the ability to disturb is what makes the projects presented in the exposition (and other samples not found in it) deconstructive. Subsequently, disruption becomes really structural and no item works without its neighbor thus deconstructivist buildings are integral despite apparent chaos. Every item composing it is essential to its being³³.

Along with the refusal of Euclidean forms' purity, deconstructivism arrived with the inclusion of new materials and building techniques; the influence of digital tools is notorious despite their poor (but progressive) development during the 1980s and 1990s. Hence, the use of titanium, glass, stone, steel, concrete and aluminum composite became some of the preferred elements to exploit such "innovating" shapes which were often achieved by using "tangled" sub-structures as support for the form-disruption that characterized deconstructivism in most cases (Figure 36, Figure 37).

However, disruption depended on the architect's own-language. Richard Meier- for instance- made use of curvy shapes (i.e. Barcelona museum of contemporary art) as an attempt for denying the reigning cubism that characterized several of his precedent projects. However, at least

³³ In chapter two, the same principle is applied on a smaller scale, but for wider use, concerning the way part of a non-standard architectural object interacts with each other as to form a whole.



Figure 37. Confluences Museum by Coop Himmelblau, 2000-2014. On : historiasztuki.com.pl/kodowane



Figure 38. Barcelona Museum of Contemporary Art, by Richard Meier, 1995. Photo O.GÁMEZ



Figure 39. MAXXI, by Zaha Hadid, Rome-Italy, 2009. Photo O.GÁMEZ.

concerning Richard Meier's architecture, a curvy shape disrupting cubic equilibrium does not constitute a deconstructivist architectural endeavor (Figure 38). The building remains loyal to parallelism, rhythm, series, verticality, and structural orthogonality, which is the opposite to what is found in a building like the Museum of XXI Century Arts by Zaha Hadid (Figure 39).

Meier's work still matches modernist premises along with the minimalist touch once qualified as boring when Robert Venturi referred thereto as "less is a bore" (Venturi, 1977) opposing to the famous slogan "less is more" long defended by Mies Van Der Rohe. In fact, it matches very much the lack of "content" often found through modernist samples whereby empty spaces, as synonym of architectural and spatial flexibility, are found.

On the other hand, architectural samples like the Royal Ontario Museum (Figure 40) show a fragmented approach in which the Euclidean form has been distorted and parallelism is definitely not invited, at least not to the façade party. This approach is "typified" by the rupture of rhythm and modules, they exist but, as the concept of total verticality disappears, their reference plan changes all the time induced by formal compositions obeying to plastic and not necessarily functional constraints. Traces of standardized production still remain in deconstructivist samples nonetheless. If one takes a look at the Denver Art Museum (also Libeskind's -2006), titanium modules are parallel and only interrupted by geometric inflections limiting the number of special façade items to a



Figure 40. Royal Ontario Museum by Daniel Libeskind, 2007. On: wikiwand.com/nl/Royal_Ontario_Museum.

few. Pointy inclined volumes, manifold reference plans, a challenge to “apparent” stability and complex structures to sustain such vectorial shapes, seemed to be the common argument characterizing this trend that, by the 1990s was succeeded by another equally or even more complex approach. The blob.

1.4. THE BLOB-BOOM THEORY.

An attempt to introduce a dynamic-digital-conception approach in architectural design was born from a school in which one of the most prominent deconstructivist architects was working. Bernard Tschumi’s vision of architectural teaching at Columbia University led him to create the paperless studios (Comment 6), a risky step for a dean to take in one of the most traditional architectural schools in North America. A strategy that opened the way to massive use of digital tools in academic and professional practices after deconstructivism was the trend that allowed, somehow, a deeper exploration with computing as tool for conceiving and constructing buildings³⁴.

Thanks to his professional experience in the use of computers and modeling software, Tschumi saw an scenario to invite a group of architects (practitioners and theoreticians) for teaching the whereabouts of digital conception at the early stage of performing computing – the 1990s-. Among these

³⁴ Back in the 1970s, Nicholas Negro Ponte had begun to make a serious approach toward through-CAD-systems generative design. In a similar way, Paul Quinrand was trying to induce the use of informatics to architectural design in France. This will be widely discussed in chapter two of this dissertation.

architects there was Greg Lynn, whom in 1995 published an essay entitled “blobs” in which he discusses the problem of formal complexity in architecture and its connection with computing (Slessor, 2000).

The paperless studio started under the guidance of Bernard Tschumi in his debut as dean of the Faculty of Architecture at Columbia University by the late 1980s. As Tschumi points out, the shift in teaching things no one else was teaching at the moment boosted the design possibilities architects could explore with and actually yield as product.

There existed precedent endeavors in exploring with CAD programs and advanced modeling (see section 2.1) but had limited resources (financial and physical) inasmuch as performing hardware was expensive and design software was not precisely efficient.

The arrival of more performance hardware sets along with the appropriation of design technologies used in disciplines alien to architecture allowed him to propose an approach in which students would gain advanced design capabilities all because, in time, they would master digital tools in a manner no one else could. The benefit was that, by the mid-1990s, Columbia graduates were being hired just because they had that extra-knowledge in architectural computing, which started a new era in architectural design.

After all, using computers for architectural design was not a simple matter of representation or drafting.

Comment 6. The paperless studios, as adapted from (Celedón, 2014; Davidson, 2003; Slessor, 2000)

The philosophic approach of the blob is not covered by the scope of this work as is Lynn who has – perhaps- made the deepest, *complex* and epistemologically difficult-to-understand study on the matter³⁵; nonetheless the association of the concept to symbiotic or cellular behavior-like organisms, along with the concept of complexity, is something worth of being discussed. “Blobiness” can be understood as the absence of internal forces regulating a shape whose inner composition, contained by a flexible – almost fragile – skin, is fluid, adaptable, easily affected by its surroundings and easily deformed by the objects it gets in contact with (Lynn, 1998). In other words it can fit almost anywhere being simultaneously difficult to master, uneasy to be controlled.

Lynn’s analysis on complexity states that the term’s very notion is ambiguous though complexity can be understood in two ways: either by deriving it from a single set of primitive objects (Figure 41) from which a bigger complex is made of (emergence), or as a simple organization (a whole) from which basic components can be identified by reduction so that the theories of complexity by emergence and reduction are confronted. Such confrontation differs from an absolute negation,

³⁵ Please refer to the works by this author: Folds, Bodies and Blobs. Collected Essays, 1998. Animate Form, 1999.

simplicity is separated from complexity because of a continuum that is gradually changed by exterior forces (Lynn, 1998).

Considering the primary concept of blob as “something of vague or indefinite form” or “a drop or small lump of a thick, viscous substance” (Collins dictionary, 2015); in formal terms a “blob” is abstract, it does not meet a morphological condition previous to its existence other than a pure platonic form; as to put it in a less abstract fashion, Lynn uses the example of a “supple” sphere located into infinite space where no forces affect it so the sphere keeps its form unless something obliges it to change its condition.

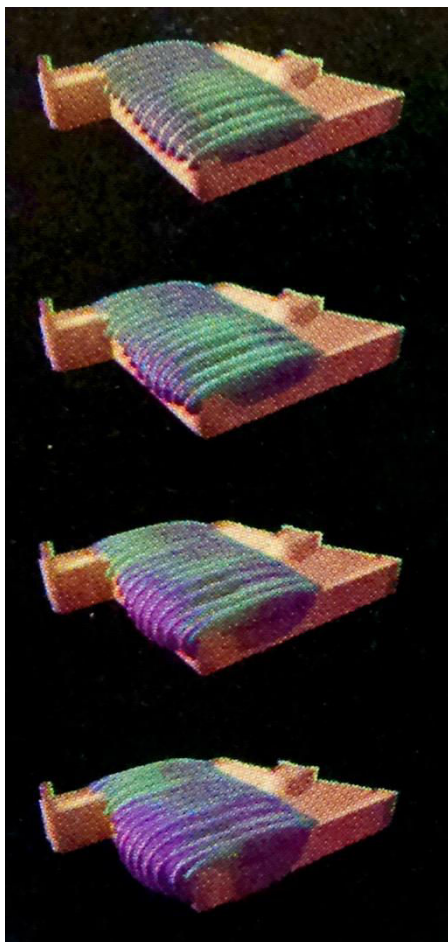

Figure 41. Morphological exploration with a blob-invasive shape, for the undulated roof of Korean Presbyterian Church of New York, By G. Lynn, D. Garofalo, M. Mcinfurt. 1999. Source: *Architecture 88-10-1999*

Digitally, the term comes out from the study of isomorphic polysurfaces which, according to Lynn, “in the special effects and animation industry are referred-to as meta-clay, meta-ball or blob models³⁶” (Lynn, 1998, p. 163). At this level, blobs have physical properties such as attraction, gravity and/or repulsion so that when they merge, the process is not Boolean, nor a geometric intersection like it would happen on a standard modeling software either. What occurs with blobs is comparable to what happens with two oil drops close to each other, an attraction force obliges them to transform themselves and merge to create common physical and morphological properties (Figure 42).

Considering the above facts, it is possible to think that proposing a blob volume representing an

³⁶ A closer look to the Meta-Balls software allows for identifying the fashion in which digital modeling entities merge themselves, creating a composed geometry affected by outer conditions that can be digitally emulated as to change their behavior, thus their form.

architectural concept, requires specific properties from the context where the blob is going to be placed at, so that the proposed shape will interact with its adjacent context in a way that might end in a reasonable symbiotic coupling.

Adaptability of blobby shapes has been tested not only by Lynn but others like Peter Cook (Kunsthaus – Graz 2003) or Arquimedia (Communications Palace - Madrid 2011), in both cases the blob is constrained by its neighboring shapes, it tries to absorb them but when it realizes the impossibility of doing so, it solves the problem either by juxtaposing itself to the context, making attraction forces to merge; or by rejection, in which case it is (in some way) contained thus its form is adapted to its environment's morphology as is the case of the Communications Palace in Madrid (by Arquimedia), where architects tested with a balloon contained in a shoe-box as to determine the shape of the new roof for the palace's delivery yard (Figure 43)

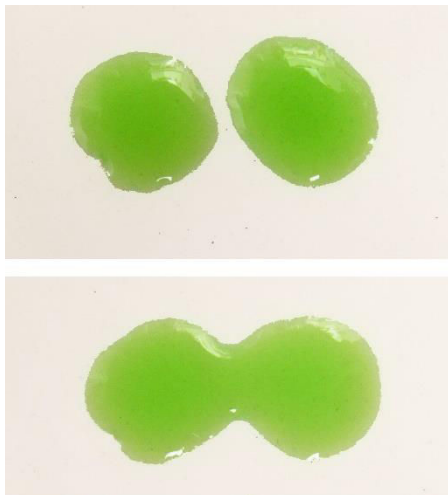

Figure 42. Two viscous bodies, close to each other, merge together as to create a new "blob" body.

At a point it becomes difficult to understand the movement to which a building and/or its style corresponds. Blob architecture deals with much of the aspects of what will be described as Non-Standard architecture, mainly the part in which architectural items become Non -serial therefore customized as for achieving the building's final aspect. However, making a real difference between one architect's style to another's, or from one project to another, requires a well-educated eye and a well-founded theoretical background.

In fact, the legacy of the blob lies in being a reaction to postmodernism and deconstructivism by using digital tools –at a higher level - as an instrument for exploration in architectural conception and production. In an interview with Alejandra Celedón, Lynn talks about the “Archeology of the Digital Exposition” at the Montreal Centre of Canadian Architecture (CCA) which served to make a digital compilation of projects and prototypes made in the late 1980s and early 1990s (Celedón, 2014). The sample displays the evolution from deconstructivism to blob architecture as seen through deconstructivism. The blob trend aims not to define a language or paradigm but to establish formal propositions in which inner space can be defined differently avoiding the eternal Cartesian paradigm of spatial rectangularity or parallelism (Figure 44).



Figure 43. Blob glazed-roof for the Communications Palace, by Arquimedia, Madrid 2011. Photo, O.GÁMEZ



Figure 44. London City Hall, by Foster+partners, 2002. Photo O.GÁMEZ.

It is precisely parallelism the argument used by more traditional observers and theoreticians in architecture, as to argue about the constructability of very complex architectural forms. When proposing non Euclidean shapes in architecture the question about how to build them comes in mind, since traditional or standardized building techniques are not adaptable to accomplish the formal challenges

imposed by computational design.

It is then when the concept of Architectural geometry, discussed by Helmut Pottman in the 80-4 Issue of Architectural Design (Pottmann, 2010), arises as to explain the intrinsic relationship between CAD tools and complex-shaped architecture's constructability. The term itself refers to the kind of geometry first used in the making of products for the automotive and aerospace industries which were not common in architecture (except -perhaps- for roofing solutions such as Plexiglas or polycarbonate domes), until digital tools and 3D modeling software became a design tool by the time deconstructivism appeared.

Specialized modeling software such as Catia, Alias, Wavefront, Softimage or Solidworks, intended for other purposes but the architectural one, came to motivate a field of geometric exploration in which amorphous bodies could be conceived without being constrained by the rules of parallelism (Figure 45), cubism or linearism present in architecture up until then.



Figure 45. Oblique WTC Office tower conceptual design, by L. Spuybroek, C.Seung-Woo and K. Mun. 2001. Source: nox-art-architecture.com.

The kind of data obtained through such modeling software in the early years of digital architecture amazed users that were confronted to it for making architecture or architecture-related activities, with an outcome of abstract diagrams, weather and thermal patterns in which turned to be a kind of information of such quality and quantity that was not common in architectural practice or research up until then (Cramer and Guiney 2000)

The blob approach then happens to have a

closer philosophical background close to that of Architectural Geometry (Pottmann, 2010, p. 74), since the workflow for achieving the forms, derived from the former, needs high-comprehensive digital tools for its conception and even more specialized ones towards its ulterior rationalization for construction purposes. A step that Greg Lynn himself had to take after making the New York Korean Presbyterian Church, since mastering the principles of machining complex forms is essential in the achieving of complex geometries (Giovannini 1999).

The trend itself has had many interpretations and blob architecture is not Greg Lynn's perspective only. Others, as well as him, were seduced by the attractiveness of digital modelers and their capacity to produce forms uneasy to create and analyze by using traditional or "analog" methods (Gómez et al., 2015b)³⁷. Such is the case of Renzo Piano and the Rome Auditorium in which an attempt for using the curvilinear approach, typical in blob architecture (Giovannini, 1999), turns out into a complex in which buildings look like giant bugs facing each other whose skin is made of big metal sheets instead of glass panels, juxtaposed over rectangular brick-made hosts (Figure 46).



Figure 46 Auditorium at Parco della Musica, by Renzo Piano, 2002. Photo: O.GÁMEZ

Design criteria for creating blob architecture, not only comes from an interest in Non-orthogonal forms but from an interest in curvatures and, for such purpose, architects themselves have to be comfortable and confident with such language in

³⁷ A paper that discusses the role of traditional (analog) conception and construction methods and their contribution to the digital environment applied to conception and construction stages on wooden Non-standard architectures.

order to master it. Something that is even more interesting to explore when using the adequate tools and, for such endeavor, digital tools seem to perform very well due to their pre-visualization capabilities along with their graphics and physics simulation resources (Celedón, 2014).

Citing the statements made by Lynn to the “Materia Arquitectura” journal, and this is a fact, after the interest shown by him and others like Eisenman, Foster, Spuybroek or Piano himself; software companies became interested in these big offices’ needs. Before that, those pioneers had to adapt themselves to the possibilities offered by the software available in the 1980s and 1990s. By the end of the latter, people from McNeel, Autodesk, Solidworks and other major software companies, came to these gurus’ offices to offer modeling and design solutions free of charge in order to develop their products.

So, as Lynn claims, architects like Norman Foster, Lars Spuybroek are *“examples of architects whose projects generated a variety of digital tools which today are just taken for granted as everyday possibilities”* (Celedón, 2014, p. 22). In order to conclude this discussion about Blob architecture, it is worth to say that one of its main contributions to contemporary architecture, along with the deconstructivist movement and its representatives, is the spreading of the use of digital tools for architectural design.

However it is not only the use of digital tools but the challenges architectural practice, from the point

of view of deconstructivists and blobbists³⁸, imposed over such tools to oblige them to be improved in favor of the architectural world so that their use was no more a privilege of aero-space, automotive, gaming, product design and/or graphics industries.

Starting from the 1980s, design suites like Archicad began to improve user interaction by incorporating architectural reasoning to their graphics interface. However, such reasoning did not allow for creating defying shapes or forms since architectural software was heavily intended for the industry and, most of all, architectural standards.

The real breakpoint came with the creation of the paperless studios at Columbia university, which encouraged the exploration on a different type of modeling thus architectural conception, based on the experience of former deconstructivists and the typological and topological possibilities offered by 3D modelers not intended for architecture.

As well as former members of the paperless studio concluded, the outcome turned out to be a bit similar between one proposition and another (Figure 47). All because – perhaps – the methods used for modeling geometries in the framework of this approach ended in an exercise of deforming mesh-based objects that could be stretched or compressed as to give them a specific shape.

Confronted to its realization, blob architecture opened the way to a further field of exploration in the matters of fabrication, mass customization and mounting of complex forms for Non -Euclidean



Figure 47. Even long after digital tools made it into form-searching in architecture, some projects continue to have similar morphologic properties. At some point many architects coincided in proposing glass-bubbled-like façades as architectural solutions.

Top: Koln P&C department store by Renzo Piano, 1995-2005. **Bottom:** Strasbourg Railway Station by J.M. Duthilleul, 2007. Photos O.GÁMEZ

³⁸ Those who, in one way or another, dared to conceive and produce Blob architecture.

buildings. That is maybe the frontier between the blob approach and what will be defined as Non-Standard architecture. Let us not forget the existing relationship of these two concepts with the genesis of form from complex organic and geometric arrangements achieved by way of digital means for non-representative but generative³⁹ purposes, aka, digital-architectural morphogenesis.

1.5. FROM SIMPLY DIGITAL TO HIGH COMPLEXITY = NON-STANDARD

In order to understand the conceptual relevance the term (non-standard) has about the architectural matters discussed in this work, it is necessary to explore its backgrounds, which are not purely architectural. By the end of this section, there will be a deeper discussion on complexity as one of the base concepts for defining what non-standard means.

1.5.1. NON-STANDARD MATHEMATICS

The “Non-Standard” notion, was introduced by Abraham Robinson in 1961 (Kutateladze, 2013) as to state a theory defining and analyzing infinitely small numbers (infinitesimals). Known as Non-Standard analysis, this theory has had a wide repercussion in the field of modern calculus by bringing mathematics and logic together (Dauben, 1982). As for Non-Standard modeling (as concept), it is characterized by the action of true and false propositions being explicitly defined in order to allow for verification and discrimination between them (Kutateladze, 2013),

³⁹ A deeper discussion on this and other related concepts is made in chapter two.

a principle frequently found when working with parametric modeling tools like the Grasshopper plugin for Rhinoceros or the Dynamo software for Autodesk Vasari⁴⁰.

1.5.2. ARCHITECTURAL NON-STANDARD

The term (Non-Standard) was used in a book entitled “*Architectures non standards*” (Migayrou and Mennan, 2003) in an attempt for creating a heterogeneous sample of architectural realizations⁴¹ which up until then were a kind of antithesis facing the architectural models that emerged in modernism.

It also embodies architectural evolution in terms of tendencies, as it marks the step after the blob trend, as research performed by avant-garde architects on the way contemporary works are to be produced and built with the aid of computing tools and automated machinery first intended for serial purposes. Such architectural avant-garde gave top-end fabrication technology the chance to become even more productive by changing the purpose of robotics from simple serial cutting-assembling tasks to **Computer Numerical Controlled** machines that can be programmed to perform complex Non -serial fabrication routines in about the same time they would for serialized items⁴².

It is finally architecture (and design), along with engineering, the disciplines that found that

⁴⁰ Beta version already discontinued. Autodesk Dynamo currently runs along with Autodesk Revit.

⁴¹ The way it happened with MOMA expositions on the New York Five and Deconstructivist Architecture, as well as the CCA’s exposition on Blob architecture.

⁴² The first attempts date from the late 1940s. For more details please refer to Comment 18 in section 3.1.2.

new purpose by proposing digital-created shapes that needed a production approach not akin to industrial standards (Carpo, 2015b). Some architecture theoreticians and critics (in architecture schools and conferences) often suggest that digital architecture is nothing but a stylistic trend based on software and computer capabilities ignoring, maybe, that computers and software cannot work by themselves unless there is a creative brain behind. Other authors, using a different speech, state that the Non-Standard form might be achieved by setting standard geometries in a way that they can represent Non-Standard forms, which in the end is achieved with a loss of fidelity (deformation) as stated by Ciblac (Ciblac, 2011) when speaking about geodesic domes built with equal length elements⁴³ (Figure 48).

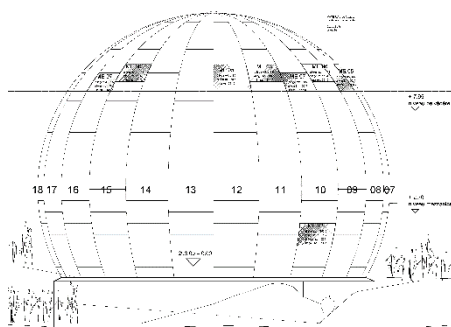

Figure 48. EDF Toul Pavilion, by Alain Cartignies. 2014. Drawings by A. Cartignies. Use under consent of Cartignies-Canonica Architects.

The facts stated by T. Ciblac (2011) about achieving non-standard architectures through standard elements might be partially true. Although Non-Standard architectural forms call for standard geometries as monads for creating complex geometries, the introduction of form variation applied to standard shapes constitutes the principle of mass customization (Anzalone et al., 2009), in which the parts of a whole (structural or architectural) contain slight geometric variations for describing a Non - Euclidean form composed by a pattern of Euclidean geometries.

⁴³ This is a very particular case that finds a physical full-scale representation in the form of the ERDF pavilion for solar energy located at Toul-Roisières (France), a project by Cartignies-Canonica Architects to which we will refer-to in the upcoming chapters.

Also, when Ciblac speaks about “*solving constraints for 3D structures with standard elements*” (Ciblac, 2011), he might be speaking about the use of geometric patterns (Gámez et al., 2015a) as a method for decomposing Non-Standard architectural forms into small pieces (Carpo, 2015b) as they adapt themselves in the best way possible to represent and materialize Non-Standard buildable objects (Figure 49).

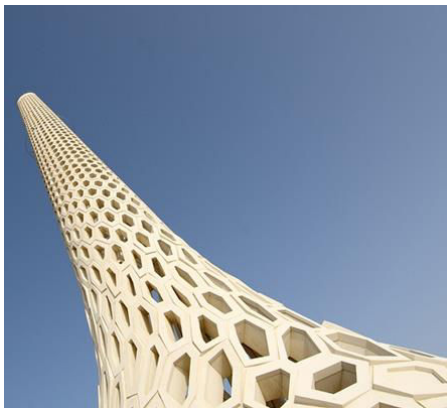

Figure 49. Spatial arrangement of deformed hexagons as pattern for the KAUST university Beacon, Saudi Arabia. By Daniel Tobin, 2009. Source: architecturelinked.com/profiles/blogs/kaust-breakwater-beacon

1.5.3. MASS CUSTOMIZATION AND THE ORGANIC APPROACH.

The term arises as an antonym of mass production which is explained by the capacity of a given facility to make morphologically heterogeneous items needed to assemble a whole by using means such as Computer Numerically Controlled (CNC) milling machines, CNC laser cutting machines and robotic arms equipped either with milling or laser cutting tools (Figure 50). However, mass customization might not be a consequence of serial production but an outcome of architectural computing.

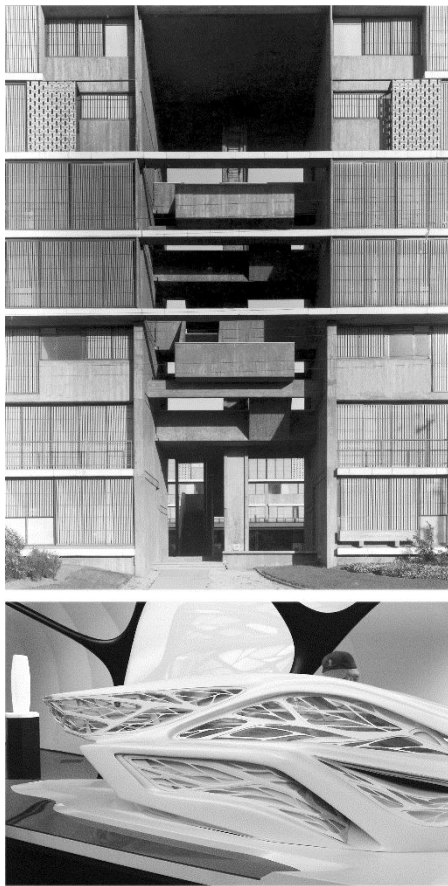

Figure 50. Laser-cut aluminum façade tessellation for the Paris Philharmonic, by Jean Nouvel. 2014. Photo O.GÁMEZ

As mentioned back in section 1.4, it was in the field of digital architecture where the question about how to build digital models arose, as the challenge was not found in architecture itself but in the coupling of digital design with architecture, material, and material shaping.

As digital architecture is in a given way related to the organic paradigm, architecture itself evolved towards formal complexity, not in the sense of ornament but in the sense of formal

variation though formal experiments derived from the reinterpretation of form by way of epistemic analysis regarding the way constitutive parts of an organic whole evolve in nature. This can be understood in terms of stasis (Figure 51). Stasis is a typical feature in modernism, therefore, many components of modern architecture are static all because form is conceived in a dimensional static space (Lynn, 1999). Additionally, organic postulates in architecture found a difficult way to go through, as technologic means of the 20th century would not match the dynamism organic form possesses, which might be the reason why serialism almost wiped out any interest in exploring with non-regular forms the way constructivism did (refer back to section 1.3).



*Figure 51. Stagnancy vs. Dynamism in architecture. **Top**, Villa Portales Residential Unit, Santiago de Chile. 1958 – 1968. On: Unidad Vecinal Portales. **Bottom**: 3D-printed model for the Abu Dhabi Performing Arts Centre, by Zaha Hadid. 2007. Photo O.GÁMEZ.*

It required computation to be highly developed as to face the challenge of building real-size-Non-serial shapes. The fact is that organic shapes appeared long before rational ones did⁴⁴. However, the latter were better welcomed by the serial trend that characterized industrial modernist production, giving the organic approach a role that remained latent until the digital trend was powerful enough to transform industrial production means, thus opening the way to produce the outcome offered by the Non-Standard approach.

Organic architecture defies stasis by turning architecture into a dynamic state whereby the architectural object responds to forces, which might be external (context), internal (function) or

⁴⁴ As well as constructivism, with its formal disruption, appeared long before deconstructivism did.

arbitrary (plastics). That dynamism is then processed through digital modeling, which turns it into a responsive object that can be adapted to a set of forces affecting it.

The result is not only a Non -Euclidean shape but a language in which the components of the shape itself suffer variations as to adjust themselves to the dynamic essence of the whole⁴⁵.

Figure 52. External forces, digitally affect a three-dimensional shape as to form an architectural Object. Embryological House by G.Lynn. Early 90s. On: <http://www.docam.ca>.

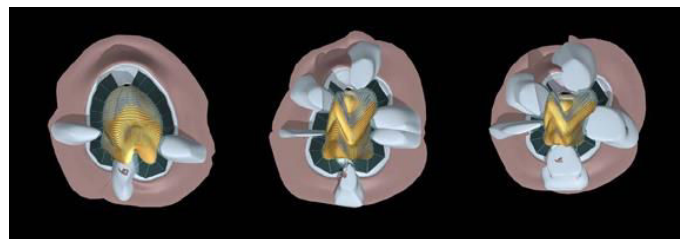

To physically produce those variations, a standardized approach is not appropriate. First, when architectural shapes become complex their base components are not similar because they must adapt their own morphology to particular efforts demanded by the shape itself in order to take form, the same way animal or vegetal tissues adapt their inner structures as to form a body (Figure 53).

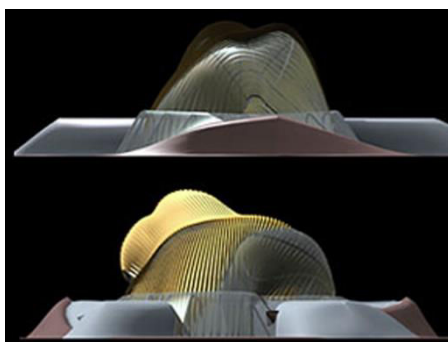

Figure 53. Embryological House, by Greg Lynn. Early 90s. On: <http://www.docam.ca>.

Said so, when items composing an architectural shape need to be put together, each one has morphological properties unique to its own. If we understand those items as monads composing a whole, when treating those monads from the organic approach's outlook, each monad is absolutely relevant since there is no whole if one single monad is missing and there is no way

⁴⁵ It is also related to the concept of elemental combinatorial systems as defined in section 2.1.

to replace it with a similar object because there is no other object like it (Figure 54).

So now that architecture has become complex because of the organic approach's reintroduction, the problem for those who began experimenting with digital architecture's resulting forms was how to produce them.



Figure 54. Unique monads forming Non-Standard benches for the UNIRE/UNITE project by UMD at MAXXI, Rome. 2012. Photo O.GÁMEZ.

The answer lies in rethinking the use of automated machinery by turning its purpose from producing serialized items towards custom-shaped objects. As Mario Carpo states, cost is no object anymore since, more or less, producing a custom-shaped object by using digital and automated means has about the same cost than making a serialized one (Carpo 2005).

So far, this is perhaps the feature that characterizes Non-Standard architecture the most; it is not morphology by itself but the capacity shown by contemporary architecture (and architects) of materializing complex forms at about the same speed and cost the modern and serial paradigms do⁴⁶.

1.5.4. NON-STANDARD SHAPE AND CONTEMPORARY PRODUCTION MEANS.

As seen in previous paragraphs, one of the features that has built the Non-Standard concept (in architecture) is its position facing serial and standardized production.

We can even say that Non-Standard architecture existed long before it was called that

⁴⁶ This discussion is widened in chapter three, where the concepts around digital fabrication as means for mass customization and digital fabrication will be treated.

way (Figure 55). It does not take long to realize, for example, that at least parts of the works at the Sagrada Familia, by Gaudi, are ruled by this principle. Columns, pillars, vaults (and many others) might look similar but they are not. There are slight variations from one item to another meaning that they belong to the same genus, but they are not identical therefore they do not fit into the serial production concept⁴⁷.

However, despite the existence of these intrinsic variations, the employed production methods aimed to materialize the Sagrada Familia (up before the 1990s) are distant from the Non-Standard concept, in terms of production, because there was no mass customization but craftsmanship at Gaudi's work⁴⁸; not at least until CAD/CAM technologies were introduced into the construction workflow (Burry, 2002; Halabi, 2016) (Figure 56)



Figure 55. Waved walls and roofs at the Sagrada Familia school. Standard monads (bricks) are used to build these Non-Euclidean bodies. Although regular monads are used for its construction; a specific placing technique and joint distance variation allow for the achievement of form. Notice that special formwork was needed as well. Antoni Gaudi, 1907. Photo O.GÁMEZ

However, sometimes, is not even the variation on form what gives an architectural object its Non-Standard character but the way its composing items are assembled. This is particularly true if we look at the work of Gramazio Kohler Research at the ETH when making Non-Standard brick-walls.

All bricks are identical but the way they are placed, the gaps between them and the axis displacement from one unit to another, completely changes the appearance and the

⁴⁷ This assertion is validated by discussions and works on the topic found in: (Carpo, 2016; Halabi, 2016; RMIT University, 2012)

⁴⁸ At least at its initial stage. Actual works at the Sagrada Familia heavily rely on digital tools to understand the formal thinking of Gaudi's.

morphological approach of a wall that, in principle, should be absolutely straight and vertical. Even if it was, the positioning pattern used for designing it avoids the wall from losing its Non-Standard qualities (Figure 57).

Not for the fact of applying Non-Standard analysis in mathematics, mathematics stop being mathematics, they keep on being it, the only thing that changes is the way of reasoning with them and the resulting outcome. In the same way, Non-Standard architecture is not a matter of style, or variety for the sake of variety (Celedón, 2014) but the way architecture and its components are conceived and made, and for that, Mass Customization achieved through industrial robots, is the key.

1.5.5. ARCHITECTURE'S POST-MACHINIST AGE.

Account taken of the precedent paragraphs, contemporary architects, designers, and engineers are obliged, more than ever, to master digital tools along with a comprehensive understanding of constructing processes derived from the use of digital tools applied to contemporary architectural practices.

The contemporary architect masters form and function as it is his purpose, but mastering digital tools and understanding the way they work constitutes a knowledge layer that architects in the age of modernism did not have to worry about (not too much).



Figure 56. Columns at the Sagrada Família, by Gaudi. 1882-? Variations on shafts and knots are visible throughout the cathedral. Photo O.GÁMEZ.

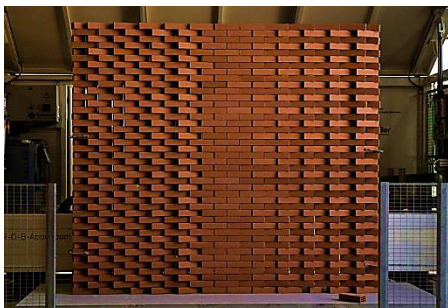

Figure 57. The Flex-brick project by Gramazio-Kohler research, 2010. ETH Zurich. On: gramaziokohler.arch.ethz.ch/web/e/forschung/152.html

It is not that every single architect in the world must be confronted to this post-machinist trend, however, a deeper knowledge on informatics and complex modeling is necessary as to achieve complex forms. A discussion on this matter is carried out in the 80 issue of the AD magazine (entitled New Structuralism). It shows a sample of what dealing with informatics and Numerical-Controlled-Machines is about, with subjects that go from the collaborative work between architects and engineers in the digital era to a description of the new tasks those professionals have to achieve to do their job, all related to architectural non-serial production (Castle 2010).

To put it in simpler words, the post-machinist age in architecture has to deal with architectural complexity at a level other than ornament. Such complexity goes further and does not obey to the base principles of structural behavior and architectural composition as seen in previous ages of architecture and engineering applied to it. In this new age the machine does not act like an automata, it serves as a bridge that allows for materializing complex cognitive endeavors represented in also complex digital models embodying intricate human habitats. Such process does not accept serial models since there is –perhaps- no unknown challenge in it anymore.

1.5.6. CONCEPTUAL APPROACH

As for the matters concerning this dissertation, the Non-Standard concept groups three essential

aspects (concepts): Form, Complexity, and Materiality.

Form itself is capable of being affected by variations, external or internal (as afore-seen in Figure 52). External variations affect the way a given architectural object is shaped into space thus its envelope's morphological properties are defined (Figure 58). Internal variations affect inner structures so that the envelope might remain the same but the way in which items composing it are arranged, is altered or reformulated (Figure 59). Form is no longer defined by types or styles but by form-searching.

However, the form-searching experience, as taken to the realization field, is not a solitary endeavor carried out by architects on their own. Engineering is called into the equation to perform as an active modifier that validates every topologic or morphologic operation made on the object under conception. This close collaborative work is what Oxman (2010) identifies as new structuralism. Namely, this new structuralism refers to design endeavors in which structure and architecture evolve together, completely tied to each other as to achieve a common result.

The results of such approach can be seen in the methods used by people such as F.O. Gehry or M.Burry , as the variation architecture proposes is fed into structural analysis (as data) allowing to perform structural studies that lead to form-searching through structural optimization. This is precisely the concept behind parametric

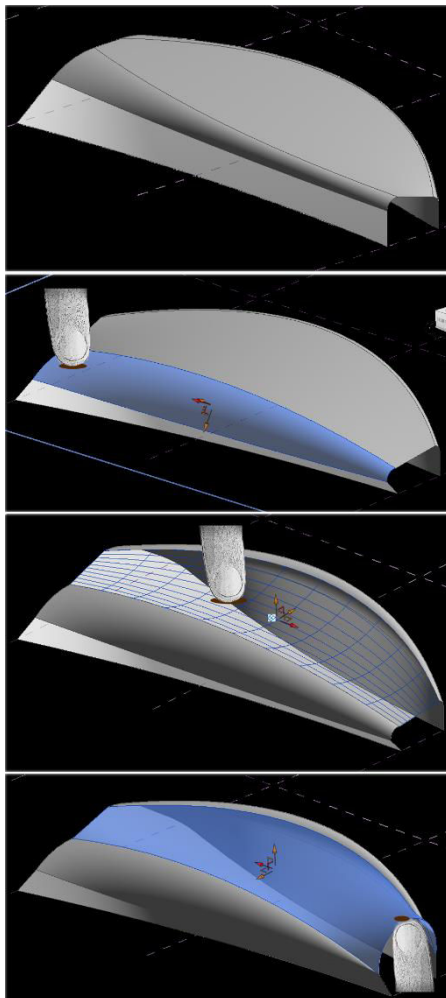

Figure 58. Non-Euclidean envelope altered by exterior forces (as vectors). Observe how inner structure changes as form is altered. (Third picture from Top to Bottom).

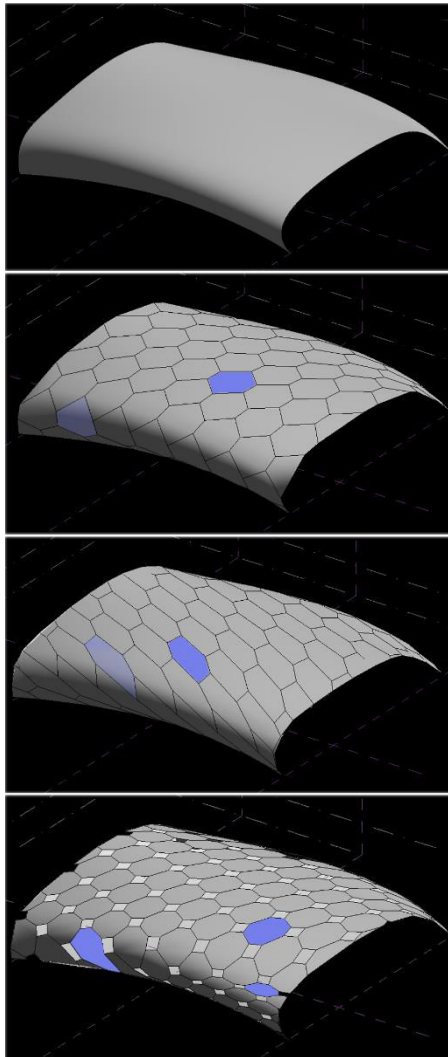

Figure 59. Internal variation of a non-regular shape whose structure is defined by a geometrical pattern. Observe that the pattern can be altered by changing its frequency, skewing it or by rotating its axis; creating an outcome of manifold items sharing the same geometric genus.

The pattern, as structure, can be changed thus giving a different inner structural arrangement for the same body (Bottom picture).

Such variations (external and internal) define the geometric character of items composing a body, therefore, increasing or reducing its morphological complexity.

tools such as Karamba (Preisinger, 2013), or Kangaroo (Piker et al., 2015) in which iteration for structural analysis and shape optimization can lead to finding varied morphological intentions. The impact this new structuralism has had in architecture can be seen through the discussions and comments found in sections 2.1.1, 2.2.3, 3.3.3 and 6.2.2.

Complexity is brought forth through form-searching⁴⁹ and the intrinsic relationships ruling an architectural object's inner and outer structures (Figure 58, Figure 59). Such complexity can be a premise or a consequence derived from a design cognitive process in which complexity itself is bound to logical and computational processes that render a geometric whole and its specific components into feasible objects (Gámez et al., 2015a). To understand this statement, it is necessary to dig into the computational boundaries of complexity, which go back in time up to the early 20th century; by that time the discussion about the concept was entirely mathematical and dealt with the notions of disorganized and organized complexity, as discussed by Warren Weaver in 1948⁵⁰.

Disorganized complexity represents amounts of data containing a significant quantity of variables, seen as mathematical problems, whose individual solution would be impractical given the large number of operations that might

⁴⁹ The term refers to a process in which, by means of digital tools, a designer explores through heterogeneous morphological outcomes to find a solution that matches the best his design's conceptual approach. See chapter two for more variables on the term.

⁵⁰ An interesting paper published in the # 36 issue of the American Scientist Journal. 1948.

be needed to treat all of them one by one.

As Weaver explains, one thing is analyzing trajectories and collisions for three billiard balls in a table and one another exponentially more complex is analyzing the same data for 15 balls, as in pool (Weaver, 1948). That problem, nonetheless, can be partially solved through probability and statistics which is what disorganized complexity is all about, however, the question on the specific points where the balls hit the rail or the exact coordinates in the table where collisions occur, is a matter of a more complex analysis.

Solving specifics is what Weaver defines as organized complexity. In architecture, such specific data is retrieved through digital simulations as in thermal analysis. Thanks to the advanced capabilities of contemporary computing, it is possible to know the exact temperature variations of a room throughout the year by considering statistic data regarding, for example, average temperatures and humidity rates throughout seasons.

So far we have used both, disorganized complexity (as to obtain average data) and organized complexity to obtain accurate data about comfort temperatures. Such data allows architects and engineers to adopt specific architectural solutions, either active or passive, in order to optimize their designs.

To the mixture of disorganized and organized

complexity, another factor must be added: Computation. By 1948, the capabilities of primitive computing machines astonished the people of that time, since their ability of computing data 40.000 times faster than a human operator was quite an improvement (Weaver, 1948, p. 7). The essential here is not the speed, nor the fact of computing being at a primitive stage either but the fact that scientist were conscious that computing was about to play an important role in the development of all sciences including, of course, architecture⁵¹.

In digital architectural conception, disorganized complexity comes to represent a state in which the architectural object is not completely defined, in other words, it is the simulation stage in which the object is constantly altered until a satisfactory formal approach is found. On the other hand, organized complexity is embodied by the object itself and its composing parts at the stage when those monads are defined so that structural and morphological solutions are yielded (Figure 60).

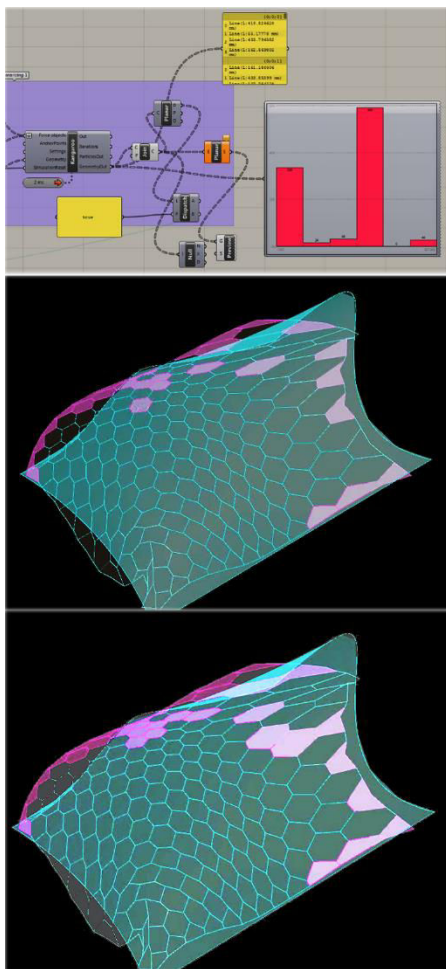

Figure 60. A simulation, ran on grasshopper, helps finding a solution to planarize polygons over a Nurbs surface. The software starts by testing probable solutions (Top and middle) until it finds a specific one that satisfies not one but several neighboring items (Bottom).

Managing such amount of data is obviously difficult to handle by the human brain, so that a mechanism to deal not only with formal (plastic) complexity but with data derived from formal complexity is needed. It is then when the notion of big data arises. According to Mario Carpo, the capacity of handling huge amounts of data is a privilege the human race acquired with the

⁵¹ Refer to chapter two as to see what the first attempts to develop performing computing for architectural design purposes were.



Figure 61. Façade panels derived from a digitally-made biologic-like pattern. Two types of pattern are repeated and adapted over a manifold set of panels whose dimensions change in function of the stadium's geometry. Paris Rugby Stadium at Boulogne-Billancourt, by Rudy Ricciotti. 2007. Photo O.GAMEZ

While writing this chapter an article by Mario Carpo was published in the 86-2 issue of *Architectural Design*. The document describes how parametricism, therefore Non-Standard architecture, were present even before the digital architectural era. On his writing, Carpo compares the complexity that lies in ancient gothic architectures (just like the example on this dissertation regarding the *Sagrada Familia*) to that of contemporary architecture by making emphasis on how parameters have conceptually evolved through the years to become real-time modifiers as they are known in the world of architectural advanced computing

Comment 7. External discussions about parametricism.

development of modern computing, that capability of processing data for evaluation, simulation, filtering and obtaining results without being concerned by the mathematical specifics is what Carpo defines as Big Data. (Carpo 2015).

The precedent arguments support the fact that digital architecture requires complex mathematical operations, performed through computing, as to achieve complex bodies composed by a variation of monads (Figure 61), which in the end; constitute the basis of the Non-Standard concept. Subsequent chapters in this dissertation, dealing with the concept of Digital Morphogenesis, will refer to the concept of complexity as to explain the way morphogenetic methods used to yield Non-Standard architecture.

As for **materiality**, the concept represents the physical dimension of the research project discussed throughout this dissertation whose global framework is wood construction. In this approach, material transfers its properties to design as to avoid detaching architectural decision from material usage.

The term has been widely discussed in contemporary research and practice as materials have gradually turned into design drivers (Oxman, 2010; Weinand and Hudert, 2010), an outlook that has a stronger background on morphogenetic and biomimetic driven processes. According to Oxman, materiality in contemporary design functions more or less the same way it does in nature: material – structure – shape. The

weight of such fact is evidenced in the conceptual and experimental stages described in this dissertation⁵². To this extent, material properties like flexibility, workability, shrinkage, hardness, acidity, even mechanical response to rotary tools, are considered as part of a model considering these facts as part of a complex process in which evolutive, generative and adaptive models are used to create an aided-conception parametric tool for timber walls and envelopes.

Based on the concepts discussed in previous paragraphs, the non-standard notion, as applied to architecture and engineering, features those design endeavors taking into account much of the considerations discussed throughout this section.

Furthermore, concepts such as mass-customization, non-standard fabrication, wood construction and data management will come to shape a complex idea of what the non-standard is (Comment 7). As it will be stated in forthcoming sections, modeling for the sake of modeling is no more useful, as pure representation might become a useless effort inasmuch as design modeling using data management has become a source for design-problem solving, or as Yves Weinand (2010) would put it:

“The seductive aesthetics of digital architectural modelling and visualisation have often dominated over attention towards materiality and building construction. Ambivalent images were, and still are, produced with digital tools. They display architectural visions that neglect the constraints of the physical laws and the constraints associated with building construction.”

To this extent, when discussing about non-standardization, the idea of material as generator or facilitator of design becomes an indissociable aspect with which designers deal from end to end in design-to-production processes. It is within these boundaries that the Non-standard notion is used throughout this dissertation.

⁵² Please refer to the discussions in Chapter 6 and Chapter 7.

Chapter 2. DIGITAL MORPHOGENESIS: MACHINES, PATTERNS AND ARCHITECTURE.

Precedent sections presented a summary on architectural trends that evolved and reacted from and to modernism yielding a series of post-modernities that embodied manifold (sometimes opposing) architectural knowledges defining the Non-Standard concept in architecture. By the same time modernism was being intensely criticized because of its alleged “failure” in solving the problem of space, function, form, and context (post-modernity’s emergence); an interest in digitally conceiving architecture appeared in parallel to vivid discussions about whether modernism was already dead or not.

To facilitate understanding the principles leading to a model structuring this dissertation’s aims, it becomes necessary to identify the endeavors that made possible digital design to be the way it is nowadays. Sections 1.4 and 1.5 stated that a series of complex digital-made operations lead to create complex forms that need equally complex reasoning and understanding. It was also stated that a change in architectural thinking started with the arrival of advanced 3D modeling to the computed-architectural world, an improvement that was originated from other industries since architectural computing remained somehow loyal to reproducing standard archetypes.

To this respect; in a work titled “an Evolutionary Architecture”, John Frazer⁵³ set a stance criticizing the way digital tools were being used by most architects up until then (and unhappily up until our time), by stating CAD should not be used for drafting but for innovating and testing with new formal approaches and of course, breaking paradigms. (Frazer, 1995). A statement of the same nature was earlier asserted by Nicholas Negroponte in “Toward a Theory of Architecture Machines” published in 1969⁵⁴.

⁵³ J. Frazer worked at the Architectural Association by the time the book was released.

⁵⁴ A paper offering an overview to a more thorough work on the topic titled “the Architecture Machine”. (Negroponte, 1970)

By the same time (early 1970s), architectural researchers in Europe were also interested in developing computing tools for simplifying design tasks as an effort to emulate what was being done in the U.S, or even better. An editorial by Philippe Fouquey published in the 1/2 8-2000 issue of *Le Carré Blue*, points out -citing François Lapied- that by the 1970s research in architectural computing was far more developed in the United States than in France or England. He argues that it was only until the 2000s that computing for architecture became obtainable and powerful enough to develop research (Fouquey, 2000).

Following the developments of architectural computing and digitally driven morphogenetic design methods, the discussion will be enriched by a section dealing with the use of geometric patterns in generative design, the roles they play in architectural and structural intention as well as their capacity to adapt (as tessellations) to almost any shape.

The topic calls for disciplines such as computing and biology as to describe the way in which biomimetics (Schwinn et al., 2013) and computing reasoning (Gholipour, 2011) act on architectural conception by merging reinterpretations of patterns into organizing systems suitable for design planning and execution.

2.1. EARLY ARCHITECTURAL COMPUTING: FROM NEGROPONTE (1970s) TO FRAZER (1990s)

Whereas comprehensive use of advanced computing applied to architecture became more powerful by the mid-1990s, research in architectural aided-design began twenty years earlier by the hand of some visionaries who saw in computing an alternative, not only for facilitating tasks, but for challenging architecture itself.

The work of such pioneers is referenced in this writing with the aim of helping understand under what circumstances architectural computing emerged and the way it helped to

succeed in the search for digital tools that later came not only to boost but to add dynamism to architectural design. Between the 1960s and 1970s the discourse and notions on this topic were taken by conservative academicians and practitioners as fictional, “utopian”, or even threatening (Negroponte, 1970).

2.1.1. THE ARCHITECTURE MACHINE “UTOPIA”.

Back in the late 1960s Nicholas Negroponte published a paper giving an overview of what he thought an architecture machine was or could be. His writing does not deal with the kind of machine that could actually make architecture or architectural objects but a machine able to be paired with an architect in order to follow his reasoning and choice (Negroponte, 1969) - Figure 62-.

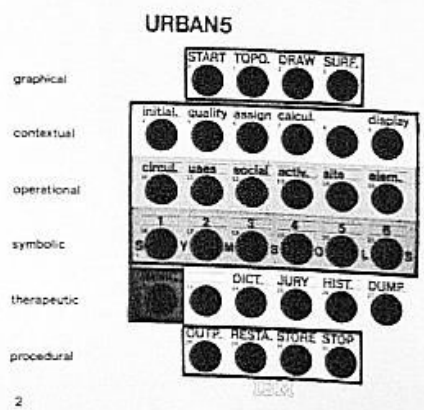

Figure 62. Perspective generated using Urban 5, by N. Negroponte. “A system that monitors design procedures”. The user interacts with the machine as to create architectural-like graphics based on pre-defined contexts or modes, eligible from a range of options the user can choose through key buttons. On: *The Architecture Machine*. MIT Press 1970.

Such machine would have to deal with information so complex that handling it by a single architect (even a group of them) would become impractical. Not only because of the intricacy of handling big amounts of data, but because of the triviality of dealing with details that oftentimes trouble design tasks so hard they are left to be resolved in execution stages.

That kind of machine would probably simplify efforts not only for the benefit of architects and the industry, but also for improving design and construction quality. Nowadays a model that matches the capabilities of such machine exists under the concept of Building Information



Figure 63. Frank Gehry's design method was highly improved by the use of digital tools. As design emerges from a physical model in which form-searching is highly dynamical because of human-material interaction, digitizing devices and modeling software allow for introducing function into the initial model's empty envelope. **Top**, cardboard model. **Middle**, model digitalization. **Bottom**, digital interactive model. Stills from: *Sketches of Frank Gehry*⁵⁵.

Modeling⁵⁶.

Negroponte's model of the architecture machine was conceptually right inasmuch as it would perform exactly the way most computing machines and software do in present time by acknowledging the fact that the problem of design is not a simple matter of conception and execution but a collaborative endeavor.

Collaborative work (which is not in the scope of this writing) is also the key for achieving complex tasks in architecture and engineering since it tackles to resolve coordination and execution problems before they happen by assessing them in conception stages. This stance answers a question asked by Negroponte himself: "*Can a machine deduce responses from a host environmental data?*" The answer is yes, it can. Perhaps not in the way He could have imagined, but it certainly does.

Contemporary computers and software offer features that were somewhat fictional by the time the architecture machine discussion started. For the machine to be operational, it needed a rote apparatus (Negroponte, 1970, p. 115); nowadays such rote apparatus is represented by modeling software (Figure 63), no matter under which environment it works (Windows, Mac, Linux), it assesses problems,

⁵⁵ Jim Glymph (Gehry's software specialist in 2005) points out that despite the fact three-dimensional models perform better for design purposes, somehow architectural, administrative and engineering worlds still run on paper. (Pollack, 2007)

⁵⁶ BIM helps in solving detailing and coordination problems frequently solved once construction works were already started; one of the goals Negroponte aimed to optimize and improve design efforts. For more information on BIM practices please refer to: (Boton and Kubicki, 2014).

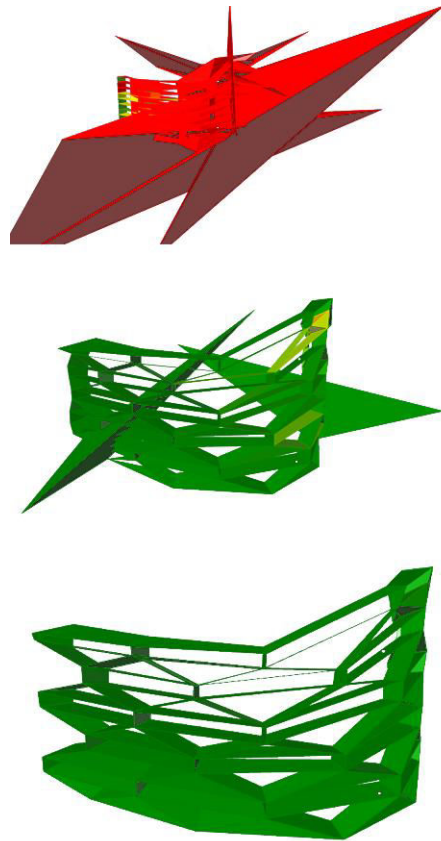

Figure 64. Cellular three-dimensional planarized arrangement. By changing and merging planarization parameters; manifold versions, from successful tests, are obtained and then used for design decision. **Top**, dislocated outcome. **Middle**, hybrid outcome. **Bottom**, “clean” (less interesting) result. Planarization achieved through RGH and Kangaroo.

identifies solutions and applies them accordingly to the user’s desires and needs. When a specific problem reappears, a previously stocked solution is then used so that it is no longer a problem. In other words, it allows to establish a design pattern, (please refer to section 2.3)

Through software, computers can not only assess problems and generate solutions but learn from the latter in order to boost the tasks they are intended for⁵⁷. This is known as generative design; a concept that was already latent in research projects of the 1970s such as those of Negroponte’s and Quintrand’s⁵⁸. It only needed technology to match ambitions of the models stated by them (and their equals) as to provide the necessary tools that came to succeed since between the 1980s and 1990s up until our days.

2.1.2. EVOLUTIONARY DESIGN.

In 1995 John Frazer published a book titled “Evolutionary Architecture” that discusses most of the concepts that are now usual in contemporary architectural language.

Evolutionary design⁵⁹, as concept, is yielded from digital tools’ capacity of saving versions of a given design action, which allows for choosing a specific solution from a set of options later

⁵⁷ For a deeper understanding on Negroponte’s theories and experiments, please refer to “The Architecture Machine, Toward a More Human Environment.”

⁵⁸ Paul Quintrand founded the GMSAU laboratory, which since the 1970s carried out endeavors to create CAD tools that actually helped in taking design decisions. See “*La CAO en Architecture*” (Quintrand et al., 1985).

⁵⁹ Not to be confused with evolutionary solvers (such as Galapagos) since evolutionary solvers fit more or less into the notion of genetic algorithms. However, the ability of choosing the best items from a bunch of solutions, renders both approaches somewhat closer.

submitted for formal and functional evaluation. At given times, merging versions may produce unexpected outcomes that might satisfy most design constraints (Figure 64).

The faculty of producing self-evolving design from applying improvements and then save them throughout the process, takes the discipline to a higher level (a dynamic one) in which tasks are not –perhaps- less demanding but way more productive than they used to be before computing boosted architectural design.

Along with versioning comes adaptation. Back in the 1970s Paul Quintrand analyzed the problem of increasing complexity as more complex architectural problems emerged from a constantly-growing society that brought up more demanding needs, which is a fact that made architecture to require aided-design tools able to boost tasks by self-finding solutions to specific design challenges.

The first approaches on the matter had to do with solving arrangements for urban planning or architectural programs through genetic-like tools such as COMPROGRAPH 3 (Figure 65) or LOKAT (Figure 66); the former was developed in the U.S and the latter in Canada.

COMPROGRAPH 3 was a schematic plan generation program that, by means of a three-dimensional relational matrix, helped in proposing space arrangements for a flat or a house. The program itself responded to constraints (as inputs) to which it had to adapt a

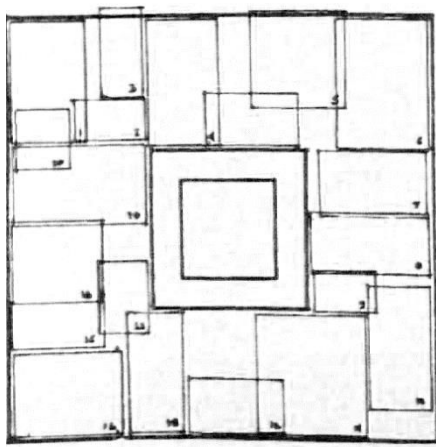

Figure 65. COMPROGRAPH 3 outcome. The program yields an arrangement of spaces based on inputs from a three-dimensional matrix. On: The Architecture Machine. MIT Press 1970.

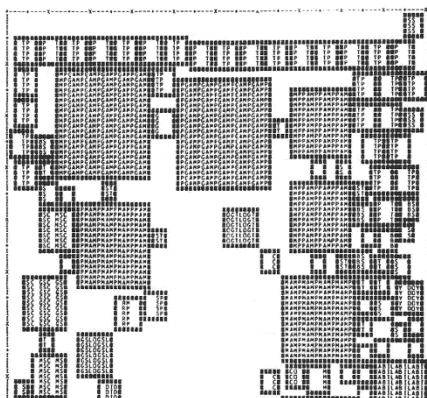

Figure 66. Spatial arrangement for a law faculty yielded through LOKAT, by Bernholtz and Fosburg. On: "La CAO en Architecture". Hermes 1985.

range of spatial solutions (Negroponte, 1970).

A sentence in P.Quintrand's book states that *"for a given program, solutions are multiple and the architect does not possess the means for analyzing all possible combinations and find the best solution"* (Quintrand et al., 1985). In other words, it suggests that an architectural program's analysis can and would have diverse solutions, therefore, evidencing that traditional design approaches fail in exploring in-depth space possibilities since architects usually do not count on the tools to perform such operations in reasonable time.

A research endeavor carried out at GAMSAU on a topic defined by P.Quintrand as *"Space Allocation"* (Quintrand et al., 1985) deals with the way spatial arrangements, obtained through various primitive CAD programs, are explored. One of those pioneer CAD tools under study was LOKAT: A program capable of arranging a set of digitally defined spaces, based on a database containing spatial relationship constraints as well as space dimensions, surfaces and hierarchies.

"John Holland has developed a theoretical framework for an adaptive model [...] He defines an adaptation's salient features as the progressive modification of a given structure by the repeated action of certain operators [...]. An environment is then defined for the system undergoing adaptation [...]"

Comment 8. J.Frazer explains how adaptive models emerge, based on J.H Holland's Adpatation in Natural and Artificial Systems. On: (Frazer 1995)

Both works⁶⁰ prove that, from the very beginning, CAD tools in architecture intended to become evolutionary by proposing an adaptive logic (Comment 8) that would allow for finding multiple solutions to a particular architectural problem by starting from a bunch of digitally-defined constraints. Digital models achieved

⁶⁰ And others like them, as discussed in the Works of Negroponte's and Quintrand's.

through such premises were later defined by J. Frazer as adaptive models (Frazer, 1995, p. 57).

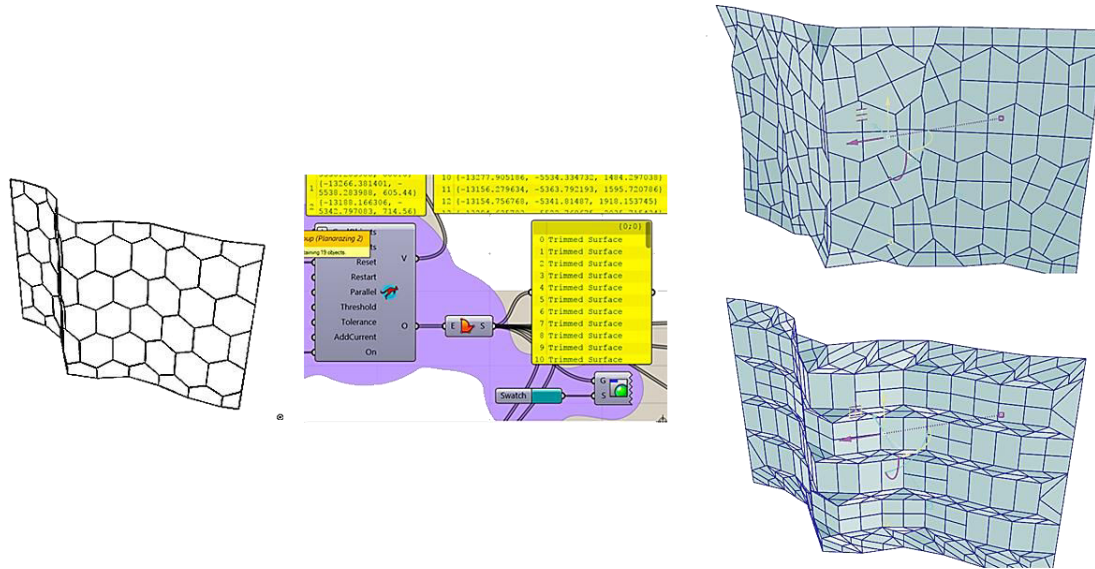

Figure 67. Cellular arrangement (pattern⁶¹) over a single-curved surface. Planarization through GH and Kangaroo offers different morphological solutions merging given constraints: <arrangement> <boundary surface> <planarize>. The resulting outcomes allow the designer to choose and use any option.

Adaptive models make use of genetic algorithms to yield solutions derived from a set of variables or operators, applied to a given body under specific environmental constraints⁶². Solutions are analyzed under previously defined criteria so that partial solutions, fitting given requirements, are chosen to yield a set of definite results (Figure 67).

According to Frazer, genetic algorithms in digital conception act like chromosomes in nature. They are characterized by string-like structures that represent coded parameters acting upon and controlling a specific problem (Frazer, 1995, p. 58), making the algorithm to

⁶¹ The concept of pattern and the way patterns are used in surface panelization-planarization will be discussed in forthcoming sections.

⁶² Artificial, natural or both.

iterate and perform calculations, based on positive-partial results, until it gradually finds the way to fit the pre-instated conditions it is intended to satisfy⁶³.

2.2. DIGITALLY-CONCEIVED FORM

There are features digital architectural conception has borrowed from other disciplines (i.e. Biology). Those features have a lot to do with the way bodies (organisms) emerge in such realms and how they react to external (and internal) stimuli by experiencing physical changes that help them, not only to protect themselves, but to interact with their surrounding environment (performative behavior).

As described in previous sections, aided-design conception was -in principle- intended to make architecture adaptable (through performative transformation) and reciprocal in respect to its entourage as well as to itself. We will retain those two concepts; adaptability and reciprocity, as to explain the way in which digital design takes shape and evolves in contemporary architecture.

During the last twenty years research on architectural computing has led to develop organic-like modeling environments in which architecture takes a behavioral dimension⁶⁴. Environmental constraints, usage flows, and limitations (among other design boundaries) are introduced into design by means of simulation, which is a fact that makes digital design environments to be less stagnant than paper-driven design.

In paper-conceived architecture all constraints affecting a project are not often assessed in real time; even worse, most of them are usually assessed long after preliminary design stages⁶⁵. Problems in architectural design are now different. They have a lot to do with the way buildings behave so digital conception plays an

⁶³ Even though Frazer makes an approach from the architectural point of view, understanding cellular automata can be important as to comprehend what genetic algorithms are about. A paper by Philip Anderson(1999) provides a thorough bibliography on the topic, as it also explains the way genetic algorithms act as part of adaptive models in problem solving. Please refer to section 7.2 to see how these principles are applied for developing the main topics of this dissertation.

⁶⁴ Please refer to works like those of Branko Kolarevic (2005), (2003); Stanislav Roudavski (2009).

⁶⁵ One of the big limitations in paper-designed architecture, which are not limited to paper only -since some CAD tools are still used as if they were paper-, was that projects could not be fully assessed in early design stages.

important role by literally simulating every step in the making of a building from the very first idea to its delivery. Throughout the process, some digital tools and digitally-based design methods define a set of necessary steps to follow when performing computer-aided design. The following concepts might be considered as relevant in a general approach towards digital morphogenesis as digitally-driven modeling techniques range from data acquisition -passing through pure representation-, to generative processes.

2.2.1. MODELING DATA RETRIEVING TECHNIQUES: LASERGRAMMETRY

As seen in section 2.1, Frank Gehry's design techniques found in digitizing a powerful tool to master complex shapes and accomplish equally complex architectural programs. Through time, Lasergrammetry has evolved through various stages of quality that became superior as electronics and software have been constantly developing.

From point clouds to complex meshes; this technique allows for turning physical objects, regardless of their scale, into a data collection of small objects containing space-related properties that make possible to digitally rebuild any object (Figure 68).

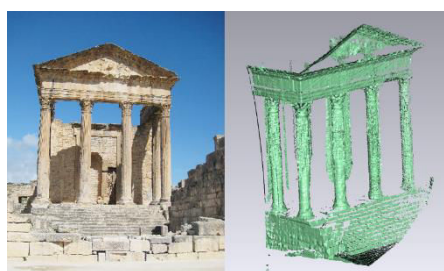

Figure 68. Roman capitol at Dougga. 3D laser scanning performed with a single-point laser scanner. C.R.A.I 2003.

*Left photo on:
megalithic.co.uk/article.php?sid=18429*

An interesting feature this data retrieving method offers in conception stages, lies on the fact of the designer being capable to start from a three-dimensional physical model as representation of a building; however, that model's architectural dimension is not bound to a mere representation. In a judicious design effort, such physical model should have considered a series of outer and inner efforts that will finally shape it. Such efforts, which

apply to almost any design method, do not have the same impact when being subjectively measured by means of a physical model, than if they are digitally treated and reintroduced into a digital-generative one.

At this point, physical models might be considered as a powerful starting point suitable for improvement through digitization and optimized through generative modeling as an integrator of environmental and physical constraints. For design purposes, lasergrammetry can be used for at least two goals:

- Documentation: Already-built structures are not always digitally represented. At this point lasergrammetry is widely used for surveying heritage settlements (Figure 69), buildings and structures so that rehabilitation and reinforcement works can be digitally treated, thus creating a responsive environment between the target object and the architectural and/or engineering solutions aimed to be performed upon it. In a wider approach, lasergrammetry is applied on topographic surveys as well as in urban planning and surveying, turning it into a reliable study and design starter too.
- Modeling and design: It is more or less Frank Gehry's design approach. Even though his office is certainly not the only one in performing such practice (Figure 70); from a larger point of view, lasergrammetry may perform as a powerful pre-design tool since it



Figure 69. 3D model of the town of Epinal-France. This survey model is taken from a scale model of the town's ancient ramparts. New scanners and software allow for collecting data including not only geometric but texture information out of the surveyed model. C.R.A.I 2015.

allows for digitizing and optimizing analog designs.

That is a fact architecture schools should explore and make use of, as it keeps students in contact with matter whilst making use of advanced modeling and conception techniques at the same time.

2.2.2. MODELING DATA RETRIVING TECHNIQUES: PHOTOGRAMMETRY

As well as lasergrammetry, photogrammetry is widely used in surveying urban environments, geographic locations, and buildings for measuring and performing reverse engineering. Photogrammetry's capabilities have increasingly improved throughout the last decade as software has become more powerful and boundaries have been pushed away with the arrival of drones and the like. In such scenario, photogrammetry is quite an affordable and practical technique inasmuch as it allows documenting inaccessible places by making use of light remote-controlled devices.

The outcome from photogrammetric surveys is rendered in the shape of meshes or point clouds, which are later retouched as to obtain clean geometries for digital treatment. Photogrammetrically-obtained models are useful for integrating already-built environments into new designs, so that constraints are digitally set and designers can manipulate data for tackling architectural problems involving ancient and new buildings.

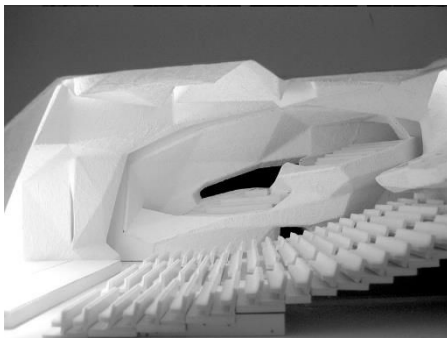

Figure 70. Architects like Fernando Menís (Spain), make use of physical models as to enlighten design tasks. For his CKK Jordanki, in Poland (2015), Menís used plaster models as to perform an acoustic study for the auditorium as well as for defining its shape. The plaster model was then digitized and later integrated into the building's digital model.

On: menis.es/multifunctional-concert-hall-jordanki/#!prettyPhoto

*"Digital Parametricism, as we know it today, was born on page 26 of the first edition of Gilles Deleuze's book *The Fold*, Published in French in 1988"*

Comment 9. M. Carpo citing Gilles Deleuze's "le Pli". (Carpo, 2016)

2.2.3. PARAMETRIC-GENERATIVE MODELING

To speak about 3D modeling might seem useless nowadays since most design tasks are performed under such environment. However, parametric-generative modeling (Comment 9) which has been in the scope of architectural research for more than fifteen years now, keeps on being the subject of several studies on the matter as the achievement of complex architectural forms still supposes a challenge depending on how complex they are.

Precedent sections gave an overview about generative-adaptive models and their connection to problem solving through genetic models. This section will inquire on how those approaches work in parametric modeling and the way they feed the architectural discourse and architecture itself.

Parametricism (as Patrik Schumacher defines it) has taken over architectural conception in a way that, at least in avant-garde practices, the formal aspects of a building obey to more than formal criteria (Schumacher, 2009). As seen in previous paragraphs, external stimuli affecting a building and its surroundings can be simulated through digital tools. Parametric modelers happen to accomplish all the expectations on this matter insofar as they can perform as generative, genetic, and performative simulation tools by which architectural objects can be assessed, designed, and tested even before they reach physical form.



Figure 71. Galaxy Soho Project by Zaha Hadid Architects. Beijing, 2012. Parametric-conceived architecture act as an enriching urban element that brings landscape renewal to already worn city areas. On: zaha-hadid.com/architecture/galaxy-soho/

It is no surprise that shapes yielded through these methods possess special morphologies that can vary from supple objects to extremely intricate

and dislocated forms (Carpo, 2015a), shaping what is been defined as a new style (Schumacher, 2009)⁶⁷. Schumacher's stance found a deeper approach in an article published in the #86 issue of AD, in which J.Frazer stands for denying that parametricism on its own defines a style by explaining that it is the aims, not the means, which really constitute a concept of style on this topic (Comment 10). Aims can go from just a formal approach to proposing contextually-driven social changes (Figure 71).

Amid those two layers, there is a series of intermediate stages in which digital-parametric yielded architecture tests itself against the constraints already described through this writing (inner and outer forces or efforts), which obey to principles of adaptability and reciprocity. The former seems to be the most achieved one so far and the latter the one for which parametricism 2.0 (Schumacher, 2016) is setting its aim.

A look back in history, might show it would not be rare to find out that parametricism in architecture is not breaking news. As M. Carpo points out, architectural (and archetypal) parameters existed long before the computing era. I.e. Gothic cathedrals needed a lot of geometric analysis and mathematics in the reasoning of their architectural conception as to achieve their construction.

Classic, medieval and renaissance architecture

While writing this dissertation, two AD issues, dealing with theories on parametricism and non-standard architecture, were published (86 & 87). It is with surprise that I found they were somewhat structured the same way I did as to describe the background of what digital morphogenesis is about (starting with history on architectural computing). I must accept it was a bit discouraging because it took me months to search and write about those topics –early architectural computing, digital morphogenesis and contemporary architectural computing based on parametric modeling- but, at the same time, I found my approach was not entirely wrong. Nonetheless, the contents published in those two Issues concentrate a diverse literature on the matters of contemporary digital architecture and the way it is supposed to evolve in forthcoming years.

Comment 10. Personal comment by the author on the non-standard architectural discussion.

⁶⁷ A stance that finds fine critical analyses in M. Rucker's paper, "Parametricism: If, In What Style Should We Build". (Rucker, 2011) and in Gürsel's "Creative exploration by parametric generative systems in architecture" (Gürsel Dino, 2012).

construction rules that, in the end, constitute the parameters with which classical orders are reproduced and built⁶⁸ (Figure 72).

Back to the current concept of parametric modeling, it is worth to say that not all methods and environments work the same way. There are degrees of complexity in parametric modeling as well, which have much to do with what a specific tool is capable to do in terms of data management and outcome.

The faculty of managing data, which varies in extent, is what makes some methods more adaptable than others in terms of what can be produced with. That is to say; purely representative methods cannot introduce and analyze performative data since they do not operate under an iterative approach. Furthermore, parametric methods are classified into three more categories that define their capacity to iterate and, by extension, their ability to carry out complex mathematically-based design tasks.

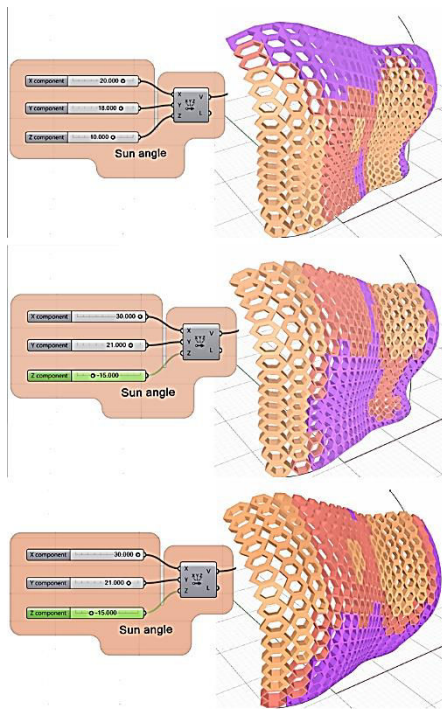

Figure 73. A surface representing a façade wall is panelized. Orange zones represent façade areas receiving more solar gain, purple areas represent receiving the less. Depending on sun light intensity, voids get bigger or smaller. This is a case in which a performative behavior (solar gain) helps a generative design effort setting random window sizes in function of sunlight incidence.

This is possible through iteration processes within the parametric modeler that allow for calculating the incidence of the sun (as a bunch of vectors) on as many points as possible over a façade. The more panels the façade has, the bigger the number of calculation points is. Calculation time depends on façade's complexity. From a model like this, it is also possible to acquire information about windows and panel sizes.

Patrick Janssen identifies all four categories as “*object modeling, associative modeling, dataflow modeling and procedural modeling*”⁶⁹; being the former the embodiment of pure-object targeted modelers (representative tools like SketchUp) and the latter being the most sophisticated iterative approach of them all (Janssen, 2015).

⁶⁸ In-depth information about parametric modeling's origins can be found on the works by Mario Carpo, John Frazer and Mark Burry. Such works are referenced in the #86-2 issue of AD titled Parametricism 2.0.

⁶⁹ These categories will hence be identified as OM, AM, DFM and PM respectively.

Iteration degrees change from one category to another. As the first category is not iterative at all, the other three, in their due order, support single-operation, implicit multi-operation and explicit multi-operation iterations.

Physical and correlational properties often have a lot to do with the way the outcome yielded from parametric modeling endeavors takes shape. Chapter three contains a wider discussion on how digital tool, which vary in design-performance capabilities, participate from automated-like production processes as feedback information towards design.

Comment 12. Parametric modeling links towards production workflows.

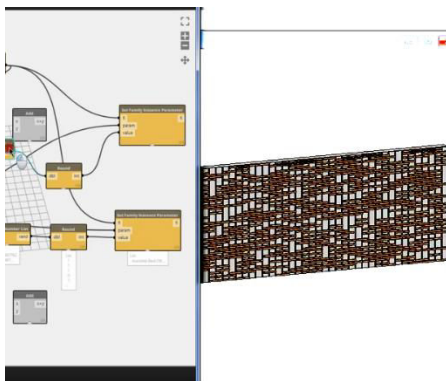

Figure 74. A brick-patterned wall modelled in Revit, undergoes a random-reduce operation (in Dynamo) that yields a pattern of voids on it. On: [youtube.com/watch?v=AH9rBCacKTK](https://www.youtube.com/watch?v=AH9rBCacKTK)

To better explain what each iteration degree does, Janssen exemplifies by indicating that, for instance, a single operation method is represented by software such as 3DS max or Maya, in which parameters (as inputs) exist, but the capacity of performing adaptation in function of performative data (for example) is limited or inexistent. On the next two levels, he identifies Generative Components (GC)⁷⁰ and RGH (perhaps the most used) as ideal tools (or methods) that can perform a decent amount of iterations allowing to pass from simple geometric processes to complex simulation and analytic endeavors (Figure 73) in which a genetic approach might be necessary.

On a higher level (perhaps), a program like Dynamo⁷¹ establishes a direct connection to BIM models so that yielded outcomes can be immediately inserted into a BIM project containing material and building properties inherent to such approach. Through this method, reverse engineering is possible by taking a family from Revit into Dynamo and parametrically redefine it as to change its morphological and physical properties

⁷⁰ Generative Components is a parametric environment developed by Bentley software. Compared to GH, GC works more or less the way Dynamo does, by being integrated into a design bundle for tackling specific design tasks that require parameterization. Other software suites like CATIA, intended of product design, also offer parametric capabilities-

⁷¹ Dynamo is the parametric environment associated to Autodesk Revit.

(Figure 74)⁷².

Depending on the application field, one approach can perform better than other. (I.e. Probably, someone interested in developing games, would be more interested in parametric modeling through Houdini rather than with RGH or 3DS max).

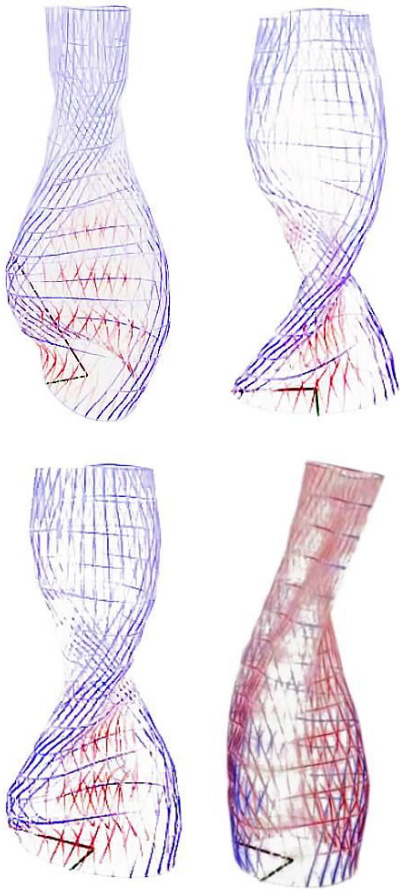

On its side, architectural parametric modeling is directly linked to engineering approaches (as does BIM modeling) turning engineering into an intrinsic feature of architectural design as every conceived body must participate in design exploration along with its own physical and correlational properties (Comment 12) (Figure 75).

The acknowledgement of such features turns parametric modeling (thus parametricism) into a high complex design task that requires exceptional capabilities from designers (Scheurer, 2010); capabilities that are not limited to a vague use of digital means but enhanced through deep technological knowledge that must match a great deal of architectural decision and good judgement.

Figure 75. Finite Element analysis using Karamba plugin for GH. The structure is tested against live loads as to assess its admissible deformation. Such tests can too be used in form searching endeavors, preserving a balance between structural stability and form richness. Stills from Danil Nagy's work on [youtube.com/watch?v=-t3yE1xxMUo](https://www.youtube.com/watch?v=-t3yE1xxMUo)

Architectural decision comes in the shape of form-searching through generative approaches, which means form is an outcome and not a predefined set of architectural formulae responding to given architectural problems. In other words, parametric-generative design approaches are the shift that allows architects to construct adaptive models that yield a range of selectable solutions

⁷² On CAADRIA proceedings 2015, P. Janssen presents a model showing how Implicit multi-operation, explicit multi-operation and using-recursion iterations perform when treating generative-modeling data (Janssen, 2015, p. 161).

from which them (designers) must choose the one (or ones) that fit the best their intentions as well as any given architectural requirement.

Under such scope, one can even think about simulating how old a building can get through time and envisage the possible upgrades it will undergo as human needs and technology mutate, so that the edifice itself remains on being adaptable by making potential interventions part of the design process. Hence, creating dynamic approaches on usage, maintenance, and renewal patterns, only foreseeable through BIM practices based on parametric-generative modeling.

To illustrate so, on-building usage impact analyses can be achieved through parametric-like human behavior simulation. A method intended for finding the impact human activity will have on a building (or any given space) replacing observation-based assessments by statistic data-based calculations and models that can actually simulate how stressed a space (or a building) will become under ordinary and critic operation situations.



Figure 76. Human behavior simulation.

Based on a BIM model, a simulation allows to estimate how crowded a space can get thus helping to establish whether rooms and corridors are big enough in case use intensity suddenly increases.

Bnai Zion Medical Hospital, Y.Kalay, 2012. Top On: [youtube.com/watch?v=i05WVWUjpmYU](https://www.youtube.com/watch?v=i05WVWUjpmYU)

The research scope on this approach focuses on facilities like hospitals, schools, airports and the like (Schaumann et al., 2015)⁷³, which undergo variable use frequencies and, at some point, can get overcrowded rendering the space insufficient, thus suitable for physical intervention in short and middle terms.

Human behavior simulation creates a virtual environment in which usage patterns are

⁷³ Please refer to works of Yehuda Kalay, dean of architecture at Technion (Schaumann et al., 2015).

dimensioned and tested; so, to help finding the right size and proportion for common and private spaces, the designer can add such data to his design (Figure 76). Such information is appended to the global design approach, turning it into a factor that helps deciding on the actual size a building (or part of it) can attain⁷⁴. Human Behavior simulation then acts like a genetic algorithm responding to an “if-then”-like clause: IF an X average number of people can potentially occupy a given space, THEN how big that space should be to never get overcrowded, neither over-dimensioned?

Computer-aided conception has increased its power by means of generative methods, from which parametric modeling is the one that makes possible to find a computational host into a single environment integrating performative, generative and genetic approaches that facilitate achieving complex architectural design tasks. The current state of architectural practice and research shows that computer-aided design tools might continue to develop under two basic approaches: Parametricism and parametric-based BIM modeling.

For taking advantage of such approaches, architectural practice requires a wider knowledge in engineering and computer fields insofar as architecture is turning into a discipline that merges both approaches as a master design-based one⁷⁵

As M.Carpo claims, never before a design

⁷⁴ HBS can prove to be quite advantageous in pre-design stages. However, a first architectural proposition is needed as to perform it.

⁷⁵ Mass customization, for instance, requires a big deal of understanding on material mechanics, robot programming, scripting and engineering-related building methods.

discipline had pushed so hard (and so far) into the use of tools that once were alien to it. Never before did it gained such relevance in a technological breakthrough (Carpo, 2016, p. 27) by challenging them (tools) and integrating needs to the computing world that made software companies to become interested in what architects do with their products and invest in developing tools for their use in improving architectural practice (Celedón, 2014, p. 22).

2.3. PATTERNS.

The universe of patterns might be as complex and vast as the realms of geometry, mathematics, biology, and architecture themselves. In that order, a deep research dealing exclusively on patterns should be carried on. However -since it is not in the main scope of this dissertation's goals-, an overview to the field of patterns will provide key concepts of what patterns are as well as the way architecture deals with them.

In that sense, architecture uses patterns as means for exploring form, function and space-solving by applying generic solutions to recurrent problems, which is the reason why, works like Neufert's architect's data (2002) became a reference work in architecture schools and design offices inasmuch as it explored a series of experience-based functional alternatives for solving most common space distribution problems. From Salingaros's (1999) point of view, the use of patterns for architectural design represents a " mathematical combinatorial approach"⁷⁶ that exponentially increases the possibility of finding manifold spatial and formal solutions to a set of architectural tasks.

The same conceptual outlook is used in computing. When designing software, the programmer faces the fact of creating a generic solution capable of tackling recurrent problems, or different variables of a single problem. Namely, a design pattern becomes the common solution of problem within a given context (Audibert, 2014).

⁷⁶ A.Salingaros borrows the concept from Alexander's " *A pattern language*"

Furthermore, the term itself embodies various conceptual and perceptual scales; a pattern can be a flow, a function or an action, a tiling, lattice, grid, mosaic or a tessellation (Figure 77); it affects a city the same way it does a building and certainly some patterns affect both; nonetheless, they are never isolated thus are complementary to each other.

Theories on patterns might have been present ever since human being started using them as means of expression, ornament, and order; as is often found in ancient cultures such as the Romans, Greeks or Muslims. Such widespread use gives patterns a conceptual extent symbolizing complexity beyond perception. A pattern can be social, cultural, political, human, artificial, and natural at the same time.

One of those theories, if not the most comprehensive one, was written by C. Alexander in the 1970s. Alexander's work deals with (almost) all the dimensions a pattern can embody. Other works like those of Escher's⁷⁷ or Penrose's, stand for more specific outlooks by dealing with the geometric and mathematical dimensions of patterns.

2.3.1. CATEGORIZING PATTERNS.

From an abstract point of view, patterns should not be exclusively seen as visual entities but also as mathematical abstract forces with manifold purposes. They can represent flows, capacity, usage, crowding, emptiness, a simplified solution, a method, or an abstract function set; namely, a pattern can be a condenser whose representation changes according to its use. This is where many discussions about patterns coincide, and the reason why the work of Alexander's is a common reference⁷⁹.

⁷⁷ Escher proposed a model of patterned periodic tessellations composed by single to multiple tiling morphologies. A deeper approach on Escher's and Penrose's work is made by Roberto Serrentino (1999).

⁷⁹ I.E. Salingaros (1999) cites it to talk about mathematics in architecture, Gholipour (2011) refers it to establish a common response to a set of architectural problems, and Audibert (2014) mentions it within the framework of a theory on design patterns as applied to UML.

At an architectural level and when proposing a building, patterns act as vectors affecting and altering space. The impact such patterns effect in design depends on the scale of the latter.

For instance, Zaha Hadid's works often consider global vector-like forces for shaping buildings as they arise from the urban landscape and merge with it. On a smaller scale, the building itself is affected by local tensions defining the outer and inner patterns that will shape its being (Figure 78). By observing the intrinsic interaction of global and local vector-like forces, three kind of patterns affecting architectural conception in our time can be identified: Computational, Functional, and Morphologic.

2.3.1.1. COMPUTATIONAL PATTERNS.

The concept has a lot to do with the the way architectural practice is carried on nowadays. The use of digital tools and computers for architecture and engineering adds a variable in which computational constraints play an important role. Moreover, computer and architectural design related problems call for design patterns capable of creating generic solutions from both points of view. The architectural problem is not purely architectural no more. It has a direct relationship with the way design is managed via computer-aided conception and the digital resources computation uses to further design.

Many of the solutions found through this approach become formulistic inasmuch as they apply predefined answers to similar problems,



*Figure 77. **Top.** A Lattice as facade structure for a triangle-glass tessellation. Al Dar headquarters by MZ architects, 2010. Photo: S. Medina. **Bottom.** An angel's face mosaic at St Peter's Basilica, Rome. Tiling from drawings by Giuseppe Cesari (1603-1613). Photo: O.G.*

though they might not be serialist (Comment 13).

Computational patterns as applied for architectural design, might function as in object modeling, in which case design patterns possess some or most of the following assets (Audibert, 2014; Gamma et al., 1994; Gholipour, 2011):

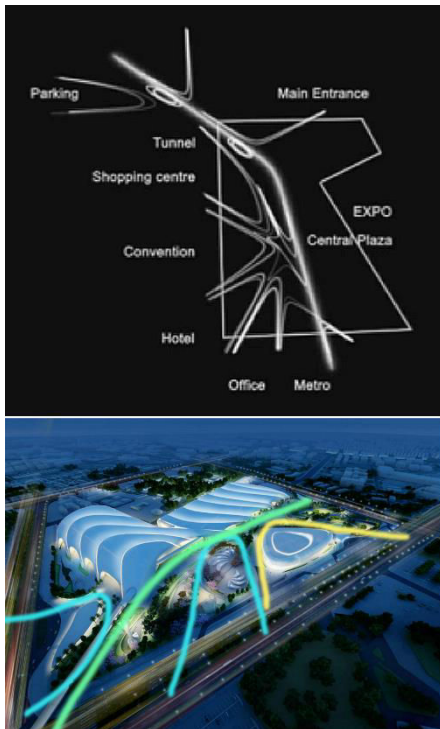

Figure 78. Incoming and outgoing flows as design-determining patterns for the Cairo Expo City, by ZHA, 2009. On : zaha-hadid.com/masterplans/cairo-expo-city/

- They establish solutions as well as they define the context on which the former is applied.
- Solutions are normally applied to a range of recurrent problems or tasks.
- Defining a design pattern usually requires identifying it, describing the problem, and stating the solution.
- They facilitate conception by providing a solution database from which specific answers can be retrieved.
- They improve team communication as common references are generated in function of a given project.

2.3.1.2. FUNCTIONAL PATTERNS

This pattern category is characterized for being a set of altering constraints affecting space along with tangible and abstract elements that define the building itself and the activities it hosts. Human behavior, as criterion for assessing space use and dimension, is a genus of pattern; the kind of those Alexander described as ground elements for architectural design such as car and pedestrian traffic, urban scale, urban profiles, culture,

The case applies to instances and blocks as in DWG drafting. The block utility represents a design pattern offering a standard solution to a wide set of individual problems. The Case is similar in BIM approaches with families (for Revit) and GDL (for archicad). In all cases, a method allows creating individual objects based on a set of parameters.

Comment 13. Computational patterns.

traditions... In other words no thing is isolated from its surroundings (Alexander et al., 1977) even if it is intended to function as if it was (a prison, a nuclear power plant).

2.3.1.3. MORPHOLOGIC PATTERNS AND BIOMIMETICS

Patterns of this category are the ones in charge of shaping the building, they act as a living being's skeleton and/or skin providing the building with protection and resistance against inner and exterior forces such as wind, airflow, heat, cold, sunlight, precipitations, sand, live and dead loads. This group of patterns is equally abstract but more palpable in physical terms. It is the kind of pattern allowing an architectural object to be recognized.

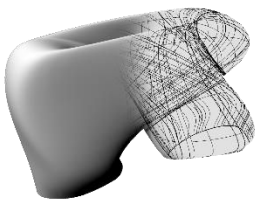
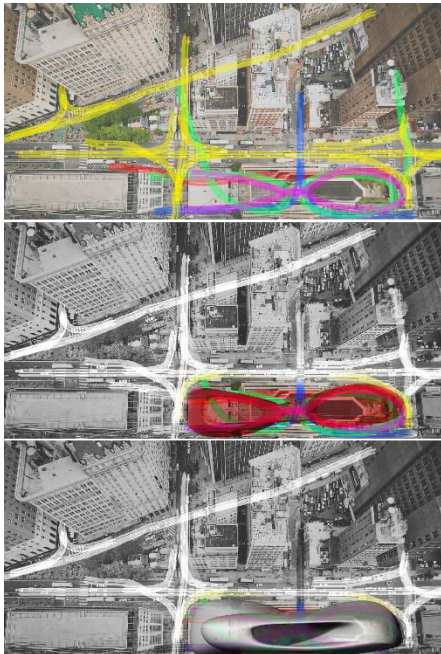

Figure 79. Top to bottom. Car and pedestrian traffic flows help in creating a building's shape. Once parameterized, flow confluences give shape to the building acting as form-searching vectors introduced into parametric modeling as an architectural conception resource.

This last concept will be the one used for the matters of this writing.

Given these statements, the interaction of forces representing behavioral, usage and formal patterns in a building should be understood as a set of interconnected architectural problems, since *"no pattern is an isolated entity"* (Alexander et al., 1977). Under such scope, the problem of form and function does not depend on form itself but on form's and function's adaptability to each other, along with a reciprocal bond in respect to the building's environment ⁸⁰ (Figure 79). Such functioning is somehow inspired by and emulated from nature.

To imitate that kind of behavior, a mathematical approach, perhaps not seen often in

⁸⁰ Geographic, economic and cultural.

traditional, modern or some post-modern architectures⁸¹ is succeeded by incorporating two concepts into the design equation: biology and computing. But how?

Geometric (formal) patterns, as used in architecture, oftentimes look like those derived from morphogenetic studies in Biology. Recent architectural trends have shown a particular interest in biologic-like behaviors as well as biologic-like geometric patterns.

As patterns in nature have manifold morphologies that change according to the environment in which they arise (organic, inorganic; from vegetal tissues to animal tissues), their emulation in the realm of architecture is more or less restrained to the organic-vegetal domain⁸². In order to understand the whys of such statement, a look towards how vegetal organisms emerge and interact in respect of their environment will provide with a behavioral pattern that architecture, through sustainable approaches, has been trying to emulate for decades.

The achievement of such sustainable goals has become easier to conquer since computer-aided architectural design became both generative and performative. In a work titled “towards morphogenesis in architecture”, Stanislav Roudavski makes an overview about the way models for showing the way form emerges in

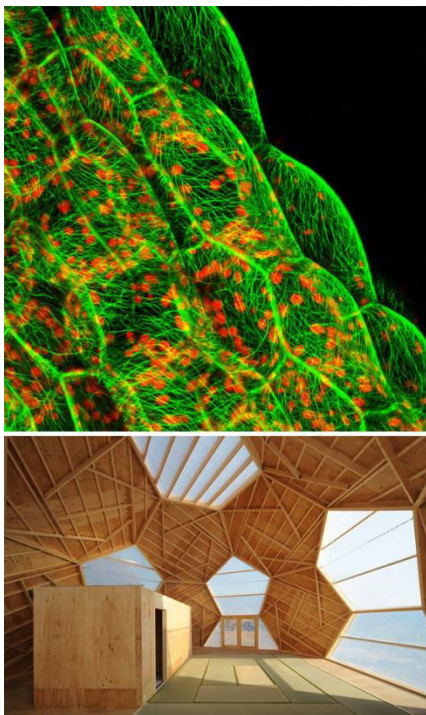

*Figure 80. Top. Arabidopsis' hexagon-like cell architecture. Image by Juliet Coates. On: www2.warwick.ac.uk
Bottom. Cellular-like wooden structure for the Odense pavilion, by Shinsaku Munemoto (2014). On: archilovers.com*

⁸¹ This statement obeys to the fact that not all post-modernities care about sustainable design or the analysis of patterns, as seen by Alexander (Alexander, 1979), in conception endeavors. Some are just the product of architectural practice detached from all engagements but economical profit or showcase

⁸² Please notice that the way plants and buildings behave is way less dynamic than in animals or moving beings. In the vegetal realm Items “(cells) do not move relative to each other” (Scheres, 2013).

biology are not that distant from the way they do in architecture, stating, however, that methods are inverse and the comparison is bound by **geometrical** similarities between both processes⁸³ (Roudavski, 2009) (Figure 80).

As well as in architecture, studies in biology also make use of modelers to illustrate results. In biology, modelers are made to perform a kind of reverse engineering about the way morphogenesis is yielded under the influence of a peculiar environment. Conversely, parametric modelers in architecture are intended for the creation of form as response to the potential influence of a surrounding context. In both cases, when an entity is affected by its close context, its body is adapted to respond to such demands (Figure 81). Consequently, the structure's pattern becomes particular and specific to that body (or species) only.



Figure 81. **Top.** *Mimosa Pudica* before and after receiving stimulus. The plant reacts by closing its leaves after perceiving contact from an alien body. **Bottom.** *HygroSkin-Meteorosensitive Pavilion* by Achim Menges, 2013. Wood diaphragms react to moisture and light changes by expanding or contracting their fibers. On achimmenges.net

The process by which form emerges in nature (by forming tissues and bodies) and architecture (by generating structures⁸⁴ and entities) fit under the concept of self-organization, which, according to Y.Sasai (2013), is “the spontaneous formation of ordered patterns and structures from a population of elements (or individuals) that have no or minimal patterns”.

However, precaution on this approach is advised. As Roudavski points out, though some

⁸³ The usefulness of organic patterns as for understanding and proposing morphogenetic processes in architecture, emerges from a formal and behavioral abstraction assuming that an architectural body can be structured the same way a biological entity would, as they both respond to external stimuli (within noteworthy boundaries of function and scale).

⁸⁴ Spatial and physical.

mechanisms work under simulated environments, it does not mean they will work in real life⁸⁵. Also, evocation to biological forms, functioning and patterns must be used carefully as to argue architectural conception based on such principles⁸⁶. Furthermore, the output of the biomimetic approach as used for generating morphologic patterns is often translated into geometrical entities, which is the topic discussed in next section.

2.3.2. PATTERNS AS GEOMETRIC ENTITIES.

For what purpose do we use formal patterns in architecture? Is it a question of ornament, expression, or style? Is it a matter of tradition and/or contemporariness depending on cultural contexts and time?



Figure 82. Brick-like patterned structures for the Serpentine Pavilion 2016. Monads are brick-like fiberglass cassettes whose depth varies in function of a horizontal progressive displacement. All cassettes form two grid-like walls sharing the pavilion's structural stability as they are supported on each other. 2016, BIG architects. London, England.

One might say yes to all since patterns not only do reflect visual arrangements incarnating complex geometric and mathematical operations but also cultural features forcing them to change according to a given purpose.

Depending on their nature, patterns may behave as purely ornamental (as in mosaics) or play a double role, as in brickwork. A bearing wall -for instance- can have a layout performing as structural and ornamental at the same time; a feature that can be achieved by adding modifiers such as color or displacement -Figure 82-.

⁸⁵ In regard to the kind of shapes obtained by using parametric-generative modelers. Sometimes their geometric conditions are already challenging in the computer model, making their realization something impractical. Such boundaries are nonetheless constantly challenged, which in the end is the goal parametricism aims for.

⁸⁶ Applicable to the cases in which behavioral and performative processes, as emerged from biology, are used as to conceptually defend an architectural proposition.

The same principle might be applied to biomimetically emulated patterns as found in vegetal and animal tissues. They all embody specific layouts that can perform as architectural and structural arrangements. Within the framework of this dissertation, the geometric dimension of patterns, regardless of their origin, becomes the topic of interest as geometric patterns can be translated into organizing sets capable of achieving a material dimension beyond the bidimensional plane.

A paper published in 1998, dealing with the concept of lattices, patterns and grids under the notion of "trame" (French for weft or tissue); stated that such "wefts" perform as an organized beam composed by stripes separated by gaps. Stripes follow one or several directions and the gaps, in-between stripes, are defined as variable or fix distance parameters (steps). The term, as used by J.C Bignon, describes an arranging pattern capable of organizing structures, tessellating planes and proportionate architectural design. In other words, it is an abstract structuring network capable of helping architects to succeed design endeavors at all levels.

Since Bignon's approach is somehow generic, it does not differentiate a lattice from a pattern or a grid, nor does it succeed in defining what happens with regular tessellations when citing Christopher Norton's cladding designs.

After taking a closer look to the concepts Bignon stands for; the notion of pattern, as generic concept, arises as to match the French word "trame", instead of just illustrating a weft or lattice. A pattern, as well as a "trame" is universal as it is suitable for all environments using the Universal Coordinate System (UCS). Furthermore, as a local structuring network, it can adopt UV coordinates as means to fragment planes the way lattices, grids and tessellations do. So, the way J.C Bignon puts it, a "trame" is a pattern.

Comment 14. A brief analysis on "La trame: un assistant à la conception technique". (Bignon, 1998)

To this extent, patterns can be geometrically referred to as as tilings, lattices, grids, mosaics or tessellations (Comment 14). However a detailed description of each one of them will make their use clearer throughout this writing:

- **Tilings, mosaics, and tessellations:** the three concepts might be understood as synonyms. A tiling represents a group of tessellas or tiles. A tile (tessella) is the unit by which a plane can be divided as to produce a tessellation. For this to be true, tessellas cannot overlap, nor can there be any gaps between tiles. In geometrical terms, a tile is a region enclosed by adjacent line segments (Serrentino, 1999) derived from the connexion of close vertices on an Euclidean plane. Namely, the interconnected relation between vertices creates lines (edges) enclosing a region thus creating a cell, tessella or tile (Boots, 2005) (Figure 83). Tilings or tessellations, are the mechanism by which

mosaics have been made through history.

- **Grid:** A grid can be understood as an arrangement of points set over a given plane, following a frequency established through U and V directions (Akos and Parsons, 2014). Grids are the base-ordering elements for NURBS surfaces since the former define UV coordinates.
- **Lattice:** It is a network in which grid points are connected to each other in function of their UV directions (this is also relative to NURBS surfaces). Points are interconnected so they produce a network of crossing lines equally following U and V directions. (I.e. A fiber-made basket is a lattice of crossing fibers). Lattices and grids share a common ground since they possess their own coordinate system as well as they respond to a principle of periodicity that turns them into ordering layouts. Lattices are not only orthogonal, they also might be triangular and hexagonal as well (Boots, 2005, p. 518).
- **Pattern:** A dictionary definition suggests patterns are decorative designs⁸⁷ made out of shapes repeated at regular intervals over a plane. Since tessellations are a kind of a decorative design and repetition at regular intervals is a fact present in tessellations as well as in patterns, both concepts might represent groups of tessellas dividing a

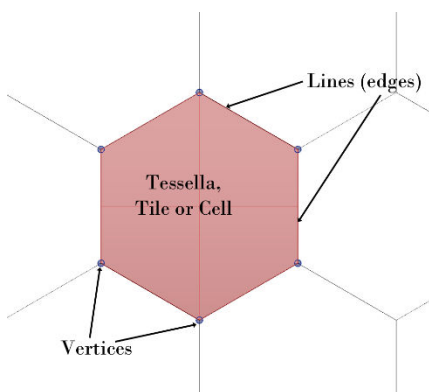

Figure 83. Composition of a tile or tessella.

⁸⁷ Collins dictionary

plane as to produce a tiling. Hence, for the matters of this dissertation, a geometric pattern will be a synonym of tessellation and tiling.

Although geometric patterns represent tessellations, it must be acknowledged that not all tessellations are the same, nor are they yielded by using the same methods. A compact but precise taxonomy made in 1966 by Millington and Millington –as cited by M.A. Harasymowycz (2008)-, stated that tessellations should be grouped into three categories:

“Regular - one kind of regular polygon is used. Only three patterns are possible (triangles, squares or hexagons); semi-regular - regular polygons of any kind are used, but all common vertices must be congruent; non-homogeneous -these are infinite in variety and include patterns using only one irregular shape”.

As to identify how those tessellation categories look like, forthcoming paragraphs will illustrate their particularities in order to facilitate their recognition (next section end).

2.3.3. WORKING WITH TESSELLATIONS.

Discussions on tessellations have different conceptual approaches as they have much to do with the notion of covering (as a finish, skin or envelope). Geometric approaches change depending on cultural and scientific backgrounds; mathematic-geometric approaches, for instance, led to studies such as those of M.C Escher’s or

Penrose's⁸⁸.

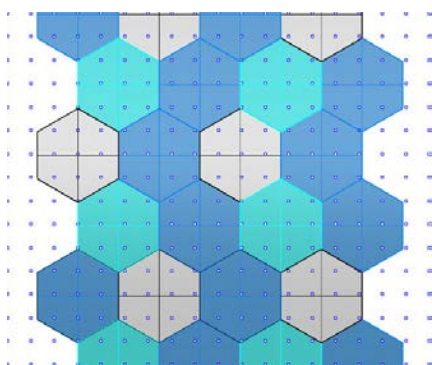

Figure 84. An arrangement of hexagons creates a Monohedral periodic tessellation.

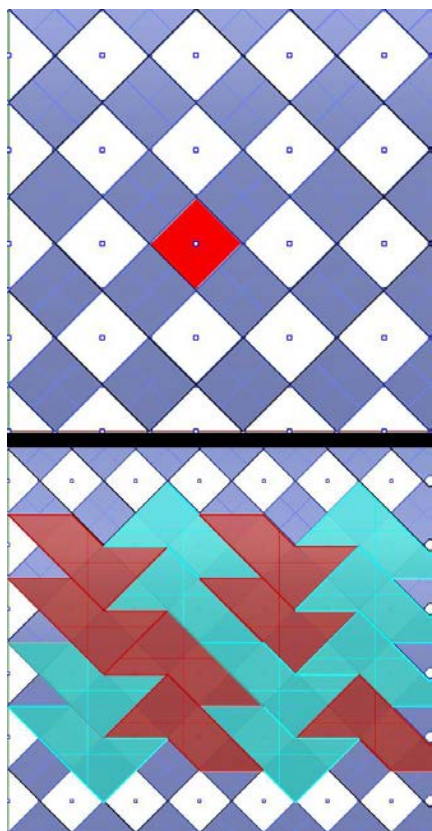

Figure 85. **Top.** A single prototile is defined for a regular tessellation, based on a grid. **Bottom.** A composite prototile is formed by merging several tiles from the above example. A new tessellation type is created.

Escher's approach on tessellations identifies several pattern families and sub-families whose name and properties depend on the mathematic and geometric methods used in their definition. In his work on Escher's tessellations, R. Serrentino (1999) identifies families of regular tessellations whose taxonomies vary from monohedral, to k-hedral tilings⁸⁹. Such sub-families can be produced by following a set of rules based on repetition, symmetry, periodicity, displacement, and rotation.

In Escher's work, a regular tessellation is derived from the repetition of a shape along a plane (or surface). If there is but one kind of shape tessellating the plane, the tessellation will then be defined as monohedral (Figure 84). Furthermore, because of a tessellation being derived from a single tessella, such tessella will be called a prototessella or prototile. Namely, such tile is the tessellation's basic monad (Figure 85).

Although, there is not one kind of prototile only; prototiles can be simple or composite. A simple prototile consists of a basic geometric shape acting as a tiling's monad; a composite prototile uses the same monad as root to create a composite shape that will spread all over a plane. Frequently, a composite prototile is obtained by simply translating, rotating, or mirroring the base shape.

⁸⁸ M.C Escher's studies focused on periodic tessellations. On his Side, R. Penrose focused on non-periodic tessellations. Each type will be described in forthcoming paragraphs.

⁸⁹ The "k" represents the number of base tiles composing a tessellation. However, tessellations composed from up to three different tiles are called monohedral (1 tile) dihedral (2 tiles) and trihedral (3 tiles).

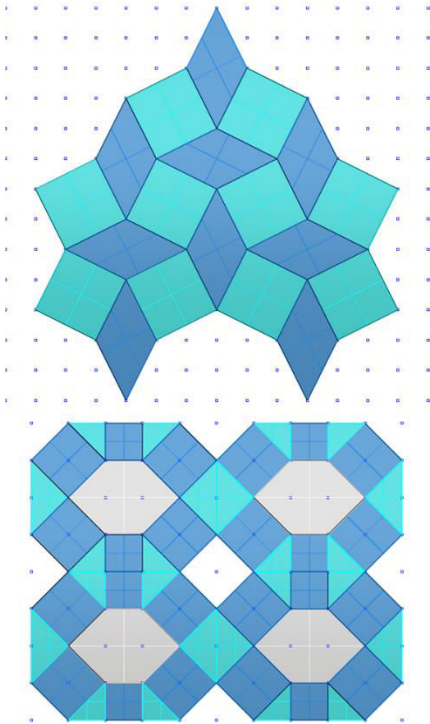

Figure 86. **Top.** Dihedral tessellation yielded from squares and rhombs. **Bottom.** Trihedral tessellation built from hexagons, squares and triangles.

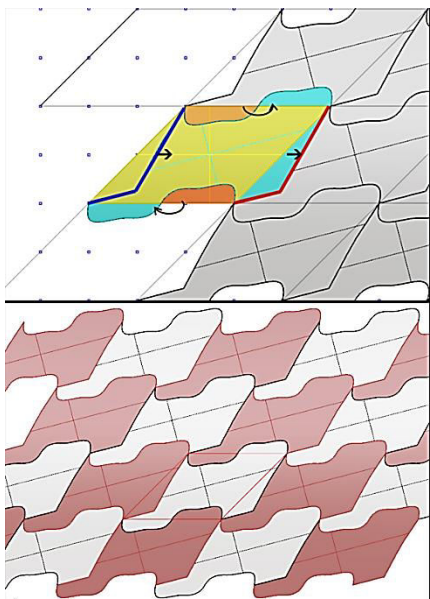

Figure 87. **Top.** Parallelogram-based Escher-like tessellation created by translation and rotation. Vertical edges are redefined and displaced, while horizontal ones are modified by drawing a shape from the edge-axis towards a side. The shape is then rotated by 180° and the edge redefined. **Bottom.** Escher-like arrangement spread over a plane.

Concerning dihedral and trihedral tessellations, those are obtained by mixing up to three different shapes. In this case, each shape is proportionally related to each other so they match without leaving gaps or creating overlaps. The same principle applies to k-hedral tessellations. Consequently, the more monads make part of a tessellation, the more complex the proportional and geometric bond between them becomes.

Variations on regular tessellations can be performed by means of symmetry and translation operations. Tilings can be generated by rotating and mirroring a shape over its edges, thus creating non-uniform geometric rhythms (Figure 86).

Also, morphologically affecting tessellas results in enriched tilings as tile edges can be geometrically transformed by simple geometric actions like creating a wave on one side or a notch on the other (Figure 87, Figure 88). According to a given tessella's nature, the changes induced on a monad will affect the entire tessellation; which is the reason why, from a simple pentagon (or any polygon), a varied series of tessellations can be obtained. This is possible by following simple geometric rules consisting on translation, rotation and mirroring as explained by K.O Deger (2012).

In the field of tessellations, those obtained by using M.C Escher's approach are known as periodic and obey to basic rules of translation and mirroring that have, as sole constraint, the fact of

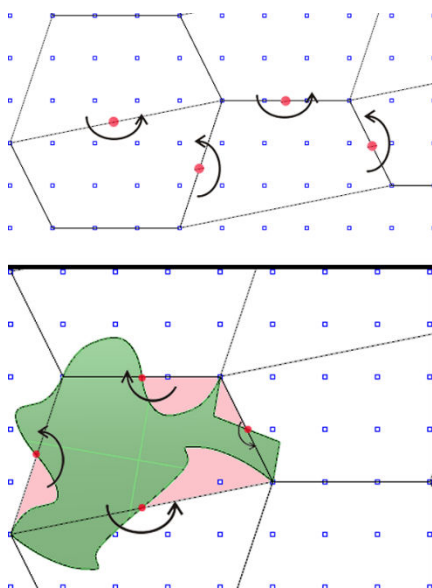

Figure 88. Escher-like tessellation yielded by rotating base polygons and polygon half-edges. **Bottom.** Irregular shapes are drawn on each half-edge then rotated 180° for achieving a new tile.

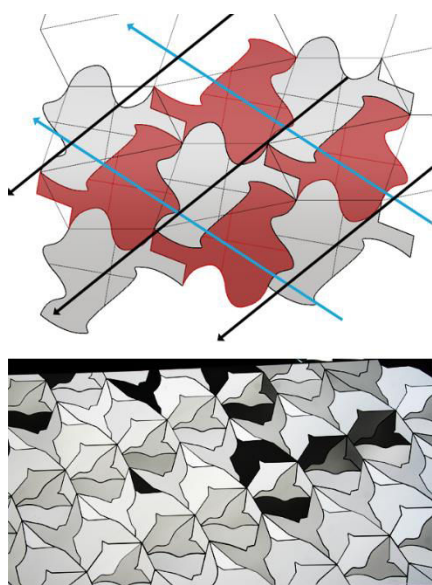

Figure 89. **Top.** As result of edge and tile rotation, lattice patterns emerge as to organize Escher-like tessellations. **Bottom.** Escher-like Tessellation of the Paris Philharmonie's concert hall façade, by Jean Nouvel, 2014. Photo O.G

not being repeated on parallel diagonal translations, as repetition pattern (a lattice) -Figure 89-.

Another approach, that of R.Penrose's tilings, deals with the creation of **non-periodic tessellations** based on two basic elements: kites and darts (Serrentino and Borsetti, 1999), or just small and large kites (Richardson, 2000).

By using this method, a simple rhomb is split into two asymmetric components whose only common ground is the fact that the incidence angle between edges is a multiple of 36°. Namely, angles must be 36°, 72°, 108°, 144° and 216° (Figure 90). With that simple rule, a whole set of components, yielding non-uniform tilings, can be created. The reason these patterns are not uniform, lies in the fact of the tessellation not following an organized network of parallelograms (a lattice) as in Escher's tessellations (Figure 89)

To organize darts and kites in a manner they will conform a pattern, Serrentino identified two structuring principles, defined as linear and central respectively⁹⁰, that make Penrose's tessellations to happen. As Richardson (2000) shows, with just two components the results are quite impressive as tessellation rules do not entirely rely on the tiles' geometry but on the way they are arranged and coupled (Figure 91). A fact that allowed Penrose to prove, back in the 1970s, that five-fold symmetry was possible.

⁹⁰ Please refer to "Las teselas de Penrose" (Serrentino and Borsetti, 1999)

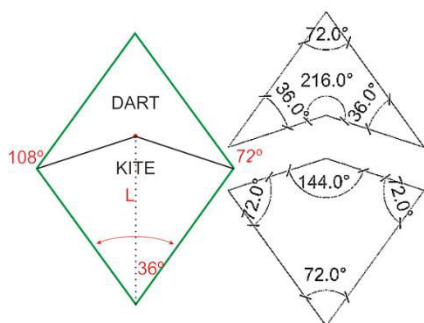

Figure 90. Kites and darts obtained from a parallelogram. A given axis line with an L length is rotated by 36° on both sides, its top vertex helps defining the line splitting the parallelogram.

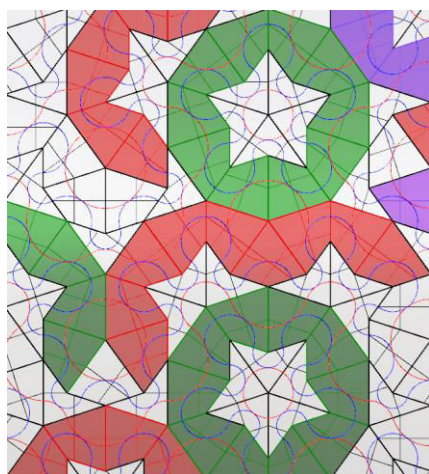

Figure 91. A Penrose-like non-periodic tessellation. Observe that red arcs on kites, and blue arcs on darts, help finding the right position of each tile in the tessellation⁷⁸.

Non-homogeneous tessellations become a bit harder to illustrate, insofar as using a single irregular shape only seems quite complex from geometric and mathematical points of view. Voronoi patterns might fit into that definition as they fulfill the condition of possessing tesselas that become irregular by collision. However, quads, triangles and hexagons are also modifiable by using morphing as mechanism to create non-homogeneous tessellations.

For instance, parametrically-modeled hexagonal tilings show that negative Gaussian curvature has an effect of “tile inversion”⁹¹ as tesselas get compressed by their neighbors when adapting themselves to a given geometry (often a NURBS surface). Inversion seems to exclusively appear on hexagons (Figure 92), however, quads, triangles and other polygons alike also suffer topologic transformations when undergoing adaptation as they participate from tessellation processes on non-uniform surfaces.

As for Voronoi and Delaunay tessellations, those possess organic, mathematic and geometric (stochastic) characteristics that make them a case requiring a specific discussion.

2.3.4. STOCHASTIC TESSELLATIONS BY COLLISION AND TRIANGULATION. VORONOI DIAGRAMS AND DELAUNAY TESSELLATIONS.

Voronoi patterns have been under the scope of research in mathematics (and of other fields as

⁷⁸ For deeper information please refer to Serrentino (1999) and Richardson(2000).

⁹¹ This means, the polygon stopping being convex but concave. In mathematical terms, concave polygons contain angles greater than 180°

well) since the 1630's, when (apparently) René Descartes used them as to show “*The disposition of matter in the solar system and its environs*” (Okabe et al., 2000, p. 6). Later, in the 1850's, Peter Dirichlet considered the form of the Voronoi diagram in studies on positive quadric forms, followed by advanced studies on the matter by Georges Voronoï in the early 1900s.

Literature on the topic is vast⁹² and so are approaches dealing with the concept (Comment 15); however, a basic definition of a Voronoi diagram, equally applicable to all domains, might be:

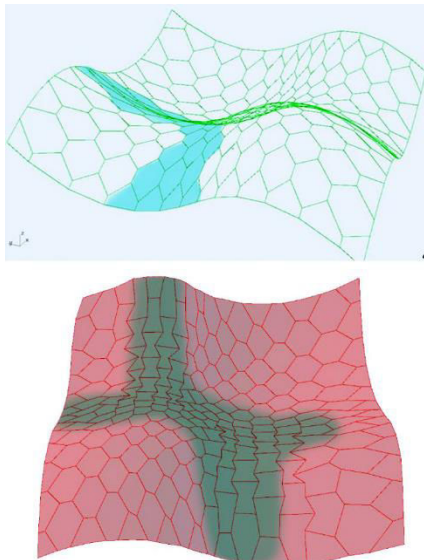

“*The partitioning of a plane with n points into convex polygons such that each polygon contains exactly one generating point and every point in a given polygon is closer to its generating point than to any other. A Voronoi diagram is sometimes also known as a Dirichlet tessellation. The cells are called Dirichlet regions, Thiessen polytopes, or Voronoi polygons*”. (Weisstein, 2014)

Namely, a cluster of points (random or not) populates a bi-dimensional plane (infinite region) so that every location in the space is assigned to the closest point in the set, which makes every point in the collection to be associated to a Voronoi cell.

One way (perhaps) to easily understand the way a Voronoi diagram is created, is by arguing that cells (regions), primarily conceived as circles with variable radiuses (Vr), progressively increase

Figure 92. **Top.** Hex pattern tessellating a NURBs surface. Without planarization, hexagons are not too deformed since pressure on edges to achieve negative Gaussian curvature is not too high. **Bottom.** As the tessellation undergoes planarization, hexagons must be re-fit to succeed tessellation in negative Gaussian curvature areas (green zones). That is when edge inversion occurs in a hex tessellation.

⁹² Please refer to: (Boots, 2005; Okabe et al., 2000). The former contains a thorough work on history and analysis of Voronoi and Delaunay patterns. The latter analyses the use of Voronoi patterns in GIS, taking as starting point the work of Okabe's, which in turn makes reference to the Works of Dirichlet, Voronoy, Delone and Delaunay. Research on the topic aims frequently to both authors and the references cited by them.

Voronoi diagrams and Delaunay tessellations are used in manifold fields. The list includes activities such as:

“Anthropology, archaeology, astronomy, biology, cartography, chemistry, computational geometry, crystallography, ecology, forestry, geography, geology, linguistics, marketing, metallography, meteorology. Operations research, physics, physiology, remote sensing, statistics, and urban and regional planning.”

Architecture itself and engineering might well be included into, since recent architectural works, made under the flag of parametricism, recurrently use Voronoi diagrams as design resource for structural and architectural language.

Comment 15. Multidisciplinary usage of Voronoi Patterns. Quoted text from Okabe (2000).

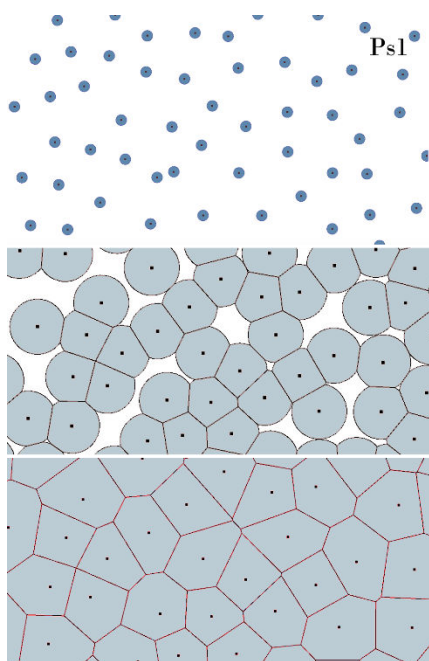

Figure 93. **Top.** A random set of points (Ps_1) over the Euclidean plane acting as cell generators. **Middle.** Generators expand (as circles) with Vr 's as random distances in the population. Ce 's start colliding and stretching. **Bottom.** Cells attain maximum expansion and Ce 's are completely defined. Voronoi Diagram achieved.

their diameter until they reach neighboring cells. When cell edges (Ce) start to collide, cells do not overlap but morph themselves until they find nowhere else to expand to (Figure 93). The result is a set of polygons whose geometry change if, for instance, point distances or seeds⁹³ throughout the population are altered, thus cell diameters too.

The principle is not so distant from that discussed by Leonardi et al (2012), in which Voronoi diagrams are produced from spheres with lognormal distributed diameters. In Leonardi's work, the study is focused on nano-polycrystalline structures in which scale matters a lot and, sometimes, other alternatives to the Voronoi tessellation such as the Laguerre, Johnson-Mehl and Poisson-Voronoi tessellations render equally valuable outputs.

Back to the geometric approach, it is important to be aware of the fact that morphologic results on the Voronoi diagram change in function of the point set's morphology. For instance, Let Ps_1 be a random point set with manifold distances between points, the resulting Voronoi Diagram should look like in Figure 93. Now, let Ps_2 be a lattice-like point cluster, the resulting Voronoi Diagram should look like in Figure 94. Namely, most Voronoi tessellations are derived from random point sets, nonetheless, some others can be obtained from equidistant point clusters, as shown by B.Boots (2005) when referring to lattice-like point arrangements that represent equidistant

⁹³ A seed is a random value (algorithm) that allows for altering the location, in the Euclidean plane, of elements belonging to a set.

locations following regular latticed patterns, over a given plane, for GIS analyses.

As for Delaunay tessellations (*DT*), those are considered complementary with Voronoi tessellations, allowing inferring that Voronoi tessellations can be derived from Delaunay triangulations and vice versa. A *DT* is obtained by connecting sets of Voronoi generation points that yield a simplicial complex (nerve); or, as Okabe (2000, p. 1) points out:

“The Delaunay tessellation may also be constructed directly from the point set by taking each $(m+1)$ -ad of points and examining its circumsphere⁹⁴. If the interior of this does not contain a point of the set, we construct the simplex determined by the $(m+1)$ points, but if it is not empty we do nothing.”

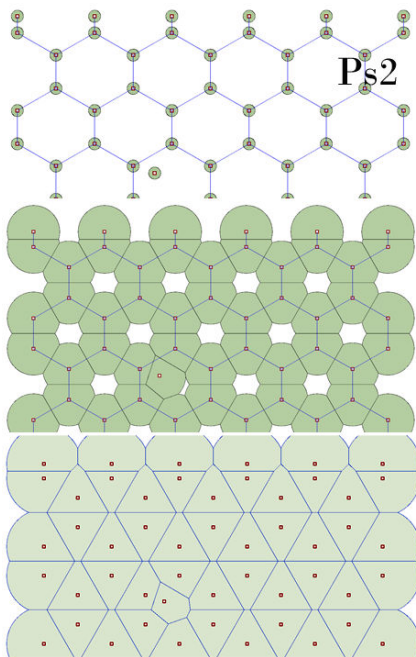

Figure 94. **Top.** Cell generators created from a hexagonally-arranged point set (*Ps2*). **Middle.** Voronoi cells appear as diameter start to increase. Observe that there are no *Vr*'s since there are no variable distances between points. **Bottom.** A Voronoi-like tessellation is obtained from a lattice-like set of points. Observe that disruption can be added by setting an alien point as part of the initial point set.

That is to say, $m+1$ represents a set of points located close to a common edge between Voronoi cells. If by circumscribing them into a circle, one finds there is no other point inside (Np), the triangulation (Okabe et al., 2000) is valid and the process continues on. Each triangle is a non-overlapping simplex and each simplex has its own circumcircle (Hashemi et al., 2010), consequently the simplicial complex (nerve) will constitute the triangulation's convex hull. (Figure 95)

Conversely to what happens with hexagonal tessellations, Voronoi and Delaunay ones are quite adaptable when used for meshing or subdividing NURBS surfaces since polygon convexity is not lost, hence the pattern's morphology remains stable even if the host

⁹⁴ Or circumcircle, it depends whether the triangulation is based on a 2d or 3d simplex.

surface undergoes topological transformation.

The use of Voronoi and Delaunay tessellations in architecture has increased in the last fifteen years, since the introduction of generative and parametric modelers intended not only for architecture but for engineering (as used for architectural purposes).

However, thorough studies on these patterns have been tackled by other disciplines such as flow simulation of polycrystalline microstructures, area-catching analysis and mathematics (among many others as seen in Comment 14), whose main goal for using tessellations, such as the Voronoi diagram, is to perform statistical analyses based on mathematical-geometric approaches.

Voronoi cells, for instance, can be weighted as to indicate the range of population to which a hospital extends. The yielded pattern can provide information about how long it takes to a person to get to a hospital for receiving primary attention or how difficult it is for a medical team to get to a remote location within the hospital's catching area.

All those behaviors can be simulated by using a modeler such as GH, as most of the mathematical and statistical scopes covered by studies and improvements on Voronoi and Delaunay tessellations can be simulated by making use of the iteration capabilities found in contemporary parametric-generative modelers.

Furthermore, criteria recovered from phenomena such as solar gains, wind flows, glare intensity, or precipitation might be considered for

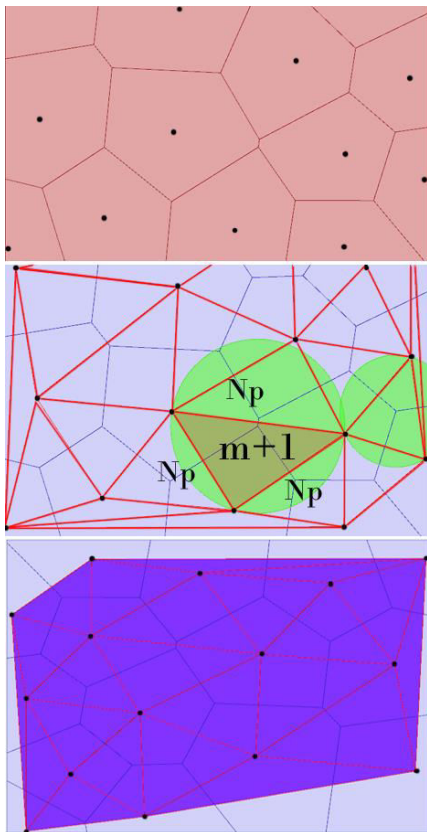

*Figure 95. **Top.** Generator points on a Voronoi tessellation. **Middle.** Delaunay triangulation is performed by linking generation points. A simplex ($m+1$) is valid when its circumcircle has no other points (N_p) than those belonging to $m+1$. **Bottom.** Triangulation's convex hull.*

performing form-searching by using stochastic tessellations for architectural design purposes (facades, envelopes and partitions).

In that order, tessellations (in general) can be modified as to accomplish a performative behavior or an architectural intention. Attractor points, gradient rotation, progressive cell-scaling and the like, are all parametric modifiers that can help in achieving architectural and engineering form-searching operations in function of performative targets and architectural judgement.

2.4. CHAPTER CONCLUSIONS

An overview on the use of digital tools for architectural conception stated that there exists a range of techniques and tools that evolved as computing technologies did too. A look on pioneering endeavors undertaken in the U.S.A and Europe, showed that the intention of creating generative modelers was already present since the 1970s and that it was only a matter of time until architects and engineers could count on performing tools to propose a new approach on design as post-modern trend.

As mentioned in chapter one, the 1990s represented a decade in which a breakthrough in architectural practice took place. It did not only happen by the effort of pioneer architects but because of the interest software companies took in what architects were able to do when using digital tools that, oftentimes, were not conceived for architectural practice but for game developing or product design.

Although, the most important contribution this breakthrough yielded was not represented by computing tools themselves but by the methods derived from the analytic use of computing tools as research environment based on mathematics as solver of architectural problems. Namely, the resolution of an architectural program stopped being purely compositional and buildings stopped being stagnant to become dynamic in conception and after-conception stages.

Such conceptual turn of events became possible thanks to the introduction of generative and adaptive models into architectural design, a fact that has allowed

contemporary practice to move from stagnancy to dynamism by way of form-searching. Behind those concepts of adaptation and evolution, the notion of pattern arose as an organizing concept. A pattern can be many things depending on the outlook. It can be a design strategy, a computing method, an exterior stimulus, and a set of internal loads or usage loads, a façade's tessellation, the tiling of a floor or even a collaborative communications network. Patterns have multiple dimensions, as studied by C.Alexander as well as others, which make them omnipresent in architecture as well as in other disciplines.

Three basic pattern categories were deduced and considered: computational, functional, and morphologic. They all can be treated by parametric-generative modeling as forces affecting functional, structural, and aesthetical features of a building. If functional patterns embody the environment by which a building is surrounded of, morphologic patterns represent its physical dimension and computational patterns might embody its planning and functioning.

As derived from a morphologic approach, geometric patterns serve in representing and materializing the components of an edifice at different scales, be it a structure, envelope, or finishing. A deepening on this topic showed that there are several approaches towards how patterns or tessellations are generated and what kind of outcome they can yield; also, several types of patterns were identified and the general methods they are produced through, explained.

Chapter 3. NON-STANDARD FABRICATION: WHEN CHALLENGING THE DIGITAL TO GO PHYSICAL COMPLETES THE LOOP.

Precedent chapters dealt with two breakthroughs in architectural culture. Modernism, the former, was boosted by economic, political, and industrial practices driven by the theories of Taylorism and Fordism, which led to the concept of mass production that has remained valid until our days.

Non-standard Architecture, or parametricism, embodies the latter. This one has been boosted by the fast development of digital tools applied to architectural conception and construction.

It is in the realm of construction where challenges happen. Digital architecture acknowledges that fact perhaps better than any other architectural trend in past times, since almost all construction tasks make part of designing processes and must be tackled *in-digital*. Conversely, traditional design and construction practices, often address challenges as works go on.

With BIM modeling as the conception and construction model that “foresees all”, and data management as spine of almost any contemporary production model, generative modeling has come to be (perhaps) the preferred research and innovation environment in which standards can be defied and boundaries pushed further time and time again. As form-searching embodies architectural innovation, materializing avant-garde architectural languages requires innovation too.

That is where digital fabrication comes to play into the equation. The following sections will deal with what digital fabrication environments are about and how, and with what tools, they feed the design chain as to integrate all processes, from fabrication to production, in a workflow in which design is (and should) be nourished by the material and embodying dimensions of the architectural form.

3.1. THE ROBOT AND THE ARCHITECT. FROM INDUSTRIAL TO POST-INDUSTRIAL USAGE

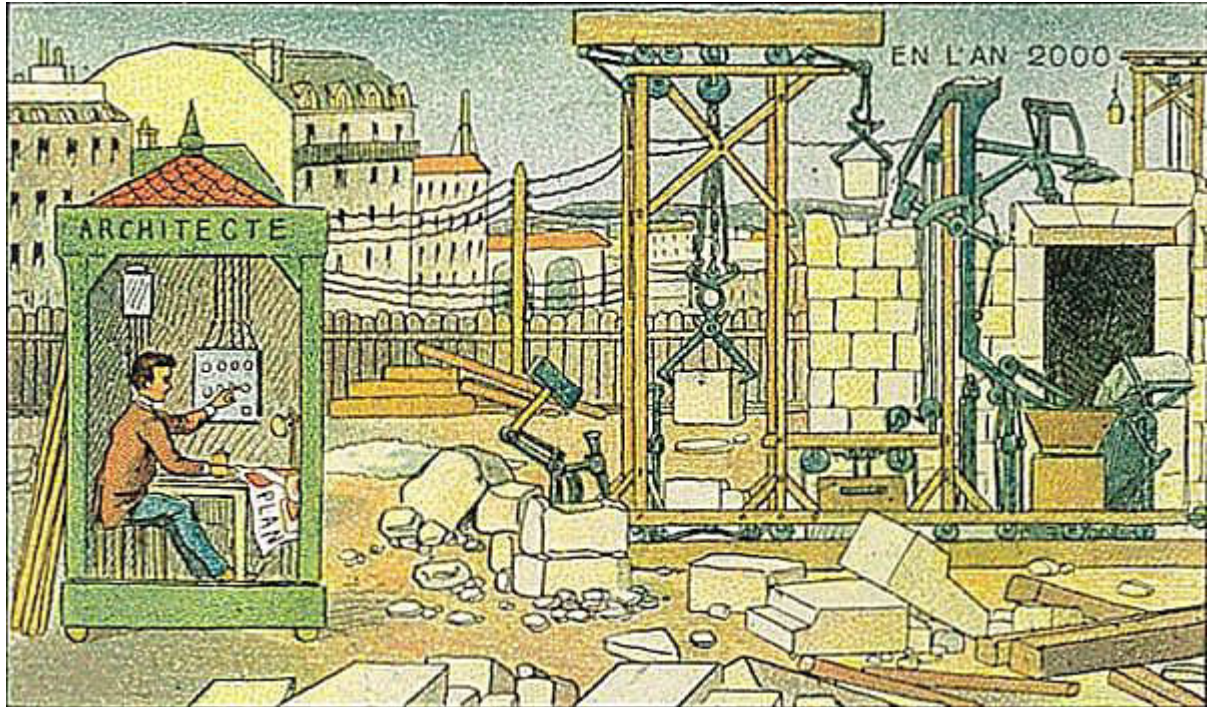

Figure 96. "Chantier de construction électrique", by Villemard. 1910.
On: expositions.bnf.fr/utopie/grand/3_95a2.htm

Figure 96, as section starter, allows imagining quite a few things. If one looks at it and tries to decipher what was in Villemard's mind, one cannot help but notice that the architect is someone hidden behind a control board, pushing some buttons as to give instructions he previously read on a set of plans. He stays sit most of the day, while miraculously a series of robotic-like arms somehow build what is in the drawings. No order is present in the worksite whatsoever but works get going. However, What happens when the architect leaves? The answer might appear as this chapter develops.

The way Villemard imagined the “*chantier de construction électrique*” as an imaginary in which robots⁹⁵ take over construction works replacing human work-force, starts to take form in present time as automation has been seamlessly introduced in the world of architectural conception. Nonetheless, full automation in construction is still a bit far from being completely real despite some efforts already achieved in the search for it.

Cases regarding full automation in construction will be mentioned as the discussion explains how robotics became involved in architectural practice.

3.1.1. THE JAPANESE CASE

Research on industrial robots began around the 1950s and their potential use was seen as booster for serial tasks. Studies on the matter were then addressed by mechanical engineers and scientists (Brell-Çokcan and Braumann, 2013), which helped -over the next decades- industrial robots to take over assembly lines in automotive and the like industries. Such fact allowed not only to optimize production time and quality but to prevent humans from performing dangerous tasks such as welding, painting and lifting (Figure 97).



Figure 97. Industrial manipulators being used as welders in unattended mode at a Nissan Factory in Sunderland U.K. On: masonholden.wordpress.com/tag/carr-factory/

The aim creating robots had in the industrial approach⁹⁶, was to perform repetitive and demanding tasks that required not only precision but speed and long-lasting effort; which is something humans can do but at higher cost⁹⁷. Serialism became then sublimated as modern

⁹⁵ From Czech *Robota* (work), old Slavic *Rabota* (servitude), German *Arbeit* (work) (Collins Dictionary, 2016)

⁹⁶ Also defined as industrial manipulators. (Schwinn et al., 2013)

⁹⁷ Economical, physical and physiological.

theories of mass production were applied at their major extent and industries could now afford non-stop production schedules.

Exploration in the field of industrial manipulators for construction purposes began in the late 1970s by the hand of Japanese building visionaries who saw in such machines a way to increase profit in the long term. However, It was only until the late 1980's that Japanese building corporations started raising actual buildings in full-automation mode; that means replacing humans for performing most construction tasks as, according to Wakisaka et al. (1997), by the end of the 1980's japan was affected by a lack of human work-force and an increasingly elder population. A wide range of robots, for executing an equal range of tasks, was invented and improved between 1989 and the early 2000s ⁹⁸ (Figure 98).



Figure 98. BIG CANOPY. A system for erecting buildings in full automation mode. The canopy has a set of manipulators that perform construction operations. As floors are finished, the canopy will then add another section to the vertical displacement rails as to keep climbing up. Obayashi Corp. 1995. For more information please refer to (Wakisaka et al., 1997). Image On: www.obayashi.co.jp

From simple painters, passing through welders and finishers to a fully-automated construction canopy; building corporations such as Takanaka, Obayashi and Shimizu invested in robot-related research projects that represented about 1% of their total income. In time, such investment was reduced and eventually stopped as the economic return would not come as soon as expected (Taylor et al., 2003).

Even though the approach is not about spatial quality but product profit, the Japanese approach showed a glimpse of the *“inevitable evolution of*

⁹⁸ Please refer to the work of Taylor's (2003, p. 37), in which a list of constructed works illustrates the extent attained by the Japanese approach on the utilization of industrial manipulators in full-scale construction up until the 2000s.

building industry” (Kolarevic, 2005).

3.1.2. THE ADVENT AND FLOURISHING OF MASS CUSTOMIZATION.

Post-industrial usage of industrial manipulators was not exactly preceded by the Japanese endeavors but by architectural research. Early in the 1990s, the question of the digital, as used in conception, favored the emergence of a new questioning. How to achieve complex architectural objects?

The answers were eagerly searched at the core of institutions like the MIT in Massachusetts or the ETH in Zurich (later on). By that time (1990s) the question about materializing complex digitally-shaped buildings was already in the scope, so investments in the matter were made. According to G.Celani (2012), by 1994 the MIT started giving thoughts to the idea of using rapid prototyping for producing scale models directly from digital environments by using an educational format that took form about seventy years before: the studio or workshop.

[...]”In Bauhaus, formation in craftsmanship must be considered as an educational tool instead and not just a mean on its own.

In a future, no doubt, this educational endeavor might well be developed by means of a more advanced technique (machine). If the perception of the whole is preserved, the outcome will be, nonetheless, quantitatively but not qualitatively different.” [...]

Comment 16. The why of craftsmanship education in Bauhaus. L. Moholy-Nagy (2015)

A look back at the methods used in the Bauhaus for instructing *alumni* (Comment 16), shows that efforts were focused following two principles: a) theoretical (formal) instruction and b) formation in craftsmanship (Mohogoly-Nagy, 2015). The approach is valid inasmuch as architects and designers propose what they can draw and build. A deeper thought would suggest that architects draw what they are able to build thus they design what they think is buildable.

From a professional outlook, it is commonplace that many architects often make audacious architectural propositions without fully acknowledging their technical dimension. When designers find that what they propose is hard to defend in technical terms, they end by giving up to technical advice (or imposition) from prescriptive⁹⁹ professionals, technicians or even clients; which is why, to achieve design improvement, a knowledge exchange between conception and materialization is needed.

That's exactly what László Moholy-Nagy¹⁰⁰ implemented as model for education in the Bauhaus (Celani, 2012, p. 471); such approach allowed to establish not only a practical and educational paragon but a means for scientific research and exploration in architecture: The studio; which is the kind of environment used by architecture offices at almost all levels, also happens to be the preferred environment in architectural teaching

The studio allows for exchanging ideas, comparing results, and learn from what others do (Figure 99). It is a discussion environment that, when taken to a dimension other than just designing, offers designers the chance to interact with materials and figure out the way they behave, how they look like; and what they physically, aesthetically and structurally represent. In that sense, designers improve their abilities not only by



Figure 99. **Top.** F.L.Wright in his studio at Taliesin West. On: arizonaexperience.org/. **Middle,** a workshop on parametric modeling and fabrication. **Bottom,** Students working with a 2D laser-cutting CNC machine. Middle and bottom images by C.R.A.I 2014.

⁹⁹ The term is here used to define professionals whose competencies are oriented towards problem-solving by applying standardized known formulae instead than by exploring innovative solutions.

¹⁰⁰ László Moholy-Nagy was originally an abstract painter that later saw himself interested in other artistic design fields such as photography, advertising arts, typography and theater (Schlemmer et al., 1961).

dealing with materials but also by exploiting their formal richness and physical features (heat gains and losses, thermal inertia, deformation, span, torsion).

Now, since the arrival of digital tools into architectural education ¹⁰¹ the question of achieving complex forms became relevant to the mind of avant-garde architects and researches. Back in 2000, G.Lynn expressed that his interest, after completing the Korean Presbyterian church project in New York (Figure 41), was now oriented towards *“hunkering down and learning”* the principles of machining to produce architectural components (Slessor, 2000). The possibility of having a machine at hand to explore ways to develop a specific shape or shape grammar, without depending 100% on engineers, technicians or industrialists, should have been amazing back in the 1990s; it is still amazing nowadays.

As new design methods started being introduced in architecture back in the 1960s, architectural research started chasing new goals mainly based on the use and development of computers, along with approaches on artificial intelligence (A.I)-(Comment 17) .

To do so, science laboratories, underpinned on architectural concepts and architectural-applied computing, emerged, and led to endeavors like those already described in section 2.1.

“1. To design better, by understanding the process of design; 2) to externalize the design process, allowing large teams to collaborate; 3) to allow repetitive parts of the design process to be automated by the computer [...].”

Comment 17. Research goals as identified by G.Celani, citing S.Gregory.

¹⁰¹ See the paperless studios at Columbia University. Section 1.4

The appearance of architectural science-labs also led to an increasing interest in the use of CNC machines, which started to happen by the late 1970s and early 1980s in the UK and the U.S, through built examples that showed the potential CNC milling machines could deliver, as seen in the stone components for the façade works at the New York's Cathedral (Kvan and Kolarevic, 2002). A similar approach was used later on at the Sagrada Familia in an effort to match Gaudi's construction guidelines (Burry, 2002).

The first attempts for creating Numerically-controlled machines date from 1949 when the MIT was asked to explore on the making of stiffened skins for aircraft. Since the mid-1950s, available machines worked based on commands printed in punched paper, which yielded an equivalent number of programming languages because of every producer having its own programming patterns. The use of CNC machines in industry became widespread with machines being capable to meet a wide variety of tasks and the apparition of G-code which, once again, was developed at the MIT in the late 1950s. With the introduction of CAD in the 1970s, the "C" appeared in the acronym as all commands were now processed by computers. Ever since, improvements have continuously been made along with conceptual modifications that started with the model established by John Parsons back in the late 1940's. Parsons is known as the father of the second industrial revolution because of the invention of numerically controlled machines.

Comment 18. Beginnings of CNC machining. (Klein, 1965; Marty, 2013; Williams and Williams, 1964)

The same way G.Lynn showed interest in using machines to improve architectural practice and step up towards digital architecture's materialization, architectural schools and akin institutions did. That is why CAD laboratories rapidly adopted the use of 3D printing, CNC milling and laser-cutting machines which, by the end of the 1990s, not only were affordable but highly improved ¹⁰² compared to what Numerically-Controlled machines were back in the 1950's (Comment 18) – (Figure 100).

Later, in the 2000s, the MIT as well as other educational fabrication laboratories installed in Germany, the Netherlands and Switzerland, not just did succeed in creating scale models but in building real-size prototypes by proposing novel construction methods based on the utilization of Industrial manipulators as machines for non-serialized industrial use. But how did architects figure out the way to use robots otherwise?

¹⁰² CNC machinery was of large use in mechanical-like industries such as wood carpentry, steel structures, product engineering and automotive industry among others.

As serialism was being put in question, the arrival of new architectural trends along with new construction needs, encouraged exploration towards finding new approaches for materializing customized shapes and the CNC approach was the first in fulfilling that expectation. The fact that using CNC equipment allowed to produce customized items at almost the same cost than producing serial ones (Carpo, 2005; Kolarevic, 2001; Slessor, 2000), boosted research on the topic towards full exploration by universities and companies decided to invest in it, giving way to what is nowadays known as fabrication laboratories or Fab-Labs.

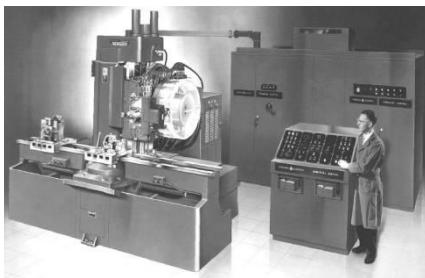

Figure 100. 1959 NC Machine. Machining data used to be stored in magnetic tapes or punched-paper cards. On: cnccookbook.com.

“Digitally-made, mass customized architectural objects can be, within limits, custom-made just like traditional hand-made objects used to be, but without the cost of hand-making; and can be serially mass-produced as machine-made objects used to be, but without the constraint of identical reproduction.”

Comment 19. Mass customization as illustrated by M.Carpo (2005).

Progressively, research evolved from rapid prototyping (3D printing and CNC machining) towards full-detail prototyping through robotic arms, giving birth to a shift that emerged from design disciplines to push serialism away and use the machines intended for it differently. Such shift became the ground for developing post-industrial production methods (Celani, 2012, p. 472) whose outcome allow for producing mass-customized objects (Comment 19).

Research in architecture did not aim to re-invent industrial manipulators or change the way they work but to use them differently (Brell-Çokcan and Braumann, 2013). What caught the eye of pioneers in the field was the liberty of freedom such machines could achieve compared to what CNC equipment could do.

Whilst many laser-cutters work on a three-axis

displacement range, meaning they can perform layered manufacturing (LM) (Ryder et al., 2002), and CNC routers work with up to 4 displacement axes; robotic arms can transform matter with up to seven displacement axes, that is to say, objects are worked in the way a craftsman would do (Sharif, 2015).

Because of their claimed multi-functionality and relative low cost¹⁰³, academics and professionals have focused on learning how to obtain the most out of these machines and complete the digital continuum started by blob modelers that, by 2006¹⁰⁴, had already turned into parametric-generative ones. The next section will better describe what how each one of this fabrication approaches work.

3.2. IMPROVING DESIGN THROUGH FABRICATION

Fabrication methods require digital approaches that must be taken into account when designing. The digital designer must act as digital maker too, that is to say, digital architecture must-be construction-aware at all conception and pre-execution stages as to succeed in the making of what is being designed (see Architectural Geometry in section 1.4)¹⁰⁵.

In that order, depending on the envisaged fabrication methods to use, there is a feedback towards digital design that changes the whole or

¹⁰³ According to Brell-Çokcan and Braumman (2013), by 2012 robotic arms were 70% cheaper than in the 1990s.

¹⁰⁴ By this year, the ETH in Zurich started developing robotic-made assemblies that led to innovating prototypes that eventually became constructive solutions

¹⁰⁵ Discussion widened in section 3.3

part of the latter. To understand the fabrication criteria that should be introduced in parametric-generative design endeavors, an overview to the three most used fabrication techniques will progressively reveal a minimal set of fabrication parameters necessary to achieve complex architectural designs. Please notice that an architectural object might be formally simple, however, the arrangement of objects or pieces composing it, might be intricate.



Figure 101. Basic fabrication approaches as they are commonly known. **Top.** 3D printing. **Middle.** CNC (laser) cutting on: <http://topcncmachine.com>. **Bottom.** Robot manipulation. Still. (Gramazio Kohler Research, 2006).

Three main approaches have been identified so far (Figure 101): 3D printing, CNC cutting and robotic manipulation. The first might be considered mainly as an additive method, the second might be considered as purely subtractive¹⁰⁶ and the third might be any of them inasmuch as post-industrial manipulators can be set up to subtract, add and morph matter (Comment 20). In that sense, fabrication can also be tackled from either a two-dimensional or a three-dimensional outlook, depending on the nature of components to be fabricated (flat or sculpted pieces).

Even though the capacity of every type of machine for transforming matter depends on how constrained it is to move; CNC routers, laser-cutting machines (most of them) and 3D printers have the power of moving in X, Y and Z axes, which gives them the freedom of working as layering or carving devices respectively¹⁰⁷. Robotic Manipulators, on their side, can perform movements in up to seven-

¹⁰⁶ Concepts on the matter might sometimes be misleading. If one considers that routing or laser-cutting a wood sheet for making individual pieces consists of splitting the stock by subtracting parts of it, the method is then subtractive.

¹⁰⁷ Please notice that in some cases, Z axis displacement is used for positioning instead than for cutting.

axes, which makes them kind of all-purpose fabrication machines.

Based on machines' capabilities and the types of material they can handle, four categories in matter transformation are identified: additive, subtractive, formative¹⁰⁸, and hybrid. All fabrication types intervene as factors that can impact design decisions, which is the reason why they must be considered in early design stages (Celani, 2012, p. 474; Keating and Oxman, 2013a).

[...]pioneering work was done at ETH Zurich by Fabio Gramazio and Mathias Kohler, whose projects such as the Gantenbein Vineyard Façade (Figure 102) showed that robotic arms are not only capable of replicating human labor, but can perform fabrication strategies that are outside the scope of human labor [...]

Comment 20. Pioneering work in the utilization of industrial manipulators for architectural use. (Brell-Çokcan and Braumann, 2013)



Figure 102. Non-standard brick posing for the Gantenbein Vineyard Façade by Gramazio Kohler Architects. 2006. On: <http://gramaziokohler.arch.ethz.ch/>.

3.2.1. ADDITIVE FABRICATION

Additive fabrication is a manufacturing technique consisting of juxtaposing layers of a given material to create a three-dimensional body. The principle is derived from the stereolithography technique in which an object is progressively produced as layers of a thermos-sensitive polymer are melted and cured one over the other (Corbel et al., 2011; Ryder et al., 2002, p. 282) by an ultraviolet beam (Figure 103). Produced pieces are post-processed and maximum hardness is acquired through ultraviolet exposure along with manual finishing processes. In digital terms, data used for building stereolithography models is produced on a CAD environment and exported in a STL format, which is the common export language the industry adopted to carry out additive fabrication endeavors.

Depending on the scale on which the technique is used, it can perform as means for initial

¹⁰⁸ Other approaches identify four categories, as is the case of B.Kolarevic (2005), whose approach on fabrication might suggest that carved or burned matter, for two-axis cutting processes, is not big enough to consider the technique as subtractive. Therefore, categories are identified as two-dimensional fabrication, subtractive fabrication, additive fabrication and formative fabrication.

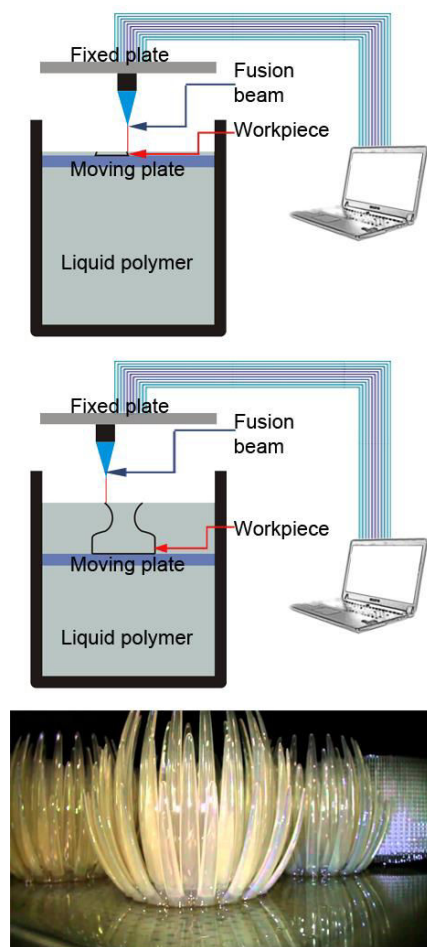

Figure 103. Stereolithography process. A STL file containing model data to build passes through a CAM interface to create layering data. **From top to middle:** As the plate moves down by small intervals, an ultraviolet beam solidifies a new layer of material. **Bottom** An object produced by SLA. Still from: [youtube.com/watch?v=gA8CTTMBdkE](https://www.youtube.com/watch?v=gA8CTTMBdkE)

prototyping or finished-product fabrication. Additive fabrication embodies a range of techniques that goes from basic 3D printing to concrete contour crafting (Zhang and Khoshnevis, 2013) passing through dealing with materials such as polymers, titanium, foam or carbon fiber (Dzaman, 2015; Ning et al., 2015) . Two stages of additive fabrication are then identified: rapid prototyping RP and rapid manufacturing RM (Aant van der Zee, 2014), though the boundaries between both are sometimes blurry since both approaches can deliver finished products.

Rapid prototyping can be defined as an outcome that is not a final product regardless of the method it is built with, and is often related to scale models. Conversely, rapid manufacturing allows for yielding full-scale finished products regardless of the fabrication method.

All additive methods are LM based, though the way layers are formed varies from method to method, nonetheless, some parameters like layering speed, extrusion or fusion temperatures as well as support quality and density, are commonplace among these techniques. Depending on every method's operational features and final product quality, six current LM methods are identified (Aant van der Zee, 2014; Dufaud and Corbel, 2004; Gosselin et al., 2016; Ryder et al., 2002; Wu et al., 2016; Zhang and Khoshnevis, 2013): Fused Deposit Modeling (FDM), Stereo Lithography (SLA), Selective laser sintering (SLS), Laminated object manufacturing (LOM), Electron

Beam melting (EBM)¹⁰⁹ and Contour Crafting (CC).

If an architect has ever get in touch with a 3D printer and realizes how it works, he might likely have an idea of how each one of these techniques work. In brief, they are all –within boundaries- like 3D printers; what really changes is the physical methods they employ for putting matter together (Figure 104) and the quality level the yield¹¹⁰. The common denominator in the approach is, regardless of the material in use, layers being bonded together by melting, fusing or blending.

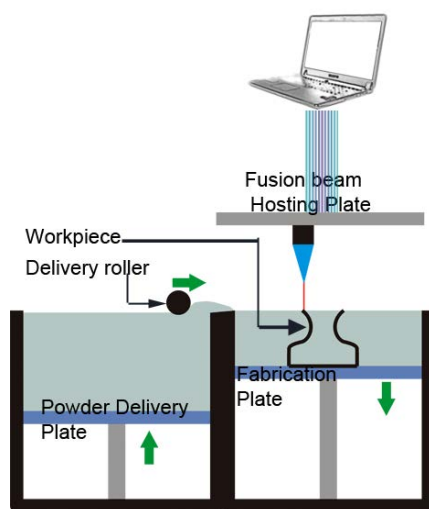

Figure 104. LM by selective laser sintering. As well as in FDM, EBM and LOM, as the piece is being formed the fabrication plate descends. Using the same principle of SLA, LOM, EBM and SLS use the same matter used for constructing a piece as support of it. In SLS, a laser melts thin layers of matter as the fabrication plate descends and a roller feeds the workable layer with more material provided by a delivery plate. FDM, most commonly known as 3D printing, makes an exception to the support rule by actually adding supports to the fabrication process as the piece is built. Such supports must be manually removed after the layering process is finished.

In recent time, there has been a special interest in CC as well as in other techniques based on the use of cementitious compounds as layering materials for research in the construction industry.

Some interesting tests on the topic have been made at the ETH by Gramazio Kohler research, by casting spiral-like concrete pillars with a concrete extrusion nozzle driven by a 6 axis robot (Smart Dynamic Casting project), which is a kind of layered process in which the physical properties natural to concrete like relative humidity, cohesibility, aggregate size, hardening speed and air content are adjusted as to obtain a material that can be extruded (pump mixture) without losing dimensional and initial structural stability¹¹¹ (Lloret et al., 2015).

A similar approach, emulating experiments undertaken at Loughborough University (Aant van der Zee, 2014; Lim et al., 2016), is explored by a

¹⁰⁹ As information provided in this section is aimed to make an overview on LM methods, it is suggested that referenced works are read in conjunction as to deepen in the concepts here referred.

¹¹⁰ For deeper information please refer to : (Aant van der Zee, 2014; Ryder et al., 2002)

¹¹¹ Please visit <http://www.gramaziokohler.arch.ethz.ch/web/e/forschung/223.html>



Figure 105. Top. Contour Crafting technology as conceived by B. Khoshnevis (2013). The extrusion head, driven by a gantry robot, pours layers of mortar as it displaces along a construction path. On: dailymail.co.uk/sciencetech. Bottom. Smart Dynamic Casting method (Lloret et al., 2015) gradually pours fine-aggregate low-retraction concrete as the extrusion pre-shaped nozzle also gradually revolves on its own axis. The method allows for casting concrete columns with different shaft morphologies without the help of any fixed formwork. On: <http://gramaziokohler.arch.ethz.ch/web/e/forschung/223.html>

French team mainly focused on the construction of structural concrete/mortar elements (Gosselin et al., 2016) by layered extrusion using a 6-axis ABB robot. The method, which is FDM-based¹¹², creates a layered structure with a truss-like cross-section. Such principle allows for making almost any vertical structural member, be it a wall, a column or a multifunctional wall (Comment 21).

Additive fabrication methods are then possible in various ways and scales (Figure 105). Architecture makes use of them in RP, as part of design stages, under the form of FDM and SLS which are, perhaps, the most commercial 3D printing techniques. On a larger scale, there are multidisciplinary research projects based on RM like that of Fischer's and Herr's (Thomas Fischer and Christiane M. Herr, 2016), or that of Gardiner's (Gardiner and Janssen, 2014).

The former's goal is to build morphologically complex pillars and walls by using layered mortar/concrete extrusion along with industrial manipulators under parametric CAD/CAM environments (Figure 106). The latter deals with studies on 3D large-scale printing that have led to propositions such as wax-freeform 3D printed formworks. In this approach, an industrial manipulator equipped with an extrusion nozzle creates a wax die intended for casting freeform mortar or concrete structural or architectural members.

¹¹² Along with Contour Crafting and Smart Dynamic Casting, additive fabrication through cementitious materials is FDM-based.

3.2.2. SUBTRACTIVE FABRICATION

Please notice that this kind of endeavor is usually accompanied by specialists in material sciences and structural engineering. The right properties for the material to behave accordingly to given design parameters are only achievable when appropriate research teams are assembled.

Comment 21. Innovation comes along with interdisciplinary collaborative work.



*Figure 106. Full-scale house additive fabrication. This RM method, developed by Yingchuang New Materials (China), claims the ability to build the walls of a basic house in 24 hours. Using an approach similar to that of B. Khoshnevis, this Chinese company says to use a cementitious compound made of construction waste and cement to build walls. (New China TV, 2014). **Top.** Extrusion nozzle pouring layers of cementitious material. **Bottom.** Tessellated wall made using the aforementioned method. These walls were horizontally poured, then tilted-up for final placement. On: yhbm.com*

Subtracting matter to obtain a shape out of raw material is perhaps one of the most ancient manufacturing techniques and it has been performed by men and human-controlled machines long before the automation age. Milling machines, for instance, exist since the dawn of industrialism as tools intended for the manufacturing of complex mechanical pieces (most of them).

Be it performed by a craftsman or by a machine (whichever time it belongs to), subtractive matter transformation, also known as matter reduction (Kolarevic, 2005), basically consists on carving¹¹³, grinding, cutting, chipping, melting or burning on a raw piece of material as a means to obtain a specific product with a given geometry.

Subtractive methods are also used in rough processes such as timber or stone gross-cutting. Even though, tools might seem a bit similar, the things they do are not. Namely, whilst a sawmill is meant to split tree trunks into planks, a bandsaw will do the same -in a smaller scale- by splitting planks into workable pieces as well as workable pieces into pre-finished products (Figure 107).

Both cases are subtraction-based, though their aim is different thus subtractive fabrication mostly refers to a process aimed to obtain final products (Comment 22).

¹¹³ Carving and the like subtractive methods have also sub-techniques that escape this dissertation's scope, however, interesting information on the topic can be found in a book titled *Robotic Fabrication in Architecture, Art and Design* (McGee and Ponce de Leon, 2014).

Within this context, subtractive fabrication is usually format-and-material dependent insofar as mass-processed materials are usually cut as bars or sheets. I.e. In timber construction, beams and columns have a volumetric dimension that makes joint-making and detailed machining to be made under a three-dimensional approach whereas cutting is generally a two-dimensional task. Under such perspective, subtractive fabrication can be categorized in two branches: Two-axis cutting and multi-axis subtraction.

3.2.3. TWO AXIS CUTTING

The term refers to subtractive processes performed perpendicularly to a work plane. Namely, the subtracting tool remains perpendicular at all times thus cutting angles are perpendicular too. Techniques go from milling to water-jet cutting passing through laser and plasma cutting (Kolarevic, 2005). As pieces to be cut are derived from a two-dimensional digital fabrication approach, the method is suitable for performing LM; even though the principle of stereolithographic-like manufacturing is absent, digital layering is needed nonetheless.



Figure 107. Splitting of a log into boards with a band saw. (LindasSawmillCinema, 2016)

In rough cutting (timber conversion) robots are suitable to be used too, however such application is material dependent. In wood production a robot might well lift and move tree trunks for gross cutting; whilst when working with stone, a robot would be definitely more suitable for shaping final products than for gross-cutting and lifting (except when using gantry robots).

Comment 22. Robot usability in rough and fine tasks.

LM through two-axis cutting methods consists in digitally decomposing an object into layers as to create an arrangement of flat profiles that, once reassembled, will reconstitute the modeled object (Figure 108); nevertheless, the method is highly consuming in regard to the material suitable for it (wood, steel, aluminum, polycarbonate, acrylic sheets and the like).

In architecture, two-axis cutting is used for RP and RM. RP models often use wood as main material because of its claimed usage flexibility, availability and relative low cost insofar as materials used in wood-RP are often composite ones like MDF, HDF, OSB and the like. Furthermore, dealing with wood-RP allows for using less powerful machines than when performing RM.

Two-axis RM is often used to produce real-size low-thickness workpieces. Such elements act in buildings as bearing, partition, and façade members that must accomplish construction regulations to act as such. In that order sections, lengths, and weights might be higher than in RP so machines are bigger and more specialized. This last criterion is also applied in multi-axis subtractive fabrication.



Figure 108. **Top.** Layered bench structure for the MAXXI YAP project 2012, by Urban Movement Design architects. NY. On: [facebook.com/UrbanMovementDesign/](https://www.facebook.com/UrbanMovementDesign/). **Bottom.** Prototype of a timber-layered structure made with 5mm MDF. School of architecture of Nancy, 2012 by L.Kovaleva, I.Cervantes and M.Potapova.

3.2.4. MULTI-AXIS SUBTRACTION

The term refers to the capacity of a machine to perform displacement routines in more than two axes (X.Y). Multi-axis subtraction is possible to achieve with machines whose displacement range varies from three up to seven axes and it can be equally performed by laser-cutting or milling machines. However, as laser-cutting¹¹⁴ machines need a controlled environment to function, working boundaries are, for instance, more constrained for a laser-cutting machine than for a 6-axis robotic arm.

A basic classification of multi-axis CNC machines and industrial manipulators, allows to classify them in function of their displacement axis

¹¹⁴ Laser-cutting environments are usually isolated to prevent users from accidents and radiation. Robotic environments on the other hand, usually deal with workpieces that cannot be machined into a cabin. Nevertheless, exposure to radiation is absent when working with milling tools.

number and machining capabilities (milling or laser-cutting), as shown in table 1.

Table 1. Classification of CNC machines and industrial robots by axis number as potentially used in construction and architectural research.

MACHINE TYPE	MILLING	LASER	TOOL DISPLACEMENT PARAMETERS
<i>Three-axis CNC machines</i>	YES	YES	<i>X, Y, Z orthogonal</i>
<i>Four-axis CNC machines</i>	YES	YES	<i>X, Y, Z orthogonal. Fourth axis composed by a fixed lathe.</i>
<i>Five-axis CNC Machines</i>	YES	YES	<i>X, Y, Z orthogonal. Vertical and horizontal rotation is added to the spindle head</i>
<i>Five-axis robots</i>	YES	NO	<i>X, Y, Z rotatory and/or orthogonal. Spindle head can rotate in 360°.</i>
<i>Six-Axis robots</i>	YES	NO	<i>X, Y, Z rotatory and/or orthogonal. Fist and spindle head can rotate in 360°.</i>
<i>Seven-axis robots</i>	YES	NO	<i>X, Y, Z rotatory and/or orthogonal. Fist and spindle can rotate in 360°. A rotary fabrication table is added.</i>

Adding displacement axes to a CNC machine makes it more efficient but also more expensive. CNC two-axis laser cutting machines, for instance, are relatively affordable and it is the reason why many architecture faculties and schools have at least one of those. Five-axis laser cutting machines, on the other hand, are somewhat expensive and specialized which makes them more suitable for mechanical environments such as the automotive industry.

Subtractive techniques are volume-based insofar as for cutting and sculpting matter, needs to be eliminated thus its volume reduced making the decision to use one or another, material depending. For metalwork one should probably use laser cutting techniques but for sculpting wood, concrete or stone, a milling process would be preferable (Comment 23).

In recent years, research on materials and construction has led to a manifold set of experiences that, most of times, use wood as kind of a preferred material for experimentation (Schwinn et al., 2013).

It is not that other materials such as stone, aluminum or steel are not suitable for that purpose. As a matter of fact, decent works using material other than wood, make also use of CAD/CAM approaches as to replace human labor in performing demanding tasks, as it was mentioned in previous paragraphs when referring to the works at the Sagrada Familia, back in the early 1990s. NC subtractive fabrication added a shift to the making of columns following the codex established by Gaudí (Figure 109).

Multi-axis laser-cutting techniques are more suitable for dealing with non-organic materials such metal or acrylic. Using a five-axis laser cutting machine for wood carving, for example, would be impractical inasmuch as the resulting piece would be literally grilled and covered with carbon, making it difficult to clean and turning the task into a demanding and anti-economic effort.

Comment 23. Milling vs laser-cutting in wood carving.

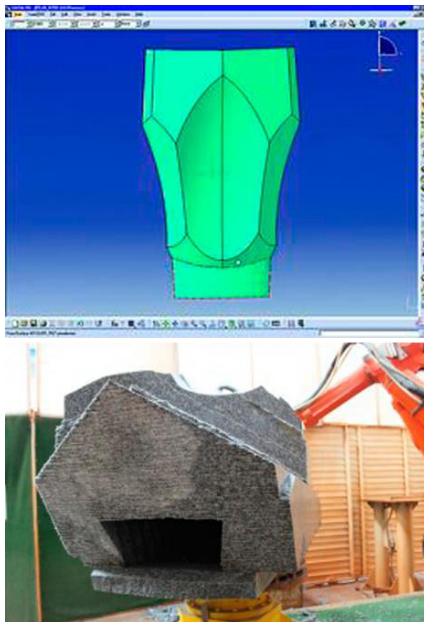

Figure 109. Top. 3D model of a Pillar using CATIA V5 (Filipovski, 2015). Bottom. Stone milling using a multi-axis robot (RMIT University, 2012).

By the 1990s, a NC saw could perform a decent work in shaping the stones that serve as permanent formwork for the ruled-surface-based helical columns at the cathedral. Mark Burry, makes a detailed description of how the parameterization of a 1990s state-of-the-art machine not only boosted but made possible to better reproduce Gaudí's guidelines (Burry, 2002; Halabi, 2016). Burry's work also points out that the introduction of CAD/CAM technologies associated to CNC machining, allowed for a direct passage towards fabrication without going back to plaster models as means for stonework molding and verification.

Back to the use of wood, this last one material is argued by some architects to be a dynamic renewable resource with natural CO2 storage

capabilities that help in maintaining a positive carbon footprint in regard to industrial processes (Schwinn et al., 2013). Such fact is supposed to make the wood industry part of a sustainable approach that encourages the use of wood as prime material for building. Such framework gives CNC subtractive techniques a wide scope to work on, as most wood transforming processes are carving-based.

For that purpose not only simple CNC machines but complex machining centers (Figure 110) incorporating an optimized set of tools for timber woodworking, give wood construction a high production performance equally applied throughout the whole production chain, from gross structural elements to detailed woodworking (joinery) and that's where CNC multi-axis machines and robots participate.

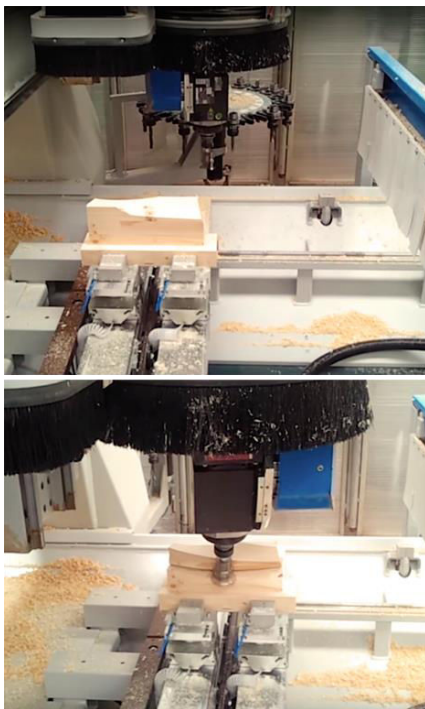

Figure 110. 5-axis wood machine center. **Top.** The CNC machine chooses a tool from a set, according to the cutting and finishing program defined through a CAM environment. **Bottom.** The machine performs a roughing/finishing routine. Still on: <https://www.youtube.com/watch?v=ISkJ5SjebVc>

Because of their kinematic freedom, multi-axis machinery can perform multiple cuts without using a large set of tools, which means a set of mill-ends and saws with the appropriate physical features¹¹⁵ can perform all the necessary carving and cutting operations on a workpiece (within application limits of course). An approach that might be opposite to traditional woodworking, in which a more than wide set of machines and tools, is necessary to execute similar operations.

3.2.5. FORMATIVE FABRICATION

Formative fabrication refers to a set of processes whose aim is to modify matter by plastic

¹¹⁵ Diameter, length, hardness, roughness

deformation, which implies that target objects receive physical and/or chemical stimuli in order to change their shape.

A common case of formative fabrication is steel bending. Steel girders, pipes, rebar and the like often undergo formative processes as to produce structural products for mechanical, automotive, construction and other akin industries. Common steel forming techniques include rolling, deep drawing, bending, forging and extrusion. Depending on the type of steel and thickness, the above processes sometimes need to be complemented with heat as to diminish steel's resistance to forming.

As well as steel, other construction materials also require forming to obtain a final product. Concrete is shaped by die-casting, aluminum is by bending and extrusion, wood is shaped by bending and pressure forming, carbon fiber uses a hybrid forming approach (Comment 24), and glass is formed by thermic-rolling and pressure¹¹⁶.

However, since CNC environments are not restrained to shaping processes, other forming methods designed to better emulate the shapes produced through contemporary digital modelers arise as to solve the gap between digital design and construction. Forming of curved and double-curved compound surfaces, requires materials to be shaped with technologies other than die-cast-forming (Fuxing et al., 2008; Lee and Kim, 2012;

Carbon fiber manufacturing does not happen in one single step. Because of being a nonwoven kind of fabric, it possesses high flexibility and resistance to tension, bending, torsion and shearing efforts, which combined with chemical hardeners and curing, provides the material with high resistance coefficients. Carbon fiber workpieces usually undergo 2D-cutting, molding, chemical hardening and curing. Carbon fiber is mostly used in automotive, product manufacturing and aerospace industries. Construction industry makes use of carbon fibers for structural use.

Comment 24. Carbon fiber fabrication and use properties. (ACP composites, 2012; Daldry, 2012; He et al., 2016; Hegde et al., 2004)

¹¹⁶ Please notice that techniques change from industry to industry and depend on purpose, so aforementioned techniques are illustrative. Depending on application requirements hybrid techniques are also used (Keating and Oxman, 2013b).

Liyong and Le, 2010). Hydraulic and pneumatic presses, equipped with a series of numerically-controlled pins (Multi-Point Forming MPF), serve to shape surfaced materials like titanium, steel, aluzinc¹¹⁷, aluminum and other akin materials.

Other forming techniques include Stretch Bending, Die (cast) Forming, Single Point Forming, Single Point Incremental Forming, Hydroforming and Explosive Forming. A case study on the forming of doubled curved façade panels for the Dongdaemun Design Park (Zaha Hadid 2014), shows how using hybrid state-of-the-art forming techniques (Lee and Kim, 2012), allows for creating a CNC environment capable of eliminating gaps between panels, which is a common problem in projects such as the Experience Music Project (by F.Gehry 2.000) or the Mercedes Benz Museum (by UN studio 2006) .

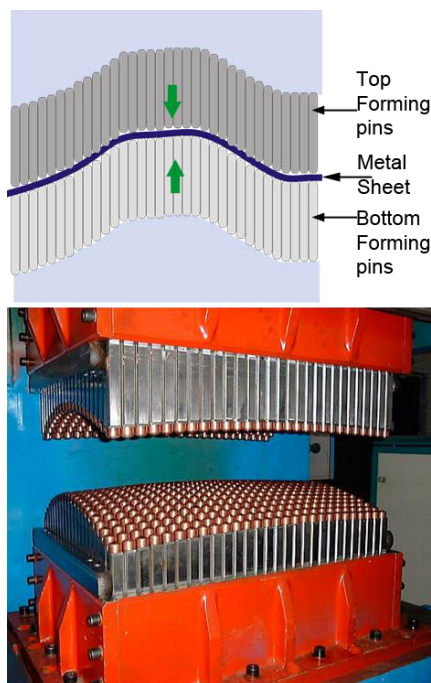

Figure 111. Multi-point forming. **Top**, the process uses the perimeter of an unfolded NURBS surface, which is used to cut a metal sheet that is later formed by a series of hydraulic or pneumatic pins. The system allows for achieve double curved panels with minor or null curving errors. **Bottom**. A prototype for a CNC multi-point forming machine. DATAFORM project (Ponticel, 2008)

However, forming is not always a matter of high-tech machinery. In 2014, the AA students at Hooke park developed a bending system composed by an artisanal steam box, a series of pneumatic jacks and fixed guides arranged along a projected profile. The aim for this set up was to shape a series of timber structural members making part of a canopy structure for the timber seasoning shelter project¹¹⁸.

Every component's template was perpendicularly projected over a bending table so that the jacks could be positioned as to give beech

¹¹⁷ CR galvanized Steel sheet with a metal coating composed by aluminum (55%), Zinc (43.4%), and Silicon (1.6%) (Arcelormittal, 2013; Souto and Scantlebury, 2005). It is widely used for producing façade panels and thermo-acoustic roofs.

¹¹⁸ See more information on <http://pr2014.aaschool.ac.uk/DESIGN-AND-MAKE/Phase-2--Timber-Seasoning-Shelter#image-14>



Figure 112. Timber Seasoning Shelter Project. AA, London - Hooke Park. 2014. Structural beech members being bent after undergoing steam softening. Top. Workpiece placed over a template before forming. Bottom. Pneumatic jacks making pressure over workpieces to give them the desired shape. Some planks break,. Some others perform as needed.

lamellas the correct curvature required by the design. Lamellas were then softened in a steam box to make them pliable enough to deform according to the structure's requirements. Although the method was experimental and its success heavily depended on information collected through testing, the results available on the AA's website show that timber bending requires industrial treatment inasmuch as cross-section, fiber density, humidity, hardness and the presence of knots play an important role in how a wood-workpiece will react to steam softening and bending.

Furthermore, timber steam forming has a lot of variable that depend on the timber's grain structure, ergo [...] *"Small changes in grain (e.g. runout or knots) can significantly alter the shape of a bend or sometimes result in material failure and careful handling/drying after bending is needed to minimize springback"* [...] (Schwartz et al., 2014)

In general, formative fabrication is achieved by stressing the plastic and elastic limits of a given material without breaking it or degrading its physical properties.

3.2.6. IN THE THRESHOLD

As sometimes a single fabrication method is not enough for giving a material (or a set) the desired shape properties; oftentimes, techniques must be mixed in which has been defined as **Hybrid Fabrication** (Keating and Oxman, 2013a). Hybrid fabrication calls for a conjunction of two or plus fabrication techniques, therefore several combinations are possible: additive + subtractive,

additive + forming, subtractive + forming and so on (Figure 113).

But in the threshold there are other possibilities used in fabrication endeavors such as those performed by Gramazio-Kohler Research, in which the approach is more about manipulation than fabrication itself, show an innovative perspective nonetheless.

The aforementioned research works aim to make a shift in the way things happen in worksites, arguing that traditional construction practices can be optimized from a new industrial point of view in which serialism is replaced by variation, for in variation there might not be place for craftsmanship, not in reasonable time. All of this is claimed to be possible inasmuch as robots are no more seen as sedentary but nomad machines. Whereas the typical environment of an industrial manipulator is constrained to an operation radius, these new approaches take robots out of the workshop, and out of the cabin, to put them side by side with humans.

Such outlooks have a new perspective in task integration, one in which Man and machine share the workplace. The machine handles items, repeating tasks regardless of form variation while the human tells it where to put the first piece and what trajectory to follow (Figure 114). The human might no more be obliged to climb scaffoldings and no more and accident will have something to do with losing lives but with repairing or replacing machines, which in the end is way better and



*Figure 113. Manufacturing carbon fiber pieces requires a mixture of techniques that go from 2D laser-cutting to die forming. **Top.** A component for a F1 race car wing is cut with a 2D laser CNC machine. **Bottom.** Pieces for the same wing are being put in place into a die so they acquire a specific form. Carbon fiber is later hardened with an epoxy resin and cured in an autoclave. (Daldry, 2012)*

relieving than doing it with humans.

With this in mind, the so called threshold gives way to techniques, like “*in-situ robotic fabrication*” (Helm et al., 2014), which consists of positioning and placing bricks with the help of a mobile robot station that can be installed directly into a worksite as it only needs to know the place and trajectory of the wall to be built. However, what about concrete pillars? Smart Dynamic Casting mixes concrete slip forming with robotic kinematics to yield a method in which casting a concrete column by segments is possible. The method not only relies on kinematics but on cementitious materials’ chemical and physical behavior, inasmuch as concretes and mortars, in order to be extruded, need an acceptable slump to be pumped as well as an excellent cohesibility index to allow a proper mechanical bond between layers. They also need fast initial drying and resistance times, while maintaining an almost zero retraction coefficient.

In the end, the problem does not really lie in using robots but in making the proper mixture with the right pumping speed and the correct kinematics velocity to achieve an extruded mortar/concrete column. As it can be deduced, the equation behind the picture is not as simple as the picture itself.



Figure 114. *In-Situ robotic fabrication project by V.Helm (2014). A robot builds a non-standard brick wall, by recognizing (through sensors) a drawn path. Image on: <http://gramaziokohler.arch.ethz.ch>*

Non-physical techniques come to compose this threshold in what might be well named as Robot-Assisted Fabrication since it seems that, in the end, almost any contemporary production system will be at least using a 5-axis CNC machine that works more or less like a robot would. Within that range of



Figure 115. Light Painting. An image drawn in space through robotic kinematics. The drawn light pattern is captured through long exposure photography. On: <http://matter.media.mit.edu/tools>

non-physical techniques (Figure 115), Keating identifies a bunch of practices that include (but are not limited to) light painting, inverse light painting, volumetric measuring and surveying, optical scanning, acoustical mapping and spatial chemical analysis (Keating and Oxman, 2013a). Also, transforming a material by changing its physical properties without direct mechanical force or manipulation is possible. Be it by adding cold, heat or by making electricity flow through a body, physical properties can be changed without infringing a single wound on a given piece of matter.

3.3. WORKFLOWS FOR DIGITAL FABRICATION

Even though the processes that lead to yield non-standard architectures, from digital conception and manufacturing, might be inferred from aforementioned sections, a set of common and uncommon specificities exist that are worth of being identified. This section discusses the use of digital environments, file formats and translation tools as to understand how fabrication processes provide design processes with feedback and adjustment criteria that has much to do with the way data is treated, making design process to be aware of production constraints that can be introduced into digital modeling using CAD and BIM modeling interfaces as well as visual-programming parametric modelers. The discussion in this section is in part based on software tests using different BIM, CAD and CAM programs¹¹⁹.

3.3.1. DIGITAL DESIGN-TO-FABRICATION ENVIRONMENTS

Previous sections referred to a set of digital tools that, since the 1970s, have been appearing for speeding and improving the work architects and engineers do in regard with architecture.

¹¹⁹ Please refer to Appendix 13 to see the full list of digital tools and software used throughout this research.

It was also mentioned that first architecture-intended software generations aimed for reproducing standard and traditional archetypes in a way to take the drafting table to a screen (Pg 38). Then the blob trend came and with it the use of modelers that were not intended for architecture (Comment 25); a fact that did not discourage architects from using them and proposing challenging shapes whose feasibility was on the edge.

In contrast to early architectural computing, the extent of architectural modelers nowadays is vast. There are hundreds of solutions for an even bigger number of needs and budgets and, for an obvious capitalist reason, the better the tool, the more expensive it is (most of times). It might not be wrong to state that, due to the large offer of modeling solutions, learning and using CAD modelers has become the equivalent of learning and using a new language as a means to increase exchange between. In culture, mastering several languages opens way to trade an intercultural exchange. In architectural computing, mastering several software environments, not only increases design performance but helps improving design methods.

Comment 25. Language, exchange and computing.

As contemporary practice in architecture follows some common guidelines software intended for it does to, so there will be no need to mention every CAD software that ever existed or actually exists. Based on the short taxonomy described in section 2.2.3, forthcoming paragraphs present a state of what most used CAD programs are and what they deliver in terms of data for fabrication. But before dealing with what modelers do (section 3.3.3), it is perhaps necessary to make a pause and recall the way modeling-and-making (CAD/CAM) environments communicate with each other

Design and manufacturing programs adopt languages to communicate, some are restricted to a few environments and some others are more generic and oriented towards language standardization as a means to make tasks easier and affordable to a wider public. Such languages are often known as a file formats.

3.3.2. FILE FORMATS

File formats allow encoding information produced through software in a way that it guarantees that no data is lost and that files, as well as data contained in them, are stable and reliable. In contemporary architectural practice, designers often face the fact of exchanging files with colleagues that do not necessarily work under the same digital environment; namely, every organization (company, school, and research lab) assembles its own working environment and, for collaborative endeavors to succeed, sharing/exchanging files is an important task (Figure 116).

As important as sharing information is, understanding the way data passes from one environment to another is too; that is to say, if someone speaks Russian and someone else does Finnish, maybe an exchange language will be English. However, in the transfer of information from one language to another, pieces of information may get lost, though a lossless language would be desirable.

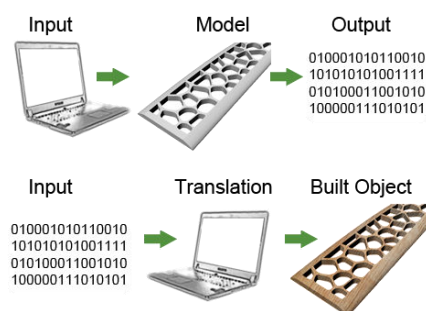

Figure 116. File formats act as output or input depending on which side of the design-to-production workflow they participate of. **Top.** A file format concatenates model data as output of a design process. **Bottom.** Input data, as file format, is introduced in a translation environment to yield a mockup through digital manufacturing.

That is exactly what happens when sharing and converting files between digital environments; therefore, it is relevant to understand what file formats are, the kind of data they are able to store and how reliable they are when migrating information from one environment to another.

File format exchange is commonplace in digital design and fabrication efforts, thus the way design information is exchanged has a lot to do with

success in design-to-fabrication workflows.

Table 2 makes a brief description of most common file formats used for exchanging data in design-to-design and design-to-production endeavors, this information will not only help to understand the workflows described in this section but those to be implemented in the framework of this dissertation.

Table 2. Most used CAD/CAD AND CAD/CAM file exchange formats in digital design-to-fabrication workflows.

FILE FORMAT	DESCRIPTION	NATIVE ENVIRONMENT / DEVELOPER	USE
ASCII	Character-based output file formats. No properties such as texture or color are saved. I.e. STL, GIS and SAT formats are based on ASCII code.	American Standards Association	File exchange towards other modelers and CAM environments.
DGN	File format based on Intergraph's ISFF standard or the Bentley's V8 DGN standard.	Bentley's MICROSTATION	2D drafting, 3D modeling, animation, rendering, annotating and measuring.
DWG	Database for 2D and 3D drawings in the form of vector image data and metadata as definers of a file's content. Many (if not most) CAD programs use and exchange information in .dwg format.	Autodesk AutoCAD	2D drafting, 3D modelling, rendering, annotating and measuring. CAM exchange.
DXF	ASCII-based format. It manages data as tagged data, which means each element in the file is preceded by an integer or group code. Integers indicate data type and data meaning for given objects. All information in a .dwg file can be represented in DXF format.	AutoCAD	2D drafting, 3D modelling, rendering, annotating and measuring. CAM exchange.
FBX	An exchange file format that keeps the model properties as to be used in different programs belonging to the same producer. File interoperability and compatibility is kept within the boundaries of Autodesk's products.	Autodesk AutoCAD 3DS max	Import and export 2D and 3D data with minimal or no information loss.
IFC	BIM standard based on the STEP physical file structure according to ISO10303-21. Although, some programs have problems sharing IFC data and data loss is not totally avoidable.	Building-SMART	Retrieval of general and detailed building information. Structure, HVC, masonry, window systems etc. CAM data can be obtained.

IGES	Acronym for “Initial Graphics Exchange Specification”. Neutral translator designed to transfer 2D and 3D data between dissimilar CAD and CAM systems. It has two formats: fixed-length and compressed length. Multiple translation often generates errors.	***	Multi-environment CAD/CAM data exchange.
OBJ	ASCII-based format. It contains three-dimensional object data such as vertex, surface attributes, spline properties, elements (points, faces, and lines), curve and surface parameters as well as object attributes.	Wavefront Technologies	Multi-platform file exchange format supporting a wide range of objects from polygons to complex NURBS surfaces.
SAT (sab)	Acronym for “Standard ACIS Text”. Modeling information is stored as ASCII text. Binary coding is possible and in that case the file format changes to SAB. SAT is a neutral exchange file format	Dassault’s Spatial modeling software	Data exchange between multiple systems. CAD, CAM, CAE, AEC, CMM, 3D animation, and shipbuilding.
STEP (stp)	Standard for the Exchange of Product data. “ a ISO standard industrial automation systems product data representation and exchange format”	ISO	Three-dimensional exchange data representation to be used by multiple CAM programs.
STL	StereoLithography file. An exchange format readable by multiple CAD/CAM environments. Data contained in STL files is a set of cross-sections (layers) in which a surface-like geometry is decomposed. It works on binary and ASCII interfaces.	3D Systems	Visualization. Additive fabrication, CAD/CAM file exchange.
X_T	Contains modeling data along with model properties such as color, topology and geometry. Standard for sharing Parasolid CAD models in text format. CAM platforms like Edgecam and Mastercam accept and translate data from X_T files.	Siemens Parasolid	3D CAD/CAM exchange format
BTL & BTLx	Standard exchange format for wood CNC machining since 2006. BTLx is an XML-based improved version of BTL.	LignoCAM	Exchange between CAD and CAM environments.
File format information from : (Autodesk, 2016; Burns, 1989; design2machine, 2016; Fileinfo.com, 2016a, 2016b; Janowski, 1999; Ryder et al., 2002; Siemens, 2016)			

3.3.3. OBJECT MODELING (OM) TOOLS

OM tools embody the first category of the four discussed in section 2.2.3. This kind of software has been characterized for being purely representative thus its capabilities for parameterization and

problem-solving are either limited or inexistent. Though visual results vary in quality, making modifications usually brings a lot of work insofar as entities are more or less stagnant and a lot of modeling has to be done to apply any modification on the model. Furthermore, features such as NURBS modeling or free-form shaping are limited (even absent), because of the absence of a powerful modeling architecture. Usually, such deficiencies are solved with the use of plugins, which add advanced modeling features to the base software. Trimble's SketchUp is an example of this.

Nonetheless, having limitations does not mean complex models are not achievable. In fact, SketchUp's 3D warehouse contains plenty of complex models of buildings such as the HSB Turning Torso Building (Figure 117), however such models remain on being representative as no buildable information can be retrieved from such, even if RP and RM information is obtainable in STL and DXF formats. Namely, rising an entire building out of a Sketch Up model is perhaps not practical ¹²⁰, but exporting RM data for two-dimensional product cutting is always possible (SketchUp, 2015).

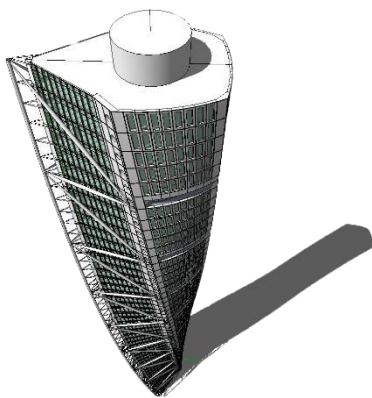

Figure 117. Image of a Sketch Up model of the Turning Torso Building by Santiago Calatrava. 2001. On: christosgatzidis.blogspot.fr

In this category, digital design markets offer other applications that, like Sketch Up, provide an intuitive way to produce 3D models that might deliver information for documenting, RM and/or RP. Programs like Floorplanner (2007), Belight's Live Interior 3D (Belight, 2016), pCon.planner

¹²⁰ Complex construction documents are obtainable by creating a series of templates and customized views as explained in Matt Donley's Book (Donley and Sonder, 2016)

(EasternGraphics, 2016) or Autodesk’s Homestyler are examples of representation-oriented software for architecture, some of them, which happen to be cloud-operating, can yield image, dwg and/or dxf files (Table 3).

3.3.4. ASSOCIATIVE MODELING (AM) TOOLS

Modelers in this category, provide basic parametric inputs that allow for dealing with more complex geometric approaches that make form-searching more fluid, within the boundaries of processing and iteration capabilities every application may have.

For those who know the way things were in the mid-1990s and early 2000s, not few would agree that by then most modeling (and drafting) tasks were “hand-made”. Users had to deal with a lot of “picking and dragging” even if values as height, width, depth, radius, diameter, object coordinates, subdivisions and akin parameters were already managed as floating numbers modified by means of a button or slider.

Such features have been present through the years in software packages such as 3DsMax, Autodesk Inventor and more recently in programs like , Modo, or Creo Parametric which, despite the fact of offering parametric input management¹²¹, might still need the user to record macros and histories to apply repetitive tasks (The Foundry, 2014). Such input mode does not facilitate creating generic solutions equally applicable to a wide set of

Table 3. MO-Like software

Name	Website
Trimble’s SketchUp	http://www.sketchup.com/
Autodesk Homestyler	http://www.homestyler.com/
pCon.planner	http://www.easterngraphics.com/en/products/pconplanner.html
Floorplanner	http://www.floorplanner.com/
Live Interior 3D	http://www.belightsoft.com/products/liveinterior/win/index.php

¹²¹ Complexity changes in function of the program. Modo’s parametric inputs are as complex as 3DS Max’s, on the contrary, pCon.planner’s parametric inputs are quite basic.

different objects for yielding manifold results, which is a feature parametric-generative modelers possess.

Moreover, geometric operations need (sometimes) to be manually updated or re-made as the model is modified. That is something usual in 3DS max insofar as i.e. Boolean and ProBoolean operations are somewhat parametric for as long as entities are not converted into meshes or polys. In such case, geometric controls migrate towards points, polygons, and patches so sliders become restraint to local adjustments making geometric edition for architectural form-searching a demanding effort (Figure 118).

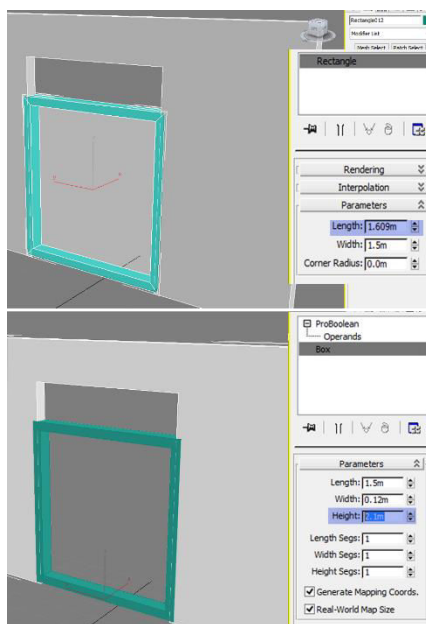

Figure 118. A window opening modeled using the ProBoolean compound operation in 3DS Max. **Top.** The window is originated from a rectangle that has its own width and length (height) parameters. It does not follow the ProBoolean operation parameters as the rectangle cannot be a child from such operation thus it is not constrained by it. **Bottom.** The ProBoolean allows for making a clean solid subtraction whose height and width parameters are adjustable at all times. However, such changes do not affect the window itself. As entities are not parametrically attached, adjustments must be made manually.

Variation (depending on iteration capabilities) is also constrained. Clones, instances and replicas (from a specific object) allow to create a series of objects acting as geometric children, which means any changes on the parent will equally affect the children¹²². However, if a bunch of polygons with different height values is to be extruded, the task might get a bit complex inasmuch as the children inherit its parent properties without admitting variation (Figure 119).

Please notice that aforementioned modelers are intended for product design, game design, or character modeling. Namely, they apply variation to specific details that might not need to be repeated or spread through a body, changing their formal properties as the body itself changes its own.

¹²² In programs like 3DS Max, a Parent is a given geometry whose modification will be equally applied to any clone of it (Children), under the condition of the clone being an instance of the parent as to inherit the changes made on the former.

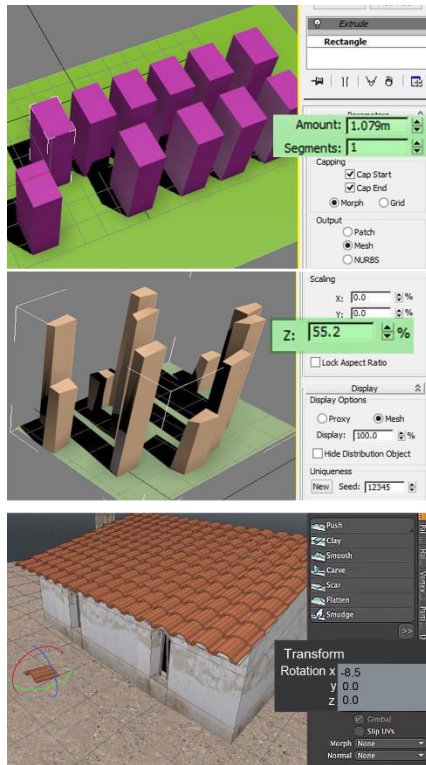

Figure 119. **Top.** Multiple extrusion. Notice that random extrusion height is not possible. In this case, a population of instances (replicas) adopt the extrusion factor of their parent (3DS Max). **Middle.** Scatter compound operation (3DS Max). An object is randomly spread over a surface. Even though a random seed parameter is found, location has no proximity parameter. Moreover, random height is percental and does not belong to a domain of defined values for iteration. **Bottom.** Multiple item rotation in Modo (The Foundry, 2014). Replicas adopt the rotation factor of their parent responding to a single orientation vector. Multiple orientation vectors from a single parent are not available.

In that case, modelers like Autodesk inventor are good for creating a piece or an assembly of pieces that will make part of a body independently of its nature (car suspension parts, window assemblies, furniture assemblies, bearings, structural fittings etc.). However, their modeling features, i.e. NURBS modeling, allow for dynamically exploring with forms in a way that a visual feedback on form-shaping is given as parameters gizmos and control points are changed to induce modifications in a model, which is a feature modelers specially intended for architecture and construction now possess thanks to a higher iteration degree.

To this extent, BIM and CAD/CAM modelers develop an important function, as they not only allow for shaping design intentions but for introducing building and technical criteria into design¹²³.

From the appearing of the first notions on BIM modeling back in the 1960's¹²⁴ to its advent in the 1990s, design in architecture and engineering has been able to integrate parametric modeling, construction constraints, processes and analysis directly into a single workflow. BIM tools not only feature advanced modeling capabilities (including parameterization and iteration), but add data containing physical and buildable information. Such data is later treated by CAD/CAM environments that will use it as needed to build the whole or a part of a building.

¹²³ It does not mean product-aimed modelers are not aware of production processes. Indeed, they are, but data contained in them is specifically nested for mechanical processes (most of them), so the models they yield do not contain the physical properties a model for architectural use should.

¹²⁴ Please check on the work of Engelbart's (1962), in which he introduces the conceptual model of what later became known as the BIM approach. Refer to Appendix 2

Imagine a model in which a set of columns, attached to a roof, whose height varies as the roof slope increases yielding a manifold series of column-heights (Figure 120). For this modeling operation to succeed, when columns are attached to the roof the model not only creates a series of inputs giving each column a different height value, but generates sets of data-lists containing such values (parameters) so that every time the roof slope is changed (master parameter), column heights will change too.

Namely, the program with which the model is made has to be capable of creating a series of inputs yielding manifold outputs by using three basic input parameters: Roof slope, roof height and column position. However, each set of components is treated once at a time and only one solution is given at a time because only one operation is allowed.

Most of the processes performed by the modelers here discussed are based on single-operation iteration as entities are transformed through single-value parameters (Janssen, 2015, p. 160) yielding a single transformation each time modifications are applied over a digital entity.

3.3.5. DATAFLOW MODELING (DFM) TOOLS.

DFM tools are characterized for dealing with multiple parameters at a time, in which has already been referred as implicit multi-operation iteration.

This is a privilege BIM modelers like Autodesk's Revit, Graphisoft's Archicad or Bentley's AECOsim possess attain when coupled to tools like Generative components, Autodesk Dynamo or

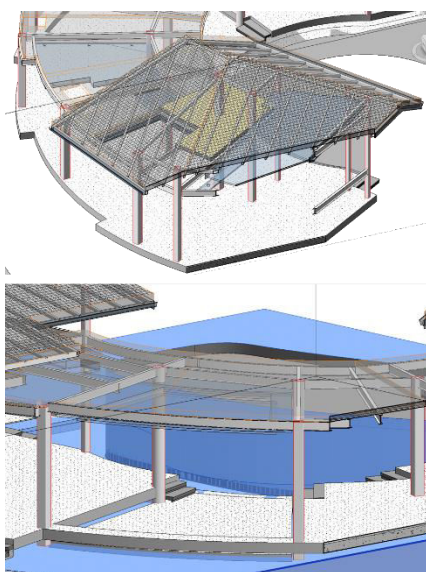

Figure 120. Top and bottom. A set of columns and a roof framing attached to a roof geometry. As the slope increases, columns and roof framing (beams, joists and rafters) adapt to match the roof's geometry. Model made using Autodesk Revit 2013.

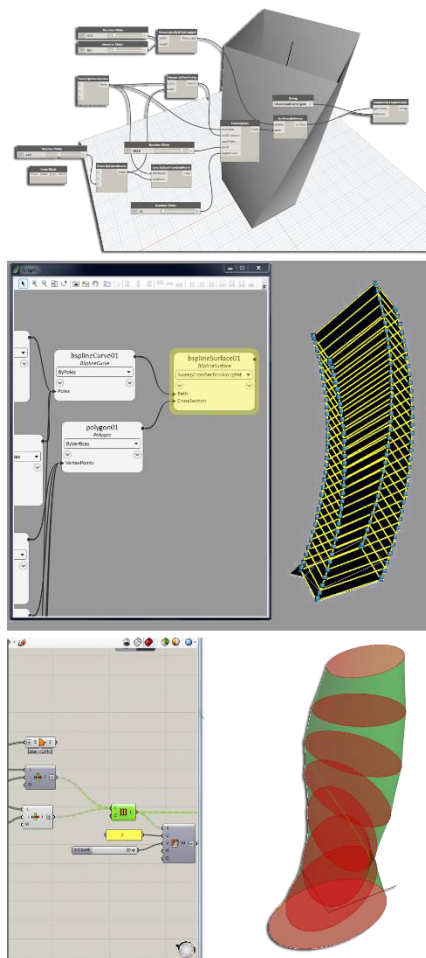

Figure 121. Visual Programming Modeling (VPM). Interfaces are somewhat alike, however, functionality and logic changes a bit from environment to environment. A twisting tower sketch modeled using the three main PG programs shows that, even though the logic might be similar, the way in which parameters should be defined varies from interface to interface. In GC and Dynamo, clusters have a built-in set of variables that can be programmed or changed without needing additional clusters to intervene on a single operation i.e. a sweep operation. On the contrary, GH needs various cluster sets to do so. Also, in GC and Dynamo, scripting can be directly performed into the cluster's interface. Programming in GH needs an independent cluster for programming.
From Top to Bottom. Dynamo, Generative Components and Grasshopper PG modeling interfaces

grasshopper. Such parametric-generative environments offer enhanced modeling capabilities accessible through a visual programming environment whose features change from package to package (Figure 121). In other words, inputs and entities must be defined from zero, as predefined ones are all but inexistent.

Insofar as contemporary digital design asks for building information to be considered in conception stages, such fact is not absent in parametric-generative modeling. All three visual programming environments cited thus far, allow the user to deal with detailed modeling and building information. The only limit in this case, is the designer's capacity of scripting such data in a manner that it is modeled as he/she intends to, along with the buildable properties that will allow what is in the digital interface to be materialized. At his point, the user must make sure data is correctly structured (dependencies, lists and trees order) as to achieve the desired behavior. For GC, GH and Dynamo users this is common place as any error in data structure usually leads to undesirable or null data outputs.

For both approaches, BIM and generative modeling, the goal is the same: Yield buildable information as usable data for production through CAD/CAM environments based on the fabrication techniques discussed in previous sections.

3.3.6. PROCEDURAL MODELING (PM) TOOLS

PM is a higher stage in parametric-generative modeling. Normally, most BIM software would not fit into this category as performing explicit multi-operation iteration is perhaps not possible or quite limited through such interfaces. Nonetheless, and according to P.Janssen, Autodesk Dynamo along with Revit, seem to be the only set capable of such iteration level using recursion (Janssen, 2015), which is one of the dimensions explicit multi-operation has, along with data sink.

But what is data sink and data recursion? Both terms have to do with the way data lists are processed and how the information within them is used to solve problems, which is a matter of matter of computing applied to architectural problem-solving and modeling.

Recursion refers to the solving of a problem by using known answers and resolving problems from such answers in an evolutionary way. In other words, a routine calls itself (Howe, 1996; Terzidis, 2006) to solve a given problem, which is, by the way, very consuming in terms of hardware performance.

Data sink is basically any input data absorbed by a system or device (Aitken, 1999), however the way it is used in digital modeling have much to do with treating data structures and sub-structures in a parallel way i.e., data iteration from polygons (as list) and the points composing such polygons in parallel processes (another list) (Janssen, 2015, p. 161).

PM not only allows for exploring with free-form shapes as architectural entities but also provides a way to incorporate construction properties to architectural objects in a digital model, by making use of BIM software for assigning physical properties to any given geometry. i.e., a swept surface stops just being the representation of a profile along a curve; once properties are assigned to it, physical features such as hardness, conductivity, resistance and the like are added. The aforementioned geometry acquires a buildable dimension that can be used for fabrication purposes as it allows selecting the proper material and machining method for its materialization (Comment 26).

The case is common for GH, GC and dynamo. Geometries can be retrieved from and exported again to visual BIM interfaces. GH can make it towards Revit or Archicad by using plugins like hummingbird; GC does it towards AECOSim, and Dynamo does it towards Revit.

Comment 26. Geometry and data exchange between BIM and PG interfaces.

3.4. WHY CAD/CAM? A CLOSER LOOK ON CAD/CAM INTERFACES.

It is commonplace to hear about CAD/CAM software. Advertising usually puts it that way and most of times, architects, designers and engineers do not know what it is about. Many of them are somewhat aware of what a CAD program is, not so many know what CAM is, and quite a few do not even know what both terms mean and the processes they embody.

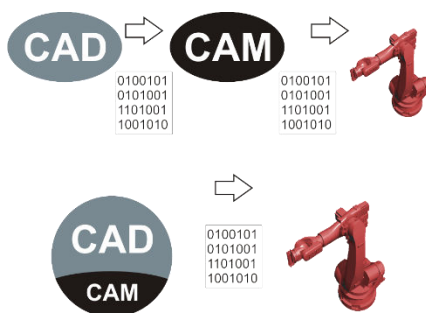

*Figure 122. **Top.** CAD-to-CAM workflow. Modeling data is exported to a CAM environment that translates it into a comprehensible format for fabrication. **Bottom.** CAD-and-CAM workflow. The CAD environment possesses a built-in CAM interface allowing to define the machining routines for object being conceived. It directly delivers fabrication data.*

CAD/CAM can be interpreted as CAD-to-CAM or as CAD-and-CAM workflows. The former represents a translation of CAD information (in whichever format it is contained) towards a CAM environment that will try to understand what is contained in a given file as to establish a series of fabrication

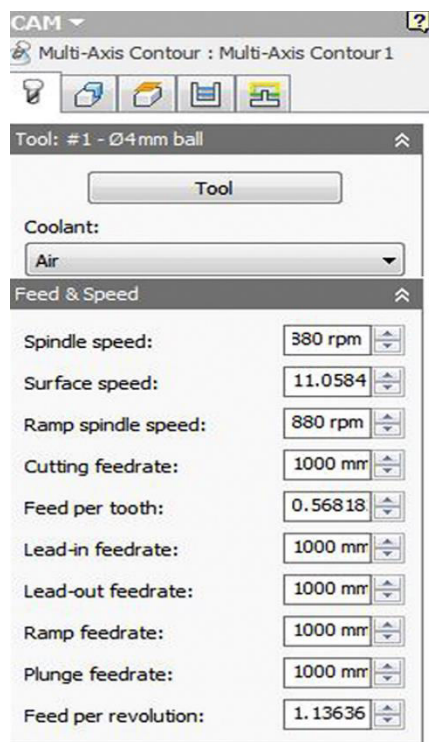

Figure 123. Settings for CNC machining using HSM for Autodesk Inventor.

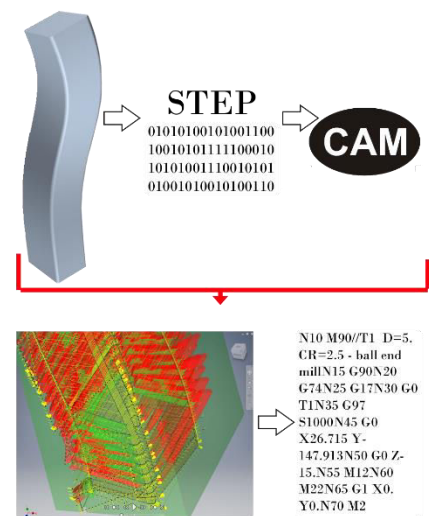

Figure 124. Gcode generation in a CAD-to-CAM workflow. **Top.** The model is exported in STEP format towards the CAM environment for translation and toolpath generation. **Bottom.** Toolpath calculation (trajectories and collisions). Once validated, Gcode for CNC fabrication is created.

routines out of it. The latter, represents a workflow integrating CAD and CAM capabilities. Namely, this is the kind of software that is capable of offering a decent modeling interface associated to CAM routines allowing for exporting fabrication data directly out of the modeling interface, avoiding tedious file exchanges and data loss¹²⁵ (Figure 122).

At this point, it is understandable what CAD programs do but, what are exactly the capabilities CAM programs have?

Applications vary from domain to domain, as machining different materials requires different fabrication approaches. I.e. spindle rotation speeds are not the same for steel than for wood, mill-ends have different flute configurations depending on the material they are intended to transform, cooling might be performed by liquid flow when machining metals, but for wood, it might be better to use airflow (Figure 123).

For all these reasons CAD/CAM software is not always the same, though the fabrication approach obeys somewhat to the same guidelines.

In CAD-to-CAM workflows, a model contained i.e. in a STEP format is imported into a CAM environment capable of decomposing the piece to fabricate into packets of data (Gcode) that will guide a given tool. Insofar as the process is far from being automatic, the user needs to choose and modify a

¹²⁵ Which is perhaps the most optimal workflow. It can be emulated via parametric modelers in cases when a CAD-and-CAM or a CAD-to-CAM pre-built interface is not capable of translating all buildable output data generated through a parametric-generative modeler. Discussions in chapters five and six deal with such approach.

set of parameters to build a given piece regardless of its industrial nature, be it a mechanical piece, a wood structure or any other product (Comment 27) (Figure 124).

It is the case in which a custom set of pieces (or a single one) is sent for fabrication. Programs such as BobCAD, DDX's EasyWOOD or Autodesk's Inventor HSM allow for setting up fabrication parameters starting from a neutral model file. Though industrial purposes are different for each program, the workflow's general setup follows more or less the same rules.

Comment 27. CAM setup guidelines as found through software testing

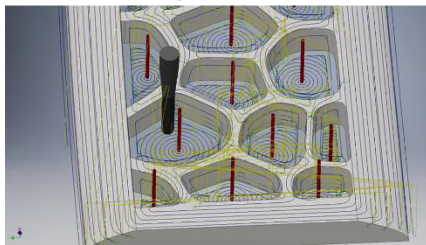
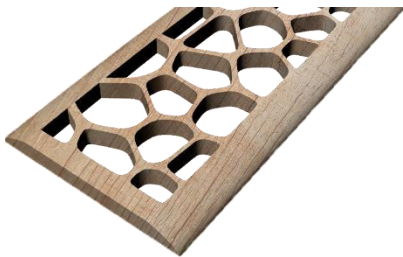

```

1 N10 M90
2 //T1 D=5. CR=2.5 - ball end mill
3 N15 G90
4 N20 G74
5 N25 G17
6
7 N30 G0 T1
8 N35 G97 S1000
9 N45 G0 X26.715 Y-147.913
10 N50 G0 Z-15.
11 N55 M12
12 N60 M22
13
14 N65 G1 X0. Y0.
15 N70 M2
    
```

*Figure 125. Fabrication simulation and Gcode export for a customized wooden workpiece. **From top to bottom.** Workpiece -manufacturing simulation using Autodesk Inventor - Gcode for fabrication.*

In CAD-and-CAM workflows, the CAM interface is hosted as part of a CAD environment designed for a specific purpose. Such is the case of Autodesk's Inventor HSM, Cadwork Wood, or HsbCAD in which CAM features are integrated to the application's kernel as to offer the user the possibility to set up machining routines according to a specific use.

Inventor HSM, for instance, is aimed to satisfy Autodesk's Inventor requirements insofar as materials and fabrication routines, embedded in the built-in CAM environment, are oriented towards product manufacturing. Nonetheless, custom material and fabrication routines can be set up as to satisfy other industrial purposes like wood construction (Figure 125).

On their side, HsbCAD and Cadwork wood are BIM-based tools specifically conceived for wood construction. As they can exchange IFC¹²⁶ data with native BIM programs, wood-frame elements can be re-computed to allow woodworking joint-generation (Figure 126). Also, data flows and workspaces are aimed towards delivering data such as drawings and fabrication commands. This last part requires a fine-tuned model for producing machining commands. All joint parameters, as well as fastener and hardware positions, need to be defined (Figure

¹²⁶ Acronym for Industry Foundation Classes.

126) based on an embedded database that can be modified or complemented with custom joints and accessories.

Machining processes can be directly set up by using the built-in CAM interface, which contains a collection of machines and machine-oriented exchange file formats that facilitate the interchange of information with production facilities. Based on the chosen machining environment, fabrication files can be exported in neutral and/or proprietary formats as to accomplish the manufacturer's standards (Comment 28). In CAD-and-CAM workflows, the user does not require to use a complementary CAM interface to define machining processes though simulation is not always available.

Please notice that not all CAD-and-CAM-based programs feature machining simulation and/or tool choice, which is the case of Cadwork wood. Whereas the program allows to define machining routines, it does not allow to setup the machining process, thus parameters such as spindle speed, tool type, tool length and the like are not accessible. Such fabrication settings must be set up in a CAM-only environment i.e. LignoCAM.

A different approach is found in Inventor HSM, inasmuch as the CAM environment allows to set up and customize all the aspects regarding the machining process, besides, machining simulation is possible.

Comment 28. Features of CAM-and-CAM workflows vary depending on brands and software producers. Simulation capabilities might not be present in some built-in CAM solutions.

As seen, CAM environments act as data translation bridges that give numerically-controlled machines, regardless of their nature, a set of commands that allows them to perform a series of kinematics-based tasks aimed to transform matter. However, CAM must not be taken for granted, the idea of the push-to-fabricate button (Bechthold, 2007) does not exist and designers must be aware of it; which is the reason why, showing how CAD/CAM environments participate in production workflows, has been considered important to discuss as it is a fact to face when engaging in full conception-to-fabrication endeavors¹²⁷.

¹²⁷ Even if designers do not directly participate in fabrication processes.

3.5. FABRICATION-TO-DESIGN FEEDBACK

The concepts discussed up to this point, help inferring that parameters and operations necessary to achieve fabrication processes are wide and change depending on fabrication environments themselves, which is not something that entirely relies on machinery but on digital design itself.

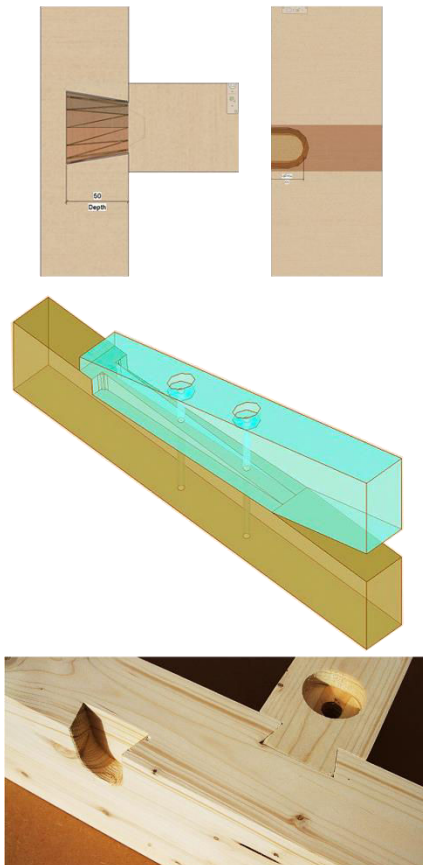

Figure 126. Top. Joint definition using HSBcad (<https://hsbcad.uservoice.com>). The program has a direct link to Autodesk Revit, allowing it to import framing models thus giving the base parameters to define the best jointing method for a set of structural members. Middle. Joist-rafter joint (including drillings) as calculated through a CAD-and-CAM software. Bottom. Machined wood joinery as derived from CAD-to-CAM or CAD-and-CAM workflows.

The workflows described thus far show there is a loop between conception and fabrication and - unless conception endeavors are meant to stay on the screen or paper- a direct involvement with production processes and their whereabouts might be necessary (Figure 127), reaffirming what was stated in section 2.2 regarding paper-driven architectural design. In traditionally paper-driven design many details are solved in execution stages as works go on, which is in part a logical consequence of the approach¹²⁸.

If bricks and concrete exist, I, as designer, might not need to trouble with bricks or concrete properties as they are formulistic and surely a table telling what kind of material to use under certain conditions will solve detailing problems when works start, except for cases in which special features are added to space. That is the claimed advantage of industrialization in most cases. Serial dwelling construction is an application case of architectural, engineering and construction formulae.

However, mass-customized architecture and

¹²⁸ Depending on the project's size and its nature (public, private, individual) detailing approaches vary from comprehensive to somewhat absent thus on-site problem solving is directly depending on such criteria.

engineering need a more close approach towards construction and production, which is the reason why the following considerations, as feedback data flowing from production to fabrication, ought to be taken into account.

3.5.1. MATERIAL AND DESIGN ITSELF.

Material is an important part of design that is oftentimes (if not most of times) neglected. That is not possible in the Non-Standard approach.

Mass customization is material-related, which makes design to be obliged to acknowledge material properties before design itself gets to take a definite form. A nice parametrically-conceived building skin is not a skin until its properties are defined. The intention does not embody the object itself.

Parametric-generative design offers the possibility of reaching different detail levels that vary from purely representative and unfeasible to highly-detailed and buildable, in which case, complexity exponentially changes as design criteria gets construction-aware.

I.e. a free-form surface has no constructive dimension by itself, however, once it has been subdivided and its composing parts acquired physical-emulated dimensions involving material features, connection assemblies, weight and structural behavior; the surface stops being a surface. It turns into the aforementioned skin.

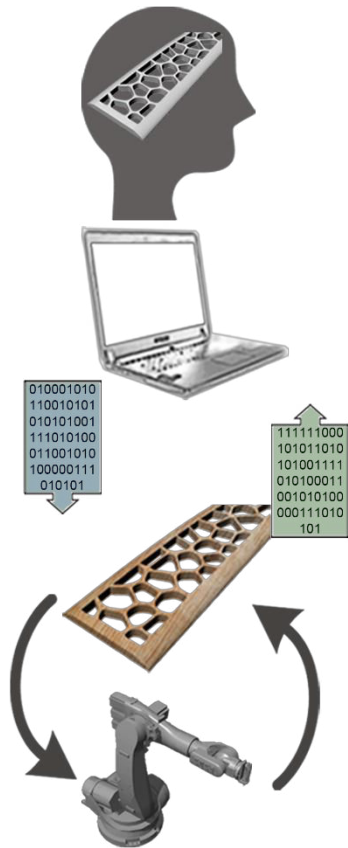

Figure 127. **The basic workflow.** From **top to bottom**, counterclockwise. A given designed object, intended to be manufactured through RM using a CAM interface, is exported as data. The CAM environment, prior to the fabrication stage, retrieves the same object (as data) including its machining routines to be validated by the designer or to change the model as necessary to satisfy both, the design intention and the manufacturing environment capabilities.

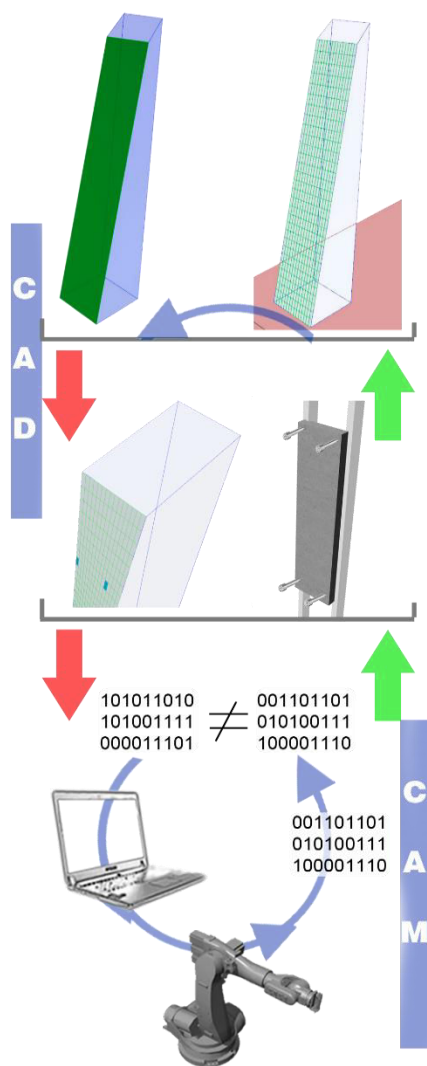

Figure 128. **The façade example.** A NURBS based façade delivers customized façade module-data for mass-customized fabrication. As seen in precedent workflows, fabrication data is reintroduced into the generative model. This time it considers global changes by acknowledging detailing specificities particular to a given family of components (façade panels) **From top to bottom and counterclockwise:** A given façade envelope is panelized. Modeling data retrieves information from the building system and the production environment (as data) to adjust the design as necessary. The loop stops when design needs, fabrication parameters and construction constraints are satisfied.

With this in mind, to propose i.e. a façade skin, a design must consider material formats and properties ¹²⁹, mounting and handling processes (handling granite sheets is not the same as dealing with aluminum sheets); which are all related to production stages.

In that order, panelizing a façade stops being just a matter of form-searching for the sake of form searching but a matter of form-searching in function of a series of physical and operational constraints that must be respected unless the design in question is privileged with unlimited resources, which is not always the case.

Mass customization cannot be managed the same way as mass-production insofar as each fabrication program is unique (Scheurer, 2010) thus schedules and material takeoffs are too. In sight of such condition, design teams must be aware that mass-producing components for architecture and engineering cannot be seen with the same perspective as when working with serial production, which supposes a change of mind not a lot of people in practice and education is willing to engage in -even if they think they do- (Figure 128).

3.5.2. PRODUCTION ENVIRONMENT CAPABILITIES

As seen in sections 2.2.3, 3.2.2 and 3.3; there are manifold CNC machine and robotic environments driven by an equally large number of digital applications fed by a no smaller amount of CAD programs (generative and non-generative). Such

¹²⁹ Hardness, weight, rough formats, malleability, workability, storage conditions, moisture sensitivity (for wood) etc.

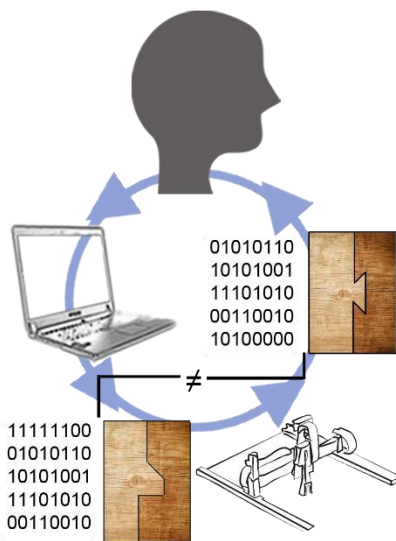

Figure 129. In parametric-generative design processes applied to wood construction, joinery can be customized out of the traditional standards. Customized joinery (as data) is not always possible to achieve through predefined CAM machining routines or predefined CNC tool settings. Intended joint-making methods might be altered in function of the machining environment's specificities. **From top to bottom, counterclockwise.** A joint design developed for a specific purpose passes through a CAD/CAM environment and then validated against the machining environment. If design data does not match the machining environment capabilities, it might need re-parameterization as to render its making possible.

plurality calls for standards (file formats) to translate and match the data emerging from such manifold sources. However, it does not end there. Inasmuch as there are as many CNC machines and routines as industrial applications exist and to this extent, an equal number of fabrication methods.

Early non-standard design stages need to acknowledge the production means intended for a specific project. Such acknowledgement demands for knowing the size and capabilities of the machines to deal with if the design team is to engage in tackling fabrication by its own¹³⁰.

Generative design has the capacity of taking into account such constraints so building components can be adjusted to match a given fabrication scenario. Back to the façade skin case, a paneling or tessellation operation will have to take into account the size of rough pieces accepted by an “X” machine, which means finished parts might be smaller, but size is not the sole constraint to be aware of.

Displacement freedom (2,3 or more displacement axes) and machining tools (mill-ends) to be used are also important in the feedback towards design, which is a case often found in wood construction as matter-transformation processes are mainly subtractive¹³¹.

An example of it is wood joinery, especially if one tries to assemble members the old way, that is

¹³⁰ Though designers might not be directly involved in fabrication, being aware of what tools to count on might save time and money in translating design into workable data.

¹³¹ For laser-cutting, material thickness is the main constraint inasmuch as laser-beams need to be powerful enough to cut thick pieces.

to say, by using friction joints. Wood joint-making requires complex machining and hand-made operations also requiring a wide set of tools. CNC machining centers, for instance, are conceived for minimizing workshop sizes by simplifying the number of tools and machines used in woodworking processes. When such facilities are available, the feedback towards digital conception consists of knowing what joinery operation the machining center and its CAM interface are able to understand, depending also on the scale of objects to be machined i.e. gross structural members or small façade panels and/or sidings (Figure 129) (Comment 29).

The following examples show some of the possible situations that might arise under the referenced context:

- a) *The chosen equipment is not capable of making the joinery the design proposes: Designers might need to be in capacity of proposing a set of assemblies fitting within the tolerance and operation ranges supported by the machine.*
- b) *Items to be machined have sizes not supported by the chosen equipment: Solutions might depend on the nature of the elements to process. Be it structural members (dimension lumber beams and the like), finding somewhere else to perform the whole operation is probably the right thing to do. In the case of façade and partition components, CAD models can be adjusted to a given set of production constraints; a task that might be easier to achieve when working with parametric-generative CAD solutions.*

Comment 29. Design adjustment through fabrication feedback.

Thus far, the described scenarios do not illustrate a comprehensive list of situations leading to changes in design due to fabrication constraints. However, the idea here is to show that in a situation like such, designers should either look for a machine to make things such as they are (it might become impractical but possible nonetheless) or adapt their propositions to whichever available production environment they might find. What must be taken for sure is that modifications will be due at some stage and design must be aware of it¹³².

3.5.3. WHEN MATERIALS AND KNOW-HOW TRY TO SPEAK.

Knowledge and materiality (which is different from matter itself) are also important factors to consider as feedback parameters facing design-to-production loops.

¹³²Considering that modeling properties must be kept, it is in situations like these when parametric-generative design allows to apply the necessary modifications and assess the resulting outcome faster than BIM modeling and way much faster than non-iterative CAD tools.

Most of times a good advice avoids for wasting hours of hard work, consulting people who is used to deal with CAM environments and production facilities is one of the more practical ways of getting through fabrication without taking major risks and making newcomer mistakes. It must not be forgotten that almost any known industrial process had a pre-industrial handcrafted form, even if industrial machines were already there.

This happens to be the case of milling machines and lathes before they became numerically controlled. The operator (craftsman) usually had a lot of knowledge in dealing with different materials so that getting to know which tools to use on each one is a know-how acquired through time and experience insofar as machining settings cannot be equally used in different materials. Even though there is advanced research on the topic (Keating and Oxman, 2013a, p. 258), machines cannot yet emulate human reasoning in receiving feedback from materials (Dickey et al., 2014; Sharif, 2015) (Figure 130).



Figure 130. For a robot to perform clay molding the way humans do, it would need a complex end effector plus also a set of complex sensors to emulate the way human hands behave on and react to matter as it progressively changes. Perhaps that is still the long way to go and one of the most interesting research topics in the field.

Whereas advice and fine material comprehension are not parameters that can be added as such, activities revolving around the concepts they integrate (which happen to be abstract) need to be incorporated into design by using the capabilities parametric-generative modelers offer. This notion might be a bit opposite to how BIM modelers work despite the large set of material properties they concatenate, insofar as they do not consider such dimension (material comprehension) as a materialization input.

3.6. CLOSING THE LOOP.

Throughout chapter three a state on the way robots, CNC machines and modeling software are used in architectural practice and research, showed how design professions took over serial-production-intended machinery as means for replacing mass-production with mass customization as part of an architectural thinking and technological shift as claimed by no-few avant-garde architects, historians and philosophers.

A shift that required architectural practice and education to integrate a set of technologies, other than just computing, to the discipline's tool set as means of innovation, succeeded through exploration and challenge. Exploration has been made by using tools formerly conceived for practices alien to architecture, whereas challenge is been tackled by proving that using such tools could actually embody a research field in which professional and educational approaches would find a way to achieve architectural form not through sketching, but through non-standard production-based form-searching.

The integration of advanced modeling techniques, founded on deep computing and mathematic languages along with the appropriation of automated machinery for mass-customized production, is what has allowed design professions to plastically and conceptually challenge themselves as well as to challenge engineering towards novel non-absolute and non-formulistic methods for building materialization.

That is the reason why, nowadays, architectural knowledge is fed by topics that formerly concerned industrial production only. Architects and engineers need now to be aware, perhaps more than ever, about succeeding design-to-construction workflows by acknowledging all the technological intricacies they embody, and merge them into design as parameters and/or constraints.

In order to make clear how and what such materialization parameters and constraints are, the chapter made a state on fabrication and translation resources, which ought to be considered as important in a contemporary architectural conception workflow, inasmuch as the paper-driven architectural age is about to come to an end and designers will need to play a double role: Designer and maker. After all, and as Burry (2002) points out by citing John Ruskin's text:

“[...] we want one man to be always thinking, and another to be always working, and we call one a gentleman, and the other an operative; whereas the workman ought often to be thinking, and the thinker often to be working [...]”

As the myth of automatic push-the-button production has been discredited, the topics discussed so far show that the architect might not be sitting in his little command center at all while things are getting done, but taking care of cutting and assembling processes carefully studied and planned in digitally-driven design endeavors. It is possible that in future time, when the architect or the engineer leaves the work site, “robots” will be, at least, pre-assembling and casting walls, welding and mounting structures or installing finishes and windows .

However, a word of caution is necessary. Human labor force cannot be replaced from construction even if machines take over dangerous and specialized tasks. Today’s human functions in construction works might well evolve towards the role of highly trained technicians charged of monitoring machines and feeding them with the material they need to work as shown in Khoshnevis’s Contour Crafting or in Ercan’s Mobile Robot Tiling (Ercan, 2015; Zhang and Khoshnevis, 2013). A more practical outlook would suggest that even by automating production processes through robots and CNC multi-axis machines, the workflow will be divided into two basic stages: a) prefabrication tasks, in which automated machines are in charge of cutting, finishing and re-assembling and b) human-driven installation tasks, in which humans are charged of helping putting in place mass-customized components produced through aided-manufacturing¹³³.

¹³³ Please refer to “Interaction of Analogic and Digital Workflows for Architectural Design and Production” (Gámez et al., 2015b). The paper discusses the way human-performed construction tasks are the start point for creating automated fabrication and construction routines based on the non-standard approach.

***PART 2. NON-STANDARD TIMBER
CONSTRUCTION AND PROPOSITION OF
AN A.C.P.T.***

Chapter 4. WOOD CONSTRUCTION: MATERIALS, BUILDING SYSTEMS AND JOINTING METHODS.

Precedent chapters have dealt with manifold concepts applied to architecture and construction with recurrent references to materials such as concrete, wood, steel and titanium, among several others, as applied for prototyping and full-scale manufacturing. As the discussion evolves throughout this document, the reader may have noticed that wood, as building material, is present in all scales of architectural practice and research.

A look back to any architect's background will probably tell that such architect was once confronted to making a model and, that probably not only one model but several models were made using timber, even if such timber was in the form of thin sheets or sticks. Nowadays much of architectural research and teaching uses timber as matter for experimenting, which is the reason why it remains on being on the scope of contemporary architectural practice as a flexible material whose workability seems to be at hand at all times, perhaps more than with other materials like concrete or steel.

Wood construction is oftentimes related to building tradition, culture, and natural resources but also to sustainability. In contexts like the north American or the western and northern European ones¹³⁴, timber construction is been culturally ever present insofar as the resource is plenteous and countries, through the years, have developed quite numerous programs to ensure resource renewability and preservation. However, and because of the intensive use of timber in construction and other industrial activities tall trees, therefore big lumber lengths and cross-sections are either rare or not available anymore (Bignon, 1984), which has given way to the development of alternatives aimed to a minimum waste in lumber industrial processes. The basic information contained in this chapter will allow showing how wood, as material, serves in architectural and engineering practice and research as a "matter" that specially furthers to embody architectural expression.

¹³⁴ Not exclusively. It must not be forgotten that Asian countries like China or Japan have a rich timber construction tradition and an even much richer know-how in joint-making.

4.1. WOOD AS IT IS.

By definition, wood is the hard and solid matter that constitutes the roots, bole and branches of a tree (Guitard and Polge, 1987), being the log the usable part of it. Wood, as matter, is composed by a complex arrangement of cellular structures containing lignin, cellulose, and extraneous materials. The chemistry existing in cells themselves along with the aforementioned organic elements is what makes a living being out of the tree (Wiemann, 2010). They all serve as to ensure the tree's life and, to that extent, any property wood may have due to its organic and chemical structures (such as smell, color, hardness, acidity) have no other purpose than ensuring the life and stability of the living tree (Wiedenhoeft, 2010).

Trees, as natural stabilizers, stock big amounts of liquid in the form of water and nutrients (sap) which is the reason why wood matter is highly hygroscopic. For wood to become a material as used in construction, it needs to be dried and its cells freed of any liquids, making the process of drying wood a delicate one in which the tree, transformed into a log and later into lumber, needs an appropriate atmosphere to dry and not to get invaded by plagues that would potentially harm it and ruin its properties (Table 4).

Table 4. Basic composition of anhydrous wood. As adapted from (Guitard and Polge, 1987).

Element	%	S
Carbon	50,0%	C
Oxygen	43,0%	O
Hydrogen	6,0%	H
Nitrogen	1,0%	N
Note	From the total composition, there might be a presence of minerals, as ashes, of about 1 to 3 %	

As building material, the most important asset wood has to offer is its in-dry-state low density (Vercey and Bignon, 1998), which makes it relatively light compared to other materials such as

steel or concrete¹³⁵, though not all woods have the same density¹³⁶. Another positive asset wood possesses is its low thermal conductivity (k) measured along the grain¹³⁷, which is 2083 times smaller than in aluminum and 450 times smaller than in carbon steel (Green et al., 2012). Conversely, its main weaknesses lie on its low resistance to fire and to humidity in a higher degree. Whereas a softwood beam exposed to fire creates a char layer at a linear rate of 1.24 mm/min, forming a natural layer that protects and prevents the core of the beam from collapsing¹³⁸ (White and Dietenberger, 2010). Conversely, humidity can -in time- deteriorate lumber fibers and allow for fungi and insects to increase the decay rate of a structural member.

4.2. WOOD AVAILABILITY, EXPLOITATION AND SUSTAINABILITY.

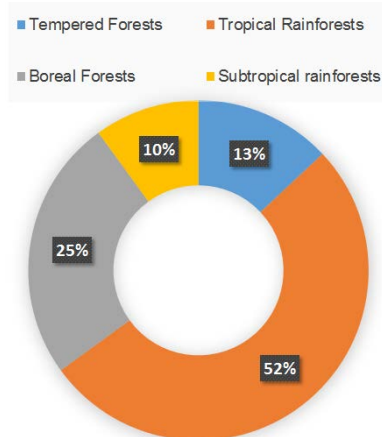

Figure 131. Forest distribution in the world, as adapted from (Guinard, 2009)

Forests, spread across the world, occupy only 30% of the emerged lands and, as for 2009, the distribution of forests around the world was mainly concentrated in tropical areas (52%) - Figure 131. However, countries enforcing laws and programs for the use of wood as renewable resource are mainly located in tempered regions of the planet and such group is mostly composed by highly industrialized nations, therefore the forest percentage those nations can get to manage corresponds to a 13% of all forests in the planet (Guinard, 2009); that 13% is

¹³⁵ Steel density range varies from 7850 kg/m³ up to 8050 kg/m³.

¹³⁶ Whereas *Ceiba Pentandra* (Ceiba tree) has a density of 320 kg/m³, *Manikara Bidentata* (Bulletwood) has a density of 1060 kg/m³

¹³⁷ As measured in white pine.

¹³⁸ Under fire conditions, wood remains stable for as long as the char layer remains intact; in which case, increasing temperature will not rapidly affect its mechanical properties.

constantly exploited and renewed making wood industry in regions such as northern and western Europe, North America, China and Southern South America an active pole in producing most of the wood those regions consume and export in a sustainable way (Falk, 2010).

Despite the good numbers the northern hemisphere has (and part of the southern), wood exploitation has a negative impact in other regions of the world. In tropical rainforest areas deforestation is a phenomenon that has increasingly taken some species such as *Swietenia Macrophylla* (Broad Leaf Mahogany) to a risk of extinction (SINCHI, 2006). Such trees have become very vulnerable (IUCN, 1998a) because of the properties of their wood (The Economist, 2009) which had led several species to be overexploited without any government hardly doing anything to avoid so.

An article on the Mogabay website states that tropical rainforests are being reduced at a rate of 32.374 ha per day with an exponential loss of wildlife as well as other plant species and, most of all, water.

A major impact is seen in the Amazon region in which Brazil occupies rank #1 in deforestation charts, accompanied by Perú and Colombia, which makes the perspectives for the Amazon River basin far from being hopeful.

Please refer to Appendix 3 to compare the amount of world forest loss against forest gain over a 14 year period.

Comment 30. Deforestation in numbers. (Butler, 2012)

Exotic or high quality woods like the aforementioned mahogany, usually undergo wood smuggling (towards countries in which certain wood species do not exist) (Greenpeace, 2004), clearing for cropping and illegal exploitation in an uncontrolled manner that is not only breaking the balance of forests themselves but that of entire ecosystems too, as natural habitats are being destroyed every year for obtaining low-cost high-quality woods. Add corruption to the recipe and you have it perfectly cooked.

Rainforest deforestation is critical in many parts of Central and South America as well as in

southeast Asia and Africa. As the trend shows (Comment 30), areas of the world, rich in hydric resources, are being dried for wood overexploitation, cropping and mining. In sight of these facts the whole wood industry's claimed sustainability might be put in question, not without forgetting that the most wood is processed the more energy and chemicals it demands, therefore the lesser the carbon storage is. Just something to think about¹³⁹ (Comment 31).

By 2022, 26 billion T^m of CO₂ is sequestered within standing trees, forest litter and, wood debris.

Forests reduce human carbon emissions through photosynthesis and carbon remains stored in wood for as long the latter does not undergo processing, burning or decay.

Therefore, solid lumber produces less carbon emissions than composite lumber as the latter undergoes physical and chemical processes for its manufacturing.

Deforestation in tropical areas of the world is responsible of about 20% of total human-produced CO₂ per year.

In sustainable approaches the carbon footprint of wood construction is claimed to be zero. However, when lumber needs to be over-transported for processing until it reaches final destination all gathered grey energy, as generated through the production-and-transportation chain, might well turn the balance into negative.

Comment 31. Wood industry environmental facts as adapted from: (Falk, 2010; Greenpeace, 2004; Guinard, 2009).

4.3. HARDWOODS, SOFTWOODS AND WOOD ANATOMY.

An essential taxonomy of the way wood is found in nature divides it into two broad classes. Hardwoods and Softwoods (Figure 132).

The term "Hardwood" represents those trees whose biological properties allow them to classify them as angiosperms, namely flowering trees (Wiedenhoeft, 2010). Hardwoods are characterized for being broad leaf deciduous trees possessing a complex cellular structure formed by vessels or pores that transport nutrients along the tree (Triboulot, 2015).

Conversely, the word "Softwood" is used to catalogue trees scientifically known as conifer gymnosperms that possess a simpler cellular structure and are mostly found in tempered areas in which they progressively replace gymnosperm trees

¹³⁹ This kind of fact is not exclusively a responsibility of wood industry. In general, all human activities have a harming impact on environment, being the construction industry one of the most polluting activities the human being performs.

as latitude and altitude¹⁴⁰ increase (Guitard and Polge, 1987, p. 19).

It must be noticed that not all softwoods are soft, neither all hardwoods are hard. Hardness and/or softness is inherent to specific tree families and species so they can be used for different purposes that vary from product manufacturing to the construction industry, however, timber building mostly uses softwoods like fir for producing structural members (Vercey and Bignon, 1998).

Table 5 makes an approach towards the properties of hardwoods and softwoods by describing a sample of both, which has been considered important and wide enough as to understand their basic features.

Even though the table does not make a description of the pine genus because of the many species catalogued under such label (Vercey and Bignon, 1998), a general taxonomy considering the variations in density, hardness, stiffness, strength, grain, decay and insect resistance pines possess, is possible nonetheless. According to Meier (2016) two broad pine classes, soft pines and hard pines, can be grouped in function of the aforementioned characteristics (Comment 32).



Figure 132. Left. An angiosperm or Hardwood tree. Right. A gymnosperm or Softwood tree.

Soft pines such as *Pinus lambertiana*, *Pinus monticola* and *Pinus strobus* possess densities ranging from 400 to 450 kg/m³.

Conversely, hard pines (whose taxonomy happens to be wider) have densities ranging from 450 up to 673 kg/m³, being the densier ones *Pinus taeda*, *Pinus echinata*, *Pinus elliottii* and *Pinus palustris*.

Comment 32. Soft pines and hard pines.

Table 5. Hardwoods and softwoods as adapted from (Bignon, 1984; Guitard and Polge, 1987; IUCN, 1998b;

¹⁴⁰ In some tropical regions, softwoods can be found at altitudes over 1470 meters at average annual temperatures oscillating between 10°C and 24°C (Rojas, 2009).

Meier, 2016; SINCHI, 2006; Vercey and Bignon, 1998; Wiemann, 2010)

HARDWOODS				
Species	Scientific Name	Properties	Uses	Location
Mahogany (true Mahogany)	<i>Swietenia macrophylla</i>	<i>Dimensionally stable. Fine grain, pink to reddish brown color. Resistant to fungi and less resistant to insects. Dry state density: 480 to 833 kg/m³</i>	<i>Furniture, interior woodworking, boats, musical instruments, paneling.</i>	<i>Central and South America, Africa.</i>
Oak, European oak, white oak.	<i>Quercus, Quercus robur, Quercus alba [...]</i>	<i>Coarse irregular or interlocked grain. Very durable. Color varies from medium brown to reddish. Dry state density: 704 to 993 kg/ m³</i>	<i>Decoration, boat building, furniture, interior woodworking,</i>	<i>Numerous subspecies present almost worldwide. Strongly present all over the American continent and Europe.</i>
American beech, European beech	<i>Fagus grandifolia, Fagus sylvatica</i>	<i>Pale cream color, straight grain, and medium to fine texture. Perishable and vulnerable to insects. Heavy, hard and strong wood. Dry state density: 710 to 720 kg/ m³</i>	<i>Interior woodworking, framing (weather protected),</i>	<i>1, Eastern North America. 2, Europe</i>
Rosewood	<i>Dalbergia nigra, Aniba rosaeodora</i>	<i>Red to violet darkish color. Coarse texture, straight grain. Hard and heavy wood. Highly durable, resistant to fungi and insects. Dry state density: 752 to 897 kg/ m³</i>	<i>Furniture, veneer, oil extraction, musical instruments.</i>	<i>South America and India</i>
Sycamore	<i>Platanus occidentalis</i>	<i>Reddish brown color. Fine texture, interlocked grain. Stiffness, hardness, heaviness and strength are moderate. Perishable and vulnerable to insect attack. Dry state density: 545 kg/ m³</i>	<i>Lumber, veneer, fencing, furniture.</i>	<i>North America</i>
European Sycamore	<i>Acer pseudoplatanus</i>	<i>Color varies from white to reddish brown. Straight wavy grain. Perishable and vulnerable to insect attack. Dry state density: 615 kg/ m³</i>	<i>Lumber, veneer, fencing, furniture, musical instruments.</i>	<i>Europe, southwestern Asia</i>
Teak	<i>Tectona grandis</i>	<i>Color varies from yellow to dark-golden brown. Oily, straight grain, occasionally wavy or interlocked. Highly resistant to decay and insect attack. Dry state density: 655 kg/ m³</i>	<i>Furniture, exterior flooring, framing, boatbuilding, exterior construction.</i>	<i>India, southeast Asia, Latin America and Africa</i>

Sweet Chestnut, American Chestnut	1, <i>Castanea sativa</i> . 2, <i>Castanea dentata</i>	Color goes from light-greyish brown to brown. Straight to spiral coarse grain, very shrinkable. Moderate weight and hardness. Moderately low strength and stiffness. Dry state density: 480 - 590 kg/ m ³	Reclaimed lumber (Comment 33) , rustic furniture, paneling, interior woodworking, veneer, carvings.	1, Europe and Asia Minor. 2, North America
SOFTWOODS¹⁴¹				
European spruce, Eastern Spruce	1 <i>Picea abies</i> , 2(<i>Picea rubens</i> <i>Picea glauca</i> , <i>Picea mariana</i>)	Light color (pinkish or pale), moderate shrinkage, hard and moderately strong. Some species possess high strength. Dry state density: 405 to 450 kg/ m ³	Pulpwood, framing, lumber, ancient aircraft construction, furniture, doors, windows, flooring, veneer.	1, Northern and central Europe, 2, North America.
Cottonwood, Yellow poplar	1, <i>Populus</i> genus. 2, <i>Liriodendrontulipifera</i>	Light color (greyish to white), low strength against bending and compression, moderately soft, high shrinkage, fuzzy surface, difficult to work. Dry state density: 385 to 455 kg/ m ³	Veneer, cases, boxes, pulpwood, lumber.	North America. 2, Western Europe, Asia.
Douglas Fir	<i>Pseudotsuga menziesii</i>	Color goes from Reddish to yellowish brown. Medium to coarse texture, straight or wavy grain. Moderately durable, not entirely immune to insect attack. Dry state density: avg 510 kg/ m ³	Veneer, plywood, framing, construction lumber	North America
Fir	<i>Abies</i> (genus)	Color range goes from creamy white to pale gray. Lightweight, low bending and compression resistance, soft-to-low stiffness, low-to-moderate shrinkage. Dry state density: avg 410 kg/ m ³	Pulpwood, lumber, framing, siding, interior woodworking, construction.	Europe, western and eastern North America
Larch (American & European)	1, <i>Larix occidentalis</i> . 2, <i>Larix decidua</i>	Yellow to reddish-brown color. Straight or spiraled grain. Stiff, moderately strong, hard and heavy. Shrinkable (high-moderate). Dry state density: 575 kg/ m ³	Veneer, pulpwood, lumber, construction, framing, flooring, fencing, boatbuilding. Properties similar to Douglas-fir.	1, North America, Central Europe.

Getting to know what wood offers in terms of hardness, shrinkage, grain anatomy and direction as well as workability adds a dimension that can be considered as a set of parameters for conception and digital fabrication. Even though the aim of this

¹⁴¹ Please notice that wood-fiber insulation manufacturers mostly use softwood waste for producing roof, wall, and floor insulation products. Conversely, products such as wood wool panels are obtained from hardwoods like fir. (CELENIT SPA, 2015; Pavatex S.A, 2016)

thesis is not getting to know all the properties wood as material may have, inasmuch as every wood has different workability and use properties, aforementioned aspects might help decide if a set of workpieces are to be joined by friction or by using mechanical fasteners. Not all woods (oak and beech), for instance, are easy to nail, therefore it is preferable to join pieces through carved joints rather than with metallic fasteners. In some cases, the situation can be the opposite.

Inasmuch as material feedback is important in design and wood is not exempt from such fact, any properties being worth of consideration in global or detailed design need to be introduced as parameters at some stage of the design-to-production chain. On a larger scale, a given wood type may help define the characteristics of a given structure and, on smaller scales, such properties are decisive in defining, assembling, machining even mounting processes since all woods do not equally respond to such constraints.

(1)As for American chestnut, the species was almost wiped out from the north-American territory because of a blight back in the early 1910s. As trunk diameters up to 2.0 meters have become rare, American chestnut lumber is often found in old barns, reprocessed, and sold as reclaimed lumber.

(2) Reclaiming is one of the main assets wood, as material, possesses, as it allows recycling healthy structural members for new structures thus reducing impact on forest consumption.

Comment 33. (1)Scarceness of american chestnut because of the blight of the 1910s. (2) Reclaiming as positive asset in the wood construction industry.

4.3.1. WOOD ANATOMY

The tree, as the living body it is, is divided into two main parts. The roots and the shoot (Figure 133).

Roots are responsible for anchoring the tree and they grow as the tree does to ensure the tree's stability as well as the absorption of nutrients from soil. On the other hand, the shoot is composed by the trunk, branches and leaves of the tree. The shoot is the part of the tree used for industrial use as the trunk delivers sawn wood and the branches deliver particles for making derivatives.

As for this discussion, the bole (trunk) as part from which logs are derived and sawn, is the one under analysis.

The bole ensures not only the tree's stability but its biological functions as well. Two main regions are transversally identified in a tree's trunk: Sapwood and heartwood (Triboulot, 2015; Wiedenhoef, 2010).

By performing a transversal section of a tree (Figure 134), it will be found that sapwood is the lighter, actually alive, portion adjacent to the bark which is responsible of transporting and synthetizing sap, biochemicals and water, lengthwise and widthwise the tree. On the other hand, heartwood is the part of the tree that is actually composed by dead wood. Its main function is to keep the tree standing as it is the hardest wood a tree possesses. Heartwood is commonly darker than sapwood.

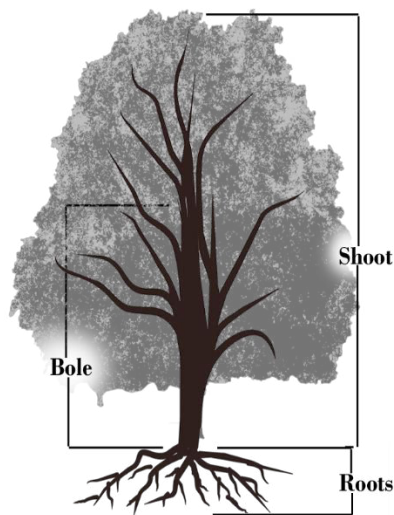

Figure 133. Sketch of a tree. Roots, shoot and bole.

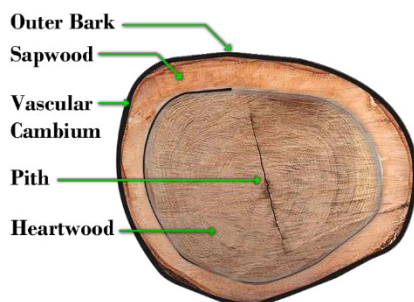

Figure 134. Transverse section of a tree trunk as adapted from (Guitard and Polge, 1987; Triboulot, 2015)

Such differentiation leads to identify two main structures acting in the tree: An axial and a radial structure. The axial structure (lengthwise) is responsible for providing mechanical strength to the tree whereas the radial system, which is oriented from pith to bark, provides for lateral transport of biochemicals as well as it performs the storage function of the tree. In other words, the axial system is mainly embodied by heartwood while the radial system is mainly composed by sapwood (Guitard and Polge, 1987; Wiedenhoef, 2010, pp. 3–3).

Moreover, there are the external layers of the tree, extended from roots to branches that protect sapwood and heartwood; such layers are the outer

bark, the inner bark and the vascular cambium. They are all responsible for protecting the tree, transporting sap and biochemicals as well as allowing the tree to grow.

The outer bark is the dry portion of the tree's skin that mechanically protects the inner bark from the surrounding environment as well as it prevents water from evaporating. The inner bark's role is to transport and stock sugars and sap produced from photosynthesis, along the tree down to the roots as it also protects the vascular cambium, which is simultaneously responsible for the tree's growth and adding growth rings to the tree as sapwood and heartwood gradually grow (Figure 135) (Guitard and Polge, 1987; Triboulot, 2015; Wiedenhoef, 2010).

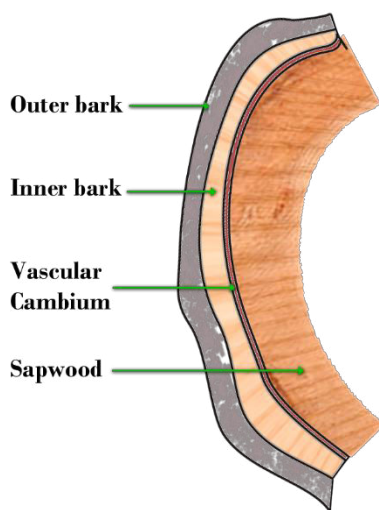

Figure 135. Detailed view of the tree's external layers.

4.4. WOOD AS PRODUCT.

Commercially, wood products are known under two basic categories: Dimensional lumber and wood-based composite materials.

For the construction industry, the concept of dimensional lumber covers all the pieces obtained from sawn logs such as studs, beams, planks, boards, joists, siding and paneling, plates, posts and rafters. In standardized wood construction and, more specifically in wood-frame construction, such products provide pre-dimensioned elements that satisfy most building needs (Figure 136).

Lumber sizes have dramatically decreased through more than a century. Logs have passed from having sections of about 150 to 450 mm and lengths of about 20 meters to have, in last decades,



Figure 136. Dimension lumber as obtained from sawn logs. On: thedesignconfidential.com

sections ranging between 80 and 240 mm and lengths up to 5 meters, which makes big-sized lumber elements difficult to obtain in one solid piece. Such fact might be due to non-regulated exploitation as well as shorter harvest periods, which have given way to the development of fast-growing clones intended for higher productivity in detriment of quality (Vercey and Bignon, 1998).

Within such context, wood-based composites emerge as to compensate the dimensional deficiencies natural to lumber and as a means to make use of what can be considered as defective or waste lumber. Composites are made either of veneer or wood particles which at the same time are graded according to their size and physical properties. Three main categories are then identified: Structural Composite Lumber (SCL), Composite timbers - Glulam timber (Glulam) and Cross Laminated Timber (CLT)-, and Composite panels (boards).

4.4.1. STRUCTURAL COMPOSITE LUMBER

It refers to a range of products engineered and manufactured to improve the quality and physical properties of lumber. It is characterized for assembling small lumber pieces as to obtain the sizes already common in solid-sawn lumber so that SCL components can easily replace dimension lumber members and vice versa (Comment 34) .

SCL can be obtained from veneer or stranded lumber and its properties depend on the way veneers and/or strands are bonded together. Four main products are classed in this category: Laminated Veneer Lumber (LVL), Parallel Strand Lumber (PSL), Laminated Strand Lumber (LSL) and oriented Strand Lumber (OSL).

Comment 34. SCL products.

These products possess, in general, a good structural performance which is given by the fact of using structural adhesives that help in diminishing potential strength losses. At the same time, such



Figure 137. From **top** to **bottom**. LVL, PSL and LSL wood composites. On: woodhavenlumber.com & materia.nl.



Figure 138. **Top**. Glulam beams. Vincent Van Gogh High School by Cartignies-Canonica architects, 2006, Blénod-lès-Pont-à-Mousson – France. **Bottom**. A CLT panel.

losses are also dispersed along the veneer and strand material so that larger spans and lesser dimensional changes can be achieved by using SCL products (Stark et al., 2010, pp. 11–20) (Figure 137).

4.4.2. GLULAM AND CROSS LAMINATED TIMBER (CLT)

Glulam and CLT composites are both softwood-derived products used to replace solid-sawn lumber in two basic scenarios: Glulam does it to create long-span structural members and CLT does it to replace framed walls, as used for façade and partition applications, with solid timber panels. Moreover, CLT panels are also suitable for building plates and roofs.

Glulam is obtained through bonding end-to-end finger joined timber layers (up to 50 mm thick) as to constitute a structural member whose dimensions are usually limited by transport, mounting, and manufacturing-facility constraints. Glulam structural elements can attain lengths (span) of about 100 meters and heights up to 2 meters (Vercey and Bignon, 1998) (Figure 138). As glulam is mostly used for making long-span beams, such elements are oftentimes curved to increase their span-support properties and, to this extent, the sharper the curvature radius of a structural member is, the thinner the timber layers are –about 19 mm- (Stark et al., 2010).

CLT, also known as Mass Timber (Green et al., 2012), consists of panels made by perpendicularly bonding timber layers in odd numbers (as in

plywood) that allow for manufacturing big-sized elements in a single piece (Figure 138 & Figure 155). Such feature is possible by the fact that CLT panels are available in widths of up to 3.0 meters and lengths of up to 16.50 meter, with thicknesses ranging from 60 mm to 500 mm (Stein and Storti, 2006).

4.4.3. COMPOSITE PANELS

Following a similar principle to that of SCL, composite panels also make use of different wood derivatives such as veneer, strands, particles and fibers as to obtain several panel types and grades defining a manifold set of properties that can be aimed towards specific uses. Average standard panel sizes are 2.44 (h) meters by 1.22 (w) meters, and thicknesses range from 4 mm to 40 mm (Stein and Storti, 2006), though industrial sizes can be up to 2.44 meters wide and 7.32 meters, as it is the case of OSB panels (Structural Board Association, 2005)¹⁴².

According to this description, three main composite panel categories can be identified: plywood, coarse and fine particle boards, and fiber boards, though alternative materials have been progressively introduced as to widen not only the offer but the range of available sustainable materials (Comment 35).

Plywood, conversely to CLT, uses sheets of veneer (from hardwoods and softwoods) as prime material (Stark et al., 2010). Each veneer layer is

Since the 1990s, alternative products akin to wood-derived ones have come to the industry's attention.

Bamboo variations such as Guadua Angustifolia Kunth offer the possibility of manufacturing panels that offer lower or equal charring rates than plywood as well as they offer moisture resistance rates. Applications of Guadua panels are similar to those of plywood including finishes (like floors) and/or sheathing panels offering a finished layer.

To this extent, the Bamboo genus is suitable for structural use in its raw state as beams and columns (reinforced with concrete) or as BLVL in which case bamboo is veneered to produce long-span structural members. Bamboo species are claimed to grow faster than wood and to store more CO₂ than wood (40 times more per square meter per year than pine trees

Comment 35. Bamboo composites. BLVL and panels for structural and decorative use. (Anwar et al., 2004; Chen et al., 2016; Mena et al., 2012; Nurhazwani et al., 2015; Vercey and Bignon, 1998)

¹⁴² American and UK width and length standards. European standard dimensions range from 1200 mm to 2500 mm width, and 2500 mm to 5000 mm length. As for plywood, length and with standards range from 1200 mm to 1500 mm and 2500 mm to 3100 mm respectively. (Benoit and Paradis, 2009)

cross-bonded to each other and any plywood panel is made of an odd number of crossed layers. Internally, each layer is made by two or more plies, which are not crossed but parallel to each other.

Since plywood can be used for different applications that range from interior to exterior use, and raw to finished appearance; two plywood standards are the identified: a) Construction (Figure 139) and industrial and, b) hardwood and decorative (Stark et al., 2010).



Figure 139. **Top.** Plywood used as structural material for the Solar Energy House project (see section 5.5). **Middle.** Moisture-resistant particle board used as roof sheathing at the wood challenges 2015. **Bottom.** OSB panels used as wall sheathing at the wood challenges 2016. Photos O.G.

Coarse Particle Boards follow the same production principle of OSB in which lumber strands are sliced lengthwise, glued and heat-compressed to obtain a rigid lumber member that, for this case, is a panel composed by coarser strand particles at the core layer and fine particles on the outer layers to give both rigidity and a soft finish. Commonly known as Oriented Strand Boards (OSB), particle boards are often used flooring, as well as for roof and wall sheathing in wood-frame construction (Figure 139) and have become one of the most used materials in such along with plywood (Structural Board Association, 2005). **Fine particle boards** are the kind of panels made of smaller lumber particles which are consolidated and pressed as to form dense boards that can be used for wall and roof sheathing (Figure 139) as well as for furniture and other akin applications (cabinets, drawers etc.)

Fiberboards, usually classed as non-structural panels, are mainly composed by wood-fiber packets obtained through mechanical fiber separation,

blended and compacted by making use of synthetic resins as well as lignin itself. (Guitard and Polge, 1987; Vercey and Bignon, 1998).

As densities and fiber bounding vary depending on the use these panels may have, they are classed in three groups: Hardboard –High Density- (HDF), Medium Density (MDF) and Cellulosic fiberboards (Stark et al., 2010).

HDF and MDF panels can be used to replace plywood in several applications to produce items such as furniture (mainly cabinets), doors, drawers, and desks among several others. Using HDF or MDF essentially depends on whether or not the object to be manufactured is going to be exposed to moisture, as well as on the mechanical exigencies it will have to undergo (Figure 140).

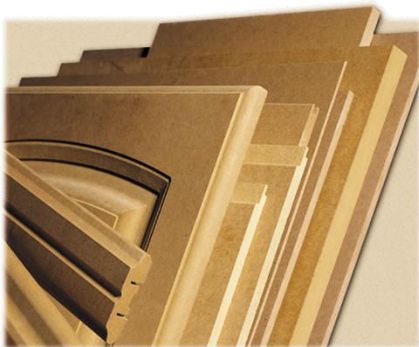

Figure 140. **Top.** MDF as used in door manufacturing. On: <http://bucina-ddd.sk>. **Bottom.** HDF as used in laminate flooring. Photo O.G

Because of their lower density (≤ 400 kg/m³), cellulosic fiberboards are often used in wall and sound insulation or as wood-framing sheathing, even when framing is intended for structural use. Mixed with plaster, low-density fiber boards can be used as non-structural finished sheathing (Benoit and Paradis, 2009; Stein and Storti, 2006).

4.5. WOOD-BASED BUILDING SYSTEMS.

The previously mentioned products and forms in which wood is transformed to be used in construction, allow for creating manifold building possibilities which are regulated by local organisms depending on the country such products are used. Nonetheless, all of the aforementioned products use industry standards so that their use is





homologated in most countries where wood is a current construction material.

Due to the many ways in which wood is available, there exist several construction systems using most or part of the items described in sections 4.4.1, 4.4.2 and 4.4.3. Considering that construction practices are never the same around the world and construction codes are not equally strict either, this section focuses on the most used wood structural systems as used in France, Canada and the U.S, by making an overview of their main features as well as the human activities in which they participate from.

For that purpose, Table 6 shows a group of seven building systems that make use of most of lumber and lumber-derived products described herein.

Table 6. Most used wood-based construction systems, as adapted from (American Forest & Paper Association, 2003; Benoit and Paradis, 2009; C.R.I.T., 2013; Denancé et al., 2000; Green et al., 2012; Sherwood and Stroh, 1989; Stein and Storti, 2006; Wacker, 2010)

	Name	Description	Used for...	Sample
Light-Frame Construction	Balloon Framing	<i>Light-frame system, Full height structural members, It is said to be a current structural practice until up before the 20th century. Exterior and interior walls have a bearing function, though exterior framing is continuous up to the roof. The system is mainly composed by dimension lumber in the shape of studs, shafts, joists and lintels. The structure was usually supported by foundation walls. Flooring was usually made with planks as well as wall and roof sheathing.</i>	<i>Mainly for dwelling and commerce. Items were partially prefabricated and much of construction items were usually manufactured in-situ.</i>	

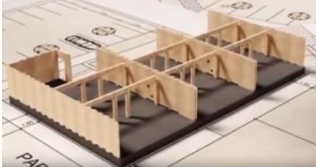
	<p>Platform framing</p>	<p>In active use and development since the 1930s. Exterior and interior walls fulfill bearing functions. The system is usually supported on a concrete slab though making foundations walls is also possible. It uses dimension lumber for joists, studs and rafters as well as composite lumber such as LVL joists and beams for slabs and beams. Subflooring, wall and roof sheathing is made with plywood and/or OSB panels</p>	<p>Mainly for dwelling, also for institutional buildings, commercial and/or semi-industrial facilities. Every floor is built on top of each other. Lies on prefabricated items and dimensional lumber as to avoid in situ manufacturing. Construction is basically a mounting operation.</p>	
<p style="writing-mode: vertical-rl; transform: rotate(180deg);">Framed systems</p>	<p>Heavy timber</p>	<p>Uses large-sawn items for timber framing. Hand-manufactured joints are used for putting items together i.e. Mortise and Tenon. Framing members have large cross-sections. Standard exterior boards are used for closing-in: plywood, OSB and composite sheathing panels featuring insulation layers.</p>	<p>Used for roofing. Dwelling, warehouse and industrial facilities are also built using the system. Barns and Mills previous to the 20th century were usually built with it.</p>	
	<p>Half timbering</p>	<p>A common technique usually seen in Northern and Central Europe. Consists of vertical, horizontal and slanting exposed structural members. The term emerges from cutting logs to a half to obtain posts and shafts. Structural intervening section is filled i.e. with brick, clay, straw bale and/or mortar.</p>	<p>Dwelling and commerce, though typological differences might not exist.</p>	
	<p>Plank & beam</p>	<p>Simplified version of light-framing systems. It uses fewer and larger pieces to assemble a structure. Beams are used for making structural frames while planks are used as structural sheathing, flooring and ceiling, though partitions can be installed using framed walls.</p>	<p>Dwelling, warehouses, barns and mills.</p>	
<p>Mass systems</p>	<p>Mass timber</p>	<p>System based on the use of solid CLT, LVL and/or LSL bearing members. All items are prefabricated. Structural in-situ works are limited to foundation construction and structural-member mounting.</p>	<p>Dwelling, commerce, institutional.</p>	

	<p>Log construction</p>	<p><i>The systems uses solid round or shaped lumber logs which are piled and connected through longitudinal halving joints. In contemporary log construction, logs are manufactured in a manner that insulation components are built-in into the log's core as to fulfill today's structural and comfort requirements.</i></p>	<p><i>Huts and/or cabins, dwelling, warehouses, vacation houses.</i></p>	
--	-------------------------	--	--	---

Image credits. Balloon framing: 1stdibs.com. Heavy timber: fitzgeraldtimberframes.com. Mass timber: (KLH LIGNATEC, 2013) Log building: countrysideinfo.co.uk. All others O.G

For further documentation on the matter as well as all the specificities concerning this chapter, the reader is encouraged to check on the references cited along sections 4.4 and 4.5, which contain more than detailed information applicable to French, Canadian and U.S construction contexts.

4.6. TIMBER JOINERY

Architectural objects have the particularity of not being monolithic entities, they all have structures and such structures have smaller items composing them and, if one goes deeper, such items have smaller structures and so on. In sight of such large and interesting research scope, this section's approach will deal with two basic approaches in joinery: a) the way in which structural timber elements are connected to each other to work as one and, b) the most important jointing methods as used in wood construction and woodworking as the necessary information for this dissertation's aims. The latter will also tell that a basic jointing taxonomy, as derived from contemporary carpentry and woodworking practices, allows to classify timber joinery in two main groups: **a)** Mechanical (fastenings) and **b)** frictional (mono-material contact joints) (Cecobois, 2012).

Fastenings constitute the logic answer of mass production to the needs of wood industry and, particularly, the wood-construction one (Comment 36). Conversely, interlocking joinery, which has been present for centuries in woodworking at almost all scales from furniture manufacturing to building construction, has gradually fallen in disuse because of its complexity and low industrial profitability (Schwinn et al., 2013). That might well be the reason why the market of industrial metallic connectors has taken an important role in standardized wood construction and manufacturing. However, such trend has been put in discussion as industrial manipulators as well as multi-axis CNC machines have helped in reintroducing woodworking joinery at industrial levels.

The fastening-manufacturing industry offers a wide range of products adapted to local markets and needs. However, a general fastening categorization based on most common uses is possible.

Applications such as joist-column, beam-column, beam-beam, beam-plate, stud-plate, stud-lintel, board-joist, board-rafter, rafter-ridge etc. use most, if not all, of the following fastenings: Screws, nails, bolts, spikes, staples, drift bolts, metal plate connectors, joist hangers, shear-plate connectors and spiked connectors.

All these fastenings can be combined according to particular needs and mechanical requirements which are also regulated by local construction codes. More detailed information about these fastenings is available in the references cited down below.

Comment 36. Mechanical fastenings, as adapted from (Cecobois, 2012; Rammer, 2010)

The use of robots facilitates the making of complex highly-elaborated joints that had been abandoned as their making was laborious and slow to execute. At some point, that fact led carpenters to lose interest in them not only because of them being slow to produce but because of the economic disadvantages they represented in the making of lumber structures (Dounas, 2014; Mermet, 2013; Robeller et al., 2014). Conversely, the high-end furniture field has privileged woodworking joinery making (as an added value), no matter how intricate it is. But why using these old and complex jointing methods in construction when all-purpose industrial mechanically-based accessories already exist?

Whilst mechanical connectors perform well in the making of standard structures as they are easily introduced in calculation software and their price is

reduced as their use intensity increases, their use for non-regular structures is limited. It is not possible to say that a non-regular architectural object is not feasible by using standardized mechanical joinery, however and, based on some particular cases, their use is a bit constrained when used in free-form structures¹⁴³.

The making of non-regular structures requiring complex jointing solutions calls for the use of three-dimensional connections capable of dealing with sharp plane deviations. In such case, nailing and or/fastening might get just too difficult to master as jointing elements can become numerous for achieving a stiff and stable joinery pattern throughout a geometrically intricate structure (Robeller et al., 2014); a fact that, in some cases, might bring aesthetic problems due to the high presence of metallic connectors.

That is why contact joints emerge as a flexible and useful solution not only capable of interlocking elements regardless of plane deviation but also of aesthetically concealing the mechanical aspect of the joint itself as it also helps in diminishing dead structural loads (Schwinn et al., 2013).

4.6.1. BASIC PRINCIPLES FOR JOINT-CHOICE AND USE.

The choice on whether to use or not a specific jointing method mostly obeys to a set of parameters that have much to do with the material on which the joint will act and the efforts to which the workpiece will have to respond to. The main goal of the joint is

¹⁴³ Please refer to section 5.2

helping workpieces to act together as a whole and, for such purpose, the chosen joint must not weaken but strengthen matter instead. In achieving such goal, mechanical analysis and advice is desirable as to avoid undesired joint behavior. Also when choosing a specific joint type for structural purposes regardless of its nature (mechanical or frictional), its use should be evaluated considering the following criteria¹⁴⁴:

- Admittable connector/joint size
- Fiber perpendicular resistance
- Joint combination
- Feasibility – simplicity
- Aesthetics
- Movement and gapping
- Stain resistance¹⁴⁵

With those concepts in mind, it is up to the designer and the mechanical analyst to choose the kind of joint that fits the best the structure's physical and aesthetic needs. Moreover, some joints might be chosen upon predefined criteria (effort and use tables) and/or an empiric analysis on the mechanical properties of a specific wood type (chipping, shrinkage, workability, tendency to warp or twist, machining and turning tolerance etc...), which might help in making a correct decision too.

¹⁴⁴ As adapted from (Cecobois, 2012)

¹⁴⁵ Notice that when using beech or oak timbers, wood acidity levels might deteriorate metallic joints and fasteners if the latter have no stain protection (i.e. zinc coating).

4.6.2. FRICTIONAL JOINT TYPES

Because of the aforementioned mechanical and aesthetic values woodworking joints have, this section will focus on such joint types as a means for achieving structural unity within acceptable boundaries of stiffness and joint stability. Before tackling such purpose, it must be made clear that focusing on woodworking joints does not intend to discourage the use of mechanical joinery but to propose an alternative to mechanical methods by reintroducing classic joint systems.

In contrast to standardized mechanical connectors (Comment 37), friction joints can be parametrically conceived and built for achieving special geometric and tectonic purposes, a fact enhanced by their capability of working without the use of mechanical fasteners, though when glued it might take some time for the bonding to be mechanically efficient depending, of course, on the glue's properties. Also, mechanical fasteners can be replaced and friction joints can be improved by adding i.e. friction-locking elements such as pegs, butterflies and/or hunches, depending on the joint type. (Bullar, 2013; Tamke et al., 2008).

Woodworking joint families are numerous and have as many variations as cultures exist, being perhaps the most interesting (and complex) ones, those used in Chinese and Japanese timber construction (Figure 141), not only because of their complexity and aesthetic value but for the way they work as interlocking structural elements. As well as

Mechanical connectors emerge from a template based on formulistic calculations which, in case of variation, call for a change of connector type or family.

On the other hand, parametrically conceived joints respond to a particular requirement by means of a customized-generic non-repetitive solution. Namely, the generic parametric-generative solution induces joint-topological change as the structure's requirements vary in function of architectural form-searching.

In the case of industrialized mechanical joints, parametric joint-responsiveness can be achieved by designing an algorithm capable of assigning a given connector to a given range of morphological and structural changes. In other words, a formulistic reasoning is added to a parametric iterative process in order to make prefabricated mechanical joints adaptable to a non-uniform structural system. This is, more or less the case of Kreod and SUTD pavilions. Please refer to sections 5.2 and 5.8.

Comment 37. Formulistic and generative solutions in joint making.

the far-east woodworking joinery, western joint-making has also its intricacies, though it is less complex but functional nonetheless.

There might be about 34 different joint families (or plus) and for every family there are sub-families containing several variations as is the case of i.e. finger joints and dovetails. The latter possess a variation range that goes from single-large dovetails to bevel-top and twisted dovetails being the second-mentioned the most complex but better interlocking ones

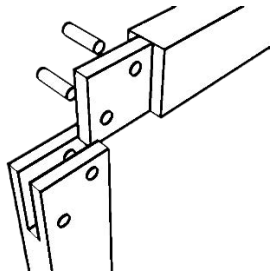
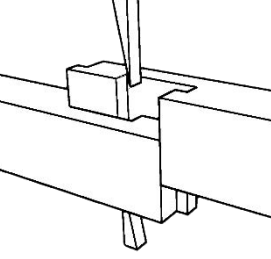
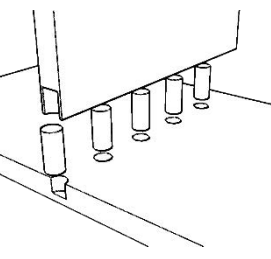
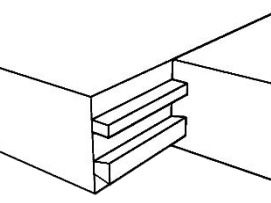
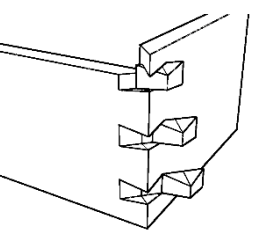
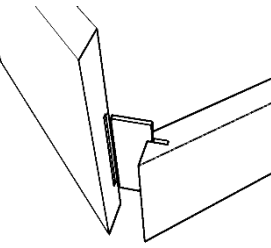

Figure 141. **Top.** Scarf-like Japanese beam-joint. (Building Channel, 2016)
Bottom. Three-way Japanese interlocking joint (Wandel, 2015).

Table 7 lists a series of woodworking joints that might be considered as the most useful in the manufacturing of structures and furniture. However, and considering the aims of this dissertation, the selected joints have been chosen considering their use for structural purposes at rapid prototyping and rapid manufacturing scales.

Table 7. most common woodworking joints as adapted from (Bullar, 2013; Campbell, 2015; Zwerger, 1997).
 Illustrations O.G

Joint type	Characteristics	Uses	Sample
Halving joint	Lapped (intersected) joint in which one piece crosses another at a given angle. Each piece cuts half the thickness of the other crossing piece, making the connection to interlock. It can be strengthen by adding glue or pegs (or both)	Furniture, frameworks, structural framing.	
Mortise and Tenon	Consists of a tongue and a slot carved on two different intersecting pieces each. The tongue must fit tight into the slot, no too tight to break it, no too loose to not to lock. This joint is susceptible of loosening by shrinkage. To strengthen, it can be glued, pegged, knocked-down, wedged-in, haunched...	Furniture (chairs, tables), structural framing.	

<p>Bridle joint</p>	<p>Consists of a pin that slides into a socket. Conversely to the Tenon-mortise joint, this one is open, so it must be precise to have a good pin's fit. It must be strengthened by gluing. <u>Adding pegs</u> is also possible, to avoid rotatory displacement of the joint.</p>	<p>Furniture, frameworks, structural framing.</p>	
<p>Scarf joint</p>	<p>Like halving joints, Scarf joints are produced by intersecting two workpieces longitudinally, not perpendicularly, by carving half of the joint on every workpiece. It has several variations: half-lap, dovetailed, plated, tenoned, double tenoned [...]. It can be glued, bolted and/or pegged.</p>	<p>Structural framing makes use of plated, tenoned and dovetailed scarf joints. In general, it is used to lengthen timbers.</p>	
<p>Dowel joint</p>	<p>Joint method whose purpose is to perpendicularly joint two workpieces. Drillings are made on both pieces as to connect them by means of a set of pegs with the proper radius and depth to ensure the joint's stability. It is usually glued to prevent pegs and the joint itself from sliding apart.</p>	<p>Furniture and structural use i.e. thick board connections</p>	
<p>Tongue and Groove</p>	<p>Edge-to-edge / edge-to-face board jointing method composed by the insertion of the tongue (or dovetail) of one piece into the slot of another. Variations include double tongued and double dovetailed joints. Joints should be glued.</p>	<p>Furniture i.e. tabletops, roof sheathing and subflooring, wall sheathing and finishing (if necessary)</p>	
<p>Miters</p>	<p>Normally angled cut, the miter joint is made of workpieces bonded by gluing, although interlocking is possible by carving notches on the invisible edge of the joint, carving splines on the exterior angle or by making notches on both pieces to insert a key.</p>	<p>Furniture (drawers, boxes, vaults). In structure as jointing method when using CLT and plywood boards.</p>	
<p>Biscuit joints</p>	<p>Variation of miter and butt joints. Uses a slot, carved on the end-grain side of both workpieces, as host for inserting a piece of hardwood that, once glued, will keep the miter together preventing it from rotating and/or axially sliding.</p>	<p>Furniture, table boards. In structures it can help jointing sheathings, and or cassettes (as in Solar Energy House or Swissbau pavilion).</p>	

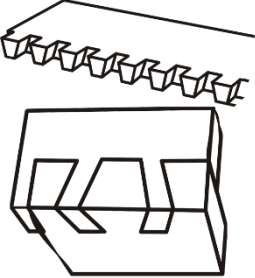
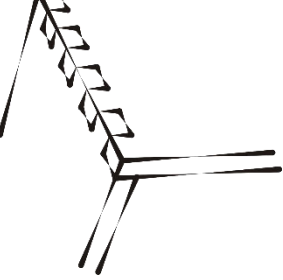
<p>Dovetails</p>	<p><i>Dovetails are formed by intersecting workpieces and subtracting equivalent amounts of mater for them to merge (pin and slot). Dovetails are interlocking because of the inverted-sloped edges at the base of the joint. Variations are named as: single large, <u>lapped</u>, blind-lapped, <u>twisted</u>, bevel-top [...]</i></p>	<p><i>Furniture (drawers, boxes, bookcases, cabinets). Structure. CLT walls (as in Jules Ferry project) and board-based structures.</i></p>	
<p>Finger joints (comb joints)</p>	<p><i>Finger joints act more like halving joints inasmuch as the locking function is given by pure grain-friction as joint geometry does not allow for full interlocking.</i></p>	<p><i>Furniture (drawers, boxes, bookcases, cabinets). Structure. CLT walls and panels (as in Schwinn's timber-plate pavilion)</i></p>	

The referred joint list introduces an exploration field in which customized interlocking joinery might be used for achieving timber-based non-standard architectures in a way that joinery itself will have a direct incidence in design-to-production workflows. Namely, choosing a specific joint type as generic solution assembling a structure might generate a series of interrelations in which a parametrically driven model can gather built-in information enough to create a real-time bidirectional data flow capable of adjusting and updating design without missing any parameters. This topic will be further referred as an **Aided-Conception Parametric Tool (ACPT)** (refer to section 6.2.2).

4.7. CHAPTER CONCLUSIONS

As this chapter discussed certain generalities and specificities about wood industry and wood construction, the concepts and information herein gathered allow illustrating the main elements participating in any design and construction attempt involving the use of wood as material, which, as with any other material, have to acknowledge the specifics of its transformation and use for a specific purpose.

Important aspects, that might appear redundant, such as discussing what softwoods and hardwoods are, allow for associating the properties of such lumber categories to transformation processes in which lumber workability is important to acknowledge. Although the discussion itself is not intended to be a treatise in wood construction, all related processes are aimed to help the reader to understand aspects like:

- Not all woods have the same properties, therefore tackling a specific design goal involving lumber usage or any of its composite material will need the awareness of such in order to make a correct aesthetic and functional judgement. In other words, by using the information contained in Table 5 the reader will be aware that using oak for exterior use might not be a wise decision as it is intended for uses like furniture or interior woodworking, though structural use is possible under well-protected conditions.
- Construction systems are diverse thus aesthetic choice depends also on the chosen building system. Being aware of such fact allows not only for widening design judgement but for taking advantage of local resources in favor of functionality and aesthetic quality.
- Jointing systems are also diverse and serve not only to ensure architectural unity and structural stability but also to enrich architectural quality. Frictional joints are particularly customizable and have the power to become an enriching aesthetical asset that can be achieved within reasonable budgetary and schedule boundaries thanks to the possibility of manufacturing them by means of digital detailing through CAD/CAM environments along with CNC and robotic-like machinery.

From a modeling point of view, all the aspects discussed throughout the chapter can be treated as parameters in regard to parametric-generative design processes. Just try to imagine a framing system in which a set of joints is programmed to change according to the scale of the building and a range of structural parameters to which the structural system must respond to.

It might sound highly complex but in order to do so, the theoretical modeling method would need to acknowledge architectural intention as to assess the incidence of all involved parts and establish a structural system. Furthermore, for the structural system to work, the modeling tool might need to know what kind of timber is going to be used in order to adjust structural calculation to that specific timber's properties. On a more detailed level, the so-called tool might need to offer a range of joints to choose from as to satisfy structural needs by enriching architectural quality.

All the aforementioned properties wood has as material, along with the possibilities parametric-generative modeling and CAD/CAM environments offer, is what makes possible all the research in the topic to happen. The outcome yielded from research in wood construction applied to non-standard approaches via parametric-generative modeling, form-searching and aided-manufacturing (aka digital fabrication) is illustrated by a set of experimental and actual projects discussed in Chapter 5.

Chapter 5. NON-STANDARD APPROACHES IN WOOD CONSTRUCTION.

As stated in previous sections, wood, as material, has served well in prototyping and full-scale manufacturing efforts that have much to do with current research and practice in architecture.

Non-standard wood architecture has the ability (perhaps the capacity) to happen without using intricate facilities. Theoretically, one can do well with just a Cartesian CNC machine to cut MDF or timber layers that later will form a structure or an object (Figure 142). That fact depends on the scale of the object to be built, without that factor being a real constraint inasmuch as large structures and objects can be built out of smaller components when production means are not capable of dealing with large-scale items (Sass and Chen 2015), which, at least theoretically speaking, might well work out.

In sight of the aforesaid facts, this chapter shows a series of projects in which many of the principles discussed along this dissertation such as plane tessellations, tessellation-based structural patterns, timber structures (CLT and glulam), wood types and species, non-standard architecture and the like, are present.

Projects are displayed and analyzed in function of their scale and complexity. Special attention is given to factors like conception strategies (when available), digital workflows, structural principles, jointing methods, openings management, and production methods (materials and machining approaches). All of them are interlinked concepts establishing a direct relation between conceptual intention and the succeeded project regardless of the scale and function of the latter. Please notice that in many cases, the building's envelope acts also as bearing component. In such cases, the envelope will be referred as the structure itself.

5.1. GLAM POD

The glam pod is a tiny house designed by British architect Robert Gaukroger in 2012 (Thompson, 2011). The concept behind the pod lies on the idea of having an ephemeral structure as extension of a main dwelling, namely, the kind of space that can be used as an exterior guest room or a place to which kids can escape as to make their own living for a while.



Figure 142. Layered timber structural prototype at “Les Grands Ateliers”, Lyon-France, 2012. Photo O.G



Figure 143. **Top.** Glam Pod’s timber framing seamlessly decreases diameter towards the extremities creating a varying frame-sizing. **Bottom.** Plank-based sheathing system discontinuously follows the structure’s curvature.
On:gaukrogerandpartners.com¹⁴⁶

No evidence could be found about the pod being designed by using any digital tools, CNC machines, or industrial manipulators. The conceptual approach of glam pod emulates that of Malaysia’s traditional long houses (Thompson, 2011) by setting a linear arrangement of spaces contained into a NURBS-like volume; that is to say, the structure functions like a monocoque container.

The structure is composed by a series of circular frames joined by two longitudinal base-beams (foundation) and three longitudinal curved ridges, which, along with the interior and exterior plank sheathing, make the structure to work like a plank-beam system (Figure 143). Though the structure’s framing follows the skin’s shape, the form variation of the latter obliges to have at least six different frame types (size variation). Structural elements are put together by means of woodworking joints (halving, bridle, and tenon joints) and metallic fasteners (nails and screws).

¹⁴⁶ This site is actually offline.

As for siding, the skin's curvature forces to bend the siding ribs as they are installed, causing mechanical traction on the fixation system (be it fasteners or nails), which seems to be acceptable in function of the deformation range acceptable by the English cedar ribs (Figure 144 top and middle).

Even though the morphological approach is not completely challenging, the architect claims that manufacturing a glam pod takes about 11 weeks (Thompson, 2011); such building time, along with the formal approach, could be optimized by using parametric modeling and CNC cutting.

Openings management follows the standard approach of placing orthogonal doors and windows over a vertical plane so the curved framing is not interrupted by any opening.

A close approach to that of glam pod's can be seen in the last versions of the wood challenges (*défis du bois*)¹⁴⁷ in which tiny houses, digitally designed by students, are made by using a traditional construction approach (Figure 144 bottom). The aim is to push design boundaries by keeping feasibility within respectable ranges of execution time, although it might need to integrate parametric design and automated fabrication to push boundaries even further in future versions.



Figure 144. **Top.** English cedar siding is curved following the pod's geometry. **Middle.** The Glam Pod in its finished state. On gaukrogerandpartners.com **Bottom.** Cabin (tiny house) designed and built by students at the wood challenges (*Défis du bois*). Photo O.G

¹⁴⁷ www.defisbois.fr

5.2. SWISSBAU PAVILION - ETH ZURICH, AND KREOD PAVILION - LONDON.

These two projects have several things in common that make them worth of being analyzed at the same time. Both are developed using tessellated shell structures, though different tessellation patterns, supposing different modeling and building challenges, are set: a collection of topologic quads for the Swissbau pavilion and a hexagonal structure for the Kreod pavilion.

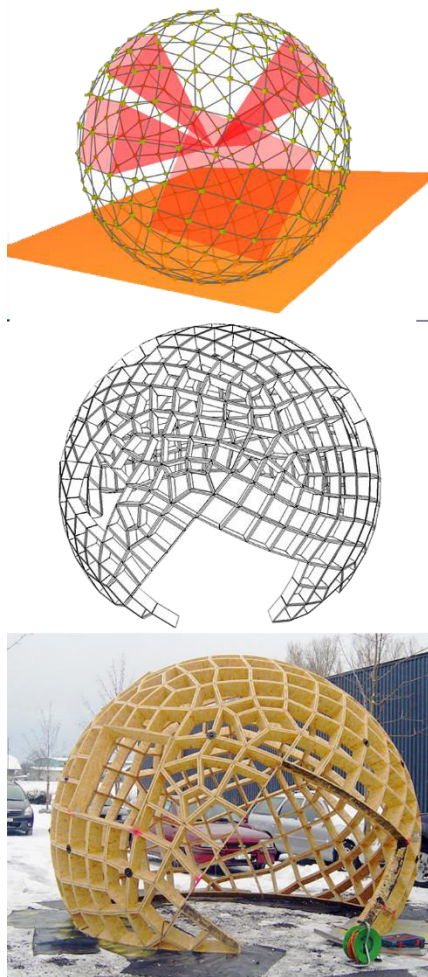

Figure 145. Swissbau Pavilion **Top.** Form-searching java model. **Middle.** Cell arrangement as structure. **Bottom.** Assembled OSB cellular structure (Scheurer, Schindler, and Braach 2005)

Unlike Glam Pod and the Wood Challenges' cabins, both projects are conceived using digital parametric-iterative design tools, which provides a higher degree in shape variation as well as in structural complexity¹⁴⁸.

The Swissbau pavilion uses a digital approach based on java programming that allows launching a real-time simulation of a sphere that emerges as evolution of a basic quad mesh. Essentially, the sphere from which the pavilion is derived, virtually self-generates and organizes its own growing process until it fulfills a given morphological criterion (Scheurer, 2007).

The model is exported as XML data to a CAD program by means of a customized translation script containing a considerable amount of information that includes all the items composing the structure such as workpieces, joints, numbering, fixation drillings, and the like. A second script nests all the items and helps programming their

¹⁴⁸ Although each pavilion's shape is quite basic, the way each structure is generated creates a complex set of geometric relationships derived from morphologic variations in structural components and connections (joints).

machining so the information can be sent to a CAM environment in the form of Gcode (Scheurer et al., 2005). The key here is the close link between iterative-generative modeling as design method, along with automated fabrication and construction, which, in the end, is the kind of interaction that improves feedback loops between such operations.

In this case, the envelope is a bearing skin whose morphology provides it with a structural pattern composed by OSB quad cells. Openings are deliberately placed over the mesh so the latter has to align itself not only to openings but to the floor plane as well. (Scheurer, 2007, p. 81).

The Kreod pavilion uses also a generative approach oriented towards machining optimization and flexibility of use. The pavilion is basically composed of three similar pods that, once assembled together, can adopt different installation configurations thus several possibilities of use: gallery, pavilion and or exhibition hall (Li, 2013).

The digital workflow includes generative modeling using Bentley's Generative Components (Chib, 2011) along with mesh, structural and paneling optimization performed via Evolute Tools (Hammerberg, 2012). The basic pod is derived from a free-form surface on which a lattice of quads, tessellating the surface, is generated. Structural optimization forces a structural surface-tessellation change that adopts a triangle-based hex pattern, as a means to avoid node torsion (Evolute, 2012), in which cell edges overlap and generate a reciprocal

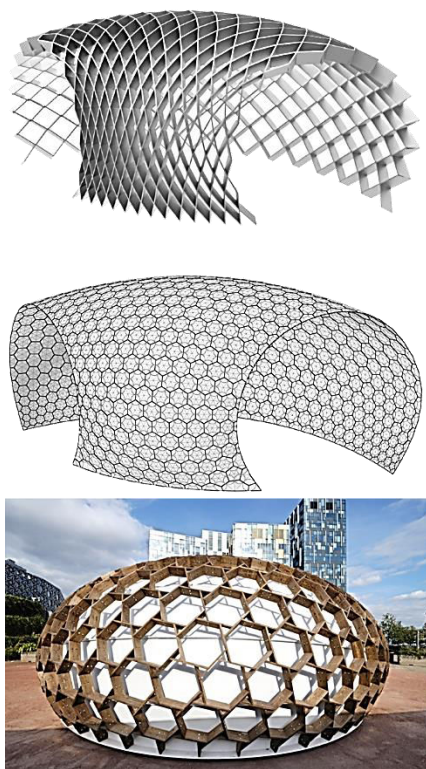

Figure 146. Kreod Pavilion. **Top.** Initial model based on a lattice-like tessellation. **Middle.** On-surface structural optimization. **Bottom.** Interlocking hex pattern as used in the actual structure.

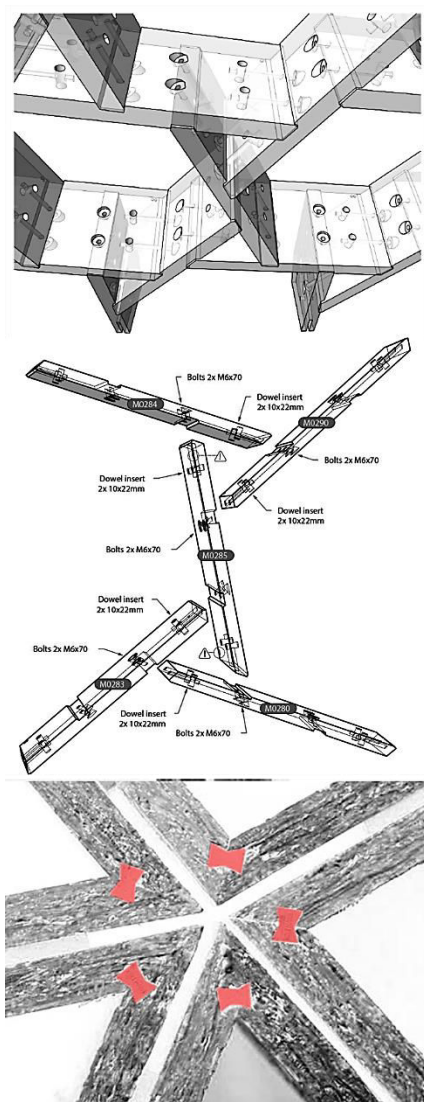

Figure 147. Jointing generic solutions
Top. Member detailing after structural-based tessellation optimization, KREOD. **Middle.** Member connection detailing. Dowels, bolts, grooves, KREOD. **Bottom.** Swissbau pavilion member jointing solution. Butterfly notches joint cell items as metallic fasteners do on cells to assemble the structure. Top and middle images by (Evolute, 2012); bottom image (Scheurer, 2005).

framed structure¹⁴⁹ (Figure 146) (Kohlhammer and Kotnik, 2011). All structural members are planks made of a timber product called Kebony®¹⁵⁰, which offers mechanical performances similar to those of hardwoods but using softwoods instead.

The yielded digital model delivers CNC machining data in the form of miters, groove joints, drillings, contours, and production marks for the processing of Kebony® workpieces (Figure 147).

Connections are generated by using a detailing routine developed using Rhinoscript (Evolute, 2012). The connection system, conversely to the plank system, is very complex and composed of about 14 fasteners and connectors per workpiece which leads to an equal number of drillings that vary in diameter and depth (Figure 147 top and middle).

In both projects, parametric-generative modeling plays an important role not in managing complexity. At first sight, the shape of both pavilions looks quite simple; however, items composing them are very complex. Perhaps one of the most complex things to digitally manage -aside from structure and mesh generation- is ensuring stability and integrating mechanical aspects into design. The challenge in both projects was to create a generic jointing method capable of satisfying all the morphologic variations that happen throughout the whole set of structural members and their composing items (Figure 147).

¹⁴⁹ The structural principle is also known as the Zollinger system (Martin Tamke et al., 2010)

¹⁵⁰ <http://kebony.com/en/projects/kreod>

In the case of the Swissbau pavilion, the generic solution is a miter-and-notch joint (Scheurer et al., 2005), that looks more like a biscuit joint, along with interstitial connectors putting structural cells together (Figure 147 bottom). As for the Kreod pavilion, the proposed strategy is very complex because of the fastening system's intricacy, which, along with the wood product used, ensures the pavilion's durability. All such aspects are parallel to the design process and interrelated to each other from beginning to end.

5.3. EUREKA PAVILION, LONDON.

The Times Eureka Kew Gardens pavilion is an ephemeral structure, derived from a biomimetic design endeavor, whose purpose was to serve as shelter for the visitors to the Chelsea Flower Show in London, back in 2011 (Blumer Lehmann, 2012).

The project was conceived by British firm Nex Architecture using a Voronoi pattern as structural and architectural solution for form generation. According to the documentation published in Nex's website, the Voronoi pattern is projected over an unfolded parallelepiped in order to create Voronoi-cell continuity regardless of the plane rotation that arises as consequence of re-folding the former (Figure 148 top).

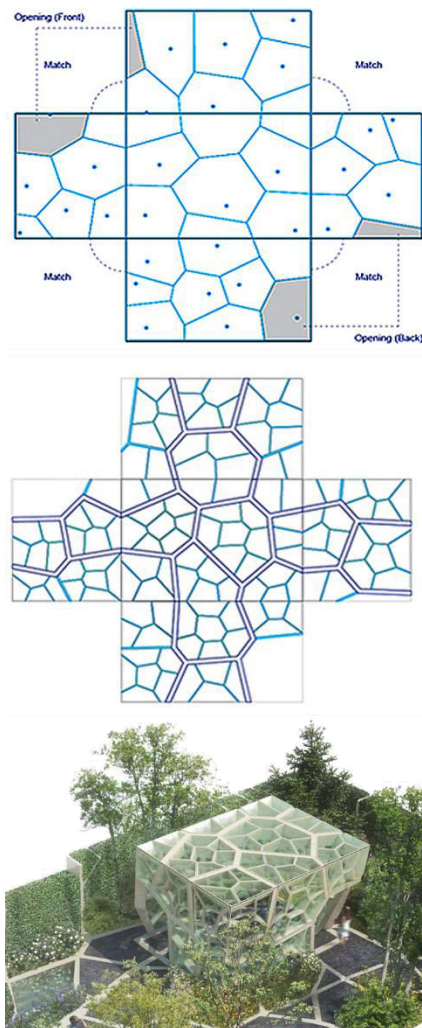

Figure 148. Times Eureka Pavilion. **Top**, main structure from Voronoi pattern over the unfolded box. Observe that openings are made by skipping corner cells. **Middle**, nested Voronoi group for non-bearing members. **Bottom**. Biomimetic aspect of the pavilion as inserted into its context. All images (Nex Architecture, 2011)

The main Voronoi structure is made of timber while a nested Voronoi pattern, made of plastic, works as a mechanism to filter the view from the interior to the exterior and vice versa (Figure 148 middle). The modeling process creates door openings by eliminating some cell edges located at

the corners of the box, so the concept of door is embodied by the absence of part (or the whole) of a cell, therefore, no orthogonal elements, aside from the containing shape, are present in the pavilion.

Even though parametric modeling is perhaps not the most complex operation in the making of the pavilion, working with Voronoi-derived joints as well as fastener positioning and drillings might just be. Structure calculations as well as production logistics were coordinated with digital fabrication as to establish a system of interlocking joints carved on spruce glulam members (Bender, 2016) (Figure 149). Moreover, a wide number of miters belonging to timber cassettes concealing the main structure, all having different joint angles, needed to be CNC milled in order to make precise joints. It took about 5 months to fulfill the whole workflow from design to mounting in which there was a mandatory feedback between manufacturing and conception environments¹⁵¹.



Figure 149. **Top.** Timber structural members. Observe the complex geometries yielded as result of carving joinery on workpieces. **Bottom.** Interior view. Observe how structural items are jointed at manifold intersecting angles. Top image (Blumer Lehmann, 2012), bottom image (Nex Architecture, 2011)

5.4. VACATION COTTAGES AT XERTIGNY - FRANCE

The Xertigny holiday-hut project, also known as “Les Woodies” (Ville de Xertigny, 2015), is composed of several holiday cottages all having different architectural designs.

Although most huts are designed and built using standard framing systems, interior finishes call for different wall-finishing patterns to induce variation. By following such purpose a special hut, whose structure is quite different from the others, arises as

¹⁵¹ Please refer to Appendix 4 for further details on this project’s production environment.

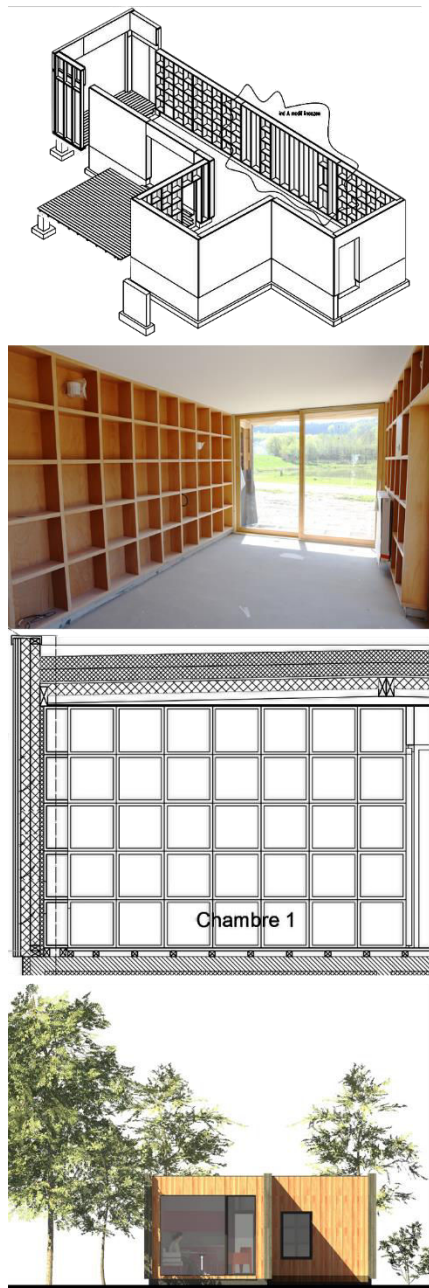

Figure 150. Tetrís holiday cottage. **Top & middle-top.** Beech-CLT walls acting as waffle-like structure for the entire cottage. **Middle-bottom.** First structural approach. Notice that beech cassettes are thicker independent-closed entities compared to those in the middle-top image. **Bottom.** Exterior aspect of the cottage. Plans and renders courtesy of WM Architects. As-built photo, O.G.

to mark a different architectural and structural approach.

The model known as “Tetrís”, has a grid-like structure that resembles a vertical waffle enclosing the entire hut; otherwise said, the structure is a lattice-like arrangement of regular cells (quads) that act together as the cottage’s bearing members. According to architect Aurélien Zavattiero (WM architects), the idea of using such structural arrangement led to think about using beech cassettes (as cells) joined by fasteners as part of a system in which they could work together as a structural whole (Zavattiero, 2014).

However, structural analysis and optimization led to replace cassettes by a lattice of vertical and horizontal CLT panels, though the formal concept kept being loyal to architectural intention. As Mr. Zavattiero explains, cassettes had the issue of being material and time consuming in manufacturing terms; conversely, making a lattice-like structure proved to help improving not only fabrication but material consumption and mounting times (Zavattiero, 2014).

In sight of aforementioned facts, the Tetrís’s inner beech structure has a dual function: Firstly, to support the hut and create an interior environment in which no drawers or shelves are needed; secondly, to improve interior design by taking advantage of the aesthetic value beech has to offer as this wood species gives a soft and uniform finish (in the form of beech-CLT panels¹⁵²)

¹⁵² Lineazen

Although the particular approach of the Tetris cottage has no proximity to non-standard architecture, it might be enhanced by exploring with non-regular tessellations as means to propose alternative, more challenging and innovating structural arrangements as part of architectural expression, be it by using the waffle or the cell (cassette) construction method. The project proves that not only material, but the way a given material is processed, helps in optimizing design by proposing structural and production strategies respectful of architectural intention.

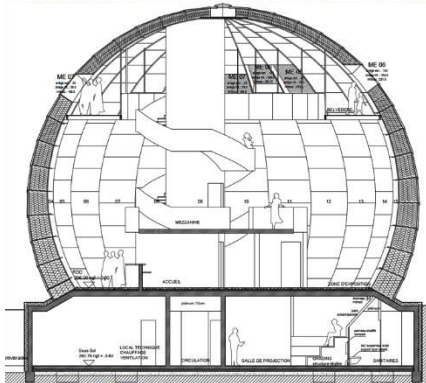

Figure 151. Solar Energy House. **Top.** Structural members staggered. Notice that the roof rests over the cassette-made enclosing wall. **Middle.** Closing wall variable section. **Bottom.** Aerial view of the structure's mounting process. Notice that timber cassettes are installed empty. Insulating material was blown-in once the mounting was finished. Image credits. Top, O.G; Middle, Cartignies-Canonica architects; Bottom, charpentres-bois.com

5.5. SOLAR ENERGY HOUSE, TOUL ROSIÈRES - FRANCE.

The solar energy house is a project led and funded by EDF-France, and architecturally developed by Cartignies-Canonica architects.

Delivered in 2015, the project uses the igloo principle as morphologic and structural concept. A series of timber cassettes are vertically staggered to constitute a geodesic dome whose top and bottom sections are eliminated as to create the roof as well as the structure's foundation line (Figure 151 top). In order to diminish concentric inertia and weight on the top of the building, all timber cells are extruded towards the dome's geometric center with a variable value that decreases as the structure gains height (Figure 151).

As well as in Kreod and Swissbau pavilions, the envelope plays a role as both structure and skin; still, in this particular case, the remaining geodesic dome's section acts more like a continuous self-

bearing wall supporting the roof.

According to architect Alain Cartignies (2016), the roof could not be made following the igloo principle because its mounting would become very complex as result of the increasing gravity load generated in function of the incidence angle timber cells acquire as the dome starts to close. For such reason, the architect decided to install a roof made of glulam timber (Figure 151). The inner face of the roof's structure is covered with thin poplar-plywood sheets to follow the rhythm of the structure (Figure 152).

Although it is difficult to see it in pictures and drawings, variation is present all around the building. Timber cells vary in section and concavity as the structure reaches the top, a fact that turns into imperative the use of CNC cutting in order to manage the fabrication of such manifold items and structural members. As Cartignies himself states, using digital tools for managing such amount of elements is helpful inasmuch as this kind of approach does not allow for any generous tolerances, otherwise the dome might never close (Cartignies, 2016).

Unlike described pavilions in section 5.2, this building must meet not only structural but comfort codes. To such extent the decision of using a cassette-based structure turns to be the right one, not only because it allows a rapid mounting of the structure (once cassettes get to the construction site) but because insulation can be blown-in as the structure is mounted thus creating a boosting

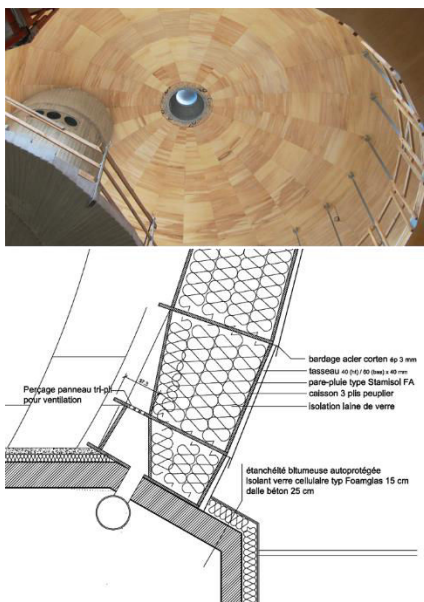

Figure 152. **Top.** Poplar thin panels as roof interior finish. **Bottom.** Blown-in insulation in structural cassettes. Image credits. Top, O.G; Bottom, Cartignies-Canonica architects.

overlap in construction tasks (Figure 152 bottom).

With all of this in mind, the energy solar house might well validate what Ciblac (2011) conceptualizes as standard-element-based non-standard architecture¹⁵³.

5.6. NURSERY FACILITY AT GUEBVILLER – FRANCE

The Guebwiller nursery facility is a claimed bioclimatic building, conceived by Alsatian architect Thomas Weulersse. The building was given to service in 2015 (Comment 38).

This section's contents were acquired thanks to the cooperation of Julien Meyer and Matthias Knoblauch as they helped in making the interview that provided information about this project.

Comment 38. Interview's shared credit.

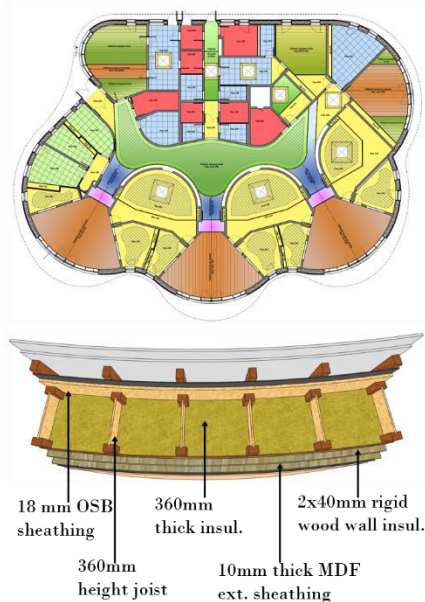

*Figure 153. **Top.** Floorplan. Wall curvature changes from convex to concave. **Bottom.** Wall curvature first solution. A set of joists subdivide walls into short segments to facilitate sheathing panel bending and insulation blowing-in as well as a smooth appearance throughout envelope and partition walls. Plans and details courtesy of Dform architecture.*

Unlike precedent cases, this project is even more complex from constructive and environmental points of view. According to Mr. Weulersse, it is quite difficult to figure out a passive building that considers a sinuous non-compact language as architectural approach inasmuch as insulation thickness is a factor that makes curvature radiuses critical throughout the building's envelope (Figure 153).

The design-to-construction digital chain employs BIM software (Archicad) to design the building and integrate site, engineering, mechanical and architectural constraints into a sole model. Such approach allows to make a complicated by advantageous file exchange that boosts design and construction tasks at the same time. As Mr. Weulersse acknowledges, the simple idea of sharing building information, as data that can be read in a remote environment, allows for not only

¹⁵³ To check the validity of this statement, please refer to Appendix 5, which contains an extract from Ciblac's work on the topic.

T. Weulersse states that even though automation in construction processes has given a general boost to the business, there is a lot of work that is done manually, which he considers good in terms of employment. However, he regrets that at least two out of three workers are not qualified to execute construction tasks (In France). A fact he considers to be against the industry's competitiveness as most building companies are always in need of personnel.

Comment 39. Automation and employment in construction. From (Weulersse, 2013)

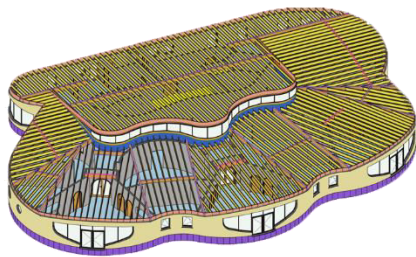

*Figure 154. **Top.** BIM model including carpentry data. **Bottom.** Wall curvature second solution by full-scale prototyping. A 2x10 mm OSB sheathing replaces 18 mm sheathing for achieving a smoother bending and avoid breaking. Top image courtesy of Dform architecture. Bottom image J.M.*

economizing time and money but to generate gains in accuracy that, in the end, is perhaps the most important contribution digital tools make in design and construction endeavors.

Furthermore, the project's digital workflow consists of modeling the building using BIM software and exporting data concerning the entire building's structure and walls, via the Dietrich CAD/CAM environment. The carpenter uses such data to verify bearing and non-bearing timber elements so the joinery system can be generated as well as all the elements suitable for CNC fabrication (Figure 154 top), though mounting and assembling processes were performed manually (Comment 39).

As this project's design uses the BIM approach, feedback towards design stages comes from prototyping. Inasmuch as the project is rich in double-curved walls, the problem to tackle was to succeed in assembling such walls without leaving air leaks and/or generating excessive efforts on their sheathing elements. To face the situation, the architect and the technical team decided to test different sheathing thicknesses as to evaluate their deformation range.

The findings helped concluding that OSB sheathing over 18 mm thick would not do the job in a single layer as it would not bend but break. To overcome the challenge, 10 mm thick OSB boards, disposed as double-layer sheathing, did the job of adapting to the curvature the project's walls possess while keeping insulating properties as needed (Figure 154 bottom).

By making and adjusting full-size prototypes, the construction process itself gives feedback towards BIM design so that wall profiles could be updated in order to make the design coherent with the aforesaid prototypes and make a helpful double-way construction-to-design workflow out of technical constraints.

5.7. JULES FERRY SOCIAL DWELLINGS, ÉPINAL – FRANCE.

The Jules Ferry project, inaugurated in 2014, is a building aimed for satisfying the dwelling needs of low-income population. To satisfy such needs, the dwellings not only need to be inhabitable but affordable in terms of energy consumption and other expenses concerning the building's maintenance program.

According to architect Antoine Pagnoux, the key in succeeding such premises is standardization in all stages (Actu-Environnement, 2014): modeling (which he defines as “classic”), production and construction. With that in mind, standardization is oriented towards achieving a passive building that fulfills low-energy-consumption constraints as well as an economical balance to make the project competitive.

With that in mind, the architect proposed a mixed constructive system based on CLT bearing walls and glulam beams and columns that fulfills several requirements: Structural stability, construction speed, air and moisture proofing, and a finished interior (Figure 155). The use of a CLT envelope structure meant no further finishing works would be



Figure 155. Top. CLT structure. Walls, beams and columns. Middle. Interior finish given by timber panels. Bottom. Timber cassettes as insulating envelope. Image credits. (KLH LIGNATEC, 2013; Pagnoux, 2014)

needed once the structure was mounted (Pierré, 2016).

To achieve low energy consumption the project calls for a skin made of timber cassettes containing straw bale as insulation material. Cassettes are made of standard timber panels that inherit material's standard sizing, except for the cases in which plane direction changes. Engineer Vincent Pierré states that such approach makes part of an optimization process in which a material like straw, often considered as waste by farmers, proves to behave as well as any other insulation material. Namely, the use of timber as structure and straw as insulation material are the consequence of a design process in which the building needs to make the best in reducing its impact on the environment by taking the less from it and, by partially covering its own energy needs by using solar panels. (Le Off du DD, 2014).



Figure 156. Top. Façade envelope straw-bale-filled insulating unit (cassette). Bottom. Jules Ferry Dwellings. Image credits. Top-J.C Bignon, Bottom (Pagnoux, 2014)

As well as in the Solar Energy House project, the envelope system plays a structural role, although it is not that of supporting the building itself. The Jules Ferry project uses the envelope of insulating cassettes as support for waterproofing membranes and sidings in a manner that it avoids translating vertical and shearing loads to the building's main structure.

Despite the fact of not having the “non-standard architecture” flag, the way in which the project manages the envelope to create a structurally detached skin suggests that such approach can be taken to the non-standard architectural field. There,

it might well work for proposing innovating architectural solutions oriented towards façade renovation and environmental performance improvement for old buildings, without needing to make an important intervention on bearing non-wood components.

5.8. CHAPTER CONCLUSIONS

Although this chapter described a sample of projects in which timber construction is oriented towards design and construction endeavors that seek to find alternatives to traditional design and building approaches, the sample is still narrow compared to the wide list of projects that had not only made use of parametric-generative approaches in design, but have also changed design approaches regardless of conception and production means.

This chapter also made clear that timber construction, perhaps more than techniques such as brick construction, is relying more and more on digital conception-to-production workflows regardless of the architectural approach. The fact is digital approaches have not only boosted design processes themselves but the whole production chain. Errors, when early assessed, can be tackled, and solved in less time and without affecting production, all because timber construction allows full prefabrication reducing *in-situ* works to a minimum.

In sight of such fact, there are no few examples of the way in which timber construction can be exploited to push formal and industrial boundaries by means of experimentation in research labs, schools and in actual architectural projects. As previously mentioned, a thorough sample collecting a meaningful amount of projects in which wood construction turns into non-standard architecture is just too large to be shown and analyzed in this dissertation. For that reason and, as complement to the projects analyzed in this chapter, Figure 157 shows twelve reference projects that can be considered as illustrative in terms of design approaches and manifold construction techniques.

From Larry sass at the MIT to Fabio Gramazio at ETH Zurich (among many others) there have been a series of research endeavor developing design methods whose aim is to propose design solutions based on problem solving and form-searching. Furthermore, the production approaches such works tackle have a lot to do with the digital chain between humans, computers, and industrial manipulators as treated in Chapter 3 and in the next chapter. The possibility of managing those aspects via aided-conception parametric tools is what gives ground (in part) for proposing the ACPT model discussed in Chapter 6.

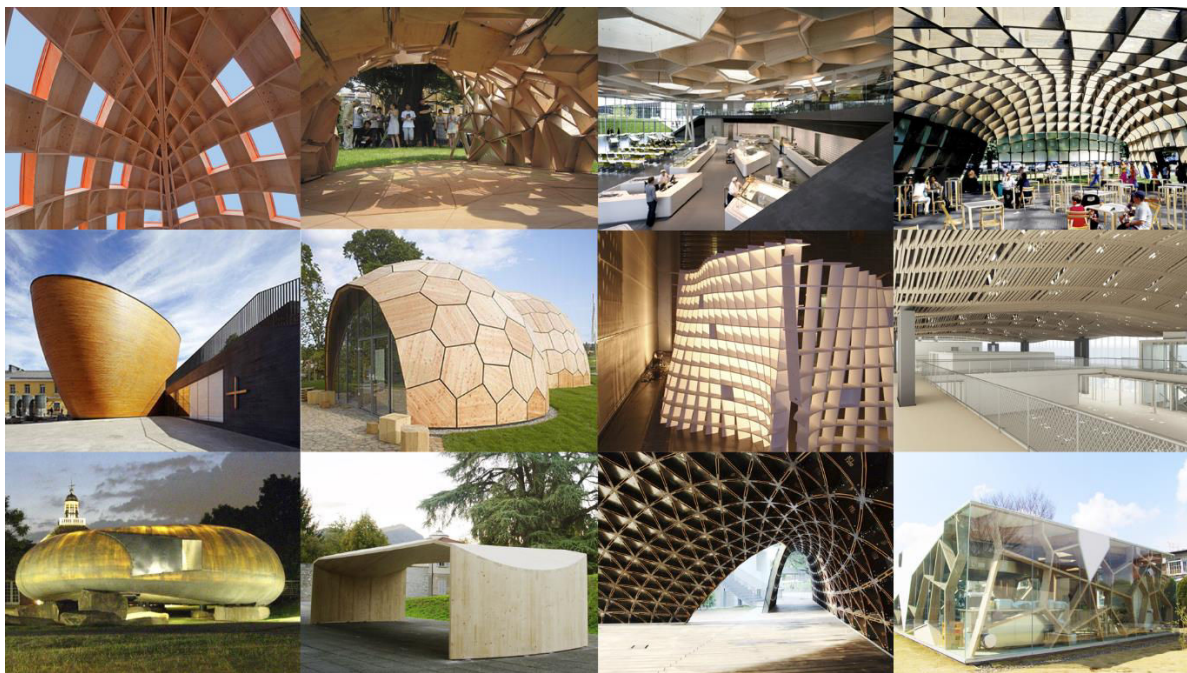
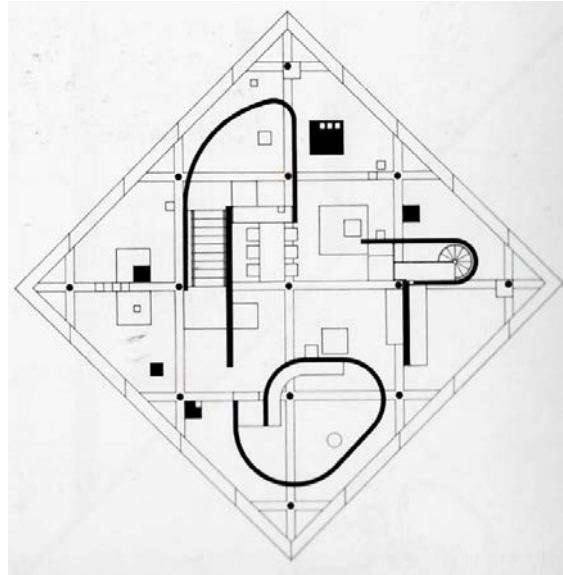

Figure 157. From left to right. **Top Row.** *My green world pavilion*, Venlo 2012 by 2D3D architecture (2D3D, 2012). *130008252010 pavilion*, Tokyo 2010. (Ko and Liotta, 2011). *Blautopf cafeteria*, Ditzingen 2008. (Barkow and Leibinger, 2008). *Serpentine pavilion*, London 2005. (Siza et al., n.d.). **Middle Row.** *Kamppi chapel*, Helsinki 2012 by Ks2 architects. (Ks2 Architects, 2008; Uusheimo, 2012). *Landesgartenschau Exhibition Hall*, 2014 by A.Menges (Menges, 2014). *Experimental prototype* by students at "les Grands Ateliers. Lyon-France 2012. Photo O.G. *The Sequential roof*, Zurich 2015 by Gramazio Kohler research (Willmann et al., 2016). **Bottom Row.** *Serpentine Pavilion 2014* by Smiljan Radic. Photo O.G. *Curved folded thin shell structure*, 2014 by C.Robeller (Robeller et al., 2014). *SUTD library pavilion*, 2013 by City Form Lab (Sevtsuk and Kalvo, 2014, 2013). *Sumika Pavilion*, 2007 by Toyo Ito (Santiago, 2009; Tokyo Gas and Ito, 2007).

Chapter 6. A DIGITAL MORPHOGENETIC MODEL FOR NON-STANDARD TIMBER WALLS AND ENVELOPES.



Back in section 1.2, it was stated: *“the wall, beyond its physical condition, is capable of transmitting sensations and transforming the inner dimension of the space in which one dwells.”*

Figure 24¹⁵⁴, now enlarged at the beginning of this chapter, transmits a certain embodied-in-walls sensuality. In an architectural project, the wall has the ability, the capacity, and the sole responsibility, regardless of its materiality, of protecting, enclosing, as well as defining spaces and uses. It also reveals sensations, fluidity, dynamics, or stasis; in other words, it is a space modifier.

Within that context, this chapter will state a condition in which non-standard timber walls become a design approach for design endeavors in which walls are not work as partition or envelope elements only. Instead, they can be used as solutions for specific purposes involving aesthetics and function as morphologic definers. Application cases could involve using the approach for designing concert halls, sound barriers, playgrounds, and classrooms, among many others. In such cases,

¹⁵⁴ The Diamond House. On (Libeskind, 1985).

non-standard timber walls acquire a morphological dimension in which components participate in the characterization of space itself (WILLIAMS et al., 2013).

If there is one asset the non-standard approach has, is that architectural elements have a bigger participation in the expression of the building through their bare structure, they hide nothing. The classic view of the wall as a plane derived from the extension of a line (Ching, 2007), provides it with a static dimension. In today's architectural state of things, the concept of wall transcends that dimension because of the blurry boundaries that exist between vertical-uniform planes and segmented plane collections as product of freeform approaches in which the computational and mathematical definitions of a wall –seen as an abstract entity- step aside from Ching's postulates.

In this dissertation's framework, walls are assumed as part of either a building, a floor or a space. Within such context, walls acquire morphological features that can be enhanced via morphologic exploration through generative-parametric modeling and, to such extent, this chapter's aim is to state a model capable of processing a given wall or envelope as derived from a design process in which total or partial non-standardization is considered as design goal.

6.1. CONCEPTS.

Proposing a model requires conceptual clarity and, for conceptual clarity to happen, specific definitions are needed so that no room for misinterpretation is left. This section will state a set of concepts that will act as input and output data depending on the model's stage in which they might participate.

Concepts such as walls, cells, tessellations, joints, patterns and parameters have already been tackled in precedent chapters; however, a refinement of such is necessary to understand them within the context of the model to be proposed herein. (Sections 6.4 and 6.5)

6.1.1. PARAMETER.

The concept of parameter has been implicitly defined as a string-like data structure containing coded information acting on a specific problem or

condition (section 2.1.2) (Frazer, 1995). According to Mario Carpo, a parameter is the means by which a rule, or a set of such, is applied to a specific architectural problem as to give a generic solution under variable circumstances (Carpo, 2016). In both approaches, the parameter represents a data string coming from different sources that can be either geometric (shape), descriptive (text) or mathematical (value). Due to the manifold sources data strings are originated from, values derived from such sources can perform either as a static or a variable values defining the properties of a given object, be it an entire building or just a volute. An accurate concept of parameter is given by Carlos Barrios (2005) as he defines parameters as attributes that can be either static (explicit) or variable (Comment 40).

Namely, a parameter is an input that can change from explicit to variable depending on the particularities of the object being parameterized and the expected output the parameterized routine is meant to yield.

6.1.2. WALLS

Walls, on a larger scale, have the capacity of being partition, bearing, or wrapping elements whose properties can be uniform or variable depending on local factors. Such factors include, but are not limited to, building methods, comfort constraints, engineering requirements (loads), as well as weather exposure and fire resistance.

Let us think of walls as entities whose three-dimensional state is not always given by the

"[...] The attributes that are fixed are called explicit, and attributes that are subject to change are called variables. Explicit attributes become variables through parameterization, a process that defines which components of the model will vary and how the variation occurs. Variables can also be constraint to a particular range of values. The variables can be independent, where the variable can have any value that is assigned to have, or they can be dependent, in which the value of the variable is related or linked to the value of another entity of the model [...]"

*Comment 40. Definition of parameter.
(BARRIOS, 2005)*

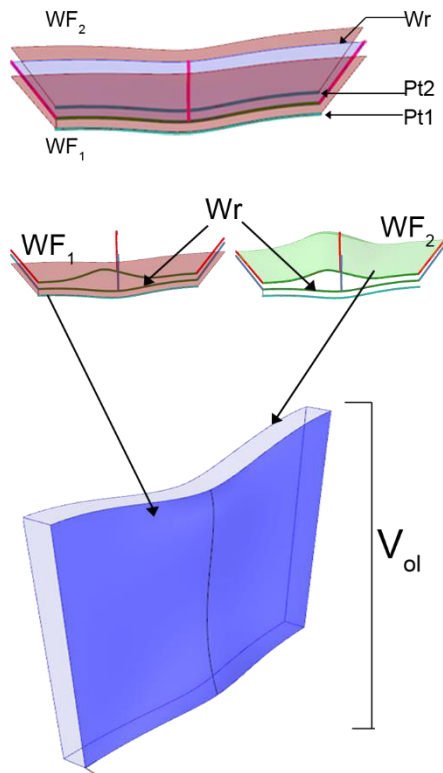

Figure 158. Three-dimensional state of a non-standard wall.

As seen in section 4.5, timber framing systems are flexible enough to adapt to a given wall morphology, even though most systems are used for orthogonal vertically-based wall arrangements. Moreover, Chapter 5 showed that there are non-traditional wall-supporting systems that, like the traditional ones, allow giving any wall under almost any architectural circumstances the necessary stability to accomplish their function (Sections 5.3 & 5.6).

Comment 41. Note on the architectural purpose of walls and envelopes in non-standard approaches.

condition of a surface being projected along a vector that yields parallel wall-faces. Let (Pt₁ and Pt₂) be two paths from which an abstract representation w_r of a wall is yielded. As w_r defines the 3D abstract state of the wall, its volumetric state V_{ol} defines its actual condition in space. Notice that faces (W_{F1} , W_{F2}) might not always be parallel to w_r . If faces are constrained not to intersect with w_r , V_{ol} can represent different volumetric states of the same wall as wall faces can have different topologic approaches. Namely, they are instances of w_r that can be topologically adapted to specific purposes i.e, W_{F1} can be an exterior face whilst W_{F2} can be an interior one of any wall type (partition, wrapping, or bearing) regardless of whether it follows a closed footprint or not (Figure 158).

From a structural outlook, walls are not monolithic bodies even if they visually look as such. As any building component, walls have a structure that adapts to the wall's morphology, topology and function and, to such extent, the structure assumes specific transformations to help the wall in fulfilling its architectural purpose (Comment 41).

In such context, a non-linear wall is hardly a seamless object. At some point, its body and structure are composed by a chain of facets whose proportion is small enough to allow a seamless perception of the wall, which was -at least- the approach i.e. the blob trend aimed to fulfill (section 1.4).

Conversely, facets are not a problem in non-standard architecture. They help in enriching the architectural language of a given body by exalting the structure it is made of. That is perhaps the reason why the mechanism by which walls are assembled is either partially or fully visible as to express the formal principle that leads a given building to be what it is. Facets and/or panels are the means by which complex envelopes and non-regular framings are subdivided and yielded. Unlike traditional framing structures, contemporary framing can get as arrhythmic as the structure's morphology commands, without that fact implying structural instability. The arguments that help equating traditional and non-standard approaches in wall framing are discussed in next section.

6.1.3. CELLS, PATTERNS AND FRAMED STRUCTURES

Framed structures are characterized for being an arrangement of closed loops, which are usually filled with a material different of that of the framing. Back in section 2.3.2, the referenced literature showed that such closed loops are called cells and that the elements defining a cell are called edges which simultaneously make part of bigger structures called patterns or tessellations (Comment 42). An abstract look towards the way common framing systems are arranged, suggests that they fit in the "regular tessellations" category (see 2.3.3), with structural pattern-variations ranging from monohedral to dihedral. To this extent, these tessellation patterns, as abstracted from traditional framing systems, are more a result

The term cell (cellula in Latin) was originally intended to identify the chambers of a monastery.

Furthermore, the term has been used to name enclosed spaces such as prison cells.

By analogy to monastic cells, biology borrowed the term "cell" since Robert Hooke used it to define the small chambers structuring cork back in 1665. The term will extend its usage to the field of living tissues by the 19th century.

Comment 42. Origin and first usages of the term "Cell." See (Encyclopædia Britannica, 2014)

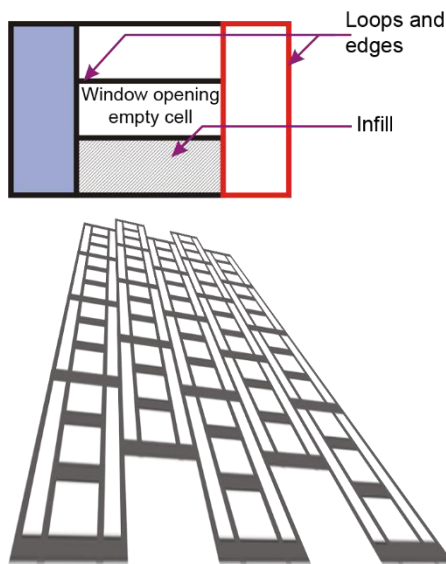

Figure 159. Abstraction of a light-framed wall. **Top.** Frames are composed by edges that yield closed loops or cells. Cells can be empty or filled with an infill of insulating material. Furthermore, cells can be partially or totally open (as in windows). **Bottom.** A façade plane tessellated by the pattern of the top image. The base module is displaced a half row every other column to make modules look like a vertical running bond.

[...] Except perhaps for half-timbering framings, in which the fact of structural members being exposed often led to arrangements in which the structural pattern embodied the architectural richness of the building.

Comment 43. Architectural composition from light-framing timber arrangements.

of mechanical criteria rather than of formal composition (Comment 43).

By using abstraction, it is possible to see structural patterns to adapt themselves as the building's shape entails, which might oblige cells to be split, stretched, or combined in order to adjust to space requirements or to add other components hosted in walls such as window and door openings, in which case, cells can be implicit or imposed.

An implicit cell-opening directly emerges from a pattern; it adopts the tessellation's morphology and topologically adapts itself as the tessellation requires to. Conversely, imposed cells geometrically differ from the rest of the cellular arrangement and have their own morphology hosted by the whole tessellation via cell re-accommodation or trimming, as to give room to the imposed cell regardless of its morphology. However, strict verticality is the undeniable feature standard light-framing systems have, ergo the cellular arrangement they are made of will always remain orthogonal.

On the contrary, non-standard approaches implicitly and consciously consider patterns as means for design rather than an instrument for construction only. I.e. irregular tessellations can be intentionally used for proposing framing systems in which cells are more responsive, in respect to structural topologic changes, than they can when using standardized systems.

Why referring to light framing systems and not heavy timber or log construction as cellular arrangements? As illustrated in Figure 160, i.e. column-beam-based framed systems function as concentrated-load transmission arrangements in which loads are conducted through diaphragms towards concentrated transmission members represented by columns and shear walls. Conversely, log timber systems are built as bearing solid wall arrangements in which logs, because of their heaviness and dimensional stability, efficiently distribute loads along their footprint as well as simultaneously absorb all the efforts a structure must undergo, however, height might be limited because of high inertia moments and dead loads.

Like log building, light framing systems continuously transfer loads along the length of structural members but with less weight, which is the reason why every item composing a framed wall has structural responsibility in keeping not only the wall but the whole construction stable (Figure 161). This last principle equally applies to projects like those discussed in sections 5.2, 5.3 and 5.8, in which patterned envelopes act as structural systems. In such cases, the entire cellular arrangement is responsible for structural stability, continuous load transmission and dissipation (diaphragm), and cladding/siding support.

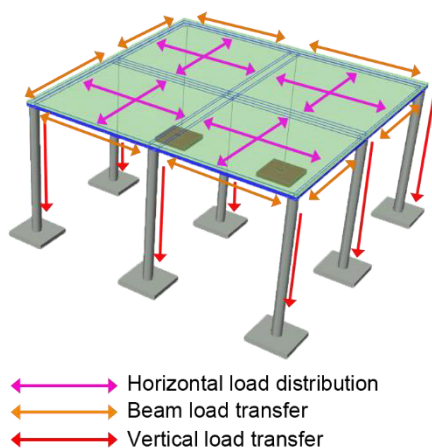
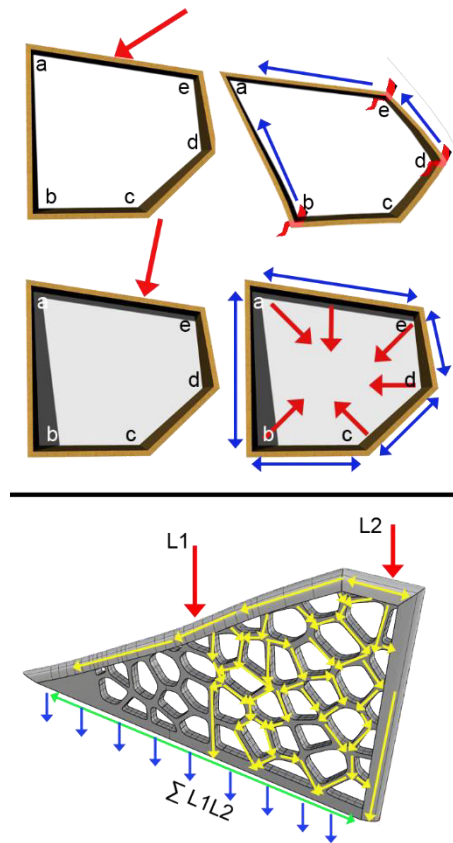

Figure 160. Load transmission in framed systems. Horizontal loads are dissipated means of diaphragm-like members. Horizontal and vertical members concentrate loads to transfer them to the supporting ground.

In sight of such facts, the cell turns into a multipurpose abstract unit featuring all of the aforementioned qualities.

6.1.4. JOINTS

A basic outlook towards jointing would suggest that joints have the essential function of coupling workpieces. A wider perspective suggests that jointing workpieces is what makes systems to be feasible. In this dissertation's particular environment, joints can be considered as generic modifiers that change depending on the scale in which they are meant to perform.



- **At the scale of a wall**, joints play an important role in creating a morphologic stable unit whose items are indispensable for the whole system to stand; such role consists in keeping elements together as well as in maintaining mechanical efforts within acceptable limits.

For such purpose, the mechanical bond between structural members should be conceived to allow uniform dead and live loads distribution and absorption throughout the structure as seen in the solutions adopted in the SUTD pavilion (Sevtsuk and Kalvo, 2014), the Kred Pavilion (Li, 2012), or the 130008252010 pavilion (Ko and Liotta, 2011).

In all cases, structural bonding was made by means of mechanical steel fastenings capable of absorbing the mechanical efforts present in structural knots, which makes the problem of cell-grouping a main structural concern. Alternatives to steel fastening are possible through timber-made inter-cell fastenings such as wedged or tusked clamp-like keys (Figure 162).

Figure 161. Load transmission in cellular systems. **Top**, left to right, top to bottom. An open cell receiving a vertical load cannot stand by itself as no combining or bracing elements are present to keep cell-walls together; theoretically, joints would fail to maintain the cell stable. In a second scenario, a closed cell undergoes the same vertical load. Charges are uniformly distributed through cell-walls with the help of a diaphragm (cell cover) avoiding the cell from collapsing. **Bottom**. A theoretic gravity effort, caused by two transformed gravity loads L1 and L2, acts over a set of confined cells. All elements work as a whole despite being open. Loads, as grouped in $\Sigma L1L2$, are transmitted through cell-walls and confinements to a lower member that uniformly distributes them to the ground.

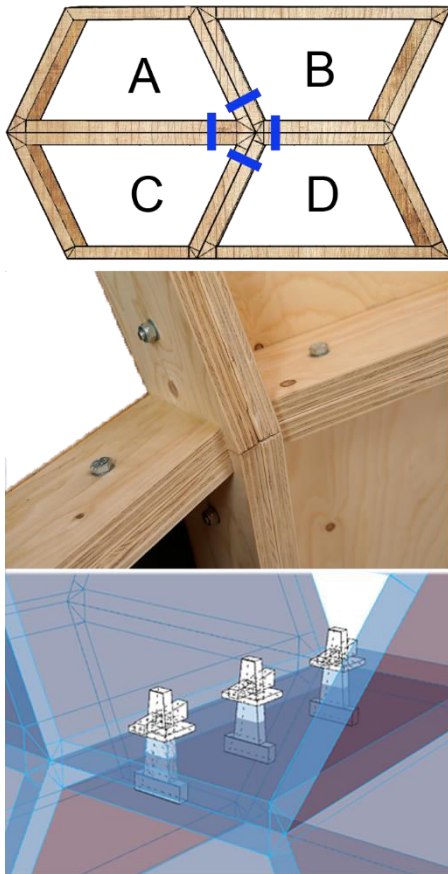

- **At the scale of the cell**, the jointing of its items requires a fastening mechanism that guarantees its stability as unit. Coupling cell items (cell-walls and cell-covers) can be achieved by means of friction joints such as dovetails, finger joints, biscuit joints and the like. The most relevant aspect here is to keep cell-walls attached in such a stable manner that the whole from which they make part of is never structurally compromised.

Within this work, joints will play an important role since they can be considered both as explicit or variable parameters that will be simultaneously fed by also explicit and variable geometric and mathematic parameters. To such extent, joints might be understood as articulating data entries and outputs for form-searching and materialization workflow loops.

*Figure 162. Inter-cell jointing. **Top.** A set of cells requiring a jointing solution near a knot. **Middle.** An option using bolts as fastening system. Inter-cell jointing solution for the Tides and Times pod by Amenity Space, 2009, London. Photo JC Bignon. **Bottom.** A fastening solution using tusked clamp-like timber keys made through CNC 2D laser cutting.*

The cell by itself is a self-bearing entity. Imagine a one-story house as a cell in which walls are bearing members forming a closed loop. The bottom cover acts as a foundation slab and the top cover acts as a roof. Imagine all walls are made of a solid material, i.e. CLT panels as well as the roof. In this model of cell-like dwelling, all exterior walls are bearing items while roof and floor act as dissipating diaphragms controlling lateral multi-axis displacement, making the cell to act as a stable monolithic entity.

In a theoretical approach, the usage of such concept might indicate that a collection of smaller cells, featuring similar characteristics, can compose a structure in which they assume loads the way bricks do.

Comment 44. Theorizing on cells as structural units regardless of scale.

6.2. GOALS, BOUNDARIES AND RESEARCH CONTEXT

The search of the adequate form to fulfill function in order to make design to be coherent, is a hard task that requires patience, knowledge and no small amount of problem-solving (pg. 57), which sometimes must be tackled by questioning the act of design itself: What happens when dealing with particularities becomes a burden for the whole project? What to do if architectural design asks for non-uniform solutions instead of regularization? What happens when not all spaces are to be enclosed as rectangular lifeless boxes but dynamic volumes? How to expect space to transmit sensations by itself instead of relying on decoration or furniture for such purpose?

In the middle of such questions, the problem of solving space oftentimes has a lot to do with the way it is structured, and walls are the key element that helps -perhaps- the most in doing so. The example of Hejduk's walls comes to mind as to challenge the reader, once again, to modify them and see what other dimension space can attain in sight of such modifications, giving place to another question. Why is it that a specific element such as a wall can so heavily affect the perception of space?

A look back towards planes as inevitable definers of three-dimensional space, helps in realizing the reason why non-standard architecture, as well as non-cubic spaces, provoke so much wowing in people when confronted to sensing space in a manner they have never experienced. However, curvy or distorted shapes are not the only strategy to transform space into a source of sensations inasmuch as there exist other instruments to achieve so.

6.2.1. TACKLING INDIVIDUAL ARCHITECTURAL ELEMENTS TO CREATE DESIGN SENSATIONS AND EXPERIENCES.

Patterns, tessellations, lattices. Close concepts all of them (section 2.3), have a powerful influence as space modifiers without the latter being in need to turn into a distorted volume. A quick look to the Villa Vaché, designed by architect P.Quintrad in 1965, shows that changing the morphologic properties of a single wall can totally change the way a project is perceived and experienced.

The dining hall's façade, covered by a curtain wall composed by an arrangement of cement pipes of manifold diameters, exposes a clear example of customization and variation from standardized components (Ciblac, 2011)(Figure 163).

At this point, the question is not about the curtain wall's morphology but about the means by which the architect got to such result. According to documentation on the matter (Marantz-Jaen et al., 2010), the work of designing the façade was a coordinated task with a plastic artist who helped architect P.Quintrand in defining the guidelines of such proposition. The same pattern and method was used in the design of a labyrinth for "l'École de la Pinette" at Aix-en-Provence (Figure 163) (Comment 45).

6.2.2. SETTING THE AIM

Because specific changes in architectural propositions often lead to bigger changes in global design, and modifying entities one-by-one is far from being practical; parametric-generative form-searching methods become useful mechanisms for creating aided-design tools capable of tackling such tasks in a manner that generating design options does not turn into a burden but into a real-time form browsing.

The trend has become widespread through the years as the main environments (GH, GC and Dynamo) have given birth to development communities in which people -some specialized, some not- create small packages based on scripting and visual programming for tackling

Mr Quintrand's background as a pioneer in research and development of computer-aided architectural tools opens a small gap for speculation and suggests that such endeavor could have been made with the help of a computer program, basic as it could be in the mid-1960s, capable of tackling problem-solving tasks. If the speculation is false, then a set of analogic parameters for placing the main pieces of the arrangement could have helped in solving the façade.

Comment 45. Speculation on Quintrand's work

specific design tasks (Comment 46). Such small programs are what have been herein defined as **ACPTs** (Pg 172).

Under environments such as GH, ACPTs are presented under the form of add-ins, add-ons, plugins or packages whose purpose range between tasks such as Finite Element (FE) analysis, form-searching, problem-solving iteration, fabrication routines, CAM analysis and simulation, software data exchange and so on. The list can become endless as every so often there is someone launching the first version of some kind of ACPT¹⁵⁵.

Some ACPTs are in fact small in terms of disk cost. They only take a couple of megabytes to operate, however, their architecture and functioning vary in robustness depending on the capabilities the ACPT may have.

A plugin like i.e. paneling tools normally operates under-low system-impact as the operations it performs demand low-to-medium iteration rates. Conversely, plugins of the nature of Kangaroo or Karamba, usually must carry on complex problem-solving and form-searching operations demanding higher iteration rates that will necessarily impact the RGH application.

Chapter 7 will show that having a robust solution (algorithm), returns high iteration rates that result in long processing times regardless of hardware performance, inasmuch as the RGH environment uses one processing core only.

Comment 46. Small ACPTs are not that small.

Within such wide framework there are still some gaps to be filled and **this dissertation's aim** is to help filling them by proposing **a)** A method for computer-aided architectural design in which non-standard timber walls play a role different from that of pavilions or showcase architectures. **b)** An ACPT capable of translating the method into a data generating structure whose function range includes tasks such as retrieving raw design data, transform it into form-searching modeling, create iterative solutions based on parameterized inputs and, generate fabrication and CAM data for aided-manufacturing.

¹⁵⁵ To august 2016, there exist up to 871 packages for Dynamo, at least a dozen add-ins for GC and about 150 add-ons for GH without including those for Rhinoceros. (dynamobim.org, 2016; McNeel Europe, 2016; Smith and David, 2011)

6.3. GOAL CONSIDERATIONS

The aims for proposing a method and a model for developing an ACPT, as stated in the preceding section, require the establishment of a series of specific goals and constraints that will help better define the scope of the ACPT's model. In sight of the aforesaid facts and the current state of architectural research and avant-garde practice, the ACPT method to be proposed in this dissertation will need to take into account the following considerations:

6.3.1. DEVELOPMENT ENVIRONMENT.

A first outlook would suggest that either working with Bentley-GC, RGH, or Revit-Dynamo environments would be more or less a similar approach. However, despite the fact of all packages including visual programming interfaces, the digital environment will be mainly focused on the RGH environment for 2 basic reasons: **a)** It is about the most used environment in the field of visual programming and iterative-generative parametric modeling. **b)** It is the mastered and taught environment at C.R.A.I and the School of Architecture of Nancy, which makes any research endeavor on the topic easier to master as experienced researchers and students make use of the same language to tackle design exploration. Such fact facilitates things a lot when asking students or interns to perform specific tasks, while simultaneously reducing inter-environmental file exchange that might lead to data translation errors.



Figure 163. **Top.** Villa Vaché 1965.
Bottom, « École de la pinette, 1966.
Arch. Paul Quintrand. *On* (Marantz-Jaen et al., 2010)

6.3.2. DATA RETRIEVING.

The method should be capable of retrieving data from an external source by means of data exchange through a compatible environment. Data to be retrieved is supposed to partially or totally embody the digital representation of an architectural element, following functional and aesthetic principles agreeable with timber construction.

6.3.3. FORM-SEARCHING.

The method, as well as the ACPT it will yield, should serve as a form-searching (Carpo, 2015a) environment for generating and/or redefining walls and envelopes (skins) as part of non-standard low-scale timber design-to-construction endeavors. The emphasis in working on a low-scale approach lies on the fact that generic solutions do not need large scales to be applied. Furthermore, as the activities tackled in this study constitute a first development stage, it might be better to isolate as many problems as possible in a controlled-scale environment. As results should start proving to be functional, their use might be considered for making tests at larger scales; such fact will depend on the evolution the method as well as its ACPT acquire.

6.3.4. DESIGN SPAN.

Based on the cases studied in Chapter 5 the method will focus on two design cases: bearing and non-bearing entities for brand-new and renovation projects.

- In **new designs**, the method's aim is to intervene at early design stages, through form-searching, as a means to allow an early assessment on design decisions. The method should be capable to propose a mechanism to further the ACPT to treat specific design targets as well as global design approaches. The application in new designs should be suitable for at least two scenarios: **Focalized Decision Making** and **Global Decision Making** (Comment 47).
- **Renovation projects**. At this scale the method should propose strategies for tackling design tasks involving non-bearing partition walls and façade envelopes such as that of the Jules Ferry Dwellings (section 5.7), in which the exterior envelope has a reduced structural involvement. The difference is that the morphologic outcome can be targeted towards the non-standard approach, though a standard outcome should be possible nonetheless if design requirements demand so.

Focalized Decision Making (FDM) refers to design decisions of the kind of the cement-pipe curtain wall as seen in the villa Vaché by P. Quintrand. **Global Decision Making (GBM)** has to do with cases such as those studied in sections 5.1 to 5.6 in which the non-standard approach, as applied to timber construction, can involve a whole bearing envelope.

Comment 47. Localized Decision Making and Global Decision Making definitions

This category's approach should be particularly useful in passive-aimed renovation projects for which energy consumption optimization is a main concern.

6.3.5. EXPECTED OUTCOME.

Although foreseeing positive results out of form-searching endeavors could be considered as speculative, the idea of submitting design to form-searching should obey to the architect's desire for exploring with the non-standardization of form. To

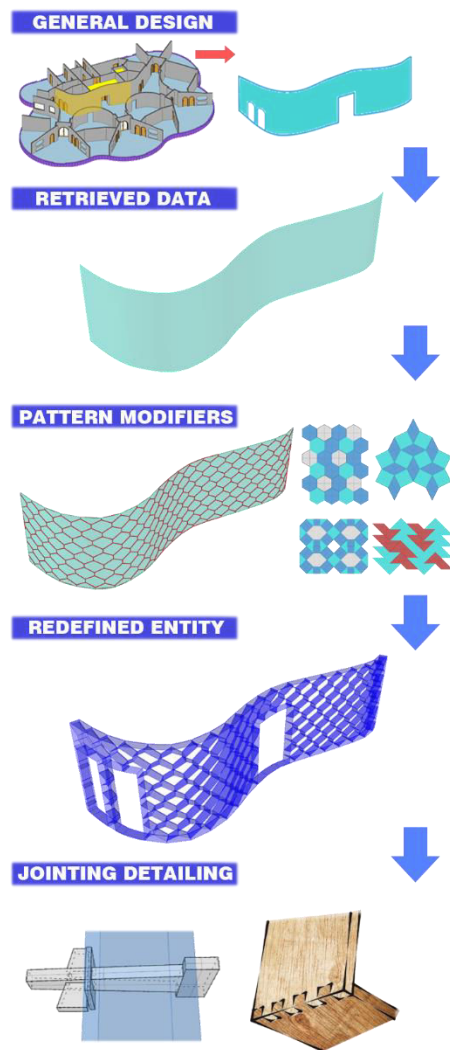

Figure 164. Expected ACPT's form-searching and detailing general workflow.

this point, the designer should expect shape mutation in a morphological and topological way that even undesired results might emerge, especially when using iterative problem-solving processes like i.e Galapagos or Kangaroo, whose outcome cannot be fully anticipated.

In general, terms, the data generated by the ACPT to be proposed in sections 6.4 and 0 should be capable of generating a decent range of design options based on the retrieved data. Such design options might include a range of morphologic and construction modifiers in order to allow for producing a data set including general design and jointing detailing information (Figure 164).

In a final step, the ACPT should be capable of packing and exporting the generated data towards a CAM environment via universal CAD/CAM file exchange formats for RM. A more ambitious approach would suggest there would be a built-in G-code generator to avoid inter-environmental file exchange.

6.4. DESIGN OF A MODEL FOR AN AIDED-CONCEPTION PARAMETRIC TOOL. STAGE 1: GENERAL APPROACH

Now that the aim of the ACPT proposed in the framework of this dissertation has been identified, a look on the properties walls have as entities that make part of a whole (building) will better help in characterizing them according to the role they play not only as enclosing elements but as space modifiers. As such properties already exist in the form of IFC data models and codes, we will borrow the definitions and classes used in the IFC technology environment to build the data model that will help in designing the intended process for creating and aided conception-to-fabrication tool. As main constraint and, for any notional or design matter, the model and methods hereby proposed will assume that any given project's architectural and

environmental design constraints are already assessed, therefore defining or redefining walls and envelopes should be part of a global design endeavor in which the morphological aspect such items acquire through the process has a well-defined purpose. Given the fact that no entity is conceptually detached from its host, the concept of wall -as part of a whole- will be reduced to its minimal attributes in order to revise it and redefine it as to match many of the principles of non-standardization and the IFC technology.

6.4.1. WALL CHARACTERIZATION

As stated in section 6.1.2 a wall is not necessarily the representation of an orthogonal-vertical enclosing plane. It can be embodied by free-form footprints provided with extended morphologic attributes i.e. NURBS curves modifiable by means of parametric control points. Such representation requires functional and spatial attributes to gain purpose, so the first attributes to take in consideration are the wall's morphology and its bounding perimeter (Figure 165).

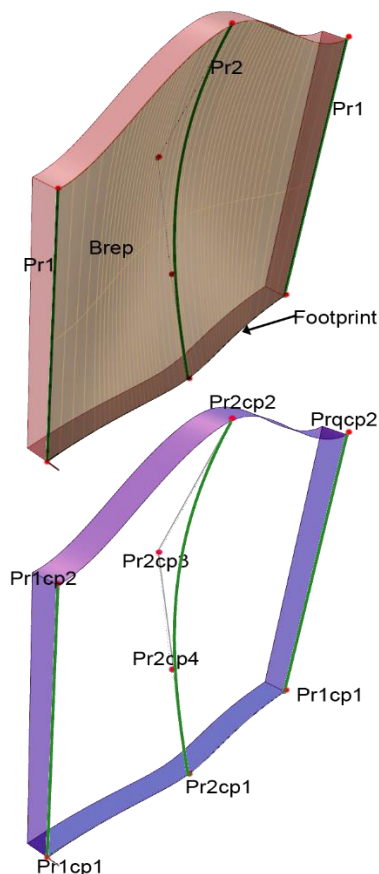

Figure 165. **Top.** Two parametric profiles (Pr1 -Pr2) are swept through a footprint as wall emplacement. The product is a boundary representation of a topologically modified wall. **Bottom.** A boundary, represented by the wall's edges, hosts parametric profiles and control points. Topology can be changed, though the wall remains contained in its boundary.

According to the premises defined in section 6.3 the model should propose a method to retrieve geometry from a given project whose global design approach is already defined, as in the a series of projects presented in Figure 166 in which walls have different characteristics derived from factors like function, morphology, permeability and adaptability. Those special attributes are not usually defined in i.e. BIM approaches inasmuch as standards, such as IFC, do not consider such morphological features as classes to define i.e. a wall. (Comment 48), ergo they should be considered in proposing i.e. enhanced IFC features.

An example that illustrates this fact is the geometric definition of a wall derived from a footprint and a profile such as the one seen in Figure 164. According to the standard geometric representation stated by the IFC standards, an IFC wall is defined by a "SweptSolid Representation" characterized as:

[...] "If the wall body can be described by a vertical extrusion of a polygonal footprint of the wall body (where vertical = into the direction of the global Z axis), the subtype *IfcWallStandardCase* should be used. If the extrusion is not equal to global Z, then the *IfcWall* with 'SweptSolid' representation should be used. The *IfcShapeRepresentation* shall have the following values:

RepresentationIdentifier : 'Body'

RepresentationType :
'SweptSolid'

The following additional constraints apply to the swept solid representation:

Solid: *IfcExtrudedAreaSolid* is required,

Profile:
IfcArbitraryClosedProfileDef shall be supported.

Extrusion: The extrusion axis shall be perpendicular to the swept profile, i.e. pointing into the direction of the z-axis of the *Position* of the *IfcExtrudedAreaSolid*. [...]

Please notice that the extrusion policy is constrained to a perpendicular vector, ergo free-form walls would not fit into this data description, nor in the data model either.

Comment 48. IFC wall geometric definition. Quotation from (IAI International Council Limited, 2006).

The standard language for identifying building elements is nowadays defined by the ISO-12006-3 standard, relative to the "based ontology for the building and construction industry" (IAI International Council Limited, 2006). Within this framework, the terms henceforth used will attempt to agree to such standard in order to make language used in making the model proposed in this dissertation, as generic as possible.

6.4.2. STANDARD WALL DEFINITIONS AND ADAPTATION TO THE ACPT'S AIM.

The definitions herein contained are adapted from the Building Smart Data Dictionary (buildingSMART International, 2016a), and presented in the form of data objects. The terminology from now on used, will be focused on walls and the various dimensions they take as partition, bearing or envelope¹⁵⁶ entities. This equivalence is made due to the current and increasing interest architects and engineers pay to BIM practices, which turns the incorporation of a standard language to this model into a useful resource towards the future development of the ACPT and its potential integration into BIM workflows.

Wall: According to ISO standard 6707-1, a wall is a "vertical construction usually in masonry or in concrete which bounds or subdivides a construction works and fulfills a load bearing or retaining function". According to the IAI, a wall is an entity that "represents a vertical construction that bounds or subdivides spaces. Walls are

¹⁵⁶ Envelope walls are also known as curtain walls. The ISO 6707-1 standard states that a curtain wall is a [...] "non-load bearing wall positioned on the outside of a building and enclosing it" [...] (IAI International Council Limited, 2006)

usually vertical, or nearly vertical, planar elements, often designed to bear structural loads. A wall is however not required to be load bearing". (IAI International Council Limited, 2006).

Figure 167, makes a comparison between wall classes as defined in Ifc2 and Ifc4 standards. Notice that the class that matches the best the notion of non-standard wall is the "CurtainWall" one, though its attributes lack some definitions and/or operations that have been included in a new class named "Non-StandardWall" (NSClss). Notice that some fix attributes such as "exterior" are now a Boolean that makes it possible for a non-standard wall to act as an interior or exterior entity regardless of its morphology whereas in the IFC standard the "CurtainWall" class was exclusively intended to describe an exterior entity.



Figure 166. Architectural design often requires focusing on individual items to achieve a language. Herein, enclosing planes perform different functions (envelope, roof, façade and/or partition) as specific design solutions for global design goals. **Top and Middle.** Holiday huts, wood challenges 2016. Photos O.G. **Bottom.** Nursery Facility (Weulersse, 2013).

As non-standard walls are a kind of multi-purpose entities that can adapt to almost any usage and compositional pattern, the new NSClss merges attributes that were exclusive of more "static" wall definitions as the "StandardWallCase" and its super-class, the "Wall" class. Also, new operations that were absent or perhaps considered as "explicit" by the IFC standards -such as "setAssemblyPattern" or "setShapeOptimization"- intervene as modifiers particular to the ACPT proposed herein.

CLASS TYPE	IFC STANDARD WALL CLASSES			ACPT WALL CLASS
CLASS DEFINITION	WallStandardCase localPlacement thickness : int productDefinitionShape isExterior : boolean hasOpenings : boolean setMaterialLayerSetUsage()	Wall localPlacement productDefinitionShape varThickness : string isExterior : boolean hasOpenings : boolean setMaterialLayerSetUsage()	CurtainWall localPlacement productDefinitionShape exterior nonLoadBearing setMaterialLayerSetUsage() setMemberType()	Non-StandardWall globalId localPlacement productDefinitionShape varThickness : string isExterior : boolean hasOpenings : boolean isLoadBearing : boolean setMaterialLayerSetUsage() setAssemblyPattern() setShapeCustomization() setInterCellJoiningSystem() setInCellJoiningSystem() runMachiningProgram()
	Straight walls only Non-aggregate entities	Freeform and non-freeform walls by geometric Brep Non-aggregate entities	Freeform and non-freeform walls and envelopes by geometric Brep Aggregate entities No customization	Aggregate-customized entities Freeform and non-freeform walls Geometry by Brep
CLASS CAPABILITIES				

Figure 167. Comparison between IFC standard wall classes and the non-standard wall class (NSClass) proposed in this dissertation. The NSClass concentrates the capabilities of all other classes in a single item¹⁵⁷.

6.4.3. SETTING THE MODEL

With the precedent concepts in mind, there is now enough information to propose a process map describing the way the ACPT, henceforth named Fab-Cell, will operate (Comment 49). By synthesizing the processes shown in Figure 164, an abstraction of the general model ruling Fab-Cell shows that the main tasks it tackles are divided into three kernels governed by four operation groups and three feedback loops (Figure 168).

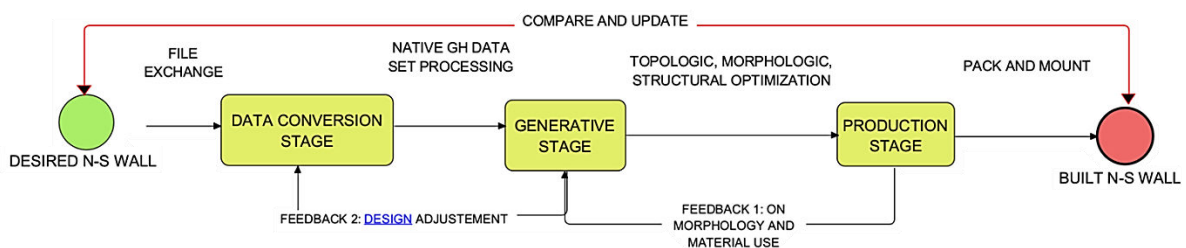

Figure 168. General model's process map. Yellow= kernels. Top texts = operations.

¹⁵⁷ Some attributes have been adapted from the IFC literature on walls and its standard definitions (buildingSMART International, 2016b; IAI International Council Limited, 2006). Therefore, classes, as presented herein, do not have the same structure as in the IFC model standards.

However, this is just a synthesized version of a more detailed activity diagram in which the objects and operations, considered important for Fab-Cell to work, are stated (Figure 169 & Figure 170).

Fab-Cell is an acronym for "Fabrication and building of cellular structures". It is applied to those structures making part of architectural bodies conceived following biomimetic principles, yielded through computational modeling methods such as those discussed along this dissertation.

Namely, it is the embodiment of the concept of disorganized complexity, as it deals with how digital modeling outcomes can deliver complex design and fabrication arrangements by means of big data management.

Comment 49. Definition of Fab-Cell.

The activity diagram splits the entire operation from conception to production into the already mentioned kernels (Figure 168). Henceforth a kernel will define a set of functions able of running a process by itself, generating an output that can be used either as result or as a parameter for another data set.

Next section describes the main function each kernel performs as well as it details the classes intervening in every kernel's process set. Aforementioned processes will be organized into a class object-oriented model that will depict the attributes of every kernel's class.

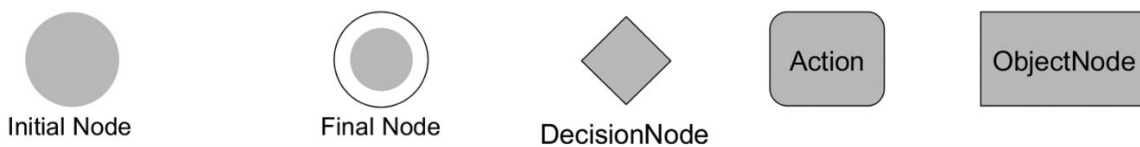

Figure 169. Activity diagram conventions.

A digital morphogenetic model...

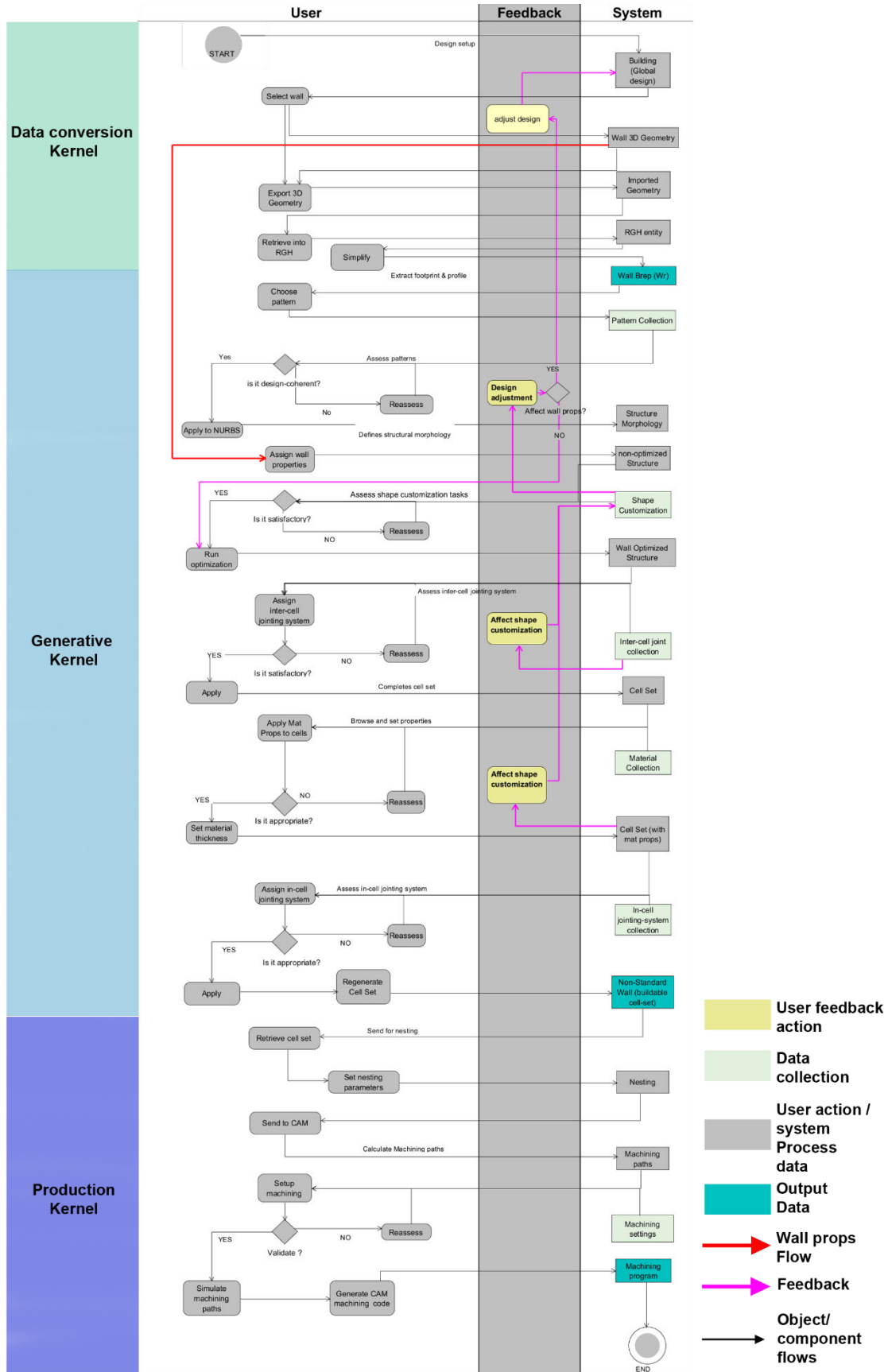

Figure 170. Fab-Cell activity diagram. Please refer to Appendix 6 for a larger version.

6.5. DESIGN OF A MODEL FOR AN AIDED-CONCEPTION PARAMETRIC TOOL. STAGE 2: DETAILED APPROACH.

Although the activity diagram offers quite a detailed outlook about the functioning of Fab-Cell, a more detailed approach is required as to identify the particularities every kernel needs to deal with. This will facilitate the process of setting components and relations in the RGH interface at the time of assembling a parametric-generative solution for Fab-Cell. Based on the information contained in Figure 168 and Figure 170, kernels will process data as follows¹⁵⁸:

6.5.1. DATA CONVERSION KERNEL FUNCTION RANGE.

The data conversion kernel embodies two main functions: **a)** To retrieve data directly from design (a geometry set) and **b)** to convert it into native GH geometric data suitable for generative modeling.

For this purpose, the geometry set in question ought to be simplified to a footprint and a profile for creating a boundary representation of the wall¹⁵⁹. Figure 171 shows the classes composing the *data conversion* kernel, their inner relations, and the result of reducing the geometry imported from design to a Brep (*wBrep*).

Generative kernel: In the generative kernel a collection of parametric geometric patterns (tessellations) acts on a *wBrep* (Figure 173) to split it into a set of aggregates that will now act as a “*productDefinitionShape*” attribute.

¹⁵⁸ Please refer to Appendix 7 to see the complete object class model.

¹⁵⁹ This concept can be equally applied on bearing and non-bearing walls or envelopes.

A digital morphogenetic model...

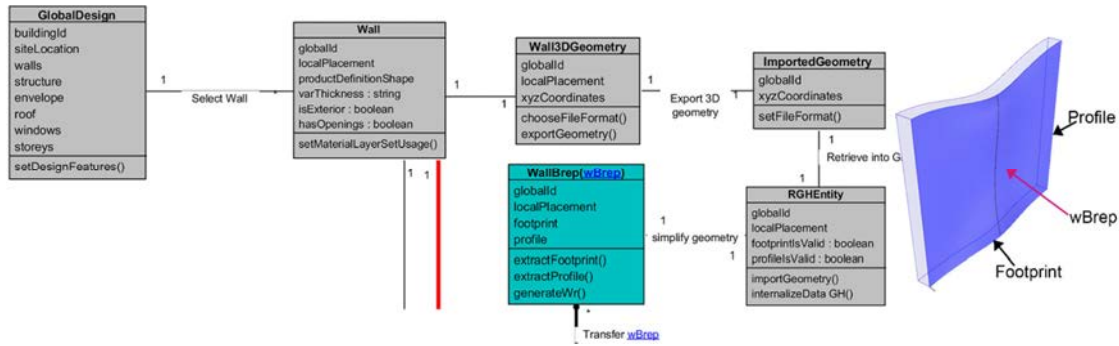

Figure 171. Fab-Cell Data conversion kernel, and desired output (on the right)

The idea behind packing tessellations and patterns into a single class is that the designer should not need to define them by himself but just use them by browsing and changing parameters for performing form-searching operations. This class's output will be a set of breps (aggregates) that will work as morphologic and (eventually) topologic modifiers.

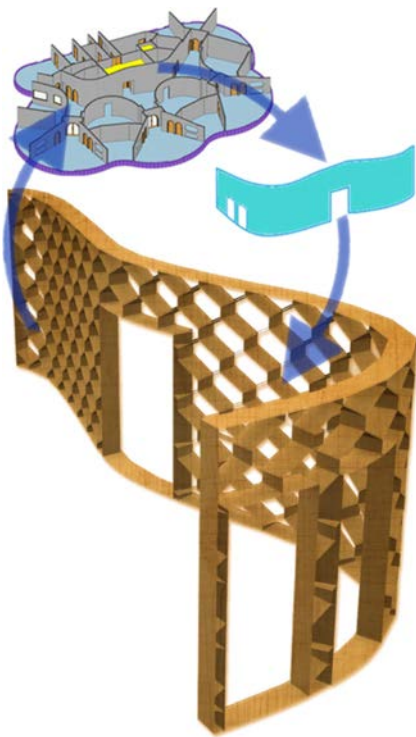

Figure 172. Generative kernel's desired output and workflow. **From left to right:** Global design, Data translation, generative output. The output should be reinserted into global design to validate it.

In addition, the generative kernel should have a bigger iteration load because processes that are more complex happen into it. Inasmuch as the wBrep should have gained a structural morphologic definition, the generative kernel should be able to optimize it; to this extent, the wall's aggregate set should be by now conformed by a group of planar or curved entities.

However, insofar as the manufacturing process is aimed to use standard timber composite panels, all aggregates ought to be planar for the model to succeed in sending information to the next kernel. In order to accomplish such constraint two options are to be tested: **a)** to use a segmented footprint and profile to obtain a non-uniform surface or; **b)** to

planarize aggregates after a tessellation splits the *wBrep*.

In a final stage, the generative kernel ought to be capable of applying wall properties -as defined by design- and yield a set of non-intersecting Breps (cells) that, put together, would embody a wall (Figure 172).

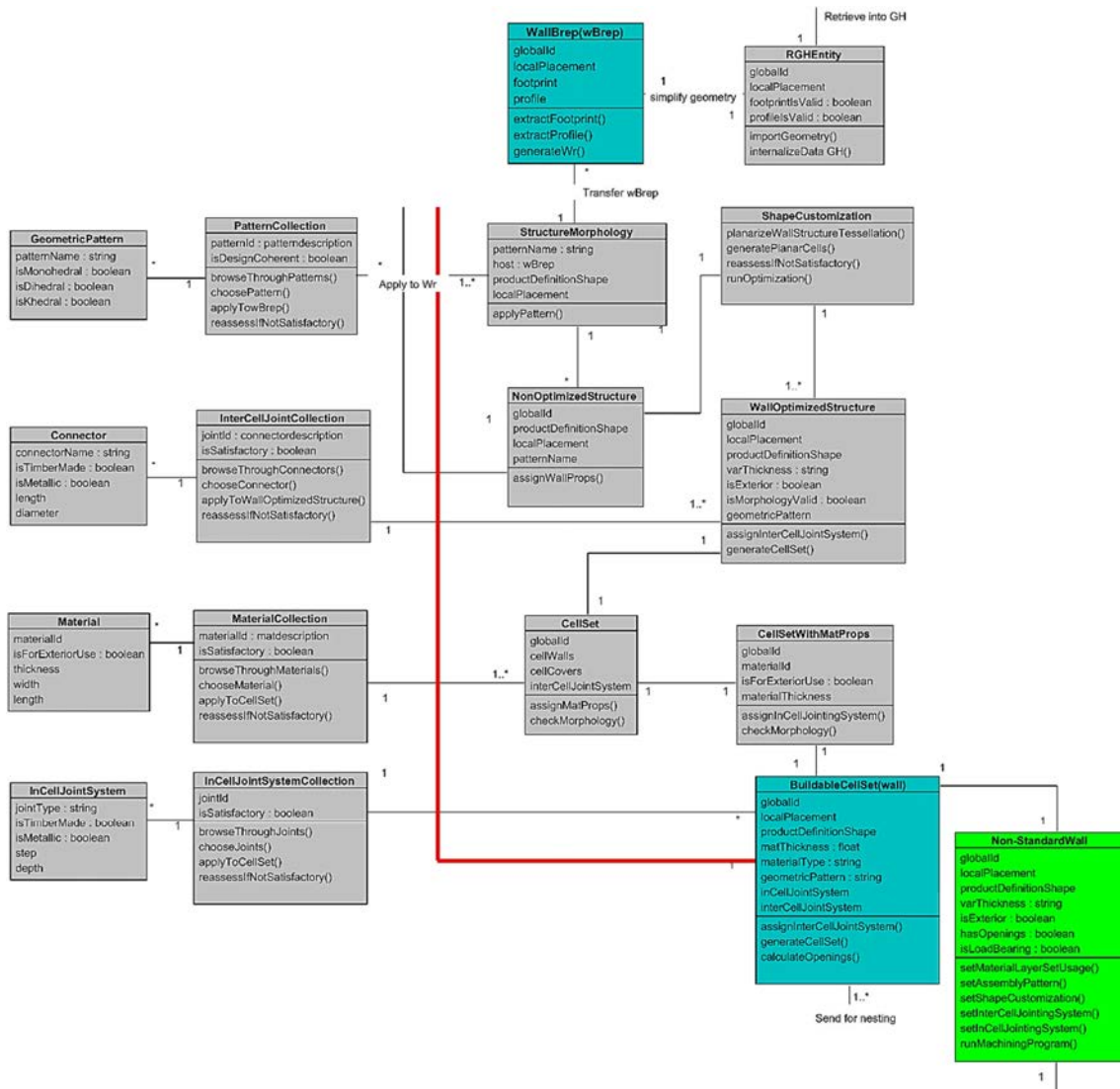

Figure 173. Fab-Cell generative Kernel. This kernel's output is shown in Figure 172

Production Kernel: The production kernel should retrieve the cells yielded from the generative kernel and process them to assign joints to folds in cell-walls and cell-covers. A set of parameters acting on a joint collection should allow adjusting, browsing, and choosing the joint-type that adapts the best to the cell-set, in function of cell sizes, wall depth, material thickness, and mechanical behavior (Figure 174).

In another step, the kernel should be able to process all cells one by one -or by sets- depending on the complexity of the programming routine to achieve so. Once joints will be calculated the kernel's algorithm should be able to nest items, calculate their milling trajectories, and transform those machining paths into fabrication CNC code.

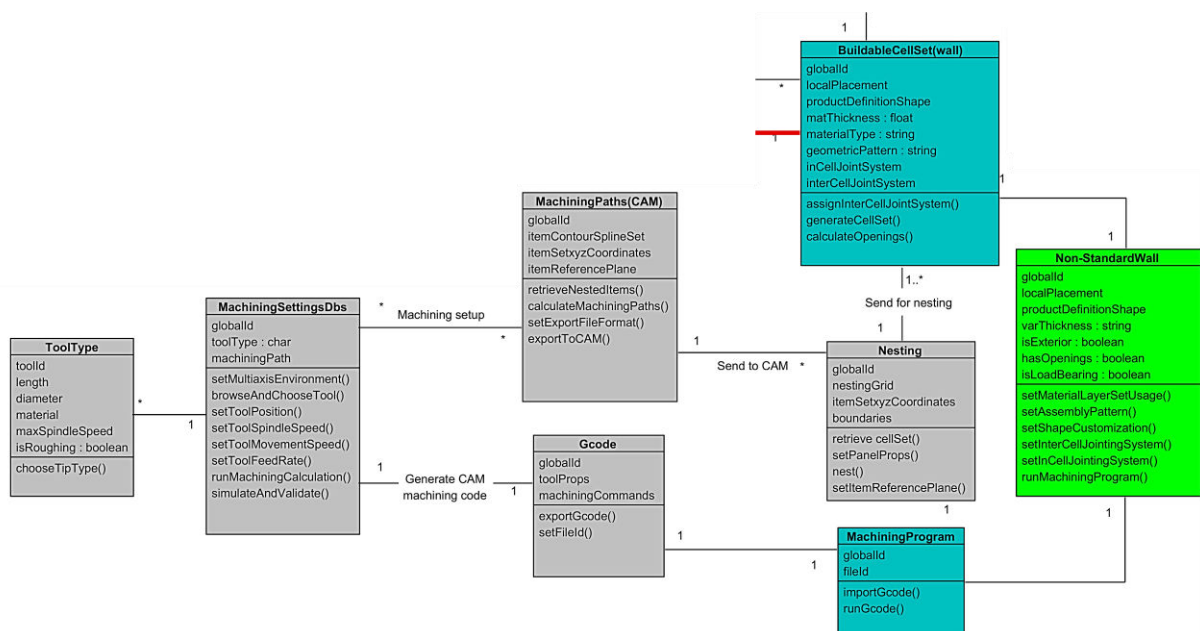

Figure 174. Fab-Cell production kernel

The desirable outcome should be a CNC cutting code package containing machining, tool-change, spindle rotation, and tool-trajectory commands, as the most relevant features a Gcode set should contain (Figure 175). Nonetheless, the more thorough the machining settings operation is, the more complex the set of CNC instructions will become and the more detailed workpieces are going to be (at least theoretically).

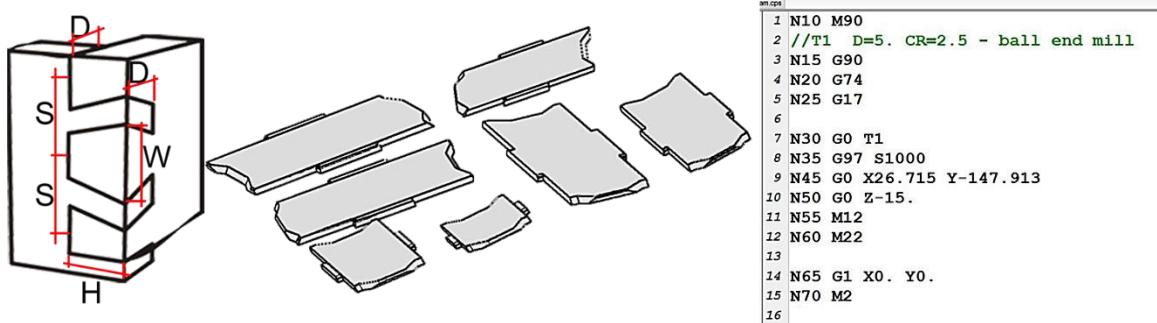

Figure 175. production kernel desired output, from left to right: Cell splitting and joint parameterization; wall-item nesting; CNC code generation.

6.6. CHAPTER CONCLUSIONS

This chapter stated a process on which an ACPT called Fab-Cell should operate and yield a set of results that have been foreseen as ideal. Most tasks the ACPT is aimed to fulfill are oriented towards form-searching and design optimization architectural designs in which the walls and/or envelopes to transform must be clearly defined, although “in-the-void” form-searching and design should also be possible, as is the case of the prototypes presented in next session.

All the considerations made for proposing this model take into account the fact that Fab-Cell, as a product, should be flexible enough to adapt to manifold design, fabrication and mounting processes though a question might well arise: what is the place of the mounting process in this digital chain?

The mounting process is an endeavor that depends on human workforce; namely, the variables the process might have are excessively numerous, though there might

A digital morphogenetic model...

be a way in which human workforce can influence Fab-Cell's data model: through manufacturing and mounting optimization. That kind of feedback is one of the key elements for Fab-Cell's evolution that was implemented via large-scale-prototyping, as the next chapter describes.

***PART 3. ACPT VALIDATION AND
IMPROVEMENT***

Chapter 7. MODEL EVOLUTION AND VALIDATION

Theoretic models tend to undergo changes as they are tested since oftentimes not all the intricacies of setting up a new development can be fully assessed. Also, taking ideas into realization leads to face challenges that, even if they are considered in conception stages, practice proves them to be either more difficult or easier to achieve depending on a random set of situations that can only be tackled once experimentation is launched.

This chapter describes Fab-Cell's development stages by testing and pushing the boundaries of generative and production kernels, which will prove to be the more sensible and complex ones to deal with. To do so and to move towards an evolution of the proposed model, the making of two prototypes in the framework of the wood Challenges (défis du bois) 2014 was conducted. The results of this first experience showed that several components of the modeling interface needed improvement as well as it proved that tackling digital full-scale fabrication¹⁶⁰ endeavors with limited equipment might become impractical.

The first experience's legacy is that the Fab-Cell's modeling environment underwent two optimization stages that improved the ACPT's capabilities to a state in which it can tackle to digitally define and redefine non-standard timber walls and produce generic fabrication data suitable to be fed into a RM multi-axis environment.

By the end of the chapter, a summary of the improvements performed on Fab-Cell will allow to compare the model designed in Chapter 6 against the workflow that emerged as result of such improvements.

7.1. FIRST EVOLUTION AND VALIDATION STAGE. THE “DEFIS DU BOIS” 2014 CASE.

The challenges for the first validation stage were to **a)** build a modeling environment capable of processing free-form geometries and convert them into actual free-form walls, and **b)** setting up a fabrication workflow that would allow producing complex

¹⁶⁰ Prototyping sessions had the support of the School of Architecture of Nancy (ENSAN) and the Superior National School of Technologies and Wood Industries (ENSTIB). Prototyping works were developed from May 13 to May 20, 2014.

items through timber subtractive fabrication. For that purpose, the ENSAN¹⁶¹ and the ENSTIB¹⁶² agreed in supporting the experiment by providing the equipment that would facilitate achieving the prototyping endeavor. Upcoming sections will make a description of the entire process from the modeling interface setup to the mounting of the prototypes (Table 8).

Two structural morphologies were assessed throughout the experiment: **a)** a variable quad geometric pattern and **b)** a Voronoi pattern.

7.1.1. BUILDING FAB-CELL. FIRST GENERATIVE APPROACH

Making the referred prototypes tackles a series of intricacies derived from a modeling process that involves conception premises as well as production constraints. Facing such intricacies requires a model capable of testing the boundaries of what is formally conceivable against what is practically feasible.

With that in mind, the first modeling approach consisted in proposing challenging free-form surfaces representing two walls that would perform as a gate for entering the wood challenges' 2014 site (Bignon, 2014). Walls were defined either by rectilinear or free-form footprints and profiles, so the NURBS surface representing each wall could be easily transformed from a straight element into a free-form entity.

In this particular case, cells were the product of splitting the NURBS surface by means of a line network that increases or decreases its density depending on the curvature the NURBS surface might have. Namely, it is the NURBS surface's

Table 8. Prototype-making general facts

<i>Fab-Cell's Prototype execution sheet</i>		
<i>Modeling tasks</i>	<i>Start</i>	<i>04/02/2014</i>
	<i>End</i>	<i>30/04/2014</i>
<i>File Exchange and data optimization</i>	<i>Start</i>	<i>25/03/2014</i>
	<i>End</i>	<i>02/05/2014</i>
<i>CNC programming, fabrication and mounting</i>	<i>Start</i>	<i>05/05/2014</i>
	<i>End</i>	<i>20/05/2014</i>
<i>Post-production evaluation</i>	<i>Start</i>	<i>26/05/2014</i>
	<i>End</i>	<i>20/06/2014</i>
<i>CNC programming</i>	<i>Anis Bouali</i>	
<i>Robot operator</i>	<i>Julien Lallemand</i>	
<i>Collaborators</i>	<i>Marie Claude Plourde</i>	
	<i>Julien Meyer</i>	
	<i>Franck Besançon</i>	
	<i>Esmael Moussavi</i>	

¹⁶¹ French acronym for National Superior School of Architecture of Nancy.

¹⁶² Acronym for Superior National School of Technologies and Wood Industries.

wireframe the entity in charge of generating cells.

Three-dimensional cells are derived from extruding the NURBS' fragments along an axis and performing a series of extrusion and morphing operations in order to obtain cell-walls and cell-covers. This method showed being slow to run because of the number of iterations necessary to solve the modeling algorithm.

Furthermore, problems regarding the dimensional stability of cell items were identified when performing a check on cell-thickness accuracy that would not allow geometry to be exported towards a CAM environment, as it would not fulfill the accuracy requirements semi-automated fabrication processes demand.

In sight of these facts, the approach needed to be abandoned, though it produced quite decent results in respect to cell concavity and convexity management (Figure 176). Moreover, an issue regarding cell-collision and cell-torsion caused by excessive curvature was identified, leading to decide on whether to tackle this particular situation only or totally change the approach in order to avoid collisions regardless of whichever structural morphology walls might have. The second option was taken, as Fab-Cell's first version could not ensure no collisions would appear when dealing with acute double-curved walls (Figure 177).

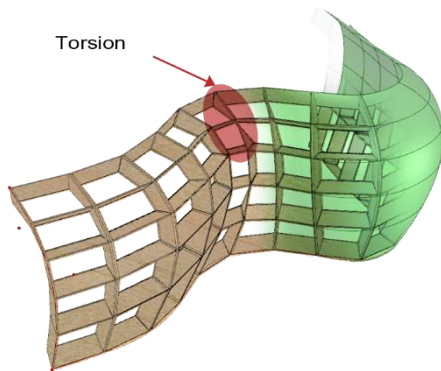

Figure 176. Torsion on vertical and horizontal members of a wall structure caused by excessive curvature. Conversely, cell-concavity and cell-convexity are well managed.

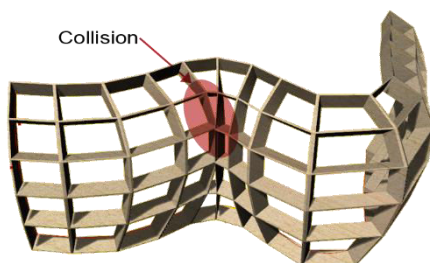



Figure 177. Vertical member collision due to acute curvature. The thicker walls are, the less permitting they are concerning curvature.

7.1.2. BUILDING FAB-CELL: PROGRESSIVE ENHANCEMENT.

Building Fab-Cell's modeling interface required a set of successive improvements aimed to increase the

ACPT's functionality. To facilitate the reading of the capabilities every version had, as well as the improvements made as bugs were found, a record of such actions will show the evolution the ACPT underwent within the period of time it took place (Table 9)

Table 9. Fab-Cell first evolution stage.

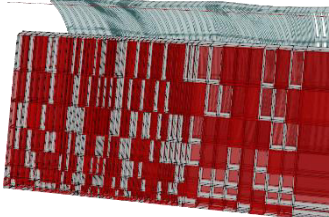
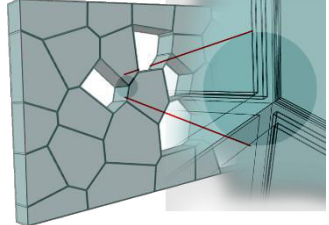
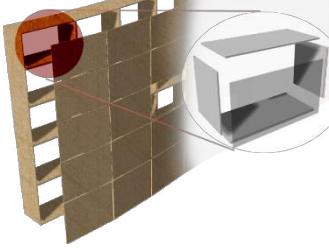
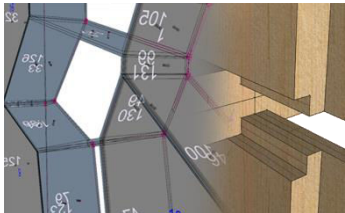
Version	Capabilities / issues	Improvements	Thumbnail
0	Deals with single curved NURBS Creates quad cells - no joint management Manifold cell-sizes. Deals with cell thickness (material) Random cell-density and cell-cover filtering. Cell-thickness instability		
0.1	Single curved NURBS Creates quad cells - no joint management Manifold cell-sizes. Random cell-density and cell-cover filtering. Cell-thickness instability + acute curvature collision and torsion	Improved NURBS management (double curved) Cell- Frequency parameters improved	
0.2 to 0.4	Random cell-density and cell-cover filtering. Manages Manifold cell-sizes Variable material thickness up to 30 mm. Deals with quadrangular and Voronoi tessellations. Cell-cover halving joints are not calculated if polygons are not planarized	Voronoi pattern managed by an independent algorithm Halving joints on cell-covers Bottom and top plates added (prototype support)	
0.5 to 0.7	Random cell-density and cell-cover filtering. Pattern density is fully parametric Variable material thickness up to 30 mm Deals with quadrangular and Voronoi tessellations. Nesting Function added	Cell-thickness dimensional stability reached Basic planarization allows halving joints to work correctly.	
1.0	-NURBS surface splitting by a pattern. -Cell generation (cell-walls and cell-covers) -Cell-cover filtering Item tagging -Processes in-cell and inter-cell jointing systems -Nesting function -Roof function added -Function grouping for making clusters	Cell-covers and cell-walls are nested independently for material optimization. Miter and Halving joint calculation is optimized. Items are split by Brep intersection. Material thickness is uniform An issue regarding traces of Boolean operations was addressed	

As the main goal in this development stage was to produce a prototype within a fixed period, efforts were aimed to find the best generic solution to a set of manifold modeling problems derived from mutations the modeling environment is obliged to undergo whenever changes are made to walls. Sections 7.1.3 to 7.1.6 will show, step-by-step, the process by which both prototypes were modeled, calculated and built, as well as the intricacies that led to simplify their design in order to optimize production and mounting.

7.1.3. DIGITAL CHAIN FROM MODELING TO EXECUTION. THE MODELING ENVIRONMENT

This section starts with version 1.0, which happened to be the most stable one by the time the making of the prototypes was engaged. In this modeling stage, the algorithms composing the modeling environment were capable of tackling most of the tasks Fab-Cell is designed for. However, by the time version 1.0 was released, the processing of quad and Voronoi patterns was performed in separate algorithms, thus pattern integration was not fully operational yet.

To understand the approach, Figure 178 and Figure 179 give an overview towards the two modeling algorithms¹⁶³ as each one represents a different morphologic approach. In both cases the modeling algorithm is composed by kernels grouping the main functions as seen in the activity diagram (refer back to Figure 170).

¹⁶³ The first algorithm is named Fab-Cell Grid Wall, and the second Fab-Cell Voronoi Wall.

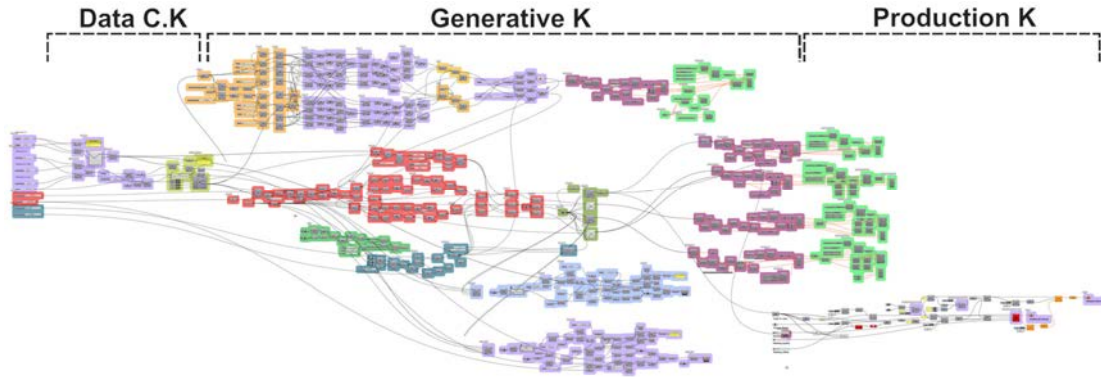

Figure 178. Fab-Cell version 1.0, Grid Wall Model.

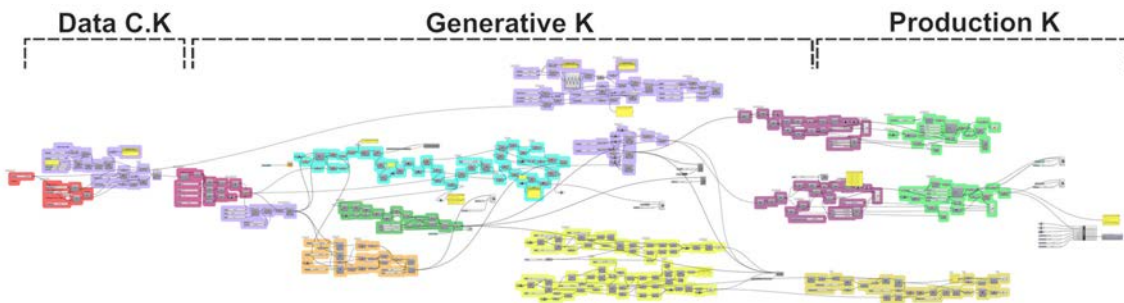

Figure 179. Fab-Cell version 1.0, Voronoi Wall Model.

In both cases modeling, generative and production kernels are organized from left to right and data is provided as GH components require. As design occurs inside Fab-Cell, some components had to be incorporated in order to explore design possibilities and enter feedback data as required by the model.

Figure 180 makes summarizes -following the same layout- the way both modeling algorithms operate by simplifying processing modules as well as data bridges between them.

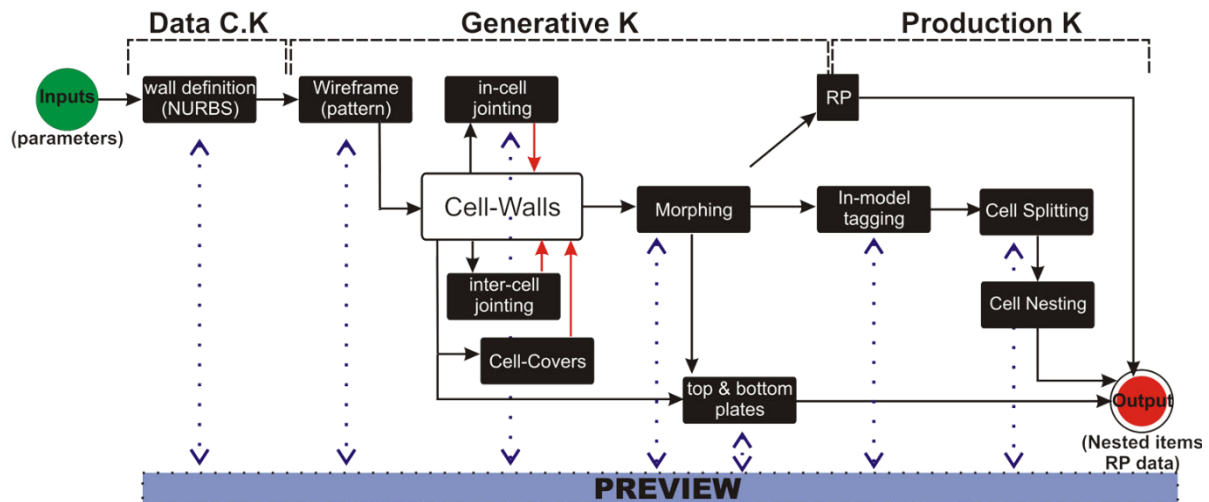

Figure 180. Voronoi and grid wall models. Module Synthesis workflow. Please notice that all modeling stages offer a preview, which helps having an instant feedback of all processes and furthers adjusting the model as needed.

Namely, each activity represents a group of GH components depicted in detail in Table 10, which also makes a detailed description of the modeling, fabrication, and mounting activities necessary to achieve this validation exercise. Nonetheless, a description of the context in which such experimentation took place is necessary before getting into such details.

7.1.4. GETTING INTO CONTEXT: THE WOOD CHALLENGES 2014

The “wood challenges” is a contest organized by the ENSTIB, the ENSAN, the C.R.A.I, the “Université de Lorraine” and the town of Épinal – France. The event, whose first edition dates back to 2004, is one of the most diffused student contests in the Lorraine Region. Every year ten student teams gather to challenge not only their creativity but their knowledge to produce innovative timber structures according to a subject previously set. They must also adapt to challenging conditions of

material, equipment, weather, and interdisciplinary work.

It is within this framework that Fab-Cell's first validation stage was carried on, thus some of the challenges students have to face, plus some other inherent to CNC programming and robotic fabrication, had to be tackled during the experimentation process herein described.

The worksite. The 2014 edition of the wood challenges is located at "Parc du cours" in the town of Épinal-France and the first prototypes produced making use of Fab-Cell were intended to perform as the southern gate to the event (Figure 181). The municipality did not allow digging any foundations on the alley's ground so the structure's bottom plates needed to be heavy enough to prevent them from overturning.

Manufacturing facilities. Whereas all modeling tasks were performed at C.R.A.I, the facilities for producing the prototypes were provided by the ENSTIB (Figure 182), which counts with workshops, warehouses and all the necessary equipment for timber processing (stationary, manual and power tools), plus a Güdel industrial 5-axis gantry robot driven by an ABB controller.

Materials. The same way student teams are not allowed to choose which material they want to work with, the prototypes herein described had to adapt to an imposed material. Such constraint gave an interesting feedback towards the generative kernel in which all components, as well as the jointing mechanisms, were adjusted on the go, as by the

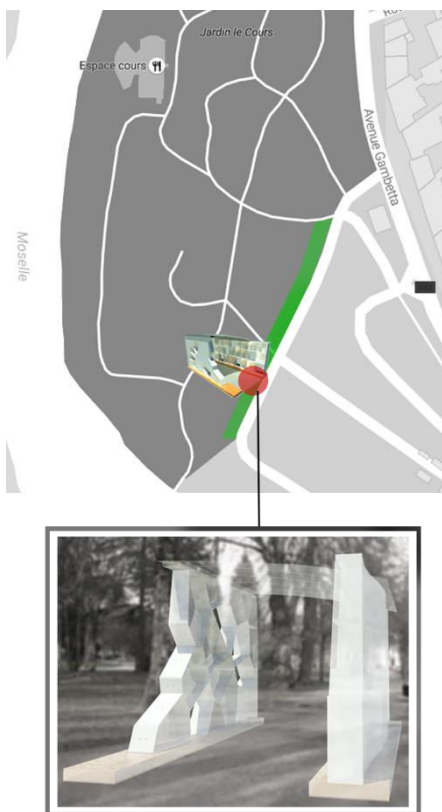

Figure 181. **Top:** The wood challenges 2014 site (in green) at "Foligneuses" alley, Épinal – France.)maps.google.com **Bottom:** render of the prototypes at their intended location.

start of the modeling stage the material to be used was all but unknown. The organizing committee provided the project with 12.5×2500×1220 (mm) exterior-use plywood stocks for structural components (cells), 12.5mm × 50mm bolts as inter-cell connectors and #6 × 25.4 mm screws for in-cell assembling.

7.1.5. MODELING PROTOTYPES

As shown back in Table 8, digital works for achieving these prototypes started on February 4th 2014, so the first data exchanges with the robot operators started by the end of march 2014. In the meantime, Fab-Cell’s interface was adjusted to deliver the most complete buildable data set possible. The process chain to achieve so is described as follows:



Figure 182. The ENSTIB facilities at Épinal - France.

Table 10. Prototyping activities from conception to production.

Task description	Thumbnail
<p>Wall definition (NURBS). Abstract representations of both walls (W_r) are yielded through a GH sweep operation based on a NURBS curve whose sinuosity is defined by wave-like adjustable parameters so any given wall’s footprint can be swapped from straight to sinuous. Once again, and because of the particular circumstances in which the prototypes needed to be made, this is an exception in comparison to what has been aimed in the model proposed back in sections 6.4 and 6.5 .</p>	
<p>Geometric pattern. Grid Wall. The geometric pattern for the grid wall consists of a tessellation defined by a line network in U and V directions across W_r. It splits W_r into a set of aggregates (sub surfaces) and delivers complementary data such as subsurface borders, nodes and lines, which are later used in calculating inter-cell and in-cell joints. The pattern’s density can be adjusted by increasing or decreasing the number of UV divisions¹⁶⁴.</p>	

¹⁶⁴ Quad patterns were obtained using the Dragon add-on for GH (Yazdi, 2014)

<p>Geometric pattern. Voronoi wall. The Voronoi pattern is less complicated to achieve, though processing the pattern for jointing is more complex than with the quad pattern because of the manifold angles that occur at cell-wall intersections. The pattern is formed by using a random point population, a point reduction component to control cell sizes, and a Voronoi component to generate the pattern. In this case, the line network is composed by cell boundaries that will later split W_r into a cell-set.</p>	
<p>Cell-walls. The data obtained from pattern subdivision yields a set of contours defining cell-walls. At this point, cell-walls have no thickness or depth. Such properties are added by offsetting cell borders and extruding them so they reach a solid dimension. This Fab-Cell's version deals with cell-wall and cell-cover thicknesses ranging from 10 to 30 mm.</p>	
<p>Cell-covers. Cell covers make use of the contours derived from pattern subdivision too. They are also extruded to add thickness, though cover thickness can be different from that of cell-walls. The concept of gap is already present in these items as covers are intended to feature rabbet joints in order to be assembled with cell-walls¹⁶⁵.</p>	
<p>In-cell and inter-cell jointing. In-cell jointing is calculated from intersections that happen at every pattern knot. As cells acquire thickness, it is possible to calculate intersections at these knots by projecting cell-wall boundaries onto each other to create intersection lines and filter them to extract joint profiles. The process is the same for miters and rabbets. Inter-cell fasteners (bolts) are located by means of a plane over the cell-walls. The average normal between planes defines the normal on which bolts are placed, thus it is possible to set one, or several bolts referred to the aforementioned plane. Distance between bolts is defined by an array operation.</p>	

¹⁶⁵ Rabbet joints use the same principle as halving joints in which concerns the way items are coupled.

Morphing. Morphing is actually a composite operation involving several components whose function is to perform topologic and/or morphologic changes on the prototypes. Two modifiers are relevant to this case. Firstly, a second W_r (W_r2), acting as topologic modifier, induces tangential subtraction on any of the walls, adding irregularity to one of their faces. Secondly, a shear component creates a variable section effect also acting on one face only. Both modifiers were used to add complexity to the aggregate set in order to push the feasible boundaries of the modeling interface and the production environment.

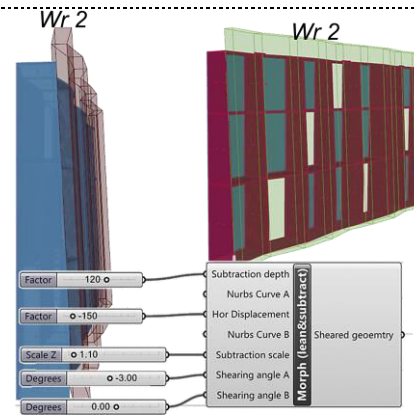

Top and bottom plates. Top and bottom plates are normally not included in Fab-Cell's functional span, however, it does not mean it is not possible for the user to retrieve the wall's footprint and create customized top and bottom plates. That is the case of these prototypes. Both walls required heavy bottom plates that actually followed every wall's footprint to work not only as support elements but also as stabilizers preventing walls to turn over themselves.

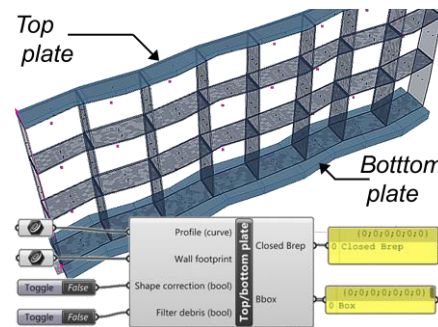

In-model tagging. This process starts the production kernel. In-model tagging uses the same reference planes employed to place bolts so tags are placed at the item's geometric center. The same tagging is reused in nesting to avoid losing trace of items during assembling and mounting operations. Cell-covers and cell-walls are tagged in separate series insofar as cover-tags identify cells and cell-walls belong to a specific cell-cover.

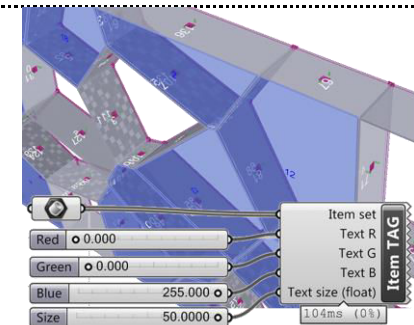

Cell-splitting. The task consists of separating cell items (cell-walls and cell-covers) to prepare them for nesting. Cell splitting also makes use of bolt reference-planes to project and orient items onto a flat grid of reference planes, which is the previous phase to nesting.

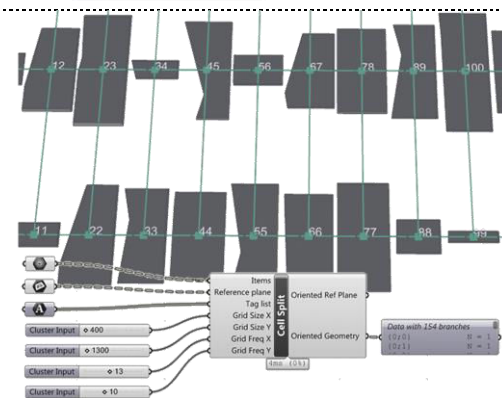

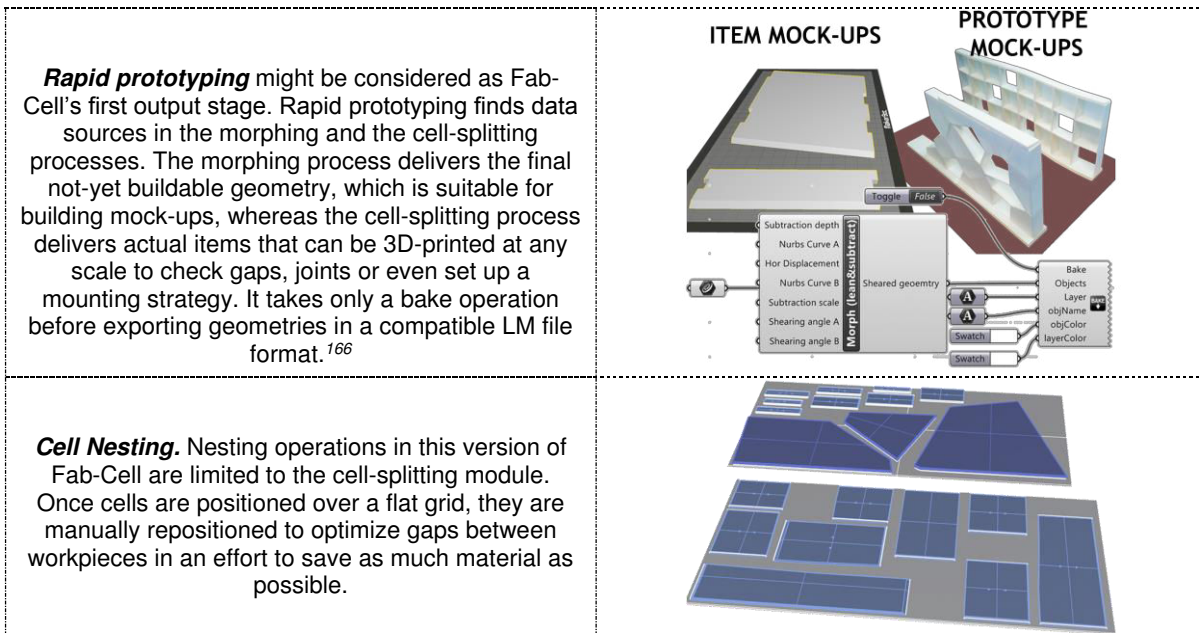

Rapid prototyping might be considered as Fab-Cell's first output stage. Rapid prototyping finds data sources in the morphing and the cell-splitting processes. The morphing process delivers the final not-yet buildable geometry, which is suitable for building mock-ups, whereas the cell-splitting process delivers actual items that can be 3D-printed at any scale to check gaps, joints or even set up a mounting strategy. It takes only a bake operation before exporting geometries in a compatible LM file format.¹⁶⁶

Cell Nesting. Nesting operations in this version of Fab-Cell are limited to the cell-splitting module. Once cells are positioned over a flat grid, they are manually repositioned to optimize gaps between workpieces in an effort to save as much material as possible.

Up to this stage, all processes run in digital. However, CAD/CAM operations happen externally inasmuch as Fab-Cell's production kernel is not yet capable of producing its own machining code. Furthermore, an alternative approach was used and for this matter, the ENSTIB offered the following environment: **a)** A Güdel Robot equipped with a 25 mm mill-end and a 15" saw for both gross cutting and finishing. **b)** A CAD/CAM environment composed by Cadwork V19.0 and LignoCAM, which were thought to be well-performing options. Reality proved things different, as discussed in next section.

7.1.6. CNC PROGRAMMING, FABRICATION, AND MOUNTING.

The tasks for programming, fabricating and mounting the first wall prototypes using Fab-Cell are set as follows (Figure 183):

¹⁶⁶ Baking attributes are set up using the Lunchbox add-on for GH (Miller, 2016). The "object bake" feature is external to Fab-Cell, thus the user only needs to install the aforesaid add-on.

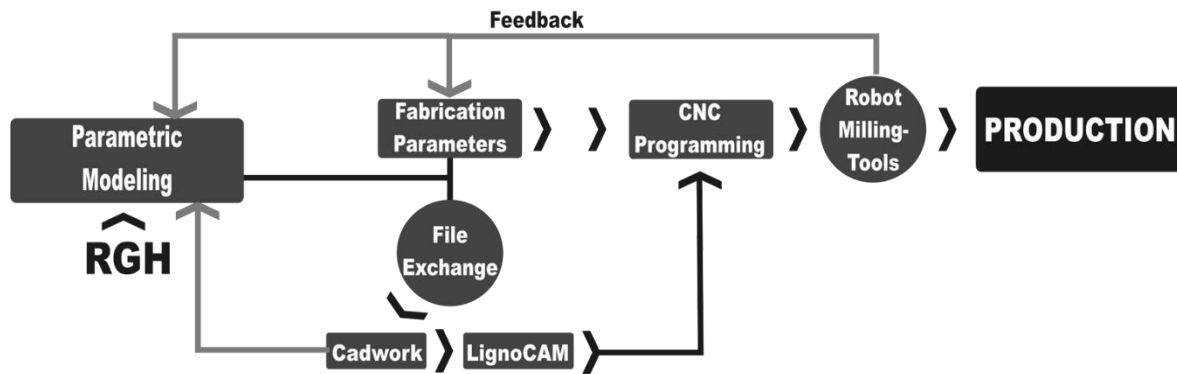

Figure 183. Fab-Cell ver 1.0 modeling-to-production workflow.

The precedent workflow shows that the modeling environment of Fab-Cell's has more than a mere visual and computational feedback but also an external one. Such feedback occurs because of the ACPT still not having its own CAM processing module, a fact that lead to use the CAD/CAM environment recently described.



Aspects like mill-end diameter, geometry data loses and programming limitations led to “rigidize” the way joints behave in the model thus the modeling environment had to adapt to aforementioned constraints.

After performing such adjustments all items are nested and rearranged into Rhinoceros prior to their export towards Cadwork. The file exchange is made via a standard Step file so Cadwork reads geometry, calculates machining routines, and sends them towards LignoCAM to generate ISO machining code. This sequence, as well as its related tasks, is described down below in Table 11.

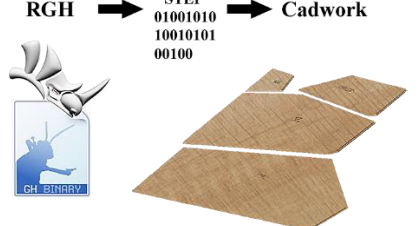
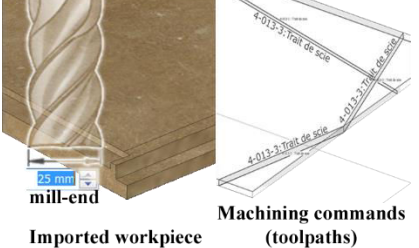
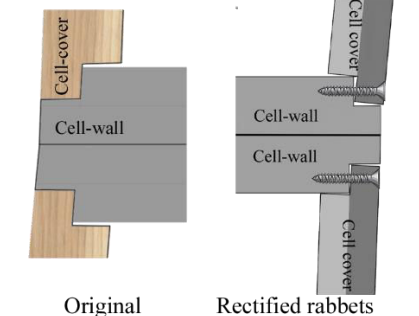
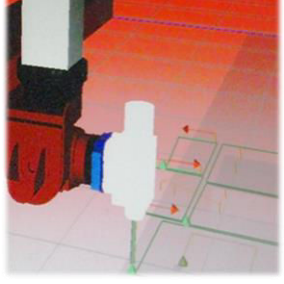
Table 11. CAD/CAM/fabrication process for Fab-Cell first prototype production.

Task description	Thumbnail																					
<p>Cadwork geometry import. Cadwork reads the Step file used for geometry export and retrieves its contents as timber workpieces. During the process, adjustments on units' precision and item grouping were required to attain the needed precision level.</p>																						
<p>CNC programming. Toolpaths are created by using a predefined set of machining routines within Cadwork. This stage became critical as concave rabbets and highly acute miters were not read by Cadwork, neither could they be properly achieved by using a mill-end as big as the one available. The programming of such joints had to be made manually typed into LignoCAM. As the task showed being time consuming, some items had to be machined manually¹⁶⁷.</p>																						
<p>Adjustment of digital joints. As consequence of limitations for calculating joints via Cadwork, along with the equipment's, the model was forced to diminish footprint curvature and eliminate morphing effects in order to obtain straight joint-profiles. As result, rabbets turned readable by the Cadwork's machining database so the Grid Wall could be entirely machined in automated mode. As for the Voronoi wall, cell-covers were the only ones machined in automated mode; conversely, cell-walls were machined manually because machining programmers would not be able to find an optimal way to set up manifold miter angles.</p>																						
<p>Toolpath simulation: Tool paths and machining routines are simulated before launching the cutting process. LignoCAM, as well as the robot's interface, allow launching a real-time simulation that helps identifying possible collisions and/or programming mistakes. Once the cutting program is clear from errors, machining starts.</p>	<table border="1" data-bbox="1018 1167 1302 1279"> <thead> <tr> <th>code d'usinage</th> <th>Nom d'usinage</th> <th>Numero d'usinage</th> </tr> </thead> <tbody> <tr> <td>130</td> <td>Mi-bois</td> <td>153</td> </tr> <tr> <td>130</td> <td>Mi-bois</td> <td>145</td> </tr> <tr> <td>130</td> <td>Mi-bois</td> <td>139</td> </tr> <tr> <td>130</td> <td>Mi-bois</td> <td>138</td> </tr> <tr> <td>130</td> <td>Mi-bois</td> <td>152</td> </tr> <tr> <td>150</td> <td>Contour libre</td> <td>133 G:1</td> </tr> </tbody> </table> 	code d'usinage	Nom d'usinage	Numero d'usinage	130	Mi-bois	153	130	Mi-bois	145	130	Mi-bois	139	130	Mi-bois	138	130	Mi-bois	152	150	Contour libre	133 G:1
code d'usinage	Nom d'usinage	Numero d'usinage																				
130	Mi-bois	153																				
130	Mi-bois	145																				
130	Mi-bois	139																				
130	Mi-bois	138																				
130	Mi-bois	152																				
150	Contour libre	133 G:1																				

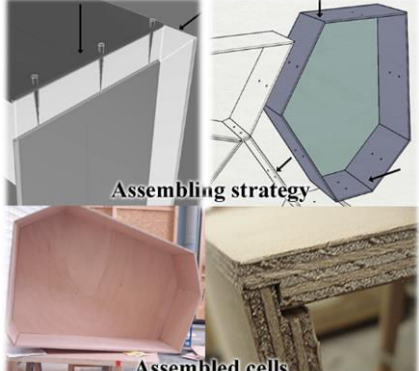
¹⁶⁷ For miter joints to be programmed it required about 10 minutes to calculate toolpaths for a single item. A projection of the time needed for calculating toolpaths for about 150 items showed that at least 3.5 working days would be needed to perform the task. In sight of the tight schedule, it was decided to machine items manually.

<p>Machining. Processing a plywood stock takes about 18 minutes including stock fastening, cutting, numbering, cleaning, clearing and sorting items¹⁶⁸. During the process, some workpieces were damaged either because the entry path of the robot was over-dimensioned or because the spindle rotation speed was not correctly set for the material. Such issues seemed to be more a problem of experience than a problem of planning and/or modeling. Unsuccessful items were removed and refabricated separately.</p>	
<p>Assembling: Already-classified items are manually assembled following an assembling procedure defined in the modeling process. Moreover, an axonometric of the prototypes indicating item numbering and locations allows placing items correctly, which demonstrated to be particularly helpful in the assembling of the Grid Wall prototype (refer to Appendix 4). Assembling of the Voronoi prototype was more intuitive as items were far from being identical.</p>	
<p>In-workshop mounting. Before sending assembled cells to the worksite, all items were mounted at the workshop to verify that positioning was correct and that no defective items were present, in which case, they had to be fixed before being dispatched.</p>	
<p>Mounting: As all prototype components were already assembled, the tasks to perform at the worksite were limited to bottom plate placing and fixing, cell mounting and fastening, and roof installation. Inasmuch as the roof was an accessory element, none of its components was digitally fabricated, though they were digitally conceived. Mounting the prototypes took about 48 hours.</p>	

Though the achieved results were acceptable (Figure 184, Appendix 4), a small set of aspects required attention in order to improve Fab-Cell's functionality and design span. Pattern management and creation, joint range and management and, fabrication data generation proved to be the most sensible aspects to optimize.

¹⁶⁸ Please notice that digital numbering was not possible because engraving was not a capability of the machining environment and the programming of engraving toolpaths was not calculated automatically. In fact, engraving paths were not even readable in Cadwork.

Moreover, the algorithm's performance showed task simplification to be necessary in order to increase iteration rates. That way, it would take less time to calculate and preview simple operations like pattern browsing, footprint setup, and joint browsing.

As for the CAD/CAM exchange environment, it was clear that the Cadwork approach was misleading inasmuch as data fidelity and freedom-of-design were affected. Namely, finding an alternative approach for generating machining code became imperative.



Figure 184. Finished prototypes validating Fab-Cell's first version functional span.

As for the fabrication process, the main lesson was that tackling the endeavor with the inappropriate material and/or machinery was impractical. Machining 12-mm thick plywood sheets with a 25-mm mill-end not only yielded a poor finishing but a big limitation regarding the possibility of creating

more complex joints on 12-mm stocks.

7.1.7. AFTER PRODUCTION EVALUATION.

The validation exercise did not finish with the completion of the prototypes. The difficulties found during modeling and production processes demanded a close follow up of the prototypes after installed out in the open.

Considering the fact that wind, rain, and heat would induce dimensional changes on the prototypes, a survey was carried on to check on the possible changes produced by the aforesaid phenomena (Comment 50). It also allowed to find precision differences between the “desired” digital items and the real ones once produced. Regarding this matter, the survey focused on two essential aspects: item dimensional precision, and joint accuracy and quality. The exposure to weather allowed finding out how hard dimensional changes might occur under extreme conditions and how they might affect a whole structure. Let us keep in mind that the prototypes are made with exterior-use plywood, so the material should behave well under open-air conditions.

The survey took place on June 12th 2014, it started at 10:30 am and finished at 15:20. The forecast was sunny; the temperature ranged between 21°C in the mornig and 27°C by the time the survey was finished. For the same period, humidity ranged between 71% and 54%.

The analysis focused on four items. Three of them (# 0,4,22) belonged to the Grid wall and only one (#19) to the Voronoi wall. The reason of concentrating most of the survey on quadrangular items is that most automated machining issues occurred when working with the grid walls' components (Figure 185).

Comment 50. Survey facts

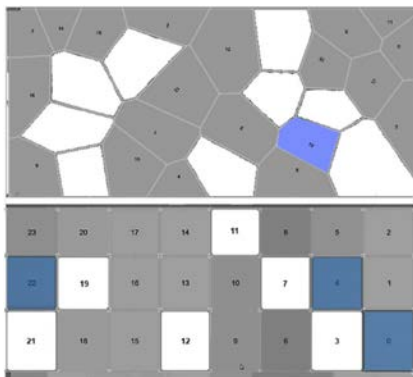

Figure 185. Samples studied during survey.

The survey started by measuring structural gaps and plywood expansion if there was any. Measurements showed that despite the fact of the prototypes being exposed to rain and sun, no expansion was visible and/or measurable (Figure 186 top). Nominal thickness remained stable in most studied items except those who suffered damage during the milling phase, as the inner plywood layers became exposed to weather (Figure

186 bottom).

Structural gaps remained stable despite the presence of accumulated moisture in some cells. Inter-cell connectors also remained without signs of unscrewing or untightening despite the fact of some cells being slightly short at the moment of mounting (Figure 187 top).

A humidity test allowed checking if excessive humidity was permeating the outer layers of plywood, which could eventually provoke the material's expansion (Figure 187 bottom).

Moisture measurements were taken at an average depth of 3mm and values ranged from 14.20% to 18.20% depending on the items' exposition to rain and sun. A comparison against workpiece moisture data recovered at the workshop shows a variation ranging between 1.7% and 5.7%.

In sight of such results, it was deduced that for the time the structures were going to be exposed to the public, there would not be an apparent risk of fast decay that could provoke collapse. It also shows, as it was also proven by the Solar Pavilion energy, that exterior-use plywood fulfills its purpose quite nicely from the structural and the aesthetic points of view, even under open-air conditions.

The survey finished with a measurement regarding toolpath vertical deviation during the milling process. A few items were disposed because rabbet depths were abnormal. In an effort to find out the causes of it, three questions arose as to start the survey on this matter: **a)** Was path deviation caused by a lack of calibration in the

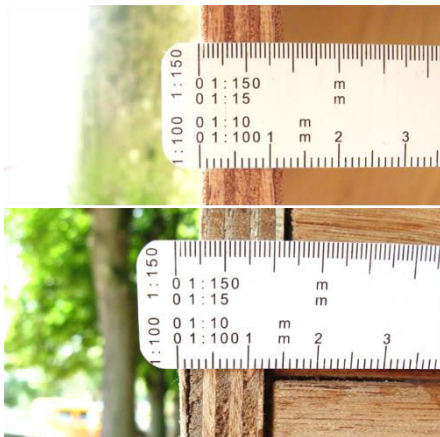

Figure 186. Plywood expansion control measurements. **Top:** unharmed items do not show any expansion caused by open-air conditions. **Bottom:** A harmed item during fabrication shows degradation as moisture accumulates under one of its outer layers.



Figure 187. **Top:** Visual inspection and gap measurement showed no dimensional changes in items exposed to open-weather conditions. **Bottom:** Moisture measurement on rain-exposed cells.

machine? **b)** Was there a human mistake either during programming or when attaching plywood stocks to the machining bed? **c)** Was it because the mill-end was disproportionate in regard to the stock's thickness?

The first question was sent to the ENSTIB and they found a calibration problem causing the robot head to have a deviation over the Z-axis ranging between minus one and plus three millimeters. Namely, the deviation percentage ranged between (-) 16.6% and (+) 50% over a 6mm-depth rabbet (Figure 188 top and bottom left).

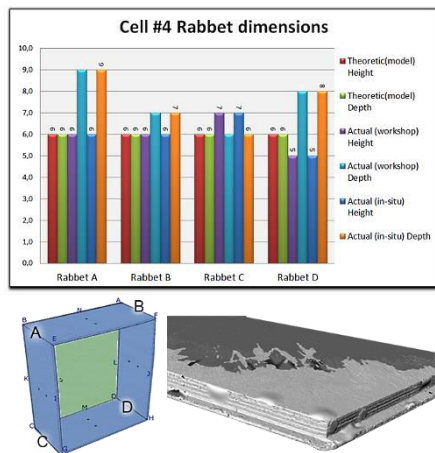

Figure 188. **Top**, rabbet dimensional variation for a single cell. **Bottom left**: rabbet Id's. **Bottom right**: Lasergrammetry acquired data for digital measuring.

Deviation data was taken by performing a lasergrammetry test on a series of damaged items that have to be disposed because their rabbets did not guarantee joint stability. With the acquired data, it was possible to make accurate digital measurements (Figure 188 bottom right).

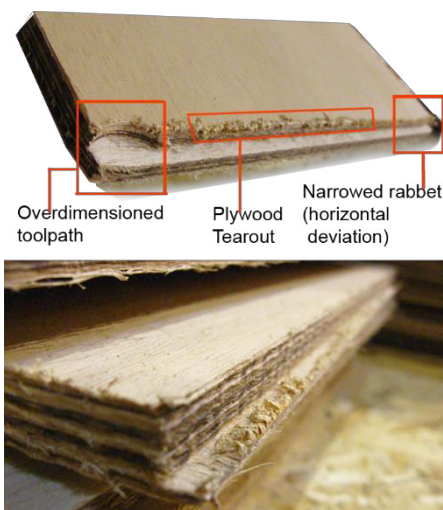

Figure 189. **Top**: Main fabrication defects found throughout the prototyping sessions. **Bottom**: Vertical toolpath deviation plus vibration-provoked tearout on a single workpiece.

Precedent data quite answers the question about calibration problems, however, an excess of vibration could have caused items not to be cut properly. Vibration might have been provoked by plywood stocks not being properly attached to the cutting bed, which could have made outer item edges to vibrate while being machined (Figure 189).

The fixation problem was evidenced by horizontal deviation in the cutting path, caused by workpiece rotation as the mill-end advanced (Figure 189). Therefore, a mixture of calibration problems and human mistakes led to produce unusable items, which also resulted in significant time loss.

The positive part of it is that such difficulties will further in advising newcomers about not committing the same mistakes or, just anticipate the kind of situations underwent during the conception and production of the prototypes.

7.2. SECOND EVOLUTION AND VALIDATION STAGE. IMPROVING PARAMETRIC GENERATION PROCESSES FOR CELLULAR SUBDIVISION AND JOINT SETUP.

Up to this stage, Fab-Cell's functional range partially accomplishes the goals stated in Chapter 6 as well as it has proven to be functional in practical terms. However, the difficulties and challenges faced during the modeling and making of the prototypes showed that improvements are necessary for the ACPT to perform better.

In the first place, the whole modeling structure of the ACPT required increasing iteration rates and accelerating visual feedback. Secondly, it was necessary to introduce a pattern browsing mechanism in order to increase the ACPT's form-searching capabilities.

Furthermore, joint-making required a more developed algorithm to calculate and browse through jointing options whereas void management needed more testing, as version 1.0 only managed to randomly cull a few cells to create voids but could not create door or window openings. Finally yet importantly, CNC programming also required a more flexible built-in approach in order to integrate CAM feedback into the digital chain. With those goals in mind, here is how improvements were performed.

7.2.1. INTERFACE OPTIMIZATION.

Based on the logic with which GH components work, it became clear that the process chain working within Fab-Cell could not be concatenated into a single algorithm. Therefore, the interface's optimization began by splitting the parametric algorithm into simpler functions, though the functional scheme should remain within the boundaries established in the data model.

Given the fact each module deals with a specific kind of data, the optimizing of modules consisted in simplifying processes by eliminating redundant components, creating functions, and simplifying modeling processes.

In the end, all modules should function as illustrated back in Figure 180, except that the output each one yields is internalized into generic components before starting a new process to avoid overcharging the algorithm. The advantage of using data internalization is that already-finished processes no longer iterate, as they become explicit entities.

7.2.2. IMPROVING PATTERN CREATION. FIRST STAGE

As works for validating the functionality of Fab-Cell's first version were still on the go, research focused on the way patterns could be created and introduced in the modeling environment was already being performed.

During the modeling stage prior to the prototyping sessions, the way patterns were produced and used showed little flexibility regarding morphologic variation. Moreover, it was not possible to just plug and unplug a specific geometric pattern to check how it worked in function of a given wall's morphology.

To tackle the problem and create a set of regular patterns similar to those described back in section 2.3, a set of options needed some exploration.

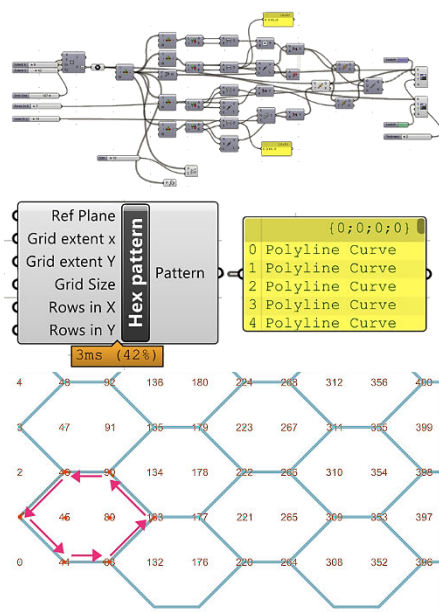

Figure 190. Attempting parametric pattern creation. Development of a cluster for hexagonal patterns. **Top.** Parametric algorithm. **Middle:** Algorithm concatenated into a cluster yielding a set of polyline curves as cells. **Bottom:** Cells created by picking points from a grid. Points are ordered following a specific path to form a tessella, which is then disseminated over a plane to obtain a pattern.

The general idea behind using grids for creating patterns is to have a dimensioning mechanism allowing obtaining an approximate measuring of cells, which can be achieved by means of grid UV distance and/or frequency parameters.

If the designer's intention is to adjust cells to match a given stock size, this method seems to be appropriate to achieve so. It also furthers establishing the number of components splitting a W_r before tackling its subdivision.

Comment 51. Using grids as proportioning tool for patterns.

At first, the idea of creating a set of clusters containing an equal number of patterns was considered. The pattern creation method would emulate the premises discussed back in section 2.3.2, in which the creation of regular tessellation considers the use of a point-grid to draw a pattern.

An attempt to establish a method for creating customized patterns, consisting of creating a tessella from a set of points extracted from a grid, is illustrated in Figure 190. The tile is then spread over a plane to create the pattern. The method became functional and clean despite some patterns -hexagonal ones especially- that would not adapt themselves to negative Gaussian curvature, as shown back in section 2.3.3, (Figure 92).

The question that came to mind when testing this approach was; what if an already-functioning plugin was tested? The answer was not so obvious since the GH database possesses a wide offer of plugins capable of tessellating surfaces be it by using mesh subdivision or surface splitting. After all, why to invest time in reinventing what has already been invented? Might it not be better to improve what has been already invented?¹⁶⁹

By browsing through available add-ons, it was possible to test solutions such as paneling tools (PT), lunch box, weaverbird, bullant, evolute tools, and dragon (Hammerberg, 2012; Issa, 2013; Miller, 2016; Mirtschin, 2014; Yazdi, 2014).

¹⁶⁹ The question becomes relevant as the central aim is creating an iterative interface for structuring non-standard walls and envelopes. Therefore, whereas patterns are important to achieve the desired results, a focused research on this matter is not considered important towards achieving the goals of this thesis.

Inasmuch as the approach is to create patterns by linking grid points, the search showed that whereas meshing add-ons did not operate over a grid, add-ons like lunch box, dragon or paneling tools do are grid-based thus compatible with the intended approach.

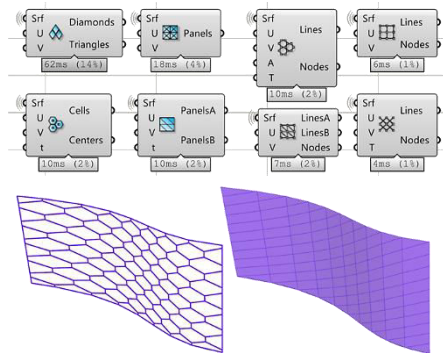

Figure 191. An overview of the components found in Lunch box and the outcome they yield. Notice that tessellations are set over UV point-grid, which allows having a preview of pattern adaptation and density.

The experimentation turned then towards lunchbox and PT. The first facilitates to rapidly setup a tessellation by just plugging-in a surface and UV parameters, although, pattern customization is not possible outside the morphologic options offered by the add-on (Figure 191).

The latter, showed to be more flexible insofar as it allows connecting points along customized paths to produce equally customized tessellas, though it has no built-in predefined patterns. Not at least into the GH interface. Table 12 shows the process through which patterns are obtained using PT.

Table 12. Creating and applying patterns with paneling tools.

Task	Thumbnail
<p>Grid setup. A grid is composed into rhinoceros using the paneling tools menu. To do so, the grid is parameterized over the default XY plane. A reference point arbitrary located over the XY plane starts the grid and parameters like UV spacing, as well as number of rows and columns, is set.</p>	
<p>Pattern definition. Just as shown back in Figure 85 and Figure 190, picking a set of points is enough to draw the path defining the pattern's unit or tessella. Please notice that all modules must be drawn clockwise. Indistinctly drawing every other tessella clockwise and/or counter-clockwise, will lead to obtain reversed tessellas into the aggregate set.</p>	

algorithm intended for creating Voronoi tessellations (Figure 192).

7.2.3. IMPROVING PATTERN CREATION. SECOND STAGE

A second outlook towards pattern generation, provided by two interns who joined the project in 2016¹⁷¹, helped expanding the tessellation database as well as the parametric interface of Fab-Cell’s morphologic module.

At first, the interns’ work was focused on developing the PT approach for increasing the pattern database. The sole constrain was to keep tessellation intricacy within boundaries of adaptability and compatibility with timber construction.

The first pattern database was kept along with its grid generators and modifiers, and the inclusion of new and faster plugins was integrated into the generative kernel. A search on the topic showed that, in addition to add-ons explored in the first optimization stage, other plugins like Mesh+, Starfish or Viper would provide the tools to propose a wider pattern database¹⁷².

Whilst testing with Mesh+ yielded five more different pattern types, plus three variables each; starfish helped achieving dihedral and trihedral tessellations. Viper is used to improve complex pattern creation (Voronoi tessellations) (Figure 193)

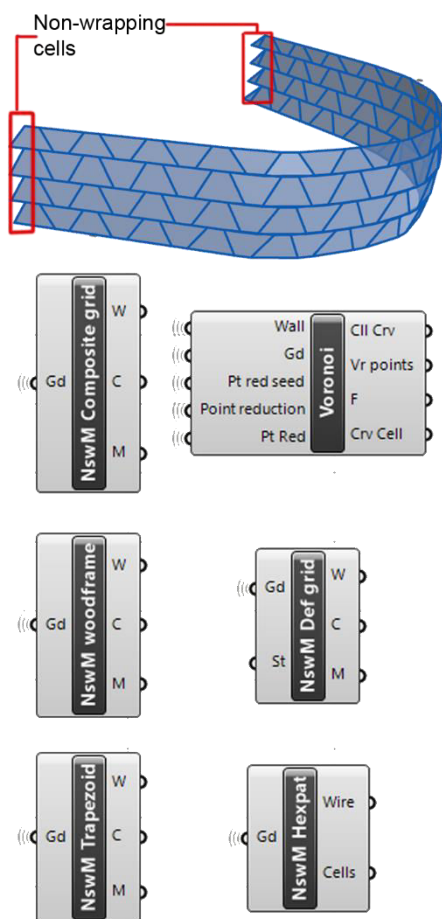

Figure 192. **Top.** Missing wrapping cells. **Bottom.** Pattern collection. Please refer to Appendix 9 for further details.

¹⁷¹ Guillaume Ginefri and Thomas Ehrhardt, under the advisory of Gilles Duchanois and Oscar Gámez.

¹⁷² Please refer to Appendix 13 to see the full list of digital tools and software used throughout this research.

7.2.3.1. BUILDING PATTERNS WITH MESH+

A first advantage when using Mesh+ is the rapidity it provides for making mesh-based tessellations, though surfaces are constrained to be subdivided into triangles and quads.

Furthermore, Mesh+ clusters are open so they can be reprogrammed, as needed, which is one of the main assets the add-on possesses. To build a pattern, most Mesh+ components require inputs such as:

- A NURBS surface as Brep. (Wr)
- Two independent numeric values to manage pattern density
- A “Close” Boolean toggle to wrap patterns. (It performs the same wrapping function seen back in section 7.2.2)
- A set of Boolean operators allows modifying attributes such as aggregate filtering, pattern deformation (evaluate), pattern offset, and pattern flipping.

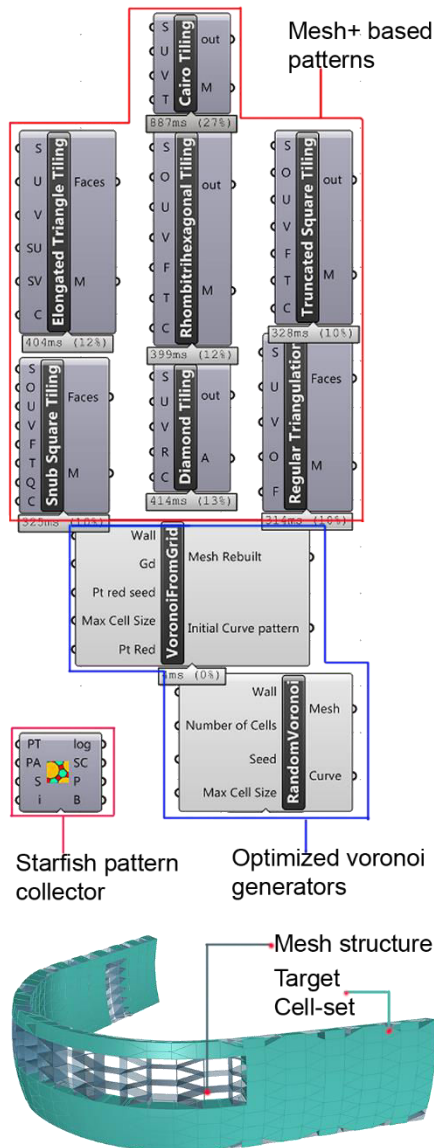

Figure 193. **Red boundary.** Patterns made using Mesh+ generate five different pattern morphologies. **Middle Blue boundary.** Improved Voronoi generators incorporate mesh rebuild features for mesh extrusion. **Middle red boundary.** The starfish plugin is added to the collection to generate k -hedral tessellations. **Bottom.** Redefined Wr entity using the “elongate triangle” cluster. (top left)

The output is simplified compared to pattern clusters of the first development stage. Clusters created through Mesh+ deliver geometry (as meshes) and data reports (Figure 194).

Although patterns created using Mesh+ are quite diverse, the possibility of projecting customized patterns by normal, UV and oriented projections was added as a functionality allowing

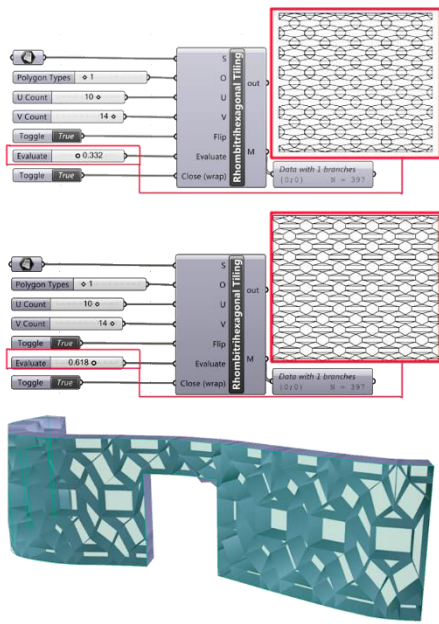

Figure 194. **Top and middle.** Common properties in Fab-Cell patterns built with Mesh+. Please notice that changing the evaluate slider changes pattern typology. **Bottom.** Morphologic redefinition of a Wr entity through Fab-Cell's Rhombitrihexagonal pattern component. Notice that trihedral tessellations are possible to obtain with this method,

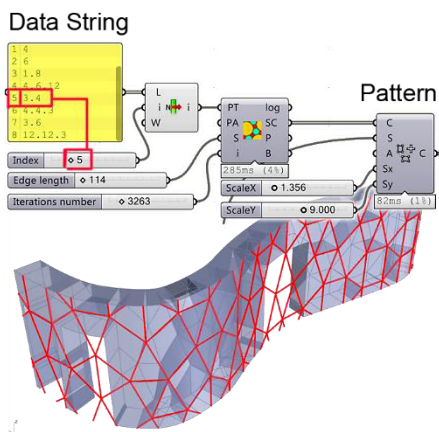

Figure 195. **Top,** from left to right, instructions for pattern generation are introduced as data strings containing the sides number of each polygon (as integers). Combined strings are separated by points. **Bottom.** The tessellation is applied to morphologically define a wall.

mapping any customized pattern over a Wr entity.

7.2.3.2. BUILDING PATTERNS WITH STARFISH

Although precedent pattern-making methods offer a decent range of options, including dihedral, trihedral or K-hedral tessellations (Figure 194), that feature is also achievable through Starfish.

The method used by starfish resembles the one initially proposed back in section 7.2, therefore, the add-on only needs a data string to calculate and generate patterns (Figure 195).

Starfish patterns are applied to Wr through of mapping. The plugin automatically calculates reference planes and projects the pattern onto Wr. The sole disadvantage is the user loses control over cell sizes inasmuch as the proportioning method is approximative.

7.2.4. WORKING WITH PLANAR ITEMS

Since Fab-Cell is meant for working with timber products as prime material, it acknowledges that such material is usually produced in flat stocks or sheets. To this extent, stock flexibility is expected to be none, so, theoretically, all cell items should be flat too.

In sight of these facts, the challenge was to transform all pattern cell items¹⁷³ into planar co-adjacent entities. Namely, all items should have zero curvature whilst their edges should always be in contact as in Fab-Cell's Grid Wall prototype.

¹⁷³ Cell-walls and cell-overs

Adjusting edge adjacencies for polygon planarization is a topic treated from outlooks such as those of Wang (2009) or Pottman (Pottman 2009) shows that obtaining customized planarized panel patterns is not a simple matter of morphology but mathematics too.

Depending on the subdivision technique, the process can be more or less complicated. Planar hexagonal meshes, for instance, require the calculation of a tangent plane intersection on which all edges common to a cell and its neighbors will coincide.

Comment 52. Notes on adjacencies for planar hexagonal meshes. For further information please refer to the works of (Pottman, 2009; Troche, 2008; Wang and Liu, 2009)

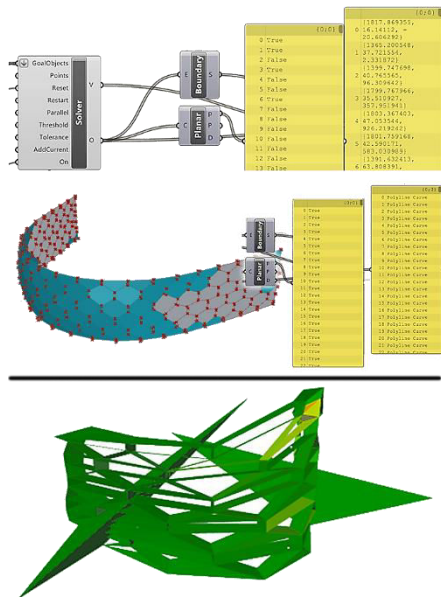

*Figure 196. Planarizations using Kangaroo for GH. **Top.** A planarization test on a regular pattern as applied to a given W_r . With the right parameters, the add-on achieves the given goals in a matter of seconds. **Bottom.** When constraints are too difficult to fulfill the solving tool will however output a morphologically and topologically altered geometry set.*

As the problem of planarizing polygons is not central to this dissertation aims, but a tool for achieving a morphologic result, it seemed more practical to test a solution that could actually calculate edge adjacencies within constrained geometric and topologic boundaries (Comment 52). For that purpose, two GH add-ons were tested: Kangaroo and Anemone (Zwierzycki, 2015).

The former proposes a range of problem-solving tools including geometry optimization through edge elasticity and strength. Namely, the solver will iterate within a range of constraints to stretch and contract edge cells and try to find a planarizing solution.

The latter creates solving loops allowing progressively flattening cell edges and finding a common plane for all of them, while trying to keep edge adjacencies as accurate as possible¹⁷⁴.

Testing polygon planarization with Kangaroo proved to be temperamental as the goals and forces used to make cell boundaries coplanar, as well as cell entities adjacent, only needed a slight variation to turn from acceptable into disparate (Figure 196).

On the other hand, attempting to planarize polygons using anemone required two stages:

- Each tessella's median plane is calculated from its vertices coordinates (Figure 197).

¹⁷⁴ This approach validates evolutionary concepts discussed back in page 1, as studied by J.Frazer(1995) and P.Anderson (1999). Loop solvers collect partially valid answers helping construct a complex solution for a given problem.

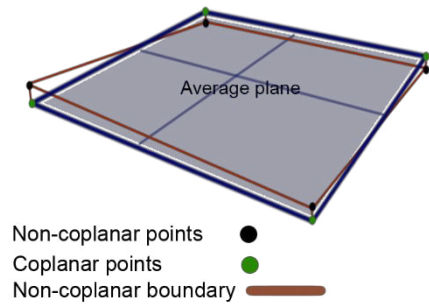

Figure 197. Vertices of a tessella are turned into coplanar by projecting them onto an average plane.

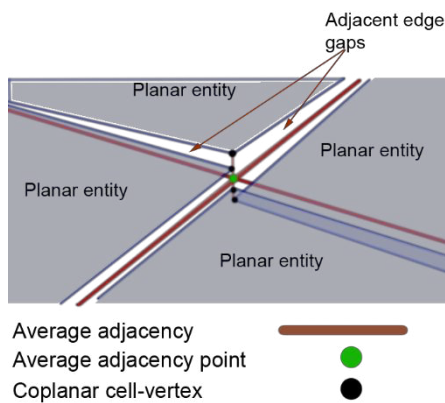

Figure 198. Gaps between cell edges affecting edge-adjacency. Adjacency is recovered by calculating the average distance between knot points. (cell-reacomodation)

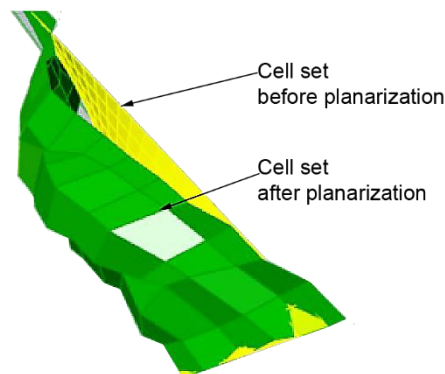

Figure 199. Planarization result using Anemone. The result is topologically distant from the initial cell-set.

Then, every vertex is projected over the median plane to make vertices coplanar so the new cell's boundary can be created, though edge adjacencies are lost leaving gaps between cells (Figure 198).

- As all vertices create structural knots, the average distance between points at every knot is calculated to force edge adjacency, so cell-vertex coplanarity becomes the sole fixed constraint (Figure 198).

Using anemone proved to be time consuming and morphologically unstable. When calculating the first loops to test vertex and edge adjacencies, a topological change could be seen (Figure 199). As the tool starts running, topology transformations slowly turned into morphologic degradation, so the results achieved by using anemone ended in abandoning planarization through it.

Account taken of the results obtained with the Anemone add-on, planarization efforts had to be reoriented towards Kangaroo in order to find a satisfying solution for most patterns. Nevertheless, the final planarizing solution included partially using Human for finding average planes as well as for saving planarization history and Kangaroo for setting up planarization goals and forces.

The new planarization solution is embodied by a component set that considers the following tasks simplifying the interaction as follows:

- Planarization forces are independently applied on each wall's edge. This is useful to make the entire approach more flexible.

Now, every edge can be calculated with different constraining forces, instead of submitting the whole cell-set to a single force setting.

- b) As every planarization endeavor is different in function of the cell-set morphology, two value ranges help the user to find the best setup to do so. Force value ranges within domains from 1.5 to 50 and 49 to 50¹⁷⁵. The user picks either domain and then tests it by means of an Anemone loop solver (Figure 200).

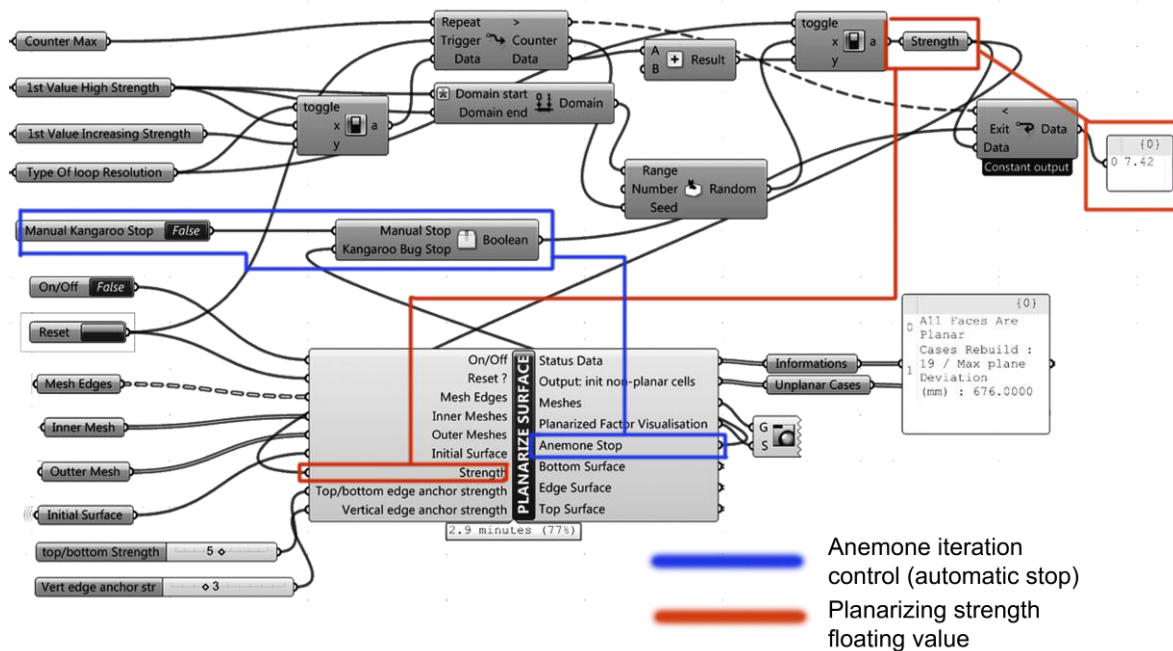

Figure 200. Fab-Cell's morphologic solver (planarization). Planarizing forces are regulated by loop component that dispatches and tests values for positive planarization. When the correct value is found, anemone stops iterating and lets Kangaroo to go on until it completes the solution.

- c) The anemone loop saves planarization history in function of the testing range introduced by the user. In both cases, Anemone will tell kangaroo to stop iterating

¹⁷⁵ Each domain is an Anemone loop-value within which kangaroo will try to find a planarizing solution.

once cell-set is planarization is done (Figure 200).

Despite the fact this method works well, it is necessary to rebuild cell covers in order to not only optimize pattern-cell adjacencies but also three-dimensional cell adjacencies.

To do so, extruded cells are decomposed and cell-covers recalculated. The process uses the same principle described back in Figure 197. In this case, cell-wall vertices –belonging to every cell side – are used to calculate de median plane.

Cell planarization finishes when median planes, on each side of the cell, intersect and split the latter to fix non-adjacent cell-covers (Comment 53). At this point, all cell-items are totally flat thus suitable for joint-calculation (Figure 201). In general, the planarization solution is already functional, though it still needs developments insofar as dealing with high-acute curvature reduces the planarizing cluster’s efficacy.

The planarization interface, offers the user a set of data outputs allowing process status verification. A “bug fixer” helps fixing cells not achieving full planarity; however, the debugging process might force cells to accommodate so hard that gaps between them might appear.

The planarizing environment also includes a visualization tool that helps the designer checking planarization as it is succeeds throughout items.

Please notice that GH assumes an object is planar when surface deviation is inferior to 10^{-3} mm. Refer to Appendix 10 to see how the process appears on the screen as it runs.

Comment 53. Planarization visualization.¹⁷⁶

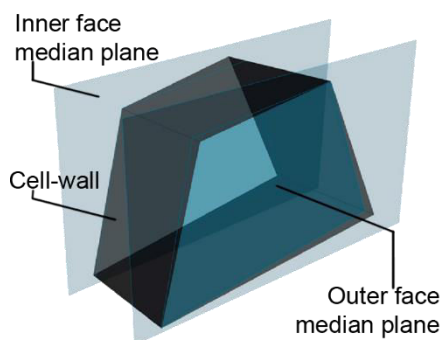

Figure 201. Cell-covers are retrimmed in order to optimize face planarization on both sides of a wall.

7.2.5. OPENINGS MANAGEMENT

As mentioned back in section 7.1.5 and at the beginning of this section, void management required more work. Moreover, a first approach in openings management assumes that a version of W_r , including openings as defined by design, might be split by any tessellation regardless of the method used for constructing the latter. The key factor to consider is that all cells must be closed edge-adjacent entities (Figure 202).

¹⁷⁶ Visualization features are borrowed from a Daniel piker’s planarization solution. Refer to (Piker and Najm, 2015)

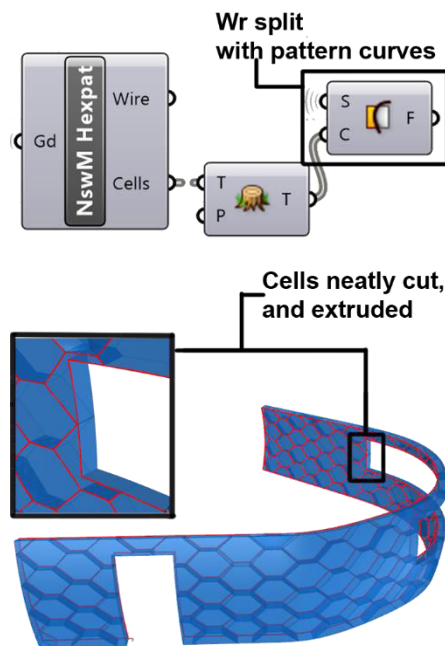

Figure 202. Openings management first approach. A *Wr* entity containing doors and windows void data is split by pattern curves. Cells inherit void information but they are not planar.

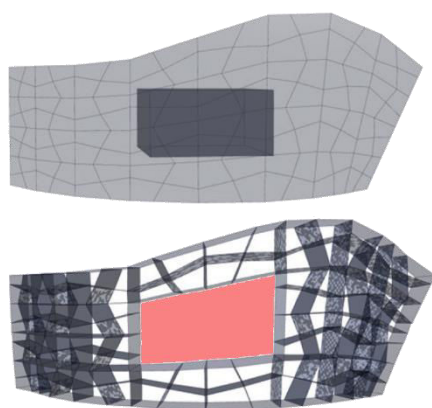

Figure 203. Opening by collision. **Top.** A Cairo pattern over a *Wr* entity. A Boolean operator intersects the cell-set. **Bottom.** Cells within the Boolean operator are cut as necessary to generate an opening.

Based on this premise, it is possible to obtain a cell-set including the original openings of a given wall regardless of the tessellation subdividing it. This first alternative was tested prior to planarization tasks and proved particularly efficient when using PT direct tessellation approaches as the entire cell-set extrudes well. Conversely, it was not so efficient when using patterns yielded from both Mesh+ and Starfish. Despite the fact the cell-set is properly cut, some cells are skipped from extrusion.

A second approach proposed by the interns involved in the project¹⁷⁷, suggests that openings can be managed by means of Boolean operations in which colliding the cell-set against a Boolean operator, splits and rebuilds cells as necessary to incorporate openings according to the initial design. Three different methods for openings management are then proposed: opening by collision, opening by surface center, and rebuilt opening¹⁷⁸.

a) Opening by collision. This modifier splits the cell-set into two groups by separating cells found inside the Boolean operator from those outside of it. (Figure 203)

b) Opening by surface center. It filters cells whose geometric center is located within the volume of the Boolean operator and separates them from the cell-set. The opening does not acquire the exact shape of the original design as cells are removed, not

¹⁷⁷ Opening management functions developed and tested by Thomas Ehrhardt.

¹⁷⁸ Please refer to Appendix 11 to find the GH components created for openings management.

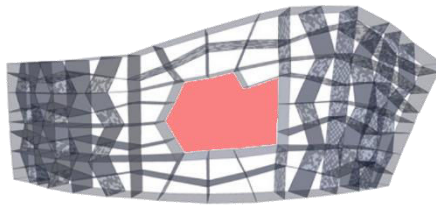

Figure 204. Opening by surface center. Cell in contact with the boolean operator are filtered. No cuts are executed.

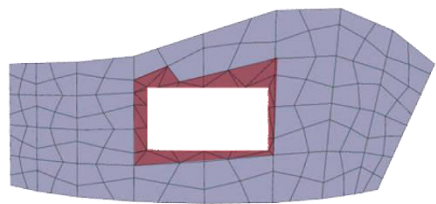

Figure 205. Rebuilt opening. The opening's boundary is kept and cells adjacent to it redefined (red area) notice that very small items might appear when executing this component.

During the improvements described Back in section 7.2.2, the idea of having doubled patterned walls was explored as grounding concept for bilateral extrusion.

A test using launch box allows producing topologically different facing cells. Tessellas on every face of the wall have the same position and number of sides so it only needs a loft operation to create cell walls. Cell covers are different on each side of the wall (Figure 206).

This system does not allow using rigid materials, though it would be buildable using thin or formed plywood. This type of wall morphology might be suitable, for instance, for building responsive light façades.

Comment 54. Exploring with double patterned walls. Refer to Figure 206.

cut. The result is an irregular opening (Figure 204).

- c) **Rebuilt opening.** The modifier runs a more complex algorithm that automatically readjusts cells around the Boolean operator to render an accurate opening; however, cells around the latter might become too small to be digitally fabricated (Figure 205).

For this particular evolution, applying void modifiers works better after the cell-set has been planarized, so the designer can be sure what he/she sees is the real output (V_o) the cell-set will have.

7.2.6. CELL-SET EXTRUSION.

Cell extrusion runs parallel to cell-set planarization. Using the volumetric modifiers contained in Mesh+, a set of four extrusion clusters is proposed: Bilateral extrusion (Comment 54), extrusion by attractor points, extrusion by curvature, and simple mesh extrusion.



The minimum input parameters for the extrusion modifiers to operate are:

- A mesh or a mesh-set as representation of the wall's cell-set.
- A value for wall thickness.
- A Boolean toggle for flipping the extrusion normal.

The outcome is about the same for every modifier in terms of data: Cell-walls and cell-covers are yielded as meshes. Every cell's item preserves

the cell's ID as mechanism to enhance data lists that will facilitate cell regrouping.

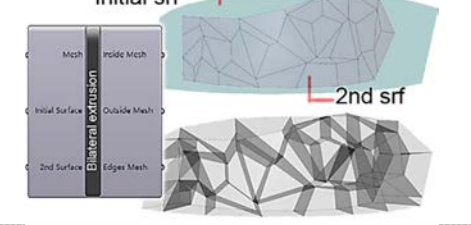
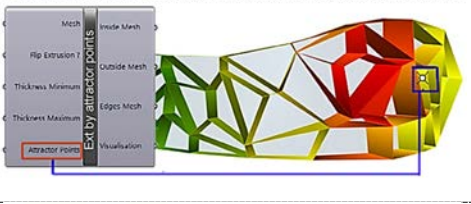
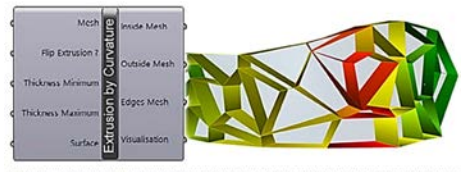
Table 13. Fab-Cell Volumetric modifiers

Task	Thumbnail
<p>Bilateral extrusion. It uses the initial W_r as well as a second NURBS surface to extrude the tessellation by lofting. The second surface can be parallel to W_r, in which case thickness is constant, or, it can have a slightly different morphology in which case wall thickness is variable.</p>	
<p>Extrusion by attractor points. It creates variable wall thickness using attractor points acting over the wall's grid. Colored visualization allows for identifying which cells are closer to the attractor point. The closer a cell is to an attractor point, the thicker the wall becomes at that cell's place.</p>	
<p>Extrusion by curvature. It generates variable thickness in function of W_r's curvature. The higher curvature acuteness is, the thicker the wall becomes. A minimum thickness value is set to avoid zero thickness when curvature is none.</p>	
<p>Simple mesh extrusion. The simplest method for cell-set extrusion. It delivers constant thickness for the entire wall.</p>	

7.2.7. CELL-JOINTING OPTIMIZATION. FIRST STAGE.

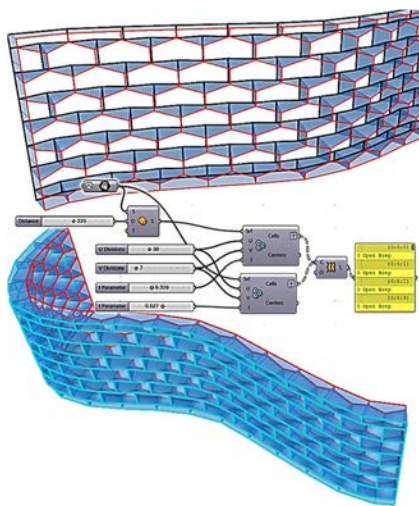

Figure 206. Double patterned cell-set extrusion using pattern topology via Lunch box.

Cell jointing optimization is focused on two main aspects: Algorithm optimization and joint-type diversification. After the wood challenges 2014, the need for implementing and interlocking jointing system became imperative inasmuch as assembling wall components with fasteners only favored assembling inaccuracy.

The entire process was carried out in two stages. The first concentrates in developing a method for creating morphologically variable dovetails and finger joints. The second makes a

general debugging of the jointing-generation algorithm and tunes up its capabilities to increase joint-programming flexibility.

7.2.7.1. CREATION OF FINGER JOINTS AND DOVETAILES.

Based on the experiences described in sections 7.1.5 and 7.1.6 a new joint-programming algorithm was developed. The module retrieves information from a generic geometry component in which a cell set is saved as internalized data.

However, the entire cell-set is not necessary for joint-making processing. Cell-wall data is enough for starting a process divided into three stages: **a)** Joint profile and gap generation. **b)** Cell-item thickness management. **c)** Cell-splitting.

Because operations within the jointing generation algorithm might become numerous, cells are processed one at a time. Depending on jointing complexity, calculating a single cell takes about 2.5 seconds.

a) Joint profile generation. Joint profiles are polylines calculated over cell-wall knots.

A cell-knot is made by a vertex extruded along a vector forming a line with a given length equal to the wall thickness at that specific knot (joint axis J_a) (Figure 207). The joint is created by dividing and waving J_a in as many parts as needed to form finger joint and dovetail crests and valleys.

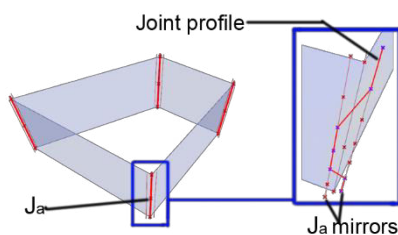

Figure 207. Creation of a joint profile in a cell-set knot.

The Z normal plane (Vr_N) of J_a serves as reference for projecting the profile inwards

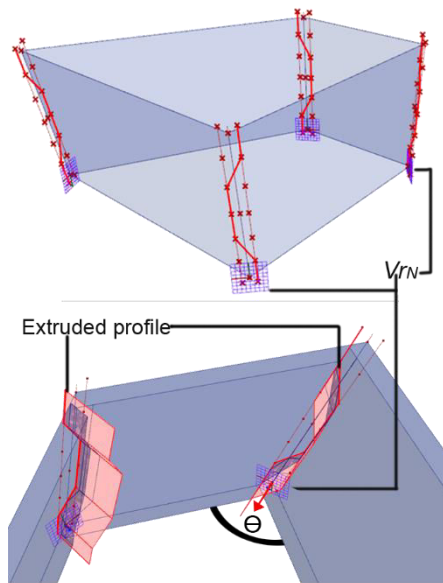

Figure 208. joint profiles extruded inwards a cell. Profile projection vectors are perpendicular to V_{rN}

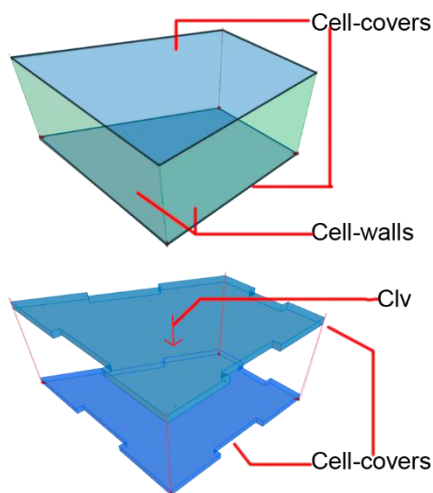

Figure 209. Cell cover rebuilding and joint definition. **Top.** Cell-wall boundaries are used to recover cell-cover geometry. **Bottom.** After joint profiles are added, cell-covers are extruded along a Clv vector.

the cell and perpendicular to cell-folds. The algorithm itself adjusts profile normals regardless of cell-fold angles (Θ) (Figure 208)

Gap generation is derived from profiles being extruded perpendicularly to their surface. The extrusion is made on both sides of the profile so gaps are symmetrical to it.

As for cell-covers, joints are calculated over the cover boundary. Moreover, every cover edge is processed the same way as cell knots, except that V_{rN} is calculated based on the cell's deviation vector (Clv) instead than on the profile's (Figure 209).

b) Cell thickness management. As cells are treated one by one, cell contours are received by the jointing algorithm without any thickness. The wood challenges experience proved that adding thickness to the extruded structure rendered the algorithm iterations slow to process. Furthermore, cell thickness plus jointing processing, all within the same core, brought instability to the model.

In order to avoid such complications, thickness is added to cells within the jointing algorithm. The process is faster and more reliable.

Cell thickness for cell-walls only requires a solid extrusion inwards the cell, respecting

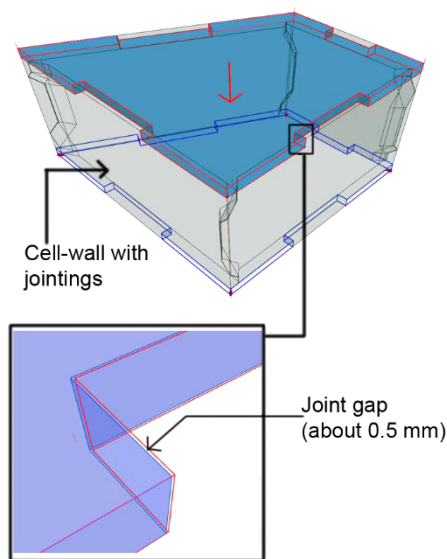

Figure 210. Gaps on cell covers. **Top.** Cell-wall joints are subtracted from cell-covers. **Bottom.** Gaps are added to cell-cover to facilitate coupling.

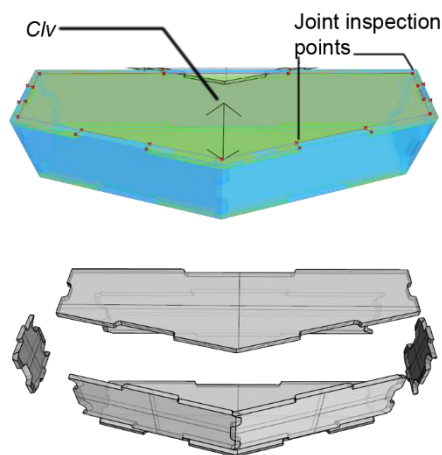

Figure 211. Top. GH internalized entity allowing joint verification. Bottom. Rhinoceros baked geometry allows for visual inspection.

the chosen stock's depth. Conversely, cell covers need first to be rebuilt from cell-wall boundaries (Figure 209), to be extruded inwards the cell and along Cl_v .

c) Cell splitting. This process occurs in two stages. Firstly, cell-walls are split via surface intersection through joint profiles, gaps are verified, and cell-wall closed Breps rebuilt.

Secondly, cell-covers are subtracted from cell walls. As gaps need to be left, the process is made in also two stages. The first is achieved by performing a Boolean operation between cell-wall Breps and cell-cover Breps. The second consists on exploding cell-covers, offsetting joint profiles inwards the cover, retrim cover faces, filter geometry debris and rebuild the cell-cover (Figure 210). This operation's output is the actual cell-cover.

7.2.7.2. OUTPUT

This process renders more complex cell-walls and cell-covers suitable for rapid manufacturing (RM). Cells are processed one by one and the user can check the results immediately on the screen. The interface possesses a bake utility allowing exporting GH geometries into Rhinoceros to manipulate cell-walls and cover directly for inspection (Figure 211). Moreover, panels within the GH environment allow for checking whether all entities are closed Breps.

Before sending cell items for nesting, the results of jointing calculation and cell splitting can be stored within a GH geometry component as internalized data along with the cell's Ids and tags.

7.3. CELL-JOINTING OPTIMIZATION. SECOND STAGE.

The first cell-jointing optimization stage defined the structure and the functioning scheme with which in-cell joints were to be processed within Fab-Cell. The optimization process described in this section was tackled by intern Guillaume Ginefri and his main goal was to improve the interface functioning, simplify algorithms, identify and fix bugs, increase functionality, and improve data visualization and data output.

Table 14, describes and compares the features that underwent optimization during this stage.

Table 14. In-cell solution development. Evolutive comparison between stages one and two.

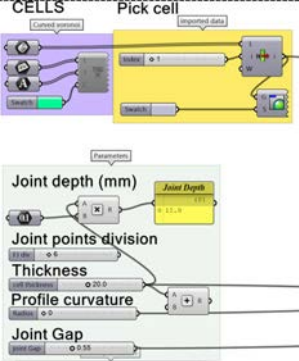
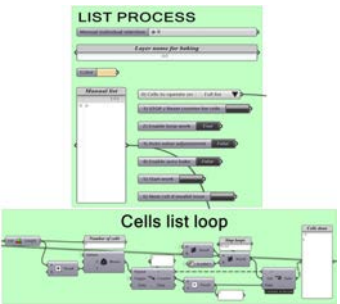
Task	Stage 1	Stage 2
<p>Cell retrieving. In <u>stage one</u>, the algorithm retrieves cells as a geometry collection. Cells are processed by selecting a number from the list. In <u>stage two</u>, a more complex algorithm filters all cells, allowing the user to manually select them or let the algorithm to process them automatically by means of a loop timer. In automatic mode, the process is launched one time only and it can be stopped once all joinery is calculated.</p>		

Input panel. Although stage 1 shows most functions are already accessible, there was no actual preview of jointing types treated by the algorithm, or the time the later takes to process items. In stage two, such functions are added plus a set of Boolean toggles to enable loop processing, face flipping, and select joint type and proportion.

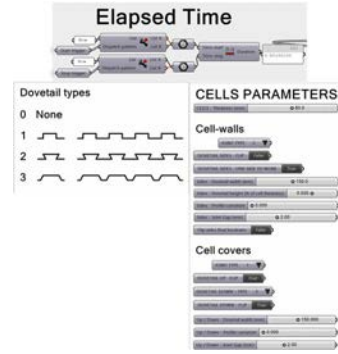

Jointing database. In stage one, the algorithm could only process one joint type at a time, and there was no way to choose joint types from a list or banner. Stage two not only provided list banner to pick an option, but also allows the user to choose not to have the same joint on all edges, which might improve assembling or even use different materials into the same cell.

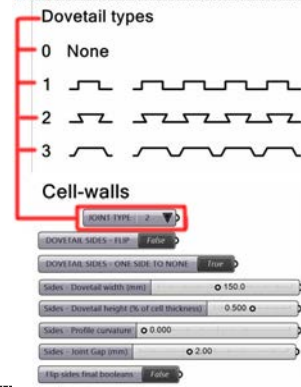
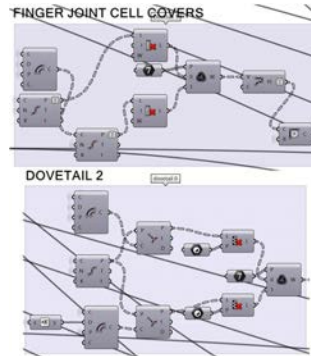

Cell validity. Stage one required the user to plug panels or bake geometry into Rhinoceros to verify geometry quality. In stage two, the algorithm has been provided with a geometry check algorithm that tests geometry, calculates deviations and searches for collisions. This is to prevent the algorithm from yielding geometries incompatible with CAM environments. Results are displayed on the screen.

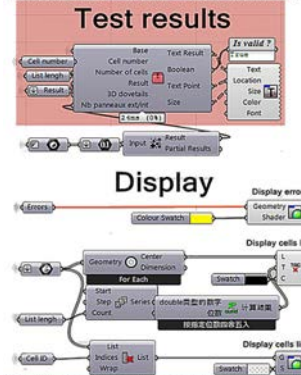
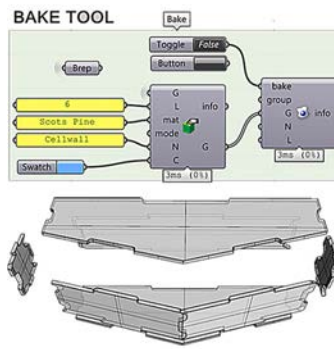

Debugging tool. In optimization stage two, this new feature assesses all inputs and compares them against the results in progress. If there is any error, the algorithm has a set of Boolean operators that, based on tolerance ranges, make an automatic adjustment of cell-wall flipping and joint profile roundness. The number of iterations is limited to eight by default.

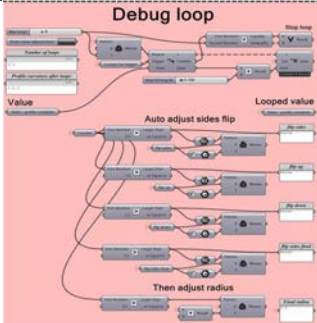
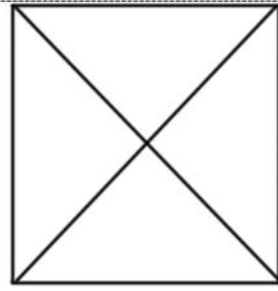

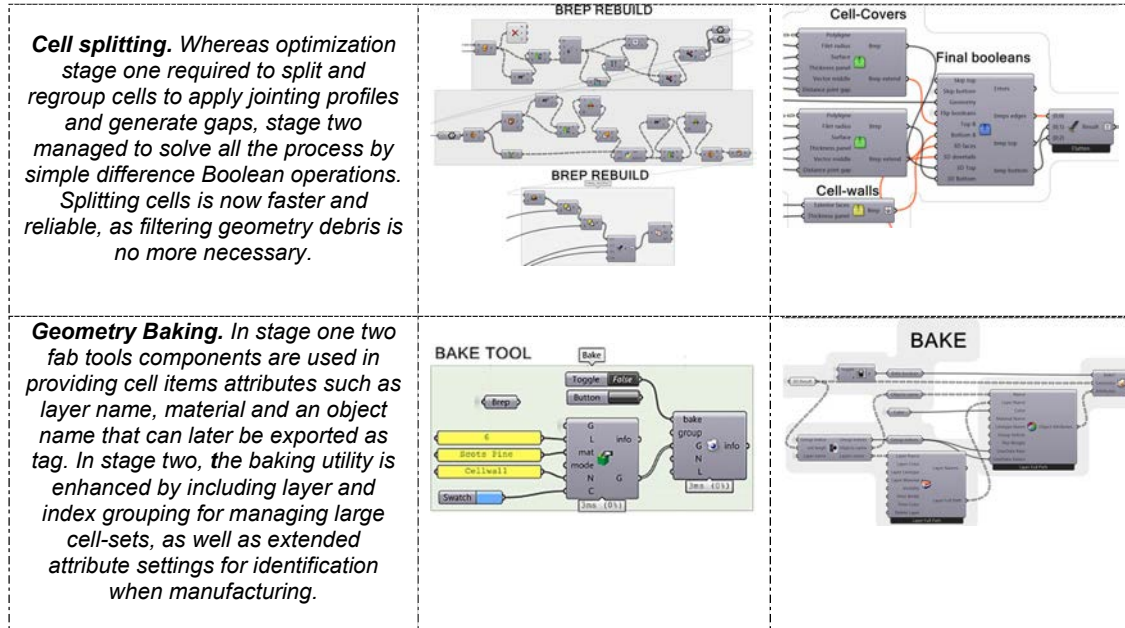

7.4. NESTING UTILITY.

The algorithm with which prototypes for the wood challenges were made did not have an operating nesting solution. Furthermore, this aspect became imperative to develop, as it was needed to boost the preproduction stage in order to assess material consumption, necessary equipment, and facilities.

A first version of the nesting utility divides the task into three processes: **a)** A flattening stage in which the cell-set is split and cells oriented over a flat grid for cell-splitting (Figure 212). **b)** A pre-nesting stage, in which all cell items are tagged, individualized, and oriented over a flat grid¹⁷⁹. As well as the jointing algorithm, the pre-nesting module treats cells one by one through a slider actioned by the user. (Figure 213) **c)** A nesting phase that uses pre-nested items to place them within the stock preserving item and cell Ids as well as their tags (Figure 214). The nesting algorithm

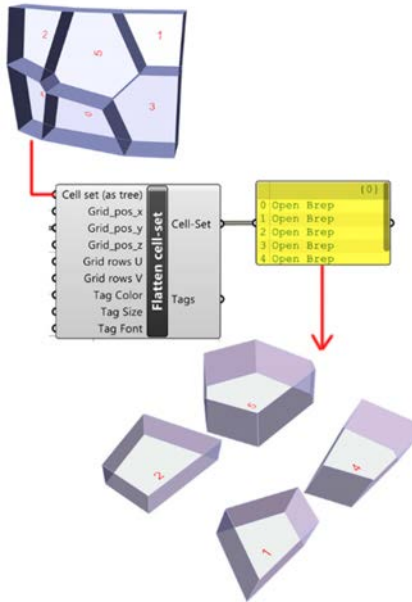

Figure 212. The cell set is split and individual cells are oriented over a flat grid

¹⁷⁹ As it actually functioned in Fab-Cell ver 1.0, but optimized.

uses the Generation add-on to approximate a nesting solution and deliver material consumption (Turello, 2012).

The second version of the nesting utility was tackled by intern G. Ginefri. In this new version, the pre-nesting and the nesting algorithms merge to create one single solution. Furthermore, the algorithm is capable of sorting items by cell, layer, or by face. A gene pool and a gap optimization utility help in the tasks of reorienting and setting machining gaps between workpieces. This improvement did not prove useful, inasmuch as it does not better than Generation's nesting component on its own.

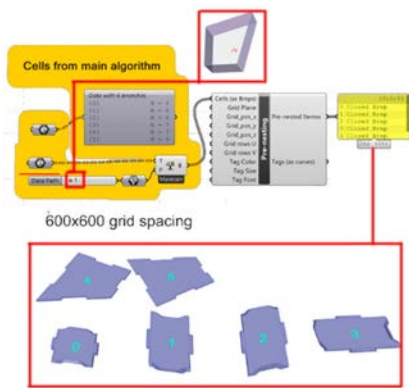

Figure 213. Cell items are separated, tagged and oriented over a flat grid to fulfill pre-nesting

A final enhancement regarding item tagging helps keeping an accurate record of cells and their components as it performs a better tag management for associating items by cell number (Figure 215).

7.5. CAM INTEGRATION.

Taking as a start point the difficulties in CNC programming describe back in section 7.1.6, the search for new alternatives in CNC programming and aided manufacturing became imperative.

As seen back in section 3.4, there are plentiful solutions that were worth of testing. GH add-ons such as Woodpecker (design2machine, 2016), HAL, Taco ABB or Kuka PRC offer the possibility of integrating CNC programming into GH solutions along with previsualization capabilities often found in CAM suites such as Solidworks or Inventor.



Figure 214. Pre-nested items are once again reoriented into stocks by means of reference plane. Nesting gaps can be adjusted with the nesting quality value



Figure 215. The second optimization stage mainly improves item tagging and referencing. nesting quality is however not better than in the first version thus the first version is kept.

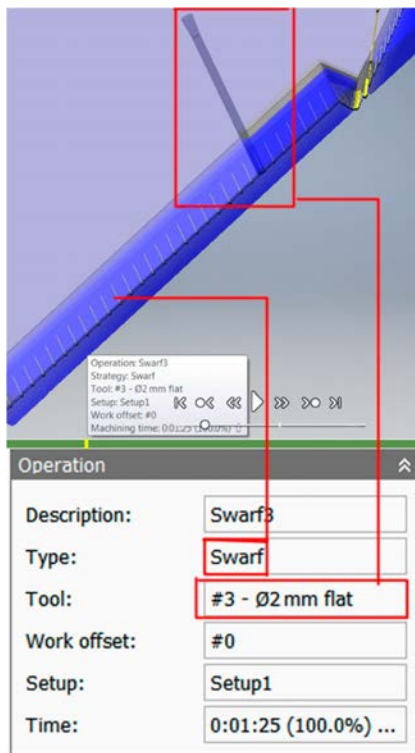

Figure 216. Machining set up test using Inventor 2016. A cut operation is tested on an item similar to those obtained through Fab-Cell. For such detailed items, swarf operations, using a thin mill-end, look promising towards achieving complex cuts.

To this extent, two GH add-ons were tested in function of the features offered by the digital fabrication facilities of the ENSTIB, which happens to be the closest workshop to where the research works of this thesis have been developed. Tests using Woodpecker and Kuka PRC showed a similar approach in path simulation and programming, regarding the kind of workpieces Fab-Cell delivers.

Both add-ons generate cutting paths based on swarf-like paths calculated from the workpiece contour (Figure 216). Namely, the mill-end executes gross cutting and finishing operations by tangentially following the machining path. However, the output is different (comment on file type output.)

As visualization and path adjustment proved to be more flexible to deal with than with woodpecker, the Kuka|PRC environment opened a new perspective towards fabrication that has not been explored yet. So far, the prototyping sessions made use of a Güdel gantry robot that uses an ABB controller and which is fed by machining code generated through LignoCAM. However exploring with a Kuka environment was still unknown.

Kuka|PRC has a robot database allowing programming machining routines under different fabrication environments that vary in function of every robot's capabilities. For this particular case, the model used for simulation is the Kuka series 2000 Kr 210-2, which is available at the facilities of the ENSTIB.

7.5.1. SETTING UP FABRICATION PATHS

Kuka PRC offers several databases including virtual robots, command cores, virtual tools, and toolpath utilities¹⁸⁰.

Once the user chooses a robot, a virtual tool, and generates the command interface, he starts programming machining paths using the object's contour. Please notice that programming complex object machining requires several steps for the programming routine to succeed. To do so, the machining path must be subdivided into straight cuts, sloped cuts, and inverted-sloped cuts to assemble a fabrication routine¹⁸¹. Namely, the robot will execute every machining type independently and it is up to the user to decide which paths are to be executed first (Figure 217).

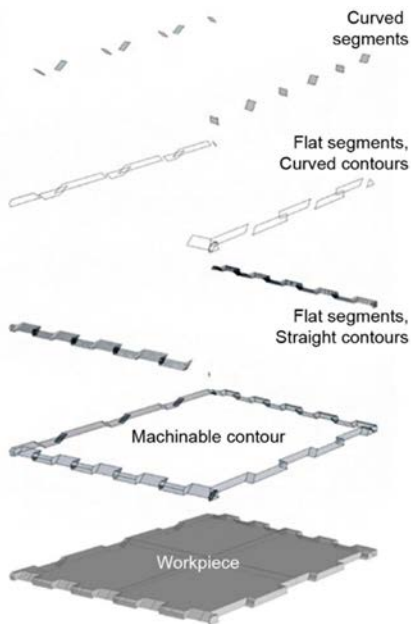

Figure 217. Filtering machining tasks for producing complex machinable items.

Moreover, defining machining tool entries and exits requires a bit of attention, since a maneuver gap must be considered when programming paths to avoid machine collisions. Either way, the user will be able to identify such collisions during the machining simulation and fix them as necessary.

7.5.2. OUTPUT.

The outcome obtained by using the Kuka|PRC plugin consists of a simulation and a data set.

The simulation is the first way in which the user gets into contact with the way fabrication instructions are generated. That way, the user can assess aspects like machining tool convenience

¹⁸⁰ For further information please visit <http://forum.robotsinarchitecture.org/>

¹⁸¹ Programming and simulations of the built-in CAM Module using Kuka|Prc were developed by intern G.Ginefri.

(length-diameter), machining environment (size, logistics), and timing. The data set is composed by actual fabrication commands in the form of Kuka|PRC code (Figure 218).

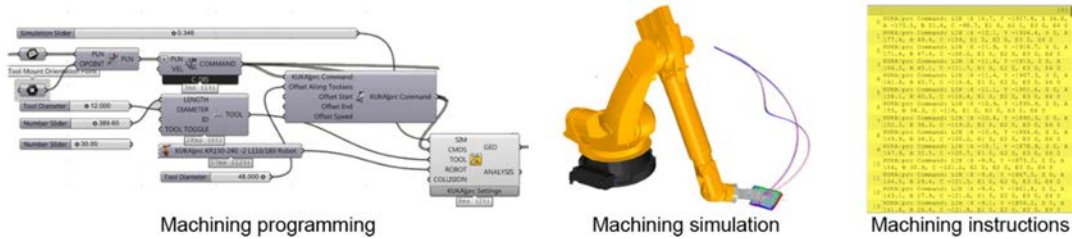

Figure 218. Kuka|Prc workflow.

7.6. CHAPTER CONCLUSION AND RESULTS.

So far, Fab-Cell’s development state shows the ACPT has a potential worth of development. Most of the goals fixed in section 6.2 are now accomplished and the parametric tool is in an operational state in which it can actually retrieve walls or envelopes and redefine them through a series of topologic and morphologic options.

The outcome is a buildable set suitable for aided-manufacturing production. The results of this process are represented as follows:

- a) A GH component set called “Wall tessellation” that executes the tasks concatenated in Fab-Cell’s data conversion and generative kernels¹⁸².
- b) A set of jointing calculation, nesting, and CAM modules that actually embody Fab-Cell’s production kernel at its full.
- c) An enhanced data model that shows how the production kernel sends feedback to the generative kernel and induces morphologic and topologic changes concerning joint-type manufacturing, material thickness, even mounting constraints (Figure 219) (Appendix 12).

¹⁸² Based on the developments described in sections 7.1 and 7.2, the generative kernel is concatenated into a set of GH user components called “wall tessellation”. Refer to Appendix 11 to see the full component set.

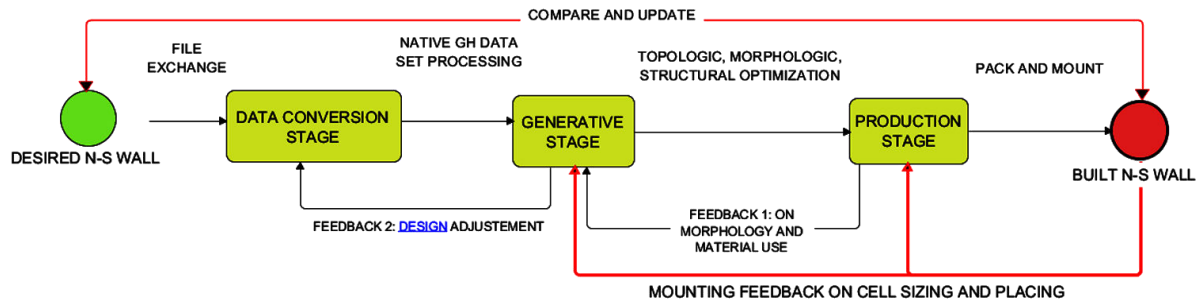

Figure 219. Fab-Cell 's final data model (summarized). Production and mounting processes send feedback to generative stages even before tackling construction. Building can be assessed by means of simulation and prototyping in order to optimize the buildable set within the digital environment.

A comparison between the initial data model and the resulting data model showed that tasks like material type (nor thickness) or inter-cell jointing system might not be critical in defining a cell set. Moreover, on-worksite handling and mounting tasks, when properly anticipated, can offer the possibility of adjusting cell sizing in order to synchronize design, production means, and workforce.

Chapter 8. GENERAL CONCLUSION, RESEARCH PERSPECTIVES, AND RELATED PUBLICATIONS.

8.1. GENERAL CONCLUSION

As seen through the different discussions along this writing, architecture, design, and engineering have not exactly reinvented production means; instead, they have been proposing novel methods for adapting advanced industrial production mechanisms in favor of design creativity.

Since timber construction is inseparable from design or engineering, the use of advanced industrial production methods has also been participating of the shift from serial production towards mass customization. Moreover, a case study on set of projects whose conceptual approaches embed notions like biomimetics¹⁸³, morphogenesis, tessellations, and material use (wood), provided an outlook of the field on which this research endeavor is focused.

To this extent, and after comparing academic research against day-to-day architectural practices, it was clear that there still exists a breach preventing both approaches to merge. Interviews with experienced French architects showed that facts like workmanship or limited digital design and production skills prevent common architectural projects from incorporating non-standard approaches.

It is within this context that a gap was found to propose an aided-conception parametric tool (ACPT), called Fab-Cell, which could help architects to incorporate non-standard language into their work. The ACPT's data model is grounded on the principle that proposing free-form walls and envelopes often requires a building approach different from standard practices. That fact has been proved several times through pavilions and actual projects, in which prototypes need to be made in order to propose a design-to-production strategy.

That is the case of projects like the Solar Energy pavilion, or the Nursery facility at Guebwiller, for which standard production means could not match architectural

¹⁸³ In the form of cellular-like timber structures.

intention. That is the goal tackled by Fab-Cell, as discussed throughout this dissertation. Namely, the ACPT deals with the problem of restructuring architectural elements to make them feasible without having to spend time in proposing a building strategy for achieving a given architectural morphology.

The method described back in Chapter 6 stated Fab-Cell should be capable of retrieving and actual wall or envelope and redefine its morphology, topology, and structure to turn it into a non-standard entity. It also stated that such decision is the architect's, so Fab-Cell is not intended to solve design but to help taking decisions relative to it.

A data model allowed designing Fab-Cell's functional span, as well as the guidelines for building it was made in order to define inputs, functions, and output. The outcome is an iterative interface built on GH, which processes an architectural element (wall-envelope) as data, modifies its topological and morphological attributes, and delivers a buildable data set containing information about the entity's geometry, location, dimensions, components, jointing system, component IDs and fabrication instructions.

The activities inside and outside the ACPT, are represented by a workflow that evolved as improvements were made. An early-development prototyping experience allowed identifying the strengths and weaknesses the modeling interface and the general workflow possessed. Such pros and cons could be translated into evolution goals that were later achieved by means of an evolved data model, an improved modeling interface, a cleaner geometric outcome, and a richer data output for production.

Subsequent improvement endeavors led to optimize functions such as morphing, joint management, pattern creation, debugging, and CNC programming and simulation. To this point, although some processes were narrowed (i.e morphologic pattern options), the ACPT functional range is aimed towards offering a functional degree applicable to variable design environments in which walls (bearing and non-bearing aggregate sets) could be adapted to a series of spatial and morphological requirements compatible with two basic principles: non-standardization and cellular morphologies. Such aims brought up limitations relative to aided-manufacturing that vary from case to case. In other words, the ACPT'S capabilities are bounded to

production means that inevitably affect the morphological outcome. As seen in section 7.1.6, the capabilities of a specific set of machinery can impose serious limitations to design to a point of binding its freedom.

The parameters within Fab-Cell allow the user to explore with as many morphological options as he wishes; however, the availability of a specific CNC equipment may limit such exploration. Therefore, the real boundaries or limitations are not found exactly within fab-cell but between fab-cell and any given production environment's capabilities. Theoretically, and given the tests carried out with Autodesk Inventor and Kuka Prc, there would be no limitations for as long as the needed CNC machinery is available, if it is not, then adjustments can negatively affect design.

Nonetheless, it is true the knowing how to use the aforementioned resources, along with a familiarization with theRGH environment, might favor the achievement of better results in terms of form generation and fabrication command creation. Let us not forget that Fab-Cell can be improved by the user himself, as it would happen with i.e any Linux distribution. In the end, the functions Fab-cell performs can exponentially increase as the user gets used to it and reaches to test all of tis capabilities in order to tackle developing new ones.

Given this scenario, the ACPT is capable of performing the following functions in the framework of any design process:

- a)** Retrieve external wall representations (Wr's) and convert them into native GH data.
- b)** Redefine a wall or envelope, regardless of its function, in terms of morphology and topology, respecting the boundaries established by the designer
- c)** Allow the designer to browse within a range of morphologic modifiers (patterns) to redefine a given entity's morphology and/or topology
- d)** Provide a mechanism to visualize and apply different material thicknesses to components of a given entity.
- e)** Filter components to create rhythms, voids and permeability

- f) Offer a component (cell) jointing-browsing mechanism allowing parameterizing joints in function of a given material's type and thickness.
- g) Provide a nesting environment allowing placing and tagging components for digital fabrication. It also allows to make an estimate of the amount of material needed for a given fabrication attempt.
- h) Provide a CNC programming environment that furthers the designer in previewing and assessing the intricacies of a fabrication endeavor.
- i) Provide visual and data feedback to adjust the process at any phase when necessary. I.E, it is possible to change cell sizes, jointing steps, material thickness in function of any other attribute including those of a CAM interface.

A wider outlook suggests the tool's potential goes well beyond walls and envelopes embodied by cellular-like structures. The usefulness of the ACPT herein discussed can be extended to design and fabrication tasks for siding, paneling, interior and exterior wall and roof claddings, as well as CLT wall jointing assuming dwells as closed cells. Aforementioned use purposes open way to a set of research perspectives that might be considered for future research projects in the field digital architecture.

Last but not least, it must not be forgotten that full-automation is not yet possible within Fab-Cell. So far, improvements on digital functions are aimed to avoid performing manual tasks such as those described back in section 7.1.6, when dealing with the prototypes built for the wood challenges 2014. However, automated mounting is not yet explored.

8.2. RESEARCH PERSPECTIVES

Although Fab-Cell's has attained a decent functional range, the research project itself proves to deserve future development from different outlooks ranging from pattern database expansion, morphing and form-searching optimization, and jointing database development to daylight heat-gain optimization. Furthermore, the tool should be consistently tested and improved in workshops and classes in which digital conception and fabrication might be involved.

That is to say, academic contests such as de “wood challenges” might take advantage of Fab-Cell’s mass customization capabilities to push the contestants to challenge their design abilities and test an alternative way of making things. From the computational point of view, many of the tasks performed within Fab-Cell’s algorithms might become more powerful if a skilled programmer could convert many of the clusters into code by using any of the interfaces compatible with the RGH environment (Python, Vb, Rhinoscript). The concept equally applies to morphologic functions that necessarily require the writing of a script to avoid the excessive plugging-and-unplugging that currently exists within the ACPT’s.

The environmental aspect should not be left aside. For that purpose, the potential of Fab-Cell lies in its capability of generating buildable structures. Such feature offers an improvement possibility regarding daylighting energy gains. Taking into account that the current modeling algorithm is capable of filtering cells for modifying permeability (as voids), a solar analysis algorithm would allow regulating void density and transparency in function of grid density and cell size.

The ACPT’s structure could easily allow incorporating attractor points to apply random size variation in order to make geometric patterns adjustable to daylighting annual variation averages. In the end, the algorithm would not only deliver buildable but weather performative non-standard walls and envelopes. Such principles are explored back in section 2.2.3, Figure 73, in which the idea of a responsive skin is used to illustrate in which manner not only patterns, but responsive design, further optimizing energy savings by filtering sunlight and controlling heat gains. A similar approach can help finding acoustic solutions for auditoriums and concert halls by means of cellular timber structures.

In sight of the referred potential, along with the capabilities offered by wood derivatives, incorporating a structural analysis tool into Fab-Cell might enhance its material dimension by pushing the elastic and plastic limits offered by timber. Finite element analysis along with detailed structural and fiber stress analysis appear to be next step in the development chain suggesting a higher involvement of engineers and technicians into the study, which might confer the approach herein developed a dimension in which it becomes a means for enhancing architectural creativity along with technical challenge. In other words, by entwining creativity and generative

design along with a challenging structural approach, one might achieve a state of materiality in which stasis gives way to what might be called augmented architecture (Engelbart, 1962).

Fabrication is perhaps the final step. Geometries produced by Fab-Cell are aimed for the timber industry, however, such data can also be introduced in additive fabrication endeavors to widen ACPT's spectrum towards different materials such as polymers, concrete, foam or even stone carving. In fact, by just retrieving the basic structure as obtained before cells are subdivided into smaller items, it is possible to pass directly towards generating data for additive fabrication. Notice that the means for doing so would need to be considered separately.

That is to say, a well-assembled multidisciplinary team could help giving Fab-Cell the next step towards becoming a fully developed aided-design solution incorporating an interesting range of data outputs as needed in non-standard design and construction.

8.3. RELATED PUBLICATIONS.

A set of three papers makes part of the works carried out during the making of this dissertation. Moreover, the contribution of interns Guillaume Ginefri and Thomas Ehrhardt is contained in a work entitled "*structures cellulaires Non-standards en bois*"¹⁸⁴. The report describes the way interns developed a set of improvements regarding pattern database expansion, jointing creation, interface optimization, cluster packing, and CAM programming integration. Namely, it describes in thorough detail the last optimization phase of Fab-Cell's. The five publications are listed as follows:

Gámez Oscar. 2017. "*N-sWArm. Outil d'aide à la conception de parois non-standards en bois*" In "*Actes du 7ème Forum Internatinoal Bois Construction FBC 2017*" Épinal- Nancy, France, April 5-7, 2017. Pg 291–308. *Forumholzbois*.

Ehrhardt, Thomas, and Guillaume Ginefri. 2016. "*Structures Cellulaires Non-standards en Bois.*" *Internship report. Nancy: Map CRAI.*

¹⁸⁴ Advised by Prof. Gilles Duchanois and Oscar Gámez.

Gámez, Oscar, Jean Claude Bignon, and Gilles Duchanois. 2015. “Assisted Construction of Non-Standard Wooden Walls and Envelope Structures by Parametric Modeling.” In *16th International Conference, CAAD Futures 2015, São Paulo, Brazil, July 8-10, 2015. Selected Papers*, 527:291–308. 1865-0929. Sao Paulo, Brazil: Springer Berlin Heidelberg.

Gámez, Oscar; Jean-Claude Bignon and Gilles Duchanois. 2015. “Assisted Construction of Non-Standard Wooden Walls and Envelope Structures by Parametric Modeling.” In *Proceedings of the 20th International Conference of the Association for Computer-Aided Architectural Design Research in Asia (CAADRIA 2015)*. Daegu: 653-662.
http://cumincad.scix.net/cgi-bin/works/Show?id=caadria2015_010&sort=DEFAULT&search=G%e1mez&hits=1.

Gámez, Oscar, Julien Meyer, Jean-Claude Bignon, and Gilles Duchanois. 2015. “Interaction of Analogic and Digital Workflows for Architectural Design and Production.” In *Project Information for Interaction*. Florianopolis, Brazil.

APPENDIXES

**Appendix 1. DESIGN STRATEGIES DEFINING POST-
MODERN ARCHITECTURE, AS STATED BY ROBERT
STERN**

“The use of ornament. Though ornament is often the handmaiden of historical allusion, the decoration of the vertical plane need not be justified in historical or cultural terms [...]

The manipulation of forms to introduce an explicit historical reference. [...] not to be confused with the simplistic eclecticism that has too often in the past substituted pat, pre-digested typological imagery for more incisive analysis. The principle is rather that there are lessons to be learned from history as well as from technological innovation and behavioral science, that the history of buildings is the history of meaning in architecture. [...] This Post-Modernist examination of historical precedent grows out of the conviction that appropriate references to historical architecture can enrich new work and thereby make it more familiar, accessible, and possibly even meaningful for the people who use buildings. [...]

The conscious and eclectic utilization of the formal strategies of orthodox Modernism, together with the strategies of the pre-Modern period. Borrowing from forms and strategies of both orthodox Modernism and the architecture that preceded it, Post-Modernism declares the past-ness of both; as such it makes a clear distinction between the architecture of the Modern period, which emerged in the middle of the eighteenth century in western Europe, and that puritanical phase of the Modern period which we call the Modern Movement.

The preference for incomplete or compromised geometries, voluntary distortion, and the recognition of growth of buildings over time. This is manifest in a marked preference for the Aalto of the fifties over the Corbusier of the twenties, for the plans of Lutyens over those of Voysey, and for the long love affair with the American Shingle Style of the nineteenth century. [...]

The use of rich colors and various materials that effect a materialization of architecture's imagery and perceptible qualities, as opposed to the materialization of technology and constructional systems that remain so overtly significant in brutalist architecture.

The emphasis on intermediate spaces, that is, the “pochés” of circulation, and on the borders, that is, on the thickness of the wall. [...] an architecture made of spaces whose configuration is much more neutral and supple [...].

The configuration of spaces in terms of light and view as well as of use.

The adjustment of specific images charged with carrying the ideas of the building. It is thus possible for the architect to create simultaneously two premises or spatial units within one building or two buildings in a complex that do not resemble each other even if their compositional elements are the same. [...].”

**Appendix 2. ENGELBART'S EARLY APPROACH TO
CONTEMPORARY DESIGN AND BIM METHODS. ON:
(Engelbart, 1962)**

upon the computer's help. By this same strategy, we recommend that an initial research effort develop a prototype system of this sort aimed at increasing human effectiveness in the task of computer programming.

To give the reader an initial orientation about what sort of thing this computer-aided working system might be, we include below a short description of a possible system of this sort. This illustrative example is not to be considered a description of the actual system that will emerge from the program. It is given only to show the general direction of the work, and is clothed in fiction only to make it easier to visualize.

Let us consider an "augmented" architect at work. He sits at a working station that has a visual display screen some three feet on a side; this is his working surface, and is controlled by a computer (his "clerk") with which he can communicate by means of a small keyboard and various other devices.

He is designing a building. He has already dreamed up several basic layouts and structural forms, and is trying them out on the screen. The surveying data for the layout he is working on now have already been entered, and he has just coaxed the "clerk" to show him a perspective view of the steep hillside building site with the roadway above, symbolic representations of the various trees that are to remain on the lot, and the service tie points for the different utilities. The view occupies the left two-thirds of the screen. With a "pointer," he indicates two points of interest, moves his left hand rapidly over the keyboard, and the distance and elevation between the points indicated appear on the right-hand third of the screen.

Now he enters a reference line with his "pointer" and the keyboard. Gradually the screen begins to show the work he is doing--a neat excavation appears in the hillside, revises itself slightly, and revises itself again. After a moment, the architect changes the scene on the screen to an overhead plan view of the site, still showing the excavation. A few minutes of study, and he enters on the keyboard a list of items, checking each one as it appears on the screen, to be studied later.

Ignoring the representation on the display, the architect next begins to enter a series of specifications and data--a six-inch slab floor, twelve-inch concrete walls eight feet high within the excavation, and so on. When he has finished, the revised scene appears on the screen. A structure is taking shape. He examines it, adjusts it, pauses long enough to ask for handbook or catalog information from the "clerk" at various points, and readjusts accordingly. He often recalls from the "clerk" his working lists of specifications and considerations to refer to them, modify them, or add to them. These lists grow into an ever-more-detailed, interlinked structure, which represents the maturing thought behind the actual design.

Prescribing different planes here and there, curved surfaces occasionally, and moving the whole structure about five feet, he finally has the rough external form of the building balanced nicely with the setting and he is assured that this form is basically compatible with the materials to be used as well as with the function of the building.

Now he begins to enter detailed information about the interior. Here the capability of the "clerk" to show him any view he wants to examine (a slice of the interior, or how the structure would look from the roadway above) is important. He enters particular fixture designs, and examines them in a particular room. He checks to make sure that sun glare from the windows will not blind a driver on the roadway, and the "clerk" computes the information that one window will reflect strongly onto the roadway between 6 and 6:30 on midsummer mornings.

Next he begins a functional analysis. He has a list of the people who will occupy this building, and the daily sequences of their activities. The "clerk" allows him to follow each in turn, examining how doors swing, where special lighting might be needed. Finally he has the "clerk" combine all of these sequences of activity to indicate spots where traffic is heavy in the building, or where congestion might occur, and to determine what the severest drain on the utilities is likely to be.

**Appendix 3. FOREST GAINS AND LOSSES OVER A 14
YEAR PERIOD.**

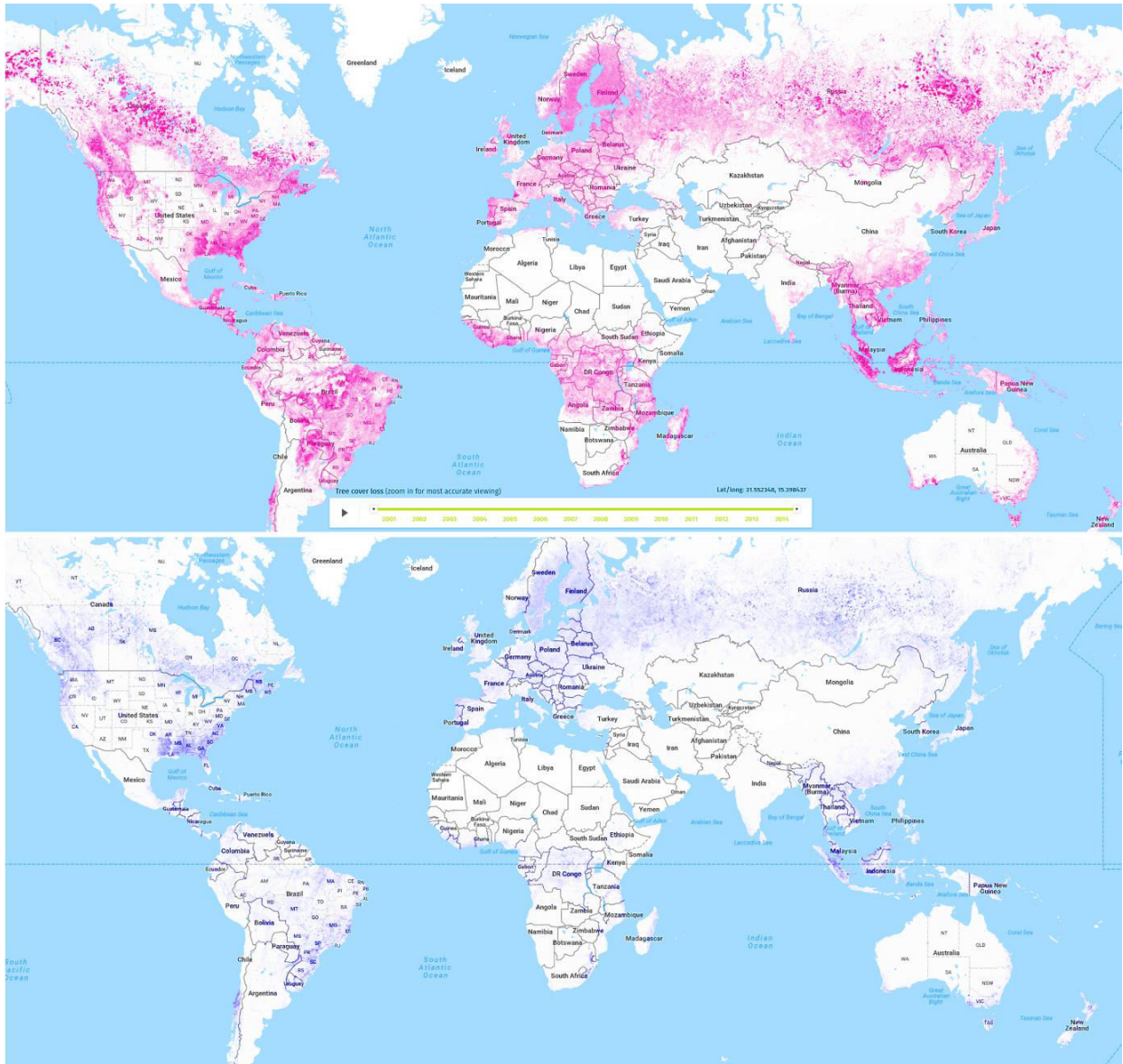

Figure 220. **Top.** Forest loss over a 14 year period (2000-2014). **Bottom.** Forest loss over the same period. Notice that reforested areas occur specially on the northern hemisphere, conversely, tropical and subtropical areas tend more to a less sustainable behavior as reforestation happens on a much smaller scale. (Margono et al., 2014). Images from <http://www.globalforestwatch.org>

**Appendix 4. EUREKA PAVILION STRUCTURE
MANUFACTURING INFORMATION.**

Oscar Gámez

De: Martin Bender <martin.bender@blumer-lehmann.ch>
Enviado el: vendredi 23 septembre 2016 14:29
Para: Oscar Gámez
Asunto: AW: Eureka pavilion Structure information for research purposes
Datos adjuntos: timeseureka_e_A3.pdf
Estado de marca: Marcado

Hello Mr. Gamez,

Please find attached our reference sheet of the Times Eureka Kew Gardens Pavilion.

Below some additional information:

Planning incl. shop drawings: 543 h
Programming CAD/CAM: 42 h
Cost of production: approx. 160'000 Euro

<u>Machine</u>	<u>Fabrication time (Machine)</u>	<u>Fabrication time (Machinist)</u>
Hundegger K3	12.5 h (netto !)	54 h
Lignomatik	10 h (netto!)	34 h

planning work:

- work planning timber structure
 - o create details and structural evidences of the connections
 - o ordering material
 - o drawings and 3d models for production, assembling and erection
- project management, coordination, supervising and quality control
- CAM programming NC codes for the CNC machine (pre-cutting in 3 axis)

material specifications:

- Spruce according to EC5
- primary structure: Glue lam beams, spruce, FSC or PEFC-standard, visible-quality
- cassette plates: massive laminated plates, spruce, FSC or PEFC-standard, visible-quality
- interfaces see chapter 6

structural parts

- foundation beams underneath the walls and two cross beams on the 4 meter side and one cross beam on the 6 meter side. Dimension 200/400mm
- primary structure – dimensions from the rhino model.
- cassettes, and infill plates thickness 20mm, height – walls 230mm, roof 330mm
- frame boards on the all outer edges of the pavilion
- connections – invisible (they are discussed in the meeting, if there are some changes we will inform the architect)

Please do not hesitate to contact me again, if you need further information or you need pics.

Kind regards

Martin Bender
Business Unit Manager

[Número de página]

Blumer-Lehmann AG
The fascinating world of wood

T +41 71 388 52 38
M +41 79 715 00 80
F +41 71 388 58 59
www.blumer-lehmann.ch

Von: Oscar Gámez [mailto:gamezboh1@univ-lorraine.fr]
Gesendet: Donnerstag, 22. September 2016 16:22
An: Martin Bender
Betreff: Eureka pavilion Structure information for research purposes

Good morning Mr. Bender.

I'm writing on behalf of the Center of research of architecture and engineering of the School of architecture of Nancy - France.

The reason to contact you today is because we are writing a paper on non-standard architecture and automated-like production in timber construction and, the Times Eureka Pavilion is in the scope of our referenced projects. However, we have no deep knowledge about the specificities of the structure so far, which is the reason why we kindly ask you to share some information that will be valuable for us and cited as needed in our academic publications.

The facts we need to know about the structure's manufacturing are.

- **Material.** We know it was Spruce but we do not know whether it was spruce glulam, spruce LVL or any other spruce composite.
- **Manufacturing process.** It's sure workpieces were CNC machined, however it'd be nice to know a bit more about the fabrication environment. CAM interface, CNC machining type (5 axis, 4 axis), and digital workflow.
- **Digital structural analysis environment.** Namely, the software blumer-lehmann used for calculating and optimizing the structure (this is not mandatory though)
- **Fabrication time.**

Hoping this will not mean a burden in your daily activities, we kindly ask you to spare five minutes of your time to answer our request since this kind of information is scarce in common media.

Kind regards,

Oscar L. GAMEZ
Architecte - doctorant
MAP-CRAI / UMR 3495 CNRS/MCC
Centre de Recherche en Architecture et Ingénierie, ENSA Nancy
Tél. : (+33) 3.83.30.81.46
2 rue Bastien-Lepage, B.P. 40435 - 54001 Nancy Cedex
gamez@crai.archi.fr - gamezboh1@univ-lorraine.fr
http://meurthe.crai.archi.fr/wordpressFr/?page_id=35&num_proj=47
Mobile: + 33 6 41 99 97 70

[Número de página]

**Appendix 5. STANDARD ELEMENTS FOR NON-
STANDARD ARCHITECTURE AFTER CIBLAC (2011)**

PARAMETRIC DESIGN WITH STANDARD ELEMENTS FOR ...

2.2. Construction of 3D structures from standard elements

The resolution of constraints systems for 3D structures constructed with standard elements is even more difficult to carry out than for 2D structures. With too many constraints the system may have no solution. For instance geodesic domes constructed with equal length elements can only be platonic polyhedrons and don't really look like domes. So, even if the fine discretization of the Buckminster Fullers domes gives the feeling of equal length elements, it is not the actual case. In Figure 3 (left) a geodesic dome constructed from a discretized icosahedron projected on a sphere from its center is presented. It can be noticed that the discretized icosahedron is constituted of equilateral triangles but the projected ones are not equilateral any more. Thanks to symmetries, some elements have the same length: the structure is partially standardized.

If the designer (architect) chooses the spherical shape as a priority, he/she must lose the choice of the same length for all the elements. The new goal becomes to determine the number, the length and the arrangement of the elements. Conversely, if the priority is to have the same length of elements, the determination of the non spherical shape becomes the goal. So the designer has to give the priority in the constraints in order to solve the problem. In this apparently simple example of a spherical dome, the solutions of structures constructed with standard elements can be only partial. Another way to construct a partially standardized dome consists of choosing particular polygonal curve on it as defined in 2.1. In fig. 3 (right) such a discretized dome is presented with standard elements on longitudes. This is a classical alternative way to discretize a sphere.

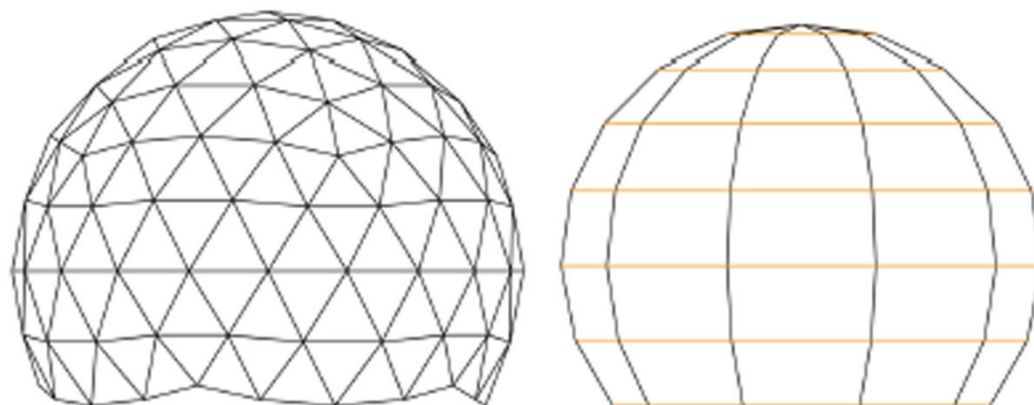
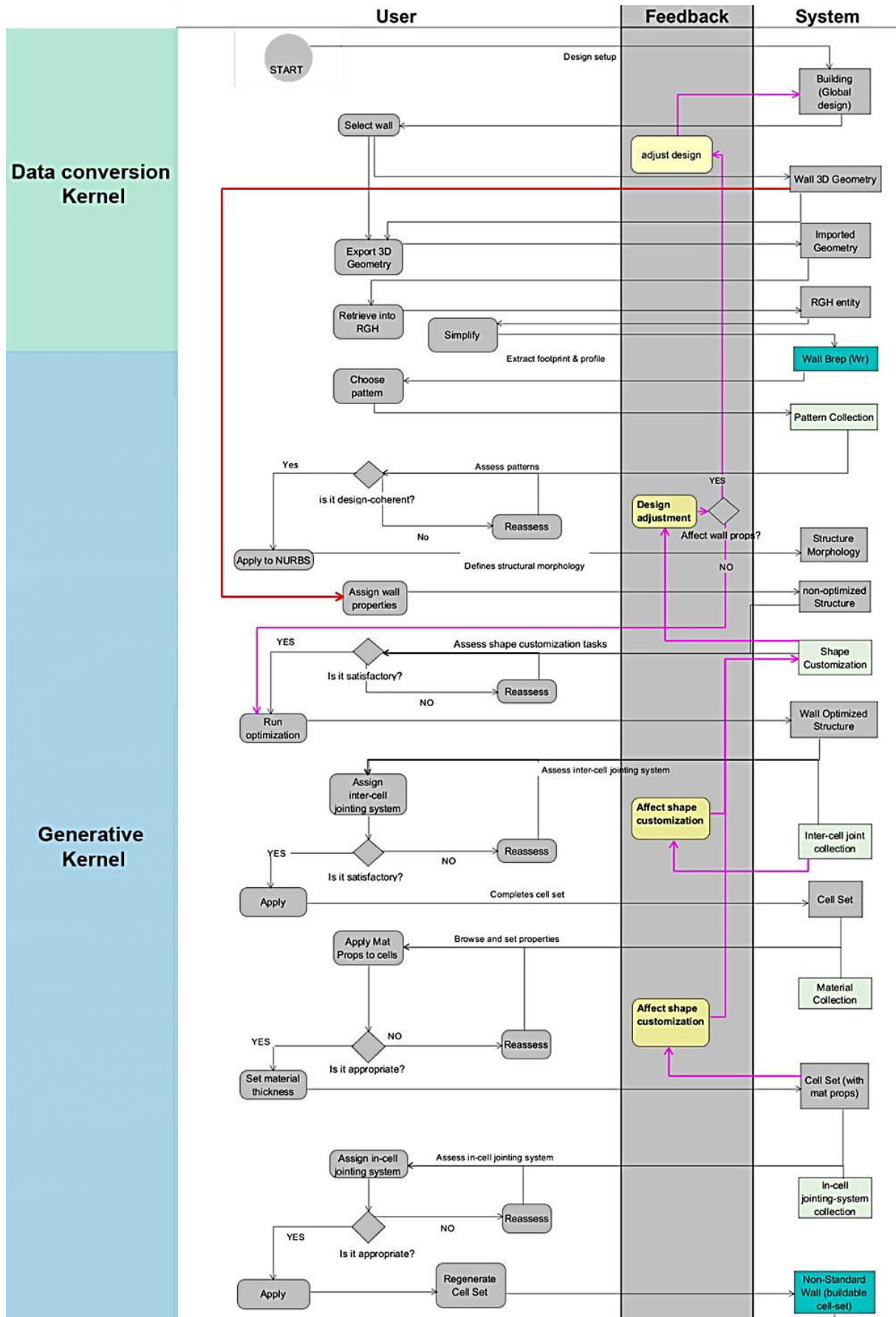
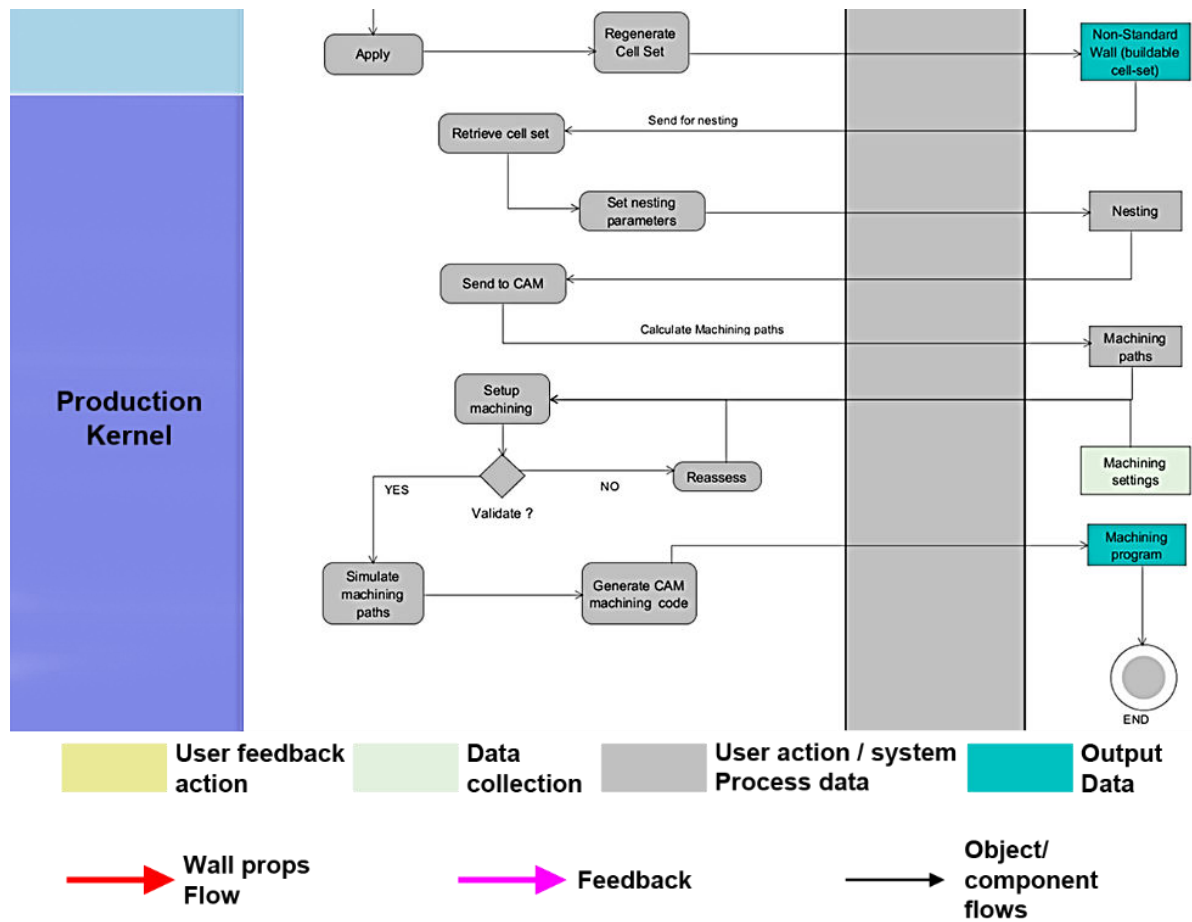

Fig. 3. Geodesic dome constructed from a discretized icosahedron (left) and geodesic dome discretized with standard elements on longitudes.

More generally, the designer is faced with the choice between the shape and the standardization. In both cases a realistic solution consists of a partially standardized structure. If a shape is primary chosen the arrangement of standard

**Appendix 6. FAB-CELL DATA MODEL ACTIVITY
DIAGRAM.**





Appendix 7. FAB-CELL OBJECT CLASS DATA MODEL.

Appendixes

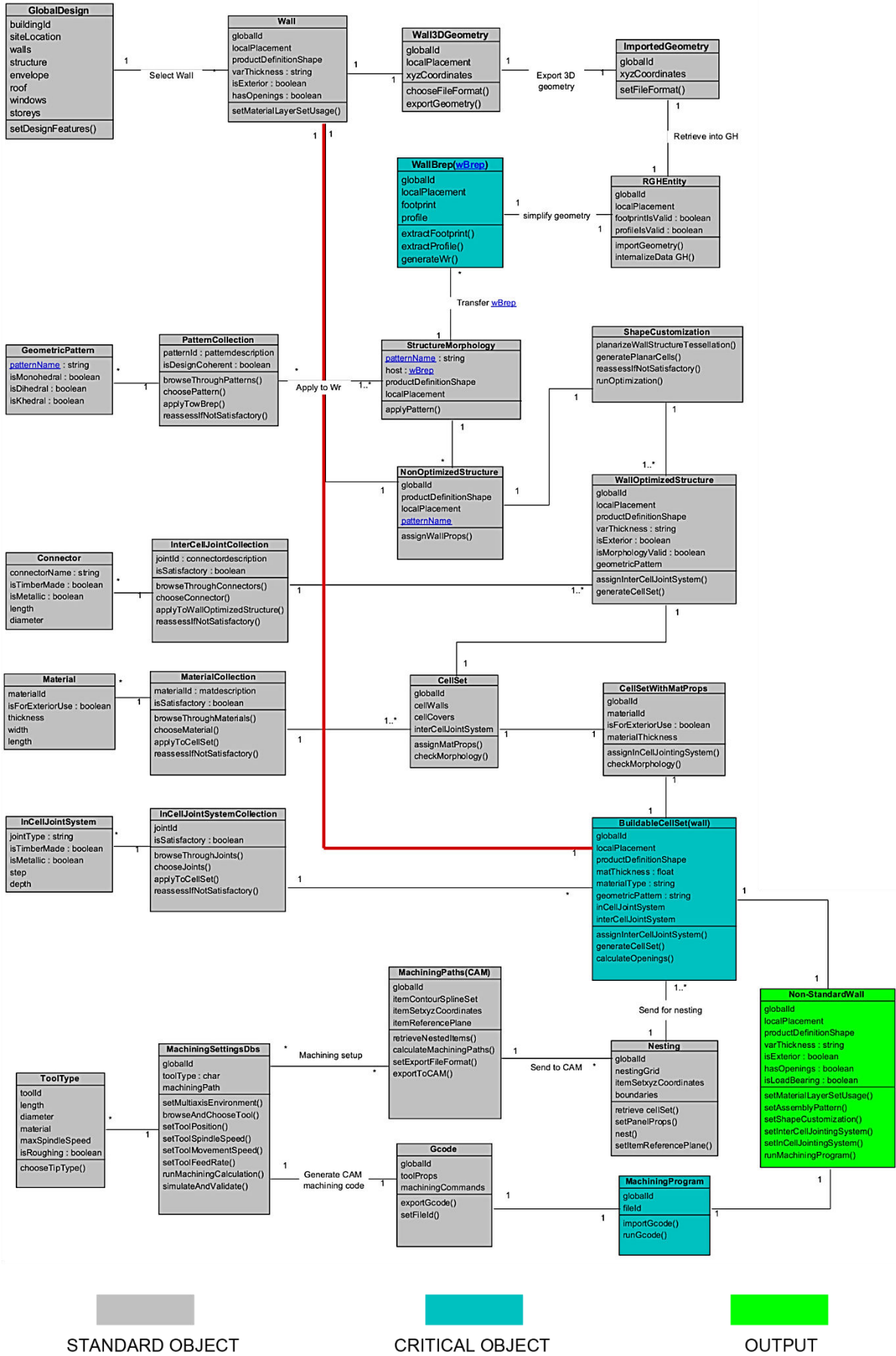

**Appendix 8. FAB-CELL'S FIRST VALIDATION STAGE
PROTOTYPES.**

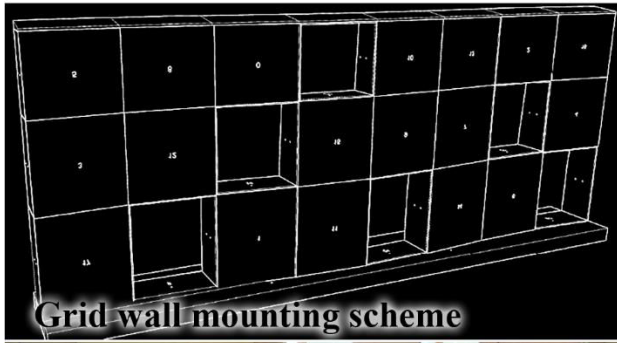

Grid wall mounting scheme



Voronoi Wall



Voronoi and Grid Walls

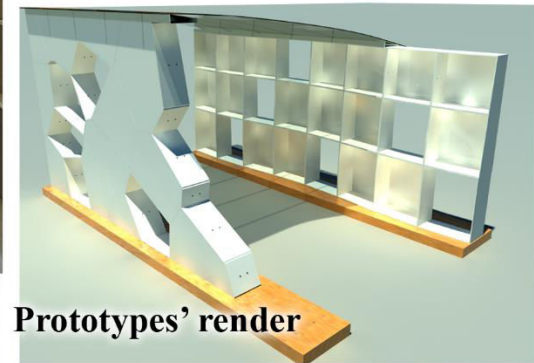

Prototypes' render



Tighting fasteners - inter-cell joints

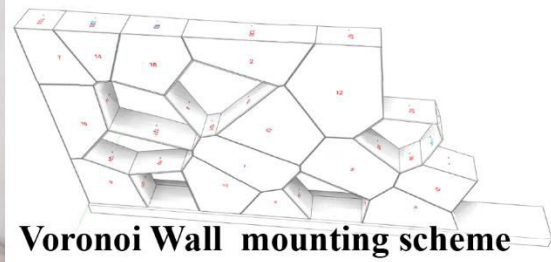

Voronoi Wall mounting scheme



Finished prototypes

Appendix 9. FAB-CELL'S PATTERN COLLECTION FIRST OPTIMIZATION

N-sWArM Grids

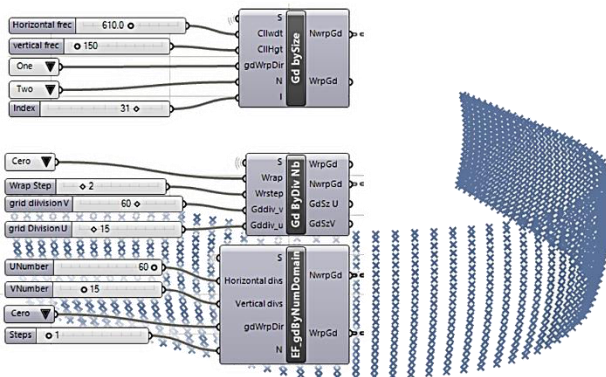

N-sWArM possesses a collection of grid generators that generated grids based on grid frequency (spacing) and grid subdivision (division number). Grids are adaptable to any surface type so they can help generating adaptable patterns. All grid functions are based on PT grid components.

Grid Distort

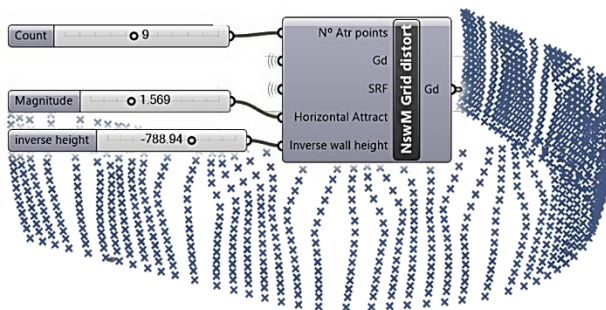

The grid distort modifier applies a series of attraction forces over a grid in order to alter the wall's topology, therefore, its aggregates' topology is affected too. The grid can be altered vertically and horizontally. The modifier does not however change the grid's frequency.

Woodframe Pattern

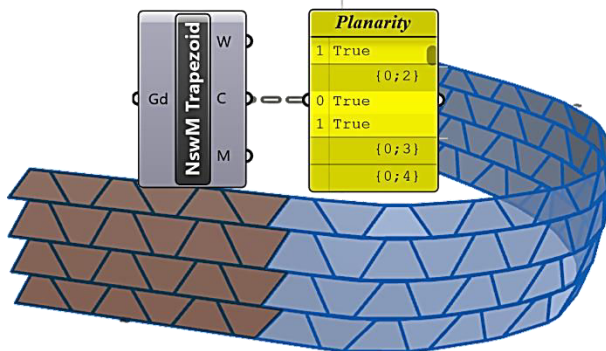

N-sWArM possesses a collection of grid generators that generated grids based on grid frequency (spacing) and grid subdivision (division number). Grids are adaptable to any surface type so they can help generating adaptable patterns. All grid functions are based on PT grid components. Cell planarity is limited..

Hex Pattern

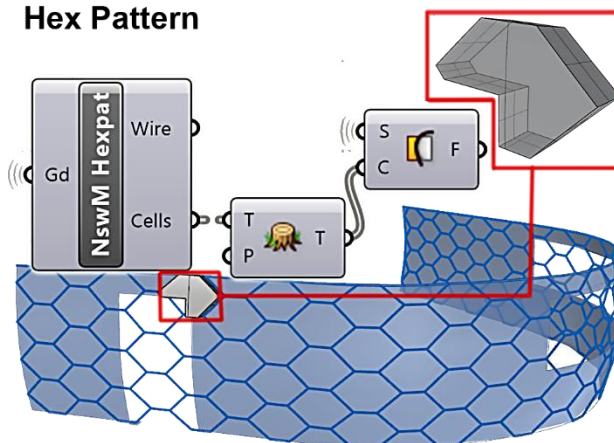

N-sWArM's hex pattern is made from no more than seven GH components including one PT component. Though it does not adapt cells to negative Gaussian curvature, it performs well with single-curved walls. It also manages voids and, as all other pattern clusters, it creates closed cells. A wrapping problem was solved by just splitting the surface with cell boundaries, which yielded clean cells for extrusion (see red square).

Voronoi Pattern

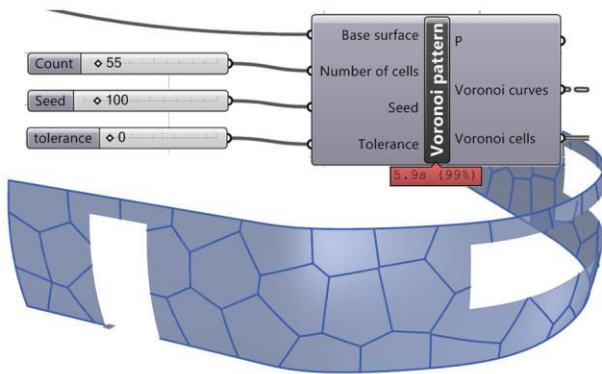

The Voronoi cluster uses a standard Voronoi 3D component intersecting and splitting W_r into a set of aggregates. The outcome is a list of Voronoi generating points, cell-walls as edges and a set of open Breps as aggregates. These closed polylines can be extruded to obtain actual cells (as it happens with all the cells produced with this approach).

Deformed Grid Pattern

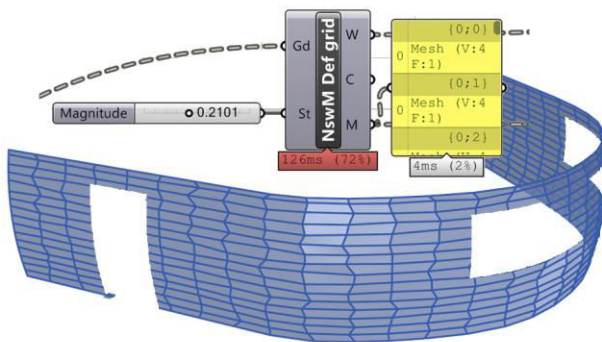

The deformed grid component includes a series of point attractors whose function is to distort the grid on which the pattern is created. The result is a manifold set of cells whose sizes and topology vary randomly. Cells as yielded as lines, closed loops, and meshes.

Composite Grid Pattern

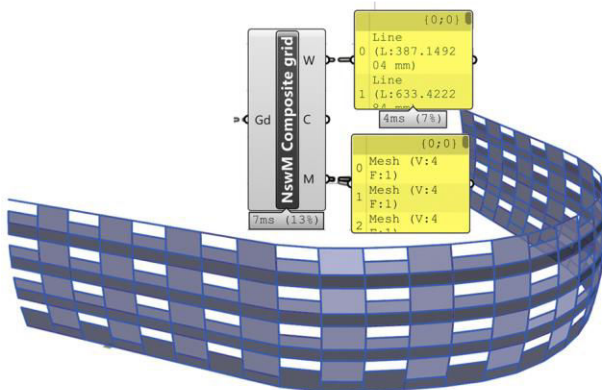

The composite grid component delivers a set of staggered quad cells. Some cells of the pattern are skipped to create a void pattern. Customization is limited to variation in cell-height proportion. Cells are yielded as meshes, lines, and polyline boundaries. This component does not perform custom void management.

Woodframe Pattern

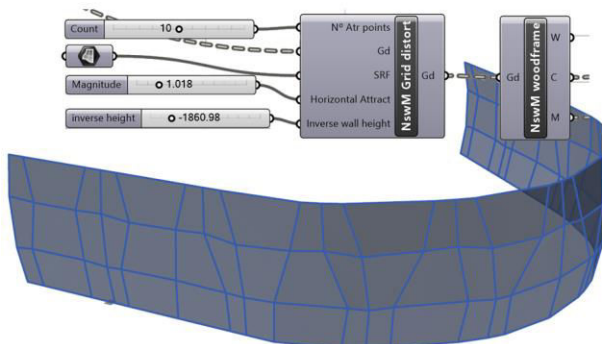

The woodframe pattern uses the principle of standardized woodframing to create a tessellation. That is to say, the grid basically agrees the 2440 mm x (400-600) mm spacing standard of woodframe construction, however, a grid modifier adds distortion to the aggregate set to create a non-standard woodframe arrangement. The outcome is a set of planar non-regular quad-cells (breps). The component's algorithm does not automatically perform void management.

Appendix 10. FAB-CELL'S PLANARIZATION PROCESS

Planarization start

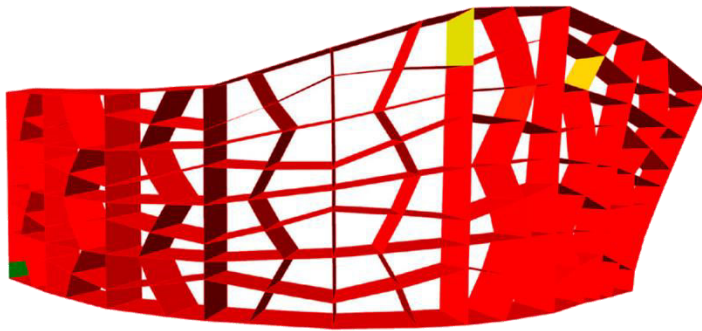

The planarizing process can be read by means of colors. Cells in red are elements not planarized yet. Items in yellow and orange are those undergoing planarization.

Planarization in progress

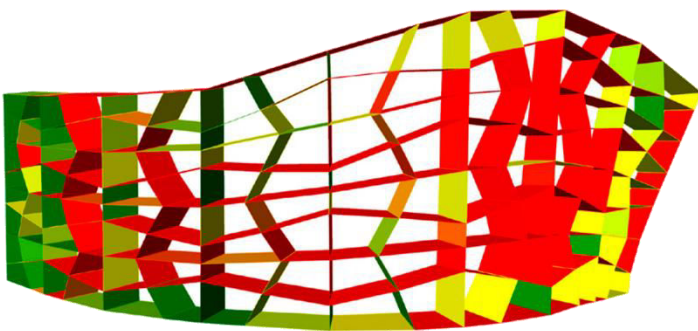

As planarization runs, the user can follow up elements whose planarization is not resolved so fast to keep an eye on elements that might need rebuilding. Items in green are already planarized.

Planarization ending

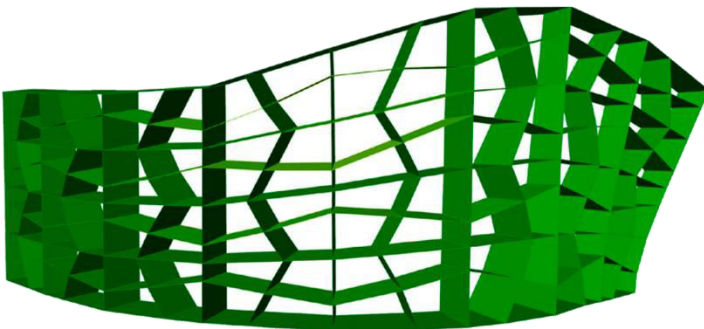

When items turn green planarization is almost complete.

Finished cell-set planarization

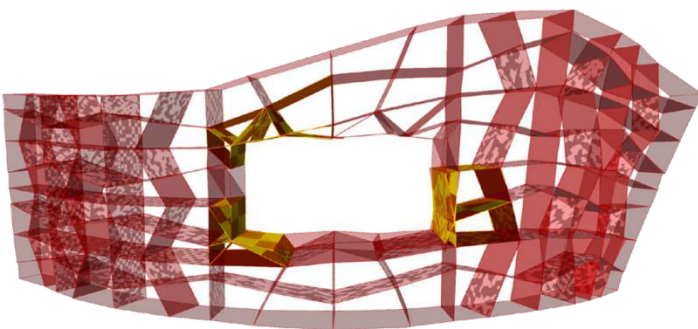

When cell-set planarization is finished the algorithm proceeds to rebuild failed items. In this image, yellow cells underwent geometry rebuilding to fit into the cell-set after subtracting the opening's Boolean operator.

Appendix 11. FAB-CELL GENERATIVE KERNEL AS GH USER COMPONENT SET

GH component set for installation.



Drag items into GH's user objects folder and the add-on is installed

Grid modifiers



Openings modifiers

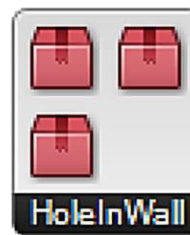

Pattern modifiers

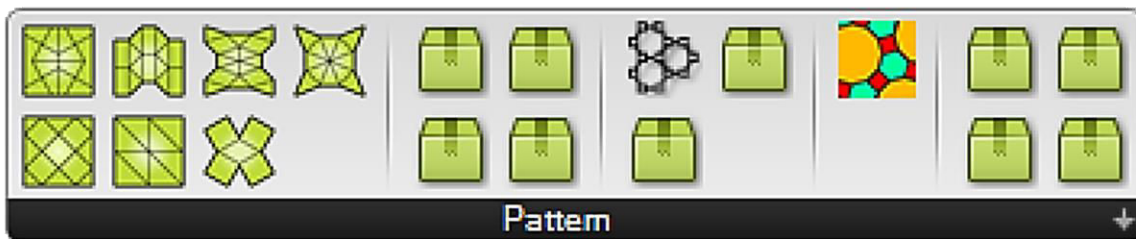

Morphologic modifiers

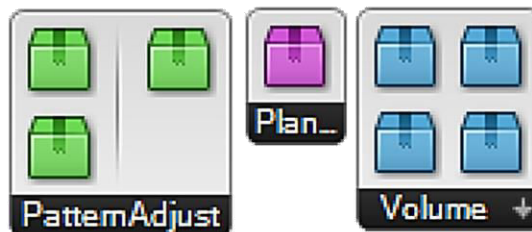

**Appendix 12. FAB-CELL DATA MODEL. EVOLVED
ACTIVITY DIAGRAM**

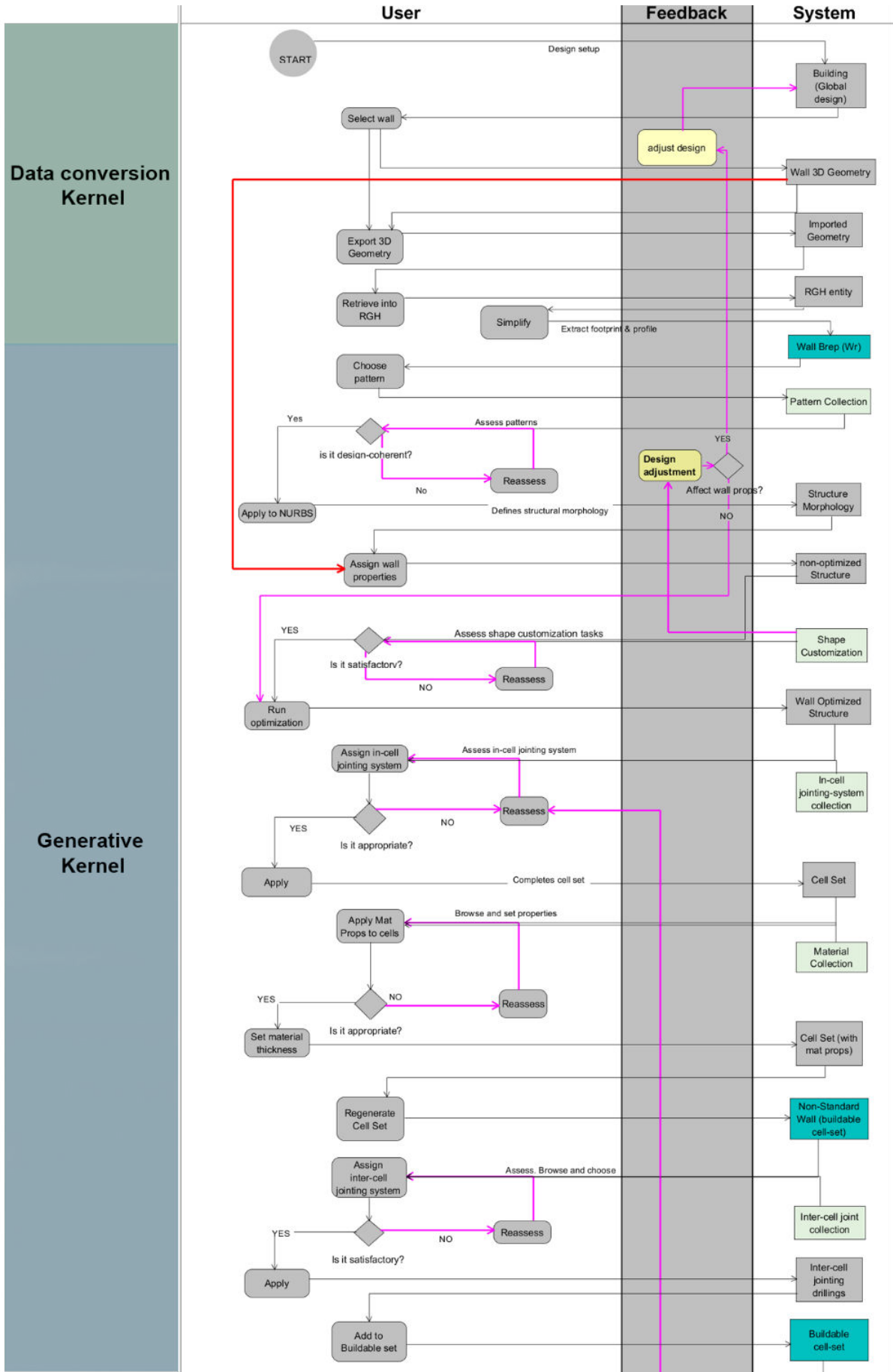

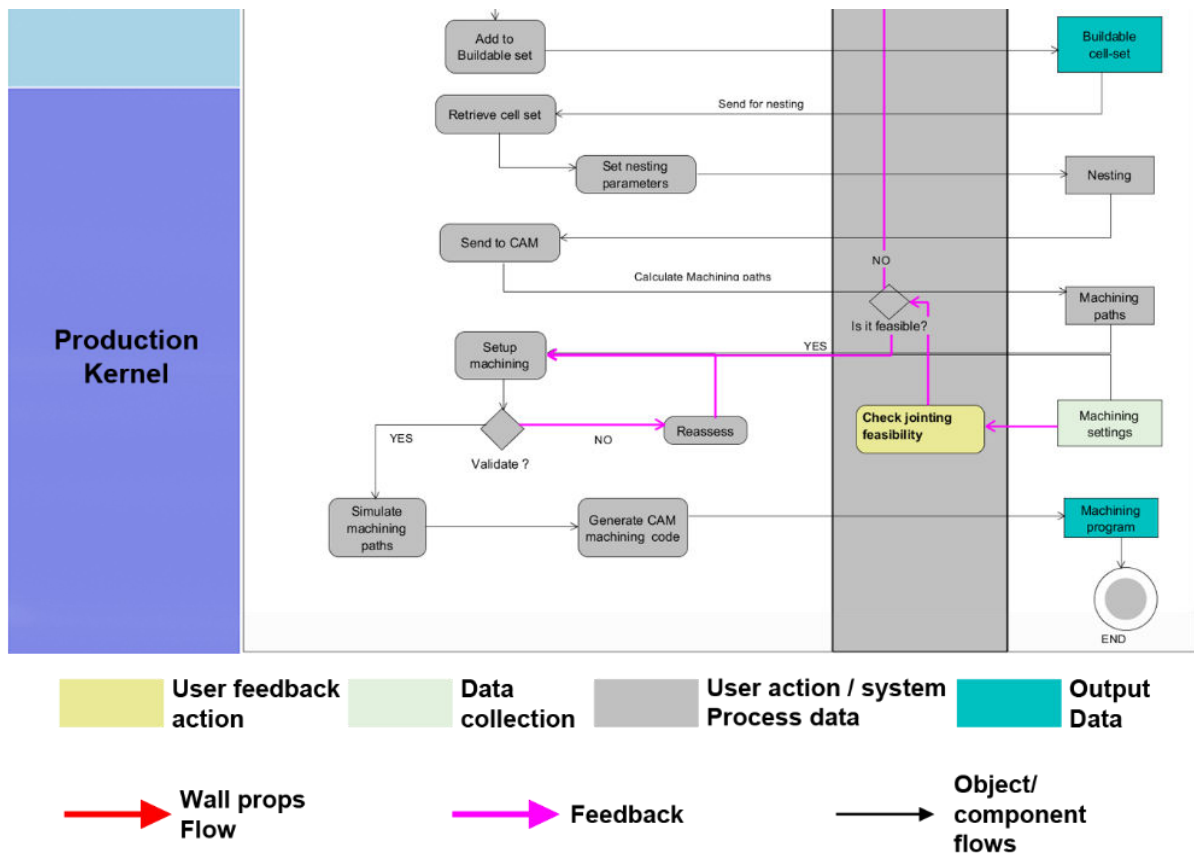

**Appendix 13. DIGITAL TOOLS USED FOR DEVELOPMENT
AND TESTING.**

Table 15. SUMMARY OF DIGITAL TOOLS AS EMPLOYED DURING FAB-CELL'S DEVELOPMENT

<i>Digital tools used in development and experimentation</i>			
Tool (software)	Category	Development usage	Website
Rhinoceros	CAD	Modeling	https://www.rhino3d.com/
Grasshopper	Visual Scripting	Visual programming, modeling, scripting.	http://www.grasshopper3d.com/
Cadwork	CAD/CAM	File exchange, toolpath creation, visualization	http://www.cadwork.com/indexL1a.jsp
Lignocam (btl reader)	CAM	Toolpath programing	http://www.lignocam.com/index.php/en/
Makerware (Makerbot)	Additive Fabrication	RP (3D printing)	http://www.lignocam.com/index.php/en/
Kuka PRC	GH add-on	Toolpath programing	http://www.robotsinarchitecture.org/
Starfish	GH add-on	Pattern generation	http://www.food4rhino.com/app/starfish
Paneling tools	GH add-on	Pattern generation	http://www.food4rhino.com/app/panelingtools-grasshopper-rhino-50
Mesh +	GH add-on	Pattern generation	http://www.neoarchaic.net/mesh/
Vipers	GH add-on	Pattern enhancement	http://www.food4rhino.com/app/vipers
Kangaroo Physics	GH add-on	Tessellation planarization	http://kangaroo3d.com/
Anemone	GH add-on	Planarization enhancement, history saver.	http://www.food4rhino.com/app/anemone
Lunch box	GH add-on	Pattern generation. Pattern topology	http://www.theprovingground.org/
Generation	GH add-on	Nesting	https://antonioturIELlo.blogspot.com.co/2012/05/generation.html
Fab Tools	GH add-on	Nesting, tagging and geometry baking	http://blickfeld7.com/architecture/rhino/grasshopper/FabTools/
Weaverbird	GH add-on	Mesh-based tessellation generation	http://www.giulopiacentino.com/weaverbird/
Bullant	GH add-on	Tessellation and mesh edition	http://www.geometrygym.com/
Dragon	GH add-on	Data filtering and generation. Pattern creation	http://www.food4rhino.com/app/dragon

Table 16. DIGITAL TOOLS AS USED FOR TESTING AND EXPLORING GENERATIVE AND PRODUCTION ALTERNATIVES

<i>Digital tools used for testing and exploration</i>			
<i>Tool (software)</i>	<i>Category</i>	<i>Usage</i>	<i>Website</i>
Woodpecker	GH add-on	Toolpath programing testing	http://www.designtoproduction.com/en/
HAL	GH add-on	Toolpath programing testing	http://www.hal-robotics.com/
TACO ABB	GH add-on	Toolpath programing testing	http://blickfeld7.com/architecture/rhino/grasshopper/Taco/
Autodesk inventor 2016	Mechanical CAD/CAM	File exhancge and fabrication	www.autodesk.com
HSM 2016 for Autodesk inventor	Settings and simulation CAM environment	CAM toolpath programming	www.autodesk.com
Sketch Up	Digital modeling	Non iterative modeling	http://www.sketchup.com/
Dynamo	Generative modeling	Generative modeling, scripting and data exchange. Iteration testing.	http://dynamobim.org/
Generative components	Generative modeling	Generative modeling and scripting. Iteration testing.	https://www.bentley.com/en/products/product-line/modeling-and-visualization-software/generativecomponents
pConplanner	Interior Design CAD	Software testing, non-iterative modeling	http://pcon-planner.com/es/
Modo	3D modeling and rendering	Software testing and iterative modeling	https://www.thefoundry.co.uk/products/modo/
CREO parametric	Mechanical CAD/CAM	Software testing and iterative modeling	http://www.ptc.com/cad/creo/parametric
3DS Max	3D modeling and rendering	Software and iteration testing	www.autodesk.com
Autodesk Revit	BIM modeling	Software and iteration testing	www.autodesk.com
HsbCAD	BIM, CAD/CAM	Software testing and CAM programming	http://www.hsbcad.com/
BobCAD-CAM	BIM, CAD/CAM	Software testing and CAM programming	http://bobcad.com/
DDX's EasyWood	Timber-aimed CAD/CAM	Software testing and CAM programming	https://ddxgroup.com/en/software/easywood

REFERENCES

- 2D3D, 2012. My Green World. My Green World 2D3D.
- Aant van der Zee, B. de V. and T.S., 2014. From rapid prototyping to automated manufacturing, in: Proceedings of the 32nd ECAADe Conference. Presented at the eCAADe, Department of Architecture and Built Environment, Faculty of Engineering and Environment, Thompson, Emine Mine (ed.), Fusion -, Newcastle upon Tyne, England, UK, pp. 455–461.
- ACP composites, 2012. Mechanical Properties of Carbon Fiber Composite Materials.
- Actu-Environnement, 2014. La construction bois/paille prend de la hauteur.
- Aitken, P., 1999. Data Sources, Data Sinks. [WWW Document]. Aivosto. URL <http://www.aivosto.com/visdev/data.html> (accessed 1.13.16).
- Akos, G., Parsons, R., 2014. Mode Lab | Grasshopper Primer, Modelab. ed.
- Alexander, C., 1979. The Timeless Way of Building. Oxford University Press, New York.
- Alexander, C., Ishikawa, S., Silverstein, M., Jacobson, M., Fiksdahl-King, I., Angel, S., 1977. A Pattern Language: Towns, Buildings, Construction. Oxford University Press, New York.
- American Forest & Paper Association, 2003. Plank-and-Beam Framing for Residential Buildings. American Wood Council, Washington D.C.
- Anderson, P., 1999. Complexity Theory and Organization Science. Organ. Sci. 10, 216–232.
- Anwar, U.M.K., Zaidon, A., Paridah, M.T., Razak, W., 2004. The potential of utilising bamboo culm (*Gigantochloa scortechinii*) in the production of structural plywood. J. Bamboo Rattan 3, 393–400. doi:10.1163/1569159042464653
- Anzalone, P., Vidich, J., Draper, J., 2009. Non-Uniform Assemblage: Mass Customization in Digital Fabrication - Non-Uniform Assemblage__Mass Customization in Digital Fabrication.pdf [WWW Document]. Acadia.org/papers. URL https://acadia.s3.amazonaws.com/paper/file/PD26RH/Non-Uniform_Assemblage__Mass_Customization_in_Digital_Fabrication.pdf (accessed 10.20.14).
- Arcelormittal, 2013. Aluzinc®: steels with aluminium-zinc coating - Constructalia [WWW Document]. Aluzinc. URL http://www.constructalia.com/english/products/roofing/coatings_and_materials_for_roofing/ (accessed 7.26.16).
- Aubin, M.P.F., 2013. Renaissance Revit: Creating Classical Architecture with Modern Software, 1B edition. ed. CreateSpace Independent Publishing Platform.
- Audibert, L., 2014. UML 2 de l'Apprentissage à la Pratique, 2e édition. ed. Ellipses Marketing, Paris.
- Autodesk, 2016. Autodesk Knowledge Network [WWW Document]. URL <https://knowledge.autodesk.com/> (accessed 2.8.16).
- Barkow, F., Leibinger, R., 2008. 'Blautopf', Ditzingen [WWW Document]. Blautopf_ditzingen. URL http://www.barkowleibinger.com/archive/view/blautopf_ditzingen (accessed 12.6.16).

- BARRIOS, C., 2005. Transformations on Parametric Design Models, in: Proceedings of the 11th International Conference on Computer Aided Architectural Design Futures. Presented at the Computer Aided Architectural Design Futures 2005, Vienna (Austria), pp. 393–400.
- Bechthold, M., 2007. Teaching Technology: CAD/CAM, Parametric Design and Interactivity, in: 25th ECAADe Conference Proceedings. Presented at the Predicting the Future, Frankfurt-Germany, pp. 767–775.
- Belight, 2016. Live Interior 3D — Interior Design Software for Windows. Belight Software, Ltd., Odessa - Ukraine.
- Bender, M., 2016. Eureka pavilion Structure information.
- Benoit, Y., Paradis, T., 2009. Construction de maisons à ossature bois, 2e édition. ed. Eyrolles, Paris; Institut technologique FCBA; Paris.
- Bignon, J.-C., 2014. Les Défis du Bois. Une aventure architecturale, humaine, environnementale, technique et poétique. Ministère de la culture et de la Communication, France Bois Forêt, Labex ARBRE, Fédération Française du Bâtiment, Union des métiers du Bois, Épinal, France.
- Bignon, J.-C., 1998. La Trame. Un assistant à la conception technique. Cah. Rech. Archit. Urbaine N° 40 Imagin. Tech. 29–38.
- Bignon, J.-C., 1984. Le bardage en bois : architecture d'un produit. Nancy : C.A.U.E.. Ecole d'architecture de Nancy.
- Bletter, R.H., 1979. Review of Five Architects. Eisenman, Graves, Gwathmey, Hejduk, Meier; Five on Five. J. Soc. Archit. Hist. 38, 205–207. doi:10.2307/989447
- Blumer Lehmann, 2012. The cell.
- Boots, B., 2005. Spatial Tessellations, in: Goodchild, M.F., Maguire, D.J., Rhind, D.W., Longley, P.A. (Eds.), Geographical Information Systems: Principles, Techniques, Management and Applications. Wiley, Hoboken, N.J, pp. 503–526.
- Boton, C., Kubicki, S., 2014. Maturité des pratiques BIM. Dimensions de modélisation, pratiques collaboratives et technologies, in: Actes du 6ème Séminaire de Conception Architecturale Numérique. SCAN'14. Presented at the Interaction(s) des maquettes numériques., PUN- Editions Universitaires de Lorraine, Luxembourg, pp. 45–56.
- Braumann, J., Brell-Cokcan, S., 2012. Real-Time Robot Simulation and Control for Architectural Design, in: Proceedings of the 30th ECAADe Conference. Presented at the Digital Physicality, Prague, pp. 479–486.
- Brell-Çokcan, S., Braumann, J., 2013. Introduction, in: Brell-Çokcan, S., Braumann, J. (Eds.), Rob | Arch 2012. Springer Vienna, pp. 8–11. doi:10.1007/978-3-7091-1465-0_1
- Building Channel, 2016. wood joints according to Japan {part 19}.
- buildingSMART International, 2016a. buildingSMART Data Dictionary Browser [WWW Document]. Build. Data Dict. URL [http://bsdd.buildingsmart.org/#concept/details/2Xuqs0qXKHuO00025QrE\\$V](http://bsdd.buildingsmart.org/#concept/details/2Xuqs0qXKHuO00025QrE$V) (accessed 10.20.16).
- buildingSMART International, 2016b. IFC4 Addendum 2.
- Bullar, J., 2013. The Complete Guide to Joint-Making. GMC Publications, Lewes.
- Burns, M., 1989. The StL Format [WWW Document]. fabbers.com. URL http://www.fabbers.com/tech/STL_Format#Sct_ASCII (accessed 3.8.16).
- Burry, M., 2002. Rapid prototyping, CAD/CAM and human factors. Autom. Constr., Rapid Prototyping 11, 313–333. doi:10.1016/S0926-5805(00)00107-2

- Butler, R., 2012. A World Imperiled: Forces Behind Forest Loss [WWW Document]. Mongabay.com. URL <http://rainforests.mongabay.com/0801.htm> (accessed 8.17.16).
- Çakır İlhan, A., Deger, K.O., Deger, A.H., 2012. The World Conference on Design, Arts and Education (DAE-2012), May 1-3 2012, Antalya, Turkey An Application of Mathematical Tessellation Method in Interior Designing. *Procedia - Soc. Behav. Sci.* 51, 249–256. doi:10.1016/j.sbspro.2012.08.154
- Campbell, F., 2015. The Scarf Joint. [WWW Document]. URL <http://sawdustmaking.com/woodjoints/scarf.htm> (accessed 3.24.16).
- Carpo, M., 2016. Parametric Notations: The Birth of the Non-Standard. *Archit. Des.* 86, 24–29. doi:10.1002/ad.2020
- Carpo, M., 2015a. The New Science of Form-Searching. *Archit. Des.* 85, 22–27. doi:10.1002/ad.1949
- Carpo, M., 2015b. Big Data are for adding, not for subtracting, in: *Mutations Du Projet. Milieux et Cultures Numériques*. Presented at the Colloquium “Mutations du projet. Milieux et cultures numériques,” Paris, pp. 23–27.
- Carpo, M., 2005. The demise of the identical. Architectural standardization in the age of digital reproductibility. Presented at the First International Conference on the Histories of Media, Art, Science and Technology, Banff Media Institute, Banff.
- Cartignies, A., 2016. *Matinée du Contreplaqué*.
- Cecobois, 2012. *Guide de conception des assemblages pour les charpentes en bois*.
- Celani, G., 2012. Digital Fabrication Laboratories: Pedagogy and Impacts on Architectural Education. *Nexus Netw. J.* 14, 469–482. doi:10.1007/s00004-012-0120-x
- Celedón, A., 2014. Greg Lynn: Beyond the Blob. *Mater. Arquit.* 18–25.
- CELENIT SPA, 2015. CELENIT N.
- Chen, F., Jiang, Z., Wang, G., Li, H., Simth, L.M., Shi, S.Q., 2016. The bending properties of bamboo bundle laminated veneer lumber (BLVL) double beams. *Constr. Build. Mater.* 119, 145–151. doi:10.1016/j.conbuildmat.2016.03.114
- Chib, M., 2011. *Generative Components Capturing the Concept*.
- Ching, F.D.K., 2007. *Architecture Form, Space And Order*, 3rd Edition. ed. John Wiley & Sons.
- Ciblac, T., 2011. Parametric Design with Standard Elements for Non-Standard Architecture, in: *Computer Aided Architectural Design Futures 2011 [Proceedings of the 14th International Conference on Computer Aided Architectural Design Futures / ISBN 9782874561429] Liege (Belgium) 4-8 July 2011*, Pp. 119-132.
- Collins Dictionary, 2016. Robot | Definition, meaning & more [WWW Document]. URL <http://www.collinsdictionary.com/dictionary/english/robot> (accessed 4.12.16).
- Collins dictionary, 2015. Definition of “blob.” *Collins Am. Engl. Dict.*
- Collins, G.R., 1979. Visionary Drawings of Architecture and Planning: 20th Century through the 1960s. *Art J.* 38, 244–256. doi:10.2307/776374
- Corbel, S., Dufaud, O., Roques-Carmes, T., 2011. Materials for Stereolithography, in: *Bártolo, P.J. (Ed.), Stereolithography*. Springer US, pp. 141–159. doi:10.1007/978-0-387-92904-0_6
- Corbusier, L., Sert, J.L., 1973. *The Athens Charter: 2, First Edition*. ed. Studio, New York.

- Corporacion Colegio de Villa de Leyva (Ed.), 1996. Estado, ciudad y vivienda: Urbanismo y arquitectura de la vivienda estatal en Colombia, 1918-1990, 1a ed. ed. Inurbe, Bogotá• .
- C.R.I.T, 2013. Murs à ossature en bois [WWW Document]. Murs À Ossat. En Bois. URL <http://www.crit.archi.fr> (accessed 12.10.13).
- Daldry, J., 2012. Anatomy of a Formula 1 Team.
- Dauben, J.W., 1982. Abraham Robinson and Nonstandard Analysis: History, Philosophy and Foundations of Mathematics, in: Minnesota Center for Philosophy of Science. Presented at the Philosophy of science, Yale University, p. 24.
- Davidson, C., 2003. Bernard Tschumi: The Exit Interview. Log 141–147.
- Davis, D., 2013. Modelled on Software Engineering: Flexible Parametric Models in the Practice of Architecture. School of Architecture and Design College of Design and Social context RMIT University, Melbourne.
- Denancé, M., Skoutarides, H., Pesce, C., 2000. CONSTRUCTION A OSSATURE BOIS. Conception et mise en oeuvre. Eyrolles, Paris.
- design2machine, 2016. Why BTLx ? [WWW Document]. URL <http://www.design2machine.com/btlx/index.html> (accessed 7.19.16).
- Diaz C., Y.M., 2007. Housing for Workers - Pacifying or Modernizing Element? Rev. Archit. 5–12.
- Dickey, R., Huang, J., Mhatre, S., 2014. Objects of Rotation, in: McGee, W., Leon, M.P. de (Eds.), Robotic Fabrication in Architecture, Art and Design 2014. Springer International Publishing, pp. 233–247. doi:10.1007/978-3-319-04663-1_16
- Donley, M., Sonder, N., 2016. Sketchup & Layout for Architecture: The Step by Step Workflow of Nick Sonder. Bizfound, LLC.
- Dounas, T. and A.B.S., 2014. Universal Dovetail Joint, in: Rethinking Comprehensive Design: Speculative Counterculture, Proceedings of the 19th International Conference on Computer-Aided Architectural Design Research in Asia (CAADRIA 2014) / Kyoto 14-16 May 2014, Pp. 409–418.
- Dufaud, O., Corbel, S., 2004. Dispositif de déposition de couches de suspensions de céramiques appliqué à la stéréolithographie. Can. J. Chem. Eng. 82, 986–993. doi:10.1002/cjce.5450820514
- dynamobim.org, 2016. Dynamo Packages [WWW Document]. Dynamo Package Manag. URL <https://dynamopackages.com/> (accessed 9.15.16).
- Dzaman, B., 2015. KUKA weaving with carbon fibre. Poznań School of Form.
- EasternGraphics, 2016. pCon.planner. EasternGraphics GmbH, Ilmenau - Germany.
- Encyclopædia Britannica, 2014. Robert Hooke | British scientist | [WWW Document]. URL <https://global.britannica.com/biography/Robert-Hooke> (accessed 8.6.14).
- Engelbart, D.C., 1962. Augmenting Human Intellect: A Conceptual Framework. Stanford Research Institute, Washington D.C.
- Ercan, S., 2015. Mobile Robotic Tiling [WWW Document]. URL <http://gramaziokohler.arch.ethz.ch/web/e/forschung/257.html> (accessed 7.27.16).
- Evolute, 2012. Evolute delivers geometry for KREOD.
- Falk, R.H., 2010. Wood as a Sustainable Building Material, in: Wood Handbook. Wood as an Engineering Material. U.S. Department of Agriculture, Madison, WI:, pp. 3–1, 3–18.
- Fileinfo.com, 2016a. DWG File Extension - Open .DWG Files [WWW Document]. URL <http://fileinfo.com/extension/dwg> (accessed 7.12.16).

- Fileinfo.com, 2016b. ASCII File Extension - Open .ASCII Files [WWW Document]. URL <http://fileinfo.com/extension/ascii> (accessed 7.13.16).
- Filipovski, I., 2015. PLM solutions used in cathedral construction - CG [WWW Document]. URL <http://www.cgweb.co.za/article.aspx?pkarticleid=3378> (accessed 8.18.15).
- Floorplanner, 2007. Floorplanner - Create floor plans, house plans and home plans online. Floorplanner, Rotterdam, The Netherlands.
- Fouquey, P., 2000. La création architecturale et l'informatique. Editorial. Carré Bleu 73.
- Frazer, J., 1995. An Evolutionary Architecture: Themes VII. Architectural Association Publications.
- Fuxing, T., Mingzhe, L., Zhongyi, C., Xiangji, L., 2008. Formability analysis on the process of multi-point forming for titanium alloy retiary sheet. *Int. J. Adv. Manuf. Technol.* 41, 1059–1065. doi:10.1007/s00170-008-1548-8
- Gámez, O., Bignon, J.C., Duchanois, G., 2015a. Assisted Construction of Non-standard Wooden Walls and Envelope Structures by Parametric Modeling, in: 16th International Conference, CAAD Futures 2015, São Paulo, Brazil, July 8-10, 2015. Selected Papers, 1865-0929. Presented at the Computer-Aided Architectural Design Futures. The Next City - New Technologies and the Future of the Built Environment, Springer Berlin Heidelberg, Sao Paulo, Brazil, pp. 291–308.
- Gámez, O., Meyer, J., Bignon, J.-C., Duchanois, G., 2015b. Interaction of Analogic and Digital Workflows for Architectural Design and Production, in: Project Information for Interaction. Presented at the Sigradi 2015, Florianopolis, Brazil.
- Gamma, E., Helm, R., Johnson, R., Vlissides, J., Booch, G., 1994. Design Patterns: Elements of Reusable Object-Oriented Software, 1 edition. ed. Addison-Wesley Professional.
- Gardiner, J.B., Janssen, S.R., 2014. FreeFab, in: McGee, W., Leon, M.P. de (Eds.), *Robotic Fabrication in Architecture, Art and Design 2014*. Springer International Publishing, pp. 131–146. doi:10.1007/978-3-319-04663-1_9
- Gartman, D. [b1] (analytic), 1998. Postmodernism ; Or, the cultural logic of post-Fordism ? (English). *Sociol. Q.* 39, 119–137.
- Gholipour, V., 2011. Éco-conception collaborative de bâtiments durables. Institut National Polytechnique de Lorraine, Nancy - France.
- Giovannini, J., 1999. Building a better blob. *Architecture* 88.
- Girmscheid, G., 2005. Industrialization in building construction. *Underst. Constr. Bus. Co. New Millenn.* 1, 427–441.
- Goldhagen, S.W., 2005. Something to Talk about: Modernism, Discourse, Style. *J. Soc. Archit. Hist.* 64, 144–167. doi:10.2307/25068142
- Gosselin, C., Duballet, R., Roux, P., Gaudillière, N., Dirrenberger, J., Morel, P., 2016. Large-scale 3D printing of ultra-high performance concrete – a new processing route for architects and builders. *Mater. Des.* 100, 102–109. doi:10.1016/j.matdes.2016.03.097
- Gramazio Kohler Research, 2006. Winery Gantenbein. ETH Zurich.
- Green, M.C., Equilibrium Consulting, mgb ARCHITECTURE + DESIGN, LMDG Ltd, BTY Group, 2012. The case for tall wood buildings.
- Greenberg, A., 1995. Allan Greenberg: Selected Works, 1 edition. ed. Academy Press.

- Greenpeace, 2004. Contrabando de Caoba [WWW Document]. Greenpeace Esp. URL <http://www.greenpeace.org/espana/es/news/2010/November/contrabando-de-caoba/> (accessed 6.14.15).
- Guillén, M.F., 2004. Modernism without modernity: The rise of modernist architecture in Mexico, Brazil, and Argentina, 1890-1940 (English). *Lat. Am. Res. Rev.* 39, 6–34.
- Guinard, D., 2009. La filière bois en Europe et dans le monde. *Ann. Mines - Responsab. Environ.* 1, 49–55.
- Guitard, D., Polge, H., 1987. *Mécanique du matériau bois et composites* [Texte imprimé], Collection Nabla. Toulouse : Cépaduès Editions. Copyright 1987, DL 1987.
- Gürsel Dino, I., 2012. Creative Design Exploration by Parametric Generative Systems In Architecture. *METU J. Fac. Archit.* 29, 207–224. doi:10.4305/METU.JFA.2012.1.12
- Halabi, M., 2016. The Sagrada Família: The Starting Point of CAD/CAM in Architecture. *J. Civ. Eng. Archit.* Volume 2, 12–19.
- Hammerberg, K., 2012. *EvoluteTools Primer for Rhino*.
- Harasymowycz, M.A., 2008. Mathematics and Art: Tessellations. *Math. Sch.* 37, 12–15.
- Hashemi, L., Abolfazl, M., Pouliot, J., 2010. Voronoi diagram: An adaptive spatial tessellation for processes simulation, in: Cakaj, S. (Ed.), *Modeling Simulation and Optimization - Tolerance and Optimal Control*. InTech.
- He, H., Huang, W., Gao, F., 2016. Comparison of four methods for determining fiber content of carbon fiber/epoxy composites. *Int. J. Polym. Anal. Charact.* 21, 251–258. doi:10.1080/1023666X.2016.1139395
- Hegde, R.R., Dahiya, A., Kamath, M.G., 2004. CARBON FIBERS.
- Helm, V., Willmann, J., Gramazio, F., Kohler, M., 2014. In-Situ Robotic Fabrication: Advanced Digital Manufacturing Beyond the Laboratory, in: Röhrbein, F., Veiga, G., Natale, C. (Eds.), *Gearing up and Accelerating Cross-fertilization between Academic and Industrial Robotics Research in Europe*., Springer Tracts in Advanced Robotics. Springer International Publishing, pp. 63–83. doi:10.1007/978-3-319-02934-4_4
- Hillier, B., 2010. John Hejduk. Representations of the imaginary.
- Howe, D., 1996. FOLDOC - Computing Dictionary [WWW Document]. Free -Line Dict. Comput. URL <http://foldoc.org/recursion> (accessed 10.14.15).
- IAI International Council Limited, 2006. IFC2x Edition 3.
- Issa, R., 2013. *PanelingTools for grasshopper*.
- IUCN, 1998a. *Swietenia macrophylla*: World Conservation Monitoring Centre: The IUCN Red List of Threatened Species 1998: e.T32293A9688025.
- IUCN, 1998b. *Aniba rosodora*: Varty, N.: The IUCN Red List of Threatened Species 1998: e.T33958A68966060.
- Jacobs, J., 1993. The Bauhaus and spatial theory. *Topos* 56–67.
- Janowski, D., 1999. Transferring CAD/CAM Files. *Mod. Mach. Shop* 2.
- Janssen, P. and R.S., 2015. Types of Parametric Modelling, in: *Proceedings of the 20th International Conference of the Association for Computer-Aided Architectural Design Research in Asia (CAADRIA 2015)* /. Presented at the Emerging Experience in Past, Present and Future of Digital Architecture, Daegu, South Korea, pp. 157–166.

- Jencks, C., 2010. What is Then Post-Modernism?, in: *The Post-Modern Reader*. Wiley, Chichester, West Sussex, U.K, pp. 14–37.
- Johnson, P., Wigley, M., 1988. *Deconstructivist Architecture*, 1st edition. ed. Museum of Modern Art/Little Brown and Company, Boston : Greenwich, Conn.?
- Keating, S., Oxman, N., 2013a. Robotic Immaterial Fabrication, in: Brell-Çokcan, S., Braumann, J. (Eds.), *Rob | Arch 2012*. Springer Vienna, pp. 256–266. doi:10.1007/978-3-7091-1465-0_30
- Keating, S., Oxman, N., 2013b. Compound fabrication: A multi-functional robotic platform for digital design and fabrication. *Robot. Comput.-Integr. Manuf.* 29, 439–448. doi:10.1016/j.rcim.2013.05.001
- Klein, H.E., 1965. Numerical Control: From Class to Mass Market. *Manage. Rev.* 54, 16.
- KLH LIGNATEC, 2013. *Résidence Jules Ferry - Structure KLH animation*.
- Ko, K., Liotta, S.-J., 2011. Digital tea house: Japanese tea ceremony as a pretext for exploring parametric design and digital fabrication in architectural education, in: *Proceedings of the 16th International Conference on Computer Aided Architectural Design Research in Asia*. The University of Newcastle, Australia, pp. 71–80.
- Kohlhammer, T., Kotnik, T., 2011. Systemic Behaviour of Plane Reciprocal Frame Structures. *Struct. Eng. Int.* 80–86.
- Kolarevic, B., 2015. From Mass Customisation to Design ‘Democratisation.’ *Archit. Des.* 85, 48–53. doi:10.1002/ad.1976
- Kolarevic, B., 2005. *Architecture in the Digital Age: Design and Manufacturing*, New Ed edition. ed. Taylor & Francis, New York.
- Kolarevic, B., 2003. Computing the performative in architecture, in: *Proceedings of the 21st Conference on Education in Computer Aided Architectural Design in Europe*. Presented at the Digital Design, Wolfgang Dokonal, Graz, pp. 457–463.
- Kolarevic, B., 2001. *Designing and Manufacturing Architecture in the Digital Age [WWW Document]*. *Archit. Inf. Manag.* 19th ECAADe Conf. Proc. ISBN 0-9523687-8-1 Hels. Finl. 29-31 August 2001 Pp 117-123. URL http://cumincad.scix.net/cgi-bin/works/Show?_id=3826&sort=DEFAULT&search=Kolarevic&hits=43 (accessed 10.20.14).
- Ks2 Architects, 2008. *Kamppi Chapel*. *A+U* 12, 60–69.
- Kutateladze, S., 2013. *Nonstandard Analysis: its Creator and Place*. Preprint 0–18.
- Kvan, T., Kolarevic, B., 2002. Rapid prototyping and its application in architectural design. *Autom. Constr., Rapid Prototyping* 11, 277–278. doi:10.1016/S0926-5805(00)00110-2
- Le Off du DD, 2014. *LeOffduDD2015 - Residence Jules Ferry, Saint Dié des Vosges (88)*.
- Lee, G., Kim, S., 2012. Case Study of Mass Customization of Double-Curved Metal Facade Panels Using a New Hybrid Sheet Metal Processing Technique. *J. Constr. Eng. Manag.* 138, 1322–1330.
- Leonardi, A., Scardi, P., Leoni, M., 2012. Realistic nano-polycrystalline microstructures: beyond the classical Voronoi tessellation. *Philos. Mag.* 92, 986–1005. doi:10.1080/14786435.2011.637984
- Li, C.Q., 2013. *Kreod. Pavilion Architecture*. Concept 16–25.
- Li, C.Q., 2012. *KREOD Pavilion*. Details 162–167.

- Libeskind, J.H.; introduction de D., 1985. *Mask of medusa*. New-York : Rizzoli International Publications.
- Lim, S., Buswell, R.A., Valentine, P.J., Piker, D., Austin, S.A., De Kestelier, X., 2016. Modelling curved-layered printing paths for fabricating large-scale construction components. *Addit. Manuf.* 12, 216–230. doi:10.1016/j.addma.2016.06.004
- LindasSawmillCinema, 2016. *Family With Wood-Mizer Mills Oak Split*.
- Liyong, W., Le, L., 2010. Computer simulation of thick plate multi-point forming process, in: 2010 International Conference on Computer Design and Applications (ICCD). Presented at the 2010 International Conference on Computer Design and Applications (ICCD), pp. V3-143-V3-146. doi:10.1109/ICCD.2010.5541017
- Lloret, E., Shahab, A.R., Linus, M., Flatt, R.J., Gramazio, F., Kohler, M., Langenberg, S., 2015. Complex concrete structures: Merging existing casting techniques with digital fabrication. *Comput.-Aided Des., Material Ecology* 60, 40–49. doi:10.1016/j.cad.2014.02.011
- Luigi, G., 1982. *L'architecture post moderne*. Neuf 19–22.
- Lynn, G., 1999. *Animate Form*. New York : Princeton Architectural Press.
- Lynn, G., 1998. *Folds, bodies and blobs. collected essays.*, Michele Lachowsky and Joel Benzakin. ed, *Books-By-Architects*. La lettre volée.
- Marantz-Jaen, E., Bertrand, F., Hérat, A., 2010. *Inventaire de la production architecturale et urbaine de la période 1900-1980 sur les communes d'Arles et de Tarascon*. Villa Vaché.
- Margono, B.A., Potapov, P.V., Turubanova, S., Stolle, F., Hansen, M.C., 2014. Primary forest cover loss in Indonesia over 2000–2012. *Nat. Clim. Change* 4, 730–735. doi:10.1038/nclimate2277
- Martin Tamke, Jacob Riiber, Hauke Jungjohann, 2010. *Generated Lamella*, in: *LIFE in: Formation, On Responsive Information and Variations in Architecture*, Proceedings. Presented at the *Acadia 2010, ACADIA*, New York, N.Y, pp. 340–347.
- Marty, 2013. *History of CNC Machining: How the CNC Concept Was Born*. CMS N. Am. Blog.
- McGee, W., Ponce de Leon, M. (Eds.), 2014. *Robotic Fabrication in Architecture, Art and Design 2014 - Springer*, Taubman College of Architecture and Urban Planning University of Michigan. ed. Ann Arbor, MI.
- McNeel Europe, 2016. *All Add-ons for Grasshopper | Food4Rhino [WWW Document]*. URL <http://www.food4rhino.com/grasshopper-addons/last-updated?page=14&etx=> (accessed 9.15.16).
- Meier, E., 2016. *The Wood Database*.
- Mena, J., Vera, S., Correal, J.F., Lopez, M., 2012. Assessment of fire reaction and fire resistance of *Guadua angustifolia kunth* bamboo. *Constr. Build. Mater.* 27, 60–65. doi:10.1016/j.conbuildmat.2011.08.028
- Menges, A., 2014. *Landesgartenschau Exhibition Hall*. achimmenges.net.
- Mermet, G., 2013. *Charpentier : Un métier d'art et d'avenir*. Editions de la Martinière, Paris.
- MichaelBlackwoodProd, 2011. *DECONSTRUCTIVIST ARCHITECTS [trailer]*.
- Migayrou, F., Mennan, Z., 2003. *Architectures non standard*. Paris.
- Miller, N., 2016. *LunchBox*.
- Mirtschin, J., 2014. *BullAnt*. Australia.
- Mohogoly-Nagy, L., 2015. *Du matériau à l'architecture*. Paris : Editions de La Villette.

- MoMa, 1988. MOMA_1988_0029_29.pdf [WWW Document]. Mus. Mod. Art. URL http://www.moma.org/momaorg/shared/pdfs/docs/press_archives/6526/releases/MOMA_1988_0029_29.pdf?2010 (accessed 10.6.15).
- Munemoto, S., 2014. ODNENSE, Miyako, 2011 - Shinsaku Munemoto & ASSOCIATES, ARCHITECTS [WWW Document]. Archilovers. URL <http://www.archilovers.com/projects/128924/odense.html> (accessed 6.10.16).
- Naruse, T., 1991. Taylorism and Fordism in Japan. *Int. J. Polit. Econ.* 21, 32–48.
- Navascués Palacio, P., 1988. Reflexiones sobre el modernismo en España. *Bol. Académico Esc. Téc. Super. Arquit. Coruña* 8–19.
- Negroponte, N., 1970. *The Architecture Machine: Toward a More Human Environment*. The MIT Press.
- Negroponte, N., 1969. Toward a Theory of Architecture Machines. *J. Archit. Educ.* 23, 9–12. doi:10.1080/00472239.1969.11102296
- Neufert, E., Neufert, P., Baiche, B., Walliman, N., 2002. *Neufert Architects' Data, Third Edition, 3rd edition*. ed. Wiley-Blackwell, Oxford ; Malden, MA.
- New China TV, 2014. 3D printers print ten houses in 24 hours.
- Nex Architecture, 2011. Times Eureka Pavilion. Nex Archit.
- Ning, F., Cong, W., Qiu, J., Wei, J., Wang, S., 2015. Additive manufacturing of carbon fiber reinforced thermoplastic composites using fused deposition modeling. *Compos. Part B Eng.* 80, 369–378. doi:10.1016/j.compositesb.2015.06.013
- Nurhazwani, O., Jawaid, M., Tahir, P.M., Abdul, J.H., Hamid, S.A., 2015. Hybrid Particleboard Made from Bamboo (*Dendrocalamus asper*) Veneer Waste and Rubberwood (*Hevea brasilienses*). *BioResources* 11, 306–323. doi:10.15376/biores.11.1.306-323
- Okabe, A., Boots, B., Sugihara, K., Chiu, S.N., 2000. *Spatial Tessellations: Concepts and Applications of Voronoi Diagrams, 2 edition*. ed. Wiley, Chichester ; New York.
- Oosterhuis, K., 2012. Simply complex, toward a new kind of building. *Front. Archit. Res.* 1, 411–420. doi:10.1016/j.foar.2012.08.003
- Oxman, N., 2010. Structuring Materiality: Design Fabrication of Heterogeneous Materials. *Archit. Des.* 80, 78–85. doi:10.1002/ad.1110
- Oxman, R., Oxman, R., 2010. New Structuralism: Design, Engineering and Architectural Technologies. *Archit. Des.* 80, 14–23. doi:10.1002/ad.1101
- Pagnoux, A., 2014. Immeuble bois-paille Passiv Haus / 12 mois de travaux - 2014/05/15.
- Pavatex S.A, 2016. PAVAWALL [WWW Document]. URL <http://www.pavatex.com/download/data-sheets/> (accessed 12.8.16).
- Pierré, V., 2016. Performances d'un bâtiment bois 8 niveaux, labellisé PassivHaus [WWW Document]. XPair. URL http://conseils.xpair.com/actualite_experts/performances-batiment-bois-8-niveaux-passivhaus.htm (accessed 8.26.16).
- Piker, D., Cervellione, R., Piacentino, G., 2015. Kangaroo.
- Piker, D., Najm, H., 2015. Planarize mesh.
- Pollack, S., 2007. Sketches of Frank Gehry.
- Ponticel, P., 2008. Europe investigating new aerospace press-forming possibilities - SAE International [WWW Document]. *Eur. Investig. New Aerosp. Press-Form. Possibilities*. URL <http://articles.sae.org/3795/> (accessed 8.1.16).
- Pottman, H., 2009. Geometry and New and Future Spatial Patterns. *Archit. Des.* 79, 60–65. doi:10.1002/ad.980

- Pottmann, H., 2010. Architectural Geometry as Design Knowledge. *Archit. Des.* 80, 72–77. doi:10.1002/ad.1109
- Preisinger, C., 2013. Linking Structure and Parametric Geometry. *Archit. Des.* 83, 110–113. doi:10.1002/ad.1564
- Quintrand, P., Autran, J., Florenzano, M., Zoller, J., 1985. *La conception assistée par ordinateur en architecture*, Hermes. ed. Hermes, Paris.
- Rammer, D.R., 2010. Fastenings, in: *Wood Handbook. Wood as an Engineering Material*. U.S. Department of Agriculture, Madison, WI., pp. 8–1, 8–28.
- Rappaport, N., 2008. Observations on Fuller. *Log* 138–138.
- Richardson, B., 2000. A Short Tale about Two Small Tiles. *Math. Sch.* 29, 16–17.
- RMIT University, 2012. *Basilica de la Sagrada Família: Passion Facade* | RMIT SIAL.
- Robeller, C., Nabaei, S.S., Weinand, Y., 2014. Design and Fabrication of Robot-Manufactured Joints for a Curved-Folded Thin-Shell Structure Made from CLT, in: McGee, W., Leon, M.P. de (Eds.), *Robotic Fabrication in Architecture, Art and Design 2014*. Springer International Publishing, pp. 67–81. doi:10.1007/978-3-319-04663-1_5
- Rocker, I.M., 2011. Apropos Parametricism: If, In What Style Should We Build? *Log* 89–100.
- Rojas, A.M., 2009. Pinos Colombianos: Ocho Nativos en Peligro. *Rev. El Mueble Madera* 18–24.
- Roudavski, S., 2009. Towards Morphogenesis in Architecture. *Int. J. Archit. Comput.* 7, 345–374. doi:10.1260/147807709789621266
- Ryder, G., Ion, B., Green, G., Harrison, D., Wood, B., 2002. Rapid design and manufacture tools in architecture. *Autom. Constr., Rapid Prototyping* 11, 279–290. doi:10.1016/S0926-5805(00)00111-4
- Salingaros, N.A., 1999. Architecture, Patterns, and Mathematics. *Nexus Netw. J.* 1, 75–86. doi:10.1007/s00004-998-0006-0
- Santiago, I., 2009. *Sumika pavilion_Toyo ITO_6* [WWW Document]. Flickr. URL <https://www.flickr.com/photos/sumikaproject/3407268139/> (accessed 9.1.16).
- Sasai, Y., 2013. Cytosystems dynamics in self-organization of tissue architecture. *Nature* 493, 318–326. doi:10.1038/nature11859
- Schaumann, D., Kalay, Y.E., Hong, S.W., Simeone, D., 2015. Simulating Human Behavior in Not-yet Built Environments by Means of Event-based Narratives, in: *Proceedings of the Symposium on Simulation for Architecture & Urban Design, SimAUD '15*. Society for Computer Simulation International, Alexandria, VA. U.S.A, pp. 5–12.
- Scheres, B., 2013. Integrated Molecular Circuits for Stem Cell Activity in Arabidopsis Roots, in: Capasso, V., Gromov, M., Harel-Bellan, A., Morozova, N., Pritchard, L.L. (Eds.), *Pattern Formation in Morphogenesis*, Springer Proceedings in Mathematics. Springer Berlin Heidelberg, pp. 37–39. doi:10.1007/978-3-642-20164-6_5
- Scheurer, F., 2010. Materializing complexity. *Archit. Des.* 80, 86–93.
- Scheurer, F., 2007. Getting complexity organised: Using self-organisation in architectural construction. *Autom. Constr., CAAD Futures*, 2005 16, 78–85. doi:10.1016/j.autcon.2005.10.006
- Scheurer, F., 2005. *SwissbauPavilion* [WWW Document]. URL <http://wiki.arch.ethz.ch/twiki/bin/view/Main/SwissbauPavilion.html> (accessed 7.18.14).

- Scheurer, F., Schindler, C., Braach, M., 2005. From design to production: Three complex structures materialised in wood, in: Proceedings of the GA 2005 International Conference on Generative Art 2005. Celestino Soddu, Milan.
- Schlemmer, O., Mohogoly-Nagy, L., Molnár, F., 1961. Die Bühne im Bauhaus. Wesleyan University Press.
- Schumacher, P., 2016. Parametricism 2.0: Gearing Up to Impact the Global Built Environment. *Archit. Des.* 86, 8–17. doi:10.1002/ad.2018
- Schumacher, P., 2009. Parametricism: A New Global Style for Architecture and Urban Design. *Archit. Des.* 79, 14–23. doi:10.1002/ad.912
- Schwartz, T., Bard, J., Ganon, M., Jacobson-Weaver, Z., Jeffers, M., Tursky, R., 2014. All Bent Out..., in: McGee, W., Leon, M.P. de (Eds.), *Robotic Fabrication in Architecture, Art and Design 2014*. Springer International Publishing, pp. 305–317. doi:10.1007/978-3-319-04663-1_21
- Schwinn, T., Krieg, O.D., Menges, A., 2013. Robotically Fabricated Wood Plate Morphologies, in: Brell-Çokcan, S., Braumann, J. (Eds.), *Rob | Arch 2012*. Springer Vienna, pp. 48–61. doi:10.1007/978-3-7091-1465-0_4
- Serrentino, R.H., 1999. Modular Architectural Groupings from Escher Periodic Tessellations, in: *AVOCAAD Conference Proceedings*. Presented at the Second International Conference, Brussels, pp. 205–219.
- Serrentino, R.H., Borsetti, R., 1999. Las teselas de Penrose como generadoras de agrupamientos de formas arquitectonicas modulares., in: [SIGRADI Conference Proceedings. Presented at the III Congreso Iberoamericano de Grafico Digital, Montevideo, pp. 161–164.
- Sevtsuk, A., Kalvo, R., 2014. A freeform Surface Fabrication Method with 2d Cutting, in: *2014 Proceedings of the Symposium on Simulation for Architecture and Urban Design*. Dr. David Gerber and Rhys Goldstein, Tampa, Florida, pp. 109–116.
- Sevtsuk, A., Kalvo, R., 2013. SUTD Library Pavilion / City Form Lab [WWW Document]. *ArchDaily*. URL <http://www.archdaily.com/387696/sutd-library-pavilion-city-form-lab/> (accessed 8.1.14).
- Sharif, S. and T.R.G., 2015. Design Cognition Shift from Craftsman to Digital Maker, in: *Proceedings of the 20th International Conference of the Association for Computer-Aided Architectural Design Research in Asia (CAADRIA 2015)*. Daegu, pp. 683–692.
- Sherwood, G.E., Stroh, R.C., 1989. FRAMING AND CLOSING IN, in: *Wood-Frame House Construction, Agriculture Handbook*. United States Department of Agriculture, Washington D.C, p. 260.
- Siemens, 2016. Parasolid XT Format Reference - XT_Format_April_2008_tcm73-62642.pdf.
- Silva, M. de M.G. da, Azevedo Bezerra, C., Álvares Pinto, K., Bezerra da Silva Bezerra, A.C., 2009. ARQUITETURA MODERNA NAS ROCAS: Um estudo sobre os processos de introdução, afirmação, e descaracterização dos elementos modernos no cenário popular, in: *Um panorama da iniciação científica em arquitetura e urbanismo no Brasil*. Presented at the CICAU 2009 – Congresso de Iniciação Científica em Arquitetura e Urbanismo, mdc . revista de arquitetura e urbanismo Ir para conteúdo, Belo Horizonte.
- SINCHI, 2006. *Especies Maderables Amenazadas*, ministerio de Ambiente, Vivienda y Desarrollo Social. ed. Bogotá D.C.
- Siza, A., Moura, E.S. de, Balmond, C., n.d. Serpentine Gallery Pavilion 2005 [WWW Document]. *Serpentine Galleries*. URL

- <http://www.serpentinegalleries.org/exhibitions-events/serpentine-gallery-pavilion-2005-alvaro-siza-and-eduardo-souto-de-moura-cecil-balmond-0> (accessed 12.6.16).
- SketchUp, 2015. Visiting Connor Wood Bicycles.
- Slessor, C., 2000. Digitizing Düsseldorf. *Architecture* 118–124.
- Smith, M., David, C., 2011. Add-ins - Generative Components Community Wiki - GenerativeComponents - Bentley Communities [WWW Document]. URL http://communities.bentley.com/products/products_generativecomponents/w/generative_components_community_wiki/4882 (accessed 9.15.16).
- Souto, R.M., Scantlebury, D.J., 2005. Cathodic delamination of coil coatings produced with different Zn-based intermediate metallic layers. *Prog. Org. Coat.* 53, 63–70. doi:10.1016/j.porgcoat.2005.01.008
- Stark, N.M., Cai, Z., Carll, C., 2010. Wood-Based Composite Materials Panel Products, Glued-Laminated Timber, Structural Composite Lumber, and Wood–Nonwood Composite Materials, in: *Wood Handbook. Wood as an Engineering Material*. U.S. Department of Agriculture, Madison, WI:, pp. 11–1, 11–28.
- Stein, A., Storti, G., 2006. *Maisons bois : Construction et art de vivre*. Editions Vial, Dourdan (Essonnes).
- Stern, R., 1998. "Gray Architecture as Post-Modernism, or, Up and Down from Orthodoxy, in: *Architecture Theory since 1968*. MIT Press, pp. 240–245.
- Structural Board Association, 2005. *Oriented Strand Board in Wood Frame Construction*, U.S edition 2005. ed. Structural Board Association, Ontario, Canada L3R 5L9.
- Tamke, M., Thomsen, M.R., Riiber, J., 2008. Complex geometries in Wood, in: *First Symposium on Architectural Geometry*. Presented at the Advances in Architectural Geometry, Vienna, Austria, pp. 65–68. doi:10.5075/epfl-thesis-4572
- Taylor, M., Wamuziri, S., Smith, I., 2003. Automated construction in Japan. *Civ. Eng.*, Proceedings of the Institution of Civil Engineers 34–41.
- Terzidis, K., 2006. *Algorithmic Architecture*, Architectural Press. ed. Burlington, MA.
- The Economist, 2009. A hard act to follow. *The Economist*.
- The Foundry, 2014. *Modeling - MODO*.
- Thomas Fischer, Christiane M. Herr, 2016. Cumincad : Works : Paper caadria2016_549:Parametric Customisation of A 3D Concrete Printed Pavilion, in: *Proceedings of the 21st International Conference of the Association for Computer-Aided Architectural Design Research in Asia*. Presented at the Living Systems and Micro-Utopias: Towards Continuous Designing, CAADRIA, Melbourne, pp. 549–558.
- Thompson, S., 2011. Glam Pod - *Sunday Times*.
- Tokyo Gas, Ito, T., 2007. SUMIKA PAVILION. *Domus* 19.
- Triboulot, M.-C., 2015. *Anatomie du bois : formation, fonctions et identification, Synthèses*. Versailles : Éditions Quæ. cop. 2015.
- Troche, C., 2008. Planar Hexagonal Meshes by Tangent Plane Intersection, in: *Advances in Architectural Geometry 2008*. Presented at the First Symposium on Architectural Geometry, Axel Kilian, Austria, pp. 57–60.
- Turello, A., 2012. *Generation*.
- Urban, F., 2012. Japanese "Occidentalism" and the Emergence of Postmodern Architecture. *J. Archit. Educ.* 65, 89–102. doi:10.1111/j.1531-314X.2011.01195.x

- Uusheimo, T., 2012. Kamppi chapel of silence. *Des. Archit. Des. Mag.*
- Venturi, R., 1977. *Complexity and Contradiction in Architecture*, 2nd edition. ed. The Museum of Modern Art, New York, New York : Boston.
- Vercey, P., Bignon, J.-C., 1998. *Le Bois*. Bull. CRIT 4.
- Ville de Xertigny, 2015. *Les Woodies* [WWW Document]. URL <http://www.mairie-xertigny.fr/Loisirs-tourisme-culture/Hebergement-Insolite/Woodies.html> (accessed 11.18.15).
- Wacker, J.P., 2010. Use of Wood in Buildings and Bridges, in: *Wood Handbook. Wood as an Engineering Material*. U.S. Department of Agriculture, Madison, WI:, pp. 17–1, 17–12.
- Wakisaka, T., Furuya, N., Hishikawa, K., Inoue, Y., Shiokawa, T., Yoshino, K., Hamada, K., Inoue, F., Kurita, K., Wakisaka, T., Furuya, N., Hishikawa, K., Inoue, Y., Shiokawa, T., Yoshino, K., Hamada, K., Inoue, F., Kurita, K., 1997. Automated construction system for high-rise reinforced concrete buildings. *ISARC Proc. 1997 Proceedings of the 14th ISARC*, Pittsburgh, USA, 111–118.
- Wandel, M., 2015. Clever 3-way joint (Kawai Tsugite) explained.
- Wang, W., Liu, Y., 2009. A Note on Planar Hexagonal Meshes, in: Emiris, I.Z., Sottile, F., Theobald, T. (Eds.), *Nonlinear Computational Geometry, The IMA Volumes in Mathematics and Its Applications*. Springer New York, pp. 221–233.
- Watson, N., 2005. The Whites vs the Grays: re-examining the 1970s avant-garde. *Fabrications* 15, 55–69. doi:10.1080/10331867.2005.10525203
- Weaver, W., 1948. Science and Complexity. *Am. Sci.* 36, 535–544.
- Weinand, Y., Hudert, M., 2010. Timberfabric: Applying Textile Principles on a Building Scale. *Archit. Des.* 80, 102–107. doi:10.1002/ad.1113
- Weisstein, E.W., 2014. Voronoi Diagram [WWW Document]. URL <http://mathworld.wolfram.com/VoronoiDiagram.html> (accessed 9.19.14).
- Weulersse, T., 2013. Non-standard design and building using wood. Dform architecture studio.
- White, R.H., Dietsberger, M.A., 2010. Fire Safety of Wood Construction, in: *Wood Handbook. Wood as an Engineering Material*. U.S. Department of Agriculture, Madison, WI:, pp. 18-1 ; 18-22.
- Wiedenhoeft, A., 2010. Structure and Function of Wood, in: *Wood Handbook. Wood as an Engineering Material*. U.S. Department of Agriculture, Madison, WI:, pp. 3–1, 3–18.
- Wiemann, M.C., 2010. Characteristics and Availability of Commercially Important Woods, in: *Wood Handbook. Wood as an Engineering Material*. U.S. Department of Agriculture, Madison, WI:
- Williams, L.K., Williams, C.B., 1964. The Impact of Numerically Controlled Equipment on Factory Organization. *Calif. Manage. Rev.* 7, 25.
- WILLIAMS, N., DAVIS, D., PETERS, B., LEON, A.P.D., BURRY, J., BURRY, M., 2013. Cumincad : Works : Paper caadria2013_135:FabPOD: An Open Design-to-Fabrication System, in: *Proceedings of the 18th International Conference on Computer-Aided Architectural Design Research in Asia*. Presented at the Open Systems:, CAADRIA, Center for Advanced Studies in Architecture, Singapore, pp. 251–260.
- Willmann, J., Knauss, M., Bonwetsch, T., Apolinarska, A.A., Gramazio, F., Kohler, M., 2016. Robotic timber construction — Expanding additive fabrication to new dimensions. *Autom. Constr.* 61, 16–23. doi:10.1016/j.autcon.2015.09.011

- Wu, P., Wang, J., Wang, X., 2016. A critical review of the use of 3-D printing in the construction industry. *Autom. Constr.* 68, 21–31.
doi:10.1016/j.autcon.2016.04.005
- Yazdi, M., 2014. *Dragon*. Teheran.
- Younés, S., 2004. The Empire of Masks: Pluralism and Monism in Politics and Architecture. *Philosophy* 79, 533–551.
- Zavattiero, A., 2014. Standard variation in wood design and construction. Xertigny holiday huts.
- Zhang, J., Khoshnevis, B., 2013. Optimal machine operation planning for construction by Contour Crafting. *Autom. Constr.* 29, 50–67.
doi:10.1016/j.autcon.2012.08.006
- Zwenger, K., 1997. *Wood and wood joints: building traditions of Europe and Japan*. Basel: Birkhäuser, 1997. -278 p.:fig. fotogr.; bibliogr.
- Zwierzycki, M., 2015. *Anemone*.

LIST OF FIGURES

FIGURE 1. VILLERNARD’S VISION OF THE ROLE OF ROBOTS AND THE INTERACTION WITH THE ARCHITECT IN THE WORKSITE. 1910. ON:EXPOSITIONS.BNF.FR/UTOPIE/GRAND/3_95A2.HTM.....	I
FIGURE 2. A COLLECTION OF NON-STANDARD TIMBER ARCHITECTURES PROVES THAT TIMBER CONSTRUCTION, OR TIMBER-RELATED CONSTRUCTION TECHNIQUES, CONTINUOUSLY PROVIDE AN EXPERIMENTATION FIELD IN WHICH NEW FORMAL AND BUILDING APPROACHES CAN BE TESTED BECAUSE OF THE AESTHETICAL AND MECHANICAL FEATURES WOOD OFFERS. SEE DETAILS IN FIGURE 157	III
FIGURE 3. FAB-CELL’S SUMMARIZED DATA MODEL. STAGES = PROCESSING KERNELS	IV
FIGURE 4. FAB-CELL’S DATA CONVERSION AND GENERATIVE STAGES SUMMARIZED. LEFT TO RIGHT: RETRIEVED GEOMETRY; MORPHOLOGIC AND TOPOLOGIC REDEFINITION; BUILDABLE CELLULAR-LIKE SET.	IV
FIGURE 5. FAB-CELL’S PRODUCTION STAGE SUMMARIZED. LEFT TO RIGHT: ITEM (CELLS) SPLITTING AND JOINTING CALCULATION; ITEM NESTING; ITEM CNC PROGRAMMING AND SIMULATION.	V
FIGURE 6. STEEL WORKERS MOUNTING A PRE-ASSEMBLED GIRDER FOR THE CONSOLIDATED GAS COMPANY BUILDING. N.Y 1913. SOURCE: ETSY.COM.....	3
FIGURE 7. OUTINORD SYSTEM. IN USE SINCE 1955, WAS CONCEIVED TO IMPROVE CONSTRUCTION TIMES AND OPTIMIZE CONCRETE CONSUMPTION. ON: OUTINORD.FR	4
FIGURE 8. THE EXISTENZMINIMUM. CIAM 1919. ON: ESTADO, CIUDAD Y VIVIENDA[...] 1996.....	4
FIGURE 9. MAN + MACHINE, BY KURT SCHMIDT. ON: DIE BÜHNE IM BAUHAUS, 1925.....	5
FIGURE 10. THIS MODEL FOR A MECHANICAL STAGE, BY HEINZ LOEW, LEADS TO AN IDEA OF HOW THE INTERACTIVE MACHINE-HOUSE SHOULD WORK. ON: DIE BÜHNE IM BAUHAUS, 1925.	5
FIGURE 11. THE FAGUS FACTORY. ON: GERMANY.TRAVEL	7
FIGURE 12. NATIONAL UNIVERSITY OF COLOMBIA. 1934-1941. KARL BRUNNER. PHOTO O.GÁMEZ	7
FIGURE 13. MUSEUM OF ARCHITECTURE. NATIONAL UNIVERSITY OF COLOMBIA. LEOPOLDO ROTHER, 1945. PHOTO O.GÁMEZ.	8
FIGURE 14. PALAU DE LA MÚSICA CATALANA. 1908, DOMENECH & MONTANER. PHOTO O.GÁMEZ	9
FIGURE 15. SYNDICAL HOUSE OF MADRID. CABRERO AND ABURTO 1951. PHOTO O.G.....	10
FIGURE 16. VILLAVERDE HOUSING PROJECT. RAFAEL ABURTO 1954. ON: TALLER 4 BLOGSPOT	10
FIGURE 17. WORKING-CLASS HOUSING. ACEVEDO TEJADA NEIGHBORHOOD. BOGOTÁ- COLOMBIA, 1940S. PHOTO: ANDRÉS ROJAS, ANDRESROJASGB.BLOGSPOT.COM.CO	11
FIGURE 18. VERMILION GRANITE FAÇADE AT THE BLUMENAU CATHEDRAL BY GOTTFRIED BOEHM. 1958, PHOTO O.GÁMEZ	11
FIGURE 19. CHICAGO SCHOOL-STYLE FLATIRON BUILDING BY DANIEL BURNHAM, NY, 1902. ON: NYC-ARCHITECTURE.COM.	12
FIGURE 20. BARCELONA PAVILION BY MIES VAN DER ROHE, 1929. PHOTO O.GÁMEZ	13
FIGURE 21. INTERNATIONAL STYLE. LEVER HOUSE BUILDING BY GORDON BUNSHAFT, 1952. ON: MICHAELMINN.NET	13
FIGURE 22. ORGANIC AND ORTHOGONAL SHAPES IN THE DIAMOND MUSEUM BY JOHN HEJDUK , 1967. ON: MASK OF MEDUSA.	14
FIGURE 23. SOCIAL HOUSING IN BUENOS AIRES -ARGENTINA. SIMON BOLÍVAR NEIGHBORHOOD, 1953. ON: BOCIO.BLOGSPOT.COM.CO	15
FIGURE 24. EXPLORATION WITH CURVED WALLS. DIAMOND HOUSE BY JOHN HEJDUK, 1962-1967. ON: MASK OF MEDUSA.....	17
FIGURE 25. THE NEWS BUILDING. ALLAN GREENBERG -1992. ON: ALLANGREENBERG.COM.....	18
FIGURE 26. STYLE-MIXED COMMERCIAL HOUSE FEATURING AN ECLECTIC EXTERIOR LANGUAGE. ON: BUILDERHOUSEPLANS.COM	19
FIGURE 27. VERNACULAR APPROACH. LAKESIDE RESIDENCE. STANLEY TIGERMAN, 1982? ON: TIGERMAN-MCCURRY.COM.....	20
FIGURE 28. A MIX OF INTERNATIONAL STYLE ALONG WITH CONCRETE BRUTALISM AND BIG CORNICES AS ORNAMENT ON THE ROOF ARE FOUND AT THE COLÓN TOWERS BY ANTONIO LAMELA, MADRID 1976. PHOTO O.GÁMEZ	21

FIGURE 29. VERNACULAR AND SIMPLE. FAMILY HOUSE IN IBIZA BY RICARDO BOFILL, 1960. ON: RICARDOBOFILL.COM	23
FIGURE 30. ARCOLOGY - CITY IN THE IMAGE OF MAN BY PAOLO SOLARI, 1969, THE MIT PRESS.	24
FIGURE 31. SKEWED GEOMETRY OF THE KIO TOWERS BY PHILLIP JONHSON, 1989-1996. PHOTO O.GÁMEZ.	26
FIGURE 32. ROOFTOP REMODELING BY COOP HIMMELBLAU. PHOTO BY JOHN HILL, ON: ARCHIDOSE.BLOGSPOT.COM.CO	27
FIGURE 33. TATLIN TOWER. PHOTO JC BIGNON.	27
FIGURE 34. ZHIVOPISKAYA ARKHITEKTONIKA BY L.POPOVA, 1918. ON: RUSSIAN CONSTRUCTIVISM. C.LODDER	28
FIGURE 35. PROJECT FOR A NEIGHBORHOOD-HOUSE BY LADOVSKI, 1920. ON: CONSTRUCTIVISMO RUSSO. C.COOKE.	28
FIGURE 36. BEARING AND FAÇADE STRUCTURES FOR THE CONFLUENCES MUSEUM AT LYON- FRANCE, BY COOP HIMMELBLAU. PHOTO 2012, O.GÁMEZ.	28
FIGURE 37. CONFLUENCES MUSEUM BY COOP HIMMELBLAU, 2000-2014. ON : HISTORIASZTUKI.COM.PL/KODOWANE	29
FIGURE 38. BARCELONA MUSEUM OF CONTEMPORARY ART, BY RICHARD MEIER, 1995. PHOTO O.GÁMEZ	29
FIGURE 39. MAXXI, BY ZAHA HADID, ROME-ITALY, 2009. PHOTO O.GÁMEZ.	29
FIGURE 40. ROYAL ONTARIO MUSEUM BY DANIEL LIBESKIND, 2007. ON: WIKIWAND.COM/NL/ROYAL_ONTARIO_MUSEUM.	30
FIGURE 41. MORPHOLOGICAL EXPLORATION WITH A BLOB-INVASIVE SHAPE, FOR THE UNDULATED ROOF OF KOREAN PRESBYTERIAN CHURCH OF NEW YORK, BY G. LYNN, D. GAROFALO, M. MCINFURT. 1999. SOURCE: ARCHITECTURE 88-10- 1999	32
FIGURE 42. TWO VISCOUS BODIES, CLOSE TO EACH OTHER, MERGE TOGETHER AS TO CREATE A NEW “BLOB” BODY.	33
FIGURE 43. BLOB GLAZED-ROOF FOR THE COMMUNICATIONS PALACE, BY ARQUIMEDIA, MADRID 2011. PHOTO, O.GÁMEZ	34
FIGURE 44. LONDON CITY HALL, BY FOSTER+PARTNERS, 2002. PHOTO O.GÁMEZ.	34
FIGURE 45. OBLIQUE WTC OFFICE TOWER CONCEPTUAL DESIGN, BY L. SPUYBROEK, C.SEUNG-WOO AND K. MUN. 2001. SOURCE: NOX-ART-ARCHITECTURE.COM.	35
FIGURE 46 AUDITORIUM AT PARCO DELLA MUSICA, BY RENZO PIANO, 2002. PHOTO: O.GÁMEZ	36
FIGURE 47. EVEN LONG AFTER DIGITAL TOOLS MADE IT INTO FORM-SEARCHING IN ARCHITECTURE, SOME PROJECTS CONTINUE TO HAVE SIMILAR MORPHOLOGIC PROPERTIES. AT SOME POINT MANY ARCHITECTS COINCIDED IN PROPOSING GLASS-BUBBLED-LIKE FAÇADES AS ARCHITECTURAL SOLUTIONS.....	38
FIGURE 48. EDF TOUL PAVILION, BY ALAIN CARTIGNIES. 2014. DRAWINGS BY A. CARTIGNIES. USE UNDER CONSENT OF CARTIGNIES-CANONICA ARCHITECTS.....	41
FIGURE 49. SPATIAL ARRANGEMENT OF DEFORMED HEXAGONS AS PATTERN FOR THE KAUST UNIVERSITY BEACON, SAUDI ARABIA. BY DANIEL TOBIN, 2009. SOURCE: ARCHITECTURELINKED.COM/PROFILES/BLOGS/KAUST-BREAKWATER-BEACON.....	42
FIGURE 50. LASER-CUT ALUMINUM FAÇADE TESSELLATION FOR THE PARIS PHILHARMONIC, BY JEAN NOUVEL. 2014. PHOTO O.GÁMEZ	42
FIGURE 51. STAGNANCY VS. DYNAMISM IN ARCHITECTURE. TOP , VILLA PORTALES RESIDENTIAL UNIT, SANTIAGO DE CHILE. 1958 – 1968. ON: UNIDAD VECINAL PORTALES. BOTTOM : 3D-PRINTED MODEL FOR THE ABU DHABI PERFORMING ARTS CENTRE, BY ZAHA HADID. 2007. PHOTO O.GÁMEZ.	43
FIGURE 52. EXTERNAL FORCES, DIGITALLY AFFECT A THREE-DIMENSIONAL SHAPE AS TO FORM AN ARCHITECTURAL OBJECT. EMBRYOLOGICAL HOUSE BY G.LYNN. EARLY 90S. ON: HTTP://WWW.DOCAM.CA	44
FIGURE 53. EMBRYOLOGICAL HOUSE, BY GREG LYNN. EARLY 90S. ON: HTTP://WWW.DOCAM.CA	44
FIGURE 54. UNIQUE MONADS FORMING NON-STANDARD BENCHES FOR THE UNIRE/UNITE PROJECT BY UMD AT MAXXI, ROME. 2012. PHOTO O.GÁMEZ.....	45
FIGURE 55. WAVED WALLS AND ROOFS AT THE SAGRADA FAMILIA SCHOOL. STANDARD MONADS (BRICKS) ARE USED TO BUILD THESE NON-EUCLIDEAN BODIES. ALTHOUGH REGULAR MONADS ARE USED FOR ITS CONSTRUCTION; A SPECIFIC PLACING TECHNIQUE AND JOINT DISTANCE VARIATION ALLOW FOR THE ACHIEVEMENT OF FORM. NOTICE THAT SPECIAL FORMWORK WAS NEEDED AS WELL. ANTONI GAUDI, 1907. PHOTO O.GÁMEZ	46

FIGURE 56. COLUMNS AT THE SAGRADA FAMILIA, BY GAUDI. 1882-? VARIATIONS ON SHAFTS AND KNOTS ARE VISIBLE THROUGHOUT THE CATHEDRAL. PHOTO O.GÁMEZ.....	47
FIGURE 57. THE FLEX-BRICK PROJECT BY GRAMAZIO-KOHLER RESEARCH, 2010. ETH ZURICH. ON: GRAMAZIOKOHLER.ARCH.ETHZ.CH/WEB /E/FORSCHUNG/152.HTML	47
FIGURE 58. NON-EUCLIDEAN ENVELOPE ALTERED BY EXTERIOR FORCES (AS VECTORS). OBSERVE HOW INNER STRUCTURE CHANGES AS FORM IS ALTERED. (THIRD PICTURE FROM TOP TO BOTTOM).....	49
FIGURE 59. INTERNAL VARIATION OF A NON-REGULAR SHAPE WHOSE STRUCTURE IS DEFINED BY A GEOMETRICAL PATTERN. OBSERVE THAT THE PATTERN CAN BE ALTERED BY CHANGING ITS FREQUENCY, SKEWING IT OR BY ROTATING ITS AXIS; CREATING AN OUTCOME OF MANIFOLD ITEMS SHARING THE SAME GEOMETRIC GENUS. THE PATTERN, AS STRUCTURE, CAN BE CHANGED THUS GIVING A DIFFERENT INNER STRUCTURAL ARRANGEMENT FOR THE SAME BODY (BOTTOM PICTURE).	50
FIGURE 60. A SIMULATION, RAN ON GRASSHOPPER, HELPS FINDING A SOLUTION TO PLANARIZE POLYGONS OVER A NURBS SURFACE. THE SOFTWARE STARTS BY TESTING PROBABLE SOLUTIONS (TOP AND MIDDLE) UNTIL IT FINDS A SPECIFIC ONE THAT SATISFIES NOT ONE BUT SEVERAL NEIGHBORING ITEMS (BOTTOM).	52
FIGURE 61. FAÇADE PANELS DERIVED FROM A DIGITALLY-MADE BIOLOGIC-LIKE PATTERN. TWO TYPES OF PATTERN ARE REPEATED AND ADAPTED OVER A MANIFOLD SET OF PANELS WHOSE DIMENSIONS CHANGE IN FUNCTION OF THE STADIUM'S GEOMETRY. PARIS RUGBY STADIUM AT BOULOGNE-BILLANCOURT, BY RUDY RICCIOTTI. 2007. PHOTO O.GAMEZ.....	53
FIGURE 62. PERSPECTIVE GENERATED USING URBAN 5, BY N. NEGROPONTE. "A SYSTEM THAT MONITORS DESIGN PROCEDURES". THE USER INTERACTS WITH THE MACHINE AS TO CREATE ARCHITECTURAL-LIKE GRAPHICS BASED ON PRE-DEFINED CONTEXTS OR MODES, ELIGIBLE FROM A RANGE OF OPTIONS THE USER CAN CHOOSE THROUGH KEY BUTTONS. ON: THE ARCHITECTURE MACHINE. MIT PRESS 1970...	57
FIGURE 63. FRANK GEHRY'S DESIGN METHOD WAS HIGHLY IMPROVED BY THE USE OF DIGITAL TOOLS. AS DESIGN EMERGES FROM A PHYSICAL MODEL IN WHICH FORM-SEARCHING IS HIGHLY DYNAMICAL BECAUSE OF HUMAN-MATERIAL INTERACTION, DIGITIZING DEVICES AND MODELING SOFTWARE ALLOW FOR INTRODUCING FUNCTION INTO THE INITIAL MODEL'S EMPTY ENVELOPE. TOP , CARDBOARD MODEL. MIDDLE , MODEL DIGITALIZATION. BOTTOM , DIGITAL INTERACTIVE MODEL. STILLS FROM: SKETCHES OF FRANK GEHRY.....	58
FIGURE 64. CELLULAR THREE-DIMENSIONAL PLANARIZED ARRANGEMENT. BY CHANGING AND MERGING PLANARIZATION PARAMETERS; MANIFOLD VERSIONS, FROM SUCCESSFUL TESTS, ARE OBTAINED AND THEN USED FOR DESIGN DECISION. TOP , DISLOCATED OUTCOME. MIDDLE , HYBRID OUTCOME. BOTTOM , "CLEAN" (LESS INTERESTING) RESULT. PLANARIZATION ACHIEVED THROUGH RGH AND KANGAROO.	59
FIGURE 65. COMPROGRAPH 3 OUTCOME. THE PROGRAM YIELDS AN ARRANGEMENT OF SPACES BASED ON INPUTS FROM A THREE-DIMENSIONAL MATRIX. ON: THE ARCHITECTURE MACHINE. MIT PRESS 1970...	60
FIGURE 66. SPATIAL ARRANGEMENT FOR A LAW FACULTY YIELDED THROUGH LOKAT, BY BERNHOLTZ AND FOSBURG. ON: "LA CAO EN ARCHITECTURE". HERMES 1985.....	60
FIGURE 67. CELLULAR ARRANGEMENT (PATTERN) OVER A SINGLE-CURVED SURFACE. PLANARIZATION THROUGH GH AND KANGAROO OFFERS DIFFERENT MORPHOLOGICAL SOLUTIONS MERGING GIVEN CONSTRAINTS: <ARRANGEMENT> <BOUNDARY SURFACE> <PLANARIZE>. THE RESULTING OUTCOMES ALLOW THE DESIGNER TO CHOOSE AND USE ANY OPTION.	62
FIGURE 68. ROMAN CAPITOL AT DOUGGA. 3D LASER SCANNING PERFORMED WITH A SINGLE-POINT LASER SCANNER. C.R.A.I 2003.	64
FIGURE 69. 3D MODEL OF THE TOWN OF EPINAL-FRANCE. THIS SURVEY MODEL IS TAKEN FROM A SCALE MODEL OF THE TOWN'S ANCIENT RAMPARTS. NEW SCANNERS AND SOFTWARE ALLOW FOR COLLECTING DATA INCLUDING NOT ONLY GEOMETRIC BUT TEXTURE INFORMATION OUT OF THE SURVEYED MODEL. C.R.A.I 2015.	65
FIGURE 70. ARCHITECTS LIKE FERNANDO MENÍS (SPAIN), MAKE USE OF PHYSICAL MODELS AS TO ENLIGHTEN DESIGN TASKS. FOR HIS CKK JORDANKI, IN POLAND (2015), MENÍS USED PLASTER MODELS AS TO PERFORM AN ACOUSTIC STUDY FOR THE AUDITORIUM AS WELL AS FOR DEFINING ITS SHAPE. THE PLASTER MODEL WAS THEN DIGITIZED AND LATER INTEGRATED INTO THE BUILDING'S DIGITAL MODEL....	66
FIGURE 71. GALAXY SOHO PROJECT BY ZAHA HADID ARCHITECTS. BEIJING, 2012. PARAMETRIC-CONCEIVED ARCHITECTURE ACT AS AN ENRICHING URBAN ELEMENT THAT BRINGS LANDSCAPE RENEWAL TO ALREADY WORN CITY AREAS. ON: ZAHA-HADID.COM/ARCHITECTURE/GALAXY-SOHO/	67
FIGURE 72. PARAMETRIC SETUP FOR A VOLUTE AND AN ARCHITRAVE USING AUTODESK REVIT. ON: RENAISSANCE REVIT, BY P.AUBIN 2013.	69

FIGURE 73. A SURFACE REPRESENTING A FAÇADE WALL IS PANELIZED. ORANGE ZONES REPRESENT FAÇADE AREAS RECEIVING MORE SOLAR GAIN, PURPLE AREAS REPRESENT RECEIVING THE LESS. DEPENDING ON SUN LIGHT INTENSITY, VOIDS GET BIGGER OR SMALLER. THIS IS A CASE IN WHICH A PERFORMATIVE BEHAVIOR (SOLAR GAIN) HELPS A GENERATIVE DESIGN EFFORT SETTING RANDOM WINDOW SIZES IN FUNCTION OF SUNLIGHT INCIDENCE.	70
FIGURE 74. A BRICK-PATTERNED WALL MODELLED IN REVIT, UNDERGOES A RANDOM-REDUCE OPERATION (IN DYNAMO) THAT YIELDS A PATTERN OF VOIDS ON IT. ON: YOUTUBE.COM/WATCH?V=AH9RBCACKTK ...	71
FIGURE 75. FINITE ELEMENT ANALYSIS USING KARAMBA PLUGIN FOR GH. THE STRUCTURE IS TESTED AGAINST LIVE LOADS AS TO ASSESS ITS ADMISSIBLE DEFORMATION. SUCH TESTS CAN TOO BE USED IN FORM SEARCHING ENDEAVORS, PRESERVING A BALANCE BETWEEN STRUCTURAL STABILITY AND FORM RICHNESS. STILLS FROM DANIL NAGY'S WORK ON YOUTUBE.COM/WATCH?V=-T3YE1XXMUO.....	72
FIGURE 76. HUMAN BEHAVIOR SIMULATION. BASED ON A BIM MODEL, A SIMULATION ALLOWS TO ESTIMATE HOW CROWDED A SPACE CAN GET THUS HELPING TO ESTABLISH WHETHER ROOMS AND CORRIDORS ARE BIG ENOUGH IN CASE USE INTENSITY SUDDENLY INCREASES. BNAI ZION MEDICAL HOSPITAL, Y.KALAY, 2012. TOP ON: YOUTUBE.COM/WATCH?V=I05WVWUPMYU-	73
FIGURE 77. TOP. A LATTICE AS FACADE STRUCTURE FOR A TRIANGLE-GLASS TESSELLATION. AL DAR HEADQUARTERS BY MZ ARCHITECTS, 2010. PHOTO: S. MEDINA. BOTTOM. AN ANGEL'S FACE MOSAIC AT ST PETER'S BASILICA, ROME. TILING FROM DRAWINGS BY GIUSEPPE CESARI (1603-1613). PHOTO: O.G.....	77
FIGURE 78. INCOMING AND OUTGOING FLOWS AS DESIGN-DETERMINING PATTERNS FOR THE CAIRO EXPO CITY, BY ZHA, 2009. ON : ZAHA-HADID.COM/MASTERPLANS/CAIRO-EXPO-CITY/.....	78
FIGURE 79. TOP TO BOTTOM. CAR AND PEDESTRIAN TRAFFIC FLOWS HELP IN CREATING A BUILDING'S SHAPE. ONCE PARAMETERIZED, FLOW CONFLUENCES GIVE SHAPE TO THE BUILDING ACTING AS FORM-SEARCHING VECTORS INTRODUCED INTO PARAMETRIC MODELING AS AN ARCHITECTURAL CONCEPTION RESOURCE.	79
FIGURE 80. TOP. ARABIDOPSIS' HEXAGON-LIKE CELL ARCHITECTURE. IMAGE BY JULIET COATES. ON: WWW2.WARWICK.AC.UK BOTTOM. CELLULAR-LIKE WOODEN STRUCTURE FOR THE ODENSE PAVILION, BY SHINSAKU MUNEMOTO (2014). ON: ARCHILOVERS.COM	80
FIGURE 81. TOP. MIMOSA PUDICA BEFORE AND AFTER RECEIVING STIMULUS. THE PLANT REACTS BY CLOSING ITS LEAVES AFTER PERCEIVING CONTACT FROM AN ALIEN BODY. BOTTOM. HYGROSKIN-METEOROSENSITIVE PAVILION BY ACHIM MENGES, 2013. WOOD DIAPHRAGMS REACT TO MOISTURE AND LIGHT CHANGES BY EXPANDING OR CONTRACTING THEIR FIBERS. ON ACHIMMENGES.NET	81
FIGURE 82. BRICK-LIKE PATTERNED STRUCTURES FOR THE SERPENTINE PAVILION 2016. MONADS ARE BRICK-LIKE FIBERGLASS CASSETTES WHOSE DEPTH VARIES IN FUNCTION OF A HORIZONTAL PROGRESSIVE DISPLACEMENT. ALL CASSETTES FORM TWO GRID-LIKE WALLS SHARING THE PAVILION'S STRUCTURAL STABILITY AS THEY ARE SUPPORTED ON EACH OTHER. 2016, BIG ARCHITECTS. LONDON, ENGLAND. ...	82
FIGURE 83. COMPOSITION OF A TILE OR TESSELLA.	84
FIGURE 84. AN ARRANGEMENT OF HEXAGONS CREATES A MONOHEDRAL PERIODIC TESSELLATION.	86
FIGURE 85. TOP. A SINGLE PROTOTILE IS DEFINED FOR A REGULAR TESSELLATION, BASED ON A GRID. BOTTOM. A COMPOSITE PROTOTILE IS FORMED BY MERGING SEVERAL TILES FROM THE ABOVE EXAMPLE. A NEW TESSELLATION TYPE IS CREATED.	86
FIGURE 86. TOP. DIHEDRAL TESSELLATION YIELDED FROM SQUARES AND RHOMBS. BOTTOM. TRIHEDRAL TESSELLATION BUILT FROM HEXAGONS, SQUARES AND TRIANGLES.	87
FIGURE 87. TOP. PARALLELOGRAM-BASED ESCHER-LIKE TESSELLATION CREATED BY TRANSLATION AND ROTATION. VERTICAL EDGES ARE REDEFINED AND DISPLACED, WHILE HORIZONTAL ONES ARE MODIFIED BY DRAWING A SHAPE FROM THE EDGE-AXIS TOWARDS A SIDE. THE SHAPE IS THEN ROTATED BY 180° AND THE EDGE REDEFINED. BOTTOM. ESCHER-LIKE ARRANGEMENT SPREAD OVER A PLANE.	87
FIGURE 88. ESCHER-LIKE TESSELLATION YIELDED BY ROTATING BASE POLYGONS AND POLYGON HALF-EDGES. BOTTOM. IRREGULAR SHAPES ARE DRAWN ON EACH HALF-EDGE THEN ROTATED 180° FOR ACHIEVING A NEW TILE.....	88
FIGURE 89. TOP. AS RESULT OF EDGE AND TILE ROTATION, LATTICE PATTERNS EMERGE AS TO ORGANIZE ESCHER-LIKE TESSELLATIONS. BOTTOM. ESCHER-LIKE TESSELLATION OF THE PARIS PHILHARMONIE'S CONCERT HALL FAÇADE, BY JEAN NOUVEL, 2014. PHOTO O.G	88
FIGURE 90. KITES AND DARTS OBTAINED FROM A PARALLELOGRAM. A GIVEN AXIS LINE WITH AN L LENGTH IS ROTATED BY 36° ON BOTH SIDES, ITS TOP VERTEX HELPS DEFINING THE LINE SPLITTING THE PARALLELOGRAM.	89

FIGURE 91. A PENROSE-LIKE NON-PERIODIC TESSELLATION. OBSERVE THAT RED ARCS ON KITES, AND BLUE ARCS ON DARTS, HELP FINDING THE RIGHT POSITION OF EACH TILE IN THE TESSELLATION.	89
FIGURE 92. TOP. HEX PATTERN TESSELLATING A NURBS SURFACE. WITHOUT PLANARIZATION, HEXAGONS ARE NOT TOO DEFORMED SINCE PRESSURE ON EDGES TO ACHIEVE NEGATIVE GAUSSIAN CURVATURE IS NOT TOO HIGH. BOTTOM. AS THE TESSELLATION UNDERGOES PLANARIZATION, HEXAGONS MUST BE REFIT TO SUCCEED TESSELLATION IN NEGATIVE GAUSSIAN CURVATURE AREAS (GREEN ZONES). THAT IS WHEN EDGE INVERSION OCCURS IN A HEX TESSELLATION.	90
FIGURE 93. TOP. A RANDOM SET OF POINTS (Ps1) OVER THE EUCLIDEAN PLANE ACTING AS CELL GENERATORS. MIDDLE. GENERATORS EXPAND (AS CIRCLES) WITH Vr'S AS RANDOM DISTANCES IN THE POPULATION. Ce'S START COLLIDING AND STRETCHING. BOTTOM. CELLS ATTAIN MAXIMUM EXPANSION AND Ce'S ARE COMPLETELY DEFINED. VORONOI DIAGRAM ACHIEVED.	91
FIGURE 94. TOP. CELL GENERATORS CREATED FROM A HEXAGONALLY-ARRANGED POINT SET (Ps2). MIDDLE. VORONOI CELLS APPEAR AS DIAMETER START TO INCREASE. OBSERVE THAT THERE ARE NO Vr'S SINCE THERE ARE NO VARIABLE DISTANCES BETWEEN POINTS. BOTTOM. A VORONOI-LIKE TESSELLATION IS OBTAINED FROM A LATTICE-LIKE SET OF POINTS. OBSERVE THAT DISRUPTION CAN BE ADDED BY SETTING AN ALIEN POINT AS PART OF THE INITIAL POINT SET.	92
FIGURE 95. TOP. GENERATOR POINTS ON A VORONOI TESSELLATION. MIDDLE. DELAUNAY TRIANGULATION IS PERFORMED BY LINKING GENERATION POINTS. A SIMPLEX (M+1) IS VALID WHEN ITS CIRCUMCIRCLE HAS NO OTHER POINTS (NP) THAN THOSE BELONGING TO M+1. BOTTOM. TRIANGULATION'S CONVEX HULL. 93	
FIGURE 96. "CHANTIER DE CONSTRUCTION ÉLECTRIQUE", BY VILLEMARD. 1910. ON:EXPOSITIONS.BNF.FR/UTOPIE/GRAND/3_95A2.HTM.....	97
FIGURE 97. INDUSTRIAL MANIPULATORS BEING USED AS WELDERS IN UNATTENDED MODE AT A NISSAN FACTORY IN SUNDERLAND U.K. ON:MASONHOLDEN.WORDPRESS.COM/TAG/CAR-FACTORY/.....	98
FIGURE 98. BIG CANOPY. A SYSTEM FOR ERECTING BUILDINGS IN FULL AUTOMATION MODE. THE CANOPY HAS A SET OF MANIPULATORS THAT PERFORM CONSTRUCTION OPERATIONS. AS FLOORS ARE FINISHED, THE CANOPY WILL THEN ADD ANOTHER SECTION TO THE VERTICAL DISPLACEMENT RAILS AS TO KEEP CLIMBING UP. OBAYASHI CORP. 1995. FOR MORE INFORMATION PLEASE REFER TO (WAKISAKA ET AL., 1997). IMAGE ON: WWW.OBAYASHI.CO.JP	99
FIGURE 99. TOP. F.L.WRIGHT IN HIS STUDIO AT TALIESIN WEST. ON: ARIZONAEXPERIENCE.ORG/. MIDDLE, A WORKSHOP ON PARAMETRIC MODELING AND FABRICATION. BOTTOM, STUDENTS WORKING WITH A 2D LASER-CUTTING CNC MACHINE. MIDDLE AND BOTTOM IMAGES BY C.R.A.I 2014.	101
FIGURE 100. 1959 NC MACHINE. MACHINING DATA USED TO BE STORED IN MAGNETIC TAPES OR PUNCHED-PAPER CARDS. ON: CNCCOOKBOOK.COM.	104
FIGURE 101. BASIC FABRICATION APPROACHES AS THEY ARE COMMONLY KNOWN. TOP. 3D PRINTING. MIDDLE. CNC (LASER) CUTTING ON: HTTP://TOPCNCMACHINE.COM . BOTTOM. ROBOT MANIPULATION. STILL. (GRAMAZIO KOHLER RESEARCH, 2006).	106
FIGURE 102. NON-STANDARD BRICK POSING FOR THE GANTENBEIN VINEYARD FAÇADE BY GRAMAZIO KOHLER ARCHITECTS. 2006. ON: HTTP://GRAMAZIOKOHLER.ARCH.ETHZ.CH/	107
FIGURE 103. STEREO LITHOGRAPHY PROCESS. A STL FILE CONTAINING MODEL DATA TO BUILD PASSES THROUGH A CAM INTERFACE TO CREATE LAYERING DATA. FROM TOP TO MIDDLE: AS THE PLATE MOVES DOWN BY SMALL INTERVALS, AN ULTRAVIOLET BEAM SOLIDIFIES A NEW LAYER OF MATERIAL. BOTTOM AN OBJECT PRODUCED BY SLA. STILL FROM: YOUTUBE.COM/WATCH?V=GA8CTTMBdKE	108
FIGURE 104. LM BY SELECTIVE LASER SINTERING. AS WELL AS IN FDM, EBM AND LOM, AS THE PIECE IS BEING FORMED THE FABRICATION PLATE DESCENDS. USING THE SAME PRINCIPLE OF SLA, LOM, EBM AND SLS USE THE SAME MATTER USED FOR CONSTRUCTING A PIECE AS SUPPORT OF IT. IN SLS, A LASER MELTS THIN LAYERS OF MATTER AS THE FABRICATION PLATE DESCENDS AND A ROLLER FEEDS THE WORKABLE LAYER WITH MORE MATERIAL PROVIDED BY A DELIVERY PLATE. FDM, MOST COMMONLY KNOWN AS 3D PRINTING, MAKES AN EXCEPTION TO THE SUPPORT RULE BY ACTUALLY ADDING SUPPORTS TO THE FABRICATION PROCESS AS THE PIECE IS BUILT. SUCH SUPPORTS MUST BE MANUALLY REMOVED AFTER THE LAYERING PROCESS IS FINISHED.	109
FIGURE 105. TOP. CONTOUR CRAFTING TECHNOLOGY AS CONCEIVED BY B. KHOSHNEVIS (2013). THE EXTRUSION HEAD, DRIVEN BY A GANTRY ROBOT, POURS LAYERS OF MORTAR AS IT DISPLACES ALONG A CONSTRUCTION PATH. ON: DAILYMAIL.CO.UK/SCIENCETECH. BOTTOM. SMART DYNAMIC CASTING METHOD (LLORET ET AL., 2015) GRADUALLY POURS FINE-AGGREGATE LOW-RETRACTION CONCRETE AS THE EXTRUSION PRE-SHAPED NOZZLE ALSO GRADUALLY REVOLVES ON ITS OWN AXIS. THE METHOD ALLOWS	

FOR CASTING CONCRETE COLUMNS WITH DIFFERENT SHAFT MORPHOLOGIES WITHOUT THE HELP OF ANY FIXED FORMWORK. ON: [HTTP://GRAMAZIOKOHLE.ARCH.ETHZ.CH/WEB/E/FORSCHUNG/223.HTML](http://GRAMAZIOKOHLE.ARCH.ETHZ.CH/WEB/E/FORSCHUNG/223.HTML)..... 110

FIGURE 106. FULL-SCALE HOUSE ADDITIVE FABRICATION. THIS RM METHOD, DEVELOPED BY YINGCHUANG NEW MATERIALS (CHINA), CLAIMS THE ABILITY TO BUILD THE WALLS OF A BASIC HOUSE IN 24 HOURS. USING AN APPROACH SIMILAR TO THAT OF B. KHOSHNEVIS, THIS CHINESE COMPANY SAYS TO USE A CEMENTITIOUS COMPOUND MADE OF CONSTRUCTION WASTE AND CEMENT TO BUILD WALLS. (NEW CHINA TV, 2014). **TOP.** EXTRUSION NOZZLE POURING LAYERS OF CEMENTITIOUS MATERIAL. **BOTTOM.** TESSELLATED WALL MADE USING THE AFOREMENTIONED METHOD. THESE WALLS WERE HORIZONTALLY POURED, THEN TILTED-UP FOR FINAL PLACEMENT. ON: YHBM.COM 111

FIGURE 107. SPLITTING OF A LOG INTO BOARDS WITH A BAND SAW. (LINDASAWMILLCINEMA, 2016) 112

FIGURE 108. **TOP.** LAYERED BENCH STRUCTURE FOR THE MAXXI YAP PROJECT 2012, BY URBAN MOVEMENT DESIGN ARCHITECTS. NY. ON: FACEBOOK.COM/URBANMOVEMENTDESIGN/. **BOTTOM.** PROTOTYPE OF A TIMBER-LAYERED STRUCTURE MADE WITH 5MM MDF. SCHOOL OF ARCHITECTURE OF NANCY, 2012 BY L.KOVALEVA, I.CERVANTES AND M.POTAPOVA. 113

FIGURE 109. **TOP.** 3D MODEL OF A PILLAR USING CATIA V5 (FILIPOVSKI, 2015). **BOTTOM.** STONE MILLING USING A MULTI-AXIS ROBOT (RMIT UNIVERSITY, 2012). 115

FIGURE 110. 5-AXIS WOOD MACHINE CENTER. **TOP.** THE CNC MACHINE CHOOSES A TOOL FROM A SET, ACCORDING TO THE CUTTING AND FINISHING PROGRAM DEFINED THROUGH A CAM ENVIRONMENT. **BOTTOM.** THE MACHINE PERFORMS A ROUGHING/FINISHING ROUTINE. STILL ON: [HTTPS://WWW.YOUTUBE.COM/WATCH?V=LskJ5SjebVc](https://www.youtube.com/watch?v=LskJ5SjebVc) 116

FIGURE 111. MULTI-POINT FORMING. **TOP,** THE PROCESS USES THE PERIMETER OF AN UNFOLDED NURBS SURFACE, WHICH IS USED TO CUT A METAL SHEET THAT IS LATER FORMED BY A SERIES OF HYDRAULIC OR PNEUMATIC PINS. THE SYSTEM ALLOWS FOR ACHIEVE DOUBLE CURVED PANELS WITH MINOR OR NULL CURVING ERRORS. **BOTTOM.** A PROTOTYPE FOR A CNC MULTI-POINT FORMING MACHINE. DATAFORM PROJECT (PONTICEL, 2008) 118

FIGURE 112. TIMBER SEASONING SHELTER PROJECT. AA, LONDON - HOOKE PARK. 2014. STRUCTURAL BEECH MEMBERS BEING BENT AFTER UNDERGOING SETAM SOFTENING. **TOP.** WORKPIECE PLACED OVER A TEMPLATE BEFORE FORMING. **BOTTOM.** PNEUMATIC JACKS MAKING PRESSURE OVER WORKPIECES TO GIVE THEM THE DESIRED SHAPE. SOME PLANKS BREAK, SOME OTHERS PERFORM AS NEEDED. 119

FIGURE 113. MANUFACTURING CARBON FIBER PIECES REQUIRES A MIXTURE OF TECHNIQUES THAT GO FROM 2D LASER-CUTTING TO DIE FORMING. **TOP.** A COMPONENT FOR A F1 RACE CAR WING IS CUT WITH A 2D LASER CNC MACHINE. **BOTTOM.** PIECES FOR THE SAME WING ARE BEING PUT IN PLACE INTO A DIE SO THEY ACQUIRE A SPECIFIC FORM. CARBON FIBER IS LATER HARDENED WITH AN EPOXY RESIN AND CURED IN AN AUTOCLAVE. (DALDRY, 2012) 120

FIGURE 114. IN-SITU ROBOTIC FABRICATION PROJECT BY V.HELM (2014). A ROBOT BUILDS A NON-STANDARD BRICK WALL, BY RECOGNIZING (THROUGH SENSORS) A DRAWN PATH. IMAGE ON: [HTTP://GRAMAZIOKOHLE.ARCH.ETHZ.CH](http://GRAMAZIOKOHLE.ARCH.ETHZ.CH) 121

FIGURE 115. LIGHT PAINTING. AN IMAGE DRAWN IN SPACE THROUGH ROBOTIC KINEMATICS. THE DRAWN LIGHT PATTERN IS CAPTURED THROUGH LONG EXPOSURE PHOTOGRAPHY. ON: [HTTP://MATTER.MEDIA.MIT.EDU/TOOLS](http://matter.media.mit.edu/tools)..... 122

FIGURE 116. FILE FORMATS ACT AS OUTPUT OR INPUT DEPENDING ON WHICH SIDE OF THE DESIGN-TO-PRODUCTION WORKFLOW THEY PARTICIPATE OF. **TOP.** A FILE FORMAT CONCATENATES MODEL DATA AS OUTPUT OF A DESIGN PROCESS. **BOTTOM.** INPUT DATA, AS FILE FORMAT, IS INTRODUCED IN A TRANSLATION ENVIRONMENT TO YIELD A MOCKUP THROUGH DIGITAL MANUFACTURING. 124

FIGURE 117. IMAGE OF A SKETCH UP MODEL OF THE TURNING TORSO BUILDING BY SANTIAGO CALATRAVA. 2001. ON: CHRISTOSGATZIDIS.BLOGSPOT.FR..... 127

FIGURE 118. A WINDOW OPENING MODELED USING THE PROBOOLEAN COMPOUND OPERATION IN 3DS MAX. **TOP.** THE WINDOW IS ORIGINATED FROM A RECTANGLE THAT HAS ITS OWN WIDTH AND LENGTH (HEIGHT) PARAMETERS. IT DOES NOT FOLLOW THE PROBOOLEAN OPERATION PARAMETERS AS THE RECTANGLE CANNOT BE A CHILD FROM SUCH OPERATION THUS IT IS NOT CONSTRAINED BY IT. **BOTTOM.** THE PROBOOLEAN ALLOWS FOR MAKING A CLEAN SOLID SUBTRACTION WHOSE HEIGHT AND WIDTH PARAMETERS ARE ADJUSTABLE AT ALL TIMES. HOWEVER, SUCH CHANGES DO NOT AFFECT THE WINDOW ITSELF. AS ENTITIES ARE NOT PARAMETRICALLY ATTACHED, ADJUSTMENTS MUST BE MADE MANUALLY. 129

FIGURE 119. **TOP.** MULTIPLE EXTRUSION. NOTICE THAT RANDOM EXTRUSION HEIGHT IS NOT POSSIBLE. IN THIS CASE, A POPULATION OF INSTANCES (REPLICAS) ADOPT THE EXTRUSION FACTOR OF THEIR PARENT (3DS MAX). **MIDDLE.** SCATTER COMPOUND OPERATION (3DS MAX). AN OBJECT IS RANDOMLY SPREAD OVER A SURFACE. EVEN THOUGH A RANDOM SEED PARAMETER IS FOUND, LOCATION HAS NO PROXIMITY PARAMETER. MOREOVER, RANDOM HEIGHT IS PERCENTAL AND DOES NOT BELONG TO A DOMAIN OF DEFINED VALUES FOR ITERATION. **BOTTOM.** MULTIPLE ITEM ROTATION IN MODO (THE FOUNDRY, 2014). REPLICAS ADOPT THE ROTATION FACTOR OF THEIR PARENT RESPONDING TO A SINGLE ORIENTATION VECTOR. MULTIPLE ORIENTATION VECTORS FROM A SINGLE PARENT ARE NOT AVAILABLE. 130

FIGURE 120. **TOP AND BOTTOM.** A SET OF COLUMNS AND A ROOF FRAMING ATTACHED TO A ROOF GEOMETRY. AS THE SLOPE INCREASES, COLUMNS AND ROOF FRAMING (BEAMS, JOISTS AND RAFTERS) ADAPT TO MATCH THE ROOF'S GEOMETRY. MODEL MADE USING AUTODESK REVIT 2013..... 131

FIGURE 121. **VISUAL PROGRAMMING MODELING (VPM).** INTERFACES ARE SOMEWHAT ALIKE, HOWEVER, FUNCTIONALITY AND LOGIC CHANGES A BIT FROM ENVIRONMENT TO ENVIRONMENT. A TWISTING TOWER SKETCH MODELED USING THE THREE MAIN PG PROGRAMS SHOWS THAT, EVEN THOUGH THE LOGIC MIGHT BE SIMILAR, THE WAY IN WHICH PARAMETERS SHOULD BE DEFINED VARIES FROM INTERFACE TO INTERFACE. IN GC AND DYNAMO, CLUSTERS HAVE A BUILT-IN SET OF VARIABLES THAT CAN BE PROGRAMMED OR CHANGED WITHOUT NEEDING ADDITIONAL CLUSTERS TO INTERVENE ON A SINGLE OPERATION I.E. A SWEEP OPERATION. ON THE CONTRARY, GH NEEDS VARIOUS CLUSTER SETS TO DO SO. ALSO, IN GC AND DYNAMO, SCRIPTING CAN BE DIRECTLY PERFORMED INTO THE CLUSTER'S INTERFACE. PROGRAMMING IN GH NEEDS AN INDEPENDENT CLUSTER FOR PROGRAMING. **FROM TOP TO BOTTOM.** DYNAMO, GENERATIVE COMPONENTS AND GRASSHOPPER PG MODELING INTERFACES 132

FIGURE 122. **TOP.** CAD-TO-CAM WORKFLOW. MODELING DATA IS EXPORTED TO A CAM ENVIRONMENT THAT TRANSLATES IT INTO A COMPREHENSIBLE FORMAT FOR FABRICATION. **BOTTOM.** CAD-AND-CAM WORKFLOW. THE CAD ENVIRONMENT POSSESSES A BUILT-IN CAM INTERFACE ALLOWING TO DEFINE THE MACHINING ROUTINES FOR OBJECT BEING CONCEIVED. IT DIRECTLY DELIVERS FABRICATION DATA. 134

FIGURE 123. SETTINGS FOR CNC MACHINING USING HSM FOR AUTODESK INVENTOR. 135

FIGURE 124. GCODE GENERATION IN A CAD-TO-CAM WORKFLOW. **TOP.** THE MODEL IS EXPORTED IN STEP FORMAT TOWARDS THE CAM ENVIRONMENT FOR TRANSLATION AND TOOLPATH GENERATION. **BOTTOM.** TOOLPATH CALCULATION (TRAJECTORIES AND COLLISIONS). ONCE VALIDATED, GCODE FOR CNC FABRICATION IS CREATED. 135

FIGURE 125. FABRICATION SIMULATION AND GCODE EXPORT FOR A CUSTOMIZED WOODEN WORKPIECE. **FROM TOP TO BOTTOM.** WORKPIECE -MANUFACTURING SIMULATION USING AUTODESK INVENTOR - GCODE FOR FABRICATION. 136

FIGURE 126. **TOP.** JOINT DEFINITION USING HSBCAD ([HTTPS://HSBCAD.USERVOICE.COM](https://hsbcad.uservoice.com)). THE PROGRAM HAS A DIRECT LINK TO AUTODESK REVIT, ALLOWING IT TO IMPORT FRAMING MODELS THUS GIVING THE BASE PARAMETERS TO DEFINE THE BEST JOINTING METHOD FOR A SET OF STRUCTURAL MEMBERS. **MIDDLE.** JOIST-RAFTER JOINT (INCLUDING DRILLINGS) AS CALCULATED THROUGH A CAD-AND-CAM SOFTWARE. **BOTTOM.** MACHINED WOOD JOINERY AS DERIVED FROM CAD-TO-CAM OR CAD-AND-CAM WORKFLOWS. 138

FIGURE 127. **THE BASIC WORKFLOW.** FROM **TOP TO BOTTOM**, COUNTERCLOCKWISE. A GIVEN DESIGNED OBJECT, INTENDED TO BE MANUFACTURED THROUGH RM USING A CAM INTERFACE, IS EXPORTED AS DATA. THE CAM ENVIRONMENT, PRIOR TO THE FABRICATION STAGE, RETRIEVES THE SAME OBJECT (AS DATA) INCLUDING ITS MACHINING ROUTINES TO BE VALIDATED BY THE DESIGNER OR TO CHANGE THE MODEL AS NECESSARY TO SATISFY BOTH, THE DESIGN INTENTION AND THE MANUFACTURING ENVIRONMENT CAPABILITIES. 139

FIGURE 128. **THE FAÇADE EXAMPLE.** A NURBS BASED FAÇADE DELIVERS CUSTOMIZED FAÇADE MODULE-DATA FOR MASS-CUSTOMIZED FABRICATION. AS SEEN IN PRECEDENT WORKFLOWS, FABRICATION DATA IS REINTRODUCED INTO THE GENERATIVE MODEL. THIS TIME IT CONSIDERS GLOBAL CHANGES BY ACKNOWLEDGING DETAILING SPECIFICITIES PARTICULAR TO A GIVEN FAMILY OF COMPONENTS (FAÇADE PANELS) **FROM TOP TO BOTTOM AND COUNTERCLOCKWISE:** A GIVEN FAÇADE ENVELOPE IS PANELIZED. MODELING DATA RETRIEVES INFORMATION FROM THE BUILDING SYSTEM AND THE PRODUCTION ENVIRONMENT (AS DATA) TO ADJUST THE DESIGN AS NECESSARY. THE LOOP STOPS WHEN DESIGN NEEDS, FABRICATION PARAMETERS AND CONSTRUCTION CONSTRAINTS ARE SATISFIED. 140

FIGURE 129. IN PARAMETRIC-GENERATIVE DESIGN PROCESSES APPLIED TO WOOD CONSTRUCTION, JOINERY CAN BE CUSTOMIZED OUT OF THE TRADITIONAL STANDARDS. CUSTOMIZED JOINERY (AS DATA) IS NOT

ALWAYS POSSIBLE TO ACHIEVE THROUGH PREDEFINED CAM MACHINING ROUTINES OR PREDEFINED CNC TOOL SETTINGS. INTENDED JOINT-MAKING METHODS MIGHT BE ALTERED IN FUNCTION OF THE MACHINING ENVIRONMENT'S SPECIFICITIES. **FROM TOP TO BOTTOM, COUNTERCLOCKWISE.** A JOINT DESIGN DEVELOPED FOR A SPECIFIC PURPOSE PASSES THROUGH A CAD/CAM ENVIRONMENT AND THEN VALIDATED AGAINST THE MACHINING ENVIRONMENT. IF DESIGN DATA DOES NOT MATCH THE MACHINING ENVIRONMENT CAPABILITIES, IT MIGHT NEED RE-PARAMETERIZATION AS TO RENDER ITS MAKING POSSIBLE. 141

FIGURE 130. FOR A ROBOT TO PERFORM CLAY MOLDING THE WAY HUMANS DO, IT WOULD NEED A COMPLEX END EFFECTOR PLUS ALSO A SET OF COMPLEX SENSORS TO EMULATE THE WAY HUMAN HANDS BEHAVE ON AND REACT TO MATTER AS IT PROGRESSIVELY CHANGES. PERHAPS THAT IS STILL THE LONG WAY TO GO AND ONE OF THE MOST INTERESTING RESEARCH TOPICS IN THE FIELD. 143

FIGURE 131. FOREST DISTRIBUTION IN THE WORLD, AS ADAPTED FROM (GUINARD, 2009) 149

FIGURE 132. LEFT. AN ANGIOSPERM OR HARDWOOD TREE. RIGHT. A GYMNOSPERM OR SOFTWOOD TREE. 152

FIGURE 133. SKETCH OF A TREE. ROOTS, SHOOT AND BOLE. 156

FIGURE 134. TRANSVERSE SECTION OF A TREE TRUNK AS ADAPTED FROM (GUITARD AND POLGE, 1987; TRIBOULOT, 2015) 156

FIGURE 135. DETAILED VIEW OF THE TREE'S EXTERNAL LAYERS. 157

FIGURE 136. DIMENSION LUMBER AS OBTAINED FROM SAWN LOGS. ON: THEDESIGNCONFIDENTIAL.COM 157

FIGURE 137. FROM **TOP TO BOTTOM.** LVL, PSL AND LSL WOOD COMPOSITES. ON: WOODHAVENLUMBER.COM & MATERIA.NL. 159

FIGURE 138. **TOP.** GLULAM BEAMS. VINCENT VAN GOGH HIGH SCHOOL BY CARTIGNIES-CANONICA ARCHITECTS, 2006, BLÉNOD-LÈS-PONT-À-MOUSSON – FRANCE. **BOTTOM.** A CLT PANEL. 159

FIGURE 139. **TOP.** PLYWOOD USED AS STRUCTURAL MATERIAL FOR THE SOLAR ENERGY HOUSE PROJECT (SEE SECTION 5.5). **MIDDLE.** MOISTURE-RESISTANT PARTICLE BOARD USED AS ROOF SHEATHING AT THE WOOD CHALLENGES 2015. **BOTTOM.** OSB PANELS USED AS WALL SHEATHING AT THE WOOD CHALLENGES 2016. PHOTOS O.G. 161

FIGURE 140. **TOP.** MDF AS USED IN DOOR MANUFACTURING. ON: [HTTP://BUCINA-DDD.SK](http://BUCINA-DDD.SK). **BOTTOM.** HDF AS USED IN LAMINATE FLOORING. PHOTO O.G 162

FIGURE 141. **TOP.** SCARF-LIKE JAPANESE BEAM-JOINT. (BUILDING CHANNEL, 2016) **BOTTOM.** THREE-WAY JAPANESE INTERLOCKING JOINT (WANDEL, 2015). 170

FIGURE 142. LAYERED TIMBER STRUCTURAL PROTOTYPE AT "LES GRANDS ATELIERS", LYON-FRANCE, 2012. PHOTO O.G 176

FIGURE 143. **TOP.** GLAM POD'S TIMBER FRAMING SEAMLESSLY DECREASES DIAMETER TOWARDS THE EXTREMITIES CREATING A VARIATING FRAME-SIZING. **BOTTOM.** PLANK-BASED SHEATHING SYSTEM DISCONTINUOUSLY FOLLOWS THE STRUCTURE'S CURVATURE. ON:GAUKROGERANDPARTNERS.COM... 176

FIGURE 144. **TOP.** ENGLISH CEDAR SIDING IS CURVED FOLLOWING THE POD'S GEOMETRY. **MIDDLE.** THE GLAM POD IN ITS FINISHED STATE. ON GAUKROGERANDPARTNERS.COM **BOTTOM.** CABIN (TINY HOUSE) DESIGNED AND BUILT BY STUDENTS AT THE WOOD CHALLENGES (DÉFIS DU BOIS). PHOTO O.G..... 177

FIGURE 145. SWISSBAU PAVILION **TOP.** FORM-SEARCHING JAVA MODEL. **MIDDLE.** CELL ARRANGEMENT AS STRUCTURE. **BOTTOM.** ASSEMBLED OSB CELLULAR STRUCTURE (SCHEURER, SCHINDLER, AND BRAACH 2005) 178

FIGURE 146. KREOD PAVILION. **TOP.** INITIAL MODEL BASED ON A LATTICE-LIKE TESSELLATION. **MIDDLE.** ON-SURFACE STRUCTURAL OPTIMIZATION. **BOTTOM.** INTERLOCKING HEX PATTERN AS USED IN THE ACTUAL STRUCTURE..... 179

FIGURE 147. JOINTING GENERIC SOLUTIONS **TOP.** MEMBER DETAILING AFTER STRUCTURAL-BASED TESSELLATION OPTIMIZATION, KREOD. **MIDDLE.** MEMBER CONNECTION DETAILING. DOWELS, BOLTS, GROOVES, KREOD. **BOTTOM.** SWISSBAU PAVILION MEMBER JOINTING SOLUTION. BUTTERFLY NOTCHES JOINT CELL ITEMS AS METALLIC FASTENERS DO ON CELLS TO ASSEMBLE THE STRUCTURE. TOP AND MIDDLE IMAGES BY (EVOLUTE, 2012); BOTTOM IMAGE (SCHEURER, 2005). 180

FIGURE 148. TIMES EUREKA PAVILION. **TOP,** MAIN STRUCTURE FROM VORONOI PATTERN OVER THE UNFOLDED BOX. OBSERVE THAT OPENINGS ARE MADE BY SKIPPING CORNER CELLS. **MIDDLE,** NESTED VORONOI GROUP FOR NON-BEARING MEMBERS. **BOTTOM.** BIOMIMETIC ASPECT OF THE PAVILION AS INSERTED INTO ITS CONTEXT. ALL IMAGES (NEX ARCHITECTURE, 2011) 181

FIGURE 149. **TOP.** TIMBER STRUCTURAL MEMBERS. OBSERVE THE COMPLEX GEOMETRIES YIELDED AS RESULT OF CARVING JOINERY ON WORKPIECES. **BOTTOM.** INTERIOR VIEW. OBSERVE HOW STRUCTURAL

ITEMS ARE JOINTED AT MANIFOLD INTERSECTING ANGLES. TOP IMAGE (BLUMER LEHMANN, 2012), BOTTOM IMAGE (NEX ARCHITECTURE, 2011)	182
FIGURE 150. TETRIS HOLIDAY COTTAGE. TOP & MIDDLE-TOP. BEECH-CLT WALLS ACTING AS WAFFLE-LIKE STRUCTURE FOR THE ENTIRE COTTAGE. MIDDLE-BOTTOM. FIRST STRUCTURAL APPROACH. NOTICE THAT BEECH CASSETTES ARE THICKER INDEPENDENT-CLOSED ENTITIES COMPARED TO THOSE IN THE MIDDLE- TOP IMAGE. BOTTOM. EXTERIOR ASPECT OF THE COTTAGE. PLANS AND RENDERS COURTESY OF WM ARCHITECTS. AS-BUILT PHOTO, O.G.	183
FIGURE 151. SOLAR ENERGY HOUSE. TOP. STRUCTURAL MEMBERS STAGGERED. NOTICE THAT THE ROOF RESTS OVER THE CASSETTE-MADE ENCLOSING WALL. MIDDLE. CLOSING WALL VARIABLE SECTION. BOTTOM. AERIAL VIEW OF THE STRUCTURE'S MOUNTING PROCESS. NOTICE THAT TIMBER CASSETTES ARE INSTALLED EMPTY. INSULATING MATERIAL WAS BLOWN-IN ONCE THE MOUNTING WAS FINISHED. IMAGE CREDITS. TOP, O.G; MIDDLE, CARTIGNIES-CANONICA ARCHITECTS; BOTTOM, CHARPENTES- BOIS.COM.....	184
FIGURE 152. TOP. POPLAR THIN PANELS AS ROOF INFERIOR FINISH. BOTTOM. BLOWN-IN INSULATION IN STRUCTURAL CASSETTES. IMAGE CREDITS. TOP, O.G; BOTTOM, CARTIGNIES-CANONICA ARCHITECTS.	185
FIGURE 153. TOP. FLOORPLAN. WALL CURVATURE CHANGES FROM CONVEX TO CONCAVE. BOTTOM. WALL CURVATURE FIRST SOLUTION. A SET OF JOISTS SUBDIVIDE WALLS INTO SHORT SEGMENTS TO FACILITATE SHEATHING PANEL BENDING AND INSULATION BLOWING-IN AS WELL AS A SMOOTH APPEARANCE THROUGHOUT ENVELOPE AND PARTITION WALLS. PLANS AND DETAILS COURTESY OF DFORM ARCHITECTURE.....	186
FIGURE 154. TOP. BIM MODEL INCLUDING CARPENTRY DATA. BOTTOM. WALL CURVATURE SECOND SOLUTION BY FULL-SCALE PROTOTYPING. A 2X10 MM OSB SHEATHING REPLACES 18 MM SHEATHING FOR ACHIEVING A SMOOTHER BENDING AND AVOID BREAKING. TOP IMAGE COURTESY OF DFORM ARCHITECTURE. BOTTOM IMAGE J.M.	187
FIGURE 155. TOP. CLT STRUCTURE. WALLS, BEAMS AND COLUMNS. MIDDLE. INTERIOR FINISH GIVEN BY TIMBER PANELS. BOTTOM. TIMBER CASSETTES AS INSULATING ENVELOPE. IMAGE CREDITS. (KLH LIGNATEC, 2013; PAGNOUX, 2014).....	188
FIGURE 156. TOP. FAÇADE ENVELOPE STRAW-BALE-FILLED INSULATING UNIT (CASSETTE). BOTTOM. JULES FERRY DWELLINGS. IMAGE CREDITS. TOP-J.C BIGNON, BOTTOM (PAGNOUX, 2014)	189
FIGURE 157. FROM LEFT TO RIGHT. TOP ROW. MY GREEN WORLD PAVILION , VENLO 2012 BY 2D3D ARCHITECTURE (2D3D, 2012). 130008252010 PAVILION , TOKYO 2010. (KO AND LIOTTA, 2011). BLAUTOPF CAFETERIA , DITZINGEN 2008. (BARKOW AND LEIBINGER, 2008). SERPENTINE PAVILION , LONDON 2005. (SIZA ET AL., N.D.). MIDDLE ROW. KAMPPI CHAPEL , HELSINKI 2012 BY Ks2 ARCHITECTS. (Ks2 ARCHITECTS, 2008; UUSHEIMO, 2012). LANDESGARTENSCHAU EXHIBITION HALL , 2014 BY A.MENGES (MENGES, 2014). EXPERIMENTAL PROTOTYPE BY STUDENTS AT "LES GRANDS ATELIERS. LYON-FRANCE 2012. PHOTO O.G. THE SEQUENTIAL ROOF , ZURICH 2015 BY GRAMAZIO KOHLER RESEARCH (WILLMANN ET AL., 2016). BOTTOM ROW. SERPENTINE PAVILION 2014 BY SMILJAN RADIC. PHOTO O.G. CURVED FOLDED THIN SHELL STRUCTURE , 2014 BY C.ROBELLER (ROBELLER ET AL., 2014). SUTD LIBRARY PAVILION , 2013 BY CITY FORM LAB (SEVTSUK AND KALVO, 2014, 2013). SUMIKA PAVILION , 2007 BY TOYO ITO (SANTIAGO, 2009; TOKYO GAS AND ITO, 2007).....	191
FIGURE 158. THREE-DIMENSIONAL STATE OF A NON-STANDARD WALL.	195
FIGURE 159. ABSTRACTION OF A LIGHT-FRAMED WALL. TOP. FRAMES ARE COMPOSED BY EDGES THAT YIELD CLOSED LOOPS OR CELLS. CELLS CAN BE EMPTY OR FILLED WITH AN INFILL OF INSULATING MATERIAL. FURTHERMORE, CELLS CAN BE PARTIALLY OR TOTALLY OPEN (AS IN WINDOWS). BOTTOM. A FAÇADE PLANE TESSELLATED BY THE PATTERN OF THE TOP IMAGE. THE BASE MODULE IS DISPLACED A HALF ROW EVERY OTHER COLUMN TO MAKE MODULES LOOK LIKE A VERTICAL RUNNING BOND.	197
FIGURE 160. LOAD TRANSMISSION IN FRAMED SYSTEMS. HORIZONTAL LOADS ARE DISSIPATED MEANS OF DIAPHRAGM-LIKE MEMBERS. HORIZONTAL AND VERTICAL MEMBERS CONCENTRATE LOADS TO TRANSFER THEM TO THE SUPPORTING GROUND.	198
FIGURE 161. LOAD TRANSMISSION IN CELLULAR SYSTEMS. TOP , LEFT TO RIGHT, TOP TO BOTTOM. AN OPEN CELL RECEIVING A VERTICAL LOAD CANNOT STAND BY ITSELF AS NO COMBINING OR BRACING ELEMENTS ARE PRESENT TO KEEP CELL-WALLS TOGETHER; THEORETICALLY, JOINTS WOULD FAIL TO MAINTAIN THE CELL STABLE. IN A SECOND SCENARIO, A CLOSED CELL UNDERGOES THE SAME VERTICAL LOAD. CHARGES ARE UNIFORMLY DISTRIBUTED THROUGH CELL-WALLS WITH THE HELP OF A DIAPHRAGM (CELL	

COVER) AVOIDING THE CELL FROM COLLAPSING. BOTTOM. A THEORETIC GRAVITY EFFORT, CAUSED BY TWO TRANSFORMED GRAVITY LOADS L1 AND L2, ACTS OVER A SET OF CONFINED CELLS. ALL ELEMENTS WORK AS A WHOLE DESPITE BEING OPEN. LOADS, AS GROUPED IN $\Sigma L1L2$, ARE TRANSMITTED THROUGH CELL-WALLS AND CONFINEMENTS TO A LOWER MEMBER THAT UNIFORMLY DISTRIBUTES THEM TO THE GROUND.....	199
FIGURE 162. INTER-CELL JOINTING. TOP. A SET OF CELLS REQUIRING A JOINTING SOLUTION NEAR A KNOT. MIDDLE. AN OPTION USING BOLTS AS FASTENING SYSTEM. INTER-CELL JOINTING SOLUTION FOR THE TIDES AND TIMES POD BY AMENITY SPACE, 2009, LONDON. PHOTO JC BIGNON. BOTTOM. A FASTENING SOLUTION USING TUSKED CLAMP-LIKE TIMBER KEYS MADE THROUGH CNC 2D LASER CUTTING.	200
FIGURE 163. TOP. VILLA VACHE 1965. BOTTOM, « ÉCOLE DE LA PINETTE, 1966. ARCH. PAUL QUINTRAND. ON (MARANTZ-JAEN ET AL., 2010).....	204
FIGURE 164. EXPECTED ACPT'S FORM-SEARCHING AND DETAILING GENERAL WORKFLOW.	207
FIGURE 165. TOP. TWO PARAMETRIC PROFILES (Pr1 -Pr2) ARE SWEEPED THROUGH A FOOTPRINT AS WALL EMPLACEMENT. THE PRODUCT IS A BOUNDARY REPRESENTATION OF A TOPOLOGICALLY MODIFIED WALL. BOTTOM. A BOUNDARY, REPRESENTED BY THE WALL'S EDGES, HOSTS PARAMETRIC PROFILES AND CONTROL POINTS. TOPOLOGY CAN BE CHANGED, THOUGH THE WALL REMAINS CONTAINED IN ITS BOUNDARY.	208
FIGURE 166. ARCHITECTURAL DESIGN OFTEN REQUIRES FOCUSING ON INDIVIDUAL ITEMS TO ACHIEVE A LANGUAGE. HEREIN, ENCLOSING PLANES PERFORM DIFFERENT FUNCTIONS (ENVELOPE, ROOF, FAÇADE AND/OR PARTITION) AS SPECIFIC DESIGN SOLUTIONS FOR GLOBAL DESIGN GOALS. TOP AND MIDDLE. HOLIDAY HUTS, WOOD CHALLENGES 2016. PHOTOS O.G. BOTTOM. NURSERY FACILITY (WEULERSSE, 2013).	210
FIGURE 167. COMPARISON BETWEEN IFC STANDARD WALL CLASSES AND THE NON-STANDARD WALL CLASS (NSCLSS) PROPOSED IN THIS DISSERTATION. THE NSCLSS CONCENTRATES THE CAPABILITIES OF ALL OTHER CLASSES IN A SINGLE ITEM.....	211
FIGURE 168. GENERAL MODEL'S PROCESS MAP. YELLOW= KERNELS. TOP TEXTS = OPERATIONS.	211
FIGURE 169. ACTIVITY DIAGRAM CONVENTIONS.	212
FIGURE 170. FAB-CELL ACTIVITY DIAGRAM. PLEASE REFER TO APPENDIX 6 FOR A LARGER VERSION.	213
FIGURE 171. FAB-CELL DATA CONVERSION KERNEL, AND DESIRED OUTPUT (ON THE RIGHT)	215
FIGURE 172. GENERATIVE KERNEL'S DESIRED OUTPUT AND WORKFLOW. FROM LEFT TO RIGHT: GLOBAL DESIGN, DATA TRANSLATION, GENERATIVE OUTPUT. THE OUTPUT SHOULD BE REINSERTED INTO GLOBAL DESIGN TO VALIDATE IT.	215
FIGURE 173. FAB-CELL GENERATIVE KERNEL. THIS KERNEL'S OUTPUT IS SHOWN IN FIGURE 172	216
FIGURE 174. FAB-CELL PRODUCTION KERNEL.....	217
FIGURE 175. PRODUCTION KERNEL DESIRED OUTPUT, FROM LEFT TO RIGHT: CELL SPLITTING AND JOINT PARAMETERIZATION; WALL-ITEM NESTING; CNC CODE GENERATION.....	218
FIGURE 176. TORSION ON VERTICAL AND HORIZONTAL MEMBERS OF A WALL STRUCTURE CAUSED BY EXCESSIVE CURVATURE. CONVERSELY, CELL-CONCAVITY AND CELL-CONVEXITY ARE WELL MANAGED.	223
FIGURE 177. VERTICAL MEMBER COLLISION DUE TO ACUTE CURVATURE. THE THICKER WALLS ARE, THE LESS PERMITTING THEY ARE CONCERNING CURVATURE.	223
FIGURE 178. FAB-CELL VERSION 1.0, GRID WALL MODEL.	226
FIGURE 179. FAB-CELL VERSION 1.0, VORONOI WALL MODEL.....	226
FIGURE 180. VORONOI AND GRID WALL MODELS. MODULE SYNTHESIS WORKFLOW. PLEASE NOTICE THAT ALL MODELING STAGES OFFER A PREVIEW, WHICH HELPS HAVING AN INSTANT FEEDBACK OF ALL PROCESSES AND FURTHERS ADJUSTING THE MODEL AS NEEDED.	227
FIGURE 181. TOP: THE WOOD CHALLENGES 2014 SITE (IN GREEN) AT "FOLIGNEUSES" ALLEY, ÉPINAL – FRANCE.)MAPS.GOOGLE.COM BOTTOM: RENDER OF THE PROTOTYPES AT THEIR INTENDED LOCATION.	228
FIGURE 182. THE ENSTIB FACILITIES AT ÉPINAL - FRANCE.....	229
FIGURE 183. FAB-CELL VER 1.0 MODELING-TO-PRODUCTION WORKFLOW.	233
FIGURE 184. FINISHED PROTOTYPES VALIDATING FAB-CELL'S FIRST VERSION FUNCTIONAL SPAN.	236
FIGURE 185. SAMPLES STUDIED DURING SURVEY.....	237
FIGURE 186. PLYWOOD EXPANSION CONTROL MEASUREMENTS. TOP: UNHARMED ITEMS DO NOT SHOW ANY EXPANSION CAUSED BY OPEN-AIR CONDITIONS. BOTTOM: A HARMED ITEM DURING FABRICATION SHOWS DEGRADATION AS MOISTURE ACCUMULATES UNDER ONE OF ITS OUTER LAYERS.	238

FIGURE 187. TOP: VISUAL INSPECTION AND GAP MEASUREMENT SHOWED NO DIMENSIONAL CHANGES IN ITEMS EXPOSED TO OPEN-WEATHER CONDITIONS. BOTTOM: MOISTURE MEASUREMENT ON RAIN-EXPOSED CELLS.	238
FIGURE 188. TOP, RABBET DIMENSIONAL VARIATION FOR A SINGLE CELL. BOTTOM LEFT: RABBET ID'S. BOTTOM RIGHT: LASERGRAMMETRY ACQUIRED DATA FOR DIGITAL MEASURING.	239
FIGURE 189. TOP: MAIN FABRICATION DEFECTS FOUND THROUGHOUT THE PROTOTYPING SESSIONS. BOTTOM: VERTICAL TOOLPATH DEVIATION PLUS VIBRATION-PROVOKED TEAROUT ON A SINGLE WORKPIECE.	239
FIGURE 190. ATTEMPTING PARAMETRIC PATTERN CREATION. DEVELOPMENT OF A CLUSTER FOR HEXAGONAL PATTERNS. TOP. PARAMETRIC ALGORITHM. MIDDLE: ALGORITHM CONCATENATED INTO A CLUSTER YIELDING A SET OF POLYLINE CURVES AS CELLS. BOTTOM: CELLS CREATED BY PICKING POINTS FROM A GRID. POINTS ARE ORDERED FOLLOWING A SPECIFIC PATH TO FORM A TESSELLA, WHICH IS THEN DISSEMINATED OVER A PLANE TO OBTAIN A PATTERN.	242
FIGURE 191. AN OVERVIEW OF THE COMPONENTS FOUND IN LUNCH BOX AND THE OUTCOME THEY YIELD. NOTICE THAT TESSELLATIONS ARE SET OVER UV POINT-GRID, WHICH ALLOWS HAVING A PREVIEW OF PATTERN ADAPTATION AND DENSITY.	243
FIGURE 192. TOP. MISSING WRAPPING CELLS. BOTTOM. PATTERN COLLECTION. PLEASE REFER TO APPENDIX 9 FOR FURTHER DETAILS.	245
FIGURE 193. RED BOUNDARY. PATTERNS MADE USING MESH+ GENERATE FIVE DIFFERENT PATTERN MORPHOLOGIES. MIDDLE BLUE BOUNDARY. IMPROVED VORONOI GENERATORS INCORPORATE MESH REBUILD FEATURES FOR MESH EXTRUSION. MIDDLE RED BOUNDARY. THE STARFISH PLUGIN IS ADDED TO THE COLLECTION TO GENERATE K-HEDRAL TESSELLATIONS. BOTTOM. REDEFINED WR ENTITY USING THE "ELONGATE TRIANGLE" CLUSTER. (TOP LEFT).....	246
FIGURE 194. TOP AND MIDDLE. COMMON PROPERTIES IN FAB-CELL PATTERNS BUILT WITH MESH+. PLEASE NOTICE THAT CHANGING THE EVALUATE SLIDER CHANGES PATTERN TYPOLOGY. BOTTOM. MORPHOLOGIC REDEFINITION OF A WR ENTITY THROUGH FAB-CELL'S RHOMBITRIHEXAGONAL PATTERN COMPONENT. NOTICE THAT TRIHEDRAL TESSELLATIONS ARE POSSIBLE TO OBTAIN WITH THIS METHOD,.....	247
FIGURE 195. TOP, FROM LEFT TO RIGHT. INSTRUCTIONS FOR PATTERN GENERATION ARE INTRODUCED AS DATA STRINGS CONTAINING THE SIDES NUMBER OF EACH POLYGON (AS INTEGERS). COMBINED STRINGS ARE SEPARATED BY POINTS. BOTTOM. THE TESSELLATION IS APPLIED TO MORPHOLOGICALLY DEFINE A WALL.	247
FIGURE 196. PLANARIZATIONS USING KANGAROO FOR GH. TOP. A PLANARIZATION TEST ON A REGULAR PATTERN AS APPLIED TO A GIVEN WR. WITH THE RIGHT PARAMETERS, THE ADD-ON ACHIEVES THE GIVEN GOALS IN A MATTER OF SECONDS. BOTTOM. WHEN CONSTRAINTS ARE TOO DIFFICULT TO FULFILL THE SOLVING TOOL WILL HOWEVER OUTPUT A MORPHOLOGICALLY AND TOPOLOGICALLY ALTERED GEOMETRY SET.....	248
FIGURE 197. VERTICES OF A TESSELLA ARE TURNED INTO COPLANAR BY PROJECTING THEM ONTO AN AVERAGE PLANE.	249
FIGURE 198. GAPS BETWEEN CELL EDGES AFFECTING EDGE-ADJACENCY. ADJACENCY IS RECOVERED BY CALCULATING THE AVERAGE DISTANCE BETWEEN KNOT POINTS. (CELL-REACOMODATION)	249
FIGURE 199. PLANARIZATION RESULT USING ANEMONE. THE RESULT IS TOPOLOGICALLY DISTANT FROM THE INITIAL CELL-SET.....	249
FIGURE 200. FAB-CELL'S MORPHOLOGIC SOLVER (PLANARIZATION). PLANARIZING FORCES ARE REGULATED BY LOOP COMPONENT THAT DISPATCHES AND TESTS VALUES FOR POSITIVE PLANARIZATION. WHEN THE CORRECT VALUE IS FOUND, ANEMONE STOPS ITERATING AND LETS KANGAROO TO GO ON UNTIL IT COMPLETES THE SOLUTION.	250
FIGURE 201. CELL-COVERS ARE RETRIMMED IN ORDER TO OPTIMIZE FACE PLANARIZATION ON BOTH SIDES OF A WALL.....	251
FIGURE 202. OPENINGS MANAGEMENT FIRST APPROACH. A WR ENTITY CONTAINING DOORS AND WINDOWS VOID DATA IS SPLIT BY PATTERN CURVES. CELLS INHERIT VOID INFORMATION BUT THEY ARE NOT PLANAR.	252
FIGURE 203. OPENING BY COLLISION. TOP. A CAIRO PATTERN OVER A WR ENTITY. A BOOLEAN OPERATOR INTERSECTS THE CELL-SET. BOTTOM. CELLS WITHIN THE BOOLEAN OPERATOR ARE CUT AS NECESSARY TO GENERATE AN OPENING.....	252
FIGURE 204. OPENING BY SURFACE CENTER. CELL IN CONTACT WITH THE BOOLEAN OPERATOR ARE FILTERED. NO CUTS ARE EXECUTED.....	253

FIGURE 205. REBUILT OPENING. THE OPENING'S BOUNDARY IS KEPT AND CELLS ADJACENT TO IT REDEFINED (RED AREA) NOTICE THAT VERY SMALL ITEMS MIGHT APPEAR WHEN EXECUTING THIS COMPONENT.	253
FIGURE 206. DOUBLE PATTERNED CELL-SET EXTRUSION USING PATTERN TOPOLOGY VIA LUNCH BOX.	254
FIGURE 207. CREATION OF A JOINT PROFILE IN A CELL-SET KNOT.....	255
FIGURE 208. JOINT PROFILES EXTRUDED INWARDS A CELL. PROFILE PROJECTION VECTORS ARE PERPENDICULAR TO VRN	256
FIGURE 209. CELL COVER REBUILDING AND JOINT DEFINITION. TOP. CELL-WALL BOUNDARIES ARE USED TO RECOVER CELL-COVER GEOMETRY. BOTTOM. AFTER JOINT PROFILES ARE ADDED, CELL-COVERS ARE EXTRUDED ALONG A CLV VECTOR.	256
FIGURE 210. GAPS ON CELL COVERS. TOP. CELL-WALL JOINTS ARE SUBTRACTED FROM CELL-COVERS. BOTTOM. GAPS ARE ADDED TO CELL-COVER TO FACILITATE COUPLING.....	257
FIGURE 211. TOP. GH INTERNALIZED ENTITY ALLOWING JOINT VERIFICATION. BOTTOM. RHINOCEROS BAKED GEOMETRY ALLOWS FOR VISUAL INSPECTION.	257
FIGURE 212. THE CELL SET IS SPLIT AND INDIVIDUAL CELLS ARE ORIENTED OVER A FLAT GRID	260
FIGURE 213. CELL ITEMS ARE SEPARATED, TAGGED AND ORIENTED OVER A FLAT GRID TO FULFILL PRE-NESTING.....	261
FIGURE 214. PRE-NESTED ITEMS ARE ONCE AGAIN REORIENTED INTO STOCKS BY MEANS OF REFERENCE PLANE. NESTING GAPS CAN BE ADJUSTED WITH THE NESTING QUALITY VALUE	261
FIGURE 215. THE SECOND OPTIMIZATION STAGE MAINLY IMPROVES ITEM TAGGING AND REFERENCING. NESTING QUALITY IS HOWEVER NOT BETTER THAN IN THE FIRST VERSIONM THUS THE FIRST VERSION IS KEPT.....	262
FIGURE 216. MACHINING SET UP TEST USING INVENTOR 2016. A CUT OPERATION IS TESTED ON AN ITEM SIMILAR TO THOSE OBTAINED THROUGH FAB-CELL . FOR SUCH DETAILED ITEMS, SWARF OPERATIONS, USING A THIN MILL-END, LOOK PROMISING TOWARDS ACHIEVING COMPLEX CUTS.	262
FIGURE 217. FILTERING MACHINING TASKS FOR PRODUCING COMPLEX MACHINABLE ITEMS.	263
FIGURE 218. KUKA PRC WORKFLOW.	264
FIGURE 219. FAB-CELL 'S FINAL DATA MODEL (SUMMARIZED). PRODUCTION AND MOUNTING PROCESSES SEND FEEDBACK TO GENERATIVE STAGES EVEN BEFORE TACKLING CONSTRUCTION. BUILDING CAN BE ASSESSED BE MEANS OF SIMULATION AND PROTOTYPING IN ORDER TO OPTIMIZE THE BUILDABLE SET WITHIN THE DIGITAL ENVIRONMENT.	265
FIGURE 220. TOP. FOREST LOSS OVER A 14 YEAR PERIOD (2000-2014). BOTTOM. FOREST LOSS OVER THE SAME PERIOD. NOTICE THAT REFORESTED AREAS OCCUR SPECIALLY ON THE NORTHERN HEMISPHERE, CONVERSELY, TROPICAL AND SUBTROPICAL AREAS TEND MORE TO A LESS SUSTAINABLE BEHAVIOR AS REFORESTATION HAPPENS ON A MUCH SMALLER SCALE. (MARGONO ET AL., 2014). IMAGES FROM HTTP://WWW.GLOBALFORESTWATCH.ORG	280

LIST OF TABLES

TABLE 1. CLASSIFICATION OF CNC MACHINES AND INDUSTRIAL ROBOTS BY AXIS NUMBER AS POTENTIALLY USED IN CONSTRUCTION AND ARCHITECTURAL RESEARCH.....	114
TABLE 2. MOST USED CAD/CAD AND CAD/CAM FILE EXCHANGE FORMATS IN DIGITAL DESIGN-TO-FABRICATION WORKFLOWS.....	125
TABLE 3. MO-LIKE SOFTWARE	128
TABLE 4. BASIC COMPOSITION OF ANHYDROUS WOOD. AS ADAPTED FROM (GUITARD AND POLGE, 1987). .	148
TABLE 5. HARDWOODS AND SOFTWOODS AS ADAPTED FROM (BIGNON, 1984; GUITARD AND POLGE, 1987; IUCN, 1998B; MEIER, 2016; SINCHI, 2006; VERCEY AND BIGNON, 1998; WIEMANN, 2010)	152
TABLE 6. MOST USED WOOD-BASED CONSTRUCTION SYSTEMS, AS ADAPTED FROM (AMERICAN FOREST & PAPER ASSOCIATION, 2003; BENOIT AND PARADIS, 2009; C.R.I.T, 2013; DENANCÉ ET AL., 2000; GREEN ET AL., 2012; SHERWOOD AND STROH, 1989; STEIN AND STORTI, 2006; WACKER, 2010)	163
TABLE 7. MOST COMMON WOODWORKING JOINTS AS ADAPTED FROM (BULLAR, 2013; CAMPBELL, 2015; ZWERGER, 1997). ILLUSTRATIONS O.G.....	170
TABLE 8. PROTOTYPE-MAKING GENERAL FACTS	222
TABLE 9. FAB-CELL FIRST EVOLUTION STAGE.....	224
TABLE 10. PROTOTYPING ACTIVITIES FROM CONCEPTION TO PRODUCTION.	229
TABLE 11. CAD/CAM/FABRICATION PROCESS FOR FAB-CELL FIRST PROTOTYPE PRODUCTION.	234
TABLE 12. CREATING AND APPLYING PATTERNS WITH PANELING TOOLS.	243
TABLE 13. FAB-CELL VOLUMETRIC MODIFIERS	254
TABLE 14. IN-CELL SOLUTION DEVELOPMENT. EVOLUTIVE COMPARISON BETWEEN STAGES ONE AND TWO..	258
TABLE 15. SUMMARY OF DIGITAL TOOLS AS EMPLOYED DURING FAB-CELL'S DEVELOPMENT	304
TABLE 16. DIGITAL TOOS AS USED FOR TESTING AND EXPLORING GENERATIVE AND PRODUCTION ALTERNATIVES	305

INDEX

A

Aided-Conception Parametric Tool (ACPT), 172
Architecture
A complex computing system. I.e. Software architecture, 127

B

Beech
(French - Hêtre), 153
Bending (wood)
(French - Cintrer, courber), 119
Bug
An error within a computing program that causes unexpected malfunctioning, 224

C

CLT
(French - Panneaux contrecollés en bois massif), 159

D

Density
Mass per unit volume. Compactness measure., 148
Douglas Fir
(French - Douglas), 154
Dovetail
(French - Queue d'aronde), 172

E

ENSAN, 222
ENSTIB, 222
European spruce
(French-Épicéa), 154
European Sycamore
(French - Érable Sycomore), 153

F

Fir
(French-Sapin), 154
Force

Kangaroo- Any variable whose parameters affect the solution of a goal., 248

G

Gantry robot
A heavy duty robot type for large operations. It is usually mounted on longitudinal and transversal beams for X and Y axis movement. Z-axis displacement is given by the height of lateral pillars supporting the y-axis beam., 105
Glulam
(French - Bois Lamellé-collé BLC), 159
Goal
kangaroo- Problem-solving constraint container defining the boundaries of a given problem., 248
Growth rings
(French - Cernes), 157

H

Hardwood
Angiosperm trees. (French - Bois feuillu), 151
Heartwood
(French - Duramen), 156

I

Inner bark
(French - Écorce interne (Liber)), 157
Internalise
GH data internalisation consists in stocking data within a generic component to convert it into non-iterative data., 241

J

Ja
Cell joint axis, 255
Jointing
A junction, created by combined effort, of two or more objects. (French - Assemblage), 165

K

Kernel
Essential subset of a programming language (French - Noyau), 136

L

Larch

(French- Mèlèze), 154

List, 132, 254

Log

The trunk of a tree with all branches removed.

(French- Grume), 148

M

Mahogany

(French – Acajou), 153

O

Oak

(French - Chêne), 153

Outer bark

(French - Écorce externe (Rythidome)), 157

P

Parent

An object that controls one or more children. A parent object is often controlled by another superior parent object., 129

Pattern (Geometric)

Synonym of tessellation. Geometric arrangement subdividing a plane into smaller units or tesellas. (French -motif), 85

Plywood

(French - contreplaqué), 160

ProBoolean

A Boolean routine allowing multiple object combination, 129

R

Robot

From Czech Robota (work), 6, 74, 99, 109, 110, 114, 121, 126, 228, 229, 234, 235, 239, 262, 263

Rosewood

(French - Palissandre), 153

S

Sapwood

(French – Aubier), 156

Sheathing

(French - contreventement), 161

Softwood

Gymnosperm trees, mostly conifers. (French - Bois résineux), 151

Sweet Chestnut

(French - Chataignier), 154

Sycamore

(French-Sycomore), 153

T

Teak

(French - Teck), 153

Tessellation

Collection of tiles that conform regular or irregular geometric patterns. (French - tessellation/motif), 56

U

UML

Unified Modeling Language, 76, 89

Y

Yellow poplar

(French-Peuplier), 154