



HAL
open science

Contribution to evaluation and optimal configuration of distributed energy systems based on industrial waste heat recovery

Feng Huang

► **To cite this version:**

Feng Huang. Contribution to evaluation and optimal configuration of distributed energy systems based on industrial waste heat recovery. Electric power. Université Paul Sabatier - Toulouse III, 2016. English. NNT : 2016TOU30297 . tel-01688126

HAL Id: tel-01688126

<https://theses.hal.science/tel-01688126>

Submitted on 19 Jan 2018

HAL is a multi-disciplinary open access archive for the deposit and dissemination of scientific research documents, whether they are published or not. The documents may come from teaching and research institutions in France or abroad, or from public or private research centers.

L'archive ouverte pluridisciplinaire **HAL**, est destinée au dépôt et à la diffusion de documents scientifiques de niveau recherche, publiés ou non, émanant des établissements d'enseignement et de recherche français ou étrangers, des laboratoires publics ou privés.

Université Fédérale



Toulouse Midi-Pyrénées

THÈSE

En vue de l'obtention du

DOCTORAT DE L'UNIVERSITÉ DE TOULOUSE

Délivré par :

Université Toulouse 3 Paul Sabatier (UT3 Paul Sabatier)

Faculty of Urban Construction and Environmental Engineering, Chongqing University (CQU)

Présentée et soutenue par :

Mme HUANG Feng 黄锋

le 24 décembre 2016

Titre :

Contribution à l'évaluation et à la configuration optimale des Systèmes à
Energie Distribuée basés sur la Récupération de Rejets de Chaleur
Industrielle

Contribution to evaluation and optimal configuration of Distributed Energy
Systems based on industrial waste heat recovery

École doctorale et discipline ou spécialité :

ED MEGEP : Energétique et transferts

Unité de recherche :

Laboratoire PHASE

Directeur/trice(s) de Thèse :

Prof. ZHENG Jie (CQU) &

Prof. THELLIER Françoise assisted by Dr. BALEYNAUD Jean-Michel (UT3-PS)

Jury :

Mme. LIU Shuli, Professeur, Coventry University (Royaume Uni)

M. YUAN Yanping, Professeur, Southwest Jiaotong University (Chine)

Mme. THELLIER Françoise, Professeur, PHASE, UT3 - Paul Sabatier (France)

Mme. ZHENG Jie, Professeur, Chongqing University (Chine)

M. LU Jun, Professeur, Chongqing University (Chine)

Mme. WU Weilan, Ingénieur de Recherche, China CMCU Engineering (Chine)

Title: *Contribution to evaluation to optimal configuration of Distributed Energy Systems based on industrial waste heat recovery*

ABSTRACT

Nowadays, industry accounts for about a third of the world's total energy consumption and 36% of CO₂ emissions. Based on the current developing status of industry, substantial opportunities should be seized to improve global energy efficiency and energy utilization, particularly in industrial parks to fulfill the responsibilities of environmental protection and the achievement of economic development. Distributed Energy System (DES) is generally adopted as the energy infrastructure of the industrial park for meeting various energy demand of industrial production and daily working. Energy cascade utilization is core principle in designing and operating DES project, which enables high-grade energy to be preferentially used in meeting high-grade energy requirement rather than meeting low-grade energy requirement. As the development of waste heat recovery technologies, more low-grade waste heat can be recovered to improve gross energy efficiency of DES, providing more opportunities to reduce primary energy consumption.

A review of waste heat recovery - a critical solution of waste energy disposal - is made in order to show the current status of heat recovery potentials and the technologies available in industry. The concept of industrial waste heat is defined, potential sources of waste heat in industry are determined and a conclusion is reached. Then, the technologies available for waste heat recovery are classified as heat pumps, heat exchangers, heat pipes, boilers, refrigeration cycles, power cycles and heat storage according to the mode of transfer of waste heat within the recovery process. Moreover, the opportunities for waste heat recovery both in developed and developing countries are discussed in order to determine the benefits of heat recovery as well as to carry out a general survey of the development of heat recovery technologies globally.

CCHP-DH system is proposed to broaden and deepen the principle of energy cascade utilization. It is illustrated in detail that how to realize energy cascade utilization in the industrial park. With the development of waste heat recovery

technologies, the concept and principle of energy cascade utilization has been extended leading to more and more patterns of manifestation of DES. Circulating cooling water from power plant, waste heat from absorber and condenser of absorption refrigerators are identified as available and feasible waste heat sources of DH in this study. Therefore, serial arrangement, parallel arrangement and mixed arrangement of multiple waste heat sources are proposed to integrate waste heat sources to CCHP system to form new CCHP-DH system. The application rules of multiple waste heat sources arrangement are illustrated in detail with the involvement of thermal storage to fit the seasonal change between heating season and non-heating season. Besides, alternative heat source of low-pressure steam from the steam pipe of refrigeration station is suggested as backup and peak-shaving heat source of DH in heating season.

Several configurations of DES plants devoted to industrial parks are simulated and compared. They are corresponding to various operative modes of an extended DES representing an existing plant under development in Liangjiang industrial park (China) whose programmed and potential extensions are taken into account and experimented in this study. The static simulation was constructed in a modelling environment based on the optimization method of Pinch Analysis. To begin with, optimal configurations of multiple waste heat sources for DH, i.e. serial, parallel and mixed arrangement of waste heat sources of CCHP-DH are analyzed to compare the treatment of waste heat sources using compression heat pumps (so-called V00 in serial arrangement and V01 in parallel arrangement) to the treatment of waste heat sources, based on operational flexibility of absorption refrigerator and thermal power plant condenser to increase the temperature of waste heat sources associating with the extraction of a certain amount of LP steam, using heat exchangers for DH (so-called V02). It is demonstrated V00 and V01 have the similar performance which perform better than the model V02 based on techno-economic analysis.

Then, considering the possible operating modes of DES project to meet the real industrial energy demand, CCHP-DH (V01), CCHP (V1), CHP-DH (V21) and CHP (V3) models are proposed to compare the energy, economic and environmental performance of different models. In terms of energy performance, Gross Energy

Efficiency and Heat to Power Ratio are employed to perform comparative analysis, respectively; In the process of economic performance analysis, two status of the installation of DES are considered: 1) different operative models of DES are installed according to different configurations of DES; 2) different operative models of DES are installed in the unique configuration of CCHP-DH, provided that CCHP-DH system is completely installed but actual operation is based on different models of DES. All the Payback Periods of any model are less than 9 years mainly as each system is assumed to operate at 100% load resulting in high power output of each unit. Besides, sensitivity analysis of the price of DH is performed considering the investment motivation of investors as well as the purchase will of end-users, so the price of energy product should not be lower than an acceptable limit considering the investment profit and not be higher than the end-users' expectation and receptivity; In terms of environmental performance, two aspects are considered: a) one is the distribution of air pollutants of gas-steam combined cycle power plant, the possible victims are identified using the software FLUENT in different heights based on local wind condition; b) the other is the influence of global warming caused by the emission of final waste heat to the environment. By comparing different models, CCHP-DH (V01) has the least waste heat emission to the environment.

The indicators of 3E (Energy, economic and environmental) evaluation are reviewed, respectively. Among those indicators, Gross energy efficiency, Total investment, Electricity Gas Rate and CO₂ emission are decided to be integrated to comprehensive performance evaluation of DES. In the process of comprehensive performance evaluation, Outside Boundary (OB) analysis and Inside Boundary (IB) analysis are proposed to evaluate DES system. In OB analysis, three-dimension OB analysis is proposed to show the general performance of DES system without considering the process energy conversion and economic investment detail. It potentially shows more favorable and feasible option by comparing potential configurations of the project. As shown in analysis results, V01 has the most favorable performance. In Inside Boundary (IB) analysis, relative 3E index I'_{3E} is

introduced to evaluate DES comprehensively considering 3E performance. The main steps of the derivation of I'_{3E} are illustrated including process energy intensity, process GHG intensity and recovered waste heat ratio. Waste heat recovery has a promising impact on comprehensive performance of DES system. When waste heat recovery is excluded, model V01 and V02 perform better than base case, however, when waste heat recovery is included, more models of V21 and V22 perform better than base case. IB analysis is beneficial to detect the process improvement precisely, while relative 3E index I'_{3E} is greatly influenced by process performance, so more attention should be paid to the work of data collection of each process as the data quality of each process will decisively influence the final output.

Finally, as the development of DES requires the participation of multiple stakeholders with different interests, barrier evaluation is performed using Stakeholder analysis to identify the core stakeholders in different stages of DES project. Consequently, the Owner/Operator of Power Plant, Primary Energy Provider and Power Grid Controller are identified to be core stakeholders during the life cycle in this DES project, so their interests should be seriously considered in each process of developing DES project.

Key words: Distributed Energy System; Industrial waste heat recovery; District Heating; 3E performance; Barrier Evaluation.

Titre: *Contribution à l'évaluation et à la configuration optimale des Systèmes à Energie Distribuée basés sur la Récupération de Rejets de Chaleur Industrielle*

ABSTRACT

De nos jours, l'industrie représente environ un tiers de la consommation totale d'énergie dans le monde et 36% des émissions de CO₂. Compte tenu de l'état actuel de développement de l'industrie, il conviendrait de se saisir d'opportunités conséquentes pour améliorer l'efficacité énergétique mondiale et l'utilisation de l'énergie, en particulier dans les parcs industriels, pour assumer les responsabilités de protection de l'environnement et de développement économique. Le système d'énergie distribuée (SED) est généralement adopté comme infrastructure énergétique de parc industriel afin de répondre aux diverses demandes énergétiques de production industrielle au quotidien.

L'utilisation des cascades énergétiques est le principe fondateur de la conception et du fonctionnement des projets SED, permettant d'utiliser préférentiellement une énergie de haute qualité pour répondre à une exigence énergétique de haut niveau plutôt que de la consacrer à une demande de faible qualité énergétique. Le développement des technologies de récupération de chaleur résiduelle permet de revaloriser davantage de chaleur de bas niveau, ce qui améliore l'efficacité énergétique globale des SED, ainsi que des solutions de réduction de la consommation d'énergie primaire.

Une revue bibliographique de la revalorisation de la chaleur perdue - solution essentielle à l'élimination des rejets énergétiques - est effectuée afin de montrer l'état actuel des potentiels de revalorisation de la chaleur et des technologies disponibles dans l'industrie. Le concept de rejet de chaleur industrielle est défini, les sources potentielles de chaleur résiduelle dans l'industrie sont déterminées et une conclusion est formulée.

Les technologies disponibles pour la récupération de chaleur résiduelle sont classées en tant que pompes à chaleur, échangeurs de chaleur, caloducs, chaudières,

cycles de réfrigération, cycles de puissance et stockage de chaleur selon le mode de transfert mis en œuvre dans le processus de revalorisation.

De plus, les possibilités de revalorisation de la chaleur inutilisée, tant dans les pays développés que dans les pays en développement, sont discutées afin de déterminer les avantages de la récupération de la chaleur et d'effectuer une étude générale de l'évolution des technologies de revalorisation de la chaleur au niveau mondial.

Le système CCHP-DH est proposé pour élargir et approfondir le principe de l'utilisation de la cascade d'énergie. Il est illustré en détail comment réaliser l'utilisation de la cascade d'énergie dans un parc industriel. Avec le développement des technologies de récupération de chaleur résiduelle, le concept et le principe de l'utilisation de la cascade d'énergie a été étendu conduisant à un développement croissant de SED. L'eau de refroidissement de la centrale thermique, la chaleur résiduelle de l'absorbeur et celle de condensation du réfrigérateur à absorption sont identifiées comme étant des sources de chaleur résiduelles disponibles et viables dans l'objectif de DH de cette étude. Ainsi, un arrangement sériel, un arrangement parallèle et un arrangement mixte de récupération de plusieurs sources de chaleur résiduelles sont proposés pour leur intégration au système de CCHP pour l'application chauffage urbain CCHP-DH. Les règles de disposition de sources de chaleur résiduelles multiples sont illustrées en détail en y incluant un stockage thermique permettant l'adaptation aux transitions saisonnières. En outre, la source de chaleur alternative offerte par la vapeur à basse pression est envisagée comme source de chaleur de secours et de contrôle des pics de demande de DH pendant la saison de chauffage.

Plusieurs configurations d'installations de SED dédiées aux parcs industriels sont simulées et comparées. Elles correspondent à divers modes opératoires d'un SED étendu représentant une usine existante en développement dans le parc industriel de Liangjiang (Chine) dont les extensions programmées et potentielles sont prises en compte et expérimentées dans cette étude. La simulation statique a été construite dans

un environnement de modélisation basé sur la méthode d'optimisation dite du Pincement.

Pour commencer, des configurations optimales de plusieurs sources de chaleur résiduelle pour DH, c'est-à-dire des dispositions en série, parallèle et mixte de sources de chaleur résiduelles de CCHP-DH sont analysées pour comparer le traitement des sources de chaleur résiduelles avec des pompes à chaleur à compression (dénommées V00 en série et V01 en parallèle) au traitement des sources de chaleur résiduelles à l'aide d'échangeurs de chaleur associés à l'extraction d'une certaine quantité de vapeur de LP (appelée V02). Il est démontré que V00 et V01 ont sensiblement la même performance et qu'ils fonctionnent mieux que le modèle V02 selon l'analyse techno-économique faite.

Les modèles CCHP-DH (V01), CCHP (V1), CHP-DH (V21) et CHP (V3) sont ensuite proposés pour comparer les énergies, les économies et la performance environnementale de différents modèles. En termes de performance énergétique, l'efficacité énergétique brute et le rapport chaleur-puissance sont utilisés comme indicateurs de l'analyse comparative. Respectivement; dans le processus d'analyse de performance économique, on considère deux étapes de l'installation de SED: 1) différents modèles opératoires de SED sont installés selon différentes configurations de SED; 2) différents modèles opératoires de SED sont installés dans la configuration unique de CCHP-DH, à condition que le système CCHP-DH soit complètement installé à terme, mais que le fonctionnement réel soit basé sur différentes configurations de SED. Les temps de retour sur investissement de tous les modèles sont inférieurs à 9 ans, principalement parce que chaque système est supposé fonctionner à pleine charge, correspondant à la génération de puissance électrique maximale de chaque unité.

En outre, l'analyse de sensibilité du prix de DH est effectuée en tenant compte de la volonté d'investissement des investisseurs ainsi que la volonté d'achat des utilisateurs finaux, de sorte que le prix du produit énergétique ne devrait pas être inférieure à une limite acceptable compte tenu du profit d'investissement et ne pas être

plus élevé que les attentes et la réceptivité des utilisateurs finaux. En termes de performance environnementale, deux aspects sont pris en considération: a) la distribution des polluants atmosphériques de la centrale à cycle combiné gaz-vapeur: les éventuels préjudices causés par la centrale aux populations environnantes sont identifiées à l'aide du logiciel FLUENT à différentes altitudes en fonction des vents; B) l'influence de l'émission de chaleur résiduelle finale vers l'environnement qui influe sur le réchauffement climatique.

La comparaison de différents modèles fait apparaître que: CCHP-DH (V01) émet le moins de rejets vers l'environnement. Les indicateurs de l'évaluation 3E (Énergétique, Économique et Environnemental) sont considérés. Parmi ces indicateurs, l'efficacité énergétique brute, l'investissement total, les tarifs de gaz et d'électricité et les émissions de CO₂ sont choisis pour faire partie intégrante de l'évaluation globale de la performance des 36SED. Dans le cadre de l'évaluation globale des performances, les conditions aux limites de l'analyse: extérieures (OB) intérieures (IB) sont proposées pour évaluer le système SED. Dans l'analyse OB, une analyse tridimensionnelle est effectuée pour évaluer la performance générale du système SED sans tenir compte de la conversion de l'énergie du processus ni du détail des investissements économiques. Il en ressort la mise en évidence de l'existence d'une option plus favorable et plus réalisable que les autres parmi les configurations potentielles du projet. Ainsi que le montrent les résultats de l'analyse, V01 a la performance la plus encourageante. Dans l'analyse interne (IB), l'indice 3E relatif est introduit pour évaluer le système SED par considération globale de sa performance 3E.

Les principales étapes de la dérivation de l'indicateur sont illustrées, y compris l'intensité énergétique du procédé, l'intensité de GHG du procédé et le taux de chaleur résiduelle récupérée. La récupération de chaleur a un impact prometteur sur la performance globale du système SED. Hors récupération de chaleur perdue, les modèles V01 et V02 obtiennent de meilleurs résultats que le cas de base, cependant, lorsque la récupération de la chaleur rejetée est incluse, les modèles V21 et V22 obtiennent de meilleurs résultats que le cas de base. L'analyse IB est précisément

valable pour détecter l'amélioration des processus, tandis que l'indice 3E relatif est fortement influencé par la performance du processus, il faut donc accorder plus d'attention à la collecte de données de chaque processus car elle influence de manière décisive le résultat final.

Enfin, comme le développement des systèmes SED nécessite la participation de multiples parties prenantes ayant des intérêts différents, l'évaluation des verrous potentiels est effectuée par l'examen des parties prenantes afin d'identifier les parties prenantes principales à diverses étapes du projet SED. Ainsi, le propriétaire / exploitant de la centrale, le fournisseur d'énergie primaire et celui qui contrôle le réseau électrique sont identifiés comme étant les principaux intervenants au cours du cycle de vie de ce projet SED, de sorte que leurs intérêts devraient être prioritairement pris en compte dans chaque processus de développement du projet SED.

Une configuration optimale du système SED adaptée pour répondre à la demande énergétique réelle du parc industriel est essentielle pour réaliser un développement efficace et prometteur du projet SED.

Une évaluation globale du rendement est favorable pour l'amélioration de la performance du système, tandis que l'évaluation des verrous permet d'accroître la volonté d'engagement des parties prenantes clés en limitant les principaux conflits et en équilibrant les intérêts fondamentaux afin de promouvoir un développement durable du projet SED sur l'ensemble de son cycle de vie.

Mots-clés: Système à Energie Distribuée; Revalorisation des Rejets de Chaleur Industrielle; Chauffage Urbain; Performance 3E; Evaluation des Verrous.

ABSTRACT

CONTENTS

ABSTRACT.....	3
ABSTRACT.....	7
CONTENTS.....	13
1 Introduction.....	5
1.1 Background.....	5
1.2 Waste heat recovery in industrial parks	8
1.2.1 Definition of waste heat	8
1.2.2 Sources of industrial waste heat.....	8
1.2.3 Industrial heat recovery technologies	9
1.3 Heat recovery opportunities and perspectives in industry	19
1.3.1 Industrialization impacts on energy consumption and CO ₂ emission	19
1.3.2 Heat recovery opportunities in the developed countries.....	20
1.3.3 Heat recovery opportunities in the developing countries	22
1.3.4 Perspectives of waste heat recovery in industry	23
1.4 Case studies in Asian countries.....	24
1.5 Research contents and technical roadmap	29
1.5.1 Research contents.....	29
1.5.2 Technical roadmap.....	30
2 Optimal configuration of waste heat sources of CCHP-DH based on energy cascade utilization.....	35
2.1 Energy cascade utilization in industrial parks	35
2.1.1 New energy-driven CCHP	37
2.1.2 New technology-coupled CCHP.....	44
2.2 Description of CCHP-DH system.....	48
2.3 Optimal configuration of waste heat sources.....	49
2.3.1 Waste heat sources of CCHP system	49

CONTENTS

2.3.2 Optimal configuration of multiple waste heat sources	53
2.3.3 Low pressure steam used as peak shaving and backup heat source	55
2.4 Conclusions.....	57
3 Comparative performance analysis of different configurations of DES system.	63
3.1 Pinch analysis.....	63
3.1.1 Methodology	63
3.1.2 Utility system	64
3.2 Introduction to THERMOPTIM software	64
3.3 Case study	66
3.3.1 Background	66
3.3.2 Energy demand of industrial park.....	70
3.3.3 Main equipment	71
3.3.4 Gas-steam combined cycle unit	72
3.4 Comparison of optimal configuration of waste heat sources.....	76
3.4.1 Model description	76
3.4.2 Simulation results.....	80
3.5 Comparative analysis based on different configurations of DES	81
3.5.1 Model description	82
3.5.2 Energy performance of different configurations of DES.....	85
3.5.3 Economic analysis of different configurations of DES	87
3.5.4 Environmental analysis of different configurations of DES.....	91
3.6 Conclusions.....	95
4 Comprehensive performance evaluation of DES system.....	101
4.1 Importance of 3E evaluation in DES system	101
4.2 Application of 3E evaluation in DES system	102
4.2.1 Energy evaluation indicator	102
4.2.2 Economic evaluation indicator	105
4.2.3 Environmental evaluation indicator	107

CONTENTS

4.3 Comprehensive performance evaluation of DES based on coordination of 3E performance	108
4.3.1 Interaction of 3E performance in DES system	108
4.3.2 How to coordinate 3E performance	111
4.4 Conclusions.....	119
5 Barrier evaluation of the development of DES project.....	127
5.1 Stakeholder analysis.....	127
5.2 Barriers and problems of the development of DES project	134
5.3 Suggestions on promoting the development of DES	136
5.4 Conclusions.....	137
6 Conclusions and prospects	143
6.1 Conclusions.....	143
6.2 Main innovation points	146
6.3 Prospects for the future research.....	148
References.....	151
Acknowledgments.....	162
Annex-A Simulation model of DES system in THERMOPTIM.....	164
Annex-B Simulation results of pollutant distribution of chimney of power plant using FLUENT.....	165
Annex-C Glossary of acronyms	173

CONTENTS

Résumé Français du Chapitre 1 Introduction

Dans le premier chapitre qui constitue une revue de l'état de l'art dans le domaine de la revalorisation des chaleurs rejetées qui comprend une analyse critique de la nature des énergies fatales, est développé un inventaire destiné à mettre en évidence l'état actuel des potentiels de récupération ainsi que des technologies disponibles dans l'industrie.

Pour débiter cette présentation, les différentes ressources énergétiques sont passées en revue, telles qu'analysées dans la bibliographie, en termes de potentialité dans un contexte de développement durable, sous les angles techniques et socio-économiques.

La diversification des ressources et leur combinaison y apparaissent en tant que contexte de base de la fourniture de l'énergie requise pour les applications nécessaires à la vie moderne.

Le concept de rejet industriel est défini, les sources de chaleur rejetée potentiellement valorisables sont identifiées et une conclusion proposée. Les technologies disponibles pour la récupération de la chaleur rejetée comptent les pompes à chaleur, les échangeurs de chaleur, les caloducs, les bouilleurs, les cycles de réfrigération, les cycles de puissance et le stockage de chaleur suivant le mode de transfert de la chaleur rejetée au sein du processus de récupération.

Les sources potentielles de récupération et de revalorisation offertes par les rejets industriels sont proposées, ainsi que des applications pratiques d'ores et déjà expérimentées.

Ainsi la figure suivante, regroupe les solutions qui peuvent être mises en œuvre pour la valorisation des énergies qui sont pour l'instant au statut "pertes fatales".

Les technologies applicables sont passées en revue, des composants passifs de transfert de chaleur aux systèmes actifs intégrables dans les réseaux de conversion de l'énergie, appuyée sur une abondante bibliographie scientifique et industrielle récente. Les avantages et limites des solutions en ressource sont envisagées au cas par cas et une estimation de leur pertinence dans un contexte donné, est proposée.

Plus encore, les potentiels de récupération d'énergie sont discutés en fonction du niveau de développement des pays, afin de d'évaluer les bénéfices de la récupération de chaleur et de mettre en œuvre une étude globale du développement des technologies de récupération de chaleur.

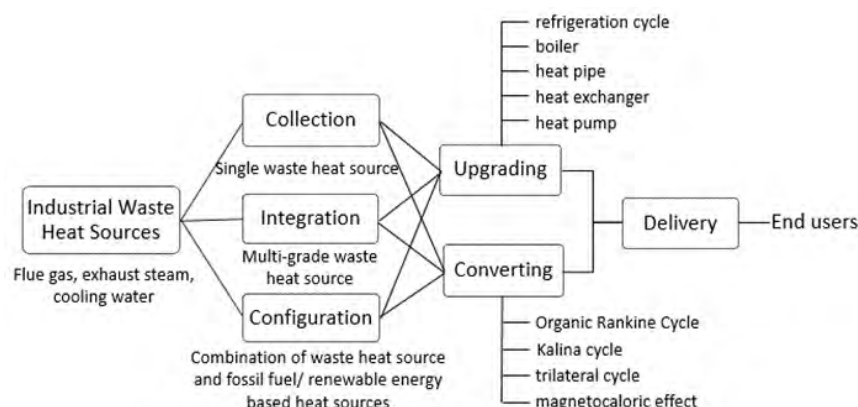

Enfin est proposé un aperçu des travaux de recherche les plus typiques dans le domaine des rejets industriels dans les pays Asiatiques et plus spécifiquement en Chine, afin de mettre en évidence la performance de la pratique en ingénierie. Parmi ces avancées, certaines connaissent des mises en applications à l'échelle industrielle, s'appuyant sur les plans mis en place par le gouvernement chinois et concrétisant les solutions dans une série d'installations pilotes.

Le contexte des parcs industriels est présenté, de sa fondation aux Etats Unis dans les années cinquante à la dissémination de cette forme de concentration d'activités de part le monde. Cette configuration permet la mutualisation des ressources et également la redistribution des matières et énergies entre les centres d'activité voisins.

Dans un objectif de développement durable et compte tenu de la part des processus industriels dans la consommation globale des pays développés, il apparaît pertinent de faire porter les efforts davantage sur l'amélioration de l'efficacité des procédés que sur une simple réduction de la quantité de l'énergie mise à disposition. La réduction de la demande découlant d'un meilleur usage de l'énergie consommée, notamment par la mise en œuvre de procédés destinés à limiter les rejets, découle de la même problématique et en est tout à fait complémentaire.

Basée sur ces constats, est présentée la feuille de route qui a été suivie au cours des travaux de recherche et reprise dans leur exposé qui suit dans ce manuscrit. Ainsi seront successivement abordés :

- *l'utilisation des cascades énergétiques dans les parcs industriels;*
- *l'étude par simulations comparées de différentes configurations de Systèmes à Energie Distribuée;*
- *l'évaluation globale de la performance et analyse des verrous au développement des Systèmes à Energie Distribuée.*

Mots-clefs : *Systèmes à énergie distribuée; utilisation des cascades énergétiques; récupération de chaleur industrielle; Analyse Totale de Site; évaluation 3E; Parc industriel*

1 Introduction

1.1 Background

Energy is the driving force of the development of global and national economies, so the world energy crisis has brought enormous economic losses globally due to over-exploitation and over-use of energy. Even so, the overall energy consumption has never been cut by lowering the energy for manufacturing and living requirements, thus it is necessary to improve the energy efficiency rather than reduce basic energy for production. Nowadays, industry accounts for about a third of the world's total energy consumption and 36% of CO₂ emissions [1]. It was reported by IEA that, based on the level of 1971, industrial energy consumption had increased by 61% in 2004, caused by the rapidly increasing energy demand of developing countries. In practice, the energy cannot be totally converted into useable heat or power in industrial processes due to the limited conversion efficiency of the equipment. Ideally, it would be most profitable to recover the waste heat as fully as possible without extra cooling or heating from a utility system [2]. At the beginning of industrialization, industrial activities were restricted to isolated individual plants and each plant was generally equipped with a separate energy and material supply system. Since 1950, the practice of industrial parks was firstly launched in the United States, one well known example being Silicon Valley. The characteristics of an industrial park differ from independent industries or factories in that all plants located in the same zone could share a common energy system and infrastructure, which may reduce the construction investment and operational costs [3, 4]. As industrial systems evolved and became upgraded, along with the energy efficiency and environmental protection requirements, the concept of Eco-industrial Park emerged and has been rapidly and vigorously applied to the design and construction of industrial parks [5-8]. Although most industrial parks and industrial symbiosis practices have been successful, some installations suffered from suspended operation for consolidation, or production shut down to improve environmental standards (domestic and overseas) or due to the

global effects of world economic restructuring [9]. However, based on the current developing status of industry, substantial opportunities should be seized to improve global energy efficiency and energy utilization, particularly in industrial parks to fulfill the responsibilities of environmental protection and the achievement of economic development.

Thus, sustainable development in industry should be achieved by improving energy supply, energy consumption, the amount of waste energy and the conditions of energy rejection. Admittedly, exploiting renewable energy instead of fossil fuels is an efficient way to relieve the environmental burden and energy crisis, contributing to social development. In [10], a comprehensive overview was made to illustrate solar technologies, classified according to the processes of photovoltaic and concentrating solar power generation. More importantly, the influence of using solar energy was evaluated according to current research knowledge in order to provide a reference for evaluating the feasibility and risks of solar technology in the desired areas. In [11], the available wind technologies were discussed and an overview of the performance of wind energy in terms of economic, technical, social and environmental challenges was made to show the potential of wind energy deployment. In fact, hybrid renewable energy systems are more popular in practice compared to the use of a single energy source [12]. Especially in terms of power generation, combining several types of renewable energy together could maximize efficiency by optimizing the configuration [13]. Besides, renewable energy systems with the help of waste heat recovery could be more effective in both improving energy efficiency and relieving environmental pollution [14, 15]. Therefore, the deployment of renewable energy has boosted social sustainability by playing the role of energy supply. However, waste heat recovery is not only a source of useable energy, but also an effective way to recycle waste energy to lower gas emissions and mitigate global warming. As shown in Table 1.1, typical applications of waste heat recovery in the recent literature was reviewed to show the successful practice of waste heat recovery.

Table 1.1

Typical applications of waste heat recovery in the recent literature.

Waste Heat Source	Waste Heat Temperature	Application	Illustration
Flue gas	250°C at the exit	Heat recovery steam generator in waste incineration	Heat exchangers as key equipment in the process [21, 22]
	350°C	Refrigerant vapor output in industries with flue gases	Superheated NH ₃ -H ₂ O vapor was used in cascade [24]
	164 °C	Meet the freezer requirement from 25 to -18 °C in crisps manufacturing plant	Two refrigeration systems were compared in terms of thermodynamic performance [25]
	90~131°C	Replace part of the extraction steam in heating the condensed water to increase work output in coal-fired power plant	Based on the location of condensed water, four typical cases of exhaust utilization have been implemented [26]
	122.8°C	Low-pressure economizer was used for heating feed water in coal-fired power plant with wet stack	Acid corrosion was a key consideration when selecting the optimal scheme among three cases [27]
	200~300°C (165 °C to ORC module)	ORC modules for power generation in ceramic industry	The characteristic is to verify the performance of ORC operating in actual industrial conditions compared to laboratory data [28]
	416°C	ORC model for power generation based on field data in a gas treatment plant	By setting and comparing the basic model and regenerative model for modifying the ORC model in order to decide the most suitable working fluid and the most effective working condition [29]
Exhausted steam	37°C	DH in cogeneration	Due to heat recovery units, the heat capacity increased to 400 MW, satisfying the heat requirement of 6.4 million m ² [30]
Cooling water	8~20°C	Heat pumps for heating buildings based on waste from wastewater treatment	Wastewater shows high and stable temperature compared to the ambient air [31]
	55~85°C	Waste heat for activating adsorption desalination	Heat recovery between the condenser and the evaporator was also considered [23]
Multiple sources	20~90°C	DH based on waste from copper smelter	Waste heat is the basic heat source for DH while the fossil-fuel heat is used for the purpose of the peak shave [20]

1.2 Waste heat recovery in industrial parks

1.2.1 Definition of waste heat

When considering the reuse of waste heat in industry, how waste heat is identified as a potential alternative to primary energy is important for selecting the suitable waste heat recovery technologies. There is a general idea of “waste heat” that it can be regarded as the heat emitted directly into the environment [16]. In an industrial park where high-grade waste heat has already been reused within the processes and across the industries, most waste heat of less than 200 °C is still discarded into the atmosphere [20]. But in fact, there are avoidable and unavoidable waste heats in industrial processes. Due to the restrictions of the second law of thermodynamics and the technologies available, unavoidable waste heat cannot be converted into an avoidable form and the recovery yield of avoidable waste heat depends primarily on the system design and operation. In order to reduce global warming, more attention should be paid to waste heat recovery, so it is important clearly define what waste heat really is. According to the type of carrier medium, the waste heat can be recovered from flue gas, cooling fluids and exhaust steam [17]. Furthermore, exhaust steam is defined as Low Pressure steam (below saturation temperature of 180°C), Medium Pressure steam (saturation temperature from 180°C to 250°C) and High Pressure steam (above saturation temperature of 250°C) in ref. [18] in order to better price the steam for calculating the recovered utility value. In the implementation plan of a waste-heat driven DH (District Heating) project, low-grade waste heat refers to liquid and exhaust steam at less than 100°C, flue gas at less than 200°C, sensible heat of the solid above 400°C and other medium/high-grade waste heat sources not to be fully recovered due to scattered heat sources and high recovery cost [19].

1.2.2 Sources of industrial waste heat

To achieve better performance of heat recovery technologies, it is important to explore the stable and ample waste heat sources for activating and supporting the operation of heat recovery systems. Generally speaking, there are many unexploited

low-grade waste heat sources including flue gas, exhaust steam and cooling water in which temperature levels normally fluctuate. In [18], waste heat was derived from the cold end of the process with the heat being ejected into cold utilities, mainly air and cooling water. Besides, steam at different temperatures from recovered waste heat could generate hot utilities in one plant for transferring to the utility system of another plant at the appropriate level in order to offset the need for utility generation in the plant.

The sustainability of the waste heat resource is also very important to keep the waste energy recovery technology operating in the long term. Generally, waste heat can be reused either internally or externally in the industrial energy process. For the purpose of internal usage, waste heat recovery will increase the energy efficiency of the industrial processes. While for external usage, waste heat recovery may provide the energy motivation for other industrial processes and utility services, whose requirements of energy can be satisfied by low grade energy. So, the target of waste heat recovery should be detailed to maximize internal heat recovery to improve energy efficiency within the main industrial system and to identify the heat recovery potential externally for other energy requirements with the consideration of economic and environmental benefits.

1.2.3 Industrial heat recovery technologies

To capture and reuse the low-temperature waste heat produced by industrial processes and utilities, the suitability and feasibility of waste heat recovery technologies have been analyzed and evaluated as possible solutions for recovering low temperature waste heat, which has been reported as: heat pump, heat exchanger, heat pipe, boiler, refrigeration cycle, power cycle and heat storage. In [17], waste heat recovery was divided into active and passive technologies according to usage planned. Hence, if recovered heat is used directly at the same or a lower temperature, the technology is so-called "passive", and "active" when the heat is converted into other forms of energy or is used at higher temperature. As a result, the technologies of heating and cooling production and power generation are regarded as typical active

heat recovery strategies, while heat exchangers and thermal energy storage are regarded as typical passive heat recovery strategies. However, in this study, waste heat recovery is divided into direct and indirect recovery technologies without considering temperature level, only considering waste heat treatment mode, i.e. whether waste heat is transformed into other type of energy in the process of waste heat recovery. Therefore, heat pump, heat exchanger, heat pipe, boiler and refrigeration cycle are typical direct heat recovery technologies to upgrade the waste heat, while power cycles like Organic Rankine Cycle, Kalina cycle, trilateral cycle and magnetocaloric effect are typical indirect technologies to transform the waste heat into other type of energy like electric and mechanical power [32]. As shown is Fig.1.1, before being delivered to the end users, the industrial waste heat will experience collection, integration or configuration depending on the waste heat process mode and then enter into suitable waste heat recovery equipment.

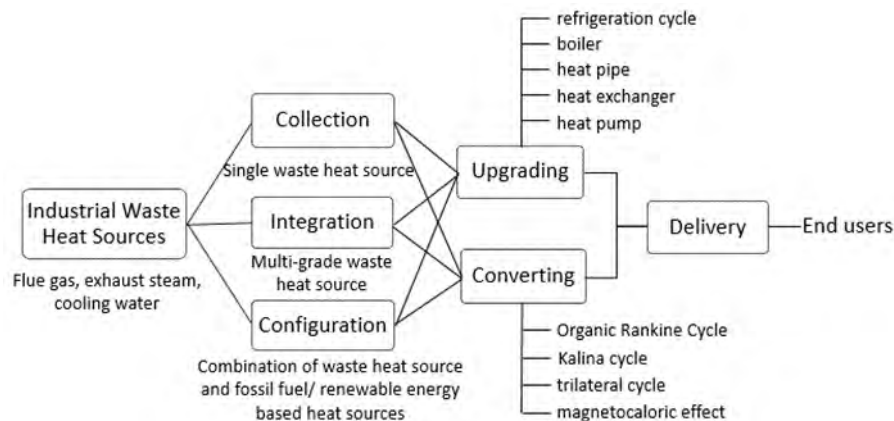

Fig. 1.1 The diagram of industrial waste heat recovery

1.2.3.1 Heat recovery by heat pump

The thermodynamic principle of the heat pump is quite simple. It transfers low-temperature heat to high-temperature heat by consuming some high-quality energy as driving force. It is generally acknowledged that air, surface and underground water, geothermal energy sources, and other renewable energy are available low-temperature heat sources for heat pumps. Besides, the increasing heat contained in exhaust gases and waste water has been considered as an alternative heat

source for heat pumps. According to the operating principle, heat pumps can be known as compression-resorption heat pumps, vapor compression heat pumps and trans-critical heat pumps [32]. Many researchers have focused on theoretical and practical studies of heat recovery using heat pumps. Theoretically, from the point of view of the pinch point [2], heat pumps should be placed across the pinch point to achieve the greatest general efficiency and benefits. While for maximizing the efficiency of recovery by heat pumps, it is necessary to optimize the energy network by identifying the pinch point. Practically, a successful application of heat recovery by heat pumps is the case of DH. The low-grade waste heat is normally unstable and fluctuates with the production level. These outstanding features distinguish low-grade industrial waste heat based DH system from conventional fossil-fueled system, e.g. CHP (Combined Heating and Power) plants and water boilers.

1.2.3.2 Heat recovery by heat exchanger

Heat exchangers are used to transfer heat between the hot fluid and cold fluid in order to meet the technical requirements of industrial processes and production. According to the operational mode of the heat-transfer medium, heat exchangers can be classified as recuperative heat exchangers and regenerative heat exchangers. Besides, the recuperative heat exchangers include dividing-wall heat exchangers and hybrid heat exchangers. The characteristic of dividing-wall heat exchangers is that hot fluid and cold fluid are separated by solid wall without mixing, which is most commonly used in practical applications. Hybrid heat exchangers rely on direct heat transfer between cold and hot fluids in order to avoid the progressive clogging caused by the dividing wall. As for regenerative heat exchangers, heat-conducting porous mass plays an important role in storing the thermal energy, with the advantage that it can be used in a higher temperature environment. Specifically when the operational temperature is higher than 1300°C, regenerative heat exchangers may be the only choice compared to recuperative heat exchangers [33].

In the waste heat recovery system, the heat exchanger is a very important piece of equipment. To recover low-temperature waste heat, recuperative heat exchangers

showed their obvious advantages in heat exchange efficiency. In experimental conditions [34], the heat exchange efficiency reached 83.56% by combining a plate heat exchanger with a thermoelectric generator. Compared to traditional plate heat exchange, the new design involved filling open-cell metal foams in the flow channel which greatly improved the performance of heat transfer evaluated by indicators of heat exchange efficiency and pumping power. Besides, the influence of cold-water flow rate and heated air inlet temperature were analyzed to improve the performance of the heat exchanger.

1.2.3.3 Heat recovery by heat pipe

The heat pipe is an active and effective heat transfer device with simple configuration, fine compactness and without power requirements or movable mechanical parts. Compared to typical heat exchangers, as a device of recovering waste heat, heat pipe can transfer a quantity of waste heat over a long distance by virtue of its high thermal conductivity and environmental adaptability. As shown in Fig. 1.2, a typical application of waste heat recovery from combustion gases uses heat pipes. The end of the heat pipe inserted into the hot waste gas is regarded as the evaporator to recover the waste heat from the flue gas. The heat-carrying medium in the pipe turns from liquid into vapor flowing to the condenser end. The condenser end is embedded into the cold/inlet air and preheats the intake air. The cooled vapor condenses and returns to the evaporator by capillary action. Apart from the evaporator and the condenser, an adiabatic section is also a necessary part in the middle of the heat pipe. It maintains a temperature difference between the evaporator end and the condenser end. The performance of heat pipes mainly depends on the heat transfer rate of the heat pipe which can be improved by broadening the heat pipe and arranging heat pipes inline [38]. Although the increased temperature of hot/ waste gas contributes to the increased heat transfer rate, it is not beneficial because the higher temperature of waste gas also means more heat loss from the combustion process in the furnace. By taking full advantage of heat pipes, about 20% of fuel consumption could be saved in the furnace [39].

In [35], an overview was made of both traditional and modern heat pipes which can be implemented as thermal connections and highly effective heat exchangers in different systems to transfer waste heat. The heat pipe was regarded as the main component of the heat recovery system for improving energy efficiency of the whole system. Besides, in the studies of the same cooperating research teams from Australia and Malaysia [36, 37], it was found that the heat pipes could be combined with a thermoelectric system for generating the power using the waste heat. A new concept of a passive heat transfer system was introduced in their research. It was composed of a thermoelectric generator (TEG) with heat pipes to heat up one side of the TEG by transferring the heat from the lower duct to the upper duct resulting in cooling the other side. A theoretical model was firstly described to provide a good start for understanding the performance of the new system laying the foundation for more detailed experimental analysis. In this system, the energy performance was greatly influenced by the ratio of mass flow rate from the upper duct to the lower duct [36]. Besides, the increase of air face velocity in the cold duct could improve the effectiveness of the heat pipes by recovering more free energy from the industrial waste heat [37].

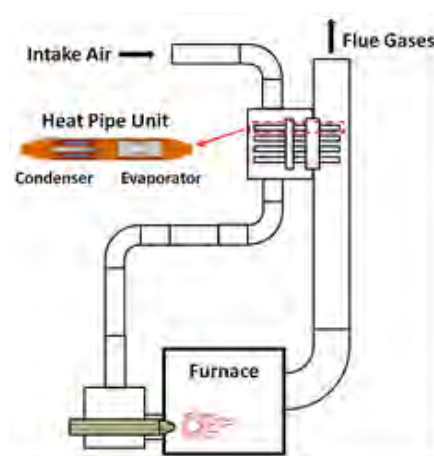

Fig. 1.2 Waste heat recovery using heat pipes [39]

1.2.3.4 Heat recovery by boiler

The temperature of the waste heat from a traditional natural gas boiler is 120~250 °C, which can be the heat source for a heat recovery system. However, due to the energy structural characteristics of the boiler, it is beneficial and practical to recycle the waste heat of boilers within the boiler system. Consequently, a condensing boiler was designed and used to recover the latent heat from flue gases in order to achieve higher efficiencies and less emission than the traditional boiler. Moreover, based on the principle of the existing condensing boiler, some improvements were made to optimize and enhance the performance of the condensing boiler to propose a new condensing boiler schematic [26, 27, 40]. A low temperature economizer is commonly adopted in improved boiler systems to pre-heat boiler feed water and combustion air by substituting the regenerative heater to save the extraction steam [41]. A new waste heat recovery condensing boiler was proposed in [40] where the interesting schematic diagrams of both traditional and new boiler were shown. The air ratio and exhaust gas temperature influences the efficiency of boilers. Analysis based on this fact demonstrated that high performance can generally be achieved when the boiling system is operated with a combustion chamber air inflow ratio approaching 1.0 and the outflow of low-temperature exhaust gas near 50~60°C. The corrosion by flue gas from the boiler of the heat recovery component/equipment is a key issue for recovering low temperature flue gases. It restricts the potential of waste heat recovery at temperatures lower than 90°C in the common boiler applications. So, the condensed water temperature should be lower than the flue gas temperature in the condensing boiler. However, if acid-corrosion resistant materials or more reasonable heat exchange modes are feasible in the waste heat recovery boiler system, greater benefits will be acquired by lower temperature waste heat recovery.

1.2.3.5 Heat recovery by refrigeration cycle

The use of waste heat in refrigeration cycles is possible for making good use of low-grade industrial waste heat. Generally, vapor compression refrigeration, absorption refrigeration and thermoelectric refrigeration are the three main refrigeration cycles, however, the absorption refrigeration cycle is the most readily

available cycle for low-temperature waste heat recovery in industry. A comprehensive review was made in 2001[42] to summarize the various absorption refrigeration technologies in general terms and to illustrate heat recovery between absorber and generator known as GAX (Generator Absorber Heat Exchanger) in detail. It was studied using pinch analysis to maximize the potential of internal heat recovery, but waste heat recovery to activate generator operation was not mentioned in this review. Moreover, in recent decades, the shortage of primary energy and the development of industrialization have pushed ahead the use of industrial waste heat as the driving force of refrigeration cycles not limited to the steam from a boiler. So, it is meaningful to consider the application of heat recovery in refrigeration cycles. It has been noted that a high temperature is required to drive the operation of refrigeration cycles in industrial waste heat applications. Operation of the LiBr-H₂O system requires high temperature heat source such as 85°C or higher for activating single effect system and 150 °C for double-effect system [43]. As for low-temperature heat source, it is necessary to be upgraded to higher level for satisfying the driving demand. If a high-temperature heat source is not available, a mechanically driven heat pump can be added to the refrigeration cycle.

More new refrigeration systems were suggested based on the absorption refrigeration cycles. To satisfy energy requirements for low-temperature cooling, the heat-driven absorption-compression refrigeration system showed more obvious advantage than the traditional absorption system because it is more economical and energy-efficient for low-temperature cooling by the combination of absorption and compression cycles [44]. In [24], a new hybrid refrigeration system was proposed to utilize the flue gases in cascade for generating the refrigerant vapor. Compared to the traditional refrigeration cycles, the proposed one has its advantages in terms of rational strategy of heat source usage and the cascaded use of the mixed working medium vapor. The combination of power and ejector-refrigeration is also an effective way of achieving cooling by recovering the low temperature heat. When more heat was transferred from the power cycle to the ejector cycle, the cooling

efficiency and total energy utilization rate of the system was improved. Increasing the heat source temperature will improve the thermal efficiency and lower the total thermal conductance.

Besides, heat recovery technologies combined with adsorption were explored in industrial applications with the advantage of employing low-grade (60-150°C) heat and the disadvantage of low efficiency and large system size [25]. An adsorption refrigeration system is made up of three main components: adsorbent containers, condenser and evaporator. Under constant pressure, the temperature influences the refrigerant concentration on the adsorbent, so the operating principle of the system is that varying the temperature of the mixture could achieve the process of adsorption and desorption [45].

1.2.3.6 Heat recovery by power cycle

In practice, it is feasible to recover waste heat for power generation in industrial park, which can be used directly on-site in production or transferred to other places for residential users. Many studies focusing on waste heat based power generation have been carried out in different regions case by case [23, 28, 29]. The potential power cycles using low temperature engines for converting the low temperature waste heat into electricity mainly include: Organic Rankine cycle (ORC), Kalina cycle and Trilateral cycle (TLC). Normally, the benefit of power cycles is lower than that of heat pump cycles when the waste heat is at about 60 °C, but this is not always true for higher waste heat temperatures: TLC engines could compete with heat pumps when the available waste heat is around 100°C and the temperature of waste heat for both ORC and Kalina cycle has to be 130°C or higher to compete with heat pumps [32]. The principle and components of power cycles were described in [46] in terms of ORC, KCS11 (Kalina cycle system 11 for power generation with low-temperature waste heat) and TLC cycles. As shown in Fig. 3 a), the basic ORC cycle is composed of an evaporator/heat recovery boiler, a turbine, a condenser and a working fluid pump. The working fluid absorbs the waste heat by heat change in the evaporator. In Fig. 3 b), for all the Kalina cycles, the working fluid is an ammonia-water mixture,

the advantage of which is to have different boiling and condensing temperatures, resulting in lower exergy destruction. In Fig. 3 c), the TLC cycle consists in a pump, a heater, a two-phase expander and a condenser. Compared to the other two cycles, the characteristic of TLC cycle is that it is able to match the expected temperature profile on the source and sink sides of the cycle.

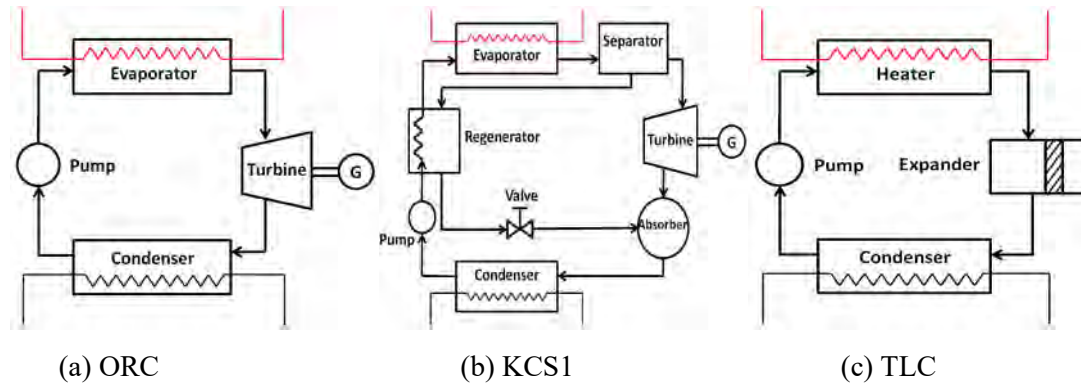

Fig. 1.3 Schematic diagram for basic power cycles [46]

The practice of using power cycles for recovering industrial waste heat of medium to high temperature has made great progress in recent years [29, 47]. However, for recovering the waste heat lower than 200 °C, several key issues should be addressed to ensure that the power cycles operate efficiently. Many studies have focused on the performance of the working fluid in operating the ORC cycle, which plays a significant role in the successful operation of ORC cycles [48]. Besides, it is necessary to improve the evaporator/heater efficiency for absorbing the industrial waste heat effectively. Additionally, lack of standardization of the actual application in the design and operation of power cycles with low temperature waste heat makes it difficult to assess the technical feasibility and economic viability of power cycles. In fact, waste heat recovery by power cycles is capital-intensive and less effective. When the temperature of waste heat is between 85°C and 116°C, the net conversion factor varies from 6.62% to 7.57%, while with the waste heat higher than 116°C, the net conversion factor may reach 10% but in theory less than 20% [49]. Therefore, it was concluded that only when the plan of employing the power cycles based on industrial

waste heat was considered in depth and when no other technologies are available to recover the waste heat, power cycles could be adopted [50].

1.2.3.7 Heat storage in industrial waste heat recovery

Stable and sufficient waste heat sources are important to promote the development of technologies for recovering more waste heat. Due to the availability and stability characteristics of industrial waste heat, satisfying energy requirements at the peak time of the system is problematic [52]. The main function of heat storage, indirect heat recovery technology for collecting waste heat, is to confer operating flexibility on the waste heat recovery system, which takes waste heat usage out of the time-dependent process streams. Besides, for projects with long-distances between the industrial waste heat source and the heat users, M-TES (Mobile Thermal Energy Storage) was proposed to transport the heat over large distances [51]. Therefore, heat storage could make the waste heat recovery system become time independent by adjusting peak demands of the system and distance independent by improving the waste heat transportation. In [20], two modes of heat storage were discussed: long-term heat storage and short-term heat storage. Long-term storage is a simple and natural way of heat storage, which is to conserve the waste heat in rock at temperatures above 50°C during the summer and extract it from the rock in winter. Short-term heat storage on the other hand is relatively common and has become a reliable way to reduce the fluctuations of industrial waste heat. In [53], waste steam from an incineration plant was used to charge the mobile sorption heat storage with 130 °C hot air to operate an industrial drying process, which resulted in reducing the primary energy costs by 73 €/MWh and saving operational time. Pursuing this idea, solutions associating renewable energy sources and resources including multiple thermal wastes at various temperature levels were considered and put into application to provide flexible energy productions [54-56]. These procedures make it possible to extend the prospects for the energy revalorization of heat rejections.

Therefore, heat storage can be used not only for collecting the heat from energy sources, but also for integrating multi-grade heat sources as well as for peak shaving

of the system [20]. In order to improve the efficiency of the heat recovery system, traditional and variable temperature storage (VTS) systems were compared and analyzed, showing 37% more heat recovered with VTS system based on the same minimum temperature approach [54].

1.3 Heat recovery opportunities and perspectives in industry

1.3.1 Industrialization impacts on energy consumption and CO₂ emission

In the process of industrialization, energy consumption is closely related to economic growth. In the early stages and medium-term of industrialization, energy consumption in general experienced a steadily upward trend. When economic development entered the period of post-industrialization, a significant change occurred to the economic growth as energy consumption began to decline. Similarly, this kind of inverted U-shaped nonlinear relationship existed in the link between industrialization and CO₂ emissions according to empirical findings in [57, 58]. Hence, in order to reduce the influence of industrialization upon the environment, many researchers focused on the relationships between industrialization, energy consumption and CO₂ emissions. In [59], a literature review was made in terms of impacts of industrialization/urbanization on energy consumption and CO₂ emission, respectively. As for energy consumption, the research was reviewed from cross-country, national and city level context. There was no consistency for concluding the impacts of industrialization on energy consumption due to the complicated industrialization process and policies. For CO₂ emission, representative literatures mainly focusing on industrialization development since the 1970s were listed for helping to understand the impact of industrialization on CO₂ emissions. Besides, it was pointed out that the developmental level influences the energy consumption / CO₂ by dividing 73 countries into four groups according to GDP per capita. Therefore, the developmental level of industrialization is an important factor for energy consumption, CO₂ emission and economic growth.

Industrial heat recovery requires technological and financial investments with economic and environmental benefits, which experienced varying degrees of development in different countries. In this article, the heat recovery opportunities and current technologies of both the developed countries and developing countries were considered according to published papers and research and the applicable technologies and policies were recommended internationally, especially for assisting developing countries to achieve industrialization in an efficient and environmental-friendly way.

1.3.2 Heat recovery opportunities in the developed countries

The heat recovery opportunities are not only related to the feasibility of technologies but also concerned by the process of industrialization which influences the availability of waste heat sources and the necessity of heat recovery. Most developed countries have experienced the process of industrialization and deindustrialization. In recent years, by reconsidering the importance of manufacturing in economic growth for creating employment opportunities and national income, the strategy of reindustrialization has been put forward by USA, Germany, France, Japan and so on for adjusting the industrial structure. Industrial energy consumption accounts for almost 20% of the total energy consumption [60], so there is a great potential for recovering waste heat especially the low-temperature waste heat under 200 °C in developed countries.

In the process of industrial development, most developed countries have adopted heat recovery technologies for improving energy efficiency. The UK has been practicing industrial heat recovery for more than four decades. Many articles have been published with the aim of sharing the successful engineering practices in terms of the performance of different waste heat recovery technologies as well as the difficulties and problems encountered. In recent decades, among the developed countries, UK is one of the countries with the most papers published pertaining to industrial waste heat recovery in terms of identifying waste heat sources and opportunities, optimizing the configuration of heat supply and heat demand and

choosing suitable heat recovery technologies and systems [60-63]. Compared to other countries, the energy data of industrial waste heat have been recorded by the improved supervisory system, which is important to know the status and contribution of industrial heat recovery technologies and perform quantitative analysis [60, 61]. Besides, the energy audit is a prevailing way of accessing energy consumption data, but the adoption and investment of energy efficiency technologies will be influenced by the quality of the energy audit [64]. So, efficient energy management and data collection mode will make the advantages and benefits of waste heat recovery more visible and convincing for others. However, in Germany, the rules of data protection are so strict for the sake of trade secrets that most industrial waste heat data are not available directly from industries, so reliable estimation methods could be an effective alternative for calculating the amount of available waste heat indirectly [65]. For EU 27, the new heat roadmap was proposed by considering the recovery of surplus heat from power plants, industries, and waste incineration and re-injecting it into a network of DH, which will increase the proportion of reused waste heat in the total amount of energy consumption in Europe [2].

Industrial waste heat recovery can be more practical in the most developed countries with the help of advanced technologies, centralized industries and strict limitation of CO₂ emission. Certain measures have been tested in real practice for years, with constant modification according to the demand of practical activities. This sets a good example for other countries. However, it is also a fact that the total amount of energy consumption in developed countries is high which makes the contribution of industrial waste heat for saving primary energy rare especially in the case that the industrial waste heat is considered for the supply of heating or hot water to residential users [65]. Obviously, the traditional energy system needs to be supplemented to fulfill the energy demand. Apart from the energy and economic benefits, the environmental issues should be considered completely as it has played an increasingly important role in global development [66].

1.3.3 Heat recovery opportunities in the developing countries

Most developing countries are in the process of industrialization and urbanization facing the shock of globalization, so opportunities and challenges coexist for the promotion of sustainable development. The development of heat recovery technologies, as one of the sustainable technologies, suffers from technological, financial, and institutional barriers in developing countries [67]. Specifically, in the context of global competition, it is difficult for developing countries to obtain the advanced technologies and hence gain access to the international technology market and suffer limited ability and experience for choosing the optimal technologies. The historic Paris agreement on climate change adopted by representatives of 195 countries in COP21, declaring that the agreement will full consider the special circumstance and demand of less developed countries in financing and technical transformation. Besides, the lack of budget for both fundamental research and imported technologies and equipment is the delicate situation of heat recovery technology in developing countries. Moreover, the institutional establishment is the cornerstone for ensuring the stability and sustainability of heat recovery technologies in terms of policies, financial allocation, information exchange, supervision systems and so on.

However, the desire for rapid economic development in a sustainable way by assimilating the experience gained during the industrialization of developed countries based on the environmental requirements of reducing greenhouse gas emission provides a great potential for installing heat recovery technologies during industrialization of developing countries. Unlike in the 20th century, when the efforts of industrialization projects in developing countries were rare and tentative, more recently, structural improvements in the industry at the national level have been beneficial for industrial expansion [68]. Accompanied by the tendency towards globalization, the market of developing industries and infrastructures will attract more attention from developed countries to boost industrialization. It is actually a typical win-win situation called exchanging the market for technologies and investment in the

process of industrialization. China is the largest economic entity of the developing countries, and accounts for 30% of global economic increment. Keeping economic growth and promoting new-style industrialization are still the main targets of the Chinese national plan of “Thirteenth Five-Year Plan”, while the promise to the whole world of fulfilling the target of decreased CO₂ emission should be achieved in a scientific and harmonious way, which provides opportunities of green development by recovering industrial waste heat.

1.3.4 Perspectives of waste heat recovery in industry

The importance of waste heat recovery in industrial parks will receive more attention with the increase of economic development and serious air pollution. For researchers and technicians, it is necessary to update the information on state of the art heat recovery technologies in order to improve the energy performance of industrial systems. Besides, it is important to consider the adaptability of new technologies and the influence of the adoption of waste heat recovery systems in the original industrial process. For managers and investors, the economic benefits and pollutant discharges are the top priorities because the former is the motivation of investment and the latter is increasingly required by the government, aiming to fulfill the sustainable development by protecting the environment. For the government, acting effectively in the process of macroscopic readjustment and control by supporting and promoting the application of practical and beneficial heat recovery technologies requires drawing from successful experience in both developed and developing countries. A comprehensive review of heat recovery technologies benefits knowing well the current status and the market perception of technologies for the purpose of improving the technical adaptability. Also it supports decision-making progress of industrial parks by specifying technical parameters of the integration of industrial process systems and heat recovery systems for newly installed plant.

Industrial waste heat recovery is essentially the exploitation of the exhaust gases and steam and cooling water that result from the inefficiencies of industrial equipment and utilities. The adoption of more efficient production technologies and advanced

management modes may therefore limit the waste heat available in the future. Besides, the structural revolution of industrialization in developed countries, could considerably affect the availability of waste heat [60]. However, for most developing countries, accounting for more than a half of the world population, industrialization is still in progress, and will require a long time to achieve industrialization in an orderly way. The engineering and management experiences from developed countries and well-industrialized zones of developing countries will provide examples for the developing countries to avoid taking wrong turnings on their way towards industrialization. Therefore, for a long time yet, it will remain meaningful to pay great attention to industrial heat recovery globally.

1.4 Case studies in Asian countries

In [69], four cases from France, Germany, Spain and Canada were compared with their sub-regions respectively in terms of energy consumed by the industry, industrial waste heat potential and its share in industrial energy consumption. The common characteristic of these countries and sub-regions is that industrial energy consumption plays a pivotal role in total energy consumption. All are industrialized countries and all the sub-regions are industry-centered zones in their countries. However, the waste heat potential varies from country to country and from region to region. It is difficult to come to any general conclusions because the data from the literature use different methods of analysis and sources of information whose reliability is not always totally convincing and in addition, the industrial processes are so complicated and unstable that no clear profile of industrial waste heat can be given. Even so, it is meaningful to give a general outline of waste heat potential for developing the waste heat recovery technologies in different countries based on case studies. In this article, attention has been paid to Asian countries, most of which are in the process of industrialization. Case studies of waste heat potential and waste heat recovery engineering applications in China, Malaysia, and Singapore, which were not mentioned in [69] are reviewed below.

Case 1: China and its District Heating

In China, existing industries contributed to the waste of industrial energy consumption by as much as 50%. Based on the consideration of economic and environmental condition, DH has only been performed in northern China since 1980s supported by the government. Recently, some DH projects were performed at the level of industrial parks and residential areas according to local requirements beyond northern China. As a result, the comfort of the indoor thermal environment has been improved, but it also brought about several serious problems such as high energy consumption and high environmental pollution.

The retrofit of DH for improving energy efficiency has been considered, planned and performed for decades by introducing applicable technologies. While for new ventures, many new technologies have been fully applied to develop DH in the form of demonstration projects with the financial support from government, aiming to reduce the consumption of primary energy and relieve the environmental burden. In fact, more and more demonstration projects have been put into practice, and have proved to be an effective way of testing the feasibility and adaptability of new technologies.

Collecting industrial waste heat for DH shows great potential in northern China [19]. As shown in table 1.2, while about 34% of industrial low-temperature waste heat could be used as the heat source of DH, theoretically, all DH could operate without consuming primary energy when calculations are based on the energy data of 2009. So far, concerning the low-temperature industrial waste heat for the DH, only two projects have been found in published articles.

One is located in Chifeng City, northern China. The research team has published two articles in international journals about this project. The first [70] focused on heat collection from different waste heat sources of both a copper smelter and a cement plant, which involved and solved the issue of the integration of different types of equipment for collecting different grades of the waste heat in cascade. The second [20] reported the critical issues in the process of recovering waste heat for DH,

including waste heat sources collection and integration, which has also been studied in detail in [70], involving long distance delivery and peak shaving. These issues were solved successfully in the case study for providing the reference of the same project with similar. Consequently, 390,000 GJ of waste heat was recovered resulting in the reduction of 35,000 t of CO₂ emission

The same research team was in charge of technical support and research of the industrial waste heat recovery project located in Qianxi, a county of Tangshan City [71]. The demonstrative project considered recovering the waste heat from slag-flushing water, cooling water and low-pressure steam for driving DH. As the industrial waste heat source is much larger than the current heat demand, so the plan and construction of industrial waste heat recovery project is performed in three stages. The devices employed in the waste heat recovery system include heat exchangers and absorption heat pump for recovering the waste heat together with absorption temperature transformer for lowering the temperature of return water of DH system. The economic performance of waste heat recovery system is mainly influenced by the distance between waste heat sources and waste heat end users, but the economic and health benefits are obvious. So, it is meaningful to promote the application of industrial waste heat recovery technologies.

The other case study was located in Datong City, northern China [30]. The fundamental system of combining the cogeneration and absorption heat pump (Co-ah system) was introduced by establishing waste heat recovery units and absorption heat exchange units for recovering exhaust steam in order to satisfy the heating requirement of DH. The expected results were obtained based on experimental data that the total heating power could reach 138 MW from waste steam, which was capable of providing sufficient heat for added residential heating area.

Besides, our research team studied a demonstration project of Cloud Computing centers with CCHP energy system considering the waste heat recovery, located in Chongqing, China [72-75]. In our study case, the waste heat sources include low temperature exhaust steam from steam turbine, low-temperature heat produced by

server heat dissipation from Data Centers and cooling water from a power plant. Low temperature exhausted steam was used to provide cooling for Data Centers using LiBr-H₂O absorption refrigeration, and both low temperature heat from Data Centers and cooling water were considered as the heat sources of DH to provide the heating for residential buildings.

Table 1.2

Energy Consumed by the Industry and DH of Northern China.

Northern China (2009)	Industries	District Heating
Energy Consumption	42.85 billion GJ ^a	2.6 billion GJ ^b
Low-temperature Waste Heat Potential	7.6 billion GJ ^b	-
Share	17.74%	34% of industrial waste heat recovery

^a Data source: China Energy Conservation Development Report 2011

^b Data source: [70]

Case 2: Malaysia and its oil palm industries

Malaysia is a country with a large amount of energy sources, being famous for oil and natural gas. Even the Malaysian government has made efforts to promote the development of renewable energy, acceptance of renewable energy technologies is not yet maximal and the market share of renewable energy is too low to be commercially available [76]. Palm oil is the fundamental backbone industry of Malaysian economic growth. As the palm oil industries expand, the palm oil biomass waste has been paid more attention as a source of renewable energy. From the point of view of energy recovery, palm oil biomass waste could be put into combustion directly to produce useful energy as an alternative to primary energy. To produce 1-ton palm oil needs 75~1000 kWh electricity and 2.5 tons steam. At the same time, 4 tons of dry biomass is produced as by-product which should be reused or will result in global warming. While to obtain 75~1000 kWh electricity and 2.5 tons steam, only 0.3-0.4 tons biogas is required [77, 78]. However, the electricity produced by palm oil industry waste only reached about 1~1.5 billion kWh, which was equal to 2% of 2003 power generation in Malaysia. Benefitting from the policies of developing renewable

energy and the application of promising technologies, the ratio of waste-activated power to fossil fuel activated power is improving but still limited as shown in [79] that palm oil industry waste did not show the overwhelming advantage compared to other renewable energy sources.

Case 3: Singapore and its industrial parks

Singapore is one of the developed countries in Asia with a successful experience of industrialization, especially famous for the construction and operation of industrial parks. In 1961, the Jurong Industrial Estate/Park was established for accelerating the process of industrialization as well as developing the national economy, and has proved to be a great success. Currently, there are more than 30 industrial parks in Singapore, amounting to 11.2% of national territorial area. However, the industrial sector consumed about 51.6% of the total energy in 2012 according to the IEA statistics [80], increasing to 65% in 2013 according to Singapore Energy Statistics [81]. To cope with the shortage of energy and land resources, the ecosystem concept has been applied to designing the industrial parks since 2004 [82] and evolved to become the idea of Eco-industrial Park. One of the most important characteristics of the eco-industrial park is to reuse flows of materials and energy between different industrial processes.

The energy structure of Singapore is characterized by the self-supply of power and processes heavily reliant on imported oil and natural gas [83]. As shown in table 1.3, the majority of electricity, natural gas and oil were attributed to the industrial-related sector. As for the power generation industry, 97% of electricity was generated by Combined Cycle Turbines, Co-Generation Plants and/or Tri-Generation Plants, while the remainder was generated by steam turbines, open cycle gas turbines and waste-to-energy plants. Considering industrial waste heat recovery, there was no project in operation found in the previous literature. Only it was recorded NatSteel enterprise introduced a heat recovery system for reusing the heat from the steel production process in 2013, but there is no related article and even no idea about the destination of the recovered industrial waste heat.

Table 1.3

Total energy consumption and industry-related consumption in Singapore

Energy type	Total consumption	Industrial-related consumption
Electricity (2014)	46TWh	20TWh
Natural gas (2014)	59,427 TJ	52,436 TJ
Oil (2013)	8,136 ktoe	5,886 ktoe
Total final energy consumption (2013)	13,425ktoe	8,779ktoe

Data sources: Singapore Energy Statistics 2015 [81]

1.5 Research contents and technical roadmap

1.5.1 Research contents

Although many researchers have carried out the studies in the field of waste heat recovery technologies and application in the industrial park, few studies focused on the integration of multiple low-temperature waste heat sources to CCHP system. So CCHP-DH system, i.e. Combined Cooling, Heating and Power (CCHP) coupled with District Heating (DH), is proposed based on the low-temperature waste heat recovery for DH system. Besides, more attention has been paid to the optimal configuration of multiple waste heat sources for DH and optimal configuration of Distributed Energy System (DES) for meeting various groups of energy demand of industrial park. Therefore, research contents in the study can be concluded as follows:

- ① Energy cascade utilization in the industrial park;

It is illustrated in detail that how to realize energy cascade utilization in the industrial park. With the development of waste heat recovery technologies, the concept of energy cascade utilization has been extended leading to more and more patterns of manifestation of DES. Finally, CCHP-DH system is proposed based on the integration of waste heat recovery for DH.

- ② Comparative simulation analysis of different configurations of DES;

The thermodynamic software THERMOPTIM was developed based on the optimization method of Pinch Analysis, which is employed to simulate DES system in

this study. Based on potential waste heat sources of DES of a case study of demonstrative industrial park in Chongqing, China, different configurations of multiple waste heat sources for CCHP-DH, i.e. parallel arrangement, serial arrangement and mixed arrangement, are proposed and compared according to simulation results. Besides, optimal configuration of DES to meet the possible energy requirement of the industrial park is presented and compared based on techno-economic analysis.

③ Comprehensive performance evaluation and barrier evaluation analysis of the development of DES project.

Comprehensive performance index is proposed to consider energy, economic and environmental performance of DES synthetically, which is more holistic to show more effective and promising configuration of DES in terms of system performance. However, as the development of DES project requires the participation of multiple stakeholders with different interests, barrier evaluation analysis is performed using Stakeholder analysis to identify the core stakeholders in different stages to promote the sustainable development of DES project during life cycle.

1.5.2 Technical roadmap

According to the research objectives and contents, the technical road map of this study is illustrated as follows.

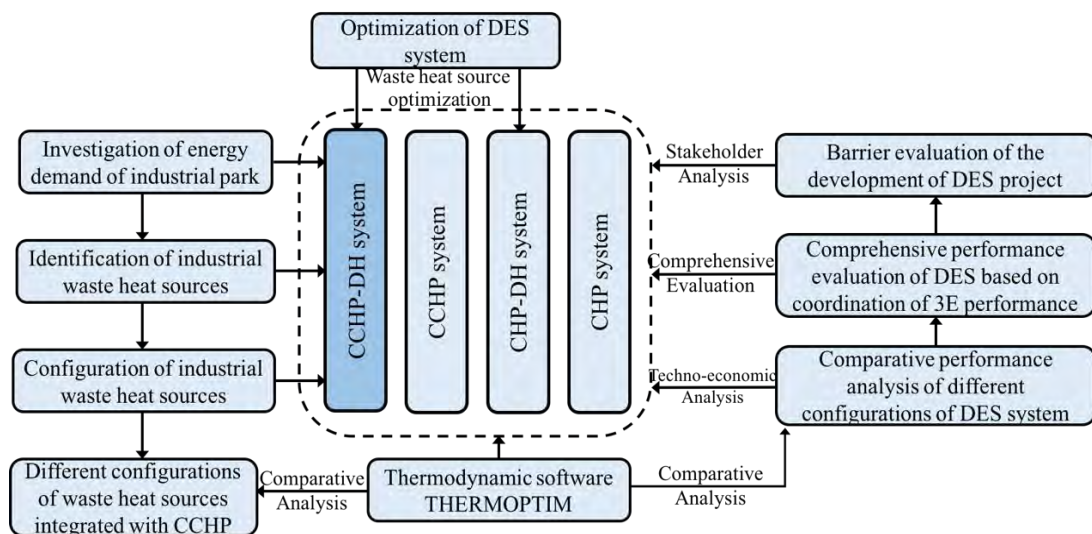
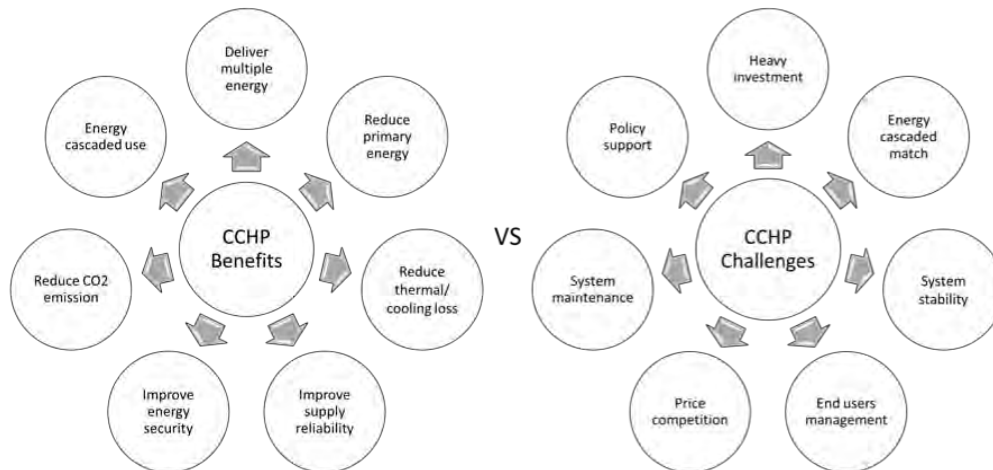

Fig. 1.4 Technical roadmap

Résumé Français du Chapitre 2: Configuration optimale des sources de chaleur résiduelles des CCHP-DH basée sur l'utilisation des cascades énergétiques

Le concept de "parc industriel" date des années 1950 où il s'est développé pour s'adapter à la réforme structurale de l'industrie et accélérer le développement économique; ce concept a depuis lors évolué vers celui d' "éco-parc industriel" pour la prise en compte duale de l'efficacité énergétique et des questions environnementales. En Chine, c'est en 1984 que le gouvernement a lancé des plans attractifs pour les investisseurs étrangers dans 14 zones côtières.

La concentration industrielle va de pair avec celle de l'énergie et des processus de conversion énergétique, ce qui ne va pas sans causer des soucis environnementaux. La nécessité de sécurité et de stabilité des processus amène à une évaluation globale des efficacités des processus mis en jeu et de leur cycle de vie, tout particulièrement dans les grandes installations. La figure ci-dessous illustre les enjeux et défis du développement des installations de génération combinée de puissance et de chaleur.



L'efficacité énergétique de la récupération des chaleurs réputées "fatales" et des systèmes à énergie distribuée se fonde sur l'optimisation de la valorisation des cascades énergétiques. L'utilisation et la valorisation de sources multiples fait ainsi appel à la combinaison de solutions technologiques multiples dont l'agencement permet de réduire les pertes des réseaux par la mise en œuvre de processus de revalorisation, tels que ceux décrits dans le chapitre précédent.

Dans ce chapitre sont envisagés les développements potentiels des cycles de cogénération et leur extension à des usages de rafraîchissement et de chauffage urbain; il discourt également d'usages modérateurs pouvant être attribués à une partie de la vapeur résiduelle de fin de turbinage.

Ainsi, dans le contexte des systèmes à énergies distribuées, sont proposées et comparées différentes variantes d'installations de cogénération par cycles combinées de génération de puissance mécanique, associés à des pompes à chaleur pour des conversions de niveau énergétique de sources de chaleur, allant de la réfrigération au chauffage urbain.

Les ressources et systèmes potentiellement utilisables sont passés en revue: le solaire photovoltaïque et thermique, la biomasse, l'incinération des déchets, mais également celle offerte par les centres de calcul dont le développement et consécutivement la demande énergétique se trouve être en pleine expansion avec des besoins équivalents en électricité et en rafraîchissement. Face à ces ressources, sont proposées les solutions de revalorisation existantes: les cycles dérivés de ceux de Stirling, Ericsson, Rankine, mais également les pompes à chaleur, notamment de réfrigération, utilisant les principes de compression de fluide condensable mais aussi celui de l'absorption basé sur des solutions salines. Des exemples de systèmes de récupération de chaleurs sont cités et illustrés, car particulièrement appropriés aux développements envisagés pour l'étude de cas qui sera présentée dans le chapitre 3 suivant.

Ces solutions ont pour objectifs essentiels de restreindre le recours à l'utilisation d'énergie de source fossile, de stabiliser la disponibilité des ressources énergétiques au niveau attendu et de limiter les rejets de chaleur ultime.

La récupération de l'énergie chaleur implique en général l'utilisation d'échangeurs dont l'efficacité comporte des limites et dans le cas des systèmes à énergie distribuée, la capacité d'échange prend une importance qui peut s'avérer décisive. Pour cette raison, des investigations ont été faites afin de rechercher les configurations les plus adaptées aux cas qui se présentent afin d'optimiser la récupération autant que faire se peut.

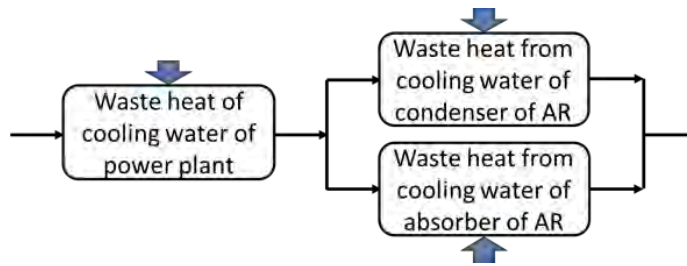

Les configurations classiques en parallèle et en série sont adaptées à des conditions stables tant en terme de niveau de température et de gradients que de puissances transmises et peuvent faire l'objet d'une optimisation relativement commode. Pour des configurations plus contraintes ou plus instables, des montages hybrides associant des montages d'échangeurs mais également des capacités de stockage en parallèle et en série permettent de répondre de manière satisfaisante à la plupart des besoins, même si l'optimisation s'avère plus complexe, les conditions de fonctionnement se trouvant souvent à quelque distance des conditions nominales d'exploitation. Un exemple applicable au cas d'étude du chapitre 3 est illustré par la figure suivante.

Un cas particulier particulièrement intéressant est la valorisation de la vapeur basse pression. En effet, elle dispose alors de relativement moins de force pour la conversion en énergie mécanique et son utilisation thermique devient tentante. Les systèmes de soutirage pour les préchauffages de turbines à vapeur en sont une illustration. Par contre son utilisation directe dans le chauffage urbain apparaît peu opportune du fait des débits à assurer et des pertes exergetiques exagérées qui découleraient de gradient trop importants.

Dans le cas d'étude proposé au chapitre 3, un centre de calcul est rafraîchi par des pompes à chaleur à absorption dont le bouilleur est alimenté par de la vapeur basse pression. La chaleur de condensation peut être valorisée pour le chauffage urbain, pour peu que les distances entre les installations restent limitées. Les caractéristiques d'utilisation saisonnière sont telles que la consommation de vapeur (et le besoin de refroidissement) sont moindres en période de chauffage. Auquel cas, la vapeur basse pression non nécessaire pour l'alimentation des refroidisseurs peut servir à l'effacement des pics de demande d'énergie.

Le contexte des parcs industriels est particulièrement favorable à la mise en application d'une exploitation des cascades énergétiques. Les systèmes à énergie

distribuée évoluent par l'intégration des énergies nouvelles mais également par des configurations plus optimisées qui confèrent une flexibilité accrue aux installations et à la disponibilité des énergie attendues.

Mots-clefs : *Systèmes à énergie distribuée; utilisation des cascades énergétiques; récupération de chaleur industrielle; Echangeurs de chaleur; Stockage thermique; Conversion Vapeur Force - Vapeur Thermique; Gestion des Pics.*

2 Optimal configuration of waste heat sources of CCHP-DH based on energy cascade utilization

2.1 Energy cascade utilization in industrial parks

The industrial park was first explored in the United States in the 1950s to accommodate the reform of industry structure to accelerate the economic development, which has been evolved to Eco-industrial Park with the integrating the concept of ecology aiming to improve the energy utilization efficiency as well as the environmental adaptability. However, the first batch of development zones in 14 coastal cities were approved by Chinese government to attract the foreign investment by providing preferential policies until the late 1984, which was the primitive type of industrial park. From then on, no matter large and small industrial parks or high-tech parks came out like bamboo shoots after a spring rain. The industrial park consumed a large amount of energy with the original intention of industrial production in a linear process of energy consumption, which had been studied continually to improve the energy efficiency of system. The safety and stability of energy system is closely bound up with the vitality and efficiency of industrial park. Facing the intense energy situation globally, it is imperative to improve the comprehensive energy efficiency of energy system. Especially for the large-scale projects with a great amount of different energy demand and complicated energy supply network, it is necessary to consider the energy performance from the point of view of the life cycle of the energy system from the design, construction, operation and maintenance, which should coordinate step by step in order to maximize the energy utilization. Energy cascaded utilization is to maximize the energy utilization by matching the energy quality of demand and supply according to the specific energy requirement of industrial park including energy type i.e. electricity, heat and cooling, and energy capacity. The concept of energy cascade utilization getting involved in design stage of system can avoid the emission of recoverable waste heat and reduce the repeated construction of infrastructure and installation of scattered devices with poor energy efficiency. DES is an efficient way to realize energy cascade utilization in industrial park for satisfying different energy requirement.

In the early period, the launch of DES was based on the power generation system. The concept of CHP was firstly proposed in USA and the system come into use in the field of industry. In the early 20th century, CHP was maturely applied in engineering practice in order to improve the efficiency of energy system, waste heat of power generation cycle was used to meet heat requirement of end users. In thermal power generation cycle of CHP system, power capacity is almost in proportion to heat capacity, so it is necessary to control the output of power and heating efficiently according to different energy demand of end users. However, periodic variation of power demand is not often consistent with that of heat demand. For instance, in summer, power generation unit should operate in full load but little heat is required, which cannot fulfill the advantage of CHP system. As a result, CCHP system was proposed based on the concept of CHP with the involvement of absorption refrigeration technology to utilize surplus heat of thermal power plant to activate absorption refrigerators to produce cooling energy. Note that no matter CHP or CCHP system, heat recovery technologies play a vital role in achieving energy cascade utilization of DES system. Normally, low-grade energy can be satisfied by recovering waste heat from DES system rather than seeing high-grade electricity as the first choice.

DES aims to fulfill the target of reducing the energy cost, increasing comprehensive energy utilization rate, upgrading the energy security and improving the environmental performance [84]. The concept of energy cascade utilization is broadened in the application of DES from the development of CHP to CCHP. The benefits and challenges of developing CCHP system is concluded in Fig. 2.1. The application of CCHP system should maximize the benefits of CCHP system and take effective measures to face the challenges of CCHP. Consequently, in order to tap energy conversion potential and superiority of DES, it is meaningful to seek for innovative application of DES by deepening and broadening the concept of energy cascade utilization [85]. Based on more and more successful study and applications of DES, new concept, new energy source and new technology are explored to couple with traditional DES.

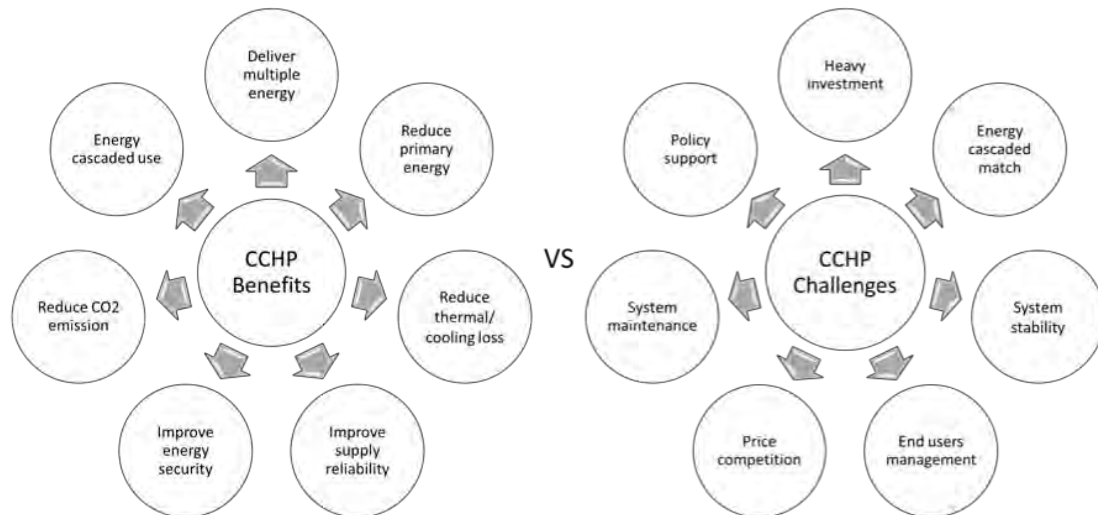

Fig. 2.1 Benefits and challenges of CCHP system

2.1.1 New energy-driven CCHP

Generally, natural gas is the driving energy source of various prime movers, including internal combustion engine, gas turbine, steam turbine, Stirling engine, fuel cells and so on. Besides, natural gas has no dust and malodor after combustion. Therefore, natural gas is widely used as primary energy to drive the DES system [84]. However, even natural gas-fired DES system is more environmental-friendly than separated coal-fired heating and power generation system, natural gas is actually one type of non-renewable energy resource with certain amount of greenhouse gas resulting in global warming. Therefore, from the point of view of sustainable development, it is not feasible to realize the social sustainable development depending too much on a single non-renewable energy. With the development and mature of new technology, the driving force of traditional CCHP/CHP system is not limited to fossil fuels such as natural gas, coal, petroleum and so on, contrarily, increasingly new energy is employed to drive CCHP system in order to fulfill the aim of energy conversion and environmental protection. The motivation of this kind of developing tendency can be illustrated as follows: on the one hand, comprehensive energy benefits of new energy-driven CCHP is higher than not only separated energy system but also traditional CCHP in terms of saving primary energy and stabilizing energy supply; on the other hand, new energy-driven CCHP creates more opportunities for promoting the economic development of the poor and developing zones who was ever lacking of fossil fuels to support the development in industry and society. The

common new energy-driven CCHP includes renewable energy fired CCHP, waste-to-energy fired CCHP and multi-source energy fired CCHP.

2.1.1.1 Renewable energy fired CCHP

Renewable energy fired CCHP refers to using renewable energy instead of fossil fuels to drive CCHP for power generation, heating and cooling. Renewable energy fired CCHP integrates the advantage of energy cascade utilization of traditional CCHP and the advantage of renewable energy in sustainable development in order to enrich the application of CCHP system with different energy sources. However, due to unstable characteristic of renewable energy resource, specific sources and limited output of renewable energy, renewable energy is not common to be used all alone as primary energy to activate the operation of CCHP. More commonly, either renewable energy is coupled with fossil fuels to drive the prime mover or different renewable energy sources cooperates to drive the prime mover. According to the available references, solar energy and biomass are widely studied and applied to activate CCHP system based on current renewable energy technologies and most of cases show the obvious energy, economic and environmental benefits when the system operates steadily.

1) Solar energy driven CCHP system

In solar energy driven CCHP system, it is beneficial to use concentrating solar energy cell and photovoltaic (PV) collector to absorb optical energy of the sun for power generation, which is well-known as solar PV power generation technology; the other feasible practice is to use concentrating solar energy cell and solar thermal collector to collect the thermal energy of the sun to generate power as the driving force of ORC system. Therefore, PV thermal system can not only solar optical energy for generating power but also provide thermal energy as by-product to heat users, which is simple configuration of CHP system. The typical schematic of CCHP with solar power generation system and solar thermal system is shown in Fig. 2.2. PV thermal system and PV collectors are combined to absorb the optical energy as the driving force of PV power generation. The power can be used directly by the consumers, while part of electricity is stored in the battery as backup and the rest is transferred to the power grid; hot water tank is used for supplying domestic hot water, whose thermal energy comes from solar energy collected by evacuated collectors, cooling water of PV system as well as auxiliary heater; hot water storage tank is also

the heat source of absorption refrigerator for providing the cooling for end users. The solar energy driven CCHP system is so complicated that optimal configuration is required to improve the comprehensive performance of the system. The aim of optimal configuration is to reduce the unnecessary equipment installation and operational investment without satisfying the necessary energy requirement, so it is important to carry out optimal configuration at the beginning of the CCHP project. In ref. [86], a new methodology was proposed based on energy, exergy, economic analysis and multi-objective optimization to optimize the solar energy driven CCHP system in terms of the optimal quantity and parameter of devices to improve relative net annual benefit and exergy efficiency of system. The solar energy is characterized as an inexhaustible and clean energy to be obtained everywhere, which has a wide prospect of engineering application. With the technical development of solar collectors, the stability, flexibility and economic benefits of solar CCHP can be improved to be widely used both in domestic and industry.

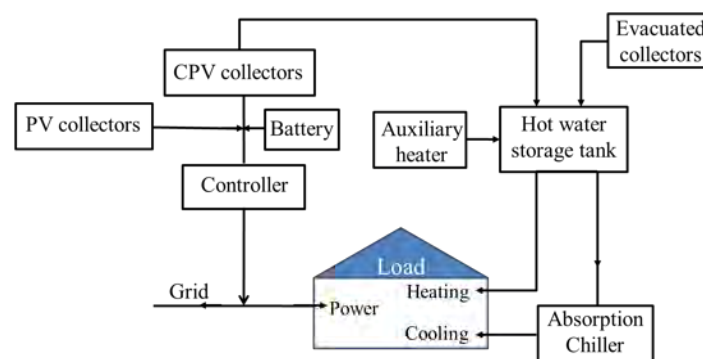

Fig. 2.2 Schematic description of solar-driven CCHP system [86]

2) Biomass fired CCHP

Biomass fired CCHP is developed based on the increasing mature of biomass energy utilization technologies who is compatible to integrate with CCHP system. The combination of biomass and CCHP system leads to the improved biomass energy utilization efficiency and engineering adaptability of CCHP system. The schematic of biomass-fired CCHP system is shown in Fig.2.3. A large amount of heat is produced when the biomass is combusted in biomass burner. The heat is partly used to drive prime mover for generating power with the emission of waste heat which can be recovered for heating, and partly used to direct heating as well as drive the cooling system indirectly. For the small-scale CCHP system, ORC, Stirling engine and Diesel

cycle are suitable for integrating with biomass-fired prime mover to provide power, cooling and heating. Due to the characteristic of biomass energy, it is important to perform the feasibility study to match the energy supply and energy demand. Since the system is normally operated in changeable working condition, it is necessary to do feasibility study under different working conditions. Take the example of a small town in Spain [88], for the towns with inhabitants from 10000 to 20000, the matched installed capacity of biomass-fired thermal power plant can be between 2 and 9 MWe. Especially in the zones of high summer severity, when the system operates in full load mode, biomass-fired CCHP system is more beneficial than CHP system, which means if cooling is integrated to CHP system in hot summer, the economic performance of the whole system will be better. Besides, the price competitiveness of biomass-fired CCHP should be considered when comparing to traditional CCHP. It has been demonstrated that the price of biomass gas has a great impact on the energy product of biomass-fired CCHP. Specifically, the price of heating and cooling gets the most obvious influence while the price of power and domestic hot water suffers the slightest influence [89]. The most apparent difference between vegetable oil (biomass gas) CCHP and natural gas CCHP in system configuration is that the former uses compression ignition engines and the latter uses spark ignition engines. Comparative analysis was performed between both CCHP systems in terms of energy utilization, economic benefit and environmental impact. Most obviously, vegetable oil CCHP has few influence on natural environment, whose pollutant concentration is less than 2%, better than natural gas fired CCHP system [90].

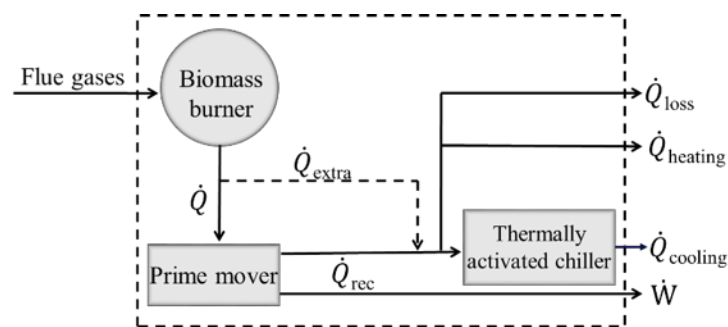

Fig.2.3 Schematic description of biomass-fired CCHP system [87]

2.1.1.2 Waste-to-energy fired CCHP

Waste-to-energy CCHP system is to recover the energy from all kinds of domestic and industrial waste to replace natural gas to drive CCHP system. Generally, there are

two waste-to energy ways in CCHP system, as shown in Fig. 2.4, one is producing heat directly from waste incineration to drive CCHP system; the other is producing combustible gas from the process of anaerobic digestion and gasification to drive gas turbine of CCHP system. The energy source of waste-to-energy CCHP comes from varieties of waste, such as kitchen waste, waste tyres, shell waste, straw waste, sludge waste and other general waste. Because the untreated waste is in different forms, so it is necessary to select adaptive recovery and treatment methods to process different kind of waste according to the characteristic of waste. The main standard of dividing different waste is humidity, heat value and organic content of waste. In order to improve recycling efficiency of waste, merits (✓) and demerits (✗) of CCHP system coupled with the process of waste incineration, anaerobic digestion and gasification are concluded separately in the following [91]:

1) Waste-to-heat based on waste incineration to drive CCHP:

- ✓ Waste materials with high calorific value;
- ✓ Match with high-production and continuous working units;
- ✓ Thermal energy used for power generation and heating;
- ✗ Disposal of hydrated, high temperature, low calorific value and chlorinated waste;
- ✗ Waste incineration with the ash of toxic metal, with the particle emission of SO_x , NO_x , from HCl to dioxins;
- ✗ High capital investment and operational cost;
- ✗ Located in cities.

2) Waste-to-gas based on anaerobic digestion to drive CCHP:

- ✓ Combustible gas can be used for multiple purposes ;
- ✓ Improved pollution control compared to waste incineration;
- ✗ Net energy recovery can be interrupted by excess temperature of rejected materials;

3) Waste-to-gas based on gasification to drive CCHP:

- ✓ No power required for filtering and transforming rejected materials;
- ✓ Combustible gas can be used directly in enclosed loop system;

- ✓ Avoid the interruption of odor, corrosion and raise dust, no visible pollutants,
- ✓ Few social opposition and save the land resource by compact design;
- ✓ Positive influence on environment;
- ✗ Not for processing rejected materials with less organic content.

The development of waste-to-energy CCHP system is based on the emerging industry of waste recycling, which is a hazard-free waste treatment method. It is a win-win measure to employ waste-to-energy CCHP because not only rejected materials and waste can be handled in an environmental way, but also great economic benefit is gained by recovering waste energy. Note that by-products of the process of waste-to-energy should be treated carefully to avoid secondary pollution of the environment. It is worth exploiting the research in the field of waste-to-energy CCHP due to its advantages, which has a wide marketing prospect.

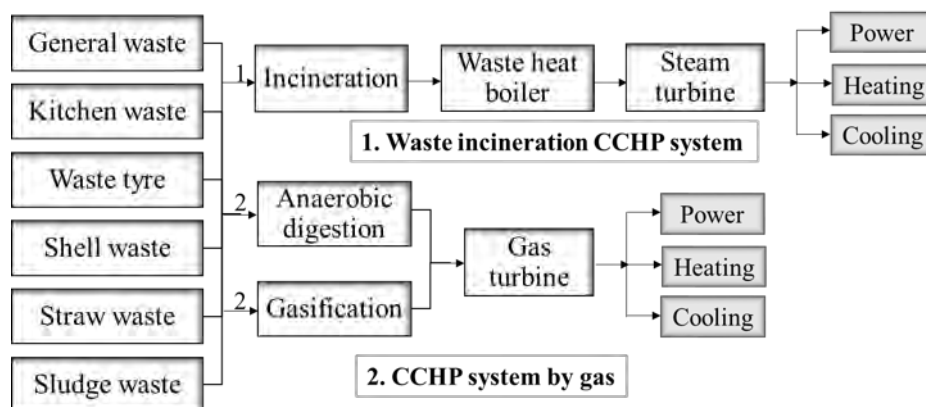

Fig. 2.4 Waste-to-energy process of CCHP system [91]

2.1.1.3 Multi-source fired CCHP

Multi-source fired CCHP is based on the development of the concept of multi-energy complement to drive CCHP. Solar energy, wind energy, geothermal energy and biomass energy vary along with the change of time, season, climate and location, while domestic and industrial energy demand is quite stable during a period. Considering the availability of renewable energy and stability of energy demand, it is generally necessary to add fossil fuel as the complement to make sure the stable operation of CCHP system to meet the energy requirement of end users. Specifically, for the purpose of industrial production, the energy consumption is continuous and

enormous, it is so risky to adopt the renewable energy as the driving force of CCHP system that fossil fuel should be added to improve the stability and continuity of renewable energy and flexibility of CCHP system. With more and more successful applications of multi-source CCHP, the concept of multi-source energy complement can be better expressed in the practice of CCHP system to understand the flexibility of multi-source system, which can facilitate complementary utilization of both renewable and non-renewable energy as well as reduce the heavy dependence of traditional CCHP on fossil fuels.

More and more multi-source CCHP has been widely studied in forms of solar energy coupled with natural gas fired CCHP, solar energy, biomass gas coupled with natural gas fired CCHP, solar energy coupled with Methanol fired CCHP, solar energy coupled with geothermal energy fired CCHP, solar energy coupled with biomass gas fired CCHP and so on.

In ref. [92, 93], solar energy and natural gas were used as the primary energy of CCHP system. In ref. [92], comparative analysis was performed to study the performance of both solar energy and natural gas fired CCHP and CHP system. The results showed that CCHP system has better performance in terms of energy utilization rate and greenhouse gas emission. In ref. [93], solar energy was collected by parabolic trough collectors to drive CCHP system. While natural gas-fueled condensing boiler is installed as backup, which is operated when solar energy is not enough to meet consumers' demand. Moreover, case study was performed to demonstrate that the energy performance of solar energy coupled with natural gas fired CCHP system is better compared to solar energy driven CCHP system, whose energy efficiency is 58% compared to 10.2% and exergy efficiency is 15.2% compared to 12.5%, respectively.

In ref. [94, 95], solar energy, biomass and natural gas were coupled to drive CCHP system. Solar energy was collected by PV plate to generate power; biomass gas was used to activate internal combustion engine to generate power as well as produce heat; waste heat from internal combustion engine was recovered to drive absorption refrigerators. In the peak period of energy consumption, electricity was downloaded from power grid as peak-shaving of power and natural gas-fired boiler was installed as peak-shaving of heating. Performance evaluation analysis is important to assess the actual performance of multi-source CCHP system, while the indicators of evaluation system may be different from traditional CCHP. In ref. [94],

the variety and accessibility of renewable energy were considered in the evaluation system of multi-source driven CCHP. Besides, the concept of thermo-ecological cost (TEC) was introduced in the methodology of performance evaluation [95]. Compared to traditional thermo-economic analysis (TEA), it was pointed out that TEC is able to get access to actual performance of evaluation results if multiple sources including renewable and non-renewable energy was applied to drive CCHP system.

In ref. [96], both solar energy and methanol were introduced to drive internal combustion engine of CCHP system. Two operational conditions were studied: when solar energy is not put into use, methanol is used separately to fire CCHP system; when solar energy is put into use, methanol is decomposed into synthesis gas (mainly H_2 and CO) and solar energy is absorbed to preheat and activate the reaction of synthesis gas in reaction tubes to provide the fuel for internal combustion engine. However, when the traditional methanol production process is integrated to CCHP system, the multi-source CCHP system is not energy efficient from the point of view of full chain of energy system compared to the traditional energy supply systems.

The promotion of multi-source driven CCHP system not only needs to take full advantage of the superior characteristic of separated device of the system, but also requires the effective cooperation of multiple energy sources and multiple applied technologies to work as a concerted system. Therefore, based on the support of mature technologies of traditional CCHP and successful applications of CCHP system, it is important to match the suitable and effective devices to related type of energy according to the characteristic of energy. Energy, economic and environmental analysis is important to assess the matching results of the system, while optimal configuration is necessary to improve the organization and matching of the system to achieve the optimal operational situation of multi-source CCHP.

2.1.2 New technology-coupled CCHP

With the innovation of energy transfer and conversion technologies, the comprehensive performance of traditional CCHP system improves greatly. Due to increasingly serious environmental constraint, the improved emission standard required the reduction of waste heat emission of CCHP system to a lower level to relieve global warming. In fact, waste heat recovery technologies have been adopted to recover the waste heat of power generation unit for realizing energy cascade utilization in the process of CCHP. While the low-grade waste heat generally emitted

to the environment from traditional CCHP can be recovered more and more using improved waste heat recovery technologies. Although waste heat recovery technologies are not able to recover all types and all levels of waste heat, attempts should be made to maximize waste heat recovery based on rational economic performance. Low-temperature waste heat recovery technologies coupled with CCHP deepen the concept of energy cascade utilization to improve the conversion and utilization rate of primary energy.

1) CCHP-ORC (CCHP coupled with Organic Rankine Cycle)

ORC is an effective waste heat technology by recovering heat to drive power generation cycle. CCHP-ORC system is to recover the waste heat produced by CCHP system to generate the power using ORC. In the operational process of real project, energy supply of CCHP system doesn't completely match with energy demand of end users. If heating and power are supplied according to heating-to-power ratio of power generation unit, it is not able to fulfill the advantage of CCHP system in the case of meeting the demand of user. Besides, if thermal storage is adopted to CCHP system, additional investment to devices influences economic benefit and heat loss is not avoidable in the process of heat transfer and conversion of recycling thermal storage. However, CCHP-ORC can adjust the output of heating-to-power ratio in real time by recovering low-temperature waste heat to achieve efficient energy utilization of primary energy [97]. The basic principle of ORC is to recover the waste heat from CCHP system to heat organic working medium with low boiling point and the evaporated organic working medium is used to drive the turbine motor for generating the power. The schematic of CCHP-ORC system is described as shown in Fig. 2.5, ORC is used to adjust the output ratio of heating and power by recovering the waste heat. For the existed CCHP system, the matched ORC can be added to recover the waste heat. While for new CCHP-ORC system, it is necessary to investigate the cooling, heating and power load to select the optimal prime mover at the design stage. When comparing the characteristic of prime movers of gasoline engine, diesel engine and gas turbine, it is better to adopt gas turbine for the end users with low electricity demand and high heating demand while gasoline engine performs well in the system of high electricity output and low heating output [98].

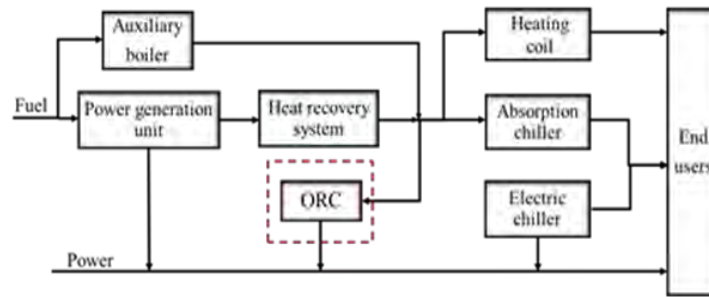

Fig.2.5 Schematic description of CCHP-ORC system

2) Co-ah system (CHP coupled with absorption heat exchanger)

The establishment of Co-ah system was based on the concept of absorption heat exchange proposed by Tsinghua University in 2007. On the one hand, it is to improve heat capacity of CHP system; on the other hand, it is to explore and address the issue of condensing waste heat recovery of power plant. The configuration of Co-ah system involves the increase of absorption heat exchanger to primary heat exchanging system for widening the temperature gap of supply and return heating medium water by cascade heat exchange according to the temperature of heat sources, which can improve the waste heat recovery performance of heating network. As shown in Fig. 2.6, heating medium water is heated step by step by heat exchanging with heat sources from power plant. In the first step, heat exchange is in low-temperature heater (as marked 1 in the figure) with circulating cooling water, where the temperature of heating medium water is heated up to 35°C; in the second step, heat exchange is performed using absorption heat pump (as marked 2 in the figure) with both low-temperature cycling cooling water and high-grade extracted steam, where the temperature of heating medium water is heated up to 90°C; in the third step, heat exchange aims to further elevate the supply temperature of hot water up to 120°C in peak-shaving heat exchanger (as marked 3 in the figure) via exchanging heat with extracted steam of power plant. Cascade heat exchange broadens the supply and return water of heating network effectively to improve heat delivery capacity and thus reduce the construction fee of pipe network and electricity consumption of circulation pump.

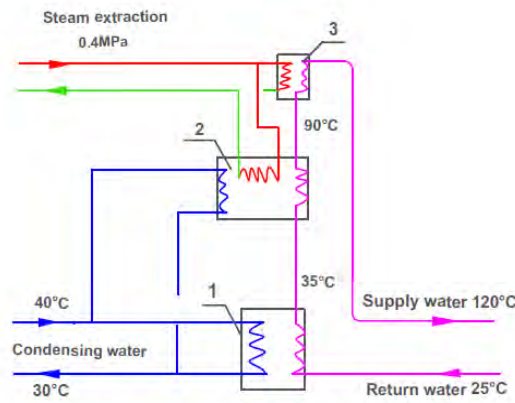

Fig.2.6 Diagram of cascade heat exchange of heating network [99]

3) CCHP-CD (CCHP coupled with Central Dehumidification)

CCHP-CD system is to recover the waste heat of CCHP system to drive absorption dehumidifier for meeting dehumidification requirement of the end users. Take internal combustion engine based CCHP for example, CCHP-CD is proposed to recover the low-grade jacket water of internal combustion engine, whose temperature changes with power, to improve the comprehensive thermal performance of CCHP system. As shown in Fig. 2.7, different from operational process of traditional internal combustion engine based CCHP, low/medium temperature flue gas emitted from absorption refrigerator transfers waste heat via heat exchanger to produce medium temperature hot water. By mixing medium temperature hot water with recovered jacket water to produce hot water as the heat sources of LiBr-H₂O absorption refrigerator and absorption dehumidifier units. Because the temperature of heat source required to drive absorption dehumidifier is not high, so it is feasible to recover various low-temperature waste heat to meet dehumidification demand of end users.

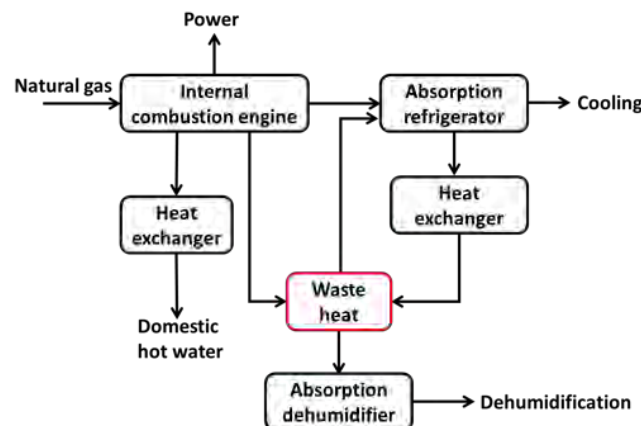

Fig. 2.7 Schematic description of CCHP-CD system [84]

2.2 Description of CCHP-DH system

Industrial waste heat recovery for DH is of great significance in engineering practice, which can improve comprehensive energy utilization efficiency based on evolving the profound meaning of energy cascade utilization. With the acceleration of industrialization process and extension of industrial zones, more and more potential and valuable industrial waste heat can be explored and reused. Effective industrial waste heat recovery can not only save the primary energy and but also relieve the pressure of surging heating demand resulting from rapid urbanization and increasingly severe environmental protection. In October 2015, National Development and Reform Commission and Ministry of Housing Urban-Rural Development of China jointly issued *Plans to implement projects on waste heat recovery for residential heating*, which supports and incentives the development of recovering industrial waste heat for DH. It was pointed out in the implement programme that heating area of DH using industrial waste heat replacing coal-fired source will reach 2 billion m² by the end of 2020, which will reduce the consumption of raw coal more than 50 million tons. Besides, 150 demonstrative cities will be selected to explore the economic model and classical configuration of recovering waste heat for DH [19].

The exploration of industrial waste heat recovery for DH in this study is based on the traditional CCHP with stable heating, cooling and power supply around the year for the purpose of industrial production. The stable industrial production will produce relatively stable waste heat not influencing obviously by seasonal change. The CCHP-DH system is proposed and illustrated to show the expression of the concept of energy cascade utilization in Fig.2.8. There are four processes integrated to CCHP-DH system. Specifically, in the first process of gas-steam combined cycle generation, natural gas is burned in the combustion chamber of gas turbine to activate power cycle with the emission of plenty of high-temperature flue gas. Flue gas flows to heat recovery boiler for producing high pressure, medium and low pressure steam. High/medium pressure steam flows to steam turbine for power generation as well as producing low-pressure steam. Then, both low-pressure steam flow to low-pressure steam for power generation and low-pressure flue gas is emitted into atmosphere by chimney. In the second process of process heating with extracted steam, low-pressure steam is extracted from low-pressure steam turbine and transferred to industrial steam

users. In the third process of District Cooling (DC), low-pressure steam from low-pressure steam turbine is used as heat source of LiBr-H₂O absorption refrigerators in refrigeration station and then cooling is distributed in the form of chilled water to each Data Center via pipe network. In the fourth process of waste heat recovery, both circulating cooling water of power plant and waste heat from Data Centers are considered to be heat sources of DH. As the temperature of waste heat is not high enough to be used for DH, so suitable technologies and devices should be suggested to upgrade the waste heat.

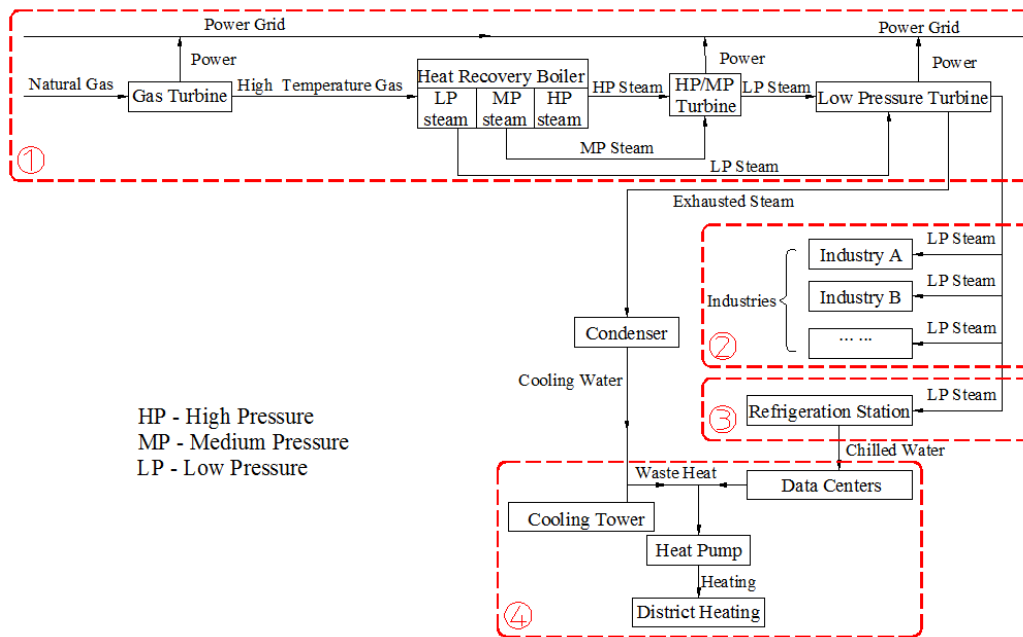

Fig. 2.8 Schematic description of CCHP-DH system

2.3 Optimal configuration of waste heat sources

As the stability and availability of waste heat source plays a critical role in the successful application of waste heat recovery technologies, multiple waste heat sources of CCHP system are discussed in the following.

2.3.1 Waste heat sources of CCHP system

2.3.1.1 Circulating cooling water of thermal power plant

Normally, waste heat sources of thermal power plant mainly include flue gas emitted from the chimney of boiler and circulating cooling water from low-pressure turbine. Due to high efficiency of waste heat recovery boiler, flue gas has few energy saving and recovery potentials. So more attention should be paid to recover the circulating cooling water of power plant. As circulating cooling water is in low

quality, whose temperature is not high enough to be used directly for heating. Currently, waste heat recovery technologies of circulating cooling water include [99]: 1) low-vacuum operation technology. The saturation temperature of condensing water increases with back-pressure of power generation units, which can be used to heat the hot water of heating network; 2) compression heat pump is used to upgrade the low-grade cooling water; 3) absorption heat pump is used to exchange heat directly between cooling water and heat medium water, which can lower the return water of heating network to 20-40°C. However, high-grade steam is required to drive absorption heat pump. Therefore, the adoption of suitable waste heat technologies for recovering circulating cooling water should base on the actual situation of thermal power plant.

2.3.1.2 Waste heat of Data Center

Gas-steam combined cycle power plant can produce power together with a large amount of high-grade heat which can be used to drive absorption refrigerator for cooling. This is the basic concept of CCHP system. Data Center can be exactly preferred and promising application of CCHP system to show great benefits in energy cascade utilization owing to its energy characteristic of stable and enormous power and cooling demand[100, 101]. Meanwhile, a large amount of waste heat is emitted from Data Center to atmosphere which may reinforce global warming, so the promising solution should be considered to recover the waste heat of Data Centers.

Waste heat recovery technologies can be used to recover the waste heat from hot air of Data Centers at 30-40°C, while waste heat recovery system also can be integrated with absorption refrigeration system of Data Center, which probably permit a greater proportion of waste heat to be recovered even at lower temperature. For the Cloud Computing center with more than one Data Center, it is more efficient to collect waste heat together from refrigeration system.

There are several waste heat recovery technologies available for recovering the waste heat of Data Centers.

As shown in Fig. 2.9 (a), one of the most competitive Data Center waste heat recovery technologies is to collect the waste heat from two processors on each server blades of Data Center to activate the generator of absorption refrigerator thanks to the huge high-temperature heat emission of Data Centers. However, the main challenge is to capture enough heat from Data Centers to energize the generator of absorption

refrigeration [102]. Even the solutions have been proposed in ref.[103], but it is complicated and not feasible in District Cooling for more than one Data Center.

Besides, waste heat of Data Centers is able to be recovered as heat source of DH system due to its thermal characteristic. As shown in Fig. 2.9 (b), (c), (d) and (e), the waste heat can be recovered indirectly from absorption refrigerators via heat exchangers. By comparing the different schemes, the advantages and disadvantages of each scheme are concluded as follows: 1) In Fig. 2.9 (b), it should be a win-win measure to recover the waste heat from return water of chilled water for DH because on the one hand waste heat source replaces the primary energy used for DH and on the other hand the temperature of return water of chilled water can be lowered by DH system thanks to waste heat recovery. However, return water of chilled water is general less than 20°C, so additional energy is required to upgrade the heat medium water of DH system. More importantly, when return water is directly integrated to DH system, there is the risk of destroying the stability of chilled water loop. 2) As shown in Fig. 2.9 (c), recovering waste heat of Data Centers from evaporator seems to be more efficient to avoid the heat loss, but integrating waste heat recovery system with evaporator may be difficult to keep the evaporator to be low-pressure and easier to break the balance of absorption circulation. 3) Recovering the waste heat from condenser is practical and beneficial to absorption refrigeration. In Fig. 2.9 (d), not only waste heat can be reused to increase the energy performance of the system but also the temperature of cooling water can be lowered to designed temperature returning back to condenser without additional cooling device. 4) Absorber is the main component of absorption refrigerators, whose heat exchange area accounts to 40% of the whole refrigeration system. The performance of absorption refrigeration can be directly and greatly influenced by absorber. There is a large amount of dissolution heat in the process of absorption, where cooling water is required to take away the waste heat. So, as shown in Fig. 2.9 (e), it is also feasible to recover the waste heat from absorber to promote the process of absorption reaction, leading to the improved performance of absorption refrigeration.

Based on the above analysis, waste heat from both absorber and condenser of absorption refrigerator is considered as waste heat sources of DH. To recover waste heat, both temperature and flowrate of cooling water of absorber and condenser should be considered to perform optimal configuration of waste heat sources.

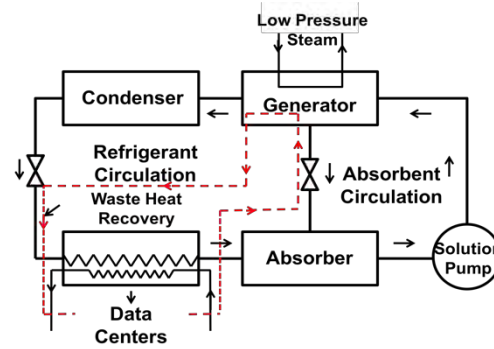

(a) Waste heat recovery from hot air of Data Centers for Generator [103]

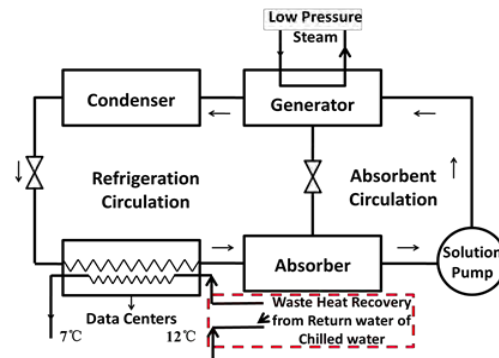

(b) Waste heat recovery from Return water of chilled water [74]

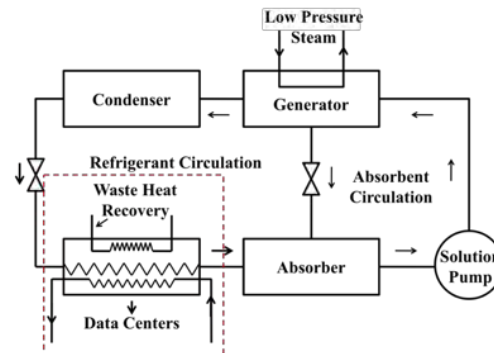

(c) Waste heat recovery from Evaporator for DH [72]

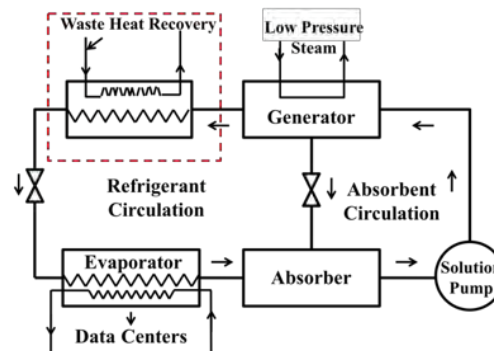

(d) Waste heat recovery from Condenser for DH

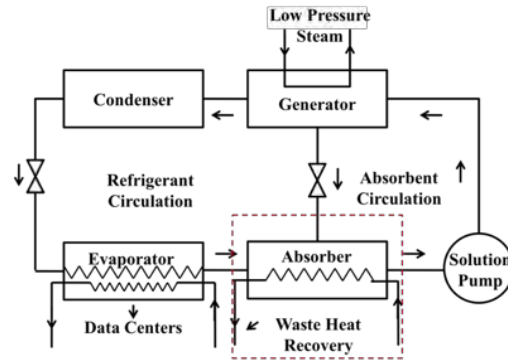

(e) Waste heat recovery from Absorber for DH

Fig.2.9 Waste heat recovery from Data Centers

2.3.2 Optimal configuration of multiple waste heat sources

The stability of waste heat sources lays foundation for the application of waste heat recovery system, while the optimal configuration of waste heat sources improves the performance and benefit of waste heat recovery system. According to the characteristic of above-mentioned waste heat sources of DES system, three main optimal configuration schemes are proposed as follows:

1) Multiple waste heat sources in parallel arrangement. As shown in Fig. 2.10 a), it is the case of optimal configuration of two waste heat sources for simplicity. The waste heat sources of circulating cooling water of power plant and waste heat of Data Center, located in different places, are integrated in parallel. Stream flow control switches are critical components in the process of optimal configuration of multiple waste heat sources. The function of stream flow control switch includes: one is to select the number of waste heat sources according to the heating load of buildings; the other is to adjust the stream flow rate of each waste heat source branch to be compatible in the main stream of waste heat recovery system. Moreover, waste heat sources are available all the year, but DH is only operated in the heating season. So thermal storage is adopted to capture and store the waste heat in non-heating season. One efficient method of thermal storage is to heat the ground in depth under energy station of DH or under the buildings area using a series of tubes buried under the ground level, thus expecting heat to come back up the ground level in heating season. The function of thermal storage is activated by stream flow rate switches, so the switches 3 and 4 are turned on (the rest are turned off) to allow waste heat flowing to thermal storage in non-heating season. However, normally, the switches 3, 4 and 9, 10 are turned off and the rest are turned on according to the heating load of end users in

heating season, while if the waste heat from waste heat sources are not able to satisfy users' heating requirement in peak hours, waste heat in thermal storage should be activated i.e. turn on the switches 9 and 10, to be heat sources of DH as peak-shaving.

2) Multiple waste heat sources in serial arrangement. As shown in Fig. 2.10 b), it is the case of optimal configuration of two waste heat sources for simplicity. In non-heating season, the switch 1 and 2 are turned on to capture the waste heat and the switch 3 is turned off. However, thermal storage can be inactivated in heating season by turning off the switches 1 and 2, while generally turned on in peak hours. When waste heat recovery system is in operation, the heat medium water exchanges heat with waste heat sources one by one from low temperature waste heat source to high temperature waste heat source.

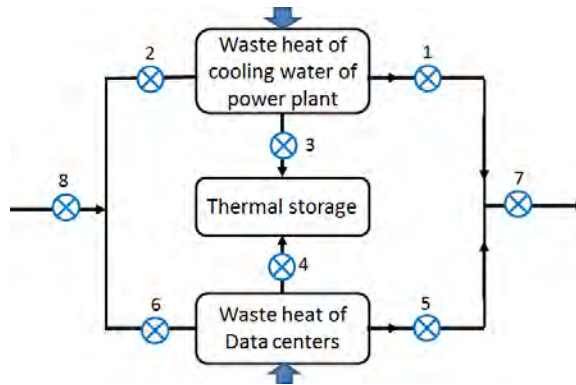

a) Two waste heat sources in parallel arrangement with thermal storage

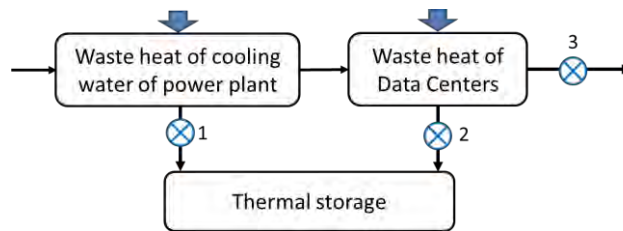

b) Two waste heat sources in serial arrangement with thermal storage

Fig. 2.10 Parallel & Serial arrangement of waste heat sources of DES system

By comparing two optimal configuration schemes, the advantage of waste heat sources in parallel arrangement is that waste heat sources are convenient to be controlled and optimized independently to meet varying heating requirement of end users. Besides, it is more suitable to the integration of waste heat sources with similar recovery temperature and flowrate and there is no limitation of waste heat source quantities. However, for waste heat sources in serial arrangement, less investment is required in the pipe contribution of the branches and it is suitable for the integration

of waste heat sources with greater temperature differences. Greater temperature difference leads to better heat exchange performance of heating medium water with each waste heat source. Besides, the number of waste heat sources should not be too large for one waste heat recovery loop because waste heat exchange efficiency and heat loss in the heat exchange process will be influenced by the increased waste heat sources.

3) Multiple waste heat sources in mixed arrangement. As aforementioned, cooling water from absorber and condenser of Absorption Refrigerator (AR) is potential waste heat source from Data Centers. Similarly, absorber and condenser waste heat sources can be arranged in series or in parallel according to the matching of temperature and flow rate of all the waste heat sources. So there are possibilities of parallel, serial and mixed arrangement of three waste heat sources. As shown in Fig. 2.11, it is one possibility of mixed arrangement of waste heat sources, where thermal storage is not shown. The mixed arrangement of waste heat sources makes it flexible to optimize the configuration of multiple waste heat sources. Moreover, renewable energy and high-grade energy can be practically integrated to low-temperature waste heat recovery system with the help of mixed arrangement if waste heat sources are not stable and sufficient to meet the increased requirement of DH.

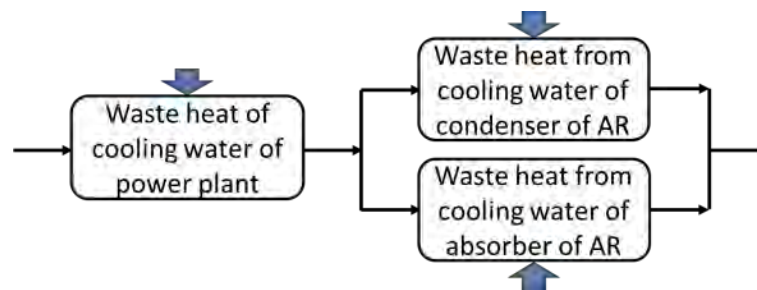

Fig. 2.11 Mixed arrangement of three waste heat sources of DES system

According to the thermal characteristic of waste heat sources in the demonstrative industrial park of Case Study, it is possible to have three arrangements of waste heat sources. In next chapter, potential configuration of waste heat sources integrated to CCHP system are proposed and optimized to perform comparative analysis of energy performance based on simulation results

2.3.3 Low pressure steam used as peak shaving and backup heat source

In traditional CCHP system for space heating, 0.3~1.0MPa steam is extracted directly from low pressure steam turbine as heat source of DH as shown in Fig. 2.12.

However, the aim of DH is normally to keep the room temperature at around 20°C. So, it is obvious that the energy grade of heat source and heat sink is not matched at all. The exergy of heat source decreased apparently when going through the process of heat exchange in traditional DH based on CCHP system, which means a great potential of energy conservation improvement.

District Cooling of the proposed CCHP-DH system is used for cooling Data Centers, produced by absorption refrigerators using low pressure steam from low pressure turbine of thermal power plant. The hourly steam consumption of absorption refrigerators is shown in Fig. 2.13 that the peak steam consumption is in summer due to the increase of cooling load of Data Centers, which means more waste heat can be recovered from cooling system of Data Centers. While in heating season, the steam consumption of absorption refrigerators is relatively low with corresponding low emission of waste heat. So apart from the waste heat from thermal storage, low pressure steam can be used as peak shaving and backup heat source and absorption heat pump is a promising device of waste heat recovery for DH. However, as waste heat sources are located in two different places far from each other, so absorption heat pump mentioned in ref. [99] can be installed in either in refrigeration station or thermal power plant to recover the waste heat of circulating cooling water and waste heat of Data Centers, respectively. Note that thermal power plant and refrigeration station are about 3km and 1.8 km far away from energy station of DH system, respectively. Absorption heat pump can use low-pressure steam as driving force and waste heat as main heat source of DH system, while low-pressure steam from refrigeration station is preferred to be used by absorption heat pump considering economical cost of steam transportation.

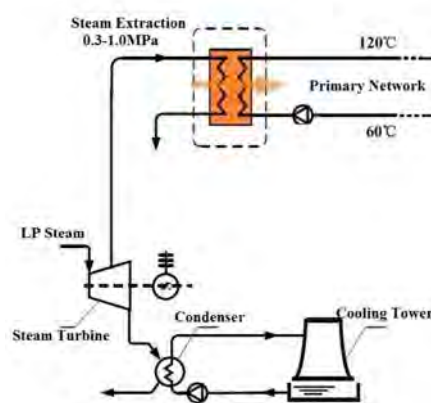

Fig. 2.12 DH system based on traditional CCHP system [99]

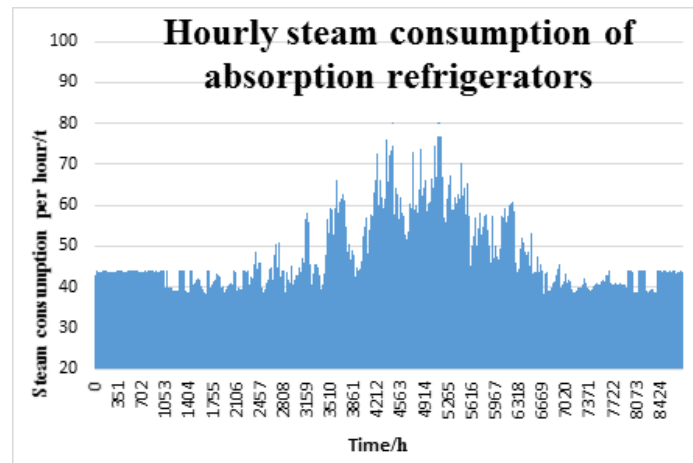

Fig. 2.13 Hourly steam consumption of absorption refrigerators

2.4 Conclusions

The concept of energy cascade utilization is illustrated in detail to show how to realize energy cascade utilization in DES system in industrial park. With the development of waste heat recovery technologies and the mature application of renewable energy as primary energy, the pattern of manifestation of DES system is not limited to traditional CCHP/CHP system, which can be evolved to new energy-driven CCHP system and new technology-coupled CCHP system. Besides, CCHP-DH system is proposed based on multiple waste heat sources recovery for DH system, which further deepens the concept of energy cascade utilization. Moreover, optimal configuration of multiple waste heat sources is carried out by comparing the two main schemes, i.e. in parallel and in serial arrangement of waste heat sources. Based on the main schemes, the mixed arrangement is proposed to improve the flexibility of the integration of waste heat sources, which makes it easier to consider the involvement of various renewable energy or high-grade energy. Finally, considering the steam consumption characteristic of absorption refrigerators, it is feasible to install absorption heat pump as peak shaving and backup of DH. Besides, low pressure steam from the steam pipe of refrigeration station is suggested to be extracted as driving force and supplementary heat source of absorption heat pump.

Résumé Français du Chapitre 3: Etude par simulations comparées de différentes configurations de Systèmes à Energie Distribuée

La comparaison des configurations opérationnelles se fonde sur la méthode de l'analyse du pincement. La méthodologie a été initialement développée les échangeurs de chaleur; elle a ensuite été étendue pour le génie chimique pour démontrer la faisabilité des systèmes et leur optimisation. elle se base sur les premier et second principe de la thermodynamique. L'identification du point de pincement permet à la fois d'assurer la faisabilité des transformations requises et la minimisation des pertes exergetiques. Les Courbes Composites chaudes et froides qu'elle propose résultent du tracé des données intégrées des flux de chaleur chauds et froid sur un diagramme enthalpie-température. La courbe Grand Composite montre l'écart entre les énergies disponibles sur les sources chaudes et celles requises par les sources froides. Ainsi, l'usage de cette méthode conduit à maximiser l'efficacité des processus et réduire les pertes fatales. Si chaque transformateur énergétique a son point de pincement, il peut en être défini un pour chaque processus ou fonctionnalité du système par intégration. Dans un processus existe un pincement qui interdit tout transfert énergétique non déperditif. En revanche, au niveau du système, le pincement peut être transgressé sans accroissement de pertes fatales.

La méthode est ainsi tout particulièrement adaptée à la valorisation des cascades énergétiques. Elle est mise en œuvre par l'usage de l'environnement de modélisation thermodynamique ThermoptimTM développé par Mines Paritech. Ce logiciel destiné initialement à l'enseignement de la thermodynamique appliquée, a depuis connu des applications plus larges dans l'étude des systèmes complexes. Il se fonde d'une part sur une fenêtre de description graphique fonctionnelle par intégration de composants de base et de liens entre éléments et d'autre part sur une série de fenêtre de description d'états thermodynamique ; la mise en cohérence de l'ensemble construit le simulateur statique. Une présentation sommaire de l'environnement est faite dans ce chapitre.

L'étude de cas porte sur un parc industriel situé à Chongqing (CN), dont l'ensemble fonctionnalité/énergie est structuré comme un système à énergies distribuées ; Chauffage et Climatisation y sont opérationnels à longueur d'année de

manière relativement stable. Il est ainsi proposé d'y mettre en œuvre le système CCHP-DH (cycle de cogénération puissance, réfrigération et chaleur et application chauffage urbain) afin de minimiser le recours à l'énergie primaire.

En Chine, Chongqing fait partie des sites pilotes de développement de systèmes à énergie distribuée au même titre que certaines provinces, des éléments de contexte sociétal, économique et technique sont proposés en détail dans le texte original. Ainsi, il est mis en évidence la tendance actuelle à la réduction des rejets de polluants et le recours à des technologies plus écologiques et soutenables; notamment la fermeture progressive des installations brûlant du charbon, à commencer par les moins performantes. Les projets de SED opérationnels et en cours de développement sont présentés et commentés au regard des enjeux régionaux et nationaux .

L'installation correspondant au cas étudié est une centrale thermique qui alimente en puissance électrique le parc industriel. Il est prévu de doter le parc de 5 unités de combinées de type 9F (467MW) fabriquées par General Electric, deux sont en opération avec soutirage de vapeur 300°C-0,9MPa pour applications industrielles. Le générateur de vapeur s'appuie sur la turbine à gaz naturel et nourrit 3 étages de turbines, des applications industrielles de biochimie et le bouilleur de la centrale de réfrigération par absorption du centre de calcul. Les données d'exploitation ont été fournies par l'exploitant. Le parc industriel se caractérise par une demande énergétique stable et fortement contrainte, en toutes saisons, de la part du centre de calcul et des industries environnantes.

La turbine à gaz fonctionne entre 1427°C et 597°C en sortie sur le générateur de vapeur exploité sur la gamme de pression 5,5-14MPa pour des températures allant de 500 à 565°C et une puissance générée de 30 à 300MW. Le générateur de vapeur est pourvu de soutirages, d'une installation de récupération de chaleur et de capacités très souples de régulation des niveaux de température et de pression à tous niveaux.

Il est mis en évidence que les performances de la centrale dépendent significativement des conditions atmosphériques et des conditions opérationnelles ; ces deux aspects font l'objet d'une étude basée sur les données d'exploitation fournies par l'opérateur. Ainsi, l'état de l'air entrant joue pour 10% de la puissance électrique et 20% de la fourniture de chaleur, à l'avantage de l'utilisation en hiver. Le rendement global dépend davantage des conditions d'exploitation, en particulier du taux de charge, à hauteur d'un accroissement de 34% par passage de tiers de charge nominale à pleine charge.

Les différentes configurations opérationnelles envisagées ont été modélisées dans l'environnement ThermoOptimTM et fiabilisées sur la base des données d'exploitation fournies par l'exploitant. V0 étant la configuration de base du système CCHP-DH, il en découle 3 variantes caractérisées par l'agencement des sources de revalorisation et les processus opérés. V00 réalise le chauffage urbain en valorisant la condensation de la vapeur basse pression, la condensation et l'absorption du cycle de rafraîchissement à absorption, ces sources étant placées en série et leur niveau rehaussé par une pompe à chaleur à compression; V01 agit de même mais place ces sources en parallèle et V02 remplace la pompe à chaleur à compression par une exploitation plus étendue des capacités du système refroidisseur et un soutirage de vapeur basse pression à plus haut niveau.

Une série d'indicateurs sont définis pour évaluer les performances, d'une part des données énergétiques brutes, mais aussi un certain nombre de ratios adimensionnels. La comparaison des configurations est faite à consommation d'énergie primaire constante. En termes de production, l'avantage revient à V01 (très proche de V02). En revanche, en termes d'efficacité énergétique, V02 s'avère meilleur, la puissance du compresseur de la pompe à chaleur étant alors pris en compte.

Le développement du parc industriel se faisant graduellement et consécutivement donc, celui de sa centrale d'énergies, le choix des configurations opérationnelles prend en compte d'autres éléments, dont économiques et environnementaux, mais aussi les risques de sous-exploitation des ressources offertes: en chauffage urbain, mais surtout en rafraîchissement. Afin d'évaluer les conséquences de ces risques, d'autres configurations, réduites, ont été étudiées: CHP-DH (sans réfrigération, sous deux versions V21 et V22 (dérivées des V01 et V02)), CHP (sans réfrigération ni chauffage urbain : V3). Dans ce cas, la version V22

Toutes ces configurations ont été évaluées en termes d'incidence économique, de l'investissement au temps de retour, prenant en compte les frais d'exploitation: coût de combustible, de personnel et de maintenance, également les ressources potentielles de la revente des énergies ; des indicateurs spécifiques sont déterminés. Le temps de retour sur investissement de ces configuration reste en dessous de 9 ans sous réserve d'un fonctionnement à pleine charge. Toutefois, il convient de noter que ce résultat dépend fortement des tarifs de l'énergie pratiqués localement, tant à l'achat qu'à la revente. Néanmoins, les configurations CCHP-DH (V01) et CHP-DH (V21), dans une moindre mesure, améliorent le retour sur investissement.

Les aspects environnementaux, comprenant les nuisances acoustiques mais également les effets nocifs des rejets de polluants sur le secteur, ont fait l'objet d'une étude. Il en résulte une série d'indicateurs spécifique complémentaires. Les nuisances sonores, provenant des pompes et compresseurs peuvent être limitées par des protections adaptées. Les rejets de polluant restent très nettement en dessous des seuils préconisés par les normes en vigueur. Toutefois, le rejet ultime sera pris en compte dans un indicateur environnemental; à cet égard, V01 est le plus performant.

Mots-clefs : *Systèmes à énergie distribuée; Analyse du pincement ; Modélisation de systèmes thermodynamiques ; Utilisation des cascades énergétiques; Récupération de chaleur industrielle; Echangeurs de chaleur; Stockage thermique; Conversion d'énergie; Performance énergétique ; Performance économique ; Performance environnementale .*

3 Comparative performance analysis of different configurations of DES system

3.1 Pinch analysis

Pinch analysis is one of the most practical methods to improve the energy efficiency in the field of process integration, which has been developed in order to maximize heat recovery in an economical way as well as minimize the demand for external utilities [2]. Generally, it was applied to address the single objective of engineering problem, which has been extended to solve multiple objectives pinch analysis problems by introducing several study cases to demonstrate their feasibility and adaptability [104]. Regarding the issues of the collection and integration of multiple-grade waste heat, pinch analysis have been widely used to study the heat exchanging process in terms of how to seek the location of pinch point [105, 106], how to assess the pinch point characteristic as the limit temperature shift for the heat exchange process pursued in the project [107] and how to perform the pinch analysis method in a practical way to deal with the problem of actual project [108, 109]. It is true that for some engineering process pinch analysis is not suitable to be applied to heat recovery analysis like in the study case mentioned in [20] where heat flow rates of industrial processes are totally similar and only hot fluid temperature is influenced by the industrial processes, in such a case, it is suggested the use of another feasible technology based on the principle of pinch analysis.

3.1.1 Methodology

Pinch analysis is based on the first and second laws of thermodynamics in which energy is conservative and heat flows only in one direction from high temperature to low temperature if no additional energy consumes. Pinch analysis can be used to maximize the potential of waste heat recovery leading to maximum energy flow from hot stream to cold stream, and calculate the minimum energy requirement of a given process. Pinch point is defined as the point of zero heat flow in a cascade,

alternatively, as the point of closest approach of composite curves in a “heating and cooling” problem. The concept of composite curves was introduced by plotting all integrated hot stream data and cold stream data separately on temperature enthalpy diagram. Grand Composite Curve (GCC) represents the difference between the heat available from hot streams and the heat required by cold streams. According to GCC, minimum utility requirement can be easily determined, which is important for the design of energy system especially the configuration of heat exchange network.

3.1.2 Utility system

Utility system refers to the goal of the energy system used for the process of heating or cooling, thus DES is a typical utility system for the industrial industrial park. Pinch analysis can bring benefits in a large-scale utility system for optimizing the configuration to achieve minimum energy requirement of primary energy. For the industrial process, there is an existing process pinch that cannot allow energy transfer without the dissipation of a part of the energy to be devoted to its realization, resulting into expansive excess in entropy generation. For utility system, there is utility pinch but no immediate energy penalty if heat transfers across a utility pinch. However, the addition of utility pinch over and above the process pinch can cause a remarkable increase in the installation of heat exchange units. In most cases, it is practical to reduce the levels and loads of the intermediate utility to simplify the utility network because the cost for transferring heat across utility pinch is pretty less than violating process pinch. Therefore, steam can generally be divided into High Pressure (HP), Medium Pressure (MP) and Low Pressure (LP) steam in DES. For the specific process requirement of steam, the adjustment device can be used to adjust the temperature and pressure of steam at the end-user side.

3.2 Introduction to THERMOPTIM software

THERMOPTIM software aims at facilitating thermodynamic analysis, it has been developed by Prof. Renaud GICQUEL in the frame of Mines Paristech, France. Initially THERMOPTIM was developed for the purpose of solving the problem encountered in teaching applied thermodynamics. However, due to its powerful

functionality, it has been proved liability for solving much more complicated problem like industrial schematic design. For example, it has been used to analyze system integration of cogeneration and advanced electricity generation production plants with plenty of components.

Main functions: THERMOPTIM is able to calculate full state of both hot and cold fluids and the simulation results can be shown including the parameters of temperature, pressure, mass volume, enthalpy, internal energy, entropy, exergy and quality. The fluids of energy systems are subject to various process of energy transformations [110], most current ones are implemented inside the environment:

- 1) Compression and expansion process, which are characterized by isentropic or polytropic efficiency;
- 2) Combustion process at set pressure, volume or temperature;
- 3) Isenthalpic throttling;
- 4) Heat exchanges with other fluids;
- 5) Other non-standard evaluations may also be described and treated using the software development facilities for specific purposes.

Modeling: THERMOPTIM consists in a modeling environment including four interconnected working elements: a diagram editor / synoptic screen, a simulator, interactive charts, and an optimization tool, allowing to easily vary the characteristic and parameters of the system under investigation. Diagram editor is used for editing graphically the flow diagram of working fluids and integrating the pre-processed transformers modules and access the input characteristics and parameters. Hence, the simulation model and state parameter output of the system can be shown in diagram editor; interactive chart can present the simulation results intuitively. The optimization tool is used to optimize energy transformation of the components, process and system.

Optimization: Optimization method of complex energy system in THERMOPTIM software is based on combining the exergy method with pinch analysis. The traditional optimization approach of thermodynamic system mainly focuses on maximizing various component one by one but it is relatively poor for

choosing optimal configuration of the entire system. While the optimization method applied in THERMOPTIM can ensure better consistency and matching of all the energy demands and energy sources as well as operational facilities to decrease systemic irreversibility resulting from the integration of components and space distance.

For modeling and simulating the energy system in THERMOPTIM, optimization method is implemented in the following four steps:

1) To select both cold and hot streams put into consideration according to the principles of pinch analysis;

2) To calculate the minimum heating to determine the utilities required. By accurately determining the minimum utility requirements, a target is defined to precisely quantify the difference between the theoretical optimum and the best solution from a technical and financial standpoint;

3) To construct the composite curves is the foundation of pinch analysis. The appearance of pinch points mentions the involved streams play a critical role in the system configuration, and the involved system zones should be paid more attention.

4) To construct heat exchangers by matching the streams which starts only when the model parameters are deemed compatible.

3.3 Case study

3.3.1 Background

Case study is a demonstrative industrial park located in Chongqing, China, whose utility/energy system is in the form of Distributed Energy System. Both District Heating and District Cooling system operate almost the whole year for industrial process heating and cooling without seasonal interruption and variation. By operating the utility system, there is a large amount of waste heat produced from system which can be recovered for DH. So CCHP-DH is proposed to meet the energy demand of the demonstrative industrial park with the aim of minimum requirement of primary energy and least impact on the environment as possible. However, considering the risk of non-implementation of DH system and DC system due to price competition

and the consumption will of the end-users, CCHP, CHP-DH and CHP system are proposed to show out the performance of different configurations of DES based on techno-economic analysis.

3.3.1.1 DES development in Chongqing

Chongqing is one of the four municipalities directly under the central government of P.R. China. The development of DES in Chongqing cannot move forward without the involvement and support of local government because almost all DES in Chongqing have the symbiotic relationship with industrial park based on Strategic Cooperation Agreement (SCA) supported by local government. Generally, SCA is signed between primary energy supplier (mainly natural gas supplier), the owner of DES and management committee of industrial park before the launch of a new DES for industrial application. The owner of DES varies according to the capital source, who may not only be the investors of the project but also be in charge of civil engineering construction and equipment installation, operating and maintenance management of DES. In view of the current energy structure in Chongqing, there is no sufficient condition to promote the development of micro-DES for building applications due to the economic inefficiency of gas-fired micro-DES and the environmental inefficiency of coal-fired micro DES.

The development of DES of industrial park in the past decade is shown in Table 3.1. It is not difficult to predict that more projects will adopt the natural gas as the primary energy to drive the DES even if coal-fired DES cannot be replaced for a long time based on the characteristic of energy structure in Chongqing. According to the requirement of the department in charge of environmental protection, it is compulsory to perform the environmental impact assessment before starting constructing the coal-fired DES or power plant. At present, the old coal-fired plant of low-efficiency and high-pollution have been shut down gradually by the strong hand of government.

Table 3.1

Development of DES mainly including CHP/CCHP in Chongqing

No.	Project	Main equipment	Note
1	CCHP: Central Business District Headquarter Economic Zone	2*1063kW gas engine; 2*1021kW hot water fired AR; 2*5250kW(cooling)/5800kW (heating)	To be expanded in the second stage
2	Tongnan Gas-fired CCHP	2* 400 MW gas-fired combined cycle units; 2* tri-pressure waste heat boiler	To be expanded in the second stage
3	CHP: Nanchuan industrial park	3*50 MW heating units; 350MW super-critical coal-fired generator unit	In operation
4	CHP: Baitao chemical industrial park	2*440t/h cycled fluidized bed boiler; 50MW gas turbine and generator	In operation
5	CHP: Qijiang industrial park of Aluminum	330MW generator unit; 4*82.5MW generator unit; 1025t/h coal-powder boiler; 4*700t/h fluidized bed boiler	In operation
6	CHP: Longqiao thermal power plant	Phase 1: 450t/h cycled fluidized bed boiler+ 50MW generator unit; 1100t/h cycled fluidized bed boiler+ 300MW generator unit; Phase 2: 450t/h cycled fluidized bed boiler+ 500MW generator unit.	In operation
7	CHP: Zhengyang industrial park	Total installed power of 60MW: 2*150MW extraction-condensing units; 4*80MW back-pressure units	In operation
8	CHP : Ziguangxudong chemical industrial park	2*130 t/h cycled fluidized bed boiler; 15MW gas turbine generator unit	In operation
9	CHP: Fengdu chemical industrial park	2*130 t/h cycled fluidized bed boiler; 25MW gas turbine generator unit with steam extraction of 260t/h	In operation
10	CHP: Bridgeport industrial park in Yongchuan	2*350MW super-critical coal-fired generator units	Under construction
11	CHP: East Hope cement plant	3*150t/h CFB boiler; 15MW+18MW gas turbine generator units	Under construction

As shown in Fig. 3.1, local output of natural gas reached the top of production, up to 8 billion m³ in 2008, but showed linear decrease year by year to 5 billion m³ in 2013. Although the local output of natural gas seemed not to keep up with the development of natural gas-fired DES in Chongqing, the total natural gas is not only sufficient to support the development of DES but also affluent to cover the demand of 95% domestic users in the urban area thanks to the West-East gas pipeline from Sichuan province where Chongqing has the geographic advantage of approaching to natural gas origin.

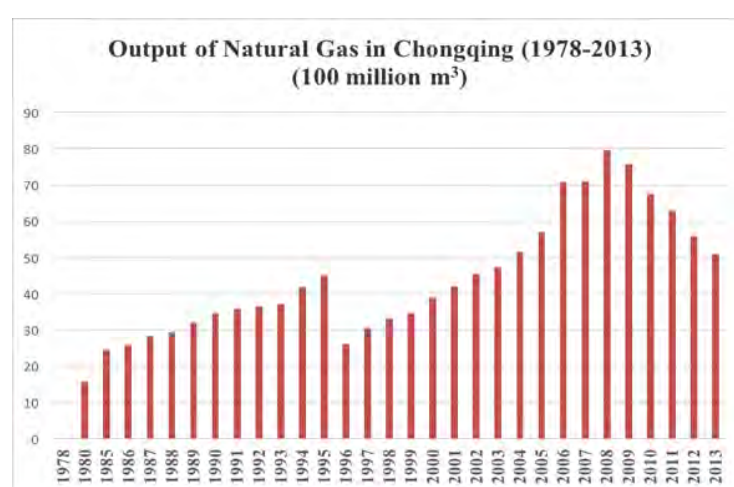

Fig.3.1 The annual output of natural gas in Chongqing (1978-2013)

Data source: Department of Chongqing Statistics

3.3.1.2 Project description of demonstrative industrial park

There is a natural gas-fired thermal power plant in the demonstrative industrial park, which is the driving force of DES system. The natural gas comes from the gas substation on the transportation roadmap of the natural gas from west to east of China. 5 sets of 9F-grade gas-steam combined cycle power generation units manufactured by General Electric Company are planned to be installed in thermal power plant and two of them are in operation with the installed power capacity of 467MW per unit, steam extraction pressure of 0.9MPa and temperature of 300°C which can be lower to 200°C for industrial end users. The configuration of gas-steam combined cycle unit is in the form of one-on-one mode, mainly including one gas turbine, one HRSG, and one steam turbine. Natural gas is combusted in the combustible chamber of gas turbine to

generate the power with the secondary product of high-temperature exhaust gas, which could be recovered by HRSG to provide HP, MP and LP steam. The steam from LP steam turbine is extracted to satisfy the heat requirement of bio-chemical industries and to activate absorption refrigerators for cooling five Data Centers in Cloud Computing center. Besides, all the power generated in thermal power plant is uploaded to power grid of Chongqing, while the main part is planned to be used in industrial park for maintaining the operation and production of industrial park and the rest is used for peak shaving of power supply.

3.3.2 Energy demand of industrial park

In the demonstrative industrial park, the thermal demand i.e. cooling demand and heating demand was mainly acquired based on the field investigation to the committee of industrial park and industrial energy consumers. The industrial park is characterized by Cloud Computing center whose cooling demand is huge and stable without significant seasonal variation and has specific temperature and humidity requirement. Cooling can be produced by thermally-driven absorption refrigeration using the LP steam. Besides, heating is supplied in the form of low-pressure steam to industrial production of bio-chemical plants whose capacity is huge with the amount operational hours of 7200h~8000h annually. The main process heating and cooling demand in the industrial park are shown in Table 3.2 and 3.3, respectively. While heating load of office buildings in the industrial park (end-users of DH) and other buildings (potential end-users of DH) around the industrial park were calculated as shown in Table 3.4.

Table 3.2
Cooling load of Data Centers

Data Center	Cooling load (kW)	Chilled water temperature
A	8954	7°C/12°C
B	8000	7°C/12°C
C	10700	7°C/12°C
D	12040	7°C/12°C
E	16178	7°C/12°C
Total	55872	

Table 3.3

Industrial heat requirement

Type ¹	Heat extraction (t/h)	T (°C)	P (MPa)	Heating period (h)
A	40+20+20+18	180	0.6~0.7	7200
B	4+60+50+15	180	0.6~0.7	8000
C	6+12+4	180	0.6~0.7	1600
Total	249²			

Note: ¹According to heating period;²Peak demand of industrial heat. Type A and B are used for industrial process heating, up to 227t/h=188.86MW**Table 3.4**

District Heating for space heating

Building	Heating Area ($\times 10^4 \text{m}^2$)	Heating load (MW)	Operating hour
Public ¹ building	30.6	20.312	8:00-20:00
Other building ²	60	30.12	24h

Note: ¹End-users of DH;²Potential end users of DH, including residential buildings of $55.9 \times 10^4 \text{m}^2$ heat area and one middle school of about $4 \times 10^4 \text{m}^2$ heating area.

3.3.3 Main equipment

9F-grade gas-steam combined cycle unit with installed capacity of 467MW is decided to be driving force of DES system, whose performance is important and influential to the comprehensive energy performance of DES. The main composition of gas-steam combined cycle unit is gas turbine, steam turbine and HRSG according to one on one configuration. The characteristic of main equipment is shown in Table 3.5, 3.6 and 3.7. Gas turbine is the main factor affecting the power output of the system. M701F4 gas turbine is decided to drive the DES with the temperature of 1427°C at the inlet of first grade turbine and with the temperature of 597.9 °C at the inlet of HRSG. In general, higher grade steam entering steam turbine leads to better thermal efficiency. The power of steam turbine ranges from 30-300MW and the main steam pressure ranges from 5.5 to 14 MPa with the temperature ranging from 500°C to 565°C [111]. In this case study, the power of steam turbine is 154.1MW under pure

condensate condition, and the main (HP) steam is 12.33MPa with the temperature of 539.9°C.

Table 3.5
Characteristic of main equipment

(a) Gas turbine				
Gas turbine	Parameter			
Type	Axial turbine			
Net power(MW)	312			
Net efficiency(%)	39.3			
Pressure ratio	18			
Combuster type	dry-type; low NO _x			

(b) Steam turbine				
Steam turbine	Parameter			
Type	three pressure; reheat; impluse			
Shaft end output(MW)	154.1 (pure condensate condition)			
Discharging pressure (kPa)	5.37(pure condensate condition)			
Steam distribution mode	full arc admission ; no control stage			

(c) HRSG (Heat Recovery Steam Generator)				
Heat recovery boiler	triple-pressure; reheat; no afterburning			
	HP part	Reheat part	MP part	LP part
Steam quantity (t/h)	274.7	329.97	64.36	48.32
Steam pressure (MPa)	12.33	3.15	3.34	0.67
Steam temperature(°C)	539.9	568	290.2	244.9
Condensed water temperature	49.4°C			

3.3.4 Gas-steam combined cycle unit

All-state performance of gas-steam combined cycle unit lays the core foundation for analyzing the performance of DES system under different operating conditions. All-state performance of gas-steam combined cycle unit includes the performance of the unit under ISO full condensing/ full steam-extraction, average full condensing/full steam-extraction, summer full condensing/full steam-extraction, and winter full

condensing/full steam-extraction operating conditions. Generally, ISO operating condition (air pressure 101.33 kPa, atmosphere temperature 15°C and relative humidity 60%) is regarded as design point to know about the performance of combined cycle unit under the design condition. In this study, ISO operating condition is also seen as the base and benchmark of the performance analysis of DES system. As shown in Fig. 3.2, under ISO full condensing condition, power output and gross thermal efficiency of gas-steam combined cycle unit increases with operating load rate. When the unit is operated at full rate, the power output is 467MW and gross thermal efficiency is 58.3%. Besides, under ISO full steam-extraction condition, when the steam extraction is 225t/h, power output is 422.54MW and gross thermal efficiency is 75.7%; when the steam extraction is 340t/h, power output reduces 27MW but gross thermal efficiency increases 0.9% comparing with steam extraction of 225t/h.

Steam-water system of three-pressure reheat HRSG in gas-steam combined cycle is illustrated in Fig. 3.3, which is important for connecting gas turbine and steam turbine to realize high temperature flue gas recovery for power generation and steam extraction. The temperature/pressure shown in Fig. 3.3 is based on ISO operating condition. The inlet temperature of flue gas from gas turbine is 597.9°C and the outlet temperature of flue gas from the chimney of HRSG is about 90°C to atmosphere.

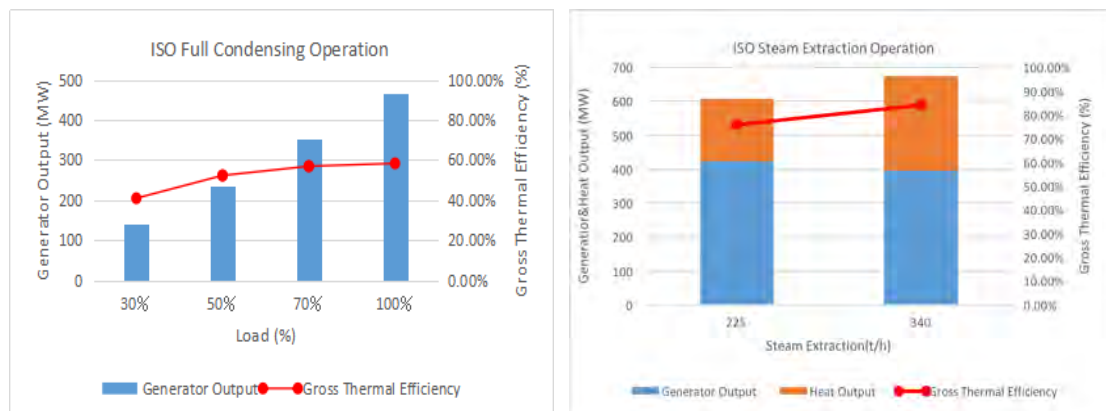

Fig. 3.2 Performance of Gas-steam combined cycle unit under ISO full condensing/ steam extraction operating condition (Base case)

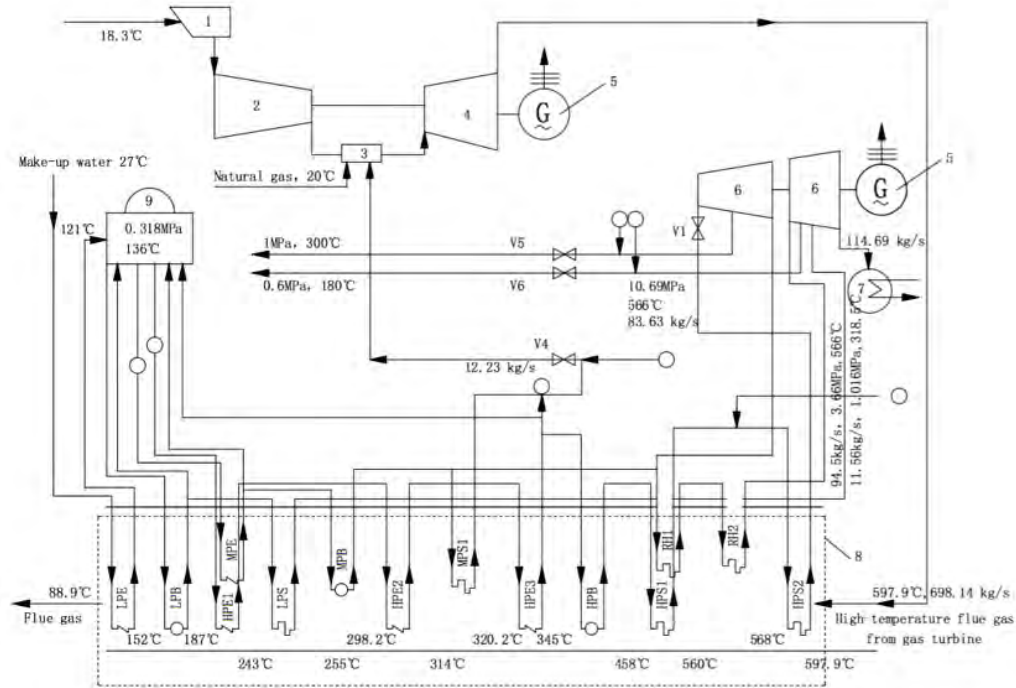

Fig.3.3 Steam-water system of three-pressure reheat HRSG in combined cycle

1-air filter; 2-compressor; 3-combustor; 4-gas turbine; 5-generator; 6-steam turbine; 7-condenser; 8-HRSG; 9-deaerator; HP-high pressure; MP-middle pressure; LP-low pressure; E-Economizer; B-Evaporator; S-Super-heater; RH-Reheater.

Atmosphere condition has obvious impact on the output of combined cycle unit, especially the atmosphere temperature. Thus, the performance of combined cycle unit is shown under other variable operating condition: 1) average full condensing/steam extraction operating condition with air pressure 98.57kPa, atmosphere temperature 18.3°C and relative humidity 80%; 2) summer full condensing/steam extraction operating condition with air pressure 99.44kPa, atmosphere temperature 7.6°C and relative humidity 84%; 3) winter full condensing/steam extraction operating condition with air pressure 97.42kPa, atmosphere temperature 28.4°C and relative humidity 76%. The simulation results are shown in Fig. 3.4, 3.5 and 3.6. Under the same operating condition, the increase of atmosphere temperature of 10°C will result in the decline of power output of around 5~6%. Under the full condensing operating condition, winter full condensing has the largest power output of 473.4MW (100% load), followed by average full condensing of 448.35 (100% load) and winter full condensing of 419.45 MW (100% load). Besides, obviously, no matter under which

variable operating condition, steam extraction operating condition (see figures on the left) has better gross thermal efficiency than full condensing operating condition (see figures on the right). These considerations demonstrate the fact that it is not economically relevant to operate thermal power plant as pure power plant. The most advantageous operating conditions of thermal power plant should be fully valorized to supply the heat for potential end-users.

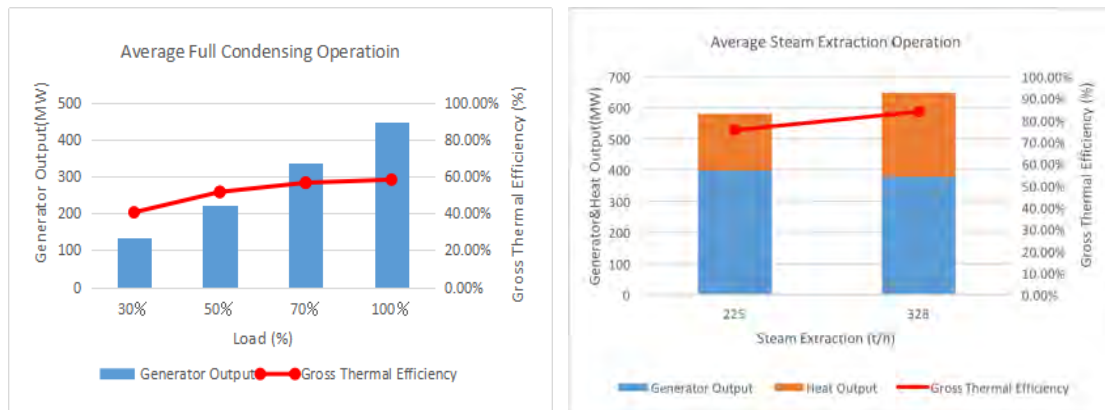

Fig. 3.4 Performance of average full condensing/steam extraction operating condition

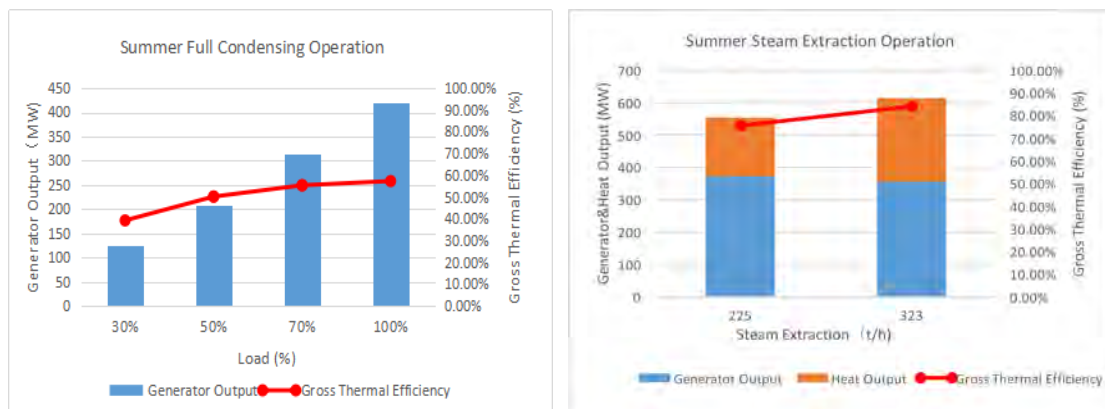

Fig. 3.5 Performance of summer full condensing/steam extraction operating condition



Fig. 3.6 Performance of winter full condensing/ steam extraction operating condition

3.4 Comparison of optimal configuration of waste heat sources

3.4.1 Model description

As mentioned in Section 2.3, there are three configurations of waste heat sources. Considering the characteristic of waste heat sources, the possible configurations of waste heat sources are integrated into CCHP system to form CCHP-DH system. In this study, the thermodynamic analysis software THERMOPTIM is employed to simulate the energy system. CCHP-DH model is marked as V0 in the process of simulation, but there are three models (V00, V01 and V02) of CCHP-DH system to be established considering different configurations of waste heat sources. In the model of CCHP-DH, circulating cooling water of thermal power plant and cooling water of condenser, together with waste heat from absorber of absorption refrigerator are regarded as waste heat sources of DH system. The configuration of V0 is illustrated in the following:

- ✓ Gas Turbine: 1) Power generation;
2) Generation of Heat recycled by HRSG;
- ✓ HRSG: 1) Recovery upon flue gas of Gas Turbine;
2) Generation of HP/MP/LP steam;
- ✓ Steam Turbine: 1) Power generation;
2) Extracted Steam reused for:
 - Industrial Process Heating: Bio-Chemistry;
 - Driving Absorption Refrigerator (AR);3) Circulating cooling water as waste heat source of DH;
- ✓ Absorption Refrigeration: 1) Cooling Data Centers without interruption;
2) Emit a large waste heat via condenser/absorber
- ✓ Recovery Control Loop: Waste heat sources from
 - 1) Circulating cooling water;
 - 2) Cooling water of condenser of AR;
 - 3) Cooling water of absorber of AR.
- ✓ District Heating: 1) Heat pump for upgrading waste heat

- Waste heat sources in serial arrangement (V00);
 - Waste heat sources in parallel arrangement (V01).
- 2) LP steam extracted to upgrade waste heat for DH (V02).

Based on the basic configuration of CCHP-DH system, the models V00 and V01 are established to compare the energy performance of two main optimal configurations of waste heat sources according to simulation results, i.e. serial arrangement and parallel arrangement of waste heat sources. Besides, the model V02 is proposed based on basic configuration of CCHP-DH system with waste heat sources in mixed arrangement. Differing from V00 and V01, a certain amount of LP steam is extracted to increase the temperature of waste heat sources accompanied by adjusting the pressure of heat medium LiBr in order to test and evaluate the global output of CCHP-DH system with the operational optimization of absorption refrigerator flexibility for recovering the waste heat. The specific part of the models V00, V01 and V02 are explained in detail in the following:

For models V00 and V01, normally, as the temperature of two condensers and the absorber is of similar level of around 55°C and variation similarly along the heat exchange, it seems to be more advantageous to have parallel arrangement of waste heat sources as in model V01, while serial arrangement is more favorable if there is larger temperature difference of heat medium water of DH and the return water of heat medium water has large heat capacity. In the model V01, heat medium water exchanges heat orderly with cooling water of absorber, condenser of AR, and circulating cooling water of thermal power plant. In the model V01, there will technically be a common tank with a fluid capacity for a damping, thus one exchange surface of exchangers is in common, the other one with the fluid in the tank that carries recovered heat. The models V00 and V01 are shown in Fig. 3.7 (a) and (b) to show different arrangement of multiple waste heat sources (for specific model shown in THERMOPTIM, the example of model V00 is attached in Annex-A), respectively. The arrangement of three waste heat sources is marked with red dotted box in both figures.

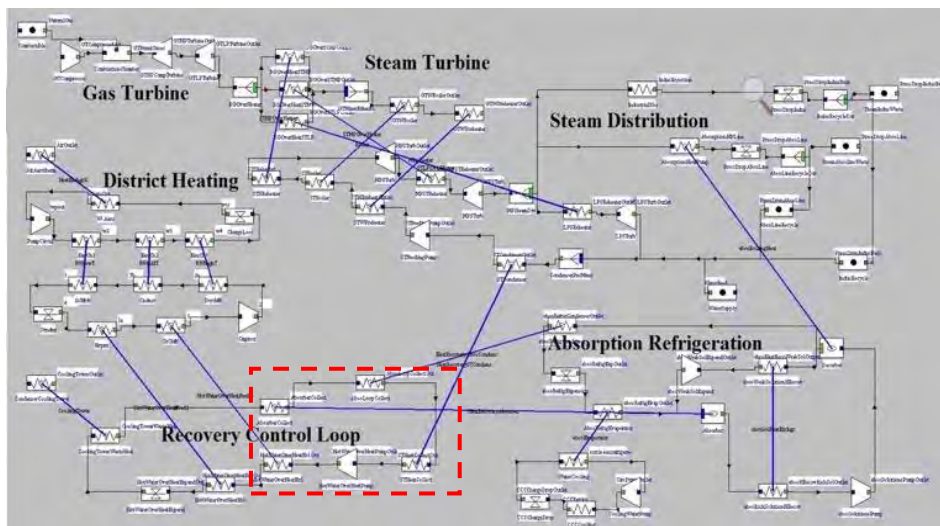

(a) Model V00 with serial arrangement of waste heat sources

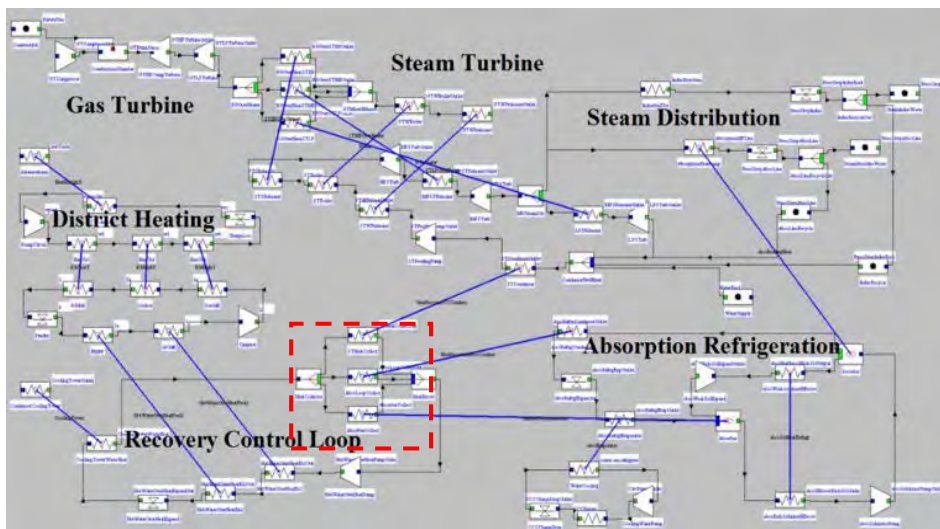

(b) Model V01 with parallel arrangement of waste heat sources

Fig.3.7 Simulation model of CCHP-DH system with compression heat pump for DH

For the model V02, when the temperature of both condensers are different with the absorber and changes along with the heat exchange, thus it is generally more rational to propose a mixed arrangement for waste heat collection. Waste heat from absorber is collected first at relatively low level for the purpose of preparatory heating to the heat medium water loop of DH. Then, waste heat from condensers is collected in parallel. Technically, this will also be made using a common tank taking advantage of the fluid capacity for creating a damping effect, thus an exchange surface of exchangers is in common, the other one with the recovered heat carrier fluid. The model of V02 is shown in Fig. 3.8.

In the models of V00 and V01, the condenser temperature of AR is about 55°C; while in the model of V02, the desorber temperature is about 100°C thanks to a change in temperature and concentration sink in the desorber, controlled by the desorber pressure, thus the condenser temperature rises to 110°C. Apart from the different configuration of waste heat sources, V02 is an alternative solution for DH, which uses the operational flexibility of absorption refrigerator instead of compression heat pump to upgrade the waste heat leading to less cost of equipment. Besides, although the configuration of absorption refrigeration loop looks apparently the same, the differences are residing in the operation and regulation of the loop.

There might be several advantages of the model of V02 for DH: with a higher temperature difference, the heat output is better for DH by principle and practically in case that the adequate absorption machine is equipped. Provided the regulation of the LP Steam is adapted at the pressure of 0.4MPa and the temperature of 125°C, both condensers can directly provide their heat recovery to the heating loop for DH and the contribution of the compression heat pump is no more necessary in model V02. Obviously, LP steam extracted for the purpose of DH will result in losing a little part of power, but there is also a reduction of power consumption due to the absence of compressor power required for the compression heat pump. As for the comprehensive energy performance of the models V00, V01 and V02, comparative analysis is carried out in the next section.

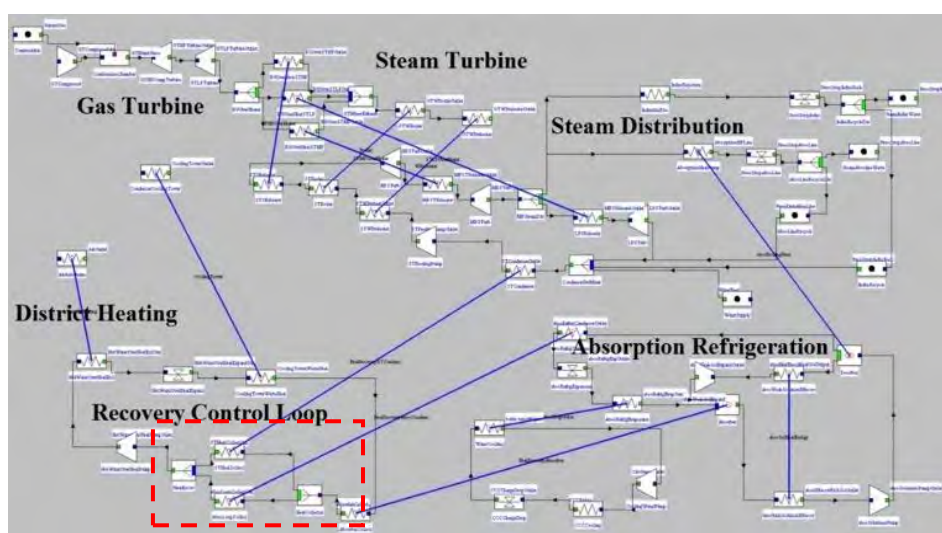

Fig.3.8 Simulation model of CCHP-DH (V02) system

3.4.2 Simulation results

Comparing with simulation results of V00 and V01, energy performance of two models are quite the same not only in terms of the same output of cooling, heating and power of CCHP, but also similar output of DH with 84.9 MW in V00 and 85.3MW in V01. So model V01 is selected to compare with model V02.

The indicators used for analyzing the energy performance of CCHP-DH (V01 and V02) are presented in the Table 3.6. The comparative simulation and analysis is performed to compare the performance of two models with different configurations of waste heat sources.

Table 3.6

Energy performance indicator of CCHP-DH system

Indicator	CCHP-DH model	
	V01	V02
Gas Consumption(MW)	765.82	765.82
Gross Energy Efficiency	89.81%	86.05%
Power Supply(MW)	380.41	373.72
Industrial Heat Supply ¹ (MWt)	194.75	170.34
HPR ²	0.87	0.76
DH(MW)	85.30	72.36
DC(MW)	51.54	44.76
Total Heat Supply (MW)	331.59	287.46

¹Industrial Heat Supply is related to Heat extraction, which can be calculated using the Eq. (3.1)

$$\text{Heat Supply} = \frac{F_s \times H_s - F_w \times H_w}{3600}$$

Where F_s refers to Steam Extraction (t/h); H_s refers to enthalpy of extracted steam (kJ/kg); F_w refers to feedwater flowrate of condenser (t/h); H_w refers to enthalpy of feed water (kJ/kg).

²HPR refers to Heat to Power Ratio.

As shown in Table 3.6, natural gas consumption of models V01 and V02 are the same, while the model V01 performs pretty better than V02 in terms of Power Supply, Industrial Heat Supply, DH and DC. As in order to upgrade the heating medium water of DH system with heat exchangers, in model V02, a fraction of LP steam is extracted from LP steam turbine and the steam pipe of Refrigeration Station to increase the

temperature of the cooling water of thermal power plant and the waste heat of AR, respectively. Consequently, it leads to the reduction of 24.41 MW industrial heat supply compared with V01 model. According to the indicator of Gross Energy Efficiency, V01 performs not too much better than V02 with only 3.76% higher value of Gross Energy Efficiency even all the output of V01 is larger than V02. The main reason is that quite a large amount of power consumption by compression heat pump in V01. Overall, the model V01 is actually more energy-efficient. However, compression heat pump is more expensive than heat exchangers. Consequently, an economic analysis is required for making a conclusion of techno-economic performance of two models.

3.5 Comparative analysis based on different configurations of DES

As DES system is regarded as energy infrastructure to support the daily operation of the industrial park, DES system should provide sufficient energy for both industrial and living energy to end-users of the industrial park. According to the energy requirement of the industrial park, CCHP-DH model (V0) has been proposed to realize energy cascade utilization in industrial park. However, CCHP-DH system is constructed step by step based on gas-steam combined cycle power plant i.e. CHP system. It will take a long time to complete the whole CCHP-DH system as the industrial energy demand is not required as expected in terms of timeliness and quantity. Therefore, there is the risk of unemployment of DC and DH considering price competition and energy supply stability. For DC, all Data Centers have their own electric chillers to provide cooling, which is stable but neither cost-saving nor energy-efficient, so DH should take the advantage in economic performance as well as improve the supply stability of the system; for DH, it is common for people staying and living in office buildings and residential buildings to use domestic air-conditioners in winter, so the heat price from DH should not be higher than air-conditioner and the maintenance of terminal devices should not be complicated and time-consuming. Therefore, different configurations of DES system are proposed and simulated to compare the energy performance of DES system with consideration

of the risk of non-adoption of DC and DH. In the following section, the models of CCHP, CHP-DH and CHP are introduced and simulated to show the energy and economic performance of each type of DES system based on the case study of the industrial park. The comparative results can be the reference for stakeholders in decision-making and risk management.

3.5.1 Model description

In order to perform techno-economic analysis of DES system with different configurations, another three models of CCHP, CHP-DH and CHP are described in detail in the following:

1) CCHP: Combined Cooling, Heating and Power

The goal of CCHP is to meet the basic industrial energy demand of power, cooling and heating based on the gas-steam combined cycle power plant. Differing from most of the traditional CCHP system, both cooling and heating in this industrial park are in huge demand around the year for the purpose of industrial production resulting in a large amount of waste heat emission. The configuration of CCHP system can be illustrated in the following:

- ✓ Gas Turbine: 1) Power generation;
2) Generation of Heat recycled by HRSG;
- ✓ HRSG: 1) Recovery upon flue gas of Gas Turbine;
2) Generation of HP/MP/LP steam;
- ✓ Steam Turbine: 1) Power generation;
2) Extracted Steam reused for:
 - Industrial Process Heating: Bio-Chemistry;
 - Driving Absorption Refrigerator (AR);
- 3) Circulating cooling water emits waste heat;
- ✓ Absorption Refrigeration: 1) Cooling Data Centers without interruption;
2) Emit a large waste heat via condenser/absorber
- ✓ Recovery Control Loop: No recovery control.
- ✓ District Heating: No waste heat recovery for DH.

2) CHP-DH: Combined Heating and Power coupled with District Heating

CHP-DH model is set to consider the risk of non-adoption of DC by the operators of Data Centers due to cooling price competition and system stability, and to propose the available heat source to drive DH system for realizing the energy cascade utilization in industrial park. Considering absorption refrigerator is not included in DES system, the available waste heat can only be circulating cooling water in case study. Normally, compression heat pump is used to upgrade the waste heat in DH system to establish V21 model. However, thanks to heat exchange with the extracted LP steam from LP steam turbine, it is possible to increase the cooling water to a higher temperature at about 110°C without the involvement of water recovery loop and compression heat pump, which is the concept of V22 model. Thus, the model of CHP-DH (V2) can be identified as V21 and V22 based on the different way of waste heat treatment and recovery. The configuration of CHP-DH system, so called V2 model, could be illustrated as follows:

- ✓ Gas Turbine: 1) Power generation;
2) Generation of Heat recycled by HRSG;
- ✓ HRSG: 1) Recovery of flue gas of Gas Turbine;
2) Generation of HP/MP/LP steam;
- ✓ Steam Turbine: 1) Power generation;
2) Extracted Steam reused for:
 - Industrial Process Heating: Bio-Chemistry;
- ✓ Recovery Control Loop: 1) Waste heat from circulating cooling water;
2) Heat pump for upgrading waste heat (V21);
- ✓ District Heating: 1) Waste heat recovery via heat pump for buildings (V21);
2) LP steam extracted to upgrade waste heat for DH (V22).

V21 and V22 models are proposed to simulate the performance of CHP-DH system to further know about the the different performance of DH system with and without heat pump to upgrade single waste heat source. The analysis aims to study the impact of different configurations of single waste heat source recovery of CHP-DH

system. Specifically, heat pump is integrated to DH system of V21 to upgrade the circulating cooling water while several heat exchangers replace heat pump to be integrated to DH system of V22 with the help of LP steam only extracted from thermal power plant to increase the inlet temperature of heat medium water of DH. The simulation results are shown in Table 3.7. Gas Consumption in both models are assumed to be the same value of 765.82 MW. As a fraction of low-pressure steam is extracted from LP steam turbine in model V22, so industrial heat supply and power supply reduces by 18.47 MW and 4.51 MW, respectively, compared to V21 model. Moreover, Gross Energy Efficiency of two models almost the same as more power is used to drive compression heat pump in V21 model. Based on the above analysis, it is difficult to declare which model is better for single waste heat source recovery. The main reason is that V21 model has higher power supply and industrial heat supply to meet the demand of industrial end-users with a bit more investment on heat pumps while V22 model has more output of DH to office buildings and less waste heat emission as well as less initial investment. Moreover, one waste heat source makes it flexible and feasible to operate the heat exchanging process with heat exchangers, while in CCHP-DH system mentioned above, it is complicated to achieve a better energy performance based on organizing the heat exchanging of three waste heat sources using heat exchangers. For the different configurations of CHP-DH system is necessary to compare economic performance of each model.

Table 3.7
Energy performance of CHP-DH system

Indicator	CHP-DH model	
	V21	V22
Gas Consumption(MW)	765.82	765.82
Power Supply(MW)	397.02	392.51
Industrial Heat Supply(MWt)	194.75	176.28
DH(MW)	33.12	52.33
Gross Energy Efficiency	80.23%	80.10%
HPR	0.57	0.58
Total Heat Supply (MW)	227.87	228.61

3) CHP: Combined Heating and Power

The model of CHP system is exactly established based on gas-steam combined cycle power plant, providing industrial heating and power to the industrial park. Actually, DES system of the industrial park has been operated for a period only with the output of power and steam for industrial steam consumers, because most users of DC and DH are not ready to use the energy from DES system. So it is meaningful to analysis the energy performance of CHP system. The configuration of CHP system (V3) is illustrated as follows:

- ✓ Gas Turbine: 1) Power generation;
2) Generation of Heat recycled by HRSG;
- ✓ HRSG: 1) Recovery of flue gas of Gas Turbine;
2) Generation of HP/MP/LP steam;
- ✓ Steam Turbine: 1) Power generation;
2) Extracted Steam reused for industrial heating;
3) Waste heat of cooling water emitted to atmosphere.
- ✓ Recovery Control Loop: No recovery control.
- ✓ District Heating: No waste heat recovery for DH.

3.5.2 Energy performance of different configurations of DES

In the gas-steam combined cycle DES system, gas turbine is the main factor affecting power supply efficiency of the system. M701F4 gas turbine has obvious advantages in the stability of heating supply, improved economic efficiency and energy savings and reduced flue gas emissions of the boiler of power plant [111]. As previously mentioned, Model V0 simulated the original design and planning of the energy system of the industrial park as the base case with low-temperature waste heat recovery, i.e. CCHP-DH. Based on comparative results of different configurations of waste heat sources of CCHP-DH system, Model V01 is decided to perform comparative analysis in energy performance. Similarly, there are two configurations of DH in CHP-DH system with similar energy performance, Model V21 of traditional configuration using compression heat pump is adopted to perform comparative analysis. Consequently, simulation results of energy performance of different

configurations of DES are shown in Table 3.8. In all models, natural gas consumption is assumed to be identical. Gross Energy Efficiency is defined as the ratio of energy output and energy input. Consequently, Gross Energy Efficiency of Model V01, V1, V21 and V3 is 89.81%, 81.74%, 80.23% and 76.91%, respectively. Comparing V01 system with V3 system, Gross Energy Efficiency only increases by about 12.9%, which is due to that a large amount of steam (heat) is extracted from gas-steam combined cycle unit for high-grade industrial production rather than heating the buildings in winter, leading to high energy performance of CHP system. Also, Model V01 has the highest HPR of 0.87 and Model V3 has the lowest HPR of 0.49. The higher is HPR of thermal power plant, the better is the energy performance of the system. HPR of all models is higher than 30%, which meets the requirement of Chinese energy industrial standard.

The development of DES is to satisfy the cooling demand of Data Centers which is one of the main original targets of DES system. Provided the project is carried out successfully as planned, DC requirement is 55872 kW according to the energy demand of the industrial park, if five Data Centers operates simultaneously without expanding their capacity. As shown in Table 3.6, cooling supply in Model V01 can reach to 51540kW, which is less than overall cooling demand of Data Centers. However, in reality, the operation of Data Centers is performed step by step rather than reaching the full load of Data Centers at the same time. So, it is not difficult to predict that the operation of one gas-steam combined cycle unit is generally sufficient to meet the cooling demand of Data Centers for a long period. Even if all Data Centers operate at full load simultaneously, there are two solutions: one is to extract more LP steam from LP steam turbine for driving absorption refrigerators at the expense of a limited amount of power output, noting that absorber refrigerators with cooling capacity of 6×9300 kW have been installed; the other is to operate the electric chillers in Data Center as supplementary. According to the simulation result, if steam (heat) output is up to 272.47MW instead of 188.64MW, power output will reduce only 22.23MW from gas-steam combined cycle unit.

Industrial heat demand of the industrial park is 188.86MW, while heat supply of V01 is 194.75MW which is generally sufficient for industrial process heating. Besides, gas-fired boiler is employed as the back-up of LP steam supply for industrial production in thermal power plant, in case that the heat supply is not sufficient to meet the peak demand and in case of the interruption of gas-steam combined cycle operation.

As for DH, the currently fixed energy demand is 20.31 MW, used for heating office buildings located in Cloud Computing service center, the model of V21 (CHP-DH) can meet the demand of DH. While Model V01 can offer up to 85.30MW space heating, which is far more than current energy demand of DH. So potential end-users of public rental apartments and one middle school near the industrial park can be encouraged to use space heating from DH.

Table 3.8
Energy performance of different configurations of DES

Model	Configuration	Energy input (kW)		Energy output (kW)			Gross energy efficiency (%)	HPR (%)
		Natural gas	Power	Power	Heating	Cooling		
V01	CCHP-DH	765821	26962	380410	194746 ¹ 85297 ²	51540	89.81	0.87
V1	CCHP	765821	2054	381380	194746 ¹	51540	81.74	0.65
V21	CHP-DH	765821	13005	397020	194746 ¹ 33120 ²	---	80.23	0.57
V3	CHP	765821	1841	395680	194746 ¹	---	76.91	0.49

Note: ¹ Industrial process heating; ² DH for space heating.

3.5.3 Economic analysis of different configurations of DES

The aim of technical analysis is to evaluate and compare the feasibility and energy performance of the different configurations of DES system to fulfill the task of industrial production according to actual situation of the project. However, the economic analysis is required to figure out the profit of project investment and propose effective measures to maximize the profit under the different circumstance of the actual operation of industrial production. The cost of power generated by gas

turbine mainly involves depreciation cost of the equipment, operational and maintenance cost of the unit, and fuel cost. In the following, economic analysis is performed to compare the economic performance of different configurations of DES system based on engineering progress. Currently, DES is operated in the model of CHP, but absorption refrigerators units have been installed to be integrated in order to raise it as CCHP system. Therefore, the price of power and industrial heating produced by DES is already known in the process of economic analysis, while the price of cooling and space heating is predicted by comparing cooling cost of electric chiller and domestic air-conditioner with current cooling price in District Cooling market of China.

Main results of economic analysis of different configurations of DES system are shown in Table 3.9. The total investment is calculated according to the different device configurations of DES system. The specific configuration of devices of each model is listed in the table. As gas-steam combined cycle units and absorption refrigerator units have been installed, so the number of the unit and the price of each unit are fixed, while for the other devices, both are estimated according to the energy demand of industrial park and the equipment price offered by equipment suppliers, respectively.

Payback Period of models V01, V02, V1, V21, V22 and V3 varies slightly from 7.48, 8.10, 7.23, 8.48, 8.86 and 8.37, respectively. All the Payback Periods are less than 9 years as each system is assumed to operate in 100% load with the high output of power.

In Table 3.9, the price of space heating, i.e. DH, is assumed to be RMB 0.25/kWh, profit before tax of model V01 is lower than V1, which is not rational in terms of economic interest. When the price of DH increases to be RMB 0.3822/kWh, profit before tax of model V01 equals to V1. So in order to stimulate investment motivation of investors, the price of DH should not be lower than RMB 0.3822/kWh. However, price acceptability of end-users of DH should also be considered. With the space heating price of RMB 0.3822/kWh, Payback Period of V01 is reduced to be 7.32

years, which is not quite different from Payback Period of 7.48 shown in Table 3.9, mainly for the reason that DH only operates in heating season for almost 100 days.

In addition, there is possibility that when all the devices are installed according to the design of CCHP-DH model, the system is not operated in the mode of CCHP-DH as the end-users choose to use their own equipment to produce cooling and space heating rather than use the energy produced by DES system. So the economic analysis is performed based on the total investment of CCHP-DH system, but the output varies from the models of CCHP-DH (V01), CCHP, CHP-DH (V21) and CHP. The analysis results are shown in Table 3.10, considering the price of DH of RMB 0.25/kWh and RMB 0.3822/kWh, respectively. When the price of DH increases to RMB 0.3822/kWh, Payback Period reduces 0.16 year and 0.09 year for CCHP-DH (V01) and CHP-DH (V21) models, respectively. Net Present Value (NPV) increases by 2.3% and 0.8% and Return on Investment (ROI) increases by 0.45% and 0.17% for the models of CCHP-DH and CHP-DH, respectively.

According to the main results shown in Table 3.9 and 3.10, it is found that the price of DH influences the performance of DH system, so the economic feasibility of DH system will be doubted if the price the DH is not made in a rational range. Besides, the influence of District Cooling is larger than District Heating in terms of economic interest. For example, in Table 3.10, with the consideration of District Cooling, ROI in CCHP-DH and CCHP model is higher than 17%, while in CHP-DH and CHP, ROI is lower than 15%. In terms of economic performance, effective measures should be taken to ensure the sustainable operation of District Cooling while cooling price is one of the main factors which should be priced seriously and rationally both considering the profits of operators of DES project and the accessibility of end-users.

Table 3.9

Main results of economic analysis of different configurations of DES: economic flows.

Initial Investment (RMB)	CCHP-DH		CCHP	CHP-DH		CHP
	V01	V02	V1	V21	V22	V3

3 Comparative simulation analysis of different configurations of DES system

	Units					
Gas-steam combined cycle units: 147.075×10 ⁷ /unit	2	2	2	2	2	2
Absorption Refrigerator units : 0.43×10 ⁷ /unit	6	6	6	0	0	0
Heat pump units: 0.73×10 ⁷ /unit	6	0	0	6	0	0
Heat exchanger units: 4.2×10 ⁵ /unit	0	13	0	0	13	0
Total investment: (×10 ⁷ RMB)	301.11	297.3	296.7	298.5	294.7	294.2
Annual Depreciation 5% Discount rate, 20 years	(×10 ⁸ RMB per year)					
	14.3	14.12	14.09	14.17	14.00	13.97
Annual operational cost	(×10 ⁷ RMB per year)					
Natural gas: 2.84 RMB/m ³	183	183	183	183	183	183
Electricity: 0.629 RMB/kWh	4.56	1.345	1.045	1.755	0.941	0.937
Maintenance & Human source cost:	3.832	3.786	3.715	3.734	3.69	3.619
Total:	191.707	188.447	188.076	188.805	187.948	187.872
Annual revenues	(×10 ⁷ RMB per year)					
Sale of power: 0.629 RMB/kWh	191.84	191.44	191.91	199.21	199.21	199.11
Sale of industrial heating: 0.3RMB/kWh	46.739	40.882	46.739	46.739	42.307	46.739
Sale of Cooling: 0.4RMB/kWh	16.493	14.323	16.493	0	0	0

Sale of Space heating (DH): 0.25RMB/kWh	2.559	2.171	0	0.994	1.570	0
Total:	257.63	248.819	255.142	246.940	243.084	245.845
Profit before tax	($\times 10^7$ RMB per year)					
	51.618	46.25	52.971	43.952	41.138	44.000
Investment analysis	(Discount rate 5%,20 year)					
Payback Period (Years)	7.48	8.10	7.23	8.48	8.86	8.37
Net Present Value ($\times 10^7$ RMB)	614.119	567.383	622.569	549.170	523.532	546.841
ROI (%)	17.14	15.56	17.85	14.72	13.96	14.96

Table 3.10

Investment analysis of different DES with the same initial investment as CCHP-DH system

Investment analysis	CCHP-DH(V01)		CCHP	CHP-DH(V21)		CHP
	Low ¹	High ²		Low	High	
Payback Period (Years)	7.48	7.32	7.35	8.57	8.48	8.6
Net Present Value ($\times 10^7$ RMB)	611.297	625.300	623.145	549.509	553.850	547.756
ROI (%)	17.14	17.59	17.51	14.55	14.72	14.47

¹Low indicates the price of DH is RMB0.25/kWh;²High indicates the price of DH is RMB0.3822/kWh.

3.5.4 Environmental analysis of different configurations of DES

This study concerns the analysis of the main sources of environmental pollution of gas-steam combined cycles based DES, which includes exhausted gas from chimneys, waste water of power plant, and also acoustic pollution from the power plant.

Natural gas is the primary energy and fuel of power plant, so the main air pollutants are SO₂ and NO_x. In fact, environmental protection measures have been taken to improve the environmental performance of gas-steam combined cycle units.

Low-nitrogen burner is adopted and there are SCR flue gas denitration equipment after each HRSG. Besides, in the process of power plant project site selection, it is required to minimize the influenced area of residential buildings, so the power plant is located in the corner of the industrial park.

The operation of DES system requires a large amount of water and drains away waste water, including device cleaning waste water, feed-in water and disposal sewerage. According to the type of waste water, some of them are used to wash the roads and some flows into sewage treatment plant.

The acoustic pollutant comes from the devices of power plant when it begins operating. So it is necessary to make a rational layout of the devices to reduce the influence of noise waste. Besides, effect measures of sound insulation, sound absorption and shock absorption should be taken to control the sound waste.

Considering the research emphasis of this study, more attention has been drawn to the influence of waste gas of power plant. Natural gas fired thermal power plant is generally recognized as an environmentally-friendly way of power generation, however, since the first ignition of gas-steam combined cycle units of power plant in Aug. 2014, Environmental Protection Agency of Chongqing has reported three cases of complaint, handling about exhaust emission from chimneys of gas-fired power plant, appealed by people living around the industrial park. So, it is necessary to analyse the environmental influence of DES to the surrounding environment. The height of each chimney is 80 meters and on-site chimneys of thermal power plant are shown in Fig. 3.9. According to the data of pollutant emission issued in *Monitoring Report on Completion Acceptance of Environmental protection* of gas-steam combined cycle power plant, the main pollutant diffusion diagrams of SO₂ and NO_x are simulated to know more about the diffusion of pollutant at the outlet of chimney and analyze the influence of pollutant diffusion on office buildings in the industrial park as well as people living around the industrial park.



Fig. 3.9 On-site view of chimneys of thermal power plant

Although monitoring data of pollutant emission issued from Monitoring Report based on two-day's field monitoring does not exceed the limiting value of the standard issued by Chinese and local government shown in Table 3.11, it is still important to analyse the diffusion of the exhausted gas to predict the potential sufferers in case that the air pollutant from chimney is out of the boundary of limiting value. The local wind condition greatly influences the diffusion of the exhausted gas from the chimney of thermal power plant. In the case study of the industrial park, wind speed and wind direction of Chongqing City is seriously considered to simulate the diffusion of exhausted gas. Wind-rose diagram and monthly average wind speed of Chongqing are shown in Fig.3.10 and Fig. 3.11, respectively. The simulation results and analysis are shown in the Fig. B.3~B.14 (seen Annex-B).

Table 3.11

Limiting emission value of exhausted gas

Waste gas source	type	Limiting value of emission		Reference standard
		Concentration (mg/m ³)	Limiting value of gross emission (t/a)	
Exhausted gas from chimney of HRSG	Smoke dust	5	100.5	<i>Emission standard of air pollutants for thermal power plants</i> (GB1323-2011)
	SO ₂	35	367.2	
	NO _x	50	2318.7	
	Darkness degree	Level 1	-	

Besides, exhausted gas emitted to environment can enlarge the influence of global warming. Its influence is not obvious in a short time but cannot be neglected from the point of view of sustainable development of life cycle of DES project. The final waste heat emitted to environment mainly including flue gas from chimneys, waste heat reserved in cooling water of recovery control loop and heat transformation loss in this case study, which is shown in Table 3.12. Especially, by virtue of waste heat recovery technology using compression heat pump, waste heat emitted to environment decreased by 62.52MW by comparing the models of CCHP-DH and CCHP based on multiple waste heat recovery, while as single waste heat recovery, the waste heat emitted to atmosphere decreased by about 23.33MW by comparing the models of CHP-DH and CHP. Besides, waste heat emission of V02 is far larger than V01 considering multiple waste heat recovery using different methods, while waste heat emission of V22 is less than V21 considering single waste heat recovery from circulating cooling water.

Table 3.12

Final waste heat to environment of different models of DES

Models	CCHP-DH		CCHP	CHP-DH		CHP
	V01	V02	V1	V21	V22	V3
Final waste heat emission (MW)	69.90	101.95	132.42	145.83	138.54	169.16

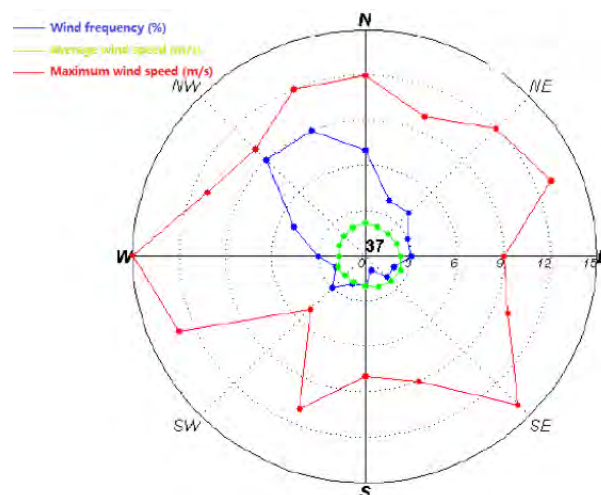
**Fig. 3.10** Wind-rose diagram of Chongqing [112]

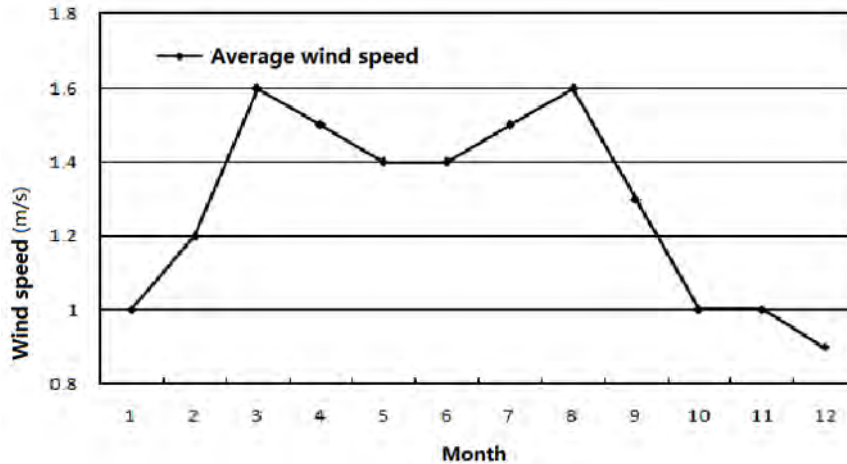

Fig.3.11 Monthly average wind speed during 1971-2000 of Chongqing [112]

3.6 Conclusions

In this chapter, the thermodynamic software THERMOPTIM is introduced to simulate the different configurations of DES system of Case Study. Based on the simulation results, energy, economic and environmental performance is analyzed to compare the different configurations of DES system. The main work and conclusions are listed as follows:

- 1) The process optimization based on the principle of Pinch analysis in the software of THERMOPTIM is illustrated. Traditional optimization approach of thermodynamic system mainly focuses on maximizing various component one by one but it is poor to choose optimal configuration of the entire system. While the optimization method applied in THERMOPTIM could make sure better consistency and match of all the energy demand and energy source as well as decrease systemic irreversibility resulting from the integration of components and space distance.
- 2) By comparing different configurations of waste heat recovery system based on multiple waste heat sources, it shows that there is not clear difference between the models of V00 and V01 with three waste heat sources in serial and parallel arrangement, respectively, while the model V01(V00) using compression heat pump performs better than the model V02 using the operational flexibility of

absorption refrigerators and condenser of thermal power plant with the extraction of certain LP steam in terms of energy, economic and environmental performance. However, by comparing V21 and V22 with the single waste heat source for DH, V22 has almost the same energy performance as V21; V22 performs better than V21 in environmental performance and poorer than V22 in economic performance.

- 3) Considering the possible operating models of DES project based on the real industrial energy demand, CCHP-DH (V01), CCHP (V1), CHP-DH (V21) and CHP (V3) models are proposed to compare the energy, economic and environmental performance of different models. In terms of energy performance, Gross Energy Efficiency of Model V01, V1, V21 and V3 is 89.81%, 81.74%, 80.23% and 76.91%, respectively. In terms of economic performance, Payback Period of operative models V01, V1, V21, and V3 varies from 7.32(7.48), 7.35, 8.48(8.57) and 8.6 when the price of DH is RMB 0.3822/kMh (*RMB 0.25/kMh*) if DES is installed in the complete form of CCHP-DH. All the Payback Periods are less than 9 years as each system is assumed to operate in 100% load with the high power output. Besides, the price of DH will influence the investment motivation of investors and the purchase will of end-users, the price should not be lower than RMB 0.3822/kWh in this project. Moreover, District Cooling influences more than DH in Payback Period and specific measures should be taken to avoid the risk of non-adoption of DC system.
- 4) In terms of environmental performance, two aspects are considered: a) one is the influence of air pollutants of gas-steam combined cycle power plant, the possible victims are detected using the software FLUENT in different heights based on local wind condition; b) the other is the influence of global warming caused by the emission of final waste heat to the environment. By comparing different models, CCHP-DH (V01) has the least waste heat emission to the environment.

Résumé Français du Chapitre 4: Evaluation globale de la performance et analyse des verrous au développement des Systèmes à Energie Distribuée

La revalorisation de la chaleur rejetée et notamment par le développement des systèmes à énergie distribuée nécessite une approche globale afin de définir l'installation soutenable à long terme.

A l'heure actuelle, la méthode 3E a servi à l'évaluation de la performance globale de nombre de SED car elle permet de se placer sur les points de vue énergétiques, économiques et environnementaux. En effet, la performance globale des installations joue un rôle sur leur durabilité d'exploitation et consécutivement sur la "soutenabilité" du développement sociétal. La prise en compte des interactions entre les différents facteurs caractérisant les performances selon les différents point de vue et ceci de la manière la plus exhaustive possible justifie la mise en œuvre de la méthode 3E. La méthode se fonde sur la définition d'une série d'index énergétiques (En), économiques (Ec) et environnementaux (Ew).

Du point de vue énergétique, le premier est le ratio HPR, défini comme le rapport des chaleurs et des travaux générés et valorisés dans le processus mis en œuvre. Il est en général contraint de façon normative au dessus de 30%. L'efficacité globale est définie comme le rapport des puissances générées aux puissances absorbées, incluant les auxiliaires. Concernant les composants élémentaires et cycles de transformation d'énergie, les COP (coefficients de performances) suivent les définitions usuelles. Le diagramme de Sankey proposé reprend le schéma du système CCHP-DH et porte à titre indicatif, quelques valeurs.

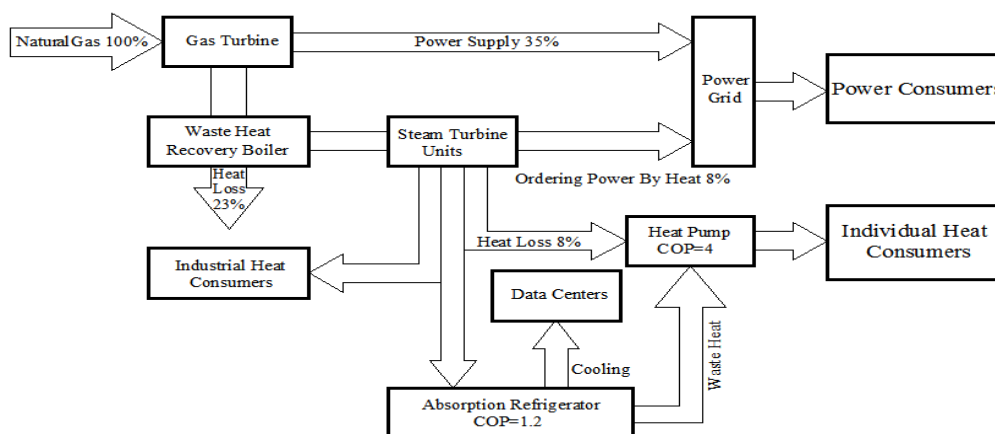

Les indicateurs économiques sont en premier lieu l'Investissement Total qui reprend l'investissement initial, les coûts opérationnels et de maintenance, les taxes environnementales et prend en compte le coût du combustible. La Valeur Nette Actuelle s'intéresse à l'évaluation de la rentabilité de l'opération, en évaluant la différence entre la valeur actuelle de l'installation et l'investissement initial en se référant aux revenus créés et aux coûts encourus. Cette valeur doit rester positive. Le Temps de Retour sur Investissement permet d'évaluer la date de rentabilité de l'opération. Le rapport tarifaire Electricité/Gaz est également une grandeur très significative pour cette évaluation.

Au niveau environnemental, on considère l'émission de CO₂, relativement à l'énergie primaire en fonction de facteurs normalisés.

La performance globale du Système à Energie Distribuée (SED) est alors évaluée par la combinaison de ces indicateurs. En effet, c'est l'effet de leurs couplages qui s'avère significatif. Les progrès techniques permettent d'améliorer l'efficacité des composants et des systèmes SED, mais c'est la rentabilité économique qui déclenche la réalisation des projets et de plus en plus, ce sont les aspects environnementaux qui régissent leur durabilité.

Ainsi, les conséquences sur l'environnement et la santé ont un coût qui incombe à la société qui les génère ou a pu les générer par ses options technologiques et est imputé au budget. Les contraintes environnementales pèsent sur la disponibilité énergétique, tout particulièrement pour les pays en développement; il est ainsi fondamental de restreindre les rejets ultimes autant que possible.

La coordination des indices d'évaluation est faite par la méthode d'analyse totale de site, qui correspond à une observation du système à sa frontière extérieure ; celle-ci est complétée par une analyse individuelle des processus à la frontière interne du système. Il en découle une analyse globale synthétique qui est complétée par une analyse de risque.

L'analyse externe s'appuie sur une approche vectorielle permettant de prendre en compte l'assiette des configurations en fonction de leur performance selon les trois points de vue et leur convergence avec la solution idéale. Il apparaît ainsi un intérêt majeur pour les systèmes CCHP-DH, moins marqué pour CCHP et CHP-DH.

L'analyse interne définit pour l'énergie un coefficient intégratif ("intensité") comme rapport de l'écart entre l'offre et la demande à la valeur économique de l'énergie produite. Une intensité analogue caractérise les rejets. Une intensité globale

I_{3E} adimensionnelle résulte de la combinaison de ces index qui est étendue au niveau global sous la dénomination I'_{3E}.

Il découle de la mise en application le caractère performant des modèles CCHP-DH et CHP-DH. A noter toutefois la grande sensibilité de l'index I'_{3E} à la performance énergétique et donc aux rejets ultimes, ce qui peut fausser l'analyse.

Mots-clefs : *Systèmes à énergie distribuée; Récupération de chaleur industrielle; Conversion d'énergie; Performance énergétique ; Performance économique ; Performance environnementale ; Performance globale ;*

4 Comprehensive performance evaluation of DES system

In the field of industry, waste heat recovery system has been widely applied due to the requirement of current social-economic development. In order to promote the waste heat recovery technologies in DES, it is necessary to evaluate the energy, economic and environmental performances of the comprehensive energy system coupled with waste heat recovery technologies. Currently, 3E evaluation system has been widely used to assess the DES system while it focuses on assessing the energy system from the point of view of energy, economic and environment, respectively. However, the coordinated development of energy, economic and environmental performance of DES system plays a vital role in sustainable development of society, so it is important to discuss the coordination of 3E performances. Since the correlations of energy, economic and environment factors in the development of energy system cannot be reflected in 3E evaluation system, comprehensive performance evaluation including the interaction and evaluation of 3E performance is proposed to show comprehensive performance of DES system.

4.1 Importance of 3E evaluation in DES system

3E performances of DES system should respect the development of social-economic. To pursue high energy efficiency is the basic and intrinsic requirement of DES. However, to promote the development of DES systems, the measures undertaken cannot only be restricted to improve the energy performance but also economic and environmental performance. Generally, efficient energy conversion technologies are adopted to meet different energy demand of end users in accordance with local conditions. But it is necessary to compare the economic performance of different energy conversion technologies, which is normally required by the investors. Only rational economic benefit could increase the investment enthusiasm. Besides, environmental performance has already been paid more and more attention due to the serious environmental issues globally. It has been a trend

that protecting the environment is not only depending on the voluntary behavior but also the compulsory requirement of social responsibility.

When it comes to utilize waste heat recovery technologies for recovering the waste heat of DES, energy performance can be used to show the efficiency and stability of technologies; economic performance can be used to show the benefit of recovered waste heat compared to the investment of equipment and operational cost; while it is beneficial to the environment in terms of global warming reduction when the waste heat is recovered even if a bit more emission increases due to the addition of waste heat recovery technologies. So, waste heat recovery system will contribute to the improvement of 3E performance of DES project.

3E performance of DES were evaluated respectively in the references and few papers have paid the attention to the interaction of 3E performance. In fact, 3E performance of DES have cooperating, complementary and synchronized relationship to each other. The well-coordinated 3E performance of DES contributes to the sustainable development and power competition in the whole energy system.

4.2 Application of 3E evaluation in DES system

4.2.1 Energy evaluation indicator

Many indicators have been studied to show energy performance of DES from different points of view. The choice of indicators of energy performance is important to evaluate the performance of DES. In the following, the main energy evaluation indicators are presented in detail.

1) Heat to power ratio (HPR). As thermal power plant is mainly used for heating and the power is only used as the supplementary and peak-shaving of power grid, so it is better to achieve a higher HPR for DES system. HPR is primarily decided by the configuration and operational condition of thermal power plant unit. As shown in Eq. (4.1), HPR is the ratio of heat supply to power supply.

$$\text{HPR} = \frac{Q_h}{W_e} \quad (4.1)$$

Where Q_h is heat supply of DES system, W_e is power supply from thermal power plant to power grid. For gas-steam combined cycle power plant, HPR is required to be higher than 30% according to Chinese industrial rule. As shown in Table 4.1, based on experimental analysis, in rated steam extraction operating condition, HPR of two gas-steam combined cycle units, i.e. CHP model are around 0.5 in this study.

Table 4.1

HPR of gas-steam combined cycle units based on experimental analysis

Gas-steam turbine combined units	Rated steam extraction operating condition		
	Power supply (MW)	Heat supply (MWt)	HPR
NO. 1	382.34	193.14	0.505
NO. 2	391.71	198.26	0.506

2) Gross energy efficiency. DES is regarded as energy conservation technologies, so gross energy efficiency can be improved compared to separate energy system, which is important to shown the overall energy performance of DES system. As shown in Eq. (4.2),

$$\varphi_g = \frac{W_e + Q_h}{Q_f + W_a} \quad (4.2)$$

Where φ_g is gross energy efficiency of DES system; Q_h can be the sum of heating for process heating, DH and DC; Q_f is total fuel consumption; W_a is auxiliary power consumption of main devices.

3) Coefficient of performance (COP). COP of mechanical heating or cooling systems shows the heating or cooling can be obtained from electricity energy. While COP of DH and DC in DES system can be expressed in Eq. (5.3) and (5.4) to show the energy performance of DH system with compression heat pump and DC system with absorption refrigerator.

$$\frac{\dot{Q}_{DH}}{\dot{W}_{net}} = \left(\frac{\frac{1}{T_{MT}}}{\left(\frac{1}{T_{LT}} - \frac{1}{T_{MT}} \right)} \right) - \left(\frac{\phi(s)}{W_e \cdot \left(\frac{1}{T_{LT}} - \frac{1}{T_{MT}} \right)} \right) \quad (5.3)$$

Where \dot{W}_{net} is the power consumption of main devices of DH system; Q_{DH} is the heating for DH system. The second term represents the irreversible part, where $\phi(s)$ is the flux of generated entropy, which can be ignored in first approximation.

Considering the case of the absorption refrigerators used for Cloud Computing center, it consists in a tri-thermal source cycle applied as refrigerator. In such a cycle, the drive energy is heat Q_{HT} , where index "HT" stands for High Temperature of the cycle, Q_{MT} is the heat rejected by the condenser at mid level temperature, to be recovered in the collection loop and further reused for DH, (eventually upgraded by the compression heat pump) and Q_{LT} is the heat collected by the evaporator at low level temperature, from the cooling of the low source, i.e. Data Centers, respectively the corresponding source temperatures are affected with the same index. In such a process, the efficiency in refrigeration is defined as:

$$\text{COP}_{DC} = \frac{Q_{DH}}{\dot{W}_{net}} = \left(\frac{\left(\frac{1}{T_{MT}} + \frac{1}{T_{HT}} \right)}{\left(\frac{1}{T_{LT}} + \frac{1}{T_{MT}} \right)} \right) - \left(\frac{\phi(s)}{\dot{Q}_H \left(\frac{1}{T_{LT}} - \frac{1}{T_{MT}} \right)} \right) \quad (5.4)$$

Where Q_{DC} is the heating for DC system. The former part of the second term represents the reversible part of the cycle and the latter is the irreversible part, where $\phi(s)$ is the flux of generated entropy. Here is given the expression of the cycle efficiency in the case of a simple effect machine design. In case the Compression Heat Pump is skipped in the recovery process, T_{MT} is corresponding to T_{DH} .

Besides, due to the necessity of the circulation of fluids exists in the recovery and control loops, the motion of the heat transfer fluid is performed by pumps whose electric consumption must be taken in account. Heat transfer loops are also suffering of the imperfection of heat exchangers, thus a thermal loss, hopefully limited, occurs while heat is transferred to DH, this one needs to be taken in account too and controlled as being limited to an acceptable level.

The energy flowchart of CCHP-DH system in the study case is shown in Fig. 4.1, COP of double-effect LiBr-H₂O absorption refrigerator for DC is assumed to be 1.2 [100] and COP of heat pump for DH is assumed to be 4.

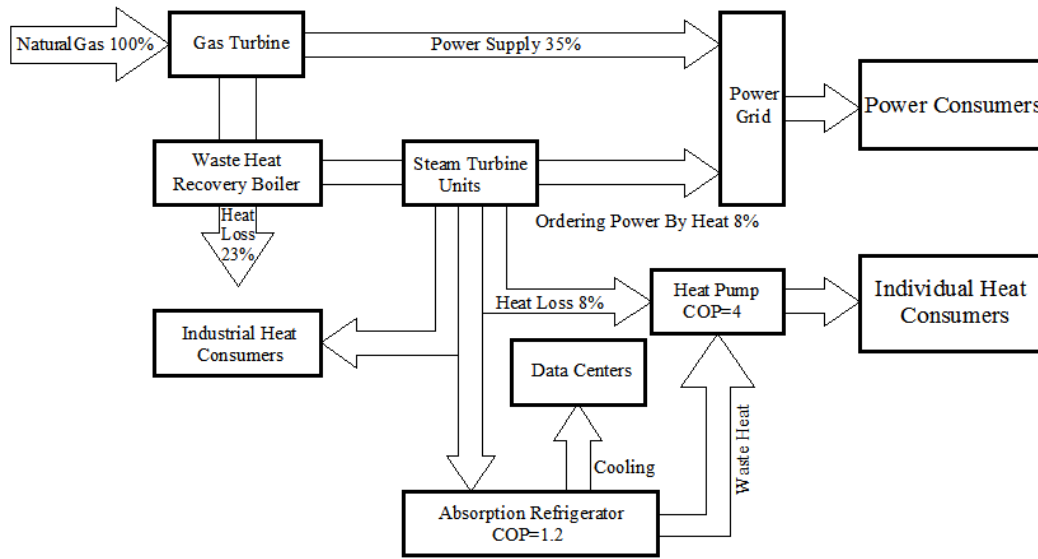

Fig. 4.1 Energy flowchart of CCHP-DH system

4.2.2 Economic evaluation indicator

Economic performance is the most important factor of the sustainable development of DES project for stakeholders. The implementation of the project only takes place when DES is justified to be economically feasible. The variety of economic evaluation indicators helps to perform comprehensive evaluation to reflect the different views of economic performance of DES system.

1) **Total investment** C_{total} . The total investment of DES includes the initial investment $C_{initial}$, operational and maintenance (O&M) cost $C_{O\&M}$, environmental tax $C_{en,tax}$ and fuel cost C_{fuel} , which can be expressed in Eq. (4.5) [113]

$$C_{total} = C_{initial} + C_{O\&M} + C_{en,tax} + C_{fuel} \quad (4.5)$$

Where $C_{en,tax}$ generally refers to carbon tax for natural gas-fired DES, which varies in different countries. Carbon tax was first levied in Holland, then extended to other developed countries. China has been explored the feasible model of carbon tax by Chinese environment, but carbon tax hasn't yet been implemented.

2) **Net present value (NPV)**. NPV is used to evaluate and compare the different schemes of the project to show the profitability of the project, which refers to the difference value between the present value of total cost and initial investment as shown in Eq. (4.6)

$$NPV = \sum_{t=1}^n \frac{CI_t - CO_t}{(1+i_0)^t} \quad (4.6)$$

Where CI_t is the revenue of total energy products in year t ; CO_t is the total cost of DES system in year t ; i_0 is the discount rate. If $NPV > 0$, the project is economically feasible to be implemented; if $NPV < 0$, the economic benefit of the project is not positive and the scheme of the project should be redesigned.

3) **Payback Period P_t** . Payback Period shows the flow rate of the capital. The shorter, the better in reducing the investment risk of the engineering project. There are two types of Payback Period. a) Static investment payback period; and b) Dynamic investment payback period. Both of them can be calculated according to Eq. (4.7) and Eq. (4.8), respectively.

$$P_{t,s} = \frac{C_{initial}}{R_{all} - (C_{O\&M} + C_{fuel})} \quad (4.7)$$

Where R_{all} refers to the revenue of power, heating and cooling. In this study. The heating revenue includes the revenue of industrial process heating and DH.

$$P_{t,d} = m - 1 + \frac{\sum_{m-1} NPV_{m-1}}{NPV_m} \quad (4.8)$$

Where m refers to the year in which the cumulative NPV becomes positive for the first time. NPV_{m-1} is the absolute value of NPV until the year $m-1$; NPV_m is the net income in the year m .

4) **Electricity Gas Rate (EGR)**. For natural gas-fired DES based on the thermal power plant, EGR is a vital indicator for showing the economic feasibility of using natural gas to generate the power. As shown in Eq. (4.9), EGR is the ratio of electricity price in equivalent heat value (RMB/kJ) to natural gas price in equivalent heat value (RMB/kJ) [115].

$$EGR = \frac{\text{Electricity Price}}{\text{Gas Price}} \quad (4.9)$$

In China, the value of EGR is relatively low because of the pricing strategy of electricity and gas influenced by the planned economic system. For example, according to the price policy of power issued by the government of Chongqing as mentioned in the case study, EGR in Chongqing is around 2.75. Compared to

coal-fired power plant and hydro-plant, power generation of thermal power plant is not competitive in terms of profitability. However, there is more economic benefit if the thermal power plant is required to give priority to thermal requirement of heat consumers. Therefore, the principle of ordering power by heat should be necessarily applied to design and operate thermal power plant.

4.2.3 Environmental evaluation indicator

The cost of air pollution is based on the negative effects of air pollution on the health of society, economic and environment. As the increasing air pollution and global warming issues have been exposed to the public, environmental performance of DES should be considered to improve comprehensive performance of the energy system. The industrial energy consumption contributes to a large amount of global energy consumption and pollutant emission. For the natural gas-fired DES system, normally there are lower air pollutant emissions after flue gas treatment, compared to other fossil fuel fired DES system. The main influence to the environment is greenhouse gas, which could be measured by the indicator of Global Warming Potential (GWP). Normally, CO₂ contributes mainly to the global warming even $GWP_{CO_2}=1$ is relatively low but the amount of CO₂ is far larger than other gases as shown in Table 4.2. Therefore, calculation of the amount of CO₂ emission can be one of the most important steps in evaluating the influence of DES system to the environment. However, even using emission factor to estimate CO₂ emission is not necessarily the best option, but currently it is the most feasible method due to the lack of any continuous and practical emission measurement. The emission of CO₂ C_{e,CO_2} can be estimated using Eq. (4.10),

$$C_{e,CO_2} = \sum \lambda_{CO_2,i} Q_{e,i} \quad (4.10)$$

Where $\lambda_{CO_2,i}$ refers to emission factor of CO₂ of primary energy, i.e. for the electricity, $\lambda_{CO_2} = 233\text{kg/GJ}$; while for the natural gas, $\lambda_{CO_2} = 53.9\text{kg/GJ}$; $Q_{e,i}$ refers to the amount of primary energy consumption, such as electricity and natural gas in gas-fired DES system, the unit should be J ($1\text{kWh} = 3.6 \times 10^6\text{J}$); i refers to the type of primary energy.

Table 4.2

The amount of the main air pollutant for natural gas

Pollutant	Natural gas (gr/kg)
CO ₂	2712.6
CO	31.8021
NO _x	2.4×10^{-7}
SO ₂ *	-

* SO₂ emission is greatly influenced by the composition of natural gas, which is normally subtle when emits to environment after flue gas treatment.

Based on the overview of energy, economic and environmental evaluation indicators, Gross energy efficiency, Total investment, Electricity Gas Rate and CO₂ emission are decided to be integrated to comprehensive performance evaluation of DES considering the coordination of 3E performance.

4.3 Comprehensive performance evaluation of DES based on coordination of 3E performance

It is indeed important to evaluate the performance of DES system from different points of view using energy, economic and environmental evaluation indicators. However, the coordination of 3E performance is more important to the sustainable development of social-economic. Therefore, it is necessary to evaluate the comprehensive performance of DES system through coordinating and coupling 3E performance. The coordination evaluation of DES system includes the evaluation of pairwise correlation or triadic relation of 3E performance. The distribution of coordination degree is the representation of stability of social-economic development and decisive factor and basic foundation of comprehensive and sustainable development. The proposed methodology has adopted a well-balanced approach considering energy, environmental and economic performance of DES system.

4.3.1 Interaction of 3E performance in DES system

Energy efficiency is closely linked to economic benefit of energy system that more energy saved will lead to more economic benefit gained using the same technological level. However, with the involvement of advanced energy conversion

technologies in DES, both energy and economic performances should be considered to evaluate the feasibility of DES project. Economic performance is generally used as the key motivation in deciding the implementation of DES system in the industrial park, while energy performance is generally used as the key indicator in selecting the schematic of DES system to meet end-users' energy demand. However, as the environmental issues become more serious, more attentions should be paid to avoid and lower environmental damage in the process of industrialization and urbanization. The concept of sustainable development in recent years requires the coordination and coupling of energy, economic and environmental performance of society. Energy industry such as DES system is part of social components, so its performance should take into account the coordination of 3E performances of the system. This implies that traditional concept and method of developing energy system focusing on the economic motivation should be revised to be compatible with the trend of sustainability. In the following, the increasing impact of environment on economic and energy performance are illustrated to lay the foundation for developing the comprehensive evaluation model based on coordination of 3E performance.

4.3.1.1 Environmental restriction reflects in economic performance

The most obvious environmental restriction of DES system is the restriction of pollution discharge. For natural gas-fueled power plant, the main restriction is greenhouse gas (GHG) emission. According to *Law of the People's Republic of China on the Prevention and Control of Atmospheric Pollution* issued in Aug. 2015, it is required to make a plan of potential producing serious air pollution to national prevention and control area due to the emission of industrial park, development zone, regional industry and development, and it is compulsive to perform environmental impact evaluation in accordance with the law. Therefore, taking into account environmental performance is no longer a voluntary and selective behavior but compulsory requirement for energy industry, which definitely limits the economic performance but reflects and supports the idea of sustainable development.

Environmental restriction in DES will definitely result in hindering pursuing economic benefit blindly and temporarily. Otherwise, the society has to pay the price

for air pollution caused by industrial production without caring about the environment. It was predicted by World Bank that China will have to pay 390 billion dollars for the disease caused by coal consumption by 2020 based on the current developing trend, which accounts to 13% of Global Domestic Product of China.

Besides, the environmental protection measures and technologies increase the cost of industrial production. The gas-steam combined cycle power plant in this study invested 3.75% of total investment to environmentally protective facility mainly including SCR flue gas denitration equipment. For the industry with CO₂ emission, the addition of carbon capture technology will increase the initial investment of equipment and operational cost, but carbon emission is reduced due to the carbon capture technology, which leads to the decrease of carbon tax. But in China, carbon capture technology has not been widely adopted because carbon tax policy has not been implemented and only some of the pilot projects have been constructed to explore the carbon tax policy in social and economic environment of China.

4.3.1.1 Environmental condition restricts energy consumption

Environmental issues become increasingly serious due to over-exploitation over-consumption and over-discharge to the nature, which have drawn worldwide attention to figure out the way to realize sustainable development of nature and society. Especially, for the developing countries, who are under double-pressure of promoting the development based on energy consumption and carrying out environmental protection, it is difficult but necessary to make a balance to maximize the benefits in a sustainable way. The industrial production contributes to a large amount of energy consumption accompanied with pollutant emissions. Some of the pollutants can be reduced by optimizing the industrial production process, but for the rest that is unavoidable, it is necessary to take the measures to lower the emission to the atmosphere in order to improve the environmental performance of DES.

The public was made aware of the impact of energy consumption on environment has been known to the public, but how to reduce the environmental impact in an efficient way is still been explored to maximize energy efficiency together with minimizing environmental influence. DES consumes primary energy for producing

the power, heating and cooling for industrial production. The environmental capacity is limited globally, so the improved environmental standard will restrict not only energy consumption but also energy production. Due to different industrialized stages between developing and developed countries, the balance of environmental performance and energy performance can be weighed according to the estimation of social responsibility and economic ability.

4.3.2 How to coordinate 3E performance

The sustainable development of DES requires the coordination of Energy, Economic and Environmental (3E) performances of DES. So comprehensive performance evaluation based on the coordination of 3E performance is proposed to evaluate the performance of DES in different configurations. As illustrated in Section 4.3.2, CCHP-DH system is regarded as the base case of the study, while CCHP system, CHP-DH system and CHP system are used to study the performance of different configurations of DES to select the optimal energy system servicing for the industrial park. As shown in Fig. 4.2, design objectives/schematics are shown into four cases according to potential energy requirement of industrial park. In fact, the four cases have been modeled and optimized separately within the process using ThermoOptim software and the data from simulation results lay the foundation for the proposed comprehensive evaluation of DES. Next, it keeps necessary to optimize the energy system from the site level to identify waste heat recovery potentials out of the processes. For evaluating the different configurations of DES, traditional 3E performance evaluation method has been adopted to show the performance of DES visually from the different points of view of energy, economy and environment. However, based on traditional 3E performance, comprehensive performance evaluation of DES is proposed to show the coordination of 3E performance. By comparing comprehensive performance evaluation of different cases of DES, risk controls are proposed based on barrier evaluation to ensure the benefits of DES project in the real industrial park.

Based on the previous study, comprehensive performance evaluation is carried out step by step to demonstrate the feasibility of the methodology for evaluating the performance of DES considering the coordination of 3E performance.

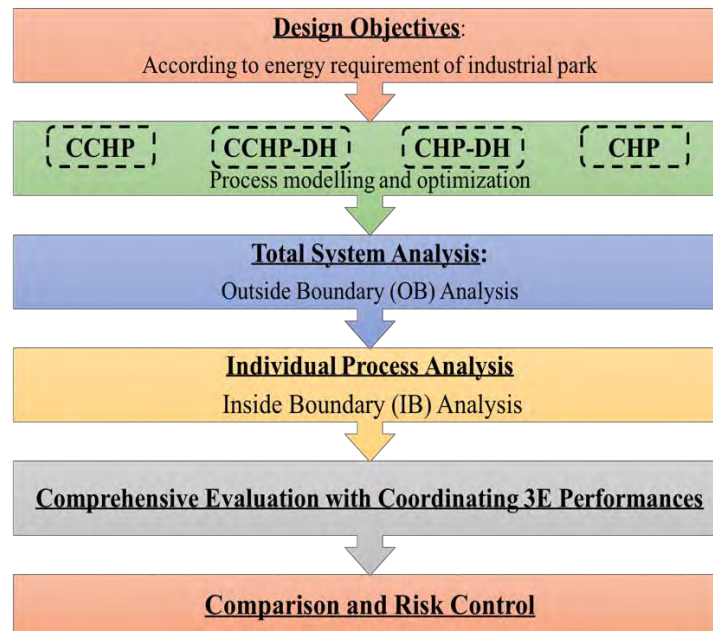

Fig. 4.2 Comprehensive evaluation of DES based on coordination of 3E performance

4.3.2.1 Boundary definition

Boundary definition is important to prescribe a limit to research object of system engineering. The main challenge of boundary definition is to identify the key boundary of system for different analysis process where experience and heuristics are required. It is an important step to define the inside and outside boundaries of DES system because the comprehensive evaluation based on coordination of 3E performance will be performed using the process information within the defined boundary. As shown in Fig. 4.3, the inside boundary is defined as the process of power generation, cooling and heat production and waste heat recovery, while the outside boundary is defined as the whole DES system.

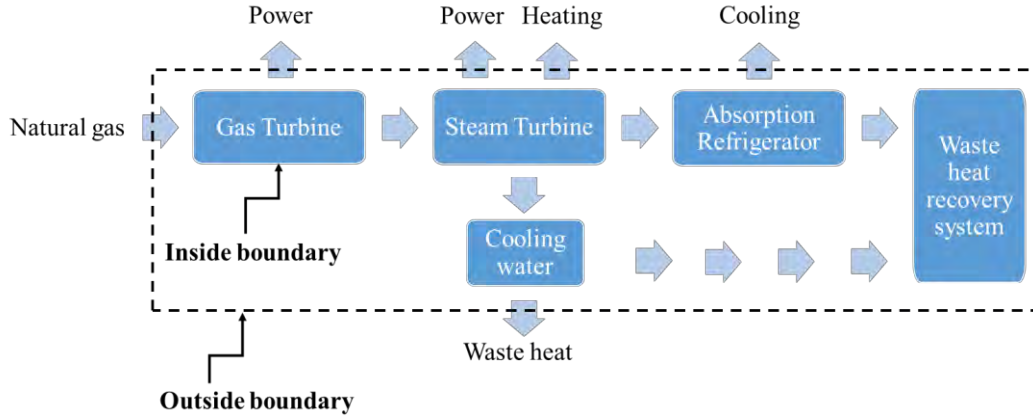

Fig. 4.3 Boundary definition

In the following, the outside boundary and inside boundary analysis are based on the methodology proposed in ref. [116] with some necessary improvement to better reflect the performance of case study of DES project.

4.3.2.2 Outside boundary analysis

Outside boundary (OB) analysis is used to perform preliminary and general analysis of DES system in this study. The analysis takes into account the energy and economic values of fuel (input) and energy product (output) of DES system as well as waste heat emission (output) at the outside boundary of system. Economic value ratio (E_c), Energy value ratio (E_n) and Waste heat emission ratio (E_w) are expressed as follows in Eq. (4.11), Eq. (4.12) and Eq. (4.13).

$$E_c = \frac{\text{Economic value of energy product}}{\text{Economic value of fuel}} \quad (4.11)$$

$$E_n = \frac{\text{Energy value of energy product}}{\text{Energy value of fuel}} \quad (4.12)$$

$$E_w = \frac{\text{Total waste heat emission}}{\text{Total energy product}} \quad (4.13)$$

$E_c=1$ means the economic value of fuel consumption is equal to that of energy output, while E_c should be generally higher than 1 to stimulate investment motivation. According to the law of the thermodynamics, $E_n=1$ should be the upper boundary of a feasible operation of energy system. However, when the value of E_n is closer to 1, the energy performance of the energy system is better.

Based on simulation results of each model, Economic value ratio (E_c), Energy value ratio (E_n) and Waste heat emission ratio (E_w) of various configurations of DES system are calculated. E_c of each model is higher than 1. Specifically, V01 and V02 have the same $E_c=1.46$, followed by V22, V1, V21 and V3 with $E_c= 1.41, 1.38, 1.37$ and 1.33 , respectively. It is necessary to mention that the economic investment of initial investment and maintenance cost is not reflected in E_c . Nevertheless, it potentially shows more favorable and feasible option by comparing potential configurations of the project [116]. In fact, the definition of E_n is similar to gross energy efficiency of DES without considering the energy conversion of the process. E_n varies from 0.77 of V3 to 0.9 of V01, while V21 and V22 have the same highest $E_n=0.8$. Apparently, due to waste heat recovery from both circulating cooling water and the refrigeration system of Data Centers, the waste heat emission ratio E_w of V01 and V02 is relatively lower than other models. V1, V21 and V22 have approximate $E_w= 0.17$ as there is cooling product of V1 is larger than V21 and V22 even they recover the waste heat for DH.

Model V01 is selected as the base case of OB analysis. Relative value of E_c , E_n and E_w of each model compared with V01 is shown in Fig. 4.4. Closer distance to V01 in the coordinate axis means better comprehensive performance of the model.

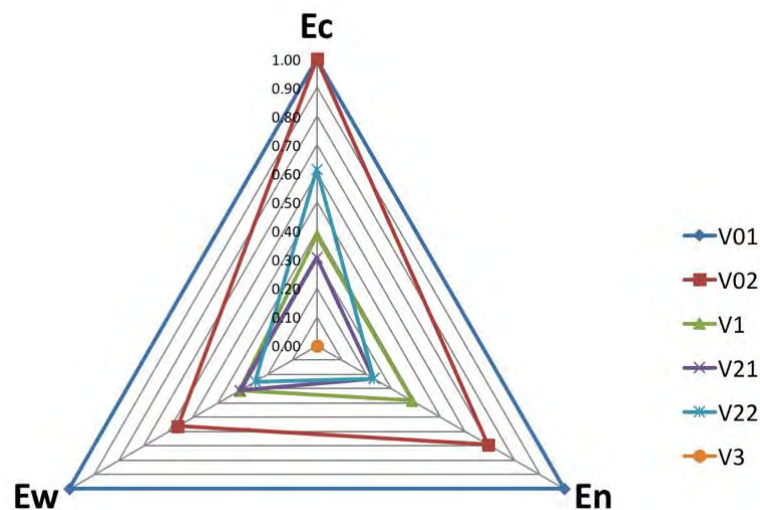

Fig. 4.4 OB analysis results of various configurations of DES system

Table 4.3

Further OB analysis results of various configurations of DES system

Configuration Model	CCHP-DH		CCHP	CHP-DH		CHP	Best
	V01	V02	V1	V21	V22	V3	
Distance to Best ¹	0.00	0.53	1.11	1.24	1.14	1.73	Low
Rank (Distance)	1	2	3	5	4	6	
Normed Score ²	0.29	0.49	0.11	0.07	0.11	0.00	High
Rank (Normed Score)	2	1	3	5	4	6	
Normed Score Filtered ³	0.29	0.19	0.01	0.00	0.00	0.00	High
Rank (Norm Score Filter)	1	2	3	0	0	0	

Note:

¹Distance to Best: the norm of the vector which coordinates are the distance to best, according to its definition;

²Normed Score: the norm of the scalar product of the vector that is normal to each triangle by the best possible vector;

³Normed Score filtered: multiplies the Normed Score by all coordinates of relative E_c , E_n , and E_w in order to eliminate the worst solution and provides the most discriminating feedback.

As shown in Table 4.3, further OB analysis is performed to show more favorable model of DES based on case study of demonstrative industrial park. Consequently, based on the rank of Norm Score Filter, Model V01 is proved again as the most favorable model. Note that although Model V02 with the attempt of using heat exchangers to recover low-temperature industrial waste heat is less favorable than V01 with compression heat pump for recovering and upgrading the waste heat, V22 with the attempt of using heat exchangers to recover the waste heat is more favorable than V21 with compression heat pump probably as single waste heat recovery is easier to be controlled.

4.3.2.3 Inside boundary analysis

Inside boundary (IB) analysis is used to perform detailed analysis within the process of energy production. The aim of IB analysis is to quantify the 3E

performances of each configuration of the project to decide the most favorable option by transferring energy performance indicator and environmental performance indicator into economic performance indicator for the purpose of the unification of 3E performance indicators[116]. Energy intensity (I_e) in the process i , CO_2 intensity (I_{CO_2}) in the process i , Recoverable waste heat intensity (I_w) are defined as follows.

$$ED_i^{net} = ED_i - EG_i \quad (4.14)$$

$$I_e = \sum_{i=1}^n \frac{ED_i^{net}}{Ep_i} \quad (4.15)$$

Where ED_i^{net} is the net energy (power/heat) demand in the process i , MW; ED_i is the energy (power/heat) demand in the process i , MW; EG_i is the energy generation (power/heating/cooling) in the process i , MW; Ep_i is the energy value of energy product in the process i , MW; n is the total number of processes. Note that fuel demand is not considered in inside boundary analysis of energy as it comes from the outside of the system but fuel can be combusted to become heat entering inside boundary.

$$CO_{2,i}^{net} = CO_{2,i}^{emi} - CO_{2,i}^{rec} \quad (4.16)$$

$$I_{CO_2} = \sum_{i=1}^n \frac{CO_{2,i}^{net}}{E_{f,i}} \quad (4.17)$$

Where $CO_{2,i}^{net}$ is the net CO_2 generation in the process i , kg/h; $CO_{2,i}^{emi}$ is the CO_2 emission from the process i , kg/h; $CO_{2,i}^{rec}$ is the reduction of CO_2 emission due to heat recovery by the process i , kg/h; $E_{f,i}$ is the energy value of feed in the process i , MW.

$$I_w = \sum_{i=1}^n \frac{H_i}{E_{f,i}} \quad (4.18)$$

$$\gamma_{rec} = \sum_{i=1}^n \frac{H_{r,i}}{E_{f,i}} \quad (4.19)$$

Where γ_{rec} refers to low-temperature waste heat recovery ratio of DES system; H_i and $H_{r,i}$ is the total waste heat released and the total waste heat recovery from the process i , MW.

The core principle of the methodology of comprehensive evaluation system with the coordination of 3E performance is to transfer energy and environmental value into economic equivalent value, so it is extremely important to find the conversion factor for unifying 3E performance evaluation indicators. $\Delta v_{p(f)}/\Delta TAC$ was introduced to set up the relationship between energy and economic performance, environment and economic performance of DES project.

$$\left[\frac{\Delta v_p}{\Delta TAC} \right]_{k,0} = \frac{q_{p,k}/q_{p,0}}{\text{Normalised } TAC_{k,0}} \quad (4.20)$$

$$\left[\frac{\Delta v_f}{\Delta TAC} \right]_{k,0} = \frac{q_{f,k}/q_{f,0}}{\text{Normalised } TAC_{k,0}} \quad (4.21)$$

Where Δv_p and Δv_f are the relative value of product and feed, respectively; ΔTAC is the relative total annualized cost; $q_{p,k}/q_{p,0}$ is the ratio of the quantities per unit time of product between model k and base case; $q_{f,k}/q_{f,0}$ is the ratio of the quantities per unit time of feed between model k and base case; $\text{Normalised } TAC_{k,0}$ is the ratio of the relative total annualized cost between model k and base case.

The derivation of 3E index is demonstrated in ref. [116] and the expression of I_{3E} is shown in Eq. (4.22):

$$I_{3E} = \sum_{i=1}^n \left[I_{e,i} \times \left(\frac{\Delta v_p}{\Delta TAC} \right)_i \right] + \sum_{i=1}^n \left[I_{CO_2,i} \times LHV_{p,i} \times \left(\frac{\Delta v_p}{\Delta TAC} \right)_i \right] - \sum_{i=1}^n \left[I_{w,i} \times \left(\frac{\Delta v_f}{\Delta TAC} \right)_i \right] \quad (4.22)$$

Where $LHV_{p,i}$, Low Heating Value of product in the process i , is introduced to yield a dimensionless metric.

However, due to the technology limitation, not all waste heat released to the environment can be recovered, so only recovered waste heat is considered in this study. Besides, as not all the models include the process of power, heating and cooling, so it is more rational to compare the average value of each process in each model rather than compare the sum of each process. Based on Eq. (4.22), I'_{3E} is used to evaluate the comprehensive performance of DES project with different

configurations in Case study of gas-steam combined cycle based DES system. The expression of improved relative 3E index I'_{3E} is shown in Eq. (4.23),

$$I'_{3E} = \frac{1}{n} \sum_{i=1}^n \left[I_{e,i} \times \left(\frac{\Delta v_p}{\Delta TAC} \right)_i \right] + \frac{1}{n} \sum_{i=1}^n \left[I_{CO_2,i} \times LHV_{f,i} \times \left(\frac{\Delta v_f}{\Delta TAC} \right)_i \right] - \frac{1}{n} \sum_{i=1}^n \left[\gamma_{rec} \times \left(\frac{\Delta v_f}{\Delta TAC} \right)_i \right] \quad (4.23)$$

Where $LHV_{f,i}$ is Low Heating Value of feed in the process i . γ_{rec} exists in the configuration with waste heat recovery system for DH.

The process of inside boundary analysis and results of I'_{3E} of different configurations of DES is shown in Table 4.4.

The model CCHP(V1) is selected as the base case in inside boundary analysis and I'_{3E} shows comprehensive performance of each model compared with base case. The results of process energy intensity and process GHG intensity assessment shows the negative influence, so the lower are the indicators, the better is the performance. However, waste heat recovery has positive influence to society, so the higher is the output of recovered waste, the better is heat assessment, which is included in I'_{3E} with minus in front of the expression. Overall, the lowest value of I'_{3E} is corresponding to the best performance of DES system. As can be seen from Table 4.4, according to the relative 3E index of I'_{3E} , only model V01 and V02 perform better than base case if waste heat recovery is not considered, however, when waste heat recovery is included in I'_{3E} , more models of V21 and V22 perform better than base case. Apparently, waste heat recovery plays an important role in the comprehensive performance of DES project with considering energy, economic and environmental performance. However, in different situations, its influences on comprehensive performance of DES differs from case to case. For instance, $I'_{3E}(\text{exc.ER})$ of V01 is 0.056 higher than V02, and $I'_{3E}(\text{inc.ER})$ of V01 is 0.012 lower than V02, which means V01 with compression heat pump for DH benefits more from waste heat recovery. However, for

models V21 and V22, V21 with compression heat pump for DH benefits less from waste heat recovery, which demonstrates it is favorable to recover the waste heat from circulating cooling water with the involvement of a little part of LP steam from steam turbine, like in V22, 18.7MW LP steam is extracted to be used for DH without compression heat pump.

In this case study of DES with the products of power, heating/cooling for industrial park, the indicator of process GHG intensity is far larger than other two indicators, which doesn't indicate the influence of process GHG intensity to the performance of DES system is larger than others. It is more important to compare the models with base case. In process energy intensity assessment, V01 has the same best energy performance as base case, followed by V02 and the rest having the same performance. In process GHG intensity assessment, V02 has the lowest GHG emission intensity. It is more meaningful to find the exact GHG emission situation of each process of the models, which can greatly help the reduction of global warming by virtue of the adoption of effective renovation technology focusing on the process with serious GHG emission.

Obviously, inside boundary (IB) analysis is powerful in detecting the process performance of DES as there are not too many types of products of DES system mainly including power, heating and cooling, leading to simple and clear process illustration and analysis. However, relative 3E index I'_{3E} is greatly influenced by process performance, so more attention should be paid to data selection as data quality of each process will decisively influence the final output of I'_{3E} .

4.4 Conclusions

In this chapter, comprehensive performance evaluation with coordination of 3E performance is studied, some conclusions are illustrated as follows:

- 1) Energy, economic and environmental evaluation indicators of DES system are overviewed, and Gross energy efficiency, Total investment, Electricity Gas

Rate and CO₂ emission are employed and integrated in comprehensive performance evaluation of DES with different configurations.

- 2) Three-dimension Outside Boundary (OB) analysis is proposed to show the general performance of DES system without considering the process energy conversion and economic investment detail. It potentially shows more favorable and feasible option by comparing potential configurations of the project. V01 performs better than other models in OB analysis, whose E_c is 1.46, $E_n=0.9$ and E_w is 0.15. To perform further OB analysis, based on the rank of Norm Score Filter, Model V01 is proved again to be the most favorable model.
- 3) In Inside Boundary (IB) analysis, relative 3E index I'_{3E} is introduced to evaluate DES comprehensively considering 3E performance. The main steps of the derivation of I'_{3E} are illustrated including process energy intensity, process GHG intensity and recovered waste heat ratio. Waste heat recovery plays an important role in the comprehensive performance of DES project, however, in different situations, its influences on comprehensive performance of DES differs from case to case. IB analysis is beneficial to detect the process improvement precisely, while relative 3E index I'_{3E} is greatly influenced by limited process performance, so more attention should be paid to the work of data collection as the data quality of each process will decisively influence the final output of I'_{3E} .

4 Comprehensive performance evaluation of DES system

Table 4.4 Inside boundary (IB) analysis process and results of 3E index I'_{3E}

Component	CCHP-DH			CCHP			CHP-DH			CHP					
	V01		V02	V1		V21	V22		V3						
	Process 1 Power	Process 2 Heating	Process 3 Cooling	Process 1 Power	Process 2 Heating	Process 3 Cooling	Procee 1 Power	Process 2 Heating	Process 3 Cooling	Procee 1 Power	Process 2 Heating	Procee 1 Power	Process 2 Heating		
Process energy intensity assessment															
Net power demand, ED (MW)	7.420	1.989	0.065	7.290	1.981	0.519	7.440	1.989	0.065	7.742	1.834	7.654	1.844	7.716	1.841
Energy value of product, Ep(MW)	380.410	194.750	51.540	373.720	170.340	44.760	381.380	194.750	51.540	397.020	194.750	392.510	176.280	395.680	194.750
Process energy intensity, EI	0.020	0.010	0.001	0.020	0.012	0.012	0.020	0.010	0.001	0.020	0.009	0.020	0.010	0.020	0.009
$\Delta Vp/\Delta TAG$	0.979	0.981	1.000	0.978	0.873	0.867	1.000	1.000	1.000	1.037	0.996	1.030	0.906	1.040	1.002
$EI \times \Delta Vp/\Delta TAG$	0.019	0.010	0.001	0.019	0.010	0.010	0.020	0.010	0.001	0.020	0.009	0.020	0.009	0.020	0.009
Ave.	0.010			0.013			0.010			0.015		0.015		0.015	
Process GHG intensity assessment															
Energy value of feed, Ef(MW)	587.146	188.079	61.913	610.345	164.746	54.231	587.166	188.079	61.913	587.472	187.924	605.033	170.285	587.442	187.931
Process CO2 intensity, CO2I	2.584	2.576	2.537	2.583	2.942	2.573	2.591	2.582	2.538	2.597	2.581	2.591	2.845	2.597	2.581
$\Delta Vf/\Delta TAG$	0.981	0.981	0.981	1.020	0.860	0.860	1.000	1.000	1.000	0.997	0.995	1.031	0.906	1.002	1.001
$CO2I \times LHVp \times \Delta Vf/\Delta TAG$	2.535	2.527	2.490	2.635	2.529	2.212	2.591	2.582	2.538	2.588	2.568	2.673	2.579	2.603	2.584
Ave.	2.518			2.459			2.570			2.578		2.626		2.594	

4 Comprehensive performance evaluation of DES system

(Continue)

Recovered waste heat assessment															
Waste Heat recovered (MW)	0.000	42.650	42.650	0.000	36.180	36.180	0.000	0.000	0.000	0.000	33.120	0.000	52.330	0.000	0.000
Energy Value of feed, Ef (MW)	587.146	188.079	61.913	610.345	164.746	54.231	587.166	188.079	61.913	587.472	187.924	605.033	170.285	587.442	187.931
Recovered energy ratio, ER	0.000	0.227	0.689	0.000	0.220	0.667	0.000	0.000	0.000	0.000	0.176	0.000	0.307	0.000	0.000
$\Delta T_f / \Delta T_{AG}$	0.981	0.981	0.981	1.020	0.860	0.860	1.000	1.000	1.000	0.997	0.995	1.031	0.906	1.002	1.001
$ER \times \Delta T_f / \Delta T_{AG}$	0.000	0.223	0.676	0.000	0.189	0.573	0.000	0.000	0.000	0.000	0.175	0.000	0.279	0.000	0.000
Ave.		0.449			0.381			0.000			0.175		0.279		0.000
Relative SE Index, I'_{3E} (Inc. ER)		2.079			2.091			2.581			2.418		2.362		2.608
Relative SE Index, I'_{3E} (Exc. ER)		2.528			2.472			2.581			2.593		2.640		2.608

Résumé Français du Chapitre 5: Verrous techniques au développement des Systèmes à Energies Distribuées (SED)

L'analyse globale complète est nécessaire pour déterminer la faisabilité du projet de SED et évaluer les résultats qui peuvent en être attendus. Toutefois, il est également nécessaire d'identifier les obstacles au développement afin de prendre les mesures nécessaires à la levée des verrous potentiels. Le propriétaire et les intervenants principaux du projet SED doivent choisir ensemble le schéma le plus favorable pour le montage, qui maximisera les bénéfices aux niveaux énergétiques, économiques et environnementaux.

Une analyse des relations entre les intervenants et leurs intérêts et rôles permet d'identifier les partenaires-clefs à chaque étape du projet. En effet, suivant les intérêts et les implications de chacun à chaque étape du projet, les opinions peuvent diverger et avoir une incidence sur la stabilité de l'opération aux phases de prise de décision.

Dans le cas étudié, les partenaires sont Huaneng Thermal Power Plant (HTPP), le gouvernement local, China National Petroleum Corp. (CNPC), le contractant bâtiments (BC), L'institut de Conception et Recherches (DRI), l'équipementier (EMS), le réseau d'état (SG), l'industrie biochimique (BP), la communication entre entreprises (CE), le comité de gestion du parc industriel (MCIP), la municipalité (LC), l'agence de protection de l'environnement (EPA), le personnel et les media. Le rôle de chacun est précisé en détail dans le chapitre. En fonction de leur position, de leurs rôles et de leurs intérêts, les parties prenantes sont rangées dans trois niveaux : cœur du projet (core), niveau stratégique et zone périphérique.

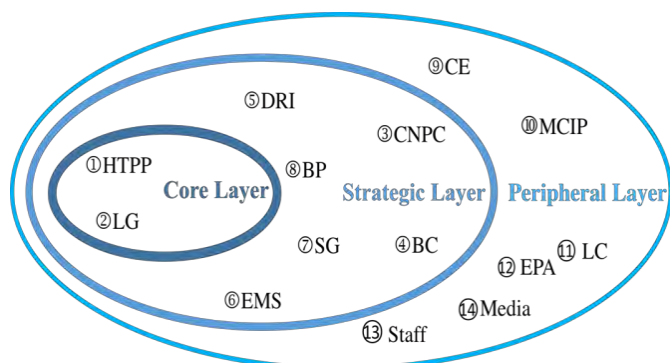

Les partie-prenantes du cœur du projet jouent un rôle critique pour son développement et sa viabilité, à savoir le constructeur exploitant et les autorités locales; au niveau stratégique se trouvent des partenaires ressources; les autres

auront un impact plus limité sur le développement du projet mais leur contribution est essentielle pour un développement stable et durable.

Les intérêts de chacun à la réussite du projet sont analysés en détail. Il en ressort une table d'influence et d'intérêt de chacun des partenaires pour chacune des étapes de prise de décision, soit aux niveaux: initial, mise en œuvre et opérationnel. Les résultats proposés découlent de l'observation faite par 20 experts invités, des chercheurs et des étudiants en PhD qui ont suivi les opérations et sont recalés sur des procédures analogues référencées.

Les résultats montrent l'évolution des influences de chaque partie prenante en fonction de l'avancement du projet et affinent la définition des domaines de compétence. Ainsi, HTPP, CNPC et SG sont les éléments-clef pour le projet, du point de vue de son cycle de vie et leurs intérêt apparaissent primordiaux. DRI, EMS and BP apparaissent à deux étapes en position-clef, ce qui atteste de leur influence sur la vie du projet SED. Cette étude confirme les résultats observés dans d'autres projets. L'influence de BC est très variable selon les cas, mais éventuellement forte, ce qui le classe comme partie prenante de premier rang.

Il existe des verrous et barrières connus au développement des projets de SED. Ainsi, ce type de projet est très vulnérable aux aléas politiques, réglementaires ou dépendant des marchés financiers et du coût de l'énergie ; le principe de partage équitable des risques et des profits entre les parties prenantes au prorata de leur implication est une stratégie payante.

Les conflits d'intérêt identifiés concernent le fournisseur d'électricité et l'opérateur sur les tarifs du réseau électrique en entrée et sortie ; le fournisseur de gaz naturel et l'utilisateur au niveau du marché de l'énergie ; le consommateur de vapeur vive et son fournisseur au niveau du tarif réglementaire. Le coût fluctuant de l'énergie et celui des technologies importées sont ainsi des éléments critiques.

L'appréciation de la valeur de l'énergie sous ses diverses formes (en particulier le rafraichissement) est primordiale et l'établissement des tarifs de revente de ressources à leur juste prix est indispensable mais délicate du fait d'un environnement fortement contraint d'une part du point de vue réglementaire et d'autre part du fait d'aléas internes et externes peu prévisibles et contrôlables. Il en ressort l'identification d'une valeur plancher admissible du coût de l'énergie pour la viabilité du projet.

Quelques remarques et suggestions sont formulées quant à la promotion du développement des SED. Ainsi, la réussite de l'opération dépend davantage du macro-environnement du projet que de l'optimisation énergétique de l'installation; la construction et la conduite sont primordiales. La mise en œuvre d'un SED déstabilise la chaîne de profit de l'énergie au niveau local en développant la concurrence. Les consommateurs ont le choix des fournisseurs pour toutes les applications visées; le contrôle des prix de l'énergie sous ses diverses formes se doit d'être constamment réaliste et cohérent avec les objectifs nationaux.

Mots-clefs : *Systèmes à énergie distribuée; Gestion de Projet; Verrous de Développement; Performance énergétique ; Performance économique ; Performance environnementale ; Performance globale ;*

5 Barrier evaluation of the development of DES project

Indeed, comprehensive performance evaluation of DES system is necessary to show the feasibility of the project before setting up the project and trace the operational performance of the system. Comparing the evaluation results of different configurations of DES system, the owner and the relevant participants of the project can choose a favorable scheme to maximize the benefit considering energy, economic and environmental performance comprehensively. However, apart from comprehensive performance evaluation of DES system, barrier evaluation is also important for the development of DES as it is a complicated project involving many stakeholders from different fields, who have different aspiration to strive for their own benefits. Thus, for the capital-intensive project, it is necessary to carry out barrier evaluation and update the project information according to the real progress of the project and changeable energy market in order to reduce the risk of the project in the process of constructing and operating the project.

5.1 Stakeholder analysis

Stakeholder analysis is good at identifying the core stakeholders on the decision-making of the project. As not all the stakeholders have the same opinion to the issues related to project, the different opinions should be considered in decision-making. However, the impact of the opinions of stakeholder on decision-making is different, so it is necessary to identify the core influential stakeholders and to balance the benefits of the core stakeholders to improve the stability of strategy and reduce the risk of implementation.

The stakeholders involved in DES project of Case Study are recognized according to previous studies focusing on the development of DES in Fujian, China and large scale construction project based on Stakeholder Theory. In this study, stakeholders include Huaneng Thermal Power Plant (HTPP), Local Government (LG), China National Petroleum Corporation(CNPC), Building Contractor (BC), Design and

Research Institute (DRI), Equipment Supplier (ES), State Grid (SG), Bio-chemical Plants (BP), Communication Enterprises (CE), Management Committee of Industrial Park (MCIP), Local Community (LC), Environmental Protection Agency (EPA), Staff and Media. The roles of stakeholders in implementing demonstrative DES project are illustrated in brief as follows.

HTPP is affiliated to Huaneng Power International Incorporated. The primary service is to develop, construct and operate large-scale power plant. While HTPP is developed to provide not only power but also heating and cooling. Supported by local government, HTPP settles in the demonstrative industrial park as the sources of driving force of industrial production. HTPP signed the contract to buy the natural gas from Chongqing Gas and sells electricity to State Grid and heating and cooling to plants in the industrial park.

LG has strong power hands in policy-making and subsidy to promote the development of DES project. DES project cannot live without the subsidy from government in China, so it is necessary to make differentiated local subsidy policies for DES project [117]. Besides, policy orientation from government has direct influence on the prices of natural gas price and electricity and taxes.

CNPC is a state-owned company as the producer and supplier of oil and natural gas in China. Natural gas consumed in the case study of DES project is supplied by CNPC. The stability of natural gas supply and the price of natural gas are very important to the sustainable development of DES project.

BC are in charge of constructing the civil engineering of the industrial park according to design drawing. It should complete all its work before the operation of DES.

DRI is in charge of designing the system and selecting the equipment according to the real energy demand of the industrial park which makes a great influence on the operation of DES system. Besides, it offers the technological support and optimized strategy for the operation of DES, especially when DES is not operated as well as it should be according to design idea.

ES provides the main equipment of DES as well as after-service of maintenance

and repair.

SG is the only seller of power in Chongqing. Both residents and industries have to buy the electricity from SC. So the power generated by HTPP should be transferred to power grid of SG and all the end-users including industries in industrial park have to buy power from SG. The price of the power generated by HTPP is higher than traditional coal-fired and hydroelectric generation, influenced by the price of natural gas.

BP and CE are the industrial heating and cooling consumers, respectively. In addition to heating and cooling from HTPP, BP and CE have alternative energy supplier which greatly influences the final configuration of DES system. So HTPP should take full advantage of benefits of DES in the price competition and stability of energy supply.

MCIP is in charge of daily management of operation and maintenance of the industrial park. Also, it can utilize the network platform to attract more promising entrepreneurs settling down in industrial park, which is important to improve the vigor and vitality of industrial park.

LC may benefit the by-product of CCHP system by recovering the waste heat for DH as well as the opportunity. Meanwhile, LC residents pays more attention to environmental issue, so they care much about the air pollutant of HTPP. Since the first ignition of power plant, LC residents have complained to local EPA the waste emission of the chimneys of HTPP.

EPA is in charge of monitoring the environmental issues of DES project. Especially, sewage treatment and air pollutant emission are strictly required to meet the industrial emission standard.

Staff refers to people who works for DES project and the economic performance of DES is related to their income. As for Media, it is in charge of broadcasting the relative trend of policy, business information of industrial park to society.

According to the above introduction of stakeholders of DES project, stakeholder analysis is performed to identify the influential stakeholders. As shown in Fig. 5.1, based on field investigation and literature investigation, stakeholders are divided into

three layers: Core Layer, Strategic Layer and Peripheral Layer. Three layers show the different influences of stakeholders to DES project without considering the interest of each stakeholder.

Stakeholders belonging to Core Layer indicate that they play a critical and decisive role in the survive and development of DES project. DES project will be influenced immediately without the involvement and support from these stakeholders. In this study, ①HTPP and ②LG are regarded as two main stakeholders in this layer.

Stakeholders belonging to Strategic Layer indicate that they are critical resources of the development of DES project. Their support is very important to DES project. In this study, ③CNPC, ④BC, ⑤DRI, ⑥EMS, ⑦SG, ⑧BP, ⑨CE are regarded as main stakeholders in this layer.

Stakeholders belonging to Peripheral Layer indicate that they don't have strong impact on the development of DES project, but it should pay more attention to the benefits of these stakeholders in order to keep stable and sustainable development of DES project. In this study, ⑩MCIP, ⑪LC, ⑫EPA, ⑬Staff and ⑭Media are regarded as main stakeholders in this layer.

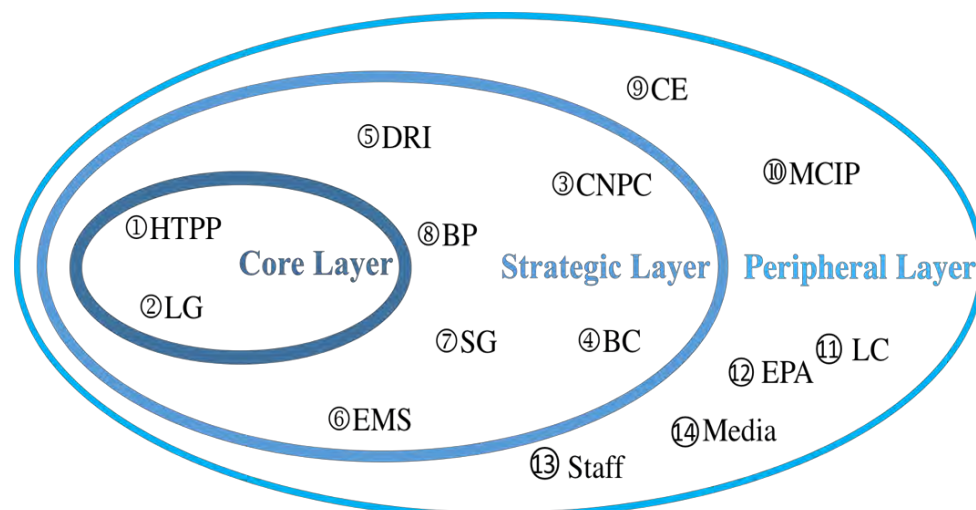

Fig. 5.1 Circle layer of influence of stakeholders of DES project

In the following, the interest of each stakeholder of demonstrative DES project is illustrated in Table 5.1.

Table 5.1
Interest of each stakeholder of demonstrative DES project

NO.	Stakeholder	Interest
①	Huaneng Thermal Power Plant	Rational investment and operating profit; Land use right; Optimal performance of DES; Optimal supporting facility.
②	Local government	Promote the development of regional economy; Provide job opportunity; Increase the tax income; Guarantee social stability in the process of implementation of DES.
③	China National Petroleum Corporation	Rational selling profit; Stable gas requirement.
④	Building Contractor	Make a profit; To be paid on time.
⑤	Design and Research Institute	Make a profit; Forge enterprise brand; Talent cultivation.
⑥	Equipment and Material Supplier	Rational selling profit.
⑦	State Grid	Improve the stability of power grid; Peak-shaving; Profit guarantee
⑧	Bio-chemical Plants	Lower production cost; Improve stability of heat source
⑨	Communication Enterprises	Lower operational cost; Improve stability of cooling source
⑩	Management Committee of Industrial Park	Increase the experience of construction and management of industrial park; Effective policy execution.
⑪	Local Community	Improve local economic; Focus on environmental protection and community safety; Employment opportunity; Suggestions to be considered.
⑫	Environmental Protection Agency	Protect the surrounding environment of project; Safe and civilized construction and production
⑬	Staff	Income and social benefit; Favorable working environment; Safety guarantee and legal right; Individual development; Right to make suggestions
⑭	Media	News source; Career opportunity

Besides, according to professional evaluation of DES project, each stakeholder's influence and interest on different stages of DES project i.e. decision-making stage, implementation stage and operation stage is analyzed using statistical and ranking

method. 20 experts including the engineers and participants of the case study as well as PhD focusing on the research of DES project and Engineering Project Management were invited to mark the evaluation table of interest and influence of each stakeholder of DES project, using 1~10 to show degree of interest and influence from low to high. To improve the reliability and credibility of evaluation results, the relevant research results of PhD theses [118,119] related to infrastructure project and large scale construction project were extracted to be used as reference if necessary. Then, average value of each stakeholder is used to rank the interest and influence of each stakeholder. As shown in Fig. 5.2, it is evaluation results of interest–influence matrix of stakeholders for demonstrative DES project of case study. Horizontal ordinate shows the rank of influence of each stakeholder, which increase from left to right. Similarly, the interest is shown on vertical ordinate.

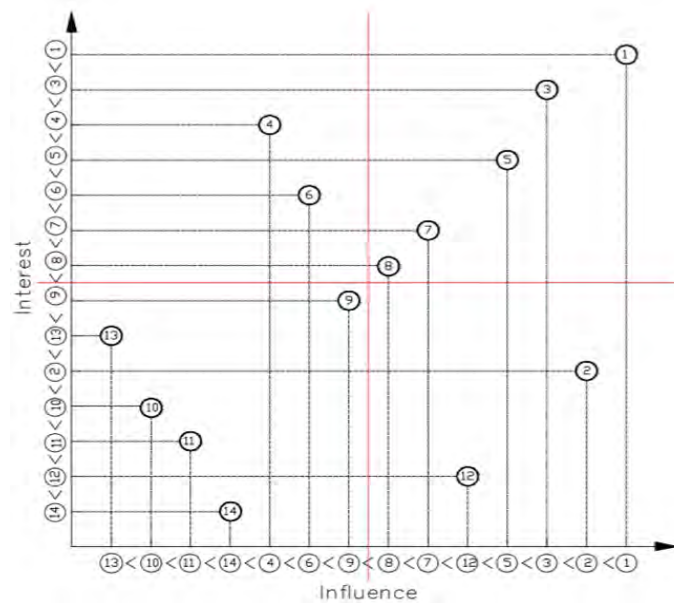

(a) Decision-making stage

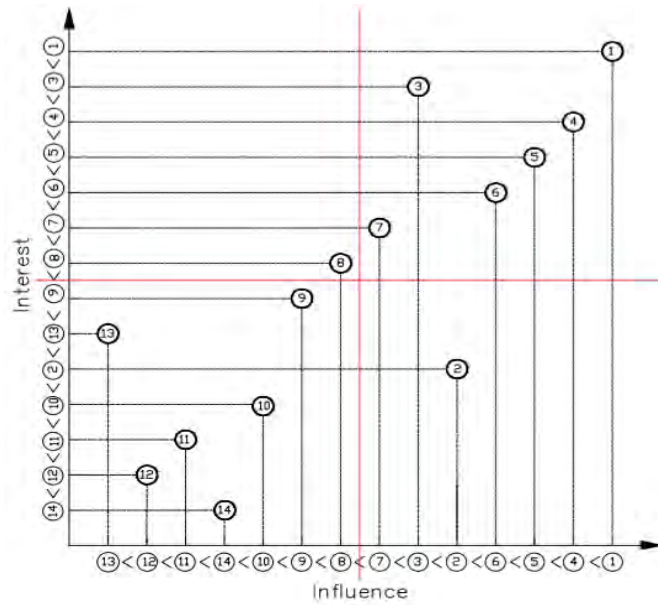

(b) Implementation stage

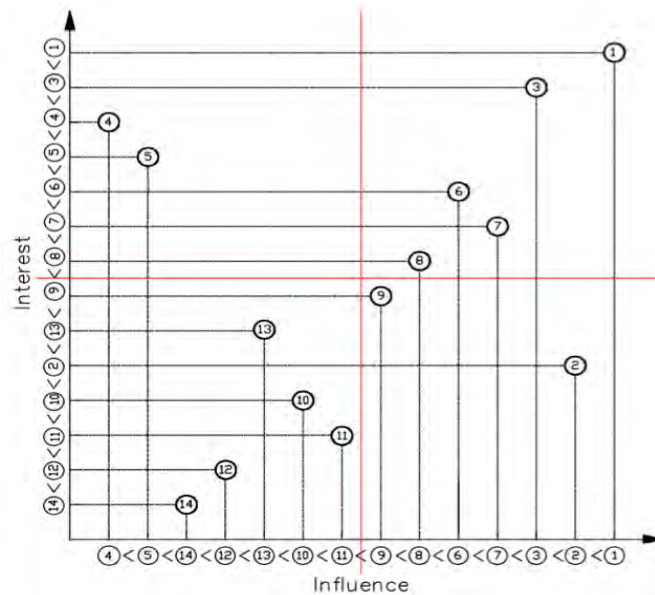

(c) Operation stage

Fig. 5.2 Interest–influence matrix for demonstrative DES project of case study

As shown in Fig. 5.2 (a), (b) and (c), the influence of the same stakeholder varies in different stages of Life Cycle of DES project. The core stakeholders with high influence and interest should locate in upper right zone of coordinate axis in each stage of Life Cycle. Consequently, ①HTPP, ③CNPC and ⑦SG are the core stakeholders during Life Cycle of DES project. Their interests should be paid the most attention as they have the greatest influence on DES project. Besides, ⑤DRI, ⑥EMS and ⑧BP shows up twice in main stakeholder zone, which means they are still

important during Life Cycle of DES project. In ref. [120], Stakeholder Analysis was adopted to study the DES project located in Xiamen, China, whose analysis result shows that the main stakeholders are similar to this DES project including ①HTPP (similar to CHD in ref. [120], investor and operator), ③CNPC (similar to CR Gas, gas source), ⑦SG(similar to SG CC, electric power company), ⑧BP (similar to XM CST, industrial heating users). However, according to Life Cycle Analysis of DES project, ⑤DRI and ⑥EMS are also included in the zone of main stakeholders. Besides, the influence of ④BC varies in different stage of DES project. For example, ④BC has Top 3 of interest and it has great influence in implementation stage, so it is regarded as the main stakeholder, but in other two phase, its influence is not strong enough to be counted among main stakeholders. So, it will not count to be core stakeholders, but more attention should be paid to it when the project is in implementation stage.

5.2 Barriers and problems of the development of DES project

There are common barriers of the development of DES project even if different stakeholders and contracts are involved according to the type, size and location of the project. Specifically, on one hand, vigor and vitality of project is highly dependent on the changes in policy, regulation, the finance market and the low cost fossil fuel incumbent [121]; one the other hand, the principle of sharing the profit grounds on maximizing and balancing the benefits between the core stakeholders according to their influence and contribution.

Barriers of the development of DES was studied in detail and concluded briefly in [120] based on the case study in Fujian province. It was pointed out that the conflicts between the core stakeholders resulted in the failure of the DES project, which could be listed as the conflict between the electricity producer and operator in terms of connection with electricity grid and feed-in tariff, the conflict between the natural gas supplier and user in terms of the market monopoly in gas supply and the conflict between the steam consumer and supplier in terms of the steam price regulated by the government. All of above-mentioned conflicts were elaborated based on one real case

study which could be used to warn the launch of new DES project with the similar policy and market environment. Besides, some issues existed in ref. [114] that the development of gas-fired CCHP based DES suffers from a lack in reasonable pricing mechanism and has difficulties in integrating power into network in terms of policy problem. Besides, the heavy dependency on the imported technologies of main devices could hinder the development of gas-fired CCHP, resulting in higher initial investment and maintenance cost.

Besides, it is well-recognized in the industry of DES that higher cooling price makes it less competitive compared with traditional cooling system and less acceptable by residential cooling. Given the example of less energy-efficient domestic electric air-conditioner with COP=2.5, 1kWh power can return at least 2.5kWh cooling. However, in most District Cooling system, cooling is priced to be RMB0.6~1, which is two times more than separated electric chillers. So it is important to rationally price the cooling in DES project.

In this study, to avoid the barrier of failing to integrate power into network in the development of DES system, the power generated by the natural gas-fired DES system has been agreed to feed in the grid network completely and to be downloaded when in use. However, it is difficult to make a good control of integration in the initial stage since the power generated by the CCHP system is positioned as the role of peak shaving and backup in the peak demand of power grid. Besides, Chongqing government has issued a price of power generated by the CCHP system in this case study, which is RMB0.629 /kWh (temporarily adopted, which could be adjusted according to the energy market) higher than RMB0.4213 /kWh of coal-fired power generation. However, the price mechanism of power selling to State Grid is not efficient enough to consider all the necessary impact factors but the influence of natural gas price. Consequently, it is vulnerable to the market competition and it is not flexible to follow the fluctuation of energy price. Moreover, as for the heating in DES, the price is not advantageous for alternative heating technologies because the output of LP steam required for industrial production is lower than it was supposed to be. The main reason is that the economic target of de-capacity issued by central

government has a great influence on industrial production, thus industrial energy requirement decreases deeply, which is not foreseeable and evaluated at the stage of decision-making of DES. District Cooling has not been put into operation. Similarly, the cooling consumers of Data Centers do not settle down to industrial park on-time as expected and also many of them are not operated at full capacity which leads to great reduction of cooling load. Therefore, precautions should be undertaken to lower the influence resulting from the reduction of energy demand of industrial park, especially the price.

5.3 Suggestions on promoting the development of DES

The development of DES project should not only pay much attention to the optimization of the system itself but also to the macro-environment for supporting the operation of DES project in a benign and sustainable way. The important issue of the development of DES is to overcome the barrier and solve the problem in the process of construction and operation of DES project.

The implementation of DES will break up the stable profit chain of power grid company by competing for the end-users. Currently, it is not really relevant and obvious as Chinese electric power law protects power grid company from fierce competition by restricting the quantity of power integration of DES, which greatly hinders the development of DES project. So it is necessary to balance the interest of main stakeholders by establishing efficient benefit sharing system.

As for cooling and heating, consumers have multiple choices for cooling and heating modes and equipment, so price competition should be considered seriously to take full advantage of DES system. Most importantly, pricing mechanism should reflect the price competition in energy market. With the favorable energy price, it is beneficial to win the stable and increasing amount of consumers.

More sustainable energy sources should be explored to fire DES system for optimizing the primary energy structure with competitive fuel price, which lays the foundation for the development of DES in energy market.

Last but most importantly, government plays a manipulated role in promoting the development of DES project, so it is necessary to take effective measures to stimulate the stakeholders to fulfill their responsibilities in the activities of DES. Initiative governmental action will lead the development of DES project to a promising industry.

5.4 Conclusions

Barrier evaluation of DES system is important to promote the development of DES project in a sustainable way. As DES is a complicated and inter-profit project involving many stakeholders, the benefit and influence of each stakeholder should be identified in order to detect the core stakeholders and take effective preventive measures to avoid the fatal risk of the project. In this chapter, Stakeholder analysis is adopted to identify the core stakeholders of DES project of case study. Consequently, the Owner/Operator of Power Plant (Huaneng Thermal Power Plant), Primary Energy Provider (China National Petroleum Corporation) and Power Grid Controller (State Grid) are identified to be core stakeholders during life cycle of DES project. Besides, barriers of the development of DES project are identified and illustrated accompanied with some suggestions proposed to overcome the barriers and solve the problem.

Résumé Français du Chapitre 6: Conclusions et perspectives

Les Systèmes à Energie Distribuée représentent la solution généralement adoptée pour l'alimentation des parcs industriels, afin de répondre aux contraintes d'usage et de production. La valorisation des cascades est le principe fondateur de conception et d'exploitation des SED, ce qui permet de dédier l'usage des énergies de haut niveau à des demandes de haut niveau. La récupération des rejets de chaleur ultime permet d'améliorer l'efficacité globale de l'installation. Notre étude défend la nécessité d'une approche globale qui a été réalisée à l'occasion de l'étude de cas présentée, correspondant à l'implantation d'un système CCHP-DH dans un parc industriel. Ce système a pour objectif de récupérer et valoriser la chaleur rejetée à bas niveau dans un but de chauffage et rafraîchissement urbain. L'usage d'un environnement de simulation thermodynamique et énergétique de système a permis d'étudier en détail les processus envisagés pour la valorisation des sources à bas niveau et de comparer diverses configurations opérationnelles. Il en résulte les travaux de recherche effectués et leurs conclusions essentielles:

- 1. Une revue des potentiels de récupération et des technologies adaptées à un parc industriel propose des exemples applicatifs correspondant aux pays asiatiques;*
- 2. Le système CCHP-DH est proposé comme solution pour l'exploitation optimale des cascades énergétiques dans un contexte de parc industriel; il permet une valorisation des rejets actuels sous forme de chauffage et rafraîchissement urbain;*
- 3. Différentes configurations de collecte de sources multiples sont envisagées; la valorisation de la vapeur basse pression et le rôle des systèmes de stockage sont étudiés;*
- 4. Les résultats estimés de différentes configurations opérationnelles de SED sont comparés; il en ressort deux types à très haut rendement énergétique global (de l'ordre de 80 à 90%), correspondant à des usages dédiés compatibles et dont le temps de retour sur investissement est de l'ordre de 7 ans et demie, suivant un tarif de revente donné de l'énergie; les performances environnementales découlent des rejets d'effluents et de leur propagation dans la zone industrielle et habitée voisine, mais également des nuisances acoustiques;*

5. *Une série d'indicateurs énergétique (En), économique (Ec) et environnemental (Ew) est définie, dont l'exploitation permet une évaluation de performance globales sous le point de vue placé à l'extérieur des frontières du système étudié (OB), mais aussi, sous le point de vue placé à l'intérieur des frontières (IB), à une évaluation des processus mis en œuvre par l'usage de I'_{3E} (3E index prenant en compte l'intensité énergétique du système); la mise en œuvre de ces mesures évaluatives permet l'appréciation globale des configurations opérationnelles envisagées;*
6. *Enfin, sont identifiés et évalués les obstacles au développement des SED; ainsi, les parties prenantes du projet sont identifiées, ainsi que leurs intérêts et influences; une analyse est opérée qui permet d'identifier les intervenants clefs aux diverses étapes du projet (de sa conception à son exploitation, en passant par la construction); il en ressort le rôle prépondérant du propriétaire-opérateur, du fournisseur d'énergie primaire et du gérant du réseau électrique local, mais aussi le rôle essentiel de certains autres à diverses étapes; il apparaît alors fondamental d'organiser un partage équitable des profits entre les parties prenantes afin d'assurer la "soutenabilité" du projet.*

Les éléments innovants de cette étude concernent:

1. *La nouvelle configuration de SED proposée (CCHP-DH) approfondit et étend la valorisation des cascades énergétiques dans un contexte de parc industriel où les rejets de chaleur sont multiples, tant en nature qu'en niveau; l'étude extensive des configurations opérationnelles à un niveau global de système et de site permet une approche fine de la performance qui peut être attendue;*
2. *La flexibilité de la réfrigération par absorption permet l'adaptation à diverses conditions d'exploitation, en particulier à la valorisation d'une partie de la vapeur basse pression, tout en assurant la production de chaleur et de froid attendue; Dans certains cas, le recours à la compression pour élever le niveau de température peut s'avérer inutile;*
3. *L'analyse technico-économique associée à l'étude énergétique des configurations fournit une information quantitative probante qui peut servir de base à la prise de décision des investisseurs; Elle peut également*

permettre d'anticiper les risques découlant d'une surestimation de la demande énergétique des clients; Ainsi, la réorientation du projet peut être argumentée;

- 4. L'analyse globale de performance du système SED s'appuie sur une série d'indicateurs dédiés et sur une méthode assez originale d'évaluation globale de système SED "en soi" (OB: basée sur une assiette générale de projet et sur une convergence avec la configuration opérationnelle idéale) et en détail du point de vue des processus (IB: index 3E relatif).*

Il reste encore beaucoup à faire pour l'optimisation de ces systèmes. En effet, ils sont vulnérables à nombre de contraintes. En premier lieu, il y a la demande des clients, souvent fluctuante, mais plutôt favorable dans le cas étudié, où le projet est en cours de finalisation.

- 1. La configuration opérationnelle ne sera réellement effective que lorsqu'elle pourra s'appuyer sur des températures et débits mesurés des sources de chaleur rejetées; soit sur des données réelles;*
- 2. L'évaluation de la performance globale du projet justifierait la mise au point d'un indicateur unifié qui intégrerait l'ensemble des indicateurs des analyses internes et externes; Dans le cas étudié, c'est la performance économique qui prévaut, il pourrait être envisagé d'intégrer les indicateurs énergétiques et environnementaux dans la performance économique;*
- 3. La distance qui sépare les sources de chaleurs re-valorisables de leur utilisation (chauffage urbain) n'a pas été intégrée dans l'évaluation présentée mais mériterait de l'être aux niveaux énergétiques et économiques;*
- 4. Le SED étudié n'est pas exploité à pleine charge pour l'instant, ce qui invalide l'intérêt économique d'un processus de revalorisation des eaux de refroidissement des processus de biochimie industrielle; Par contre, la faible distance séparant cette industrie de la zone à chauffer justifie d'une utilisation directe et ces eaux correspondent alors à la source rejetée valorisée par le chauffage urbain.*

Mots-clefs : Systèmes à énergie distribuée; Gestion de Projet; Verrous de Développement; Performance énergétique ; Performance économique ; Performance environnementale ; Performance globale ;

6 Conclusions and prospects

6.1 Conclusions

Distributed Energy System (DES) is generally adopted as the energy infrastructure of the industrial park for meeting various energy demand of industrial production and daily working. Energy cascade utilization is core principle in designing and operating DES project, which enables high-grade energy to be preferentially used in meeting high-grade energy requirement rather than meeting low-grade energy requirement. As the development of waste heat recovery technologies, more low-grade waste heat can be recovered to improve gross energy efficiency of DES, providing more opportunities to replace primary energy consumption. In this study, a comprehensive review is made concerning about waste heat recovery potentials and technologies in industrial parks. Based on a demonstrative industrial park, CCHP-DH system is proposed to recover the potential low-temperature waste heat of the industrial park for DH system. Besides, more attention has been paid to compare the performance of different configurations of multiple waste heat sources using simulation thermodynamic software THERMOPTIM and comprehensive performance evaluation and barrier evaluation are performed. The main research contents and conclusions are presented as follows:

- 1) Review of waste heat recovery potentials and technologies in industrial park.

A review of waste heat recovery - a critical solution of waste energy disposal - is made in order to show the current status of heat recovery potentials and the technologies available in the industrial park. The technologies available for waste heat recovery are classified as heat pumps, heat exchangers, heat pipes, boilers, refrigeration cycles, power cycles and heat storage according to the mode of transfer of waste heat within the recovery process. Besides, the opportunities for waste heat recovery both in developed and developing countries are discussed in order to identify the benefits of heat recovery as well as to carry out a general survey of the development of heat recovery technologies globally.

2) CCHP-DH system is proposed to broaden and deepen the principle of energy cascade utilization.

To begin with, it is illustrated in detail that how to realize energy cascade utilization in the industrial park. With the development of waste heat recovery technologies, the concept and principle of energy cascade utilization has been extended leading to more and more patterns of manifestation of DES. Then, CCHP-DH system is proposed based on the integration of waste heat recovery for DH. Circulating cooling water from power plant, waste heat from absorber and condenser of absorption refrigerators are identified as available and feasible waste heat sources of DH in this study.

3) Different configuration modes of multiple waste heat sources to be integrated to CCHP system.

Serial arrangement, parallel arrangement and mixed arrangement of multiple waste heat sources are proposed to integrate waste heat sources to traditional CCHP system. The rules of application in multiple waste heat sources are illustrated in detail with the involvement of thermal storage to fit the seasonal change between heating season and non-heating season. Besides, alternative heat source of low-pressure steam from the steam pipe of refrigeration station is suggested as backup and peak-shaving heat source of DH in heating season considering economical cost of steam transportation.

4) Comparative simulation analysis of different configurations of DES system.

The thermodynamic software THERMOPTIM was developed based on the optimization method of Pinch Analysis, which is employed to simulate DES system in this study. Based on case study of the industrial park in Chongqing, China, different configurations, i.e. serial, parallel and mixed arrangement of waste heat sources of CCHP-DH are analyzed to compare the treatment of waste heat sources using compression heat pumps (so-called V00 in serial arrangement and V01 in parallel arrangement) with the treatment using heat exchangers associating with the extraction of a certain amount of LP steam (so-called V02). It is demonstrated V00 and V01

have quite similar performance and they perform better than the model V02 based on techno-economic analysis.

Considering the possible operating models of DES project based on the real industrial energy demand, CCHP-DH (V01), CCHP (V1), CHP-DH (V21) and CHP (V3) models are proposed to compare the energy, economic and environmental performance of different models. In terms of energy performance, Gross Energy Efficiency of Model V01, V1, V21 and V3 is 89.81%, 81.74%, 80.23% and 76.91%, respectively; In terms of economic performance, Payback Period of operative models V01, V1, V21, and V3 varies from 7.32(7.48), 7.35, 8.48(8.57) and 8.6 when the price of DH is RMB 0.3822/kMh (*RMB 0.25/kMh*) based on the completed installation of CCHP-DH system. All the Payback Periods are less than 9 years mainly as each system is assumed to operate at 100% load with high power output. Besides, the price of DH influences the investment motivation of investors and the purchase will of end-users, the price should not be lower than RMB 0.3822/kWh considering the investment profit of DH in this project. Moreover, District Cooling influences more than DH in Payback Period; In terms of environmental performance, two aspects are considered: a) one is the influence of air pollutants of gas-steam combined cycle power plant, the possible victims are identified using the software FLUENT in different heights based on local wind condition; b) the other is the influence of global warming caused by the emission of final waste heat to the environment. By comparing different models, CCHP-DH (V01) has the least waste heat emission to the environment.

5) Comprehensive performance evaluation of DES.

The indicators of Energy, Economic and Environmental evaluation are reviewed, respectively. Among those indicators, Gross energy efficiency, Total investment, Electricity Gas Rate and CO₂ emission are decided to be integrated to comprehensive performance evaluation of DES. Outside Boundary (OB) analysis and Inside Boundary (IB) analysis are proposed to analyze comprehensive performance of DES system. In OB analysis, three-dimension OB analysis is proposed to show the general

performance of DES system without considering the process energy conversion and economic investment detail. It potentially shows more favorable and feasible option by comparing potential configurations of the project. As shown of analysis results, V01 performs better than other models, whose E_c is 1.46, $E_n=0.9$ and E_w is 0.15, which is proved again with further OB analysis using further OB analysis based on the rank of Norm Score Filter. In Inside Boundary (IB) analysis, relative 3E index I'_{3E} is introduced to evaluate DES comprehensively considering 3E performance. The main steps of the derivation of I'_{3E} are illustrated including process energy intensity, process GHG intensity and recovered waste heat ratio. The analysis results of relative 3E index I'_{3E} indicates that the lowest value of I'_{3E} is corresponding to the best performance of DES system. Waste heat recovery has a promising impact on comprehensive performance of DES system. When waste heat recovery is excluded in I'_{3E} only model V01 and V02 perform better than base case, however, when waste heat recovery is included in I'_{3E} , more models of V21 and V22 perform better than base case. IB analysis is beneficial to detect the process improvement precisely, while relative 3E index I'_{3E} is greatly influenced by process performance, so more attention should be paid to data collection in the process of IB analysis as the data quality of each process will decisively influence the final output of I'_{3E} .

6) Barrier evaluation of the development of DES project.

As the development of DES requires the participation of multiple stakeholders with different interests, barrier evaluation is performed using Stakeholder analysis to identify the core stakeholders in different stages of DES project. Consequently, the Owner/Operator of Power Plant, Primary Energy Provider and Power Grid Controller are identified to be core stakeholders during the life cycle in this DES project, so their interests should be seriously considered in each process of developing DES project.

6.2 Main innovation points

The main innovation points of this study are concluded as follows.

- 1) The new manifestation pattern of DES, i.e. CCHP-DH system, is proposed to deepen and broaden the concept of energy cascade utilization in industrial park based on recovering multiple sources of waste heat for DH system. Circulating cooling water from power plant, cooling water from condenser and absorber of absorption refrigerator are identified as low-temperature industrial waste heat sources. Optimal configuration of multiple waste heat sources in serial, parallel and mixed arrangement are presented and compared by clarifying the application rule and showing comprehensive energy performance in CCHP-DH.
- 2) Operational flexibility of absorption refrigerators and thermal power plant condenser is innovatively proposed to improve the temperature of waste heat source associating with the extraction of a certain amount of LP steam and then heat exchangers are used to recover improved low-temperature waste heat for DH. Based on case study, heat exchanger based on operational flexibility of devices performs better in single waste heat source than multiple waste heat sources compared with compression heat pump for DH.
- 3) Techno-economic analysis is performed to study and compare different configurations of DES to meet changed and potential energy requirement of the demonstrative industrial park. The comparison results will offer a reference for stakeholders of the project to take the measures to cope with the accident of the absence of energy consumers to achieve the sustainable profit. Besides, system performance analysis is recommended to trace the elaboration process of DES project in order to seize the emerging opportunity for making promising adjustment and re-orientation of DES based on updated energy requirement and system status.
- 4) Comprehensive performance evaluation system is proposed based on Outside Boundary (OB) and Inside Boundary (IB) analysis. In OB analysis, three-dimension coordinate is first proposed to demonstrate Economic value ratio (E_c), Energy value ratio (E_n) and Waste heat emission ratio (E_w) based on relative value and the indicator of Normed Score filtered is proposed to

eliminate the worst solution and provides the most discriminating feedback among different models/design schemes, multiplied the Normed Score by all coordinates of relative E_c , E_n , and E_w . In IB analysis, Relative 3E index is optimized to better evaluate gas-steam combined cycle based DES project comprehensively considering 3E performance.

6.3 Prospects for the future research

The configuration of DES system is greatly dependent on energy requirement of end-users. Currently, in demonstrative industrial park, absorption refrigerators are in the commissioning stage, DES system will be instantly operated in the form of CCHP mode for meeting heating, cooling and power demand of the industrial park. So, the waste heat output of DES system is more clear and stable, which is beneficial to perform waste heat recovery analysis. In the coming future, the research of optimal configuration of waste heat sources can be further improved and explored.

- 1) When operational data of CCHP system such as the temperature and flowrate of waste heat source are available, it can be used to configure and optimize the DH system rather than using simulation data, which is more reliable to analyze the possible heat supply for the potential space heating users.
- 2) Considering the importance of economic performance of DES project, comprehensive performance evaluation is proposed by transferring energy performance indicator and environmental performance indicator into economic performance indicator for the purpose of the unification of 3E performance indicators in the process of Inside Boundary analysis. However, for certain project, energy performance is more important and even in the future environmental performance may decisively influence the development of DES project, so it is still meaningful to explore transferring other performance indicators into energy or environmental performance indicator for unifying 3E performance indicators in the future research.

- 3) The distance between waste heat source and DH energy station and the distance between DH energy station and end-users have not seriously considered in this study for neither energy analysis nor economic analysis. So, distance delivery can be analyzed in further research for performing energy and economic feasibility of waste heat recovery for DH.
- 4) DES is not currently operated at full load, so it is not economic to recover cooling water from Bio-chemical factories (industrial heating users) whose temperature is around 30~40°C. However, due to close distance between Bio-chemical factories and energy station of DH, cooling water from factories can be considered as the waste heat source of DH.

References

1. Efficiency, E. (2007) Tracking Industrial Energy Efficiency and CO₂ Emissions. International Energy Agency, 34, 1-12.
2. Kemp, IC. (2007) Pinch analysis and process integration: a user guide on process integration for the efficient use of energy. Second ed. Oxford, UK.
3. Geng, Y., Hengxin, Z. (2009) Industrial park management in the Chinese environment. *Journal of Cleaner Production*, 17, 1289-1294.
4. Heikkilä, A.-M., Malmén, Y., Nissilä, M., Kortelainen, H. (2010) Challenges in risk management in multi-company industrial parks. *Safety science*, 48, 430-435.
5. Maes, T., Van Eetvelde, G., De Ras, E., Block, C., Pisman, A., Verhofstede, B., Vandendriessche, F., Vandeveldel, L. (2011) Energy management on industrial parks in Flanders. *Renewable and Sustainable Energy Reviews*, 15, 1988-2005.
6. Qu, Y., Liu, Y., Nayak, R. R., Li, M. (2015) Sustainable development of eco-industrial parks in China: effects of managers' environmental awareness on the relationships between practice and performance. *Journal of Cleaner Production*, 87, 328-338.
7. Taddeo, R., Simboli, A., Morgante, A. (2012) Implementing eco-industrial parks in existing clusters. Findings from a historical Italian chemical site. *Journal of Cleaner Production*, 33, 22-29.
8. Yu, F., Han, F., Cui, Z. (2015) Evolution of industrial symbiosis in an eco-industrial park in China. *Journal of Cleaner Production*, 87, 339-347.
9. Mannino, I., Ninka, E., Turvani, M., Chertow, M. (2015) The decline of eco-industrial development in Porto Marghera, Italy. *Journal of Cleaner Production*, 100, 286-296.
10. Aman, M., Solangi, K., Hossain, M., Badarudin, A., Jasmon, G., Mokhlis, H., Bakar, A., Kazi, S. (2015) A review of Safety, Health and Environmental (SHE) issues of solar energy system. *Renewable and Sustainable Energy Reviews*, 41, 1190-1204.
11. Kumar, Y., Ringenberg, J., Depuru, S. S., Devabhaktuni, V. K., Lee, J. W., Nikolaidis, E., Andersen, B., Afjeh, A. (2016) Wind energy: Trends and enabling technologies. *Renewable and Sustainable Energy Reviews*, 53, 209-224.

12. Upadhyay, S., Sharma, M. (2014) A review on configurations, control and sizing methodologies of hybrid energy systems. *Renewable and Sustainable Energy Reviews*, 38, 47-63.
13. Krishna, K. S., Kumar, K. S. (2015) A review on hybrid renewable energy systems. *Renewable and Sustainable Energy Reviews*, 52, 907-916.
14. Gude, V. G. (2015) Energy storage for desalination processes powered by renewable energy and waste heat sources. *Applied Energy*, 137, 877-898.
15. Liu, Z.-H., Guan, H.-Y., Wang, G.-S. (2014) Performance optimization study on an integrated solar desalination system with multi-stage evaporation/heat recovery processes. *Energy*, 76, 1001-1010.
16. Bendig, M., Maréchal, F., Favrat, D. (2013) Defining “Waste Heat” for industrial processes. *Applied Thermal Engineering*, 61, 134-142.
17. Brückner, S., Liu, S., Miró, L., Radspieler, M., Cabeza, L. F., Lävemann, E. (2015) Industrial waste heat recovery technologies: An economic analysis of heat transformation technologies. *Applied Energy*, 151, 157-167.
18. Stijepovic, M. Z., Linke, P. (2011) Optimal waste heat recovery and reuse in industrial zones. *Energy*, 36, 4019-4031.
19. National Development and Reform Commission, Ministry of Housing and Urban-rural. Plans to implement projects on waste heat recovery for residential heating. http://www.sdpc.gov.cn/zcfb/zcfbtz/201511/t20151104_757519.html.
20. Fang, H., Xia, J., Jiang, Y. (2015) Key issues and solutions in a district heating system using low-grade industrial waste heat. *Energy*, 86, 589-602.
21. Pavlas, M., Touš, M., Klimek, P., Bébar, L. (2011) Waste incineration with production of clean and reliable energy. *Clean Technologies and Environmental Policy*, 13, 595-605.
22. Kilkovsky, B., Stehlik, P., Jegla, Z., Tovazhnyansky, L. L., Arsenyeva, O., Kapustenko, P. O. (2014) Heat exchangers for energy recovery in waste and biomass to energy technologies–I. Energy recovery from flue gas. *Applied Thermal Engineering*, 64, 213-223.
23. Thu, K., Yanagi, H., Saha, B. B., Ng, K. C. (2013) Performance analysis of a low-temperature waste heat-driven adsorption desalination prototype. *International Journal of Heat and Mass Transfer*, 65, 662-669.

24. Sun, L., Han, W., Jin, H. (2015) Energy and exergy investigation of a hybrid refrigeration system activated by mid/low-temperature heat source. *Applied Thermal Engineering*, 91, 913-923.
25. Aneke, M., Agnew, B., Underwood, C., Menkiti, M. (2012) Thermodynamic analysis of alternative refrigeration cycles driven from waste heat in a food processing application. *International journal of refrigeration*, 35, 1349-1358.
26. Xu, G., Huang, S., Yang, Y., Wu, Y., Zhang, K., Xu, C. (2013) Techno-economic analysis and optimization of the heat recovery of utility boiler flue gas. *Applied Energy*, 112, 907-917.
27. Wang, C., He, B., Sun, S., Wu, Y., Yan, N., Yan, L., Pei, X. (2012) Application of a low pressure economizer for waste heat recovery from the exhaust flue gas in a 600 MW power plant. *Energy*, 48, 196-202.
28. Peris, B., Navarro-Esbrí, J., Molés, F., Mota-Babiloni, A. (2015) Experimental study of an ORC (organic Rankine cycle) for low grade waste heat recovery in a ceramic industry. *Energy*, 85, 534-542.
29. Khatita, M. A., Ahmed, T. S., Ashour, F. H., Ismail, I. M. (2014) Power generation using waste heat recovery by organic Rankine cycle in oil and gas sector in Egypt: A case study. *Energy*, 64, 462-472.
30. Li, Y., Fu, L., Zhang, S. (2015) Technology application of district heating system with Co-generation based on absorption heat exchange. *Energy*, 90, 663-670.
31. Alekseiko, L. N., Slesarenko, V. V., Yudakov, A. A. (2014) Combination of wastewater treatment plants and heat pumps. *Pacific Science Review*, 16, 36-39.
32. van de Bor, D., Ferreira, C. I., Kiss, A. A. (2015) Low grade waste heat recovery using heat pumps and power cycles. *Energy*, 89, 864-873.
33. Willmott, J. A. (2001) *Dynamics of regenerative heat transfer*, CRC Press.
34. Wang, T., Luan, W., Wang, W., Tu, S.-T. (2014) Waste heat recovery through plate heat exchanger based thermoelectric generator system. *Applied Energy*, 136, 860-865.
35. Vasiliev, L. L. (2005) Heat pipes in modern heat exchangers. *Applied Thermal Engineering*, 25, 1-19.
36. Remeli, M., Kiatbodin, L., Singh, B., Verojporn, K., Date, A., Akbarzadeh, A. (2015) Power Generation from Waste Heat Using Heat Pipe and Thermoelectric Generator. *Energy Procedia*, 75, 645-650.

37. Remeli, M., Verojporn, K., Singh, B., Kiatbodin, L., Date, A., Akbarzadeh, A. (2015) Passive Heat Recovery System using Combination of Heat Pipe and Thermoelectric Generator. *Energy Procedia*, 75, 608-614.
38. L. Yodrak, S. Rittidech, N. Poomsa-ad, P. Meena, Waste heat recovery by heat pipe air-preheater to energy thrift from the furnace in a hot forging process, *Am. J. Appl. Sci.* 7 (2010) 675–681.
39. Shabgard, H., Allen, M. J., Sharifi, N., Benn, S. P., Faghri, A., Bergman, T. L. (2015) Heat pipe heat exchangers and heat sinks: Opportunities, challenges, applications, analysis, and state of the art. *International Journal of Heat and Mass Transfer*, 89, 138-158.
40. Lee, C.-E., Yu, B., Lee, S. (2015) An analysis of the thermodynamic efficiency for exhaust gas recirculation-condensed water recirculation-waste heat recovery condensing boilers (EGR-CWR-WHR CB). *Energy*, 86, 267-275.
41. Xu, G., Xu, C., Yang, Y., Fang, Y., Li, Y., Song, X. (2014) A novel flue gas waste heat recovery system for coal-fired ultra-supercritical power plants. *Applied Thermal Engineering*, 67, 240-249.
42. Sriksirin, P., Aphornratana, S., Chungpaibulpatana, S. (2001) A review of absorption refrigeration technologies. *Renewable and Sustainable Energy Reviews*, 5, 343-372.
43. Wang, R., Xia, Z., Wang, L., Lu, Z., Li, S., Li, T., Wu, J., He, S. (2011) Heat transfer design in adsorption refrigeration systems for efficient use of low-grade thermal energy. *Energy*, 36, 5425-5439.
44. Chen, Y., Han, W., Jin, H. (2015) An absorption–compression refrigeration system driven by a mid-temperature heat source for low-temperature applications. *Energy*, 91, 215-225.
45. Lucia, U. (2013) Adsorber efficiency in adsorption refrigeration. *Renewable and Sustainable Energy Reviews*, 20, 570-575.
46. Yari, M., Mehr, A., Zare, V., Mahmoudi, S., Rosen, M. (2015) Exergoeconomic comparison of TLC (trilateral Rankine cycle), ORC (organic Rankine cycle) and Kalina cycle using a low grade heat source. *Energy*, 83, 712-722.
47. Campana, F., Bianchi, M., Branchini, L., De Pascale, A., Peretto, A., Baresi, M., Fermi, A., Rossetti, N., Vescovo, R. (2013) ORC waste heat recovery in European energy intensive industries: Energy and GHG savings. *Energy Conversion and Management*, 76, 244-252.

48. Jung, H., Krumdieck, S., Vranjes, T. (2014) Feasibility assessment of refinery waste heat-to-power conversion using an organic Rankine cycle. *Energy Conversion and Management*, 77, 396-407.
49. Minea, V. (2014) Power generation with ORC machines using low-grade waste heat or renewable energy. *Applied Thermal Engineering*, 69, 143-154.
50. Lu, H., Price, L., Zhang, Q. (2016) Capturing the invisible resource: Analysis of waste heat potential in Chinese industry. *Applied Energy*, 161, 497-511.
51. Chiu JNW, et al., Industrial surplus heat transportation for use in district heating, *Energy* (2016).
52. Anastasovski, A., Rašković, P., Guzović, Z. (2015) Design and analysis of heat recovery system in bioprocess plant. *Energy Conversion and Management*, 104, 32-43.
53. Krönauer, A., Lävemann, E., Brückner, S., Hauer, A. (2015) Mobile sorption heat storage in industrial waste heat recovery. *Energy Procedia*, 73, 272-280.
54. Walmsley, T. G., Walmsley, M. R., Atkins, M. J., Neale, J. R. (2014) Integration of industrial solar and gaseous waste heat into heat recovery loops using constant and variable temperature storage. *Energy*, 75, 53-67.
55. Atkins, M. J., Walmsley, M. R., Morrison, A. S. (2010) Integration of solar thermal for improved energy efficiency in low-temperature-pinch industrial processes. *Energy*, 35, 1867-1873.
56. Walmsley, T. G., Walmsley, M. R., Tarighaleslami, A. H., Atkins, M. J., Neale, J. R. (2015) Integration options for solar thermal with low temperature industrial heat recovery loops. *Energy*, 90, 113-121.
57. Xu, B., Lin, B. (2015) How industrialization and urbanization process impacts on CO₂ emissions in China: Evidence from nonparametric additive regression models. *Energy Economics*, 48, 188-202.
58. Shahbaz, M., Uddin, G. S., Rehman, I. U., Imran, K. (2014) Industrialization, electricity consumption and CO₂ emissions in Bangladesh. *Renewable and Sustainable Energy Reviews*, 31, 575-586.
59. Li, K., Lin, B. (2015) Impacts of urbanization and industrialization on energy consumption/CO₂ emissions: Does the level of development matter? *Renewable and Sustainable Energy Reviews*, 52, 1107-1122.
60. Hammond, G., Norman, J. (2014) Heat recovery opportunities in UK industry. *Applied Energy*, 116, 387-397.

61. McKenna, R. C., Norman, J. B. (2010) Spatial modelling of industrial heat loads and recovery potentials in the UK. *Energy Policy*, 38, 5878-5891.
62. Ammar, Y., Joyce, S., Norman, R., Wang, Y., Roskilly, A. P. (2012) Low grade thermal energy sources and uses from the process industry in the UK. *Applied Energy*, 89, 3-20.
63. Sun, L., Doyle, S., Smith, R. (2015) Heat recovery and power targeting in utility systems. *Energy*, 84, 196-206.
64. Fleiter, T., Schleich, J., Ravivanpong, P. (2012) Adoption of energy-efficiency measures in SMEs—An empirical analysis based on energy audit data from Germany. *Energy Policy*, 51, 863-875.
65. Brückner, S., Schäfers, H., Peters, I., Lävemann, E. (2014) Using industrial and commercial waste heat for residential heat supply: A case study from Hamburg, Germany. *Sustainable Cities and Society*, 13, 139-142.
66. Jain, V., Sachdeva, G., Kachhwaha, S. S. (2015) Energy, exergy, economic and environmental (4E) analyses based comparative performance study and optimization of vapor compression-absorption integrated refrigeration system. *Energy*, 91, 816-832.
67. Suzuki, M. (2015) Identifying roles of international institutions in clean energy technology innovation and diffusion in the developing countries: matching barriers with roles of the institutions. *Journal of Cleaner Production*, 98, 229-240.
68. Szirmai, A. (2012) Industrialisation as an engine of growth in developing countries, 1950–2005. *Structural Change and Economic Dynamics*, 23, 406-420.
69. Miró, L., Brückner, S., Cabeza, L. F. (2015) Mapping and discussing Industrial Waste Heat (IWH) potentials for different countries. *Renewable and Sustainable Energy Reviews* 51, 847-855.
70. Fang, H., Xia, J., Zhu, K., Su, Y., Jiang, Y. (2013) Industrial waste heat utilization for low temperature district heating. *Energy Policy*, 62, 236-246.
71. Li Y., Xia, J., Fang H, Su, Y., Jiang, Y. (2016) Case study on industrial surplus heat of steel plants for district heating in Northern China. *Energy* 102, 397-405.
72. Huang, F., Lu J., Zheng J., Baleynaud, JM, (2015) Feasibility of Heat Recovery for District Heating Based on Cloud Computing Industrial Park. *Proceedings of 4th International Conference on Renewable Energy Research and Applications*.

73. Li, C., (2013) Research on the Coupling Characteristics and System Optimization of District CCHP, Chongqing University (in Chinese, PhD thesis).
74. Yang, L., (2014) The Research about Waste Energy Utilization in "Cloud Computing" Industrial Parks, Chongqing University, Master thesis (in Chinese).
75. Zhang, S., (2014) Optimal Research of CCHP System in Cloud Computing Industrial Park. Chongqing University, Master thesis (in Chinese).
76. Karooni, R., Yusoff, S. B., Kari, F. B. (2016) Renewable energy technology acceptance in Peninsular Malaysia. *Energy Policy*, 88, 1-10.
77. Sulaiman, F., Abdullah, N., Gerhauser, H., Shariff, A. (2011) An outlook of Malaysian energy, oil palm industry and its utilization of wastes as useful resources. *Biomass and bioenergy*, 35, 3775-3786.
78. Hosseini, S. E., Wahid, M. A. (2015) Utilization of biogas released from palm oil mill effluent for power generation using self-preheated reactor. *Energy Conversion and Management*, 105, 957-966.
79. Ali, R., Daut, I., Taib, S. (2012) A review on existing and future energy sources for electrical power generation in Malaysia. *Renewable and Sustainable Energy Reviews*, 16, 4047-4055.
80. Chai, K.-H., Baudelaire, C. (2015) Understanding the energy efficiency gap in Singapore: a Motivation, Opportunity, and Ability perspective. *Journal of Cleaner Production*, 100, 224-234.
81. Authority, E. M., (2015) Singapore Energy Statistics, Singapore Government. http://www.ema.gov.sg/cmsmedia/Publications_and_Statistics/Publications/ses/2015/energy-consumption/index.html.
82. Yang, P. P.-J., Lay, O. B. (2004) Applying ecosystem concepts to the planning of industrial areas: a case study of Singapore's Jurong Island. *Journal of Cleaner Production*, 12, 1011-1023.
83. Kannan, R., Leong, K., Osman, R., Ho, H. (2007) Life cycle energy, emissions and cost inventory of power generation technologies in Singapore. *Renewable and Sustainable Energy Reviews*, 11, 702-715.
84. Jiang, R. (2014) The CCHP System Integration Theory with Enhancement on Optimization Analysis and its Off-design Performance. PhD Thesis (in Chinese).
85. REN H., WU Q., Gao W. (2015) Current status and future prospect of distributed cogeneration systems in Japan. *Energy Conservation*. 389(2) (in Chinese).

-
86. Sanaye S., Sarrafi A. (2015) Optimization of combined cooling, heating and power generation by a solar system. *Renewable Energy* 80, 699-712.
 87. Maraver D., Sin A., Sebastián F., Royo J. (2013) Environmental assessment of CCHP (combined cooling heating and power) systems based on biomass combustion in comparison to conventional generation. *Energy* 57, 17-23.
 88. Uris M., Linares J., Arenas E. (2015) Size optimization of a biomass-fired cogeneration plant CHP/CCHP (Combined heat and power/Combined heat, cooling and power) based on Organic Rankine Cycle for a district network in Spain. *Energy* 88, 935-945.
 89. Wang J., Mao T. (2015) Cost allocation and sensitivity analysis of multi-products from biomass gasification combined cooling heating and power system based on the exergoeconomic methodology. *Energy Conversion and Management*, 105, 230-239.
 90. Iodice P., Accadia M., Abagnale C., Cardone M. (2016) Energy, economic and environmental performance appraisal of a trigeneration power plant for a new district: Advantages of using a renewable fuel. *Applied Thermal Engineering*, 95, 330-338.
 91. Gao P., Dai Y., Tong Y., Dong P. (2015) Energy matching and optimization analysis of waste to energy CCHP (combined cooling, heating and power) system with exergy and energy level. *Energy*, 79, 522-535.
 92. Nosrat A., Swan L., Pearce J. (2013) Improved performance of hybrid photovoltaic-trigeneration systems over photovoltaic-cogeneration systems including effects of battery storage. *Energy*, 49, 366-374.
 93. Zhai H., Dai Y., Wu J., Wang R. (2009) Energy and exergy analyses on a novel hybrid solar heating, cooling and power generation system for remote areas. *Applied Energy*, 86, 1395-1404.
 94. Gazda W., Stanek W., (2016) Energy and environmental assessment of integrated biogas trigeneration and photovoltaic plant as more sustainable industrial system. *Applied Energy*, 169, 138-149.
 95. Stanek W., Gazda W., Kostowski W. (2015) Thermo-ecological assessment of CCHP (combined cold-heat-and-power) plant supported with renewable energy. *Energy*, 92, 279-289.

-
96. Li S., Sui J., Jin H., Zheng J. (2013) Full chain energy performance for a combined cooling, heating and power system running with methanol and solar energy. *Applied Energy*, 112, 673-681.
 97. Fang F., Wei L., Liu J., Zhang J. (2012) Complementary configuration and operation of a CCHP-ORC system. *Energy*, 46, 211-220.
 98. Hajabdollahi H. (2015) Investigating the effects of load demands on selection of optimum CCHP-ORC plant. *Applied Thermal Engineering*, 87, 547-558.
 99. Li Y. (2012) Research on the Configuration and Operation Strategy of District Heating System with Co-generation based on Absorption Heat Exchange (Co-ah). PhD Thesis in Chinese.
 100. G.F. Davies, G.G. Maidment, R.M. Tozer. (2016) Using data centres for combined heating and cooling: An investigation for London. *Applied Thermal Engineering*. 94, 296–304.
 101. Xu D., Qu M. (2013) Energy, environmental, and economic evaluation of a CCHP system for a Data Center based on operational data. *Energy and Buildings*, 67, 176-186.
 102. Haywood A., Sherbeck J., Phelan P., Varsamopoulos G. (2012) Thermodynamic feasibility of harvesting Data Center waste heat to drive an absorption chiller. *Energy Conversion and Management*, 58, 26-34.
 103. Ebrahimi K., Jones G., Fleischer A (2014) A review of Data Center cooling technology, operating conditions and the corresponding low-grade waste heat recovery opportunities. *Renewable and Sustainable Energy Reviews*, 31, 622-638.
 104. Priya G., Bandyopadhyay S. (2016) Multiple objectives Pinch Analysis. *Resources, Conservation and Recycling*.
<http://dx.doi.org/10.1016/j.resconrec.2016.02.005>
 105. Guo C., Du X., Yang L., Yang Y. (2014) Performance analysis of organic Rankine cycle based on location of heat transfer pinch point in evaporator. *Applied Thermal Engineering*, 62, 176-186.
 106. Wu S., Zhou S., Xiao L., Li Y. (2014) Determining the optimal pinch point temperature difference of evaporator for waste heat recovery. *Journal of the Energy Institute*, 87, 140-151.

-
107. Kim K., Ko H., Kim K. (2014) Assessment of pinch point characteristics in heat exchangers and condensers of ammonia–water based power cycles. *Applied Energy*, 113, 970-981.
 108. Gadalla M. (2015) A new graphical method for Pinch Analysis applications: Heat exchanger network retrofit and energy integration. *Energy*, 81, 159-174.
 109. Gadalla M. (2015) A novel graphical technique for Pinch Analysis applications: Energy Targets and grassroots design. *Energy Conversion and Management*, 96, 499-510.
 110. <http://direns.mines-paristech.fr/Sites/Thopt/en/co/presentation-thermoptim.html>.
 111. Li Y., Abakr Y., Qiu Q., You X. (2016) Energy efficiency assessment of fixed asset investment projects – A case study of a Shenzhen combined-cycle power plant. *Renewable and Sustainable Energy Reviews*, 59, 1195-1208.
 112. Chen S., (2012) The Research of Wind Environment in Near Ground Layer for Mountainous City Planning. Chongqing University, PhD thesis.
 113. Vandani A., Joda F., Boozarjomehry R. (2016) Exergic, economic and environmental impacts of natural gas and diesel in operation of combined cycle power plants. *Energy Conversion and Management*, 109, 103-112.
 114. Yan B., Xue S., Li Y., Duan J. (2016) Gas-fired combined cooling, heating and power (CCHP) in Beijing: A techno-economic analysis. *Renewable and Sustainable Energy Reviews*, 63, 118-131.
 115. Long W. (2011) More understanding about the principal of “determining power by heating load” in heat and power cogeneration. *HV&AC*, 41(2), 18-22.
 116. Ng K., Hernandez E. (2016) A systematic framework for energetic, environmental and economic (3E) assessment and design of polygeneration systems. *Chemical Engineering Research and Design*, 106, 1-25.
 117. Dong R., Xu J. (2015) Impact of differentiated local subsidy policies on the development of distributed energy system. *Energy and Buildings*, 101, 45-53.
 118. Gan X. (2014) Research on Sustainable Construction Decision Making of Infrastructure Project Based on Stakeholder Theory. Chongqing University, PhD thesis (in Chinese).
 119. Wang J. (2008) Research on the Success Criteria of Large Scale Construction Projects---Based on Stakeholders Theory. Central South University, PhD thesis (in Chinese).

120. Liu J., Wang R., Sun Y., Lin Y. (2013) A barrier analysis for the development of distributed energy in China: A case study in Fujian province. *Energy Policy*, 60, 262–271.
121. Wright D., Dey P., Brammer J. (2014) A barrier and techno-economic analysis of small-scale bCHP (biomass combined heat and power) schemes in the UK. *Energy*, 71, 332-345.

Acknowledgments

Financial support of ERASMUS MUNDUS Techno 2 project and hospitality of laboratory PHASE of UT3-PS in the framework of project “OptiMEP: Management of Energy for Patrimonial purpose”, is gratefully acknowledged. Meanwhile, thanks for the project support of National Science Foundation of China (No. 51478058) and data collection from Chongqing Liangjiang New area shuitu High-tech industrial park.

I spent part of my PhD life in Laboratory PHASE of University Paul Sabatier, France. It lasted not for a long time in my life but every day was unforgettable. I appreciate having this opportunity to study in France and know more about French culture.

Firstly, I would like to thank my supervisor Prof. Françoise THELLIER and co-supervisor Dr. Jean-Michel BALEYNAUD from Laboratory PHASE of University Paul Sabatier. Thanks for giving me this opportunity to do research in France. Especially, I would like to thank Dr. Jean-Michel BALEYNAUD for teaching me a lot when I was confused in my research; thanks for helping me when I have difficulties no matter in the research or in my life during my stay in Toulouse. Even when I come back to China, you still give a hand to me about my PhD research via emails. You are not only my supervisor in my student life but also a nice friend in my life. Many thanks to you and all the best for you.

Secondly, I would like to thank all the people I met in Lab PHASE. The director Prof. Vincent GIBIAT, thanks for welcoming me to Lab PHASE and thanks for sharing so many interesting things with our foreign students; the secretary Myriam BOYER, thanks for teaching me how to learn French like French kids, thanks for sharing French culture and lifestyle with me, thanks for regarding me as little sister and taking care of me all the time; my colleague Thibaut DOCHY, thanks for accompanying me having lunch in “poor” student restaurant rather than going home to enjoy delicious food your mother prepares, thanks for inviting me to your family

and introducing me to your elegant mother, thanks for driving me to the supermarket on weekends and to the airport when I left Toulouse. Besides, the first embrace I got from Miss Sandra SPAGNOL when finishing my first presentation in the lab is unforgettable forever---it was so warm, friendly and full of love. I am so lucky to meet so many nice people in PHASE Lab. All the best for all of you.

Thirdly, I would like to thank my Chinese friends who were studying in Toulouse, France. We spent Chinese Spring Festival together and we helped each other no matter when and who were in need of help. Especially, I would like to thank Dr. Song XIAO. Both of us are from Chongqing University, it was so lucky to have such a nice and social friend in France. Thanks for introducing so many friends to me when I arrived in Toulouse and thanks for helping a lot.

Life is like a trip. Thanks for meeting so many nice people in my life and thanks for so many amazing things happened to me.

Feng HUANG
Chongqing, China
Dec. 2016

Annex-B Simulation results of pollutant distribution of chimney of power plant using FLUENT

In the simulation model, office buildings are located at the northeast of chimney of thermal power plant. According to the distribution diagram of wind speed of Chongqing area, there is a great possibility that the air pollutant spreads to the buildings located within the zone between 25° and 5° east of north. The largest and average wind speed is considered in simulating the process of air pollutant diffusion. So the simulation is divided into following four cases as shown in the Table B.1:

Table B.1:

Simulation cases of air pollutant distribution of thermal power plant			
Simulation Case	Wind Direction	Wind Speed (m/s)	Note
A	25° east of north	5.12	$X_z^1 = -4.64\text{m/s}$, $X_x^2 = 2.16\text{m/s}$
B	25° east of north	1.6	$X_z = -1.45\text{m/s}$, $X_x = 0.68\text{m/s}$
C	5° east of north	9.03	$X_z = -9\text{m/s}$, $X_x = 0.8\text{m/s}$
D	5° east of north	2.01	$X_z = -2\text{m/s}$, $X_x = 0.17\text{m/s}$

¹Axis Z points to South; ²Axis X points to East.

According to the layout of the industrial park shown in Fig. B.1 and the detail of the layout of gas-steam combined cycle power plant (location of chimney), the simulation model of pollutant distribution is established as shown in Fig. B.2.

The emission value of the main air pollutant of SO₂ and NO_x is extracted from *Monitoring Report on Completion Acceptance of Environmental protection* of gas-steam combined cycle power plant. The diffusion diagrams of SO₂ and NO_x at the height Y=10m、20m and 80m are exported to know about the diffusion of pollutant at the outlet of chimney and analyze the influence of pollutant diffusion on buildings in the industrial park or around. The air pollutants are simulated when thermal power plant operates at full load. The simulation results are shown in the Fig. B.3~B.14, in which the chimney is located at the right top corner.

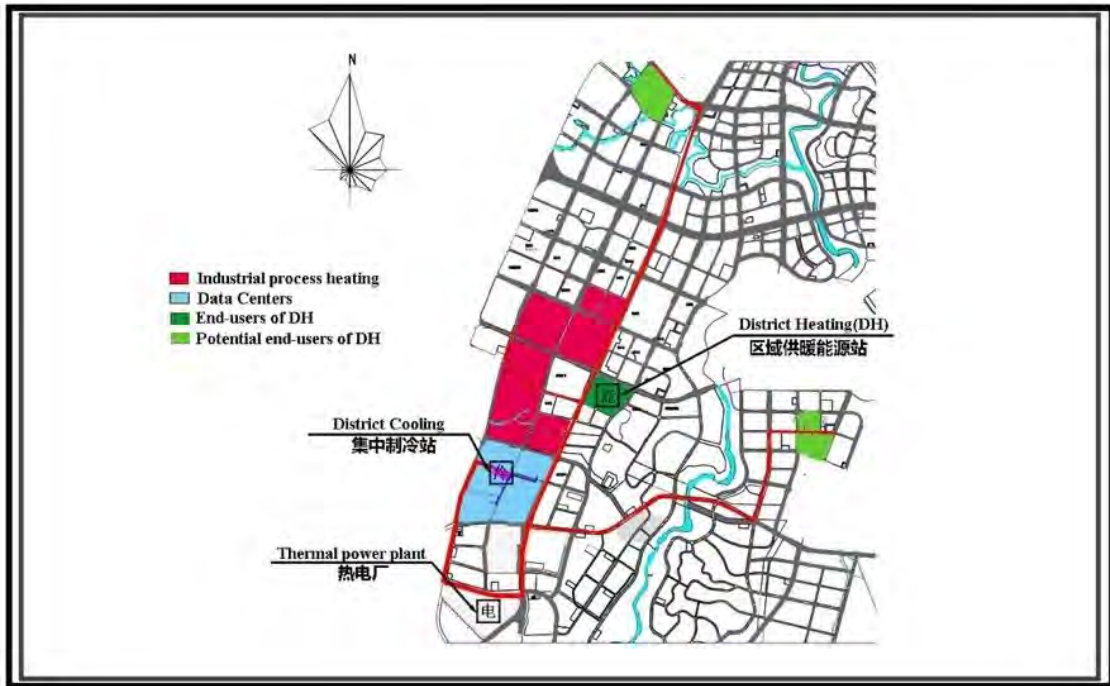

Fig. B.1 Layout of DES of demonstrative industrial park

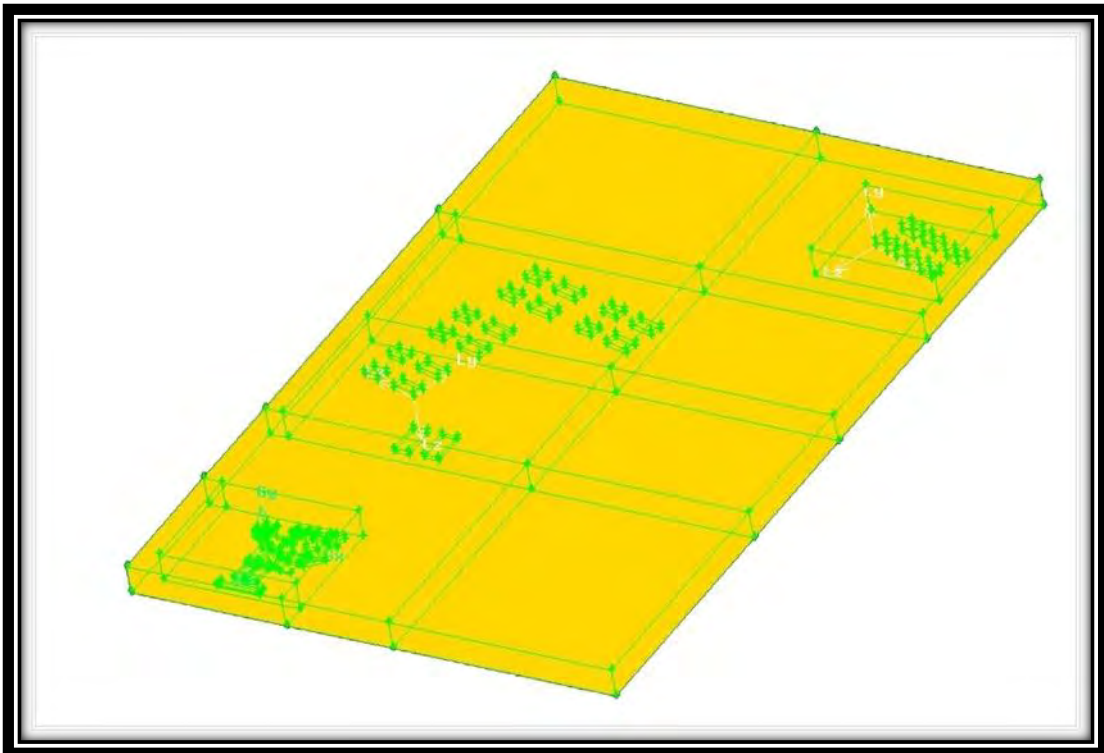
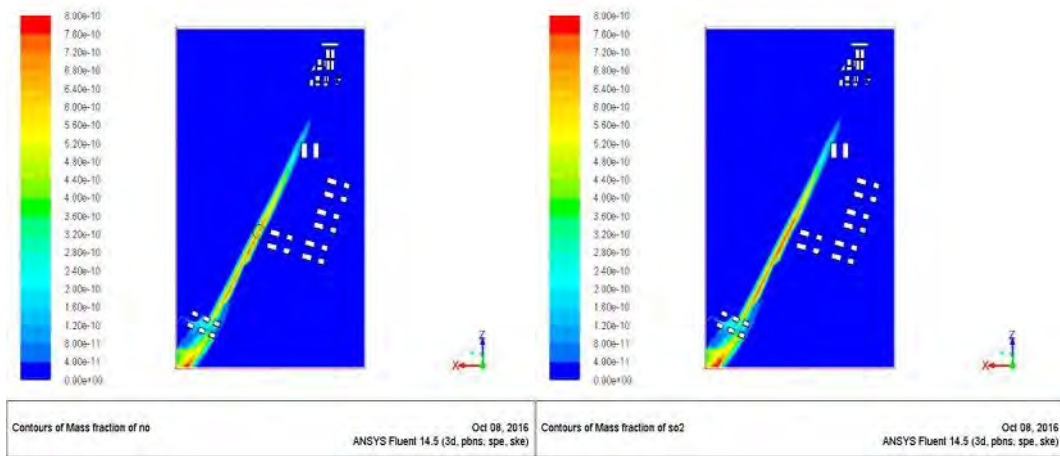

Fig. B.2 Diagram of mesh generation of the model (up to 20.12 billion grids)

Case A:

1) Cross-sectional views at the height Y=10m:



(a) NO_x

(b) SO₂

Fig. B.3 Distribution of mass concentration of air pollutant at the height Y=10m

2) Cross-sectional views at the height Y=20m:

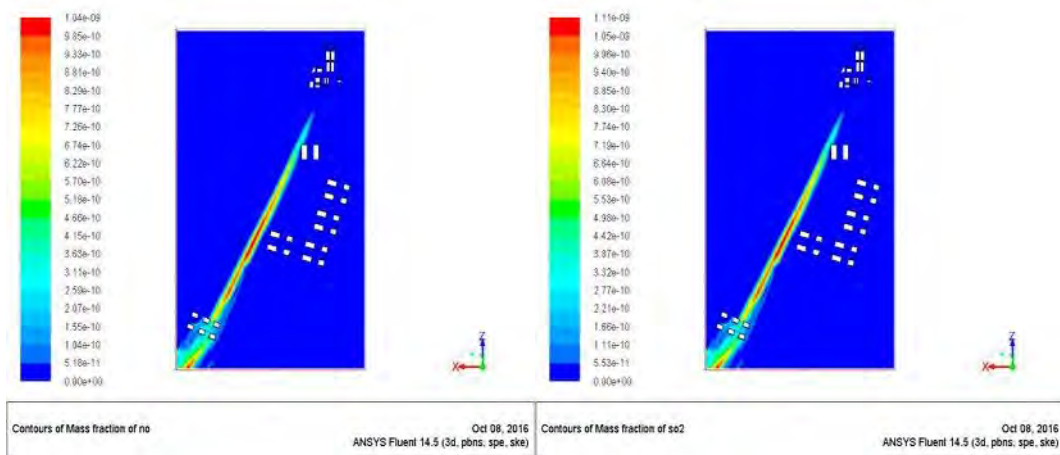

(a) NO_x

(b) SO₂

Fig. B.4 Distribution of mass concentration of air pollutant at the height Y=20m

As the air pollutant emission from the chimney in the simulation case is obviously under the limiting value of emission, so no spot suffers serious air pollution. However, as shown in Fig. B.3 and Fig. B.4, people working and living in Cloud Computing industrial service center are vulnerable to air pollution if the air pollutant from chimney doesn't meet the emission standard.

3) Cross-sectional views at the height Y=80m:

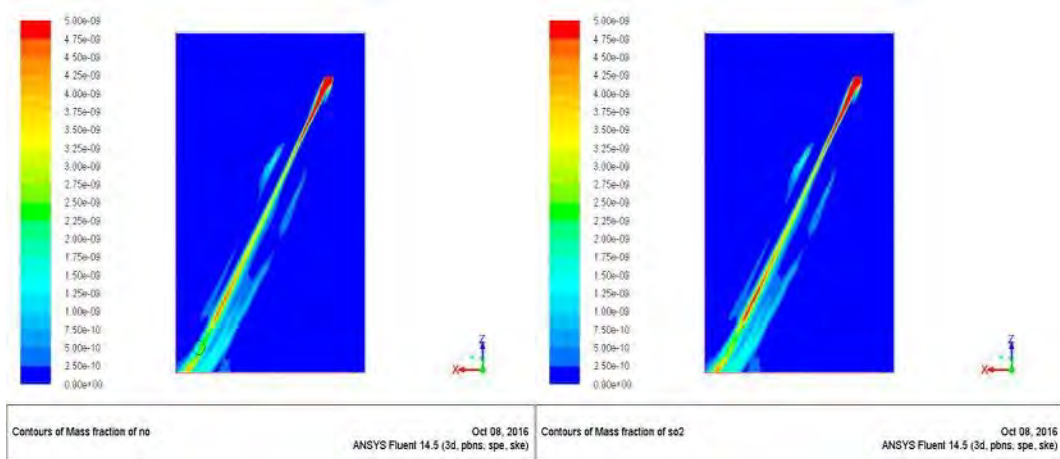

(a) NO_x

(b) SO₂

Fig. B.5 Distribution of mass concentration of air pollutant at the height Y=80m

As shown in Fig.B.5, the maximum emission of both NO_x and SO₂ is at the outlet of chimney, reaching 0.077mg/m³ and 0.006mg/m³, respectively, extending along the wind direction for a certain distance. At the overhead of Cloud Computing service center, the concentration of air pollutant is higher than its surrounding but a bit lower than the outlet of chimney. Meanwhile, the air pollutant decreases from the top of the chimney to the bottom by comparing Fig. B.3~B.5.

Case B:

1) Cross-sectional views at the height Y=10m:

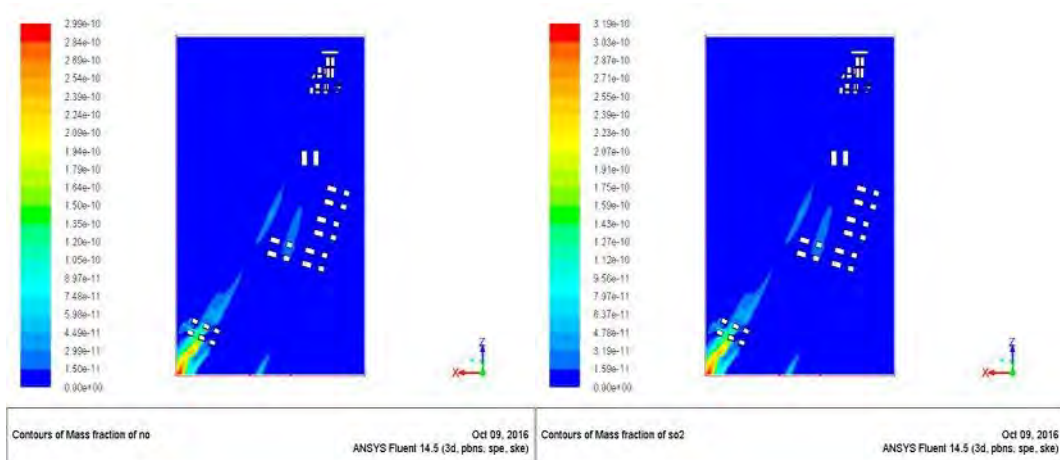

(a) NO_x

(b) SO₂

Fig. B.6 Distribution of mass concentration of air pollutant at the height Y=10m

2) Cross-sectional views at the height Y=20m:

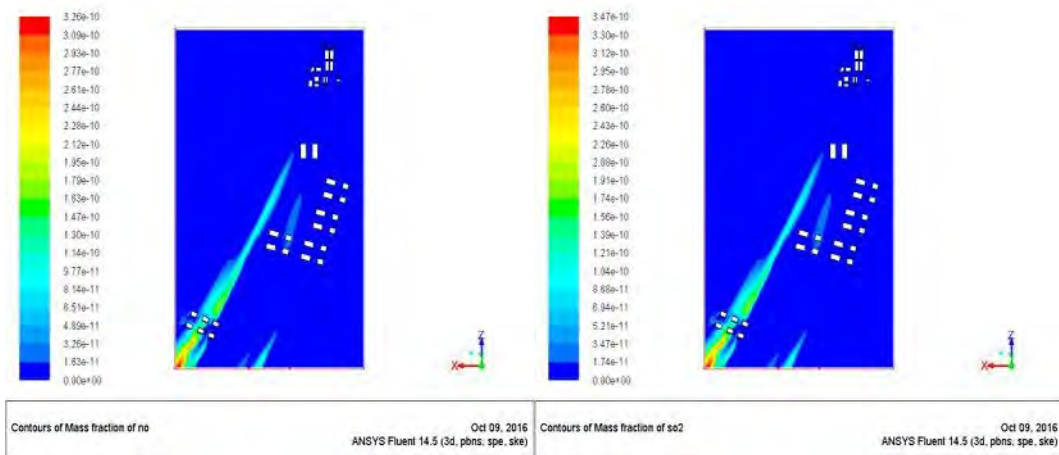

Fig. B.7 Distribution of mass concentration of air pollutant at the height Y=20m

3) Cross-sectional views at the height Y=80m:

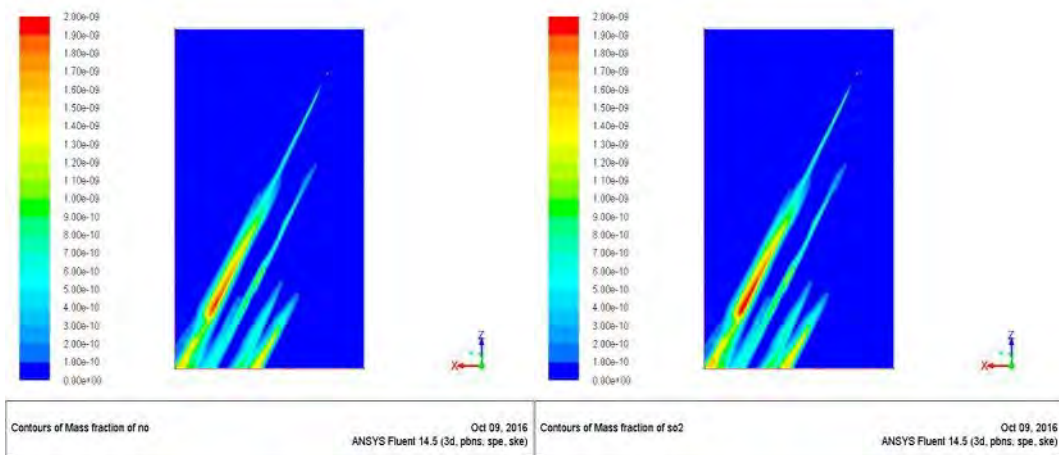
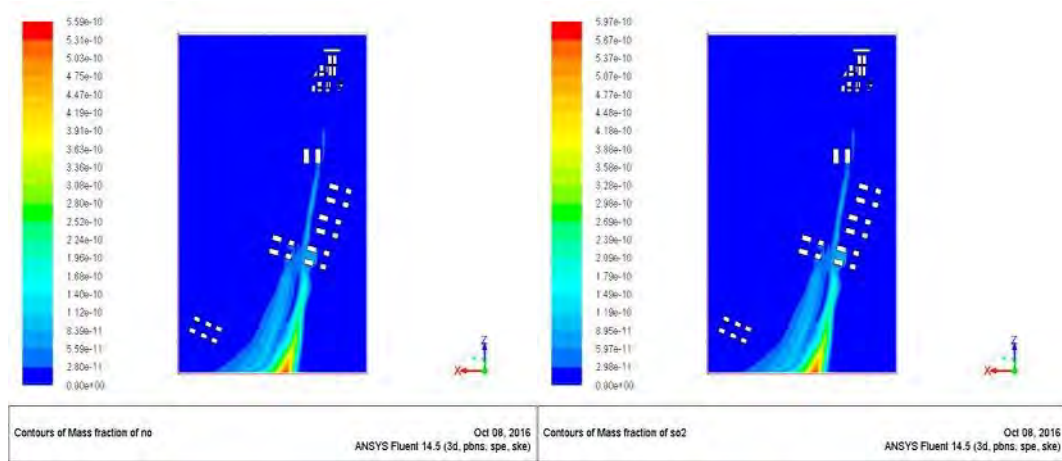

Fig. B.8 Distribution of mass concentration of NO at the height Y=80m

As shown in Fig. B.6~B.8, the maximum emission of both NO_x and SO₂ is also at the outlet of chimney, reaching 0.0312mg/m³ and 0.0024mg/m³, respectively. However, the maximum emission zone is concentrated to a spot rather than extending along the wind direction for a certain distance as shown in Case A. The air pollutant decreases from the top of chimney to bottom. As shown in Fig. B.6 and B.7, people working and living in Cloud Computing service center are vulnerable to air pollution if air pollutant from chimney doesn't meet the emission standard, but the affected zone zooms out compared to that of Case A due to the reduction of speed wind.

Case C:

1) Cross-sectional views at the height Y=10m:



(a) NO_x

(b) SO₂

Fig. B.9 Distribution of mass concentration of air pollutant at the height Y=10m

2) Cross-sectional views at the height Y=20m:

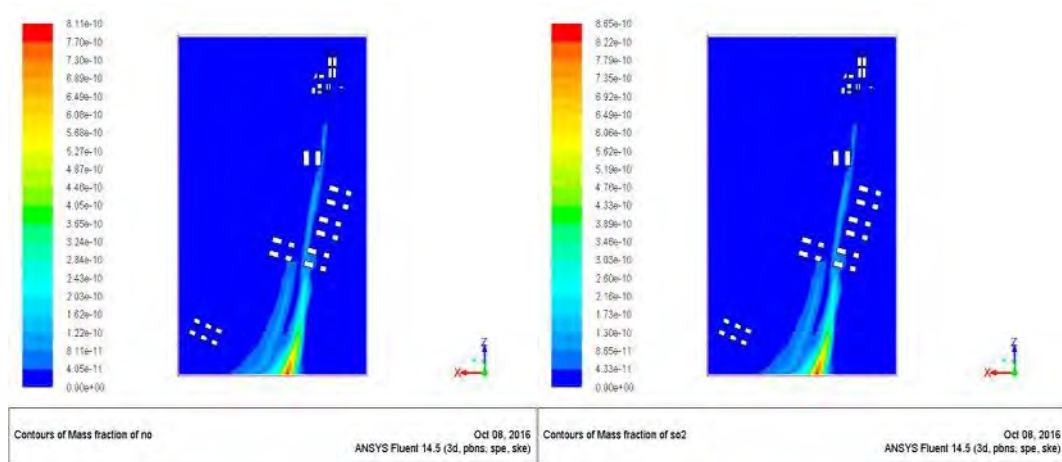

(a) NO_x

(b) SO₂

Fig. B.10 Distribution of mass concentration of air pollutant at the height Y=20m

As the air pollutant emission from the chimney in the simulation case is obviously under the limiting value of emission, so no spot suffers serious air pollution. As shown in Fig. B.9 and B.10, people working and living in Cloud Computing service center don't need to worry about the air pollution from thermal power plant even if wasted gas emission doesn't meet the emission standard.

3) Cross-sectional views at the height Y=80m:

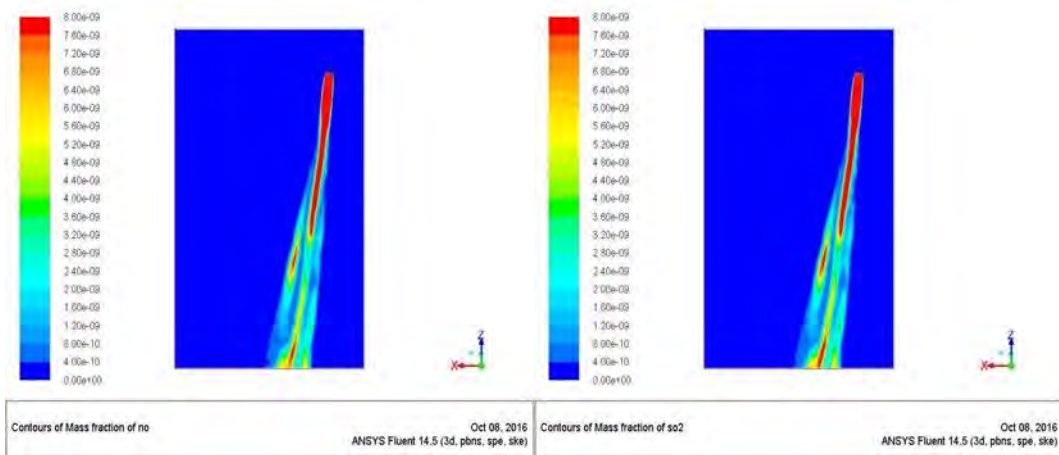

(a) NO_x

(b) SO₂

Fig. B.11 Distribution of mass concentration of air pollutant at the height Y=80m

As shown in Fig. B.9~B.11, the maximum emission of both NO_x and SO₂ is at the outlet of chimney, reaching 0.1248 mg/m³ and 0.0096 mg/m³, respectively, extending along the wind direction to the overhead zone of Data Centers. The air pollutant decreases greatly from the top of the chimney to the bottom by comparing Fig. B. 9~B.11, thus there is few air pollutants when the wind flows through the buildings of Data Centers.

Case D:

1) Cross-sectional views at the height Y=10m:

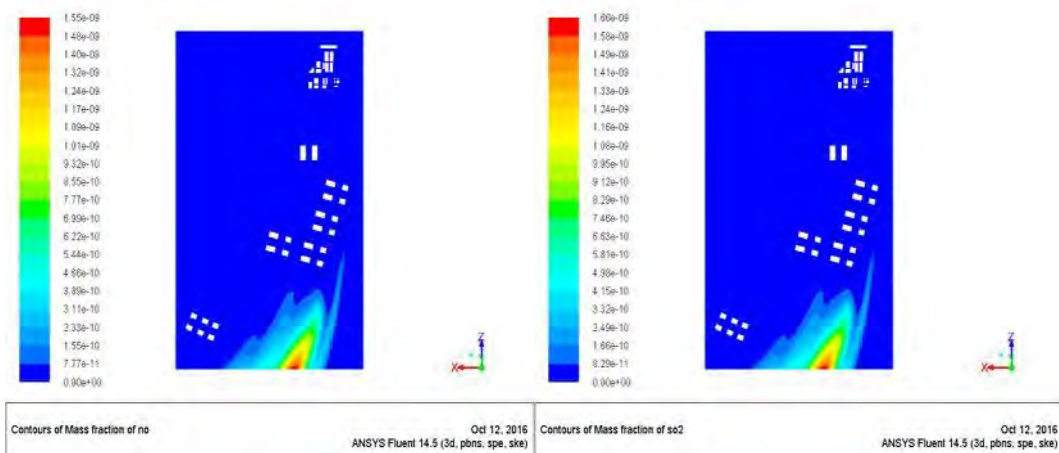

(a) NO_x

(b) SO₂

Fig. B.12 Distribution of mass concentration of air pollutant at the height Y=10m

2) Cross-sectional views at the height Y=20m:

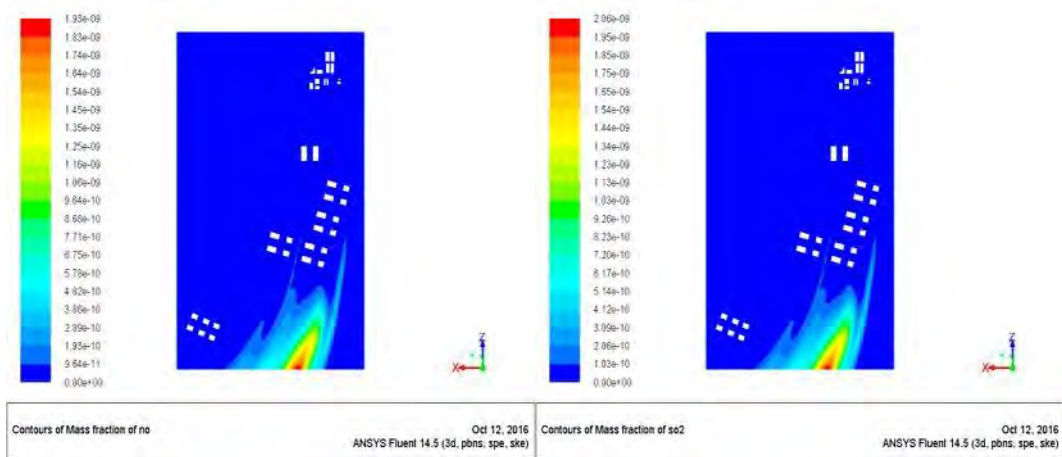

(a) NO_x

(b) SO₂

Fig. B.13 Distribution of mass concentration of air pollutant at the height Y=20m

3) Cross-sectional views at the height Y=80m:

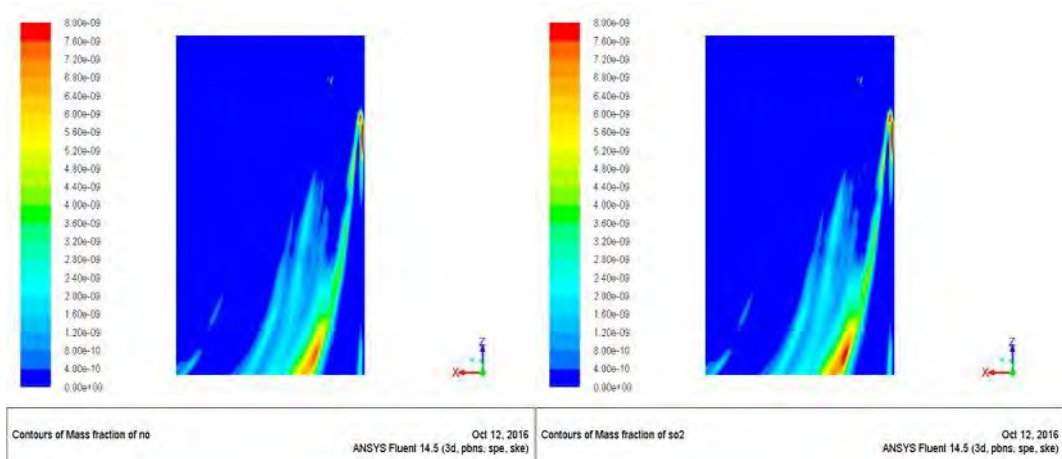

(a) NO_x

(b) SO₂

Fig. B.14 Distribution of mass concentration of NO at the height Y=80m

As shown in Fig. B.12~B.14, the maximum emission of both NO_x and SO₂ only appears at a spot zone of the outlet of chimney, reaching 0.1248 mg/m³ and 0.0096 mg/m³, respectively. In this case, people working and living in Cloud Computing industrial service center don't need to worry about the air pollution from thermal power plant even if wasted gas emission doesn't meet the emission standard. However, at the overhead of Bio-chemical plants, the concentration of air pollutants is higher than other zones except the outlet of chimney.

Annex-C Glossary of acronyms

AR Absorption Refrigerator;

CCHP Combined Cooling, Heating and Power;

CHP Combined Heating and Power;

CCHP-DH Combined Cooling, Heating and Power coupled with District Heating;

CHP-DH Combined Heating and Power coupled with District Heating;

COP Coefficient of Performance;

DES Distributed Energy System;

DH District Heating;

DC District Cooling;

GCC Grand Composite Curve;

HP High Pressure;

HT High Temperature;

MP Medium Pressure;

MT Medium Temperature;

LP Low Pressure;

LT Low Temperature;

SCA Strategic Cooperation Agreement;

HRS Heat Recovery Steam Generator;

HPR Heat to Power Ratio;

NPV Net Present Value;

ROI Return on Investment;

GHG Greenhouse Gas;

SCR Selective Catalytic Reduction;

3E performance Energy, Economic and Environmental performance;

OB analysis Outside Boundary analysis;

IB analysis Inside Boundary analysis;

- ER** Energy recovery / waste heat recovery;
- HTPP** Huaneng Thermal Power Plant;
- LP** Local Government;
- CNPC** China National Petroleum Corporation;
- BC** Building Contractor;
- DRI** Design and Research Institute;
- ES** Equipment Supplier;
- SG** State Grid;
- BP** Bio-chemical Plants;
- CE** Communication Enterprises;
- MCIP** Management Committee of Industrial Park;
- LC** Local Community;
- EPA** Environmental Protection Agency;
- EGR** Electricity Gas Rate;
-
- V0** represents CCHP-DH model;
- V00** represents CCHP-DH model with multiple waste heat sources in serial arrangement;
- V01** represents CCHP-DH model with multiple waste heat sources in parallel arrangement;
- V02** represents CCHP-DH model with multiple waste heat sources in mixed arrangement based on the extraction of a certain amount of LP steam for DH;
- V1** represents CCHP model;
- V2** represents CHP-DH model;
- V21** represents CHP-DH model with compression heat pump for DH;
- V22** represents CHP-DH model with heat exchanger for DH based on the extraction of a certain amount of LP steam;
- V3** represents CHP model;
- T** Temperature;
- P** Pressure;
- Ec** Economic value ratio;

En Energy value ratio;

Ew Waste heat emission ratio;

Ie Energy intensity in the process i ;

Ico₂ CO₂ intensity in the process i ;

Iw Recoverable waste heat intensity;

γ_{rec} Low-temperature waste heat recovery ratio of DES system;

Δv_p Relative energy value of product;

Δv_f Relative energy value of feed;

ΔTAC Relative total annualized cost;

$q_{p,k}/q_{p,0}$ Ratio of the quantities per unit time of product between model k and base case;

$q_{f,k}/q_{f,0}$ Ratio of the quantities per unit time of feed between model k and base case;

Normalised TAC_{k,0} Ratio of the relative total annualized cost between model k and base case;

I_{3E} Relative 3E index;

I'_{3E} Relative 3E index of Case Study;

LHV_{p,i} Low Heating Value of product in the process i ;

C_{total} Total investment of DES project;

Délivré par l'Université Toulouse 3 Paul Sabatier (UT3 Paul Sabatier) et la Faculty of Urban Construction and Environmental Engineering, Chongqing University (CQU)

Ecole Doctorale MEGeP - Spécialité Énergétique et transferts - Le 24 décembre 2016

Mme HUANG Feng

Contribution à l'évaluation et à la configuration optimale des Systèmes à Energie Distribuée basés sur la Récupération de Rejets de Chaleur Industrielle

A l'heure actuelle, l'industrie représente environ le tiers de la consommation énergétique et des émissions de CO₂. Des opportunités substantielles existent pour faire face aux enjeux environnementaux et économiques, passant par l'efficacité énergétique en général et l'utilisation de l'énergie, en particulier dans les parcs industriels.

Les Systèmes à Energie Distribuée (SED) correspondent en ce sens à une solution courante et prometteuse.

Nous avons donc entrepris une démarche d'approche globale de site, incluant l'agrégation de l'ensemble des variables énergétiques, économiques, environnementales et managériales influentes dans une installation de ce type. Une mise en application sur une installation pilote et sa validation ont permis d'identifier les verrous scientifiques et techniques et de mesurer pertinence et efficacité des éléments et modes opératoires des systèmes en mode stationnaire.

Cette étude offre une méthode d'utilisation coopérative des indicateurs des domaines impactés et ouvre également des perspectives sur des développements en mode dynamique à des fins d'aide à la conduite optimale.

Mots-clés: Systèmes à Energie Distribuée; Revalorisation des Rejets de Chaleur Industrielle; Chauffage Urbain; Performance 3E; Evaluation des verrous.

Contribution to evaluation and optimal configuration of Distributed Energy Systems based on industrial waste heat recovery

Nowadays, industry accounts for about one third of energy consumption and CO₂ emissions. Substantial opportunities exist to address environmental and economic challenges, including energy efficiency in general and the use of energy, especially in industrial parks.

Distributed Energy Systems (DES) correspond in this sense to a common and promising solution.

We have therefore undertaken a global site approach, including the aggregation of all influential energy, economic, environmental and managerial variables in an installation of this type. Implementation on a pilot plant and its validation have made it possible to identify the scientific and technical locks and to measure the relevance and efficiency of the elements and stationary operating modes of the systems.

This study offers a method of cooperative use of the indicators of impacted domains and also opens perspectives on developments in dynamic mode for the purposes of optimum driving assistance.

Key-words: Distributed Energy System; Industrial waste heat recovery; District Heating; 3E performance; Barrier Evaluation.

Laboratoire PHASE (Physique de l'Homme Appliquée à Son Environnement)

Université Toulouse 3 Paul Sabatier

118, route de Narbonne 31062 TOULOUSE CEDEX 9