



**HAL**  
open science

# Proposals for tangible, intuitive and collaborative design of manufactured products through virtual and augmented reality environments

Channarong Trakunsaranakom

## ► To cite this version:

Channarong Trakunsaranakom. Proposals for tangible, intuitive and collaborative design of manufactured products through virtual and augmented reality environments. Graphics [cs.GR]. Université Grenoble Alpes, 2017. English. NNT : 2017GREAI022 . tel-01701715

**HAL Id: tel-01701715**

**<https://theses.hal.science/tel-01701715>**

Submitted on 6 Feb 2018

**HAL** is a multi-disciplinary open access archive for the deposit and dissemination of scientific research documents, whether they are published or not. The documents may come from teaching and research institutions in France or abroad, or from public or private research centers.

L'archive ouverte pluridisciplinaire **HAL**, est destinée au dépôt et à la diffusion de documents scientifiques de niveau recherche, publiés ou non, émanant des établissements d'enseignement et de recherche français ou étrangers, des laboratoires publics ou privés.



## **THÈSE**

Pour obtenir le grade de

## **DOCTEUR DE LA COMMUNAUTÉ UNIVERSITÉ GRENOBLE ALPES**

Spécialité : GI : Génie Industriel : conception et production

Arrêté ministériel : 25 mai 2016

Présentée par

**Channarong TRAKUNSARANAKOM**

Thèse dirigée par **Frédéric NOEL** et codirigée par **Philippe MARIN**

préparée au sein du **Laboratoire des Sciences pour la Conception, l'Optimisation et la Production de Grenoble** dans l'**École Doctorale I-MEP2 - Ingénierie - Matériaux, Mécanique, Environnement, Energétique, Procédés, Production**

**Propositions pour une conception de produits manufacturiers collaborative, intuitive et tangible via des environnements de réalité virtuelle et augmentée.**

**Proposals for tangible, intuitive and collaborative design of manufactured products through virtual and augmented reality environments.**

Thèse soutenue publiquement le **21 juin 2017**, devant le jury composé de :

**Monsieur Frédéric MERIENNE**

Professeur, Institut Image, Rapporteur

**Monsieur Georges DUMONT**

Professeur, IRISA, Campus universitaire de Beaulieu, Rapporteur

**Monsieur Vincent CHEUTET**

Professeur, INSA, Bâtiment Léonard de Vinci, Président

**Monsieur Philippe MARIN**

Professeur assistant, G-SCOPGrenoble INP, Co-directeur de thèse

**Monsieur Frédéric NOEL**

Professeur, G-SCOPGrenoble INP, Directeur de thèse

(This page is intentionally left blank)

## **ACKNOWLEDGEMENTS**

Foremost, I would like to thank my advisors Professor Frédéric Noël and Thanks Professor Philippe Marin for the continuous support of my PhD study and research, for their patience, motivation, enthusiasm and immense knowledge. I would like to express my sincere gratitude Institut National Polytechnique De Grenoble for letting me fulfill my dream of being a PhD student here. I would like to thanks the staff of G-SCOP laboratory for their good reception.

I wish to thank all members of the jury for the attention they have kindly given to this work: (Professor Frédéric MERIENNE) for doing me honor to chair this jury, (Professor Georges DUMONT), and (Professor Vincent CHEUTET) for accepting the burden to be Reviewer and (Professor Frédéric Noël) for allowing me the honor to consider it. They find here my gratitude for having taken some of their time to read this brief and give constructive criticism.

My sincere thanks also goes to Mr.Patrick Maigrot and his Visionair team, for supporting me with the device for simulation, the valuable advice for development of my application and the software.

I would like to thank the G-SCOP laboratory for supporting me for the two international conference fees. I would like to thank the Princess of Naradhiwas University and Office of the Higher Education Commission, Thai Ministry of Education for awarding me a scholarship and providing me with the facilities to complete this thesis.

I would like to thank all the PhD students of G-SCOP laboratory for the exchanges of ideas and advices during the last three years.

**Channarong Trakunsaranakom**

(This page is intentionally left blank)

## TABLE OF CONTENTS

	Page
Acknowledgement	iii
List of the Table	vii
List of the Figure	viii
Chapter 1 Introduction about VR assessment	1
1.1 Introduction	1
1.2 Research Context	4
1.3 Research Questions	8
1.4 Methodology of the Thesis	10
1.5 Organization of the Thesis	10
1.6 Conclusion	12
Chapter 2 State of the Art about VR Assessment Technique	15
2.1 Introduction	15
2.2 Literature review	16
2.3 State of the Art	23
2.4 Hypothesis about High Level Abstract Assessment	29
2.5 Conclusion	34
Chapter 3 The Assessment of Virtual Reality Environment	37
3.1 Introduction	37
3.2 Method Proposal	41
3.3 Basic Sensors and High Level Criteria	46
3.4 Conclusion	49
Chapter 4 Experimentation to Validate Proposal	51
4.1 Introduction	51
4.2 Case study : Sub-part of Jig & Figure	53
4.3 CAD to VR Process	53
4.4 System Overview	55
4.5 Experimentation Framework	63
4.6 Experimental Result and Analysis	68
4.7 Conclusion	71

## TABLE OF CONTENTS (CONTINUOUS)

	Page
Chapter 5 Detail High Level Assessment Technique	75
5.1 Introduction	75
5.2 A Barrel Cam Mechanism Analysis	76
5.3 Expected Added Value of VR for Designers	80
5.4 Preparation of the Virtual Reality Environments	82
5.5 Experimentation Description	87
5.6 Analysis of Basic Sensors by the use of Mechanism Simulation	89
5.7 High Level Abstract Assessment	103
5.8 Analysis of the questionnaire	107
5.9 Conclusion	112
Chapter 6 Discussion, Conclusion, and Perspectives	113
6.1 Discussion	113
6.2 Overall conclusion	118
6.3 Perspectives	119
Bibliography	121
Appendix A	137
Appendix B	151
Appendix C	159
Appendix D	163
Appendix E	189
Appendix F	215
Appendix G	225
Appendix H	257
Biography	279

## LIST OF TABLES

Tables	Page
2-1 The history before 21 <sup>st</sup> century of virtual reality	16
2-2 The history of virtual reality in the 21 <sup>st</sup> century	19
2-3 The detailed specification of VIRTUOSE 6D	28
3-1 The questionnaires for high level criteria assessment	48
4-1 The summary of experimental results	70
4-2 The summary were adapted to the same scale	71
5-1 The various dimensions that affect for a barrel cam rotation	90
5-2 Experimental results of the task duration for barrel cam 6 types	91
5-3 Experimental results of the gesture instability for the barrel cam 6 types	94
5-4 The duration average values of four environments	96
5-5 The gesture instability average values of four environments	98
5-6 The weight rating of the 30 participants by the used block model	101
5-7 Experimental result of the basic sensors combined with the quality value	102
5-8 The questionnaire of the first participant	108
5-9 The average value of the high level criteria assessment	110
5-10 The experimental result of the high level criteria assessment	110
6-1 Summary of sensors and abstract assessment marks for very environment	116
6-2 Influence tendencies of high level criteria respect to the basic sensors	119



## LIST OF FIGURE

Figure	Page
1-1 The strategic plan towards the vision 2021	7
1-2 An overview of the thesis structure	11
1-3 The limousine car was sold by Thailand Rung Union Car company	13
2-1 Goldman sachs global investment research for virtual reality and augmented reality	22
2-2 The general state of the art to performance assessment of VRE	23
2-3 A participant interacts with the collaborative virtual environment either in 2D or 3D and either with or without force feedback	26
2-4 A haptic arm interface is an haption Virtuose 6D35-45	27
2-5 The main feature will be to performance assessment	30
2-6 A haptic arm function application	30
3-1 The general structure for the virtual reality environment assessment	42
4-1 The Jig & Fixture system and the sub part of Jig & Figure for the performance assessment in our research	53
4-2 An overall process for design activity with virtual reality environment	54
4-3 CVE-Generic editor for experiment framework	56
4-4 The scene imported file into CVE Viewer	57
4-5 ODE Piston behavior and Piston joint for six screws assemble	59
4-6 The several basic sensors in CVE Analysis on the CVES	60
4-7 Six docking sensors for six screws assemblies	61
4-8 The relative difference provides the gesture instability	63
4-9 The main structure of collaborative virtual environment system	64
4-10 The gestures and position of the experiment	65
4-11 The environments to assess the performance on CVE	66
4-12 Every participant was expected to repeat the task 6 times which for equivalent screw insertions in 3 different axis directions	67
4-13 The curves of average docking each repetition step	68
4-14 The curves of each repetition step	69

## LIST OF FIGURE (CONTINUOUS)

Figure	Page
4-15 The curves of average instability	70
4-16 The average docking, duration, and stability of the four environments	74
5-1 The barrel cam modelled in a conventional CAD system	77
5-2 The overall barrel cam system to be included in the VR environment	79
5-3 Check blocking of the mechanism and analyze design issues	80
5-4 The 3D models imported into CVE and creates the scene	83
5-5 Avatar linking between human and a haptic arm device for collaboration virtual environment system	84
5-6 Two basic sensors (Duration and Instability sensors) have been applied for the barrel cam mechanism simulation	85
5-7 The participants work in a comfortable stand postures by the use stereoscopy with force-feedback to manipulate the mechanism	87
5-8 The experimentation protocol of the barrel cam mechanism simulation for the performance assessment of virtual reality environment system	88
5-9 The specific features dimension that affect for the rotate simulation, left and right pictures are two different versions	89
5-10 The task duration graph of barrel cam six types for the four experiment environments	91
5-11 Response answer surface for environment 4	92
5-12 Response answer surface for each environment + the average one	93
5-13 The gesture instability graph of barrel cam six types for the four experimental environments	95
5-14 The graph of duration average values of the 4 environments	97
5-15 The graph of the gesture instability values for the 4 environments	99
5-16 The spider graph of the completeness assessment	103
5-17 The spider graph of the high level criteria assessment	111
6-1 Influence of speedness over abstract assessment criteria	117
6-2 Influence of quality over abstract assessment criteria	118
6-3 Influence of stability over abstract assessment criteria	119



# CHAPTER 1

## INTRODUCTION ABOUT VR ASSESSMENT

*This chapter introduces general concepts for performance assessment of virtual reality environments which are relevant to the design activity of manufactured products. The chapter identifies contexts and methods to organize and to perform our research objectives. This introduction aims to present also the context of the research respect to the Thai automotive industry, because this thesis expect to build new knowledge for the benefit of Thailand economy. Then the important points are the methods and procedures of the research implementation which includes the problem statement, and the research question definition. These points justify the scope of the thesis and its organization.*

### **1.1 Introduction**

The current international competition, with the trends toward shorter development times to market requires to challenge the keystones of product design and innovation. New and innovative product development which uses the advance manufacturing technologies is a process that requires resource investment and also involves collaboration between various experts including mechanical engineers, industrial designer, manufacturing engineers, marketing, etc. A car is developed to match a market demand to apply technological research through design, prototype tools, and manufacturing preparation of the innovative product. Especially, the engineering design process is usually split into the following stages: ideation, conceptualization, feasibility assessment, design requirements, preliminary design, detailed design, production planning and tool design, and production (Ertas, A. and Jones, J., 1996). We are interested in contributing to the design process for the automotive and aerospace industries. Therefore, designers and engineers must find new tools or advanced technologies. The integrated CAD/CAE/CAM systems are

modern technologies which have been widely used for the complex manufacturing industry in the past five decades. CAD technology is widely popular to increase the productivity of designers, and manufacturing experts, improving the quality of design. In addition, it improves communications through documentation, and creates a common database for manufacturing (K. Lalit Narayan et al., 2008) enhancing collaboration. CAD technology is mainly used for detailed engineering of 3D models and/or 2D drawings of physical components, but it is also used throughout the engineering process from conceptual design and layout of products, through strength and dynamic analysis of assemblies to define manufacturing methods of components.

Notwithstanding CAD great development, CAD technology has limitations for complex design and advance dynamic simulation. It is an assumption that virtual reality (VR) could support to overpass these limitations because of its high potential for 3D visualization and interaction. VR should support the manufacturing design and simulation as well. Currently, VR is demonstrated within professional applications for design engineers and manufacturing experts. VR technology can be referred as immersive multimedia or computer-simulated reality, it replicates an environment that simulates a physical real world or an imagined world, allowing the user to interact with this world. Virtual realities artificially creates, sensory experiences, which can include vision, hearing, touch, smell and why not taste.

Most up-to-date VR world are displayed either on a computer screen or with stereoscopic displays. Some VR simulations include additional sensory information and focus on real sound via speakers or headphones targeted towards VR users. Some advanced haptic systems provide tactile force feedback, generally widely demonstrated within medical, gaming industrial, and military applications. Furthermore, virtual reality covers remote communication environments which provide virtual presence of distant users. The concepts of telepresence and telexistence introduced via VR, Virtual artifact (VA) either driven by standard input devices such as a keyboard and mouse, or through more recent devices such as wired gloves or omnidirectional treadmills. The simulated environment is similar to the real world in order to create a lifelike experience. But simulations for pilot or combat training can differ significantly from reality (Divya Singla and Luv Mendiratta, 2014).

There are a lot of VR environments different design and manufacturing tasks. VR environment selection still remains highly task dependent. Despite some success story with VR, core knowledge about its usage is still lacking to answer “*Which VR environments is better for a given task?*”. The aim of our research is thus the performance assessment of virtual reality environments respect to design tasks. In our research, design concerns manufactured products for which designers and engineers perform assembly simulation. Experiments are expected to determine which virtual environments best fits a dedicated activity. Two usual design tasks are combined to illustrate the assessment process:

1. To support CAD designer, engineer, and manufacturing experts to assembly simulation in a collaborative virtual reality environment.
2. To support CAD designer, engineer, and manufacturing experts to analyze and to incorporate manufacturing dimension and variation constraints early in the design process. It should save both time and cost.

In this research, we conducted experimentations to validate and compare the performance of virtual reality environments. Various virtual environments differ respect to arrangements of the engines/equipment. At G-SCOP laboratory, a collaborative virtual environment system (CVE) was developed: the CVE Tools consist of several VR modules. The modules must be connected to support an expected task. In order to achieve, assess and compare the performance of a virtual reality environment, we used the collaboration virtual environment software analysis module which provides several sensors. These sensors, called “*basic sensor*” measure position quality through docking, task duration, gesture instability, etc. But a global assessment could not be reported only with such measures. We expect to access more abstract assessment about high level characteristics; Affordance, Ergonomics, Intuitiveness, Tangibility, and Tiredness (F. Noël et al., 2012). We thus conducted experience to compare 4 different VR environments through both low and high level assessment. The main goal is not the comparison of a few specific environment, but the comparison itself.

## **1.2 Research context**

I had the opportunity to study and research under design projects while I was working in Thailand with Associate Professor Suthep Butdee (He is associate professor of the King Mongkut's University of Technology North Bangkok). We were a team of consultants for the automotive manufacturers and our important role is counseling service, research & development associated with the design phase and the manufacturing process. We often faced problem during the design phase about the 3D model storage of standard components and the 3D model retrieval to be used for production process monitoring. A main significant issue concerns assembly and simulation of prototypes. Engineers, designers, expert manufacturing, spent a lot of time to perform these tasks. Furthermore, Thai engineers / designers have ability and potential for virtual reality technology but resources are not fully operational and the technology is not ready yet. For these reasons, Thai government (Ministry of Industry) needs plans to found some centers for research and development about virtual reality technology for the automotive industries in the future; Thailand remains relatively at a low level development in many aspects such as in high technology and education. Incidentally, virtual reality technology application for Thai industries is less prevalent especially in automotive industries.

I was advised to study at the doctoral level in VR technology and innovation design by Associate Professor Suthep Butdee but I have chosen to study and do the research mainly about virtual reality. After that, I decided to study at Grenoble INP, France. I started my PhD in October 2012 under the supervision of Professor Frederic Noel and Associate Professor Philippe Marin at G-SCOP laboratory. I worked at "Conception Collaborative" (Collaborative Design) group which works about design collaborative expertise, to understand and model the interactions between experts involved in the design of manufactured products and / or associated services. The group proposes media (based on trades representations), tools (integrate the designers environments) and methods (integrated in the company organization) to facilitate these interactions. Furthermore, my thesis came simultaneously within the frame of the Vision Advanced Infrastructure for Research (VISIONAIR) which was European research infrastructure, founded by the European Union, with the aim of providing for

a wide range of European researchers high-level visualization and interaction facilities for scientific data visualization and interaction.

The context of this research was placed by myself under the Vision for Thailand Automotive Industry (TAI) 2021 and coupled with the National Science and Technology Development Agency (NSTDA). The main expectation for the two organizations is that successful research and development leads to useful outputs. This depends on the sets of problems and needs of the clusters and target industries. But we need to learn about proper selection and use of technologies; current and under development or future technology capabilities joint operation with stakeholders and alliances. The NSTDA & TAI ministry has reduced the number of targeted research clusters from 8 to 5. They are: agriculture and food; energy and environment; health and medicine; bio-resources, communities and the underprivileged; and manufacturing and service industries. Here we are clearly consistent with the cluster about the manufacturing and service industries.

NSTDA is aware of the importance of research and development (R&D) for technologies in the manufacturing and service industries in order to enhance capability to create added value and thereby to improve competitiveness in these industries. It has set up R&D strategies for the manufacturing and service industries for the years 2011-2016, focusing on manufacturing industries vital to Thailand's economy. These are the hard disk drive industry, the air-conditioning and refrigerator industry, and the automobile industries. For this research, we were thinking about the *automotive and automotive parts industry program*. It focused on helping to build local capacity for the design of automotive parts including energy efficient electronic driving systems. In the short term NSTDA will support the commercial production of multi-purpose vehicles and electric car prototypes, while the medium-term plans are to produce light-weight body parts and chassis, and to come up with technologies that will help design and produce light-weight small passenger cars. Such products will be competitive in performance, weight, and price without compromising safety. Furthermore, Thailand Automotive Institute is directly responsible to define directions of automotive industry development by capitalizing the success of the Thailand Automotive Industry Master Plan 2007–2011. The vision 2011 was “For Thailand to



be the automotive production base of Asia, thus enhancing domestic value creation by strengthening the vehicle parts industry.” The vision of Thailand Automotive Industry Master Plan 2012–2016 create a vision for the next 10 years up to 2021. Vision 2021 emphasizes on developing competitive advantages to promote Thailand automotive industry from Asian production based on an eco-friendly global production base and to maximize the benefits for Thailand by creation of value in the automotive industry supply chain. Vision 2021 emphasizes on being Green automotive production base with two main 2 characteristics; 1. Eco-friend, 2. International standard especially about safety (Thailand Automotive Institute, 2012:71-72). Thus the Vision 2021 defines;

***“Thailand as a global green automotive production base with strong domestic supply chains which create high added value for the country”***

The strategic vision development creates 3 centers of excellence and 2 good business environments, formulated by 5 year action plan 2012–2016 to facilitate:

*Strategy 1:* COE-1; Excellence in research and technology development. This strategy is the automotive development must be consistent with globalization to conserve energy and material. The main issues consists of alternative energy, light weight vehicles, vehicle safety, and advanced production technology.

*Strategy 2:* COE-2; Excellence in human resources development. It consists integrated Automotive Human Resource Development (AHRD) system development, capability upgrading and AHRD alliance.

*Strategy 3:* COE-3; Entrepreneur strength enhancement consisting in productivity improvement, cluster/supply chain network and green manufacturing.

*Strategy 4:* ENV-1; Infrastructure development for suitable environment referring to fundamental facilities and systems serving the country, city, or on area. It includes the services and facilities necessary for its economy to work.

From this strategy, we contribute to: test and development of R&D centers as well as automotive information and academy centers.

*Strategy 5: ENV-2; Government policy integration for suitable business environment which is the planning and management policies of government is an important strategy.*

Five strategies that have been mentioned earlier. We are interested in strategy 1, associated with a thesis, to provide research and technology for the automotive industry in Thailand, needs to support and develop virtual reality technology.

Virtual reality technology is widely recognized for the design and manufacturing processes are of great importance to the automotive industry. The strategic plan towards the vision consists of three centers of excellence (COEs) and two environments (ENVs). Figure 1-1 summarizes the government vision for 2021.

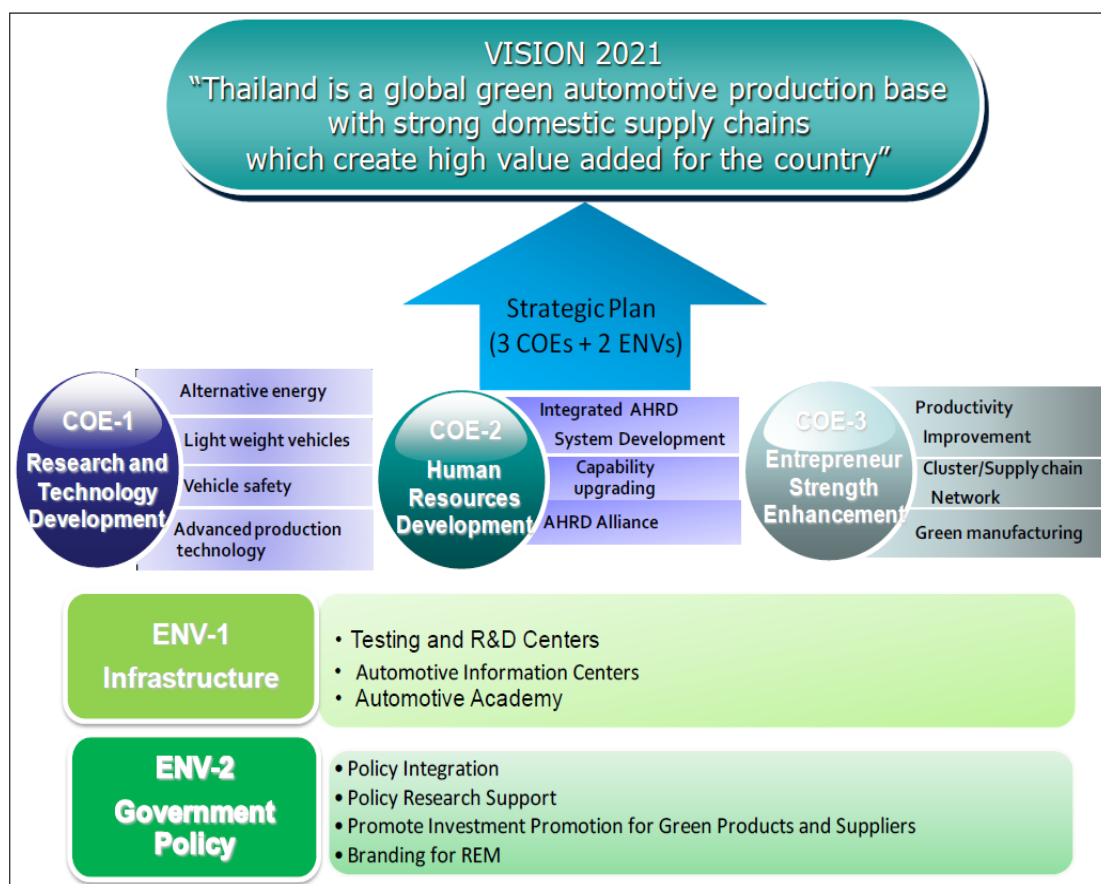

**FIGURE 1-1** The strategic plan towards the vision 2021  
 (Thailand Automotive Institute and CEO Forum,  
 2012 : 72)

Design process and prototyping is an important task that takes time and is expensive. To reduce such problems, VR technology must be assessed and analyzed respect the performance of its applications. Therefore, VR technologies applications implement the strategic and action plans in Thailand Automotive Industry Master Plan 2012–2016. Currently, VR technologies applications in Thailand is very low, especially VR technologies applications for in-depth study and complex research because researchers or professionals with expertise remains scarce in the country. Interaction devices and 3D visualization technologies are also missing in the Thai automotive industry. Design engineers and manufacturing experts use new computers and machines every day for production. They have ever less been accustomed to use VR technology to help designers and engineers to use virtual reality technology for the design and simulation tasks in the industrial automotive sector. We thus used activities associated with the design and simulation to evaluate and compare virtual reality environments within two use cases described in Chapter 4 and 5:

### **1.3 Research questions**

Currently, designers, engineers, and manufacturing experts integrated CAD/CAE/CAM system for manufacturing activities to solve manufacturing process problems. Today's VR technology offers enormous potential for improving the understanding of design and simulation data which implies declining error rate (Neugebauer et al., 2007), which increases global competition, and which leads to better quality, shorter lead-time, more competitive cost and higher customer satisfaction. Limitations of CAD system respect to usual case study are due to lack of 3D perception but also to some human–machine interaction constraints:

- 3D perception issues: CAD systems provide 3D visualization but are projected onto 2D displays. Interactive assembly simulation does not provide to user a good depth perception. VR technology usually provides such a perception as a core function. We must check the benefit of depth perception for assembly related tasks.
- Human-machine interaction constraint: CAD systems are based on usual 2D interaction (mouse style). They assist in the creation, modification, analysis, or optimization of a design (K. Lalit, 2008). Good motion are simulated but users do not

have a perfect perception of 3D gestures. Moreover there is no opportunity of force feedback. The point is not to demonstrate that VR is better than within the 2D display but investigate when VR fits design tasks. We perform or operate a collaborative virtual environments system to evaluate its added value for complex design and advanced dynamic simulation.

Current VR technologies promise to enhance visualization and interaction (Neugebauer et al., 2007) and with product design methods in professional fields, especially in design and manufacturing such as in the automotive and aerospace industries. Based on new navigation techniques designers and engineers should interact with a model with more affordance, ergonomics, intuitiveness, tangibility, and with less tiredness. But this assumption must be demonstrated and properly assessed. Then the research questions becomes *“how to assess and compare virtual environments in order to be able to cover activities that are associated with all designs and simulation?”*. *What activities are relevant to the design and simulation?*, *Which virtual reality environment may be used for our experiments?*, *What activities engineers and designers may be associated with the design and simulation on virtual reality environment technology?* We translated these question into two main sub question categories:

1. The first category, assesses the performance of collaborative virtual environments system for activities involved within preliminary design:

1.1 Does stereoscopy lead to better performance, usability and utility than non-stereoscopy?

1.2 Does manipulation with force-feedback lead to better performance, usability and utility than non-force feedback?

1.3 Which environment have better performance, usability and utility for the basic motions in assembly activity?

1.4 How visualization may be assessed and which environments are natural for collaborative design activities?

2. The second category, asses to collaboration virtual environment through high abstract level criteria. The research questions include the following:

2.1 Has visualization inspection of dimensional, motion, and rotation in the collaborative virtual environment systems better performance than a CAD system?

2.2 Visualization inspection of dimensional, motion, and rotation by the use of high level criteria combined with the low level basic sensors for mechanical simulation or not?

2.3 Are we able to check design behavior with VR?

The research questions drive our research and the preparation of our experiments.

#### **1.4 Methodology of the thesis**

We expect to build a high level abstract assessment technique to assess performance and to compare several virtual environments. We propose first a process to measure objective criteria by the use of low level measures. The VR session is instrumented with basic sensors (docking quality, duration delay, gesture instability) that can be reported automatically.

Then we propose a second process based on subjective questionnaires and statistics analysis. This process should be reported as a high level abstract assessment.

We developed two experiences, the first one instantiate the first process only, while the second one instantiates both. It is then possible to discuss a potential link between low and high level criteria.

The two experiments were performed in the virtual reality environment system developed at the laboratory “Collaboration Virtual Environment” (abbreviation called “CVE”). In our research, design concerns manufactured products for which designers and engineers perform virtual assembly simulation. The experiments are expected to determine the virtual environments that best fit the dedicated activities.

#### **1.5 Organization of the thesis**

This document reports a process to search for new knowledge about a methodology to assess virtual environment. The chapters of our thesis are organized as described in Figure 1-2.

### Organization of the thesis

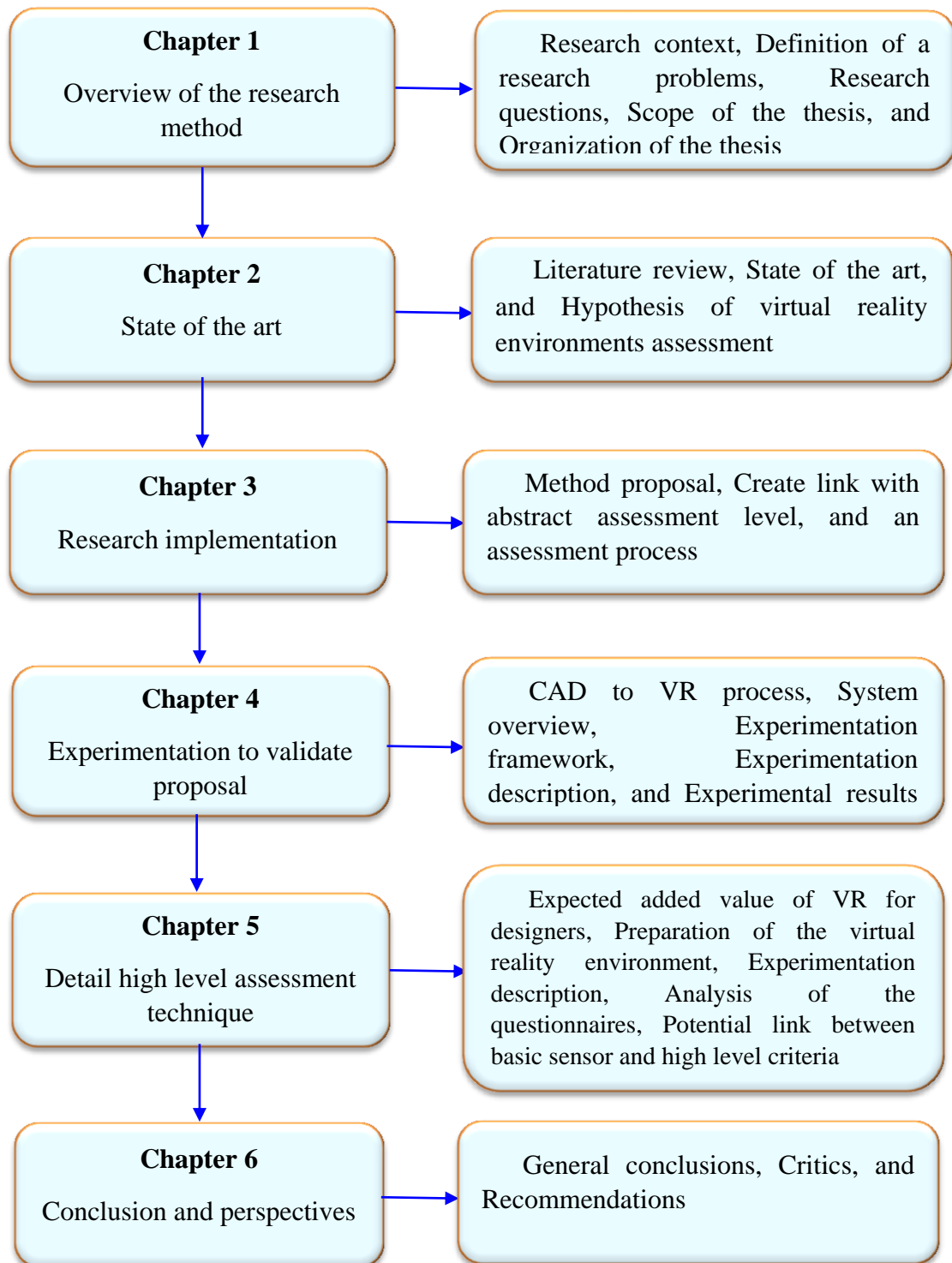

**FIGURE 1-2** An overview of the thesis structure

The current research process starts with *Chapter 1*, where we develop the main research questions. This phase of the research is also an overview of a research method which helps to understand the problem, and how research is conducted in the next steps. *Chapter 2*, begins with the literature survey and reference collection. The review of the literature used for the state of the art creation deals with demonstrator, user interface, and human factors. Incidentally, in the meanwhile it must be consistent with the research hypothesis as well. State of the art underlines the research assumption about high abstract level such as affordance, ergonomics, intuitiveness, tangibility, and tiredness. *Chapter 3*, summarizes the content in order to drive the research as expected. It explains the research implementation. *Chapter 4*, reports an experimentation to validate our method. It evaluates and compares the performance of the virtual reality environments by low basic objective sensors. We implemented experiment about four different environments and we invited 40 participants to follow our experiment protocol. *Chapter 5*, details high level assessment technique. In this chapter, we use a barrel cam mechanism simulation. We added value of virtual reality for designers or engineers. In this chapter, we prepared the basic measures that must be consolidated into the high level performance abstract assessment. Here an experience with X? participants was conducted. Finally, *Chapter 6*, propose such a consolidation, summarizes the research and opens recommendations in order to support new research hypothesis.

## **1.6 Conclusion**

The complexity of design or global innovative design are challenges for designers and engineers but the main issue is to offer them a correct design framework. The tools used (CAD/CAE/CAM) for design are widely popular. Designer, engineers, and manufacturing experts use VR technology in high performance platform but they often do not know, which platform or which environment will be the most effective for the expected tasks. Therefore, our research aims to assess the performance of a collaborative virtual environment by the use of low level basic sensors combined with high level criteria abstract assessment.

If our research is successful as expected, we may have use virtual reality technology in order to develop capabilities in design and manufacturing for the industry through the application of automotive technology in design activities such as assembly and simulation for the development of a limousine pickups which the limousine car shown in Figure 1-3.



**FIGURE 1-3** The limousine car was sold by Thailand Rung Union Car company (National Science and Technology Development Agency: Strategic Planning Alliance 2012-2016, 2012)



(This page is intentionally left blank)

## CHAPTER 2

### STATE OF THE ART

*This chapter presents a literature review covering several contexts of Human-Computer Interaction (HCI) research and the Virtual Reality (VR) history as well as evolution including adoption of the VR assessment in the industrial and educational sector. The state of the art that has direct relevance for the current research includes: user interface, and human factor issues but also usability assessment which is much important but the wish here is to go a step further towards utility assessment. These research will focus on high abstract level assessment criteria including: affordance, ergonomics, intuitiveness, tangibility, and tiredness assessments.*

#### **2.1 Introduction**

Our state of the art, starts with an introduction of the concept and techniques of virtual reality. It is expected to evaluate and compare the performance of virtual reality environment by the use of high level abstract assessment respect to expected tasks. Section 2.2 discusses the literature associated with virtual reality. Section 2.3 discusses composed user interface and human factor issues. Section 2.4 describes theories associated with virtual reality assessment.



Computer graphics are necessary in several aspects of our current life. At the end of the 20<sup>th</sup> century, it was difficult for engineers, architect, or interior designers to imagine designing without computer graphics workstation (Tomasz Mazuryk and Michael Gervautz, 1996). In the past year, microprocessor technology was developed rapidly (Jozef Novák-Marcinčin, 2007) and provided faster high-performance computers to the market. These machines are equipped with better and faster graphics boards (Andreas Athanasopoulos et al., 2011) and their prices fall down rapidly. It became possible to move into the world of computer graphics (Sharmist Mandal, 2013). Interest for the virtual world started with computer games. (Guy Merchant, 2009) and lasts forever. It provides to see the surrounding world in other dimension

and to experience (Brian Whitworth, 2007) things that are not accessible in real life or although not yet created. Furthermore, the world of three-dimensional graphics (Amandeep Kouris, 2015) has neither borders nor the constraints (Sharmistha Mandal, 2013) and can be manipulated by ourselves. This technology became widely popular and innovative in the current decade (Amandeep Kouris, 2015); it is called “*Virtual Reality Technology*”, as soon as immersion is combined with interaction.

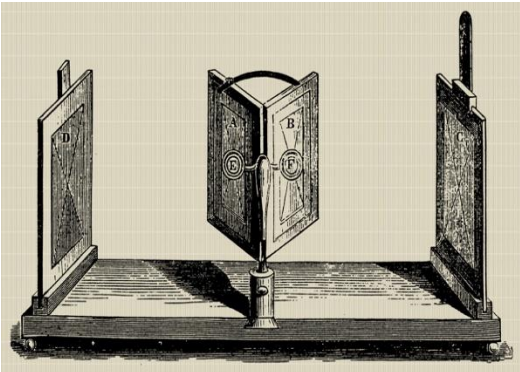

## 2.2 Literature review

Virtual reality has an extensive technical history when starting back to the 1830s. In this section, we will discuss the history of VR and how it evolved since this early step to now, a summary of the evolution of VR before the 21<sup>st</sup> century is provided in Table 2-1.



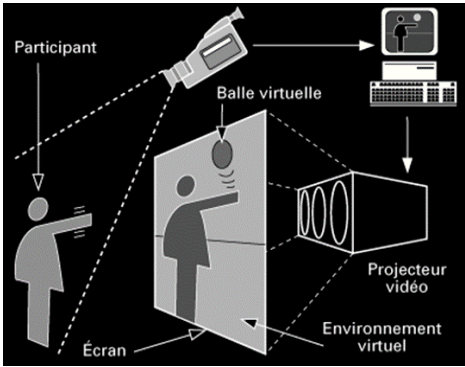
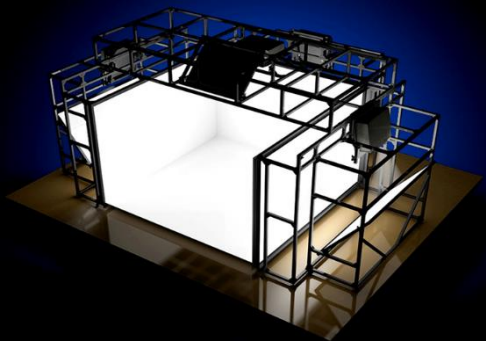

**TABLE 2-1** The history before 21<sup>st</sup> century of virtual reality.

Virtual reality technology	Innovative features
 <p data-bbox="256 1518 683 1554">(Wheatstone mirror stereoscope)</p>	<p data-bbox="762 1160 1289 1464">In 1838, Sir Charles Wheatstone invented and created Wheatstone mirror stereoscope. It is a pair of mirrors at 45 degree angles to the user's eyes, each mirrors reflecting a picture located off to the side (Welling William, 1978).</p>
 <p data-bbox="309 1877 628 1912">(Pygmalion's spectacles)</p>	<p data-bbox="762 1626 1289 1881">In 1935, Stanley G. Weinbaum invented and explained the pygmalion's spectacles. It is a goggle based game, can watch, record, and touch of virtual stories (Avisekhhar Roy, 2016).</p>

**TABLE 2-1 (CONTINUED)** The history before 21<sup>st</sup> century of virtual reality.

Virtual reality technology	Innovative features
 <p data-bbox="416 824 699 857">(View-master system)</p>	<p data-bbox="842 488 1385 790">In 1939, Sawyer's manufactured and sold the view-master system. It is thin cardboard disks containing seven stereoscopic 3-D pairs of small color photographs on film (M.A. and W. Sell, 2000).</p>
 <p data-bbox="448 1417 667 1451">(The sensorama)</p>	<p data-bbox="842 913 1385 1440">In 1957-1962, Morton Heilig invented and created the sensorama machine. It is a simulator device for a few persons (1-4 peoples) that provides the illusion of reality using a 3-D motion picture (B.N. Sindhu Tejaswini and B. Anuradha Srinivas, 2014) with smell, stereo sound, vibrations of the seat, and the wind was blew through the hair to create the illusion. (Edin Koricanin et al., 2014).</p>
 <p data-bbox="316 1888 801 1921">(Glowflow and Videoplace principle)</p>	<p data-bbox="842 1552 1385 1854">In the mid-1970s, Myron Krueger created Glowflow and Videoplace. This system projected on a virtual environment (large screen) (H. Rheingold, 1992) and introduces virtual interaction.</p>

**TABLE 2-1 (CONTINUED)** The history before 21<sup>st</sup> century of virtual reality.

Virtual reality technology	Innovative features
 <p data-bbox="225 723 703 808">(Visually Coupled Airborne Systems Simulator (VCASS))</p>	<p data-bbox="746 443 1291 801">In 1982, Thomas A. Furness demonstrated the Visually Coupled Airborne Systems Simulator (VCASS) for test pilots wore the Darth Vader helmet and sat in a cockpit mockup at Wright Patterson Air Force Base in Ohio (Thomas A. Furness, 1982).</p>
 <p data-bbox="277 1211 651 1245">(Sega virtual reality headset)</p>	<p data-bbox="746 887 1291 1245">In 1991, Sega Genesis developed a virtual reality headset delivered a new perspective on several games. It provided internal LCD screens, stereo headphones (Andrew Uerkwitz and Martin Yang, 2015), and sensors capable of detecting inertia (Haik Kalantarian et al., 2016),</p>
 <p data-bbox="220 1659 707 1693">(Cave automatic virtual environment)</p>	<p data-bbox="746 1317 1291 1626">In 1995, Dr. Carolina Cruz and graduate students invented and developed a cave automatic virtual environment (CAVE) projectors are directed to between three and six walls of a room-sized cube (Dalma Geszten et al., 2015).</p>
 <p data-bbox="376 1939 555 1973">(Virtual boy)</p>	<p data-bbox="746 1720 1291 1966">Also in 1995, Virtual boy was developed and manufactured by Nintendo, can transmit a video signal or visual image to display a video game (Magy Seif El-Nasr and Su Yan, 2006).</p>

**TABLE 2-1 (CONTINUED)** The history before 21<sup>st</sup> century of virtual reality.



Virtual reality technology	Innovative features
 <p data-bbox="491 689 625 725">(I-glasses)</p>  <p data-bbox="469 1021 647 1057">(Cyber maxx)</p>	<p data-bbox="842 602 1385 909">About 1995, many virtual reality devices were created in those years: such as I-glasses created by Virtual I-O (Mark Billinghurst and Hirokazu Kato, 1999) and CyberMaxx invented by Victormaxx (Vikas Kamde et al., 2016).</p>

Table 2-2 presents the latest evolutions of virtual reality in the 21<sup>st</sup> century, the first sixteen years of the 21<sup>st</sup> century saw a rapid advancement in the development of virtual reality technology.

**TABLE 2-2** The history of virtual reality in the 21<sup>st</sup> century

Virtual reality technology	Innovative features
 <p data-bbox="475 1861 644 1897">(Wii remote)</p>	<p data-bbox="842 1529 1385 2000">In 2005, Wii Remote was created by Nintendo Wii Co., Ltd. It interacts with and manipulates items on the screen via gesture recognition (Kamal K Vyas et al., 2013). The device was used of Micro-Electro Mechanical System-based accelerometers (Alhussein Albarbar et al., 2008) and optical sensor (Fidanboylyu, K. et al., 2009) technology.</p>

**TABLE 2-2 (CONTINUED)** The history of virtual reality in the 21<sup>st</sup> century

Virtual reality technology	Innovative features
 <p data-bbox="363 824 560 860">(Kinect X-box)</p>	<p data-bbox="746 439 1291 909">In 2009, Kinect was communicated as a motion sensing input devices by Microsoft dedicated to Xbox 360 (Marcel Valentin, 2016) and Xbox is a video game consoles (Pierre Delforge and Noah Horowitz, 2014) for Windows PCs. The device behavior was based around a webcam-style add-on peripheral (Behrang Parhizkar et al., 2012).</p>
 <p data-bbox="347 1361 576 1397">(Oculus rift DK1)</p>	<p data-bbox="746 1055 1291 1308">In 2012 – 2014, Palmer freeman Luckey and Brendan Iribe designed Oculus VR (Hoonhee Nam et al., 2016) for video game and first versions, is referred as the DK1 (Development Kit 1).</p>
 <p data-bbox="347 1872 576 1908">(Oculus rift DK2)</p> <p data-bbox="300 1921 628 1957">Virtual reality technology</p>	<p data-bbox="746 1570 1291 1823">In September 2014, Oculus Rift once again presented an updated version of the Oculus Rift, referred as the DK2 (Development Kit 2) (Simon Davis et al., 2015)</p>

**TABLE 2-2 (CONTINUED)** The history of virtual reality in the 21<sup>st</sup> century

Virtual reality technology	Innovative features
 <p data-bbox="400 775 719 808">(Smartphone VR HMD)</p>	<p data-bbox="842 465 1377 723">In 2015 – 2016, Samsung Gear developed and released a smartphone virtual reality head-mounted display (Kevin Boos et al., 2016) on 27 November 2015 by Samsung Electronics.</p>
 <p data-bbox="480 1245 639 1279">(HTC Vive)</p>	<p data-bbox="842 889 1377 1146">In 2016, Taiwanese electronics company headquarter manufactured and sold HTC Vive in the market. It is a virtual reality headset (Sean Peasgood and Marcel Valentin, 2016).</p>
 <p data-bbox="408 1641 711 1675">(Sony play station VR)</p>	<p data-bbox="842 1344 1377 1653">Also in 2016, Sony Play station VR (Ross Sandler et al., 2016), proposes a virtual reality head-mounted display developed by Sony Interactive Entertainment (Brian Pitz et al., 2016), which launched on October 13, 2016.</p>

The summary of virtual reality (VR) and its evaluation are important steps for computer platforms. Heather Bellini summarized in the types or categories, and components as well as practical applications of virtual reality or augmented reality (Heather Beellini, et al., 2016).



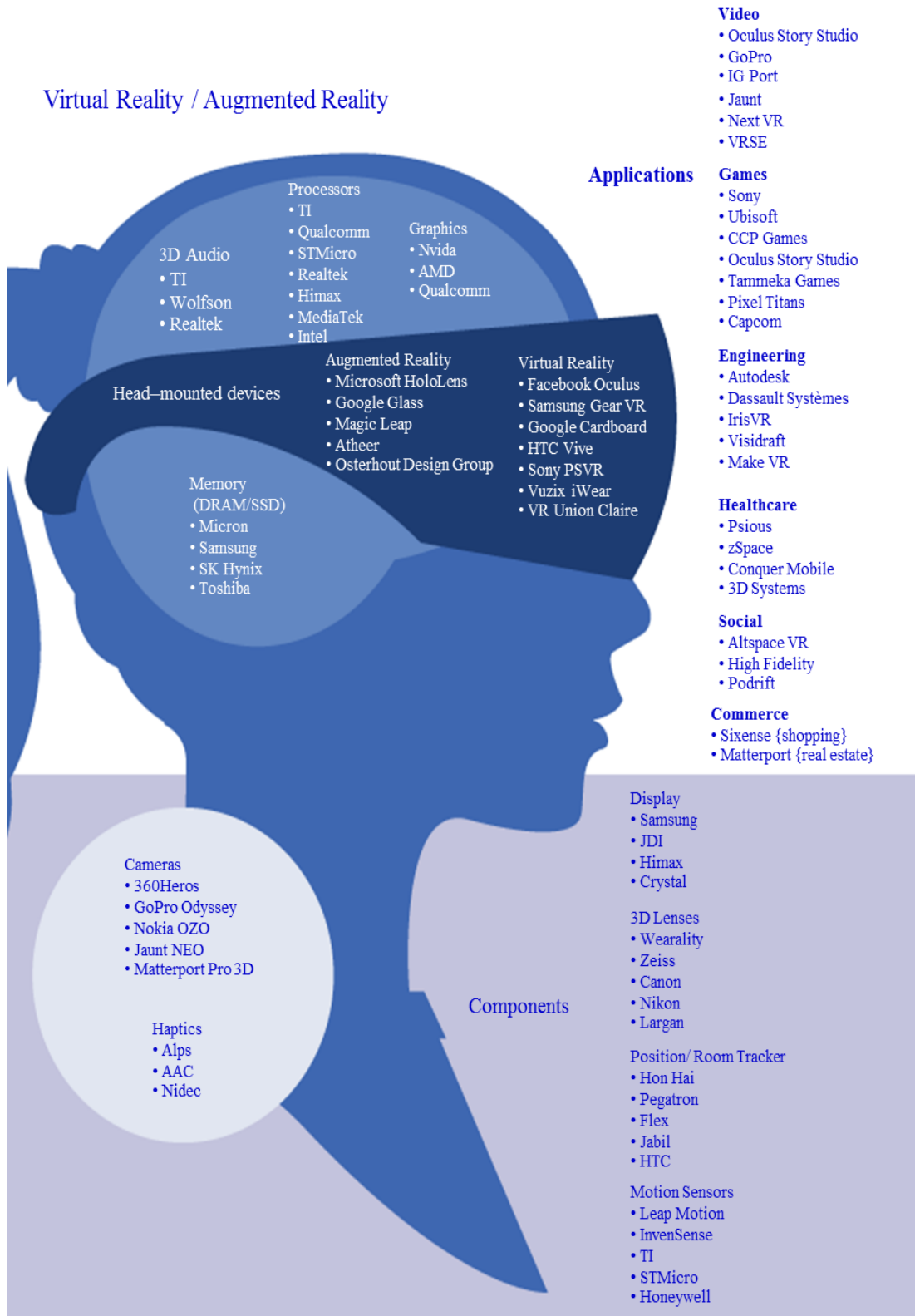
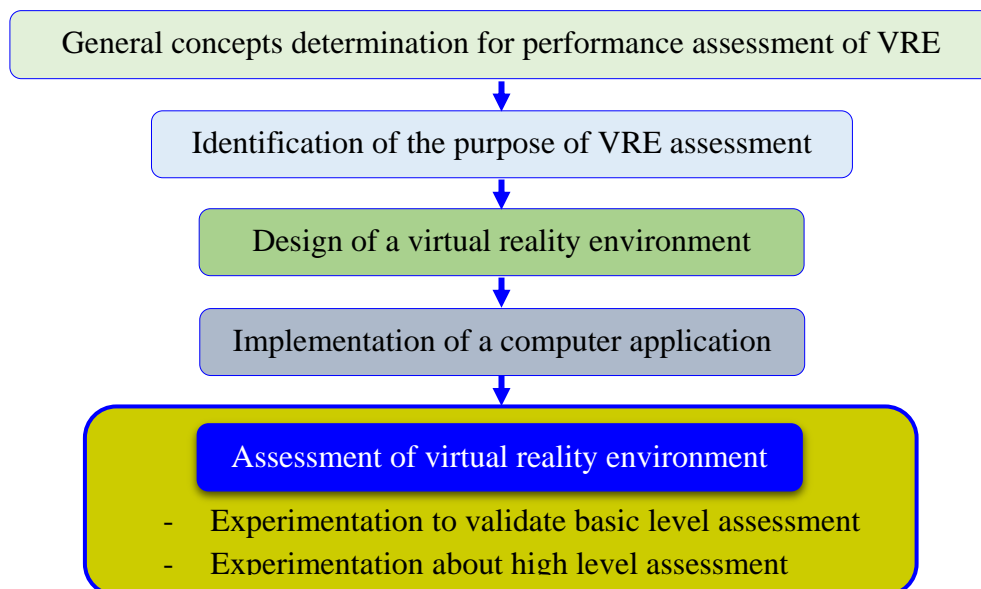

**FIGURE 2-1** Goldman sachs global investment research for virtual reality and angmented reality (Heather Beellini, et al., 2016)

### 2.3 State of the art

If technology arises fastly, then performance assessment is important to consider the implementation of virtual reality platform. It must undertake users need to use VR at its highest performance (Kay M. Stanney et al., 1998). Therefore, the technology developer must be able to determine the performance of the system that needs to be deployed and to compare alternatives in order to find the device that best suits his professional task. To achieve those goals, the technology developer must have basic knowledge about the definitions and methods to analyze the performance of VR systems.

Performance assessment (Thomas D. PARSONS et al., 2008) is an issue by itself. Virtual reality assessment depends on the measure method selection, task, and assessment techniques (Bireswar Laha et al., 2014). The general concepts for performance assessment of virtual reality environments, relevant for the design activity of manufactured products, are associated with the trends toward shorter development times to market and require to challenge the keystones of product design and innovation. Our procedure for performance assessment of virtual reality environment is summarized in Figure 2-2. This chart is built to fit the needs of our approach and our methodology.



**FIGURE 2-2** Organizing the performance assessment of a VRE

As described in Figure 2-2, performance assessment of virtual reality environment process follows the next steps:

1. The general concepts for performance assessment of VRE must be adapted to the design activity of manufactured products. Nowadays, there are many companies using virtual reality technology for the design and simulation (Christopher J. Turner et al., 2016), especially, in the manufacturing industry which includes design tasks of manufacturing processes. Engineers or designers use high-performance virtual reality environment (Andreas Kunz et al., 2016) depending on applications and the potential of each company but they usually do not know which virtual environment is best for their practices. Here, we recognize that virtual reality environments should be assessed and compared (Ioannis Tarnanas et al., 2014) in order to conclude which virtual reality environment is suitable for efficient activities. This step identifies the main concept to use for such comparison.

2. The identification of the purpose of VRE assessment of virtual reality environment (Thomas D. PARSONS et al., 2008), expects guidelines for engineers or designers to select the appropriate virtual reality environment for future design and simulation tasks (Robert J. Mislevy, 2011).

3. The design of a virtual reality environment, deals with activities involved at design stage or at manufacturing preparation stage (Viral Mehta and Joyce Smith Cooper, 2003). Here we will consider assembly activity and motion simulation. At this step, including computer aided design to virtual reality process (T.S. Mujber et al., 2004), the overall engineering process starting from the design tools and leading to virtual reality applications must be drawn. Furthermore, the creation and selection of virtual reality environment is absolutely necessary. The virtual reality environment design should be consistent with the existing tools and equipment of the company. For our research, the main equipment consists of the haptic arm, a 2D stereoscopic wall screen with 3D projector, a virtual computer hardware platform, and used computer network resources. A haptic arm enables interaction device, and force feedback or non-force feedback (Jurgen Broeren et al., 2004). In addition, the stereoscopic wall is the visualization device can be used with or without stereoscopy for 3D or 2D visualization. For our experiments, virtual reality environment design is restricted to the aforementioned devices.

4. The implementation of a software that will connect together 3D visualization, interaction devices, through internet communication networks. We used the home made collaborative virtual environment software (called CVE) that allows manipulation, tests for virtual reality and other applications. CVE consists of several modules but the most frequently used options are the following ones: a communication server, a configuration editor, a 3D viewer enabling virtual reality usage, an analysis module, and a haptic arm connector. (1) CVE Editor module, 2) CVE Viewer module, 3) CVE ODE module, 4) CVE Happy module, and 5) CVE Analysis module.) Details of the entire system is described in Section 4.3.

5. The assessment of virtual reality environment, in the context of performance assessment of virtual reality environment, was planned through two experiences:

1. The first experience validated the evaluation and comparison of VRES by the use of low basic sensors consisting of docking quality, task duration, and gesture instability sensor.

2. The second experience evaluated and compared the performance of virtual reality environments by the use of high level abstract assessment technique combined with the low level sensors.

The state of the art was built to support these five steps. In this context, we will focus on the core component to be consistent with our research.

### 2.3.1 Experience observator and participants

Experiences about human factor leaded activities expect almost an observatory and practitioner participants. The observator is an individual who organizes and manages the experiments. He will introduce the person to use the interaction and stereoscopic device and demonstrate how to manipulate an haptic arm, how to switch on-off force feedback on the wrist of the haptic arm and how to manipulate stereoscopy devices on 2D and 3D scene. Here, the observator is the author of this thesis or a colleague in order to support participants. In our research, participants are expected to control direction and position of the haptic arm motion combined with 3D scene visualization on a collaborative virtual reality environment. Furthermore, the participants may use a haptic arm with or without force feedback and may be or not wear stereoscopic glasses to perceive the 3D model in three dimensions on the wall screen or in a 2D perspective (Figure 2-3).



**FIGURE 2-3** A participant interacts with the collaborative virtual environment either in 2D or 3D and either with or without force feedback

### 2.3.2 User interface

The user interface connects the user to the devices through their inputs and outputs. The user interface process defines the behavior of the virtual world. The user interface is the piece of software that handles the human-machine interaction. In the context of computing the term typically extends as well to the software dedicated to control the physical elements used for human-computer interaction. The engineering of the human-machine interfaces is enhanced by considering ergonomics and other human factors (Griffin et al., 2014). The corresponding disciplines are human factors engineering (HFE) and usability engineering (UE), which is part of systems engineering (Jan et al., 2012). Tools used for incorporating human factors in the interface design are developed based on knowledge of computer science, such as

computer graphics, operating systems, and programming languages (Ronald L. Boring, 2010).

Nowadays, we use the expression graphical user interface for human-machine interface on computers (Griffin et al., 2014), as nearly all of them are now using graphics and are not based on text only. But moreover in VR systems, there is often much more than visual interaction as physical manipulation systems are developed to detect complex movements of the user and even allow 2-ways force interaction. The main interaction device of our research, is the Virtuose 6D35-45 force-feedback (HAPTION). It provides 6 degrees-of-freedom with in a large workspace (450 mm). The VIRTUOSE 6D is one of the few force-feedback system of the market today. The VIRTUOSE 6D is composed of two main articulated segments fixed on a rotating base. The second segment ends with an articulated wrist, which can rotate around three concurrent axes which the configuration of Virtuose 6D35-45 as shown in Figure 2-4.



**FIGURE 2-4** A haptic arm interface is a haption Virtuose 6D35-45

As a consequence, the haptic interface is a 6 degrees-of-freedom device, with force-feedback in all directions. The workspace of the VIRTUOSE 6D is large enough to include a 45 cm size cube. The resolution in position is 0.02 mm. The detailed specification of VIRTUOSE 6D Haptic arm is shown in Table 2-3.

**TABLE 2-3** The detailed specification of VIRTUOSE 6D

Axis	Clearance	Continuous joint torque N.m.	Maximum joint torque N.m.
1	90	6	22
2	90	3.5	13
3	90	3.5	13
4	300	1	3.1
5	100	1	3.1
6	250	1	3.1

In addition, the user takes hold of the haptic device using a gripper or handle placed at the tip (Florian Gosselin et al., 2016) and called “end- effector.” The end-effector is easy to remove and replace, so that a frequent change of tool is possible (Nitin Chaudhari and Vilas B Shinde, 2014), in order to customize the application and reinforce the sensation of immersion. The gripping tool is equipped with several push-buttons as described in Figure 2-6.

### 2.3.3 Human factors

A human factor is a physical or cognitive property of an individual or social behavior which is specific to humans and influences functioning of technological systems (John R. Wilson, 2014) as well as human-environment balances. In addition, human factors focus on how people interact with tasks, machine and environment with the consideration that humans have limitations and capabilities (Alan Hobbs, 2008). Ben Tzion Karsh and his colleagues identified the characteristics of ergonomics within three main fields of research: physical, cognitive and organizational ergonomics. There are many specializations within these broad categories (Ben Tzion Karsh et al., 2013). Specializations in the field of physical ergonomics includes visual ergonomics (Hamza Jafri and KM Moeed, 2016) and cognitive ergonomics includes usability, human–computer interaction, and user experience engineering.

We will focus about feeling of users when they are using the equipment and virtual reality environment: for example, the user feeling when using a haptic arm in different contexts. Users may feel fatigue faster than usual when he uses a haptic arm with force feedback compared to its use without force feedback or compared to the same task with a traditional desktop mouse. In addition to fatigue, human factor that is

associated with the use of the haptic arm may lead to excitement, anxiety, stress, convenient and so. One of the most prevalent types of work-related injuries is musculoskeletal disorder. Work-related musculoskeletal disorders (WRMDs) result in persistent pain, loss of functional capacity and work disability (Olanre Okunribido and Tony Wynn, 2010). Certain jobs or work condition cause a higher rate of worker complaints of undue strain, localized fatigue, discomfort, or pain that does not go away after overnight rest.

Another important aspect of human factors on our virtual environment comes with the use of stereoscopy. Stereoscopy involves human factor for our virtual reality environment as well. Brightness and darkness environments of 2D wall screen affects visibility but the main difference comes with the use or not of stereoscopy. Some of these issues can be evaluated with objective sensors surveying a given task, but we expect that a more abstract analysis may lead to more or less efficient / acceptable environment.

#### **2.4 Hypothesis about high level abstract assessment**

This section mentions hypotheses of research to access higher abstract criteria. In such discussion, we do not use low level performance sensors but we expect to qualify environments respect to affordance, ergonomics, intuitiveness, tangibility, and tiredness. The next subsection try to define these concepts. To approach the context, we have studied the basics of VR environment and equipment currently available in our laboratory. It provides us with an idea for hypotheses to evaluate the VR environment and it is possible to classify primary VR environment. It was divided into two categories about interaction device and visualization.

We must identify a process for assessing high level criteria. We focus on the human performance efficiency in virtual world (Kay M. Stanney, et al., 1998) by the use of interaction and virtualization devices (Himanshu Raj and Karsten Schwan, 2007). We investigate the impact of either visualization or interaction onto the abstract criteria. A haptic arm manipulation by the use of force feedback or non-force feedback is used to investigate interaction issues. Switching on or off stereoscopy allows to investigate also various visualization mode on task. Characteristics function to determine about high level abstract assessment assumptions as shown in Figure2-5.



Technically, we can switch on or off this function through hardware buttons directly on the devices (buttons of Figure 2-6).

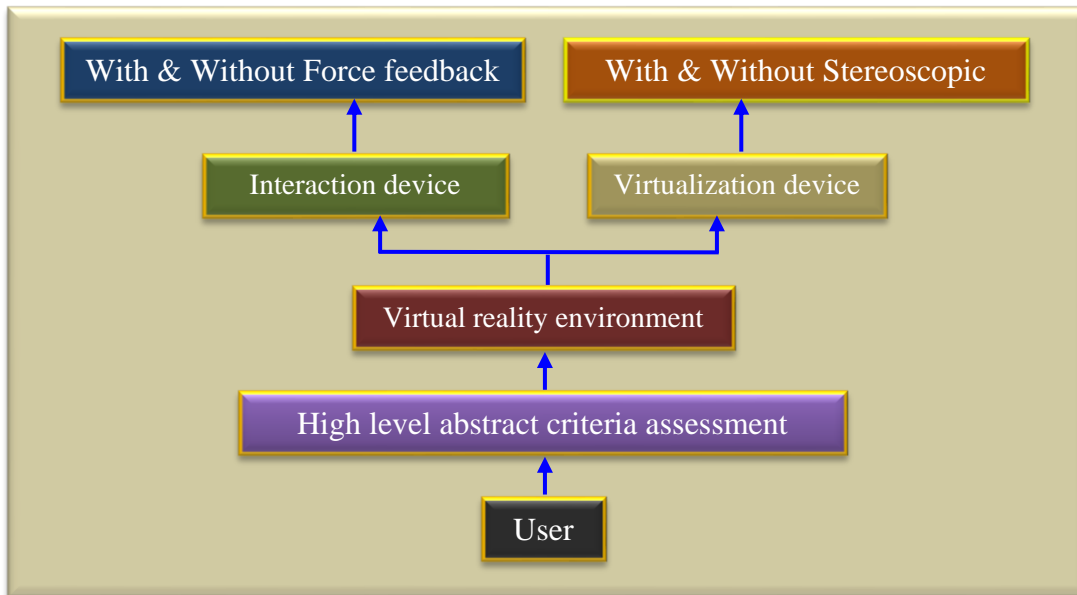

**FIGURE 2-5** The main feature will be to performance assessment

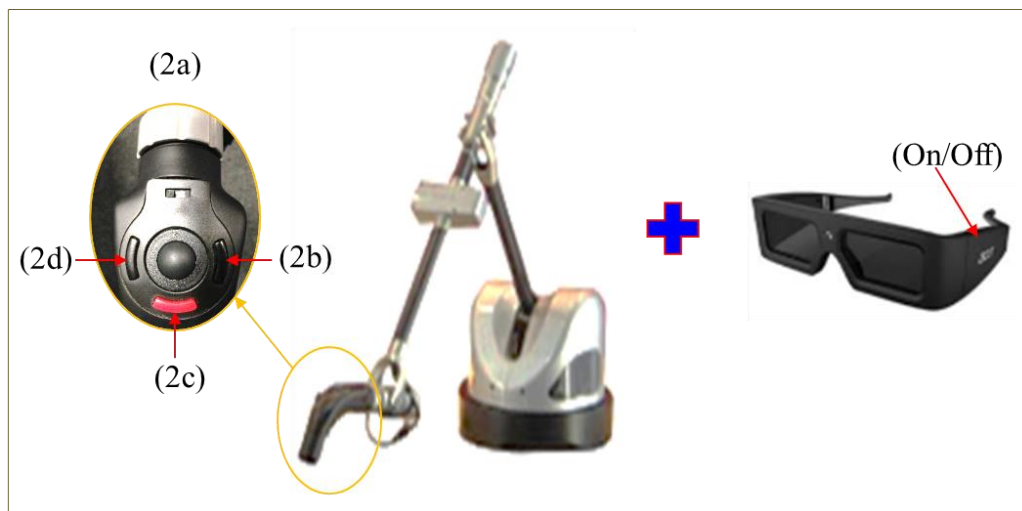

**FIGURE 2-6** A haptic arm function application consisting of (2a) switch, it must be switched on left side, (2b) no function attached, (2c) click and - maintain to reposition the haptic device without changing the scene, (2d) click on part to select/unselect the part click elsewhere to -

manipulate the view (rotation, zoom) and a stereoscopic functional (Switch on/off)

Figure 2-5 and 2-6 because it illustrate the assumptions clearly. For this context, it can be assessed with the use of basic sensors and high level criteria. The assessment methods by the use of basic sensors is not to complicate because criteria are measured directly. But the assessment of high level criteria expect to define them more sharply.

#### 2.4.1 Affordance

Affordance, is a potential action that is made possible by a given object or environment (is the possibility of an action on an object or environment) (J.J Gibson, 1979); especially, one that is made easily discoverable and a term created by the perceptual psychologist J. J. Gibson to refer to the qualities of the physical world to suggest the possibility of interaction relative to the ability of an actor (person or animal) to interact (Joanna McGrenere and Wayne Ho, 2000). His theory, gives an indication of the product meaning. The indication for use of the device can be separated into the perception and the action (Brett R. Fajen, et al., 2008).

Thus, we must assess the perception and the action of affordances during design tasks with VR environments. Affordance, relates more to interaction and should be more impacted by haptic arm but the visual perception plays also a role to perceive affordance. The attribute and behavior function of both devices (a haptic arm and stereoscopic display) was shown in Figure 2-6, when users observed attribute and behavior function of devices.

For example, when users saw the wrist handle of the haptic arm. He should see the various features of the wrist handle (Attributes) such as materials, colors, sizes and shapes. At this step, users collect information inside his brain. During action users will start questioning what's the catch? If the function of the wrist handle enables motion, orientation and rotation (Ozlem Durmaz Incel, 2015), users can start handling the avatar by the use of the haptic arm dragging rotation and manipulating of various points of the waist, shoulder, elbow, and wrist along with switch control of the haptic arm and stereoscopic. So we can see how the perception would be affected by the action.

The main incumbency of this context, is to assess affordance (Abdulmalik Yusuf Ofemile, 2015) for design task on VR environments. This research cannot directly measure affordance by the basic sensor, we have no affordance sensor. However, we may use questionnaires to assess VR environment affordance respect to subjective feelings.

#### 2.4.2 Ergonomics

The root of the term “ergonomics” stems from the Greek “ergo” meaning work and “nomos” meaning rule (Golnar Shojaei and Malihe Hamzavi, 2013). Ergonomics, is the study of working conditions within the relationship between the worker and the environment (Anil P Sarode and Manisha Shirsath, 2014). The work is considered to be performed in a workplace being designed or modified to be suitable for worker or not in order to prevent any problems that may affect the safety and health at work and leading to increase performance as well. Several pin connection of the haptic arm allows users to move and orient avatar more conveniently and rapidly than a basic mouse. The working posture (sitting and standing) are important of ergonomics principle as well. Moreover, the distance between the 2D/3D wall screen and the user as well as the brightness of the environment is important for ergonomics. Application of ergonomics in the workplace brings benefits including making user healthier: better working conditions are safer. In this context, most of them are related to the VR environment. Thus, this research require ergonomics assessment of user during the use of VR environment for design tasks. Concerning the measurement methods, it could be measured directly or assessed by a questionnaire which will capture subjective ergonomics feeling. There are obvious direct measure of positions but they do not integrate all the ergonomic issues, and they must be extended with subjective questionnaires.

#### 2.4.3 Intuitiveness

Intuition comes from a word "in", which means "no" and "tuition", which means "teaching". Intuition means, something we can know ourselves without anyone to teach us and is connected to “instinct.” For this research, we can summarize attributes associated with intuitiveness assessment:

*Ease-of-Use.* In the haptic perception of orientation, the several pin connections of a haptic arm allows users to provide movement, orientation (Ryo Wako and Saho

Ayabe-Kanamura, 2016) and rotation of the avatar more conveniently and rapidly than a basic mouse. The ease of use is related to intuitiveness.

*Suitability.* By suitability of interaction device, we are referring to a haptic arm and stereoscopic display that can respond the design task and the VR environment with no further complicate support (Arjan J. F. Kok and Robert van Liere, 2007).

*Consistency.* The interaction between the user and the VR environment must be consistent. The VR environment system can be applied to many contexts such as design, simulation, analysis, guided tours, and more. An overlap between one action and multiple responses may confuse users and is therefore undesirable working if less intuitive.

*Coordination.* The system can connect multiple interaction devices including multiple work functions. A strong relationship with 3D stereoscopic virtual reality visualization, but also with the use of the haptic arm with force feedback and collision simulation. The condonation of all this behaviors is a factor of intuitiveness.

#### 2.4.4 Tangibility

Tangibility is associated with environments where object may be handled with natural hand gestures. Tangible virtual reality interfaces should benefit of the haptic arm with force feedback. In the tangible VR approach the physical objects and interactions are as important as the virtual 3D projection to interact with the VR interface. Tangible user interfaces provide seamless interaction with objects (Ehud Sharlin, et al., 2009), but may introduce a separation between the interaction space and the display space. In contrast most VR interfaces overlay graphics on the real world interaction space and so provide a spatially seamless display (Vicki Ha, et al., 2006). Here, we can assess how VR makes design task more or less tangible.

#### 2.4.5 Tiredness

Assessment of tiredness due to work in a virtual reality environment should be considered and analyzed to limit task durations. Tiredness is a common symptom from working, playing sport and any other activities. Working in a virtual environment has obvious tiredness symptoms. The illnesses symptom from working in a virtual environment that is “*Fatigue in Virtual Reality and Augmented Reality*” (Philip J. Bos, et al., 2016) occurs when exposure to a virtual environment causes symptoms that are similar to motion tiredness symptoms (Simon Davis, et al., 2015).

The most common symptoms are general visual and physical tiredness (Brian Allen, et al., 2016). Furthermore, Atsuo Murata found only slightly symptoms include postural instability and retching (Atsuo Murata, 2004).

Visual tiredness symptoms in a virtual reality environment when user use stereoscopy (the 3D viewer), is an eye condition that manifests itself through nonspecific symptoms such as fatigue, pain in or around the eyes, blurred vision, headache and occasional double vision (Kristin Musolin, 2012). The distance between the large screen close to the user can induce visual tiredness symptoms likewise because users must use high power of sight and view of eyes wide. Symptoms often occur after reading, computer work, virtual reality environment or other close activities that involve tedious visual tasks (Shahid Ramzan and Mohammad Irfan, 2016). A haptic arm often expect a hand up position which is much more tiring than a mouse sliding on desktop.

Physical tiredness symptoms in a virtual reality environment appear when user use a haptic arm specifically for a long time. The most common physical tiredness symptoms are generally for lower and upper arms, shoulder as well as legs and torso (Sharon Schutte-Rodin, et al., 2008). Most users use a haptic arm by rocking, rotation, dragging and so on. Such actions, if prolonged will cause tiredness for user. Using a haptic arm with force feedback can cause tiring faster than the use of a haptic arm without force feedback. Furthermore, users need to flex the muscles of arms and hands when using a haptic arm with force feedback due to tiredness.

Additionally, the amount of time spent in virtual reality environment can increase tiredness symptoms (Valeria Manera, et al., 2016). A haptic arm motion is not the same direction as the difference between the movement and the motion that the user expects. It is possible to induce motion tiredness in virtual reality when the frequencies of mismatched motion are similar to those for motion tiredness in VR environment.

## **2.5 Conclusion**

This Chapter 2 provides a review of key recommendations to help us access VR tasks. From the state of the art, we focus on the principles and model of VR assessment. Procedures and processes of assessment will use low basic sensors and

high level abstract criteria. The considered high level abstract criteria are Affordance, Ergonomics, Intuitiveness, Tangibility, and Tiredness because it is relevant to an assessment of virtual environments. The method and procedure of the assessment will be discussed in the next chapter.

(This page is intentionally left blank)

## CHAPTER 3

### ASSESSMENT OF VIRTUAL REALITY ENVIRONMENT

*This chapter, builds an assessment method of virtual reality for given activities. We are specifically concerned by activities involved at design stage or at manufacturing preparation stage and we will have a deep focus on assembly activity and motion simulation. The design of a virtual reality environment and the implementation of a computer application that supports the evaluation of these activities are presented. The main objective of such application remains the assessment of the performance of virtual reality environments to support the tasks of designers and engineers.*

#### **3.1 Introduction**

This chapter studies and proposes methods to assess usability and utility of a virtual reality environment. We focus on the assessment and on the comparison of virtual reality devices performance. Here users are engineers, designers, and manufacturing experts who perform activities related to design or to manufacturing in industry. It is considered that virtual reality opens great opportunities for professional applications but that there exist many brakes to pass over demonstration step and to support an efficient deployment of VR applications. It is thus important not only to assess usability but also utility. The following new question arises; *how to measure utility of the interfaces between users and computer devices? This refers to human-computer interaction (HCI) (also sometimes referred to human-machine interaction (HMI)) for manufacturing design or industrial design activities within virtual reality environment (VRE)*. In order to build this assessment and comparison methods, we propose to use as a reference the International Standards (ISO) which is widely recognized as a good guidance for operational, research, and production. We refer to ISO 9241 standard (<https://www.iso.org>) among which several parts cover a number of aspects related to people working with computers. It was retitled to a more generic



context by *Ergonomics of Human System Interaction* and contains the following chapters:

1. Part 1: General introduction
2. Part 2: Guidance on task requirements
3. Part 3: Visual display requirements
4. Part 4: Keyboard requirements
5. Part 5: Workstation layout and postural requirements
6. Part 6: Guidance on the work environment
7. Part 7: Display requirements with reflections
8. Part 8: Requirements for displayed colors
9. Part 9: Requirements for non-keyboard input devices
10. Part 10: Dialogue principles
11. Part 11: Guidance on usability
12. Part 12: Presentation of information
13. Part 13: User guidance
14. Part 14: Menu dialogues
15. Part 15: Command dialogues
16. Part 16: Direct manipulation dialogues
17. Part 17: Form filling dialogues
18. Part 20: Accessibility guidelines for ICT equipment and services

Among these, we mainly base our work on ISO 9241:11 (Part 11: Guidance on usability). It consists of guidelines on usability, providing definitions of usability, general guidance on the specification and measurement of usability. Generally, applications would take into consideration the type of work to be performed as well as physical and social characteristics that may be associated with the use of software products. The guidance includes procedures to measure usability (see details in the Section 3.2.1). This section explores how the term usability was defined and used in HCI. Furthermore, we propose a definition and analyze a wide variety of assessment methods from the literature consistent with the state of the art and hypothesis about VRE as described in Chapter 2.

Beyond that, we plan and prepare to assess VRE by applying the theories and principles of utility criteria. It is the state or condition of being useful and a measure of preferences over some set of goods and services. Utility assessment method will be used in our work for VR technology selection. Main criteria will be related to the performance of engineers, designers, and manufacturing experts while they use virtual reality environment system (VRES), and we have focused on a specific measure for the performance of their work in a virtual environment. We have prepared activities for preliminary design and manufacturing in a way that will facilitate comparisons of virtual reality environment. We implement performance measure through low level basic sensors (see details in the Chapter 4) which mainly consist of sensors about task duration, docking, and gesture instability sensors.

Furthermore, we also try to evaluate VR tasks using high level abstract criteria (see details in the Chapter 5) which consist of the following assessment criteria: affordance, ergonomic, intuitiveness, tangibility, and tiredness, already introduced in Chapter 2.

We assume these criteria are more adapted to assess utility. Specifically, the principles of human-computer interaction and human factor & ergonomics must be used for VRE in our experiments. Eberts described four Human-Computer Interaction (HCI) design approaches that may be applied to develop user-friendly, efficient, and intuitive user experiences for humans (Eberts and R.E., 1994). These four approaches include the *Anthropomorphic Approach*, the *Cognitive Approach*, the *Predictive Modeling Approach*, and the *Empirical Approach*. One or more of these approaches may be used in a single user interface design (Eberts and R.E., 1994). Furthermore, *The Association for Computing Machinery* defines human-computer interaction as "*a discipline concerned with the design, evaluation and implementation of interactive computing systems for human use and with the study of major phenomena surrounding them*"(Hewett et al., 2014). The criteria previously mentioned can be implemented in this research section to approach HCI assessment in VRE. Furthermore, human factors expect to include ergonomic, comfort design and functional design for application to product design, and manufacturing preparation. We must take into account the interaction between the tools and the people who use them. Therefore, we have considered and selected these criteria as interesting

measures for our use cases. It is assumed that they can be applied for the assessment of collaborative virtual environment (CVE) at two levels:

1. *The first evaluation level uses low level basic sensors, which stands for objective measures.*

2. *The second evaluation level uses our high level criteria such as affordance, ergonomics, intuitiveness, tangibility, and tiredness. They are usually considered as subjective criteria.*

Both levels are described in the next step of this chapter (see details in the Section 3.3.1 and 3.3.2). Both levels must be used for experience assessment and drive our experience protocols. This chapter proposes separated assessment methods for the two level.

Anyhow it must be taken into account the state of the art about assessment techniques and we expect to integrate in our methods existing principles and theories of the HCI about human factor or ergonomic. The primary methods for measuring the ergonomics has been popular with many methods such as: assessment by using ISO/TS 20646-1 standard. This research, we will focus on three commonly used methods:

1. The rapid upper limb assessment (RULA) has been developed by Dr. Lynn McAtamney and Professor E. Nigel Corlett, They are from the University of Nottingham in England (McAtamney, L. & Corlett, E.N., 1993). The RULA is a postural targeting method for estimating the risks of work-related upper limb disorders. Furthermore, they have wrote that *“A RULA assessment gives a quick and systematic assessment of the postural risks to a worker which the analysis can be conducted before and after an intervention to demonstrate that the intervention has worked to lower the risk of injury”*. If reader interest for such an approach, he can be thorough study on <http://www.humanics-es.com/rula-1.htm> or in book of the rapid upper limb assessment.

2. The rapid entire body assessment (REBA) is the posture assessment work, undertaking of the neck, torso, legs, arms and hands. The method was invented by Sue Hignett (Criteria) who is an ergonomics specialist at the hospital of the city of Nottingham, United Kingdom and Lyn Mc. Atamney director of a company that provides services in the field of ergonomics and occupational health (Occupational

health and ergonomic services Ltd) in the UK as well. Assessment by REBA is suitable for assessing the body that looks for change stance quickly or are not in place. Do not sit or stand at work in the same manner over time. Including a posture that are not predictable. Services such as REBA method have been used to assess the demeanor of the employees in industries such as lumber mill (Jones and Kumar, 2010) and so on.

3. The ovako working posture analyzing system (OWAS) was developed by the mills steel factory in Finland with the Finnish Institute of Occupational Health (Finnish Institute of Occupational Health) at about 1970 on the assessment of the workers in the steel plants. The problem is to help workers with increased morbidity and increased turnover. This problem is caused by disorders of the musculoskeletal of how OWAS is an easy way to evaluate and to applicate in industry and services such widespread construction (Andrzej Marek Lasota, 2013), woodworking (Mattila et al., 1993) Nursing (Christopher Brandi et al., 2015) Agriculture (Nevala-Puranen, 1995) and sugarcane (Messias and Okuno, 2012) warehouse (Andrzej Marek Lasota, 2013) producing charcoal (Maia. and Francisco, 2012) wine industry (Dima Al Madani and Awwad Dababneh, 2016). The OWAS method is used to evaluate the performances by observing the work in each posture throughout the work, on the back, arms, legs and muscle exertion.

These methods can be adapted to any environments. Industries such as aviation manufacturing and the military have applied knowledge of human factors to improve systems and services for many years now (Cooper N. et al., 2006) because it has been recognized and applied in many disciplines such as anatomy, physiology, physics and biomechanics.

### **3.2 Method proposal**

Our research proposes an implementation for virtual reality environment assessment. The general structure and procedure of virtual reality environment assessment (VREA) for this context includes: the intended purposes, system, and implementation methodology in order to reach the desired goals which are shown in Figure 3-1. Content details will be described in the next section.

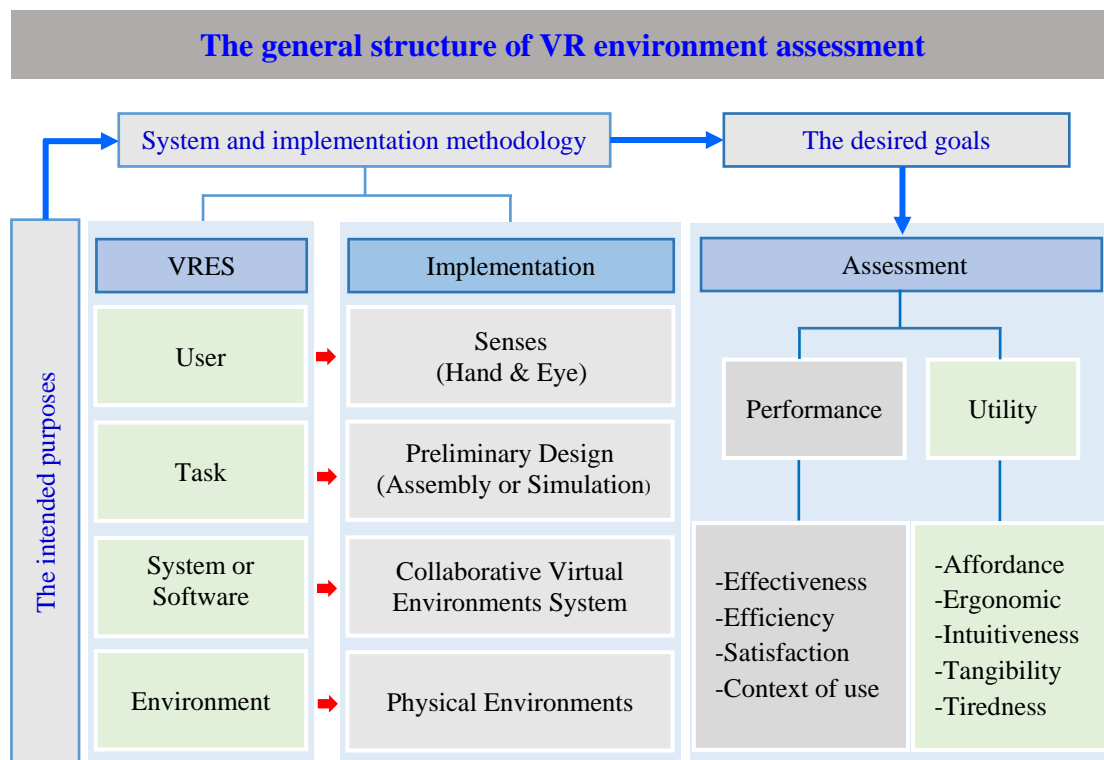

**FIGURE 3-1** The general structure for the virtual reality environment assessment

### 3.2.1 The VRES and implementation methodology

Figure 3-1 shows the general structure of the virtual reality environment assessment. For this research, we will work on the assessment of haptic arm linked to an avatar by dynamics of hand, wrist, and arm motion are movements caused by such devices. Our model of the VRES consists of four core components:

1. *The user or participant*, interacts with computers. This experiment is an assessment of human senses and they have normally at least five senses. These senses are: sight, hearing, smell, touch, and taste. But for this experiment, we focus on only sight or vision and touch or traction (see details in Section 3.3).

2. *The task*, is the activity related to the design phase and will be tested in this research, for assembly and motion test tasks. These tasks are implemented by employing a haptic arm either with or without force feedback and with stereoscopic or non-stereoscopic display in order to interact with 3D visualization.

3. *The system*, is called a Collaborative Virtual Environment System (CVES). We used a homemade technology which consists of several modules but for our research we selected the following ones: the server, a configuration editor, a 3D viewer enabling virtual reality usage, an analysis module, and various tracking extensions (see details in Section 4.4 and 4.5), to connect a haptic arm.

4. *The environment*, defines the used hardware. Our aim will be to compare four environments (see details in Section 4.5.1) with various combinations of interaction and visualization defining four environments:

1. The environment 1 consists of the haptic arm with non-force feedback + non stereoscopy + on the 2D wall screen.

2. The environment 2 consists of the haptic arm with non-force-feedback + stereoscopy + on the 3D wall screen.

3. The environment 3 consists of the haptic arm with force-feedback + non-stereoscopy + on the 2D wall screen.

4. The environment 4 consists of the haptic arm with force-feedback + stereoscopy + on the 3D wall screen.

We thus expect to assess and compare these four environment respect to their performance and utility within design task.

### 3.2.2 The nature assessment of virtual reality environment

As we presented in previous sections, ISO 9241 standard (Nigel Bevan, 1995) covers a number of aspects about people who work with computers, and all these aspect refer to usability criteria. But we did not find valuable references about utility or no much difference is made between usability and utility. Concerning the assessment criteria for this research, we intend to differentiate usability and utility.

#### 3.2.2.1 Usability assessment method

Usability defines the capacity of users to achieve specified goals with effectiveness, efficiency and satisfaction in a specified context of use (usability definitions from the <https://www.iso.org/obp/ui/#iso:std:iso:9241:-11:ed-1:v1:en>) which is the state or condition of being usable. Indeed it refers the degree to which an object, device, software application, etc. is easy to use with no specific training. According to (Deborah Mayhew, 1999) "usability engineering" is a field that is concerned generally with human-computer interaction and specifically with devising

human-computer interfaces that have high usability or user friendliness. It provides structured methods for achieving efficiency and elegance in interface design. On the other hand the term “usability engineering”, focuses more on assessing and making recommendations to improve usability than it does on design. However, usability engineers may still engage in design to some extent (Jakob Nielsen et al., 1993). The theoretical foundations of the field come from specific domains like human perception and action, human cognition, behavioral research methodologies, quantitative and statistical analysis techniques. Jakob Nielsen wrote “usability testing is a technique used in user-centered interaction devices to evaluate a product by testing it on users. This can be seen as an irreplaceable usability practice, since it gives direct input on how real users use the system” (Nielsen J., 1994). He has promoted an evaluation and comparison method but non means-test in contrast with current usability inspection methods where experts use different method to evaluate a user interface without involving users.

The international organization for standardization (ISO 9241-11) defines usability to be used in sub-sequent related ergonomic standards as “the extent to which a product can be used by specified users to achieve specified goals with effectiveness, efficiency and satisfaction in a specified context of use”. It is then claimed as supported by:

1. Effectiveness: the accuracy and completeness with which users achieve specified goals.
2. Efficiency: the resources expended in relation to the accuracy and completeness with which users achieve goals.
3. Satisfaction: freedom from discomfort, and positive attitude to the use of the product.
4. Context of use: characteristics of the users, tasks and the organizational and physical environments.

This definition is a step beyond the dictionary definition since it is not limited to the capacity to realize the task and it includes a value assessment. Furthermore, we expect to assess usability of human – computer interaction devices respect to case studies about the assembly and simulation. Both case studies are activities of the design process for product design or manufacturing. In addition, usability testing

usually involves systematic observation under controlled conditions to determine how well people can use the product (Rolf Molich and Jakob Nielsen, 1990). Our usability assessment focuses on measuring a hand-movement (manipulating a haptic arm) to meet its intended purpose such as translation, rotation, orientation, insertion, and fastening of mechanical parts together. It is the procedure to control the direction of the avatar and to be able to implement such activities (assembly and simulation) on a 3D wall screen. What is intended is usability assessment that aim to measure the ease of use of a specific device or set of devices, whereas general human-computer interaction studies attempt to formulate universal principles.

One of the activities that has been used as a basis for the VRE assessment is an experimental task consisting in assembling a set of simple screws at their dedicated positions in a given product 3D model. It allows the analysis of the basic movements. This type of assembly activity may appear in design phases. In this task, the overall system configuration is defined, diagrams, and layouts of the project will provide early project configuration (Ertas, A. and Jones, J., 1996). During detailed design and optimization, the parameters of the part being created will change, but the preliminary design focuses on creating the general framework to build the project on.

The movements are one of kinematics disciplines and is the branch of classical mechanics which describes the motion of points, bodies (objects), and systems of bodies without consideration of the masses of those objects nor the forces that may have caused the motion (Edmund T.W., 1904) and (Joseph S.B., 1983). So in our work there will be no gravity and parts weight simulation, but nevertheless when using the haptic arm for manipulation of a part, force feedback may be provided to the user in case of collision with other parts.

#### 3.2.2.2 Utility assessment method

Generally speaking, the utility of an object is related to quality of practical use, usefulness and serviceability (L. Pareto et al., 2008). On the other hand, utility assessment method is an assessment of the happiness or satisfaction gained from a good or service in economics and game theory (James T. Edwards and John A. List, 2013).

The utility can be applied to an entire system or to an individual or to a component of the system. It is recognized that utility could not be measured or



observed directly (Jan Flasar et al., 2005). Utility definitely does not refer the same state as usability does. While it is often necessary for an object to be usable to become useful, the opposite assertion does not make sense.

In this context the research question expect to find a protocol to assess how interaction is natural to make it useful. Natural interaction will be higher if its ergonomic is high, if artifacts are tangible, if it is not too much tiring and if affordance is high. Then the environment will be easily accepted and used on an everyday basis. We made the assumption that these criteria appear as good indicators for utility but they remain abstract and subjective. The next section reports an experiment to assess usability to better prepare a proposition of process to assess utility. The utility assessment methods will be built from questionnaires about high level criteria.

### **3.3 Basic sensors and high level criteria**

This research deals with an assessment of the operational efficiency of participants using interaction devices. In general, the user performance assessment has been associated through five senses because these are the physiological capacity of organisms that provides data for perception.

The touch and sight senses have a relationship with a haptic arm and stereoscopy devices used within virtual environments. Haptic or kinesthetic communication recreates partially the sense of touch by applying force-feedback, non-force feedback, vibrations, or motions to the user (Gabriel Robles-De-La-Torre, 2010). It can be used to assist the creation of virtual objects in a computer simulation, to control such virtual objects, and to enhance the remote control of machines and devices (tele robotics). Haptic devices may incorporate tactile sensors that measure forces exerted by the user on the interface. The sense of touch may be classified as passive and active (Bergmann T. et al., 2009) and the term "haptic" is often associated with active touch to communicate or recognize objects (Vincent Hayward et al., 2004). Furthermore, the sight sense is associated with non-stereoscopy and 3D stereoscopy on a screen. A stereoscope is a device for viewing a stereoscopic pair of separate images, depicting left-eye and right-eye views of the same scene. These two-dimensional images are then combined by the brain to give the perception of 3D depth. This technique is distinguished from 3D displays that display an image in three

full dimensions. It is a technique for creating or enhancing the illusion of depth in an image by means of stereoscopy for binocular vision which is allowing the observer to increase information about the 3-dimensional objects being displayed by head and eye movements.

### 3.3.1 The basic level sensors

The fundamental sensors are important to measure performance of user who is working with the virtual reality environment system. The basic level sensors is implanted as a module of our home made collaborative virtual environment analysis module (CVE-Analysis). CVE-Analysis is dedicated to trace sensors on a running activity and to report automatically the selected sensors. CVE analysis module of our system has several basic sensors concerning docking quality, test duration, real sensor, transform sensor, gesture instability, and vector sensor. But we used three main sensors the docking, duration, and instability sensors (Section 4.4.5 will describe how we used these sensor for performance assessment).

### 3.3.2 The high level criteria

The high level criteria assessment is the overall performance assessment of virtual reality environment without using the basic sensors for evaluation. It is a measure of the participant feelings about the experience. The purpose of our assessment, is to get feedback from the users (participant) about their feeling respect to Affordance, Ergonomic, Intuitiveness, Tangibility, and Tiredness but tested users must not be aware of this goal. The performance assessment of the VR environment through high level abstract criteria is obtained by a questionnaire. Essentially, the questionnaire for high level abstract criteria assessment is related to the overall performance assessment of virtual reality environment. The questionnaire never use criteria wording but ask feeling as perceived by the user. In order to comply with the research question, we map the questions with the high level criteria by associating a weight to every question and for every high level abstract criteria (see Table 3-1).

**TABLE 3-1** The questionnaires for high level criteria assessment

NO.	Questionnaires	Tangibility	Affordance	Intuitiveness	Tiredness	Ergonomic
1.	Was it easy to capture the cone?			1		1
2.	Was it easy to drive the system accordingly?	1	1	1		
3.	Was the system providing blurred vision?	1			1	
4.	Did you experienced double-vision?				1	
5.	Did you perceive visually why some configuration cannot work?	1		1		
6.	Did you prepare the process before action?		1	1		
7.	Would you have expected more explanations about how to drive the system?		-1	-1		
8.	Did you felt vertigo?				1	
9.	Did you search the limit respective positions of the mechanism?	1	1			
10.	In your opinion was the system adapted to the task?	1	1	1	-1	1
11.	Did you find easily the good criteria to decide if the system works or not?		1	1		
12.	Did you investigate how to achieve the expected task?		-1	-1		
13.	When selecting the hand avatar did you elaborate any strategy?		-1	1		
14.	Did you felt some blurred vision after a while?				1	
15.	Did you felt the contrast evolving?				1	
16.	Did you felt some stress in the eyes?				1	
17.	Did you felt increasing anxiety?				1	
18.	Did you felt a lack of luminance?	-1			1	-1
19.	Would you expect to sit down?				1	-1
20.	Did you felt your articulations at limit position and angles?					-1
21.	How many time could you stay working with the environment?				-1	1
22.	Which is the more comfortable environment?				1	1

The corresponding weight may obviously be discussed. The questions could be also improved. But indeed, more than value, in a first approach we are mainly looking for a process to assess high level criteria. If this process works all these figures will have to be refined shortly.

Notwithstanding, each question of the questionnaire is a mapping of the questionnaire with high level criteria and associated with a positive or negative weight to each criteria (see details in the Table 5-6). Details about method procedures of this association are provided in the Section 5.6 of the Chapter 5.

### **3.4 Conclusion**

To assess virtual reality environment, we presented two main criteria usability and utility. For usability assessment, we propose to follow the international organization for standardization-approved definitions (ISO 9241-11) which defines usability in sub-sequent related ergonomic standards as “the extent to which a product can be used by specified users to achieve specified goals with effectiveness, efficiency and satisfaction in a specified context of use”. For utility assessment, we built questionnaires about high level criteria. The goal is to get feedback from the users about their feeling respect to Affordance, Ergonomic, Intuitiveness, Tangibility, and Tiredness but they are not aware of this goal. The questionnaire never use these words but ask feeling as perceived by the user.

The main objective of the virtual reality environment assessment remains to answer and support designers, engineers and expert manufacturing in the factories. The conducted experiments are presented in Chapters 4 (Experimentation to validate proposal) and Chapter 5 (Details high level assessment technique). In addition, the main conclusion of this chapter is that assessment is two folded. On one hand we can assess performance through basic measures. On the other hand usefulness many depend on high level criteria. By the end, Chapter 6 will intend to create bridges between both.

(This page is intentionally left blank)

## CHAPTER 4

### EXPERIMENTATION TO VALIDATE BASIC SENSOR ASSESSMENT

*Following the proposal presented in Chapter 3, this chapter describes a first experimentation to validate the evaluation and comparison of the performance of the VRES by the use of low basic sensors consisting of docking quality, task duration, and gesture instability sensor.*

*The experimental task is a set of simple screw assemblies allowing the analysis of the basic movements such as translation, rotation, orientation, and insertion into the holes. We have implemented the experiment on four environments and invited 40 participants to our experiment protocol.*

#### 4.1 Introduction

Current virtual reality (VR) systems provide an enormous potential for enhancing the visualization (R. Neugebauer et al., 2012) of product design methods in professional fields, especially in design and manufacturing (F. Noël et al., 2012). Based on new navigation techniques the designers and engineers are able to interact (R. Neugebauer et al., 2012), with a model in a more intuitive and tangible efficient way. This chapter presents a reference framework for applications based on the performance assessment (C. Trakunsaranakom et al., 2014) of 3D visualization and interaction devices in collaborative virtual environment software (CVES) for activities being involved in preliminary design. The design task of a part is usually carried out in a computer-aided design (CAD) system (D. Weidlich et al., 2009), where assembly drawings and detailed part drawings are produced. In our research, we assume assembly simulations are important to improve design and efficiency of product development processes, based on the analysis of the basic movements: translation, rotation (R. Iacob et al., 2013), orientation, and insertion into the holes. During design, engineers and designers must evaluate the relative merits of many alternative concepts. Experience of both are able to justify basic relationships between

the physical structure of alternatives and performance of the device and can therefore eliminate many alternatives without the need for detailed design. Designers who mainly use CAD systems to create virtual 3D model (Nicos Bilalis, 2000) and manufacturing experts who use these digital mockups to assess the manufacturing process (C. Pontonnier et al., 2012) do not practice so much virtual reality tools. The assessment process is applied to a virtual assembly which remains one of the key applications in advanced design of manufactured products (Abdulrahman M Al-Ahmari et al., 2016). VR applications have been in active use in the automobile and aerospace industries as well as in production engineering since the 1990s. Today's VR technologies offer enormous potential for improving the comprehensibility of design and simulation data which implies declining error rates (R. Neugebauer et al., 2012) and VR is able to increase global competition which leads to better quality, shorter lead-time, more competitive cost and higher customer satisfaction. The goal of the present experimentation is to evaluate and compare several virtual reality environment interaction devices with collision detection (F. Noël, 2012) and kinematics joint constraints through basic objective criteria: docking quality, duration of the task and gesture instability. An analysis module was developed to trace these sensors during a virtual reality activity by linking the sensors to specific state values of the virtual environment. The experiment enables the assessment of four VR configurations for the same design task environmental conditions. This experiment and its first results have been published initially for *Conference and Exhibition of the European Association of Virtual and Augmented Reality (2014)* through a paper entitled "Assessment of Virtual Reality Environments for Assembly Simulation" and this work allowed to highlight some bias in the experimental protocol, related both the small number of participants, and to the order in which the manipulations had been proposed to them. A new paper has been later presented where randomized order in manipulations, an increased number of participants and the integration of a new docking quality sensor. This paper was published for *AIP PRIMECA (Ateliter Inter Établissement De Productique Et Pôle De Ressources Informatiques Pour La Mécanique) 2015 national conference* with a paper entitled "Assessment of Virtual Reality Environments for Activities Involved in Preliminary Design". These new updated results are detailed in the next Sections 4.2 to 4.6.

## 4.2 Case study : Sub-part of jig & fixture

During the design phase, product performance can be estimated based on available behavioral models, and design hypotheses for each concept. In this chapter, the design of the jig & fixture system (as shown in Figure 4-1 a) for the automotive industry is the use case for our performance assessment. To reproduce main assembly operations an experiment was performed that involved the basic movements translation, rotation, orientation, and insertion of the parts together by using a sub-part of the jig & fixture model (as shown in Figure 4-1 b) for the performance assessment of 3D visualization and interaction devices. In the described experiment, several users were employed to realize the virtual assembly and their performance were recorded within several virtual environments. There are several research questions in this research: 1) can the use of stereoscopy lead to better intuitiveness than without stereoscopy?, 2) can the use of manipulation with force feedback lead to better intuitiveness than with non-force feedback ?, 3) which environments are natural and intuitive for the basic movements in assembly activity ?.

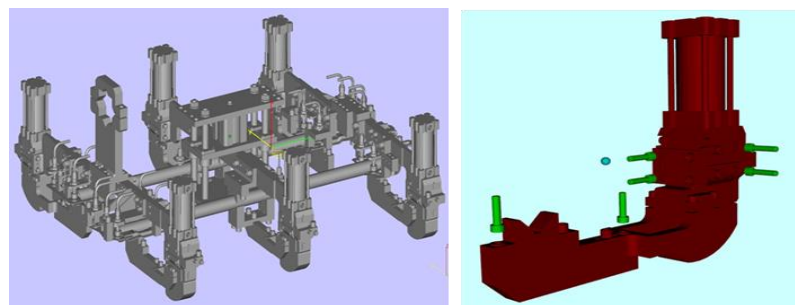

(a) The full Jig & Fixture

(b) The sub of Jig & Fixture

**FIGURE 4-1** The Jig & Fixture system and the sub part of Jig & Fixture for the Performance assessment in our research

## 4.3 CAD to VR process

The potential of 3D visualization techniques to become the right support instrument for design is explored. Both 3D visualization techniques and internet communication networks (W.W. Wits et al., 2011) provide new opportunities. To achieve this goal, the overall process starting from the design tools and leading to



virtual reality applications must be drawn. We propose to use the process of Figure 4-2. A designer uses computer aided design software to create the jig and fixture model dedicated to clamp the workpiece of the car door for the welding process. When the model is complete, it is sent to the manufacturing expert and the both should collaborate around the digital mock up (DMU). They basically expect to visualize the assembly, to measure it, to perform various analyses including complex simulation, and to save design decisions. These functions should be realized with the support of VR.

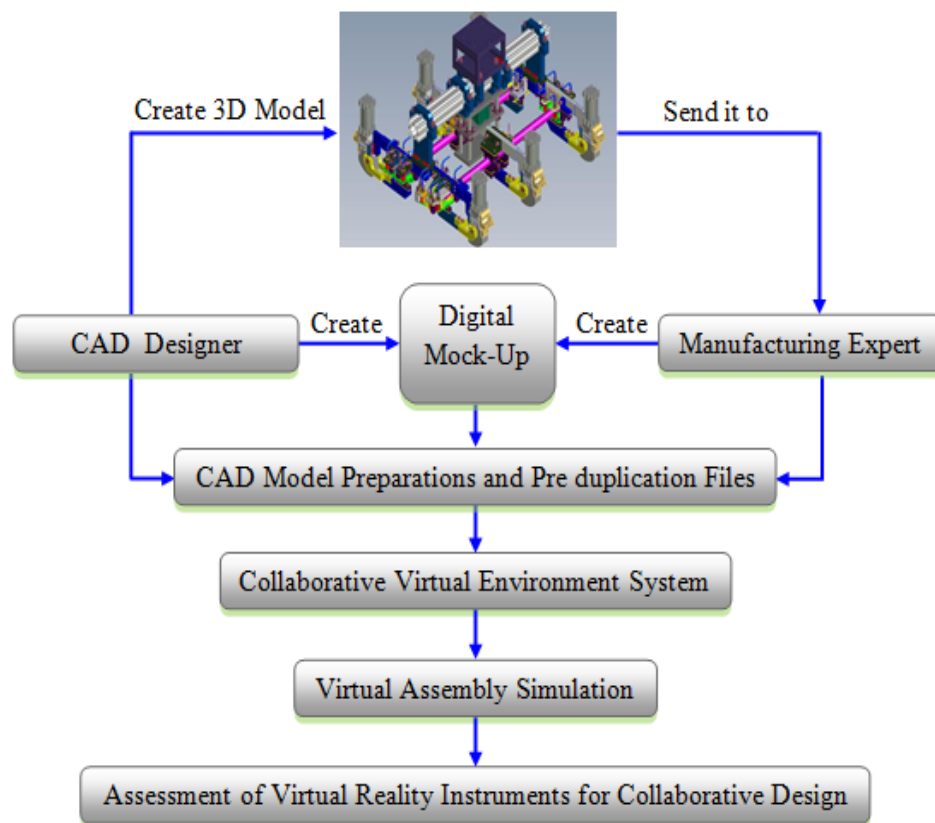

**FIGURE 4-2** An overall process for design activity with virtual reality environment

First the 3D model must be translated and sent to the VR environment. In our research, the 3D model was created within SolidWorks™. As most CAD system, SolidWorks™ can export the CAD model in other formats (STL, STEP AP203, VRML, etc.). For direct conversion towards virtual reality systems, the CAD parts were individually exported into STL files format. Then the mesh module of the

SolidWorks™ was used to reopen the STL file format merge nodes and to export the meshes into OBJ files. The main reason to use OBJ file format is to get a good level of compression while it is available to import into most virtual reality viewers. But the several CAD systems do not export directly into OBJ file format. Therefore, an intermediary step is performed through the STL to OBJ file format conversion. In addition, for basic assembly simulation on the virtual environment expects the definition of potential kinematic joints (John E. Brough, et al., 2007). As transferring 3D geometry of parts is not enough (G. Gonzalez-Badillo et al., 2013), the kinematics constraints were rebuilt from scratch directly in the virtual environment in our case. Some works are currently made to automate this process and to make it transparent for designers. Here it is just considered that each part is represented by a single polyhedron in the virtual reality environment, and that the assembly refers to potential kinematic joints which can be activated when parts are properly aligned.

#### **4.4 System overview**

For the general purpose of 3D visualization and interaction devices manipulation and tests for virtual reality and other applications, a collaborative virtual environment software (called CVE) was developed at G-SCOP and used at the *GINOVA* platform. CVE consists of several modules but we selected the following ones: a communication server, a configuration editor, a 3D viewer enabling virtual reality usage, an analysis module, and haptic connector. The server dispatches events between the various modules. Moreover, CVE is a multi-agent based system dedicated to collaboration within a virtual/augmented environment. A socket based communication system is employed to ensure the communication between agents. Every agent is in charge of a behavior of the global virtual environment. Figure 4-3 shows the various CVE modules used in our experiment. In the current experiment, the expected sub-behaviors correspond to five modules:

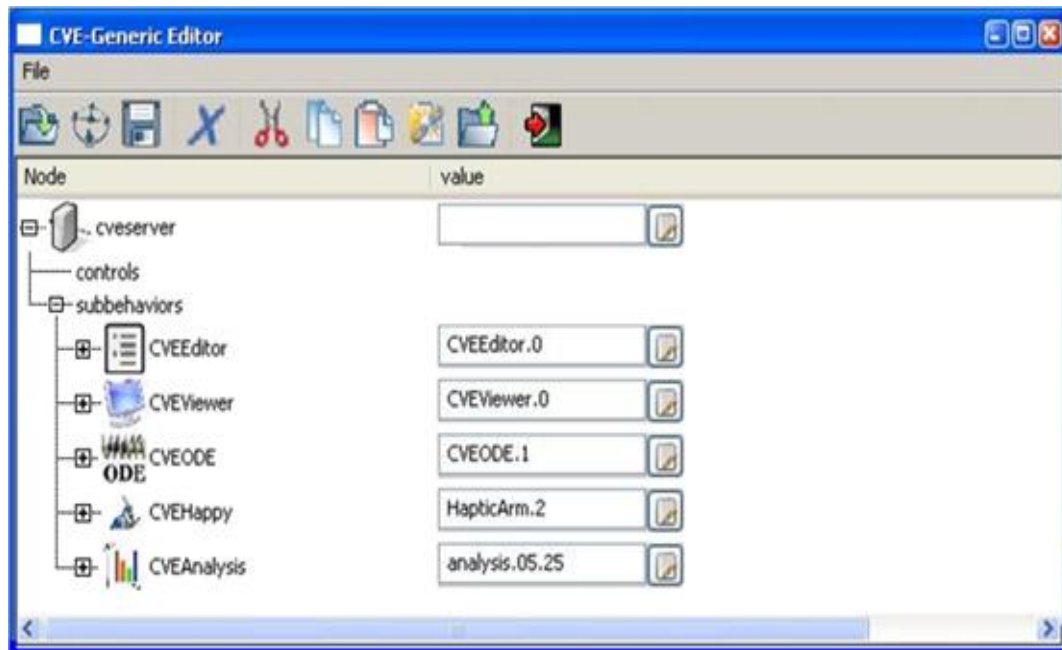

**FIGURE 4-3** CVE-Generic editor for experiment framework

#### 4.4.1 CVE Editor module

The CVE-Editor module enables to import and to export the object format. Moreover, in this module we are able to modify the scene (colors) and provide access to any state value of the scene. “It is necessary to import” a STL or OBJ file format into CVE Editor before working with the collaboration virtual environment software.

#### 4.4.2 CVE Viewer module

CVE - Viewer is in charge of creating the 3D visualization and of sending it to the final display which can be holographic, stereoscopic or a simple 2D screen. CVE Viewer opens 3D windows which can display diverse imported 3D objects (as OBJ files). Concerning the 3D models imported for this experiment, we have categorized the sub-parts components of the jig & fixture system into seven elements: On one side the sub-arm grips of jig & figure (shown as red parts on Figure 4-4), and the six screws (shown as green parts). All elements were imported and exported in OBJ data formats by the use SolidWorks™ software. The OBJ file format can be imported directly into CVE Viewer module which generates the scene and 3D models as shown in Figure 4-4. The extra sphere in the model in the avatar of a hand driven by the haptic arm.

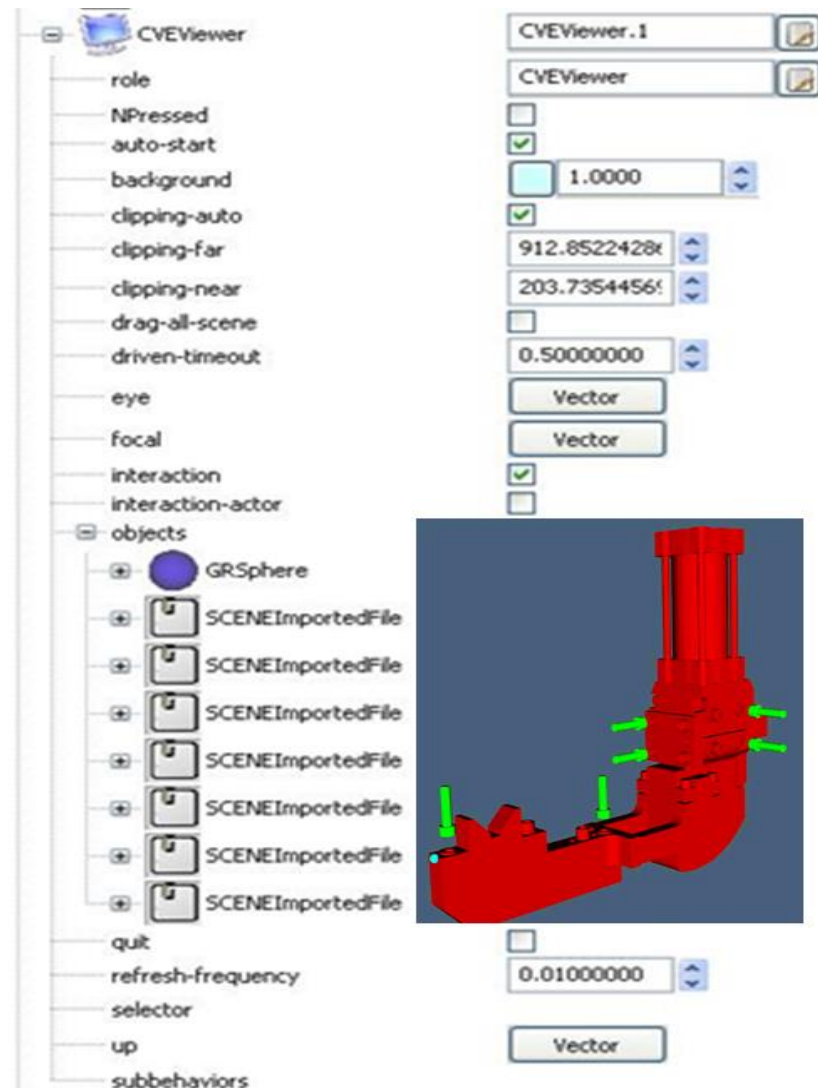

**FIGURE 4-4** The scene imported file into CVE Viewer

#### 4.4.3 CVE-ODE module

The CVE-ODE module is especially important for simulating dynamics articulated rigid body, which will be the invisible model for collision detection and force-feedback. It is particularly good for simulating moving objects in changeable virtual reality environments because it is quite fast, robust, and stable. Collision detection prevents part interpenetration for the user regarding how to move position and orientation of the parts to finish the operation. In this experiment, we selected two CVE-ODE kinematic joints.

#### 4.4.3.1 ODE Fix Behavior

The ODE fix behavior is the fixed joint that maintains a fixed relative position and orientation between two bodies or between a body and the static environment of this experiment. As sub-arm grips of Jig & fixture (the red elements in Figure 4-4) are originally made of a number of different parts, we have defined their relative positions and orientations by the use of a geometric transform matrix. They are all fixed together.

#### 4.4.3.2 ODE Piston Behavior

The ODE piston behavior, is a joint that allows together a translation in a defined direction and a rotation around the same axis (usual pin kinematic joint). This piston joint has been used to define the behavior of the screw when it is inserted in its associated hole. The hole is called “body1” and the screw is called “body2”. The joint will try to keep the distance of this point fixed with respect to body2. The input is specified in world coordinates. If there is no body attached to the joint this function has no effect. The joint anchor point, is get in world coordinates. This returns the point on body 2. If the joint is perfectly satisfied, this will return the same value and then the piston axis is set, the current position of the attached bodies is examined and that position will be the angle zero. When the anchor is set, the current position of body1 and the anchor is examined and that position will be the position zero with the body1 at that position with respect to the anchor will return zero. The angle is measured between the two bodies, or between the body and the static environment and CVE-ODE creates a force inside the piston. This force will be applied on the 2 bodies. Then force is applied to the center of mass of each body and the orientation of the force vector is along the axis of the piston. The ODE piston behavior and a piston joint description in CVE-Editor are shown in Figure 4-5.

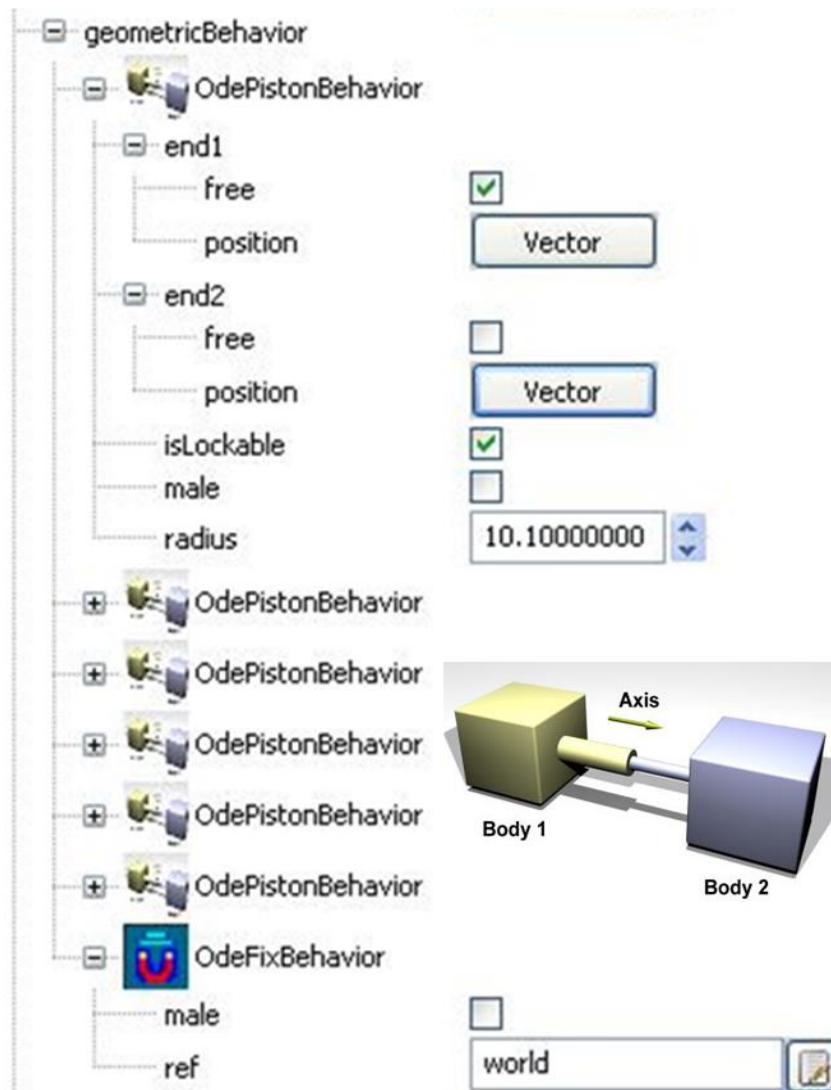

**FIGURE 4-5** ODE Piston behavior and piston joint for six screws assemble

In this experiment, we have selected 6 ODE piston behaviors because we have to insert a screw into each hole of sub-arm grips of jig & figure, as our use case has six screws that must be inserted in the holes.

#### 4.4.4 CVE Happy module

CVE-Happy is a module to take in charge the connection with a haptic arm. It can survey the position of the human operator's hand and it drives the arm actuators to apply a force feed-back, if feedback is activated (N. Bajcinca et al., 2003) during virtual assembly. The haptic arm available in our laboratory, is the Virtuose 6D35-45

which is composed of two main articulated segments fixed on a rotating base. The technical characteristics of a haptic arm are presented in detail in the APPENDIX C.

#### 4.4.5 CVE Analysis module

CVE analysis module has several basic sensors which can be selected and adjusted from the CVE-editor as illustrated in Figure 4-6. We selected three basic sensors to evaluate the way users performed the assembly tasks during our experiment. These sensors are the docking, duration, and instability sensors.



**FIGURE 4-6** The several basic sensors in CVE Analysis on the CVES

The CVE-Analysis is dedicated to trace sensors on a running activity and the report depends on the selected sensors. The experimental results are stored and saved automatically. Incidentally, user should understand the nature of the motion of design activities such as the movement, sliding, rotation, and so on. Low basic sensor inconsistencies may have an effect on the experiment leading to unexpected conclusions. For this experiment, we have selected docking, task duration, and gesture instability sensor. The detail characteristics and the specific features of each sensor, will be explained in the next section, but this section provides a minimal well balanced set of measures: docking refers to task quality, duration refers to task delay and instability to task comfort. Other criteria and sensors should have been used but we must try to keep independent measures about the performed task.

##### 4.4.5.1 The docking sensor

The docking sensor measures the quality of placement of a specific object relatively to the target position after it has been placed by the user. The docking sensor surveys a position defined by a transformation matrix. For instance, the current

position of the considered object 3D model is defined by a transformation matrix and its target position is also identified as a transformation matrix; this target is the value that should be reached by the surveyed position. The surveyed position should be initiated with a start position at the beginning of the analysis. This function will enable to repeat the analysis with a same initial configuration. Two points (point 1 and 2) must be given at a relative position respect to the surveyed position. The points identify a segment. The docking sensor reports the distance between the final points 1 and 2 positions and the target points 1 and 2 positions. The max of this two distances is reported by the docking sensor and this is considered as a measure of placement quality of the object at the end of the analysis. The task in this experiment consists to insert six screws into their respective holes. Thus we defined 6 docking sensors. The CVE-Analysis module refers this six virtual sensors, and the VR model are shown in Figure 4-7.

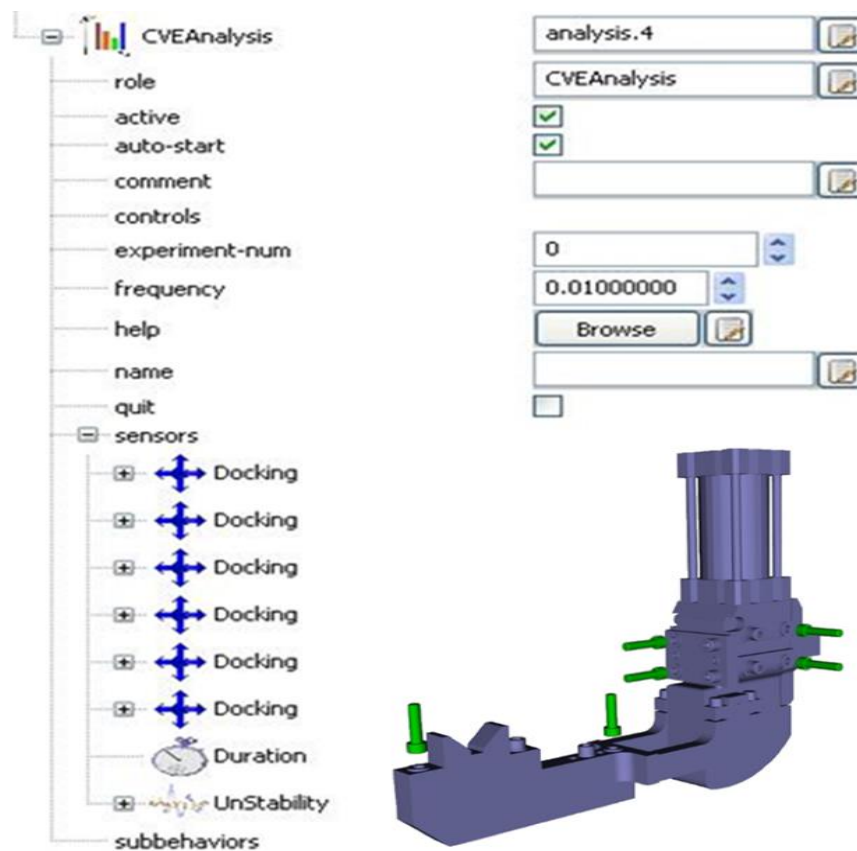

**FIGURE 4-7** Six docking sensors for six screws assemblies



The docking sensor is used to assess the quality of the finalized task. Indeed, it measures the distance of an object from its target position when the placement is declared as finalised. If  $[Ms]$  is the homogeneous transformation matrix of a surveyed object, two characteristic points, P1 and P2 belonging to the object are initially selected. If the target position of the object is defined by the matrix  $[Mt]$  then in ideal placement  $[Ms] = [Mt]$  which can be expressed as the following equation.

$$\forall i \in [1, 2] d_i = d([Ms] \{P_i\} - [Mt] \{P_i\}) = 0 \quad \text{Eq. (4-1)}$$

When the matrix are not exactly equal then  $d_i \neq 0$ . In this case  $d = \max(d_1, d_2)$  is used as a distance indicator between the surveyed position and the target one. Since the goal of the task is to position parts at a target location, this criterion provides a direct measure of the task quality.

#### 4.4.5.2 The duration sensor

The duration sensor measures the duration of the experiments. The duration is the interval of time between the event launching the analysis and the event stopping the analysis. No special attributes are expected to define this sensor since it is a global sensor associated with the whole analysis which it was shown in Figure 4-7 above.

#### 4.4.5.3 Instability sensor

The instability sensor intends to measure the evolution of a position during a laps of time. Instability sensor evaluates the gesture instability. The position of two points in a frame defined by a transformation matrix defining the position of the manipulated object is continuously analyzed. The trajectory of these points is linearized by small intervals of time and the sensor compares the real path length of the point respecting to the linearized trajectory interval per interval. The ratio gives an idea of the oscillation of the trajectory around a more efficient straight path. It depicts the gesture shivers. This ratio is recorded by the analysis module for every conducted experiments. A task can be defined, processed and repeated several times as a record file provides the raw result of these basic sensors.

The instability sensor surveys the instability of a gesture. Technically speaking, if  $[Ms]$  is a homogenous matrix positioning an object two characteristic points, P1 and P2 are surveyed in real time. A frame rate is defined by a duration  $\Delta t$ . The straight line

between two positions of  $P_i$  is a line linking  $P_i(t)$  and  $P_i(t + \Delta t)$ . As a basic measure we capture at the resolution  $\Delta t$ , the distance between the real path and the straight line. The selection of  $\Delta t$  must be associated to a natural gesture framework. The instability sensor measures the doubts or uncertainty and may assess the difficulty for the user to go more or less directly, straight forward to the task goal. We must fix all as a correct time reduction to approximate the real path as the straight line and thus compare the real path to the straight line. An integration of this relative difference provides the gesture instability as shown in Figure 4-8.

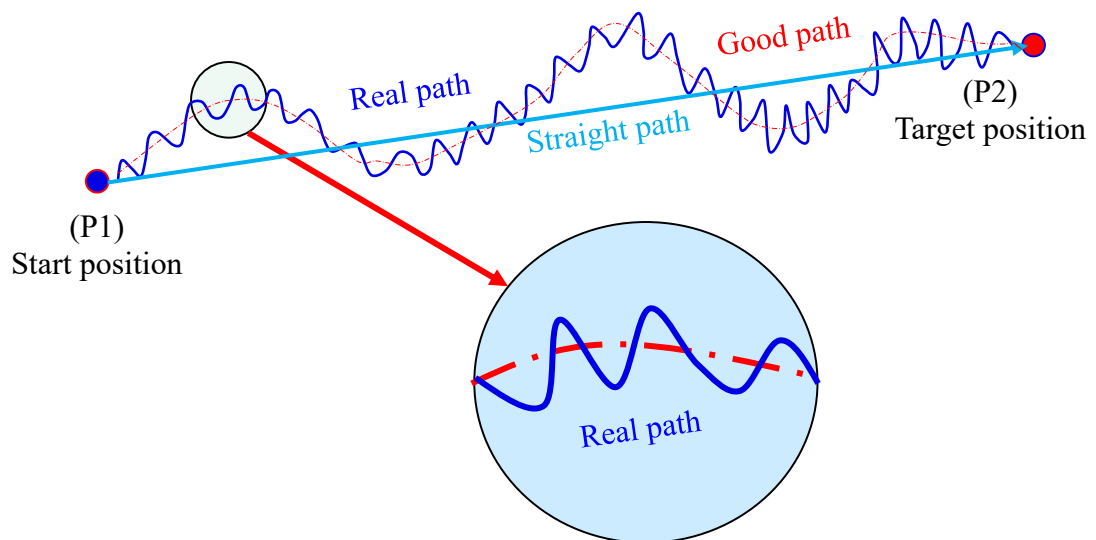

**FIGURE 4-8** The relative difference provides the gesture instability

#### 4.5 Experimentation framework

As presented in previous section, we use the collaborative virtual environment software (CVE) in order to assess performance of the virtual reality environments by employing a haptic arm with force feedback or non-force feedback and with stereoscopic or non-stereoscopic display. As suggested by Figure 4-9, assessment is implemented through the communication of modules which define the sub-behaviors of the virtual environment. The five corresponding modules set as independent agents which edit shared state values in real time. The CVE analysis surveys this state value and reports item into a comma-separated values (CSV) file that will be used for further statistics analysis.

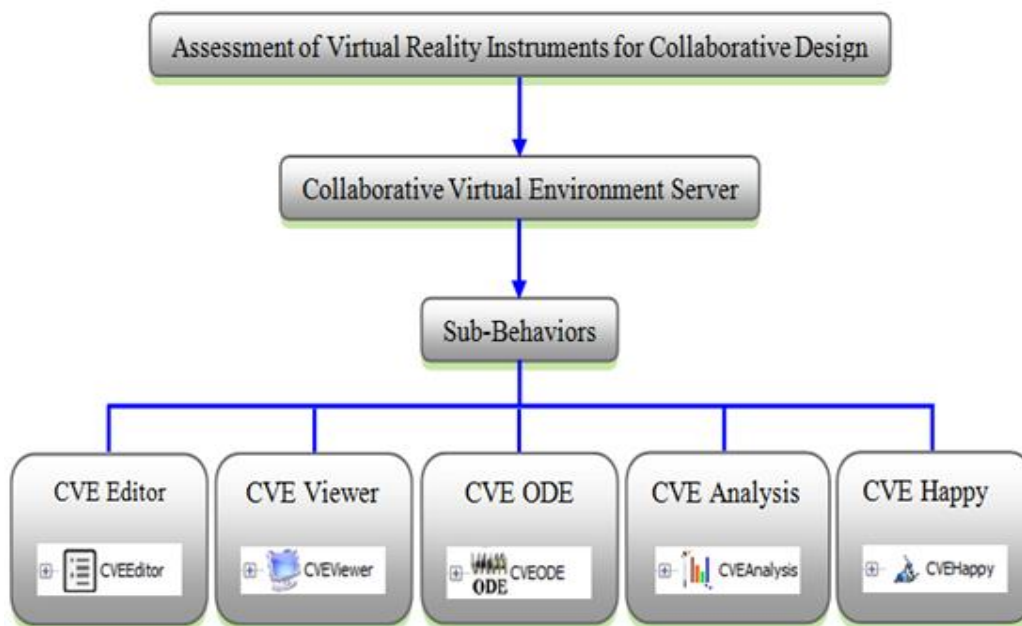

**FIGURE 4-9** The main structure of collaborative virtual environment system

#### 4.5.1 Description of the participants

In this experiment, we have invited forty participants to practice our task. They are PhD students of our laboratory and other laboratories. Some of them have engineering design knowledge but others have no knowledge of engineering yet. From a short interview before running the experiment, we could check if they were or not experienced with our internal virtual reality system CVE or with another VR system. For all of them it is their first time to employ virtual reality equipment. It has been elucidated to the participants how to employ the devices and the assembly procedure to be performed in the experiment. They were allowed to make a first try before the experiment in order to be sure they understood how to perform the tasks. The participants were conducted in a comfortable stand postures by standing about 2 meters away from a 2D wall screen. We provided them the freedom to perform experiments on the attitude and the most convenient gestures according to their feeling and we did not put any pressure or stress about time during the experiment. Furthermore, no participants dropped out in the middle of the experiment and all of them went through the experiment smoothly up to the end of each manipulation. Figure 4-10 shows one participant in action.

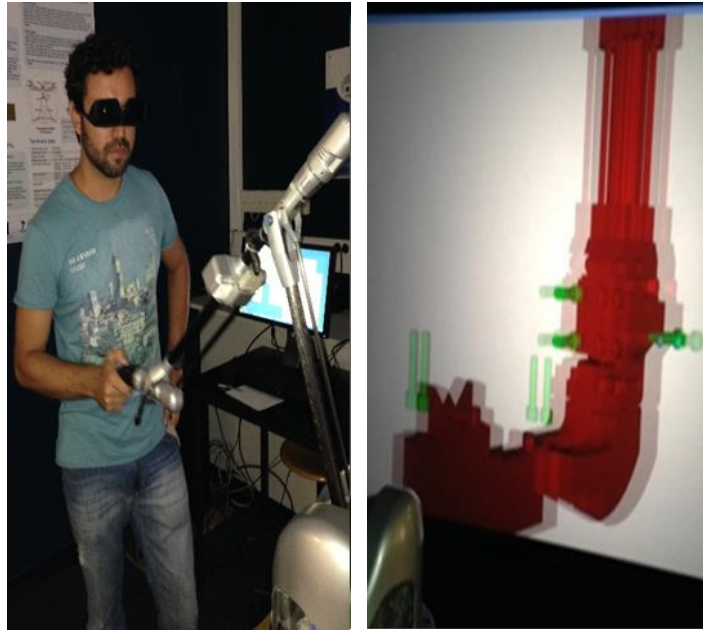

**FIGURE 4-10** The gestures and position of the experiment

#### 4.5.1 Description of the devices

In our system 3D visualization devices are a stereoscopic screen (on the 3D wall screen: crystal eyes 3D glasses + Christie digital mirage HD3 projector) versus classical a 2D display (the same without activation of stereoscopy). Concerning manipulation, a haptic arm, the virtuose 6D35-45 is a device which offers force-feedback on all 6 degrees of freedom together with a large workspace. It is especially recommend for scale 1 manipulation and it was employed for interaction, i.e. for the user to take the screws one by one, move them near their respective holes and insert them into the hole to their target location. The haptic arm may be employed with or without force-feedback.

As it is shown in Figure 4-11, this selection of devices creates four environments as follows:

1. The first environment consists of the haptic arm without force feedback + on the 2D wall screen.
2. The second environment consists of the haptic arm without force-feedback + stereoscopy + on the 3D wall screen.

3. The third environment consists of the haptic arm with force-feedback + on the 2D wall screen.

4. The fourth environment consists of the haptic arm with force-feedback + stereoscopy + on the 3D wall screen.

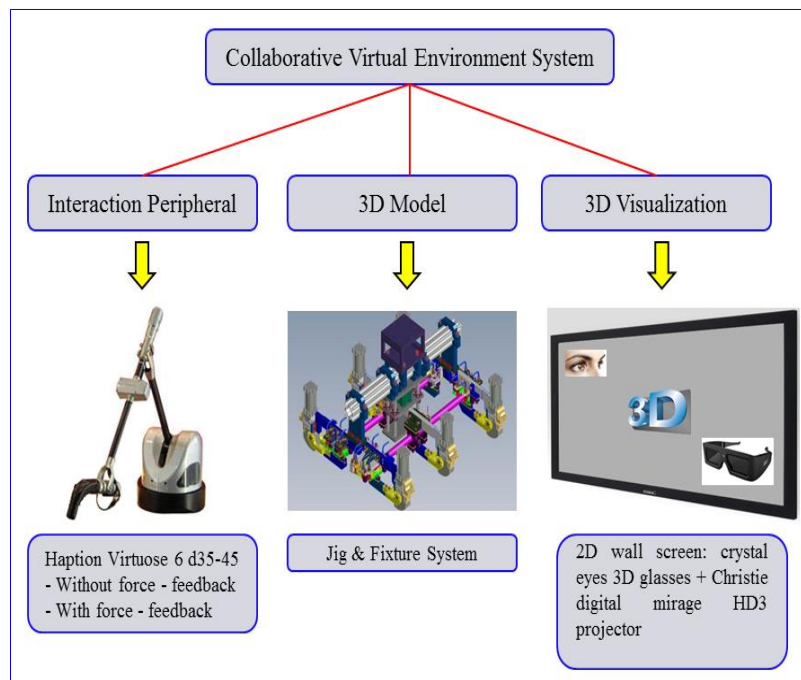
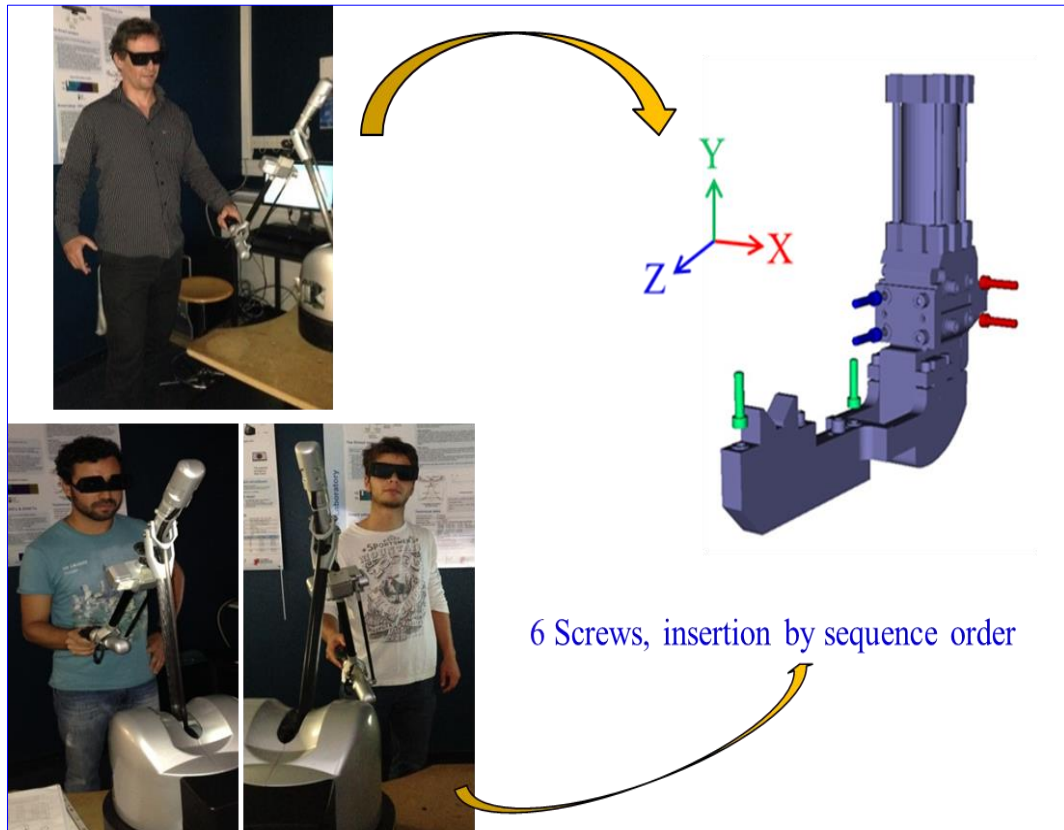

**FIGURE 4-11** The environments to assess the performance on CVE

#### 4.5.3 Experiment protocol

As already discussed, a virtual assembly task of a sub-jig & fixture was selected in our experiment protocol since assembly activity involved a lot of interaction and real-time simulation. The system was simplified and a few parts to be assembled were selected to keep a reasonable experiment time. It was decided to limit the experimentation elementary task to the insertion of a single screw in its corresponding hole. Every participant was expected to repeat the task 6 times which means for 6 equivalent screw insertions in 3 different axis directions as shown in Figure 4-12. A longer task was thus forbidden for a reasonable experimentation time. The sub-part of jig & fixture has several components which were imported as the main component in

crimson color. The screws were imported and highlighted in green color. The task is quite simple: selecting the screw and inserting it in the right hole.



**FIGURE 4-12** Every participant was expected to repeat the task 6 times which for 6 equivalent screw insertions in 3 different axis directions

Anyway, every participant repeated 6 times within the four environments by random order. This leads to about 10 minutes of work on every environment configuration. The experience manager (myself) has a simple text field to identify a test and a single button to start or stop the experiment. When the experiment is started, every part is assigned at an initial position such that every test is driven in the same conditions. Only the user devices are parameters making the operation different. Participants can lead and manipulate screws by using a haptic arm to assemble screws into the holes. When the observer had launched the analysis, the raw sensors values were recorded automatically into a comma separated value file format for complementary statistics.

## 4.6 Experimental results and analysis

As discussed previously in this context, we aimed to develop a first set of simple sensors that should be used to measure some aspects of higher level indicators for tangibility and intuitiveness. A total of 40 participants were recruited for the performance assessment of 3D visualization and interaction devices for assembly activity on 4 environments. The set up protocol for the performance assessment of 3d visualization and interaction devices uses basic activities related to assembly simulation and consists in insertion of screws in their holes. The devices manipulation order has been randomized among participants to avoid potential bias related to training effect during the experiment. The raw recorded files have been processed with basic statistics to get average value of docking, duration, and instability. The experimental data obtained includes the minimum, mean, maximum, and standard deviation of all participants for each environment and inserted screw.

### 4.6.1 Experimental results of average value of docking criteria

In the context of docking sensor development, the docking sensor surveys a position defined by a transformation matrix, used to measure the start position to target position of assembly activity and the surveyed docking value of a good assessments should be near zero. The average value of docking of 4 environments is shown in Figure 4-13.

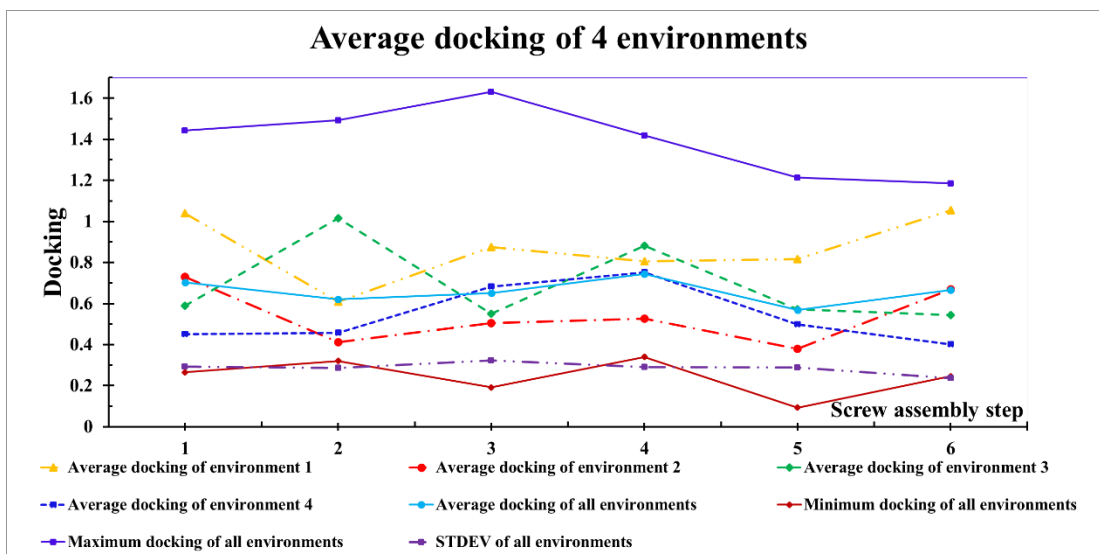
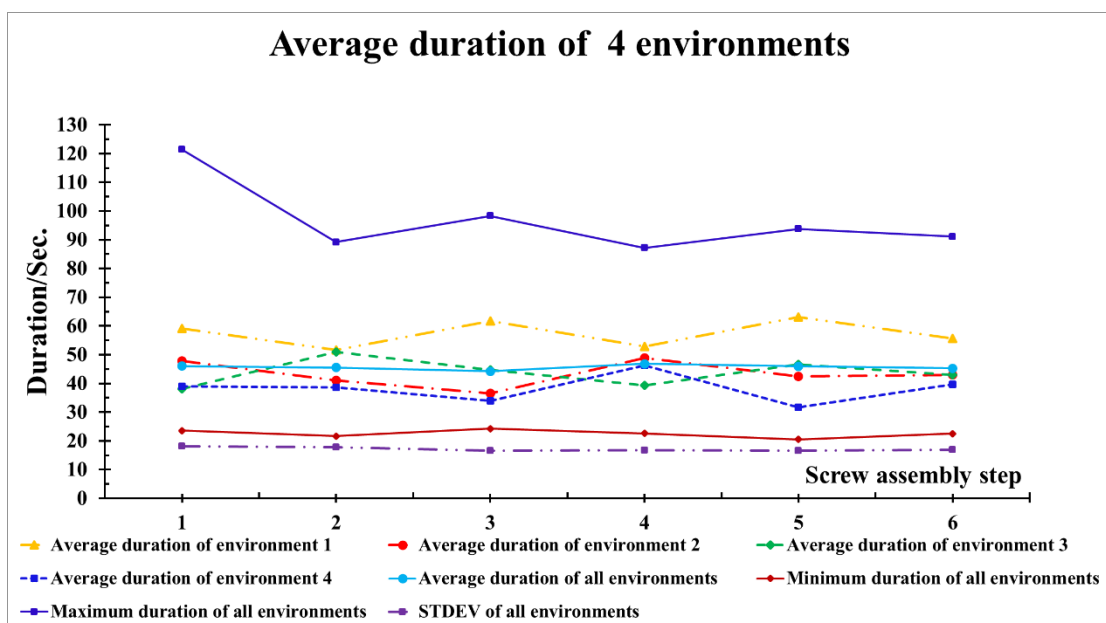

**FIGURE 4-13** The curves of average docking each repetition step

The results suggest that the environment 2 has the best average value respect to docking quality as it is often near zero or under average docking of all environments line. The environment 4 got also a good average value of this sensor. The common feature of these two environments is the use of stereoscopy, which means the use of stereoscopy without force feedback seem more appropriate for docking precision in this assembly activity even the use of stereoscopy with force feedback makes also sure. On the opposite, the worst environment for docking criterion in this context is the environment 1, and environment 3 when the participants do not use stereoscopy. Therefore, for respect to the docking value the use of stereoscopy seems appropriate for experiments at this time.

#### 4.6.2 Experimental results of average value of duration

The results of the 4 environments from the graph in Figure 4-14 show that the environment 4 obtained the best average value respect to task duration because it provides the shortest time. It is followed by the environment 2. This means the use of stereoscopy with force-feedback is the most appropriate for the duration sensor, thus for a fast screw insertion in assembly activity, and is followed by the use of stereoscopy with non-force feedback.

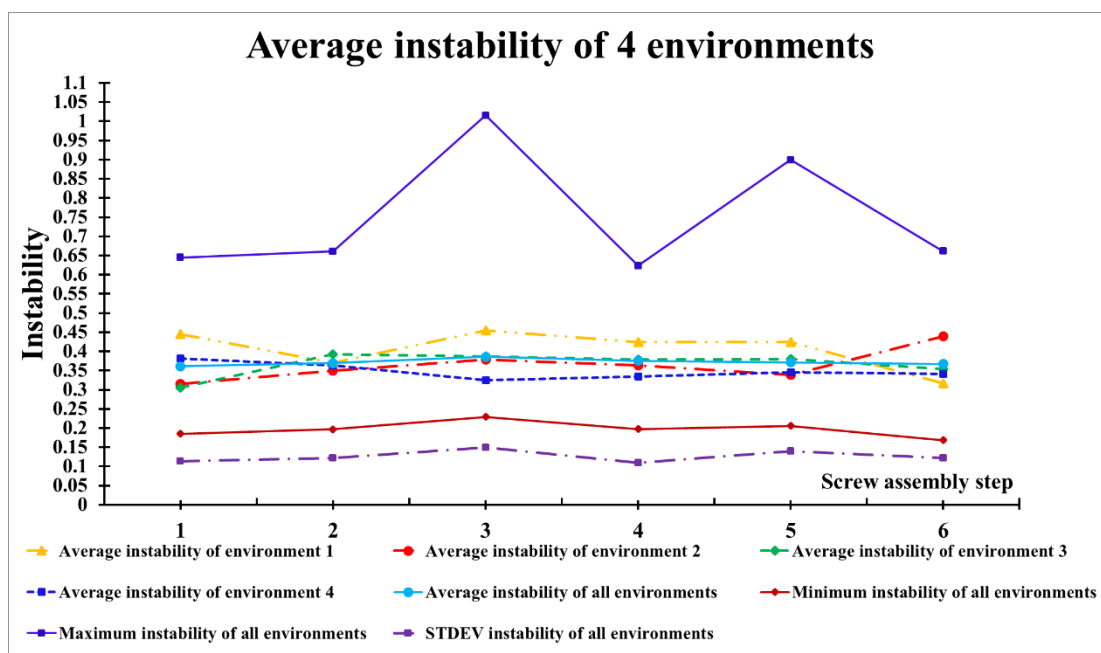

**FIGURE 4-14** The curves of each repetition step



#### 4.6.3 Experimental results of average gesture instability

Experimental results of the 4 environments reported in graph of Figure 4-15 are not very discriminant but they at least suggest that the environment 4 has the best (minimum) average gesture instability. It is followed by the environment 2 that also has a good average gesture instability value. This means that the use of stereoscopy with force feedback is the most appropriate for stability in our protocol experiment and it is followed by the use of stereoscopy with non-force feedback.



**FIGURE 4-15** The curves of average instability

#### 4.6.4 Overall results

As a synthesis of this set of experiments using basic sensors, for the assessment of 3D visualization and interaction device performance. Table 4-1 presents a summary of experimental results for the four environments.

**TABLE 4-1** The summary of experimental results

Environments	1	2	3	4
Docking average values	0.867	0.537	0.693	0.540
Duration average values	57.327	43.345	43.791	38.196
Instability average values	0.406	0.364	0.361	0.348

## 4.7 Conclusion

In this chapter, a sub-part of jig & fixture is used as a use case of traditional assembly process to assess and compare various configurations of a virtual reality environment. Raw sensors were employed to record the activities that are involved in preliminary design and forty participants repeating 6 times an equivalent task were involved to validate statistical results. Virtual reality systems can be employed to simulate, analyze and optimize manufacturing processes including assembly activity, leading to more intuitive, tangible, and natural way to simulate activities that are involved in preliminary design of new products before manufacturing processes. The context of our research is the development of sensors for the performance assessment of virtual reality environments, which consists of the following three sensors: docking quality, duration, and gesture instability sensor. Our experimental results can be summarized by considering three criteria, docking quality, duration, and gesture instability of which global average values are summarized in Table 4-1 and Table 4-2 is a table where values were scaled keep every sensors value in a quite normalized interval.

**TABLE 4-2** The summary were adapted to the same scale

Environments	1	2	3	4
Docking average values	0.867	0.537	0.693	0.540
Duration average values	0.573	0.433	0.437	0.382
Instability average values	0.406	0.364	0.361	0.348
<b>An overall results</b>	<b>1.846</b>	<b>1.334</b>	<b>1.491</b>	<b>1.270</b>

The global and normalized experimental results are shown in Table 4-2. Values obtained from three sensors that are on average close to zero is the best experimental results. Therefore, we can propose the following analyses:

1. The first sensor is *docking*. The docking average value is closer to zero for the second environment (*The second environment consists of the haptic arm with non-force-feedback + stereoscopy + on the 2D wall screen*) which docking average value is equal to 0.537 and the second best docking average value is related to the fourth environment (*The fourth environment consists of the haptic arm with force-feedback*

+ *stereoscopy + on the 3D wall screen*) which docking average value is equal to 0.540.

2. The second sensor is *duration*. The duration average value is closer to zero for the fourth environment which duration average value is equal to 0.382 and the secondary duration average value is obtained with the second environment which duration average value equal to 0.433.

3. The third sensor is *instability*. The instability average value is closer to zero with the use of the third environment which instability average value is equal to 0.348 and the secondary instability average is obtained with the third environment (*The third environment consists of the haptic arm with force-feedback + 2D wall screen*) which instability average value is equal to 0.361.

If we have considered an overall result, environment 4 used for assessment performance is the best one with an overall result equal to 1.270 (*This number is the sum of the three sensors*) and the second is the fourth environment with an overall score equal to 1.334. A raw conclusion about duration sensor could be that providing stereoscopy with force-feedback leads to shorter time for this experimental protocol. Furthermore, a raw conclusion of docking sensor for this experiment protocol is that the environment 2 leads to near zero docking but do not differ much from the environment 4. Experimental results for instability sensor the values do not differ much.

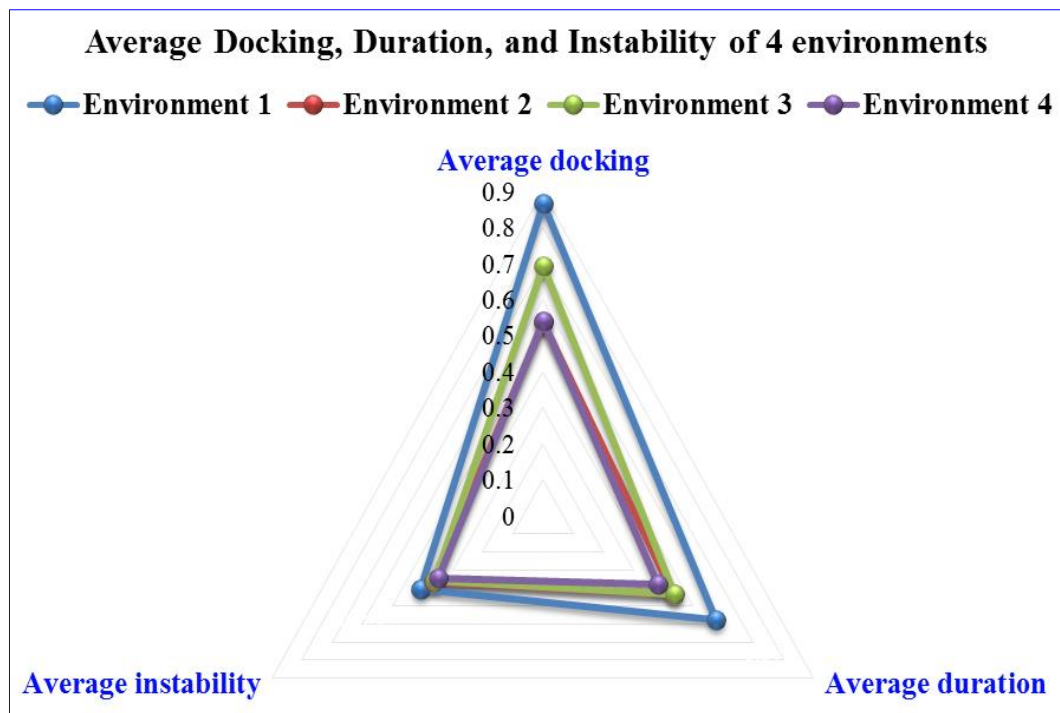

**FIGURE 4-16** The average docking, duration, and stability of the four environments

The overall experimental results are summarized on the graph of Figure 4-16, the fourth environment and second environment are the best for the screws assembly activity which means that using stereoscopy and a haptic arm with force feedback are stable and fast for screws assembly. But never the less the experimental results does not show important differences among various environments. We assume our experiment is performed in a too short time for screw assembly activity because the distance of screws from the holes was small. Furthermore, the author is convinced that task was really easy. Any how it is not surprising that 3D stereoscopy help for 3D alinement while haptic was not here the main sense involved for performing the task. We can thus conclude that this evaluation process leads to a correct low level assessment method and provide results that were anticipated.

These basic measures must be consolidated into more high abstract assessment level such as affordance, ergonomic, intuitiveness, tangibility, and tiredness of the virtual environment for the corresponding task (see details in Chapter 5). Such classifications of technologies may be proposed on the basis of its apparent relevance

(F. Noël, 2012) to reach intuitive and tangible support but an experimental process must reinforce these classifications.

Thus concerning the experiment for the next steps will continue towards the assessment higher level leading to evaluation of affordance, ergonomic, intuitiveness, tangibility, and or tiredness of the virtual reality systems. In addition, the case of Chapter 5 will be also slightly more complex to avoid the effects of two simple tasks this one was analyzed.

## CHAPTER 5

### EXPERIMENT ABOUT HIGH LEVEL ASSESSMENT

*This chapter expects to go a step further within the assessment of virtual reality devices for design tasks. Indeed the previous chapter assessed the usage or not of the haptic arm force-feedback combined or not with 3D stereoscopic display through basic sensors only. If we expect to assess usefulness a more abstract perspective must lead the assessment process. As described in Chapter 3, it becomes important to assess also affordance, tangibility, and tiredness which make the virtual environment natural enough for design usage. Obviously the experience about basic sensors can be repeated but it can be completed with extra observations to may be create a link between basic sensors results and a holistic usefulness assessment level.*

*The second experience was thus organized around a barrel cam mechanism simulation which is operated with a single rotation motion but which provides a complex cam 3D trajectory. Even design experts may have some difficulties to anticipate the behavior of this system. They usually experience difficulties when tuning design parameters to ensure that the mechanism is working well. It is thus investigated virtual reality capacity to overpass these difficulties. If this capacity is demonstrated, it is also expected to evaluate and compare the performance of the virtual reality environment system by the use of high level abstract assessment technique combined with the low sensors. Here thirty participants have been involved in this experience where both basic sensors were captured and high level assessment criterria were conduced through a questionnaire. Once again the four environments including either stereoscopy or haptic force-feedback device were used to establish comparisons respect to this new task.*

#### **5.1 Introduction**

This chapter introduces a new experience. A realistic design goal concerning mechanical behavior analysis is introduced on a barrel cam mechanism case study : it

is presented in the next section. Then Section 5.3 discusses the a priori expected added value of virtual reality for the current design task and describes the model used within a virtual reality environment. This section makes assumptions justifying the experience organized in Section 5.4. The experience results are observed in Section 5.6 through the basic sensors level as in the previous chapter, and in Section 5.7 through a questionnaire analysis which is supposed to assess the abstract usefulness level. The potential links that could be made between the basic sensors results and abstract usefulness level will be discussed as an overall conclusion in Chapter 6.

## **5.2 A barrel cam mechanism analysis**

### **5.2.1 Barrel cam mechanism**

An early cam was built into hellenistic water-driven automata from the 3<sup>rd</sup> century BC (Wilson and Andrew, 2002). Cams were later employed by Al-Jazari, who used them in his own automata (Georges Ifrah, 2001). The cam and camshaft appeared in European mechanisms from the 14<sup>th</sup> century (A. Lehr, 1981). Cam mechanism are still used in automotive production because they still provide sharper manufacturing reproduction than numerical commands. The cam trajectory itself is usually a 3D curve not really complex but hard to design and to optimize on 2D displays with usual CAD systems. Here a barrel cam (Cylindrical cam) is designed and checked by simulation before it is produced. It is a component of a manufacturing process selected as a normal complexity use case but its design is not simple to finalize. Any efficient support to this design activity is welcome for industrial practice.

The barrel cam has a follower riding on a cylinder surface. In the most common type, the follower rides in a groove cut into the surface of a cylinder. These cams are principally used to convert rotational motion to linear motion parallel to the rotational axis of the cylinder. It automates the driving law of a manufacturing tool. A cylinder may have several grooves cut into the surface and thus it drives several followers. Barrel cams can provide motions that involve more than a single rotation of the cylinder and generally provides positive positioning, removing the need for a spring or other provision to keep the follower in contact with the control surface. To work well, correct dimensions and tolerances must be fixed. Specifically, a risk of blocking

motion is possible in some specific area of the groove cut depending on the curvature and often inflexions of the groove. Figure 5-1 shows such a cam system designed within the CAD system (SolidWorks™ software) by engineers and designers. The system remains simple with indeed a single degree of freedom. But the 3D intrinsic nature of the groove cut makes the overall motion not so easy to anticipate on a cognitive point of view. The top figures of Figure 5-1 highlights the risky area where the motion can be blocked.

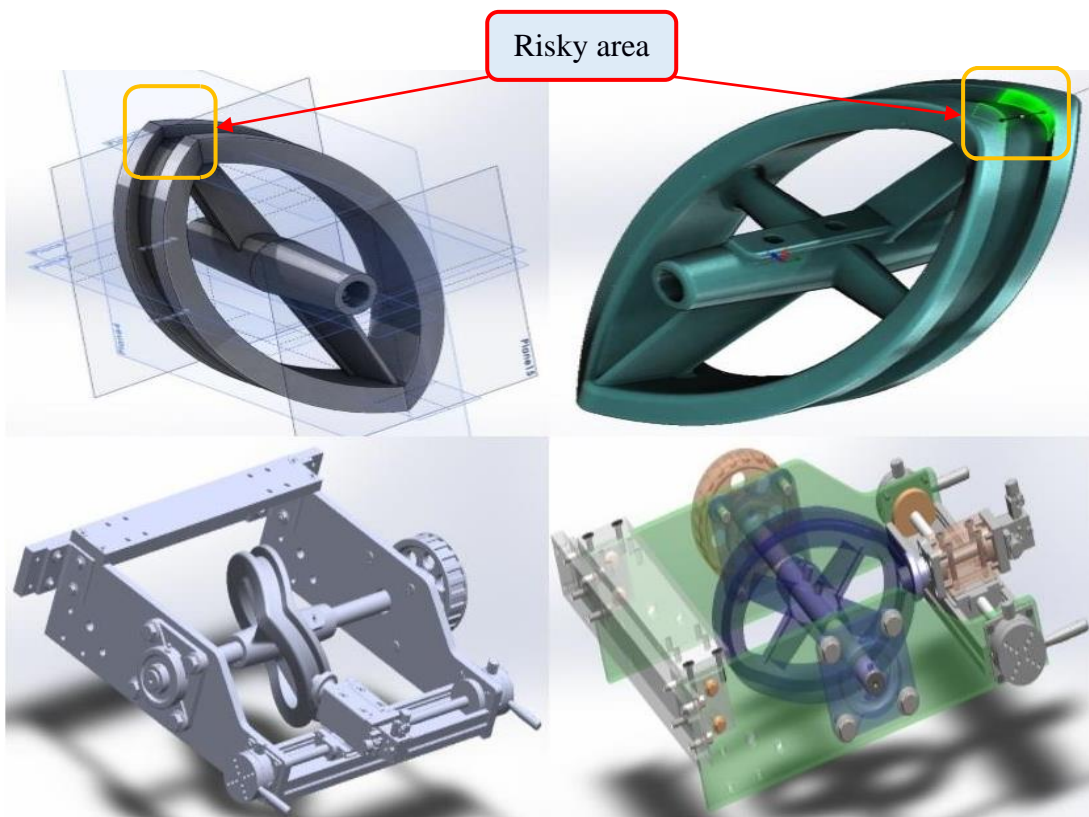

**FIGURE 5-1** The barrel cam modelled in a conventional CAD system

Mechanism simulation is the process of creating and analyzing a digital prototype of a mechanism model to predict its performance in the real world. It is used by engineers to understand whether, and under what conditions, a part could fail and what loads it withstands. The mechanism simulation is a crucial step in the design process. The increasing variety product complexity increases requirements in terms of quality within a usual cost savings constraint. The design of such a mechanism must



assess its correct behavior. Automatic mechanism analysis will usually fail here because too many potential contacts should create fake hyper static positions: the model tolerance is too close from the real tolerance. CAD system has insufficient potential for advanced dynamic simulation. Here it cannot be claimed that mechanism models could not be created but if it exists the modelling effort for designer is more complex than the expected result and such analysis will not be performed in most cases. Complex mechanism design, kinematics and performance optimization expect both dynamics solid mechanisms and deformation simulation (usually through the finite element method (FEM)). Simulation is an attempt to model a real-life or hypothetical situation on a computer so that it can be studied to see how the system works. By changing variables in the simulation, predictions is made about the behavior of the system (Jerry Banks, 2001). It is a tool to investigate the virtual behavior of the system under study. It enables to analyze geometric contours dimensions and tolerance errors.

#### 5.2.2 Role of the virtual environment for designers

If traditional mechanism analysis does not provide efficient simulation for designers, it becomes interesting to test if the deep dimension of 3D visualization plus interaction device operation with force feedback or non-force feedback lets better anticipate the corresponding behavior. The main assumption is that potential blocking situations cause may be understood just by visualizing the 3D contacts when it occurs. If the engineer visualizes properly the current contact configurations he will directly perceive the main design parameters without complex simulation.

The challenge becomes to create an appropriate virtual environment where engineers will be able to basically simulate the global mechanical behavior but will refine their understanding by interacting with the model rather than to expect a direct simulation output.

The virtual environment can integrate basic contact simulation but it will remain insufficient to check the critical position where motion are blocked. The integration of basic mechanics enables valid motions, as rotation, sliding (with some collision detections and kinematics joint constraints). We thus need to get the barrel cam mechanism model as presented in Figure 5-2 within the virtual reality environment.

The CAD part shapes can be transferred and visualized in the virtual environment quite easily.

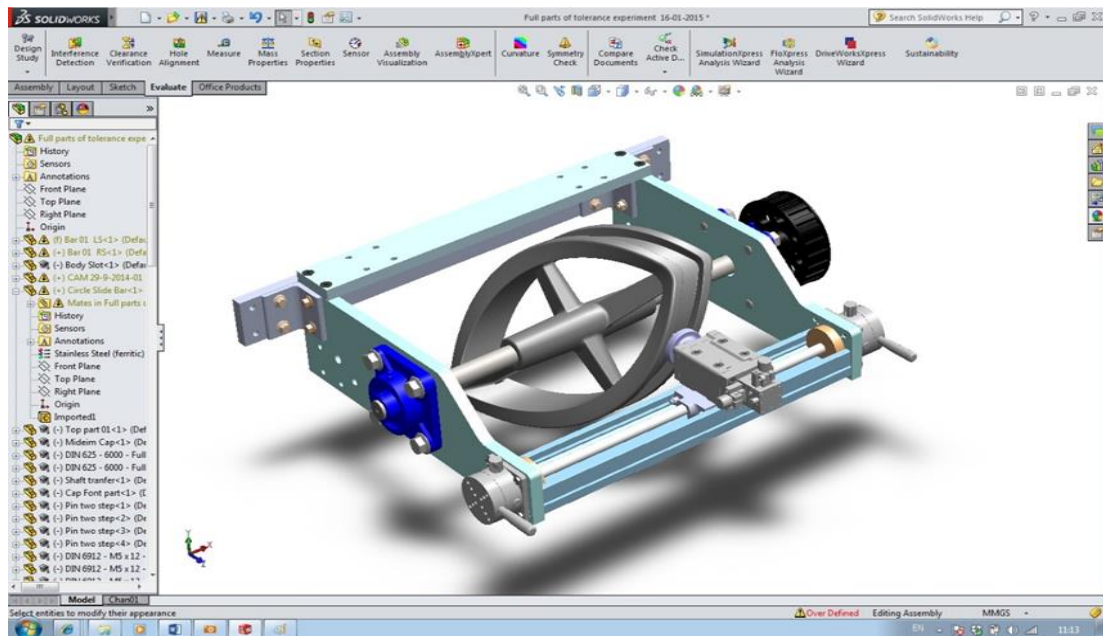

**FIGURE 5-2** The overall barrel cam system to be included in the VR environment.

For the experiment, we focus on the good behavior when playing with a single degree of freedom, indeed the rotation, of the barrel. The designer is supposed to check any problem of the barrel cam mechanism blocking during this motion. Figure 5-3 shows a user analyzing the barrel cam system within the virtual environment combining a stereoscopic display and a haptic arm.

If experience proves that the virtual environment is reliable then virtual reality will be deployed more easily for engineers, designers, and manufacturing experts. But to prove this reliability we must check that usual engineers will first achieve the task efficiently and will find the environment natural enough through affordance, ergonomics, intuitiveness, tangibility, and tiredness concepts.

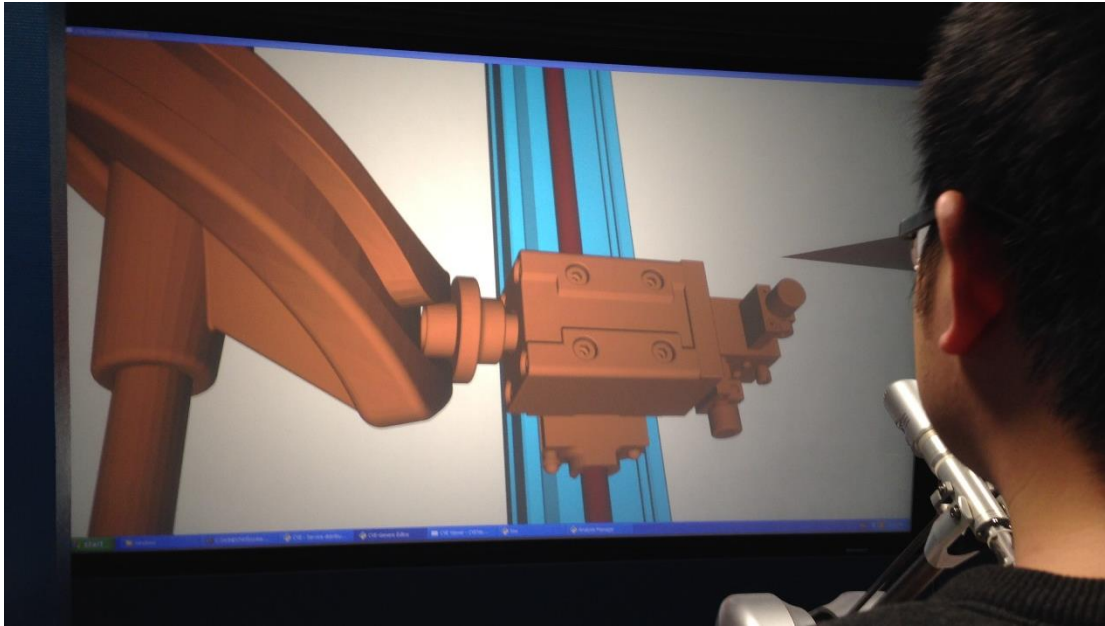

**FIGURE 5-3** Check blocking of the mechanism and analyze design issues

### **5.3 Expected added value of VR for designers**

#### **5.3.1 Expected impact on design**

It is assumed that Virtual Reality (VR) has a great potential to help designers and engineers because it gives access to a product mock-up during its development and thus opens new simulation methods. It should offer a rapid loop between product model edition and simulations. Especially, business operations are highly competitive in terms of performance and cost for the product. Direct and rapid 3D model edition avoids the ancient engineering drawing standard and its complex consequences for many departments when updates are expected. Product development cost is increased by every defects in the design process. In the meantime, VR technology should support anticipation of future product lifecycle steps. It is expected to save cost by minimizing the time for design, simulation and testing loop.

Even with a large manufacturing experience we still find machines or products that cannot be processed. Therefore, design must be improved to ensure machines and final goods to work properly. To ensure good final behavior engineers usually create prototypes which can be physic prototype or virtual reality prototype.

Currently, physical prototypes are viewed as highly expensive while virtual reality prototypes are promising more potential and superior performance. Despite designers, engineers, and manufacturing experts already experienced CAD/CAE/CAM technologies for manufacturing design in many industries, these CAD systems remain limited as well. Especially, most designers and engineers are using CAD systems to assist the creation, the modification, the analysis, or the optimization of design and to create a database for manufacturing (Narayan and K. Lalit, 2008). Therefore, limitations of CAD/CAE/CAM technologies (see section 1.3) make virtual reality technologies (virtual reality prototype) really attractive. Designers and engineers, expect new methods where VR technology is part of the solution. But it remains a lack of knowledge about efficient application of VR.

### 5.3.2 Virtual reality environment expectation

CAD systems are not appropriate for every design and simulation activities as already mentioned in Section 1.3. We expect new opportunities from the capabilities, potentials, and performance of VR technology which can be extended as “Collaborative Virtual Environment Software”. The main issue for the barrel cam case study is to analyze potential blocking positions when rotating the barrel. Here it is proposed before production, to check mechanism dimension with virtual reality environments.

As manufacturing companies pursue higher quality products, they spend much of their effort monitoring and controlling variation. Dimensional variation in production parts accumulate or stack up statistically, and propagate through kinematic joints, causing critical features of the final product. Such dimension variations can cause expensive issues during simulation, requiring extensive rework or scrapped parts, and it can also cause unsatisfactory performance of the finished product, drastically increasing warranty cost and creating unsatisfied customers.

We expect to implement our case study within a virtual reality environment so that our research assumptions may be validated at the low basic sensor level but also at the high abstract assessment level.

## 5.4 Preparation of the virtual reality environments

Designers, engineers, and manufacturing experts use 3D geometric models created in CAD systems. A translation of CAD model to VR model is thus, once again the initial process for working on virtual reality environment system. The 3D model was created within SolidWorks™ software which exports models into file formats such as STL file that we converted in OBJ file. As for Chapter 4, the main reason to use OBJ file format is to get a good level of compression; it is also available for import inside most virtual reality system. In addition, for the barrel cam mechanism simulation, the virtual reality environment system expects the definition of kinematic joints (Abouel Nasr et al., 2013). Transferring 3D geometry of parts is not enough (G. Gonzalez-Badillo et al., 2013). As in Chapter 4, for this new use-case, kinematics constraints were rebuilt from scratch directly in the virtual reality environment. Therefore, it is just considered that each part is represented by a single polyhedron in the virtual reality environment system leaded by pre-defined kinematic joints.

### 5.4.1 Import 3D model files into CVE Viewer module

The barrel cam mechanism consists of five bodies: 1) the machine structure, 2) the bearing housings, 3) the barrel cam, 4) the slider element, and 5) the slide bar. All elements were imported and exported in OBJ data formats from SolidWorks™. The OBJ file format is directly imported into the CVE Viewer module and becomes a *Scene Imported File* as shown in Figure 5-4.

An avatar of the hand is created: we use a simple cone shape. The position and behavior of this avatar will be linked to the user gesture (through the haptic arm device). The distance between the projection 2D wall screen and the interaction device (haptic arm) has been set at 2 meters. We do not use here head-tracking system. The cone is thus a remote representation of the hand. Background color and objects colors were also fixed directly in the viewer since color information was lost when exporting into the STL format. Colors seem important to make a good distinction of parts but we did not make variation of color distribution to measure a potential impact on performance.

#### 5.4.2 Kinematic joint parameter setting functions on CVE ODE module

Here again, we used G-SCOP, CVE VR modeller. It enables rapid connection of various modules. The viewer is one of these modules. The CVE ODE module is another one in charge of real time object dynamics simulation. It uses the *Object Dynamic Engine* (<http://www.ode.org/>) developed by *Russel Smith*.

The CVE ODE module is an agent with two main functions: it is in charge of collision detection but it was extended to rigid body kinematics. The collision detection engine needs the 3D model shape of each body. At each time step, it figures out which bodies touch each other and passes the resulting contact point information to the dynamic engine. It was up to us to model the kinematic joints between the 5 bodies. The joint geometry and parameter setting should only be called after the joint has been attached to bodies, and those bodies must have been correctly positioned, otherwise the joint may not be initialized correctly. For the barrel cam system the joints, types ODE Fix, ODE Hinge, and ODE Slider were used (APPENDIX B).

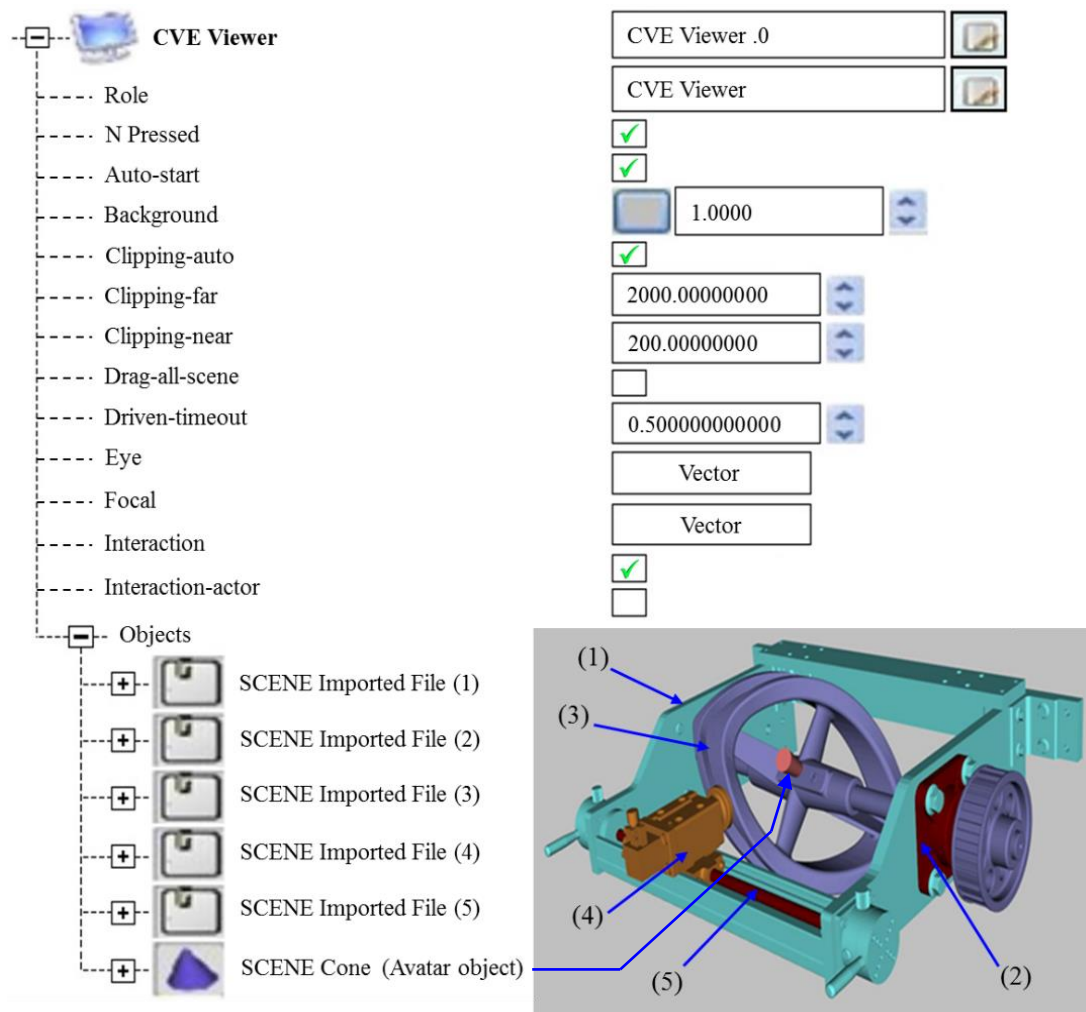

**FIGURE 5-4** The 3D models imported into CVE and creates the scene

#### 5.4.3 Avatar connection with the interaction device

An avatar is used to provide a visual feedback of the position of the interactor within the virtual space. The haptic arm device is here again the Virtuose 6D from Haption company. Chapter 4 experience demonstrated also the positive impact of haptic within a virtual reality scene. The avatar, a cone, replicates the motions of the haptic hand tasked via the haptic arm device.

The haptic arm has a button which is used to create a selection/deselection event. When the cone intersects a body of the barrel cam, a selection event creates a virtual spring between the selected object and the cone. The spring is a generalized spring which acts on both translations and rotations. The spring stiffness parameters creates a scaled effort which is both a force and a torque. It replicates a simulated

force feedback (currently there is no damping behavior). Figure 5-5 shows the configuration of the interactor in the CVE editor.

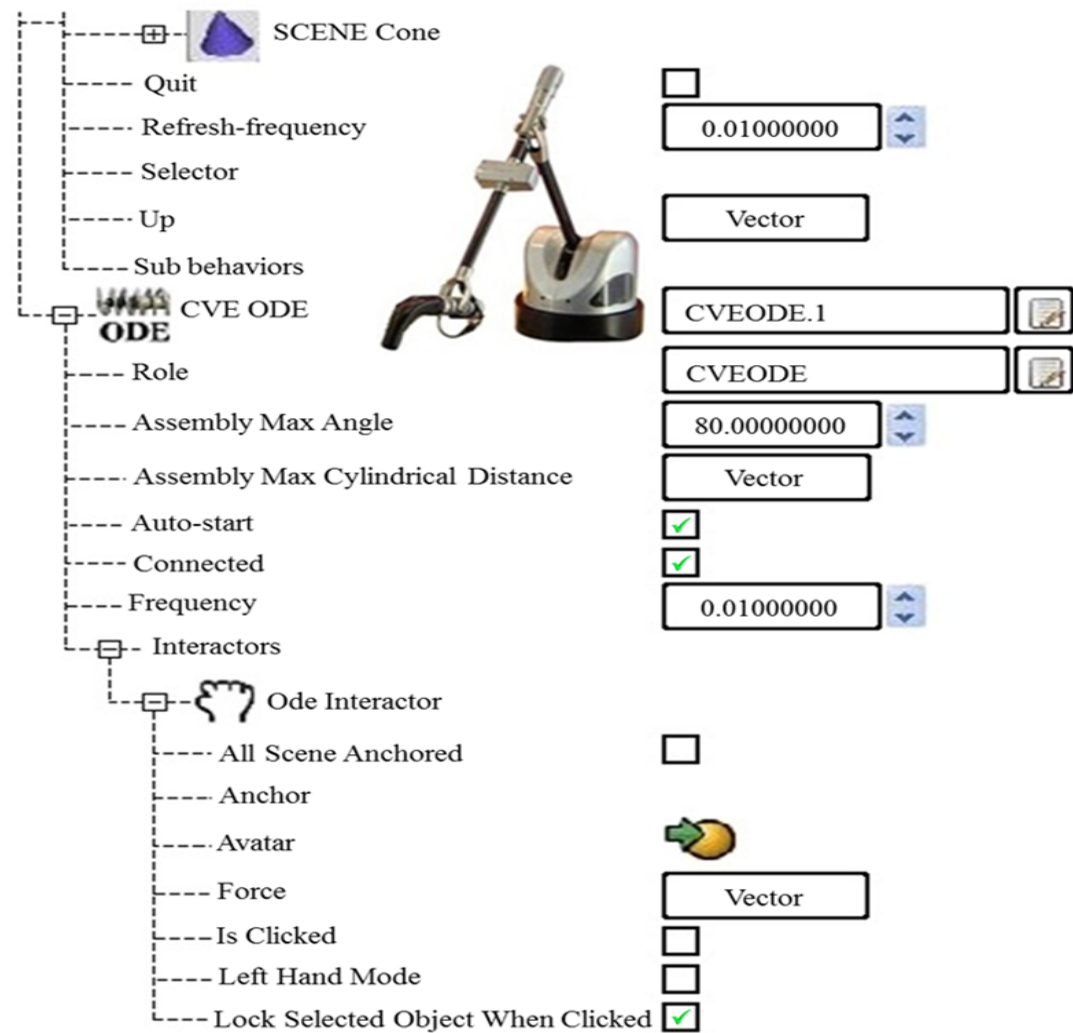

**FIGURE 5-5** Avatar links human seesight perception to a haptic arm device

#### 5.4.4 Basic sensors

The VR model checks interaction with collision detection and kinematics joint constraints to achieve a design analysis: it should help to fix dimensions to avoid blocking cases. Three objective basic criteria are observed: 1) The duration of the task: the VR environment will be relevant as soon as it help saving time, 2) the gesture instability which highlights some ergonomic and tiredness issues and, 3) the completion of the task in Chapter 4 completion was measured by a docking quality.



Here we expect that the user identify the correct dimensions for the barrel cam. Figure 5-6 shows the CVE configuration including the two sensors in the CVE analysis module which automate the observation. During the experimentation several barrel cam dimensions will be presented to the user and the user will have to check if there is a blocking point or not and why. A mark providing the number of good identifications over the overall number of checked configurations will be used as an objective completion criteria.

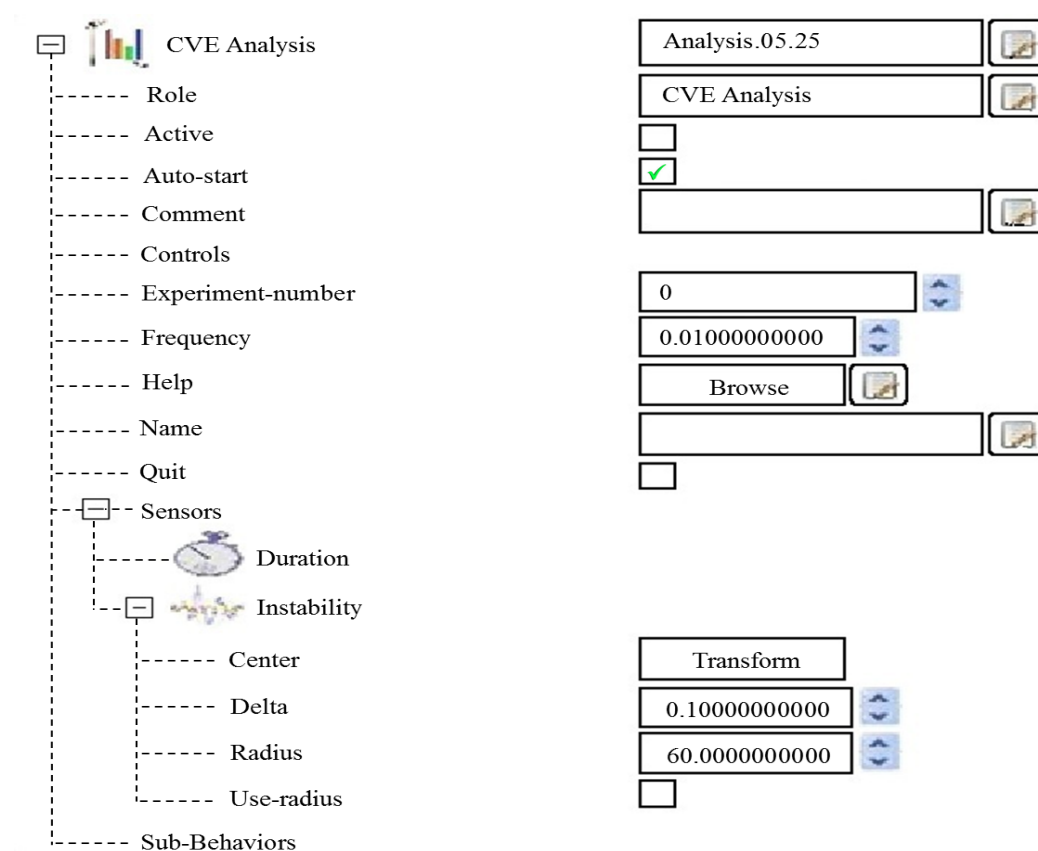

**FIGURE 5-6** Two basic sensors (Duration and Instability sensors) have been applied for the barrel cam mechanism simulation

As in Chapter 4, the duration sensor measures the duration of the task. The duration is the interval of time between the event launching the analysis and the event stopping the analysis. The instability sensor intends to measure the evolution of a position during a laps of time. The position of two points (point 1 and 2) in a frame

defined by a transformation matrix is permanently analyzed, as already presented in Chapter 4.

## 5.5 Experimentation description

### 5.5.1 Description of the participants

Once again, the participants to the experiment are PhD students and graduate students of G-SCOP laboratory and other close laboratories. This time thirty participants participated to this experiment. They have engineering design knowledge but some never used this virtual reality environment system or they never manipulated virtual reality environment equipment at all. A few ones already experienced once such equipment and it will be for them a second experience (they participated to the previous experience). It has been elucidated to the participants, before the experiment starts, how to employ the interaction devices. They all test the selection, the rotation, movement, and simulation procedure to be performed in the experiments before the capitalized session. The participants were conducted in a comfortable stand postures by standing about 2 meters away from the screen. Figure 5-7 shows the gestures of participants for the barrel cam simulation. Once again, no participant dropped out in the middle of the experiment and all of them went through the experiment smoothly. The haptic arm enables to handle the motion of the barrel cam while they can also handle the view point with a traditional mouse.

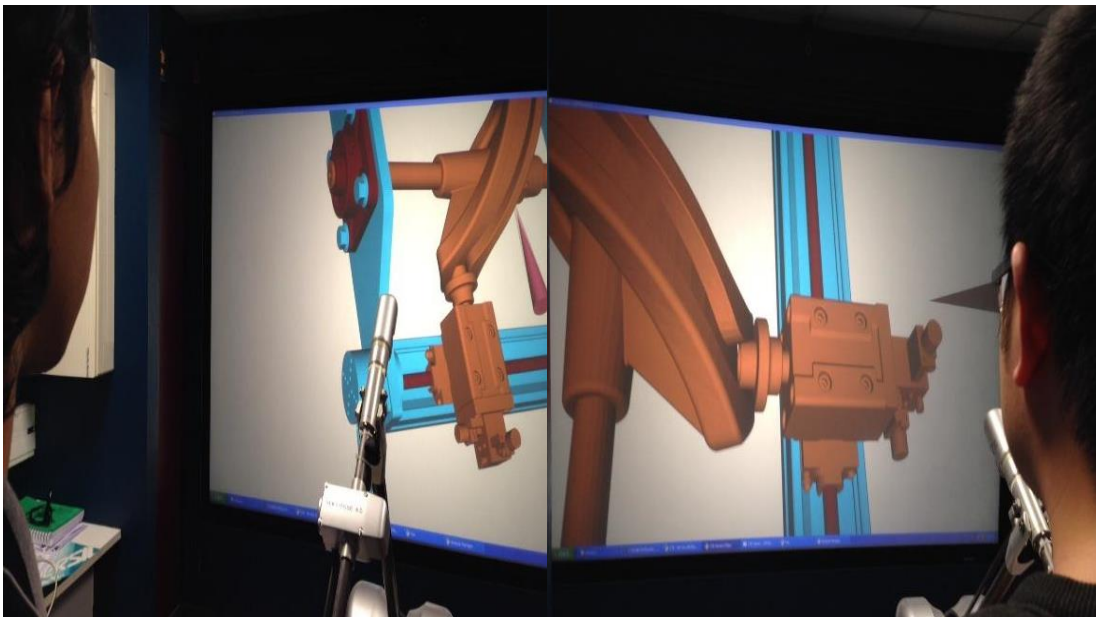

**FIGURE 5-7** The participants work in a comfortable stand postures by the use stereoscopy with force-feedback to manipulate the mechanism

### 5.5.2 Experimentation protocol

The thirty participants are invited to assess mechanism blocking by the use of CVE tools (Figure 5-8). The haptic arm Virtuose 6D35-45 is the device which offers force-feedback on all 6 degrees of freedom together with a large workspace). It is the main equipment with the stereoscopic display leading four environment as for the experience of Chapter 4:

1. The first environment consists of the haptic arm without force-feedback + non-stereoscopy + on the 2D wall screen.
2. The second environment consists of the haptic arm without force-feedback + stereoscopy + on the 3D wall screen.
3. The third environment consists of the haptic arm with force-feedback + non-stereoscopy + 2D wall screen.
4. The fourth environment consists of the haptic arm with force-feedback + stereoscopy + on the 3D wall screen.



**FIGURE 5-8** The experimentation protocol of the barrel cam mechanism simulation for the performance assessment of virtual reality environment system

Every user experiences in a random order all the four environments and various dimensions configurations: dimensional variations are applied to the cam cut leading to more or less blocking situations. As in Chapter 4 we expect to compare the four environments to achieve the barrel cam mechanism dimensioning task. The basic use case of Chapter 4 was to be confirmed by a second experience on a more realistic task. We also expect to go a step further in the experience analysis: the abstract level of assessment must also be reached with this experience.

## 5.6 Analysis of basic sensors by the use of barrel cam mechanism simulation

### 5.6.1 Finding appropriate dimensions by rotating simulation on the barrel cam

The goal for the “designer” involved in this experiment, is to find the appropriate dimension of internal and external arc radius for the barrel cam. Within a good machinery parts design, the designer or engineer must identify the accurate dimensions and tolerancing to avoid any damage or crash, and of course to allow the cam system to work properly.

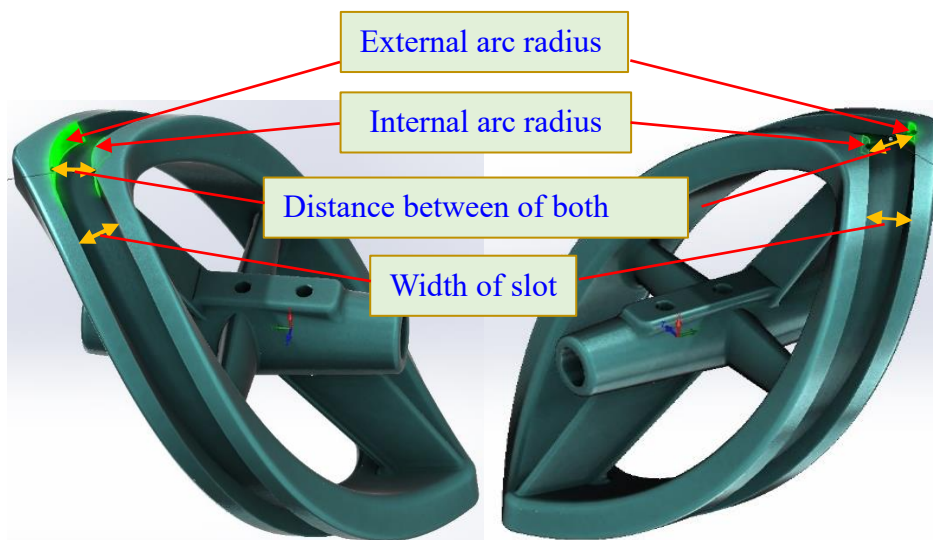

**FIGURE 5-9** The specific features dimension that affect for the rotate simulation, left and right pictures are two different versions.

As presented in Section 5.2.1 and Figure 5.1, the critical zone is situated where the cam slot should stop the follower translation and make it go backward. The slot

geometry in this area is complex and defined by several parameters which alltogether determine the positive or negative gap between the slot and the follower cylinder. A bad set of values may lead to unwanted blocking behavior for the mechanism, instead of the expected fluidity of movement when the cylinder crosses this area.

The main dimensions that affect the barrel cam behavior include the following (Figure 5-9):

- Internal arc radius
- External arc radius
- Width of slot
- Distance between the two arcs

This experiment context aims to analyze and find the appropriate dimension of internal and external arc radius for the barrel cam design. The user is supposed to analyze the possibility for the barrel cam to rotate continuously without blocking or having other unwanted behavior. Simultaneously the balance and stability of manipulation is evaluated in the experiment by the use of basic sensors of the “Collaborative Virtual Environment Software”. Factors affecting the expected movement for a barrel cam are the dimension of internal and external arc radius as well as the distance between the two arcs. A barrel cam model was created by using SolidWork™ software where arc radius were created by the “fillet” command. Therefore, the distance between internal and external was related to the two arcs independently issued from the CAD fillet command. For the experiment, we considered the dimension of a barrel cam through six couple of radius values defining the distance between both arcs as shown in Table 5-1.

**Table 5-1** The various dimensions that affect for a barrel cam rotation

Type	Internal arc (Radius)	External arc (Radius)	Width of slot	Distance between both arcs
1.	Non radius	Non radius	20 mm.	24.00 mm.
2.	05 mm.	25 mm.	20 mm.	20.17 mm.
3.	10 mm.	30 mm.	20 mm.	20.98 mm.
4.	15 mm.	35 mm.	20 mm.	20.98 mm.
5.	20 mm.	40 mm.	20 mm.	20.92 mm.
6.	25 mm.	45 mm.	20 mm.	20.39 mm.

As shown by Table 5-1, the distance arcs is not uniformly equal to 20 millimeters creating differences for cam sliding motion.

### 5.6.2 Experimental results of the task duration for barrel cam 6 types

In this section, the experimental results about the task duration for 20 participants and the four environments issued from the Table D-1 to Table D-24 of the APPENDIX D (raw result of the duration sensor) are reported. The reports of duration for the 6 types of barrel cam and for every environments is depending on the repetition of the task respect to the six configurations. The user analyzes the possibility for the barrel cam to rotate fluently or having other unwanted movement behavior like friction or instability. These results are summarized from the table in appendix D and the average of all environments are shown in Table 5-2.

**Table 5-2** Experimental results of the task duration for barrel cam 6 types

Environments	The type of a barrel cam					
	Type 1	Type 2	Type 3	Type 4	Type 5	Type 6
Environment 1	2.262 Sec.	2.174 Sec.	2.233 Sec.	2.127 Sec.	2.216 Sec.	2.071 Sec.
Environment 2	2.143 Sec.	2.327 Sec.	2.473 Sec.	2.126 Sec.	2.308 Sec.	2.302 Sec.
Environment 3	2.158 Sec.	2.348 Sec.	2.227 Sec.	2.160 Sec.	2.424 Sec.	2.159 Sec.
Environment 4	2.176 Sec.	2.375 Sec.	2.276 Sec.	2.199 Sec.	2.327 Sec.	2.165 Sec.
Average	2.185 Sec.	2.306 Sec.	2.302 Sec.	2.153 Sec.	2.319 Sec.	2.174 Sec.

For better understanding, we had converted the task duration data from Table 5-2 into the graphics of Figure 5-10. It may be noted that repetitions do not decrease the task duration. No obvious explanation helps to understand this graph. We need to make a correlation between duration and the two main parameters, the slot distance, and the radius value, to get a deeper understanding.

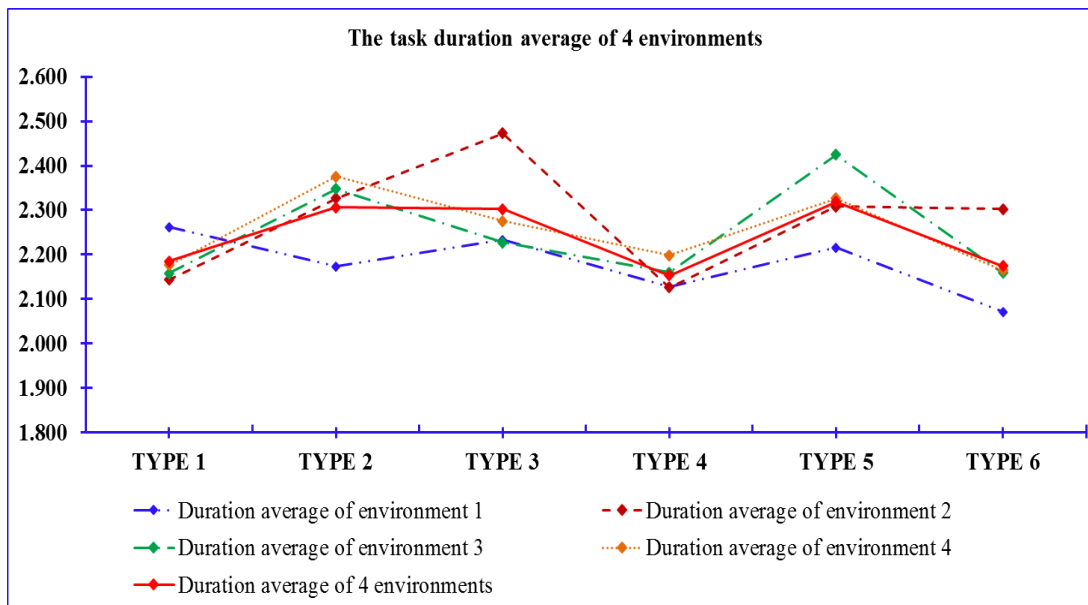

**FIGURE 5-10** The task duration graph of barrel cam six types for the four experimental environments

Figure 5-10, the best results of the task duration are located under the red line (average values of all environments). Here, the first environment (Environment 1 consists of the haptic arm without force-feedback + non-stereoscopy + 2D wall screen) is the blue line which is the best result respect to task duration. This means that the use of a haptic arm without force-feedback and non-stereoscopy leads to quicker task. Furthermore, we want to find and analyze the various dimensions that affect a barrel cam rotation. Thus, the best dimension for the barrel cam design, according to time simulation criteria, seems to be the type 4 because the experiments durations are low whatever the environment step repetition and the product configuration.

The dimensional configurations were identified by a radius and a gap value. A set of users had to perform a task on the various environments and the duration of the task was recorded durations depending on the product configuration and on the environment.

Intuitively, we can anticipate that in case of big radius the motion should be very easy since it is close to a straight line. For clarity again, the data from Table 5-1, we have 6 dimensional configurations of a product (a barrel cam) tested on four

environments. Then we computed the average duration value of task for one configuration on every environment. We have created response answer surface to extrapolate for other configuration. The result for the environment 4 is plotted in Figure 5-11.

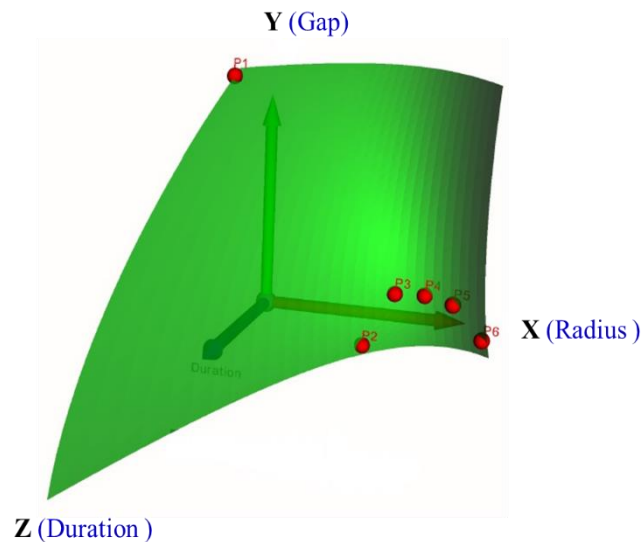

**FIGURE 5-11** Response answer surface for environment 4

The X axis defines the radius while the Y axis provides the Gap value. The third axis (Z axis) reflects the average duration of the task for every configuration. The green surface was built with the previous response answer construction. The relative error is about 0.7% which means that the measured point fits perfectly on this surface. The figure was normalized to get ranges of values for the measured points fitting a unit cube. By itself it does not provide much information even if we can state that duration of task is much more impacted by the gap parameter than by the radius.

The analysis may be repeated for every environment and we can build a virtual environment by taking the average values of the four environments. Then we obtain 5 surfaces : one per environment plus the average surface for every environment.

The five surfaces of the 6 dimensional configurations of a product (a barrel cam) tested on four environments are drawn on Figure 5-12.



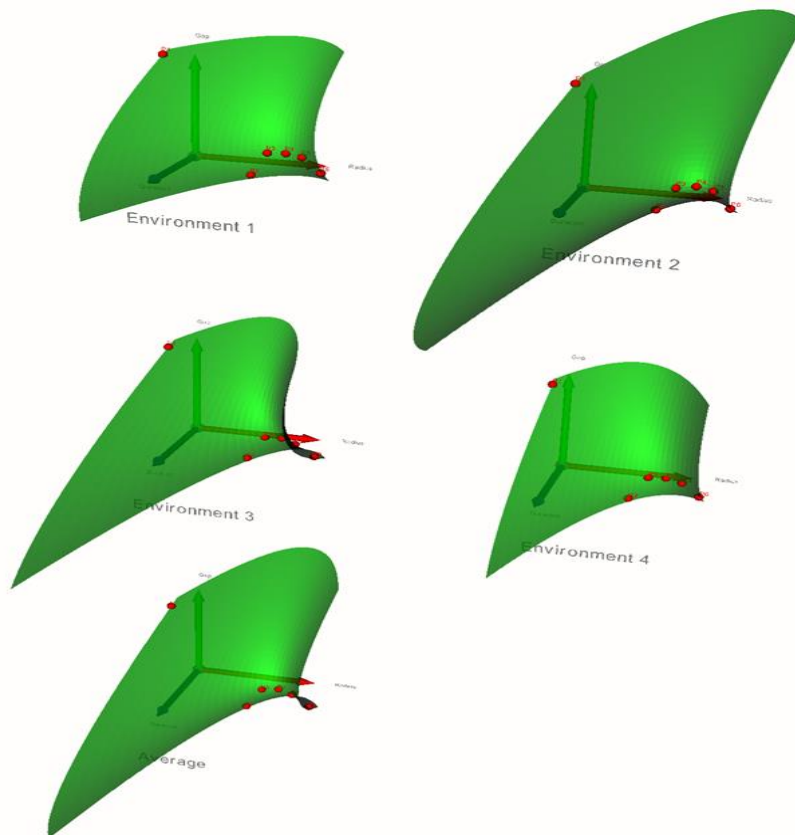

**FIGURE 5-12** Response answer surface for each environment + the average one

This figure opens interesting discussion points as following:

1. We must not care of the surface outside the unit cube. The extension of duration to negative values or high values does not make sense but the response surface may be valid close to the measured points, and it does not reflect 4 points but indeed 20 x 4 experiences

2. The shape is always the same: a kind of horse back. Gap seems to have much more influence on duration than radius.

3. For every environments the configurations have the same relative position. It seems that the results are not deeply dependent of the selected environment, but also it argues that the experience make sense. Results are definitely not randomized and there is thus a real dependence between gap, radius and task duration.

There is no theory to say which environment provides a duration in relation with the complexity of the physics. Anyhow, the response surface observation almost

demonstrates the experience quality. But indeed fast may fight quality. It would be necessary to associate the environment with the quality of the performed task : which environnement provides a correct surface. This result was not expected then a new experiment should be processed to measure this issue, and we did not have the capacity to make this new experience in the PhD project.

### 5.6.3 Experimental results of the gesture instability for 6 barrel cam types

In this section, the experimental results of the gesture instability are reported for the 20 participants and the four environments. The data from Table E-1 to Table E-24 of the APPENDIX E (instability sensor) are used to calculate the average values of every environments: the results are summarized in Table 5-3.

**Table 5-3** Experimental results of the gesture instability for the 6 barrel cam types

Environments	The type of barrel cam					
	Type 1	Type 2	Type 3	Type 4	Type 5	Type 6
Environment 1	0.425	0.420	0.450	0.433	0.402	0.436
Environment 2	0.467	0.454	0.426	0.519	0.473	0.510
Environment 3	0.408	0.393	0.428	0.445	0.435	0.437
Environment 4	0.496	0.439	0.468	0.466	0.462	0.510
Average	0.449	0.426	0.443	0.466	0.443	0.473

From the Table 5-3 above, the gesture instability values of all the environments and every types of the barrel cam is not much different. For better understanding, we had converted the gesture instability values from Table 5-3 data into the graphics of Figure 5-13. It may be noted that repetitions do not decrease the gesture instability values. Then it seems that there is no obvious learning or training effect whatever is the environment. Nevertheless, the graph on Figure 5-13 describes our experimental results.

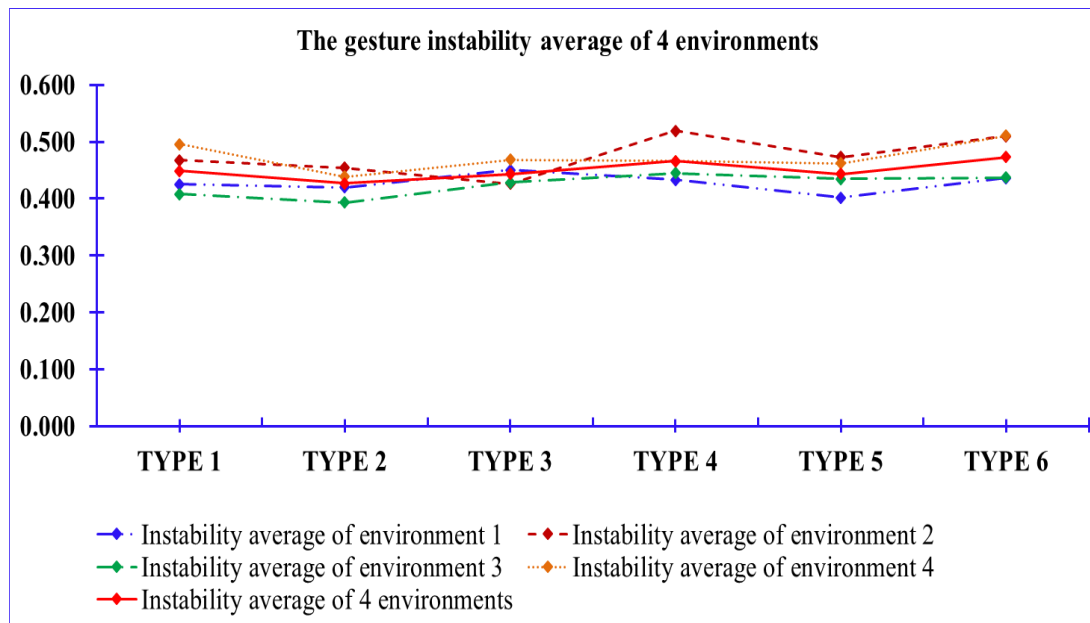

**FIGURE 5-13** The gesture instability graph of barrel cam six types for the four experimental environments

The best results are located under the red line (average values of all environments). Here, the third environment (The third environment consists of the haptic arm with force-feedback + non-stereoscopy + 2D wall screen) is the green line which seems to be the best result for the gesture instability. Furthermore, we want to find and analyze the various dimensions that affect a barrel cam rotation. It means that the value of the great gesture instability is under the average line. Thus, the perfect dimension for a barrel cam design is a barrel cam-type 4 because the several lines graph provides low gesture instability value: a low graph line means a lower gesture instability.

From the experimental results, we can choose the appropriate dimension of a barrel cam which is the fourth type. Again to ensure the accuracy for our experiment, we have assessed the 4 environments by use of *barrel cam-type 4* and the same experiment with 20 participants (details in Section 5.5.4).

#### 5.6.4 Analysis of the task duration results

In this section, the experimental results about the task duration of every environments issued from the Table F-1 of the APPENDIX F (raw result of the duration sensor) are reported. It reports the task duration for every environment

depending on the repetition of the task respect to the ten configurations tested by every user (the participant twisted the roll axis of the haptic arm to rotate 180 degrees per time order equal to 1 configuration and we will count the twisted clockwise or counterclockwise). The duration usually decreases while repeating the task unless the 10<sup>th</sup> average value for environment 1 is over the average value. This was due to a specific measure point that should be removed from the raw results. Then we can analyse a kind of basic learning.

**TABLE 5-4** The duration average values of four environments

Environments	Times order number										
	1	2	3	4	5	6	7	8	9	10	Average
Environment1	2.985	2.876	2.803	2.524	2.655	2.656	2.631	2.680	2.594	2.381	2.678
Environment2	2.864	2.670	2.794	2.569	2.644	2.532	2.657	2.493	2.713	2.400	2.634
Environment3	2.780	2.515	2.619	2.577	2.445	2.567	2.458	2.434	2.482	2.783	2.566
Environment4	2.605	2.568	2.606	2.462	2.558	2.382	2.542	2.557	2.602	2.451	2.533
Average	2.808	2.657	2.705	2.533	2.575	2.534	2.572	2.541	2.598	2.504	2.603

Anyhow the average duration from the Table 5-4 for each environment is very similar because the participant just twisted the roll axis of the haptic arm to rotate 180 degrees per time order which it was a short-term rotation and the task still remains simple. Anyhow, the best average duration is the lowest value which is reached with *the fourth environment* (The fourth environment consists of the haptic arm with force-feedback + stereoscopy + on the 3D wall screen). It confirms the experience from Chapter 4 and it seem, that haptics has a positive effect here. A good average duration is also reached with the third environment (a haptic arm with force-feedback + non-stereoscopy + on the 2D wall screen). Then comes the environment 2 with an average duration of 2.634s. The second environment consists of the haptic arm without force-feedback + stereoscopy + on the 3D wall screen. And at last the first environment consisting of the haptic arm without force-feedback + non-stereoscopy + on the 2D wall screen) reaches the higher average duration. Table 5-4 was converted into Figure 5-14 for another highlight of the figures: the red line is the average value of all environments.

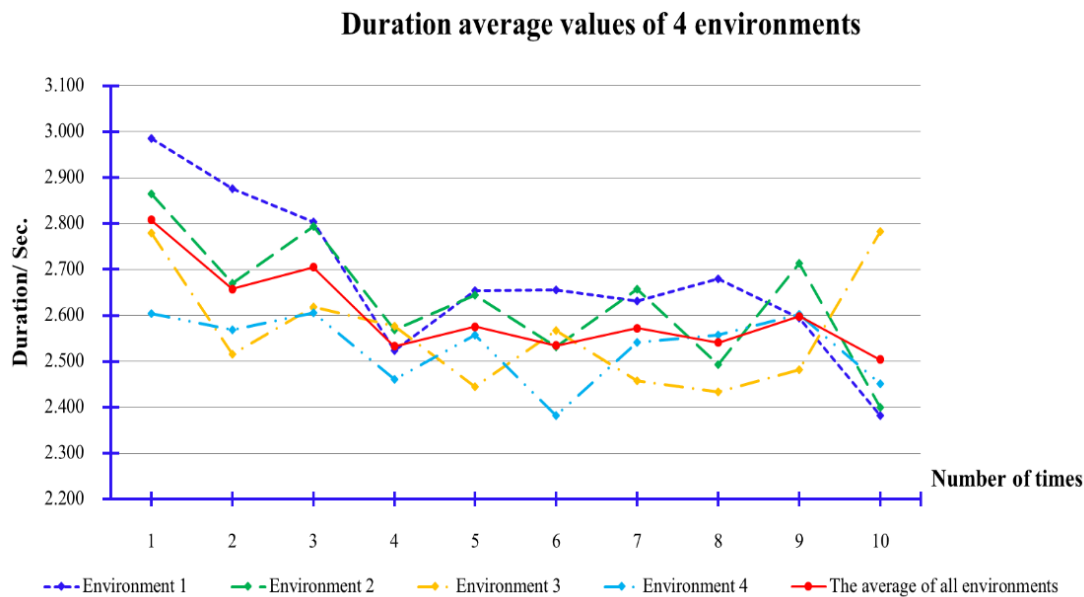

**FIGURE 5-14** The graph of duration average values of the 4 environments

The best results are located under the red line (average values of all environments). If we consider that the average value of the sky blue line is the lowest one, the fourth environment is the best for this activity respect to the single duration criteria.

#### 5.6.5 Analysis of the gesture instability values

In this section, the experimental results about the gesture instability are reported for the four environments. The data from Table F-2 of the APPENDIX F (instability sensor) are used to calculate the average values of each environment: the results are summarized in Table 5-5.

**TABLE 5-5** The gesture instability average values of four environments

Environments	Times order number										Average
	1	2	3	4	5	6	7	8	9	10	
Environment1	0.297	0.282	0.316	0.292	0.316	0.292	0.305	0.328	0.343	0.339	0.311
Environment2	0.343	0.299	0.307	0.352	0.341	0.324	0.354	0.326	0.323	0.321	0.329
Environment3	0.375	0.339	0.378	0.395	0.403	0.373	0.433	0.415	0.399	0.405	0.392
Environment4	0.381	0.370	0.375	0.366	0.427	0.364	0.406	0.438	0.381	0.403	0.391
Average	0.349	0.323	0.344	0.351	0.372	0.338	0.375	0.377	0.362	0.367	0.356

Once again instability average value does not vary so much respect to each environment: the barrel cam mechanism simulation activity of our experiment lasts a very short time about 3 seconds. Nevertheless the more instable experience are obtained with environment 3 and 4 which both use the haptic arm with force feedback. The force feedback constraint the gesture resulting in non-expected gestures from the user. Here again, stereoscopy does not provide an obvious added value (environment 2 and 4 respectively compared to environment 1 and 3).

For better understanding, we had converted instability data from Table 5-5 into the graphics of Figure 5-15. It may be noted that repetitions do not decrease instability. Then it seems again that there is no obvious learning effect whatever is the environment.

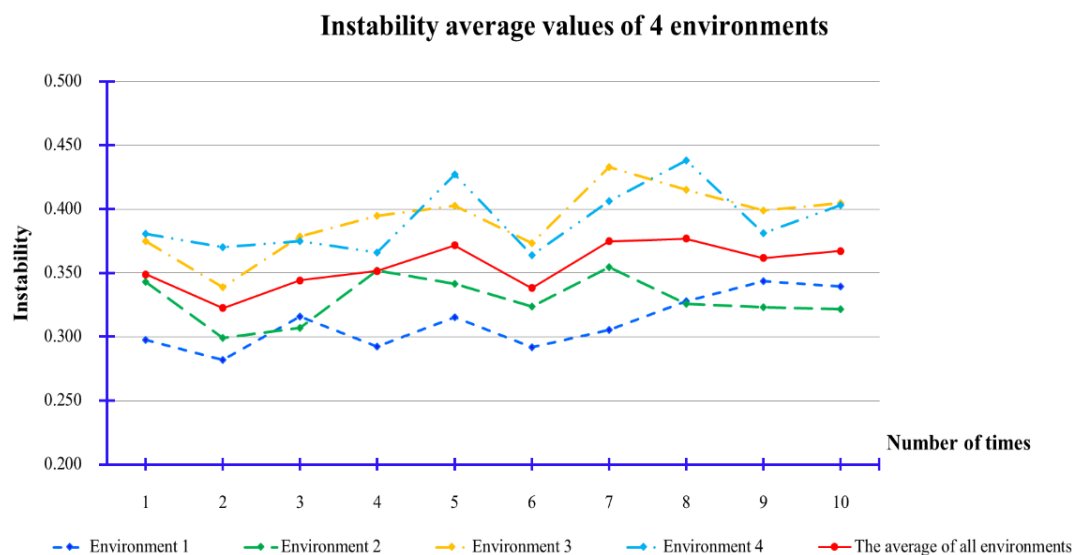

**FIGURE 5-15** The graph of the gesture instability values for the 4 environments

Figure 5-15 above, provides the red line as the average values of every environments. The best instability values of the virtual reality environment is the lowest graph and it is under the average line (red line graph). Assessing results of instable values for the four environments, it appears that the environment is unstable under the average line. The two best environments following this analysis are the first environment (The haptic arm without force-feedback + non-stereoscopy + on the 2D wall screen), and the second environment (The second environment consists of the

haptic arm without force-feedback + stereoscopy + on the 3D wall screen) which are the blue line and the green line graphs. Without force-feedback, the participant seems to find a simplest and more convenient control of movement direction of a haptic arm. To summarize briefly this assessment, the haptic arm without force-feedback is more stable than haptic arm with force-feedback. But for sure, we would like to assess the performance of virtual reality environment combining this result with other basic sensors but also with higher abstract criteria assessment of Section 5.7. Discomfort does not mean bad task quality.

#### 5.6.6 Finding quality of VR environment by check blocking configurations

In this context, we expect to assess the quality of the four virtual reality environments by the use of a barrel cam blocking model. The participants must be conducted to achieve the objectives under the three main conditions of the question as follows:

1. Will you be able to recognize and feel when a barrel cam is blocked ?.
2. Will you be able to see clearly the position of barrel cam when it was Blocked ?.
3. Will you be able to understand why it was blocked ?.

If an end user can answer correctly to these questions, then the VR environment will provide added value to the design task. This why we suggest to check this criteria as a quality assessment.

Conducting experiments in this respect, the participants attempted to rotate and to analyze the blocking issue of barrel cam by the use of 4 environments. The participants had to fill out the scores in the questions of the Table 5-6 when they had used all the four environments and complete the experiments. The status of score rating, the characteristics of weight rating for this experiment consists of the following: Excellent = 4, Well = 3, Fairly = 2, and Inefficient = 1.

The scores weight of the 30 participants applied to the 4 environments for the blocking issue of the barrel cam was recorded and are shown in Table 5-6.

**TABLE 5-6** The weight rating of the 30 participants by the used block model

The quality of the environments				
Participants	Environment 1	Environment 2	Environment 3	Environment 4
1	2	1	3	4
2	1	3	2	4
3	1	3	2	4
4	2	1	4	3
5	1	2	3	4
6	1	2	3	4
7	2	1	3	4
8	2	3	1	4
9	1	2	3	4
10	1	2	4	3
11	1	2	4	3
12	2	1	3	4
13	1	2	3	4
14	2	1	4	3
15	2	1	3	4
16	1	3	2	4
17	1	2	4	3
18	1	2	3	4
19	1	2	3	4
20	2	1	3	4
21	1	2	3	4
22	1	2	4	3
23	2	1	4	3
24	2	1	3	4
25	1	2	3	4
26	1	3	2	4
27	1	4	2	3
28	2	1	3	4
29	1	2	3	4
30	1	2	3	4
Minimum	1	1	1	3
Average	1.367	1.900	3.000	3.733
Maximum	2	4	4	4
STDEV	0.490	0.803	0.743	0.450



The quality of the environment is depending on the rating weight of the participants because we have no direct sensors to measure quality of virtual reality environments. The result seem very clear here. The best quality is reached with environment 4, then environment 3, 2 and the wrost is the environment 1. Both stereoscopy and haptic arm seem to improve quality. For this use case, environment 3 provides better quality than environment 2. We must conclude that for this case, haptic arm is more important than stereoscopy. In chapter 4, the contrary was concluded. Then it confirms that environment must be selected for every task.

#### 5.6.7 Comparison of basic sensor results

In order to conclude the experimental results about basic sensors as compared; the duration average of Table 5-4 and an instability average of Table 5-5 plus the quality environment average of Table 5-6 for every environments are combined and shown in Table 5-7.

**TABLE 5-7** Experimental results of the basic sensors combined with the quality value

Environments	Speedness/ Sec.	Stability	Quality
Environment 1	0.373	3.215	1.367
Environment 2	0.380	3.040	1.900
Environment 3	0.390	2.551	3.000
Environment 4	0.395	2.558	3.733
Average of all environments	0.384	2.810	2.500

For better understanding and comparison convenience, we convert experimental results of the basic sensor combined with the quality value data from Table 5-7 into the graphics as shown in Figure 5-16.

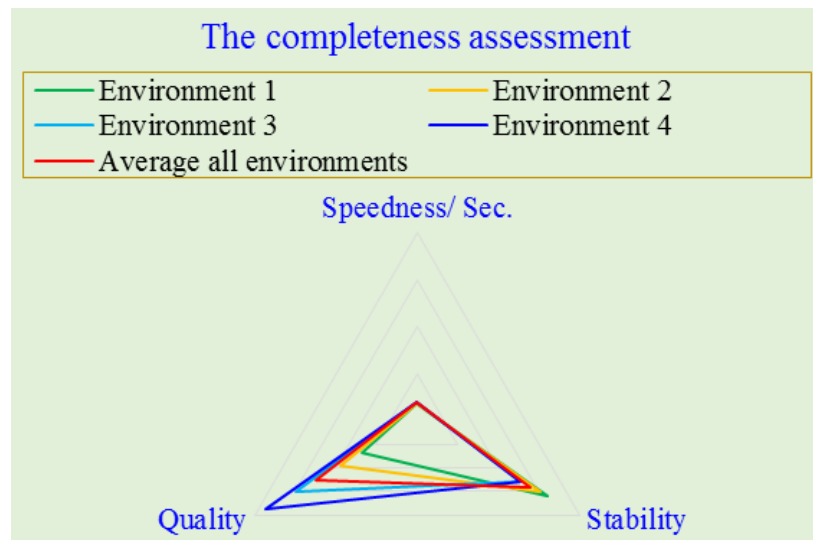

**FIGURE 5-16** The spider graph of the completeness assessment

The spider graph shown in Figure 5-16, provides the red line graph as the average values of every environments. The best completeness assessment values of the virtual reality environment is outside the average line (red line graph). The graph is summarized respect to three main conclusions:

1. *No speedness influence*, because the experiment activity remains very fast, no high difference can be perceive here.
2. *Respect to stability*, the first and second environments provide more stable gesture than the fourth and third environments.
3. *Respect to quality*, the fourth environments has the best quality value, the third environment is also a good quality environment. But the worst quality environment are the first and second environment.

Thus if the assessment is 3-folded (Speedness/ Stability/ Quality) the criteria have contradictory influence, and the environment selection will be a compromise.

### 5.7 High level abstract assessment

The high level criteria assessment are related to the overall performance assessment of virtual reality environment. It is less objective than basic sensors since it is related to participant feelings. In this case a questionnaire was built to be consistent with the barrel cam mechanism simulation assessment. In this section, a

link with hypothesis about virtual reality environments assessment which was previously mentioned in Section 2.4 is used. This link addresses abstract assessment level, as mentioned in Section 3.4.

A questionnaire was created and proposed to every user after their participation to the experience. The goal is to get feedback from the users about their feeling respect to Affordance, Ergonomic, Intuitiveness, Tangibility, and Tiredness but they are not aware of this goal. The questionnaire never uses these words but ask feeling as perceived by the user. In order to comply with the research question, we map the questions with the high level criteria by associating a weight to every question and for every high level abstract criteria: Tangibility, Affordance, Intuitiveness, Tiredness and Ergonomics.

Each question of the questionnaire is associated with a positive or negative weight to each criteria as shown in Table 3-1.

#### 5.7.1 Definition of criteria in conjunction with the questionnaires

To justify Table 3-1, we describe the definition of the relationship between criteria and the question of our questionnaires.

1. The first question about *easiness to capture the cone* means that the participant felt easy to capture the cone by the use of a haptic arm and that the action was suitable to operate on 2D or 3D wall screen. Hence, this question corresponds to intuitiveness and ergonomic, and has positive weights for both criteria.
2. The second question about *easiness to drive the system accordingly* means that the participant has a good understanding before to use an haptic arm to perform task or drive the system (rotating at the wrist of an haptic arm). When the participant goes straight forward. He should have positive feeling about affordance, tangibility, and intuitiveness. Then the positive weights were associated to these 3 criteria.
3. The third question about *the system providing blurred vision* means that the participant will experience visual discomfort during the experiment respect to the use or not of stereoscopy. The visual avatar should be less tangible and the user should feel tiredness.

4. The fourth question about *double-vision experience* means that the participant felt double-vision symptoms similar to the third question and thus similar with weight.
5. The fifth question about *visual perception why some configuration cannot work* means that the participant easy understand, why a barrel cam cannot work. The 3D visualization let him understand the issue. Hence, this question corresponds to intuitiveness and tangibility, with positive weight for both.
6. The sixth question about *preparation of the process before action* asks if the participant needs or not to prepare the process before action. Here, we mean that the participant easily understands the interface and easily uses the devices without specific preparation. Hence, this question corresponds to affordance and intuitiveness, with a positive influence for both.
7. The seventh question about *more explanations about how to drive the system* means that the participant has more difficulties to understand and to operate the environment. With this reason, the question corresponds to affordance and intuitiveness, and in this case has negative influence for both.
8. The eight question about *vertigo* means that the participant felt vertigo. This is related to discomfort and we linked it also to tiredness.
9. The ninth question about *the respective limit positions of the mechanism* means that the participant was able to recognize and feel the barrel cam blocking by the use of CVE environment. This is related to tangibility and affordance.
10. The tenth question about *system correspondness to the task* means that the participant has good feeling about the possible improvements for the barrel cam system to avoid blocking situations, when they employed the related VR environment. So they could easily understand, or percieve the system behaviour. The VR environment is user friendly and convenient to operate and they do not feel tiredness with this system.

11. The eleventh question about *easiness to identify criteria to decide if the system works or not* means that the participant could easily understand how to perform the technical task. This is related to affordance and intuitiveness.
12. The twelfth question about *how to achieve the expected task* means that the participant did not have to check out how to accomplish the mission expected. This is once again related to affordance and intuitiveness.
13. The thirteenth question about *avatar selection* means that the participant may have difficulties for the perception but easily uses the interaction: the haptic arm.
14. The fourteenth question about *any experience of some blurred vision after a while*. This question is related to tiredness and thus its weight has a positive value.
15. The fifteenth question about *feeling evolving contrast* means that the participant see clearly 3D model on 2D and 3D wall screen. It is a positive for tiredness.
16. The sixteenth question about *stress in the eyes* when the participant has used stereoscopy for veiwing on 3D wall screen. It also influences tiredness.
17. The seventeenth questionnaire, about "*increasing anxiety*" means that the participant felt excited and anxiously when he conducts the experiment. Here again, this question may only correspond to tiredness criteria.
18. The eighteenth question about *lack of luminance* means that the participant felt too much darkness when he looks to 3D object. He might feel eye fatigue because it results iris's hard work. It causes the perceived less brightness and causes fatigue.
19. The nineteenth question about *expectation to sit down*. If the participant need to sit down that mean the working in a standing position for him is inappropriate. If he works for a long time, it can cause fatigue. It is these related both to tiredness and ergonomics.

20. The twentieth question about articulations at limit position and angles means that the participants often blocked against the limit positions and angles of the haptic arm when they rotated the wrist of a haptic arm with force feedback. So they had to move back a while before continuing the movement. This is clearly related to ergonomics.
21. The twenty-first question “How many time could you stay working with the environment” assume it is posible to be exhausted. It is once again related to Tiredness and ergonomics.
22. The twenty-second and last question “Which is the more comfortable environment” means that the participant has felt more comfortable with this environment and can choose the VR environment that can work well. It should be clearly related to tiredness and ergonomics.

Every user is expected to answer the 22 questions in Eckert scale format: from 0 to 4 respectively *Not, Less, Medium, Very, Very much*. Then combining the weight and scores we create a score for the abstract level criteria.

As stated in the experience protocol participant were using every environment in a random order and they answered the questionnaire after the experiment is completed, for every environment filling a checkmark or a crosshairs in the rectangular space. Basic sensors are recorded automatically. When each participant has filled the questionnaire, experimental results are converted to global scores for convenient statistical analysis. We analyze the corresponding results through the following function: Minimum, Average, maximum, and the standard deviation value.

Every result (from the 30 Participants) are reported in the appendix F and G and are analyzed in the next section.

## **5.8 Analysis of the questionnaire**

This section analyses experimental results of the performance assessment of VRE through the high level criteria of the environment 1 to environment 4. The raw results are reported in appendix G. Experimental results of appendix G can be converted into scores as presented in table H-1 to H-4 of appendix H. The questionnaire as shown in Table 5-8 (is an example of row questionnaire filled by the first participant).

**TABLE 5-8** the questionnaire of the first participant

No,	Questions	Environment1				Environment2				Environment3				Environment4			
		Very much	Very	Mediu	Less	Not	Very much	Very	Mediu	Less	Not	Very much	Very	Mediu	Less	Not	
		4	3	2	1	0	4	3	2	1	0	4	3	2	1	0	
		0	1	2	3	4	0	1	2	3	4	0	1	2	3	4	
1.	Was it easy to capture the cone ?																
2.	Was it easy to drive the system accordingly ?																
3.	Was the system providing blurred vision ?																
4.	Did you experienced double-vision ?																
5.	Did you perceive visually why some configuration cannot work ?																
6.	Did you prepare the process before action ?																
7.	Would you have expected more explanations about how to drive the system ?																
8.	Did you felt vertigo ?																
9.	Did you search the limit respective positions of the mechanism ?																
10.	In your opinion was the system adapted to the task ?																
11.	Did you find easily the good criteria to decide if the system works or not ?																
12.	Did you investigate how to achieve the expected task ?																
13.	When selecting the hand avatar did you elaborate any strategy ?																
14.	Did you feel some blurred vision after a while ?																
15.	Did you feel the contrast evolving ?																
16.	Did you felt some stress in the eyes ?																
17.	Did you fill increasing anxiety ?																
18.	Did you felt a lack of luminance ?																
19.	Would you expect to sit down ?																
20.	Did you felt your articulations at limit position and angles ?																
21.	How many time could you stay working with the environment ?	0.30h	1.00h	1.30h	2.00h	2.30h	0.30h	1.00h	1.30h	2.00h	2.30h	0.30h	1.00h	1.30h	2.00h	2.30h	
22.	Which is the more comfortable environment ?																

Environment 1 = Non-Stereoscopy + Non-Force feedback  
 Environment 2 = Stereoscopy + Non-Force feedback  
 Environment 3 = Non-Stereoscopy + Force feedback  
 Environment 4 = Stereoscopy + Force feedback

Participant: *01*

- How do you feel, when you look at 3D object on the 2D wall screen by Non-Stereoscopy and stereoscopy ?  
 - How do you feel and how do you think about the haptic arm application, when do you use a haptic arm to manipulate 3D object on the 2D screen by using a haptic arm with Non-force feedback and force feedback ? (Answer the question by filling in the spaces marked 'x' in the table)

The last phase of the experiment aims at defining the high level criteria assessment for the all environment. During this phase the participants have to express their feeling after they have completed the experiment for each environment by filling in the questionnaires (The participant must answer the 22 questions).

Furthermore, the five categories of high level criteria (see Section 2.4) are calculated to determine the average values for each environment by taking the average value of each high level criteria proposed by all participants for this environment divided by the number of each high level criteria. It is expressed by the equation:

$$\text{HLCA} = \text{SA} / n \quad \text{Eq. (5-1)}$$

HLCA is the high level criteria (HLC) average values for each category, the sum average value of each high level criteria was represented by SA, and n is the number of questions related to the considered HLC. In order to make it easier to understand and calculate, it has been divided into five categories:

1. The tangibility is measured through question: 2, 3, 5, 9, 10, and 18 which is the

SA /n (n = 6 questions).

2. Affordance was measured by the question: 2, 6, 7, 9, 10, 11, 12 and 13 which is the SA /n (n = 8 questions).

3. Intuitiveness was measured by the questions: 1, 2, 5, 6, 7, 10, 11, 12, and 13 which is the SA /n (n = 9 questions).

4. Tiredness was measured by the questions: 3, 4, 8, 10, 14, 15, 16, 17, 18, 19, 21, and 22 which is the SA /n (n = 12 questions).

5. Ergonomic was measured by the questions: 1, 10, 18, 19, 20, 21, and 22 which

is the SA /n (n = 7 questions).

That also means that the questionnaire is not perfect. The five criteria are not analyzed with the same focus and some question could be re-formulated. But indeed the experience is reported as it was executed, and its process could be repeated. Lack of time is the main reason why the questionnaire was not improved.



The new average values for the high level criteria assessment of all the environments was divided into five categories such as Affordance, Ergonomic, Intuitiveness, Tangibility, and Tiredness. It was detailed in Table H-1 to Table H-4 of appendix H and the new average values of all environment as shown in Table 5-9.

**TABLE 5-9** The average values of the high level criteria assessment

Environments	Affordance	Ergonomic	Intuitiveness	Tangibility	Tiredness
Environment 1	2.183	2.498	2.174	2.006	0.711
Environment 2	2.183	2.538	2.200	2.294	1.311
Environment 3	2.196	2.595	2.337	2.272	0.869
Environment 4	2.158	2.286	2.370	2.478	1.211
Average values	2.180	2.479	2.270	2.263	1.026

For better understanding, we had inverted the average value of *Tiredness* to get *easyness* value noted (In), If Tiredness is noted (Ti), then (In) is expressed by the following simple equation.

$$In = 1 / Ti \quad \text{Eq. (5-2)}$$

Once again, we are required to transform the all average values of tiredness into the average values of the easyness criteria for all environments are shown in Table 5-10.

**TABLE 5-10** The experimental result of the high level criteria assessment

Environments	Affordance	Ergonomic	Intuitiveness	Tangibility	Easyness
Env. 1	2.183	2.498	2.174	2.006	1.406
Env. 2	2.183	2.538	2.200	2.294	0.763
Env. 3	2.196	2.595	2.337	2.272	1.151
Env. 4	2.158	2.286	2.370	2.478	0.826
Average values	2.180	2.479	2.270	2.263	1.037

For better understanding and for comparison, we have converted experimental results of the high level criteria assessment data from Table 5-8 into the graphics as shown in Figure 5-17.

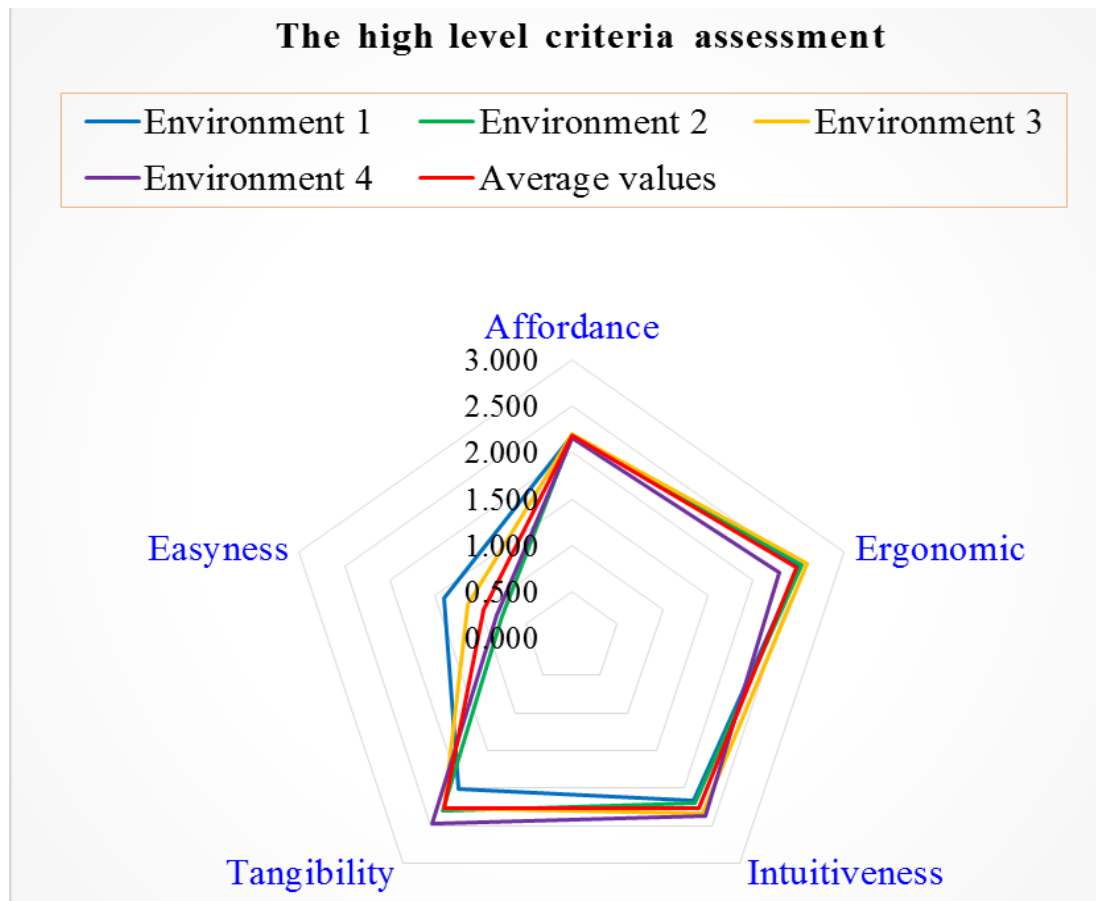

**FIGURE 5-17** The spider graph of the high level criteria assessment

The spider in Figure 5-17, includes the red line as the average values of every environments. The best result of the virtual reality environment assessment is outside of red lines graph. On the other hand, the worst result of the virtual reality environment assessment is inside the red lines graph. It's rather difficult to draw definitive conclusions from the complete experiment. However, we can summarize the main results as following:

1. Affordance criteria: every environment seems to have a very similar affordance. Here affordance was not effective. Surely, the task simplicity, with few explanation minimizes affordance impact.

2. *Ergonomics criteria*: environment 3 has the best ergonomic score and then the force feedback (of environment 3) seems to be the main parameter influencing ergonomics for this task, even if stereoscopy remains an important parameter (environment 2). Here the conclusion of chapter 4 is inverted. We conclude that assessment is highly task dependent.

3. *Intuitiveness criteria*: a good 3D perception (stereoscopy) + haptic feedback make the environment more intuitive respect to the current task. Here again force feedback has a more positive impact than stereoscopy.

4. *Tangibility criteria*: we have a similar conclusion as for intuitiveness here. If environment 1 is the easiest one, it fails to be convinced for all other criteria. It demonstrates the interest to get a multi-folded analysis.

## 5.8 Conclusion

We summarize our experiments results as follow:

1. *The stability assessment*, demonstrates that the use of a haptic arm without force-feedback combined with non- stereoscopy (environment 1) is more stable than the use of a haptic arm without force-feedback combined with stereoscopy (the second environment) which is stable for rotation simulation task.

2. The quality assessment demonstrates that the use of a haptic arm with force-feedback combined with stereoscopy (environment 4) provides more quality. Environment 3 provides also a good quality because force-feedback supports recognition of blocking cases.

With these few results, no generic conclusion can be made since the results appears to be highly task dependent. Anyhow, it can be searched if we can find links between low level objective sensors, and high level abstract sensor. In chapter 6, we propose a general conclusion discussing this potential link to be confirmed as a perspective work.

## CHAPTER 6

### DISCUSSION, CONCLUSION AND PERSPECTIVES

*This chapter, concludes our thesis the performance assessment of virtual reality environment. This research mainly consists in two case studies: the first case study is a screw assembly process by the use of a sub-part of jig & fixture (Chapter 4) and the second case study concern the rotation simulation a barrel cam system (Chapter 5).*

*For the two experiments, we employed low level basic sensors. For the second use case we also assessed high level abstract criteria. High level abstract criteria remains subjective. It would be a real added value to deduce high level assessment from the low level sensors. We did not achieve this goal, but we start to discuss such a link here.*

#### **6.1 Discussion**

From the experiment described in Chapter 4 we described and analyzed the raw results from objective basic sensors consisting of duration or speedness, instability or stability, and quality to achieve the task in term of docking accuracy. For this experiment, we have chosen to use a sub-part of jig & fixture for the screw assemblies task.

Meanwhile, experimental analysis in the Chapter 5 followed the same kind of procedures with basic sensors as in Chapter 4. In addition, Chapter 5 adopts extra questionnaires and provided measures about abstract assessment of the virtual reality environments. In this last chapter, before an overall conclusion and perspectives the potential link between basic sensors and abstract assessment is discussed. For this purpose, we draw in the three following figures the evolution of abstract assessment criteria respect to the values of speedness, quality and stability coming from the barrel cam rotation -simulation task. The overall experimental results is a combination of the objective basic sensors from Table 5-7 combined with the high level criteria assessment

from Table 5-11 as reported in Table 6.1

**TABLE 6-1** Summary of sensors and abstract assessment marks for every environments.

Environments	Objective basic sensors			Abstract assessment criteria respects				
	Speedness	Stability	Quality	Affordance	Ergonomic	Intuitiveness	Tangibility	Easyness
Environment 1	0.373	3.215	1.367	2.183	2.498	2.174	2.006	1.406
Environment 2	0.380	3.040	1.900	2.183	2.538	2.200	2.294	0.763
Environment 3	0.390	2.551	3.000	2.196	2.595	2.337	2.272	1.151
Environment 4	0.395	2.558	3.733	2.158	2.286	2.270	2.263	0.826

For better understanding, we have converted the influence from objective basic sensors onto the abstract assessment criteria from Table 6-1 into the graphics by the classification of the objective basic sensors into three groups as follows; 1) Influence of speedness over abstract assessment criteria, 2) Influence of quality over abstract assessment criteria and, 3) Influence of stability over abstract assessment criteria. For each figure the environments are sorted to get increasing values of the basic sensor.

The first comment is that the evolutions are not always significant and the analysis is sometimes difficult. Three types of curves can be observed:

1. Flat horizontal curves: the basic sensor does not seem to have influence on the abstract assessment level.

2. Monotonous curve: decreasing or positive influence of the basic sensor on the abstract assessment level.

3. Oscilating curves: no conclusion can be made from these curves.

Influence of speedness over abstract assessment criteria: we consider the *speedness* measured with basic sensors in relation with the high level abstract assessment criteria of four environments. This relation is shown in Figure 6-1.

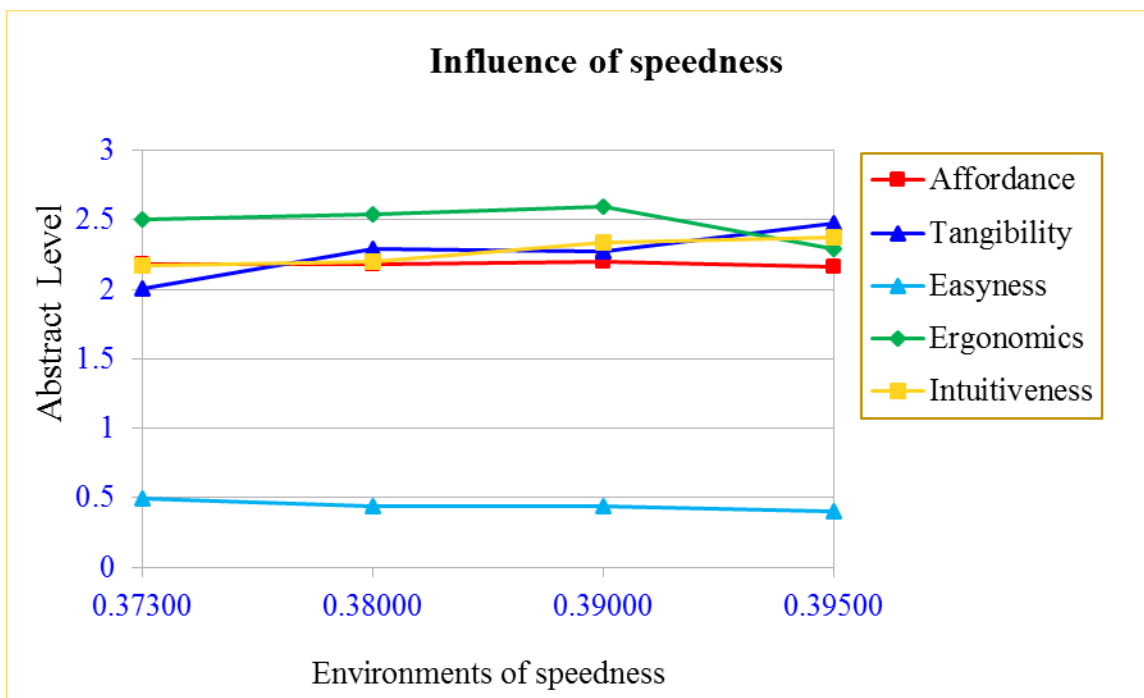

**FIGURE 6-1** Influence of speedness over abstract assessment criteria

On the graph from Figure 6-1 above, the two monotonously increasing curves show the influence of speedness on tangibility and intuitiveness, especially for the first environment. The other curves are more or less constant, except for ergonomics that seems a bit worse for the fourth environment than with other environments, but with no clear relation with speediness evolution.

About influence of quality over abstract assessment criteria: here *the quality* issued from objective basic sensors is linked to the high level abstract assessment criteria of four environments. The relation is shown on Figure 6-2.

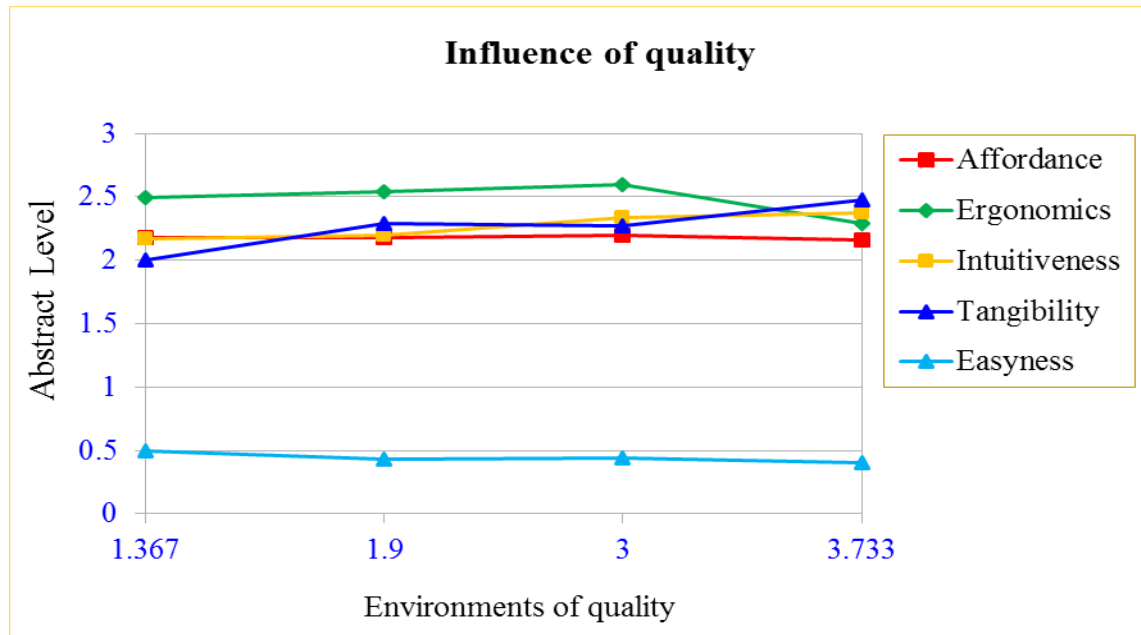

**FIGURE 6-2** Influence of quality over abstract assessment criteria

On the graph from Figure 6-2 above, the evolutions are very similar to the curves of Figure 6-1 and a similar analysis is made. The monotonously increasing curves show that tangibility and intuitiveness are positively influenced by quality as defined in our experiment, and no clear influence can be observed about quality on the other abstract assessment criteria.

About influence of stability over abstract assessment criteria: we consider the stability issued from basic sensors regarding the high level abstract assessment criteria of the four environments as shown in Figure 6-3. On the graph from Figure 6-3, ergonomics is not a monotonous curve here. It seems to be no clear monotonous influence of stability on any high level criteria, except may be a tendency to decrease intuitiveness and tangibility. But of course, the number of 4 environments tested is probably too small to provide a strong tendency. We could read “unstable environment lead to more intuitive and tangible environments”.

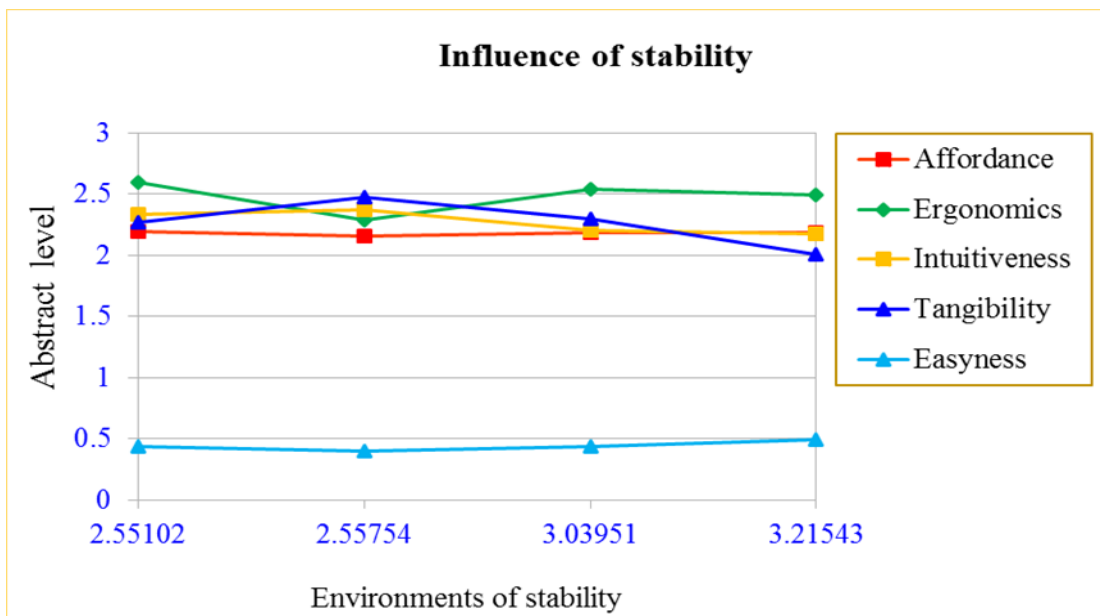

**FIGURE 6-3** Influence of stability over abstract assessment criteria

Observation of curves lets create Table 6-2 where the tendency of the high level criteria respect to the basic sensors is reported.

**TABLE 6-2** Influence tendencies of high level criteria respect to the basic sensors

	Speedness	Quality	Stability
Affordance	–	↓	–
Ergonomics	?	?	?
Intuitiveness	↑	↑	↓
Tangibility	↑	↑	?
Easyness	↓	↓	?

**Legend:** – : No influence,                    ? : No obvious influence  
 ↑ : Increasing influence,    ↓ : Decreasing influence



In any case the number of tested environments (4) is too small to draw definitive decisions but the discussion has the interest to be the first tentative to create this link. To go forward, experiences increasing the basis of basic sensors and the number of environment could help to create a better link between the basic level and the abstract assessment level.

## **6.2 Overall conclusion**

For the experimental result of the first use case (screws insertion activity within a sub-part of jig & fixture). 40 participants were recruited for the performance assessment of 3D visualization and interaction devices for screw assemblies in the hole by randomized manipulation on 4 environments. The results have been classified and summarized according to docking quality, task duration, and gesture instability.

Concerning the overall results from this experiment, we can tell which environments suits best the expected task. Nevertheless the experimental results do not present big differences, and this may be due to the relatively short time of our experiment as for screws assembly activity, the initial position of the screws were not so far from the holes. Furthermore, the experience remained very simple. For Chapter 4 experiment, we would need to continue towards higher level criteria leading to evaluate affordance, ergonomics, intuitiveness, tangibility, and or tiredness of the virtual reality system. In addition, the use case should be slightly complicated to provide more confidence.

The second use case concerns the simulation of the activity about a barrel cam system. It is finally expected to evaluate and compare the performance of the virtual reality environment systems in this particular context, by the use of high level abstract assessment technique combined with some of the previous low level sensors.

Thirty participants have been involved in this experience where both basic sensors were captured and high level assessment was conducted through a questionnaire. The overall results from this experiment, tells that environment 3 and 2 appear to be the most suitable for a barrel cam rotation simulation activity, which means that using non-stereoscopy and a haptic arm without force feedback are stable, fast, and provide a good

quality for this use case. Our experiments is still incomplete especially the second case study to rotate simulation of the barrel cam by the use of high level abstract assessment criteria because it has no sensor directly involved to assess high level performances in virtual reality environment.

Some people did not understand the meaning of certain questions in the questionnaires. It affects answers quality and leads to experimental result discrepancies. In addition, experiment was executed in very short delay. It affected the results we can expect, as it did not allow a wide variety in either users behaviors, nor in sensors measurements.

### **6.3 Perspectives**

From the previous conclusion it appears for the next steps of this research, should be the design of an experiment that takes more time and should select a more difficult and more complicate case study.

Furthermore, some sensors should be used for human feelings evaluation. We could think about sensor-based measurements used in human medicine such as sensors able to measure the muscle activities, to evaluate tiredness through heart or brain activities, or eyes movements such eye tracking technologies, or other sensory perception.

The advancement of virtual reality technology becomes very popular. Especially, the application of such technology in various professions such as engineering, education, medicine, military, and others. Here, we focus on the key applications of engineering and education. The virtual reality technology is only used by engineers or designers in the automotive and aerospace factories of developed countries. As I am from Thailand, we have automotive manufacturing plants but we have no factories that produce vehicles using these technologies yet. Virtual reality technology is a new alternative for engineers or designers who work in automotive manufacturing plants for Thailand. I sincerely hope, that the application solutions and experiments I have done at G-SCOP laboratory will show important reasons and help me convince institutional, industrial, and academic

partners, so that the Thai government or Thai factories are encouraged to use this technology in a company or factory. Furthermore, I expect we shall widely use this technology in educational institutions or universities in Thailand as well.

To a whole advance level of virtual reality technology should be focusing on engineering tolerance and friction by the use of computer aided engineering (CAE) combined with virtual reality environment to produce rapid prototypes and tooling.

In addition, Thailand's industry is currently guided by The National Industrial Development Master Plan (2012-2031), the vision of which is to attain innovative, well-balanced, and sustainable industrial sector, summarized as follows:

- (1) knowledge-based industry (2012-2016), to build a strong foundation throughout the value chain by improving regulations, laying down efficient structures for raw materials and labour, developing industrial clusters, and creating Association of Southeast Asian Nations (ASEAN) supply chain in preparation for the Asean Economics Community (AEC).
- (2) innovative industry (2012-2021), to adopt more advanced technology and to innovate products and services in response to customers' needs and enhance sectors' competitiveness.
- (3) sustainable industry (2012-2031), to become not only creative but also green economy by taking into account adverse social and environmental impacts, and at the same time promoting Thai brands to gain global recognitions.

From the above mentioned, we refer to The National Industrial Development Master Plan of Thailand 2012-2031 (Trade policy review, 2015). We will apply virtual reality technology to innovative industry (2012-2021) which can be applied in various industries.

## BIBLIOGRAPHY

- Abdulrahman M Al-Ahmari et al. "Development of a virtual manufacturing assembly simulation system". *Advances in Mechanical Engineering*". Special Issue Article. DOI: 10.1177/1687814016639824. (2016) : 1-13.
- Abdulmalik Yusuf Ofemile. "Assessing Affordances of Selected Cloud Computing Tools for Language Teacher Education in Nigeria". *Journal of Education and Practice*. ISSN 2222-1735, Volume 6, No.3 (2015).
- Abouel Nasr, et al. "Virtual Assembly in a Semi-Immersive Environment". *Journal of Mechanical, Aerospace, Industrial, Mechatronic and Manufacturing Engineering*. Volume 7, No. 2 (2013).
- Alan Hobbs. "An overview of human factors in aviation maintenance". Australian Transport Safety Bureau. ISBN 978-1-921490-93-4, AR-2008-055, (2008).
- A. Lehr. "De Geschiedenis van het Astronomisch Kunstuurwerk". Den Haag. (1981) : 227.
- Alhussein Albarbar, et al. "Suitability of MEMS Accelerometers for Condition Monitoring: an experimental study". *Sensors*. ISSN 1424-8220, (2008): 784-799.
- Alicia Farmer. "Perceptions of Undergraduate Students Towards the Use and Application of Virtual Reality Technologies in the Classroom". (2016).
- Amandeep Kouris. "a Survey on Virtual World". *International Journal of Scientific and Research Publications*. Volume 5, Issue 4, ISSN 2250-3153, (2015).
- Andreas Athanasopoulos, et al. "GPU Acceleration for Support Vector Machines". 12<sup>th</sup> International Workshop on Image Analysis for Multimedia Interactive Services (WIAMIS 2011). (2011).
- Andreas Kunz and Konrad Wegener. "Towards Natural User Interfaces in VR/AR for Design and Manufacturing". *Institute of Machine Tools and Manufacturing*. (2013).
- Andreas Kunz et al. "Real walking in virtual environments for factory planning and evaluation". 6<sup>th</sup> CIRP Conference on Assembly Technologies and Systems (CATS). *Procedia CIRP* 44 (2016) : 257 – 262.

- Andrew Uerkwitz and Martin Yang. "Virtual Reality Industry Report". Oppenheimer & Co Inc. (2015).
- Andrzej Marek Lasota. "Packer's Workload Assessment, Using the OWAS Method". Logistics and Transport. No. 2 (18). (2013) : 25-31.
- Anil P Sarode and Manisha Shirsath. "The Factors Affecting Employee Work Environment & It's Relation with Employee Productivity". International Journal of Science and Research (IJSR). Volume 3 Issue 11, (2014).
- Anthony Vetro, et al. "Towards a 3D Video Format for Auto-Stereoscopic Displays". Mitsubishi Electric Research Laboratories. (2008).
- Arjan J. F. Kok and Robert van Liere. "A multimodal virtual reality interface for 3D interaction with VTK". Knowledge and Information Systems. (2007).
- Atamney, Mc.L. & Corlett, E.N.RULA. "a Survey Method for the Investigation of Work Related Upper Limb Disorders". Applied Ergonomics. (1993) : 91-99.
- Atsuo Murata. "Effects of Duration of Immersion in a Virtual Reality Environment on Postural Stability". International Journal of Human-Computer Interaction. Volume 17(4). (2004) : 463-477.
- Avishekhar Roy. "The Android Game Developer's Handbook". Packt Publishing. ISBN 9781785885860 (2016).
- Bakker, H. L. Chechurin, W. Wits. "Integrating TRIZ Function Modeling in CAD Software". (2011).
- Barry K. Mills. "Virtual reality: From WoW to the Real World". The Boston Company. (2016).
- Behrang Parhizkar, et al. "Motion Detection Real Time 3D Walkthrough in Limkokwing University of Creative Technology (Modet-Walk) using Kinect Xbox". (IJCSI) International Journal of Computer Science Issues. Volume 9, Issue 6, No 2 (2012).
- Ben Tzion Karsh et al. "The Science of Human Factors: Separating Fact from Fiction". Quality and Safety in Health Care. (2013) : 1-8.
- Bergmann Tiest and W.M. "Cues for Haptic Perception of Compliance". IEEE Transactions on Haptics. (2009) : 189-199.

- Billingshurst M., et al. "Asymmetries in Collaborative Wearable Interfaces; Asymmetries in Collaborative Wearable Interfaces". Conference: Wearable Computers. 1999.
- Bireswar Laha, et al. "Effects of VR System Fidelity on Analyzing ISO Surface Visualization of Volume Data sets". IEEE Transactions on Visualization and Computer Graphics. Volume 20, NO. 4 (2014).
- B.N. Sindhu Tejaswini and B.Anuradha Srinivas. "Augmented Reality An Exciting Experience of Real World in Future" International Journal of Combined Research & Development. ISSN : 2321-225X; ISSN : 2321-2241 Volume 3; Issue 1, (2014)
- Bowman D. A., et al. "Higher Levels of Immersion Improve Procedure Memorization Performance". Joint Virtual Reality Conference of EGVE–ICAT–EuroVR. (2009).
- Brett R. Fajen, et al. "Information, affordances, and the control of action in sport". Int. J. Sport Psychol. (2008) : 79-107.
- Brian Allen, et al. "Visual 3D motion acuity predicts discomfort in 3D stereoscopic environments". Entertainment Computing, Elsevier journal. Volume 13, (2016) : 1-9.
- Brian Pitz, et al. "Interactive Entertainment PlayStation VR and an Update from the Game Developers Conference". Jefferies US Interactive Entertainment. (2016).
- Brian Whitworth. "The Physical World as a Virtual Reality". Brian Whitworth Massey University, Albany, Auckland, New Zealand. CDMTCS-316. (2007).
- Carrol J.M. "Human-Computer Interaction: Psychology as a Science of Design". Annul Rev., Psychol. (1997) : 61–83.
- Charles Herold. "Could Nintendo Be Planning 3D Home Console Gaming". About.com Tech. (2015).
- Charles N. Jeffress. "Biodynamics and Ergonomics Symposium". University of Connecticut, Farmington, Conference. (2000).
- Christopher J. Turner et al. "Discrete Event Simulation and Virtual Reality Use in Industry: New Opportunities and Future Trends". Browse Journals &

- Magazines. *IEEE Transactions on Human-Machine Systems*, Volume 46, Issue: 6, (2016).
- Cheng, et al. "ATP-dependent Pre-replicative Complex Assembly is Facilitated by add in Budding Yeasts". *Journal Futile Research Support*. (2010).
- Christopher Brandl et al. "A new concept to support the ergonomic intervention process based on an analysis of working postures with OWAS". *Proceedings 19<sup>th</sup> Triennial Congress of the IEA*. (2015) : 1-8.
- Clayes S., et al. "Clinical Evaluation of a Single Daily Dose of Phenylpropanolamine in the Treatment of Urethral Sphincter Mechanism Incompetence in the Bitch". *Canadian Veterinary Journal* 52(5), (2011) : 501- 505.
- Cooper N, Forrest K, Cramp P. "Essential Guide to Generic Skills". Malden, MA, Blackwell. (2006).
- C. Pontonnier et al. "Cutting Force and EMG Recordings for Ergonomics Assessment of Meat Cutting Tasks: Influence of the Workbench Height and the Cutting Direction on Muscle Activation Levels". *ASME 2012 11th Biennial Conference on Engineering Systems Design and Analysis Volume 4*, (2012).
- C. Trakunsaranakom et al. "Assessment of Virtual Reality Environments for Design Activities". *Conference and Exhibition of the European Association of Virtual and Augmented Reality : EURO-VR 2014*, (2014).
- Dalma Geszten, et al. "Qualitative analysis of user experience in a 3D virtual Environment". *ASIST 2015*. (2015).
- Darren Edge and Alan F. Blackwell. "Peripheral Tangible Interaction by Analytic Design". *The Third International Conference on Tangible and Embedded Interaction (TEI'09)*, (2009).
- Dave Their. "Sony Announces Project Morpheus Virtual Reality Headset for PS4". (2014).
- David Sir Brewster. "The Stereoscope; its History, Theory, and Construction, with its Application to the Fine and Useful Arts and to Education: with Fifty Wood Engravings". (1856).

- Deborah, J. Mayhew. "The Usability Engineering Lifecycle: a Practitioner's Handbook for User Interface Design". San Francisco, Calif: Morgan Kaufmann Publishers. ISBN-978-1558605619, (1999).
- Diana Pagliari and Livio Pinto. "Calibration of Kinect for Xbox One and Comparison between the Two Generations of Microsoft Sensors". Sensors. ISSN 1424-8220, (2015).
- Dima Al Madani and Awwad Dababneh. "Rapid Entire Body Assessment: A Literature Review". American Journal of Engineering and Applied Science. Science Publications. (2016) : 107-118.
- Divya Singla and Luv Mendiratta. "ANDROID VS IOS". International Journal of Innovative Research in Technology. ISSN : 2349-6002, Volume 1, Issue 5, (2014).
- Donghao Ren, et al. "Evaluating Wide-Field-of-View Augmented Reality with Mixed Reality Simulation". IEEE Virtual Reality Conference, Greenville (2016).
- D. Weidlich et al. "Virtual reality approaches for immersive design". International Journal on Interactive Design and Manufacturing. Volume 3, Issue 2, (2009) : 103-108.
- Eberts, R.E. "User Interface Design". NJ: Prentice-Hall. (1994).
- Edwin E. Mayer. "Stating History of Sawyers". Int. The Morris and McAnulty Connection. (2013).
- Ehud Sharlin, et al. "A tangible user interface for assessing cognitive mapping ability". Int. J. Human-Computer Studies 67 (2009)269:278.
- Emiliano Miluzzo. "Eye Phone: Activating Mobile Phones With Your Eyes". MobiHeld 2010. (2010).
- Engler, Craig E. "Adorable VR by 1994". Computer Gaming World. (2014).
- Enzel, Y., Kitagawa, H., et al. "Scientific Party: Lithology of the Long Sediment Record Recovered by the ICDP Dead Sea Deep". Drilling Project, (2014).
- Ertas, A and Jones, J. "The Engineering Design Process". Second Edition, John Wiley & Sons, Inc. (1996).
- F. Noel. "From integrated to intuitive design thanks to new technologies". MITIP, (2012).



- Florian Gosselin et al. "Development of a New Backdrivable Actuator for Haptic Interfaces and Collaborative Robots". *Actuators* (2016).
- Fidanboyu, K., et al. "Fiber Optic Sensors and Their Applications". 5<sup>th</sup> International Advanced Technologies Symposium (IATS'09). (2009).
- Gabriel Robles-De-La-Torre. "International Society for Haptics: Haptic Technology". an Animated Explanation. (2010).
- Garb, Yaakov. "Virtual Reality". *Whole Earth Review* (57): (1987).
- Gaugne R., et al. "Large-Scale Immersive Reconstitution of a Neohthic". *Corbel Dome*. (2012).
- Gaudiosi, John. "Why the HTC Vive Delayed Launch is Good News for Oculus". (2015).
- Gaudiosi, John. "Gloveone: Feel Virtual Reality". *Kickstarter*, Retrieved, (2016).
- Georges Ifrah. "The Universal History of Computing: From the Abacus to the Quantum Computer". *Trans. E.F. Harding*, John Wiley & Sons, Inc. (2001) : 171.
- G. Gonzalez-Badillo et al. "Development of a haptic virtual reality system for assembly planning and evaluation". *The 2013 Iberoamerican Conference on Electronics Engineering and Computer Science. Procedia Technology* 7. (2013) : 265-272.
- Giacomin. J. "What is Human Centered Design". *The Design Journal*, 17 (4). (2014) : 606-623.
- Griffin et al. "The user interface of a mechanical system, a vehicle or an industrial installation is sometimes referred to as the human-machine interface (HMI)". (2014).
- Golnar Shojaei and Malihe Hamzavi. "A Study of The Relationship between Stress and Ergonomics in Shahrood's Gas Company". *Life Science Journal* (2013).
- Gong Y and Zhang Z. "Alternative Pathway Approach for Automating Analysis and Validation of Cell Perturbation Networks and Design of Perturbation Experiments". (2007).
- Gonzales, D. "Automation and Robotics for the Space Exploration Initiative: Results from Project Outreach". 92 (17897), (1991) : 35.

- Gonzalez Badillo and Hugo L. “A new methodology to evaluate the performance of physics simulation engines in haptic virtual assembly”. *Assembly Automation*. Volume 34, ISS: 2, (2014) : 128-140.
- Guangqi Ye, et al. “Gesture Recognition Using 3D Appearance and Motion Features”. *Computer Vision and Pattern recognition Workshop, IEEE Xplore*. (2004).
- Guy Merchant. “Literacy in virtual worlds”. *Journal of Research in Reading*. Volume 32, Issue 1, ISSN 0141-0423, (2009) : 38–56.
- Haik Kalantarian, et al. “A comparison of piezoelectric-based inertial sensing and audio-based detection of swallows”. *Science Direct Obesity Medicine* 1. (2016) : 6-14.
- Havenith, G. “International Society for Environmental Ergonomics”. (2005).
- Hamza Jafri and K M Moeed. “Ergonomic Design of Computer Workstation”. *International Research Journal of Engineering and Technology*. Volume 3, Issue 5, ISSN 2395-0072, (2016) : 2152-2156.
- Heather Beellini et al. “Virtual & Augmented Reality: Understanding the race for the next computing platform”. *Goldman Sachs Global Investment Research*”. (2016) : 1-30.
- Hewett Baecker, et al. “Card; ACM SIGCHI Curricula for Human-Computer Interaction”. *ACM SIGCHI*, Retrieved. (2014).
- Himanshu Raj and Karsten Schwan. “High Performance and Scalable I/O Virtualization via Self-Virtualized Devices”. *HPDC’07*. (2007).
- Hoonhee Nam, et al. “Analysis of Game Genre Suitable for HMD Environment”. *Advanced Science and Technology Letters*, Volume 125, (Art, Culture, Game, Graphics, Broadcasting and Digital Contents). (2016) : 30-34.
- Horowitz Ken. “Sega VR: Great Idea or Wishful Thinking”. *Sega-16*. Archived from the original on 2010-01-14. (2010).
- Howard Rheingold. “Presence: Teleoperators and Virtual Environments”. *Virtual Reality*. Volume 1, Issue 1, (1992) : 153-154.
- \_\_\_\_\_. “International Stereoscopic Union Stereoscopic”. *Numbers 65-72*. (2006) :18.

- \_\_\_\_\_. “Introducing Trimming and Function Ranking to Solid Works Based on Function Analysis”. In: TRIZ Future Conference. 2-4 November (2011).
- Ioannis Tarnanas et al. “Assessing Virtual Reality Environments as Cognitive Stimulation Method for Patients with MCI”. *Technologies of Inclusive Well-Being*. Volume 536 of the series *Studies in Computational Intelligence*. (2014) : 39-74.
- Jacek Lebedź and Mariusz Szwoch. “Virtual Sightseeing in Immersive 3D Visualization Lab”. *Conference on Computer Science*. (2016).
- Jakob Nielsen et al. “Comparative Design Review: An Exercise in Parallel Design”. *Interchi '93*. (1993).
- James T. Edwards and John A. List. “Toward an Understanding of Why Suggestions Work in Charitable Fundraising: Theory and Evidence from a Natural Field Experiment”. *National Bureau of Economic Research*. Jel No. C9,C93,H41. (2013) : 1-39.
- Jan Dul et al. “A strategy for human factors/ergonomics: developing the discipline and profession”. *Ergonomics*. Taylor & Francis. (2012) : 1-27.
- Jan Flasar et al. “VRECKO: Virtual Reality Framework”. *EG UK Theory and Practice of Computer Graphics*. The Eurographics Association. (2005).
- Jean Miller. “How Linden Lab Built a Virtual World for Business and Education”. *Springer Science + Business Media*, DOI 10.1007/978-1-4614-6286-62, New York. (2013).
- Jerry Banks. “Panel Session: The Future of Simulation”. *Proceedings of the 2001 Winter Simulation Conference*. (2001) : 1453-1460.
- Jinjakam C and Kazuhiko H. “Study on parallax affect on simulator sickness in one-screen and three-screen immersive virtual environment”. (2011) : 34–39.
- Jinjakam C., et al. “Comparative study of virtual sickness between a single-screen and three-screen from parallax affect”. *International Science Index* 5 (3). (2011) : 195–198.
- J.J Gibson. “The Theory of Affordances”. *Lawrence Erlbaum Associates*. ISBN 0-89859-959-8. (1979) : 127-143.

- Joanna McGrenere and Wayne Ho. "Affordances: Clarifying and Evolving a Concept". Accepted for publication in the Proceedings of Graphics Interface 2000. (2000) : 1-8.
- John E. Brough, et al. "Towards the development of a virtual environment-based training system for mechanical assembly operations". *Virtual Reality*. Volume 11, Issue 4, (2007) : 189-206.
- John E. Stone, et al. "Immersive Molecular Visualization with Omnidirectional Stereoscopic Ray Tracing and Remote Rendering". *IEEE Xplore*. (2016).
- John Rife. "Project Natal as an off-the-Shelf Gesture Capture System for the Dancing the Earth: a Mixed-reality Science Center Program Based on Whole-body Interaction and Virtual Docents". *Interactive and Applied Storytelling*. (2009).
- John R. Wilson. "Fundamentals of systems ergonomics/human factors". *Applied Ergonomics* 45. (1014) : 5-13.
- Jones , J. and S. Kumar. "Comparison of Ergonomic Risk Assessment Output in Four Saw Mill Jobs". *Int, J. Occup Saf Ergon*, 16 (1). (2010) : 105-111.
- Jozef Novák-Marcinčin. "Application of the Virtual Reality Modeling Language in Automated Technological Workplaces Design". *Eng. Rev.*, 27-1. (2007) : 1-6.
- Jurgen Broeren et al. "Virtual reality and haptics as a training device for movement rehabilitation after stroke: A single-case study". *Archives of Physical Medicine and Rehabilitation*. Volume 85, Issue 8, August (2004) : 1247-1250.
- Kalawsky, R. S. "The Science of Virtual Reality and Virtual Environments: a Technical". *Scientific and Engineering Reference on Virtual Environments*. (1993).
- Kamal K Vyas, et al. "Gesture Recognition and Control". *International Journal on Recent and Innovation Trends in Computing and Communication*. Volume: 1, Issue: 7, ISSN 2321 –8169, (2013).
- Kay M. Stanney, et al. "Human Factors Issues in Virtual Environments: a Review of the Literature". *Presence*. Vol. 7, No. 4, August (1998) : 327–351.

- Kevin Boos, et al. “Flash Back: Immersive Virtual Reality on Mobile Devices via Rendering Memorization”. MobiSys’16. 25-30 June 2016.
- K. Lalit Narayan et al. “Computer Aided Design and Manufacturing”. PHI Learning Private Limited. (2008).
- Kirandeep Kaur and Shivani. “Virtual Reality the Hope of a New Future”. IJERSS. Volume 2, Issue 1, (2015).
- Kristin Musolin. “Assessment of Visual and Neurologic Effects Among Video Hub Employees – New York”. Health Hazard Evaluation Report, HETA 2011-0149-3165, (2012).
- Kruger Myron K. “Artificial Reality 2”. FUTURE IJERSS, Volume 2/ Issue 1, (2015).
- Kolasinski, E. M. “Simulator Sickness in Virtual Environments (ARI 1027)”. U.S. Army Research Institute for the Behavioral and Social Sciences. (2014).
- La Viola, J. J. Jr. “a Discussion of Cyber Sickness in Virtual Environments”. ACM SIGCHI Bulletin 32. (2000) : 47–56.
- Lin, J. J., Duh, H., et al. “Effects of Field of View on Presence, Enjoyment, Memory, and Simulator Sickness in a Virtual Environment”. Proceedings of IEEE Virtual Reality 9. (2002) : 164–171.
- L Pareto, et al. “Virtual reality, haptics and post-stroke rehabilitation in practical Therapy”. ICDVRAT with art abilitation. ISBN 07 049 15 006, (2008) : 245-252.
- M.A. and W.Sell. “View-Master Memories”. ISBN B0006S314I, (2000).
- Magy Seif EI-Nasr and Su Yan. “Visual Attention in 3D Video Games”. ACM SIGCHI International Conference on Advances in Computer Entertainment Technology. DOI 10.1145/1178823.1178849, (2006) : 14-16.
- Maia IM, Francisco AC. “Worker’s Postural Conditions in the Charcoal Production Process Based on Vertical Metallic Cylinders”. Us National Library of Medicine, National Institutes of Health. (2012).
- Marcel Valentin. “VRTO Top VR and AR Talent Meets in Toronto”. Sean Peasgood, Sophic Capital. (2016) : 1-9.

- Mark Billingham and Hirokazu Kato. "Marker Tracking and HMD Calibration for a Video-based Augmented Reality Conferencing System". The 2nd IEEE and ACM International Workshop on Augmented Reality '99. (1999) : 85-94.
- Mattila M., et al. "Analysis of Working Postures in Hammering Tasks on Building Construction Sites Using the Computerized OWAS Method". *Appt. Ergon*, 24 (6). (1993) : 405-412.
- Mary Ann et al. "View-Master Memories". M.A. and W. Sell. ISBN B0006S314I, (2000).
- McAtamney Lynn and E Nigel Corlett. "RULA : a Survey Method for the Investigation of Work-related Upper Limb Disorders". *Applied Ergonomics*. (1993) : 91-99.
- Memmel, T. "Agile Usability Engineering". Retrieved 4 November (2013).
- Messias and Okuno. "Study of Postures in Sugarcane Cutters in the Pongal of Paranapanema-SP". *Brazil Work*. Volume 41, Supplement 1, (2012) : 5389-5391.
- Mubaid, H. Al-E.S., et al. "Using Data Mining the Manufacturing Systems for CAD Model Analysis and Classification". *Int. J. Agile Systems and Management*. Volume 3, No. 1/2. (2008) : 147-162.
- Narayan, K. Lalit. "Computer Aided Design and Manufacturing". New Delhi: Prentice Hall of India. ISBN 812033342X, (2008) : 3.
- Narayan, K. Lalit. "Computer Aided Design and Manufacturing". PHI Learning Pvt. Ltd., 5 May (2009).
- Naveen H. Giri and Ankit Pandey. "Virtual Reality". *International Journal of New Technology and Research (IJNTR)* ISSN:2454-4116, Volume-2, Issue-5, May (2016) :154 -158.
- N. Bajcinca et al. "Haptic Control for Steer-by-Wire Systems". *Intl. Conference on Intelligent Robots and Systems*. (2003) : 2004-2009.
- Nevala-Puranen N. "Reduction of Farmers' Postural Load Press During Occupationally Oriented Medical Rehabilitation". *Applied Ergonomics* 26 (6). (1995) : 411-415.

- Neugebauer et al. "Virtual reality aided design of parts and assemblies". *International Journal on Interactive Design and Manufacturing*. Volume 1, Issue 1, (2007) : 15-20.
- Nicholas Carlini et al. "Hidden Voice Commands". *USENIX Association, 25<sup>th</sup> USENIX Security Symposium*. 10-12 August (2016).
- Nicos Bilalis. "Computer Aided Design Cad". Report produced for the EC funded project. *INNOREGIO : dissemination of innovation and knowledge management techniques*. (2000) : 1-27.
- Nielsen, J. "Usability Engineering". Academic Press Inc, (1994) : 165.
- Nigel Bevan. "Human-Computer Interaction Standards". *Proceedings of the 6<sup>th</sup> International Conference on Human Computer Interaction*. (1995).
- Nitin Chaudhari and Vilas B Shinde. "Recent Trends in Robotic end of Arm Tooling (Gripper)". *International Journal of Mechanical Engineering and Robotics Research*". ISSN 2278-0149, Volume 3, No. 2, (2014) : 171-180.
- Olanre Okunribido and Tony Wynn. "Ageing and work-related musculoskeletal disorders". *Health and Safety Executive*. (2010) : 1-50.
- Ozlem Durmaz Incel. "Analysis of Movement, Orientation and Rotation-Based Sensing for Phone Placement Recognition". *Sensors*, (2015).
- Parth Rajesh Desai et al. "a Review Paper on Oculus Rift-a Virtual Reality Headset". *International Journal of Engineering Trends and Technology (IJETT)*. Volume 13, Number –Jul, (2014).
- Philip J. Bos, et al. "Simple Method to Reduce Accommodation Fatigue in Virtual Reality and Augmented Reality Displays". *SID Symposium Digest of Technical Papers*. Volume 47, Issue 1. (25 May 2016) : 354:357.
- Pierre Delforge and Noah Horowitz. "The Latest-Generation Video Game Consoles". *NRDC issue Paper IP:14-04-b*. May (2014).
- Piyush Kumar. "Hand Data Glove: A Wearable Real-Time Device for Human Computer Interaction". *International Journal of Advanced Science and Technology*. Volume 43, June (2012).
- Pontonnier, C., Dumont, G. "From Motion Capture to Muscle Forces in the Human Elbow Aimed at Improving the Ergonomics of Workstations". *Virtual Phys Prototype*. (2010) : 113–122.

- Pontonnier, C., et al, “Cutting Force and EMG Recording for Ergonomics Assessment of Meat Cutting Tasks: Influence of the Workbench Height and the Cutting Direction on Muscle Activation Levels”. In ASME 2012 11<sup>th</sup> Biennial Conference on Engineering Systems Design and Analysis. 2012.
- Porter, William. “View-Master Moving Work to Mexico”. The Denver Post. Retrieved 2016-05-29. (2016).
- Rheingold, H. “Virtual Reality”. Simon & Schuster. New York, (1992).
- R. Iacob and Diana Popescu. “Generation of Disassembly Directions Based on Component Mobility”. Studies in Informatics and Control. Volume 22, No. 4, (2013) : 307-318.
- Rich McCormick. “Valve Showing off New Virtual Reality Hardware and Updated Steam Controller Next Week”. (2015).
- Richmond Y, et al. “When a Product Is Still Fictional: Anticipating and Speculating Futures through Concept Videos”. DIS 2016, 04-08 June (2016).
- Robert J. Mislevy. “Evidence Centered Design for Simulation-Based Assessment”. The National Center for Research on Evaluation, Stands, and Student Testing. (2011).
- Rolf Molich and Jakob Nielsen. “Improving a Human Computer Dialogue”. Communications of the ACM. Computing Practices. Volume 33, Number 3, (1990) : 338 -348.
- Ronald Laurids Boring. “Human Reliability Analysis for Design : Using Reliability Methods for Human Factors Issues”. American Nuclear Society. (2010).
- R. Neugebauer et al. “Realistic Machine Simulation with Virtual Reality”. 45<sup>th</sup> CIRP Conference on Manufacturing Systems 2012. Procedia CIRP 3. (2012) : 103 – 108.
- Ross Sandler, et al. “Industry Virtual Reality”. Deutsche Bank Securities Inc, 3 March (2016).
- Ruddle, R. A. “The Effect of Environment Characteristics and User Interaction on Levels of Virtual Environment Sickness”. Proceedings of IEEE Virtual Reality 11: 141–148. doi:10.1109/VR.2004.1310067. (2004).



- Ryo Wako and Saho Ayabe-Kanamura. "Characteristics of Haptic Peripersonal Spatial Representation of Object Relations". PLOS ONE | July 27, (2016).
- Sean Peasgood and Marcel Valentin. "Virtual Reality: It's Real All Right". Sean Peasgood. 22 March (2016).
- Sell, et al. "View-Master Memories". Cincinnati, Ohio: M.A. and W. Sell. OCLC 51484619. (2000).
- Shahid Ramzan and Mohammad Irfan, 2016. "Impact of Computer Vision Syndrome on Health of Computer usage Bank Employee". Volume 2, Issue 7, Paper 7, (July 2016); 40:53.
- Sharmistha Mandal. "Brief Introduction of Virtual Reality & its Challenges". International Journal of Scientific & Engineering Research, ISSN 2229-5518 Volume 4, Issue 4, (April-2013) ; 304;309.
- Sharon Schutte-Rodin, et al. "Clinical Guideline for the Evaluation and Management of Chronic Insomnia in Adults". Journal of Clinical Sleep Medicine, Vol. 4, No. 5, (2008); 487:504.
- Siddhesh Manjrekar et al. "CAVE: An Emerging Immersive Technology - A Review". 2014 UKSim-AMSS 16<sup>th</sup> International Conference on Computer Modelling and Simulation. (2014).
- Simon Davis, et al. "Comparing the onset of cyber sickness using the Oculus Rift and two virtual roller coasters". Proceedings of the 11<sup>th</sup> Australasian Conference on Interactive Entertainment (IE 2015) : 27 – 30, January (2015).
- Sindy Shi, et al. "Alibaba Cloud Partners with HTC to Advance Virtual Reality Development with Cloud Computing Solutions". Alibaba Group's cloud computing arm. 9 August (2016).
- Steven M. Sheffrin. "Economics: Principles in Action". Upper Saddle River, New Jersey 07458: Pearson Prentice Hall. ISBN0-13-063085-3. (2003) : 310.
- Sturman, D. J., and Zeltzer, D. "A Survey of Glove-based Input". IEEE Computer Graphics and Applications 14(1). (1994).
- Sullivan, O and Sheffrin, M. "Economics Principles in Action". Boston, Massachusetts Upper Saddle River, New Jersey. (2003).

- Sung, Sami Garbaya. "a New Methodology to Evaluate the Performance of Physicphysic Simulation Engines in Haptic Virtual Assembly". *Assembly Automation*. Volume 34, Issue 2, (2014) : 128-140.
- Tassawar Iqbal et al. "Second Life for Illiterates: A 3D Virtual World Platform for Adult Basic Education". *Education and Learning iiWAS20108-10*. November (2010).
- Thailand. "Trade Policy Review Body on Thailand". World Trade Organization. (2015) : 1-26.
- Thailand Automotive Institute Ministry of Industry. "Master Plan for Automotive Industry 2012-2016". (2012) : 1-109.
- Thomas B. Sheridan. "Tele robotics, Automation and Human Supervisory Control". MIT Press, Cambridge, Massachusetts. (1992).
- Thomas D., et al. "Virtual Environment for Assessment of Neurocognitive Functioning: Virtual Reality Cognitive Performance Assessment Test". *Medicine Meets Virtual Reality 16*J.D. (Eds.) IOS Press. (2008).
- Thomas D. PARSONS et al. "Virtual Environment for Assessment of Neurocognitive Functioning" *Virtual Reality Cognitive Performance Assessment Test*. *Medicine Meets Virtual Reality 16*. IOS Press, (2008) : 351-356.
- Timothy Sanders and Paul Cairns. "Time Perception, Immersion and Music in Video Games". *BCSHCI*. (2010).
- Tomasz Mazuryk and Michael Gervautz. "Virtual reality History, Applications, Technology and future". TR-186-2-96-06, February (1996).
- Tom Warren. "Valve's VR Headset Revealed with Oculus-like Features". (2014).
- Trakunsaranakom C., et al. "Assessment of Virtual Reality Environments for design activity". *Conference and Exhibitions of the European Association of Virtual and Augmented Reality*. (2014).
- T.S. Mujber et al. "Virtual reality applications in manufacturing process simulation". *Journal of Materials Processing Technology*. Volumes 155-156, 30 November (2004) : 1834–1838.
- Valeria Manera, et al. "A Feasibility Study with Image-Based Rendered Virtual Reality in Patients with Mild Cognitive Impairment and

- Dementia”. PLOS ONE | DOI:10.1371/journal.pone.0151487, 18 March, (2016).
- Vicki Ha, et al. “Direct intentions: the effects of input devices on collaboration around a tabletop display”. *Horizontal Interactive Human-Computer System*. (2006).
- Vikas Kamde, et al. “a Review on Virtual Reality and its Impact on Mankind”. *International Journal for Research in Computer Science*. Vol., 2, Issue 3, March (2016).
- Vincent Hayward et al. “Haptic Interfaces and Devices”. *Sensor Review*. (2004).
- Viral Mehta and Joyce Smith Cooper. “Review and analysis of PEM fuel cell design and manufacturing”. *Journal of Power Sources*. Volume 114, Issue 1, (2003) : 32-53.
- \_\_\_\_\_. “Valve is making a VR headset and its own Steam Machine”. Retrieved 1 March (2015).
- Warwick, K., et al. “Reality in Engineering”. Peter Peregrinus. (1993).
- Welling William. “Photography in America”. (1978) ; 23. 0690014511.
- Wilson, Andrew. “Machines, Power and the Ancient Economy”. *The Journal of Roman Studies*. Volume 92(16), (2002) :1–32.
- W.W.Wits et al. “Exploring the Potential of 3D Visualization Techniques for Usage in Collaborative Design”. *CIRP Design Conference*. (2011) : 187-193.
- Yuta Itoh et al. “OST Rift: Temporally Consistent Augmented Reality with a Consumer Optical See-Through Head-Mounted Display”. (2016).

## APPENDIX A

The experimental results of the performance assessment of virtual reality environments for activities involved in preliminary design by the use low level basic sensors

(Case study: Sub-Part of Jig & Fixture)

**TABLE A-1** The docking average values of the environment 1

Participants	The docking average values of the environment 1					
	S.A. 1	S.A. 2	S.A. 3	S.A. 4	S.A. 5	S.A. 6
1	0.596	0.323	1.205	1.626	2.019	1.987
2	1.505	0.532	0.142	0.036	0.146	2.159
3	1.096	1.480	2.497	1.237	1.567	3.416
4	1.365	0.747	0.275	0.399	0.116	0.918
5	1.051	0.037	0.622	0.041	0.270	0.864
6	1.906	0.048	0.275	0.180	1.761	1.091
7	0.184	0.201	0.168	0.114	0.081	0.869
8	0.053	0.037	0.249	0.959	0.195	0.807
9	0.649	0.402	0.535	0.184	0.038	0.811
10	0.297	0.048	0.243	0.555	0.191	0.181
11	0.352	0.465	0.308	0.509	0.285	0.915
12	0.710	0.075	2.228	1.403	1.667	0.880
13	1.001	1.287	0.249	0.128	1.857	0.248
14	1.371	3.003	0.235	3.208	0.110	0.816
15	0.928	0.479	1.639	0.987	0.795	1.606
16	1.254	0.880	0.337	0.764	0.990	0.949
17	1.178	0.689	0.171	0.100	0.691	0.888
18	0.842	0.817	0.259	1.659	0.139	0.816
19	1.239	0.112	0.534	1.453	0.391	0.038
20	2.477	0.864	0.676	0.052	0.810	2.042
21	2.394	0.053	0.488	0.515	0.740	1.460
22	0.394	0.053	0.374	0.882	0.828	0.978
23	0.684	0.741	0.507	0.633	0.532	0.929
24	0.538	0.464	0.325	0.052	0.172	0.088
25	1.465	0.230	0.581	2.130	2.708	0.954
26	0.861	0.060	2.275	0.509	1.640	1.597
27	1.040	0.618	0.760	0.247	1.922	1.865
28	0.730	0.259	1.167	0.561	0.061	1.144
29	2.361	0.065	2.796	0.366	0.385	1.076
30	0.707	0.883	0.171	0.520	0.630	0.881
31	0.631	0.449	1.880	1.035	0.246	0.057
32	1.707	0.877	0.016	0.558	2.191	1.149
33	0.773	1.156	0.167	0.699	0.525	0.895
34	1.420	0.112	0.429	0.444	0.431	1.146
35	1.428	1.220	1.561	1.012	1.225	0.817
36	0.929	0.117	0.308	1.195	0.625	0.828
37	1.261	0.969	1.790	1.804	1.426	0.959
38	0.697	1.898	2.400	1.037	1.738	1.329
39	0.424	0.045	1.813	2.041	0.264	0.858
40	1.089	1.598	2.350	0.384	0.261	0.865

\*\* Notation\*\* S.A. is step assembly of the screws by randomized.

**TABLE A-1** The docking average values of the environment 2

Participants	The docking average values of the environment 2					
	S.A. 1	S.A. 2	S.A. 3	S.A. 4	S.A. 5	S.A. 6
1	0.459	0.204	0.135	0.770	0.625	0.596
2	0.828	0.113	0.044	0.130	0.668	0.125
3	0.478	0.246	0.313	0.506	0.143	0.451
4	0.129	0.467	0.035	0.714	0.248	0.327
5	0.810	0.096	0.239	0.131	0.037	0.417
6	1.008	0.301	0.199	0.687	0.021	1.055
7	0.830	0.173	0.030	0.036	0.025	0.673
8	0.811	0.068	0.036	0.128	0.245	0.576
9	0.813	0.354	0.696	0.308	0.691	0.775
10	0.709	0.297	0.026	0.216	0.107	1.492
11	0.807	0.126	0.905	0.049	0.142	0.352
12	1.555	0.307	0.940	1.621	0.083	0.522
13	0.805	0.204	0.705	0.389	0.177	0.736
14	0.910	0.118	1.393	0.295	0.046	1.547
15	0.822	1.280	2.818	3.345	0.650	1.728
16	1.749	0.059	1.360	1.546	0.024	0.330
17	1.161	0.666	0.030	0.888	0.058	0.573
18	0.270	0.302	0.687	0.011	0.095	0.592
19	0.493	0.202	0.951	1.032	0.103	2.103
20	0.301	1.250	0.047	0.325	0.460	0.954
21	0.868	0.205	0.082	0.023	0.387	0.912
22	0.623	0.753	1.223	0.813	0.771	0.277
23	0.979	0.046	0.038	0.084	0.032	0.465
24	0.852	0.338	0.086	0.177	0.121	0.749
25	0.516	0.378	1.618	0.027	0.312	0.872
26	0.818	0.400	0.048	1.047	0.110	0.288
27	0.810	1.016	0.012	0.068	0.229	1.264
28	0.120	0.498	0.606	0.508	0.560	0.051
29	0.076	0.973	0.034	0.145	0.035	0.040
30	0.058	0.655	0.021	0.269	0.298	0.383
31	0.774	0.434	0.059	0.583	0.172	0.537
32	0.778	0.093	0.797	0.558	0.671	0.524
33	0.321	0.917	0.832	0.493	0.928	0.545
34	0.819	0.654	0.819	0.580	1.575	1.950
35	0.849	0.713	0.045	0.645	0.669	0.039
36	0.978	0.059	0.823	0.624	1.193	0.707
37	0.826	0.554	0.074	0.054	0.074	0.325
38	0.571	0.491	0.440	0.197	0.976	0.472
39	0.986	0.063	0.734	0.757	0.758	0.425
40	0.865	0.409	0.188	0.320	0.686	0.034

**\*\* Notation\*\*** S.A. is step assembly of the screws by randomized.

**TABLE A-1** The docking average values of the environment 3

Participants	The docking average values of the environment 3					
	S.A. 1	S.A. 2	S.A. 3	S.A. 4	S.A. 5	S.A. 6
1	0.182	1.144	1.250	1.172	1.185	0.752
2	0.010	0.772	0.659	0.660	0.092	0.118
3	2.979	2.237	0.878	1.738	0.922	0.044
4	0.200	0.760	0.609	0.861	0.624	0.126
5	0.030	0.813	0.174	1.001	0.017	0.045
6	0.043	0.811	0.128	0.654	0.135	0.103
7	0.169	0.798	0.278	1.320	0.491	0.594
8	0.114	0.824	0.241	0.844	0.003	0.445
9	0.326	0.856	0.204	0.910	0.287	0.302
10	0.028	0.160	0.587	0.326	0.793	0.058
11	0.296	0.799	0.927	0.550	0.315	0.839
12	1.125	0.801	0.360	1.714	0.161	0.157
13	1.760	1.184	0.238	1.307	1.250	0.200
14	1.648	1.541	2.089	1.082	0.912	0.507
15	0.059	1.326	0.113	0.411	0.439	0.563
16	1.019	0.915	0.190	0.468	0.111	0.351
17	0.066	1.056	0.262	0.573	0.394	0.485
18	0.641	0.689	0.135	0.707	0.389	0.297
19	0.905	0.784	1.069	2.076	0.728	1.959
20	0.106	2.382	0.975	0.455	0.089	0.372
21	0.398	0.816	0.218	0.396	0.888	0.946
22	0.041	0.911	0.400	0.113	1.488	0.504
23	0.379	0.908	1.341	0.866	0.138	0.188
24	0.064	0.570	0.191	0.749	0.049	0.051
25	0.450	0.955	0.843	1.511	1.601	0.108
26	0.452	0.978	0.293	0.707	1.639	2.366
27	0.870	1.865	0.526	0.629	0.067	0.247
28	1.049	0.814	0.308	0.966	1.178	0.156
29	0.034	1.240	0.197	0.470	1.490	0.726
30	0.808	1.118	1.182	0.721	0.490	0.726
31	0.135	1.514	1.529	1.014	0.582	1.237
32	0.452	2.019	0.210	0.741	0.227	0.084
33	0.510	0.780	0.261	0.900	0.671	0.148
34	1.047	0.803	0.040	0.948	0.289	0.038
35	0.334	0.840	0.151	0.828	0.020	0.668
36	0.951	0.678	0.689	1.261	0.428	0.804
37	1.183	0.836	1.765	1.243	1.437	1.410
38	0.172	0.901	0.217	1.252	0.040	0.423
39	0.352	1.057	0.068	1.078	0.825	0.828
40	2.211	0.370	0.260	0.080	0.031	1.762

\*\* Notation\*\* S.A. is step assembly of the screws by randomized.

**TABLE A-1** The docking average values of the environment 4

Participants	The docking average values of the environment 4					
	S.A. 1	S.A. 2	S.A. 3	S.A. 4	S.A. 5	S.A. 6
1	0.245	0.471	0.937	0.896	0.152	0.174
2	0.670	0.663	0.660	0.869	0.498	0.528
3	0.069	1.040	0.934	0.923	0.344	0.162
4	0.104	0.285	0.573	0.794	0.022	0.246
5	0.319	0.340	0.927	0.793	0.048	0.137
6	0.079	0.255	1.492	0.899	0.057	0.072
7	0.005	0.980	0.621	0.856	0.010	0.122
8	0.340	0.524	0.933	0.235	0.042	0.042
9	0.001	0.264	0.098	0.838	0.161	0.069
10	0.026	1.022	0.555	0.477	1.705	0.752
11	0.251	0.110	0.167	0.837	0.469	0.519
12	0.157	0.478	1.236	0.880	0.212	0.389
13	0.398	0.278	0.277	0.803	0.680	0.767
14	1.841	0.985	2.805	0.872	2.092	1.516
15	0.220	0.688	0.787	0.933	2.343	0.065
16	1.629	0.032	0.468	1.421	0.909	1.324
17	1.629	0.308	0.578	0.801	0.779	0.226
18	0.244	0.428	0.682	0.801	0.323	0.129
19	1.488	0.312	1.211	0.023	0.683	0.116
20	0.920	1.471	0.472	1.057	0.239	0.532
21	0.050	0.210	0.421	0.754	1.976	0.439
22	0.934	0.120	0.997	0.250	0.228	0.968
23	0.504	0.063	1.067	1.004	0.016	1.190
24	0.069	0.052	0.164	0.820	0.044	0.095
25	0.309	0.185	0.365	0.389	0.232	0.079
26	0.366	0.973	0.707	0.759	0.034	0.147
27	0.477	0.380	1.213	1.598	0.443	1.364
28	0.645	0.171	0.096	0.853	0.121	0.030
29	0.146	1.061	1.078	0.377	0.415	0.201
30	0.138	0.503	0.532	0.032	0.032	0.172
31	0.806	0.224	0.264	0.738	0.896	0.117
32	0.229	0.478	0.741	0.823	0.459	0.038
33	0.734	0.397	0.566	0.625	0.138	0.134
34	0.481	0.062	0.599	1.110	0.478	0.015
35	0.058	0.473	0.179	0.804	0.740	0.388
36	0.804	0.788	0.261	0.826	0.451	0.628
37	0.066	0.033	0.243	0.829	0.080	0.458
38	0.220	0.293	0.176	0.591	0.475	0.828
39	0.033	0.689	0.707	0.057	0.951	0.828
40	0.306	0.182	0.523	0.793	0.006	0.026

**\*\* Notation\*\*** S.A. is step assembly of the screws by randomized.



**TABLE A-2** The duration average values of the environment 1

Participants	The duration average values of the environment 1					
	S.A. 1	S.A. 2	S.A. 3	S.A. 4	S.A. 5	S.A. 6
1	73.258	38.727	43.800	33.560	45.568	53.350
2	26.834	49.544	51.575	29.228	35.167	46.291
3	28.724	22.196	30.183	22.764	32.118	26.052
4	37.211	23.587	22.143	26.799	23.121	22.787
5	19.125	26.641	33.360	23.172	29.344	27.397
6	35.998	30.376	27.619	30.011	52.225	40.165
7	32.336	23.405	29.962	31.180	26.590	28.789
8	34.086	26.512	26.776	36.035	34.610	28.209
9	70.215	68.770	52.193	84.806	111.510	79.403
10	36.375	48.390	47.860	37.078	49.407	36.438
11	28.187	33.152	36.960	26.774	20.267	41.414
12	121.186	65.756	188.764	61.785	95.418	90.109
13	51.547	62.162	46.223	67.543	41.416	55.386
14	165.179	81.033	105.779	57.949	165.331	123.869
15	44.235	31.037	79.724	43.651	53.307	64.805
16	44.881	38.511	68.147	41.447	48.778	32.498
17	55.980	38.750	51.349	37.852	72.032	97.801
18	32.532	29.089	47.044	53.383	43.739	26.141
19	75.760	42.668	73.478	72.697	79.567	91.275
20	57.338	49.073	79.591	88.116	78.442	77.208
21	37.516	40.984	58.219	49.969	78.687	49.897
22	49.897	78.687	49.969	58.421	37.516	40.984
23	44.141	46.000	48.719	47.135	65.592	52.471
24	87.448	142.572	70.607	57.936	65.841	47.889
25	63.724	52.605	82.301	83.459	92.969	61.425
26	121.702	123.407	89.244	63.695	110.212	46.783
27	98.500	123.531	103.469	114.032	120.516	121.093
28	68.962	36.116	40.754	48.155	38.277	52.190
29	98.344	47.352	67.373	88.553	74.286	60.037
30	34.485	24.813	30.593	25.219	25.469	24.469
31	35.209	48.817	87.976	57.562	72.547	61.656
32	63.456	83.138	97.532	79.125	88.884	67.217
33	33.428	30.104	36.057	28.263	35.310	39.528
34	38.338	39.791	45.662	39.437	50.646	34.462
35	52.099	39.427	79.707	51.092	95.242	72.801
36	87.097	54.032	35.183	47.510	62.743	50.443
37	63.794	34.153	89.165	61.887	53.122	67.695
38	69.062	41.031	87.531	76.437	66.469	77.625
39	58.341	49.229	61.497	63.259	61.836	53.346
40	85.203	99.609	62.781	69.563	88.156	55.000

\*\* Notation\*\* S.A. is step assembly of the screws by randomized.

**TABLE A-2** The duration average values of the environment 2

Participants	The duration average values of the environment 2					
	S.A. 1	S.A. 2	S.A. 3	S.A. 4	S.A. 5	S.A. 6
1	62.379	33.305	38.770	62.195	45.983	60.571
2	26.278	39.682	28.012	33.732	19.468	22.921
3	30.063	27.625	17.844	26.469	33.688	20.203
4	31.730	32.130	26.694	31.880	24.194	27.455
5	25.135	24.090	20.559	25.212	23.430	21.522
6	33.886	28.639	31.014	42.857	29.858	30.469
7	32.320	31.757	26.560	31.997	29.012	23.248
8	41.426	32.323	28.727	33.820	29.603	40.584
9	86.192	47.016	69.446	87.088	29.686	45.488
10	44.120	38.223	27.052	38.451	36.723	42.697
11	48.752	39.719	21.461	28.733	16.556	28.187
12	72.824	40.185	33.232	90.031	89.244	117.478
13	49.996	42.976	31.178	61.319	51.274	30.182
14	119.327	107.624	69.500	110.936	98.436	63.123
15	50.056	37.311	36.936	33.126	46.979	36.468
16	40.107	30.221	29.143	33.844	26.863	36.334
17	41.810	29.186	38.092	59.842	36.110	46.610
18	21.947	31.145	25.727	36.176	29.432	31.068
19	60.419	70.513	47.341	60.998	93.185	45.361
20	72.750	40.804	41.459	47.848	50.260	95.131
21	58.781	35.564	41.434	42.329	29.985	33.172
22	42.684	39.252	45.024	49.486	27.909	53.673
23	65.249	40.191	35.513	65.243	50.632	40.829
24	56.686	63.685	34.858	56.530	54.639	42.186
25	91.307	64.905	51.622	55.195	54.881	67.814
26	82.545	37.553	76.483	80.697	67.699	69.696
27	82.719	74.979	41.591	98.916	54.361	46.208
28	44.845	29.488	22.855	48.142	26.047	45.617
29	16.769	83.482	32.420	45.098	48.458	66.435
30	17.933	21.050	27.983	25.628	22.713	20.071
31	47.297	43.890	32.000	30.594	33.391	30.766
32	21.927	23.719	75.319	86.041	88.373	84.440
33	23.920	18.960	18.828	30.699	22.382	32.051
34	51.006	31.760	14.390	41.156	37.813	24.172
35	41.689	27.994	27.628	31.324	21.948	21.653
36	18.773	36.833	33.758	28.851	26.920	30.157
37	64.194	45.083	50.669	53.275	47.673	45.892
38	40.283	49.041	23.687	39.766	49.860	41.859
39	49.959	43.499	53.330	35.776	48.444	17.817
40	5.812	30.672	36.672	36.250	45.703	38.977

**\*\* Notation\*\*** S.A. is step assembly of the screws by randomized.

**TABLE A-2** The duration average values of the environment 3

Participants	The duration average values of the environment 3					
	S.A. 1	S.A. 2	S.A. 3	S.A. 4	S.A. 5	S.A. 6
1	41.166	39.970	36.893	17.218	34.199	43.291
2	39.567	23.241	32.531	27.618	39.563	23.033
3	23.134	29.417	28.855	20.593	37.133	25.563
4	31.314	29.668	28.796	22.437	23.062	21.625
5	29.223	27.779	20.729	17.076	26.639	21.103
6	28.257	37.454	22.913	27.427	30.473	30.089
7	23.077	33.889	27.961	30.070	26.555	37.782
8	33.169	42.497	26.764	34.419	36.388	25.327
9	64.250	62.843	51.594	32.281	91.437	62.953
10	34.192	39.950	35.740	36.468	45.238	38.105
11	16.203	41.557	18.793	21.482	24.602	21.122
12	26.234	186.141	83.718	36.438	58.297	74.109
13	37.902	43.477	30.490	28.958	48.053	31.185
14	58.532	97.735	68.437	43.546	83.906	114.406
15	44.464	43.148	51.600	89.673	43.501	73.438
16	35.766	70.734	40.484	40.359	37.157	30.641
17	31.031	36.297	41.078	13.172	48.422	34.375
18	18.336	36.996	21.314	36.425	27.596	32.202
19	39.703	45.031	56.093	52.390	56.392	37.353
20	62.275	73.808	44.826	40.656	71.063	39.937
21	35.047	33.703	27.500	33.656	40.344	31.485
22	39.324	41.172	27.547	50.078	24.921	33.250
23	29.707	55.637	34.880	29.944	57.965	49.629
24	31.171	57.045	40.467	11.046	49.998	37.309
25	69.969	66.837	70.178	47.187	93.668	48.193
26	49.107	104.342	140.995	25.008	4.350	88.553
27	55.215	61.093	66.109	50.015	4.883	54.032
28	37.464	44.634	40.227	55.999	56.358	35.375
29	12.401	60.630	56.341	78.366	59.935	25.481
30	23.691	23.691	20.060	20.761	19.935	25.481
31	29.117	37.764	46.611	43.645	40.951	38.886
32	33.624	77.741	50.453	93.364	61.562	70.015
33	26.902	33.690	22.447	19.014	32.124	21.187
34	23.406	43.735	34.969	25.093	38.343	34.281
35	30.776	13.164	27.202	29.046	43.990	25.564
36	47.609	29.916	63.794	34.153	79.165	61.887
37	56.458	59.395	56.653	52.722	50.210	47.996
38	72.572	50.667	57.959	104.164	72.649	61.300
39	46.964	51.070	54.400	43.884	73.223	52.901
40	55.951	49.061	81.065	60.242	69.670	59.067

**\*\* Notation\*\*** S.A. is step assembly of the screws by randomized.

**TABLE A-2** The duration average values of the environment 4

Participants	The duration average values of the environment 4					
	S.A. 1	S.A. 2	S.A. 3	S.A. 4	S.A. 5	S.A. 6
1	26.592	19.110	19.681	34.897	15.033	37.491
2	18.046	23.241	32.531	27.618	39.563	23.033
3	25.345	19.894	22.627	37.321	23.043	24.634
4	25.344	27.547	24.187	18.449	21.437	28.593
5	23.742	24.473	22.578	24.954	17.112	26.956
6	25.543	25.949	30.854	29.591	24.201	36.560
7	27.234	28.984	27.875	34.531	27.672	33.942
8	33.666	25.586	33.841	28.566	36.334	25.747
9	58.422	46.078	33.328	77.234	56.687	105.640
10	48.165	38.837	38.068	40.264	32.242	30.316
11	18.135	20.038	23.180	25.445	20.678	28.198
12	21.156	64.715	87.674	90.109	43.471	66.878
13	49.780	57.423	45.048	53.516	32.299	34.844
14	142.468	47.261	40.122	58.886	27.426	63.016
15	67.075	79.051	51.274	49.749	42.723	68.571
16	27.875	28.813	14.078	44.941	30.965	38.301
17	46.438	38.516	34.219	50.671	30.687	48.812
18	24.758	25.066	22.797	29.912	20.713	28.778
19	31.858	40.208	30.700	48.630	35.578	49.797
20	44.704	26.359	51.937	55.312	38.391	34.469
21	28.391	31.015	39.734	29.922	27.453	49.531
22	24.006	22.517	21.427	22.231	25.270	18.541
23	54.919	50.107	50.572	64.710	37.117	44.987
24	40.969	42.594	36.438	84.969	27.781	56.344
25	57.536	60.042	38.466	51.934	41.075	61.026
26	16.769	83.482	32.420	115.098	48.458	66.435
27	45.684	48.862	41.526	37.898	48.739	37.292
28	52.952	35.874	43.311	61.139	37.421	32.515
29	68.112	47.237	41.657	83.172	31.906	40.156
30	18.112	17.237	24.657	23.172	23.906	20.156
31	35.953	34.139	31.757	37.468	21.187	30.803
32	51.681	68.253	24.265	90.368	47.516	54.595
33	26.060	22.724	40.450	24.375	20.987	30.277
34	31.625	28.500	22.937	34.203	18.093	25.172
35	26.697	26.247	17.409	29.288	25.980	31.518
36	33.122	37.695	34.194	45.083	35.008	44.306
37	43.206	46.989	13.522	30.953	38.941	33.676
38	32.674	35.328	43.614	58.623	49.662	4.926
39	35.406	46.964	41.070	34.400	17.499	33.884
40	52.362	49.589	34.981	30.037	25.096	35.186

**\*\* Notation\*\*** S.A. is step assembly of the screws by randomized.

**TABLE A-3** The instability average values of the environment 1

	<b>The instability average values of the environment 1</b>					
<b>Participants</b>	S.A. 1	S.A. 2	S.A. 3	S.A. 4	S.A. 5	S.A. 6
1	0.795	0.303	0.454	0.246	0.678	0.552
2	0.419	0.292	0.423	0.253	0.285	0.255
3	0.258	0.233	0.693	0.465	0.307	0.244
4	0.700	0.197	0.213	0.188	0.269	0.205
5	0.208	0.215	0.260	0.478	0.210	0.226
6	0.247	0.318	0.594	0.435	0.330	0.298
7	0.186	0.391	0.251	0.991	0.273	0.184
8	0.190	0.198	0.461	0.495	0.313	0.254
9	0.269	0.196	0.228	0.268	0.717	0.235
10	0.235	0.401	0.251	0.269	0.302	0.396
11	0.222	0.205	0.478	0.197	0.165	0.202
12	0.465	0.886	2.060	0.279	0.198	0.495
13	0.691	0.319	0.253	0.220	0.219	0.242
14	0.254	0.418	0.623	0.759	0.579	0.283
15	0.572	0.242	0.293	0.238	0.973	0.201
16	0.476	0.237	0.255	0.210	0.228	0.223
17	0.736	0.351	0.264	0.224	0.241	0.279
18	1.554	0.234	0.330	0.214	2.001	0.232
19	0.432	0.525	0.040	0.902	0.633	0.903
20	0.217	0.226	0.386	0.324	0.269	0.248
21	0.515	0.233	0.227	0.841	0.380	0.269
22	0.269	0.380	0.841	0.227	0.515	0.233
23	0.331	0.294	0.287	0.775	0.156	0.296
24	0.321	0.707	0.260	0.632	0.341	0.375
25	0.403	0.624	0.668	0.443	0.970	0.577
26	0.227	0.337	0.371	0.383	0.645	0.578
27	0.296	0.772	0.972	0.063	0.203	0.188
28	0.918	0.221	0.816	0.235	0.201	0.178
29	0.242	0.528	0.339	0.597	0.807	0.204
30	0.322	0.226	0.280	0.263	0.302	0.358
31	0.670	0.297	0.304	0.545	0.266	0.658
32	0.557	0.937	0.947	0.423	0.167	0.329
33	0.320	0.202	0.197	0.260	0.220	0.246
34	0.249	0.306	0.274	0.381	0.375	0.238
35	0.288	0.244	0.446	0.269	0.272	0.377
36	0.348	0.298	0.778	0.250	0.934	0.327
37	0.391	0.509	0.295	0.666	0.248	0.238
38	0.363	0.255	0.798	0.872	0.341	0.352
39	0.735	0.544	0.036	0.720	0.226	0.289
40	0.928	0.521	0.234	0.475	0.201	0.220

**\*\* Notation\*\*** S.A. is step assembly of the screws by randomized.

**TABLE A-3** The instability average values of the environment 2

Participants	The instability average values of the environment 2					
	S.A. 1	S.A. 2	S.A. 3	S.A. 4	S.A. 5	S.A. 6
1	0.719	0.321	0.268	0.575	0.248	0.511
2	0.324	0.257	0.328	0.238	0.295	0.300
3	0.615	0.261	0.305	0.326	0.306	0.264
4	0.455	0.440	0.418	0.209	0.384	0.187
5	0.200	0.342	0.574	0.230	0.309	0.657
6	0.189	0.202	0.248	0.356	0.243	0.615
7	0.690	0.516	0.335	0.255	0.453	0.220
8	0.254	0.202	0.189	0.507	0.491	0.262
9	0.421	0.222	0.431	0.828	0.724	0.950
10	0.190	0.463	0.219	0.226	0.469	0.637
11	0.190	0.225	0.255	0.187	0.213	0.222
12	0.211	0.243	0.348	0.309	0.479	0.374
13	0.207	0.290	0.249	0.247	0.233	0.294
14	0.307	0.406	0.696	0.350	0.655	0.238
15	0.210	0.289	0.208	0.213	0.362	0.537
16	0.255	0.101	0.201	0.211	0.184	0.781
17	0.279	0.221	0.252	0.262	0.246	0.216
18	0.245	0.281	0.193	0.277	0.285	0.598
19	0.355	0.519	0.208	0.832	0.028	0.248
20	0.274	0.235	1.134	0.514	0.245	0.057
21	0.359	0.252	0.479	0.217	0.226	0.256
22	0.179	0.458	0.451	0.630	0.280	0.305
23	0.227	0.329	0.275	0.351	0.288	0.368
24	0.323	0.260	0.435	0.297	0.229	0.992
25	0.164	0.372	0.314	0.804	0.358	0.675
26	0.935	0.607	0.219	0.643	0.980	0.278
27	0.283	0.319	0.650	0.246	0.218	0.187
28	0.246	0.238	0.755	0.422	0.239	0.098
29	0.271	0.560	0.264	0.231	0.195	0.609
30	0.298	0.268	0.299	0.258	0.255	0.309
31	0.234	0.870	0.601	0.340	0.217	0.282
32	0.356	0.264	0.266	0.422	0.377	0.790
33	0.175	0.188	0.234	0.231	0.224	0.871
34	0.285	0.255	0.238	0.236	0.384	0.299
35	0.237	0.204	0.350	0.247	0.302	0.341
36	0.037	0.417	0.302	0.348	0.231	0.813
37	0.228	0.239	0.298	0.270	0.325	0.426
38	0.388	0.702	0.895	0.263	0.228	0.310
39	0.765	0.910	0.399	0.580	0.948	0.280
40	0.052	0.256	0.384	0.357	0.170	0.905

**\*\* Notation\*\*** S.A. is step assembly of the screws by randomized.

**TABLE A-3** The instability average values of the environment 3

Participants	The instability average values of the environment 3					
	S.A. 1	S.A. 2	S.A. 3	S.A. 4	S.A. 5	S.A. 6
1	0.679	0.757	0.556	0.796	0.236	0.266
2	0.278	0.252	0.323	0.259	0.475	0.266
3	0.261	0.885	0.253	0.234	0.340	0.285
4	0.203	0.193	0.360	0.238	0.179	0.224
5	0.260	0.291	0.506	0.217	0.249	0.271
6	0.415	0.239	0.183	0.282	0.645	0.251
7	0.250	0.452	0.212	0.269	0.898	0.250
8	0.253	0.724	0.357	0.263	0.300	0.224
9	0.374	0.222	0.180	0.253	0.615	0.333
10	0.546	0.375	0.258	0.505	0.528	0.335
11	0.251	0.228	0.240	0.230	0.203	0.169
12	0.192	0.295	1.374	0.280	0.221	0.249
13	0.224	0.363	0.177	0.251	0.272	0.280
14	0.241	0.335	0.349	0.482	0.931	0.480
15	0.400	1.000	0.809	0.243	0.630	0.330
16	0.209	0.267	0.848	0.336	0.159	0.244
17	1.066	0.301	0.251	0.166	0.291	0.283
18	0.249	0.255	0.253	0.230	0.262	0.330
19	0.252	0.446	0.601	0.277	0.526	0.247
20	0.287	0.298	0.458	0.466	0.251	0.221
21	0.196	0.265	0.355	0.300	0.217	0.279
22	0.223	0.254	0.293	0.670	0.324	0.281
23	0.279	0.378	0.108	0.362	0.800	0.826
24	0.267	0.228	0.264	0.268	0.313	0.460
25	0.490	0.291	0.291	0.949	0.056	0.296
26	0.256	0.232	0.209	0.269	0.054	0.597
27	0.218	0.188	0.187	0.227	0.407	0.063
28	0.292	0.245	0.926	0.202	0.331	0.289
29	0.198	0.949	0.413	0.967	0.483	0.921
30	0.274	0.248	0.252	0.949	0.483	0.921
31	0.190	0.537	0.268	0.460	0.939	0.226
32	0.217	0.245	0.256	0.369	0.222	0.239
33	0.226	0.217	0.223	0.223	0.203	0.718
34	0.297	0.362	0.263	0.268	0.273	0.535
35	0.291	0.341	0.257	0.333	0.229	0.282
36	0.107	0.120	0.391	0.509	0.295	0.666
37	0.282	0.257	0.283	0.250	0.219	0.306
38	0.235	0.965	0.282	0.294	0.258	0.089
39	0.605	0.370	0.586	0.208	0.304	0.354
40	0.167	0.818	0.805	0.814	0.564	0.280

\*\* Notation\*\* S.A. is step assembly of the screws by randomized.

**TABLE A-3** The instability average values of the environment 4

Participants	The instability average values of the environment 4					
	S.A. 1	S.A. 2	S.A. 3	S.A. 4	S.A. 5	S.A. 6
1	0.264	0.706	0.277	0.265	0.240	0.503
2	0.265	0.252	0.323	0.259	0.475	0.266
3	0.278	0.241	0.358	0.271	0.274	0.253
4	0.239	0.243	0.526	0.321	0.302	0.849
5	0.190	0.219	0.290	0.237	0.639	0.315
6	0.441	0.233	0.229	0.405	0.244	0.242
7	0.443	0.614	0.264	0.233	0.281	0.845
8	0.581	0.224	0.595	0.270	0.211	0.260
9	0.200	0.222	0.194	0.345	0.530	0.288
10	0.236	0.260	0.240	0.238	0.239	0.329
11	0.267	0.226	0.239	0.176	0.418	0.251
12	0.187	0.258	0.280	0.495	0.841	0.237
13	0.481	0.331	0.306	0.236	0.245	0.323
14	0.585	0.562	0.505	0.736	1.434	0.324
15	0.567	0.420	0.273	0.246	0.271	0.316
16	0.466	0.181	0.346	0.268	0.262	0.245
17	0.499	0.253	0.261	0.258	0.448	0.229
18	0.519	0.958	0.223	0.848	0.334	0.274
19	0.813	0.212	0.300	0.263	0.314	0.239
20	0.834	0.239	0.233	0.986	0.210	0.251
21	0.520	0.212	0.338	0.224	0.202	0.207
22	0.241	0.240	0.300	0.248	0.204	0.277
23	0.844	0.865	0.329	0.333	0.346	0.972
24	0.422	0.895	0.753	0.317	0.237	0.356
25	0.344	0.137	0.321	0.297	0.231	0.426
26	0.271	0.560	0.264	0.231	0.195	0.609
27	0.309	0.240	0.184	0.681	0.196	0.235
28	0.209	0.260	0.242	0.398	0.257	0.321
29	0.040	0.263	0.112	0.246	0.181	0.912
30	0.203	0.187	0.204	0.190	0.271	0.223
31	0.340	0.369	0.276	0.262	0.477	0.203
32	0.230	0.237	0.786	0.259	0.666	0.260
33	0.247	0.179	0.264	0.207	0.176	0.236
34	0.597	0.209	0.445	0.253	0.244	0.250
35	0.295	0.263	0.350	0.237	0.320	0.262
36	0.248	0.238	0.228	0.239	0.020	0.023
37	0.416	0.797	0.290	0.241	0.255	0.250
38	0.232	0.721	0.069	0.278	0.239	0.020
39	0.336	0.605	0.370	0.586	0.155	0.408
40	0.558	0.187	0.621	0.317	0.759	0.362

**\*\* Notation\*\*** S.A. is step assembly of the screws by randomized.



(This page is intentionally left blank)

## APPENDIX B

The details preparation of the virtual reality environment for the assessment performance by the use high level criteria combined with the low basic sensors of barrel cam simulation

## **1. ODE Fix Behavior**

ODE fix behavior is the fixed joint maintains a fixed relative position and orientation between two bodies or between a body and the static environment which it has previously mentioned in section 4.4.3.1. In this experiment, we had fixed the position and orientation of the machine structure by the used geometric behavior through the transform matrix behavior which most of the machine structures are stock-still and limited mobility in place. In this experiment, we have been conducted experiments by the absolutely imperative to be fixed machine structures in order to the simulation as realistic for experiment activity. Another important issue of the ODE Fix behavior module is the specific machine structure which is a male or female and we do not identify as male because the machine structure for our experiment do not have to fit system such as clearance, transition, and interference.

In addition, position and orientation of the machine structure are more important for the kinematic joint application. Using this joint is almost never a good idea in practice, except when debugging. If we need two bodies to be glued together it is better to represent that as a single body. Call this on the fixed joint after it has been attached to remember the current desired relative offset and desired relative rotation between the bodies which ODE Fix behavior module on the CVES (the scene imported file of machine structure and transform editor) as shown in Figure B-1 on the next page.

## **2. ODE Hinge Behavior**

A hinge joint as shown in Figure B-2, is get the joint anchor point in world coordinates. This returns the point on body 1 and if the joint is perfectly satisfied this will be the same as the point on body 2. The anchor joint were the center of the axis for body1 and body2 which the both are able to rotate 360 degrees around the anchor joint axis. For this experiment, we have been fixed the both of bearing housings by the use fix behavior module to fix the position and orientation of the bearing housings are more important for kinematic joint applications. The main objective of fix behavior in order to impound constraint position of bearing housings which it is incapable to moved and rotated when the position and orientation were blocked by the used ODE fix behavior transforms.

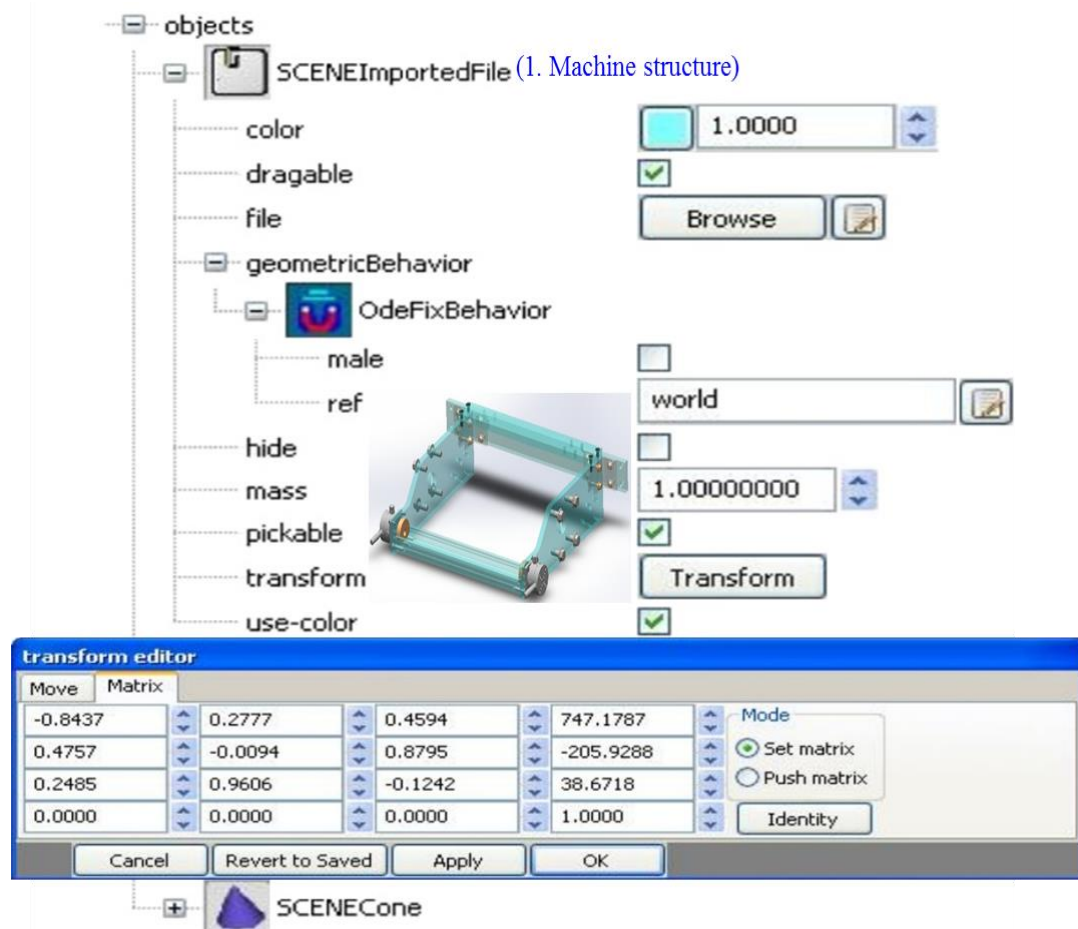

**FIGURE B-1** Kinematic joint parameter setting functions of machine structure by the used ODE fix behavior transforms only

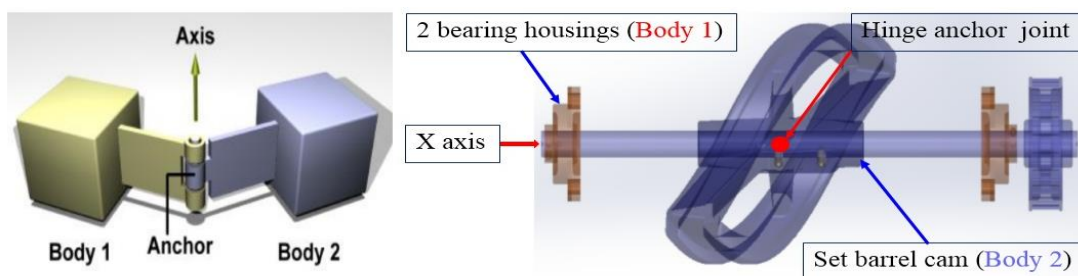

(a) A hinge anchor joint

(b) A hinge anchor joint of the barrel cam

**FIGURE B-2** A hinge anchor joint of the body 1, body 2, and hinge anchor joint of the bearing housing with the hinge anchor joint of barrel cam

While experiments, we had been rotated the barrel cam only 180 degrees by the rotated forth and back because a haptic arm device has limit for rotation. It is unable to rotate 360 degrees around X axis and the major axis of rotation is determined by the X-axis vector is (1, 0, 0) and the centre vector is (158.57, 332.42, 417.82). In ODE behaviour module, we had been not selected fill a check mark in the male box and the radius has determined equal to 100 millimetre which this method of perform as shown in Figure B-4. In addition, the kinematic joint parameter setting functions of bearing housing by the used ODE fix and hinge behavior transforms together. The both behaviors are great need to use for returns the point on body 2. If the joint is perfectly satisfied this will return the same value as Joint Get Hinge Anchor. If not this value will be slightly different.

This can be used, for example, to see how far the joint has come apart. Get the hinge angle and the time derivative of this value. The angle is measured between the two bodies, or between the body and the static environment. When the hinge anchor or axis is set, the current position and orientation of the attached bodies is examined and that position will be the zero angle.

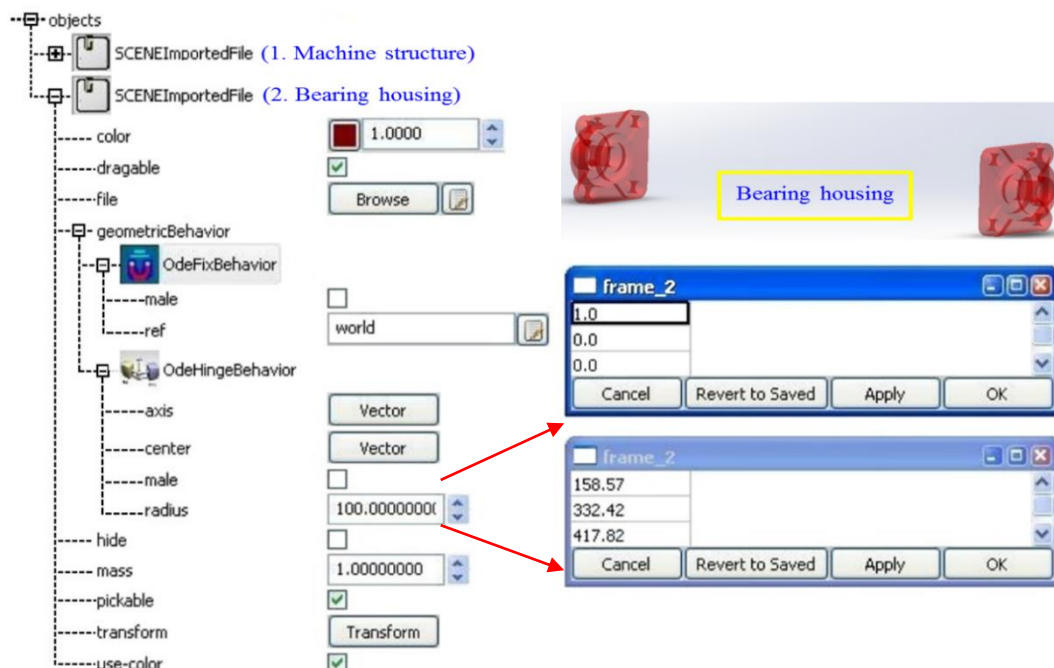

**FIGURE B-3** Kinematic joint parameter setting functions of bearing housing by the used ODE fix and hinge behavior transforms

Moreover, the barrel cam component was fixed by the used ODE hinge behavior for setting the position and orientation too. The positioning, to define the vector of the x-axis and the center of the cam to be in the same position with the bearing housings as well. The position and orientation of the barrel cam for this experiment as following: the X-axis vector is 1, 0, and 0 (x, y, and z axis) and the center vector is 158.57, 332.42, and 417.82 (x, y, and z axis). Moreover, we had been selected the fill a check mark in the male box and the radius has determined equal to 100 millimeters which the scene imported file of the barrel cam and method of perform as shown in Figure B-4.

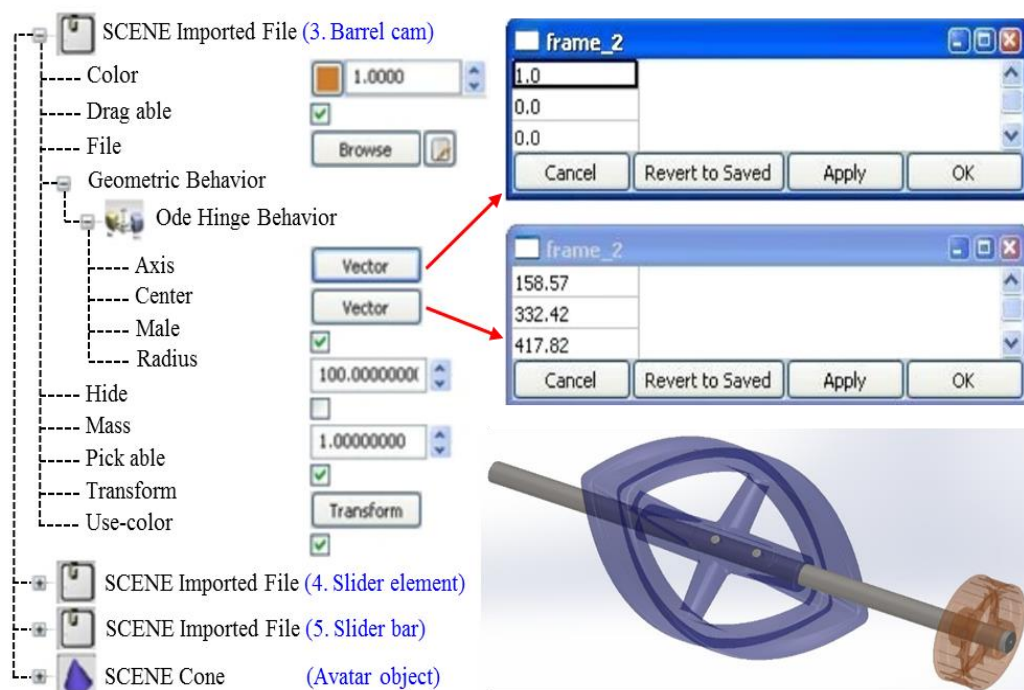

**FIGURE B-4** Kinematic joint parameter setting functions of the barrel cam by the used ODE hinge behavior transforms only

### 3. ODE Slider Behavior

A slider joint is get the slider linear position (i.e. the slider's "extension") and the time derivative of this value. If the axis is set such as pointing to Body 2 from Body 1 then the position and rate will be positive has the distance increase between the 2 bodies as shown in Figure B-5.

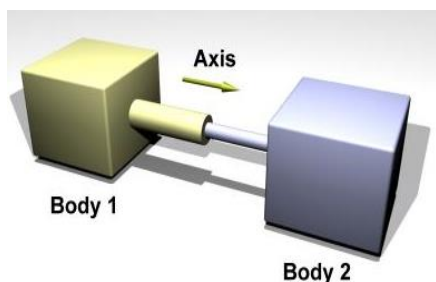

**FIGURE B-5** A slider joint of the body 1 and body 2

When the axis is set the current position and orientation of the attached bodies is examined and that position will be the zero position [Russell Smith, 2006]. The slider element for this experiment, we had been defined its position of the slider element by the used ODE slider behavior as shown in Figure B-6.

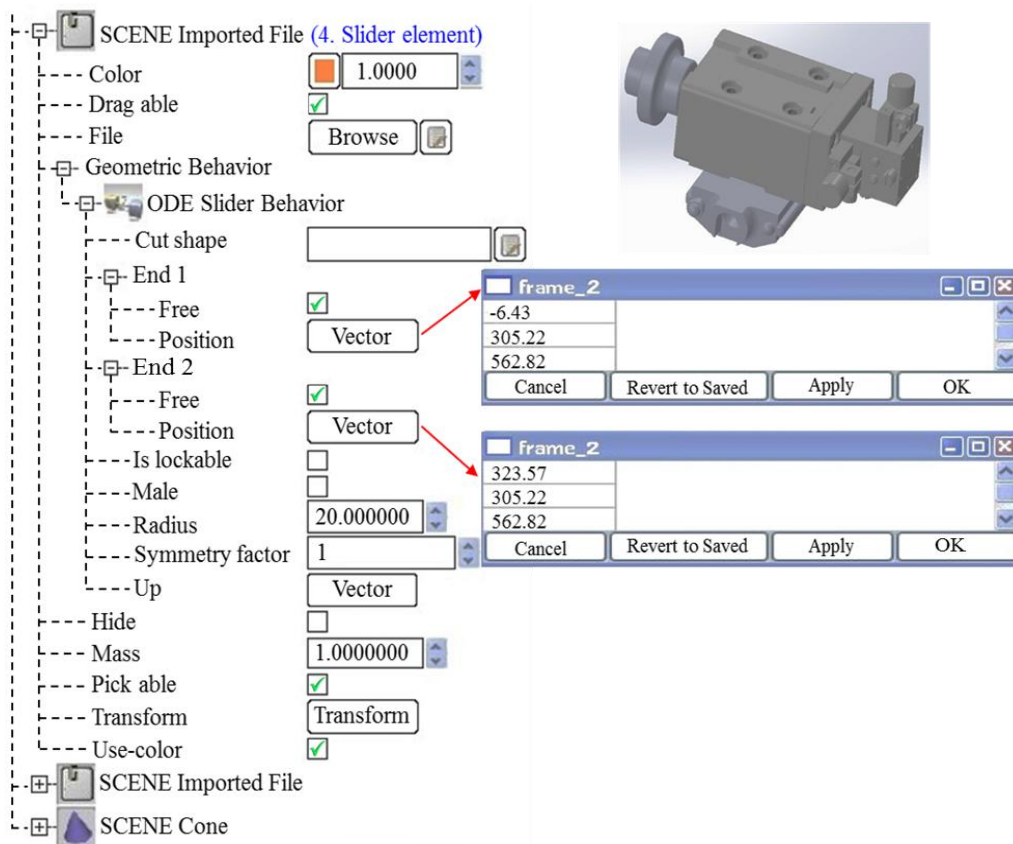

**FIGURE B-6** Kinematic joint parameter setting functions of the slider element by

the used ODE slider behavior transforms only

ODE slider behavior module application for slider element, we want to simulate the slider parts can be slide back and forth, we had been determined that it is in a position for independent of movement. The placement position of the end 1 by clicking the checkmark in the square box and the vector position is -6.43, 305.22, and 562.82 which this position is according to CAD system in accordance as following: x, y, and z axis. In addition, the placement of the end 2 by clicking the checkmark in the square box and the vector position is 323.57, 305.22, and 562.82 which the position is according to CAD system and it's the same with the position of the end1 as well. Particularly important, we have set a radius is 20 mm which refers to the size of the slider element hole.

The placement position of the slider bar, we had been employed the both behavior by the used ODE fix and ODE slider together. How to perform it?. The placement position or implementation of the slider bar in most of the ODE fix behavior which it has previously mentioned in section B.2.1 and in the case of ODE slider behavior which it has previously mentioned in section B.2.3. Appearance and how to position it has been shown in the Figure B-7.



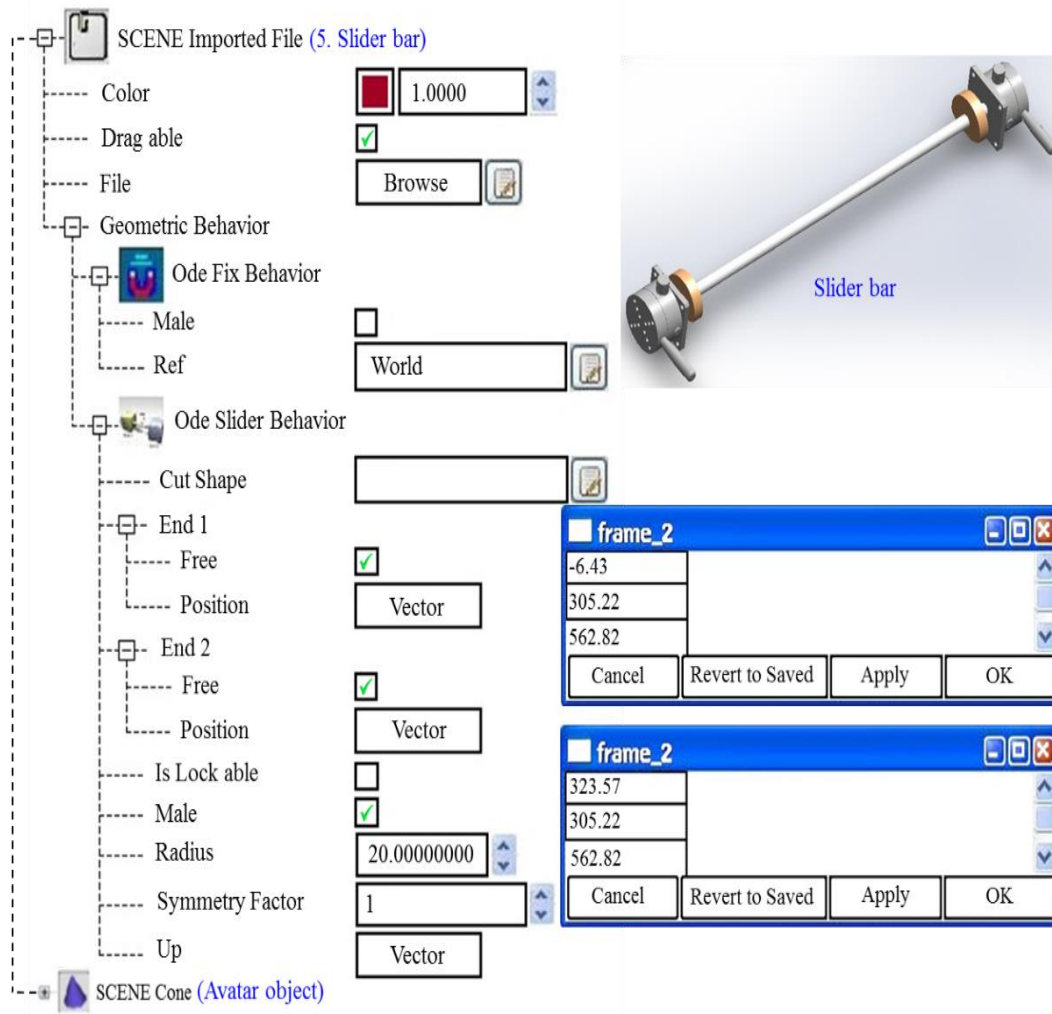

**FIGURE B-8** Kinematic joint parameter setting functions of the slider element by the used ODE Fix behavior and ODE Slider transforms

## APPENDIX C

The technical characteristics of a haptic arm



## HAPTION → virtuose 6D35-45

The Virtuose 6D35-45 is a 6 degrees-of-freedom haptic device, specifically designed for work in Virtual Reality environments.

Thanks to its large workspace and its high forces, it enables a scale one interaction with digital models coming from CAD.

Its main applications are:

- ergonomic studies
- accessibility studies
- assembly simulation
- project review

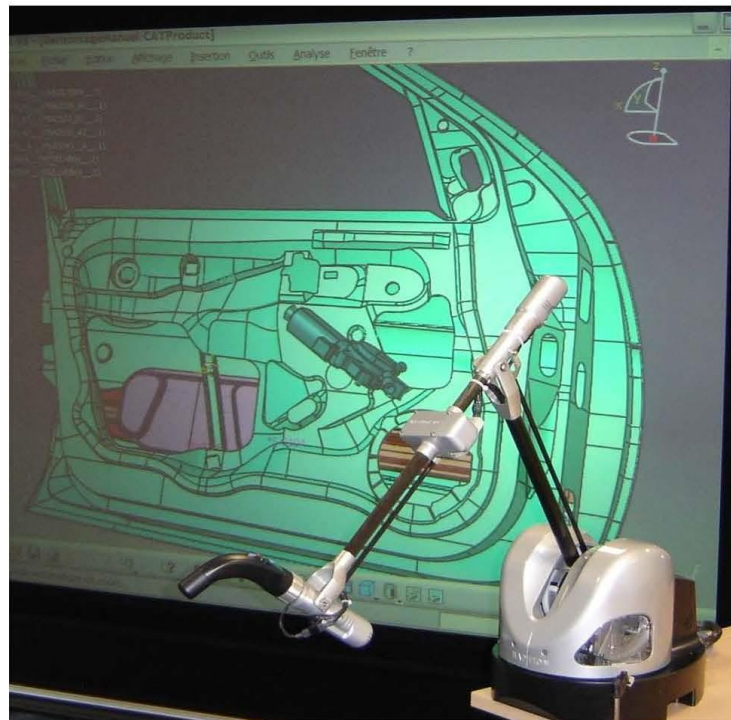

### Technical characteristics

The VIRTUOSE 6D35-45 is the only force-feedback system of the market today, which offers the following characteristics:

- ✓ Force-feedback on all 6 degrees-of-freedom (3 translations and 3 rotations)
- ✓ Operational workspace corresponding to the movements of a human arm
- ✓ Length of the segments constituting the arm: 450 mm
- ✓ Maximum force of 35N (10 N continuous), i.e. high enough to simulate the handling of heavy objects
- ✓ Maximum rotation torque of 3 Nm (1Nm continuous), i.e. high enough for two-handed handling of large virtual objects
- ✓ Exact static compensation of the device's own weight
- ✓ Modular end-effector equipped with programmable switches
- ✓ Gripping tool equipped with a proximity sensor, connected to a "dead-man" function: as long as the user does not hold the gripping tool in his hand, and as soon as he releases it, the motors are switched off, and no active movement can occur
- ✓ Reduced weight, transportable without specific equipment
- ✓ Development kit (API) available for the major operating systems
- ✓ Demonstrated compatibility with the major software applications on the market today, using dedicated plug-ins: Vortex™, Havok™, ODE, Virtools™, Catia™ V5, OpenMask, etc.
- ✓ Compatibility with tracking device like ART

## Virtuose 6D35-45

### Device workspace

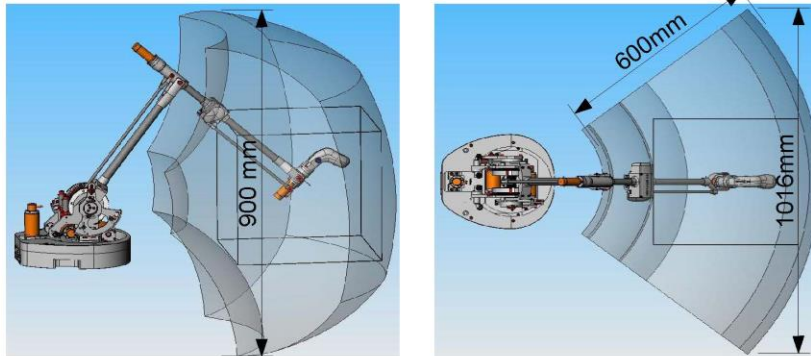

The VIRTUOSE 6D35-45 is composed of two main articulated segments fixed on a rotating base. The second segment ends with an articulated wrist, which can rotate around three concurrent axes. As a consequence, the haptic interface is a 6 degrees-of-freedom device, with force-feedback in all directions. The workspace of the VIRTUOSE 6D35-45 is large enough to include a cube 45 cm in size.  $6 \times 10^{-3}$  mm.

### Detailed specification

Débattement en °	Couple articulaire continu en N.m	Couple articulaire crête en N.m
79	5	15
100	3.1	9.3
100	3.1	9.3
215	0.79	2.37
111	0.79	2.37
162	0.79	2.37

### Modularity



The user takes hold of the haptic device using a gripper or handle placed at the tip (called "end-effector"). The end-effector is easy to remove and replace, so that a frequent change of tool is possible, in order to customize the application and reinforce the sensation of immersion. The gripping tool is equipped with three push-buttons. One of the push-buttons is dedicated to the offset function (see the control system functionalities hereafter). The state of the other buttons can be accessed using the VIRTUOSE API.

#### HAPTION S.A.

Atelier relais ZA Route de Laval – 53210 SOULGE SUR OUETTE – France  
 tel. +33(0)2 43 64 51 20  
 fax. +33(0)2 43 64 51 21  
 e-mail. [contact@haption.com](mailto:contact@haption.com)  
<http://www.haption.com>

(This page is intentionally left blank)

## APPENDIX D

The experimental results about the task duration for twenty participant and the four environments issued (raw result of the duration sensor)

**TABLE D-1** Experimental results of the task duration for environment 1

Participants	Environment 1 (Internal arc = 0 mm., External arc = 0 mm.)									
	Time order									
	Time 01	Time 02	Time 03	Time 04	Time 05	Time 06	Time 07	Time 08	Time 09	Time 10
01	2.701	2.625	2.812	2.577	3.062	2.921	2.327	3.140	2.374	2.780
02	2.859	2.812	2.265	2.188	2.407	2.156	2.281	2.406	2.265	2.453
03	2.578	2.187	2.110	1.844	1.937	1.907	2.219	2.407	2.203	1.969
04	3.547	3.172	2.875	3.125	3.188	3.344	3.016	2.781	2.422	2.453
05	2.750	2.750	2.563	2.703	2.516	2.125	2.890	2.219	2.531	2.281
06	2.577	2.982	2.814	2.508	2.661	2.480	2.494	2.258	2.793	2.493
07	2.145	1.881	2.021	1.909	1.881	2.117	2.118	2.160	1.992	2.369
08	2.562	1.984	2.437	2.062	2.375	2.016	2.203	2.063	2.250	2.250
09	2.596	2.071	2.190	2.490	2.715	2.626	2.206	2.355	2.819	2.603
10	2.197	1.777	2.213	2.524	2.322	2.057	2.399	2.415	2.228	2.353
11	2.375	3.093	2.733	3.421	2.937	2.624	2.812	2.733	3.483	3.389
12	2.070	2.325	2.610	2.235	2.340	2.400	2.130	1.935	1.905	1.800
13	2.068	1.916	1.763	2.069	1.861	1.694	1.722	1.596	1.680	1.667
14	2.729	2.145	2.220	2.070	2.129	2.009	2.609	1.755	2.339	1.950
15	2.500	1.922	2.375	2.094	2.000	1.813	1.766	2.078	1.922	1.969
16	2.063	2.015	2.125	2.641	1.938	1.671	1.750	1.797	1.918	1.588
17	2.281	2.266	2.047	2.203	2.344	1.781	1.891	1.891	2.047	2.157
18	2.400	1.914	1.817	2.109	2.191	1.609	1.859	1.934	1.754	1.964
19	2.623	1.934	2.489	2.054	2.338	2.428	2.234	2.219	2.171	2.079
20	1.731	1.676	1.468	1.523	1.315	1.357	1.482	1.344	1.136	1.080

**TABLE D-2** Experimental results of the task duration for environment 2

Participants	Environment 2 (Internal arc = 0 mm., External arc = 0 mm.)									
	Time order									
	Time 01	Time 02	Time03	Time04	Time 05	Time 06	Time 07	Time 08	Time 09	Time 10
01	2.906	2.485	2.781	2.500	3.156	2.734	2.781	2.453	3.140	2.891
02	2.375	2.375	2.407	2.000	2.125	1.922	2.265	2.140	1.672	2.265
03	2.015	2.000	1.844	2.516	1.844	1.844	1.860	1.703	1.750	1.844
04	2.734	2.422	2.765	2.515	2.406	2.610	2.594	2.437	2.813	2.016
05	2.250	2.328	2.531	2.234	2.266	2.406	2.328	2.485	2.266	2.563
06	2.388	2.492	2.433	2.298	2.327	2.253	2.492	2.343	2.733	2.507
07	2.146	2.146	2.550	2.090	2.173	2.243	2.567	2.238	2.252	2.388
08	2.156	2.015	2.375	1.968	2.328	2.125	2.593	2.484	2.422	2.594
09	2.233	2.387	2.711	2.818	2.341	2.618	2.541	3.062	2.489	3.154
10	1.967	2.092	2.217	1.920	2.200	1.888	2.232	1.935	1.842	1.780
11	2.063	2.359	2.156	1.687	2.062	2.093	1.984	2.140	2.687	2.141
12	2.700	2.221	2.040	2.100	2.190	1.635	1.770	2.070	1.875	1.935
13	1.589	1.739	1.799	1.380	1.559	1.560	1.710	1.470	1.634	1.754
14	1.756	2.248	2.411	3.060	2.706	2.535	2.134	2.379	2.301	2.255
15	1.511	1.532	1.337	1.402	1.434	1.521	1.629	1.510	1.273	1.338
16	1.681	1.572	1.650	2.164	2.179	2.444	1.821	1.961	1.619	2.008
17	2.297	2.375	2.141	1.859	2.015	2.187	2.343	2.282	2.359	2.828
18	2.159	1.829	2.114	2.010	1.739	1.859	1.919	1.859	2.339	2.174
19	2.110	2.171	2.033	2.232	2.140	2.217	2.063	2.208	2.179	2.350
20	1.246	1.412	1.564	1.371	1.302	1.385	1.454	1.468	1.709	1.753



**TABLE D-3** Experimental results of the task duration for environment 3

Participants	Environment 3 (Internal arc = 0 mm., External arc = 0 mm.)									
	Time order									
	Time 01	Time 02	Time 03	Time 04	Time 05	Time 06	Time 07	Time 08	Time 09	Time 10
01	2.719	4.453	4.109	3.359	2.296	2.891	2.640	2.187	2.500	2.875
02	2.437	2.563	2.547	2.360	2.329	2.250	2.453	2.281	2.391	2.188
03	1.907	2.187	2.281	1.875	1.704	2.062	2.156	1.937	1.609	1.953
04	2.390	2.125	2.141	2.188	2.266	2.469	2.438	2.250	2.203	2.438
05	1.984	2.109	2.734	2.672	2.516	2.578	2.656	2.343	2.609	2.281
06	2.418	2.372	2.343	2.643	2.507	2.493	2.763	2.763	2.866	2.788
07	1.982	2.387	2.088	2.162	2.808	2.207	2.193	2.258	2.482	2.553
08	2.437	2.094	2.172	2.125	2.594	2.500	2.328	2.328	2.406	2.422
09	2.303	2.118	2.149	2.381	2.410	2.675	2.410	2.037	2.518	2.767
10	1.842	1.842	1.858	2.186	2.138	2.138	2.091	2.154	2.029	2.529
11	2.296	2.359	2.827	2.031	2.703	2.109	2.703	2.703	2.906	2.656
12	1.848	2.002	2.002	1.894	1.864	2.187	2.094	2.387	1.971	2.427
13	1.560	1.665	1.814	1.650	1.844	1.755	1.800	1.935	1.889	2.129
14	2.285	2.410	2.177	2.472	2.208	2.223	1.959	2.457	2.472	2.550
15	1.403	1.348	1.693	1.694	1.736	1.666	1.486	1.500	1.555	1.777
16	1.681	1.946	1.961	1.821	1.759	1.931	1.899	1.837	1.821	1.759
17	1.409	1.398	1.570	1.699	1.495	1.581	1.495	1.570	1.549	1.517
18	1.560	2.209	1.649	1.739	1.769	1.844	1.934	1.619	1.875	1.863
19	2.040	2.380	2.179	2.348	2.254	2.223	2.348	2.083	2.006	2.099
20	1.469	1.618	1.798	1.724	1.498	1.559	1.904	1.828	1.798	1.588

**TABLE D-4** Experimental results of the task duration for environment 4

Participants	Environment 4 (Internal arc = 0 mm., External arc = 0 mm.)									
	Time order									
	Time 01	Time 02	Time03	Time04	Time 05	Time 06	Time 07	Time 08	Time 09	Time 10
01	2.640	2.391	2.124	2.984	2.343	2.469	2.437	2.500	2.078	2.641
02	2.125	3.015	1.875	1.703	1.953	1.984	1.609	2.157	2.172	2.078
03	1.750	1.641	2.187	2.032	1.922	1.875	1.859	1.906	1.969	2.094
04	2.422	2.172	2.297	2.391	2.375	2.343	1.716	1.508	1.748	1.781
05	2.422	2.406	2.453	2.469	2.391	2.422	2.047	2.156	2.343	2.672
06	2.665	2.897	2.588	2.480	2.773	2.403	2.613	2.645	2.737	2.876
07	2.297	2.658	2.117	2.583	1.907	2.748	1.982	2.357	2.326	2.511
08	3.453	2.672	2.750	2.109	2.563	2.406	2.297	2.468	2.375	2.687
09	2.333	2.767	2.861	2.316	2.301	2.550	2.659	2.814	2.348	2.410
10	1.545	1.795	1.764	2.107	1.765	1.765	2.014	1.718	1.749	3.015
11	2.047	2.202	2.281	2.468	2.640	2.202	2.375	2.140	2.000	2.515
12	2.860	2.456	2.502	2.362	2.269	2.347	2.471	2.440	3.123	2.005
13	1.934	1.971	3.157	2.048	1.909	1.894	1.787	1.755	1.740	1.895
14	2.099	2.332	2.223	2.255	2.084	2.052	2.270	1.944	1.975	2.527
15	1.847	1.736	1.680	1.597	1.694	1.666	1.819	2.124	1.569	1.721
16	1.837	1.763	1.732	2.012	1.654	1.873	1.561	1.810	1.779	4.135
17	1.602	1.355	1.290	1.376	1.528	1.484	1.441	1.258	1.398	1.398
18	2.433	1.832	2.125	1.679	2.294	2.494	2.140	2.326	2.387	2.602
19	2.037	2.347	2.363	2.737	3.048	2.410	2.550	1.851	2.519	2.348
20	1.648	1.753	1.693	1.723	1.723	1.919	1.648	1.769	1.843	2.098

**TABLE D-5** Experimental results of the task duration for environment 1

Participants	Environment 1 ( Internal arc = 5 mm.,External = 25 mm.)									
	Time order									
	Time01	Time02	Time 03	Time 04	Time 05	Time 06	Time 07	Time 08	Time 09	Time 10
01	1.912	1.981	2.037	2.051	2.080	1.953	1.911	2.023	2.373	1.982
02	2.254	2.410	2.409	2.005	2.130	2.021	1.896	1.928	2.176	2.223
03	2.125	2.328	2.172	2.328	2.390	2.266	1.922	2.344	2.219	2.422
04	2.177	2.342	2.280	2.450	1.987	2.480	2.973	2.711	3.620	2.711
05	2.463	2.538	2.237	2.583	2.387	2.568	2.208	2.223	2.568	2.702
06	2.375	2.860	2.469	1.715	2.272	2.053	1.791	1.671	1.682	1.802
07	2.718	2.553	2.733	2.553	2.328	1.937	2.342	2.282	2.673	3.214
08	1.859	2.437	2.219	2.516	2.297	2.156	2.985	2.156	2.609	2.406
09	2.187	3.176	2.693	3.021	2.382	2.133	2.912	2.460	2.164	2.429
10	1.844	2.203	1.875	1.953	2.235	1.937	1.906	1.907	1.890	2.484
11	2.250	2.374	2.141	2.375	2.078	2.250	2.015	2.078	2.625	2.249
12	2.319	2.351	2.522	2.585	2.434	2.793	2.185	2.278	2.434	2.247
13	2.764	1.999	2.234	2.156	2.062	2.093	2.296	2.374	2.717	2.109
14	2.729	2.145	2.220	2.070	2.129	2.009	2.609	1.755	2.339	1.950
15	1.701	1.576	1.747	1.872	1.623	1.997	1.950	1.700	2.090	2.028
16	1.735	1.765	1.938	2.719	1.594	1.813	1.844	1.937	1.641	1.860
17	2.109	2.344	2.078	1.813	2.000	2.250	2.500	2.042	1.494	1.547
18	1.952	2.171	2.108	2.249	2.280	2.077	1.875	1.968	2.124	2.139
19	2.179	1.775	2.148	1.852	1.997	2.309	1.950	2.043	2.060	1.934
20	1.649	1.650	1.572	1.354	1.401	1.338	1.463	1.416	1.618	1.478

**TABLE D-6** Experimental results of the task duration for environment 2

Participants	Environment 2 ( Internal arc = 5 mm.,External = 25 mm.)									
	Time order									
	Time01	Time02	Time 03	Time 04	Time 05	Time 06	Time 07	Time 08	Time 09	Time 10
01	1.912	1.981	2.037	2.051	2.080	1.953	1.911	2.023	2.373	1.982
02	2.254	2.410	2.409	2.005	2.130	2.021	1.896	1.928	2.176	2.223
03	2.125	2.328	2.172	2.328	2.390	2.266	1.922	2.344	2.219	2.422
04	2.177	2.342	2.280	2.450	1.987	2.480	2.973	2.711	3.620	2.711
05	2.463	2.538	2.237	2.583	2.387	2.568	2.208	2.223	2.568	2.702
06	2.375	2.860	2.469	1.715	2.272	2.053	1.791	1.671	1.682	1.802
07	2.718	2.553	2.733	2.553	2.328	1.937	2.342	2.282	2.673	3.214
08	1.859	2.437	2.219	2.516	2.297	2.156	2.985	2.156	2.609	2.406
09	2.187	3.176	2.693	3.021	2.382	2.133	2.912	2.460	2.164	2.429
10	1.844	2.203	1.875	1.953	2.235	1.937	1.906	1.907	1.890	2.484
11	2.250	2.374	2.141	2.375	2.078	2.250	2.015	2.078	2.625	2.249
12	2.319	2.351	2.522	2.585	2.434	2.793	2.185	2.278	2.434	2.247
13	2.764	1.999	2.234	2.156	2.062	2.093	2.296	2.374	2.717	2.109
14	2.729	2.145	2.220	2.070	2.129	2.009	2.609	1.755	2.339	1.950
15	1.701	1.576	1.747	1.872	1.623	1.997	1.950	1.700	2.090	2.028
16	1.735	1.765	1.938	2.719	1.594	1.813	1.844	1.937	1.641	1.860
17	2.109	2.344	2.078	1.813	2.000	2.250	2.500	2.042	1.494	1.547
18	1.952	2.171	2.108	2.249	2.280	2.077	1.875	1.968	2.124	2.139
19	2.179	1.775	2.148	1.852	1.997	2.309	1.950	2.043	2.060	1.934
20	1.649	1.650	1.572	1.354	1.401	1.338	1.463	1.416	1.618	1.478

**TABLE D-7** Experimental results of the task duration for environment 3

Participants	Environment 3 ( Internal arc = 5 mm.,External = 25 mm.)									
	Time order									
	Time 01	Time 02	Time 03	Time 04	Time 05	Time 06	Time 07	Time 08	Time 09	Time 10
01	3.687	2.969	2.797	2.515	5.531	3.203	2.531	2.328	2.235	2.063
02	2.779	3.726	5.288	6.445	2.389	2.235	2.019	2.605	2.281	2.157
03	1.750	2.032	2.031	2.094	2.109	2.157	2.250	1.969	2.015	2.343
04	2.522	2.606	2.480	2.480	2.425	2.732	2.794	3.004	3.304	2.974
05	2.313	2.272	2.062	2.076	2.397	1.937	1.979	2.090	2.188	2.104
06	2.891	2.594	2.656	2.391	2.688	2.547	2.718	2.359	2.890	3.391
07	1.936	2.132	2.968	2.076	2.536	1.965	2.494	2.397	2.620	2.704
08	1.984	2.156	2.172	2.391	2.359	2.390	2.078	2.312	2.312	2.328
09	2.811	2.921	3.139	3.014	2.717	2.468	3.592	3.483	2.577	2.530
10	2.453	2.422	2.484	2.515	2.281	2.234	2.391	2.859	2.516	2.390
11	2.078	2.296	2.203	2.219	2.344	2.234	2.188	2.375	2.375	2.328
12	1.828	1.844	2.437	2.093	1.953	2.125	2.172	2.414	2.367	2.336
13	2.294	1.840	2.153	2.465	2.636	2.371	2.464	2.420	2.484	2.358
14	2.285	2.410	2.177	2.472	2.208	2.223	1.959	2.457	2.472	2.550
15	2.628	1.867	1.850	1.897	1.866	2.038	2.084	1.679	1.648	1.897
16	1.937	1.998	1.733	1.858	1.780	2.077	1.889	2.093	1.842	2.092
17	2.531	2.937	2.484	2.187	2.187	2.250	2.297	1.969	2.421	1.968
18	1.544	1.857	1.731	1.872	1.903	1.825	1.825	2.262	2.028	2.046
19	1.860	2.109	2.078	2.047	2.828	2.615	2.257	2.460	2.319	2.537
20	1.608	1.624	1.515	1.625	1.687	1.609	1.563	1.594	1.797	1.500

**TABLE D-8** Experimental results of the task duration for environment 4

Participants	Environment 4 ( Internal arc = 5 mm.,External = 25 mm.)									
	Time order									
	Time 01	Time 02	Time 03	Time 04	Time 05	Time 06	Time 07	Time 08	Time 09	Time 10
01	2.891	2.578	2.485	2.688	2.078	2.172	2.203	1.968	2.141	2.250
02	3.070	2.329	3.004	2.179	1.953	2.509	2.719	1.893	2.794	2.719
03	1.610	1.922	1.937	1.937	1.719	2.468	1.765	2.454	2.015	1.797
04	2.208	3.302	2.494	2.327	2.202	2.522	2.411	2.941	3.275	3.428
05	2.870	2.940	2.536	2.411	2.439	3.219	2.550	2.327	2.313	3.065
06	2.750	2.671	2.734	2.484	2.860	2.484	2.156	2.969	3.375	2.922
07	2.707	3.093	3.278	2.784	3.078	3.371	3.495	3.232	3.077	2.984
08	3.015	2.484	2.485	2.968	2.562	2.422	2.344	2.750	2.296	2.250
09	3.182	2.699	3.806	3.166	2.823	3.358	3.202	3.405	2.921	2.843
10	2.141	2.047	2.749	2.750	2.172	2.203	2.343	2.265	2.578	2.499
11	2.249	2.437	2.374	2.203	2.328	2.484	2.391	2.531	2.359	2.891
12	2.374	1.905	2.108	1.983	2.998	2.045	2.202	2.639	2.030	2.421
13	2.699	2.590	2.231	2.356	2.277	1.888	2.231	2.059	2.230	2.122
14	2.099	2.332	2.223	2.255	2.084	2.052	2.270	1.944	1.975	2.527
15	2.355	1.860	2.025	2.257	2.180	2.056	2.334	2.133	2.273	1.964
16	1.967	2.014	1.827	1.999	1.843	2.202	2.467	1.983	1.827	1.733
17	1.397	1.622	1.869	1.795	1.688	1.730	1.665	1.580	1.612	1.956
18	2.293	2.121	3.073	2.153	2.043	1.997	2.012	2.153	2.168	2.215
19	2.077	2.561	2.593	2.468	2.608	2.421	2.437	2.563	1.860	2.468
20	1.609	1.718	1.734	1.890	1.702	1.703	1.625	1.812	2.062	2.077

**TABLE D-9** Experimental results of the task duration for environment 1

Participants	Environment 1 ( Internal = 10 mm., External = 30 mm.)									
	Time order									
	Time 01	Time 02	Time 03	Time 04	Time 05	Time 06	Time 07	Time 08	Time 09	Time 10
01	2.117	2.382	2.335	2.476	2.009	2.662	2.210	2.605	2.528	2.294
02	1.926	1.926	2.133	2.223	1.953	5.799	2.013	2.253	2.103	2.449
03	2.000	2.266	2.375	2.281	2.219	2.078	1.953	2.141	2.093	2.312
04	2.808	2.478	2.808	2.568	2.568	2.703	2.913	2.478	2.508	2.809
05	2.422	2.469	2.641	2.391	2.562	2.156	2.562	2.328	2.453	2.593
06	2.028	2.477	2.673	2.327	4.250	2.853	2.868	2.358	2.696	2.496
07	2.561	2.592	2.686	2.468	2.842	2.702	2.639	3.046	2.234	3.279
08	2.219	2.203	2.203	2.093	2.062	2.297	2.453	2.391	2.313	3.000
09	1.890	2.748	2.514	3.045	3.420	3.045	2.780	3.544	2.780	2.733
10	2.032	1.906	2.141	1.782	2.156	2.344	2.969	2.171	2.359	2.515
11	2.000	2.220	2.188	1.953	2.001	2.141	2.047	2.032	2.266	2.891
12	2.000	1.938	2.312	2.047	2.016	2.328	2.344	2.718	2.797	2.281
13	1.844	1.890	2.063	1.843	1.750	1.734	1.906	1.921	2.391	1.985
14	2.729	2.145	2.220	2.070	2.129	2.009	2.609	1.755	2.339	1.950
15	1.930	2.226	2.272	1.743	1.650	1.852	1.713	1.837	1.728	1.697
16	1.813	1.828	2.296	1.859	2.672	2.172	1.469	1.609	1.656	1.797
17	1.813	1.954	1.656	1.891	1.844	2.000	1.984	2.000	2.109	1.985
18	1.747	1.716	1.653	1.856	1.685	1.685	1.732	1.748	1.887	1.717
19	2.140	2.218	2.281	1.937	1.937	2.124	1.890	2.061	2.484	1.983
20	1.500	1.640	1.625	1.484	1.515	1.562	1.609	1.562	1.750	1.500

**TABLE D-10** Experimental results of the task duration for environment 2

Participants	Environment 2 ( Internal = 10 mm., External = 30 mm.)									
	Time order									
	Time 01	Time 02	Time 03	Time 04	Time 05	Time 06	Time 07	Time 08	Time 09	Time 10
01	3.000	2.500	2.937	2.813	2.796	2.704	2.553	2.397	2.491	2.164
02	1.934	1.363	1.363	2.108	1.800	1.689	1.703	1.912	1.633	1.912
03	2.610	2.094	1.968	1.797	1.609	1.719	1.625	2.000	1.875	2.110
04	2.717	3.330	3.079	3.052	2.466	2.982	2.717	2.898	2.620	3.414
05	2.750	3.188	2.594	2.797	2.656	2.562	2.703	2.672	2.407	2.610
06	2.118	2.216	2.480	2.020	1.839	2.062	1.937	2.410	1.895	2.382
07	3.119	3.712	2.386	4.055	2.730	3.790	3.057	3.666	2.839	5.053
08	3.672	4.031	2.562	4.015	2.953	2.562	3.062	2.766	2.828	2.187
09	2.528	3.043	2.746	2.574	2.918	2.200	2.949	2.637	2.574	2.669
10	2.500	2.500	2.391	2.281	2.109	2.859	3.265	2.781	2.297	2.375
11	2.843	3.187	2.375	2.906	2.172	2.625	3.046	2.406	2.530	2.266
12	2.342	2.327	2.404	2.311	2.420	1.749	2.436	2.576	2.311	2.498
13	2.640	2.172	2.375	2.125	2.047	2.266	2.297	2.906	2.266	2.156
14	1.756	2.248	2.411	3.060	2.706	2.535	2.134	2.379	2.301	2.255
15	1.734	2.218	1.812	2.499	1.984	2.249	1.999	2.468	1.952	2.640
16	2.250	2.250	1.969	2.687	2.031	1.984	2.109	2.015	1.859	1.984
17	2.390	2.375	2.234	2.547	2.438	2.718	2.547	2.344	2.110	2.593
18	4.404	3.237	2.210	2.412	2.574	3.011	2.542	2.606	2.730	2.543
19	2.357	1.827	2.186	2.248	1.936	2.108	2.202	2.233	2.326	2.373
20	2.172	2.828	2.703	2.046	1.907	2.125	1.953	2.468	2.218	2.281



**TABLE D-11** Experimental results of the task duration for environment 3

Participants	Environment 3 ( Internal = 10 mm., External = 30 mm.)									
	Time order									
	Time 01	Time 02	Time 03	Time 04	Time 05	Time 06	Time 07	Time 08	Time 09	Time 10
01	2.040	2.350	2.242	2.413	2.086	2.273	2.164	2.257	2.226	2.211
02	2.121	1.870	1.856	1.828	2.065	1.968	1.940	1.786	1.939	2.178
03	2.110	2.125	2.031	2.390	2.328	2.281	2.172	2.328	2.344	2.437
04	2.257	2.829	2.648	2.746	2.662	2.564	2.452	2.690	3.979	2.943
05	2.609	2.453	2.422	2.187	2.359	2.344	2.438	2.281	2.438	2.437
06	1.630	2.958	2.058	2.492	2.688	2.312	2.898	2.358	2.733	2.823
07	2.667	2.714	2.776	2.682	2.542	2.543	2.417	2.667	2.589	2.793
08	2.156	2.281	2.484	2.203	2.188	1.984	2.281	2.203	2.296	2.562
09	2.545	2.732	2.857	3.107	2.639	2.748	2.577	2.748	2.701	2.686
10	2.031	2.016	2.406	2.313	2.500	2.406	2.531	2.625	2.656	2.562
11	2.250	1.954	2.641	2.141	2.172	2.437	2.391	2.328	2.360	2.094
12	2.389	2.186	2.514	1.952	2.264	1.733	2.718	2.640	2.437	2.718
13	1.579	1.875	2.187	2.000	2.094	2.125	2.031	1.922	1.828	1.985
14	2.285	2.410	2.177	2.472	2.208	2.223	1.959	2.457	2.472	2.550
15	2.032	2.047	2.281	1.860	1.812	1.844	1.875	1.672	1.781	1.687
16	1.765	2.031	1.921	2.188	1.703	1.844	1.718	1.984	2.062	1.968
17	2.578	2.453	2.047	2.141	2.016	2.203	1.860	1.984	1.968	2.188
18	2.137	2.028	1.825	1.872	1.888	1.888	2.262	1.997	1.981	1.934
19	1.889	1.999	2.061	2.093	2.077	2.093	2.014	1.874	1.936	2.076
20	1.234	1.578	1.453	1.687	1.453	1.500	1.625	1.781	1.500	1.500

**TABLE D-12** Experimental results of the task duration for environment 4

Participants	Environment 4 ( Internal = 10 mm., External = 30 mm.)									
	Time order									
	Time 01	Time 02	Time 03	Time 04	Time 05	Time 06	Time 07	Time 08	Time 09	Time 10
01	2.122	2.496	2.278	2.138	2.122	2.122	2.200	2.294	1.997	1.872
02	1.983	1.878	1.833	1.848	1.887	1.638	1.682	1.953	2.074	1.758
03	1.812	1.708	1.314	1.336	1.259	1.401	1.237	1.412	1.270	1.488
04	3.243	2.688	2.928	2.447	2.658	2.448	3.243	3.378	2.973	3.005
05	2.172	2.469	2.594	2.485	2.656	2.657	2.547	2.547	2.703	3.313
06	2.064	2.536	2.489	2.150	2.953	2.490	3.108	2.644	2.336	2.752
07	2.467	3.452	2.248	3.670	2.109	3.155	2.405	3.967	2.670	3.498
08	1.922	2.625	2.359	2.594	2.547	2.328	2.890	2.625	2.656	2.640
09	2.218	2.328	2.515	2.390	3.233	2.749	2.390	2.671	2.688	3.046
10	2.094	3.515	2.656	2.547	2.969	2.297	2.734	2.375	2.485	2.828
11	2.453	1.922	1.875	2.265	2.078	2.266	2.312	1.891	2.062	2.000
12	2.812	2.187	2.734	2.578	2.124	2.468	2.624	2.390	2.046	2.531
13	2.359	2.234	2.079	2.250	2.218	2.375	2.203	2.234	2.250	2.594
14	2.099	2.332	2.223	2.255	2.084	2.052	2.270	1.944	1.975	2.527
15	2.537	1.806	1.805	2.382	1.774	1.466	1.747	1.763	1.934	1.685
16	1.953	1.844	1.828	1.688	1.875	2.250	2.031	2.360	1.609	2.359
17	2.500	2.515	1.953	2.141	2.297	2.329	2.532	2.281	2.000	2.406
18	2.076	2.030	1.998	2.358	1.920	2.186	2.342	2.217	2.046	2.264
19	1.765	1.890	2.109	1.875	2.077	2.250	2.328	2.047	2.202	2.062
20	1.609	1.703	1.875	1.844	1.843	2.078	1.859	1.969	1.750	2.109

**TABLE D-13** Experimental results of the task duration for environment 1

Participants	Environment 1 (Internal arc = 15 mm., External arc = 35 mm.)									
	Time order									
	Time 01	Time 02	Time 03	Time 04	Time 05	Time 06	Time 07	Time 08	Time 09	Time 10
01	2.117	2.382	2.335	2.476	2.009	2.662	2.210	2.605	2.528	2.294
02	1.906	2.157	2.188	2.703	2.110	2.063	2.125	2.281	2.218	2.563
03	2.031	2.547	2.344	2.313	2.516	2.047	2.250	2.391	2.359	2.125
04	2.072	2.193	2.253	2.012	2.177	2.102	2.252	2.388	2.162	2.749
05	2.264	2.572	2.342	2.388	1.987	2.403	2.242	2.181	3.016	2.969
06	1.862	2.388	2.013	2.057	2.372	2.234	2.249	2.203	2.742	2.619
07	2.266	2.624	2.094	2.484	2.531	2.421	2.250	2.281	2.156	2.313
08	2.234	2.062	2.359	2.578	2.047	2.266	2.453	2.734	2.203	2.468
09	2.187	2.422	2.452	2.218	2.203	2.546	2.469	2.516	2.703	2.703
10	1.844	1.968	1.828	1.969	1.906	1.828	2.328	2.109	2.203	2.421
11	2.312	1.609	1.625	1.672	1.703	1.843	1.766	1.937	1.781	2.047
12	2.094	2.001	2.000	1.953	1.797	1.828	2.141	2.219	2.141	2.265
13	1.863	1.894	2.002	1.833	1.863	1.802	1.941	1.802	1.940	2.125
14	1.620	1.860	1.875	2.264	1.785	2.100	1.710	1.935	1.710	1.679
15	1.530	1.740	1.775	2.162	1.683	2.310	1.830	2.743	1.623	1.587
16	1.830	1.740	2.085	1.650	1.650	3.090	1.755	1.965	2.094	2.095
17	1.649	2.204	2.189	2.234	2.204	2.384	2.009	2.069	2.018	2.294
18	2.219	2.047	2.234	2.328	2.125	2.625	2.531	2.484	2.141	2.203
19	2.171	2.000	2.015	1.890	1.609	1.953	1.813	2.156	2.187	2.219
20	1.586	1.809	1.497	1.497	1.997	1.576	1.607	1.701	1.623	1.544

**TABLE D-14** Experimental results of the task duration for environment 2

Participants	Environment 2 (Internal arc = 15 mm., External arc = 35 mm.)									
	Time order									
	Time 01	Time 02	Time 03	Time 04	Time 05	Time 06	Time 07	Time 08	Time 09	Time 10
01	3.000	2.500	2.937	2.813	2.796	2.704	2.553	2.397	2.491	2.164
02	2.188	2.015	1.938	1.766	1.859	2.031	1.859	2.234	2.141	1.984
03	1.891	1.828	1.797	2.078	2.141	2.343	2.281	2.313	2.390	2.094
04	1.811	2.216	1.938	2.174	2.133	1.993	2.146	2.188	2.203	2.411
05	2.285	2.229	2.257	2.285	2.174	2.215	2.299	2.355	2.341	2.257
06	1.993	2.258	2.536	2.328	2.538	2.373	2.719	2.523	2.478	2.418
07	2.422	2.532	2.782	2.438	2.250	2.188	2.500	2.203	2.907	2.329
08	2.171	2.281	2.375	1.874	2.453	2.078	2.406	2.266	2.531	2.391
09	2.250	2.438	2.484	2.781	2.374	2.594	2.249	2.562	2.391	2.578
10	2.078	2.233	2.421	2.390	2.640	2.343	2.593	2.202	2.046	1.874
11	1.734	2.172	1.719	1.796	1.844	2.016	1.828	1.875	1.813	2.062
12	1.968	2.031	2.172	1.766	2.140	2.125	2.156	1.797	1.937	1.797
13	2.235	1.680	1.785	1.710	1.694	2.460	1.725	1.799	1.815	1.800
14	1.723	1.642	1.808	1.810	1.634	1.233	1.864	1.888	1.832	1.789
15	1.819	1.541	1.707	1.763	1.749	1.721	1.916	1.736	1.721	1.944
16	1.916	6.915	1.610	1.486	1.541	1.694	1.486	1.207	1.736	1.680
17	2.122	1.789	1.994	2.174	2.129	2.219	2.279	1.814	2.353	2.264
18	1.985	1.798	2.266	2.516	2.297	2.297	2.234	2.328	2.203	2.110
19	1.703	1.828	2.078	1.641	1.766	2.124	1.922	1.984	2.078	2.109
20	1.835	1.974	1.757	1.913	2.052	1.741	1.850	1.773	1.586	1.912

**TABLE D-15** Experimental results of the task duration for environment 3

Participants	Environment 3 (Internal arc = 15 mm., External arc = 35 mm.)									
	Time order									
	Time 01	Time 02	Time 03	Time 04	Time 05	Time 06	Time 07	Time 08	Time 09	Time 10
01	2.040	2.350	2.242	2.413	2.086	2.273	2.164	2.257	2.226	2.211
02	2.203	2.468	2.344	2.500	2.172	2.516	1.891	2.172	2.391	2.531
03	2.312	2.468	2.078	2.141	2.437	2.125	2.281	2.219	2.172	2.266
04	1.792	1.519	2.118	2.508	2.133	2.146	2.257	2.579	1.965	2.091
05	1.672	2.439	2.369	2.703	2.355	2.494	2.132	2.244	2.661	2.327
06	2.105	2.718	2.300	2.021	2.244	1.853	2.034	2.327	1.826	2.397
07	3.077	3.327	2.889	2.829	2.485	2.689	2.657	2.626	2.344	2.797
08	2.125	2.469	2.344	2.110	1.953	2.390	2.156	2.281	2.328	2.640
09	2.562	1.765	2.124	2.203	2.266	2.547	2.343	2.359	2.078	2.546
10	2.421	2.328	2.172	2.421	2.061	2.046	2.374	2.093	2.280	2.406
11	2.890	2.594	2.766	2.000	2.609	2.672	2.625	2.625	3.250	2.515
12	2.405	2.172	2.109	2.062	2.109	2.812	2.015	2.140	2.062	2.125
13	1.763	1.555	2.069	1.833	1.694	1.707	1.846	1.985	2.000	1.920
14	2.485	2.165	2.193	2.221	2.444	1.749	2.068	1.874	1.929	1.902
15	1.827	1.968	1.843	2.030	1.826	1.968	1.843	2.155	1.748	2.233
16	1.903	2.153	1.874	1.736	1.736	1.903	1.833	1.805	2.027	2.444
17	1.900	1.775	2.094	1.831	1.803	1.803	1.956	1.886	1.817	1.734
18	2.110	1.985	2.001	1.985	2.031	2.031	1.938	1.859	2.063	1.672
19	2.031	2.156	1.953	1.906	1.906	2.015	2.375	2.328	1.937	1.969
20	1.788	1.679	1.648	1.540	1.539	1.617	1.586	1.540	1.772	1.477

**TABLE D-16** Experimental results of the task duration for environment 4

Participants	Environment 4 (Internal arc = 15 mm., External arc = 35 mm.)									
	Time order									
	Time 01	Time 02	Time 03	Time 04	Time 05	Time 06	Time 07	Time 08	Time 09	Time 10
01	2.122	2.496	2.278	2.138	2.122	2.122	2.200	2.294	1.997	1.872
02	2.125	1.969	2.078	2.015	1.813	2.031	1.953	2.157	2.032	2.109
03	1.985	2.359	2.765	2.812	2.421	2.875	2.859	2.688	2.672	2.344
04	2.133	1.951	2.222	2.178	2.118	2.237	2.207	2.358	2.298	2.297
05	2.672	2.193	2.388	2.342	2.448	2.177	2.388	2.283	2.538	2.223
06	2.538	2.478	2.703	2.523	2.313	2.327	2.328	2.522	2.433	2.674
07	2.313	3.094	2.656	2.578	2.312	2.750	2.156	2.937	2.484	2.531
08	1.875	2.078	6.656	2.391	2.172	2.672	2.563	2.484	2.124	2.624
09	2.202	2.328	2.484	2.250	2.047	2.218	2.562	2.140	2.390	2.515
10	2.312	2.343	2.250	2.062	2.281	2.453	2.156	2.110	2.313	2.312
11	1.953	2.234	2.125	2.093	1.796	1.937	1.860	1.906	2.094	1.781
12	1.968	2.031	2.078	2.078	1.765	1.969	2.046	1.921	2.422	2.156
13	2.130	1.920	2.024	1.980	2.025	1.770	2.040	2.010	2.070	2.099
14	2.100	1.950	2.055	1.830	1.889	1.620	1.709	1.770	1.965	1.965
15	2.123	1.830	2.122	1.750	1.788	1.196	1.987	1.678	1.876	2.223
16	2.954	3.164	3.479	2.250	2.475	2.040	2.160	1.995	1.965	2.295
17	2.324	2.309	2.473	2.429	2.294	2.189	2.354	2.309	2.219	2.414
18	1.890	2.187	2.375	1.890	2.062	1.891	2.000	2.016	1.890	1.765
19	1.796	2.015	1.922	2.374	2.499	2.203	2.078	2.078	2.124	2.406
20	1.497	1.591	1.482	1.357	2.090	1.373	1.498	1.341	1.217	1.357

**TABLE D-17** Experimental results of the task duration for environment 1

Participants	Environment 1 ( Internal arc = 20 mm., External arc = 40 mm.)									
	Time order									
	Time 01	Time 02	Time 03	Time 04	Time 05	Time 06	Time 07	Time 08	Time 09	Time 10
01	1.996	2.683	2.090	2.418	2.184	2.515	2.014	1.953	1.984	2.717
02	2.043	1.908	2.284	1.983	2.208	2.013	1.938	1.788	1.923	1.968
03	2.553	2.628	3.078	2.808	3.079	2.927	3.112	2.481	2.558	2.896
04	2.437	2.516	2.188	2.343	2.032	2.265	2.312	1.726	1.791	1.900
05	2.264	2.452	3.358	2.592	2.546	2.639	2.811	3.014	3.124	2.671
06	2.358	1.967	2.959	2.327	2.342	2.402	2.568	2.178	2.583	2.222
07	2.156	2.766	2.203	2.844	2.376	2.609	2.110	2.281	2.313	2.516
08	2.656	2.406	2.624	1.969	2.406	2.156	2.218	2.531	2.297	2.343
09	2.312	1.890	2.047	2.062	2.093	2.219	2.203	2.156	2.109	2.250
10	2.790	2.445	2.520	2.310	2.416	2.400	2.115	2.160	2.279	2.326
11	2.086	2.178	2.287	2.075	2.232	2.169	2.169	2.403	2.216	2.107
12	2.032	2.219	2.016	2.406	2.141	2.172	2.375	2.500	2.485	2.548
13	1.841	1.857	1.888	1.685	2.091	2.060	1.763	1.779	1.857	2.060
14	1.743	1.978	2.113	1.876	1.838	1.940	2.243	1.878	2.342	2.756
15	2.702	2.577	2.311	1.983	2.920	1.984	2.249	1.952	2.265	2.811
16	1.669	1.950	2.046	2.061	2.140	2.124	2.265	2.796	2.046	1.749
17	1.841	1.919	2.090	1.778	2.013	2.044	2.184	2.074	1.841	2.090
18	2.672	2.485	2.500	2.203	2.437	2.078	2.156	1.750	2.234	2.125
19	1.634	1.634	1.739	1.589	1.484	1.586	1.663	1.663	1.601	1.586
20	1.328	1.641	1.468	1.625	1.406	1.734	1.484	1.484	1.828	1.906

**TABLE D-18** Experimental results of the task duration for environment 2

Participants	Environment 2 ( Internal arc = 20 mm., External arc = 40 mm.)									
	Time order									
	Time 01	Time 02	Time 03	Time 04	Time 05	Time 06	Time 07	Time 08	Time 09	Time 10
01	1.981	2.527	2.168	2.402	2.386	2.511	1.997	2.745	2.044	2.528
02	1.623	1.488	1.533	1.592	1.848	1.608	1.908	1.668	1.863	2.073
03	2.568	2.929	3.244	2.914	3.244	2.763	3.665	2.629	2.553	2.538
04	2.312	3.531	2.578	2.593	2.515	2.609	2.297	2.734	2.703	2.984
05	2.921	2.655	2.718	2.405	2.468	2.717	2.561	2.562	3.014	2.998
06	2.814	2.564	2.104	2.718	2.313	2.357	2.717	2.312	2.838	2.078
07	2.281	2.766	2.719	2.828	2.813	2.782	3.047	3.579	2.797	3.516
08	2.234	2.125	2.313	2.672	1.984	2.281	2.140	2.734	2.312	2.656
09	2.328	2.093	2.641	2.265	2.452	2.500	2.812	2.219	2.078	2.250
10	2.220	2.385	2.176	2.190	2.010	2.401	2.176	2.415	2.100	2.535
11	1.961	2.085	2.116	1.991	2.101	1.805	2.054	2.008	2.132	2.272
12	2.296	1.953	2.187	2.234	2.000	2.202	1.859	2.390	1.953	2.547
13	1.841	2.012	1.981	1.888	1.903	1.872	1.919	2.418	2.153	2.091
14	1.876	2.546	2.987	2.342	2.432	2.133	2.234	1.870	2.431	2.234
15	2.184	2.683	2.247	2.449	2.293	2.277	2.340	1.919	2.511	2.169
16	1.888	2.044	1.700	2.589	1.747	2.199	1.653	2.121	1.856	2.325
17	1.950	2.340	2.325	2.293	2.575	2.169	2.730	1.545	2.356	2.247
18	2.531	2.219	2.501	2.578	2.406	2.423	2.625	2.485	2.562	2.516
19	2.159	2.099	2.158	2.009	1.769	2.234	2.053	2.099	2.144	2.278
20	1.672	1.781	1.703	1.594	1.984	1.625	2.000	1.485	1.906	1.907



**TABLE D-19** Experimental results of the task duration for environment 3

Participants	Environment 3 ( Internal arc = 20 mm., External arc = 40 mm.)									
	Time order									
	Time 01	Time 02	Time 03	Time 04	Time 05	Time 06	Time 07	Time 08	Time 09	Time 10
01	2.721	5.411	2.550	3.125	2.348	2.627	2.612	2.644	2.441	2.830
02	2.515	1.824	3.503	2.694	3.070	2.470	3.447	2.680	2.665	2.582
03	3.416	3.319	3.263	2.969	3.095	2.984	2.941	3.764	2.942	2.761
04	2.703	2.672	3.000	2.672	3.031	2.765	2.750	2.750	2.813	3.078
05	2.480	3.323	2.699	2.448	2.480	2.589	2.511	2.979	3.073	2.480
06	1.748	1.879	1.869	2.745	2.410	2.466	2.271	2.368	2.396	2.759
07	2.719	3.062	3.109	3.266	3.406	2.640	2.500	2.656	3.140	3.515
08	3.374	2.484	2.453	2.656	2.563	2.390	2.109	2.219	2.469	2.360
09	2.406	2.406	2.484	2.781	2.656	2.687	2.375	2.578	2.531	2.797
10	1.546	2.308	2.140	1.695	2.181	2.057	2.404	2.071	2.376	2.306
11	2.297	2.281	1.984	2.360	2.265	2.688	2.218	2.031	2.453	3.344
12	1.860	1.843	2.016	2.078	2.187	2.219	2.156	2.343	2.422	2.109
13	1.836	1.882	1.867	1.804	1.944	1.914	1.976	1.820	1.914	1.992
14	2.597	2.022	2.347	2.581	2.208	2.161	1.913	2.270	2.162	2.332
15	2.432	2.122	2.432	2.324	2.654	2.342	1.865	2.430	2.321	2.432
16	2.316	1.990	1.974	2.534	3.156	3.359	3.607	1.990	5.613	1.794
17	2.519	2.192	2.332	2.255	2.209	2.130	2.099	2.083	2.052	2.022
18	2.141	2.015	2.343	2.140	1.999	2.250	1.766	2.031	1.812	1.859
19	2.676	1.580	2.287	1.719	2.010	1.858	1.996	1.871	1.761	1.872
20	1.719	1.625	1.750	1.844	1.813	1.672	1.500	1.735	1.563	1.875

**TABLE D-20** Experimental results of the task duration for environment 4

Participants	Environment 4 ( Internal arc = 20 mm., External arc = 40 mm.)									
	Time order									
	Time 01	Time 02	Time 03	Time 04	Time 05	Time 06	Time 07	Time 08	Time 09	Time 10
01	2.504	3.151	2.542	3.104	2.340	2.371	2.559	2.714	2.137	2.324
02	2.024	1.786	1.535	1.898	1.717	1.646	1.675	1.619	1.675	1.619
03	1.980	2.189	3.332	2.593	2.816	2.690	3.109	2.551	3.049	2.583
04	2.531	3.079	2.735	2.531	2.438	2.719	2.516	2.687	2.235	3.032
05	3.026	2.807	2.839	2.620	3.213	2.777	2.464	2.324	2.231	2.452
06	2.229	2.006	2.452	2.313	2.202	2.202	2.104	2.564	2.396	2.327
07	2.656	3.171	2.641	2.969	2.781	2.796	3.468	3.031	3.281	3.234
08	2.047	2.266	2.500	2.296	2.469	2.374	2.453	2.437	2.547	2.562
09	3.062	2.750	3.531	3.578	2.812	2.577	2.984	2.531	2.375	2.296
10	2.098	1.806	1.890	2.210	2.028	2.473	1.987	1.973	1.848	2.057
11	2.474	2.365	2.645	2.054	1.649	1.992	1.992	2.117	1.977	2.101
12	2.093	2.328	2.531	2.218	2.593	2.328	2.516	2.453	2.406	2.265
13	1.602	1.587	1.851	1.851	1.727	1.882	1.857	1.856	2.293	2.153
14	2.332	2.378	2.535	2.162	2.381	2.605	1.918	1.966	1.810	1.950
15	2.432	2.212	2.436	2.432	2.454	2.542	1.918	1.897	1.783	1.860
16	2.027	1.575	2.043	1.762	1.997	1.716	1.888	2.356	1.841	2.309
17	1.929	1.975	2.550	2.535	2.255	2.535	2.348	2.457	2.737	2.892
18	2.093	2.423	2.172	2.516	2.562	2.626	2.578	2.829	3.672	2.532
19	1.709	1.964	1.784	2.009	2.204	2.114	2.278	2.279	2.099	1.964
20	1.625	1.828	1.969	2.110	1.719	1.578	1.781	1.844	2.156	2.016

**TABLE D-21** Experimental results of the task duration for environment 1

Participants	Environment 1 ( Internal arc = 25 mm., External arc = 45 mm.)									
	Time order									
	Time 01	Time 02	Time 03	Time 04	Time 05	Time 06	Time 07	Time 08	Time 09	Time 10
01	2.329	2.219	2.688	2.140	2.281	2.469	2.531	2.203	2.500	2.547
02	1.781	2.047	2.172	2.125	2.141	2.031	2.203	1.875	2.360	2.250
03	2.013	2.268	2.599	2.433	2.448	2.508	2.508	2.553	2.764	2.403
04	1.867	1.713	2.675	2.188	2.438	2.633	3.247	2.104	2.062	2.257
05	2.109	3.953	2.688	2.672	2.531	3.250	3.329	2.109	2.500	2.531
06	2.047	2.359	2.297	2.422	2.078	2.313	2.265	2.375	2.140	2.484
07	2.515	2.172	2.078	2.313	2.516	1.938	2.375	2.219	1.906	2.704
08	2.328	2.047	2.156	1.797	2.437	2.172	2.281	2.187	2.125	2.718
09	1.635	1.980	1.980	1.786	1.965	1.800	1.950	2.115	2.461	2.656
10	1.981	1.685	2.090	1.560	2.215	1.684	2.122	1.934	1.949	2.278
11	1.431	1.779	1.667	1.612	1.831	1.500	1.396	1.845	1.770	1.800
12	2.265	2.265	2.188	2.250	1.984	2.718	2.031	1.969	2.328	2.203
13	1.742	1.930	1.789	1.743	1.867	1.898	2.178	2.059	2.449	1.997
14	2.465	1.935	1.841	2.059	1.748	1.935	2.496	2.309	1.950	1.919
15	2.567	1.875	1.879	2.135	1.873	1.786	2.543	2.321	1.873	1.789
16	1.197	1.186	1.262	1.337	1.262	1.305	1.347	1.121	1.273	1.337
17	1.651	1.898	1.696	1.556	1.681	1.821	1.728	1.790	1.728	1.883
18	2.171	2.047	2.422	2.062	2.156	2.297	2.187	2.219	2.328	2.609
19	1.809	2.028	1.840	1.965	1.840	1.950	1.654	1.435	1.950	2.106
20	1.780	1.671	1.592	1.592	1.437	1.530	1.406	1.499	1.561	1.437

**TABLE D-22** Experimental results of the task duration for environment 2

Participants	Environment 2 ( Internal arc = 25 mm., External arc = 45 mm.)									
	Time order									
	Time 01	Time 02	Time 03	Time 04	Time 05	Time 06	Time 07	Time 08	Time 09	Time 10
01	3.640	2.422	2.593	2.531	2.469	2.594	2.344	2.219	2.078	2.140
02	2.391	2.234	2.265	2.188	3.453	2.172	1.938	1.938	1.781	1.968
03	3.318	2.026	4.267	2.328	2.760	2.565	2.621	2.510	2.607	2.371
04	1.693	1.956	1.606	1.977	1.671	1.748	1.671	1.814	1.650	1.912
05	2.859	2.453	2.453	3.468	3.640	2.172	3.766	2.406	3.688	2.531
06	2.516	2.453	2.750	2.672	2.562	2.672	2.860	2.157	2.750	2.797
07	2.594	3.828	2.922	2.156	2.609	2.484	2.453	2.187	2.485	2.531
08	2.609	3.140	2.281	2.922	2.438	2.281	2.235	2.468	2.484	2.203
09	2.126	2.057	2.126	2.126	1.890	2.057	1.973	2.307	1.862	2.251
10	2.643	2.813	2.860	2.347	2.222	2.114	2.129	2.347	2.518	2.300
11	1.375	1.796	1.668	1.654	1.431	1.570	1.501	1.528	1.556	1.667
12	2.562	2.344	2.094	2.203	2.328	2.234	2.578	2.343	2.452	2.109
13	1.813	1.688	1.797	1.922	2.437	2.422	2.163	2.722	2.209	2.567
14	2.320	2.864	2.304	2.366	2.007	2.241	2.242	2.024	1.852	2.397
15	1.511	1.532	1.337	1.402	1.434	1.521	1.629	1.510	1.273	1.338
16	1.154	1.175	0.874	1.013	0.982	2.596	4.872	1.957	1.791	1.791
17	1.936	1.952	1.874	2.624	2.515	2.515	2.609	2.514	2.437	2.296
18	2.656	2.250	2.625	2.734	2.484	2.328	2.344	2.516	2.453	2.547
19	1.679	2.300	2.254	2.145	2.099	2.332	1.897	3.389	1.989	2.410
20	1.982	2.434	2.028	2.324	1.872	2.247	2.090	1.825	2.215	2.090

**TABLE D-23** Experimental results of the task duration for environment 3

Participants	Environment 3 ( Internal arc = 25 mm., External arc = 45 mm.)									
	Time order									
	Time 01	Time 02	Time 03	Time 04	Time 05	Time 06	Time 07	Time 08	Time 09	Time 10
01	2.703	2.578	2.531	2.422	2.313	2.234	2.531	2.453	2.453	2.703
02	2.657	1.968	2.031	2.219	2.250	2.140	2.078	2.157	2.516	2.406
03	2.358	2.403	2.313	2.449	2.163	2.103	2.448	2.253	2.280	2.326
04	2.628	2.102	2.838	2.328	2.883	2.312	2.478	3.078	2.537	2.748
05	3.610	2.078	2.953	2.109	4.579	2.391	3.312	2.281	3.953	2.265
06	2.219	2.719	2.281	2.250	2.218	2.016	2.547	2.672	2.390	2.750
07	2.079	2.688	3.439	2.876	2.407	2.219	2.219	2.454	1.923	2.438
08	2.516	2.328	2.328	2.281	2.109	2.344	2.015	2.235	2.156	2.391
09	1.980	2.280	2.280	2.536	2.355	2.070	2.695	2.341	2.957	2.295
10	1.996	2.105	2.169	2.137	2.027	1.934	1.934	2.200	2.561	2.311
11	1.560	1.621	1.560	1.651	1.620	2.551	1.320	1.591	1.695	1.965
12	2.328	2.172	2.235	2.109	2.298	2.313	2.047	2.188	2.125	2.422
13	2.012	1.825	1.779	2.137	3.416	2.137	2.028	2.246	2.184	2.355
14	2.029	1.872	1.936	2.327	2.046	1.874	1.858	2.030	2.061	1.827
15	1.403	1.348	1.693	1.694	1.736	1.666	1.486	1.500	1.555	1.777
16	1.937	2.109	1.813	1.625	1.829	1.703	1.703	1.765	1.891	1.843
17	1.650	1.494	1.619	1.618	2.194	1.603	1.680	1.712	1.759	1.759
18	2.062	1.953	1.969	1.969	1.922	2.047	2.156	1.984	2.187	2.109
19	1.825	1.513	1.669	1.622	1.809	1.763	1.700	1.809	1.700	1.856
20	1.499	1.577	1.452	1.561	1.405	1.266	1.655	1.843	1.359	1.421

**TABLE D-24** Experimental results of the task duration for environment 4

Participants	Environment 4 ( Internal arc = 25 mm., External arc = 45 mm.)									
	Time order									
	Time 01	Time 02	Time 03	Time 04	Time 05	Time 06	Time 07	Time 08	Time 09	Time 10
01	2.109	2.250	2.531	2.609	2.203	2.094	1.937	2.172	2.015	2.172
02	2.157	1.937	1.797	2.125	1.703	1.906	1.954	1.687	1.734	2.047
03	2.259	2.287	2.454	2.677	2.621	2.329	2.789	2.342	2.245	2.373
04	1.628	1.551	1.716	2.010	1.825	1.617	1.715	2.230	2.202	2.717
05	4.609	2.218	2.219	2.016	2.657	3.328	2.438	2.844	2.172	3.343
06	2.515	2.500	2.563	2.250	2.329	2.297	2.453	2.094	2.125	2.342
07	2.125	2.250	2.859	2.827	2.671	2.172	2.578	2.469	2.359	2.391
08	2.406	2.281	2.265	2.375	2.249	2.313	2.328	2.953	2.578	2.672
09	1.765	1.904	2.432	2.376	2.098	2.140	1.904	1.863	1.862	2.206
10	1.974	2.518	2.409	2.875	2.425	2.036	2.324	2.199	2.262	2.465
11	1.723	1.598	2.042	1.709	1.793	1.543	1.681	1.557	1.500	1.640
12	2.234	2.359	1.938	2.469	2.094	2.312	2.172	1.953	2.203	2.031
13	1.945	1.867	2.007	1.976	1.883	1.836	1.913	1.961	2.504	2.318
14	1.245	1.986	1.897	2.342	1.987	2.985	1.876	1.987	2.254	2.896
15	2.319	2.211	2.138	2.121	1.887	2.215	2.137	2.278	2.403	3.058
16	1.186	1.348	1.315	1.218	1.175	1.283	1.240	1.164	0.927	1.132
17	2.062	2.781	2.265	2.172	1.969	2.641	2.469	2.313	2.391	2.812
18	2.172	2.656	2.234	2.266	2.188	2.141	2.312	2.281	2.688	2.500
19	2.176	2.783	1.990	2.238	2.036	1.835	2.021	2.223	1.896	2.317
20	1.779	1.999	2.186	1.702	1.827	1.748	1.921	1.827	1.686	1.967

(This page is intentionally left blank)

## APPENDIX E

The experimental results about the task instability for twenty participant and the four environments issued (raw result of the instability sensor)



**TABLE E-1** Experimental results of the task instability for environment 1

Participants	Environment 1 ( Internal arc = 0 mm., External arc = 0 mm.)									
	Time order									
	Time 01	Time 02	Time 03	Time 04	Time 05	Time 06	Time 07	Time 08	Time 09	Time 10
01	0.243	0.282	0.238	0.267	0.188	0.313	0.458	0.337	0.330	0.426
02	0.477	0.492	0.285	0.464	0.349	0.553	0.415	0.239	0.364	0.326
03	0.312	0.615	0.426	0.604	0.797	0.597	0.350	0.389	0.383	0.421
04	0.028	0.032	0.035	0.032	0.032	0.030	0.033	0.036	0.042	0.041
05	0.388	0.612	0.237	0.458	0.886	0.605	0.191	0.431	0.518	0.356
06	0.656	0.424	0.562	0.452	0.379	0.513	0.417	0.403	0.496	0.439
07	0.488	0.444	0.509	0.409	0.461	0.464	0.335	0.538	0.446	0.411
08	0.339	0.345	0.356	0.334	0.417	0.484	0.441	0.435	0.603	0.383
09	0.398	0.460	0.451	0.322	0.420	0.326	0.356	0.317	0.396	0.301
10	0.388	0.636	0.599	0.333	0.332	0.463	0.380	0.388	0.357	0.436
11	0.550	0.227	0.433	0.266	0.259	0.385	0.421	0.504	0.909	0.341
12	0.612	0.534	0.378	0.274	0.501	0.450	0.346	0.470	0.384	0.367
13	0.625	0.513	0.463	0.557	0.508	0.833	0.678	0.779	0.657	0.794
14	0.472	0.516	0.463	0.395	0.524	0.359	0.478	0.640	0.340	0.386
15	0.129	0.447	0.431	0.667	0.370	0.247	0.506	0.425	0.390	0.174
16	0.371	0.511	0.346	1.117	0.526	0.578	1.308	0.547	0.412	0.392
17	0.293	0.353	0.343	0.392	0.345	0.557	0.352	0.461	0.358	0.328
18	0.548	0.531	0.337	0.506	0.224	0.316	0.578	0.516	0.541	0.489
19	0.552	0.305	0.260	0.340	0.330	0.249	0.312	0.270	0.249	0.642
20	0.521	0.572	0.415	0.547	0.474	0.671	0.432	0.603	0.293	0.696

**TABLE E-2** Experimental results of the task instability for environment 2

Participants	Environment 2 ( Internal arc = 0 mm., External arc = 0 mm.)									
	Time order									
	Time 01	Time 02	Time 03	Time 04	Time 05	Time 06	Time 07	Time 08	Time 09	Time 10
01	0.334	0.502	0.572	0.313	0.956	0.381	0.241	0.446	0.282	0.279
02	0.332	0.525	0.323	0.378	0.327	0.557	0.561	0.591	0.641	0.469
03	0.373	0.495	0.666	0.171	0.456	0.338	0.568	0.444	0.535	0.468
04	0.037	0.042	0.036	0.040	0.042	0.039	0.039	0.041	0.036	0.050
05	0.515	0.488	0.336	0.448	0.557	0.426	0.509	0.585	0.610	0.414
06	0.414	0.667	0.544	0.356	0.742	0.427	0.700	0.408	0.390	0.431
07	0.515	0.336	0.579	0.312	0.609	0.364	0.424	0.274	0.414	0.300
08	0.440	0.429	0.529	0.571	0.560	0.336	0.524	0.470	0.442	0.387
09	0.456	0.408	0.418	0.321	0.345	0.538	0.392	0.300	0.481	0.389
10	0.429	0.468	0.345	0.381	0.275	0.575	0.486	0.451	0.379	0.472
11	0.638	0.477	0.390	0.457	0.550	0.615	0.353	0.377	0.374	0.402
12	0.457	0.465	0.654	0.881	0.495	0.661	0.413	0.488	0.360	0.436
13	0.730	0.494	0.589	0.713	0.730	0.569	0.544	0.619	0.696	0.475
14	0.516	0.423	0.479	0.394	0.391	0.353	0.522	0.404	0.488	0.882
15	0.883	0.833	0.801	0.872	0.962	0.642	0.764	0.914	0.833	0.780
16	0.538	0.475	0.662	0.633	0.402	0.368	0.735	0.607	0.599	0.588
17	0.353	0.307	0.364	0.407	0.410	0.392	0.333	0.504	0.318	0.783
18	0.373	0.314	0.417	0.343	0.383	0.489	0.464	0.522	0.422	0.350
19	0.488	0.396	0.330	0.355	0.312	0.346	0.320	0.499	0.370	0.504
20	0.502	0.499	0.607	0.497	0.438	0.815	0.536	0.665	0.499	0.397

**TABLE E-3** Experimental results of the task instability for environment 3

Participants	Environment 3 ( Internal arc = 0 mm., External arc = 0 mm.)									
	Time order									
	Time 01	Time 02	Time 03	Time 04	Time 05	Time 06	Time 07	Time 08	Time 09	Time 10
01	0.302	0.112	0.208	0.294	0.493	0.442	0.293	0.462	0.483	0.326
02	0.259	0.341	0.182	0.428	0.340	0.407	0.679	0.429	0.457	0.257
03	0.524	0.425	0.314	0.415	0.562	1.762	0.497	0.714	0.157	0.460
04	0.042	0.047	0.047	0.046	0.044	0.041	0.041	0.045	0.046	0.041
05	0.254	0.383	0.236	0.472	0.354	0.312	0.257	0.345	0.627	0.545
06	0.437	0.317	0.234	0.418	0.455	0.554	0.385	0.226	0.294	0.403
07	0.547	0.291	0.429	0.500	0.303	0.393	0.389	0.308	0.337	0.411
08	0.358	0.349	0.491	0.485	0.311	0.476	0.552	0.318	0.342	0.365
09	0.175	0.275	0.300	0.389	0.294	0.368	0.336	0.350	0.426	0.388
10	0.454	0.322	0.377	0.456	0.388	0.310	0.277	0.325	0.495	0.307
11	0.376	0.382	0.403	0.469	0.355	0.528	0.288	0.384	0.350	0.355
12	0.426	0.318	0.479	0.496	0.285	0.424	0.388	0.546	0.397	0.957
13	0.603	0.582	0.701	0.552	0.759	0.353	0.641	0.645	0.550	0.677
14	0.473	0.413	0.408	0.433	0.385	0.538	0.497	0.359	0.323	0.344
15	0.829	0.672	0.541	0.423	0.512	0.533	0.707	0.623	0.597	0.454
16	0.333	0.391	0.429	0.573	0.411	0.328	0.411	0.348	0.404	0.431
17	0.630	0.792	0.521	0.760	0.400	0.615	0.510	0.576	0.470	0.499
18	0.361	0.537	0.431	0.402	0.464	0.315	0.457	0.362	0.308	0.316
19	0.324	0.305	0.430	0.170	0.300	0.144	0.375	0.311	0.296	0.403
20	0.472	0.671	0.415	0.448	0.257	0.413	0.330	0.411	0.249	0.498

**TABLE E-4** Experimental results of the task instability for environment 4

Participants	Environment 4 ( Internal arc = 0 mm., External arc = 0 mm.)									
	Time order									
	Time 01	Time 02	Time 03	Time 04	Time 05	Time 06	Time 07	Time 08	Time 09	Time 10
01	0.256	0.495	0.553	0.340	0.478	0.344	0.298	0.246	0.224	0.362
02	0.450	0.369	0.534	0.602	0.441	9.729	0.399	0.411	0.416	0.418
03	0.554	0.348	0.346	0.281	0.345	0.286	0.421	0.300	0.329	0.251
04	0.042	0.046	0.044	0.042	0.042	0.043	0.059	0.067	0.058	0.056
05	0.537	0.525	0.678	0.415	0.658	0.522	0.543	0.425	0.741	0.427
06	0.363	0.355	0.400	0.574	0.592	0.324	0.431	0.506	0.417	0.229
07	0.381	0.274	0.394	0.239	0.480	0.311	0.419	0.348	0.359	0.287
08	0.343	0.390	0.587	0.438	0.429	0.353	0.448	0.387	0.465	0.415
09	0.546	0.499	0.496	0.492	0.476	0.556	0.321	0.576	0.485	0.458
10	0.322	0.413	0.297	0.368	0.399	0.478	0.303	0.476	0.333	0.442
11	0.815	0.300	0.478	0.513	0.515	0.474	0.502	0.253	0.586	0.401
12	0.324	0.629	0.650	0.396	0.423	0.449	0.600	0.492	0.605	0.476
13	0.503	0.412	0.416	0.536	0.396	0.425	0.532	0.516	0.611	0.373
14	0.426	0.521	0.516	0.373	0.438	0.667	0.410	0.328	0.482	0.378
15	0.493	0.565	0.512	0.657	0.573	0.576	0.505	0.675	0.818	0.555
16	0.559	0.386	0.674	0.726	0.679	0.523	0.646	0.613	0.451	0.543
17	0.729	0.664	0.599	0.675	0.597	1.268	0.861	0.733	0.593	0.885
18	0.456	0.377	0.498	0.337	0.423	0.482	0.417	0.321	0.656	0.373
19	0.440	0.453	0.427	0.503	0.483	0.393	0.473	0.306	0.325	0.407
20	0.479	0.373	0.553	0.541	0.443	0.452	0.473	0.469	0.450	0.431

**TABLE E-5** Experimental results of the task instability for environment 1

Participants	Environment 1 ( Internal arc = 5 mm., External arc = 25 mm.)									
	Time order									
	Time 01	Time 02	Time 03	Time 04	Time 05	Time 06	Time 07	Time 08	Time 09	Time 10
01	0.109	0.845	0.538	0.548	0.409	0.323	0.294	0.499	0.304	0.417
02	0.355	0.326	0.339	0.310	0.389	0.744	0.291	0.297	0.252	0.205
03	0.649	0.317	0.484	0.368	0.271	0.365	0.585	0.435	0.333	0.331
04	0.434	0.303	0.390	0.315	0.569	0.300	0.125	0.645	0.414	0.314
05	0.163	0.466	0.421	0.370	0.621	0.356	0.528	0.657	0.373	0.642
06	0.518	0.332	0.325	0.716	0.487	0.485	0.669	0.424	0.907	0.610
07	0.376	0.342	0.221	0.307	0.394	0.260	0.373	0.257	0.392	0.580
08	0.524	0.539	0.459	0.386	0.307	0.384	0.425	0.608	0.369	0.356
09	0.440	0.459	0.263	0.322	0.257	0.286	0.254	0.259	0.405	0.536
10	0.317	0.357	0.571	0.572	0.329	0.369	0.286	0.417	0.429	0.302
11	0.496	0.371	0.485	0.859	0.711	0.440	0.277	0.334	0.404	0.206
12	0.268	0.440	0.329	0.283	0.799	0.399	0.290	0.319	0.448	0.336
13	0.546	0.347	0.379	0.364	0.493	0.417	0.426	0.430	0.448	0.527
14	0.472	0.516	0.463	0.395	0.524	0.359	0.478	0.640	0.340	0.386
15	0.545	0.564	0.528	0.499	0.408	0.391	0.508	0.323	0.388	0.472
16	0.525	0.341	0.373	0.190	0.459	0.556	0.396	0.433	0.472	0.533
17	0.354	0.526	0.584	0.266	0.873	0.509	0.150	0.299	1.464	0.515
18	0.542	0.581	0.347	0.396	0.337	0.357	0.408	0.331	0.225	0.359
19	0.555	0.448	0.444	0.323	0.224	0.216	0.312	0.243	0.311	0.413
20	0.458	0.340	0.271	0.465	0.239	0.410	0.278	0.418	0.306	0.461

**TABLE E-6** Experimental results of the task instability for environment 2

Participants	Environment 2 ( Internal arc = 5 mm., External arc = 25 mm.)									
	Time order									
	Time 01	Time 02	Time 03	Time 04	Time 05	Time 06	Time 07	Time 08	Time 09	Time 10
01	0.697	0.778	1.672	0.815	0.729	0.880	0.464	0.618	0.745	0.565
02	0.331	0.373	0.407	0.344	0.252	0.387	0.432	0.403	0.293	0.344
03	0.368	0.282	0.428	0.248	0.382	0.437	0.372	0.301	0.567	0.292
04	0.310	0.413	0.234	0.411	0.357	0.482	0.440	0.442	0.657	0.463
05	0.476	0.332	0.536	0.504	0.397	0.429	0.391	0.302	0.523	0.433
06	0.404	0.260	0.386	0.486	0.212	0.493	0.459	0.430	0.369	0.524
07	0.391	0.315	0.329	0.260	0.399	0.245	0.367	0.243	0.217	0.283
08	0.345	0.421	0.543	0.332	0.405	0.259	0.579	0.323	0.405	0.322
09	0.538	0.400	0.412	0.311	0.430	0.588	0.408	0.497	0.357	0.379
10	0.369	0.428	0.492	0.473	0.450	0.237	0.457	0.297	0.297	0.506
11	0.386	0.363	0.399	0.459	0.391	0.395	0.298	0.354	0.375	0.373
12	0.408	0.398	0.448	0.237	0.329	0.388	0.376	0.559	0.375	0.313
13	0.872	0.520	0.445	0.303	0.622	0.554	0.503	0.539	0.531	0.508
14	0.516	0.423	0.479	0.394	0.391	0.353	0.522	0.404	0.488	0.882
15	0.533	0.558	0.492	0.562	0.482	0.680	0.576	0.572	0.465	0.491
16	0.402	0.472	0.494	0.496	0.404	0.300	0.426	0.491	0.449	0.504
17	0.870	0.415	0.402	0.445	0.357	0.470	0.461	0.480	0.440	0.449
18	0.601	0.468	0.453	0.352	0.729	0.443	0.410	0.357	0.385	0.449
19	0.535	0.398	0.529	0.463	0.439	0.546	0.413	0.501	0.510	0.403
20	0.563	0.490	0.439	0.780	0.663	0.665	0.500	0.463	0.627	0.638

**TABLE E-7** Experimental results of the task instability for environment 3

Participants	Environment 3 ( Internal arc = 5 mm., External arc = 25 mm.)									
	Time order									
	Time 01	Time 02	Time 03	Time 04	Time 05	Time 06	Time 07	Time 08	Time 09	Time 10
01	0.424	0.237	0.199	0.234	0.110	0.234	0.414	0.691	0.275	0.297
02	0.384	0.320	0.398	0.509	0.270	0.290	0.317	0.871	0.309	0.267
03	0.359	0.379	0.464	0.373	0.364	0.505	0.382	0.432	0.308	0.377
04	0.444	0.215	0.441	0.439	0.421	0.328	0.364	0.295	0.234	0.317
05	0.532	0.526	0.636	0.806	0.404	0.333	0.703	0.283	0.534	0.281
06	0.343	0.641	0.656	0.578	0.252	0.561	0.615	0.448	0.441	0.367
07	0.417	0.568	0.457	0.406	0.389	0.458	0.405	0.420	0.404	0.368
08	0.360	0.318	0.325	0.389	0.374	0.592	0.346	0.481	0.419	0.344
09	0.317	0.744	0.366	0.332	0.339	0.459	0.290	0.340	0.542	0.389
10	0.345	0.480	0.251	0.367	0.323	0.321	0.307	0.301	0.274	0.269
11	0.383	0.352	0.401	0.556	0.463	0.211	0.347	0.378	0.505	0.524
12	0.329	0.677	0.466	0.462	0.368	0.440	0.532	0.225	0.411	0.422
13	0.241	0.259	0.406	0.444	0.394	0.347	0.398	0.477	0.627	0.452
14	0.473	0.413	0.408	0.433	0.385	0.538	0.497	0.359	0.323	0.344
15	0.259	0.500	0.441	0.419	0.323	0.435	0.375	0.403	0.448	0.354
16	0.350	0.343	0.692	0.410	0.388	0.242	0.506	0.388	0.393	0.309
17	0.264	0.412	0.376	0.521	0.389	0.275	0.308	0.366	0.262	0.271
18	0.441	0.311	0.430	0.318	0.401	0.566	0.314	0.435	0.559	0.407
19	0.247	0.374	0.307	0.239	0.201	0.199	0.339	0.389	0.142	0.225
20	0.545	0.381	0.400	0.411	0.331	0.235	0.442	0.243	0.322	0.303

**TABLE E-8** Experimental results of the task instability for environment 4

Participants	Environment 4 ( Internal arc = 5 mm., External arc = 25 mm.)									
	Time order									
	Time 01	Time 02	Time 03	Time 04	Time 05	Time 06	Time 07	Time 08	Time 09	Time 10
01	0.406	0.280	0.365	0.330	0.315	0.370	0.403	0.391	0.257	0.321
02	0.381	0.266	0.266	0.357	0.449	0.360	0.404	0.499	0.396	0.427
03	0.391	0.327	0.406	0.317	0.435	0.243	0.361	0.284	0.481	0.380
04	0.353	0.356	0.332	0.669	0.310	0.681	0.378	0.452	0.382	0.680
05	0.438	0.458	0.427	0.553	0.426	0.406	0.687	0.389	0.680	0.321
06	0.391	0.407	0.447	0.416	0.405	0.361	0.349	0.317	0.417	0.448
07	0.426	0.242	0.343	0.348	0.409	0.282	0.378	0.222	0.369	0.297
08	0.385	0.254	0.540	0.228	0.400	0.400	0.421	0.246	0.422	0.427
09	0.412	0.336	0.403	0.254	0.473	0.256	0.425	0.295	0.549	0.529
10	0.448	0.312	0.524	0.245	0.501	0.427	0.430	0.460	0.239	0.326
11	0.397	0.247	0.428	0.208	0.352	0.298	0.444	0.257	0.348	0.333
12	0.457	0.328	0.455	0.468	0.418	0.207	0.436	0.324	0.898	0.379
13	0.390	0.463	0.541	0.334	0.460	0.376	0.434	0.516	0.315	0.430
14	0.426	0.521	0.516	0.373	0.438	0.667	0.410	0.328	0.482	0.378
15	0.396	0.408	0.462	0.654	0.375	0.493	0.472	0.522	0.558	0.420
16	0.609	0.388	0.321	0.443	0.363	0.495	0.447	0.410	0.595	0.296
17	0.855	0.809	1.319	0.831	1.048	0.649	0.788	0.787	0.833	0.753
18	0.530	0.447	0.515	0.455	0.390	0.537	0.563	0.503	0.437	0.642
19	0.459	0.358	0.592	0.547	0.513	0.317	0.392	0.522	0.610	0.460
20	0.488	0.395	0.540	0.617	0.435	0.493	0.422	0.409	0.444	0.395



**TABLE E-9** Experimental results of the task instability for environment 1

Participants	Environment 1 ( Internal arc = 10 mm., External arc = 30 mm.)									
	Time order									
	Time 01	Time 02	Time 03	Time 04	Time 05	Time 06	Time 07	Time 08	Time 09	Time 10
01	0.451	0.386	0.434	0.347	0.395	0.319	0.445	0.242	0.396	0.299
02	0.254	0.449	0.458	0.426	0.372	0.148	0.477	0.432	0.371	0.233
03	0.530	0.537	0.438	0.284	0.406	0.276	0.553	0.448	0.772	0.473
04	0.417	0.364	0.769	0.577	0.519	0.464	0.421	0.884	0.313	0.506
05	0.460	0.317	0.443	0.337	0.467	0.213	0.309	0.302	0.418	0.476
06	0.440	0.362	0.586	0.413	3.280	0.499	0.442	0.326	0.455	0.396
07	0.989	0.854	0.586	0.403	0.367	0.512	0.348	0.372	0.530	0.319
08	0.395	0.276	0.443	0.438	0.343	0.389	0.330	0.273	0.358	0.285
09	0.459	0.969	0.390	0.287	0.372	0.386	0.479	0.300	0.517	0.278
10	0.372	0.267	0.364	0.415	0.340	0.431	0.321	0.456	0.376	0.422
11	0.446	0.544	0.324	0.620	0.333	0.534	0.221	0.610	0.375	0.393
12	0.366	0.613	0.480	0.474	0.371	0.364	0.339	0.534	0.423	0.507
13	0.316	0.364	0.467	0.677	0.803	0.569	0.891	0.367	0.462	0.433
14	0.472	0.516	0.463	0.395	0.524	0.359	0.478	0.640	0.340	0.386
15	0.575	0.724	0.383	1.565	0.565	0.282	0.395	0.312	0.465	0.440
16	0.388	0.427	0.289	0.326	0.284	0.314	0.540	0.320	0.363	0.335
17	0.568	0.466	0.453	0.683	0.633	0.766	0.306	0.415	0.330	0.448
18	0.422	0.400	0.403	0.353	0.333	0.519	0.625	0.369	0.412	0.467
19	0.271	0.374	0.205	0.260	0.236	0.318	0.270	0.462	0.200	0.206
20	0.349	0.516	0.406	0.429	0.572	0.249	0.871	0.331	0.478	0.379

**TABLE E-10** Experimental results of the task instability for environment 2

Participants	Environment 2 ( Internal arc = 10 mm., External arc = 30 mm.)									
	Time order									
	Time 01	Time 02	Time 03	Time 04	Time 05	Time 06	Time 07	Time 08	Time 09	Time 10
01	0.381	0.381	0.393	0.281	0.373	0.476	0.343	0.473	0.268	0.479
02	0.529	0.799	0.617	0.489	0.722	0.720	0.754	0.444	0.388	0.760
03	0.408	0.224	0.327	0.441	0.375	0.388	0.418	0.607	0.567	0.321
04	0.672	0.324	0.414	0.786	0.604	0.404	0.563	0.467	0.391	0.298
05	0.371	0.272	0.521	0.334	0.353	0.353	0.433	0.427	0.421	0.430
06	0.526	0.340	0.510	0.213	0.419	0.269	0.423	0.304	0.534	0.458
07	0.221	0.350	0.405	0.267	0.698	0.352	0.349	0.289	0.494	0.284
08	0.350	0.282	0.309	0.315	0.483	0.431	0.310	0.369	0.258	0.504
09	0.486	0.491	0.412	0.562	0.298	0.652	0.636	0.436	0.545	0.359
10	0.337	0.211	0.372	0.314	0.378	0.373	0.317	0.224	0.263	0.430
11	0.455	0.431	0.360	0.319	0.623	0.432	0.355	0.753	0.452	0.370
12	0.397	0.269	0.487	0.487	0.203	0.406	0.307	0.668	0.264	0.532
13	0.438	0.348	0.347	0.387	0.514	0.382	0.496	0.364	0.612	0.420
14	0.516	0.423	0.479	0.394	0.391	0.353	0.522	0.404	0.488	0.882
15	0.439	0.383	0.245	0.344	0.448	0.408	0.380	0.317	0.374	0.407
16	0.373	0.263	0.374	0.371	0.311	0.341	0.363	0.388	0.452	0.329
17	0.344	0.294	0.178	0.295	0.361	0.253	0.360	0.392	0.748	0.424
18	0.362	0.399	0.445	0.345	0.399	0.342	0.333	0.313	0.862	0.433
19	0.357	0.541	0.560	0.657	0.478	0.630	0.844	0.855	0.488	0.499
20	0.459	0.435	0.288	0.528	0.356	0.326	0.615	0.290	0.274	0.350

**TABLE E-11** Experimental results of the task instability for environment 3

Participants	Environment 3 ( Internal arc = 10 mm., External arc = 30 mm.)									
	Time order									
	Time 01	Time 02	Time 03	Time 04	Time 05	Time 06	Time 07	Time 08	Time 09	Time 10
01	0.427	0.477	0.406	0.302	0.343	0.422	0.460	0.302	0.464	0.312
02	0.284	0.484	0.300	0.607	0.421	0.293	0.436	0.749	0.396	0.274
03	0.431	0.454	0.410	0.948	0.276	0.352	0.498	0.447	0.281	0.478
04	0.239	0.506	0.548	0.361	0.831	0.589	0.444	0.530	0.392	0.517
05	0.281	0.279	0.440	0.219	0.330	0.556	0.283	0.431	0.364	0.336
06	0.646	0.403	0.466	0.381	0.394	0.371	0.447	0.556	0.365	0.393
07	0.370	0.455	0.434	0.388	0.365	0.433	0.413	0.385	0.283	1.906
08	0.309	0.321	0.324	0.252	0.586	0.334	0.401	0.380	0.280	0.424
09	0.387	0.552	0.471	0.263	0.314	0.491	0.273	0.390	0.715	0.356
10	0.222	0.287	0.438	0.427	0.304	0.347	0.490	0.307	0.562	0.359
11	0.499	0.788	0.289	0.350	0.288	0.692	0.303	0.506	0.392	0.526
12	0.468	0.536	0.406	0.493	0.323	0.565	0.442	0.398	0.356	0.524
13	0.373	0.374	0.330	0.406	0.469	0.327	0.439	0.325	0.713	0.401
14	0.473	0.413	0.408	0.433	0.385	0.538	0.497	0.359	0.323	0.344
15	0.627	0.527	0.462	0.538	0.610	0.420	0.431	0.467	0.328	0.309
16	0.384	0.302	0.508	0.248	0.603	0.405	0.399	0.356	0.310	0.304
17	0.567	0.585	0.398	0.348	0.720	0.323	0.390	0.335	0.384	0.672
18	0.369	0.617	0.581	0.346	0.354	0.265	0.371	0.374	0.515	0.652
19	0.581	0.225	0.343	0.270	0.358	0.493	0.284	0.205	0.450	0.370
20	0.243	0.352	0.264	0.363	0.422	0.521	0.693	0.304	0.807	0.349

**TABLE E-12** Experimental results of the task instability for environment 4

Participants	Environment 4 ( Internal arc = 10 mm., External arc = 30 mm.)									
	Time order									
	Time 01	Time 02	Time 03	Time 04	Time 05	Time 06	Time 07	Time 08	Time 09	Time 10
01	0.368	0.349	0.335	0.393	0.365	0.338	0.436	0.341	0.306	0.502
02	0.456	0.400	0.598	0.440	0.405	0.376	0.457	0.429	0.412	0.508
03	0.449	0.430	0.750	0.627	0.732	0.558	0.620	0.545	0.933	0.689
04	0.410	0.825	0.394	0.398	0.478	0.393	0.290	0.474	0.284	0.392
05	0.578	0.546	0.489	0.444	0.280	0.486	0.559	0.444	0.442	0.443
06	0.207	0.452	0.237	0.452	0.293	0.426	0.347	0.606	0.234	0.444
07	0.467	0.398	0.387	0.286	0.438	0.339	0.404	0.313	0.455	0.296
08	0.383	0.483	0.339	0.395	0.512	0.515	0.457	0.344	0.406	0.358
09	0.610	0.659	0.594	0.673	0.828	0.407	0.423	0.402	0.521	0.731
10	0.366	0.511	0.413	0.679	0.551	0.422	0.538	0.373	0.499	0.193
11	0.453	0.507	0.490	0.624	0.406	0.390	0.442	0.445	0.463	0.821
12	0.545	0.553	0.497	0.554	0.457	0.449	0.390	0.675	0.446	0.408
13	0.481	0.599	0.423	0.453	0.578	0.548	0.683	0.338	0.594	0.424
14	0.426	0.521	0.516	0.373	0.438	0.667	0.410	0.328	0.482	0.378
15	0.415	0.409	0.743	0.455	0.499	0.376	0.541	0.570	0.358	0.670
16	0.422	0.454	0.466	0.470	0.434	0.392	0.439	0.341	0.578	0.486
17	0.182	0.465	0.346	0.469	0.368	0.861	0.486	0.298	0.439	0.747
18	0.465	0.697	0.332	0.440	0.517	0.394	0.388	0.364	0.448	0.410
19	0.471	0.450	0.464	0.346	0.338	0.627	0.485	0.392	0.478	0.579
20	0.412	0.741	0.515	0.474	0.498	0.618	0.445	0.442	0.411	0.458

**TABLE E-13** Experimental results of the task instability for environment 1

Participants	Environment 1 (Internal arc = 15 mm., External arc = 35 mm.)									
	Time order									
	Time 01	Time 02	Time 03	Time 04	Time 05	Time 06	Time 07	Time 08	Time 09	Time 10
01	0.451	0.386	0.434	0.347	0.395	0.319	0.445	0.242	0.396	0.299
02	0.247	0.364	0.498	0.318	0.415	0.418	0.531	0.486	0.483	0.295
03	0.469	0.267	0.410	0.458	0.427	0.402	0.740	0.380	0.543	0.362
04	0.380	0.379	0.332	0.378	0.426	0.414	0.352	0.360	0.442	0.395
05	0.342	0.479	0.514	0.214	0.332	0.354	0.553	0.425	0.404	0.417
06	0.314	0.279	0.504	0.269	0.505	0.577	0.504	0.683	0.401	0.388
07	0.228	0.376	0.725	0.333	0.416	0.318	0.501	0.518	0.470	0.372
08	0.306	0.401	0.342	0.430	0.357	0.400	0.308	0.397	0.231	0.299
09	0.527	0.815	0.418	0.310	0.455	0.453	0.534	0.285	0.481	0.319
10	0.409	0.439	0.448	0.465	0.443	0.592	0.550	0.494	0.505	0.670
11	0.295	0.751	0.696	0.254	0.470	0.656	0.410	0.325	0.376	0.645
12	0.403	0.502	0.310	0.387	0.407	0.478	0.391	0.463	0.451	0.482
13	0.517	0.333	0.549	0.318	0.385	0.650	0.518	0.545	0.632	0.436
14	0.435	0.387	0.258	0.317	0.496	0.135	0.548	0.305	0.876	0.543
15	0.387	0.323	0.260	0.382	0.546	0.251	0.603	0.299	0.419	0.485
16	0.378	0.473	0.490	0.700	0.282	0.433	0.383	0.569	0.441	0.673
17	0.568	0.497	0.384	0.226	0.254	0.291	0.440	0.333	0.405	0.510
18	0.354	0.735	0.502	0.571	0.472	0.635	0.405	0.519	0.508	0.395
19	0.374	0.485	0.455	0.176	0.718	0.489	0.423	0.397	0.335	0.236
20	0.499	0.478	0.566	0.400	0.449	0.455	0.583	0.579	0.463	0.379

**TABLE E-14** Experimental results of the task instability for environment 2

Participants	Environment 2 (Internal arc = 15 mm., External arc = 35 mm.)									
	Time order									
	Time 01	Time 02	Time 03	Time 04	Time 05	Time 06	Time 07	Time 08	Time 09	Time 10
01	0.381	0.381	0.393	0.281	0.373	0.476	0.343	0.473	0.268	0.479
02	0.455	0.550	0.552	0.555	0.596	0.683	0.627	0.484	0.503	0.783
03	0.603	0.433	0.441	0.373	0.456	0.366	0.263	0.336	0.452	0.326
04	0.630	0.354	0.471	0.586	0.613	0.583	0.589	0.589	0.692	0.566
05	0.501	0.597	0.643	0.600	0.535	0.566	0.536	0.561	0.595	0.512
06	0.471	0.536	0.828	0.431	0.383	0.446	0.640	0.393	0.501	0.528
07	0.567	0.428	0.535	0.553	0.370	0.418	0.722	0.406	0.419	0.377
08	0.495	0.455	0.469	0.494	0.425	0.431	0.456	0.327	0.340	0.378
09	0.372	0.407	0.499	0.414	0.417	0.472	0.412	0.453	0.532	0.496
10	0.458	0.583	0.424	0.622	0.482	0.759	0.475	0.481	0.461	0.565
11	0.516	0.421	0.800	0.718	0.550	0.558	0.572	0.733	0.612	0.724
12	0.676	0.609	0.480	0.506	0.603	0.621	0.890	0.400	0.661	0.419
13	0.301	0.356	0.552	0.471	0.524	0.473	0.583	0.559	0.504	0.468
14	0.541	0.430	0.398	0.965	0.548	0.785	0.437	0.357	0.675	0.532
15	0.791	0.760	0.442	0.846	0.622	0.603	0.598	0.769	0.421	0.483
16	0.589	0.123	0.558	0.510	0.539	0.546	0.809	0.548	0.553	0.688
17	0.759	0.671	0.600	0.541	0.486	0.552	0.396	0.499	0.442	0.508
18	0.455	0.517	0.414	0.444	0.576	0.364	0.568	0.313	0.413	0.465
19	0.564	0.460	0.376	0.398	0.518	0.347	0.526	0.903	0.618	0.382
20	0.626	0.399	0.362	0.503	0.394	0.396	0.429	0.400	0.364	0.841

**TABLE E-15** Experimental results of the task instability for environment 3

Participants	Environment 3 (Internal arc = 15 mm., External arc = 35 mm.)									
	Time order									
	Time 01	Time 02	Time 03	Time 04	Time 05	Time 06	Time 07	Time 08	Time 09	Time 10
01	0.427	0.477	0.406	0.302	0.343	0.422	0.460	0.302	0.464	0.312
02	0.248	0.181	0.443	0.318	0.299	0.311	0.207	0.333	0.267	0.313
03	0.403	0.251	0.536	0.376	0.478	0.604	0.405	0.435	0.566	0.272
04	0.627	0.973	0.616	0.349	0.636	0.513	0.454	0.419	0.536	0.386
05	0.485	0.537	0.570	0.316	0.476	0.350	0.661	0.523	0.524	0.384
06	0.490	0.609	0.593	0.450	0.535	0.579	0.555	0.397	0.430	0.409
07	0.346	0.250	0.614	0.280	0.416	0.256	0.495	0.343	0.528	0.284
08	0.544	0.337	0.311	0.343	0.475	0.432	0.392	0.451	0.371	0.384
09	0.406	0.539	0.330	0.405	0.384	0.554	0.437	0.421	0.462	0.450
10	0.487	0.224	0.650	0.371	0.301	0.415	0.391	0.407	0.375	0.360
11	0.427	0.399	0.355	0.476	0.589	0.418	0.349	0.750	0.235	0.524
12	0.513	0.763	0.355	0.573	0.546	0.455	0.601	0.484	0.305	0.523
13	0.832	0.484	0.862	0.376	0.593	0.495	0.526	0.615	0.608	0.421
14	0.387	0.446	0.698	0.445	0.459	0.520	0.294	0.397	0.460	0.441
15	0.389	0.409	0.664	0.386	0.504	0.449	0.580	0.364	0.464	0.357
16	0.477	0.402	0.517	0.471	0.475	0.570	0.418	0.533	0.385	0.497
17	0.383	0.475	0.375	0.397	0.489	0.518	0.515	0.390	0.490	0.362
18	0.618	0.434	0.373	0.335	0.247	0.365	0.263	0.358	0.246	0.454
19	0.243	0.226	0.591	0.504	0.264	0.450	0.215	0.325	0.392	0.343
20	0.404	0.347	0.445	0.408	0.379	0.885	0.873	0.601	0.385	0.494

**TABLE E-16** Experimental results of the task instability for environment 4

Participants	Environment 4 (Internal arc = 15 mm., External arc = 35 mm.)									
	Time order									
	Time 01	Time 02	Time 03	Time 04	Time 05	Time 06	Time 07	Time 08	Time 09	Time 10
01	0.368	0.349	0.335	0.393	0.365	0.338	0.436	0.341	0.306	0.502
02	0.368	0.422	0.487	0.401	0.524	0.431	0.467	0.405	0.420	0.358
03	0.474	0.352	0.545	0.310	0.542	0.416	0.471	0.357	0.432	0.383
04	0.549	0.496	0.495	0.315	0.534	0.604	0.540	0.656	0.431	0.525
05	0.526	0.525	0.423	0.686	0.616	0.419	0.540	0.468	0.496	0.538
06	0.396	0.578	0.455	0.518	0.437	0.499	0.490	0.400	0.406	0.535
07	0.407	0.440	0.533	0.403	0.401	0.365	0.516	0.307	0.855	0.450
08	0.503	0.350	0.544	0.425	0.432	0.400	0.455	0.477	0.363	0.471
09	0.530	0.437	0.425	0.545	0.552	0.458	0.438	0.406	0.469	0.447
10	0.407	0.525	0.527	0.239	0.561	0.453	0.427	0.237	0.364	0.477
11	0.443	0.519	0.515	0.519	0.467	0.813	0.535	0.607	0.851	0.785
12	0.728	0.561	0.523	0.649	0.804	0.454	0.446	0.442	0.532	0.437
13	0.483	0.389	0.473	0.482	0.380	0.490	0.371	0.480	0.447	0.420
14	0.659	0.765	0.397	0.658	0.679	0.542	0.578	0.589	0.437	0.478
15	0.476	0.692	0.295	0.537	0.586	0.435	0.494	0.481	0.368	0.392
16	0.706	0.182	0.429	0.674	0.338	0.397	0.495	0.510	0.396	0.419
17	0.552	0.537	0.485	0.546	0.551	0.429	0.556	0.486	0.456	0.660
18	0.443	0.423	0.397	0.330	0.323	0.387	0.271	0.133	0.290	0.340
19	0.543	0.658	0.385	0.700	0.454	0.520	0.591	0.452	0.634	0.457
20	0.408	0.257	0.489	0.406	0.238	0.501	0.319	0.400	0.382	0.369



**TABLE E-17** Experimental results of the task instability for environment 1

Participants	Environment 1 (Internal arc = 20 mm., External arc = 40 mm.)									
	Time order									
	Time 01	Time 02	Time 03	Time 04	Time 05	Time 06	Time 07	Time 08	Time 09	Time 10
01	0.454	0.318	0.378	0.435	0.427	0.321	0.501	0.290	0.451	0.253
02	0.317	0.268	0.280	0.253	0.278	0.410	0.354	0.413	0.243	0.428
03	0.489	0.472	0.304	0.212	0.351	0.379	0.428	0.422	0.948	0.411
04	0.311	0.325	0.795	0.223	0.390	0.309	0.466	0.574	0.566	0.583
05	0.413	0.393	0.373	0.393	0.253	0.317	0.367	0.366	0.388	0.306
06	0.322	0.394	0.384	0.361	0.307	0.511	0.431	0.578	0.349	0.495
07	0.343	0.342	0.334	0.383	0.558	0.490	0.331	0.283	0.482	0.399
08	0.282	0.467	0.305	0.444	0.283	0.336	0.408	0.456	0.496	0.491
09	0.416	0.666	0.429	0.557	0.283	0.633	0.402	0.378	0.282	0.510
10	0.534	0.433	0.447	0.429	0.288	0.360	0.325	0.487	0.373	0.447
11	0.340	0.352	0.536	0.492	0.738	0.204	0.743	0.512	0.460	0.582
12	0.361	0.427	0.549	0.479	0.487	0.508	0.563	0.382	0.391	0.391
13	0.332	0.350	0.376	0.304	0.518	0.380	0.546	0.452	0.422	0.345
14	0.411	0.324	0.314	0.460	0.239	0.322	0.555	0.558	0.496	0.303
15	0.324	0.467	0.234	0.386	0.165	0.487	0.683	0.436	0.586	0.489
16	0.597	0.412	0.274	0.350	0.367	0.271	0.327	0.204	0.383	0.372
17	0.429	0.314	0.312	0.388	0.241	0.322	0.403	0.282	0.413	0.212
18	0.332	0.353	0.431	0.347	0.345	0.327	0.293	0.496	0.338	0.323
19	0.763	0.430	0.326	0.361	0.460	0.410	0.360	0.314	0.308	0.445
20	0.464	0.295	0.436	0.424	0.338	0.275	0.503	0.461	0.360	0.327

**TABLE E-18** Experimental results of the task instability for environment 2

Participants	Environment 2 (Internal arc = 20 mm., External arc = 40 mm.)									
	Time order									
	Time 01	Time 02	Time 03	Time 04	Time 05	Time 06	Time 07	Time 08	Time 09	Time 10
01	0.563	0.246	0.327	0.456	0.426	0.166	0.512	0.319	0.414	0.352
02	0.495	0.355	0.489	0.406	0.385	0.344	0.337	0.331	0.356	0.377
03	0.617	0.446	0.473	0.565	0.366	0.511	0.866	0.563	0.394	0.457
04	0.497	0.459	0.442	0.445	0.477	0.436	0.522	0.491	0.526	0.370
05	0.408	0.444	0.423	0.459	0.322	0.559	0.382	0.371	0.388	0.432
06	0.409	0.472	0.472	0.535	0.436	0.398	0.599	0.564	0.466	0.475
07	0.429	0.438	0.359	0.419	0.434	0.408	0.427	0.497	0.340	0.477
08	0.413	0.479	0.477	0.412	0.370	0.551	0.510	0.396	0.528	0.380
09	0.592	0.436	0.580	0.512	0.603	0.393	0.505	0.669	0.488	0.478
10	0.498	0.582	0.830	0.351	0.437	0.581	0.429	0.416	0.445	0.377
11	0.533	0.514	0.937	0.611	0.624	0.551	0.889	0.535	0.640	0.533
12	0.472	0.466	0.510	0.538	0.605	0.541	0.664	0.796	0.571	0.525
13	0.379	0.435	0.331	0.349	0.377	0.430	0.945	0.415	0.389	0.402
14	0.398	0.434	0.376	0.398	0.342	0.428	0.386	0.327	0.269	0.265
15	0.422	0.542	0.482	0.482	0.389	0.319	0.361	0.427	0.377	0.395
16	0.320	0.417	0.367	0.206	0.444	0.413	0.437	0.456	0.406	0.434
17	0.477	0.463	0.370	0.401	0.514	0.478	0.517	0.806	0.541	0.370
18	0.390	0.463	0.514	0.422	0.418	0.437	0.416	0.426	0.471	0.402
19	0.477	0.530	0.482	0.400	0.423	0.451	0.565	0.409	0.802	0.444
20	0.681	0.802	0.542	0.488	0.752	0.475	0.945	0.474	0.361	0.520

**TABLE E-19** Experimental results of the task instability for environment 3

Participants	Environment 3 (Internal arc = 20 mm., External arc = 40 mm.)									
	Time order									
	Time 01	Time 02	Time 03	Time 04	Time 05	Time 06	Time 07	Time 08	Time 09	Time 10
01	0.405	0.229	0.466	0.306	0.450	0.255	0.294	0.413	0.367	0.271
02	0.809	0.583	0.705	0.237	0.402	0.546	0.585	0.547	0.380	0.364
03	0.745	0.277	0.421	0.479	0.448	0.286	0.462	0.706	0.437	0.438
04	0.468	0.392	0.376	0.493	0.418	0.506	0.286	0.363	0.323	0.388
05	0.378	0.263	0.353	0.565	0.618	0.397	0.541	0.352	0.346	0.234
06	0.377	0.481	0.834	0.426	0.482	0.434	0.521	0.607	0.427	0.409
07	0.387	0.414	0.468	0.233	0.408	0.227	0.313	0.271	0.401	0.271
08	0.524	0.327	0.318	0.350	0.351	0.406	0.374	0.262	0.327	0.355
09	0.487	0.456	0.373	0.465	0.482	0.358	0.369	0.376	0.432	0.322
10	0.877	0.542	0.483	0.377	0.584	0.763	0.610	0.564	0.418	0.489
11	0.598	0.358	0.490	0.362	0.492	0.516	0.375	0.497	0.423	0.431
12	0.441	0.538	0.334	0.627	0.556	0.301	0.506	0.421	0.558	0.460
13	0.543	0.428	0.443	0.345	0.776	0.408	0.605	0.342	0.452	0.463
14	0.549	0.766	0.447	0.561	0.573	0.476	0.698	0.430	0.287	0.342
15	0.489	0.656	0.374	0.416	0.417	0.652	0.764	0.550	0.346	0.402
16	0.263	0.668	0.437	0.358	0.287	0.589	0.189	0.430	0.245	0.543
17	0.362	0.348	0.237	0.292	0.280	0.408	0.519	0.338	0.313	0.340
18	0.292	0.357	0.301	0.303	0.277	0.332	0.411	0.405	0.386	1.013
19	0.593	0.423	0.255	0.403	0.393	0.511	0.479	0.463	0.304	0.279
20	0.464	0.383	0.480	0.381	0.434	0.359	0.538	0.251	0.271	0.352

**TABLE E-20** Experimental results of the task instability for environment 4

Participants	Environment 4 (Internal arc = 20 mm., External arc = 40 mm.)									
	Time order									
	Time 01	Time 02	Time 03	Time 04	Time 05	Time 06	Time 07	Time 08	Time 09	Time 10
01	0.177	0.211	0.384	0.314	0.221	0.375	0.271	0.309	0.444	0.412
02	0.763	0.223	0.607	0.448	0.469	0.621	0.490	0.676	0.599	0.371
03	0.252	0.527	0.628	0.476	0.676	0.497	0.757	0.553	0.406	0.598
04	0.426	0.433	0.440	0.439	0.347	0.415	0.374	0.414	0.421	0.434
05	0.439	0.443	0.330	0.283	0.531	0.244	0.451	0.250	0.437	0.590
06	0.378	0.502	0.594	0.506	0.591	0.531	0.533	0.624	0.701	0.384
07	0.338	0.398	0.329	0.515	0.332	0.375	0.364	0.340	0.468	0.590
08	0.453	0.460	0.347	0.457	0.448	0.494	0.535	0.521	0.366	0.413
09	0.453	0.593	0.536	0.354	0.450	0.551	0.377	0.405	0.482	0.461
10	0.558	0.786	0.508	0.736	0.410	0.527	0.350	0.490	0.505	0.474
11	0.424	0.474	0.432	0.496	0.562	0.279	0.403	0.528	0.491	0.492
12	0.409	0.514	0.598	0.434	0.838	0.381	0.591	0.463	0.468	0.420
13	0.381	0.483	0.333	0.444	0.607	0.515	0.390	0.524	0.389	0.500
14	0.366	0.547	0.398	0.343	0.416	0.769	0.530	0.532	0.368	0.508
15	0.453	0.651	0.486	0.361	0.532	0.848	0.486	0.427	0.465	0.404
16	0.470	0.485	0.427	0.282	0.450	0.399	0.499	0.433	0.374	0.504
17	0.428	0.495	0.535	0.403	0.374	0.423	0.281	0.646	0.324	0.298
18	0.341	0.390	0.373	0.529	0.431	0.432	0.476	0.458	0.422	0.542
19	0.603	0.321	0.416	0.419	0.403	0.603	0.429	0.426	0.482	0.426
20	0.500	0.570	0.496	0.450	0.655	0.327	0.617	0.701	0.472	0.602

**TABLE E-21** Experimental results of the task instability for environment 1

Participants	Environment 1 (Internal arc = 25 mm., External arc = 45 mm.)									
	Time order									
	Time 01	Time 02	Time 03	Time 04	Time 05	Time 06	Time 07	Time 08	Time 09	Time 10
01	0.365	0.329	0.536	0.470	0.248	0.278	0.256	0.354	0.746	0.406
02	0.387	0.480	0.953	0.393	0.188	0.261	0.220	0.325	0.211	0.192
03	0.310	0.348	0.434	0.255	0.385	0.294	0.319	0.399	0.283	0.279
04	0.299	0.455	0.453	0.497	0.555	0.558	0.541	0.531	0.354	0.408
05	0.485	0.359	0.569	0.471	0.422	0.798	0.426	0.403	0.361	0.465
06	0.195	0.350	0.422	0.336	0.928	0.510	0.306	0.389	0.544	0.309
07	0.377	0.464	0.469	0.486	0.417	0.337	0.376	0.316	0.577	0.371
08	0.391	0.526	0.417	0.483	0.496	0.326	0.286	0.286	0.495	0.298
09	0.558	0.398	0.585	0.514	0.465	0.532	0.134	0.468	0.634	0.526
10	0.444	0.282	0.247	0.228	0.261	0.339	0.376	0.621	0.323	0.304
11	0.402	0.360	0.565	0.571	0.322	0.915	0.527	0.234	0.468	0.356
12	0.400	0.486	0.483	0.507	0.325	0.485	0.476	0.474	0.475	0.460
13	0.443	0.525	0.510	0.428	0.440	0.442	0.318	0.515	0.262	0.396
14	0.344	0.390	0.341	0.228	0.390	0.537	0.270	0.428	0.431	0.367
15	0.829	0.672	0.541	0.423	0.512	0.533	0.707	0.623	0.597	0.454
16	0.730	0.642	0.514	0.698	0.767	0.674	1.041	0.762	0.526	1.003
17	0.588	0.450	0.501	0.387	1.464	0.400	0.338	0.225	0.360	0.317
18	0.282	0.417	0.476	0.555	0.533	0.784	0.449	0.409	0.459	0.260
19	0.481	0.290	0.261	0.299	0.260	0.395	0.247	0.479	0.228	0.278
20	0.537	0.266	0.435	0.270	0.420	0.582	0.597	0.451	0.594	0.740

**TABLE E-22** Experimental results of the task instability for environment 2

Participants	Environment 2 (Internal arc = 25 mm., External arc = 45 mm.)									
	Time order									
	Time 01	Time 02	Time 03	Time 04	Time 05	Time 06	Time 07	Time 08	Time 09	Time 10
01	0.378	0.365	0.384	0.355	0.316	0.422	0.289	0.434	0.518	0.501
02	0.486	0.361	0.276	0.373	0.294	0.237	0.343	0.426	0.547	0.386
03	0.331	0.799	0.392	0.503	0.512	0.606	0.380	0.605	0.505	0.599
04	0.926	0.559	0.882	0.965	0.359	0.838	0.825	0.432	0.678	0.368
05	0.370	0.383	0.404	0.317	0.546	0.435	0.383	0.423	0.384	0.507
06	0.584	0.532	0.317	0.709	0.488	0.629	0.507	0.488	0.398	0.472
07	0.360	0.498	0.349	0.342	0.328	0.435	0.515	0.489	0.376	0.447
08	0.298	0.353	0.568	0.595	0.591	0.455	0.385	0.480	0.509	0.480
09	0.690	0.433	0.386	0.634	0.551	0.707	0.640	0.822	0.582	0.731
10	0.520	0.584	0.359	0.637	0.551	0.552	0.536	0.558	0.328	0.572
11	0.903	0.917	0.734	0.437	0.460	0.719	0.591	0.507	0.902	0.703
12	0.412	0.443	0.557	0.407	0.573	0.424	0.480	0.436	0.578	0.513
13	0.318	0.476	0.402	0.415	0.380	0.384	0.436	0.424	0.502	0.426
14	0.472	0.672	0.325	0.660	0.440	0.751	0.651	0.492	0.419	0.442
15	0.883	0.833	0.801	0.872	0.962	0.642	0.764	0.914	0.833	0.780
16	0.884	0.707	0.699	0.850	0.678	0.645	0.201	0.367	0.548	0.765
17	0.379	0.629	0.486	0.437	0.550	0.491	0.463	0.465	0.451	0.461
18	0.530	0.599	0.495	0.355	0.549	0.364	0.555	0.504	0.531	0.536
19	0.388	0.423	0.425	0.541	0.396	0.283	0.422	0.320	0.449	0.372
20	0.581	0.798	0.824	0.640	0.546	0.498	0.543	0.569	0.518	0.514

**TABLE E-23** Experimental results of the task instability for environment 3

Participants	Environment 3 (Internal arc = 25 mm., External arc = 45 mm.)									
	Time order									
	Time 01	Time 02	Time 03	Time 04	Time 05	Time 06	Time 07	Time 08	Time 09	Time 10
01	0.260	1.437	0.391	0.409	0.362	0.383	0.277	0.507	0.286	0.434
02	0.325	0.300	0.416	0.306	0.348	0.298	0.202	0.242	0.305	0.290
03	0.407	0.397	0.314	0.417	0.269	0.459	0.278	0.560	0.393	0.472
04	0.258	0.377	0.415	0.416	0.517	0.410	0.491	0.320	0.412	0.551
05	0.496	0.489	0.202	0.636	0.287	0.449	0.320	0.479	0.199	0.286
06	0.341	0.450	0.434	0.244	0.433	0.225	0.307	0.348	0.329	0.364
07	0.448	0.431	0.884	0.899	0.510	0.604	0.765	0.490	0.442	0.451
08	0.239	0.284	0.385	0.515	0.458	0.389	0.359	0.417	0.423	0.403
09	0.370	0.340	0.461	0.424	0.447	0.489	0.358	0.269	3.545	0.302
10	0.262	0.717	0.503	0.375	0.346	0.465	0.597	0.416	0.575	0.431
11	0.517	0.538	0.550	0.405	0.619	0.418	0.485	0.528	0.551	0.527
12	0.407	0.388	0.455	0.478	0.510	0.607	0.334	0.560	0.389	0.294
13	0.492	0.389	0.459	0.301	0.029	0.348	0.340	0.418	0.474	0.509
14	0.370	0.696	0.536	0.307	0.407	0.301	0.667	0.674	0.363	0.386
15	0.829	0.672	0.541	0.423	0.512	0.533	0.707	0.623	0.597	0.454
16	0.370	0.696	0.536	0.307	0.407	0.301	0.667	0.674	0.363	0.386
17	0.499	0.418	0.533	0.363	0.411	0.373	0.427	0.355	0.527	0.330
18	0.460	0.540	0.560	0.504	0.231	0.268	0.402	0.582	0.954	0.404
19	0.283	0.344	0.317	0.353	0.255	0.302	0.266	0.237	0.281	0.238
20	0.507	0.308	0.584	0.276	0.602	0.541	0.497	0.224	0.297	0.326

**TABLE E-24** Experimental results of the task instability for environment 4

Participants	Environment 4 (Internal arc = 25 mm., External arc = 45 mm.)									
	Time order									
	Time 01	Time 02	Time 03	Time 04	Time 05	Time 06	Time 07	Time 08	Time 09	Time 10
01	0.533	0.481	0.280	0.204	0.355	0.415	0.546	0.457	0.449	0.432
02	0.402	0.507	0.421	0.338	0.559	0.405	0.370	0.417	0.486	0.312
03	0.489	0.578	0.432	0.661	0.465	0.523	0.490	0.735	0.522	0.582
04	0.907	0.910	0.889	0.636	0.818	0.571	0.410	0.573	0.547	0.471
05	0.386	0.451	0.398	0.232	0.687	0.454	0.503	0.337	0.503	0.469
06	0.566	0.316	0.504	0.698	0.557	0.290	0.438	0.319	0.441	0.395
07	0.437	0.538	0.450	0.594	0.527	0.524	0.502	0.683	0.398	0.490
08	0.320	0.650	0.372	0.472	0.364	0.505	0.374	0.487	0.567	0.509
09	0.585	0.754	0.657	0.665	0.620	0.722	0.472	0.666	0.481	0.564
10	0.438	0.501	0.375	0.555	0.556	0.363	0.543	0.354	0.607	0.423
11	0.885	0.544	0.543	0.523	0.669	0.525	0.551	0.496	0.485	0.606
12	0.370	0.431	0.567	0.527	0.491	0.435	0.544	0.478	0.584	0.507
13	0.476	0.520	0.498	0.411	0.503	0.481	0.531	0.485	0.381	0.553
14	0.423	0.510	0.416	0.443	0.541	0.547	0.337	0.607	0.293	0.421
15	0.493	0.565	0.512	0.657	0.573	0.576	0.505	0.675	0.818	0.555
16	0.968	0.738	0.581	0.620	0.960	0.442	1.039	0.882	1.079	0.878
17	0.466	0.668	0.637	0.451	0.481	0.452	0.452	0.803	0.524	0.506
18	0.311	0.336	0.549	0.633	0.547	0.495	0.483	0.369	0.482	0.445
19	0.389	0.249	0.565	0.393	0.302	0.381	0.368	0.319	0.333	0.327
20	0.488	0.403	0.609	0.589	0.431	0.658	0.586	0.365	0.515	0.660



(This page is intentionally left blank)

## APPENDIX F

The experimental results of the performance assessment of virtual reality environment  
for the barrel cam mechanism simulation by the use duration and instability sensors  
(Case study: The barrel cam mechanism simulation)

**TABLE F-1** The duration average values of environment 1

Participants	The number of times									
	1	2	3	4	5	6	7	8	9	10
1	3.454	4.283	4.986	4.783	4.548	4.626	4.235	4.689	3.720	3.720
2	2.813	1.406	2.782	2.156	2.641	2.172	2.188	2.360	2.312	1.703
3	4.329	3.915	3.724	2.944	4.536	2.276	2.594	2.689	2.324	2.403
4	3.232	2.964	3.858	2.661	3.122	2.645	2.399	2.300	3.138	2.677
5	2.797	2.985	2.141	2.547	2.750	2.125	3.328	3.563	2.672	2.766
6	4.744	3.262	2.975	2.928	2.927	3.357	2.944	2.817	3.357	2.911
7	2.686	3.296	3.686	2.452	2.515	2.702	3.030	3.858	2.530	2.640
8	3.906	2.484	2.359	2.469	2.969	2.406	2.359	3.281	2.422	1.703
9	3.671	3.437	3.108	1.859	3.172	4.515	4.859	3.890	3.765	3.187
10	1.953	2.360	2.421	1.859	2.265	2.000	1.796	2.969	3.733	1.672
11	3.500	2.719	2.547	2.406	2.687	2.547	3.016	2.500	2.250	1.735
12	3.003	3.571	2.924	2.212	3.467	4.628	3.341	3.216	2.824	2.557
13	2.196	2.290	1.992	2.259	1.961	1.852	2.118	1.946	1.863	1.643
14	1.829	1.688	2.079	1.611	2.095	1.454	1.845	2.064	1.595	1.641
15	1.953	1.750	1.937	1.968	1.875	2.750	1.906	1.625	1.906	1.765
16	2.254	3.960	2.864	2.958	2.771	3.427	2.019	2.301	2.755	2.502
17	3.000	4.797	3.203	3.921	1.625	2.688	1.891	3.157	2.079	2.532
18	2.844	2.656	2.922	2.484	2.328	2.171	2.047	2.187	2.140	2.094
19	2.469	3.422	2.187	2.781	2.296	2.937	2.281	3.000	3.015	3.563
20	3.657	2.766	3.547	2.344	2.438	2.750	2.703	1.704	2.328	3.156
21	1.985	2.969	2.313	2.094	2.281	2.422	2.141	2.312	1.875	2.484
22	4.562	3.485	3.094	2.750	3.328	3.500	4.141	3.422	3.188	2.672
23	4.158	3.505	2.485	1.928	1.832	1.737	2.246	1.768	2.171	2.187
24	2.068	2.026	1.948	1.791	1.995	2.026	1.728	1.838	2.592	1.948
25	2.654	2.136	2.576	2.089	2.309	2.246	2.450	2.309	2.655	2.151
26	3.783	2.323	3.107	3.641	3.782	2.589	3.107	2.762	2.652	2.527
27	2.894	3.305	2.593	2.515	2.609	2.735	2.388	2.625	2.704	2.214
28	2.376	2.391	2.579	2.438	1.891	2.329	3.188	2.953	2.453	2.735
29	2.282	1.953	2.485	2.406	2.203	2.188	2.078	2.329	2.094	2.078
30	2.499	2.171	2.672	2.453	2.422	1.891	2.563	1.953	2.718	1.875
Minimum	1.829	1.406	1.937	1.611	1.625	1.454	1.728	1.625	1.595	1.641
Mean	2.985	2.876	2.803	2.524	2.655	2.656	2.631	2.680	2.594	2.381
Maximum	4.744	4.797	4.986	4.783	4.548	4.628	4.859	4.689	3.765	3.720
STDEV	0.827	0.813	0.671	0.660	0.727	0.809	0.770	0.731	0.566	0.569

**TABLE F-1 CONTINUE** The duration average values of environment 2

Participants	The number of times									
	1	2	3	4	5	6	7	8	9	10
1	4.125	4.328	4.484	5.110	4.969	5.750	4.906	5.688	3.821	3.977
2	3.034	2.276	2.469	2.243	2.518	2.001	2.905	2.082	2.356	1.808
3	3.527	3.198	2.147	1.990	1.802	2.994	2.179	2.288	1.881	2.069
4	2.202	2.415	2.958	2.908	2.695	3.122	2.645	2.267	2.497	2.831
5	3.245	3.530	3.334	2.977	3.102	2.977	3.530	2.870	3.619	2.532
6	3.010	3.009	2.680	2.351	2.163	1.912	2.806	2.602	3.323	1.739
7	3.187	2.812	3.281	3.141	3.609	2.531	2.953	2.905	3.421	4.140
8	2.797	2.422	2.344	2.093	2.547	2.453	2.062	2.562	2.422	2.360
9	4.016	3.828	4.359	4.750	2.109	3.438	2.781	3.406	3.517	3.146
10	2.432	1.734	2.516	2.001	2.532	1.531	1.750	1.797	2.141	1.390
11	3.942	3.194	3.024	2.208	2.430	2.412	2.548	2.446	2.549	2.922
12	3.523	2.520	3.335	3.084	2.787	2.364	2.505	2.286	2.990	2.536
13	2.158	1.751	2.095	1.954	1.595	1.923	2.220	1.923	1.751	1.704
14	1.781	1.937	1.985	1.735	1.860	1.766	2.110	1.923	1.829	1.923
15	2.156	1.844	1.985	2.079	2.469	1.578	2.015	1.797	2.250	1.797
16	2.579	3.516	2.438	2.719	2.563	2.547	2.313	3.000	2.282	2.657
17	2.312	1.937	2.859	2.109	2.578	2.015	2.375	2.422	2.531	2.375
18	2.016	2.141	2.406	1.875	1.719	2.437	2.344	2.406	2.297	2.672
19	3.419	2.953	4.108	3.306	3.178	2.953	3.691	2.841	3.659	3.130
20	3.281	3.328	2.344	2.516	2.312	2.516	2.281	2.640	2.359	2.391
21	2.141	2.203	3.047	1.953	3.126	2.859	2.704	2.047	2.844	2.313
22	2.297	2.344	2.282	2.359	2.047	2.579	2.641	2.578	2.328	2.391
23	2.753	2.268	2.502	1.643	1.955	1.940	2.331	2.221	2.362	2.002
24	3.267	2.611	2.471	2.767	2.767	2.173	2.720	2.423	2.814	2.172
25	2.547	2.813	2.594	2.891	3.344	2.141	2.906	2.407	3.735	1.844
26	3.585	2.938	3.440	2.847	4.681	3.637	3.700	2.341	3.289	3.068
27	2.872	2.684	2.590	2.244	2.260	2.699	2.527	2.071	2.197	2.222
28	2.735	3.266	2.687	2.406	2.891	2.375	2.750	2.219	3.813	1.797
29	1.937	2.062	2.485	2.250	2.296	2.062	2.187	2.484	2.109	2.187
30	3.047	2.250	2.578	2.547	2.407	2.266	2.328	1.843	2.406	1.907
Minimum	1.781	1.734	1.985	1.643	1.595	1.531	1.750	1.797	1.751	1.390
Mean	2.864	2.670	2.794	2.569	2.644	2.532	2.657	2.493	2.713	2.400
Maximum	4.125	4.328	4.484	5.110	4.969	5.750	4.906	5.688	3.821	4.140
STDEV	0.648	0.651	0.649	0.778	0.765	0.794	0.629	0.712	0.640	0.640

**TABLE F-1 CONTINUE** The duration average values of environment 3

Participants	The number of times									
	1	2	3	4	5	6	7	8	9	10
1	4.792	2.036	5.668	5.230	4.040	5.183	3.930	4.134	4.321	4.651
2	1.961	1.961	1.913	2.403	1.898	2.434	2.193	2.198	1.770	2.324
3	1.643	2.440	2.581	2.095	2.080	2.722	2.393	2.096	2.596	1.924
4	2.810	2.011	2.595	2.140	2.218	2.497	1.906	2.401	2.086	2.481
5	3.218	2.857	3.332	3.234	3.645	3.349	3.103	2.365	2.856	2.043
6	1.924	1.987	2.190	3.050	2.753	2.221	2.721	2.597	3.019	3.269
7	2.422	2.625	3.156	3.031	2.219	2.406	2.719	2.109	2.703	2.344
8	4.297	2.672	2.344	2.375	2.937	2.344	2.219	2.094	2.390	2.281
9	3.469	3.839	3.635	2.719	3.509	3.462	3.414	2.893	3.604	2.798
10	1.875	1.969	1.640	2.359	1.953	1.891	1.875	1.813	1.875	2.603
11	2.305	2.337	2.627	2.224	1.982	1.934	1.691	2.244	1.785	2.292
12	3.252	2.314	2.439	2.439	1.939	2.830	2.658	3.486	2.345	3.486
13	2.094	2.672	2.156	2.423	1.500	2.016	1.719	1.719	1.531	9.080
14	1.797	1.844	1.688	1.719	1.906	1.859	1.641	1.562	2.094	2.328
15	2.735	3.126	2.073	1.716	1.919	1.443	2.310	1.919	2.157	1.664
16	3.097	2.894	2.972	2.892	2.876	2.767	2.532	2.298	2.876	2.939
17	3.766	2.781	2.969	2.844	2.562	3.297	4.281	3.625	2.891	3.421
18	3.094	2.235	2.188	2.750	2.281	2.922	2.187	2.937	2.094	2.703
19	2.651	3.534	2.825	3.298	2.303	2.919	2.556	2.446	3.724	3.281
20	2.453	2.578	2.031	2.516	2.312	2.516	2.281	2.640	2.359	2.391
21	3.328	2.156	2.437	2.140	2.765	2.110	2.719	2.671	2.766	2.203
22	2.487	2.296	2.678	3.267	2.375	2.741	2.312	2.885	2.200	2.311
23	1.672	1.641	2.094	2.579	2.110	2.141	2.469	1.875	2.251	2.001
24	2.220	2.844	2.000	1.844	1.891	1.969	2.126	2.157	2.000	2.188
25	3.703	2.172	2.406	2.25	2.813	1.922	2.656	2.391	2.954	2.797
26	4.523	4.348	3.747	2.467	3.795	3.225	2.546	2.783	2.657	2.667
27	2.783	2.799	2.579	2.235	2.736	2.752	2.501	2.251	2.782	2.658
28	2.265	2.454	2.844	2.234	2.000	2.750	2.109	2.235	1.969	2.078
29	2.236	2.080	2.220	2.486	1.782	2.236	1.876	2.266	1.892	2.329
30	2.516	1.953	2.531	2.343	2.250	2.141	2.093	1.921	1.906	1.953
Minimum	1.643	1.641	1.640	1.716	1.500	1.443	1.641	1.562	1.531	1.664
Mean	2.780	2.515	2.619	2.577	2.445	2.567	2.458	2.434	2.482	2.783
Maximum	4.792	4.348	5.668	5.230	4.040	5.183	4.281	4.134	4.321	9.080
STDEV	0.836	0.606	0.773	0.655	0.634	0.702	0.603	0.571	0.632	1.332

**TABLE F-1 CONTINUE** The duration average values of environment 4

Participants	The number of times									
	1	2	3	4	5	6	7	8	9	10
1	4.134	5.183	5.074	4.979	3.898	3.988	4.238	5.676	4.691	3.972
2	2.574	2.385	2.166	2.715	2.166	2.244	2.856	2.009	2.950	2.432
3	1.846	1.971	2.220	2.314	2.579	1.672	2.688	2.594	2.610	2.407
4	2.596	2.387	2.960	2.119	2.197	2.165	2.387	2.371	2.228	2.292
5	2.938	2.233	3.875	2.610	3.516	2.784	3.437	2.816	2.959	2.211
6	2.047	2.594	3.017	2.532	2.391	2.375	2.407	2.188	2.204	2.423
7	2.984	3.124	2.657	2.125	3.546	2.188	3.093	2.656	3.156	2.563
8	2.297	1.906	2.265	2.140	2.218	2.437	2.171	2.421	2.360	1.859
9	3.098	3.146	2.956	3.209	3.114	3.225	4.046	4.284	3.414	2.956
10	2.625	2.063	2.078	1.625	2.204	1.547	1.563	1.672	2.265	1.563
11	2.824	2.338	2.103	2.099	2.255	2.020	2.004	1.926	1.582	2.255
12	2.705	2.205	1.908	2.330	2.439	2.189	1.798	2.252	2.096	2.455
13	2.359	2.797	1.844	1.672	2.406	1.984	2.032	2.238	1.955	2.581
14	1.765	1.656	1.813	1.875	1.906	1.875	1.718	1.750	1.625	2.171
15	2.336	2.240	2.208	2.304	2.031	2.095	2.062	2.337	2.433	2.031
16	3.158	2.594	3.220	2.892	3.064	2.611	2.829	2.563	2.782	2.705
17	3.187	3.187	3.515	3.844	3.406	4.906	3.453	3.375	2.703	3.391
18	2.125	2.078	1.922	2.234	2.125	2.516	1.875	2.360	1.735	2.500
19	2.964	2.697	2.916	3.669	2.567	2.223	3.364	2.754	3.881	2.864
20	2.672	2.782	2.312	2.219	2.343	2.719	2.360	2.703	2.344	2.640
21	2.688	1.906	2.687	1.765	2.109	1.641	2.422	2.015	2.093	2.188
22	2.282	3.635	2.518	2.659	2.817	2.896	3.037	2.974	2.990	2.565
23	2.563	1.953	2.953	2.734	2.688	1.922	2.438	2.219	2.016	2.016
24	2.485	2.015	2.531	2.125	2.532	2.172	2.578	1.890	3.047	2.266
25	2.594	2.234	2.469	2.249	2.688	1.938	2.297	2.610	2.578	2.500
26	3.201	2.306	2.542	2.856	2.904	2.652	2.228	2.903	3.217	2.589
27	2.282	4.470	2.266	2.110	2.329	2.157	2.172	2.110	2.328	2.094
28	2.703	2.688	2.485	2.375	2.219	2.421	1.953	2.188	3.407	2.219
29	1.985	2.313	2.297	1.860	2.173	1.625	2.516	2.470	2.125	2.157
30	2.125	1.953	2.390	1.609	1.906	2.281	2.235	2.391	2.281	2.672
Minimum	1.765	1.656	1.813	1.609	1.906	1.547	1.563	1.672	1.582	1.563
Mean	2.605	2.568	2.606	2.462	2.558	2.382	2.542	2.557	2.602	2.451
Maximum	4.134	5.183	5.074	4.979	3.898	4.906	4.238	5.676	4.691	3.972
STDEV	0.489	0.768	0.676	0.719	0.517	0.694	0.659	0.780	0.686	0.452

**TABLE F-2** The instability average values of environment 1

Participants	The number of times									
	1	2	3	4	5	6	7	8	9	10
1	0.263	0.236	0.205	0.153	0.205	0.199	0.233	0.167	0.283	0.243
2	0.376	0.271	0.306	0.212	0.225	0.326	0.224	0.237	0.255	0.325
3	0.375	0.207	0.287	0.386	0.229	0.339	0.153	0.385	0.151	0.275
4	0.265	0.168	0.241	0.244	0.357	0.261	0.354	0.187	0.331	0.221
5	0.298	0.182	0.178	0.407	0.250	0.201	0.305	0.209	0.299	0.289
6	0.314	0.276	0.199	0.265	0.247	0.177	0.248	0.211	0.682	0.266
7	0.407	0.420	0.334	0.321	0.426	0.212	0.389	0.829	0.398	0.416
8	0.437	0.292	0.179	0.244	0.358	0.216	0.282	0.270	0.276	0.315
9	0.351	0.178	0.573	0.208	0.494	0.288	0.459	0.159	0.336	0.303
10	0.557	0.317	0.350	0.333	0.420	0.279	0.741	0.354	0.847	0.496
11	0.271	0.313	0.338	0.310	0.325	0.207	0.360	0.319	0.454	0.338
12	0.275	0.276	0.397	0.232	0.206	0.215	0.218	0.205	0.268	0.219
13	0.307	0.382	0.423	0.222	0.433	0.321	0.451	0.588	0.267	0.320
14	0.212	0.327	0.366	0.476	0.293	0.325	0.362	0.228	0.204	0.425
15	0.214	0.343	0.292	0.218	0.439	0.266	0.251	0.272	0.219	0.322
16	0.123	0.348	0.271	0.359	0.258	0.622	0.560	0.685	1.075	0.554
17	0.166	0.307	0.230	0.286	0.481	0.253	0.353	0.271	0.237	0.361
18	0.216	0.243	0.274	0.276	0.305	0.343	0.254	0.222	0.276	0.321
19	0.252	0.236	0.354	0.229	0.244	0.286	0.260	0.236	0.289	0.403
20	0.327	0.267	0.197	0.247	0.406	0.188	0.188	0.244	0.149	0.242
21	0.354	0.269	0.385	0.435	0.477	0.535	0.334	0.220	0.336	0.603
22	0.227	0.345	0.618	0.388	0.275	0.299	0.238	0.412	0.191	0.463
23	0.495	0.280	0.333	0.292	0.263	0.436	0.245	0.328	0.234	0.299
24	0.139	0.316	0.327	0.314	0.238	0.277	0.220	0.786	0.493	0.409
25	0.249	0.311	0.321	0.292	0.305	0.268	0.292	0.368	0.228	0.319
26	0.302	0.228	0.229	0.280	0.222	0.503	0.209	0.371	0.230	0.347
27	0.309	0.250	0.295	0.263	0.195	0.230	0.299	0.304	0.267	0.228
28	0.236	0.227	0.306	0.358	0.300	0.284	0.177	0.309	0.294	0.314
29	0.315	0.322	0.307	0.283	0.261	0.157	0.228	0.235	0.469	0.345
30	0.289	0.318	0.362	0.236	0.329	0.236	0.269	0.227	0.261	0.200
Minimum	0.123	0.168	0.178	0.153	0.195	0.157	0.153	0.159	0.149	0.200
Mean	0.297	0.282	0.316	0.292	0.316	0.292	0.305	0.328	0.343	0.339
Maximum	0.557	0.420	0.618	0.476	0.494	0.622	0.741	0.830	1.075	0.603
STDEV	0.096	0.060	0.101	0.074	0.092	0.108	0.122	0.174	0.203	0.097

**TABLE F-2 CONTINUE** The instability average values of environment 2

Participants	The number of times									
	1	2	3	4	5	6	7	8	9	10
1	0.434	0.614	0.152	0.414	0.167	0.149	0.536	0.191	0.174	0.209
2	0.297	0.364	0.305	0.354	0.309	0.243	0.507	0.237	0.216	0.319
3	0.173	0.201	0.283	0.404	0.271	0.313	0.405	0.298	0.256	0.161
4	0.316	0.307	0.343	0.165	0.357	0.233	0.262	0.151	0.278	0.355
5	0.273	0.446	0.137	0.206	0.160	0.324	0.792	0.306	0.229	0.389
6	0.237	0.233	0.263	0.317	0.306	0.247	0.292	0.300	0.215	0.256
7	0.521	0.424	0.317	0.550	0.416	0.570	0.445	0.542	0.463	0.419
8	0.349	0.281	0.315	0.214	0.276	0.270	0.225	0.340	0.237	0.221
9	0.303	0.332	0.217	0.216	0.172	0.216	0.234	0.280	0.279	0.424
10	0.664	0.316	0.579	1.145	0.793	0.610	0.470	0.211	0.532	0.435
11	0.219	0.165	0.394	0.218	0.319	0.204	0.334	0.338	0.268	0.184
12	0.301	0.251	0.420	0.222	0.709	0.202	0.245	0.197	0.244	0.338
13	0.332	0.334	0.401	0.518	0.573	0.486	0.387	0.874	0.467	0.249
14	0.429	0.375	0.300	0.288	0.311	0.421	0.333	0.488	0.272	0.493
15	0.415	0.366	0.294	0.336	0.293	0.319	0.295	0.277	0.511	0.596
16	0.208	0.324	0.441	0.369	0.400	0.477	0.325	0.309	0.289	0.418
17	0.371	0.249	0.337	0.322	0.354	0.268	0.240	0.407	0.487	0.203
18	0.238	0.261	0.209	0.393	0.366	0.213	0.461	0.313	0.308	0.357
19	0.366	0.389	0.307	0.328	0.309	0.292	0.261	0.247	0.266	0.333
20	0.496	0.185	0.341	0.373	0.443	0.408	0.357	0.438	0.410	0.342
21	0.272	0.285	0.416	0.223	0.374	0.218	0.408	0.376	0.262	0.441
22	0.422	0.216	0.297	0.515	0.322	0.311	0.238	0.231	0.390	0.210
23	0.307	0.259	0.297	0.365	0.307	0.726	0.330	0.247	0.232	0.178
24	0.265	0.322	0.299	0.374	0.323	0.310	0.387	0.468	0.368	0.457
25	0.248	0.296	0.264	0.258	0.330	0.327	0.425	0.261	0.579	0.320
26	0.317	0.220	0.270	0.268	0.221	0.234	0.259	0.301	0.224	0.265
27	0.803	0.195	0.258	0.277	0.267	0.289	0.280	0.364	0.276	0.175
28	0.205	0.231	0.291	0.179	0.310	0.225	0.421	0.214	0.566	0.264
29	0.198	0.201	0.154	0.248	0.163	0.281	0.152	0.251	0.149	0.303
30	0.311	0.329	0.313	0.504	0.322	0.335	0.326	0.324	0.250	0.330
Minimum	0.173	0.165	0.137	0.165	0.160	0.149	0.152	0.151	0.149	0.161
Mean	0.343	0.299	0.307	0.352	0.341	0.324	0.354	0.326	0.323	0.321
Maximum	0.803	0.614	0.579	1.145	0.793	0.726	0.792	0.874	0.579	0.596
STDEV	0.142	0.095	0.091	0.183	0.142	0.132	0.123	0.137	0.121	0.112



**TABLE F-2 CONTINUE** The instability average values of environment 3

Participants	The number of times									
	1	2	3	4	5	6	7	8	9	10
1	0.300	0.050	0.308	0.318	0.196	0.256	0.264	0.341	0.362	0.386
2	0.176	0.258	0.172	0.443	0.333	0.350	0.352	0.390	0.381	0.333
3	0.346	0.329	0.401	0.401	0.232	0.319	0.799	0.947	0.402	0.263
4	0.389	0.347	0.486	0.397	0.332	0.727	0.526	0.670	0.577	0.369
5	0.621	0.447	0.476	0.404	0.389	0.438	0.593	0.436	0.484	0.386
6	0.385	0.153	0.224	0.206	0.404	0.231	0.405	0.292	0.112	0.282
7	0.642	0.406	0.456	0.413	0.493	0.374	0.431	0.430	0.442	0.541
8	0.283	0.410	0.394	0.348	0.369	0.399	0.295	0.440	0.412	0.332
9	0.241	0.607	0.289	0.463	0.353	0.339	0.308	0.354	0.360	0.355
10	0.334	0.622	0.502	0.955	0.547	0.448	0.372	0.428	0.378	0.367
11	0.381	0.304	0.525	0.305	0.413	0.323	0.453	0.457	0.551	0.415
12	0.396	0.343	0.439	0.462	0.559	0.421	0.865	0.389	0.520	0.341
13	0.505	0.336	0.345	0.565	0.718	0.487	0.874	0.453	0.569	0.925
14	0.306	0.341	0.387	0.356	0.352	0.648	0.391	0.346	0.268	0.980
15	0.296	0.375	0.382	0.279	0.347	0.239	0.549	0.327	0.342	0.249
16	0.377	0.304	0.158	0.718	0.284	0.264	0.371	0.243	0.313	0.710
17	0.388	0.378	0.415	0.332	0.383	0.264	0.433	0.497	0.409	0.280
18	0.319	0.360	0.389	0.278	0.348	0.326	0.328	0.440	0.454	0.304
19	0.284	0.212	0.216	0.164	0.175	0.432	0.294	0.373	0.404	0.304
20	0.442	0.434	0.395	0.373	0.443	0.408	0.357	0.438	0.410	0.342
21	0.511	0.458	0.515	0.443	0.418	0.344	0.336	0.301	0.538	0.279
22	0.380	0.359	0.410	0.374	0.383	0.346	0.399	0.469	0.379	0.303
23	0.417	0.346	0.364	0.363	0.399	0.351	0.382	0.467	0.438	0.406
24	0.300	0.277	0.481	0.290	0.694	0.441	0.417	0.551	0.383	0.683
25	0.295	0.309	0.420	0.249	0.371	0.307	0.400	0.337	0.401	0.328
26	0.360	0.225	0.316	0.612	0.460	0.332	0.378	0.276	0.290	0.269
27	0.294	0.226	0.311	0.238	0.165	0.236	0.297	0.201	0.247	0.209
28	0.495	0.320	0.460	0.331	0.600	0.430	0.351	0.472	0.455	0.553
29	0.432	0.368	0.333	0.462	0.504	0.458	0.361	0.473	0.289	0.387
30	0.361	0.271	0.386	0.306	0.412	0.265	0.411	0.227	0.399	0.254
Minimum	0.176	0.050	0.158	0.164	0.165	0.231	0.264	0.201	0.112	0.209
Mean	0.375	0.339	0.378	0.395	0.403	0.373	0.433	0.415	0.399	0.405
Maximum	0.642	0.622	0.525	0.955	0.718	0.727	0.874	0.947	0.577	0.980
STDEV	0.103	0.114	0.097	0.158	0.133	0.113	0.158	0.141	0.101	0.190

**TABLE F-2 CONTINUE** The instability average values of environment 4

Participants	The number of times									
	1	2	3	4	5	6	7	8	9	10
1	0.301	0.179	0.151	0.235	0.346	0.346	0.278	0.222	0.390	0.324
2	0.226	0.439	0.420	0.338	0.318	0.438	0.308	0.512	0.347	0.472
3	0.286	0.303	0.203	0.259	0.254	0.242	0.258	0.289	0.220	0.356
4	0.357	0.581	0.506	0.256	0.885	0.334	0.509	0.385	0.634	0.566
5	0.257	0.406	0.476	0.333	0.829	0.380	0.561	0.399	0.418	0.410
6	0.382	0.267	0.317	0.183	0.273	0.276	0.361	0.389	0.362	0.292
7	0.523	0.520	0.600	0.341	0.513	0.381	0.505	0.472	0.349	0.587
8	0.315	0.319	0.260	0.357	0.452	0.409	0.529	0.332	0.360	0.321
9	0.282	0.367	0.337	0.336	0.448	0.275	0.204	0.301	0.199	0.274
10	0.282	0.686	0.451	0.453	0.370	0.407	0.407	0.506	0.387	0.464
11	0.515	0.459	0.420	0.392	0.342	0.389	0.441	0.428	0.459	0.392
12	0.485	0.317	0.287	0.404	0.369	0.451	0.346	0.331	0.421	0.453
13	0.364	0.252	0.358	0.350	0.368	0.322	0.402	0.443	0.396	0.368
14	0.514	0.632	0.559	0.582	0.363	0.522	0.510	0.809	0.327	0.354
15	0.428	0.335	0.311	0.446	0.328	0.367	0.240	0.460	0.280	0.379
16	0.327	0.266	0.284	0.229	0.258	0.329	0.333	0.354	0.525	0.356
17	0.360	0.332	0.355	0.299	0.369	0.329	0.340	0.393	0.391	0.381
18	0.397	0.384	0.353	0.456	0.360	0.292	0.391	0.279	0.315	0.267
19	0.208	0.221	0.267	0.432	0.795	0.430	0.421	0.490	0.371	0.593
20	0.303	0.246	0.270	0.388	0.452	0.345	0.508	0.282	0.486	0.319
21	0.453	0.298	0.455	0.350	0.409	0.290	0.383	0.358	0.378	0.441
22	0.386	0.453	0.465	0.418	0.561	0.479	0.532	0.382	0.429	0.439
23	0.358	0.233	0.462	0.286	0.464	0.224	0.452	0.319	0.532	0.539
24	0.503	0.357	0.373	0.440	0.507	0.359	0.706	0.530	0.444	0.469
25	0.308	0.340	0.409	0.375	0.343	0.400	0.416	0.375	0.442	0.469
26	0.493	0.483	0.356	0.306	0.288	0.376	0.261	0.300	0.264	0.362
27	0.323	0.444	0.370	0.382	0.480	0.490	0.337	1.720	0.301	0.364
28	0.480	0.347	0.431	0.717	0.324	0.436	0.587	0.439	0.371	0.425
29	0.506	0.285	0.362	0.292	0.388	0.237	0.348	0.363	0.274	0.351
30	0.497	0.356	0.380	0.353	0.365	0.358	0.317	0.284	0.373	0.307
Minimum	0.208	0.179	0.151	0.183	0.254	0.224	0.204	0.222	0.199	0.267
Mean	0.381	0.370	0.375	0.366	0.427	0.364	0.406	0.438	0.381	0.403
Maximum	0.523	0.686	0.600	0.717	0.885	0.522	0.706	1.720	0.634	0.593
STDEV	0.096	0.122	0.100	0.106	0.158	0.076	0.116	0.266	0.093	0.089

(This page is intentionally left blank)

## APPENDIX G

The questionnaires and rating scale for 30 participants

**Participant: 01.**

**Environment 1** = Non-Stereoscopy + Non-Force feedback  
**Environment 2** = Stereoscopy + Non-Force feedback  
**Environment 3** = Non-Stereoscopy + Force feedback  
**Environment 4** = Stereoscopy + Force feedback

- How do you feel, when you look at 3D object on the 2D wall screen by Non-Stereoscopy and stereoscopy ?  
 - How do you feel and how do you think about the haptic arm application, when do you use a haptic arm to manipulate 3D object on the 2D screen by using a haptic arm with Non-force feedback and force feedback ? (Answer the question by filling in the spaces marked 'x' in the table)

No.	Questions	Environment1					Environment2					Environment3					Environment4									
		Very much 5	4	3	2	1	Very much 5	4	3	2	1	Very much 5	4	3	2	1	Very much 5	4	3	2	1					
1.	Was it easy to capture the cone ?																									
2.	Was it easy to drive the system accordingly ?																									
3.	Was the system providing blurred vision ?																									
4.	Did you experienced double-vision ?																									
5.	Did you perceive visually why some configuration cannot work ?																									
6.	Did you prepare the process before action ?																									
7.	Would you have expected more explanations about how to drive the system ?																									
8.	Did you felt vertigo ?																									
9.	Did you search the limit respective positions of the mechanism ?																									
10.	In your opinion was the system adapted to the task ?																									
11.	Did you find easily the good criteria to decide if the system works or not ?																									
12.	Did you investigate how to achieve the expected task ?																									
13.	When selecting the hand avatar did you elaborate any strategy ?																									
14.	Did you feel some blurred vision after a while ?																									
15.	Did you feel the contrast evolving ?																									
16.	Did you felt some stress in the eyes ?																									
17.	Did you fill increasing anxiety ?																									
18.	Did you felt a lack of luminance ?																									
19.	Would you expect to sit down ?																									
20.	Did you felt your articulations at limit position and angles ?																									
21.	How many time could you stay working with the environment ?	0.30h	1.00h	1.30h	2.00h	2.30h	0.30h	1.00h	1.30h	2.00h	2.30h	0.30h	1.00h	1.30h	2.00h	2.30h	0.30h	1.00h	1.30h	2.00h	2.30h	0.30h	1.00h	1.30h	2.00h	2.30h
22.	Which is the more comfortable environment ?																									

[Thank you very much for your answer the questions]

- How do you feel, when you look at 3D object on the 2D wall screen by Non-Stereoscopy and stereoscopy ?  
 - How do you feel and how do you think about the haptic arm application, when do you use a haptic arm to manipulate 3D object on the 2D screen by using a haptic arm with Non-force feedback and force feedback ? (Answer the question by filling in the spaces marked 'x' in the table)

Environment 1 = Non-Stereoscopy + Non-Force feedback  
 Environment 2 = Stereoscopy + Non-Force feedback  
 Environment 3 = Non-Stereoscopy + Force feedback  
 Environment 4 = Stereoscopy + Force feedback

Participant: 02

No.	Questions	Environment1					Environment2					Environment3					Environment4									
		Very much	Much	Mediu	Less	Not	Very much	1.00h	1.30h	2.00h	2.30h	Very much	1.00h	1.30h	2.00h	2.30h	Very much	1.00h	1.30h	2.00h	2.30h	Very much	1.00h	1.30h	2.00h	2.30h
1.	Was it easy to capture the cone ?																									
2.	Was it easy to drive the system accordingly ?																									
3.	Was the system providing blurred vision ?																									
4.	Did you experienced double-vision ?																									
5.	Did you perceive visually why some configuration cannot work ?																									
6.	Did you prepare the process before action ?																									
7.	Would you have expected more explanations about how to drive the system ?																									
8.	Did you felt vertigo ?																									
9.	Did you search the limit respective positions of the mechanism ?																									
10.	In your opinion was the system adapted to the task ?																									
11.	Did you find easily the good criteria to decide if the system works or not ?																									
12.	Did you investigate how to achieve the expected task ?																									
13.	When selecting the hand avatar did you elaborate any strategy ?																									
14.	Did you feel some blurred vision after a while ?																									
15.	Did you feel the contrast evolving ?																									
16.	Did you feel some stress in the eyes ?																									
17.	Did you fill increasing anxiety ?																									
18.	Did you felt a lack of luminance ?																									
19.	Would you expect to sit down ?																									
20.	Did you felt your articulations at limit position and angles ?																									
21.	How many time could you stay working with the environment ?																									
22.	Which is the more comfortable environment ?																									

[Thank you very much for your answer the questions]

Participant: 03

Environment 1 = Non-Stereoscopy + Non-Force feedback  
 Environment 2 = Stereoscopy + Non-Force feedback  
 Environment 3 = Non-Stereoscopy + Force feedback  
 Environment 4 = Stereoscopy + Force feedback

- How do you feel, when you look at 3D object on the 2D wall screen by Non-Stereoscopy and stereoscopy ?  
 - How do you feel and how do you think about the haptic arm application, when do you use a haptic arm to manipulate 3D object on the 2D screen by using a haptic arm with Non-force feedback and force feedback ? (Answer the question by filling in the spaces marked 'x' in the table)

No.	Questions	Environment1					Environment2					Environment3					Environment4				
		Very much	1.00h	1.30h	2.00h	2.30h	Very much	1.00h	1.30h	2.00h	2.30h	Very much	1.00h	1.30h	2.00h	2.30h	Very much	1.00h	1.30h	2.00h	2.30h
1.	Was it easy to capture the cone ?																				
2.	Was it easy to drive the system accordingly ?																				
3.	Was the system providing blurred vision ?																				
4.	Did you experienced double-vision ?																				
5.	Did you perceive visually why some configuration cannot work ?																				
6.	Did you prepare the process before action ?																				
7.	Would you have expected more explanations about how to drive the system ?																				
8.	Did you felt vertigo ?																				
9.	Did you search the limit respective positions of the mechanism ?																				
10.	In your opinion was the system adapted to the task ?																				
11.	Did you find easily the good criteria to decide if the system works or not ?																				
12.	Did you investigate how to achieve the expected task ?																				
13.	When selecting the hand avatar did you elaborate any strategy ?																				
14.	Did you feel some blurred vision after a while ?																				
15.	Did you feel the contrast evolving ?																				
16.	Did you felt some stress in the eyes ?																				
17.	Did you fill increasing anxiety ?																				
18.	Did you felt a lack of luminance ?																				
19.	Would you expect to sit down ?																				
20.	Did you felt your articulations at limit position and angles ?																				
21.	How many time could you stay working with the environment ?																				
22.	Which is the more comfortable environment ?																				

[Thank you very much for your answer the questions]

- How do you feel, when you look at 3D object on the 2D wall screen by Non-Stereoscopy and stereoscopy ?  
 - How do you feel and how do you think about the haptic arm application, when do you use a haptic arm to manipulate 3D object on the 2D screen by using a haptic arm with Non-force feedback and force feedback ? (Answer the question by filling in the spaces marked 'x' in the table)

Environment 1 = Non-Stereoscopy + Non-Force feedback  
 Environment 2 = Stereoscopy + Non-Force feedback  
 Environment 3 = Non-Stereoscopy + Force feedback  
 Environment 4 = Stereoscopy + Force feedback

Participant...04

4 3 2 1 0

No.	Questions	Environment1					Environment2					Environment3					Environment4				
		Very much	1.00h	1.30h	2.00h	2.30h	Very much	1.00h	1.30h	2.00h	2.30h	Very much	1.00h	1.30h	2.00h	2.30h	Very much	1.00h	1.30h	2.00h	2.30h
1.	Was it easy to capture the cone ?																				
2.	Was it easy to drive the system accordingly ?																				
3.	Was the system providing blurred vision ?																				
4.	Did you experienced double-vision ?																				
5.	Did you perceive visually why some configuration cannot work ?																				
6.	Did you prepare the process before action ?																				
7.	Would you have expected more explanations about how to drive the system ?																				
8.	Did you felt vertigo ?																				
9.	Did you search the limit respective positions of the mechanism ?																				
10.	In your opinion was the system adapted to the task ?																				
11.	Did you find easily the good criteria to decide if the system works or not ?																				
12.	Did you investigate how to achieve the expected task ?																				
13.	When selecting the hand avatar did you elaborate any strategy ?																				
14.	Did you feel some blurred vision after a while ?																				
15.	Did you feel the contrast evolving ?																				
16.	Did you felt some stress in the eyes ?																				
17.	Did you fill increasing anxiety ?																				
18.	Did you felt a lack of luminance ?																				
19.	Would you expect to sit down ?																				
20.	Did you felt your articulations at limit position and angles ?																				
21.	How many time could you stay working with the environment ?																				
22.	Which is the more comfortable environment ?																				

[Thank you very much for your answer the questions]



**Participant: 05**

**Environment 1 = Non-Stereoscopy + Non-Force feedback**  
**Environment 2 = Stereoscopy + Non-Force feedback**  
**Environment 3 = Non-Stereoscopy + Force feedback**  
**Environment 4 = Stereoscopy + Force feedback**

- How do you feel, when you look at 3D object on the 2D wall screen by Non-Stereoscopy and stereoscopy ?

- How do you feel and how do you think about the haptic arm application, when do you use a haptic arm to manipulate 3D object on the 2D screen by using a haptic arm with Non-force feedback and force feedback ? (Answer the question by filling in the spaces marked 'x' in the table)

4 3 2 1 0

No,	Environment1				Environment2				Environment3				Environment4								
	Very much	1.00h	1.30h	2.00h	2.30h	Not	Rating scale	Very much	1.00h	1.30h	2.00h	2.30h	Not	Rating scale	Very much	1.00h	1.30h	2.00h	2.30h	Not	
1.																					
2.																					
3.																					
4.																					
5.																					
6.																					
7.																					
8.																					
9.																					
10.																					
11.																					
12.																					
13.																					
14.																					
15.																					
16.																					
17.																					
18.																					
19.																					
20.																					
21.																					
22.																					

[Thank you very much for your answer the questions]

- How do you feel, when you look at 3D object on the 2D wall screen by Non-Stereoscopy and stereoscopy ?  
 - How do you feel and how do you think about the haptic arm application, when do you use a haptic arm to manipulate 3D object on the 2D screen by using a haptic arm with Non-force feedback and force feedback ? (Answer the question by filling in the spaces marked 'x' in the table)

Environment 1 = Non-Stereoscopy + Non-Force feedback  
 Environment 2 = Stereoscopy + Non-Force feedback  
 Environment 3 = Non-Stereoscopy + Force feedback  
 Environment 4 = Stereoscopy + Force feedback

Participant...06

No.	Questions	Environment1					Environment2					Environment3					Environment4				
		Very much	1.00h	1.30h	2.00h	2.30h	Very much	1.00h	1.30h	2.00h	2.30h	Very much	1.00h	1.30h	2.00h	2.30h	Very much	1.00h	1.30h	2.00h	2.30h
1.	Was it easy to capture the cone ?																				
2.	Was it easy to drive the system accordingly ?																				
3.	Was the system providing blurred vision ?																				
4.	Did you experienced double-vision ?																				
5.	Did you perceive visually why some configuration cannot work ?																				
6.	Did you prepare the process before action ?																				
7.	Would you have expected more explanations about how to drive the system ?																				
8.	Did you felt vertigo ?																				
9.	Did you search the limit respective positions of the mechanism ?																				
10.	In your opinion was the system adapted to the task ?																				
11.	Did you find easily the good criteria to decide if the system works or not ?																				
12.	Did you investigate how to achieve the expected task ?																				
13.	When selecting the hand avatar did you elaborate any strategy ?																				
14.	Did you feel some blurred vision after a while ?																				
15.	Did you feel the contrast evolving ?																				
16.	Did you felt some stress in the eyes ?																				
17.	Did you fill increasing anxiety ?																				
18.	Did you felt a lack of luminance ?																				
19.	Would you expect to sit down ?																				
20.	Did you felt your articulations at limit position and angles ?																				
21.	How many time could you stay working with the environment ?																				
22.	Which is the more comfortable environment ?																				

[Thank you very much for your answer the questions]

- How do you feel, when you look at 3D object on the 2D wall screen by Non-Stereoscopy and stereoscopy ?  
 - How do you feel and how do you think about the haptic arm application, when do you use a haptic arm to manipulate 3D object on the 2D screen by using a haptic arm with Non-force feedback and force feedback ? (Answer the question by filling in the spaces marked 'x' in the table)

Environment 1 = Non-Stereoscopy + Non-Force feedback  
 Environment 2 = Stereoscopy + Non-Force feedback  
 Environment 3 = Non-Stereoscopy + Force feedback  
 Environment 4 = Stereoscopy + Force feedback

Participant: 07

A 3 2 1 0

No.	Environment1				Environment2				Environment3				Environment4			
	Very much	Medium	Less	Not	Very much	Medium	Less	Not	Very much	Medium	Less	Not	Very much	Medium	Less	Not
1.																
2.																
3.																
4.																
5.																
6.																
7.																
8.																
9.																
10.																
11.																
12.																
13.																
14.																
15.																
16.																
17.																
18.																
19.																
20.																
21.																
22.																

[Thank you very much for your answer the questions]

- *How do you feel*, when you look at 3D object on the 2D wall screen by Non-Stereoscopy and stereoscopy ?  
 - *How do you feel and how do you think about the haptic arm application*, when do you use a haptic arm to manipulate 3D object on the 2D screen by using a haptic arm with Non-force feedback and force feedback ? (Answer the question by filling in the spaces marked 'x' in the table)

Environment 1 = Non-Stereoscopy + Non-Force feedback  
 Environment 2 = Stereoscopy + Non-Force feedback  
 Environment 3 = Non-Stereoscopy + Force feedback  
 Environment 4 = Stereoscopy + Force feedback

Participant: **Q.B**

No.	Environment1					Environment2					Environment3					Environment4									
	Very much	Medium	Less	Not	Rating scale	Very much	Medium	Less	Not	Rating scale	Very much	Medium	Less	Not	Rating scale	Very much	Medium	Less	Not	Rating scale					
1.					1					3					3					3					3
2.					2					3					3					3					3
3.					4					2					2					4					1
4.					4					4					4					4					4
5.					2					3					3					3					3
6.					1					1					1					1					1
7.					3					3					3					3					3
8.					0					0					0					0					0
9.					3					3					3					3					3
10.					3					3					3					3					3
11.					3					3					3					3					3
12.					3					3					3					3					3
13.					1					1					1					1					1
14.					4					4					4					4					4
15.					4					4					4					4					4
16.					4					4					4					4					4
17.					4					4					4					4					4
18.					4					4					4					4					4
19.					4					4					4					4					4
20.					1					1					1					1					1
21.					4					4					4					4					4
22.					4					4					4					4					4

[Thank you very much for your answer the questions]

- How do you feel, when you look at 3D object on the 2D wall screen by Non-Stereoscopy and stereoscopy ?  
 - How do you feel and how do you think about the haptic arm application, when do you use a haptic arm to manipulate 3D object on the 2D screen by using a haptic arm with Non-force feedback and force feedback ? (Answer the question by filling in the spaces marked 'x' in the table)

Environment 1 = Non-Stereoscopy + Non-Force feedback  
 Environment 2 = Stereoscopy + Non-Force feedback  
 Environment 3 = Non-Stereoscopy + Force feedback  
 Environment 4 = Stereoscopy + Force feedback

Participant: 01

1 2 3 4

No,	Environment1					Environment2					Environment3					Environment4									
	Very much	Medium	Less	Not	Rating scale	Very much	Medium	Less	Not	Rating scale	Very much	Medium	Less	Not	Rating scale	Very much	Medium	Less	Not	Rating scale					
1.																									
2.																									
3.																									
4.																									
5.																									
6.																									
7.																									
8.																									
9.																									
10.																									
11.																									
12.																									
13.																									
14.																									
15.																									
16.																									
17.																									
18.																									
19.																									
20.																									
21.																									
22.																									

[Thank you very much for your answer the questions]

Environment 1 = Non-Stereoscopy + Non-Force feedback  
 Environment 2 = Stereoscopy + Non-Force feedback  
 Environment 3 = Non-Stereoscopy + Force feedback  
 Environment 4 = Stereoscopy + Force feedback

Participant: 10

- How do you feel, when you look at 3D object on the 2D wall screen by Non-Stereoscopy and stereoscopy?  
 - How do you feel and how do you think about the haptic arm application, when do you use a haptic arm to manipulate 3D object on the 2D screen by using a haptic arm with Non-force feedback and force feedback? (Answer the question by filling in the spaces marked 'x' in the table)

No,	Environment1				Environment2				Environment3				Environment4			
	Very much	Medium	Less	Not	Very much	Medium	Less	Not	Very much	Medium	Less	Not	Very much	Medium	Less	Not
1.																
2.																
3.																
4.																
5.																
6.																
7.																
8.																
9.																
10.																
11.																
12.																
13.																
14.																
15.																
16.																
17.																
18.																
19.																
20.																
21.																
22.																

[Thank you very much for your answer the questions]

Participant: 11

Environment 1 = Non-Stereoscopy + Non-Force feedback  
 Environment 2 = Stereoscopy + Non-Force feedback  
 Environment 3 = Non-Stereoscopy + Force feedback  
 Environment 4 = Stereoscopy + Force feedback

- How do you feel, when you look at 3D object on the 2D wall screen by Non-Stereoscopy and stereoscopy ?  
 - How do you feel and how do you think about the haptic arm application, when do you use a haptic arm to manipulate 3D object on the 2D screen by using a haptic arm with Non-force feedback and force feedback ? (Answer the question by filling in the spaces marked 'x' in the table)

No,	Environment1					Environment2					Environment3					Environment4									
	Very much	1.00h	1.30h	2.00h	2.30h	Very much	1.00h	1.30h	2.00h	2.30h	Very much	1.00h	1.30h	2.00h	2.30h	Very much	1.00h	1.30h	2.00h	2.30h					
1.																									
2.																									
3.																									
4.																									
5.																									
6.																									
7.																									
8.																									
9.																									
10.																									
11.																									
12.																									
13.																									
14.																									
15.																									
16.																									
17.																									
18.																									
19.																									
20.																									
21.																									
22.																									

[Thank you very much for your answer the questions]

Participant: A.R.

Environment 1 = Non-Stereoscopy + Non-Force feedback  
 Environment 2 = Stereoscopy + Non-Force feedback  
 Environment 3 = Non-Stereoscopy + Force feedback  
 Environment 4 = Stereoscopy + Force feedback

- How do you feel, when you look at 3D object on the 2D wall screen by Non-Stereoscopy and stereoscopy?  
 - How do you feel and how do you think about the haptic arm application, when do you use a haptic arm to manipulate 3D object on the 2D screen by using a haptic arm with Non-force feedback and force feedback? (Answer the question by filling in the spaces marked 'x' in the table)

4 3 2 1 0

No.	Environment1					Environment2					Environment3					Environment4									
	Very much	Very	Medium	Less	Not	Very much	Very	Medium	Less	Not	Very much	Very	Medium	Less	Not	Very much	Very	Medium	Less	Not					
1.																									
2.																									
3.																									
4.																									
5.																									
6.																									
7.																									
8.																									
9.																									
10.																									
11.																									
12.																									
13.																									
14.																									
15.																									
16.																									
17.																									
18.																									
19.																									
20.																									
21.																									
22.																									

[Thank you very much for your answer the questions]



- How do you feel, when you look at 3D object on the 2D wall screen by Non-Stereoscopy and stereoscopy ?  
 - How do you feel and how do you think about the haptic arm application, when do you use a haptic arm to manipulate 3D object on the 2D screen by using a haptic arm with Non-force feedback and force feedback ? (Answer the question by filling in the spaces marked 'x' in the table)

Environment 1 = Non-Stereoscopy + Non-Force feedback  
 Environment 2 = Stereoscopy + Non-Force feedback  
 Environment 3 = Non-Stereoscopy + Force feedback  
 Environment 4 = Stereoscopy + Force feedback

Participant: 12

1 2 3 4 1 0

No,	Environment1					Environment2					Environment3					Environment4					
	Very much	1.00h	1.30h	2.00h	2.30h	Very much	1.00h	1.30h	2.00h	2.30h	Very much	1.00h	1.30h	2.00h	2.30h	Very much	1.00h	1.30h	2.00h	2.30h	
1.	X					X					X					X					
2.	X					X					X					X					
3.						X					X					X					
4.						X					X					X					
5.						X					X					X					
6.						X					X					X					
7.						X					X					X					
8.						X					X					X					
9.						X					X					X					
10.						X					X					X					
11.						X					X					X					
12.						X					X					X					
13.						X					X					X					
14.						X					X					X					
15.						X					X					X					
16.						X					X					X					
17.						X					X					X					
18.						X					X					X					
19.						X					X					X					
20.						X					X					X					
21.						X					X					X					
22.						X					X					X					

[Thank you very much for your answer the questions]

Environment 1 = Non-Stereoscopy + Non-Force feedback  
 Environment 2 = Stereoscopy + Non-Force feedback  
 Environment 3 = Non-Stereoscopy + Force feedback  
 Environment 4 = Stereoscopy + Force feedback

Participant...1.A

- How do you feel, when you look at 3D object on the 2D wall screen by Non-Stereoscopy and stereoscopy ?  
 - How do you feel and how do you think about the haptic arm application, when do you use a haptic arm to manipulate 3D object on the 2D screen by using a haptic arm with Non-force feedback and force feedback ? (Answer the question by filling in the spaces marked 'x' in the table)

4 3 2 1 0

No.	Questions	Environment1					Environment2					Environment3					Environment4				
		Very much	1.00h	1.30h	2.00h	2.30h	Very much	1.00h	1.30h	2.00h	2.30h	Very much	1.00h	1.30h	2.00h	2.30h	Very much	1.00h	1.30h	2.00h	2.30h
1.	Was it easy to capture the cone ?																				
2.	Was it easy to drive the system accordingly ?																				
3.	Was the system providing blurred vision ?																				
4.	Did you experienced double-vision ?																				
5.	Did you perceive visually why some configuration cannot work ?																				
6.	Did you prepare the process before action ?																				
7.	Would you have expected more explanations about how to drive the system ?																				
8.	Did you felt vertigo ?																				
9.	Did you search the limit respective positions of the mechanism ?																				
10.	In your opinion was the system adapted to the task ?																				
11.	Did you find easily the good criteria to decide if the system works or not ?																				
12.	Did you investigate how to achieve the expected task ?																				
13.	When selecting the hard avatar did you elaborate any strategy ?																				
14.	Did you feel some blurred vision after a while ?																				
15.	Did you feel the contrast evolving ?																				
16.	Did you felt some stress in the eyes ?																				
17.	Did you fill increasing anxiety ?																				
18.	Did you felt a lack of luminance ?																				
19.	Would you expect to sit down ?																				
20.	Did you felt your articulations at limit position and angles ?																				
21.	How many time could you stay working with the environment ?																				
22.	Which is the more comfortable environment ?																				

[Thank you very much for your answer the questions]





Environment 1 = Non-Stereoscopy + Non-Force feedback  
 Environment 2 = Stereoscopy + Non-Force feedback  
 Environment 3 = Non-Stereoscopy + Force feedback  
 Environment 4 = Stereoscopy + Force feedback

Participant: 17

- How do you feel, when you look at 3D object on the 2D wall screen by Non-Stereoscopy and stereoscopy?  
 - How do you feel and how do you think about the haptic arm application, when do you use a haptic arm to manipulate 3D object on the 2D screen by using a haptic arm with Non-force feedback and force feedback? (Answer the question by filling in the spaces marked 'x' in the table)

0 3 2 1 0

No,	Environment1					Environment2					Environment3					Environment4				
	Very much	Very	Medium	Less	Not	Very much	Very	Medium	Less	Not	Very much	Very	Medium	Less	Not	Very much	Very	Medium	Less	Not
1.	X					X					X					X				
2.		X					X					X					X			
3.				X				X					X					X		
4.			X			X					X					X				
5.		X					X					X					X			
6.			X					X					X					X		
7.			X					X					X					X		
8.					X					X					X					X
9.					X					X					X					X
10.		X					X					X					X			
11.			X					X					X					X		
12.			X					X					X					X		
13.			X					X					X					X		
14.			X					X					X					X		
15.			X					X					X					X		
16.			X					X					X					X		
17.			X					X					X					X		
18.			X					X					X					X		
19.			X					X					X					X		
20.			X					X					X					X		
21.	0.30h	1.00h	1.30h	2.00h	2.30h	0.30h	1.00h	1.30h	2.00h	2.30h	0.30h	1.00h	1.30h	2.00h	2.30h	0.30h	1.00h	1.30h	2.00h	2.30h
22.																				

[Thank you very much for your answer the questions]

Participant: **10**

Environment 1 = Non-Stereoscopy + Non-Force feedback  
 Environment 2 = Stereoscopy + Non-Force feedback  
 Environment 3 = Non-Stereoscopy + Force feedback  
 Environment 4 = Stereoscopy + Force feedback

- How do you feel, when you look at 3D object on the 2D wall screen by Non-Stereoscopy and stereoscopy?  
 - How do you feel and how do you think about the haptic arm application, when do you use a haptic arm to manipulate 3D object on the 2D screen by using a haptic arm with Non-force feedback and force feedback? (Answer the question by filling in the spaces marked 'x' in the table)

+ 4 3 2 1 0

No.	Environment1					Environment2					Environment3					Environment4				
	Very much	Medium	Less	Not	Rating scale	Very much	Medium	Less	Not	Rating scale	Very much	Medium	Less	Not	Rating scale	Very much	Medium	Less	Not	Rating scale
1.					3					3					3					3
2.					2					2					2					2
3.					2					2					2					2
4.					1					1					1					1
5.					1					1					1					1
6.					1					1					1					1
7.					1					1					1					1
8.					1					1					1					1
9.					1					1					1					1
10.					2					2					2					2
11.					2					2					2					2
12.					1					1					1					1
13.					1					1					1					1
14.					1					1					1					1
15.					3					3					3					3
16.					3					3					3					3
17.					3					3					3					3
18.					1					1					1					1
19.					1					1					1					1
20.					1					1					1					1
21.					0					0					0					0
22.					1					1					1					1

[Thank you very much for your answer the questions]

No,	Questions	Environment1					Environment2					Environment3					Environment4									
		Very much	Medium	Less	Not		Very much	Medium	Less	Not		Very much	Medium	Less	Not		Very much	Medium	Less	Not						
		Rating scale					Rating scale					Rating scale					Rating scale									
1.	Was it easy to capture the cone ?						X						X					X					X			
2.	Was it easy to drive the system accordingly ?						X						X					X					X			
3.	Was the system providing blurred vision ?												X													
4.	Did you experienced double-vision ?																									
5.	Did you perceive visually why some configuration cannot work ?																									
6.	Did you prepare the process before action ?																									
7.	Would you have expected more explanations about how to drive the system ?																									
8.	Did you felt vertigo ?																									
9.	Did you search the limit respective positions of the mechanism ?																									
10.	In your opinion was the system adapted to the task ?																									
11.	Did you find easily the good criteria to decide if the system works or not ?																									
12.	Did you investigate how to achieve the expected task ?																									
13.	When selecting the hand avatar did you elaborate any strategy ?																									
14.	Did you feel some blurred vision after a while ?																									
15.	Did you feel the contrast evolving ?																									
16.	Did you felt some stress in the eyes ?																									
17.	Did you fill increasing anxiety ?																									
18.	Did you felt a lack of luminance ?																									
19.	Would you expect to sit down ?																									
20.	Did you felt your articulations at limit position and angles ?																									
21.	How many time could you stay working with the environment ?																									
22.	Which is the more comfortable environment ?																									

Environment 1 = Non-Stereoscopy + Non-Force feedback  
 Environment 2 = Stereoscopy + Non-Force feedback  
 Environment 3 = Non-Stereoscopy + Force feedback  
 Environment 4 = Stereoscopy + Force feedback

Participant: 10

- How do you feel, when you look at 3D object on the 2D wall screen by Non-Stereoscopy and stereoscopy ?  
 - How do you feel and how do you think about the haptic arm application, when do you use a haptic arm to manipulate 3D object on the 2D screen by using a haptic arm with Non-force feedback and force feedback ? (Answer the question by filling in the spaces marked 'x' in the table)

[Thank you very much for your answer the questions]

Environment 1 = Non-Stereoscopy + Non-Force feedback  
 Environment 2 = Stereoscopy + Non-Force feedback  
 Environment 3 = Non-Stereoscopy + Force feedback  
 Environment 4 = Stereoscopy + Force feedback

Participant: 20

- How do you feel, when you look at 3D object on the 2D wall screen by Non-Stereoscopy and stereoscopy?  
 - How do you feel and how do you think about the haptic arm application, when do you use a haptic arm to manipulate 3D object on the 2D screen by using a haptic arm with Non-force feedback and force feedback? (Answer the question by filling in the spaces marked 'x' in the table)

+ 4 3 2 1 0

No.	Environment1					Environment2					Environment3					Environment4									
	Very much	Very	Medium	Less	Not	Very much	Very	Medium	Less	Not	Very much	Very	Medium	Less	Not	Very much	Very	Medium	Less	Not					
1.																									
2.																									
3.																									
4.																									
5.																									
6.																									
7.																									
8.																									
9.																									
10.																									
11.																									
12.																									
13.																									
14.																									
15.																									
16.																									
17.																									
18.																									
19.																									
20.																									
21.																									
22.																									

[Thank you very much for your answer the questions]









- How do you feel, when you look at 3D object on the 2D wall screen by Non-Stereoscopy and stereoscopy ?  
 - How do you feel and how do you think about the haptic arm application, when do you use a haptic arm to manipulate 3D object on the 2D screen by using a haptic arm with Non-force feedback and force feedback ? (Answer the question by filling in the spaces marked 'x' in the table)

Environment 1 = Non-Stereoscopy + Non-Force feedback  
 Environment 2 = Stereoscopy + Non-Force feedback  
 Environment 3 = Non-Stereoscopy + Force feedback  
 Environment 4 = Stereoscopy + Force feedback

Participant: 2.4

1 0 3 2 1 0

No.	Environment1				Environment2				Environment3				Environment4			
	Very much	Medium	Less	Not	Very much	Medium	Less	Not	Very much	Medium	Less	Not	Very much	Medium	Less	Not
1.	X				X				X				X			
2.		X				X				X				X		
3.			X				X				X				X	
4.				X				X				X				X
5.				X				X				X				X
6.		X						X				X				X
7.			X					X				X				X
8.				X				X				X				X
9.				X				X				X				X
10.		X				X				X				X		
11.		X				X				X				X		
12.				X				X				X				X
13.			X					X				X				X
14.				X				X				X				X
15.				X				X				X				X
16.			X					X				X				X
17.				X				X				X				X
18.				X				X				X				X
19.				X				X				X				X
20.		X						X				X				X
21.		X						X				X				X
22.				X				X				X				X

[Thank you very much for your answer the questions]

- How do you feel, when you look at 3D object on the 2D wall screen by Non-Stereoscopy and stereoscopy ?  
 - How do you feel and how do you think about the haptic arm application, when do you use a haptic arm to manipulate 3D object on the 2D screen by using a haptic arm with Non-force feedback and force feedback ? ( Answer the question by filling in the spaces marked 'x' in the table)

Environment 1 = Non-Stereoscopy + Non-Force feedback  
 Environment 2 = Stereoscopy + Non-Force feedback  
 Environment 3 = Non-Stereoscopy + Force feedback  
 Environment 4 = Stereoscopy + Force feedback

Participant: 2.5

4 3 2 1 0

No.	Environment1					Environment2					Environment3					Environment4					
	Very much	1.00h	1.30h	2.00h	2.30h	Very much	1.00h	1.30h	2.00h	2.30h	Very much	1.00h	1.30h	2.00h	2.30h	Very much	1.00h	1.30h	2.00h	2.30h	
1.	X																				
2.			X																		
3.				X																	
4.					X																
5.																					
6.																					
7.																					
8.																					
9.																					
10.																					
11.																					
12.																					
13.																					
14.																					
15.																					
16.																					
17.																					
18.																					
19.																					
20.																					
21.																					
22.																					

[Thank you very much for your answer the questions]

Participant. 2.6

Environment 1 = Non-Stereoscopy + Non-Force feedback  
 Environment 2 = Stereoscopy + Non-Force feedback  
 Environment 3 = Non-Stereoscopy + Force feedback  
 Environment 4 = Stereoscopy + Force feedback

- How do you feel, when you look at 3D object on the 2D wall screen by Non-Stereoscopy and stereoscopy ?  
 - How do you feel and how do you think about the haptic arm application, when do you use a haptic arm to manipulate 3D object on the 2D screen by using a haptic arm with Non-force feedback and force feedback ? (Answer the question by filling in the spaces marked 'x' in the table)

No.	Environment1				Environment2				Environment3				Environment4			
	Very much	Very	Medium	Less	Not	Very much	Very	Medium	Less	Not	Very much	Very	Medium	Less	Not	
1.																
2.																
3.																
4.																
5.																
6.																
7.																
8.																
9.																
10.																
11.																
12.																
13.																
14.																
15.																
16.																
17.																
18.																
19.																
20.																
21.																
22.																

[Thank you very much for your answer the questions]



235

Participant: **28**

Environment 1 = Non-Stereoscopy + Non-Force feedback  
 Environment 2 = Stereoscopy + Non-Force feedback  
 Environment 3 = Non-Stereoscopy + Force feedback  
 Environment 4 = Stereoscopy + Force feedback

- How do you feel, when you look at 3D object on the 2D wall screen by Non-Stereoscopy and stereoscopy?  
 - How do you feel and how do you think about the haptic arm application, when do you use a haptic arm to manipulate 3D object on the 2D screen by using a haptic arm with Non-force feedback and force feedback? (Answer the question by filling in the spaces marked 'x' in the table)

+ 4 3 2 1 0

No.	Environment1					Environment2					Environment3					Environment4					
	Very much	Medium	Less	Not	Rating scale	Very much	Medium	Less	Not	Rating scale	Very much	Medium	Less	Not	Rating scale	Very much	Medium	Less	Not	Rating scale	
1.					2					2					2						2
2.					1					1					1						1
3.					3					3					3						3
4.					2					2					2						2
5.					1					1					1						1
6.					3					3					3						3
7.					3					3					3						3
8.					3					3					3						3
9.					1					1					1						1
10.					2					2					2						2
11.					1					1					1						1
12.					2					2					2						2
13.					3					3					3						3
14.					2					2					2						2
15.					3					3					3						3
16.					2					2					2						2
17.					3					3					3						3
18.					3					3					3						3
19.					3					3					3						3
20.					2					2					2						2
21.					2					2					2						2
22.					4					4					4						4

[Thank you very much for your answer the questions]



245

Participant: 249

Environment 1 = Non-Stereoscopy + Non-Force feedback  
 Environment 2 = Stereoscopy + Non-Force feedback  
 Environment 3 = Non-Stereoscopy + Force feedback  
 Environment 4 = Stereoscopy + Force feedback

- How do you feel, when you look at 3D object on the 2D wall screen by Non-Stereoscopy and stereoscopy?  
 - How do you feel and how do you think about the haptic arm application, when do you use a haptic arm to manipulate 3D object on the 2D screen by using a haptic arm with Non-force feedback and force feedback? (Answer the question by filling in the spaces marked 'x' in the table)

+ 4 3 2 1 0

No.	Questions	Environment1					Environment2					Environment3					Environment4								
		Very much	Medium	Less	Not	Rating scale	Very much	Medium	Less	Not	Rating scale	Very much	Medium	Less	Not	Rating scale	Very much	Medium	Less	Not	Rating scale				
1.	Was it easy to capture the cone?	✓				4	✓				4	✓				4	✓				4	✓			
2.	Was it easy to drive the system accordingly?		✓			1		✓			2		✓			2		✓			2		✓		
3.	Was the system providing blurred vision?			✓		3			✓		0			✓		0			✓		0			✓	
4.	Did you experienced double-vision?			✓		3			✓		3			✓		2			✓		2			✓	
5.	Did you perceive visually why some configuration cannot work?			✓		3			✓		2			✓		2			✓		2			✓	
6.	Did you prepare the process before action?			✓		3			✓		2			✓		2			✓		2			✓	
7.	Would you have expected more explanations about how to drive the system?			✓		3			✓		2			✓		2			✓		2			✓	
8.	Did you felt vertigo?			✓		3			✓		2			✓		2			✓		2			✓	
9.	Did you search the limit respective positions of the mechanism?			✓		3			✓		2			✓		2			✓		2			✓	
10.	In your opinion was the system adapted to the task?			✓		3			✓		3			✓		3			✓		3			✓	
11.	Did you find easily the good criteria to decide if the system works or not?			✓		3			✓		2			✓		2			✓		2			✓	
12.	Did you investigate how to achieve the expected task?			✓		3			✓		1			✓		1			✓		1			✓	
13.	When selecting the hand avatar did you elaborate any strategy?			✓		3			✓		1			✓		1			✓		1			✓	
14.	Did you felt some blurred vision after a while?			✓		3			✓		3			✓		3			✓		3			✓	
15.	Did you felt the contrast evolving?			✓		3			✓		3			✓		3			✓		3			✓	
16.	Did you felt some stress in the eyes?			✓		3			✓		3			✓		3			✓		3			✓	
17.	Did you felt increasing anxiety?			✓		3			✓		3			✓		3			✓		3			✓	
18.	Did you felt a lack of luminance?			✓		3			✓		3			✓		3			✓		3			✓	
19.	Would you expect to sit down?			✓		3			✓		3			✓		3			✓		3			✓	
20.	Did you felt your articulations at limit position and angles?			✓		3			✓		3			✓		3			✓		3			✓	
21.	How many time could you stay working with the environment?			✓		3			✓		3			✓		3			✓		3			✓	
22.	Which is the more comfortable environment?			✓		3			✓		3			✓		3			✓		3			✓	

[Thank you very much for your answer the questions]

265

Participant: 30

Environment 1 = Non-Stereoscopy + Non-Force feedback  
 Environment 2 = Stereoscopy + Non-Force feedback  
 Environment 3 = Non-Stereoscopy + Force feedback  
 Environment 4 = Stereoscopy + Force feedback

- How do you feel, when you look at 3D object on the 2D wall screen by Non-Stereoscopy and stereoscopy?  
 - How do you feel and how do you think about the haptic arm application, when do you use a haptic arm to manipulate 3D object on the 2D screen by using a haptic arm with Non-force feedback and force feedback? (Answer the question by filling in the spaces marked 'x' in the table)

+ 4 3 2 1 0

No.	Environment1					Environment2					Environment3					Environment4					
	Very much	1.00h	1.30h	2.00h	2.30h	Very much	1.00h	1.30h	2.00h	2.30h	Very much	1.00h	1.30h	2.00h	2.30h	Very much	1.00h	1.30h	2.00h	2.30h	
1.	X					X					X					X					
2.			X					X					X					X			
3.				X					X					X					X		
4.					X										X						
5.																					
6.																					
7.																					
8.																					
9.																					
10.																					
11.																					
12.																					
13.																					
14.																					
15.																					
16.																					
17.																					
18.																					
19.																					
20.																					
21.																					
22.																					

[Thank you very much for your answer the questions]

(This page is intentionally left blank)

## APPENDIX H

The experimental results of the environment 1, 2, 3, and environment 4 by the use  
high level criteria assessment combine with the basic sensors  
(Case study: The barrel cam mechanism)

**TABLE H-1** The high level criteria assessment of the environment 1 (Affordance)

Titles Participants	Affordance							
	2	6	(-)7	9	10	11	(-)12	(-)13
1	3	2	2	2	4	2	2	0
2	3	2	4	2	2	2	3	4
3	3	1	2	3	3	3	2	2
4	3	1	3	1	2	3	1	3
5	3	0	2	0	3	2	3	2
6	3	1	3	0	2	2	4	2
7	3	3	3	2	2	3	3	3
8	2	2	1	0	3	3	1	1
9	3	0	4	0	2	3	2	2
10	3	3	3	2	3	2	3	4
11	2	2	4	0	3	3	2	2
12	2	1	3	3	2	1	3	2
13	4	2	2	0	4	3	1	3
14	3	2	3	4	3	1	0	0
15	3	3	0	2	3	3	1	1
16	4	0	0	2	4	4	0	0
17	3	1	2	0	3	0	3	3
18	2	0	4	2	3	2	3	4
19	3	2	4	3	3	3	0	2
20	1	2	3	1	2	2	2	4
21	3	3	3	3	1	3	1	3
22	2	0	2	3	3	1	2	2
23	3	1	3	2	4	3	2	3
24	3	2	3	0	3	2	3	3
25	2	1	1	2	1	1	1	1
26	2	3	1	2	2	1	3	3
27	2	1	4	3	3	2	1	2
28	1	1	3	1	2	1	2	3
29	2	1	4	1	4	3	2	1
30	3	2	3	0	3	3	2	3
Minimum	1.00	0.00	0.00	0.00	1.00	0.00	0.00	0.00
Mean	2.63	1.50	2.63	1.53	2.73	2.23	1.93	2.27
Maximum	4.00	3.00	4.00	4.00	4.00	4.00	4.00	4.00
STDEV	0.72	0.97	1.16	1.22	0.83	0.94	1.05	1.17

**TABLE H-1** The high level criteria assessment of the environment 1 (Ergonomic)

Titles Participants	Ergonomic						
	1	10	(-)18	(-)19	(-)20	21	22
1	2	4	4	4	2	3	0
2	3	2	4	3	1	1	0
3	3	3	4	4	2	2	0
4	3	2	4	4	3	2	0
5	2	3	4	2	3	4	0
6	1	2	2	1	4	4	0
7	2	2	3	3	3	2	0
8	1	3	4	4	1	4	4
9	2	2	4	4	4	1	0
10	2	3	4	4	3	1	0
11	2	3	4	4	4	2	0
12	2	2	4	4	4	4	0
13	4	4	4	4	2	4	0
14	2	3	4	4	3	4	0
15	3	3	1	2	1	2	0
16	4	4	0	4	0	2	0
17	4	3	4	2	4	3	4
18	3	3	4	4	2	2	0
19	3	3	4	4	3	2	0
20	3	2	4	4	1	3	0
21	3	1	3	4	3	4	0
22	2	3	4	4	4	1	0
23	3	4	4	4	3	2	0
24	4	3	4	4	1	2	0
25	3	1	4	4	0	0	0
26	2	2	4	4	2	1	0
27	3	3	4	4	3	2	3
28	2	2	3	3	2	4	0
29	4	4	4	4	3	3	0
30	4	3	4	3	3	1	4
Minimum	1.00	1.00	0.00	1.00	0.00	0.00	0.00
Mean	2.65	2.68	3.48	3.48	2.39	2.32	0.48
Maximum	4.00	4.00	4.00	4.00	4.00	4.00	4.00
STDEV	0.88	0.83	0.97	0.82	1.20	1.19	1.31

**TABLE H-1** The high level criteria assessment of the environment 1 (Intuitiveness)

Titles Participants	Intuitiveness								
	1	2	5	6	(-)7	10	11	(-)12	13
1	2	3	1	2	2	4	2	2	4
2	3	3	2	2	4	2	2	3	0
3	3	3	2	1	2	3	3	2	2
4	3	3	0	1	3	2	3	1	1
5	2	3	2	0	2	3	2	3	2
6	1	3	0	1	3	2	2	4	2
7	2	3	2	3	3	2	3	3	1
8	1	2	1	2	1	3	3	1	3
9	2	3	0	0	4	2	3	2	2
10	2	3	0	3	3	3	2	3	0
11	2	3	1	2	4	3	3	2	2
12	2	2	1	1	3	2	1	3	2
13	4	4	0	2	2	4	3	3	1
14	2	3	0	2	3	3	1	0	4
15	3	3	2	3	0	3	3	1	3
16	4	4	1	0	0	4	4	0	4
17	4	3	1	1	2	3	0	3	1
18	3	2	1	0	4	3	2	3	0
19	3	3	0	2	4	3	3	0	2
20	3	1	2	2	3	2	2	2	0
21	3	3	1	3	3	1	3	1	1
22	2	2	1	0	2	3	1	2	2
23	3	3	3	1	3	4	3	2	3
24	4	3	0	2	3	3	2	3	1
25	3	2	2	1	1	1	1	1	3
26	2	2	2	3	1	2	1	3	1
27	3	2	3	1	4	3	2	1	2
28	2	1	1	1	3	2	1	2	1
29	4	2	4	1	4	4	3	2	3
30	4	3	1	2	3	3	3	2	3
Minimum	1.00	1.00	0.00	0.00	0.00	1.00	0.00	0.00	0.00
Mean	2.70	2.67	1.23	1.50	2.63	2.73	2.23	2.00	1.87
Maximum	4.00	4.00	4.00	3.00	4.00	4.00	4.00	4.00	4.00
STDEV	0.88	0.71	1.04	0.97	1.16	0.83	0.94	1.05	1.20

**TABLE H-1** The high level criteria assessment of the environment 1 (Tangibility)

Titles Participants	Tangibility					
	2	3	5	9	10	(-)18
1	3	0	1	2	4	4
2	3	0	2	2	2	4
3	3	0	2	3	3	4
4	3	0	0	1	2	4
5	3	0	2	0	3	4
6	3	0	0	0	2	2
7	3	2	2	2	2	3
8	2	0	1	0	3	4
9	3	0	0	0	2	4
10	3	0	0	2	3	4
11	3	1	1	0	3	4
12	2	0	1	3	2	4
13	4	0	0	0	4	4
14	3	0	0	4	3	4
15	3	2	2	2	3	1
16	4	0	1	2	4	0
17	3	0	1	0	3	4
18	2	0	1	2	3	4
19	3	0	0	3	3	4
20	1	0	2	1	2	4
21	3	0	1	3	1	3
22	2	1	1	3	3	4
23	3	0	3	2	4	4
24	3	0	0	0	3	4
25	2	0	2	2	1	4
26	2	1	2	2	2	4
27	2	0	3	3	3	4
28	1	1	1	1	2	3
29	2	0	4	1	4	4
30	3	0	1	0	3	4
Minimum	1.00	0.00	0.00	0.00	1.00	0.00
Mean	2.67	0.27	1.23	1.53	2.73	3.60
Maximum	4.00	2.00	4.00	4.00	4.00	4.00
STDEV	0.71	0.58	1.04	1.22	0.83	0.97



**TABLE H-1** The high level criteria assessment of the environment 1 (Tiredness)

Titles Participants	Tiredness											
	3	4	8	(-)10	14	15	16	17	18	19	(-)21	(-)22
1	0	0	0	0	0	0	0	0	0	0	3	0
2	0	0	0	2	0	3	0	0	0	1	1	0
3	0	0	3	1	0	0	0	0	0	0	2	0
4	0	0	0	2	0	0	0	0	0	0	2	0
5	0	0	0	1	0	0	1	1	0	2	4	0
6	0	0	0	2	0	3	0	0	2	3	4	0
7	2	2	0	2	2	1	1	1	1	1	2	0
8	0	0	1	1	0	4	0	0	0	0	4	4
9	0	0	0	2	0	0	0	0	0	0	1	0
10	0	0	0	1	0	0	0	0	0	0	1	0
11	1	0	0	1	0	2	0	0	0	0	2	0
12	0	0	0	2	1	1	1	1	0	0	4	0
13	0	0	0	0	0	0	0	0	0	0	4	4
14	0	0	0	1	0	2	0	0	0	0	4	0
15	2	2	1	3	2	3	2	2	3	2	2	0
16	0	0	0	0	0	4	0	0	4	0	2	0
17	0	0	0	1	0	0	0	0	0	2	3	4
18	0	0	0	1	0	3	0	1	0	0	2	0
19	0	0	0	1	0	0	0	0	0	0	2	0
20	0	0	0	2	0	0	0	0	0	0	3	0
21	0	0	1	3	1	1	1	1	1	0	1	0
22	1	2	2	1	2	2	0	0	0	0	1	0
23	0	0	0	0	0	0	0	1	0	0	2	0
24	0	0	0	1	0	4	0	1	0	0	2	0
25	0	0	0	3	0	0	0	0	0	0	0	0
26	1	0	0	2	0	1	0	0	0	0	1	0
27	0	0	0	1	0	4	0	0	0	0	2	3
28	1	2	1	2	1	2	1	1	1	1	4	2
29	0	0	0	0	0	3	1	1	0	0	3	0
30	0	0	0	1	0	4	0	1	0	1	1	4
Minimum	0.00	0.00	0.00	0.00	0.00	0.00	0.00	0.00	0.00	0.00	0.00	0.00
Mean	0.27	0.27	0.30	1.33	0.30	1.57	0.27	0.40	0.40	0.43	2.30	0.70
Maximum	2.00	2.00	3.00	3.00	2.00	4.00	2.00	2.00	4.00	3.00	4.00	4.00
STDEV	0.58	0.69	0.70	0.88	0.65	1.57	0.52	0.56	0.97	0.82	1.18	1.47

**TABLE H-2** The high level criteria assessment of the environment 2 (Affordance)

Titles Participants	Affordance							
	2	6	(-)7	9	10	11	(-)12	(-)13
1	3	3	4	4	3	1	0	0
2	4	1	3	2	3	2	2	3
3	2	2	3	3	1	2	1	2
4	3	1	3	1	2	3	1	3
5	3	0	3	1	2	1	3	2
6	2	1	2	0	2	2	4	3
7	3	3	2	2	2	3	3	3
8	3	1	1	0	1	1	1	1
9	3	0	4	0	4	2	2	4
10	3	3	3	1	3	2	3	4
11	4	2	4	0	4	3	3	3
12	3	2	2	3	3	3	3	2
13	4	0	1	0	3	3	1	2
14	4	4	3	4	3	2	0	0
15	3	2	0	3	3	3	4	1
16	4	0	0	3	4	4	0	0
17	3	1	2	1	2	0	3	3
18	3	0	4	1	2	3	2	4
19	3	0	4	3	3	3	0	2
20	2	1	4	0	3	2	2	4
21	3	3	3	1	1	1	1	3
22	1	1	4	3	1	1	3	0
23	3	1	2	2	4	3	2	3
24	3	2	4	0	3	2	4	3
25	2	2	2	3	2	2	1	1
26	1	2	2	2	2	1	3	3
27	2	0	4	2	3	2	1	2
28	1	1	3	2	2	2	2	3
29	2	2	2	2	4	3	2	1
30	3	2	2	0	3	3	2	2
Minimum	1.00	0.00	0.00	0.00	1.00	0.00	0.00	0.00
Mean	2.77	1.43	2.67	1.63	2.60	2.17	1.97	2.23
Maximum	4.00	4.00	4.00	4.00	4.00	4.00	4.00	4.00
STDEV	0.86	1.10	1.18	1.30	0.93	0.91	1.22	1.25

**TABLE H-2** The high level criteria assessment of the environment 2 (Ergonomic)

Titles Participants	Ergonomic						
	1	10	(-)18	(-)19	(-)20	21	22
1	2	3	3	4	1	3	0
2	4	3	3	4	3	1	0
3	2	1	3	4	2	2	0
4	3	2	4	4	2	3	0
5	2	2	4	3	2	3	4
6	0	2	1	1	4	1	0
7	2	2	2	3	3	2	0
8	3	3	4	4	1	2	0
9	3	4	4	4	4	1	0
10	3	3	4	4	3	1	0
11	3	4	4	3	4	3	4
12	3	3	3	3	3	4	4
13	4	3	4	4	2	1	0
14	4	3	4	4	2	4	4
15	3	3	1	2	1	2	0
16	4	4	0	4	0	2	0
17	4	2	4	2	2	2	0
18	3	2	4	4	2	2	4
19	3	3	4	4	3	1	0
20	3	3	3	4	2	3	4
21	3	1	3	4	3	2	0
22	2	1	4	4	4	1	0
23	3	4	4	4	3	1	0
24	4	3	4	4	3	1	4
25	2	2	4	4	1	0	0
26	2	2	4	4	2	1	0
27	2	3	4	4	2	1	2
28	1	2	1	3	2	2	4
29	4	4	4	4	3	2	0
30	4	3	4	3	3	2	0
Minimum	0.00	1.00	0.00	1.00	0.00	0.00	0.00
Mean	2.83	2.67	3.30	3.57	2.40	1.87	1.13
Maximum	4.00	4.00	4.00	4.00	4.00	4.00	4.00
STDEV	0.99	0.88	1.15	0.77	1.00	0.97	1.80

**TABLE H-2** The high level criteria assessment of the environment 2 (Intuitiveness)

Titles Participants	Intuitiveness								
	1	2	5	6	(-)7	10	11	(-)12	13
1	2	3	2	3	4	3	1	0	4
2	4	4	3	1	3	3	2	2	1
3	2	2	1	2	3	1	2	1	2
4	3	2	0	1	3	2	3	1	1
5	2	3	3	0	3	2	1	3	2
6	0	2	0	1	2	2	2	4	1
7	2	3	2	3	2	2	3	3	1
8	3	3	2	1	1	3	3	1	3
9	3	3	1	0	4	4	2	2	0
10	3	2	2	3	3	3	2	3	0
11	3	4	2	2	4	4	3	3	1
12	3	3	2	2	2	3	3	3	2
13	4	4	2	0	1	3	3	1	2
14	4	4	1	4	3	3	2	0	4
15	3	3	2	2	0	3	3	4	3
16	4	4	2	0	0	4	4	0	4
17	3	3	2	1	2	2	0	3	1
18	3	3	2	0	4	2	3	2	0
19	3	3	1	0	4	3	3	0	2
20	3	2	2	1	4	3	2	2	0
21	3	3	2	3	3	1	1	1	1
22	2	1	0	1	4	1	1	3	0
23	3	3	3	1	2	4	3	2	1
24	4	3	1	2	4	3	2	4	1
25	2	2	0	2	2	2	2	1	3
26	2	1	2	2	2	2	1	3	1
27	2	2	3	0	4	3	2	1	2
28	1	1	1	1	3	2	2	2	1
29	4	2	3	2	2	4	3	2	3
30	4	3	2	2	2	3	3	2	2
Minimum	0.00	1.00	0.00	0.00	0.00	1.00	0.00	0.00	0.00
Mean	2.80	2.70	1.70	1.43	2.67	2.67	2.23	1.97	1.63
Maximum	4.00	4.00	3.00	4.00	4.00	4.00	4.00	4.00	4.00
STDEV	0.96	0.88	0.92	1.10	1.18	0.88	0.90	1.22	1.22

**TABLE H-2** The high level criteria assessment of the environment 2 (Tangibility)

Titles Participants	Tangibility					
	2	3	5	9	10	(-)18
1	3	0	4	4	3	3
2	4	2	3	2	3	3
3	2	1	1	3	1	3
4	3	1	0	1	2	4
5	3	1	3	1	2	4
6	2	2	0	0	2	1
7	3	3	2	2	2	2
8	3	2	2	0	3	4
9	3	0	1	0	4	4
10	3	2	2	1	3	4
11	4	0	2	0	4	4
12	3	0	2	3	3	3
13	4	4	2	0	3	4
14	4	0	1	4	3	4
15	3	3	2	3	3	1
16	4	0	2	3	4	0
17	3	1	2	1	2	4
18	3	2	2	1	2	4
19	3	2	1	3	3	4
20	3	2	2	0	3	3
21	3	1	2	1	1	3
22	1	4	0	3	1	4
23	3	1	3	2	4	4
24	3	1	1	0	3	4
25	2	3	0	3	2	4
26	1	2	2	2	2	4
27	2	1	3	2	3	4
28	1	2	1	2	2	1
29	2	4	3	2	3	4
30	3	2	2	0	3	4
Minimum	1.00	0.00	0.00	0.00	1.00	0.00
Mean	2.80	1.63	1.77	1.63	2.63	3.30
Maximum	4.00	4.00	4.00	4.00	4.00	4.00
STDEV	0.85	1.22	1.01	1.30	0.85	1.15

**TABLE H-2** The high level criteria assessment of the environment 2 (Tiredness)

Titles Participants	Tiredness											
	3	4	8	(-)10	14	15	16	17	18	19	(-)21	(-)22
1	0	4	0	1	0	0	2	1	1	0	3	0
2	3	3	3	1	3	3	3	2	1	0	1	0
3	1	2	1	3	1	1	1	0	1	0	2	0
4	1	1	0	2	0	1	1	0	0	0	3	0
5	1	0	1	2	0	0	1	1	0	1	3	4
6	2	1	0	2	3	1	4	0	3	3	1	0
7	3	2	1	2	2	2	2	1	2	1	2	0
8	2	3	3	1	1	3	3	3	0	0	2	0
9	0	0	0	0	2	2	0	0	0	0	1	0
10	2	2	3	1	0	0	3	3	0	0	1	0
11	0	0	0	0	0	3	0	0	0	1	3	4
12	0	0	0	1	1	1	1	1	1	1	4	4
13	4	4	2	1	2	0	3	0	0	0	1	0
14	0	0	0	1	0	4	0	0	0	0	4	4
15	3	3	1	1	3	3	1	1	3	2	2	0
16	0	0	0	0	0	4	1	0	4	0	2	0
17	1	2	2	2	1	1	2	1	0	2	2	0
18	2	1	0	2	0	3	0	1	0	0	2	4
19	2	0	1	1	0	1	1	0	0	0	1	4
20	1	1	0	1	0	0	1	0	1	0	3	4
21	1	3	3	3	3	3	3	3	1	0	2	0
22	4	3	4	3	4	4	3	3	0	0	1	0
23	1	0	0	0	1	1	1	1	0	0	1	0
24	1	1	1	1	0	3	1	0	0	0	1	4
25	3	2	2	2	2	2	2	0	0	0	1	0
26	2	1	2	2	1	1	1	1	0	0	1	0
27	1	0	0	1	0	4	0	0	0	0	1	2
28	2	2	2	2	2	2	2	2	3	1	2	4
29	4	3	1	0	3	3	3	4	0	0	2	0
30	2	3	2	1	0	4	1	1	0	1	2	0
Minimum	0.00	0.00	0.00	0.00	0.00	0.00	0.00	0.00	0.00	0.00	1.00	0.00
Mean	1.63	1.57	1.17	1.33	1.17	2.00	1.57	1.00	0.70	0.43	1.90	1.27
Maximum	4.00	4.00	4.00	3.00	4.00	4.00	4.00	4.00	4.00	3.00	4.00	4.00
STDEV	1.25	1.33	1.21	0.88	1.26	1.39	1.14	1.17	1.15	0.77	0.92	1.86

**TABLE H-3** The high level criteria assessment of the environment 3 (Affordance)

Titles Participants	Affordance							
	2	6	(-)7	9	10	11	(-)12	(-)13
1	4	4	4	4	4	2	0	0
2	3	0	3	3	3	3	2	3
3	3	1	3	1	3	3	2	3
4	2	1	3	2	2	3	2	2
5	2	0	4	1	3	1	3	4
6	4	2	2	2	3	2	4	2
7	3	3	2	3	2	3	2	3
8	1	1	3	3	3	3	1	1
9	2	0	2	1	2	2	2	2
10	2	3	4	1	3	2	3	4
11	4	1	4	0	4	4	4	3
12	3	2	2	2	3	2	3	1
13	4	0	1	0	4	3	1	2
14	4	4	3	4	3	2	0	0
15	3	1	0	3	3	3	3	1
16	4	0	0	3	4	4	0	0
17	2	1	2	1	1	0	2	2
18	1	1	3	3	1	0	4	2
19	4	2	2	2	3	3	4	4
20	1	3	2	2	1	2	1	2
21	1	3	3	3	1	1	1	1
22	3	1	4	4	3	4	2	2
23	2	1	3	2	4	3	2	3
24	3	1	4	0	2	2	4	3
25	1	1	2	2	2	1	1	1
26	0	2	2	2	2	2	3	2
27	1	1	4	2	3	2	2	1
28	2	1	3	2	2	2	2	3
29	3	0	4	1	3	3	0	1
30	3	1	3	0	2	3	2	1
Minimum	0.00	0.00	0.00	0.00	1.00	0.00	0.00	0.00
Mean	2.50	1.40	2.70	1.97	2.63	2.33	2.07	1.97
Maximum	4.00	4.00	4.00	4.00	4.00	4.00	4.00	4.00
STDEV	1.17	1.16	1.12	1.19	0.93	1.03	1.26	1.16

**TABLE H-3** The high level criteria assessment of the environment 3 (Ergonomic)

Titles Participants	Ergonomic						
	1	10	(-)18	(-)19	(-)20	21	22
1	4	4	4	4	1	2	4
2	3	3	4	4	1	4	4
3	3	3	4	4	2	2	4
4	2	2	4	4	2	2	4
5	1	3	4	3	1	3	0
6	3	3	2	1	4	4	4
7	2	2	2	3	2	2	4
8	1	3	3	4	1	3	0
9	1	2	4	4	4	1	0
10	2	3	4	4	3	1	4
11	3	4	4	4	3	2	0
12	3	3	3	3	3	4	0
13	4	4	4	4	2	4	0
14	4	3	4	4	4	4	0
15	3	3	1	2	1	2	4
16	4	4	0	4	0	1	4
17	3	1	4	2	1	1	0
18	1	1	4	4	1	1	0
19	2	3	4	4	3	2	0
20	1	1	4	4	1	3	0
21	1	1	3	4	1	3	4
22	3	3	4	4	1	1	0
23	3	4	4	4	3	2	4
24	4	2	4	4	2	1	0
25	1	2	4	4	1	0	0
26	1	2	4	4	1	1	0
27	2	3	4	4	2	1	4
28	2	2	3	3	2	4	1
29	4	3	4	4	3	3	4
30	4	2	4	3	3	2	0
Minimum	1.00	1.00	0.00	1.00	0.00	0.00	0.00
Mean	2.50	2.63	3.50	3.60	1.97	2.20	1.77
Maximum	4.00	4.00	4.00	4.00	4.00	4.00	4.00
STDEV	1.14	0.93	1.01	0.77	1.10	1.19	1.99



**TABLE H-3** The high level criteria assessment of the environment 3 (Intuitiveness)

Titles Participants	Intuitiveness								
	1	2	5	6	(-)7	10	11	(-)12	13
1	4	4	3	4	4	4	2	0	4
2	3	3	3	0	3	3	3	2	3
3	3	3	3	1	3	3	3	2	1
4	2	2	3	1	3	2	3	2	2
5	1	2	3	0	4	3	1	3	0
6	3	4	2	2	2	3	2	4	2
7	2	3	3	3	2	2	3	2	1
8	1	1	3	1	3	3	3	1	3
9	1	2	2	0	2	2	2	2	2
10	2	2	3	3	4	3	2	3	1
11	3	4	3	1	4	4	4	4	1
12	3	3	3	2	2	3	2	3	3
13	4	4	3	0	1	4	3	3	2
14	4	4	2	4	3	3	2	0	4
15	3	3	3	1	0	3	3	3	3
16	4	4	3	0	0	4	4	0	4
17	3	2	3	1	2	1	0	2	2
18	1	1	3	1	3	1	0	4	2
19	2	4	3	2	2	3	3	4	0
20	1	1	3	3	2	1	2	1	2
21	1	1	3	3	3	1	1	1	3
22	3	3	1	1	4	3	4	2	2
23	3	2	4	1	3	4	3	2	1
24	4	3	2	1	4	2	2	4	1
25	1	1	1	1	2	2	1	1	3
26	1	0	2	2	2	2	2	3	2
27	2	1	3	1	4	3	2	2	3
28	2	2	1	1	3	2	2	2	1
29	4	3	4	0	4	3	3	0	3
30	4	3	3	1	3	2	3	2	3
Minimum	1.00	0.00	1.00	0.00	0.00	1.00	0.00	0.00	0.00
Mean	2.50	2.50	2.70	1.40	2.70	2.63	2.33	2.13	2.13
Maximum	4.00	4.00	4.00	4.00	4.00	4.00	4.00	4.00	4.00
STDEV	1.14	1.17	0.75	1.16	1.12	0.93	1.03	1.25	1.11

**TABLE H-3** The high level criteria assessment of the environment 3 (Tangibility)

Titles Participants	Tangibility					
	2	3	5	9	10	(-)18
1	4	0	3	4	4	4
2	3	0	3	3	3	4
3	3	0	3	1	3	4
4	2	0	3	2	2	4
5	2	0	3	1	3	4
6	4	0	2	2	3	2
7	3	2	3	3	2	2
8	1	0	3	3	3	3
9	2	0	2	1	2	4
10	2	0	3	1	3	4
11	4	1	3	0	4	4
12	3	0	4	3	2	2
13	4	0	3	0	4	4
14	4	0	2	4	3	4
15	3	1	3	3	3	1
16	4	0	3	3	4	0
17	2	0	3	1	1	4
18	1	0	3	3	1	4
19	4	0	3	2	3	4
20	1	0	3	2	1	4
21	1	1	3	3	1	3
22	3	2	1	4	3	4
23	2	0	4	2	4	4
24	3	0	2	0	2	4
25	1	0	1	2	2	4
26	0	2	2	2	2	4
27	1	0	3	2	3	4
28	2	1	1	2	2	3
29	3	0	4	1	3	4
30	3	0	3	0	2	4
Minimum	0.00	0.00	1.00	0.00	1.00	0.00
Mean	2.50	0.33	2.73	2.00	2.60	3.47
Maximum	4.00	2.00	4.00	4.00	4.00	4.00
STDEV	1.17	0.66	0.78	1.20	0.93	1.04

**TABLE H-3** The high level criteria assessment of the environment 3 (Tiredness)

Titles Participants	Tiredness											
	3	4	8	(-)10	14	15	16	17	18	19	(-)21	(-)22
1	0	0	0	0	0	0	0	0	0	0	3	4
2	0	0	0	1	0	3	0	0	0	0	4	4
3	0	0	0	1	0	0	0	0	0	0	2	4
4	0	0	0	2	0	0	0	0	0	0	2	4
5	0	0	0	1	0	0	1	0	0	1	3	0
6	0	0	0	1	0	3	0	0	2	3	4	4
7	2	2	0	2	2	3	1	1	2	1	2	4
8	0	0	0	3	0	4	1	1	1	0	3	0
9	0	0	3	2	0	1	0	2	0	0	1	0
10	0	0	0	3	0	0	0	0	0	0	1	0
11	1	0	0	0	0	2	0	1	0	0	2	0
12	0	0	2	2	3	2	2	0	2	1	4	0
13	0	0	0	0	0	0	0	1	0	0	4	0
14	0	0	0	1	0	4	0	0	0	0	4	0
15	1	0	0	1	3	3	1	1	3	2	2	4
16	0	0	0	0	0	4	0	0	4	0	1	4
17	0	0	0	1	0	0	0	2	0	2	1	0
18	0	0	0	3	0	2	0	2	0	0	1	0
19	0	0	0	1	0	0	0	1	0	0	2	0
20	0	0	0	2	0	0	1	2	1	0	2	0
21	1	0	1	3	1	1	1	3	1	0	3	4
22	2	3	1	1	0	3	1	1	0	0	1	4
23	0	0	0	0	0	0	0	1	0	0	2	4
24	0	0	0	2	0	4	0	0	0	0	1	0
25	0	0	0	2	0	0	0	0	0	0	0	0
26	2	0	0	2	0	0	0	0	0	0	1	0
27	0	0	0	1	0	4	0	0	0	0	1	4
28	1	1	1	2	1	1	1	1	1	1	4	1
29	0	0	0	1	0	4	1	3	0	0	3	4
30	0	0	1	2	0	3	1	1	0	1	2	0
Minimum	0.00	0.00	0.00	0.00	0.00	0.00	0.00	0.00	0.00	0.00	0.00	0.00
Mean	0.33	0.20	0.30	1.43	0.33	1.70	0.40	0.80	0.57	0.40	2.20	1.77
Maximum	2.00	3.00	3.00	3.00	3.00	4.00	2.00	3.00	4.00	3.00	4.00	4.00
STDEV	0.66	0.66	0.70	0.94	0.84	1.64	0.56	0.92	1.04	0.77	1.19	1.99

**TABLE H-4** The high level criteria assessment of the environment 4 (Affordance)

Titles Participants	Affordance							
	2	6	(-)7	9	10	11	(-)12	(-)13
1	3	3	4	4	3	1	0	0
2	4	1	3	4	2	3	3	3
3	3	1	2	3	3	3	1	3
4	2	1	3	2	2	2	2	2
5	2	0	3	0	1	1	3	4
6	4	2	2	2	3	2	3	2
7	2	3	2	1	2	2	2	3
8	3	1	3	4	4	3	0	0
9	2	1	3	2	3	3	2	2
10	1	3	4	1	3	0	2	3
11	4	1	4	0	4	4	4	3
12	3	3	2	3	2	2	2	1
13	3	0	1	0	2	3	1	3
14	4	4	3	3	3	1	0	0
15	2	1	1	3	3	3	4	3
16	4	0	0	4	4	4	0	0
17	2	1	2	0	1	0	2	2
18	2	0	4	1	2	0	1	1
19	2	0	4	2	2	3	4	4
20	1	3	2	3	2	2	1	1
21	1	3	3	3	3	3	1	1
22	2	2	3	4	4	3	2	3
23	2	1	2	2	4	3	2	2
24	3	1	4	1	3	2	3	3
25	1	2	2	2	2	2	1	1
26	1	2	2	2	2	2	2	2
27	3	0	4	2	3	2	1	1
28	2	1	3	2	2	3	2	2
29	2	0	4	2	3	3	2	1
30	2	2	3	0	1	3	2	2
Minimum	1.00	0.00	0.00	0.00	1.00	0.00	0.00	0.00
Mean	2.40	1.43	2.73	2.07	2.60	2.27	1.83	1.93
Maximum	4.00	4.00	4.00	4.00	4.00	4.00	4.00	4.00
STDEV	0.97	1.17	1.05	1.31	0.89	1.08	1.15	1.17

**TABLE H-4** The high level criteria assessment of the environment 4 (Ergonomic)

Titles Participants	Ergonomic						
	1	10	(-)18	(-)19	(-)20	21	22
1	2	3	3	4	1	2	0
2	4	2	3	4	1	3	0
3	3	3	3	4	2	2	0
4	2	2	4	4	2	2	0
5	1	1	4	3	2	3	0
6	4	3	2	1	2	2	0
7	3	2	2	3	3	1	0
8	3	4	1	4	1	1	0
9	1	3	2	3	4	1	4
10	1	3	4	4	2	1	0
11	4	4	4	4	3	2	0
12	3	2	2	3	4	4	0
13	4	2	4	4	2	1	0
14	4	3	4	4	3	4	0
15	2	3	1	2	1	2	0
16	4	4	0	4	0	1	0
17	3	1	4	2	1	1	0
18	2	2	4	4	2	1	0
19	2	2	4	4	3	1	0
20	2	2	3	4	1	2	0
21	3	3	3	4	1	2	0
22	2	4	4	4	0	1	0
23	3	4	3	4	3	1	0
24	3	3	4	4	2	1	0
25	1	2	4	4	1	1	4
26	2	2	3	3	1	1	4
27	3	3	4	4	2	1	1
28	1	2	1	3	2	2	3
29	4	3	4	4	3	2	0
30	3	1	3	3	3	3	0
Minimum	1.00	1.00	0.00	1.00	0.00	1.00	0.00
Mean	2.63	2.60	3.03	3.53	1.93	1.73	0.53
Maximum	4.00	4.00	4.00	4.00	4.00	4.00	4.00
STDEV	1.03	0.89	1.16	0.78	1.05	0.91	1.31

**TABLE H-4** The high level criteria assessment of the environment 4 (Intuitiveness)

Titles Participants	Intuitiveness								
	1	2	5	6	(-7)	10	11	(-)12	13
1	2	3	4	3	4	3	1	0	0
2	4	4	4	1	3	2	3	3	1
3	3	3	4	1	2	3	3	1	3
4	2	2	4	1	3	2	2	2	2
5	1	2	4	0	1	1	1	3	0
6	4	4	3	2	2	3	2	3	2
7	3	2	4	3	2	2	2	2	1
8	3	3	4	1	3	4	3	0	4
9	1	2	3	1	3	3	3	2	2
10	1	1	4	3	4	3	0	2	1
11	4	4	4	1	4	4	4	4	1
12	3	3	4	3	2	2	2	2	3
13	4	3	4	0	1	2	3	1	1
14	4	4	3	4	3	3	1	0	4
15	2	2	4	1	1	3	3	4	1
16	4	4	4	0	0	4	4	0	4
17	3	2	4	1	2	1	0	2	2
18	2	2	4	0	4	2	0	3	1
19	2	3	4	0	4	2	3	4	0
20	2	1	4	3	2	2	2	3	3
21	3	1	4	3	3	3	3	1	1
22	2	2	3	2	3	4	3	2	1
23	3	2	4	1	2	4	3	2	2
24	3	3	3	1	4	3	2	3	1
25	1	1	0	2	2	2	2	1	3
26	2	1	2	2	2	2	2	2	2
27	3	3	3	0	4	3	2	1	3
28	1	2	1	1	3	2	3	2	2
29	4	2	3	0	4	3	3	2	3
30	3	2	4	2	3	1	3	2	2
Minimum	1.00	1.00	0.00	0.00	0.00	1.00	0.00	0.00	0.00
Mean	2.63	2.43	3.47	1.43	2.67	2.60	2.27	1.97	1.87
Maximum	4.00	4.00	4.00	4.00	4.00	4.00	4.00	4.00	4.00
STDEV	1.03	0.97	0.97	1.17	1.09	0.89	1.08	1.16	1.17

**TABLE H-4** The high level criteria assessment of the environment 4 (Tangibility)

Titles Participants	Tangibility					
	2	3	5	9	10	(-)18
1	3	0	4	4	3	3
2	4	3	4	4	2	3
3	3	0	4	3	3	3
4	2	1	4	2	2	4
5	2	1	4	0	1	4
6	4	2	3	2	3	2
7	2	3	4	1	2	2
8	3	3	4	4	4	1
9	2	1	3	2	3	2
10	1	0	4	1	3	4
11	4	0	4	0	4	4
12	3	0	4	3	2	2
13	3	2	4	0	2	4
14	4	0	3	3	3	4
15	2	2	4	3	3	1
16	4	0	4	4	4	0
17	2	1	4	0	1	4
18	2	0	4	1	2	4
19	3	1	4	2	2	4
20	1	1	4	3	2	3
21	1	3	4	3	3	3
22	2	2	3	4	4	4
23	2	1	4	2	4	3
24	3	0	3	1	3	4
25	1	2	0	2	2	4
26	1	2	2	2	2	3
27	3	1	3	2	3	4
28	2	2	1	2	2	1
29	2	3	3	2	3	4
30	2	3	4	0	1	1
Minimum	1.00	0.00	0.00	0.00	1.00	0.00
Mean	2.43	1.33	3.47	2.07	2.60	2.97
Maximum	4.00	3.00	4.00	4.00	4.00	4.00
STDEV	0.97	1.12	0.97	1.31	0.89	1.22

**TABLE H-4** The high level criteria assessment of the environment 4 (Tiredness)

Titles Participants	Tiredness											
	3	4	8	(-)10	14	15	16	17	18	19	(-)21	(-)22
1	0	4	0	1	0	0	2	1	1	0	2	0
2	3	3	3	2	4	4	4	4	1	0	3	0
3	0	0	0	1	1	1	1	0	1	0	2	0
4	1	1	0	2	1	1	1	0	0	0	2	0
5	1	0	1	3	1	1	1	0	0	1	3	0
6	2	1	0	1	3	1	2	0	2	3	2	0
7	3	3	2	2	3	3	3	1	2	1	1	0
8	3	3	3	0	3	1	3	3	3	0	1	0
9	1	1	1	1	2	2	1	2	2	1	1	4
10	0	0	0	1	1	3	3	3	0	0	1	0
11	0	1	0	0	0	2	0	1	0	0	2	0
12	0	0	2	2	3	2	2	0	2	1	4	0
13	2	1	2	2	1	0	1	1	0	0	1	0
14	0	0	0	1	0	4	0	0	0	0	4	0
15	2	1	0	1	3	3	1	2	3	2	2	0
16	0	0	0	0	0	4	1	0	4	0	1	0
17	1	2	2	3	1	1	2	2	4	2	1	0
18	0	0	0	2	0	2	0	1	0	0	1	0
19	1	1	1	2	0	0	1	0	0	0	2	0
20	1	0	0	2	0	0	1	2	1	0	2	0
21	3	3	3	1	1	3	3	1	3	0	2	0
22	2	4	1	0	0	1	1	1	0	0	1	0
23	1	0	0	0	1	1	1	2	1	0	1	0
24	0	1	1	1	0	3	1	0	0	0	1	0
25	2	2	1	2	2	2	3	0	0	0	0	4
26	2	1	1	2	1	1	1	1	1	1	1	4
27	1	0	0	1	0	4	0	0	0	0	1	1
28	2	2	2	2	1	2	2	2	3	1	2	3
29	3	3	0	2	0	4	1	2	0	0	2	0
30	3	3	1	3	1	1	0	2	1	1	3	0
Minimum	0.00	0.00	0.00	0.00	0.00	0.00	0.00	0.00	0.00	0.00	0.00	0.00
Mean	1.33	1.37	0.90	1.43	1.13	1.90	1.43	1.13	1.17	0.47	1.73	0.53
Maximum	3.00	4.00	3.00	3.00	4.00	4.00	4.00	4.00	4.00	3.00	4.00	4.00
STDEV	1.12	1.33	1.03	0.90	1.20	1.32	1.07	1.11	1.32	0.78	0.94	1.31



(This page is intentionally left blank)

## **BIOGRAPHY**

Name : Mr.Channarong Trakunsaranakom

Thesis : Proposals for tangible, intuitive and collaborative design of  
manufactured products through virtual and augmented reality  
environments

Major Field : Industrial Engineering

### **Background**

Background and personal information, currently resides at home number 146.  
Moo 3, Laharn Sub-district, Yi-ngo District, Narathiwat Province, Postal code 96180.

History of education, I have graduated education in a Bachelor Degree of  
Mechanical Technology academic year 2000 (Division of Mechanical Design) at  
Industrial Technology College, King Mongkut's Institute of Technology North  
Bangkok. And I have graduated education in a Master Degree of Production  
Engineering Academic Year 2009 (Division of Engineering Design and Machine Tool)  
at Faculty of Engineering, King Mongkut's University of Technology North Bangkok.

Career History, I am a lecturer at Department of Industrial Engineering, Faculty  
of Engineering, Princess of Naradhiwas University since 2009 to the present.

Contact the office, Department of Industrial Engineering, Faculty of Engineering,  
Princess of Naradhiwas University address 90 Kok Kian Sub-district, Mueang  
Narathiwat District, Narathiwat Province 96000, Thailand and my E-mail address is  
Channarongtrakunsaranakom@gmail.com.