



**Thèse de doctorat  
de l'Université Sorbonne Paris Cité  
Préparée à l'Université Paris Diderot**

**École doctorale : Savoirs Scientifiques (ED 400)**  
*Laboratoire SPHERE, UMR 7219*

---

**Construction d'un concept de temps  
mathématiquement manipulable  
en philosophie naturelle  
(Document d'accompagnement)**

---

Par **Vincent DAUDON**

**Thèse de doctorat d'Histoire et philosophie des sciences  
Dirigée par Jean-Jacques SZCZECINIARZ**

Présentée et soutenue publiquement à l'université Paris Diderot le 15 décembre 2017

**JURY**

**Vincent JULLIEN** (Président)

Professeur à l'Université de Nantes

**Laurence BOUQUIAUX** (Rapporteur)

Professeur à l'Université de Liège (Belgique)

**Jean SEIDENGART** (Rapporteur)

Professeur émérite à l'Université Paris Nanterre (Paris x)

**Michel BLAY**

Directeur de recherche émérite au CNRS

**Christian BRACCO**

Maître de Conférences à l'Université de Nice Sophia-Antipolis

**Antoni MALET**

Professeur à Universitat Pompeu Fabra, Barcelone (Espagne)

**Anne-Lise REY**

Maître de conférences à l'Université de Lille

**Jean-Jacques SZCZECINIARZ** (Directeur de thèse)

Professeur à l'Université Paris Diderot (Paris 7)







---

**Construction d'un concept de temps  
mathématiquement manipulable  
en philosophie naturelle  
(Document d'accompagnement)**

---

Vincent DAUDON



Ce document d'accompagnement présente la reproduction scannée des pages 313 - 424 du volume 8 des *Mathematical papers* de Newton édités par D.T. Whiteside. Cette partie des *Mathematical papers* correspond aux diverses rectifications de la proposition x du second livre des *Principes Mathématiques de la Philosophie naturelle* écrites de la main de Newton. Il nous a semblé bon de les placer en annexe de notre thèse puisqu'elles constituent les textes originaux sur lesquels nous avons basé l'écriture de notre chapitre 4 « Le recours à la méthode des suites infinies ». Cependant, afin d'en permettre un accès aisé et non contraignant, par des aller-retours incessants entre le texte et la fin du manuscrit, il nous a paru opportun de les regrouper dans un volume à part. Le lecteur peut ainsi commodément se reporter aux textes sources sans être gêné dans sa lecture.



**Les brouillons de la rectification de la proposition x du second livre des *Principes Mathématiques de la Philosophie naturelle*.**

PROPOSITION X OF THE  
PRINCIPIA'S SECOND BOOK  
REWORKED<sup>(1)</sup>

[autumn 1712]

From originals in the University Library, Cambridge

§1. TOTTERING STEPS TOWARDS ACHIEVING  
A VALID ARGUMENT.<sup>(2)</sup>

[1]<sup>(3)</sup> [Sit *AK* planum illud<sup>(4)</sup> plano Schematis perpendiculare, *ALK* linea curva, *C* corpus in ipsa motum, & *CF* recta ipsam tan]gens in *C*. Temporibus

---

(1) When in late September 1712 Johann Bernoulli's nephew, Niklaus I, arrived in London ready to disclose to Abraham de Moivre (who lost no time in imparting to Newton himself) his uncle's discovery two years before that an independent check from first principles revealed that 'Exempl. 1' of the tenth proposition of Book 2 of the *Principia*—and hence, therefore, the argument of the parent proposition from which this particular case of resisted motion in a semi-circle was correctly deduced (though neither Johann or Niklaus were themselves properly ever to detect wherein its error lies)—was wrong by a numerical factor, Newton applied himself urgently first to check the validity of the objection, and then to recast his original general argument into a corrected form which would yield Bernoulli's result as its prime example. The erroneousness of his 1687 'Exempl. 1' he quickly confirmed by reducing it, again under Bernoulli's guiding hand, to a *non sequitur* (see Appendix 2.1: note (6) below). The magnitude of the lengthy mental effort which it cost him to mend the argument of his 1687 text can only properly be gauged from the physical bulk of the great many surviving work-sheets and attendant scraps of calculation where he endeavoured in a variety of ways to do so, and whose main portion is reproduced in the following pages. We have de Moivre's statement in a letter to Johann Bernoulli on 18 October, a fortnight or so after this initial breakthrough, that it was only 'deux ou trois jours' after Newton first said he would examine the matter that 'il me dit que l'objection [de M. Bernoulli] étoit bonne, et qu'il avoit corrigé la conclusion [de sa proposition]; en effet il me montra sa correction, et elle se trouva conforme au calcul de M. votre neveu' (K. Wollenschläger, 'Der mathematische Briefwechsel zwischen Johann I Bernoulli und Abraham de Moivre' (*Verhandlungen der Naturforschenden Gesellschaft in Basel*, 43, 1933: 151–317): 270–4, especially 271); plus his report of Newton's assurance that 'cette erreur procede simplement[!] d'avoir considéré une tangente à rebours, mais que le fondement de son calcul et les suites dont il s'est servi doivent subsister' (*ibid.*). And to be sure, while the latter assertion is not strictly true—his original expression of the resistance over successive arcs of the projectile path by the difference of the segments of the single tangent drawn opposite ways from their common point is not itself mistaken in its validity, and is very simply adapted (had Newton but seen this) to yield the correct numerical increase of the 1687 value for the ratio of resistance to gravity to be half as much again (see Appendix 2.1: note (13) below)—Newton's private papers make it abundantly clear that he saw his way through to correcting the argument of his *editio princeps* only after he adopted the alternative approach of

## Translation

[1]<sup>(3)</sup> Let  $AK$  be that plane<sup>(4)</sup> perpendicular to the plane of the figure,  $ALK$  the curved line,  $C$  the body moved in it and  $CF$  the straight line touching it at  $C$ .

considering the pair of tangents drawn the same way from corresponding end-points of the infinitesimal arcs successively traversed. Discovery, however, of a variant way of attaining the true goal was here not enough: short of reprinting the two hundred and forty or so pages following (or, yet less satisfactorily still, of messily running over into duplicated pages terminating at their end in an ugly bridging blank), the recast argument had of necessity to be cut down and tailored exactly to fit the gap now left on pages 232–44 of the already printed-off main text of the *editio secunda* after discarding the unchanged repeat of the 1687 text of the present proposition which initially filled that space. Not till three months later, in fact, did Newton communicate a finished replacement to his editor, Roger Cotes, in Cambridge. Here, in §1, we reproduce the preliminary sequence of draftings by way of which he attained the initial version (§1.6) of the correct reasoning which he straightaway transmitted in person to Niklaus Bernoulli about the beginning of October 1712; and in sequel, in §2, the further restylings and remouldings whereby over the ensuing weeks—and for safety's sake contriving an *idem aliter* where the continuous curve of the projectile path is approximated by the linked chain of its infinitesimal chords—he shaped and honed that corrected mode of argument to be the *tour de force* which he made public in the summer of 1713 in the second edition of his *Principia*.

(2) At the end of September, namely, or just possibly during the first few days of October; see the previous note. In Appendix 2.1 below we reproduce Newton's preparatory check on the accuracy with which in the initial version of his proposition—the text (*Principia*, 1687: 260–74) is, for convenience of reference and of commentary, reprinted in the preceding Appendix 1—he had applied his faulty measure there of the ratio of resistance to gravity: having confirmed that his correctly computed result in 'Exempl. 1' does indeed yield Bernoulli's nonsensical corollary, in this particular case of a resisted semi-circular path, that the total motion of the projectile is unaccelerated, he here went on to make a number of fruitless probings of his general reasoning to try to locate its flaw (of which we instance one). In Appendix 2.2/3 we print our edited text of two roughly jotted preliminary attempts, effectively equivalent one to the other in their broad structure, where Newton first thought to attain his goal by an alternative argument taking into account the tangential motions the same way from corresponding end-points of the arcs successively traversed, but in each case failed accurately to determine the increment of motion due to gravity in its proper ratio to the decrement due to resistance. We here take up the unfolding story of his behind-scenes effort to correct his 1687 text (as his surviving manuscripts would appear fully to tell it) at the point where, making a renewed attempt to master the niceties involved in making comparison of the forces of resistance and gravity by way of the linear increments which these generate in the same infinitesimal time, he for the first time attempts directly to amend his original statement of it in the *editio princeps*.

(3) Add. 3965. 12: 196<sup>r</sup>. Newton begins this recasting of the parent proposition *in medio* at the head of page 261 in the *Principia's* first edition (see page 374 below): to round out its text we have interpolated a lightly amended version of his opening sentence at the bottom of page 260. The manuscript figure is of the right-hand quadrant only, and its points  $O, d, g, B, C, D, F$  and  $H$  were originally there denoted by  $A, B, C, D, E, F, k$  and  $n$  respectively, being referred—in the absence of the ordinate  $mp$  here shown—to a desultory opening computation

$$\begin{aligned} AB &= x, BD = o, BC = e, DE = e + ao + boo + co^3 + \&c = g. \\ AD &= z, DF = p. DE = g. FG = g + ap + bpp + cp^3 + \&c [!]. \\ En &= Gk = boo + co^3 = n'. \end{aligned}$$



æqualibus describat corpus arcus  $gC$ ,  $CG$  et ad  $A[K]$  demittantur perpendiculara  $gd$ ,  $GD$ . Et producta  $DG$  occurrat tangenti  $CF$  in  $F$ . Sit  $Bm = Bd$  et erecta perpendicularis  $[mn]$  occurrat tangenti  $CF$  in  $p$ , et compleatur  $pgrm$ <sup>(5)</sup>  $GFp[q]$ .<sup>(6)</sup>

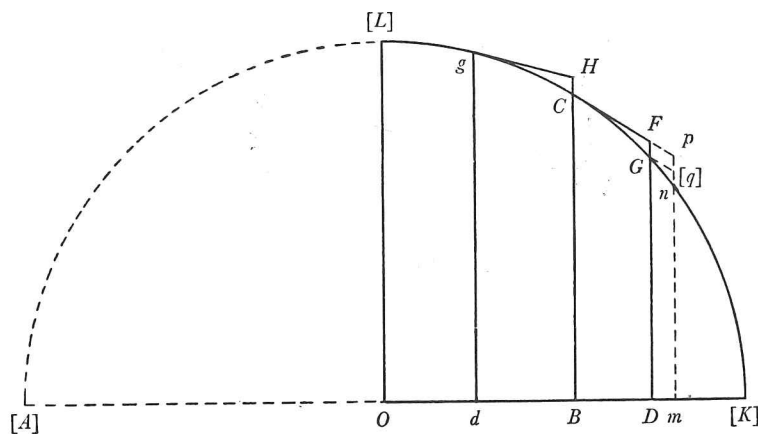

Jam ob tempora æqualia æquales sunt lineolæ  $CH$ ,  $GF$  a gravitate<sup>(7)</sup> genitæ. Si nulla esset resistentia, corpus in fine temporis reperiretur in  $n$ . Per resistentiam fit ut corpus reperiretur in  $G$ , ideoque lineola  $[q]G$ <sup>(8)</sup> vel  $pF$  per resistentiam generatur estque resistentia ad gravitatem ut  $Fp$  ad  $FG$ <sup>(9)</sup> id est ut  $\frac{Dm \times gH^{(10)}}{dB}$  ad  $FG = CH$ , seu  $Dm \times gH$  ad  $Bd \times CH$  vel  $\frac{pn - FG}{2} \times gH$  ad  $CH^2$ .<sup>(11)</sup>

*Exempl. 1.*<sup>(12)</sup> [In semicirculo  $ALK$  sit diametrum]  $AK = 2n$ . [ideoque ponendo]  $OB = a$ .  $BC = e$ .  $Bd$  vel  $B[m] = o$ . [fit]  $aa + ee = nn$ .

For simplicity's sake we have omitted to reproduce a further ordinate  $il$  drawn (as in the *editio princeps*) parallel to  $BC$  at the distance  $iB = BD$  from it, since no use of it is made in the present remoulded argument; and have also for consistency's sake, because the figure has again to do double duty both for the general case and the particular instance of the semi-circle in 'Exempl. 1', added the left-hand quadrant shown in broken line. The preceding statement of the problem survives, it is understood, unchanged, the body being supposed to move (in the vertical plane of the paper) under the joint action of a constant force of gravity straight downwards 'directe ad planum Horizontis' and of the medium's resistance directly opposed to its onrush in the instantaneous direction of its motion.

(4) 'Horizontis' (of the horizontal), namely, as Newton specifies it in his preceding enunciation; compare the previous note.

(5) Read 'parallelogrammum'.

(6) In his manuscript figure Newton by an oversight takes  $n$  to mark both the intersection of  $mp$  with the arc  $\widehat{GK}$ , and also the meet with  $mp$  of the parallel through  $G$  to  $CFp$ ; for distinction's sake the latter intersection is here denoted by  $q$ .

(7) Strictly, both the deviations  $CH$  and  $GF$  will also share equal third-order components of the decelerating resistance to motion along the arclets  $\widehat{gC}$  and  $\widehat{CG}$  traversed in successive equal times; see Appendix 2.1: note (13) below.



In equal times let the body describe the arcs  $\widehat{gC}$ ,  $\widehat{CG}$ , and to  $AK$  let fall the perpendiculars  $gd$ ,  $GD$ ; and let  $DG$  produced meet the tangent  $CF$  in  $F$ . Let  $Bm = dB$ , and the erected perpendicular  $mn$  meet the tangent  $CF$  in  $p$ , then complete the parallelogram  $GFpq$ .<sup>(6)</sup> Now because of the equal times the linelets  $CH$  and  $GF$  begotten by gravity<sup>(7)</sup> are equal. Were the resistance nil, the body at the end of the time would be found at  $n$ . Through the resistance it comes that the body is found at  $G$ , and consequently the linelet  $qG$ ,<sup>(8)</sup> or  $pF$ , is generated by the resistance; and so the resistance is to gravity as  $Fp$  to  $FG$ ,<sup>(9)</sup> that is, as  $Dm \times gH/dB$ <sup>(10)</sup> to  $FG = CH$ , or as  $Dm \times gH$  to  $dB \times CH$  or  $\frac{1}{2}(pn - FG) \times gH$  to  $CH$ .<sup>(11)</sup>

*Example 1.*<sup>(12)</sup> In semicircle  $ALK$  let the diameter  $AK = 2n$ , and consequently on setting  $OB = a$ ,  $BC = e$  and  $dB$  or  $Bm = o$  there comes to be  $a^2 + e^2 = n^2$ . There

(8) Newton here wrote ' $nG$ '; compare note (6) preceding.

(9) This should be ' $2FG$ ', the exponent of the increment in speed,  $g\theta$ , due to gravity  $g$  acting over the time  $\theta$  in which the arc  $\widehat{CG}$  is traversed by the missile, during which its deceleration in speed due to resistance is accurately represented by the decrement in the tangential direction; compare Appendix 2.2: note (25) below.

(10) More precisely,  $Fp = (Dm/dB) \times fC$  where (as in the 1687 text; see the figure on page 374 below)  $f$  is the meet of  $dg$  with the extension beyond  $C$  of the tangent  $FC$ ; but the substitution of  $fC$  by  $gH$  is allowable within the limits of accuracy which Newton here assumes.

(11) Read ' $2CH^2$ ' ( $2CH^2$ ) *recte*, on mending the slip which we indicated in note (9) preceding. Newton here assumes—accurately so to a near enough approximation—that the infinitesimal arc  $\widehat{CG}$  traversed in resisted motion from  $C$  coincides with the corresponding portion of the parabolic arc  $\widehat{Cn}$  travelled in unresisted motion; whence there is  $pn:FG = Cp^2:CF^2$  and so  $(pn - FG):FG = (Cp^2 - CF^2):CF^2$ , that is, (since  $Fp$  is supposed indefinitely small in comparison with  $CF$ )

$$\frac{1}{2}(pn - FG):(FG \text{ or } HC) = Fp:(CF \approx) Cp = Dm:(Bm \text{ or } dB).$$

In the analytical equivalent introduced in the following 'Exempl. 1' (here as in the *editio princeps*) it follows that, corresponding to the series expansion of the augmented ordinate  $DG = e_{a+o}$  as  $e + Qo + Ro^2 + So^3 + \dots$  (where  $Q \equiv Q_a = de/da$ ,  $R \equiv R_a = \frac{1}{2}d^2e/da^2$  and

$$S \equiv S_a = \frac{1}{6}d^3e/da^3 = \frac{1}{6}dR/da),$$

there is likewise, on setting

$Bm = dB = p$ ,  $mn = e_{a+p} = e + Qp + Rp^2 + Sp^3 + \dots$  and  $dg = e_{a-p} = e - Qp + Rp^2 - Sp^3 + \dots$ ; so that  $np = Rp^2 + Sp^3 + \dots$  and  $CH = R_{a-p}p^2 + S_{a-p}p^3 + \dots$ , that is,  $Rp^2 - 2Sp^3 + \dots$ , and therefore Newton's present (unamended) measure for the ratio of resistance to gravity is  $\frac{1}{2}(3Sp^3 + \dots) \cdot p \sqrt{(1 + Q_{a-p}^2)/(Rp^2 + \dots)^2} = \frac{3}{2}S \sqrt{(1 + Q^2)/R^2}$  in the limit as  $p$  comes to vanish. Through making a trivial numerical slip in applying this to the particular case of the semicircular path  $e = +\sqrt{(n^2 - a^2)}$  in his ensuing reworked 'Exempl. 1', Newton was not at once to notice that the result is double the true value which Bernoulli had independently found. When, in the fuller version ([2] following) which he elaborated upon this same basis, he did discover the error in his calculation of 'Exempl. 1', Newton omitted to notice that the mistake was readily rectified by doubling (as it should be) the exponent  $FG$  of the downwards thrust of gravity, but put himself vainly (in [3] ensuing) to distinguish the resisted and unresisted arcs  $\widehat{CG}$  and  $\widehat{Cn}$ .

(12) We reproduce only the essentials of the following computation, ignoring the several rough intermediate multiplications and divisions of terms and the incomplete evaluations of line-lengths which pack out the manuscript here (at the bottom of f. 196r).

[Quare erit]

$$mn = e - \frac{ao}{e} - \frac{nnoo}{2e^3} - \frac{anno^3}{2e^5} - \&c.$$

[necnon]

$$dg = e + \frac{ao}{e} - \frac{nnoo}{2e^3} + \frac{anno^3}{2e^5} [-\&c].$$

$$[adeoq] \quad dg^3 = e^3 + 3eao. \quad [ut \ et] \quad pn = \frac{nnoo}{2e^3} + \frac{anno^3}{2e^5}.$$

$$[et \ similiter] \quad CH = \frac{nnoo}{2dg^3} + \frac{anno^3}{2dg^5} = \frac{nnoo}{2e^3 + 6eao} + \frac{anno^3}{2e^5} = \frac{nnoo}{2e^3} - \frac{anno^3}{e^5}.$$

$$[itaq] \quad pn - CH = \frac{3anno^3}{2e^5}. \quad [Fit \ igitur]$$

$$\begin{aligned} \frac{pn - CH}{2} \times gH \text{ ad } CH^a :: \frac{3anno^3}{4e^5} \times \sqrt{oo + \frac{aa}{ee} oo} \cdot \frac{n^4 o^4 (13)}{2e^6} \\ :: \frac{3an^3 o^4}{4e^6} \cdot \frac{n^4 o^4}{2e^6} :: 3a \cdot 2n :: \text{resi[s]t. grav.}^{(14)} \end{aligned}$$

[2]<sup>(15)</sup> [Sit *AK* planum illud plano Schematis perpendicularare, *ACK* linea curva, *C* corpus in ipsa motum, & *CF* recta ipsam tan]gens in *C*. Ad planum

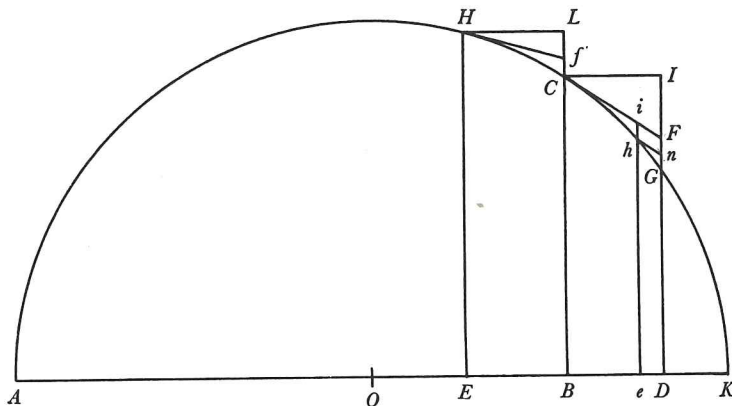

horizontale *AK* demittantur perpendiculara *HE*, *CB*, *he*, *GD* ea lege ut intervalla *EB*, *BD* sint æqualia, & arcus *HC*, *Ch* a corpore mōto *C* describantur temporibus æqualibus. Agantur *Hf*, *CiF* curvam descriptam tangentes in punctis *H* et *C*, et perpendicularis *BC*, *eh* et *DG* productis occurrentes in *f*, *i* et *F*. Et compleantur parallelogramma *BCID*, *Fihn*. Si corpus resistantiam nullam pateretur tempora quibus transit inter perpendiculara *EH* et *BC*, *BC* et *DG* æqualibus intervallis ab invicem distantia, forent æqualia, et corpus his temporibus æqualibus vi gravitatis descend[en]do a tangentibus æquales describeret altitudines *fC* et *Fn*, ideoq[ue] in fine temporum reperiretur in loco *n*. Per resistantiam fit ut corpus in fine temporum reperiat in loco *h*. Ideoq[ue] lineola *nh* vi resistantiæ et lineola



will therefore be  $mn = e - (a/e) o - \frac{1}{2}(n^2/e^3) o^2 - \frac{1}{2}(an^2/e^5) o^3 - \dots$ , and also

$$dg = e + (a/e) o - \frac{1}{2}(n^2/e^3) o^2 + \frac{1}{2}(an^2/e^5) o^3 \dots,$$

so that  $dg^3 = e^3 + 3eao \dots$ , and again  $pn = \frac{1}{2}(n^2/e^3) o^2 + \frac{1}{2}(an^2/e^5) o^3$ , and similarly

$$\begin{aligned} CH &= \frac{1}{2}(n^2/dg^3) o^2 + \frac{1}{2}(an^2/dg^5) o^3 = \frac{1}{2}n^2 o^2 / (e^3 + 3eao) + \frac{1}{2}(an^2/e^5) o^3 \\ &= \frac{1}{2}(n^2/e^3) o^2 - (an^2/e^5) o^3, \end{aligned}$$

and accordingly  $pn - CH = \frac{3}{2}(an^2/e^5) o^3$ . There comes therefore to be

$$\begin{aligned} \frac{1}{2}(pn - CH) \times gH: CH^2 &= \frac{3}{4}(an^2/e^5) o^3 \sqrt{(o^2 + (a^2/e^2) o^2)}: \frac{1}{2}(n^4/e^6) o^4 \text{ (13)} \\ &= \frac{3}{4}(an^3/e^6) o^4: \frac{1}{2}(n^4/e^6) o^4 = 3a: 2n \end{aligned}$$

equal to the resistance to gravity.<sup>(14)</sup>

[2]<sup>(15)</sup> Let  $AK$  be that plane perpendicular to the plane of the figure,  $ACK$  the curved line,  $C$  the body moved in it and  $CF$  the straight line touching it at  $C$ . To the horizontal plane  $AK$  let fall the perpendiculars  $HE$ ,  $CB$ ,  $he$ ,  $GD$  with the stipulation that the intervals  $EB$ ,  $BD$  be equal and the arcs  $\widehat{HC}$ ,  $\widehat{Ch}$  be described by the moving body  $C$  in equal times. Draw  $Hf$ ,  $CiF$  touching the curve described at the points  $H$  and  $C$ , and meeting the perpendiculars  $BC$ ,  $eh$ ,  $DG$  produced in  $f$ ,  $i$ ,  $F$ . And complete the parallelograms  $BCID$ ,  $Fihn$ . Were the body to suffer no resistance, the times in which it passes between the perpendiculars  $EH$  and  $BC$ , and  $BC$  and  $DG$ , standing at equal distances from one another, would be equal and the body, descending in these equal times by the force of gravity from tangents, would describe equal heights  $fC$  and  $Fn$ , and would consequently at the end of the times be found at  $n$ . Through the resistance it comes that the body is at the end of the times found at the place  $h$ . Consequently the linelets  $nh$  and  $Fn$  or  $ih$  are, by the force of the resistance and that of gravity respec-

(13) This square of  $CH = \frac{1}{2}(n^2/e^3) o^2 - \dots$  should (with terms in higher powers of  $o$  ignored) read  $\frac{n^4 o^4}{4e^6}$ ! This numerical slip neatly—to Newton's immediate joy in the next line, and to his subsequent confusion in [2] where he catches it—balances out his earlier error in putting the exponent of the downwards gravity to be only half its just value (see note (9) preceding).

(14) We may imagine Newton's delight in attaining this correct result, and picture him dashing straight on to compose (in [2]) the more rounded out and elaborate version of his present argument, only too quickly to detect the numerical mistake (see the previous note) which turned sour the sweetness of his illusory success.

(15) Add. 3965.12: 197<sup>v</sup>/197<sup>r</sup>. Newton proceeds to mould his seemingly triumphant recast approach in [1] preceding into a full-scale revision of the 1687 text—to emerge crest-fallen at the end when a corrected calculation of the application of his new-found ratio of resistance to gravity in the semi-circular path of his prime *Exemplum* yields a value twice as large as the true one. The draft again takes up the *editio princeps* at the top of page 261, starting in mid-word almost at the close of its opening sentence, which for clarity's sake we here make good by an editorial interpolation founded on Newton's revised beginning to the redraft in [6] below.

$F_n$  vel  $ih$  vi gravitatis simul generantur,<sup>(16)</sup> estq̄ resistētia ad gravitatem ut  $hn^{(17)}$  ad  $hi$  vel  $Cf$  adeoq̄ resistētia est ut  $\frac{hn}{Cf}$ .<sup>(17)</sup>

Est autem tempus ut  $\sqrt{Cf}$  et velocitas ut descripta longitudo  $Ci$  directe et tempus inverse seu [ut]  $\frac{Ci}{\sqrt{Cf}}$  et resistētia eiq̄ proportionalis  $\frac{hn}{Cf}$  ut Medij densitas et quadratum velocitatis, adeoq̄ Medij densitas ut resistētia directe & quadratum velocitatis inverse, id est ut  $\frac{hn}{Ci \times Ci}$ . Q.E.I.

*Corol. 1.* Est resistētia ad gravitatem ut  $\frac{1}{2}nG \times Ci$  ad  $Cf^{\text{quad}}$ . Nam resistētia erat ad gravitatem ut  $hn$  ad  $Cf_{[i]}$  hoc est ut  $hn \times Cf$  ad  $Cf^{\text{quad}}$ . Et  $Ci$  est ad  $hn$  ut  $Cf$  vel  $nF$  ad  $\frac{1}{2}nG$ .<sup>(18)</sup>

*Corol. 2.* Et Medij densitas est ut  $\frac{nG}{Ci \times Ci}$ .

*Corol. 3.* Cūm  $Ci$  et  $CF$  ob infinite minorem  $iF$  sint ad invicem in ratione æqualitatis, erit densitas Medij ut  $\frac{nG}{2CF, Cf}$ , et resist[entia] ad grav[itatem] ut  $\frac{1}{2}nG \times CF$  ad  $Cf^q$ , et velocitas ut  $\frac{CF}{\sqrt{Cf}}$ .

Et hinc si Curva [linea definiatur per relationem inter basem seu abscissam  $AB$  & ordinatim applicatam  $BC$  (ut moris est) & valor ordinatim applicatæ resolvatur in seriem convergentem: Problema per primos seriei terminos expedite solvetur; ut in Exemphis sequentibus].<sup>(19)</sup>

*Exempl. 1.* [Sit linea  $ACK$  . . . . & curvatura Curvarum.]<sup>(20)</sup>

[At nota] p. 264 l. 12. pro exhibet scribe determinat.

Præterea cum  $Ci$  et  $CF$  ob infinite minorem  $iF$  s[i]nt ad invicem in ratione æqualitatis, erit  $Ci$  latus quadratum ex  $CI^q$  et  $IF^q_{[i]}$  hoc est ex  $BD^q$  et quadrato termini secundi.<sup>(21)</sup> Et scribendo  $BE$  pro  $BD$  seu  $-o$  pro  $+o$  valor  $DG$  convertitur in valorem  $EH$ . Et in valore ipsius  $IF$  scribendo  $a-o$  pro  $a$  et  $EH$  pro  $e$ <sup>(22)</sup> habebitur  $Lf$ . Et inde simul prodeunt  $Cf$  vel  $F_n$  et  $nG$ . Terminos autem in quibus  $o$  est plusquam trium dimensionum semper negligo ut infinite minores quam qui in hoc Problemate considerandi veniant. Itaq̄ si designatur  $DG$  universaliter hac serie<sup>(23)</sup>  $BC + Qo + Roo + So^3$ , erit  $IF$  æqualis  $Qo$ ,  $CF$  æqualis  $\sqrt{oo + QQoo}$ ,  $FG$  æqualis  $Roo + So^3$ ,

$$EH = e - Qo + Roo - So^3 \quad \& \quad CL = -Qo + Ro^2 - So^3.$$

(16) Newton falls into the same subtle error as before (see [1]: note (9) above). In fact, corresponding to the linelet  $F_n$  generated by the force of gravity, the force of resistance will engender a decrement of only  $\frac{1}{2}Fi = \frac{1}{2}nh$ .

(17) In consequence, for ' $hn$ ' here read ' $\frac{1}{2}hn$ ' recte.

(18) Newton again makes the assumption (compare [1]: note (11) preceding) that, to



tively,<sup>(16)</sup> simultaneously generated, and so the resistance is to gravity as  $hn$ <sup>(17)</sup> to  $hi$ , or  $Cf$ , and hence the resistance is as  $hn$ <sup>(17)</sup>/ $Cf$ .

The time, however, is as  $\sqrt{Cf}$ , and the speed as the described length  $Ci$  directly and the time inversely, or as  $Ci/\sqrt{Cf}$ , while the resistance—and  $hn/Cf$  proportional to it—is as the density of the medium and the square of the speed, and hence the density of the medium is as the resistance directly and the square of the speed inversely, that is, as  $hn/Ci^2$ . As was to be found.

*Corollary 1.* The resistance is to gravity as  $\frac{1}{2}nG \times Ci$  to  $Cf^2$ . For the resistance was to gravity as  $hn$  to  $Cf$ , that is, as  $hn \times Cf$  to  $Cf^2$ , while  $Ci$  is to  $hn$  as  $Cf$ , or  $nF$ , to  $\frac{1}{2}nG$ .<sup>(18)</sup>

*Corollary 2.* And the density of the medium is as  $nG/Ci^2$ .

*Corollary 3.* Since  $Ci$  and  $CF$  are, because of  $iF$  being indefinitely small, to each other in a ratio of equality, the density of the medium will be as  $\frac{1}{2}nG/CF \times Cf$ , and the resistance to gravity as  $\frac{1}{2}nG \times CF$  to  $Cf^2$ , and the speed as  $CF/\sqrt{Cf}$ .

And hence if the curved line be defined by the relationship between its base or abscissa  $AB$  and ordinate  $BC$  (as is customary) and the value of the ordinate be resolved into a converging series, then the problem will promptly be solved by means of the first terms of the series; as in the following examples.

*Example 1.* Let the line  $ACK \dots$  and the curvature of curves.<sup>(20)</sup>

(But note: on p. 264, l. 12 in place of 'exhibits' read 'determines'.)

Moreover, since  $Ci$  and  $CF$  are, because of  $iF$  being indefinitely small, in a ratio of equality to each other,  $Ci$  will be the square root of  $CI^2 + IF^2$ , that is, of  $BD^2$  and the square of the second term.<sup>(21)</sup> And by writing  $BE$  in place of  $BD$  or  $-o$  for  $+o$  the value of  $DG$  is converted into the value of  $EH$ . And by in the value of  $IF$  writing  $a-o$  for  $a$  and  $EH$  for  $e$ <sup>(22)</sup> there will be had  $Lf$ . And thereby at one go there ensue  $Cf$ , or  $Fn$ , and  $nG$ . The terms, however, in which  $o$  is of more than three dimensions I ever neglect as infinitely less than the ones to come to be considered in the present problem. Accordingly, if  $DG$  be denoted universally by this series<sup>(23)</sup>  $BC + Qo + Ro^2 + So^3$ , there will be  $IF$  equal to  $Qo$ ,  $CF$  equal to  $\sqrt{(o^2 + Q^2o^2)}$ ,  $FG$  equal to  $Ro^2 + So^3$ ,  $EH = e - Qo + Ro^2 - So^3$  and so

---

sufficient accuracy, the infinitesimal arc  $\widehat{Ch}$  of the curve  $\widehat{ACK}$  of resisted motion coincides (along its length) with the corresponding parabolic arc  $\widehat{CG}$  of unresisted free fall under gravity; whence  $Ci^2:CF^2 = ih(\text{or } Fn):FG(\text{or } Fn + nG)$ , so that  $Ci:CF = Fn:(Fn + \frac{1}{2}nG)$ , and therefore  $Ci:(CF - Ci \text{ or } hn) = Fn:\frac{1}{2}nG$ .

(19) We fill out the manuscript's jejune 'Et hinc si Curva &c' from the text of the *editio princeps*, as Newton intends, to furnish a proper lead-in to what follows.

(20) Understand the three opening paragraphs of this 'Exempl. 1' as they are printed in the *editio princeps* (*Principia*, 1687: 263, l. 10 - 264, l. 15 [= pages 378-9 below]).

(21) Namely, in the series expansion of the incremented ordinate  $DG = e_{a+o}$  in terms of powers of the base increment  $BD = o$ ; whence  $IF = Qo$ .

(22) That is,  $BC$ .

(23) 'his terminis' (by these terms) was first, less adequately, written.

Et in valore ipsius  $IF$  scribendo  $OE$  pro  $OB^{(24)}$  et  $EH$  pro  $BC$  habebitur  $Lf$  quæ subducta de  $CL$  relinquit  $Cf$  vel  $Fn$ . Et hæc subducta de  $FG$  relinquit  $nG$ .

Sic in problemate jam solvendo<sup>(25)</sup> erit  $IF$  seu  $Qo = -\frac{ao}{e}$ .

$$Ci \text{ [vel } CF] \text{ seu } \sqrt{oo + QQoo} = \sqrt{oo + \frac{aao}{ee}} = \frac{no}{e} \cdot FG \text{ seu } Roo + So^3 = -\frac{nnoo}{2e^3} - \frac{anno^3}{2e^5}.$$

$$[itaq] \quad Lf = \frac{\overline{a-o} \times o}{e + \frac{ao}{e} - \frac{nnoo}{2e^3}} = \frac{ao}{e} - \frac{nnoo}{e^3} + \frac{3anno^3}{2e^5} \quad (26)$$

[ut et]  $Cf = CL - Lf = \frac{nnoo}{2e^3} - \frac{anno^3}{e^5} = [ih \text{ vel}] Fn$ . [adeoq]  $nG^{(27)} = \frac{3anno^3}{2e^5}$ . [Unde evadit] Resist. ad Grav. ut  $[\frac{1}{2}nG \times Ci \text{ ad } Cf_{quad} \text{ vel}] \frac{3anno^3}{4e^5} \times \frac{no}{e}$  ad  $\frac{n^4o^4}{4e^6}$  seu  $3a$  ad  $n$ .<sup>(28)</sup>

[3]<sup>(29)</sup> [...] Fingatur autem corpus in progressu impediri a Medio.]<sup>(30)</sup> Temporibus æqualibus describat Corpus sine resistantia et gravitate spatia æqualia  $AF$ ,  $FG$ ,<sup>(31)</sup> per gravitatem solam sine resistantia arcus Parabolicos  $AH$ ,  $HI$ , per gravitatem et resistantiam arcus  $AD$ ,  $DE$ , et  $FH$  vel  $BD$ <sup>(32)</sup> erit spatium quod corpus vi gravitatis cadendo describit prima temporis parte &  $GI$  vel  $CE$ <sup>(32)</sup> erit spatium quod corpus vi gravitatis cadendo describit toto tempore, et ob duplum tempus erit hoc spatium quadruplum spatij

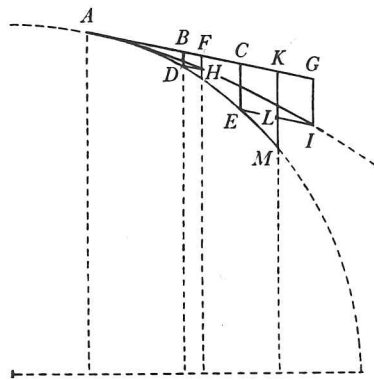

(24) That is,  $a-o$  in place of  $a$ .

(25) In a cancelled initial presentation of the following calculation, doubtless abandoned by him as fulsome (and rightly so), Newton first continued at this point: 'si scribatur  $-\frac{a}{e}$  pro  $Q$ ,

$o\sqrt{1 + \frac{aa}{ee}}$  seu  $\frac{no}{e}$  pro  $o\sqrt{1 + QQ}$  [seu]  $Ci$  vel  $CF$ ,  $-\frac{nn}{2e^3}$  pro  $R$ ,  $-\frac{ann}{2e^5}$  pro  $S$ ' (if there be written  $-a/e$  for  $Q$ ,  $o\sqrt{(1 + a^2/e^2)}$  or  $(n/e)o$  for  $o\sqrt{(1 + Q^2)}$ , that is,  $Ci$  or  $CF$ ,  $-\frac{1}{2}n^2/e^3$  for  $R$ , and  $-\frac{1}{2}an^2/e^5$  for  $S$ ).

(26) That is,  $oQ_{a-o} = Qo - 2Ro^2 + 3So^3 - \dots$  in the general case. Newton's division which derives this in the present instance, where  $Q \equiv Q_a = -(a/e)o$ , is separately preserved on Add. 3968.41: 145<sup>v</sup>.

(27) Namely,  $FG - Fn = 3So^3 \dots$  in the general case.

(28) Which—with the square of  $Cf = \frac{1}{2}(n^2/e^3)o^2 \dots$  now correctly calculated (compare [1]: note (13))—thoroughly deflates the 'victory' which by this variant argument he had thought to have won over a problem which yet remained stubborn in its own in-built resistance to his mathematical attack! Thoroughly dismayed as he here must have been, but undeterred, Newton now passes, in [3] ensuing, to see if there is fruit in making distinction between the parabolic path  $\widehat{CG}$  of free fall and the corresponding arc  $\widehat{Ch}$  of the curve traversed in resisted



$CL = -Qo + Ro^2 - So^3$ . And in the value of  $IF$  by writing  $OE$  in place of  $OB^{(24)}$  and  $EH$  in place of  $BC$  there will be had  $Lf$ , which when taken from  $CL$  leaves  $Cf$ , or  $nF$ . And this when taken from  $GF$  leaves  $nG$ .

Thus in the problem now to be solved<sup>(25)</sup> there will be

$$IF \text{ (that is, } Qo) = -(a/e) o,$$

$$Ci \approx CF \text{ (or } \sqrt{o^2 + Q^2 o^2}) = \sqrt{o^2 + (a^2/e^2) o^2} = (n/e) o,$$

and

$$FG \text{ (or } Ro^2 + So^3) = -\frac{1}{2}(n^2/e^3) o^2 - \frac{1}{2}(an^2/e^5) o^3;$$

accordingly

$$fL = (a-o) o / (e + (a/e) o - \frac{1}{2}(n^2/e^3) o^2) = (a/e) o - (n^2/e^3) o^2 + \frac{3}{2}(an^2/e^5) o^3,^{(26)}$$

while also  $Cf = CL - fL = \frac{1}{2}(n^2/e^3) o^2 - (an^2/e^5) o^3 = hi$ , or  $nF$ , so that

$$nG^{(27)} = \frac{3}{2}(an^2/e^5) o^3.$$

Whence there results the resistance to gravity as  $\frac{1}{2}nG \times Ci$  to  $Cf^2$  or

$$\frac{3}{4}(an^2/e^5) o^3 \times (n/e) o \text{ to } \frac{1}{4}(n^4/e^6) o^4,$$

that is,  $3a$  to  $n$ .<sup>(28)</sup>

[3]<sup>(29)</sup> . . . Imagine, however, that the body is in its progress impeded by the medium.<sup>(30)</sup> In equal times let it without the resistance and gravity describe the equal distances  $AF$ ,  $FG$ ; <sup>(31)</sup> through gravity alone without resistance the parabolic arcs  $\widehat{AH}$ ,  $\widehat{HI}$ ; through gravity and the resistance the arcs  $\widehat{AD}$ ,  $\widehat{DE}$ ; and  $FH$ , or  $BD$ ,<sup>(32)</sup> will be the distance which the body in falling by the force of gravity describes in the first part of the time, and  $GI$ , or  $CE$ ,<sup>(32)</sup> will be the distance which the body in falling by the force of gravity describes in the total

motion. He is yet blind to the fact that this untoward doubling of the true ratio of resistance to gravity in the semi-circular instance arises from his failure properly to relate the increments generated by the two in equal infinitesimal times (on which see note (16) above).

(29) Add. 3965.12: 196v. Newton attempts a more radical recasting of [2] on the facing manuscript page, but now commits two independent errors (see notes (32) and (34) following) which only partially cancel each other out in Newton's ensuing measure of the ratio of resistance to gravity (on which see note (36) below).

(30) The manuscript text begins at the third sentence of the opening paragraph of the first edition (*Principia*, 1687: 261, l. 7). We insert in prelude to it a light reshaping of the preceding sentence (*ibid.*: ll. 1-7) which better bridges the gap to what goes before (and is understood by Newton here to stand unaltered).

(31) Not a little confusingly, Newton now drastically changes his previous denotations of points in his accompanying figure (which we have here extended in broken line to show more closely its correspondence with his previous ones):  $F$  continues to mark its former point, but  $A$  is what was before  $C$  (and the points  $D$  and  $H$ , correspondingly, are what Newton denoted by  $h$  and  $n$  respectively in his figure in [2] preceding), while the configuration  $CEGIKLM$  is here, of course, wholly new.

(32) The equalities  $BD = FH$  and  $CE = GI$  here silently assumed by Newton hold true, in fact, only to the order of the square of  $AB$ . He will come to grief below (see note (36) following) in thinking that these magnitudes may be substituted indiscriminately one for the other in evaluating the difference  $LM = KM - KL$ , of  $O(AB^3)$ .

prioris  $FH$  (per Lem. [XI] Libr. 1).<sup>(33)</sup> Compleantur parallelogramma  $BFDH$  &  $CGIE$  et erit  $HD$  lineola per vim resistantiæ genita in prima parte temporis et  $IE$  lineola per resistantiam genita in toto tempore. Et hæc lineola (per Lem. [XI] Libr. 1)<sup>(33)</sup> est quadrupla prioris. Et resistantia erit ad gravitatem ut  $DH$  ad  $BD$ <sup>(34)</sup> vel  $EI$  ad  $EC$ .<sup>(34)</sup> Cape  $BK$  æqualem  $AB$  et  $CK$  erit dupla ipsius  $BF$  vel  $DH$  ideoq; resistantia erit ad gravitatem ut  $\frac{1}{2}EL$  ad  $BD$ , id est ut  $\frac{AB-BC}{2}$  ad  $BD$ .<sup>(35)</sup>

Est autem tempus ut  $\sqrt{BD}$  et velocitas ut descripta longitudo  $AD$  vel  $AB$  directe et tempus  $\sqrt{BD}$  inverse seu [ut]  $\frac{AB}{\sqrt{BD}}$ , et resistantia eiq; proportionalis  $\frac{EL}{2BD}$  ut Medij densitas et quadratum velocitatis, adeoq; Medij densitas ut resistantia directe et quadratum velocitatis inverse<sub>[1]</sub> id est ut  $\frac{EL}{2AB^q}$ .

*Corol. 1.* Resistentia est ad gravitatem ut  $LM \times AB$  ad  $8BD^q$ . Nam resistantia erat ad Gravitatem ut  $\frac{1}{2}EL$  ad  $BD$  hoc est ut  $EL \times BD$  ad  $2BD^q$ . et  $\frac{1}{4}LM$  est ad  $[\frac{1}{4}EC$  seu]  $\frac{1}{4}KL=BD$  ut  $EL$  ad  $BC$ , [itaq;]  $LM$  est ad  $EL$  ut  $EC$  seu  $4BD$  ad  $BC$  vel  $AB$ .<sup>(36)</sup>

*Corol. 2.* Medij densitas est ut  $\frac{LM}{8AB \times BD}$ .

*Corol. 3.* Et hinc si curva &c.<sup>(37)</sup>

*Exempl. 1.* Sit Linea . . . . .  $a$  ad  $e$ .<sup>(38)</sup> Termini sequentes  $\frac{nmoo}{2e^3} + \frac{anno^3}{2e^5}$  &c

(33) This Lemma (see vi: 116) lays down generally that the vanishingly small linear increment generated by any force is proportional to the square of the infinitesimal time in which it acts; whence in twice the time a length four times as long is generated.

(34) Read '2BD' and '2EC' on making proper comparison of the contemporaneous increments due respectively to the resistance and to gravity; compare [1]: note (9).

(35) Whence this ratio should be  $\frac{1}{2}(AB-BC):2BD$ . The slip is carried through into the sequel (see the next note). In the analytical equivalent (compare [1]: note (11) preceding) there is here, *mutatis mutandis*,  $AB = o\sqrt{1+Q^2}$  and  $BD = Ro^2 + So^3 + \dots$ , while also  $AB:AF:AG = o:p:2p$ , so that  $AB:BF:CG = o:(p-o):4(p-o)$  and consequently

$$AC = AB \cdot (2p - 4(p-o))/o = AB \cdot (2 - 2(p-o)/o);$$

accordingly, since also  $BD = Rp^2 - 2Sp^3 \dots$  (compare Appendix 2.1: note (13) below) and hence  $p^2 = o^2 + 3(S/R)o^3 \dots$  or  $p = o + \frac{3}{2}(S/R)o^2 \dots$ , the corrected measure

$$\frac{1}{4}(AB-BC)/BD = \frac{1}{4}(2AB-AC)/BD$$

yields  $\frac{1}{4}(2(p-o)\dots)\sqrt{1+Q^2}/(Ro^2+\dots) = \frac{3}{4}S\sqrt{1+Q^2}/R^2$  for the true ratio of resistance to gravity. Newton himself, unfortunately, now proceeds to introduce a second error in his ensuing computation.

(36) For, because the resisted path  $\widehat{ADM}$  is effectively a parabola (to sufficient accuracy here) and also  $AK = 2AB$  (by construction), the tangent at  $M$ —that is, since  $CK = 2BF$  is infinitesimal in comparison with  $AK$ , the extension of the chord  $ME$ —will pass through  $B$ , and therefore  $BC:CE = EL:LM$ . The assumption, however, that  $CE$  is equal to  $4BD$ , that is,

$$4(Ro^2 + So^3 \dots),$$



time, and, because the time is double, the distance will (by Lemma XI of Book 1)<sup>(33)</sup> be four times the previous one. Complete the parallelograms  $BFHD$  and  $CGIE$ , and then  $HD$  will be the linelet born through the force of resistance in the first part of the time, and  $IE$  the linelet begotten through the resistance in the total time; and this latter linelet is (by Lemma XI of Book 1)<sup>(33)</sup> four times the previous one. And the resistance will be to gravity as  $DH$  to  $BD$ ,<sup>(34)</sup> or  $EI$  to  $EC$ .<sup>(34)</sup> Take  $BK$  equal to  $AB$ , and  $CK$  will be twice  $BF$  or  $DH$ ; and consequently the resistance will be to gravity as  $\frac{1}{2}EL$  to  $BD$ , that is, as  $\frac{1}{2}(AB - BC)$  to  $BD$ .<sup>(35)</sup>

The time, however, is as  $\sqrt{BD}$ , and the speed as the described length  $AD$  or  $AB$  directly and the time  $\sqrt{BD}$  inversely, or as  $AB/\sqrt{BD}$ , while the resistance—and  $\frac{1}{2}EL/BD$  proportional to it—is as the density of the medium and the square of the speed, and hence the density of the medium as the resistance directly and the square of the speed inversely, that is, as  $\frac{1}{2}EL/AB^2$ .

*Corollary 1.* The resistance is to gravity as  $LM \times AB$  to  $8BD^2$ . For the resistance was to gravity as  $\frac{1}{2}EL$  to  $BD$ , that is, as  $EL \times BD$  to  $2BD^2$ , and  $\frac{1}{4}LM$  is to  $(\frac{1}{4}EC$  or)  $\frac{1}{4}KL = BD$  as  $EL$  to  $BC$ , so that  $LM$  is to  $EL$  as  $EC$ , that is,  $4BD$ , to  $BC$  or  $AB$ .<sup>(36)</sup>

*Corollary 2.* The density of the medium is as  $\frac{1}{8}LM/AB^2$ .

*Corollary 3.* And hence if the curve. . . .<sup>(37)</sup>

*Example 1.* Let the line ( $ACK$ ) be . . . . .  $a$  to  $e$ .<sup>(38)</sup> The following terms

whereby he computes  $LM$ —the excess of  $KM = R(2o)^2 + S(2o)^3 \dots = 4Ro^2 + 8So^3 \dots$  over  $CE$ —to be  $4So^3 \dots$ , is mistaken; accurately,  $CE$  is

$$R(2o - 2(p - o))^2 + S(2o - 2(p - o))^3 \dots = 4Ro^2 + 8So^3 - 8Ro(p - o) \dots,$$

whence Newton's equation of this to  $4Ro^2 + 4So^3 \dots$  implies  $p = o + \frac{1}{2}(S/R) o^2 \dots$  whereas *recte* (see the previous note)  $p = o + \frac{3}{2}(S/R) o^2 \dots$ , thus producing  $CE = 4Ro^2 - 4So^3 \dots$  and in consequence  $LM (= KM - CE) = 12So^3 \dots$ , three times the length ensuing by Newton's computation. Allowing, further, for his improvident earlier doubling of the fraction  $\frac{1}{4}(AB - BC)/BD$  which correctly expresses the ratio of resistance to gravity (see the two previous notes), we will not be surprised that his resulting evaluation of  $\frac{1}{8}LM \times AB/BD^2$  as  $\frac{1}{8}(4So^3 \dots) \cdot o \sqrt{(1 + Q^2)}/(Ro^2 \dots)$ , that is,  $\frac{1}{2}S \sqrt{(1 + Q^2)}/R^2$  in the limit as  $o$  vanishes, leads him back circuitously to the measure of his *editio princeps*, only two-thirds of the true one. And so he himself finds when he makes the calculation in the particular instance of the semicircular path in 'Exempl. 1' following.

(37) Understand that Corollary 3 of the original proposition (*Principia*, 1687: 263) is to follow unchanged. At this point Newton recurs to the scheme of his *editio princeps*, henceforth referring to his present denotation of the points of his figure only in brackets until his last couple of lines, when he again confusingly understands only his above figure. (But we should not forget that the present piece is only a rough, unfinished draft never intended for publication.)

(38) Here are to go in the two opening paragraphs and first three sentences of the third of 'Exempl. 1' in the *editio princeps* of the *Principia* (1687: 263-4, l. 4; see pages 378-9 below).

In sequel Newton first went on to copy, as there, 'Terminus tertius qui hic est  $\left[ \frac{nnoo}{2e^3} \right]$ ' before breaking off to make the following minimal rephrasing of the remainder of the paragraph.

designant lineolam  $FG$  ( $BD$ )<sup>(39)</sup> quæ jacet inter tangentem et Curvam adeoq̄ determinat angulum contactus  $FCG$  seu curvaturam quam Curva linea habet in  $C$ . Si lineola illa  $FG$  minuatur in infinitum, termini subsequentes evadent infinite minores tertio ideoq̄ negligi possunt. Terminus quartus qui hic est  $\frac{anno^3}{2e^5}$  determinat variationem Curvaturæ quintus variationem variationis, & sic deinceps. Unde &c [. . . curvatura] Curvarum.

Præterea  $CF$  ( $AB$ )<sup>(39)</sup> est latus quadratum ex  $CI^a$  et  $IF^a$  hoc est ex  $BD^a$  et quadrato termini secundi<sub>[1]</sub>, id est in hoc exemplo  $\sqrt{oo + \frac{aaoo}{ee}}$  seu  $\frac{no}{e}$ . Et scribendo  $2o$  pro  $2BD$  (= <sup>(40)</sup> prodit  $KM = \frac{2nnoo}{e^3} + \frac{4anno^3}{e^5}$  <sub>[1]</sub>) et ablato  $KL$  seu  $4BD$  hoc est  $\frac{2nnoo}{e^3} + \frac{2anno^3}{e^5}$  <sup>(41)</sup> manet  $\frac{2anno^3}{e^5} = LM$ . Unde Medij densitas est ut  $\frac{a}{2ne}$ , et Resistentia ad Gravitationem ut  $a$  ad  $n$ .<sup>(42)</sup>

[4]<sup>(43)</sup> [Sit  $AK$  planum illud plano Schematis perpendiculare,  $LCK$  linea curva, &  $C$  corpus in ipsa motum. Fingatur autem corpus in progressu impediri a Medio.]<sup>(44)</sup> Æqualibus temporis momentis<sup>(45)</sup> describat corpus spatia  $CG$ ,  $Gg$  sitq̄ arcus  $Gh$  æqualis  $C[G]$ , et differentia  $gh$  erit decrementum spatij quod viribus gravitatis et resistentiæ conjunctis momento temporis generatur. Ducantur rectæ  $CF$   $Gf$  curvam descriptam tangentes in punctis  $C$  et  $G$ .

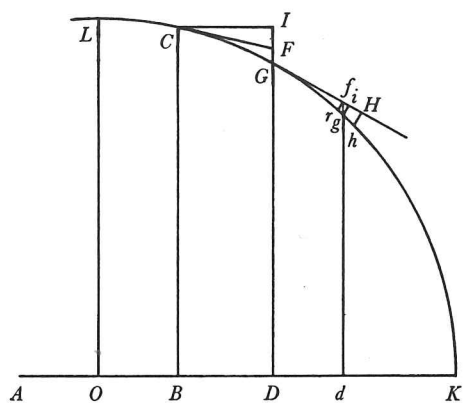

(39) The ' $FG$ ' and ' $CF$ ' relate to the figure in the 1687 text (for which see Appendix 1 below), while the ' $BD$ ' and ' $AB$ ' are their respective equivalents in the present redrawn and relettered diagram; compare note (31) preceding. For convenience we adjoin in our English version a scheme indicating the elements of the former which are here pertinent, augmented (in broken line) by the third ordinate which lies through the points  $K$ ,  $L$  and  $M$  of the latter one.

(40) There is no correspondent to  $2BD$ —that is,  $BN$  in our 'English' figure (as we have interpolated the accompanying text there to specify)—in Newton's present scheme, and so he has had perforce here to leave a blank. Understand this to be, of course, the horizontal distance of  $KLM$  from the prime ordinate through  $A$  (that is,  $BC$  in the 1687 text).

(41) Read  $[4Ro^2 - 4So^3 =] \frac{2nnoo}{a^3} - \frac{2anno^3}{e^5}$  recte, whence on taking this away from  $KM$  there ought in sequel to remain  $[12So^3 =] \frac{6anno^3}{e^5} = LM'$ ; compare note (36) preceding.

(42) And so Newton is once more led back to the 'impossible' result of his 1687 text in this particular instance of resisted motion in a semi-circle—obtained, it is true, this time *via* two contrary errors (see notes (35) and (36) above) which do not together wholly compensate for each other's fault. Undeterred by this fresh failure, he presses on to try yet a further avenue



$\frac{1}{2}(n^2/e^3) o^2 + \frac{1}{2}(an^2/e^5) o^3$  designate the linelet  $FG$  ( $BD$ )<sup>(39)</sup> which lies between the tangent and the curve, and hence determines the angle of contact  $\widehat{FCG}$ , and thus the curvature which the curved line has at  $C$ . If that linelet  $FG$  now be diminished indefinitely, the subsequent terms will prove to be infinitely less than the third, and can accordingly be neglected. The fourth term—here  $\frac{1}{2}(an^2/e^5) o^3$ —determines the variation of the curvature, the fifth the variation of the variation, and so on. Whence . . . the curvature of curves.

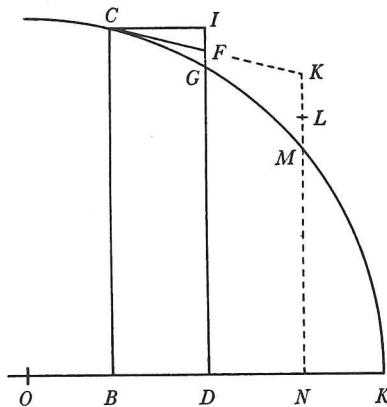

Furthermore,  $CF$  ( $AB$ )<sup>(39)</sup> is the square root of  $CI^2 + IF^2$ , that is, of  $BD^2$  and the square of the second term—in the present example, namely,  $\sqrt{o^2 + (a^2/e^2) o^2}$  or  $(n/e) o$ . And upon writing  $2o$  in place of  $2BD$  ( $[BN]$ )<sup>(40)</sup> there results

$$KM = 2(n^2/e^3) o^2 + 4(an^2/e^5) o^3,$$

and when  $KL$  (or  $4BD$ ), that is,  $2(n^2/e^3) o^2 + 2(an^2/e^5) o^3$ <sup>(41)</sup> is taken away there remains  $LM = 2(an^2/e^5) o^3$ . Whence the density of the medium is as  $\frac{1}{2}a/ne$ , and the resistance to gravity as  $a$  to  $n$ .<sup>(42)</sup>

[4]<sup>(43)</sup> Let  $AK$  be that plane perpendicular to the plane of the figure,  $LCK$  the curved line and  $C$  the body moved in it. Imagine, however, that the body is in its progress impeded by the medium.<sup>(44)</sup> Let the body in equal moments of time<sup>(45)</sup> describe the distances  $\widehat{CG}$ ,  $\widehat{Gg}$  and let the arc  $\widehat{Gh}$  be equal to  $\widehat{CG}$ , and the difference  $\widehat{gh}$  will be the decrement of the (arc-)distance which is generated by the forces of gravity and resistance jointly in a moment of time. Draw the straight lines  $CF$ ,  $Gf$  touching the described curve at the points  $C$  and  $G$ . And

of approach in [4] and [5] following, one which will finally lead him to his goal in [6] after further adjustment.

(43) Add. 3965. 12: 200<sup>r</sup>. Newton now for the first time attempts to construct the equation of motion in the instantaneous tangential direction, conceiving the projectile's deceleration at any point of its path—as measured by the difference in length of its vanishingly small arcs described in equal infinitesimal times—to be compounded of the accelerative component in that direction of the force of downwards gravity—denoted by the equal distances fallen away from the tangent in those times—and of the combating action the opposite way of the medium's resistance to the missile's motion through it; whence the latter resistance is equal (but opposite in sense) to the sum of the body's acceleration and the component (acting the same way) of gravity.

(44) Newton again, as in [3] preceding (compare note (30) thereto), commences his recasting of the 1687 text *in medio* at the third sentence of its first paragraph (*Principia*: 261, l. 7); and yet once more we interpolate a lightly restyled version of the two opening ones to afford a less drastic entrance into what follows.

(45) Originally just 'Temporibus æqualibus' (in equal times), as in [3].

Et ad planum Horizonti parallelum  $AOK$  demittantur perpendiculara  $CB$ ,  $GD$ ,  $gd$  et producantur  $DG$ ,  $dg$  donec tangentibus illis occurrant in  $F$  et  $f$ . Et æqualia erunt spatia  $FG$ ,  $fg$  quæ corpus vi gravitatis cadendo æqualibus illis temporis momentis describit. In arcu  $Cg$  capiatur  $Gr$  æqualis tangenti  $Gf$ , et erit  $rg^{(46)}$  incrementum arcus vi gravitatis in momento temporis, ideoque  $rh^{(47)}$  erit decrementum arcus ex resistentia Medij in eodem momento, et resistentia erit ad gravitatem ut  $rh$  ad  $rg$ .<sup>(48)</sup>

Pro arcuum differentia  $gh$  scribatur vel differentia chordam<sup>(49)</sup>  $CG$ ,  $Gg$  vel differentia tangentium  $CF$  [ $G$ ] $f$  et sit differentia illa  $D$  et pro  $rg$  scribatur  $\frac{Dd \times gf}{GF}$  vel  $\frac{BD \times GF}{CF} = d$ , et erit resistentia ad gravitatem ut  $D + d$  ad  $d$ .<sup>(50)</sup>

Est autem tempus ut  $\sqrt{GF}$  et velocitas ut descripta longitudo  $CG$  vel  $CF$  directe et tempus  $\sqrt{GF}$  inverse, et resistentia ut Medij densitas et quadratum velocitatis, adeoque Medij densitas ut resistentia directe et quadratum velocitatis inverse, id est ut  $\frac{D+d}{d}$  directe &  $GF^{(51)}$  inverse, sive ut  $\frac{D+d}{d \times GF}$ . Q.E.[I].

... ..<sup>(52)</sup>

*Exempl. 1.* Sit Linea  $ACK$  semicirculus ... .. et evadet

$$DG = e - \frac{ao}{e} - \frac{nnoo}{2e^3} - \frac{anno^3}{2e^5} \text{ \&c ... .. curvatura Curvarum.}^{(53)}$$

Sit jam  $OD = b$ .  $DG = f$  et  $Dd = p$  et erit  $dg = f - \frac{bp}{f} - \frac{nnpp}{2f^3} - \frac{bnnp^3}{2f^5}$ . et

$$fg = \frac{nnpp}{2f^3} + \frac{bnnp^3}{2f^5}. \text{ Est autem } CF = \sqrt{oo + \frac{aaoo}{ee}} = \frac{no}{e} \text{ et } Gf = \sqrt{pp + \frac{bbpp}{ff}} = \frac{np}{f}.$$

[Itaque]  $FG = \frac{nnpp}{2f^3} + \frac{bnnp^3}{2f^5} = fg = \frac{nnoo}{2e^3} + \frac{anno^3}{2e^5}$ . et  $\frac{ffpp + bp^3}{f^5} = \frac{eeoo + ao^3}{e^5}$ .

(46) This should be '2rg' recte, when proper comparison of the decrement

$$\widehat{CG} \text{ (or } FH) - \widehat{Gg} = gh$$

is made with  $(\rho - g \cdot rg/fg) \theta^2$ , where  $\rho$  is the medium's resistance and  $g\theta^2 = 2fg$  is twice the vertical distance fallen from the tangent  $GH$  under downwards gravity  $g$  in the infinitesimal time  $\theta$  in which the missile traverses the arc  $\widehat{Gg}$  of its resisted path; compare [1]: note (9) above, and Appendix 2.2: note (25) following.

(47) In the terms of the previous note, this should be  $(\rho\theta^2 =) 2rg + gh$ , that is, 'rg + rh'.

(48) Newton's slip for 'fg' of course. Over and above this *lapsus calami*—which is, unfortunately, perpetuated in the sequel—the correct ratio should (see the two previous notes) be  $(\frac{1}{2}\rho\theta^2 : \frac{1}{2}g\theta^2 =) \frac{1}{2}(rg + rh) : fg$ .

(49) 'chordarum'.

(50) Again read 'fg'; see note (48).

(51) Further confusion! Newton means  $\frac{CF^2}{GF}$  ( $CF^2/GF$ ).



to the plane  $AOK$  parallel to the horizon let fall the perpendiculars  $CB, GD, gd$  and extend  $DG, dg$  till they meet those tangents in  $F$  and  $f$ . Then will there be equal the distances  $FG, fg$  which the body will on falling by the force of gravity in those equal moments of time describe. In the arc  $\widehat{Cg}$  take  $\widehat{Gr}$  equal to the tangent  $Gf$ , and then will  $rg^{(46)}$  be the increment of the arc by the force of gravity in a moment of time, and consequently  $rh^{(47)}$  will be the decrement of the arc ensuing from the resistance of the medium in the same moment, and so the resistance will be to gravity as  $rh$  to  $rg$ .<sup>(48)</sup>

For the difference  $gh$  of the arcs write either the difference of the chords  $CG$  and  $Gg$  or the difference of the tangents  $CF$  and  $Gf$ , and let that difference be  $D$ ; while in place of  $rg$  write  $Dd \times gf/GF$  or  $BD \times GF/CF$ , which let equal  $d$ : the resistance will then be to gravity as  $D + d$  to  $d$ .<sup>(50)</sup>

The time, however, is as  $\sqrt{GF}$ , and the speed as the described length  $CG$  or  $CF$  directly and the time  $\sqrt{GF}$  inversely, and the resistance as the density of the medium and the square of the speed, and hence the density of the medium as the resistance directly and the square of the speed inversely, that is, as  $(D + d)/d$  directly and  $GF^{(51)}$  inversely, or as  $(D + d)/d \times GF$ . As was to be found.

... .. (52)

*Example 1.* Let the line  $ACK$  be a semicircle ... .. and there will prove to be  $DG = e - (a/e) o - \frac{1}{2}(n^2/e^3) o^2 - \frac{1}{2}(an^2/e^5) o^3 \dots$ , ... .. the curvature of curves.<sup>(53)</sup>

Now let  $OD = b$ ,  $DG = f$  and  $Dd = p$ , and there will be

$$dg = f - (b/f) p - \frac{1}{2}(n^2/f^3) p^2 - \frac{1}{2}(bn^2/f^5) p^3$$

and so  $fg = \frac{1}{2}(n^2/f^3) p^2 + \frac{1}{2}(bn^2/f^5) p^3$ . However,

$$CF = \sqrt{(o^2 + (a^2/e^2) o^2)} = (n/e) o \quad \text{and} \quad Gf = \sqrt{(p^2 + (b^2/f^2) p^2)} = (n/f) p.$$

Accordingly

$$FG = \frac{1}{2}(n^2/f^3) p^2 + \frac{1}{2}(bn^2/f^5) p^3 = fg = \frac{1}{2}(n^2/e^3) o^2 + \frac{1}{2}(an^2/e^5) o^3,$$

(52) We here omit a following paragraph in the manuscript where Newton began, out of sequence, to redraft the latter portion of the third paragraph of the ensuing 'Exempl. 1' (*viz.* *Principia*, 1687: 264, ll. 4–11), beginning 'Terminus tertius & sequentes  $\frac{nmoo}{2e^3} + \frac{anno^3}{2e^5} + \&c$  designabunt lineolam  $FG$  quæ jacet inter tangentem et curvam, adeoq; determ[in]ant angulum contactus  $F CG$  seu curvaturam quam curva linea habet in  $C$ . Si lineola illa  $FG$  minuatur in infinitum, termini subsequentes evadent infinite minores tertio ideoq; negligi possunt, & solus terminus tertius curvaturam determinabit. Terminus quartus [ $\&c$ ]. This minimal rephrasing was taken over word for word by Newton into his finished revise (§2.1 below), and we will not here dwell upon it.

(53) Understand the first three paragraphs of the original text of this prime instance (*Principia*, 1687: 263–4, l. 15 [= pages 378–9 following]), with the trivial replacement of 'fiet' (*ibid.*: 263, l. 16) by an equivalent 'evadet'.

$$[\text{At}] \quad b = a + o. \quad f = e - \frac{ao}{e}. \quad [\text{Fit igitur}] \quad \frac{eepp - 2aopp + ap^3}{e^5 - 5ae^3o} = \frac{eeoo + ao^3}{e^5}. \quad [\text{sive}]$$

$$eepp - 2aopp + ap^3 = eeoo - 4ao^3.$$

[adeoq]

$$oo.pp :: ee - 2ao + ap . ee - 4ao :: ee - ao . ee - 4ao :: ee . ee - 3ao$$

$$[\text{vel}] \quad BC . BC - 3IG. \quad (54)$$

[5]<sup>(55)</sup> Curvam  $LNCGgK$  tangant rectæ  $NE$ ,  $CF$  in punctis  $N$  et  $C$  et quærat Medij densitas qua corpus in hac curva moveri potest. Sit  $NE$  tangens quam corpus in momento temporis describit et  $EC$  altitudo quam describeret cadendo in eodem momento, et in fine momenti corpus reperietur in  $C$ . Sit  $CF$  tangens quam corpus describeret in momento proximo et  $FG$  altitudo quam describeret in eodem momento cadendo et in fine momenti corpus reperietur in  $G$ .<sup>(56)</sup> Et differentia arcuum  $NCCG$  vel quod perinde est, differentia tangentium  $NE$ ,  $CF$  erit decrementum spatij quod corpus singulis momentis describit.<sup>(57)</sup>

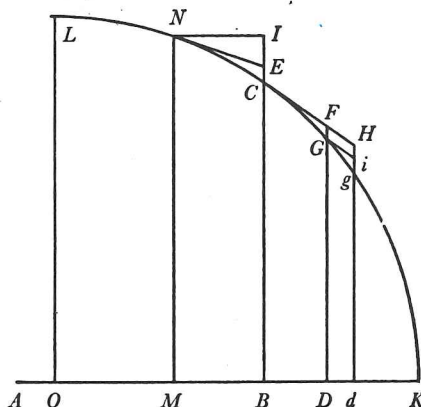

(54) Whence at once ' $o.p :: ee . ee - \frac{3}{2}ao$ ' and consequently ' $p = o - \frac{3a}{2ee}oo$ ' (recte, on ignoring terms of the order of  $o^3$ ), so that  $|gh| = (Gf - CF)$  or  $np/f - no/e$ , that is,

$$no(1 - \frac{3}{2}(a/e^2)o)/e(1 - (a/e^2)o) - no/e = \frac{1}{2}(an/e^3)o^2$$

is (to the same order) equal to  $rg = (a/n)fg$ . Whether or not he foresaw that setting the resistance to be to gravity as  $rh/rg$  here, in this semi-circular instance, yields the impossible result that the resistance must everywhere be twice the gravity, and so itself constant (and hence countering a uniform speed of the missile's motion), Newton at this point broke off to rephrase his argument anew on the next manuscript leaf (f. 201), which we now pass to reproduce in [5]. Even had he mended his careless slip of writing ' $rg$ ' for ' $fg$ ' in his basic ratio (see note (48) above) he would, we might add, have attained the unacceptable value  $gh/fg = 2a/n$  in the present example.

In the general case, if (with Newton) we expand the incremented ordinate  $DG = e_{a+o}$  into the series  $e + Qo + Ro^2 + So^3 + \dots$  (where, as ever,  $Q \equiv Q_a = de/da$ ,  $R \equiv R_a = \frac{1}{2}dQ/da$  and  $S \equiv S_a = \frac{1}{3}dR/da$ ), so that  $CF = o\sqrt{1+Q^2}$  and  $FG = Ro^2 + So^3 \dots$ , then correspondingly when the augmented base  $OD = a + o = b$  receives the further increment  $Dd = p$  there is  $Gf = p\sqrt{1+Q^2}$ , that is,  $p\sqrt{1+(Q+2Ro+\dots)^2} = p\sqrt{1+Q^2} \cdot (1+2QRo/(1+Q^2)\dots)$  and also  $fg = R_p p^2 + S_p p^3 + \dots = (R+3So+\dots)p^2 + (S+\dots)p^3$ ; whence, on equating the distances  $FG$  and  $fg$  fallen away from the initial tangential direction in equal times, there comes to be  $p^2 + (S/R)p^3 \dots = (Ro^2 + So^3 \dots)/(R+3So \dots) = o^2 - 2(S/R)o^3 \dots$  or  $p^2 = o^2 - 3(S/R)o^3 \dots$ , and consequently  $p = o - \frac{3}{2}(S/R)o^2 \dots$  (Compare [3]: note (36), where the present successive base increments  $p$  and  $o$  are interchanged.) It follows that

$$Gf = o\sqrt{1+Q^2} + (-\frac{3}{2}S\sqrt{1+Q^2}/R + 2QR/\sqrt{1+Q^2})o^2 \dots,$$



and so  $(f^2p^2 + bp^3)/f^5 = (e^2o^2 + ao^3)/e^5$ . But  $b = a - o$  and  $f = e - (a/e)o$ . There comes therefore  $(e^2p^2 - 2aop^2 + ap^3)/(e^5 - 5ae^3o) = (e^2o^2 + ao^3)/e^5$  or

$$e^2p^2 - 2aop^2 + ap^3 = e^2o^2 - 4ao^3,$$

and hence

$$o^2 : p^2 = e^2 - 2ao + ap : e^2 - 4ao = e^2 - ao : e^2 - 4ao = e^2 : e^2 - 3ao,$$

or  $BC : (BC - 3IG)$ .<sup>(54)</sup>

[5]<sup>(55)</sup> Let the straight lines  $NE$ ,  $CF$  touch the curve  $LNCGgK$  at the points  $N$  and  $C$ , and let there be sought the density of the medium whereby the body can move in this curve. Let  $NE$  be the tangent which the body describes in a moment of time, and  $EC$  the height which it would describe by falling in the same moment, and at the end of the moment the body will be found at  $C$ . Let  $CF$  be the tangent which the body would describe in the next moment, and  $FG$  the height which it would describe in the same moment by falling, and at the end of the moment the body will be found at  $G$ .<sup>(56)</sup> And the difference of the arcs  $\widehat{NC}$  and  $\widehat{CG}$ , or, what is effectively the same, the difference of the tangents  $NE$  and  $CF$ , will be the decrement of the distance which the body describes in the separate moments.<sup>(57)</sup> Call this difference  $D$  and let  $E$  be the excess of arc  $\widehat{NC}$

and hence  $gh = CF - Gf = (\frac{3}{2}S\sqrt{1+Q^2}/R - 2QR/\sqrt{1+Q^2})o^2\dots$ , while also

$$rg = (Dd/Gf) \times fg = (Q_b/\sqrt{1+Q_b^2}) \cdot FG = (QR/\sqrt{1+Q^2}) o^2\dots;$$

accordingly, Newton's intended ratio  $rh/fg = (rg+gh)/fg$  of resistance to gravity (again see note (48)) yields, in the limit as the incremented ordinates  $DG$  and  $dg$  come to coalesce with  $BC$  (that is, as  $o$  and  $p$  each vanish), the erroneous corresponding measure  $\frac{3}{2}S\sqrt{1+Q^2}/R^2 - Q/\sqrt{1+Q^2}$ . (The true expression  $\frac{3}{2}S\sqrt{1+Q^2}/R^2$  results straightforwardly, we need not say, from the corrected ratio  $\frac{1}{2}(rg+rh)/fg$ .)

(55) Add. 3965. 12: 201<sup>r</sup>, a minor reshaping of the argument in [4] preceding (on the second leaf of the same folded manuscript sheet). Newton impercipiently repeats both his previous slips—of carelessly expressing the action of gravity, in proportion to that of resistance, by its component in the direction of motion, and of failing to assign the proper numerical coefficients in the equation of forces acting in that direction (see notes (58) and (59) below)—before uselessly attempting to reduce to computationally more amenable form the mistaken ratio of resistance to gravity which he thereby derives.

(56) In a cancelled first continuation Newton initially went on to repeat his basic argument in [1] and [2] above before again taking up the modified approach of [4] preceding, there writing: 'Producatur tangens  $CF$  ad  $H$  ut sit  $CH$  æqualis tangenti  $NE$ , et tangentium differentia  $FH$  erit decrementum spatij singulis momentis descripti ex resistentia oriundum adeoq̄ resistentia erit ad gravitatem ut  $FH$  ad  $FG$ ' (Produce the tangent  $CF$  to  $H$  so that  $CH$  be equal to the tangent  $NE$ , and the difference  $FH$  of the tangents will be the decrement of the [arc-] distance described in the single instants which must arise from the resistance, and hence the resistance will be to gravity as  $FH$  to  $FG$ ). *Recte*, of course, this ratio should be  $FH$  to  $2FG$ ; compare [1]: note (9) above.

(57) In sequel Newton went on to specify 'Et hoc decrementum oritur a viribus gravitatis et resistentiæ conjunctis' (And this decrement arises from the forces of gravity and resistance conjoined) and began to adjoin 'Gravitas auget [et resistentia minuit...]' (Gravity increases [and resistance diminishes...]) before breaking off to cancel the whole.

Dicatur hæc differentia  $D$  et sit  $E$  excessus arcus  $NC$  supra tangentem  $NE$ , vel quod perinde est sit  $E = \frac{IE \times CE}{[NE]}$ . et erit  $E^{(58)}$  incrementum spatij singulis momentis descripti, ex gravitate oriundum,  $D$  decrementum ejus ex resistentia et gravitate oriundum, et  $D + E^{(58)}$  decrementum ejus ex resistentia sola oriundum, adeoq; resistentia erit ad gravitatem ut  $D + E$  ad  $E$ .<sup>(59)</sup>

Est autem tempus ut  $\sqrt{EC}$  et velocitas ut descripta longitudo  $NC$  vel  $NE$  directe & tempus  $\sqrt{EC}$  inverse seu [ut]  $\frac{NE}{\sqrt{EC}}$ , et resistentia ut Medij densitas et quadratum velocitatis adeoq; Medij densitas ut resistentia directe & quadratum velocitatis inverse, id est ut  $\frac{D+E}{E} \times \frac{EC}{NE^2}$ .<sup>(60)</sup> Q.E.I.

Corol. 1. Capiatur  $Bd = BM$  et erigatur  $\perp^{(61)}$   $dgH$  Curvæ occurrens in  $g$  et tangenti ejus  $CF$  productæ in  $[H]$  et compleatur pgrm<sup>(61)</sup>  $GF[H]i$ . et erit<sup>(62)</sup>  $[H]i + \frac{1}{2}ig \cdot \frac{1}{2}ig :: [H]C \cdot [H]F$ . Et  $[H]i + \frac{1}{2}ig \cdot Hi :: C[H] \cdot CF$ . seu<sup>(63)</sup>

$$\frac{CE + [Hg]}{2} \cdot CE :: C[H] \cdot CF.$$
<sup>(64)</sup>

[6]<sup>(65)</sup> Sit  $AK$  planum illud plano schematis perpendiculare;  $ACK$  linea curva;<sup>(66)</sup>  $C$  corpus in ipsa motum &  $FC$  recta ips[a]m tangens in  $C$ . Fingatur autem Corpus  $C$  progredi ab  $A$  ad  $K$  per lineam illam  $ACK$ , et interea impediri a Medio resistente. Et a puncto  $C$  ad rectam  $AK$  demittatur perpendiculum  $CB$  et in recta illa

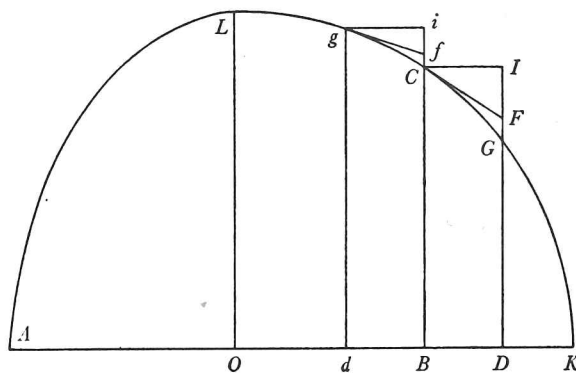

(58) This should be '2E' in each case; compare [1]: note (9) and [4]: note (46) preceding.

(59) Newton intends 'CE' here, and not its projection in the tangential direction at  $C$ , but repeats his careless slip in [4] preceding at the corresponding place (see our note (48) thereto). On further introducing the numerical coefficients here also omitted (see the previous note) the correct ratio of resistance to gravity is in fact as  $D + 2E$  to  $2CE$ . And the sequel needs correspondingly to be adjusted.

(60) While Newton now attaches—as he did not in [4] preceding (see note (51) thereto)—the proper factor proportional to the reciprocal of the square of the speed

$$NE/\sqrt{2CE/g} \propto NE/\sqrt{CE}$$

where  $g$  is the downwards gravity, this measure of the density needs (see the previous note) yet further correction to be accurately 'ut  $\frac{D+2E}{2CE} \times \frac{CE}{NE^2}$ ' that is, as  $(D+2E)/NE^2$ .

(61) Read 'perpendiculum' and 'parallelogrammum' respectively.

(62) Again presupposing (compare [1]: note (11); [2]: note (18); [3]: note (36)) that the resisted path  $\widehat{CG}$  is, to sufficient accuracy, a parabola; whence  $Hg$ : ( $FG$  or)  $Hi = HC^2:FC^2$ , and therefore  $(\sqrt{Hg \times Hi} \approx) Hi + \frac{1}{2}ig$ :  $Hi = HC:FC$ .



over the tangent  $NE$ —or, what is effectively the same, let  $E = IE \times CE/NE$ —and then  $E^{(58)}$  will be the increment of the distance described in separate moments arising from gravity,  $D$  its decrement arising from the resistance and gravity, and  $D + E^{(58)}$  its decrement arising from the resistance alone, and hence the resistance will be to gravity as  $D + E$  to  $E$ .<sup>(59)</sup>

The time, however, is as  $\sqrt{EC}$ , and the speed as the described length  $\widehat{NC}$ , or  $NE$ , directly and the time  $\sqrt{EC}$  inversely, that is, as  $NE/\sqrt{EC}$ ; while the resistance is as the density of the medium directly and the square of the speed inversely, and hence the density of the medium as the resistance directly and the square of the speed inversely, that is, as  $((D + E)/E) \times EC/NE^2$ .<sup>(60)</sup> As was to be found.

*Corollary 1.* Take  $Bd = MB$  and erect the perpendicular  $dgH$  meeting the curve in  $g$  and its tangent  $CF$  produced in  $H$ , and complete the parallelogram  $GFHi$ . There will then<sup>(62)</sup> be  $(Hi + \frac{1}{2}ig) : \frac{1}{2}ig = CH : FH$ , and so  $(Hi + \frac{1}{2}ig) : Hi = CH : CF$ , that is,<sup>(63)</sup>  $\frac{1}{2}(CE + Hg) : CE = CH : CF$ .<sup>(64)</sup>

[6]<sup>(65)</sup> Let  $AK$  be that plane perpendicular to the plane of the figure,  $ACK$  the curved line,<sup>(66)</sup>  $C$  the body moved in it and  $FC$  the straight line touching it at  $C$ . Imagine, however, that the body  $C$  advances from  $A$  to  $K$  by way of that line  $ACK$  and is all the while impeded by the resisting medium. And from the point  $C$  to the straight line  $AK$  let fall the perpendicular  $CB$ , take in that straight line

(63) Because  $Hi = (FG \text{ or } RC)$  and  $ig = Hg - Hi$ , that is,  $Hi + \frac{1}{2}ig = (Hi + Hg)$ .

(64) At this point, evidently conscious that this adaptation of his previous elaboration in [3] above here leads him nowhere, Newton breaks off to begin the more radically reconstructed mode of approach by which he will, in [6] ensuing, at long last achieve his goal. Subsequently, ever thrifty in his economical re-use of what was then become mere scrap, he employed the final few inches of paper left blank at the foot of the page to draft a neat variant proof (cited in Appendix 2.8 note (70)) that the surrounding medium offers no resistance to motion in the simple 'Galileian' parabola which is the second example set by him to illustrate his problem.

(65) Add. 3965.12: 219<sup>r</sup>(+220<sup>r</sup>)/219<sup>v</sup>. Deterred by his repeated failure to mend his 1687 argument by way of its basic assumption of arcs successively traversed in equal instants of time, Newton here in lieu supposes that it is the projection of the resisted motion upon the horizontal which uniformly increases in 'æqualibus temporis momentis'. After a slight initial fumble (see note (68) following) he was thereby able for the first time correctly to express the change in speed in the missile's motion due to the joint action of the resistance of the medium and of the component of gravity in the instantaneous tangential direction, and thence to deduce the true ratio of resistance to gravity which he here states, in a version straightaway simplified, in his Corollary 1. After confirming in the primary instance of a semi-circular resisted path—the growing roughness of the manuscript's handwriting and (see note (75) below) the increasing ellipticity in its verbal exposition jointly afford a revealing glimpse of his desperate effort here to be in agreement—that his general ratio does indeed in this special case yield the result independently obtained by Johann Bernoulli and passed to him by Niklaus as indication that the argument of his 1687 text was at fault, Newton is at last free to pen (with a near-audible sigh of relief) the quick letter to Johann's nephew whose draft we cite in our concluding note (76), enclosing with it a copy of his present recast scheme of argument.

(66) As in the *editio princeps* the accompanying figure is meant to depict the semi-circle of 'Exempl. 1', for which it also does duty, but we faithfully reproduce the proportions of the

sumantur hinc inde lineolæ æquales  $BD$ ,  $Bd$  & erigantur perpendiculara  $DG$ ,  $dg$  Curvæ occurrentia in  $G$  ac  $g$ . Producat  $DG$  donec tangenti  $CF$  occurrat in  $F$  & compleatur parallelogrammum  $CBDI$  & agatur recta  $gf$  Curvam tangens in  $g$  & perpendicularo  $BC$  producto occurrens in  $f$ . Et tempora quibus corpus describit arcus  $gC$ ,  $CG$  erunt in subduplicata ratione altitudinum  $fC$ ,  $FG$  quas corpus temporibus illis cadendo a tangentibus describere posset, & velocitates ut longitudines descriptæ  $gC$ ,  $CG$  directe et tempora inverse. Quare exponantur tempora per  $\sqrt{Cf}$  &  $\sqrt{FG}$ <sup>(67)</sup> & velocitates per  $\frac{gC}{\sqrt{Cf}}$  &  $\frac{CG}{\sqrt{FG}}$ , vel quod perinde est per  $\frac{gf}{\sqrt{Cf}}$  &  $\frac{CF}{\sqrt{FG}}$ ; & decrementum velocitatis tempore  $\sqrt{FG}$  exponetur per  $\frac{gf}{\sqrt{Cf}} - \frac{CF}{\sqrt{FG}}$ ,<sup>(68)</sup> hoc decrementum oritur ex resistentia et gravitate conjunctis. Resistentia decrementum auget,<sup>(69)</sup> gravitas diminuit. Est autem  $\frac{2FG}{\sqrt{FG}}$  seu  $2\sqrt{FG}$ <sup>(69)</sup> velocitas quam corpus tempore  $\sqrt{FG}$  cadendo & altitudinem  $FG$  describendo acquireret. Et hæc velocitas est ad velocitatem quam gravitas eodem tempore addit velocitati corporis in arcu  $CG$  ut  $FG$  ad  $CG - CF$  sive ad  $\frac{IF \times FG}{CF}$ , ideoq; velocitas quam gravitas addit velocitati corporis est  $\frac{2IF \times FG}{CF \times \sqrt{FG}}$  seu  $\frac{2IF \times \sqrt{FG}}{CF}$ . Et hæc velocitas addita prædicto velocitatis decremento ex resistentia et gravitate oriundo componit decrementum velocitatis ex resistentia

free-hand drawn manuscript diagram, in which the left-hand quadrant  $ALO$  has been squashed affinely into the elliptical shape depicted. Initially, it would appear, Newton wrote 'LK linea curva' ( $LK$  the curved line) and, correspondingly, drew just the right-hand quadrant; then amended this to be as it is here set, but without finding space enough to the right of what he had already written to afford the augmented figure its full horizontal extension.

(67) Since the times of free fall from rest under gravity  $g$  through the distances  $Cf$  and  $FG$  are in fact  $\sqrt{(2Cf/g)}$  and  $\sqrt{(2FG/g)}$  respectively, Newton here supposes a scaling factor of  $\sqrt{(\frac{1}{2}g)}$ .

(68) Much as in his preliminary listing on f. 197<sup>r</sup> of the main lines of the present mode of argument (there keyed to a differently lettered figure whose variant markings of points we see no use in here specifying), Newton initially here (on f. 219<sup>r</sup>) went on to conclude: 'et incrementum velocitatis ex gravitate sola'—acting in the instantaneous direction of the body's motion, that is—'exponetur per  $\frac{CG - CF}{\sqrt{FG}}$ , vel quod perinde est, per  $\frac{FI \sqrt{FG}}{CF}$ , et decrementum velocitatis ex resistentia sola per  $\frac{gf}{\sqrt{Cf}} - \frac{CF}{\sqrt{FG}} + \frac{FI \sqrt{FG}}{CF}$ , et velocitas cadendo genita per  $\sqrt{GF}$ '

(and the increment in speed from gravity alone will be represented by  $(\widehat{CG} - CF)/FG$ , or, what is exactly the same, by  $(FI/CF) \sqrt{FG}$ , and so the decrement in speed from resistance alone by  $gf/\sqrt{Cf} - CF/\sqrt{FG} + (FI/CF) \sqrt{FG}$ , and the speed engendered in falling by  $\sqrt{FG}$ ). The resulting expression  $gf/\sqrt{(Cf \times FG)} - CF/FG + FI/CF$  for the ratio of resistance to gravity is of course



on either hand equal linelets  $DB$ ,  $Bd$ , and erect perpendiculars  $DG$ ,  $dg$  meeting the curve in  $G$  and  $g$ . Extend  $DG$  till it meets the tangent  $CF$  in  $F$ , complete the rectangle  $CBDI$ , and draw the straight line  $gf$  touching the curve at  $g$  and meeting the perpendicular  $BC$  produced in  $f$ . Then the times in which the body describes the arcs  $\widehat{gC}$ ,  $\widehat{CG}$  will be in the halved ratio of the heights  $fC$ ,  $FG$  which the body were by falling from the tangents able to describe, and the speeds as the lengths  $\widehat{gC}$ ,  $\widehat{CG}$  described directly and the times inversely. In consequence, represent the times by  $\sqrt{Cf}$  and  $\sqrt{FG}$ ,<sup>(67)</sup> and so the speeds by  $\widehat{gC}/\sqrt{Cf}$  and  $\widehat{CG}/\sqrt{FG}$  or, what is effectively the same, by  $gf/\sqrt{Cf}$  and  $CF/\sqrt{FG}$ , and the decrement of the speed in time  $\sqrt{FG}$  will be expressed by  $gf/\sqrt{Cf} - CF/\sqrt{FG}$ :<sup>(68)</sup> this decrement arises from the resistance and gravity jointly, the resistance increasing it and gravity diminishing it. Further,  $2FG/\sqrt{FG}$  or  $2\sqrt{FG}$ <sup>(69)</sup> is the speed which the body would acquire by falling in time  $\sqrt{FG}$  and covering the height  $FG$ ; and this speed is to the speed which gravity adds in the same time to the speed of the body in the arc  $\widehat{CG}$  as  $FG$  to  $CG - CF$ , that is,  $IF \times FG/CF$ , and consequently the speed which gravity adds to the speed of the body is

$$2IF \times FG / (CF \times \sqrt{FG}) \quad \text{or} \quad 2IF \times \sqrt{FG} / CF.$$

And so this speed, when added to the previously mentioned decrement of speed arising from the resistance and gravity, makes up the decrement of the speed

erroneous; we leave the reader to confirm that it again produces the faulty measure

$$\frac{3}{2}S \sqrt{(1+Q^2)/R^2} - QR/\sqrt{(1+Q^2)}$$

which was deduced analogously in [4]: note (54) above, and which in the prime instance of the semi-circle  $e = \sqrt{(n^2 - a^2)}$  correspondingly dictates the resistance there to be to gravity as '2a ad n'—and so Newton himself observed, after a rapid checking computation, on his preliminary worksheet f. 197<sup>r</sup>. At this point, on going back through the steps of his prior general reasoning he at last caught the mistake which had, in one form or another, bedevilled all his previous attempts in [1]–[5] to frame a correct argument, and straightaway inserted coefficients '2' at the pertinent places of his preceding sentence, changing it to read 'et incrementum velocitatis ex gravitate sola exponetur per  $\frac{2CG - 2CF}{\sqrt{FG}}$ , vel quod perinde est, per  $\frac{2FI \sqrt{FG}}{CF}$ , et decrementum velocitatis ex resistentia sola per  $\frac{gf}{\sqrt{Cf}} - \frac{CF}{\sqrt{FG}} + \frac{2FI \sqrt{FG}}{CF}$ , et velocitas cadendo genita per  $2\sqrt{GF}$ '; whence the ratio of resistance to gravity ensues *recte* to be as  $\frac{1}{2}gf/\sqrt{(Cf \times FG)} - \frac{1}{2}CF/FG + FI/CF$  to unity. Then on his next manuscript leaf (f. 220<sup>r</sup>) he straightaway refashioned this crucial sentence, augmenting it to make clear why the 'incrementum velocitatis ex gravitate' needs thus to be doubled (compare the next note), and this replacement we here print in sequel, following Newton's instruction in the original (by way of a referent '†') to do so.

(69) Since  $2FG$  is the distance which the body would cover in the time  $\sqrt{FG}$  were it to move uniformly with the speed which, in falling from rest at  $F$  under the downwards pull of gravity, it attains at the point  $G$ . In the terms of note (67) preceding, the same results on scaling down the terminal velocity  $\sqrt{(2g \cdot FG)}$  in the 'exponent' ratio  $\sqrt{(\frac{1}{2}g)}$ .

sola oriundum  $\frac{gf}{\sqrt{Cf}} - \frac{CF}{\sqrt{FG}} + \frac{2IF \times \sqrt{FG}}{CF}$ . Proindeq̄ resistentia est ad vim gravitatis ut  $\frac{gf}{\sqrt{Cf}} - \frac{CF}{\sqrt{FG}} + \frac{2IF \sqrt{FG}}{CF}$  ad  $2\sqrt{FG}$  sive ut  $\frac{gf}{2\sqrt{Cf} \times \sqrt{FG}} - \frac{CF}{2FG} + \frac{IF}{CF}$  ad 1.<sup>(70)</sup>

Est autem resistentia ut Medij densitas et quadratum velocitatis conjunctim, & propterea densitas Medij ut resistentia directe & quadratum velocitatis inverse, id est ut  $\frac{gf}{2\sqrt{Cf} \times \sqrt{FG}} - \frac{CF}{2FG} + \frac{IF}{CF} \times \frac{FG}{CG^2}$ . Q.E.I.

Corol. 1. Resistentia est ad gravitatem ut  $\frac{gf}{Cf+FG} - \frac{CF}{2FG} + \frac{IF}{CF}$  ad 1. Nam pro  $2\sqrt{Cf \times FG}$ <sup>(71)</sup> scribere licet  $Cf + FG$ .

Corol. 2. Si curva linea [definiatur per relationem inter basem seu abscissam] . . . ut in Exemplis sequentibus.<sup>(72)</sup>

Exempl. 1. Sit linea ACK semicirculus super diametro AK descriptus, & requiratur Medij densitas quæ faciat ut projectile in hac linea moveatur.

Bisecetur semicirculi diameter AK in O, et dic OK n, OB a, BC e et BD vel Bd o; et erit DG<sup>2</sup> seu

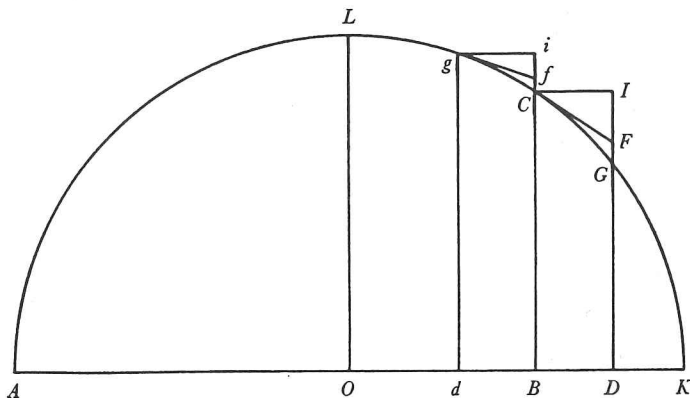

OG<sup>2</sup> - OD<sup>2</sup> æquale  $nn - aa - 2ao - oo$  seu  $ee - 2ao - oo$ ; et radice per methodum nostram extracta, fiet  $DG = e - \frac{ao}{e} - \frac{oo}{2e} - \frac{aaoo}{2e^3} - \frac{ao^3}{2e^3} - \frac{a^3o^3}{2e^5} - \&c.$  Hic scribatur  $nn$  pro  $ee + aa$  et evadet  $DG = e - \frac{ao}{e} - \frac{nnoo}{2e^3} - \frac{anno^3}{2e^5} - \&c.$

(70) Et voilà! In the analytical equivalent in which the general point C(a, e) of the path LCK is defined by some given relationship  $e = e_a$  between the abscissa OB = a and ordinate BC = e, on expanding the incremented ordinate DG = e<sub>a+o</sub> as the series  $e + Qo + Ro^2 + So^3 + \dots$  (where, as ever,  $Q \equiv Q_a = de/da$ ,  $R \equiv R_a = \frac{1}{2}dQ/da$ ,  $S \equiv S_a = \frac{1}{3}dR/da$ , ...) there is once more  $IF = Qo$ ,  $GF = Ro^2 + So^3 + \dots$  and so  $CF = o\sqrt{1 + Q^2}$ ; while corresponding to the decremented ordinate  $dg = e_{a-o}$  there is likewise

$$Cf = R_{a-o}o^2 + S_{a-o}o^3 + \dots \text{ or } (R - 3So\dots) o^2 + (S - \dots) o^3\dots = Ro^2 - 2So^3\dots$$

and  $gf = o\sqrt{1 + Q_{a-o}^2}$  or  $o\sqrt{1 + (Q - 2Ro\dots)^2} = o\sqrt{1 + Q^2} - 2(QR/\sqrt{1 + Q^2}) o^2\dots$ ;  
so that  $\sqrt{Cf \times GF} = \sqrt{(R^2o^4 - RSo^5\dots)} = Ro^2 - \frac{1}{2}So^3\dots$ ,

and therefore the ratio of resistance to gravity comes at last correctly to be

$$\frac{o\sqrt{1 + Q^2} - 2(QR/\sqrt{1 + Q^2}) o^2\dots}{2(Ro^2 - \frac{1}{2}So^3\dots)} - \frac{o\sqrt{1 + Q^2}}{2(Ro^2 + So^3\dots)} + \frac{Q}{\sqrt{1 + Q^2}} = \frac{3S\sqrt{1 + Q^2}o^4\dots}{4R^2o^4 + 2RSo^5}$$



arising from the resistance alone  $gf/\sqrt{Cf - CF}/\sqrt{FG} + 2IF \times \sqrt{FG}/CF$ . As a result, the resistance is to the force of gravity as  $gf/\sqrt{Cf - CF}/\sqrt{FG} + 2IF \times \sqrt{FG}/CF$  to  $2\sqrt{FG}$ , or as  $gf/2\sqrt{(Cf \times FG) - CF}/2FG + IF/CF$  to 1.<sup>(70)</sup>

The resistance, however, is as the density of the medium and the square of the speed jointly, and accordingly the density of the medium is as the resistance directly and the square of the speed inversely, that is, as

$$(gf/2\sqrt{(Cf \times FG) - CF}/2FG + IF/CF) \times FG/CG^2.$$

As was to be found.

*Corollary 1.* The resistance is to gravity as  $gf/(Cf + FG) - CF/2FG + IF/CF$  to 1. For in place of  $2\sqrt{(Cf \times FG)}$ <sup>(71)</sup> it is allowable to write  $Cf + FG$ .

*Corollary 2.* If the curved line be defined by a relationship between the base or abscissa . . . as in the following examples.<sup>(72)</sup>

*Example 1.* Let the line  $ACK$  be a semicircle described upon diameter  $AK$ , and let there be required the density of the medium which shall make a projectile move in this line.

Bisect the semicircle's diameter  $AK$  at  $O$ , and call  $OK = n$ ,  $OB = a$ ,  $BC = e$  and  $BD$  or  $dB = o$ : then will  $DG^2$ , that is,  $OG^2 - OD^2$ , be equal to

$$n^2 - a^2 - 2ao - o^2 \quad \text{or} \quad e^2 - 2ao - o^2;$$

and, when the root is extracted by our method, there will come

$$DG = e - (a/e)o - \frac{1}{2}(1/e + a^2/e^3)o^2 - \frac{1}{2}(a/e^3 + a^3/e^5)o^3 - \dots$$

Here write  $n^2$  in place of  $e^2 + a^2$  and there will prove to be

$$DG = e - (a/e)o - \frac{1}{2}(n^2/e^3)o^2 - \frac{1}{2}(an^2/e^5)o^3 - \dots$$

that is,  $\frac{3}{2}S\sqrt{(1+Q^2)}/R^2$  in the limit as the infinitesimal increment (decrement)  $BD = dB = o$  becomes zero. For any particular resisted path, let us observe, the values of  $Cf$  and  $gf$  are readily computable from first principles by direct calculation of  $Q_{a-o}$  and  $R_{a-o}$  without pausing separately to evaluate their equivalents  $Q - 2Ro + 3So^2 \dots$  and  $R - 3So + \dots$  respectively; and so Newton determines these in sequel in his prime instance of the semicircle in 'Exempl. 1' following (see note (75) below).

In a cancelled final sentence of the manuscript paragraph Newton initially went on to notice that 'Hic pro  $2\sqrt{Cf \times \sqrt{FG}}$  scribi potest  $Cf + FG$ . Et sic gravitas erit ad resistentiam [!] ut  $\frac{gf}{Cf + FG} - \frac{CF}{2FG} + \frac{IF}{CF}$  ad 1' (Here in place of  $2\sqrt{Cf \times \sqrt{FG}}$  there can be written  $Cf + FG$ . And thus [resistance] will be to [gravity] as  $gf/(Cf + FG) - CF/2FG + IF/CF$  to 1)—and make two further reductions of the ratio to would-be simpler terms which in fact increase its complexity (and in the latter of which he errs in confusing  $Cf$  with  $CF$ )—before delaying this remark to be a separate 'Corol. 1' to his main argument. Correspondingly, ' $Cf + FG$ ' was first written in place of ' $2\sqrt{Cf \times \sqrt{FG}}$ ' in the ensuing paragraph.

(71) That is,  $\sqrt{((Cf + GF)^2 - (-Cf + GF)^2)}$ , where (see the previous note)  $GF = Ro^2 + So^3 \dots$  and  $Cf = Ro^2 - 2So^3 \dots$ , and so their difference  $3So^3$  will, in the limit as  $o$  vanishes, come to be infinitely less than their sum  $2Ro^2 - So^3 \dots$

(72) Understand the text of 'Corol. 2' as it is printed in the *editio princeps* of the *Principia* (1687: 263 [= pages 376-8 below]).

Hujusmodi series distinguo in terminos successivos in hunc modum. Terminum primum . . . . . [Terminus quartus qui hic est]  $\frac{anno^3}{2e^5}$  determinat variationem Curvaturæ . . . & curvatura Curvarum.<sup>(73)</sup>

Præterea  $CF$  est latus quadratum ex  $CI^q$  et  $IF^q$  hoc est ex  $oo$  et  $\frac{aao}{ee}$  sive  $\frac{nnoo}{ee}$ , ideoq̄ est  $\frac{no}{e}$ . Et linea  $DG$  mutando signum ipsius  $o$ , vertitur in lineam

$dg = e + \frac{ao}{e} - \frac{nnoo}{2e^3} + \frac{anno^3}{2e^5}$  &c. Unde habetur  $Ci = \frac{ao}{e} - \frac{nnoo}{2e^3} + \frac{anno^3}{2e^5}$  &c. Et lineæ  $GF$  et  $CF$  scribendo  $Od$  pro  $OB$ <sup>(74)</sup> et  $dg$  pro  $BC$  vertuntur in  $Cf$  et  $gf$ . Et inde prodeunt  $Cf = \frac{nnoo}{2e^3} - \frac{anno^3}{e^5}$  et  $gf = \frac{no}{e} - \frac{aano}{e^3}$ .<sup>(75)</sup>

$$\left[ \text{Unde } \frac{gf}{Cf+GF} - \frac{CF}{2GF} = \right] \frac{\frac{nnoo}{2} - \frac{anno^3}{ee}}{\frac{nnoo}{2} + \frac{anno^3}{2ee}} - \frac{\frac{no}{ee} + \frac{anno^3}{e^4}}{\frac{nnoo}{2} + \frac{anno^3}{2ee}}$$

$$[\text{sive}] \frac{\frac{ee-ao}{no} - \frac{e^4}{noe+ano}}{\frac{no}{2ee}} = \frac{[+]\frac{1}{2}aeeano}{eeano} = +\frac{a}{2n}$$

$$\left[ \text{ut et } \frac{FI}{CF} = \frac{a}{n}. \text{ Fit resistentia ad gravitatem ut } \frac{a}{2n} \right] + \frac{a}{n} \text{ ad } 1 \text{ seu } 3a \text{ ad } 2n.<sup>(76)</sup>$$

(73) Here understand the third paragraph of 'Exempl. 1' in the 1687 text [= pages 378-9 below], with the minor replacement of 'exhibet' (p. 264, l. 12) by 'determinat'.

(74) That is, 'a-o pro a' (a-o in place of a).

(75) As his preliminary computation on f. 201<sup>v</sup> places beyond doubt—except that he there made the slip of calculating  $Cf$  to be  $R_{a+o}o^2 + S_{a+o}o^3 + O(o^4)$ , that is,

$$\frac{'nnoo, ee - 2ao + ano^3'}{2e^5 - 10e^3ao} = \frac{nnoo}{2e^3} + \frac{4anno^3}{2e^5}$$

—Newton derives these values of the lengths of  $Cf$  and  $gf$  as

$$(R_{a-o}o^2 + S_{a-o}o^3 =) \frac{1}{2}(n^2/e_{a-o}^3) o^2 + \frac{1}{2}(an^2/e_{a-o}^5) o^3 \quad \text{and} \quad (o\sqrt{1+Q_{a-o}^2} =) no/e_{a-o}$$

respectively, in each case rounding off the ensuing series in ascending powers of  $o$  to their first two terms which are alone pertinent to the remaining stages of the computation. At this crucial stage in his computation he abandons verbal explanation in his anxiety to gain the end



Series of this sort I distinguish into their successive terms in this fashion. The first term . . . . . The fourth term, here  $\frac{1}{2}(an^2/e^5) o^3$ , determines the variation of the curvature. . . and the curvature of curves.<sup>(73)</sup>

Moreover,  $CF$  is the square root of  $CI^2 + IF^2$ , that is, of  $o^2 + (a^2/e^2) o^2$  or  $(n^2/e^2) o^2$ , and is consequently  $(n/e) o$ . And the line  $DG$ , by changing the sign of  $o$ , turns into the line  $dg = e + (a/e) o - \frac{1}{2}(n^2/e^3) o^2 + \frac{1}{2}(an^2/e^5) o^3 \dots$ . Whence there is had  $Ci = (a/e) o - \frac{1}{2}(n^2/e^3) o^2 + \frac{1}{2}(an^2/e^5) o^3 \dots$ . And the lines  $GF$  and  $CF$ , on writing  $Od$  in place of  $OB$ <sup>(74)</sup> and  $dg$  in place of  $BC$ , turn into  $Cf$  and  $gf$ . And thence there result  $Cf = \frac{1}{2}(n^2/e^3) o^2 - (an^2/e^5) o^3$  and  $gf = (n/e) o - (an/e^3) o^2$ .<sup>(75)</sup> Whence

$$gf/(Cf+GF) - CF/2GF \\ = (e^2no - ano^2)/(n^2o^2 - \frac{1}{2}(an^2/e^2) o^3) - no/((n^2/e^2) o^2 + (an^2/e^4) o^3),$$

that is,

$$(e^2 - ao)/(no - \frac{1}{2}(an/e^2) o^2) - e^4/(e^2no + ano^2) = \frac{1}{2}ae^2no^2/e^2n^2o^2 = \frac{1}{2}a/n,$$

and also  $FI/CF = a/n$ . The resistance comes, therefore, to be to the gravity as  $\frac{1}{2}a/n + a/n$  to 1, that is,  $3a$  to  $2n$ .<sup>(76)</sup>

result, and the mathematical calculations themselves are set down *staccato*. We have made suitable editorial interpolations to bring out their sense.

(76) Correct at last! With tangible relief Newton passed straightaway to jot down a minimal augmentation of his preceding paragraph—in which, between '...negligi possunt.' and 'Terminus quartus...' (*Principia*, 1687: 264, l. 11), there was now to be inserted the additional sentence 'In hoc Problemate pro lineola  $FG$  adhibemus terminum tertium et quartum' (In this problem in place of the linelet  $FG$  we employ the third and fourth terms)—and then, immediately beneath, dashed off the draft of a short letter to Niklaus Bernoulli: 'I send you inclosed the solution of y<sup>e</sup> Probleme about the density of resisting Mediums set right. I desire you to shew it to your Unkle & return my thanks to him for sending me notice of y<sup>e</sup> mistake' (f. 219<sup>v</sup>; see also *Correspondence of Isaac Newton*, 5, 1975: 348). This 'solution' was, we may presume, the carefully tidied and slightly augmented revision of the present paper which is reproduced (from the original at Add. 3965.12: 190<sup>r</sup>–191<sup>r</sup>) in §2.1 next following. But whether Johann's nephew in fact received his intended copy of it there is (see §2: note (2) below) every reason to doubt.

Subsequently, we may add, Newton used the considerable blank space remaining at the bottom of f. 219<sup>v</sup> (continuing on f. 220<sup>v</sup>) to draft the preliminary reworking of the latter half of §2.1 which is set out in Appendix 2.4, and at a yet later time—one more witness to what was never far from the forefront of his mind in this autumn of 1712—he penned on a still vacant area at the foot of f. 220<sup>r</sup> his rough initial essay at what were to be notes \* and \*\* on page 104 of his anonymous edition (soon to go to press under the Royal Society's *imprimatur*) of the *Commercium Epistolicum D. Johannis Collins et Aliorum de Analysi promota* by which he sought 'impartially' to document his historical claim to be first inventor of the calculus, against Leibniz' counter-assertion of his own prior and essentially independent discovery.

§2. REFINING THE CORRECTED ARGUMENT,  
CONTRIVING A VARIANT MODE OF PROOF, AND  
MOULDING THE WHOLE TO FILL THE  
SAME PRINTED SPACE.<sup>(1)</sup>

[1]<sup>(2)</sup>*Prop. X. Prob. III.*

*Tendat uniformis vis gravitatis directe ad planum Horizontis, sitq̄ resistentia ut Medij densitas et quadratum velocitatis conjunctim: requiritur tum Medij densitas in locis singulis, quæ faciat ut corpus in data quavis linea curva moveatur, tum corporis velocitas et Medij resistentia in locis singulis.*

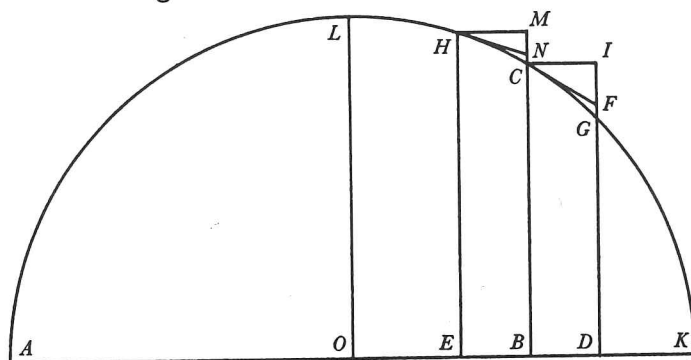

Sit  $AK$  planum illud plano schematis perpendiculare,  $ALCK$  linea curva,  $C$  corpus in ipsa motum, et  $CF$  recta ips[a]m tangens in  $C$ . Fingatur corpus  $C$  progredi ab  $L$  ad  $K$  per lineam illam  $ACK$ , et interea impediri a Medio resistente.

(1) Having by the beginning of October 1712 (in the rough first casting reproduced in §1.6 preceding) finally attained a correct measure of the resistance to gravity in a projectile's given path of fall through an impeding medium, Newton now proceeds at a deal more leisurely pace, first (in [1]) to write out its derivation in a neater and verbally amplified form; then (in [2]) to fashion an alternative mode of argument whereby the opposing forces of resistance and of gravity—hitherto presumed continuous in their action—are assumed equivalently to be impressed 'instantaneously' as discrete impulses at successive moments of time; and lastly (in [3]) further to refashion the primary approach through continuously acting resistance and gravity into a form which differs only in inessential fine details from that which three months afterwards, early in January 1713, he sent to Cotes in Cambridge for inclusion in the second edition of the *Principia*.

(2) Add. 3965.12: 190<sup>r</sup>–191<sup>r</sup>, an augmented elaboration (by way of a much rougher intermediate outline on f. 194 which lacks the present last paragraph and concluding sentence of the penultimate one) of §1.6 preceding. From the unusually careful way in which Newton has penned the original, we must presume that this is the 'solution' of the problem of resisted motion 'set right' which in his first flush of generosity—until at least his dour native unforthcomingness took hold—he intended (see §1: note (76)) to communicate to Niklaus Bernoulli (then still in London) for onward transmission to his uncle Johann in Basel. Abraham de Moivre, our sole reporter on the spot of what in fact took place, informed Johann a few days



## Translation

[1]<sup>(2)</sup>

## Proposition X, Problem III.

Let the uniform force of gravity tend directly to the plane of the horizon, and let the resistance be as the density of the medium and the square of the speed jointly: there is required both the density of the medium at individual places which shall make a body move in any given curved line, and the speed of the body and the resistance of the medium at individual places.

Let  $AK$  be that plane perpendicular to the plane of the figure,  $ALCK$  the curved line,  $C$  the body moved in it and  $CF$  a straight line touching it at  $C$ . Imagine the body  $C$  to advance from  $L$  to  $K$  by way of that line  $ACK$  and all the

after the event that 'Monsieur Newton, . . . ayant . . . corrigé la conclusion, . . . me montra sa correction, et elle se trouva conforme au calcul de M. votre neveu; là-dessus il ajouta qu'il avoit dessein de voir M. votre neveu pour l'en remercier, et me pria de le mener chez lui, ce que je fis' (Wollenschläger, 'Briefwechsel' (§1: note (1)): 271). When he came face to face with Niklaus, Newton reassured him in a general way that the error in his 1687 argument proceeded—in de Moivre's words (*ibid.*)—'d'avoir considéré une tangente à rebours' (*viz.* taking the motion in the arc  $\widehat{gC}$  to be approximated by that along the tangent at its end-point  $C$  and not that along the one at  $g$ , correspondingly as the tangent at  $C$  approximates the motion along the successive arc  $\widehat{CG}$ , in the terms of his original figure), but that 'le fondement de son calcul et les suites dont il s'est servi doivent subsister'. No script, however, where Newton penned out a corrected working of his problem would seem then to have changed hands; and a few weeks later, when Niklaus described his London visit to Johann, he wrote only briefly and vaguely that his [!] 'objection against Mr Newton' had led the latter to make 'a correction to his second edition', which Johann had to infer concerned 'the [problem of] resistance' which, he had shown, was 'incorrectly determined' in the case of the circle and the 'other curves' in which Newton had instanced his solution. (Niklaus' letter of ?early November 1712 to his uncle reporting upon his stay in London is lost, but we paraphrase the pertinent portion of Johann's yet unpublished reply on 23 November (N.S.), now in Basel University Library (MS. L Ia 22.9), where he wrote: 'Ich hätte wohl wünschen mögen zu wissen worin Ewer Objection wider H[errn] Newton bestanden, darauff Er eine Correction in seiner newen edition gemacht und euch davon eine Copie zugestellet, dan ich forchte es seye just eine von meinen remarques als zum exempel betreffend die resistenz, so Er unrecht in dem circul und anderen *curvis* determinieret', adding the revealing aside that 'darüber ich etwas zu schreyben under händen habe umb in den *actis Lips.* zu publizieren [-> 'De motu Corporum gravium, Pendulorum, & Projectilium in mediis non resistentibus & resistentibus supposita Gravitate uniformi & non uniformi atque ad quodvis datum punctum tendente, et de variis aliis huc spectantibus, Demonstrationes Geometricæ', *Acta Eruditorum* (February/March 1713): 77-95/115-32, especially 91-3; on which see Appendix 1: note (14) below] welches aber zimlich schlecht stehen würde wann mich der H. Newton mit seiner correction prævenierte'. Johann Bernoulli wrote in similar terms to de Moivre the same day (see Wollenschläger, 'Briefwechsel': 276) that he was 'impatient de voir la nouvelle impression des *Princ. Math. phil. natur.* de M. Newton, que mon neveu me marque qu'elle sera achevée dans ce présent mois [November 1712]; comme je suis sur le point d'achever un petit écrit contenant quelquesunes de mes remarques que je fis autrefois sur la vieille édition, et que je publierai peut-être cet écrit dans les Actes de Leipsic, je serois bien aise de voir si j'auerois eu le bonheur de me rencontrer avec M. Newton dans les nouvelles additions et corrections que l'on trouvera, à ce qu'on me dit, dans cette seconde

A puncto  $C$  ad rectam  $AK$  horizonti parallelam demittatur perpendiculum  $CB$ , et in recta illa sumantur hinc inde lineolæ æquales  $EB$ ,  $BD$ , et erigantur perpendicula  $EH$ ,  $DG$  curvæ occurrentia in  $H$  et  $G$ . Producat  $DG$  donec tangenti  $CF$  occurrat in  $F$ , compleatur parallelogrammum  $CBDI$ , et agatur recta  $HN$  curvam tangens in  $H$  & perpendiculo  $[BC]$  producto occurrens in  $N$ . Et tempora quibus corpus describit arcus  $HC$ ,  $CG$  erunt in subduplicata ratione altitudinum  $NC$ ,  $FG$  quas corpus temporibus illis describere posset a tangentibus cadendo, et velocitates erunt ut longitudines descriptæ  $HC$ ,  $CG$  directe et tempora inverse. Exponentur tempora per  $\sqrt{CN}$  et  $\sqrt{FG}$  et velocitates per  $\frac{HC}{\sqrt{CN}}$  et  $\frac{CG}{\sqrt{FG}}$ , vel quod perinde est, per  $\frac{HN}{\sqrt{CN}}$  et  $\frac{CF}{\sqrt{FG}}$ : et decrementum velocitatis tempore  $\sqrt{FG}$  factum exponetur per  $\frac{HN}{\sqrt{CN}} - \frac{CF}{\sqrt{FG}}$ . Hoc decrementum oritur a resistentia corpus retardante & gravitate corpus accelerante, et augeri debet ea velocitatis parte quam gravitas generat, ut habeatur decrementum velocitatis a resistentia sola oriundum. Gravitas in corpore cadente & spatium  $FG$  cadendo describente generat velocitatem  $\frac{2FG}{\sqrt{FG}}$  seu  $2\sqrt{FG}$ , at in corpore arcum  $CG$  describente generat velocitatem  $\frac{2CG - 2CF}{\sqrt{GF}}$ , id est  $\frac{2FI\sqrt{FG}}{CF}$ . Est enim  $CF$  ad  $FI$  ut  $FG$  ad  $CG - CF$ .<sup>(3)</sup> Addatur hæc velocitas ad decrementum prædictum et habebitur decrementum velocitatis ex resistentia sola oriundum, nempe

$$\frac{HN}{\sqrt{CN}} - \frac{CF}{\sqrt{FG}} + \frac{2FI\sqrt{FG}}{CF}.$$

Proindeq; resistentia est ad gravitatem ut  $\frac{HN}{\sqrt{CN}} - \frac{CF}{\sqrt{FG}} + \frac{2FI\sqrt{FG}}{CF}$  ad  $2\sqrt{FG}$ , sive ut  $\frac{HN}{2\sqrt{CN \times FG}} - \frac{CF}{2FG} + \frac{FI}{CF}$  ad 1. Et cum resistentia sit ut densitas Medij et quadratum velocitatis conjunctim, densitas Medij erit ut resistentia directe et

---

édition. Mon neveu me mande, qu'il a eu l'honneur de faire à M. Newton une petite[!] objection, laquelle lui doit avoir donné lieu d'ajouter quelque correction à sa nouvelle édition de ses *Principes*; je ne sçais si c'est justement quelqu'une de mes remarques que mon neveu a vû ici. . . .) In later years neither Niklaus nor his uncle ever spoke of having been shown a preliminary version of the corrected argument of the *editio secunda*. Let us add the clincher that the present text was, almost before its ink was dry, further amended in Newton's usual perfectionist manner both by minor replacements and interlineations in the manuscript itself, and then by the more radical recasting of its latter half which is reproduced in Appendix 2.4 below. Newton would never have handed over to the Bernoullis' microscopic inspection an already superseded version of his revised reasoning!

(3) Clearly dissatisfied with his wording of this sentence, Newton subsequently roughed



while to be impeded by the resisting medium. From the point  $C$  to the straight line  $AK$ , parallel to the horizon, let fall the perpendicular  $CB$ , and in that line on either hand take equal linelets  $EB$  and  $BD$ , and erect the perpendiculars  $EH$  and  $DG$  meeting the curve in  $H$  and  $G$ . Extend  $DG$  till it meets the tangent  $CF$  in  $F$ , complete the rectangle  $CBDI$ , and draw the straight line  $HN$  touching the curve at  $H$  and meeting the perpendicular  $BC$  produced in  $N$ . And the times in which the body describes the arcs  $\widehat{HC}$  and  $\widehat{CG}$  will be in the halved ratio of the heights  $NC$  and  $FG$  which the body would in those times be able to describe by falling from the tangents, and the speeds will be as the lengths  $\widehat{HC}$  and  $\widehat{CG}$  described directly and the times inversely. Represent the times by  $\sqrt{CN}$  and  $\sqrt{FG}$ , and the speeds by  $\widehat{HC}/\sqrt{CN}$  and  $\widehat{CG}/\sqrt{FG}$ , or, what is effectively the same, by  $HN/\sqrt{CN}$  and  $CF/\sqrt{FG}$ , and then the decrement of the speed attained in time  $\sqrt{FG}$  will be represented by  $HN/\sqrt{CN} - CF/\sqrt{FG}$ . This decrement arises from the resistance retarding the body and gravity accelerating it, and must be increased by the part of the speed which gravity generates in order to have the decrement of the speed arising from the resistance alone. Gravity in a falling body which, as it falls, describes the distance  $FG$  generates the speed  $2FG/\sqrt{FG}$ , that is,  $2\sqrt{FG}$ , but in the body describing the arc  $\widehat{CG}$  it generates the speed

$$2(\widehat{CG} - CF)/\sqrt{FG},$$

that is,  $2FI \times \sqrt{FG}/CF$ ; for there is  $CF$  to  $FI$  as  $FG$  to  $\widehat{CG} - CF$ .<sup>(3)</sup> Add this speed to the above-mentioned decrement and there will be had the decrement of the speed arising from the resistance alone, namely

$$HN/\sqrt{CN} - CF/\sqrt{FG} + 2FI \times \sqrt{FG}/CF.$$

Accordingly, the resistance is to gravity as  $HN/\sqrt{CN} - CF/\sqrt{FG} + 2FI \times \sqrt{FG}/CF$  to  $2\sqrt{FG}$ , or as  $HN/2\sqrt{CN \times FG} - CF/2FG + FI/CF$  to 1. And since the resistance is as the density of the medium and the square of the speed jointly, the

---

out on the verso of a loose folio worksheet (now Add. 3968.41: 119) an elaboration where he would have it read '[Gravitas in corpore cadente &] spatium  $FG$  cadendo describente generat velocit[at]em qua duplum illud spatium  $2FG$  eodem tempore describi posset,<sup>1)</sup> ut ex demonstratis Galilæi notum est, id est velocitatem quæ exponitur per spatium  $2FG$  applicatum ad tempus  $\sqrt{FG}$ ,<sup>2)</sup> hoc est velocitatem  $2\sqrt{FG}$ : at in corpore arcum  $CG$  [describente] generat tantum velocitatem quæ sit ad hanc velocitatem ut  $CG - CF$  ad  $FG$  vel  $FI$  ad  $CF$ , id est velocitatem  $\frac{2FI}{CF} \sqrt{FG}$ ' ([Gravity in a falling body which] in falling describes the distance  $FG$  generates a speed whereby twice that distance,  $2FG$ , were able to be described in the same time, as is known from Galileo's demonstrations; that is, a speed which is expressed through the distance  $2FG$  divided by the time  $\sqrt{FG}$ , or a speed  $2\sqrt{FG}$ : but in the body describing the arc  $\widehat{CG}$  it generates merely a speed which is to this one as  $\widehat{CG} - CF$  to  $FG$  or  $FI$  to  $CF$ , that is, a speed  $2(FI/CF) \sqrt{FG}$ ). On Newton's precise knowledge of the 'demonstrata Galilæi' which he here cites, see note (14) below.

quadratum velocitatis inverse, id est ut  $\frac{HN}{2\sqrt{CN \times FG}} - \frac{CF}{2FG} + \frac{FI}{CF}$  in  $\frac{FG}{CG^2}$ .  
Q.E.I.<sup>(4)</sup>

*Corol. 1.* Resistentia est ad gravitatem ut  $\frac{HN}{CN+FG} - \frac{CF}{2FG} + \frac{FI}{CF}$  ad 1. Nam pro  $2\sqrt{CN \times FG}$  scribere licet  $CN+FG$ .<sup>(5)</sup>

*Corol. 2.* Densitas Medij est ut  $\frac{HN}{CN+FG} - \frac{CF}{2FG} + \frac{FI}{CF}$  in  $\frac{FG}{CF^2}$ .

*Corol. 3.* Et hinc si curva linea definiatur per relationem inter basem seu abscissam  $AB$  et ordinatim applicatam  $BC$  (ut moris est) et valor ordinatim applicatæ resolvatur in seriem convergentem: Problema per primos seriei terminos expedite solvetur ut in Exemplis sequentibus.

*Exempl. 1.* Sit linea  $ACK$  semicirculus super diametro  $AK$  descriptus, et requiratur Medij densitas quæ faciat ut projectile moveatur in hac linea.

Bisecetur semicirculi diameter  $AK$  in  $[O]$  et dic  $OK$   $n$ ,  $OB$   $a$ ,  $BC$   $e$ , et  $BD$  vel  $BE$   $o$ , et erit  $DG^2$  seu  $OG^2 - OD^2$  æquale  $nn - aa - 2ao - oo$ , seu  $ee - 2ao - oo$ , et radice per methodum nostram extracta fiet

$$DG = e - \frac{ao}{e} - \frac{oo}{2e} - \frac{aao}{2e^3} - \frac{ao^3}{2e^3} - \left[ \frac{a^3o^3}{2e^5} \right] - \&c.$$

Hic scribatur  $nn$  pro  $aa + ee$  et evadet  $DG = e - \frac{ao}{e} - \frac{nnoo}{2e^3} - \frac{anno^3}{2e^5} - \&c.$

Hujusmodi series distinguo in terminos successivos in hunc modum. Terminum primum appello in quo quantitas infinite parva  $o$  non extat; secundum in quo quantitas illa extat unius dimensionis; tertium in quo extat duarum; quartum in quo trium est,<sup>6</sup> et sic in infinitum. Et primus terminus qui hic est  $e$ , denotabit semper longitudinem ordinatæ  $BC$  insistentis ad indefinitæ quantitatis initium  $B$ ; secundus terminus qui hic est  $\frac{ao}{e}$ , denotabit differentiam inter  $BC$  &  $DF$ , id est lineolam  $IF$  quæ abscinditur complendo parallelogrammum  $BCID$ , atq; adeo positionem tangentis  $CF$  semper determinat: ut in hoc casu capiendo  $IF$  ad  $IC$  ut est  $\frac{ao}{e}$  ad  $o$  seu  $a$  ad  $e$ .<sup>(6)</sup> Terminus tertius & sequentes  $\frac{nnoo}{2e^3} + \frac{anno^3}{2e^5} + \&c$  designabunt lineolam  $FG$  quæ jacet inter tangentem et curvam, adeoq; determinant angulum contactus  $FCG$ , seu curvaturam quam Curva linea habet in  $C$ . Si lineola illa  $FG$  minuatur in infinitum, termini subsequentes evadent infinite minores tertio ideoq; negligi possunt, & solus terminus tertius curvaturam

(4) Except for renaming the decremented ordinate  $dg$  now to be  $EH$  (and correspondingly altering the lower-case denotations of the old points  $f$  and  $i$  here to be  $N$  and  $M$  respectively), this is all virtually word for word as in §1.6 preceding. What hereafter follows in the ensuing paragraphs is more considerably amplified and improved in its statement (and will be yet



density of the medium will be as the resistance directly and the square of the speed inversely, that is, as  $(HN/2\sqrt{(CN \times FG) - CF/2FG + FI/CF}) \times FG/CG^2$ . As was to be found.<sup>(4)</sup>

*Corollary 1.* The resistance is to gravity as  $NH/(CN + FG) - CF/2FG + FI/CF$  to 1. For in place of  $2\sqrt{(CN \times FG)}$  it is allowable to write  $CN + FG$ .<sup>(5)</sup>

*Corollary 2.* The density of the medium is as

$$(HN/(CN + FG) - CF/2FG + FI/CF) \times FG/CF^2.$$

*Corollary 3.* And hence if the curved line be defined by a relationship between the base or abscissa  $AB$  and ordinate  $BC$  (as is customary) and the value of the ordinate be resolved into a converging series, the problem will promptly be solved through the first terms of the series, as in the following examples.

*Example 1.* Let the line  $ACK$  be a semicircle described upon diameter  $AK$ , and let there be required the density of the medium which shall make a projectile move in this line.

Bisect the semicircle's diameter  $AK$  in  $O$  and call  $OK = n$ ,  $OB = a$ ,  $BC = e$  and  $BD$  or  $EB = o$ , and then  $DG^2$ , that is,  $OG^2 - OD^2$ , will be equal to

$$n^2 - a^2 - 2ao - o^2,$$

that is,  $e^2 - 2ao - o^2$ , and when the root is extracted by our method there will come  $DG = e - (a/e)o - \frac{1}{2}(1/e + a^2/e^3)o^2 - \frac{1}{2}(a/e^3 + a^3/e^5)o^3 - \dots$ . Here write  $n^2$  in place of  $a^2 + e^2$  and there will prove to be

$$DG = e - (a/e)o - \frac{1}{2}(n^2/e^3)o^2 - \frac{1}{2}(an^2/e^5)o^3 - \dots$$

Series of this sort I distinguish into their successive terms in this manner. The first term I call that in which the indefinitely small quantity  $o$  does not occur; the second that in which it occurs of one dimension; the third that in which it occurs of two; the fourth that in which it occurs of three, and so on indefinitely. And the first term, here  $e$ , will ever denote the length of the ordinate  $BC$  standing at the beginning,  $B$ , of the indefinite quantity; the second term, here  $(a/e)o$ , will denote the difference between  $BC$  and  $DF$ , i.e. the linelet  $IF$  which is cut off by completing the rectangle  $BCID$ , and hence ever determines the position of the tangent  $CF$ —in this case, specifically, by taking  $IF$  to  $IC$  as  $(a/e)o$  to  $o$ , that is,  $a$  to  $e$ .<sup>(6)</sup> The third and following terms,  $\frac{1}{2}(n^2/e^3)o^2 + \frac{1}{2}(an^2/e^5)o^3 + \dots$ , will designate the linelet  $FG$  which lies between the tangent and the curve, and hence determines the angle of contact  $\widehat{FCG}$ , or the curvature which the curve has at  $C$ ; should that linelet  $FG$  be diminished infinitely, the subsequent terms will prove to be infinitely less than the third, and can consequently be neglected, the third term alone determining the curvature. The fourth term, here

---

more radically changed in the draft revision of this latter portion which is reproduced in Appendix 2.4 below).

(5) See §1: note (71) above, *mutatis mutandis*.

(6) The following sentence is copied without deviation from the preliminary draft on f. 200r.

determinabit. Terminus quartus qui hic est  $\frac{anno^3}{2e^5}$  exhibet variationem Curvaturæ; quintus variationem variationis, & sic deinceps.<sup>(7)</sup> Unde obiter patet usus non contemnendus harum serierum in solutione Problematum quæ pendent a tangentibus & curvatura Curvarum.

Præterea  $CF$  est latus quadratum ex  $CI^a$  &  $IF^a$  hoc est ex  $oo + \frac{aao}{ee}$  sive ex  $\frac{nnoo}{ee}$ , ideoq; est  $\frac{no}{e}$ . Et linea  $DG$  mutando signum ipsius  $o$  vertitur in lineam  $EH$ , et lineolæ  $GF$  ac  $CF$  scribendo  $OE$  pro  $OB$  et  $EH$  pro  $BC$  vertuntur in lineolas  $CN$  et  $HN$ . Inde q; prodeunt

$$EH = a + \frac{ao}{e} - \frac{nnoo}{2e^3} + \frac{anno^3}{2e^5} - \&c, \quad CN = \frac{nnoo}{2e^3} - \frac{anno^3}{e^5},$$

$$HN = \frac{no}{e} - \frac{aoo}{e^3}, \quad \text{et} \quad \frac{HN}{CN+FG} - \frac{CF}{2FG} + \frac{FI}{CF} = \frac{3a}{2n} \quad (8)$$

Est igitur resistentia ad gravitatem ut  $\frac{3a}{2n}$  ad 1 sive  $3a$  ad  $2n$ , et densitas Medij ut  $\frac{3a}{2n} \times \frac{FG}{CF^a}$  id est ut  $\frac{a}{e}$ . Et velocitas  $\frac{CF}{\sqrt{FG}}$  fit  $\sqrt{2e}$ . Ideoq; si corpus  $C$  certa cum velocitate, secundum lineam ipsi  $OK$  parallelam, exeat de loco  $L$ , et Medij densitas in locis singulis  $C$  sit ut  $\frac{OB}{OC}$ , et resistentia etiam in loco aliquo  $C$  sit ad vim gravitatis ut  $3OB$  ad  $2OK$ ; corpus illud describet circuli quadrantem  $LCK$ . Q.E.I.

At si corpus idem de loco  $A$  secundum lineam ipsi  $AK$  perpendiculararem egrederetur, sumenda esset  $OB$  seu  $a$  ad contrarias partes centri  $O$ , et propterea signum ejus mutandum esset & scribendum  $-a$  pro  $+a$ . Quo pacto prodiret Medij densitas ut  $\frac{-a}{e}$ . Negativam autem densitatem (hoc est quæ motus corporum accelerat) Natura non admittit, & propterea naturaliter fieri non potest ut corpus ascendendo ab  $A$  describat circuli quadrantem  $AL$ . Ad hunc effectum deberet corpus a Medio impellente accelerari, non a resistente impediri.<sup>(9)</sup>

(7) See Appendix 1: note (20) below, and compare VII: 113, note (146).

(8) Newton's checking computations to this end are preserved on Add. 3968.41: 11r/3968.12: 176v and on the reverse of the folio (now in private possession) on which he set down the draft of the 'Royal Society Committee' report on Leibniz' claim to calculus priority which is reproduced in 2, Appendix 1.4 below. In essence these successively calculate:

$$\frac{NH}{CN+FG} = \frac{\frac{eeno - aoo \times e^5}{e^3, eennoo - \frac{2ae}{e}}}{\frac{anno^3}{e^5}} = \frac{e^4 - ae^2o}{eeno - \frac{1}{2}aoo} = \frac{ee}{no} - \frac{a}{2n}.$$



$\frac{1}{2}(an^2/e^5) o^3$ , exhibits the variation of the curvature; the fifth the variation of the variation, and so on.<sup>(7)</sup> Whence, incidentally, there is opened up a use of these series not to be disdained in the solution of problems which depend on tangents and the curvature of curves.

Moreover,  $CF$  is the square root of  $CI^2 + IF^2$ , that is, of  $o^2 + (a^2/e^2) o^2$ , that is, of  $(n^2/e^2) o^2$ , and consequently is  $(n/e) o$ . And the line  $DG$ , by changing the sign of  $o$ , turns into the line  $EH$ , while the linelets  $GF$  and  $CF$ , by writing  $OE$  in place of  $OB$  and  $EH$  in place of  $BC$ , turn into the linelets  $CN$  and  $HN$ ; and thence there ensue

$$EH = a + (a/e) o - \frac{1}{2}(n^2/e^3) o^2 + \frac{1}{2}(an^2/e^5) o^3 - \dots, \quad CN = \frac{1}{2}(n^2/e^3) o^2 - (an^2/e^5) o^3,$$

$$HN = (n/e) o - (an/e^3) o^2 \text{ and so } HN/(CN + FG) - CF/2FG + FI/CF = \frac{3}{2}a/n.^{(8)}$$

Therefore the resistance is to gravity as  $\frac{3}{2}a/n$  to 1, or  $3a$  to  $2n$ , and the density of the medium as  $\frac{3}{2}(a/n) \times FG/CF^2$ , that is, as  $a/e$ ; and the speed  $CF/\sqrt{FG}$  comes to be  $\sqrt{(2e)}$ . Consequently, if the body  $C$  should go off from the point  $L$  with a certain speed, following a line parallel to  $OK$ , and the density of the medium in individual places be as  $OB/OC$ , and the resistance also in any arbitrary point  $C$  be to the force of gravity as  $3OB$  to  $2OK$ : that body will describe the circle-quadrant  $L\widehat{C}K$ . As was to be found.

But if the same body should set off from the place  $A$  following a line perpendicular to  $AK$ , you would have needed to take  $OB$ , or  $a$ , on the opposite side of the centre  $O$ , and on that account to change its sign and to have written  $-a$  in place of  $+a$ ; and on this basis there would have resulted a density of the medium (varying) as  $-a/e$ . But a negative density—one, that is, which accelerates the motions of bodies—is not admitted in nature, and for that reason it cannot naturally happen that a body, in ascending from  $A$ , shall describe the circle-quadrant  $A\widehat{L}$ . To this effect a body would have needed to be accelerated by an impelling medium, not impeded by a resisting one.<sup>(9)</sup>

---

[necnon] 
$$\frac{CF}{2FG} = \frac{no}{e} \times \frac{e^5}{eenmoo + anno^3} = \frac{e^4}{eeno + anoo} = \frac{ee}{no} - \frac{a}{n}.$$

[adeoq] 
$$\frac{HN}{CN + FG} - \frac{CF}{2FG} = \frac{aee}{2nee + an^3o} = \frac{a}{2n}. \quad [\text{ut et}] \quad \frac{FI}{CF} = \frac{a}{n}.$$

(9) The ensuing Examples 2, 3 and 4 are understood to follow from similar application of the corrected measure  $HN/(CN + FG) - \frac{1}{2}CF/FG + FI/CF$  of resistance to gravity in the case of the 'Galileian' parabola—which remains, of course, the unresisted fall-path—and of the conic/higher-order hyperbolas, where the expressions derived in the *editio princeps* will now likewise need to be increased in the ratio of 3 to 2. In sequel, Newton passed these minimal ameliorations by, returning at once to his preceding corollaries to rework them, on ff. (200<sup>v</sup>→) 219<sup>v</sup>/220<sup>v</sup>, into the form which is printed in Appendix 2.4 below, before going on yet more radically to recast his general argument (by way of the preliminary draft in Appendix 2.8) into its final version in [3] following.



[2]<sup>(10)</sup>*Idem aliter.*

Invenienda sit Medij densitas qua Projectile moveatur in linea curva  $PRQ$  progrediendo ab  $R$  versus  $Q$ . Et sit  $[P]ABQ$  basis vel abscissa Curvæ sintq̄  $BF$ ,  $CG$ ,  $DH$ ,  $EI$  ordinatæ quatuor ad æquales ab invicem distantias infinite parvas

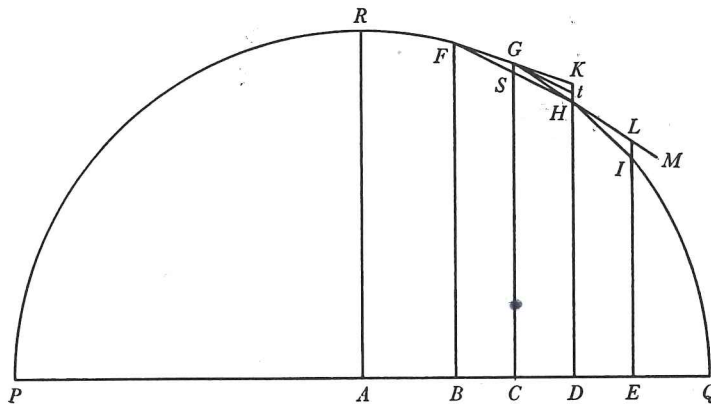

$BC$ ,  $CD$ ,  $DE$  basi insistentes in punctis  $B$ ,  $C$ ,  $D$  et  $E$  & Curvæ occurrentes in punctis  $F$ ,  $G$ ,  $H$  et  $I$ . Agantur chordæ  $FG$ ,  $GH$ ,  $HI$ . Et producantur chordæ  $FG$  &  $GH$  donec prior occurrat ordinatæ  $DH$  in  $K$  et posterior occurrat ordinatæ  $EI$  in  $L$ . Concipe autem projectile moveri in chordis illis infinite parvis  $FG$ ,  $GH$ ,  $HI$ , alijsq̄ similibus innumeris per totam Curvæ longitudinem  $PQ$ , et resistantiam ac gravitatem agere tantum in punctis  $F$ ,  $G$ ,  $H$ ,  $I$ , & actionibus suis mutare motum corporis in solis illis punctis & efficere ut co[r]pus postquam descripsit chordam<sup>(11)</sup>  $FG$  non longius pergat in hac chorda producta versus  $K$  sed in puncto  $G$  cursum mutet et recta pergat ad  $H$ , et ubi chordam  $GH$  descripsit non longius pergat in hac chorda versus  $L$  sed cursum mutet et recta pergat in chorda  $HI$  & sic deinceps in infinitum. Ac tempora quibus chordæ  $GH$ ,  $HI$  describuntur erunt in subduplicata ratione altitudinum  $KH$ ,  $LI$  per quas corpus vi impulsuum gravitatis temporibus illis descendit recedendo a rectis  $FGK$ ,  $GHL$ . Ducatur chorda  $FH$  ordinatam  $GC$  secans in  $S$ : et recta<sup>(12)</sup> huic parallela per punctum  $G$  ducta bisecabit rectam  $KH$  puta in  $t$  et curvam satis accurate tanget in  $G$ . Et si corpus moveretur<sup>(13)</sup> in ipsa curva describendo non chordas arcuum sed ipsos arcus  $FG$ ,  $GH$ ,  $HI$ , & simul per uniformem et continuam vim gravitatis impelleretur deorsum, hoc corpus interea dum describit arcū  $GH$ , vi gravitatis descenderet a tangente  $Gt$  per spatium  $tH$ , id est per spatium  $\frac{1}{2}KH$ .<sup>(14)</sup> Sunt igitur altitudines  $KH$   $LI$  duplo majores altitudinibus

(10) Add. 3965.12: 198<sup>r</sup>–199<sup>r</sup>. Having temporarily become stuck in his endeavours (see Appendix 2.4 below, and especially our concluding note (46) thereto) to refine the measure of the ratio of resistance to gravity attained in (§1.6 →) §2.1 preceding, Newton here successfully tries an alternative approach—its kernel appears in stark clarity in the two preliminary

[2]<sup>(10)</sup>*The same another way.*

Let there need to be found the density of a medium whereby a projectile shall move in the curved line  $PRQ$ , advancing from  $R$  towards  $Q$ . Let  $PABQ$  be the base or abscissa of the curve, and  $BF, CG, DH, EI$  four ordinates at equal, infinitely small distances  $BC, CD, DE$  from each other, standing on the base at the points  $B, C, D$  and  $E$  and meeting the curve in the points  $F, G, H$  and  $I$ . Draw the chords  $FG, GH, HI$ ; and extend the chords  $FG$  and  $GH$  till the former meets the ordinate  $DH$  in  $K$  and the latter meets the ordinate  $EI$  in  $L$ . Now conceive that the projectile moves in the infinitely small chords  $FG, GH, HI$  and innumerable other similar ones throughout the length of the curve  $\widehat{PQ}$ , and that the resistance and gravity act merely at the points  $F, G, H, I$ , by their actions changing the motion of the body at those points alone, and achieving that the body, after it has described the chord<sup>(11)</sup>  $FG$ , shall no longer proceed in the extension of this chord towards  $K$ , but shall change its course at the point  $G$  and proceed straight towards  $H$ ; and, when it has described the chord  $GH$ , shall no longer pass on in this chord towards  $L$ , but change its course and proceed in the chord  $HI$ , and so on indefinitely. And the times in which the chords  $GH, HI$  are described will be in the halved ratio of the heights  $KH, LI$  through which the body by dint of impulses of gravity in those times descends, falling away from the straight lines  $FGK, GHL$ . Draw the chord  $FH$  cutting the ordinate  $GC$  in  $S$ ; and the straight line<sup>(12)</sup> drawn parallel to this through the point  $G$  will bisect the straight line  $KH$ , in  $t$  say, and accurately enough touch the curve at  $G$ . And were the body to move<sup>(13)</sup> in the curve itself, describing not the chords of the arcs but the arcs  $\widehat{FG}, \widehat{GH}, \widehat{HI}$  and at the same time be impelled downwards through a uniform and continuous force of gravity, this body would, all the while it describes the arc  $\widehat{GH}$ , descend by the force of gravity from the tangent  $Gt$  through the distance  $tH$ , that is, through the distance  $\frac{1}{2}KH$ .<sup>(14)</sup> The heights  $KH$  and  $LI$ ,

schemes of computation reproduced in Appendix 2.5/6—whereby the forces of resistance and gravity are now conceived to act not continuously over infinitesimal moments of time but ‘simul et semel’ at the beginning of each such successive instant (compare VI: 540, note (8)).

(11) In momentary forgetfulness of his present approximation of the curve  $\widehat{FGHI}$  by the chain of infinitesimal chords  $FG/GH/HI$ , Newton here first slipped to write ‘arcum’ (arc).

(12) Specified in the manuscript as ‘ $Gt$ ’, but the identification is rendered both superfluous and clumsy in its anticipation of Newton’s subsequent explicit introduction of the point  $t$  of this tangent’s intersection with  $KH$  (in the phrase ‘puta ut  $t$ ’ interlineated by him as an afterthought). As ever, of course, he here assumes that the vanishingly small arc  $\widehat{FGH}$  is (to sufficient approximation) parabolic, so that the tangent at its mid-point  $G$  can accurately be taken as parallel to its chord  $FH$ , and therefore  $Ht = SG (= \frac{1}{2}HK)$ .

(13) Initially, in a cancelled preceding phrase whose differences are otherwise insignificant, ‘pergeret’ (. . . proceed) was written.

(14) Newton first went on to add ‘et interea velocitatem acquireret qua uniformiter continuata corpus eodem tempore describere[t] duplum illu[d] spatium<sub>1,1</sub> id est spatium



quas corpus vi gravitatis cadendo describeret interea dum describit arcus  $GH$ ,  $HI$ ; ideoque altitudines illæ  $KH$   $LI$  sunt ut quadrata temporum quibus chordæ  $GH$ ,  $HI$  describuntur si modo corpus moveatur in chordis. Velocitates autem sunt ut chordæ descriptæ et [inverse ut] tempora describendi, id est ut  $\frac{GK}{\sqrt{KH}}$  et  $\frac{HI}{\sqrt{LI}}$ . Et velocitas corporis in loco quovis  $G$  æqualis est velocitati corporis in eodem loco Parabolam in vacuo describentis cujus vertex locus ille  $G$ , diameter est  $GC$ , et latus rectum est  $\frac{2GH^a}{HK}^{(15)}$ .

Concipe jam quod corpus ubi chordam  $GH$  descripsit recta progrediatur versus  $M$  eadem cum velocitate. Et si capiatur  $HM$  ad  $GH$  ut tempus describendi arcum  $HI$  ad tempus describendi arcum  $GH$ , id est ut  $\sqrt{LI}$  ad  $\sqrt{KH}$ : corpus perveniet ad punctum  $M$  quo tempore per impulsus resistantiæ et gravitatis in loco  $H$  perveniret ad  $I$ . Et propterea corpus per impulsum resistantiæ in puncto  $H$  ita retardatur ut vice longitudinis  $HM$  describat tantum longitudinem  $HL$  & per impulsum gravitatis ita acceleratur deorsum ut recedendo a recto tramite  $HL$  simul describat altitudinem  $LI$ . Est igitur resistantia ad gravitatem ut  $LM$  ad  $LI$ . Et densitas Medij ut  $\frac{LM}{LI} \times \frac{LI}{GH^a}$  id est reciproce ut  $\frac{GH^a}{LM}$ .

Quare si inveniantur longitudines Ordinarum  $BF$ ,  $CG$ ,  $DH$ ,  $EI$ , et pro  $KH$  ponatur dupla sagitta  $GS$  id est  $2CG - BF - DH$ , & similiter pro  $LI$  ponatur  $2DH - CG - EI$ . et capiatur  $LM$  ad  $GH$  ut  $\sqrt{LI} - \sqrt{KH}$  ad  $\sqrt{KH}$  id est ut  $\sqrt{LI \times KH} - KH$  ad  $KH$  sive ut  $\frac{LI - KH}{2}$  ad  $KH$  (nam pro  $\sqrt{LI \times KH}^{(16)}$  scribi potest  $\frac{LI + KH}{2}$ ) solvetur Problema.<sup>(17)</sup>

---

totum  $KH$ , ut Galilæus demonstravit' (and in the meanwhile would acquire a speed whereby, if it were uniformly continued, the body would in the same time describe twice that distance, that is, the total distance  $KH$ , as Galileo has demonstrated). While the vellum worksheet, ULC. Add. 3958.2: 45, on which he penned his comparison of the earth's diurnal centrifugal force with that of its gravity shows that he was already then, in the middle 1660's, familiar (by way of Salusbury's 1661 translation) with the passage in the Second Day of Galileo's *Dialogo* . . . *sopra i due Massimi Sistemi del Mondo* where this speed rule was lightly adumbrated in its mean-speed form (compare J. W. Herivel, *The Background to Newton's 'Principia'* (Oxford, 1966): 183), we may again lightly insist that he had no direct knowledge—even via Salusbury's rare 1665 English version—of the *Discorsi e Dimostrazioni Matematiche* . . . *Attenenti alla Mecanica & i Movimenti Locali* (Leyden, 1638) where, in 'Theor. I' of the propositions on uniformly accelerated motion included in its 'Giornata Terza', Galileo afterwards came to give this 'Merton rule' more rigorous demonstration; indeed, in his present phrasing Newton much more closely follows Christiaan Huygens' formulation of the theorem in his *Horologium Oscillatorium sive de Motu Pendulorum ad Horologia aptato Demonstrationes Geometricæ* (Paris, 1673), where in Propositio V of the 'Pars Secunda. De Descensu Gravium . . .' it is asserted: 'Spatium



therefore, are twice as big as the heights which a body would in falling by the force of gravity describe all the while it describes the arcs  $\widehat{GH}$ ,  $\widehat{HI}$ ; and consequently those heights  $KH$ ,  $LI$  are as the squares of the times in which the chords  $GH$ ,  $HI$  are described should it but be that the body moves in the chords. The speeds, however, are as the chords described and (inversely as) the times of their description, that is, as  $GK/\sqrt{KH}$  and  $HI/\sqrt{LI}$ . And the speed of the body at any place  $G$  is equal to the speed of a body in the same place describing in a vacuum a parabola whose vertex is that place  $G$ , diameter is  $GC$  and *latus rectum* is  $2GH^2/HK$ .<sup>(15)</sup>

Now conceive that when the body has described the chord  $GH$  it shall go straight on towards  $M$  with the same speed. Then, if  $HM$  be taken to  $GH$  as the time of describing the arc  $\widehat{HI}$  to the time of describing the arc  $\widehat{GH}$ , that is, as  $\sqrt{LI}$  to  $\sqrt{KH}$ , the body will arrive at the point  $M$  in the time in which it would through impulses of resistance and gravity at the place  $H$  have reached  $I$ . Accordingly, let the body be so slowed at the point  $H$  through an impulse of resistance that instead of the length  $HM$  it describes merely the length  $HL$ , and so accelerated downwards through an impulse of gravity that in falling away from the straight path it simultaneously describes the height  $LI$ : in consequence, the resistance is to gravity as  $LM$  to  $LI$ ; and the density of the medium as  $(LM/LI) \times LI/GH^2$ , that is, reciprocally as  $GH^2/LM$ .

Wherefore, if the lengths of the ordinates  $BF$ ,  $CG$ ,  $DH$  and  $EI$  be found out, and in place of  $KH$  there be put twice the *sagitta*  $GS$ , that is  $2CG - BF - DH$ , and similarly in place of  $LI$  there be put  $2DH - CG - EI$ , and if  $LM$  be taken to  $GH$  as  $\sqrt{LI} - \sqrt{KH}$  to  $\sqrt{KH}$ , that is, as  $\sqrt{(LI \times KH) - KH}$  to  $KH$ , or as  $\frac{1}{2}(LI - KH)$  to  $KH$  (for in place of  $\sqrt{(LI \times KH)}$ <sup>(16)</sup> there can be written  $\frac{1}{2}(LI + KH)$ ), the problem will be solved.<sup>(17)</sup>

peracto certo tempore, à gravi è quiete casum inchoante, dimidium esse ejus spatii quod pari tempore transiret motu æquabili, cum celeritate quam acquisivit ultimo casus momento' (*ibid.*: 29).

(15) That is,  $(GH^2/Ht \approx) Gt^2/Ht$ .

(16) Since  $4LI \times KH = (LI + KH)^2 - (LI - KH)^2$ , where the difference  $LI - KH$  is infinitesimal in proportion to  $LI$  and  $KH$ , and so to their sum; compare §1.6: note (71) above.

(17) In a subsequent computation on Add. 3965.10: 136<sup>v</sup> Newton afterwards confirmed that where  $CG = e$  and, corresponding to the increment  $CD = o$  of the base  $AC (= a)$ , the augmented ordinate  $DH$  has the series expansion  $e + fo + go^2 + ho^3 + \dots$ —the coefficients  $f (= de/da)$ ,  $g (= \frac{1}{2}df/da)$  and  $h (= \frac{1}{3}dg/da)$  are, of course, what he elsewhere calls  $Q$ ,  $R$  and  $S$  respectively—this mode of solution yields generally that 'Resistentia erit ad Gravitatem ut  $3h\sqrt{1+ff}$  ad  $4gg$ . Velocitas ut  $\sqrt{\frac{1+ff}{g}}$ . et Medij densitas ut  $\frac{h}{g\sqrt{1+ff}}$ .' (See Appendix 2.7

following, where we reproduce the gist of this checking calculation.) Here, however, he passes to apply the present geometrical construction of the ratio of resistance to gravity, and of the density of the medium, severally to each of the four *Exempla* which he had set to illustrate his

*Exempl. 1.* Sit  $PRQ$  semicirculus centro  $A$  diametro  $PQ$  descriptus, et nominentur  $AP$  vel  $AQ = n$ ,  $AC = a$ ,  $BC = CD = DE = o$  &  $CG (= \sqrt{nn - aa}) = e$ . Et prodibit  $DH = \sqrt{ee - 2ao + oo} = e - \frac{ao}{e} - \frac{nnoo}{2e^3} - \frac{anno^3}{2e^5} - \&c.$

$$[\text{adeoq}] \quad EI = e - \frac{2ao}{e} - \frac{2nnoo}{e^3} - \frac{4anno^3}{e^5}. \quad BF = e + \frac{ao}{e} - \frac{nnoo}{2e^3} + \frac{anno^3}{2e^5}.$$

$$HK = \frac{nnoo}{e^3}. \quad IL = \frac{nnoo}{e^3} + \frac{3anno^3}{e^5}. \quad GH = \sqrt{oo + GC - DH^q} = \frac{no}{e} + \frac{anno}{2e^3}.$$

[ut et]  $LM = \frac{3anno}{2e^3}$ . [Fit igitur] Resistentia ad Gravitatem ut  $\frac{3anno}{2e^3}$  ad  $\frac{nnoo}{e^3}$  seu  $3a$  ad  $2n$ . Velocitas ut  $\sqrt{e}$ . Densitas Medij ut  $\frac{3a}{2ne}$  id est ut  $\frac{a}{e}$ .

*Exempl. 2.* Sit linea  $PRCK$  Parabola axem habens  $AR$  horizonti  $AK$  perpendicularem, et requiratur Medij densitas quæ faciat ut projectile in ipsa moveatur.

In hac figura lineæ  $HK$  et  $IL$  invenientur æquales, ideoq; lineæ  $GH$  et  $HM$  æquales erunt & puncto  $M$  in puncto  $L$  incidente, linea  $LM$  eiq; proportionalis resistentia erit nulla. Et nulla Medij densitate projectile movebitur in Parabola uti olim Galilæus demonstravit.<sup>(18)</sup>

*Exempl. 3.* Sit linea  $PRGQ$ <sup>(19)</sup> Hyperbola, Asymptoton habens  $NX$  plano horizontali  $AK$  perpendicularem, et quærat Medij densitas quæ faciat ut Projectile noveatur in hac linea.

Sit  $AX$  Asymptotos altera, ordinatim applicatæ  $DH$  productæ occurrens in  $V$ , et ex natura Hyperbolæ, rectangulum  $XV$  in  $VH$  dabitur. Datur autem ratio  $DN$  ad  $VX$ , et propterea datur etiam rectangulum  $DN$  in  $V[H]$ .<sup>(20)</sup> Sit illud  $bb$ ; & completo parallelogrammo  $DNXZ$ , dicatur  $CN$   $a$ ,  $CD$   $o$ ,  $NX$   $c$ , et ratio data  $VZ$  ad  $ZX$  vel  $DN$  ponatur esse  $\frac{m}{n}$ . Et

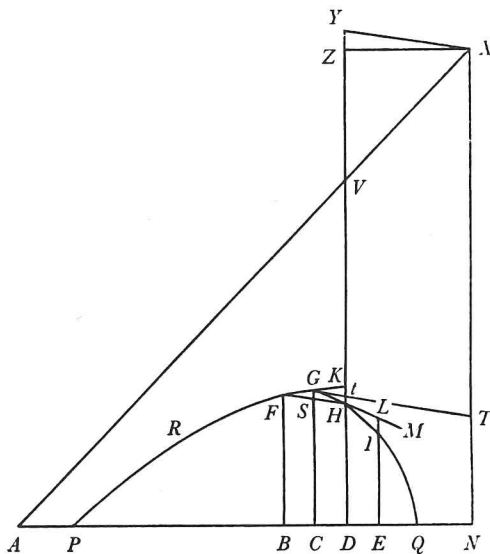

erit  $DN$  æqualis  $a - o$ ,  $VH$  æqualis  $\frac{bb}{a - o}$ ,  $VZ$  æqualis  $\frac{m}{n} \frac{bb}{a - o}$  et  $DH$  seu  $NX - VZ - VH$  æqualis  $c - \frac{m}{n} a + \frac{m}{n} o - \frac{bb}{a - o}$ . Resolvatur  $\frac{bb}{a - o}$  in seriem conver-

proposition in the *editio princeps* of the *Principia* (see Appendix 1 below), confirming *ab initio* in each instance—or, more strictly, in Examples 1, 3 and 4, since the surrounding medium



*Example 1.* Let  $PRQ$  be a semicircle described with centre  $A$  and diameter  $PQ$ , and name  $PA$  or  $AQ = n$ ,  $AC = a$ ,  $BC = CD = DE = o$

and  $CG (= \sqrt{(n^2 - a^2)}) = e$ .

There will then ensue

$$DH = \sqrt{(e^2 - 2ao + o^2)} = e - (a/e)o - \frac{1}{2}(n^2/e^3)o^2 - \frac{1}{2}(an^2/e^5)o^3 - \dots,$$

and hence  $EI = e - 2(a/e)o - 2(n^2/e^3)o^2 - 4(an^2/e^5)o^3 \dots,$

$$BF = e + (a/e)o - \frac{1}{2}(n^2/e^3)o^2 + \frac{1}{2}(an^2/e^5)o^3 \dots, \quad HK = (n^2/e^3)o^2 \dots,$$

$$IL = (n^2/e^3)o^2 + 3(an^2/e^5)o^3 \dots,$$

$$GH = \sqrt{(o^2 + (GC - DH)^2)} = (n/e)o + \frac{1}{2}(an/e^3)o^2 \dots$$

and also  $LM = \frac{3}{2}(an/e^3)o^2 \dots$ . The resistance comes, therefore, to be to gravity as  $\frac{3}{2}(an/e^3)o^2$  to  $(n^2/e^3)o^2$ , or  $3a$  to  $2n$ ; the speed as  $\sqrt{e}$ ; the density of the medium as  $\frac{3}{2}a/ne$ , that is, as  $a/e$ .

*Example 2.* Let the line  $PRCK$  be a parabola having its axis  $AR$  perpendicular to the horizontal  $AK$ , and let there be required the density of the medium which shall make a projectile move in it.

In this instance the lines  $HK$  and  $IL$  in the figure will be found to be equal, and consequently the lines  $GH$  and  $HM$  will be equal, and so, with the point  $M$  coincident with the point  $L$ , the line  $LM$  will be nothing, and the resistance proportional to it nil. And so with nil density of the medium the projectile will move in the parabola, as Galileo once demonstrated.<sup>(18)</sup>

*Example 3.* Let the line  $PRGQ$ <sup>(19)</sup> be a hyperbola, having asymptote  $NX$  perpendicular to the horizontal plane  $AK$ , and let there be required the density of the medium which shall make a projectile move in this line.

Let  $AX$  be the other asymptote, meeting the ordinate  $DH$  produced in  $V$ , and from the nature of the hyperbola the product  $XV \times HV$  will be given. Now there is given the ratio of  $ND$  to  $VX$ , and in consequence there is also given the product  $ND \times HV$ . Let that be  $b^2$ , and, having completed the rectangle  $DNXZ$ , call  $NC = a$ ,  $DC = o$ ,  $NX = c$ , and set the given ratio  $VZ$  to  $XZ$  or  $ND$  to be  $m/n$ . Then will then be  $ND = a - o$ ,  $HV = b^2/(a - o)$ ,  $VZ = (m/n)(a - o)$  and  $DH$ , or  $NX - VZ - HV$ ,  $= c - (m/n)a + (m/n)o - b^2/(a - o)$ . Resolve  $b^2/(a - o)$  into the

continues to offer no resistance to motion in the parabolic path of Example 2—that the resistance as he had evaluated it in his 1687 text needs to be increased by half as much again.

(18) See Appendix 1: note (26), and compare vi: 106, note (35).

(19) The manuscript lacks an accompanying figure; that which we here supply to fill the want is founded on the diagram which illustrates the corresponding 'Exempl. 3' in the *editio princeps* (*Principia*, 1687: 267; see page 382 below).

(20) Newton wrote 'VG' in a momentary slip of his pen.



gentem  $\frac{bb}{a} + \frac{bb}{aa} o + \frac{bb}{a^3} oo + \frac{bb}{a^4} o^3 + \&c$  et fiet  $DH$  æqualis

$$c - \frac{m}{n} a - \frac{bb}{a} + \frac{maa - nbb}{naa} o - \frac{bb}{a^3} oo - \frac{bb}{a^4} o^3 - \&c.$$

Pro  $c - \frac{m}{n} a - \frac{bb}{a}$  scribatur  $e$ , et habebuntur Ordinatae quatuor

$$BF = e + \frac{nbb - maa}{naa} o - \frac{bb}{a^3} oo + \frac{bb}{a^4} o^3 - \&c. \quad CG = e.$$

$$DH = e + \frac{maa - nbb}{naa} o - \frac{bb}{a^3} oo - \frac{bb}{a^4} o^3. \quad EI = e + \frac{2maa - 2nbb}{naa} o - \frac{4bb}{a^3} oo - \frac{8bb}{a^4} o^3.$$

Et inde  $HK = \frac{2bb oo}{a^3}$ .  $IL = \frac{2bb oo}{a^3} + \frac{6bb o^3}{a^4}$ . [ $\&$ ]  $IL - HK = \frac{6bb o^3}{a^4}$ .

Estq;  $DN \cdot GT^{(22)} :: CD \cdot GH = \frac{GT}{a} o$ . et  $KH \cdot \frac{LI - KH}{2} :: GH \cdot LM = \frac{3GT}{2aa} oo$ .

Adeoq; Resistentia ad Gravitationem ut  $\frac{3GT}{2aa}$  ad  $\frac{2bb}{a^3}$  seu  $3GT$  ad  $4VH$ .<sup>(23)</sup> Velocitas autem est ut  $\frac{GH}{\sqrt{HK}}$  id est ut  $GT$  in  $\sqrt{a}$ , et Medij densitas, ut Resistentia  $\frac{3GT}{4VH}$  directe et quadratum velocitatis  $a \times GT^2$  inverse, id est<sup>(24)</sup> ut  $\frac{1}{GT}$ . Et velocitas in loco quovis  $G$  ea est quacum corpus in Parabola pergeret verticem  $G$  diametrum  $GC$  & latus rectum  $\frac{2GH^2}{HK}$  seu  $\frac{GT^2}{VH}$  habente.

*Exempl. 4.* Ponatur indefinite quod linea  $PRGQ$  Hyperbola sit centro  $X$ , asymptotis  $AX$ ,  $NX$ , ea lege descripta ut constructo rectangulo  $XZDN$  cujus latus  $ZD$  secet Hyperbolam in  $H$  & Asymptoton ejus in  $V$ , fuerit  $VH$  reciproce ut ipsius  $ZX$  vel  $DN$  dignitas aliqua  $ND^n$  cujus index est numerus  $n$ : et quæretur Medij densitas qua projectile progrediatur in hac curva.

(21) That is,  $CG$ .

(22) Understand this to be (as we show it in the accompanying figure) the extension of  $Gt$ , drawn parallel to the chord  $FH$  (and so bisecting  $HK$  in  $t$ ), till its meet  $T$  with  $NX$ . This will of course be tangent to the infinitesimal arc  $\widehat{FH}$  of the resisted path at its mid-point  $G$ .

(23) Newton's preliminary calculations to this end survive on Add. 3968.41: 119<sup>v</sup> (there entered, starting from the page bottom, in a blank space below a preliminary draft of a passage in the unpublished lengthy original English preface to the *Commercium Epistolicum* which is reproduced in 2, Appendix 1.5 below; see our note (47) thereto). Since these are more detailed than the present bare statement of their result, we may here give their gist, namely:

$$'CG - DH = \frac{-maa + nbb}{naa} o + \&c. \quad GH = \frac{\sqrt{mma^4 - 2mnaabb + nnb^4 + nna^4}}{naa} o + \&c.$$

converging series  $b^2/a + (b^2/a^2) o + (b^2/a^3) o^2 + (b^2/a^4) o^3 + \dots$  and there will come to be

$$DH = c - (m/n) a - b^2/a + ((ma^2 - nb^2)/na^2) o - (b^2/a^3) o^2 - (b^2/a^4) o^3 - \dots,$$

For  $c - (m/n) a - b^2/a^{(21)}$  write  $e$ , and there will be had the four ordinates

$$BF = e + ((nb^2 - ma^2)/na^2) o - (b^2/a^3) o^2 + (b^2/a^4) o^3 - \dots,$$

$$CG = e, \quad DH = e + ((ma^2 - nb^2)/na^2) o - (b^2/a^3) o^2 - (b^2/a^4) o^3 \dots$$

and  $EI = e + 2((ma^2 - nb^2)/na^2) o - 4(b^2/a^3) o^2 - 8(b^2/a^4) o^3 \dots$

And thence  $HK = 2(b^2/a^3) o^2 \dots$ ,  $IL = 2(b^2/a^3) o^2 + 6(b^2/a^4) o^3 \dots$

and so  $IL - HK = 6(b^2/a^4) o^3 \dots$ . There is, further,  $DN:GT^{(22)} = CD:GH$  or  $GH = (GT/a) o$ , and  $HK: \frac{1}{2}(IL - HK) = GH:LM$  or  $LM = \frac{3}{2}(GT/a^2) o^2$ .<sup>(23)</sup> And hence the resistance is to gravity as  $\frac{3}{2}GT/a^2$  to  $2b^2/a^3$ , that is,  $3GT$  to  $4HV$ . While the speed is as  $GH/\sqrt{HK}$ , that is, as  $GT \times \sqrt{a}$ ; and the density of the medium as the resistance  $3GT/4HV$  directly and the square of the speed  $a \times GT^2$  inversely, that is,<sup>(24)</sup> as  $1/GT$ . And the speed at any place  $G$  is that with which the body would proceed in a parabola having vertex  $G$ , diameter  $GC$  and *latus rectum*  $2GH^2/HK$ , that is,  $GT^2/HV$ .

*Example 4.* Suppose indefinitely that the line  $PRGQ$  be a hyperbola described with centre  $X$  and asymptotes  $AX, NX$  with the stipulation that, on constructing the rectangle  $XNDZ$  whose side  $DZ$  shall cut the hyperbola in  $H$  and its asymptote in  $V$ , there be  $HV$  reciprocally as some power of  $(XZ$  or)  $ND, ND^n$ , whose index is the number  $n$ : then let there be sought the density of the medium whereby a projectile shall move onward in this curve.

$$[KH = ] \frac{2bb_{oo}}{a^3} \cdot [\frac{1}{2}, \overline{LI - KH} = ] \frac{6bb_{oo}^3}{a^4} ( : : a \cdot 3 \times o )$$

$$: : GH \cdot LM = \frac{3\sqrt{mma^4 - 2mnaabb + nnb^4 + nna^4}}{na^3} oo.$$

[unde] Resist. grav. : :  $3\sqrt{mma^4 - 2mnaabb + nnb^4 + nna^4} \cdot 2nbb$ .

[Etiam]  $DN = a[-o] \cdot XY : : o \cdot \frac{XY}{a} = GH$ . [ut et]  $\frac{2b_{oo}}{a^3} \cdot \frac{6bb_{oo}^3}{a^4} : : \frac{XY, o}{a} \cdot \frac{3XY, oo}{[2]aa} = LM$ .

[adeoq]  $\frac{3XY, oo}{2aa} \cdot \frac{2bb, oo}{a^3} : : 3XY \cdot \frac{4bb}{a} : : \text{Resist. Grav.} : : 3XY \cdot 4VH = 2YG$  [sic]'

(on minimally adjusting the last line). There follows on the worksheet a drafting of the two next sentences which in its final version does not differ from that which here ensues other than for insignificant verbal honings; we need not dwell on the near-trivial point that the *latus rectum*  $2GH^2/HK$  of the parabola approximating the arc  $\widehat{FGH}$  was initially there specified to be

$$\frac{'2GT^a, oo, a^3}{aa, 2bb_{oo}} = \frac{GT^a, a'}{bb}$$

(24) Since  $VH = b^2/a$  is proportional to  $1/a$ .

Pro  $CN$ ,  $CD$ ,  $NX$  scribantur  $n$ ,  $o$ ,  $c$  respective sitq̄  $VZ$  ad  $ZX$  vel  $DN$  ut  $d$  ad  $f$ , &  $VH$  æqualis  $\frac{bb}{DN^n}$ : et erit  $DN$  æqualis  $a-o$ ,  $VH$  æqualis  $\frac{bb}{a-o^n}$ ,  $VZ = \frac{d}{f}$  in  $a-o$ , &  $DH$  seu  $NX - VZ - VH$  æqualis  $c - \frac{da}{f} + \frac{do}{f} - \frac{bb}{a-o^n}$ . Resolvatur terminus ille  $\frac{bb}{a-o^n}$  in seriem infinitam  $\frac{bb}{a^n} + \frac{nbbo}{a^{n+1}} + \frac{nn+n}{2a^{n+2}} bbo[o] + \frac{n^3+3nn+2n}{6a^{n+3}} bbo^3$  &c & pro terminis  $c - \frac{da}{f} - \frac{bb^{(21)}}{a^n}$  scribatur  $e$ : ac fiet  $DH$  æqualis

$$e + \frac{do}{f} - \frac{nbbo}{a^{n+1}} - \frac{nn+n}{2a^{n+2}} bboo - \frac{n^3+3nn+2n}{6a^{n+3}} bbo^3 \text{ \&c.}$$

Et inde fiet

$$EI = e + \frac{2do}{f} - \frac{2nbbo}{a^{n+1}} - \frac{2nn+2n}{a^{n+2}} bboo - \frac{4n^3+12nn+8n}{3a^{n+3}} bbo^3.$$

et  $BF = e - \frac{do}{f} + \frac{nbbo}{a^{n+1}} - \frac{nn+n}{2a^{n+2}} bboo + \frac{n^3+3nn+2n}{6a^{n+3}} bbo^3.$

Et inde  $HK = \frac{nn+n}{a^{n+2}} bboo$ .  $IL = \frac{nn+n}{a^{n+2}} bboo - \frac{n^3+3nn+2n}{a^{n+3}} bbo^3.$

&  $IL - HK = \frac{n^3+3nn+2n}{a^{n+3}} bbo^3.$

Estq̄  $DN.GT^{(22)}::CD.GH = \frac{GT}{a} o.$

Et  $KH.\frac{IL-HK}{2}::GL.LM = \frac{n+2}{2aa} oo, GT.$

Adeoq̄ resistentia ad Gravitationem ut  $\frac{n+2}{2aa} GT$  ad  $\frac{nn+n}{a^{n+2}} bb$  seu  $\frac{n+2}{2nn+2n} GT$  ad  $VH.$ <sup>(25)</sup>

[3]<sup>(26)</sup>

*Prop. X. Prob. III.*

*Tendat uniformis vis gravitatis directe ad planum Horizontis, sitq̄ resistentia ut Medij densitas et quadratum velocitatis conjunctim: requiritur tum Medij densitas in locis*

(25) Newton here leaves off, leaving the remainder of his manuscript sheet (ff. 199<sup>r</sup> [bottom half]/199<sup>v</sup>) blank—evidently with the intention of adjoining yet other things. As we have already mentioned in note (17) above, Newton jotted down on Add. 3965.10: 136<sup>v</sup> (virtually as we reproduce its edited text in Appendix 2.7 following) a rough confirmation that his present alternative mode of solution to his problem does indeed yield the corrected general measure of the ratio of resistance to gravity (in terms of the coefficients of the series expansion of the augmented ordinate in powers of the related base increment), but this he never wrote up in a finished form. Yet more fragmentary is the abandoned preliminary computation immediately above (on the same f. 136<sup>v</sup>) for what was manifestly destined to be the further worked example of a yet more complicated logarithmico-hyperbolic path of resisted fall.



For  $NC$ ,  $DC$ ,  $NX$  write  $n$ ,  $o$ ,  $c$  respectively, and let  $VZ$  be to  $XZ$  or  $ND$  as  $d$  to  $f$ , and  $HV = b^2/ND^n$ : then will there be

$$ND = a - o, \quad HV = b^2/(a - o)^n, \quad VZ = (d/f)(a - o)$$

and  $DH$ , that is,  $NX - VZ - HV$ , =  $c - (d/f)a + (d/f)o - b^2/(a - o)^n$ . Resolve the term  $b^2/(a - o)^n$  into the infinite series

$$b^2/a^n + n(b^2/a^{n+1})o + \frac{1}{2}(n^2 + n)(b^2/a^{n+2})o^2 + \frac{1}{6}(n^3 + 3n^2 + 2n)(b^2/a^{n+3})o^3 \dots$$

and in place of the terms  $c - (d/f)a - b^2/a^{n(21)}$  write  $e$ , and there will come to be  $DH = e + (d/f - nb^2/a^{n+1})o - \frac{1}{2}(n^2 + n)(b^2/a^{n+2})o^2 - \frac{1}{6}(n^3 + 3n^2 + 2n)(b^2/a^{n+3})o^3 \dots$ . And thence will come

$$EI = e + 2(d/f - nb^2/a^{n+1})o - 2(n^2 + n)(b^2/a^{n+2})o^2 - \frac{4}{3}(n^3 + 3n^2 + 2n)(b^2/a^{n+3})o^3 \dots$$

and

$$BF = e - (d/f - nb^2/a^{n+1})o - \frac{1}{2}(n^2 + n)(b^2/a^{n+2})o^2 + \frac{1}{6}(n^3 + 3n^2 + 2n)(b^2/a^{n+3})o^3 \dots;$$

and thence  $HK = (n^2 + n)(b^2/a^{n+2})o^2 \dots$ ,

$$IL = (n^2 + n)(b^2/a^{n+2})o^2 - (n^3 + 3n^2 + 2n)(b^2/a^{n+3})o^3 \dots,$$

and so  $IL - HK = (n^3 + 3n^2 + 2n)(b^2/a^{n+3})o^3 \dots$ . Now there is

$$ND:GT^{(22)} = DC:GH \quad \text{or} \quad GH = (GT/a)o,$$

and  $HK:\frac{1}{2}(IL - HK) = GL:LM$  or  $LM = \frac{1}{2}(n + 2)(GT/a^2)o^2$ ;

and hence the resistance is to gravity as  $\frac{1}{2}(n + 2) \cdot GT/a^2$  to  $(n^2 + n)b^2/a^{n+2}$ , that is,  $(\frac{1}{2}(n + 2)/(n^2 + n))GT$  to  $HV$ .<sup>(25)</sup>

[3]<sup>(26)</sup>

*Proposition X, Problem III.*

*Let the uniform force of gravity tend directly to the plane of the horizon, and let the resistance be as the density of the medium and the square of the speed jointly: there is required both the density of the medium in individual places which shall make a body move*

Perhaps this intended illustration also was meant to be adjoined to the present piece. Let the reader look at Appendix 2.9 (where, for lack of any more appropriate place, we reproduce the essence of its text) and decide for himself.

(26) Add. 3965. 12: 192<sup>r</sup>-193<sup>v</sup>, the definitive version of Newton's mended solution of the general problem of resisted motion under constant downwards gravity, now finally recast from [1] preceding (by way of the intermediate draft reproduced in Appendix 2.8 below) with the variant approach of [2] briefly encapsulated in the opening paragraph of the augmented ensuing scholium—the latter in fact, for want of room in the space available, not to appear at all in the published *editio secunda* of the *Principia*. With minimal verbal polishing and a few terminal additions (which, for completeness' sake, we include in our present text) this is 'the tenth Proposition of the second Book corrected' (now Trinity College. R. 16.38: 262-5) which

*singulis quæ faciat ut corpus in data quavis linea curva moveatur, tum corporis velocitas et Medij resistantia in locis singulis.*

Sit  $PQ$  planum illud plano schematis perpendicularè;  $PFHQ$  linea plano huic occurrens in punctis  $P$  et  $Q$ ; <sup>(27)</sup> $G, H, I, K$  loca quatuor corporis in hac curva ab  $F$  ad  $Q$  pergents; &  $GB, HC, ID, KE$  ordinatæ quatuor parallelæ ab his punctis

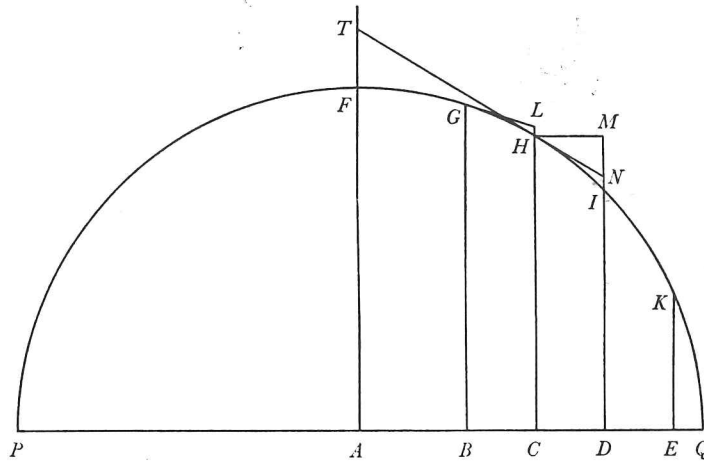

ad horizontem demissæ & lineæ horizontali  $PQ$  ad puncta  $B, C, D, E$  insistentes; & sint  $BC, CD, DE$  distantiæ Ordinatarum inter se æquales. A punctis  $G$  et  $H$  ducantur rectæ  $GL, HN$  curvam tangentes in  $G$  et  $H$  et ordinatis  $CH, DI$  sursum productis occurrentes in  $L$  et  $N$  et compleatur parallelogrammum  $HCDM$ . Et tempora quibus corpus describet arcus  $GH, HI$  erunt in subduplicata ratione altitudinum  $LH, NI$  quas corpus temporibus illis describere posset, a tangentibus cadendo: et velocitates erunt ut longitudines descriptæ  $GH, HI$  directe et tempora inverse. Exponentur tempora per  $T$  et  $t$  & velocitates per  $\frac{GH}{T}$  et  $\frac{HI}{t}$ :

et decrementum velocitatis tempore  $t$  factum exponetur per  $\frac{GH}{T} - \frac{HI}{t}$ . Hoc decrementum oritur a resistantia corpus retardante et gravitate corpus accelerante. Gravitatis in corpore cadente et spatium  $NI$  cadendo describente, generat velocitatem qua duplum illud spatium eodem tempore describere potuisset (ut Galilæus demonstravit<sup>(28)</sup>), id est velocitatem  $\frac{2NI}{t}$ : at in corpore

arcum  $HI$  describente auget arcum illum sola longitudine  $HI - HN$  seu  $\frac{MI \times NI}{HI}$

ideoq; generat tantum velocitatem  $\frac{2MI \times NI}{t \times HI}$ . Addatur hæc velocitas ad decrementum prædictum & habebitur decrementum velocitatis ex resistantia sola



in any given curved line, and also the speed of the body and resistance of the medium at individual places.

Let  $PQ$  be that plane perpendicular to the plane of the figure;  $PFHQ$  a line meeting this plane in the points  $P$  and  $Q$ ; <sup>(27)</sup> $G, H, I, K$  four places of the body proceeding in this curve from  $F$  to  $Q$ ; and  $GB, HC, ID, KE$  four parallel ordinates let fall from these points to the horizon and standing on the horizontal line  $PQ$  at the points  $B, C, D, E$ , and let the distances  $BC, CD, DE$  from one another be equal. From the points  $G$  and  $H$  draw straight lines  $GL, HN$  touching the curve at  $G$  and  $H$  and meeting the ordinates  $CH$  and  $DI$  extended upwards in  $L$  and  $N$ , and complete the rectangle  $HCDM$ . Then the times in which the body shall describe the arcs  $\widehat{GH}, \widehat{HI}$  will be in the halved ratio of the heights  $LH, NI$  which the body could in those times describe in falling from the tangents; and the speeds will be as the lengths  $\widehat{GH}, \widehat{HI}$  described directly and the times inversely. Express the times by  $T$  and  $t$ , and the speeds by  $\widehat{GH}/T$  and  $\widehat{HI}/t$ ; and then the decrement of the speed achieved in time  $t$  will be expressed by  $\widehat{GH}/T - \widehat{HI}/t$ . This decrement arises from the resistance slowing the body and gravity accelerating it. Gravity in a falling body which, as it falls, describes the distance  $NI$  generates a speed with which it could have covered twice that distance in the same time (as Galileo demonstrated<sup>(28)</sup>), *i.e.* the speed  $2IN/t$ ; but in a body describing the arc  $\widehat{HI}$  it increases that arc by the length  $\widehat{HI} - HN$  alone, that is, by  $IM \times IN/\widehat{HI}$ , and in consequence generates merely the speed  $2IM \times IN/t \times \widehat{HI}$ . Add this speed to the previously noted decrement and there will be had the

Newton eventually sent to his editor, Roger Cotes, on 6 January 1712/13 with the scanty comment that 'it will require the reprinting of a sheet and a quarter from pag. 230 to pag. 240. There is a wooden cut [of the figure] belonging to it w<sup>ch</sup> I intend to send you by the next Carrier. I think this Proposition as it is now done will take up much the same space as before' (*ibid.*: 261, first published by Edleston in his edition of *The Correspondence of Sir Isaac Newton and Professor Cotes* (London, 1850): 145 [= *Correspondence of Isaac Newton*, 5, 1975: 361]). So lightly he dismissed his hard sweat over many days to mend and reconstruct the detail of his solution to a problem in a variety of ways, as only he knew how!

(27) Newton initially went on to specify, much as in [1] preceding (compare the intervening draft in Appendix 2.8 below): ' $H$  corpus in ipsa motum, et  $[H]N$  recta ipsam tangens in  $[H]$ . Fingatur autem corpus  $H$  progredi ab  $F$  ad  $Q$  per lineam illam curvam  $PFHQ$ , et interea impedi a Medio resistente' ( $H$  the body moved in it, and  $HN$  the straight line touching it at  $H$ . Imagine, however, the body  $H$  to advance from  $F$  to  $Q$  by way of that curved line  $PFHQ$ , and all the while to be impeded by the resisting medium). In the manuscript original he carelessly omitted wholly to adapt the text of this cancelled passage to refer accurately to his re-lettered accompanying figure, where the denotations  $A, B, C, D, E$  of points in the base  $PQ$  and those,  $F, G, H, I, K$ , of corresponding points in the arc  $\widehat{FHQ}$  itself now logically mirror in their advancing sequence the successive positions of the projectile  $H$  in its resisted flight from  $F$  to  $Q$ . A few similar trivial lapses on Newton's part are silently corrected by us into their intended referents in sequel.

(28) See [2]: note (14) above, where we suggest that Newton might here more appropriately have written 'ut Hugenius demonstravit'.



oriundum, nempe  $\frac{GH}{T} - \frac{HI}{t} + \frac{2MI \times NI}{t \times HI}$ . Proindeq; cum gravitas eodem tempore in corpore cadente generet velocitatem  $\frac{2NI}{t}$ , Resistentia erit ad gravitatem ut  $\frac{GH}{T} - \frac{HI}{t} + \frac{2MI \times NI}{t \times HI}$  ad  $\frac{2NI}{t}$ , <sup>(29)</sup> sive ut  $\frac{t, GH}{T} - HI + \frac{2MI \times NI}{HI}$  ad  $2NI$ .

<sup>(30)</sup>Jam pro Abscissis  $BC$ ,<sup>(31)</sup>  $CD$ ,  $[C]E$  scriba[n]tur  $-o$ ,  $o$ ,  $2 \times o$ , pro ordinata  $CH$  scribatur  $P$ , et pro  $MI$  scribatur series quælibet  $Qo + Roo + So^3 + \&c$ . Et seriei termini omnes post primum, nempe  $Roo + So^3 + \&c$  erunt  $NI$ , & Ordinatae  $DI$ ,  $EK$  et  $BG$  erunt  $P - Qo - Roo - So^3$ ,  $P - 2Qo - 4Ro[o] - 8So^3$  &  $P + Qo - Roo + So^3$  respective. Et quadrando Differentias Ordinarum  $BG - CH$  et  $CH - DI$  & ad quadrata prodeuntia addendo quadrata ipsarum  $BC$ ,  $CD$ , habebuntur arcuum  $GH$ ,  $HI$  quadrata  $oo + QQoo - 2QRo^3$  &  $[c]$  et  $oo + QQoo + 2QRo^3 + \&c$ . Quorum radices  $o\sqrt{1+QQ} - \frac{QRoo}{\sqrt{1+QQ}}$  &  $o\sqrt{1+QQ} + \frac{QRoo}{\sqrt{1+QQ}}$  sunt arcus  $GH$  et  $HI$ . Præterea si ab Ordinata  $CH$  subducatur semisumma Ordinarum  $BG$  et  $DI$ , et ab Ordinata  $DG$  subducatur semisumma Ordinarum  $CH$  et  $EK$ , manebunt arcuum  $GI$  et  $HK$  sagittæ  $Roo$  et  $Roo + 3So^3$ . Et hæ sunt lineolis  $LH$  et  $NI$  proportionales<sup>(32)</sup> adeoq; in subduplicata<sup>(33)</sup> ratione temporum infinite parvorum  $T$  et  $t$ , ideoq;<sup>(34)</sup> ratio temporum  $\frac{t}{T}$  est  $\sqrt{\frac{R+3So}{R}}$  seu  $\frac{R+\frac{3}{2}So}{R}$ . Et  $\frac{t}{T}GH - HI + \frac{2MI \times NI}{HI}$  substituendo ipsorum  $\frac{t}{T}$ ,  $GH$ ,  $HI$ ,  $MI$  et  $NI$  valores jam inventos evadit

(29) This is the fundamental equation of motion in the tangential direction at  $H$ , as will perhaps more readily appear to modern eyes on naming the forces of resistance and gravity acting instantaneously upon the missile at  $H$  to be (in our usual notation)  $\rho$  and  $g$  respectively, and also setting  $V = \widehat{GH}/T$  and  $v = \widehat{HI}/t$  to be the (mean) speeds over the successive arcs  $\widehat{GH}$  and  $\widehat{HI}$ : for then, since  $MI/HI = MN/HN$  to adequate accuracy, there comes, on compounding (with Newton) the various increments and decrements of speed here generated, to be  $\rho t = V - v + (MN/HN) \cdot 2NI/t$  where ( $NI = \frac{1}{2}gt^2$  and so)  $2NI/t = gt$ , and consequently  $-(v - V)/t = \rho - (MN/NH) \cdot g$ ; that is, the deceleration of the body at  $H$  is instantaneously hereby compounded of the medium's direct resistance to its motion and the contrary acceleration of its speed due to the component of downwards gravity acting along the tangent  $HN$ .

(30) We may notice (for what it is worth) that Newton's preparatory draft of the next sentence and a half—in exactly the same words (and with the same slip '... ,  $DE$  scribatur' which we mend in immediate sequel)—is found at the bottom of Add. 3965.10: 136v.

(31) More precisely, in line with Newton's following assignation of its length as  $-o$ , this should read ' $CB$ ', and so Cotes—whom we follow in our English version—changed it to be in the fair copy of the present text which (see note (26) preceding) he received in January 1713.

(32) In fact  $LH = Ro^2 - 2So^3$  and  $NI = Ro^2 + So^3$ , and these are indeed (on ignoring higher powers of  $o$ ) in the given ratio  $(Ro^2 - 2So^3)/Ro^2 = (Ro^2 + So^3)/(Ro^2 + 3So^3) = 1 - 2(S/R)o$  to the corresponding *sagittæ*; and this holds true generally since, corresponding to the tangential

decrement of the speed arising from the resistance alone, namely

$$\widehat{GH}/T - \widehat{HI}/t + 2IM \times IN/t \times \widehat{HI}.$$

Accordingly, since gravity in the same time in a falling body generates the speed  $2IN/t$ , the resistance will be to gravity as  $\widehat{GH}/T - \widehat{HI}/t + 2IM \times IN/t \times \widehat{HI}$  to  $2IN/t$ ,<sup>(29)</sup> that is, as  $\widehat{GH} \times t/T - \widehat{HI} + 2IM \times IN/\widehat{HI}$  to  $2IN$ .

<sup>(30)</sup> Now for the abscissas  $CB, CD, CE$  write  $-o, o$  and  $2o$ , for the ordinate  $CH$  write  $P$ , and in place of  $IM$  write any series  $Qo + Ro^2 + So^3 + \dots$  you please. Then all the terms of the series after the first, namely,  $Ro^2 + So^3 + \dots$ , will be  $IN$ ; and the ordinates  $DI, EK$  and  $BG$  will be

$$P - Qo - Ro^2 - So^3 \dots, \quad P - 2Qo - 4Ro^2 - 8So^3 \dots \quad \text{and} \quad P + Qo - Ro^2 + So^3 \dots$$

respectively. And by squaring the differences of ordinates  $BG - CH$  and  $CH - DI$ , and to the resulting squares adding the squares of  $BC$  and  $CD$ , there will be had the squares of the arcs  $\widehat{GH}$  and  $\widehat{HI}$ ,

$$o^2 + Q^2o^2 - 2QRo^3 \dots \quad \text{and} \quad o^2 + Q^2o^2 + 2QRo^3 + \dots;$$

the roots of which,

$$o\sqrt{1+Q^2} - QRo^2/\sqrt{1+Q^2} \quad \text{and} \quad o\sqrt{1+Q^2} + QRo^2/\sqrt{1+Q^2},$$

are the arcs  $\widehat{GH}$  and  $\widehat{HI}$ . Moreover, if from the ordinate  $CH$  there be taken the half-sum of the ordinates  $BG$  and  $DI$ , and from the ordinate  $DG$  be taken the half-sum of the ordinates  $CH$  and  $EK$ , there will remain the *sagittæ* of the arcs  $\widehat{GI}$  and  $\widehat{HK}$ , viz.  $Ro^2$  and  $Ro^2 + 3So^3$ : these are proportional to the linelets  $HL$  and  $IN$ ,<sup>(32)</sup> and hence in the doubled<sup>(33)</sup> ratio of the infinitely small times  $T$  and  $t$ , so that<sup>(34)</sup> the ratio of the times  $t/T$  is  $\sqrt{(R+3So)}/\sqrt{R}$ , or  $(R+\frac{3}{2}So)/R$ . And so  $\widehat{GH} \times t/T - \widehat{HI} + 2IM \times IN/\widehat{HI}$  comes, by substituting for  $t/T, \widehat{GH}, \widehat{HI}, IM$  and

deviation  $R_{a+(n-1)o}o^2 + S_{a+(n-1)o}o^3 = Ro^2 + (3n-2)So^3$  where the base increment is  $no$ , the related *sagitta* is  $\frac{1}{2}(e_{a+(n-1)o} + e_{a+(n+1)o}) - e_{a+no} = Ro^2 + 3nSo^3$ , with

$$(Ro^2 + (3n-2)So^3)/(Ro^2 + 3nSo^3) = 1 - 2(S/R)o, \text{ constant,}$$

on again neglecting higher powers of  $o$ . But to demonstrate this proportionality of tangential deviation to corresponding *sagitta* we need first to evaluate both. It is curious that Newton should here assume the constancy of this ratio as 'evident' in seeking to forgo computation of the deviations  $LH$  and  $NI$  in favour of their more directly calculable 'arrows'.

(33) We render in our English version the sense of the 'duplicata' which Newton meant—here as in his preparatory draft (see Appendix 2.8: note (64))—to write. The obtrusive prefix 'sub' was afterwards struck out by Cotes in the fair copy sent to him in January 1713 (see note (26) above), and the mote did not endure to impair the clarity of vision of the reader of the *Principia's* ensuing *editio secunda*.

(34) Afterwards trivially altered to be 'et inde' (and thence) in the copy sent to Cotes for publication.



$\frac{3S_{00}}{2R} \sqrt{1+QQ}$ .<sup>(35)</sup> Et cum  $2NI$  sit  $2R_{00} + \&C_{[3]}$  Resistentia jam erit ad gravitatem ut  $\frac{3S_{00}}{2R} \sqrt{1+QQ}$  ad  $2R_{00}$ , id est ut  $3S\sqrt{1+QQ}$  ad  $4RR$ .<sup>(36)</sup>

Velocitas autem ea est quacum corpus de loco quovis  $H$  secundū tangentem  $HN$  egrediens, in Parabola diametrum  $HC$  et latus rectum  $\frac{HN^2}{NI}$  seu  $\frac{1+QQ}{R}$  habente, deinceps in vacuo moveri potest.<sup>(37)</sup>

(35) On ignoring terms of the order of  $o^3$ , that is. Newton's checking computation survives at the bottom of Add. 3965.10: 136<sup>v</sup>, evaluating  $(t/T)\widehat{GH} - \widehat{HI} + 2MI \times NI/HI$ , that is,

$$(1 + \frac{3}{2}(S/R)o) (o\sqrt{1+Q^2} - QRo^2/\sqrt{1+Q^2}) - (o\sqrt{1+Q^2} + QRo^2/\sqrt{1+Q^2}) + 2QRo^2/\sqrt{1+Q^2}$$

to be 
$$'o\sqrt{\quad} - \frac{QR_{00}}{\sqrt{\quad}} + \frac{3S_{00}\sqrt{\quad}}{2R} - \frac{3S_{00}Q}{2\sqrt{\quad}} - o\sqrt{\quad} - \frac{QR_{00}}{\sqrt{\quad}} + \frac{2QR_{00}}{\sqrt{\quad}}'$$

therein rejecting mutually cancelling terms and suppressing the relatively negligible  $-\frac{3}{2}QS_{00}^3/\sqrt{1+Q^2}$  to achieve his final  $'\frac{3S_{00}\sqrt{1+QQ}}{2R}'$ .

(36) Newton initially went on to conclude his paragraph with a first version of Corollary 1 below, stating: 'Ordinata quævis  $AF$  et tangens  $HN$  productæ concurrant in  $T$ , et erit  $CD$  ad  $HN$  ut  $AC$  ad  $HT$ , adeoque  $\frac{HT}{AC} = \frac{HN}{CD} = \sqrt{1+QQ}$ ' (Let any ordinate  $AF$  and the tangent  $NH$  meet, when produced, in  $T$ , and there will then be  $CD$  to  $HN$  as  $AC$  to  $HT$ , and hence  $HT/AC = HN/CD = \sqrt{1+Q^2}$ ).

(37) For in the terms of note (29) preceding, since the projectile in its curving path from  $H$  deviates from its tangential motion along  $HN$  under the downwards pull of gravity  $g$  through the distance  $NI = \frac{1}{2}gt^2$  in the infinitesimal time  $t$  in which the vanishingly small arc  $\widehat{HI}$  of its trajectory is covered, the square of its instantaneous speed  $v = \widehat{HI}/t \approx HN/t$  at  $H$  is therefore  $HN^2/(2NI/g) \propto HN^2/NI = \lim_{o \rightarrow \text{zero}} [o^2(1+Q^2)/(Ro^2 + \dots)] = (1+Q^2)/R$ , the latus rectum of the parabola which osculates the projectile path over its infinitesimal arc  $\widehat{GHI}$ , having for its diameter the line (*viz.*  $HC$ ) drawn through its vertex  $H$  parallel to  $NI$ .

From this value,  $v = \sqrt{(\frac{1}{2}g \cdot (1+Q^2)/R)}$  in explicit form, for the body's instantaneous speed, Newton's preceding ratio for the ratio of resistance  $\rho$  to gravity  $g$  can be directly obtained—without any need to make prior calculation of the lengths of the arclets  $\widehat{GH}$ ,  $\widehat{HI}$  and the ratio  $T/t$  of the times in which these are successively traversed—from the basic equation of motion at  $H$ , namely (again see note (29) above)  $\rho - (MN/HN) \cdot g = -(v-V)/t$ , that is,  $-v(v-V)/HN$ ; for at once, since  $MN = Qo$  and so  $HN = o\sqrt{1+Q^2}$  where  $HM = CD = o$  is the increment  $d(AC)$  of the abscissa  $AC = a$ , and  $v-V$  is the related increment of the speed  $v$ , there is in Leibnizian equivalent  $\rho - (Q/\sqrt{1+Q^2}) \cdot g = -v \cdot dv/da \cdot \sqrt{1+Q^2}$  and consequently  $\rho/g = (Q - \frac{1}{2}d(v^2/g)/da)/\sqrt{1+Q^2}$ ; whence, because  $Q, R, S$  are the coefficients of the Taylorian expansion  $e + Qo + Ro^2 + So^3 + \dots$  of the incremented ordinate  $DI = e_{a+o}$  (and so  $Q = de/da$ ,  $R = \frac{1}{2}d^2e/da^2 = \frac{1}{2}dQ/da$ ,  $S = \frac{1}{6}d^3e/da^3 = \frac{1}{3}dR/da$ ), there is

$$\frac{1}{2}d(v^2/g)/da = \frac{1}{2}d((1+Q^2)/R)/da = \frac{1}{2}(4Q - (1+Q^2) \cdot 3S/R^2)$$

and consequently  $\rho/g = \frac{3}{2}S\sqrt{1+Q^2}/R^2$ , as before. Except for the last reduction to Newton's corrected expression of this ratio in the *Principia's* second edition—but with the elegance that



*IN* the values now found, to be  $\frac{3}{2}(S/R) \sqrt{(1+Q^2)} o^2$ .<sup>(35)</sup> And since  $2IN$  is  $2Ro^2 + \dots$ , the resistance will now be to gravity as  $\frac{3}{2}(S/R) \sqrt{(1+Q^2)} o^2$  to  $2Ro^2$ , that is, as  $3S\sqrt{(1+Q^2)}$  to  $4R^2$ .<sup>(36)</sup>

The speed, however, is that with which a body, setting out from any place *H* in the direction of the tangent *HN*, can thereafter move *in vacuo* in a parabola having diameter *HC* and *latus rectum*  $HN^2/NI$ , that is,  $(1+Q^2)/R$ .<sup>(37)</sup>

the speed *v* was there determined by setting the component  $g/\sqrt{(1+Q^2)}$  of gravity normal to the curve at *H* equal to the *vis centripeta*  $v^2/r$ , where  $r = (1+Q^2)^{\frac{3}{2}}/2R$  is the radius of curvature at the point (compare vi: 131, note (86), and also 548–9, note (25))—this mode of solution had been attained two years earlier by Johann Bernoulli, and had indeed then led him on to detect Newton's error in 'Exempl. 1' in its original evaluation of the ratio of resistance to gravity in the instance of the semicircle  $e = \sqrt{(n^2 - a^2)}$  to be (on accurately applying the deficient general measure  $\frac{1}{2}S\sqrt{(1+Q^2)}/R^2$ ) but  $a/n$ . Here of course there is  $r = n$  by geometrical definition, while straightforwardly  $Q = de/da = -a/e$ , so that  $\sqrt{(1+Q^2)} = -n/e$  and consequently  $d(v^2/g)/da = d(n/\sqrt{(1+Q^2)})/da = -de/da$ , whence there is  $\rho/g = (Q - \frac{1}{2}(-Q))/\sqrt{(1+Q^2)} = \frac{3}{2}a/n$  *recte*; and so Bernoulli found it, privately communicating the particular result—and an outline of its derivation—to Leibniz on 12 August 1710 (N.S.) (see (ed. C. I. Gerhardt) *Leibnizens Mathematische Schriften*, 3 (Halle, 1856): 855). Five months afterwards Bernoulli sent the gist of the general formula  $\rho = (gQ - v \cdot dv/da)/\sqrt{(1+Q^2)}$  to Paris in a letter (addressed to Varignon?) of 10 January 1711 (N.S.) which was read out eighteen days later to the assembled members of the *Académie des Sciences* (though not to be printed till 1714 in its *Mémoires de Mathématique & de Physique pour l'Année M.DCCXI* [ $\rightarrow$  Paris, 1730: 47–54]), and where he again pointed in a concluding 'Remarque' to Newton's 'méprise... dans l'application qu'il a faite, Pag. 265. de sa solution du Prob. 3. pag. 260. au cercle... dans ses *Princ. Math.*' (see *ibid.*: 50–1). In this form the solution to the direct problem of resisted motion under a general 'force centripete de pesanteur' *g* was in early October 1712 shown by Johann's nephew Niklaus (during the latter's stay in London) personally to both Newton and Abraham de Moivre; in consequence of which de Moivre wrote to Johann on the following 17 December to report that 'M. Newton... souhaite que je sçache, si vous voudriez qu'on imprimât un théoreme de vous, que Monsieur votre neveu nous a communiqué pour déterminer la raison de la résistance à la force centripete, ou si vous aimez mieux attendre que son traité [the *Principia* in its *editio secunda auctior et emendatior*] paroisse, qui sera vers la fin du mois de février prochain...', adding on his own account that 'je l'ai examiné plusieurs fois, et il me paroit très beau et digne de vous' (Wollenschläger, 'Briefwechsel' (§1: note (1)): 277). But—even as Newton was honing his mended Proposition X into its present final version—Bernoulli himself, doubtless spurred on yet more fiercely by de Moivre's news that his nephew had imparted his theorem on resisted motion under gravity (to a finite force-centre in a straightforward generalization) to Newton, was hard at work in Basel elaborating the geometrical construction of its equivalent form  $\rho/g = (Q - \frac{1}{2}d(r/\sqrt{(1+Q^2)})/da)/\sqrt{(1+Q^2)}$  to be the basic 'Problema I' of what he described in his reply to de Moivre on 18 February 1713 (N.S.) as 'un écrit de 40 pages... qui porte pour titre: "De motu corporum gravium, pendulorum, et projectilium in mediis non resistentibus et resistentibus, supposita gravitate uniformi et non uniformi, atque ad quodvis datum unum punctum tendente, et de variis [aliis] huc spectantibus, demonstrationes geometricæ"' [et que] j'ai envoyé au commencement de cette année à Leipsic... pour être publié dans les *Actes* [ $\rightarrow$  *Acta Eruditorum* (February/March 1713): 77–95/115–32]... Vous y [= §§35–38 (+ *Additio*): 115–18 (+ 132)] trouverez la démonstration de mon théoreme que mon neveu vous a communiqué pour déterminer la raison de la résistance à la force centripete, dont j'ai donné l'analyse il y a 3[!] ans à l'Académie des Sciences de Paris dans une piece [qui] se trouvera dans les *Mémoires* de l'Académie de l'an 1710[!] nouvellement imprimé, à ce qu'on m'écrit,

[Et] Resistentia [est] ut Medij densitas & quadratum velocitatis conjunctim & propterea Medij densitas ut Resistentia directe & quadratum velocitatis inverse, id est ut  $\frac{3S\sqrt{1+QQ}}{4RR}$  directe &  $\frac{HI^q}{t}$  seu  $\frac{1+QQ}{R}$  inverse, hoc est ut  $\frac{S}{R\sqrt{1+QQ}}$ . Q.E.I.<sup>(38)</sup>

*Corol. 1.* Si tangens  $HN$  producatur utrinque donec occurrat Ordinatae cuilibet  $AF$  in  $T$ : erit  $\frac{HT}{AC}$  æqualis  $\sqrt{1+QQ}$ , adeoque in superioribus pro  $\sqrt{1+QQ}$  scribi potest. Qua ratione Resistentia erit ad gravitatem ut  $3S \times HT$  ad  $4RR \times AC$ , Velocitas erit ut  $\frac{HT}{AC\sqrt{R}}$  et Medij densitas erit ut  $\frac{S \times AC}{R \times HT}$ .

*Corol. 2.* Et hinc si Curva linea  $PFHQ$  definiatur per relationem inter basem seu abscissam  $AC$  et Ordinatum applicatam  $CH$  (ut moris est) et valor ordinatum applicatae resolvatur in seriem convergentem: Problema per primos seriei terminos expedite solvetur, ut in exemplis sequentibus.

*Exempl. 1.* Sit linea  $PFHQ$  semicirculus super diametro  $PQ$  descriptus, & requiratur Medij densitas quæ faciat ut Projectile in hac linea moveatur.

Bisecetur semicirculi diameter  $PQ$  in  $A$  et dic  $AQ$   $n$ ,  $AC$   $a$ ,  $CH$   $e$ , et  $CD$   $o$ : et erit  $DI^q$  seu  $AQ^q - AD^q = nn - aa - 2ao - oo$  seu  $ee - 2ao - oo$ , et radice per methodum nostram extracta fiet  $DI = e - \frac{ao}{e} - \frac{oo}{2e} - \frac{aao}{2e^3} - \frac{ao^3}{2e^3} - \frac{a^3o^3}{2e^5}$  &c. Hic scribatur  $nn$  pro  $ee + aa$  et evadet  $DI = e - \frac{ao}{e} - \frac{nnoo}{2e^3} - \frac{anno^3}{2e^5} [-]$  &c.

Hujusmodi series distinguo in terminos successivos in hunc modum. Terminum primum appello in quo quantitas infinite parva  $o$  non extat; secundum in [quo] quantitas illa est unius dimensionis; tertium in quo extat duarum,

---

mais si vous croyez digne qu'on l'imprime séparément dans vos *Transactions*, je vous en laisse le maître, pour le faire paroître en telle maniere que vous jugerez à propos' (Wollenschläger, 'Briefwechsel': 282-3). There could of course, as Bernoulli very well knew, be no question of giving a simultaneous printing in the *Philosophical Transactions* of a lengthy article which bid fair to render the *editio secunda* of the *Principia* obsolete even before it was published. When shown Bernoulli's letter by de Moivre, Newton's reaction was to seek to dampen the growl of his thunder. 'I heare', he wrote on 31 March to his editor, Roger Cotes, in Cambridge, 'that M<sup>r</sup> Bernoulli has sent a Paper of 40 pages to be published in the *Acta Leipsica* relating to what I have written upon the curve Lines described by Projectiles in resisting Mediums. And therein he partly makes Observations upon what I have written & partly improves it. To prevent being blamed by him or others for any disingenuity in not acknowledging my oversights or slips in the first edition I beleive it will not be amiss to print next after the old *Præfatio ad Lectorem*, the following Account of this new Edition. *In hac secunda Principiorum Editione, multa sparsim emendantur & nonnulla adjiciuntur...*' (Trinity College, Cambridge. R. 16. 38: 284 [=Correspondence of Isaac Newton, 5, 1975: 400]). That Newton did not in this newly inserted *Auctoris Præfatio* mention either Bernoulli's name or the 'Libri secundi Prop. X'



While the resistance is as the density of the medium and square of the speed jointly, and accordingly the density of the medium is as the resistance directly and the square of the speed inversely, that is, as  $3S\sqrt{(1+Q^2)}/4R^2$  directly and  $\widehat{HI}^2/t$  or  $(1+Q^2)/R$  inversely—in other words, as  $S/R\sqrt{(1+Q^2)}$ . As was to be found.<sup>(38)</sup>

*Corollary 1.* If the tangent  $HN$  be produced either way till it shall meet any ordinate  $AF$  you please in  $T$ , there will then be  $TH/AC$  equal to  $\sqrt{(1+Q^2)}$ , and hence can be written in the above in its place. For which reason the resistance will be to gravity as  $3S \times TH$  to  $4R^2 \times AC$ , the speed will be as  $TH/AC \sqrt{R}$ , and the density of the medium as  $S \times AC/R \times TH$ .

*Corollary 2.* And hence, if the curved line  $PFHQ$  be defined by means of a relationship between the base or abscissa  $AC$  and the ordinate  $CH$  (as is customary) and the value of the ordinate be resolved into a converging series, then the problem will be promptly solved through the first terms of the series, in the following examples.

*Example 1.* Let the line  $PFHQ$  be a semicircle described upon the diameter  $PQ$ , and let there be required the density of the medium which shall make a projectile move in this line.

Bisect the semicircle's diameter  $PQ$  in  $A$  and call  $AQ = n$ ,  $AC = a$ ,  $CH = e$  and  $CD = o$ : then will there be  $DI^2$ , that is,  $AQ^2 - AD^2 = n^2 - a^2 - 2ao - o^2$ , or  $e^2 - 2ao - o^2$ , and with the root extracted by our method there will come to be  $DI = e - (a/e)o - \frac{1}{2}(1/e + a^2/e^3)o^2 - \frac{1}{2}(a/e^3 + a^3/e^5)o^3 \dots$ . Here write  $n^2$  in place of  $e^2 + a^2$  and there will prove to be  $DI = e - (a/e)o - \frac{1}{2}(n^2/e^3)o^2 - \frac{1}{2}(an^2/e^5)o^3 - \dots$

Series of this sort I distinguish into their successive terms in this fashion. The first term I call that in which the infinitely small quantity  $o$  does not occur; the second one that in which the quantity occurs of one dimension; the third that in which it occurs of two dimensions, the fourth that in which it is of three, and

which the latter had (by way of his nephew) led him to reconstruct with so much trouble was at once a meanness—if not spite—and a cowardice which stored up in Bernoulli's mind a hoard of bitter recrimination which, once publicly displayed, both lived on to regret. (The tale is briefly told in our preceding introduction.) It was not, we may here anticipate, seemingly till six years afterwards in 1719 that Bernoulli, taunted by what he took to be a challenge from John Keill to solve the inverse problem (see note (50) below) of determining the path  $e = e_a$  of a projectile through a medium which resists its onrush instantaneously as some given power of its speed, at length made equivalent reduction of his resistance equation to derive from it Newton's measure  $\rho/g = \frac{3}{4}S\sqrt{(1+Q^2)}/R^2$ —or more precisely, in his preferred Leibnizian terms,  $\rho/g = \frac{1}{2}(d^3e/da^3)(ds/da)/(d^2e/da^2)$ , where  $\widehat{FH} = s$  is the arc-length of the missile path corresponding to the base distance  $AC = a$  travelled.

(38) As in the preliminary version reproduced in Appendix 2.8 (see our note (62) thereto), these last two paragraphs of the main text are found in reverse order in the manuscript, but we obey Newton's subsequent instruction to invert their sequence, minimally recasting the original opening 'Est autem Resistencia ut...' (The resistance, however, is as...) to be as it is in the lightly corrected copy of the present proposition sent to Cotes in January 1713 for publication.

quartum in quo trium est, & sic in infinitum. Et primus terminus qui hic est  $e$  denotabit semper longitudinem ordinatæ  $CH$  insistentis ad initium<sup>(39)</sup> indefinitæ quantitatis  $o$ ; secundus terminus qui hic est  $\frac{ao}{e}$ , denotabit differentiam inter  $CH$  et  $DN$ , id est lineolam  $MN$  quæ abscinditur complendo parallelogrammum  $HCDM$ , atq; adeo positionem Tangentis  $HN$  semper determinat: ut in hoc casu capiendo  $MN$  ad  $HM$  ut est  $\frac{ao}{e}$  ad  $o$ , seu  $a$  ad  $e$ . Terminus tertius qui hic est  $\frac{nmoo}{2e^3}$  designabit lineolam  $IN$  quæ jacet inter tangentem et Curvam adeoq; determinat angulum contactus  $IHN$  seu curvaturam quam curva linea habet in  $H$ . Si lineola illa  $IN$  finitæ est magnitudinis, designabitur per terminum tertium una cum sequentibus in infinitum. At si lineola illa minuatur in infinitum, termini subsequentes evadent infinite minores tertio, ideoq; negligi possunt. Terminus quartus qui hic est  $\frac{anno^3}{2e^5}$ , determinat variationem curvaturæ, quintus variationem variationis, & sic deinceps.<sup>(40)</sup> Unde obiter patet usus non contemnendus harum serierum in solutione Problematum quæ pendent a Tangentibus et Curvatura curvarum.

Conferatur jam series  $e - \frac{ao}{e} - \frac{nmoo}{2e^3} - \frac{anno^3}{2e^5}$  & c qua ordinata  $DI$  in Problemate jam solvendo designatur cum serie  $P - Qo - Roo - So^3$  [& c] qua designabatur in inventione solutionis, et perinde pro  $PQR$  et  $S$  scribantur  $e, \frac{a}{e}, \frac{nn}{2e^3}$  &  $\frac{ann}{2e^5}$ , et pro  $\sqrt{1+QQ}$  scribatur  $\sqrt{1 + \frac{aa}{ee}}$  seu  $\frac{n}{e}$ , et prodibit Medij densitas ut  $\frac{a}{ne}$ , hoc est (ob datam  $n$ ) ut  $\frac{a}{e}$  seu  $\frac{AC}{CH}$ , id est, ut Tangentis longitudo illa  $HT$  quæ ad semidiametrum  $AF$  ipsi  $PQ$  normaliter insistentem terminatur: & resistentia erit ad gravitatem ut  $3a$  ad  $2n$  id est ut  $3AC$  ad circuli diametrum  $PQ$ ; velocitas autem erit ut  $\sqrt{2CH}$ .<sup>(41)</sup> Quare si corpus<sup>(42)</sup> justa cum velocitate secundum lineam ipsi  $PQ$  parallelam exeat de loco  $F$ , et Medij densitas in singulis locis  $H$  sit ut longitudo tangentis  $HT$ , & resistentia etiam in loco aliquo  $H$  sit ad vim gravitatis ut  $3AC$  ad  $PQ$ , corpus illud describet circuli quadrantem  $FHQ$ . Q.E.I.

At si corpus idem de loco  $P$  secundum lineam ipsi  $PQ$  perpendicularem

(39) The point  $C$  at which the linelet  $CD = o$  begins.

(40) See Appendix 1: note (20) below, where we also remark that when he came subsequently to review the text of the *Principia's editio secunda* he tentatively framed an addition *Ad pag. 240*—after the fifth paragraph of the ensuing scholium as it is here augmented—where he showed how the linelet  $NI = Ro^2 + \dots$  yields, jointly with the tangent  $HN = o\sqrt{1+Q^2}$ , the chord  $HN^2/NI = (1+Q^2)/R$  of the circle which osculates the curve  $FHQ$  over its infinitesimal arc  $\widehat{HI}$ ; whence at once the radius of curvature of the curve at the point  $H$  is  $(1+Q^2)^{\frac{3}{2}}/2R$ ,



so on indefinitely. And the first term, here  $e$ , will ever denote the length of the ordinate  $CH$  standing (on the base) at the beginning<sup>(39)</sup> of the indefinite quantity  $o$ ; the second term, here  $(a/e) o$ , will denote the difference between  $CH$  and  $DN$ , that is, the linelet  $NM$  which is cut off by completing the rectangle  $HCDM$ , and hence ever determines the position of the tangent  $HN$ : in this case, specifically, by taking  $NM$  to  $HM$  as is  $(a/e) o$  to  $o$ , or  $a$  to  $e$ . The third term, here  $\frac{1}{2}(n^2/e^3) o^2$ , will designate the linelet  $IN$  which lies between the tangent and the curve, and hence determines the angle of contact  $\widehat{IH}N$ , or the curvature which the curved line has at  $H$ : if that linelet  $IN$  is of finite size, it will be denoted by the third term together with the ones following on to infinity; but if that linelet be infinitely diminished, the subsequent terms will prove to be infinitely less than the third, and can consequently be neglected. The fourth term, here  $\frac{1}{2}(an^2/e^5) o^3$ , determines the variation of the curvature, the fifth the variation of the variation, and so on.<sup>(40)</sup> Whence, incidentally there is opened up a use not to be despised of these series in the solution of problems which depend on tangents and the curvature of curves.

Now compare the series  $e - (a/e) o - \frac{1}{2}(n^2/e^3) o^2 - \frac{1}{2}(an^2/e^5) o^3 \dots$  whereby the ordinate  $DI$  in the problem now to be solved is denoted with the series  $P - Qo - Ro^2 - So^3 \dots$  by which it was designated in finding out the solution, and likewise in place of  $P$ ,  $Q$ ,  $R$  and  $S$  write  $e$ ,  $a/e$ ,  $\frac{1}{2}n^2/e^3$  and  $\frac{1}{2}an^2/e^5$ , and so for  $\sqrt{(1+Q^2)}$  write  $\sqrt{(1+a^2/e^2)}$ , that is,  $n/e$ ; and there will result the density of the medium as  $a/ne$ , that is (because  $n$  is given) as  $a/e$  or  $AC/CH$ , in other words as the length  $TH$  of the tangent which terminates at the radius  $AF$  standing at right angles to  $PQ$ ; while the resistance will be to gravity as  $3a$  to  $2n$ , that is, as  $3AC$  to the circle's diameter  $PQ$ ; and the speed will be as  $\sqrt{(2CH)}$ .<sup>(41)</sup> In consequence, should a body<sup>(42)</sup> go forth from the place  $F$  with a proper speed along a line parallel to  $PQ$ , and the density of the medium in individual places  $H$  be as the length of the tangent  $TH$ , and the resistance also at an arbitrary place  $H$  be to the force of gravity as  $3AC$  to  $PQ$ , the body will describe the circle-quadrant  $\widehat{FH}Q$ . As was to be found.

But should the same body set off from the place  $P$  along a line perpendicular

that is,  $(ds/da)^3/(d^2e/da^2)$  in the more familiar Leibnizian equivalent (compare note (37) preceding). No such insertion was made, there or at any other place, in the *Principia's* third edition in 1726, but its three surviving drafts are reproduced in Appendix 4.

(41) This is rounded off to be just 'ut  $\sqrt{CH}$ ' (as  $\sqrt{(CH)}$ ) in the corrected copy of the present text which Newton later (see note (26) preceding) forwarded to Cotes to be printed.

(42) As Newton himself was to do in the copy which he subsequently sent to Cambridge for publication, we here omit an outmoded ensuing 'C'—that is, 'H' in the present figure (see note (27) preceding)—which he at this point carelessly copied into the manuscript from his preliminary draft (Appendix 2.8 following).

egrederetur et in arcu circuli moveri inciperet, sumenda esset  $AC$  seu  $a$  ad contrarias partes centri  $A$  & propterea signum ejus mutandum esset & scribendum  $-a$  pro  $+a$ . Negativam autem densitatem, hoc est quæ motus corporum accelerat, Natura non admittit; et propterea naturaliter fieri non potest ut corpus ascendendo a  $P$  describat circuli quadrantem  $PF$ . Ad hunc effectum deberet corpus a Medio impellente accelerari<sub>1</sub>, non a resistente impediri.

*Exempl. 2.* Sit linea  $PFHQ$ <sup>(43)</sup> Parabola & c<sup>(44)</sup>

[Pag. 268. lin. 10, lege ut  $3XY$  ad  $2YG$ .]<sup>(45)</sup>

[Pag. 269. lin. 8, lege ut  $3S$  in  $\frac{XY}{a}$  ad  $4RR$ , id est ut  $XY$  ad  $\frac{2nn+2n}{n+2} VG$ .]<sup>(45)</sup>

Pag. 269. lin. 11. After the words habente. Q.E.I. insert these two Paragraphs.<sup>(46)</sup>

*Schol.*

Fingere liceret quod projectile pergeret<sup>(47)</sup> in arcuum  $GH$ ,  $HI$ ,  $IK$  chordis, et in solis punctis  $G$ ,  $H$ ,  $I$ ,  $K$  per vim gravitatis & vim resistentiæ agitaretur,<sup>(47)</sup> perinde ut in Propositione prima Libri primi corpus per vim centripetam intermittentem agitabatur, deinde chordas in infinitum diminui ut vires redderentur<sup>(47)</sup> continuæ. Et solutio Problematis hac ratione facillima evaderet.<sup>(48)</sup>

(43) So we 'translate' the manuscript reading ' $ALCK$ ' transcribed by Newton from his draft, which is keyed to a differently lettered figure. The oversight was carried over by him into the copy which he subsequently transmitted to Cambridge to be printed, but was there caught by Cotes before it could pass into the *editio secunda*.

(44) Understand that the remainder of the text of this second worked example of the 'Galileian' unresisted parabolic path is here to follow exactly as in the first edition (*Principia*, 1687: 266) except for the few transliterations necessitated by its now being referred to the figure on page 356 above, whose points are (see note (27) thereto) differently denoted.

(45) These corrections to the 1687 text of the ensuing hyperbolic Examples 3 and 4—immediate consequences of course (compare Appendix 1: note (35)) of Newton's present multiplication by a like factor of  $\frac{3}{2}$  of his original, deficient general value  $\frac{1}{2}S\sqrt{(1+Q^2)}/R^2$  for the ratio of resistance to gravity—are here inserted in the manuscript text (which lacks any version of them) from the equivalent place on the last page (Trinity College. R. 16.38: 265) of the augmented copy of the mended proposition which he sent to Cotes early in January 1713. Newton's preliminary framings of these minor adjustments, set out—immediately below a first roughing-out of the first of the two paragraphs which form in sequel a new opening to the ensuing scholium (compare note (47) below)—on the back (Add. 3968.37: 548<sup>v</sup>) of a draft of the English preface to his edition of the *Commercium Epistolicum* then also in the press, are identically worded.

(46) This instruction was afterwards altered in the copy sent to Cotes to read equivalently: '*pag. 269. lin. 12. lege sequentia*' (at page 269, line 12 read the following).

(47) In the version passed on to Cotes for publication these phrases were minimally changed to read 'Fingere... projectile pergere' (... imagine the projectile to proceed), '&... agitari' (and to be disturbed) and 'reddantur' (shall be rendered) respectively. In his initial framing of this paragraph on Add. 3968.37: 548<sup>v</sup> (see note (45) above) Newton first began little differently: 'Fingere licet quod corpora pergerent...' (It is permissible to imagine that bodies proceed...).



to  $PQ$  and begin to move in the arc of the circle, you would need to take  $AC$ , that is,  $a$ , on the opposite side of the centre  $A$ , and accordingly to change its sign, writing  $-a$  in place of  $+a$ . A negative density however—one, that is, which accelerates the motions of bodies—is not admitted in nature; and accordingly it cannot naturally happen that a body in ascending from  $P$  shall describe the circle-quadrant  $\widehat{PF}$ : to this effect a body would have needed to be accelerated by an impelling medium, not impeded by a resisting one.

*Example 2.* Let the line  $PFHQ$ <sup>(43)</sup> be a parabola. . . .<sup>(44)</sup>

*Page 268, line 10.* Read as  $3XY$  to  $2YG$ .<sup>(45)</sup>

*Page 269, line 8.* Read as  $3S \times XY/a$  to  $4R^2$ , that is, as  $XY$  to

$$(2(n^2 + n)/(n + 2)) VG.$$
<sup>(45)</sup>

*Page 269, line 11.* After the words having. . . . As was to be found. insert these two paragraphs.

*Scholium.*

It would have been permissible to imagine that the projectile were to proceed<sup>(47)</sup> in the chords  $GH$ ,  $HI$ ,  $IK$  of the arcs, and be disturbed<sup>(47)</sup> through the force of gravity and the force of resistance at the sole points  $G$ ,  $H$ ,  $I$  and  $K$ , exactly as in Proposition I of the first book a body was disturbed through an intermittent centripetal force; and then the chords to be infinitely diminished so that the forces were rendered<sup>(47)</sup> continuous. And the solution of the problem by this means would have turned out very easy.<sup>(48)</sup>

---

(48) Newton alludes to the variant mode of solution set out in his 'Idem aliter' (§2.2 preceding) whereby the forces of gravity and resistance are conceived to act on the projectile instantaneously in discrete unit-impulses, 'simul et semel', at successive infinitesimal moments of time. Unfortunately, on the lone page 240 of the *editio secunda* yet remaining unassigned in the re-set proposition there proved to be not quite room sufficient to include the whole of the scholium's augmented beginning (which, let us remind, included not only the two additional paragraphs here newly inserted but also the first two of the old opening). Space enough could have been contrived in one or more of several obvious ways—in his covering letter to Cotes on 6 January 1712/13 (Trinity College. R. 16. 38: 261 [= *Correspondence*, 5: 361]) Newton himself made the practical suggestions that an extra line might, as needed, be added on each of the preceding pages 231–9 still in the printer's frame, and also that the text might be packed more closely in around the 'cuts' (as could easily have been done, at the cost of resetting the next page and a half, with the sprawling block on page 238 illustrating the hyperbolic Examples 3/4)—but Cotes elected instead, when the matter came to the crunch, to suppress the present paragraph *in toto* to gain room for what comes after, ultimately presenting the excision as a *fait accompli* to its author (who, if he noticed the omission, is not known to have objected) and in the meanwhile mildly responding to him that 'Some things in Your Paper I have altered, [but] they are not worth Your Notice. . . .' (*ibid.*: 266 [= *Correspondence*, 5: 370]). The paragraph thus denied its rightful place in the *Principia*'s second edition disappeared straight into an oblivion from which it was retrieved only in the middle of the following century through the care of Joseph Edleston, who published its text as communicated to Cotes, in a footnote to his

Eadem ratione qua prodijt densitas Medij ut  $\frac{S \times AC}{R \times HT}$  in Corollario primo: si Resistentia ponatur ut Velocitatis  $V$  dignitas quaelibet  $V^n$  cujus index est numerus  $n$ ; prodibit densitas Medij ut  $\frac{S}{R^{\frac{4-n}{2}}} \times \frac{AC}{HT} |^{n-1}$  <sup>(49)</sup>. Et propterea si curva inveniri potest ea lege ut  $\frac{S}{R^{\frac{4-n}{2}}}$  sit ad  $\frac{HT}{AC} |^{n-1}$ , vel  $\frac{S^2}{R^{4-n}}$  ad  $1 + QQ |^{n-1}$ , in data ratione: corpus movebitur in hac curva in uniformi Medio cum resistentia quæ sit ut velocitatis dignitas  $V^n$ .<sup>(50)</sup> Sed redeamus ad curvas simpliciores.

Quoniam [motus non fit in Parabola nisi in Medio non resistente &c].

[Pag. 270, lin. 9 & 14. lege  $\frac{2nn+2n}{n+2}$  pro  $\frac{3nn+3n}{n+2}$ .]<sup>(51)</sup>

[In the errata put Pag. 274. lin. 4 lege  $\frac{2nn-2n}{n-2}$  VG.]<sup>(52)</sup>

first printing of the latter's letter of reply to Newton from which we have just now quoted, in his edition of the *Correspondence of Sir Isaac Newton and Professor Cotes* (London, 1850): 147, note \*. He did not of course know of the full argument of the parent 'Idem aliter', whose manuscript remained closeted for another twenty years and more in the private possession of Lord Portsmouth at Hurstbourne Park along with Newton's other scientific papers (see 1: xxviii) before at length being brought to Cambridge, in whose University Library it has this past century found a permanent resting-place (even if its significance there too went unappreciated by the outer world).

(49) For there is (see note (37) above)  $V = \sqrt{(\frac{1}{2}g \cdot (1+Q^2)/R)}$ , where  $g$  is the constant force of downwards gravity; whence, on putting  $\delta$  to be the medium's density at  $H$ , the resistance  $\frac{1}{2}gS\sqrt{(1+Q^2)}/R^2$  is proportional to  $\delta V^n \propto \delta((1+Q^2)/R)^{\frac{1}{2}n}$ , and consequently there ensues  $\delta \propto R^{\frac{1}{2}n-2}S/(1+Q^2)^{\frac{1}{2}(n-1)}$ . In here presenting this result Newton introduces the elegance of replacing  $(1+Q^2)^{\frac{1}{2}}$  by the equal ratio  $HN/(HM$  or  $)CD = TH/AC$ , but this is mere geometrical decoration. In his preliminary derivation, on Add. 3968.37: 548<sup>v</sup>, of this general measure of the variation of density along the projectile path (see Appendix 2.10) he stated it without any such cloaking embellishment, and then went on to display the pattern of the particular forms which it assumes in the instances where successively  $n = 0, 1, 2, 3, \dots, 7$ . On Add. 3965.12: 201<sup>v</sup>, where Newton subsequently mapped out the summary of this scheme which he now gives, he initially was content solely to adduce the prime case  $n = 2$  of the sequel, affirming, namely,

that 'Cum densitas Medij per Corol. 1 fuerit ut  $\frac{S \times AC}{R \times HT}$ , si Curva inveniri possit ea lege ut  $S \times AC$  sit ad  $R \times HT$  in data ratione, movebitur Corpus in hac curva in uniformi medio' (Since the density of the medium was, by Corollary 1, as  $S \times AC/R \times TH$ , if a curve might be found obeying the law that  $S \times AC$  be in a given ratio to  $R \times TH$ , the body will move in this curve in a uniform medium); and only afterwards there added more generally: 'Et si Velocitas dicatur  $V$  et  $n$  sit index dignitatis ejus et Resistentia sit ut Medij de[n]sitas et  $V^n$ , erit medij

densitas ut Resistentia directe &  $V^n$  inverse, id est ut  $\frac{3S\sqrt{1+QQ}}{4RR}$  directe &  $\frac{1+QQ}{R} |^{\frac{n}{2}}$  inverse,



In the same manner as the density of the medium resulted to be as

$$(S/R) \cdot (AC/TH)$$

in Corollary 1: if the resistance be put as any power of the speed  $V$  you please,  $V^n$ , whose index is the number  $n$ , the density of the medium will result to be as  $(S/R^{2-\frac{1}{2}n}) \cdot (AC/TH)^{n-1}$ .<sup>(49)</sup> Accordingly, if a curve can be found obeying the law that  $S/R^{2-\frac{1}{2}n}$  be to  $(TH/AC)^{n-1}$ , or  $S^2/R^{4-n}$  be to  $(1+Q^2)^{n-1}$ , in a given ratio, then the body will move in this curve in a uniform medium subject to a resistance which shall be as the power  $V^n$  of the speed.<sup>(50)</sup> But let us return to simpler curves.

Because motion does not take place in a parabola except in a non-resisting medium. . . .

Page 270, lines 9 and 14. Read  $2(n^2+n)/(n+2)$  in place of  $3(n^2+n)/(n+2)$ .<sup>(51)</sup>

In the errata put: 'Page 274, line 4. Read  $2(n^2-n) \cdot VG/(n-2)$ .'<sup>(52)</sup>

hoc est ut  $\frac{3S \times \overline{1+QQ}^{\frac{-n+1}{2}}}{4R^{\frac{4-n}{2}}}$  (And if the speed be called  $V$ , and  $n$  the index of its power, and

so the resistance as the medium's density and  $V^n$ , the medium's density will then be as the resistance directly and  $V^n$  inversely, that is, as  $\frac{3}{2}S\sqrt{(1+Q^2)}/R^2$  directly and  $((1+Q^2)/R)^{\frac{1}{2}n}$  inversely, or as  $\frac{3}{2}S(1+Q^2)^{\frac{1}{2}(-n+1)}/R^{\frac{1}{2}(4-n)}$ .

(50) The draft of this sentence on f. 201<sup>v</sup> (in sequel to that cited in the previous note) begins slightly differently by positing 'Et propterea si hujusmodi Curva inveniri potest ut  $SS$  in  $R^{n-4}$  sit ad  $\overline{1+QQ}^{n-1}$  in ratione data, . . .' (And accordingly, if a curve can be found of this sort that  $S^2 \times R^{n-4}$  shall be to  $(1+Q^2)^{n-1}$  in a given ratio, . . .). Newton's condition for motion through a uniformly dense medium resisting as some given  $n$ th power of the transient body's speed—in a path defined, namely, by the relationship  $e = e_a$  connecting the abscissa  $AC = a$  and ordinate  $CH = e$  of its general point  $H(a, e)$ , with  $Q, R$  and  $S$  the coefficients of the powers  $o, o^2$  and  $o^3$  in the series expansion of the incremented ordinate  $DI = e_{a+o}$  corresponding to the augmented abscissa  $AD = a+o$ —can be looked directly upon as a criterion for testing whether any particular curve  $\widehat{FHI}$  can be traversed through a uniform medium under any specified law of resistance. And so, certainly, he himself went straightaway on to apply it, in the brief lines of calculation which are reproduced (with a deal of editorial fleshing out) in Appendix 2.11 following, to fail the logarithmic curve

$$e \propto - \int_b^a (x+cx^2)^{-1} \cdot dx = \log(c+1/a) - \log(c+1/b),$$

$b$  the maximum horizontal range attained (at the origin) from the firing point  $(b, 0)$ , as a path traversable in the primary case where the medium resists as the square of the projectile's speed; and thereafter abortively to make trial of the more general curve  $e \propto \int_b^a (x^m+cx^{m+1})^n \cdot dx$  as a possible trajectory in the less physically realistic case where the medium resists the flight of the missile uniformly at all points (and so  $n = 0$ ). But from the inverse viewpoint, since (as Newton himself already well appreciated—see VII: 98—if he could never make it clear to the Bernoullis that he had long before attained this key insight) the coefficient of the power  $o^i$  in the Taylorian series expansion of  $e_{a+o}$  is the adjusted corresponding derivative  $(1/i!) d^i e/da^i$ ,  $i = 1, 2, 3, \dots$

successively, so that here (compare note (37) above) there is

$$Q = de/da, \quad R = \frac{1}{2}d^2e/da^2 = \frac{1}{2}dR/da \quad \text{and} \quad S = \frac{1}{6}d^3e/da^3 = \frac{1}{6}dR/da,$$

this same criterion encapsulates a third-order derivative condition from which one may work back to determine, for any given index  $n$ , the totality of possible projectile curves traversible through a medium resisting as the  $n$ th power of the speed. In the simplest instance ( $n = 1$ ) where the resistance is proportional to the speed the condition requires that

$$R^{-\frac{1}{2}}S (= \frac{1}{6}R^{-\frac{1}{2}} \cdot dR/da)$$

be constant, whence a first integration yields  $R^{-\frac{1}{2}} \propto m - na$  or  $2R (= dQ/da) \propto (m - na)^{-2}$ , and a second integration produces  $Q (= de/da) \propto k - n/(m - na)$ , so that finally there ensues

$$e \propto ka + l + \log(m - na):$$

the defining Cartesian equation of the general point  $(a, e)$  of the *curva logarithmica* which, *mutatis mutandis*, Newton had already geometrically attained in autumn 1684 in the concluding scholium of his treatise 'De motu Corporum'—there, unbeknownst, following in the steps of Christiaan Huygens in then still unpublished researches of sixteen years earlier—by compounding from first principles the horizontal and vertical components of the resisted motion under downwards gravity which he had separately obtained in his preceding Problems 6 and 7 (see vi: 68–72, and our note (113) thereto), and whose minimally reshaped construction he afterwards printed as Proposition IV of the second book of his *Principia* (1687: 241–3 [= vi: 85–7]). Determination of the general trajectory where the resistance is proportional to the square of the speed, and for which no parallel separation of the motion into like resisted (and downwards gravitationally accelerated) components is possible, is far less easy; indeed, no comparable explicit solution of the instance  $n = 2$  of Newton's condition—which he himself put to be ' $eS = R\sqrt{1 + QQ}$ ', where  $e$  is some constant parameter (see Appendix 2.11: note (84))—is possible, other than by successive approximation by series and iterations not themselves easy to contrive, in terms of the elementary algebraic and circular/hyperbolic functions which (whether in analytical form or framed in the model of conic-areas) he alone admitted into his workaday mathematical scheme of things. And yet when David Gregory came to visit him in Cambridge early in May 1694 Newton stated his belief that the solution of finding the projectile trajectory in this 'true' hypothesis of the medium's resistance to its motion was 'in his power' not merely where the gravity is constant and straight downwards, but also acts more generally as the inverse square of the distance from a finite force-centre. (See Gregory's long revised memorandum C42, now in Edinburgh University Library, in which he summarized the content of his talks 'Maio 1694' with Newton, there reporting *inter alia* that the latter 'Propositioni X Lib: II [*Princip.*] subnexurus est aliud problema quo semita projecti investigatur in vero rerum systemate, hoc est posita gravitate reciproce ut quadratum distantiae a centro et resistentia directe ut quadratum velocitatis, quod nunc in potestate esse credit'; compare H. W. Turnbull's English translation in *The Correspondence of Isaac Newton*, 3, 1961: 384. Similarly worded accounts of what Newton claimed 'se nunc nosse' are found in Gregory's further memoranda C33 and C44, now in the Royal Society, of 'adnotata Phys: et Math: cum Newtono Cantabrigiae 4. 5. 6. 7 Maij 1694'; see *Correspondence*, 3: 313, 335.) What then did Newton have it in mind to do in supplement to his published Proposition X? Perhaps a shade over-generous to our hero, we find it easy to believe that he had then, in the instance  $n = 2$  at least, taken the short further step which obtains the solution of the presently stated differential condition in parametric form, *viz.* on transposing this to be  $R^{\frac{1}{2}n-1}S \propto (1 + Q^2)^{\frac{1}{2}(n-1)}R$ ; whence a first integration produces  $R^{\frac{1}{2}n} \propto \int (1 + Q^2)^{\frac{1}{2}(n-1)} \cdot dQ \equiv I_Q$ , say, and consequently

$$R (= \frac{1}{2}dQ/da) \propto (I_Q)^{2/n};$$



and therefrom, by a second integration,  $a \propto \int (I_Q)^{-2/n} . dQ$  where

$$e \left( = \int Q . da \right) \propto \int Q (I_Q)^{-2/n} . dQ.$$

Whether this approaches the historical truth or no, when in January 1697 Newton received—and (see 1 above) solved—Johann Bernoulli's challenge to identify the *curva brevissimi descensus* we again have David Gregory's testimony in a memorandum dated '20 febr<sup>rii</sup> 1697<sup>g</sup>' (A90, now in Edinburgh University Library; reproduced in *Correspondence*, 4, 1967: 266) that 'Newtonus vicissim propositurus erat Bernoullio et Leibnitio Problema de via projecti cum resistentia est in duplicata ratione velocitatis, quod perperam solverat Leibnitius in *Actis Lipsiæ*'. (On the last point see vi: 70–1, note (109); where let us withdraw our false conjecture that 'Newton seemingly remained ignorant of [Leibniz]' 'Schediasma' for a quarter of a century till John Keill brought it to his notice'. Gregory, noting the gist of a conversation with Newton 'Londini 7 Martij 1698<sup>g</sup>' in a yet unpublished memorandum (ULE/A78<sup>1</sup>), reports the latter as already complaining that 'Libnitius fallitur dum iter projectilis determinat. . . in medio ubi resistitur in ratione duplicata velocitatis. Error male provenit, quod hoc de Compositione Motus conficiat'.) Had Newton in 1697 posed to Bernoulli—or indeed to Leibniz or (in the words of Bernoulli's *Programma*) generally 'Acutissimis qui toto Orbe florent Mathematicis'—this counter-challenge to determine the path of a projectile through a medium resisting as the square of its speed, we may well doubt that the latter was then well practised enough in the subtleties of reducing the equation of such resisted motion to its equivalent third-order differential form, and in the techniques whereby this might be integrated to yield its general solution. Things stood wholly differently twenty years later when in late January 1718 Pierre Rémond de Montmort quoted to Bernoulli a like provocative sentence from a letter written by John Keill the previous summer to Brook Taylor (and passed forthwith by its recipient to Montmort) where Keill, tired of Bernoulli's blanket claims for the superiority of Leibnizian mathematical analysis, snappishly countered that 'if he would apply his skill to something of use I desire he would solve the problem Mr Leibnitz attempted but erroneously mistook and could not solve,<sup>(1)</sup> to find the curve a Projectile describes in the air in the most simple supposition of gravity and the density of the medium being both uniform: but the resistance in duplicate proportion of the velocity'. (So Montmort quoted it back to Keill himself in late October 1718 in a letter, loose in Packet 2 of the 'Lucasian papers' (ULC. Res. 1893a), which is now printed in *Correspondence of Isaac Newton*, 7, 1977: 11; Keill himself was displeased that this sentence of his letter should have been transmitted to Bernoulli, but whether this was wholly 'contrary to his intention'—as Edleston surmises in his comment upon Montmort's letter in his edition of the *Correspondence of Sir Isaac Newton and Professor Cotes, including Letters of other Eminent Men*. . . (London, 1850): 187, note †—is arguable.) Quick to seize this opportunity of scoring off the man who had over the preceding five years grown to be the arch 'antagonist' and defender of the Newtonian supremacy in all things mathematical, Bernoulli now hastened to reduce his equivalent 1713 expression (see note (37) above) for the resistance to projectile motion under constant downwards gravity, deducing in his preferred Leibnizian form—without any mention of Newton's prior attainment of its equal in the *Principia*!—the prime result of the present, corrected proposition that 'positis [gravitate]  $g$  &  $dy [= da]$  constantibus [erit]  $ddp = \frac{\mp 2[\rho] dp^2}{g\sqrt{1+pp}}$  where  $p$  is the trajectory's slope (*viz.* Newton's  $Q$ , whence  $dp = 2R . dy$  and  $d^2p = 6S . dy^2$ ); and was able, from his supposition that the resistance  $\rho$  is equal to  $\frac{1}{2}v^{2m} = \frac{1}{2}(g(1+p^2) . dy/dp)^m$ , at once to conclude that ' $dp^{m-1}ddp = \mp g^{m-1}dy^m dp \times \overline{1+pp}^{m-\frac{1}{2}}$  & integrando  $\frac{dp^m}{m} = \mp g^{m-1}dy^m \int dp \times \overline{1+pp}^{m-\frac{1}{2}}$ '. And so he was six months afterwards to publish his general solution to the 'Problema. Construere Curvam (concessis quadraturis), quam

corpus uniformiter grave tendens perpendiculariter ad horizontem describit in medio uniformiter denso; supposita resistantia in quacunque multiplicata ratione velocitatis' at the end of his anti-Keillian 'responsio ad non-neminis provocationem' in *Acta Eruditorum* (May 1719): 216–26 [= *Opera*, 2 (Lausanne/Geneva, 1742): 393–402]; see especially 224–5. The full, parametral solution 'du probleme de Mr. Keill, pris dans un sens general' was subsequently set out by Bernoulli, effectively as we have (in Newtonian equivalent) outlined it above, in a letter to Montmort on the following 13 July (N.S.)—'Vous verrez', he wrote, 'que toute ceste analyse n'est qu'une chaine d'égalités deduites de la formule generale pour la determination des resistances, que j'ai donnée dans les journaux de Leipsic de 1713 p. 118 & 119'—and this, cast into Latin, he made public two years later in the *Acta* (May 1721): 228–30 [= *Opera*, 2: 513–16] as the 'Operatio analytica per quam deducta est... solutio'. That Bernoulli should in his 'Responsio' (page 219) think to castigate as a 'crassly contradictory hallucination' the very proposition of the *Principia* in which Newton first stated—if deficiently so in its *editio princeps*—his geometrical equivalent of the fundamental differential condition on which Bernoulli now founded his solution of Keill's 'challenge' is a circumstance which we can attribute only to unseeing ill-will on his part.

(51) We again borrow a needed correction from the augmented text which Newton passed to Cotes on 6 January 1712/13. The draft on Add. 3968.37: 548<sup>v</sup> (on which see note (45) above) reads just 'p. 270. lin. 9, 14.  $\frac{2nn+2n}{n+2}$ '. There follows immediately after this a first version

'injuriam Newtono illatam repellendo' of a phrase which appears in line 3 of the printed 'Ad Lectorem' to the *Commercium Epistolicum D. Johannis Collins* passing at this time through press as 'injuriam D. Newtono oblatam propulsans'. Since advance copies of the *Commercium* were (see its Journal Book) brought in to the Royal Society by Newton's presidential order on 8 January 'to be delivered to each person of the Committee appointed for that purpose, to examine it before publication', the amended preface had been put to the printer some little while before; and we infer that an equal time intervened between Newton drafting the present final version of his *Principia* proposition and subsequently transmitting its augmented fair copy to Cotes on 6 January, two days before this.

(52) This, of course, to save resetting the whole leaf Ii2 in the *Principia's editio secunda* in order merely thus (twice) to adjust an erroneous coefficient '3' to be '2'. And so it was done (compare Appendix 1: note (50)).



APPENDIX 1. THE ORIGINAL TEXT  
AS PRINTED IN 1687.<sup>(1)</sup>

From the *Principia's* editio princeps<sup>(2)</sup>

|| Prop. X. Prob. III.

||[260]

*Tendat uniformis vis gravitatis directe ad planum Horizontis, sitq̄ resistentia ut medii densitas & quadratum<sup>(3)</sup> velocitatis conjunctim: requiritur tum Medii densitas in locis singulis, quæ faciat ut corpus in data quavis linea curva moveatur, tum corporis velocitas in iisdem locis.*

(1) Though the first edition of the *Principia* has twice been reproduced in photo-facsimile in recent years (London, 1953; Brussels, 1965), and the text of the present Proposition X of its second book was more than two centuries ago reprinted in parallel column alongside that of the corrected 1713 *editio secunda* by the editor, Gabriel Cramer, of Johann Bernoulli's *Opera Omnia*, 1 (Lausanne/Geneva, 1742 [-> (facsimile offset) Hildesheim, 1968]): 481-93 in an 'Excerptum' making plain their differences, in visual testimony of the profit here derived by Newton from Bernoulli's intervention in autumn 1712, we make no apology for once more printing in full Newton's original 'solution' of the problem of determining the motion of a projectile under constant downwards gravity through a medium directly opposing its onrush from point to point according to its own varying density and the moving body's instantaneous speed. Not only does this allow us conveniently to adduce the *ipsissima verba* in which Newton presented the flawed 1687 version upon whose main foundation he twenty-five years later built the succession of recastings reproduced in Appendix 2 below and §§ 1/2 preceding; but it permits us, following in Lagrange's footsteps (see note (6) below), to indicate in our commentary precisely wherein the defects of this initial attempted solution lie.

(2) *Philosophiæ Naturalis Principia Mathematica* (London, 1687): 260-74. Other than for Humphrey Newton's secretary copy of the finished text (Royal Society, MS LXIX, coded as 'M' in A. Koyré and I. B. Cohen, . . . *The Third Edition (1726) with Variant Readings* (Cambridge, 1972), where the *variorum* text of the present Proposition X of Book 2 is set out on pp. 376-94)—this has only the single non-trivial variant which we cite in note (18) following—there survive no preliminary worksheets or drafts relating to this portion of the *editio princeps* which might allow us any independent insight into Newton's mind as he broached the solution of the general problem of resisted projectile motion which he here essays. In reproducing these printed pages we have indicated their division in our outer margins, and have also for the most part retained the minor standardizations of Newton's punctuation which the printer introduced into Humphrey Newton's press copy in setting this up in type. We have, however, everywhere reduced to lower-case *o* the flurry of capitalized increments *O* which, by way of Humphrey Newton's careless secretarial pen, confusingly and inconsistently bespatter its 'Exempl. 4'. (In an all too familiar fashion the slip eluded Cotes' notice when he went through the *Principia's* text in preparation for the second edition, and was equally unseeingly passed by Pemberton into its *editio ultima* in 1726, whence it is perpetuated in all subsequent editions.)

(3) An unnecessary restriction upon the power of the speed entering the law of resistance: one too rigidly according with the purview of the 'Sect. II. De motu corporum quibus resistitur in duplicata ratione velocitatum' of the second book of the *Principia* wherein—in sequel to the preceding Propositions V/VI/VII and VIII/IX which treat the two special cases (of nil gravity and of straight upwards/downwards fall respectively) where the resisted motion





quadratum temporis conjunctim, adeoq; (ob datam gravitatem) ut quadratum temporis; & lineola  $HF$  ut resistentia & quadratum temporis, hoc est ut resistentia & lineola  $FG$ . Et inde resistentia fit ut  $HF$  directe &  $FG$  inverse, sive ut  $\frac{HF}{FG}$ . Hæc ita se habent in lineolis nascentibus. Nam in lineolis finitæ magnitudinis hæ rationes non sunt accuratæ.

Et simili argumento est  $fg$  ut quadratum temporis, adeoq; ob æqualia tempora æquatur ipsi  $FG$ ;<sup>(8)</sup> & impulsus quo corpus regrediens urgetur est ut  $\frac{hf}{fg}$ . Sed impulsus corporis regredientis || & resistentia progredientis ipso motus initio ||<sup>[262]</sup> æquantur, adeoq; & ipsis proportionales  $\frac{hf}{fg}$  &  $\frac{HF}{FG}$  æquantur; & propterea ob æquales  $fg$  &  $FG$  æquantur etiam  $hf$  &  $HF$ , suntq; adeo  $CF$ ,  $CH$  (vel  $Ch$ <sup>(9)</sup>) &  $Cf$  in progressionem Arithmetica, & inde  $HF$  semidifferentia est ipsarum  $Cf$  &  $CF$ ; & resistentia quæ supra fuit ut  $\frac{HF}{FG}$ , est ut  $\frac{Cf - CF}{[2]FG}$ .<sup>(10)</sup>

Serret) *Œuvres*, 9, Paris, 1881: 360–76])—see especially §204: 257–8 (= 1813: §§20/21)—if we suppose that the moving body  $C$  traverses the tangent  $CF$  under the directly retarding resistance  $\rho$  in the vanishingly small time  $\theta$ , and all that time is subject also to the constant downwards ‘pull’ of gravity  $g$ , then, where the related increments of the base  $OB = x$  and ordinate  $BC = y$  are ( $BD =$ )  $o$  and  $p$  respectively, there is at once  $\dot{x} = o/\theta$  and (on setting  $\dot{y}/\dot{x} = dy/dx = Q$ )  $\dot{y} = Qo/\theta$ , so that  $\dot{y} - Q\dot{x} = 0$  and hence  $\ddot{y} - Q\ddot{x} - \dot{Q}\dot{x} = 0$ ; whence the instantaneous speed  $v$  at  $C$  is  $\sqrt{(\dot{x}^2 + \dot{y}^2)} = \dot{x}\sqrt{(1 + Q^2)}$ , and the Eulerian equations of motion are  $\ddot{x} = -\rho/\sqrt{(1 + Q^2)} = -\rho\dot{x}/v$  and  $\ddot{y} = -\rho Q/\sqrt{(1 + Q^2)} - g = Q\ddot{x} - g$ , so that

$$\ddot{y} - Q\ddot{x} = \dot{Q}\dot{x} = -g$$

and therefore  $\dot{y} - Q\dot{x} = \dot{Q}\dot{x} = (-g\dot{x}/\dot{x}$  or  $g\rho/v$ . Further  $o = \dot{x}\theta + \frac{1}{2}\ddot{x}\theta^2 + \frac{1}{6}\ddot{\dot{x}}\theta^3 + \dots$ , and so  $CF = o\sqrt{(1 + Q^2)} = v\theta - \frac{1}{2}\rho\theta^2 \dots$ , whence by inversion

$$\theta = (\sqrt{(1 + Q^2)}/v) o + \frac{1}{2}(\rho/v^3) (1 + Q^2) o^2 \dots;$$

while similarly  $p = \dot{y}\theta + \frac{1}{2}\ddot{y}\theta^2 + \frac{1}{6}\ddot{\dot{y}}\theta^3 + \dots$ . Accordingly, there is

$$FG = -(p - Qo) = \frac{1}{2}g\theta^2 - \frac{1}{6}(g\rho/v) \theta^3 + O(\theta^4).$$

(7) *Principia*, 1687: 32 (= vi: 116).

(8) Since in the terms of note (6) preceding (because the arcs  $\widehat{gC}$  and  $\widehat{CG}$  are supposed traversed in equal times) there is manifestly  $fg = \frac{1}{2}g(-\theta)^2 - \frac{1}{6}(g\rho/v)(-\theta)^3 + O(\theta^4)$ , the linelets  $fg$  and  $FG$  differ in fact by the third-order term  $\frac{1}{6}(g\rho/v)\theta^3$  which cannot, as Newton supposes, in the sequel be neglected. To the order of  $\theta^2$ , of course, the two are indistinguishable.

(9) The tangent-lengths  $hC$  and  $CH$  are the distances traversed each way from  $C$  in equal times when the medium offers no resistance to the body's motion; in the terms of note (6) above there is  $hC = CH = v\theta$ , manifestly (as Newton goes on equivalently to affirm) the arithmetic mean of  $fC = v\theta + \frac{1}{2}\rho\theta^2$  and  $CF = v\theta - \frac{1}{2}\rho\theta^2$ .

(10) We insert a numerical coefficient lacking—as it here may—in the denominator of the fraction as printed, so as accurately to pave the way into Corollary 2 below. Thus amended, Newton's fraction exactly represents the ratio of the resistance to gravity, for since (once more in the terms of note (6) above)  $HF = hf = \frac{1}{2}(fC - CF) = \frac{1}{2}\rho\theta^2$  and  $FG = \frac{1}{2}g\theta^2 \dots$ , at once  $\rho/g = \lim_{\theta \rightarrow 0} [(fC - CF)/2FG]$ .

Est autem resistentia ut Medii densitas & quadratum velocitatis. Velocitas autem ut descripta longitudo  $CF$  directe & tempus  $\sqrt{FG}$  inverse, hoc est ut  $\frac{CF}{\sqrt{FG}}$ , adeoq; quadratum velocitatis ut  $\frac{CF^2}{FG}$ . Quare resistentia, ipsiq; proportionalis  $\frac{Cf-CF}{FG}$  est ut Medii densitas &  $\frac{CF^2}{FG}$  conjunctim; & inde Medii densitas ut  $\frac{Cf-CF}{FG}$  directe &  $\frac{CF^2}{FG}$  inverse, id est ut  $\frac{Cf-CF}{CF^2}$ . Q.E.I.<sup>(11)</sup>

*Corol. 1.* Et hinc colligitur quod si in  $Cf$  capiatur  $Ck$  æqualis  $CF$ , & ad planum horizontale  $AK$  demittatur perpendicularum  $ki$  secans curvam  $ACK$  in  $l$ , fiet Medii densitas ut  $\frac{FG-kl}{CF \times FG+kl}$ . Erit enim  $fC$  ad  $kC$  ut  $\sqrt{fg}$  seu  $\sqrt{FG}$ <sup>(12)</sup> ad  $\sqrt{kl}$ , & divisim  $fk$  ad  $kC$ , id est  $Cf-CF$  ad  $CF$  ut  $\sqrt{FG}-\sqrt{kl}$  ad  $\sqrt{kl}$ , hoc est (si ducatur terminus uterq; in  $\sqrt{FG}+\sqrt{kl}$ ) ut  $FG-kl$  ad  $kl+\sqrt{FG} \times kl$ , sive ad  $FG+kl$ . Nam ratio prima nascentium  $kl+\sqrt{FG} \times kl$  &  $FG+kl$  est æqualitatis. Scribatur itaq;

$$\frac{FG-kl}{FG+kl} \text{ pro } \frac{Cf-CF}{CF},$$

& Medii densitas quæ fuit ut  $\frac{Cf-CF}{CF^{\text{quad}}}$  evadet ut  $\frac{FG-kl}{CF \times FG+kl}$ <sup>(13)</sup>.

||[263] *Corol. 2.* Unde cum  $2HF$  &  $Cf-CF$  æquentur, et  $FG$  &  $kl$  (ob rationem æqualitatis) componunt  $2FG$ , erit  $2HF$  ad  $CF$  ut  $FG-kl$  ad  $2FG$ ; & inde  $HF$  ad  $FG$ , hoc est resistentia ad gravitatem, ut rectangulum  $CF$  in  $FG-kl$  ad  $4FG^{\text{quad}}$ .<sup>(13)</sup>

(11) We make good a trivial slip in the *editio princeps* at this point from the 'Errata Sensus turbantia' on its concluding page (signature Ooo4<sup>r</sup>).

(12) Newton's crucial *faux pas*. If  $fg$  is left unreplaced by  $FG$  the measures of the density of the medium and of the ratio of its resistance to the force of gravity which Newton proceeds to derive in this corollary and the next one are exact; see the following note.

(13) Since  $fg$ ,  $FG$  and  $kl$  differ from each other only by terms of order  $\theta^3$  (see notes (6) and (8) preceding),  $fg$  cannot, as Newton supposes, here be validly replaced by  $FG$  in the difference  $fg-kl$ . When no such substitution is made, his present argument accurately derives the true measures,  $(fg-kl)/CF(FG+kl)$  and  $CF(fg-kl)/4FG^2$  respectively, of the density of the resisting medium and of the ratio of its resistance to gravity. With foreknowledge of the Lagrangian deductions from the pertinent equations of motion which we outlined in note (6) above, and in anticipation of the Taylorian expansions of the incremented ordinates  $y_{x \pm o}$  which Newton adduces in his primary *Exemplum* in sequel, it is a simple matter to amend the equivalent analytical expressions for these measures which he himself there deduces from his present erroneous geometrical ones. For, on positing (with Newton) the expansion of  $DG = y_{x+o}$  into the series  $y + Qo + Ro^2 + So^3 \dots$ , there follows  $FG = Ro^2 + So^3 \dots = \frac{1}{2}g\theta^2 - \frac{1}{8}(g\rho/v)\theta^3 \dots$  where  $\theta = (\sqrt{(1+Q^2)}/v)o + \frac{1}{2}(\rho/v^3)(1+Q^2)o^2 \dots$ , so that

$$R = \frac{1}{2}(g/v^2)(1+Q^2) \quad \text{and} \quad S = \frac{1}{8}(g\rho/v^4)(1+Q^2)^{\frac{3}{2}},$$

and hence  $fg = \frac{1}{2}g\theta^2 + \frac{1}{8}(g\rho/v)\theta^3 \dots = Ro^2 + 2So^3 \dots$ ; while correspondingly, since likewise  $il = y_{x-o} \equiv y - Qo + Ro^2 - So^3 \dots$ , there is  $kl = Ro^2 - So^3 \dots$ . In the limit as  $\theta \rightarrow 0$ , therefore, there results

$$\frac{fg-kl}{CF(FG+kl)} = \frac{3S}{2R\sqrt{(1+Q^2)}} \quad \text{and} \quad \frac{CF(fg-kl)}{4FG^2} = \frac{3S\sqrt{(1+Q^2)}}{4R^2}.$$



*Corol. 3.* Et hinc si curva linea [ACK] definiatur per relationem inter basem seu abscissam  $AB$  & ordinatim applicatam  $BC$  (ut moris est<sup>(14)</sup>) et valor ordi-

To Newton in the autumn of 1712, when Niklaus Bernoulli verbally put to him his uncle's objection that the value of the ratio of resistance to gravity obtained from his 1687 expression ought, in the particular case of the resisted semicircular path treated in 'Exempl. 1', to be increased by half as much again, it did not seem in the least way clear how he was to adjust the argument of his *editio princeps* so as to squeeze out of its amended form the factor  $\frac{3}{2}$  by which both his original measure of density and that of the ratio of resistance to gravity were deficient. (Johann Bernoulli himself, as Niklaus no doubt told Newton, had been able to detect the error in the semi-circle case only by independently computing the correct result from first principles; he could find no fault with the preceding general argument of Newton's 1687 Proposition X, and subsequently gave his support to his nephew's misguided—if ingenious and persuasive—claim that Newton had 'failed' to notice that the 'true' expansion of the incremented ordinates 'should' have been  $y_{a\pm o} = y \pm Qo + \frac{1}{2}Ro^2 \pm \frac{1}{6}So^3 \dots$ , whence the 1687 coefficients  $R$  and  $S$  'ought' to have been entered as  $2R$  and  $6S$  respectively. See our preceding introduction.) In his initial efforts to correct his reasoning in the *editio princeps* he first confirmed Bernoulli's related objection (see Appendix 2.1: note (6)) that, in the case of motion in a semicircular arc which is Newton's 'Exempl. 1', the projectile's speed must impossibly be both uniform and gravitationally accelerated; but he could not immediately rid himself of his false supposition that, because  $fg$  is indistinguishable from  $FG$  to the order of  $\theta^2$ , the latter may without appreciable error be everywhere substituted in the former's place. In lieu, he recast his original argument to treat the change in motion over the arcs  $g\widehat{C}$  and  $\widehat{C}G$  when these are considered to be successively traversed by the projectile moving the *same* way from  $g \rightarrow C$  and from  $C \rightarrow G$ ; and, after a considerable battle with the attendant complication of correctly introducing the component of gravity (see Appendix 2.2/3 and §1.1–5 above), at length successfully attained his objective (see §1.6 preceding). Thereafter, he further shaped and rounded out his corrected argument into the polished revise (§2.3) which Cotes lightly tailored to fit the space available for it on pages 232–44 of the *Principia*'s second edition.

(14) Namely, in the standard system of perpendicular Cartesian coordinates in which the abscissa  $AB = a$  and ordinate  $BC = e$  (as Newton proceeds to denote these lines using Fermatian variables) define the general point  $C(a, e)$  of a given curve on positing the appropriate analytical relationship  $e = e_a$  between them. Though he was not (in any manuscript known to us) to make explicit verbal statement of the fact till he penned Proposition XII of his 1691 treatise *De quadratura Curvarum* some half dozen years later (see VII: 98 and our notes (107) and (109) thereto), it seems harsh to deny that Newton was already fully aware that the successive coefficients in the expansion of the incremented ordinates  $DG = e_{a+o}$  and  $il = e_{a-o}$  into an equivalent 'converging' series are proportional to the corresponding fluxional derivatives of  $e$  with respect to  $a$ : specifically, where  $e_{a\pm o} = e \pm Qo + Ro^2 \pm So^3 \dots$ , then  $Q = \dot{e} (= de/da)$ ,  $R = \frac{1}{2}\ddot{e} (= d^2e/da^2)$ ,  $S = \frac{1}{6}\ddot{\dot{e}} (= \frac{1}{6}d^3e/da^3)$ , and so on. Insight into the general form of these coefficients is not, of course, needed in determining the series-expansions of the incremented ordinates  $e_{a\pm o}$  in the case of particular curves of defining Cartesian equation  $e = e_a$ , nor does Newton linger on the point in obtaining from first principles the pertinent 'converging series' for the four instances of the semicircle  $e = +\sqrt{(n^2 - a^2)}$ , the parabola  $e = (ca - a^2)/b$ , the common Apollonian hyperbola  $e = c - (m/n)a - b^2/a$  and its higher-order generalization  $e = c - ka - b^2/a^n$  which he proceeds to cite in exemplification of his general measures for the density of the medium through which the projectile passes in these curves, and for the resistance which opposes its passage. Knowledge of the precise form of the relationships  $Q = de/da$ ,  $R = \frac{1}{2}dQ/da$  and  $S = \frac{1}{6}dR/da$  (in some equivalent) is, however, of crucial importance when—as Newton himself went on for the first time publicly to do (see §2.3: note (50) above) in the two opening paragraphs by which he augmented the ensuing scholium to his present Proposition X in the *Principia*'s second edition—we seek, departing from the (cor-





secundum in quo quantitas illa extat unius dimensionis, tertium in quo extat duarum, quartum in quo trium est, & sic in infinitum. Et primus terminus, qui hic est  $e$ , denotabit semper longitudinem ordinatæ  $BC$  insistentis ad indefinitæ quantitatis [ $o$ ] initium  $B$ ; secundus terminus, qui hic est  $\frac{ao}{e}$ , denotabit differentiam inter  $BC$  &  $DF$ , id est lineolam  $IF$ , quæ abscinditur complendo parallelogrammum  $BCID$ , atq; adeo positionem Tangentis  $CF$  semper determinat:<sup>(19)</sup> ut in hoc casu capiendo  $IF$  ad  $IC$  ut est  $\frac{ao}{e}$  ad  $o$  seu  $a$  ad  $e$ . Terminus tertius, qui hic est  $\frac{nnoo}{2e^3}$ , designabit lineolam  $FG$  quæ jacet inter Tangentem & Curvam, adeoq; determinat angulum contactus  $FCG$ , seu curvaturam quam curva linea habet in  $C$ .<sup>(20)</sup> Si lineola illa  $FG$  finitæ est magnitudinis, designabitur per terminum tertium una cum subsequentibus in infinitum. At si lineola illa minuatur in infinitum, termini subsequentes evadent infinite minores tertio, ideoq; negligi possunt. Terminus quartus, qui hic est  $\frac{anno^3}{2e^3}$ , exhibet variationem Curvaturæ; quintus variationem variationis, & sic deinceps. Unde obiter patet usus non contemnendus harum Serierum in solutione Problematum quæ pendent a Tangentibus & curvatura Curvarum. [[264]

(19) This *secundus terminus*  $[-](a/e) o$  in the series expansion of the incremented ordinate  $e_{a+o} = +\sqrt{(n^2 - (a+o)^2)}$  is  $Qo = (de/da) o$ , that is,

$$BD \cdot d(BC)/d(OB) \text{ or } BD \cdot (IF/CI) = IF;$$

whence the linelet  $FG$  is  $(DG - BC - IF)$  or  $e_{a+o} - e - Qo = Ro^2 + So^3 + \dots$ , where (see note (17) preceding)  $R = \frac{1}{2}d^2e/da^2$ ,  $S = \frac{1}{8}d^3e/da^3$ , and so on.

(20) When, at least, the linelet  $FG$ —that is,  $\frac{1}{2}(d^2e/da^2) o^2$  on ignoring terms in  $o^3$  and higher powers of  $o$  as ‘indefinitely’ small—stands, like the neighbouring parent ordinate  $BC$ , at right angles to the vanishingly small arclet  $\widehat{CG}$ , and therefore  $de/da = 0$ : in all other positions the *exponens curvaturæ* will more generally be  $FG/(CF/CI)^3 \propto \frac{1}{2}(d^2e/da^2)/(1 + (de/da)^2)^{\frac{3}{2}}$ , the reciprocal of the diameter of the circle osculating the curve at  $C$ . Newton was to make this very necessary restriction explicit when, half a dozen years later, he introduced his present measure of the horn-angle between tangent and curve into Proposition XIII of his 1691 treatise ‘De quadratura Curvarum’ (see vii: 112–14) along with the following notion of likewise expressing variations in such *curvatura* through the successive coefficients,  $S$ ,  $T$ , ... of the powers of  $o$  in the series  $(FG - Ro^2) = So^3 + To^4 + \dots$ , there specifying that these are respectively the higher-order derivatives  $\frac{1}{8}d^3e/da^3$ ,  $\frac{1}{24}d^4e/da^4$ , and so on. (Compare vii: 112–13, note (146).) Yet another quarter of a century on, when he came in the middle/late 1710’s to look over the *editio secunda* of his *Principia* for a new edition of its text, he thought for a time—not least to substantiate his claim elsewhere to have independently attained such a general measure for the curvature of a curve in his October 1666 tract on fluxions—to specify how the *lineola*  $FG = Ro^2$ , taken in conjunction with the tangential deviation  $IF = Qo$ , does in fact straightforwardly yield the formula  $(1 + Q^2)^{\frac{3}{2}}/[2]R$ , that is,  $(1 + (de/da)^2)^{\frac{3}{2}}/(d^2e/da^2)$ , for the radius of curvature at  $C(a, e)$ . Such an addition was not made in the *editio tertia* in 1726, but in Appendix 4 following we reproduce three surviving drafts of an *addendum* to this effect intended to be inserted, at (see note (37) below) a not altogether happy place, in the ensuing scholium.

Præterea  $CF$  est latus quadratum ex  $CI^a$  &  $IF^a$ , hoc est ex  $BD^a$  & quadrato termini secundi. Estq;  $FG + kl$  æqualis duplo termini tertii, &  $FG - kl$  æqualis duplo quarti. Nam valor ipsius  $DG$  convertitur in valorem ipsius  $il$  & valor ipsius  $FG$  in valorem ipsius  $kl$  scribendo  $Bi$  pro  $BD$  seu  $-o$  pro  $+o$ . Proinde cum  $FG$  sit  $-\frac{nnoo}{2e^3} - \frac{anno^3}{2e^5}$  &c erit  $kl = -\frac{nnoo}{2e^3} + \frac{anno^3}{2e^5}$  &c. Et horum summa est  $-\frac{nnoo}{e^3}$ , differentia  $-\frac{anno^3}{e^5}$ . Terminum quintum & sequentes<sup>(21)</sup> hic negligo ut infinite

minores quam qui in hoc Problemate considerandi veniant. Itaq; si designetur Series<sup>(22)</sup> universaliter his terminis  $\mp Qo - Roo[\mp]So^3$  &c, erit  $CF$  æqualis  $\sqrt{oo + QQoo}$ ,  $FG + kl$  æqualis  $2Roo$ , &  $FG - kl$  æqualis  $2So^3$ . Pro  $CF$ ,  $FG + kl$  &

||[265]  $FG - kl$  scribantur || hi earum valores, & Medii densitas quæ erat ut  $\frac{FG - kl}{CF \text{ in } FG + kl}$

jam fiet ut  $\frac{S}{R\sqrt{1+QQ}}$ <sup>(23)</sup>. Deducendo igitur Problema unumquodq; ad seriem convergentem, & hic pro  $Q$ ,  $R$  &  $S$  scribendo terminos seriei ipsis respondentes; deinde etiam ponendo Resistentiam Medii in loco quovis  $G$  esse ad Gravitatem ut  $S\sqrt{1+QQ}$  ad  $2RR$ ,<sup>(23)</sup> & velocitatem esse illam ipsam quacum corpus de loco  $C$  secundum rectam  $CF$  egrediens, in Parabola diametrum  $CB$  & latus rectum  $\frac{1+QQ}{R}$  habente deinceps moveri posset,<sup>(24)</sup> solvetur Problema.

Sic in Problemate jam solvendo si scribantur  $\sqrt{1 + \frac{aa}{ee}}$  seu  $\frac{n}{e}$  pro  $\sqrt{1 + QQ}$ ,  $\frac{nn}{2e^3}$  pro  $R$ , &  $\frac{ann}{2e^5}$  pro  $S$ , prodibit Medii densitas ut  $\frac{a}{ne}$ , hoc est (ob datam  $n$ ) ut  $\frac{a}{e}$  seu  $\frac{OB}{BC}$ , id est ut Tangentis longitudo illa  $CT$  quæ ad semidiametrum  $OL$  ipsi  $AK$  normaliter insistentem terminatur; et resistentia erit ad gravitatem ut  $a$  ad  $n$ , id est ut  $OB$  ad circuli semidiametrum  $OK$ , velocitas autem erit ut  $\sqrt{2BC}$ . Igitur si corpus  $C$  certa cum velocitate secundum lineam ipsi  $OK$  parallelam exeat de

(21) Namely '+  $To^4$  + &c', to continue Newton's assignation of coefficients in the series expansion of  $e_{a+o}$  as  $e + Qo + Ro^2 + So^3 \dots$

(22) Understand those for  $IG = (BC - DG)$  or  $e - e_{a+o}$  and for  $BC - il = e - e_{a-o}$ .

(23) Duly corrected (see note (13) above) by a factor of  $\frac{3}{2}$  these ratios should be  $\frac{3S}{2R\sqrt{1+QQ}}$ ,

and 'ut  $3S\sqrt{1+QQ}$  ad  $4RR$ ' respectively.

(24) Whence explicitly, on setting the force of gravity as before to be  $g$ , the body's speed  $v$  at  $C$  is assigned to be  $\sqrt{(\frac{1}{2}g \cdot (1 + Q^2)/R)}$ . For at once, since  $FG = Ro^2 + \dots$  is  $\frac{1}{2}g\theta^2 - \dots$  where (as in note (6) above)  $\theta$  is the time taken by the body to traverse the arc  $\widehat{CG} = o\sqrt{1+Q^2} + \dots$ , there is (in the limit as  $o$  and  $\theta$  each become vanishingly small)  $v = o\sqrt{1+Q^2}/\theta$  where  $o/\theta = \sqrt{(\frac{1}{2}g/R)}$ .



loco  $L$ , & Medii densitas in singulis locis  $C$  sit ut longitudo tangentis  $CT$ , & resistentia etiam in loco aliquo  $C$  sit ad vim gravitatis ut  $OB$  ad  $OK$ : corpus illud describet circuli quadrantem  $LCK$ . Q.E.I.

At si corpus idem de loco  $A$  secundum lineam ipsi  $AK$  perpendiculararem egrederetur, sumenda esset  $OB$  seu  $a$  ad contrarias partes centri  $O$ , & propterea signum ejus mutandum esset, & scribendum  $-a$  pro  $+a$ . Quo pacto prodiret Medii densitas ut  $-\frac{a}{e}$ . Negativam autem densitatem (hoc est quæ motus corporum

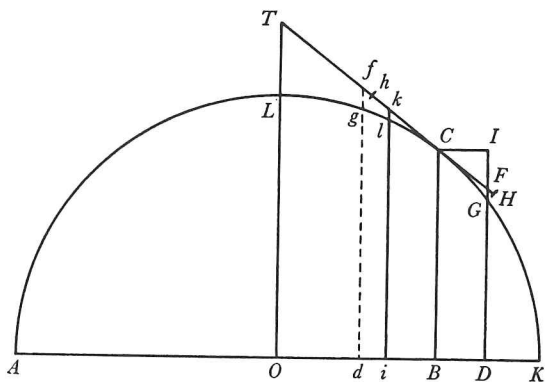

||[266]

accelerat) Natura non admittit, & propterea naturaliter fieri non potest ut corpus ascendendo ab  $A$  describat circuli quadrantem  $AL$ . Ad hunc effectum deberet corpus a Medio impellente accelerari, non a resistente impediri.

*Exempl. 2.* Sit linea  $ALCK$  Parabola axem habens  $OL$  horizonti  $AK$  perpendiculararem, & requiratur Medii densitas quæ faciat ut projectile in ipsa moveatur.

Ex natura Parabolæ rectangulum  $ADK$  æquale est rectangulo sub ordinata  $DG$  & recta aliqua data: hoc est, si dicatur recta illa  $b$ ,  $AB$   $a$ ,  $AK$   $c$ ,  $BC$   $e^{(25)}$  &  $BD$   $o$ , rectangulum  $a+o$  in  $c-a-o$  seu  $ac-aa-2ao+co-oo$  æquale est rectangulo  $b$  in  $DG$ , adeoq;  $DG$  æquale  $\frac{ac-aa}{b} + \frac{c-2a}{b}o - \frac{oo}{b}$ . Jam scribendus esset hujus

seriei secundus terminus  $\frac{c-2a}{b}o$  pro  $Qo$ , & ejus coefficientis  $\frac{c-2a}{b}$  pro  $Q$ ; tertius

item terminus  $[-] \frac{oo}{b}$  pro  $Roo$ , & ejus coefficientis  $[-] \frac{1}{b}$  pro  $R$ . Cum vero plures

non sint termini, debet quarti termini  $So^3$  coefficientis  $S$  evanescere, & propterea quantitas  $\frac{S}{R\sqrt{1+QQ}}$  cui Medii densitas proportionalis est, nihil erit.

Nulla igitur Medii densitate movebitur Projectile in Parabola, uti olim demonstravit Galilæus.<sup>(26)</sup> Q.E.I.

*Exempl. 3.* Sit linea  $AGK$  Hyperbola Asymptoton habens  $NX$  plano horizontali

(25) So that the defining Cartesian equation of the parabola is  $e = e_a \equiv a(c-a)/b$ .

(26) And Thomas Harriot, who twenty years before Galileo considered also resisted motion in tilted parabolic paths (see vi: 7, note (17)), even more so; Newton here repeats his earlier affirmation in scholium to the 'Leges Motus' at the beginning of Book 1 of the *Principia* (1687: 20) that 'adinvenit Galilæus... motum projectilium fieri in Parabola, conspirante experientia, nisi quatenus motus... per aeris resistentiam aliquantulum retardantur' (compare vi: 106, note (35)).

$AK$  perpendicularem, & quærat Medii densitas quæ faciat ut Projectile moveatur in hac linea.

¶[267] Sit  $MX$  Asymptotos altera ordinatim applicatæ  $DG$  pro||ductæ occurrens in  $V$ , & ex natura Hyperbolæ rectangulum  $XV$  in  $VG$  dabitur. Datur autem ratio  $DN$  ad  $VX$ , & propterea datur etiam rectangulum  $DN$  in  $VG$ . Sit illud  $bb$ , &

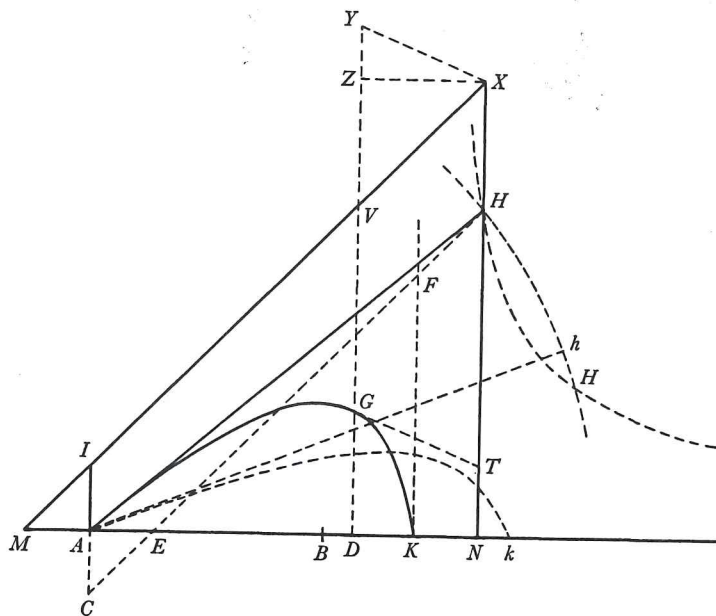

completo parallelogrammo  $DNXZ$ , dicatur  $BN a$ ,  $BD o$ ,  $NX c$ , & ratio data  $VZ$  ad  $ZX$  vel  $DN$  ponatur esse  $\frac{m}{n}$ .<sup>(27)</sup> Et erit  $DN$  æqualis  $a-o$ ,  $VG$  æqualis  $\frac{bb}{a-o}$ ,  $VZ$  æqualis  $\frac{m}{n} \frac{a-o}{a-o}$  &  $GD$  seu  $NX - VZ - VG$  æqualis  $c - \frac{m}{n} a + \frac{m}{n} o - \frac{bb}{a-o}$ . Resolvatur terminus  $\frac{bb}{a-o}$  in seriem convergentem  $\frac{bb}{a} + \frac{bb}{aa} o + \frac{bb}{a^3} o^2 + \frac{bb}{a^4} o^3$  & c., & fiet  $GD$  æqualis  $c - \frac{m}{n} a - \frac{bb}{a} + \frac{m}{n} o - \frac{bb}{aa} o - \frac{bb}{a^3} o^2 - \frac{bb}{a^4} o^3$  & c. Hujus seriei terminus secundus  $\frac{m}{n} o - \frac{bb}{aa} o$ <sup>(28)</sup> usurpandus est pro  $Qo$ , tertius cum signo mutato  $\frac{bb}{a^3} o^2$ <sup>(28)</sup>

(27) Whence on setting the ordinate  $BC$  (not shown in Newton's accompanying figure) to be  $e$ , as before, the defining Cartesian equation of the hyperbolic path  $AGK$  of general point  $C(a, e)$  is  $e = e_a \equiv c - (m/n)a - b^2/a$ .

(28) As N. R. Hanson first observed—but failed adequately to amend—in a short note in *Scripta Mathematica*, 26, 1961: 83–5, Newton here makes a muddle in assigning the values of the coefficients  $Q (= de/da)$  and  $R (= \frac{1}{2} d^2e/da^2)$  in the series expansion  $e - Qo + Ro^2 - So^3 + \dots$  of the (here decremented) ordinate  $DG = e_{a-o}$ . Read correctly: ‘... terminus secundus cum signo mutato  $-\frac{m}{n} o + \frac{bb}{aa} o$  usurpandus est pro  $Qo$ , tertius  $-\frac{bb}{a^3} o^2$  pro  $Ro^2$ , ...’.



pro  $Ro^2$ , & quartus cum signo etiam mutato  $\frac{bb}{a^4} o^3$  pro  $So^3$ , eorumq; coefficientes  $\frac{m}{n} - \frac{bb}{aa}, \frac{bb^{(29)}}{a^3}$  &  $\frac{bb}{a^4}$  scribendæ sunt || in Regula superiore pro  $Q, R$  &  $S$ . Quo facto ||[268] prodit medii densitas ut

$$\frac{\frac{bb}{a^4}}{\frac{bb}{a^3} \sqrt{1[+] \frac{mm}{nn} - \frac{2mhb}{naa} + \frac{b^4}{a^4}}} \text{ seu } \frac{1}{\sqrt{aa + \frac{mm}{nn} aa - \frac{2mhb}{n} + \frac{b^4}{aa}}}$$

id est, si in  $VZ$  sumatur  $VY$  æqualis  $VG$ , ut  $\frac{1}{XY}$ . Namq;  $aa$  &  $\frac{mm}{nn} aa - \frac{2mhb}{n} + \frac{b^4}{aa}$  sunt ipsarum  $XZ$  &  $ZY^{(30)}$  quadrata. Resistentia autem invenitur in ratione ad Gravitationem quam habet  $XY$  ad  $YG$ , & velocitas ea est quacum corpus in Parabola pergeret verticem  $G$  diametrum  $DG$  & latus rectum  $\frac{YX^{quad.}}{VG}$  habente.<sup>(31)</sup>

(29) Here, correspondingly, read ' $-\frac{m}{n} + \frac{bb}{aa}, -\frac{bb}{a^3}$ '.

(30) That is, since the increment  $DB$  is assumed to be vanishingly small, and  $YX$  is drawn parallel to the tangent  $GT$  to the infinitesimal arc  $\widehat{CG}$ , ' $NB$  &  $NB$  in  $Q$ '. More precisely, as  $D$  comes to coincide with  $B$  there is  $ZX=a$  and  $ZY = -(m/n)a + b^2/a = -VZ + GV$ .

(31) Newton understands his previous 'semicircular' figure, with the infinitesimal arc  $\widehat{CG}$  of the trajectory  $A\widehat{CK}$  (where  $DG$  lies infinitely close to the parallel ordinate  $BC$ ) taken to coincide with that of the parabola ( $G$ ) in which  $FG \propto CF^2$  'hugging' it; this has latus rectum  $r = CF^2/FG = (1+Q^2)/R$  in the limit as  $CF = o\sqrt{1+Q^2}$  and  $FG = Ro^2 + So^3 + \dots$  each pass to be vanishingly small, while the body's speed over  $\widehat{CG} \approx CF$  is

$$CF/\sqrt{(FG/\frac{1}{2}g)} = \sqrt{(\frac{1}{2}gr)}$$

in the same limit. In the present instance of the hyperbola  $BC = c - (m/n)NB - b^2/NB$ , where  $YX$  is constructed equal and parallel to the trajectory's tangent  $GT = ND\sqrt{1+Q^2}$ , Newton's values for the density of the medium, the ratio of its resistance to gravity, and the projectile's speed at  $C(\approx G)$  readily result on substituting (in his respective measures

$$S/R\sqrt{1+Q^2}, \quad \frac{1}{2}S\sqrt{1+Q^2}/R^2$$

and

$$\sqrt{(\frac{1}{2}g \cdot (1+Q^2)/R)}$$

of these) the quantities  $Q = -m/n + b^2/a^2$ ,  $R = -b^2/a^3$  and  $S = b^2/a^4$  which are the coefficients in the series expansion of the decremented ordinate  $DG = e_{a-o} = BC - Qo + Ro^2 - So^3 + \dots$ ; that is, on going over (with him) from  $NB = a$  to the decremented abscissa  $ND = a - o$  with which it coincides in the limit as  $BD = o$  vanishes, by entering

$$Q = -m/n + b^2/ND^2 = -(NT - DG)/ND, \quad R = -b^2/ND^3 = -GV/ND^2$$

and  $S = b^2/ND^4 = -R/ND$ .

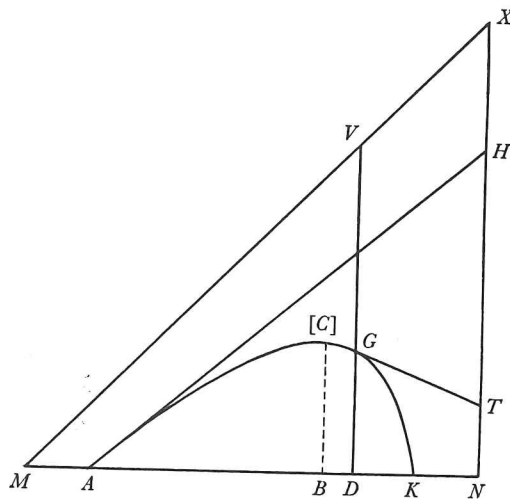

Ponatur itaq̄ quod Medii densitates in locis singulis  $G$  sint reciproce ut distantiae  $XY$  quodq̄ resistentia in loco aliquo  $G$  sit ad gravitatem ut  $XY$  ad  $YG$ , & corpus de loco  $A$  justa cum velocitate emissum describet Hyperbolam illam  $AGK$ . Q.E.I.

*Exempl. 4.* Ponatur indefinite quod linea  $AGK$  Hyperbola sit, centro  $X$  Asymptotis  $MX$ ,  $NX$  ea lege descripta ut constructo rectangulo  $XZDN$  cujus latus  $ZD$  secet Hyperbolam in  $G$  & Asymptoton ejus in  $V$ , fuerit  $VG$  reciproce ut ipsius  $ZX$  vel  $DN$  dignitas aliqua  $ND^n$ , cujus index est numerus  $n$ ; & quærat Medii densitas qua Projectile progrediatur in hac curva.<sup>(32)</sup>

Pro  $[B]N$ ,  $BD$ ,  $NX$  scribantur  $a$ ,  $o$ ,  $c$ <sup>(33)</sup> respective, sitq̄  $VZ$  ad  $ZX$  vel  $DN$  ut  $d$  ad  $e$  &  $VG$  æqualis  $\frac{bb}{DN^n}$ , & erit  $DN$  æqualis  $a - o$ ,  $VG = \frac{bb}{a - o^n}$ ,  $VZ = \frac{d}{e}$  in  $a - o$ , &  $GD$  seu  $NX - VZ - VG$  æqualis  $c - \frac{d}{e}a + \frac{d}{e}o - \frac{bb}{a - o^n}$ . Resolvatur terminus ille  $\frac{bb}{a - o^n}$  in seriem infinitam  $\frac{bb}{a^n} + \frac{nbb}{a^{n+1}}o + \frac{nn+n}{2a^{n+2}}bb^2 + \frac{n^3+3nn+2n}{6a^{n+3}}bb^3$  &c ac fiet

||[269]  $GD$  æqualis  $c - \frac{d}{e}a - \frac{bb}{a^n} || + \frac{d}{e}o - \frac{nbb}{a^{n+1}}o - \frac{nn+n}{2a^{n+2}}bb^2 - \frac{n^3+3nn+2n}{6a^{n+3}}bb^3$  &c. Hujus seriei terminus secundus<sup>(34)</sup>  $[-]\frac{d}{e}o[+] \frac{nbb}{a^{n+1}}o$  usurpandus est pro  $Qo$ , tertius  $[-]\frac{nn+n}{2a^{n+2}}bb^2$  pro  $Ro^2$ , [&] quartus<sup>(34)</sup>  $\frac{n^3+3nn+2n}{6a^{n+3}}bb^3$  pro  $So^3$ . Et inde Medii densitas  $\frac{S}{R \times \sqrt{1+QQ}}$  in loco quovis  $G$  fit  $\frac{n+2}{3 \sqrt{a^2 + \frac{dd}{ee}a^2 - \frac{2dnbb}{ea^n}a + \frac{nnb^4}{a^{2n}}}}$ , adeoq̄ si in  $VZ$  capiatur  $VY$  æqualis  $n \times VG$ , est reciproce ut  $XY$ . Sunt enim  $a^2$  &  $\frac{dd}{ee}a^2 - \frac{2dnbb}{ea^n}a + \frac{nnb^4}{e^{2n}}$  ipsarum  $XZ$  &  $ZY$  quadrata. Resistentia autem in eodem loco  $G$  sit ad Gravitatem ut  $S$  in  $\frac{XY}{a}$  ad  $2RR$ , id est  $XY$  ad  $\frac{3nn+3n}{n+2}VG$ . Et

(32) Whence, more generally, the defining Cartesian equation of the point  $C(a, e)$  of the hyperbolic path  $ACGK$  is now put to be  $BC = e = e_a \equiv c - (d/e)a - b^2/a^n$ . (The trivial replacement here of the coefficient of the term in  $-a$  in the preceding example which is its prime case merely, of course, permits Newton to reserve the constant  $n$  for its more familiar rôle as index of a general power.)

(33) Here and in sequel the printer has set these three letters as capitals, but for consistency's sake—and, we believe, as Newton himself intended (compare note (2) above)—we everywhere reduce these to lower-case.

(34) Read 'cum signo mutato' in each case. In the printed original—whose text is adjusted in no subsequent edition—Newton here falls again into his earlier confusion in ascribing the signs of the coefficients  $Q$ ,  $R$  and  $S$  of the successive powers of  $o$  in the series expansion of the decremented ordinate  $DG = e_{a-o}$ .



velocitas ibidem ea ipsa est quacum corpus projectum in Parabola pergeret verticem  $G$ , diametrum  $GD$  & Latus rectum  $\frac{1+QQ}{R}$  seu  $\frac{2XY^{\text{quad}}}{nn+n}$  in  $VG$  habente.<sup>(35)</sup>  
Q.E.I.

*Scholium.*

Quoniam motus non fit in Parabola nisi in Medio non resistente, in Hyperbolis vero hic descriptis fit per resistantiam perpetuam, perspicuum est quod linea quam Projectile in Medio uniformiter resistente describit, propius accedit ad Hyperbolas hasce quam ad Parabolam. Est utiq; linea illa Hyperbolici generis, sed quæ circa verticem magis distat ab Asymptotis; in partibus a vertice remotioribus propius ad ipsas accedit quam pro ratione Hyperbolarum quas hic descripsi. Tanta vero non || est inter has & illam differentia quin illius loco ||[270] possint hæ in rebus practicis non incommode adhiberi. Et utiliores forsân futuræ sunt hæ quam Hyperbola magis accurata & simul magis composita. Ipsæ vero in usum sic deducuntur.

Compleatur parallelogrammum  $XYGT$ , & ex natura harum Hyperbolarum facile colligitur quod recta  $GT$  tangit Hyperbolam in  $G$ <sup>(36)</sup> ideoq; densitas Medii in  $G$  est reciproce ut tangens  $GT$  & velocitas ibidem ut  $\sqrt{\frac{GT^2}{GV}}$ , resistantia autem ad vim gravitatis ut  $GT$  ad  $\frac{3nn+3n}{n+2} GV$ .<sup>(37)</sup>

(35) That is, explicitly, the body's speed over the infinitesimal arc  $\widehat{CG}$  is

$$\sqrt{\left(\frac{1}{2}g \cdot 2YX^2/(n^2+n)\right) \cdot GV}$$

where  $g$  is the constant downwards force of gravity. These generalized values for the density of the medium, the ratio of its resistance to gravity, and the projectile's velocity result in the same way as in the preceding particular case  $n = 1$  (see note (31) above) on making substitution of the coefficients

$$Q = -d/e + nb^2/a^{n+1}, \quad R = -\frac{1}{2}n(n+1) b^2/a^{n+2} \quad \text{and} \quad S = \frac{1}{3}n(n+1)(n+2) b^2/a^{n+3}$$

in the series expansion  $DG = e_{a-o} = BC - Qo + Ro^2 - So^3 + \dots$ ; whence, on replacing  $NB = a$  by the decremented abscissa  $ND = a - o$  (as Newton again confusingly specifies his construction), there is  $YZ = ND \sqrt{1+Q^2}$ ,  $Q = -d/e + nb^2/ND^{n+1}$ ,  $R = -\frac{1}{2}n(n+1) \cdot GV/ND^2$  and  $S = -\frac{1}{3}(n+2) R/ND$ . On increasing the preceding defective measure  $\frac{1}{3}S \sqrt{1+Q^2}/R^2$  correctly in the ratio of 3 to 2 (see note (13) above), Newton in his *editio secunda* here (*Principia*, 21713: 239, l. -3)—and *mutatis mutandis* in his previous 'Exempl. 3' (where  $n = 1$ ) correspondingly—had but numerically to adjust the ratio of the resistance to gravity to be as  $XY$  to  $\frac{2nn+2n}{n+2} VG$ .

(36) Since it is constructed parallel to  $XY$ , of slope  $YZ/ND = Q = de/da$ , where  $e = c - (d/e) a - b^2/a^n$ ; see notes (31) and (35) preceding.

(37) Read  $\frac{2nn+2n}{n+2} GV$  on correcting the deficient general measure from which (see note (35)) this value for the ratio of resistance to gravity in the hyperbolic trajectory of 'Exempl. 4' preceding is derived; and so Newton adjusted it in the *editio secunda* of the *Principia* (21713:

Proinde si corpus de loco  $A$  secundum rectam  $AH$  projectum describat Hyperbolam  $AGK$ , &  $AH$  producta occurrat Asymptoto  $NX$  in  $H$  actaq;  $AI$  occurrat alteri Asymptoto  $MX$  in  $I$ : erit Medii densitas in  $A$  reciproce ut  $AH$ , & corporis velocitas ut  $\sqrt{\frac{AH^q}{AI}}$ , ac resistentia ibidem ad Gravitationem ut  $AH$  ad  $\frac{3nn+3n}{n+2}$  in  $AI$ .<sup>(38)</sup> Unde prodeunt sequentes Regulæ.

*Reg. 1.* Si servetur Medii densitas<sup>(39)</sup> in  $A$  & mutetur angulus  $NAH$ , manebunt longitudines  $AH$ ,  $AI$ ,  $HX$ . Ideoq; si longitudines illæ in aliquo casu inveniantur, Hyperbola deinceps ex dato quovis angulo  $NAH$  expedite determinari potest.

*Reg. 2.* Si servetur tum angulus  $NAH$  tum Medii densitas in  $A$  & mutetur velocitas quacum corpus projicitur, servabitur longitudo  $AH$  & mutabitur  $AI$  in duplicata ratione velocitatis reciproce.

*Reg. 3.* Si tam angulus  $NAH$  quam corporis velocitas in  $A$  gravitasq; acceleratrix servetur, & proportio resistentiæ in  $A$  ad gravitatem motricem augeatur in ratione quacuncq; augebitur proportio  $AH$  ad  $AI$  in eadem ratione, manente Parabolæ latere recto eiq; proportionali longitudine  $\frac{AH^q}{AI}$ , & propterea ||[271] minuetur  $AH$  in eadem ratione, &  $AI$  minuetur in ratione illa duplicata. Augetur vero proportio resistentiæ ad pondus ubi vel gravitas specifica sub æquali magnitudine fit minor, vel Medii densitas major, vel resistentia ex magnitudine diminuta diminuitur in minore ratione quam pondus.

*Reg. 4.* Quoniam densitas Medii prope verticem Hyperbolæ m[aj]or est quam in loco  $A$ , ut servetur densitas mediocris debet ratio minimæ tangentium  $GT$  ad Tangentem  $AH$  inveniri & densitas in  $A$ , per Regulam tertiam, diminui in ratione paulo minore quam semisummæ Tangentium ad Tangentem  $AH$ .

*Reg. 5.* Si dantur longitudines  $AH$ ,  $AI$  & describenda sit figura  $AGK$ : produc  $HN$  ad  $X$  ut sit  $HX$  æqualis facto sub  $n+1$  &  $AI$ , centroq;  $X$  & Asymptotis  $MX$ ,  $NX$  per punctum  $A$  describatur Hyperbola ea lege ut sit  $AI$  ad quamvis  $VG$  ut  $XV^n$  ad  $XI^n$ .

*Reg. 6.* Quo major est numerus  $n$ , eo magis accuratæ sunt hæ Hyperbolæ in ascensu corporis ab  $A$ , & minus accuratæ in ejus descensu ad  $[K]$ , & contra.<sup>(40)</sup>

240). It was at this none too pertinent place that Newton afterwards thought to append his derivation of the length of the radius of curvature at  $C$  by the formula  $(1+Q^2)^{\frac{1}{2}}/2R$  (see Appendix 4 below) in amplification of his previous oblique statement that  $R(= \frac{1}{2}d^2e/da^2)$  is a measure of the curvature of the curve  $\widehat{ACK}$  there; on which see note (20) above.

(38) This particular value of the preceding ratio of resistance to gravity when the body  $C$  is at  $A$  needs (see the previous note) likewise to be adjusted to be 'ut  $AH$  ad  $\frac{2nn+2n}{n+2}$  in  $AI$ '; and so it was repaired in the *editio secunda* of the *Principia* (1713: 240, *lin. ult.*).

(39) Understand 'ut et corporis velocitas'.



Hyperbola Conica mediocrem rationem tenet, estq̄ cæteris simplicior. Igitur si Hyperbola sit hujus generis, & punctum  $K$  ubi corpus projectum incidet in rectam quamvis  $AN$  per punctum  $A$  transeuntem quærat: occurrat producta  $AN$  Asymptotis  $MX$ ,  $NX$  in  $M$  &  $N$ , & sumatur  $NK$  ipsi  $AM$  æqualis.

Reg 7. Et hinc liquet methodus expedita determinandi hanc Hyperbolam<sup>(41)</sup> ex Phænom[e]nis. Projiciantur corpora duo similia & æqualia eadem velocitate in angulis diversis  $HAK$ ,  $ha[k]$  incidentq̄ in planum Horizontis in  $K$  et  $k$ , & notetur proportio  $AK$  ad  $ak$ . Sit ea  $d$  ad  $e$ . Tum erecto cujusvis longitudinis perpendicularo  $AI$ , assume utcunq̄ longitudinem  $AH$  vel  $Ah$  & inde collige graphice longitudes  $AK$ ,  $Ak$  per Reg. 6. Si ratio  $AK$  ad  $Ak$  sit eadem cum ratione  $d$  ad  $e$ , longitudo  $AH$  recte assumpta fuit. Sin minus cape in recta infinita

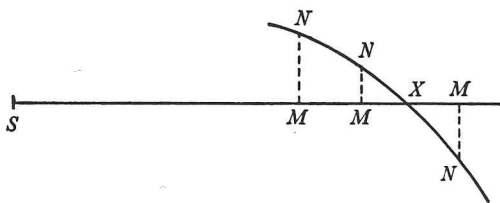

$SM$  longitudinem  $SM$  æqualem assumptæ  $AH$  & erige perpendicularum  $MN$

æ||quale rationum differentiæ  $\frac{AK}{Ak} \frac{d}{e}$  ||[272]

ductæ in rectam quamvis datam.<sup>(42)</sup>

Simili methodo ex assumptis pluribus longitudinibus  $AH$  invenienda sunt

plura puncta  $N$ : & tum demum si per omnia agatur Curva linea regularis  $NNXN$ , hæc abscindet  $SX$  quæsitæ longitudini  $AH$  æqualem.<sup>(43)</sup> Ad usus Mechanicos sufficit longitudes  $AH$ ,  $AI$  easdem in angulis omnibus  $HAK$  retinere. Sin figura ad inveniendam resistantiam Medij accuratius determinanda sit, corrigendæ sunt semper hæ longitudes per Regulam quartam.

(40) Since for given initial firing speed and direction at  $A$ , and hence fixed inclination of  $IVX$  to  $ADN$ , there is  $GV(=b^2/ND^n) \propto XV^{-n}$ , increasing the index  $n$  ( $> 0$ , of course, for a hyperbolic trajectory  $\widehat{AGK}$ ) will make the ascending portion of the projectile path steeper and shallower, and its ensuing part less rounded and more nearly vertical, and the whole more closely approaching the sides of the angle  $\widehat{AHN}$ . Whether, particularly for the low missile speeds of musket and cannon shot obtaining in the practice of ordnance in the later seventeenth century, the first better approximates the empirical truth, and whether, for the relatively high resistance afforded by the (usually) damp maritime air of England, the latter deviates more from it, we may well doubt. Certainly, the simple conic hyperbola ( $n = 1$ ), that of his 'Exempl. 3' preceding, for which Newton goes on to plump as maintaining a reasonable mean between these two see-sawing extremes has, for all its mathematical simplicity, not very much to commend it as an accurate representation of the resisted projectile trajectory, even as an approximation to be refined 'per Reg. 4' (as he states at the end of the next paragraph).

(41) 'Conicam', that is.

(42) Since the ratios  $AK/Ak$  and  $d/e$  are themselves pure numbers, without the requisite linear geometrical dimension.

(43) It will evidently be accurate enough to draw the *curva regularis*  $\widehat{NNXN}$  free-hand, 'æquo manus motu' as Newton had phrased it a year or so before in Chapter 3 of his 'Matheseos Universalis Specimina' (see iv: 560 and 561, note (112)) in specifying an analogous geometrical rule of false position, without appealing to more precise methods of passing a curve 'smoothly' through the error-points  $N$ .





bolæ hujus & circuli descripti. Q.E.D. Notandum est autem quod hæc operatio perinde se habet sive recta  $AKN$  horizonti parallela sit sive ad horizontem in angulo quovis inclinata; quodq; ex duabus intersectionibus  $H$ ,  $H$  duo prodeunt anguli  $NAH$ ,  $NAH$  quorum minor<sup>(47)</sup> eligendus est; & quod in Praxi mechanica sufficit circulum semel describere, deinde regulam interminatam  $CH$  ita applicare ad punctum  $C$  ut ejus pars  $FH$  circulo & rectæ  $FK$  interjecta æqualis sit ejus parti  $CE$  inter punctum  $C$  & rectam  $[A]K$  sitæ.

Quæ de Hyperbolis dicta sunt facile applicantur ad Parabolas. Nam si  $XAGK$  Parabolam designet quam recta  $XV$  tangat in vertice  $X$ ,<sup>(48)</sup> sintq; ordinatim applicatæ  $IA$ ,  $VG$  ut quælibet abscissarum  $XI$ ,  $XV$  dignitates  $XI^n$ ,  $XV^n$ ,<sup>(49)</sup> agantur  $XT$ ,  $TG$ ,  $HA$ , quarum  $XT$  parallela sit  $VG$  et  $TG$ ,  $HA$  parabolam tangant in  $G$  &  $A$ : et corpus de loco quovis  $A$  secundum rectam  $AH$  productam justa cum velocitate projectum describet hanc Parabolam, si modo densitas Medij in locis singulis  $G$  sit reciproce ut tangens  $GT$ . Velocitas autem in  $G$  ea erit quacum Projectile pergeret, || in spatio non resistente, in Parabola Conica verticem  $G$ , diametrum  $VG$  deorsum productam & latus rectum  $\sqrt{\frac{2TG^2}{nn-n} \times VG}$  habente. Et resistentia

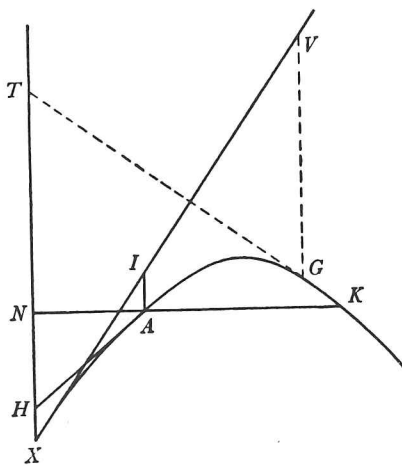

||[274]

in  $G$  erit ad vim Gravitatis ut  $TG$  ad  $\frac{3nn-3n}{n-2} VG$ .<sup>(50)</sup> Unde si  $NAK$  lineam

(47) This is not shown by Newton in his figure, but starts off from  $A$  in the direction of the lower of the two points  $H$ . But why he should here decree that the shallower of the two trajectories  $\widehat{AK}$  possible must invariably be selected is not at all clear. (When an obstacle of some kind intervenes between the firing-point  $A$  and target  $K$  there is evidently practical advantage in lofting the projectile—a mortar-shell, say—along the higher trajectory which is depicted in the accompanying figure.) Newton himself subsequently saw no need thus arbitrarily to restrict his choice, and the present phrase does not appear in his second and third (and hence all subsequent) editions of the *Principia*.

(48) Understand that this (general higher-order) parabola has for its accompanying diameter the extension of  $TNX$  below  $X$ .

(49) Whence the defining 'symptom' of the parabolic trajectory  $\widehat{XGK}$  is  $GV \propto XV^n$ , in contrast with that,  $GV \propto XV^{-n}$ , for the preceding hyperbolic path. It follows without further ado that the results obtained previously for the latter, hyperbolic trajectory adapt themselves to the present parabolic one merely by substituting  $n \rightarrow -n$ .

(50) Read  $\frac{2nm-2n}{n-2} VG$ , recte on bumping up the parent measure for the ratio of resistance to gravity by the factor  $\frac{2}{3}$  (see note (13) above); the adjustment was made in the *editio secunda*, but only as a last-minute addition to the concluding 'Corrigenda' (*Principia*, 21713: signature Rrr2<sup>v</sup>). This and the preceding results for the density of the medium and the projectile's speed

horizontalem designet, et manente tum densitate Medij in  $A$  tum velocitate quacum corpus projicitur mutetur utcumq; angulus  $NAH$ , manebunt longitudines  $AH$ ,  $AI$ ,  $HX$  et inde datur Parabolæ vertex  $X$  & positio rectæ  $XI$ , et sumendo  $VG$  ad  $IA$  ut  $XV^n$  ad  $XI^n$  dantur omnia Parabolæ puncta  $G$  per quæ Projectile transibit.<sup>(51)</sup>

readily ensue from Newton's corresponding evaluations in the case of the earlier hyperbolic trajectory on substituting  $-n$  in place of  $n$  (see the previous note). From first principles, alternatively, because—on extending  $VG$  downwards, much as before, till it meet  $D$  with the horizontal through  $X$ , and understanding  $DG$  to be the incrementation of the ordinate  $BC$  with respect to the increment  $BD$  of the base—the lines  $XV$  and  $DV$  are in given proportion to the base  $XD$ , it follows, on setting  $XB = a$  and  $BC = e$  to be the (mutually perpendicular) coordinates of its general point  $C(a, e)$ , that the defining Cartesian equation of the trajectory  $XACK$  is  $e = e_a \equiv ka - la^n$ , where  $k$  is the slope of the tangent  $XV$  at the vertex  $X$  and

$$l = GV/XD^n = (1+k^2)^{\frac{1}{2}n} \cdot (GV/XV^n).$$

(Since the firing-point  $A(NA, XN)$  is by definition on the path, there will also be  $l = (XN - k \cdot NA)/NA^n$ .) The 'Taylor' series expansion of  $DG = e_{a+o}$  in powers of the increment  $BD = o$  will then straightforwardly yield the coefficients

$$Q (= de/da) = k - nla^{n-1}, \quad R (= \frac{1}{2}d^2e/da^2) = -\frac{1}{2}n(n-1)la^{n-2}$$

and

$$S (= \frac{1}{6}d^3e/da^3) = -\frac{1}{6}n(n-1)(n-2)la^{n-3};$$

that is, by transporting the construction (with Newton) to the incremented ordinate  $DG$  which is 'ultimately' coincident with  $BC$ ,

$$Q = k - (nl \cdot XD^{n-1} \text{ or } n \cdot GV/XD), \quad R = -\frac{1}{2}n(n-1) \cdot GV/XD^2 \quad \text{and} \quad S = \frac{1}{6}n(n-2)R/XD.$$

Substitution of these values in Newton's previously derived general measures

$$S/R \sqrt{(1+Q^2)} = (S/R) \cdot XD/GT, \quad \frac{1}{2}S \sqrt{(1+Q^2)}/R^2 = \frac{1}{2}(S/R^2) \cdot GT/XD$$

and

$$\sqrt{(\frac{1}{2}g \cdot (1+Q^2)/R)}$$

for the density of the medium, the ratio of its resistance to gravity, and the body's speed respectively yields at once the expressions

$$\frac{1}{6}(n-2)/GT \propto 1/GT, \quad |-\frac{1}{6}(n-2)/n(n-1)| \cdot GT/GV \quad \text{and} \quad \sqrt{(\frac{1}{2}gr)}$$

(where *latus rectum*  $r = GT^2/R \cdot XD^2 = |-1/\frac{1}{2}n(n-1)| \cdot GT^2/GV$ ) here assigned by him for these.

(51) Newton could well have gone on at this point to develop an analogous higher-order generalization of the tilted Apollonian parabola which James Gregory had in 1672—retracing, we now know, the steps of Thomas Harriot three-quarters of a century before him—adduced, as the path which a falling body traverses under a constant uni-directional resistance, in his little tract *De Motu Penduli & Projectorum* which Newton himself knew well. (See VI: 7, notes (16) and (17).) But here he breaks off, content to have noticed the generalization of the simple, unresisted Galileian parabola which maintains the verticality of its axis.

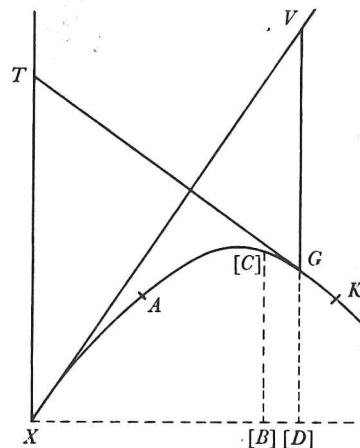



APPENDIX 2. INITIAL ATTEMPTS  
(LATE SEPTEMBER? 1712) TO ADJUST THE  
DEFECTIVE 1687 ARGUMENT.<sup>(1)</sup>

From originals in the University Library, Cambridge and in private possession

[1]<sup>(2)</sup> [Positis]  $OB = a$ .  $BC = e$ .

[ut et]  $BD = o = Bi$ .  $Bd = p$ .<sup>(3)</sup>

[erit]  $\frac{ao}{e} = IF$ .  $GF = \frac{nno^2}{2e^3} + \frac{anno^3}{2e^5}$ .<sup>(4)</sup>

[adeoq]  $CF = \sqrt{oo + \frac{aaoo}{e[e]}} = \frac{no}{e}$ .

[Jam existente]  $gf = [GF, fit]$

$$\frac{nnpp}{2e^3} - \frac{annp^3}{2e^5} [+ \&c] = \frac{nnoo}{2e^3} + \frac{anno^3}{2e^5} + \&c.$$

[sive]  $pp - \frac{ap^3}{ee} = oo + \frac{ao^3}{ee}$ . [hoc est]  $oo.pp :: ee - ap.ee + ao$ .

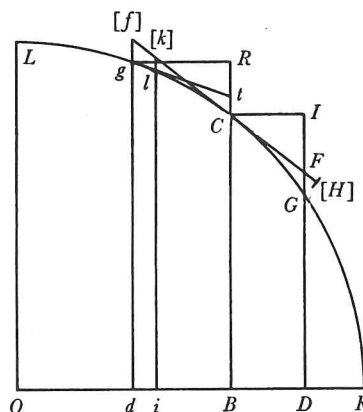

(1) When about the end of September 1712 Abraham de Moivre communicated to Newton the shattering counterblast to the truth of Proposition X of the *Principia's* second book (as it was even then being reprinted without change) which Johann Bernoulli transmitted through his nephew Niklaus by his independent demonstration from first principles that the result of its 'Exempl. 1' (dealing with resisted motion in a semicircular arc) was a third too small, we have de Moivre's subsequent report to Bernoulli (see §1: note (1) above) that Newton took 'two or three days' to satisfy himself that the objection was valid, and to produce an alternative general argument—where tangents to the two successive infinitesimal arcs of the projectile path whose comparison was basic to both original and amended versions were now drawn the same way from corresponding end-points (and not, as earlier, opposite ways from their common point)—which merely(!) bumped up the general measure derived, in Corollary 2, for the ratio of resistance to gravity by the same numerical factor  $\frac{3}{2}$  which rectified the deficiency in its prime *Exemplum*. During those few days, in fact, Newton's pen filled sheet after sheet of paper in abortive attempts first to make minor repair to the edifice of the argument of his *editio princeps* (on which see our running commentary to the reprinting of its text in Appendix 1 preceding) and then in essaying a variety of increasingly more radical reconstructions, each in their several ways equally defective, before gradually coming piece by piece to lay the foundations of the soundly built replacement of it which he put to the world at large in his *editio secunda*, adroitly cementing it into the hole left there by the excision of its parent. The later stages in this rebuilding are set out in §§1/2 preceding: here we reproduce the more fragmentary record of his initial efforts to comprehend wherein lay the error in the argument of his 1687 version—he at length did so, it would appear, but only afterwards when he returned to probe it (see Appendix 3 following)—and then to draft alternatives to it.

(2) ULC. Add. 3965. 10: 109<sup>r</sup>/103<sup>r</sup>; the former page is reproduced in photocopy as Plate III (facing page 64) in A. R. and M. B. Hall, *Unpublished Scientific Papers of Isaac Newton. A selection from the Portsmouth Collection in the University Library, Cambridge* (Cambridge, 1962). Newton here checks the accuracy of the computation by which the result in 'Exempl. 1' of resisted motion in

$$[\text{itaq}] \quad o.p :: \sqrt{ee - ap} = e - \frac{ap}{2e} \cdot \sqrt{ee + ao} = e + \frac{ao}{2e} :: e \cdot e + \frac{ao}{e} \quad (5)$$

$$[\text{seu}] \quad o.p - o :: e \cdot \frac{ao}{e} :: BC \cdot IF :: CF \cdot kf = Cf - CF = 2FH = \frac{naoo}{e^3}.$$

$$[\text{Unde}] \quad \frac{naoo}{2e^3} = FH \cdot \frac{nnoo}{2e^3} = FG :: a \cdot n.$$

Ergo  $GH \perp FH$  et corpus non acceleratur.<sup>(6)</sup> [Rursus quia]  $\frac{naoo}{2e^3} = Cf - CF$ .

$$[\text{fit}] \quad \frac{a}{n} = \frac{Cf - CF^{(7)}}{FG} \quad \text{ut resistentia.} \quad [\text{et}] \quad \frac{a}{2ne} \left[ = \frac{Cf - CF}{CF^q} \right] \quad \text{ut densitas.}$$

the circle quadrant  $\widehat{LCK}$ , of radius  $OK = OC = n$ , is derived from the preceding general measure  $FH/FG = [\frac{1}{2}](fC - CF)/FG$  as deduced in the *editio princeps* (see pages 374–80 above). In our edited version of the roughly written manuscript text we make one or two small transpositions the better to convey its sense; compare the next note.

(3) Newton sets this ‘opening’ explanation of terms after ‘ $Ct = FG$ ’ below, in fact. As in the *editio princeps*, understand that the circle-arcs  $\widehat{gC}$  and  $\widehat{CG}$  are traversed in equal, indefinitely small times.

(4) Ignoring terms of the order of  $o^4$ , that is. Similar suppositions are made *mutatis mutandis* in sequel.

(5) Since  $p = o + O(o^2)$ .

(6) For  $FH$  will be at once the increment of the component of gravity acting in the direction of motion along the tangent  $CH$  (inclined at  $\widehat{BCH} = \widehat{BOC} = \cos^{-1}(a/n)$  to the vertical), and also the decrement in the body’s motion due to the contrary resistance of the medium. Which is impossible, because the constant downwards acceleration of the body must have a component in the direction  $CH$  which is proportional to  $\cos \widehat{BCH} = a/n$ , while if the body’s total motion in that direction is not accelerated there can be no variation in the resistance of the medium to that uniform progress. This *reductio ad absurdum* of the ratio obtained in ‘Exempl. 1’ of the *editio princeps* for resistance to semicircular motion in a plane perpendicular to the horizontal had, as his nephew Niklaus doubtless informed Newton at their meeting in London in early October 1712, already been made by Johann Bernoulli, and privately communicated by him to Leibniz in a letter of 12 August 1710 (N.S.) (first printed in *Got. Gul. Leibnitii et Johan. Bernoullii Commercium Philosophicum et Mathematicum*, 2 (Lausanne/Geneva, 1745): 231–2 [= (ed. C. I. Gerhardt) *Leibnizens Mathematische Schriften*, 3 (Halle, 1856): 854–5]). Bernoulli made his objection publicly known a few months afterwards in his long article ‘De motu Corporum gravium, Pendulorum, & Projectilium in mediis non resistentibus & resistentibus, supposita Gravitate uniformi...’ (*Acta Eruditorum* (February/March 1713): 77–95/115–32): 93: §32, where he laid heavy stress on what he called a ‘manifesta contradictio’.

(7) The denominator of this 1687 measure of the ratio of resistance to gravity ought (see Appendix 1: note (10)) to read ‘ $2FG$ ’. When, however, as Johann Bernoulli first remarked in 1710 (again see his letter to Leibniz of 12 August that year) and as his nephew informed Newton—in what detail we do not know—at London in the last days of September 1712, we argue directly from first principles in the present case of the semicircle  $e = +\sqrt{(n^2 - a^2)}$  for which (in Leibnizian terms) there is  $da:de:ds = e:-a:n$  where  $\widehat{LC} = s$ , since the instantaneous speed  $v = ds/dt$  at  $C$  (where  $t$  is the time of passage over  $\widehat{LC}$ ) is  $\sqrt{(\frac{1}{2}g \cdot (1 + Q^2)/R)} = \sqrt{(-ge)}$ , while the medium’s resistance  $\rho$  counteracts both the curvilinear acceleration  $dv/dt = v \cdot dv/ds$  and the



[Cape]  $GF = \frac{CF^q}{2GD} = \text{dato}$ . [Erit]  $CF^q$  ut  $GD$  [id est]  $CF$  ut  $GD^{\frac{1}{2}}$ . Velocitas ut  $GD^{\frac{1}{2}}$ . [Quia hic est  $o^2$  ut  $e^3$  erit]  $BD$  ut  $GD^{\frac{1}{2}}$ . [et]  $GI$  ut  $OD, DG^{\frac{1}{2}}$ , utq; decrementum  $\square^{ti(8)}$  velocitatis.<sup>(9)</sup>

[Est]  $\frac{Cf - CF}{2} = HF$ . [FG =]  $\frac{CF^q}{2CB}$  [hoc est] resist. Grav. ::

$$\frac{\sqrt{fg} \times \sqrt{fd + dg} - \sqrt{FG} \times \sqrt{FD + GD}}{2} \cdot FG.$$

[sive]  $\sqrt{fd + dg} - \sqrt{FD + DG} \cdot 2\sqrt{FG}^{(10)} :: \sqrt{dg} - \sqrt{DG} \cdot \sqrt{2FG}$ .

[Pone  $DG = e + Qo + Roo + So^3$  &c.<sup>(11)</sup> Evadit  $Q = -\frac{a}{e}$ .  $R = -\frac{nn}{2e^3}$ .  $S = -\frac{ann}{2e^3}$ . adeoq; resistentia ad gravitatem ut]  $2So^3\sqrt{oo} + QQoo$  ad  $4RRo^4$ .<sup>(12)</sup> [id est]

component  $-g \cdot de/ds$  of gravity  $g$  acting in the instaneous direction of motion, there ensues  $\rho/g = -d(\frac{1}{2}v^2/g - e)/ds = \frac{3}{2}de/ds$ , that is,  $\frac{3}{2}a/n$  recte. It is Newton's purpose in the sequel to recover this adjusted result from a correspondingly corrected general measure for the ratio of resistance to gravity for an arbitrary given curve.

(8) Read 'quadrati'.

(9) Since  $d(v^2) = -d(ge) \propto de$ . How to go on from here is not evident, and Newton in sequel goes back to his 1687 measure  $\frac{1}{2}(fC - CF)/FG$  of the ratio of resistance to gravity.

(10) Newton here makes the error of dividing top and bottom in the fraction in the previous line by  $\sqrt{fg} \approx \sqrt{FG}$ . In his ensuing terms, however, there is (see Appendix 1: note (13))  $fg = Ro^2 + 2So^3 + \dots$  and  $FG = Ro^2 + So^3 + \dots$ , and the ratio  $1 + (s/R)o \dots$  of these cannot be neglected, so that this would-be simplification is invalid. For what it is worth, the further reduction which follows is accurate since it is valid here to replace  $\sqrt{(fd + gd)} - \sqrt{(FD + GD)}$ , that is,

$$\sqrt{(2gd + FG)} - \sqrt{(2GD + FG)} = (\sqrt{(2gd)} - \sqrt{(2GD)}) (1 - \frac{1}{2}FG/\sqrt{(dg \times DG)} \dots),$$

by  $\sqrt{(2gd)} - \sqrt{(2GD)}$  tout court. But, not least (we suppose) because it would evidently prove harder than ever to resolve the resulting limit-ratio  $(\sqrt{dg} - \sqrt{DG})/\sqrt{(2FG)}$  to a standard equivalent algorithm in terms of  $Q$ ,  $R$  and  $S$ , Newton there wisely leaves over, returning to the parent fraction  $\frac{1}{2}(fC - CF)/FG$  to essay (see note (12) below) yet another reduction of it to a computationally more amenable form.

(11) The series expansion of the incremented ordinate  $e_{a+o}$  into terms in advancing powers of  $o$ , namely, where  $e = e_a$  is the Cartesian equation of the curve  $LCK$  of general point  $C(a, e)$ , so that  $Q = de/da$ ,  $R = \frac{1}{2}d^2e/da^2$  and  $S = \frac{1}{6}d^3e/da^3$  (see Appendix 1: note (14)); whence  $CF = o\sqrt{(1 + Q^2)}$  and  $FG = Ro^2 + So^3 \dots$ . Analogously, corresponding to the decrement  $Bd = -p$ , there will be  $dg = e_{a-p} = e - Qp + Rp^2 - Sp^3 \dots$ ; whence  $fC = p\sqrt{(1 + Q^2)}$  and  $fg = Rp^2 - Sp^3$ .

(12) That is ' $S\sqrt{1 + QQ}$  ad  $2RR$ ' on dividing through the antecedent and consequent members of this ratio by the common factor  $2o^4$ . This evaluation would seem to arise by reducing the parent fraction  $(fC - CF)/2FG$  to be  $(fC^2 - CF^2)/2FG(fC + CF)$  or

$$(fC^2/CF^2 - 1) \cdot CF/4FG = (p^2 - o^2) \cdot o\sqrt{(1 + Q^2)}/4(Ro^2 + \dots)o^2,$$

where, on equating  $fg = Rp^2 - Sp^3 \dots$  to  $FG = Ro^2 + So^3 \dots$ , there is in consequence

$$p^2 = o^2 + 2(S/R)o^3 \dots$$

Having again attained his defective 1687 measure, when in sequel he applies it to the semi-circular case of 'Exempl. 1' he of course duly repeats the 'impossible' result which he there before found (on which see note (6) above).

$$\frac{ann}{2e^5} \times \frac{n}{e} \text{ ad } \frac{n^4}{2e^6} [\text{seu}] \text{ ut } \frac{a}{2} \text{ ad } \frac{n}{2}. [\text{Unde}] \text{ Grav. resist.}:: [n.a.]$$

$$[\text{Tangat } gt \text{ curvam } LCK \text{ ad } g. \text{ Erit}] Ct = FG. (13)$$

$$\text{Grav. Resist.}:: FG.FH = \frac{1}{2}f[k]. (14) [\text{Jam quia}]$$

$$fg.[kl]:: [fC^q.kC^q = \overline{fC} - fk^q \text{ sive}] \frac{1}{2}fC. \frac{1}{2}fC - f[k].$$

(13) This equation—a late insertion penned in blacker ink to the left of the specification of quantities which we have here advanced to be the opening line of the piece (see note (3) above, and also the printed photo-facsimile of the manuscript cited in note (2) preceding)—marks the point at which Newton first considered the deviation from straight over the arc  $g\widehat{C}$  by considering, in parallel with that,  $CF$ , to the arc  $\widehat{CG}$ , the tangent  $gt$  from its second end-point  $C$ . He was here perhaps wiser than he knew, since the downwards components of resistance (which he had hitherto neglected to take into account in asserting the equality of  $fg$  and  $FG$ ) now act the same way: specifically, continuing to understand that the infinitesimal arcs  $g\widehat{C}$  and  $\widehat{CG}$  are traversed in equal times,  $\theta$  say, we may show (compare note (6) to Appendix 1 preceding) that, on ignoring terms of the order of  $\theta^4$ , the projectile in its successive motion from  $g$  and  $C$  respectively is, under the joint action of the constant downwards pull of gravity  $g$  and the component in that direction of the medium's resistance  $\rho$  opposing the missile's onrush at  $C$ , diverted from its initial tangential paths  $gt$  and  $CF$  through the equal distances  $tC = FG = \frac{1}{2}g\theta^2 - \frac{1}{8}(g\rho/v)\theta^3$ , where  $v$  is the projectile's instantaneous speed. Had he thought to make the connection, Newton could here straightforwardly have gone on to make correct deduction of the properly adjusted expression for the ratio of resistance to gravity from the basic geometrical measure  $\frac{1}{2}(fC - CF)/FG$  stated by him in his *editio princeps*. For, corresponding to the base increment  $BD = o$ , the series expansion of the incremented ordinate  $DG = e_{a+o}$  as  $e + Qo + Ro^2 + So^3 + \dots$  (where there is  $Q \equiv Q_a = de/da$ ,  $R \equiv R_a = \frac{1}{2}d^2e/da^2 = \frac{1}{2}dQ/da$  and  $S \equiv S_a = \frac{1}{6}d^3e/da^3 = \frac{1}{3}dR/da$ ) again yields  $CF = o\sqrt{(1+Q^2)}$  and  $FG = Ro^2 + So^3 + \dots$ ; while likewise, corresponding to the decrement  $Bd = -p$ , there is  $dg = e_{a-p} = e - Qp + Rp^2 - Sp^3 + \dots$  and consequently

$$tC = R_{a-p}p^2 + S_{a-p}p^3 + \dots = (R - 3Sp + \dots)p^2 + (S - \dots)p^3 = Rp^2 - 2Sp^3 \dots$$

Whence, on equating the deviations  $FG$  and  $tC$ , there ensues

$$p^2 = o^2 + 3(S/R)o^3 \dots \quad \text{or} \quad p = o + \frac{3}{2}(S/R)o^2 \dots,$$

so that  $\frac{1}{2}(fC - CF)/FG = \frac{1}{2}(p - o)\sqrt{(1+Q^2)}/(Ro^2 + \dots)$  comes, in the limit as  $o$  vanishes, to be  $\frac{3}{2}S\sqrt{(1+Q^2)}/R^2$  recte. Newton himself would not appear to have seen this relatively simple way of mending the argument of his *editio princeps* till after he had come (in the variant fashions of §2.1/2 preceding) more radically to recast his original reasoning, when he returned privately (see Appendix 3 following) to consider anew wherein its faultiness lay, there (in Appendix 3.3) obtaining the ratio of  $o$  to  $p$  equivalently *ex sagittis*.

In immediate sequel (on f. 109<sup>r</sup>), unable yet to shake himself free from the *idée fixe* that  $fg$  and  $FG$  have equal length, he set himself vainly to derive a correct argument from the thoroughly confused premiss ' $GF = C[t] = g[f]$ ', properly maintaining that ' $Cf - CF = \text{decr[ementum] mot[us]}$ ' measures the resistance over  $g\widehat{CG}$ . We see no need to reproduce these ineffective computations in their full detail, thinking it enough instance of their quality to print one typical passage (almost at the page bottom) where a late replacement of  $fg$  by  $FG$  (see note (15) following) leads Newton inescapably on to duplicate once more the result attained in the 1687 text.

(14) That is,  $\frac{1}{2}(fC - CF)$ , since  $iB = BD$  and so  $kC = CF$ .



$$[\text{fit}] fg \cdot fg - [kl] :: fC \cdot 2f[k]. \quad [\text{unde}] f[k] = \frac{fg - [kl]}{2fg} fC.$$

$$[\text{Itaq}] \text{ Grav. R[es]ist} :: FG \cdot \frac{fg - [kl]}{4fg} fC :: 4FG^a \cdot \overline{FG - [kl]} \text{ in } fC^{(15)} ::$$

$$\frac{n^4 o^4}{e^6} + \frac{2an^4 o^5}{e^8} \cdot \frac{\text{anno}^3}{e^5} \times \frac{no}{e} :: n \cdot [a].$$

[2]<sup>(16)</sup> Sit  $A$  altitudo ad quam corpus  $C$  velocitate sua sursum versa ascendat sine resistentia<sup>(17)</sup> et erit velocitas corp[or]is in  $C$  ad vim quam corpus sine resistentia movendo interea acquirat dum pergit a  $C$  ad  $G$  in subduplicata ratione  $A + IG$  ad  $A$  sive ut  $A + \frac{1}{2}IG$  ad  $A$ . Quare si velocitas in  $C$  fuerit  $V$ , incrementum velocitatis in  $G$  sine resistentia foret  $\frac{\frac{1}{2}IG}{A} V$ <sup>(18)</sup> & decrementum ex resistentia et grav[itate]<sup>(19)</sup>  $\frac{cf - CF}{CF} V$ ,

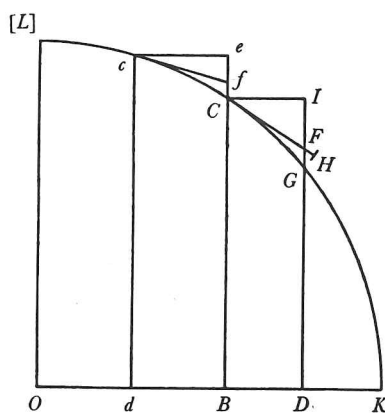

(15) The quiet replacement by  $FG$ , here, of  $fg$  in the preceding numerator  $fg - kl$  equivalently repeats the basic error of the 1687 argument (see Appendix 1: note (8)); whence, *de rigeur*, the impossible result obtained in 'Exempl. 1' of the *editio princeps* again ensues when Newton in the next line applies his 'new' measure to compute the ratio of resistance to gravity in the instance of the semi-circular projectile path.

(16) From the recto of a folio sheet in private possession; Newton afterwards used the space left blank at the page bottom to draft the two long footnotes \* on pages 70 and 90 of his anonymously edited compendium of the *Commercium Epistolicum D. Johannis Collins et Aliorum de Analysi promotum* (London, 1713) which he put to press in November 1712. We omit a few opening lines where Newton again duplicated his calculation in 'Exempl. 1' of the *editio princeps* to confirm that in the case of the semicircle  $e = \sqrt{(n^2 - a^2)}$  the measure ' $S\sqrt{1 + QQ}$  ad  $2RR$ ' which he had obtained in 1687 does indeed here lead to the erroneous result 'Resist ad Grav. ... ::  $a \cdot n$ ', and take up the manuscript text at the point where—employing for the first time his new-found insight (see note (13) to [1] preceding) that the tangents to the arcs  $c\widehat{C}$  and  $\widehat{CG}$  ought better to be drawn 'the same way' from the corresponding end-points  $c$  and  $C$ —he broaches a modification of his original mode of reasoning.

(17) Using Newton's present denotations of  $V$  for the missile's speed at  $C$ , and  $t$  for the equal infinitesimal times in which it successively describes the arcs  $c\widehat{C}$  and  $\widehat{CG}$ , it is readily shown that, where (as ever)  $g$  is the constant downwards force of gravity, then

$$\sqrt{(2gA)} = V = (\widehat{CG}/t \approx) CF/t$$

and therefore, since  $GF = \frac{1}{2}gt^2$ ,  $A = \frac{1}{4}CF^2/GF = \frac{1}{4}(DG + DF)$ , that is,  $\frac{1}{2}BC$  in the limit as the incremented ordinate  $DG$  (and so  $DF$  also) comes to coincide with  $BC$ . But the explicit value of  $A$  is not here pertinent, because it will in the sequel be more conveniently replaced by its equal  $CF^2/4FG$ .

(18) That is,  $IG \cdot g/V = (IG/GF) \cdot gt$  where  $gt = 2GF/t = 2(GF/CF) \cdot V$  is the downwards increment in the projectile's speed due to the pull of gravity  $g$  in the time  $t$  in which  $\widehat{CG}$  is traversed.

(19) Namely  $-(\widehat{CG} - c\widehat{C})/t = -(CF - cf)/t$ .

[itaq] ex resistentia sola  $\frac{IG}{2A} + \frac{cf-CF}{CF} \times V$  et ex gravitate sola  $GF, V$ .<sup>(20)</sup> Est ergo resistentia ad gravitatem ut  $\frac{IG}{2A} + \frac{cf-CF}{CF}$  ad  $GF$ .<sup>(21)</sup> [Jam posito  $t$  pro temporibus æqualibus quo corpus pergit a  $c$  ad  $C$  ut et a  $C$  ad  $G$  erit]  $2Cf.Cc::t.\frac{Cc,t}{2Cf}$ .

[adeoq]  $tt.\frac{Cc^a, tt}{4Cf^a}::Cf.A=\frac{Cc, Cc}{4Cf}=\frac{1}{2}CB$ . [Quare est] Resistentia ad Gravitatem

ut  $\frac{2IG, Cf}{Cc, Cc} + \frac{cf-CF}{CF}$  ad  $GF = Cf$ .

[Unde fit]

Resistentia ut  $\frac{2IG, Cf}{Cc, Cc} + \frac{cf-CF}{CF}$ .

□<sup>(22)</sup> Velocitatis ut  $\frac{Cc, Cc}{Cf}$ .

Densitas ut  $\frac{2IG, Cf^a}{Cc^4} + \frac{Cf, cf-Cf, CF}{CF, Cc, Cc}$  sive ut  $\frac{R, Cf}{Cc, Cc}$ .<sup>(23)</sup>

Vel sic. [Est]  $CF.IF::GF.\frac{IF, GF}{CF}$  = increment[o] tangentis<sup>(24)</sup> ex gravitate.

Decrementum ex resisten[tia] - gravitate [est]  $cf-CF$ .<sup>(25)</sup> [Ergo] Decrementum

ex resistentia [est]  $cf-CF + \frac{IF, GF}{CF}$ .<sup>(26)</sup> [adeoq] Resistentia ad Gravitatem ut

$cf-CF + \frac{IF, GF}{CF}$  ad  $FG$ .<sup>(27)</sup>

(20) This should (see note (18)) read ' $\frac{2GF}{CF}, V$ '.

(21) Whence this should be ' $\frac{2GF}{CF}$ ', thus yielding the ratio of resistance to gravity here to be correctly as  $(\frac{1}{2}IG \times CF/A)$  or  $2(IG/CF) \times GF + cf - CF$  to  $2GF$ , where

$$IG/CF = IF/CF = \cos \widehat{BCF}$$

in the limit as  $DGF$  passes to coincide with  $BC$ .

(22) Read 'Quadratum'.

(23) Where, of course,  $R$  denotes the 'R[esistentia]'.

(24) Namely  $CF$ .

(25) That is,  $-(\widehat{CG} - \widehat{cC}) = -d(\widehat{LC})$ . This, however, represents the decrement  $t.dV$  in speed of motion ensuing from the countering pulls of resistance and gravity along the tangent  $CF$ . The corresponding downwards 'incrementum velocitatis ex gravitate' is  $t.gt = 2GF$ , and the component of this along  $CF$  will be  $2(IF/GF) \times GF$ . This subtlety will be the remaining obstacle to Newton's attaining the correct measure of resistance to gravity, one not easily overcome by him.

(26) This should (see the previous note) be ' $+\frac{2IF, GF}{CF}$ '.

(27) And consequently this ratio must be recte 'ut  $cf - CF + \frac{2IF, GF}{CF}$  ad  $2GF$ ' (as in note (21) above). We omit to reproduce the rough jottings following in the manuscript where Newton



[3]<sup>(28)</sup> [Sit]  $EB = BD$ .  $OE, OB, OD$  abscissæ.  $EH, BC, DG$  Ordinatæ.  $HN, CF$  tangentæ. Per terminos seriei inveniuntur  $HN, CN, CF, FG$  et habebitur  $HC - HN = \frac{EH - BN}{HN}$  in  $CN$  et addendo  $HN$  habebitur  $HC$ . Sit

$$Cf.CF::\sqrt{CN}.\sqrt{FG}$$

& acta  $fgd$  ordinatis parallela, erit  $fg = CN$ ,<sup>(29)</sup> & arcus  $HC, Cg$  erunt synchroni, & eorum decrementum momentaneum erit  $HC - Cg$  vel (quod perinde est)  $HN - Cf$ . Ab hoc decremento gravitas detrahit  $Cg - Cf$  vel  $HC - HN$ ,<sup>(30)</sup> ideoq; resistentia generat

$$HN - Cf + HC - HN = HC - Cf,$$
<sup>(31)</sup>

et erit resistentia ad gravitatem ut  $HC - Cf$ <sup>(31)</sup> ad  $fg$  vel  $CN$ .<sup>(32)</sup>

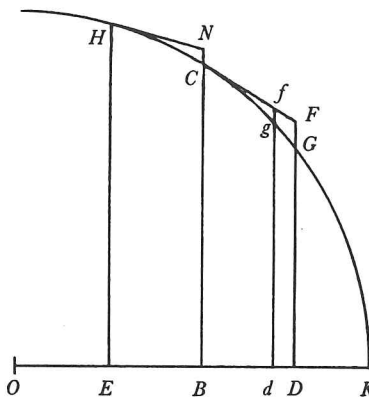

began tentatively to recast his 1687 text by instructing that ‘a puncto  $G$  in tangentem demittatur perpendicularum  $Gn$ ’, thus obtaining the ‘incrementum tangentis ex gravitate’ directly as  $Fn$ . Overleaf Newton has checked yet once more that the series expansion of the incremented ordinate  $DG = \sqrt{(e^2 - 2ao - o^2)}$  is indeed as he evaluated it to be in his 1687 text; and then went on briefly to convert the coordinates of  $C$  to be the truly Cartesian ‘ $OB = x. BC = y$ ’, now supposing that  $DG = y_{x+o}$  has the Taylorian expansion ‘ $y + bo + coo + do^3$  [&c]’, whence ‘ $\dot{x} = o. -bo = IF. -coo = FG. CF = q = o\sqrt{1+bb}$ ’, but the calculations tail off uselessly in an attempt to evaluate the erroneous measure ‘Grav. Resist:: $FG.FH = \widehat{CF} + Fn$ ’ with ‘ $\widehat{CF}$ ’ (=  $cf - CF$ ) computed, by a slip, as the true fluxion  $\dot{q}$ . Even had he calculated aright from his false measure, Newton would have found that

$$cf = o\sqrt{1+b^2} - 2(bc/\sqrt{1+b^2})o^2 \dots, \quad CF = (1 - \frac{3}{2}(d/c)o \dots) o\sqrt{1+b^2}$$

and therefore  $\widehat{CF} = (\frac{3}{2}d\sqrt{1+b^2}/c - 2bc/\sqrt{1+b^2})o^2 + O(o^3)$ , while  $Fn = (b/\sqrt{1+b^2})co^2$ , so that the ensuing ratio of resistance to gravity would have been  $\frac{3}{2}d\sqrt{1+b^2}/c^2 - b/\sqrt{1+b^2}$ .

(28) ULC. Add. 3968. 18: 261<sup>r</sup>. This minor recasting of [2] preceding is jotted down on the back of a transcript in Newton’s hand of Leibniz’ letter to Hans Sloane of 29 December 1711 (N.S.)—the original is now British Library. MS Sloane 4043: 19/20 (and reproduced in its context in *The Correspondence of Isaac Newton*, 5, 1975: 207)—whence it was first printed a few weeks later in Newton’s *Commercium Epistolicum D. Johannis Collins et Aliorum*...: 118/119.

(29) Understanding that the arcs  $\widehat{HC}$  and  $\widehat{Cg}$  are traversed in successive equal ‘instants’ of time (compare note (13) above).

(30) This should (compare note (25) above) be ‘ $2\widehat{Cg} - Cf$  vel  $2\widehat{HC} - HN$ ’.

(31) Whence read ‘ $HN - Cf + 2HC - 2HN = 2HC - Cf - HN$  vel  $HC + Cg - 2Cf$ ’ here.

(32) This should (again see note (25)) read ‘ $2fg$  vel  $2CN$ ’. Accurately adjusted, therefore, the ratio of resistance to gravity will be as  $\frac{1}{2}(\widehat{HC} + \widehat{Cg}) - Cf$  to  $fg$ . In the analytical equivalent in which (as in the 1687 text)  $OB = a$  and  $BC = e = e_a$  are the coordinates of the general point  $C(a, e)$  of the trajectory, and the increment  $BD = o$  yields the series expansion

$$e + Qo + Ro^2 + So^3 + \dots$$

of the ordinate  $DG = e_{a+o}$ , there is correspondingly  $EH = e_{a-o} = e - Qo + Ro^2 - So^3 + \dots$  and so  $CN = Ro^2 - 2So^3 + \dots$ ; whence, if we name  $Bd = p$ , so that  $fg = Rp^2 + Sp^3 + \dots$ , the equality

In circulo cujus centrum  $O$ , radius  $OK$ , est  $HN = \sqrt{CN \times 2CB}$  &  $Cf = \sqrt{fg \times 2gd}$ <sup>(33)</sup>

&  $HN - Cf = \sqrt{CN}$  in  $\sqrt{2CB} - \sqrt{2gd}$  et  $HC = HN + \frac{EH - BN}{HN} \times CN$ .

[itaq]  $HC - Cf = \sqrt{CN}$  in  $\sqrt{2CB} - \sqrt{2gd} + \frac{EH - BN}{HN} CN$ .

[atq accuratius]<sup>(34)</sup>  $HC - Cf = CN$  in  $\frac{\sqrt{2CB + CN} - \sqrt{2gd + CN}}{\sqrt{CN}} + \frac{OB}{OC}$ .

[hoc est]  $= CN$  in  $\frac{2CB + CN - 4\sqrt{CB, gd} + 2CN, 2CB}$ <sup>(35)</sup>  
 $HN$

[4]<sup>(36)</sup> *Corol. 1.* Resistencia est ad gravitatem ut  $\frac{HN}{CN + FG} - \frac{CF}{2FG} + \frac{FI}{CF}$  ad 1.  
Nam pro  $2\sqrt{CN \times FG}$  scribere licet  $CN + FG$ .

of the deviations  $CN$  and  $fg$  from their tangents  $HN$  and  $Cf$  (see note (25) preceding) gives  $p^2 = o^2 - 3(S/R) o^3 \dots$  and so  $p = o - \frac{3}{2}(S/R) o^2 \dots$ . Accordingly,

$$HN = o\sqrt{(1 + Q^2)_{a-o}} = o\sqrt{(1 + (Q - 2Ro + 3So^2 - \dots)^2)},$$

that is,  $o\sqrt{(1 + Q^2 - 4QRo + \dots)} = o\sqrt{(1 + Q^2) - 2(QR/\sqrt{(1 + Q^2)}) o^2 \dots}$ , and correspondingly

$$Cf = p\sqrt{(1 + Q^2)} = o\sqrt{(1 + Q^2) - \frac{3}{2}(S\sqrt{(1 + Q^2)}/R) o^2 \dots},$$

while also  $\widehat{HC} - HN = \widehat{Cg} - Cf = CN \cdot Q/\sqrt{(1 + Q^2)}$ . In consequence, therefore, in the limit as  $BD = o$  comes to vanish, Newton's present measure  $(\widehat{HC} - Cf)/fg$  yields the same erroneous value  $\frac{3}{2}S\sqrt{(1 + Q^2)}/R^2 - Q/\sqrt{(1 + Q^2)}$  for the ratio of resistance to gravity as would, *mutatis mutandis*, result (see note (27) above) from that of [2] preceding, while of course the adjusted measure  $(\frac{1}{2}(\widehat{HC} + \widehat{Cg}) - Cf)/fg$  correctly produces  $\frac{3}{2}S\sqrt{(1 + Q^2)}/R^2$ .

(33) More accurately, since  $HN^2 = CN \times (BC + BN)$  for the circle osculating the trajectory over its arc  $\widehat{HC}$ , there is  $HN = \sqrt{(CN \times (2BC + CN))}$ ; and correspondingly

$$Cf = \sqrt{(gf \times (2dg + gf))},$$

that is (because the deviations  $CN$  and  $gf$  are equal),  $\sqrt{(CN \times (2dg + CN))}$ . And so Newton will amend them in the sequel.

(34) See the previous note.

(35) Newton breaks off before completing the radical with its needed terms '+2CN, 2fg + CN<sup>2</sup>' (and with the last ratio '+OB/OC' still to adjoin). There now follow—if we have rightly restored the chronological sequence of these manuscript drafts—the fuller and more verbally finished attempts by him to correct the argument of his 1687 text which we have set out in §1 preceding, and which culminate at long last (at the end of §1.6) in the magic moment when for the first time he attains his goal.

(36) Add. 3965.12: 219<sup>v</sup>/220<sup>v</sup>, filled out (as the manuscript implicitly directs) from the preliminary draft on *ibid.*: 200<sup>v</sup>. Newton here endeavours to reduce the general measure of the ratio of resistance to gravity derived in §2.1 above—and slightly simplified in its Corollary 1 (here repeated without change)—into a form which is easier to evaluate when applied in particular instances; but he fails to remark that two of the three terms in the resulting equivalent measure in 'Corol. 2' cancel each other out, leaving (see note (39) following) a yet simpler reduced ratio still.



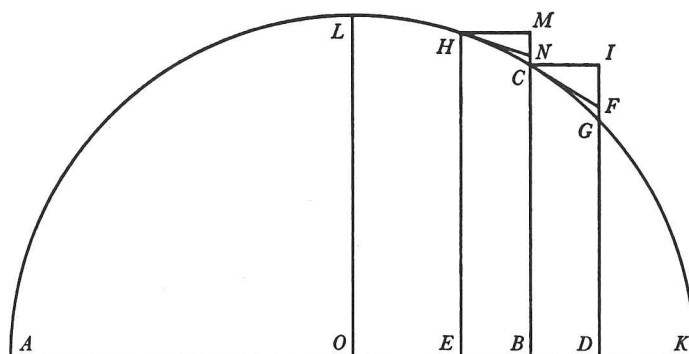

*Corol. 2.*<sup>(37)</sup> Si pro  $FG-CN$  scribatur  $A$  et pro  $CF-HN$  scribatur  $B$ , erit Resistentia ad Gravitationem ut  $\frac{HN}{2FG-A} - \frac{CF}{2FG} + \frac{FI}{CF}$  ad 1, id est ut<sup>(38)</sup>

$$\frac{CF, A}{4FG^2} - \frac{B}{2FG} + \frac{FI}{CF}$$

ad 1.<sup>(39)</sup> Ubi,<sup>(40)</sup> si  $IF-MN$  dicatur  $D$ , scribi potest  $\frac{IF, D}{CF}$  pro  $B$ .

*Corol. 3.* Et hinc si Curva Linea definiatur per relationem inter [basem seu abscissam  $AB$  & ordinatim applicatam  $BC$  (ut moris est) et valor ordinatim applicatæ resolvatur in seriem convergentem: Problema per primos seriei terminos] expedite solvetur. Sit  $BD=0$  et  $DG=P-Qo-Ro^2-So^3-\&c$ <sup>(41)</sup> & distinguantur hujusmodi series [in terminos successivos in hunc modum. Terminus primus appelletur in quo quantitas infinite parva  $o$  non extat;

(37) Newton initially phrased this to assert erroneously: 'Si pro  $FI-NM$  scribatur  $A$ , pro  $FG-CN$  scribatur  $B$ , et pro  $CF$  scribatur  $C$ : Resistentia erit ad gravitationem ut

$$\frac{B \times C}{2FG^2} - \frac{A \times FI}{2C \times FG} + \frac{FI}{4C} [!] \text{ ad } 1'$$

(38) In a cancellation at this point in the draft on f. 200<sup>v</sup> Newton, replacing  $HN$  by its equal  $CF-B$ , initially went on to insert the equivalent of the intervening step

$$\frac{-2FG \times B + CF \times A}{4FG^2 - 2FG \times A} + \frac{FI}{CF} \text{ sive}$$

here (understanding of course that the difference  $A = GF-CN$  is infinitely less than  $GF$  itself).

(39) Because (on ignoring terms of the order of  $BD^3$  and smaller) the difference  $B = CF-HN$  is readily shown—compare Newton's own reduction of the present linelets to their Cartesian equivalents which we cite in note (43) following—to be equal to  $2FG \times FI/CF$ , this ratio reduces at once (as Newton himself fails here to observe) to be 'ut  $CF \times A$  ad  $4FG^2$ ', *tout court*.

(40) Understand, as Newton explicitly stated in his draft at this place, 'cum sit  $IF$  ad  $CF$  ut  $CF-HN$  ad  $IF-MN$ '.

(41) This, as ever, to allow  $P, Q, R$  and  $S$  to have positive signs in the particular case of the semicircle in 'Exempl. 1' below. For simplicity in our own exposition we assume the equivalent expansion  $e + Qo + Ro^2 + So^3 + \dots$  of the incremented ordinate  $DG = e_{o+o}$ .

secundus in quo quantitas illa extat unius dimensionis; tertium in quo extat duarum; quartum in quo trium est, et sic in infinitum. Et primus terminus qui hic est  $e$ , denotabit semper longitudinem ordinatæ  $BC$  insistentis ad indefinitæ quantitatis  $o$  initium  $B$ ; secundus terminus  $Qo$  denotabit differentiam inter  $BC$  et  $DF^{(42)}$  id est lineolam  $IF$  quæ abscinditur complendo parallelogrammum  $BCID$ , atq; adeo positionem Tangentis  $CF$  semper determinat. Tertius terminus & subsequentes  $Roo + So^3 + \&c$  designabunt lineolam  $FG$  quæ jacet inter Tangentem & Curvam adeoq; determinat angulum contactus  $FCG$  seu curvaturam quam Curva linea habet in  $C$ . Si lineola illa minuatur in infinitum, termini subsequentes evadent infinite minores tertio ideoq; negligi possunt, & solus terminus tertius determinabit curvaturam curvæ. Terminus quartus  $So^3$  determinat variationem curvaturæ, quintus variationem variationis, & sic deinceps. Unde obiter patet usus non contemnendus harum serierum in solutione Problematum quæ pendent a Tangentibus & curvatura curvarum.

Præterea  $CF^q$  est latus quadratum ex  $CI^q$  et  $IF^q$  sive ex  $oo + QQoo$ , et  $GD$  mutando signum ipsius  $BD$  vel  $o$  mutatur in  $EH = P + Qo - Roo + So^3 - \&c$ . Et inde habetur  $CM = Qo - Roo + So^3 - \&c$ . Et] scribendo  $AE$  pro  $AB$  vel  $KE$  pro  $KB$ , quantitas  $IF$  mutatur in  $MN$ . Et simul prodeunt  $IF - MN = D$ ,  $MC - MN = NC$ ,  $FG - NC = A$ .  $\frac{IF \times D}{CF} = B$ . Et Resistentia ad Gravitationem ut  $\frac{CF, A}{4FG^q} - \frac{B}{2FG} + \frac{FI}{CF}$  ad 1.<sup>(43)</sup> Res exemplis patebit.

*Exempl. 1.* Sit linea  $ACK$  semicirculus super diametro  $AK$  descriptus, et requiratur medij densitas quæ faciat ut projectile moveatur in hac linea.

(42) Where of course  $CF$  is tangent at  $C$ .

(43) Which on deleting the equal terms  $B/2FG$  and  $FI/CF$  again (see note (39) above) reduces to be 'ut  $CF \times A$  ad  $4FG^q$ '. We should not insist too hard on Newton's oversight here, however, for it would at once have been corrected had he thought to convert his present measure to its equivalent expression in terms of the coefficients  $Q$ ,  $R$  and  $S$  in the series expansion of the incremented ordinate  $DG$ . In a parallel calculation which survives on Add. 3968.41: 119<sup>r</sup> he found no difficulty in thus reducing (much as we restored this computation in §1.6 preceding) the primary measure  $HN/(CN+FG) - \frac{1}{2}CF/FG + FI/CF$ , there successively evaluating: ' $IF = Qo$ .  $FG = Roo + So^3$ .  $CN = Roo - 2So^3$ .  $CF = o\sqrt{1+QQ}$ .  $HN = o\sqrt{1+QQ} - \frac{2QRoo}{\sqrt{}}$ '

[itaq;]

$$\frac{CF}{2FG} = \frac{\sqrt{1+QQ}}{2Ro+2So^3} \cdot \frac{HN}{CN+FG} = \frac{o\sqrt{1+QQ} - \frac{2QRoo}{\sqrt{1+QQ}}}{2Roo - So^3} = \frac{\sqrt{1+QQ} - \frac{2QRo}{[\sqrt{1+QQ}]}}{2Ro - So^2}$$

[adeoq; earum differentia est]

$$\frac{2Ro\sqrt{1+QQ} - So^2\sqrt{1+QQ} - 2Ro\sqrt{1+QQ} - 2So^3\sqrt{1+QQ} + 4QR^2o^2[\sqrt{1+QQ}]}{4RRoo + 2RSO^3} = \frac{-3S\sqrt{1+QQ}}{4RR} \left[ + \frac{Q}{\sqrt{1+QQ}} \text{ seu } \frac{FI}{CF} \right];$$

whence 'resistentia erit ad gravitationem ut  $3S\sqrt{1+QQ}$  ad  $4RR$ '. (On the same manuscript page, we may add, Newton has roughed out what were to be notes \* on pages 41 and 42 [top] of his *Commercium Epistolicum D. Johannis Collins et Aliorum*....)



Bisecetur semicirculi diameter in  $O$ , et dic  $OKn$ ,  $OBa$ ,  $BCe$ , &  $BD$  vel  $BEo$ , et erit  $DG^a$  seu  $OG^a - OD^a = nn - aa - 2ao - oo$  seu  $ee - 2ao - oo$ , et radice per methodum nostram extracta fiet  $DG = e - \frac{ao}{e} - \frac{oo}{2e} - \frac{aao}{2e^3} - \frac{ao^3}{2e^3} - \frac{a^3o^3}{2e^5}$  [- &c]. Hic scribatur  $nn$  pro  $aa + ee$  et evadet  $DG = e - \frac{ao}{e} - \frac{nnoo}{2e^3} - \frac{anno^3}{2e^5}$  - &c. Unde fit  $BC = e$ .  $IF = \frac{ao}{e}$ ,  $FG = \frac{nnoo}{2e^3} + \frac{anno^3}{2e^5}$ . et  $CF = o\sqrt{1+QQ} = o\sqrt{1+\frac{aa}{ee}} = \frac{no}{e}$ . Et mutando signum ipsius [o] prodit  $EH = e + \frac{ao}{e} - \frac{nnoo}{2e^3} + \frac{anno^3}{2e^5}$  - &c et  $CM = \frac{ao}{e} - \frac{nnoo}{2e^3} + \frac{anno^3}{2e^5}$ . Et scribend[o]  $a - o$  pro  $OE$  vertitur  $IF$  seu  $\frac{ao}{e}$  in

$$\frac{ao - oo}{EH} = \frac{ao}{e} - \frac{aao}{e^3} + \frac{ao^3}{2e^3} - \frac{3a^3o^3^{(44)}}{2e^5} = MN.$$

Unde fit

$$CM - MN = \frac{nnoo}{2e^3} - \frac{anno^3}{2e^5} = NC.$$

$$FG - NC = \frac{anno^3}{e^5} = A^{(45)} \quad IF - MN = \frac{aao}{e^3} = D^{(45)} \quad \frac{anoo}{e^3} = B^{(46)}$$

(44) This should be  $\frac{ao}{e} - \frac{nnoo}{e^3} + \frac{3anno^3}{2e^5}$ , whence in sequel ' $CM - MN = \frac{nnoo}{2e^3} - \frac{anno^3}{e^5} = NC$ '.

(45) Correctly  $\frac{3anno^3}{2e^5} = A$  and  $\frac{nnoo}{e^3} = D$ .

(46) *Recte!* even though Newton could not have derived this from his erroneous preceding value for  $D$ , as  $(IF/CF) \times D$ . On substituting Newton's computed values in the reduced expression  $A \times CF/4FG^2$  (see note (39)) for this ratio—as he himself would appear to have gone on to compute on Add. 3968.41: 14<sup>v</sup>—it follows that 'resistentia erit ad gravitatem ut  $\frac{anno^3}{e^5} \times \frac{no}{e}$  ad  $\frac{4n^4o^4}{4e^6} :: a.n$ ', that is, the deficient result of the *editio princeps* once more. On rectifying Newton's value for  $A$  (see the previous note) we of course accurately increase this ratio by a factor of  $\frac{3}{2}$  to be ' $3a$  ad  $n$ '.

In yet further abortive endeavours to remodel the present measure of the ratio of resistance to gravity obtained in (§1.6 →) §2.1 preceding, Newton first began to argue (Add. 3968.41: 119<sup>r</sup>) that

'Decrementum spatij  $-HC + CG = -HN + CF$ , ex resist + Grav.

[this should be ' $-\frac{1}{2}, -HC + CG = \frac{1}{2}, -HN + CF$ ']

Incre[ementum] ex Grav. =  $CG - CF$  [ $= \frac{FI}{CF} \times GF$ ]. [adeoq;]

Decr. ex resi[s]t. =  $CF - HN + \frac{FI, FG}{CF}$  ad descens[um] ex Grav. =  $GF$

[hoc est] Resist. Grav. ::  $\frac{CF}{GF} - \frac{HN}{GF} + \frac{FI}{CF} \cdot 1$ ;

[5]<sup>(47)</sup> [Posito quod ordinatæ  $AG$ ,  $BH$ ,  $CI$ ,  $DK$  ab invicem æqualiter distant, et ductis  $HN$ ,  $IPR$  curvam ad puncta  $H$  et  $I$  tangentibus, evadent sagittæ]

$$IN = 2BH - AG - CI. \quad KP = 2CI - BH - DK.$$

[eritq]

$$IN.KP] :: \text{temp[us] in } HI. \text{ temp in } IK^{(48)} :: HI.IR.$$

$$[\text{Unde}] \frac{HI}{IN} \cdot \frac{IK^{(49)}}{KP} :: \text{veloc[it]as in } HI. \text{ veloc in } IK.$$

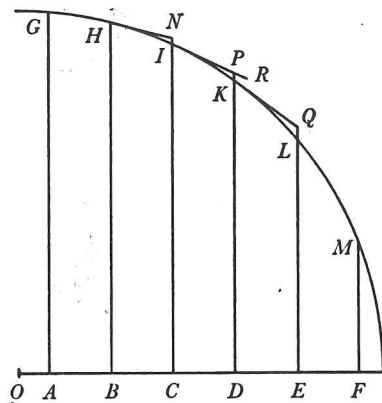

and then (*ibid.*: 11<sup>r</sup>), after realizing that the arcs  $\widehat{HC}$ ,  $\widehat{CG}$  are not traversed in equal times, he directed that there be taken  $P$  in  $\widehat{CG}$  such that ' $CP.CG :: \sqrt{CN}.\sqrt{FG}$  & arcus  $HC$ ,  $CP$  erunt synchroni,' et  $HC-CP$  [read ' $\frac{1}{2}\widehat{HC}-\widehat{CP}$ ' recte] erit decrementum momentaneum ex resist & grav. Est  $HC-HN$  increm. momentaneum ex grav. Ergo  $2HC-CP-HN$  decem. moment. ex resist.' On correcting the last decrement to be ' $\frac{3}{2}HC-\frac{1}{2}CP-HN$ ', this will accurately be in ratio to the 'descensus ex Grav.'  $FG$  as the resistance to gravity. (For, if the ordinate  $VP$  be drawn through  $P$  to meet the tangent  $CF$  in  $W$ , on calling  $BV = p$  there will, with Newton's own notations in 'Corol. 3' assumed, be  $\widehat{HC}-\widehat{CP} = HN-CW =$

$$(o\sqrt{1+Q^2} - 2(QR/\sqrt{1+Q^2})o^2 \dots) - p\sqrt{1+Q^2},$$

where  $p/o = \widehat{CP}/\widehat{CG} = \sqrt{CN}/\sqrt{GF} = \sqrt{(Ro^2 - 2So^3 \dots)}/\sqrt{(Ro^2 + So^3 \dots)}$ , that is,  $1 - \frac{3}{2}(S/R)o \dots$ , while  $\widehat{HC}-HN = (FI/CF) \times GF$  is  $(Q/\sqrt{1+Q^2}).(Ro^2 + \dots)$ ; and  $\frac{1}{2}(\widehat{HC}-\widehat{CP}) + \widehat{HC}-HN$  will be in ratio to  $GF$  as  $\frac{3}{2}S\sqrt{1+Q^2}/R^2$  to unity in the limit as  $BD = o$  becomes vanishingly small.) This appeal to 'synchronous arcs'—an indirect return to the basis of his 1687 argument—was to afford the foundation on which, by way of the preparatory draft in [8] below, Newton built the final version (§2.3 preceding) of its soundly reconstructed reasoning.

(47) Add. 3968.18: 261<sup>r</sup>, a first, faulty computation of the ratio of resistance to gravity along a given fall-path according to the variant notion, elaborated (and corrected in its detail) in [6] following and fully developed in the *Idem aliter* in §2.2 preceding, that these forces shall act but 'once and instantaneously' at the beginning of each successive moment of time. As ever, we round out the angular outline of its bare calculations with a dress of verbal interpolations which will shape and point the niceties of their sequence. (The original, we may briefly notice, is jotted on the verso of a transcription by him of Leibniz' letter to Hans Sloane on 29 December 1711 (N.S.) claiming priority of invention in calculus, and published by Newton a few weeks afterwards in his anonymously edited printing of related extracts of the *Commercium Epistolicum D. Johannis Collins et Aliorum de Analysi promota* (London, 1712): 118-19; see also *The Correspondence of Isaac Newton*, 5, 1975: 207.)

(48) This should read ' $\sqrt{IN}.\sqrt{KP} :: \text{temp in } HI. \text{ temp in } IK$ ' recte.

(49) Whence this ratio should be  $\frac{HI}{\sqrt{IN}} \cdot \frac{IK}{\sqrt{KP}}$ . The slip is perpetuated in the sequel (see the next note) and carried thereafter into the ensuing computation in the semicircular instance, producing a mistaken doubling of the true result.

$$(50) \text{ Read } \frac{HI \text{ in } \sqrt{KP} - \sqrt{IN}}{\sqrt{IN}} = \frac{HI \text{ in } KP - IN}{\sqrt{IN} \cdot \sqrt{KP} + IN} \text{ hoc est } \frac{HI \text{ in } KP - IN}{2IN}.$$



$$[\text{adeoq}] PR.PK::\text{Resist. Grav}::\frac{HI, KP - HI, IN}{IN} = \frac{HI \text{ in } KP - IN^{(50)}}{IN} . KP$$

$$:: HI \text{ in } \frac{AG - 3BH + 3CI - DK}{IN} . KP:: AG - 3BH + 3CI - DK . \frac{IN \times KP}{HI}^{(51)}$$

[Sit jam curva semicirculus cujus radius æqualis est  $n$ . Cape  $OB = a$ .  $BH = e$ . &  $AB = BC = CD = o$ . Fit  $aa + ee = nn$ . ut et]

$$AG = e + \frac{ao}{e} - \frac{nnoo}{2e^3} + \frac{anno^3}{2e^5}$$

$$BH = e.$$

$$CI = e - \frac{ao}{e} - \frac{nnoo}{2e^3} - \frac{anno^3}{2e^5}$$

$$DK = e - \frac{2ao}{e} - \frac{2nnoo}{e^3} - \frac{4anno^3}{e^5}$$

$$[\text{Itaq}] AG - 3BH + 3CI - DK = \frac{3anno^3}{e^5}. IN = \frac{nnoo}{e^3}. KP = \frac{nnoo}{e^3} + \frac{3anno^3}{e^5}. HI = \frac{no}{e}.$$

$$[\text{Quare est}] \text{Resist. Grav}::\frac{3anno^3}{e^5} . \frac{n^3o^3^{(52)}}{e^5} :: 3a.n.$$

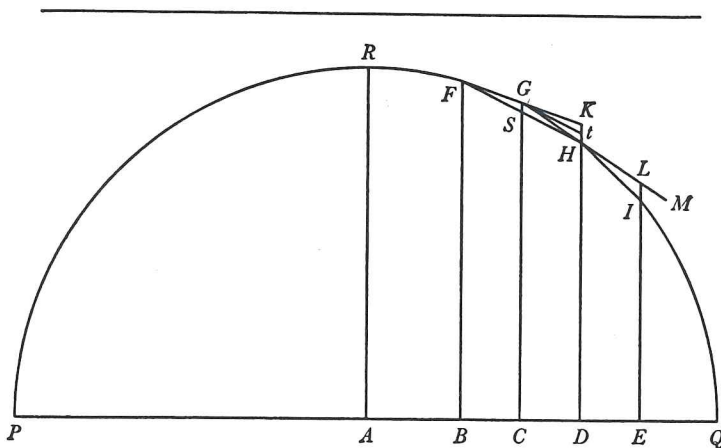

[6]<sup>(53)</sup> . [Sit]  $PRQ$  Curva.  $BC = CD = DE$  [æquales] partes Abscissæ.  $BF, CG, DH, EI$  ordinatæ.  $FG, GH$  chordæ ordinatis  $DH, EI$  productis occurrentes in  $K$  et  $L$ .  $HI$  chorda tertia. [Erit]  $HK = 2CG - BF - DH$ .  $IL = 2DH - CG - EI$ .

(51) Whence 'Resist. Grav::  $AG - 3BH + 3CI - DK . \frac{2IN \times KP}{HI}$ ' correctly.

(52) This needs (see the previous note) to be doubled, yielding

$$\text{'Resist. Grav}::\frac{3anno^3}{e^5} . \frac{2n^3o^3}{e^5} :: 3a.2n'$$

(53) Add. 3965. 12: 198<sup>r</sup>, a lightly remodelled (and now correct!) version of [5] preceding.

Cape  $HM$  ad  $GH$  ut tempus describendi chordam  $HI$  ad tempus describendi chordam  $GH$ , id est ut  $\sqrt{IL}$  ad  $\sqrt{HK}$  seu  $\sqrt{HK} \times IL$  ad  $H[K]$  id est ut  $\frac{HK+IL}{2}$  ad  $HK$ . Et Resistentia erit ad Gravitatem ut spatium  $ML$  ex resistentia amissum ad spatium  $LI$  gravitate genitum.

*Exempl.* Sit  $RPQ$  semicirculus. [Pone]  $AC=a$ .  $AQ=n$ .  $CG=e=\sqrt{nn-aa}$ .

[necnon]

$$BC=CD=DE=o.$$

[erit]

$$DH=\sqrt{nn-aa-2ao-oo}=e-\frac{ao}{e}-\frac{nnoo}{2e^3}-\frac{anno^3}{2e^5}.$$

[itaq̄]

$$BF=e+\frac{ao}{e}-\frac{nnoo}{2e^3}+\frac{anno^3}{2e^5}. \quad EI=e-\frac{2ao}{e}-\frac{2nnoo}{e^3}-\frac{4anno^3}{e^5}.$$

[adeoq̄]

$$HK=\frac{nnoo}{e^3}. \quad IL=\frac{nnoo}{e^3}+\frac{3anno^3}{e^5}. \quad GH=\frac{no}{e} \text{ [&c].}$$

[Unde]

$$LM.GH::\frac{IL-HK}{2}.HK::\frac{3anno^3}{2e^5}.\frac{nnoo}{e^3}. \text{ [sive] } LM=\frac{3anno}{2e^3}.$$

[Quare] Resistentia ad gravitatem ut  $\frac{3anno}{2e^3}$  ad  $\frac{nnoo}{e^3}$  seu  $3a$  ad  $2n$ .<sup>(54)</sup>

[7]<sup>(55)</sup> [Vel generalius] Sunt  $BC=CD=DE=o$ .  $CG=e$ , ac [pone]

$$DH=e-fo-goo-ho^3 \text{ [&c].}$$

Et Ordinatae reliquæ duæ  $BF$  et  $EI$  erunt

$$e+fo-goo+ho^3 \quad \& \quad e-2fo-4goo-[8]ho^3.$$

Et inde fit  $HK$ <sup>(56)</sup>  $=2goo$ .  $IL$ <sup>(56)</sup>  $=2goo+6ho^3$ . [itaq̄]  $\frac{IL-HK}{2}=3ho^3$ .  $GH=o\sqrt{1+ff}$ .

[Unde]  $LM$ <sup>(57)</sup>  $=\frac{3ho^2\sqrt{1+ff}}{2g}$ . [Quare] Resistentia ad Gravitatem [sive  $LM$  ad  $IL$ ]

(54) Rightly, of course. There follows immediately after (on ff. 198<sup>r</sup>-199<sup>r</sup>) the fully elaborated 'Idem aliter' which is reproduced in §2.2 preceding.

(55) Add. 3965.10: 136<sup>v</sup>, a stray computation deriving from the geometrical constructions of the ratio of resistance to gravity and of the medium's density in §2.2 preceding (compare our note (17) thereto) the correct general measures of these in terms of the coefficients in the 'Taylor' expansion of the incremented ordinate. We see no need here to repeat the figure (that on page 346 above) which Newton here understands, or to reproduce the faulty opening calculation which he straightaway discards to pen what now—increased by a few editorial interpolations the better to bring out the sense—here follows.

(56) That is,  $2CG-BF-DH$  and  $2DH-CG-EI$  respectively.

(57) Namely,  $GH(LI-KH)/2KH$  as Newton constructs it on page 348 above.



ut  $3h\sqrt{1+ff}$  ad  $4gg$ . Velocitas [sive  $\frac{GH}{\sqrt{HK}}$ ] ut  $\sqrt{\frac{1+ff}{g}}$ . Et Medij densitas [seu  $\frac{LM}{GH^q}$ ] ut  $\frac{h}{g\sqrt{1+ff}}$ . Velocitas illa ipsa<sup>(58)</sup>

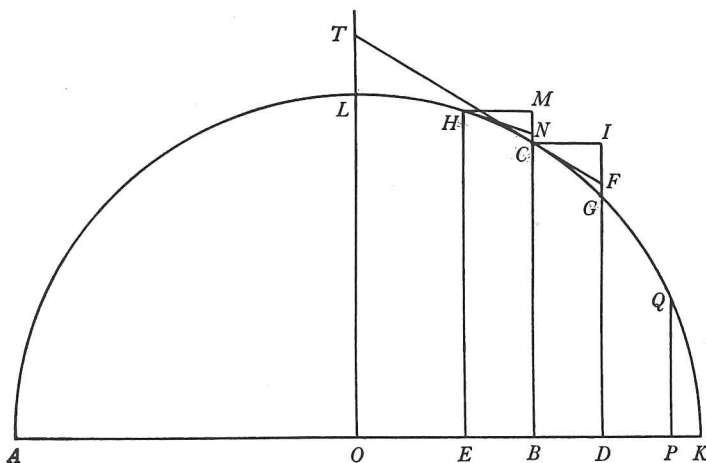

[8]<sup>(59)</sup> [Sit  $AK$  planum illud plano schematis perpendiculare,  $ALCK$  linea curva,  $C$  corpus in ipsa motum, et  $CF$  recta ipsam tangens in  $C$ . Fingatur corpus  $C$  progredi ab  $L$  ad  $K$  per lineam illam  $ACK$ , et interea impediri a Medio resistente. A puncto  $C$  ad rectam  $AK$  horizonti parallelam demittatur perpendicularum  $CB$ , et in recta illa sumantur hinc inde lineolæ æquales  $EB$ ,  $BD$ ,  $DP$ <sup>(60)</sup> et

(58) Newton evidently intended to adjoin, much as at the corresponding place in 'Exempl. 1' of the *editio princeps* (*Principia*, 1687: 265; see page 380 above), 'Velocitas illa ipsa est quacum corpus de loco  $G$  secundum rectam  $GL$  egrediens, in Parabola diametrum  $GC$  et latus rectum  $\frac{1+ff}{g}$  habente deinceps moveri posset'.

(59) Add. 3965.10: 135<sup>v</sup>–136<sup>v</sup>, a preliminary recasting of §2.1 into the finished form of §2.3 preceding, wherein Newton for the first time introduces the clarification of explicitly naming the (unequal) infinitesimal times in which the successive arcs  $\widehat{HC}$  and  $\widehat{CG}$  are traversed in uniform horizontal motion  $E \rightarrow B \rightarrow D$ . This intermediate draft takes up the text of §2.1 in the middle of its fifth opening sentence (at 'quas corpus temporibus illis...'), but we here adjoin the beginning which Newton understands—and add the right-most ordinate  $PQ$  and the tangent  $CT$  to the original figure (on Add. 3965.12: 190<sup>r</sup>) in accord with the demands of the present argument—so that the piece may be a self-contained unit. We see no need to repeat the bulk of the running commentary which we have already made, *mutatis mutandis*, at corresponding places in the final version in §2.3 above, but for the most part restrict our editorial remarks in sequel to certain special (mostly textual) points.

(60) We insert these specifications of the additional base-point  $P$  and corresponding ordinate  $PQ$  (in the opening sentences of §2.1 preceding which we otherwise here copy) to agree with Newton's assumptions in what follows. This new ordinate  $PQ$  is here introduced of course—in a remnant of the alternative approach in §2.2 where the resistance and gravity are conceived to act in instantaneous impulses 'simul et semel' only at the successive points  $H, C, G, \dots$

erigantur perpendiculara  $EH$ ,  $DG$ ,  $PQ$ <sup>(60)</sup> curvæ occurrentia in  $H$ ,  $G$  et  $Q$ . Producat  $DG$  donec tangenti  $CF$  occurrat in  $F$ , compleatur parallelogrammum  $CBDI$ , et agatur recta  $HN$  curvam tangens in  $H$  & perpendicularo producto occurrentis in  $N$ . Et tempora quibus corpus describit arcus  $HC$ ,  $CG$  erunt in subduplicata ratione altitudinum  $NC$ ,  $FG$ ] quas corpus temporibus illis describere posset a tangentibus illis cadendo. Et velocitates erunt ut longitudes descriptæ  $HC$ ,  $CG$  directe & tempora inverse. Exponentur tempora per  $T$  et  $t$  et velocitates per  $\frac{HC}{T}$  et  $\frac{CG}{t}$ ; & decrementum velocitatis tempore  $t$  factum exponetur per  $\frac{HC}{T} - \frac{CG}{t}$ . Hoc decrementum oritur a resistentia corpus retardante & gravitate corpus accelerante & augeri debet ea velocitatis parte quam gravitas generat ut habeatur decrementum velocitatis a resistentia sola oriundum. Gravitas in corpore cadente & spatium  $FG$  cadendo generante generat velocitatem qua duplum illud spatium eodem tempore describere posset,<sup>(61)</sup> id est velocitatem  $\frac{2FG}{t}$ . At in corpore arcum  $CG$  describente generat tantum velocitatem quæ sit ad velocitatem  $\frac{2FG}{t}$  ut  $CG - CF$  ad  $FG$  seu  $GI$  ad  $CG$ , id est velocitatem  $\frac{2FG \times GI}{t \times CG}$ . Addatur hæc velocitas ad decrementum prædictum et habebitur decrementum velocitatis ex resistentia sola oriundum, nempe  $\frac{HC}{T} - \frac{CG}{t} + \frac{2FG, GI}{t, CG}$ . Proindeq; cum Gravitas eodem tempore generet velocitatem  $\frac{2FG}{t}$ , Resistentia erit ad Gravitatem ut  $\frac{HC}{T} - \frac{CG}{t} + \frac{2FG, GI}{t, CG}$  ad  $\frac{2FG}{t}$ , sive ut  $\frac{t}{T} HC - CG + \frac{2FG, GI}{CG}$  ad  $2FG$ .<sup>(62)</sup>

Jam pro  $BD$ ,  $BP$ ,  $BE$  scribe  $o$ ,  $2 \times o$ ,  $-o$  & pro Ordinata scribe seriem quamvis interminatam  $d - eo - foo - go^3[-]$  &c. & O[r]dinatæ reliquæ  $EH$ ,  $BC$ ,  $PQ$  erunt  $d + eo - foo + go^3$ ,  $d$ ,  $d - 2eo - 4foo - 8go^3$  respective, et secundus seriei

—to represent the deviation  $FG$  from the tangential motion along  $CF$  by the related *sagitta*  $DG - \frac{1}{2}(BC + PQ)$ ; on which see note (63) below.

(61) 'per Lem X lib. 1' is deleted in sequel—rightly so, since this is nothing to the point. Newton intends the reference 'ex demonstratis Galilæi' as he phrased it in his preparatory elaboration of §2.1 at this point, or the 'ut Galilæus demonstravit' which he rephrased this to be in the final version in §2.3; on the accuracy of this reference to Galileo see §2.2: note (14). We have mended a trivial slip of 'gravitate' for 'resistentia' in the previous sentence.

(62) Newton subsequently squeezed in between this and the following paragraphs a separate line 'Est autem  $\odot$ — $\odot$ ' reminding himself to advance the next paragraph but one to follow immediately after in the redraft: this he did not immediately do, however, and he had again to insert a similar instruction in the revised version to invert their sequence (see §2.3: note (38))—which in our edited text we have there carried out, in line with what was finally printed.



assumptæ terminus  $eo$  erit  $IF$ , ac tertius & sequentes  $foo + go^3 + \&c$  erunt  $FG$ . Et quadrando differentias Ordinarum  $HE - CB$  &  $CB - GD$  et ad quadrata prodeuntia addendo quadrata ipsarum  $EB, BD$ , habebuntur arcuum  $HC, CG$  quadrata  $oo + eoo - 2efo^3$  &c et  $oo + eoo + 2efo^3$  &c. Quorum radices

$$o\sqrt{1+ee} - \frac{efoo}{\sqrt{1+ee}} \&c \quad \text{et} \quad o\sqrt{1+ee} + \frac{efoo}{\sqrt{1+ee}} \&c$$

sunt arcus ipsi  $HC$  et  $CG$ . Præterea si ab ordinata  $BC$  subducatur semisumma Ordinarum  $EH$  et  $DG$  et ab ordinata  $DG$  subducatur semisumma ordinata[rum]  $BC$  et  $PQ_{[1]}$ , manebunt arcuum  $HC$  et  $CG$  sagittæ  $foo$  et  $foo + 3go^3$ . Hæ sunt lineolis  $CN$  et  $FG^{(63)}$  proportionales adeoq; in subduplicata<sup>(64)</sup> ratione temporum  $T$  et  $t$ . Et pro ratione temporum  $\frac{t}{T}$  scribi potest  $\sqrt{\frac{f+3go}{f}}$  seu  $\frac{2f+3go}{2f}$ .

Pro  $\frac{t}{T}$ ,  $HC, CG, FG$  et  $GI$  scribantur eorum valores et prodibit Resistentia ad Gravitatem ut  $3g\sqrt{1+ee}$  ad  $4ff$ .<sup>(65)</sup>

Est autem Resistentia ut Medij densitas et quadratum velocitatis et propterea Medij densitas ut resistentia directe et quadratum velocitatis inverse<sub>[1]</sub> id est ut  $\frac{3g\sqrt{1+ee}}{4ff}$  directe et  $\frac{CG^2}{t}$  seu  $\frac{1+ee}{f}$  inverse, hoc est ut  $\frac{g}{f\sqrt{1+ee}}$ .

Velocitas autem ea est quacum corpus de loco  $C$  secundum rectam  $CF$  egrediens, in Parabola diametrum  $CB$  et latus rectum  $\frac{CF^2}{FG}$  seu  $\frac{1+ee}{f}$  habente deinceps in vacuo moveri potest. Q.E.I.

*Corol. 1.* Si tangens  $CF$  producatur utrinq; donec occurrat Ordinatæ  $OL$  in  $T$ , erit  $\frac{CT}{OB} = \sqrt{1+ee}$ , adeoq; Resistentia ad gravitatem ut  $3g \times CT$  ad  $4ff \times OB$  & Medij densitas ut  $\frac{g, OB}{f, CT}$ .

(63) To be precise, these are  $fo^2 - 2go^3$  and  $fo^2 + go^3$  respectively (on ignoring terms in  $o^4$  and higher powers of  $o$ ), and are consequently in the constant ratio  $1 - 2(g/f)o$  to the corresponding sagittæ  $BC - \frac{1}{2}(EH + DG)$  and  $DG - \frac{1}{2}(BC + PQ)$ ; compare, *mutatis mutandis*, our fuller comment on this point in §2.3: note (32) above.

(64) Read 'duplicata' *tout court*. The slip is explained if we remark that Newton initially phrased his present sentence to read 'Hæ sunt lineolis  $CN = \dots$  et  $FG = \dots$  proportionales quorum radices pro temporibus  $T$  et  $t$  scribi possunt'. The obtrusive prefix 'sub' was carried over by Newton into his finished version and on into the fair copy of it which he transmitted to Cotes, but was caught by the latter before it gained standing in print in the *Principia*'s second edition. The lapse does not of course affect the sequel.

(65) Newton first concluded by straightaway adjoining without break of paragraph: 'Et Medij densitas ut  $\frac{g}{f\sqrt{1+ee}}$ . Velocitas autem ea erit quacum corpus de loco  $C$  secundum rectam  $CF$  egrediens, in Parabola diametrum  $CB$  et latus rectum  $\frac{CF^2}{FG}$  seu  $\frac{1+ee}{f}$  habente deinceps in vacuo moveri posset. Q.E.I.'

*Corol. 2.*<sup>(66)</sup> Cum Densitas Medij sit ut  $\frac{g}{f\sqrt{1+ee}}$ , si quantitas  $g$  datam habeat rationem ad quantitatem  $f\sqrt{1+ee}$  (puta rationem  $p$  ad 1), densitas Medij erit uniformis. Proinde si inveniri potest<sup>(67)</sup> linea curva cujus hæc sit proprietas ut si a quovis ejus puncto ducatur abscissa horizontalis  $o$  & Ordinata perpendicularis in seriem convergentem resolutæ tres primi termini semper prodeant  $eo + foo + pf\sqrt{1+ee}$  in  $o^3$ , Corpus in Medio uniformi justa cum velocitate  $e$  quovis hujus Curvæ puncto secundum tangentem ejus egrediens perget semper moveri in hac Curva.

*Exem[pl]. 1.* Sit linea  $ACK$  semicirculus . . . . et curvatura curvarum.<sup>(68)</sup>

Conferantur jam termini hujus seriei cum terminis seriei superius assumptæ et pro illius terminis<sup>(69)</sup>  $d, e, f, g$  scribantur hujus termini  $e, \frac{a}{e}, \frac{nn}{2e^3}, \frac{ann}{2e^5}$  et prodibit resistentia ad gravitatem ut  $\frac{3ann}{2e^5} \sqrt{1 + \frac{aa}{ee}}$  ad  $\frac{n^4}{4e^6}$  seu  $3a$  ad  $2n$ , id est ut  $3OB$  ad  $AK$ , et Medij densitas ut  $\frac{a}{e}$  seu  $\frac{OB}{BC}$ , id est ut Tangentis longitudo illa  $CT$  quæ ad semidiametrum  $OL$  ipsi  $AK$  normaliter insistentem terminatur. Proinde si corpus  $C$  certa cum velocitate . . non a resistente impediri.<sup>(70)</sup>

(66) In its original statement this 'Corol. 2' affirmed merely that 'Cum velocitas sit ut spatium descriptum  $CG$  directe & tempus invers[e] & tempus sit ut  $\sqrt{GF}$ , quadratum velocitatis erit ut  $\frac{CG^a}{GF}$  [sive]  $\frac{1+ee}{f}$ '. In cancelling it Newton doubtless reckoned that he had already made this point well enough (if only implicitly) in the last paragraph of his preceding main text.

(67) 'Curva cujus abscissa horizontalis  $o$  a quovis curvæ puncto ducta sit, et ordinata sit  $d + eo + foo + \frac{f\sqrt{1+ee}}{p}$  [!] in  $o^3$ . . .', Newton first went on before checking himself. In our edited version of his revised continuation we silently adjust his trivial slip of dividing (and not, as he must, multiplying) by the constant  $p$ .

(68) Understand the first three paragraphs of this prime example of the semicircle as they are printed in *Principia*, 1687: 263–4 [= pages 378–9 above].

(69) Newton means 'coefficientibus' of course. Strictly, however, where the first coefficient  $d$  is equated with the first term  $e$  in the expansion of  $e_{a+o} \equiv \sqrt{(n^2 - (a^2 - o^2))}$ , there is correspondingly  $e = -a/e$ ,  $f = -\frac{1}{2}n^2/e^3$  and  $g = -\frac{1}{2}an^2/e^5$ . The double use of  $e$  here is manifestly confusing, and Newton in his final version (§2.3 preceding) wisely recurs to the letters  $P, Q, R, S$  which he had employed in his 1687 text to express the Taylorian expansion of the general incremented ordinate. The series  $e - fo - go^2 - ho^3$  . . . for this, by which (on f. 136<sup>v</sup> following, in the manuscript sequence at least) he derived the equivalent measure  $\frac{3}{2}h\sqrt{(1+f^2)}/g^2$  of the ratio of resistance to gravity in the afterthought to §2.2 reproduced in [7], evidently marks a stage on the road back at which Newton saw no need other than briefly to tarry.

(70) Understand that, as in the parent text (§2.1), the concluding portion of 'Exempl. 1' in the *editio princeps* (*Principia*, 1687: 265) is to follow with the minimal change that now 'resistentia . . . in loco aliquo  $C$  sit ad vim gravitatis ut  $3OB$  ad  $2OK$ '. And the same likewise for the remaining Examples 2–4.



[9]<sup>(71)</sup> [Asymptotis  $AZ$ ,  $YZ$  describatur hyperbola  $LPM$  habens semidiametrum unitati æqualem. Cape]  $ZB = x$ .<sup>(72)</sup> [unde]  $BP = \frac{1}{x}$ . [Tum ponendo]  $ALPB$ <sup>(73)</sup> =  $z$ . [et]  $AB = y$ . [sit]  $\frac{z^{n+1}}{y^n} = BF$  [ordinatæ lineæ curvæ  $AFK$  in qua projectile moveatur].<sup>(74)</sup> [Existente jam decremento]  $BC = o$ . [erit]

$$CQ = \frac{1}{x-o} = \frac{1}{x} + \frac{o}{x^2} + \frac{oo}{x^3} + \frac{o^3}{x^4} [+ \&c].$$

[ut et] Area  $AL[Q]$   $C$ <sup>(75)</sup>

$$= z + \frac{o}{x} + \frac{oo}{2x^2} + \frac{o^3}{3x^3} + \frac{o^4}{4x^4} [+ \&c].$$

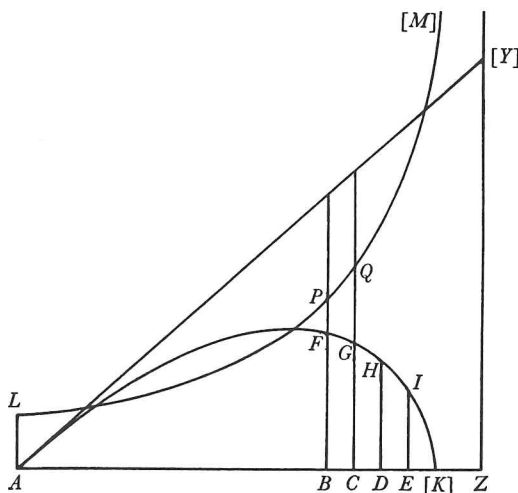

In a stray draft on Add. 3965.12: 200<sup>v</sup>, we may add, Newton set down an elegant variant conclusion to his discussion of unresisted parabolic motion in 'Exempl. 2': there, presupposing that the incremented ordinate  $DG = e_{a+o}$  of the parabola  $e = e_a \equiv (ac - a^2)/b$  has been reduced to its equal series  $(ac - a^2)/b + ((c - 2a)/b) o - (1/b) o^2$  as in the 1687 text, Newton went on to argue from first principles that 'Tertius terminus  $\frac{oo}{b}$  designat lineolam  $FG$ , et scribendo  $OE$  pro  $OB$  et  $EH$  pro  $BC$  non mutatur, ideoq; designat etiam lineolam  $CN$ , & propter æqualitatem harum lineolarum  $CN$  et  $FG$  tempora describendi arcus  $HC$  et  $CG$  sunt æqualia, et propterea motus corporis secundum horizontem non retardatur. Nulla igitur Medij densitate projectile movebitur in Parabola, uti olim demonstravit Galilæus. Q.E.I.' (He then passed a deal less fruitfully to apply the geometrical measure  $HN/(CN + GF) - CF/2GF + FI/CF$  attained in §2.1 directly to compute the ratio of resistance to gravity in the hyperbolic instance  $e_a \equiv c - (m/n) a - b^2/a$  of the ensuing 'Exempl. 3', correctly there evaluating  $GF$  and  $CF$ , but erroneously calculating their 'incremented' forms  $CN$  and  $HN$  'substituendo  $NE$  [!] pro  $NB$  seu  $a + o$  pro  $a$ '—the true substitution is  $(NB =) a \rightarrow (ND =) a - o$  of course—and further mangling the reduction of the resulting value of  $HN$  to its equivalent series expansion in powers of the decrement  $o$ , before at length breaking off in some muddle and confusion.) Within the tight confines of the 10-page scissure in the already printed-off sheets of the *editio secunda* which needed to be filled, there was, we may or may not regret, no room spare to indulge the luxury of adducing alternative modes of solution—and still less so to append such further illustrative instances of 'realistic' projectile path as the logarithmico-hyperbolic curve which Newton toyed briefly and ineffectively with in the fragment whose gist we reproduce in [9] now following.

(71) Add. 3965.10: 136<sup>v</sup>. This unfinished sketch of an intended further worked *Exemplum* of a resisted projectile path would—had its definition been mended (see note (74))—doubtless have been furnished with some neat geometrical construction of the ratio of resistance along its arc to the downwards force of gravity, and of the consequent variation of the surrounding medium's density which will permit such a curving motion of a projectile through it, much in the manner of the simpler hyperbolic trajectories examined in Examples 3/4 of the published proposition (and further elaborated in the ensuing scholium). The original jotted calculations (here verbally fleshed out in our usual fashion) are penned at the head of a page on which they

[Ubi  $n=1$ , hoc est  $BF = \frac{ZZ}{y}$ , evadit] Area  $AL[Q]C$  quad[rata]

$$= ZZ + \frac{2, oZ}{x} + \frac{zoo}{xx} + \frac{2z, o^3}{3x^3} [\&c] \\ + \frac{oo}{xx} + \frac{o^3}{x^3}$$

[et] Hæc area quad. applicata ad  $[AC = ] y + o$  [est  $CG =$

$$\frac{ZZ}{y} - \frac{z^2o}{yy} + \frac{z^2oo}{y^3} - \frac{z^2o^3}{y^4} [\&c].^{(76)} \\ \left[ + \frac{2zo}{xy} \quad \dots \quad \dots \right]$$

are immediately followed by the *addendum* to §2.2 above which is set out in [7] of this Appendix; it could therefore well be (as we have tentatively conjectured in §2.2: note (25)) that this logarithmic-cum-hyperbolic curve was meant there also to be adjoined in its finished form.

(72) Previously in his Proposition X, of course, Newton has invariably employed the Fermatian variable  $a$  to denote this general abscissa, but he here for once shows his proper colours as a true disciple of Descartes.

(73) This is,  $\log(b/x)$  on setting the base length  $AZ = b$ .

(74) In explicit form, accordingly, the defining Cartesian equation of Newton's posited curved  $\widehat{AFG}$  is  $e = [\log(b/x)]^{n+1}/(b-x)^n = [\log(b/(b-y))]^{n+1}/y^n$ , where  $ZB = x$  ( $AB = y$ ) and  $BF = e$  are the mutually perpendicular coordinates of its general point  $F(x, e) \equiv (y, e)$ , and  $AZ = x+y = b$  is a given constant base-length. In his accompanying figure (here accurately reproduced in its proportions, with a few of its points additionally named for convenience of reference) Newton depicts this in the familiar shape of a resisted projectile path, falling away from the tangent  $AY$  at its initial 'firing' point  $A$  to meet the horizontal in a point—we mark it as  $K$ , as in the published hyperbolic Examples 3/4—between  $E$  and  $Z$ . But this cannot be. On expanding  $\log(b/x)$  as an infinite series in  $y = b-x$  the defining equation reduces to be  $e = y^{-n} \cdot (y/b + \frac{1}{2}y^2/b^2 + \frac{1}{3}y^3/b^3 + \dots)^{n+1} = y/b^{n+1} + \frac{1}{2}(n+1)y^2/b^{n+2} + \dots$ , and hence the slope of the curve at  $F$  is ( $de/dy =$ )  $1/b^{n+1} + (n+1)y/b^{n+2} + \dots$ , which increases with  $AB = y$  to be infinitely great when  $y = b$ . (No real points exist on the curve when  $y > b$ , of course.) In other words, Newton's trajectory climbs ever higher away from its initial tangent  $AY$ , asymptotically to close with  $ZY$  at an infinite distance above the point  $Z$ —as indeed will be geometrically obvious, since the hyperbola-area ( $ALPB$ ) =  $\log(b/(b-y))$  comes to be infinitely great as  $y \rightarrow b$ . Let us comment in the fullness of hindsight that Newton would have done a deal better—as may be it was his intention?—to choose  $BF = y^{n+1}/z^n$  for the defining 'symptom' of this variant species of resisted path: below the initial tangent  $AY$  (fixed by  $ZY = AZ^{n+1}$ ) this falls smoothly away towards the 'horizon'  $AZ$  to be near-vertical in its final portion, tangent in the last to  $ZY$  (the point  $K$  in the figure here coinciding with  $Z$ ). In his manuscript text, however, he himself presses on to make further computation regarding the particular instance  $n = 1$  of his 'fall' path before abandoning his calculation as the complexities increase.

(75) The decremented hyperbola-area  $\log(b/(x-o))$ , that is,  $\log(b/x)$  [or  $z$ ] —  $\log(1-o/x)$ .

(76) And there Newton leaves off his evaluation of the incremented ordinate in this simplest instance of the curve defined by  $e = e_y \equiv z^2/y$ . The coefficients  $Q = -z^2/y^2 + 2z/xy$ ,  $R = z^2/y^3 \dots$  and  $S = -z^2/y^4 \dots$  in this expansion of  $e_{y+o}$  as  $z^2/y + Qo + Ro^2 + So^3 \dots$  serve as before, of course,



[10]<sup>(77)</sup> Cum Resistentia sit ad gravitatem ut  $3S\sqrt{1+QQ}$  ad  $4RR$ ; sit hæc resistentia ut Medij densitas et velocitatis  $V$  potestas  $V^n$ : & Medij densitas erit ut resistentia directe & velocitatis potestas  $V^n$  inverse, id est ut  $\frac{3S\sqrt{1+QQ}}{4RRV^n}$ . Pro

$V$  scribatur  $\sqrt{\frac{1+QQ}{R}}$ ,<sup>(78)</sup> et Densitas erit ut  $\frac{3S\sqrt{1+QQ}}{4RR \times \frac{1+QQ}{R}^{\frac{n}{2}}} = \frac{SR^{\frac{n-4}{2}}}{1+QQ|^{\frac{n-1}{2}}}$ .

Sit  $n = 1$ , et Densitas erit ut  $\frac{S}{R^{\frac{1}{2}}}$ . Sit  $n = 3$  et Densitas erit ut  $\frac{S}{1+QQ \text{ in } R^{\frac{1}{2}}}$ . Sit  $n = 5$  et Densitas erit ut  $\frac{SR^{\frac{1}{2}}}{1+QQ|^2}$ . Sit  $n = 4$  et densitas Medij erit ut  $\frac{S}{1+QQ|^{\frac{3}{2}}}$ . Sit  $n = 2$  et Dens. erit ut  $\frac{S}{R\sqrt{1+QQ}}$ . [Hoc est] Sit  $n = 0, 1, 2, 3, 4, 5, 6, 7$  et Densitas Medij erit ut  $\frac{S\sqrt{1+QQ}}{RR}$ ,  $\frac{S}{R^{\frac{3}{2}}}$ ,  $\frac{S}{R\sqrt{1+QQ}}$ ,  $\frac{S}{R^{\frac{1}{2}} \times 1+QQ}$ ,  $\frac{S}{1+QQ|^{\frac{3}{2}}}$ ,  $\frac{SR^{\frac{1}{2}}}{1+QQ|^2}$ ,  $\frac{SR}{1+QQ|^{\frac{3}{2}}}$ ,  $\frac{SR^{\frac{3}{2}}}{1+QQ|^3}$ , &c. Or  $\frac{S}{R^2 \times 1+QQ|^{-\frac{1}{2}}}$ ,  $\frac{S}{R^{\frac{3}{2}}}$ ,  $\frac{S}{R \times 1+QQ|^{\frac{1}{2}}}$ ,  $\frac{R^{\frac{1}{2}}}{1+QQ|^1}$ ,  $\frac{R^0 \times 1+QQ|^{\frac{1}{2}}}{S}$ ,  $\frac{R^{-\frac{1}{2}} \times 1+QQ|^2}{S}$ ,  $\frac{R^{-1} \times 1+QQ|^{\frac{3}{2}}}{S}$ ,  $\frac{R^{-\frac{3}{2}} \times 1+QQ|^3}{S}$ , &c.

Et universaliter,

Velocitas ut  $\overline{1+QQ|^{\frac{1}{2}}} \times R^{-\frac{1}{2}}$ , Resistentia ut  $\overline{1+QQ|^{\frac{1}{2}}} \times S \times R^{-2}$ ,

Densitas ut  $S \times R^{\frac{n-4}{2}} \times \overline{1+QQ|^{\frac{1-n}{2}}}$ .<sup>(79)</sup>

to determine the ratio  $\frac{3}{4}S\sqrt{(1+Q^2)}/R^2$  of the medium's resistance to gravity, and the related exponents,  $\sqrt{(1+Q^2)/R}$  and  $S/R\sqrt{(1+Q^2)}$  respectively, of the body's instantaneous speed and of the medium's density (where the resistance is supposed to be as the square of the speed).

(77) Add. 3968.37: 540<sup>v</sup>, a preliminary jotting on a draft of the English preface to the *Commercium Epistolicum* printed in 2, Appendix 1.5. Newton computes the variation of density in a medium resisting the passage of a body through it in a given curve according as some general  $n$ -th power of the speed; and thereafter enumerates—haphazardly at first, and then more systematically in two alternative displays of the pattern of its succeeding particular varieties of form—the simpler modes in which this manifests itself when  $n = 0, 1, 2, 3, \dots, 7$  before again encapsulating its general expression in an equivalent formulation.

(78) Strictly,  $V = \sqrt{(\frac{1}{2}g \cdot (1+Q^2))/R}$  where  $g$  is the force of downwards gravity; see §2.3: note (37) above. But here, of course, the neglected factor  $\sqrt{(\frac{1}{2}g)}$  can be appropriately absorbed into the constant of proportionality.

(79) Whence, by way of an intermediate draft at Add. 3965.12: 201<sup>v</sup> (on which see §2.3: note (49) above), this general formula for the density was remoulded to be as it afterwards appeared in the *Principia's editio secunda* in the opening paragraph of the augmented scholium to Proposition X of the second book ( $\frac{1}{2}$ 1713: 240; compare page 368 above).





$$[\text{adeoq}] \text{ Area}^{(83)} = \frac{1}{x+cx} o - \frac{1+2cx}{2 \times x+cx} o^2 + \frac{[1]+3cx+3ccxx}{3 \times x+cx} o^3 - \&c.$$

[Itaq; si resistentia ponatur esse ut quadratum velocitatis, prodeunte scilicet]

$$eS = R\sqrt{1+QQ}^{(84)}$$

$$[\text{evadit}] \sqrt{\frac{1+xx+2cx^3+ccx^4}{x+cx}} \text{ in } \frac{1+2cx}{2 \times x+cx} = \frac{e+3ecx+3eccxx}{3 \times x+cx}^{(85)}$$

[Vel generalius finge  $CQ=y=] x^m+cx^{m+1}]^n =^{(86)}$

$$x^{mn} + ncx^{mn+1} + \frac{[n]n-n}{2} \times c^2x^{mn+2} + \frac{n^3-3nn+2n}{6} c^3x^{mn+3} [+ \&c].$$

[Erit] Ord[inata  $CG$ ]<sup>(87)</sup> =

$$\frac{1}{mn+1} x^{mn+1} + \frac{nc}{mmnn+3mn+2} x^{mn+2} + \frac{[n]nnc^3-nc^3}{2m^3n^3+12mmnn+22mn+12} x^{mn+3} [+ \&c].^{(88)}$$

consequently

$$\dot{y} = (dy/dx \text{ or}) -1/x^2+c^2/(1+cx)^2, \quad \ddot{y} = (d\dot{y}/dx \text{ or}) 2/x^3-2c^3/(1+cx)^3, \\ \dot{y} = -6/x^4+6c^4/(1+cx)^4, \quad \dots$$

$$(83) \text{ Namely} \quad (BPQC) = \left( \int_x^{x+o} y \cdot dx \text{ or} \right) \int_0^o y_o \cdot do.$$

The ensuing evaluation of this as  $Qo+Ro^2+So^3+\dots$  (where  $Q=y$ ,  $R=\frac{1}{2}\dot{y}$ ,  $S=\frac{1}{6}\ddot{y}$ , ...), by expanding  $y_o$  into its Taylorian series (see the previous note) and then integrating this term by term, yields of course (since  $y=\dot{z}$ ,  $\dot{y}=\ddot{z}$ ,  $\ddot{y}=\ddot{z}$ , ...) the parallel Taylorian expansion of the equal quantity  $BF-CG=z_{x+o}-z$  which Newton in sequel requires.

(84) Where, that is,  $Q$ ,  $R$  and  $S$  are the coefficients of the successive powers of  $o$  in the preceding series expansion of  $z_{x+o}-z$  (see the previous note) and  $e$  is some constant. The quantity  $S/R\sqrt{1+Q^2}$  is (see [10] preceding) the measure of the density of the medium which permits a projectile to traverse the curve  $z=z_x$  when the resistance is—as Newton here puts it to be—proportional to the square of the body's speed, and so its constancy is the criterion for such resisted motion through a uniform medium.

(85) 'Q[uod] F[ieri] N[on] e[st] q[uod] N[on] e[st]', as Newton would no doubt have tagged this impossibly asymmetric identity had he written out his present argument more formally. He gives up pursuing this present chimera, and passes forthwith from this instance (where  $m=1$ ,  $n=-1$ ) to consider the more general projectile curve defined by the Cartesian equation

$$z = z_x \equiv \int_0^x y \cdot dx,$$

where now  $y = (x^m+cx^{m+1})^n$ .

(86) On expanding this binomial  $x^{mn}(1+cx)^n$  into its equivalent series, that is.

$$(87) \text{ Namely } z = \int_0^x y \cdot dx.$$

(88) This would-be integration term by term of the preceding series merits our rare editorial accolade of a double exclamation!! The denominators of the coefficients here are successively  $mn+1$ ,  $(mn+1)(mn+2)$  and —as Newton laboriously calculated in a blank space a little way above after an erroneous computation of this triple product in his head  $-2(mn+1)(mn+2)(mn+3)$ , that is, ' $mn+3 \times 2m^2n^2+6mn+4$ '.

[Existente igitur resistentia uniformi, vel  $S\sqrt{1+QQ} = \frac{4}{3}RR$ , fiet]

$$\frac{\sqrt{mmnn+2mn+1 \text{ in } x^{2mn+2} + ee^{(89)}}}{mn+1} \times \frac{[n]nnc^3 - nc^3}{2, mn+1 \times mn+2 \times mn+3} = \frac{\frac{4}{3}nnc}{mn+1 \times mn+1} \quad (90)$$

(89) The expression under the radical is gobbledygook for ' $mmnn + 2mn + 1 + x^{2mn+2}$ '.

(90) Newton blithely substitutes for  $Q$ ,  $R$  and  $S$ , in his preceding criterion for uniform resistance to motion in the curve  $z_x = \int_0^x y \cdot dx$ , the first three terms in the preceding Wallisian evaluation of this area ( $CQMXZ$ ) =  $CG$  (by expanding the binomial  $y = x^{mn}(1+cx)^n$  into its equivalent series in powers of  $x^{mn+p}$ ,  $p = 0, 1, 2, \dots$  and integrating these term by term), thereby ignoring that these are in fact the successive coefficients of powers of  $o$  in the like expansion of the area ( $BPQC$ ) =  $\int_0^o y_o \cdot do = z_{x+o} - z$  (see note (83) above) upon replacing  $y_o$  by its equivalent Taylorian series  $y + \dot{y}o + \frac{1}{2}\ddot{y}o^2 + \dots$  and integrating this term by term (so that  $Q = y = z$ ,  $R = \frac{1}{2}\dot{y} = \frac{1}{2}\dot{z}$  and  $S = \frac{1}{6}\ddot{y} = \frac{1}{6}\ddot{z}$  recte). The oversight still gets him nowhere, of course, since the lone variable  $x^{2mn+2}$  obtrudes within the radical on the left-hand side of this otherwise numerical equation. We may imagine the somewhat ratty mood in which he straightaway drew a line across the manuscript page and began to set down his derivation of the formula for the variation of density along a given flight path, in a medium resisting as a general power of the speed, which we have reproduced in [10] above.



APPENDIX 3. THREE DRAFTS OF A  
RETROSPECTIVE ATTEMPT (LATE AUTUMN? 1712)  
ONCE MORE TO SALVAGE THE 1687 ARGUMENT.<sup>(1)</sup>

From the original worksheet in the University Library, Cambridge

[1]<sup>(2)</sup> [Sit  $AK$  planum illud plano Schematis perpendiculare,  $LCK$  linea curva,  $C$  corpus in ipsa motum,  $fCF$  recta ipsam tangens in  $C$ . Fingatur autem corpus  $C$  nunc progredi per lineam illam, nunc vero regredi per eandem lineam; & in progressu impediri a Medio, in regressu æque promoveri, sic ut in iisdem locis eadem sit corporis progredientis & regredientis velocitas. Æqualibus autem temporibus describat corpus progrediens arcum quam minimum  $CG$ ] et corpus regrediens arcum  $Cg$ , et a punctis  $C, G, g$  ad planum horizontale  $AK$  demittantur perpendicul[a]  $CB, GD, gd$ , quorum  $GD$  ac  $gd$  sursum productæ tangenti occurrant in  $F$  et  $f$ . Et  $FG, fg$  erunt altitudines quas corpus æqualibus tempori-

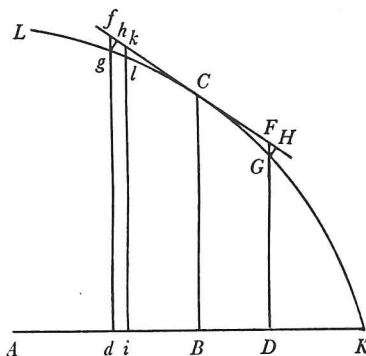

(1) These last (known) endeavours by Newton to preserve essentially intact, with only minor adjustment of the structure of its reasoning, the original form of Proposition X of the *Principia's* second book, are all found on the single folio sheet (now Add. 3965.10: 135/136) from which we printed Appendix 2.7, 8 and 9 preceding. Because the preliminary revise of [1] which is reproduced in [2] occurs (on f. 136<sup>v</sup>) immediately below his prior derivation (see Appendix 2.7) of the general formula for the ratio of resistance to gravity from the equivalent geometrical measure attained in the 'Idem aliter' (in §2.2) to the reconstructed proposition, while his present final attempt in [3] to salvage the 1687 argument precedes (on f. 135<sup>v</sup>) the preparatory recasting of the radical reworking in (§1.6 →) §2.1 to be §2.3 which is set out in Appendix 2.8, we infer that this last try to repair the fault in his original proposition without drastically rebuilding it from its foundations upwards—one which may, if (see the concluding footnote) we interpret a careless calculation on Add. 3968.41: 132<sup>v</sup> aright, well have been ultimately successful—took place only a short while before (at the very end of 1712?) Newton drafted the finished version of the recast proposition which he sent to Cotes on 6 January 1712/13 to be published in the *editio secunda* (see §2: note (1) preceding). It would, we need not say, have been a face-saving triumph for him to have mended the lapse in his 1687 argument with the little adjustment which version [3] here requires, and we can think it was only through pressure of time—he was at this period both composing his 'Scholium generale' to the *Principia* in its *editio secunda* and seeing his edition of the *Commercium Epistolicum* through the press, in addition to carrying out his normal duties at the Mint and as P.R.S.—that he omitted to work it up into a form fit to replace its defective original in print.

(2) Add. 3965.10: 135<sup>r</sup>. The roughly penned (and subsequently much corrected and interlineated) original begins abruptly *in medio*, taking up the parent printed text some way into the third sentence of its scene-setting first paragraph. We here make the deficiency good, introducing within our usual editorial square brackets a light tailoring of the omitted opening lines (*Principia*, 1687: 260, l. 30 – 261, l. 10), and, for convenience, placing alongside an abstract of

bus vi gravitatis descendendo a tangente, describit, adeoq̄ æquantur inter se.<sup>(3)</sup> Et tangenti  $Ff$  parallela et æqualis est chorda arcus  $Gg$  & utriq̄ æqualis est arcus ille quam minimus  $gG$ . A punctis  $g, G$  in tangentem demittatur perpendiculara  $gh, GH$ : et arcus  $gC, CG$  æquales erunt tangents partibus  $Ch, CH$  seu  $Cf-fh$  &  $CF+FH$ . Et horum arcuum differentia erit  $Cf-CF-2fh$ . Hæc differentia<sup>(4)</sup> oritur ab actionibus resistentiæ et gravitatis conjunctim interea dum corpus describit arcū alterutrum. Resistentia motum corporis retardat, gravitas accelerat & accelerando auget arcum  $CG$  longitudine  $FH$ .<sup>(5)</sup> Addatur hæc longitudo ad differentiam prædictam & habebitur longitudo quam resistentia sola generat, nempe  $Cf-CF-fh$ .<sup>(6)</sup> Et Gravitatis eodem tempore generat descensum  $FG$ . Proindeq̄ resistentia est ad gravitatem ut  $Cf-CF-fh$ <sup>(6)</sup> ad  $FG$ . Hæc ita se habent in lineolis nascentibus; nam in lineolis finitæ magnitudinis hæc ratio non est accurata.

Est autem resistentia ut Medij densitas [& quadratum velocitatis. Velocitas autem ut descripta longitudo  $CF$  directe & tempus  $\sqrt{FG}$  inverse, hoc est ut  $\frac{CF}{\sqrt{FG}}$ , adeoq̄ quadratum velocitatis ut  $\frac{CF^2}{FG}$ . Quare resistentia ipsiq̄]<sup>(7)</sup> proportionalis  $\frac{Cf-CF-fh}{FG}$  [est ut Medij densitas &  $\frac{CF^2}{FG}$  conjunctim; & inde Medij densitas]<sup>(7)</sup> ut  $\frac{Cf-CF-fh}{FG}$  directe et  $\frac{CF^2}{FG}$  inverse, id est ut  $\frac{Cf-CF-fh}{CF^2}$ . Q.E.I.

---

Newton's accompanying figure, redrawn (since it does not here do double duty for the prime *exemplum* of the semicircle) to show a general projectile path  $LCK$ , and with the perpendiculars  $gh, GH$  from  $g, G$  to the tangent  $fCF$  at  $C$  inserted in accord with his present direction. The last two paragraphs as they stand in the manuscript (with Newton's suspension dashes not replaced, as here, by the corresponding portions of the 1687 text) are, we may add, reproduced by I. B. Cohen in his *Introduction to Newton's 'Principia'* (Cambridge, 1971): 108 but without comment upon their dynamical context or mathematical truth.

(3) This is (see Appendix 1: note (8) above) true only when rounding-off is made to the order of the square of the base increment  $BD$  ( $Bd$ ). Apart from his further lapses, dynamical and mathematical, Newton will in his Corollary 1 below repeat his error in the *editio princeps* text (compare *ibid.*: note (13)) of assuming it valid to replace the third-order difference  $fg-kl$  by its 'equal'  $FG-kl$ .

(4) Since Newton goes on to consider the actions of the retarding resistance and the component of downwards accelerating gravity only over  $\widehat{CG} = \frac{1}{2}g\widehat{CG}$ , this should read 'Hujus differentia dimidium', viz.  $\frac{1}{2}(fC-CF)-fh$ .

(5) Understand 'seu  $fh$ ' since  $FH$  and  $fh$  are the projections along the tangent  $fCF$  of the downwards gravitational deviations  $FG$  and  $fg$  from it, which take place in equal times and may therefore (at the second-order level of accuracy here supposed) be considered equal.

(6) This should accordingly be  $\frac{1}{2}(fC-CF)$  *tout court*. The ensuing (correct) measure  $\frac{1}{2}(fC-CF)/FG$  of the ratio of resistance to gravity is of course that attained in the *editio princeps* (*Principia*, 1687: 262; compare Appendix 1: note (10) above).

(7) In each case we replace dashes in the manuscript by the pertinent sections of the parent printed text (*Principia*, 1687: 262), as Newton intends.



*Corol. 1.* Et hinc colligitur [quod si in  $Cf$  capiatur  $Ck$  æqualis  $CF$ , & ad planum horizontale  $AK$  demittatur perpendicularum  $ki$  secans curvam  $LCK$  in  $l$ ]<sup>(7)</sup> fiet

Medij densitas ut  $\frac{FG - kl - fh}{CF \text{ in } \overline{FG + kl}}$ <sup>(8)</sup>.

[2]<sup>(9)</sup> Sit  $AK$  planum illud plano schematis perpendicularare;  $ACK$  linea curva;  $C$  corpus in ipsa motum;  $fCF$  recta ipsam tangens in  $C$ ; &  $gC$ ,  $CG$  arcus quam minimi æqualibus temporis momentis<sup>(10)</sup> descripti. A punctis  $g$ ,  $C$ ,  $G$  ad planum horizontale  $AK$  demittantur perpendiculara  $gd$ ,  $CB$ ,  $GD$ , quorum  $gd$  ac  $GD$  sursum product[æ] tangenti occurrant in  $f$  et  $F$ . Et in tangente capiantur hinc inde longitudines  $Ch$   $CH$  arcubus  $Cg$   $CG$  æquales respective. Jam quo tempore corpus describit arcum  $CG$ , idem absq[ue] gravitate describeret rectam  $CF$ . Gravitas deducit corpus a tangente deorsum & descendere facit per altitudinem  $FG$ , et longitudini  $CF$  quam corpus absq[ue] gravitate describeret addit longitudinem  $FH$ . Arcuum  $gC$ ,  $CG$  differentia  $gC - CG$ <sup>(11)</sup> est decrementum spatij quod corpus singulis temporis momentis describit & hoc decrementum oritur a resi[s]tentia et gravitate conjunctim. Gravitas auget descriptum spatium longitudine  $FH$ , ideoq[ue] decrementum ejus ex resistentia sola oriundum est  $gC - CF$ , seu  $Ch - CF$  id est  $Cf - CF - FH$ .<sup>(12)</sup> Gravitas autem eodem temporis momento generat altitudinem  $FG$ . Et propterea resistentia est ad gravitatem ut  $Ch - CF$  ad  $FG$ .<sup>(13)</sup>

[3]<sup>(14)</sup> [Sit  $AK$  planum illud plano Schematis perpendicularare,  $LCK$  linea

(8) Two exclamation marks are warranted here!! On replacing  $CF$  by its equal  $kC$ , the ratio  $(fC - CF)/CF$  becomes  $(fC - kC)/kC = (\sqrt{fg} - \sqrt{kl})/\sqrt{kl}$  (since, to sufficient accuracy, the vanishingly small arc  $glC$  may be taken to be a parabola of vertex  $C$  and diameter  $CB$ , whence  $fC:kC = \sqrt{fg}:\sqrt{kl}$ ), that is  $(fg - kl)/(\sqrt{fg} + \sqrt{kl})\sqrt{kl} = (fg - kl)/(fg + kl)$  (because  $fg$  comes to coincide with  $kl$  in the limit, and only their difference is significant); and in this Newton puts the 'equal' deviation  $FG$  in place of  $fg$  (erroneously so when the difference  $fg - kl$  is thereby replaced; see note (3) above). Even so, he should here have ended up with the fraction  $\frac{FG - kl}{CF \text{ in } \overline{FG + kl}} - \frac{fh}{CF}$ . Perhaps realizing as much, Newton here breaks off to redo his main argument before repairing its present corollary.

(9) Add. 3965.10: 136<sup>v</sup>. This light recasting of [1] preceding is squashed in, below the calculations reproduced in Appendix 2.7, at the foot of the left-hand page when the manuscript sheet (ff. 135/136) is opened out to have f. 135<sup>r</sup> (bearing the text of [1]) on the right.

(10) 'particulis' is replaced.

(11) This should read 'semidifferentia  $\frac{1}{2}, \overline{gC - CG}$ '; compare [1]: note (4).

(12) Whence this should be ' $\frac{1}{2}gC - CG + FH$  seu  $fh$ , id est  $\frac{1}{2}fC - CF$ '.

(13) Correctly (see the preceding notes) 'ut  $fC - CF$  ad  $2FG$ ', the measure obtained in the 1687 parent text, which Newton again here seeks uselessly to alter by his faulty present argument.

(14) Add. 3965.10: 135<sup>r</sup>/135<sup>v</sup> (where it follows immediately after the text given in [1] preceding). Newton makes a last effort to salvage the structure of his 1687 argument, now correctly relating the times of passage successively over the equal arcs  $gC$  and  $CG$  by the square

curva,  $C$  corpus in ipsa motum,  $fCF$  recta ipsam tangens] in  $C$ . Describat autem corpus æqualibus temporis particulis arcus quam minimos  $gC$ ,  $CG$  ijsq̄ æquales sint  $Ch$ ,  $CH$  in tangente sumptæ, et a punctis  $g$ ,  $C$ ,  $G$  ad planum horizontale  $AK$  demit[t]antur perpendiculara  $gd$ ,  $CB$ ,  $GD$  quorum  $gd$  ac  $GD$  sursum productæ tangenti occurrant in  $f$  et  $F$ . & Vis gravitatis quo tempore Corpus describit arcum  $CG$ , descendere facit idem a tangente & altitudinem  $FG$  descendendo describere.<sup>(15)</sup> Arcuum  $Cg$ ,  $CG$  differentia  $Cg - CG$ <sup>(16)</sup> oritur ab actionibus resistentiæ et gravitatis conjunctim.<sup>(17)</sup> Resistentia differentiam auget, gravitas diminit ac diminuendo [in] singulis tem[poris] particulis aufert lineolam  $FH$ . Addatur hæc lineola, et hab[eb]itur decrementum arcus singulis temporis particulis descripti a resistentia sola oriundum, nempe  $Cg - CG + FH$ .<sup>(18)</sup> Gravitas autem eodem tempore generat descensum  $FG$  ut supra. Et propterea resistentia est ad gravitatem ut  $Cg - CG + FH$  ad  $FG$ .<sup>(19)</sup>

Sit jam Ordinata quævis  $BC = P$ , Abscissæ particula  $BD = o$ , et Ordinata proxima  $DG = P - Qo - Roo - So^3 - \&c$ .

Et hujus seriei terminus secundus designabit lineolam  $FI$  quam tangens aufert a parallelogrammi  $DBCI$  latere  $DI$ . Termini reliqui  $Roo + So^3 [+ \&c]$  designabunt lineolam  $FG$  quæ tangenti & Curvæ interjacet. Et tertius quidem terminus  $Roo$  determinabit curva-

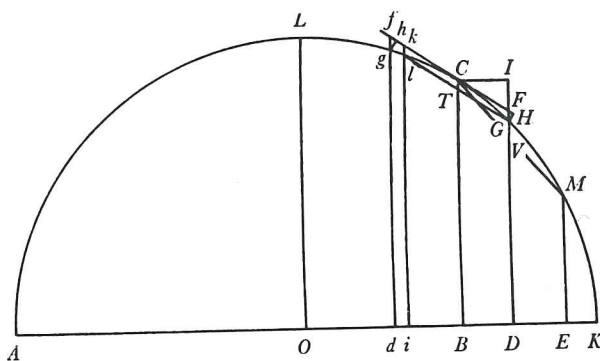

roots of the *sagitta*  $CT$  and  $GV$  at their corresponding end-points  $C$  and  $G$  (see note (20) below), but again tripping into a numerical lapse (see note (16)) which once more leads him to depart from the correct basic geometrical measure of resistance to gravity as he had accurately obtained it in the *editio princeps*. A stray line and a half of calculation on Add. 3968.41:132<sup>v</sup>, itself spoiled by a like careless numerical slip, would, however, indicate that he did ultimately (to his private, otherwise undocumented satisfaction) complete the repair of his original proposition by reverting to its measure  $\frac{1}{2}(fC - CF)/FG$  of the ratio of resistance to gravity, and then calculating the correct analytical equivalent,  $\frac{3}{2}S\sqrt{(1+Q^2)}/R^2$ , to this by employing his present reasoning *ex sagittis*; see our concluding note (22).

(15) Newton initially went on to specify more fully: 'Et si corpus ijsdem velocitatis gradibus regrederetur in arcu  $Cg$  et quo tempore pervenit a  $G$  ad  $C$  eodem perveniret a  $C$  ad  $g$ , vis gravitatis descendere faceret corpus a tangente et altitudinem  $fg$  describere. Et propter æqualitatem temporum altitudines  $FG$ ,  $fg$  a gravitate genitæ sunt æquales. Et triangulorum rectangulorum & similium  $FGH$ ,  $fgh$  latera  $FH$  et  $fh$  sunt etiam æqualia. Et arcuum  $Cg$ ,  $CG$  differentia  $Cg - CG = Ch - CH$  est  $Cf - CF - 2FH$ . Oritur hæc differentia ab actionibus...'

(16) Again (see [2]: note (11) above) this should read 'semidifferentia  $\frac{1}{2}, gC - CG$ '.

(17) 'in singulis temporis particulis' is deleted in sequel.

(18) Correctly, this should (see [2]: note (12)) be ' $\frac{1}{2}, gC - CG + FH$ , id est  $\frac{1}{2}, fC - CF$ '.

(19) Whence determining, *recte*, that 'resistentia est ad gravitatem ut  $gC - CG + 2FH$ , seu  $fC - CF$ , ad  $2FG$ ', as in the *editio princeps*.



turam hujus lineæ curvæ ad punctum  $C$ , quartus  $So^3$  determinabit variationem curvaturæ, Quintus variationem variationis & sic deinceps in infinitum. In Abscissa ad utramq; partem punctorum  $B, D$  cape  $DE, B[i]$  ipsi  $BD$  æquales, et erectis ordinatis  $E[M]$  et  $[il]$  et in serie pro  $BE$  et  $B[i]$  scribendo  $2 \times o$  et  $-o$  prodibit  $E[M] = P - 2Q[o] - 4Roo - 8So^3$  et  $[il] = P + Qo - Roo + So^3$ . Jungantur chordæ  $lG$  et  $C[M]$  secantes ordinatas  $BC$  et  $DG$  in  $[T]$  et  $[V]$ , et sagitta  $C[T]$  æqualis erit excessui Ordinaturæ  $BC$  supra  $B[T]$  id est supra semisummam Ordinarum  $[il]$  et  $DG_{[v]}$  id est quantitati  $Roo$ , et simili argumento sagitta  $G[V]$  erit  $Roo + 3So^3$ . Tempora autem quibus corpus describit arcus  $lC, CG$  sunt in subduplicata ratione spatiorum quæ corpus his temporibus cadendo describere posset,<sup>[1]</sup> & hæc spatia sunt ut hæc sagittæ.<sup>(20)</sup> Ideoq; tempus describendi arcum  $lC$  est ad tempus describendi arcum  $CG$  vel [describendi]  $gC$  ut  $\sqrt{Roo}$  ad  $\sqrt{Roo + 3So^3}$  id est ut  $R$  ad  $\sqrt{RR + 3RSo}$  seu  $R$  ad  $R + \frac{3}{2}So$ , et in hac ratione est arcus  $lC$  ad arcum  $gC$ . Et propterea arcus  $gC$  est  $lC$  in  $\frac{R + \frac{3}{2}So}{R}$ .

Et Resistentia est ad Gravitationem ut  $lC$  in  $\frac{2R + 3So}{2R} - CG + FH$  ad  $FG$ .<sup>(21)</sup> Est autem  $lC^q = [i]B^q + [il] - BC$  id est  $oo + QQoo - 2QRo^3$  &c et extracta radice fit  $lC = o\sqrt{1 + QQ} - \frac{QRoo}{\sqrt{1 + QQ}}$ . Et simili argumento fit  $CG = o\sqrt{1 + QQ} + \frac{QRoo}{\sqrt{1 + QQ}}$ .

Et inde  $lC$  in  $\frac{2R + 3So}{2R} - CG$  fit  $-\frac{2QRoo}{\sqrt{1 + QQ}} + \frac{3So}{2R} \times \sqrt{1 + QQ}$ . Adde

$$FH = \frac{GI \times CF}{CG} = \frac{Qo \times Roo}{o\sqrt{1 + QQ}} \left[ \text{seu } \frac{QRoo}{\sqrt{1 + QQ}} \right]$$

et fiet resistentia ad Gravitationem ut  $\frac{3So\sqrt{1 + QQ}}{2R} - \frac{QRoo}{\sqrt{1 + QQ}}$  ad  $Roo$  [id est ut  $\frac{3S\sqrt{1 + QQ}}{2RR} - \frac{Q}{\sqrt{1 + QQ}}$  ad 1].<sup>(22)</sup>

(20) See §2.3: note (32) preceding.

(21) This should be ' $\dots - CG + 2FH$  ad  $2FG$ ', on correcting Newton's parent measure (see note (19) above). His preparatory calculations for what follows survive on Add. 3968. 41: 132<sup>v</sup> (immediately below an unused comment of his on the third paragraph of Leibniz' letter to Wallis of 28 May 1697 (N.S.) as printed in the *Commercium Epistolicum D. Johannis Collins et Aliorum* which he was soon to publish 'for' the Royal Society), where he successively computes: 'temp[us in  $lC$ ]. temp [in  $gC$ ]::  $R \cdot \sqrt{RR + 3RSo} = R + \frac{3}{2}So$ . [adeoq;]

$$gC = lC \text{ in } 1 + \frac{3So}{2R} = o\sqrt{1 + QQ} - \frac{QRoo}{\sqrt{1 + QQ}} + \frac{3So\sqrt{}}{2R}.$$

[ut et]  $CG = o\sqrt{}} + \frac{QRoo}{\sqrt{}}. [\text{fit}] gC - CG = \frac{3So}{2R\sqrt{}} - \frac{2QRoo}{\sqrt{}}. \text{Add [e } FH = \frac{QRoo}{\sqrt{}} \text{ et } \dots]$ .

(22) On adjusting the parent ratio to be 'ut  $gC - CG + 2FH$  ad  $2FG$ ' (see note (19) above), it

APPENDIX 4. AN ADDENDUM (POST-1713)  
ON THE CURVATURE OF CURVES.<sup>(1)</sup>

From the original drafts<sup>(2)</sup> in private possession and in the University Library, Cambridge

[1] <sup>(3)</sup>Dixi supra quod si Lineæ Curvæ Abscissa augeatur momento  $o$  &

follows, *recte*, that 'fiet resistentia ad gravitatem ut  $\frac{3S_{00}\sqrt{1+Q\bar{Q}}}{2R}$  ad  $2R_{00}$ , id est ut  $3S\sqrt{1+Q\bar{Q}}$  ad  $4RR$ '. We must allow that Newton himself afterwards attained this final repair of his faulty argument in the *editio princeps*; for in a line and a half subsequently appended by him immediately after the preparatory calculation on Add. 3968.41: 132<sup>v</sup> cited in the previous note he recomputed there to be (where now  $e, f$  and  $g$  fill the place of the previous coefficients  $Q, R$  and  $S$ ):

$$1 + \frac{3go}{f} \text{ in } o\sqrt{\quad} - \frac{efoo}{\sqrt{\quad}} : -o\sqrt{1+ee} - \frac{efoo}{\sqrt{\quad}} : + \frac{2foo, eo}{o\sqrt{\quad}} = + \frac{-2efoo}{\sqrt{\quad}} + \frac{3goo\sqrt{\quad}}{f}.$$

[adeoq] resistentia ad gravitatem ut  $\frac{3g\sqrt{1+ee}}{f}$  ad  $2f$ , seu  $3g\sqrt{1+ee}$  ad  $2ff$ .' It was thereafter but the work of a moment to adjust the careless transliteration here of the previous ratio ' $\frac{R+\frac{3}{2}So}{R}$ ' (of the times of passage over the arcs  $\widehat{gC}$  and  $\widehat{lC}$ ) now to be ' $1 + \frac{3go}{2f}$ ', and so mend this computation of  $\widehat{gC} - \widehat{CG} + (2FH \text{ or } ) 2CF \times GI/CG$  to yield ' $\frac{3goo\sqrt{\quad}}{2f}$ '; whence, on dividing by  $(2FG =)$  ' $2foo$ ', the ratio of resistance to gravity results accurately to be 'ut  $\frac{3g\sqrt{1+ee}}{2f}$  ad  $2f$ , seu  $3g\sqrt{1+ee}$  ad  $4ff$ '. But in its uncorrected state Newton left off the calculation. Why indeed should he bother, in this stray scrap not intended to be communicated to posterity, to ink in a '2' in a denominator when he now knew it ought to be there!

(1) This intended addition to Proposition X, of Book 2 in the *Principia*'s second edition—'ad pag. 240', Newton specifies in his two revised versions of it ([2] and [3] below), at a less than wholly suitable place in its scholium (see Appendix 1: note (37) preceding)—elaborates his somewhat elliptical observation in its 'Exempl. 1' (*Principia*, 1687: 263–4 [= 21713: 235–6]; compare Appendix 1: note (20)) that the successive coefficients in the Taylorian expansion of the incremented ordinate of a curve, in powers of the related base increment  $o$ , determine the curvature of a curve at a point and its several orders of variation. There are no surprises here for those familiar—as his contemporaries were not!—with Newton's previous explorations of the problem of constructing the osculating circle (see especially I: 245–64, 387–8, 419–27; III: 150–6; VI: 606–8) and that of assessing the variation in the measure of curvature which the reciprocal of its radius furnishes (see VII: 108–18), but it is interesting that he was at last, in old age, willing to let the world see the elegant general formula for the radius of curvature which he had written down half a century before in his (yet wholly unpublished) 1666 tract on fluxions, and here newly presents in [3], as ever without adducing any demonstration. Had Newton lived to put this *addendum* into print, his successors might have known something.

(2) Newton's handwriting in these strongly suggests a date of composition of around 1715–16. It is tempting to connect this planned disclosure of his method of curvature with the brief glimpse of the content of his earliest papers on series and fluxions which he permitted the outside world—in witness that he 'invented' these methods 'in the Year 1665, and improved them in the Year 1666'—in the 'Observations' upon Leibniz' letter to Conti of 9 April 1716



Ordinata deinceps resolvatur in æquationem convergentem<sup>(4)</sup> qualis est hæc  $P + Qo + Roo + So^3 + To^4$ <sup>(5)</sup> + &c, terminus primus  $P$  designabit Ordinatam ejus insistentem Abscissæ nondum auctæ,<sup>(6)</sup> secundus seriei terminus  $Qo$  determinabit tangentem Curvæ, tertius  $Roo$  determinabit ejus Curvaturam, Quartus  $So^3$  variationem Curvaturæ, Quintus  $To^4$  variationem variationis. Et hinc patet me fluxiones fluxionum olim considerasse cum variatio variationis nihil aliud sit quam fluxio fluxionis Curvaturæ. Terminus secundus  $Qo$  determinat variationem seu fluxionem Ordinatæ, & hæc variatio dat positionem Tangentis. Tertius determinat motum angularem Tangentis seu variationem aut fluxionem hujus anguli ubi angulus fluit uniformiter, & hæc fluxio proportionalis est angulo contactus ut et Curvaturæ hujus Lineæ Curvæ; Quartus determinat variationem seu fluxionem Curvaturæ ubi arcus fluit uniformiter; Quintus determinat variationem variationis seu fluxionem fluxionis, id est fluxionem secundam Curvaturæ, et hæc fluxio proportionalis est fluxioni tertiæ Anguli quem Tangens continet cum Ordinata, & sic deinceps.

Sit  $AB$  Abscissa,  $BC$  Ordinata<sup>(7)</sup> &  $Bb$  momentum Abscissæ. Compleatur [parallelogrammum  $CBbG$ ...] <sup>(8)</sup>

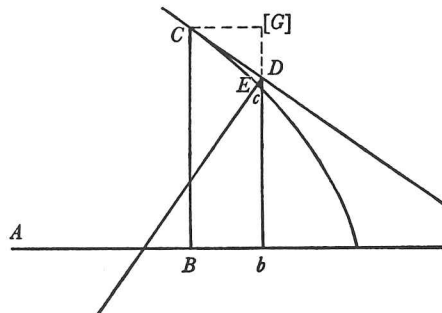

[2]<sup>(9)</sup> Pag 240<sup>(10)</sup> post —vim gravitatis ut  $GT$  ad  $\frac{2nn+2n}{n+2}GV$ . adde

Dixi supra quod si Curvæ cujusvis Abscissa momento  $o$  augeatur et prodiens Ordinata resolvatur in Seriem<sub>1,1</sub> puta  $e \pm Qo - Roo [\pm] So^3$  &c, hujus seriei terminus secundus  $Qo$  dabit Tangentem Curvæ, tertius  $Roo$  dabit curvaturam

(N.S.) which he inserted in his augmented edition of Joseph Raphson's *History of Fluxions* (London, 1717 [both Latin and English versions]): 11–19 [= *Correspondence of Isaac Newton*, 6, 1976: 341–8], especially 115–16. But this must remain our undocumented conjecture.

(3) Newton first began: 'In Scholio [read 'Exemplo 1'!] ad hujus Propositionem decimam, dico quod si Curvæ cujusvis Abscissa  $AC$  momento uno augeatur & prodiens Ordinata resolvatur in seriem convergentem, seriei hujus terminus secundus dabit Tangentem Curvæ, tertius dabit ejus Curvaturam, quartus dabit variationem Curvaturæ, quintus variationem variationis, & sic deinceps'.

(4) This replaces 'Differentiallem'!

(5) In the printed Proposition X Newton makes no explicit mention of this fifth term in the series expansion of the incremented *ordinata*.

(6) This clause was subsequently deleted.

(7) Understand 'ad rectos angulos'.

(8) Newton breaks off to begin the redraft in [2], without completing his accompanying figure.

(9) Add. 3965.13: 374<sup>r</sup>, a first revision of [1].

ejus, quartus  $So^3$  dabit variationem Curvaturæ, quintus variationem variationis & sic deinceps.

Sit  $ACcE$  Curva,  $AB$  Abscissa ejus,  $Bb$  momentum primum Abscissæ =  $o = CG$ .  $BC$  Ordinata =  $bG$ .  $GD$  momentum primum Ordinatæ<sup>(11)</sup> =  $Qo$ .  $Dc$  momentum secundum Ordinatæ =  $Ro$  [&c]. Jungatur  $CD$  et hæc Curvam tanget in  $C$ . Ducatur  $DE$  perpendicularis ad Curvam et erit  $DE$  ad  $Dc$  seu  $Ro$  ut  $CG$  seu  $o$  ad  $CD$ . Producat  $DE$  ad  $Q$  ut sit  $DQ$  ad  $CD$  ut  $CD$  ad  $DE$ <sup>(12)</sup> et erit  $DQ$  vel  $CQ$  radius Curvaturæ =

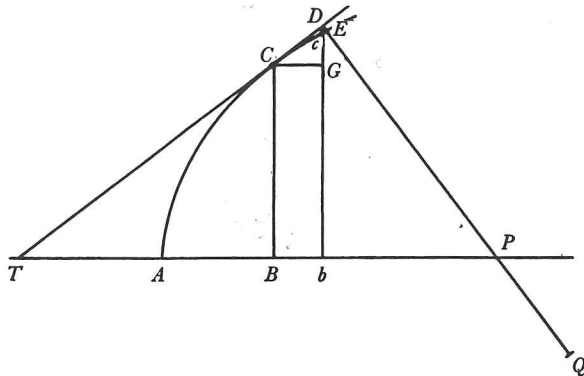

$$\frac{o + Qo}{Ro^3} \sqrt{o + Qo} = \frac{1 + QQ}{R} \quad (13)$$

[3]<sup>(14)</sup> pag. 240.<sup>(10)</sup> Post verba —vim gravitatis ut  $GT$  ad  $\frac{2nn + 2n}{n \times 2} GV$  adde

Dixi supra quod tertius seriei terminus  $Ro$  seu  $NI$  determinat angulum contactus  $IHN$  seu curvaturam quam Curva linea habet in  $H$ . Sit  $HIK$  Curva quævis cujus curvatura in puncto  $H$  inveniri debet,<sup>(15)</sup> et circulus ducatur qui Curvam tangat in puncto  $H$  et secet in puncto  $I$  ipsi infinite propinquam. Et hic

(10) That is, after the fourth paragraph in the augmented opening to the scholium in the *editio secunda* [= second paragraph in *Principia*, 1687: 270]; again see Appendix 1: note (37).

(11) Here and in the next line we mend a careless 'Abscissa' in the manuscript. Again understand this ordinate  $BC(bc)$  to be at right angles to the abscissa  $AB(b)$ .

(12) Since  $CD^2 = DE \times 2DQ$ , this should be '2DE'.

(13) Here, correspondingly, the denominators need to be doubled to be '2Ro<sup>3</sup>' and '2R' respectively. In the Fermatian notation used by Newton in his main proposition, where the (mutually perpendicular) abscissa  $AB = a$  and ordinate  $BC = e$  determine the general point  $C(a, e)$  of the curve  $AD$ , the coefficients in the series expansion of the incremented ordinate  $bc = e_{a \pm o} = e \pm Qo + Ro^2 \pm \dots$  are successively  $Q = de/da$  and  $R = \frac{1}{2}d^2e/da^2$ , so that Newton's (corrected) formula  $(1 + Q^2)^{\frac{3}{2}}/2R$  for the radius of curvature at  $C$  is merely the familiar Leibnizian one  $(1 + (de/da)^2)^{\frac{3}{2}}/(d^2e/da^2)$  writ differently.

(14) Add. 3965.13: 377<sup>r</sup>. Newton's unfinished final version of his intended *addendum* to Book 2, Proposition X of the *Principia* explaining how the third term  $Ro^2$  in the Taylorian expansion of the incremented ordinate  $e_{a \pm o}$  is a measure of the curvature at the point  $(a, e)$  of a curve defined (now in general oblique coordinates) by some given Cartesian equation  $e = e_a$ .

(15) This rightly replaces a too dogmatic initial 'invenienda est'.



circulus eandem habebit curvaturam quam Curva proposita habet in puncto  $H$ , et ex natura Circuli si  $NI$  producat ad  $R$  ut sit  $NR$  ad  $NH$  ut  $NH$  ad  $NI$ , dabitur punctum  $R$  per quod circulus transibit, & inde dabitur circulus.<sup>(16)</sup>

Hoc fundamento<sup>(17)</sup> sequentem Problematis constructionem olim condidi quod ex Tractatu sub finem anni 1666 conscripto<sup>(18)</sup> hic describam.

Sit Abscissa  $PC = x$  & Ordinata<sup>(19)</sup>

$CH = y$ , et æquationis cujuscunq; qua habitudo ipsarum  $x$  et  $y$  ad invicem definitur termini omnes ex eodem æquationis latere dispositi & nihilo æquales facti significantur per litteram  $\mathfrak{C}$ . Et symbolo  $\mathfrak{C}$  significantur ijdem termini in ordinem redacti secundum dimensiones ips[us]  $x$  et per progressionem<sup>(20)</sup> quancunq; multiplicati. Et symbolo  $\mathfrak{C}$  significantur ijdem termini in ordinem redacti secundum dimensiones ipsius  $y$  et per progressionem<sup>(20)</sup> quancunq; multiplicati. Symbolo autem  $\mathfrak{C}$  significantur idem termini in ordinem redacti secundum dimensiones ips[us]  $x$  et multiplicati per duas arithmeticas progressionis arithmeticas intervallo termini unius ab invicem differentes. Et symbolo  $\mathfrak{C}$  significantur ijdem termini in ordine dispositi secundum dimensiones ipsius  $y$

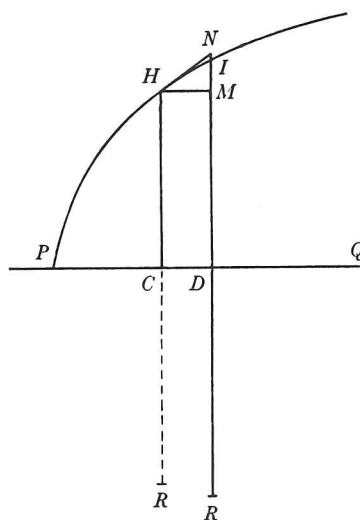
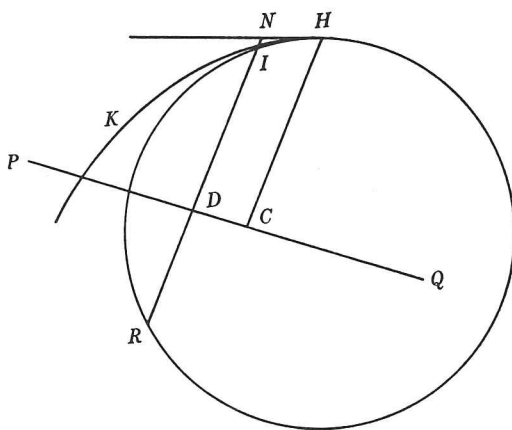

(16) Newton here summarizes the construction of the chord of curvature along an ordinate of a curve which he had expounded, in fluxional equivalent, in Proposition XIII of his 1691 treatise 'De quadratura Curvarum' (see VII: 108–10). He could here have passed likewise to specify that, if the coordinates  $PC = x$  and  $CH = y$  of the point  $H(x, y)$  of the given curve are inclined at the angle  $\widehat{PCH} = \cos^{-1}k$ , then, where  $CD = o$  and the decremented  $DI = y_{x-o}$  has the series expansion  $y - Qo + Ro^2 - \dots$  ( $Q = dy/dx = \dot{y}$ ,  $R = \frac{1}{2}d^2y/dx^2 = \frac{1}{2}\ddot{y}$ ), so that  $CH - DN = Qo$  and  $NI = Ro^2 \dots$ , there is accordingly  $NH = o\sqrt{(1 - 2kQ + Q^2)}$  and hence  $NR = o^2(1 - 2kQ + Q^2)/(Ro^2 \dots)$ ; wherefore in the limit as ( $o \rightarrow$  zero and so)  $NR$  comes to coincide with the chord of the osculating circle this is yielded to be  $(1 - 2kQ + Q^2)/R$ , that is,  $(1 - 2k\dot{y} + \dot{y}^2)/\frac{1}{2}\ddot{y}$  in the fluxions equivalent. The particular case where the ordination angle  $\widehat{PCH}$  is right (and so  $k = 0$ ) is, *mutatis mutandis*, that of [2] preceding.

(17) This is only broadly true. Newton in historical fact attained his following theorem (initially in May 1665; see I: 280–90) from first principles by constructing the centre of curvature at a given point of a curve—like Apollonius (*Conics*, v) and Huygens (compare I: 271,

et multiplicati per duas progressionēs arithmeticas intervālo termini unius ab invicem differentes. Symbolo autem  $\mathfrak{C}$  significantur ijdem termini in ordinem redacti secundum dimensiones ipsius  $x$  et multiplicati per majorem progressionem duarum per quas  $\mathfrak{C}$  multiplicata fuit, et subinde in ordinem redacti secundum dimensiones ipsius  $y$  et multiplicati per majorem duarum progressionum per [quas]  $\mathfrak{C}$  multiplicata fuit. Et interea Progressiones omnes æquales habeant terminorum differentias & eodem terminorum ordine procedant respectu dimensionum ipsarum  $x$  et  $y$ . Et linea  $HR$  erit

$$\frac{\mathfrak{C} \mathfrak{C} \mathfrak{C} yy + \mathfrak{C} \mathfrak{C} \mathfrak{C} xx}{-\mathfrak{C} \mathfrak{C} \mathfrak{C} y + 2 \mathfrak{C} \mathfrak{C} \mathfrak{C} y - \mathfrak{C} \mathfrak{C} \mathfrak{C} y} \quad (21)$$

Ut si æquatio<sup>(22)</sup>

note (75)) before him did he then but know it—as the limit-meet of the normals to the curve in the point's immediate vicinity. The deeper insight and sophistication of his later researches into curvature were then still mostly in the egg.

(18) The October 1666 fluxional tract whose text is reproduced on I: 400–48. The following formula is that expounded 'in such cases where  $y$  is ordinately applied to  $x$  at right angles' as the general construction (there undemonstrated) of the tract's 'Prob. 2<sup>d</sup>. To find  $y^e$  quantity of crookednesse of lines' (*ibid.*: 419–24, especially 421).

(19) Once more this needs to be restricted to be 'ad rectos angulos', as Newton specifies in his original account (see the previous note).

(20) In each case understand 'arithmeticam' (as on I: 421, whose English text Newton here otherwise accurately renders into Latin).

(21) This is 'Theoreme 1<sup>st</sup>' on I: 421, trivially re-keyed to the present figure. In modern partial-derivative notation, let us remind, where the curve ( $H$ ) is defined with respect to abscissa  $AB = x$  and ordinate (at right angles to it)  $BC = y$  by the general algebraic equation  $\mathfrak{C} \equiv f(x, y) = 0$ , Newton's  $\mathfrak{C}$ ,  $\mathfrak{C}$  and  $\mathfrak{C}$ ,  $\mathfrak{C}$ ,  $\mathfrak{C}$  are the homogenised first- and second-order derivatives  $xf_x$ ,  $yf_y$  and  $x^2f_{xx}$ ,  $xyf_{xy}$ ,  $y^2f_{yy}$ ; whence his formula constructs  $HR$ , the vertical projection of the radius of curvature, to be equal to  $-(f_x^2 + f_y^2)f_y / (f_x^2f_{yy} - 2f_xf_yf_{xy} + f_y^2f_{xx})$ .

(22) Newton breaks off without adducing any illustrative example(s) applying his preceding algorithm to a particular case. We might reasonably suppose that he would have gone on to work, *inter alia*, one or other species of the general conic determined by the Cartesian equation  $y^2 = rx \pm (r/q)x^2$ , where  $r$  is its *latus rectum* and  $q$  its main axis. (Compare I: 422–3; VII: 110–12.) It is perhaps not wholly irrelevant here to add that there survive on Add. 3965.19: 751<sup>v</sup> contemporary calculations by him where he begins to employ the main construction of 'Prob. 2<sup>d</sup>' of the 1666 tract (see I: 420) in the case of the ellipse ' $rx - exx = yy$ ', passing to compute ' $r\dot{x} - 2ex\dot{x} = 2y\dot{y}$  [adeoq]  $\dot{x}:\dot{y}::y:\frac{1}{2}r - ex$ ' and thence the subnormal  $y\dot{y}/\dot{x} = \frac{1}{2}r - ex$  and the related normal  $y\sqrt{(1 + \dot{y}^2/\dot{x}^2)}$ , and their incremented forms as  $x \rightarrow x + o$ , before making a geometrical slip and leaving off.