



**HAL**  
open science

# The continuous generation of discontinuous innovations in international organizations

Marion Neukam

► **To cite this version:**

Marion Neukam. The continuous generation of discontinuous innovations in international organizations. Business administration. Université de Strasbourg, 2017. English. NNT : 2017STRAB007 . tel-01721572

**HAL Id: tel-01721572**

**<https://theses.hal.science/tel-01721572v1>**

Submitted on 2 Mar 2018

**HAL** is a multi-disciplinary open access archive for the deposit and dissemination of scientific research documents, whether they are published or not. The documents may come from teaching and research institutions in France or abroad, or from public or private research centers.

L'archive ouverte pluridisciplinaire **HAL**, est destinée au dépôt et à la diffusion de documents scientifiques de niveau recherche, publiés ou non, émanant des établissements d'enseignement et de recherche français ou étrangers, des laboratoires publics ou privés.

# UNIVERSITÉ DE STRASBOURG

ÉCOLE DOCTORALE AUGUSTIN COURNOT [ED 221]

Bureau d'Economie Théorique et Appliquée, UMR 7522

## THÈSE

présentée par : **Marion NEUKAM**

soutenue le : **26 Septembre 2017**

pour obtenir le grade de : **Docteur de l'Université de Strasbourg**

Discipline/Spécialité : **SCIENCES DE GESTION**

<h3>The Continuous Generation of Discontinuous Innovations in International Organizations</h3>
--

#### THÈSE dirigée par :

LLERENA, Patrick

Professeur en Sciences Economiques, Université de Strasbourg

CULLMANN, Sabine

Maître de conférences en Sciences de Gestion, Université de Strasbourg

#### RAPPORTEURS :

HUSSLER, Caroline

Professeure en Science de Gestion, IAE Lyon School of Management

WAGNER, Marcus

Professeur en Sciences de Gestion, Université d'Augsbourg

#### AUTRES MEMBRES DU JURY :

BURGER-HELMCHEN, Thierry

Professeur en Sciences de Gestion, Université de Strasbourg

RUFI, Frédéric

Responsable R&D, Bürkert SAS (Partenaire CIFRE)

# UNIVERSITÉ DE STRASBOURG

ÉCOLE DOCTORALE AUGUSTIN COURNOT [ED 221]

Bureau d'Economie Théorique et Appliquée, UMR 7522

## THÈSE

présentée par : **Marion NEUKAM**

soutenue le : **26 Septembre 2017**

pour obtenir le grade de : **Docteur de l'Université de Strasbourg**

Discipline/Spécialité : **SCIENCES DE GESTION**

<p><b>La génération continue d'innovations discontinues dans des entreprises internationales</b></p>
--

### THÈSE dirigée par :

LLERENA, Patrick

Professeur en Sciences Economiques, Université de Strasbourg

CULLMANN, Sabine

Maître de conférences en Sciences de Gestion, Université de Strasbourg

### RAPPORTEURS :

HUSSLER, Caroline

Professeure en Science de Gestion, IAE Lyon School of Management

WAGNER, Marcus

Professeur en Sciences de Gestion, Université d'Augsbourg

### AUTRES MEMBRES DU JURY :

BURGER-HELMCHEN, Thierry

Professeur en Science de Gestion, Université de Strasbourg

RUFI, Frédéric

Responsable R&D, Bürkert SAS (Partenaire CIFRE)

*To my beloved parents – who taught me to reach for the stars  
while having both feet firmly on the ground.*

---

## ACKNOWLEDGMENTS

To Professor *Caroline HUSSLER*, Professor *Marcus WAGNER* and Professor *Thierry BURGER-HELMCHEN* for accepting to be my jury.

To Professor *Patrick LLERENA* and *Sabine CULLMANN*, my PhD supervisors, for accepting me as doctoral student, for their support and trust throughout the PhD and their help in revising my doctoral thesis.

To *Claude GUITTARD* for countless inspiring discussions throughout writing and revising, his countless suggestions, his brilliant support, and his constant encouragement.

To *Eric SCHENK* and *Laurent BACH* for their availability, their openness and their feedback helping me revising my thesis.

To the BETA laboratory and the Augustin Cournot Doctoral School for accepting me as doctoral student.

To the ARNT for supporting this research project by the CIFRE contract.

To *Virginie GOTHIE*, *Danielle GENEVÉ*, *Géraldine DEL FABBRO* and *Claudine BERST* for their help with the administrative challenges of my dissertation and the joyful chats.

To my fellow doctoral students at the laboratory for the cheerful discussions and support. Thank you, *Marlène LE KIM*, *Nuria MORATAL-FERRANDO* and *Sophie RAEDERSDORF*, for your advices during writing and revising, and thank you, girls, for many occasions to share experiences, also during long evenings at the BETA laboratory which were fun because of you.

To *BÜRKERT* for accepting to be part of the CIFRE program. This dissertation would not have been possible without this involvement.

To *Frédéric RUFİ*, my supervisor at *BÜRKERT SAS*, for his constant support and trust, for his infallible advices during the whole time, his suggestions and help in writing and revising my thesis and for his encouragement to leave my comfort zone.

To my colleagues at *BÜRKERT SAS*, specifically to *Arnaud ZAEPFEL*, *Maité ACKERMANN* and *Nicolas DA MOTA*, for their support during hours of discussions and their always useful advice.

To *3D PLUS* and *ELECTRO*, the two replication cases, for accepting to be part of this research project and for their openness during the interviews.

To *Maximiliane HANFT*, my long-standing friend, for her mental support, the uncountable chat sessions, her detailed feedback and her help in revising my papers.

To my uncle, *Alfred MATT*, and my aunt, *Danièle MATT*, for constantly supporting me and offering me a place to stay.

To my cat *FIESTA* for keeping company during long Saturday evenings in front of my PC.

To *Pierre-Louis SCHNEIDER* for sharing joy and burden of this work life, for his patience, his support, his unfailing advices, his useful comments, and his philosophy about live which encouraged me to do things to be happy and not only things which are reasonable.

First and foremost to my beloved family, my brother, *CHRISTIAN*, and my parents, *MARIE-CLAUDE* and *KONRAD*, for enabling me to follow my dreams, for their endless love, their constant encouragement and for unceasingly rebuild my moral in difficult moments. Thank you, papa, for giving me the sense to be curious, for your patience and your undeniably helpful advices. Mama, thank you for our uncountable, long and deep conversations, your strong shoulder to lean on and for being always there for me. You two enabled me to be who I am and I hope you are proud of this final result which would not have been possible without you.

# OVERVIEW CONTENTS

<b>PART I PREPARATION FOR THE EXPLORATION .....</b>	<b>1</b>
1.1 THE CONTEXT: A SPATIAL JOURNEY .....	2
1.2 RESEARCH OBJECTIVE OF THE DISSERTATION.....	5
1.3 RESEARCH OUTLINE: A MISSION STATEMENT.....	8
<b>PART II THEORETICAL FOUNDATIONS.....</b>	<b>12</b>
2.1 IT STARTS WITH INNOVATION.....	14
2.2 CLARIFYING A FUZZY CONCEPT: THE FUZZY FRONT-END.....	28
2.3 THINK ‘FUZZY’ - ACT GLOBALLY .....	53
<b>PART III THE SETTING.....</b>	<b>68</b>
3.1 EPISTEMOLOGICAL FOUNDATIONS .....	70
3.2 A CASE STUDY DESIGN .....	77
3.3 THE FIELD CONTEXTS .....	97
3.4 CONCLUDING REMARKS .....	118
<b>PART IV THE PROXIS-TELESCOPE .....</b>	<b>120</b>
4.1 ORGANIZATIONAL PROXIMITY .....	125
4.2 SOCIAL PROXIMITY .....	146
4.3 COGNITIVE PROXIMITY .....	169
4.4 DISCUSSION: COMPLETE THE PROXIS-TELESCOPE .....	196
<b>PART V DYNAMIC EXTENSION OF THE PROXIS-MODEL .....</b>	<b>202</b>
5.1 PROXIMITY AND GROWTH.....	204
5.2 THE FFE AT THE REPLICATION CASES.....	225
5.3 CROSS-CASE COMPARISON.....	251
<b>PART VI BACK TO EARTH - GENERAL CONCLUSION.....</b>	<b>266</b>
6.1 RÉSUMÉ OF THE THESIS .....	268
6.2 CONTRIBUTION .....	277
6.3 OUTLOOK OF THE THESIS .....	281
<b>PART VII RESUME DE LA THESE .....</b>	<b>286</b>
PARTIE I : LE POINT DE DÉPART.....	287
PARTIE II : LE CADRE THÉORIQUE.....	288
PARTIE III : LES FONDEMENTS MÉTHODOLOGIQUES .....	295
PARTIE IV : LE PROXIS-TÉLESCOPE.....	299
PARTIE V : UNE EXTENSION DYNAMIQUE DU PROXIS-MODÈLE.....	314
PARTIE VI : CONCLUSION GÉNÉRALE .....	324
<b>REFERENCES.....</b>	<b>326</b>

# CONTENTS

<b>PART I PREPARATION FOR THE EXPLORATION .....</b>	<b>1</b>
1.1 THE CONTEXT: A SPATIAL JOURNEY .....	2
1.2 RESEARCH OBJECTIVE OF THE DISSERTATION .....	5
1.3 RESEARCH OUTLINE: A MISSION STATEMENT.....	8
<b>PART II THEORETICAL FOUNDATIONS .....</b>	<b>12</b>
2.1 IT STARTS WITH INNOVATION .....	14
2.1.1 Innovation: A definition.....	15
2.1.2 The Innovation Process .....	21
2.1.3 The Scope of this Research .....	27
2.2 CLARIFYING A FUZZY CONCEPT: THE FUZZY FRONT-END .....	28
2.2.1 A Multitude of Definitions .....	29
2.2.2 One Size Does Not Fit All .....	40
2.2.3 Removing the Fuzziness: A Conclusion .....	50
2.3 THINK ‘FUZZY’ - ACT GLOBALLY .....	53
2.3.1 Thinking International at the FFE: A Literature Review .....	54
2.3.2 Across Borders: International Management .....	59
2.3.3 The Research Question: A Paradox .....	65
<b>PART III THE SETTING .....</b>	<b>68</b>
3.1 EPISTEMOLOGICAL FOUNDATIONS .....	70
3.1.1 A Variety of Paradigms .....	70
3.1.2 Exploration vs Testing: Grounded Theory .....	74
3.1.3 Content vs Process Research .....	75
3.2 A CASE STUDY DESIGN.....	77
3.2.1 Case Studies: A Typology .....	78
3.2.2 The Phases of the Case Study.....	83
3.2.3 The Units of Analysis .....	85
3.2.4 Data Collection .....	90
3.2.5 Methods of Analysis .....	94
3.3 THE FIELD CONTEXTS .....	97
3.3.1 BÜRKERT – Fluid Control Systems.....	98
3.3.2 Data Collection at BÜRKERT.....	101
3.3.3 Replication Case Studies .....	111
3.4 CONCLUDING REMARKS .....	118



<b>PART IV THE PROXIS-TELESCOPE .....</b>	<b>120</b>
4.1 ORGANIZATIONAL PROXIMITY .....	125
4.1.1 Theoretical Specifications .....	126
4.1.2 Results .....	130
4.1.3 Analysis .....	134
4.1.4 Discussion .....	139
4.1.5 Concluding Remarks .....	144
4.2 SOCIAL PROXIMITY .....	146
4.2.1 Theoretical Specifications .....	148
4.2.2 Results .....	150
4.2.3 Analysis .....	159
4.2.4 Discussion .....	165
4.2.5 Concluding Remarks .....	167
4.3 COGNITIVE PROXIMITY .....	169
4.3.1 Theoretical Specifications .....	172
4.3.2 Methodological Specifications .....	176
4.3.3 Results .....	179
4.3.4 Analysis .....	187
4.3.5 Discussion .....	191
4.3.6 Concluding Remarks .....	193
4.4 DISCUSSION: COMPLETE THE PROXIS-TELESCOPE .....	196
4.4.1 What About the Positioning of the Lenses? .....	198
4.4.2 How To Know Where to Look in the Sky? .....	199
4.4.3 Which Part of the Telescope Should Be Improved as Priority? .....	200
<b>PART V DYNAMIC EXTENSION OF THE PROXIS-MODEL .....</b>	<b>202</b>
5.1 PROXIMITY AND GROWTH .....	204
5.1.1 Theoretical Specifications .....	206
5.1.2 Methodological Specifications .....	207
5.1.3 Results .....	211
5.1.4 Analysis .....	216
5.1.5 Discussion .....	221
5.1.6 Concluding Remarks .....	223
5.2 THE FFE AT THE REPLICATION CASES .....	225
5.2.1 3D PLUS: About Innovation in Space and Space in Innovation .....	226
5.2.2 Participative Innovation at ELECTRO .....	239
5.3 CROSS-CASE COMPARISON .....	251
5.3.1 Analysis .....	254
5.3.2 Discussion .....	257
5.3.3 Concluding Remarks .....	264

<b>PART VI BACK TO EARTH - GENERAL CONCLUSION .....</b>	<b>266</b>
6.1 RÉSUMÉ OF THE THESIS .....	268
6.1.1 General Structure of the Thesis .....	269
6.1.2 Empirical Findings .....	270
6.2 CONTRIBUTION .....	277
6.2.1 Theoretical Contributions .....	277
6.2.2 Managerial Contributions .....	280
6.3 OUTLOOK OF THE THESIS .....	281
6.3.1 Restrictions of the Framework .....	281
6.3.2 Extensions for Future Research .....	284
<b>PART VII RESUME DE LA THESE .....</b>	<b>286</b>
PARTIE I : LE POINT DE DÉPART .....	287
PARTIE II : LE CADRE THÉORIQUE .....	288
Chapitre 2.1 : L’Innovation .....	288
Chapitre 2.2 : Le Fuzzy Front-End et les Innovations Discontinues .....	290
Chapitre 2.3 : Une Approche Internationale du Fuzzy Front-End .....	293
PARTIE III : LES FONDEMENTS MÉTHODOLOGIQUES .....	295
Chapitre 3.1 : Les Fondements Epistémologiques .....	295
Chapitre 3.2 : La Méthode de la Recherche .....	296
Chapitre 3.3 : Les terrains de recherche .....	298
PARTIE IV : LE PROXIS-TÉLESCOPE .....	299
Chapitre 4.1 : La Proximité Organisationnelle .....	301
Chapitre 4.2 : La Proximité Sociale .....	304
Chapitre 4.3 : La Proximité Cognitive .....	308
Chapitre 4.4 : Discussion du Proxis-Télescope .....	312
PARTIE V : UNE EXTENSION DYNAMIQUE DU PROXIS-MODÈLE .....	314
Chapitre 5.1 : La Proximité et la Croissance Organisationnelle .....	314
Chapitre 5.2 : Les Cas de Réplication .....	317
Chapitre 5.3 : L’Analyse Transversale – Le Proxis-Modèle Dynamique .....	320
PARTIE VI : CONCLUSION GÉNÉRALE .....	324
<b>REFERENCES.....</b>	<b>326</b>

## FIGURES

Figure 1 – The Objective of the Dissertation: Resolve a Paradox.....	7
Figure 2 – Mission Statement of the Dissertation. ....	8
Figure 3 – Outline of the Dissertation. Present Part: General Introduction.....	11
Figure 4 – Outline of the Dissertation. Current Part: Theoretical Foundations.....	13
Figure 5 – The Development Funnel of Wheelwright and Clark (1992, p. 112).....	24
Figure 6 – Scope of the Research. ....	27
Figure 7 – Fuzzy Front-End Information Flow and Decision-Making Process: Discontinuous Innovations (Reid and De Brentani, 2004, p. 178). ....	34
Figure 8 – The Three Steps of the FFE (Cohendet <i>et al.</i> , 2013, p. 136).....	52
Figure 9 – The Analysis Grid of the Analytical Part. ....	67
Figure 10 – Outline of the Dissertation. Present Part: Methodological Foundations. ....	69
Figure 11 – Reasoning Models and Scientific Knowledge (Charreire Petit and Durieux, 2007, p. 64 translated by MN); Chosen Approach Highlighted by MN. ....	73
Figure 12 – Content and Process Research: Complement to the Analysis Grid of the Dissertation. ....	75
Figure 13 – Case Study Model of the Dissertation Based on Yin (2003), Gassmann (1999) and Eisenhardt (1989).....	84
Figure 14 – Structure of the Pilot Case: Embedded Units of Analysis.....	88
Figure 15 – Technology and Market Driven Input for the Project Roadmap at BÜRKERT (Internal Document).....	100
Figure 16 – Timeline of the Pilot Case Study at BÜRKERT.....	102
Figure 17 – Evolution of the Workforce. 2010: 83 Employees; 2017: 185 Employees (Internal Document).....	112
Figure 18 – Data Collection Process at 3D PLUS.....	113
Figure 19 – Data Collection Process at ELECTRO.....	116
Figure 20 – Epistemological Foundations: An Overview. ....	118
Figure 21 – Outline of the Dissertation. Present Part: The ProxIS-Telescope.....	122
Figure 22 – The ProxIS-Telescope: Managing Space at the FFE of Discontinuous Innovations (by MN).....	123
Figure 23 – A Knowledge Flows-Based Framework (Gupta and Govindarajan, 1991, p. 774).....	127
Figure 24 – The Knowledge Flows-Based Framework (Gupta and Govindarajan, 1991) adapted to the FFE (by MN).....	129
Figure 25 – The International FFE Network at BÜRKERT (by MN). ....	130
Figure 26 – The International FFE Typology (Adapted by MN from Gupta and Govindarajan, 1991). .....	139
Figure 27 – The International FFE Matrix and Its Coordination Mechanisms. ....	142

Figure 28 – The Technology Fields of BÜRKERT (Internal Document).....	154
Figure 29 – The FFE of Discontinuous Innovations at BÜRKERT. ....	158
Figure 30 – A Representation of the Community Structure at BÜRKERT (by MN).....	162
Figure 31 – Conditional Model for Creative Crystallization and Diffusion (adapted from Neukam and Guittard, 2017a).....	166
Figure 32 – The Research Framework: Coordination Mechanisms for Cognitive Proximity during the FFE of Discontinuous Innovations. ....	171
Figure 33 – Resulting Coordination Mechanisms for Cognitive Proximity at BÜRKERT.....	194
Figure 34 – The Elements of the ProxIS-Telescope and the Coordination Mechanisms at BÜRKERT (by MN).....	197
Figure 35 – Galilei Telescope (a) and Kepler Telescope (b) (Cheng, 2009, p. 2). ....	198
Figure 36 – Outline of the Dissertation. Present Part: The Dynamic ProxIS-Model. ....	203
Figure 37 – Research Framework for this Chapter.....	205
Figure 38 – Greiner’s model of Growth (Greiner, 1998, p. 58). ....	206
Figure 39 – Evolution of the Workforce of BÜRKERT (Left Hand Scale) and of its French Subsidiary (Right Hand Scale). ....	208
Figure 40 – The R&D Department at BÜRKERT exceeded the threshold of 150 actors between 2012 and 2013. ....	218
Figure 41 – Correlation between Organizational Growth and Proximity Dimensions. ....	221
Figure 42 – The FFE of Discontinuous Innovations at 3D PLUS and its Sources of Input.....	231
Figure 43 – Knowledge-Management Structure at 3D PLUS.....	235
Figure 44 – The Three Field Contexts and their Strategy during the FFE of Discontinuous Innovations with regards to the International Dimensions and the Number of Actors Involved. ....	252
Figure 45 – The Dynamic ProxIS-Model (adapted from Neukam and Guittard, 2017b).....	258
Figure 46 – Underlying Dimensions of the Dynamic ProxIS-Model.....	264
Figure 47 - Outline of the Dissertation. Present Part: General Conclusion.....	267
Figure 48 – The Dynamic ProxIS-Model Applied to Bürkert: Initial, Current, and Possible Future Stages.....	274
Figure 49 – Le ProxIS-Télescope et ses éléments fondamentaux (par MN).....	299
Figure 50 – Le ProxIS-Télescope chez BÜRKERT et les mécanismes de coordination relevés (par MN). ....	313
Figure 51 – Le ProxIS-Modèle Dynamique. ....	322

## TABLES

Table 1 – Overview of Central Statements Regarding the FFE of Discontinuous Innovations. ....	51
Table 2 – Extract from Koen <i>et al.</i> (2014): Empirical Studies of Front-End Practices. ....	55
Table 3 – Typology of Multicultural Teams (Chevrier, 2008, p. 349 translated by MN): Correlating Types for FFE Highlighted by MN.....	57
Table 4 – Comparison of the Objectives of the Dissertation and the Field of Economic Geography. ..	62
Table 5 – Comparison of the Interpretivist Paradigm and the Present Research.....	72
Table 6 – Basic Types of Case Studies (Yin, 2003, p. 40). Chosen Type Highlighted by MN.....	78
Table 7 – Case Study Tactics (Yin, 2003) Compared to Practical Solutions for the Dissertation (by MN). ....	82
Table 8 – Eight Steps for Theory Building (Eisenhardt, 1989, p. 533). ....	83
Table 9 – Units of Analysis (Collis and Hussey, 2003, p. 122) Highlighted for the Three Cases (by MN). ....	85
Table 10 – The Project Cases, their Degree of Innovation, the International Degree and the Range of Success. ....	87
Table 11 – Timeline of the Project Cases. ....	88
Table 12 – Six Sources of Evidence: Strengths and Weaknesses (Yin, 2003, p. 88 ff.). ....	91
Table 13 – The Observation Gathering Support Table used during the Case Studies (by MN). ....	93
Table 14 – Example of the Coding Process of the Conducted Interviews.....	96
Table 15 – Comparison of the Three Field Contexts BÜRKERT, ELECTRO, and 3D PLUS.....	97
Table 16 – The BÜRKERT Applications (Bürkert GmbH & Co. KG, 2014).....	99
Table 17 – The Research Questions of the Semi-Structured Project Interviews. ....	103
Table 18 – Structured Interview Guide for Project Interviews (Descriptive Part). ....	105
Table 19 – Structured Interview Guide for Project Interviews (Evaluative Part).....	106
Table 20 – The Interview Phases and the Interviews Conducted. ....	108
Table 21 – Types of Documents Collected at BÜRKERT. ....	110
Table 22 – Data Collection at 3D PLUS.....	114
Table 23 – Data Collection at ELECTRO. ....	117
Table 24 – Overview of the Research Methods for Each of the Three Case Studies. ....	119
Table 25 – Extract of the Coding Process: Verbatim for Coordination Mechanisms. ....	135
Table 26 – Examples of Verbatim Accounts of the Decreasing Market Success.....	151
Table 27 – Examples of Verbatim Accounts of the Decreasing Innovation Structure. ....	152
Table 28 – The Technology Circle at BÜRKERT in Comparison with Bootz (2015, p. 22). Main Observations Highlighted by MN.....	160
Table 29 – Evolution of the Workforce at BÜRKERT (Internal Document).....	163
Table 30 – The Project Cases and their Degree of Cultural Diversity. ....	178

---

Table 31 – Examples of Verbatim Accounts of the Decision-Making Process. ....	182
Table 32 – Strategies Developed by FFE Teams to Deal with National Cultural Differences (x: Strategy Applied in Project). ....	183
Table 33 – Examples of Verbatim Accounts of the Importance of Regular Meetings. ....	185
Table 34 – Overview of the Internationalization Process during the FFE at BÜRKERT. ....	210
Table 35 – Evolution of Non-Spatial Proximity Dimensions per Period. ....	216
Table 36 – Managerial Practices for an International FFE in Growing Teams. ....	222
Table 37 – Examples of Verbatim Accounts of the Notion of Rigor at 3D PLUS. ....	236
Table 38 – Coordination Mechanisms for Non-Spatial Proximity Dimensions during the FFE at 3D PLUS. ....	238
Table 39 – Coordination Mechanisms for Non-Spatial Proximity Dimensions during the FFE at ELECTRO. ....	249
Table 40 – Examples of Verbatim Accounts of the Impact of Size in the Replication Cases. ....	252
Table 41 – The Approximate Number of Actors Involved During the FFE in the Three Companies. ....	253
Table 42 – The Elements of the ProxIS-Telescope and the Coordination Mechanisms in the Three Cases. ....	254

---

## ABBREVIATIONS

ANRT	Association Nationale de la Recherche et de la Technologie
BETA	Bureau d'Economie et Théorique Appliquée
BtoB	Business to Business
BtoC	Business to Consumer
CEO	Chief executive officer
CIFRE	Conventions Industrielles de Formation par la Recherche
ESA	European Space Agency
FFE	Fuzzy Front-End
HR	Human Resources
ICT	Information and Communication Technologies
IT	Information Technology
MN	Marion Neukam (author)
MNC	Multinational Company
NASA	National Aeronautics and Space Administration
NPD	New Product Development
OECD	Organization for Economic Co-operation and Development
PMO	Project Management Office
ProxIS	Proximity in Idea Sharing
ROI	Return on Investment
SME	Small and Medium Sized Enterprises

*“I think we’re going to the moon because it’s in the nature of the human being to face challenges. It’s by the nature of his inner soul... we’re required to do these things just as salmon swim upstream.”*

Neil Armstrong





**PART I**  
**PREPARATION FOR THE**  
**EXPLORATION**

## 1.1 THE CONTEXT: A SPATIAL JOURNEY

*“Globalization brings us in close contact with other cultures. We could experience it as very enriching; but the foreign can also be disturbing.”*  
(Crouch, 2017 translated by MN)

It is indisputable that advances in information and communication technologies (ICT), the creation of free trade areas, and the increasing mobility of people results in nations becoming more interconnected and interdependent with each other. As well as impacting on political configurations, globalization has also brought changes to the realities of business activity (De Brentani *et al.*, 2010). All kinds of organizations, independently of their size or activity, are sensitive to the effects of globalization. However, in contemporary discourses, globalization is being portrayed as both a blessing and a curse for today’s society.

Globalization can be regarded as a blessing because organizations which deliberately made the choice of operating globally had numerous motivations to do so: market advantages created through economies of scale, the specialization of tasks, or the closeness to local markets (Cavusgil *et al.*, 2008; Hakanson and Zander, 1986); the acquisition and generation of new knowledge to foster creative processes (Leenders *et al.*, 2003; Zaheer *et al.*, 2012); or the detection of new opportunities by adapting to local demands (Meyer and Mizushima, 1989). Independently of the motivations which push organizations to go international, researchers argue that this choice is related to higher competitive advantages compared to firms which continue to act locally (Cavusgil *et al.*, 2008).

However, it seems that globalization can also be regarded as a curse. Despite its advantages for international business, globalization has become a buzz-word and has started to take on negative connotations; not only for society but also for organizations. Product life cycles are shortened (Harvey and Griffith, 2007), global competition is tougher than on a local level (Brem and Voigt, 2009; Mudambi *et al.*, 2007), and business has to take into account different commercial, currency, cross-cultural, or country-specific risks which are linked to the governmental and other institutional differences between home and host country business activity (Cavusgil *et al.*, 2008). Management of international activities is considered to be highly complex compared to a local scope of action. Not every company is prepared to face those challenges or the resulting fierce competition.

Nevertheless,

*“unless one assumes a neo-classical, single site firm existing in a homogenous, aspatial world, real world firms encounter problems operating in geographical space”*  
(Howells and Bessant, 2012, p. 930).

Even firms which have decided not to operate on an international level are affected by an increasingly global environment; whether it is due to interactions with international suppliers, third parties, or customers, or because of the increasing mobility of individuals engendering an international workforce (Mayrhofer and Urban, 2011).

In light of this situation, researchers suggest that all types of organizations should focus on their capacity for innovation (Loilier and Tellier, 2013; Mayrhofer and Urban, 2011; Moenaert *et al.*, 2000). It is argued that the only way to survive on the long term in such conditions is the continual development of highly innovative products (Bissola *et al.*, 2014; Kleinschmidt *et al.*, 2007; Malecki, 2010). Such innovative products, also called discontinuous innovations, consist of the range of products that constitute more than just the continuous amelioration of existing products: they integrate a new user benefit, a new technology, or both at the same time (Garcia and Calantone, 2002). Compared to incremental innovations, such products require more effort, as more ideas need to be collected and assessed to generate the one creative idea leading to a discontinuous product concept (Bullinger, 2008). Nevertheless, this greater effort is crucial to assuring an organization’s long-term survival. Incremental innovations, even though they are important for generating short-term cash flows, are not sufficient in order to maintain an organization’s activity over time (Bissola *et al.*, 2014; Kleinschmidt *et al.*, 2007; Malecki, 2010).

As a result, managers should reconsider their innovation processes and create a fertile organizational setting which fosters the continuous generation of discontinuous innovations. It is worth noting that this challenge is not only related to the commercialization strategy of the final product, nor its development. If managers really want to foster discontinuous innovations, they are obliged to start at the early phase of their innovation processes, the ‘Fuzzy Front-End (FFE)’ (Reid and De Brentani, 2004; Veryzer, 1998). This is the first phase of the innovation process before an idea is evaluated to enter the formal ‘New Product Development (NPD)’ process (Khurana and Rosenthal, 1998; Moenaert *et al.*, 1995). Already here, researchers suggest that the difference between incremental and discontinuous innovations is made. They argue that discontinuous innovations emerge *via* a complex

---

bottom-up process from the individual level and then enter into organizational awareness (De Brentani and Reid, 2012; Reid and De Brentani, 2004).

During this early phase and taking into account challenges inherent in globalization, it is not sufficient for organizations to focus exclusively on their local knowledge (Hansen, 2015; Meyer *et al.*, 2011). Already during the FFE, real competitive advantage can only be created by the exploitation of a firm's knowledge assets including knowledge located at its international entities (Brannen, 2009). Researchers argue that the high potential inherent in international knowledge is one of the major motivations for organizations to localize their research and development (R&D) activities abroad to access new business and markets, new resources, and thus their specific international knowledge (Bell and Zaheer, 2007; Gassmann, 2006; Meyer *et al.*, 2011; Mors, 2015; Von Zedtwitz and Gassmann, 2002). The resulting internationalization of an organization's activities therefore nurtures creative processes during the FFE through diversity and represents huge potential for generating discontinuous innovation (Cavusgil *et al.*, 2008; Zaheer *et al.*, 2012). However, it forces managers to act over a larger spatial scale. Despite remarkable advances in information and communication technologies and the shared societal impression that the world is becoming more closely interconnected, researchers claim that the geographic dimension still matters for innovation and confronts managers with significant challenges (Ghemawat, 2003; Howells and Bessant, 2012; Meyer and Mizushima, 1989).

This is the reason why Howells and Bessant (2012) suggest that the two fields of global business and innovation should no longer remain separate and that more overlapping research is required. Regarding this situation, a new research stream has emerged over the last few years in innovation studies which combines the fields of economic geography and management studies to capture the challenges of globalization for innovation. From this perspective, the coordination of knowledge and the role knowledge plays in innovation processes are critical considering that knowledge is the key driver for organizations acting over space (Howells and Bessant, 2012). Consequently, the agenda of this new stream calls for new insights about the coordination of global knowledge and the resulting patterns in order to foster benefits for firm development.

## 1.2 RESEARCH OBJECTIVE OF THE DISSERTATION

*“The effective management of international business is an enduring theme and of central interest to researchers in management in an increasingly globalized world.”*

(Howells and Bessant, 2012, p. 933)

The contemporary economic context of today’s international organizations challenges them to manage their internal knowledge assets during the FFE across the international spatial scale (Kleinschmidt *et al.*, 2007). On the one hand, international knowledge represents huge potential for the generation of discontinuous innovations. On the other hand, this knowledge is dispersed over space as global teams are indeed a true representation of today’s economic reality.

However, informal and interdisciplinary physical encounters are still necessary to generate creative solutions. Geographic proximity between actors is therefore a crucial prerequisite during the FFE of discontinuous innovations (Gassmann and Schweitzer, 2014a; Reid and De Brentani, 2004). Consequently, managers face a paradox as they are urged to balance out the advantages of international knowledge and the requirements for proximity during that phase. These insights lead to the focal research objective of this thesis:

### **The Paradox**

How can international organizations manage the continuous generation of discontinuous product innovations at the fuzzy front-end (FFE) which requires geographic proximity between actors given the fact that this proximity does not correlate with today’s organizational reality?

The FFE is a holistic concept and should also be analyzed as such (Khurana and Rosenthal, 1998). To capture the international dimension during this phase and to reply to the call of Howells and Bessant (2012) that innovation and spatial dynamics should no longer remain separate, this dissertation applies a current model from the field of economic geography, the ‘analytical model of proximity’ (Boschma, 2005). In situations where geographic proximity is inexistent, economic geographers such as Hansen (2015) propose to replace it by non-spatial dimensions, in particular organizational, social, and cognitive proximity.

Similarly, Cohendet *et al.* (2013) analyzed the FFE from the perspective of dynamic capabilities. In their conclusion, the authors suggested that indeed, further research is necessary “*to assess the cognitive, social, and organizational dynamics of the fuzzy front-end*” (Cohendet *et al.*, 2013, p. 145).

With respect to this statement and under consideration of their substitutional effects on geographic proximity, the three non-spatial dimensions are applied to the present research to assure a holistic approach to the FFE. Ultimately, appropriate managerial solutions for organizations acting over space will be derived.

Still, the fundamental prerequisite for a successful FFE across an international spatial scale remains the willingness of management to engage in such a global approach (Boeddrich, 2004). Even though discontinuous innovations are enriched by informal and unexpected encounters, managers should not assume that such activities happen on their own (Kelley *et al.*, 2013). If managers fail to create a fertile organizational environment, knowledge remains in the heads of their employees and cannot be used efficiently (Boeddrich, 2004; Cohendet and Simon, 2007).

Considering, however, the potential of such international knowledge, managers should actively generate an organizational setting:

*“[W]here contributions and knowledge from members in different countries are valued and actively shared across geographic units.”* (De Brentani *et al.*, 2010, p. 152)

Several authors suggest that global teams perform better compared to purely local teams because of a higher diversity (Harvey and Novicevic, 2002; Moenaert *et al.*, 2000; Salomo *et al.*, 2010). However, once strategic decisions are taken to engage in an international approach to the FFE, managers are faced with further challenges linked to international management. For instance, current reasons for global teams’ failure include a misalignment of the team, a lack of clarity, differences in geography, language, and culture, a dearth of the necessary knowledge and skills, and missing trust between team members (Govindarajan and Gupta, 2003). Thus, organizations require consistent coordination mechanisms to correctly manage such global teams during the early innovation phase.

In the following, figure 1 summarizes the previous reflections and illustrates the objective of the present research.

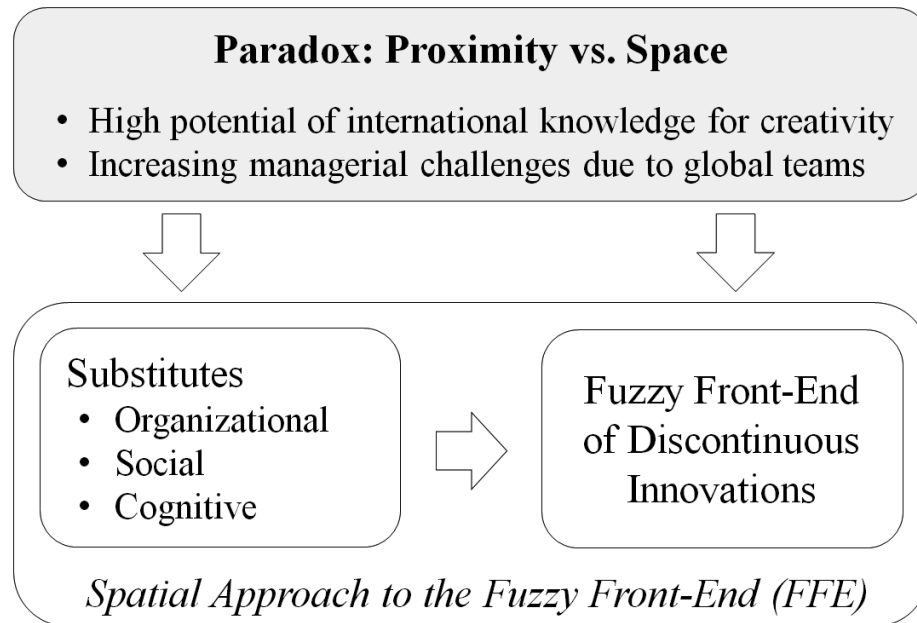

Figure 1 – The Objective of the Dissertation: Resolve a Paradox.

In essence, the spatial approach to the FFE of discontinuous innovations is articulated around two objectives in order to fully reply to the research paradox. Firstly, it analyzes an organizational setting which is beneficial for creativity and innovation during the FFE with regards to the substitutes of geographic proximity, the three non-spatial dimensions. Based on this analysis, a new model is elaborated in this thesis which proposes a first conceptual solution to the research paradox. Secondly, concrete coordination mechanisms will be deduced from this model to support managers in the creation of a fertile organizational setting which is favorable to the generation of discontinuous innovations.



## 1.3 RESEARCH OUTLINE: A MISSION STATEMENT

*“An effective mission statement defines the fundamental, unique purpose that sets a business apart from other firms of its type and identifies the scope of the business’ operations in product and market terms.”*  
(Pearce and David, 1987, p. 109)

It is argued that the research outline of a thesis is in its central reflections similar to an organization’s mission statement (Glahn, 2011). In figure 2, the mission statement of this dissertation, the corresponding components, as well as the resulting outline are presented.

MISSION STATEMENT	COMPONENT	OUTLINE OF THESIS
MOTIVATION	General Introduction	<b>Part I – Preparation for the Exploration</b>
TARGET	Theoretical Foundations	<b>Part II – Theoretical Foundations</b> <div style="display: flex; justify-content: space-around;"> <div style="border: 1px solid black; border-radius: 10px; padding: 5px; text-align: center;"> <b>Chapter 2.1</b> It starts with Innovation         </div> <div style="border: 1px solid black; border-radius: 10px; padding: 5px; text-align: center;"> <b>Chapter 2.2</b> The Fuzzy Front-End         </div> <div style="border: 1px solid black; border-radius: 10px; padding: 5px; text-align: center;"> <b>Chapter 2.3</b> Think ‘Fuzzy’ Act Globally         </div> </div>
ACTION	Methodological Foundations	<b>Part III – The Setting</b> <div style="display: flex; justify-content: space-around;"> <div style="border: 1px solid black; border-radius: 10px; padding: 5px; text-align: center;"> <b>Chapter 3.1</b> Epistemological Foundations         </div> <div style="border: 1px solid black; border-radius: 10px; padding: 5px; text-align: center;"> <b>Chapter 3.2</b> A Case Study Design         </div> <div style="border: 1px solid black; border-radius: 10px; padding: 5px; text-align: center;"> <b>Chapter 3.3</b> The Field Contexts         </div> </div>
PRODUCT	Research Results	<b>Part IV – The ProxIS-Telescope</b> <div style="display: flex; justify-content: space-around;"> <div style="border: 1px solid black; border-radius: 10px; padding: 5px; text-align: center;"> <b>Chapter 4.1</b> Organizational Proximity         </div> <div style="border: 1px solid black; border-radius: 10px; padding: 5px; text-align: center;"> <b>Chapter 4.2</b> Social Proximity         </div> <div style="border: 1px solid black; border-radius: 10px; padding: 5px; text-align: center;"> <b>Chapter 4.3</b> Cognitive Proximity         </div> </div> <div style="border: 1px solid black; border-radius: 10px; padding: 5px; text-align: center; margin-top: 5px;"> <b>Chapter 4.4</b> – Discussion: Complete the ProxIS-Telescope         </div> <b>Part V – Dynamic Extension of the ProxIS-Model</b> <div style="border: 1px solid black; border-radius: 10px; padding: 5px; text-align: center; margin-top: 5px;"> <b>Chapter 5.1</b> – Proximity and Growth         </div> <div style="display: flex; justify-content: space-around; margin-top: 10px;"> <div style="border: 1px solid black; border-radius: 10px; padding: 5px; text-align: center;"> <b>Chapter 5.2</b> Replication Cases         </div> <div style="border: 1px solid black; border-radius: 10px; padding: 5px; text-align: center;"> <b>Chapter 5.3</b> Cross-Case Comparison         </div> </div>
QUALITY	General Conclusion	<b>Part VI – Back to Earth</b>

Figure 2 – Mission Statement of the Dissertation.

The motivation of this dissertation has been elucidated in the previous sections. The research question was placed within its overall context mentioning its core aspects which will be investigated during analysis.

The theoretical purpose of this research is established in **PART II**. To understand the aim of the present research, it is necessary to describe the target and thus the state of the art of the early innovation phase over space. Therefore, PART II starts by providing relevant definitions in the field of innovation management and clarifies the position of this research within this research area. Based on these definitions, it will be explained why the scope of this research is set on discontinuous product innovations. In a second step, the early innovation phase is introduced and the *status quo* of research on the FFE is described. This includes an assessment of existing contributions about differences which were identified in the literature between discontinuous and continuous innovations during the FFE. A third part is dedicated to the field of economic geography with a special focus on the ‘analytical model of proximity’ as the core literature capturing international issues in this dissertation. The bridging element between these streams of literature – the FFE, economic geography and innovation management – is the knowledge-based view of the firm which represents the underlying theoretical approach for the analytical part. This has important implications for the following analysis as it defines a framework where the coordination of knowledge from an internal perspective on organizations matters.

Before providing the research results of this dissertation, the action plan of the present thesis should be established to better understand how the results were achieved. **PART III** elaborates therefore the methodological foundations of the present dissertation. It starts with an epistemological classification within the phenomenological framework and enters then into the chosen research method which is based on a multiple case study design. This includes an in-depth case study in the pilot company BÜRKERT. This is a medium-market company with its headquarters located in Germany. It is active in the industrial field of fluid control systems. This pilot case study is completed by two further case studies. These replication cases challenged the initial research results in two further fields, a small company and a big group, both active in the industrial sector. At the end of this part, all three cases are investigated in more detail to set the terrain for the following analysis. Consequently, **PART IV** and **PART V** present the final results of the research including the three case studies.

Firstly, **PART IV** elaborates the in-depth case study at BÜRKERT. With regards to the observations at the pilot case, I developed what I call the ‘ProxIS-Telescope’ (Proximity in Idea Sharing). This telescope represents a conceptual model which enables managers at the pilot company to coordinate knowledge over space during the early innovation phase. It represents three elements which combine evidences from in-depth investigations on all relevant non-spatial proximity dimensions (organizational, social, and cognitive). These elements are a relationship of trust, the creation of a common platform, and a shared mental model in analogy to the research of Liu and Dale (2009). Simultaneously, PART IV clarifies the resulting coordination mechanisms which were applied at BÜRKERT for each of the three elements. These mechanisms are articulated around a specific form of trust (i.e. swift trust), a hybrid form of internal knowledge communities, and the company’s organizational and professional cultures.

**PART V** starts with the suggestion that the initial coordination mechanisms of the ProxIS-Telescope evolved over time in the pilot case. This dynamic approach to the elements of the ProxIS-Telescope required the integration of the two replication cases into the research framework. PART V therefore displays the varying articulation of the initial elements of the ProxIS-Telescope in the two other case companies, which can be distinguished from the pilot case because of their size. The initial reflections were challenged by these two cases and thus extended for a small and a big company. The processing and reasoning of this multi-case approach resulted in the emergence of a new theoretical model, the ‘Dynamic ProxIS-Model’, which is a dynamic extension of the ProxIS-Telescope.

In **PART VI**, the dissertation guides us from a journey over space back to earth and concludes on the quality of the developed model. This includes reflections about managerial implications and methodological limitations which are, for instance, the restricted generalizability of case-study evidence. That being said, the main interest of PART VI still remains in unfolding the contributions of this research to science and summarizing this dissertation.

The use of a case-study design led to in-depth insight into this new phenomenon which is a spatial approach to the FFE of discontinuous innovations. By considering the holistic dimension based on the analytical model of proximity, this thesis provides appropriate mechanisms which support managers, like a telescope, in their activity to reach for the stars which are their spatially dispersed knowledge assets. Thus, an answer to the initial research

paradox is provided by the ProxIS-Telescope and its dynamic extension. This represents a new solution for management to increase their innovation capacity and thus an organization's long-term survival in a global and spatially extended world.

To provide orientation, the following graphic illustrates the different parts of this dissertation as previously presented. This illustration will be displayed at the beginning of each part and the current part will be highlighted.

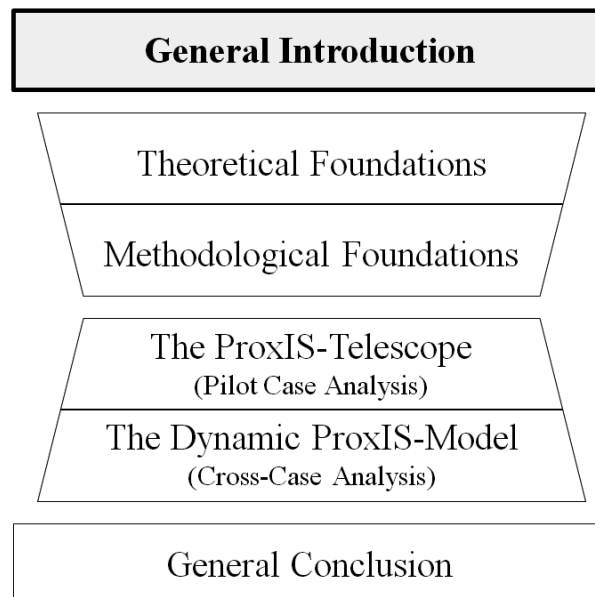

Figure 3 – Outline of the Dissertation. Present Part: General Introduction.

**PART II**  
**THEORETICAL**  
**FOUNDATIONS**

Considering the challenges described in the introductory part, it is necessary to understand the state of the art in the academic literature which led to the formulation of the research question as it was presented in the previous section.

Therefore, the objective of this part is to provide a synthesis of the fundamental theories in the academic fields relevant to this dissertation. This refers primarily to literature about the FFE, in order to define its core concepts and to generate a common understanding. However, this is not sufficient for the theoretical framework. The FFE is part of overall innovation processes within organizations. Therefore, it is necessary to understand which approach to innovation is chosen. Considering that innovation management is a broad field, it is necessary to clearly delimit its frontiers.

**Chapter 2.1** firstly sets out the field of innovation management and provides a theoretical framework for this dissertation. Secondly, **chapter 2.2** focusses on the FFE and the state of the art on this topic in the academic literature. Thirdly, **chapter 2.3** considers the chosen approach to capturing the notion of space during the FFE. Finally, all these elements lead to the underlying research question which, as previously outlined, is formulated as a paradox. For orientation, figure 4 highlights this part of the dissertation which is about the theoretical foundations.

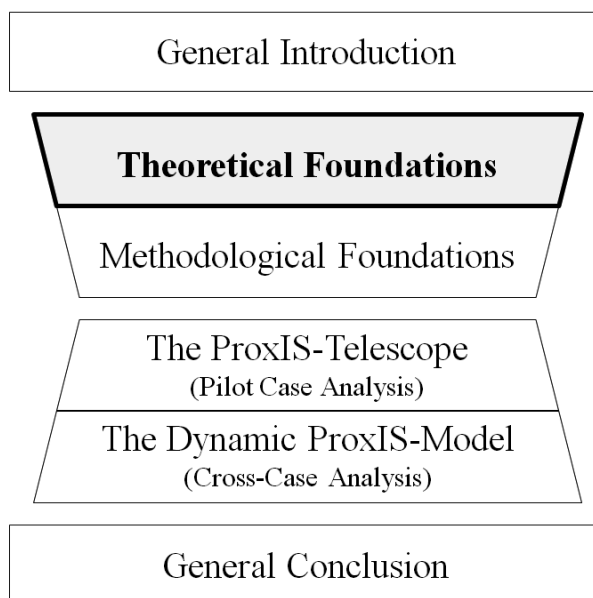

Figure 4 – Outline of the Dissertation. Current Part: Theoretical Foundations.

## 2.1 IT STARTS WITH INNOVATION

*“In less than half a century, the process to generate innovation represents the major area of competition of contemporary capitalism and an essential means to achieving the sustainable development of contemporary companies.”*

(Le Masson *et al.*, 2006, p. 23 translated by MN)

Disruptive innovations spread across the world with incredible speed leading to the situation that existing products are permanently replaced by newer versions (Le Masson *et al.*, 2006). Regarding these tendencies, innovation is a major factor of competition for organizations and this is also why it represents the starting point for this research. Before entering the core subject – the fuzzy front-end of innovation – it is necessary to understand what innovation is in order to clarify the positioning of this research within this broad field. At the end of this chapter, the following questions are answered:

- What is an innovation and what distinguishes it from an invention (**chapter 2.1.1.1**)? This chapter provides a differentiation between the terms invention, imitation, and innovation.
- How to classify innovations and which definition applies in this research (**chapters 2.1.1.2 and 2.1.1.3**)? This question considers the nature of innovation (process innovations, organizational innovations, and product innovations) as well as the degree of innovation (radical/incremental vs. continuous/discontinuous).
- What organizational activities are aimed at generating such innovations (**chapter 2.1.2.1**)? Exploration and exploitation activities are briefly covered.
- Innovation management provides propositions on how to coordinate a firm’s innovation capacities: how can product innovations be generated and where does the difference between discontinuous and continuous innovations come from (**chapter 2.1.2.2**)? These questions are addressed by literature on New Product Development.

At the end of chapter 2.1, the answers to these questions provide – through their delimitations and definitions – a precise approach to innovation as it is used in this research. It highlights the reasons why the interest of this study is focused on the FFE. This will be the transition to chapter 2.2, which analyses this early innovation phase in more depth.

## 2.1.1 INNOVATION: A DEFINITION

*“At least regarding their references, theorists in innovation innovate marginally. There is rarely an article or a book which does not start with an obligatory reminder of the analyses of Schumpeter.”*

(Dumez, 2001, p. 7 translated by MN)

Given that innovation is not only a widespread phenomenon touching many disciplines but is also as old as humanity, there are nearly as many definitions as authors (Bullinger, 2008). The term innovation is used – and sometimes over-used – everywhere. Without a clear positioning, the term loses consistency and becomes a buzz word (Hauschildt, 1993; Le Masson *et al.*, 2006).

The origins of research on innovation in the organizational sciences go back to Schumpeter, who is considered to be the ‘father of innovation’ (Pénin, 2016). As Pénin (2016) points out, Schumpeter’s main contribution is the consideration that a capitalist economy is not stable but instead regularly introduces innovations and is therefore dynamic. Since this initial work, a huge body of literature has examined innovation. Due to the large number of definitions, the Organization for Economic Co-operation and Development (OECD) aimed to find a common consensus and published the 3<sup>rd</sup> edition of the Oslo Manual in 2005, a document which is widely diffused on an international level as a reference for innovation. Here, the OECD defines innovation as follows:

*“An innovation is the implementation of a new or significantly improved product (good or service), or process, a new marketing method, or a new organizational method in business practices, workplace organization or external relations.”* (OECD, 2005a, p. 46).

The OECD proposes a broad definition for a broad concept. While it does not satisfy the demand for a precise delimitation of the concept, it still provides a definition to which most people would agree regardless of their background. Due to its wide field of application, the definition is used on the following pages as a guideline to analyze the concept of innovation by breaking it down into its fundamental elements: the differentiation of an innovation from an invention or imitation, the categories of innovation (product, process, organization, and marketing) together with their application (internal/external to the firm), and finally the degree of novelty (new or significantly improved). This definition will be challenged by comparing it with the prevailing literature in the field of innovation management.



### 2.1.1.1 Innovation Requires Implementation

The Oslo Manual describes an innovation as the implementation of something new. The OECD (2005a) argues that independently of the innovation at hand, this is a central point which is common for all innovations. A new product, a new service, a new process or any other kind of innovation has to be applied somewhere to be classified as an innovation. This dimension is the main difference between an innovation and an invention. According to Schumpeter (1934), an invention requires only the (technical) development of a new product based on creative ideas. The invention stops here. An innovation is more than the technical development of something new: by its implementation it integrates an important economic and social aspect (Garcia and Calantone, 2002; Schumpeter, 1934). An innovation is:

*“[A] discovery that moves from the lab into production, and adds economic value to the firm (even if only cost savings)”* (Garcia and Calantone, 2002, p. 112).

A product innovation is, for instance, a creative idea which has been implemented and introduced into the market, and as such may respond to specific customer needs (De Sousa, 2006; Freeman and Engel, 2007). This requires not only technical knowledge but all kinds of diverse skills such as market knowledge, financial skills, production knowledge, etc. (Fagerberg *et al.*, 2005).

Freeman and Engel (2007) described an innovation as *“a process that begins with a novel idea and concludes with market introduction”* (p. 94). From this perspective and in accordance with Schumpeter, an invention is one part of a bigger process (innovation) but not automatically the most critical one (Pénin, 2016). An invention is only one step in this process and there must be at least an attempt to apply it (in a market or internally in the firm) in order to be classified as an innovation (Hauschildt, 1993; Loilier and Tellier, 2013; OECD, 2005a). Hence, it is rather a question about management and the coordination of several skills/competencies than about a pure technical concern (Pénin, 2016). In essence, scholars claim that an innovation is implemented somewhere; in a market, in the internal structure of an organization, in production processes, etc. Similarly, Bullinger (2008) argues that it can be distinguished from an invention, which is only the physical or technical part of innovation.

### 2.1.1.2 Categories of Innovation

According to the Oslo Manual, there are four categories of an innovation: product innovations (services and goods), process innovations, marketing innovations and organizational innovations (OECD, 2005a). A similar classification *via* innovation categories was also done by Schumpeter (1934); but instead of four, he distinguished five types of innovation considering new sources of supply as equally innovative (Fagerberg *et al.*, 2005). Similar typologies have emerged in the literature, but many of them concentrate exclusively on product and process innovation where the latter has been characterized to produce the former (Fagerberg *et al.*, 2005). However, some scholars agree that a third category should be included: organizational innovation. Organizational innovation does not only occur inside a firm, it is also possible that organizational innovation modifies entire fields of industry (Fagerberg *et al.*, 2005). Several similar typologies are found in the innovation literature (see also Christensen, 1997; Tushman and O'Reilly, 2002); but almost all of them exclude marketing innovations (see Bullinger, 2008; Loilier and Tellier, 2013; Lundvall, 1992). Bullinger (2008) argues that marketing innovations are often considered to be a combination of the three other types. Product innovations generate competitive advantage and are designated for the external environment of a firm (Bullinger, 2008). Nevertheless, the term 'implementation' does not only refer to the commercialization of a new product. In the case of process or organizational innovations, a new idea might as well revolutionize the internal structure of a company or an industry.

These categorizations provide insight into the vast impact of innovation on firms and on their external environment. However, as each category is linked to different challenges, different actors and/or different applications, there are different ways to deal with them. All types of innovation merit equal attention due to their impact on organizations, but in order to respond to the necessary in-depth investigation of this thesis, a delimitation is required. This is the reason why the focus in the present dissertation is on product innovations. This choice is based on the fact that this is the prevailing type of innovation in the company cases.

<p>This thesis considers product innovations and thus physical objects which are commercialized or which are at least intended for launch on the market. To assure sufficient care is taken regarding the topic, new services or other categories of innovation (process/organizational) are not considered.</p>
--

Product innovations are perceived as novel compared to existing products on the market (Loilier and Tellier, 2013). Product innovations are new products or products integrating

sensible modifications compared to what is currently available, generating a user benefit for customers (OECD, 2005a). This definition excludes seasonal changes or designs which do not significantly change the functionalities of a product (OECD, 2005a). A specific example of this is the high-tech industries, where product innovations do not target an innovation that is radically different for the market but primarily sustain the present activity (Christensen, 1997). Christensen (1997) uses the example of the Hard Disk Drive industry where the market continually demands increasingly powerful products. In this case, new products provide the exact same user benefit, but important efforts are necessary in order to reach this target.

### 2.1.1.3 The Degree of Novelty

Although the example dates from 1997, the Hard Disk Drive industry still illustrates that product innovations represent something radically new or sustain the core activity of organizations (Christensen, 1997). In fact, this example anticipates another way to classify innovations: by their degree of novelty.

Different types of innovation have varying impacts on an industry. An increased memory capacity of a new USB stick is less revolutionary than the first USB stick. The latter represents a radical innovation whereas its improvement is classified as incremental innovation. In the case of product innovations, radical innovations are new products where new knowledge or know-how was mobilized (Loilier and Tellier, 2013). If a new version of an existing product obtains a significant improvement in its performance, it is an incremental innovation (Loilier and Tellier, 2013). Scholars suggest that these kinds of innovation rely mainly on knowledge that already exists within the company (Song and Montoya-Weiss, 1998; Verworn *et al.*, 2008). As incremental innovations assure the continuity of the business of a firm, the term continuous innovations is used henceforth (Veryzer, 1998).

Notwithstanding, the opposite of continuous innovations – *discontinuous innovations* – is not a synonym for radical innovations: multiple terms exist in the literature (Veryzer, 1998). For instance, Loilier and Tellier (2013) point out that radical innovations have a revolutionary character, but some radical innovations have a deeper impact on society than others. From this perspective, the digital camera caused the bankruptcy of leading companies in the analog photography industry (Loilier and Tellier, 2013). Scholars refer in such cases to game changers, which they describe as breakthrough or disruptive innovations (Christensen, 1997; Loilier and Tellier, 2013; Utterback and Acee, 2005). Utterback and Acee (2005) perceive,

however, the compact disc as a radical innovation due to its revolutionary dimension but do not consider it a game changer. Consequently, the distinction between ‘new’ and ‘significantly improved’ in the Oslo Manual is not specific enough (Crawford and Di Benedetto, 2011). A resulting juxtaposition between incremental and radical innovations is not sufficient to capture entirely the degree of novelty (Loilier and Tellier, 2013).

In many cases, scholars refer to the degree of technological newness (Veryzer, 1998). For instance, Crawford and Di Benedetto (2011) distinguish between first-to-market products, adaptations, and imitations, which differ according to their degree of technology. Also, the Oslo Manual specifies the term ‘new’ in more detail on subsequent pages. The document defines the novelty of an innovation *via* three aspects: new for the firm (lowest level of novelty), new to the market, and new to the world (highest level of novelty). Regarding the notion of new to the market, it is mentioned that it depends on the operational market of a firm which can be geographically limited or include international markets depending on the scope of the firm. This differentiation is similar to the notion of technological newness, but it acknowledges that non-technical solutions could sometimes be more innovative than products by integrating a radically new technology (Loilier and Tellier, 2013). This is why the Oslo Manual extends the definition of radical innovations as follows:

*“[A radical innovation] can be defined as an innovation that has a significant impact on a market and on the economic activity of firms in that market. This concept focuses on the impact of innovations as opposed to their novelty.”* (OECD, 2005a, p. 58)

Consequently, besides the technical dimension of an innovation, another dimension has to be taken into account: its impact referring in the case of product innovations to the market perspective. Thus, innovation not only has an effect on established firms, but equally on customer behavior (Markides and Geroski, 2005). Loilier and Tellier (2013) capture the degree of novelty of an innovation using two dimensions: newness of the technology and newness of the business model. Veryzer (1998) uses two similar axes for product innovations: the technology capability of a new product and its product capability. The former is consistent with the degree of technology outlined by many scholars, whereas the latter describes a new user benefit. Regarding this typology, continuous innovations provide new features for an existing technology and the same user benefit. They generate short-term cash flows for organizations and are easy to implement (Reid and De Brentani, 2004). Discontinuous innovations integrate a new technology, a new user benefit, or both (Veryzer, 1998). In their

comprehensive literature review, Garcia and Calantone (2002) build on this typology and develop it slightly further. According to their modified typology, only new products which are technologically and commercially discontinuous are radical innovations. A new product with a new technology or a new user benefit is classified as a ‘really new innovation’ (Garcia and Calantone, 2002). Several scholars suggest that all three types of discontinuous innovations give organizations the edge over their competition and are important for their long-term survival (Garcia and Calantone, 2002; Reid *et al.*, 2014; Veryzer, 1998).

In the typology of Loilier and Tellier (2013), the confusion between the terms ‘radical’ and ‘disruptive’ is obvious; even the OECD uses both terms as synonyms. To avoid further confusion, this dissertation refers henceforth to the framework of Garcia and Calantone (2002) based on the typology of Veryzer (1998). This choice is motivated by several reasons. Firstly, Garcia and Calantone elaborate their typology based on a thorough literature review. Furthermore, they argue that the newness of a product can be classified independently of later market success. Even before its launch, an organization can determine if the product integrates a new user benefit and/or a new technology. The impact on the market mentioned by the OECD can only be measured (sometimes long) after the market introduction. This represents a methodological problem for empirical studies with limited time frames such as in the case of this dissertation. A typology in line with Garcia and Calantone (2002) resolves this methodological issue. With regard to the fact that the authors focus on product innovations, their framework is indeed perfectly adapted to this dissertation.

Continuous and discontinuous innovations are important for organizations. However, it is argued that less information about market needs is available for discontinuous innovations (Verworn *et al.*, 2008). Scholars claim that the resulting managerial differences impact the whole innovation process from the beginning (Reid and De Brentani, 2004; Veryzer, 1998), through development (Crawford and Di Benedetto, 2011; Verworn *et al.*, 2008), until commercialization (Christensen, 1997; Utterback and Acee, 2005). Hence, the decision was made in this dissertation to concentrate only on one type: discontinuous innovations. These are explicitly addressed because they are closely linked to an organization’s long-term survival (Reid *et al.*, 2014), and because they remain less intensively explored than continuous innovations (Reid and De Brentani, 2004).

<p>The focus of this dissertation is on discontinuous innovations. They are radical as well as really new innovations and provide a new technology, a new user benefit, or both at the same time.</p>
---

## 2.1.2 THE INNOVATION PROCESS

*“Scholars in the field of innovation have traditionally viewed innovation as an information processing activity”*  
(Moenaert *et al.*, 2000, p. 363).

The innovation process describes successive sequences of activities to transform an idea into a product, which is then launched on the market (Loilier and Tellier, 2013). Analysis of Apple or other creative companies appear to suggest that they seem to be able to launch highly innovative products almost instantly (Crawford and Di Benedetto, 2011). From this perspective, traditional management approaches seem no longer to be appropriate and organizations need to find new solutions to continually generating innovations (Le Masson *et al.*, 2006).

In the following section, exploration and exploitation activities are distinguished before presenting fundamental innovation processes such as the Stage-Gate process of Cooper (1990). Afterwards, a brief note about open innovation and crowdsourcing elucidates that innovation processes should no longer concentrate exclusively on the internal world of a company but be opened up to include its external environment. This section ends with the introduction of the concept of the FFE as the fundament for the difference between discontinuous and continuous innovations.

### 2.1.2.1 Exploration vs. Exploitation Activities

Regarding the assumption that continuous and discontinuous innovations require different skills, organizations need a clear strategy to balance out their innovation efforts. Is the main activity of an organization to explore new possibilities or to exploit existing ones? This question leads to an important discussion in the literature about the ambidexterity between two distinct kinds of activities. This dilemma goes back to March (1991) who clarified the trade-off between exploration and exploitation. According to his research, exploration is necessary in order to identify new alternatives for existing practices, create a new technology, and engage in experimentation. Exploitation activities, however, increase competencies about a known technology. They create routines. He argues that their balance is a question about the distribution of scarce resources, but also about costs and benefits. Exploration activities are associated with high costs. If an organization concentrates entirely on this type of activity, costs cannot be transformed into benefits. Exploitation activities transform these efforts into

concrete benefits, but no new alternatives are investigated. March (1991) also argues that exploration is long-term oriented whereas exploitation has a short time horizon. The implementation of the latter is easier and rapidly beneficial for companies, but not sufficient to maintain an organization's activity. This distinction is important for this dissertation because in the literature, the terms exploration/exploitation and continuous/discontinuous (or incremental/radical depending on the position of the author) are sometimes confusingly used as synonyms (Calantone and Rubera, 2012).

Exploration activities are internal activities of an organization to accumulate new knowledge. This knowledge might be used for discontinuous as well as for continuous innovations. It is possible that exploration activities do not lead to discontinuous innovations whereas exploitation activities may result in highly innovative solutions (Calantone and Rubera, 2012). In addition, it is possible that the results of exploration activities are integrated into a product which is classified as a discontinuous innovation and at the same time into a product which is a simple improvement of an already existing technology.

Overall, discontinuous innovations are not necessarily the result of exploration activities. Still, there is a correlation between the creation of new knowledge (exploration) and the integration of a new technology and/or a new user benefit (discontinuous innovation). Consequently, exploration activities are of important interest for this dissertation.<sup>1</sup>

As this thesis concentrates on the generation of discontinuous innovations, the focus lies on exploration activities as they are aimed at the acquisition of new knowledge. These activities are fundamental for an innovation process leading to discontinuous innovations.

---

<sup>1</sup> Several scholars propose solutions for ambidexterity between exploration and exploitation activities (e.g. Gibson and Birkinshaw, 2004; O'Reilly and Tushman, 2004). For reasons of brevity and space this dissertation is not able to enter into more detail.



### 2.1.2.2 The New Product Development (NPD) Process

Existing innovation processes are as numerous as the definitions about innovation. Depending on the innovation at hand, but also on the context of the company (size, strategy, etc.), innovation processes may differ (Pavitt, 2005). In general, the innovation process is a set of activities organized in a temporal succession (Bullinger, 2008). As the decision was made here to concentrate on new products, the underlying innovation process for this dissertation should also focus on processes for new products. One of the most widely diffused processes is the Stage-Gate process developed by Cooper (1990) and Cooper and Kleinschmidt (1990). This Stage-Gate process describes the alignment of activities in several stages. After each stage, the idea passes a gate which represents a Go/No-Go decision. They distinguish five stages: preliminary assessment, detailed investigation preparation, development, testing and validation, and full production and market launch.

Similar approaches in five stages are used elsewhere in the literature (e.g. Herstatt and Verworn, 2003; Wheelwright and Clark, 1992). In accordance with existing models, Crawford and Di Benedetto (2011) summarize them as follows: opportunity identification and selection, concept generation, concept/project evaluation, development (includes both technical and marketing tasks), and launch. From this perspective, the innovation process starts with an idea and ends with its commercialization. These activities can be synthesized into three subsequent phases (Koen *et al.*, 2001; Pavitt, 2005):

- The pre-development phase or the fuzzy front-end (FFE) of innovation;
- The New Product Development (NPD); and
- The commercialization phase.

The literature on innovation proposes a clear set of methods and models to manage the second phase, the NPD. However, attention has shifted in the last few years towards the consideration of innovation as a whole, where the detection of opportunities and the acquisition of new competences are equally crucial (Le Masson *et al.*, 2006). By analogy with the model of Wheelwright and Clark (1992) shown in figure 5, many scholars refer to a funnel filtering ideas little by little when describing the innovation process (Bullinger, 2008; Loilier and Tellier, 2013).<sup>2</sup>

---

<sup>2</sup> For an overview, see also Boeddrich (2004) and Brem and Voigt (2009).



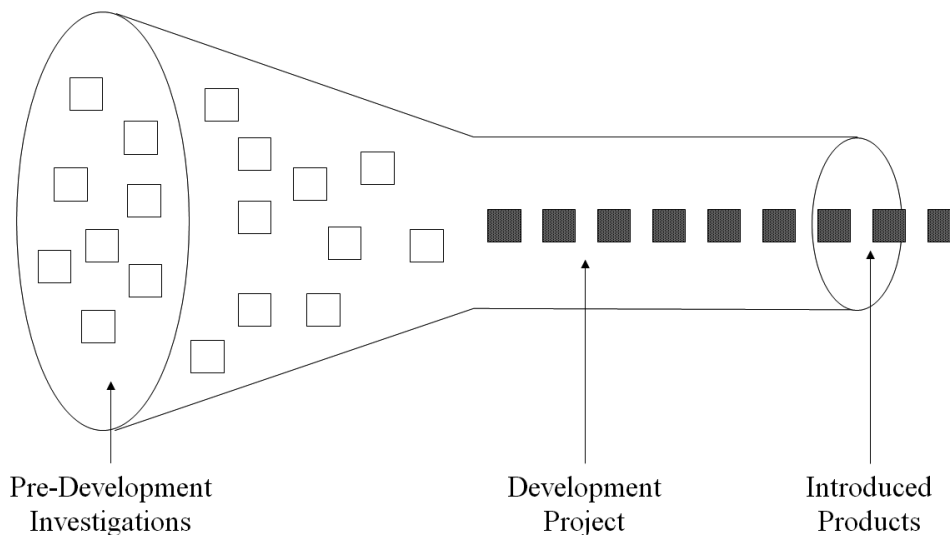

Figure 5 – The Development Funnel of Wheelwright and Clark (1992, p. 112).

From this perspective, many ideas should enter the process but only a few of them should be launched (Loilier and Tellier, 2013; Wheelwright and Clark, 1992). This underlines one of the main difficulties for organizations: selecting the best ideas. Indeed, scholars underline that the main challenge for organizations is in most cases not to create new ideas, but to select the best ones as early as possible and to insert them into the NPD (Reinertsen, 1999; Rice *et al.*, 2001).

Furthermore, most representations of the innovation process suggest a linear follow-up of activities. However, in order to explain what innovation is *not*, Kline and Rosenberg (1986), demonstrated the limits of such linear approaches. As innovation is complex, it is not possible to apply a process which fits all types of innovation. In addition, innovation is generated from iteration, feedback-loops, and steps back and forth within the process (Crawford and Di Benedetto, 2011). As a result, scholars underline a non-sequential and iterative interpretation of their innovation processes (see for example Cooper, 2008).

A further point to note about the innovation process is its internal or external orientation. Many models do not explicitly address this problematic, but fundamental changes in society ask for fundamental changes in innovation processes. From this perspective, Chesbrough (2003b) claimed that it should be mandatory for organizations to open up their innovation processes towards the external environment. His open innovation model seeks to integrate external knowledge into the internal innovation process ('outside-in') and at the same time add value of the internal competencies in the external environment ('inside-out'). He pronounced the necessity of collaborative projects with external partners. In the years

following this research, the opening of the innovation process, together with technical evolutions of the internet, led to new approaches, for instance, crowdsourcing.

By using this mode to innovate, an organization makes an open call to the public (i.e. the crowd) (Loilier and Tellier, 2016). The crowd is anonymous and consists of several heterogeneous participants (Guittard and Schenk, 2010). Different roles might be attributed to the crowd, depending on the output an organization wishes to mobilize. This might concern clearly innovative and creative activities leading to new solutions, access to further content, or simply access to time and further resources (Burger-Helmchen and Pénin, 2011). In essence, such open forms are becoming increasingly current in today's business practices as they adapt to a dynamic world where resources are dispersed all around the world and where technology develops more and more rapidly (Chesbrough, 2003b).

In conclusion, product innovations emerge *via* a broad process which requires different competences at different moments in time. The opening up of the innovation process gains increasing importance for research as well as for practitioners. The development phase is a well-known process with a huge body of literature about suggestions and implications for management. In contrast, the first phase of the innovation process – the fuzzy front-end – has earned less attention (Cohendet *et al.*, 2013).

However, it has been observed already here that discontinuous product innovations do not follow the same pathway as continuous innovations (Crawford and Di Benedetto, 2011; Kelley *et al.*, 2013; Reid and De Brentani, 2004; Veryzer, 1998). Some authors claim that whereas a process approach based on quantitative methods seems adequate for continuous innovations, a qualitative and learning-based approach should be used for innovations with higher technological and/or market uncertainty (Verworn and Herstatt, 1999). Uncertainty is understood here as:

*“[T]he difference between the amount of information required to perform a particular task, and the amount of information already possessed by the organization”*  
(Galbraith, 1974, p. 28).

Verworn *et al.* (2008) argue independently that if an organization is confronted by a discontinuous or a continuous innovation, activities at the FFE reduce uncertainty to the same extent in both cases before entering development. Nonetheless, the authors acknowledge that at the beginning of the innovation process, uncertainty is higher for breakthrough products

than in the case of continuous innovations. Therefore, the FFE of discontinuous innovations is expected to take more time and involve greater efforts to reduce that uncertainty (Verworn *et al.*, 2008). Contrastingly, Kelley *et al.* (2013) argue that the FFE is exactly the same for both types of innovation until new knowledge is integrated into the FFE. Only up until then can the process change its pathway leading to a discontinuous innovation.

Finally, Reid and De Brentani (2004) unfold the idea that from the very beginning of the innovation process, the approach to continuous compared to discontinuous innovations is not the same. In the case of continuous innovations, strategic decisions at the organizational level initiate the innovation process at the operating level ('top-down'):

*“This is because technological and/or market conditions can more readily be anticipated, studied, and communicated at the organizational level”* (De Brentani and Reid, 2012, p. 71).

The researchers go on to argue that discontinuous innovations, on the other hand, enter the organizational sphere *via* individuals at the boundary of the firm. In a bottom-up process, information passes *via* several gates before arriving at the organizational level (De Brentani and Reid, 2012; Reid and De Brentani, 2004). Regarding these varying pathways, scholars suggest that organizations should already focus on this phase if they want to generate discontinuous innovations. For this reason this dissertation concentrates on the FFE as key to the innovation process considering that the scope of this research is about discontinuous innovations.

Regarding the innovation processes of new products, this dissertation focusses on the first phase of the process, which is the 'fuzzy front-end', as already at this moment discontinuous innovations take a different pathway compared to continuous innovations.

### 2.1.3 THE SCOPE OF THIS RESEARCH

The objective of this chapter was to position the dissertation in its overall context. The delimitations applied were necessary to provide an unambiguous contribution to this field.

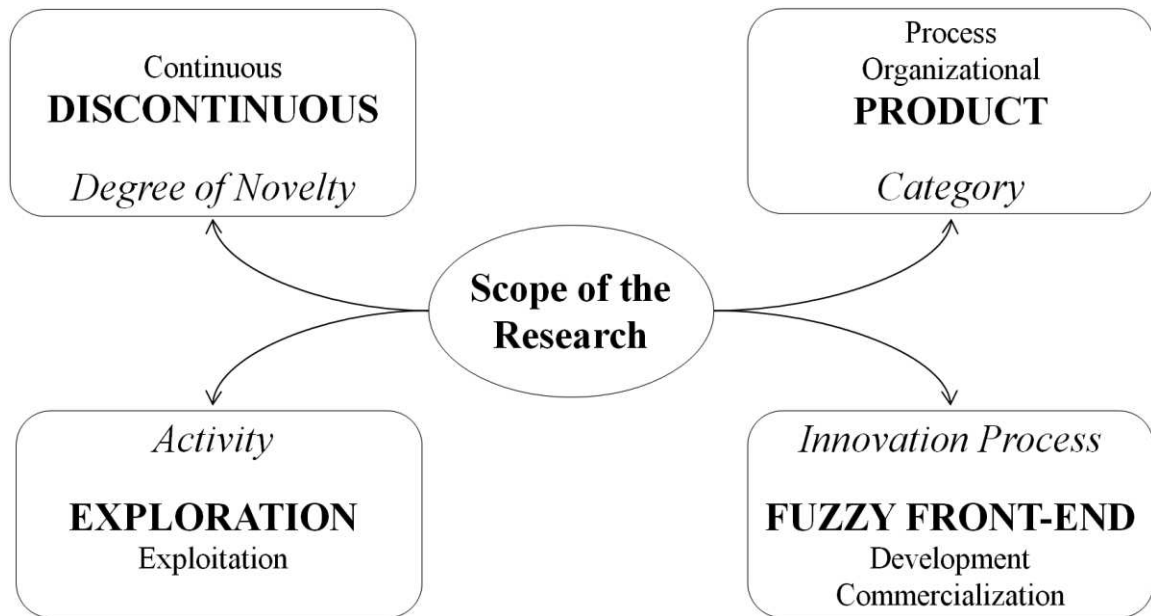

Figure 6 – Scope of the Research.

As illustrated in figure 6, the focus lies in product innovations as the company cases maintain their competitive position mainly *via* the development of new products. Discontinuous innovations are of major interest for this research because of their potential to sustain the activity of the companies over time. This effect is reinforced by actual evolutions of global markets leading to severe global competition and a rapid shortening of product life cycles. Considering exploration compared with exploitation activities, it has been illustrated that a company may orient its business towards innovation by fostering the generation of new knowledge and not only the exploitation of existing knowledge assets. Finally, the assumption has been reinforced that it is neither during the commercialization phase, nor during the development phase of the innovation process that the distinction between both innovation types is made. As previously elucidated, several authors claim that the fundamental difference is already made at the fuzzy front-end, the first phase of the innovation process. The following chapter provides an overview about current research on the FFE which all primarily has the objective of reducing the fuzziness of this underexplored phase of the innovation process (Cohendet *et al.*, 2013).

## 2.2 CLARIFYING A FUZZY CONCEPT: THE FUZZY FRONT-END

“‘Fuzzy’ – Definition:

[1] *Having a frizzy texture or appearance.*

[2] *Difficult to perceive; indistinct or vague.*

[3] *(of a person or the mind) unable to think clearly; confused.”*

(Oxford Dictionaries, 2016a)

As organizations need innovations to pursue their business *vis-à-vis* global competition, they are increasingly interested in powerful strategies to maintain it. However, their strategic reflections rarely concentrate on the fuzzy front-end (FFE). Later innovation phases like the new product development or commercialization phases are generally well covered, but there is still a lack of awareness of the high potential at the FFE (Gassmann and Schweitzer, 2014a). Improvements in this phase enhance the competitive advantage of an organization (Reid and De Brentani, 2004); it represents the highest potential for saving time and money (Smith and Reinertsen, 1992); or it simply improves the overall innovation capacity of an organization (Cooper and Kleinschmidt, 1987; Harvey *et al.*, 2015; Kim and Wilemon, 2002; Koen *et al.*, 2001; Verworn *et al.*, 2008).

In this chapter, the theoretical framework of the FFE is set out. Firstly, the concept of the FFE is embedded in the context of the innovation literature, which results in a definition of the FFE as it is used in this dissertation (**chapter 2.2.1.1**). In a second step, prevailing models in the current literature are identified (**chapter 2.2.1.2**). Afterwards, critical reflection is provided on the issue of whether the distinction between continuous and discontinuous innovations is already made at the FFE. After justifying the choice of the knowledge-based view of the firm (**chapter 2.2.2.1**), the main differences at the FFE between the two types of innovations are laid out (**chapter 2.2.2.2**). Finally, a common understanding of the FFE concept is obtained (**chapter 2.2.3**) in order to remove its conceptual ‘fuzziness’ before entering any empirical investigations.

## 2.2.1 A MULTITUDE OF DEFINITIONS

*“It is impossible to improve a process if one does not have a way of discussing or sharing it.”*  
(Koen *et al.*, 2001, p. 53)

When considering a three-stage model of the innovation process such as proposed by Koen *et al.* (2001), the FFE represents the first phase of innovation. The concept of the FFE initially came into academic awareness in the work of Cooper and Kleinschmidt (1987). By comparing successful and failed new product developments, they identified predevelopment activities as one of the most critical success factors for organizations:

*“One implication is that management must recognize the importance of these up-front steps, and be prepared to devote the necessary resources – people, time, and money – to see that they are carried out well.”* (Cooper and Kleinschmidt, 1987, p. 181)

In the following years, the same authors strengthened their results *via* an extensive empirical study. Their insights led to an increasing body of academic work on this topic. What they called ‘pre-development activities’ has also been described as ‘pre-phase Zero’ (Khurana and Rosenthal, 1998) or ‘pre-project activities’ (Verganti, 1997). Only with the work of Smith and Reinertsen (1998) did the term ‘fuzzy front-end’ emerge and then become widely diffused. According to the authors, the attribute ‘fuzzy’ portrays the extensive challenges for scholars as well as for managers in innovative organizations. From a managerial point of view, ‘fuzzy’ is a coherent description for this phase because:

*“[I]t is a crossroads where complex information processing, a broad range of tacit knowledge, conflicting organizational pressures including cross-functional inputs, considerable uncertainty, and high stakes must meet”* (Khurana and Rosenthal, 1998, p. 72).

In organizations, the New Product Development is well-defined (Cohendet *et al.*, 2013). Clear processes and structures such as the Stage-Gate process are broadly accepted (Gaubinger and Rabl, 2014). This is not the case for the FFE: this phase is – as the name indicates – fuzzy, dynamic and therefore less structured or formalized (Gaubinger and Rabl, 2014; Murphy and Kumar, 1997). If an organization wants to improve significantly its innovation processes and thus its competitive advantage, focusing on the FFE should be its

main concern (Cooper and Kleinschmidt, 1987; Kim and Wilemon, 2002; Koen *et al.*, 2001; Reinertsen, 1999; Verworn *et al.*, 2008).

Since the work of Cooper and Kleinschmidt in 1987, diverse approaches to capture this fuzzy phase have emerged; providing similar but still slightly varying definitions. The ‘fuzziness’ – e.g. the imprecise perception – of these definitions is mainly linked to difficulties in delineating the starting point of this phase. By considering it as part of the innovation process, its end point is consistent for all definitions. In Cooper’s Stage-Gate process, it ends with the Go/No-Go decision initiating the development process (Cooper, 1990). This correlates with the definition of Smith and Reinertsen (1992), where the FFE ends “*when we mount a serious effort on the development project*” (p. 49). The decision to invest resources in a new product concept is therefore the critical milestone before an idea enters the development process (see also Markham, 2013; Moenaert *et al.*, 1995; Reinertsen, 1999). Less consistency exists regarding the initiation of the FFE. One of the most cited definitions of Kim and Wilemon (2002) remains rather broad:

*“[W]e define the FFE as the period between when an opportunity is first considered and when an idea is judged ready for development”* (Kim and Wilemon, 2002, p. 270).

This definition does not specify by whom the opportunity is first considered: is the organization aware of the idea or is there an individual within the organization who identified an opportunity? The initial work of Cooper and Kleinschmidt considers that the initial idea already exists and has to be refined. The definition of Smith and Reinertsen (1998) is quite similar in that it describes the starting point only as the moment “*when the opportunity is known*” (p. 49). Also the definition of Moenaert *et al.* (1995) integrates the assumption that the phase starts when an initial idea already exists within the company.

However, Khurana and Rosenthal (1998) describe the idea generation together with the market and technology analysis and the definition of the product/portfolio strategy as the starting point of the innovation process. This is also consistent with the research of Murphy and Kumar (1997), which includes idea generation in the FFE. Since then, the creative generation of an idea has been integrated into the FFE by many authors (Brem and Voigt, 2009; Bullinger, 2008; Florén and Frishammar, 2012; Harvey *et al.*, 2015; Reid and De Brentani, 2004). To take yet another step in this direction, Eling *et al.* (2013) even claimed that the major tasks during the FFE are congruent to creative processes.



### 2.2.1.1 Towards a Common Definition

A first attempt to reduce the fuzziness within these definitions was made by Koen *et al.* (2001). By providing the ‘New Concept Development’ model, the authors argue that FFE activities can be performed in a non-linear manner. According to their research, the FFE consists of:

*“[T]hose activities that come before the formal and well-structured new product and process development (NPPD) or stage gate process”* (Koen *et al.*, 2001, p. 49).

However, the order in which activities are performed is of less significance. Either the FFE is initiated by the identification of a promising opportunity; or it starts with an idea without responding to a specific opportunity or a pre-defined problem. Even if Koen *et al.* (2001) agree that the *“activities are often chaotic, unpredictable and unstructured”* (p. 49), they claim that their approach limits the fuzziness of the front-end. To underline this, they introduced the term ‘front-end of innovation’ (FEI) and removed the term ‘fuzzy’.

This dissertation is in accordance with definitions that include idea generation in the FFE; even if this step is conducted beyond an organization’s awareness. Regarding the terminological designation of this phase, this dissertation will continue to apply the term ‘fuzzy front-end’. Koen *et al.* (2001) made a compelling argument and indeed limited significantly the nebulous character of this phase *via* a universal definition. Still, the attribute ‘fuzzy’ is maintained in this dissertation in accordance with Bullinger (2008) who argues that:

*“[F]uzzy even onomatopoeically indicates the diffuse, creative, dynamic and unstructured activities typical for the early phases”* (Bullinger, 2008, p. 35).

From a similar perspective, Gassmann and Schweitzer (2014b) pointed out that the fuzziness of this phase is not necessarily considered as a barrier but it characterizes critical potential for creativity. In accordance with this positive perception of fuzziness, the term ‘fuzzy front-end’ or FFE will henceforth be used in this dissertation.

**Definition: The Fuzzy Front End (FFE)**

The fuzzy front-end comprises all activities until the moment when an idea enters the NPD process after the official Go/No-Go decision on the organizational level. This includes the creative process during idea generation, even when it occurs outside an organization’s awareness.



## 2.2.1.2 Diversity of Models: From Process Approaches to Dynamic Capabilities

The frontiers of the FFE have been set up, but it is still not entirely clear what happens within this phase. Many models concentrate on a procedural alignment of tasks, but the research of Koen *et al.* (2001) weakens the perception that the FFE is only the alignment of specific tasks. Furthermore, current models confront the dilemma between space for creativity and a systematic approach (Gaubinger and Rabl, 2014; Verworn and Herstatt, 1999). This paragraph provides an overview about principal models from those dealing with process, decision-making and role models, to less structured approaches based on dynamic capabilities and bootlegging.

### 2.2.1.2.1 Process Models

Historically, academics focused on core activities at the FFE. Cooper and Kleinschmidt (1987, 1994) distinguished five activities which take place in the early phases of the Stage-Gate process mentioned earlier. The research of Cooper and Kleinschmidt has provided evidence in theory and in practice that their systematic approach helps organizations to increase the success of their innovation processes. However, its rigidity is often criticized as it does not provide sufficient flexibility (Verworn and Herstatt, 1999). From a similar perspective, Khurana and Rosenthal (1998) identified three activities – idea generation, market analysis, and technology appraisal – as core tasks of the pre-phase zero which ends in a feasibility study and project planning before the Go/No-Go decision and the New Product Development starts.

Disregarding slight variations, similar core activities are current in the FFE literature in other process perspectives with differing levels of complexity (Brem and Voigt, 2009). Compared to these models, the New Concept Development (NCD) of Koen *et al.* (2001) entails a differential approach. Even though the authors consider opportunity identification and analysis, idea generation and selection, and concept and technology development as core activities of a successful FFE, they apply an iterative framework instead of aligning tasks in a sequential process. At the end of the FFE, all five activities should be executed, but within the FFE, actors are given flexibility to absolve them in a way which suits the situation at hand.

Gaubinger and Rabl (2014) compared the three prevailing process approaches of Cooper, Khurana and Rosenthal as well as Koen *et al.* assessing their relative weaknesses and

strengths. Based on this comparison, the authors developed a new conceptual design of the FFE to overcome the shortcomings of the three models. In their holistic framework, they not only include a flexible shift from incremental to radical innovations, but they also introduce technology development as a separate activity. At a specific routing gate (RG), the decision is taken if a technology development, a concept development or a lean concept development project is started. This decision depends on the level of novelty of the potential project and on its level of risk (Gaubinger and Rabl, 2014).

Consequently, it is possible to adapt the process to the specificities of the idea. Not all ideas need development of a technology in advance of the concept development, but in some cases, such a project might be necessary to learn more about a new idea before development.

#### **2.2.1.2.2 Role Models and Decisional Models**

Instead of concentrating on tasks, Markham *et al.* (2010) describe the FFE as a gap between research and commercialization. They call this gap the ‘Valley of Death’ and claim that the most important difficulty for organizations is to get past this gap. Thus, they propose a consideration of the roles of actors instead of activities:

*“By understanding the ‘front-end’ as being aspects of a valley or gap between parts and roles of the organization rather than as a set of preparatory tasks, practitioners are better able to design processes to cross that valley”* (Markham *et al.*, 2010, p. 403)

By applying role theory, they propose that the roles of idea champion, idea sponsor, and gatekeeper are fundamental to crossing the Valley of Death. The three roles are interdependent and managers should identify them internally to make resources available and to assure the transition from the FFE to development.

From a similar perspective, Reid and De Brentani (2004) developed a decisional model which requires interactions between several key actors. In contrast to Markham *et al.* (2010), they defined roles regarding the information flow and resulting decisional steps. As the authors explain, this representation of the FFE (figure 7) is the first model that takes into account the specificities of discontinuous innovations and which explains the differing dynamics of breakthrough innovations compared to continuous ameliorations.

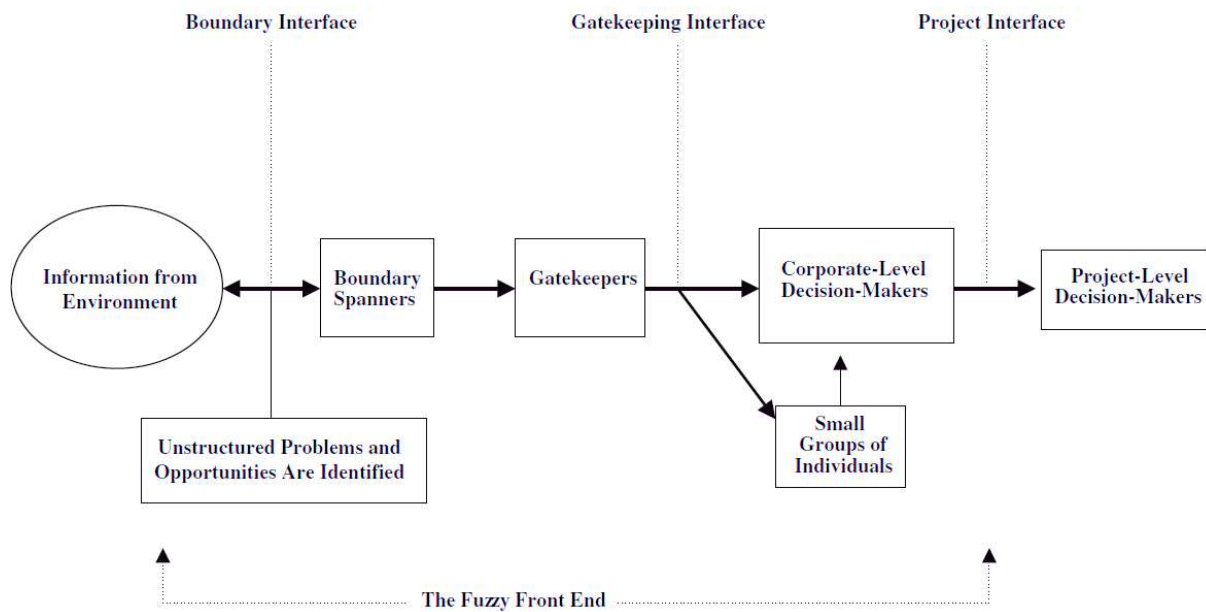

Figure 7 – Fuzzy Front-End Information Flow and Decision-Making Process: Discontinuous Innovations (Reid and De Brentani, 2004, p. 178).

In addition, their research is based on the resource-based view claiming that not only human resources, but especially their situated knowledge, represent a competitive advantage for firms (Grant, 2002). Similarly, Eling *et al.* (2013) highlighted decisional steps and distinguished generation decisions (what to focus on) from evaluation decisions (what to do with this outcome) in their description of the process.

### 2.2.1.2.3 Dynamic Capabilities to Understanding the Fuzzy Front-End

More models exist in the literature, but independently of whether those models focus on concrete tasks, decisional steps, or role profiles, most authors agree that the prevalent objective of this phase is to assure that the requirements are understood (Kim and Wilemon, 2002), the competitive environment is analyzed (Ancona and Caldwell, 1997), and the concept is stable enough for later developments (Markham *et al.*, 2010). Hence, academics have started to spotlight additional factors instead of solely processes in order to improve the FFE (Gassmann and Schweitzer, 2014b; Koen *et al.*, 2014). It is claimed that the NPD does indeed need processes and clear coordination, etc., but that the focus should be on people and not on sophisticated though impersonal processes. A clear strategy and appropriate processes are crucial, but other methods and tools such as interdisciplinary networks, the organizational culture and a management oriented towards people (finding the right people, coaching them and identifying the creative potential of individuals) are gaining more awareness amongst scholars (Gassmann and Schweitzer, 2014b). Recent approaches concentrate therefore on

open innovation methods based on the research of Chesbrough (2003b) or inventive design tools (Le Masson *et al.*, 2006). This is also why at the other end of the continuum, Augsdorfer (2005) strongly calls for distance from formal processes. Instead of operationalizing the FFE *via* processes, he argues that this part of innovation should remain underground – outside of an organizations awareness and control. In his opinion, managers should “*leave some resources unallocated*” (Augsdorfer, 2005, p. 45) in order to foster the innovative capacity of an organization and not to consider bootlegging as a threat that leads to a leaking away of control.

In between both extremes – a highly formalized process on the one hand and the total absence of a process on the other hand – several authors argue that a holistic approach to the FFE is required to assure its success (Boeddrich, 2004; Bullinger, 2008; Herstatt *et al.*, 2004). Apart from formalized processes, these scholars claim that soft factors like the corporate culture should be considered as well. Accordingly, Cohendet *et al.* (2013) used dynamic capabilities to better understand the FFE. As an extension of the resource-based view of Penrose (1972), dynamic capabilities describe an organization’s ability to adapt to changing environments by reconfiguring and recombining internal and external knowledge assets (Teece, 2007). Cohendet *et al.* (2013) analyzed the creative generation of new ideas during the FFE from the perspective of dynamic capabilities which combine:

*“[T]he capacity (1) to sense and shape opportunities and threats, (2) to seize opportunities, and (3) to maintain competitiveness through enhancing, combining, protecting, and, when necessary, reconfiguring the business enterprise’s intangible and tangible assets.”* (Teece, 2007, p. 1319)

Cohendet *et al.* (2013) differ from previous researchers by describing the FFE as an evolutionary phase where actors move back and forth between three defined steps: sensing the opportunity, seizing the idea, and reconfiguring the concept. In the first step, an opportunity is detected and an actor feels that there is potential for innovation. On sensing an opportunity, the actor discusses his idea with his community (i.e. personal network, colleagues, etc.), which accords him psychological safety. Such communities are not a new concept to management studies. Their first mention goes back to the research of Lave and Wenger (1991). Since then, a huge body of literature has emerged and several definitions describe different types of communities within organizations. Wenger *et al.* (2002) defines the concept by using the term ‘communities of practice’ which:

*“[A]re groups of people who share a concern, a set of problems, or a passion about a topic, and who deepen their knowledge and expertise in this area by interacting on an ongoing basis.”* (Wenger *et al.*, 2002, p. 4)

This definition already underlines the crucial role of socialization generated through interactions between people. With regards to the multitude of different terms used to describe this concept, Harvey *et al.* (2015) give a brief summary of the literature and they introduce the umbrella term ‘knowing communities’ to describe all existing concepts about communities. Building on their extensive literature review, the term knowing communities is applied in this research in accordance with Harvey *et al.* (2015) to avoid semantic inconsistencies.

During the FFE, the efficiency of knowing communities during the opportunity sensing phase depends on the absorptive capacity of this community because external knowledge is integrated into the organization to recombine it with new ideas (Cohendet *et al.*, 2013). Absorptive capacity depends on the prior knowledge existing within the firm and has therefore been defined as:

*“The ability of a firm to recognize the value of new, external information, assimilate it, and apply it to commercial ends”* (Cohen and Levinthal, 1990, p. 128).

Similar to Chesbrough (2003b), Cohendet *et al.* (2013) claim that it is not enough to emphasize only the internal dimension of a firm: links between the internal and external environment of a company are critical. This link is managed by members of knowing communities which act both externally as well as internally in a firm. However, the transfer of ideas towards the final decision-makers is managed by a firm’s internal knowing communities. During the second step of the FFE, Cohendet *et al.* (2013) explain that creative entrepreneurs develop the detected opportunity further and convince others about its potential. At the end of this step, the idea is transformed into a valuable concept for the firm’s development. The last step (reconfiguring the concept) describes the learning effort of the organizations where especially unlearning of routines assures the success of the FFE. In these researchers’ opinion, a new idea always initiates modifications in a firm’s internal configurations:

*“[T]he success of an idea happens only when the concept itself can change the routines and collective understanding of the firm’s activities”* (Cohendet *et al.*, 2013, p. 142).

This approach can be distinguished from previous models by considering the dynamics of knowledge flows. An idea is not perceived as something given, but is modified, refined, contextualized, or combined with other ideas. The initial idea and the final output could be totally different. Moreover, the authors explain that several stakeholders interact with each other resulting in the enrichment of the idea. According to them, creativity is not inherent to the R&D department but ideas can come from anywhere (employees of the firm, business partners, customers, etc.). Consequently, knowing communities gain a critical role in the innovation process as they assure the necessary space for creativity (Cohendet *et al.*, 2013). This approach combines previous insights about role models, knowledge flows, and procedural steps of the FFE. In the authors' opinion, existing FFE models are too rigid for a successful integration of new knowledge because efficient innovative firms have to:

*“[R]emain open to the maximum of knowledge and depart from the closed and rigid model presented by most authors”* (Cohendet *et al.*, 2013, p. 144).

Furthermore, this approach differs from previous research regarding the final Go-/No-Go decision. As the authors explain, ideas which do not pass the Go-/No-Go decisions in classic process models are generally eliminated and not considered any longer. However, under the dynamic perspective of organizational capabilities, such ideas nurture the ‘creative slack’ of an organization. Almost all organizations have a stock of knowledge or other internal resources which remains unused but which is a determining factor of growth (Penrose, 1972). Cyert and March (1992) described this phenomenon as organizational slack, where internal resources are invested without organizational awareness or beyond strategic objectives. Cohendet and Simon (2006) developed this notion further by claiming that for innovative firms, this organizational slack:

*“[I]s essentially a creative one which plays the role of an important reservoir of opportunities of innovative knowledge for the organization, and guides to a large extent, the growth of the organization”* (Cohendet and Simon, 2006, p. 7).

Ideas are not necessarily forgotten, and some actors may rework the idea, store the acquired knowledge, and use it eventually at a later date. This is most efficiently managed by knowing communities considering that *“they rather easily memorize the routines their members practice”* (Cohendet *et al.*, 2013, p. 134).

From a similar perspective, Harvey *et al.* (2015) claim that knowing communities are a helpful device for fostering the creative process in the FFE. According to their research, this

requires an *equilibrium* between autonomy and control over the community's members. This model neither concentrates on the development of specific activities at the FFE nor on decisional steps, role models or other similar aspects. Instead, Harvey *et al.* (2015) ask for managerial actions to create a fertile organizational setting to foster creativity at the FFE with the objective in mind to "*fuel the creative fire, and steer it toward strategic objectives*" (Harvey *et al.*, 2015, p. 52). The network between an organization's knowing communities enables management to integrate knowledge from diverse sources and thus to nourish the FFE.

Compared to previous research about the FFE, this represents a shift of attention from rigid processes or single parameters of the FFE, like roles or decisions, towards a holistic approach of the organizational and environmental context. This links to the research of Koen *et al.* (2014) who suggest that:

*"[S]ucceeding in the front end, first and foremost, requires a holistic and integrative perspective from senior management with a focus on commitment, resources, vision, strategy, and culture rather than on specific project initiatives"* (Koen *et al.*, 2014, p. 42).

The research of Koen *et al.* (2014) revealed that organizational attributes such as top-management commitment, resource commitment, a clear organizational strategy and vision, as well as an adapted organizational culture, have a higher impact on the performance at the FFE than activity elements such as opportunity identification, ideation, or concept development. In their three-year study that included 197 US companies, 53% of performance variations at the FFE were explained by organizational attributes. Thus, the researchers underline that the organizational setting in which the FFE takes place should have more attention paid to it than specific processes or concrete activities.



### 2.2.1.3 Synthesis of Current FFE Research

This chapter has provided an overview about leading research on the concept of the FFE. It is generally described as the first step of the innovation process where specific up-front tasks have to be done before an idea can advance towards development. Disagreements exist in the literature about the starting point of this phase. After examining these arguments, this dissertation takes the line that idea generation is part of the FFE.

Current models mainly use process approaches to describe the FFE. These might be structured (Cooper and Kleinschmidt, 1990) or provide room for flexibility (Gaubinger and Rabl, 2014; Koen *et al.*, 2001), but they almost always represent a process. Apart from processes which focus on the alignment of specific tasks to reduce the fuzziness (Cooper and Kleinschmidt, 1990; Koen *et al.*, 2001), further approaches take into account the roles of actors (De Brentani and Reid, 2012; Markham *et al.*, 2010) or decisional steps within the process (Eling *et al.*, 2013; Reid and De Brentani, 2004).

Some scholars claim that no processes at all should be applied in order to leave sufficient room for flexibility (Augsdorfer, 2005). Thus, managers should work on a fertile organizational setting rather than on concrete tasks (Koen *et al.*, 2014). The evolutionary process of Cohendet *et al.* (2013) proposes a mediation between the two contrasting approaches (structured processes vs. no processes) by applying dynamic capabilities to capture an evolutionary FFE. Harvey *et al.* (2015) further pursue these reflections by proposing to manage knowledge flows at the FFE *via* an organization's knowing communities. Instead of focusing on the process, the authors describe managerial activities to design an organizational setting which favors creativity at the FFE.

Except for the model of Reid and De Brentani (2004), the models presented earlier do not make a distinction between continuous and discontinuous innovations (Koen *et al.*, 2014). However, the assumption that both types of innovation already follow a different pathway during the FFE calls into question the sufficiency of these models to entirely capture the FFE in terms of discontinuous innovations. Before drawing conclusions about this question, the next chapter investigates in more detail where exactly these differences are situated during the FFE.



## 2.2.2 ONE SIZE DOES NOT FIT ALL

*“[W]e believe that while the domain of the fuzzy front-end of innovation may be mature and well recognized in studies on new product development and innovation management, new technologies as well as emerging management practices and paradigms, both within firms and at their boundaries, may challenge established insights.”*  
(Van Den Ende *et al.*, 2015, p. 5)

As briefly mentioned in the previous section, several scholars defend the opinion that discontinuous and continuous innovations already differ in the FFE. Based on these insights, the objective of this chapter is to provide a detailed understanding about what really constitutes the difference. In order to efficiently guide these investigations, a specific analytical grid will be applied. Considering that the core reason why firms exist is to manage resources and specifically knowledge in an efficient way (Conner and Prahalad, 2002; Foss, 1996; Grant, 1996; Kogut and Zander, 1992), the FFE should equally be investigated with regards to its underlying knowledge flows. Thus, a knowledge-based view is applied in this dissertation to clarify differences depending on the degree of novelty during the FFE.

Firstly, in this section, the choice for this knowledge-based view is justified (**chapter 2.2.2.1**). Secondly, the FFE of discontinuous innovations is analyzed with these theoretical lenses (**chapter 2.2.2.2**). At the end of this chapter, the dynamics of discontinuous innovations during the FFE are clarified.

### 2.2.2.1 The Knowledge-Based View of the Firm: A Brief Review

The knowledge-based view of the firm goes back to the work of Penrose (1972) and her theory about organizational growth. Under the assumption that “*a firm is basically a collection of resources*” (Penrose, 1972, p. 77), her work is considered to be the foundation of the resource-based view of the firm. In her view, there are physical, organizational as well as human resources which provide services for the production processes determining organizational growth. These resources create competitive advantage *via* their rareness, their value, their imperfect imitability, and their non-substitutability (Barney, 1991). Asymmetries of resources thus explain performance differences between firms (Conner and Prahalad, 2002). Consequently, Conner and Prahalad (2002) mention that this theory seeks to elucidate the question as to why firms exist, and it provides explanations about a firm’s scale and scope.

In addition, the resource-based view considers internal resources and capabilities of organizations because:

*“[T]hese are the factors that will to a large extent determine the response of the firm to changes in the external world and also determine what it ‘sees’ in the external world”* (Penrose, 1972, p. 79 f.).

The main external challenge is to acquire the best resources on the market in order to differentiate themselves from other companies (Curado, 2006). Furthermore, Conner and Prahalad (2002) argued that the main focus in the strategic management resource-based literature lies on knowledge as a key resource for firms. Due to its intangible dimension, knowledge is difficult to imitate and thus it creates competitive advantages for firms by creating sustainable differentiation (Curado, 2006; Nonaka, 1991). As a consequence, the knowledge-based view of the firm represents an extension of the resource-based view, as it focuses on knowledge as the most important strategic resource of a company (Curado, 2006; De Carolis, 2002; Grant, 1996; Nonaka, 1991).

As Grant (2002) points out, knowledge is a term loaded with a multitude of varying meanings, which have not necessarily created a common consensus. With regards to the long history of research on knowledge going back to ancient Greece, the choice was made for this dissertation to focus on the research of Nonaka (1994), who simply claims that knowledge is more than information. The author explains that information is a *“flow of messages”* (Nonaka, 1994, p. 15), which creates knowledge based on human action. From this perspective, Nonaka (1991) argues that knowledge is more than just codified and structured information. In addition to outlining this explicit dimension of knowledge which is easily transferrable, he introduces the notion of ‘tacit knowledge’. Nonaka and Von Krogh (2009) defined tacit knowledge as:

*“Knowledge tied to the senses, tactile experiences, movement skills, intuition, unarticulated mental models, or implicit rules of thumb is ‘tacit’. Tacit knowledge is rooted in action, procedures, routines, commitment, ideals, values, and emotions.”* (Nonaka and Von Krogh, 2009, p. 636)

Tacit knowledge is highly personal and anchored in human action. The core objective of Nonaka’s ‘knowledge-creating company’ should be to efficiently exploit these knowledge assets. Therefore, the process of conversion between explicit and tacit knowledge is crucial (Nonaka and Takeuchi, 1995; Nonaka and Von Krogh, 2009). Its objective is to expand an

individual's expertise and create something together which goes beyond an individual's knowledge (Nonaka and Von Krogh, 2009). From this perspective, Nonaka *et al.* (2000) elucidated that:

*“[K]nowledge is dynamic, since it is created in social interactions amongst individuals and organizations”* (Nonaka *et al.*, 2000, p. 7).

Henceforth, social interactions between employees of a firm are of increasing importance for growth compared to traditional economic productive factors (Barney, 1991). Similarly, the knowledge-based view of the firm considers knowledge to be situated, in accordance with Brown and Duguid (1991) and with Nonaka and Von Krogh (2009). Similarly to the resource-based view, this approach considers the inside of the firm and the internal coordination of knowledge. It analyzes the organizational structure, the role of management, the allocation of decision-making, and the firm boundaries regarding the successful application of knowledge (Grant, 1996). With regards to the development of a consistent knowledge-based theory, several central roles have been assigned to firms. They have been described as arrangements to facilitate knowledge creation, integration (Grant, 1996) and the transfer within several knowing communities (Brown and Duguid, 1998; Kogut and Zander, 1992). Other scholars describe them as aggregates of several communities into one functional structure (Cohendet and Diani, 2003), where hierarchical structures facilitate the integration and exploitation of new knowledge (Schulz, 2001). Therefore, in analogy to the resource-based view, Kogut and Zander (1992) define organizations as:

*“[S]ocial communities in which individual and social expertise is transformed into economically useful products and services by the application of a set of higher-order organizing principles”* (Kogut and Zander, 1992, p. 384).

A main challenge is the transfer of knowledge through a firm and to find coordination mechanisms to integrate specialized knowledge (Grant, 1996; Szulanski, 2003; Wenger and Snyder, 2000). However, this depends on the absorptive capacity of individuals (Cohen and Levinthal, 1990). It has been widely discussed as to whether the knowledge-based view of the firm can be considered to be a theory or not. As Grant (2002) pointed out, there is still a lack of consistency within the existing concepts and definitions. More research is necessary to reach the unification required to declare the knowledge-based view as a new theory (Curado, 2006). Nevertheless, scholars still underline its relevance, as it places knowledge at the center of attention (for an extensive literature review on the knowledge-based view, see Curado

(2006)). For instance, Nonaka and Von Krogh (2009) explain that diverse tacit knowledge that is acquired by an individual's social practice enhances creativity. From this perspective, tacit knowledge indeed represents an important competitive advantage, as it is difficult to imitate (Parjanen, 2012). Simultaneously, it has been acknowledged by several authors that knowledge remains the prevailing determinant for sustainable competitive advantage with regards to the current economic context, in which organizations become increasingly international and consequently geographically dispersed (Curado, 2006; Grant, 1996).

This dissertation focuses on the knowledge-based view of the firm because it is in line with current challenges in society regarding the international environment (Grant, 2002). As previously mentioned in the introductory chapter of this dissertation, the international dimension represents a critical component of this research about the FFE. Therefore, a theory in line with this economic context is indispensable. Yet another reason is the fact that “[t]he role of knowledge transfer is clearly central to the innovation process” (Powell and Grodal, 2005, p. 74). Innovation is more than an information processing activity. It is a process by which organizations actively generate new knowledge to respond to a specific challenge (e.g. to resolve a specific problem) (Nonaka, 1994). This critical role of knowledge in innovation processes has also been underlined above by the differentiation between exploration and exploitation activities. The former are crucial to creating new knowledge to fostering the generation of discontinuous innovations. Overall, a knowledge-based view correlates with this understanding of innovation as a knowledge processing activity. Considering this brief literature review, the decision in favor of the knowledge-based view has important implications for this thesis. The theory places knowledge at the center of the field of interest and highlights its successful transfer and application. In addition, this theory takes an internal perspective on firms, and it seeks to identify appropriate coordination mechanisms for management to facilitate this transfer as well as the application of knowledge (Grant, 1996).

The knowledge-based view is used for this research in order to take a closer look at the fuzzy front-end of discontinuous innovations. This decision impacts this research in several ways:

- The successful transfer and application of knowledge is the main concern of this thesis;
- An internal perspective on organizations is chosen; and
- The focus lies on the identification of appropriate coordination mechanisms.

### **2.2.2.2 The FFE of Discontinuous Innovations: A Knowledge-Based View**

From the perspective of the knowledge-based view of the firm, fundamental differences between the FFE of discontinuous compared to continuous innovations are now identified. This paragraph is to an important extent inspired by the research of Reid and De Brentani (2012; 2004), who took a closer look at such differences. The following review is split into four broad sub-categories of differences: the first is about the position towards markets that should be adopted during the FFE. The other three parts summarize structural differences at the FFE with regards to information flows, network structures, and knowledge creation.

#### **2.2.2.2.1 Implications for Market Approaches**

As continuous innovations are based on known technologies and concentrate on known markets, information is available before the innovation process starts. In the case of discontinuous innovations, uncertainty is higher because less information is available at the beginning (De Brentani and Reid, 2012; Florén and Frishammar, 2012). Thus, market size and customer potentials are less easy to identify (Verworn *et al.*, 2008). Consequently, it has been argued that formal market analyses could be misleading (Christensen, 1997; Kim and Wilemon, 2002; Lüthje and Herstatt, 2004).

Even if some authors suggest that uncertainty is reduced to the same amount before entering development (Verworn *et al.*, 2008), they acknowledge that uncertainty still influences the whole FFE structure as more efforts are needed to reduce it as well as the decision-making process, depending on an individual's ability to handle uncertainty. According to these scholars, the purpose during the FFE should therefore be to reduce uncertainty before entering development (Markham *et al.*, 2010; Verworn *et al.*, 2008). This is also the reason why some scholars argue that no formal processes should be applied for discontinuous innovations because this would represent a barrier to creativity (Björk and Magnusson, 2009; Florén and Frishammar, 2012; Griffin *et al.*, 2014). Conversely, several theories such as the concept-knowledge theory were developed with the objective of reducing uncertainty or even using it as a push-factor to nurture creativity (Le Masson *et al.*, 2006).

Regarding the way uncertainty is reduced during the FFE, scholars disagree about the required proximity to the reality in the market. Some argue that a purely technology driven instead of a customer driven perspective should be applied (Calantone and Rubera, 2012;

Veryzer, 1998). They explain this by the fact that today's customers are not able to express future needs. In addition, customers refer to existing products, therefore impeding the emergence of highly novel ideas which are not within their habitual scope (von Hippel, 1986; Im and Workman Jr, 2004; Kim and Wilemon, 2002; Veryzer, 1998). For this reason these authors recommend that R&D and marketing departments in organizations should be kept separate during the whole FFE.

However, while formal market analyses are recognized as obstructive in the case of discontinuous innovations (Kim and Wilemon, 2002; Song and Montoya-Weiss, 1998), Reid and De Brentani (2010, 2012) still suggest that 'market vision' is crucial to gaining a better understanding of future trends. They define market vision as:

*“[A] clear and specific mental model or image that organizational members have of a desired and important product-market for a new advanced technology”* (Reid and De Brentani, 2010, p. 500).

According to these authors, market vision is enhanced through market visioning competence, describing the ability to create a link between promising technologies and future market opportunities (Reid and De Brentani, 2012). In line with the resource-based view with a special focus on dynamic capabilities, Reid and De Brentani (2010, 2012) found that market vision and market vision capability may evolve over time and that learning effects on these dimensions enhance an organization's competitive advantages and thus increase the overall performance at the FFE. Market visioning competence depends on an individual's involvement in networks and their ability to push new ideas through the organization and thus gain the commitment of management (Reid and De Brentani, 2010). On an organizational level, a proactive market orientation focusing on customer's unexpressed needs and specific market learning tools such as scenario analysis or roadmapping sustain market visioning competences and in the long run performance during the FFE in the case of discontinuous innovations (Reid and De Brentani, 2010). Organizations should foster the development of this market visioning competence by encouraging informal and formal activities, enabling individuals to have open access to a large variety of information and an open mindset oriented towards diversity (Reid *et al.*, 2014).

Market vision is crucial in order to increase the acceptance of a radically new product on the market as it turns a promising new technology into a useful product concept (Griffin *et al.*, 2014; Song and Montoya-Weiss, 1998). Overall, scholars renounce the utility of detailed

market studies but still claim that market vision is required to identify future customer needs (Crawford and Di Benedetto, 2011; Reid *et al.*, 2014).

Regarding managerial implications, it is therefore argued that the R&D and marketing departments of an organization should not remain disconnected and should interact already in the FFE to assure the transition towards commercialization (Markham *et al.*, 2010; Moenaert *et al.*, 1995). Regarding the diversity of professional backgrounds of the actors during the FFE, Cohendet *et al.* (2013) suggest here that communities are a useful method to facilitating such an interdisciplinary collaboration at the FFE. According to their research, communities manage the translation of knowledge into a language that is comprehensible for all actors: they translate a technical idea into a concept with a specific economic value.

#### **2.2.2.2.2 A Bottom-Up Process**

Reid and De Brentani (2012; 2004) revealed that continuous innovations are generated *via* a top-down process where organizations detect a product gap and initiate the innovation process. In most cases, the marketing department identifies these gaps in collaboration with key customers, and the R&D department responds to this opportunity.

Furthermore, the authors argue that most discontinuous innovations emerge on an individual level or within small working groups. Hence, they describe this as a bottom-up process where idea champions are employees of the organization and transfer their idea to final decision-makers. As the authors argue, discontinuous innovations depend on some few individuals (i.e. boundary spanners) who detect and transfer innovative ideas. Consequently, organizations have less control over this part of the innovation process: individual judgment is critical because if individuals do not push an idea towards development, the organization will not be aware of its potential (Florén and Frishammar, 2012; Koen *et al.*, 2001; Reid and De Brentani, 2010). This is the reason why several scholars integrate role theory for the FFE for discontinuous innovations: the person who had an innovative idea (i.e. inventor) requires in most cases an idea champion or a sponsor to support him, pushing the idea within the process (Boeddrich, 2004; Griffin *et al.*, 2014; Kim and Wilemon, 2002; Markham *et al.*, 2010). Cohendet *et al.* (2013) equally describe a bottom-up process where a few actors detect an opportunity and discuss it first with their corresponding community before inserting it into organizational processes. In their terms, these communities manage the interface between the 'creative entrepreneur' (i.e. an idea champion) and the organizational level in order to reach consensus.



A successful FFE of discontinuous innovations requires sensitive management that is aware of individual behavior and corresponding role profiles in order to pursue ideas within the process (Boeddrich, 2004; Koen *et al.*, 2002; Meyer and Mizushima, 1989). This point represents a challenge for firms (Rice *et al.*, 2001), and scholars suggest that management should encourage fluent communication between actors during the whole FFE (De Brentani and Reid, 2012). However, even though communication has often been described as a crucial factor in the early innovation phase, few authors have modeled it (Moenaert *et al.*, 1995). From this perspective, De Brentani and Reid (2012) found that efficiency of communication depends on speed and quality of the information flow. But information is not systematically complete or available in the case of discontinuous innovations. The necessity for sufficient communication between actors is therefore higher than in the case of continuous innovations (Liu *et al.*, 2015).

Conversely, some scholars argue that communication should rather remain moderate, because too much as well as not enough communication can restrict innovation (Leenders *et al.*, 2003). From this point of view, the design of a moderate communication structure is crucial for a fluent FFE; especially in the case of discontinuous innovations, as these rely on informal interactions to absorb high-quality information (Tang *et al.*, 2015).

#### **2.2.2.2.3 Informal and Interdisciplinary Networks**

In line with the bottom-up process, authors have acknowledged the role of individual networks in ensuring quality and acceptance of novel ideas at the FFE (Björk and Magnusson, 2009; De Brentani and Reid, 2012; Kijkuit and Van Den Ende, 2007). Whereas research on collaboration networks is current in the field of production processes, the intersections between networks and innovation is a relatively new field for research (Powell and Grodal, 2005). However, scholars underline that discontinuous innovations are built on individual networks which are nurtured by interactions between them (Green and Cluley, 2014). In accordance with Cohendet *et al.* (2001) networks are described as follows:

*“A network’s objective is to allow a mutually negotiated speciali[z]ation. It is made of heterogeneous agents whose cognitive activity is to exchange knowledge. They interact together through informal and formal meetings and the recruitment rule is mutual trust. People are held together in networks by the need to gain complementary knowledge.”* (Cohendet *et al.*, 2001, p. 5)



Regarding the FFE, two characteristics of networks have specifically been highlighted: they should be informal as well as interdisciplinary. Within such networks, scholars argue that no formal roles should be assigned (Markham *et al.*, 2010). The roles of boundary spanners, idea champions or other role assignments described earlier represent informal roles where the individual himself decides if he participates in the process or not (Reid and De Brentani, 2004; Schulze and Hoegl, 2006). Consequently, scholars also argue that informal communication nurtured by high levels of personal interaction is necessary for a fluent FFE of discontinuous innovations, because this enhances the circulation of complex information (Gassmann and Schweitzer, 2014a; Powell and Grodal, 2005; Tang *et al.*, 2015). Moreover, it is recommended that final decision-makers remain distant to idea champions during the early steps of the FFE. Even if FFE actors themselves are required to work closely together, strong ties with decision-makers would not be advantageous at the beginning of the FFE (Kijkuit and Van Den Ende, 2007). Only during evaluation are strong relations with decision-makers required to assure the insertion into the NPD (Kijkuit and Van Den Ende, 2007). A similar dynamic perspective of the network structure during the FFE is described by Cohendet *et al.* (2013). Before directly confronting decision-makers with the idea, creative entrepreneurs have the opportunity to challenge it with other actors and remain thus distant from the decision-makers in the first place. These ties are created afterwards by means of the communities mentioned earlier. From this perspective, the communities are informal structures within an organization which manage the direct link between creative entrepreneurs and decision-makers.

Apart from the informal character of these networks, the research of Cohendet *et al.* (2013) also takes into account a second prerequisite for discontinuous innovations: an interdisciplinary interface. Innovative ideas emerge in general between actors from different disciplines (Parjanen, 2012). Similarly, communities are key to fostering such interdisciplinary networks by creating links with other communities (Harvey *et al.*, 2015). Cohendet *et al.* (2013) argue that actors switch from homogeneous to heterogeneous groups during the FFE thanks to the implication of internal and external communities. Therefore, they may modify, adapt, and increase the potential of an idea *via* interdisciplinary interactions (Cohendet *et al.*, 2013). In fact, the closer these communities collaborate, the higher the creative output is likely to be (Batallas and Yassine, 2006).

#### 2.2.2.2.4 Knowledge Creation

*“Japanese companies have been successful because of their skills and expertise at ‘organizational knowledge creation’. By organizational knowledge creation we mean the capability of a company as a whole to create new knowledge, disseminate it throughout the organization, and embody it in products, services, and systems”*  
(Nonaka and Takeuchi, 1995, p. 3).

The integration of new knowledge is crucial for discontinuous innovations (compare also to Schulze and Hoegl, 2006; Woodman *et al.*, 1993). Generally speaking, scholars explain that new knowledge is acquired from the external environment (Koen *et al.*, 2014). Besides that, new knowledge can equally be created by combining already existing knowledge within a company (Penrose, 1972). Therefore, individual as well as collective creativity is necessary to push this ideation process (Parjanen, 2012). The exploitation of tacit knowledge is important here because it is difficult to imitate and therefore creates a specific competitive advantage for companies (Mudambi and Swift, 2012).

This situation, however, challenges an individual’s absorptive capacity because the transfer of tacit knowledge is more difficult than in the case of explicit knowledge (Nonaka and Von Krogh, 2009). Cohen and Levinthal (1990) elucidate that the absorptive capacity depends on the existence of a common knowledge base between two persons, including at least a common language, shared meanings, and a commonality of specialized knowledge. This requires cognitive proximity between individuals (Nooteboom, 1999). The cognitive proximity should be high enough to assure knowledge integration without being too high, considering that diversity is still necessary in order to enhance creativity (Boschma, 2005; Cohen and Levinthal, 1990; Parjanen, 2012).

In essence, discontinuous innovations rely to an important extent on new as well as on tacit knowledge. This knowledge can be acquired from the external environment and/or can be internally recombined *via* collective creativity.

## 2.2.3 REMOVING THE FUZZINESS: A CONCLUSION

In the first section of this chapter the concept of the FFE was defined. As Cohendet *et al.* (2013) argue, ideas are not just developed in the R&D department and then inserted into a process. According to their research, ideas are the result of a creative process between different actors who interact at an interdisciplinary interface. For this reason, creative idea generation is considered to be part of the FFE in this dissertation.

Then the focus was on differences between discontinuous and continuous innovations at the FFE. An internal view of the firm has been chosen, focusing on the role of knowledge integration and transfer in accordance with the knowledge-based view of the firm. Table 1 synthesizes central statements which have been discussed in the literature regarding the FFE of discontinuous innovations.

As illustrated before, most models of the FFE do not distinguish between discontinuous and continuous innovations. Nevertheless, the overview in table 1 and the resulting different pathways of continuous and discontinuous innovations underline why organizations should already focus on this early phase of their innovation processes. This review is in line with the research of Reid and De Brentani (2004) showing a model for the FFE which is different for both types of innovations.

Nonetheless, the representation of the FFE that has been selected for this dissertation is based on the research of Cohendet *et al.* (2013). Even if the authors did not position themselves explicitly on discontinuous innovations, it is interesting to note that their approach *via* dynamic capabilities does indeed correlate with specificities of discontinuous innovations. Their research ultimately takes into account all of the differences presented earlier between the two approaches to discontinuous and continuous innovations. More importantly, their use of dynamic capabilities correlates with the knowledge-based view of the firm. Thus, the research of Cohendet *et al.* (2013) does not only propose a comprehensive approach to the FFE, it is also adapted to today's evolution of society as it has been described by the knowledge-based view of the firm.

Central Statements about the FFE of Discontinuous Innovations (Literature)	Key Author(s)
<b>GENERAL</b>	
Uncertainty at the FFE is higher for discontinuous innovations.	Florén and Frishammar (2012); Reid and De Brentani (2004); Verworn <i>et al.</i> (2008)
Formal processes and structures at the FFE are a barrier for discontinuous innovations.	Björk and Magnusson (2009); Florén and Frishammar (2012); Griffin <i>et al.</i> (2014)
<b>MARKET APPROACH</b>	
In the exploration process, departments (marketing/R&D) should be kept separate.	Calantone and Rubera (2012); Veryzer (1998)
Market studies are not of great value for discontinuous innovations.	Christensen (1997); Im and Workman Jr (2004); Kim and Wilemon (2002); Song and Montoya-Weiss (1998)
A market vision is needed for the FFE of discontinuous innovations.	Crawford and Di Benedetto (2011); Florén and Frishammar (2012); Langerak <i>et al.</i> (2004); Reid and De Brentani (2010)
<b>THE INFORMATION FLOW</b>	
In the case of discontinuous innovations, it is a bottom-up information flow.	Cohendet <i>et al.</i> (2013); Reid and De Brentani (2004, 2010); De Brentani and Reid (2012)
The information flow is based on the actors involved for discontinuous innovations.	Florén and Frishammar (2012); Reid and De Brentani (2010); Tang <i>et al.</i> (2015)
<b>A NETWORK OF INDIVIDUALS</b>	
Discontinuous innovations require an informal network based on individuals.	De Brentani and Reid (2012); Markham <i>et al.</i> (2010) Schulze and Hoegl (2006); Tang <i>et al.</i> (2015)
An interdisciplinary network fosters creativity at the FFE.	Green and Cluley (2014); Harvey <i>et al.</i> (2015); Parjanen (2012)
<b>KNOWLEDGE CREATION</b>	
Discontinuous innovations depend on the successful generation of new knowledge.	Schulze and Hoegl (2006); Woodman <i>et al.</i> (1993)
Knowledge from the outside of the company must be integrated.	Cohen and Levinthal (1990); De Brentani and Reid (2012); Koen <i>et al.</i> (2014) ; Reid and De Brentani (2004)

Table 1 – Overview of Central Statements Regarding the FFE of Discontinuous Innovations.

Figure 8 schematizes the FFE as it is represented by Cohendet *et al.* (2013), but the authors underline that this representation should be considered as:

*“[L]ess linear and more recursive; that is, agents and their diverse communities usually move back and forth between the various steps”* (Cohendet *et al.*, 2013, p. 135).

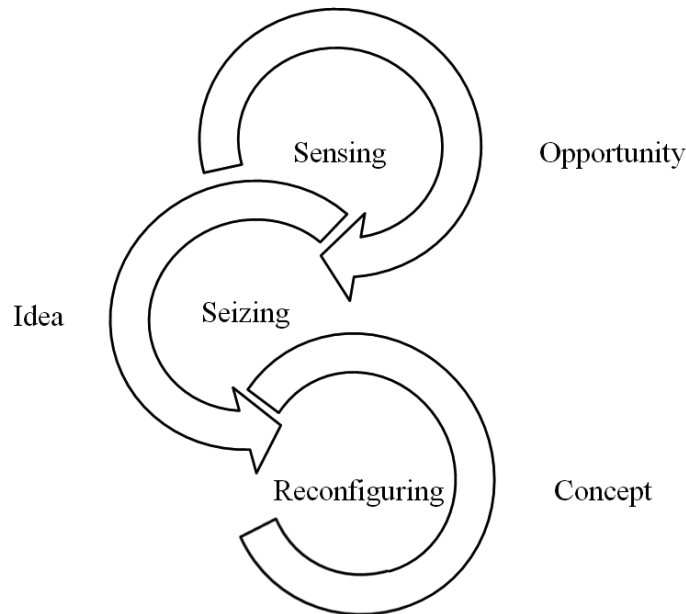

Figure 8 – The Three Steps of the FFE (Cohendet *et al.*, 2013, p. 136).

Overall, this analysis of Cohendet *et al.* (2013) is applied in this dissertation as an approach to the FFE. It provides a better understanding of this fuzzy phase and correlates with the knowledge-based view of the firm. Due to its significance and correlation with core concepts for discontinuous innovations, this representation provides a consistent framework for this dissertation. Although the authors do not explicitly address discontinuous innovations, this representation shows significant overlaps with the research of Reid and De Brentani (2004, 2012), which has specifically been dedicated to discontinuous innovations.

## 2.3 THINK 'FUZZY' - ACT GLOBALLY

*“Glocal” – Definition:  
Reflecting or characterized by both local and global considerations.  
Example: All companies in the 21st century will need to be both global and  
local (or “glocal”) at the same time, but not to the same extent for all  
industries and not in the same proportion for all aspects of a given business.”  
(Oxford Dictionaries, 2016b)*

The FFE models presented earlier provide propositions for how management could deal with this chaotic phase of the innovation process. Besides the aforementioned conceptual differences, almost all models share one tacit assumption: the necessity of proximity between actors. In the case of regional innovation activities, for instance, geographic proximity has indeed often been cited as the facilitator for the creation of innovative clusters (Balland *et al.*, 2015; Breschi and Malerba, 2005). This is due to the fact that geographic proximity enhances localized knowledge spillovers where companies may easily share knowledge and internal competencies with other closely located collaboration partners within the cluster (Breschi and Malerba, 2005).

Moreover, innovation depends to an important extent on communication (Moenaert *et al.*, 2000). From this perspective, it is often argued that low geographic proximity increases communication costs especially in communication-intensive industries (De Brentani *et al.*, 2010; Ghemawat, 2003; Moenaert *et al.*, 2000). Furthermore, it increases transportation costs (Magnani *et al.*, 2015) and the risk for duplicating R&D costs if activities are not sufficiently coordinated (Meyer and Mizushima, 1989). In addition, it renders the secrecy of confidential information difficult (Moenaert *et al.*, 2000). In the worst case scenario, the costs may exceed the benefits of geographically dispersed innovation activities (Mors, 2015; Singh, 2008).

Nevertheless, scholars discuss whether geographic space does really play a role in innovation regarding current advances in information and communication technologies (ICT). Indeed, it is often argued that such technologies may replace geographic proximity in the innovation process (Hussler, 2004; Torre and Rallet, 2005). Ganesan *et al.* (2005) even suggest that high levels of face-to-face communication are an indicator of a difficult collaboration. However, many scholars insist on face-to-face communication when discussing, for instance, confidential or sensitive topics or interpersonal problems (Katz, 1994; Meyer and Mizushima, 1989; Torre and Rallet, 2005).

With regards to the FFE, scholars generally underline high levels of interactions between employees in order to foster high performance in this phase. But as mentioned before, this is only possible under the assumption of geographic proximity between actors. Current tendencies towards internationalization of innovation activities contradict this requirement of proximity. Hence, the objective of this chapter is to answer the following questions:

- What is the state of the art of FFE literature regarding international issues, what exactly is an international FFE and what are implications for international FFE teams (**chapter 2.3.1**)?
- What does the international management literature propose in order to capture this phenomenon (**chapter 2.3.2**)?

The objective of this chapter is to explain fundamental reflections leading to the research question as elucidated in **chapter 2.3.3**.

## 2.3.1 THINKING INTERNATIONAL AT THE FFE: A LITERATURE REVIEW

Recently, Koen *et al.* (2014) provided an overview of existing empirical studies about the FFE (table 2). The authors illustrate that almost all of these studies applied national empirical settings. Only one was conducted in a multinational organization. The research of Khurana and Rosenthal (1998) proposed that such an international setting could give rise to divergent individual perceptions of an optimal decision-making process at the FFE due to different cultural backgrounds. However, there appears to be a lack of a deeper focus on international issues.

Regarding later NPD activities, Kleinschmidt *et al.* (2007) published a study where they declared themselves to be the first researchers who integrated the topic of international management into this stream of the literature. Similar advancements to those in the NPD literature have not been distinguished for the FFE. Considering the high requirements of proximity for creativity, communication, and knowledge-sharing, this gap in current FFE research is no longer coherent with current evolutions of society. A holistic approach to the FFE, taking the international context into account is therefore indispensable.

Authors	Sample
Bacon <i>et al.</i> , 1994	6 Fortune 100 companies in the U.S.
Moenaert <i>et al.</i> , 1995	40 Belgian companies with median sales of \$62 million
Khurana and Rosenthal, 1998	12 multinational companies, 8 from the US and 4 from Japan
Langerak <i>et al.</i> , 2004	126 Dutch firms with mean sales of \$31 million
Verworn <i>et al.</i> , 2008	475 Japanese companies with 5–70,000 employees
Verworn, 2009	175 German companies with 5–6,700 employees
Poskela and Martinsuo, 2009	133 Finnish companies with >50 employees
Martinsuo and Poskela, 2011	107 Finnish companies with median 350 employees

Table 2 – Extract from Koen *et al.* (2014): Empirical Studies of Front-End Practices.

Given the weak situation regarding research on the international FFE, it should be determined now what will be understood in this thesis by the international FFE and what an international FFE team is. In the NPD literature, an international project for product innovations is defined as:

*“[A] project for which the functional responsibilities on R&D, production and marketing are not concentrated in one single country”* (Moenaert *et al.*, 2000, p. 361).

By analogy with this statement, the international FFE is defined in this dissertation as follows:

**International FFE (definition by MN)**

It is the early innovation phase before the classic NPD for which actors involved are not concentrated in one single country.

Considering, moreover, the role models presented earlier, an international FFE team implies that its team members are dispersed beyond national boundaries. For analytical purposes all relevant actors with regards to role models of the FFE presented earlier are considered as one FFE team. With respect to the internal perspective based on the knowledge-based view of the firm, an international FFE team is defined here as follows:

**International FFE Team (definition by MN)**

The international FFE team of a company comprises all relevant internal actors of a company independently of their geographic location.



As Cohendet *et al.* (2013) suggest, there is no internal department of an organization that is in an exclusive position to provide input for innovation. On the contrary, most ideas do not emerge within the R&D department, even though this is the place where one might expect the highest innovative potential (Cohendet *et al.*, 2013). In accordance with considerations about interdisciplinary networks mentioned earlier, this implies that an international FFE team should also be interdisciplinary. In order to describe this international FFE team in more detail, the typology of Chevrier (2008) shown in table 3 is applied, as it provides precision about current activities of international teams. Her typology differentiates international teams by their activity (coordination vs. production), the profile of the actors (how many different nations are involved), the communication mode (face-to-face or at a distance; frequency), the duration (permanent or temporary), and the institutional context (uniform or mixed context; organization, job, service, etc.).

Regarding this typology, two categories apply to the FFE. Similarly to the category ‘Development project team’, actors at the FFE should work closely together until the idea is inserted into the NPD process. From a restricted point of view, this FFE team is temporary in nature and requires regular interactions. However, a knowledge-based company requires at the same time a continual commitment to managing internal knowledge assets. In this case, an international FFE team should be in charge of continually transferring knowledge and ideas. This is particularly crucial for the FFE of discontinuous innovations where an idea is created on a local level and then transferred to the organizational level. Regarding the typology of Chevrier (2008), such activities fall within the category of ‘Interactions headquarters/subsidiary’ where the communication of information from and to the headquarters is a main objective. Consequently, putting aside the temporary nature of international FFE teams in the case of a concrete idea, a permanent and yet internationally oriented team organization for knowledge-sharing and informal communication is essential in order to continually coordinate knowledge at the FFE.

**International FFE Team Dynamics (definition by MN)**

International FFE team members require intense collaboration on a temporary basis in the case of a concrete idea generation process. Simultaneously, they should be permanently interconnected to assure continual knowledge flows.

	<b>Actors</b>	<b>Objective</b>	<b>Institutional context</b>	<b>Communication</b>	<b>Duration</b>	<b>Illustration</b>
<b>Strategic coordination</b>	Representatives of national entities	Assure the coherence of local actions	Every member defends his interests	Periodic consultations	Permanent	Committee of the directors of European subsidiaries
<b>Management of mixed unities</b>	Two equilibrated national groups	Daily management of the operations	The national divides cover organizational divides	Cooperation and daily compromises to define the <i>modus vivendi</i>	Permanent	Management of an alliance or a co-organization
<b>Interactions headquarters/subsidiary</b>	Managers are at the interface between the headquarters and the subsidiaries	Communication, adaptation, translation of information and directives between the headquarters and the subsidiary (in both directions)	Relationship headquarters/subsidiary: tensions between control and autonomy	Interactions in general at a distance	Permanent	Local responsible person of a department who is in permanent contact with a counterpart at the headquarters
<b>Development project team</b>	Team with diverse nationalities, departments and jobs	Design of new products for the international market	High constraints regarding costs, deadlines and quality	Close daily interactions	Temporary	Conception projects and the development of new services
<b>Team sharing the same job</b>	Multiple nationalities but sharing the same job	Professional experts work together	Convening power of the profession	Mix of meetings and work at a distance	Temporary	R&D team
<b>Export service</b>	National employees in business relationship with “foreign” clients	Commercial negotiation and elaboration of international contracts	Relationship client/supplier	Physical meetings and work at a distance	Occasional or durable	Conception projects on the international market
<b>Expatriate in unitary team</b>	National team with rare exceptions	Differs depending on the nature of the team	Local environment of the organization	Local organization	Floating	A national service with some foreign employees

Table 3 – Typology of Multicultural Teams (Chevrier, 2008, p. 349 translated by MN): Correlating Types for FFE Highlighted by MN.

From a general perspective, an international FFE team is similar to any other global business team which manages its activities across borders. In addition to varying functions and businesses, they also include different nationalities and cultures (Govindarajan and Gupta, 2003). The knowledge management literature offers several propositions as to how to manage global innovation teams. Many of these propositions are based on advanced information and communication technologies (see for example Luo and Bu, 2016), on the balance between a global and a local knowledge structure (Brinks and Schmidt, 2015), or on concrete coordination mechanisms such as data-driven decisions or the rotation of the location for team meetings (Govindarajan and Gupta, 2003).

Closer investigations are proposed in the next chapter in order to understand to what extent such propositions apply to the FFE of discontinuous innovations as literature in the field of international management already provides a broad perspective on international issues.

## 2.3.2 ACROSS BORDERS: INTERNATIONAL MANAGEMENT

*“Rather than start with the belief that differences are something that must be overcome, then, we must instead begin by regarding them as something that must be understood.”*  
(Zaheer *et al.*, 2012, p. 26)

International business refers to the *“performance of trade and investment activities by firms across national borders”* (Cavusgil *et al.*, 2008, p. 4). A company is located in its home country, but activities are not exclusively located in this geographic area. Considering the fact that globalization is still developing, countries are becoming more interconnected and economic interdependence between countries is increasing (Cavusgil *et al.*, 2008). Accordingly, it is nearly impossible for a company to act within national borders without any international relations, whether it is *via* international customers, competitors, suppliers, or because of international competencies acquired on a local level (Schroll-Machl, 2013).

### 2.3.2.1 International Management is about Managing Distance

Once a company decides to engage in an international business strategy, its activities stop being situated at one geographic location and space between employees is unavoidable. To capture managerial challenges inherent in this situation, the concept of distance has earned a central place in international management research (Magnani *et al.*, 2015; Malecki, 2010; Zaheer *et al.*, 2012). From this point of view, Zaheer *et al.* (2012), for instance, declare that:

*“Essentially, international management is management of distance”* (Zaheer *et al.*, 2012, p. 19).

Such a conceptualization of distance is a widely used approach in the international management literature. However, this concept is threatened by the tendency to oversimplify its measurements (Shenkar, 2001). Zaheer *et al.* (2012) argued therefore that distance constructs are only valuable and powerful conceptualizations under the constraint that distance is considered as a holistic concept that consists of several key dimensions (not only geographic, but also temporal, cultural, etc.).

This is why Ghemawat (2001) proposes a similar holistic approach to international management in his CAGE model. Instead of merely opposing similarities and differences of

two countries, he distinguishes four types of distance: cultural, aadministrative, geographic and economic distance (CAGE). He declares that different time zones, climates, natural conditions, the size of a country or divergent infrastructures impact on international collaborations. Based on this model, the author has developed several suggestions on how to enlarge the value of global activities.

Besides examining the concept of distance, an important body of research has developed in the international management literature considering strategies of implantation (see for example Cavusgil, 1998); cultural differences (Hall, 1960; Hofstede *et al.*, 2010; Schein, 1996; Trompenaars and Hampden-Turner, 1998); and how to differentiate the role of international subsidiaries (Bartlett and Ghoshal, 2002; Gupta and Govindarajan, 1991).

This research represents only fragmented examples of topics that matter in international management. For this dissertation, some of these approaches provide general implications for the structure of an international FFE throughout the analytical part. However, it is still necessary to be more restrictive when choosing an overall approach to an international FFE. The core interest of this research is on innovation and as laid out in the next paragraph, there is one specific stream of research which has explicitly combined international challenges and innovation: economic geography.

### **2.3.2.2 Economic Geography: Proximity Instead of Distance**

Meyer and Mitsuhashi (1989) claimed that “*the topic of innovations in multinational companies has received little attention*” (p. 135). Since then, scholars have increasingly oriented their research on this topic. Thus, extensive synergies have been created between the fields of economic geography and innovation (Howells and Bessant, 2012; Hussler, 2004). Similar to in the CAGE model, studies combining these two specific fields focus on the fact that it is not only the geographic space, but also other kinds of space that impact on innovation (e.g. organizational space, economic space, relational space, cultural space, technological space (see Hussler, 2004)). Here, a crucial semantic difference of economic geographers compared with the research in international management presented previously is the fact that the former do not analyze distance, but build their argumentation on the concept of proximity. By analogy with the CAGE model, economic geographers consider further dimensions besides physical/geographic proximity. Hussler (2004), for instance, focused on seven dimensions of space: geographic, cultural, organizational, technological, economic, and

social space as well as absorptive capacity as crucial dimensions to assure the diffusion and integration of new knowledge. Bouba-Olga and Grossetti (2008) distinguish spatial compared to socio-economic proximity – the latter including proximity in resources and in coordination – whereas Torre and Rallet (2005) base their model on geographical and organized proximities. Within this variety of models in the field of economic geography, the work of Boschma (2005) has received substantial attention. He provides consistent definitions of proximity dimensions and their impact on innovation collaborations (Knoben and Oerlemans, 2006). He systematically analyzes the impacts of five proximity dimensions on innovation: geographic, cognitive, organizational, social, and institutional proximity. A fundamental difference of all these advancements compared to the concept of distance is the assumption that organizations always have to deal with space, even when acting on a national level (Howells and Bessant, 2012). A company which maintains subsidiaries at different geographic locations in the same country is still confronted with managerial challenges regarding this space, in a similar way to an international company. Nevertheless, it is equally obvious that as soon as activities get internally or externally international, organizations automatically have to deal with space (Howells and Bessant, 2012).

Since the beginning of a common research agenda, crossovers in the fields of innovation, economic geography, and management have declared significant advancements in this field (Howells and Bessant, 2012). As innovation is the center of attention of this dissertation, economic geographers indeed provide interesting insights for international dynamics.

A crucial challenge at the FFE is enabling the cross-fertilization of innovation processes through unexpected and interdisciplinary encounters between people (Cohendet and Simon, 2006; Parjanen, 2012). Given the assumption that actors are geographically dispersed, and due to the lack of literature integrating international issues into the FFE, the question is raised as to how organizations could successfully coordinate knowledge to generate discontinuous innovations in the international context. Regarding the broad field of international management, the approach of economic geographers underlining the importance of proximity and not of distance is used for this dissertation. This choice is justified by several reasons.

Firstly, economic geography combines the challenges of space with innovation issues. Insights from this stream are not only applied in economic studies, but also in organizational and regional sciences, sociology, and management (Balland *et al.*, 2015; Knoben and

Oerlemans, 2006). Economic geographers seek to understand the dynamics of space in relation to innovation and this is a core issue of this dissertation.

Secondly, research in the field of economic geography considers the coordination of knowledge over space. This correlates with the knowledge-based view of the firm. Both, the knowledge-based view as well as economic geography aim to identify appropriate coordination mechanisms to increase the innovative potential of a firm. Both consider the internal view of the firm where knowledge is the key asset that has to be coordinated when geographic proximity is not present between actors (Howells and Bessant, 2012).

Although economic geography is part of economic studies, it has deliberately been chosen for this dissertation to complement the stream of management science. The decision for an interdisciplinary approach follows the advice of Zaheer *et al.* (2012) that:

*“[F]ollowing the adage that ‘the best tool is the one that fits the job’, we suggest that research into a particular process or decision may sometimes be best informed by theory and measures from fields other than international business itself.” (Zaheer et al., 2012, p. 25)*

Table 4 illustrates the underlying assumptions of the international FFE as defined in this dissertation in comparison with the field of economic geography.

<b>International FFE of discontinuous innovations</b> (Key assumptions based on literature review)	<b>Economic geography: Proximity and innovation</b>
Informal and interdisciplinary encounters are crucial.	Considers proximity between the actors.
Knowledge is the most important asset.	Analyzes interactions between innovation and knowledge.
Identification of appropriate coordination mechanisms.	<i>“Organizational coordination across function and geography is one of the key essences of a firm’s set of core competences” (Howells and Bessant, 2012, p. 931).</i>
Considers the internal view of the firm.	<i>“The internal organization of firms and how they are coordinated and managed over space remains a major concern for managers” (Howells and Bessant, 2012, p. 931).</i>

Table 4 – Comparison of the Objectives of the Dissertation and the Field of Economic Geography.

Approaching international management issues through the lens of economic geography is appropriate for this dissertation. In addition, one approach is predominant in the field of economic geography: the analytical framework of proximity (Boschma, 2005). The following chapter explains why it is taken into consideration here.

### **2.3.2.3 The Analytical Framework of Proximity**

Boschma developed this concept based on research of the French School of Proximity Dynamics which started to analyze the spatial notion of geographic space in the 1990s in order to better understand economic activities (Balland *et al.*, 2015). His initial motivation was to isolate geographic proximity from other dimensions in order to assess its real impact on innovation. In his conclusion, Boschma (2005) highlighted that:

*“[G]eographic proximity per se is neither a necessary nor a sufficient condition for learning to take place”*(Boschma, 2005, p. 62).

For this reason he created a framework which includes spatial as well as non-spatial dimensions of proximity: geographic proximity (spatial) on the one hand and social, institutional, organizational, and cognitive proximity (non-spatial) on the other hand. In his research, the author refers to innovation networks and seeks to explain knowledge linkages between actors across space. The framework does not only correlate with the knowledge-based view of the firm, but it also considers an essential element of the FFE in the case of discontinuous innovations: Boschma (2005) analyzes interactions between actors who share and generate knowledge for innovation. As elucidated before, this is a core issue for a successful FFE of discontinuous innovations. In addition, he was not the first author to distinguish non-spatial proximity dimensions, as illustrated by the extensive literature review about inter-organizational collaborations offered by Knoblen and Oerelemans (2006). They found that proximity dimensions do not only differ from one author to another, they are also measured differently. Considering this broad variety of approaches, the proximity model of Boschma (2005) has deliberately been chosen for this dissertation as a predominant model which is widely diffused in this field.

Bouba-Olga and Grossetti (2008) illustrate that depending on the author, the spatial dimension – geographic proximity – might equally be designated as physical or spatial proximity. According to them, the indicator to measure physical space should not be reduced to physical distance, but also include transportation time or communication costs. In his



analytical framework, however, Boschma (2005) limits the definition of geographic proximity to the physical space which lies between actors.

Regarding non-spatial proximity dimensions, Boschma (2005) defines them as follows: Social proximity refers to the relationship (close/distant) between people, institutional proximity characterizes the degree to which actors share the same set of norms (formal and/or informal) and organizational proximity is reached through control. It is therefore often observed between headquarters and subsidiaries. Finally, cognitive proximity indicates the extent to which a common knowledge base exists between actors. In contrast to prevailing opinion, Boschma (2005) and later Boschma and Frenken (2010) found that too little as well as too much proximity are both restrictive for innovation.

Balland *et al.* (2015) integrated a dynamic perspective and increased the explanatory potential of the framework. They found that the five dimensions evolve over time *via* learning, decoupling, institutionalization, integration, and agglomeration. By collaborating, individuals learn from each other and create a common knowledge base: this increases cognitive proximity. The decoupling effect impacts on social proximity and refers to the fact that former colleagues who do not work any longer in the same company stay in touch because of a relationship of trust. The dynamic aspect of institutional proximity is institutionalization. Collaboration on a continual basis creates a shared set of rules, goals and values. Organizational proximity is enhanced by an increased integration of organizational entities (e.g. initially external establishments which are integrated into the organizational structure). Finally, the authors suggest that agglomeration decisions impact on geographic proximity between actors (Balland *et al.*, 2015).

With their dynamic model, Balland *et al.* (2015) break down an often discussed oversimplification regarding static proximity dimensions. They still argue that these dynamics are not identical for each dimension as they are linked to differing costs. Cognitive proximity, for instance, evolves rapidly whereas geographic proximity is less easy to impact. It implies high costs caused for example by the relocation of employees or the construction of a new plant (Balland *et al.*, 2015).

### 2.3.3 THE RESEARCH QUESTION: A PARADOX

*“Paradox’ – Definition: A situation or statement that seems impossible or is difficult to understand because it contains two opposite facts or characteristics”*

(Cambridge Dictionary, 2016).

The review of the literature above has shed light on the gap which needs to be addressed: international challenges at the FFE have not been sufficiently taken into account. However, the review has shown that the FFE is a complex organizational phenomenon which currently remains undefined and ambiguous within the organizational sciences. Hence, a first approach for the terms international FFE and international FFE team was proposed in **chapter 2.3.1**. These definitions are still broad and will thus require further investigation throughout this dissertation. Nevertheless, the objective of this research has larger scope than the simple intention to fill in a gap in the academic literature. In fact, it is research about a paradox.

More precisely, it is a proximity paradox at the FFE of discontinuous innovations. Almost all authors who discuss the FFE presume at least physical (geographic) proximity between actors. Conversely, with regards to the current economic context, it was illustrated that such proximity is nearly nonexistent in today’s organizations (Howells and Bessant, 2012). On the contrary, geographic space at the FFE offers opportunities by enhancing creativity and thus also the quality of this phase. Obviously, the necessity to act across space matters for every company as soon as it has more than one location.

However, this dissertation focuses on an extreme case where space between FFE actors is unavoidable: international organizations. The international context implies automatically that employees are geographically dispersed. Internally available knowledge to foster the FFE is not located at one entity. Thus, the research question of this dissertation is formulated as follows:

**The Paradox:**

How can international organizations manage the continuous generation of discontinuous product innovations at the fuzzy front-end, which requires geographic proximity between actors given the fact that this proximity does not correlate with today’s organizational reality?

If organizations fail to manage space at the FFE, knowledge remains in creative slack and cannot be exploited. Given the fact that international management is a vast field, this dissertation focuses on the concept of proximity in conformity with economic geography to provide answers to this research question.

The aim is definitely not to develop a new process for the FFE only by integrating an international dimension. In fact, there already exists a huge amount of different representations on the form of FFE processes in the literature (see chapter 2.2.1.2). As Koen *et al.* (2014) requested, research about the FFE should therefore shift towards other soft factors to analyze this phase instead of focusing on tasks or process factors. In order to comply with that call, the international FFE in this dissertation will be analyzed from a holistic perspective.

Thus, the analytical part will not be one-dimensional but will take into account several considerations with the objective in mind to describe an organizational setting to favor discontinuous innovations in international companies. These considerations are based on current advancements in the field of economic geography. In fact, scholars in this field have focused on substitutional and overlapping mechanisms (Balland *et al.*, 2015). Substitutional mechanisms replace geographic proximity whereas overlapping mechanisms can be replaced by geographic proximity (Hansen, 2015; Mattes, 2012). As Hansen (2015) based his research about innovation collaborations on the analytical model of Boschma (2005), his research is of particular interest for this dissertation. He found that geographic proximity can be substituted by social, organizational, and cognitive proximity. In addition, social and institutional proximity can be replaced by geographic proximity (overlapping).

In the case of this dissertation, overlapping mechanisms are not of further interest. The assumption was made for this research that geographic proximity needs to be replaced by other solutions in international FFE teams. Thus, this dissertation focuses specifically on substitutional mechanisms which are the three dimensions of organizational, cognitive, and social proximity. This is why these dimensions are of prevailing interest and will be investigated as illustrated in figure 9.

Organizational proximity is often used to describe the balance of control and autonomy between headquarters and subsidiaries. As this determines the design of an organizational framework within which an international FFE takes place, this will be the first angle of research. In a second step, the question is raised as to how to increase social proximity in international FFE teams. Furthermore, cognitive proximity requires further investigation

integrating the cultural dimension as a crucial aspect. Finally, the dynamics between all three dimensions and their role in geographically dispersed FFE teams will be taken into account by analogy with Balland *et al.* (2015), who claimed that these dimensions should not be investigated separately.

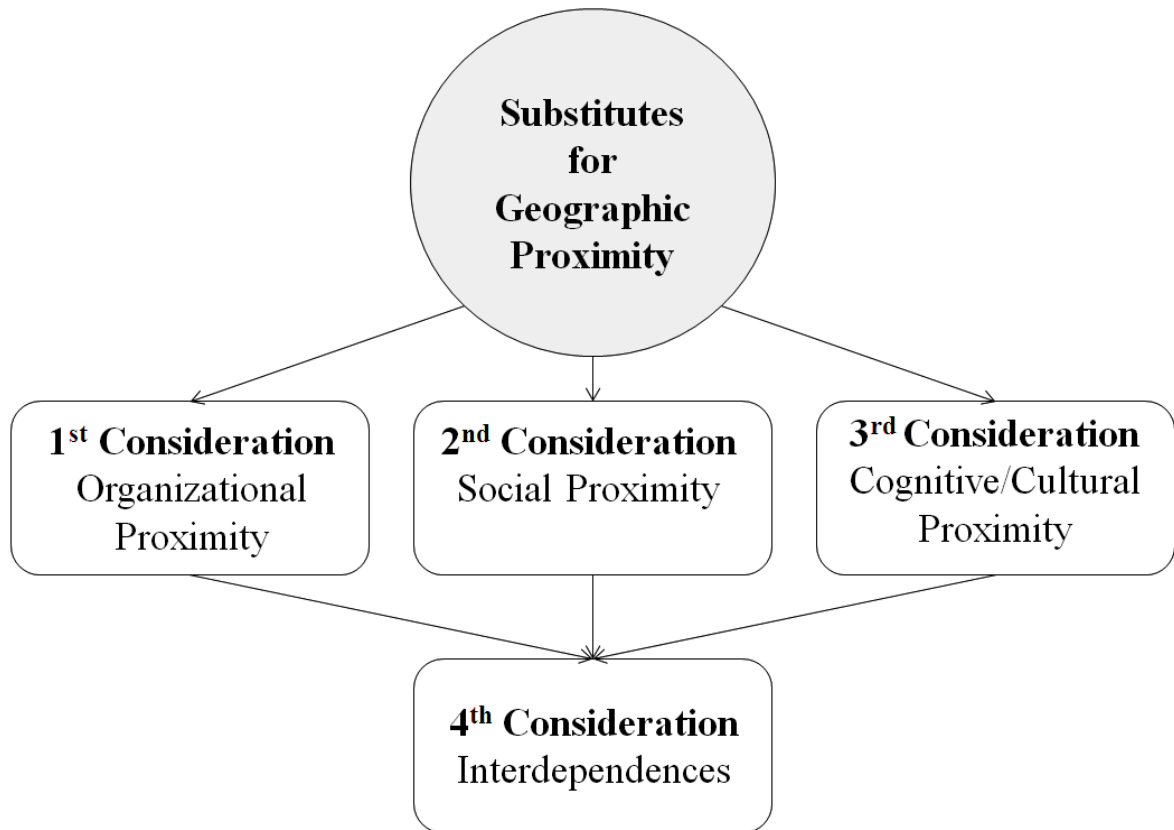

Figure 9 – The Analysis Grid of the Analytical Part.

These investigations seek to answer the research paradox presented previously about space at the FFE. Each investigation will lead to further sub-questions which will be elucidated at the beginning of each analytical chapter.

**PART III**  
**THE SETTING**

*“The more efficient you are at doing the wrong thing, the wronger you become. It is much better to do the right thing wronger than the wrong thing righter. If you do the right thing wrong and correct it, you get better.*

*Russel L. Ackoff”*  
(AZQuotes.com, 2017)

The overview of current FFE research has revealed that up to now it has not taken into account international challenges and particularly the notion of space during the FFE. This dissertation seeks to bring light into the darkness by proposing solutions for the previously described research paradox. The resulting methodology has specifically been adopted to create a new concept which seeks to respond to this challenge.

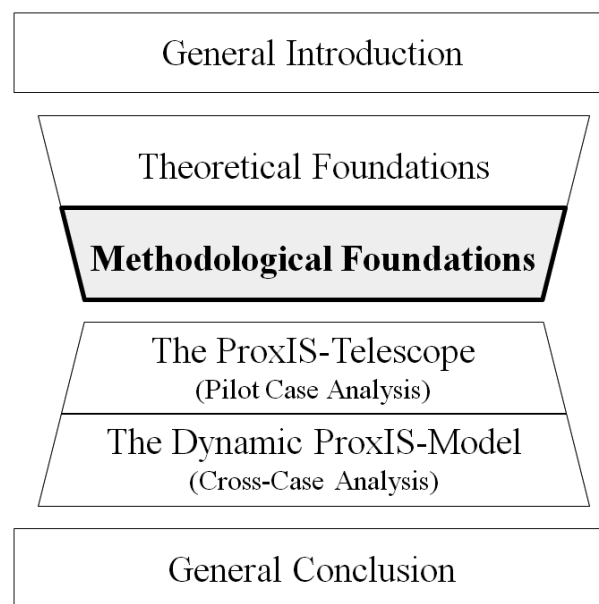

Figure 10 – Outline of the Dissertation. Present Part: Methodological Foundations.

Before entering the analytical part, the following chapters provide the methodological framework to ensure that the right thing will be done to answer the research question of this dissertation. **Chapter 3.1** describes the epistemological foundations on which the present research is constructed. In **chapter 3.2** abductive reasoning based on a qualitative research approach leads to the chosen case study design. This case study design has been corrected in order to take into account new insights from the pilot case.

Subsequently, the field contexts of this case study are investigated in more detail in **chapter 3.3** before concluding the methodological issues section in **chapter 3.4**. Towards the end of this PART III, relevant specifications about the chosen research approach are laid out in order to increase the internal as well as the external validity of the present research.

## 3.1 EPISTEMOLOGICAL FOUNDATIONS

*“It is better to choose a philosophy of science than to inherit one by default”*  
(Van de Ven, 2007, p. 2)

Traditionally, epistemology was a philosophical field about theories of knowledge generation, whereas today, the term describes the researcher’s approach to building valuable knowledge (Gavard-Perret *et al.*, 2012). The epistemological decision to choose a specific paradigm is therefore a crucial step to determining the foundations of the research design (Perret and Séville, 2007). Wacheux (1996) argued that especially in social science, reflections on the epistemological paradigm authorize a researcher to provide an opinion about an organization’s social life and its processes. Each epistemological paradigm represents a pathway of how to pursue research and to assure the validity of the research results that will then be accepted by the research community in a certain field (Gavard-Perret *et al.*, 2012). It is therefore indispensable to take care in selecting the epistemological framework in order to choose an approach that is coherent with the research.

With regards to the fact that current academic literature does not provide sufficient insights to enable the resolution of the underlying research paradox of the present dissertation, this dissertation opted for the interpretivist epistemological paradigm with an abductive reasoning model using grounded theory based on content and process research as the fundamental approach. In the following sections more details are provided to justify these decisions.

### 3.1.1 A VARIETY OF PARADIGMS

Methodology is not a synonym for the term epistemology as these are two distinct concepts (Gavard-Perret *et al.*, 2012). Epistemology represents the overall framework or philosophy of the research (Collis and Hussey, 2003). Methodology is a subcategory of the epistemological paradigm describing the tool kit of methods which are applied to develop new knowledge in accordance with the chosen epistemological paradigm (Gavard-Perret *et al.*, 2012).

Academic literature does not provide consistently used designations for epistemological paradigms (Giordano, 2003). While Gavard-Perret *et al.* (2012) distinguish five epistemological paradigms (scientific realist, critical realist, pragmatic constructivist, interpretivist, and constructivist), Van de Ven (2007) describes four philosophies of science (positivism, relativism, pragmatism, and realism). Finally, Giordano (2003) based his

epistemological consideration on only three frameworks: the positivist, the interpretivist, and the constructivist traditions. According to Perret and Séville (2007), the distinction between these three traditions is the most appropriate because they designate the three main paradigms in management research.

In the positivist paradigm, the researcher does not interact with the observed reality and remains independent (Giordano, 2003). The interpretivist and the constructivist paradigms are in opposition to the positivist approach (Perret and Séville, 2007). Here, the researcher cannot be disconnected from the observed reality as he is interdependent with his environment. The constructivist approach claims to co-construct the interpretations together with the involved actors, which demands a close relationship with them (Giordano, 2003). In the interpretivist paradigm – which is sometimes also called the phenomenological paradigm (Collis and Hussey, 2003) – the researcher observes and interprets the phenomenon, develops empathy for the subjects, and gives sense to the phenomenon (Giordano, 2003).

### **3.1.1.1 Decision: The Interpretivist Paradigm**

The epistemological reflections of this dissertation are based on the interpretivist paradigm. This decision was made in accordance with Gavard-Perret *et al.* (2012), as social reality cannot be separated from the researcher. As these authors clarified, the knowledge created depends on the researcher and the experiences he/she had during the study: he/she is totally immersed in the field studied and describes not only the phenomenon but also the perceptions of the observed actors. The generalization of the results is not effectuated by statistical analysis but by inductive or abductive approaches (see figure 11), as this takes into account the valuable tacit knowledge of the phenomenon in complex environments (Gavard-Perret *et al.*, 2012). The interpretivist paradigm enables the researcher to analyze the phenomenon in its natural setting and to take into account the specific contextual and historical reality (Perret and Séville, 2007). Because the researcher is interdependent with the field setting, the interpretation of the phenomenon depends on the time, the space, and the context of the research: results are therefore not universal (Perret and Séville, 2007).

The present research is positioned within this paradigm because the objective is to understand the FFE of discontinuous innovations in an international setting. As argued by Koen *et al.* (2014), the FFE is a complex phenomenon which requires a holistic vision in order to fully understand it. Consequently, the epistemological paradigm should equally be



adapted to a holistic vision. This is the case for the interpretivist paradigm which targets a holistic comprehension of the social reality of a phenomenon: its overall aim is to explore a phenomenon instead of testing an existing theory (Allard-Poesi and Maréchal, 2007). By means of an increasing interaction with the field and the development of a fundamental comprehension of the phenomenon, the researcher proposes a final conceptualization of the phenomenon studied (Allard-Poesi and Maréchal, 2007).

Table 5 summarizes the basics inherent in the interpretivist paradigm in comparison with the present research.

<b>Interpretivist Paradigm</b> (Key assumptions based on literature review)	<b>The Present Research</b> (in accordance with PART I and II)
Holistic approach to the phenomenon.	A holistic analysis of the international FFE regarding organizational, cognitive and social proximity.
The researcher is interdependent with the field.	I was totally immersed in the field <i>via</i> a CIFRE contract (i.e. professional PhD program in France).
The phenomenon depends on the time, the space, and the context in which it was observed.	The FFE of discontinuous innovations is analyzed in an international context.
Explore a phenomenon (not test it).	No prevailing model exists for the research paradox. Exploration is the only solution.

Table 5 – Comparison of the Interpretivist Paradigm and the Present Research.

The iterative approach to the research question and my position towards the studied field justify the decision to choose the interpretivist paradigm.

### 3.1.1.2 The Reasoning Model: Abduction

Depending on the epistemological paradigm, there are two different ways of reasoning to construct new knowledge (Charreire Petit and Durieux, 2007). Deductive research aims to test or demonstrate an existing theory or general rule:

*“Deductive research is a study in which a conceptual and theoretical structure is developed and then tested by empirical observations; thus particular instances are deduced from general inferences.”* (Collis and Hussey, 2003, p. 15)

In other words, the deductive approach uses an existing theory and tests it *via* empirical research. If the aim is not to test a theory but to formulate a general rule based on a particular

case, induction logic applies. Regarding the chosen epistemological paradigm, the inductive approach is appropriate as “*it is referred to as moving from the specific to the general*” (Collis and Hussey, 2003, p. 15). This choice is strengthened by the fact that deduction correlates in general with the positivist and induction with the interpretivist paradigm.

In management science, a third option has evolved in line with inductive reasoning. It is possible that the aim of research is not to develop a general rule but to propose a new conceptualization or new explanations about a phenomenon in form of a new model, or a new theory, or new hypotheses. In this case, the research uses an abductive approach where data and existing theory are used in parallel (Gioia *et al.*, 2013). Figure 11 illustrates the interplay between the three reasoning models and highlights the chosen pathway.

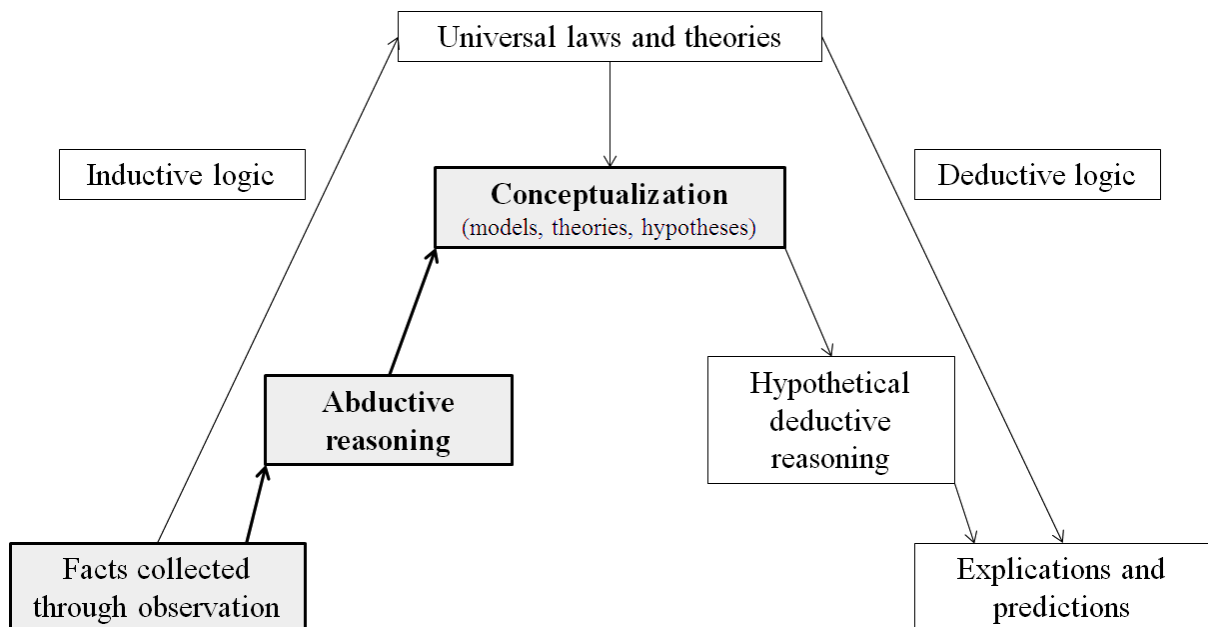

Figure 11 – Reasoning Models and Scientific Knowledge (Charreire Petit and Durieux, 2007, p. 64 translated by MN); Chosen Approach Highlighted by MN.

This research is positioned towards abductive reasoning. It seeks not to develop a general theory but a first conceptualization of a new phenomenon. This conceptualization should be empirically tested to transform it into a general theory but this step is consciously excluded from the research. This is in line with the exploratory character of the interpretivist approach.

Conforming to the interpretivist approach, abductive reasoning is the chosen reasoning model.  
Results of this research will be a first conceptualization of the phenomenon.

### 3.1.2 EXPLORATION VS TESTING: GROUNDED THEORY

For data analysis, abductive logic correlates with grounded theory as developed by Glaser and Strauss (1999). This approach is used when no theory exists to explain a phenomenon (Creswell, 2012). Regarding the present phenomenon, there are theoretical models to explain some of its parts. For instance, research about creativity and the impact of national culture cover one aspect of the research. However, no theory provides a holistic approach to the FFE of discontinuous innovations in an international organization.

Furthermore, grounded theory implies that as a first step, categories and their properties are collected and coded. Such categories can partly be based on existing literature as has been done in the theoretical chapter presented earlier (Glaser and Strauss, 1999). However, this approach requires staying open to the identification of new categories. This process leads, at its end, to assumptions which are “*suggestions, not tested, relations among categories and their properties*” (Glaser and Strauss, 1999, p. 39).

Concordant with abductive logic, grounded theory is therefore not based on an existing theoretical model. The theoretical framework is continually developed by gathering and analyzing collected material (Glaser and Strauss, 1999). Hence, theory is not static, but evolves over time (Glaser and Strauss, 1999).

Finally, grounded theory correlates with the interpretivist paradigm in that it encourages the researcher to directly interact with the field context and interpret the situation:

*“Building theory, by its very nature, implies interpreting data, for the data must be conceptualized and the concepts related to form a theoretical rendition of reality (a reality that cannot actually be known, but is always interpreted).”* (Strauss and Corbin, 1990, p. 22)

All in all, several aspects of the methodological reflections are in accordance with the grounded theory as it aims to generate new theory for the present research question.

Due to the high correlation of grounded theory with abductive reasoning, it is used as the fundamental research approach for the present dissertation.

### 3.1.3 CONTENT VS PROCESS RESEARCH

With regards to the way in which a research object is studied, two broad approaches can be distinguished: content and process research (Grenier and Josserand, 2007). Grenier and Josserand (2007) illuminate that content research studies a phenomenon at an instant ‘t’ where time has no further impact on the study. Process research, on the other hand, is described by the authors as a film where time represents a crucial variable. The authors explain that both approaches are not mutually exclusive and can be applied to complement each other. As a result, the present research uses a mix of both approaches as illustrated in figure 12.

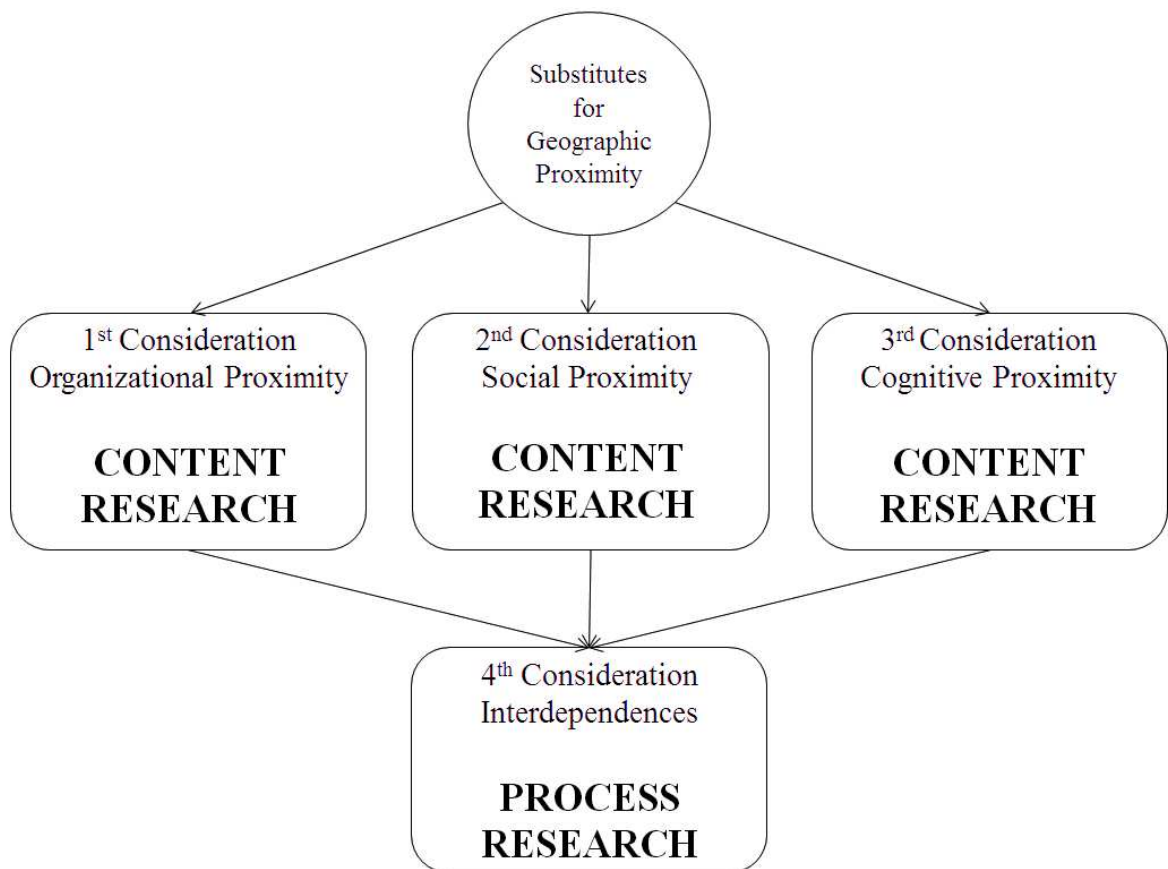

Figure 12 – Content and Process Research: Complement to the Analysis Grid of the Dissertation.

Process research is generally used to describe a phenomenon or to explain it (Grenier and Josserand, 2007). For a successful piece of process research, it is:

*“necessary to know, through content research, the categories which form the process before a piece of process research is conducted”* (Grenier and Josserand, 2007, p. 136 translated by MN).

This is assured by the separate consideration of each proximity dimension in the first place. Content research is applied to investigate the phenomenon in detail with regards to the three non-spatial proximity dimensions to substitute geographic proximity during the FFE of discontinuous innovations. The objective is to develop initial coordination mechanisms to reply to the research paradox. Subsequently, the fourth consideration analyzes the interdependence between these proximity dimensions *via* process research. Studies using process research vary regarding the underlying research question (Van de Ven and Huber, 1990). Process research concentrates on a variation of independent and dependent variables to examine the question of ‘whether’ change happens and ‘how’ organizational change emerges and develops (Van de Ven and Huber, 1990). The aim of the fourth consideration will be to take a closer look at how the FFE and the proximity dimensions evolved over time.

In essence, for this study, content research will provide an overview about the current state of management of the FFE of discontinuous innovations in international organizations, whereas process research will enable the integration of a dynamic dimension to this investigation.

<p>This research combines both ways to study the phenomenon: content research to identify the management of the FFE at an instant ‘t’ as well as process research analyzing variations over time.</p>
---

## 3.2 A CASE STUDY DESIGN

*“[G]iven the strengths of this theory-building approach and its independence from prior literature or past empirical observation, it is particularly well-suited to new research areas or research areas for which existing theory seems inadequate.”*  
(Eisenhardt, 1989, p. 548 f.)

The choice of a research method depends on the research question and the underlying epistemological paradigm. The present research asks ‘how’ international organizations manage the continual generation of discontinuous product innovations at the FFE. In addition, the body of existing literature is deficient about the phenomenon. As a result, a case study design was chosen. Case studies respond to ‘how’ or ‘why’ questions and are in line with the interpretivist paradigm (Wacheux, 1996; Yin, 2003). They are often referred to as exploratory research (Collis and Hussey, 2003) and this is why Wacheux (1996) suggests advancing from the individual case to a general study afterwards when engaging in a new research area. Still, case studies do not only explore a phenomenon: their main objective is to understand it entirely (Yin, 2003). Especially if the phenomenon is complex, case studies provide sufficient data to capture the entire organizational reality (Wacheux, 1996; Yin, 2003). Considering that the objective of the present dissertation is to investigate the studied phenomenon in its natural organizational setting, a case study design is perfectly appropriate (Yin, 2003).

The pilot case is BÜRKERT which is a family-owned German company active in the industrial sector. Two replication cases complete the analysis. 3D PLUS is a small company with headquarters in Paris and ELECTRO<sup>3</sup> is a big company with two headquarters, one in Germany and one in France. All three field contexts will be described in more detail in chapter 3.3. The present chapter focusses on the general methodological approach to the case studies. In five steps, it clarifies:

- The typology of the case study based on Yin (2003) and Eisenhardt (1989) (chapter 3.2.1);
- The phases of the case study integrating all three field contexts (chapter 3.2.2);
- The units of analysis of the pilot case and the two replication cases (chapter 3.2.3);
- The data collection specifying the methods used in this research (chapter 3.2.4); and
- The methods of analysis based on a vertical and a horizontal approach (chapter 3.2.5).

<sup>3</sup> The big company will, for reasons of confidentiality, be designated ELECTRO (the pseudonym indicates the core activity in which it is active)

### 3.2.1 CASE STUDIES: A TYPOLOGY

*“[Y]ou should not think that a case study’s design cannot be modified by new information or discovery during data collection. [...] The point is that the needed flexibility should not lessen the rigor with which case study procedures are followed.”*  
(Yin, 2003, p. 55)

Case studies are flexible methods which may adapt to unexpected insights without losing any of their benefits as long as the researcher maintains sufficient rigor during the conducting of the case study (Yin, 2003). The following overview of Yin (2003) illustrates two distinct categorizations for case studies: single vs. multiple and holistic vs. embedded case designs.

	Single-Case Design	Multiple-Case Design
<b>Holistic</b> (single unit of analysis)	<b>TYPE 1</b> <ul style="list-style-type: none"> <li>• Critical case (to test a well-formulated theory)</li> <li>• Extreme or unique case</li> <li>• Representative or typical case</li> <li>• Revelatory case</li> <li>• Longitudinal case (study the same single case at two or more different points in time)</li> </ul>	<b>TYPE 2</b> <p>Comparative studies. Every case serves a specific purpose and follows a ‘replication’ logic.</p> <p>Predict</p> <ul style="list-style-type: none"> <li>• similar results or</li> <li>• contrasting results for predictable reasons</li> </ul>
<b>Embedded</b> (multiple units of analysis)	<b>TYPE 3</b> <p>More than one unit of analysis (different data collection techniques could be used for each level of analysis)</p>	<b>TYPE 4</b> <p><b>Multiple-case study with embedded units of analysis.</b></p>

Table 6 – Basic Types of Case Studies (Yin, 2003, p. 40). Chosen Type Highlighted by MN.

The present research is based on type 4 and thus an embedded multiple-case design. In accordance with Yin (2003), the objective was to avoid a current problem of the holistic approach: no specific subunits are defined and a case study risks remaining on a superficial or abstract level. The embedded design, by introducing several subunits, enables detailed insights on a deeper level. Even if this design integrates other pitfalls like the danger of getting into too much detail and losing the overall objective of the case study, it was still considered as better adapted to the current research (Yin, 2003).

Furthermore, the choice for a multiple-case design increased the external validity of the research results (Yin, 2003). Initially, a type 3 design was intended for the present research with one in-depth embedded case study at BÜRKERT. However, during the analytical part, it was considered necessary to integrate two further case studies to render the whole concept more robust. Eisenhardt (1989) claims that a case study design should be fixed before entering the field. At the same time, the author still suggests that this design should not be rigid and leave room for flexibility. It should remain possible to adapt the research design of exploratory research (Musca, 2006).

The optimal number of cases is not predefined and depends on the heterogeneity of the research question (Wacheux, 1996). Yin (2003) claims that the fields for further case studies should be chosen:

- Because it can be assumed that research results are repeated (i.e. literal replication); or
- Because they produce different results (i.e. theoretical replication).

The initial model based on the insights of the pilot case study led to the assumption that the results depend crucially on a dimension that was not taken into account before: the number of individuals involved during the FFE. As in case studies, the phenomenon often depends on the context (Yin, 2003), the two replication field contexts were chosen because of their size. Whereas BÜRKERT is a medium-market company (2,600 employees), ELECTRO is a large company with more than 11,000 employees. 3D PLUS numbers around 185 employees and therefore represents a smaller company than BÜRKERT. The three cases still have specific similarities: they are active in the industrial sector (principally Business to Business (BtoB)), they are family-owned, and they have at least one subsidiary in France and one abroad. Before entering the field, it was assumed that the three field contexts would provide varying results and they are therefore considered as theoretical replications.

The choice of multiple-case design occurred during the initial case study. It was integrated into the methodological framework to increase external validity of the research (Yin, 2003).

The chosen methodological approach is a case study design type 4 (i.e. embedded multiple-case study). The two additional cases are theoretical replication cases.



### 3.2.1.1 The Role of the Researcher

The role of the researcher in the interpretivist paradigm requires closeness and empathy for the subject studied. It is therefore necessary to think about the position of the researcher during field work. The challenges for the researcher are great. On one hand, he/she should be completely integrated into organizational life in order to understand the processes in full and collect all the relevant data; on the other hand, he must remain objective during the analysis process (Wacheux, 1996). Access to the field is therefore a crucial step in the research as a number of negotiations with the relevant actors are necessary (Wacheux, 1996).

In the case of the present research, there were different approaches for each field context. During the pilot case, I was completely integrated into day-to-day business (as Innovation Manager under a 'CIFRE' contract). I had open access to the data and it was possible to create a relationship of trust with the actors involved without unduly influencing the course of events. The interplay of objectivity and subjectivity of observations was assured during notation by using different color codes for observations and subjective interpretations.

During the two replication cases, objectivity was no barrier as I only interacted with the company setting on a few occasions. However, access to the field is crucial for successful data collection (Gavard-Perret *et al.*, 2012). Regarding the two replication field contexts, several aspects facilitated data collection. At ELECTRO, the company had already worked on research projects together with the University of Strasbourg. In addition, several informal exchanges had occurred between ELECTRO and BÜRKERT. Both companies were familiar with the responsible persons of the other company. In the case of 3D PLUS, a close collaboration between BÜRKERT and 3D PLUS existed already thanks to a joint development project. As this development project was conducted over five years, both companies constructed a close relationship of trust.

### 3.2.1.2 Increasing the Validity of the Research

Research requires internal and external validity. Internal validity asks for stringency and accuracy concerning data collection and data analysis (Avenier and Thomas, 2012). Especially for the interpretivist approach, internal validity is crucial (Yin, 2011). According to Pratt (2009), there are two challenges regarding internal validity inherent to the interpretivist paradigm: either the research exhibits not enough primary data and thus only its interpretation, or it describes the context in detail without interpreting it.

Gavard-Perret *et al.* (2012) advise that internal validity is ensured by an intense dialogue with the relevant actors. This takes place in iterative steps during the research. In the present dissertation, this was fulfilled by the researcher's total integration into day-to-day business at the pilot company. Therefore, it was possible to regularly interact with the actors involved and clarify points directly with them. Eventual tensions or irregularities are able to be rapidly identified to complete existing information (Gavard-Perret *et al.*, 2012) and to re-interpret the current situation (Pratt, 2009).

The diversity of collected data represents one of the advantages of the interpretivist approach. However, this risks falling into the trap of describing data without interpreting it (Pratt, 2009). To avoid this, the researcher should constantly explain the chain of evidence and how he/she got from the raw material to the actual interpretation of the data (Pratt, 2009). This is assured by the use of consistent verbatim accounts during the analytical part of this thesis to enable the reader to comprehend the interpretations.

The external validity of acquired knowledge is less crucial for research using the interpretivist paradigm (Avenier and Thomas, 2012; Gavard-Perret *et al.*, 2012). Nevertheless, the chosen multiple-case design helps increase external validity. Table 7 summarizes several tactics for obtaining greater validity of the research based on Yin (2003). Moreover, it synthesizes the solutions which were chosen for the present dissertation to increase the overall validity of the research.

Tests	Case Study Tactic (Yin, 2003)	Solutions (by MN)
Construct validity	<ul style="list-style-type: none"> <li>• Use multiple sources of evidence</li> <li>• Establish chain of evidence</li> <li>• Have key informants review draft case study report</li> </ul>	<ul style="list-style-type: none"> <li>• Method triangulation to combine several sources of evidence</li> <li>• Chain of evidence: illustrated by verbatim accounts which indicate the coding process</li> <li>• Constant discussion of research results with the research supervisor at BÜRKERT and the involved actors</li> </ul>
Internal Validity	<ul style="list-style-type: none"> <li>• Do pattern-matching</li> <li>• Do explanation building</li> <li>• Address rival explanations</li> <li>• Use logic models</li> </ul>	<ul style="list-style-type: none"> <li>• Close collaboration with the field contexts, especially in the case of the pilot company</li> <li>• Identification of rival statements and discussion of them with the actors</li> </ul>
External Validity	<ul style="list-style-type: none"> <li>• Use theory in single-case studies</li> <li>• Use replication logic in multiple-case studies</li> </ul>	<ul style="list-style-type: none"> <li>• Multiple-case study with theoretical replication</li> </ul>
Reliability	<ul style="list-style-type: none"> <li>• Use case study protocol</li> <li>• Develop case study database</li> </ul>	<ul style="list-style-type: none"> <li>• Creation of identical case study database for each field context</li> <li>• Systematic collection of data</li> </ul>

Table 7 – Case Study Tactics (Yin, 2003) Compared to Practical Solutions for the Dissertation (by MN).

### 3.2.2 THE PHASES OF THE CASE STUDY

*“Case study theory building is a bottom up approach such that the specifics of data produce the generalizations of theory.”*  
(Eisenhardt, 1989, p. 547)

With the objective of increasing the validity of case studies as a research method for theory building in mind, Eisenhardt (1989) combined the insights of Glaser and Strauss (1999), Yin (2003), and Miles and Huberman (1984) with the case study method in an effective way. To increase the quality of case study research for theory building, the author proposes eight steps which have been followed step-by-step during the current research (table 8).

These steps are not sequential but iterative and feedback loops between the different steps are crucial (Eisenhardt, 1989). Gassmann (1999) described this approach of case studies later as an iterative learning process where the researcher continually shifts between theory and empirical findings to shape his/her reflections and resulting hypotheses.

<b>1</b>	<b>Getting started:</b> Definition of the research question	Neither theory nor hypotheses
<b>2</b>	<b>Selecting Cases:</b> Specified population	Theoretical, not random, sampling
<b>3</b>	<b>Crafting Instruments and Protocols:</b> Multiple data collection methods	Qualitative and quantitative data combined
<b>4</b>	<b>Entering the Field:</b> Overlap of data collection and analysis, including field notes	Allows investigators to take advantage of emergent themes and unique case features
<b>5</b>	<b>Analyzing Data:</b> Within-case analysis and cross-case pattern search using divergent techniques	
<b>6</b>	<b>Shaping Hypotheses:</b> Iterative tabulation of evidence for each construct	Replication, not sampling logic across cases
<b>7</b>	<b>Enfolding Literature:</b> Comparison with conflicting and similar literature	Sharpens generalizability
<b>8</b>	<b>Reaching Closure:</b> Theoretical saturation when possible	Ends process when marginal improvement becomes small

Table 8 – Eight Steps for Theory Building (Eisenhardt, 1989, p. 533).

After each discovery of contradictory results, the initial theory should be revisited before further pursuing the research. In figure 13, these models have been adapted to the current research. According to the adapted model, an initial theory is developed after conducting the

pilot case study, which is then applied to a second and a third case. Feedback loops enable the adaptation of the research design to modify or to complete the initial theoretical model.

The pilot case study provides a full description of the research phenomenon. This description in combination with the theoretical foundations represents the body of knowledge to construct an initial model. This model is then applied to the two replication case studies. The second and third field contexts were identified based on the evolution of the exploratory research. Once data had been collected from these two replication cases, cross-case analysis became possible and a synthesized conclusion could be drawn.

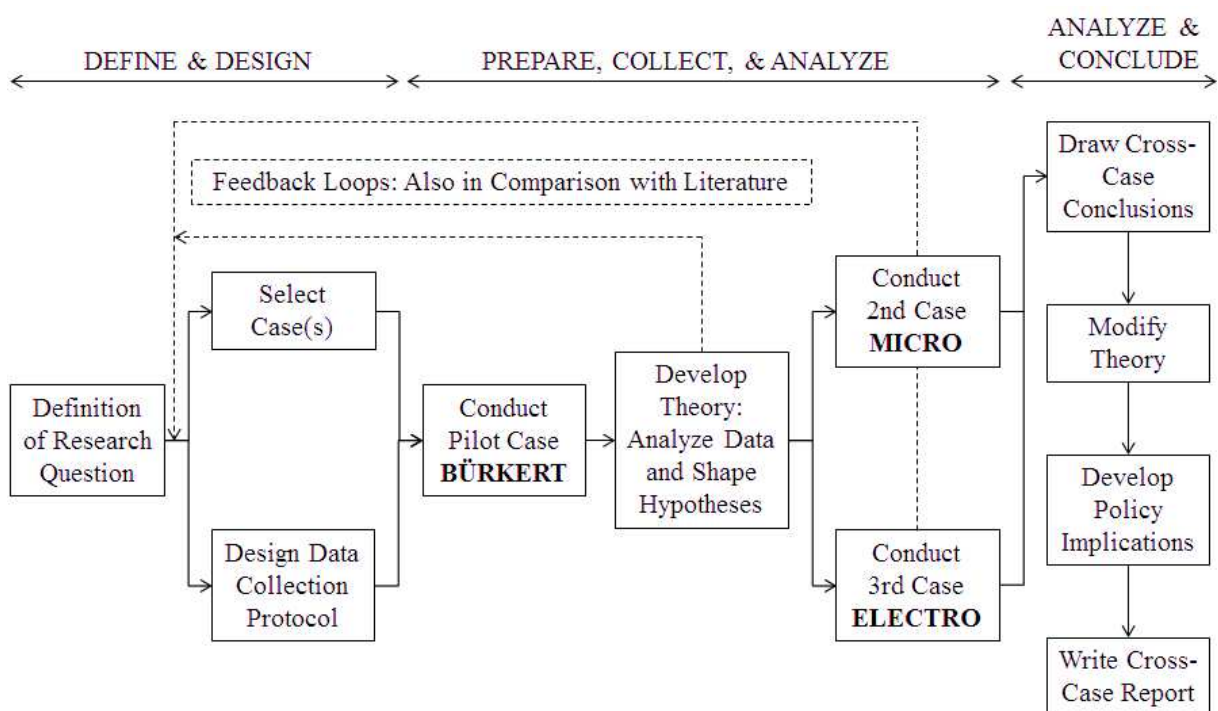

Figure 13 – Case Study Model of the Dissertation Based on Yin (2003), Gassmann (1999) and Eisenhardt (1989).

### 3.2.3 THE UNITS OF ANALYSIS

*“A unit of analysis is the kind of case to which the variables or phenomena under study and the research problem refer, and about which data is collected and analyzed.”*

(Collis and Hussey, 2003, p. 68)

In case studies, the choice of the unit of analysis is a crucial step. It should be coherent to the phenomenon studied and ideally refer to the lowest level possible (Collis and Hussey, 2003). Table 9 illustrates several possible units of analysis.

<b>Unit of analysis</b>	<b>Description</b>
An individual	A person is the most common unit of analysis in business research; for example, a manager, a union member or a customer.
<b>An event</b>	This is a particular incident; for example, a strike, a decision to relocate or a purchase.
An object	In business research this is likely to be a commodity; for example, a machine, a product or a service.
<b>A body of individuals</b>	This includes groups of people and organizations; for example, a work group, a committee or a department.
A relationship	This is a connection between two or more individuals or bodies; for example, a buyer/seller relationship, a manager/employee relationship, a management/union relationship, a company/supplier relationship or a relationship between a head office and its retail outlets. (An individual or body may be part of more than one relationship).
An aggregate	This is a collection of undifferentiated individuals or bodies with no internal structure; for example, supporters of a particular football club, parents of children at a certain school, sole traders in a particular part of a city, or companies in a specific industry.

Table 9 – Units of Analysis (Collis and Hussey, 2003, p. 122) Highlighted for the Three Cases (by MN).

For this study, a distinction between the pilot case and the other two field contexts is necessary. All three cases apply a body of individuals as the predominant unit of analysis. However, the pilot case is an embedded case study: this implies that besides a general view on the company (i.e. the body of individuals) several subunits have been identified (Yin, 2003).

### **3.2.3.1 The Subunits in the Pilot Case Study**

At BÜRKERT, five innovation projects (i.e. events) complete the units of analysis during the overall case study. The five project cases were systematically chosen together with the R&D responsible person from the group according to specific criteria adapted to the research subject (i.e. reasoned choice (Royer and Zarlowski, 2007)). While the different project cases can and should be compared to each other, random selection was not considered as appropriate in this instance (Eisenhardt, 1989). To assure objectivity and to make the project cases comparable, the FFE of all five project cases lie in the past. The choice for the five cases was made based on three criteria:

- The degree of innovation;
- The degree of spatial collaboration; and
- The range of success.

#### **3.2.3.1.1 The Degree of Innovation**

The objective of the underlying research question was to take a closer look at the FFE of innovative projects. The degree of innovation was identified based on the definition of Garcia and Calantone (2002), and decided together with the R&D responsible person from the group. Four projects have been classified as discontinuous innovation projects, of which one was a radical innovation (new user benefit and new technology at the same time). Furthermore, a reference project (continuous innovation project) was integrated into the study to compare the generation of discontinuous innovations to the process for continuous innovations at BÜRKERT.

#### **3.2.3.1.2 The Degree of Spatial Collaborations**

To analyze challenges across space, the project cases needed to differ regarding the degree of spatial collaboration. This dimension was captured by the number of local entities represented in the FFE team. As soon as more than one entity was represented, geographic space between actors was observed. Within the five cases, four projects were collaborative projects over space whereas one local team was integrated as the reference project. Besides collaborations between FFE team members which were coordinated across space, the degree of spatial collaborations also took into account those spatial collaborations on a strategic level where FFE team members interacted with decision-makers of another entity (i.e. headquarters).

### 3.2.3.1.3 The Range of Success

In order to identify barriers and success factors for an international FFE, the project cases were chosen according to their range of success. A project case was considered as successful when the final idea/concept entered into development. The FFE was not successful if the development of the idea was stopped before implementation. At BÜRKERT, an initial idea which gets a project number in the current project management system can be regarded as successful, as this marks the starting point for development. From the five project cases, four entered into development and only one project was stopped before being developed. During the FFE of this project, an external opportunity was presented to the company to develop a similar product in less time. As a result of the market situation of this product, it was stopped due to a clear make-or-buy decision in favor of the external solution (see table 11).

### 3.2.3.1.4 Five Project Cases

Based on the criteria presented, the following project cases have been selected. For confidentiality reasons, they are called ‘NAT’ (i.e. National project), ‘INC’ (i.e. incremental project), and the three international and discontinuous projects ‘A’, ‘B’, and ‘C’.

Case	Degree of Innovation	Degree of spatial collaborations	Success
NAT	<b>Really new innovation</b> A new technology is used for the same user benefits	<b>Local FFE team</b> Example of the company’s standard processes in Germany.	YES
INC	<b>Continuous innovation</b> Improvement of an already existing product line.	<b>Spatial collaboration on strategic level</b> French team members interacted with German decision-makers and product managers.	YES
A	<b>Really new innovation</b> A known technology creates a new user benefit.	<b>Local team and one international expert</b> Mainly German team except for one French team member	YES
B	<b>Really new innovation</b> A new technology is used for the same user benefits	<b>Spatial collaboration on strategic level</b> German project leader and decision-makers and French segment/product manager.	NO
C	<b>Radical innovation</b> Integration of a new technology which creates new user benefits.	<b>International FFE team</b> French and German R&D team members developed the project concept together.	YES

Table 10 – The Project Cases, their Degree of Innovation, the International Degree and the Range of Success.



In line with Eisenhardt (1989), the five cases were systematically compared to each other. Figure 14 illustrates the position of the embedded units of analysis considering the spatial dimension within the FFE team and the degree of innovation of the project.

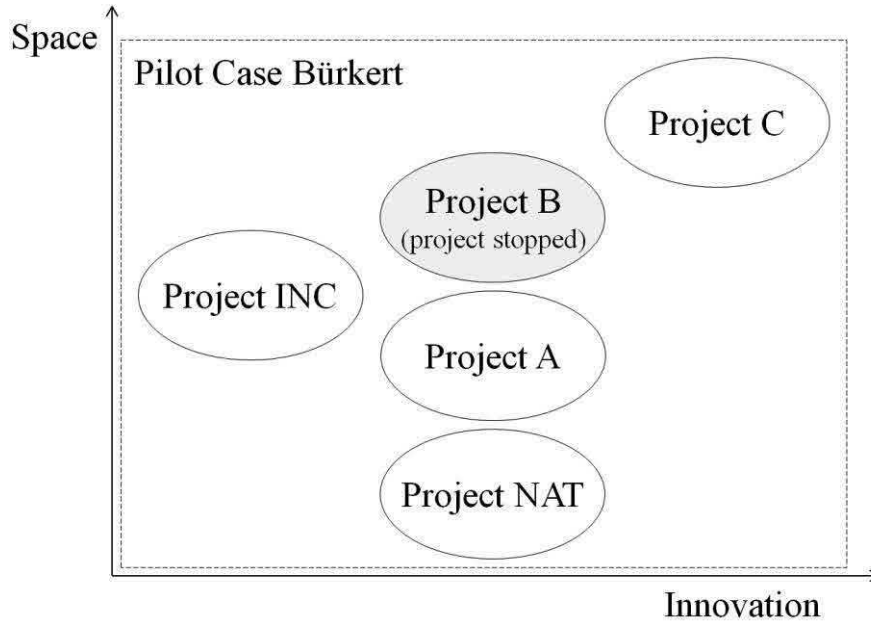

Figure 14 – Structure of the Pilot Case: Embedded Units of Analysis.

The fact that for all three discontinuous innovation projects NAT, A, and C, patent applications have been made, underlines their innovative character. As project B has been stopped before development, no patents have been applied. However, its overall objective to break with current knowledge motivated the classification as a discontinuous innovation.

As mentioned before, all FFE phases lie in the past. As illustrated in table 11 the FFE in projects A and C were relatively long compared to the other project cases. Interviewees explained that these projects faced interruptions in 2010 linked in both cases to staff turnover.

	2005	2006	2007	2008	2009	2010	2011	2012	2013	2014	2015
<b>NAT</b>			FFE			NPD					
<b>INC</b>	FFE		NPD								
<b>A</b>				FFE						NPD	
<b>B</b>								FFE			
<b>C</b>			FFE						NPD		

Table 11 – Timeline of the Project Cases.

Furthermore, the five cases also differ regarding their market application. Whereas Project INC and Project C are part of the sensor product portfolio, projects A and NAT led to the development of two new valves to regulate small amounts of fluids. Finally, the objective of project B was to revolutionize concepts of existing process valves. With regards to the anonymity of interviewees, the decision was made not to provide further information about the concrete technical specifications and their market applications for each project because this could cause conclusions from the quotations throughout the empirical part to the persons behind the statements.

### **3.2.3.2 The Units of Analysis at ELECTRO and 3D PLUS**

The two replication case studies involved less intense data collection than the pilot case. The unit of analysis remained at the organizational level (i.e. body of individuals). The two case studies were not embedded case studies but holistic ones where the organization was considered as a whole entity. This decision is justified by the fact that the initial pilot case provided in-depth insights about the observed phenomenon and the data collection was refined. Hence, the analysis grid was established during the pilot case and was then applied to the two replication cases. Nevertheless, these two case studies are part of an overall exploratory design. The objective was still not to test the initial model but to complete it regarding contextual conditions (size). The approach to the field contexts focused on concrete variables but remained open for exploratory research.

The unit of analysis is a body of individuals (i.e. organizations) for all three case studies. This is complemented by an embedded design for the pilot case focusing on five events (i.e. projects).
---

## 3.2.4 DATA COLLECTION

*“By qualitative analysis, we do not mean the quantification of qualitative data, but a non-mathematical process of interpretation with the objective in mind to discover concepts and relations between raw data and to organize them in a theoretical and explanatory theory.”*  
(Strauss and Corbin, 2004, p. 28 translated by MN)

Inductive or abductive reasoning often implies a qualitative data collection methodology (Giordano, 2003). Qualitative data is used for theory building that is not based on statistical or other quantitative methods (Strauss and Corbin, 2004). With respect to the research question and in accordance with the interpretivist framework, a qualitative methodology was applied for this dissertation. Qualitative research enables the analysis of a phenomenon in detail to understand it entirely (Strauss and Corbin, 2004). However, it does not exclude the integration of quantitative elements (Giordano, 2003).

### 3.2.4.1 General Sources of Data

It is often suggested that a combination of several methods, termed triangulation, increases the internal validity of qualitative research. Triangulation applies such diverse sources of evidence as documentation, archival records, interviews, (participant) observations, and physical artefacts (Yin, 2003). Table 12 summarizes the strengths and weaknesses of each source based on Yin (2003).

Considering the fact that no method is entirely without its weaknesses, the use of triangulation of methods appears to be unavoidable. Triangulation enables the researcher to overcome the weaknesses of each method and to gain a complete picture of the case. Consequently, triangulation increases the internal validity of qualitative research that is based on an interpretivist paradigm (Gavard-Perret *et al.*, 2012).

Source of Evidence	Strengths	Weaknesses
<p><b>Documentation</b></p> <p>(Letters, memoranda, and other communiqués; agendas, announcements and minutes of meetings; other written reports of events; administrative documents; formal studies; newspaper clippings)</p>	<ul style="list-style-type: none"> <li>• Stable – can be reviewed repeatedly</li> <li>• Unobtrusive – not created as a result of the case study</li> <li>• Exact – contains exact names, references and details of an event</li> <li>• Broad coverage – long period of time, many settings</li> </ul>	<ul style="list-style-type: none"> <li>• Retrievability can be low</li> <li>• Biased selectivity if collection is incomplete</li> <li>• Reporting bias – reflects (unknown) bias of author</li> <li>• Access – may be deliberately blocked</li> </ul>
<p><b>Archival records</b></p> <p>(Service records; organizational records, maps and charts; lists of names; survey data; personal records)</p>	<ul style="list-style-type: none"> <li>• Same as above for documentation</li> <li>• Precise and quantitative</li> </ul>	<ul style="list-style-type: none"> <li>• Same as above for documentation</li> <li>• Accessibility due to privacy reasons</li> </ul>
<p><b>Interviews</b></p>	<ul style="list-style-type: none"> <li>• Targeted – focusses directly on case study topic</li> <li>• Insightful – provides perceived causal inferences</li> </ul>	<ul style="list-style-type: none"> <li>• Bias due to poorly constructed questions</li> <li>• Response bias</li> <li>• Inaccuracies due to poor recall</li> <li>• Reflexivity – interviewee gives what interviewer wants to hear</li> </ul>
<p><b>Direct observations</b></p>	<ul style="list-style-type: none"> <li>• Reality – covers events in real time</li> <li>• Contextual – covers context of event</li> </ul>	<ul style="list-style-type: none"> <li>• Time-consuming</li> <li>• Selectivity – unless broad coverage</li> <li>• Reflectivity – event may proceed differently because it is being observed</li> <li>• Cost – hours needed by human observers</li> </ul>
<p><b>Participant observation</b></p>	<ul style="list-style-type: none"> <li>• Same as above for direct observations</li> <li>• Insightful into interpersonal behavior and motives</li> </ul>	<ul style="list-style-type: none"> <li>• Same as above for direct observations</li> <li>• Bias due to investigator’s manipulation of events</li> </ul>
<p><b>Physical artifacts</b></p> <p>(A technological device, a tool or instrument, a work of art, or some other physical evidence)</p>	<ul style="list-style-type: none"> <li>• Insightful into cultural features</li> <li>• Insightful into technical operations</li> </ul>	<ul style="list-style-type: none"> <li>• Selectivity</li> <li>• Availability</li> </ul>

Table 12 – Six Sources of Evidence: Strengths and Weaknesses (Yin, 2003, p. 88 ff.).

### 3.2.4.2 The Methods Selected for this Dissertation

In all three case studies, semi-structured interviews represented the principal data collection method. For qualitative research and especially in management sciences, interviews are one of the most appreciated methods (Giordano, 2003). They are often used to study phenomena with complex individual processes (Gavard-Perret *et al.*, 2012). Furthermore, Giordano (2003) clarified that:

*“The aim is to understand the organizational reality as it is imagined by the actors through asking them what they think about it”* (Giordano, 2003, p. 177 translated by MN).

The reality in an interpretivist framework is not objective but socially constructed by the actors. This includes the fact that the perceptions and interpretations of the actors are as important as the hard facts themselves (Giordano, 2003). All these arguments correlate with the present study as the FFE of discontinuous innovations depends on the actors involved, their creativity, and their internal motivation to advance ideas. Moreover, the perception of space in international management is a subjective dimension. Each individual has a different perception about proximity and its impact on their day-to-day work. Empathy for the research subjects as described earlier is essential and best maintained by choosing interviews as the main method for data collection.

Simultaneously, direct and participant observations enable the identification of tacit correlations between variables. With regards to the individual perceptions of the interviewees, observations verify subjective declarations (Gavard-Perret *et al.*, 2012). In accordance with Chevrier (2000), observations therefore have four main advantages as follows – they:

- Avoid a difference between the act and the spoken word;
- Discover elements the observed person is not conscious of;
- Identify processes which are difficult to identify by indirect methods such as questionnaires; and
- Avoid problems in the capacity of verbalization of the observed person.

To avoid data collection that is not relevant for the research, an observation checklist is necessary. Gavard-Perret *et al.*, (2012) and Wacheux (1996) distinguish between two different types of observations: floating and systematic observations. Floating observations refer to

opportunities that emerge in the field and are then identified by the researcher. In complex environments, floating observations may fulfill a predefined checklist of theory or develop a completely new one: these observations represent the basics for systematic observation gathering (Gavard-Perret *et al.*, 2012). In the pilot case, participant observations are categorized as floating observations. Throughout the case study, observation gathering was refined until a structured collection of observations was possible. The two replication cases were based on systematic observations.

In addition, two dimensions of observation gathering should be considered: the objective and the subjective level (Gavard-Perret *et al.*, 2012). During all three cases, observation gathering was supported by a unified table. All observations were noted indicating the date and the place where the observation was made. By using a diary form, the notes consisted of two distinct sections. Firstly, the situation was described and the observation was written down in a neutral tone. In a second step, spontaneous ideas about this observation completed the entry of the data. The objective was to remember spontaneous feelings and impressions that were caused by the situation. Documents, archival records, or other relevant material were stored and tracked in a similar way as shown in table 13.

Notes from participant/direct observations						Case Study No.
Date	Context	Description of Situation	Observation	Codes (if possible)	Category concerned	Remarks/ Interpretation

Table 13 – The Observation Gathering Support Table used during the Case Studies (by MN).

More details about the data collection process are provided in chapter 3.3 as each field context required slightly different applications of the data collection methods.

## 3.2.5 METHODS OF ANALYSIS

The collected data are of a qualitative nature. In comparison to quantitative data, they are more rich and complex than quantitative material (Gavard-Perret *et al.*, 2012). Therefore, the way in which the material is analyzed should be adapted, too. In the case of qualitative research, this step is crucial in the development of theory. However, this process is less standardized than for quantitative studies (Gavard-Perret *et al.*, 2012). Analyzing data only at the end of the data collection process risks ruling out:

*“[T]he possibility of collecting new data to fill in gaps or to test new hypotheses that emerge during analysis.”* (Miles *et al.*, 2014, p. 93)

Consequently, the researcher should not pursue a linear but a circular analysis approach (Creswell, 2012). This correlates with the case study model presented earlier (figure 13), which is based on feedback loops and a non-linear process.

The following paragraphs describe how the data for the three case studies was analyzed. Almost all the interviews were transcribed in full and (participant) observations were noted in the research journal. Therefore, most data exists in written form and it was possible to code the information and to classify it into categories (Gavard-Perret *et al.*, 2012). This was conducted following three steps: the pre-analysis, the exploitation of the material, and the treatment of the results, inference, and interpretation (Gavard-Perret *et al.*, 2012).

### 3.2.5.1 The Vertical Analysis

During the first phase of the pilot case, a specific number of pertinent codes was developed which were applied in a second step to the entire material. Codes are:

*“[L]abels that assign symbolic meaning to the descriptive or inferential information compiled during a study.”* (Miles *et al.*, 2014, p. 71)

It is thus more than just a collection of labels but a first step in the analytical process (Miles *et al.*, 2014). In the present research, this was effectuated by a vertical analysis of the interviews (Gavard-Perret *et al.*, 2012). The interviews were analyzed individually and coded for the first time. Therefore, an in-depth analysis of each interview was required. In line with grounded theory, this step is described as microanalysis (Strauss and Corbin, 2004). Two reasons motivated the choice for this vertical approach.

Firstly, the objective was to understand entirely what happens at the FFE in an international context. It was necessary to capture individual processes of the interviewees, their perceptions of the social construct, and their motivations for their actions. An in-depth approach to every interview was necessary to get a clear picture of the situation.

Secondly, vertical analysis identified a first set of concepts and categories. Categories are classifications which group similar concepts together on a higher level of abstraction (Strauss and Corbin, 2004). During an open coding process all categories and their dimensions are identified (Strauss and Corbin, 2004). Then, sub-categories are identified which describe these categories as well as their interrelation (Strauss and Corbin, 2004). This step – axial coding – links categories regarding their dimensions and characteristics (Strauss and Corbin, 2004).

### 3.2.5.2 The Horizontal Analysis

As this research uses a multilayer approach which takes into account several different aspects (organizational, cognitive and social proximity), a second horizontal analysis of the interviews was required. In accordance with Gavard-Perret *et al.* (2012), the objective was to detect patterns within the interviews. For this second step, central categories represent core concepts of the research (selective coding) (Strauss and Corbin, 2004). A central category exists when all other categories are interconnected and when indicators for this category can be found in nearly every case (Strauss and Corbin, 2004). This process is facilitated *via* horizontal analysis.

The following table provides an example for the coding process. Concepts were identified and then regrouped into categories. Then, a central category was identified which interconnects these categories on a more abstract level. Based on these insights, an analysis grid with a specific list of categories and their central concepts was elaborated. This analysis grid was applied for the two replication cases without excluding that new categories could be added to the initial coding list. While the objective of the research was to explore the subject in its entirety, it was crucial to remain open to new emergent ideas (Gavard-Perret *et al.*, 2012).



Quotes (Examples)	Initial Code: 1 <sup>st</sup> level of abstraction	Concept: 2 <sup>nd</sup> level of abstraction	Category	Central concept
<i>Our organizational culture is particularly convenient for creativity. It provides the necessary space and the flexibility which are necessary to be creative. Ideas are created through discussion!</i>	Creativity is assured through space and flexibility	Collaborative creativity	Innovation Structure	<b>ORGANIZATIONAL CULTURE</b>
<i>We did a lot of tests. Also with the idea in mind that we wanted to support the marketing department if they need further data to take their decision.</i>	Project team provides active support for decision-making	Proactive behavior	Coordination mechanism	
<i>In some ways, we managed to create a level of collaboration where no barriers exist: no linguistic barriers, no problems with confidence. There is no competition and it is great teamwork.</i>	Project created trust relationship between subsidiary and headquarters	Common project work	Coordination mechanism	<b>TRUST</b>
<i>When you need a technical solution, you go and look around if anybody has an idea. That works out quite well that two or three colleagues can find a solution together.</i>	Informal problem solving	Informal network facilitates problem solving	Coordination mechanism	<b>COMMUNITY</b>
<i>Considering innovation, I do think that a lot of knowledge is existent in the Bürkert countries but we fail to insert it in the right place.</i>	International knowledge is not sufficiently exploited	Creative slack	Innovation Structure	

Table 14 – Example of the Coding Process of the Conducted Interviews.

### 3.3 THE FIELD CONTEXTS

The pilot company is BÜRKERT, a German medium-market company. One of the two replication cases will, for reasons of confidentiality, be designated ELECTRO. The second replication case is 3D PLUS a French SME (Small and Medium-sized enterprise). The cases were identified based on specific criteria to assure their fit with the research question. Table 15 aggregates general differences and similarities of the three cases.

	<b>3D PLUS</b>	<b>BÜRKERT</b>	<b>ELECTRO</b>
Size (approx.)	Small ~ 185 employees	Medium ~ 2,600 employees	Big > 11,000 employees
Employees in R&D (approx.)	8	180	760
Headquarters	Paris, France	Ingelfingen, Germany	Societas Europeae
Subsidiaries	<ul style="list-style-type: none"> <li>• One international subsidiary (USA)</li> </ul>	<ul style="list-style-type: none"> <li>• 4 German production sites;</li> <li>• 1 international R&amp;D center (France);</li> <li>• 5 international production sites for local markets;</li> <li>• Over 38 sales subsidiaries.</li> </ul>	<ul style="list-style-type: none"> <li>• 28 production sites in 11 countries;</li> <li>• Numerous acquisitions worldwide;</li> <li>• Over 60 nations represented in internal structure.</li> </ul>
Business	BtoB	BtoB	BtoB and BtoC

Table 15 – Comparison of the Three Field Contexts BÜRKERT, ELECTRO, and 3D PLUS.

In the following, the general organizational structure of the three cases is described, with a focus on their innovation strategy. Furthermore, the approach to the companies and the methods applied for data collection are laid out for each of the three field contexts.

### 3.3.1 BÜRKERT – FLUID CONTROL SYSTEMS

The core activity of BÜRKERT is the development of systems to regulate and control all kinds of fluids (liquids and gases). These systems combine different types of valves and sensors to assure a perfect flow of fluids. Their total workforce exceeds 2,600 employees worldwide of which 1,700 are located in Germany. The company has five production sites and 38 sales subsidiaries all around the world. Four of the five production sites are located in the south of Germany and one in the Alsace region, in France. These entities are also in charge of the development of new products. Furthermore, five international entities located in Germany, China, and in the United States are in charge of the development of complete systems combining already existing products to respond to local needs (so called ‘Systemhäuser’).

The French subsidiary with its 210 employees obtains a special position within the international network. Compared to all other international entities, this Alsatian subsidiary is the only entity with an entire value chain to create, develop, industrialize, and commercialize products. Furthermore, it is the center of competencies for sensor technology, which is one of the core technologies of the group. Because they develop products together, the international collaboration between this French subsidiary and the German headquarters is intense.

#### 3.3.1.1 The Activity of the Company

The founder of the company, Christian Bürkert, started its activities with an incubator for chicken eggs to regulate the internal temperature in order to create a perfect environment for the eggs. From this core activity, the company rapidly started to diversify its product range. Thus, today, the classic products of the company are valves. These are simple regulators which control the fluid flow by opening and closing. They are not intelligent and need to be regulated *via* further components. Solenoid valves are sophisticated versions of valves and are controlled electronically. This enables precise control of the fluid. Sensors are devices which provide the information that is necessary to decide the action of the valve. BÜRKERT proposes a wide range of sensors to measure all kinds of parameters of fluids (pH, chlorine, redox, temperature, etc.). Today, the unique selling point of the company is the proposition of complete systems for specific applications. These systems combine BÜRKERT products to one functional device. As fluids exist literally everywhere, BÜRKERT classifies its activities into four core segments: Water, Hygienic, Gas, and Microfluidics as shown in table 16.

Segment	Application
Water	Media Filtration; Membrane Filtration; Ion Exchange/Demineralization; Reverse Osmosis/Nano Filtration; Electro-deionization (EDI) Neutralization; Quality Monitoring; Cooling Tower; Boiler Feed Water; Process Heating and Cooling
Hygienic	Clean in Place and Sterilize in Place; Clean Utilities Production and Distribution; Sterilizer and Autoclave Control; Steam Control and Heat Transfer; Filling, Mixing, and Batching; Filtration, Separation and Chromatography; Fermentation
Gas	Flame and Plasma; Atmosphere Control; Gas Blending; Nitriding and Nitrocarbonizing; Medical Equipment; Analytical Systems; New Energy
Micro	In Vitro Diagnostics; Molecular Diagnostics / Gene Diagnostics; Tissue Diagnostics; Dialysis; Dental Treatment Centre; Digital Inkjet Printing; Beverage Vending Systems

Table 16 – The BÜRKERT Applications (Bürkert GmbH & Co. KG, 2014).

### 3.3.1.2 The Organizational Structure of BÜRKERT

BÜRKERT has been family-owned since its foundation in the late 1940s. This has led to stable corporate values, and the company defined organizational culture as one of three main pillars of the corporate strategy besides financial independence, and technology and quality leadership. The company does not depend on external investors (it demonstrates financial independence) and technology and quality leadership underlines its ability to innovate. Finally, experience of the BÜRKERT culture does not only refer to the fact that members adhere to corporate values. These values should equally be reflected in the product solutions that BÜRKERT offers to its customers.

In 2013, BÜRKERT communicated its new corporate strategy: ‘Perspectives 2023’. The financial indicator is a turnover of €1 billion in 2023 which is an ambitious target (in 2014, the company reached a turnover of €412 million). After the roll-out of this strategy, BÜRKERT segmented it in concrete milestones in order to advance step by step towards the financial target. ‘Perspectives 2023’ is not only a general vision; it breaks down this target into clear strategies in order to transform BÜRKERT into a learning organization which puts the final customers at the center of the process. BÜRKERT adhered to a process organization in which the overall organizational structure is modelled in a procedural manner initiated by the customer. Every service is responsible for specific tasks within the processes.

### 3.3.1.3 The Innovation Processes at BÜRKERT

Since its foundation, BÜRKERT evolved towards a typical company of the so called German ‘Mittelstand’. BÜRKERT grew with customer projects where the portfolio was adapted to specific customer demands. As a result, the current product portfolio is wide ranging because for a long time there was no standardized portfolio planning on a group level.

Today, the overall objective is not only to respond to certain customers, but to understand the customer’s current and future needs. The group has the objective of redefining itself continually and of developing not only continuous but also really new or radical innovations. A repartition of 80% of continuous and 20% of discontinuous innovations was identified as an achievable target. In order to maintain this rhythm in a growing company, BÜRKERT developed a specific innovation strategy segregated into a product and a technology roadmap. Both innovation processes are closely linked to each other in order to assure a logical alignment between products and technologies. Figure 15 illustrates the innovation processes at BÜRKERT by highlighting the dual structure (market driven input and technology driven input) to nurture the project roadmap of the company.

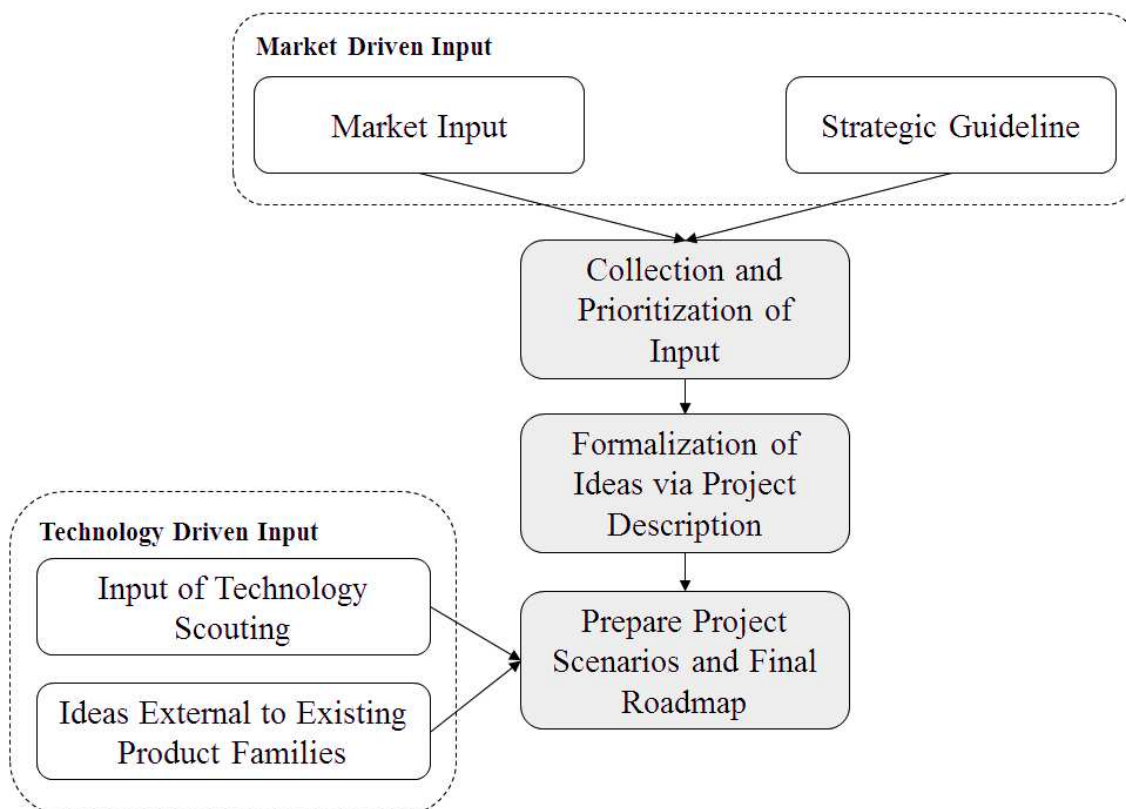

Figure 15 – Technology and Market Driven Input for the Project Roadmap at BÜRKERT (Internal Document).

The generation of discontinuous innovations is supervised by the portfolio manager in charge of the technological development. This process concentrates on the evolution of the company's core technologies and is initiated by the R&D department (technology driven input). This process will be investigated in more detail during the content analysis as this is a crucial part of the internal processes that are under investigation within this dissertation.

### 3.3.2 DATA COLLECTION AT BÜRKERT

*“The pilot case is more formative, assisting you to develop relevant lines of questions—possibly even providing some conceptual clarification for the research design as well.”*  
(Yin, 2003, p. 79)

The research project was a follow-up of a previous project about the company's capacity to work in intercultural teams. Afterwards, the proposition came up to enlarge the subject and to continue with a research project on the overall innovation capacity of the company. This subject was negotiated with the R&D responsible person at BÜRKERT who was willing to support this research. Several reasons motivated the choice to engage in research about the FFE of discontinuous innovations at BÜRKERT:

Firstly, the innovation capacity is of high priority for the company considering that it was declared as one of the three main strategic pillars. The large product portfolio challenges the company to focus on the continual generation of highly innovative products to replace old technologies. This requires incremental innovations to improve existing products as well as new and highly innovative products (i.e. discontinuous innovations) which enable the acquisition of new business areas. To master this challenge, R&D teams depend on their creativity and the know-how of the organization's employees.

Secondly, as a system provider, BÜRKERT requires an intense collaboration between its R&D centers considering that the components of a system are developed by different entities depending on their core competencies. For this reason BÜRKERT fosters a strong international collaboration between its French and German R&D teams.

Finally, direct access to BÜRKERT was assured thanks to the previous research project. The CIFRE agreement (ANRT) helped to avoid problems of trust or confidentiality which might have hampered access to valuable information. Overall, BÜRKERT represents an appropriate context for the research question.

### 3.3.2.1 The Phases of the Pilot Case Study

In general, qualitative research has six distinct phases: the negotiation of the research, access to the field, the data collection, the ending of the observation process, the analysis of the data, and the return to the field (Wacheux, 1996). The first two phases, which have already been explained above, took place in 2013. All other phases were planned iteratively as suggested by Eisenhardt (1989). The following figure provides an overview about the timeline and the phases of the research.

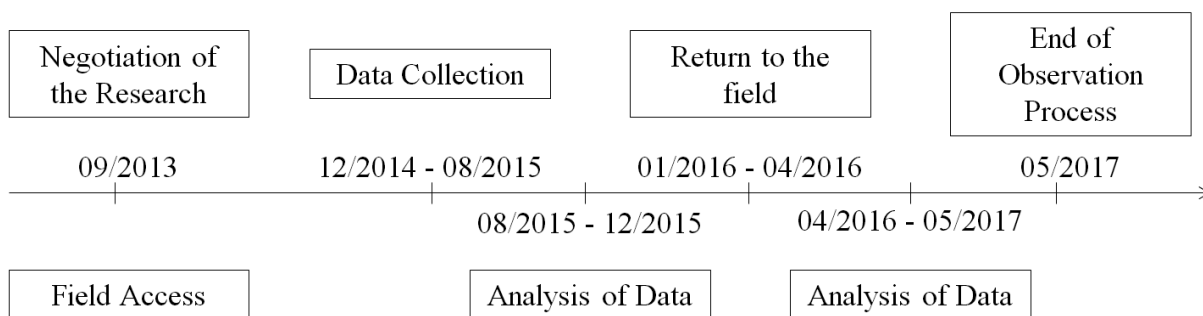

Figure 16 – Timeline of the Pilot Case Study at BÜRKERT.

The data collection started in 2014 when the first interviewees were identified. In addition, the documentation of participant observations started and was ongoing until the end of the research project in May 2017. Between the interview sessions, data was analyzed. This analysis required further collection of data and a return to the field in 2016. Data collection ended in May 2017 with the end of the CIFRE collaboration project.

### 3.3.2.2 The Interviews

The interviews conducted at BÜRKERT were semi-structured in line with abductive reasoning requiring a less directive approach than would be necessary for deductive research (Giordano, 2003). As shown in table 17, open questions guided the interviewees to enter into the subject without providing too many constraints. Overall, two categories of interviews were used: project and field interviews.

#### 3.3.2.2.1 Project Interviews

In the first step, the corresponding project leaders were contacted by telephone or e-mail and a first informal discussion was fixed in December 2014. The objective was to get the agreement of the project leaders to participate in the research project and to confirm that the

chosen projects correlate with the previously fixed list of categories (i.e. degree of innovation, degree of internationalization, and range of success). All five project cases were considered eligible for the research.

Based on the insights from these first informal contacts, the project interviews were prepared. For each of the five project cases, the project leader (R&D) and the corresponding product manager (Marketing) were interviewed. In some cases, further interviews with project members and other stakeholders were necessary to obtain complete information. The semi-structured interviews, based on a guide proposed by Gavard-Perret *et al.* (2012), consisted of:

- An introduction where the participant was assured of the confidentiality of the information and asked for permission to record the interview;
- A centering of the interview where the discussion was oriented towards the core subject;
- A phase to explore the subject more in depth; and
- A concluding phase with space for further remarks.

To guide the interview towards the core topic, four leading questions were asked consistently to all interviewees:

1	Please describe the first stages from the idea to the project
2	What are the Lessons Learned of this project: What went well and what would you do differently now?
3	How would you imagine the perfect idea-management for BÜRKERT?
4	How would you describe the organizational culture regarding innovation?

Table 17 – The Research Questions of the Semi-Structured Project Interviews.

The questions were sent to the interviewee in advance to give them an idea about the subject of the interview. In some cases, the FFE of the projects was already accomplished several years ago. Consequently, this enabled the project leaders to prepare for the interview and, if necessary, verify some historical facts (dates of milestones, etc.) about the projects in question.

Notwithstanding, the questions only served as orientation. The partners were free to answer in their own words and to take an active part in the orientation of the interview. As Giordano (2003) explains, this is a useful approach to give the interviewee the possibility to underline



---

those aspects which seem pertinent for him/her. All further questions which emerged during the interview were connected to the answers of the interviewees. By means of the four lead questions, the discussion was reoriented if it moved too far away from the initial research subject, without interrupting the dynamic of the discussion (Combessie, 2007).

To ensure that no crucial aspect was left out, a structured interview guide was developed beforehand which detailed the four leading questions (table 18 and table 19). This second guide was not sent to the interviewees nor was it shown during the discussion, to avoid influencing the direction of the interview. The details were based on theoretical reflections which are the direct result of the literature review about the FFE of discontinuous innovations.

The first part (i.e. description) was essential to understanding what happened in the project. For this reason many sub-questions were formulated based on the literature review. As the interpretivist paradigm emphasizes empathy with the research subject, the subjective perceptions of the interviewees were equally investigated.

In general, most of the questions were naturally covered by the interviewees during the descriptive part. Depending on the course of the interview, in some cases questions were no longer appropriate and the decision was made not to ask them at all. For instance, it would not have been appropriate to ask the project leader of project NAT about international collaborations if obviously the case had been selected because of its local character.

	Description	References
1	<b>Please describe the first stages from the idea to the project</b>	
	When was the ideation creation exactly?	-
	Who initiated the project: one person or a team?	Parjanen (2012)
	What are the steps of the process? <ul style="list-style-type: none"> <li>• Which kind of information was used at which point in time?</li> <li>• How did the idea evolve over time?</li> <li>• What was the length of each step?</li> <li>• Who were the people and functions involved at each step?</li> </ul>	Reid and De Brentani (2004, 2012)
	Describe the communication during this early project phase. <ul style="list-style-type: none"> <li>• Who was responsible for the systematic gathering, evaluation and communication of idea-related information?</li> <li>• Who was aware of the idea at which stage?</li> <li>• How and why was the decision taken to communicate the idea to others?</li> </ul>	Koen <i>et al.</i> (2002) Leenders <i>et al.</i> (2003) Moenaert <i>et al.</i> (2000)
	Describe the marketing involvement in this process. <ul style="list-style-type: none"> <li>• When and why was marketing involved in the project?</li> <li>• What were the strategic objectives of the project?</li> <li>• What were the product vision and the project priorities?</li> </ul>	Calantone and Rubera (2012) Kim and Wilemon (2002) Reid <i>et al.</i> (2014)
	How was the Go/No-Go decision taken? <ul style="list-style-type: none"> <li>• Who decided it and based on which criteria?</li> <li>• Formality of the decision: Was the decision taken during discussions, meetings, or other channels?</li> </ul>	Briley <i>et al.</i> (2000) Eling <i>et al.</i> (2013) Koen <i>et al.</i> (2002)
	Describe the international collaboration during the project. <ul style="list-style-type: none"> <li>• What were the challenges: Did they impede the process? If yes, how?</li> <li>• What were positive points?</li> </ul>	Boschma (2005) Meyer <i>et al.</i> (2011)
	Describe the final product of the project: <ul style="list-style-type: none"> <li>• Does it integrate new technical knowledge?</li> <li>• Does it help to acquire a new market or new customers?</li> <li>• How would you describe the risk of the idea?</li> <li>• What do you consider as a discontinuous innovation?</li> </ul>	Reid and De Brentani (2004) Veryzer (1998)

Table 18 – Structured Interview Guide for Project Interviews (Descriptive Part).

Own opinion		References
2	<b>What are the ‘Lessons Learned’: What went well and what would you do differently now?</b>	
3	<b>How would you imagine the perfect idea-management for BÜRKERT?</b>	
	<ul style="list-style-type: none"> <li>• Which are the steps to take to insert an idea into development?</li> <li>• What are the time and resources needed?</li> <li>• Who should be integrated in the process?</li> </ul>	-
4	<b>How would you describe the organizational culture regarding innovation?</b>	
	In your opinion, what are the strengths and weaknesses of the organizational culture?	Büschgens <i>et al.</i> (2013); Chiu and Kwan (2010); Hansen (2015)
	How would you describe the organizational culture regarding innovation (Rewarding systems, encouragement to submit ideas, risk taking)?	De Brentani and Kleinschmidt (2004); Koen <i>et al.</i> (2002); Wang <i>et al.</i> (2010).
	How would you describe the commitment of the top management during the FFE?	De Brentani <i>et al.</i> (2010); De Brentani and Kleinschmidt (2004); Salomo <i>et al.</i> (2010)
	How would you describe an ideal working environment to foster innovation?	Erez and Nouri (2010); Hofstede (2001)

Table 19 – Structured Interview Guide for Project Interviews (Evaluative Part).

### 3.3.2.2.2 Field Interviews

Field interviews focused on the overall strategy of the company regarding its FFE activities. The interviewees were selected because of their involvement in FFE activities over the previous period or because of their position within the innovation network at BÜRKERT. This included the R&D leader in France, the portfolio managers in charge of the strategic development of product and technology projects, representatives of the HR department, and further R&D team coaches because of their involvement in the development of discontinuous innovations. For the international dimension, data collection was completed by interviews with former expatriates and an international project leader.

The questions for the field interviews were elaborated depending on the interviewee. In the case of the HR representative, for instance, the questions referred to the organizational culture and the international perception of this culture in other subsidiaries. In the case of the portfolio managers, the questions referred to the concrete innovation process at BÜRKERT, the strategy, and how it is implemented at the current point in time.

### 3.3.2.2.3 Interview Phases

Data collection was separated into three main steps. As explained above, the project interviews were initiated firstly by informal discussions to ensure the interviewee agreed to further project interviews. Then, an intense interview period took place from January until August 2015. After a first review of the interviews, a second interview period was conducted from January 2016 to April 2016. This second period had two distinct objectives:

- Further clarifications to understand the subject and avoid misleading interpretations;
- Opportunities to provide feedback about the research: this was necessary to ensure a positive perception about my research within the company. The interviewees invested time and therefore, it was considered important to provide feedback about the results.

38 interviews have been conducted during the pilot case study. The interviews that were carried out to secure access to the field setting and in the first interview period have been fully transcribed. Regarding the second interview period, not all interviews were transcribed in full but only sections that provided complementary information. In accordance with Beaud and Weber (2003) the interviews were prioritized into three categories: informative interviews provide little new information (not necessary to transcribe), interviews for clarification with specific answers to open questions (partly transcribed: selection of parts to answer the question), interviews which provide new insights or confirm observations (transcription in full). Table 20 provides an overview of the interviews, the profiles of the interviewees, their location and the cryptography for anonymity of the interviewees. This cryptography indicates the following 5 positions: 1<sup>st</sup> – BÜRKERT (B); 2<sup>nd</sup> – France (1) or Germany (2); 3<sup>rd</sup> – Field (F) or Project (P); 4<sup>th</sup> – number of interview in alphabetic order; 5<sup>th</sup> – 1<sup>st</sup> or 2<sup>nd</sup> interview. Ex: The 5<sup>th</sup> field interview in Germany → B2 (Germany) + F (Field) + E (5<sup>th</sup> interview) → B2FE.

	Duration	Role Profile	Location	Interview type	Code
Field access	14 min	R&D team coach/project leader	Ingelfingen	Field	B2FA
	40 min	Portfolio management	Ingelfingen	Field	B2FB
	35 min	R&D team coach	Karlsruhe	Field	B2FC
	49 min	R&D project leader	Ingelfingen	Field	B2FD
	62 min	R&D team coach	Triembach	Field	B1FA
	3h 20min	4 Interviews in German language 1 Interview in French language		5 Field interviews	
1 <sup>st</sup> interviews: Data collection	44 min	Technology portfolio manager	Ingelfingen	Field	B2FE
	50 min	HR member	Ingelfingen	Field	B2FF
	54 min	Product portfolio manager	Ingelfingen	Field	B2FG
	23 min	FSM sales member	Ingelfingen	Field	B2FH
	61 min	Material planner	Ingelfingen	Field	B2FI
	99 min	IT team coach	Triembach	Field	B1FB
	80 min	R&D project leader	Ingelfingen	Project	B2P3A
	63 min	R&D project member	Ingelfingen	Project	B2P3B
	60 min	R&D team coach	Ingelfingen	Project	B2P3C
	120 min	R&D project leader	Ingelfingen	Project	B2P3D
	64 min	R&D team coach	Karlsruhe	Project	B2P5A
	56 min	R&D project leader	Ingelfingen	Project	B2P5B
	74 min	R&D team coach/project leader	Ingelfingen	Project	B2P4A
	51 min	Product manager	Ingelfingen	Project	B2P3F
	57 min	R&D project member	Ingelfingen	Project	B2P1B
	55 min	R&D project member	Ingelfingen	Project	B2P4B
	85 min	Product manager	Ingelfingen	Project	B2P2B
	78 min	R&D project leader	Triembach	Project	B1P2A
	80 min	R&D team coach	Triembach	Project	B1P1A
	93 min	R&D project leader	Triembach	Project	B1P2C
78 min	Segment manager	Triembach	Project	B1P5B	
83 min	R&D project member	Karlsruhe	Project	B1P3E	
	25h 08min	16 Interviews in German language 6 Interviews in French language		6 Field interviews 16 Project interviews	
2 <sup>nd</sup> interviews: return to the field	48 min	Technology portfolio manager	Ingelfingen	Field	B2FE_2
	60 min	R&D team coach	Triembach	Field	B1FC
	98 min	Factory director	Triembach	Field	B1FD
	100 min	HR director France	Triembach	Field	B1FE
	60 min	Product portfolio manager	Ingelfingen	Field	B2FG_2
	79 min	R&D project leader	Ingelfingen	Project	B2P3A_2
	71 min	Project member	Ingelfingen	Project	B2P3B_2
	50 min	R&D project leader	Ingelfingen	Project	B2P3D_2
	63 min	R&D team coach/project leader	Ingelfingen	Project	B2P3C_2
	92 min	R&D second project leader	Triembach	Project	B1P2B
	46 min	R&D team coach	Ingelfingen	Project	B2P4A_2
	12h 47min	7 Interviews in German language 4 Interview in French language		5 Field interviews 6 Project Interviews	
	41h 15min	27 Interviews in German language 11 Interviews in French language		16 Field interviews 22 Project interviews	

Table 20 – The Interview Phases and the Interviews Conducted.

### 3.3.2.3 Participant Observations

*“Through participant observation, it is possible to describe what goes on, who or what is involved, when and where things happen, how they occur, and why—at least from the standpoint of participants—things happen as they do in particular situations.”*  
(Jorgensen, 1989, p. 12)

Participant observation is a useful method to collect rich information about phenomena where little is known (Jorgensen, 1989). The researcher does not only observe, but participates in the daily and routinized activity of the observed persons (Gavard-Perret *et al.*, 2012), even though without manipulating it (Jorgensen, 1989). He is not only perceived in the field context as a researcher, but also as an internal professional (Gavard-Perret *et al.*, 2012). The researcher is able to collect data which might not be accessible for external observers (Gavard-Perret *et al.*, 2012). The position of the researcher is defined by the equilibrium between participation and observation leading to four possible profiles (Jorgensen, 1989):

- The total outsider who only observes;
- The participant-as-observer who observes more than he participates;
- An observer-as-participant who participates more than he observes; and
- A total participant.

In contrast to one of the dominant opinions arising from a positivist tradition a highly involved researcher loses objectivity, participant observation is a useful method for collecting accurate data because the researcher has the opportunity to eliminate misunderstandings: he/she is able to contact actors again and ask them about their feelings, interpretations, and other subjective perceptions of the phenomena (Jorgensen, 1989). Participant observations are applied during in-depth case studies and correlate with grounded theory (Jorgensen, 1989).

Participant observations at BÜRKERT led to a diverse collection of data. In my role as innovation manager, I was in charge of the project management structure at the French subsidiary which enabled me to collect diverse participant observations at this entity. Moreover, I was in close contact with the PMO (Project Management Office) at the headquarters. Therefore, participant observations were collected in both countries *via* meetings, informal conversations or during the day-to-day business of the company.

### 3.3.2.4 Document Analysis

Document analysis completed the data collection process. Documents were collected regarding the project cases as well as the overall structure of the company. This included Power Point presentations about the product concepts or “kick-off” presentations. Further documents to fully understand the technological and market constraints were also consulted. On the corporate level, documents about the current strategy (official communications), the organizational culture and the market approach of the company were collected.

	<b>Document type</b>	<b>Content</b>
Project-related	Power Point presentations	Technology descriptions, Project descriptions, efforts in creativity
	Posters	Technology descriptions, Project descriptions, efforts in creativity
Organizational documents	Corporate internet site	Overview about products, the organization, corporate values, etc.
	Power Point presentations	Market approach, innovation approach, knowledge management structure, historical evolution
	Paper documents	Organizational strategy, culture, structure....

Table 21 – Types of Documents Collected at BÜRKERT.

Documents were recorded during the whole time of the research project. They were systematically collected and indexed based on the table presented previously (see chapter 3.2.4.2).

### 3.3.3 REPLICATION CASE STUDIES

With regard to the results of the pilot case, the two replication cases 3D PLUS and ELECTRO enlarge the initial case study design. Based on the fact that I was not integrated into the day-to-day business of the two companies, the field work approach can be distinguished significantly from the pilot case. In the following, the two replication cases are described in more detail followed by the description of the methods used for each case.

#### 3.3.3.1 3D PLUS

Since its foundation in 1995, the company is today the leading supplier of high density microelectronic components for space applications. Their unique technology enables the company to interconnect electronic components in three dimensions and reduce thus their weight and volume in electronic systems by a factor of ten. Due to this unique technology, 3D PLUS is active in several fields of application. Apart from space markets, this includes fields such as aircraft and unmanned vehicles, defense and security, computer boards and embedded systems, the industrial sector, and finally the medical sector. The company cultivates a rich product portfolio which is certified by the ISO9001 certification for high quality standards and accredited by several international space agencies. Furthermore, the company provides solutions combining electronic components into one miniaturized package. These are customized concepts which have been elaborated together with the client in question.

Since 2011, the company is part of a big shareholding structure but this has had no apparent impact on the internal structure of the company (vision, innovation processes, workforce, etc.). In the same year, a technical center was created in the United States to access the American market. In 2017, the company numbered 185 employees who were mainly located at their headquarters in France with a small number in the United States. One core objective of the company is to grow continually; not only in terms of the total workforce, but also the product portfolio. Over the last few years, the company grew significantly and has today more than doubled the size of its workforce compared to 2010 (figure 17).

Considering that the company is mostly active in the space sector, its quality policy is crucial to assuring the reliability of its products. Thus, yearly customer satisfaction surveys, customer feedback, visits and audits are part of a continual quality improvement plan. Consequently, a direct relationship with its clients is a central source of new product



development. This implies not only the evaluation of customer feedback and specific client-oriented development projects, but also an open innovation approach where core clients are directly asked to identify future trends.

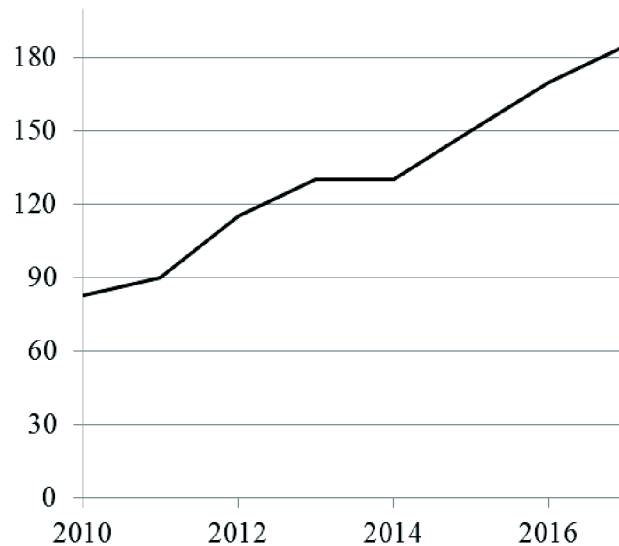

Figure 17 – Evolution of the Workforce. 2010: 83 Employees; 2017: 185 Employees (Internal Document).

### 3.3.3.1.1 Choice of 3D PLUS as Research Partner

Several reasons justify the choice to integrate 3D PLUS into this research project. Firstly, despite its significant growth, the company is classified as an SME and extends the case study downward. Furthermore, 3D PLUS relies on product innovations, similar to the pilot case. Consequently, the company meets two important preconditions: it differs regarding the total workforce but is similar to the pilot case in terms of the core activity.

### 3.3.3.1.2 Data Collection at 3D PLUS

The first contact was made in February 2016 *via* the R&D responsible person at BÜRKERT. Both companies had already worked together on a development project for several years. As a result of working jointly on this project, both companies trusted their respective collaborative partner, which facilitated access to the field context. Figure 18 illustrates the data collection process of the case study at 3D PLUS in its three phases: access to the field, collection of data, and analysis of data.

The CEO (Chief Executive Officer) of the company confirmed that 3D PLUS would be available for further investigation. A telephone conference with the responsible person at the Design Center of the company was realized in February 2016 to obtain an overview of the company and its innovation processes. Due to his position, this person was able to procure

general information about the company and its innovation processes. Based on this meeting, the objectives of the research were clarified and the appropriate interviewees identified.

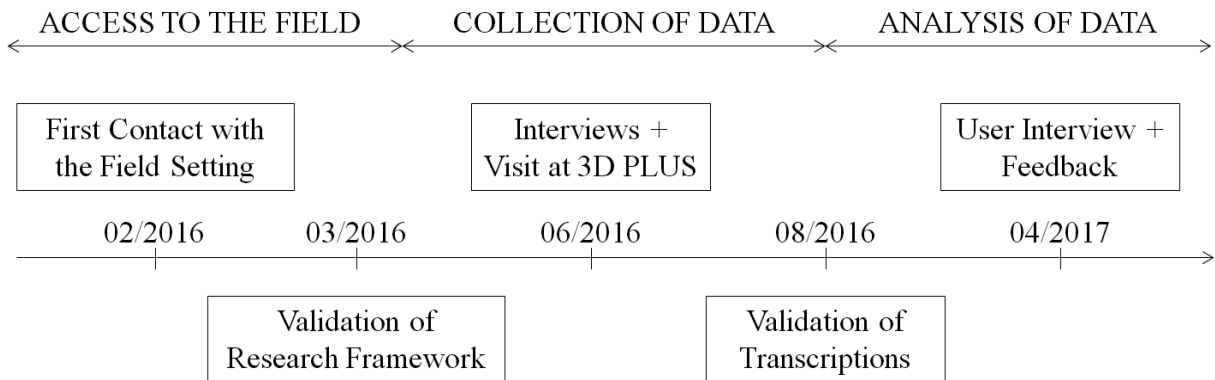

Figure 18 – Data Collection Process at 3D PLUS.

For data collection, two face-to-face interviews were conducted in June 2016. Beforehand, a document was sent to the interviewees to illustrate:

- The context of the research: from both a theoretical (innovation management) and a practical (collaboration with BÜRKERT) point of view;
- An interview guide with exemplary questions (semi-structured interview); and
- Further information about confidentiality and contact details.

Besides the interviews, the visit in June enabled me to gather observations about the headquarters in Paris where the interviews took place. These observations were collected during a general visit of the company as well as during lunch with the design team including informal conversations. As this case study was not based on participant observations but only on one visit, the note-taking for observations was limited. Table 22 provides an overview about data collection at 3D PLUS.

Notes were taken during the telephone interview. The two face-to-face interviews were recorded and transcribed in full. They were sent to the interviewees for verification in August 2016. All observations have been documented in a similar format as for the pilot company. The company was contacted again at the end of 2016. To avoid any misleading interpretations of the qualitative data, the responsible person at the design center was interviewed again. This time, the objective was two-fold – to:

- Discuss open issues about the general structure of 3D PLUS; and
- Interview a user of current innovation processes: verify interpretations and success rate.

Interviews	Duration	Role
Telephone interview (no transcription)	55 min	Responsible Design Center
Face-to-face interviews (transcribed in full)	105 min	Product Manager
	130 min	Product Manager
Telephone interview (partially transcribed)	85 min	Responsible Design Center
	6h 15 min	
Observations	Duration	Notes about...
Visit to the headquarters	June 2016	... the physical location; ... the general social environment; and ... the general organization of the company (how many employees, their age, gender, ethnicity if possible...).

Table 22 – Data Collection at 3D PLUS.

The results regarding the case company 3D PLUS specifically were discussed with the interviewees afterwards to ensure that organizational details had been correctly described.

### 3.3.3.2 ELECTRO

Similar to BÜRKERT, ELECTRO is a family-owned German company. It was founded in 1955 in a region which today is part of Germany but which was under French administration at that time. Hence, when this region changed back to German jurisdiction, the family wanted to maintain its access to the French market. For this reason, a second headquarters was founded in the Alsace region. Due to this dual structure, the company today has the status of a ‘societas Europaeae’. The company is active in the BtoB as well as BtoC sectors and supplies all kinds of electrical installations. These products comprise a wide range of customer solutions from energy distribution to automation and security systems.

The difference to BÜRKERT is the fact that ELECTRO has a turnover of over €1.9 billion and numbers more than 11,000 employees worldwide. More than 700 employees work in the

R&D department of the group. Furthermore, employees are dispersed over the 60 countries in which the company operates. The company is therefore significantly bigger than BÜRKERT. ELECTRO grew to an important extent *via* acquisitions. Besides a slight stagnation in 2009, it has undergone constant growth. Some of the acquisitions preserved their initial label due to marketing reasons. However, many were integrated into the organization and are now distributed under the label of the headquarters.

In terms of innovation, the company switched from being a supplier of products to a provider of solutions in 2015. These technological solutions are part of innovation fields which have a concrete focus on electric mobility or building automation.

#### **3.3.3.2.1 Choice of ELECTRO as Research Partner**

During the research program for this PhD, ELECTRO was chosen as a supplementary field setting for a replication case study. ELECTRO, with its international structure located in 28 production sites all around the world and representation in more than 60 nations, represents a perfect field context for the research question. Furthermore, the structure of ELECTRO is similar to BÜRKERT on several points:

- It is active in the industrial sector and covers BtoB activities;
- It has its headquarters in Germany, and due to the second headquarters in France there is a strong German-French collaboration; and
- It is a family-owned company with strong cultural values defined by the family.

Considering these general aspects, ELECTRO provides a field context which seems to distinguish it from the pilot case mainly due to its size. Hence, it is assumed that under these constraints it will be possible to isolate differences in the innovation processes at the FFE depending on the size of the company and the number of actors involved during that phase.

Finally, besides an organizational setting similar to the pilot case, the decision to work with ELECTRO was also motivated by the fact that access to the field context was facilitated by previous collaborations with the University of Strasbourg.

### 3.3.3.2.2 Data Collection at ELECTRO

First contact with ELECTRO was made in June 2015. Figure 19 illustrates the process of data collection at ELECTRO.

In June 2015, the first meeting with the responsible person for R&D at ELECTRO was held. During that meeting, a general agreement with ELECTRO for their participation in this project was reached. As the R&D responsible person went into retirement at the end of 2016, a second meeting was organized in May 2016 to validate the research framework again with the new R&D responsible person.

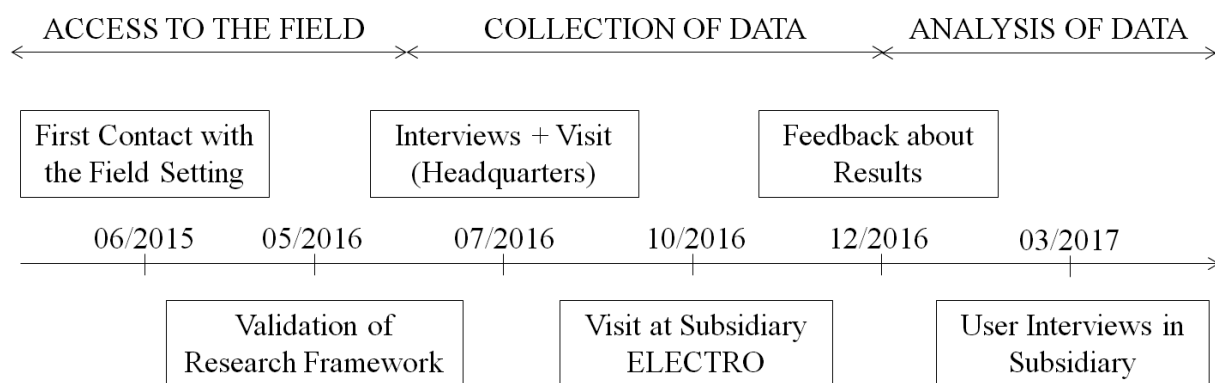

Figure 19 – Data Collection Process at ELECTRO.

In June/July 2017, interviews with the two responsible persons of innovation processes were conducted. A similar document to that sent in the case of 3D PLUS was sent to the interviewees beforehand. The document for ELECTRO was just more detailed. This is due to the fact that ELECTRO is a large company and it was possible to gather more information about the general structure of the company. The document was composed of the sections:

- Organizational structure: Description of the organization, the organizational culture and the international structure;
- The innovation process for breakthrough ideas: Description of the process and knowledge management at ELECTRO; and
- Concrete FFE cases.

Each section listed example questions underlining once again the semi-structured character of the interviews. During the interviews, it was rapidly clarified that concrete FFE cases were of no further interest for this research project. Hence, the interviews focused mainly on the general structure of the innovation processes at ELECTRO. Simultaneously, a further collaboration possibility emerged with a French subsidiary of ELECTRO and BÜRKERT. In

this context, it was possible to participate in an internal innovation event at ELECTRO. In December 2016, feedback about the research was provided to the interviewees at the headquarters. In the following, the decision was made to conduct five user interviews at the French subsidiary. The objective was to challenge the experiences at ELECTRO in terms of their perceived efficiency. Table 23 illustrates data collection at ELECTRO:

<b>Interviews</b>	<b>Duration</b>	<b>Function</b>
Face-to-face interviews (transcribed in full)	65 min	Innovation manager: general focus
	79 min	Innovation manager: technical focus
	2h 24 min	
Face-to-face interviews (partially transcribed)	26 min	Manager technical service/innovation facilitator
	31 min	Technician quality assurance
	18 min	Manager maintenance (no recording)
	19 min	Production manager
	32 min	Technician technical service
	2h 06 min	
<b>Observations</b>	<b>Timing</b>	<b>Notes about...</b>
Visit to the headquarters	• June 2015	... the physical location
	• May 2016	... the general social environment
	• July 2016	... the general organization of the company (how many employees, their age, gender, ethnicity if possible...)
Visit to subsidiary: Innovation Day	• October 2016	... a concrete event: how are their activities organized?
	• March 2017	... the general social environment
Feedback to interviewees	December 2016	... the innovation processes. Validation of interpretations of interviews

Table 23 – Data Collection at ELECTRO.

Four visits to the headquarters were effectuated. The innovation event in October 2016 took place at the French subsidiary of ELECTRO. This event enabled me to obtain a better idea about the creative and innovative dynamics at the case company and its local articulation. Similar to the 3D PLUS case, a feedback meeting was conducted in December 2016 to present the general results of the research and discuss the specific interpretations of the ELECTRO case to avoid any misleading results.

### 3.4 CONCLUDING REMARKS

Part III described the epistemological foundations of the present research, the applied methodology, and the methods utilized. The following figure illustrates the epistemological foundations of the research:

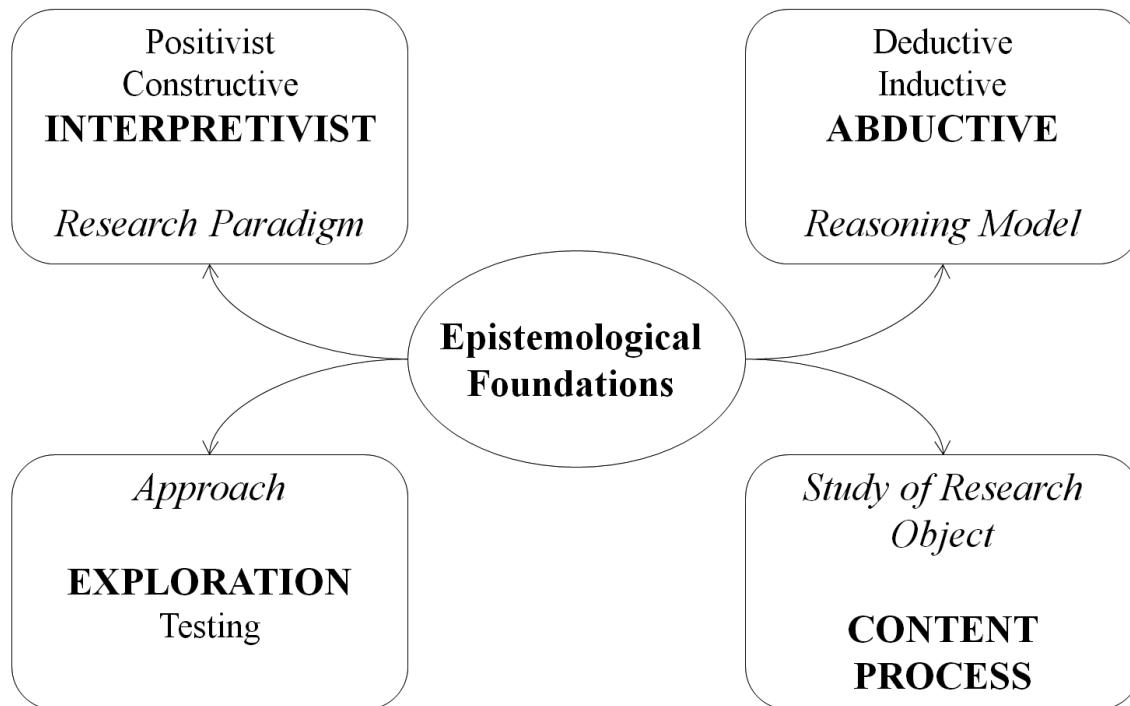

Figure 20 – Epistemological Foundations: An Overview.

The epistemological framework is based on the interpretivist paradigm with an abductive reasoning model. The overall objective of this research is to propose a first conceptualization of a new phenomenon without intending to represent the development of a general rule. The FFE of discontinuous innovations is a complex phenomenon and its integration into an international context requires a holistic perspective. Abductive reasoning is fully appropriate for answering the research question. Equally, the research question requires an explorative approach which is covered in the current research by applying grounded theory. The objective is not to test an existing model, but to explore a new phenomenon. Finally, the epistemological framework revealed that this research integrates content as well as process research, as both approaches are complementary to each other.

This research is based on a multiple-case study design. Due to the exploratory advancements of the pilot case, an embedded multi-case study design has been applied (type 4). The overall collection of methods was similar in all three cases (semi-structured

interviews, observations, document analysis). However, some differences have been discussed in the previous chapters as illustrated in table 24.

	<b>3D PLUS</b>	<b>BÜRKERT</b>	<b>ELECTRO</b>
<b>Interviews (semi-structured)</b>	Yes 4	Yes 38	Yes 7
<b>Observations</b>	On a few occasions 1 company visit	Participant observations	On a few occasions 6 company visits
<b>Immersion in FFE Processes</b>	No Confidentiality reasons	Yes Role profile: Innovation manager	On a few occasions Participation at one FFE workshop for organizational innovation
<b>Document Availability</b>	Official organizational documents	Official documentation + project material	Official organizational documents

Table 24 – Overview of the Research Methods for Each of the Three Case Studies.

Data analysis was coherent with grounded theory development. During PART IV and V of this research, the coding process will be illustrated by the use of verbatim accounts to guide through the argument. Due to the huge amount of data collected, it will not be possible to present the entire coding process compiling more than 900 codes. Taking together all three case studies, 50 hours of qualitative semi-structured interviews were conducted, of which most of them were transcribed in full. Furthermore, participant observations were collected during 36 months at BÜRKERT and on a few occasions at the two replication case settings. The aim of this thesis will be to provide a concise but still authentic synthesis of the collected qualitative data.



**PART IV**  
**THE PROXIS-**  
**TELESCOPE**

---

*“Local contexts are likely to become more rather than less important as locations that provide the necessary infrastructure for sophisticated business operations proliferate.”*  
(Meyer *et al.*, 2011, p. 248)

The head office of BÜRKERT is located in the south of Germany at Ingelfingen in the Hohenlohe region in Baden-Wuerttemberg. This is quite a remote region which is not directly connected to an urban area. The situation of the French entity is similar considering that the village where it is located in the North of France, Triembach-au-Val, is a small and rather remote place. However, this geographical remoteness has not necessarily resulted in isolation in terms of innovation. On the contrary, the Hohenlohe region has been part of one of the ten strongest industrial regions in Germany (FOCUS Online, 2014; PC Magazin, 2014). Similarly, the remote location of the factory at Triembach-au-Val is not perceived as a barrier but rather as a chance to access a wider range of industrial or research partners. The entity is located within reachable distance of big cities in three different countries, including Strasbourg and Mulhouse in France, Karlsruhe and Stuttgart in Germany and Basle in Switzerland.

As elucidated by Gibson *et al.* (2012), such remoteness is not necessarily a disadvantage in terms of innovation. Areas which are not closely located to a city might be closer to another region thus enabling the exploitation of the input of both regions. The authors argue that much of the current research has focused too much on large cities and not enough on rural areas. At the same time, it is ultimately not the remoteness of an area which determines the intensity of inter-firm collaborations in a regional area, but rather the external orientation of local actors (Rondé and Hussler, 2005). Without systematic networking between them, even highly qualified staff and plentiful resources in this area would not be sufficient for regional innovation (Rondé and Hussler, 2005). Recent tendencies in the literature therefore focus increasingly on the exploration of rural areas and their innovative capacity. With this overall economic context in mind, the following chapters take a closer look at BÜRKERT and how the company manages the notion of proximity during the FFE of discontinuous innovations.

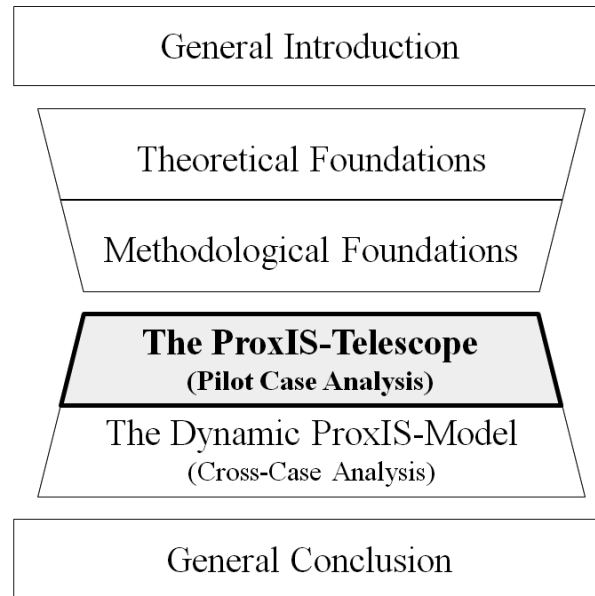

Figure 21 – Outline of the Dissertation. Present Part: The ProxIS-Telescope.

As defined in PART II (theoretical foundations), the focus of this research lies in an internal perspective about innovation processes at the pilot company. With regards to the insights about economic geography in PART II, this analysis is based on the three proximity dimensions which substitute geographic space that is inherent in international innovation teams: organizational, social, and cognitive proximity.

In the following, a metaphor from astrophysics was chosen to illustrate the results of this case study by analogy with the challenge to capture knowledge across space. When looking at the sky, we see many stars and we might be aware of the huge expanse of space which lies all around them. However, the human eye rapidly reaches its limits due to a restricted field of vision which impedes us from perceiving all the stars in the sky (Cheng, 2009). Thus, we require appropriate tools – such as a telescope – to look deeper into space and detect stars which we would not have been able to see with the naked eye alone. From a similar perspective, the management of BÜRKERT is aware that there is potential for innovation at its local subsidiaries. Since awareness alone is not sufficient, the company requires a functional device to perceive and then to exploit the knowledge of its international entities.

Based on these reflections, **PART IV** will elucidate the model which has been developed throughout this research and which I call ProxIS-Telescope (Proximity in Idea Sharing). It represents a parsimonious approach which enables BÜRKERT to look into space and apply input from its international employees during the FFE. Figure 22 schematically illustrates the elements of this telescope and their role during the FFE of discontinuous innovations.

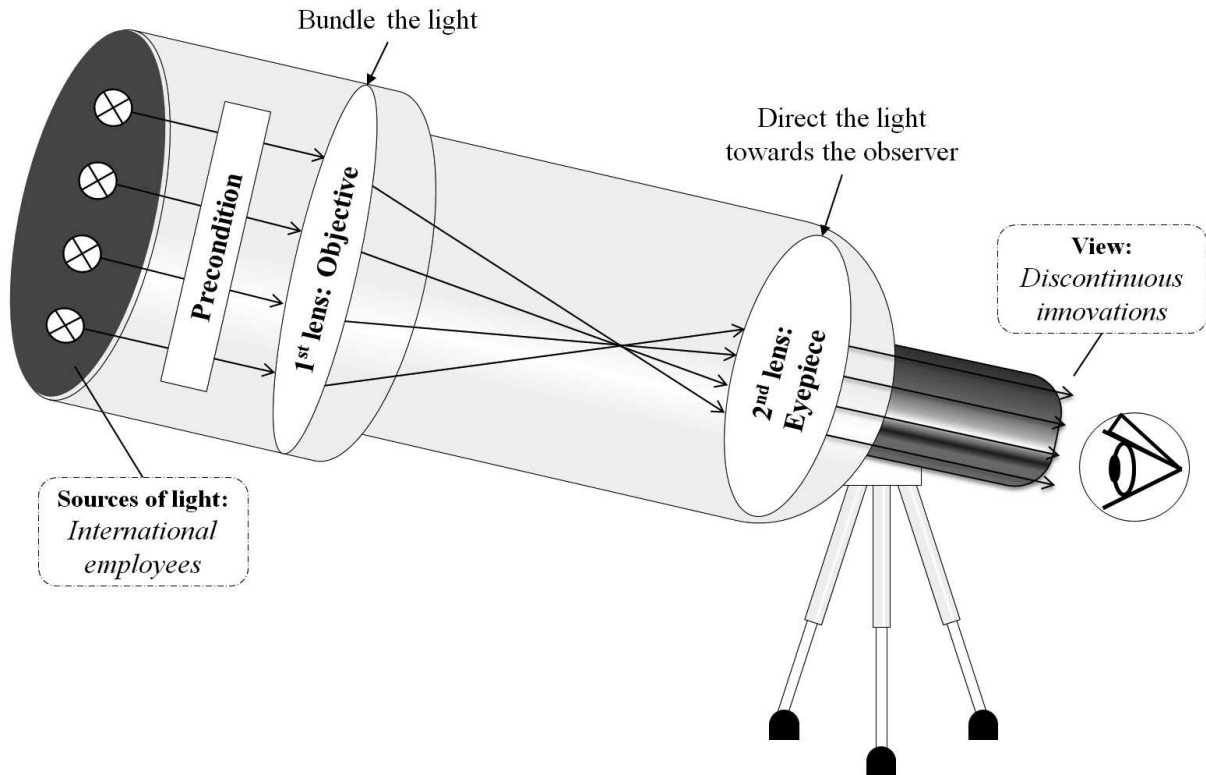

Figure 22 – The ProxIS-Telescope: Managing Space at the FFE of Discontinuous Innovations (by MN).

The source of light and thus the stars in the sky are employees who are dispersed over the international entities of the company. To perceive their knowledge and use it to generate discontinuous innovations during the FFE, three elements are necessary for a functional telescope.

First of all, a telescope can only capture a picture of the stars which send out light. Therefore, a precondition is necessary to encourage employees to share their knowledge. This precondition is based on reflections about organizational proximity in **chapter 4.1**. Furthermore, a telescope consists of two lenses. The first lens, the objective, bundles light. It is placed close to the object that is being viewed (Cheng, 2009). In terms of the ProxIS-Telescope, this first lens gathers the input from international collaborators and enables crossover between the different types of knowledge needed to generate discontinuous innovations. This first lens of the ProxIS-Telescope will be elucidated in **chapter 4.2** in the context of social proximity. The second lens, the eyepiece, targets the light and directs it towards the eye of the observer. The eyepiece is generally placed close to the observer's eye (Cheng, 2009). **Chapter 4.3** explores solutions to creating sufficient cognitive proximity between spatially dispersed actors during the FFE at BÜRKERT in order to target the international input towards common goals. The observer, finally, represents BÜRKERT, and

more precisely the decision-makers who are in charge of the final Go/No-Go decision. These people coordinate the entire knowledge input at BÜRKERT and the telescope enables them to perceive international discontinuous innovations.

A telescope is more than just a tool as it is only useful if it interacts with the human eye (Vogl, 2001). Vogl (2001) explored the semantic difference between seeing and perceiving: telescope and eye interact not only to see a picture but also to interpret it. Depending on the person who looks through the telescope, the perception of the image may not be the same. In other words, the observer is a crucial element of the whole telescope. In managerial terms this implies that if the management does not have the strategic willingness to look through the telescope, it will not be able to gather and assess input over space. The best mechanisms within the telescope would be useless. At BÜRKERT, the management is clearly oriented towards global teamwork. The company is convinced of the high potential of international teams, especially with regards to innovation. The management therefore took the fundamental strategic decision to engage in international collaborations and this commitment assures that the telescope is successful during the FFE. Only then the ProxIS-Telescope represents a tool to support management in their objective to foster the continual generation of discontinuous innovations. It should not be understood as a process with three steps but as the representation of an overall fertile organizational setting aiming to favor creative collaborations across space during the FFE.

In the following, the elements of the ProxIS-Telescope (*Proximity in Idea Sharing*) will be elaborated step-by-step:

- The precondition to send out light (organizational proximity);
- The 1<sup>st</sup> lens: The objective (social proximity); and
- The 2<sup>nd</sup> lens: The eyepiece (cognitive proximity).

The telescope stands for an appropriate organizational setting which favors the generation of discontinuous innovations within teams that are spatially distributed.

The next chapters will guide the reader through the analysis of this telescope and lay out each of its elements and the resulting concrete coordination mechanisms which were applied at BÜRKERT.

## 4.1 ORGANIZATIONAL PROXIMITY

*“[O]rganizational proximity is defined as the extent to which relations are shared in an organizational arrangement, either within or between organizations. To be precise, this involves the rate of autonomy and the degree of control that can be exerted in organizational arrangements.”*  
(Boschma, 2005, p. 65)

The term ‘organizational proximity’ is often used to describe the relationship between headquarters and subsidiaries and determines if they are loosely coupled systems or strongly interrelated (Boschma, 2005). In this chapter, it is argued that the participation of a local subsidiary to the corporate innovation process at the FFE depends on the organizational proximity and thus its role within the network of multinational companies (MNCs).

It seems that there is no study which contextualizes the impact of MNC network structures on FFE success. However, given the huge innovative potential which is inherent in the management of international knowledge, it is crucial to determine the preconditions which an organization should meet in order to motivate international employees to share their knowledge and thus enhance the exploitation of this potential. In a first place, this requires a typology for the FFE which classifies the role of international subsidiaries during this phase. Secondly, follow-up questions of this chapter are: How to increase the international collaboration in MNCs during the FFE so as to foster the generation of discontinuous innovations? What lies behind a local and an international FFE in an MNC, and how can a local subsidiary be integrated into an international innovation strategy at this early phase? Overall, the sub-questions of this chapter can be synthesized as follows:

**Sub-question 1 – Classify the MNC network at the FFE**

How to classify an MNC’s subsidiaries regarding their innovation activities?

**Sub-question 2 – Reposition subsidiaries towards discontinuous innovations**

How to reposition them as active players for an international FFE of discontinuous innovations?

Regarding the dichotomy between proximity required at the FFE to foster informal encounters and the potential inherent in sharing international knowledge, it is necessary to gain a better understanding of the underlying knowledge flows from and to the international subsidiary on an organizational level during that phase. With this in mind, the knowledge flows-based framework developed by Gupta and Govindarajan (1991) is introduced to provide the theoretical foundation for the present chapter.

This chapter seeks to answer the sub-question by applying the knowledge flows-based framework of Gupta and Govindarajan (1991). An initial parsimonious typology and its underlying coordination mechanisms will be proposed to classify and reposition an MNC's international subsidiary.

In a first step, a theoretical proposal for an international matrix regarding FFE activities within MNCs is elaborated. This typology is then explored by reference to BÜRKERT. In fact, the case study not only correlates with the typology, but helps also to identify two coordination mechanisms to reposition international subsidiaries within the MNC network and so enable their active participation in the generation of discontinuous innovations: the trust relationship between the headquarters and the international subsidiary, and the active integration into corporate innovation processes.

### 4.1.1 THEORETICAL SPECIFICATIONS

Defining an MNC as a network of several subsidiaries which are not located at the same geographic place, Gupta and Govindarajan (1991) developed a comprehensive framework to determine the role of these subsidiaries within the network. Their typology is concerned with “*intracorporate knowledge flows*” (Gupta and Govindarajan, 1991, p. 773) and thus the transfer of expertise and external market data. The authors do not consider other information flows like monthly reports or other administrative knowledge exchanges. In consideration of the intensity of knowledge flows from and to the subsidiaries, Gupta and Govindarajan developed four different profiles. First, the ‘Global Innovator’ generates knowledge which is valuable for the rest of the company but receives less input from other corporate entities. Second, the ‘Integrated Player’ scores high on the creation of new knowledge but “*is not self-sufficient in the fulfillment of its own knowledge needs*” (Gupta and Govindarajan, 1991, p. 774). A high inflow from the rest of the corporation to this entity is needed to assure efficient knowledge management. Third, the ‘Implementor’ has no significant knowledge outflows but depends on knowledge inflows from the headquarters as well as from other subsidiaries; whereas, finally, the ‘Local Innovator’ is independent from all other structures.

		<b>Inflow of knowledge from the rest of the corporation to the focal subsidiary</b>	
		<b>Low</b>	<b>High</b>
<b>Outflow of knowledge from the focal subsidiary to the rest of the corporation</b>	<b>High</b>	Global Innovator	Integrated Player
	<b>Low</b>	Local Innovator	Implementor

Figure 23 – A Knowledge Flows-Based Framework (Gupta and Govindarajan, 1991, p. 774).

By classifying international subsidiaries within this matrix, Gupta and Govindarajan (1991) propose in a second step a guideline for MNCs to manage their international network *via* strategic control systems. In accordance with Mintzberg's (1978) notion of 'intended strategy' (a strategy which has been defined *ex ante*), they consider the characteristics of knowledge flows as predetermining the strategic role of the subsidiary within the MNC network. Harzing and Noorderhaven (2006a) reaffirmed the typology of Gupta and Govindarajan by an empirical study covering 169 international subsidiaries. At the same time, they found that today's MNCs reveal clear tendencies towards the transnational solution of Bartlett and Ghoshal (2002). The authors describe a promising configuration where dispersion, specialization and interdependence are predominant characteristics of the MNC network. They articulate this transnational solution around two axes: a high pressure for subsidiaries to be integrated into a global structure of the MNC and a high pressure to adapt to local needs. The role of the integrated player as described by Gupta and Govindarajan correlates with this transnational solution and thus represents the most desired position of an international subsidiary for an MNC.

With the objective of enhancing the potential of an MNC's international subsidiaries to fill the role of the integrated player, the model of Gupta and Govindarajan (1991) proposes several informal and formal control mechanisms that can be employed to reposition its subsidiaries. These coordination mechanisms play a fundamental role in attaining the intended transnational network model, where subsidiaries are interconnected with each other and with the headquarters (Harzing and Noorderhaven, 2006a). However, scholars argue that the



decision to implement appropriate coordination mechanisms is impacted by the geographic space between the headquarters and the foreign location (Harzing and Noorderhaven, 2006b). In addition to this, researchers found that the knowledge flows depend on social interactions between the managers of the different entities; a high level of social interaction at a top-management level stimulates the knowledge sharing process between subsidiaries, which is especially important for the transfer of tacit knowledge (Noorderhaven and Harzing, 2009).

With regards to the present research, the typology of Gupta and Govindarajan (1991) provides an appropriate starting point to describe the role of international subsidiaries during the FFE. This is not only due to the fact that their typology is consistent with other international models (Bartlett and Ghoshal, 2002; Teece, 1976) and therefore widely accepted in the academic world. Since it classifies subsidiaries by their incoming and outgoing knowledge flows, it correlates with current approaches to the FFE using dynamic capabilities where knowledge is required to circulate fluidly between actors (Cohendet *et al.*, 2013).

#### **4.1.1.1 A Theoretical Matrix of the FFE**

In the case of discontinuous innovations, it has been elucidated in PART II (theoretical foundations) that ideas emerge on the individual level (bottom-up process) *via* creative combinations of existing knowledge and the integration of new knowledge from the external environment. From this point of view, the outflow of specific technical knowledge from the subsidiary to the headquarters is indispensable if the company wants to exploit the international creative slack. External market data are of equal strategic importance to create the necessary market vision for actors involved at the FFE (Reid and De Brentani, 2010). Hence, in accordance with the earlier-presented knowledge flows-based framework, the objective of an organization to generate discontinuous innovations requires at least that the international subsidiary occupy a position as global innovator or integrated player (i.e. upper line of the framework). This assumption equally reflects the research of Yang *et al.* (2008) revealing that the knowledge outflow from the subsidiary towards the rest of the corporation depends on the relevance of this knowledge for corporate businesses. Thus, their research suggests that a specifically creative subsidiary is characterized by a high knowledge outflow.

Conversely, in the case of continuous innovation, it is sufficient to undertake a market research on an organizational level, and then instruct a local R&D department to adapt products already existing within the corporate product portfolio to respond to the detected

market gap. This requires no specific knowledge outflows from the subsidiaries, but a high inflow of knowledge about external market data from the corporate level to the local subsidiary. In analogy to Gupta and Govindarajan (1991), the subsidiary occupying the position as implementor would be sufficient for an international FFE where continuous innovations are targeted.

If both inflows and outflows of knowledge are low between a subsidiary and the rest of the corporation, it is assumed that no international FFE is observed, neither for continuous nor discontinuous innovation. Figure 24 summarizes these reflections in analogy to the knowledge flows-based framework.

		<b>Inflow of knowledge from the rest of the corporation to the focal subsidiary</b>	
		Low	High
<b>Outflow of knowledge from the focal subsidiary to the rest of the corporation</b>	High	<b>International FFE of Discontinuous Innovations</b>	
	Low	<b>No International FFE</b>	<b>International FFE of Continuous Innovations</b>

Figure 24 – The Knowledge Flows-Based Framework (Gupta and Govindarajan, 1991) adapted to the FFE (by MN).

In view of this parsimonious approach, the question remains open how an MNC could reposition its subsidiaries to foster the generation of discontinuous innovations in collaboration with its international subsidiaries. Further, it is not totally clear in this typology if there is a difference between global and integrated players at the FFE. To answer these questions, the case study at BÜRKERT was conducted. The focus remains on the elaboration of a coherent international matrix, so that MNCs could classify their international subsidiaries regarding their FFE activities. Simultaneously, criteria are elaborated to justify this classification, leading to the identification of underlying coordination mechanisms which could be used to reposition the subsidiaries.

## 4.1.2 RESULTS

The BÜRKERT group has a presence in several locations worldwide. As reflected in the literature, these subsidiaries might have different roles within the company's network. Closer investigation into the innovation processes, especially concerning international collaborations during the FFE, led to the identification of examples for each category of the international FFE matrix presented earlier.

		<b>Inflow of knowledge from the rest of the corporation to the focal subsidiary</b>	
		<b>Low</b>	<b>High</b>
<b>Outflow of knowledge from the focal subsidiary to the rest of the corporation</b>	<b>High</b>	<ul style="list-style-type: none"> <li>• <i>Canadian sales-subsidiary</i></li> <li>• <i>R&amp;D center Karlsruhe</i></li> </ul>	<i>French subsidiary after 2005</i>
	<b>Low</b>	<i>American "Systemhaus"</i>	<i>French subsidiary before 2005</i>

Figure 25 – The International FFE Network at BÜRKERT (by MN).

These examples were collected based on the analysis of the interviews as well as through participant observation. In the following, each type is explained in further detail, adding concrete examples from the company to justify their classification.

### 4.1.2.1 The American Systemhaus: Local FFE Innovator

In the theoretical framework, a local FFE innovator was defined as a subsidiary which during the FFE does not have any specific knowledge inflows or outflows with the rest of the company. In the case of BÜRKERT, this situation was observed for the American 'Systemhaus'. At BÜRKERT, a so called 'Systemhaus' is an entity which delivers customized versions of existing products for their local clients. This requires technical knowledge, but with a clear focus on local market needs. Furthermore, even if production facilities are not as developed as in the four German and the French factories, 'Systemhäuser' are to a certain degree able to produce products themselves and take charge of local industrialization.

In recent years, the entity in America has grown significantly and acquired important competencies through their local strategy. Together with these competencies, they developed a highly innovative product for the medical sector. However, besides the American subsidiary, the rest of the company was not aware of this idea proposal: *“And now, this is inserted into our organization, no matter if it can digest it or not”* (B2FG\_2)

The belated communication about the existence of the innovation posed difficulties for the sales and marketing forces which would be in charge of the distribution of this new product, as well as for other production sites which are probably not prepared to produce such a product. The local FFE innovator generated a discontinuous innovation, but its market potential cannot be optimized as it does not necessarily correlate with the existing product portfolio of the company. The American Systemhaus acted independently of the corporate innovation structure. The example illustrates that the outflow from the subsidiary to the rest of the corporation during the FFE was low. At the same time, no specific inflow was observed.

#### **4.1.2.2 Karlsruhe and Canada: Global FFE Innovators**

At BÜRKERT, two examples of a global FFE innovator were identified during data analysis: the Canadian sales subsidiary and the German R&D center in Karlsruhe. The Canadian sales subsidiary has around 20 employees who are in charge of the commercialization of BÜRKERT products in Canada. Besides their sales forces, most of the employees have a sufficient technical background to assure an appropriate marketing strategy for the local market. Due to this combination of market vision and technical know-how, these collaborators regularly generate new ideas. However, it was observed that when a Canadian employee had an idea for a new product, he did not know where to apply it to get it inserted on a corporate level and to push its development. On a local level, BÜRKERT's sales subsidiaries do not have a proper production site. To assure the transition from the FFE to the NPD, they depend therefore on the wider corporate production systems. However, interviews revealed that the German headquarters (where all the decision-makers are located) is similar as to a 'black box'. Canadian employees share the predominant assumption that if they send an idea to a particular person at headquarters with whom they are already in touch, the idea is systematically taken into account. However, 1,700 of the total of 2,570 employees are located at the headquarters, and it is therefore possible that the contact person in Germany would not know to whom to transfer the idea. If this person does not feel directly connected with the idea and thus is not able to evaluate its innovativeness, interviewees explained, in most cases

the idea gets lost, even if it might be highly innovative. Knowledge outflow from the Canadian sales subsidiary was observed as being high but no significant inflow from the rest of the corporation to the subsidiary was identified during the FFE.

The second example is the R&D center in Karlsruhe. This center is located close to local universities and therefore has access to highly valuable external knowledge. As it is the only pure R&D center of the group, this location pushes new technologies and integrates this knowledge. However, it does not dispose of a local production site, similar to the Canadian example. Their outflow of knowledge is high, as they communicate their insights as much as possible with the rest of the corporation by sending out Newsletters, stocking knowledge on corporate platforms, etc. in order to find appropriate product applications for new technologies. Nevertheless, it was observed that not long after the beginning of its activities in 2013 many new ideas were being refused by the decision-makers at the headquarters during the final Go/No-Go decision, even before the NPD process started. In their ‘cemetery of stranded ideas’ this location collected all the ideas which did not make the transition to the NPD and remained in a demonstration state. Even though the location has an important knowledge outflow, the knowledge inflow from the rest of the corporation is considered low.

In both cases, the employees of the Canadian sales subsidiary and the R&D center in Karlsruhe provided ideas with a high potential for the BÜRKERT group. As neither entity had local production facilities, they were not able to develop ideas locally, and depended on the rest of the corporation for the transition to the NPD. However, it was observed that many ideas remained in the heads of the international employees and were not developed further.

#### **4.1.2.3 The French Subsidiary before 2005: FFE Implementor**

The implementor at the FFE was defined as a subsidiary which participates in the corporate innovation processes to generate continuous innovations. This was the case for the French subsidiary in the period between 2001 and 2005. The French entity is one of five factories in the group. It therefore has not only an R&D department, but also production and even local sales forces in charge of the commercialization of BÜRKERT products on the French market. In 1998, this entity was labelled a ‘center of competencies for sensor technology’. Since the restructuring of the corporate innovation processes in 2001, the subsidiary has been entirely integrated into the corporate innovation structure. For the first time, these activities concentrated on the re-engineering of existing products and ‘me-too’ sensors. In the following

years, the factory acquired valuable competencies in the field of sensor technology. In the period between 2001 and 2005, the decision-makers of the company guided the product portfolio for sensor technology based on global market information and decided on the products to be developed by the French entity. Over the years, this led to the creation of sophisticated products, but with a clear continuous degree of innovation. The FFE process had an international orientation given the fact that the opportunity sensing and idea seizing took place at the German headquarters, whereas the last step of the FFE, the reconfiguration of the concept, was localized abroad. This equally facilitated the transition to the NPD process, as the factory disposed of its own production facilities. All in all, a high inflow from the rest of the corporation to the local subsidiary was identified to develop a consistent product portfolio for sensor technology. The concept development during the FFE took place on a local level. Transnational collaborations inducing knowledge outflows from the French entity towards the rest of the corporation were not observed during that period.

#### **4.1.2.4 The French Subsidiary after 2005: Integrated FFE Player**

After 2005, the French subsidiary evolved towards the position of an integrated FFE player. The purpose of the group was to work closely together with the French subsidiary. Thus, the R&D officer of the group decided to develop between 2005 and 2007 an innovative product matrix together with the French R&D officer and the other R&D team coaches in Germany.<sup>4</sup> Based on this matrix, employees from both countries together identified promising opportunities and developed discontinuous product concepts which were afterwards inserted into the development process. A first product, an online analysis system for water analysis for a very limited space, was launched in 2014 and represents today one of the core innovations of the group.

Besides this product application, several engineers of the French subsidiary started to participate in internal knowledge communities for different core technology fields with the objective to share knowledge beyond national borders. This structure not only spawns highly innovative solutions like the aforementioned online analysis system, but is also a means for the French employees to apply their ideas rapidly and in a goal-oriented fashion. Knowledge outflows as well as knowledge inflows at the FFE are high between the French competence center and the rest of the corporation, justifying its position as integrated FFE player.

---

<sup>4</sup> For more information: a detailed historical evolution of the German-French relations will be elucidated during the process approach in chapter 5.1.

### 4.1.3 ANALYSIS

The description in the previous section suggests that local subsidiaries do indeed illustrate different positions within BÜRKERT's network as regards FFE activities. The French subsidiary post-2005 is an extraordinary example of an integrated FFE player, where international knowledge transfers in both directions enabled the company to generate discontinuous innovations.

The case study therefore reveals two important considerations. First of all, it was possible to unambiguously identify the position of the local subsidiaries in accord with the theoretical international FFE matrix. This implies that specific characteristics apparently exist which precisely determine the knowledge flows at the FFE. Secondly, the French subsidiary occupies a special role within BÜRKERT's international FFE network as it has changed its position over time. Hence, much as proposed by Gupta and Govindarajan (1991), it indeed seems possible to reposition subsidiaries within the international FFE typology.

Table 25 provides some extracts from the interviews and a rough overview over the coding process. For reasons of complexity, it focusses on the initial code (1<sup>st</sup> level of abstraction) and the two resulting central concepts which were identified as common pattern to determine the role of the observed subsidiaries within the FFE network: the relationship of trust between the subsidiary and headquarters, and the integration of international FFE activities within the corporate innovation processes.

In the following, the international subsidiaries will be compared regarding these two dimensions in order to provide further insights about the case.



	Quotes	Initial Code	Central Concept
Canadian subsidiary	<i>"If you don't send it [idea; added by author] to the right address, it remains somewhere in the factory."</i> (B2FH)	Missing targeting of ideas	INTEGRATION
R&D center Karlsruhe	<i>"We constructed the cemetery of stranded ideas"</i> (B2FJ)	Ideas without follow-up	
French subsidiary (2001-2005)	<i>"BÜRKERT claimed [after 2001; added by author] that France is an important entity and it is important to maintain it, also due to historical reasons. There was now a new top-management team in France and they said: 'ok, we'll try it'. After some years, they saw that this worked out and that the people started to work with Germany."</i> (B1FA_2)	Recognition of competences	
	<i>"I remember the time [before 2001; added by author] when I started to work for BÜRKERT. The level of our collaboration was at zero or even below. Only our CEOs went to Germany and when we went together with them, we weren't allowed to talk to them. This was very special."</i> (B1FD)	Construct confidence with international colleagues	
	<i>"I remember the time [before 2001; added by author] when I started to work for BÜRKERT. The level of our collaboration was at zero or even below. Only our CEOs went to Germany and when we went together with them, we weren't allowed to talk to them. This was very special."</i> (B1FD)	Strategic decision not to share knowledge	
French subsidiary (2005-2015)	<i>"The communication channels are short. I have a good contact to the colleagues from France. [...] Everywhere else, you have to talk to your boss first, he talks to his boss, and only now you get the permission 'ok, you are allowed to talk to each other'. This is not the case at BÜRKERT. I only take the phone and I get my information."</i> (B2FE)	Direct information and knowledge circulation over distance	TRUST
American Systemhaus	<i>"The local employee thought 'I have a really good idea with a high market potential which will revolutionize the market. But if I insert it into the official innovation processes, the idea might be averted and this will not work. I'll do it locally.' I don't think that he had a malicious intention. They only feared that their idea will not be accepted and they did not have enough trust."</i> (B2FG_2)	Not enough trust	
Canadian subsidiary	<i>"I think that the CEO has a huge influence on the atmosphere. He attached great importance to the BÜRKERT culture and expected us to live these values and to act with respect for the corporate strategy."</i> (B2FH)	High commitment towards headquarters	

Table 25 – Extract of the Coding Process: Verbatim for Coordination Mechanisms.



### **4.1.3.1 Nothing Can Be Created From Nothing: Trust and the Willingness to Share Knowledge**

In consideration of the quotations above, the reason why the American employees did not communicate their idea is assumed to be a concern it would be refused by the headquarters. It seems that they did not have sufficient trust in the corporate structure to take decision to validate the project. As a consequence, they did not transfer their highly valuable knowledge to the rest of the company during the FFE.

Besides this missing relation of trust with the headquarters, participant observation equally led to the observation that the international ‘Systemhäuser’ are generally not active players in the new product development process. The NPD is historically located at the European factories (Germany and France). Thus, FFE activities in America are also not explicitly recognized and therefore not taken into account on an organizational level. At the same time, the American ‘Systemhaus’ has its own production facilities and is able to take charge of the entire innovation process. This reinforces their independent position from the corporate innovation structure and enables them to pursue a local FFE.

The Canadian sales subsidiary was not explicitly integrated into the corporate innovation processes either, but it still openly shared knowledge. The Canadian manager of this small structure (20 employees) attached great importance to the fact that his employees adhere to the BÜRKERT culture and its values. As a result, his exemplary behavior induced local collaborators to share their knowledge voluntarily and frequently. This resulted in a direct knowledge flow where the Canadian employees autonomously contacted their German colleagues. Working within a system of flat hierarchies, they were not obliged to validate everything with him beforehand.

Neither the Canadian nor the American subsidiaries are part of the corporate innovation processes. However, knowledge outflows are higher from the Canadian entity. Throughout the coding process, this difference was linked to a varying level of trust towards the headquarters.

### **4.1.3.2 A Dead End for Ideas: Open the Black Box**

The high knowledge outflow of the Canadian subsidiary towards the rest of the company ended in a ‘black box’ – an ambiguous place where they did not know exactly what happens with their input. Their input was not exploited during the corporate ideation phase at the FFE and ideas remained in the creative slack.

The same situation was observed for the R&D center in Karlsruhe between 2013 and 2015. The role of this entity was initially to engage in applied research activities to advance the core technology fields of the company. The product focus was less crucial. However, the company rapidly realized that this concentration on research activities increased the risk of isolation of the R&D department. Similar to the case of the Canadian sales entity, this was not linked to the lack of a trusting attitude towards the rest of the company. On the contrary, the R&D center opted for open knowledge circulation. They shared their insights with all other subsidiaries, for instance, through newsletters on specific topics. Nevertheless, many project ideas remained unused. As with the Canadian subsidiary, the R&D center did not dispose of a local production facility. Hence, both entities depended on the corporate structure to assure the transition from the FFE to the NPD phase. However, the low success rate of the ideas at the Go/No-Go decision point can be explained by the lack of a clear process whereby these ideas come to be inserted into development.

Considering this situation, the company recently decided to open the black box and design a process for the early innovation phase. Besides a product-focused roadmap, the company is about to create a technology roadmap which includes technology-focused projects. At the same time, an incubation process will be expanded to international subsidiaries. These evolutions will enhance the R&D center and the Canadian subsidiary with regards the application of their ideas.

### **4.1.3.3 The French Subsidiary: Trust Changes Everything**

Before 2001, the French factory was autonomous from corporate innovation processes. Subsequently, the BÜRKERT family decided to change this situation and to integrate the French factory into the innovation structure of the group. In a first step, the BÜRKERT group acknowledged the strategic role of the French factory by denominating it as ‘center of competencies for sensor technology’. The internal processes were restructured and adapted to

the corporate standards. Further, the management of the French factory was taken in charge by a German member of the board. At first, these changes were not evident:

*“There was a wall between us. Now, we had to work together and this was also our intention. I for myself was sometimes blamed because I used the same software for the conception as them. For me, it was logical to use the same program as the Germans.”*  
(B1FC).

The integration of innovation activities at the corporate level was reconfirmed in 2005 when the French R&D officer participated in the development of the innovation matrix. This was the first milestone for the creation of an international FFE leading to discontinuous innovations, as the most innovative idea which emerged from this matrix expressed a combination of French and German competencies. This evolution towards an integrated FFE player was only possible as both sides started to gain confidence in the competencies of each actor. Between 2001 and 2005, the employees of the two entities had not been used to sharing their knowledge, and outflows were rare. During the FFE, activities remained rather separate as opportunity seizing and sensing was located in the German headquarters whereas only the reconfiguring of the concept happened abroad in France. Over time, common projects and collaborations on several levels enabled the two entities to become interdependent. On a corporate level, BÜRKERT started to focus on the elaboration of a relationship based on mutual trust. Through regular physical meetings in France and a close contact with their French colleagues, the German manager in charge of the subsidiary after the restructuring process gained the esteem of the French entity. After his retirement in 2014, the BÜRKERT group transferred his responsibility for the French factory to a French manager. Even though this move might seem obvious on first impressions, it still represents a strong message to the French entity in that it demonstrated the high trust accorded from headquarters to the French employees.

In this organizational setting, the French employees gained the confidence to communicate their knowledge openly with German colleagues. Based on close interconnections on an organizational level, even employees who did not know each other started to share their knowledge without restrictions. These were direct contacts, which did not necessarily pass through the hierarchical system first.

*“The communication channels are short. I have a good contact with the colleagues from France. It is easy to create the contact due to the corporate culture. This is not the same in other companies, where you have to communicate via hierarchies.”*  
(B2FE)

This notably increased the quality and speed of the knowledge flows at the FFE. Hence, the company was able to construct a subsidiary–headquarters relation where knowledge circulates unfiltered in both directions, and which positioned the French location as an integrated FFE player on an international level. From now on, several projects have been created within international FFE teams where actors were able to create dynamic capabilities during all three steps of this phase.

#### 4.1.4 DISCUSSION

Based on the observations from the case study, the initial international FFE typology can be detailed as shown in figure 26.

		<b>Inflow of knowledge from the rest of the corporation to the focal subsidiary</b>	
		Low	High
<b>Outflow of knowledge from the focal subsidiary to the rest of the corporation</b>	High	<i>Global FFE Innovator</i> <b>Black-Box</b> (Dead end for innovation)	<i>Integrated FFE Player</i> <b>International FFE of discontinuous innovations</b>
	Low	<i>Local FFE Innovator</i> <b>Local FFE</b> (continuous/discontinuous innovations)	<i>FFE Implementor</i> <b>International FFE of continuous innovations</b>

Figure 26 – The International FFE Typology (Adapted by MN from Gupta and Govindarajan, 1991).

The FFE Implementor represents a subsidiary which generates continuous innovations for the corporate product portfolio. The outflow of knowledge is low but the inflow of knowledge about market data etc. from the headquarters towards the subsidiary is high. The headquarters delegates the generation of continuous innovations to entities which are most competent to do the job on an international level. However, these subsidiaries do not participate in the

generation of new product ideas. This is the role of a subsidiary which is positioned as Integrated FFE Player. This subsidiary is closely interconnected with the rest of the corporation, and communicates local knowledge and innovative ideas so that they may be exploited on a corporate level. Simultaneously, it collects input from the rest of the company to increase the strategic fit of the idea with the corporate product portfolio. These are the fundamental conditions of an international FFE which fosters discontinuous innovations. Cognitive diversity and an international pool of knowledge favor the emergence of such ideas. On the other side of the continuum, the Local FFE Innovator exclusively generates ideas for local markets. These ideas could be continuous or discontinuous ideas, but they are not managed or developed further on a corporate level. Finally, the Global FFE Innovator (high outflow and low inflow) is an important idea generator which can enhance technological knowledge about a specific domain but is not able to exploit this knowledge locally. When such a subsidiary is not integrated into the corporate structure, the transition to the NPD cannot be assured and ideas remain in the creative slack.

In the examples drawn from the case study company, the more-or-less intense trust relationship between the headquarters and the international subsidiary was a crucial factor which determined whether the members of the international entities shared their knowledge or not. The FFE is less structured and formalized than the later NPD steps, and this knowledge transfer is less evidently managed by explicit processes (Koen *et al.*, 2001). An inter-organizational relationship based on trust constitutes a consistent framework where tacit knowledge can circulate across boundaries (compare to Ichijo *et al.*, 1998; Noorderhaven and Harzing, 2009). In the example of the French subsidiary, it took several years before the relationships were stable enough to assure sufficient psychological security for the French employees to share their ideas unconditionally with their international colleagues. In fact, trust between individuals is constructed over time through sharing a common history alongside repeated proof of the stability of the partnership (Mayer *et al.*, 1995). Repeated interactions can support this process of trust generation (Ter Wal, 2014; Torre, 2008). In MNCs, actors do not necessarily know each other in advance, and in such configurations they do not always have time to construct a trust relationship based on their own experiences (Meyerson *et al.*, 1996). Yet Meyerson *et al.* (1996) found that in such cases, individuals are able to accord a certain level of trust *ex ante*. The simple fact that, for example, they are employees of the same company could induce people to show trust-related behavior. And even where people do not know each other, they may trust each other enough to share their

knowledge. So-called swift trust “*is less about relating than doing*” (Meyerson *et al.*, 1996, p. 191). Swift trust can be observed in temporary teams who come together for a specific project and who do not expect to work together again in the future (Meyerson *et al.*, 1996). Meyerson *et al.* (1996) explain that in such temporary teams, people trust each other because they trust in the role each plays: they believe that the other person was allocated to the team due to her ability to fulfil her role. They accept that if top-management considers the person to be suitable, other team members will as well. Where people continue to work together on other projects, this form of temporary trust may be replaced over time by a more classical form of knowledge-based trust created by personal experiences (Robert *et al.*, 2009).

During the FFE of discontinuous innovations, unexpected encounters enhance the combination of different knowledge bases and create new innovative ideas (Parjanen, 2012). Hence, in accordance with the literature, the international FFE can indeed be considered as a temporary system comprising

*“a set of diversely skilled people working together on a complex task over a limited period of time.”* (Goodman and Goodman, 1976, p. 494)

In MNCs, FFE actors are spread out in space and therefore do not necessarily know each other, so swift trust can be a powerful mechanism to assure fluidity in knowledge sharing. In the case study, such swift trust was observed between the French subsidiary and the German headquarters. Collaborators of both entities did trust each other based on the simple fact that they worked for the same company. By maintaining and continually increasing a trust relationship on the corporate level, the top-managers of both sites created a solid foundation for the international actors who are involved during this informal and unstructured innovation phase. This is crucial, especially when an organization seeks to keep strategic knowledge diffusion under control (Balland *et al.*, 2015).

This leads to the assumption that international FFE actors will readily share knowledge with international colleagues if there is already a close trust relationship established on an organizational level. This also correlates with the social learning perspective of Noorderhaven and Harzing (2009), who identified that social interactions between international managers are a crucial aspect in coordination. Furthermore, tacit knowledge is more easily shared between members of the same organization than between members of two different companies (Balland *et al.*, 2015). However, even within the same firm, departments in different geographic locations require trust to avoid opportunistic behavior (Boschma, 2005).

To sum this up regarding the international FFE matrix, the trust relationship between the international subsidiary and the rest of the corporation determines the intensity of knowledge outflows.

Considering the knowledge inflow from the rest of the corporation to the local subsidiary, this depends on the second factor: the integration of the subsidiary into the corporate innovation processes. At BÜRKERT, this factor distinguished the French factory from the other international subsidiaries. The examples of the Canadian subsidiary and the R&D center in Karlsruhe demonstrated that high trust is an important but not sufficient precondition to successfully make use of the internationally distributed creative slack. Especially when a subsidiary does not dispose of local production facilities, it depends on integration into the corporate innovation structure to assure the transition to the later NPD.

All in all, the theoretical international FFE matrix has been approved in the field of the case study. The examples collected expand the explanatory power of this matrix by the integration of two coordination mechanisms, ‘Trust’ and ‘Integration’, which enable the repositioning of an international subsidiary within the MNC network at the FFE (Figure 27).

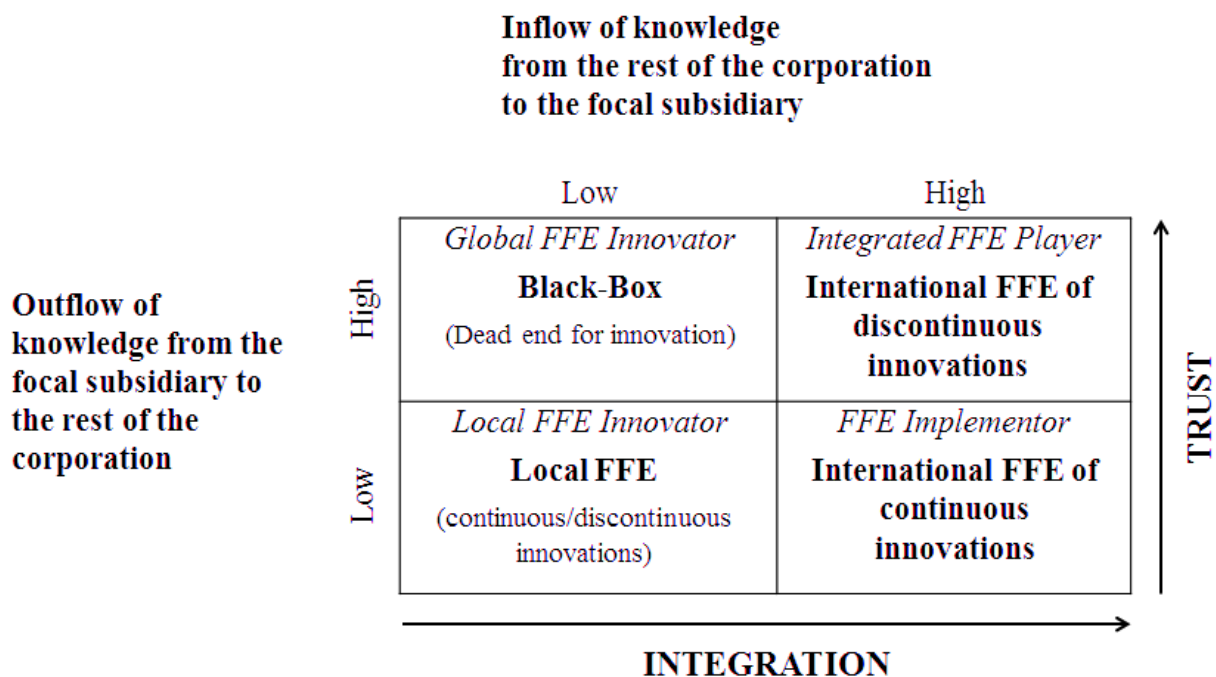

Figure 27 – The International FFE Matrix and Its Coordination Mechanisms.

The better the integration of the local subsidiary into the corporate innovation process (knowledge inflow), the higher is the probability that space will be created for employees to participate actively in an international FFE. This is crucial to make efficient use of the



internationally distributed creative slack, whether for continuous or for discontinuous innovations. The trust relationship between the headquarters and the subsidiary has to be strengthened to increase the knowledge outflow of the international subsidiary towards the rest of the company. Once a close trust relationship on a corporate level is generated, the notion of swift trust assures that people who are not used to talking to each other will provide enough confidence to share their knowledge and thus foster the generation of discontinuous innovations.

Finally, an observation should be made regarding the transition to the NPD. This transition represents one of the main challenges for management to assure a successful innovation process (Markham *et al.*, 2010). The case study leads to the assumption that the existence of a local production site facilitates the insertion into the NPD. It enables an international subsidiary to take charge of the development process for an idea, but at the same time it inherits the risk of the isolation of FFE activities on a local level. On the other hand, if a subsidiary does not have its own production facilities, it is greatly dependent on the corporate innovation process. If ideas do not find their way through all the three steps of an international FFE (opportunity sensing, idea seizing, and concept reconfiguration), the subsidiary is stuck in the position of a global FFE player where ideas remain in the creative slack. Product development at least for the local market thus cannot be realized. Production facilities are required in the case of FFE implementors, because the subsidiary is not only in charge of the later FFE activities (reconfiguration of the concept) but should equally assure the transition to the NPD which is managed locally. The final concept at the end of the FFE should correspond to local production requirements in order to facilitate the transition to development.

From this perspective, it is interesting to note that specifically in the case of an integrated FFE player, it does not matter if a subsidiary has its own production facilities or not. The international FFE of discontinuous innovations requires a high knowledge outflow, but once an idea has made it through the process, its insertion into the NPD can be managed on a corporate level. The transition towards development of a final product is ensured by the most relevant location having all the necessary resources at its disposal. It is thus not required that the local subsidiary that generated the idea takes charge of the later development steps.



## 4.1.5 CONCLUDING REMARKS

Based on the knowledge flows-based framework of Gupta and Govindarajan (1991), this chapter established an initial typology for the FFE in an international company. This typology illuminates the position of international subsidiaries within the innovation network of an MNC in respect of their activities at the FFE. Given that the continual generation of discontinuous innovations requires subsidiaries which are positioned as integrated FFE players, this typology is equally in line with current tendencies towards the transnational solution of Bartlett and Ghoshal (2002).

Furthermore, two coordination mechanisms were identified an organization could use to reposition its international subsidiaries. First of all, the FFE of discontinuous innovations depends on a bottom-up knowledge flow from the individual to the organizational level, requiring a high knowledge outflow from the subsidiary to the rest of the corporation. This knowledge outflow can be coordinated by a relationship of trust. Without trust on the organizational level, individuals might resist sharing their knowledge with the rest of the company and ideas remain in the creative slack. Therefore, this coordination mechanism represents the first element of the ProxIS-Telescope to enable stars to send out their light. At BÜRKERT, proximity on an organizational level induced by this trust relationship enhanced the probability that individuals who are not used to working together share knowledge – even tacit knowledge – through the creation of swift trust. This specific form is therefore the first coordination mechanism at BÜRKERT to enhance international knowledge flows.

However, this trust relationship will not be fruitful if the local subsidiary is not sufficiently integrated into corporate innovation processes. Such integration, secondly, increases the knowledge inflow from the rest of the corporation to the local subsidiary. For the moment, this second aspect remains rather generic and will therefore require further investigations during the next chapter of how to integrate international knowledge during the FFE.

Still, the typology provides an initial approach for managers to analyze their international innovation activities. Based on this analysis, and in accordance with the corporate innovation strategy, organizations should focus on the repositioning of their international subsidiaries by using both coordination mechanisms. Creating a close trust relationship is a long and time-consuming process. Once established, swift trust is a dynamic and short-term solution which enables informal and unexpected interactions to take place. It may take up to several years to

gain the confidence of international employees, especially with regard to the ‘not-invented-here syndrome’. It is worth noting, though, that this dimension enables organizations to reposition a subsidiary on the upper line and increase the likelihood of generating discontinuous innovation on a corporate level. Hence, despite the substantial time investment, managers should attend to this element of the ProxIS-Telescope, and focus on cultivating contacts with the international entities with an eye to the generation of mutual trust.

Integration into the corporate innovation processes should be modelled and then transferred to the international operative units of the company. Once a clear strategy is established, managers should make sure that it is known everywhere and that the international employees adhere to it. The question how to provide a place where international employees may apply their knowledge will be investigated in more detail in the next chapter.

#### **CONTRIBUTIONS**

This chapter establishes a first international typology for the FFE regarding the activities of the international subsidiaries within the network of an MNC.

##### **Sub-question 1 – Classify the MNC network at the FFE**

The typology proposes four positions determined by the knowledge outflows and inflows from the focal subsidiary towards the rest of the corporation during the FFE with regards to the knowledge flows-based framework (Gupta and Govindarajan, 1991).

##### **Sub-question 2 – Reposition subsidiaries towards discontinuous innovations**

Two coordination mechanisms determine the role of an international subsidiary during the FFE:

- The integration of the subsidiary into the corporate innovation structure to enhance the international dimension of the FFE; and
- The trust relationship between the international actors to foster the generation of discontinuous innovations during an international FFE.

Managers should build up on these insights to reposition their subsidiaries as integrated FFE players to foster an international FFE of discontinuous innovations.

All in all, this chapter illustrates the necessary preconditions for a successful international FFE. Thanks to a relationship of trust, individuals will be motivated to send out light and share their ideas openly with the rest of the corporation. In a next step, the two lenses of the ProxIS-telescope will be identified at BÜRKERT to complete the picture.

## 4.2 SOCIAL PROXIMITY

*“Early work proposed that knowledge creation in organizations is influenced by factors such as organizational culture, leadership, organizational structures, and incentives systems, which provide a social context for, enable, or constrain the process where people with different knowledge and interests interact”*

(Nonaka and Von Krogh, 2009, p. 640)

As shown in chapter 4.1, employees who are dispersed over space are likely to be willing to share their knowledge as soon as a relationship of trust exists on an organizational level. This would seem to support the notion of swift trust, which it is argued fosters individual participation in the innovation structures of a company (Meyerson *et al.*, 1996).

It remained open, though, how exactly a company might integrate this knowledge now into its innovation processes. Consequently, a second element for a successful international FFE is necessary which is similar to the internal workings of a telescope: multiple rays of light are generated, and then they have to be bundled together. Thus, a first lens is necessary to capture this light from the stars. However, the objective of this first lens is not only to gather the light. In a similar way to the Keplerian telescope, the rays of light are refracted to converge in order to increase the telescope’s efficiency and to achieve a much bigger picture (Cheng, 2009). With regards to this functionality of the first lens – the convergence of the rays of light – this chapter considers social proximity between actors: a dimension which is crucial for the convergence between people to generate new ideas together across space. According to Boschma (2005),

*“[s]ocial proximity is defined here in terms of socially embedded relations between agents at the micro-level.”* (Boschma, 2005, p. 66)

Boschma (2005) underlines that economic relationships are closely linked to the social context in which they take place. Former colleagues who have remained friends outside of the office are likely to trust each other and may continue to exchange knowledge, even after they have stopped working together. The researcher argues that too much as well as too little social proximity has a negative impact on innovation. Whereas the former situation leads to opportunity costs, the latter hampers the circulation of knowledge due to a lack of trust. Apart from Boschma, many scholars have underlined the crucial role of social proximity for organizational knowledge creation (see e.g. Cassi and Plunket, 2015).

The theoretical part (PART II) made clear that scholars accredit a special role to tacit knowledge during the FFE of discontinuous innovations (Malecki, 2010; Mudambi and Swift, 2012). Nonaka and Takeuchi (1995) describe in their knowledge conversion model ('SECI-model') how tacit knowledge is transferred and shared through collaboration between individuals and thus by socialization. As a consequence, sufficient social proximity between actors is crucial during the FFE to enable them to share their tacit knowledge and generate new ideas and creative solutions (Bouba-Olga and Ferru, 2009). From a similar perspective, sociological theorists as well as network specialists have equally identified that strong social ties characterized by intensive interactions of actors enhance the radical nature of innovation (Bathelt *et al.*, 2004; Cassi and Plunket, 2015; Coleman, 1988; Rost, 2011).

Cohendet and Diani (2003) argued that the social dimension of knowing communities provides an efficient and not very costly construct for capturing the whole potential of knowledge – better than firms themselves. This is why Cohendet *et al.* (2013) propose that managers should focus on a company's internal and external communities in order to create dynamic capabilities during the FFE. Further scholars propose that organizations should refer to knowing communities as a way of collecting and managing tacit knowledge that requires only a small amount of financial effort (e.g. Cohendet and Simon, 2007; Harvey *et al.*, 2015).

In the business world, many large companies already rely on these constructs in order to manage knowledge within and between organizations (Cohendet, 2014). Brown and Duguid (1991) argued that only where the structuration of organizational processes in autonomous internal communities succeeds in creating a link to the external environment enables companies to overcome the lethargy inherent in large and bureaucratic structures. Regarding SMEs, scholars found that their innovation processes could equally be based on knowledge communities, even if these are less organized and therefore similar to spontaneous communities of practice (Metailler, 2016).

However, the question remains an open one in the literature as to how medium-market companies manage knowledge at the FFE and whether knowing communities are also here an appropriate coordination mechanism to enhance social proximity. Medium-market companies are situated at the interface between flexible management styles of SMEs and highly organized structures of large companies (Greiner, 1998). With regards to the fact that BÜRKERT represents such a medium-market structure, this leads to the following sub-question of this chapter:

**Sub-question 3 – Social proximity at the FFE of discontinuous innovations**

How to enhance social proximity in a medium-market structure such as BÜRKERT to manage the access to spatially distributed knowledge during the FFE of discontinuous innovations?

Owing to the relevance of their social dimension, this chapter considers specifically the literature about knowing communities. Knowing communities at BÜRKERT are investigated in more detail in order to assess their capacity to enhance social proximity during the FFE. The concept of knowing communities has already been mentioned briefly in PART II. Before beginning the analysis of BÜRKERT's internal communities, this concept requires closer investigation here.

## 4.2.1 THEORETICAL SPECIFICATIONS

Wenger (1998) identified communities as constructs for social learning considering that learning is not only an individual but also a social activity. Therefore, communities serve as a place to store knowledge, expand it, and create new knowledge, but also to integrate novices into a specific field of expertise (Wenger, 1998). Due to their huge potential for the coordination of internal and external knowledge resources, the management of many companies seek to intentionally use knowing communities to benefit their organizational systems (Bootz, 2015).

This is why Harvey *et al.* (2015) focused explicitly on the role of knowing communities in managing the FFE. Similar as Cohendet *et al.* (2013), they argue that communities coordinate the required knowledge and combine it to find new innovative solutions for product innovations. Management can directly and indirectly support its communities by using unscripted and scripted activities. Unscripted activities have no direct impact on a concrete FFE project, but create an environment which fosters interactions between communities, for instance by creating a co-working space. Scripted activities are directly guided by management. Both might happen inside the company or outside its organizational boundaries. The distinction between scripted and unscripted activities correlates with other researchers, for instance Kijkut and Van Den Ende (2007), who claim that activities should be informal at the beginning of the FFE and only turn into more formal and thus scripted activities in later steps.

In general, communities emerge through the passion and interests of some employees of organizations and persist as long as their members see an interest in nurturing the community

(Lièvre *et al.*, 2016). Scholars underline, therefore, the spontaneous character of communities, which lies outside an organization's influence (Brown and Duguid, 1991; Gongla and Rizzuto, 2001; Wenger, 1998). However, several authors suggest that communities can still be driven and thus be created and supervised by management (Bootz, 2015; Probst and Borzillo, 2008; Wenger *et al.*, 2002). Bootz and Lièvre (2017) even suggest that in some cases, the implication of management could be a stabilization factor for communities' activities. The question of whether communities should be embedded in the organizational level or remain spontaneous has gained a critical position in the discussion about the communities' efficiency for organizational knowledge creation and management.

Following the premise that knowing communities can be actively driven by organizations, Bootz (2015) proposes a typology to distinguish such driven from spontaneous forms of communities. The former are intentionally created to develop strategic knowledge and the innovative performance of a company whereas the latter are groups created spontaneously for the purposes of knowledge exchange and diffusion (Bootz, 2015). Thus, there are different types of communities existing within organizations which are classified by Bootz (2015) as hierarchic groups, spontaneous communities, and driven communities. The latter distinguish between strategically driven communities for exploration and operational communities for exploitation and respond therefore to organizational ambidexterity.

Even if Bootz (2015) suggests that spontaneous and driven communities fulfill different objectives, Arzumanyan (2014) found that both types may still coexist in companies and thus simultaneously nurture the knowledge creation processes. This has also been underlined by the research of Bootz and Lièvre (2017) illustrating a case where two types of communities have been observed within the same structure. From this perspective, authors argue that the role of management is crucial to merging both structures into a functional device for knowledge management (Arzumanyan, 2014; Bootz and Lièvre, 2017). Similarly, McDermott and Archibald (2010) assessed the degree to which managers should interact with their communities. They stated that communities will not be efficient unless they are able to earn sufficient attention from management. Thus, they argue that:

*“Today they're an actively managed part of the organization, with specific goals, explicit accountability, and clear executive oversights. To get experts to dedicate time to them, companies have to make sure that communities contribute meaningfully to the organization and operate efficiently.”* (McDermott and Archibald, 2010, p. 3)

Taking into account the crucial social dimension raises the question of whether management could apply this concept to coordinating knowledge across space by maintaining social proximity between employees during the FFE. Indeed, this concept has increasingly gained attention amongst practitioners as well as researchers in their attempts to understand and manage knowledge; also in light of an increasing internationalization of organizations (Wenger, 2011). For this reason, the communities at BÜRKERT are now investigated in more detail in order to assess their potential to overcome geographical and spatial differences during the FFE of discontinuous innovations.

## 4.2.2 RESULTS

### 4.2.2.1 The Context

The presentation of the company in PART III of this dissertation already detailed a two-sided innovation process where input is collected from a market as well as from a technology perspective. Since its foundation, BÜRKERT has evolved into a medium-market company for technological solutions and the product portfolio has emerged through continuous development of the existing product ranges. However, some of the important milestones in its historical evolution are discontinuous innovations. Most of them were customer driven: direct contact between the R&D department and the company's core clients was established in order to provide input for innovative new product solutions. Especially between 2005 and 2013, the company continually broadened the product portfolio to strengthen its market position and to demonstrate its innovative capacity. This led to a vast portfolio with a variety of products and applications: *"I call this in general an organic development of the product portfolio"* (B2FG).

Nevertheless, this organic development caused changes in the organizational strategy because technology leadership was difficult to maintain with such a large product range; especially in light of the fierce international competition and the resulting shortening of product life cycles. The view therefore emerged (compare to verbatim in table 26) that new product developments were not sufficiently coordinated with regard to concrete market needs, thus reducing their later market success.



<i>The products which we developed were not bad at all, but their market success decreased continually.</i>	<b>B2FG</b>
<i>Many innovations came directly from the R&amp;D department without necessarily taking into account what is really needed in the market. As a result, we developed several products which were not attuned to prevailing market conditions.</i>	<b>B2P3D</b>
<i>Only because we have a good idea, does not make sure that we can sell it later on.</i>	<b>B2P3C</b>
<i>We were very innovative in the past. There was always something new coming in, but it was not targeted. Such ideas ended up in just any product.</i>	<b>B2P3F</b>
<i>We cannot continue to develop something only because it is technically possible and only think about its market application afterwards.</i>	<b>B2FB</b>

Table 26 – Examples of Verbatim Accounts of the Decreasing Market Success.

Since 2013, this situation has caused organizational changes shifting to coordinated portfolio and project management under the vision of the new strategic guideline ‘Perspective 2023’. Internal processes, including the corporate innovation process, were systematically analyzed and standardized. Several measures have already been implemented. Regarding, for instance, the project landscape of BÜRKERT, two new services were established: the Project Management Office (PMO) and the Portfolio Management Office, which manage a structured approach to the product portfolio.

Nevertheless, this new structure was described by several interviewees as highly bureaucratic because it was perceived to slow down daily business and thus the entire innovation process. Indeed, people were aware that “*the problem is not that there are no ideas*” (POb) but that regarding the increasing organizational structure, ideas do not arrive at the final Go/No-Go decision before development.

*“I think that we could do a lot here. The knowledge is hidden somewhere in the firm and we cannot make it to insert it into the right place and develop it further.”* (B2FI)

Employees who have worked for the company for several years underlined their concerns that the increasing bureaucracy limits creativity and therefore the emergence of truly innovative products (see table 27). The failure rate of ideas which did not enter the NPD was considered to be high from the point of view of members of the R&D department. To illustrate that, one of the R&D centers created the earlier mentioned ‘cemetery of stranded ideas’.



This cemetery exposed all ideas which have been stopped prior to entering the NPD. After they had been stopped, the project proposals were brought to the status of a demonstrator in order to document and store the acquired knowledge.

<i>I'm not sure if our current project would have been accepted under the new structure. Sometimes, I have the feeling that this would not be the case today. It was indeed easier in the past, but I hope that I'm wrong.</i>	<b>B2P3C</b>
<i>When you show courage, which is a corporate value, and you say that you want to develop a new product which has a totally new approach to put BÜRKERT in the role of an innovative leader, this courage is punished by our project management. Because you add risks to the project and these risks could lead to the fact that you miss the objective, which is the SOP date. So you're only allowed to develop products when you exactly know how to do that. But this is nothing really innovative. It is only something you already know how to do.</i>	<b>B2P5B</b>
<i>We strengthened the project management, we shortened product life cycles and I think that this hampers creativity.</i>	<b>B2P5B</b>

Table 27 – Examples of Verbatim Accounts of the Decreasing Innovation Structure.

#### 4.2.2.2 Introduction of a Community of Communities

Since 2013, the product portfolio uses distinct and clear decision-making criteria to objectively decide about new projects. In most cases, projects which are evaluated by the product portfolio management are already quite advanced, which makes it possible to use quantitative criteria like price calculations or the Return-on-Investment (ROI). The company knew that this would not be possible for ideas which are still in the early stages of the FFE process and this is why a rather informal approach was introduced in 2013 for these cases. With regards to the difficulties described earlier in pushing discontinuous innovations, the company had to react in order to counterbalance the increasingly complex organizational structure:

*“At the moment, we work very formally. But the pendulum is now swinging back and we will work more informally again.” (B2P3C)*

As a result, the process of discontinuous innovations was decoupled from the standard development process for product improvements. Under the supervision of the technology portfolio manager, discontinuous innovations were now managed by the so-called ‘Technology Circle’. The objective of this circle is to centralize reflections about relevant technologies which could be integrated into the BÜRKERT portfolio. It is in charge of:

- The management of existing internal knowledge of the organization's core technology fields (knowledge stock, transversal knowledge flow, and creating visibility of existing knowledge);
- The identification of current and future technology trends;
- The screening of actual technological evolutions in the scientific fields ('outside-in');
- The detection of internal needs for new technologies at an early stage (e.g. an existing product needs a new solution; does BÜRKERT already have the technology for this solution?);
- Assessing new ideas before they enter development; and
- Providing strategic recommendations about the technological development of the company.

The activities of the technology circle in enriching the innovation process were internally classified into two broad categories. The first one is purely a technology-push. This includes all activities to identify future technology trends without a concrete product focus. The second approach is internally described as 'technology-pull'. These activities are necessary when existing products need a new technology in order to respond to a concrete market demand. In this case, the inquiry is initiated by the marketing or sales department due to an observation of market characteristics.

As illustrated in figure 28, the circle is structured around the company's core technology fields. These fields represent the fundamental basics of the company: Actuators, Modeling and Simulation, Data Processing, Sensors, Materials and Manufacturing. For each technology field, 'focus groups' are the operative entity of this structure. The objective of the focus groups is to insert external knowledge into the organizational structure and to be open to new ideas from employees located close to them. Looking at the company's history, the first efforts to create such focus groups can be traced back to 2005. However, not all of them persisted over time:

*"It has been criticized that the preparation of the meetings took a lot of time. And this is always a problem. Furthermore, after a certain time, we didn't know anymore what we could tell each other once everybody has had his turn. From the moment that there are no new projects or anything else, it becomes even boring. Some focus groups persisted over time; others were stopped as soon as the motivation decreased."*  
(B2P1B)

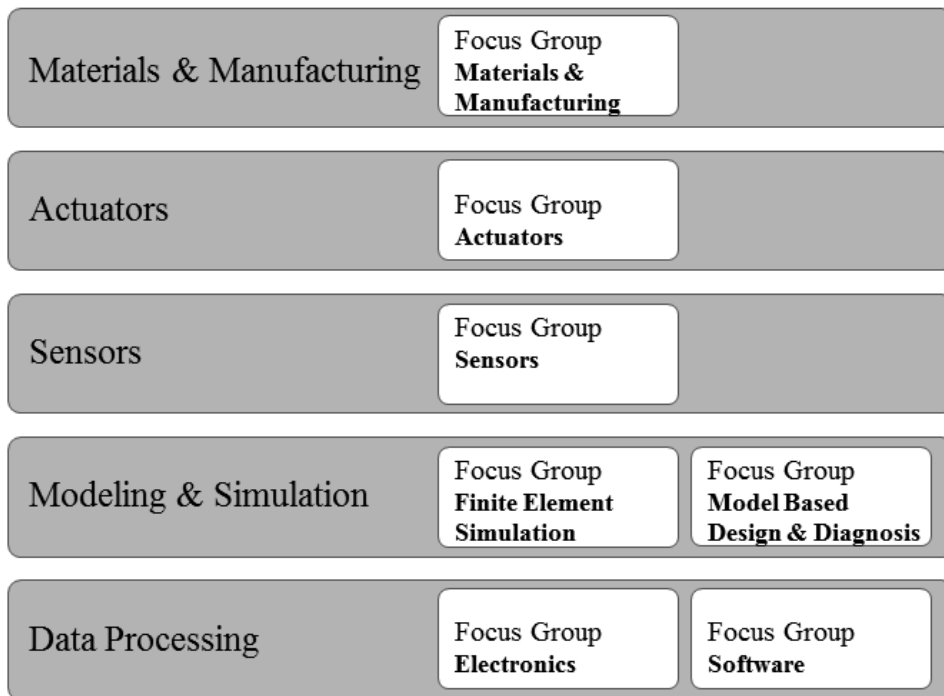

Figure 28 – The Technology Fields of BÜRKERT (Internal Document).

Focus groups which survived until 2013 were integrated into the new structure. For all missing technology fields, new focus groups were created under the supervision of the technology portfolio management.

#### 4.2.2.3 The Project Landscape of Discontinuous Innovations at BÜRKERT

The core technology fields have been identified by the technological requirements of markets where BÜRKERT is present. Every technology field has its own requirements and technological challenges. For this reason, the focus groups are in charge of the monitoring of these fields in order to advance technology. Based on the input of the focus groups, the technology circle develops the long-term strategy of the technological evolution of BÜRKERT. This strategy is developed in close collaboration with the top-management of the company.

All these efforts are then developed into technology projects where a specific technology is pushed forward. The aim is to get a better understanding of a certain technology, gain further experience in this field and think about a possible application within the BÜRKERT product portfolio. Technology projects are projects initiated officially that have passed a first Go/No-Go decision taken by the technology circle. The end result of a technology project is not

necessarily a final product idea or a prototype. However, it prepares all the fundamentals before starting a product project.

An idea that is not retained during this process is not immediately abandoned. It is documented and archived to remain available for later use. Only concepts which are regarded as not relevant for any key technology of BÜRKERT are definitely discarded. Once a project idea is developed or a new technology is considered as interesting enough to be applied in a concrete product project, BÜRKERT takes the final Go/No-Go decision (start of the product project during the NPD and end of the FFE). The technology circle collects all the relevant information but the decision itself is taken by an interdisciplinary steering committee.

#### **4.2.2.4 Configuration of the Community**

Essentially, all BÜRKERT staff is able to participate in the focus groups, leaving room for self-assignment and personal motivation. The technology circle is delegated by the technology portfolio manager who is responsible for the strategic technology development of the BÜRKERT group. He has created a strategic team around him consisting of several R&D team coaches. These members were assigned with respect to their closeness to the exploration activities of their teams that go beyond the development of standard products. Besides R&D team coaches located at the headquarters, this includes representatives of the French competence center for sensor technology and of the German R&D center in Karlsruhe.

The focus groups are also called ‘expert circles’ because they consist of the company’s experts who are in charge of the collection of knowledge from the external and internal organizational environment and its diffusion in their respective field of competence. Basically, experts at BÜRKERT are persons whose daily business is already oriented towards research activities and who are enthusiastic about technology. In most cases, these are members of the R&D department who due to their role profile, are already close to the company’s core technologies. Nevertheless, the technology portfolio manager explained:

*“We only check what the person can contribute to the specific circle and what his motivations are and if somebody wants to participate, why not? Frontiers have to stay open. In fact, we don’t have frontiers. Everybody has the right to present his idea. I have the slogan: ‘Don’t kill ideas.’” (B2FE)*

Each focus group is facilitated by a member of the technology circle who plays the role of ‘Mentor’. Even if the members of the technology circle are quite often R&D team coaches, they are not considered as hierarchical superiors. Not every expert in the focus groups is hierarchically subordinated to the mentors of their focus group. Therefore, the mentors are also described as ‘focus group coordinators’ in the BÜRKERT vocabulary and are meant to animate the focus groups.

The steering committee which takes the final Go/No-Go decision before entering into a new product development is composed of members of the board, the Portfolio Management and the R&D and Marketing departments. Its role is to detect actual technological gaps as well as future trends. To assure the transparency of the decision-making process, two members of the technology circle take full part in the steering circle. They provide all the relevant information necessary in order to take an adequate decision about the proposal.

#### **4.2.2.5 Ideation Process**

The technological input of the technology circle was integrated into the corporate process landscape. However, instead of creating a formal process with detailed steps, the company decided to mention it only as the input provider for the final roadmap development. No further formal steps are determined in the process.

The activity of the technology circle and the focus groups starts when ideas are inserted by the focus groups or by the marketing or sales department. The early FFE activities, managed by the experts, comprise collection and assessment of these ideas and opportunities regarding the technological strategy of the company. The technology circle coordinates this input into the later FFE activities and follows up only on those technologies which have been considered to be relevant for the corporate strategy. The technology circle therefore creates the necessary space for the idea champion to assure the technological incubation of these ideas. In accordance with Cohendet *et al.* (2014) space has to be understood here as a cognitive construct which is in contrast to places which are physical artefacts. From this perspective, space is a platform where members exchange knowledge, even if they are not located physically nearby.

Anyone within the company who has a new idea for a highly innovative concept addresses the expert who is closely located to him or to one of the mentors. He discusses his idea with them and if the idea (or its modification) corresponds to the technological strategy of the

company, he is encouraged to follow his idea. Most recently, the company introduced a 5-Days Award to push individual initiatives. This award is accorded by the technology circle and enables employees to work on a new idea for five days. To win the award, applicants have to fill in a short template mentioning:

- A short description of the idea (WHAT);
- The expected benefit of the idea (WHY);
- Possible collaborations with external partners (WHO); and
- A proposition of presumed activities during the five days to strengthen the idea concept (HOW).

The proposal is developed by the interactions between the idea champion and the experts to improve its quality and it is then presented in the technology circle to rapidly evaluate it in accordance with the corporate strategy. If the concept has been validated, the idea champion has the opportunity to work for five days on the idea. During this time, his main objective should not only be to strengthen the technological concept of the idea, but also to identify possible internal market sponsors who might be interested in integrating this idea into their product family in the future. At the end of the five days, the idea champion is expected to present a rough business model of this idea enabling the technology circle to propose further steps. If an idea does not convince but if it is still in line with the strategy, it is stocked in the idea accumulator. If, however, the idea or concept proposal demonstrates a certain maturity, a technology project is started.

The objective of a technology project is to increase the knowledge about a new idea and take it to a higher level of understanding. Already at this stage of the innovation process, market vision is assured by the implication of the marketing department into the steering committee of the project:

*“This increases our chances of market acceptance. [...] [T]his also allows us to react rapidly and change priorities if the technology is not efficient enough.” (B2P5A)*

The company’s objective is to start a new technology project rapidly after the opportunity detection to test if the chosen direction is coherent with the existing strategy. Only when a technology is ready for implementation in a concrete product application is it inserted into the NPD process after the final Go/No-Go decision of the steering circle and then the process is completed.

To sum this up, figure 29 represents the FFE activities for discontinuous innovations at BÜRKERT. The process to generate discontinuous innovations at BÜRKERT starts with individual initiatives. These are captured by the focus groups of the different technology fields. The experts help the idea champion to formalize his idea into a 5-Days Award. This formalization is crucial; not only to assure sufficient documentation of the idea, but also to make ideas to some extent comparable. To avoid this being perceived as a further bureaucratic step before the insertion of new ideas, the company clearly underlined that this step should be done in collaboration with the experts of a focus group. The personal contact between the idea champion and the corresponding community is crucial here. Technology projects enable the company to enhance the project description and to acquire further knowledge about the idea. All these steps are supervised by the company's internal communities. Only when an idea is ready for development of a concrete product, the final Go/No-Go decision is taken by the steering circle on the organizational level. This is the termination of the FFE.

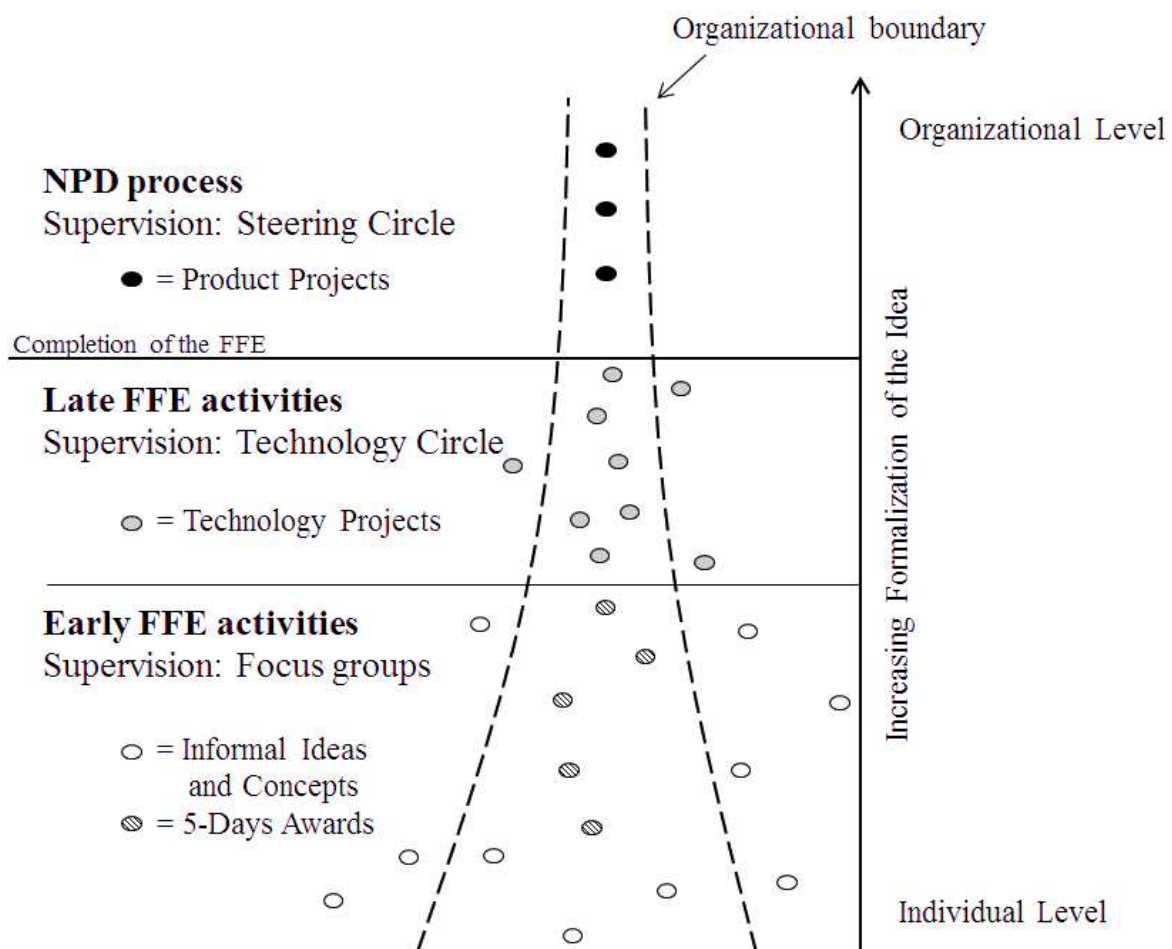

Figure 29 – The FFE of Discontinuous Innovations at BÜRKERT.



### 4.2.3 ANALYSIS

Today, the FFE of discontinuous innovations is nurtured by three R&D centers at BÜRKERT, but employees all around the world should have the potential to insert highly innovative ideas into the pipeline. With regards to organizational challenges caused by an increasing structuration of internal processes since 2013, BÜRKERT, however, had difficulties in accessing international creative slack. For this reason BÜRKERT re-established an informal structure by creating the technology circle and its focus groups to counterbalance the high levels of bureaucracy.

The product portfolio management is in charge of the concrete product development of the company and manages therefore the later NPD process with all necessary stage gates and performance indicators. In the case of discontinuous innovations, BÜRKERT decided to coordinate them by internal communities. As illustrated in figure 29, the process starts with the creative collaboration between the idea champion and the experts of the focus groups, passes to a superior level of aggregation (technology circle) and arrives finally at the organizational level by the insertion into a technology roadmap. Nevertheless, this structure of FFE activities relies on two fundamental conditions: the typology of the community and the size of the company.

#### 4.2.3.1 Condition 1: The Typology of the Community

With regards to Bootz (2015), spontaneous communities and strategically driven communities for explorative activities best describe the community structure at BÜRKERT because they best correlate with the objectives of the company. From this point of view, hierarchical groups and operational communities who carry out activities classed as exploitation are not relevant for the FFE of discontinuous innovations at BÜRKERT. Table 28 compares the two types with the current structure at BÜRKERT to justify this statement. This table illustrates the descriptions of Bootz and elucidates the adaptation of each category at BÜRKERT and thus in reference to the observations from the case study.



<b>Bootz (2015) in comparison with BÜRKERT</b>		
	<b>Spontaneous communities</b>	<b>Strategically driven communities for exploration activities</b>
<b>Objective</b>	Develop competencies about a given practice. <i>BÜRKERT: focus groups are in charge of the continual development of technological knowledge in their core technology field.</i>	Development of strategic knowledge and innovative performance factors. <i>BÜRKERT: the technology circle is in charge of technology scouting and assessment to provide recommendations for strategic decision-makers.</i>
<b>Governance</b>	The objectives are defined by the members and not by the hierarchy and concern in general the improvement of the activity. <i>BÜRKERT: objectives are defined in the technology circle and not in the focus groups.</i>	The strategic objectives are mutually fixed between the sponsor and the manager. The sponsor monitors the coherence between the activity of the community and the organizational objectives. <i>BÜRKERT: the technology circle is sponsored by the technology portfolio manager. Together with the mentors, strategic objectives are discussed to create a common understanding of the organizational strategy.</i>
<b>Steering</b>	Those structures are invisible to the rest of the organization and take place in a self-organized manner. <i>BÜRKERT: the focus groups have been made visible for the organization. They are, however, still free to organize their activities themselves.</i>	The hierarchy actively supports the community via the sponsor who facilitates the interaction between the members. There is active leadership by the manager (regular connections and reporting to the sponsor). <i>BÜRKERT: The sponsor of the technology circle has full top-management support. He regularly interacts with the managers to assure coherence in the innovation process.</i>
<b>Knowledge Circulation</b>	Internal circulation through the exchange of tacit knowledge. No diffusion or systematic formalization of best practice. <i>BÜRKERT: the focus groups assure an internal circulation of tacit knowledge within their community.</i>	Diffusion of knowledge to the hierarchy. <i>BÜRKERT: the technology circle manages a bottom-up knowledge flow from the individual to the organizational level. Transversal knowledge circulation is assured by the mentors of the focus groups.</i>
<b>Composition</b>	Homogeneous members (practitioners) <i>BÜRKERT: the focus groups aggregate the experts of the corresponding technology field. They are homogenous groups.</i>	Heterogeneous members <i>BÜRKERT: the technology circle consists of heterogeneous members of the R&amp;D department.</i>

Table 28 – The Technology Circle at BÜRKERT in Comparison with Bootz (2015, p. 22). Main Observations Highlighted by MN.

Table 28 highlights three main observations in comparison with previous research about communities. The first observation concerns the objective of the community. Whereas the technology circle together with its mentors is in charge of the strategic alignment of the knowledge process, the focus groups manage the creative operative work by developing competencies in the technology fields. Consequently, this structure combines objectives of spontaneous and of strategically driven communities for exploration activities.

The second observation refers to the fact that knowledge circulation is not only horizontal as described for strategic communities. There is equally a vertical knowledge circulation process within the focus groups. Experts assure knowledge transfer within their concrete technology field. In addition, the mentors of each focus group are in charge of transversal knowledge flow. During regular meetings of the technology circle, the mentors create links to other technological fields and transport ideas from one focus group to another. This has been observed, for instance, during a meeting of the Sensor focus group. One of the experts presented a highly interesting technology in the area of miniaturization, but this technology did not correspond to the specific field of sensor technology. The mentor took the idea into account and discussed it during the next meeting of the technology circle where an overlap with another focus group was targeted. Today, this new idea is under evaluation by this second focus group. Consequently, independently of the geographic location and the proximity to the ‘right’ expert, people may address any expert. If the contacted person does not have the necessary knowledge to assess the incoming idea, he can still transfer it rapidly to the corresponding expert *via* his internal network. In the corporate vocabulary, the technology circle described this function as a “*multidimensional knowledge hub*” (POb). As a result of these processes, new ideas and valuable knowledge are less likely to get lost.

Finally, the third observation shows that the composition of the communities varies for the two constructs. The technology circle consists of heterogeneous members. Even if it is mainly composed of R&D team coaches, they have varying specializations and thus different technical backgrounds. In contrast, focus groups are homogeneous communities as they aggregate all experts of one specific technology field.

Some characteristics of the focus groups correlate with spontaneous communities; even if not all focus groups are based on a spontaneous initiation. Some of them emerged by the intrinsic motivation of some experts. The technology circle, on the other hand, clearly reflects

the objectives and artefacts of a strategically driven community for exploration activities. Figure 30 illustrates the composition of this community structure.

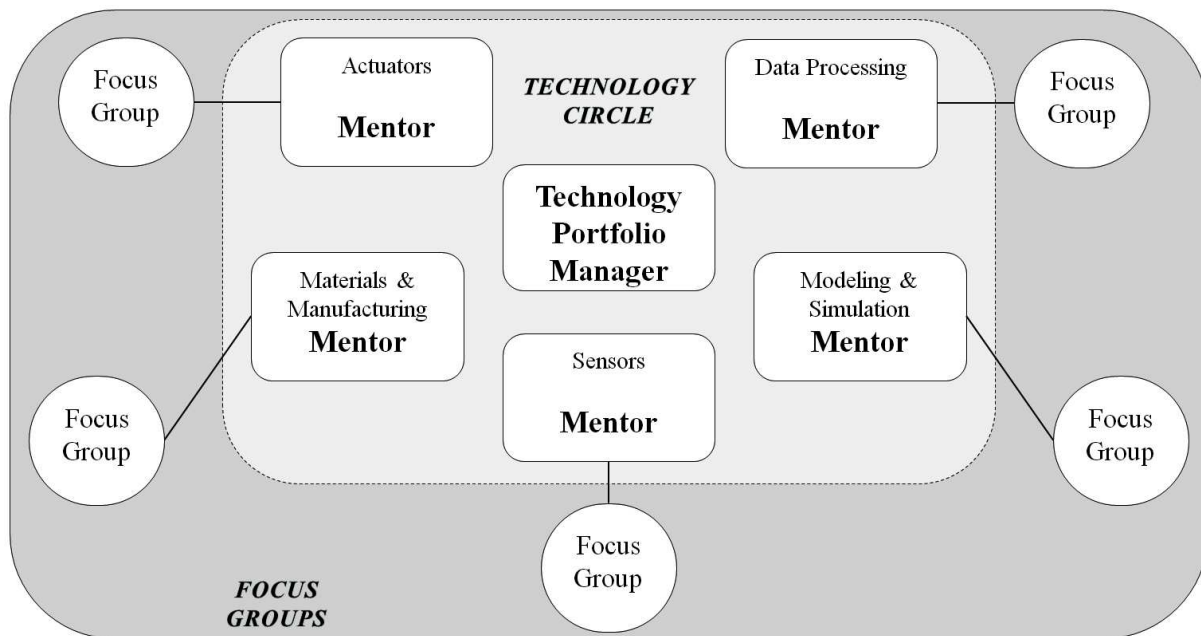

Figure 30 – A Representation of the Community Structure at BÜRKERT (by MN).

The community at BÜRKERT is thus a hybrid structure combining artefacts of spontaneous and strategically driven communities. This hybrid combination of both types within one structure has made it possible for BÜRKERT to crystallize knowledge which is diffused over distance and to transport ideas towards their development. Interviewees deduced that the first attempts to carry out focus groups were perceived as not successful because of missing strategic guidance: in 2005, the initial focus groups were only in charge of collecting knowledge and sharing it with their members.

*“What was missing sometimes was a clear objective. Monitoring is important, but you need also to take a step back sometimes. Exchanging information, that’s only one part.” (B1FC)*

Today, experts have greater responsibility for actively gathering and structuring the input received from their direct environment (internal colleagues and the external environment). They are in charge of a first assessment of incoming ideas and technologies in line with the organizational strategy. This diversification of activities leads to a higher legitimization of the community as it is now part of strategic decision making. Furthermore, the company acknowledged the role of the experts by according them 10–20% of their time to this activity. This percentage is officially noted in the role profiles of the experts and validated by their

hierarchical superiors. Therefore, experts have top-management support, which ensures the persistence of the focus groups over time. Such a legitimization of community activities has also been described in the case study of Bootz and Lièvre (2017) showing that the managerial integration of the community into the organizational structure assured finally the persistence of the community over time.

In essence, focus groups at BÜRKERT are in charge of the creative operative part during the early FFE. The technology circle assures space and alignment with the organizational strategy and is in charge of later FFE steps. Neither type of community is sufficient without the other to transport an idea towards development considering that both are in charge of different but complementary tasks.

#### 4.2.3.2 Condition 2: The Size

Another condition of the model presented earlier based on knowing communities is the size of the company. This variable was identified as a critical factor for change in the internal innovation processes since 2013. As mentioned earlier, the internal processes of the company were revised in order to fulfill requirements for structuration in line with the new corporate strategy. These changes were necessary in order to adapt to a growing workforce:

*“BÜRKERT grew substantially over the last few years and it will continue to grow. This transition period from a medium-market organization to a big group needs different structures.” (B2FE)*

Due to the overwhelming bureaucracy that has appeared since 2013, BÜRKERT decided to again rely on internal communities to enhance its creative approach. Interviewees argued that the communities in 2005 did not persist over time because of the weak objectives that were attributed to them. Thus, it is argued here that the effectiveness of today’s knowing communities at BÜRKERT in coordinating knowledge during the FFE differs also from previous attempts due to the challenges that are linked to a growing workforce.

Year	2005	2013
Total number of employees at BÜRKERT	1585	2375 +49%
Total number of employees at the French entity	128	162 +26%

Table 29 – Evolution of the Workforce at BÜRKERT (Internal Document).

As indicated in table 29, the workforce at BÜRKERT grew considerably between 2005 and 2013. Up to 2013 the workforce at BÜRKERT was significantly less numerous. When the company was smaller, it was possible for employees to keep an overview of all existing internal competencies without requiring a systematic approach. Individuals shared knowledge with their colleagues on an informal basis:

*“We documented the knowledge to a maximum. But it was based on word-of-mouth that new knowledge is communicated somewhere. In most cases, you hear about that from other people. When you have new information, you go to those colleagues for whom this could be interesting. You don’t talk to everybody, but to those colleagues who are likely to be concerned by the topic.” (B2P1B)*

In their opinion, this made systematic knowledge management redundant, even across space. Even if the R&D centers were dispersed over space (France and Germany) knowledge flows between them were fluent during the FFE. However, this changed as the company grew significantly until 2013. People started to have difficulties in identifying corresponding experts as they no longer knew every colleague personally:

*“I really appreciated in the beginning that you could speak to everybody and you knew everyone who could help you. In the meantime, this is not the same anymore. I do not know anymore what the other development teams are working on. This depends also on the size of the company. In the beginning, you had an overview.” (B2P5B)*

The fact that experts were not located at the same geographical entity intensified this situation. Unexpected encounters between employees were expected to happen less frequently. The growing size caused a more complex organizational structure to be formed which was necessary to coordinate this workforce efficiently, but it simultaneously impeded informal social relationships between employees. Under those circumstances, the knowing communities became an efficient coordination mechanism to manage internal and yet spatially diffused knowledge: by counterbalancing organizational structure through a social dimension, people again gained visibility about ‘who knows what’. This visibility was primordial to coordinating internal knowledge flows to transfer the right knowledge at the right time to the right group of persons during the FFE. The hybrid structure of the knowing community presented earlier reintroduced social proximity between people.

### 4.2.3.3 Condition 3: Social Proximity

In reference to the literature review in part II, the FFE requires social proximity between actors, especially in the case of discontinuous product innovations: informal interactions between actors from different interdisciplinary fields increase the creative output of the FFE. However, this condition depends again on the two previously exposed conditions to be operational in a medium-market firm: the size of the firm as well as the hybrid structure of the community.

At BÜRKERT, the technology circle and the focus groups created a platform for individuals where they could interact and remain connected, even across space. The size of the company, even though it grew significantly during the last few years, remained the size of a medium-market company. In combination with the hybrid structure of the community, these two aspects generated a specific level of social proximity enabling the generation of discontinuous innovations during the FFE.

## 4.2.4 DISCUSSION

Based on the insights at BÜRKERT about the management of knowledge at the FFE in a medium-market company acting across space, a more generic model is elaborated in figure 31: the ‘Model of Creative Crystallization and Diffusion’. This model describes a generic solution for organizations to capture and share international knowledge in order to foster the generation of discontinuous innovations across space based on a hybrid form of internal knowing communities.

The model depends on three conditions: the size of the company and the type of the community leading to a specific level of social proximity. First of all, the model is only valuable in medium-market companies such as BÜRKERT. This is due to the assumption that SMEs, for instance, have fewer needs for a structured model to manage their access to any creative slack within a firm. Due to the smaller workforce, it can be assumed that they are able to manage knowledge flows by direct and informal communication channels which do not require structured (and often bureaucratic and costly) mechanisms. On the other extreme, large companies have more resources at their disposal to invest in research programs. However, they do know the dilemma between bureaucratic structures and requirements of a flexible management of creative capacities.

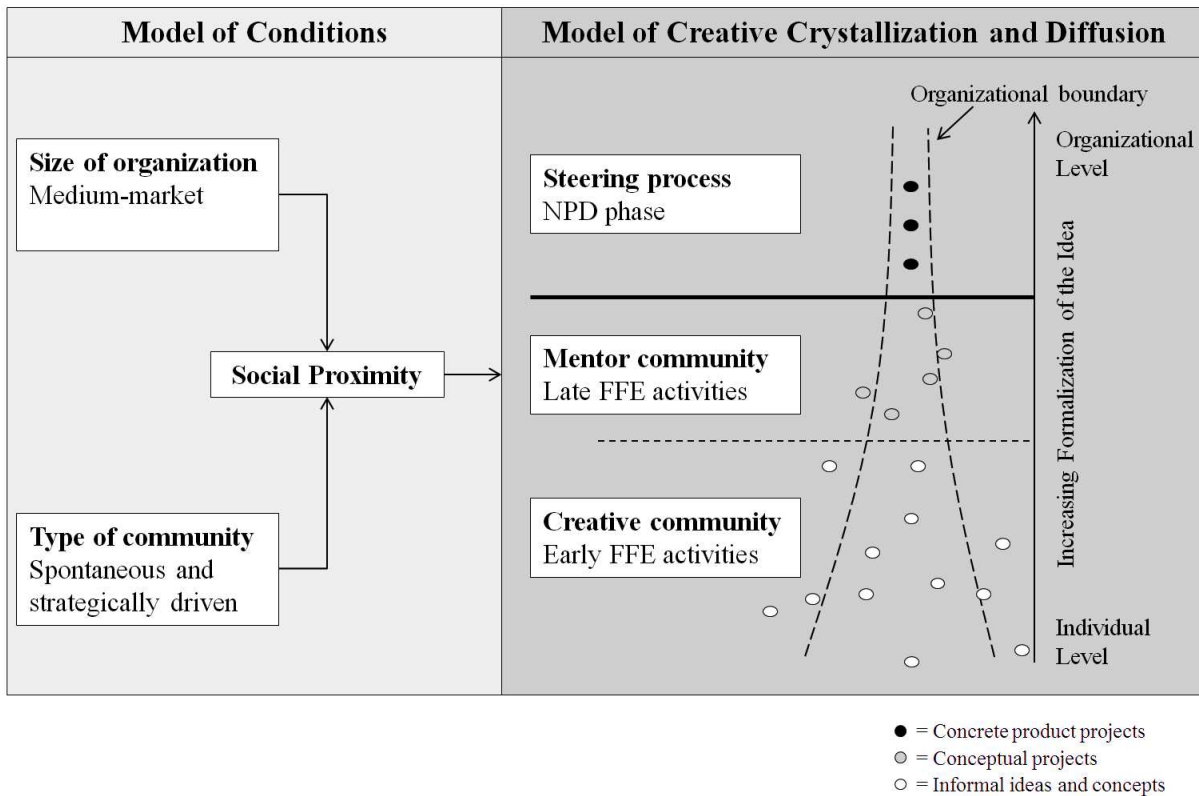

Figure 31 – Conditional Model for Creative Crystallization and Diffusion (adapted from Neukam and Guittard, 2017a).

It is assumed that in big structures hybrid knowing communities as presented in the model would not be sufficient. Considering the advances in information and communication technologies, increasing numbers of big companies rely on virtual teams using social software to support collective creativity (Leenders *et al.*, 2003). This requires another approach to communities and other investments in time and resources. BÜRKERT is a medium-market company. It is assumed that the developed model is valid in similar structures. Medium-market firms such as BÜRKERT might crystallize ideas *via* knowing communities based on personal and direct interactions between members. Similarly to the characteristics shown in research, adherence is based on the individual motivation of employees. Hence, fewer efforts towards managerial coordination are necessary compared to large companies.

The second condition of the model is the type of the community, which is a hybrid structure combining attributes of spontaneous and strategically driven communities to engage in operative creative work as well as in the systematic horizontal diffusion of knowledge during later FFE activities. These two conditions are basic prerequisites to ensure sufficient and still not too much social proximity for a successful FFE (i.e. the third condition).



## 4.2.5 CONCLUDING REMARKS

This chapter analyzed the social dimension during the continual generation of discontinuous innovations at the FFE at BÜRKERT. The objective was to assess knowing communities as coordination mechanism to enhance social proximity between actors. In terms of the ProxIS-Telescope, this represents the 1<sup>st</sup> lens to integrate international knowledge successfully into the corporate innovation strategy and to enable crossovers between knowledge to generate discontinuous innovations.

A conditional model to crystallize creativity and diffuse knowledge within an organization is proposed here. The elaborated model represents similarities to the open innovation model of Chesbrough (2003a) but with the difference that the present research focuses on the internal view of the firm. Here, ideas are collected inside and outside of the company and inserted into internal innovation processes. The main difficulty of managers is quite often not to create new ideas, but to transfer them into internal processes (Rice *et al.*, 2001). This is also what Cohendet and Simon (2006) described as creative slack where ideas remain outside the innovation processes of a firm. In the present model, creative slack refers to the internal potential for creative ideas by combining knowledge of a firm's international employees. The case study underlined that a hierarchical structure at BÜRKERT was not sufficient to assure the access to this internal creative slack in the period since 2013. It was assumed in this chapter that this is due to a growing workforce leading to more structuration and bureaucracy. Consequently, as soon as the hierarchy failed to efficiently exploit the internal creative slack, the company decided to react and referred to its internal knowing communities.

Furthermore, the analysis revealed that a hybrid structure combining attributes of spontaneous and strategically driven communities is required to be efficient. Regarding the fact that discontinuous innovations assure the long-term existence of companies, also their continual generation at the FFE requires a long-term vision. Internal experts of a company are able to provide this long-term approach to the technological development within and outside a company. In medium-market companies, though, these experts are often scarce resources necessary to maintaining an organization's daily activities. To assure therefore a successful FFE of discontinuous innovations based on these internal experts, managers should create sufficient space to balance a long-term vision with short-term requirements. As illustrated at BÜRKERT, sufficient legitimization for experts to spend time on long-term objectives is assured by the strategically driven community. At the same time, personal and unexpected



encounters are necessary to nurture creativity; the creative communities create a platform where experts share knowledge on a regular basis. Taken together, this combination of both community types enabled BÜRkert to counterbalance the complex organizational structure inherent in medium-market companies. As a result, the communities create not only space for creativity, but also social proximity between actors.

### CONTRIBUTIONS

This chapter establishes a 'Conditional Model of Creative Crystallization and Diffusion' to manage the FFE in international teams *via* knowing communities.

#### **Sub-question 3 – Social proximity at the FFE of discontinuous innovations**

The design of an international FFE by knowing communities enhances social proximity between actors who are not located at the same geographic place. The conditional model depends on the degree of proximity between actors which is determined by:

- The size of the company limiting it to medium-market structures such as Bürkert;
- The hybrid characteristic of the knowing communities combining aspects of spontaneous and driven knowing communities.

This chapter illustrated that international employees require a common platform to apply their knowledge (i.e. 1<sup>st</sup> lens of the ProxIS-Telescope). At BÜRkert, this common platform was created by the hybrid community. However, this chapter revealed that there is a link between the FFE managed by BÜRkert's internal communities and the size of the company. This leads to the assumption that knowing communities as concrete coordination mechanisms depend on the organizational setting. This raises the question as to why and under which conditions the mechanisms identified at BÜRkert are efficient in coordinating knowledge flows.

Before answering this question, it is necessary to complete the picture of the FFE managed across space at BÜRkert. Therefore, the next chapter investigates the third non-spatial proximity dimension to substituted geographical space: the cognitive proximity between actors. This represents the 2<sup>nd</sup> lens of the ProxIS-Telescope to target the light towards a common direction.

## 4.3 COGNITIVE PROXIMITY

*“Given the social nature of cross-cultural interactions, knowing what is going on in the mind of each individual player is not enough to capture the interactive and dynamic process. Shared mental models provide a framework that seeks to capture the process by which a group will construct a collective understanding of a given situation.”*

(Liu and Dale, 2009, p. 224)

In the previous chapters of this part, mechanisms to strengthen organizational and social proximity were presented based on the data collected at BÜRKERT. With regards to the ProxIS-Telescope, the precondition of a relationship of trust ensuring that employees are willing to share their knowledge across space with the rest of the company has been set up (i.e. swift trust at BÜRKERT) and a common platform from which to apply this knowledge and interact with other colleagues has been defined (i.e. a hybrid community at BÜRKERT). However, the last piece of the puzzle is still missing: in international teams, people have different national cultural backgrounds which can lead to specific ways of communicating. Without the creation of a common knowledge base (i.e. shared mental model, see Liu and Dale, 2009), people might be able to interact but will have difficulties in comprehension, impeding them from entirely absorbing the shared knowledge (Cohen and Levinthal, 1990). This problematic is addressed in this chapter which concentrates on the third non-spatial proximity dimension that is able to substitute geographic proximity: cognitive proximity between individuals. Cognitive proximity refers to the amount of common knowledge between actors (Boschma, 2005; Nooteboom, 1999). In contrast to further approaches of proximity, Boschma (2005) isolated cognitive distance as the specific dimension with regards to absorptive capacity.

Boschma (2005) argues that neither too much nor too little cognitive proximity is advantageous for the innovation process. What Brown *et al.* (1989) described as ‘situated action’ illustrates that the learning process is historically and culturally contextualized leading to the fact that individuals acquire different knowledge depending on the environment in which they grew up or currently live. Thus, knowledge is a subjective construct and depends on the personal experiences of each individual (Nonaka and Von Krogh, 2009). In international teams, this implies that employees have different knowledge sets leading to a more or less intense cognitive proximity with their colleagues. If this cognitive dimension differs too much, equal absorption of knowledge cannot be granted within the team. However, if the knowledge bases are too similar the team creativity suffers, because there is no room for

new or fresh insights (Balland *et al.*, 2015). Diverse knowledge is still crucial to increasing team creativity (Cohendet and Llerena, 2005).

Overall, actors require a minimal set of shared knowledge to be able to absorb new knowledge and exploit team diversity. According to Grant (1996), such minimum conditions are for instance a shared language, shared meaning, other forms of symbolic communication, and a commonality of specialized knowledge. This vision points already to a specific articulation of cognitive proximity in international teams: the extent to which shared cultural values exist. Therefore, Knobens and Oerlemans (2006) argued that the term cognitive proximity and cultural proximity are closely linked in international teams. Following their arguments, cultural proximity has been used to explain the impact of culture on core beliefs influencing the behavior of people. Conversely, the term cognitive proximity is used by these authors to describe more generally different sets of knowledge between actors. Cognitive proximity is: “*applied to a context in which knowledge transfer is important*” (Knobens and Oerlemans, 2006, p. 77).

This second term is better adapted for the following analysis as it considers knowledge to be a core value for competitive advantage, and because it is in line with the chosen proximity concept of Boschma. However, this choice does in no manner deemphasize or eliminate the role of culture. Thus, in light of the international dimension of the present study, challenges considering cognitive proximity will be captured by cultural differences between FFE actors. This chapter will take a closer look at the impact of national cultural differences on team performance during the FFE of discontinuous innovations. By definition, international teams integrate different national cultural backgrounds. Cultural diversity in international teams fosters, on the one hand, creativity through divergent thinking (Parjanen, 2012; Rocas and Garcia, 2017). On the other hand, the resulting lower cognitive proximity may impede the circulation and absorption of knowledge (Brannen, 2009), and endanger the stability of the teams (De Brentani and Reid, 2012). Consequently, culture is a critical aspect for cognitive proximity in international FFE teams. This managerial dilemma requires more investigation in order to capture the impact of culture on the dynamics in international FFE teams.

Firstly, this chapter seeks to formulate these influences based on a specific literature review of intercultural studies. The intercultural studies literature has revealed that culture influences personal as well as team behavior. However, it seems that cultural issues have not been addressed by the NPD literature or more specifically the FFE literature.

Secondly, the in-depth case study at BÜRKERT seeks to identify coordination mechanisms that maintain the innovative potential of multicultural FFE teams by reducing the negative effects of cultural differences. The objective of these mechanisms is to create a shared mental model between people with different cultural backgrounds who interact at the FFE of discontinuous innovations. A shared mental model is: *“the degree of convergence between the individually held mental models.”* (Liu and Dale, 2009, p. 225)

Its objective during the FFE should be to create sufficient cognitive proximity to assure knowledge sharing across space. Ultimately, this chapter answers the following sub-question:

**Sub-question 4 – Cognitive proximity at the FFE of discontinuous innovations**  
 How to create a shared mental model in order to manage national cultural differences of individuals successfully during the FFE of discontinuous innovations?

Culture influences personal characteristics and individual experiences. Thus, individual behavior of FFE actors at BÜRKERT is investigated in this chapter. However, considering that shared mental models emerge through social interactions between people (Liu and Dale, 2009), team dynamics are of equal interest when analyzing how cultural differences affect cognitive proximity in FFE teams. The results seek to provide initial guidelines to the management on how to coordinate the continual generation of discontinuous innovations under the constraint of a culturally diverse workforce. In the innovation management literature, the concept of organizational culture represents a well-known coordination mechanism for national cultural differences (De Brentani and Kleinschmidt, 2004). This is why organizational culture will be investigated in detail in subsequent pages. Based on these reflections, figure 32 illustrates the research framework of this chapter.

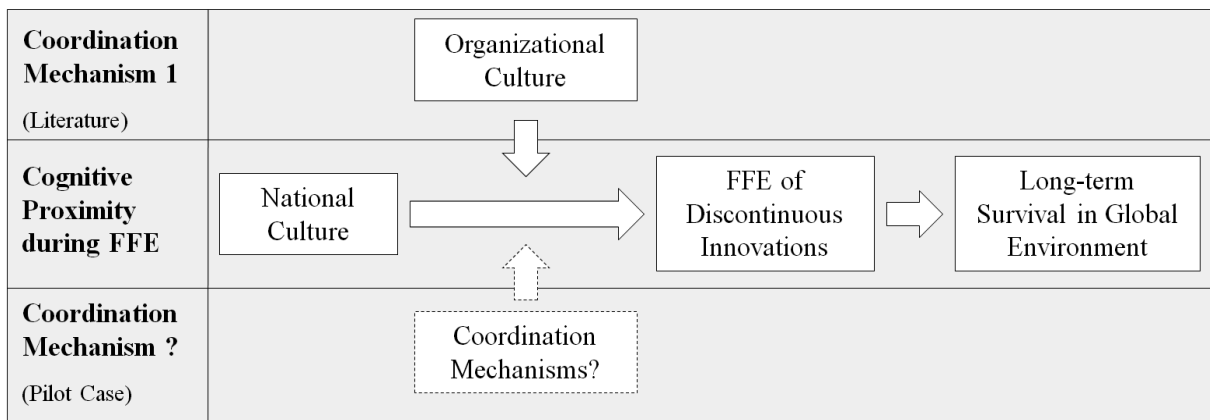

Figure 32 – The Research Framework: Coordination Mechanisms for Cognitive Proximity during the FFE of Discontinuous Innovations.

Seeing that actors at the FFE might have different cultural backgrounds, national culture acts as an independent factor impacting on FFE success. Its effects on multicultural teams are not unidirectional and can be positive or negative. Hence, the objective is to identify coordination mechanisms which limit the negative impacts and increase, or at least maintain, the positive potential of national culture in FFE teams. The theoretical specifications of this chapter introduce organizational culture as a possible moderator. However, the model still leaves room for other solutions to emerge during the analysis.

### 4.3.1 THEORETICAL SPECIFICATIONS

In the introductory part of this chapter, the term ‘culture’ has been applied several times without really defining it. This deficiency must be reviewed urgently before carrying out the analysis. Depending on which academic field is considered culture has been defined in many different ways. For example, forty years ago the field of anthropology alone had identified 150 different definitions of the term (Scholz, 2000). The generic nature of this concept leads to the fact that people have different understandings of culture, referring, for instance, to ‘national culture’, ‘cultural events’ such as Jazz or other music festivals, or even to ‘intellectual culture’ when referring to someone’s education. Examples of the application of the term culture are numerous. The objective of this dissertation is to capture the usage of the concept of culture in business. In the field of business management, the work of Hofstede *et al.* (2010) is one of the most cited references on this topic, defining culture as:

*“[T]he collective programming of the mind that distinguishes the members of one group or category of people from others” (Hofstede et al., 2010, p. 6).*

Here, culture remains a broad concept which should then be classified into diverse sub-categories such as national culture, organizational culture, gender culture, professional culture, etc., to be precise about its application (Barmeyer, 2000). Regarding a specific application to organizations, Knoblen and Oerlemans (2006) suggest that two types of subculture play a decisive role for firms: national and organizational culture.

First of all, national culture refers to the core values of the society an individual grew up in. Whether the organization is international or not, managers deal nearly all of the time with a culturally diverse workforce (Mayrhofer and Urban, 2011; Rocas and Garcia, 2017). Hofstede *et al.* (2015; 2001) initially identified four, then six, values of national cultures which he summarized in six national indexes: values influencing an individual’s perception of power

(Power Distance Index); his/her perception of uncertainty or ambiguity (Uncertainty Avoidance Index); the perception of societal frameworks (Individualism Index); the individual's preference for a competitive or a cooperative society (Masculinity vs. Femininity index); his/her long- or short-term orientation towards the future (Long-term orientation index); and finally his/her acceptance of free gratification of basic and national human drives (Indulgence vs. Restraint Index). These values are not innate but learned during childhood by socializing with other individuals (Hofstede, 2001). They are thus highly internalized and individuals often become subconsciously closely attached to them. In general, Hofstede explains that people are generally not aware of those values; even if the values influence their perception and interpretation of situations and are shared between most members of one nation. Although Hofstede *et al.*'s research has been criticized due to the methodological approach used (Baskerville, 2003; Liu and Dale, 2009; McSweeney, 2002), no other empirical study has identified more relevant results about the concept of national culture (Magnusson *et al.*, 2008). For this reason, their approach to national culture is applied in this chapter.

Secondly, companies have recognized the huge competitive advantages linked to their organizational culture, especially in light of the increasing impacts of globalization (Hofstede, 2001; Wang *et al.*, 2010). While products can be copied and even improved by competitors, it is difficult to imitate an organization's culture (Hofstede, 2001). One reason is the fact that organizational culture describes:

*“[S]imultaneously the global vision and objectives of an organization and its typical way to behave.”* (Cohendet and Diani, 2003, p. 712)

From a knowledge processing perspective, Cohendet and Diani (2003) accord not only an explicit dimension of knowledge to the organizational culture with regards to the externalization of an organization's vision. Organizational culture also integrates an intrinsic dimension for employees who incorporate a common way to act. This combination of explicit and tacit knowledge ultimately generates a set of common knowledge which is specific to each firm and which is shared and internalized by an important number of its employees. An organizational culture is classified as strong when corporate values are shared by the majority of employees, regardless of their geographic location (Sørensen, 2002).

### 4.3.1.1 Culture and the FFE of Discontinuous Innovations

The benefits of national cultural differences for innovation teams have been proven by numerous studies, suggesting that multicultural teams perform better than their homogeneous counterparts (Gelfand *et al.*, 2007; Harvey and Novicevic, 2002; Rocas and Garcia, 2017; Salomo *et al.*, 2010). The innovative potential of international teams is enhanced by different national origins of the members, leading to cultural diversity (Bellini *et al.*, 2013; Govindarajan and Gupta, 2001). This cultural diversity enlarges the existing knowledge of each member and increases the probability of finding new combinations resulting in innovative solutions. Additionally, the collaboration between individuals with complementary cultural backgrounds boosts collective creativity (Erez and Nouri, 2010; Westwood and Low, 2003). If at the same time team members have had multicultural experiences in the past, creativity within a multicultural team is fostered (Chua and Morris, 2009; Hempel and Sue-Chan, 2010; Leung *et al.*, 2008; Rocas and Garcia, 2017). All of the aforementioned aspects of national culture can be summarized as synergy effects of different national cultural backgrounds (Chevrier, 2008). It is assumed here that synergy effects have a positive influence on FFE performance because they increase the potential for generating discontinuous innovations.

However, the output of multicultural teams is only successful if team leaders are able to manage communication difficulties: different languages, communication styles, and cultural backgrounds could prevent knowledge from circulating fluently (Ayoko *et al.*, 2002). During the FFE of discontinuous innovations, national culture creates barriers to innovation through:

- Different decision-making models;
- Different communication systems; and
- The assumption that national culture is a set of pre-existing knowledge.

Different attitudes towards risk and uncertainty (Barmeyer, 2002), or preferences for collective compared to hierarchical decisions (Zhou and Su, 2010), are two examples where national culture impacts on an individual's behavior when decisions need to be taken. If cultural differences with regards to the individual decision-making process are too great within teams, individuals could feel uncomfortable with the social environment in which they take those decisions (Erez and Nouri, 2010; Zhou and Su, 2010). In the worst case scenario, they may refuse to share knowledge or avoid pitching new ideas.



Furthermore, Hall (1960) found that the way to communicate differs between individuals with different national cultural backgrounds, not only regarding the spoken language, but also relating to their communication style (direct or indirect), their relationship context (friend or stranger), the time context (monochronic or polychronic), and the spatial context (close or distant). Regarding these differences, the message sent by an individual can be received differently to its intention by an individual with a different cultural background. This might lead to misinterpretations and even tensions within international teams (Li, 1999; Moenaert *et al.*, 2000).

Finally, some scholars define national culture as a set of pre-existing knowledge (Hempel and Sue-Chan, 2010). They assume that employees with different cultural backgrounds have a partially different set of pre-existing knowledge. From this perspective, knowledge is a subjective and not a universal concept and depends therefore on the community in which an individual acquired this knowledge (Nonaka and Von Krogh, 2009). In a situation where not enough knowledge overlap can be generated between individuals, the generation and acceptance of new ideas is impeded (Hempel and Sue-Chan, 2010; Leung *et al.*, 2008).

These difficulties caused by diverging national cultures can lead to an unequal distribution of knowledge within the FFE team. For this reason this concept is summarized here as cultural information asymmetry leading to an unequal absorptive capacity in international teams. The huge potential of culturally diverse FFE teams underlines an organizations' motivation to find coordination mechanisms in order to reduce cultural information asymmetry. Overall, the aim of such mechanisms should be to maintain diverse thinking by enhancing knowledge sharing despite different communication models between individuals.

#### **4.3.1.2 Organizational Culture as Coordination Mechanism?**

Koen *et al.* (2014) found that organizational attributes which includes an organization's culture is indeed "*twice as important as any other factors*" (p. 42) in assuring FFE success. A growing body of literature argues that a supportive organizational culture fostering creative behavior is positively related to FFE success. Researchers found that the generation of highly innovative product or service solutions depends largely on organizational culture rather than on other factors (Tellis *et al.*, 2009).

A culture enabling a successful FFE should foster divergent instead of convergent thinking (Flynn and Chatman, 1997; Koen *et al.*, 2002); it should assure psychological safety and the



freedom to act as an entrepreneur, allow risk-taking, tolerate failure, and be open to new ideas and creativity (Chang *et al.*, 2012; De Brentani and Kleinschmidt, 2004; Koen *et al.*, 2002; Parjanen, 2012; Wang *et al.*, 2010). Some of these aspects are not inherently shared in all national cultures. For instance, individuals who grew up in cultures that emphasize the importance of the collective interpret the role of entrepreneurs differently than in individualistic cultures. Whereas in the latter, the entrepreneur acts on his own independently from others, the entrepreneur in collectivist nations permanently involves others, fosters collective decisions, and motivates colleagues to contribute to his idea (Hofstede, 2001). Here, greater emphasis is placed on convergent than on divergent thinking.

However, by introducing a strong framework with clear rules and guidelines to the workplace (i.e. organizational culture), national cultures play a less critical role in the professional lives of individuals (Belassi *et al.*, 2007). From this perspective, organizational culture represents a common codebook, which is nothing more than a static representation of a shared mental model (Cohendet and Diani, 2003; Liu and Dale, 2009). As organizational cultures affect only the visible parts of culture (e.g. symbols or rituals), individuals are able to adhere to a specific organizational culture fostering innovation even if they continue to have different national cultural values (Hofstede, 2001). Through the creation of a corporate innovation culture, firms may therefore overcome national cultural deficiencies that impact on their innovative capacities (Tellis *et al.*, 2009).

### 4.3.2 METHODOLOGICAL SPECIFICATIONS

Empirical research in management often led to ‘Western’ and ‘Eastern’ generalizations of cultural phenomena (Gelfand *et al.*, 2007). Such simplifications are misleading and disregard the complexity of cultural dynamics (Chiu and Kwan, 2010; Paletz and Peng, 2008). To avoid similar simplifications in this dissertation, the qualitative methodology chosen, based on an in-depth case study, takes into account the sensitivity of cultural issues. At BÜRKERT, the French and German cultures were of specific interest since all R&D centers in charge of new product development are located in these two countries. The five project cases at BÜRKERT were, among other factors (for more details, see PART III), deliberately chosen for an in-depth analysis of individual and team behavior in respect of cultural differences. Considering that the majority of interview partners were German, most participant observations took place at the French site in order to provide a balance to the data collection process. This enabled a

deeper understanding of both cultures and resolved the unequal distribution between German and French interview partners.

Nevertheless, culture should not be overestimated, as not every individual reaction is automatically linked to culture (Barmeyer and Lüsebrink, 1996; Schroll-Machl, 2013). For this reason, one project with a culturally homogeneous team was chosen as reference unit (called ‘NAT’ as an abbreviation of ‘National’). As illustrated in the methodological overview in PART III, the five project cases differed in terms of their degree of innovation and their degree of spatial collaborations. For this chapter, this classification needs to be enlarged by integrating the dimension of cultural diversity. This is required to identify the impact of national culture on the quality of the FFE. Therefore, the degree of cultural diversity is defined by allusion to Kogut and Singh (1988) as a combination of cultural proximity and the number of different national cultures within a team.

In four of the five project cases, the cultural proximity was equivalent, as the FFE team always consisted of employees with French and German cultural origins. Only the reference project NAT had no significant cultural diversity as all team members had German origins. Even though regional differences exist within one nation, for reasons of clarity and brevity these will not be further addressed in this chapter. The other four project cases differed only in the number of team members with different national cultural backgrounds. Hence, the resulting cultural diversity of the project cases is described in table 30 as:

- Low: clear cultural minority;
- Medium: one culture is slightly more present than the other one; or
- High: equal distribution of two national cultures.

BÜRKERT is entirely family-owned with three stable corporate values that have not changed over time: “*Experience, Closeness, Courage*”. Experience stands for technology and quality leadership. Closeness refers to a close relationship with the customers and between colleagues, and courage underlines the desire to think outside the box and develop innovative products. These terms are not only strong values, but they are also oriented towards innovation. The corporate culture stands for tolerance of failure and demands personal responsibility of employees. In return, it assures the necessary psychological safety and motivates employees to act as entrepreneurs. These values are not only externalized in the organization’s code of conduct, but they are also actively shared by employees around the world. This was confirmed by a 2015 international survey ‘Great Place to Work’ which was

conducted by a global research consultancy to compare organizations with regards to the quality of their workplace. In the case of BÜRKERT, this survey enabled the company to internally measure the worldwide adherence to organizational practices. The survey did indeed reveal a perception of a high level of psychological safety independent of the employees' national cultural origins. Moreover, it demonstrated that the majority of employees appreciated the trust and support of senior management. Overall, the survey noted consistently high scores in the categories of entrepreneurship, flexibility, and autonomy at all international entities.

Case	Cultural diversity	Description
NAT	None	<b>Homogeneous national culture</b> The team consisted exclusively of employees with German origins.
INC	Medium	<b>International collaboration at strategic level</b> During the FFE phase, a French project leader and his three team members interacted regularly with one German product managers and only occasionally with German decision-makers.
A	Low	<b>FFE team with cultural minority</b> The FFE team consisted mainly of German employees except one French team member.
B	Low	<b>International collaboration at strategic level</b> All decision-makers as well as the project leader were German and only the segment/product manager had French origins.
C	High	<b>International FFE team</b> German–French FFE team: R&D team members in France developed the project idea together with their German R&D and marketing colleagues.

Table 30 – The Project Cases and their Degree of Cultural Diversity.

A concrete example underlining the international acceptance of the organizational culture is the adherence of international employees to the company's process organization. As mentioned in the case description of the methodological chapter, BÜRKERT uses a process map to illustrate the company's activities in order to satisfy customer needs. This process map requires a flat hierarchical structure which is common for German companies (Hofstede, 2001). However, some international employees might be unfamiliar with flat hierarchies if due to their cultural origins they are used to a high perception of power. One of these cultures is, for instance, Indian culture, which historically is known to be accepting of an unequal

distribution of power, leading to multiple levels of hierarchy (Hofstede, 2001). Similarly, researchers have found that not all regions adhere equally to the use of formalized processes within their innovation structure (Kahn, 2017). Nevertheless, several sources of evidence from interviews and participant observations confirmed that employees of the Indian subsidiary of BÜRKERT have fully adhered to the company's process organization and thus to a system of flat hierarchies even if this is not predominant in their own national cultural background.

All these aspects – together with a high level of acceptance of cultural, gender, or other forms of diversity – transform the organizational culture at BÜRKERT into a highly innovative culture that is shared by employees around the world. In accordance with Sørensen (2002), it can therefore be described as strong.

### 4.3.3 RESULTS

The coding process produced several significant insights on culture. The following section examines the results, which correlate with existing literature about national cultural differences. This concerns synergy effects as well as the challenges discussed faced by multicultural FFE teams. Additionally, direct coordination mechanisms for a fluent FFE are presented. These mechanisms were used at BÜRKERT to enhance the output of the multicultural FFE teams. Moreover, the coding process revealed a further indirect coordination mechanism: professional culture.

#### 4.3.3.1 Multicultural FFE Teams: Identified Synergies

Projects A and C particularly demonstrated how cultural diversity was a positive factor leading to synergy effects within the teams. In project A, the teamwork between a French engineer and his German project leader was described as efficient due to complementary personalities:

*“The team fitted perfectly. The project leader was a very experienced person who had sometimes a rather critical perception of the project. But he also had the capacity to provide guidance to his colleague when the latter was perhaps a little too euphoric or optimistic. This was the ideal mixture, especially in such a project. [...] This really worked out very well.” (B2P3C)*

The German project leader agreed that he was down-to-earth and not always open to new input:

*“I’m perhaps not the most effusive and creative personality, but I’ve always thought about how to develop such an idea further and identify the potentials” (B2P3A).*

Several interviewees agreed with this observation that the complementary personalities of the two members increased the quality of the collaboration.

As illustrated in the methodological part (PART III) of this dissertation, project C was the project implemented in the setting with both the highest cultural diversity and the highest innovative output. The intercultural teamwork and the combination of internally existing knowledge of the French R&D center and the German headquarters enabled the team to create a highly innovative concept of the final product. The initial idea of the project was to develop a system to monitor several parameters at the same time in order to measure water quality such as pH or conductivity in a very limited space. The only available solution on the market at this point in time was to acquire one product for each measurement, which required a lot of space at the customers’ installation. During the FFE of project C, the team developed a concept for a whole platform which integrates all measurements in only one compact unit (*“not bigger than a shoebox” (B1P1A)*). During the ideation process, a high performing concept was elaborated. Thanks to the combination of pre-existing knowledge about miniaturization and sensor technology in France, and optical measurements in Germany, the final project concept resulted in a product which represents a big leap forward for the company with regards to its technological complexity as well as its market potential.

*“The idea was to work with the best competencies and we were pushed to work with team members regardless of whether they were working in Germany or in France. We chose the people who were the most competent to do the job. [Project C, MN] was more than a product. Apart from its extraordinary complexity, we had the vision to mount a collaborative project. The project was very ambitious and it was also a great success.” (B1P1A)*

Team members, the project leader as well as decision-makers traced the success of the project back to the intercultural synergies within the team. Only the combination of the internal existing knowledge of both entities enabled the group to create the concept for the final product. Today, this flagship product is one of the leading innovations of the company:

*“If we compare our situation to the automotive industry, then we were able to develop a bike before. Now, thanks to our international cooperation, we are able to develop a whole car!” (B1P1A)*

### **4.3.3.2 Challenges of National Cultural Differences and Direct Coordination Mechanisms**

Despite the intense international teamwork in evidence, no barriers relating to national cultural differences that would have led to a complete project cancellation were identified for the four international project cases. A few statements were made about the specific challenges of international teamwork, but they did not hamper the process, and it was not observed that they had negative influences on the FFE. One interviewee gave the example of project meetings in project C where no common language could be determined, as not all participants were able to speak English:

*“Languages are very interesting. This may occasionally lead to funny combinations. It happened a few times in the project that we were in meetings where not everybody was able to understand all participants. This was relatively funny.” (B2P3C)*

In multilingual meetings, participants therefore had to be vigilant that all new knowledge was understood and absorbed by everyone. A simultaneous translation into and from all working languages (English, German, French) was often required. This added a challenge to the communications, but it was not perceived negatively by participants. On the contrary, it was perceived in most cases as an enriching element of their day-to-day business.

Another challenge resulting from different national cultural backgrounds was identified regarding the decision-making process. Final decisions were made by members of the Project Steering Circle who are currently exclusively of German origin, located at the German headquarters. The validation process for the final Go/No-Go decision was described as ‘long’ by several team members for three of the five project cases.

<i>It took a long time and this slowed us down. They weren't sure about the key numbers.</i>	<b>Project A</b> (B1P3E)
<i>The moment between the redaction of the specification requirements and the final signature of the document took a rather long time.</i>	<b>Project A</b> (B2P3A)
<i>The first time was in 2007/2008. After that, it took a long time to decide if we do the project or not. The decision was made in 2010/2011.</i>	<b>Project B</b> (B1P5B)
<i>Sometimes, there are decisions which are not taken. But you need them to move forward in the project.</i>	<b>Project INC</b> (B1P2A)

Table 31 – Examples of Verbatim Accounts of the Decision-Making Process.

Although the perception of time is a subjective evaluation, French and German team members seemed to share the same position that the final validation of the project idea by the German decision-makers took a long time. As demonstrated by multiple interview quotes, this is not the opinion of a single person but a common pattern in the interviews. In the case of project A, the long decision-making process did increase the risk of a late market introduction:

*“It took us a long time to eliminate internal concerns because it is a new system. There were many questions. There was the opinion that we do not know enough about the application fields.”* (B2P3C)

After four months accorded to collecting further information, the decision was finally taken to continue the project due to its high potential. From the point of view of (German) decision-makers, this postponement of the final Go/No-Go decision was necessary in order to stabilize the concept. Today, the product is on the market and there is no evidence that this delay had a negative impact on its marketing or sales.

The examples of linguistic differences as well as different approaches to the decision-making process illustrate that national culture did play a role during the FFE of the projects. These observations correlate with the cultural information asymmetry mentioned earlier. In projects where such cultural challenges were observed, several strategies were identified and applied by FFE team members to reduce negative impacts. Table 32 summarizes these strategies and their application within the five project cases. They have been identified directly based on specific statements during the project interviews.



Coordination strategies	Project A	Project B	Project C	Project INC	Project NAT
Common vocabulary	x	x	x		
Proactive behavior	x	x	x	x	x
Regular meetings	x		x	x	
Global teamwork			x	x	

Table 32 – Strategies Developed by FFE Teams to Deal with National Cultural Differences (x: Strategy Applied in Project).

Considering that each strategy applies to more than one project, they will be investigated in more detail in the following paragraphs.

#### 4.3.3.2.1 A Common Vocabulary

To overcome linguistic challenges during the FFE, interviews as well as participant observations provided several examples of where a commonly shared vocabulary facilitated comprehension and communication between participants. In several cases, it was observed that members of both cultures (i.e. Germany and France) used the exact same technical terms. Especially at the French subsidiary, some German terms were internalized even by employees who do not speak German. As an example, the German terms ‘Lenkungsausschuss’ (i.e. steering committee) or ‘Steckbrief’ (i.e. fact sheet), which are specific terms in project management, are commonly used or at least understood by the majority of the French employees, independently of their own skills in the German language. Besides this, the organization works on standardizing its internal wording to facilitate a common understanding on an international level:

*“In the past, different terms were used which led to confusion. This is why we got the advice not to use them anymore but to use instead the terms defined by the company.”*  
(B2P3A)

A project is currently ongoing to identify and standardize key terms such as technical specifications or managerial concepts in order to generate a common definition.



#### 4.3.3.2.2 Proactive Behavior as a Corporate Value to Promote Innovation

In project A, the postponement of the final decision was considered necessary to collect more market information. During the four months in which the project was on hold, the FFE team supported the decision-making process as best they could by providing further evidence about the concept:

*“We conducted a lot of tests, also with the idea in mind that we wanted to support the marketing department if they need further data to take their decision.” (B2P3C)*

During project INC, French team members forced the final decision the moment they had the impression that they were not getting enough input from their German colleagues to construct the design of the product. They started to develop a design on their own based on their best knowledge:

*“In the end, we forced the decision. We said: ‘This is what we propose. If we do not hear anything within two weeks, we consider our proposition as validated and we will work on this design.’ And suddenly, we received comments from everybody. Finally, our proposition was considered very positively by the involved parties.” (B1P2A)*

By preparing a proper design proposal, the French FFE team members gathered more information and created a bigger knowledge base. In this way, they reduced uncertainty and the German decision-makers were able to now take a decision which they felt comfortable with. Similar to the example of project A, the actors took an active role during the FFE. These two examples of active involvement are not exceptions at the case company. The interviewees of the reference project NAT also testified to their intrinsic motivation to work autonomously on a new idea:

*“Nobody asked me to do that. I discussed the idea with my team coach in the evening across the desk. And then you are convinced that it is the right way and you fight for it.” (B2P4A)*

Proactive and entrepreneurial behavior is a modern way of dealing with new ideas at BÜRKERT. Especially concerning the early ideation phase, people followed an autonomous working style. Independently of national cultural origins, the expression *“Let’s just try/do it!”* was used in several project interviews to describe the start of the ideation processes.

A final example represents the situation in project C after staff turnover in 2010, when the future of the project was uncertain. Many initial team members left the company, including

the project leader. Despite high managerial risks, the responsible person at the French R&D department took charge of the project without hesitation because he was convinced of its huge potential:

*“It seemed natural for me to take over the project. [...] Why? Because I knew that it would be important for the French factory. It was fundamental and I knew that we had an ultra-competent team in Germany and in France. OK, there were some risks and a lot of other insecurities, but I was convinced that we would make it.” (B1P1A)*

By spontaneously taking over the role as project leader, he assured the continuation of the project and led to the development of the final concept.

#### 4.3.3.2.3 Regular Meetings and Global Teamwork: A Shared Global Vision

Despite the geographic space, interviewees underlined the crucial role of face-to-face meetings with their international colleagues, especially in the case of problems or strategic discussions. During the five project cases, FFE team members used regular meetings to increase the quality of their international collaboration. In project C, such regular meetings enabled them to get to know each other. On several occasions, employees underlined that this aspect was more important than the technical efficiency of the work meeting itself.

<p><i>We also had regular meetings every two weeks, where the French colleagues came here. [...] Sometimes, there were more than 20 people in the room. The efficiency of those meetings could be discussed. During those meetings, there were many things which were presented and it was rather informative than real active work. The interim time between the two phases [in 2010, MN] was rather disoriented and we missed a clear line. Those meetings brought the teams close together again.</i></p>	<p><b>Project C</b> Team member (B2P1B)</p>
<p><i>MN: What were the communication channels used with your German colleague? I: He came here very often. When he couldn't make it, I went there. We went also together to professional trade fairs to get an idea about the products of our competitors.</i></p>	<p><b>Project INC</b> Project leader (B1P2A)</p>
<p><i>If you have to take a decision, you need to go there and to see them. When you don't see the other person, it is possible that misunderstandings due to language problems are created and you won't be aware of it. When you see the other person, you can react directly.</i></p>	<p><b>Participant Observation</b> Product engineer (POb)</p>

Table 33 – Examples of Verbatim Accounts of the Importance of Regular Meetings.

Regular meetings were part of the corporate strategy to increase global teamwork because *“the intercultural dialog was a commitment of the group”* (B1FA). From this perspective, project C was more than just a product project. It also had the objective of creating an opportunity to bring German and French team members closer together:

*“This project created a close and intense collaboration between the two entities – for purely practical reasons. Because the hardware concept was developed in France, we had no choice but to have more contact with them. Regarding some of the parts which were developed here, we needed a close alignment with our French colleagues.”*  
(B2P1B)

During the concept development, international team members were obliged to work together because experts were located in both countries. The French location specializes in the development of sensors, and the construction of a clean room at this entity integrated specific knowledge about miniaturization. However, the French experts would not have been able to develop the final concept without knowledge about, *inter alia*, optical measurement. Such competences were located at the German headquarters. As a result, this common international project not only led to a discontinuous innovation for the company, but it also reduced linguistic and cultural barriers, created a close relationship, and developed trust between team members. In response to the question as to why there was such good cohesion within the team, one interviewee explained:

*“I think this is rather easy as soon as people work on the same topic. When we need to develop a common hardware that can manage different sensors, then we need to discuss a lot. And this led to an intensified collaboration.”* (B2P1B)

## 4.3.4 ANALYSIS

The common vocabulary, corporate values promoting innovation (e.g. proactive behavior), and the initiation of global teamwork generating a shared global vision were applied during project cases, thus limiting national cultural differences. The horizontal coding of the interviews identified organizational culture as a core concept linking all these strategies.

### 4.3.4.1 The Core Concept: A Strong Organizational Culture

Firstly, a common vocabulary is closely linked to the culture of organizations as it distinguishes BÜRKERT from other companies through its jargon, similar to the way different languages distinguish cultural regions from one another.

*“When you know only the external world and you come here, you need at first to adapt to the internal world.” (B2P3A)*

Secondly, some individual characteristics were traced back to cultural differences. For instance, interviewees underlined differences concerning the approach to creativity of French employees compared to their German colleagues. Several observations were made where German employees noticed the French capacity to generate many ideas in a short time. For example, this is illustrated by participant observations where a German employee explained during an internal workshop that:

*“Our French colleagues have so many ideas, it’s really impressive. But sometimes there are so many ideas that we don’t know where we should start!” (POb)*

However, despite cultural differences regarding creative output, the proactive behavior to overcome difficulties within projects was observed independently of national origins. As it was also observed during the reference project NAT, it cannot be linked to specific characteristics of one national culture or to cultural synergies. Instead, the project leader of project NAT explained that this behavior is closely linked to the organizational culture:

*“It is important to let your employees operate autonomously. It is motivating when your team coach lets you work without the constraint to report all the time about your progress. My team appreciates this. This is what distinguishes our process organization: give the possibility to your employees to take over as much responsibility as they want.” (B2P4A)*

The organizational culture requires entrepreneurial and autonomous behavior; these values transcend the process structure and the resulting flat hierarchies. As the examples demonstrate, this is not only written in a static document, but it is also part of the daily routine of employees.

Finally, the last strategy – global teamwork and regular meetings – is part of the international orientation of the organizational culture of BÜRKERT. It is part of the philosophy of the top tier of management, and aims to create strong cooperation between its German and French R&D centers:

*“The company’s culture is an international culture with a huge force: the German-French axis. It is an open-minded culture which is geared towards change and innovation. And it is also a culture that demands a certain autonomy and entrepreneurship from its employees, which is a huge advantage.”* (B1P1A)

Overall, the organizational culture was identified as the core concept for all strategies identified during the project interviews. At BÜRKERT, it created a fertile environment on an international level which fosters common teamwork and reduced international challenges caused by different national cultures.

#### **4.3.4.2 Communication Challenges and an Indirect Coordination Mechanism: Professional Cultures**

Despite the strong organizational culture, examples of communication difficulties leading to information asymmetry were still collected at the FFE. However, contrary to the assumptions derived from the literature (see chapter 4.3.1), these difficulties were not identified between German and French employees. They were, nonetheless, identified as occurring between the R&D, the marketing, and the sales department.

A concrete example was project A. The R&D team presented the final product concept during an internal event a few months before the official launch. During the presentation, a member of the sales department approached the R&D team wondering why they had not communicated the project earlier. The team replied that the project idea had already been presented several times before without any feedback from the sales department.

*“In the R&D department, we think in technical principles. The sales department considers concrete applications. When I speak to the R&D department, to the global*

*marketing department or when I communicate with the final customers, different basic communication models apply.” (B2P3C)*

Presentations of the R&D department that took place during the FFE concentrated on the technology and not on either the final product or its potential market application. Congruent with the communication pitfalls between people who do not share the same regional language, the members of the two departments (sales and R&D) did not share the same technical vocabulary. Thus, it was not possible for the sales department to comprehend the potential of the project and to give appropriate feedback.

At BÜRKERT, several similar ‘linguistic’ differences were also considered as a challenge for the final Go/No-Go decision as soon as a multidisciplinary team was involved:

*“For another project, we will now take the final decision after a lot of discussions. It is not easy to get a common opinion because the portfolio manager has a vision, the product manager has his own point of view, and the development teams also have their own ideas.” (B2P4A)*

Another interviewee did not just focus on different jargon. In his opinion, the communication problem between functional departments (R&D, marketing, etc.) went deeper:

*“When we start a technology project, the marketing department is part of the project from the very beginning and this makes sense. It can sometimes be difficult for technology developers, but it is not easy for product managers either because the two worlds collide. It is exciting to get the balance right.” (B2P5A)*

It is not only the vocabulary but also the fundamental perceptions about ideas that differ between employees of different departments. Different perceptions, distinct vocabulary: this communication problem is similar to current challenges within multicultural teams where members do not share cultural values and thus interpret situations differently. In addition, since communication challenges were also identified in the reference project NAT, this phenomenon goes beyond national cultural differences.

Between French and German FFE team members, information asymmetry was observed due to language barriers, but ultimately only a few situations have been identified where culture caused differing interpretations of the message received. In light of these circumstances, the following question emerged at BÜRKERT: how is it possible that the fundamental comprehension of a message does not differ in the international project teams but

between local employees of different departments? This situation leads to the assumption that FFE team members of the international project cases all shared a hidden characteristic that facilitated communication which is not automatically present between local employees of different departments.

This hidden characteristic has been identified by taking a closer look at the profiles of the 38 interview partners. It was observed that 33 of them have an engineering background and therefore at least a basic understanding of technical issues. This includes not only the project leaders of the R&D department but also most of the marketing members and strategic leaders interviewed. With this fact in mind, it was observed that people who had a similar professional background also shared a similar perception of the topics discussed. Besides the interviews for the project cases, participant observations were collected of a bicultural software team at BÜRKERT, which adds further evidence. For several years now, software experts from both countries have decided to come together regularly to talk about the technical problems they face in the workplace. Similarly to those observed for project C, these meetings were influenced by the fact that no common language could be determined because not everyone was able to speak English and/or German. Still, it was observed that the participants shared the same technical terms (which in the software area are quite often generic terms in English) and thus the same approach to the work. This enabled the team to overcome intercultural and linguistic difficulties. Even if the language differed, the ideas voiced were understood by all participants.

Consequently, the fact that people shared the same technical vocabulary and the same perceptions about the topic due to their professional background decreased the negative influence of national cultural differences at BÜRKERT and enhanced comprehension within the teams.



### 4.3.5 DISCUSSION

Scholars suggest that national cultural differences can lead to synergy effects for creativity (Rocas and Garcia, 2017). Indeed, the statements collected at BÜRKERT correlate with the academic literature regarding the impact of national culture on creativity. In the case of project A, the personalities of the French and German team members created synergy effects through complementary characteristics. The French employee proved to have a high capacity for increasing the novelty aspect of the idea, whereas the German team member was reserved and focused on the usefulness of the idea. Both aspects are necessary for creativity (Amabile, 1988). However, it is possible that in some cultures one of the aspects is considered to be more significant than the other one (Westwood and Low, 2003). At BÜRKERT, the French and German cultures ultimately complemented each other in project A; similarly to how it has been described in literature on creativity and culture (see also Bissola *et al.*, 2014; Erez and Nouri, 2010). Their individual behavior is certainly not exclusively linked to culture, but their national culture still reinforced the innovative characteristics of the two actors; oriented towards novelty in the case of the French employee and towards usefulness in the case of the German team member.

Moreover, the long decision-making process of the German strategic leaders in project A and INC correlates with the high perception of uncertainty avoidance of members of the German culture (Hofstede *et al.*, 2015). Literature shows that the majority of members of the German culture tend to take more time for decision-making compared to people with a French background (Barmeyer, 2002).

Notwithstanding the cultural differences identified, international employees at BÜRKERT shared common values, common practices, and a common vocabulary. Even though they did not share the same national culture, they willingly adhered to the same organizational culture and current practices (e.g. process organization). During the FFE of the project cases, the strong organizational culture was identified as a powerful coordination mechanism for limiting the negative influences of national cultural differences. The fact that the corporate values have been elaborated together with employees from all around the world fosters its acceptance on an international level. These results are especially interesting for the ‘fuzzy’ front-end because of its unstructured character. Compared to the more structured NPD with its clear milestones and project phases, the FFE proposes fewer possibilities for an organization to intervene directly in order to align and coordinate individual behavior through explicit



processes (Gassmann and Schweitzer, 2014a). For a successful international FFE, a strong organizational culture that promotes innovation values replaces this missing explicit structure. It provides a common framework on an international level that is accepted and adhered to by employees around the world.

Nevertheless, a strong organizational culture is not sufficient for a successful international FFE for discontinuous innovations. During this phase, interdisciplinary interactions are crucial to fostering creativity through diversity (Cohendet *et al.*, 2013), but this may cause problems for the absorption of knowledge independently of national cultural backgrounds of the individuals involved. At BÜRKERT, this was the case as soon as employees of different departments were involved. Considering simultaneously that no similar deficiencies with regards to the absorptive capacity of actors were identified for the international collaboration during the FFE at BÜRKERT, professional culture emerged as an indirect coordination mechanism for a smooth international knowledge flow during the FFE. Employees share a common knowledge base and are thus familiar with the same technical vocabulary; even in a foreign language. In the field of intercultural management, professional culture has already been identified as a communication facilitator between people who carry out the same job (Chevrier, 2008). In addition, this explains why international members of the same service were less affected by problems with regards to their absorptive capacity than national members of two different departments (Chevrier, 2008).

Compared to the organizational culture with its active strategies for coordinating the international collaboration during the FFE by creating a common behavioral pattern, professional culture has a less evident impact on the FFE. Nonetheless, an organization can use different professional cultures to coordinate its international FFE team members. For instance, BÜRKERT recently improved its internal processes, including the early ideation phase. The marketing department has been restructured and it now has a key position within the innovation processes as mediator between the R&D and the sales departments. Most of the marketing members have an engineering background, as they switched to the marketing department during their internal career at the case company. Due to this strategy, members of the marketing department are systematically trained to understand both professional cultures in order to mediate between the two worlds; similar to intercultural experts in international management. They ‘translate’ information from the R&D department into concrete market applications for the sales department.

In addition to the concept of strong organizational cultures, a common professional culture acts as a communication facilitator. This is crucial during the FFE of discontinuous innovations since a consensus about new ideas or concepts needs to be created between different departments in order to assure their acceptance within the company (Cohendet *et al.*, 2013). Managers still need to take care, however, because professional cultures have their limits. For example, initial engineering education is not necessarily the same in all countries (Chevrier, 2000). Presumed professional similarities could create misunderstandings due to diverging perceptions of the same topic. Additionally, professional cultures consist of further subcultures. Most of the time engineers are specialized in one specific field. This could lead to an isolation of experts within the same domain. Furthermore, diversity gets lost when the focus is too much on similar profiles. Professional cultures facilitate international communication between employees working on the same project but managers must be careful that they do not decrease team creativity.

### 4.3.6 CONCLUDING REMARKS

This chapter has taken a closer look at the cognitive proximity in international FFE teams. On the one hand, the results correlate with the current literature demonstrating that cultural diversity enhances creativity during the FFE, therefore pushing the generation of discontinuous innovations. On the other hand, the FFE is in general less structured than later innovation phases and it lacks clear processes guiding the activities of international individuals. From this perspective, cultural diversity may increase the risk of a team's misalignment due to a missing common framework. Therefore, cognitive proximity within FFE teams needs to be increased by generating a 'shared mental model' similar to that described by Liu and Dale (2009) which describes the 2<sup>nd</sup> lens of the ProxIS-Telescope. With this in mind, a strong organizational culture has been shown to be a powerful coordination mechanism for this 2<sup>nd</sup> lens at BÜRKERT and thus for national cultural differences during the FFE of discontinuous innovations. This positive role during the FFE is due to three aspects:

- A common vocabulary;
- A shared global vision created by top-management commitment and regular meetings; and
- Corporate values promoting innovation, in particular a proactive response to challenges occurring within the project.

In addition, professional culture was identified as an indirect coordination mechanism. Figure 32 from the beginning of this chapter needs therefore to be extended by the insights from this case:

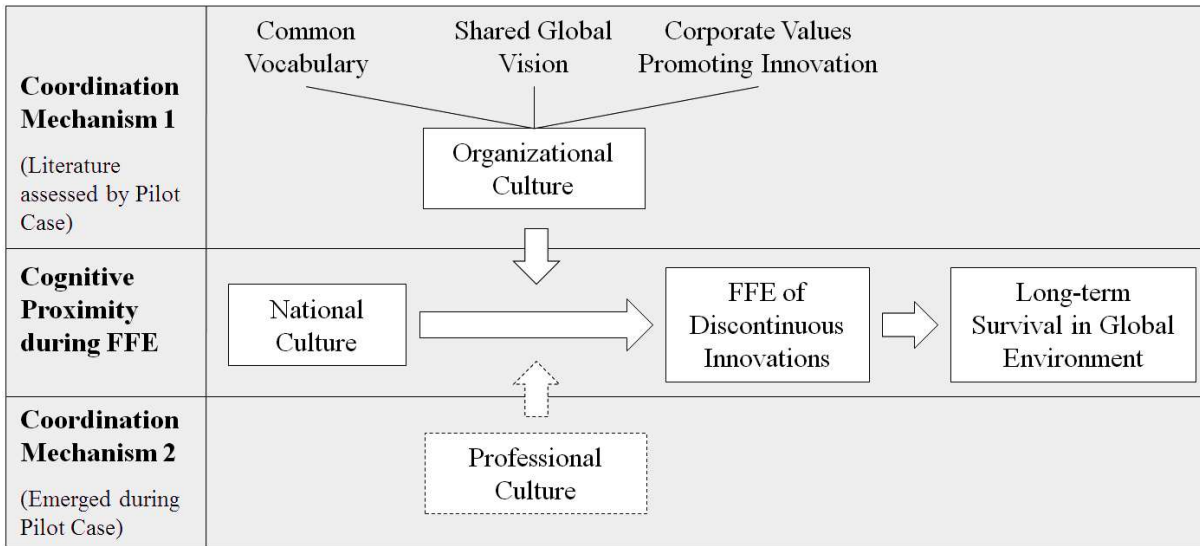

Figure 33 – Resulting Coordination Mechanisms for Cognitive Proximity at BÜRKERT.

The strong organizational culture limits the negative influence of national culture by requiring proactive behavior and an autonomous work style. In combination with a strong commitment by senior management towards international collaborations, this increases the synergy effects of FFE teams. These results are in line with recent research claiming that organizational attributes such as the organizational culture are crucial to aligning teams during the FFE; more effectively than concrete processes (Koen *et al.*, 2014).

Additionally, this chapter extends the literature about the FFE by introducing the concept of professional culture. In addition to a strong organizational culture, the professional culture has been found to facilitate knowledge flows in international teams. Regarding the fact that during the FFE of discontinuous innovations, individuals with interdisciplinary backgrounds should interact to assure idea acceptance in the organization, a common professional culture enhances absorptive capacity and thus facilitates the alignment of various perspectives.

Consequently, organizational and professional cultures are coordination mechanisms for reducing negative effects of national cultural differences in international FFE teams. They apply specifically to the generation of discontinuous innovations as this is characterized by unstructured interactions between people with diverse backgrounds who need to find a consensus about new ideas.

Managers should be cautious since the introduction of an adapted organizational culture requires a long-term approach. It does not happen automatically and requires an action plan of regular managerial activities. As Brentani *et al.* (2010) formulated it:

*“[A] strong global innovation culture can be achieved only over time and must be stimulated through such short-term initiatives as rewarding entrepreneurship”* (De Brentani *et al.*, 2010, p. 155).

In addition, organizations should focus on their recruiting process. Purely technical competences are not the only criteria that should be taken into account when recruiting. To ensure smooth knowledge flows during the FFE, the professional background of a person must fit the context of the job. Posts that are situated at the interface between several departments need interdisciplinary profiles to enable employees to act as mediators between different professional cultures. However, the consideration of professional culture does not imply that the generation of discontinuous innovations should be allocated exclusively to the R&D department. Of course, spatially diffused R&D members might have fewer difficulties in sharing knowledge than employees of different departments. Nonetheless, teams need to be interdisciplinary, and diversity (not only cultural) remains one of the central concerns of a company in increasing its innovation capacity.

#### CONTRIBUTIONS

This chapter proposes the establishment of a shared mental model as a managerial solution to overcome barriers linked to national cultural differences in international FFE teams.

##### **Sub-question 4 – Cognitive proximity at the FFE of discontinuous innovations**

To strengthen cognitive proximity between actors during the FFE, two coordination mechanisms have been identified in this chapter:

- A direct mechanism: A strong organizational culture; and
- An indirect mechanism: A shared professional culture.

These mechanisms create a ‘shared mental model’ to enable actors to collaborate at the FFE even if this phase is by its nature less structured than later phases of the innovation process.

## 4.4 DISCUSSION: COMPLETE THE PROXIS-TELESCOPE

*“The diversity of the phenomena of nature is so great, and the treasures hidden in the heavens so rich, precisely in order that the human mind shall never be lacking in fresh nourishment.” – Johannes Kepler*  
(BrainQuote.com, 2016)

Regardless of the remote locations of BÜRKERT, the previous chapters demonstrated its potential for innovation. This potential is an internal one and underlines the quotation of Kepler: the challenge for organizations is not to create new ideas, but to collect, assess and use them for further purposes (Rice *et al.*, 2001). At BÜRKERT, organizational awareness has grown that international entities have precious knowledge which could and should be exploited on a corporate level. During this case study, the focus was on French-German collaborations. In PART IV, a content approach assessed the organization’s coordination mechanisms to substitute geographic proximity between actors during the FFE to foster the generation of discontinuous innovations. Based on the results, it is possible now to set the elements of the ProxIS-Telescope and the resulting coordination mechanisms in concrete.

A trust relationship as described in chapter 4.1 represents the precondition necessary to assure that the stars (i.e. international collaborators) metaphorically send out their light and share knowledge. At BÜRKERT, a relationship of trust on top-management level enabled employees to rely on swift-trust in order to share their tacit knowledge with colleagues they not necessarily know in person. Moreover, because the first lens of a telescope should be placed close to the observed object (Cheng, 2009), a common platform should be closely connected to the international employees which, in the case of BÜRKERT, has been managed in form of a hybrid community (chapter 4.2). Such a knowing community is structured around local employees who create a bridge to a ‘mentor community’. Experts of a local entity are part of ‘creative communities’ which are closely linked to this mentor community. This requires that such experts are identified and that their role has been communicated to all other local employees. Consequently, an employee who wants to share an idea can directly communicate it to one of the experts located close to him. This prevents linguistic and cultural difficulties or personal characteristics (timidity, introversion, etc.) from creating a barrier between local employees and the headquarters. Members of the creative community act as intermediaries connecting the local idea champions with the rest of the company.

Finally, by addressing national cultural differences, the eyepiece of the ProxIS-Telescope stands for a shared mental model. At BÜRKERT, such a common vision has been generated *via* the strong organizational culture and a shared professional culture (chapter 4.3). As mentioned above, the eyepiece of a telescope should be placed close to the observer who is in this specific case represented by the organization (Cheng, 2009). A strong organizational culture sustains the core values of a company and should therefore indeed be placed close to the organization to demonstrate the corporate character of the values.

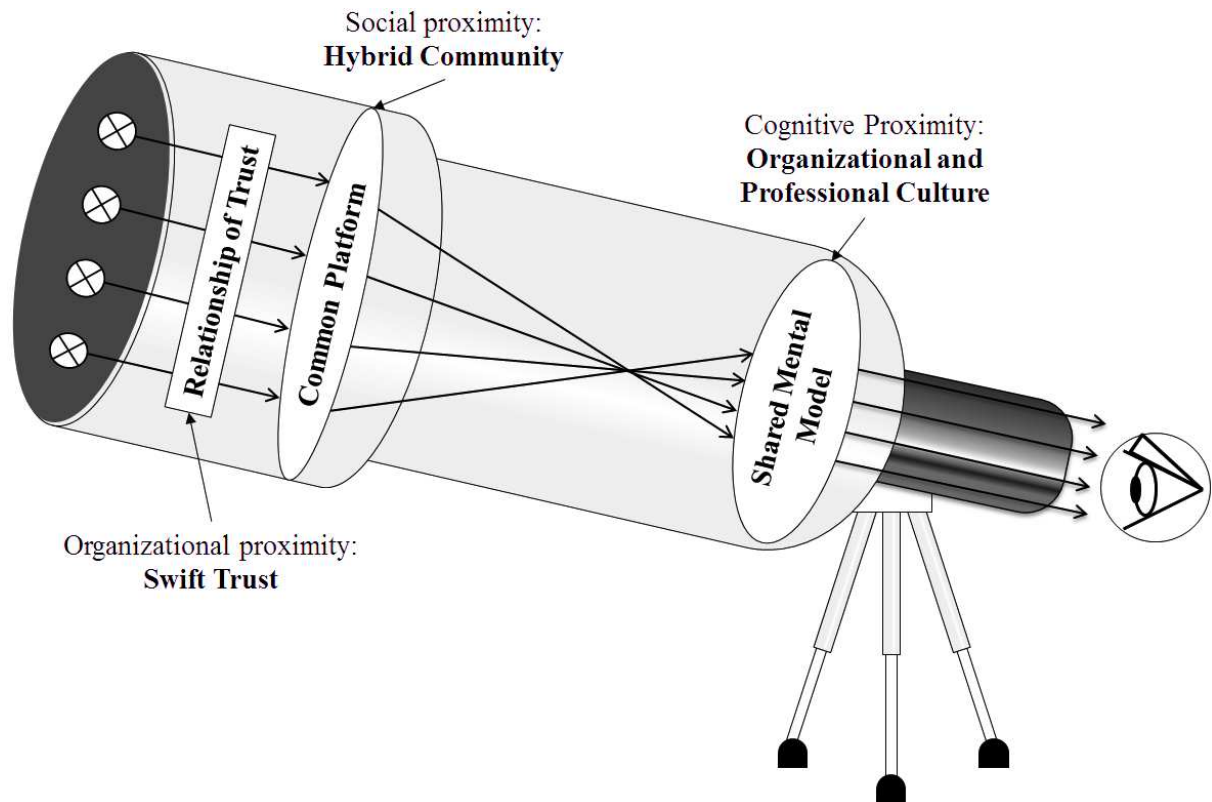

Figure 34 – The Elements of the ProxIS-Telescope and the Coordination Mechanisms at BÜRKERT (by MN).

Figure 34 illustrates the three elements of the ProxIS-Telescope to overcome geographic space during the FFE: a relationship of trust, a common platform to share knowledge and a shared mental model to create a common vision about innovative behavior. Furthermore, it shows how these elements have been implemented at BÜRKERT in form of concrete coordination mechanisms which are the generation of swift-trust, a hybrid community and a strong organizational and professional culture. Considering the metaphorical character of the telescope, several additional clarifications are necessary in order to entirely understand and apply this model to managing the FFE of discontinuous innovations across large distances.

## 4.4.1 WHAT ABOUT THE POSITIONING OF THE LENSES?

In a telescope, the distance between the two lenses is not hazardous. To be more precise, the ProxIS-Telescope is designed like a Keplerian telescope. In comparison with a Galilei telescope, the eyepiece is situated behind the focal point and the rays of light cross. Even if the picture is turned by 180°, the Keplerian telescope offers a greater field of view than the Galilei telescope (Cheng, 2009). Compared to a Galilei telescope, this increases the quality of the telescope and enhances the observer's ability to look further into space.<sup>5</sup>

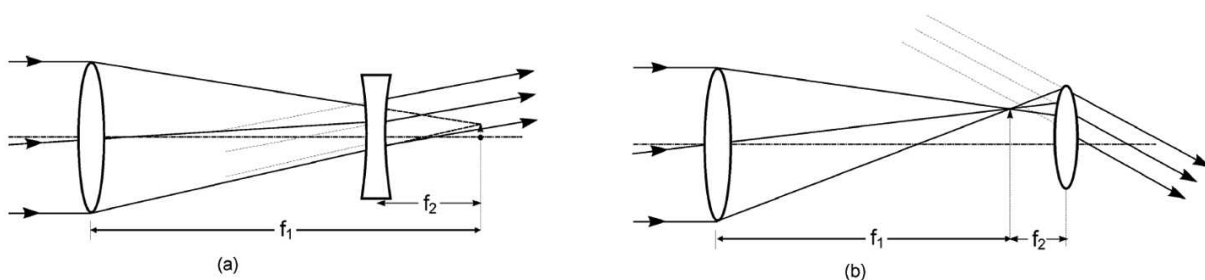

Figure 35 – Galilei Telescope (a) and Kepler Telescope (b) (Cheng, 2009, p. 2).

In the ProxIS-Telescope, the positioning of the two lenses is crucial. To increase performance, the first lens should not only collect ideas and knowledge, it should also foster crossover between ideas. For instance, the hybrid community at BÜRKERT enables personal and direct encounters between people. A knowing community does not only passively collect ideas, it brings people together. The Galilei-telescope also enables people to look into space, but without crossover between the rays. If the ProxIS-Telescope was designed as a Galilei-telescope, the managerial solution for this first lens would have been an idea or suggestion box which would only passively collect input (no crossover between rays of light). In this case, people would not interact or exchange knowledge. As idea or suggestion boxes are often criticized due to the limited knowledge processing implied, this underlines why the ProxIS-Telescope follows the Keplerian model with its crossing of the rays of light.

<sup>5</sup> A rudimentary remark about the physics of telescopes: in the Keplerian telescope, both focal points of the lenses overlap to provide a sharp image. If the focal length of the objective ( $f_1$ ) is twice as long as that of the eyepiece ( $f_2$ ), the telescope provides a double magnification. If  $f_1 = 10 \times f_2 \rightarrow$  magnification of ten (Georg-August-Universität Göttingen, 2014)



## 4.4.2 HOW TO KNOW WHERE TO LOOK IN THE SKY?

Firstly, the visual field of the ProxIS-Telescope is oriented towards the entities which have precious knowledge to share. At BÜRKERT, most experts are located in France and in Germany and this is why the ProxIS-Telescope was oriented towards these two countries. However, other international entities at BÜRKERT may equally contribute to the innovation processes during the FFE, but they are currently not monitored by the telescope. In order to take into account input from other international employees, the best option would be to enlarge the visual field of the telescope. To observe more stars, the opening angle of a telescope should be enlarged (Cheng, 2009). The opening angle depends on the diameter of the two lenses and on their thickness: the larger the diameter and the thicker the lens, the higher the opening angle of the telescope will be (Cheng, 2009). In managerial terms, this could be effectuated for the ProxIS-Telescope, for instance, by an extension of the common platform towards other international entities. At BÜRKERT, the identification and systematic integration of further experts other than those located in France into their hybrid community could increase knowledge flows between these entities. However, in terms of the metaphorical thickness of the community, this solution requires not only the expansion of a simple network where sparse contacts are created with distant colleagues. Newly identified experts should take an active role and be socially integrated into the community.

Still, the visual field of a telescope is always restricted at some point and may not capture the whole sky at once. Yet another solution to assuring that an organization orients the telescope towards the right sector of the sky is to take into account its sector of activity. Internal employees at BÜRKERT have the diverse knowledge to create new ideas but not every idea fits into the organizational strategy or the product portfolio. By structuring the technology circle around the company's core technology fields, BÜRKERT creates a framework for new ideas during the FFE. This should not be understood as a limitation to creativity. It instead enables the company to efficiently apply internal resources. The company's declaration of dissociation from atomic industries is one example. It might happen that an employee has a promising idea in this area. However, this idea is not worth noting because the ethical guidelines defined by the family clearly state that BÜRKERT products should never be used for atomic projects. Assessing ideas in this area would be a waste of time and it would be pointless to orient the telescope towards this sector.



### 4.4.3 WHICH PART OF THE TELESCOPE SHOULD BE IMPROVED AS PRIORITY?

*“To manage a system effectively, you might focus on the interactions of the parts rather than their behavior taken separately.” - Russel Ackoff (AZQuotes.com, 2017)*

Companies work with strategies and strategies lead to action plans deducing concrete actions with a short-, middle-, and long-term perspective. Management therefore needs to prioritize its actions to coordinate the internal resources available. Nevertheless, it is not possible to propose a prioritization between the three identified elements of the ProxIS-Telescope. A telescope is a system which is only functional through the interactions of its isolated parts. Each resulting coordination mechanism separately would not be sufficient. The ProxIS-Telescope is, thus, only as efficient as its weakest element.

At BÜRKERT, only one subsidiary fulfils all three mechanisms: the French competence center for sensor technology. It maintains a close relationship of trust with the headquarters on top-management level, it is integrated into the hybrid community, and it shares corporate values with the rest of the company. This has enabled French-German teams to develop the concept for several high-technology products during the FFE. In all other international entities, at least one of the three dimensions was insufficient or totally absent. The Canadian subsidiary, for instance, has a top-management structure which is closely connected to the headquarters (i.e. a trust relationship) and the local CEO defends the culture of the group by encouraging his employees to internalize these values. However, it was observed that ideas remained in the creative slack because employees had no platform from which to share knowledge with the rest of the company. The Canadian entity was not integrated into the hybrid community. As each other subsidiary, apart from the French one, lacks one of the three elements, local knowledge is currently not exploited in its entirety during the FFE.

Moreover, it was observed at BÜRKERT in around 2013 that organizational proximity was increasingly tightened up between the French and German entities, but the this structure endangered collaborations across space. Only when the overwhelming organizational proximity was counterbalanced by the hybrid community and thus by social proximity, did the company recover its creative and thus innovative power. This example illustrates a common statement found in economic geography that both too much as well as too little proximity are

limiting factors for innovation (Boschma, 2005). Hence, management should ensure that proximity dimensions remain in balance.

Similarly, the acquisition of a high quality and expensive objective for a telescope does not automatically lead to a highly efficient telescope. An excellent objective would not be sufficient to compensate for a poorly polished eyepiece. In accordance with the quote at the beginning of this paragraph, the telescope should be considered as a whole system where individual parts interact. A high quality eyepiece such as a monocle without the rest of the telescope would not enable the observer to see more stars in the sky either.

To conclude, PART IV analyzed a static representation of the state-of-the-art of the processes during the FFE at BÜRKERT. As a result, the ProxIS-Telescope provides a first approach for managers to exploit international knowledge during the FFE of discontinuous innovations. This context analysis was necessary to capture the current coordination mechanisms at BÜRKERT and set the elements of the final model in concrete. Nevertheless, this is not sufficient to entirely understand the phenomenon of an international FFE considering that Balland *et al.* (2015) claimed that:

*“Dynamics of proximities are an important issue themselves, a topic which has not been sufficiently addressed”* (Balland *et al.*, 2015, p. 3).

From this perspective, the analysis of the company’s hybrid community revealed, for instance, that the coordination mechanisms at BÜRKERT have evolved over time and are thus dynamic. This has already led to the assumption that the existence of the community generating a common platform for knowledge sharing depends on the size of the company and thus on the organizational setting at BÜRKERT. To ensure that appropriate care and attention is given to this issue, PART V will introduce a dynamic perspective to the FFE of discontinuous innovations. It completes the content analysis of PART IV by conducting a process research on the proximity dimensions during the FFE at BÜRKERT. Regarding that the size of the company was identified as an influencing factor, PART V also takes into account observations from the two replication cases, 3D PLUS and ELECTRO, to fully understand the elements of the ProxIS-Telescope and their articulation around concrete coordination mechanisms and how this depends on the organizational setting.

**PART V**  
**DYNAMIC EXTENSION**  
**OF THE PROXIS-MODEL**

*“Apparently what has happened as firms have grown larger is not that they have become inefficient, but that with increasing size both the managerial function and the basic administrative structure have undergone fundamental changes which profoundly affect the nature of the ‘organism’ itself”*  
(Penrose, 1972, p. 19).

The ProxIS-Telescope as elaborated in previous chapters includes several elements to maintain proximity between actors despite physical spatial limitations. It enhances knowledge transfer and sharing during the FFE of discontinuous innovations. Nevertheless, the conditional character of the ‘model for creative crystallization and diffusion’ led to the assumption that company growth influences the efficiency of the resulting coordination mechanisms. The company’s size was identified as a precondition of the model, limiting it to a medium-market company such as BÜRKERT. It remained an open question as to why and how exactly this factor played a role when coordinating knowledge in dispersed FFE teams.

**Chapter 5.1** seeks to provide an answer to this question by analyzing the interdependence during the FFE between proximity dimensions and organizational growth at BÜRKERT. Based on the results of this chapter, the initial single-case methodology will be complemented by the two replication cases. **Chapter 5.2** is dedicated to these two replication cases and the description of their innovation processes during the FFE of discontinuous innovations. These are the fundamentals for the analysis in **chapter 5.3**, leading to a dynamic extension of the ProxIS-Telescope. Overall, PART V is dedicated to the cross-case analysis of this dissertation.

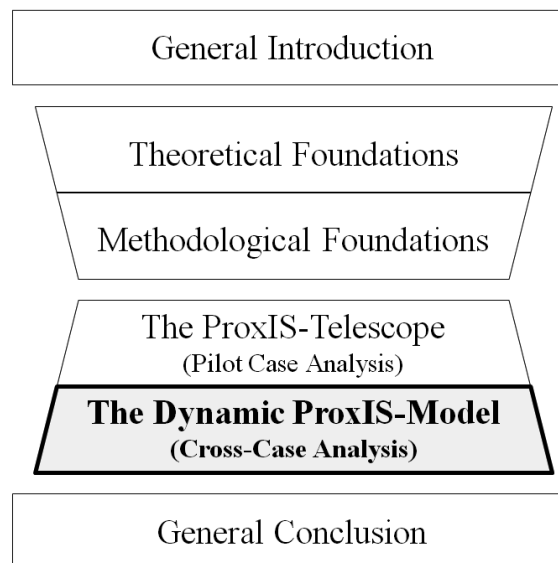

Figure 36 – Outline of the Dissertation. Present Part: The Dynamic ProxIS-Model.

## 5.1 PROXIMITY AND GROWTH

From an examination of the academic literature, it was found that the size of an organization rather than the geographic space itself determines the evolution of an organization (Torrès, 2007). From this perspective, small firms are not just smaller versions of big companies, they require different management tools (Torrès, 2007). Curado (2006), for instance, points out that knowledge-based firms abandon formal structures and prefer coordination by social rewards. Although this may be true for small structures, the author explains that this gets difficult when such firms grow. As Penrose (1972) puts it, growth is limited by several factors which are internal (managerial ability), external (product or factor markets) or a combination of both (uncertainty and risks). Consequently, the author proposes that such expansions have to be planned to make sure that all the necessary specialized resources are available.

From a similar perspective, the elaboration of the ProxIS-Telescope and its elements highlighted that the decision for one or other coordination mechanism should be adapted depending on the number of actors involved during the FFE. This chapter builds on these insights and uses the spatial and non-spatial proximity dimensions to provide an explanation as to why one or other coordination mechanism was better adapted to the international collaboration during the FFE at BÜRKERT. The overall aim of this chapter is to understand how organizational growth affects the efficiency of replacing geographic proximity by other non-spatial dimensions at the FFE of discontinuous innovations. A special focus lies here again on the German-French collaborations.

### **Sub-question 5 – Impact of growth on proximity dimensions**

How does the company's workforce influence spatial and non-spatial proximity dimensions at the FFE?

### **Sub-question 6 – Efficiency of coordination mechanisms in international FFE teams**

How does this organizational setting impact on the success of coordination mechanisms to enhance knowledge sharing at the FFE in an international company?

Firstly, it is necessary to understand why and how non-spatial proximity dimensions have evolved over time at the FFE of discontinuous innovations at BÜRKERT. For this reason, this chapter focuses on the number of actors involved during the FFE. This number corresponds to the international FFE team as defined in the theoretical foundations in part II. Thus, it includes all active actors at the FFE independently of their geographic location or their

position within the company. It is still assumed that this number is proportional to the total workforce of the company.

Secondly, the company's intentions to actively influence the evolution of these proximity dimensions within the scope of the earlier identified ProxIS-Telescope are investigated. It is assumed that the success of the chosen coordination mechanisms depends on the number of actors involved. A mechanism which is perfectly appropriate at one point in time could be inefficient under different conditions.

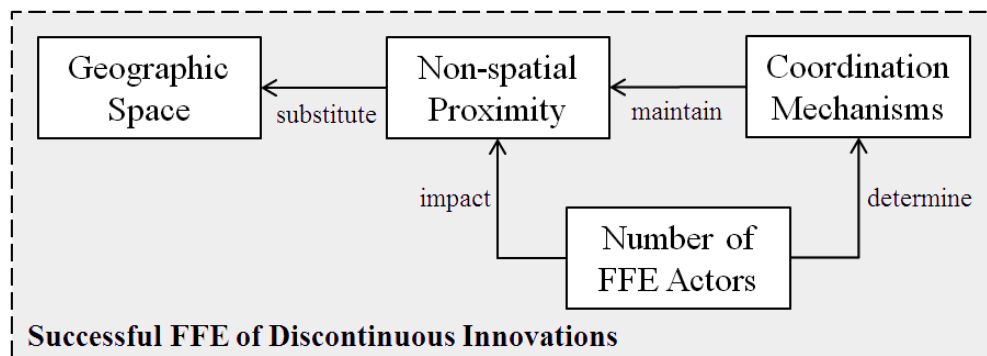

Figure 37 – Research Framework for this Chapter.

This chapter applies the 'model of growth' which has been developed by Greiner (1998) to better understand the challenges and managerial solutions in combination with organizational growth. Furthermore, this chapter seeks to provide a better understanding with regards to the impact of growth on the non-spatial proximity dimensions. Regarding, more specifically, the knowledge processes involved, scholars argue that organizational growth may impact on social proximity between individuals. Scholars in the field of economic geography such as Balland *et al.* (2015) refer in this case to the research of Dunbar (1992), who argues that the capacity to maintain social cohesion between people is biologically limited. In the following, these two approaches, Greiner's model of growth and the research of Dunbar, are investigated in more detail.

### 5.1.1 THEORETICAL SPECIFICATIONS

Based on the challenges of organizational growth elaborated by Penrose (1972) mentioned previously, Greiner (1998) synthesized these insights in his model of growth (figure 38). He describes five phases of organizational growth classified by an interplay between evolution and revolution within growing companies.

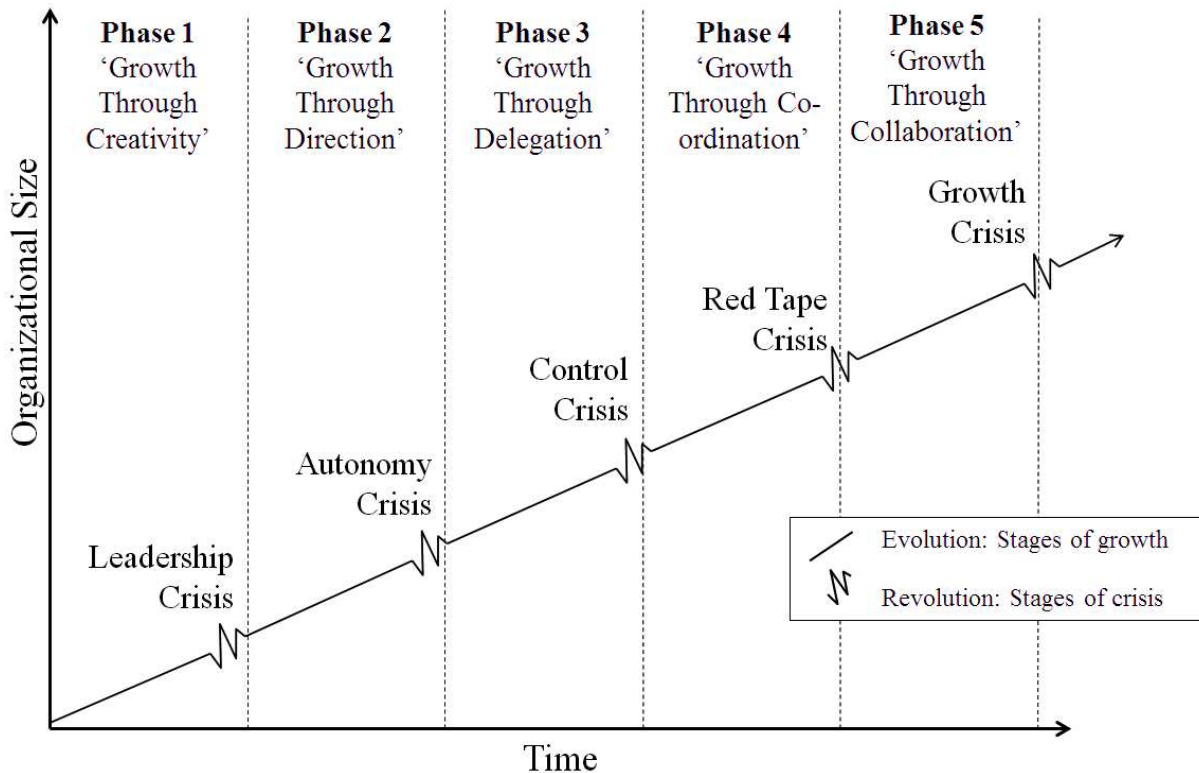

Figure 38 – Greiner's model of Growth (Greiner, 1998, p. 58).

Each stage of evolution is followed by a revolution. A revolution describes a stage of crisis triggered by organizational growth. As Greiner (1998) elucidates, specific management methods are perfectly adapted in one phase but lose their efficiency over time when the company continues to grow.

In light of the non-spatial proximity dimensions, the 'social brain hypothesis' provides in this case further explanations with regards to social proximity. Dunbar (1992) revealed that the optimal group size where an individual is able to maintain social relationships is predetermined by biological factors and should be less than approximately 150 people. This is widely referred to as 'Dunbar's number' (Dunbar, 2012). This number has been criticized as it takes into account exclusively biological factors without considering the complexity of other social variables or the evolution of today's society (Wellman, 2012). Indeed, the human brain

is able to actively remember up to 1500 people, but Dunbar (2012) argues later that the number of actual friends is still 150 (indicating the difference between friends and acquaintances). In addition, Gladwell (2003) strengthened Dunbar's number with his case study of Gore & Associates. Without being aware of Dunbar's research, the company decided to construct a new building as soon as the number of employees exceeded 150 members. They based this strategy on experimental insights collected over the years and found that 150 is the critical number for a section of the company being operational.

For the FFE, this implies that individuals are able to maintain their proper social network only up to a certain threshold. Above that (biologically determined) limit, the research of Dunbar seems to suggest that management should intervene in order to maintain social relationships. From a similar perspective, Dunbar's number remains a widely used approach in several academic fields such as business management in order to determine, for example, the optimal size of virtual social networks (Gonçalves *et al.*, 2011). For this reason, the social brain hypothesis is applied in this dissertation.

## 5.1.2 METHODOLOGICAL SPECIFICATIONS

This chapter opted for a longitudinal process design examining the internal FFE at the company between 1998 and 2015. Process research takes into account the antecedents and consequences of organizational change (Van de Ven and Huber, 1990). The aim of this process approach is to highlight how and why the non-spatial proximity dimensions evolved regarding the German-French collaborations at BÜRKERT and how management dealt with this evolution.

### 5.1.2.1 The Context: Organizational Growth

Process research should not be independent of its context (Grenier and Josserand, 2007). At BÜRKERT, this context has been prescribed by the corporate strategy, which was introduced in 2013 and relied on organizational growth. The workforce of the company increased significantly during the selected time span of the process research. Figure 39 illustrates this evolution of the BÜRKERT group and of the French subsidiary. Due to administrative reasons, it was only possible to collect data about the evolution of the workforce of the French entity starting from 2005.



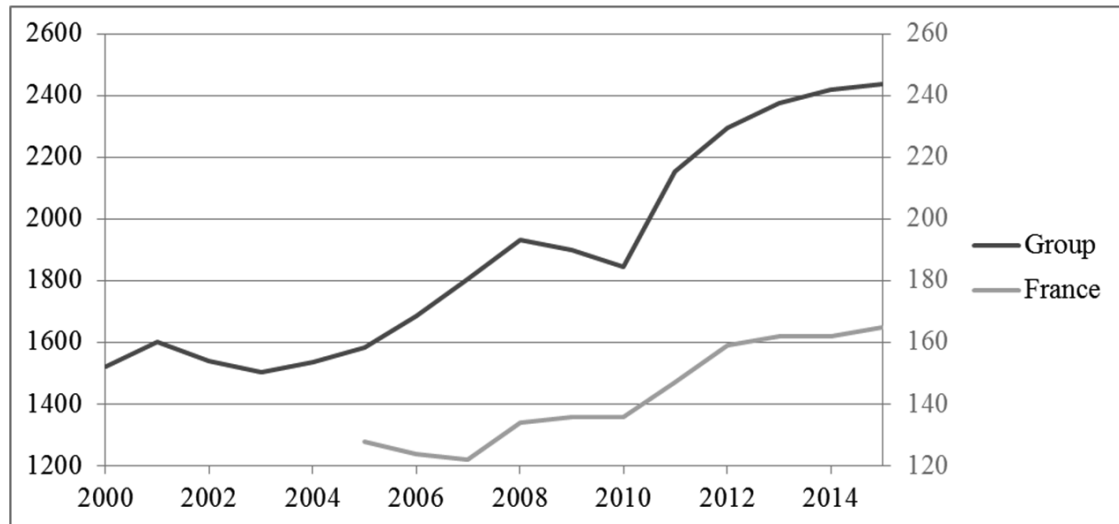

Figure 39 – Evolution of the Workforce of BÜRKERT (Left Hand Scale) and of its French Subsidiary (Right Hand Scale).

In only five years (2010-2015), the group, as well as the French entity, grew by approximately 20%. These tendencies are not entirely linear but still indicate continual growth of the company. The data collected was used to explain the evolution of the process by answering several questions: which non-spatial proximity dimension evolved in each period and why? What were the coordination mechanisms used per period to enhance knowledge-sharing beyond national borders and thus across space? How did the number of FFE actors impact on the success of these mechanisms?

### 5.1.2.2 The Milestones of the Process Research

For process research, it is recommended that the data collected go as far back in time as possible (Grenier and Josserand, 2007). At BÜRKERT, the first step towards an international collaboration at the FFE of discontinuous innovations was identified in 2001. It was still deemed appropriate to go just one step further back to the year 1998 in order to compare the initial situation with the internationalization process of the innovation strategy. In 1998, many of the available interview partners were employed in France to initiate this internationalization strategy. 2015 marks the end point of the process research as process data was collected up until this year. Table 34 illustrates the phases of the process research, the key events defining the start and end of each phase, and a short description of each phase.

In process research, phases are not always of equal length and some events are more significant than others. This is a current methodological difficulty for process research, and in

accordance with Langley (1999), ‘temporal bracketing’ structures the whole process of the current research in successive adjacent periods. Each period provides a certain level of continuity, but their frontiers describe discontinuous events leading to a change in the process. Each period is analyzed independently by clarifying the underlying actions that lead to changes. This strategy is a useful method when the objective of the research is:

*“[T]o enable the identification of specific theoretical mechanisms recurring over time”* (Langley *et al.*, 2013, p. 7).

Consequently, the years 2005-2013 are combined into one phase called ‘Towards collaboration’, as the events in 2005 and 2013 caused significant changes in the process, whereas the events in 2011 and 2012 are complementary events with a less discontinuous character. For the analysis of each period, this research is completed by the ‘narrative strategy’ (Langley, 1999). In **chapter 5.1.3**, all relevant events are provided in narrative form to understand the underlying dynamics within the process. In **chapter 5.1.4**, it is investigated as to why components changed over time (Langley, 1999). In line with Grenier and Josserand (2007), these evolutions are observed from a multilayer perspective (organizational and individual/team) for each period to provide coherent explanations for the changes.

	1998 - 2001	2001 - 2005	2005 – 2013: ‘Towards collaboration’			2013 - 2015	2015
			2005 – 2011	2011 – 2012	2012 - 2013		
<b>Title</b>	‘Centre of competences for sensor technology’	‘Fall of the wall’	‘A breath of fresh air’	‘Technology excellence’	‘Let’s meet half way’	‘Perspectives 2023’	‘Knowing communities’
<b>Phase</b>	Recognition of French competencies.	Restructuring of the internal innovation processes.	Diversification of technological knowledge, facilitation of the French-German collaborations, and construction of a functional informal network across national frontiers.			Integration of a new corporate strategy.	The knowledge assets of the firm are managed by a knowing community.
<b>Key event</b>	<b>1998</b> Recognition of sensor excellence.	<b>2001</b> Integration of the French entity into the corporate innovation strategy.	<b>2005</b> A new R&D responsible person is engaged.	<b>2011</b> A clean room was built in France.	<b>2012</b> A new R&D center is inaugurated halfway between France and Germany.	<b>2013</b> The new corporate strategy ‘Perspectives 2023’ is launched.	<b>2015</b> Technology circle and focus groups are created.
<b>Description</b>	The company recognized the technological competence of the French subsidiary by acknowledging it as knowledge leader for sensor technology.	The group opened its internal innovation processes for incremental innovations towards its French subsidiary. Discontinuous innovations were still managed at the German headquarters.	Together with the new R&D responsible person, a new technology area began. The French subsidiary was integrated into the conception of a technological roadmap leading to discontinuous innovations.	With the construction of a clean room at the French subsidiary, the company reinforced its knowledge about sensor technology.	The new R&D center at Karlsruhe is situated halfway between the French competence center and the German headquarters. It facilitates physical meetings.	The new corporate structure impacts on all internal processes leading to several organizational changes. Tacit knowledge was externalized in the organizational processes.	The group initiated systematic management of its knowledge assets. The hybrid community is now in charge of the monitoring of the key technology fields and of active idea management at the FFE.

Table 34 – Overview of the Internationalization Process during the FFE at BÜRKERT.

### 5.1.3 RESULTS

The number of actors involved at the FFE refers to the number of collaborators in the R&D department. The R&D department is dispersed over the French and German entities. Employees of this department are congruent with the members of the international FFE team during the process research considering that from a historical perspective, this department was in charge of the gathering of new ideas at the company. In the following sections, each period of this process research is considered separately in narrative form.

#### 5.1.3.1 Centre of Competences for Sensor Technology (1998-2001)

Initially, the label ‘center of competences’ enhanced the position of the French entity by accrediting the technology leadership within the group in the field of sensor technology. Besides this change, the innovation processes remained separate between France and Germany. No international knowledge sharing and transfer was observed during that period. In France, the whole R&D department consisted of approximately 20 employees, but there was no specific focus on discontinuous innovations or pure exploration activities. As a result, the FFE of discontinuous innovations of the group had a strong local character and was located at the German headquarters. Information and knowledge flows were limited between French and German entities:

*“When I arrived in 2001, I was astonished. They told me that we are an international group but after two months I was wondering ‘where are they’? I work for a German company and I haven’t seen any Germans. Our German colleagues are in Germany and there were no relations with them. Only our CEOs went to Germany.” (B1FD)*

#### 5.1.3.2 Fall of the Wall (2001-2005)

This situation changed in 2001 with the opening up of the innovation processes:

*“We realized that there are competences on both sides. It was the top-management desire to work together. [...] Before, we didn’t work together, but ‘not working together’ is not consistent with the Bürkert culture. [...] When the wall fell, we started to think about how to work together, and we decided to meet regularly.” (B1FC)*

From then on, the top-management expected the French and German R&D centers to collaborate and to integrate the competencies of both locations. The first step was to exchange all relevant information and create an initial common knowledge base. With this objective in mind, the French R&D responsible person started, for instance, to travel regularly between the two entities and made first contact with his German colleagues. To simultaneously accentuate the corporate interest in French activities, they were coordinated by a German member of the top-management team located at the headquarters. Moreover, the corporate culture was expanded to all departments of the French entity. Together with the integration into corporate innovation processes, these measures increased the control of the headquarters over foreign activities and demonstrated at the same time the willingness of the headquarters to create a close relationship. Regarding innovation processes, the French-German collaboration still concentrated on continuous innovations.

### 5.1.3.3 Towards Collaboration (2005-2013)

In 2005, the new R&D responsible person of the case study company pursued a radical approach for innovation. Notably, he concentrated a considerable part of his resources on the strategic development of discontinuous new products. New ideas were rapidly presented to the top-management for a Go/No-Go decision. The resulting development of new products pushed by the R&D department led to a broad product portfolio (i.e. without coordination of incoming ideas as each idea is evaluated separately).

*“He had a rather technology-push approach. At that time, the marketing department was less developed than today. His objective was to find the ideas where they are located. And this was mainly the R&D department. This is also historical at Bürkert.”*  
(B1P1A)

From this point in time, the French entity was entirely integrated into the process of discontinuous product innovations. The responsible person of the French R&D department was involved in the development of a common innovation matrix, which combined new customer applications with current technology trends. Based on this matrix, the first truly international collaboration project (i.e. project C) was initiated. All activities of the early innovation phase were now taken charge of by a binational team:

*“We worked together on platforms in multicultural teams over distance. This was entirely new for us. We had never done that before.”* (B1P1A)

This project was the first initiative to bring development teams closer together:

*“Together with our French colleagues we had regular project meetings every two weeks. [...] The collaboration with France has intensified and the more we worked together, the better it got.”* (B2P1B)

In the years that followed, further international projects between French and German employees were initiated. Considering this increasing collaboration on common projects, FFE actors intuitively created their own individual and informal networks across the French and German entities:

*“It was based on word of mouth that new knowledge was communicated somewhere. In most cases, you heard about that from other people. When you have new information, you go to those colleagues for whom this could be interesting.”* (B2P1B)

In addition to these informal networks, the focus groups were initiated: *“It was rather organized around people sharing the same job.”* (B1FC) As discussed in PART IV , despite the internal appreciation, most of them stopped their activities after several meetings.

In 2011, the R&D center in Karlsruhe (Germany) was created to enable the acquisition of external knowledge due to its geographic proximity to local universities. This center was situated halfway between the two entities in France and Germany. Henceforth, this increased physical contacts between collaborators of both countries.

Finally, with the construction of the clean room in 2011, the French competence center was able to reconfirm its position as the leading entity for sensor technology of the group. This clean room was unique for the group and attracted precious competences in miniaturization. The investments equally underlined the commitment of the group towards technology excellence in France:

*“Now, France is a location which is the most advanced from a technological point of view. This has to be mentioned. And this is also an extreme motivation for the people there and that’s great. I could not have imagined such an important dynamic, this is really impressive.”* (B2FG)

### 5.1.3.4 Perspectives 2023 (2013-2015)

The new corporate strategy Perspectives 2023 was clearly oriented towards growth.

*“The Bürkert philosophy is a philosophy about growth to stay independent. Why? To be able to finance innovation in order to be different from others. But innovation needs money. If you don't have money, you have to go to banks and you are dependent. If your activity decreases, you could even go bankrupt.”* (B1FC)

In this strategy, greater structure of the internal processes was required in order to avoid double investments and to encourage a systematic approach to the product portfolio. For this reason, the company created the Project Management Office (PMO) to coordinate project activities and to manage internal resources. This included the systematic utilization of a common project management methodology, a common Information Technology (IT) system, common project templates, and Return-on-Investment (ROI) calculations.

This transparency had profound implications for the FFE as research activities required from now on official validation on a corporate level in coordination with the overall product portfolio. The idea champion was asked to insert his idea as soon as possible into the standardized innovation processes before following it up. These processes were systematically written down in the organization's process map, which is nothing more than the externalization of tacit best practices of the internal processes. However, data from interviews as well as from participant observations indicated that this systematic coordination of the product portfolio impeded discontinuous ideas from passing the Go/No-Go decision. As they were coupled with higher uncertainty and risk than continuous product ideas, they were considered to be less profitable from a short/medium-term perspective. In addition, it was observed that only explicit knowledge continued to circulate between the entities and this situation impacted equally on international collaboration:

*“When we had difficulties with colleagues at the headquarters, we directly went there. Then, we started to formalize everything. As a result, we were less involved and it got less personal.”* (POb)

In line with the observed de-personalization noted above, interviewees described a perception of less intense social relationships with colleagues even if they worked in the same department. They expressed the view that informal interactions were less frequent and it became more difficult to identify the right contact persons at the FFE.

### 5.1.3.5 Knowing Communities (2015)

Given this situation, the company decided to design idea processes based on the hybrid community as described in chapter 4.2. The focus groups were re-animated and moderated by the technology portfolio manager, who had the direct support of the top-management.

*“Our objective was to fill in a Roadmap. It is not only exchange: the objective is to foster technology push, networking, and monitoring.” (B1FC)*

Independently of the geographic location, every employee at the French and German entities was now able to contact one of the experts close to him in order to insert a new idea. The idea was discussed within the corresponding focus group between the expert and the idea champion. At this level, the experts, together with the mentor of the focus group, decided about the strategic fit of the idea. In the case of an opportunity being detected, the idea was communicated to the technology circle. This ensured that the necessary space for the idea incubation was assured until the moment when more resources were needed to increase the concept. Only at that moment was the idea inserted into the standard development process.

At the same time, the company had the intention to develop its corporate culture in cooperation with its international subsidiaries. The human resource department conducted an international survey to identify key internationally shared elements of the corporate culture. Once a consensus about these values was created, they were communicated *via* several channels to the entire organization (official events, workshops, direct communication, etc.). This was the first time that international subsidiaries had been integrated into such a process. The top-management considered it to be indispensable to assure the balance between local cultures of the subsidiaries and the global corporate vision.

The structure of the technology circle and its focus groups created a social network between experts of each country and favored informal discussions. The organizational culture created a common international framework. A precondition for participation in the community was that the expert had to master the English language. Thus, the members of these circles were able to transfer ideas over national boundaries and to reduce the psychological barriers for employees located in the French competence center to communicate their ideas:

*“One of the strengths of organizations is to work with such communities. Sending letters does not work anymore. Networks are standard; not only in the virtual domain, but also for interpersonal relationships to evolve and to get faster.” (B2P3D\_2)*



## 5.1.4 ANALYSIS

### 5.1.4.1 Evolution of Proximity Dimensions

Based on the previous narratives, the evolution of each non-spatial proximity dimension is presented in table 35. Initially, no knowledge sharing was observed between French and German employees as both entities were independent. For this reason, phase 1 exhibits the initial intensity of proximity in the French-German collaboration.

<b>Phase</b> <b>Dimension</b>	<b>1</b> (1998-2001)	<b>2</b> (2001-2005)	<b>3</b> (2005-2013)	<b>4</b> (2013-2015)	<b>5</b> (2015)
Cognitive	Initial	↗	↗	-	-
Social	Initial	-	↗	↘	↗
Organizational	Initial	↗	↗	↗	-
<b>Examples of coordination</b>		<ul style="list-style-type: none"> <li>• Direct control</li> <li>• Corporate culture</li> </ul>	<ul style="list-style-type: none"> <li>• Common projects</li> <li>• Expert Circles</li> <li>• Localization decision</li> </ul>	Formal processes and standards	Technology Circle

Table 35 – Evolution of Non-Spatial Proximity Dimensions per Period.

In accordance with Balland *et al.* (2015), the increasing control over French activities leading to their progressive integration into the corporate structure strengthened the organizational proximity between the headquarters and the French entity in phase 2 (2001-2005). The loosely connected French subsidiary was now directly managed by the German headquarters. Simultaneously, by introducing a common set of norms and habits, the establishment of the corporate culture in France increased the cognitive proximity with the headquarters (compare to Boschma, 2005). No specific evolutions of social proximity have been observed in that phase.

Repeated collaborations between French and German employees during phase 3 (2005-2013) based on common projects created a common understanding about corporate objectives. In accordance with Balland *et al.* (2015), such a common vision generates trust on the corporate level and increased social proximity. That being the case, the first focus groups were then initiated. Even if they did not persist over time, they still illustrated the willingness of participants to actively share knowledge beyond national borders. Despite cultural

differences, these initiatives for mutual learning strengthened the cognitive proximity between German and French R&D employees (compare to Balland *et al.*, 2015). The localization decision halfway between the two subsidiaries in Karlsruhe enhanced social proximity between actors as they were now able to meet regularly.

At least since phase 4 (2013-2015), the French subsidiary has been considered an equal member of the corporate innovation structure. Be that as it may, it was observed that social relationships between employees decreased during that time. Moreover, the increasing organizational proximity, although it is “*believed to be beneficial for innovation and learning*” (Boschma, 2005, p. 65), had a negative impact on the innovation capacity because the company lost its flexibility and experienced a corresponding increase in control. The interviews and observations do not point to specific evolutions of cognitive proximity during that period.

As soon as the company became aware of the critical situation with regards to its innovation capacity, its intention was to re-establish social proximity between FFE actors during phase 5 (2015). The top-management decided to introduce the technology circle together with its focus groups, the hybrid form of knowing communities, to share knowledge on an informal basis:

*“It was the intention of the top-management that we designed the technology circle as a community because it fits very well with our low hierarchy.”* (B2FE)

While other mechanisms like the corporate culture, common projects, or regular meetings guided the individual behavior of FFE actors, these communities created space for informal networking and creativity (i.e. cognitive space as described by Cohendet *et al.* (2014)). The communities were embedded in the organizational structure but still depended to a great extent on the individual motivation of each actor. Henceforth, this new space re-established social proximity between FFE actors even though extensive requirements for structure and formalization were still considered to be necessary for the overall functioning of the company.

The physical distance between actors remained constant during the whole process research and the company aimed to compensate this geographic space between FFE actors by non-spatial proximity dimensions. It was observed that these dimensions were boosted by several coordination mechanisms; more or less successfully. Thereby, special attention should be paid

to the decreasing social proximity in phase 4. This represents an anomaly in the otherwise unidirectional evolution of these dimensions.

Initially, only the German R&D department at the headquarters was in charge to develop new products and the FFE of discontinuous innovations had a strong local character. This changed during phase 2 and 3 when the French R&D department was integrated into the corporate innovation structure. The FFE actors involved still remained limited to the R&D department, but in the following years, it grew continually. The evolution of this department had an impact on its internal function by rendering personal contacts difficult:

*“When there are more than 150 persons, you lose the overview. You can maintain a basis, but you won’t be able to know everyone anymore.”* (B1FC)

This quotation correlates with the evolution at BÜRKERT because this threshold was indeed exceeded in the R&D department in the time between 2012 and 2013 (see figure 40).

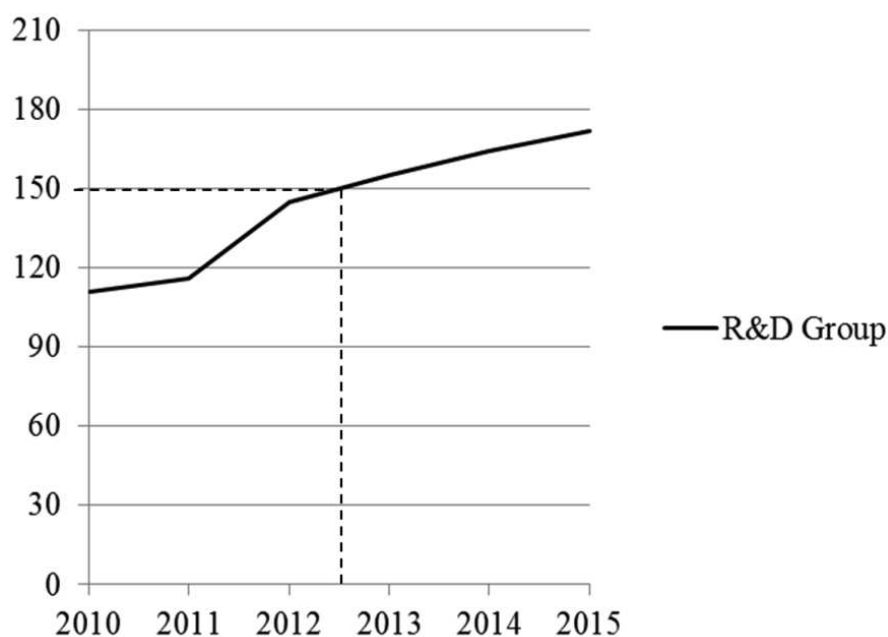

Figure 40 – The R&D Department at BÜRKERT exceeded the threshold of 150 actors between 2012 and 2013.

Several interviewees mentioned that this situation made it difficult to identify the right experts and to maintain a shared knowledge base. In addition, they explained that a social gap resulted in the increasing workforce which made it difficult for R&D members to maintain an overview about all competences shared by their colleagues:

*“When I go to the canteen, I realize that there are a lot of people I do not know anymore. This becomes also current in the R&D department.[...] There are many new*

*faces which are suddenly just there and you do not know what this person is doing. This has changed now because we got bigger.” (B2P3D\_2)*

#### 5.1.4.2 Central Observations About Proximity and Growth

The interviews underline that the increasing number of FFE actors involved impacted especially on two distinct proximity dimensions of the French-German collaboration: social and organizational proximity. Several interviewees confirmed that during the transition of phase 3 to phase 4 the observed internal control was considered as mandatory because of the growing workforce.

*“The current control through our process structure, the management of priorities, our project management structure, is higher than in the past. We accorded too much liberty in the past and we lost the focus. As we are growing now, we need more structures.” (B1FC)*

This perception is in line with Greiner’s (1998) model of growth and his crisis of control: with a growing workforce, a rather loosely coupled system requires more formal structures to coordinate scarce resources efficiently. At BÜRKERT, this situation impeded the international innovation processes because people had difficulties in identifying internal experts. It got increasingly difficult for French employees to promote their ideas on an organizational level and spontaneous informal interactions were less frequent at the company case, on an international and even on a national level:

*“It is frustrating when you get the impression that an idea is not valued. Motivation and rewards are important!” (POb)*

Similarly, as described by Greiner (1998), phase 4 resulted in a red tape crisis between 2014 and 2015. The organizational growth and thus the growth of the R&D department required more control, but the resulting overwhelming bureaucratic procedures now exceeded the gains from organizational proximity. Greiner proposes that in this case, formal structures should be replaced by a flexible social approach to favor spontaneous interactions. This was the moment when BÜRKERT decided to monitor the informal social network actively in phase 5 by creating the technology circles and its focus groups.

This evolution of social and organizational proximity leads to a second observation concerning the chosen coordination mechanisms. Before 2012, the company managed its

international FFE activities through informal mechanisms creating regular occasions to collaborate (common projects, regular meetings). This did not require specific efforts or financial and human investments besides the actual project work. Nevertheless, the first focus groups were created in 2005 with the objective of systematically coordinating international knowledge. But considering that their activity stopped again, they failed as a coordination mechanism in that specific context.

As an extension to insights from chapter 4.2, the insights of this process analysis provide an additional explanation as to why communities were not efficient in 2005. In contrast to simple networks, knowing communities such as the observed focus groups have a social dimension where people actively interact and share experience (Wenger, 1998). Before 2012, this social aspect of the community was redundant as common projects, regular meetings, or a strong organizational framework, were entirely sufficient to coordinate knowledge across space. The number of FFE actors involved was small enough to maintain social contacts and to foster informal interactions. The added value of knowing communities, their social dimension, was not required. However, Balland *et al.* (2015) explained that such social relationships do not happen automatically any more when teams start to grow. Hence, the increasing workforce at the company case required, in 2015, a coordination mechanism to actively maintain social proximity. Taken together, the driven knowing community now had a real reason to exist as its role was to enhance the social cohesion between FFE actors.

This leads to the observation that barriers to international knowledge sharing were not caused by geographic space, but by the growth strategy of the company. The longitudinal observations illustrate that the French and German entities were perfectly able to establish a social relationship between 2001 and 2012 despite spatial limitations. The company struggled to maintain these relationships only from 2013. The increasing number of FFE actors caused a high organizational proximity resulting in a decreasing social proximity; evolutions which negatively influenced the overall output of the FFE of discontinuous innovations. In fact, the shift to a driven knowing community as a formal coordination mechanism embedded at the organizational level was necessary to respond to this crisis and achieve phase 5 of Greiner's (1998) model of growth, which is about collaboration.

### 5.1.5 DISCUSSION

Based on the results from the case study, several observations should be discussed. With regards to the observed evolution of the proximity dimensions during the process research, two propositions can be drawn about the correlation between organizational growth and proximity, with a special focus on social and organizational proximity (see figure 41).

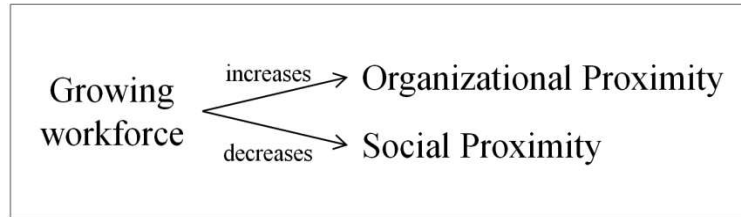

Figure 41 – Correlation between Organizational Growth and Proximity Dimensions.

Firstly, in industrial companies, a growing number of FFE actors affects organizational proximity positively by the requirement for more control. This control is henceforth necessary to assure an efficient coordination of resources. Secondly, this growth causes a decrease in social proximity. Organizational and social proximity seem therefore to follow an opposite pathway to organizational growth.

Furthermore, Balland *et al.* (2015) argued that the five proximity dimensions are not evenly dynamic because they are linked to higher or lower costs. Similarly, the results at BÜRKERT suggest that the costs to maintain social proximity are a critical factor in choosing between informal and formal coordination mechanisms. At BÜRKERT, investments for a driven knowing community incorporated on the organizational level would have been disproportionate in the small FFE team as regular meetings or common projects provided satisfactory results for social cohesion. A growing workforce reduces this trade-off between costs and expected benefits at the FFE as soon as informal mechanisms become insufficient. The observations at BÜRKERT suggest that the critical size for this shift from informal to more formal mechanisms correlates with Dunbar's number. Above this threshold, driven knowing communities replace the missing social network by a platform fostering social interactions. Table 36 summarizes the correlation between the number of actors, the type of coordination, and the interrelation with the proximity dimensions (social and organizational).

Category	< approx. 150 International FFE Actors	> approx. 150 International FFE Actors
<b>Control Requirements</b> (organizational proximity)	Low	High
<b>Social Relationships</b> (social proximity)	Individual capacity	Systematic guidance by management
<b>Costs for Coordination</b>	Low	High
<b>Type of Coordination</b>	Based on individual initiatives	Embedded on an organizational level
<b>Management Style</b>	Informal	Formal
<b>Examples</b>	<ul style="list-style-type: none"> <li>• Common projects</li> <li>• Regular (physical) meetings</li> </ul>	<ul style="list-style-type: none"> <li>• Driven knowing community</li> </ul>

Table 36 – Managerial Practices for an International FFE in Growing Teams.

These findings contradict current research about knowing communities claiming an evolutionary life cycle in five phases through which such communities emerge within organizations (Gongla and Rizzuto, 2001). The results of the case study rather suggest that the knowing community in phase 5 did not evolve from previous stages but was deliberately created by the organization's top-management. This was created because of its capacity to create social cohesion and therefore to coordinate international knowledge transfer. From this perspective, knowing communities can be considered as one coordination mechanism among others in international organizations intended to manage the FFE of discontinuous innovations. Their application and efficiency depends on the number of FFE actors involved.

Finally, this process research points to the challenges that are associated with an innovation structure where one non-spatial dimension of proximity is significantly more developed than others. Due to the increasing workforce, organizational proximity overwhelmed the innovation structure at BÜRKERT, leading to decreasing creative performance. For the purpose of counterbalancing this situation, a functional social network is crucial for the FFE. The interplay between organizational and social proximity illustrates that these dimensions should be kept in balance to assure fluent knowledge sharing in international innovation networks.

## 5.1.6 CONCLUDING REMARKS

This chapter has explored the interdependence between non-spatial proximity dimensions and organizational growth at the FFE of discontinuous innovations at BÜRKERT. It underlined the assumption from previous chapters that challenges of international knowledge sharing are not exclusively caused by physical distance but also by the growth strategy of a company.

The results unveiled that organizational proximity is positively influenced by a growing workforce whereas social proximity is negatively related to an increasing number of actors (see figure 41). Hence, based on a process analysis, this chapter identified that as long as FFE activities can be structured around few participants, informal coordination mechanisms might be sufficient to substitute geographic space. As soon as more actors are involved, such mechanisms should be embedded on a corporate level. Driven knowing communities are once again underlined as appropriate coordination mechanisms for bigger structures due to their social dimension. In fact, knowing communities are not only a useful coordination mechanism for international knowledge transfer/sharing (Cohendet *et al.*, 2014); they also help to counterbalance an increasing bureaucracy by enhancing social proximity. They provide a platform from which social interactions are maintained despite organizational growth or geographic space. Overall, they help managers of growing structures to keep the non-spatial proximity dimensions in balance.

### Contributions

At the case company, the observed barriers for international knowledge sharing were not exclusively caused by geographic space, but by the growth strategy of the company.

#### Sub-question 5 – Impact of growth on proximity dimensions

In this chapter, it has been demonstrated that a growing workforce is:

- Positively linked to organizational proximity;
- Negatively linked to social proximity.

#### Sub-question 6 – Efficiency of coordination mechanisms in international FFE teams

- As long as individuals are able to maintain sufficient social relationships, an informal management style based on individual initiatives such as regular (physical) meetings is sufficient for a fluent international knowledge sharing at the FFE.
- In a growing team, management should shift towards coordination mechanisms embedded at the organizational level such as driven knowing communities to provide systematic guidance for social interactions.



BÜRKERT represented a medium-market structure during the whole period of the process research, even if it was significantly growing during that time. In the following chapters, the objective will be to strengthen the reflections about the link between organizational growth and the management of an international FFE. For this reason, 3D PLUS, the small company, and ELECTRO, the large group, are integrated into the present study. The following chapter describes the two replication cases before comparing them to BÜRKERT.

## 5.2 THE FFE AT THE REPLICATION CASES

*“Any use of multiple-case designs should follow a replication, not a sampling logic, and an investigator must choose each case carefully. The cases should serve in a manner similar to multiple experiments, with similar results (a literal replication) or contrasting results (a theoretical replication) predicted explicitly at the outset of the investigation.”*  
(Yin, 2003, p. 53)

Multiple cases are considered instrumental in increasing the internal and external validity of case study designs, even though their complexity in terms of time and resources should not be underestimated. Therefore, the choice of a multiple-case design should be made carefully in order to ensure the efficiency of the research process. With regards to the fact that the chosen case-study design is based on an explorative research approach, a modification of the initial case design should always be possible in order to adapt to current results (Yin, 2003).

The longitudinal approach to the innovation processes at BÜRKERT in chapter 5.1 illustrated that the elements of the initial ProxIS-Telescope depend on the number of individuals involved during the FFE. This assumption requires further investigation in order to crystallize its effects on the model. Therefore, the previous chapter argued for the integration of a small as well as of a large company. To meet this requirement, the two replication fields 3D PLUS and ELECTRO were added to the pilot case.

A theoretical replication is assumed. It is proposed that due to the varying size in each company, the initial ProxIS-Telescope and its underlying coordination mechanisms will vary. The observed changes at BÜRKERT illustrate that the elements of the telescope increased in formalization over time due to the growth structure of the company. Therefore, it is supposed that at 3D PLUS – due to its small structure – coordination mechanisms rely on informal structures whereas at ELECTRO, these are systematically structured. Considering Greiner’s model of growth, this would not be surprising. Greiner (1998) already argued that management tools should adapt to the organizational setting. The aim of this chapter is thus to analyze how exactly the three non-spatial proximity dimensions substitute geographic space in the two replication cases 3D PLUS and ELECTRO during their FFE of discontinuous innovations. The following sub-questions will be addressed:

**Sub-question 7 – Description of Space**

What is the notion of space in the replication cases?

**Sub-question 8 – Coordination Mechanisms at Replication Cases**

How do the replication cases replace a missing geographic proximity during the FFE?

Before comparing the three structures during the FFE, more details about each replication case and their innovation processes are necessary. First of all, the FFE of discontinuous innovations will be presented for 3D PLUS. In a second step, more details will be provided about ELECTRO. The articulation of the proximity dimensions will be highlighted for each of the two cases.

## 5.2.1 3D PLUS: ABOUT INNOVATION IN SPACE AND SPACE IN INNOVATION

Innovation is considered to be a fundamental value at 3D PLUS. One new product launch per month: this is the ambitious goal of the company's founders. The CEO, who is one of the two founders, is in charge of taking all strategic decisions, including those decisions which affect the innovation strategy of the company. Regarding the product portfolio of the company, the CEO relies on the work of three product managers. Two of the three product managers are responsible for the space sector whereas the third person is in charge of developing industrial applications. This last sector represents what is still a recent area for the company as it has been active only since 2011.

### 5.2.1.1 Challenges and the Crucial Role of Product Managers

Most solutions generated by the company are intended for the space sector. Here, product life cycles of the clients' applications are long and the shift towards new technologies is only possible with an intense test phase beforehand. Customers are conservative and do not change rapidly to new products:

*“We are in the spatial industry which is very conservative. That's a matter of fact and we believe it. The spatial industry develops extraordinary things, but the overall approach remains conservative. They do not apply the latest software version in a satellite because if it is sent out into space once, it's definitely gone. If there is a bug, it's over.” (M1F1)*

In addition to this external situation, the resulting risks of a new product development extend the duration of the FFE before the final internal Go/No-Go decision. Considering the small structure of the company, resources are highly restricted and unsuccessful developments can hardly be compensated by the company's turnover:

*“The difficulty at our company is that we are still an SME and we have the tremendous need to reassure ourselves about the reality in the market before we enter into development. This is comprehensible for SMEs because we do not have the means to support development for several years. This is a risk which is not easily taken by the company.” (M1F1)*

In combination with high requirements regarding product quality, this impacts the speed of the FFE of discontinuous innovations. The company takes nearly twice as long for discontinuous innovations (six compared to three months) to develop a consistent concept as for continuous product ideas. This additional time is used to collect further information to answer questions about the proof of concept including a feasibility study, investigations about the industrialization compatibility, technical aspects (development specifications), but also market aspects like, for instance, the estimated market share (if possible). Only as soon as sufficient information is available, the Go/No-Go decision is taken together by the top-management including the CEOs, the production manager, and the R&D manager.

The three product managers are responsible for making sure that all relevant information is available to enable the top-management to take this final decision. Considering, however, the small size of the company, the product managers have a large role profile which accords them a key position within innovation processes:

*“We have several roles. We are an SME which is growing rapidly but we do not have one person for every job. As a result, we are in charge of each step which comes before development.” (M1F2)*

They are in charge of the whole life cycles of their products, from the idea generation to development, to commercialization, and also the product phase-out at the end. In short, they are:

- In charge to stimulate creativity by challenging internal employees:  
*“I regularly interact with our design center to ask them if they cannot increase the speed or the quality of a function or if they can develop a function which has never been developed before. And they will think about it.” (M1F1)*
- Central contact persons: they are in touch with all services throughout the entire product life cycle of their product range. Hence, they directly interact on a regular basis with almost all employees of the company.
- Multidisciplinary professionals: the product managers are in charge of the whole product life cycle, including idea incubation, concept and product development, but also internal and external communication and marketing.
- In charge of the proof of concept: they prepare a new idea for decision making and evaluate new ideas by collecting more information.
- In charge of the product roadmap: they define the product portfolio for the company by combining continuous and discontinuous product approaches.
- Managing external relationships by participating in trade fairs, expositions or conferences.
- Coordinating a network of international agents: to interact with international clients, the company relies on international agents. These agents are not direct employees of 3D PLUS but they sell products for the company. Through regular meetings and an annual conference, the product managers remain in close contact with them and collect precious market feedback. This input is systematically used to develop a consistent product strategy to fulfill short, middle, and long term requirements.

The management of the FFE is under their responsibility including the management of continuous as well as discontinuous product innovations. As will be illustrated in the next section, this central position is especially crucial during the FFE of discontinuous innovations.

### 5.2.1.2 Results

3D PLUS adopted an open innovation approach to the FFE which is nurtured through diverse sources. First of all, the product managers rely on the input of the employees at 3D PLUS. The objective of the company is to involve the whole workforce in their innovation processes. If an employee has an idea for a new product, he therefore directly addresses one of the three product managers who closely investigate the idea:

*“This is our role. Everybody can have ideas but you have to know where to look for it. I speak about my own experience; I do not know the literature, but I confirm that this is the reality. Everybody knows that we are the responsible persons for our products. And now, we work together with them and they know that they can talk to us.” (M1F2)*

The role as product manager is rather new for the company (from 2012). Still, the internal collaborators of 3D PLUS got used to directly contacting them and openly sharing their ideas. These discussions take place on an informal basis. Considering that the employees are geographically located at the same place, these discussions happen frequently and knowledge circulates rapidly. The R&D department fulfills an important role here. Initially, they are in charge of pursuing technology advancements to their limits in order to be able to respond to specific customer demands. One of the product managers explains that in many cases, this approach fosters creativity through analogy with the annex industries:

*“For us, related industries are industries with different approaches, means, and volumes but which enable us to analyze via analogy what were the equipment developed and the material used in order to compare how we could adapt these processes/materials internally. [...] This is the responsibility of our R&D department which spends a lot of time at trade fairs of different industries.” (M1F1)*

Currently, this approach has indeed enabled the company to develop a discontinuous product concept which transferred a current approach in the automotive industry to the space sector. Besides highlighting internal sources for new ideas, this statement together with the following quote indicates that the product managers rely also on external knowledge:

*“Our CEO defends the opinion that our activity should not be to do fundamental research. We are here to see what is happening around 3D PLUS. Once we’ve detected something interesting outside, we have to think about ways to adapt it to our own activity.” (M1F1)*

Indeed, the product managers insert external input from international trade fairs or conferences into the company. These inputs might be gathered by themselves or by other colleagues within the company who are open to external input. This concerns also employees at 3D PLUS who are still in touch with former colleagues from previous jobs. These contacts enable them to remain informed about current tendencies in their domain and represent a precious source of external knowledge:

*“Some of our employees still have their contacts from previous jobs. They stayed in touch with former colleagues and they have their networks.” (M1F2)*

Furthermore, a crucial source for discontinuous innovations is the collaboration with key customers. Most of these key customers are not located in Europe, but on other continents due to the export strategy of the company:

*“95% of our modules are exported. We export 35% to Asia, 35% to Europe (including the Middle East and Russia) and 35% to the United States.” (M1F1)*

The interactions with these key customers during the FFE of discontinuous innovations are free from concrete product objectives and concentrate exclusively on concepts and ideas for technological advances:

*“The most important information comes from the clients. They know the projects, they know their future needs. [...] When I go there, I won't propose a new product. I go there with a white paper. We present some functionalities with different approaches, different options for the same product family. And we think about these axes together to engage in a real conversation.” (M1F1)*

The core challenge is to distinguish between particular requirements of a few clients and the detection of overall new trends. Therefore, the product managers underlined the importance of identifying the right contact person at the client's company, considering that the objective is not to sell a product but to create a collaboration to develop new products:

*“It's more about finding the right contact person at the client's company. There are people who want to have a new project as soon as possible and there are people who rather do upstream research. And with the latter, we can discuss what happens in 3 years.” (M1F1)*

Finally, the product managers are in direct contact with external communities of the space sector which were built around international space agencies such as the 'National Aeronautics

and Space Administration (NASA)’ or the ‘European Space Agency (ESA)’. These communities are *per se* a restricted domain: “*The spatial industry is not really big and everybody knows each other.*” (M1F2)

Besides the active participation in external community activities, direct contact exists with former experts of these communities in order to discuss current trends. These experts are in general people who have built up important personal experience over several years and who are therefore able to consult the product managers about tendencies in this sector.

Figure 42 schematically represents the FFE at 3D PLUS and summarizes the previously presented diverse internal and external sources used to nurture the generation of discontinuous innovations.

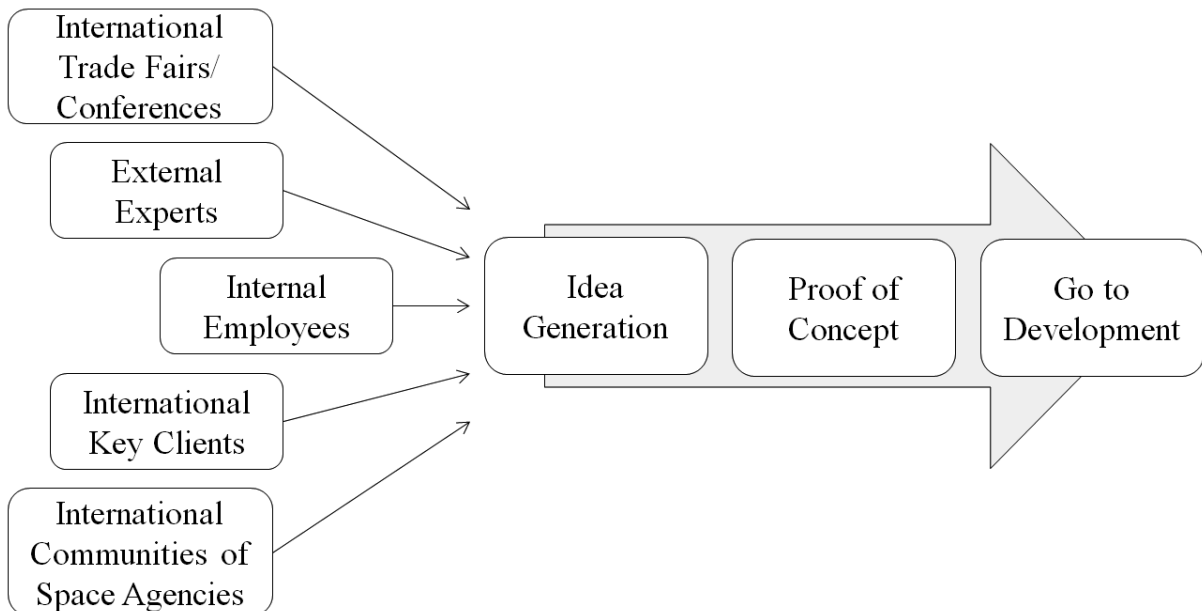

Figure 42 – The FFE of Discontinuous Innovations at 3D PLUS and its Sources of Input.

Classic market studies are not considered as the input for discontinuous innovations at 3D PLUS. Since the company bases its core activity on niche products, interviewees explained that such market studies would not provide sufficient information and would thus not be adapted to elaborate discontinuous product innovations. All the input collected from the previously presented sources is systematically assessed by the product managers. They use it to elaborate their product roadmap and prepare emerging product concepts for the final Go/No-Go decision at the end of the FFE and before development starts.



### 5.2.1.3 Analysis

Almost all employees are located in France at the headquarters. Geographic space does therefore not impact the internal knowledge sharing during the FFE. However, geographic space still exists during this phase as the company relies on external sources to foster its innovation capacity:

- International key customers;
- External communities relying on international space agencies and direct contacts with experts in the domain; and
- Individual participation to international conferences and trade fairs as well as personal contacts of employees with former colleagues.

According to Spithoven et al. (2013) it is not unusual for an SME to apply an open innovation approach due to their lack of internal resources. Hence, to nurture internal innovation processes, also 3D PLUS considers all these external contacts as crucial for the company to remain informed about trends and technological evolutions:

*“For our forecasts, we are obliged to find the information elsewhere. Sometimes, we have an idea and we think it’s good, but we cannot know. Sometimes, we can be mistaken. It is important to listen to our clients. In the private sector, we hear for example that Google is participating in a project etc. We have to be aware of what’s happening around us.” (M1F2)*

In the following, the coordination mechanisms of 3D PLUS to overcome this geographic space during the FFE are laid out in more detail with regards to the three non-spatial proximity dimensions.

#### 5.2.1.3.1 Organizational Proximity at 3D PLUS

From an internal perspective, employees know that they can share their knowledge with the product managers to get initial feedback about new ideas and their coherence with the organizational strategy:

*“This structure is well established and everybody knows that he can address the product managers. I was here before this role was introduced and now, I’m used to contacting them directly as soon as I have an idea for a new product.” (M1U1)*

Direct and informal contacts between the employees enhance organizational proximity from an internal point of view. Regarding external partners, organizational proximity gains a different dimension. According to Boschma (2005) organizational proximity describes from an extra-organizational perspective *“the extent to which relations are shared in an organizational arrangement, either within or between organizations”* (p. 65). Thus, he continues that networks based on trust between organizations enhance organizational proximity and enables external partners to innovate together.

With this point in mind, 3D PLUS also intends to encourage external partners to share their knowledge with the company by creating a relationship of trust with them. Regarding its international key clients, this relationship relies to an important part on the reputation of the company. In the space sector, this reputation is crucial due to high quality requirements.

*“Instantly, people will ask us, ‘Ok, it’s interesting, but do you have any test reports or qualifications? When do you have these results and when can we use it?’ That’s always the first question. And only afterwards, can we really discuss about it. This requires that the technology is already mature and that we have already done some tests.”*

(M1F1)

As soon as the initial commercial contacts have proven the efficiency and reliability of product solutions, the product managers are able to build up on this relationship of trust in order to create a fruitful dialog with them:

*“Starting from the moment when people realize that we are able to do innovative things, they give us a lot of details. Then we can start a greater collaboration.”*

(M1F1)

The first commercial contact happens in general *via* the international agency network. As explained above, these agents are no direct employees of 3D PLUS, but they are exclusively in charge to sell the company’s products. Thus, these agents are closely located to the local customers and facilitate therefore the creation of an initial contact with local customers. Together with proven product reliability, this opens doors for further direct collaborations between the product managers and those clients where future trends can be discussed:

*“We address our technological demands to some key clients where we already have a certain common vision and a certain trust relationship which enables us to discuss.”*

(M1F1)

Besides close contacts with internal employees, trust is fundamental to collect feedback from international customers. An open knowledge flow between the customers and 3D PLUS is enhanced by a specific form of swift-trust created by a commercial relationship created by the international agents and the product reliability. Over time, this swift-trust is replaced by a direct relationship between the product managers and the experts at the client's company.

#### 5.2.1.3.2 Social Proximity at 3D PLUS

Balland *et al.* (2015) mentioned that social proximity may be enhanced by decoupling and provide the example of employees who remain acquainted even after one them has left the company. Similarly, employees at 3D PLUS have their own external contacts with former colleagues to stay informed about external evolutions and reflect on current internal evolutions. Nevertheless, such personal relationships lie beyond organizational awareness. Therefore, it is up to the product managers to create an interface for this source of external knowledge. From this point of view, the social proximity between employees and the three product managers is crucial. The product managers have a key position here because they have direct contacts to all other services due to their large role profile and their involvement in the entire product life cycle. Thus, the interviewees stated that all employees may address them directly if they wish to discuss new knowledge or an interesting idea.

Besides strong internal ties, the product managers cultivate also direct social contacts in order to stay connected with communities of the space domain such as ESA or NASA:

*“In general, we have direct internal contacts in these communities. We participate sometimes at working groups and we discuss with producers, etc. We consider it important to have direct contact.”* (M1F2)

Similarly, it has been explained that contacts with international customers are enhanced by the international network of agents. Together with the agents, the product managers regularly visit local key clients all around the world. Therefore, the company invests also in the social connection to its international network of agents by organizing annual meetings at the headquarters in France. This is not only considered as an opportunity to disseminate information and to propose training for new products, but also to increase the relational aspect of the collaboration with these agents. All in all, 70 international agents are active for 3D PLUS all around the world. As a result, the international agents openly share their insights as soon as possible:

*“If they detect an opportunity, they communicate it to us rapidly. Sometimes, they hear about some tendencies or they see that one of our competitors is working on a specific technology. They talk to us and they send us the information.” (M1F2)*

Figure 43 illustrates this knowledge management structure at 3D PLUS. The balance between contacts with external communities and informal external contacts of internal employees enables the company to collect knowledge from the internal and external environment *via* the product managers to stay competitive. The latter consolidate this input and insert it into the FFE in order to enable the creation of discontinuous innovations.

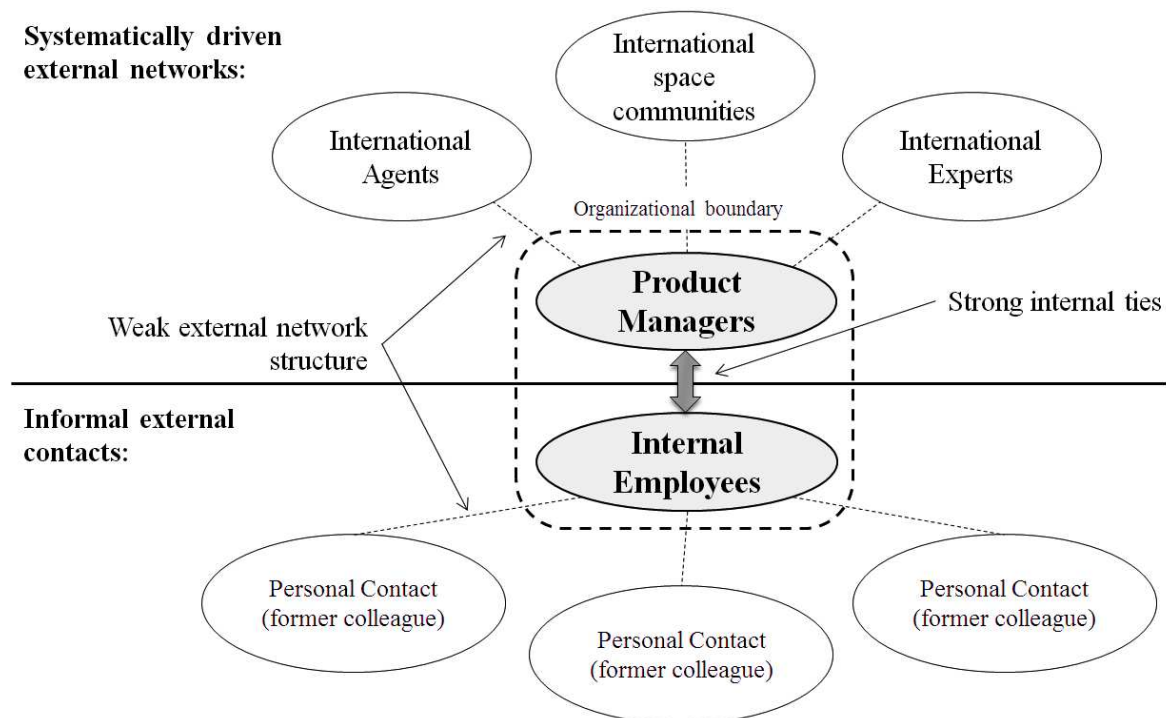

Figure 43 – Knowledge-Management Structure at 3D PLUS.

This representation of international FFE at 3D PLUS shows a high correlation with the research of Rost (2011), who merged two views on social capital: the efficiency of strong ties in professional networks, and the control benefits of weak network structures. By combining both approaches, instead of assuming a trade-off, the author argues that close internal ties enhance the sharing of tacit knowledge whereas weak connections to external partners ensure control over knowledge flows. Rost concludes that individuals who are closely connected to their own networks and at the same time have several connections to external networks are able to create the most innovative solutions. At 3D PLUS, the three product managers are in such a position as they maintain strong ties through close and regular contacts with their colleagues, and at the same time they are connected to several external sparse networks.

### 5.2.1.3.3 Cognitive Proximity at 3D PLUS

From an internal perspective, cognitive proximity during the FFE is enhanced by shared values and by the interdisciplinary background of the product managers. Regarding the shared values, interview partners at 3D PLUS confirmed that the company does not have a formalized organizational culture, but there are still common values which put the final customer at the center of the process. Consequently, all internal processes are oriented towards customer satisfaction. This customer orientation implies that quality and rigor are omnipresent core values at the company. This is not only described on the website of the company by mentioning the validation of the ISO 9001 (systematic quality management). The company also regularly actualizes an open access quality report describing its current situation and future action plans. For employees of 3D PLUS, this implies that they should be rigorous to satisfy these requirements of quality.

<i>“We master what we do and this is fairly extreme. We can reasonably be proud of ourselves. When you are able to develop a product and even 15 years later, you are always able to do so, this is great. We have managed to maintain this rigor.”</i>	<b>M1F1</b>
<i>“On an internal level, there is an important notion of rigor. We work with this culture even if this has certain limits when I interact with markets requiring higher reactivity, flexibility or even aggressiveness.”</i>	<b>M1F2</b>
<i>“Our high quality requirements are communicated to all employees via several channels such as an internal quality handbook, audit communications, or the communication of monthly quality indicators. The organizational culture as such is not formalized but our high quality standards are well known by all employees.”</i>	<b>M1U1</b>

Table 37 – Examples of Verbatim Accounts of the Notion of Rigor at 3D PLUS.

The values of quality and rigor illustrate that employees at 3D PLUS share a common way to behave. These values – although they are not formalized in a corporate culture – create a common understanding between employees about the organization’s objectives.

Furthermore, the product managers facilitate internal knowledge sharing due to their interdisciplinary background combining technical and managerial knowledge:

*“Initially, I had an engineering background and I worked in a technical environment. Then I decided to do my Master’s degree in management. This enabled me to acquire the necessary competences to communicate with other services of the company.”*  
(M1F2)

As a result, they are able to understand technical principles and at the same time, they have the necessary understanding to defend the idea from a managerial point of view. Thus, they act as nodes between the creative employees and the organization by ‘translating’ their technical ideas into a viable business model for the organization.

Finally, cognitive proximity from a cultural perspective plays also a role during the collaboration with international customers. As mentioned earlier, many key customers are not located in Europe. To therefore avoid cultural misunderstandings, the product managers rely once again on their network of agents:

*“In Japan, there are not many people who speak English. But this type of meeting has important technical and relational aspects. It is unavoidable that things will get lost with the translation. This is why it is important to rely on somebody who knows the country and who is able to read between the lines, but somebody who also has the technical knowledge. [...]”* (M1F2)

The agents are familiar with the values of 3D PLUS and they know the product variety of the company. At the same time, they are familiar with the local culture. This background enables them to act as facilitators between the product managers and the local clients:

*“Each culture has different ways of working, different rhythms and different formalities. This is why we seek to create a link with the agents beforehand. They know us, they know how we work and they know the values of our company.”* (M1F2)

From this perspective, their role is larger than to simply translate during meetings. They facilitate the negotiation process with customers and reduce the risk of cultural barriers when discussing sensitive future trends. Therefore, they help to strengthen cognitive proximity between the product managers and international partners as a sort of intercultural experts.

### 5.2.1.4 Concluding Remarks

*What is important is whether employees have the possibility to create strong relationships with some exchange partners and to be embedded in a few bridging relationships beyond their focal work groups.*  
(Rost, 2011, p. 601)

The notion of space during the FFE at 3D PLUS inherits a strong external dimension. Geographic space plays a less crucial role on an internal level at the company. However, it still impacts the FFE due to high interrelations with external partners such as international key customers. Hence, 3D PLUS is obliged to apply appropriate coordination mechanisms to overcome the spatial limitations. The previous paragraphs illustrated the company's solutions for enhancing organizational, social, and cognitive proximity. Table 38 summarizes these coordination mechanisms for each non-spatial proximity dimension differentiating between an internal and an external level.

	<b>Organizational Proximity</b>	<b>Social Proximity</b>	<b>Cognitive Proximity</b>
<b>Internal Level</b>	Direct and informal contacts to internal employees	Strong ties with internal employees	<ul style="list-style-type: none"> <li>• Interdisciplinary background of product managers;</li> <li>• Common core values such as quality and rigor.</li> </ul>
<b>External Level</b>	Key customers: swift-trust <i>via</i> product quality and international agents	Weak external network architecture	International agents as intercultural facilitators
<b>Key Role</b>	<b>PRODUCT MANAGERS</b>		

Table 38 – Coordination Mechanisms for Non-Spatial Proximity Dimensions during the FFE at 3D PLUS.

From an internal perspective, innovation is based on direct and informal interactions between the employees and the three product managers. Furthermore, the interviews revealed that the company currently counts on interactions with external partners to nurture the FFE of discontinuous innovations. These external interactions have a driven dimension where the product managers systematically interact with external experts, external knowing communities and their international agents to facilitate the contacts with key customers. As well, they represent an important node for internal employees who gather knowledge from their own personal networks. Overall, the product managers act as boundary spanners during the FFE with the objective in mind to consolidate all the inputs towards consistent new product concepts (compare to De Brentani and Reid, 2012). Thus, they represent the keystone for a functional FFE of discontinuous innovations at 3D PLUS.



## 5.2.2 PARTICIPATIVE INNOVATION AT ELECTRO

*“Innovation is a shared concern. It affects all departments. Everybody can contribute a brick to the building.”*  
(E1F1)

The activity of the ELECTRO group is diversified with a large product portfolio. This includes their subsidiaries and production sites in several countries. In addition, the company has integrated several mergers and acquisitions into the group. Hence, R&D activities are located at several international entities. Generally speaking, the company is structured into divisional entities where each sector has a specific task to accomplish. However, the company is aware that interdisciplinary and informal interactions are necessary to enhance their innovative potential. Thus, ELECTRO has recently accomplished a functional restructuring by breaking down disciplinary barriers. These changes include the shift from creating products to providing solutions, the introduction of a participative innovation approach, and the creation of a new department – the innovation department – which is in charge of the implementation of this participative approach.

### 5.2.2.1 Challenges and the Crucial Role of the Innovation Department

The interviews revealed several internal challenges regarding the FFE of discontinuous innovations. Firstly, considering that everyone can submit ideas (i.e. participative innovation) incoming ideas vary with regard to their form, their content and the degree of innovation. Hence, ideas require at first to be standardized to a certain level before being comparable to each other. Due to the amount of incoming material, knowledge management requires structured coordination to identify interconnections or crossovers between ideas.

Secondly, the company stated difficulties for discontinuous innovations in planning such ideas in their annual budgeting. In general, it is possible to assure idea incubation until the proof of concept but once this idea is elaborated, its transition towards development is less evident.



Thirdly, the FFE is challenged when the implementation of an idea requires the knowledge of several subsidiaries. This knowledge might be spatially distributed and idea champions might not be able to identify the right internal partners.

Fourth, some innovative new products might be used globally but still need to be adapted locally. As the company produces, for instance, electrical boards, each country has different norms, leading, for example, to different power sockets. Such local specificities require closer investigation for the proof of concept to be completed during the FFE.

Fifth and finally, the interviewees mentioned communication difficulties within departments. They observed that there is limited information circulation between international experts of the same domain:

*“People from local development entities won’t have an interconnection with their counterparts doing the same job in other subsidiaries.” (E1F2)*

ELECTRO is also aware that cultural differences and linguistic barriers might hamper the collaboration over space and therefore hinder the expansion of a global innovation strategy.

As a consequence, the company created a specific department to address these challenges during the FFE: the innovation department. As a member of this department elucidated, it is entirely in charge of the management of the FFE in the case of discontinuous innovations.

*“Other kinds of ideas (improvements) are things we already know. They are not managed by our department.” (E1F2)*

The department with its 15 employees is in charge of the idea collection process and the necessary knowledge acquisition before the Go/No-Go decision. In many cases, the innovation department is able to assign a distinct department of the company for concept development because ideas can explicitly be allocated to a specific core activity. However, in the case of transversal ideas integrating various competences of ELECTRO, the innovation department takes charge of the entire management of the FFE. This enables the company to always find a place for later FFE activities. The transition of the FFE towards development is managed as soon as the proof of concept is available.

### 5.2.2.2 Results

The participative innovation approach motivates all employees of the company to share knowledge and contribute to the corporate innovation processes. This approach relies to an important part on the innovation department as this is the central node in the innovation process where the inputs from employees all around the world are collected. Indeed, an interviewee confirmed that this department is a direct interlocutor which can be contacted any time when an employee has an idea:

*“When this service was created, its existence was communicated to all employees. People can talk to us. We also communicate actively during events, via corporate newsletters, on the intranet, by email, and at other kinds of corporate events. Everybody knows our names.”* (E1F2)

When an idea has been accepted for further investigation, the innovation department provides regular feedback about its current situation to the idea champion. Moreover, it enables crossovers of knowledge: it happens sometimes that the same idea emerges in two different places. In these cases, the innovation department initiates contact between the two idea champions in order to foster exchange and collaboration with the aim of increasing the quality of the idea. Since the introduction of participative innovation, these efforts are not only a vision but they are supported by the company’s employees. Thus, the company has even been rewarded twice by an independent institution for their participative innovation approach.

Regarding the FFE of discontinuous innovations, participative innovation enables employees all around the world to insert and share knowledge within the company. Besides the direct interaction with the innovation department employees have also the possibility to participate to several internal knowing communities. These have been created to specific topics and comprise in most cases the experts of the company to these topics. Currently, these communities vary in terms of the extent of their formality. Some of them exchange on a regular basis and others meet less frequently:

*“There are some communities like for example a community linking our tooling experts independently of their location. Not all of our communities are visible for the organization; they do not necessarily all use the intranet or similar communication channels.”* (E1F1)

As a result, the interviewees mentioned that there are certainly more communities than those actually known of by the company. This situation makes it difficult for new employees to identify community activities and become active members of them. This is due to the fact that people were not necessarily always able to identify all international experts of a specific topic and because people did not know that specific communities for a certain topic already existed.

With regards to this situation, the innovation department provides support to interconnect these communities and enable employees to integrate those which could be interesting for them. The communities themselves are in charge of content-related activities in order to push the knowledge bases of the company. The managerial integration of this input, however, is taken in charge by the innovation department to assure a systematic knowledge flow.

Overall, the FFE of discontinuous innovations is nurtured by the participative innovation approach at ELECTRO. This implies that employees are motivated to share knowledge independently of their localization. They might be part of a knowing community or directly address the innovation department. The latter is in charge to consolidate this knowledge and the generated concept ideas in order to push the FFE of discontinuous innovations.

### **5.2.2.3 Analysis**

With regards to the participative innovation approach, employees are spatially dispersed over the local entities and so are their competences. Not only are the employees of the international R&D departments involved during the FFE but the whole workforce has the opportunity to contribute to this phase. As the company has several international subsidiaries, the geographic space between actors during the FFE is high. To face this geographic challenge, ELECTRO has developed three coordination mechanisms, each with the specific objective to substitute geographic proximity:

- An international innovation hub managed by the innovation department;
- A balance between physical events and a virtual platform to interconnect international experts and idea generators; and
- The expansion of a creative subculture based on the strong organizational culture of the company.

In the following, each coordination mechanism with regards to the underlying proximity dimension is investigated in more detail. This review is based on interviews conducted at the French headquarters and at one French local subsidiary in order to evaluate the efficiency of the methods used.

#### **5.2.2.3.1 Organizational Proximity at ELECTRO**

The restructuring of the innovation processes from a product to a solution provider consequently required that organizational entities of ELECTRO need to collaborate. It would not be sufficient anymore just to develop a component on a local level as competencies of several departments have to be combined to provide such a solution. Thus, the local entities need to be interconnected from an organizational point of view to foster inter-organizational collaborations.

Besides such strategic considerations from a general point of view and more specifically with regards to the FFE of discontinuous innovations, the innovation department obtains a crucial role to interconnect actors from different entities. Considering the fact that more than 11 000 employees are dispersed over five continents, the few employees of the innovation department would not be able to cover the international needs for systematic innovation management. To assure therefore the expansion of participative innovation, the company decided to create local extensions of the innovation department. These local extensions are so called ‘innovation facilitators’ who are employees of the international entities. They promote the creative spirit and foster innovative behavior locally. These facilitators are in close contact with headquarters to get support for local activities. For instance, the French subsidiary was about to organize a local event during which the objective was to generate new ideas around a specific topic together with 80 local employees. Considering the complexity of this event, the innovation facilitator got in contact with the innovation department. Together, they designed the agenda of the day and identified an adapted external partner to animate the event.

Furthermore, the innovation facilitators are aimed to adapt the corporate innovation strategy locally by taking into account local/national cultures or other local peculiarities:

*“We identified the innovation facilitators to adapt the creative culture to local needs. For instance, India is highly oriented towards frugal innovation. They have another perception of innovation and this has to be taken into account.” (E1F1)*

Following the idea of ‘train the trainers’, the facilitators are able to adapt and apply a set of creativity techniques which have been provided by the innovation department to local requirements:

*“Yes, our facilitators are the key. These are people who are at close proximity and who foster creativity locally. We have them already in France or in Italy. We support them wherever we can. For the moment, this is not formalized, but we are about to identify this role. We need people who have a certain creative spirit, who are motivated and who appreciate interacting with others.” (E1F1)*

The innovation facilitators represent an extension of the innovation department to apply the participative innovation locally (top-down). Furthermore, the facilitators are in charge to diffuse local knowledge and communicate local ideas to the headquarters (bottom-up). If a local employee does not know with whom to share his idea on a global level or if he does not feel comfortable sharing knowledge in a foreign language, he could use the innovation facilitator as the communication channel. During the interviews at the local French subsidiary, the interviewees agreed that thanks to the innovation facilitator, local employees know who to contact to get information or with whom they can talk about new ideas.

At this entity, the local innovation facilitator has moved one step further and created an interdisciplinary (and non-hierarchical) team. This team organizes internal creative challenges, follows a continual amelioration plan to foster innovation, and organizes innovative events. The team consists of the innovation facilitator who creates a link with the headquarters, managers who support the innovative spirit within their teams, a local CEO who defines the vision oriented towards innovation and finally also several local ‘activators’. The latter are operative employees who have the role of collecting ideas directly from their environment. They are carefully selected to avoid barriers between them and the local employees because management is aware that hierarchical superiors would not be the optimal persons to do the job:

*“People still fear sharing their ideas and we try to change this. There is no stupid question, there are no stupid propositions; there are only stupid answers. However, the activators seem perhaps to be more easily approachable. Employees are perhaps less frightened or are less impressed to talk to them about new ideas.” (E1F6)*

Even though the local innovation team was able to reduce such hierarchical barriers significantly, it cannot be excluded that local employees might still feel more comfortable

discussing an idea with a direct colleague instead of a manager. The activators therefore represent a local solution to enhancing knowledge flows.

At the time when the case study was conducted (2016/2017), not all international facilitators were active as this structure was in the process of being constructed (Italy, France, or Poland were pioneers of this new strategy). The long-term objective of the company will be to expand this structure to all international entities. The company is therefore about to identify local employees to take over this role. The objective is to integrate up to 30 innovation facilitators into this network who meet at least once a year face-to-face in order to exchange experiences. All in all, the international innovation hub creates close ties between employees of different entities in order to enhance the organizational proximity between them. This hub has top-management support to assure its legitimization for internal innovation processes.

#### 5.2.2.3.2 Social Proximity at ELECTRO

The objective of the innovation department is to actively interconnect the internal communities of ELECTRO and the company's employees in general. To increase social cohesion despite the limitations of geographic space, this support has two distinct dimensions: a virtual and a real world dimension nurtured by face-to-face contacts.

With regards to the virtual dimension, ELECTRO relies on a virtual platform to connect people over space. An internal social software program is coordinated by the innovation department and involves all employees of the group independently of their location:

*“The chosen program is like our internal ‘Facebook’ which is continuously accessible. Our objective is still to create regular peaks of activities where we moderate the discussions. I observed also that these discussions are not necessarily only professional, but also of an informal nature like for example ‘how is the weather over there?’” (E1F1)*

The objective of this tool is to enhance the participative innovation over space and provide a virtual space for employees where they can share knowledge and discuss ideas. The language of communication is English. To prevent this fact from impeding employees from using this opportunity to exchange, the innovation department proposes partial translations into English. Besides the linguistic support, the innovation department actively and selectively moderates specific topics which are of interest for the company. The virtual platform has been greeted with different degrees of acceptance within the local subsidiaries:

*“Our Chinese colleagues participate less in this platform. I don’t know if this is linked to their culture or if they do not appreciate this system. They have a different position and participate proportionally less. The quality and quantity of ideas was different. Our Indian colleagues on the other hand participate a lot.” (E1F1)*

Interviewees of the French subsidiary argued that the platform requires a login and is thus not open to every employee, especially those who do not have access to a computer. As a result, employees at this subsidiary prefer direct face-to-face contacts to nurture local innovation processes. The adherence to this virtual tool varies but today, the platform still counts 2,500 subscribers and 600 active participants.

In completion to the virtual platform, the innovation department organizes annual innovation days at the headquarters in France to foster face-to-face contacts. During these events, every employee is encouraged to participate to submit and defend ideas. The first year, the company collected more than 2,000 ideas. In the following, this overwhelming amount of input motivated the department to structure the event around specific themes (including a general category for ideas which cannot be placed within one of the proposed themes) to better guide the idea incubation process. The innovation event at the French subsidiary is an example that this strategy is also duplicated to a local level. Besides the annual innovation day, the innovation department organizes regularly internal and external events where people can meet and share knowledge.

#### **5.2.2.3.3 Cognitive Proximity at ELECTRO**

To create a common understanding about innovative behavior and thus to enhance cognitive proximity during the FFE, the company relies on shared values. ELECTRO has been family owned since its foundation and the family underlines thus the importance of its corporate culture. It is an explicit culture which is communicated to the internal and external environment of ELECTRO. Core values such as customer orientation, team spirit, or loyalty are part of the behavioral rules which are communicated *via* several channels such as the corporate web page. The interviewees agreed that these values are widely shared by the employees:

*“We have a strong organizational culture and we share common values like courage, authenticity and integrity.” (E1F2)*



The organizational culture of ELECTRO can be described as strong which enables the international employees to identify themselves with the company. The only exceptions are a few acquisitions which maintain their own identity as a result of strategic decisions. Besides a general code of conduct, an innovative spirit is explicitly part of the organizational culture:

*“Our company believes that innovation and creativity are very important to survive in the long run. There is a lot to win.” (E1F6)*

Risk taking, entrepreneurial behavior, and openness to new ideas demonstrate the organization’s willingness to innovate. Besides such general values, the company goes one step further by adding a creative subculture. This subculture builds upon the strong organizational values oriented towards innovation and extends them by actively disseminating a corporate vision about creativity:

*“The objective is to develop the creativity of our employees. We show them how to structure creative sessions and not just claim they are doing brainstorming and say ‘give me your ideas’. This would not work. We show them a process and what is needed to be creative.” (E1F2)*

Generally, the organizational culture is managed by the HR department of the company. However, the systematic expansion of this specific creative subculture is managed by the innovation department. Some of the earlier mentioned events which are organized by the department have the objective to disseminate a common vision about creativity. Such events are for example creativity weeks where several creative sessions, conferences, or other interventions are scheduled. Each employee is given the opportunity to participate in this event organized at the headquarters. These events have no specific product focus and are not necessarily linked to the core activity of the company:

*“The first year, we used this event to define some key terms like ‘courage’ or ‘share’ to create a common understanding. The second year, we organized a physical event at the French headquarters to discover the creative profiles, meet artists from different backgrounds to work with different materials, conferences, etc. The objective was to open the minds of our employees to creativity.” (E1F2)*

Also with the idea in mind to disseminate a creative subculture, the department proposes specific creativity workshops. These workshops are aimed at employees who wish to learn more about creativity and how to apply it. This includes a general approach to creativity as



well as the introduction of standard creativity methods which have been adapted to the organizational requirements of ELECTRO. In this context, it is also possible for project leaders or idea champions to rely on the support of the innovation department if they wish to apply creativity in a concrete situation (e.g. a new project or the idea incubation for a specific problem) to maximize the output. The person in charge of these creativity workshops at the innovation department explains that:

*“We propose creativity workshops to collect ideas and how to analyze them. [...] I propose such workshops but I could not facilitate all of them. People are learning step-by-step and many of them just ask me for advice to structure their workshop and they do it themselves.”* (E1F2)

For instance, the local French subsidiary took the opportunity and trained its whole management team to apply these creativity methods. Today, they refer to these methods autonomously to increase the output of a meeting independently of the innovation department.

Also with regards to the cognitive proximity, the local innovation facilitators gain an important role. In the local French example, this facilitator elaborated together with an interdisciplinary team a common definition of innovation which then has been communicated to the local workforce:

*“Innovation is something which has never been done before within our company and which makes sense for our activities.”* (E1F3)

This definition relies on the corporate perception of innovation but has been adapted to the local requirements. After two years of intense work on this topic, the local managers testify that a cultural change has occurred where creativity and innovation are now part of day-to-day business. This cultural change has reduced barriers between hierarchical levels and enabled the subsidiary to assess incoming ideas and to create a common understanding which is in line with the corporate vision. From an international perspective, the creative subculture strengthened the cognitive proximity between international employees.

### 5.2.2.4 Concluding Remarks

It was observed that all three non-spatial proximity dimensions were covered at ELECTRO in order to overcome the limitations of spatial differences between employees and to nurture an international FFE. In their essence, the resulting coordination mechanisms rely on the innovation department and its international extension as innovation hub. This hub supports activities of internal communities, provides a virtual platform, organizes face-to-face events around the topics of innovation and creativity, and promotes the expansion of a subculture oriented towards creativity.

The local innovation facilitators enable the company to promote innovation locally and manage a global/local trade-off. The French subsidiary is a perfect example, where the local innovation facilitator created an innovation process that is adapted to local requirements. Together with the local activators, he created a close local structure based on personal and direct channels.

Table 39 summarizes the identified coordination mechanisms of ELECTRO to foster international collaboration during the FFE of discontinuous innovations:

	<b>Organizational Proximity</b>	<b>Social Proximity</b>	<b>Cognitive Proximity</b>
<b>Coordination Mechanisms</b>	International Innovation Hub: Local innovation facilitators and innovation department	<ul style="list-style-type: none"> <li>• Internal knowing communities; formalized to a varying degree;</li> <li>• Face-to-face social events and a virtual platform organized by the innovation department.</li> </ul>	<ul style="list-style-type: none"> <li>• Strong organizational culture oriented towards innovation;</li> <li>• Creative subculture and a set of creativity methods adapted to organizational requirements.</li> </ul>
<b>Key role</b>	<b>INNOVATION DEPARTMENT</b>		

Table 39 – Coordination Mechanisms for Non-Spatial Proximity Dimensions during the FFE at ELECTRO.

Now, both replication cases have been sufficiently described in order to set up a cross-case analysis between BÜRKERT, 3D PLUS, and ELECTRO.

### CONTRIBUTIONS

This chapter creates the fundamentals for the cross-case analysis.

#### Sub-question 7 – Description of Space

- 3D PLUS: Geographic space at the FFE exists between the internal actors and their external environment.
- ELECTRO: The participative approach to innovation causes geographic space between international actors at the FFE situated at diverse international entities of the company.

#### Sub-question 8 – Coordination Mechanisms at Replication Cases

##### 3D PLUS

- Create trust with key customers *via* convincing product experiences and international agency network;
- Strong internal ties and a weak external network structure; and
- Product managers as interdisciplinary node in the innovation process.

##### ELECTRO

- International innovation hub to facilitate interactions between international actors;
- Create occasions for face-to-face meetings and introduce a virtual platform; and
- Establishment of a creative subculture.

## 5.3 CROSS-CASE COMPARISON

*“Internationalization is seen as the outcome of firm actions to strengthen network positions by what is traditionally referred to as improving or protecting their position in the market.”*  
(Johanson and Vahlne, 2009, p. 1423)

Three different companies with three different approaches to the management of proximity during the FFE of discontinuous innovations: this is the apparent outcome of the replication cases. In addition, the previous chapter has elucidated that all three companies had divergent strategies of geographic diversification during the FFE. At BÜRKERT, only the R&D centers in France and Germany have been integrated into the innovation processes during the FFE and therefore, the ProxIS-Telescope was oriented towards these entities. At ELECTRO, the introduction of a participative innovation approach had the objective of including employees all around the world independently of their geographic location. Finally, 3D PLUS had a strong local dimension from an internal point of view; however, several external partners spread over space were addressed during the FFE.

This chapter seeks to identify common patterns between the three cases in order to provide an answer to the following sub-question:

**Sub-question 9 – Cross-Case Implications**

How do coordination mechanisms for discontinuous innovations during the FFE evolve with regards to the number of actors involved?

Current internationalization models assume that increasing geographic diversification requires increasingly structured management tools (see for instance Johanson and Vahlne, 2009). However, the longitudinal process analysis at BÜRKERT in chapter 5.1 led to the assumption that it is not only this international dimension, but also the size of the workforce involved which shape an organization’s strategy and which caused modifications in the management of proximity during the FFE.

The three field contexts provide compelling examples for varying organizational strategies to manage the FFE of discontinuous innovations with regards to these two dimensions. Figure 44 illustrates these strategic positions of the three cases.

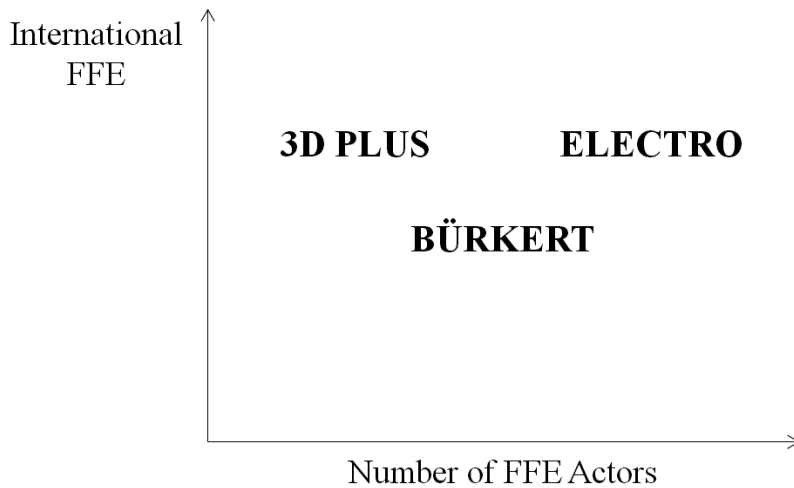

Figure 44 – The Three Field Contexts and their Strategy during the FFE of Discontinuous Innovations with regards to the International Dimensions and the Number of Actors Involved.

As elucidated above, 3D PLUS and ELECTRO score higher on the international dimension than BÜRKERT. Whereas both replication cases intend to integrate knowledge from varying international sources, the international strategy at BÜRKERT during the FFE currently focuses exclusively on the German and French R&D centers. This strategy also stipulates that the number of actors involved is limited to these departments. Conversely, participative innovation at ELECTRO and open innovation at 3D PLUS seek to integrate as much actors during the FFE as possible. As a result, not only during the pilot case, but also during the replication cases, the size of the companies and thus the number of actors involved has been mentioned as an influencing factor in the choice for coordination mechanisms.

<i>We are an SME which is growing but for the moment, the product managers are in charge of the whole phase before the development starts.</i>	<b>MIF2</b>	<b>3D PLUS</b>
<i>We are a growing SME [...]. Regarding our internal structure, we still don't work in a very structured manner.</i>	<b>MIF1</b>	
<i>As solution provider, we should take into account all competences of other international entities. The slogan 'Growing together' is communicated everywhere and describes our current strategy. We have a growth of 59% and this is a constant growth. [...] We saw that if we want to boost innovation, it is necessary to be corporate and coordinate all efforts.</i>	<b>E1F2</b>	<b>ELECTRO</b>

Table 40 – Examples of Verbatim Accounts of the Impact of Size in the Replication Cases.

At BÜRKERT, the new product development is historically located at the R&D department. At the end of the case study, this department counted almost 180 employees located in France and in Germany. At 3D PLUS, the R&D department is less important and counts around eight employees. Considering the limited size of the company, all employees at

3D PLUS were encouraged to submit ideas and share knowledge. It is not possible to conclude from this that there are 185 active participants in the FFE, but there are certainly no more than the total workforce.

Finally, the workforce at ELECTRO is larger than at BÜRKERT. Regarding the participative approach to innovation, a restriction to the R&D department would not be appropriate to get an idea about the number of internally involved actors during the FFE. In order to make at least a rough estimation, the virtual platform proposes an initial approach. From the 2,500 employees who subscribed to this virtual network, approximately 600 actively participate in sharing knowledge and discussing ideas. These participants include members of the R&D department, the marketing department, or other role profiles. Furthermore, these participants are located in France, Germany, and international subsidiaries such as in India, and occasionally in China. A figure of 600 employees might not represent the entire number of the active employees who contribute to the generation of discontinuous product solutions, and it may be supposed that more than this are actively involved during the FFE. Table 41 summarizes the approximate number of FFE actors for each company.

<b>3D PLUS</b>	<b>BÜRKERT</b>	<b>ELECTRO</b>
≤ 185	~ 180	≥ 600

Table 41 – The Approximate Number of Actors Involved During the FFE in the Three Companies.

This estimation of the number of actors involved together with the international approach to the FFE lead to the position of the three companies as indicated in figure 44. In the following the impacts of the three strategies for the coordination of knowledge during the FFE are elucidated.

### 5.3.1 ANALYSIS

The previous chapters laid out the different coordination mechanisms which were applied by the three companies to substitute geographic proximity during the FFE. In the following, these mechanisms are directly compared to each other. As the objective is to compare the replication cases to the pilot case, a reference is made to the elements which were initially identified for the ProxIS-Telescope to maintain sufficient organizational, social, and cognitive proximity:

- Precondition: The emphasis of trust as a prerequisite for knowledge sharing during the FFE;
- 1<sup>st</sup> lens: The creation of a common platform for knowledge sharing; and
- 2<sup>nd</sup> lens: A shared mental model regarding innovation and creativity.

Table 42 summarizes the insights from the three cases and the varying coordination mechanisms regarding these elements.

	<b>3D PLUS</b>	<b>BÜRKERT</b>	<b>ELECTRO</b>
<b>Precondition</b>	<ul style="list-style-type: none"> <li>• Trust based on product reliability;</li> <li>• Swift-trust between external partners and product managers.</li> </ul>	<ul style="list-style-type: none"> <li>• Trust on top-management level;</li> <li>• Swift-trust between internal actors at the FFE.</li> </ul>	Trust based on local innovation facilitators connected to international innovation hub
<b>1<sup>st</sup> Lens: Bundle the Light</b>	Product Managers: Central node	Hybrid Community	International Innovation Hub
<b>2<sup>nd</sup> Lens: Target the Light</b>	<ul style="list-style-type: none"> <li>• Interdisciplinary Interface (Product Managers);</li> <li>• International agents.</li> </ul>	<ul style="list-style-type: none"> <li>• Organizational culture;</li> <li>• Shared professional culture.</li> </ul>	<ul style="list-style-type: none"> <li>• Organizational culture;</li> <li>• Creative subculture.</li> </ul>
<b>Key Roles</b>	<b>Product Managers</b>	<b>Shared Resources</b> (Top-management, HR, R&D department)	<b>International Innovation Hub</b>

Table 42 – The Elements of the ProxIS-Telescope and the Coordination Mechanisms in the Three Cases.

The precondition of the ProxIS-Telescope is fulfilled at BÜRKERT by the trust-relationship between the headquarters and its subsidiaries on a top-management level. At 3D PLUS, trust also plays a role in enhancing knowledge flows during the FFE but less from an internal, and more from an external point of view in the context of collaborations with

external partners. The interviewees explained that key customers or members of external communities only represent a valuable source for discontinuous innovation once sufficient trust is established between them and 3D PLUS. At ELECTRO, employees have a strong sense of belonging to the company. One of the interviewees explained that the company's organizational culture creates – besides a common understanding of corporate values – the fundamentals for a relation of trust between international employees.

*“People remain at the company. They don't quit the company very often as they feel comfortable here. The family structure of the company generates proximity between our managers and everybody is very approachable, including our CEO. We have proximity between employees based on a close trust relationship.” (E1F1)*

This strengthens internal ties between employees and enhances knowledge flows between them. From an international perspective, the local innovation facilitators remain in close contact with the corporate innovation department and strengthen inter-organizational links between subsidiaries.

The hybrid knowing community at BÜRKERT enables the company to motivate French and German employees to insert ideas and share knowledge over geographic distance. The social dimension of this structure is maintained by regular meetings which are auto-organized in each focus group and coordinated by the technology circle. At 3D PLUS, no internal communities were observed during the FFE and, considering the small workforce, communication channels have been described as short and direct by the product managers:

*“Discussions are informal: we regularly get in touch with our engineers who work on our products and we discuss their feedback.” (M1F2)*

Still, the company creates links with external communities in the space sector and personal communities of employees who are still in contact with former colleagues. To bundle these knowledge flows, the company relies on its three product managers who combined all these inputs in order to generate a concept for discontinuous innovations which is stable enough to go to development. At ELECTRO, the innovation department and more specifically the earlier-described international innovation hub provides support for the knowledge management during the FFE. The internal communities in charge of the content-related activities are the platforms where employees share their knowledge, but it is the innovation hub which assures interconnections between them. To some extent, this hub superimposes a network structure on the communities to enhance transversal and interdisciplinary knowledge



flows. With this intention, it animates the virtual platform and organizes the earlier-mentioned creativity weeks or other specific events to encourage serendipitous encounters between employees with multidisciplinary backgrounds.

The strong organizational cultures at BÜRKERT and ELECTRO foster a common sense among international employees of belonging to their organization. In addition, a shared professional culture at BÜRKERT enhances multicultural and interdisciplinary communication during the FFE. This framework has generated a shared mental model in the ProxIS-Telescope for innovation and creative behavior. At ELECTRO, such a shared mental model during the FFE is reinforced by a creative subculture which has been introduced by the international innovation hub. This enables the company to generate a common vision about creativity across national boundaries, and fosters creative collaboration during the FFE. The fact that this creative culture is managed by the hub and not by the HR department (as one might expect) again underlines the supporting role of the former for the corporate innovation processes. At 3D PLUS, the product managers make particular use of their interdisciplinary backgrounds to facilitate knowledge flows with members of different departments during the FFE. Their professional culture enables them to create a similar interface as in the case of the marketing department at BÜRKERT. The external extension *via* the international agents enables the three product managers to interact with international clients because these agents take on the function of intercultural experts. Considering the informal character of the corporate culture, the targeting of knowledge flows during the FFE of discontinuous innovations is handled in particular by the three product managers and supported by the international agents.

Table 42 illustrates that the three elements of the ProxIS-Telescope to substitute geographic space are present in each company but the resulting coordination mechanisms differ. At 3D PLUS, the substitution of space is managed by a few key individuals (i.e. the three product managers) and the resulting coordination mechanisms are rather informal and based on direct knowledge flows. At ELECTRO, some of the concrete coordination mechanisms are similar to BÜRKERT. The company relies on internal communities, a strong organizational culture and a trust-relationship at top-management level. The fundamental difference with BÜRKERT is the fact that these three elements are extended by the international innovation hub creating a parallel structure to support the management of an international FFE.

### 5.3.2 DISCUSSION

In this section, a dynamic approach to the initial ProxIS-Telescope is elaborated, adjusting its elements to the organizational setting in which they are applied. This setting is shaped by the organization's strategy which is represented by the two axes in analogy to figure 44. The first axis relies on the research of Greiner (1998), and the resulting insights from the pilot case study, to indicate that a growing number of FFE actors also increases the need for more structure regarding the coordination of knowledge during the FFE.

The second axis still shows the international strategy during the FFE but in the following, this dimension refers more precisely to the revisited 'Uppsala internationalization model' of Johanson and Vahlne (2009). In accordance with the knowledge-based view of the firm, the authors describe an optimal entering for companies in a new and foreign market. Their model includes not only a step-by-step approach to foreign activities, but also implies that organizations first enter markets which are psychologically close to the home country, before diversifying their activities towards distant countries. The Uppsala model applies to a company's external diversification strategy. However, due to its coherence with the knowledge-based view, its fundamental reflections are here transposed to the FFE of discontinuous innovations. The authors describe 'international knowledge opportunities' as the reason why a company should adapt its strategy and integrate international knowledge in corporate innovation processes. According to them, firms are embedded in a larger business network. The detection of a new international knowledge opportunity is the main driver for these firms to change their position within this network. Thus, they review existing partnerships in the network and integrate new partners. In analogy with this model, it is assumed in the present dissertation that such international knowledge opportunities might equally apply within MNCs and motivate the company to change its innovation structure. A subsidiary or external partner which initially was irrelevant for the innovation structure of a company might evolve towards an interesting strategic source for knowledge sharing during the FFE due to local acquisition of valuable knowledge.

The pilot case provides a compelling example of such changing international knowledge opportunities. The American entity of BÜRKERT was initially a production and sales entity which adapted products of the corporate portfolio to local customer needs. This activity did not require specific technological expertise or know-how. However, the subsidiary has grown over recent years, and has acquired further competencies. The development of a new and

innovative solution made clear that these competencies have a high potential. This situation might now encourage BÜRKERT to reconsider its international innovation strategy and integrate this subsidiary into its innovation structure.

The two axes describe an organization's strategy during the FFE shaping the organizational setting in which actors seek to innovate. Based on the insights from the three cases in combination with academic literature, the resulting 'dynamic ProxIS-Model' leads to five positions as illustrated in figure 45.

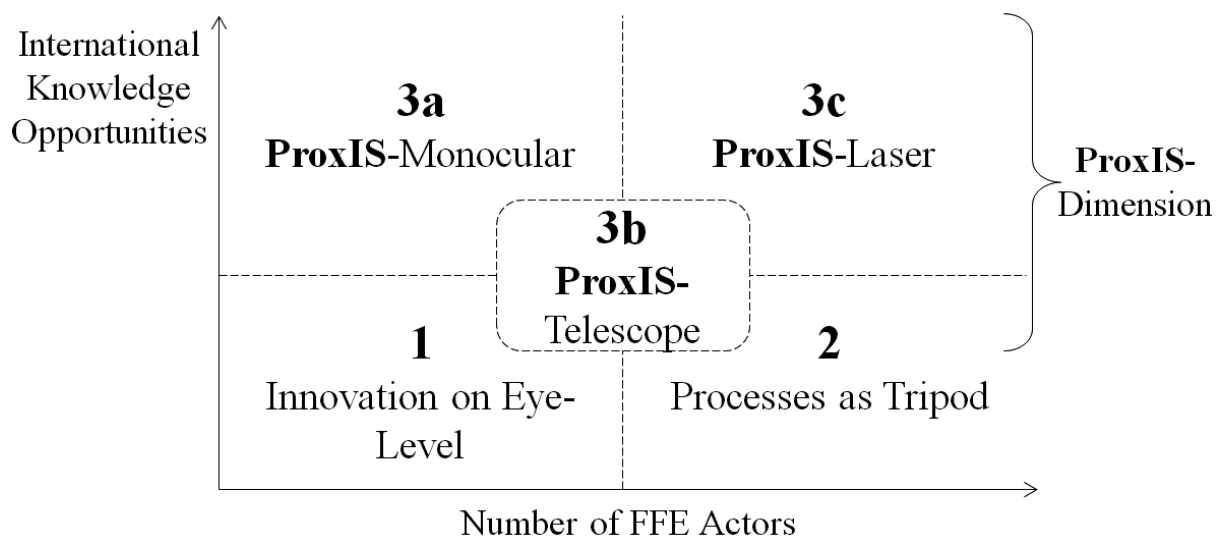

Figure 45 – The Dynamic ProxIS-Model (adapted from Neukam and Guittard, 2017b).

The previous chapters of this thesis led to the assumption that varying organizational strategies during the FFE have different impacts on the quality of knowledge sharing. From this perspective, the dynamic ProxIS-Model proposes several positions for organizations in order to apply the appropriate set of coordination mechanisms in dependence of their chosen strategy. As the designations in figure 45 suggest, the initial metaphor about the operating principles of telescopes to look into the sky is extended by further analogies from the field of optics and specifically of astronomical sciences.

The eye is our organ which sends signals to our brain and helps us perceiving the external environment. Similar to a telescope, the eye consists of several elements which interact to create an image on the retina which is then treatable for the brain (Rohen, 1977). To maintain a sharp image despite changing distances, the refracting media of the eye (*cornea* surface and lens) are able to modify the optical path of the light (Leydhecker, 1979; Rohen, 1977). These media are part of a sensible mechanism where the slightest deformation of one element has

important impacts on our eyesight (Leydhecker, 1979). Even if the underlying mechanisms are similar to a telescope, the eye has comparatively only a limited capacity to perceive objects at greater distance (Cheng, 2009). This is why part IV of this dissertation introduced a telescope as useful device to continually perceive stars which are far away.

It is possible, however, that the observer just seeks to punctually observe specific objects in the sky. In this case, his/her main objective might be to rapidly take a look into the sky and still remain flexible when moving from one place to another. Here, a monocular could already be sufficient to fulfill these requirements. A monocular is less costly than a telescope and it is much smaller. Even if it consists basically of the same elements than a telescope (an objective and an eyepiece), the observer looks through it with one eye, may hold it in his/her hands and can easily transport it.

When on the other hand the objective is to see as many stars as possible, a monocular might not be sufficient anymore because its sky coverage needs to be extended. This depends on the opening angle and thus on the largeness and thickness of the two lenses (Cheng, 2009). In this case, a telescope as described in part IV becomes a useful device. However, the more stars the observer wants to see, the bigger the telescope should be. Consequently, it gets difficult at some point for the observer to hold the telescope in his hands alone. A mechanical solution in this case is to mount it on a tripod.

When, finally, the objective is to see stars as far away as possible, there are further solutions to strengthen the power of a telescope. Stars which are far away only send us limited light and to take a picture of them, a long exposure time is required. However, the quality of the picture is diminished by factors such as pan and tilt (Teare and Restaino, 2006) and the view into the sky is blurred, for instance, by the earth's atmosphere or its rotation (Tubbs, 2003). Under these circumstances, a powerful solution is the use of a laser (Cheng, 2009). This laser is sent into the sky in parallel to the telescope and, based on its signal, specialists are able to calculate errors and thus adjust the picture (Cheng, 2009). Such laser based telescopes can be found for example in research-facilities for astronomy (Cheng, 2009).

After this short introduction in astronomical seeing, the following paragraphs will elucidate how this metaphor applies to the FFE of discontinuous innovations in international organizations. In the following, the positions of the dynamic ProxIS-Model are described in more detail based on these analogies. The ProxIS-Telescope will not be detailed here again as it has sufficiently been described in part IV.

### 5.3.2.1 Innovation on Eye Level (1)

Being situated in the lower left sector of the matrix, the position ‘Innovation on eye level’ describes a local approach to the FFE with only a few actors. This position is chosen when the strategy of an SME does not consider any relevant international knowledge opportunities. An example for this position has been described by Cullmann *et al.* (2015) in their case study about Tschoeppé – a French SME with 95 employees located on one production site. Tschoeppé is a provider for aluminium gates and railings and the authors of the case study explain that this regional company exclusively distributes its products on the French market. As a result, it could be argued that it would not be of strategic value to gain knowledge across space, but it is sufficient for the company to focus on local competencies. No specific geographic dimension during the FFE is described by the authors in this case study.

As described by Cullmann *et al.* (2015) The innovation approach of the company is inspired by the willingness to encourage a maximum of its employees to be part of new creative solutions. They continue that the company’s creative workshops represent a platform where employees meet physically and together create something new. In addition, a common understanding about innovation and creativity is created by the vision of the founder’s family, who has been in charge of the company’s activities since its foundation. As a result, it could be argued that the FFE is based on a direct exchange between internal collaborators located in one physical place. Knowledge flows appear to be manageable within the team by informal and direct coordination mechanisms. Based on the case study at Tschoeppé (Cullmann *et al.*, 2015), it is argued that the first position ‘innovation on eye level’ is closely linked to an organization’s strategy which does not require to ‘look into the sky’. The firm might be considered as one big community using participative innovation (*cornea* surface of the eye) and the founder’s vision creates a participative culture with a common perception about innovation and creativity (*lens* of the eye).

Similar to the human eye, these elements enable the company to perceive knowledge on eye level as it is located locally and thus close to the company’s decision-makers. The strategy of the company does not require a telescope because no geographic space exists between (internal as well as external) actors. The eye is totally sufficient for a company with a local strategic scope to be innovative during the FFE.

### 5.3.2.2 Processes as Tripod (2)

The second position ‘Processes as Tripod’ describes companies which seek by their strategy to integrate an important number of actors in their FFE but these actors are not necessarily located at different entities. Wide sky coverage requires a big telescope and a big telescope requires a tripod to be set up on. Such a tripod has no impact on the quality of the telescope. It does not modify the elements of the telescope but provides stability and eases its utilization. In analogy with the FFE, the literature proposes such ‘mechanical tools’ to set the FFE up on. Indeed, the overview by Koen *et al.* (2014) indicates that almost all the empirical studies have been effectuated in at least medium-market or big companies. These empirical studies are the origins of FFE processes such as the Stage-Gate process of Cooper (1990), the process model of Khurana and Rosenthal (1998) or the holistic framework of Gaubinger and Rabl (2014). These processes work like a tripod to stabilize the internal FFE and provide guidance for management and the actors involved to structure a rather chaotic phase of the innovation process. It has already been argued in this dissertation that these models do not take account of the geographic space between actors but they have still proven their applicability in the academic literature as powerful approaches to integrate a huge number of interdisciplinary actors during the FFE.

Mounting a telescope on a tripod helps to collect knowledge within interdisciplinary teams. This second position of the ProxIS-Model requires that FFE teams are located locally. A tripod does not increase a telescope’s capacity to perceive knowledge which is located far away but provides stability and orientation to coordinate a large FFE team.

### 5.3.2.3 The ProxIS-Dimension

In consideration of the shortcomings of current FFE processes regarding the international dimension, the case study at BÜRKERT established the ProxIS-Telescope (3b), which has been described in PART IV. Together with the insights from 3D PLUS and ELECTRO, the telescope is part of the ‘ProxIS-Dimension’ including the ProxIS-Monocular (3a) and the ProxIS-Laser (3c). The previous analysis has shown that all three positions of the ProxIS-Dimension rely on the same three elements to substitute geographic space (i.e. relationship of trust, a common platform, and a shared mental model) but the resulting coordination mechanisms vary for each position. Thus, this ProxIS-Dimension provides several sets of coordination mechanisms for a spatial FFE of discontinuous innovations depending on the

organization's strategy. The ProxIS-Telescope (3b) has been shown to score on a medium level on both strategic axes and this is also why the ProxIS-Telescope is situated in the middle of the model. It therefore represents a unique managerial solution for a medium-market structure such as BÜRKERT relying on a few international knowledge opportunities.

#### 5.3.2.3.1 The ProxIS-Monocular (3a)

The ProxIS-Monocular relies on direct and informal knowledge flows where some few key individuals have a central position to coordinate knowledge over space. These key individuals do not limit their activity to the internal world of the company but extend direct knowledge flows to their external environment. At 3D PLUS, the product managers represented such a central node. Besides strong ties with internal employees, they relied on their agency network and external knowing communities to get access to international knowledge. This external dimension is necessary to remain up to date of international tendencies. It is therefore part of the corporate strategy to integrate international knowledge from the external environment into internal innovation processes during the FFE.

The earlier mentioned combination of strong ties and weak network architectures is fostered at the FFE by a relationship of trust with external partners and an interdisciplinary background of the individuals positioned in the central node. To sum this up, the 'ProxIS-Monocular' comprises the following coordination mechanisms for each element:

- Precondition: Strong internal and weak external ties to create trust with core customers;
- 1<sup>st</sup> lens: A central node to merge external and internal knowledge flows on one focal point; and
- 2<sup>nd</sup> lens: A central node together with its international network to create an interdisciplinary and intercultural interface between actors.

All these coordination mechanism enable a small company to absorb international knowledge from the external environment. The ProxIS-Monocular at 3D PLUS is used to capture internal innovative potential and still to manage external links to other sources for innovation. Similar as a monocular, the product managers reinforce the capacity of their eye by their weak external network structure to perceive knowledge which is far away and to respond to international knowledge opportunities.



### 5.3.2.3.2 The ProxIS-Laser (3c)

The position 'ProxIS-Laser' represents a strategy where the company seeks to integrate a high number of actors during the FFE who are located at several geographic dispersed entities. In line with Greiner's model of growth, BÜRKERT and ELECTRO both agreed that with an increasing number of actors involved during the FFE, more structures are necessary to coordinate this workforce. Such structures, though, must be carefully chosen to avoid restraining creativity, as observed at BÜRKERT during its creative crisis around 2013. At the same time, the international dimension leads to further challenges increasing the complexity of knowledge sharing within the FFE team. The comparison between ELECTRO and BÜRKERT has shown that these international challenges might be managed by simply introducing the ProxIS-Telescope. Indeed, in its essence, ELECTRO relied on the same elements as BÜRKERT:

- Precondition: Trust on top-management level to connect international subsidiaries;
- 1<sup>st</sup> lens: Internal knowing communities to stock internal knowledge; and
- 2<sup>nd</sup> lens: A strong organizational culture to create a common consensus.

However, the participative innovation at ELECTRO leads to a higher number of actors involved than in the pilot case and the telescope was not sufficient for ELECTRO to coordinate knowledge over space during the FFE. This is why a critical extension is made. ELECTRO reinforces each element of its telescope by its international innovation hub. As previously presented, it enhances transversal knowledge sharing through a close network of innovation facilitators and local activators, it provides support for the knowing communities and it expands the organizational culture by the introduction of a creative subculture. Its objective is therefore to design an international organizational setting during the early innovation phase which overcomes the global/local trade-off in order to enhance creativity on a corporate level.

Organizations at the position 'ProxIS-Laser' should therefore not only rely on the three coordination mechanisms of the ProxIS-Telescope. Similar to a laser which is sent into space to calculate errors and adjust the picture in big telescopes, an international innovation hub such as observed at ELECTRO represents a parallel construct to the ProxIS-Telescope which systematically fosters an international FFE of discontinuous innovations in big companies.



### 5.3.3 CONCLUDING REMARKS

The dynamic ProxIS-Model combines reflections about the three case studies conducted. It considers Greiner's (1998) model of growth and Johanson's and Vahlen's (1977, 2009) Uppsala internationalization matrix, and applies these theories to the FFE of discontinuous innovations.

The dynamic extension of the initial ProxIS-Telescope implies that companies should adapt their coordination mechanisms during the FFE in respect of their strategy shaped by two dimensions: international knowledge opportunities and the number of actors involved; considering that both impact knowledge sharing of FFE teams. Based on the insights from the three case studies in combination with the literature review, figure 46 summarizes the underlying dynamics during the FFE of discontinuous innovations. As explored throughout this dissertation, it is assumed that a growing number of FFE actors correlates with the need for increasing structuration. Regarding the international dimension, it is indicated here that with increasing knowledge opportunities, management should shift from pure management of processes to the management of proximity. This is in line with the research of Koen *et al.* (2014) claiming to focus on an organization's attributes such as the culture, vision and strategy instead of only relying on internal processes.

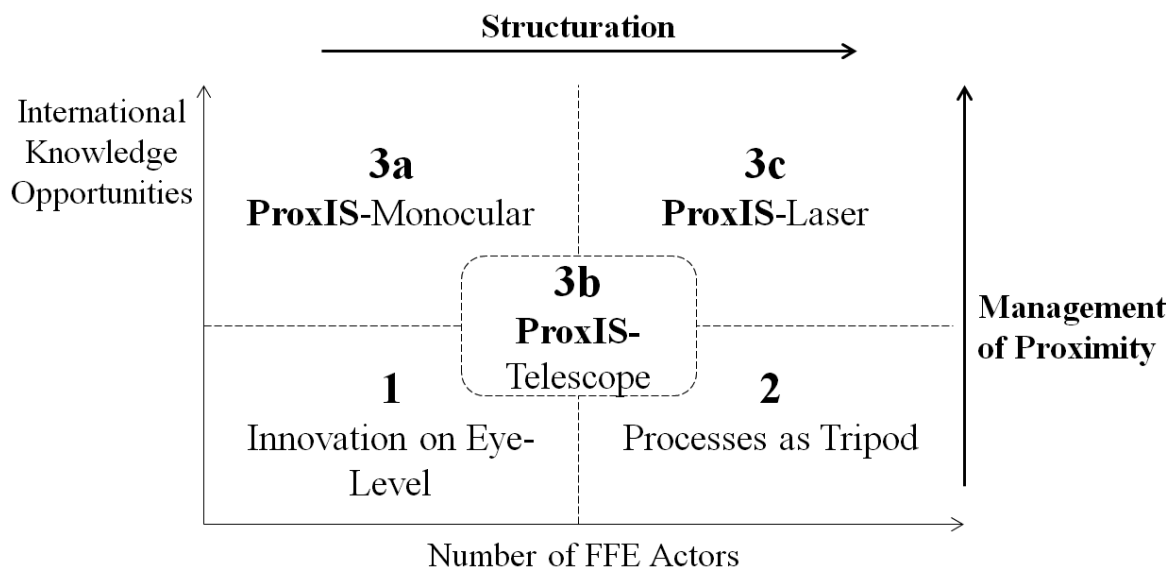

Figure 46 – Underlying Dimensions of the Dynamic ProxIS-Model.

From this perspective, it should again be underlined that the ProxIS-Dimension does not represent yet another process for the FFE but describes a fertile organizational setting where knowledge can efficiently be shared on an international level and ideas for discontinuous

innovations might emerge. The elements of the initial ProxIS-Telescope rely on the three non-spatial proximity dimensions and are thus present in each of the three ProxIS-positions. Still, the resulting concrete coordination mechanisms vary with regards to the size of the FFE team. For instance, knowing communities as coordination mechanisms range from external communities in small companies (i.e. 3D PLUS) over a hybrid form of communities in medium-market structures (i.e. BÜRKERT) towards a multiple hub connecting various internal (and probably also external) communities in big companies (i.e. ELECTRO). Indeed, knowing communities obtain crucial importance for the management of proximity in accordance with Cohendet *et al.* (2001) and Cohendet and Diani (2003). As the authors suggest, an increasing internationalization of FFE activities strengthens the role of knowing communities as coordination mechanisms over space, as they represent an appropriate platform for sharing international knowledge.

The proposed model provides an initial framework for managers to position their FFE activities of discontinuous innovations with regards to their intended strategy. If an international approach is required, the ProxIS-Dimension provides guidelines for managers to integrate international knowledge during the FFE in order to foster the generation of discontinuous innovations.

#### **CONTRIBUTIONS**

This chapter establishes the **dynamic ProxIS-Model** – a framework for the FFE of discontinuous innovations that depends on international knowledge opportunities and the number of actors.

#### **Sub-question 9 – Cross-Case Implications**

The initial coordination mechanisms of the ProxIS-Telescope are extended to smaller and bigger teams. Common patterns of the ProxIS-Dimension are:

- The emphasis of trust as a prerequisite for knowledge sharing during the FFE;
- The creation of a common platform for knowledge sharing; and
- A shared mental model regarding innovation and creativity.

The resulting concrete coordination mechanisms vary depending on the number of actors involved.

**PART VI**  
**BACK TO EARTH -**  
**GENERAL CONCLUSION**

*“It suddenly struck me that that tiny pea, pretty and blue, was the Earth. I put up my thumb and shut one eye, and my thumb blotted out the planet Earth. I didn’t feel like a giant. I felt very, very small.”*  
*Neil Armstrong*  
 (BrainyQuote.com, 2016)

Taking a step back and looking at the big picture is very comforting at the end of a three-year research project. A project with a fuzzy compilation of disconnected ideas at the beginning has merged into a complete picture. Indeed, it was helpful to be writing about the ‘fuzzy’ front-end while having the feeling of actually living it: iterations, going back and forth in the process, looking for interactions with other people to get helpful advice, etc. Nevertheless, the quotation by Neil Armstrong expresses quite well how one can feel at the end of such a project: when looking at the final picture, one might expect to feel like a giant; however, considering the huge space which still remains unexplored, one realizes that this output is like a drop in the ocean.

Before getting too sentimental, this general conclusion will present that final picture. After a short synopsis of the research context, the results of the present research will be summarized. General findings are elucidated first, before detailing the empirical results which are specific to the industrial contexts of BÜRKERT, 3D PLUS, and ELECTRO (**chapter 6.1**). **Chapter 6.2** will clarify the contributions to the existing knowledge bases from a theoretical and managerial point of view. Finally, **chapter 6.3** provides an outlook on the limits of this research and the potential for future research.

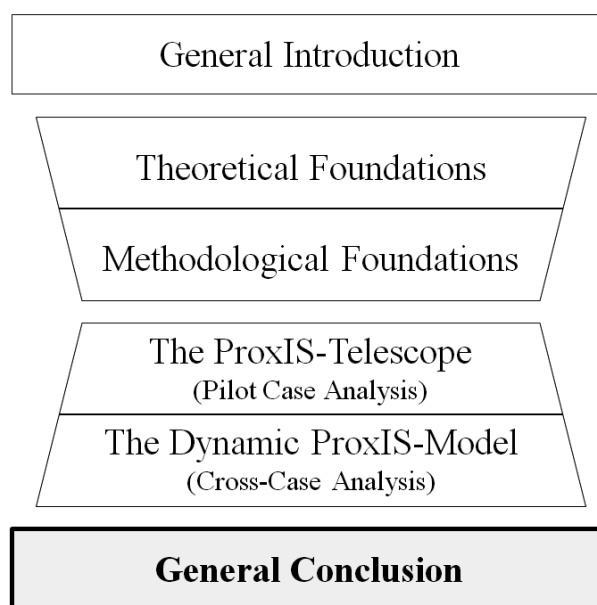

Figure 47 - Outline of the Dissertation. Present Part: General Conclusion.

## 6.1 RÉSUMÉ OF THE THESIS

In light of the increasing complexity that is due to global competition (Brem and Voigt, 2009), classic coordination mechanisms are no longer sufficient to secure a firm's persistence (Teece, 2007). Consequently, organizations should concentrate on the fuzzy front-end (FFE) of innovation, since the combination and generation of new knowledge is indispensable to creating concepts that lead to discontinuous product innovations, which may help assure the long-term survival of a company (Reid and De Brentani, 2004; Veryzer, 1998). Creative ideas and creative problem solutions already exist on the periphery of a firm; but if the company fails to exploit international knowledge, this potential remains in the creative slack (Cohendet and Simon, 2007). Consequently, management is encouraged to develop strategies to efficiently coordinate this knowledge and thus to foster creativity in international teams. This context motivated the present research project, which investigated the FFE of discontinuous innovations in international companies. Based on the theoretical framework in PART II, the research question was formulated as a paradox:

### **The Paradox:**

How can international organizations manage the continuous generation of discontinuous product innovations at the fuzzy front-end which requires geographic proximity between actors given the fact that this proximity does not correlate with today's organizational reality?

The FFE of discontinuous innovations requires proximity between actors, but geographical proximity cannot be assured in international companies. This leads to a paradox between proximity requirements on the one hand, and the innovative potential of sharing international knowledge on the other.

The research project started in 2014 as an industrial PhD at the BETA laboratory of the University in Strasbourg in cooperation with BÜRKERT as industrial partner. Over three years, valuable insights from this pilot field were collected in order to conceptualize the research question and propose the ProxIS-Telescope as a first parsimonious model for the international FFE of discontinuous innovations. This model was applied to two further fields, namely 3D PLUS and ELECTRO and suitably extended it finally to the dynamic ProxIS-Model.

## 6.1.1 GENERAL STRUCTURE OF THE THESIS

After a general introduction (**PART I**), this dissertation consisted of four main parts. First, the theoretical foundations were prepared (**PART II**). The objective was to define the framework of this research, which concerns the FFE of discontinuous product innovations. **PART III** entered into details about the fields and the methodological approach, based on a holistic multiple-cases design at BÜRKERT, 3D PLUS and ELECTRO.

**PART IV** described the results from the pilot case. The three chapters of this empirical analysis treated each of the three proximity dimensions (organizational, social, and cognitive) independently. The chosen content analysis demonstrated the state-of-the-art in the case company, and set out how it manages the FFE in international teams. The results led to the development of the initial ProxIS-Telescope with its elements combining all the coordination mechanisms which have been detected.

**PART V** starts with a process analysis, investigating the evolution of these non-spatial proximity dimensions over time at BÜRKERT in order to identify their interdependences with organizational growth. This process analysis created the fundamentals for the cross-case analysis with 3D PLUS and ELECTRO. **PART V** extends the previously developed model by adding a dynamic view (i.e. dynamic ProxIS-Model) which depends on the corporate strategy shaped by the number of actors involved and a company's international knowledge opportunities.

Overall, the results of the pilot case and of the cross-case analysis guide us finally back to earth and to the current part of this dissertation (**PART VI**): the conclusion. In the following, the empirical findings are investigated in more detail. First of all, they include an appreciation of the findings from a general perspective before entering into more details about company specific findings regarding the three field contexts.

## 6.1.2 EMPIRICAL FINDINGS

### 6.1.2.1 General Findings

PART IV focused on the pilot case at BÜRKERT and the initial ProxIS-Telescope with its elements and the resulting coordination mechanisms at BÜRKERT. To ensure that appropriate care and attention was given to each of the three non-spatial proximity dimensions, they were treated independently.

Chapter 4.1 investigated the precondition, which is that stars send out light (i.e. international employees share their knowledge). Thus, organizational proximity between the headquarters and its international subsidiaries was considered in order to identify the initial incentives for international employees to participate in the FFE on a corporate level. In allusion to the knowledge flows-based framework of Gupta and Govindarajan (1991), an international FFE typology was developed to classify local subsidiaries regarding their FFE activities. Findings suggest that during the FFE of discontinuous innovations, an international subsidiary should be positioned as ‘integrated FFE player’ which differentiates it from other positions within the matrix by a high level of trust on a top-management level as well as the systematic integration into corporate innovation processes. The comparison of the different locations at BÜRKERT, their characteristics, and their specific role in the innovation process revealed that trust on top-management level enables FFE team members to rely on context-related trust (swift-trust) to openly share knowledge across space. This is crucial for discontinuous innovations to enhance the transfer of tacit knowledge. In addition, the FFE of discontinuous innovations is a bottom-up process where ideas are generated at the individual level and then transferred to corporate innovation processes. Trust on a top-management level therefore represents the fundamental precondition for employees located in an organization’s subsidiary to voluntarily share their knowledge with the rest of the company.

Chapter 4.2 concentrated on the first lens of the telescope, which was based on social proximity between actors. The aim was to identify a common platform which enables individuals, who are not located in the same geographic place, to interact on a regular basis and enhance the possibility of unexpected encounters between them (i.e. crossovers between rays of lights). The iterative approach between literature and empirical findings encouraged the consideration of the concept of knowing communities as relevant to managing the FFE. Hence, internal communities at BÜRKERT were closely investigated as potential

coordination mechanism. At the end of this chapter, a hybrid community combining characteristics of spontaneous and driven communities was proposed to maintain social relationships between individuals across space. The technology circle together with its focus groups, represents a platform where employees of all entities are able to submit ideas and share their knowledge. Considering the growing workforce at BÜRKERT, social encounters no longer happened automatically. Under these circumstances, the hybrid community systematically strengthened social ties between actors during the FFE. However, the proposed ‘model of creative crystallization and diffusion’ was a conditional model that depended on the number of actors involved and the type of the community, as both elements were identified as factors influencing the initial degree of social proximity between individuals.

Chapter 4.3 analyzed the second lens – the eyepiece – considering the cognitive proximity between individuals and the impact of differing national cultures on the international FFE of discontinuous innovations. Regarding previous results, trust leads to the fact that international employees are willing to share knowledge, and the hybrid community encourages them to collaborate. However, without a common codebook these efforts remain pointless, because international employees will have difficulties understanding each other. To align individual behavior and create a shared vision within an international FFE team, BÜRKERT relied on its strong organizational culture, and a shared professional culture based on a background in technical educational. The findings suggest that a strong organizational culture incites individuals with different national cultural backgrounds to share a common vision about innovation and thus to adhere to common behavioral rules. The observations from the pilot case point to the fact that during a phase which is less structured than the later development process, a shared mental model (in analogy to Liu and Dale, 2009) such as a common organizational and professional culture represents a strong framework to replace what might otherwise be missing orientations for employees.

The content analysis in PART IV leads to the establishment of the ProxIS-Telescope, combining all three elements and their underlying coordination mechanisms to coordinate knowledge during the FFE across space. A dynamic dimension to this model was applied in PART V. The process research in chapter 5.1 showed that some of the coordination mechanisms – for instance, the hybrid community – evolved over time in the pilot case. Participant observation revealed that discontinuous innovations were generated in international FFE teams even before the introduction of this community. *In fine*, it was found in this chapter that the use of driven knowing communities to manage knowledge during the



---

FFE only became successful once more than approximately 150 actors were involved. Below this threshold individual activities were entirely sufficient to maintain social cohesion between international employees.

These results were confronted to the two industrial cases, 3D PLUS and ELECTRO, as described in chapter 5.2. Throughout the period, BÜRKERT remained a medium-market structure, and so it was considered relevant to confront the model with a small and a big company, assuming that the number of potential actors during the international FFE in each company would also differ. Chapter 5.3 therefore compared the management of the FFE in the three organizations. The findings suggest that all three companies used particular adaptations of the three identified elements of the ProxIS-Telescope (trust, common platform, and shared vision). The resulting coordination mechanisms required adaptation depending on the organizational strategy, notably characterized by the number of actors the company seeks to involve and the company's international knowledge opportunities. Hence, the previously presented static ProxIS-Telescope is extended through a dynamic approach. As a result, this dissertation finally establishes the dynamic ProxIS-Model where the ProxIS-Dimension proposes a set of coordination mechanisms to substitute geographic proximity to reliably generate discontinuous innovations across space in dependence of an organization's strategy.

## 6.1.2.2 Company-Specific Findings

All three companies were challenged by an international dimension during the FFE, although these challenges differed in respect of the environmental and organizational context. As a consequence, all three companies addressed the FFE of discontinuous innovations in a specific way, leading to several company specific findings.

### 6.1.2.2.1 The Pilot Case

The FFE at BÜRKERT is situated at the threshold between an informal approach based on personal networks of individuals and a systematic approach to innovation. Top-management favors innovation, considering it to be one of the three main pillars of the corporate strategy. This vision enabled the company to develop a process where different departments obtain a leading role (HR, R&D, and top-management) while all working on the same page to foster the internal innovation capacity of the company.

Furthermore, this pilot case demonstrated that geographic proximity is neither *per se* sufficient, nor is its absence a constraining factor for innovation to take place in international teams at the FFE. The French and German factories are geographically located at a distance which is still manageable in terms of regular physical meetings. However, the simple fact that geographic proximity is higher than with other international entities (e.g. in China or USA) does not automatically ensure that international collaboration takes place at the FFE. Before the year 2000, the two entities in France and Germany did not collaborate at all. Only the strategic willingness of the company to integrate this expertise into an international process facilitated innovation across space. Starting from 2001, the French and German R&D centers were able to innovate together despite distance, even though no structured approach existed until 2013 to systematically manage an international FFE.

The pilot case revealed that BÜRKERT adapted its coordination mechanisms to the changing environment. The most significant factor in this change was the number of actors involved. Before that shift, the FFE was based on a similar informal structure as at 3D PLUS. Figure 48 summarizes the historical evolution of the FFE at BÜRKERT and provides hypothetical future evolutions.

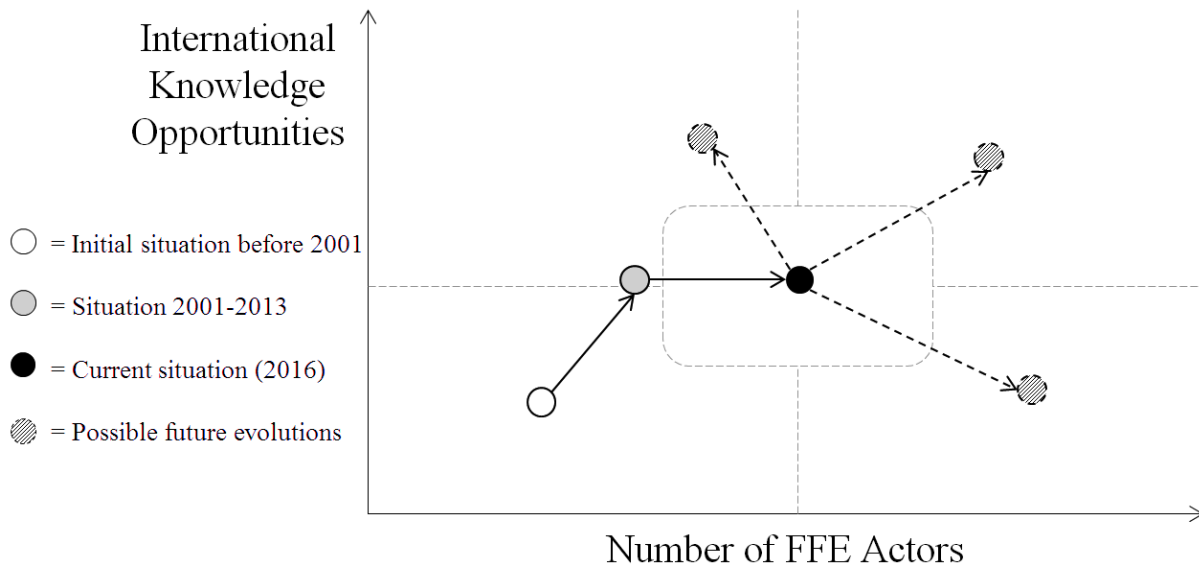

Figure 48 – The Dynamic ProxIS-Model Applied to Bürkert: Initial, Current, and Possible Future Stages.

The first stage, ‘innovation on eye-level’ represents at best the initial local organic development of the product portfolio at BÜRKERT as it was observed before 2001. After 2001 the FFE opened up to the French subsidiary and was thus already geographically diversified to some extent, even if this was limited to France and Germany. However, this phase was still described as organic development based on informal coordination mechanisms similar to the ‘ProxIS-Monocular’. Only after 2013 did the company apply the ‘ProxIS-Telescope’ due to the increasing workforce and the higher requirement for structuration. From now on, the number of active participants at BÜRKERT exceeded the threshold above which informal mechanisms were insufficient.

For the moment, the telescope still focuses exclusively on the French-German collaboration, as these are the places where new product development is located. However, crucial knowledge is located at other international entities of the company (e.g. the American subsidiary). As illustrated in figure 48 and regarding future evolutions of BÜRKERT, based on this model it is recommended that the telescope be enlarged by extending participation to other international subsidiaries considering new knowledge opportunities in the corporate strategy. It is possible that access to this knowledge adds further managerial challenges regarding the international coordination of competencies. Nevertheless, it should be the company’s objective to exploit this knowledge and integrate actors who are at greater physical distance to the headquarters.

However, if all current actors continue to participate in the FFE, the integration of further local entities into the innovation processes will obviously increase the workforce which is

active in the FFE. Consequently, the company should be aware that such a strategic decision also implies a shift in the model towards the position of the ‘ProxIS-Laser’. An international innovation hub based on a central node and local innovation facilitators as observed at ELECTRO would thus be required to manage international knowledge flows during the FFE. Notwithstanding, even if the company does not take the decision to respond to international knowledge opportunities and remains on a German-French level, it should still be aware that, as per its growth strategy (Perspectives 2023), more employees will participate in the innovation processes. In this case as well, the shift to a more structured approach is required. This implies at least the use of a tripod for the telescope, and thus the implementation of a process approach as described in the literature. As elucidated in the case description, BÜRKERT uses indeed a process map to illustrate its internal organization. Obviously, the introduction of an innovation process such as Stage-Gate or any other approach should be carefully chosen and adapted in order to be compatible with this process landscape. Finally, the company also has the possibility of continuing with a less formalized approach and still dispersing its activities across space. In this case it should be aware that the number of actors should be reduced, in order to facilitate their spatial coordination. This could be attained by relying exclusively on a few local experts in the international subsidiaries.

#### **6.1.2.2.2 The Replication Cases**

The FFE at 3D PLUS is based on direct and informal interactions, even across space. The three product managers have a central role, being in charge of the entire management of the FFE, independently of the degree of innovation (continuous and/or discontinuous). They are the eye of the organization relying on a monocular to perceive international knowledge. It is worth noting that the company does not rely on internal communities; the company still interacts with communities to nurture the FFE of discontinuous innovations, but these communities are of an external nature. The three product managers act as boundary-spanners to insert this knowledge into the internal FFE process. In accordance with Rost (2011), it is this combination of strong internal ties and weak network structures which enables the company to innovate across space despite its small size.

At ELECTRO, it was observed that the resulting coordination mechanisms are similar to the telescope of the pilot case, but with specific extensions. These extensions are required because of the higher number of people involved during the FFE and the additional resources necessary to coordinate these activities. The extensions are:

- 
- Organizational proximity: a network of international innovation facilitators to duplicate the activity of the innovation department on a local level. These innovation facilitators enable the company to promote innovation and manage the global/local trade-off.
  - Social proximity: the innovation department offers support for internal communities by interconnecting people on a virtual platform and organizing events like the innovation day, creativity workshops or other occasions to collaborate.
  - Cognitive proximity: in parallel with a strong organizational culture, ELECTRO promotes the expansion of a subculture oriented towards creativity.

All in all, ELECTRO reinforces its telescope by a dual structure managed by the full-time resources of the innovation department; similar as a laser which supports the capacity of high-technology telescopes to perceive stars which would otherwise remain outside of our visual field.

## 6.2 CONTRIBUTION

*“Geography still matters for business and the ability of firms to overcome the complexities of geography can form a crucial core competence and competitive advantage for firms.”*

(Howells and Bessant, 2012, p. 937)

The aim of this research was to understand the dynamics inherent in the FFE that manifest as soon as actors are not located at the same geographic place. Based on the insights gained in this dissertation, coordination mechanisms have been identified for discontinuous innovations. This research is situated in the field of NPD with a special focus on the FFE. Furthermore, it is based on the knowledge-based view of the firm and applies economic geography to capture the international dimension. Through the analysis, further areas such as intercultural management, network literature, or expansion theories have been integrated. The elements of the ProxIS-Telescope each make specific contributions, which have been presented separately at the end of each empirical chapter. They will not be detailed here again. Instead, general theoretical as well as managerial contributions will be highlighted.

### 6.2.1 THEORETICAL CONTRIBUTIONS

First and foremost, this research extends existing literature in innovation management by the integration of the notion of space to the FFE. As laid out in PART II, the dynamic ProxIS-model seems to be the first approach to the FFE based on a multinational empirical setting.

In the academic literature, the FFE has been represented in many different ways, whether based on detailed and structured processes (Cooper and Kleinschmidt, 1994; Gaubinger and Rabl, 2014; Khurana and Rosenthal, 1998; Koen *et al.*, 2001), decisional steps and role models (Eling *et al.*, 2013; Markham *et al.*, 2010; Reid and De Brentani, 2004), or on dynamic capabilities (Cohendet *et al.*, 2013). The literature review in PART II made clear that, starting with the FFE, discontinuous innovations differ substantially from continual ameliorations of existing product innovations in terms of the market approach (Reid and De Brentani, 2012), information and knowledge flows (Reid and De Brentani, 2004; Veryzer, 1998), the design of individual networks (Cohendet *et al.*, 2013; Parjanen, 2012), and finally with respect to the overall knowledge structure, stressing the role of new knowledge in generating discontinuous innovations (Woodman *et al.*, 1993). All these attributes make clear

that management requires different tools when dealing with discontinuous innovations compared to continuous product solutions.

The proposed ProxIS-Telescope has been established to respond to these requirements. It takes into account the assumption that ideas emerge at the individual level and enter the organizational sphere by key individuals (bottom-up); it enables unexpected encounters which might help to combine existing international knowledge in new and creative ways; and it proposes a common vision which preserves informal collaborations without restraining the FFE by formalized processes. Therefore, this model combines specific elements and their coordination mechanisms in order to create a fertile organizational setting to overcome space in one visual aid: trust (i.e. precondition), a common platform *alias* a hybrid knowing community (i.e. first lens), and a shared mental model fostered by a strong organizational culture and common professional cultures (i.e. eyepiece/second lens). In line with Koen *et al.* (2014), this model focuses on specific organizational attributes and should not be understood as a processual approach to this early innovation phase.

The dynamic extension of the model unveils a second fundamental contribution of this dissertation. Most management tools have been conceived to assure a company's expansion over space (Torrès, 2007). Consequently, scholars underline that

*“the internal organization of firms and how they are coordinated and managed over space remains a major concern for managers”* (Howells and Bessant, 2012, p. 931)

Findings of the pilot case suggest, however, that the managerial challenges during the FFE become critical because of the increasing number of actors involved (size), and not only because of the international dimension. This is in line with the research by Penrose (1972), as well as by scholars who argue that it is more the size of a company than its international expansion which determines organizational growth (Julien, 2007). In combination with the insights of 3D PLUS and ELECTRO, the dynamic ProxIS-Model suggests that greater geographic distances can be mitigated by enhancing the role of a company's internal and external communities. These results are consistent with current research about knowing communities, according them a crucial role for sharing international knowledge in regional innovation clusters (Cohendet *et al.*, 2014).

In the present dissertation, research about knowing communities and about regional innovation clusters (see for instance Bathelt *et al.*, 2004; Rost, 2011) have been transposed to

the internal view of the firm. As a result, the dynamic ProxIS-Model sheds light on how companies can manage the FFE of discontinuous innovations in respect of the number of actors involved as well as the company's international knowledge opportunities. It seems that this is the first model with regards to current FFE literature which combines both dimensions. This enlarges existing theories by applying a dynamic perspective about organizational changes, and considering the implications for the FFE of discontinuous innovations.

Finally, these insights also extend state-of-the-art literature about knowing communities. Indeed, the interdisciplinary character of this dissertation has integrated further streams of literature, leading to further contributions which have been detailed at the end of each empirical chapter. To highlight yet at least one specific contribution, this dissertation questions, for instance, the evolutionary approach of communities where one phase of their life cycle must be completed before entering the next phase (Gongla and Rizzuto, 2001; McDermott, 2000; Wenger *et al.*, 2002). The present findings suggest that management can establish the necessary coordination mechanisms in respect of the number of FFE actors involved and the initial situation of the non-spatial proximity dimensions. This implies that the corresponding form of a common platform could deliberately be created by management even if no community activities were observed at the company beforehand.

#### THEORETICAL CONTRIBUTIONS

1. Extension of FFE Literature by
  - Providing a spatial approach to the FFE *via* the **ProxIS-Telescope**;
  - Combining international knowledge opportunities and the factor 'size' by the **dynamic ProxIS-Model**.
2. Further insights in other adjoining academic fields, such as questioning the evolutionary approach to knowing communities.



## 6.2.2 MANAGERIAL CONTRIBUTIONS

The initial ProxIS-Telescope has been designed for managers to enhance collaborations over space during the FFE in medium-market structures. All formerly mentioned contributions of each chapter underline a specific role for managers during that critical phase of the innovation process. By analogy with Cohendet *et al.* (2010), managers should understand themselves as “*gardeners of knowledge*” (Cohendet *et al.*, 2010, p. 33 translated by MN). The authors refer to the fact that managers should create a fertile organizational setting which fosters knowing communities. The same proposition should be made not only for knowing communities, but in reference to the international FFE as a whole. All elements of the telescope require management which is positively inclined to international collaboration: a telescope without a person who looks through it finally remains just a tube.

When management has taken the decision to engage in an international collaboration, its main concern should be to prepare the ground for a fruitful sharing of knowledge over space. This includes a close trust relationship with its international entities, support for community activities, and the expansion of a shared mental model including intermediary role profiles (i.e. professional cultures or international facilitators) which enable interdisciplinary knowledge flows.

Managers should adapt their set of coordination mechanisms with regards to the chosen organizational strategy as this shapes a specific organizational environment where geographic space needs more or less be substituted during the FFE. As mentioned before, the present dissertation comes to the conclusion that the real managerial challenge is more to adapt to an expanding workforce than to an international context. Faced with organizational change, these insights can help managers of growing structures to keep the three non-spatial proximity dimensions in balance for a successful management of the FFE to generate discontinuous innovations.

### MANAGERIAL CONTRIBUTIONS

**A telescope without a person who looks through it remains just a tube.**

- Management should focus on the creation of a fertile organizational setting where innovation can happen.
- The ProxIS-Telescope as well as the dynamic ProxIS-Model enable managers to continually adapt the coordination mechanisms for the FFE with regards to organizational changes.

## **6.3 OUTLOOK OF THE THESIS**

As explained before, despite the insights gained about this phenomenon, there is still important work to do to explore space at the FFE. From this perspective, this chapter canvasses the open research questions and thus the potential extensions in future research. Such open issues are shaped to an important degree by the restrictions which were necessary at the outset to clearly define the framework of this dissertation.

### **6.3.1 RESTRICTIONS OF THE FRAMEWORK**

#### **6.3.1.1 Theoretical Restrictions**

One of the objectives of PART II was to clearly identify what this research is about and what it is not. Thus, some specific decisions were made which precisely delimited the area in which this research was conducted. First of all, the decision was made to focus on discontinuous product innovations. This decision was justified by the crucial role of such innovations for the long-term survival of firms, and at the same time by the fact that the three chosen organizations are active in the industrial sector based on the development of new products. These restrictions exclude all kinds of service or process innovations and do not take into account continual amelioration of existing products.

Furthermore, the theoretical foundations are constructed upon the knowledge-based view of the firm. This theory is perfectly adapted to the research question and clarifies the position of the present dissertation in research. It acted as binding factor between the FFE literature and economic geography. However, this choice had critical implications for the dissertation. First of all, it considered knowledge as the most valuable resource for firms, and thus saw innovation as a knowledge-processing activity. The coordination of knowledge was thus the main objective of the present dissertation. Secondly, the knowledge-based view of the firm concentrates on the internal coordination of knowledge. This excludes investigations of regional clusters or open innovation approaches.

### 6.3.1.2 Methodological Restrictions

Apart from restrictions regarding the theoretical foundations, further limitations are due to the methodological approach. No research methodology is entirely satisfying: some limitations may be avoided by the choice of a specific methodology, but almost all solutions add further limitations elsewhere. First of all, the interpretivist paradigm and its qualitative approach depend crucially on the research design. Qualitative data imply that a huge amount of rich information can be collected. However, the interpretation of this data relies essentially on the researcher. Data is collected, sorted, analyzed, and finally interpreted. By writing down notes about the observed field, the researcher filters information automatically (and often unconsciously). Even though this is a sign that analysis is already in progress (Collis and Hussey, 2003), it represents a source of bias as the observed reality is not totally independent of the researcher's own subjective perception (Perret and Séville, 2007).

Regarding this dissertation, it should be kept in mind that the results are based on the author's perception of the situation. Depending on the scientific field, researchers interpret and code information differently (Gavard-Perret *et al.*, 2012; Strauss and Corbin, 2004). It cannot be excluded that other researchers would have coded data differently and could have found other results in the same setting. In this specific case, the aim was to analyze the FFE in an international company from a managerial point of view. If the background of the researcher had been a financial one, a statistical one, or anything else, the results would have provided a diverging vision of the case study. The chosen methodology should therefore be considered in close correlation with the theoretical framework about innovation, the FFE of discontinuous innovations, and the analytical framework of proximity.

Finally, a well-known limit of case studies is the weak generalizability of the research results. Regarding the present research, it only can be assumed that the results will be applicable in a similar industrial area with similar environmental conditions (i.e. size of the companies etc.), but it cannot be excluded that the results might differ in other organizations. This limitation is generally accepted due to the rich information which could be gathered by this method (Collis and Hussey, 2003; Yin, 2003). Furthermore, the chosen multiple-case approach had as an objective to reduce this weakness by confronting the research results of the pilot case to two different organizational fields.

### 6.3.1.3 Practical Restrictions

The research project took place between June 2014 and May 2017. During the three years of research, I was the only person working on this project. With regards to the fact that case studies are a time-consuming method of collecting data, in-depth research was only conducted at for the pilot case at BÜRKERT. The two replication cases were investigated in less detail. Participant observation was not possible due to time and resource restrictions. Concerning the pilot case, the time schedule of the research project entailed a further challenge. The identified knowing community was only introduced in 2013. By the end of the project, four years later, it is not entirely possible to assess the long-term efficiency of this coordination mechanism.

Furthermore, most of the interviews were conducted in the French language, especially during the replication cases. My own mother tongue is German and I therefore conducted an important part of the interviews in a foreign language. It cannot be excluded that this had an impact on the comprehension of the conversation as compared to interviews conducted in my own language. As indicated by Chevrier (2000), this could limit my own subjectivity, which might represent a crucial restriction, for instance, for the chapter treating of cognitive proximity at the FFE. It cannot be excluded that the linguistic differences deformed the final interpretation of data. This could in fact not only be linked to linguistic problems but also to national cultural differences. In intercultural research, it is difficult to remain distant from one's own cultural background, and data is often analyzed from this personal perspective (Chevrier, 2000). Nevertheless, the risk of false interpretation of data was decreased by an intense sensitization to intercultural issues. My initial educational background was an interdisciplinary and intercultural training focusing on the German and French cultures. This educational background enabled me to internalize cultural specificities of both countries, and this helped me finally to improve my linguistic competencies and to reduce the risk of false interpretations of the French interviews.

Concerning cognitive differences, it is equally necessary to take into account the cultural backgrounds of the participants in the pilot study. The German headquarters of BÜRKERT is located in Baden-Württemberg and its French subsidiary is in the Alsace region. Both regions have a strong regional history. Cultural regions do not always correspond to national political boundaries and it is possible that, culturally speaking, these regions are more closely linked than, for instance, regions in the north and the south of France. This has to be taken into consideration to avoid misleading interpretations of the research results (Barmeyer, 2000;

Baskerville, 2003). The choice for qualitative interviews and not for impersonal surveys or other quantitative methods helped to limit this shortcoming. During the interviews, I interacted directly with the subjects. Eventual misinterpretations of the research questions could have immediately been detected.

Finally, a common difficulty of case studies is access to the field, but this was no limitation for the present research. At the pilot company, this was possible thanks to the CIFRE contract under which the research took place. As BÜRKERT had initial contacts with the two fields ELECTRO and 3D PLUS, the access to the supplementary case studies was equally facilitated.

All in all, case studies and their underlying interpretivist paradigm represent several shortcomings of the research. Yet this research still opted for such a design, as it was the most appropriate for the research question and the limitations are not considered to present barriers for a consistent contribution to science. Conversely, they are indeed considered above all as representing possibilities for continued research on this topic.

## **6.3.2 EXTENSIONS FOR FUTURE RESEARCH**

First of all, an extension of the investigations in the pilot company could be relevant for future research. Currently, action research is ongoing at BÜRKERT to evaluate the application of knowing communities during the FFE in international teams. This action research focuses on the acceptance of the communities and their international extension.

Regarding the state-of-the-art literature, the present dissertation provides a holistic starting point for future empirical research. Based on the fact that it was conducted in a specific industrial context, it would be relevant to investigate further industries to replicate the model elsewhere. Furthermore, by analyzing each of the proximity dimensions during this phase of the innovation process, the model provides a basis for future research which would test the research propositions with statistically representative samples. Such extensions would be needed to assess the overall significance of this model with regards to varying industrial contexts.

However, before entering upon a quantitative approach, it would be appropriate to develop the underlying theoretical reflections of the model. Future research should integrate further types of innovation such as service or process innovations. Especially when one considers the

tendencies of new innovative business models based on service providers such as Airbnb, Huber, or Netflix, such an extension would be most appropriate to the economic situation of today's society.

This implies, in addition, that future research should integrate reflections about open innovation and investigate how such an approach would modify the model. It is cautiously assumed that in such an open innovation context, a specific adjustment of all three elements of the ProxIS-Dimension during the FFE should be considered. However, it is difficult yet to say whether the resulting coordination mechanisms would still be the same, or if open innovation leads to an entirely different picture for the management of discontinuous innovations across space.

In conclusion, this dissertation leaves us with an enticing playground for further research. Hopefully, the theoretical, methodological, and practical issues will be filled out step-by-step by new inspiring research about the FFE, so as to provide a comprehensive understanding of what is really going on in space!

**PART VII**  
**RESUME DE LA THESE**

# LA GENERATION CONTINUE D'INNOVATIONS DISCONTINUES DANS LES ENTREPRISES INTERNATIONALES

## PARTIE I : LE POINT DE DEPART

Compte tenu de l'intense compétition au niveau mondial, les entreprises dépendent de plus en plus de la génération continue d'innovations discontinues pour survivre à long terme. Ce sont des innovations qui sont plus qu'une simple amélioration d'un produit existant. Elles sont nourries par la combinaison créative des connaissances des employés d'une entreprise dès la phase qui précède le projet d'innovation, défini par Smith et Reinertsen (1998) comme « fuzzy front-end » ou « FFE ». Lors de cette phase, une idée créative émerge et un concept se développe. La phase se termine dès que le concept est suffisamment stable pour entrer la phase du développement (Koen *et al.*, 2001).

Le management des entreprises internationales se voit confronté à un paradoxe lors de cette phase. D'une part, la collaboration d'employés répartis sur l'ensemble des filiales internationales renforce la capacité d'innover de l'entreprise par la diversité (Parjanen, 2012). D'autre part, la génération d'idées créatives menant à des solutions de produits hautement innovants nécessite une proximité physique entre les acteurs afin de faciliter la fréquence des interactions (Gaubinger and Rabl, 2014). La question de recherche fondamentale qui en résulte et que la présente thèse traitera est la suivante :

Comment une organisation internationale peut-elle créer un contexte organisationnel favorable à la génération continue des innovations de produit discontinues au niveau du fuzzy front-end demandant la proximité géographique entre les acteurs sachant que cette proximité ne correspond plus à une réalité organisationnelle internationale ?

La littérature actuelle en gestion de projet ne donne pas de solution adaptée à ce paradoxe de proximité pour les innovations discontinues. La présente recherche propose donc un levier novateur pour compenser le manque de proximité physique entre les employés durant l'avant-projet par d'autres dimensions de proximité sociale, cognitive et organisationnelle. Ce levier novateur sera présenté en détail dans les **parties IV et V** après avoir défini le cadre théorique de la recherche (**partie II**) et la méthodologie employée (**partie III**). Les résultats de la recherche seront résumés lors de la conclusion en **partie VI**.



## PARTIE II : LE CADRE THEORIQUE

Ce chapitre a pour objectif de délimiter la présente recherche dans le vaste domaine du management d'innovation. Cela inclut une vue globale sur les recherches en management d'innovation avec un focus plus précis sur les recherches dans le domaine du développement des produits nouveaux et le fuzzy front-end. Pour la dimension internationale, une approche de l'économie géographique sera justifiée.

### Chapitre 2.1 : L'Innovation

Le terme innovation est souvent utilisé. Il est même parfois trop utilisé, ce qui rend la mise en place d'une définition universelle difficile (Bullinger, 2008). Le Manuel d'Oslo (OECD, 2005b) propose une définition relativement large pour en assurer une vaste acceptation, indépendamment du positionnement du chercheur. Selon ce document, une innovation est

*« la mise en œuvre d'un produit (bien ou service) ou d'un procédé nouveau ou sensiblement amélioré, d'une nouvelle méthode de commercialisation ou d'une nouvelle méthode organisationnelle dans les pratiques de l'entreprise, l'organisation du lieu de travail ou les relations extérieures. »* (OECD, 2005b, p. 54)

Etant donné cette large définition et afin de limiter le sujet de la thèse, il a été décidé de se focaliser sur des innovations de produit de type discontinu. Comparées aux innovations continues, les innovations discontinues assurent la survie des organisations à long terme (Kleinschmidt *et al.*, 2007). C'est la raison pour laquelle ce type d'innovation est examiné plus en détail. Il se définit en fonction de sa capacité technologique et de son impact sur le marché (Veryzer, 1998). Le terme d'innovation discontinue inclut donc tout type d'innovation intégrant une nouvelle technologie et/ou un nouveau bénéfice pour l'utilisateur (Garcia and Calantone, 2002). Les innovations de produit ont été sélectionnées car il s'agit du type d'innovation prédominant dans les entreprises sélectionnées pour la partie empirique. Pour assurer suffisamment d'attention au sujet, les innovations organisationnelles, de processus ou de service ne seront pas pris en compte dans la présente thèse.

Une innovation de produit se distingue d'une « invention ». Comparée à l'invention, une innovation est implémentée sur un marché pour répondre à un besoin spécifique (De Sousa, 2006; Freeman and Engel, 2007). Pour implémenter une nouvelle idée, celle-ci doit passer par un processus d'innovation incluant une phase de conception (souvent appelée « fuzzy front-end »), une phase de développement et une phase de commercialisation (Koen *et al.*, 2001;

Loilier and Tellier, 2013). De manière générale, ce processus est nourri par l'équilibre entre des activités d'exploration de nouvelles connaissances et d'exploitation des connaissances déjà existants en entreprise (Gibson and Birkinshaw, 2004; March, 1991; O'Reilly and Tushman, 2004). Plus spécifiquement, la littérature traitant le développement de produit (« New product development » ou NPD) propose de nombreuses conceptions dans le but d'amener les entreprises au lancement continu de nouveaux produits. La plupart de ces modèles sont conçus pour faire rentrer une grande quantité d'idées au départ et de les filtrer rapidement dans le but de ne développer que les idées qui promettent le meilleur retour sur l'investissement (Reinertsen, 1999; Wheelwright and Clark, 1992).

Cependant, une des difficultés principales pour les entreprises subsiste dans le management efficace de la première phase du processus : le fuzzy front-end (FFE) et donc la première phase du processus d'innovation avant d'entrer dans la phase de développement (Koen *et al.*, 2001). Il en est de même pour la littérature académique. Les recherches qui se concentrent exclusivement sur cette phase sont rares par rapport aux phases ultérieures (Cohendet *et al.*, 2013; Hansen and Birkinshaw, 2007). Et ce, malgré le fait que cette phase bénéficie d'un potentiel important pour améliorer la qualité globale du processus d'innovation entier (Kim and Wilemon, 2002; Reid and De Brentani, 2004; Smith and Reinertsen, 1992). En conséquence, il sera nécessaire de compenser le manque d'attention au niveau académique et managériale dans le futur.

Finalement, le FFE n'est pas seulement un moment crucial pour réduire les coûts totaux du développement du produit (Gassmann and Schweitzer, 2014a). Lors de cette phase en amont du développement de produit, les innovations continues se distinguent aussi des innovations discontinues. Les deux types d'innovation poursuivent un cheminement différent (Reid and De Brentani, 2004; Veryzer, 1998). La présente thèse s'appuie par conséquent sur la littérature académique traitant le FFE en tant que phase charnière du processus d'innovation.

## Chapitre 2.2 : Le Fuzzy Front-End et les Innovations Discontinues

Le FFE est moins structuré et plutôt chaotique en comparaison de la phase de développement (Koen *et al.*, 2001). Ce caractère flou ne doit pas systématiquement être compris comme une barrière. Un grand nombre de chercheurs y voient un potentiel créatif accru. Ce flou donne lieu à une flexibilité qui favorise la créativité individuelle et collective. Ceci représente un potentiel élevé d'incubation d'idées (Brem and Voigt, 2009; Bullinger, 2008; Gassmann and Schweitzer, 2014b).

Depuis le début des investigations sur le FFE fondées sur la recherche de Smith et Reinertsen (1998), de nombreux modèles ont émergé dans la littérature. Ils visent à réduire ce caractère flou de cette phase. Ces représentations utilisent soit une approche processuelle (e.g. Cooper, 1990; Gaubinger and Rabl, 2014; Khurana and Rosenthal, 1998; Koen *et al.*, 2001), soit une distinction par des modèles de rôles incluant des étapes décisionnaires cruciales (Eling *et al.*, 2013; Markham *et al.*, 2010; Reid and De Brentani, 2004), soit une approche sous forme de capacités dynamiques (Cohendet *et al.*, 2013; Harvey *et al.*, 2015). La dernière rejoint un avis émergent disant que le contexte organisationnel a plus d'impact sur le succès du FFE que les activités ou leur ordre d'alignement dans le processus (Koen *et al.*, 2014).

Sous cet angle, la recherche de Cohendet *et al.* (2013) est spécifiquement intéressante. Les auteurs appliquent le concept des communautés de connaissances telles qu'elles ont été définies par Wenger (2002). Elles visent à coordonner les connaissances des employés en entreprise et favorisent des idées nouvelles. Les auteurs proposent un contexte organisationnel favorable au lieu d'un processus figé qui juxtapose diverses activités. Il semble que cette présentation du FFE ne distingue pas clairement les innovations continues des innovations discontinues. Pourtant, la recherche de Cohendet *et al.* (2013) semble prendre en compte la totalité des aspects qui ont été identifiés dans la littérature comme étant des facteurs différenciant les deux types d'innovation au niveau du FFE. Par la suite, ces différences seront présentées plus en détail.

Premièrement, les innovations discontinues intègrent de par leur nature un niveau d'incertitude plus élevé que les innovations continues (Florén and Frishammar, 2012; Verworn *et al.*, 2008). Avant d'accéder à la phase de développement, l'incertitude – en cohérence avec la définition de Galbraith (1974) – a la même intensité, mais l'effort pour la réduire va être plus élevé dans le cadre des innovations discontinues (Verworn *et al.*, 2008).

Pour surmonter cette incertitude, il est recommandé d'éviter des processus et des structures formels pour ne pas limiter la créativité (Björk and Magnusson, 2009; Griffin *et al.*, 2014).

Deuxièmement, et selon plusieurs auteurs, le FFE ne devrait pas inclure d'études de marché détaillées étant donné l'impossibilité des clients à exprimer les besoins futurs menant à des innovations discontinues (Christensen, 1997; Kim and Wilemon, 2002). Néanmoins, une certaine vision du marché reste cruciale afin d'assurer une rencontre entre innovation et besoin de l'utilisateur. Ainsi aura lieu une meilleure acceptation de l'innovation sur un marché ciblé (Crawford and Di Benedetto, 2011; Reid *et al.*, 2014).

Troisièmement, une différence de premier ordre concerne la direction du flux d'information. Dans le cadre des innovations discontinues, des recherches récentes ont montré que celles-ci suivent un processus ascendant des informations (« bottom-up »). Cela implique que les innovations discontinues dépendent d'individus clés, actifs lors de cette phase (Florén and Frishammar, 2012; Tang *et al.*, 2015). Ces individus ont une bonne idée ou créent une bonne idée en échange avec leurs collègues. Seulement dans une deuxième étape, l'idée arrive à un niveau hiérarchique suffisamment visible pour être insérée dans les processus d'innovations standards de l'entreprise (Reid and De Brentani, 2004). Il en résulte que ces acteurs ont besoin d'un réseau étroit pour échanger leurs connaissances et promouvoir leurs idées en interne (Markham *et al.*, 2010; Schulze and Hoegl, 2006). Ce réseau n'est pas seulement doté d'un caractère informel, son interdisciplinarité est tout aussi critique (Green and Cluley, 2014; Harvey *et al.*, 2015; Parjanen, 2012). Les innovations continues par contre, suivent un processus descendant (« top-down ») où l'entreprise détecte une lacune du marché (De Brentani and Reid, 2012; Reid and De Brentani, 2004).

Une dernière distinction au niveau du FFE entre les deux types d'innovation concerne le management des connaissances. Pour générer des idées qui mènent à des innovations discontinues, il est indispensable de créer des connaissances nouvelles (Schulze and Hoegl, 2006; Woodman *et al.*, 1993). Ces nouvelles connaissances peuvent tout aussi bien provenir de l'extérieur de l'entreprise qu'être créées en combinant des connaissances internes de manière créative (De Brentani and Reid, 2012; Koen *et al.*, 2014; Reid and De Brentani, 2004).

Le modèle sous forme de capacités dynamiques du FFE de Cohendet *et al.* (2013) répond à la totalité de ces différences conceptuelles. Selon mon point de vue, il présente ainsi une solution permettant de générer des innovations discontinues grâce aux communautés internes

et externes de l'entreprise. C'est également la raison pour laquelle ce modèle est appliqué comme modèle de base dans cette thèse.

Les capacités dynamiques telles qu'elles ont été utilisées dans le modèle de Cohendet *et al.* (2013) sont une extension de la théorie organisationnelle fondée sur les connaissances (Grant, 2002). Selon cette théorie, les connaissances représentent le levier primaire pour créer un avantage compétitif dans un monde de plus en plus globalisé (Curado, 2006; Grant, 2002). Sous cet aspect, l'objectif principal des entreprises doit être la création et l'intégration des connaissances (Grant, 2002), leur transfert par les communautés en interne (Brown and Duguid, 1998; Kogut and Zander, 1992), et l'exploitation des nouvelles connaissances par les structures hiérarchiques (Schulz, 2001). Etant donné que la théorie organisationnelle fondée sur les connaissances tient également compte des tendances actuelles de mondialisation (Grant, 2002), elle crée les fondations de la présente thèse. En ce qui concerne la partie empirique, il en résulte qu'une vision en interne de l'entreprise est appliquée. L'objectif est d'identifier les mécanismes appropriés pour coordonner de manière efficace les connaissances existantes en entreprise. Ces deux aspects (i.e. une vision interne et l'importance des mécanismes de coordination) sont des points fondamentaux de la théorie organisationnelle fondée sur les connaissances et représentent donc également des piliers cruciales pour la présente recherche (Grant, 2002).

Etant donné que les connaissances sont souvent dispersées géographiquement sur la totalité des filiales d'une entreprise (Kleinschmidt *et al.*, 2007), le management d'une entreprise internationale se voit finalement confronté à un challenge crucial : comment coordonner ces connaissances durant le FFE malgré la distance physique, souvent même internationale ? Dès lors, le FFE doit se mesurer dans un contexte plutôt international. Or, aucune étude empirique et théorique n'a pris en compte cette dimension (Koen *et al.*, 2014).

### Chapitre 2.3 : Une Approche Internationale du Fuzzy Front-End

En considérant le faible apport littéraire sur la notion internationale dans la littérature traitant le FFE, une définition d'une phase de FFE dite internationale est proposée dans cette thèse. En d'autres termes, c'est une phase de FFE où les acteurs sont eux-mêmes internationaux et mènent au succès cette phase préliminaire indépendamment de la localisation géographique. Selon la typologie des équipes internationales de Chevrier (2008), les activités de cette équipe peuvent avoir un caractère temporaire dans le cadre d'un projet concret. Cependant, elles peuvent en même temps avoir une dimension permanente dans le but de coordonner continuellement les connaissances internes lors du FFE.

Le champ académique du management international propose une multitude d'approches pour gérer les équipes internationales et les défis d'internationalisation des entreprises. A partir d'une telle variété dans la littérature, il s'avère nécessaire de se limiter à une théorie s'appliquant spécifiquement à cette thèse pour traiter le FFE des innovations discontinues dans une vision de théorie des connaissances.

Tandis qu'une grande partie des recherches en management international traite principalement la distance entre les acteurs, l'approche de l'économie géographique se concentre sur le concept inverse : la proximité. Même si les deux concepts semblent assez similaires, deux courants académiques différents en ont découlé. Les deux approches ne considèrent pas exclusivement la dimension géographique, et donc l'espace physique entre les acteurs, mais également différentes dimensions non-spatiales (e.g. Boschma, 2005; Ghemawat, 2003). Par contre, seul l'économie géographique analyse l'impact de cet espace sur l'innovation (Howells and Bessant, 2012). C'est la raison pour laquelle cette approche a été choisie pour la présente thèse. Même si ce courant scientifique s'inscrit dans le cadre des théories en sciences économiques, il a été retenu pour les présents travaux. Ce choix se justifie par ailleurs du fait que l'économie géographique correspond parfaitement à la théorie des connaissances. Elle met en avant la recherche de mécanismes adaptés pour coordonner les connaissances au-delà des espaces physiques (Howells and Bessant, 2012).

Plus spécifiquement, la présente thèse utilise le modèle analytique de proximité de Boschma (2005) pour comprendre les dynamiques d'un contexte international lors du FFE. Boschma (2005) et plus tard Boschma et Frenken (2010) ont identifié cinq dimensions de proximité : la proximité géographique en tant que dimension spatiale, la proximité organisationnelle, cognitive, sociale et institutionnelle décrivant les quatre dimensions non-

spatiales. Selon les auteurs, ce sont ces dimensions qui impactent les collaborations au sein des pôles de connaissances innovantes. Ces dimensions ne sont pas statiques, elles évoluent dans le temps (Balland *et al.*, 2015). Cependant, les managers d'une entreprise doivent veiller à ce que le degré de proximité ne soit ni trop élevé, ni trop bas car les deux extrêmes ont un impact négatif sur l'innovation (Balland *et al.*, 2015; Boschma and Frenken, 2010).

La considération de proximité entre les acteurs du FFE mène finalement à un paradoxe. La plupart des modèles du FFE partent de la prémisse que les acteurs soient à proximité géographique afin de faciliter les interactions nécessaires pour nourrir la créativité collective (Gassmann and Schweitzer, 2014a). Par contre, le contexte économique actuel a pour effet de disperser les acteurs auprès des filiales internationales. La littérature académique ne proposant pas de solution à ce paradoxe, la présente thèse adresse à la question de recherche suivante :

Comment une organisation internationale peut-elle créer un contexte organisationnel favorable à la génération continue des innovations de produit discontinues au niveau du fuzzy front-end demandant la proximité géographique entre les acteurs sachant que cette proximité ne correspond plus à une réalité organisationnelle internationale ?
---

En se fondant sur le modèle analytique de proximité de Boschma (2005), cette thèse s'articule autour des trois dimensions non-spatiales qui ont été identifiées dans la littérature comme étant substitutionnelles à la proximité géographique. Des auteurs tels que Hansen (2015) ont démontré que dans les situations où la proximité géographique n'est plus pertinente, elle peut être remplacée par les dimensions de proximité organisationnelle, cognitive et sociale (et non par la proximité institutionnelle). Par la suite, ce sont ces trois dimensions qui seront traitées dans la présente thèse afin de mieux comprendre leurs conséquences sur le FFE dans les entreprises internationales.

## **PARTIE III : LES FONDEMENTS METHODOLOGIQUES**

Ce chapitre présente les fondements épistémologiques et méthodologiques sur lesquels repose cette recherche.

### **Chapitre 3.1 : Les Fondements Epistémologiques**

La présente thèse s'inscrit dans le paradigme interprétativiste qui est souvent utilisé dès que l'objectif est d'explorer un phénomène nouveau (Perret and Séville, 2007). L'approche qualitative qui en résulte s'inscrit dans une démarche abductive et permettra d'élaborer une première conceptualisation pour répondre à ce nouveau phénomène (Gioia *et al.*, 2013). En se focalisant sur la théorisation ancrée de Glaser et Strauss (1999) pour l'analyse des données, l'approche abductive permettra finalement de générer une compréhension holistique d'un phénomène dont aucun modèle théorique n'existe actuellement (Glaser and Strauss, 1999). Etant donné que cette méthode de théorisation n'est pas statique mais dynamique, le choix de la démarche va permettre de rester ouvert et de choisir un cadre méthodologique adapté aux résultats intermédiaires (Glaser and Strauss, 1999).

Cette thèse applique une recherche sur le contenu et sur le processus, les deux études de recherche pouvant être considérées comme complémentaires (Grenier and Josserand, 2007). En effet, la recherche sur le contenu se focalisera séparément sur l'analyse de l'impact de chaque dimension de proximité non-spatiale sur le fuzzy front-end (organisationnelle, culturelle, sociale). La recherche sur le processus permettra de comprendre comment ces dimensions interagissent et évoluent dans le temps (Van de Ven and Huber, 1990).



## Chapitre 3.2 : La Méthode de la Recherche

Dans une démarche d'étude qualitative, une étude de cas multiple avec des unités encadrées a été choisie étant donné que cette méthode permet de répondre à des questions traitant le « comment » d'un phénomène (Yin, 2003). Cette méthode demande au chercheur de collecter les données pertinentes pour répondre à la recherche tout en gardant l'objectivité nécessaire lors de l'analyse (Wacheux, 1996). L'accès au terrain a été facilité par un contrat de recherche CIFRE (Conventions Industrielles de Formation par la Recherche) émis par l'état français. La société BÜRKERT, où ma qualité d'employée me permet de collecter toutes les données nécessaires, offre un excellent terrain pilote.

Les études de cas représentent une méthode de travail qui permet au chercheur d'alterner entre la théorie et l'empirisme (Gassmann, 1999). Des boucles itératives sont nécessaires pour garantir la cohérence entre le cadre méthodologique et les résultats sur le terrain (Eisenhardt, 1989; Yin, 2003). Étant donné les résultats de l'étude de cas chez BÜRKERT, il a été judicieux d'élargir les investigations sur deux terrains supplémentaires. Par conséquent, les deux cas de réplique ELECTRO<sup>6</sup> et 3D PLUS complètent le cadre méthodologique. Les investigations y étant moins approfondies, elles n'en ont pas moins contribué à renforcer la validité interne et externe de la recherche.

Chez BÜRKERT, cinq cas de projets de développement et leur phase FFE ont été sélectionnés comme unités d'analyse. En fonction du sujet de recherche, ces cas ont été choisis selon des critères spécifiques tels que leur degré d'innovation, le degré de diversité culturelle ainsi que leur degré de succès. L'objectif de leur intégration dans le cadre théorique a été de regarder de plus près les dynamiques d'un contexte international sur une phase de FFE concrète. Dans le cadre des deux cas de réplique ELECTRO et 3D PLUS, l'objectif était de confronter les résultats du cas pilote à un autre contexte organisationnel. Il en résulte qu'il a été considéré comme suffisant de rester sur des unités d'analyse plus large et donc au niveau organisationnel.

Finalement, la triangulation de méthodes de collecte des données a été appliquée afin de renforcer la validité interne du paradigme interprétativiste (Gavard-Perret *et al.*, 2012). Des interviews semi-structurées représentaient le moyen principal de collecte de données. Cette méthode permet de comprendre la réalité organisationnelle telle qu'elle est perçue par les

---

<sup>6</sup> Ce pseudonyme réfère à l'activité de l'entreprise pour garder son identité anonyme.

acteurs (Giordano, 2003). De plus, l'analyse de documents organisationnels complétés par des observations se sont rajoutés à la collecte des données.

Pour le cas pilote, 38 interviews ont été effectuées. Les interlocuteurs étaient les chefs de projet ainsi que les membres des projets interagissant lors du FFE sur les cinq projets sélectionnés. De plus, plusieurs autres personnes ont été interviewées du fait qu'elles étaient en mesure de décrire les processus d'innovation de la société et sa structure internationale grâce à leur fonction. Y inclus sont des managers portfolio, des expatriés, des chefs de projets internationaux, le responsable R&D de l'entité française et des membres de l'équipe des ressources humaines (RH). A part deux interviews, toutes ont été enregistrées et retranscrites pour faciliter leur codage. L'observation participante avait principalement lieu dans l'entité française. Par contre, l'interaction régulière avec les collaborateurs des autres entités a été facilité grâce à la convention CIFRE. Finalement, l'analyse des documents s'est focalisée sur les documents relatifs aux projets analysés, des documents organisationnels tels que le site internet ou des documents traitant de la culture de l'entreprise, la structure organisationnelle etc.

Chez 3D PLUS, quatre interviews ont été effectuées avec les deux responsables produits qui prennent en charge le management du FFE ainsi qu'avec deux « utilisateurs » de ce processus d'innovation. De plus, un déplacement en 2016 a permis de collecter des observations directement sur le terrain. En ce qui concerne ELECTRO, sept interviews ont été effectuées, deux dans la maison-mère française avec les personnes en charge du management du FFE ainsi que cinq « utilisateurs » localisés à distance dans une deuxième implantation française. En outre, j'ai eu l'occasion de participer à un événement d'innovation sur ce site. Cela a permis de synthétiser une idée plus concrète de leur démarche d'innovation. Des visites ponctuelles de la maison-mère française ont élargi la collecte de données.

L'analyse des données s'est effectuée sous l'angle de la théorisation ancrée en deux étapes : l'analyse verticale (analyse individuelle de chaque interview pour avoir une première liste de codes) suivie d'une analyse horizontale (identification de schémas récurrents) afin d'élaborer des catégories centrales (Gavard-Perret *et al.*, 2012).

### Chapitre 3.3 : Les terrains de recherche

Depuis sa fondation en 1946, l'entreprise de taille moyenne, BÜRKERT, est une entreprise familiale allemande. Les 2600 employés sont répartis sur les cinq centres de production européens, les 38 filiales de ventes répartis partout dans le monde ainsi que les quatre sites de production en charge de développement de systèmes pour les marchés locaux aux Etats Unis, en Europe et en Chine. Le domaine d'activité de ce spécialiste en régulation et contrôle des fluides (i.e. toute forme de liquide est gaz) est vaste. L'entreprise a la ferme volonté de garder le leadership technologique comme l'un de ses trois piliers stratégiques, avec l'indépendance financière et l'expérience de la culture familiale. BÜRKERT est fier de sa capacité d'innover pour se différencier de la concurrence. Le développement de nouveaux produits s'effectue dans les trois centres R&D de la société dont deux sont situés en Allemagne et un en France. Cette dernière entité est aujourd'hui le centre de compétence pour les capteurs. Les trois implantations collaborent étroitement.

3D PLUS a été fondé en 1995 et est toujours gérée par un de ses fondateurs. Aujourd'hui, cette entreprise compte 185 employés qui sont localisés principalement à la maison-mère en France. La société s'est spécialisée dans la production de composants micro-électroniques pour les applications spatiales. La qualité et la fiabilité de ses produits sont primordiales car ce secteur d'activité ne permet pas d'erreurs. Cette notion de qualité se reflète également dans les valeurs de l'entreprise. Comparable à BÜRKERT, ELECTRO est également une société familiale allemande. Elle a été fondée en 1955 et, suite à son évolution historique, elle tient aujourd'hui deux maisons-mère, une en Allemagne et une en France. La société produit des installations électriques pour l'industrie ainsi que pour des particuliers. Les 11 600 employés sont dispersés dans 60 pays où la société s'est implantée.

Les trois cas se différencient essentiellement par leur taille en termes d'effectifs. Toutes les trois focalisent leurs activités sur l'innovation de produit pour le secteur BtoB (i.e. Business to business). Toutes les trois sont des sociétés familiales. BÜRKERT et ELECTRO partagent en outre une culture d'entreprise que l'on peut qualifier de forte. Lors des interviews, il a été confirmé que la plupart des salariés la partagent, indépendamment de leur localisation. Cela est cohérent avec Sørensen et Sorensen (2002) qui définissent une culture organisationnelle effectivement comme étant forte quand elle est partagée par la majorité des employés indépendamment de leurs propres origines nationales.

## PARTIE IV : LE PROXIS-TELESCOPE

Cette partie de la thèse présente les résultats de l'analyse de contenu chez BÜRKERT. Chacun des chapitres suivants traitera une dimension particulière, c'est-à-dire l'une des trois dimensions non-spatiales qui remplacent la proximité géographique. Dans le but d'en faciliter la compréhension, j'ai décidé d'appliquer une métaphore. En parlant d'espace, d'idées brillantes et les grandes distances qui séparent les décideurs en entreprise souvent de ces idées, le terrain de l'astrophysique propose une excellente approche métaphorique pour rendre les résultats de la présente thèse plus vivants. Imaginons que les employés internationaux de l'entreprise soient les étoiles dans le ciel et que les décideurs du management observent ces étoiles pour exploiter leur potentiel. L'œil humain n'est malheureusement pas capable de percevoir toutes les étoiles du firmament car celles-ci sont souvent trop éloignées (Cheng, 2009). C'est pourquoi l'observateur utilise un outil de travail, le télescope.

Le top-management chez BÜRKERT est parfaitement conscient du potentiel d'innovation synergétique entre les entités internationales, encore va-t-il falloir le reconnaître et l'exploiter. Il en résulte que cette partie de la thèse proposera un outil novateur, le « ProxIS-Télescope » (Proximity in Idea Sharing), et par voie de conséquence la stratégie appliquée par BÜRKERT pour mieux appréhender les connaissances de ses employés internationaux (figure 49).

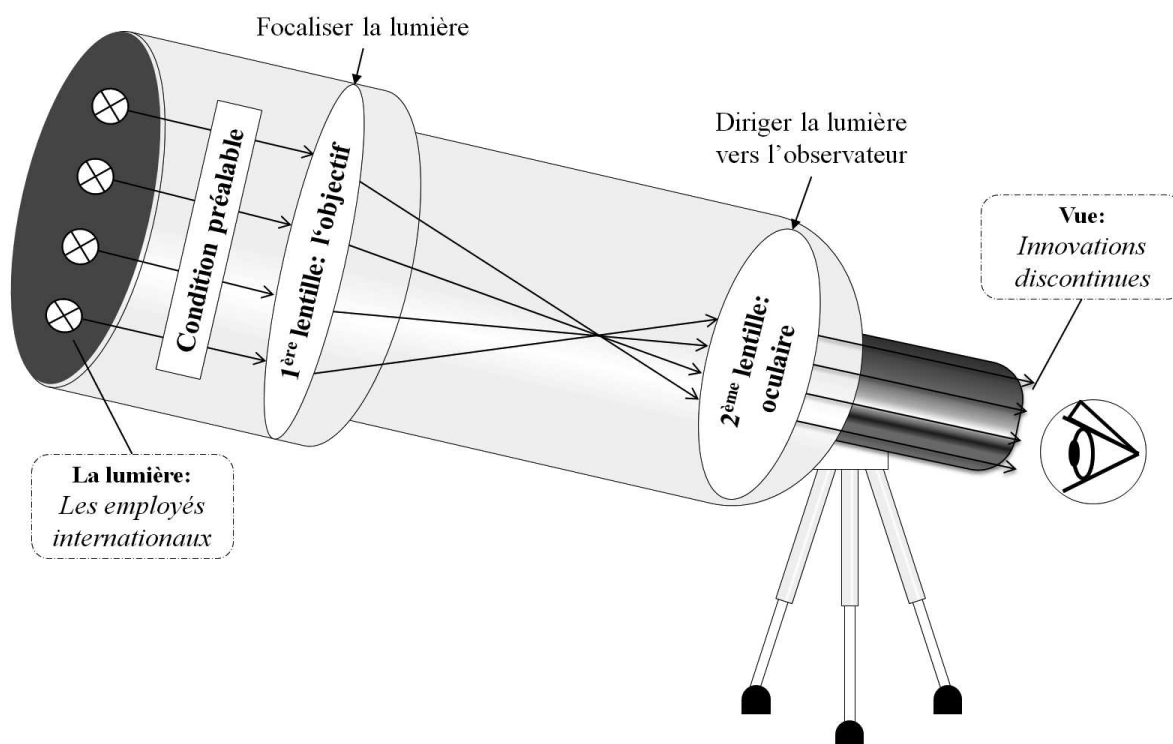

Figure 49 – Le ProxIS-Télescope et ses éléments fondamentaux (par MN).

Avant d'utiliser ce nouvel appareil d'une manière efficace, une condition primordiale doit être remplie, c'est la luminescence des étoiles qui va permettre à l'observateur de les percevoir. Cette condition préalable, qui est en entreprise la motivation des employés de partager leurs connaissances, est traitée par **chapitre 4.1** de la partie IV prenant en compte une analyse détaillée de la proximité organisationnelle.

En quoi consiste un télescope ? Un télescope contient deux lentilles qui ont deux fonctions distinctes. La première lentille ou « l'objectif » a pour but de concentrer la lumière sur un point focal où les rayons de la lumière se croisent (Cheng, 2009). Pour le ProxIS-Télescope, cette première lentille traitera la proximité sociale dans l'entreprise dans le **chapitre 4.2**. La deuxième lentille ou « un oculaire » oriente les rayons de lumière vers l'œil de l'observateur (Cheng, 2009). Cette orientation est la proximité cognitive qui vise à orienter les connaissances des employés dispersés à travers le monde vers une vision globale. Elle est décrite dans le **chapitre 4.3**.

Bien évidemment, le télescope n'est d'aucune utilité si personne ne veut observer les étoiles. Dans le cas du FFE, le management doit avoir par conséquent la volonté d'utiliser le télescope pour collecter et exploiter les connaissances internationales. Ce point crucial est en parfait accord avec la stratégie de BÜRKERT dont le top-management oriente explicitement ses efforts vers une collaboration internationale pour favoriser l'innovation.

Le ProxIS-Télescope ne représente pas un processus pour gérer le FFE. Au contraire, les éléments du télescope décrivent un environnement organisationnel favorable à la génération des innovations discontinues dans des équipes dispersées dans l'espace (i.e. distance physique).

## Chapitre 4.1 : La Proximité Organisationnelle

La proximité organisationnelle décrit la relation entre la maison-mère et les filiales locales d'une entreprise et détermine le degré de leur interdépendance (Boschma, 2005). Dans ce chapitre, il est question d'observer les caractéristiques du réseau interne d'une entreprise multinationale (MNC). Cela va permettre de déterminer le rôle des filiales lors du FFE ainsi que d'identifier les conditions pour contribuer à la génération des innovations discontinues. Ce rôle des filiales se caractérise principalement par les flux de connaissances entre les diverses entités. Il en résulte que les travaux de Gupta et Govindarajan (1991), et notamment leur modèle des flux de connaissances, sont à la base de ce chapitre.

### Fondements théoriques de ce chapitre

Gupta et Govindarajan (1991) ont développé une matrice qui décrit quatre rôles que peut avoir une filiale dans le réseau interne d'une entreprise multinationale. Ce sont l'inventeur local, l'implémenteur, l'innovateur global, et l'innovateur intégré. Ces positions se distinguent par l'intensité des flux de connaissances sur deux axes : les flux des connaissances de l'entité locale observée vers les autres filiales (connaissances sortantes), et ceux des autres filiales vers l'entité locale (connaissances entrantes). Selon les auteurs, ce sont ces flux de connaissances<sup>7</sup> qui déterminent le rôle des filiales locales dans le réseau d'une MNC. En cohérence avec les travaux de Bartlett et Ghoshal (2002), les auteurs suggèrent que la position la plus favorable pour une filiale locale est celle de l'innovateur intégré où des flux sortants et entrants peuvent être observés.

Il a été argumenté préalablement que le flux d'informations est ascendant lors du FFE des innovations discontinues. Les idées passent par des individus clés avant d'arriver au niveau organisationnel. Selon la typologie de Gupta et Govindarajan (1991), on peut donc supposer que des flux de connaissances doivent sortir de l'entité locale pour être capté au niveau organisationnel. Par conséquent, il semble qu'une filiale internationale requiert au moins la position de l'innovateur global ou de l'innovateur intégré pour participer à la génération des innovations discontinues car les deux rôles décrivent des positions où les flux sortants de l'entité local vers le reste de l'entreprise sont élevés.

---

<sup>7</sup> i.e. le transfert des connaissances et des données de marchés externes sans prendre en compte des flux d'informations tels que des rapports mensuels ou d'autres échanges administratifs.

Dans le cadre des innovations continues, l'entreprise réalise une étude de marché et, en fonction des résultats obtenus, elle demande aux départements de R&D locaux de développer un produit qui réponde aux besoins du marché. Des flux de connaissances unilatérales de la maison-mère vers l'entité locale sont suffisants (i.e. position de l'implémenteur). Si aucun flux de connaissances n'est ni reçu ni émis par l'entité locale, celle-ci n'est pas impliquée au niveau organisationnel lors du FFE (i.e. l'innovateur local). Ces réflexions théoriques mènent à deux questions supplémentaires qui seront abordées lors de l'étude de cas chez Bürkert :

- Comment une entreprise peut-elle influencer les flux de connaissances entre ses filiales ?
- Quels sont les mécanismes pour positionner une entité locale comme un acteur actif dans la génération des innovations discontinues ?

#### L'application de la typologie à BÜRKERT

Les interviews ont permis d'identifier, cinq entités locales en fonction de l'intensité de leurs flux de connaissances avec le reste de l'entreprise. Il s'agit de l'entité américaine, la filiale de vente canadienne, le centre R&D de Karlsruhe, l'entité française avant 2005 et sa position à partir de 2005. Il est possible de classer l'activité de ces succursales lors du FFE à l'aide de la typologie de Gupta et Govindarajan (1991).<sup>8</sup> Le codage des interviews a permis de reconnaître de manière évidente deux éléments majeurs pour ce classement. Ce sont d'une part la relation de confiance entre le top-management et l'entité locale et d'autre part l'intégration de celle-ci dans les processus d'innovation.

Chez BÜRKERT, l'analyse des interviews a montré que l'intégration explicite de la filiale dans les processus d'innovation a renforcé les flux de connaissances du reste de l'entreprise vers la filiale ce qui permet aux employés locaux d'identifier clairement les bons interlocuteurs. Par contre, les interviewées supposent que cela n'est pas suffisant pour des innovations discontinues nécessitant des flux de connaissances sortants de la filiale vers le reste de l'entreprise. Chez BÜRKERT, il a été observé que seules les personnes qui faisaient confiance aux décideurs de la maison-mère partagent leurs connaissances sans restriction. Dès lors, leurs connaissances peuvent être collectées, traitées et combinées avec d'autres idées pour favoriser une collaboration internationale lors du FFE.

---

<sup>8</sup> L'entité américaine = innovateur local ; la filiale de vente canadienne et le centre R&D de Karlsruhe = des innovateurs globaux ; l'entité française avant 2005 = l'implémenteur ; l'entité française à partir de 2005 = l'innovateur intégré.

A l'exemple de l'entité française depuis 2005, une relation de confiance a été observée entre le top-management de la maison-mère et la filiale française. Par la suite, une relation de confiance est également née entre collègues français et allemands même sans qu'ils aient travaillé ensemble jusque-là. Cette dimension de confiance temporaire (« swift-trust ») est essentielle pour partager des connaissances tacites avec des personnes sans historique personnel (Meyerson *et al.*, 1996). Lors du FFE, la créativité collective est alimentée par des rencontres imprévues entre des collègues qui ne se connaissent pas (Cohendet and Simon, 2006). Pour que ces personnes partagent néanmoins leurs connaissances tacites, cette confiance temporaire est primordiale.

Pour conclure, les observations chez BÜRKERT impliquent que l'intégration dans les processus d'innovation favorise la génération des innovations continues à l'échelle internationale d'une MNC car ce mécanisme facilite les flux de connaissances entrants. Cependant, c'est la relation de confiance entre les acteurs internationaux qui facilite la génération des innovations discontinues en renforçant les flux de connaissances sortants. Ce sont ces deux conditions qui permettent à une entité locale d'un réseau MNC de contribuer au FFE favorisant les innovations discontinues.

Ce chapitre a classifié les caractéristiques de base pour faciliter la génération des innovations discontinues à l'échelle internationale. Les résultats chez BÜRKERT proposent une grille d'analyse aux managers des MNC. Celle-ci permet de positionner les filiales en fonction de leurs activités lors du FFE. De plus, il est possible de les repositionner grâce à deux mécanismes qui sont d'une part la relation de confiance entre la filiale et la maison-mère et d'autre part son intégration dans les processus d'innovation.



## Chapitre 4.2 : La Proximité Sociale

Dans ce chapitre, il est question de caractériser la première lentille du ProxIS-Télescope et de fixer le rôle de la proximité sociale lors du FFE. De nombreux chercheurs soulignent le rôle crucial de cette dimension pour favoriser le partage de connaissances entre acteurs (Bathelt *et al.*, 2004; Boschma, 2005; Bouba-Olga and Ferru, 2009; Cassi and Plunket, 2015; Cohendet and Diani, 2003).

Par conséquent, Cohendet *et al.* (2013) proposent de se référer aux communautés de connaissances existantes en interne et à l'extérieur de l'entreprise. Il s'agit d'un concept qui permet, grâce à sa capacité de socialisation, de gérer les partages des connaissances entre les membres de ces communautés à moindre coût (Cohendet and Simon, 2007; Harvey *et al.*, 2015). Dans la littérature, de nombreux types de communautés ont été identifiés, chacun avec son propre objectif. C'est la raison pour laquelle Bootz (2015) propose une comparaison de ces différents types de communauté qui peuvent être observées en interne d'une entreprise en fonction, entre autres, de leur objectif et leur mode de gouvernance. Cette typologie distingue deux grandes catégories, des communautés spontanées et des communautés pilotées. Les deux types de communautés peuvent exister en entreprise de manière parallèle, ce qui attribue un rôle crucial aux managers (Arzumanyan, 2014). Le soutien du top-management pour les activités communautaires est primordial pour que les communautés puissent réellement contribuer à l'organisation (McDermott and Archibald, 2010).

Par la suite, les communautés de connaissances chez BÜRKERT vont être analysées. L'objectif est d'évaluer leur capacité de renforcer la proximité sociale entre des acteurs dispersés géographiquement pour faciliter le partage de connaissances entre eux lors du FFE.

### Les communautés chez BÜRKERT

L'évolution historique du portfolio de produits chez BÜRKERT résulte aujourd'hui d'une vaste gamme de produits. Pourtant, il est devenu difficile de maintenir tous les produits à la hauteur technologique. C'est la raison pour laquelle l'entreprise a décidé de restructurer ses processus d'innovation afin de mieux coordonner le développement des nouveaux produits. Par contre, les interviewés témoignent que ces nouveaux processus ont pour résultat une diminution de la créativité et l'émergence des innovations discontinues a été réduite. Pour visualiser cet état des faits, le centre R&D à Karlsruhe a construit un « cimetière d'idées

échouées ». Il s'agit d'une collecte de tous les concepts de produit qui ont été arrêtés avant la phase de développement.

Le management de BÜRKERT a réalisé qu'il fallait réagir. C'est la raison pour laquelle le management des connaissances a été fondé sur les communautés de connaissances. Ces communautés s'organisent autour des cinq champs technologiques qui sont centraux pour l'entreprise. Cette structure favorise les innovations discontinues. Elle propose une plateforme aux employés pour y soumettre leurs idées et partager leurs connaissances. Pour chaque champ technologique, un « focus group » a été créé. Leur objectif est d'insérer des connaissances externes dans la structure organisationnelle et d'être ouvert aux idées des collègues. Quelques focus groups ont déjà été créés en 2005, mais ils n'ont pas été de longue durée. La raison citée en est un manque d'objectifs clairs.

En 2013, ces focus groups ont été réanimés sous la supervision du manager du portfolio technologique. Ces communautés regroupent tous les experts internes du champ technologique. Chaque focus group est animé par un « mentor » qui n'est pas obligatoirement un supérieur hiérarchique. Ces mentors se réunissent régulièrement. Avec le manager du portfolio technologique, ils forment le « cercle technologique ». Ce dernier remplit des fonctions stratégiques. Il soutient les activités des focus groups et favorise l'incubation d'idées. Les focus groups et le cercle technologique ont la charge d'élaborer un concept innovant et de l'accompagner jusqu'au moment où il devient un projet de développement.

Comparé aux focus groups de 2005, le champ d'action des communautés de 2013 a été élargi. Leur but n'est pas exclusivement de collecter et partager des connaissances, mais de remplir une « roadmap technologique ». Leurs activités partent d'initiatives individuelles dans les focus groups. Par conséquent, toute la phase du FFE est construite autour des communautés internes de l'entreprise. Indépendamment de la localisation géographique des experts, ils se retrouvent tous dans ces focus groups. En outre, cette façon d'alimenter le développement technologique permet à BÜRKERT de transférer les idées locales jusqu'à leur insertion dans les processus organisationnels. La structure vit des interactions régulières et d'une communication transversale entre les focus groups et le cercle technologique. Cette façon d'organiser le FFE dépend de plusieurs conditions.

Premièrement, il faut comprendre que les communautés chez BÜRKERT remplissent à la fois les caractéristiques des communautés spontanées et des communautés pilotées. Le cercle technologique répond à des objectifs stratégiques et il est animé par le manager du portfolio

technologique. Les focus groups, quant à eux, semblent plutôt de s'auto-organiser. En charge de la partie opérative, ils regroupent des membres homogènes, c'est-à-dire des experts du même domaine qui se réunissent à leur propre rythme. Le cercle technologique, quant à lui, regroupe des membres hétérogènes. Ce sont tous les mentors des différents domaines technologiques et donc avec des connaissances technologiques plus diversifiées. Ils ont un agenda bien précis et s'inclinent au processus stratégique de l'entreprise qui implique entre autres l'établissement d'une roadmap annuelle. La structure communautaire chez BÜRKERT représente une forme hybride qui permet le partage des connaissances entre les experts du même domaine, mais également entre les différents focus groups. C'est également cette structure hybride qui permet la socialisation entre les experts. Le cercle technologique assure la légitimation de ce travail communautaire et crée le lien vers les décideurs de l'organisation.

La deuxième condition est la taille de l'entreprise. Depuis 2005, l'entreprise a grandi de manière significative (1585 employés en 2005 à 2438 en 2015). Les interviewés ont témoigné que jusqu'en 2013, ils n'avaient pas de difficulté d'identifier eux-mêmes les experts en entreprise. Pour partager leurs connaissances lors du FFE, ils n'avaient pas besoin de mécanismes spécifiques. Suite à la croissance importante, il est devenu plus difficile pour les acteurs du FFE d'identifier les bons interlocuteurs. En conséquence, l'entreprise doit manager ces liens sociaux de manière systématique. C'est la raison pour laquelle elle a décidé d'introduire le cercle technologique et les focus groups.

Les deux conditions, une typologie hybride des communautés et la taille de l'entreprise, mènent à un niveau de proximité sociale bien spécifique. La taille de l'entreprise est celle d'une entreprise de taille moyenne.<sup>9</sup> La communauté hybride, elle, crée une plateforme pour que les employés puissent tout de même partager leurs connaissances indépendamment de leur propre localisation. Ces aspects présentent les conditions de base d'un « modèle de cristallisation et diffusion créative » proposé dans ce chapitre. Ce modèle a été élaboré ici pour structurer les premières étapes du FFE autour des communautés de connaissances créatives (i.e. focus groups en charge des activités opératives). Les étapes suivantes du FFE sont prises en charge par une communauté de mentors (i.e. cercle technologique pour assurer la stabilité stratégique) avant qu'une idée soit insérée au processus de développement standard.

---

<sup>9</sup> Les processus internes de l'entreprise sont moins basés sur l'individu que dans une petite structure mais toujours moins impersonnel que dans les grands groupes.

Ce modèle favorise la créativité en renforçant la proximité sociale entre les acteurs du FFE. La forme hybride des communautés a permis à l'entreprise de contrebalancer la structuration croissante des processus en interne. Cette structuration a été nécessaire pour coordonner le nombre croissant de compétences en interne. Pourtant, cette situation cause une réduction de la créativité collective et de la génération des innovations discontinues. Par la suite, l'étude de cas chez BÜRKERT suggère que les communautés représentent un mécanisme de coordination approprié pour équilibrer cette situation et qu'elles permettent à l'entreprise de gérer les connaissances de ses employés à distance.

Les communautés hybrides représentent la première lentille du ProxIS-Télescope. Cette partie d'un télescope permet principalement des croisements entre les rayons de lumière. Ainsi, grâce à ces communautés, les employés internationaux ont une plateforme sur laquelle ils puissent interagir pour partager leurs connaissances.

### Chapitre 4.3 : La Proximité Cognitive

La condition préalable a été identifiée pour que les employés internationaux partagent leur savoir. Une plateforme a été introduite pour qu'ils puissent interagir au-delà des frontières nationales. Cependant, si ces personnes ont des difficultés de compréhension dues à des langues et/ou à des cultures différentes, les efforts de partage de connaissances s'avèrent infructueux. L'objectif de ce chapitre est d'identifier des mécanismes appropriés pour créer un modèle mental partagé qui a pour but de faciliter les échanges de connaissances dans les équipes internationales lors du FFE (Liu and Dale, 2009).

La troisième dimension pour se substituer à la proximité géographique qui en découle est en même temps la deuxième lentille du télescope : la proximité cognitive pour orienter la lumière vers une vision commune. Cette dimension dépend de la capacité d'absorption et du processus d'apprentissage des individus. Seuls les individus qui partagent un minimum de connaissances peuvent s'échanger de manière efficace (Boschma, 2005; Nooteboom, 1999). Cependant, si leurs connaissances se recoupent dans une large mesure, le potentiel créatif est réduit (Balland *et al.*, 2015).

Généralement, les connaissances des personnes sont fortement liées à leur apprentissage. Elles dépendent de leurs expériences et de leur historique personnel (Nonaka and Von Krogh, 2009; Nooteboom, 1999). Il y a des auteurs qui proposent donc que la proximité cognitive et la proximité culturelle sont étroitement liées car la culture influence les perceptions fondamentales des individus ce qui forme également les connaissances de l'individu (Knoben and Oerlemans, 2006). Etant donné que la présente thèse vise à analyser le FFE internationale et donc dans des équipes internationales, cela implique que la proximité cognitive sera analysée ici sous l'angle de la culture nationale des acteurs lors du FFE.

D'un côté, la culture nationale renforce la diversité des équipes internationales et représente un facteur positif pour l'innovation discontinue (Rocas and Garcia, 2017). De l'autre côté, il peut arriver que cette diversité culturelle ait un impact négatif sur la créativité collective si la proximité cognitive n'est pas suffisante (Brannen, 2009; De Brentani and Reid, 2012). Les différences culturelles risquent également d'avoir un impact négatif sur le FFE par rapport à plusieurs aspects. Ainsi, des personnes d'origines culturelles différentes décident (Barmeyer, 2000) ou communiquent différemment (Hall, 1960). De plus, il se peut qu'elles ne partagent pas assez de connaissances communes pour pouvoir se comprendre suffisamment (Hempel and Sue-Chan, 2010).

Dans la littérature académique, la culture organisationnelle est souvent perçue comme facteur clé de succès lors des collaborations internationales. Elle se définit en étant un système mental qui différencie les employés d'une entreprise des autres sociétés (Hofstede *et al.*, 2015). Comme une culture organisationnelle est difficilement imitable, elle permet à une entreprise de se distinguer de la concurrence tout en alignant les comportements individuels sur des règles partagées (De Brentani and Kleinschmidt, 2004). Cependant, il est possible qu'une culture organisationnelle orientée vers l'innovation ne soit pas partagée par tous les employés ayant des cultures nationales différentes. Une culture d'innovation devrait favoriser un comportement entrepreneurial de ses employés et les recherches interculturelles supposent que ce type de comportement ne semble pas être partagé dans toutes les cultures nationales (Hofstede *et al.*, 2015).

Néanmoins, il est argumenté dans la littérature que la culture organisationnelle ne cherche pas à modifier les valeurs culturelles ancrées au fond des individus.<sup>10</sup> Elle n'influence que les valeurs superficielles telles que symboles ou rites culturels. En conséquence, Hofstede (2001) propose qu'il est possible que les employés d'une entreprise multinationale adhèrent à la même culture organisationnelle sans pour autant partager la même culture nationale.

Chez BÜRKERT, les deux cultures nationales principalement représentées lors du FFE sont les cultures allemande et française. Bien évidemment, il ne faut pas survaloriser l'impact de la culture nationale sur le comportement des personnes (Barmeyer and Lüsebrink, 1996; Schroll-Machl, 2013). Pour éviter donc le risque d'une simplification excessive, un des cinq projets lors de l'étude de cas chez BÜRKERT est un projet national. Ainsi, l'objectif a été de comparer le FFE dans les équipes internationales avec une équipe nationale.

Lors du FFE des cinq projets analysés, une réduction du succès du projet liée à des différences culturelles n'a pas pu être observée. Au contraire, lors de l'analyse des données du terrain, il a été constaté que la plupart des acteurs du FFE ont appliqué diverses stratégies pour surmonter des difficultés culturelles. A titre exemplaire, un comportement autonome et proactif a été observé chez les membres d'un des cinq projets. Suite à un manque d'informations, les décideurs allemands avaient des difficultés pour décider du passage de l'idée au développement. Les membres du projet avaient pris l'initiative de collecter plus d'informations pour accélérer la prise de décision. Des réactions autonomes similaires ont été

---

<sup>10</sup> Ces valeurs nous permettent de faire la distinction entre ce qui est bien ou mauvais, juste ou injuste, beau ou moche, etc. Ces valeurs sont différentes d'une culture nationale à une autre (Hofstede *et al.*, 2010).

observées concernant les acteurs des deux pays et donc indépendamment de leur culture nationale.

Par la suite, il a été observé que toutes les stratégies appliquées par les acteurs pour faciliter les échanges interculturels<sup>11</sup> lors du FFE étaient fortement liées à la culture organisationnelle de BÜRKERT. Néanmoins, des difficultés de communication ont été observées au niveau national. Dans plusieurs cas, les interviewés témoignent d'une compréhension problématique et d'une perception divergente. Cela concerne l'interface entre R&D, marketing et vente des nouveaux produits dont les employés n'intériorisent pas les informations en circulation. Cela relève donc la question pourquoi ces difficultés de communication avaient lieu au niveau national et pourquoi pas lors des collaborations franco-allemandes. Un mécanisme de coordination indirecte a été identifié lors des échanges internationaux : une culture professionnelle partagée.

Une grande majorité des acteurs du FFE (33 des 38 personnes interviewées) partage une formation professionnelle d'ingénieur. C'est cette base de connaissances techniques commune qui augmente la proximité cognitive en facilitant la compréhension malgré d'éventuelles déficiences linguistiques ou culturelles.

Les résultats chez BÜRKERT suggèrent qu'une forte culture organisationnelle est un facteur facilitateur pour le partage des connaissances au niveau international lors du FFE. Cette phase manque de structure claire et le management a moins de possibilités d'intervenir directement pour guider les efforts créatifs (Gassmann and Schweitzer, 2014a). En conséquence, une culture organisationnelle forte remplace ce déficit de cadre commun en superposant des règles de comportement partagées.

Par contre, une culture organisationnelle forte ne suffira pas pour servir de médiateur lors de cette phase car des acteurs interdisciplinaires doivent interagir pour transmettre une idée ou un concept créatif au niveau organisationnel (Cohendet *et al.*, 2013). Dans ce cas précis, une culture professionnelle partagée permet de faciliter la communication interprofessionnelle. Chez BÜRKERT, ce résultat a été exploité par la mise en place d'un service marketing interdisciplinaire. Les membres ont à la fois une formation technique (i.e. ingénierie) et des profils avec une forte vision du marché. Comme des facilitateurs interculturels lors des échanges internationaux, ces personnes facilitent la communication entre différents

---

<sup>11</sup> i.e. vocabulaire partagé, comportement proactive, des réunions régulières au-delà des frontières nationales, une collaboration étroite à l'échelle franco-allemande.

départements (i.e. R&D et service commercial). Ainsi, ils assurent le transfert d'une nouvelle idée vers son développement (Chevrier, 2000; Cohendet and Diani, 2003).

Comme exposé dans la littérature, la forte culture organisationnelle est en effet un facteur clé de succès chez BÜRKERT. Elle a permis de limiter les aspects négatifs de cultures nationales divergentes. Avec des cultures professionnelles partagées, elle crée un modèle mental partagé pour maintenir la proximité cognitive lors du FFE. Ce modèle représente la deuxième lentille du ProxIS-Télescope pour orienter les efforts d'innovation vers une vision commune.



## Chapitre 4.4 : Discussion du ProxIS-Télescope

La recherche sur le contenu chez BÜRKERT a donné lieu à l'élaboration du « ProxIS-Télescope » (figure 50).

Lors d'une phase moins structurée que le développement de produit, ce modèle synthétise la condition préalable ainsi que les deux lentilles et donc les mécanismes de coordinations concrètes qui facilitent chez BÜRKERT le partage des connaissances entre employés distancés géographiquement.

Pour motiver les employés internationaux de partager leur savoir, l'entreprise doit veiller à maintenir une relation de confiance entre la maison-mère et la filiale (i.e. proximité organisationnelle). Cette relation de confiance permet un flux de connaissances ascendant, ce qui inclut notamment le partage des connaissances de nature tacite. Pour collecter ces connaissances et pour permettre l'échange entre collègues internationaux, l'entreprise doit mettre en place une plateforme adaptée (i.e. proximité sociale). Dans le cas de BÜRKERT, cette plateforme est une communauté hybride. Cette structure a permis à l'entreprise de valoriser les connaissances existantes en entreprise. Pour faciliter les échanges internationaux et pour limiter les effets négatifs des différences culturelles, l'entreprise doit mettre en place un modèle mental partagé (i.e. proximité cognitive). Chez BÜRKERT, celui-ci est fondé sur la forte culture organisationnelle. Il favorise des valeurs partagées axées sur l'entrepreneuriat et l'esprit créatif ainsi que sur une culture professionnelle commune.

Ces trois éléments ensemble – la relation de confiance, une plateforme partagée ainsi qu'un modèle mental partagé – permettent à l'entreprise de regarder plus loin dans l'espace pour découvrir et exploiter les connaissances internationales. Mais comme dans un télescope, ces éléments sont reliés dans un système commun : un élément seul n'est pas suffisant pour favoriser les échanges internationaux lors du FFE. Chez BÜRKERT, seul le site français intègre tous les trois éléments et c'est également le seul site actif en dehors de l'Allemagne donnant lieu à des innovations discontinues lors du FFE. Il s'y rajoute que l'efficacité du télescope dépend de l'efficacité de l'élément le plus faible. Le management doit donc veiller à ce que ces trois dimensions se développent simultanément.

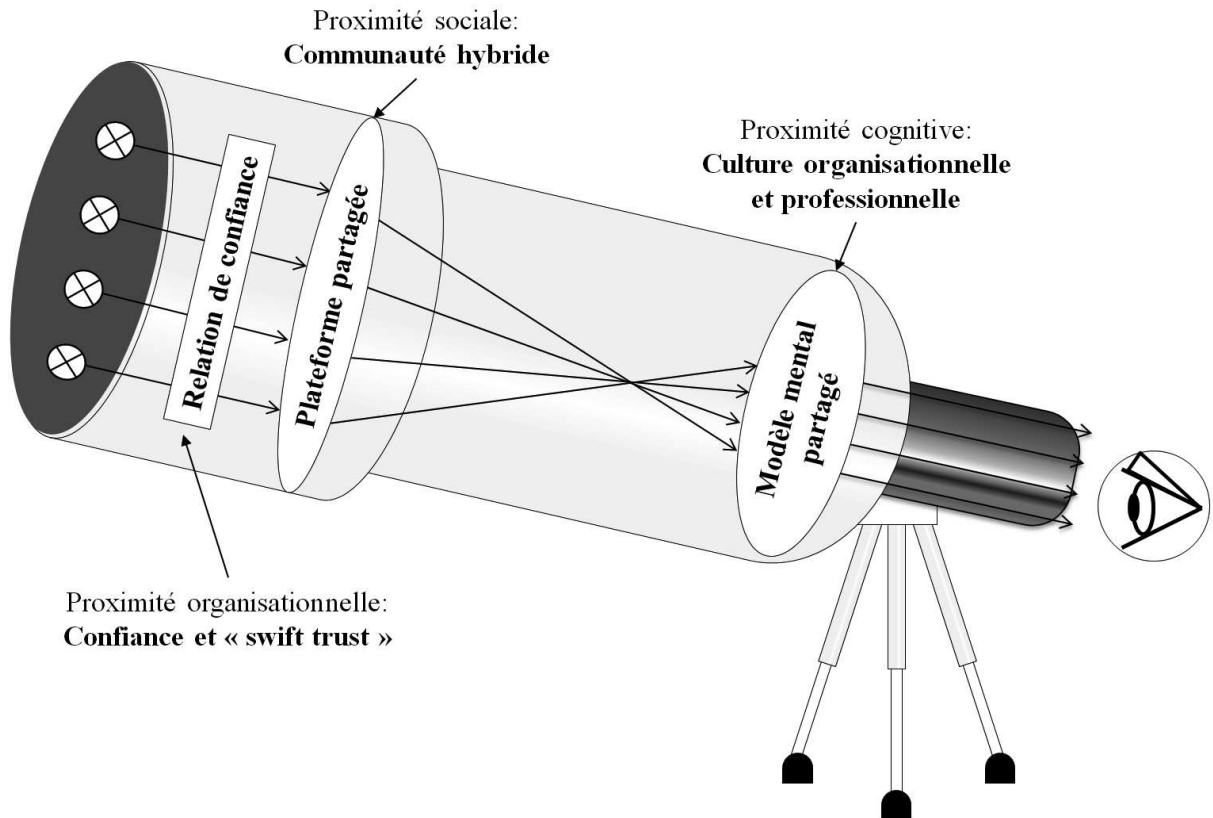

Figure 50 – Le ProxIS-Télescope chez BÜRKERT et les mécanismes de coordination relevés (par MN).

L'analyse chez BÜRKERT est fondée sur une recherche sur le contenu. C'est une approche statique du FFE. Cependant, chapitre 4.2 a relevé que les mécanismes identifiés ont évolué au fil du temps. Dans la prochaine partie, une recherche sur le processus va permettre d'analyser cette évolution. Les résultats obtenus seront comparés avec ceux des deux autres sociétés 3D PLUS et ELECTRO.

## **PARTIE V : UNE EXTENSION DYNAMIQUE DU PROXIS-MODELE**

Les résultats obtenus chez BÜRKERT ont montré que les entreprises qui agissent sous une contrainte spatiale lors du FFE sont obligées de maintenir simultanément les trois dimensions de proximité non-spatiales, la proximité organisationnelle, cognitive et sociale. Néanmoins, les résultats préalablement présentés suggèrent que le ProxIS-Télescope dépend du contexte dans lequel il s'applique. Il en résulte que le « modèle de cristallisation et de diffusion créative » (chapitre 4.2) est un modèle conditionnel qui dépend entre autres de la taille de l'entreprise. Un point ouvert du modèle est celui du rôle de la taille de l'entreprise sur le FFE.

L'évolution des dimensions de proximité non-spatiales est analysée chez BÜRKERT afin d'identifier d'éventuelles interdépendances entre elles et la taille de l'entreprise pendant le FFE. Cette analyse prend en compte l'évolution de la croissance chez BÜRKERT. Plus précisément, l'objectif n'est pas de se focaliser sur la taille de l'entreprise, mais sur le nombre d'acteurs qui interagissent lors du FFE. Les résultats sont confrontés à deux autres contextes industriels. Après avoir présenté les deux structures d'innovation des cas de répllication 3D PLUS et ELECTRO, un modèle dynamique (ProxIS-Modèle) est développé.

### **Chapitre 5.1 : La Proximité et la Croissance Organisationnelle**

Des chercheurs argumentent que la taille et non l'évolution spatiale détermine la croissance d'une entreprise (Torrès, 2007). Par conséquent, Greiner (1998) propose un modèle de croissance organisationnel. Ce modèle décrit cinq phases d'évolution. La transition entre ces phases est systématiquement déterminée par une crise – une révolution – qui provoque un changement du style managérial. L'auteur souligne que des mécanismes managériaux adaptés dans une phase perdent leur efficacité dans une autre phase. En accord avec les résultats chez BÜRKERT, il peut donc également être supposé que le management d'une entreprise doit adapter sa façon d'utiliser le ProxIS-Télescope en fonction du nombre des acteurs.

Le modèle de cristallisation et de diffusion créative a souligné que la proximité sociale est un paramètre sensible lors du FFE. Les difficultés rencontrées chez BÜRKERT montrent que le management doit intervenir dès que les acteurs ne sont plus capables de maintenir eux-mêmes cette proximité sociale. Effectivement, la recherche de Dunbar (1992) propose que les êtres humains ont des difficultés de maintenir plus d'approximativement 150 relations sociales à cause de la capacité biologique limitée du cerveau humain. Il semble d'en résulter en termes managériale qu'au-delà de ce seuil, le management d'une entreprise est obligé

d'intervenir pour coordonner systématiquement ces liens sociaux. Si cela s'applique également au FFE des innovations discontinues sera abordé entre autres dans ce chapitre.

Le chapitre présent examine l'évolution des dimensions de proximité non-spatiales chez BÜRKERT pour comprendre l'impact du nombre des acteurs sur la façon optimale de gérer le FFE. Dans ce but, une recherche de processus analyse la phase entre 1998 et 2015 plus en détail. A partir de 2001, le site français a été intégré dans les processus d'innovation au niveau du groupe. Cependant, la recherche de processus intègre la phase dès 1998 pour comparer la situation initiale avec l'internationalisation du FFE en 2001. Pendant la totalité de la phase analysée, l'entreprise a connu une forte croissance organisationnelle (d'environ 1500 en 2000 à plus de 2400 en 2015). Le terrain est donc parfaitement adapté à cette analyse.

Au cours de la phase analysée, diverses actions ont été implémentées par BÜRKERT pour faciliter les échanges à distance lors du FFE. Une gestion de projet commune, une culture organisationnelle partagée, des projets communs, des processus standardisés ainsi que l'introduction du cercle technologique n'en sont que quelques exemples. Cependant, l'efficacité de ces actions pour maintenir les proximités non-spatiales dans les équipes FFE internationales n'ont pas toutes été évaluées favorables par les interviewés.

Il a été éclairci par les interviewés que, malgré une proximité organisationnelle renforcée par des processus standardisés, notamment la proximité sociale a diminuée de manière significative à partir de 2013. Cette situation a baissé la créativité et la capacité d'innover dans l'équipe FFE. Les observations participantes ainsi que les interviews ont fait le lien entre cette évolution et le nombre croissant d'acteurs actifs lors du FFE. La croissance a rendu difficile l'identification des bonnes personnes de contact pour partager les connaissances. De plus, les interviewés ont remarqué que des rencontres spontanées et donc imprévues étaient de plus en plus rare. Et ce au niveau national ainsi qu'entre acteurs français et allemands.

En 2005, les acteurs actifs du FFE étaient moins nombreux qu'en 2013. Par conséquent, ils étaient parfaitement capables de maintenir eux-mêmes une proximité sociale malgré la distance physique. Les échanges individuels ou des projets communs étaient suffisants pour collaborer entre le site français et les sites allemands. Il en résulte qu'entre 2005 et 2010, deux concepts majeurs d'innovation aient été créés.

Il a été observé que le basculement vers une situation de « crise créative » se recoupe avec le moment où plus d'environ 150 acteurs ont fait partie du FFE. L'évolution du département

R&D de BÜRKERT donne une approche quantitative des membres du FFE. Historiquement, le FFE a toujours été géré dans ce département et entre 2012 et 2013, il a au final dépassé le seuil de 150 employés. Les interviews ont confirmé que c'était suite à la croissance de l'entreprise qu'une structuration des processus d'innovation est devenue indispensable. Par contre, il a été observé en même temps que les standardisations des processus qui en découlent ont accentué la crise créative à partir de 2013. Les interviewés confirment qu'ils avaient moins d'occasions de collaborer lors du FFE et que la proximité sociale était réduite. Pour surmonter cette crise, le management a décidé de réagir et il a introduit par la suite le cercle technologique. Etant donné la forte dimension sociale de cette communauté, l'objectif de cette mesure était de prendre en charge le management systématique des liens sociaux entre les acteurs pour renforcer de nouveau la proximité sociale.

Le nombre d'acteurs croissant a eu un impact négatif sur la proximité sociale. Parallèlement, une main d'œuvre croissante impliquait une augmentation de la proximité organisationnelle. Plus de structures et de règles étaient nécessaires pour coordonner les ressources disponibles comme indiqué dans le modèle de croissance organisationnel de Greiner (1998). En même temps, l'augmentation de la proximité organisationnelle influençait négativement le FFE car le rapprochement des acteurs par des structures croissantes limitait la créativité et la collaboration à distance chez BÜRKERT. Lors du FFE, il semble que la proximité sociale peut être gérée de manière informelle dans des équipes de taille petite. Au-delà d'un certain seuil (approximativement 150 acteurs), l'entreprise doit systématiser les liens sociaux entre les collègues. Chez BÜRKERT, c'est le travail du cercle technologique et de ses focus groups. Il en résulte donc que les outils managériaux pour gérer les dimensions de proximité non-spatiales doivent s'adapter en fonction du nombre d'acteurs impliqués.

Pendant toute l'analyse de processus, BÜRKERT était une entreprise de taille moyenne. L'évolution de croissance chez BÜRKERT a mené à la proposition que le nombre d'acteurs lors du FFE influence le choix managérial pour les mécanismes de coordination. Il en résulte que les résultats de BÜRKERT devront être confrontés à une petite entreprise (3D PLUS) et un grand groupe (ELECTRO). Avant de rentrer dans les détails d'une comparaison entre les trois cas, les processus d'innovation, et plus spécifiquement les outils de coordination lors du FFE, des deux sociétés sont présentés.

## Chapitre 5.2 : Les Cas de Réplication

Des cas de réplication sont appliqués quand le chercheur attend des résultats divergents mais prévisibles ou des résultats totalement similaires au cas initial (Yin, 2003). Dans le cas de la présente dissertation, il a été supposé que les cas de réplication vont se différencier du cas pilote. Il est suggéré que le FFE de 3D PLUS repose entièrement sur des mécanismes informels, alors que la société ELECTRO utilise une structuration renforcée. Les deux cas vont être décrits par rapport à la notion d'espace lors du FFE et par rapport aux mécanismes de coordination appliqués.

### 3D PLUS : L'innovation dans l'espace et l'espace en innovation

L'entreprise a 185 employés qui sont localisés à la maison-mère en France. La société développe des systèmes pour le secteur spatial. La fiabilité des produits est un facteur essentiel pour les clients car une fois un produit expulsé dans l'espace, il ne sera plus possible de corriger d'éventuelles erreurs. Il en résulte que l'entreprise accorde un temps considérable à la phase du FFE. En tant que petite entreprise, 3D PLUS se voit obligée d'introduire sur le marché un produit final qui réponde parfaitement aux attentes des clients. En cas d'échec, les interviewés ont souligné que l'entreprise compensera d'éventuels erreurs moins facilement qu'un grand groupe.

La décision finale de s'engager dans un projet de développement est toujours dans les mains d'un des fondateurs de la société. Il fonde sa décision sur les informations recueillies en amont par les trois managers de produit de la société. Ces derniers ont la charge de toutes les étapes du FFE jusqu'à l'insertion d'une idée dans le processus de développement. Ces trois personnes remplissent un rôle central dans l'entreprise : elles ont le devoir de stimuler la créativité ; elles sont les personnes de contact majeures pour les employés qui souhaitent soumettre une idée ; elles ont une formation professionnelle diversifiée, ce qui facilite les échanges avec les autres services ; elles ont la charge de valider des concepts finaux ; elles coordonnent les cycles de vie des produits ; et finalement, elles supervisent un réseau international d'agents commerciaux qui vendent leurs produits partout dans le monde.

En ce qui concerne le FFE, la dimension spatiale est principalement présente lors des échanges avec des partenaires externes internationaux. Mis à part les employés internes, les clients clés, les agents internationaux et des communautés externes sont des sources

d'innovation majeures. Les trois managers de produit interagissent avec toutes ces parties prenantes ; ce sont eux qui incorporent les connaissances externes à l'intérieur de l'entreprise.

Etant donné la taille limitée de la société, les employés cherchent le contact direct avec les managers de produit s'ils souhaitent faire avancer une idée. La distance physique ne joue pas de rôle primordial au niveau interne mais lors des interactions avec l'environnement extérieur. La plupart des clients clés de la société sont situés dans les pays asiatiques et américains. Afin de faciliter les échanges avec eux, la société a construit un réseau d'agents internationaux. Ces agents ne vendent pas seulement les produits, ils agissent aussi en tant que facilitateur interculturel lors des échanges entre les managers de produit et les clients. Ils parlent souvent la langue du pays et ils connaissent la culture locale. Cela permet aux managers de produit de travailler avec les clients locaux sur une page blanche dans l'optique de détecter des tendances futures. Grâce à l'identification de ces opportunités, la société est capable de développer un concept discontinu.

Le FFE obtient une notion externe importante : 3D PLUS se voit obligé, du fait de sa taille limitée, d'interagir largement avec l'environnement externe afin d'acquérir suffisamment de connaissances pour nourrir l'innovation en interne. Le FFE chez 3D PLUS est axé autour du rôle des managers de produit qui remplissent une fonction centrale lors de cette phase.

### L'innovation participative chez ELECTRO

Depuis sa création, ELECTRO a diversifié ses activités par des fusions et acquisitions ainsi que par la construction de plusieurs entités disséminées dans le monde. Il en résulte que les centres R&D du groupe sont également répartis sur plusieurs entités internationales. Lors du FFE, la société est confrontée à plusieurs défis spatiaux :

- Suite à l'introduction de l'innovation participative, tout salarié a la possibilité de soumettre des idées indépendamment de sa localisation géographique. La société a donc besoin d'un management de connaissances structuré afin de coordonner ces contributions.
- La budgétisation des idées se présente comme étant difficile pour les idées qui arrivent en dehors des processus standards.
- Il y a la difficulté de faire avancer des idées transversales qui requièrent la contribution de plusieurs compétences localisées à des endroits différentes.

- La communication transversale entre les experts des différentes entités se présente comme étant difficile. Des communautés de connaissances existent, mais il est difficile pour l'entreprise d'identifier la totalité de ces communautés et de tirer profit de leur activité.

La réponse managériale à ces défis lors du FFE a été l'introduction d'un nœud international. Il s'agit du département d'innovation de la société qui prend en charge la gestion du FFE au niveau groupe afin de faciliter les flux de connaissances internationales. Comme BÜRKERT, ELECTRO a une forte culture organisationnelle. A part des valeurs fondamentales partagées par l'ensemble des salariés, le département d'innovation favorise l'expansion d'une sous-culture axée sur la créativité. Dans ce but, le département propose des séminaires de créativité généraux pour créer une compréhension commune de créativité. De plus, le département d'innovation prend en charge l'animation d'une plateforme virtuelle pour favoriser les échanges internationaux et de faciliter le partage des connaissances. Finalement, le département anime des événements physiques où les employés ont l'occasion d'interagir. Ces événements, comme par exemple une journée d'innovation ayant lieu à la maison-mère, favorisent les rencontres inattendues pour favoriser la créativité collective.

Au niveau international, ce nœud d'innovation va être étendu par des facilitateurs d'innovation locaux. Grâce à ces facilitateurs sur place, une identité commune de l'innovation et de la créativité sera transportée vers les entités locales (i.e. « top-down »). Ces facilitateurs pourront en outre collecter les connaissances locales et transporter des idées vers les décideurs au niveau organisationnel (i.e. « bottom-up »). Les facilitateurs sont en contact étroit avec le département d'innovation ce qui facilite à la fois le transfert des connaissances vers la maison-mère mais aussi la création des liens transversaux entre les différentes entités locales.

Pour conclure, le département d'innovation tient un rôle central lors du management du FFE. Tandis que le partage des connaissances reste une des tâches principales des communautés internes de l'entreprise, ce département est en charge de faciliter les échanges transversaux et internationaux entre les communautés. Il faut donc s'imaginer ce département avec ses extensions locales (i.e. facilitateurs d'innovation) comme une structure de réseau qui se superpose à la partie opérationnelle du FFE. Ce nœud se charge du management globale du FFE sans pour autant intervenir dans le travail technique lors de l'élaboration concrète d'une idée lors du FFE. Cette approche demande pourtant des ressources dédiées au management transversal du FFE.



## Chapitre 5.3 : L'Analyse Transversale – Le ProxIS-Modèle Dynamique

Trois sociétés différentes et trois façons différentes de gérer le FFE : ceci est le résultat apparent de la comparaison des trois sociétés. Les trois cas se distinguent effectivement de manière significative par rapport à la dimension internationale. Tandis qu'il s'agit d'une dimension interne chez BÜRKERT et ELECTRO, elle est liée aux interactions avec des clients internationaux chez 3D PLUS. En termes de nombre d'acteurs lors du FFE, une approche estimative montre que chez BÜRKERT, le département R&D rassemble les principaux acteurs du FFE et donc environ 180 employés en 2015. 3D PLUS et ELECTRO déclarent impliquer la totalité de leurs employés. Chez 3D PLUS, il en résulte que 185 employés au maximum peuvent être acteurs internes lors du FFE. Chez ELECTRO, c'est la plateforme virtuelle qui donne une indication chiffrée. Des 2500 employés inscrits, 600 collaborent régulièrement. Le nombre d'acteurs est donc au moins de 600 personnes.

### Analyse transversale des trois dimensions de proximité

Malgré les différences structurelles évidentes, les trois éléments du ProxIS-Télescope (relation de confiance, plateforme partagée, modèle mental partagé) ont pu être identifiés dans les trois sociétés.

**Relation de Confiance :** Chez 3D PLUS, la relation de confiance est un facteur critique pour les échanges avec les clients internationaux. ELECTRO souhaite créer un réseau étroit avec les facilitateurs locaux parce que ces personnes locales jouissent d'une grande confiance de la part de leurs collègues sur place.

**Plateforme partagée :** Chez BÜRKERT, une communauté hybride a été identifiée comme facteur clé de succès pour faciliter les échanges à distance. Chez ELECTRO, des communautés internes existent également, mais elles sont moins pilotées que chez BÜRKERT. Par contre, le département d'innovation gère les interconnexions entre eux. En proposant la plateforme virtuelle et des événements physiques, le partage transversal des connaissances est encouragé sans pour autant intervenir directement dans les activités liées au contenu des communautés. Chez 3D PLUS, les communautés jouent un rôle crucial, mais il s'agit plutôt de communautés externes à l'entreprise. Les managers de produit représentent un nœud central pour créer des liens avec ces communautés pour favoriser le partage des connaissances avec des experts externes.

**Modèle mental partagé :** BÜRKERT et ELECTRO ont créé un modèle mental partagé entre les acteurs du FFE grâce à leur forte culture organisationnelle. Chez ELECTRO, cette dimension a été renforcée par la diffusion d'une sous-culture créative de la part du département d'innovation. Chez 3D PLUS, la culture organisationnelle n'est pas explicitement décrite. Par contre, les managers de produit disposent d'une formation interdisciplinaire et sont capables grâce à cela de créer une compréhension commune dans le processus d'innovation entre des partenaires interdisciplinaires.

### Le ProxIS-Modèle dynamique

Dans les trois entreprises, les éléments fondamentaux du ProxIS-Télescope sont présents : la notion de confiance est primordiale lors du FFE, les communautés sont impliquées comme sources de connaissances, et des valeurs partagées orientées vers l'innovation et la créativité sont diffusées. Néanmoins, des variations de ces trois éléments sont liées à la stratégie de l'entreprise qui est articulé autour de deux dimensions : le nombre d'acteurs actifs lors du FFE et les opportunités internationales d'acquérir des connaissances.

Le deuxième point se réfère à la volonté de proposer un modèle d'internationalisation du FFE. A ce but, la dénomination de l'axe fait allusion au modèle Uppsala issue de la recherche de Johanson et Vahlne (2009). Les auteurs argumentent qu'une entreprise doit adapter sa stratégie d'internationalisation en fonction des opportunités internationales. A la base, ce modèle s'applique aux opportunités de marchés internationaux. Comme ce modèle est basé sur l'évolution des flux de connaissances et donc sur la théorie organisationnelle fondée sur les connaissances, il peut tout de même être adapté à la présente thèse. Ce modèle implique qu'il est possible que le réseau d'une entreprise évolue. En termes du FFE, il peut donc être argumenté qu'une entité locale qui acquiert des connaissances précieuses au fil du temps peut devenir plus intéressante stratégiquement par rapport à ses capacités d'innover. Par la suite, il est nécessaire d'adapter la stratégie d'internationalisation et intégrer cette entité dans les processus d'innovation.

En se basant sur ce modèle Uppsala de Johanson et Vahlne ensemble avec le modèle de croissance de Greiner, il était possible d'élaborer le « ProxIS-Modèle dynamique » (figure 51). Ce modèle combine les résultats de l'étude de cas chez BÜRKERT et des études de cas supplémentaires avec la littérature académique.

La comparaison des trois sociétés ainsi que la littérature académique donnent lieu à la supposition qu'avec des opportunités internationales croissantes, le management des proximités non-spatiales devient un levier crucial pour les entreprises. Il en résulte que les communautés gagnent en importance en tant qu'outil efficace. D'un côté, cet outil permet de créer une plateforme mentale. De plus, le facteur socialisant permet de faciliter les échanges entre des membres hétérogènes au-delà des frontières nationales (voir également Cohendet *et al.*, 2001; Cohendet and Diani, 2003). Dans des grandes comme dans des petites structures, les communautés permettent de maintenir suffisamment de proximité lors du FFE pour partager les connaissances dans une ambiance de confiance.

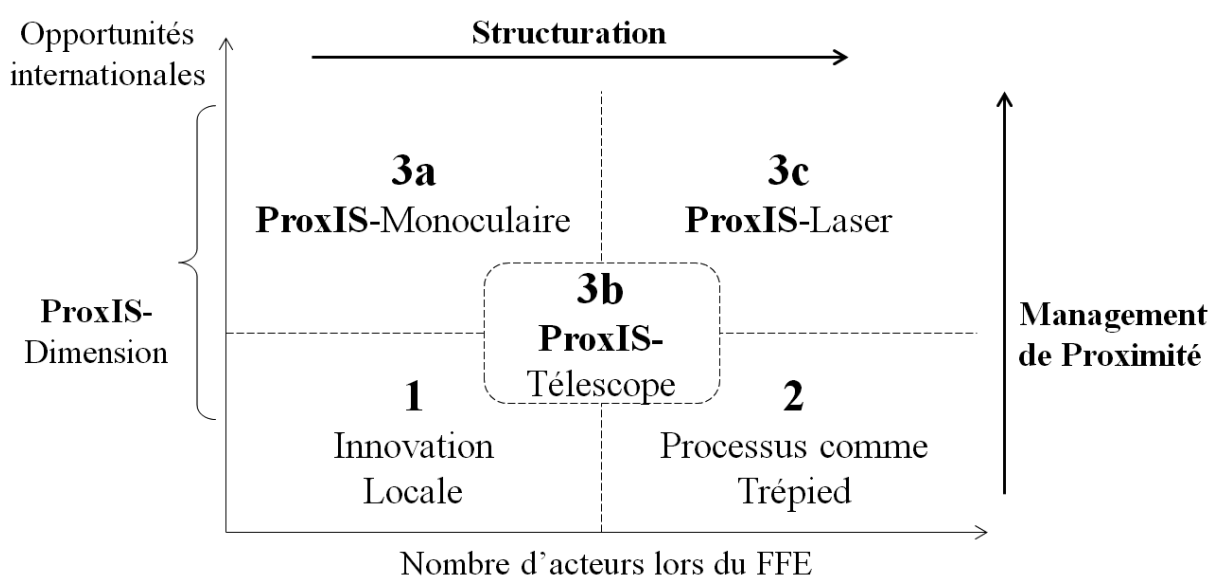

Figure 51 – Le ProxIS-Modèle Dynamique.

Chez 3D PLUS, un design du FFE basé sur des mécanismes informels est suffisant pour capter des connaissances situées loin de l'entreprise. Il faut s'imaginer que cette société utilise un monoculaire tenu dans la main de l'observateur pour voir loin dans l'espace. Les trois managers de produit sont en charge de tenir ce monoculaire. Ils n'ont pas besoin d'utiliser tout un télescope pour voir suffisamment loin dans l'espace.

Néanmoins, dès que le nombre d'acteurs s'accroît, le management d'une entreprise doit adapter cette approche à une structuration grandissante. Dans ce cas, la littérature académique propose plusieurs outils pour manager le FFE et effectivement, la plupart de ces modèles sont fondés sur des études empiriques dans les grandes entreprises (Koen *et al.*, 2014). Des modèles tels que le « Stage-Gate process » de Cooper and Kleinschmidt (1987) ou l'approche de Khurana et Rosenthal (1998) représentent aujourd'hui des processus standardisés pour

gérer le FFE dans des grandes entreprises. Ils représentent donc une sorte de trépied sur lequel une entreprise puisse poser son FFE dans les grandes équipes.

Si par contre, la stratégie de l'entreprise est de gérer simultanément la notion spatiale et une équipe FFE grandissante, il est recommandé de s'approcher d'une structure duale telle qu'elle a été observée chez ELECTRO. Cette approche combine une structuration élevée des processus en interne tout en impliquant un nœud international d'innovation pour favoriser les échanges entre les entités. Ce nœud fonctionne en parallèle du ProxIS-Télescope identifié chez BÜRKERT. Effectivement, ELECTRO utilise les mêmes mécanismes de coordination que BÜRKERT (culture organisationnelle forte, communautés internes, relation de confiance), mais le département d'innovation amplifie leur fonctionnement par une structure duale. Cela est similaire à un laser qui est envoyé en parallèle d'un télescope pour calculer les erreurs liés à l'atmosphère ou la rotation de la terre pour ajuster l'image capté par le télescope (Cheng, 2009).

Le ProxIS-Télescope est situé au milieu de la matrice. Avant 2013, la position de BÜRKERT était pour ainsi dire similaire à celle de 3D PLUS. Etant donné la croissance du nombre d'acteurs après 2013, ce modèle s'est avéré insuffisant. BÜRKERT s'est transformé vers le ProxIS-Télescope même si les relations internationales au FFE restaient concentrées au niveau franco-allemand. Cette solution utilise une approche hybride qui est pourtant moins formalisé que celle observé chez ELECTRO. Il en résulte que BÜRKERT se trouve dans une situation intermédiaire entre 3D PLUS et ELECTRO. Le ProxIS-Télescope représente une solution managériale unique pour des structures similaires à celles de BÜRKERT.

## **PARTIE VI : CONCLUSION GENERALE**

L'objectif de la présente thèse est de proposer une solution managériale afin de répondre au paradoxe spatial lors du FFE des innovations discontinues. Cette phase vit des interactions imprévues entre des personnes qui partagent des connaissances diverses. Et, bien qu'une proximité physique entre collègues soit utile, il s'avère impossible de la maintenir dès que l'entreprise souhaite intégrer tout le potentiel créatif des entités internationales.

Le « ProxIS-Télescope » et plus spécifiquement le « ProxIS-Modèle dynamique » représentent des solutions compactes pour les entreprises afin de rapprocher leurs employés au-delà des espaces physiques pour innover ensemble. L'objectif est de générer des interférences entre leurs connaissances et de favoriser ainsi des innovations discontinues. Finalement, cette recherche démontre que le véritable défi des entreprises n'est pas l'extension internationale des activités au niveau du FFE, mais le management d'une équipe croissante en termes de personnes. En fonction du nombre de personnes qui interagissent lors du FFE, l'entreprise nécessite des mécanismes de coordination plus ou moins structurés. L'extension dynamique du ProxIS-Télescope permet alors une adaptation à tout type d'entreprise.

Alors que dans une petite structure, les employés sont capables de compenser le manque de proximité géographique par des leviers informels tels que des réseaux personnels ou une communication directe, un grand groupe devra investir plus de ressources pour soutenir les éléments du ProxIS-Modèle. Les communautés nécessiteront une structure parallèle pour assurer le flux transversal des connaissances. Ce rôle de support pourrait être pris en charge par un département indépendant et par des ressources propres.

Le présent modèle est la première approche spatiale du FFE. Il en élargit les fondements par une notion internationale et enrichit la littérature sur le management de projet des innovations discontinues. Il faut toutefois souligner que le modèle développé n'est pas un processus. Il s'agit principalement de décrire un environnement organisationnel favorable à la génération d'innovations discontinues en fonction des deux conditions déterminantes : le nombre d'acteurs et les opportunités en termes de connaissances que représentent les filiales internationales d'une entreprise. C'est la première recherche qui analyse simultanément ces deux dimensions lors du FFE.

### Limites et Recherches Futures

La présente thèse a mis l'accent sur les innovations de produit de nature discontinue. Les résultats ne s'appliquent donc pas automatiquement à tout type d'innovation de service ou de procédé. De même, il est très probable que la gestion des innovations continues au niveau international demande d'autres mécanismes de coordination.

En outre, la théorie de la firme fondée sur les connaissances a été choisie comme théorie fondamentale. Cela implique qu'une approche interne a été appliquée. Il ne peut pas être supposé que le modèle développé s'applique également à un processus d'innovation ouverte ou à d'autres approches de collaboration externes.

D'autre part, en termes de méthodologie, la thèse présente une approche qualitative qui repose sur une étude de cas unique, élargie plus tard par une étude de cas multiples. Cette méthodologie a ses limites, entre autres, en termes de généralisation des résultats de recherche.

Finalement, cette thèse repose sur une recherche limitée impérativement à trois années. Dans ces limites temporaires, il était impossible d'analyser les deux cas de réplication avec la même intensité que BÜRKERT.

La thèse propose plusieurs pistes intéressantes pour de futures recherches. Comme elle propose une approche holistique des mécanismes de coordination, ce pourrait être le point de départ pour des analyses plus détaillées des éléments du ProxIS-Télescope afin de comprendre leur évolution en dépendance du contexte organisationnel. Il sera intéressant d'élargir les fondements théoriques et de prendre en compte des innovations de services ou de procédures mais également de faire une approche d'innovation ouverte et d'analyser d'éventuels changements dans le modèle initial.

La présente thèse propose un modèle initial pour gérer le FFE des innovations discontinues au-delà de la distance physique entre les acteurs. Au futur, des recherches complémentaires seront nécessaires pour comprendre entièrement les dynamiques entre l'espace géographique et l'innovation lors du FFE.

# REFERENCES

- Allard-Poesi, F. and Maréchal, G. (2007), “Construction de l’objet de la recherche”, in Thiétart, R.-A. (Ed.), *Méthodes de Recherche En Management*, 3rd ed., Dunod, Paris, pp. 34–57.
- Amabile, T.M. (1988), “A model of creativity and innovation in organizations”, *Research in Organizational Behavior*, Vol. 10 No. 1, pp. 123–167.
- Ancona, D.G. and Caldwell, D.F. (1997), “Making teamwork work: Boundary management in product development teams”, in Tushman, M.L. and Anderson, P. (Eds.), *Managing Strategic Innovation and Change: A Collection of Readings*, Oxford University Press, New York, pp. 432–440.
- Arzumanyan, L. (2014), *La Mise En Place et Le Développement D’une Communauté de Pratique En Innovation: Le Cas Du Groupe SEB*, Université Jean Moulin Lyon 3, Lyon.
- Augsdorfer, P. (2005), “Bootlegging and path dependency”, *Research Policy*, Vol. 34 No. 1, pp. 1–11.
- Avenier, M.-J. and Thomas, C. (2012), “À quoi sert l’épistémologie dans la recherche en sciences de gestion? Un débat revisité”, *Le Libellio d’AEGIS*, Vol. 8 No. 4, pp. 13–27.
- Ayoko, O.B., Härtel, C.E. and Callan, V.J. (2002), “Resolving the puzzle of productive and destructive conflict in culturally heterogeneous workgroups: A communication accommodation theory approach”, *International Journal of Conflict Management*, Vol. 13 No. 2, pp. 165–195.
- AZQuotes.com. (2017), “Russell L. Ackoff”, *AZQuotes*, available at: [http://www.azquotes.com/author/36731-Russell\\_L\\_Ackoff](http://www.azquotes.com/author/36731-Russell_L_Ackoff) (accessed 22 February 2017).
- Bacon, G., Beckman, S., Mowery, D. and Wilson, E. (1994), “Managing product definition in high-technology industries: A pilot study”, *California Management Review*, Vol. 36 No. 3, pp. 32–56.
- Balland, P.-A., Boschma, R. and Frenken, K. (2015), “Proximity and innovation: From statics to dynamics”, *Regional Studies*, Vol. 49 No. 6, pp. 907–920.
- Barmeyer, C. and Lüsebrink, H.-J. (1996), *Interkulturelle Qualifikationen im deutsch-französischen Management kleiner und mittelständischer Unternehmen*, Röhrig Universitätsverlag, St. Ingbert.
- Barmeyer, C.I. (2000), *Interkulturelles Management und Lernstile: Studierende und Führungskräfte in Frankreich, Deutschland und Quebec*, Auflage: 1., Campus Verlag, Frankfurt am Main ; New York.
- Barmeyer, C.I. (2002), “Interkulturelle Zusammenarbeit: Deutsch-französisches Projektmanagement”, *Personal*, Vol. 4 No. 6.
- Barney, J. (1991), “Firm resources and sustained competitive advantage”, *Journal of Management*, Vol. 17 No. 1, pp. 99–120.
- Bartlett, C.A. and Ghoshal, S. (2002), *Managing Across Borders: The Transnational Solution*, 2nd ed., Harvard Business School Press, Boston, Massachusetts.
- Baskerville, R.F. (2003), “Hofstede never studied culture”, *Accounting, Organizations and Society*, Vol. 28 No. 1, pp. 1–14.



- Batallas, D.A. and Yassine, A. (2006), "Information leaders in product development organizational networks: Social network analysis of the design structure matrix", *IEEE Transactions on Engineering Management*, Vol. 53 No. 4, pp. 570–582.
- Bathelt, H., Malmberg, A. and Maskell, P. (2004), "Clusters and knowledge: local buzz, global pipelines and the process of knowledge creation", *Progress in Human Geography*, Vol. 28 No. 1, pp. 31–56.
- Beaud, S. and Weber, F. (2003), *Guide de L'enquête de Terrain*, La Decouverte, Paris.
- Belassi, W., Kondra, A.Z. and Tukel, O.I. (2007), "New product development projects: The effects of organizational culture", *Project Management Journal*, Vol. 38 No. 4, pp. 12–24.
- Bell, G.G. and Zaheer, A. (2007), "Geography, networks, and knowledge flow", *Organization Science*, Vol. 18 No. 6, pp. 955–972.
- Bellini, E., Ottaviano, G.I., Pinelli, D. and Prarolo, G. (2013), "Cultural diversity and economic performance: evidence from European regions", in Crescenzi, R. and Percoco, M. (Eds.), *Geography, Institutions and Regional Economic Performance*, Springer, Berlin Heidelberg, pp. 121–141.
- Bissola, R., Imperatori, B. and Colonel, R.T. (2014), "Enhancing the creative performance of new product teams: An organizational configurational approach: creative performance of new product teams", *Journal of Product Innovation Management*, Vol. 31 No. 2, pp. 375–391.
- Björk, J. and Magnusson, M. (2009), "Where do good innovation ideas come from? Exploring the influence of network connectivity on innovation idea quality", *Journal of Product Innovation Management*, Vol. 26 No. 6, pp. 662–670.
- Boeddrich, H.-J. (2004), "Ideas in the workplace: a new approach towards organizing the fuzzy front end of the innovation process", *Creativity and Innovation Management*, Vol. 13 No. 4, pp. 274–285.
- Bootz, J.-P. (2015), "Comment concilier auto-organisation et contrôle au sein des communautés de pratique pilotées?", *International Management*, Vol. 19 No. 3, pp. 15–30.
- Bootz, J.-P. and Lièvre, P. (2017), "De l'auto-organisation au pilotage des communautés de pratique : le cas des preneurs de son", in Soulier, E. and Audran, J. (Eds.), *Communautés de Pratique et Management de La Formation*, Editions UTMB., Belfort-Montbéliard, pp. 169–183.
- Boschma, R. (2005), "Proximity and innovation: a critical assessment", *Regional Studies*, Vol. 39 No. 1, pp. 61–74.
- Boschma, R. and Frenken, K. (2010), "The spatial evolution of innovation networks. A proximity perspective", in Boschma, R. and Martin, R. (Eds.), *The Handbook of Evolutionary Economic Geography*, Edward Elgar Publishing, Cheltenham, pp. 120–135.
- Bouba-Olga, O. and Ferru, M. (2009), "La géographie des collaborations pour l'innovation: le rôle des contraintes amont", *Le Temps Des Débats*, presented at the Sixièmes journées de la proximité, CRIEF, Poitiers.
- Bouba-Olga, O. and Grossetti, M. (2008), "Socio-économie de proximité", *Revue d'Economie Régionale et Urbaine*, No. 3, pp. 1–18.

- BrainQuote.com. (2016), “Johannes Kepler Quotes”, *BrainyQuote*, available at: [https://www.brainyquote.com/quotes/authors/j/johannes\\_kepler.html](https://www.brainyquote.com/quotes/authors/j/johannes_kepler.html) (accessed 19 February 2017).
- BrainyQuote.com. (2016), “Neil Armstrong Quotes”, *BrainyQuote*, available at: [https://www.brainyquote.com/quotes/authors/n/neil\\_armstrong.html](https://www.brainyquote.com/quotes/authors/n/neil_armstrong.html) (accessed 2 February 2017).
- Brannen, M.Y. (2009), “Culture in context: New theorizing for today’s complex cultural organizations”, in Nakata, C. (Ed.), *Beyond Hofstede. Culture Frameworks for Global Marketing and Management*, Palgrave Macmillan, New York, pp. 81–100.
- Brem, A. and Voigt, K.-I. (2009), “Integration of market pull and technology push in the corporate front end and innovation management—Insights from the German software industry”, *Technovation*, Vol. 29 No. 5, pp. 351–367.
- Breschi, S. and Malerba, F. (Eds.). (2005), *Clusters, Networks and Innovation*, Oxford University Press, Oxford.
- Briley, D.A., Morris, M.W. and Simonson, I. (2000), “Reasons as carriers of culture: Dynamic versus dispositional models of cultural influence on decision making”, *Journal of Consumer Research*, Vol. 27 No. 2, pp. 157–178.
- Brinks, V. and Schmidt, S. (2015), “Global knowledge communities in temporary spaces”, presented at the Transience and Permanence in Urban Development, University of Sheffield.
- Brown, J.S., Collins, A. and Duguid, P. (1989), “Situated Cognition and the Culture of Learning”, *Educational Researcher*, Vol. 18 No. 1, pp. 32–41.
- Brown, J.S. and Duguid, P. (1991), “Organizational learning and communities of practice: Toward a unified view of working, learning, and innovation”, *Organization Science*, Vol. 2 No. 1, pp. 40–57.
- Brown, J.S. and Duguid, P. (1998), “Organizing knowledge”, *California Management Review*, Vol. 40 No. 3, pp. 90–111.
- Bullinger, A. (2008), *Innovation and Ontologies: Structuring the Early Stages of Innovation Management*, edited by Picot, A., Reichwald, R., Franck, E. and Möslein, K., 1st ed., Gabler Edition Wissenschaft, Wiesbaden.
- Burger-Helmchen, T. and Pénin, J. (2011), “Crowdsourcing : définition, enjeux, typologie”, *Management & Avenir*, No. 41, pp. 254–269.
- Bürkert GmbH & Co. KG, C. (2014), “Bürkert Application Segmentation”, *Bürkert - Fluid Control Systems*, available at: <http://www.burkert.com/en/Products-Applications/Applications/Segmentation/A-fresh-approach-can-make-all-the-difference> (accessed 15 July 2015).
- Büschgens, T., Bausch, A. and Balkin, D.B. (2013), “Organizational culture and innovation: A meta-analytic review”, *Journal of Product Innovation Management*, Vol. 30 No. 4, pp. 763–781.
- Calantone, R. and Rubera, G. (2012), “When should R&D and Marketing collaborate? The moderating role of exploration-exploitation and environmental uncertainty”, *Journal of Product Innovation Management*, Vol. 29 No. 1, pp. 144–157.

- Cambridge Dictionary. (2016), “Paradox - Definition”, available at: <http://dictionary.cambridge.org/fr/dictionnaire/anglais/paradox> (accessed 11 November 2016).
- Cassi, L. and Plunket, A. (2015), “Research collaboration in co-inventor networks: combining closure, bridging and proximities”, *Regional Studies*, Vol. 49 No. 6, pp. 936–954.
- Cavusgil, S.T. (1998), “Executive insights: International partnering - A systematic framework for collaborating with foreign business partners”, *Journal of International Marketing*, Vol. 6 No. 1, pp. 91–107.
- Cavusgil, S.T., Knight, G. and Riesenberger, J.R. (2008), *International Business: Strategy, Management, and the New Realities*, Pearson Education, Inc., New Jersey.
- Chang, Y.-C., Chang, H.-T., Chi, H.-R., Chen, M.-H. and Deng, L.-L. (2012), “How do established firms improve radical innovation performance? The organizational capabilities view”, *Technovation*, Vol. 32 No. 7–8, pp. 441–451.
- Charreire Petit, S. and Durieux, F. (2007), “Explorer et tester: les deux voies de la recherche”, *Méthodes de Recherche En Management*, 3rd ed., Dunod, Paris, pp. 58–83.
- Cheng, J. (2009), *The Principles of Astronomical Telescope Design*, Springer Science & Business Media, Charlottesville.
- Chesbrough, H. (2003a), “The logic of open innovation: Managing intellectual property”, *California Management Review*, Vol. 45 No. 3, pp. 33–58.
- Chesbrough, H.W. (2003b), *Open Innovation: The New Imperative for Creating and Profiting from Technology*, Harvard Business School Press, Cambridge, Massachusetts.
- Chevrier, S. (2000), *Le Management des Equipes Interculturelles*, Presses universitaires de France - PUF, Paris.
- Chevrier, S. (2008), “Gestion des équipes multiculturelles”, in Davel, E., Davel, J.-P. and Chanlat, J.-F. (Eds.), *Gestion En Contexte Interculturel: Approches, Problématiques, Pratiques et Plongées*, Les presses de l’université Laval., Quebec, pp. 346–378.
- Chiu, C. and Kwan, L.Y.-Y. (2010), “Culture and creativity: A process model”, *Management and Organization Review*, Vol. 6 No. 3, pp. 447–461.
- Christensen, C. (1997), *The Innovator’s Dilemma: When New Technologies Cause Great Firms to Fail*, Harvard Business Review Press, Boston, Massachusetts.
- Chua, R.Y. and Morris, M. (2009), “Innovation communication in multicultural networks: Deficits in inter-cultural capability and affect-based trust as barriers to new idea sharing in inter-cultural relationships”, *Harvard Business School Organizational Behavior Unit Working Paper*, No. 09-130.
- Cohen, W.M. and Levinthal, D.A. (1990), “Absorptive capacity: A new perspective on learning and innovation”, *Administrative Science Quarterly*, Vol. 35 No. 1, pp. 128–152.
- Cohendet, P. (2014), *Les Communautés de Connaissance: Projet BourbaKeM*, No. 6, AGeCSO.
- Cohendet, P., Creplet, F. and Dupouët, O. (2001), “Communities of practice and epistemic communities: A renewed approach of organisational learning within the firm”, *6th Workshop on Economics and Heterogeneous Interacting Agents*.

- Cohendet, P. and Diani, M. (2003), "L'organisation comme une communauté de communautés : croyances collectives et culture d'entreprise", *Revue d'Economie Politique*, Vol. 113 No. 5, pp. 697–720.
- Cohendet, P., Grandadam, D., Simon, L. and Capdevila, I. (2014), "Epistemic communities, localization and the dynamics of knowledge creation", *Journal of Economic Geography*, Vol. 14 No. 5, pp. 929–954.
- Cohendet, P., Harvey, J.F. and Simon, L. (2013), "Managing creativity in the firm: The fuzzy front end of innovation and dynamic capabilities", in Burger-Helmchen, T. (Ed.), *The Economics of Creativity: Ideas, Firms and Markets*, Routledge, Oxon, pp. 131–150.
- Cohendet, P. and Llerena, P. (2005), "Learning, technical change and public policy: how to create and exploit diversity", in Edquist, C. (Ed.), *Systems of Innovation: Technologies, Institutions and Organizations*, Routledge., Vol. 2, Oxon, pp. 223–241.
- Cohendet, P., Roberts, J. and Simon, L. (2010), "Créer, implanter et gérer des communautés de pratique", *Gestion*, Vol. 35 No. 4, pp. 31–35.
- Cohendet, P. and Simon, L. (2006), "Knowledge intensive firms, communities and creative cities", presented at the DIME conference on Communities of Practice, Durham, pp. 1–22.
- Cohendet, P. and Simon, L. (2007), "Playing across the playground: Paradoxes of knowledge creation in the videogame firm", *Journal of Organizational Behavior*, Vol. 28 No. 5, pp. 587–605.
- Coleman, J.S. (1988), "Social capital in the creation of human capital", *American Journal of Sociology*, Vol. 94, pp. 95–120.
- Collis, J. and Hussey, R. (2003), *Business Research*, 2nd ed., Palgrave Macmillan, Houndmills, Basingstoke, Hampshire.
- Combessie, J.-C. (2007), *La Méthode En Sociologie*, 5th ed., La Découverte, Paris.
- Conner, K.R. and Prahalad, C.K. (2002), "A resource-based theory of the firm", in Choo, C.W. and Bontis, N. (Eds.), *The Strategic Management of Intellectual Capital and Organizational Knowledge*, Oxford University Press, New York, pp. 103–131.
- Cooper, R.G. (1990), "Stage-gate systems: A new tool for managing new products", *Business Horizons*, Vol. 33 No. 3, pp. 44–54.
- Cooper, R.G. (2008), "Perspective: The Stage-Gate® Idea-to-Launch Process—Update, What's New, and NexGen Systems\*", *Journal of Product Innovation Management*, Vol. 25 No. 3, pp. 213–232.
- Cooper, R.G. and Kleinschmidt, E.J. (1987), "New products: what separates winners from losers?", *Journal of Product Innovation Management*, Vol. 4 No. 3, pp. 169–184.
- Cooper, R.G. and Kleinschmidt, E.J. (1990), *New Products: The Key Factors in Success*, American Marketing Association, United States.
- Cooper, R.G. and Kleinschmidt, E.J. (1994), "Determinants of timeliness in product development", *Journal of Product Innovation Management*, Vol. 11 No. 5, pp. 381–396.
- Crawford, C.M. and Di Benedetto, C.A. (2011), *New Products Management*, McGraw-Hill, Irvine.
- Creswell, J.W. (2012), *Qualitative Inquiry and Research Design: Choosing among Five Approaches*, Sage Publications, London.

- Crouch, C. (2017), “Globalisierung: Der Nationalismus globalisiert sich”, *Die Zeit*, Hamburg, 11 February, available at: <http://www.zeit.de/wirtschaft/2017-02/globalisierung-widerstand-rechte-nationalismus-donald-trump-marine-le-pen-is> (accessed 14 February 2017).
- Cullmann, S., Guittard, C. and Schenk, E. (2015), “Participative creativity serving product design in SMEs: a case study”, *Journal of Innovation Economics & Management*, No. 18, pp. 79–98.
- Curado, C. (2006), “The knowledge based-view of the firm: From theoretical origins to future implications”, Working Paper., ISEG – Universidade Técnica de Lisboa, Lisbon.
- Cyert, R.M. and March, J.G. (1992), *A Behavioral Theory of the Firm*, 2nd ed., Blackwell Publications, Massachusetts.
- De Brentani, U. and Kleinschmidt, E.J. (2004), “Corporate culture and commitment: impact on performance of international new product development programs”, *Journal of Product Innovation Management*, Vol. 21 No. 5, pp. 309–333.
- De Brentani, U., Kleinschmidt, E.J. and Salomo, S. (2010), “Success in global new product development: impact of strategy and the behavioral environment of the firm”, *Journal of Product Innovation Management*, Vol. 27 No. 2, pp. 143–160.
- De Brentani, U. and Reid, S.E. (2012), “The fuzzy front-end of discontinuous innovations: Insights for research and management”, *Journal of Product Innovation Management*, Vol. 29 No. 1, pp. 70–87.
- De Carolis, D. (2002), “The role of social capital and organizational knowledge in enhancing entrepreneurial opportunities in high-technology environments”, in Choo, C.W. and Bontis, N. (Eds.), *The Strategic Management of Intellectual Capital and Organizational Knowledge*, Oxford University Press, New York, pp. 699–709.
- De Sousa, M.C. (2006), “The sustainable innovation engine”, *VINE*, Vol. 36 No. 4, pp. 398–405.
- Dumez, H. (Ed.). (2001), *Management de L’innovation, Management de La Connaissance*, L’Harmattan, Paris.
- Dunbar, R.I. (1992), “Neocortex size as a constraint on group size in primates”, *Journal of Human Evolution*, Vol. 22 No. 6, pp. 469–493.
- Dunbar, R.I.M. (2012), “Social cognition on the Internet: Testing constraints on social network size”, *Philosophical Transactions of the Royal Society B*, Vol. 367 No. 1599, pp. 2192–2201.
- Eisenhardt, K.M. (1989), “Building theories from case study research”, *Academy of Management Review*, Vol. 14 No. 4, pp. 532–550.
- Eling, K., Griffin, A. and Langerak, F. (2013), “Using intuition in fuzzy front-end decision-making: A conceptual framework”, *Journal of Product Innovation Management*, Vol. 31 No. 5, pp. 956–972.
- Erez, M. and Nouri, R. (2010), “Creativity: The influence of cultural, social, and work contexts”, *Management and Organization Review*, Vol. 6 No. 3, pp. 351–370.
- Fagerberg, J., Mowery, D. and Nelson, R. (Eds.). (2005), *The Oxford Handbook of Innovation*, Oxford University Press, New York.



- Florén, H. and Frishammar, J. (2012), “From preliminary ideas to corroborated product definitions: Managing the front end of new product development”, *California Management Review*, Vol. 54 No. 4, pp. 20–43.
- Flynn, F.J. and Chatman, J.A. (1997), “Strong cultures and innovation: Oxymoron or opportunity”, in Tushman, M.L. and Anderson, P. (Eds.), *Managing Strategic Innovation and Change*, Oxford University Press, New York, pp. 234–251.
- FOCUS Online. (2014), “Das sind die erfolgreichsten Regionen Deutschlands”, *FOCUS Online*, available at: [http://www.focus.de/immobilien/kaufen/landkreis-ranking-2013-das-sind-die-erfolgreichsten-regionen-deutschlands\\_id\\_3511653.html](http://www.focus.de/immobilien/kaufen/landkreis-ranking-2013-das-sind-die-erfolgreichsten-regionen-deutschlands_id_3511653.html) (accessed 30 January 2017).
- Foss, N.J. (1996), “Knowledge-based approaches to the theory of the firm: Some critical comments”, *Organization Science*, Vol. 7 No. 5, pp. 470–476.
- Freeman, J. and Engel, J.S. (2007), “Models of innovation: Startups and mature corporations”, *California Management Review*, Vol. 50 No. 1, pp. 94–119.
- Galbraith, J.R. (1974), “Organization design: An information processing view”, *Interfaces*, Vol. 4 No. 3, pp. 28–36.
- Ganesan, S., Malter, A.J. and Rindfleisch, A. (2005), “Does distance still matter? Geographic proximity and new product development”, *Journal of Marketing*, Vol. 69 No. 4, pp. 44–60.
- Garcia, R. and Calantone, R. (2002), “A critical look at technological innovation typology and innovativeness terminology: A literature review”, *Journal of Product Innovation Management*, Vol. 19 No. 2, pp. 110–132.
- Gassmann, O. (1999), “Praxisnähe mit Fallstudienforschung”, *Wissenschaftsmanagement*, Vol. 5 No. 3, pp. 11–16.
- Gassmann, O. (2006), “Opening up the innovation process: towards an agenda”, *R&D Management*, Vol. 36 No. 3, pp. 223–228.
- Gassmann, O. and Schweitzer, F. (2014a), “Managing the unmanageable: The fuzzy front end of innovation”, in Gassmann, O. and Schweitzer, F. (Eds.), *Management of the Fuzzy Front End of Innovation*, Springer International Publishing AG, New York, pp. 3–14.
- Gassmann, O. and Schweitzer, F. (2014b), “Fuzzy front end of innovation: quo vadis?”, in Gassmann, O. and Schweitzer, F. (Eds.), *Management of the Fuzzy Front End of Innovation*, Springer International Publishing AG, New York, pp. 301–310.
- Gassmann, O. and Schweitzer, F. (2014c), *Management of the Fuzzy Front End of Innovation*, Springer International Publishing AG, New York.
- Gaubinger, K. and Rabl, M. (2014), “Structuring the front end of innovation”, in Gassmann, O. and Schweitzer, F. (Eds.), *Management of the Fuzzy Front End of Innovation*, Springer International Publishing AG, New York, pp. 15–30.
- Gavard-Perret, M.-L., Gotteland, D., Haon, C., Jolibert, A. and others. (2012), *Méthodologie de la Recherche en Sciences de Gestion: Réussir son Mémoire ou sa Thèse*, Pearson, Montreuil.
- Gelfand, M.J., Erez, M. and Aycan, Z. (2007), “Cross-cultural organizational behavior”, *Annual Review of Psychology*, Vol. 58, pp. 479–514.

- Georg-August-Universität Göttingen. (2014), “Das Kepler-Fernrohr”, *Lehrer-Portal*, available at: <https://lp.uni-goettingen.de/get/text/954> (accessed 3 March 2017).
- Ghemawat, P. (2001), “Distance still matters”, *Harvard Business Review*, Vol. 79 No. 8, pp. 137–147.
- Ghemawat, P. (2003), “The forgotten strategy”, *Harvard Business Review*, Vol. 81 No. 11, pp. 76–84.
- Gibson, C. (Ed.). (2012), *Creativity in Peripheral Places: Redefining the Creative Industries*, Routledge, Oxon.
- Gibson, C.B. and Birkinshaw, J. (2004), “The antecedents, consequences, and mediating role of organizational ambidexterity”, *Academy of Management Journal*, Vol. 47 No. 2, pp. 209–226.
- Gioia, D.A., Corley, K.G. and Hamilton, A.L. (2013), “Seeking qualitative rigor in inductive research: Notes on the Gioia methodology”, *Organizational Research Methods*, Vol. 16 No. 1, pp. 15–31.
- Giordano, Y. (2003), *Conduire un Projet de Recherche: une Perspective Qualitative*, 1st ed., EMS Management & société, Colombelles.
- Gladwell, M. (2003), *Le Point de Bascule : Comment Faire Une Grande Différence Avec de Très Petites Choses*, Les Éditions Transcontinental, Roubaix.
- Glahn, C. (2011), “Prepare your Ph.D. Defense Presentation”, Sciences, Chur, 30 November, available at: <http://fr.slideshare.net/phish108/prepare-your-phd-defense-presentation> (accessed 14 February 2017).
- Glaser, B.G. and Strauss, A.L. (1999), *The Discovery of Grounded Theory: Strategies for Qualitative Research*, Aldine Transaction, New Brunswick, London.
- Gonçalves, B., Perra, N. and Vespignani, A. (2011), “Modeling users’ activity on twitter networks: Validation of Dunbar’s number”, *PloS One*, Vol. 6 No. 8, pp. 1–5.
- Gongla, P. and Rizzuto, C.R. (2001), “Evolving communities of practice: IBM Global Services experience”, *IBM Systems Journal*, Vol. 40 No. 4, pp. 842–862.
- Goodman, R.A. and Goodman, L.P. (1976), “Some management issues in temporary systems: A study of professional development and manpower - The theater case”, *Administrative Science Quarterly*, Vol. 21 No. 3, pp. 494–501.
- Govindarajan, V. and Gupta, A.K. (2001), “Building an effective global business team”, *MIT Sloan Management Review*, Vol. 42 No. 4, pp. 63–71.
- Govindarajan, V. and Gupta, A.K. (2003), “Building an effective global business team”, in Gupta, A.K. and Westney, D.E. (Eds.), *Smart Globalization: Designing Global Strategies, Creating Global Networks*, Jossey-Bass, San Francisco, pp. 249–268.
- Grant, R.M. (1996), “Toward a knowledge-based theory of the firm”, *Strategic Management Journal*, Vol. 17 No. S2, pp. 109–122.
- Grant, R.M. (2002), “The knowledge-based view of the firm”, in Choo, C.W. and Bontis, N. (Eds.), *The Strategic Management of Intellectual Capital and Organizational Knowledge*, Oxford University Press, New York, pp. 133–148.

- Green, W. and Cluley, R. (2014), "The field of radical innovation: Making sense of organizational cultures and radical innovation", *Industrial Marketing Management*, Vol. 43 No. 8, pp. 1343–1350.
- Greiner, L.E. (1998), "Evolution and revolution as organizations grow", *Harvard Business Review*, Vol. 76 No. 3, pp. 55–68.
- Grenier, C. and Josserand, E. (2007), "Recherches sur le contenu et recherches sur le processus", in Thiétart, R.-A. (Ed.), *Méthodes de Recherche En Management*, 3rd ed., Dunod, Paris, pp. 107–139.
- Griffin, A., Price, R.L., Vojak, B.A. and Hoffman, N. (2014), "Serial innovators' processes: How they overcome barriers to creating radical innovations", *Industrial Marketing Management*, Vol. 43 No. 8, pp. 1362–1371.
- Guittard, C. and Schenk, E. (2010), "Le crowdsourcing: Une typologie des pratiques d'externalisation vers la foule", presented at the XIXème conférence de l'AIMS, Luxembourg.
- Gupta, A.K. and Govindarajan, V. (1991), "Knowledge flows and the structure of control within multinational corporations", *The Academy of Management Review*, Vol. 16 No. 4, pp. 768–792.
- Hakanson, L. and Zander, U. (1986), *Managing International Research and Development*, Mekanförbund, Stockholm.
- Hall, E.T. (1960), "The silent language in overseas business", *Harvard Business Review*, Vol. 38 No. 3, pp. 87–96.
- Hansen, M.T. and Birkinshaw, J. (2007), "The innovation value chain", *Harvard Business Review*, Vol. 85 No. 6, pp. 121–130.
- Hansen, T. (2015), "Substitution or overlap? The relations between geographical and non-spatial proximity dimensions in collaborative innovation projects", *Regional Studies*, Vol. 49 No. 10, pp. 1672–1684.
- Harvey, J.-F., Cohendet, P., Simon, L. and Borzillo, S. (2015), "Knowing communities in the front end of innovation", *Research-Technology Management*, Vol. 58 No. 1, pp. 46–54.
- Harvey, M. and Novicevic, M.M. (2002), "The co-ordination of strategic initiatives within global organizations: the role of global teams", *International Journal of Human Resource Management*, Vol. 13 No. 4, pp. 660–676.
- Harvey, M.G. and Griffith, D.A. (2007), "The role of globalization, time acceleration, and virtual global teams in fostering successful global product launches", *Journal of Product Innovation Management*, Vol. 24 No. 5, pp. 486–501.
- Harzing, A.-W. and Noorderhaven, N. (2006a), "Knowledge flows in MNCs: An empirical test and extension of Gupta and Govindarajan's typology of subsidiary roles", *International Business Review*, Vol. 15 No. 3, pp. 195–214.
- Harzing, A.-W. and Noorderhaven, N. (2006b), "Geographical distance and the role and management of subsidiaries: The case of subsidiaries down-under", *Asia Pacific Journal of Management*, Vol. 23 No. 2, pp. 167–185.
- Hauschildt, J. (1993), *Innovationsmanagement*, Vahlen, München.



- Hempel, P.S. and Sue-Chan, C. (2010), "Culture and the assessment of creativity", *Management and Organization Review*, Vol. 6 No. 3, pp. 415–435.
- Herstatt, C. and Verworn, B. (2003), "Bedeutung und Charakteristika der fruehen Phasen des Innovationsprozesses", in Herstatt, C. and Verworn, B. (Eds.), *Management Der Fruehen Innovationsphasen. Grundlagen, Methoden, Neue Ansaetze.*, Gabler Verlag, Wiesbaden, pp. 196–214.
- Herstatt, C., Verworn, B. and Nagahira, A. (2004), "Reducing project related uncertainty in the 'fuzzy front end' of innovation: a comparison of German and Japanese product innovation projects", *International Journal of Product Development*, Vol. 1 No. 1, pp. 43–65.
- von Hippel, E. (1986), "Lead users: A source of novel product concepts", *Management Science*, Vol. 32 No. 7, pp. 791–805.
- Hofstede, G., Hofstede, G.J. and Minkov, M. (2015), "Cultural Dimensions", *The Hofstede centre*, available at: <http://geert-hofstede.com/> (accessed 21 November 2015).
- Hofstede, G., Minkov, M. and Hofstede, G.J. (2010), *Cultures and Organizations - Software of the Mind: Intercultural Cooperation and Its Importance for Survival*, 3rd ed., McGraw Hill, New York.
- Hofstede, G.H. (2001), *Culture's Consequences: Comparing Values, Behaviors, Institutions and Organizations Across Nations*, 2nd ed., Sage Publications, Thousand Oaks CA.
- Howells, J. and Bessant, J. (2012), "Introduction: Innovation and economic geography", *Journal of Economic Geography*, Vol. 12 No. 5, pp. 929–942.
- Hussler, C. (2004), *Espaces, Externalités de Connaissance et Innovation: Eclairages Théoriques et Empiriques*, Université de Strasbourg, Strasbourg.
- Ichijo, K., von Krogh, G. and Nonaka, I. (1998), "Knowledge enablers", in von Krogh, G., Roos, J. and Kleine, D. (Eds.), *Knowing in Firms: Understanding, Managing and Measuring Knowledge*, Sage Publications, London, pp. 173–203.
- Im, S. and Workman Jr, J.P. (2004), "Market orientation, creativity, and new product performance in high-technology firms", *Journal of Marketing*, Vol. 68 No. 2, pp. 114–132.
- Johanson, J. and Vahlne, J.-E. (1977), "The internationalization process of the firm—A model of knowledge development and increasing foreign market commitments", *Journal of International Business Studies*, Vol. 8 No. 1, pp. 23–32.
- Johanson, J. and Vahlne, J.-E. (2009), "The Uppsala internationalization process model revisited: From liability of foreignness to liability of outsidership", *Journal of International Business Studies*, Vol. 40 No. 9, pp. 1411–1431.
- Jorgensen, D.L. (1989), *Participant Observation: A Methodology for Human Studies*, Vol. 15, Sage Publications, Inc, Newbury Park, CA.
- Julien, P.-A. (2007), "Croissance des PME", in Filion, L.-J. (Ed.), *Management Des PME: De La Création À La Croissance*, Editions du Renouveau Pédagogique, Paris.
- Kahn, K.B. (2017), "Examining the Relationships Between NPD Process, Strategy, and Performance: A Preliminary Investigation", *Innovation Strategies and Leadership*, presented at the 24th IPDMC, EIASM, Reykjavik.

- Katz, J. (1994), "Geographical proximity and scientific collaboration", *Scientometrics*, Vol. 31 No. 1, pp. 31–43.
- Kelley, D.J., Ali, A. and Zahra, S.A. (2013), "Where do breakthroughs come from? Characteristics of high-potential inventions", *Journal of Product Innovation Management*, Vol. 30 No. 6, pp. 1212–1226.
- Khurana, A. and Rosenthal, S.R. (1998), "Towards holistic 'front ends' in new product development", *Journal of Product Innovation Management*, Vol. 15 No. 1, pp. 57–74.
- Kijkuit, B. and Van Den Ende, J. (2007), "The organizational life of an idea: Integrating social network, creativity and decision-making perspectives", *Journal of Management Studies*, Vol. 44 No. 6, pp. 863–882.
- Kim, J. and Wilemon, D. (2002), "Focusing the fuzzy front-end in new product development", *R&D Management*, Vol. 32 No. 4, pp. 269–279.
- Kleinschmidt, E.J., De Brentani, U. and Salomo, S. (2007), "Performance of global new product development programs: A resource-based view", *Journal of Product Innovation Management*, Vol. 24 No. 5, pp. 419–441.
- Kline, S.J. and Rosenberg, N. (1986), "An overview of innovation", in Landau, R. and Rosenberg, N. (Eds.), *The Positive Sum Strategy: Harnessing Technology for Economic Growth*, National Academy Press, Washington, DC, p. 640.
- Knoben, J. and Oerlemans, L. (2006), "Proximity and inter-organizational collaboration: A literature review", *International Journal of Management Reviews*, Vol. 8 No. 2, pp. 71–89.
- Koen, P., Ajamian, G., Burkart, R., Clamen, A., Davidson, J., D'Amore, R., Elkins, C., et al. (2001), "Providing clarity and a common language to the fuzzy front end", *Research-Technology Management*, Vol. 44 No. 2, pp. 46–55.
- Koen, P.A., Ajamian, G.M., Boyce, S., Clamen, A., Fisher, E., Fountoulakis, S., Johnson, A., et al. (2002), "Fuzzy front end: Effective methods, tools, and techniques", in Belliveau, P., Griffin, A. and Somermeyer, S. (Eds.), *The PDMA ToolBook for New Product Development*, John Wiley & Sons, New York, pp. 5–36.
- Koen, P.A., Bertels, H.M.J. and Kleinschmidt, E.J. (2014), "Managing the front end of innovation part-I", *Research-Technology Management*, Vol. 57 No. 2, pp. 34–43.
- Kogut, B. and Singh, H. (1988), "The effect of national culture on the choice of entry mode", *Journal of International Business Studies*, Vol. 19 No. 3, pp. 411–432.
- Kogut, B. and Zander, U. (1992), "Knowledge of the firm, combinative capabilities, and the replication of technology", *Organization Science*, Vol. 3 No. 3, pp. 383–397.
- Langerak, F., Jan Hultink, E. and Robben, H.S. (2004), "The role of predevelopment activities in the relationship between market orientation and performance", *R&D Management*, Vol. 34 No. 3, pp. 295–309.
- Langley, A. (1999), "Strategies for theorizing from process data", *Academy of Management Review*, Vol. 24 No. 4, pp. 691–710.
- Langley, A., Smallman, C., Tsoukas, H. and Van De Ven, A.H. (2013), "Process studies of change in organization and management: Unveiling temporality, activity, and flow", *Academy of Management Journal*, Vol. 56 No. 1, pp. 1–13.

- Lave, J. and Wenger, E. (1991), *Situated Learning: Legitimate Peripheral Participation*, Cambridge University Press, Cambridge.
- Le Masson, P., Weil, B. and Hatchuel, A. (2006), *Les Processus D'innovation: Conception Innovante et Croissance Des Entreprises*, Lavoisier, Paris.
- Leenders, R.T.A.J., Van Engelen, J.M.L. and Kratzer, J. (2003), "Virtuality, communication, and new product team creativity: a social network perspective", *Journal of Engineering and Technology Management*, Vol. 20 No. 1–2, pp. 69–92.
- Leung, A.K., Maddux, W.W., Galinsky, A.D. and Chiu, C. (2008), "Multicultural experience enhances creativity: the when and how", *American Psychologist*, Vol. 63 No. 3, pp. 169–181.
- Leydhecker, W. (1979), *Augenheilkunde*, Vol. 20, Springer-Verlag, Berlin.
- Lièvre, P., Bonnet, E. and Laroche, N. (2016), "Etienne Wenger - Communauté de pratique et théorie sociale de l'apprentissage", in Burger-Helmchen, T., Hussler, C. and Cohendet, P. (Eds.), *Les Grands Auteurs En Management de L'innovation et de La Créativité*, Edition EMS., Paris, pp. 427–447.
- Liu, J., Chen, J. and Tao, Y. (2015), "Innovation performance in new product development teams in China's technology ventures: The role of behavioral integration dimensions and collective efficacy", *Journal of Product Innovation Management*, Vol. 32 No. 1, pp. 29–44.
- Liu, L.A. and Dale, C. (2009), "Using mental models to study cross-cultural interactions", in Nakata, C. (Ed.), *Beyond Hofstede - Culture Frameworks for Global Marketing and Management*, Palgrave Macmillan, New York, pp. 222–244.
- Loilier, T. and Tellier, A. (2013), *Gestion de L'innovation : Comprendre Le Processus D'innovation Pour Le Piloter*, Editions EMS, Colombelles.
- Loilier, T. and Tellier, A. (2016), "Henry Chesbrough: Repenser le business model à l'heure de l'innovation ouverte", in Burger-Helmchen, T., Hussler, C. and Cohendet, P. (Eds.), *Les Grands Auteurs En Management de l'Innovation et de La Créativité*, Editions EMS, Paris, pp. 297–322.
- Lundvall, B.-A. (1992), *National Systems of Innovation: An Analytical Framework*, Pinter, London.
- Luo, Y. and Bu, J. (2016), "How valuable is information and communication technology? A study of emerging economy enterprises", *Journal of World Business*, Vol. 51 No. 2, pp. 200–211.
- Lüthje, C. and Herstatt, C. (2004), "The Lead User method: an outline of empirical findings and issues for future research", *R&D Management*, Vol. 34 No. 5, pp. 553–568.
- Magnani, G., Zucchella, A. and Floriani, D.E. (2015), "Relativity and asymmetry in distance: The role of strategic distance in the internationalization decisions of Brazilian and Italian firms", presented at the DEM Working Paper Series, University of Pavia, Department of Economics and Management, Pavia.
- Magnusson, P., Wilson, R.T., Zdravkovic, S., Zhou, J.X. and Westjohn, S.A. (2008), "Breaking through the cultural clutter: A comparative assessment of multiple cultural and institutional frameworks", *International Marketing Review*, Vol. 25 No. 2, pp. 183–201.

- Malecki, E.J. (2010), “Global knowledge and creativity: new challenges for firms and regions”, *Regional Studies*, Vol. 44 No. 8, pp. 1033–1052.
- March, J.G. (1991), “Exploration and exploitation in organizational learning”, *Organization Science*, Vol. 2 No. 1, pp. 71–87.
- Markham, S.K. (2013), “The impact of front-end innovation activities on product performance”, *Journal of Product Innovation Management*, Vol. 30 No. S1, pp. 77–92.
- Markham, S.K., Ward, S.J., Aiman-Smith, L. and Kingon, A.I. (2010), “The valley of death as context for role theory in product innovation”, *Journal of Product Innovation Management*, Vol. 27 No. 3, pp. 402–417.
- Markides, C.C. and Geroski, P.A. (2005), *Fast Second: How Smart Companies Bypass Radical Innovation to Enter and Dominate New Markets*, John Wiley & Sons, San Francisco.
- Martinsuo, M. and Poskela, J. (2011), “Use of evaluation criteria and innovation performance in the front-end of innovation”, *Journal of Product Innovation Management*, Vol. 28 No. 6, pp. 896–914.
- Mattes, J. (2012), “Dimensions of proximity and knowledge bases: Innovation between spatial and non-spatial factors”, *Regional Studies*, Vol. 46 No. 8, pp. 1085–1099.
- Mayer, R.C., Davis, J.H. and Schoorman, F.D. (1995), “An Integrative Model of Organizational Trust”, *Academy of Management Review*, Vol. 20 No. 3, pp. 709–734.
- Mayrhofer, U. and Urban, S. (2011), *Management international: Des pratiques en mutation*, Pearson Education France, Paris.
- McDermott, R. (2000), “Knowing in community: Ten critical factors for community success”, *IHRIM Journal*, Vol. 4 No. 1, pp. 19–26.
- McDermott, R. and Archibald, D. (2010), “Harnessing your staff’s informal networks”, *Harvard Business Review*, Vol. 88 No. 3, pp. 82–89.
- McSweeney, B. (2002), “Hofstede’s model of national cultural differences and their consequences: A triumph of faith—a failure of analysis”, *Human Relations*, Vol. 55 No. 1, pp. 89–118.
- Metailler, T. (2016), “L’expertise distribuée : un modèle de gestion des connaissances comme outil de prospective pour l’innovation en PME”, *La dynamique des connaissances*, presented at the 9e Colloque International Gestion des Connaissances (GeCSO), European Business School, Paris.
- Meyer, A. and Mizushima, A. (1989), “Global R&D management”, *R&D Management*, Vol. 19 No. 2, pp. 135–146.
- Meyer, K.E., Mudambi, R. and Narula, R. (2011), “Multinational enterprises and local contexts: the opportunities and challenges of multiple embeddedness”, *Journal of Management Studies*, Vol. 48 No. 2, pp. 235–252.
- Meyerson, D., Weick, K.E. and Kramer, R.M. (1996), *Swift Trust and Temporary Groups. Trust in Organisations*, Sage, Thousand Oaks.
- Miles, M.B. and Huberman, A.M. (1984), *Qualitative Data Analysis*, SAGE Publications, Inc, Beverly Hills, CA.

- Miles, M.B., Huberman, A.M. and Saldaña, J. (2014), *Qualitative Data Analysis: A Methods Sourcebook*, 3rd ed., SAGE Publications, Inc, Thousand Oaks.
- Mintzberg, H. (1978), "Patterns in strategy formation", *Management Science*, Vol. 24 No. 9, pp. 934–948.
- Moenaert, R.K., Caeldries, F., Lievens, A. and Wauters, E. (2000), "Communication flows in international product innovation teams", *Journal of Product Innovation Management*, Vol. 17 No. 5, pp. 360–377.
- Moenaert, R.K., De Meyer, A., Souder, W.E. and Deschoolmeester, D. (1995), "R&D/marketing communication during the fuzzy front-end", *IEEE Transactions on Engineering Management*, Vol. 42 No. 3, pp. 243–258.
- Mors, M.L. (2015), "The costs and benefits of collaborating across geographic distance and organizational boundaries", presented at the DRUID Society Conference 2015, Rome.
- Mudambi, R., Mudambi, S.M. and Navarra, P. (2007), "Global Innovation in MNCs: The Effects of Subsidiary Self-Determination and Teamwork", *Journal of Product Innovation Management*, Vol. 24 No. 5, pp. 442–455.
- Mudambi, R. and Swift, T. (2012), "Multinational enterprises and the geographical clustering of innovation", *Industry and Innovation*, Vol. 19 No. 1, pp. 1–21.
- Murphy, S.A. and Kumar, V. (1997), "The front end of new product development: a Canadian survey", *R&D Management*, Vol. 27 No. 1, pp. 5–15.
- Musca, G. (2006), "Une stratégie de recherche processuelle : l'étude longitudinale de cas enchâssés", *M@n@gement*, Vol. 9 No. 3, pp. 153–176.
- Neukam, M. and Guittard, C. (2017a), "Coordinate the creative slack: Knowing communities in an international firm", *Communautés et Innovation*, presented at the 2nde Journée de l'Innovation Abbé Grégoire, CNAM, Strasbourg.
- Neukam, M. and Guittard, C. (2017b), "A Dynamic Approach to Discontinuous Innovations in International Organizations", *L'innovation Agile : Quels Défis Pour Les Individus, Les Organisations et Les Territoires?*, presented at the RRI Summer School, Nancy.
- Nonaka, I. (1991), "The knowledge-creating company", *Harvard Business Review*, Vol. 69 No. 6, pp. 96–104.
- Nonaka, I. (1994), "A dynamic theory of organizational knowledge creation", *Organization Science*, Vol. 5 No. 1, pp. 14–37.
- Nonaka, I. and Takeuchi, H. (1995), *The Knowledge-Creating Company: How Japanese Companies Create the Dynamics of Innovation*, Oxford University Press.
- Nonaka, I., Toyama, R. and Konno, N. (2000), "SECI, Ba and leadership: A unified model of dynamic knowledge creation", *Long Range Planning*, Vol. 33 No. 1, pp. 5–34.
- Nonaka, I. and Von Krogh, G. (2009), "Tacit knowledge and knowledge conversion: Controversy and advancement in organizational knowledge creation theory", *Organization Science*, Vol. 20 No. 3, pp. 635–652.
- Noorderhaven, N. and Harzing, A.-W. (2009), "Knowledge-sharing and social interaction within MNEs", *Journal of International Business Studies*, Vol. 40 No. 5, pp. 719–741.
- Nooteboom, B. (1999), "Innovation and inter-firm linkages: new implications for policy", *Research Policy*, Vol. 28 No. 8, pp. 793–805.



- OECD. (2005a), *Oslo manual: Guidelines for collecting and interpreting innovation data*, 3rd ed., Organisation for economic co-operation and development, Paris.
- OECD. (2005b), *Manuel d'Oslo*, 3rd ed., Organisation for economic co-operation and development, Paris.
- O'Reilly, C.A. and Tushman, M.L. (2004), "The ambidextrous organization", *Harvard Business Review*, Vol. 82 No. 4, pp. 74–81.
- Oxford Dictionaries. (2016a), "Fuzzy - Definition", *Oxford Dictionaries | English*, available at: <https://en.oxforddictionaries.com/definition/fuzzy> (accessed 8 October 2016).
- Oxford Dictionaries. (2016b), "Glocal - Definition", *Oxford Dictionaries | English*, available at: <https://en.oxforddictionaries.com/definition/glocal> (accessed 11 November 2016).
- Paletz, S. and Peng, K. (2008), "Problem finding and contradiction: Examining the relationship between naive dialectical thinking, ethnicity, and creativity", *Creativity Research Journal*, Vol. 21 No. 2, pp. 139–151.
- Parjanen, S. (2012), "Experiencing creativity in the organization: From individual creativity to collective creativity", *Interdisciplinary Journal of Information, Knowledge, and Management*, Vol. 7, pp. 109–128.
- Pavitt, K. (2005), "Innovation processes", in Fagerberg, J., Mowery, D. and Nelson, R. (Eds.), *The Oxford Handbook of Innovation*, Oxford University Press, New York.
- PC Magazin. (2014), "Die 10 erfolgreichsten Wirtschaftsregionen Deutschlands - Platz 9: Hohenlohekreis", *PC Magazin*, 27 March, available at: <http://www.pc-magazin.de/bildergalerie/die-erfolgreichsten-wirtschaftsregionen-deutschlands-bestenliste-region-2140759-415173.html> (accessed 30 January 2017).
- Pearce, J.A. and David, F. (1987), "Corporate mission statements: The bottom line", *The Academy of Management Executive*, Vol. 1 No. 2, pp. 109–116.
- Pénin, J. (2016), "Joseph Alois Schumpeter: Père de l'économie et de la gestion de l'innovation ?", in Burger-Helmchen, T., Hussler, C. and Cohendet, P. (Eds.), *Les Grands Auteurs En Management de L'innovation et de La Créativité*, Editions EMS., Paris, pp. 15–36.
- Penrose, E.T. (1972), *The Theory of the Growth of the Firm*, 5th ed., Basil Blackwell Publisher, Oxford.
- Perret, V. and Séville, M. (2007), "Fondements épistémologiques de la recherche", *Méthodes de Recherche En Management*, 3rd ed., Dunod, Paris, pp. 13–33.
- Poskela, J. and Martinsuo, M. (2009), "Management control and strategic renewal in the front end of innovation", *Journal of Product Innovation Management*, Vol. 26 No. 6, pp. 671–684.
- Powell, W.W. and Grodal, S. (2005), "Networks of innovators", in Fagerberg, J., Mowery, D. and Nelson, R. (Eds.), *The Oxford Handbook of Innovation*, Oxford University Press, New York, pp. 56–85.
- Pratt, M.G. (2009), "From the editors: For the lack of a boilerplate: Tips on writing up (and reviewing) qualitative research", *Academy of Management Journal*, Vol. 52 No. 5, pp. 856–862.

- Probst, G. and Borzillo, S. (2008), "Why communities of practice succeed and why they fail", *European Management Journal*, Vol. 26 No. 5, pp. 335–347.
- Reid, S.E. and De Brentani, U. (2004), "The fuzzy front-end of new product development for discontinuous innovations: A theoretical model", *Journal of Product Innovation Management*, Vol. 21 No. 3, pp. 170–184.
- Reid, S.E. and De Brentani, U. (2010), "Market vision and market visioning competences: Impact on early performance for radically new high-tech products", *Journal of Product Innovation Management*, Vol. 27 No. 4, pp. 500–518.
- Reid, S.E. and De Brentani, U. (2012), "Market vision and the front end of NPD for radical innovation: The impact of moderating effects", *Journal of Product Innovation Management*, Vol. 29 No. S1, pp. 124–139.
- Reid, S.E., De Brentani, U. and Kleinschmidt, E.J. (2014), "Divergent thinking and market visioning competence: An early front-end radical innovation success typology", *Industrial Marketing Management*, Vol. 43 No. 8, pp. 1351–1361.
- Reinertsen, D.G. (1999), "Taking the Fuzziness out of the Fuzzy Front End", *Research-Technology Management*, Vol. 42 No. 6, pp. 25–31.
- Rice, M., Kelley, D., Peters, L. and Colarelli O'Connor, G. (2001), "Radical innovation: Triggering initiation of opportunity recognition and evaluation", *R&D Management*, Vol. 31 No. 4, pp. 409–420.
- Robert, L.P., Denis, A.R. and Hung, Y.-T.C. (2009), "Individual swift trust and knowledge-based trust in face-to-face and virtual team members", *Journal of Management Information Systems*, Vol. 26 No. 2, pp. 241–279.
- Rocas, M. and Garcia, E. (2017), "Cultural intelligence and the management of creativity", *The Global Management of Creativity*, Routledge, Oxon, pp. 44–58.
- Rohen, J.W. (1977), *Funktionelle Anatomie Des Menschen*, Vol. 3, F.K. Schattauer Verlag, Stuttgart.
- Rondé, P. and Hussler, C. (2005), "Innovation in regions: What does really matter?", *Research Policy*, Vol. 34 No. 8, pp. 1150–1172.
- Rost, K. (2011), "The strength of strong ties in the creation of innovation", *Research Policy*, Vol. 40 No. 4, pp. 588–604.
- Royer, I. and Zarlowski, P. (2007), "Echantillon(s)", in Thiétart, R.-A. (Ed.), *Méthodes de Recherche En Management*, 3rd ed., Dunod, Paris, pp. 192–227.
- Salomo, S., Keinschmidt, E.J. and De Brentani, U. (2010), "Managing new product development teams in a globally dispersed NPD program", *Journal of Product Innovation Management*, Vol. 27 No. 7, pp. 955–971.
- Schein, E.H. (1996), "Culture: The missing concept in organization studies", *Administrative Science Quarterly*, Vol. 41 No. 2, pp. 229–240.
- Scholz, C. (2000), *Personalmanagement: Informationsorientierte und verhaltenstheoretische Grundlagen*, 5th ed., Vahlen, München.
- Schroll-Machl, S. (2013), *Die Deutschen - Wir Deutsche: Fremdwahrnehmung Und Selbstsicht Im Berufsleben*, 4th ed., Vandenhoeck & Ruprecht GmbH & Co KG, Göttingen.

- Schulz, M. (2001), "The uncertain relevance of newness: Organizational learning and knowledge flows", *Academy of Management Journal*, Vol. 44 No. 4, pp. 661–681.
- Schulze, A. and Hoegl, M. (2006), "Knowledge creation in new product development projects", *Journal of Management*, Vol. 32 No. 2, pp. 1–27.
- Schumpeter, J.A. (1934), *The Theory of Economic Development: An Inquiry into Profits, Capital, Credit, Interest, and the Business Cycle*, Harvard University Press, Cambridge, Massachusetts.
- Shenkar, O. (2001), "Cultural distance revisited: Towards a more rigorous conceptualization and measurement of cultural differences", *Journal of International Business Studies*, Vol. 32 No. 3, pp. 519–535.
- Singh, J. (2008), "Distributed R&D, cross-regional knowledge integration and quality of innovative output", *Research Policy*, Vol. 37 No. 1, pp. 77–96.
- Smith, P.G. and Reinertsen, D.G. (1992), "Shortening the product development cycle", *Research Technology Management*, Vol. 35 No. 3, pp. 44–49.
- Smith, P.G. and Reinertsen, D.G. (1998), *Developing Products in Half the Time: New Rules, New Tools*, 2nd ed., John Wiley & Sons, New York.
- Song, X.M. and Montoya-Weiss, M.M. (1998), "Critical development activities for really new versus incremental products", *Journal of Product Innovation Management*, Vol. 15 No. 2, pp. 124–135.
- Sørensen, J.B. (2002), "The strength of corporate culture and the reliability of firm performance", *Administrative Science Quarterly*, Vol. 47 No. 1, pp. 70–91.
- Spithoven, A., Vanhaverbeke, W. and Roijakkers, N. (2013), "Open innovation practices in SMEs and large enterprises", *Small Business Economics*, Vol. 41 No. 3, pp. 537–562.
- Strauss, A. and Corbin, J. (1990), *Basics of Qualitative Research: Grounded Theory Procedures and Techniques*, 5th ed., Sage Publications, Inc, Newbury Park, CA.
- Strauss, A.L. and Corbin, J.M. (2004), *Les Fondements de la Recherche Qualitative: Techniques et Procédures de Développement de la Théorie Enracinée*, Vol. 22, Academic Press Fribourg, Fribourg.
- Szulanski, G. (2003), *Sticky Knowledge - Barriers to Knowing in the Firm*, SAGE Publications Inc, London ; Thousand Oaks.
- Tang, F., Mu, J. and Thomas, E. (2015), "Who knows what in NPD teams: Communication context, mode, and task contingencies", *Journal of Product Innovation Management*, Vol. 32 No. 3, pp. 404–423.
- Teare, S.W. and Restaino, S.R. (2006), *Introduction to Image Stabilization*, SPIE Press, Bellingham.
- Teece, D.J. (1976), *Multinational Corporation and the Resource Cost of International Technology Transfer*, Ballinger, Cambridge, MA.
- Teece, D.J. (2007), "Explicating dynamic capabilities: The nature and microfoundations of (sustainable) enterprise performance", *Strategic Management Journal*, Vol. 28 No. 13, pp. 1319–1350.
- Tellis, G.J., Prabhu, J.C. and Chandy, R.K. (2009), "Radical innovation across nations: The preeminence of corporate culture", *Journal of Marketing*, Vol. 73 No. 1, pp. 3–23.



- Ter Wal, A.L. (2014), "The dynamics of the inventor network in German biotechnology: Geographic proximity versus triadic closure", *Journal of Economic Geography*, Vol. 14 No. 3, pp. 589–620.
- Torre, A. (2008), "On the role played by temporary geographical proximity in knowledge transmission", *Regional Studies*, Vol. 42 No. 6, pp. 869–889.
- Torre, A. and Rallet, A. (2005), "Proximity and localization", *Regional Studies*, Vol. 39 No. 1, pp. 47–59.
- Torrès, O. (2007), "Approche descriptive de la spécificité de gestion des PME: Le mix de proximité", in Filion, L.-J. (Ed.), *Management Des PME: De La Création À La Croissance*, Pearson Education, Paris, pp. 23–34.
- Trompenaars, F. and Hampden-Turner, C. (1998), *Riding the Waves of Culture*, McGraw-Hill, New York.
- Tubbs, R.N. (2003), *Lucky Exposures: Diffraction Limited Astronomical Imaging through the Atmosphere*, Cambridge University, Cambridge.
- Tushman, M.L. and O'Reilly, C. (2002), *Winning through Innovation: A Practical Guide to Leading Organizational Change and Renewal*, Revised Edition., Harvard Business Review Press, Boston, Massachusetts.
- Utterback, J.M. and Akee, H.J. (2005), "Disruptive technologies: An expanded view", *International Journal of Innovation Management*, Vol. 9 No. 1, pp. 1–17.
- Van de Ven, A.H. (2007), *Engaged Scholarship: A Guide for Organizational and Social Research*, Oxford University Press, Oxford.
- Van de Ven, A.H. and Huber, G.P. (1990), "Longitudinal field research methods for studying processes of organizational change", *Organization Science*, Vol. 1 No. 3, pp. 213–219.
- Van Den Ende, J., Frederiksen, L. and Prencipe, A. (2015), "The front end of innovation: Organizing search for ideas", *Journal of Product Innovation Management*, Vol. 32 No. 4, pp. 482–487.
- Verganti, R. (1997), "Leveraging on systemic learning to manage the early phases of product innovation projects", *R&D Management*, Vol. 27 No. 4, pp. 377–392.
- Verworn, B. (2009), "A structural equation model of the impact of the 'fuzzy front end' on the success of new product development", *Research Policy*, Vol. 38 No. 10, pp. 1571–1581.
- Verworn, B. and Herstatt, C. (1999), *Approaches to the Fuzzy Front-End of Innovation*, Arbeitspapier Nr. 2, Technische Universität Hamburg-Harburg, Hamburg-Harburg.
- Verworn, B., Herstatt, C. and Nagahira, A. (2008), "The fuzzy front end of Japanese new product development projects: Impact on success and differences between incremental and radical projects", *R&D Management*, Vol. 38 No. 1, pp. 1–19.
- Veryzer, R.W. (1998), "Discontinuous innovation and the new product development process", *Journal of Product Innovation Management*, Vol. 15 No. 4, pp. 304–321.
- Vogl, J. (2001), "Medien-Werden: Galileis Fernrohr", *Archiv Für Mediengeschichte*, Vol. 1 No. 1, pp. 115–123.
- Von Zedtwitz, M. and Gassmann, O. (2002), "Market versus technology drive in R&D internationalization: four different patterns of managing research and development", *Research Policy*, Vol. 31 No. 4, pp. 569–588.

- Wacheux, F. (1996), *Méthodes Qualitatives de Recherches En Gestion*, Paris Dauphine University.
- Wang, S., Guidice, R.M., Tansky, J.W. and Wang, Z.-M. (2010), “When R&D spending is not enough: The critical role of culture when you really want to innovate”, *Human Resource Management*, Vol. 49 No. 4, pp. 767–792.
- Wellman, B. (2012), “Is Dunbar’s number up?”, *British Journal of Psychology*, Vol. 103 No. 2, pp. 174–176.
- Wenger, E. (1998), *Communities of Practice: Learning, Meaning, and Identity*, Cambridge University Press, Cambridge, MA.
- Wenger, E. (2011), “Communities of practice: A brief introduction”, presented at the STEP Leadership Workshop, National Science Foundation, Oregon.
- Wenger, E., McDermott, R.A. and Snyder, W. (2002), *Cultivating Communities of Practice: A Guide to Managing Knowledge*, Harvard Business School, Boston, Massachusetts.
- Wenger, E.C. and Snyder, W.M. (2000), “Communities of practice: The organizational frontier”, *Harvard Business Review*, Vol. 78 No. 1, pp. 139–146.
- Westwood, R. and Low, D.R. (2003), “The multicultural muse - Culture, creativity and innovation”, *International Journal of Cross Cultural Management*, Vol. 3 No. 2, pp. 235–259.
- Wheelwright, S.C. and Clark, K.B. (1992), *Revolutionizing Product Development: Quantum Leaps in Speed, Efficiency, and Quality*, The Free Press, New York.
- Woodman, R.W., Sawyer, J.E. and Griffin, R.W. (1993), “Toward a theory of organizational creativity”, *The Academy of Management Review*, Vol. 18 No. 2, pp. 293–321.
- Yang, Q., Mudambi, R. and Meyer, K.E. (2008), “Conventional and reverse knowledge flows in multinational corporations”, *Journal of Management*, Vol. 34 No. 5, pp. 882–902.
- Yin, R.K. (2003), *Case Study Research: Design and Methods*, SAGE Publications, Thousand Oaks.
- Yin, R.K. (2011), *Qualitative Research from Start to Finish*, Guilford Press, New York.
- Zaheer, S., Schomaker, M.S. and Nachum, L. (2012), “Distance without direction: Restoring credibility to a much-loved construct”, *Journal of International Business Studies*, Vol. 43 No. 1, pp. 18–27.
- Zhou, J. and Su, Y. (2010), “A missing piece of the puzzle: The organizational context in cultural patterns of creativity”, *Management and Organization Review*, Vol. 6 No. 3, pp. 391–413.

## Résumé en français suivi des mots-clés en français

Pour survivre sur le long terme, les entreprises dépendent des innovations discontinues. Ce type d'innovation est nourri dès le début du processus d'innovation (fuzzy front-end) par la créativité collective des employés répartis sur les entités internationales de l'entreprise. Le management se voit confronté à un défi important : comment faire innover des employés qui ne sont pas physiquement localisés au même endroit ? La présente recherche propose un levier novateur pour substituer l'espace physique entre les collaborateurs lors du fuzzy front-end. Le ProxIS-Télescope est une solution compacte pour les entreprises afin de rapprocher leurs salariés dans l'optique de générer des combinaisons inattendues de leurs connaissances. De plus, cette recherche montre que le véritable défi des entreprises n'est pas seulement l'extension internationale au niveau du fuzzy front-end, mais également le management d'une équipe croissante en termes de masse salariale. L'extension dynamique du ProxIS-modèle permet de l'adapter à tout type d'entreprise en fonction du nombre de personnes ainsi que du degré d'internationalisation de l'entreprise.

### **Mots clés :**

Fuzzy Front-End ; Innovations Discontinues ; Proximité ; Croissance ; Connaissances.

## Résumé en anglais suivi des mots-clés en anglais

To assure their long term survival, organizations depend on discontinuous innovations. This type of innovation is nurtured by collective creativity between employees of an organization's subsidiaries starting from the early phase of the innovation process (fuzzy front-end). Management faces an important challenge here: how to innovate if employees are not physically located at the same place? This research proposes an innovative approach to compensate geographic space at the fuzzy front-end. The resulting ProxIS-Telescope represents a compact solution for organizations in order to enhance the collaboration between employees independently of their location and to create unexpected combinations of knowledge. Furthermore, this research reveals that a crucial challenge for companies is not only the international expansion during the fuzzy front-end, but also the management of a growing workforce. The dynamic extension of the ProxIS-model proposes thus appropriate solutions for each organizational type depending on the number of actors and the international dimension during the fuzzy front-end.

### **Keywords :**

Fuzzy Front-End; Discontinuous Innovations; Proximity; Growth; Knowledge.