



HAL
open science

Les inflammasomes : de la régulation aux maladies auto-inflammatoires

Yvan Jamilloux

► **To cite this version:**

Yvan Jamilloux. Les inflammasomes : de la régulation aux maladies auto-inflammatoires. Immunologie. Université de Lyon, 2017. Français. NNT : 2017LYSE1089 . tel-01723498

HAL Id: tel-01723498

<https://theses.hal.science/tel-01723498>

Submitted on 5 Mar 2018

HAL is a multi-disciplinary open access archive for the deposit and dissemination of scientific research documents, whether they are published or not. The documents may come from teaching and research institutions in France or abroad, or from public or private research centers.

L'archive ouverte pluridisciplinaire **HAL**, est destinée au dépôt et à la diffusion de documents scientifiques de niveau recherche, publiés ou non, émanant des établissements d'enseignement et de recherche français ou étrangers, des laboratoires publics ou privés.



N° d'ordre NNT : xxx

THESE de DOCTORAT DE L'UNIVERSITE DE LYON

opérée au sein de

l'Université Claude Bernard Lyon 1

Ecole Doctorale N° 340

Biologie Moléculaire, Intégrative et Cellulaire

Spécialité de doctorat : Sciences de la vie

Discipline : Immunologie

Soutenue publiquement le 13 juin 2017 par :

Yvan JAMILLOUX

Les inflammasomes : de la régulation aux maladies auto-inflammatoires

Devant le jury composé de :

Pr Couillin, Isabelle, Directeur de Recherche, CNRS, Université d'Orléans.....Rapporteur
Pr Touitou, Isabelle, PU-PH, Université de Montpellier.....Rapporteur
Pr Sève, Pascal, PU-PH, Université Claude Bernard Lyon 1.....Examineur
Pr Martinon, Fabio, Professeur Associé, Université de Lausanne.....Examineur
Dr Py, Bénédicte, CR1, CIRI, INSERM.....Examineur
Dr. Henry, Thomas, Directeur de Recherche, CIRI, INSERM.....Directeur de thèse

UNIVERSITE CLAUDE BERNARD - LYON 1

Président de l'Université

Président du Conseil Académique

Vice-président du Conseil d'Administration

Vice-président du Conseil Formation et Vie Universitaire

Vice-président de la Commission Recherche

Directrice Générale des Services

M. le Professeur Frédéric FLEURY

M. le Professeur Hamda BEN HADID

M. le Professeur Didier REVEL

M. le Professeur Philippe CHEVALIER

M. Fabrice VALLÉE

Mme Dominique MARCHAND

COMPOSANTES SANTE

Faculté de Médecine Lyon Est – Claude Bernard

Faculté de Médecine et de Maïeutique Lyon Sud – Charles Mérieux

Faculté d'Odontologie

Institut des Sciences Pharmaceutiques et Biologiques

Institut des Sciences et Techniques de la Réadaptation

Département de formation et Centre de Recherche en Biologie Humaine

Directeur : M. le Professeur G. RODE

Directeur : Mme la Professeure C. BURILLON

Directeur : M. le Professeur D. BOURGEOIS

Directeur : Mme la Professeure C. VINCIGUERRA

Directeur : M. X. PERROT

Directeur : Mme la Professeure A-M. SCHOTT

COMPOSANTES ET DEPARTEMENTS DE SCIENCES ET TECHNOLOGIE

Faculté des Sciences et Technologies

Département Biologie

Département Chimie Biochimie

Département GEP

Département Informatique

Département Mathématiques

Département Mécanique

Département Physique

UFR Sciences et Techniques des Activités Physiques et Sportives

Observatoire des Sciences de l'Univers de Lyon

Polytech Lyon

Ecole Supérieure de Chimie Physique Electronique

Institut Universitaire de Technologie de Lyon 1

Ecole Supérieure du Professorat et de l'Education

Institut de Science Financière et d'Assurances

Directeur : M. F. DE MARCHI

Directeur : M. le Professeur F. THEVENARD

Directeur : Mme C. FELIX

Directeur : M. Hassan HAMMOURI

Directeur : M. le Professeur S. AKKOUCHE

Directeur : M. le Professeur G. TOMANOV

Directeur : M. le Professeur H. BEN HADID

Directeur : M. le Professeur J-C PLENET

Directeur : M. Y. VANPOULLE

Directeur : M. B. GUIDERDONI

Directeur : M. le Professeur E. PERRIN

Directeur : M. G. PIGNAULT

Directeur : M. le Professeur C. VITON

Directeur : M. le Professeur A. MOUGNIOTTE

Directeur : M. N. LEBOISNE

REMERCIEMENTS

A Madame le Professeur Couillin,
Vous me faites l'honneur de rapporter ce travail et je vous en remercie.

A Madame le Professeur Toutou,
Vous me faites l'honneur de rapporter ce travail et je vous en remercie.

A Monsieur le Professeur Sève,
Vous me faites l'honneur de juger mon travail et je vous remercie.

A Monsieur le Pr Martinon,
Vous me faites l'honneur de juger mon travail et je vous remercie.

A Madame le Dr Py,
Vous me faites l'honneur de juger mon travail et je vous remercie.

A Monsieur le Dr Henry,
Vous me faites l'honneur de juger mon travail et je vous remercie.

A ma famille,

A mes amis,

A mes collègues, des laboratoires et de l'hôpital,

A ma femme,

A ma fille.

TABLE DES MATIERES

RESUME	5
ABSTRACT	6
INTRODUCTION	7
1. AVANT-PROPOS.....	9
2. INTERLEUKINE-1, INFLAMMASOME ET MALADIES AUTO-INFLAMMATOIRES	11
3. LES INFLAMMASOMES : PLATEFORMES DE L'IMMUNITE INNEE.....	27
4. INTERACTIONS ET REGULATION DES INFLAMMASOMES.....	47
5. AUTOINFLAMMATORY DISORDERS.....	63
METHODES	103
6. CELL-FREE ASSAY FOR INFLAMMASOME ACTIVATION.....	105
RESULTATS	115
AXE 1 : A PROXIMITY-DEPENDENT BIOTINYLATION (BIOID) APPROACH IDENTIFIES P62/SQSTM-1 AS A CASPASE-1 SUBSTRATE.....	117
AXE 2 : FAMILIAL MEDITERRANEAN FEVER MUTATIONS ARE HYPERMORPHIC MUTATIONS THAT SPECIFICALLY DECREASE THE ACTIVATION THRESHOLD OF THE PYRIN INFLAMMASOME.....	141
DISCUSSION	161

RESUME

Les inflammasomes sont des complexes protéiques intracellulaires qui ont un rôle majeur dans l'immunité innée. Leur activation conduit à la mort de la cellule dans un contexte hyperinflammatoire. Compte-tenu des effets potentiellement délétères, tissulaires et systémiques, les inflammasomes sont strictement régulés. A l'heure actuelle, la compréhension des mécanismes conduisant à leur activation et leur régulation reste partielle.

Dans une première partie de cette thèse, nous avons utilisé une technique de biotinylation proximale (BioID) pour identifier les protéines interagissant avec l'inflammasome. Nous avons identifié 111 protéines dont la relation étroite avec l'inflammasome était vraisemblable. Parmi ces 111 protéines, 25% avaient d'ailleurs déjà été décrites comme des protéines interagissant avec le complexe. L'identification d'un adaptateur majeur de l'autophagie, p62/sequestosome-1 (p62), nous a conduit à focaliser notre attention sur son rôle dans la régulation de l'inflammasome. Nous avons d'abord démontré que l'interaction entre p62 et l'inflammasome existait, sur le plan biochimique. Par la suite, nous avons prouvé que p62 était un substrat du complexe et que l'activation de ce dernier entraînait le clivage de p62 au niveau d'un résidu aspartique en position 329. Enfin, nous avons caractérisé les conséquences fonctionnelles de ce clivage, en montrant que les fragments protéiques générés entraînaient une régulation positive ou négative du complexe. Nous avons alors émis l'hypothèse que p62 pourrait réguler l'inflammasome de manière différente selon le signal activateur.

Dans une seconde partie, translationnelle, nous nous sommes intéressés aux conséquences des mutations dans la séquence de gènes codant les constituants de l'inflammasome ou des protéines régulatrices du complexe. Celles-ci sont à l'origine des maladies auto-inflammatoires monogéniques. Ces maladies sont caractérisées par des épisodes récurrents de fièvre associés variablement à d'autres symptômes systémiques. La plus fréquente est la fièvre méditerranéenne familiale (FMF), avec une prévalence estimée entre 1 et 5 pour 10 000 habitants en France. Les mutations du gène *MEFV*, codant la pyrine, sont à l'origine de la FMF. La pyrine peut induire la formation d'un inflammasome spécifique. Récemment, le mécanisme d'activation de l'inflammasome pyrine a été mieux caractérisé : certaines toxines (comme la toxine B du *Clostridium difficile*, TcdB) induisent l'activation de l'inflammasome pyrine. Nous avons utilisé ces nouvelles connaissances afin d'explorer les conséquences de l'activation de l'inflammasome pyrine par la TcdB dans les monocytes des patients atteints de FMF, comparés aux monocytes de donneurs sains. Nos résultats indiquent que ces mutations induisent un abaissement du seuil d'activation de l'inflammasome pyrine. Par ailleurs, les corrélations génotype/phénotype indiquent qu'il existe un effet de dosage génétique, en lien avec le nombre d'allèles mutés. Ces résultats ouvrent de nouvelles perspectives pour les patients atteints de FMF, tant dans la compréhension de la physiopathologie que dans la possibilité de mise au point de tests fonctionnels pour le diagnostic de la maladie.

Mots-clés

auto-inflammation ; inflammasome ; interleukine-1 ; p62/sequestosome-1 ; fièvre méditerranéenne familiale ; pyrine

ABSTRACT

Inflammasomes are intracellular multiprotein complexes that have a major role in innate immunity. Their activation leads to hyperinflammatory cell death. In view of potentially deleterious effects, the inflammasomes are strictly regulated. At present, the understanding of the mechanisms leading to their activation and regulation remains partial.

In a first part of this thesis, we used a technique of proximity-dependent biotinylation (BioID) to identify the proteins interacting with the inflammasome. We identified 111 proteins with a close relationship to the inflammasome. Among these 111 proteins, 25% had already been described as proteins interacting with the complex. The identification of a major adaptor of autophagy, p62/sequestosome-1 (p62), led us to focus our attention on its role in the regulation of inflammasome. We first demonstrated that the interaction between p62 and inflammasome was real, at the biochemical level. Subsequently, we proved that p62 was a substrate of the complex and that the activation of the latter led to the cleavage of p62 at the aspartate 329. Finally, we characterized the functional consequences of this cleavage and showed that the protein fragments generated led to a positive or negative regulation of the complex. We thus hypothesized that p62 could regulate the inflammasome differently according to the activator signal.

In a second translational part, we looked at the consequences of mutations in the sequence of genes coding components of the inflammasome or proteins regulating it. These are the cause of monogenic auto-inflammatory diseases. These diseases are characterized by recurrent episodes of fever associated with other systemic symptoms. The most frequent is Familial Mediterranean Fever (FMF), with prevalence estimated at between 1 and 5 per 10 000 inhabitants, in France. Mutations of the *MEFV* gene, encoding pyrin, cause FMF. Pyrin may trigger the formation of a specific inflammasome. Recently, the mechanism of activation of the pyrin inflammasome has been better characterized: toxins (such as toxin B of *Clostridium difficile*, TcdB) induce the activation of the pyrin inflammasome. We used this new knowledge to investigate the consequences of TcdB on pyrin inflammasome activation in monocytes from FMF patients compared to monocytes from healthy donors. Our results indicate that these mutations induce a decreased threshold of activation of the pyrin inflammasome. In addition, genotype / phenotype correlations indicate a gene-dosage effect, related to the number of mutated alleles. These results open new perspectives for patients with FMF, in understanding the pathophysiology of the disease and in developing functional diagnostic tests.

Key-words

auto-inflammation; inflammasome; interleukin-1; p62/sequestosome-1; familial Mediterranean fever; pyrin

INTRODUCTION

1

Avant-propos

Les inflammasomes sont des complexes protéiques intracellulaires qui ont un rôle majeur dans l'immunité innée. Leur activation conduit à la mort de la cellule dans un contexte hyperinflammatoire. Compte-tenu des effets délétères, tant au niveau tissulaire qu'au niveau systémique, que peut entraîner leur activation, ils sont très étroitement régulés. A l'heure actuelle et malgré des avancées importantes ces dernières années, la compréhension des mécanismes conduisant à leur activation et leur régulation reste partielle. Dans une première partie de cette thèse (« Axe 1 »), nous avons utilisé une technique récemment mise au point (BioID) pour identifier d'éventuelles protéines interagissant avec la caspase-1 dans le contexte d'un inflammasome actif. L'identification d'un adaptateur majeur de l'autophagie, p62/sequestosome-1, nous a conduit à focaliser notre attention sur son rôle dans la régulation de l'inflammasome.

Les mutations dans la séquence de gènes codant les constituants de l'inflammasome ou des protéines régulatrices du complexe sont à l'origine de maladies auto-inflammatoires monogéniques. Ces maladies, qui débutent généralement à l'âge pédiatrique, sont principalement caractérisées par des épisodes récurrents de fièvre associés variablement à d'autres symptômes systémiques (sérites, arthrites, éruption cutanées). La plus fréquente de ces fièvres héréditaires est la fièvre méditerranéenne familiale (FMF), avec une prévalence estimée entre 1 et 5 pour 10 000 habitants en France. Elle se manifeste par des épisodes récurrents de fièvre associée à des épanchements des séreuses, des éruptions cutanées et des arthrites. Ces manifestations cliniques sont essentiellement le fait de l'action systémique d'une cytokine pro-inflammatoire, l'interleukine-1, substrat principal des complexes inflammasomes. En 1997, les mutations à l'origine de la FMF ont été identifiées sur le gène *MEFV*, codant la protéine pyrine (ou marenostriane). Ce n'est que plus tard qu'il a été démontré que la pyrine pouvait induire la formation d'un inflammasome spécifique, faisant ainsi le lien entre la mutation, l'altération de la protéine et les symptômes cliniques. Récemment, le mécanisme d'activation de l'inflammasome pyrine a été mieux caractérisé : certaines toxines (comme la toxine B du *Clostridium difficile*, TcdB) induisent l'activation de l'inflammasome pyrine. Dans la deuxième partie de cette thèse (« Axe 2 »), nous avons utilisé ces nouvelles connaissances afin d'explorer les conséquences de l'activation de l'inflammasome pyrine par la TcdB dans les monocytes des patients atteints de FMF, comparés aux monocytes de donneurs sains.

Nous détaillons, pour commencer, la voie de l'interleukine-1 et les différents inflammasomes.

Nous rapportons ensuite les études antérieures ayant identifié des protéines interagissant avec le complexe inflammasome. Enfin, les maladies autoinflammatoires sont revues de manière systématique, en détaillant pour chacune les mutations identifiées, les manifestations cliniques et les traitements disponibles.

2

Interleukine-1, inflammasome et maladies auto-inflammatoires

Interleukin-1, inflammasome and autoinflammatory diseases

Yvan Jamilloux^{1,2}, Emilie Bourdonnay², Mathieu Gerfaud-Valentin¹,
Bénédicte F. Py², Lucie Lefeuvre², Thomas Barba¹, Christiane
Broussolle¹, Thomas Henry² et Pascal Sève¹

¹ Service de Médecine Interne, Hôpital de la Croix-Rousse,
Université Claude Bernard-Lyon 1, Lyon

² Centre International de Recherche en Infectiologie,
Inserm U1111, Université Lyon 1, Lyon

La Revue de Médecine Interne
2016. pii: S0248-8663(16)30472-6

RESUME

L'interleukine-1 est une cytokine majeure de l'immunité innée et de l'inflammation. Elle exerce divers effets systémiques au cours de la réponse inflammatoire, comme l'induction de la fièvre, la thrombopoïèse et la granulopoïèse, ou encore le recrutement leucocytaire. Si l'implication de l'interleukine-1 a été démontrée dans nombre de pathologies à médiation inflammatoire comme le diabète ou la goutte, celle-ci joue surtout un rôle pivot dans certaines maladies auto-inflammatoires, telles que les cryopyrinopathies ou la fièvre méditerranéenne familiale. Dans ces maladies, c'est une anomalie constitutionnelle de l'inflammasome, un complexe protéique responsable de l'activation de l'interleukine-1, qui explique l'hypersecretion de celle-ci. D'autres maladies auto-inflammatoires ont une physiopathologie plus complexe, impliquant une dérégulation de la voie de l'interleukine-1, en amont ou en aval de l'inflammasome ou de manière plus complexe. Dans cette Mise au Point, sont détaillées les voies de synthèse, d'activation, de signalisation et de régulation de l'interleukine-1. Nous décrivons ensuite les maladies auto-inflammatoires et apparentées pour lesquelles le rôle pathologique de l'interleukine-1 a été démontré.

ABSTRACT

Interleukin-1 is a major cytokine of innate immunity and inflammation. It exerts various systemic effects during the inflammatory response, such as fever induction, thrombopoiesis and granulopoiesis, or leukocyte recruitment. Its involvement has been demonstrated in many inflammatory-mediated diseases, such as diabetes or gout. Moreover, interleukin-1 plays a pivotal role in some autoinflammatory diseases, such as cryopyrinopathies or familial Mediterranean fever. In these diseases, a constitutional defect of the inflammasome, a protein complex responsible for the activation of interleukin-1, explains the hypersecretion of interleukin-1. Other autoinflammatory diseases have a more complex pathophysiology involving deregulation of the interleukin-1 pathway, upstream or downstream of the inflammasome, or through more complex mechanisms. In this Review, we are detailing the synthesis, the activation, the signalling, and the regulation of interleukin-1. We then describe the autoinflammatory diseases or related-diseases where the pathological role of interleukin-1 has been demonstrated.

1. Introduction

L'interleukine (IL)-1 est une cytokine majeure de l'immunité innée et de l'inflammation (1). L'intérêt suscité par cette cytokine a grandi ces dernières années du fait de la démonstration de son rôle pivot dans certaines maladies auto-inflammatoires monogéniques (2). Par ailleurs, son implication dans un nombre croissant de processus pathologiques, plus complexes et plus fréquents, est actuellement bien démontrée. C'est le cas, par exemple, de maladies communes comme le diabète et la goutte mais, également, de maladies plus rares comme la maladie de Still, la maladie de Behçet ou le syndrome de Schnitzler (3–8). Ces approches physiopathologiques ont d'ailleurs donné lieu à une nouvelle interprétation du continuum des maladies inflammatoires (9). Enfin, les résultats spectaculaires obtenus avec les biothérapies ciblant l'IL-1 ont confirmé son rôle essentiel dans nombre de maladies à composante auto-inflammatoire (10).

Dans cette mise au point, sont détaillées les voies de synthèse, d'activation et de signalisation de l'IL-1 ainsi que les données récentes concernant la régulation de ces voies. Dans un deuxième temps, nous décrivons les maladies auto-inflammatoires et apparentées pour lesquelles le rôle pathologique de l'IL-1 a été démontré.

2. Production et régulation de l'IL-1

2.1. Généralités

Initialement, la famille de l'IL-1 comportait deux cytokines, l'IL-1 α et l'IL-1 β . Cependant, l'identification d'un nombre croissant de cytokines apparentées à l'IL-1 a donné naissance au concept de « superfamille de l'IL-1 » constituée, à ce jour, de 7 cytokines proinflammatoires (IL-1 α , IL-1 β , IL-18, IL-33, IL-36 α , IL-36 β et IL-36 γ), de 3 récepteurs-antagonistes anti-inflammatoires (IL-1Ra, IL-36Ra et IL-38) et d'une cytokine anti-inflammatoire (IL-37) (11). Ces cytokines exercent leur action par l'intermédiaire des récepteurs de la « famille des récepteurs de l'IL-1 » (IL-1R) qui comporte 11 molécules susceptibles soit : de transduire le signal, d'agir comme des leurres, ou d'exercer un effet régulateur négatif (11).

Dans cette mise au point, nous n'aborderons que les trois interleukines les plus étudiées dans les maladies auto-inflammatoires : l'IL-1 β , l'IL-1 α et l'IL-18.

2.2. Synthèse des cytokines de la famille de l'IL-1

2.2.1. L'IL-1 β

L'IL-1 β est une cytokine dont la pro-forme (pro-IL-1 β) est constituée de 269 acides aminés (31 kDa) codée par le gène *IL1B*. Elle est produite par les cellules de la lignée myéloïde : monocytes circulants, macrophages tissulaires, cellules dendritiques et cellules microgliales (1). A l'état basal, la pro-IL-1 β est virtuellement absente du cytoplasme cellulaire. Cette pro-forme est synthétisée en réponse à l'activation de divers signaux dont les ligands des *toll-like receptors* (TLRs) (12). Ces ligands sont généralement des motifs microbiens, mieux connus sous la terminologie « *PAMPs* » (pour *Pathogen-Associated Molecular Patterns*) dont l'archétype est le lipopolysaccharide (LPS) de la membrane des bactéries Gram-négatif (ligand activateur de TLR4). En outre, la synthèse de la pro-IL-1 β peut être secondaire à la liaison de cytokines, comme le TNF (*Tumor Necrosis Factor*)- α , l'IL-6, ou l'IL-1 elle-même, à leur récepteur à la surface de la cellule. Cette première étape, souvent décrite comme le « signal 1 », induit l'activation du facteur de transcription NF- κ B qui promeut, entre autres, la transcription du précurseur de l'IL-1 β . La pro-IL-1 β n'a pas d'action biologique et n'est pas (ou peu) sécrétée en dehors de la cellule. L'activation puis la sécrétion de l'IL-1 β sont dépendantes d'un second signal induisant le clivage de la pro-forme et conduisant à une forme active de 17 kDa (13).

2.2.2. L'IL-1 α

Contrairement à la pro-IL-1 β , le précurseur de l'IL-1 α est constitutivement présent dans le cytoplasme des cellules épithéliales du tube digestif, du foie, des poumons et des reins, ainsi que dans les kératinocytes, les cellules endothéliales et les astrocytes (11). Ce précurseur est biologiquement actif et fonctionne comme une alarmine. En effet, la pro-IL-1 α , relarguée en cas de nécrose cellulaire (infarctus, nécrose tubulaire ou nécrose tumorale), déclenche une cascade rapide d'activation de cytokines et de chémokines proinflammatoires, à la phase précoce de l'inflammation (11).

2.2.3. L'IL-18

La pro-IL-18 est une cytokine de 193 acides aminés (24 kDa) produite par les macrophages, les cellules dendritiques, les kératinocytes, les cellules épithéliales et endothéliales (11). La pro-IL-18 est constitutivement présente dans le cytoplasme cellulaire et sa synthèse ne

requiert pas de signal 1. En revanche, comme l'IL-1 β , l'activation de l'IL-18 est dépendante d'un second signal induisant le clivage de la pro-forme (14).

2.3. Activation de l'IL-1 β et de l'IL-18 : la voie de l'inflammasome

L'activation de l'IL-1 β et de l'IL-18 nécessite donc le clivage protéolytique de leurs pro-formes respectives. Ce clivage est majoritairement assuré par un complexe macromoléculaire nommé inflammasome (13,15). Ce complexe est une véritable plate-forme multiprotéique qui se compose, dans sa forme canonique, d'un récepteur, d'un adaptateur et d'un effecteur (15–17). Il existe en réalité plusieurs inflammasomes dont la dénomination et la spécificité sont dictées par la partie réceptrice du complexe : on parle ainsi de l'inflammasome NLRP3 lorsque le récepteur impliqué est NLRP3 (*NOD-like receptor family, pyrin domain containing 3* ou cryopyrine) ; l'inflammasome sera alors assemblé en réponse aux signaux activant spécifiquement le récepteur NLRP3. Il existe plusieurs catégories de récepteurs, avec des spécificités distinctes, mais tous ont en commun d'être activés par des signaux intracytoplasmiques, les divers « signaux 2 ». Les récepteurs de la famille des *NOD-like receptors* (NLRs) capables d'induire la formation d'un inflammasome sont au nombre de 7 (NLRP1, NLRP2, NLRP3, NLRP7, NLRP12, NLRB1, NLRC4) (16). Les signaux activateurs de NLRP1, NLRP7, NLRB1 et NLRC4 sont de nature microbienne (PAMPs) tandis que NLRP3 est activé par des signaux de danger (ATP, microcristaux, modification de l'homéostasie cellulaire, dérivés actifs de l'oxygène, dommages mitochondriaux) (17–20). D'autres récepteurs caractérisés ou putatifs de l'inflammasome sont décrits : les ALRs (*AIM2-like receptors*), activés par exemple en réponse à la présence d'acides nucléiques intracellulaires et les RLRs (*RIG-I-like receptors*) activés en réponse à la détection d'ARN intracellulaire (21). Plus récemment, la protéine pyrine a été identifiée comme un authentique récepteur de l'inflammasome (*cf infra*) (22). Son rôle a longtemps été controversé : récepteur spécifique pour certains, elle constituait plutôt un régulateur inhibiteur pour d'autres auteurs (23–25).

Une fois activés, les récepteurs de l'inflammasome recrutent en cascade une molécule adaptatrice puis l'effecteur du complexe, la caspase-1. L'activation de cette caspase proinflammatoire est la fonction princeps de chaque complexe inflammasome. En effet, la caspase-1 est une enzyme protéolytique dont une des actions principales est le clivage des pro-formes de l'IL-1 β et de l'IL-18, préalable nécessaire à leur activation et à leur sécrétion (26). En parallèle, la caspase-1 induit un processus de mort cellulaire nécrotique hyperinflammatoire nommée pyroptose (27). Des études récentes ont démontré que la

pyroptose est médiée par le clivage de la gasdermine D, secondaire à l'activation de la caspase-1 et de caspases pro-inflammatoires proches de celle-ci (caspase-11 chez la souris, caspases-4 et -5 chez l'homme) (28,29).

Indépendamment de la voie de l'inflammasome, l'IL-1 β et l'IL-18 peuvent être activées *en dehors* de la cellule, notamment par des serines protéases produites par les neutrophiles, comme la protéinase 3, l'élastase ou la cathepsine-G (30).

2.4. Mécanismes de sécrétion de l'IL-1

Contrairement à la plupart des protéines sécrétées, l'IL-1 β et IL-18 n'ont pas de peptide signal et n'empruntent donc pas la voie conventionnelle (réticulum endoplasmique-appareil de Golgi). Plusieurs mécanismes de sécrétion ont été rapportés. Pour certains auteurs, c'est la perte d'intégrité de la membrane cellulaire au cours de la pyroptose qui est à l'origine d'une sécrétion passive. Néanmoins, il semble que cette sécrétion soit un événement plus précoce que la sécrétion passive, telle que celle des lactate-déshydrogénases (LDH) au travers de la membrane endommagée (31). De plus, il a été démontré que la sécrétion de l'IL-1 est, au moins pour partie, dépendante de l'activité enzymatique de la caspase-1 ; il s'agirait donc d'un phénomène actif (32). Diverses publications rapportent des mécanismes possibles de sécrétion active de l'IL-1 : sécrétion via l'autophagie et les lysosomes (sous la dépendance de la phospholipase C), via des microvésicules issues de la membrane plasmique ou encore via les exosomes (33,34). Il est possible que tous ces moyens de sécrétions coexistent au sein d'un continuum et que le mécanisme prédominant soit dicté par la nature et l'intensité du stimulus inflammatoire ainsi que par la concentration extracellulaire d'IL-1 requise pour la réponse inflammatoire (34).

2.5. Effets de l'IL-1

2.5.1. L'interleukine-1 β

L'action de l'IL-1 β est secondaire à sa fixation sur le récepteur IL1-R1. Elle se traduit à la fois par une inflammation systémique et par une amplification de la réponse immunitaire innée et adaptative au niveau local. L'IL-1 β agit : (i) sur le système nerveux central où elle induit la fièvre et la stimulation de l'axe corticotrope, (ii) sur le foie où, via l'IL-6, elle induit la synthèse des protéines de l'inflammation (CRP, complément, fibrinogène), (iii) sur la moelle osseuse où elle induit la thrombopoïèse et la granulopoïèse, (iv) sur les synoviocytes et les

chondrocytes où elle induit respectivement la production de collagénases et de métalloprotéases, et (v) sur les cellules endothéliales où elle induit la production de chémokines et de protéines d'adhésion (recrutement leucocytaire) (35). Par ailleurs, l'IL-1 β prolonge les fonctions effectrices des polynucléaires neutrophiles et des macrophages, stimule les cellules *natural killer* (NK) et la maturation des cellules dendritiques, active les lymphocytes B et CD4 et entraîne la polarisation Th17 (11). Du fait de ses actions autocrine/paracrine, l'IL-1 β joue un rôle auto-amplificateur et stimule donc, dans le même temps, les autres cytokines pro-inflammatoires (TNF- α , IL-6, IL-18).

2.5.2. L'interleukine 18

Contrairement aux autres cytokines pro-inflammatoires, l'IL-18 a peu d'effets systémiques ; elle n'induit notamment pas d'hyperthermie et n'entraîne pas la production de cyclooxygénase 2 à l'origine de l'activation des prostaglandines (36). En revanche, l'IL-18 augmente l'adhésion des leucocytes aux parois vasculaires et la production de chémokines (11). Le rôle principal de l'IL-18 est l'induction de la production par les cellules NK d'interféron (IFN)- γ et la polarisation Th1 (36). La production d'IFN- γ par les cellules NK est une étape clé de la physiopathologie du syndrome d'activation macrophagique (11).

La liaison de l'IL-18 sur son récepteur, IL-18R α , potentialisée par le corécepteur IL-18R β entraîne l'activation de ces cellules. De façon intéressante, la distribution de l'IL-18R β n'est pas ubiquitaire et celui-ci est exprimé principalement par les cellules T, les *natural killer* et les cellules dendritiques (11). Par ailleurs, la costimulation par l'IL-12 ou l'IL-15 est requise pour induire la polarisation Th1. En l'absence d'IL-12/15, l'IL-18 induit une polarisation Th2. Enfin, la costimulation IL-18/IL-23 induit une polarisation Th17 (37).

2.6. Régulation de la voie de l'IL-1

Les processus conduisant à la production et à la sécrétion d'IL-1 β , sont finement régulés (figure 1). Les mécanismes régulateurs agissent à différents niveaux :

- l'expression de l'IL-1 β , de la caspase-1 et des NLRs est restreinte à certaines populations cellulaires (1) ;
- un premier signal est nécessaire à l'activation de la transcription des gènes *IL1B* et *NLRP3* ;

- certains ARN messagers des composants de l'inflammasome sont régulés par des microARN (par exemple, l'ARNm de NLRP3 est régulée par la quantité de miR-223) (38);
- la quantité de pro-IL-1 β disponible pour être activée est régulée par l'autophagie ;
- l'activation de l'IL-1 β nécessite la présence d'un second signal activateur de l'inflammasome pour transformer le précurseur inactif en forme bioactive (17) ;
- l'activité de l'inflammasome est, elle aussi, régulée par différents mécanismes : (i) une **régulation intrinsèque** liée aux modifications moléculaires nécessaires pour activer les inflammasomes : modification du volume de la cellule, efflux de potassium (19), quantité d'AMP cyclique (39), concentration du calcium extracellulaire, processus de déubiquitination et de phosphorylation des récepteurs (40), modification du cytosquelette ou encore du statut redox de la cellule (41) ; et (ii) une **régulation extrinsèque** par des molécules inhibitrices comme : l'IFN de type 1, PSTPIP1 (*proline-serine-threonine phosphatase-interacting protein 1*) ou les *pyrin-only proteins* (POP1 et POP2) (42). Ces dernières agissent par compétition avec les récepteurs des inflammasomes tandis que d'autres protéines appelées COP (*CARD-only proteins*) agissent par compétition pour le recrutement de la caspase-1 (43). Des processus plus complexes, comme l'autophagie ou l'activation du protéasome régulent également l'activité des inflammasomes (44).
- la sécrétion de l'IL-1 β est contrôlée par l'activité enzymatique de la caspase-1, par les flux calciques et par l'autophagosome (32–34).
- Enfin, les effets de l'IL-1 β extracellulaire sont régulés par divers mécanismes de compétition au niveau de son récepteur, notamment par l'existence d'un antagoniste naturel, l'IL-1Ra, la fixation de l'IL-1 β sur un récepteur inactif IL-1R2 (leurre) et l'existence d'un récepteur qui exerce un effet dominant négatif sur la transduction du signal et sur l'activité de la caspase-1, l'IL1RAcPb (*IL-1R accessory protein isoform b*) (1,45).

D'une manière générale, les anomalies qualitatives ou quantitatives de l'un ou l'autre de ces régulateurs sont susceptibles d'entraîner une maladie auto-inflammatoire.

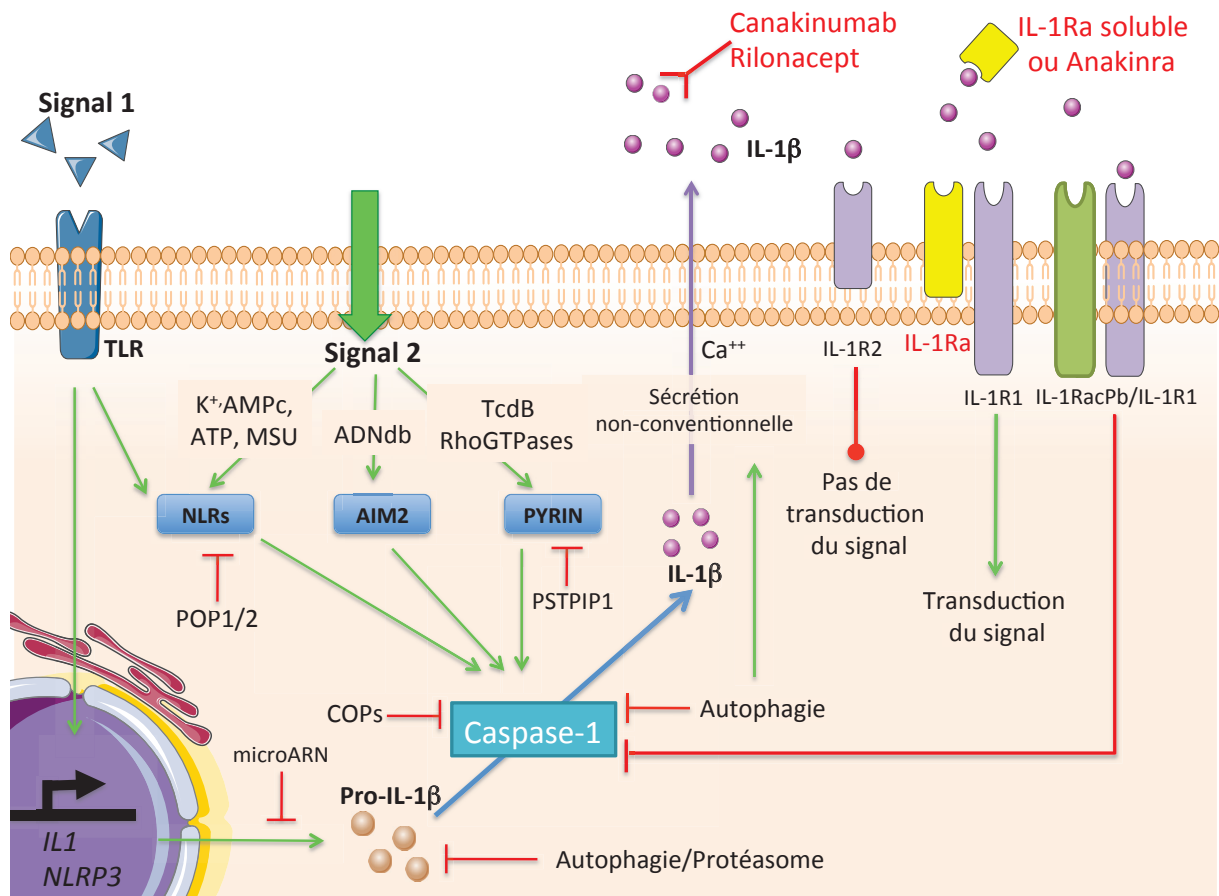

Figure 1 : Principaux mécanismes régulateurs de la voie de l'interleukine-1 β – Un signal 1, ligand d'un *Toll-like receptor* (TLR), est nécessaire pour préactiver la voie de l'interleukine (IL)-1 β et la transcription des gènes de l'IL-1 et du NLRP3 (*Nod-like receptor*, *Pyrin domain containing 3*). Des microARN peuvent inhiber par compétition les ARN de ces protéines. Un signal 2, spécifique, est ensuite requis pour activer chacun des récepteurs de l'inflammasome : efflux de potassium (K⁺), modification de l'AMP cyclique, ATP ou cristaux d'urate monosodique (MSU) pour le récepteur NLRP3 ; ADN double brin (ADNdb) pour le récepteur AIM2 (*Absent In Melanoma 2*) ; ou toxine B du *Clostridium difficile* (TcdB) pour le récepteur pyrine. Diverses protéines peuvent inhiber ces récepteurs : les *pyrin-only proteins* (POP)1/2 pour les NLRs et PSTPIP1 (*proline-serine-threonine phosphatase-interacting protein 1*) pour la pyrine. L'inflammasome activé entraîne l'activation de la caspase-1 et le clivage de la pro-forme de l'IL-1 β . La caspase-1 peut-être inhibée par les *CARD-only proteins* (COPs). L'autophagie joue un rôle régulateur à différents niveaux : diminution de la quantité de pro-IL-1 β disponible, dégradation de la caspase-1 et du complexe inflammasome, sécrétion de l'IL-1 β activée via l'autophagosome. Une fois sécrétée, l'IL-1 β exerce son effet via divers récepteurs, qui peuvent transduire ou inhiber le signal. Enfin certains récepteurs solubles ou anticorps, endogènes ou synthétiques, ont un rôle inhibiteur sur la voie de l'IL-1 β (comme l'IL-1Ra, le récepteur antagoniste du récepteur de l'IL-1).

3. Maladies auto-inflammatoires (MAI) monogéniques et MAI complexes

3.1. MAI monogéniques (tableau 1)

3.1.1 Cryopyrinopathies

Les maladies auto-inflammatoires monogéniques sont la conséquence de l'altération d'un gène codant pour une des protéines de la voie de l'IL-1. Les plus étudiées sont les syndromes périodiques associés à la cryopyrine (ou CAPS). Ces MAI, qui incluent le FCAS1

(*Familial Cold Autoinflammatory Syndrome 1*), le syndrome de Muckle-Wells et le NOMID (*Neonatal-Onset Multisystem Inflammatory Disease*), font partie des inflammasomopathies car elles résultent de l'altération du gène codant NLRP3, protéine centrale de l'inflammasome (46). La plupart des mutations génétiques de *NLRP3* sont des mutations germinales, de transmission autosomique dominante, mais on sait désormais que des mutations somatiques peuvent être à l'origine d'authentiques CAPS (47). Habituellement, la pénétrance de la maladie est élevée au sein des familles de malades. Les mutations sont le plus souvent situées dans la partie codant le domaine NACHT de NLRP3 où elles conduisent à un gain de fonction de la protéine, c'est-à-dire à la production d'une protéine constitutivement active (25,48). De ce fait, la présence du signal 2 n'est plus requise pour l'activation de l'inflammasome et la production de l'IL-1 β . Au final, il existe une dérégulation de l'activation et de la sécrétion de l'IL-1 β , dont la concentration est plus élevée dans le sérum des malades. Par ailleurs, l'efficacité remarquable des traitements ciblant l'IL-1 a donné la preuve ultime du rôle central de cette cytokine dans ces MAI (49). Les cryopyrinopathies sont revues extensivement dans un chapitre de cette revue thématique.

3.1.2 Pyrinopathies

La plus fréquente des MAI monogéniques est la fièvre méditerranéenne familiale (50). Dans cette MAI, les mutations affectent le gène *MEFV* qui code pour la pyrine (ou marénostrine). Le rôle de la pyrine a été et reste débattu : certains auteurs proposent un rôle inhibiteur de la pyrine sur les autres inflammasomes (notamment NLRP3) alors que d'autres suggèrent que cette protéine est capable d'initier par elle-même un inflammasome, l'inflammasome pyrine (22–24,51). Cette dernière hypothèse fait actuellement l'objet d'un regain d'intérêt avec la démonstration récente du rôle de la pyrine en tant qu'inflammasome en réponse à diverses toxines microbiennes, telles que la toxine B du *Clostridium difficile*. Plus exactement, la pyrine forme un inflammasome en réponse aux modifications du cytosquelette causées par l'inactivation de Rho-GTPases par ces toxines (22). Il pourrait donc s'agir d'un mécanisme global de réponse à des signaux de danger plutôt qu'à des signaux étrangers.

De façon très récente, une étude a démontré que l'activation de la pyrine était la voie finale de la physiopathologie d'une autre MAI monogénique, le syndrome Hyper-IgD (HIDS)/acidurie mévalonique. Dans cette pathologie, l'altération du gène *MVK* entraîne un déficit enzymatique de la *mevalonate kinase* qui se traduit par un syndrome périodique associant fièvre, éruption cutanée, adénopathies cervicales, hépatosplénomégalie, douleurs abdominales et arthralgies. Chez les patients atteints, ce déficit entraîne une diminution de

l'activité Rho-GTPase (*via* un déficit de prénylation) et une hypersécrétion d'IL-1 β , médiée par l'inflammasome pyrine (51).

Les mutations des gènes *MEFV* et *MVK* partagent une transmission autosomique récessive. Dans chacune de ces deux maladies les traitements ciblant l'IL-1 se sont avérés efficaces, indiquant là encore le rôle pivot de cette cytokine dans leur pathogénie.

3.1.3 MAI monogéniques impliquant d'autres NLR

Les mutations de NLRP12 sont associées à l'urticaire familiale au froid de type 2 (FCAS2 ou NAPS12) qui associe fièvre périodique, urticaire, céphalées, myalgies et arthralgies (17,52). Cette MAI a une expression clinique similaire à la cryopyrinopathie FCAS1 mais s'en distingue par l'absence d'efficacité des traitements bloquant l'IL-1. Le rôle de NLRP12 dans la cascade de l'IL-1 n'est pas encore bien défini : NLRP12 exerce un rôle inhibiteur sur le facteur de transcription NF- κ B et la perte de sa fonction pourrait être à l'origine d'une hyperactivation de cette voie pro-inflammatoire (17). Néanmoins, d'autres études ont montré que NLRP12 pouvait former, à lui-seul, un inflammasome et qu'il existait une hyperactivation de la caspase-1 chez les malades (17,53). La fonction de NLRP12 reste donc à définir, mais il pourrait s'agir d'un rôle complexe de régulateur de diverses cytokines, ce qui expliquerait la variabilité des phénotypes et l'absence de réponse aux anti-IL1.

Deux MAI ont été décrites en association avec des altérations du gène codant la protéine NLRC4 : l'une associant fièvre périodique et syndrome d'activation macrophagique (NLRC4-MAS) et l'autre associant fièvre périodique, entérocolite néonatale, coagulopathie, arthralgies et retard de croissance (AIFEC) (54,55). Une mutation de NLRC4 a également été rapportée en association avec une forme familiale modérée de FCAS (habituellement associé aux mutations de NLRP3) (56). Ces MAI, de transmission autosomique dominante, résultent de mutations activant constitutivement l'inflammasome NLRC4. Ceci entraîne une hypersécrétion d'IL-1 β mais surtout d'IL-18, dont la concentration sanguine est alors 10 à 100 fois supérieure à celle observée chez les patients atteints de CAPS (54,55). Le traitement des poussées par corticoïdes ou inhibiteurs de l'IL-1 conduit rapidement à la rémission de la maladie.

Tableau 1
Maladies auto-inflammatoires monogéniques associées à la voie de l'IL-1.

Syndrome	Gène	Transmission	Protéine	Maladie	Symptômes
CAPS	NLRP3	AD	NLRP3	FCAS1	Fièvre, pseudo-urticaire au froid, conjonctivite, arthralgies
				MW	Fièvre, pseudo-urticaire au froid, conjonctivite, arthralgies, déficit auditif précoce, amylose
PAPS	MEFV	AR	Pyrine	NOMID	Pseudo-urticaire permanent, fièvre, méningite chronique aseptique, œdème papillaire, hydrocéphalie, atrophie cérébrale cortico-sous-corticale progressive avec retard mental, diplégie/hémiplégie, épilepsie, arthropathie déformante des grosses articulations, déficit auditif précoce, atteintes inflammatoires ophtalmologiques, hématologiques, digestives, dysmorphie faciale, amylose
	MVK	AR	MVK	HIDS/AM	Fièvre, sêrites (arthralgies/arthrites, péritonite, péricardite, orchite), pseudo-érysipèle, myalgies, vascularite à IgA, amylose
NAPS12	PSTPIP1	AD	PSTPIP1	PAPA	Fièvre, éruption cutanée polymorphe, adénopathies cervicales, hépatosplénomégalie, douleurs abdominales, vomissements, diarrhée, aphtose buccale, arthralgies (+ retard psychomoteur et statur pondéral, ataxie cérébelleuse progressive, traits dysmorphiques et déficit visuel progressif dans l'AM)
	NLRP12	AD	NLRP12	FCAS 2	Arthrite purulente aseptique non axiale, pyoderma gangrenosum, acné kystique
NAPS4	NLRP4	AD	NLRP4	NLRP4-MAS AIFEC	Fièvre, pseudo-urticaire au froid, arthralgies, adénopathies, aphtose, douleurs abdominales
CRMO	IL1RN	AR	IL-1Ra	DIRA	Fièvre périodique, syndrome d'activation macrophagique
	LPIN2	AR	Lipine-2	MS	Fièvre périodique, entérocolite néonatale, coagulopathie, arthralgies, retard de croissance

CAPS : cryopyrin-associated periodic syndrome ou cryopyrinopathie ; PAPS : pyrin-associated periodic syndrome ou pyrinopathie ; NAPS : NOD-like receptor-associated periodic syndrome ; CRMO : chronic recurrent multifocal osteomyelitis ; AD : autosomique dominant ; AR : autosomique récessif ; NLRP3 : NOD-like receptor, pyrin domain containing 3 ; MVK : mevalonate kinase ; PSTPIP1 : proline-serine-threonine phosphatase-interacting protein 1 ; NLRP12 : NOD-like receptor, pyrin domain containing 12 ; NLRP4 : NOD-like receptor CARD domain containing 4 ; IL-1Ra : IL-1 récepteur antagoniste ; FCAS : familial cold autoinflammatory syndrome ou urticaire familiale liée au froid ; MW : syndrome de Muckle-Wells ; NOMID : neonatal-onset multisystem inflammatory disease ; FMF : fièvre méditerranéenne familiale ; HIDS : syndrome hyper-IgD ; AM : acidurie mévalonique ; PAPA : pyogenic arthritis, pyoderma gangrenosum, and acne ; MAS : syndrome d'activation macrophagique ; AIFEC : autoinflammation with infantile enterocolitis ; DIRA : déficience en IL-1Ra ; MS : syndrome de Majeeed.

3.1.4 MAI impliquant la signalisation en amont ou en aval de la voie de l'inflammasome

D'autres MAI n'impliquent pas directement le complexe inflammasome mais plutôt la régulation de la voie de l'IL-1 en amont ou en aval de celui-ci.

Le syndrome PAPA (*pyogenic arthritis, pyoderma gangrenosum, and acne*) est lié à des mutations du gène codant PSTPIP1, une protéine interagissant avec la pyrine, en amont de la formation de l'inflammasome. Compte-tenu du rôle controversé de la pyrine, deux hypothèses sont formulées concernant l'effet pathogénique des mutations de PSTPIP1 : un changement conformationnel activant l'inflammasome pyrine ou une levée de l'inhibition par la pyrine de l'inflammasome NLRP3 (57). Des études ultérieures devraient préciser le mécanisme qui, quoiqu'il en soit, aboutit à une sécrétion augmentée d'IL-1 chez les malades. Par ailleurs, certains arguments plaident en faveur du rôle d'autres cytokines que l'IL-1 dans la physiopathologie du syndrome PAPA, comme l'efficacité parfois partielle des anti-IL-1 et l'efficacité préférentielle des anti-TNF- α sur les manifestations cutanées.

Enfin, en aval de l'inflammasome, des mutations du gène *IL1RN*, peuvent être responsables d'un déficit en IL-1Ra. Les patients porteurs présentent une dermatose neutrophilique pustuleuse souvent associée à une ostéomyélite stérile multifocale avec périostéite, regroupées sous la désignation de syndrome DIRA (*deficiency of the IL-1 receptor antagonist*) (58). Cette MAI à début précoce est responsable de manifestations inflammatoires sévères, répondant de façon spectaculaire à l'anakinra, l'IL-1Ra synthétique.

On peut rapprocher le syndrome DIRA d'une autre MAI se manifestant par une ostéite multifocale récidivante associée à une dermatose neutrophilique : le syndrome de Majeed. Cette MAI a été associée à des mutations homozygotes du gène *LPIN2*, codant pour la lipine-2 (59,60). Celle-ci est une phosphatidate phosphatase, importante dans l'homéostasie des glycérolipides, mais dont le rôle exact dans la voie pro-inflammatoire de l'IL-1 demeure inconnu. Néanmoins, dans cette MAI, l'efficacité des anti-IL1 et l'inefficacité des anti-TNF- α , plaident en faveur d'une anomalie prépondérante dans la voie de l'IL-1 (61).

3. 2. MAI complexes

Certaines maladies sont catégorisées comme MAI complexes ou polygéniques du fait de phénotypes clinico-biologiques similaires, ou de la survenue fréquente d'un syndrome d'activation macrophagique, ou du fait de concentrations sériques élevées d'IL-1 au cours des poussées, ou enfin d'un effet spectaculaire des traitements ciblant l'IL-1. Certaines ont déjà été revues extensivement dans des mises au point récentes de la RMI (6,8).

La maladie de Still, par exemple, associe fièvre, arthrites, éruption cutanée typique et syndrome inflammatoire biologique (62). Une activation caractéristique des cellules de l'immunité innée et une fréquente association avec le syndrome d'activation macrophagique ont été rapportées. Les concentrations sériques d'IL-1 β et d'IL-18 sont significativement plus élevée chez les malades que chez des sujets contrôles. Aucun polymorphisme génétique des gènes de l'IL-1 β , de l'IL-1R n'a été mis en évidence à ce jour. Une étude fonctionnelle récente, en revanche, a mis en évidence une réponse accentuée à la stimulation de NLRP3 chez un malade (5). Enfin, et c'est l'argument le plus convaincant, les traitements anti-IL-1 se sont avérés extrêmement efficaces, notamment sur les manifestations systémiques de la maladie.

Le syndrome de Schnitzler a également été catégorisé comme MAI du fait d'une sémiologie proche des CAPS associant fièvre récurrente, éruption neutrophilique et atteinte ostéoarticulaire (6). Toutefois, à l'inverse de la plupart des MAI, l'âge de début est souvent tardif et il existe, par définition, une gammopathie monoclonale d'isotype IgM. Néanmoins, il existe une dérégulation de la voie de l'IL-1, des anomalies rapportées de l'inflammasome et une augmentation des concentrations sériques d'IL-18 chez les malades (63). Par ailleurs l'efficacité des traitements anti-IL-1 a été démontrée, ce qui renforce l'hypothèse d'un processus auto-inflammatoire.

Enfin, la maladie de Behçet, dont l'étiologie demeure inconnue, partage des similitudes épidémiologiques, cliniques et biologiques avec certaines maladies auto-inflammatoires. Il existe, de plus, quelques études ayant démontré des anomalies de la voie de l'IL-1 au cours

de la maladie de Behçet : (i) les taux sériques d'IL-1 β et d'IL-18 sont augmentés chez les patients atteints de maladie de Behçet (7), (ii) des polymorphismes génétiques des acteurs de la voie de l'IL-1 β ont été associés à la maladie de Behçet, dont des mutations de *NLRP3* (64–66). L'efficacité des anti-IL-1 au cours de la maladie de Behçet a, enfin, été rapportée de façon anecdotique mais répétée (66).

4. Conclusion

Si les inflammasomopathies (ou cryopyrinopathies) monogéniques constituent le paradigme des MAI associées à la voie de l'IL-1, les anomalies des processus de régulation de cette voie restent, à l'heure actuelle, un vaste champ d'investigation d'autres MAI plus complexes. En parallèle, la description de nouvelles affections en lien avec la régulation d'autres cytokines, notamment les interféronopathies (*voir la Mise au Point dédiée*), pose la question de la terminologie à proposer à ces maladies. En effet, sous la dénomination « maladies auto-inflammatoires » sont en réalité regroupées d'authentiques cytokinopathies, pour lesquelles la détermination de la cytokine dérégulée de manière majoritaire devrait guider la thérapeutique. A l'heure actuelle, la découverte des mécanismes conduisant au développement des MAI repose encore principalement sur les études génétiques. Néanmoins, les modèles monogéniques se raréfient. De nouvelles techniques (séquençage à haut débit, études fonctionnelles...) deviennent donc nécessaires pour améliorer la compréhension des mécanismes physiopathologiques à l'origine des MAI, notamment lorsque celles-ci sont polygéniques ou complexes.

Références

1. Dinarello CA. Interleukin-1 in the pathogenesis and treatment of inflammatory diseases. *Blood*. 2011 Apr 7;117(14):3720–32.
2. McDermott MF, Tschopp J. From inflammasomes to fevers, crystals and hypertension: how basic research explains inflammatory diseases. *Trends Mol Med*. 2007 Sep;13(9):381–8.
3. Martinon F, Pétrilli V, Mayor A, Tardivel A, Tschopp J. Gout-associated uric acid crystals activate the NALP3 inflammasome. *Nature*. 2006 Mar 9;440(7081):237–41.
4. Pascual V, Allantaz F, Arce E, Punaro M, Banchereau J. Role of interleukin-1 (IL-1) in the pathogenesis of systemic onset juvenile idiopathic arthritis and clinical response to IL-1 blockade. *J Exp Med*. 2005 May 2;201(9):1479–86.
5. Antoniou KM, Margaritopoulos GA, Giannarakis I, Choulaki C, Fountoulakis N, Siafakas NM, et al. Adult Onset Still's Disease: A Case Report with a Rare Clinical Manifestation and Pathophysiological Correlations. *Case Rep Med*. 2013;2013:981232.
6. Henry B, Néel A, Barbarot S, Masseur A, Hamidou M. [Schnitzler's syndrome]. *Rev Médecine Interne Fondée Par Société Natl Française Médecine Interne*. 2013 Apr;34(4):224–9.
7. Hamzaoui K, Hamzaoui A, Guemira F, Bessioud M, Hamza M 'hamed, Ayed K. Cytokine profile in Behçet's disease patients. Relationship with disease activity. *Scand J Rheumatol*. 2002;31(4):205–10.
8. Jamilloux Y, Sève P, Henry T. [Inflammasomes in human diseases]. *Rev Médecine Interne Fondée Par Société Natl Française Médecine Interne*. 2014 Nov;35(11):730–41.

9. Kastner DL, Aksentijevich I, Goldbach-Mansky R. Autoinflammatory Disease Reloaded: A Clinical Perspective. *Cell*. 2010 Mar 19;140(6):784–90.
10. de Boysson H. [Update in interleukin-1 inhibition]. *Rev Médecine Interne Fondée Par Société Natl Française Médecine Interne*. 2012 Apr;33(4):235–7.
11. Garlanda C, Dinarello CA, Mantovani A. The interleukin-1 family: back to the future. *Immunity*. 2013 Dec 12;39(6):1003–18.
12. Medzhitov R, Janeway CA Jr. Decoding the patterns of self and nonself by the innate immune system. *Science*. 2002 Apr 12;296(5566):298–300.
13. Martinon F, Burns K, Tschopp J. The inflammasome: a molecular platform triggering activation of inflammatory caspases and processing of proIL-beta. *Mol Cell*. 2002 Aug;10(2):417–26.
14. Siegmund B, Lehr H-A, Fantuzzi G, Dinarello CA. IL-1 β -converting enzyme (caspase-1) in intestinal inflammation. *Proc Natl Acad Sci U S A*. 2001 Nov 6;98(23):13249–54.
15. Martinon F, Mayor A, Tschopp J. The inflammasomes: guardians of the body. *Annu Rev Immunol*. 2009;27:229–65.
16. Schroder K, Tschopp J. The inflammasomes. *Cell*. 2010 Mar 19;140(6):821–32.
17. Khare S, Luc N, Dorfleutner A, Stehlik C. Inflammasomes and their activation. *Crit Rev Immunol*. 2010;30(5):463–87.
18. Compan V, Baroja-Mazo A, López-Castejón G, Gomez AI, Martínez CM, Angosto D, et al. Cell volume regulation modulates NLRP3 inflammasome activation. *Immunity*. 2012 Sep 21;37(3):487–500.
19. Pétrilli V, Papin S, Dostert C, Mayor A, Martinon F, Tschopp J. Activation of the NALP3 inflammasome is triggered by low intracellular potassium concentration. *Cell Death Differ*. 2007 Sep;14(9):1583–9.
20. Bauernfeind F, Ablasser A, Bartok E, Kim S, Schmid-Burgk J, Cavlar T, et al. Inflammasomes: current understanding and open questions. *Cell Mol Life Sci CMLS*. 2011 Mar;68(5):765–83.
21. Fernandes-Alnemri T, Yu J-W, Datta P, Wu J, Alnemri ES. AIM2 activates the inflammasome and cell death in response to cytoplasmic DNA. *Nature*. 2009 Mar 26;458(7237):509–13.
22. Xu H, Yang J, Gao W, Li L, Li P, Zhang L, et al. Innate immune sensing of bacterial modifications of Rho GTPases by the Pyrin inflammasome. *Nature*. 2014 Sep 11;513(7517):237–41.
23. Chae JJ, Wood G, Masters SL, Richard K, Park G, Smith BJ, et al. The B30.2 domain of pyrin, the familial Mediterranean fever protein, interacts directly with caspase-1 to modulate IL-1beta production. *Proc Natl Acad Sci U S A*. 2006 Jun 27;103(26):9982–7.
24. Papin S, Cuenin S, Agostini L, Martinon F, Werner S, Beer H-D, et al. The SPRY domain of Pyrin, mutated in familial Mediterranean fever patients, interacts with inflammasome components and inhibits proIL-1beta processing. *Cell Death Differ*. 2007 Aug;14(8):1457–66.
25. Masters SL, Simon A, Aksentijevich I, Kastner DL. Horror autoinflammaticus: the molecular pathophysiology of autoinflammatory disease (*). *Annu Rev Immunol*. 2009;27:621–68.
26. Thornberry NA, Bull HG, Calaycay JR, Chapman KT, Howard AD, Kostura MJ, et al. A novel heterodimeric cysteine protease is required for interleukin-1 beta processing in monocytes. *Nature*. 1992 Apr 30;356(6372):768–74.
27. Fernandes-Alnemri T, Wu J, Yu J-W, Datta P, Miller B, Jankowski W, et al. The pyroptosome: a supramolecular assembly of ASC dimers mediating inflammatory cell death via caspase-1 activation. *Cell Death Differ*. 2007 Sep;14(9):1590–604.
28. Shi J, Zhao Y, Wang K, Shi X, Wang Y, Huang H, et al. Cleavage of GSDMD by inflammatory caspases determines pyroptotic cell death. *Nature*. 2015 Oct 29;526(7575):660–5.
29. Kayagaki N, Stowe IB, Lee BL, O'Rourke K, Anderson K, Warming S, et al. Caspase-11 cleaves gasdermin D for non-canonical inflammasome signalling. *Nature*. 2015 Oct 29;526(7575):666–71.
30. Stehlik C. Multiple interleukin-1beta-converting enzymes contribute to inflammatory arthritis. *Arthritis Rheum*. 2009 Dec;60(12):3524–30.
31. Brough D, Rothwell NJ. Caspase-1-dependent processing of pro-interleukin-1beta is cytosolic and precedes cell death. *J Cell Sci*. 2007 Mar 1;120(Pt 5):772–81.
32. Keller M, Rüegg A, Werner S, Beer H-D. Active caspase-1 is a regulator of unconventional protein secretion. *Cell*. 2008 Mar 7;132(5):818–31.
33. Harris J, Hartman M, Roche C, Zeng SG, O'Shea A, Sharp FA, et al. Autophagy controls IL-1beta secretion by targeting pro-IL-1beta for degradation. *J Biol Chem*. 2011 Mar 18;286(11):9587–97.
34. Lopez-Castejon G, Brough D. Understanding the mechanism of IL-1 β secretion. *Cytokine Growth Factor Rev*. 2011 Aug;22(4):189–95.
35. Jéru I, Amselem S. [Inflammasome and interleukin 1]. *Rev Médecine Interne Fondée Par Société Natl Française Médecine Interne*. 2011 Apr;32(4):218–24.
36. Dinarello CA. Immunological and inflammatory functions of the interleukin-1 family. *Annu Rev Immunol*. 2009;27:519–50.
37. Lalor SJ, Dungan LS, Sutton CE, Basdeo SA, Fletcher JM, Mills KHG. Caspase-1-processed cytokines IL-1beta and IL-18 promote IL-17 production by gammadelta and CD4 T cells that mediate autoimmunity. *J Immunol Baltim Md 1950*. 2011 May 15;186(10):5738–48.
38. Bauernfeind F, Rieger A, Schildberg FA, Knolle PA, Schmid-Burgk JL, Hornung V. NLRP3 inflammasome activity is negatively controlled by miR-223. *J Immunol Baltim Md 1950*. 2012 Oct 15;189(8):4175–81.
39. Lee G-S, Subramanian N, Kim AI, Aksentijevich I, Goldbach-Mansky R, Sacks DB, et al. The calcium-sensing receptor regulates the NLRP3 inflammasome through Ca²⁺ and cAMP. *Nature*. 2012 Dec 6;492(7427):123–7.

40. Py BF, Kim M-S, Vakifahmetoglu-Norberg H, Yuan J. Deubiquitination of NLRP3 by BRCC3 critically regulates inflammasome activity. *Mol Cell*. 2013 Jan 24;49(2):331–8.
41. Rubartelli A, Gattorno M, Netea MG, Dinarello CA. Interplay between redox status and inflammasome activation. *Trends Immunol*. 2011 Dec;32(12):559–66.
42. Le HT, Harton JA. Pyrin- and CARD-only Proteins as Regulators of NLR Functions. *Front Immunol*. 2013;4:275.
43. Druilhe A, Srinivasula SM, Razmara M, Ahmad M, Alnemri ES. Regulation of IL-1 β generation by Pseudo-ICE and ICEBERG, two dominant negative caspase recruitment domain proteins. *Cell Death Differ*. 2001 Jun;8(6):649–57.
44. Shi C-S, Shenderov K, Huang N-N, Kabat J, Abu-Asab M, Fitzgerald KA, et al. Activation of autophagy by inflammatory signals limits IL-1 β production by targeting ubiquitinated inflammasomes for destruction. *Nat Immunol*. 2012 Mar;13(3):255–63.
45. Smith DE, Lipsky BP, Russell C, Ketchem RR, Kirchner J, Hensley K, et al. A central nervous system-restricted isoform of the interleukin-1 receptor accessory protein modulates neuronal responses to interleukin-1. *Immunity*. 2009 Jun 19;30(6):817–31.
46. Hoffman HM, Mueller JL, Broide DH, Wanderer AA, Kolodner RD. Mutation of a new gene encoding a putative pyrin-like protein causes familial cold autoinflammatory syndrome and Muckle-Wells syndrome. *Nat Genet*. 2001 Nov;29(3):301–5.
47. Zhou Q, Aksentijevich I, Wood GM, Walts AD, Hoffmann P, Remmers EF, et al. Brief Report: Cryopyrin-Associated Periodic Syndrome Caused by a Myeloid-Restricted Somatic NLRP3 Mutation. *Arthritis Rheumatol Hoboken NJ*. 2015 Sep;67(9):2482–6.
48. Stankovic K, Grateau G. [What's new in autoinflammatory diseases?]. *Rev Médecine Interne Fondée Par Société Natl Française Médecine Interne*. 2008 Dec;29(12):994–9.
49. Hawkins PN, Lachmann HJ, McDermott MF. Interleukin-1-receptor antagonist in the Muckle-Wells syndrome. *N Engl J Med*. 2003 Jun 19;348(25):2583–4.
50. Grateau G, Hentgen V, Stojanovic KS, Jéru I, Amselem S, Steichen O. How should we approach classification of autoinflammatory diseases? *Nat Rev Rheumatol*. 2013 Oct;9(10):624–9.
51. Park Y, Kastner D, Chae J. Activation of the pyrin inflammasome through the RhoA signaling pathway in FMF and HIDS. *Pediatr Rheumatol Online J*. 2015 Sep 28;13(Suppl 1):O11.
52. Jéru I, Duquesnoy P, Fernandes-Alnemri T, Cochet E, Yu JW, Lackmy-Port-Lis M, et al. Mutations in NALP12 cause hereditary periodic fever syndromes. *Proc Natl Acad Sci U S A*. 2008 Feb 5;105(5):1614–9.
53. Vladimer GI, Weng D, Paquette SWM, Vanaja SK, Rathinam VAK, Aune MH, et al. The NLRP12 inflammasome recognizes *Yersinia pestis*. *Immunity*. 2012 Jul 27;37(1):96–107.
54. Canna SW, de Jesus AA, Gouni S, Brooks SR, Marrero B, Liu Y, et al. An activating NLRC4 inflammasome mutation causes autoinflammation with recurrent macrophage activation syndrome. *Nat Genet*. 2014 Oct;46(10):1140–6.
55. Romberg N, Al Moussawi K, Nelson-Williams C, Stiegler AL, Loring E, Choi M, et al. Mutation of NLRC4 causes a syndrome of enterocolitis and autoinflammation. *Nat Genet*. 2014 Oct;46(10):1135–9.
56. Kitamura A, Sasaki Y, Abe T, Kano H, Yasutomo K. An inherited mutation in NLRC4 causes autoinflammation in human and mice. *J Exp Med*. 2014 Nov 17;211(12):2385–96.
57. Moghaddas F, Masters SL. Monogenic autoinflammatory diseases: Cytokinopathies. *Cytokine*. 2015 Aug;74(2):237–46.
58. Aksentijevich I, Masters SL, Ferguson PJ, Dancey P, Frenkel J, van Royen-Kerkhoff A, et al. An autoinflammatory disease with deficiency of the interleukin-1-receptor antagonist. *N Engl J Med*. 2009 Jun 4;360(23):2426–37.
59. Majeed HA, El-Shanti H, Al-Rimawi H, Al-Masri N. On mice and men: An autosomal recessive syndrome of chronic recurrent multifocal osteomyelitis and congenital dyserythropoietic anemia. *J Pediatr*. 2000 Sep;137(3):441–2.
60. Ferguson PJ, Chen S, Tayeh MK, Ochoa L, Leal SM, Pelet A, et al. Homozygous mutations in LPIN2 are responsible for the syndrome of chronic recurrent multifocal osteomyelitis and congenital dyserythropoietic anaemia (Majeed syndrome). *J Med Genet*. 2005 Jul;42(7):551–7.
61. Herlin T, Fiirgaard B, Bjerre M, Kerndrup G, Hasle H, Bing X, et al. Efficacy of anti-IL-1 treatment in Majeed syndrome. *Ann Rheum Dis*. 2013 Mar;72(3):410–3.
62. Gerfaud-Valentin M, Jamilloux Y, Iwaz J, Sève P. Adult-onset Still's disease. *Autoimmun Rev*. 2014 Jul;13(7):708–22.
63. Pizzirani C, Falzoni S, Govoni M, La Corte R, Donadei S, Di Virgilio F, et al. Dysfunctional inflammasome in Schnitzler's syndrome. *Rheumatol Oxf Engl*. 2009 Oct;48(10):1304–8.
64. Koné-Paut I, Sanchez E, Le Quellec A, Manna R, Touitou I. Autoinflammatory gene mutations in Behçet's disease. *Ann Rheum Dis*. 2007 Jun;66(6):832–4.
65. Touitou I, Magne X, Molinari N, Navarro A, Quellec AL, Picco P, et al. MEFV mutations in Behçet's disease. *Hum Mutat*. 2000 Sep;16(3):271–2.
66. Hatemi G, Seyahi E, Fresko I, Talarico R, Hamuryudan V. Behçet's syndrome: a critical digest of the 2014-2015 literature. *Clin Exp Rheumatol*. 2015 Dec;33(6 Suppl 94):S3-14.

3

*Les inflammasomes :
plateformes de l'immunité innée*
The inflammasomes: platforms of innate immunity

Yvan Jamilloux^{1,2,3,4,5}, Thomas Henry^{2,3,4,5}

¹ Service de Médecine interne, CHU de la Croix-Rousse, Lyon

² Centre International de Recherche en Infectiologie, Université de Lyon

³ INSERM U1111, Lyon

⁴ CNRS, UMR 5308, Lyon

⁵ Ecole Normale Supérieure, Lyon

Médecine/Science (Paris)

2013;29(11):975-84

RESUME

L'homme est constamment exposé à des pathogènes et a développé un système immunitaire extrêmement complexe pour s'en défendre. Le système immunitaire inné constitue la première ligne de défense de l'organisme. Il a évolué pour reconnaître des motifs microbiens conservés (*pathogen-associated molecular patterns* ou PAMPs) grâce un ensemble de récepteurs (*pattern recognition receptors* ou PRRs). La reconnaissance de la plupart des PAMPs par les PRRs entraîne une réponse transcriptionnelle qui se traduit par la néosynthèse de centaines de gènes. Au contraire, l'inflammasome est un complexe de l'immunité innée qui, suite à la détection de motifs microbiens ou de signaux de danger par certains PRRs, conduit à l'activation d'une caspase inflammatoire, la caspase-1. La caspase-1 activée déclenche la sécrétion de cytokines pro-inflammatoires telles que l'interleukine (IL)-1 β et l'IL-18, ainsi qu'une mort cellulaire programmée appelée pyroptose. Dans cette revue, nous décrivons les récepteurs de l'inflammasome et leurs ligands, l'assemblage et le fonctionnement de ce complexe protéique, ainsi que le rôle de l'inflammasome dans les infections bactériennes et virales.

SUMMARY

Human beings are constantly exposed to pathogens. The innate immune system is the first line of defense against microbes. It has evolved to recognize conserved microbial motifs (PAMPs or pathogen-associated molecular patterns) thanks to a limited array of receptors termed pattern recognition receptors (PRRs). Upon activation, most PRRs trigger a transcriptional response leading to neosynthesis of hundreds of genes. In contrast, engagement of various PRRs in the recently identified inflammasome complexes lead to activation of a cysteine protease, caspase-1. This inflammatory caspase has a dual activity, it triggers the release of very potent proinflammatory cytokines IL-1 β and IL-18 and an hyperinflammatory cell death, termed pyroptosis. In this review, we describe the inflammasome receptors and their ligands, the molecular mechanisms leading to the assembly of this innate immune platform and the role of the inflammasome during viral and bacterial infections.

INTRODUCTION

L'étude des mécanismes de l'immunité innée a connu un regain d'intérêt depuis la découverte des récepteurs *Toll-like*, il y a une vingtaine d'années. Par la suite, la mise en évidence d'autres récepteurs de l'immunité innée (les *RIG-I-like receptors* ou RLRs, les *C-type lectin receptors* ou CLR, et les *nucleotide-binding domain and leucine-rich repeats containing receptors* ou NLRs) a permis de décrypter les mécanismes de détection des pathogènes *via* la reconnaissance rapide de motifs microbiens conservés, nommés PAMPs (*pathogen-associated molecular patterns*). La plupart de ces motifs étant conservés dans les espèces non pathogènes, ces motifs microbiens sont aussi nommés MAMPs (*microbe-associated molecular patterns*) [1]. Les récepteurs de ces PAMPs ont été nommés PRRs (*pattern recognition receptors*). De manière plus générale, ces PRRs peuvent être activés par des signaux de dangers, regroupés sous la dénomination de DAMPs (*damage-associated molecular patterns*) [2]. Cette reconnaissance de motif permet à un nombre limité de PRRs de reconnaître une grande diversité de pathogènes. Cette large capacité de reconnaissance est augmentée par la variété de localisations de ces PRRs. Ainsi, les TLRs et les CLR surveillent le milieu extracellulaire et les compartiments endosomaux, tandis que les RLRs et les NLRs scrutent la présence de motifs microbiens ou de signaux de danger au sein du cytoplasme cellulaire. En 2002, Jurg Tschopp *et coll.* ont découvert un macrocomplexe moléculaire comportant un PRR d'un nouveau type et l'ont désigné *inflammasome* [3]. Contrairement aux PRRs identifiés précédemment, qui induisent une réponse transcriptionnelle (*via* l'activation de facteurs de transcription tels que NF- κ B ou IRF3/7) et la synthèse de centaines de protéines, la mise en jeu de l'inflammasome entraîne spécifiquement l'activation d'une caspase inflammatoire, la caspase-1 (encadré 1). La caspase-1 a un double rôle : le clivage protéolytique de pro-cytokines inflammatoires comme l'IL-1 β et l'IL-18, permettant leur maturation et leur sécrétion, ainsi que le déclenchement d'une mort cellulaire hyper-inflammatoire, la pyroptose [4].

1 Caspases inflammatoires et caspases apoptotiques

Les caspases sont des protéases à cystéine. Elles sont classées en deux groupes : les caspases apoptotiques qui déclenchent l'apoptose (une mort cellulaire largement silencieuse du point de vue immunologique), et les caspases inflammatoires qui déclenchent une mort de type nécrotique souvent accompagnée de la libération de cytokines. Chez l'homme, les caspases inflammatoires sont les caspases-1, -4, -5 et -12. Le rôle de la caspase-1 dans l'inflammation est bien décrit. Le rôle des caspases-4 et -5 est moins bien connu et est extrapolé à partir du rôle de l'homologue murin de ces caspases : la caspase-11. La caspase-11 peut activer, de manière indirecte, la caspase-1 ou déclencher la pyroptose de manière indépendante de la caspase-1. La caspase-12 est non fonctionnelle chez la majorité des humains. Dans certaines populations d'Afrique sub-saharienne, une forme longue de caspase-12 est synthétisée et semble, paradoxalement, avoir un rôle anti-inflammatoire.

Les inflammasomes sont donc définis comme des plateformes activatrices de la caspase-1. Pour chacun, leur dénomination résulte du nom du PRR impliqué. Cette revue décrit les différents inflammasomes identifiés, leurs modes d'activation et leurs implications en pathologie infectieuse.

DESCRIPTION DES INFLAMMASOMES

L'inflammasome est un complexe macromoléculaire qui se forme par oligomérisation d'un récepteur, d'un adaptateur et de la caspase-1, l'effecteur de ce complexe (Figure 1). L'association de ces différents partenaires se fait par interaction entre domaines homotypiques.

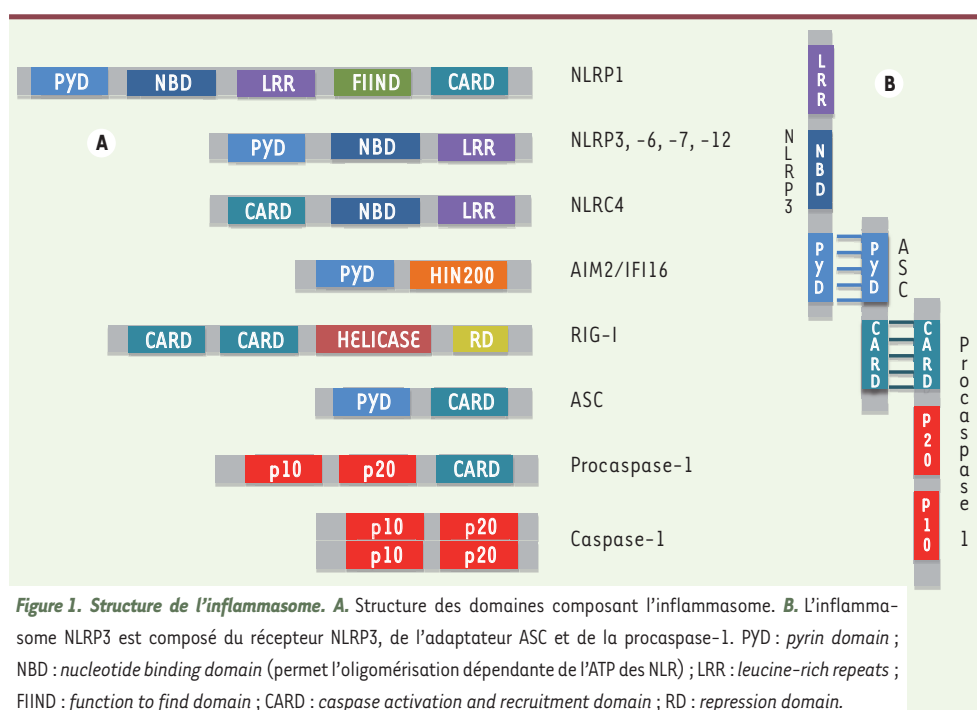

Les récepteurs :

Trois familles de récepteurs sont actuellement décrites comme principaux déclencheurs de l'activation de l'inflammasome : les NLRs, les ALRs (*AIM2-like receptors*) et les RLRs. Ces récepteurs et la cascade-inflammasome qui en résulte ont principalement été décrits dans les macrophages et les cellules dendritiques mais sont aussi présents dans d'autres cellules telles que les polynucléaires neutrophiles, les kératinocytes ou les cellules épithéliales intestinales.

1. Les récepteurs NLRs

Chez l'Homme, 22 récepteurs appartenant à la famille des NLRs ont été identifiés. Tous possèdent une structure organisée en domaines [5].

A l'instar des TLRs, l'extrémité C-terminale, comporte un domaine *leucine-rich repeats* (LRR) composé d'une répétition caractéristique de 20 à 30 acides aminés, riche en leucine. Ce domaine serait le site d'interaction entre le récepteur et son ligand.

La partie centrale, commune à tous les NLRs, correspond au domaine NBD (*nucleotide binding domain*). Ce domaine permet l'oligomérisation ATP-dépendante des NLRs (en hexamères ou heptamères) conférant à l'inflammasome sa forme typique de *doughnut* (Figure 2). Le domaine LRR possède un rôle d'autorégulation bien connu. En effet, le repliement conformationnel du domaine LRR, en dehors de toute stimulation, dissimule le domaine d'oligomérisation. L'activation du récepteur entraîne le changement de conformation et expose le domaine NBD, initiant ainsi la cascade de réactions conduisant à la formation de l'inflammasome.

L'extrémité N-terminale porte le domaine effecteur des NLRs, responsable de la transduction du signal. La nouvelle nomenclature des NLRs les regroupe en sous-familles en fonction du domaine effecteur [5]. On distingue ainsi les NLRP qui ont un *pyrin domain* (PYD), les NLRC, auxquels appartiennent NOD1, NOD2 et NLRC4/IPAF, qui ont un *caspase activation and recruitment domain* (CARD), NLRB/Naip qui a un *baculoviral inhibitor of apoptosis protein repeat* (BIR).

A l'heure actuelle, 7 NLRs ont été identifiés comme inducteurs d'une activité inflammasome. NLRP3 (ou cryopyrine), le plus largement étudié, est impliqué dans la détection de nombreux signaux de danger et des anomalies intrinsèques de ce récepteur sont la cause de diverses maladies affectant l'Homme [6–8]. NLRP1¹, NLRP7 et les complexes NLRB/NLRC4 ont un rôle plus spécialisé dans la détection de PAMPs. NLRP1 chez la souris détecte la toxine de l'anthrax. Chez l'homme, NLRP1 détecterait un fragment du peptidoglycane bactérien. NLRP7 détecte un lipopeptide des mycoplasmes. Les complexes NLRB/NLRC4 détectent la flagelline sécrétée dans le cytosol et les systèmes de sécrétion de type III des bactéries pathogènes. NLRP6, NLRP12 et NOD2 (un autre récepteur détectant des fragments de peptidoglycane) peuvent activer l'inflammasome mais leurs rôles restent moins bien caractérisés.

¹ Note de l'auteur : Depuis cette revue de 2013, les mécanismes d'activation de NLRP1 par protéolyse ont été décrits. Le sensing du peptidoglycane bactérien reste controversé.

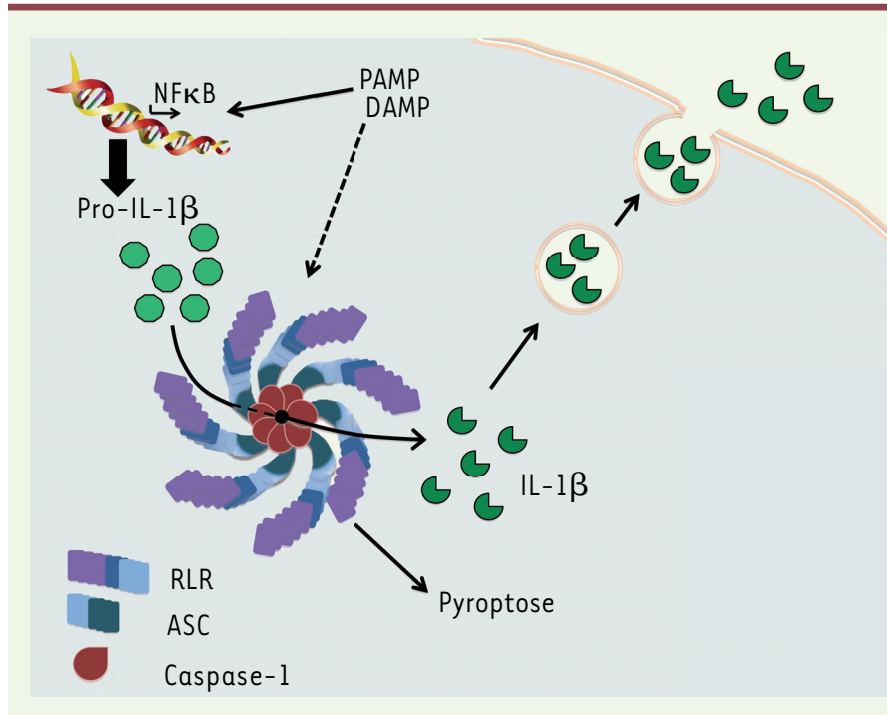

Figure 2. Schéma général du fonctionnement de NLRP3. Après une étape de pré-activation, les signaux de danger (DAMP) et/ou les motifs microbiens (PAMP) entraînent la formation de l'inflammasome par interaction entre le récepteur NLRP3, l'adaptateur ASC et l'effecteur, la procaspase-1. L'activation de la caspase-1 qui en résulte induit le clivage du prodomaine de la pro-IL-1 β , la transformant en sa forme bioactive, l'IL-1 β , qui est ensuite sécrétée dans le milieu extracellulaire.

2. Les récepteurs ALRs

Chez l'homme, la famille des ALRs comporte quatre membres : AIM2, IFI16, MDA5, et IFIX [9]. L'extrémité C-terminale des ALRs contient un domaine de liaison à l'ADN double-brin appelé HIN200. L'extrémité N-terminale contient un domaine PYD qui interagit avec le domaine PYD d'autres protéines (par exemple ASC) afin de former des macrocomplexes ayant un rôle dans l'inflammation et la mort cellulaire. Seuls AIM2 et IFI16 ont été décrits comme inducteurs de l'inflammasome suite à la détection d'ADN dans le cytoplasme et dans le noyau, respectivement [10,11].

3. Les récepteurs RLRs

La reconnaissance du récepteur cytoplasmique RIG-I (*retinoic acid inducible gene 1*) comme récepteur de l'inflammasome est récente et reste sujet à débat. La famille des RLRs comporte 3 membres : RIG-I, MDA5, et LGP2. Les RLRs comportent un domaine hélicase central responsable de la liaison aux ARN et un domaine régulateur à l'extrémité C-terminale. RIG-I et MDA5 contiennent également 2 domaines CARD en N-terminal, alors que

LGP2 n'a pas de CARD. LGP2 pourrait être, en fait, un régulateur des deux autres RLRs [12]. RIG-I et MDA5, malgré leur structure homologues, ne reconnaissent pas les mêmes ARN viraux et n'entraînent pas la transduction des mêmes signaux. En effet, si les deux récepteurs sont capables d'activer les facteurs de transcriptions IRF (*interferon regulatory factor*) et NF κ B et d'induire secondairement la transcription d'interféron (IFN) de type 1, seul RIG-I semble capable d'interactions CARD-CARD avec la caspase-1. Cependant, son rôle en tant que récepteur de l'inflammasome nécessite d'être confirmé, notamment son activation indépendamment de NLRP3 [13].

Depuis la découverte pionnière de l'inflammasome NLRP1, le nombre de récepteurs démontrés comme étant activateur de la caspase-1 n'a cessé d'augmenter. En plus de la famille des NLRPs qui contient chez l'homme 14 activateurs potentiels de l'inflammasome, des 4 ALRs et des 3 RLRs, d'autres récepteurs tels que la pyrine ou des CLRr pourraient être des activateurs directs de l'inflammasome. Leur pertinence biologique reste cependant encore à démontrer.

4. Ligands et activateurs des récepteurs

La liste des activateurs des inflammasomes s'est considérablement allongée ces dernières années, du fait de l'engouement suscité par les inflammasomes auprès des chercheurs à travers le monde. Les principaux stimuli activateurs des inflammasomes sont détaillés dans le tableau I.

5. L'activation de NLRP3

L'activation de l'inflammasome canonique NLRP3 nécessite la conjonction de deux signaux. Le signal 1 souvent généré suite à l'engagement d'un récepteur *Toll-like* induit une pré-activation de NLRP3 par modification post-traductionnelle (déubiquitination) [14], une augmentation de sa transcription ainsi que la transcription de la pro-IL-1 β . Le second signal est donné par de nombreux activateurs (voir tableau I).

L'inflammasome NLRP3 est, par exemple, activé en réponse à de nombreux de signaux de danger traduisant des dommages membranaires, des modifications de l'homéostasie ionique ou métabolique de la cellule :

- La lyse cellulaire est associée à un relargage de molécules cytosoliques qui peuvent se comporter en tant que signal de danger (DAMP). Ainsi, l'ATP est un messager extracellulaire détecté par le récepteur purinergique P2X7. L'activation de ce récepteur membranaire entraîne l'ouverture d'un canal protéique (la pannexine) et un efflux d'ions potassium hors de la cellule. La diminution de la concentration intracellulaire en potassium induit le changement de conformation de NLRP3 et l'activation de l'inflammasome NLRP3

[15–17]. De la même manière, des variations de l'homéostasie calcique pourraient participer à la détection des dommages membranaires *via* l'activation de NLRP3 [18].

- Une autre voie d'activation de NLRP3 a été proposée dans le cas des particules telles que l'amiante ou la silice [7,19], ou des cristaux d'acide urique [8] (responsable des crises de goutte), des cristaux de cholestérol [6] ou des cristaux d'hémozoïne (un cristal dérivé de l'hémoglobine qui se forme lors des infections avec *Plasmodium falciparum*, un agent du paludisme) ou enfin de la protéine β -amyloïde (maladie d'Alzheimer) [20]. Ces cristaux et particules peuvent entraîner une rupture des lysosomes ou des phagolysosomes associée à un relargage du contenu de ces organelles dans le cytosol. En particulier, le relargage de cathepsines (des protéases lysosomales) dans le cytosol serait impliqué dans l'activation de NLRP3 [21]. Les bactéries productrices de toxines formant des pores dans la membrane cellulaire (comme par exemple *Staphylococcus aureus*) activeraient NLRP3 *via* une de ces deux voies de perception des dommages membranaires. [22,23].

- Enfin, la mitochondrie semble être au carrefour de nombreux stimuli activant NLRP3. De nombreux stress cellulaires peuvent conduire à la production de dérivés réactifs de l'oxygène (ROS) par la mitochondrie. Ces ROS pourraient constituer le signal 1 et rendre compétent NLRP3 [21,24]. De plus, les ROS pourraient directement activer NLRP3 en modifiant la thioredoxine, une protéine sensible au ROS, et en libérant son partenaire d'interaction TXNIP (*thioredoxin-interacting protein*) qui pourrait alors interagir avec NLRP3 et activer cet inflammasome [25]. De plus, ces ROS ainsi que d'autres stress cellulaires conduisent à la lyse mitochondriale et entraînent un relargage d'ADN mitochondrial oxydé dans le cytosol. Cet ADN mitochondrial oxydé serait directement détecté par NLRP3 [26]. Finalement, la mitochondrie intègre les stress métaboliques cellulaires (par exemple la faillite énergétique de la cellule qui active l'inflammasome NLRP3) et peut constituer une plateforme sur laquelle se formerait l'inflammasome NLRP3.

Récepteurs	Stimulus	DAMP/ PAMP	Interaction directe/indirecte	Transduction du signal	Références
NLRP1	Toxine létale de l'anthrax	PAMP	D	CARD-CARD	[35, 36]
	Muramyl dipeptide	PAMP	D	CARD-CARD	[34]
NLRP3	Toxines formant des pores	PAMP	I	PYD-ASC-CARD	[15, 23]
	ATP extracellulaire via P2X7	DAMP	I		[15, 16, 22]
	Dérivés réactifs de l'oxygène	DAMP	I		[21, 24]
	Efflux d'ions K ⁺	DAMP	I		[15-17]
	Cristaux d'urate	DAMP	I		[8]
	Fibres d'amiante	DAMP	I		[19]
	Cristaux de silice	DAMP	I		[7,19]
	Sels d'aluminium	DAMP	I		[7]
	Cristaux de cholestérol	DAMP	I		[6]
	Protéine β -amyloïde	DAMP	I		[20]
NLRP6	?	?	?	?	[37, 38]
NLRP7	Lipopeptide bactérien	PAMP	D	PYD-ASC-CARD	[39]
NLRP12	Motif inconnu de <i>Yersinia pestis</i>	PAMP	?	PYD-ASC-CARD	[40]
NLRC4	Flagelline	PAMP	D	CARD-CARD	[27, 33]
	Systèmes de sécrétion de type 3 et 4	PAMP	D	CARD-CARD	[27, 33]
AIM2	ADN bactérien et viral	PAMP	D	PYD-ASC-CARD	[41, 45, 46]
IFI16	ADN viral nucléaire	PAMP	D	PYD-ASC-CARD	[48]
RIG-I*	ARN viral	PAMP	D	CARD-CARD ou ASC ?	[13]

Tableau 1. Principaux activateurs des inflammasomes. *Le rôle de RIG-I en tant qu'activateur de l'inflammasome reste débattu.

Transduction du signal et activation de la caspase-1

L'activation des NLRs entraîne leur oligomérisation via le domaine NBD et conduit au regroupement des domaines PYD. La protéine ASC (*apoptosis-associated speck-like protein containing a CARD*) est ensuite recrutée par interaction PYD-PYD. ASC est une protéine adaptatrice car elle contient un domaine PYD en N-terminal (interagissant avec la plupart des récepteurs) et un domaine CARD en C-terminal, ce dernier capable d'interagir à son tour avec le CARD de la procaspase-1. La protéine ASC forme également un complexe avec les récepteurs AIM2 et IFI16 lors de leur activation. En revanche, NLRC4 et RIG-I interagissent directement avec la procaspase-1. Dans le cas de NLRC4 et en fonction du stimulus, l'intensité de l'activation de la caspase-1 peut également nécessiter l'interaction d'ASC ou de NLRCB (ex-NAIP) [27–29].

Le rapprochement conformationnel de deux procaspases-1 dans le complexe ainsi formé entraîne leur clivage autoprotéolytique et leur autoactivation. Sous sa forme active, la caspase-1 est un tétramère formé de deux paires de sous-unités, p10 et p20. D'autres caspases pourraient être activées par des complexes inflammasomes non-canoniques (voir Box 2). La caspase-1 est une protéase à cystéine dont les rôles principaux sont la

conversion de la pro-IL-1 β et de la pro-IL-18 en leurs formes actives par clivage des domaines C-terminaux et le déclenchement de la pyroptose.

2 *Inflammasomes non canoniques*

L'inflammasome canonique est défini comme l'inflammasome conduisant à l'activation de la caspase-1. Récemment, deux voies de signalisation impliquant des caspases inflammatoires ou des acteurs de l'inflammasome, mais ne conduisant pas à l'activation de la caspase-1, ont été identifiées et nommées inflammasomes non canoniques. Le premier, décrit chez la souris, implique la caspase-11. Les mécanismes d'activation de cet inflammasome sont encore mal connus, mais impliqueraient la voie de l'interféron et des récepteurs encore inconnus pouvant détecter des bactéries intracytoplasmiques. L'activation de la caspase-11 conduit à la pyroptose et au relargage de nombreux DAMP (IL-1, HMGB1 [*high mobility group protein B1*], etc.). Le deuxième inflammasome non canonique implique l'adaptateur de l'inflammasome canonique, ASC, qui recrute et active la caspase-8, une caspase apoptotique. Cette voie est impliquée dans la réponse Fas/FasL, et dans la détection de champignons, de levures et de mycobactéries par des récepteurs extracellulaires. De plus, elle constitue une voie alternative à la caspase-1 lors d'infections bactériennes.

Les interleukines pro-inflammatoires

1. L'interleukine 1 β

L'IL-1 β est une cytokine majeure de la réponse inflammatoire, connue auparavant sous la dénomination de pyrogène endogène [30,31]. Elle exerce de nombreuses fonctions comme l'induction de la fièvre au niveau cérébral ou la stimulation de la moelle osseuse à l'origine d'hyperleucocytose et de thrombocytose. Par ailleurs, elle peut activer directement les lymphocytes, les cellules épithéliales et les cellules endothéliales, entraînant le recrutement de polynucléaires neutrophiles et de cellules inflammatoires au site de l'infection. L'IL-1 β peut aussi induire sa propre expression et l'expression de gènes codant pour d'autres cytokines (*tumor necrosis factor- α* : TNF- α , ou IL-6) créant ainsi une véritable cascade inflammatoire.

Du fait de sa puissance proinflammatoire et de ses effets délétères potentiels, la synthèse, la sécrétion et l'activité de l'IL-1 β sont très finement régulées :

- nécessité d'un signal activateur (*priming*) pour déclencher la transcription dépendante de NF κ B de la pro-IL-1 β sous forme inactive,
- clivage régulé par l'inflammasome,
- absence de peptide-signal de sécrétion, l'empêchant d'utiliser la voie classique d'exocytose,
- compétition extracellulaire avec un antagoniste naturel (IL-1Ra),

- fixation extracellulaire sur le récepteur IL1R2, qui ne contient pas de domaine cytoplasmique permettant la transduction du signal.

Du fait de ces différents mécanismes, il y a un découplage entre les niveaux de transcription de la pro-IL-1 β et les niveaux de sécrétion de sa forme active.

2. L'interleukine 18

Contrairement à l'IL-1 β , l'IL-18 est exprimée constitutivement dans les macrophages et ne requiert donc pas d'étape de *priming* [31]. Une des principales fonctions de l'IL-18 est l'induction d'une réponse Th1, *via* l'activation des cellules *natural killer* (NK) et la sécrétion d'IFN- γ . L'IL-18 favorise aussi la sécrétion d'autres cytokines proinflammatoires comme le TNF- α , l'IL-1 β , l'IL-8 et le GM-CSF. Ainsi l'IL-18 induit le recrutement, l'activation et l'expansion des polynucléaires neutrophiles et des macrophages au cours des infections. En outre, l'IL-18 augmente l'activité cytotoxique et la prolifération des lymphocytes T CD8+ et des cellules NK. Le rôle protecteur de l'IL-18 au cours des infections bactériennes et fongiques est principalement lié à sa capacité à entraîner la production d'IFN- γ , une cytokine qui induit l'activité microbicide des neutrophiles et des macrophages, par de nombreux mécanismes antibactériens (ex : production d'oxyde nitrique).

La pyroptose²

Outre sa fonction activatrice d'interleukines proinflammatoires, la caspase-1 est capable d'engager la cellule dans un processus de mort inflammatoire programmée, appelée pyroptose, restreinte à certains types cellulaires (dont les macrophages, les cellules dendritiques, ou les neurones) [4,32]. La pyroptose est déclenchée en réponse à de nombreux stimuli, qu'il s'agisse de PAMPs ou de DAMPs. La pyroptose est une mort cellulaire rapide, dépendante de la caspase-1, caractérisée par une rupture de la membrane plasmique et le relargage consécutif des substances proinflammatoires intracellulaires. En effet, la caspase-1 activée induit la formation de pores dans la membrane cellulaire, conduisant ainsi à une augmentation de la pression oncotique, un afflux d'eau à l'intérieur de la cellule et un gonflement cellulaire. Ces étapes aboutissent à la lyse osmotique de la cellule et au relargage des composants inflammatoires vers le compartiment extracellulaire. Contrairement à l'apoptose, ce processus est marqué par une fragmentation de l'ADN non oligonucléosomale, une condensation nucléaire sans perte d'intégrité du noyau et une destruction du cytosquelette d'actine.

² Note de l'auteur : Les mécanismes, récemment décryptés, concourant au déclenchement de la pyroptose, sont détaillés dans le Chapitre 4 : « Gasdermine D et pyroptose » de cette thèse

L'importance de ce processus est particulièrement flagrante au cours des infections à bactéries intracellulaires, dont *Legionella pneumophila*. En effet, après l'invasion de la cellule par une légionelle, celle-ci va s'établir au sein d'une vacuole de réplication intracytoplasmique où, protégée des défenses immunitaires de l'hôte, elle va effectuer de nombreux cycles de multiplication. Dans les macrophages, la détection de la flagelline de *Legionella* par NLRC4 induit la formation de l'inflammasome. L'activation de la caspase-1 et la pyroptose qui en résulte permettent non-seulement la destruction précoce du terrain de réplication de la bactérie (mort de la cellule), mais aussi l'induction d'un phénomène inflammatoire local (recrutement d'autres cellules immunitaires) concourant au confinement de l'infection. (voir revue récente Médecine/Sciences [33]).

L'INFLAMMASOME AU COURS DES MALADIES INFECTIEUSES

L'importance de l'activation de l'inflammasome dans la lutte contre les infections résulte des trois activités de la caspase-1 : 1) la pyroptose permet la suppression des niches de réplication des bactéries intracellulaires, 2) la production d'IL-1 β entraîne le recrutement des cellules inflammatoires au site de l'infection, 3) la production d'IL-18 induit la cascade de l'IFN- γ et l'activation des mécanismes bactéricides cellulaires.

Nous présentons ci-dessous les mécanismes d'activation de l'inflammasome au cours de différentes infections bactériennes (tableau II) et virales (tableau III).

Infections bactériennes

Chez l'homme, l'inflammasome **NLRP1** est activé en présence de muramyl dipeptide, un fragment du peptidoglycane présent dans la paroi de nombreuses bactéries à Gram positif comme à Gram négatif [34]. Par ailleurs, chez la souris, le Facteur Létal, un des deux constituants de la toxine létale du bacille de l'anthrax (*Bacillus anthracis*), est également reconnu par NLRP1 [35]. L'inflammasome a un rôle central dans la lutte contre *B. anthracis* dans des modèles murins mais pourrait aussi être responsable des dommages pulmonaires inflammatoires en cas d'inhalation de la toxine létale [36]. Cette action paradoxale permet de bien comprendre la nécessité de contrôler l'inflammasome et l'inflammation, en règle générale, pour lutter contre les microbes sans léser les tissus de l'hôte.

NLRP3 est activé par de nombreuses bactéries, en réponse à des signaux de danger plutôt que par interaction directe PAMP-récepteur. Les différentes voies d'activation de NLRP3 pouvant être engagées ont été détaillées plus tôt dans le texte. Les bactéries activant NLRP3 ainsi que leur motif activateur sont détaillés dans le tableau II. A titre

d'exemple, au cours des infections cutanées à *S. aureus*, l'activation de l'inflammasome NLRP3 suite à la détection des dommages membranaires causés par les toxines formant des pores est déterminante pour entraîner le recrutement précoce des neutrophiles au site d'infection, via la sécrétion d'IL-1 β .

Le rôle de **NLRP6** dans l'immunité antibactérienne a été rapporté récemment, mais de manière contradictoire et uniquement sur des modèles murins. En effet, dans un cas, les souris déficientes en NLRP6 présentaient une altération de la flore microbienne intestinale et une prédisposition pour les colites [37]. Dans l'autre cas, ces souris semblaient résistantes aux infections par *Listeria monocytogenes*, *Salmonella* et *Escherichia coli* [38]. Au total, les activateurs de NLRP6 demeurent inconnus et son rôle reste à caractériser.

NLRP7 et **NLRP12**³ ont été décrits pour leur rôle antibactérien. Le premier semble impliqué dans la reconnaissance de lipopeptides bactériens provenant d'espèces de *Mycoplasma* [39]. NLRP7 est mal caractérisé du fait de son absence dans le modèle murin. NLRP12, quant à lui, forme un inflammasome en réponse à l'infection par *Yersinia*, mais cette observation n'a été faite que sur modèle murin, et le motif détecté n'est pas identifié [40].

NLRC4 est spécifiquement activé par les systèmes de sécrétion de type III et IV de bactéries comme *Yersinia* et *Shigella*, ou par la flagelline des bactéries flagellées telles que *Salmonella*, *Legionella*, ou *Pseudomonas* [27,33]. Dans les modèles murins, la spécificité de l'inflammasome NLRC4 pour un de ses activateurs semble être conférée par la liaison préalable de l'activateur à l'une ou l'autre des protéines NAIP (*NLR family, apoptosis inhibitory protein*) [29]. Cependant, seule une protéine NLRB (homologue de NAIP) est présente chez l'être humain et, même si elle semble capable de reconnaître un motif minimal commun à *Shigella*, *Salmonella* et *Pseudomonas*, des études complémentaires sont nécessaires pour confirmer le rôle de NLRB. Chez la souris, le complexe NLRB/NLRC4 a un rôle-clé dans la détection précoce de l'invasion bactérienne au niveau de la muqueuse intestinale et dans le déclenchement d'une inflammation forte permettant le contrôle de l'infection.

³ Note de l'auteur : Le rôle de NLRP12 dans la détection de *Yersinia* a été remis en question dans des études récentes. A l'heure actuelle, le consensus autour de NLRP12 le classe comme un régulateur négatif de NF- κ B.

AIM2 reconnaît spécifiquement l'ADN double-brin présent dans le cytoplasme. Il est activé au cours des infections bactériennes ou virales lorsque l'agent pathogène se trouve en dehors du phagosome, en particulier dans les infections à *Listeria monocytogenes*, l'agent de la listériose, ou à *Francisella tularensis*, l'agent de la tularémie. Ainsi, les souris déficientes pour AIM2 sont très susceptibles à l'infection par *Francisella* [41].

De façon intéressante, le récepteur AIM2 détecte une molécule commune aux virus et à tous les êtres vivants, y compris l'homme. Le signal de danger n'est donc pas la détection de cette molécule commune, l'ADN, mais plutôt la détection de sa mauvaise localisation. En effet, AIM2 détecte l'ADN dans le cytosol cellulaire alors que, dans une cellule saine, la localisation de l'ADN est restreinte au noyau.

Inflammasomes	Bactéries	Motifs activateurs	Références
NLRP1	<i>Bacillus anthracis</i>	Toxine létale	[35, 36]
NLRP3	<i>Burkholderia pseudomallei</i>	BsaK	
	<i>Chlamydia pneumoniae</i>	?	
	<i>Escherichia coli</i>	ARNm	[22]
	<i>Streptococcus B</i>	Hémolysine β	[23]
	<i>Listeria monocytogenes</i>	Lystériolysine O	
	<i>Mycobacterium tuberculosis</i>	ESX-1, ESAT-6	
	<i>Staphylococcus aureus</i>	Hémolysine α	[22]
	<i>Streptococcus pneumoniae</i>	Pneumolysine	
	<i>Vibrio cholera</i>	Toxine cholérique B	
	<i>Yersinia pestis</i>	Système de sécrétion de type 3, YopJ	
	<i>Neisseria gonorrhoeae</i>	?	
	<i>Treponema denticola</i>	Td92	
	<i>Leptospira interrogans</i>	Glycolipoprotéine	
NLRP7	<i>Mycoplasma spp</i>	Lipopeptide acylé	
NLRP12	<i>Yersinia pestis</i>	?	[40]
NLRC4	<i>Burkholderia pseudomallei</i>	BsaK	
	<i>Escherichia coli</i>	EprJ, Escl	
	<i>Legionella pneumophila</i>	Flagelline	[27, 33]
	<i>Pseudomonas aeruginosa</i>	Flagelline, PscL	
	<i>Salmonella typhimurium</i>	Système de sécrétion de type 3, flagelline, PrgJ	
	<i>Shigella flexneri</i>	Mxil	
	<i>Yersinia pestis</i>	Système de sécrétion de type 3	
AIM2	<i>Francisella tularensis</i>	ADN	[41]
	<i>Listeria monocytogenes</i>	ADN	
	<i>Mycobacterium tuberculosis</i>	ADN	

Tableau II. Bactéries activatrices des différents inflammasomes et motifs activateurs. ESX-1 : ESAT-6 secretion system 1 ; ESAT-6 : 6-kDa early secreted antigenic target ; YopJ : Yersinia outer protein J ; Mxil : Max-interactor 1.

Infections virales

Le rôle des cytokines proinflammatoires, **IL-1 β** et **IL-18**, dans l'immunité antivirale a été démontré dans les modèles murins. Par exemple, au cours de l'infection par le virus de la grippe, la mortalité est supérieure chez les souris déficientes en IL-1R ou en IL-18 par rapport aux souris sauvages [42,43]. Par ailleurs, l'infection par le virus herpès de type 1 (HSV1) de souris déficientes en IL-1 résulte en une charge virale sanguine augmentée, un taux d'encéphalites à HSV1 plus élevé, et ce dans un contexte moins inflammatoire. L'administration d'IL-18 à un stade précoce de l'infection par HSV1 entraîne une augmentation de la survie des souris.

Un modèle intéressant d'activation de l'inflammasome **NLRP3** au cours de l'infection par le virus de la grippe A (influenza A) a été proposé récemment. Au niveau des macrophages pulmonaires, la reconnaissance de l'ARN viral par le récepteur TLR7 produirait le signal 1 conduisant à la synthèse de pro-IL-1 β . Le signal 2 serait ensuite représenté par l'insertion de la protéine M2 virale (un canal ionique) au niveau du réseau trans-golgien, entraînant des perturbations du milieu ionique intracellulaire. Une autre possibilité serait la survenue de dommages lysosomaux liés à la pénétration du virus et associés à un efflux de potassium et à une production de ROS déclenchant l'activation de NLRP3 [44].

Les données concernant l'activation de l'inflammasome **AIM2**, au cours des infections virales, sont rares et se concentrent essentiellement sur les modèles murins. Le cytomégalovirus murin, un virus à ADN de la famille des Herpesviridae, est reconnu par AIM2 [45,46]. Au contraire, d'autres herpesviridae, HSV1 et VZV, n'activent pas l'inflammasome AIM2 mais plutôt NLRP3 (HSV1 et VZV) et IFI16 (HSV1) [47,48].

La localisation intranucléaire d'**IFI16** explique son activation par l'ADN des virus KSHV (*Kaposi's sarcoma-associated herpes virus*) et HSV1, dont la réplication s'effectue à l'intérieur du noyau.

A l'heure actuelle, à notre connaissance, aucune donnée ne permet cependant de statuer sur la survenue d'une mort cellulaire pyroptotique en réponse à une infection virale.

Inflammasomes	Virus	ARN/ ADN	Motifs activateurs
NLRP3	Virus de la rougeole	ARN	?
	Virus de l'hépatite C	ARN	?
	Virus influenza	ARN	Insertion de M2
	Virus respiratoire syncytial	ARN	ROS/efflux de K ⁺
	Virus de la dengue	ARN	CLEC5A
	MVA	ADN	?
	Myxoma virus	ADN	Cathepsine B/ ROS
	Virus varicelle-zona	ADN	?
	Herpes simplex 1	ADN	?
	VIH 1	ADN	?
IFI16*	Herpes simplex 1	ADN	ADNdb ?
	KSHV	ADN	ADNdb ?
	Cytomégalovirus	ADN	ADNdb ?
RIG-I*	?	ARN?	ARNsb?

Tableau III. Virus activateurs des inflammasomes. *Les rôles directs de RIG-I et IFI16 en tant qu'activateurs de l'inflammasome restent à confirmer. CLEC5A : *C-type lectin 5A* ; VIH : virus de l'immunodéficience humaine ; db : double brin ; sb : simple brin.

CONCLUSION

Dix ans après la découverte de l'inflammasome et malgré les grandes avancées dans la compréhension de ce complexe de l'immunité innée, ses mécanismes d'activation, de régulation et ses fonctions notamment en lien avec les cellules de l'immunité adaptative sont loin d'être totalement définis. Par ailleurs, il reste très vraisemblablement de nouveaux inflammasomes à découvrir. Bien que les mécanismes moléculaires des inflammasomes soient de mieux en mieux connus, les rôles physiopathologiques de l'inflammasome sont encore largement mystérieux. S'il est bien démontré que l'inflammasome exerce un effet protecteur au cours des infections par de nombreuses bactéries, son rôle dans les infections virales, fongiques et parasitaires reste à confirmer.

Par ailleurs, l'inflammasome est un inducteur de réponses inflammatoires très puissantes dont les effets peuvent être dévastateurs. Ces effets délétères de l'inflammation médiée par l'inflammasome sont particulièrement frappant chez les patients atteints de cryopyrinopathies, des maladies auto-inflammatoires héréditaires causées par des mutations sur le gène *NLRP3*. Ces maladies pédiatriques sont l'urticaire familiale au froid, le syndrome de Muckle-Wells et le syndrome NOMID. Chez les patients possédant de telles mutations, la dérégulation de l'inflammasome du fait de la synthèse d'un récepteur NLRP3 spontanément activé provoque une hyperproduction d'IL-1 β et un état hyperinflammatoire récurrent se traduisant par des symptômes variant de la simple éruption cutanée jusqu'à la mise en jeu

du pronostic vital. Le traitement anti-IL1, et particulièrement l'administration d'un antagoniste du récepteur de l'IL-1 (IL-1Ra, anakinra), a révolutionné la prise en charge de ces pathologies. D'autres maladies séméiologiquement proches des cryopyrinopathies, comme la maladie de Still de l'enfant ou de l'adulte ou encore le syndrome de Schnitzler, pourraient aussi impliquer des dérégulations de l'inflammasome et pourraient bénéficier de traitement ciblant cette voie.

Les recherches présentes et futures devraient permettre le décryptage complet des voies de l'inflammasome et de ses fonctions physiopathologiques et entraîner *de facto* la mise au point de thérapeutiques ciblées utilisables dans nombre de situations infectieuses ou auto-inflammatoires.

REFERENCES

1. Medzhitov R, Janeway CA Jr. Decoding the patterns of self and nonself by the innate immune system. *Science* 2002 ; 296 : 298–300.
2. Matzinger P. The danger model: a renewed sense of self. *Science* 2002 ; 296 : 301–305.
3. Martinon F, Burns K, Tschopp J. The inflammasome: a molecular platform triggering activation of inflammatory caspases and processing of proIL-beta. *Mol. Cell* 2002 ; 10 : 417–426.
4. Bergsbaken T, Fink SL, Cookson BT. Pyroptosis: host cell death and inflammation. *Nat. Rev. Microbiol.* 2009 ; 7 : 99–109.
5. Ting JP-Y, Lovering RC, Alnemri ES, *et al.* The NLR gene family: a standard nomenclature. *Immunity* 2008 ; 28 : 285–287.
6. Duewell P, Kono H, Rayner KJ, *et al.* NLRP3 inflammasomes are required for atherogenesis and activated by cholesterol crystals. *Nature* 2010 ; 464 : 1357–1361.
7. Hornung V, Bauernfeind F, Halle A, *et al.* Silica crystals and aluminum salts activate the NALP3 inflammasome through phagosomal destabilization. *Nat. Immunol.* 2008 ; 9 : 847–856.
8. Martinon F, Pétrilli V, Mayor A, *et al.* Gout-associated uric acid crystals activate the NALP3 inflammasome. *Nature* 2006 ; 440 : 237–241.
9. Schattgen SA, Fitzgerald KA. The PYHIN protein family as mediators of host defenses. *Immunol. Rev.* 2011 ; 243 : 109–118.
10. Fernandes-Alnemri T, Yu J-W, Datta P, *et al.* AIM2 activates the inflammasome and cell death in response to cytoplasmic DNA. *Nature* 2009 ; 458 : 509–513.
11. Kerur N, Veettil MV, Sharma-Walia N, *et al.* IFI16 acts as a nuclear pathogen sensor to induce the inflammasome in response to Kaposi Sarcoma-associated herpesvirus infection. *Cell Host Microbe* 2011 ; 9 : 363–375.
12. Satoh T, Kato H, Kumagai Y, *et al.* LGP2 is a positive regulator of RIG-I- and MDA5-mediated antiviral responses. *Proc. Natl. Acad. Sci. U.S.A.* 2010 ; 107 : 1512–1517.
13. Poeck H, Bscheider M, Gross O, *et al.* Recognition of RNA virus by RIG-I results in activation of CARD9 and inflammasome signaling for interleukin 1 beta production. *Nat. Immunol.* 2010 ; 11 : 63–69.
14. Py BF, Kim M-S, Vakifahmetoglu-Norberg H, *et al.* Deubiquitination of NLRP3 by BRCC3 critically regulates inflammasome activity. *Mol. Cell* 2013 ; 49 : 331–338.
15. Mariathasan S, Weiss DS, Newton K, *et al.* Cryopyrin activates the inflammasome in response to toxins and ATP. *Nature* 2006 ; 440 : 228–232.

16. Kanneganti T-D, Lamkanfi M, Kim Y-G, *et al.* Pannexin-1-mediated recognition of bacterial molecules activates the cryopyrin inflammasome independent of Toll-like receptor signaling. *Immunity* 2007 ; 26 : 433–443.
17. Pétrilli V, Papin S, Dostert C, *et al.* Activation of the NALP3 inflammasome is triggered by low intracellular potassium concentration. *Cell Death Differ.* 2007 ; 14 : 1583–1589.
18. Compan V, Baroja-Mazo A, López-Castejón G, *et al.* Cell volume regulation modulates NLRP3 inflammasome activation. *Immunity* 2012 ; 37 : 487–500.
19. Dostert C, Pétrilli V, Bruggen R Van, *et al.* Innate immune activation through Nalp3 inflammasome sensing of asbestos and silica. *Science* 2008 ; 320 : 674–677.
20. Halle A, Hornung V, Petzold GC, *et al.* The NALP3 inflammasome is involved in the innate immune response to amyloid-beta. *Nat. Immunol.* 2008 ; 9 : 857–865.
21. Bauernfeind F, Ablasser A, Bartok E, *et al.* Inflammasomes: current understanding and open questions. *Cell. Mol. Life Sci.* 2011 ; 68 : 765–783.
22. Franchi L, Kanneganti T-D, Dubyak GR, *et al.* Differential requirement of P2X7 receptor and intracellular K⁺ for caspase-1 activation induced by intracellular and extracellular bacteria. *J. Biol. Chem.* 2007 ; 282 : 18810–18818.
23. Costa A, Gupta R, Signorino G, *et al.* Activation of the NLRP3 inflammasome by group B streptococci. *J. Immunol.* 2012 ; 188 : 1953–1960.
24. Tschopp J, Schroder K. NLRP3 inflammasome activation: The convergence of multiple signalling pathways on ROS production? *Nat. Rev. Immunol.* 2010 ; 10 : 210–215.
25. Zhou R, Tardivel A, Thorens B, *et al.* Thioredoxin-interacting protein links oxidative stress to inflammasome activation. *Nat. Immunol.* 2010 ; 11 : 136–140.
26. Shimada K, Crother TR, Karlin J, *et al.* Oxidized mitochondrial DNA activates the NLRP3 inflammasome during apoptosis. *Immunity* 2012 ; 36 : 401–414.
27. Coers J, Vance RE, Fontana MF, *et al.* Restriction of *Legionella pneumophila* growth in macrophages requires the concerted action of cytokine and Naip5/lpaf signalling pathways. *Cell. Microbiol.* 2007 ; 9 : 2344–2357.
28. Abdelaziz DHA, Gavrilin MA, Akhter A, *et al.* Asc-dependent and independent mechanisms contribute to restriction of *legionella pneumophila* infection in murine macrophages. *Front Microbiol* 2011 ; 2 : 18.
29. Kofoed EM, Vance RE. NAIPs: building an innate immune barrier against bacterial pathogens. NAIPs function as sensors that initiate innate immunity by detection of bacterial proteins in the host cell cytosol. *Bioessays* 2012 ; 34 : 589–598.
30. Dinarello CA. Interleukin-1 in the pathogenesis and treatment of inflammatory diseases. *Blood* 2011 ; 117 : 3720–3732.
31. Sahoo M, Ceballos-Olvera I, Barrio L del, *et al.* Role of the inflammasome, IL-1 β , and IL-18 in bacterial infections. *ScientificWorldJournal* 2011 ; 11 : 2037–2050.
32. Miao EA, Rajan JV, Aderem A. Caspase-1-induced pyroptotic cell death. *Immunol. Rev.* 2011 ; 243 : 206–214.
33. Jamilloux Y, Jarraud S, Lina G, *et al.* [*Legionella*, Legionnaires' disease]. *Med Sci (Paris)* 2012 ; 28 : 639–645.
34. Bruey J-M, Bruey-Sedano N, Luciano F, *et al.* Bcl-2 and Bcl-XL regulate proinflammatory caspase-1 activation by interaction with NALP1. *Cell* 2007 ; 129 : 45–56.
35. Terra JK, Cote CK, France B, *et al.* Cutting edge: resistance to *Bacillus anthracis* infection mediated by a lethal toxin sensitive allele of Nalp1b/Nlrp1b. *J. Immunol.* 2010 ; 184 : 17–20.
36. Kovarova M, Hesker PR, Jania L, *et al.* NLRP1-dependent pyroptosis leads to acute lung injury and morbidity in mice. *J. Immunol.* 2012 ; 189 : 2006–2016.
37. Elinav E, Strowig T, Kau AL, *et al.* NLRP6 inflammasome regulates colonic microbial ecology and risk for colitis. *Cell* 2011 ; 145 : 745–757.
38. Anand PK, Malireddi RKS, Lukens JR, *et al.* NLRP6 negatively regulates innate immunity and host defence against bacterial pathogens. *Nature* 2012 ; 488 : 389–393.
39. Khare S, Dorfleutner A, Bryan NB, *et al.* An NLRP7-containing inflammasome mediates recognition of microbial lipopeptides in human macrophages. *Immunity* 2012 ; 36 : 464–476.
40. Vladimer GI, Weng D, Paquette SWM, *et al.* The NLRP12 inflammasome recognizes *Yersinia pestis*. *Immunity* 2012 ; 37 : 96–107.
41. Jones JW, Kayagaki N, Broz P, *et al.* Absent in melanoma 2 is required for innate immune recognition of *Francisella tularensis*. *Proc. Natl. Acad. Sci. U.S.A.* 2010 ; 107 : 9771–9776.
42. Schmitz N, Kurrer M, Bachmann MF, *et al.* Interleukin-1 is responsible for acute lung immunopathology but increases survival of respiratory influenza virus infection. *J. Virol.* 2005 ; 79 : 6441–6448.

43. Liu B, Mori I, Hossain MJ, *et al.* Interleukin-18 improves the early defence system against influenza virus infection by augmenting natural killer cell-mediated cytotoxicity. *J. Gen. Virol.* 2004 ; 85 : 423–428.
44. Ichinohe T, Pang IK, Iwasaki A. Influenza virus activates inflammasomes via its intracellular M2 ion channel. *Nat. Immunol.* 2010 ; 11 : 404–410.
45. Hornung V, Ablasser A, Charrel-Dennis M, *et al.* AIM2 recognizes cytosolic dsDNA and forms a caspase-1-activating inflammasome with ASC. *Nature* 2009 ; 458 : 514–518.
46. Rathinam VAK, Fitzgerald KA. Inflammasomes and anti-viral immunity. *J. Clin. Immunol.* 2010 ; 30 : 632–637.
47. Nour AM, Reichelt M, Ku C-C, *et al.* Varicella-zoster virus infection triggers formation of an interleukin-1 β (IL-1 β)-processing inflammasome complex. *J. Biol. Chem.* 2011 ; 286 : 17921–17933.
48. Muruve DA, Pétrilli V, Zaiss AK, *et al.* The inflammasome recognizes cytosolic microbial and host DNA and triggers an innate immune response. *Nature* 2008 ; 452 : 103–107.

4

Interactions et régulation des inflammasomes

Longtemps, les seuls substrats identifiés de la caspase-1 ont été au nombre de deux : l'interleukine-1 β (IL-1 β) et l'interleukine 18. En effet, la nature insoluble du complexe inflammasome rendait la majorité des études biochimiques impossibles. Pour autant, différentes techniques ont été utilisées dans le but d'identifier d'autres substrats potentiels ou des protéines interagissant avec le complexe. Un nombre conséquent de ces protéines ont pu être identifiées par le biais de cribles, certaines autres ayant été identifiées plus fortuitement. Nous détaillons ci-après ces protéines.

1. Protéines interagissant avec l'inflammasome identifiées lors de cribles antérieurs

1.1. Mayah Saleh et le digestome de la caspase-1

Historiquement, l'un des premiers cribles ayant permis d'identifier de nouveaux substrats de la caspase-1 a été réalisé par l'équipe de Mayah Saleh en 2007 (1). Dans cette étude, les auteurs ont identifié des substrats de la caspase-1, après activation de l'inflammasome par la salmonelle, dans la lignée monocyttaire THP-1. Ce digestome comportait 41 protéines (tableau 1), incluant des protéines impliquées dans différentes voies essentielles à la survie cellulaire, au processus de traduction, au cytosquelette et au métabolisme énergétique cellulaire. Plus particulièrement, les auteurs démontraient que plusieurs enzymes de la glycolyse, telles que l'aldolase, la triosephosphate isomerase, la GAPDH, ou encore l' α -enolase, étaient ciblées par la caspase-1. Les expériences de clivage par la caspase-1 recombinante, *in vitro*, confirmaient les candidats identifiés dans ce *digestome*. La glycolyse étant une voie majeure impliquée dans la survie et l'activation cellulaire, les auteurs émettaient l'hypothèse que l'inhibition de la glycolyse était une étape-clé dans le processus de mort cellulaire dépendant de la caspase-1.

Protein	accession number	Function	Peptide coverage
β -tubulin	gi 4580988	Cytoskeleton	36.0%
β -actin	gi 13592133	Cytoskeleton	42.8%
ARP3	gi 5031573	Cytoskeleton	23.4%
F-actin capping protein alpha-1	gi 5453597	Cytoskeleton	25.8%
Aldolase A	gi 28614	glycolysis	25.6%
Triosephosphate isomerase	gi 136066	glycolysis	44.2%
Glyceraldehyde-3-phosphate dehydrogenase	gi 31645	glycolysis	36.1%
α -enolase	gi 4503571	glycolysis	44.0%
Pyruvate kinase	gi 35505	glycolysis	5.0%
L-Lactate Dehydrogenase H Chain	gi 13786848	Energy metabolism	13.8%
ATP synthase, H ⁺ transporting, beta subunit precursor	gi 32189394	Energy metabolism	32.1%
Malate dehydrogenase	gi 5174539	Energy metabolism	22.2%
Adenylate kinase 2	gi 7524346	ATP metabolism	32.0%
Adenyl-cyclase associated protein	gi 5453595	ATP metabolism	15.7%
Catalase	gi 179950	Detoxification	17.6%
Peroxioredoxin 6	gi 3318842	Detoxification	16.0%
Carbonic anhydrase II	gi 179780	Detoxification	50.0%
Glyoxalase I	gi 6573422	Detoxification	72.7%
Ribonuclease/angiogenin inhibitor (Rnh1)	gi 15029922	RNA stability	11.8%
EEF1A1	gi 48735185	translation	26.0%
Tu elongation factor	gi 704416	translation	10.2%
Ribosomal protein S9	gi 550023	translation	18.2%
HnRNP A2	gi 4504447	translation	15.3%
Proteasome alpha 7 subunit	gi 4092058	protein degradation	17.8%
SET translocation/12-PP2A	gi 4506891	Signal transduction	21.9%
PPP1A	gi 190281	Signal transduction	14.3%
GRB2, growth factor receptor-bound protein 2	gi 4504111	Signal transduction	13.6%
Ras-related C3 botulinium toxin substrate 2 (Rac2)	gi 4506381	Trafficking	15.5%
Rab GDI	gi 285975	Trafficking	11.8%
Rho GDI beta	gi 56676393	Trafficking	21.7%
RAB7	gi 1174149	Trafficking	13.0%
HSP27	gi 662841	Chaperone	12.7%
Hsp90	gi 306891	Chaperone	15.0%
Calreticulin precursor	gi 4757900	Chaperone	16.7%
Calnexin	gi 1309768	Chaperone	16.9%
ER protein 29	gi 5803013	Chaperone	25.8%
Cyclophilin B	gi 118090	Chaperone	22.7%
Chloride intracellular channel 1	gi 4588526	ion channel	18.5%
Annexin IV	gi 189617	phospholipid-binding protein	33.3%
PHAP1/April	gi 1498227	Tumor suppressor	11.8%
Caspase-1	gi 2914146	Maturation of cytokines and pyroptosis	28.6%

Tableau 1 : Liste complète des substrats de la caspase-1 identifiés par l'approche du digestome en gel diagonal (1). Les protéines ont été identifiées par spectrométrie de masse. Les numéros d'accèsion proviennent de la base de données suisse des protéines. Les pourcentages de couverture de peptides en spectrométrie de masse sont indiqués.

En 2008, une approche similaire réalisée par Lamkanfi et collègues a permis d'identifier 20 substrats de la caspase-1 clivés spécifiquement au niveau d'un résidu aspartate (tableau 2) (2). Parmi ces résidus, les auteurs ont choisi de s'intéresser à la caspase-7, un substrat non connu précédemment de la caspase-1. Les études subséquentes démontraient que beaucoup des substrats identifiés dans cette étude étaient en fait des substrats de la caspase-7, clivés par cette dernière après son activation par la caspase-1.

Accession no.	Protein name	Molecular mass, fragments
		<i>kDa</i>
Cluster I		
P97864	Caspase-7	22–11
P60710	β -Actin	1–41
P63260	γ -Actin	
P63038	Hsp60	6–56
		11–50
Q8R5A3	PREL-1	8–66
Q99KY4	Cyclin G-associated kinase	92–52
Q62318	TIF1b	73–16
Q5RJH6	SMG7	59–68
Q7TMY8	E3-histone	263–220
O35601	FYN-binding protein	46–44
P25206	MCM3	59–33
Cluster II		
P25206	MCM3	59–33
P08113	Endoplasmin	3–89
Q91WR3	Assc2	70–16
Q9JLQ2	GIT2	44–35
Q9WUK2	eIF-4H	10–17
P47713	cPLA ₂	59–26
Q61211	Ligatin	26–37
O88746	Target of Myb protein 1	36–18
Q62481	Vps72	6–35
Q8K2H1	Periphilin-1	33–11
P60710	β -Actin	27–15
P63260	γ -Actin	
Q61152	FLP-1	47–3

Tableau 2 : Liste des protéines identifiées dans le digestome de la caspase-1 par Lamkanfi et collègues (2). Les numéros d'accèsion proviennent de la base de données suisse des protéines. Les poids moléculaires des protéines et des fragments clivés sont indiqués.

1.2. L'identification des substrats de la caspase-1 par la dégradomique

En 2010, Agard et collègues ont identifié 55 substrats de la caspase-1 par une technique combinant un enrichissement N-terminal (biotinylation des néopeptides clivés par la subtiligase suivie d'une immunoprécipitation par la streptavidine) couplée à une identification par spectrométrie de masse (tableau 3) (3). Dans cette méthode de *dégradomique*, les auteurs ont utilisées trois activateurs différents des inflammasomes, incluant l'ATP, les cristaux d'urates monosodiques et le poly dA:dT. Parmi les substrats clivés en réponse à ces stimuli, seuls 6 étaient clivés par les 3 stimuli : SYAP1, la zyxine, la sous-unité de 65kDA du facteur d'épissage U2AF, MCM4, EIF3J, et la gasdermine D. Les études complémentaires de clivage in vitro montraient des susceptibilités de clivage plus ou moins importantes. De façon très intéressante, l'un des 6 substrats communs aux 3 signaux activateurs était la gasdermine D, protéine clivée le plus rapidement par la caspase-1. Cette protéine sera, plus

tard, identifiée comme une protéine majeure de la pyroptose. D'une manière générale, les auteurs concluaient à des profils de substrats de la caspase-1 différents en fonction du stimulus activateur.

Acc #	P4-P1	P1'-P4'	Start site	Protein Name
Q9H223	CDGD	GMLD	497	EH domain-containing protein 4
Q96JH7	CVAD	ALGA	1182	Deubiquitinating protein VCIP135
O15553	CVRD	SCSF	331	Pyrin
P30101	FFDD	SFSE	163	Protein disulfide-isomerase A3
O60488	FHPD	GCLQ	563	Long-chain-fatty-acid--CoA ligase 4
P10147	FIAD	YFET	50	C-C motif chemokine 3
P20810	FLLD	ALSE	514	Calpastatin
P57764	FLTD	GVPA	276	Gasdermin-D
Q9BYJ9	FMHD	AVFG	103	YTH domain family protein 1
Q8WVW9	FRHD	GYGS	290	Heterogeneous nuclear ribonucleoprotein L-like
P43243	FRRD	SFDD	188	Matrin-3
O43719	FSND	GASS	81	HIV Tat-specific factor 1
Q9UBF8	FSVD	SITS	489	Phosphatidylinositol 4-kinase beta
Q96A49	FVSD	AFDA	279	Synapse-associated protein 1
P33992	FYSD	SFGG	14	DNA replication licensing factor MCM5
Q8NC51	HAED	SVMD	338	Plasminogen activator inhibitor 1 RNA-binding protein
P12270	HRTD	GFAE	2148	Nucleoprotein TPR
P08670	IDVD	VSKP	260	Vimentin
Q96IZ7	IESD	SFVQ	239	Arginine/serine-rich coiled-coil protein 1
P62081	ILED	LVFP	133	40S ribosomal protein S7
Q2M2H8	IPYD	VQYS	364	Putative maltase-glucoamylase-like protein LOC93432
P36578	IRPD	IVNF	36	60S ribosomal protein L4
P18621	LDVD	SLVI	111	60S ribosomal protein L17
Q15942	LEID	SLSS	150	Zyxin
Q14694	LEND	GVSG	139	Ubiquitin carboxyl-terminal hydrolase 10
Q9UPT8	LEPD	SFSE	742	Zinc finger CCCH domain-containing protein 4
P61978	LESD	AVEC	129	Heterogeneous nuclear ribonucleoprotein K
P10809	LLAD	AVAV	50	60 kDa heat shock protein, mitochondrial
O43399	LLSD	SMTD	21	Tumor protein D54
P33991	LQSD	GAAA	133	DNA replication licensing factor MCM4
Q9H7D0	LQTD	GIAA	1810	Dedicator of cytokinesis protein 5
Q13263	LSLD	GADS	686	Transcription intermediary factor 1-beta
Q14161	LVPD	TAEP	626	ARF GTPase-activating protein GIT2
P60709	LVVD	NGSG	12	Actin, cytoplasmic 1
Q99590	MECD	SFCS	408	SFRS2-interacting protein
Q13501	MESD	NCSG	330	Sequestosome-1
Q15233	MMPD	GTLG	423	Non-POU domain-containing octamer-binding protein
P26368	MTPD	GLAV	129	Splicing factor U2AF 65 kDa subunit
P68104	PVLD	CHTA	363	Elongation factor 1-alpha 1
P14625	VDVD	GTVE	29	Endoplasmic
P61353	VNKD	VFRD	100	60S ribosomal protein L27
P80303	VNSD	GFLD	259	Nucleobindin-2
Q96NC0	VVKD	SINF	92	Zinc finger matrin-type protein 2
O75822	WDAD	AFSV	18	Eukaryotic translation initiation factor 3 subunit J
Q8N6H7	WDTD	AAWG	377	ADP-ribosylation factor GTPase-activating protein 2
P29466	WFKD	SVGV	298	Caspase-1
Q15366	WGLD	ASAQ	283	Poly(rC)-binding protein 2
Q8N6H7	WGMD	RVEE	383	ADP-ribosylation factor GTPase-activating protein 2
Q86V81	WQHD	LFDS	91	THO complex subunit 4
Q9UGP4	WSSD	GSLG	412	LIM domain-containing protein 1
Q9Y5Y6	WVCD	SVND	510	Suppressor of tumorigenicity protein 14
Q5T8P6	YDTD	GYNP	432	RNA-binding protein 26
P98155	YECD	CAAG	382	Very low-density lipoprotein receptor
Q9P2N5	YEPD	GYNP	488	RNA-binding protein 27
Q86V87	YFTD	SFLD	507	UPF0518 protein FAM160B2
Q15293	YIAD	MFSH	232	Reticulocalbin-1
O43852	YIGD	MYSH	217	Calumenin
Q8N954	YMSD	SFIN	15	Coiled-coil domain-containing protein 75
Q8IVL0	YMTD	GGLN	844	Neuron navigator 3
Q14444	YQRD	GYQQ	669	Caprin-1
P29466	AVQD	NPAM	120	Caspase-1
P01584	QDLN	LCPL	41	Interleukin-1 beta
Q96S66	YRPD	GGAG	391	Chloride channel CLIC-like protein 1

Tableau 3 : Substrats de la caspase-1 identifiés par la dégradomique (3). Les numéros d'accès proviennent de la base de données suisse des protéines. Les sites de clivage et leur séquence sont indiqués.

1.3. Un interactome des inflammasomes NLRP3, AIM2 et RIG-I par iTRAQ®

Enfin, en 2012, Wang et collègues ont réalisé une étude des interactomes des inflammasomes NLRP3, AIM2 et RIG-I en utilisant la technique iTRAQ® (*isobaric tagging reagents for quantitative proteomic analysis*) couplée à la spectrométrie de masse (4). Brièvement, les auteurs ont appliqué des stimuli activateurs spécifiques de chacun des 3 inflammasomes sur des cellules surexprimant la protéine ASC. Les cellules ont ensuite été lysées et la protéine ASC a été immunoprécipitée. Les protéines liées ont ensuite été marquées et identifiées par spectrométrie de masse. Chaque condition étant marquée par un marqueur différent, l'enrichissement (ou la diminution) peut ainsi être calculé. Les auteurs ont ainsi identifié 131 protéines liées au complexe inflammasome, dont 8, 13 et 22 protéines ayant un niveau enrichi en réponse à l'activation de NLRP3, AIM2 et RIG-i, respectivement (tableau 4). Trois protéines (dihydrolipoamide S-succinyltransferase, DLST; *end-binding protein 1*, EB1; et *60S ribosomal protein*, RL34) enrichies étaient communes à la réponse à l'activation des trois inflammasomes. Parmi elles, les auteurs ont identifié la protéine EB1 comme un composant majeur nécessaire à la formation des « specks » cytosoliques, reflets de l'activation de l'inflammasome AIM2, particulièrement.

1.4. La gasdermine D et la pyroptose

Plus récemment, deux cribles fonctionnels, réalisés par deux équipes en parallèle, ont permis l'identification de la gasdermine D (GSDMD) comme la protéine majeure impliquée dans la pyroptose (5,6). Cette mort cellulaire programmée est caractérisée par la formation de pores dans la membrane cellulaire entraînant un gonflement osmotique de la cellule suivi d'une lyse cellulaire associé au relargage du contenu cytoplasmique. La GSDMD, substrat de la caspase-1 (et de son paralogue murin, la caspase-11), contrôle la pyroptose. Le clivage de la GSDMD par ces caspases entraîne la formation d'un fragment effecteur N-terminal (GSDMD-NT) qui se trouve ainsi libéré du fragment C-terminal, qui a un rôle inhibiteur dans la protéine entière. GSDMD-NT forme des oligomères transportés et intégrés à la membrane plasmique où ils vont former des pores permettant des transports ioniques passifs non-sélectifs (**Figure 1**) (7,8). Les flux ioniques provoquent une augmentation du volume cellulaire et une lyse membranaire par choc osmotique. De manière caractéristique, GSDMD-NT ne peut se fixer que sur les phospholipides du feuillet interne de la membrane plasmique (9). Par conséquent, GSDMD-NT est incapable de former des pores depuis l'extérieur de la cellule, évitant l'induction d'une lyse cellulaire des cellules adjacentes (9,10). Par ailleurs, il a été démontré que GSDMD-NT peut se lier aux lipides membranaires des

bactéries, indiquant donc une fonction bactéricide additionnelle de la gasdermine D, tant sur les bactéries intracellulaires qu'extracellulaires (9).

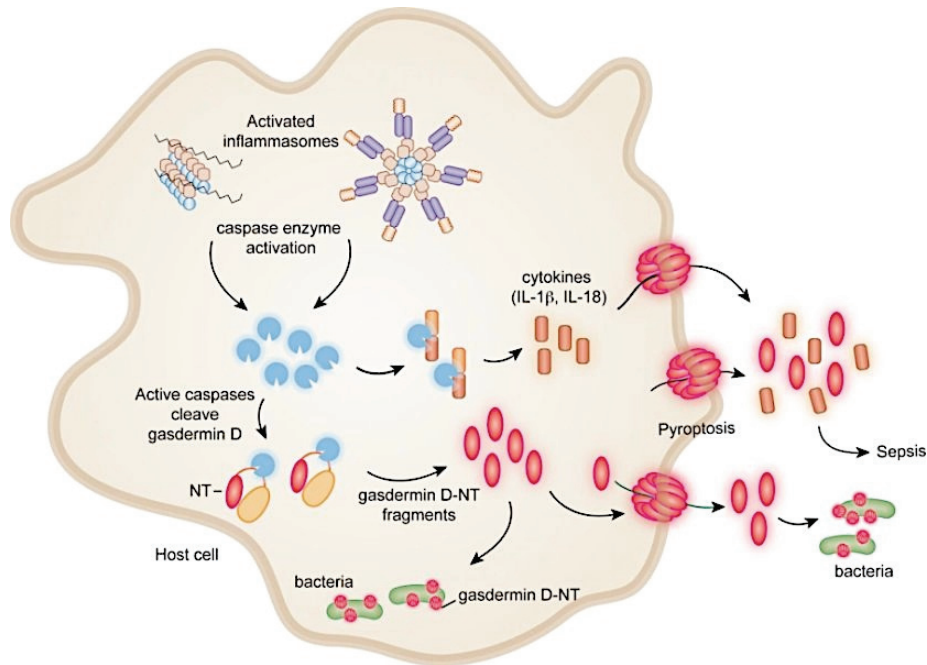

Figure 1 : Gasdermin D est une protéine formant des pores responsable de la pyroptose mais aussi une protéine bactériolytique (9).

L'activation des inflammasomes canonique et non canonique entraîne l'activation de la caspase-1 (ou de la caspase-11 murine). Ces caspases clivent et activent la pro-IL-1 β et la pro-IL-18 mais aussi la gasdermin D libérant ainsi un fragment N-terminal. Ce fragment est transporté à la membrane plasmique où son oligomérisation va permettre la création de pores entraînant la libération des cytokines inflammatoires et la pyroptose. Le fragment N-terminal est aussi capable de cibler directement les bactéries intracellulaires et extracellulaires et d'avoir une action bactériolytique.

2. Interactions identifiées en dehors de cribles

Plusieurs autres protéines ont été identifiées lors d'études spécifiques. Certaines de ces protéines sont détaillées, ainsi que leur fonction présumée au sein de la voie de l'inflammasome, dans le **tableau 4**.

Protéine	Fonction présumée dans la voie de l'inflammasome	Réfs
cPLA2	Régulation des éicosanoïdes au cours de l'inflammation induite par l'inflammasome : rôle pro-inflammatoire (initiation par le relargage de l'acide arachidonique) et anti-inflammatoire (résolution par l'induction de lipoxines) Substrat de la caspase-1 : le rôle du clivage n'est pas connu	(11–13)
cGAS	Substrat de la caspase-1 : le clivage diminue la production d'IFN de type 1 au cours des infections par des virus à ADN ; oriente vers la pyroptose ?	(14)
Fil1	Inhibiteur de la caspase-1 et de NLRP3. Protéine interagissant directement la actine-F et avec NLRP3 via la protéine LRRFIP2. Protéine de liaison entre les filaments d'actine et l'inflammasome. Son inhibition entraîne une hyperactivation de NLRP3. Substrat de la caspase-1 : le rôle du clivage reste à définir mais pourrait rendre compte d'un mécanisme de levée d'inhibition	(15–17)
SGT1	Ubiquitine-ligase dont l'inactivation inhibe l'inflammasome. Pourrait avoir un rôle dans son activation.	(18)
Nedd4	Ubiquitine-ligase. Substrat de plusieurs caspases, dont la caspase-1. Le rôle du clivage n'est pas déterminé.	(19)
TRIF	Substrat de la caspase-1 : le clivage de TRIF diminue l'autophagie (clairance de la bactérie), la production d'IFN de type 1 (immunité antimicrobienne) et augmente le relargage d'IL-1 β . Rôle dans l'activation de l'inflammasome non-canonique.	(20–22)
IL33	Substrat de la caspase-1, le clivage d'IL33 par caspase-1 inactive IL-33. Cette cytokine semble activer la voie Th2 et la production d'IL-4, -5 et -13	(23)
Parkine	Constituant d'un complexe E3-ubiquitine-ligase, particulièrement impliquée dans l'ubiquitination des mitochondries altérées et la mitophagie (inhibition de l'activation de NLRP3). Substrat de la caspase-1 : le clivage diminue la mitophagie et augmente la réponse l'inflammasome (boucle d'auto-amplification ?)	(24–26)

Tableau 4 : sélection de protéines interagissant avec la caspase-1.

3. Principaux mécanismes de régulation des inflammasomes

Les inflammasomes sont des acteurs majeurs de la défense dans la défense de l'hôte contre les pathogènes. Néanmoins, une activation non contrôlée de ces complexes peut conduire au développement de maladies auto-inflammatoires, auto-immunes, métaboliques ou neurodégénératives. De ce fait, le contrôle strict, en amont et en aval de la formation du complexe, revêt une importance cruciale permettant une réponse inflammatoire et antimicrobienne efficace, tout en évitant un effet délétère sur les tissus et l'organisme.

Les différentes étapes nécessaires à l'activation des inflammasomes ont été détaillées dans les chapitres précédents. Il s'agit essentiellement des mécanismes régulant la transcription

des composants de l'inflammasome et des cytokines proinflammatoires, ainsi que des mécanismes de régulation post-traductionnels, comme les processus d'ubiquitination / déubiquitination et de phosphorylation.

Par ailleurs, plusieurs mécanismes concourent à la régulation de l'inflammasome, en amont de son activation, c'est-à-dire une fois le complexe oligomérisé.

3.1. Les protéines leurres inhibitrices

Du fait du rôle majeur des interactions entre les domaines pyrines (PYD) et entre les domaines de recrutement des caspases (CARD) dans la formation des complexes inflammasomes, la modulation de ces interactions par des protéines leurres inhibitrices (COP, *CARD-only proteins* et POP, *pyrin-only proteins*), constitue un mode de régulation négatif important (27,28). Les protéines COP (CARD16, CARD17 et CARD18) séquestrent la caspase-1 et empêchent son activation (29–31). Néanmoins, une étude récente a démontré un rôle facilitateur de l'activation de la caspase-1 par CARD16 (32). Par conséquent, le rôle de ces protéines pourrait être plus complexe et nécessite une meilleure caractérisation. Les protéines POP (POP1, POP2 et POP3), quant à elles interfèrent dans l'interaction PYD-PYD des récepteurs des inflammasomes avec l'adaptateur ASC. POP1 et POP2 semblent plus spécifiques du récepteur NLRP3, alors que POP3 semble plus spécifique du récepteur AIM2 (33–36). Le rôle physiologique des protéines POP reste mal connu du fait qu'elles ne sont pas présentes chez la souris, modèle principal d'étude de l'inflammasome.

3.2. Régulation par les interférons

Les interférons (IFN) constituent un groupe de cytokines qui activent les cellules immunitaires et initient les défenses antimicrobiennes. Deux classes sont bien caractérisées : les IFN de type I et de type II.

Outre la réduction de l'expression pro-IL-1 β et pro-IL-18, les IFN de type I diminuent l'activité des inflammasomes NLRP1 et NLRP3 (37,38). L'inhibition de NLRP1 implique l'induction de l'interleukine-10, cytokine anti-inflammatoire, et de la voie de signalisation inhibitrice de STAT3 (*signal transducer and activator of transcription 3*) (37). Les mécanismes moléculaires d'inhibition de l'inflammasome NLRP3 par les IFN restent moins bien définis mais semblent impliqués la voie de STAT1 (*signal transducer and activator of transcription 1*) (39).

Le rôle de l'IFN- γ (IFN de type II) est mal défini mais une étude a démontré un mécanisme inhibiteur secondaire à la nitrosylation de NLRP3 par l'iNOS (*inducible nitric oxide synthase*), dans un modèle murin d'infection par le bacille de Koch (38).

À l'inverse, les IFN peuvent augmenter l'activation des inflammasomes. C'est le cas, par exemple de l'inflammasome AIM2, dont l'activation complète au cours de l'infection par *Francisella novicida* nécessite une pré-activation par l'IFN de type I (40). Le rôle des GBPs (*guanylate-binding proteins*), protéines inductibles par l'IFN impliquées dans l'immunité innée contre certaines bactéries intracellulaires, nécessite d'être mieux défini. Les données récentes ont montré qu'elles déstabilisaient les vacuoles contenant les pathogènes, induisant ainsi le relargage de LPS dans le cytosol et l'activation de l'inflammasome caspase-11 ou qu'elles tuaient les bactéries cytosoliques induisant le relargage d'acides nucléiques bactériens dans le cytosol et l'activation de l'inflammasome AIM2 (41). Néanmoins, d'autres études ont suggéré que les GBPs auraient un rôle direct sur l'oligomérisation de l'inflammasome NLRP3 ou même, plus en aval, dans l'induction de la pyroptose (42,43). La compréhension des interactions entre les GBPs et les inflammasomes est donc loin d'être complète.

3.3. Régulation des inflammasomes par l'autophagie

L'autophagie est un processus de maintien de l'homéostasie intracellulaire dont le principal rôle est de délivrer les constituants cytosoliques aux lysosomes pour leur dégradation et le recyclage des acides aminés. Il s'agit d'un mécanisme dynamique et sélectif, au cours duquel des protéines ou des organelles précédemment ubiquitinés sont délivrés par des protéines adaptatrices vers un autophagophore, structure membranaire cytosolique qui s'allonge pour les englober jusqu'à la formation de l'autophagosome, véritable vacuole à double membrane (**Figure 2**) (44). L'étape suivante est la fusion des lysosomes, donnant naissance à l'autophagolysosome, où sont dégradés et recyclés les peptides. De nombreuses protéines de l'autophagie sont impliquées dans ce processus, principalement régulé par le niveau stress cellulaire (carence en nutriments, en facteurs de croissance ou hypoxie). Outre son rôle dans l'homéostasie cellulaire, l'autophagie est également impliquée dans : (i) l'adaptation et la survie des cellules soumises à des conditions de stress ; (ii) l'immunité innée via l'élimination de certains pathogènes intracellulaires et la régulation de certaines cytokines ; et (iii) l'immunité adaptative via la production d'antigène pour les cellules présentatrices (44–46).

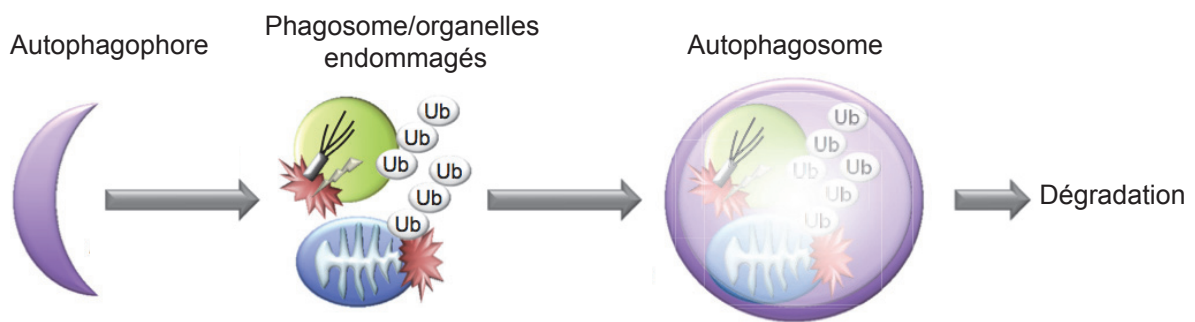

Figure 2 : Formation de l'autophagosome pour la dégradation des organelles et des phagosomes endommagés et ubiquitinés (Ub). Adapté de Saitoh & Akira (45).

Par ailleurs, l'autophagie a un rôle important dans l'activation et la régulation des inflammasomes, ainsi que dans la régulation et la sécrétion des cytokines proinflammatoires.

Les premières preuves de l'implication de l'autophagie dans la régulation de la voie de l'interleukine-1 sont venues d'études montrant une augmentation du relargage de cette cytokine chez les souris invalidées pour une protéine majeure de l'autophagie Atg16L1 (47). Cette hypersécrétion était dépendante de dérivés réactifs de l'oxygène (ROS) mitochondriaux, de l'activation de NLRP3. Les études ultérieures ont démontré que, dans les cellules déficientes pour l'autophagie ou pour la mitophagie (processus autophagique sélectif des mitochondries endommagées), il existait une accumulation de mitochondries altérées, un relargage dans le cytosol de ROS activant l'inflammasome NLRP3 (48,49). L'addition de LPS, d'ATP ou de cristaux d'urate monosodique entraîne également une altération des mitochondries et le relargage de ROS et d'ADN mitochondrial, l'activation de NLRP3 et la sécrétion d'IL-1 β et d'IL-18 (**Figure 3**) (49). Par ailleurs, l'inflammasome NLRC4, généralement activé par la reconnaissance du système de sécrétion de type III bactérien, peut être activé par le relargage de ROS mitochondriaux secondaire à l'altération des mitochondries par la bactérie *Pseudomonas aeruginosa* (50). Ces données indiquent donc que l'autophagie et la mitophagie, en maintenant l'homéostasie cellulaire et mitochondriale, agissent comme des régulateurs de l'activation des inflammasomes.

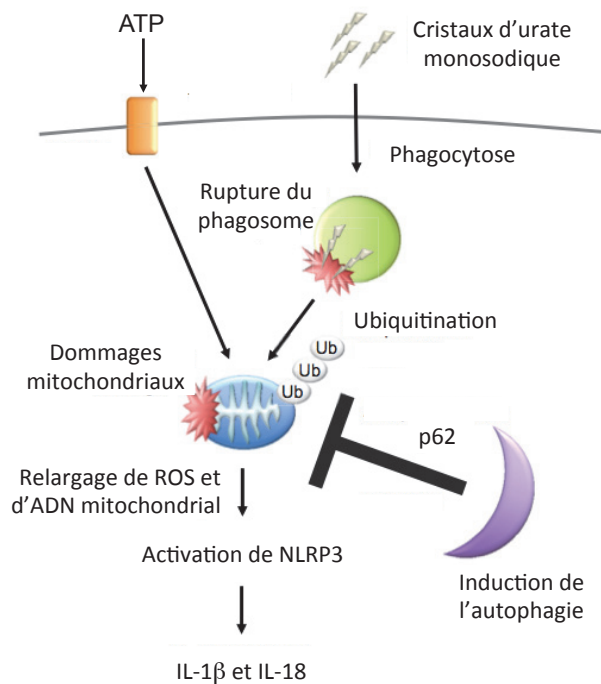

Figure 3 : L'inflammasome NLRP3 est activé via les dommages mitochondriaux et le relargage des dérivés réactifs de l'oxygène (ROS) et de l'ADN mitochondrial, en réponse à l'ATP extracellulaire (via son récepteur purinergique) ou secondairement à la rupture des phagosomes par les cristaux d'urate monosodiques (MSU). En séquestrant rapidement les mitochondries endommagées et ubiquitinées, via la protéine adaptatrice p62/sequestosome-1 (p62), l'autophagie régule négativement l'activation de l'inflammasome NLRP3. Adapté de Saitoh & Akira (45)

Un rôle préventif de l'autophagie a également été démontré sur l'activation de l'inflammasome non-canonique. Cet inflammasome est activé par la présence de bactéries Gram-négatif (ou de motifs bactériens) dans le cytoplasme de la cellule après la rupture du phagosome. L'élimination rapide des phagosomes endommagés par l'autophagie prévient la fuite du lipopolysaccharide (LPS) vers le cytosol et par là-même l'activation de l'inflammasome non-canonique (45,51).

Enfin, l'autophagie semble également impliquée dans la résolution de l'inflammation. En effet, une des fonctions principales de l'autophagie consiste à éliminer les complexes protéiques trop importants pour la dégradation protéasomale, y compris les complexes inflammasomes activés (52). La première étape de cette dégradation est l'ubiquitination des oligomères de ASC. Une protéine adaptatrice, p62/sequestosome-1 (p62), contenant un domaine d'interaction avec l'ubiquitine va ensuite servir de cargo et se lier avec la protéine LC3B, constituant majeur de la membrane de l'autophagosome (Figure 4) (53,54). Les cellules (et les souris) invalidées pour p62 ont une réponse exacerbée à l'activation de l'inflammasome, comme en témoigne l'hypersécrétion d'IL-1β (52,55). Shi et collègues ont

démontré que p62 interagissait avec ASC et délivrait le complexe inflammasome à l'autophagie pour sa dégradation (52). L'induction de l'autophagie par la privation en nutriments diminuait la réponse IL-1 β . Une étude récente a identifié un mécanisme complémentaire par lequel l'inflammasome AIM2 est délivré à l'autophagie pour destruction (56). Lors de l'activation d'AIM2, la protéine TRIM 11 (*tripartite motif 11*) lie AIM2 et est polyubiquitinée, ce qui améliore l'interaction AIM2-p62. Enfin, il a été démontré que l'autophagie régule le stock disponible de la proforme de l'IL-1 β , en délivrant la pro-cytokine à l'autophagolysosome où elle est dégradée (57).

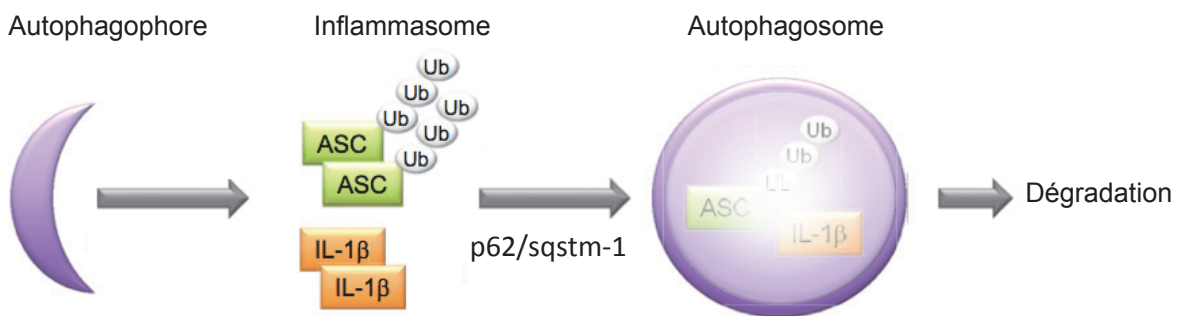

Figure 4 : Après la formation de l'inflammasome, un de ses composant principal, ASC, est ubiquitiné. La protéine adaptatrice p62/sequestosome-1 (sqstm-1) sert de cargo, liant simultanément l'ubiquitine par son domaine UBA et la protéine LC3B, constituant majeur de la membrane de l'autophagophore. Le complexe est ainsi délivré à l'autophagolysosome pour sa dégradation ultérieure, après la fusion des lysosomes. Il en résulte un mécanisme inhibiteur des inflammasomes. Adapté de Saitoh & Akira (45).

L'ensemble de ces données indique donc que l'autophagie joue un rôle majeur dans la prévention de l'excès d'inflammation, en limitant les signaux activateurs, limitant les substrats pro-inflammatoires et en dégradant les complexes en amont de leur activation. Néanmoins, l'autophagie pourrait également jouer un rôle dans la sécrétion non-conventionnelle de l'IL-1. Cependant, les données de la littérature, sur ce point, semblent contradictoires (52,57–59).

Références

1. Shao W, Yeretssian G, Doiron K, Hussain SN, Saleh M. The caspase-1 digestome identifies the glycolysis pathway as a target during infection and septic shock. *J Biol Chem*. 2007 Dec 14;282(50):36321–9.
2. Lamkanfi M, Kanneganti T-D, Van Damme P, Vanden Berghe T, Vanoverberghe I, Vandekerckhove J, et al. Targeted peptide-centric proteomics reveals caspase-7 as a substrate of the caspase-1 inflammasomes. *Mol Cell Proteomics MCP*. 2008 Dec;7(12):2350–63.
3. Agard NJ, Maltby D, Wells JA. Inflammatory stimuli regulate caspase substrate profiles. *Mol Cell Proteomics MCP*. 2010 May;9(5):880–93.
4. Wang L-J, Hsu C-W, Chen C-C, Liang Y, Chen L-C, Ojcius DM, et al. Interactome-wide analysis identifies end-binding protein 1 as a crucial component for the speck-like particle formation of activated absence in melanoma 2 (AIM2) inflammasomes. *Mol Cell Proteomics MCP*. 2012 Nov;11(11):1230–44.
5. Kayagaki N, Stowe IB, Lee BL, O'Rourke K, Anderson K, Warming S, et al. Caspase-11 cleaves gasdermin D for non-canonical inflammasome signalling. *Nature*. 2015 Oct 29;526(7575):666–71.
6. Shi J, Zhao Y, Wang K, Shi X, Wang Y, Huang H, et al. Cleavage of GSDMD by inflammatory caspases

- determines pyroptotic cell death. *Nature*. 2015 Oct 29;526(7575):660–5.
7. Chen X, He W-T, Hu L, Li J, Fang Y, Wang X, et al. Pyroptosis is driven by non-selective gasdermin-D pore and its morphology is different from MLKL channel-mediated necroptosis. *Cell Res*. 2016 Sep;26(9):1007–20.
 8. Aglietti RA, Estevez A, Gupta A, Ramirez MG, Liu PS, Kayagaki N, et al. GsdmD p30 elicited by caspase-11 during pyroptosis forms pores in membranes. *Proc Natl Acad Sci U S A*. 2016 Jul 12;113(28):7858–63.
 9. Liu X, Zhang Z, Ruan J, Pan Y, Magupalli VG, Wu H, et al. Inflammasome-activated gasdermin D causes pyroptosis by forming membrane pores. *Nature*. 2016 07;535(7610):153–8.
 10. Ding J, Wang K, Liu W, She Y, Sun Q, Shi J, et al. Pore-forming activity and structural autoinhibition of the gasdermin family. *Nature*. 2016 07;535(7610):111–6.
 11. Lüschen S, Ussat S, Krönke M, Adam-Klages S. Cleavage of human cytosolic phospholipase A2 by caspase-1 (ICE) and caspase-8 (FLICE). *Biochem Biophys Res Commun*. 1998 Dec 9;253(1):92–8.
 12. Andrei C, Margiocco P, Poggi A, Lotti LV, Torrisi MR, Rubartelli A. Phospholipases C and A2 control lysosome-mediated IL-1 beta secretion: Implications for inflammatory processes. *Proc Natl Acad Sci U S A*. 2004 Jun 29;101(26):9745–50.
 13. Atsumi G, Murakami M, Kojima K, Hadano A, Tajima M, Kudo I. Distinct roles of two intracellular phospholipase A2s in fatty acid release in the cell death pathway. Proteolytic fragment of type IVA cytosolic phospholipase A2alpha inhibits stimulus-induced arachidonate release, whereas that of type VI Ca2+-independent phospholipase A2 augments spontaneous fatty acid release. *J Biol Chem*. 2000 Jun 16;275(24):18248–58.
 14. Wang Y, Ning X, Gao P, Wu S, Sha M, Lv M, et al. Inflammasome Activation Triggers Caspase-1-Mediated Cleavage of cGAS to Regulate Responses to DNA Virus Infection. *Immunity*. 2017 Mar 8;
 15. Li J, Yin HL, Yuan J. Flightless-I regulates proinflammatory caspases by selectively modulating intracellular localization and caspase activity. *J Cell Biol*. 2008 Apr 21;181(2):321–33.
 16. Jin J, Yu Q, Han C, Hu X, Xu S, Wang Q, et al. LRRFIP2 negatively regulates NLRP3 inflammasome activation in macrophages by promoting Flightless-I-mediated caspase-1 inhibition. *Nat Commun*. 2013;4:2075.
 17. Burger D, Fickentscher C, de Moerloose P, Brandt KJ. F-actin dampens NLRP3 inflammasome activity via Flightless-I and LRRFIP2. *Sci Rep*. 2016 Jul 19;6:29834.
 18. Mayor A, Martinon F, De Smedt T, Pétrilli V, Tschopp J. A crucial function of SGT1 and HSP90 in inflammasome activity links mammalian and plant innate immune responses. *Nat Immunol*. 2007 May;8(5):497–503.
 19. Harvey KF, Harvey NL, Michael JM, Parasivam G, Waterhouse N, Alnemri ES, et al. Caspase-mediated cleavage of the ubiquitin-protein ligase Nedd4 during apoptosis. *J Biol Chem*. 1998 May 29;273(22):13524–30.
 20. Jabir MS, Ritchie ND, Li D, Bayes HK, Tourlomousis P, Puleston D, et al. Caspase-1 cleavage of the TLR adaptor TRIF inhibits autophagy and β -interferon production during *Pseudomonas aeruginosa* infection. *Cell Host Microbe*. 2014 Feb 12;15(2):214–27.
 21. Gurung P, Malireddi RKS, Anand PK, Demon D, Vande Walle L, Liu Z, et al. Toll or interleukin-1 receptor (TIR) domain-containing adaptor inducing interferon- β (TRIF)-mediated caspase-11 protease production integrates Toll-like receptor 4 (TLR4) protein- and Nlrp3 inflammasome-mediated host defense against enteropathogens. *J Biol Chem*. 2012 Oct 5;287(41):34474–83.
 22. Casson CN, Copenhaver AM, Zwack EE, Nguyen HT, Strowig T, Javdan B, et al. Caspase-11 activation in response to bacterial secretion systems that access the host cytosol. *PLoS Pathog*. 2013;9(6):e1003400.
 23. Lefrançois E, Cayrol C. Mechanisms of IL-33 processing and secretion: differences and similarities between IL-1 family members. *Eur Cytokine Netw*. 2012 Dec;23(4):120–7.
 24. Zhong Z, Umemura A, Sanchez-Lopez E, Liang S, Shalpour S, Wong J, et al. NF- κ B Restricts Inflammasome Activation via Elimination of Damaged Mitochondria. *Cell*. 2016 Feb 25;164(5):896–910.
 25. Yu J, Nagasu H, Murakami T, Hoang H, Broderick L, Hoffman HM, et al. Inflammasome activation leads to Caspase-1-dependent mitochondrial damage and block of mitophagy. *Proc Natl Acad Sci U S A*. 2014 Oct 28;111(43):15514–9.
 26. Kahns S, Kalai M, Jakobsen LD, Clark BFC, Vandenabeele P, Jensen PH. Caspase-1 and caspase-8 cleave and inactivate cellular parkin. *J Biol Chem*. 2003 Jun 27;278(26):23376–80.
 27. Latz E, Xiao TS, Stutz A. Activation and regulation of the inflammasomes. *Nat Rev Immunol*. 2013 Jun;13(6):397–411.
 28. Broz P, Dixit VM. Inflammasomes: mechanism of assembly, regulation and signalling. *Nat Rev Immunol*. 2016;16(7):407–20.
 29. Humke EW, Shriver SK, Starovasnik MA, Fairbrother WJ, Dixit VM. ICEBERG: a novel inhibitor of interleukin-1beta generation. *Cell*. 2000 Sep 29;103(1):99–111.
 30. Lamkanfi M, Denecker G, Kalai M, D'hondt K, Meeus A, Declercq W, et al. INCA, a novel human caspase recruitment domain protein that inhibits interleukin-1beta generation. *J Biol Chem*. 2004 Dec 10;279(50):51729–38.
 31. Druilhe A, Srinivasula SM, Razmara M, Ahmad M, Alnemri ES. Regulation of IL-1beta generation by Pseudo-ICE and ICEBERG, two dominant negative caspase recruitment domain proteins. *Cell Death Differ*. 2001 Jun;8(6):649–57.
 32. Karasawa T, Kawashima A, Usui F, Kimura H, Shirasuna K, Inoue Y, et al. Oligomerized CARD16 promotes caspase-1 assembly and IL-1 β processing. *FEBS Open Bio*. 2015;5:348–56.
 33. de Almeida L, Khare S, Misharin AV, Patel R, Ratsimandresy RA, Wallin MC, et al. The PYRIN Domain-

- only Protein POP1 Inhibits Inflammasome Assembly and Ameliorates Inflammatory Disease. *Immunity*. 2015 Aug 18;43(2):264–76.
34. Bedoya F, Sandler LL, Harton JA. Pypin-only protein 2 modulates NF-kappaB and disrupts ASC:CLR interactions. *J Immunol Baltim Md 1950*. 2007 Mar 15;178(6):3837–45.
 35. Dorfleutner A, Bryan NB, Talbott SJ, Funya KN, Rellick SL, Reed JC, et al. Cellular pypin domain-only protein 2 is a candidate regulator of inflammasome activation. *Infect Immun*. 2007 Mar;75(3):1484–92.
 36. Khare S, Ratsimandresy RA, de Almeida L, Cuda CM, Rellick SL, Misharin AV, et al. The PYRIN domain-only protein POP3 inhibits ALR inflammasomes and regulates responses to infection with DNA viruses. *Nat Immunol*. 2014 Apr;15(4):343–53.
 37. Guarda G, Braun M, Staehli F, Tardivel A, Mattmann C, Förster I, et al. Type I interferon inhibits interleukin-1 production and inflammasome activation. *Immunity*. 2011 Feb 25;34(2):213–23.
 38. Mishra BB, Rathinam VAK, Martens GW, Martinot AJ, Kornfeld H, Fitzgerald KA, et al. Nitric oxide controls the immunopathology of tuberculosis by inhibiting NLRP3 inflammasome-dependent processing of IL-1 β . *Nat Immunol*. 2013 Jan;14(1):52–60.
 39. Ma J, Yang B, Yu S, Zhang Y, Zhang X, Lao S, et al. Tuberculosis antigen-induced expression of IFN- α in tuberculosis patients inhibits production of IL-1 β . *FASEB J Off Publ Fed Am Soc Exp Biol*. 2014 Jul;28(7):3238–48.
 40. Man SM, Karki R, Malireddi RKS, Neale G, Vogel P, Yamamoto M, et al. The transcription factor IRF1 and guanylate-binding proteins target activation of the AIM2 inflammasome by *Francisella* infection. *Nat Immunol*. 2015 May;16(5):467–75.
 41. Meunier E, Wallet P, Dreier RF, Costanzo S, Anton L, Rühl S, et al. Guanylate-binding proteins promote activation of the AIM2 inflammasome during infection with *Francisella novicida*. *Nat Immunol*. 2015 May;16(5):476–84.
 42. Pilla DM, Hagar JA, Haldar AK, Mason AK, Degrandi D, Pfeffer K, et al. Guanylate binding proteins promote caspase-11-dependent pyroptosis in response to cytoplasmic LPS. *Proc Natl Acad Sci U S A*. 2014 Apr 22;111(16):6046–51.
 43. Shenoy AR, Wellington DA, Kumar P, Kassa H, Booth CJ, Cresswell P, et al. GBP5 promotes NLRP3 inflammasome assembly and immunity in mammals. *Science*. 2012 Apr 27;336(6080):481–5.
 44. Johansen T, Lamark T. Selective autophagy mediated by autophagic adapter proteins. *Autophagy*. 2011 Mar;7(3):279–96.
 45. Saitoh T, Akira S. Regulation of inflammasomes by autophagy. *J Allergy Clin Immunol*. 2016 Jul;138(1):28–36.
 46. Harris J, Lang T, Thomas JPW, Sukkar MB, Nabar NR, Kehrl JH. Autophagy and inflammasomes. *Mol Immunol*. 2017 Feb 26;
 47. Saitoh T, Fujita N, Jang MH, Uematsu S, Yang B-G, Satoh T, et al. Loss of the autophagy protein Atg16L1 enhances endotoxin-induced IL-1 β production. *Nature*. 2008 Nov 13;456(7219):264–8.
 48. Nakahira K, Haspel JA, Rathinam VAK, Lee S-J, Dolinay T, Lam HC, et al. Autophagy proteins regulate innate immune responses by inhibiting the release of mitochondrial DNA mediated by the NALP3 inflammasome. *Nat Immunol*. 2011 Mar;12(3):222–30.
 49. Zhou R, Yazdi AS, Menu P, Tschopp J. A role for mitochondria in NLRP3 inflammasome activation. *Nature*. 2011 Jan 13;469(7329):221–5.
 50. Jabir MS, Hopkins L, Ritchie ND, Ullah I, Bayes HK, Li D, et al. Mitochondrial damage contributes to *Pseudomonas aeruginosa* activation of the inflammasome and is downregulated by autophagy. *Autophagy*. 2015;11(1):166–82.
 51. Meunier E, Dick MS, Dreier RF, Schürmann N, Kenzelmann Broz D, Warming S, et al. Caspase-11 activation requires lysis of pathogen-containing vacuoles by IFN-induced GTPases. *Nature*. 2014 May 15;509(7500):366–70.
 52. Shi C-S, Shenderov K, Huang N-N, Kabat J, Abu-Asab M, Fitzgerald KA, et al. Activation of autophagy by inflammatory signals limits IL-1 β production by targeting ubiquitinated inflammasomes for destruction. *Nat Immunol*. 2012 Mar;13(3):255–63.
 53. Seibenhener ML, Babu JR, Geetha T, Wong HC, Krishna NR, Wooten MW. Sequestosome 1/p62 is a polyubiquitin chain binding protein involved in ubiquitin proteasome degradation. *Mol Cell Biol*. 2004 Sep;24(18):8055–68.
 54. Katsuragi Y, Ichimura Y, Komatsu M. p62/SQSTM1 functions as a signaling hub and an autophagy adaptor. *FEBS J*. 2015 Dec;282(24):4672–8.
 55. Ohtsuka S, Ishii Y, Matsuyama M, Ano S, Morishima Y, Yanagawa T, et al. SQSTM1/p62/A170 regulates the severity of *Legionella pneumophila* pneumonia by modulating inflammasome activity. *Eur J Immunol*. 2014 Apr;44(4):1084–92.
 56. Liu T, Tang Q, Liu K, Xie W, Liu X, Wang H, et al. TRIM11 Suppresses AIM2 Inflammasome by Degrading AIM2 via p62-Dependent Selective Autophagy. *Cell Rep*. 2016 Aug 16;16(7):1988–2002.
 57. Harris J, Hartman M, Roche C, Zeng SG, O’Shea A, Sharp FA, et al. Autophagy controls IL-1 β secretion by targeting pro-IL-1 β for degradation. *J Biol Chem*. 2011 Mar 18;286(11):9587–97.
 58. Schimmack G, Schorpp K, Kutzner K, Gehring T, Brenke JK, Hadian K, et al. YOD1/TRAF6 association balances p62-dependent IL-1 signaling to NF- κ B. *eLife*. 2017 Feb 28;6.
 59. Kim S-K, Choe J-Y, Park K-Y. Enhanced p62 Is Responsible for Mitochondrial Pathway-Dependent Apoptosis and Interleukin-1 β Production at the Early Phase by Monosodium Urate Crystals in Murine Macrophage. *Inflammation*. 2016 Oct;39(5):1603–16.

5

Autoinflammatory disorders

Yvan Jamilloux^{1,2}, Alexandre Belot^{1,3}, Flora Magnotti¹,
Sarah Benezech^{1,3}, Mathieu Gerfaud-Valentin², Emilie Bourdonnay¹,
Thierry Walzer¹, Pascal Seve², Thomas Henry¹

¹ Centre International de Recherche en Infectiologie, Inserm U1111, Université Lyon 1,
CNRS UMR5308, ENS Lyon, Lyon

² Department of Internal Medicine, Hopital de la Croix Rousse, Hospices Civils de Lyon,
Université Lyon 1, Lyon

³ Department of paediatric rheumatology and nephrology, Hopital Femme-Mère-Enfant,
Hospices Civils de Lyon, Université Lyon 1, Lyon

Clinical Reviews in Allergy and Immunology

(En révision mineure)

ABSTRACT

The knowledge on systemic autoinflammatory disorders (SAID) is expanding rapidly and new signalling pathways are being decrypted. In addition to inflammasomopathies and TNF receptor-associated periodic syndromes, new players driving autoinflammation have been described. This include type-1 interferonopathies, defects in ubiquitination and SAID with overlapping features of autoimmunity or immunodeficiency. Discoveries of the pathogenic role of mosaicism, intronic defects coupled to the likelihood to identify digenic or polygenic diseases are providing new challenges for physicians and geneticists. This comprehensive review depicts the various SAID, presenting them according to their predominant pathophysiological mechanism, with a particular emphasis on recent findings.

1. Introduction

The field of systemic autoinflammatory disorders (SAID) is expanding consistently and rapidly with the advance of sequencing technologies. As novel genetic defects are uncovered, new molecular mechanisms and new signalling pathways are being decrypted.

In 1997, two consortia demonstrated that mutations in the *MEFV* gene, encoding variants of the pyrin protein (also called marenostriane), cause familial Mediterranean fever [1,2]. However, it was only recently that the mechanisms linking molecular anomalies to the manifestations of the disease have been better deciphered [3]. A few years later, with the discovery of mutations in *TNFRSF1A* causing the TNF receptor-associated periodic syndrome (TRAPS), Kastner *et al.* introduced the concept of 'autoinflammation' [4]. Since then, many disorders with autoinflammatory pattern have been described. Overall, SAID are characterised by recurrent attacks of systemic inflammation with periodic fevers and are distinguished from autoimmune diseases by the absence of autoantibody production and autoantigen-specific T and B cells. Autoinflammation can thus be defined as an abnormal activation of the innate immunity.

In addition, autoinflammatory mechanisms have been shown to contribute to some more common diseases, such as gout, diabetes or systemic juvenile idiopathic arthritis [5,6].

In 2006, this renewed conception of immune disorders has led McDermott and McGonagle to propose an updated classification of the immunological diseases as a continuum from monogenic SAID to monogenic autoimmune diseases [7]. Complex or polygenic diseases, such as Crohn disease, Still's disease or Behcet syndrome, have been placed within this continuum, according to their pathophysiology. This classification has recently been updated to include the more recently described SAID [8].

Here, we depict the various SAID, presenting them according to their predominant pathophysiological mechanism, with a particular emphasis on recent findings. We will successively describe SAID: i) related to IL-1 pathway; ii) related to type-1 interferon pathway; iii) related to TNF pathway; iv) related to ubiquitination defects; v) combined with immunodeficiency; and vi) not yet classifiable.

2. SAID related to the IL-1 pathway

Due to high levels repetitively reported in the sera from patients with SAID and the description of mutations in major regulators of its secretory/signalling pathway, interleukin (IL)-1 has long been seen as the pivotal cytokine in the pathogenesis of SAID. The dramatic efficacy of its blockade in patients with SAID has strengthened this central position.

Interleukin-1 β is a major cytokine of the innate immune system with both local and systemic effects, such as pyrexia and leucocytosis. Along with IL-1 α , IL-18 and IL-36, IL-1 β belongs to the IL-1 superfamily, which includes seven cytokines [9]. To be active and secreted in the extracellular milieu, the pro-form of IL-1 β needs to be cleaved by caspase-1. The inflammasome is the multiprotein machinery that activates caspase-1 [10] (Figure 1). Various inflammasomes have been described. The specificity of each inflammasome is dictated by its receptor. Inflammasomes can be activated either by pathogen-associated molecular patterns (PAMPs) or danger-associated molecular patterns (DAMPs). Numerous defects in the IL-1 β regulatory pathway are associated with SAID.

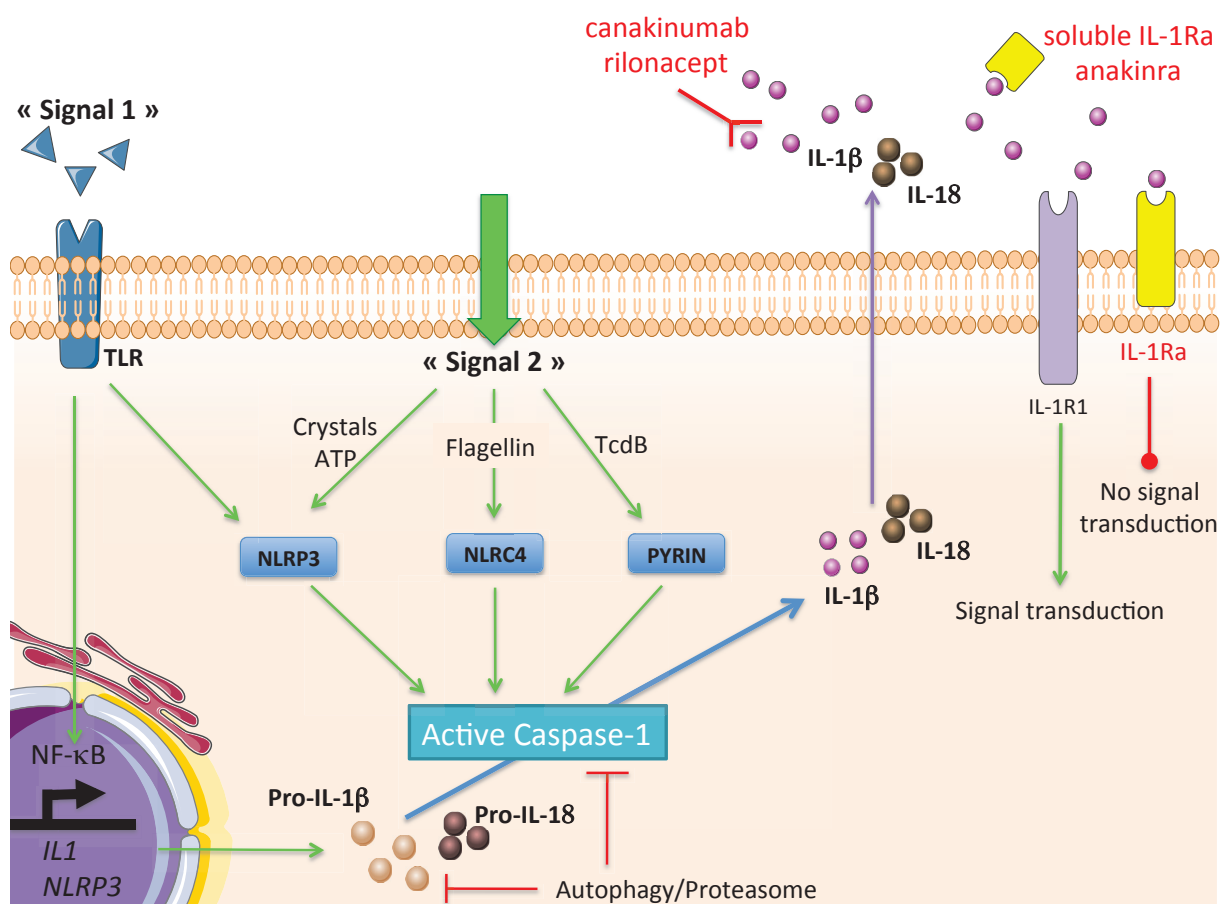

Fig. 1 The inflammasome pathway. The engagement of toll-like receptors (TLR) gives a signal 1, which is necessary for NF- κ B activation, pro-interleukin (IL)-1 transcription, and licensing of the NLRP3 inflammasome. NLRC4 and pyrin do not need a priming signal. Pro-IL-18 is constitutively present in the cytoplasm. An additive specific signal (for example: ATP or crystals for NLRP3; flagellin for NLRC4; or toxin B from *Clostridium difficile* for pyrin) triggers the oligomerization of the inflammasome and caspase-1 activation. Caspase-1 cleaves and activates IL-1 and IL-18, which are then released in the extracellular milieu. IL-1 receptor (IL-1R1) transduces the signal from IL-1, unless IL-1 receptor antagonist (IL-1Ra) traps IL-1. The mechanisms of IL-1 inhibition by recombinant inhibitors (anakinra, canakinumab, rilonacept) are shown

2.1. Pyrin-related SAID

2.1.1. Familial Mediterranean fever and pyrin-associated autoinflammation with neutrophilic dermatosis

Familial Mediterranean fever (FMF) is the most common monogenic SAID, affecting more than 100 000 individuals worldwide but mostly from the eastern Mediterranean basin [11]. It is characterized by recurrent, self-limited, episodes of fever and polyserositis. Criteria for FMF diagnosis and classification have been first proposed by at the Tel Hashomer Medical Center [12]. Since then, several other sets of diagnostic criteria have been proposed and used [13]. In 2015, using data from the Eurofever registry, the Paediatric Rheumatology International Trials Organisation (PRINTO) has proposed provisional diagnostic criteria for some SAID, including FMF (**Table 1**) [14]. The main long-term complication of FMF is end stage kidney disease due to AA amyloidosis.

Table 1 : The PRINTO/Eurofever provisional clinical classification criteria for autoinflammatory periodic fevers (adapted from [14])

FMF		MKD		CAPS		TRAPS	
Item	Points	Item	Points	Item	Points	Item	Points
Episode duration < 2 days	9	Age at onset < 2 years	10	Urticarial rash	25	Periorbital oedema	21
Chest pain	13	Aphthous stomatitis	11	Neurosensory hearing loss	25	Episode duration > 6 days	19
Abdominal pain	9	Generalised lymphadenopathy / splenomegaly	8	Conjunctivitis	10	Migratory rash	18
Eastern Mediterranean	22	Painful lymphadenopathy	13			Muscle pain	6
North Mediterranean	7	Occasional/frequent diarrhoea	20			Family history	7
		Persistent diarrhoea	37				
Absence of aphthosis	9	Absence of chest pain	11	Absence of exudative pharyngitis	25	Absence of vomiting	14
Absence of urticarial rash	15			Absence of abdominal pain	15	Absence of aphthosis	15
Absence of cervical lymphadenopathy	10						
Absence of episode duration > 6 days	13						
Positive diagnosis	≥60		≥42		≥52		≥43

FMF: familial Mediterranean fever; MKD: mevalonate kinase deficiency; CAPS: cryopyrin-associated periodic syndrome; TRAPS: TNF receptor-associated periodic syndrome

FMF is most often inherited in a recessive manner. Accordingly, the majority of FMF patients hold bi-allelic mutations in *MEFV* (mostly in exon 10), a gene encoding pyrin [15]. Nevertheless, almost 30% of patients with clinical FMF have only one mutated *MEFV* allele [16]. The effect of *MEFV* mutations on pyrin function has long been debated. Initially, pyrin was described as a negative regulator of the inflammasome and *MEFV* mutations were thought to be loss-of-function mutations [17]. However, it is now clear that pyrin is an inflammasome sensor specifically detecting Rho GTPases inactivation [3]. Recent findings from different groups have demonstrated that *MEFV* mutations are gain-of-function mutations with a seemingly gene-dosage effect (increasing with the number of mutated alleles) [18,19]. Prof Shao's group, along with Park and colleagues, have provided exciting new insights in pyrin activation process [3,20]. They have shown that two kinases, namely PKN1/2, phosphorylate the pyrin protein on two serine residues (S208 and S242). This phosphorylation results in the interaction of pyrin with 14-3-3 protein, a chaperone which sequesters pyrin, blocking its ability to form a mature inflammasome. The removal of this inhibitory mechanism is needed for the activation of the pyrin inflammasome. Indeed, bacterial toxins, such as *Clostridium difficile* toxin B (TcdB), inactivate the Rho GTPase, leading to inactivation of the kinases PKN1/2. This inhibition results in the dephosphorylation of pyrin, its release from the 14-3-3 protein, the formation of an active pyrin inflammasome and IL-1 β release (**Figure 2**).

FMF-associated *MEFV* mutations are now recognized as gain-of-function mutations, based on these findings and previous evidence: (i) only knock-in mice harbouring FMF-associated human *MEFV* mutations develop an autoinflammatory phenotype whereas pyrin-deficient mice do not [21], (ii) FMF-associated *MEFV* mutations are mostly missense mutations and null mutations are extremely rare; (iii) IL-1 β secretion following stimulation with bacterial lipopolysaccharide is significantly higher in monocytes from FMF patients, as compared to healthy donors [19].

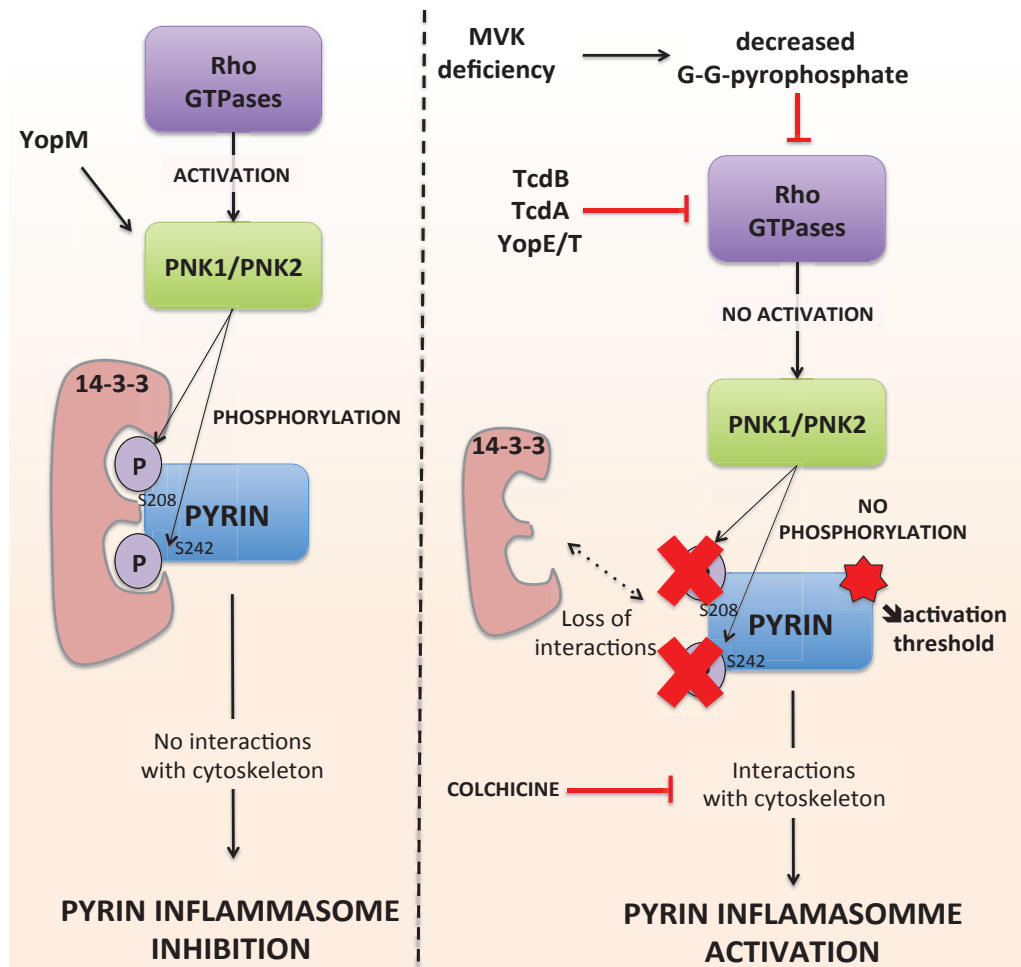

Fig. 2 The pyrin inflammasome. At steady state, the phosphorylation of pyrin on serine residues S208 and S242 by the kinases PKN1/2 results in the interaction of pyrin with 14-3-3 protein, a chaperone which sequesters pyrin and blocks its ability to form an inflammasome. Decreased geranyl-geranyl pyrophosphate (secondary to deficiency in mevalonate kinase, MVK) or addition of toxins A or B from *Clostridium difficile* or YopE/T from *Yersinia pestis* inactivate the Rho GTPases, leading to inactivation of the kinases PKN1/2. This inhibition results in the dephosphorylation of pyrin, its release from the 14-3-3 protein, the activation of the pyrin inflammasome and its interaction with microtubules, and the release of IL-1 β . *MEFV* mutations associated with familial Mediterranean fever (red star) decrease the threshold of activation of the pyrin inflammasome. Colchicine inhibits the interaction of the pyrin inflammasome with the cytoskeleton

The regulation of the pyrin inflammasome has been further elucidated by Masters et al., who have recently recapitulated the pyrin activating process by identifying a new autosomal-dominant SAID termed Pyrin-Associated Autoinflammation with Neutrophilic Dermatitis (PAAND) [22]. Patients presented with varied combinations of childhood-onset recurrent episodes of neutrophilic dermatosis, fever, elevated acute-phase reactants, arthralgia, and myalgia/myositis. PAAND is due to a specific *MEFV* mutation resulting in the loss of a 14-3-3 binding motif at phosphorylated S242 (S242R) and in constitutive activation of the pyrin inflammasome. Therapy with IL-1-blocking agent was successful in one patient [22].

Interestingly, PAAND-associated mutation does not map in the B30.2 domain, where most pathogenic FMF-associated mutations are found. This suggests that (de)phosphorylation of pyrin is not the only process that governs the pyrin inflammasome activation. Furthermore,

Lamkanfi and colleagues have recently reported that FMF-associated pyrin variants lift the obligatory requirement for polymerized microtubules in pyrin inflammasome activation [23]. These findings add to previous results indicating that pyrin may sense microbial-induced cytoskeleton modifications rather than sensing directly bacterial toxins [24]. Importantly these results provide new insights into the specificity and efficacy of colchicine, a potent microtubule polymerization inhibitor, which is now considered as a specific inhibitor of the pyrin inflammasome [25]. Finally, there is emerging evidence that numerous pathogens have co-evolved with the pyrin inflammasome. The interaction of *Yersinia* species with mammalian hosts demonstrates such an exquisite co-evolution [26,27]. Indeed, while the pyrin inflammasome detects the activities of the *Yersinia* effector proteins YopE and YopT, another *Yersinia* effector, YopM, inhibits the pyrin inflammasome by inducing pyrin phosphorylation [26].

We have observed that FMF-associated pyrin variants have a decreased threshold of activation in response to bacterial toxin modifying RhoGTPases (unpublished data). FMF-associated mutations might thus confer a benefit trait to defend against pathogen. Yet, possession of two such mutated alleles may, paradoxically, lead to detrimental exuberant inflammatory response.

Together these results suggest that the highly conserved pyrin inflammasome has a crucial role in host innate immunity and that its activation is tightly regulated by several mechanisms. More generally, these results strengthen the hypothesis that the high frequency of *MEFV* mutations in certain human populations is the result of a selective advantage to combat an ancient pathogen [28].

2.1.2. Hyper-IgD syndrome – Partial Mevalonate kinase deficiency

Hyper-IgD syndrome (HIDS) also called Mevalonate Kinase Deficiency (MKD) is caused by autosomal recessive mutations in the *MVK* gene encoding mevalonate kinase, with about 200 variants described to date [29]. This prototypic SAID is a childhood-onset disease consisting of recurrent episodes of fever associated with polyarthralgia or arthritis, splenomegaly, painful cervical lymphadenopathy, abdominal pain, vomiting, diarrhoea, and variable skin lesions. Attacks generally last for three to seven days. In first descriptions, the disease was associated with increased levels of circulating immunoglobulins (Ig) D and A, and was consequently termed Hyper-IgD Syndrome (HIDS) [30] but it is now admitted that IgD do no longer represent a reliable marker for the disease and are increased in several other autoinflammatory conditions. Eurofever/PRINTO provisional diagnostic criteria for MKD are shown in **Table 1**.

Treatments of HIDS with NSAID, short-term corticotherapy and IL-1 targeting biotherapies have proven mixed efficacy [31]. Colchicine has a very low impact on attacks prevention or treatment.

Mevalonate kinase is a key enzyme in cholesterol metabolism that converts mevalonic acid into mevalonate-5-phosphate, an intermediate for isoprenoid synthesis and sterol synthesis. HIDS-associated mutations result in decreased enzymatic activity of MVK, and subsequent depletion of farnesyl pyrophosphate and geranyl-geranyl pyrophosphate. Protein prenylation is a post-translational modification in which a farnesyl or a geranyl-geranyl group is covalently linked to a specific protein (such as RhoA) to target it to membranes. The shortage of farnesyl pyrophosphate and geranyl-geranyl pyrophosphate reduces protein prenylation. Recently, Park and colleagues have provided striking results linking MVK deficiency to the pyrin inflammasome-activating cascade [20]. Indeed, they demonstrated that the decrease in geranyl-geranyl pyrophosphate levels leads to decreased Rho GTPase activity, pyrin inflammasome activation and IL-1 β release, via PKN inhibition (**Figure 2**). This study thus suggests that the pyrin inflammasome could trigger auto-inflammation in response to specific metabolic dysfunctions and independently of *MEFV* mutations. Yet, as FMF and MVK clinical symptoms and their response to therapeutic drugs do not fully overlap, several other pathways are currently being explored to better explain the pathogenesis of HIDS. Mostly, some authors have proposed that another source of IL-1 β may also arise from the NLRP3 inflammasome activation by intracellular stress, altered redox state, mitochondrial damage, unfolded protein response and/or defective autophagy [8].

2.1.3. *PSTPIP1*-associated inflammatory diseases

Autosomal dominant mutations in *PSTPIP1*, encoding the proline-serine-threonine phosphatase-interacting protein 1 (PSTPIP1), have been first associated with pyogenic sterile arthritis, pyoderma gangrenosum, and acne (PAPA) syndrome [32,33]. PSTPIP1 is a cytoskeleton-associated adaptor protein that modulates T-cell activation, phagocyte activation/migration, cytoskeletal dynamics, and IL-1 β release. PAPA-associated mutations increase the binding of PSTPIP1 to pyrin, activate the pyrin inflammasome and result in elevated levels of circulating IL-1 β [34,35]. The spectrum of *PSTPIP1*-associated inflammatory diseases (PAID) encompasses five diseases. Four of these are characterized by pyoderma gangrenosum: i) PAPA syndrome; ii) pyogenic arthritis, pyoderma gangrenosum, acne, and suppurative hidradenitis syndrome: PAPASH; iii) pyoderma gangrenosum, acne, and ulcerative colitis syndrome: PAC; and iv) PAPA-like syndrome) [36]. The fifth PAID, termed *PSTPIP1*-associated myeloid-related proteinemia inflammatory (PAMI) syndrome, has been distinguished from the 4 others based on clinical and

biochemical features not found in patients with typical PAPA syndrome [37]. Patients with PAMI have skin inflammation and joint involvement, chronic systemic inflammation, hepatosplenomegaly, cytopenia and failure to thrive. The pathophysiology of PAID remains unclear [36]. Actin cytoskeleton dynamics, along with PSTPIP1-pyrin interactions, and phagocytes migratory phenotypes may have a major role in PAID manifestations. Elevated serum MRP8 (S100A8) and MRP14 (S100A9) are a hallmark of PAID and could serve as biomarkers. Two SAID without PSTPIP1 mutations have been related to PAID: pyoderma gangrenosum, acne, and suppurative hidradenitis syndrome (PASH, for which an increased repetition of the CCTG microsatellite motif on one PSTPIP1 allele was found), and pyoderma gangrenosum, acne, suppurative hidradenitis, and axial spondyloarthritis syndrome (PASS) [38,39]. Corticosteroids, cyclosporine, anti-TNF- α and anti-IL-1 have been proposed for the treatment of PAID.

2.1.4. Periodic Fever, Immunodeficiency, and Thrombocytopenia

Very recently, a syndrome of autoinflammatory periodic fever, immunodeficiency, and thrombocytopenia (PFIT) has been associated with a homozygous missense mutation in *WDR1*, which encodes a WD40 repeat protein that regulates actin dynamics [40]. The two Pakistani girls were born of consanguineous parents. PFIT manifested as very early-onset periodic fevers lasting three to seven days with symptom-free intervals of six to twelve weeks. The main skin manifestations were severe oral ulcers leading to disfiguring scarring and microstomy. Attacks were accompanied by elevation of acute phase reactants, hyperferritinemia, neutrophilia, high serum amyloid A and paradoxical thrombocytopenia. Both children had partial response to corticosteroids, colchicine and IL-1 blockade. Nevertheless, one girl died at age 14, from sterile systemic inflammation and multiorgan failure. The second underwent allogeneic hematopoietic stem cell transplantation at age 8, and remains well, off all medication, three years later.

Standing and colleagues found impaired actin dynamics in patients' immune cells, high levels of circulating IL-18, but normal IL-1 [40]. *In vitro*, patients' monocytes had elevated caspase-1 activation, increased secretion of IL-18 but not IL-1. Mutant protein formed aggregates, which accumulated pyrin. Together, these results suggest a role for actin-dependent pyrin inflammasome dysregulation in the pathogenesis of PFIT.

2.2. NLR-related SAID

Nucleotide-binding domain and leucine-rich repeat containing (NLR) are intracellular receptors, belonging to the larger family of pattern-recognition receptors (PPRs) [41]. The recognition of an activating stimulus triggers oligomerization, recruitment and activation of

caspase-1, which finally activates pro-inflammatory IL-1 and IL-18 and engage the cell in a programmed death, termed pyroptosis [42]. In addition to pyrin (which is not classified as a NLR), the cytosolic receptor AIM2 and three NLRs (NLRP3, NLRC4, NLRP1) are canonical inflammasome receptors. Mutations in the three latter receptors-encoding genes are associated with monogenic SAID [43]. Similarly, mutations in NLRP12 are responsible for a monogenic SAID, but it is currently unclear whether NLRP12 is a *bona-fide* inflammasome receptor or a negative regulator of inflammation.

2.2.1. Cryopyrin-associated periodic syndromes

Gain-of-function mutations in the gene *NLRP3*, which encodes the receptor protein NLRP3, are associated with three SAID, namely from the less to the most severe: Familial Cold-induced Autoinflammatory Syndrome 1 (FCAS1), Muckle-Wells Syndrome (MWS) and Neonatal-Onset Multisystem Inflammatory Disease (NOMID). Since these three SAID are due to mutations in *NLRP3* (formerly termed Cryopyrin), they are now considered as parts of a continuum of a single syndrome termed Cryopyrin-Associated Periodic Syndrome (CAPS) [44]. The inheritance of this rare disease (1-2/million individuals) is most often autosomal dominant but sporadic and somatic mutations have been described [45]. Clinically, CAPS patients present with recurrent episodes of fevers associated with urticaria-like rash, ocular inflammation, and polyarthralgia. More severe phenotypes include hepatosplenomegaly, sensorineural hearing loss (MWS), progressive amaurosis, chronic arthropathy and mental retardation (NOMID). Evidence-based diagnostic criteria for CAPS are shown in **Table 1**.

Treatment with IL-1 inhibitors has demonstrated a dramatic efficacy [46,47].

The activation of the canonical NLRP3 inflammasome requires two steps: a priming signal (signal 1) to induce the synthesis of pro-IL-1 β and to license the NLRP3 inflammasome; followed by a specific signal to activate NLRP3 (signal 2) [48,49]. The activation of NLRP3 inflammasome is tightly regulated by numerous mechanisms, including deubiquitination, ion flux, cyclic AMP binding or autophagy [50].

CAPS-associated mutations (181 variants in the Infevers registry) encode NLRP3 variants driving constitutive inflammasome activation without any requirement for a signal 2 [44]. Finally, IL-1 β autocrine/paracrine effects, along with the release of inflammasome particles (specks) into the extracellular milieu are likely to create a self-amplifying loop [51]. Such a mechanism could explain the severe clinical phenotypes observed in patients with paradoxically low-level somatic mosaicism [52].

Indeed, increasing evidence suggests that numerous mutation-negative CAPS patients may be explained by *NLRP3* mosaicism, which may also account for some apparent sporadic cases. *NLRP3* mosaicism has been reported in CAPS patients with NOMID and MWS.

Patients with somatic mutations tend to have a later onset of disease and sensorineural symptoms, an increased coincidence of arthritis, and a reduced risk of AA amyloidosis [53].

2.2.2. *NLRC4-associated Macrophage Activation Syndrome*

Activating mutations in *NLRC4*, the gene encoding another well-characterized inflammasome receptor, have been associated very recently with a SAID consisting of episodic fevers, systemic inflammation reminiscent of macrophage activation syndrome (MAS) and early-onset enterocolitis [54,55]. All patients had elevated serum IL-18 even during clinical quiescence (10-100 fold higher than in CAPS patients). The disease inheritance is autosomal dominant, since heterozygous mutations were sufficient to drive clinical manifestations. Similarly to CAPS, the severity of the disease was highly variable; with one patient dying at day 23 of life from diffuse alveolar haemorrhage whereas his mutated father had only a lifelong history of recurrent fevers. Since the seminal descriptions by Canna *et al.* and by Romberg *et al.*, *NLRC4*-mutations associated phenotype is expanding [56] and some clinical presentations that are usually associated with *NLRP3* mutations have been reported: one patient had typical symptoms of FCAS [57] and another, with high-frequency somatic mutations of *NLRC4*, initially presented with a typical NOMID [58].

Episodes were responsive to corticosteroids and IL-1 inhibitors [54,55]. Furthermore, Canna *et al.* have reported on a patient, with *de novo NLRC4* mutation and life-threatening *NLRC4*-MAS, who was successfully treated with recombinant IL-18 binding protein (IL-18BP), an IL-18 inhibitor, while non-responsive to corticosteroids, IL-1 blockade, anti-TNF drug, cyclosporine, and $\alpha 4\beta 7$ -integrin inhibition [59].

NLRC4 encodes the receptor part of the *NLRC4* inflammasome, which recognizes intracellular flagellin and components of bacterial secretion systems through a NAIP adaptor protein [60–62]. The activation of *NLRC4* inflammasome results in IL-1 β and IL-18 activation and the initiation of pyroptosis. *NLRC4*-MAS-associated mutations lead to constitutive *NLRC4* inflammasome activation, possibly by impairing an auto-inhibitory mechanism. Notably, *NLRC4* and *IL-18* are highly expressed in intestinal epithelial cells, possibly explaining the development of enterocolitis in patients [54]. The process by which mutated *NLRC4* triggers MAS is still unknown. Since lymphocytes and NK cells cytotoxicity is not impaired, *NLRC4* hyperactivity and IL-18 overproduction may directly promote self-activation and persistence, or excessive Th1 response by lymphocytes [54]. A role for caspase-8 mediated cell death has been recently suggested but is unlikely to be the predominant mechanism leading to *NLRC4*-MAS phenotype [63].

2.2.3. *NLRP1-associated SAID*

Polymorphisms in *NLRP1* have long been associated with autoimmune diseases, such as vitiligo, type 1 diabetes, systemic lupus erythematosus and rheumatoid arthritis.

Zhong et al. have reported gain-of-function mutations in *NLRP1* as causes of two overlapping skin disorders, namely multiple self-healing palmoplantar carcinoma and familial keratosis lichenoides chronica. They demonstrated that skin inflammation and epidermal hyperplasia resulted from spontaneous activation of the *NLRP1* inflammasome and paracrine IL-1 signalling, in keratinocytes [64].

Previously, one mutation of *NLRP1* (p.Met77Thr) had been associated with an autosomal dominant disorder characterized by isolated corneal intraepithelial hyperplasia with dyskeratosis and parakeratosis [65].

Very recently Touitou and colleagues have identified a novel *NLRP1*-associated SAID [66]. The disease was present in three children (aged 8, 10 and 16) from two families, either as a non-synonymous homozygous mutation in two cousins born of related parents or as *de novo* heterozygous mutation in an additional girl. Interestingly, the patients presented with combined autoinflammatory and autoimmune manifestations: recurrent fever, with elevated acute phase reactants, arthritis, intraepithelial dyskeratosis, positive antinuclear antibodies and high transitional B-cell count. The authors named this newly described disorder NAIAD for *NLRP1*-associated AutoInflammation with Arthritis and Dyskeratosis. One patient was left untreated; one received successful anti-TNF therapy (etanercept) for knee arthritis and one received successful anti-IL1 therapy after corticosteroids and methotrexate inefficacy.

Further explorations have revealed high levels of caspase-1 and IL-18 in serum of the three patients, suggesting NAIAD could be an inflammasomopathy, confirming previous data from mouse models [67]. Nevertheless, IL-1 β was only elevated in the serum of one patient. Furthermore, the three patients had clear signs suggestive of autoimmunity (antinuclear antibodies, T cell lymphopenia, B cell abnormal distribution). Thus, the authors have proposed to qualify NAIAD as a novel autoimmuno-inflammatory disorder (see 6. Conclusions [8]).

2.2.4. *Familial Cold-induced Autoinflammatory Syndrome 2*

About 30 observations of patients with *NLRP12*-associated periodic syndromes (named NAPS12 or FCAS2) have been reported to date [68]. The disease seems to be distributed worldwide and consists of recurrent fever associated with musculoskeletal symptoms and cold-induced, urticaria-like rash resembling FCAS1 [69]. During attacks, fever duration is variable but seems to last 1-15 days and the fever-free intervals 2-4 weeks. The clinical

manifestations are varied and, in addition to those cited before, include: myalgia, polyarthralgia/arthritis, abdominal pain/diarrhea, headache, lymphadenopathy, splenomegaly, chest pain, and sensorineural deafness (in 10% of the cases). Elevated acute phase reactants were reported in one-third of the patients. Treatment with corticosteroids was effective whereas colchicine had no effect.

Monoallelic mutations in *NLRP12* have been associated with the autosomal dominant FCAS2 [70]. The effect of FCAS2-related mutations on NLRP12 protein functions are still unclear; some authors have proposed either a loss of the inhibitory function of NLRP12 on NF- κ B or with increased caspase-1 activation through a putative NLRP12 inflammasome [71]. It thus remained to be demonstrated whether FCAS2 is a true inflammasomopathy and an IL-1-related disease.

2.2.5. Blau syndrome

Blau syndrome is caused by autosomal dominant gain-of-function mutations in *NOD2/CARD15*, the gene encoding NOD2 [72]. The disease is characterised by an early-onset granulomatous polyarthritis, along with uveitis and dermatitis [73]. Sporadic cases are termed early-onset sarcoidosis. Although NOD2 belongs to the NLR family, it does not form an inflammasome. Instead, following cytosolic detection of peptidoglycan fragments from the bacterial cell wall, NOD2 oligomerizes and interacts with RIPK2 [74]. RIPK2 catalyses NF- κ B, leading to proinflammatory genes expression [75]. Disease-associated mutations decrease the threshold of activation of NOD2 and result in constitutive activation of NF- κ B and subsequent inflammation [73]. The efficacy of NSAIDs, corticosteroids, anti-TNF or anti-IL-1 has been reported [76].

2.2.6. Majeed syndrome

Recessive loss-of-function mutations of *LPIN2*, the gene encoding lipin-2, have been associated with Majeed syndrome (MS) [77,78]. Patients with MS present with early-onset chronic recurrent multifocal osteomyelitis, congenital dyserythropoietic anaemia and neutrophilic dermatosis. Lipin-2 is a key enzyme in lipid metabolism suggesting that autoinflammation may be due to a metabolic dysfunction. Depletion of lipin-2 promotes the generation of proinflammatory factors in macrophages overloaded with saturated fatty acids [79]. Balboa and colleagues have recently elucidated the link between lipin-2 deficiency and the IL-1 β release. Indeed, lipin-2 controls excessive IL-1 β formation by several mechanisms: i) it regulates MAP kinases activation, which mediates synthesis of pro-IL-1 β during inflammasome priming; ii) it inhibits the activation of the purinergic receptor P2X7 and

potassium efflux; and iii) it inhibits ASC and caspase-1 processing. Overall, lipin-2 negatively regulates the activation of the NLRP3 inflammasome.

Patients may respond to NSAIDs, corticosteroids, IFN- γ , bisphosphonates and anti-TNF drugs. Blocking IL-1 had a spectacular efficacy in two case reports [80].

2.3. SAID related to IL-1 superfamily receptor antagonists

2.3.1. Deficiency of Interleukin-1 Receptor Antagonist

Deficiency of Interleukin-1 Receptor Antagonist (DIRA) is an extremely rare disorder that has been first described, in 2009, by Aksentijevich *et al.* in nine children from six families [81]. Since then about 15 variants have been reported. DIRA is an autosomal recessive disease that manifests as a combination of neonatal-onset of sterile multifocal osteomyelitis involving long bones, ribs, clavicles, vertebral bodies, and hips; periostitis; and pustulosis, associated with life-threatening systemic inflammation but no elevated fever [82,83]. Prompt treatment with recombinant IL-1 receptor antagonist (IL-1Ra, anakinra) provides rapid and sustained response.

DIRA is due to homozygous mutations of *IL1RN* that result in loss of function of the IL-1 receptor antagonist (IL-1Ra). Indeed, IL-1Ra is a soluble or membrane-bound receptor that serves as an IL-1 receptor decoy. Thus, IL-1Ra inhibits IL-1 activity by competition with IL-1R1. In DIRA, IL-1Ra is either absent or synthesized as a truncated protein that is not secreted, thereby rendering cells hyperresponsive to IL-1, with overproduction of proinflammatory cytokines, chemokines and other alarmins [83].

2.3.2. Deficiency of Interleukin-36 Receptor Antagonist

Interleukin-36 belongs to the IL-1 superfamily and consists of three isoforms (IL-36 α , IL-36 β and IL-36 γ) and one receptor antagonist, IL-36Ra. Deficiency of IL-36Ra (DITRA) has been described, in 2011, in Tunisians families, with founder effect of the associated mutations [84]. Since then, sporadic cases have been reported and at least 18 variants are known to date. Patients with DITRA have childhood-onset generalized erythematous and pustular rashes (resembling pustular psoriasis) associated with elevated fever flares, asthenia, and increased acute phase reactants [84–86]. The best treatment option seems to be acitretin, a vitamin A derivative. Oral steroids, methotrexate, cyclosporine, infliximab, or IL-1 inhibitors have not proven fully efficacious [84].

The mode of inheritance of DITRA is autosomal recessive. DITRA-related mutations are homozygous loss-of-function mutations in the *IL36RN* gene, which encodes IL-36Ra [87]. IL-

36Ra is a potent inhibitor of IL-36 signalling that prevents downstream NF- κ B activation. The lack of IL-36Ra leads to spontaneously enhanced IL-36 receptor signalling, mostly in keratinocytes where prolonged inflammatory activation leads to pustular dermatosis.

2.4. Complex SAID

Complex or polygenic SAID are defined as systemic disorders with a prominent autoinflammatory pattern but without a clearly identified genetic background (contrary to monogenic SAID). Dysregulation of the innate immune system plays a major role in the pathogenesis of these diseases, with IL-1 being the pivotal cytokine. Recent progress in genetic techniques is giving clues to better understand the cascade of events leading to the occurrence of some complex SAID.

2.4.1. Systemic Juvenile Idiopathic Arthritis and Adult-Onset Still's Disease

Systemic juvenile idiopathic arthritis (sJIA), a highly inflammatory subset of JIA, is defined by daily fever, arthritis, evanescent rash, generalized lymphadenopathy, hepato/splenomegaly and/or serositis. sJIA begins in childhood and may progress to a devastating chronic polyarthritis [88].

The absence of autoantibodies or autoreactive T cells, along with the pivotal role of IL-1 and the efficacy of IL-1 blockade led to classify sJIA as a polygenic autoinflammatory disease [89]. Furthermore, high levels of circulating IL-18 and an increased risk for the development of MAS are associated with sJIA [90].

However, recent studies have shed new lights on the pathophysiology of sJIA. First, a meta-analysis of HLA associations in populations of Western European ancestry found a strong association between susceptibility to sJIA and HLA-DRB1*11 [91]. Second, a genome-wide association studies in 770 children with sJIA collected in nine countries also revealed associations between sJIA and major histocompatibility complex (MHC) locus [92]. Genetic linkage with MHC I and II, which suggests a role for T cells, is usually seen as a hallmark of autoimmune diseases. One hypothesis to reconcile these facts suggests a biphasic process whereby a predominant autoinflammatory process gradually progresses to an autoimmune process.

In addition, a recessive monogenic form of sJIA has been described in 13 patients from five consanguineous families carrying a missense mutation in the *LACC1* gene [93]. *LACC1* encodes the laccase domain-containing 1 protein (also termed FAMIN). In a mechanistic study, Cader et al. demonstrated that FAMIN forms a complex with the fatty acid synthase on peroxisomes and drives high levels of mitochondrial fatty-acid oxidation, glycolysis and ATP

regeneration [94]. FAMIN-dependent fatty-acid oxidation controls the production of reactive oxygen species and NLRP3 inflammasome activation, further highlighting the connections between innate immunity and metabolism. sJIA-related *LACC1* mutations result in a FAMIN loss-of-function and metabolic defects at the peroxisome–mitochondrial interface. How FAMIN loss-of function results in autoinflammation is still unclear but is likely to be due to the complex coupling of metabolic functions with the innate immune responses.

In the series from Wakil *et al.*, all patients were treated with a combination of NSAIDs, systemic corticosteroids, methotrexate, and biological agents, including anti-TNF, anti-IL-6, or rituximab, but none achieved complete remission [93].

Adult-onset Still's disease (AOSD) is often considered as the same disease as sJIA but with onset after the age of 16 [90,95]. Although frequent, arthritis is not required for the diagnosis of AOSD. Patients usually present with a combination of high spiking fever, arthritis, typical salmon-pink skin rash, sore throat, lymphadenopathy, hepato-splenomegaly and elevated acute phase reactants. The pathogenesis of AOSD is complex, involving activation of innate immune cells, proinflammatory cytokines secretion (mostly IL-18) and defects in NK cell toxicity, sometimes leading to MAS [90,96]. Adaptive Th1, Th17 and T regulator cells also seem to play a role in AOSD pathophysiology. An as-yet unknown environmental trigger is suspected. Interestingly, AOSD has been reported in the elderly and some AOSD-like reactions have been associated with malignancy [97,98]. Genetic studies have associated AOSD susceptibility with several HLA haplotypes, polymorphism in the *IL18* gene, polymorphisms in macrophage migration inhibitory factor *MIF* gene, and polymorphism in the *IL6* gene promoter.

Treatment options include NSAIDs, corticosteroids, methotrexate, and biotherapies, including anti-IL-1, anti-IL-6 and anti-TNF [99].

2.4.2. Periodic fever, aphthous stomatitis, pharyngitis and cervical adenitis syndrome

Periodic fever, aphthous stomatitis, pharyngitis and cervical adenitis syndrome (PFAPA) is a polygenic SAID, which incidence is estimated at about 2/10,000. PFAPA usually affects children but adult-onset PFAPA are described [100–102]. PFAPA manifests as recurrent attacks of fever and symptoms associated with the core features of the disease (aphthous stomatitis, pharyngitis and cervical lymphadenitis) in the absence of upper respiratory tract infection, and normal growth and development. Attacks duration is usually three to seven days, with symptom-free intervals of two to eight weeks.

An infectious process has been considered as the aetiology of PFAPA but the duration of the disease for years without progression, its self-limiting nature, the efficacy of corticosteroids,

and the lack of clustering in season or geographic areas make infection unlikely to be causative [103].

The hypothesis of immune dysregulation in PFAPA is now predominantly accepted. Indeed, an inflammasome-mediated innate immune system activation is supported by several studies, which demonstrated: (i) an overexpression of IL-1-related (*IL-1B*, *IL-1RN*, *CASP1*, *IL18RAP*) and IFN-induced (*AIM2*, *CXCL10*) genes, during PFAPA attacks; (ii) an increased IL-1 β secretion by *ex vivo* LPS-stimulated monocytes from febrile patients with PFAPA; (iii) increased serum levels of IL-1 β , IL-18, caspase-1, and interferon (IFN)- γ -related chemokines during febrile episodes; and (iv) the efficacy of IL-1-blockade in most case series [103].

A very recent report by Hofer and colleagues demonstrates that, in a subset of patients, PFAPA is associated with a frameshift variant of *CARD8*, which encodes a NLRP3-interacting protein [104]. The mutation leads to a truncated *CARD8* protein, unable to interact with NLRP3. Mutated patients have a distinct PFAPA phenotype, characterized by a higher prevalence of symptoms out of flares and oral aphthosis.

However, PFAPA pathophysiology does not only rely on innate immune system dysregulation and several studies have shown the subsequent implication of the adaptive immunity, with induction of Th1 chemokines and retention of activated T cells in peripheral tissues [105].

PFAPA has long been considered as a sporadic disease. Recent case series have imbalanced this hypothesis by showing common familial clustering of PFAPA [106]. Moreover, recent genetic studies suggest a possible role of inflammasome genes, as variants of *NLRP3* or *MEFV* genes have been found with increased frequencies in PFAPA patients [107]. Actually, PFAPA could be considered as a heterogeneous entity that manifests as attenuated forms of other monogenic SAID, with oligogenic or polygenic background.

The dramatic efficacy of corticosteroids on PFAPA fever is characteristic. Other treatment options include colchicine to prevent inflammatory episodes, and IL-1 blockade or tonsillectomy for selected cases [108]. Over time, intervals between flares tend to increase and the disease usually disappears during childhood.

2.4.3. Schnitzler syndrome

Schnitzler's syndrome (SS) is hypothesized to be a late-onset SAID because of clinical manifestations resembling those of CAPS [109]. Indeed, SS consists of recurrent fever, neutrophilic urticarial-like rash, arthromyalgia, lymphadenopathy, hepato-splenomegaly, bone pain, and elevated acute reactants [110,111]. However, the disease is usually associated with a defining monoclonal gammopathy (IgM), absent in CAPS. The key role of

inflammasome activation has been suspected since: (i) circulating levels of IL-18 are increased in SS patients; (ii) *ex vivo*, monocytes from patients secrete high levels of IL-1 β , either spontaneously or upon addition of bacterial lipopolysaccharide; and (iii) dramatic success with IL-1 blockade has been repeatedly reported [112,113]. In addition, de Koning *et al.* and Zhou *et al.*, have identified three individuals with SS harbouring *NLRP3* mosaicism, restricted to the cells of myeloid lineage [114,115]. The authors proposed to include SS within the CAPS spectrum, as mosaicism seems to play a major role in late-onset CAPS and CAPS-like disorders.

3. Interferon-mediated associated diseases (Type-1 interferonopathies)

Type-1 IFN subgroup comprises 13 IFN, including IFN- α and IFN- β . Type-1 IFN binds to IFN- α receptor (IFNAR). In addition to its antiviral and antitumor effects, type-1 IFN has broad immunomodulating functions. Since 2006, the dissection of the genetic basis of Aicardi-Goutières syndromes has led to propose a new group of SAID, termed Interferon-Mediated Associated Diseases (IMADs) [116]. IMADs correspond to SAID that share evidence of a persistent up-regulation of type-1 IFN signalling, assessed by measuring the expression of IFN-stimulated genes (ISG) [117]. To date, this group comprises twenty genotypes (**Table 2**). The binding of type-1 IFN to IFNAR triggers the activation of the kinases JAK1 and TYK2, the subsequent phosphorylation of STAT1 and STAT2 and recruitment of IRF9 to form a transcriptional complex, namely ISGF3 (**Fig. 3**). This complex translocates to the nucleus to promote ISG expression. This transcriptional response is further amplified through a feed-forward amplification loop. The detection of nucleic acids within the cytosolic or the endosomal compartments through RNA/DNA sensors, belonging to innate immune system, can also promote type-1 IFN response [117–119]. RNA sensors, MDA5 and RIG-I, signal through the adaptor protein MAVS, whereas the DNA sensor, cGAS, signals through STING (stimulator of interferon genes) [120,121].

Table 2 : Type-1 interferonopathies according to genetic defects

Mutated gene	Effect	Protein function	Associated diseases
<i>TREX1</i>	loss-of-function	Exonuclease	AGS1
<i>RNASEH2B</i>	loss-of-function	Ribonuclease	AGS2
<i>RNASEH2C</i>	loss-of-function	Ribonuclease	AGS3
<i>RNASEH2A</i>	loss-of-function	Ribonuclease	AGS4
<i>SAMHD1</i>	loss-of-function	Phosphohydrolase and nuclease	AGS5
<i>ADAR1</i>	loss-of-function	RNA editing	AGS6
<i>IFIH1</i>	gain-of-function*	RNA sensor	AGS7
<i>TMEM173</i>	gain-of-function*	Adaptor for cytosolic DNA-sensing pathway	SAVI
<i>DDX58</i>	gain-of-function*	RNA sensor	SMS2
<i>SKIV2L</i>	loss-of-function	RNA helicase	THES
<i>PSMB8</i>	loss-of-function	Proteasome subunit	PRAAS/CANDLE
<i>PSMB4</i>	loss-of-function	Proteasome subunit	PRAAS/CANDLE
<i>PSMA3</i>	loss-of-function	Proteasome subunit	PRAAS/CANDLE
<i>PSMB9</i>	loss-of-function	Proteasome subunit	PRAAS/CANDLE
<i>POMP</i>	loss-of-function	Proteasome maturation protein	PRAAS/CANDLE
<i>ACP5</i>	loss-of-function	Tartrate-resistant acid phosphatase	SPENCDI
<i>C1q</i>	loss-of-function	Alternative complement pathway activity	Systemic lupus erythematosus
<i>USP18</i>	loss-of-function	Inhibition of ISG transcription	Pseudo-TORCH syndrome
<i>ISG15</i>	loss-of-function	Inhibition of ISG transcription	Mycobacterial infection susceptibility, basal ganglia calcifications
<i>POLA1</i>	X-linked recessive	Subunit of DNA polymerase A1	XLPDR

AGS: Aicardi-Goutières syndrome; SAVI: STING-associated vasculopathy with onset in infancy; SMS: Singleton-Merten Syndrome; THES: tricho-hepato-enteric syndrome; PRAAS/CANDLE: Proteasome-Associated Autoinflammatory Syndromes / Chronic Atypical Neutrophilic Dermatitis with Lipodystrophy and Elevated temperature; SPENCDI: Spondyloenchondrodysplasia with immune dysregulation; TORCH: Toxoplasmosis, Other agents, Rubella, Cytomegalovirus, and Herpes Simplex; XLPDR: X-linked reticulate pigmentary disorder; *dominantly inherited.

Type-1 IFN signalling is a highly-regulated pathway. Mutations in several genes involved in this pathway trigger dysregulated IFN responses leading to IMADs.

As of today, the treatment of interferonopathies is not codified but experimental treatments with JAK inhibitors or type-1 IFN-targeted drugs are ongoing [122].

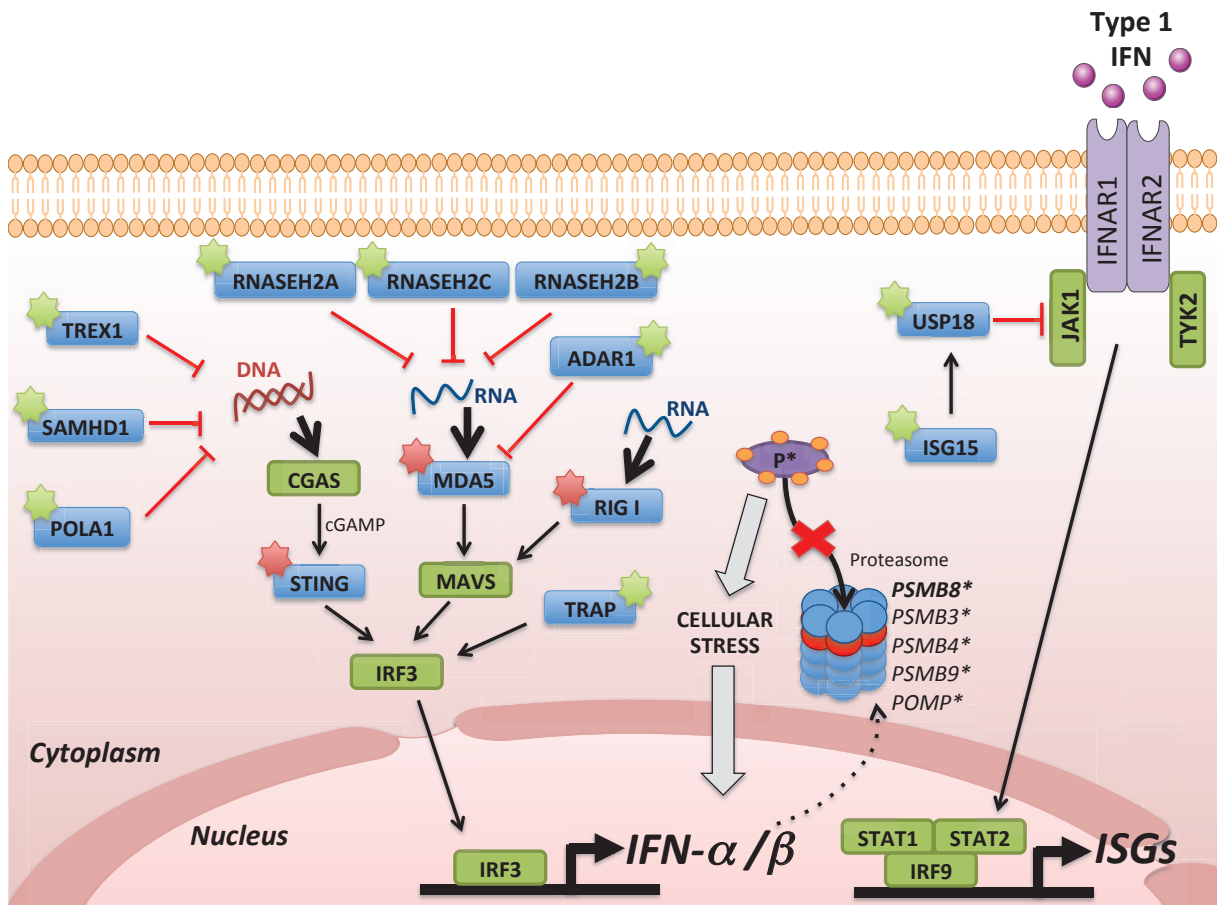

Fig. 3 Type-1 interferon pathway and interferonopathies. The binding of type-1 interferon (IFN) to IFN- α receptor (IFNAR) triggers the activation of the kinases JAK1 and TYK2, the subsequent phosphorylation of STAT1 and STAT2 and recruitment of IRF9 to form a transcriptional complex, culminating in up-regulation of interferon-stimulated genes (ISGs). Monogenic interferonopathies are marked with a green star (loss-of-function) or a red star (gain-of-function). Interferonopathies are due to: 1) loss-of-function mutations leading to increased cytosolic DNA (TREX1, SAMHD1, POLA1) or RNA (RNASEH2A, RNASEH2B, RNASEH2C) sensing; 2) loss-of-function mutations leading to a defect in RNA editing and abnormal sensing of self-RNA in the cytosol (ADAR1); (3) gain-of-function mutations leading to constitutive activation of cytosolic interferon signalling pathways (STING, MDA5, RIG-I); (4) loss-of-function mutations in IFNAR inhibitors (ISG15, USP18); (5) proteasomal dysfunction leading to increased interferon signalling through increased cellular stress (PSMB8, PSMA3, PSMB4, PSMB9, POMP); and (6) loss-of-function mutations in *ACP5*, the gene encoding tartrate-resistant acid phosphatase (TRAP)

3.1. Aicardi-Goutières syndromes

Aicardi-Goutières syndrome (AGS) constitutes a collection of rare SAID, associated with aberrant sensing of DNA/RNA, and caused by autosomal mutations in proteins involved in nucleic acids metabolism or type-1 IFN signalling pathway [123]. The causative mutations affect an exonuclease (TREX1, AGS1), ribonucleases (RNASEH2A, AGS4; RNASEH2B, AGS2; and RNASEH2C, AGS 3), an enzyme with phosphohydrolase and nuclease activity (SAMHD1, AGS5), a double-stranded-RNA-specific adenosine deaminase (ADAR1, AGS 6), or the RNA sensor MDA5 (IFIH1, AGS7) [118]. All the AGS (1-6)-causing mutations are recessively inherited loss-of-function mutations. AGS7-causing mutations are dominantly

inherited gain-of-function mutations resulting in enhanced RNA binding and constitutive activation of MDA5 with subsequent increased type-1 IFN signalling [124].

Patients with AGS (1-6) have subacute encephalomyelitis mimicking congenital viral infection; with neurological decline during a mostly monophasic disease. Most patients follow a non-progressive, chronic course, with residual brain atrophy, basal ganglion calcifications and white matter disease and microcephaly, developmental delay, and early mortality. Patients often have chilblain lesions on hands and feet, and low titers of non-pathogenic autoantibodies [116,117].

Patients with AGS7 present with spasticity, cerebral white matter disease, developmental delay, and variable combinations of skin rashes, thrombocytopenia, or arthritis [124].

Interestingly, disease onset is delayed in AGS2, AGS6, and AGS7; and two AGS7 mutation-positive carriers remained asymptomatic into adulthood.

3.2. Stimulator of interferon genes-associated vasculopathy with onset in infancy

STING-associated vasculopathy with onset in infancy (SAVI) is caused by de novo gain-of-function mutations in *TMEM173*, the gene encoding for STING [125]. STING is the major adaptor protein in the cytosolic DNA-sensing pathway (**Fig. 3**). Patients with SAVI experience symptoms before 8 weeks of age, including systemic inflammation, cutaneous rash, and pulmonary manifestations such as interstitial lung disease. Severe small vessel vasculopathy, mostly located in acral areas, can lead to vaso-occlusion and gangrene that may require amputation. All patients fail to thrive and fatal pulmonary complications may occur.

STING-associated mutations lead to constitutive transcription of *IFNB1* and to the subsequent strong IFN response. Because the STING-IFN- β pathway can be activated in endothelial cells, the onset of vasculitis is suggested to be triggered directly by endothelial cell activation [126]. The identification of the molecular mechanisms leading to SAVI suggests that STING may be a potential therapeutic target not only in rare SAID, but also in more common interferonopathies, including systemic lupus erythematosus [127].

3.3. Proteasome-Associated Autoinflammatory Syndromes

Proteasome-Associated Autoinflammatory Syndromes / Chronic Atypical Neutrophilic Dermatitis with Lipodystrophy and Elevated temperature (PRAAS/CANDLE) is a rare SAID associated with mutations in components of the proteasome [128–130]. The ubiquitin-proteasome system is a major pathway for intracellular protein degradation. The proteasome consists of different subunits (alpha or beta) encoded by several genes, some being

inducible by IFN (**Fig. 3**). The major role of the proteasome is to degrade proteins to maintain cellular proteostasis. Impaired proteolysis leads to protein accumulation in the cytosol, cellular stress and finally in proinflammatory cytokine production, such as type-1 IFN.

PRAAS/CANDLE was initially linked to homozygous *PSMB8* loss-of-function mutations. *PSMB8* encodes for the b5i-subunit, a major component of the immunoproteasome [128,130]. The immunoproteasome is a protein degradation complex induced by IFN, and essential for antigen presentation. Recently, a similar phenotype was also described in patients bearing loss-of-function mutations in genes encoding other proteasome subunits (*PSMA3*, *PSMB4* and *PSMB9*) or the proteasome maturation protein (*POMP*) [131]. Interestingly, Goldbach-Mansky and colleagues showed that CANDLE could result from the additive effects of two heterozygous mutations in two different proteasome subunits-encoding genes. These results established for the first time a digenic inheritance of CANDLE. All mutations were predicted to be pathogenic by affecting proteasome assembly and maturation. These results suggest the possibility of digenic inheritance in other unexplained autoinflammatory disorders [132,133].

Patients with PRAAS/CANDLE present with a constellation of symptoms, including recurrent fevers, skin manifestations (annular erythema, panniculitis), eyelid swelling, myositis, arthralgia with small joint contractures, hepatomegaly, and basal ganglia calcifications [128]. Lipodystrophy occurs in the same areas as chronic rash or panniculitis. Mortality is high if inflammation is not controlled and multiorgan failure can occur. Despite high levels of circulating IL-6, targeted therapies have revealed moderate efficacy. Corticosteroids are partially efficacious. Given its central role, IFN-targeted drugs are currently being tested in clinical studies [134].

3.4 Other interferonopathies

Other SAID involving the type-1 IFN pathway have been recently described:

- Singleton-Merten Syndrome 2 (SMS2) has been linked to heterozygous missense mutations in *DDX58*, which encodes RIG-I, a cytosolic RNA sensor [135]. Patients presented with glaucoma, arthritis, joint contractures, phalangeal osteoarthropathy/acro-osteolysis, aortic calcifications and psoriasis-like eruption.
- Spondyloenchondrodysplasia with immune dysregulation (SPENCDI) has been associated with loss-of-function mutations in *ACP5*, the gene encoding tartrate-resistant acid phosphatase (TRAP) [136,137]. Patients with SPENCDI develop a syndrome of axial bone dysplasia, cerebral calcifications, and immune dysregulation (mostly autoimmune features, such as haemolytic anaemia, autoimmune thyroiditis,

or systemic lupus). The type-1 IFN signature is upregulated in peripheral blood cells [138].

- X-linked reticulate pigmentary disorder (XLPDR) is due to a loss-of-function mutation in *POLA1*, which encodes for the catalytic subunit of DNA polymerase A1 (POLA1) [139]. POLA1 is an essential component of the DNA replication machinery and a critical regulator of the type-1 IFN response. Its deficiency results in increased production of type-1 IFNs through constitutive enhancement of IFN regulatory factor and NF- κ B-dependent gene expression. XLPDR symptoms include early-onset recurrent pneumonia, bronchiectasis, enterocolitis, and failure to thrive. Patients also have a characteristic diffuse and reticulated skin hyperpigmentation starting during childhood, corneal inflammation leading to blindness, a characteristic facies and female carriers can present linear hyperpigmentation following Blaschko lines [139,140].
- Patients with deficiency in IFN-stimulated gene 15 (ISG15), due to loss-of-function mutations, present symptomatic basal ganglia calcifications reminiscent of AGS and enhanced susceptibility to mycobacterial infections, without increased viral susceptibility [141,142]. ISG15 is an IFN-responsive ubiquitin-like modifier that ensures ubiquitin-specific peptidase 18 (USP18)-dependent regulation of type-1 IFN. Deficiency of intracellular ISG15 results in the enhancement and amplification of IFN response.
- Loss-of-function mutations in *USP18* have been associated with pseudo-TORCH syndrome (PTS), a disease characterized by microcephaly, enlarged ventricles, cerebral calcifications, and, occasionally, by systemic features at birth resembling the sequelae of congenital infection but in the absence of an infectious agent [143].

4. TNF-associated periodic syndromes

4.1. TNFRSFA1-associated periodic syndrome

TNF-receptor associated periodic syndrome (TRAPS) is an autosomal dominant SAID due to missense mutations in *TNFRSF1A*, which encodes the TNF receptor 1 (TNFR1) [4]. To date, 147 mutations have been reported, all of which generate dysfunctional proteins with numerous subsequent pathogenetic mechanisms, such as impaired TNFR1 shedding, defective TNFR trafficking to the cell surface and TNF-independent cell activation with increased production of IL-1 and reactive oxygen species [144,145].

TRAPS usually begins during childhood, but later onset has been described. Patients present with recurrent fever, which typically lasts from one to three weeks, with symptom-free intervals of variable duration. Other clinical manifestations include skin involvement (painful centrifugal migratory erythematous rash, erysipelas-like erythema, edematous plaques or urticarial lesions), centrifugal myalgia due to monocytic fasciitis, eye involvement (conjunctivitis, periorbital edema or uveitis), abdominal pain due to peritoneal inflammation, and joint involvement (arthralgia or arthritis) [146]. Eurofever/PRINTO provisional diagnostic criteria for TRAPS are shown in **Table 1**. Kidney amyloidosis may develop, with a higher prevalence in patients carrying mutations affecting TNFR1 cysteine residues.

First line-treatment depends on the severity of TRAPS; NSAIDs may be useful and patients are often very responsive to high-dose corticosteroids.

Interestingly, while anti-TNF therapy seemed a very logical option, it became rapidly obvious that only few patients have prolonged treatment benefit (e.g. under etanercept) [144]. Moreover, the administration of adalimumab and infliximab may lead to paradoxical exacerbation of the disease. Actually, IL-1 inhibitors, along with IL-6 inhibitors, seem to provide better efficacy and sustained effect over time [147,148]. Anakinra has been also successfully used as on-demand treatment [149].

The link between TRAPS and proinflammatory cytokines other than TNF (e.g. IL-1, IL-6) is becoming clear.

Most mutations in *TNFRSF1A* result in a misfolded protein that accumulates in the endoplasmic reticulum [145]. With the rupture of intracellular homeostasis, various mechanisms are engaged: spontaneous activation of MAP kinases pathway, production of mitochondrial reactive oxygen species resulting in NLRP3 inflammasome activation, or NF- κ B activation [150]. These processes end-up in proinflammatory cytokines secretion (TNF, IL-1 β , IL-6), which, in turn, may amplify inflammation through autocrine/paracrine stimulation of their receptors at the cell surface. A recent microarray analysis in resting TRAPS has confirmed the patients chronic inflammatory condition, characterised by constitutive overexpression of IL-1 β and IL-1R1 receptor [151]. In addition, a hyper IFN response to bacterial lipopolysaccharide stimulation and a constitutive downregulation of the TGF- β pathway were observed. These results suggest that TNF signalling might not be the cornerstone of the disease but that dysregulation of other inflammatory cytokines may be responsible for TRAPS. These findings offer new perspectives for the treatment of TRAPS.

4.2. TNFRSF11A-associated periodic syndrome

Heterozygous mutations of *TNFRSF11A*, encoding the receptor activator of NF- κ B (RANK) have been associated with recurrent fever in three patients from two families [152]. The

phenotype was close to that of TRAPS, with febrile episodes of one to five weeks with long symptom-free interval. Fever occurred with abdominal pain, arthromyalgia, lymphadenopathy, and skin involvement (macular rash, erythema nodosum). The onset of the disease was variable and ranged between 3 weeks of age to 18 years. Owing to the resemblance with TRAPS, the disease has been designated TRAPS11. Further analyses revealed that the mutations were associated with increased secretion of TNF, IL-18, IL-1Ra and IFN- γ while the molecular defects still need to be better defined [152]. Nevertheless, a gain of function for RANK and an increased activation of NF- κ B are suggested.

4.3. SAID related to TNF- α -converting enzyme deficiency

Recessive loss-of-function mutations in *ADAM17*, which encodes the TNF- α -converting enzyme (TACE), have been associated with a SAID consisting of neonatal-onset psoriasiform rash, hair abnormalities, increased susceptibility to infections, enterocolitis and cardiomyopathy [153]. TACE is necessary for the cleavage and secretion of TNF- α . *In vitro*, immune cells from patients oversecreted IL-1 β and IL-6 in response to stimulation. Treatment was not detailed.

5. SAID related to ubiquitination defects

Ubiquitination is an essential regulator of innate immunity [154]. Ubiquitin is a small polypeptide that tags proteins to target them to lysosome, proteasome, or autophagy for degradation. Beside regulating protein degradation, ubiquitin can modulate protein functions by interfering with active sites, protein-protein interactions or ligand binding [155]. Ubiquitination is a dynamic process. Ubiquitin is linked to specific lysine residues by ubiquitin-ligases whereas enzymes termed deubiquitinases hydrolyse ubiquitin moieties. Defects in deubiquitination have been associated with two newly described monogenic SAID.

5.1. Haploinsufficiency in A20

Heterozygous loss-of-function mutations of the *TNFAIP3* gene, encoding the TNF-induced protein 3 (also known as A20) have been associated with a Behçet-like phenotype consisting of childhood-onset fever, aphthous stomatitis, genital ulcers, arthralgia or arthritis, and ocular inflammation [156]. Clinical manifestations also include central nervous system vasculitis, severe enterocolitis, and immunologic thrombocytopenic purpura [157,158].

A20 is an ubiquitin-editing enzyme with one domain being involved in deubiquitination while another domain acts as an ubiquitin-ligase. In fact, these seemingly antagonist functions work in conjunction to convey strong inhibition of NF- κ B signalling [159]. In addition, A20 negatively regulates the NLRP3 inflammasome, independently of its role in the NF- κ B pathway [160,161] (**Fig. 4**).

Most mutations are found in the deubiquitinase domain and lead to the synthesis of a truncated protein, resulting in a haploinsufficiency of A20 (HA20) [156]. Indeed, in patients, wild-type A20 expression is reduced and mutant A20 is not detectable. Consequently, NF- κ B and NLRP3 inflammasome are constitutively activated and the levels of serum inflammatory cytokines (IL-1 β , IL-6, IL-17, IL-18, and TNF) are elevated in HA20 patients' sera [161].

The efficacy of IL-1 inhibitors supports an important role of the NLRP3 inflammasome in HA20 pathogenesis [156]. TNF-targeted therapies are efficacious in attenuating systemic inflammation but have a more modest effect than IL-1 targeted therapies.

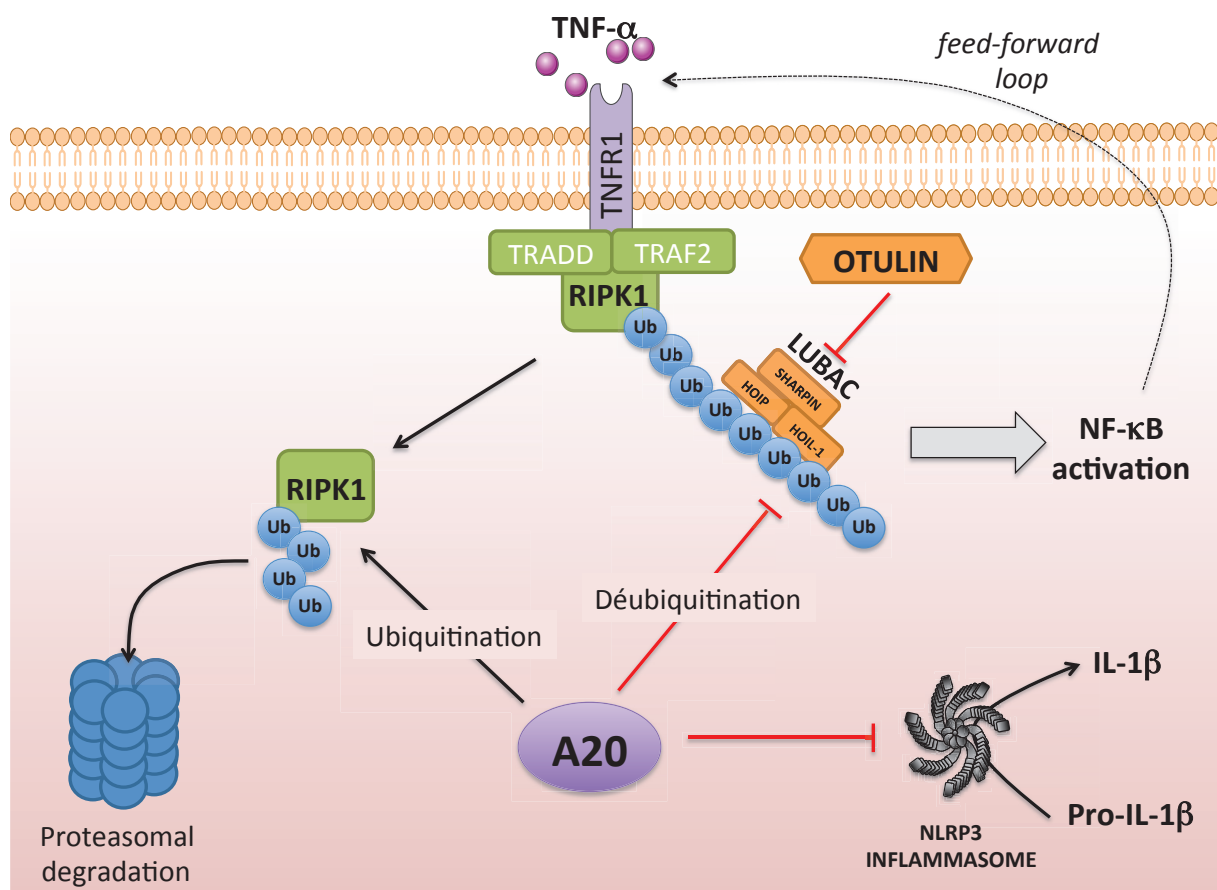

Fig. 4 Autoinflammatory disorders due to defects in ubiquitination. The binding of TNF- α to its receptor (TNFR1) induces a signalling complex that requires polyubiquitination of receptor-interacting serine-threonine kinase 1 (RIPK1) for further activation of downstream signalling complexes, leading to NF- κ B activation. Linear chains are generated by the linear ubiquitin chain assembly complex (LUBAC). OTULIN deubiquitinates linear chains to negatively regulate the NF- κ B pathway. Otulipenia results in NF- κ B hyperactivation and elevated release of proinflammatory cytokines. In addition, A20 mediates deubiquitination of LUBAC-generated linear chains, thereby inhibiting NF- κ B signalling. Another domain of A20 (zinc finger 4) ubiquitinates RIPK1 to target it

for proteasomal degradation, diminishing the NF- κ B signalling. Finally, A20 negatively regulates the NLRP3 inflammasome. Haploinsufficiency of A20 results in increased NF- κ B signalling and reduced inhibition of the NLRP3 inflammasome

5.2. Otulipenia

Polyubiquitination by linear chains is essential for the activation of NF- κ B [154,162]. Linear chains are generated by the linear ubiquitin chain assembly complex (LUBAC) consisting of HOIP, HOIL-1, and SHARPIN [163]. LUBAC has a major role in the transduction of signals originating from various immune receptors, such as TNF-R1, IL-1R, CD40, TLR, and NOD2 [162].

OTULIN is a highly conserved deubiquitinase which main function is to hydrolyse LUBAC-generated ubiquitin linear chains, to negatively regulate the NF- κ B pathway [164].

Homozygous loss-of-function mutations in the *OTULIN* gene (*FAM105B*), define otulipenia or OTULIN-related autoinflammatory disease (ORAS) [165]. Otulipenia manifests very early in life as prolonged fever associated with skin manifestations (pustular rash, erythema nodosum-like skin nodules and lipodystrophy), arthralgia, diarrhoea and failure to thrive. Otulipenia-associated mutations result in OTULIN dysfunction rather than quantitative deficit [165]. As a consequence of NF- κ B hyperactivation, elevated levels of proinflammatory cytokines (IL-1 β , IL-6, IL-12, IL-17, IL-18, TNF, and IFN- γ) have been reported in patients' sera. Treatment with anti-TNF- α provided dramatic efficacy in controlling the disease.

Interestingly, LUBAC deficiency attenuates NF- κ B signalling but patients with loss-of-function mutations in *RBCK1* or *HOIP*, the genes encoding respectively HOIL-1 and HOIP, present with paradoxical features of increased susceptibility to infection and systemic inflammation, the latter due to enhanced responses to IL-1 stimulation in monocytes [166]. The immunodeficiency observed in LUBAC-deficient patients has been linked to mutation-specific NF- κ B impairment restricted to B cells and fibroblasts.

6. SAID combined with immunodeficiency

6.1. Deficiency of adenosine deaminase 2

Recessive loss-of-function mutations of the cat eye syndrome chromosome region candidate 1 (*CECR1*) gene, resulting in deficiency of adenosine deaminase 2 (DADA2), have been associated with early-onset vasculopathy resembling polyarteritis nodosa [167,168]. Although the phenotype appears variable, the core clinical manifestations include early-onset recurrent fever, lacunar strokes, livedo reticularis, hepatosplenomegaly, mouth ulcers,

arthritis, low cell counts, hypogammaglobulinemia and small vessel vasculitis [169]. Patients with isolated pure red cell aplasia have been mentioned.

Defects in ADA1 activity result in severe combined immunodeficiency. ADA2 plays an important role in the extracellular environment and has a lower affinity to adenosine compared with ADA1. ADA2 is secreted by premonocytic cells and serves as a growth factor for the monocyte lineage, which includes macrophages and dendritic cells [170]. Monocytes from ADA2 patients are prone to differentiation into an inflammatory phenotype due to a defect in the alternative macrophage activation (M2) pathway. In addition, a pathogenic role for activated neutrophils has been suspected on the basis of neutrophil-associated genes upregulation. Data from zebrafish have also suggested an important role for ADA2 in endothelial cells [167]. Both chronic inflammation and abnormal endothelial differentiation may synergize to promote vasculitis. Treatment options include anti-TNF, anti-IL-6, sirolimus, fresh-frozen plasma, recombinant ADA2 and hematopoietic stem cell transplantation [167,168].

6.2. Other SAID with immunodeficiency

Dominant gain-of-function mutations in *PLC γ 2* have been associated with two SAID. Patients with PLC γ 2-associated antibody deficiency and immune dysregulation (PLAID) present with cold-induced urticaria, skin granuloma formation, hypogammaglobulinemia, susceptibility to infections, elevated titers of autoantibodies, and autoimmune manifestations [171]. Patients with autoinflammation and PLAID (APLAID) have early-onset recurrent erythematous plaques, pustular rash, arthralgia, corneal erosions and interstitial pneumonia [172]. The various roles of PLC γ 2 in distinct cells, along with the trigger effect of cold on PLC γ 2 activation may explain the phenotypes. Indeed, PLC γ 2 is involved in: (i) mast cells activation; (ii) regulation of NK and B cells activation and B memory cells class switching; and (iii) regulation of NLRP3 inflammasome by intracellular calcium flux, within innate immune system cells [173]. Treatment with anakinra and high-dose corticosteroids, along with cold avoidance and antihistamines, has been somewhat efficacious [171,172].

Autosomal recessive mutations in *TRNT1*, encoding an enzyme critical for mitochondrial and cytosolic transfer RNA maturation, have been associated with a syndrome of congenital sideroblastic anaemia, immunodeficiency, fevers, and developmental delay (SIFD) [174–176]. Patients had severe anaemia, recurrent fever, B-cell lymphopenia with hypogammaglobulinemia, recurrent infections, muscle weakness and sensorineural hearing loss. Impaired mitochondrial protein synthesis, intracellular stress and subsequent

inflammation are likely involved in the pathogenesis of SIFD.

Loss-of-function mutations in *NFKB1*, encoding subunits p50/p105 of NF- κ B, result in various phenotypes associating autoimmune and autoinflammatory patterns [177,178]. Depending on the variant, patients presents with antibody deficiency, susceptibility to infection, recurrent fevers, haemolytic anaemia, lymphadenopathy, hepato-splenomegaly, or Behcet-like phenotypes, with aphthous stomatitis, enterocolitis and small vessels vasculitis. Constitutive inflammasome activation was mentioned in one patient. The understanding of the exact mechanisms leading to clinical manifestations deserves further studies.

7. Other monogenic autoinflammatory disorders

Autosomal recessive mutations in *SLC29A3*, which encodes the equilibrative nucleoside transporter hENT3, have been associated with H-syndrome [179]. Patients with H syndrome have hyperpigmentation, hypertrichosis, hepato-splenomegaly, heart abnormalities and hypogonadism. Five per cent of the patients have recurrent fever [180]. The protein hENT3 is a nucleoside transporter implicated in nucleotide synthesis. Dysfunction of hENT3 leads to the accumulation of nucleosides within the lysosomes and macrophage accumulation and deposition within tissues [180]. Partial remissions have been achieved with corticosteroids and methotrexate.

Autosomal dominant or sporadic gain-of-function mutations in *CARD14*, which encodes caspase-recruitment domain family, member 14 (*CARD14*) have been associated with the *CARD14*-mediated psoriasis (CAMPS) [181,182]. *CARD14* is specifically expressed in keratinocytes and encodes an NF- κ B-activating scaffold protein downstream of protein kinase C. CAMPS-associated mutations increase NF- κ B activation leading to IL-8 and IL-36 secretion and clinical manifestations, such as early-onset generalized pustulosis, plaque psoriasis, pityriasis rubra pilaris, and nail pitting. Fever and other systemic manifestations are generally absent. Treatment options may include anti-IL-17/23 drugs [183].

Close to CAMPS, heterozygous mutations in *AP1S3*, which encodes a subunit of AP-1, have been associated with pustular psoriasis [184,185]. AP-1 mediates membrane trafficking between the post-Golgi network and the endosome and has been implicated in the formation of autophagosome. Disease-associated mutations are expected to disrupt the AP-1 complex in keratinocytes leading to impaired autophagy. This result in abnormal accumulation of p62, enhanced Toll-like receptor 2/6 signalling and up-regulated IL-36 expression and IL-1 signalling. IL-1 blockade has proven efficacious in mouse models and anti-IL-36 receptor may potentially be useful [185].

8. CONCLUSIONS

Though IL-1 remains the central player in inflammasomopathies and related diseases, other cytokinopathies (type-1 IFN, IL-18) have joined the landscape of SAID [186]. Rare monogenic disorders may shed light on more common inflammatory conditions. For example, DADA2 gives insights into polyarteritis nodosa; NLRC4-MAS brings novel clues to understand macrophage activation syndrome, and mosaic CAPS may explain AOSD.

The amazing advances in genetic techniques and the discovery of the pathogenic role of mosaicism, intronic defects and coupled to the likelihood to identify more digenic (and polygenic) diseases are providing new challenges for physicians and geneticists. Importantly, this scientific progress also brings novel therapeutic opportunities for patients in the framework of personalized medicine. Finally, the constant description of novel SAID blurs the boundaries between autoimmunity, autoinflammation and immunodeficiency. McDermott and colleagues have recently proposed a renewed conceptualization of immune diseases, along with a new terminology for these overlapping diseases termed “autoimmuno-inflammatory diseases” [8].

REFERENCES

- [1] French FMF Consortium. A candidate gene for familial Mediterranean fever. *Nat Genet* 1997;17:25–31. doi:10.1038/ng0997-25.
- [2] Ancient missense mutations in a new member of the RoRet gene family are likely to cause familial Mediterranean fever. The International FMF Consortium. *Cell* 1997;90:797–807.
- [3] Xu H, Yang J, Gao W, Li L, Li P, Zhang L, et al. Innate immune sensing of bacterial modifications of Rho GTPases by the Pyrin inflammasome. *Nature* 2014;513:237–41. doi:10.1038/nature13449.
- [4] McDermott MF, Aksentijevich I, Galon J, McDermott EM, Ogunkolade BW, Centola M, et al. Germline mutations in the extracellular domains of the 55 kDa TNF receptor, TNFR1, define a family of dominantly inherited autoinflammatory syndromes. *Cell* 1999;97:133–44.
- [5] Masters SL, Simon A, Aksentijevich I, Kastner DL. Horror autoinflammaticus: the molecular pathophysiology of autoinflammatory disease (*). *Annu Rev Immunol* 2009;27:621–68. doi:10.1146/annurev.immunol.25.022106.141627.
- [6] Martinon F, Pétrilli V, Mayor A, Tardivel A, Tschopp J. Gout-associated uric acid crystals activate the NALP3 inflammasome. *Nature* 2006;440:237–41. doi:10.1038/nature04516.
- [7] McGonagle D, McDermott MF. A proposed classification of the immunological diseases. *PLoS Med* 2006;3:e297. doi:10.1371/journal.pmed.0030297.
- [8] Peckham D, Scambler T, Savic S, McDermott MF. The burgeoning field of innate immune-mediated disease and autoinflammation. *J Pathol* 2017;241:123–39. doi:10.1002/path.4812.
- [9] Dinarello CA. Immunological and inflammatory functions of the interleukin-1 family. *Annu Rev Immunol* 2009;27:519–50. doi:10.1146/annurev.immunol.021908.132612.
- [10] Martinon F, Burns K, Tschopp J. The inflammasome: a molecular platform triggering activation of inflammatory caspases and processing of proIL-beta. *Mol Cell* 2002;10:417–26.
- [11] Heller H, Sohar E, Pras M. Ethnic distribution and amyloidosis in familial Mediterranean fever (FMF). *Pathol Microbiol (Basel)* 1961;24:718–23.
- [12] Livneh A, Langevitz P, Zemer D, Zaks N, Kees S, Lidar T, et al. Criteria for the diagnosis of familial Mediterranean fever. *Arthritis Rheum* 1997;40:1879–85. doi:10.1002/1529-0131(199710)40:10<1879::AID-ART23>3.0.CO;2-M.
- [13] Berkun Y, Eisenstein EM. Diagnostic criteria of familial Mediterranean fever. *Autoimmun Rev* 2014;13:388–90. doi:10.1016/j.autrev.2014.01.045.
- [14] Federici S, Sormani MP, Ozen S, Lachmann HJ, Amaryan G, Woo P, et al. Evidence-based provisional clinical classification criteria for autoinflammatory periodic fevers. *Ann Rheum Dis* 2015;74:799–805. doi:10.1136/annrheumdis-2014-206580.

- [15] Chae JJ, Cho Y-H, Lee G-S, Cheng J, Liu PP, Feigenbaum L, et al. Gain-of-function Pyrin mutations induce NLRP3 protein-independent interleukin-1 β activation and severe autoinflammation in mice. *Immunity* 2011;34:755–68. doi:10.1016/j.immuni.2011.02.020.
- [16] Booty MG, Chae JJ, Masters SL, Remmers EF, Barham B, Le JM, et al. Familial Mediterranean fever with a single MEFV mutation: where is the second hit? *Arthritis Rheum* 2009;60:1851–61. doi:10.1002/art.24569.
- [17] Chae JJ, Komarow HD, Cheng J, Wood G, Raben N, Liu PP, et al. Targeted disruption of pyrin, the FMF protein, causes heightened sensitivity to endotoxin and a defect in macrophage apoptosis. *Mol Cell* 2003;11:591–604.
- [18] Federici S, Calcagno G, Finetti M, Gallizzi R, Meini A, Vitale A, et al. Clinical impact of MEFV mutations in children with periodic fever in a prevalent western European Caucasian population. *Ann Rheum Dis* 2012;71:1961–5. doi:10.1136/annrheumdis-2011-200977.
- [19] Omenetti A, Carta S, Delfino L, Martini A, Gattorno M, Rubartelli A. Increased NLRP3-dependent interleukin 1 β secretion in patients with familial Mediterranean fever: correlation with MEFV genotype. *Ann Rheum Dis* 2014;73:462–9. doi:10.1136/annrheumdis-2012-202774.
- [20] Park YH, Wood G, Kastner DL, Chae JJ. Pyrin inflammasome activation and RhoA signaling in the autoinflammatory diseases FMF and HIDS. *Nat Immunol* 2016;17:914–21. doi:10.1038/ni.3457.
- [21] Chae JJ, Wood G, Masters SL, Richard K, Park G, Smith BJ, et al. The B30.2 domain of pyrin, the familial Mediterranean fever protein, interacts directly with caspase-1 to modulate IL-1 β production. *Proc Natl Acad Sci U S A* 2006;103:9982–7. doi:10.1073/pnas.0602081103.
- [22] Masters SL, Lagou V, J  ru I, Baker PJ, Van Eyck L, Parry DA, et al. Familial autoinflammation with neutrophilic dermatosis reveals a regulatory mechanism of pyrin activation. *Sci Transl Med* 2016;8:332ra45. doi:10.1126/scitranslmed.aaf1471.
- [23] Van Gorp H, Saavedra PHV, de Vasconcelos NM, Van Opdenbosch N, Vande Walle L, Matusiak M, et al. Familial Mediterranean fever mutations lift the obligatory requirement for microtubules in Pyrin inflammasome activation. *Proc Natl Acad Sci U S A* 2016;113:14384–9. doi:10.1073/pnas.1613156113.
- [24] Kim ML, Chae JJ, Park YH, De Nardo D, Stirzaker RA, Ko H-J, et al. Aberrant actin depolymerization triggers the pyrin inflammasome and autoinflammatory disease that is dependent on IL-18, not IL-1 β . *J Exp Med* 2015;212:927–38. doi:10.1084/jem.20142384.
- [25] Gao W, Yang J, Liu W, Wang Y, Shao F. Site-specific phosphorylation and microtubule dynamics control Pyrin inflammasome activation. *Proc Natl Acad Sci U S A* 2016;113:E4857-4866. doi:10.1073/pnas.1601700113.
- [26] Chung LK, Park YH, Zheng Y, Brodsky IE, Hearing P, Kastner DL, et al. The Yersinia Virulence Factor YopM Hijacks Host Kinases to Inhibit Type III Effector-Triggered Activation of the Pyrin Inflammasome. *Cell Host Microbe* 2016;20:296–306. doi:10.1016/j.chom.2016.07.018.
- [27] Ratner D, Orning MPA, Proulx MK, Wang D, Gavrilin MA, Wewers MD, et al. The Yersinia pestis Effector YopM Inhibits Pyrin Inflammasome Activation. *PLoS Pathog* 2016;12:e1006035. doi:10.1371/journal.ppat.1006035.
- [28] Schaner P, Richards N, Wadhwa A, Aksentijevich I, Kastner D, Tucker P, et al. Episodic evolution of pyrin in primates: human mutations recapitulate ancestral amino acid states. *Nat Genet* 2001;27:318–21. doi:10.1038/85893.
- [29] Houten SM, Kuis W, Duran M, de Koning TJ, van Royen-Kerkhof A, Romeijn GJ, et al. Mutations in MVK, encoding mevalonate kinase, cause hyperimmunoglobulinemia D and periodic fever syndrome. *Nat Genet* 1999;22:175–7. doi:10.1038/9691.
- [30] Prieur AM, Griscelli C. [Nosologic aspects of systemic forms of very early onset juvenile arthritis. Apropos of 17 cases]. *Ann Pediatr (Paris)* 1983;30:565–9.
- [31] Galeotti C, Georgin-Lavialle S, Sarrabay G, Toutou I, Kon  -Paut I. [Mevalonate kinase deficiency in 2016]. *Rev Med Interne* 2016. doi:10.1016/j.revmed.2016.08.019.
- [32] Lindor NM, Arsenaault TM, Solomon H, Seidman CE, McEvoy MT. A new autosomal dominant disorder of pyogenic sterile arthritis, pyoderma gangrenosum, and acne: PAPA syndrome. *Mayo Clin Proc* 1997;72:611–5. doi:10.1016/S0025-6196(11)63565-9.
- [33] Yang H, Reinherz EL. CD2BP1 modulates CD2-dependent T cell activation via linkage to protein tyrosine phosphatase (PTP)-PEST. *J Immunol Baltim Md 1950* 2006;176:5898–907.
- [34] Shoham NG, Centola M, Mansfield E, Hull KM, Wood G, Wise CA, et al. Pyrin binds the PSTPIP1/CD2BP1 protein, defining familial Mediterranean fever and PAPA syndrome as disorders in the same pathway. *Proc Natl Acad Sci U S A* 2003;100:13501–6. doi:10.1073/pnas.2135380100.
- [35] Yu J-W, Fernandes-Alnemri T, Datta P, Wu J, Juliana C, Solorzano L, et al. Pyrin activates the ASC pyroptosome in response to engagement by autoinflammatory PSTPIP1 mutants. *Mol Cell* 2007;28:214–27. doi:10.1016/j.molcel.2007.08.029.
- [36] Holzinger D, Roth J. Alarming consequences - autoinflammatory disease spectrum due to mutations in proline-serine-threonine phosphatase-interacting protein 1. *Curr Opin Rheumatol* 2016;28:550–9. doi:10.1097/BOR.0000000000000314.
- [37] Holzinger D, Fassl SK, de Jager W, Lohse P, R  hrig UF, Gattorno M, et al. Single amino acid charge switch defines clinically distinct proline-serine-threonine phosphatase-interacting protein 1 (PSTPIP1)-associated inflammatory diseases. *J Allergy Clin Immunol* 2015;136:1337–45. doi:10.1016/j.jaci.2015.04.016.

- [38] Braun-Falco M, Kovnerystyy O, Lohse P, Ruzicka T. Pyoderma gangrenosum, acne, and suppurative hidradenitis (PASH)--a new autoinflammatory syndrome distinct from PAPA syndrome. *J Am Acad Dermatol* 2012;66:409–15. doi:10.1016/j.jaad.2010.12.025.
- [39] Leuenberger M, Berner J, Di Lucca J, Fischer L, Kaparos N, Conrad C, et al. PASS Syndrome: An IL-1-Driven Autoinflammatory Disease. *Dermatol Basel Switz* 2016;232:254–8. doi:10.1159/000443648.
- [40] Standing ASI, Malinova D, Hong Y, Record J, Moulding D, Blundell MP, et al. Autoinflammatory periodic fever, immunodeficiency, and thrombocytopenia (PFIT) caused by mutation in actin-regulatory gene WDR1. *J Exp Med* 2017;214:59–71. doi:10.1084/jem.20161228.
- [41] Matzinger P. The danger model: a renewed sense of self. *Science* 2002;296:301–5. doi:10.1126/science.1071059.
- [42] Bergsbaken T, Fink SL, Cookson BT. Pyroptosis: host cell death and inflammation. *Nat Rev Microbiol* 2009;7:99–109. doi:10.1038/nrmicro2070.
- [43] Jamilloux Y, Henry T. [The inflammasomes: platforms of innate immunity]. *Médecine Sci MS* 2013;29:975–84. doi:10.1051/medsci/20132911013.
- [44] Hoffman HM, Mueller JL, Broide DH, Wanderer AA, Kolodner RD. Mutation of a new gene encoding a putative pyrin-like protein causes familial cold autoinflammatory syndrome and Muckle-Wells syndrome. *Nat Genet* 2001;29:301–5. doi:10.1038/ng756.
- [45] Tanaka N, Izawa K, Saito MK, Sakuma M, Oshima K, Ohara O, et al. High incidence of NLRP3 somatic mosaicism in patients with chronic infantile neurologic, cutaneous, articular syndrome: results of an International Multicenter Collaborative Study. *Arthritis Rheum* 2011;63:3625–32. doi:10.1002/art.30512.
- [46] Goldbach-Mansky R, Dailey NJ, Canna SW, Gelabert A, Jones J, Rubin BI, et al. Neonatal-onset multisystem inflammatory disease responsive to interleukin-1beta inhibition. *N Engl J Med* 2006;355:581–92. doi:10.1056/NEJMoa055137.
- [47] Goldbach-Mansky R. Blocking interleukin-1 in rheumatic diseases. *Ann N Y Acad Sci* 2009;1182:111–23. doi:10.1111/j.1749-6632.2009.05159.x.
- [48] Tschopp J, Schroder K. NLRP3 inflammasome activation: The convergence of multiple signalling pathways on ROS production? *Nat Rev Immunol* 2010;10:210–5. doi:10.1038/nri2725.
- [49] Martinon F, Mayor A, Tschopp J. The inflammasomes: guardians of the body. *Annu Rev Immunol* 2009;27:229–65. doi:10.1146/annurev.immunol.021908.132715.
- [50] Pétrilli V, Papin S, Dostert C, Mayor A, Martinon F, Tschopp J. Activation of the NALP3 inflammasome is triggered by low intracellular potassium concentration. *Cell Death Differ* 2007;14:1583–9. doi:10.1038/sj.cdd.4402195.
- [51] Baroja-Mazo A, Martín-Sánchez F, Gomez AI, Martínez CM, Amores-Iniesta J, Compan V, et al. The NLRP3 inflammasome is released as a particulate danger signal that amplifies the inflammatory response. *Nat Immunol* 2014;15:738–48. doi:10.1038/ni.2919.
- [52] Hoffman HM, Broderick L. Editorial: It Just Takes One: Somatic Mosaicism in Autoinflammatory Disease. *Arthritis Rheumatol Hoboken NJ* 2017;69:253–6. doi:10.1002/art.39961.
- [53] Nakagawa K, Gonzalez-Roca E, Souto A, Kawai T, Umehayashi H, Campistol JM, et al. Somatic NLRP3 mosaicism in Muckle-Wells syndrome. A genetic mechanism shared by different phenotypes of cryopyrin-associated periodic syndromes. *Ann Rheum Dis* 2015;74:603–10. doi:10.1136/annrheumdis-2013-204361.
- [54] Canna SW, de Jesus AA, Gouni S, Brooks SR, Marrero B, Liu Y, et al. An activating NLRC4 inflammasome mutation causes autoinflammation with recurrent macrophage activation syndrome. *Nat Genet* 2014;46:1140–6. doi:10.1038/ng.3089.
- [55] Romberg N, Al Moussawi K, Nelson-Williams C, Stiegler AL, Loring E, Choi M, et al. Mutation of NLRC4 causes a syndrome of enterocolitis and autoinflammation. *Nat Genet* 2014;46:1135–9. doi:10.1038/ng.3066.
- [56] Volker-Touw CML, de Koning HD, Giltay JC, de Kovel CGF, van Kempen TS, Oberndorff KMEJ, et al. Erythematous nodes, urticarial rash and arthralgias in a large pedigree with NLRC4-related autoinflammatory disease, expansion of the phenotype. *Br J Dermatol* 2017;176:244–8. doi:10.1111/bjd.14757.
- [57] Kitamura A, Sasaki Y, Abe T, Kano H, Yasutomo K. An inherited mutation in NLRC4 causes autoinflammation in human and mice. *J Exp Med* 2014;211:2385–96. doi:10.1084/jem.20141091.
- [58] Kawasaki Y, Oda H, Ito J, Niwa A, Tanaka T, Hijikata A, et al. Identification of a High-Frequency Somatic NLRC4 Mutation as a Cause of Autoinflammation by Pluripotent Cell-Based Phenotype Dissection. *Arthritis Rheumatol Hoboken NJ* 2017;69:447–59. doi:10.1002/art.39960.
- [59] Canna SW, Girard C, Malle L, de Jesus A, Romberg N, Kelsen J, et al. Life-threatening NLRC4-associated hyperinflammation successfully treated with IL-18 inhibition. *J Allergy Clin Immunol* 2016. doi:10.1016/j.jaci.2016.10.022.
- [60] Coers J, Vance RE, Fontana MF, Dietrich WF. Restriction of *Legionella pneumophila* growth in macrophages requires the concerted action of cytokine and Naip5/Ipaf signalling pathways. *Cell Microbiol* 2007;9:2344–57. doi:10.1111/j.1462-5822.2007.00963.x.
- [61] Yang J, Zhao Y, Shi J, Shao F. Human NAIP and mouse NAIP1 recognize bacterial type III secretion needle protein for inflammasome activation. *Proc Natl Acad Sci U S A* 2013;110:14408–13. doi:10.1073/pnas.1306376110.

- [62] Kortmann J, Brubaker SW, Monack DM. Cutting Edge: Inflammasome Activation in Primary Human Macrophages Is Dependent on Flagellin. *J Immunol Baltim Md 1950* 2015;195:815–9. doi:10.4049/jimmunol.1403100.
- [63] Raghawan AK, Sripada A, Gopinath G, Pushpanjali P, Kumar Y, Radha V, et al. A Disease-associated Mutant of NLRP4 Shows Enhanced Interaction with SUG1 Leading to Constitutive FADD-dependent Caspase-8 Activation and Cell Death. *J Biol Chem* 2017;292:1218–30. doi:10.1074/jbc.M116.763979.
- [64] Zhong FL, Mamař O, Sborgi L, Boussofara L, Hopkins R, Robinson K, et al. Germline NLRP1 Mutations Cause Skin Inflammatory and Cancer Susceptibility Syndromes via Inflammasome Activation. *Cell* 2016;167:187–202.e17. doi:10.1016/j.cell.2016.09.001.
- [65] Soler VJ, Tran-Viet K-N, Galiacy SD, Limviphuvadh V, Klemm TP, St Germain E, et al. Whole exome sequencing identifies a mutation for a novel form of corneal intraepithelial dyskeratosis. *J Med Genet* 2013;50:246–54. doi:10.1136/jmedgenet-2012-101325.
- [66] Grandemange S, Sanchez E, Louis-Plence P, Tran Mau-Them F, Bessis D, Coubes C, et al. A new autoinflammatory and autoimmune syndrome associated with NLRP1 mutations: NAIAD (NLRP1-associated autoinflammation with arthritis and dyskeratosis). *Ann Rheum Dis* 2016. doi:10.1136/annrheumdis-2016-210021.
- [67] Masters SL, Gerlic M, Metcalf D, Preston S, Pellegrini M, O'Donnell JA, et al. NLRP1 inflammasome activation induces pyroptosis of hematopoietic progenitor cells. *Immunity* 2012;37:1009–23. doi:10.1016/j.immuni.2012.08.027.
- [68] Jėru I, Duquesnoy P, Fernandes-Alnemri T, Cochet E, Yu JW, Lackmy-Port-Lis M, et al. Mutations in NALP12 cause hereditary periodic fever syndromes. *Proc Natl Acad Sci U S A* 2008;105:1614–9. doi:10.1073/pnas.0708616105.
- [69] Borghini S, Tassi S, Chiesa S, Caroli F, Carta S, Caorsi R, et al. Clinical presentation and pathogenesis of cold-induced autoinflammatory disease in a family with recurrence of an NLRP12 mutation. *Arthritis Rheum* 2011;63:830–9. doi:10.1002/art.30170.
- [70] Jėru I, Le Borgne G, Cochet E, Hayrapetyan H, Duquesnoy P, Grateau G, et al. Identification and functional consequences of a recurrent NLRP12 missense mutation in periodic fever syndromes. *Arthritis Rheum* 2011;63:1459–64. doi:10.1002/art.30241.
- [71] Vladimer GI, Weng D, Paquette SWM, Vanaja SK, Rathinam VAK, Aune MH, et al. The NLRP12 inflammasome recognizes *Yersinia pestis*. *Immunity* 2012;37:96–107. doi:10.1016/j.immuni.2012.07.006.
- [72] Miceli-Richard C, Lesage S, Rybojad M, Prieur AM, Manouvrier-Hanu S, Hāfner R, et al. CARD15 mutations in Blau syndrome. *Nat Genet* 2001;29:19–20. doi:10.1038/ng720.
- [73] Kanazawa N, Okafuji I, Kambe N, Nishikomori R, Nakata-Hizume M, Nagai S, et al. Early-onset sarcoidosis and CARD15 mutations with constitutive nuclear factor-kappaB activation: common genetic etiology with Blau syndrome. *Blood* 2005;105:1195–7. doi:10.1182/blood-2004-07-2972.
- [74] Kobayashi K, Inohara N, Hernandez LD, Galán JE, Nũñez G, Janeway CA, et al. RICK/Rip2/CARDIAK mediates signalling for receptors of the innate and adaptive immune systems. *Nature* 2002;416:194–9. doi:10.1038/416194a.
- [75] Magalhaes JG, Lee J, Geddes K, Rubino S, Philpott DJ, Girardin SE. Essential role of Rip2 in the modulation of innate and adaptive immunity triggered by Nod1 and Nod2 ligands. *Eur J Immunol* 2011;41:1445–55. doi:10.1002/eji.201040827.
- [76] Aróstegui JI, Arnal C, Merino R, Modesto C, Antonia Carballo M, Moreno P, et al. NOD2 gene-associated pediatric granulomatous arthritis: clinical diversity, novel and recurrent mutations, and evidence of clinical improvement with interleukin-1 blockade in a Spanish cohort. *Arthritis Rheum* 2007;56:3805–13. doi:10.1002/art.22966.
- [77] Majeed HA, Kalaawi M, Mohanty D, Teebi AS, Tunjekar MF, al-Gharbawy F, et al. Congenital dyserythropoietic anemia and chronic recurrent multifocal osteomyelitis in three related children and the association with Sweet syndrome in two siblings. *J Pediatr* 1989;115:730–4.
- [78] Ferguson PJ, Chen S, Tayeh MK, Ochoa L, Leal SM, Pelet A, et al. Homozygous mutations in LPIN2 are responsible for the syndrome of chronic recurrent multifocal osteomyelitis and congenital dyserythropoietic anaemia (Majeed syndrome). *J Med Genet* 2005;42:551–7. doi:10.1136/jmg.2005.030759.
- [79] Valdearcos M, Esquinas E, Meana C, Peña L, Gil-de-Gómez L, Balsinde J, et al. Lipin-2 reduces proinflammatory signaling induced by saturated fatty acids in macrophages. *J Biol Chem* 2012;287:10894–904. doi:10.1074/jbc.M112.342915.
- [80] Herlin T, Fiirgaard B, Bjerre M, Kerndrup G, Hasle H, Bing X, et al. Efficacy of anti-IL-1 treatment in Majeed syndrome. *Ann Rheum Dis* 2013;72:410–3. doi:10.1136/annrheumdis-2012-201818.
- [81] Aksentjevich I, Masters SL, Ferguson PJ, Dancey P, Frenkel J, van Royen-Kerkhoff A, et al. An autoinflammatory disease with deficiency of the interleukin-1-receptor antagonist. *N Engl J Med* 2009;360:2426–37. doi:10.1056/NEJMoa0807865.
- [82] Reddy S, Jia S, Geoffrey R, Lorier R, Suchi M, Broeckel U, et al. An autoinflammatory disease due to homozygous deletion of the IL1RN locus. *N Engl J Med* 2009;360:2438–44. doi:10.1056/NEJMoa0809568.
- [83] Jesus AA, Osman M, Silva CA, Kim PW, Pham T-H, Gadina M, et al. A novel mutation of IL1RN in the deficiency of interleukin-1 receptor antagonist syndrome: description of two unrelated cases from Brazil. *Arthritis Rheum* 2011;63:4007–17. doi:10.1002/art.30588.

- [84] Marrakchi S, Guigue P, Renshaw BR, Puel A, Pei X-Y, Fraitag S, et al. Interleukin-36-receptor antagonist deficiency and generalized pustular psoriasis. *N Engl J Med* 2011;365:620–8. doi:10.1056/NEJMoa1013068.
- [85] Sugiura T, Kawaguchi Y, Harigai M, Terajima-Ichida H, Kitamura Y, Furuya T, et al. Association between adult-onset Still's disease and interleukin-18 gene polymorphisms. *Genes Immun* 2002;3:394–9. doi:10.1038/sj.gene.6363922.
- [86] Kanazawa N, Nakamura T, Mikita N, Furukawa F. Novel IL36RN mutation in a Japanese case of early onset generalized pustular psoriasis. *J Dermatol* 2013;40:749–51. doi:10.1111/1346-8138.12227.
- [87] Blumberg H, Dinh H, Trueblood ES, Pretorius J, Kugler D, Weng N, et al. Opposing activities of two novel members of the IL-1 ligand family regulate skin inflammation. *J Exp Med* 2007;204:2603–14. doi:10.1084/jem.20070157.
- [88] Martini A. Systemic juvenile idiopathic arthritis. *Autoimmun Rev* 2012;12:56–9. doi:10.1016/j.autrev.2012.07.022.
- [89] Pascual V, Allantaz F, Arce E, Punaro M, Banchereau J. Role of interleukin-1 (IL-1) in the pathogenesis of systemic onset juvenile idiopathic arthritis and clinical response to IL-1 blockade. *J Exp Med* 2005;201:1479–86. doi:10.1084/jem.20050473.
- [90] Jamilloux Y, Gerfaud-Valentin M, Martinon F, Belot A, Henry T, Sève P. Pathogenesis of adult-onset Still's disease: new insights from the juvenile counterpart. *Immunol Res* 2015;61:53–62. doi:10.1007/s12026-014-8561-9.
- [91] Ombrello MJ, Remmers EF, Tachmazidou I, Grom A, Foell D, Haas J-P, et al. HLA-DRB1*11 and variants of the MHC class II locus are strong risk factors for systemic juvenile idiopathic arthritis. *Proc Natl Acad Sci U S A* 2015;112:15970–5. doi:10.1073/pnas.1520779112.
- [92] Ombrello MJ, Arthur VL, Remmers EF, Hinks A, Tachmazidou I, Grom AA, et al. Genetic architecture distinguishes systemic juvenile idiopathic arthritis from other forms of juvenile idiopathic arthritis: clinical and therapeutic implications. *Ann Rheum Dis* 2016. doi:10.1136/annrheumdis-2016-210324.
- [93] Wakil SM, Monies DM, Abouelhoda M, Al-Tassan N, Al-Dusery H, Naim EA, et al. Association of a mutation in LACC1 with a monogenic form of systemic juvenile idiopathic arthritis. *Arthritis Rheumatol Hoboken NJ* 2015;67:288–95. doi:10.1002/art.38877.
- [94] Cader MZ, Boroviak K, Zhang Q, Assadi G, Kempster SL, Sewell GW, et al. C13orf31 (FAMIN) is a central regulator of immunometabolic function. *Nat Immunol* 2016;17:1046–56. doi:10.1038/ni.3532.
- [95] Gerfaud-Valentin M, Jamilloux Y, Iwaz J, Sève P. Adult-onset Still's disease. *Autoimmun Rev* 2014;13:708–22. doi:10.1016/j.autrev.2014.01.058.
- [96] Chen D-Y, Lan J-L, Lin F-J, Hsieh T-Y. Association of intercellular adhesion molecule-1 with clinical manifestations and interleukin-18 in patients with active, untreated adult-onset Still's disease. *Arthritis Rheum* 2005;53:320–7. doi:10.1002/art.21164.
- [97] Narula N, Narula T, Abril A. Seizing the clinical presentation in adult onset Still's disease. An extensive literature review. *Autoimmun Rev* 2015;14:472–7. doi:10.1016/j.autrev.2015.01.007.
- [98] Liozon E, Ly KH, Vidal-Cathala E, Fauchais A-L. [Adult-onset Still's disease as a manifestation of malignancy: report of a patient with melanoma and literature review]. *Rev Médecine Interne Fondée Par Société Natl Française Médecine Interne* 2014;35:60–4. doi:10.1016/j.revmed.2013.02.014.
- [99] Jamilloux Y, Gerfaud-Valentin M, Henry T, Sève P. Treatment of adult-onset Still's disease: a review. *Ther Clin Risk Manag* 2015;11:33–43. doi:10.2147/TCRM.S64951.
- [100] Marshall GS, Edwards KM, Butler J, Lawton AR. Syndrome of periodic fever, pharyngitis, and aphthous stomatitis. *J Pediatr* 1987;110:43–6.
- [101] Vigo G, Zulian F. Periodic fevers with aphthous stomatitis, pharyngitis, and adenitis (PFAPA). *Autoimmun Rev* 2012;12:52–5. doi:10.1016/j.autrev.2012.07.021.
- [102] Rigante D, Vitale A, Natale MF, Lopalco G, Andreozzi L, Frediani B, et al. A comprehensive comparison between pediatric and adult patients with periodic fever, aphthous stomatitis, pharyngitis, and cervical adenopathy (PFAPA) syndrome. *Clin Rheumatol* 2017;36:463–8. doi:10.1007/s10067-016-3317-7.
- [103] Theodoropoulou K, Vanoni F, Hofer M. Periodic Fever, Aphthous Stomatitis, Pharyngitis, and Cervical Adenitis (PFAPA) Syndrome: a Review of the Pathogenesis. *Curr Rheumatol Rep* 2016;18:18. doi:10.1007/s11926-016-0567-y.
- [104] Cheung MS, Theodoropoulou K, Lugin J, Martinon F, Busso N, Hofer M. Periodic Fever with Aphthous Stomatitis, Pharyngitis, and Cervical Adenitis Syndrome Is Associated with a CARD8 Variant Unable To Bind the NLRP3 Inflammasome. *J Immunol Baltim Md* 1950 2017. doi:10.4049/jimmunol.1600760.
- [105] Stojanov S, Lapidus S, Chitkara P, Feder H, Salazar JC, Fleisher TA, et al. Periodic fever, aphthous stomatitis, pharyngitis, and adenitis (PFAPA) is a disorder of innate immunity and Th1 activation responsive to IL-1 blockade. *Proc Natl Acad Sci U S A* 2011;108:7148–53. doi:10.1073/pnas.1103681108.
- [106] Cochard M, Clet J, Le L, Pillet P, Onrubia X, Guéron T, et al. PFAPA syndrome is not a sporadic disease. *Rheumatol Oxf Engl* 2010;49:1984–7. doi:10.1093/rheumatology/keq187.
- [107] Perko D, Debeljak M, Toplak N, Avčin T. Clinical features and genetic background of the periodic Fever syndrome with aphthous stomatitis, pharyngitis, and adenitis: a single center longitudinal study of 81 patients. *Mediators Inflamm* 2015;2015:293417. doi:10.1155/2015/293417.
- [108] Ter Haar N, Lachmann H, Özen S, Woo P, Uziel Y, Modesto C, et al. Treatment of autoinflammatory diseases: results from the Eurofever Registry and a literature review. *Ann Rheum Dis* 2013;72:678–85. doi:10.1136/annrheumdis-2011-201268.

- [109] Schnitzler L, Schubert B, Verret JL, Simon L, Alquier P. [Cutaneous manifestations in disseminated intravascular coagulation syndrome]. *Ann Dermatol Syphiligr (Paris)* 1976;103:124–34.
- [110] Lipsker D. The Schnitzler syndrome. *Orphanet J Rare Dis* 2010;5:38. doi:10.1186/1750-1172-5-38.
- [111] Simon A, Asli B, Braun-Falco M, De Koning H, Feraud J-P, Grattan C, et al. Schnitzler's syndrome: diagnosis, treatment, and follow-up. *Allergy* 2013;68:562–8. doi:10.1111/all.12129.
- [112] de Koning HD, Schalkwijk J, van der Meer JWM, Simon A. Successful canakinumab treatment identifies IL-1 β as a pivotal mediator in Schnitzler syndrome. *J Allergy Clin Immunol* 2011;128:1352–4. doi:10.1016/j.jaci.2011.05.023.
- [113] de Koning HD, Schalkwijk J, van der Ven-Jongekrijg J, Stoffels M, van der Meer JWM, Simon A. Sustained efficacy of the monoclonal anti-interleukin-1 beta antibody canakinumab in a 9-month trial in Schnitzler's syndrome. *Ann Rheum Dis* 2013;72:1634–8. doi:10.1136/annrheumdis-2012-202192.
- [114] de Koning HD, van Gijn ME, Stoffels M, Jongekrijg J, Zeeuwen PLJM, Elferink MG, et al. Myeloid lineage-restricted somatic mosaicism of NLRP3 mutations in patients with variant Schnitzler syndrome. *J Allergy Clin Immunol* 2015;135:561–4. doi:10.1016/j.jaci.2014.07.050.
- [115] Zhou Q, Aksentijevich I, Wood GM, Walts AD, Hoffmann P, Remmers EF, et al. Brief Report: Cryopyrin-Associated Periodic Syndrome Caused by a Myeloid-Restricted Somatic NLRP3 Mutation. *Arthritis Rheumatol Hoboken NJ* 2015;67:2482–6. doi:10.1002/art.39190.
- [116] Crow YJ. Type I interferonopathies: a novel set of inborn errors of immunity. *Ann N Y Acad Sci* 2011;1238:91–8. doi:10.1111/j.1749-6632.2011.06220.x.
- [117] Rodero MP, Crow YJ. Type I interferon-mediated monogenic autoinflammation: The type I interferonopathies, a conceptual overview. *J Exp Med* 2016;213:2527–38. doi:10.1084/jem.20161596.
- [118] Picard C, Mathieu A-L, Hasan U, Henry T, Jamilloux Y, Walzer T, et al. Inherited anomalies of innate immune receptors in pediatric-onset inflammatory diseases. *Autoimmun Rev* 2015;14:1147–53. doi:10.1016/j.autrev.2015.08.002.
- [119] Picard C, Belot A. [Type I interferonopathies. Literature review]. *Rev Med Interne* 2016. doi:10.1016/j.revmed.2016.08.016.
- [120] Atianand MK, Fitzgerald KA. Molecular basis of DNA recognition in the immune system. *J Immunol Baltim Md* 1950 2013;190:1911–8. doi:10.4049/jimmunol.1203162.
- [121] Chen Q, Sun L, Chen ZJ. Regulation and function of the cGAS-STING pathway of cytosolic DNA sensing. *Nat Immunol* 2016;17:1142–9. doi:10.1038/ni.3558.
- [122] Frémond M-L, Rodero MP, Jeremiah N, Belot A, Jezierski E, Duffy D, et al. Efficacy of the Janus kinase 1/2 inhibitor ruxolitinib in the treatment of vasculopathy associated with TMEM173-activating mutations in 3 children. *J Allergy Clin Immunol* 2016;138:1752–5. doi:10.1016/j.jaci.2016.07.015.
- [123] Aicardi J, Goutières F. A progressive familial encephalopathy in infancy with calcifications of the basal ganglia and chronic cerebrospinal fluid lymphocytosis. *Ann Neurol* 1984;15:49–54. doi:10.1002/ana.410150109.
- [124] Rice GI, del Toro Duany Y, Jenkinson EM, Forte GMA, Anderson BH, Ariaudo G, et al. Gain-of-function mutations in IFIH1 cause a spectrum of human disease phenotypes associated with upregulated type I interferon signaling. *Nat Genet* 2014;46:503–9. doi:10.1038/ng.2933.
- [125] Liu Y, Jesus AA, Marrero B, Yang D, Ramsey SE, Montealegre Sanchez GA, et al. Activated STING in a vascular and pulmonary syndrome. *N Engl J Med* 2014;371:507–18. doi:10.1056/NEJMoa1312625.
- [126] Jeremiah N, Neven B, Gentili M, Callebaut I, Maschalidi S, Stolzenberg M-C, et al. Inherited STING-activating mutation underlies a familial inflammatory syndrome with lupus-like manifestations. *J Clin Invest* 2014;124:5516–20. doi:10.1172/JCI79100.
- [127] Crow YJ, Casanova J-L. STING-associated vasculopathy with onset in infancy--a new interferonopathy. *N Engl J Med* 2014;371:568–71. doi:10.1056/NEJMe1407246.
- [128] Agarwal AK, Xing C, DeMartino GN, Mizrachi D, Hernandez MD, Sousa AB, et al. PSMB8 encoding the β 5i proteasome subunit is mutated in joint contractures, muscle atrophy, microcytic anemia, and panniculitis-induced lipodystrophy syndrome. *Am J Hum Genet* 2010;87:866–72. doi:10.1016/j.ajhg.2010.10.031.
- [129] Arima K, Kinoshita A, Mishima H, Kanazawa N, Kaneko T, Mizushima T, et al. Proteasome assembly defect due to a proteasome subunit beta type 8 (PSMB8) mutation causes the autoinflammatory disorder, Nakajo-Nishimura syndrome. *Proc Natl Acad Sci U S A* 2011;108:14914–9. doi:10.1073/pnas.1106015108.
- [130] Kitamura A, Maekawa Y, Uehara H, Izumi K, Kawachi I, Nishizawa M, et al. A mutation in the immunoproteasome subunit PSMB8 causes autoinflammation and lipodystrophy in humans. *J Clin Invest* 2011;121:4150–60. doi:10.1172/JCI58414.
- [131] Brehm A, Liu Y, Sheikh A, Marrero B, Omoyinmi E, Zhou Q, et al. Additive loss-of-function proteasome subunit mutations in CANDLE/PRAAS patients promote type I IFN production. *J Clin Invest* 2015;125:4196–211. doi:10.1172/JCI81260.
- [132] Murarasu A, Dodé C, Sarrabay G, Klein I, Papo T, Sacré K. Digenic MEFV/TNFRSF1A autoinflammatory syndrome with relapsing aseptic neutrophilic meningitis and chronic myelitis. *Clin Exp Rheumatol* 2017.
- [133] Stoffels M, Kastner DL. Old Dogs, New Tricks: Monogenic Autoinflammatory Disease Unleashed. *Annu Rev Genomics Hum Genet* 2016;17:245–72. doi:10.1146/annurev-genom-090413-025334.
- [134] McDermott A, Jaks J, Kessler M, Emanuel PD, Gao L. Proteasome-associated autoinflammatory syndromes: advances in pathogenesis, clinical presentations, diagnosis, and management. *Int J Dermatol* 2015;54:121–9. doi:10.1111/ijd.12695.

- [135] Jang M-A, Kim EK, Now H, Nguyen NTH, Kim W-J, Yoo J-Y, et al. Mutations in DDX58, which encodes RIG-I, cause atypical Singleton-Merten syndrome. *Am J Hum Genet* 2015;96:266–74. doi:10.1016/j.ajhg.2014.11.019.
- [136] Briggs TA, Rice GI, Daly S, Urquhart J, Gornall H, Bader-Meunier B, et al. Tartrate-resistant acid phosphatase deficiency causes a bone dysplasia with autoimmunity and a type I interferon expression signature. *Nat Genet* 2011;43:127–31. doi:10.1038/ng.748.
- [137] Lausch E, Janecke A, Bros M, Trojandt S, Alanay Y, De Laet C, et al. Genetic deficiency of tartrate-resistant acid phosphatase associated with skeletal dysplasia, cerebral calcifications and autoimmunity. *Nat Genet* 2011;43:132–7. doi:10.1038/ng.749.
- [138] Briggs TA, Rice GI, Adib N, Ades L, Barete S, Baskar K, et al. Spondyloenchondrodysplasia Due to Mutations in ACP5: A Comprehensive Survey. *J Clin Immunol* 2016;36:220–34. doi:10.1007/s10875-016-0252-y.
- [139] Starokadomskyy P, Gemelli T, Rios JJ, Xing C, Wang RC, Li H, et al. DNA polymerase- α regulates the activation of type I interferons through cytosolic RNA:DNA synthesis. *Nat Immunol* 2016;17:495–504. doi:10.1038/ni.3409.
- [140] Fernandez-Guarino M, Torrelo A, Fernandez-Lorente M, Fraile G, García-Sagredo JM, Jaén P. X-linked reticulate pigmentary disorder: report of a new family. *Eur J Dermatol EJD* 2008;18:102–3. doi:10.1684/ejd.2007.0336.
- [141] Bogunovic D, Byun M, Durfee LA, Abhyankar A, Sanal O, Mansouri D, et al. Mycobacterial disease and impaired IFN- γ immunity in humans with inherited ISG15 deficiency. *Science* 2012;337:1684–8. doi:10.1126/science.1224026.
- [142] Zhang X, Bogunovic D, Payelle-Brogard B, Francois-Newton V, Speer SD, Yuan C, et al. Human intracellular ISG15 prevents interferon- α/β over-amplification and auto-inflammation. *Nature* 2015;517:89–93. doi:10.1038/nature13801.
- [143] Meuwissen MEC, Schot R, Buta S, Oudesluijs G, Tinschert S, Speer SD, et al. Human USP18 deficiency underlies type 1 interferonopathy leading to severe pseudo-TORCH syndrome. *J Exp Med* 2016;213:1163–74. doi:10.1084/jem.20151529.
- [144] Bulua AC, Mogul DB, Aksentijevich I, Singh H, He DY, Muenz LR, et al. Efficacy of etanercept in the tumor necrosis factor receptor-associated periodic syndrome: a prospective, open-label, dose-escalation study. *Arthritis Rheum* 2012;64:908–13. doi:10.1002/art.33416.
- [145] Rebelo SL, Bainbridge SE, Amel-Kashipaz MR, Radford PM, Powell RJ, Todd I, et al. Modeling of tumor necrosis factor receptor superfamily 1A mutants associated with tumor necrosis factor receptor-associated periodic syndrome indicates misfolding consistent with abnormal function. *Arthritis Rheum* 2006;54:2674–87. doi:10.1002/art.21964.
- [146] Hull KM, Drewe E, Aksentijevich I, Singh HK, Wong K, McDermott EM, et al. The TNF receptor-associated periodic syndrome (TRAPS): emerging concepts of an autoinflammatory disorder. *Medicine (Baltimore)* 2002;81:349–68.
- [147] Gattorno M, Pelagatti MA, Meini A, Obici L, Barcellona R, Federici S, et al. Persistent efficacy of anakinra in patients with tumor necrosis factor receptor-associated periodic syndrome. *Arthritis Rheum* 2008;58:1516–20. doi:10.1002/art.23475.
- [148] Sacré K, Brihaye B, Lidove O, Papo T, Pocardalo M-A, Cuisset L, et al. Dramatic improvement following interleukin 1beta blockade in tumor necrosis factor receptor-1-associated syndrome (TRAPS) resistant to anti-TNF-alpha therapy. *J Rheumatol* 2008;35:357–8.
- [149] Grimwood C, Despert V, Jeru I, Hentgen V. On-demand treatment with anakinra: a treatment option for selected TRAPS patients. *Rheumatol Oxf Engl* 2015;54:1749–51. doi:10.1093/rheumatology/kev111.
- [150] Bulua AC, Simon A, Maddipati R, Pelletier M, Park H, Kim K-Y, et al. Mitochondrial reactive oxygen species promote production of proinflammatory cytokines and are elevated in TNFR1-associated periodic syndrome (TRAPS). *J Exp Med* 2011;208:519–33. doi:10.1084/jem.20102049.
- [151] Borghini S, Ferrera D, Prigione I, Fiore M, Ferraris C, Mirisola V, et al. Gene expression profile in TNF receptor-associated periodic syndrome reveals constitutively enhanced pathways and new players in the underlying inflammation. *Clin Exp Rheumatol* 2016;34:S121–8.
- [152] Jéru I, Cochet E, Duquesnoy P, Hentgen V, Copin B, Mitjavila-Garcia MT, et al. Brief Report: Involvement of TNFRSF11A molecular defects in autoinflammatory disorders. *Arthritis Rheumatol Hoboken NJ* 2014;66:2621–7. doi:10.1002/art.38727.
- [153] Blaydon DC, Biancheri P, Di W-L, Plagnol V, Cabral RM, Brooke MA, et al. Inflammatory skin and bowel disease linked to ADAM17 deletion. *N Engl J Med* 2011;365:1502–8. doi:10.1056/NEJMoa1100721.
- [154] Hu H, Sun S-C. Ubiquitin signaling in immune responses. *Cell Res* 2016;26:457–83. doi:10.1038/cr.2016.40.
- [155] Cohen P. Immune diseases caused by mutations in kinases and components of the ubiquitin system. *Nat Immunol* 2014;15:521–9. doi:10.1038/ni.2892.
- [156] Zhou Q, Wang H, Schwartz DM, Stoffels M, Park YH, Zhang Y, et al. Loss-of-function mutations in TNFAIP3 leading to A20 haploinsufficiency cause an early-onset autoinflammatory disease. *Nat Genet* 2016;48:67–73. doi:10.1038/ng.3459.
- [157] Shigemura T, Kaneko N, Kobayashi N, Kobayashi K, Takeuchi Y, Nakano N, et al. Novel heterozygous C243Y A20/TNFAIP3 gene mutation is responsible for chronic inflammation in autosomal-dominant Behçet's disease. *RMD Open* 2016;2:e000223. doi:10.1136/rmdopen-2015-000223.

- [158] Ohnishi H, Kawamoto N, Seishima M, Ohara O, Fukao T. A Japanese family case with juvenile onset Behçet's disease caused by TNFAIP3 mutation. *Allergol Int Off J Jpn Soc Allergol* 2017;66:146–8. doi:10.1016/j.alit.2016.06.006.
- [159] Wertz IE, O'Rourke KM, Zhou H, Eby M, Aravind L, Seshagiri S, et al. De-ubiquitination and ubiquitin ligase domains of A20 downregulate NF-kappaB signalling. *Nature* 2004;430:694–9. doi:10.1038/nature02794.
- [160] Vande Walle L, Van Opdenbosch N, Jacques P, Fossoul A, Verheugen E, Vogel P, et al. Negative regulation of the NLRP3 inflammasome by A20 protects against arthritis. *Nature* 2014;512:69–73. doi:10.1038/nature13322.
- [161] Duong BH, Onizawa M, Oses-Prieto JA, Advincula R, Burlingame A, Malynn BA, et al. A20 restricts ubiquitination of pro-interleukin-1 β protein complexes and suppresses NLRP3 inflammasome activity. *Immunity* 2015;42:55–67. doi:10.1016/j.immuni.2014.12.031.
- [162] Shimizu Y, Taraborrelli L, Walczak H. Linear ubiquitination in immunity. *Immunol Rev* 2015;266:190–207. doi:10.1111/imr.12309.
- [163] Fiil BK, Gyrd-Hansen M. Met1-linked ubiquitination in immune signalling. *FEBS J* 2014;281:4337–50. doi:10.1111/febs.12944.
- [164] Elliott PR, Komander D. Regulation of Met1-linked polyubiquitin signalling by the deubiquitinase OTULIN. *FEBS J* 2016;283:39–53. doi:10.1111/febs.13547.
- [165] Zhou Q, Yu X, Demirkaya E, Deutch N, Stone D, Tsai WL, et al. Biallelic hypomorphic mutations in a linear deubiquitinase define otulipenia, an early-onset autoinflammatory disease. *Proc Natl Acad Sci U S A* 2016;113:10127–32. doi:10.1073/pnas.1612594113.
- [166] Boisson B, Laplantine E, Prando C, Giliani S, Israelsson E, Xu Z, et al. Immunodeficiency, autoinflammation and amylopectinosis in humans with inherited HOIL-1 and LUBAC deficiency. *Nat Immunol* 2012;13:1178–86. doi:10.1038/ni.2457.
- [167] Zhou Q, Yang D, Ombrello AK, Zavialov AV, Toro C, Zavialov AV, et al. Early-onset stroke and vasculopathy associated with mutations in ADA2. *N Engl J Med* 2014;370:911–20. doi:10.1056/NEJMoa1307361.
- [168] Navon Elkan P, Pierce SB, Segel R, Walsh T, Barash J, Padeh S, et al. Mutant adenosine deaminase 2 in a polyarteritis nodosa vasculopathy. *N Engl J Med* 2014;370:921–31. doi:10.1056/NEJMoa1307362.
- [169] Ben-Ami T, Revel-Vilk S, Brooks R, Shaag A, Hershfield MS, Kelly SJ, et al. Extending the Clinical Phenotype of Adenosine Deaminase 2 Deficiency. *J Pediatr* 2016;177:316–20. doi:10.1016/j.jpeds.2016.06.058.
- [170] Zavialov AV, Gracia E, Glaichenhaus N, Franco R, Zavialov AV, Lauvau G. Human adenosine deaminase 2 induces differentiation of monocytes into macrophages and stimulates proliferation of T helper cells and macrophages. *J Leukoc Biol* 2010;88:279–90. doi:10.1189/jlb.1109764.
- [171] Ombrello MJ, Remmers EF, Sun G, Freeman AF, Datta S, Torabi-Parizi P, et al. Cold urticaria, immunodeficiency, and autoimmunity related to PLCG2 deletions. *N Engl J Med* 2012;366:330–8. doi:10.1056/NEJMoa1102140.
- [172] Zhou Q, Lee G-S, Brady J, Datta S, Katan M, Sheikh A, et al. A hypermorphic missense mutation in PLCG2, encoding phospholipase Cy2, causes a dominantly inherited autoinflammatory disease with immunodeficiency. *Am J Hum Genet* 2012;91:713–20. doi:10.1016/j.ajhg.2012.08.006.
- [173] Chae JJ, Park YH, Park C, Hwang I-Y, Hoffmann P, Kehrl JH, et al. Connecting two pathways through Ca²⁺ signaling: NLRP3 inflammasome activation induced by a hypermorphic PLCG2 mutation. *Arthritis Rheumatol Hoboken NJ* 2015;67:563–7. doi:10.1002/art.38961.
- [174] Wiseman DH, May A, Jolles S, Connor P, Powell C, Heeney MM, et al. A novel syndrome of congenital sideroblastic anemia, B-cell immunodeficiency, periodic fevers, and developmental delay (SIFD). *Blood* 2013;122:112–23. doi:10.1182/blood-2012-08-439083.
- [175] Chakraborty PK, Schmitz-Abe K, Kennedy EK, Mamady H, Naas T, Durie D, et al. Mutations in TRNT1 cause congenital sideroblastic anemia with immunodeficiency, fevers, and developmental delay (SIFD). *Blood* 2014;124:2867–71. doi:10.1182/blood-2014-08-591370.
- [176] Sasarman F, Thiffault I, Weraarpachai W, Salomon S, Maffei C, Gauthier J, et al. The 3' addition of CCA to mitochondrial tRNASer(AGY) is specifically impaired in patients with mutations in the tRNA nucleotidyl transferase TRNT1. *Hum Mol Genet* 2015;24:2841–7. doi:10.1093/hmg/ddv044.
- [177] Kaustio M, Haapaniemi E, Göös H, Hautala T, Park G, Syrjänen J, et al. Damaging heterozygous mutations in NFKB1 lead to diverse immunological phenotypes. *J Allergy Clin Immunol* 2017. doi:10.1016/j.jaci.2016.10.054.
- [178] Schipp C, Nabhani S, Bienemann K, Simanovsky N, Kfir-Erenfeld S, Assayag-Asherie N, et al. Specific antibody deficiency and autoinflammatory disease extend the clinical and immunological spectrum of heterozygous NFKB1 loss-of-function mutations in humans. *Haematologica* 2016;101:e392–6. doi:10.3324/haematol.2016.145136.
- [179] Molho-Pessach V, Lerer I, Abeliovich D, Agha Z, Abu Libdeh A, Broshtilova V, et al. The H syndrome is caused by mutations in the nucleoside transporter hENT3. *Am J Hum Genet* 2008;83:529–34. doi:10.1016/j.ajhg.2008.09.013.
- [180] Melki I, Lambot K, Jonard L, Couloigner V, Quartier P, Neven B, et al. Mutation in the SLC29A3 gene: a new cause of a monogenic, autoinflammatory condition. *Pediatrics* 2013;131:e1308-1313. doi:10.1542/peds.2012-2255.

- [181] Jordan CT, Cao L, Roberson EDO, Pierson KC, Yang C-F, Joyce CE, et al. PSORS2 is due to mutations in CARD14. *Am J Hum Genet* 2012;90:784–95. doi:10.1016/j.ajhg.2012.03.012.
- [182] Fuchs-Telem D, Sarig O, van Steensel MAM, Isakov O, Israeli S, Nousbeck J, et al. Familial pityriasis rubra pilaris is caused by mutations in CARD14. *Am J Hum Genet* 2012;91:163–70. doi:10.1016/j.ajhg.2012.05.010.
- [183] Eytan O, Sarig O, Sprecher E, van Steensel M a. M. Clinical response to ustekinumab in familial pityriasis rubra pilaris caused by a novel mutation in CARD14. *Br J Dermatol* 2014;171:420–2. doi:10.1111/bjd.12952.
- [184] Setta-Kaffetzi N, Simpson MA, Navarini AA, Patel VM, Lu H-C, Allen MH, et al. AP1S3 mutations are associated with pustular psoriasis and impaired Toll-like receptor 3 trafficking. *Am J Hum Genet* 2014;94:790–7. doi:10.1016/j.ajhg.2014.04.005.
- [185] Mahil SK, Twelves S, Farkas K, Setta-Kaffetzi N, Burden AD, Gach JE, et al. AP1S3 Mutations Cause Skin Autoinflammation by Disrupting Keratinocyte Autophagy and Up-Regulating IL-36 Production. *J Invest Dermatol* 2016;136:2251–9. doi:10.1016/j.jid.2016.06.618.
- [186] Moghaddas F, Masters SL. Monogenic autoinflammatory diseases: Cytokinopathies. *Cytokine* 2015;74:237–46. doi:10.1016/j.cyto.2015.02.012.

METHODES

Les procédures expérimentales sont détaillées dans les manuscrits des différents articles, dans le texte principal ou au sein du matériel supplémentaire. La procédure d'activation de l'inflammasome dans le système « cell-free » a fait, quant à elle, l'objet d'une publication et est présentée ci-après.

6

Cell-free assay for inflammasome activation

Yvan JAMILLOUX^{1,2,3}, Fabio Martinon¹

¹ Department of Biochemistry, University of Lausanne, Epalinges, Switzerland

² International Research Center on Infectiology, Inserm U1111, CNRS UMR5308 - ENS de Lyon, Lyon, France

³ Department of Internal Medicine, Hopital de la Croix-Rousse, Université Claude Bernard-Lyon 1, Lyon, France

Methods in Molecular Biology

2016;1417:207-15

Summary

Inflammasomes are multiprotein complexes, which assembly results in caspase-1 activation and subsequent IL-1 β and IL-18 activation and secretion. In a cell-free system, based on cytosols of normally growing cells, the disruption of the cell membrane spontaneously activates the inflammasome. Studying the activation of the inflammasome in cytosolic extracts provides multiple advantages, as it is synchronised, rapid, strong, and mostly plasma membrane-free. This protocol covers the methods required to prepare cell lysates and study inflammasome activation using different read-outs. General considerations are provided that may help in the design of modified methods. This assay can be useful to study potential inflammasome interactors and the signalling pathways involved in its activation.

1. Introduction

Inflammasomes are multiprotein complexes, which are typically composed of a cytoplasmic sensor and an effector protease, caspase-1, which constitutes the catalytic active core of the complex. Most inflammasomes also require the adaptor ASC (*apoptosis-associated speck-like protein containing a CARD*) that recruits caspase-1 to the oligomeric sensor (1, 2). The assembly of these complexes depends on the recognition of infectious stimuli or danger signals and results in caspase-1 activation and subsequent IL-1 β activation and secretion. The first characterization of an inflammasome complex was made in 2002 in a cell-free system using THP-1 cell extracts (1). This assay, which is based on the hypotonic lysis of cells in low-potassium buffers (<70 mmol/L), had been adapted from previous studies that characterized and studied the apoptosome (3, 4). The apoptosome is formed upon binding of cytochrome c to APAF-1, leading to its oligomerization and further recruitment and activation of the apoptotic protease, caspase-9. While the assembly and activation of the apoptosome in cell-free extracts requires the addition of exogenous cytochrome c or its release from damaged mitochondria, the activation of the inflammasome occurs spontaneously, suggesting that its ligand or trigger is activated or released by mechanical disruption of the cell integrity.

Because the study of the inflammasome using the cell-free assay requires a relatively large amount of cells, the use of immortalized cells facilitates the set-up of this assay. However, in most immortalized cell lines the ASC promoter is highly methylated and the transcription of ASC is repressed (5). One exception is the human monocytic cell line, THP-1, that expresses ASC and is therefore, among human cell-lines, the one that best responds to inflammasome activation, including in cell-free conditions (1). Interestingly, caspase-1 was first detected and purified from THP-1 lysates prepared in buffers containing low-potassium, years before the first description of the inflammasome (6–9). It is therefore likely that the preparation of the cell-extracts in these landmark papers led to the spontaneous assembly and activation of the inflammasome that resulted in the observed caspase-1 activity. Indeed THP-1 cells do not activate caspase-1 or secrete processed IL-1 β at basal conditions.

Over the years, the cell-free assay has been used in a few studies that investigated some aspects of the inflammasome. For example, it was used to demonstrate the key role of ASC in THP-1 cells as well as in primary mouse macrophages (1, 10). It was then used to study the rates of caspase-1 activation in THP-1 cells and Bac1 mouse macrophages (11, 12). This system has also been used to demonstrate the role of low-potassium concentration on inflammasome activation (13).

This system remains of interest for the study of inflammasome activation and regulation since it allows: (1) rapid, synchronized, and strong detection of inflammasome activation,

caspase-1 cleavage, and IL-1 β processing; (2) easy manipulation of the system with the addition of putative activators or inhibitors in the cell lysates; and (3) analysis of the biochemistry of the complex including its composition at definite time points following activation, without need for further membrane crossing.

Here, we describe the successive steps required to activate the inflammasome in cell-free extracts obtained from THP-1 monocytes and give examples of available read-outs.

2. Materials

Solutions are to be prepared using ultrapure and deionized water. All reagents, including solutions, tubes and syringes, should be brought to a temperature of 4°C unless indicated otherwise.

The mechanical disruption of the cell membrane requires 22G needles and 1-mL syringes.

The incubation of cell lysates is performed in an Eppendorf ThermoMixer[®] or equivalent such as the Biosan Thermo-Shaker[®] for microtubes or the Bioer ThermoCell[®] Mixing Block.

2.1. THP-1 cells

THP-1 cells are cultured to a density of about 1.5×10^6 cells/mL. Cells can be cultured in 150-cm² plastic flasks or, alternatively, in 2-liter roller bottles. The preferred medium for THP-1 culture is RPMI 1640 complemented with 10% heat-inactivated foetal calf serum (FCS), and penicillin/streptomycin (100 μ g/mL for each). (see **Note 1**)

2.2. Buffer W with low-potassium concentration (10mM)

Before cell-membrane disruption, THP-1 must swell in hypotonic buffer W (20 mM HEPES-KOH at pH7.5, 10 mM KCl, 1.5 mM MgCl₂, 1 mM sodium EDTA, 1 mM sodium EGTA, and 0.1 mM PMSF).

To prepare Buffer W (see **Note 2**), in a 1-L graduated cylinder or a glass beaker, add 20 mL of 1M solution of HEPES-KOH adjusted at pH7.5, 10 mL of a 1M solution of KCl, 1.5 mL of a 1M solution of MgCl₂, 2 mL of a 0.5M solution of sodium EDTA, and 2 mL of a 0.5 M solution of tetrasodium EGTA. Complete to 1L with water and mix well. Since PMSF is very unstable in water, it should be added freshly for each experiment. The final concentration of PMSF is 0.1 mM (i.e. 17.4 mg/L). Alternatively, PMSF can be stored for longer time in isopropanol or ethanol (see **Note 3**). Buffer W is to be stored and used at 4°C.

2.3. Reagents for ASC aggregates assembly assay

Two buffers are required for this assay: buffer A (20 mM HEPES-KOH at pH7.5, 10 mM KCl, 1.5 mM MgCl₂, 1 mM sodium EDTA, 1 mM sodium EGTA, and 320 mM sucrose) and CHAPS buffer (20 mM HEPES-KOH at pH 7.5, 5 mM MgCl₂, 0.5 mM sodium EGTA, 0.1 mM PMSF, 0.1 % CHAPS).

To prepare buffer A, in a 1-L graduated cylinder or a glass beaker, add 20 mL of a 1M solution of HEPES-KOH adjusted at pH7.5, 10 mL of a 1M solution of KCl, 1.5 mL of a 1M

solution of MgCl₂, 2 mL of a 0.5M solution of sodium EDTA, 2 mL of a 0.5M solution of tetrasodium EGTA, and 110g of sucrose. Complete to 1L with water and mix well.

To prepare CHAPS buffer, in a 1-L graduated cylinder or a glass beaker, add 20 mL of a 1M solution of HEPES-KOH adjusted at pH 7.5, 5 mL of a 1M solution of MgCl₂, 1 mL of a 0.5M solution of tetrasodium EGTA, and 1mL of CHAPS. Complete to 1L with water and mix well. PMSF should be added freshly for each experiment at a final concentration of 0.1 mM (i.e. 17.4 mg/L).

The chemical cross-linking reagent disuccinimidyl suberate (DSS, #21555, Pierce) is to be prepared fresh each time in dimethyl sulfoxide (DMSO) according to the manufacturer's instructions.

2.4. Primary and secondary antibodies

Monoclonal anti-human caspase-1 (mouse, #AG-20B-0048-C100, AdipoGen) polyclonal anti-ASC (rabbit, AL177, #AG-25B-0006-C100, AdipoGen), and monoclonal anti-human IL-1 β (mouse, MAB201, R&D Systems) are used for western blotting. Primary antibodies are diluted at 1:1000 in milk, and incubated with the nitrocellulose membrane overnight. Horseradish peroxidase (HRP)-conjugated secondary antibodies are incubated for 1 hour, in milk. Anti-mouse and anti-rabbit (Jackson Immunoresearch) are diluted at 1:10,000.

2.5 SDS-PAGE

To prepare 4X Laemmli Sample Buffer (100 mL), mix 3g of Tris-HCl adjusted to pH 6.8, 40mL of a 40% solution of glycerol, 5g of 5% SDS, and 5mg of 0.005% bromophenol blue. Complete with water to 100mL. Stock at room temperature. When needed, fresh DTT should be added for each experiment.

To make a stock solution of 1M DTT, dissolve 1.5 g of DTT in 8 mL of water. Adjust the final volume to 10 mL with water and dispense into 1-mL aliquots. Store the stock solution in the dark, at -20°C.

The 15% SDS-polyacrylamide gel can be prepared, for 8 ml, by mixing 2.8 ml of water, 3 ml of 40 % acrylamide/bis-acrylamide solution, 2 ml of 1.5 M Tris pH 8.8, 80 μ l of 10% SDS, and 80 μ l of 10% APS. Add 8 μ l of TEMED immediately before pouring the gel. A stacking gel can be made (for 5 mL, mix 2.9 ml of water, 750 μ l of 40 % acrylamide/bis-acrylamide solution, 1.25 ml of 0.5 M Tris pH 6.8, 50 μ l of 10% SDS, 50 μ l of 10% APS, and 5 μ l of TEMED immediately before pouring the stacking gel).

3. Methods

3.1. Cell-free lysates preparation and inflammasome activation

Carry out all procedures on ice unless otherwise specified. A schematic diagram of the cell-free assay is provided in figure 1.

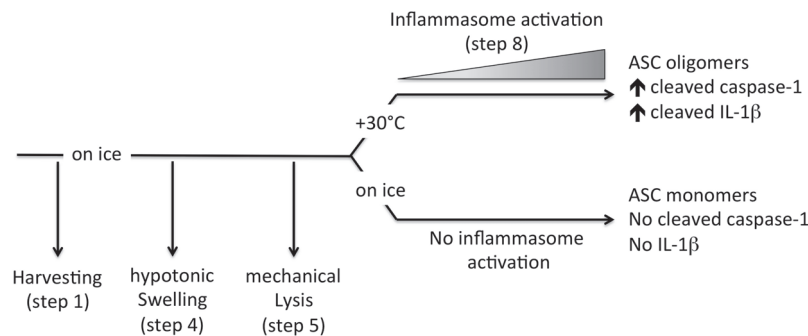

Figure 1: Schematic diagram of the cell-free assay. After hypotonic swelling and mechanical disruption of the plasmic membrane, the inflammasome complex is spontaneously activated in the lysates of THP-1 cells, upon incubation at 30°C

1. Harvest 100 million cells (see **Note 4**) in 50 ml tubes and centrifuge the cells at 4°C for 5 minutes at 400 x *g*. Wash the pellets by aspirating the supernatant, adding 2 mL of ice-cold PBS, and centrifuging the tubes again 5 minutes at 400 x *g*. Discard the supernatant, centrifuge the pellets one more time for 2 minutes at 400 x *g* and remove the remaining liquid with a Pasteur pipette. (see **Note 5**)
2. Add 2 mL of ice-cold buffer W, without resuspending cells. Centrifuge the tubes for 5 minutes at 400 x *g*. Discard the supernatant.
3. Estimate the volume of the dry pellet (see **Note 6**) and add three times that volume of ice-cold buffer W (see **Note 7**). Resuspend the cells by gentle pipetting up and down. Transfer the resuspended cells to a prechilled 1.5-mL microfuge tube. Keep cells on ice.
4. Incubate 10 minutes on ice to allow the swelling of the cells.
5. Mechanically disrupt cell membranes by 15 passages (see **Note 8**) through a 22G needle, with the 1-mL syringe. Work rapidly and stay on ice to avoid the activation of the inflammasome and avoid the generation of air bubbles.
6. Centrifuge the tubes 5 minutes at 13,000 x *g*, at 4°C.

7. Harvest the supernatant in a prechilled 1.5 mL microfuge tube. The negative control tube is to be left on ice or at -20°C. At this time, protein concentration can be checked and adjusted using commercial kits (see **Note 9**).

8. Aliquot the samples in experimental tubes using at least 25 µl of lysate per condition (see **Note 10**). Incubate the sample tubes during 30 to 120 minutes at 30 to 37°C (see **Note 11**), with agitation set at 400 rpm, in an Eppendorf ThermoMixer® or equivalent (see **Note 12**).

9. The process can be stopped at any time, either by freezing the lysates at -20°C or by adding denaturing buffers (Laemmli Sample Buffer, buffer A, or RIPA buffer) (see **Note 13**).

3.2. Read-outs

Caspase-1 cleavage and pro-IL1β processing

4X Laemmli Buffer (containing 400mM DTT) is added to the incubated samples and the negative control (from 3.1. step 9). Caspase-1 and IL-1β processing can then be analysed after boiling and fractionating on a 15% SDS-polyacrylamide gel. The procaspase-1 cleavage results in 20-kDa (p20) band of active caspase-1 (figure 2). The proIL-1β processing results in 17-kDa (p17) active fragments of IL-1β.

ASC assembly assay

1. Save a 10%-aliquot of each incubated sample (from 3.1. step 9) for WB analysis.

2. In each sample, add twice the sample volume of buffer A. Centrifuge the lysates at 2000 x g for 5 minutes at 4°C.

3. Collect the supernatant in a new 1.5 mL microfuge tube. Dilute the supernatant with 1 volume of CHAPS buffer and centrifuge at 5000 rpm for 8 minutes to pellet the ASC oligomers. Discard the supernatant.

4. Wash the ASC aggregates by resuspending the crude pellets in 1 mL of CHAPS buffer, pipetting up and down, and centrifuge the tubes for 8 min at 5000 rpm. This step should be repeated twice.

5. After three washes, discard the supernatant and resuspend the pellets in 30 µL of CHAPS buffer.

6. Crosslink by adding DSS to a final concentration of 4 mM and incubate 30 minutes at room temperature.

7. Quench the reaction with 30 µL of 2X Laemmli buffer without DTT. Add 2X Laemmli buffer without DTT to the 10%-aliquot from step 1.

8. The ASC assembly can then be analysed by WB after boiling and fractionating on a 15 % SDS-polyacrylamide gel and using an anti-ASC antibody.

The assembly of aggregated ASC is detected as ASC-monomers (22 kDa), together with dimers, and high molecular weight oligomers (figure 2).

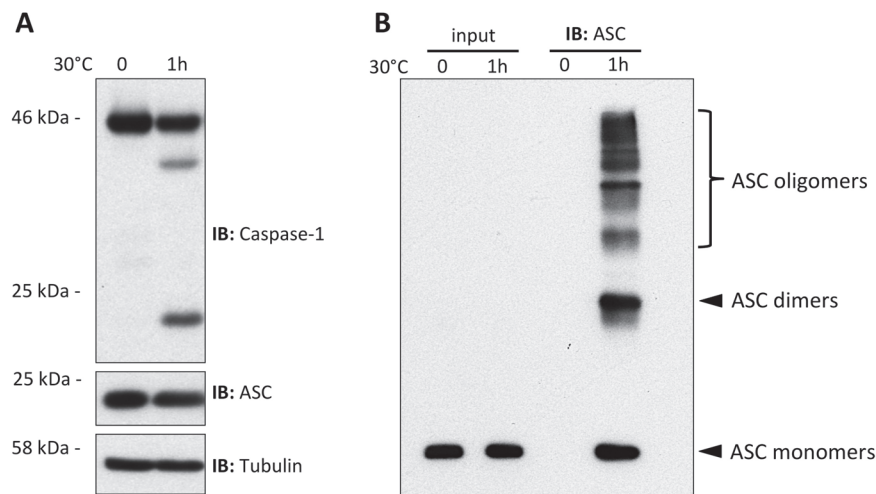

Figure 2: Possible read-outs for inflammasome activation, using the cell-free assay. A: In THP-1 cell lysates, obtained after hypotonic swelling and mechanical disruption, the inflammasome was activated upon incubation at 30°C during 1 hour, resulting in caspase-1 cleavage (20 kDa band). B: Inflammasome activation can also be demonstrated by the formation of ASC aggregates (oligomers) upon incubation at 30°C during 1 hour.

4. Notes

1. Other cells that express the inflammasome components (including ASC) can be used. For example, this assay has been successfully reported in thioglycolate-elicited mouse peritoneal macrophages (10), in mouse Bac1 macrophages (11), and in J2-immortalized mouse bone marrow-derived macrophages (13; unpublished personal data).
2. Buffer W refers to buffer A reported in Xiaodong Wang's landmark studies characterizing the apoptosome complex in a cell-free system. (4, 15, 16)
3. A buffer W with 150 mM KCl can be used as negative control, since inflammasome is only activated with potassium concentration below 70 mmol/L. However because the addition of potassium may affect the hypotonic lysis, it is recommended to add the extra KCL after mechanical lysis of the cells (step 5).
4. This amount of cells is optimised for this protocol to obtain a good lysis and a reproducible caspase-1 activity, however the assay can be scaled-up or down.
5. Remaining PBS and media may affect the efficiency of the hypotonic lysis.
6. To estimate the volume of the dry pellet, place an empty tube next to the tube containing the pellet, add the same volume of a solution (water) to reach the level of the pellet. Measure the volume of the solution with a pipette.

7. The volume of buffer W can be increased up to five times the volume of the dry pellet. This may decrease the activity of the lysate but may facilitate downstream applications.
8. The number of passages can vary from 10 to 20, depending on the volume to lyse and the experimenter.
9. For example, the Quick Start™ Bradford Protein Assay (#500-0201, Bio-Rad) can be used. Use the 'standard protocol' with 10 to 100-times dilutions of each sample in buffer W. Bovine serum albumin is used for the standard range. Pipet 5 μ L of each sample into separate microplate wells. Dispense 250 μ L of 1X dye reagent in each well with multichannel pipet. Depress the plunger repeatedly to mix the sample and reagent in the wells. Incubate 5 minutes at room temperature. Read the microplate using a spectrophotometer with wavelength set at 595 nm. Refer to manufacturer's protocol for data analysis.
10. We typically performed experiments using 25 to 500 μ l of lysate per condition without observing obvious differences in the activity per μ l. The protein concentration of the lysates typically ranges from 5 to 10 μ g/ μ l.
11. In THP-1 lysates the activation occurs within minutes. A 30°C incubation temperature should be preferred to limit protein degradation. Note that the assay can be performed at 37°C, this may result in stronger activity depending on the cell line.
12. Strong activation can also be observed using a water bath incubator rather than the ThermoMixer®.
13. Laemmli Sample Buffer can be used if the samples are directly loaded on a polyacrylamide gel electrophoresis for Western blotting. Buffer A is used if the sample are analysed for ASC oligomerization. RIPA buffer can be used in other biochemical procedures such as immunoprecipitations and molecular pull-down assays.

References

1. Martinon F, Burns K, and Tschopp J (2002) The inflammasome: a molecular platform triggering activation of inflammatory caspases and processing of proIL-beta, *Molecular cell*. 10, 417–426.
2. Martinon F, Mayor A, and Tschopp J (2009) The inflammasomes: guardians of the body, *Annual review of immunology*. 27, 229–265.
3. Cain K, Bratton SB, Langlais C et al. (2000) Apaf-1 oligomerizes into biologically active approximately 700-kDa and inactive approximately 1.4-MDa apoptosome complexes, *The Journal of Biological Chemistry*. 275, 6067–6070.
4. Salminen A, Kauppinen A, Hiltunen M et al. (2014) Epigenetic regulation of ASC/TMS1 expression: potential role in apoptosis and inflammasome function, *Cellular and molecular life sciences: CMLS*. 71, 1855–1864.
5. Ayala JM, Yamin TT, Egger LA et al. (1994) IL-1 beta-converting enzyme is present in monocytic cells as an inactive 45-kDa precursor, *Journal of Immunology (Baltimore, Md.: 1950)*. 153, 2592–2599.
6. Cerretti DP, Kozlosky CJ, Mosley B et al. (1992) Molecular cloning of the interleukin-1 beta converting enzyme, *Science (New York, N.Y.)*. 256, 97–100.
7. Kostura MJ, Tocci MJ, Limjuco G et al. (1989) Identification of a monocyte specific pre-interleukin 1 beta convertase activity, *Proceedings of the National Academy of Sciences of the United States of America*. 86, 5227–5231.
8. Miller DK, Ayala JM, Egger LA et al. (1993) Purification and characterization of active human interleukin-1 beta-converting enzyme from THP.1 monocytic cells, *The Journal of Biological Chemistry*. 268, 18062–18069.
9. Yamamoto M, Yaginuma K, Tsutsui H et al. (2004) ASC is essential for LPS-induced activation of

- procaspase-1 independently of TLR-associated signal adaptor molecules, *Genes to Cells: Devoted to Molecular & Cellular Mechanisms*. 9, 1055–1067.
10. Kahlenberg JM and Dubyak GR (2004) Differing caspase-1 activation states in monocyte versus macrophage models of IL-1 β processing and release, *Journal of Leukocyte Biology*. 76, 676–684.
 11. Kahlenberg JM and Dubyak GR (2004) Mechanisms of caspase-1 activation by P2X7 receptor-mediated K⁺ release, *American Journal of Physiology. Cell Physiology*. 286, C1100–1108.
 12. Pétrilli V, Papin S, Dostert C et al. (2007) Activation of the NALP3 inflammasome is triggered by low intracellular potassium concentration, *Cell death and differentiation*. 14, 1583–1589.
 13. Pirami L, Stockinger B, Corradin SB, et al. (1991) Mouse macrophage clones immortalized by retroviruses are functionally heterogeneous, *Proceedings of the National Academy of Sciences of the United States of America*. 88, 7543–7547.
 14. Liu X, Kim CN, Yang J et al. (1996) Induction of apoptotic program in cell-free extracts: requirement for dATP and cytochrome c, *Cell*. 86, 147–157.
 15. Zou H, Henzel WJ, Liu X et al. (1997) Apaf-1, a human protein homologous to *C. elegans* CED-4, participates in cytochrome c-dependent activation of caspase-3, *Cell*. 90, 405–413.
 16. Li P, Nijhawan D, Budihardjo I et al. (1997) Cytochrome c and dATP-dependent formation of Apaf-1/caspase-9 complex initiates an apoptotic protease cascade, *Cell*. 91, 479–489.

RESULTATS

7

Axe 1 :

*A proximity-dependent biotinylation
(BioID) approach identifies
p62/SQSTM-1 as a caspase-1 substrate*

Yvan JAMILLOUX^{1,2,3} ; Antonia DI MICCO¹ ; Emilie BOURDONNAY² ;
Brice LAGRANGE² ; Manfredo QUADRONI¹ ; Angéline PROVOST² ;
Rémy TALANT¹ ; Thomas HENRY² ; Fabio MARTINON¹

¹ Department of Biochemistry, University of Lausanne, Epalinges, Switzerland

² INSERM, U1111, Center for Infectiology Research, Lyon, France

³ Department of Internal Medicine, University Hospital Croix-Rousse, Hospices Civils de
Lyon, University of Lyon, Lyon, France

***En préparation pour soumission à
Journal of Biochemical Chemistry***

ABSTRACT

The inflammasome is a major component of the innate immunity, which main function is to activate a pro-inflammatory cysteine protease, namely caspase-1, to finally induce interleukine-1 β (IL-1 β) processing and release in the extracellular milieu. To avoid uncontrolled activation, this complex is highly regulated. The analysis of inflammasome interactions with other proteins has long been prevented by the insoluble nature of the inflammasome once complexed. Here, we used the proximity-dependent biotinylation assay (BioID) to identify uncharacterized caspase-1 interacting-proteins. Using the BioID approach in a cell-free system, in which the inflammasome is spontaneously activated, we identified 111-candidate proteins interacting with caspase-1, 75% of which had not been related before to caspase-1. By focusing on one candidate, p62/sequestosome-1 (p62) we demonstrated that p62 not only interacted with caspase-1 but also was a substrate of the protease. Subsequent analyses identified the cleavage site at Aspartate 329. Mechanistic and functional analyses revealed that caspase-1-mediated cleavage of p62 leads to its loss of cargo function in selective autophagy by truncating the protein and precluding its interaction with LC3B. Strikingly, the overexpression of p62 N-terminal fragment led to decreased IL-1 β release whereas the overexpression of p62 C-ter led to enhanced IL-1 β release. Taken together, our results indicate that, depending on the strength of the inflammasome-activating stimulus, p62 may play dual roles, either quelling inflammation or enhancing caspase-1-mediated inflammatory cell death.

INTRODUCTION

Caspase-1 is essential for processing and maturing pro-inflammatory cytokines, namely interleukin (IL)-1 β , and IL-18 (1). Caspase-1 is found in cells as an inactive precursor and is activated in response to inflammatory signals, including pathogen-associated molecular patterns (PAMPs) and damage-associated molecular patterns (DAMPs). Following the recognition of PAMPs or DAMPs, intracellular pattern-recognition receptors (PRRs) scaffold a macromolecular complex known as the inflammasome, generally via the adaptor protein ASC (2,3). Only some PRRs can mount an inflammasome; most of them belong to the family of nucleotide-binding domain and leucine-rich repeat containing receptors (NLRs). Once activated, caspase-1 cleaves and activates IL-1 β and triggers an inflammatory cell death termed pyroptosis (4). Caspases-1, -4, -5 and -11 (the latter being the murine orthologue of human caspases 4/5) cleave gasdermin D (GSDMD) and GSDMD N-terminus polypeptide oligomerizes in the plasma membrane leading to pore formation (5,6). The rupture of cell membrane leads to osmotic swelling, release of inflammatory cytokines and culminates in a rapid cell death, termed pyroptosis.

The inflammasome is a rigorously controlled machinery. Various mechanisms preventing its activation are known and some competitive inhibitors have also been described, such as pyrin-only proteins (POPs) or card-only proteins (COPs) (7). However, it is believed that inflammasome activation does not always end in inflammatory cell death and that some processes can terminate its activation (8–11).

Autophagy is an intracellular degradation system associated with maintenance of cellular homeostasis. It has been shown to play a critical role for inflammasome regulation (8,11). First, autophagy has been shown to suppress TLR4-dependent production of IL-1 β and IL-18, by inhibiting TRIF-dependent reactive oxygen species (ROS) production (12). Second, autophagy suppresses activation of the NLRP3 inflammasome by eliminating damaged mitochondria, which prevents excess production of ROS and mitochondrial DNA, in a process called mitophagy (13). Mitophagy is dependent on the adaptor p62/SQSTM-1 (hereafter called p62) (14). Finally, autophagy selectively eliminates ubiquitinated ASC and IL-1 β . Indeed, p62 targets these inflammasome components to LC3B-positive cytosolic compartment, allowing their engulfment within the autophagosome and their elimination in the autophagolysosome.

In this study, we took advantage of the proximity-dependent biotinylation coupled with mass spectrometry (BioID) to identify caspase-1 neighboring-proteins during inflammasome activation (15). We identified 111 proteins that are believed to be in close proximity, but not necessary interactors. However, 27 (25%) of them were previously described as caspase-1

interactors or substrates. Among the hits, p62 was confirmed to be a caspase-1 substrate. We demonstrate that caspase-1-mediated p62 cleavage at Asp329 leads to the loss of p62 function by precluding its interaction with both ubiquitinated proteins and LC3B-positive autophagosome.

RESULTS

Expression of BirA-caspase-1 in caspase-1^{-/-} macrophages* – BioID is a method based on proximity-dependent biotinylation of proteins that are near-neighbors of a fusion protein. Biotinylated proteins can then be identified using streptavidin affinity capture and mass spectrometry. In this system, the targeting protein is fused to a 35-kDa DNA-binding biotin protein ligase derived from *Escherichia coli* and called BirA (16). A BirA mutant (R118G, hereafter called BirA*) is defective in both self-association and DNA binding and has enhanced capacity for proximity-dependent biotin ligation (17). In addition, biotinylation is an exceptional endogenous modification in mammalian cells (18). To identify the caspase-1-interacting proteins during inflammasome activation, we set up an inducible BirA*-caspase-1 in immortalized bone marrow-derived macrophages (iBMDMs) from caspase-1^{-/-} mice (Fig. 1). We verified the inducible expression of the BirA*-caspase-1 by western-blot (Fig. 1B). As expected, the fusion protein had an extra molecular weight of 35 kDa, corresponding to the BirA*.

The activation of caspase-1 requires its cleavage within the inflammasome complex and the half-life of processed caspase-1 is very short (2,19). We fused the BirA* ligase to a mutated caspase-1, containing a Q281H substitution within the catalytic site, and observed no degradation of the BirA*-caspase-1 after 6-hours inflammasome activation in the cell-free assay (Fig.1B). We then verified that the inflammasome oligomerization was not altered by the BirA* by assaying the apoptosis-associated speck-like protein containing a CARD (ASC) oligomerization in cells and in the cell-free system. As expected, ASC oligomerization was preserved under inflammasome activating conditions in reconstituted cells or derived cell-free system (Fig. 1C, 1D).

Identification of caspase-1-interacting proteins during inflammasome activation in a cell-free assay – In the cell-free system, the disruption of the cell membrane, along with hypotonic and low-potassium conditions, spontaneously activates the inflammasome (20). Studying the activation of the inflammasome in cytosolic extracts provides multiple advantages, as it is synchronised, rapid, strong, and mostly plasma membrane-free. We thus decided to use this

system to analyse the caspase-1 interacting-proteins during inflammasome activation. Doxycycline was added to the cells to induce BirA*-caspase-1 expression, 24 h before the experiment. Cells were then mechanically lysed in a hypotonic buffer containing low-potassium at 4°C, then incubated at 37°C for 6h allowing spontaneous inflammasome activation (Fig. 2A). Control cells were left at 4°C to prevent inflammasome activation. Biotinylated proteins were subsequently captured with streptavidin-coupled beads, rigorously washed and bound proteins were analysed by mass spectrometry. Because, ASC is the main interacting protein with caspase-1 during inflammasome activation, through CARD-CARD interactions, the streptavidin pull-down of ASC was selected as the read-out for successful procedure before mass spectrometry analysis (Fig. 2B).

Proteins unique to the BioID-Caspase-1 (BirA*-caspase-1) pull-down, and not detected with identical pull-downs from control cells (no doxycycline), were then selected based on enrichment factor >2 during inflammasome activation. As expected, mass spectrometry identified ASC and caspase-1. Furthermore, caspase-1 was the most abundantly identified protein, detected at similar levels before and after inflammasome activation. Self-biotinylation of the bait protein explains this result. Among the 1108 proteins identified by mass spectrometry, 480 were not detected in control cells and 368/480 had an enrichment factor ≥ 2 (Fig. 2C). We then removed the proteins that were contained in the Contaminant Repository for Affinity Purification (www.crapome.org) because they are known usual contaminants of streptavidin-based affinity capture. This selection resulted in a final number of 111 proteins, among which 27 had previously been linked with the inflammasome complex or auto-inflammation (Table 1). The Gene Ontology enrichment analysis revealed significant enrichment in proteins involved in the regulation of NF- κ B signalling (fold enrichment: 9.23, $p < 0.01$), in the regulation of vesicle-mediated transport (fold enrichment: 6.59, $p < 0.001$), in the regulation of protein transport (fold enrichment: 3.87, $p < 0.001$) and in metabolic process (fold enrichment: 2.33, $p < 0,01$) (Fig. 2C).

Caspase-1 interacts with p62 – In our BioID screen, we identified a caspase-1 proximity biotinylation of p62, a major adaptor protein involved in selective autophagy. p62 is composed of six domains, including an N-terminal PB1 domain for oligomerization, a ubiquitin-binding domain (UBA) and a LC3B-interacting domain (LIR) (Fig. 3A) (21,22). p62 mainly serves as a cargo to drive ubiquitinated proteins to LC3B-positive autophagosome before selective degradation within the autophagolysosome. The function of the protein requires its complete integrity (23). p62/sequestosome is also implicated in cell survival,

inflammation and osteoclastogenesis through its interaction TRAF6/RANK/NFκB and in apoptosis by scaffolding ubiquitinated caspase-8 (22).

We tested the interaction between caspase-1 and p62 by performing a co-immunoprecipitation in HEK293T transfected with flag-tagged caspase-1 and HA-tagged p62 (Fig. 3B). In addition, using confocal fluorescence microscopy on human macrophages, we observed the formation of cytoplasmic specks in which caspase-1 and p62 colocalized (Fig. 3C) when the inflammasome was activated by lipopolysaccharide (LPS) + nigericin. When the inflammasome was only primed with LPS, both p62 and caspase-1 had cytosolic fluorescence but did not colocalize.

Caspase-1 cleaves p62 at Asp329 – We then found that the inflammasome activation in THP-1 derived cell-free system resulted in p62 cleavage (Fig. 4A). To further assess if the cleavage of p62 was dependent on caspase-1, we used another model of inflammasome activation and specific inhibitors. Inflammasome activation in primary human monocytes resulted in the cleavage of p62 and this cleavage was prevented by addition of z-YVAD, a caspase-1 inhibitor (Fig. 4B). In contrast, the addition of specific inhibitors of caspase-8 or calpain, two proteases known for their ability to cleave p62 (24), did not prevent this cleavage. We further confirmed that caspase-1 was sufficient to cleave p62 by cotransfecting HEK293T cells with p62 and various caspases (Fig. 4C). HEK293T cells lack the inflammasome machinery (25) but the transfection of caspases is sufficient to obtain their self-activation. In this experiment, we confirmed the specificity of the cleavage of p62 by caspase-1. In addition, we also detected a degradation of p62 by caspase-4, an orthologue of the murine caspase-11, and a pro-inflammatory caspase. As previously shown, caspase-8 also induced degradation of p62 through multiple cleavages (24).

According to the molecular weight of the fragments and to the amino-acid sequence, the cleavage of p62 was predicted to be at Asp329 or Asp347. We thus performed point mutations (*p.D329A* and *p.D347A*) in p62 plasmid to interrogate the role of these residues. Subsequently, HEK 293T cells were cotransfected with caspase-1 and either the WT or the mutated plasmids (Fig. 4D). The cleavage of p62 by caspase-1 was no longer observed in the *p.D329A* mutant, indicating that caspase-1 cleaves p62 at Asp329. Interestingly, the *p.D329A* mutation did not prevent the interaction between caspase-1 and p62, as shown in Fig. 4E.

Caspase-1 cleavage disrupts p62 interaction with LC3B and modulates IL-1 β secretion – Autophagy is known to regulate the inflammasome and p62 has previously been shown to deliver ASC and IL-1 β to the autophagosome resulting in suppression of inflammasome activation (8,26). In addition, mice/cells that are deficient in p62 show higher IL-1 β release upon inflammasome activation (8,27). We sought to determine the role of p62 cleavage by caspase-1 on its cargo function and on IL-1 β secretion. p62 interacts with the autophagosome docking protein LC3B via its LIR domain to shuttle ubiquitinated proteins into newly formed autophagosomes (21). Furthermore, the cleavage of p62 at Gly241 by a protease from coxsackievirus results in the disruption of p62 function in selective autophagy (23,28). More precisely, the C-terminal fragment retained the binding activity to LC3B and exhibited a dominant-negative effect against native p62, probably by competing for LC3B binding. Because p62 self-oligomerization is required step for ubiquitinated proteins engulfment in autophagosome (22,29), we tested if this ability was retained in both Nter and Cter fragments. While the cotransfection of full-length p62 with Nter p62 showed that this ability was retained for the Nter fragment, we demonstrated that this interaction was lost when cotransfecting full-length p62 with the Cter fragment (Fig. 5A). In addition, we found that the Nter fragment mediated the interaction of caspase-1 to p62 whereas the LC3B-binding was limited to the Cter fragment (Fig. 5B). These results indicate that the cleavage of p62 by caspase-1 disrupts p62 cargo function (Fig. 5C). To further characterise the functional consequences of the cleavage, we transduced WT iBMDMs with the cleaved fragments of p62 for inducible lentiviral expression. We then activated the inflammasome with either LPS + nigericin, LPS + monosodium urate or LPS + ATP. We demonstrated that upon inflammasome activation, the ectopic expression of the Nter fragment of p62 decreased the release of IL-1 β , following inflammasome activation, whereas the overexpression of the Cter fragment increased significantly IL-1 β release (Fig. 5D).

Taken together these results suggest that p62 may determine, at least in part, the cell fate by regulating the inflammasome either as an inhibitor or an enhancer.

DISCUSSION

In this study, we took advantage of the recently described BioID assay to identify caspase-1-neighboring proteins during inflammasome activation. The BioID assay consists of mass spectrometry identification of neighboring or interacting proteins that have been biotinylated by the BirA proximity-dependent biotin ligase fused to a “bait” protein, following streptavidin affinity capture (15). One limitation of the BioID assay is the problem of scale when dealing with low abundance proteins. Such proteins may be difficult to identify and a sufficient start

material is necessary. Indeed, in preliminary set-up experiments, we were not able to detect robust ASC biotinylation upon inflammasome stimulation in whole cells. We have thus chosen to use the previously described cell-free assay, where the inflammasome is spontaneously activated upon incubation with hypotonic, low potassium buffer (20). We assume that this method precludes the identification of various proteins usually contained in cell compartments that have been removed during cell-free soup preparation, such as cell membrane or nuclear proteins. Nevertheless, using the cell-free assay offers number advantages: strong, rapid, and synchronized inflammasome activation along with a large quantity of proteins in a reduced volume.

The analysis of inflammasome components interactions with other proteins has long been prevented by the insoluble nature of the inflammasome once complexed. The use of the BioID assay sidesteps issues associated with bait protein solubility because biotinylation occurs before protein solubilisation (15). Interactors are covalently modified with biotin and robust lysis conditions can be used to solubilize polypeptides localized to poorly soluble cellular compartments.

Another limitation of BioID relies on the expression of an exogenous protein that is fused to BirA* that may modify the protein structure, assembly properties and targeting (15). In our study, we chose to fuse the BirA* to a mutated caspase-1 (Q281H) to preclude protein degradation and to avoid a possible toxicity of its overexpression (Fig. 1A, 1B). This strategy allowed the accumulation of caspase-1 without disrupting ASC oligomerization (Fig. 1D, 1E) and ASC-caspase-1 interaction (Fig. 2B).

The BioID identified 1108 candidates, of which 480 were not detected with identical pull-downs from control cells. Upon inflammasome activation, 368 were enriched with a factor ≥ 2 . We made a final sort by using the Contaminant Repository for Affinity Purification (www.crapome.org) and identified 111 proteins interacting with caspase-1. This strategy is debatable since it could have excluded caspase-1 interactors at steady state and proteins that are usual contaminants but would still be relevant caspase-1 interactors. Indeed, many proteins involved in cell metabolism, such as glycolysis (30), may have been excluded from the analysis since a lot are known contaminants of streptavidin affinity capture (www.crapome.org).

Interestingly, we identified 27 (24%) proteins that had previously been associated with either caspase-1, or the inflammasome or autoinflammatory phenotypes in mice or humans (30–34). For instance, we identified phospholipase-C γ 2 (PLCG2), which has been recently related to a novel human autoinflammatory disease, namely PLCG2-associated antibody deficiency and immune dysregulation (PLAID) (35). The pathophysiological mechanisms linking PLCG2

structural anomalies and the autoinflammatory phenotype are being uncovered (36) but a direct interaction between caspase-1 and PLCG2 has never been reported before. In our Bioid screen, we also identified cytoplasmic phospholipase A2 (cPLA2), an enzyme that had been previously demonstrated to be a substrate of several caspases, including caspase-1 (37,38). cPLA2 is believed to be involved in the “eicosanoid storm” accompanying the inflammasome activation, a crucial link between the inflammasome and inflammatory lipids (39). As for now, most of the identified caspase-1 substrates have been related to caspase-1-induced cell death. Accumulating evidence suggests that caspase-1 may also play a role in other innate immunity-related pathways. For example, caspase-1 cleaves and dampens cGAS-STING-mediated IFN production (40). Thus, looking at caspase-1 interactors/substrates that are not involved in cell death may reveal additional functions for caspase-1.

Our screen did not identify known caspase-1 substrates, such as IL-1 β , IL-18 or GSDMD. For IL-1 β , this result was expected since we did not use any priming step, which is necessary to induce detectable pro-IL1 β within the cytosol. The BirA* may have preclude conformational changes necessary to caspase-1 interactions with some of its substrates (19). Finally, the cell-free assay process may have removed some proteins because they are bound to cell membrane.

Our screen identified p62 as a caspase-1 interacting-protein and subsequent analyses revealed that p62 was also one of its substrate. While going on with further analysis, we demonstrated that p62 was cleaved by caspase-1 at Asp329. Unexpectedly, this aspartate residue is conserved among species, including human, but is replaced by a glycine residue in *mus musculus*. This difference may suggest different regulatory functions for p62 or an alternative cleavage site in mice.

Mechanistic analyses further revealed that the cleavage of human p62 disrupts its normal interactions with LC3B leading to its loss of cargo function. Selective autophagy plays a key role in inflammasome inactivation (8–11). p62 knock-out cells/mice have increased response to the inflammasome activation, as demonstrated by increased release of IL-1 β (8,27). We sought to determine whether the cleavage of p62 at Asp329 decreased or enhanced its inhibitory role on inflammasome activation. We thus overexpressed N-terminal and C-terminal fragments in cells and observed seemingly antagonist effects of both fragments upon inflammasome activation; while the Nter strongly inhibited IL-1 β release, the Cter increased the cytokine release. Mechanistic analyses demonstrated that only the Nter was able to link full-length p62 and oligomerization of p62 is required for full adaptor function. We hypothesize that increased Nter fragment may enhance p62 oligomerization, culminating in

increased inhibitory effects through autophagic degradation. On the other hand, the Cter, which is unable to link full-length p62 but retains the ability to link LC3B, may act as a dominant-negative fragment, competing on LC3B to decrease p62 inhibition of the inflammasome. Overall, these results suggest that p62-regulatory function may be dependent on the strength of inflammasome/caspase-1 activation and act either as an enhancer (strong activation) or as an inhibitor able to quell the inflammation in case of weak inflammasome activation. (Figure 6).

CONCLUSION

Using the BioID approach, we identified 111 proteins interacting with caspase-1 during inflammasome activation; 75% of them had not been related before to the inflammasome. p62, which has been reported as a negative regulator of the inflammasome, is cleaved by caspase-1. Our results suggest that, according to the strength of the activating stimulus, the cleavage of p62 could either inhibit or increase the inflammasome activation.

EXPERIMENTAL PROCEDURES

Cell lines – iBMDMs from WT or caspase-1^{-/-} mice (a gift from D. M. Monack and P. Broz, Stanford University, Stanford, CA) and human monocytic cell line THP1 were cultured in RPMI (GIBCO) supplemented with 10% (vol/vol) FBS and 1% P/S. THP-1 cells were grown in suspension in 75-cm² flasks. HEK293T cells were grown in DMEM (GIBCO) supplemented with 10% (vol/vol) FBS, 4 mM L-Glutamine, and 1% P/S. All cells were grown at 37 °C with 5% CO₂.

Reconstitution of caspase-1^{-/-} cells and generation of HA-tagged BirA-caspase-1-overexpressing cells* – Lentiviral pINDUCER21 plasmid was obtained from Steve Elledge, Harvard Medical School, Boston (41). A human HA-tagged BirA*-caspase-1 construct was cloned into the pENTR1A dual selection vector (Invitrogen) and then cloned in the pINDUCER21, a GFP tet-inducible lentiviral vector plasmid. Lentiviruses were produced as previously described (42). Caspase-1^{-/-} and WT iBMDMs were infected with HA-tagged BirA*-caspase-1-expressing lentiviruses. GFP-positive cells were FACS-sorted 96 h post-infection. Cells were cultured in complete medium and HA-tagged BirA*-caspase-1 expression was induced using tetracycline (doxycycline, 1 µg/mL) for 24 h.

Inflammasome activation – HA-tagged BirA*-caspase-1-expressing iBMDMs were cultured to a density of about 1.5 x 10⁶ cells/mL in 150-cm² plastic flasks or in 2-liter roller bottles.

Inflammasome activation was induced in a cell-free system as previously described (20). When specified, biotin was added before inflammasome activation at a final concentration of 50 mM.

For experiments using non cell-free inflammasome activation, cells were washed twice with PBS, detached, enumerated, plated onto 12-well plates, and left to adhere overnight. The following day, culture media were changed before stimulation with OPTIMEM (GIBCO) for the Western blot analysis or with complete culture media for the ELISA analysis. Cells were primed with 1 µg/mL for 3h and stimulated with 5 µM of nigericin for 30 min or 50 µg/mL of MSU for 6 h or 1mM of ATP for 60 min. After stimulation supernatants were collected and proteins were precipitated by the methanol/chloroform method. Proteins were then analysed by western-blot after boiling and fractionating on a 15 % SDS-polyacrylamide gel.

Streptavidin pull-down and identification of biotinylated products by mass spectrometry – Protein concentrations in supernatants from cell-free assay were determined using the Bradford protein assay (Bio-Rad) and equalized in sample buffer. Supernatants were then incubated with 30 µl Dynabeads (MyOne Streptavidin C1; Invitrogen) overnight at 4°C. Beads were collected and washed twice for 8 min at RT in 1 ml wash buffer (2% SDS in dH₂O). This was repeated with a wash buffer containing 0.1% deoxycholate, 1% Triton X-100, 500 mM NaCl, 1 mM EDTA, and 50 mM Hepes, then with a wash buffer containing 250 mM LiCl, 0.5% NP-40, 0.5% deoxycholate, 1 mM EDTA, and 10 mM Tris, pH 8.1; and finally with a wash buffer containing 50 mM Tris, pH 7.4, and 50 mM NaCl. 10% of the sample was reserved for Western blot analysis. Bound proteins were removed from the beads with 50 µl of Laemmli SDS-sample buffer at 98°C. Proteins eluted from the streptavidin beads by SDS-sample buffer were reduced and alkylated and separated by 1D SDS-PAGE. Mass spectrometry was performed as previously described (15,43). The resulting .dat files were loaded into SCAFFOLD Q+ (Proteome Software). The acceptance level for proteins was two identified peptides with minimum 95% probability each.

ASC oligomerization assay – After stimulation the supernatant was removed and cells were detached with PBS containing 2 mM EDTA and centrifuged 5 min at 1,500 × g. Cells were lysed on ice in 500 µL of Buffer A (20) by syringing 30 times using a 21-G needle. The cell lysates were centrifuged in 1.5-mL Eppendorf tubes at 1,800 × g for 8 min to remove the bulk nuclei, and 30 µL of the supernatants were kept for Western blot analysis to test ASC expression in the lysates. The remaining supernatant was diluted two times with Buffer A and centrifuged 5 min at 2,000 × g. After centrifugation, supernatant was diluted with 1 vol of CHAPS buffer (20 mM Hepes-KOH, pH 7.5, 5 mM MgCl₂, 0.5 mM EGTA, 0.1 mM PMSF, 0.1% CHAPS) and again centrifuged at 5,000 × g for 8 min to pellet the ASC pyroptosome.

The supernatant was discarded and the pellet was resuspended in 50 μ L of CHAPS buffer with 4 mM of disuccinimidyl suberate (DSS, Thermo Scientific) for 30 min at room temperature (RT). Samples were centrifuged at 5,000 \times g for 8 min, and pellets were resuspended in 30 μ L of 2X loading buffer in nonreducing conditions for Western blot. For cell-free assay, the ASC oligomerization assay was performed as described previously (20).

Immunofluorescence staining and confocal microscopy – For confocal microscopy primary monocytes were sorted from healthy donors blood by sucrose gradient followed by CD14-positive selection (Miltenyi Biotec) and cultured for 6 days in complete RPMI supplemented with human M-CSF (100 ng/mL, from Immunotools). Macrophages were plated the day before the experiment on 15-mm coverslips in 12-well plates. After treatment, the cells were fixed with 2% (vol/vol) paraformaldehyde (Appllichem) for 15 min at room temperature. The cells were then permeabilized with 0.1% Triton X-100 in PBS for 10 min and washed once with PBS. The aspecific sites were blocked with 3% (wt/vol) BSA prepared in PBS for 30 min at RT. Antibodies against human p62 (Abcam) and human caspase-1 (Adipogen) were diluted 1:500 in 1% BSA and incubated on the coverslips overnight at 4°C. The next day the cells were washed five times with PBS, and the fluorescent secondary antibodies [anti-IgG (H+L) Alexa Fluor conjugates, Thermo Scientific] diluted 1:1,000 in 1% BSA were applied for 1 h. The coverslips were washed again with PBS and incubated 5 min with the Hoechst dye diluted in PBS at the final concentration of 4 μ g/mL. The coverslips were mounted on slides using ProLong Gold Antifade (Invitrogen). Images were captured using an inverted confocal microscope LSM 710 META (Zeiss) and processed with Zeiss Axiovision software.

Mutagenesis – Point mutations were performed using the HA-p62 plasmid (#28027, Addgene) to obtain D329A and D347A mutants, using the QuikChangeTM site-directed mutagenesis kit (Agilent Genomics), according to the manufacturer's instructions. The following primers (Microsynth AG) were used: 5'-GAA CAG ATG GAG TCG GCT AAC TGT TCA GGA-3' and 5'-TCC TGA ACA GTT AGC CGA CTC CAT CTG TTC-3' for p62 D329A; 5'-TCT TCA AAA GAA GTG GCC CCG TCT ACA GGT GAA-3' and 5'-TTC ACC TGT AGA CGG GGC CAC TTC TTT TGA AGA-3' for p62 D347A.

Ectopic expression of p62 Nter and Cter fragments in cells – p62 Nter and p62 Cter constructs were obtain from HA-p62 plasmid using the EcoR1 and NotI restriction enzymes (from NEB) and the following primers (Microsynth AG): 5'-AAA GAA TTC ATG GCC ATG TCC TAC GTG-3' and 5'-AAA GCG GCC GCC TAC GAC TCC ATC TGT TC-3' for p62 Nter; 5'-AAA GAA TTC AAC TGT TCA GGA GGA-3' and 5'-AAA GCG GCC GCC TAT CAC AAC GGC GGG-3' for p62 Cter.

p62 Nter and Cter constructs were then cloned into the pENTR1A dual selection vector and then cloned in the pINDUCER21. WT iBMDMs were infected with p62 Nter or Cter expressing lentiviruses. GFP-positive cells were FACS-sorted 96 h post-infection. Cells were cultured in complete medium and p62 fragments expression was induced using doxycycline (1 µg/mL) for 24 h.

HEK 293T transfection and co-immunoprecipitation – HEK 293T cells were plated the day before the experiment and transfected using homemade PEI, and incubated overnight at 37°C. The plasmids used were from Tschopp's group (described in (2,44,45)). Nter and Cter p62 constructs were cloned into a flag tag-expressing plasmid on a PCR3 backbone. HA-p62 plasmid was from Addgene (#28027). For co-transfections, the same amount of vector plasmid was transfected in control cells. Cells (1×10^6) were then washed with PBS, suspended in 200 mL lysis buffer (0.1% NP-40, 20 mM Tris-HCl pH7.8, 150 mM NaCl, 5 mM EDTA) supplemented with complete protease inhibitor (Roche), and incubated on ice for 15 minutes. Cells were then centrifuged at 1300 rpm, 4°C for 5 minutes and supernatant proteins were quantified. The supernatants were either resuspended in Laemmli SDS buffer and analysed by western-blot or incubated with 10 mL of anti-flag or anti-HA agarose (both from Sigma) at 4°C overnight, under agitation. After centrifugation at 6000 rpm for 30', supernatants were discarded and beads were washed five times with lysis buffer. Immunoprecipitated material was eluted in SDS sample buffer for 5 min at 100 °C and separated with SDS/PAGE.

Western blotting – Proteins were denaturated, separated by SDS-PAGE and transferred to nitrocellulose. Membranes were blocked in 2.5% bovine serum albumin in PBS with 0.4% Triton X-100 and incubated in the same buffer with HRP-conjugated secondary antibodies. Band intensities were quantified using ImageJ software, using arbitrary pixel intensity units.

ELISA – Cytokine release was measured in supernatants from stimulated cells. For this purpose, mouse IL-1β and human IL-1β ELISA kits (R&D Systems) were used according to the manufacturer's instructions.

Chemicals and antibodies – LPS, nigericin, ATP, calpain inhibitor and doxycycline were from Sigma. MSU crystals were prepared as previously described (46). z-YVAD-FMK, z-VAD-FMK, and z-IETD-FMK were from Abcam. The anti-mouse caspase-1 p20, anti-mouse and human ASC antibody, anti-human caspase-1, and anti-human tubulin were from Adipogen. Anti-mouse and human LC3B antibody was from Sigma-Aldrich. Anti-mouse and human p62 and anti-HA tag antibody were from Abcam. Anti-flag tag antibody was from GenScript.

REFERENCES

1. Druilhe A, Srinivasula SM, Razmara M, Ahmad M, Alnemri ES. Regulation of IL-1 β generation by Pseudo-ICE and ICEBERG, two dominant negative caspase recruitment domain proteins. *Cell Death Differ*. 2001 Jun;8(6):649–57.
2. Martinon F, Burns K, Tschopp J. The inflammasome: a molecular platform triggering activation of inflammatory caspases and processing of proIL-1 β . *Mol Cell*. 2002 Aug;10(2):417–26.
3. Martinon F, Mayor A, Tschopp J. The inflammasomes: guardians of the body. *Annu Rev Immunol*. 2009;27:229–65.
4. Bergsbaken T, Fink SL, Cookson BT. Pyroptosis: host cell death and inflammation. *Nat Rev Microbiol*. 2009 Feb;7(2):99–109.
5. Shi J, Zhao Y, Wang K, Shi X, Wang Y, Huang H, et al. Cleavage of GSDMD by inflammatory caspases determines pyroptotic cell death. *Nature*. 2015 Oct 29;526(7575):660–5.
6. Kayagaki N, Stowe IB, Lee BL, O'Rourke K, Anderson K, Warming S, et al. Caspase-11 cleaves gasdermin D for non-canonical inflammasome signalling. *Nature*. 2015 Oct 29;526(7575):666–71.
7. Latz E, Xiao TS, Stutz A. Activation and regulation of the inflammasomes. *Nat Rev Immunol*. 2013 Jun;13(6):397–411.
8. Shi C-S, Shenderov K, Huang N-N, Kabat J, Abu-Asab M, Fitzgerald KA, et al. Activation of autophagy by inflammatory signals limits IL-1 β production by targeting ubiquitinated inflammasomes for destruction. *Nat Immunol*. 2012 Mar;13(3):255–63.
9. Liu T, Tang Q, Liu K, Xie W, Liu X, Wang H, et al. TRIM11 Suppresses AIM2 Inflammasome by Degrading AIM2 via p62-Dependent Selective Autophagy. *Cell Rep*. 2016 Aug 16;16(7):1988–2002.
10. Saitoh T, Akira S. Regulation of inflammasomes by autophagy. *J Allergy Clin Immunol*. 2016 Jul;138(1):28–36.
11. Harris J, Lang T, Thomas JPW, Sukkar MB, Nabar NR, Kehrl JH. Autophagy and inflammasomes. *Mol Immunol*. 2017 Feb 26;
12. Nakahira K, Haspel JA, Rathinam VAK, Lee S-J, Dolinay T, Lam HC, et al. Autophagy proteins regulate innate immune responses by inhibiting the release of mitochondrial DNA mediated by the NALP3 inflammasome. *Nat Immunol*. 2011 Mar;12(3):222–30.
13. Lupfer C, Thomas PG, Anand PK, Vogel P, Milasta S, Martinez J, et al. Receptor interacting protein kinase 2-mediated mitophagy regulates inflammasome activation during virus infection. *Nat Immunol*. 2013 May;14(5):480–8.
14. Zhong Z, Umemura A, Sanchez-Lopez E, Liang S, Shalpour S, Wong J, et al. NF- κ B Restricts Inflammasome Activation via Elimination of Damaged Mitochondria. *Cell*. 2016 Feb 25;164(5):896–910.
15. Roux KJ, Kim DI, Raida M, Burke B. A promiscuous biotin ligase fusion protein identifies proximal and interacting proteins in mammalian cells. *J Cell Biol*. 2012 Mar 19;196(6):801–10.
16. Cronan JE. Targeted and proximity-dependent promiscuous protein biotinylation by a mutant *Escherichia coli* biotin protein ligase. *J Nutr Biochem*. 2005 Jul;16(7):416–8.
17. Kwon K, Beckett D. Function of a conserved sequence motif in biotin holoenzyme synthetases. *Protein Sci Publ Protein Soc*. 2000 Aug;9(8):1530–9.
18. Chapman-Smith A, Cronan JE. Molecular biology of biotin attachment to proteins. *J Nutr*. 1999 Feb;129(2S Suppl):477S–484S.
19. Walsh JG, Logue SE, Lüthi AU, Martin SJ. Caspase-1 promiscuity is counterbalanced by rapid inactivation of processed enzyme. *J Biol Chem*. 2011 Sep 16;286(37):32513–24.
20. Jamilloux Y, Martinon F. Cell-Free Assay for Inflammasome Activation. *Methods Mol Biol Clifton NJ*. 2016;1417:207–15.
21. Johansen T, Lamark T. Selective autophagy mediated by autophagic adapter proteins. *Autophagy*. 2011 Mar;7(3):279–96.
22. Katsuragi Y, Ichimura Y, Komatsu M. p62/SQSTM1 functions as a signaling hub and an autophagy adaptor. *FEBS J*. 2015 Dec;282(24):4672–8.
23. Shi J, Wong J, Piesik P, Fung G, Zhang J, Jagdeo J, et al. Cleavage of sequestosome 1/p62 by an enteroviral protease results in disrupted selective autophagy and impaired NF κ B signaling. *Autophagy*. 2013 Oct;9(10):1591–603.
24. Norman JM, Cohen GM, Bampton ETW. The in vitro cleavage of the hAtg proteins by cell death proteases. *Autophagy*. 2010 Nov;6(8):1042–56.
25. Fernandes-Alnemri T, Yu J-W, Datta P, Wu J, Alnemri ES. AIM2 activates the inflammasome and cell death in response to cytoplasmic DNA. *Nature*. 2009 Mar 26;458(7237):509–13.
26. Harris J, Hartman M, Roche C, Zeng SG, O'Shea A, Sharp FA, et al. Autophagy controls IL-1 β secretion by targeting pro-IL-1 β for degradation. *J Biol Chem*. 2011 Mar 18;286(11):9587–97.
27. Ohtsuka S, Ishii Y, Matsuyama M, Ano S, Morishima Y, Yanagawa T, et al. SQSTM1/p62/A170 regulates the severity of *Legionella pneumophila* pneumonia by modulating inflammasome activity. *Eur J Immunol*. 2014 Apr;44(4):1084–92.
28. Shi J, Fung G, Piesik P, Zhang J, Luo H. Dominant-negative function of the C-terminal fragments of NBR1 and SQSTM1 generated during enteroviral infection. *Cell Death Differ*. 2014 Sep;21(9):1432–41.
29. Wurzer B, Zaffagnini G, Fracchiolla D, Turco E, Abert C, Romanov J, et al. Oligomerization of p62 allows for selection of ubiquitinated cargo and isolation membrane during selective autophagy. *eLife*. 2015 Sep 28;4:e08941.

30. Shao W, Yeretsian G, Doiron K, Hussain SN, Saleh M. The caspase-1 digestome identifies the glycolysis pathway as a target during infection and septic shock. *J Biol Chem*. 2007 Dec 14;282(50):36321–9.
31. Wang L-J, Hsu C-W, Chen C-C, Liang Y, Chen L-C, Ojcius DM, et al. Interactome-wide analysis identifies end-binding protein 1 as a crucial component for the speck-like particle formation of activated absence in melanoma 2 (AIM2) inflammasomes. *Mol Cell Proteomics MCP*. 2012 Nov;11(11):1230–44.
32. Lamkanfi M, Kanneganti T-D, Van Damme P, Vanden Berghe T, Vanoverberghe I, Vandekerckhove J, et al. Targeted peptidecentric proteomics reveals caspase-7 as a substrate of the caspase-1 inflammasomes. *Mol Cell Proteomics MCP*. 2008 Dec;7(12):2350–63.
33. Agard NJ, Maltby D, Wells JA. Inflammatory stimuli regulate caspase substrate profiles. *Mol Cell Proteomics MCP*. 2010 May;9(5):880–93.
34. Keller M, Rüegg A, Werner S, Beer H-D. Active caspase-1 is a regulator of unconventional protein secretion. *Cell*. 2008 Mar 7;132(5):818–31.
35. Zhou Q, Lee G-S, Brady J, Datta S, Katan M, Sheikh A, et al. A hypermorphic missense mutation in PLCG2, encoding phospholipase C γ 2, causes a dominantly inherited autoinflammatory disease with immunodeficiency. *Am J Hum Genet*. 2012 Oct 5;91(4):713–20.
36. Chae JJ, Park YH, Park C, Hwang I-Y, Hoffmann P, Kehrl JH, et al. Connecting two pathways through Ca²⁺ signaling: NLRP3 inflammasome activation induced by a hypermorphic PLCG2 mutation. *Arthritis Rheumatol Hoboken NJ*. 2015 Feb;67(2):563–7.
37. Lüschen S, Ussat S, Krönke M, Adam-Klages S. Cleavage of human cytosolic phospholipase A2 by caspase-1 (ICE) and caspase-8 (FLICE). *Biochem Biophys Res Commun*. 1998 Dec 9;253(1):92–8.
38. Andrei C, Margiocco P, Poggi A, Lotti LV, Torrisi MR, Rubartelli A. Phospholipases C and A2 control lysosome-mediated IL-1 beta secretion: Implications for inflammatory processes. *Proc Natl Acad Sci U S A*. 2004 Jun 29;101(26):9745–50.
39. Dennis EA, Norris PC. Eicosanoid storm in infection and inflammation. *Nat Rev Immunol*. 2015 Aug;15(8):511–23.
40. Wang Y, Ning X, Gao P, Wu S, Sha M, Lv M, et al. Inflammasome Activation Triggers Caspase-1-Mediated Cleavage of cGAS to Regulate Responses to DNA Virus Infection. *Immunity*. 2017 Mar 8;
41. Meerbrey KL, Hu G, Kessler JD, Roarty K, Li MZ, Fang JE, et al. The pINDUCER lentiviral toolkit for inducible RNA interference in vitro and in vivo. *Proc Natl Acad Sci U S A*. 2011 Mar 1;108(9):3665–70.
42. Bagnis C, Bailly P, Chapel-Fernandes S. Using an EGFPmeter to evaluate the lentiviral vector production: tricks and traps. *Methods Mol Biol Clifton NJ*. 2009;515:151–63.
43. Di Micco A, Frera G, Lugin J, Jamilloux Y, Hsu E-T, Tardivel A, et al. AIM2 inflammasome is activated by pharmacological disruption of nuclear envelope integrity. *Proc Natl Acad Sci U S A*. 2016 Aug 9;113(32):E4671–4680.
44. Thome M, Hofmann K, Burns K, Martinon F, Bodmer JL, Mattmann C, et al. Identification of CARDIAK, a RIP-like kinase that associates with caspase-1. *Curr Biol CB*. 1998 Jul 16;8(15):885–8.
45. Thome M, Gaide O, Micheau O, Martinon F, Bonnet D, Gonzalez M, et al. Equine herpesvirus protein E10 induces membrane recruitment and phosphorylation of its cellular homologue, bcl-10. *J Cell Biol*. 2001 Mar 5;152(5):1115–22.
46. Martinon F, Pétrilli V, Mayor A, Tardivel A, Tschopp J. Gout-associated uric acid crystals activate the NALP3 inflammasome. *Nature*. 2006 Mar 9;440(7081):237–41.

TABLE LEGENDS

Table 1: Selected caspase-1-interacting proteins identified by the BioID assay upon inflammasome activation.

FIGURE LEGENDS

Fig. 1: Generation of HA-tagged BirA^{*}-caspase-1-overexpressing macrophages.

(A) Scheme showing caspase-1 wild-type (casp-1 WT) and the engineered Q281H-mutated caspase-1 fused to a human HA-tagged R118G BirA^{*} (casp-1^{*}-BirA). **(B)** Immortalized bone marrow-derived macrophages from caspase-1^{-/-} mice were reconstituted with a doxycycline-inducible casp-1^{*}-BirA (iCasp-1^{*}-BirA). Reconstituted cells (KO- iCasp-1^{*}-BirA) and their wild-type (WT) or caspase-1^{-/-} (KO) controls were plated in presence or absence of doxycycline (dox: 1 μ g/mL) and incubated for 24 h. Cells were harvested, centrifuged and

resuspended in a hypotonic, low potassium buffer at 4°C. Cells were mechanically lysed and bulk nuclei and plasma membrane were removed. The cell-free soup was then incubated at 37°C for 6h (T6) or not (T0). **(B)** Proteins were analysed by western-blot after boiling and fractionating on a 10% SDS-polyacrylamide gel. **(C)** ASC oligomerization was analysed after cross-linking or not with disuccinimidyl suberate (DSS) and western-blotted in nonreducing conditions. **(D)** ASC oligomerization was also verified in cells, previously plated in presence of doxycyclin, upon activation of the inflammasome by LPS (1mg/L, 3h) + nigericin (5µM, 45 min). ASC pyroptosomes were crosslinked or not with DSS, and analysed by western-blot in nonreducing conditions.

Fig. 2: Identification of caspase-1-interacting proteins during inflammasome activation in a cell-free assay. **(A)** Scheme presenting the BioID approach adapted to the cell-free assay for inflammasome activation. **(B)** Reconstituted cells (KO- iCasp-1*-BirA) and their wild-type (WT) or caspase-1^{-/-} (KO) controls were plated in presence or absence of doxycycline (dox: 1 µg/mL) and incubated for 24 h. Cells were harvested, centrifuged and resuspended in a hypotonic, low potassium buffer at 4°C. Cells were mechanically lysed and bulk nuclei and plasma membrane were removed. The cell-free soup was then incubated at 37°C for 6h (T6) or not (T0). Supernatants were then incubated with streptavidin-coated beads overnight at 4°C. Beads were collected and rigorously washed. Streptavidin-bound proteins were then analysed by western-blot after boiling and fractionating on a 15% SDS-polyacrylamide gel. ASC pull-down was selected as the read-out for successful procedure before mass spectrometry analysis. **(C)** Sorting process of the proteins identified by the caspase-1 BioID assay and the Gene Ontology enrichment according to the biological process (PANTHER Classification System).

Fig. 3: p62 interacts with caspase-1 upon inflammasome activation. **(A)** HEK 293T cells were transfected with flag-tagged caspase-1 and HA-tagged p62 and incubated overnight. Cells were detached, lysed and centrifuged. Supernatants were then incubated for 3 hours at 4°C with anti-flag or anti-HA agarose. Beads were collected and rigorously washed. Bound proteins were then analysed by western-blot after boiling and fractionating on a 10% SDS-polyacrylamide gel. **(B)** Primary human monocytes were obtained from whole blood of healthy donors and incubated for 6 days with M-CSF. Macrophages were plated the day before the experiment on coverslips in 12-well plates and treated as indicated. Cells were fixed, permeabilized, incubated with the indicated antibodies and images were captured using an inverted confocal microscope.

Fig. 4: Caspase-1 cleaves p62 at Aspartate 329. **(A)** THP-1 cells were assayed using the cell-free system. The inflammasome was activated by incubating the cell-free soup at 37°C during 1h or 2h in presence or absence of pancaspase inhibitor (z-VAD) or caspase-1 inhibitor (z-YVAD). Caspase-1 (casp-1) and p62 were then analysed by western-blot after boiling and fractionating on a 10 % SDS-polyacrylamide gel. Casp-1 p20 is the cleavage fragment, observed when caspase-1 is activated. **(B)** Primary human monocytes, obtained from whole blood of healthy donors were incubated in the presence or absence of inflammasome activators (LPS, nigericin) along with/without caspase-8 inhibitor (z-IETD), calpain inhibitor, and caspase-1 inhibitor (z-YVAD). Cells were then washed, lysed and p62 was analysed by western-blot after boiling and fractionating on a 10 % SDS-polyacrylamide gel. Ratios of cleaved/uncleaved p62 were calculated using ImageJ. **(C)** HEK 293T cells were co-transfected with p62 and various caspases (casp-1 to 9) plasmids and incubated overnight. Cells were then washed, lysed, and p62 and IL-1b were analysed by western-blot

after boiling and fractionating on a 10 % SDS-polyacrylamide gel. **(D)** HEK 293T cells were co-transfected with caspase-1 and WT or mutated p62 plasmids, containing point mutations at indicated amino acids, and incubated overnight. Cells were then washed, lysed, and p62 and caspase-1 (casp-1) were analysed by western-blot. **(E)** HEK 293T cells were co-transfected with flag-tagged caspase-1 and WT or mutated p62 plasmids. Cells were then washed, lysed and incubated with anti-flag agarose during 3h at 4°C. Beads were then rigorously washed and bound proteins were analysed by western-blot.

Fig. 5: Caspase-1 cleavage disrupts p62 interaction with LC3B and modulates IL-1b secretion. **(A)** Representation of p62 structure: the PB1 (Phox and Bem1) N-terminal domain allows p62 oligomerization and/or interactions with other autophagy adaptors; the LC3B-interacting domain (LIR) allows the interaction with LC3B-coated compartment (autophagosome); and the ubiquitin-binding domain (UBA) binds ubiquitinated proteins. ZZ is ZZ-type zinc finger domain, TBS is a TRAF6-binding domain and KIR is a KEAP1-interacting region. **(B)** HEK 293T cells were cotransfected with HA-tagged wild-type p62 (WT-HA) or its uncleavable mutant (D329A-HA) along with the flag-tagged p62 Nter (N-flag) or Cter (C-flag) plasmids and incubated overnight. Cells were then washed, lysed and incubated with anti-HA agarose during 3h at 4°C. Beads were then rigorously washed and bound proteins were analysed by western-blot. **(C)** HEK 293T cells were cotransfected with HA-tagged caspase-1 (casp1-HA) and flag-tagged p62 Nter or Cter plasmids and incubated overnight. Cells were then washed, lysed and incubated with anti-flag agarose during 3h at 4°C. Beads were then rigorously washed and bound proteins were analysed by western-blot. **(D)** Scheme presenting the interactions between p62 fragments and p62 full-length, caspase-1 and LC3B. **(E)** Wild-type iBMDMs were transduced with pINDUCER21 tet-inducible lentiviral vector containing human p62 Nter or Cter fragments. Cells were incubated with doxycycline for 24h (1 µg/mL) to induce ectopic expression of p62 fragments. The inflammasome was then activated by addition of priming signal (LPS, 1mg/L during 3 hours) followed by either nigericin (5µM, 45 min), MSU (50 µg/mL, 6h) or ATP (1 mM, 60 min). The supernatants were collected and IL-1β concentrations were measured by ELISA. *p<0.05

Fig. 6: A proposed model for p62-regulation of the inflammasome.

In case where the inflammasome is weakly activated, the caspase-1 cleavage of a minor fraction of p62 and the subsequent release of the Nter fragment (1) may favour full-length p62 self-oligomerization (2), interaction with LC3B-coated compartment (3) and engulfment of the inflammasome into the autophagosome (4), allowing quelling the inflammation.

On the other hand, when the inflammasome is strongly activated, caspase-1 cleavage may alter p62 function and give rise to a dominant-negative Cter fragment (5), which competes on LC3B binding (6) to inhibit autophagic degradation of the inflammasome (7), resulting in inflammatory cell death.

Figure 1

A

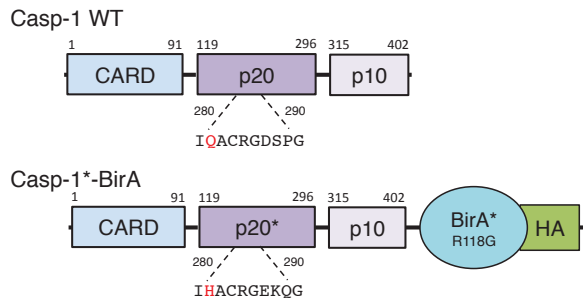

B

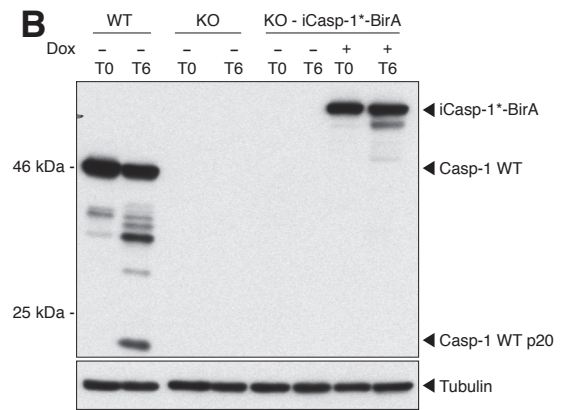

C

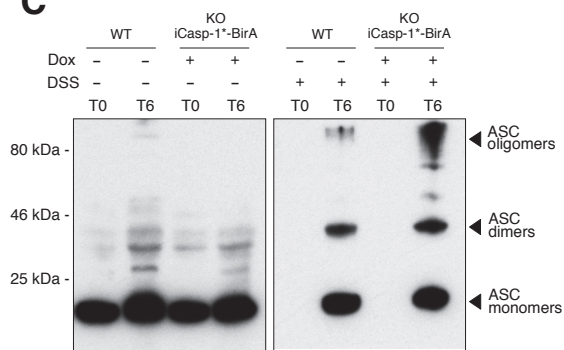

D

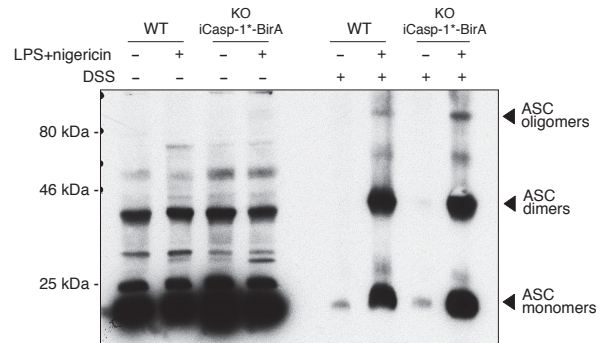
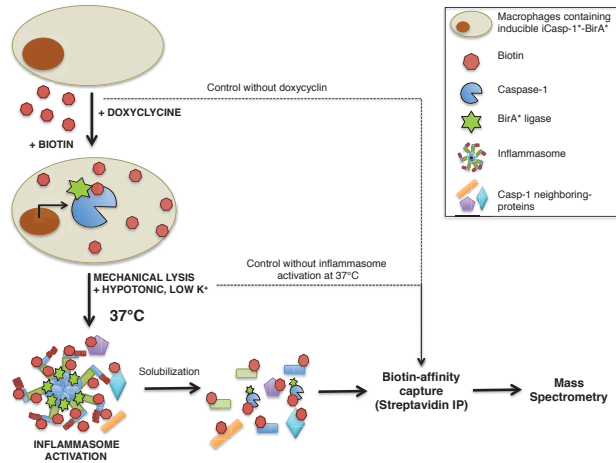
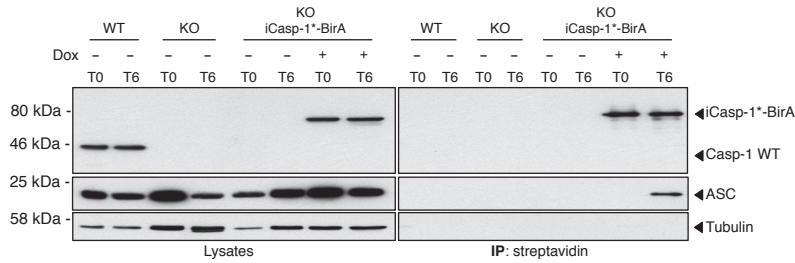

Figure 2

A



B



C

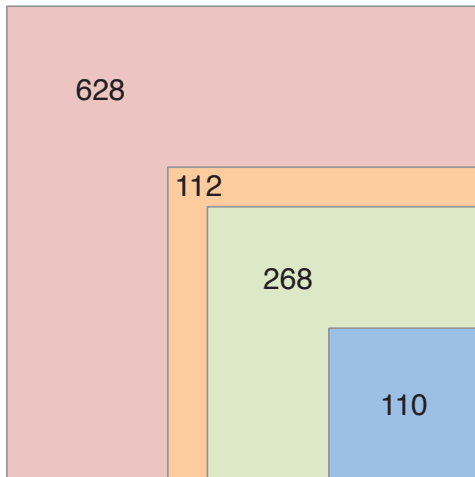

- proteins after Crapome sorting
- proteins with enrichment factor ≥ 2
- proteins not present in the background
- proteins identified in the BioID

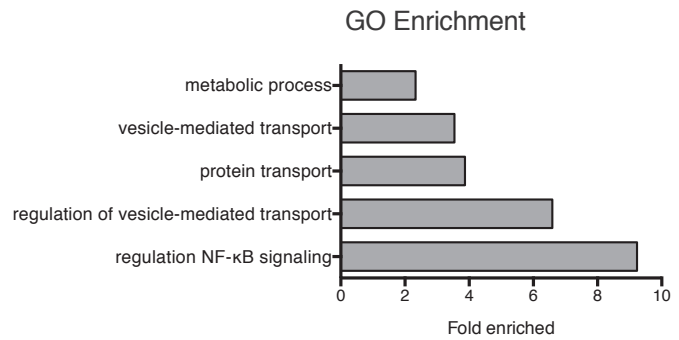
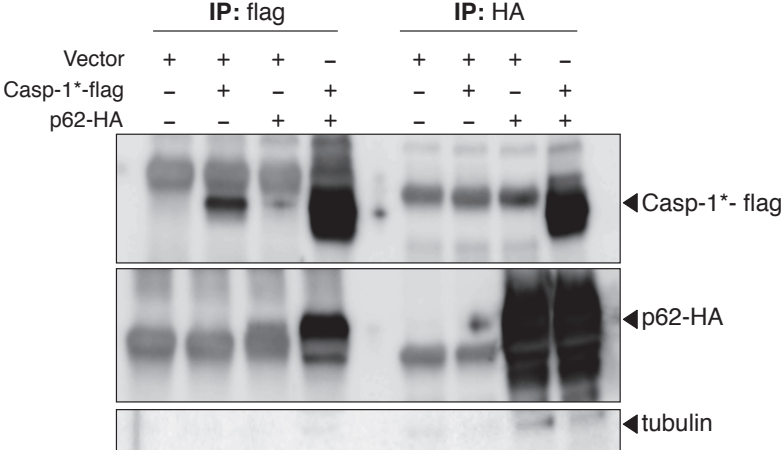

Figure 3

A



B

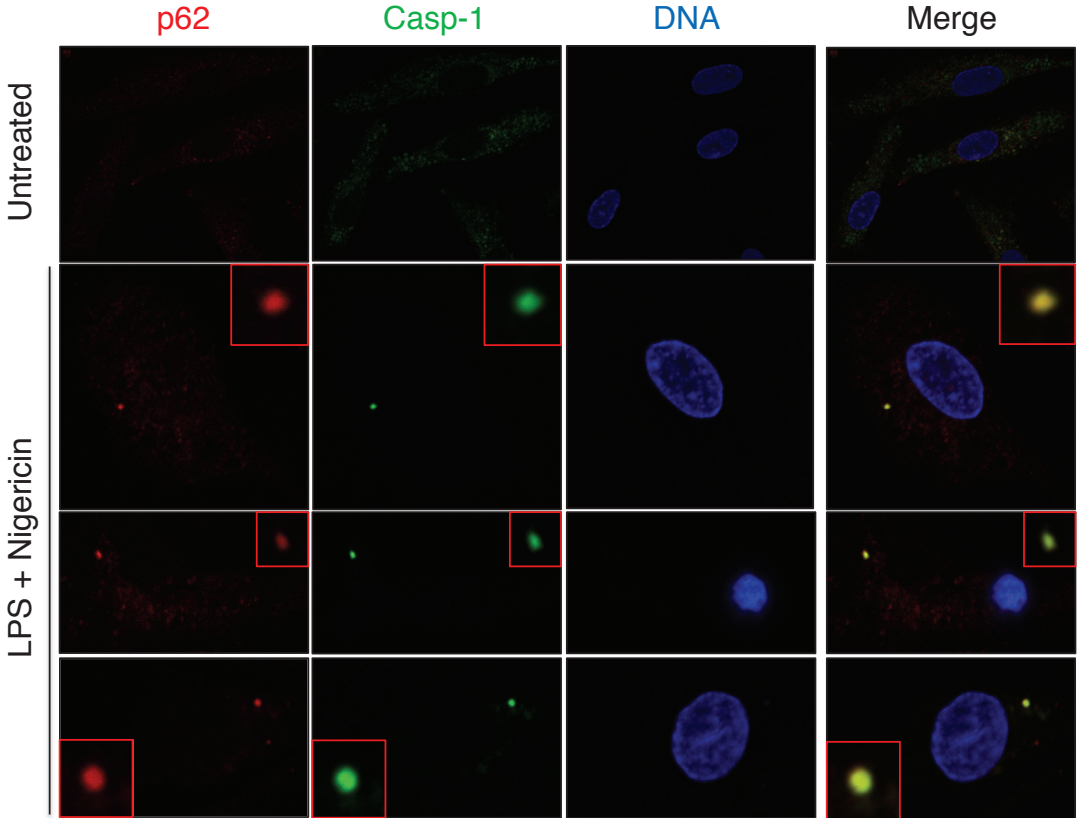

Figure 4

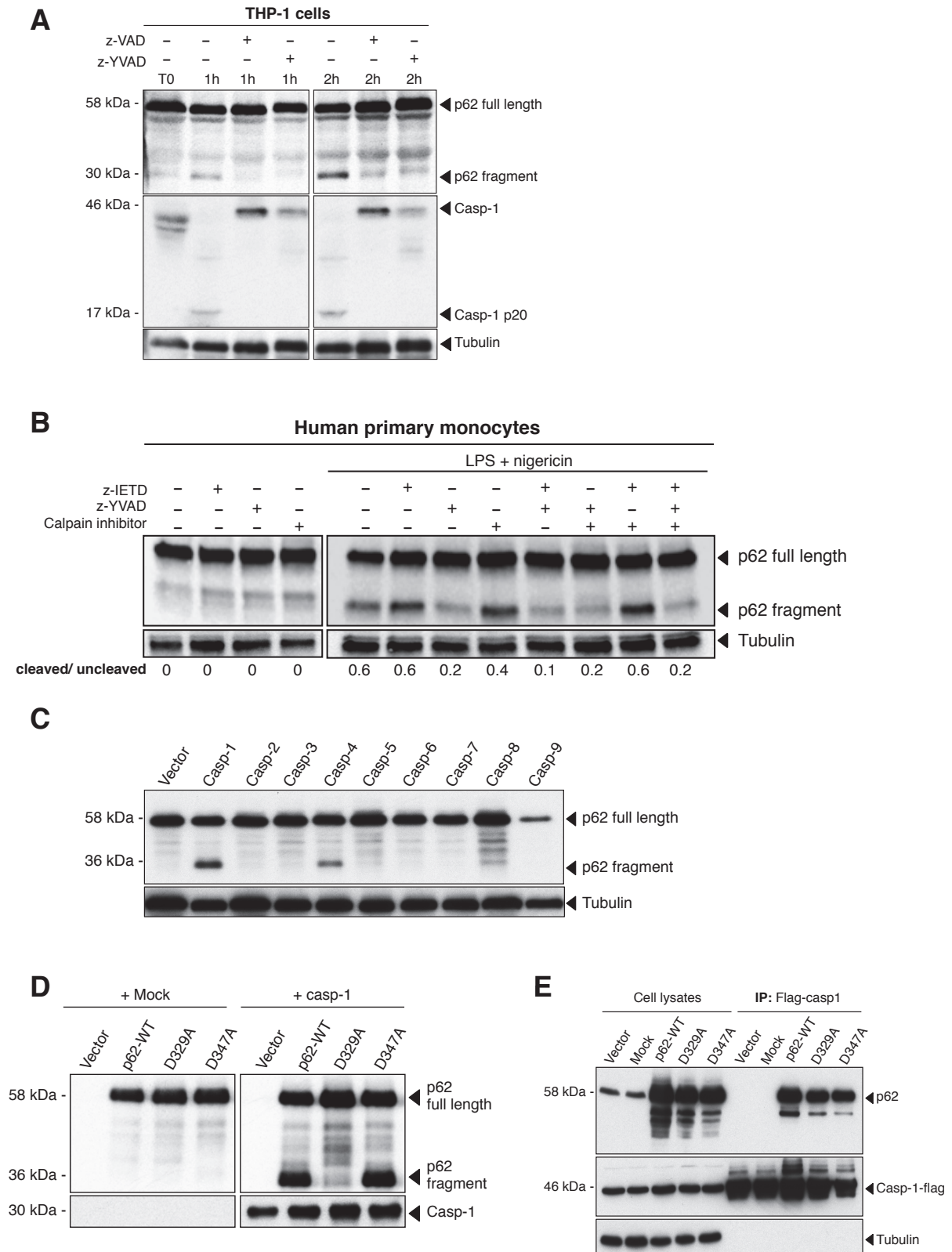

Figure 5

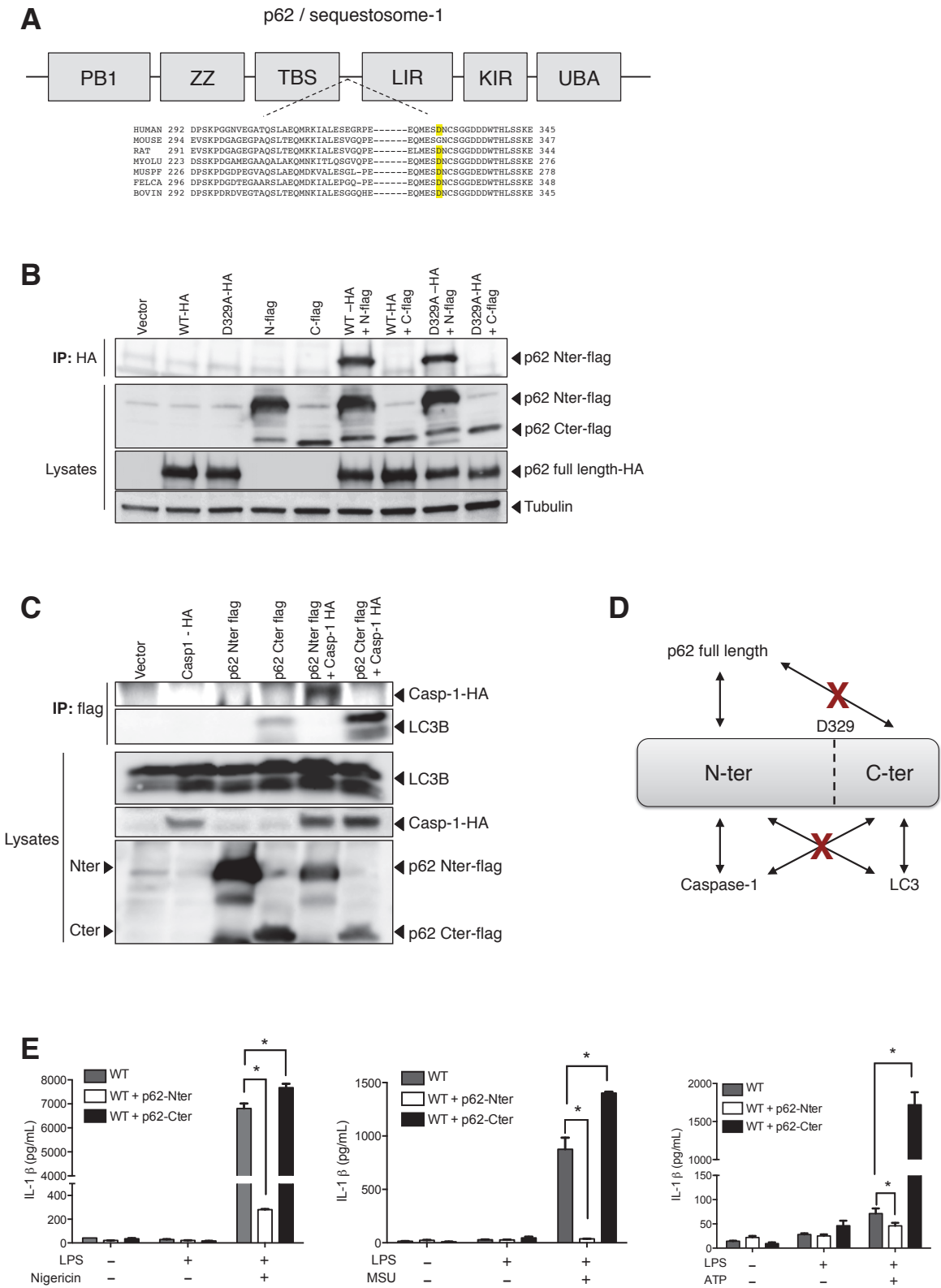
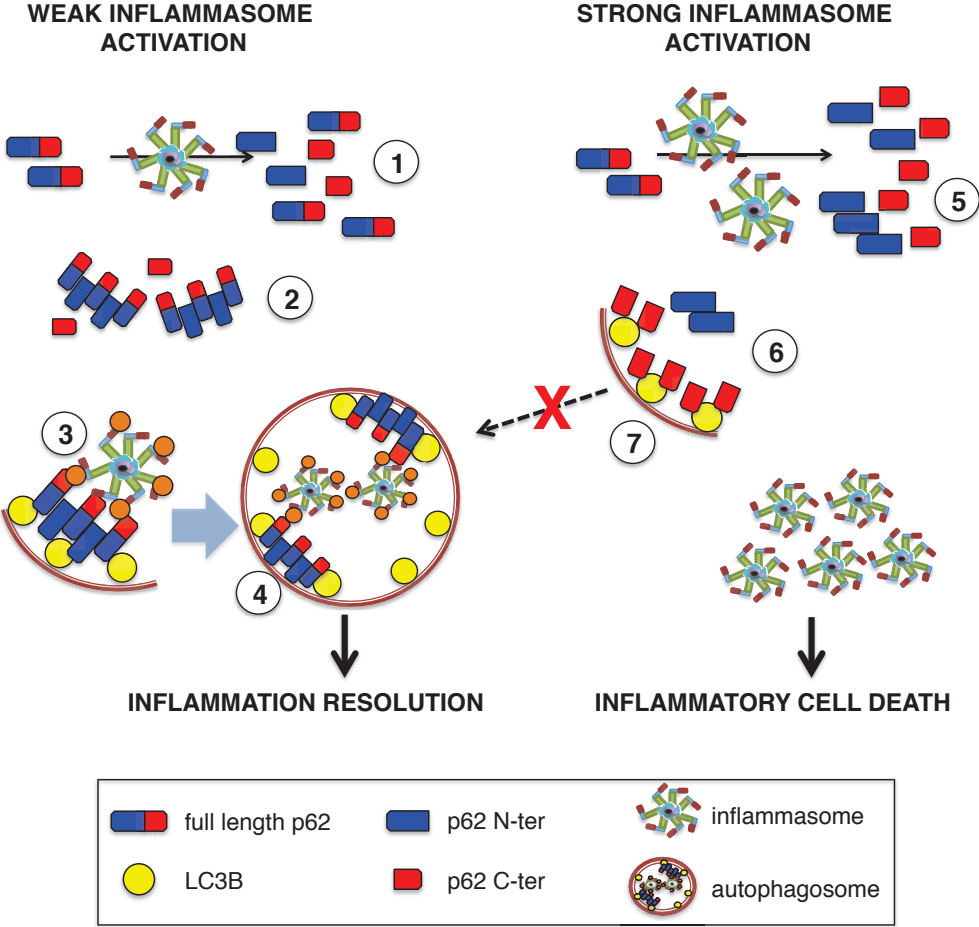

Figure 6



8

Axe 2 :

*Familial Mediterranean fever mutations
are hypermorphic mutations that
specifically decrease the activation
threshold of the Pyrin inflammasome*

Yvan Jamilloux^{1,2}; Lucie Lefeuvre^{1,3}; Amandine Martin¹; Flora Magnotti^{1,4,5}; Omran Allatif^{1,6}; Mathilde Penel-Page⁷; Véronique Hentgen⁸; Pascal Sève²; Mathieu Gerfaud-Valentin², Agnès Duquesne⁷; Marine Desjonquères⁷; Audrey Laurent⁷; Vanessa Rémy-Piccolo⁹; Rolando Cimaz⁴; Luca Cantarini⁵, Emilie Bourdonnay¹; Thierry Walzer¹; Bénédicte F. Py¹; Alexandre Belot^{1,7}; Thomas Henry¹

¹ Centre International de Recherche en Infectiologie, Inserm U1111, CNRS, UMR5308, Lyon

² Department of Internal Medicine, University Hospital Croix-Rousse, Lyon

³ Department of General Medicine, Hospices Civils de Lyon, Lyon

⁴ Pediatric Rheumatology Unit, University of Firenze, Firenze, Italy

⁵ Research Center of Systemic AIDs and Behcet's Disease Clinic, Siena, Italy

⁶ Bioinformatics and Biostatistics Service (BIBS)

⁷ Department of Paediatric Rheumatology, Hôpital Femme-Mère Enfant, Bron

⁸ French Reference Centre for Autoinflammatory Diseases (CEREMAI), Versailles

⁹ Department of Paediatric Rheumatology, Hôpital Nord Ouest, Villefranche sur Saône

Soumis pour publication

Rheumatology (Oxford)

ABSTRACT

Objectives: Familial Mediterranean fever (FMF) is the most frequent autoinflammatory disease and is associated in most patients with bi-allelic *MEFV* mutations. *MEFV* encodes Pylrin, an inflammasome sensor activated following RhoGTPase inhibition. The functional consequences of *MEFV* mutations on the ability of Pylrin variants to act as inflammasome sensors are largely unknown. Here, we assessed whether *MEFV* mutations affect the ability of Pylrin to detect RhoGTPase inhibition and other inflammasome stimuli.

Methods: IL-1 β and IL-18 released by monocytes from healthy donors (HD) and FMF patients were measured upon specific engagement of the Pylrin, NLRP3 and NLRC4 inflammasomes. Cell death kinetics following Pylrin activation was monitored in real time.

Results: Monocytes from FMF patients secreted significantly more IL-1 β and IL-18 and die significantly faster than HD monocytes in response to low concentrations of *Clostridium difficile* toxin B (TcdB), a Pylrin-activating stimulus. Monocytes from patients bearing two *MEFV* exon 10 mutations displayed an increased Pylrin inflammasome response compared to monocytes from patients with a single exon 10 mutation indicating a gene-dosage effect. Using a short priming step, the response of monocytes from FMF patients to NLRP3- and NLRC4-activating stimuli was normal indicating that *MEFV* mutations trigger a specific hypersensitivity of monocytes to low doses of a Pylrin-engaging stimulus.

Conclusions: Contrary to the *NLRP3* mutations described in CAPS, FMF-associated *MEFV* mutations do not lead to a constitutive activation of Pylrin. Rather, FMF-associated mutations are hypermorphic mutations that specifically decrease the activation threshold of the Pylrin inflammasome without affecting other canonical inflammasomes.

INTRODUCTION

Familial Mediterranean fever (FMF) is the most common hereditary autoinflammatory disorder. It is characterized by recurrent episodes of fever, polyserositis and abdominal pain [1]. The main long-term complication of FMF is renal amyloidosis [2]. Treatment with colchicine prevents disease flares and amyloidosis. FMF is most often inherited in a recessive manner [3,4]. Accordingly, the majority of FMF patients hold bi-allelic mutations in *MEFV*, a gene encoding Pyrin, an inflammasome sensor. While numerous *MEFV* sequence variants have been reported (314 in the Infevers registry [5]), the impact of these mutations on Pyrin functions remains unknown. The sequence variants in exon 10, which include the most prevalent mutation p.M694V, have been demonstrated in genotype-phenotype correlation studies as the most pathogenic variants [6,7]. Yet, a number of FMF patients display a single mutated *MEFV* allele [8] highlighting the complexity of the disease and the need for a better understanding of the underlying mechanisms.

Pyrim is an inflammasome sensor that detects an imbalance in RhoGTPases activity, such as the one caused by bacterial effectors or bacterial toxins [9–11]. The toxin B from *Clostridium difficile* (TcdB) is a paradigm of such Pyrim-activating virulence factors [9]. TcdB is a glycosylating enzyme that inactivates the RhoA GTPase, which results in activation of the Pyrim inflammasome [9]. Inflammasomes are immune platforms leading to caspase-1 activation, release of the proinflammatory cytokines IL-1 β and IL-18 and to an inflammatory cell death termed pyroptosis [12]. Different sensors define the specificity of the inflammasomes. Furthermore, while the canonical inflammasomes rely on caspase-1 as their sole enzymatic effector, alternative and non-canonical inflammasomes implicating caspases-4/5 and 8 have been described [13,14]. The inflammasomes are key immune complexes to resist to microbial infections [15]. Yet, mutations in inflammasome sensor-encoding genes are responsible for several hereditary autoinflammatory syndromes. *NLRP3* mutations cause the autosomal-dominant CAPS [16]. Gain-of-function mutations in *NLRP4* trigger severe inflammation and Macrophage Activation Syndromes (NLRP4-MAS) [17]. Similarly, a specific gain-of-function mutation in *MEFV* (S242R) causes Pyrim-Associated Autoinflammation with Neutrophilic Dermatitis (PAAND), an entity distinct from FMF [18].

How *MEFV* mutations in FMF patients alter the activity of inflammasomes is still unresolved. At odds with the recessive inheritance, functional data obtained in mouse models lacking *MEFV* or expressing various human *MEFV* variants indicate that FMF mutations are gain-of-function mutations [19]. Accordingly, Omenetti *et al.* demonstrated that monocytes from FMF patients release more IL-1 β than monocytes from healthy donors (HD) upon long-term

exposure (18h) to lipopolysaccharide (LPS) [20]. A controversy exists as to whether the FMF phenotype is NLRP3-independent (as demonstrated in mouse models of FMF [20]) or -dependent as demonstrated using primary human monocytes [19]. Furthermore, the specific impact of *MEFV* mutations on the Pyrin inflammasome response remains largely unexplored although a very recent paper suggested that the Pyrin inflammasomes of FMF patients and HD were equally able to detect bacterial toxin-mediated RhoGTPase modifications [21].

Here, using a matrix of inflammasome stimuli and several inflammasome readouts, we demonstrate that, using a short priming step, monocytes from FMF patients respond stronger and faster to low doses of TcdB than monocytes from HD. This result indicates that *MEFV* mutations are hypermorphic mutations i.e. that the encoded Pyrin variants do not gain a novel stimulus-independent function but have an increased ability to sense toxin-mediated RhoGTPase inhibition. Furthermore, we demonstrate that the number of exon 10 mutations impacts the strength of the Pyrin inflammasome response demonstrating a gene-dosage effect, which correlates with the previously described gene-dosage effect on the severity of the FMF clinical symptoms [22]. The higher reactivity of the Pyrin inflammasome toward its specific stimulus in FMF patients compared to HD is likely to contribute to the inflammatory flares.

METHODS

Subjects

Forty-two patients with FMF were included along with 3 CAPS and 26 HD (table S1). All FMF patients fulfilled the Tel Hashomer criteria for FMF and had at least one mutation in the *MEFV* gene. The potential carriage of *MEFV* mutation in HD was not assessed. Disease activity was evaluated at the time of sampling by assessing clinical manifestations and laboratory tests, including monocyte count, dosages of C-reactive protein (CRP) and serum amyloid A (SAA) (supplementary Table 1). Blood samples from HD were drawn on the same day as patients.

Ethic statement

The study was approved by the French *Comité de Protection des Personnes* (CPP, #L16-189) and by the French *Comité Consultatif sur le Traitement de l'Information en matière de Recherche dans le domaine de la Santé* (CCTIRS, #16.864). The authors observed a strict accordance to the Helsinki Declaration guidelines and informed consent have been obtained

from every patient. HD blood was provided by the *Etablissement Français du Sang* in the framework of the convention #14-1820.

Monocyte isolation

Blood was drawn in heparin-coated tubes and kept at room temperature overnight. The next day, peripheral blood mononuclear cells (PBMCs) were isolated by density-gradient centrifugation using Lymphocyte Separation Medium (Eurobio). Monocytes were isolated from PBMCs by magnetic selection using CD14 MicroBeads (Miltenyi Biotec) and the AutoMACS Pro Separator (Miltenyi Biotec) following manufacturer's instructions. Monocytes were enumerated in the presence of a viability marker (propidium iodide, 10 µg/ml) by flow cytometry (BD Accuri C6 Flow Cytometer®).

Inflammasome activation

Monocytes were seeded in 96-well plates (unless otherwise indicated at 5×10^3 cells/well) in RPMI 1640, GlutaMAX medium (Thermofisher) supplemented with 10% fetal calf serum (Lonza). Monocytes were incubated for 3 hours in the presence or absence of a priming signal consisting of LPS (10 ng/ml, Invivogen) or muramyl dipeptide (MDP; 100 ng/mL, Invivogen). Unless otherwise indicated, cells were then treated for 1h30 with inflammasome activators namely: i) for NLRP3 inflammasome: nigericin (5 µM, Invivogen) and ATP (2,5 mM, Sigma); ii) for NLRC4 inflammasome: lethal factor N-terminal (LFn) of *Bacillus anthracis* fused to the PrgI protein of the type III secretion system of *Salmonella enterica* serovar *Typhimurium* (LFn-PrgI ; 50 ng/mL [23], produced at the IBCP, Lyon ; the corresponding plasmid was a kind gift from Professor Feng Shao) associated with the protective antigen of *B. anthracis* (PA ; 50 ng/mL, Calbiochem); iii) for Pyrin inflammasome: TcdB (125 or 12.5 ng/mL, Abcam). Following the incubation, cells were centrifuged and supernatants were collected.

Cytokine detection and cell death assay

Levels of IL-1β in monocyte supernatants were quantified by ELISA (R&D Systems). IL-18 ELISA was performed using anti-human IL-18 antibody (4 µg/ml; #D044-3, MBL) and anti-human IL-18 antibody coupled to biotin (20 ng/ml, #D045-6, MBL), respectively as capture and detection antibodies.

Cell death was monitored by incubating monocytes with propidium iodide (PI, Sigma) at 5 µg/ml. Real time PI incorporation was measured every 5 minutes over 90 minutes on a fluorimeter (Tecan) using the following wavelengths: excitation 535 nm (bandwidth 15 nm); emission 635 nm (bandwidth 15 nm).

Statistical analysis

Statistical analysis was performed using R software (The R Foundation). Linear mixed-effects models pairing data from patients and HD by date were used. P-values were adjusted using the Benjamini-Hochberg procedure. Patients with various genotypes were compared using unpaired Mann-Whitney test. Figures were mounted using GraphPad Prism version 6.00 (GraphPad Software, La Jolla California USA, www.graphpad.com)

RESULTS

Development of a phenotyping platform to monitor the inflammasome activation in human monocytes

The canonical NLRP3 inflammasome activation requires two signals: a priming signal to induce proIL-1 β and license the NLRP3 inflammasome [24,25] and a specific signal to activate NLRP3. The addition of a “signal 2” is facultative in LPS-primed human monocytes due to the gradual formation of non-canonical/alternative inflammasomes, which may involve caspase-4/5 and/or caspase-8 [13,14]. As previously described by Omenetti *et al.* [20], a long-term LPS treatment, which activates non-canonical/alternative inflammasomes [13], leads to higher IL-1 β secretion by monocytes from FMF patients than by monocytes from HD (figure 1A). To specifically assess the functionality of the various inflammasomes to respond to specific “signals 2” in primary monocytes, we selected a short priming step (3h) (figure 1B). Under such experimental conditions, and over a large range of cell number (Figure S1), the non-canonical/alternative inflammasomes were not activated [13,14] and IL-1 β secretion was observed only upon addition of the specific NLRP3-(Nigericin or ATP), NLRC4-(PA+LFn-PrgI), or Pyrin-(TcdB) stimuli (figures 1B, S2). To further exclude the possible confounding factors associated with the non-canonical/alternative inflammasomes, we also used another priming signal: MDP, a Nod2 ligand. MDP treatment does not activate the non-canonical/alternative inflammasomes [13,14]. To monitor monocyte responses to a matrix of inflammasome stimuli and considering the limited volume of blood sample available from paediatric patients, we optimized our assay to use 5×10^3 monocytes per condition (figure S1).

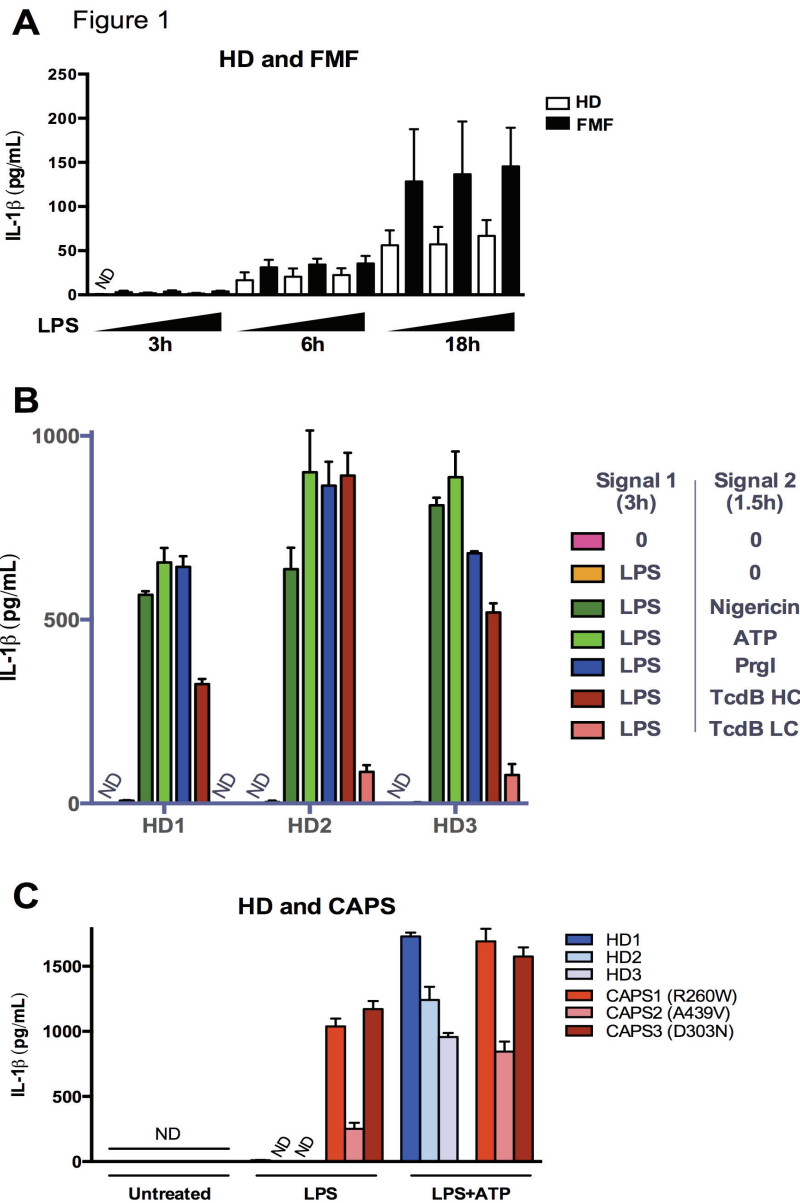

Figure 1 – An optimized assay to study the canonical inflammasomes in monocytes

(A) Monocytes from HD (n=6) and FMF patients (n=6) were primed for the indicated time with increasing LPS concentrations (10, 100, 1000 ng/ml). (B) Monocytes from HD (n=3) were primed for 3h with 10 ng/ml of LPS. NLRP3, NLRC4 and Pypin inflammasomes were activated by incubation with their specific activating-stimuli for 1h30: 5 μ M Nigericin or 2.5 mM ATP; 50 ng/ml PA+LFn-PrgI ; TcdB at 125 ng/ml (HC) or 12.5 ng/ml (LC). (C) Monocytes from HD (n=3) and patients with Cryopyrin-Associated Periodic Syndrome (CAPS, n=3) were primed for 3h with 10 ng/ml LPS and when indicated stimulated with ATP for 1h30. *NLRP3* mutation for each CAPS patient is indicated in the figure legend. (A-C) Supernatants were collected and interleukin (IL)-1 β production was assessed by ELISA. Means and standard deviation of triplicate wells are shown. (ND: not detected)

We first assessed the ability of our assay to identify deviant inflammasome responses in primary monocytes by analysing the well-characterized response of monocytes from CAPS patients [26]. *NLRP3* gain-of-function mutations are known to trigger inflammasome activation in response to short priming with LPS in absence of signal 2 [26]. Accordingly, in our assay, monocytes from 3 CAPS patients harbouring different mutations released high levels of IL-1 β upon LPS priming only. In contrast, addition of a signal 2 was required to trigger IL-1 β release from HD monocytes (figure 1C).

We then evaluated the response of monocytes from FMF patients treated with signal 1 only. Monocytes from FMF patients and HD released low to undetectable levels of IL-1 β when stimulated only with the priming signal for 3h (LPS or MDP alone - figures 1A, S1B, S3A). As previously observed using PBMCs [21,27], this result indicates that the Pyrin inflammasome is not constitutively activated in FMF patients. While CAPS and FMF are both classified as inflammasomopathies [28], the molecular mechanisms underlying the disease are thus clearly different.

Monocytes from FMF patients display a specific increased response to low doses of a Pyrin-activating stimulus relative to monocytes from HD.

We analysed the monocyte response of 3 FMF patients and 3 HD using a short priming step and various doses of ATP, PA+LFn-PrgI and TcdB to engage the NLRP3, NLRC4 and Pyrin inflammasomes, respectively (figure 2A). At the high TcdB concentrations (greater than 250 ng/ml), monocytes from HD and FMF patients secreted similar levels of IL-1 β . This result demonstrates that FMF-associated *MEFV* mutations do not impair the ability of Pyrin to detect bacterial toxin-mediated RhoGTPases modifications. This experiment confirms a very recent report by Lamkanfi and colleagues [21] and further rules out the hypothesis that FMF mutations may be loss-of function mutations [19,20,29].

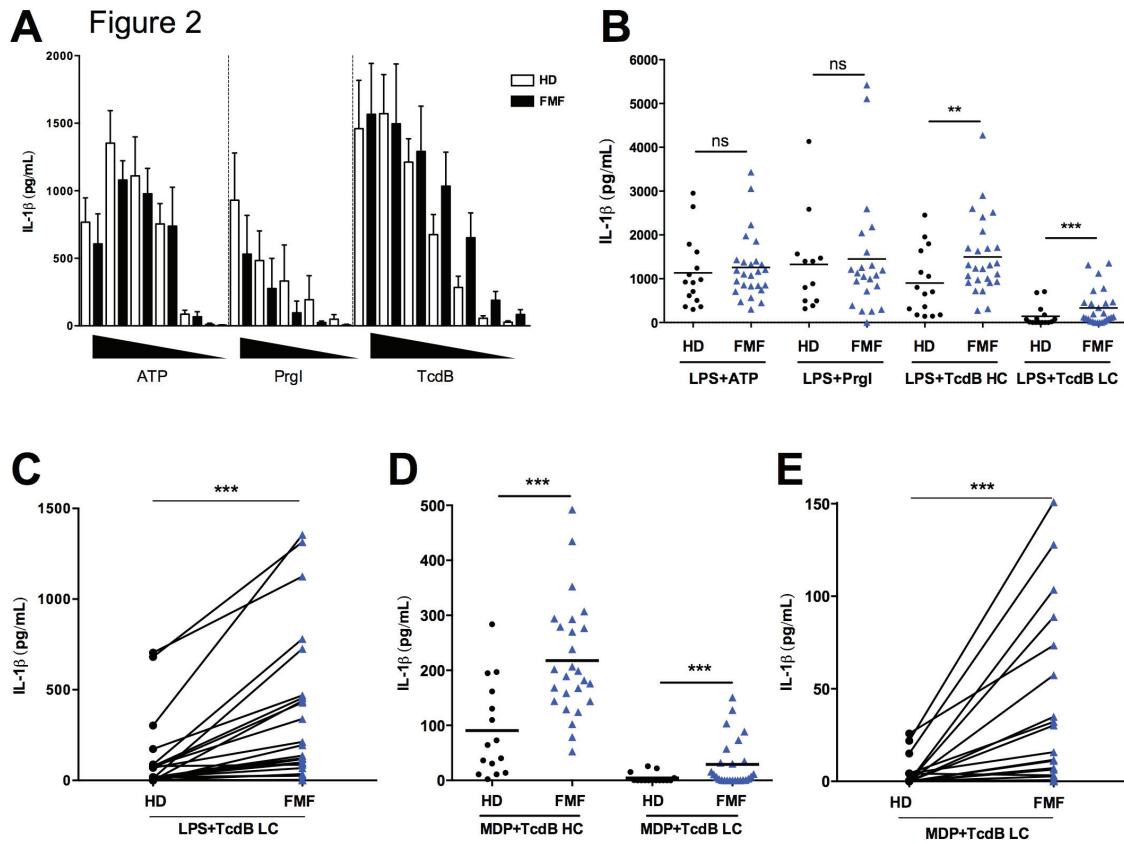

Figure 2 –Pyrin inflammasome activity is specifically heightened in monocytes from FMF patients relative to HD.

(A) Monocytes from HD (open bars, n=3) and FMF patients (back bars, n=3) were treated for 3h with 10 ng/ml LPS and decreasing doses of ATP, PA+LFn-Prgl and TcdB for 1h30 (ATP: 10-0.3mM; PA+LFn-Prgl: 100-6ng/ml; TcdB: 500-6ng/ml). Means and standard deviation are shown. (B-E) Monocytes from HD (n=15) and FMF patients (n=26) were primed for 3h with 10 ng/ml LPS or 100 ng/ml muramyl dipeptide (MDP) and incubated for 1h30 with 2.5 mM ATP, 50 ng/ml PA+LFn-Prgl, and TcdB at 125 ng/ml (HC) or 12.5 ng/ml (LC). Each symbol represents the mean value of triplicate wells from a single HD (back circle) or FMF patient (blue triangle). (A-E) Supernatants were collected and interleukin (IL)-1 β production was assessed by ELISA. (B, D) Dot-plots and mean values are presented. (C, E) Pairwise graphs illustrate the increased response of FMF patients compared to HD analysed the same day for Pyrin inflammasome activation. (B-E) HD and FMF patients analysed on the same day were paired and compared using linear mixed-effects models (adjusted p-values are indicated as follows *p<0.05; **p<0.01; ***p<0.001; ns: not significant).

Interestingly, we observed that monocytes from FMF patients sustained relatively strong IL-1 β production at low TcdB doses while, in monocytes from HD, IL-1 β secretion decreased sharply with decreasing TcdB concentrations (figure 2A). In contrast, upon engagement of NLRP3 or NLRC4 inflammasomes, the dose responses of primary monocytes from HD and FMF patients were similar (figure 2A). These results suggest that FMF-associated *MEFV* mutations, far from impairing the ability of Pyrin to detect bacterial toxin-mediated RhoGTPase modifications, may decrease specifically the activation threshold of the Pyrin inflammasome.

To strengthen this finding, we selected two TcdB concentrations in the range in which we observed a deviating response between HD and FMF patients (HC: 125 ng/ml and LC: 12.5 ng/ml) and analysed IL-1 β secretion in a large cohort of FMF patients and HD. Confirming the previous analysis, monocytes from FMF patients secreted significantly higher IL-1 β levels than HD monocytes in response to LPS + TcdB (figures 2B, 2C). This result held true when monocytes were primed with MDP (figures 2D, 2E) indicating that the observed differences were unrelated to the nature of the priming signal but, rather, specific to the Pyrin inflammasome-activating stimulus.

Using a short LPS or MDP priming step and upon stimulation of the NLRP3 or NLRC4 inflammasomes, we did not observe any statistical differences in IL-1 β secretion between HD and FMF patients (figures 2A, 2B, S3D) demonstrating that the increased inflammasome response observed in monocytes from FMF patients is Pyrin-specific.

To further investigate these Pyrin-specific responses, we studied another inflammasome-dependent cytokine: IL-18. In monocytes, proIL-18 is constitutively expressed. Pyrin and NLRC4 inflammasomes do not require a priming step. We thus monitored IL-18 release following direct addition of Pyrin- or NLRC4-activating stimuli. Monocytes from FMF patients secreted higher levels of IL-18 compared to monocytes from HD in response to TcdB (figure 3A). In contrast, engagement of NLRP3 or NLRC4 inflammasomes led to a minor decrease in IL-18 secretion by monocytes from FMF patients compared to HD (figures 3B, 3C) further highlighting the Pyrin-specificity of the increased inflammasome response.

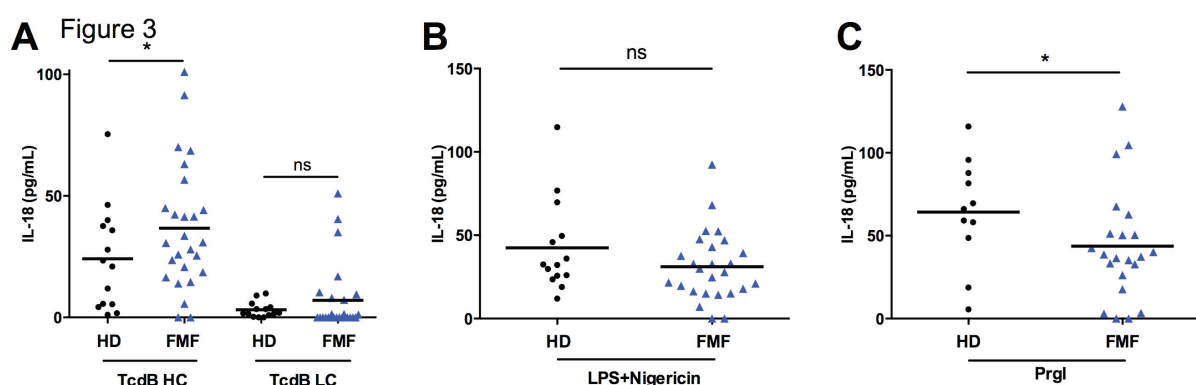

Figure 3 – IL-18 production is increased specifically upon Pyrin inflammasome activation, independently of the priming signal. Monocytes from HD (n=15) and FMF patients (n=26) were left unprimed (A,C) or primed for 3h with 10 ng/ml LPS (B) and treated for 1h30 with TcdB at 125 ng/ml (HC) or 12.5 ng/ml (LC) (A); 5 μ M nigericin (B); 50 ng/ml PA+LFn-Prgl. Supernatants were collected. IL-18 production was assessed by ELISA. Each symbol represents the mean value of triplicate wells from a single HD (black circle) or FMF patient (blue triangle). Dot-plots and mean values are presented. HD and FMF patients analysed on the same day were paired and compared using linear mixed-effects models (adjusted p-values are indicated as follows *p<0.05; **p<0.01; ***p<0.001; ns: not significant)

Finally, while inflammasome-mediated cytokines are likely central to FMF symptoms (as demonstrated using IL-1 blockers [30,31] and in mouse models [19,29]), caspase-1 activation also triggers an inflammatory cell death termed pyroptosis. Pyroptosis is associated with a very fast membrane integrity rupture, which can be monitored by following propidium iodide (PI) entry into cells and the corresponding increase in PI fluorescence. In three independent experiments, monocytes from 5 out of 6 FMF patients displayed faster cell death kinetics in response to TcdB than monocytes from HD (figure 4). This result strongly suggests that monocytes from FMF patients not only produce more cytokines in response to low doses of TcdB but also die faster, demonstrating a higher reactivity of the Pyrin inflammasome in FMF patients.

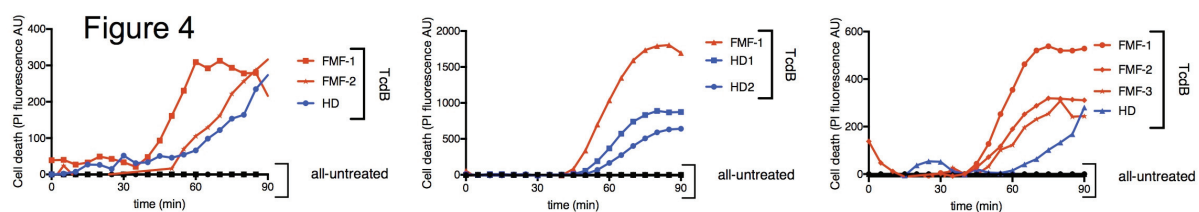

Figure 4 – Monocytes from FMF patients die faster than HD monocytes upon TcdB treatment. Primary monocytes from FMF patients (n=6) and HD (n=4) were treated with TcdB at 125 ng/ml in the presence of propidium iodide (PI). Cell death was monitored every 5 minutes for 90 minutes. Three independent experiments are shown.

Altogether these functional analyses demonstrate that, under short priming conditions, FMF-associated *MEFV* mutations decrease the activation threshold of the Pyrin inflammasome without altering NLRP3 or NLRC4 inflammasome responses.

The Pyrin inflammasome response is exacerbated in monocytes from "M694V homozygous" patients compared to monocytes from "M694V heterozygous" patients

The severity of FMF disease is linked to the nature of the *MEFV* sequence variant and to the number of alleles with a clearly pathogenic sequence [22]. To test whether this correlates with the *in vitro* strength of the Pyrin inflammasome responses, we compared the response of monocytes from FMF patients carrying one or two copies of the most prevalent and highly penetrant mutation in exon 10 (encoding the M694V variant). Monocytes from patients carrying the *p.M694V* allele at the homozygous state released significantly more IL-1 β (figure 5A) than heterozygous monocytes upon stimulation with TcdB.

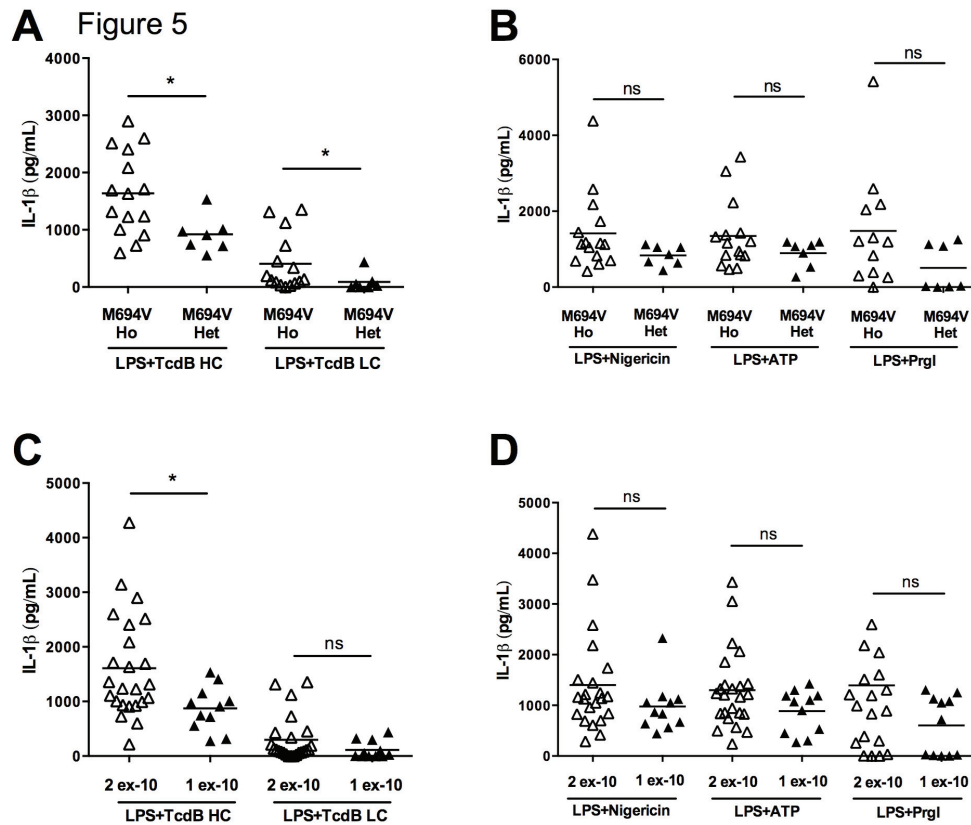

Figure 5 –Pyrin inflammasome stimulation in monocytes from patients bearing either a single or two "M694V"/exon 10 mutation(s) in *MEFV* reveals a gene-dosage effect. Monocytes from FMF patients homozygous (A-B: n=14; open triangles) or heterozygous (A-B: n=7; black triangles) for the M694V-encoding mutation of *MEFV* (A-B) or carrying two (C-D: n=24; open triangles) or a single (C-D: n=11; black triangles) *MEFV* allele(s) containing an exon 10 pathogenic mutation (277) (C-D) were primed for 3h with 10 ng/ml LPS. Inflammasomes were activated by addition of TcdB (HC=125 ng/ml; LC=12.5 ng/ml), Nigericin (5 μ M), ATP (2.5 mM) or PA+LFn-Prgl (50 ng/ml) for 1h30. Supernatants were collected, and IL-1 β production was assessed by ELISA. Each dot represents the mean value of triplicate wells from a single FMF patient. The values obtained from the two groups of carriers were compared using unpaired Mann-Whitney test. (* p <0.05; *** p <0.001; ns: not significant)

Importantly, this increased response was specific to the Pyrin inflammasome since no statistical differences were observed following stimulation of the NLRP3 and NLRC4 inflammasomes (figure 5B). Similar Pyrin-specific differences were observed when considering patients carrying a single or two exon-10 pathogenic variants [6,7] (figures 5C, 5D). This result demonstrates that the Pyrin inflammasome responses in monocytes are modulated by the copy number of pathogenic *MEFV* mutations.

DISCUSSION

The description of Pypin as an inflammasome component sensing RhoGTPase modifications [9,32] gave us the opportunity to investigate the functional consequences of *MEFV* mutations in FMF patients. Using a short priming step and a matrix of inflammasome stimuli, we demonstrate that FMF-associated Pypin variants trigger increased inflammasome responses to low concentrations of a Pypin-activating stimulus but not to NLRP3- or NLRC4-activating stimuli. Our results indicate that FMF mutations are gain-of-function mutations [19]. In contrast, to the gain-of-function mutations of *NLRP3* in CAPS patients (figure 1B), of *NLRC4* in NLRC4-MAS [17] and of *MEFV* (S242R) in PAAND [18], we did not observe IL-1 β secretion in response to a short treatment with LPS only. In agreement with previous data obtained on PBMCs [21,27], our data thus confirm that FMF mutations are not "classical" gain-of-function mutations leading to a constitutively active inflammasome. Rather, we demonstrate that FMF mutations are hypermorphic mutations that specifically decrease the activation threshold of the Pypin inflammasome. It is currently unclear whether the increased activity of the Pypin variants results from the loss of a negative regulation or from a facilitated activation mechanism.

In a concurrent work published very recently, Lamkanfi and colleagues identified that FMF mutations lift the obligatory requirement for microtubules in Pypin inflammasome activation [21]. While they did not observe any differences in IL-1 β secretion upon *C. difficile* toxin treatment between HD and FMF patients, the dose of TcdB used in their study (1 μ g/ml) was higher than the range of concentrations (125 ng/ml to 7 ng/ml) in which we observed a difference in the response of FMF patients versus HD. Similarly to their results, we observed that at high concentrations of toxins (TcdB>250ng/ml), IL-1 β responses were similar between HD and FMF patients. The poorly understood microtubule-dependent step required to activate the Pypin inflammasome in HD may be particularly important to set the threshold of activation of the Pypin inflammasome in HD. The absence of this regulatory mechanism in FMF patients may thus facilitate the response of FMF-associated Pypin variants to low doses of TcdB. In contrast, high doses of TcdB might overrule the selective microtubule-related advantage of FMF-associated Pypin variants leading to similar activation in FMF patients and HD. Further studies are needed to explore this hypothesis.

Omenetti *et al.* have described an increased NLRP3-dependent IL-1 β response to long-term LPS exposure in monocytes from FMF patients compared to HD [20], a finding which we reproduced here (figure 1A). These conditions are likely to trigger the recently described alternative/non-canonical inflammasome complexes [13, 14]. LPS treatment modifies Rho GTPase activity [33] thus providing a possible molecular explanation for the role of Pypin in

monocytes exposed to LPS only. The role of Pypin in the context of long-term LPS treatment and of alternative/ non-canonical inflammasomes remains to be investigated (see model in figure 6). Using a short priming step to avoid activation of this alternative inflammasome, we identified FMF-specific, Pypin-dependent, NLRP3-independent phenotypes. Our data dovetail with findings obtained in mouse models of FMF indicating primarily NLRP3-independent phenotypes [19].

Importantly, we observed that the magnitude of the Pypin inflammasome response is higher in patients bearing two *MEFV* exon 10 clearly pathogenic sequence variants compared to patients with a single *MEFV* exon 10 pathogenic sequence variant. This result indicates a gene-dosage effect, which correlates with the previously described impact of *MEFV* gene-dosage on the severity of FMF clinical manifestations [22].

Our work identifies FMF-associated *MEFV* mutations as hypermorphic mutations that allow the Pypin inflammasome to react faster (figure 4) and stronger (figure 2) than the Pypin inflammasome from HD to low doses of RhoGTPase-modifying toxins. The high prevalence of *MEFV* mutations in the Mediterranean basin has long been suggested to be the result of a selective advantage for the human host to combat an as-yet unknown pathogen [34]. Accordingly, numerous pathogens, including *C. difficile* and *Yersinia pestis* are sensed via the Pypin inflammasome [10,11]. Our present work demonstrating a reduced threshold of activation of the Pypin inflammasome in FMF patients strongly supports the hypothesis of a selective advantage associated with the FMF Pypin variants to fight these pathogens.

Finally, while we used a bacterial toxin as an experimental tool to specifically activate the Pypin inflammasome, the nature of the Pypin-engaging stimulus that leads to the cardinal symptoms in FMF patients is still uncharacterized. Various endogenous signals affect RhoGTPases homeostasis and, thus, are possible activators of the Pypin inflammasome [32,35–37]. These endogenous signals are likely weak activators of the Pypin inflammasome and low concentrations of toxins such as the ones used in our study may thus best recapitulate the physiological Pypin stimulation conditions observed in natural settings. One can speculate that, in FMF patients, such endogenous signals activate the Pypin inflammasome due to its reduced threshold of activation (figure 6).

Figure 6

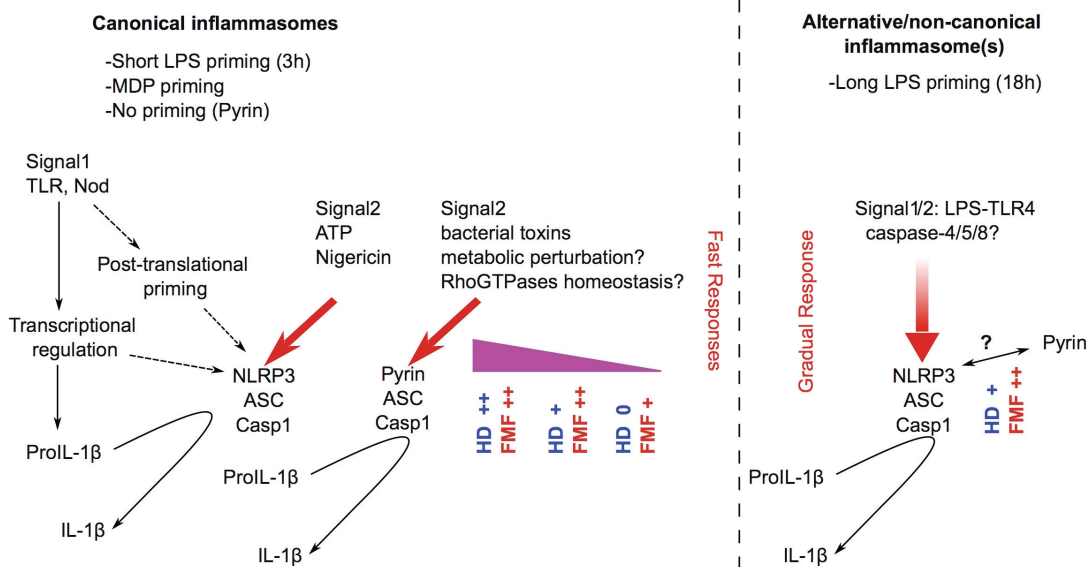

Figure 6: Model integrating the canonical and alternative/non-canonical inflammasomes and their dysfunction in FMF patients. The NLRP3 and Pyrin canonical inflammasomes are presented on the left panel (ASC -Apoptosis-associated speck-like protein containing a CARD-is the inflammasome adaptor; Casp1: caspase-1). They are typically monitored following a short-term priming step with LPS or MDP (3h). Detection of signal 2 leads to a fast inflammasome activation. The bacterial toxin TcdB activating the Pyrin inflammasome triggers similar response in HD (represented in blue) and FMF patients (represented in red) at high concentrations but at lower concentration triggers an increased response in FMF patients compared to HD (our data represented by the gradient of concentrations in magenta). Similarly, endogenous signals providing a weak Pyrin stimulation such as metabolic perturbation or perturbation of RhoGTPases homeostasis may lead to increased inflammasome activation in FMF patients. On the right panel, activation of the non-canonical/alternative inflammasomes is presented with a respective role for caspase-4/5 and caspase-8. Long-term LPS treatment (18h) provides both signal 1 and signal 2 resulting in a gradual NLRP3 inflammasome activation. In these conditions, monocytes from FMF patients secrete more IL-1 β than monocytes from HD. Model adapted from (284).

Key messages

- FMF-associated Pyrin variants detect RhoGTPase inhibition confirming that *MEFV* mutations are not loss-of-function mutations.
- The decreased threshold of activation of the Pyrin inflammasome indicates that *MEFV* mutations are hypermorphic mutations.
- The presence of two copies of *MEFV* mutations increases the Pyrin inflammasome response demonstrating a gene-dosage effect.

REFERENCES

- 1 Sonmez HE, Batu ED, Ozen S. Familial Mediterranean fever: current perspectives. *J Inflamm Res* 2016;9:13–20.
- 2 Grateau G. The relation between familial Mediterranean fever and amyloidosis. *Curr Opin Rheumatol* 2000;12:61–4.
- 3 Ancient missense mutations in a new member of the RoRet gene family are likely to cause familial Mediterranean fever. The International FMF Consortium. *Cell* 1997;90:797–807.
- 4 A candidate gene for familial Mediterranean fever. The French FMF Consortium. *Nat Genet* 1997;17:25–31.
- 5 Sarrauste de Menthiere C, Terriere S, Pugnere D, et al. INFEVERS: the Registry for FMF and hereditary inflammatory disorders mutations. *Nucleic Acids Res* 2003;31:282–5.
- 6 Shinar Y, Obici L, Aksentijevich I, et al. Guidelines for the genetic diagnosis of hereditary recurrent fevers. *Ann Rheum Dis* 2012;71:1599–605.
- 7 Federici S, Sormani MP, Ozen S, et al. Evidence-based provisional clinical classification criteria for autoinflammatory periodic fevers. *Ann Rheum Dis* 2015;74:799–805.
- 8 Jeru I, Hentgen V, Cochet E, et al. The risk of familial Mediterranean fever in MEFV heterozygotes: a statistical approach. *PLoS One* 2013;8.
- 9 Xu H, Yang J, Gao W, et al. Innate immune sensing of bacterial modifications of Rho GTPases by the Pyrin inflammasome. *Nature* 2014;513:237–41.
- 10 Chung LK, Park YH, Zheng Y, et al. The Yersinia Virulence Factor YopM Hijacks Host Kinases to Inhibit Type III Effector-Triggered Activation of the Pyrin Inflammasome. *Cell Host Microbe* 2016;20:296–306.
- 11 Ratner D, Orning MPA, Proulx MK, et al. The Yersinia pestis Effector YopM Inhibits Pyrin Inflammasome Activation. *PLoS Pathog* 2016;12:e1006035.
- 12 Bergsbaken T, Fink SL, Cookson BT. Pyroptosis: host cell death and inflammation. *Nat Rev Microbiol* 2009;7:99–109.
- 13 Gaidt MM, Ebert TS, Chauhan D, et al. Human Monocytes Engage an Alternative Inflammasome Pathway. *Immunity* 2016;44:833–46.
- 14 Vigano E, Diamond CE, Spreafico R, et al. Human caspase-4 and caspase-5 regulate the one-step non-canonical inflammasome activation in monocytes. *Nat Commun* 2015;6:8761.
- 15 Brodsky IE, Monack D. NLR-mediated control of inflammasome assembly in the host response against bacterial pathogens. *Semin Immunol* 2009;21:199–207.
- 16 Hoffman HM, Mueller JL, Broide DH, et al. Mutation of a new gene encoding a putative pyrin-like protein causes familial cold autoinflammatory syndrome and Muckle-Wells syndrome. *Nat Genet* 2001;29:301–5.
- 17 Canna SW, de Jesus AA, Gouni S, et al. An activating NLRC4 inflammasome mutation causes autoinflammation with recurrent macrophage activation syndrome. *Nat Genet* 2014;46:1140–6.
- 18 Masters SL, Lagou V, Jeru I, et al. Familial autoinflammation with neutrophilic dermatosis reveals a regulatory mechanism of pyrin activation. *Sci Transl Med* 2016;8:332ra45.
- 19 Chae JJ, Cho Y-H, Lee G-S, et al. Gain-of-function Pyrin mutations induce NLRP3 protein-independent interleukin-1beta activation and severe autoinflammation in mice. *Immunity* 2011;34:755–68.
- 20 Omenetti A, Carta S, Delfino L, et al. Increased NLRP3-dependent interleukin 1beta secretion in patients with familial Mediterranean fever: correlation with MEFV genotype. *Ann Rheum Dis* 2014;73:462–9.
- 21 Van Gorp H, Saavedra PHV, de Vasconcelos NM, et al. Familial Mediterranean fever mutations lift the obligatory requirement for microtubules in Pyrin inflammasome activation. *Proc Natl Acad Sci U S A* Published Online First: 22 November 2016.
- 22 Federici S, Calcagno G, Finetti M, et al. Clinical impact of MEFV mutations in children with periodic fever in a prevalent western European Caucasian population. *Ann Rheum Dis* 2012;71:1961–5.
- 23 Yang J, Zhao Y, Shi J, et al. Human NAIP and mouse NAIP1 recognize bacterial type III secretion needle protein for inflammasome activation. *Proc Natl Acad Sci U S A* 2013;110:14408–13.
- 24 Py BF, Kim M-S, Vakifahmetoglu-Norberg H, et al. Deubiquitination of NLRP3 by BRCC3 critically regulates inflammasome activity. *Mol Cell* 2013;49:331–8.
- 25 Bauernfeind FG, Horvath G, Stutz A, et al. Cutting edge: NF-kappaB activating pattern recognition and cytokine receptors license NLRP3 inflammasome activation by regulating NLRP3 expression. *J Immunol* 2009;183:787–91.
- 26 Agostini L, Martinon F, Burns K, et al. NALP3 forms an IL-1beta-processing inflammasome with increased activity in Muckle-Wells autoinflammatory disorder. *Immunity* 2004;20:319–25.
- 27 Ibrahim J-N, Jounblat R, Delwail R, et al. Ex vivo PBMC cytokine profile in familial Mediterranean fever patients: Involvement of IL-1beta, IL-1alpha and Th17-associated cytokines and decrease of Th1 and Th2 cytokines. *Cytokine* 2014;69:248–54.
- 28 Masters SL, Simon A, Aksentijevich I, et al. Horror autoinflammaticus: the molecular pathophysiology of autoinflammatory disease. *Annu Rev Immunol* 2009;27:621–68.
- 29 Sharma D, Sharma BR, Vogel P, et al. IL-1beta and Caspase-1 Drive Autoinflammatory Disease Independently of IL-1alpha or Caspase-8 in a Mouse Model of Familial Mediterranean Fever. *Am J Pathol* Published Online First: 17 December 2016.
- 30 Cetin P, Sari I, Sozeri B, et al. Efficacy of interleukin-1 targeting treatments in patients with familial mediterranean fever. *Inflammation* 2015;38:27–31.

- 31 Hashkes PJ, Spalding SJ, Giannini EH, *et al.* Riloncept for colchicine-resistant or -intolerant familial Mediterranean fever: a randomized trial. *Ann Intern Med* 2012;157:533–41.
- 32 Park YH, Wood G, Kastner DL, *et al.* Pyrin inflammasome activation and RhoA signaling in the autoinflammatory diseases FMF and HIDS. *Nat Immunol* Published Online First: 6 June 2016.
- 33 Chen L-Y, Zuraw BL, Liu F-T, *et al.* IL-1 receptor-associated kinase and low molecular weight GTPase RhoA signal molecules are required for bacterial lipopolysaccharide-induced cytokine gene transcription. *J Immunol* 2002;169:3934–9.
- 34 Schaner P, Richards N, Wadhwa A, *et al.* Episodic evolution of pyrin in primates: human mutations recapitulate ancestral amino acid states. *Nat Genet* 2001;27:318–21.
- 35 Yu J-W, Farias A, Hwang I, *et al.* Ribotoxic stress through p38 mitogen-activated protein kinase activates in vitro the human pyrin inflammasome. *J Biol Chem* 2013;288:11378–83.
- 36 Akula MK, Shi M, Jiang Z, *et al.* Control of the innate immune response by the mevalonate pathway. *Nat Immunol* Published Online First: 6 June 2016.
- 37 Kim ML, Chae JJ, Park YH, *et al.* Aberrant actin depolymerization triggers the pyrin inflammasome and autoinflammatory disease that is dependent on IL-18, not IL-1beta. *J Exp Med* 2015;212:927–38.

Supplementary material

Supplementary Table S1- Characteristics of FMF patients

	MEFV variant	Familial history	Gender	Age (years)	Monocytes (G/L)	CRP (mg/L)	SAA (mg/dL)	Clinical Manifestations	Colchicine treatment
1	p.M694V/p.M694V	YES	W	8	0.5	3	0	Asymptomatic	YES
2	p.M694V	YES	M	13	0.5	7	0	Asymptomatic	YES
3	p.V726A/p.E148Q	YES	W	11	0.6	1.7	10	Asymptomatic	YES
4	p.V726A	YES	M	9	0.4	2.2	5	Asymptomatic	YES
5	p.M694V/p.M694V	YES	W	43	NA	0	0	Asymptomatic	YES
6	p.M694V/p.M694V	YES	M	29	NA	0	0	Asymptomatic	YES
7	p.M694V/p.M694V	YES	M	13	0.4	2.2	NA	Asymptomatic	YES
8	(p.E167N;p.F479L);(p.V377A)	YES	M	5	0.6	2.7	7	Asymptomatic	YES
9	p.M680I/p.M694V	NO	W	4	0.5	11	7	Asymptomatic	YES
10	p.M680I/p.M694V	NO	M	7	0.5	1.2	6	Asymptomatic	YES
11	p.M680I/p.M680I	NR	M	48	0.7	4.4	NA	Asymptomatic	YES
12	p.M694V/p.M694V	NR	W	15	0.5	2	0	Asymptomatic	YES
13	p.M694V/p.M694V	YES	W	13	0.5	1.8	0	Asymptomatic	YES
14	p.M694V/p.M694V	YES	W	6	0.42	46	189	Asymptomatic	YES
15	p.M694V/p.M694V	YES	M	2	1.19	97	457	Symptomatic	NO
16	p.M694V/p.M694V	NR	M	9	0.4	2.6	133	Asymptomatic	YES
17	p.M694V/p.M694V	YES	W	13	0.48	0	0	Asymptomatic	YES
18	p.M694V	NO	M	12	0.46	0	0	Asymptomatic	NO
19	p.M694V/p.M694V	NO	W	15	1.03	21	61	Symptomatic	YES
20	p.M694V/p.M694V	YES	M	16	0.45	6	0	Asymptomatic	YES
21	p.M694V/p.M694V	YES	W	8	0.58	0	0	Asymptomatic	YES
22	p.M694V/p.M694V	NO	M	17	0.55	0	0	Asymptomatic	YES
23	p.M694V	NO	M	10	0.5	0	0	Asymptomatic	NO
24	p.M694I/p.V726A	NO	M	15	0.6	0	0	Asymptomatic	YES
25	p.M680I/p.M680I	YES	W	10	0.8	0	0.7	Asymptomatic	YES
26	p.M680I/p.M680I	YES	M	9	0.9	3.8	26	Asymptomatic	YES

27	p.E148Q/p.M694V	YES	M	12	0.7	0	0	Asymptomatic	YES
28	p.M694V/p.M694V	NO	M	10	NA	NA	NA	Symptomatic	NO
29	p.M694I/p.M694I	NO	M	39	0.7	0	0	Asymptomatic	YES
30	p.E148Q	NO	W	4	0.7	1,3	0	Asymptomatic	YES
31	p.M694I/p.V726A	NO	W	29	0.4	8,6	10	Asymptomatic	NO
32	p.M680I/p.V726A	YES	M	8	NA	2	14	Asymptomatic	YES
33	p.M694V/p.M694V	YES	M	5	NA	4	<5	Asymptomatic	YES
34	p.M680I/p.M694V	YES	M	7	0.3	0,6	<5	Asymptomatic	YES
35	p.M694V/p.E148Q	YES	M	37	0.5	3,3	NA	Asymptomatic	YES
36	p.M680I	YES	W	32	0.3	4,3	NA	Asymptomatic	NO
37	p.E148Q	YES	W	5	0.6	26	0	Asymptomatic	YES
38	p.M694V	YES	M	42	0.64	NA	NA	Asymptomatic	NO
39	p.M694V	YES	W	42	0.53	NA	NA	Asymptomatic	NO
40	p.M694V	NO	W	9	NA	NA	NA	Asymptomatic	YES
41	p.M694V/p.M694V	YES	M	26	NA	NA	NA	Asymptomatic	YES
42	p.M694V	YES	W	28	NA	NA	Na	Asymptomatic	YES

Supplementary Figures

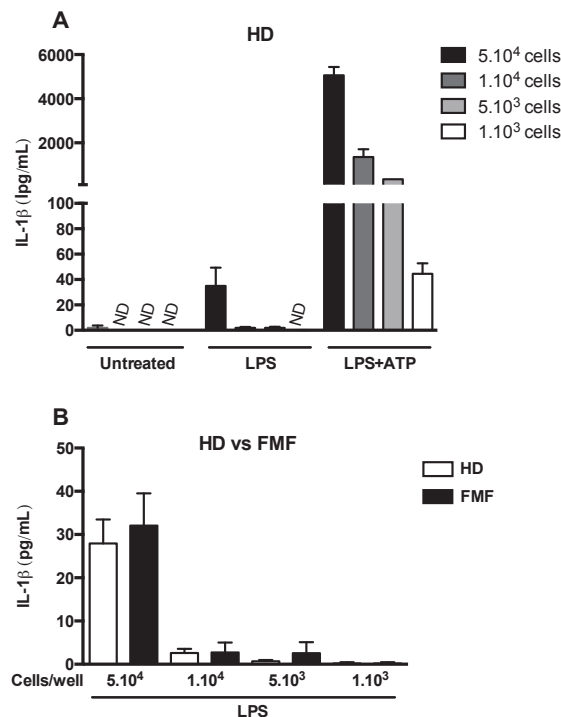

Supplementary figure S1 - IL-1 β is produced at undetectable to very low levels in presence of a short LPS priming step at various monocytes concentrations

Primary monocytes, isolated from peripheral blood mononuclear cells by magnetic sorting, from 3 healthy donors (A; n=3, B; n=3) and FMF patients (B; n=3), were plated at the indicated concentrations in a 96-well plate and left untreated or primed for 3h with 10 ng/ml LPS as indicated. (A) NLRP3 inflammasome was activated by addition of a specific activating-stimulus (2.5 mM ATP) for 1h30. (A, B) Supernatants were collected. IL-1 β production was assessed by ELISA.

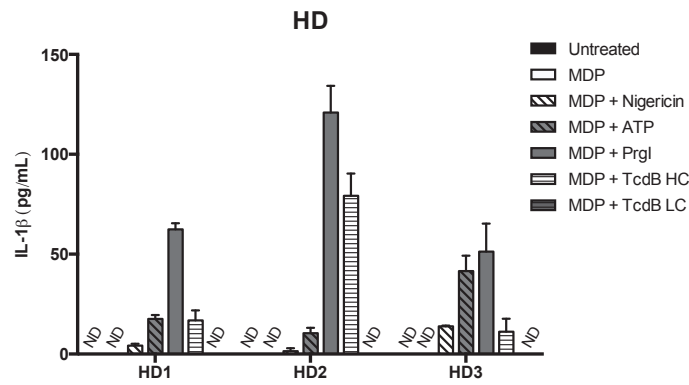

Supplementary figure S2 - Priming with MDP followed by NLRP3, NLRC4 or Pyrin Inflammasome engagement leads to IL-1β release in HD monocytes.

Primary monocytes ($5 \cdot 10^3$ per 0.3 cm^2 well), isolated from peripheral blood mononuclear cells by magnetic sorting, from HD were primed for 3h with 100 ng/ml MDP. Inflammasomes were activated by addition of their specific activating-stimuli ($5 \mu\text{M}$ Nigericin or 2.5 mM ATP for NLRP3, 50 ng/ml PA+LFn-Prgl for NLRC4, and TcdB at a high concentration (HC=125 ng/ml) or a low concentration (LC=12.5 ng/ml) for Pyrin) for 1h30. Supernatants were collected. IL-1β production was assessed by ELISA. Means and standard deviation of triplicate wells are shown. (ND: not detected)

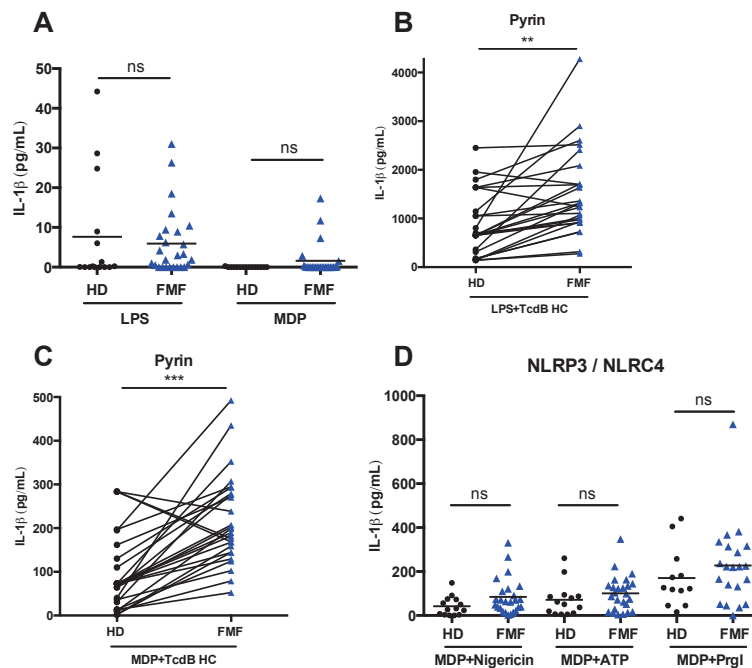

Supplementary figure S3: IL-1β release is heightened in monocytes from FMF patients compared to HD in response to activation of the Pyrin inflammasome.

(A) Primary monocytes ($5 \cdot 10^3$ per 0.3 cm^2 well) from HD (n=15, black circles) and FMF patients (n=26, triangles) were stimulated for 4h30 with 10 ng/ml LPS or 100 ng/ml MDP. IL-1β production was assessed by ELISA. No statistically significant differences were observed between HD and FMF patients.

(B) Pairwise graph showing IL-1β release after stimulation with LPS+TcdB at high concentration (HC: 125 ng/ml), with HD and FMF patients being paired for same-day experiment.

(C) Pairwise graph showing IL-1β release after stimulation with MDP+TcdB at a high concentration (HC: 125 ng/ml), with HD and FMF patients being paired for same-day experiment.

(D) Primary monocytes from FMF patients (triangles) and HD (black circles) were primed with 100 ng/ml MDP for 3h. Inflammasomes were activated by addition of their specific activating-stimuli ($5 \mu\text{M}$ Nigericin or 2.5 mM ATP for NLRP3, 50 ng/ml PA+LFn-Prgl for NLRC4) for 1h30. No statistically significant differences were observed between HD and FMF patients when NLRP3 or NLRC4 were stimulated.

DISCUSSION

1. From bench to bedside and back again... ou comment le Rare éclaire le Fréquent.

L'identification des inflammasomes et des maladies auto-inflammatoires constitue un remarquable exemple des interconnexions entre la science fondamentale et la clinique. En effet, l'histoire de leurs découvertes a été une véritable succession d'allers et retours entre la 'paillasse' et le 'lit du malade' (1). Les quatre fièvres héréditaires (fièvre méditerranéenne familiale, ou maladie périodique ; les TRAPS ou fièvre hibernienne, les CAPS et le syndrome hyper IgD) sont connues des cliniciens depuis quelques décennies. Leur diagnostic a longtemps reposé, et repose encore, sur des faisceaux d'arguments cliniques (2,3). Les études d'association familiale ont permis, à la fin du vingtième siècle, de mettre en évidence les altérations génétiques à l'origine de ces maladies (4–6). Ces découvertes fondamentales ont alors permis le décryptage des voies de signalisation impliquées dans l'immunité innée, dont la dérégulation conduisait au développement d'une maladie clinique. C'est ce décryptage qui a conduit Daniel Kastner à proposer le concept d' « auto-inflammation », engendrant une véritable révolution dans la conceptualisation des maladies dysimmunitaires (7).

Dans le même temps, Fabio Martinon dans le groupe de Jurg Tschopp, spécialiste de la biochimie, découvrait un complexe macromoléculaire dont l'activation conduisait à l'activation et à la sécrétion de cytokines pro-inflammatoires et le dénommait « inflammasome ». Rapidement, le rôle pivot de l'interleukine-1 (IL-1) au cours des maladies auto-inflammatoires a été mis en lumière. La confirmation ultime de ce rôle majeur est ensuite venue des résultats spectaculaires des traitements ciblant l'IL-1 sur les symptômes des malades. De nouvelles maladies, à la physiopathologie obscure, sont alors venues enrichir le groupe des maladies auto-inflammatoires. Pour certaines, l'absence de caractère héréditaire et de mutation identifiable les fait envisager comme des maladies « polygéniques » ou « complexes » mais, le plus souvent, des preuves du rôle prépondérant de l'IL-1 ont été fournies soit par l'analyse *in vitro* de prélèvements issus de patients (sérum, acides nucléiques, cellules) soit par l'efficacité des traitements anti-IL-1 (8–10). Ces maladies sont par exemple l'arthrite juvénile idiopathique systémique, la maladie de Still de l'adulte, le syndrome de Schnitzler ou, à un moindre degré, la maladie de Behçet (11,12). Par ailleurs, des mécanismes auto-inflammatoires ont également été décrits au cours de maladies fréquentes, comme la goutte, le diabète ou l'athérosclérose (13). Dans d'autres cas, le phénotype auto-inflammatoire (fièvre récurrente, arthrites, éruption cutanée, syndrome inflammatoire, absence d'auto-immunité) ou la ressemblance clinique avec les maladies auto-inflammatoires impliquant la voie de l'IL-1 ont conduit à des analyses génétiques

étendues permettant de mettre en évidence des mutations sur de nouveaux gènes. C'est, par exemple, le cas de maladies qui impliquent directement des protéines actrices de la voie de l'IL-1, comme celles associées aux mutations de *NLRC4* ou de *NLRP12* (14–16), ou, plus indirectement, en modifiant des protéines de la signalisation ou de la régulation de cette voie, comme les maladies associées aux mutations de *TNFRSF11A*, d'*IL-1RN* ou de *LACC1* (17–20).

Enfin, de nouveaux mécanismes, comme le mosaïcisme somatique ou les hétérozygoties composites, sont en cours d'élucidation (21–24). Ces mécanismes pourraient rendre compte des maladies polygéniques (digéniques, par exemple), des maladies atypiques ou survenant à un âge plus avancé (25–27).

Au total, les progrès des techniques de séquençage, alliés à l'expansion des réseaux de chercheurs et de cliniciens, permettent aujourd'hui une amélioration constante et exponentielle de la compréhension des mécanismes physiopathologiques à l'origine des maladies auto-inflammatoires, avec un bénéfice quasi-direct pour les malades. D'une façon plus générale, l'historique des découvertes des maladies auto-inflammatoires nous rappelle que l'analyse approfondie des maladies rares permet d'accroître notre savoir sur les maladies plus fréquentes⁴.

⁴ « *Nature is nowhere accustomed more openly to display her secret mysteries than in cases where she shows tracings of her workings apart from the beaten paths; nor is there any better way to advance the proper practice of medicine than to give our minds the discovery of the usual law of nature, by careful investigation of cases of rarer forms of disease.* »

Sir William Harvey (1578–1657)

2. Avantages et limites de la technologie BioID

Dans la première partie de cette thèse, nous nous sommes intéressés aux protéines interagissant avec l'effecteur du complexe inflammasome. Comme précisé en introduction, la nature insoluble du complexe a longtemps rendu les études biochimiques impossibles. Plusieurs équipes avaient rapporté antérieurement des interacteurs ou des substrats de la caspase-1 (28–30). L'emploi de la méthode BioID est inédit pour l'étude des protéines proximales de la caspase-1. L'atout principal de cette technique repose sur le fait que la biotinylation, exceptionnelle dans la cellule mammifère, permet une liaison forte de la biotine aux résidus lysine qui n'est pas dégradée lors de la solubilisation (31). Cette technique permet, ultérieurement, l'identification par spectrométrie de masse des protéines biotinylées après capture par la streptavidine.

Une des limites évidentes de cette technique est la nécessité de fusionner une partie de la ligase BirA à la protéine cible. Le risque de perturbation des interactions protéine-protéine, ainsi que le risque d'empêcher des modifications conformationnelles nécessaires à l'activité de la protéine cible (ici, une protéase) nécessite une réflexion préalable et des étapes de mise au point afin de s'assurer que les interactions persistent avec les interacteurs connus. Dans notre étude, l'interaction avec la protéine ASC (interaction CARD-CARD) et la capacité d'ASC à former des oligomères ont été des pré-requis aux expériences ultérieures. Une autre limite de cette approche réside dans le fait que cette méthode n'identifie pas que les protéines ayant des interactions avec la protéine cible mais détecte des protéines situées à proximité de celle-ci. Si cela offre l'avantage de pouvoir identifier des interactions faibles ou transitoires, cela entraîne également le risque de détecter des protéines n'ayant pas de rapport direct avec la protéine cible. Pour diminuer ce risque, nous avons utilisé le mutant R118G de BirA, décrit pour avoir une plus grande sélectivité proximité-dépendante pour les substrats de la ligase (32). Nous avons également réalisé des expériences préliminaires basées sur une autre méthode de biotinylation utilisant une *ascorbate peroxidase* (APEX), qui détecte des interactions fugaces et très proximales (<20 nm) (33,34). Néanmoins, cette technique nécessite l'adjonction de peroxyde d'hydrogène (H₂O₂), induisant la formation de dérivés réactifs de l'oxygène (ROS) qui sont des activateurs connus de l'inflammasome.

Au cours des étapes préliminaires, il nous a également été impossible d'obtenir *in cellulo* une biotinylation suffisamment robuste de ASC pour envisager les étapes ultérieures. En effet, un pré-requis important de l'approche BioID est la quantité de 'matériel' disponible pour l'analyse (31). Nous avons donc opté pour une autre méthodologie d'activation de

l'inflammasome, utilisée dans l'étude princeps ayant permis la découverte du complexe (35). Cette méthode, dérivée de celles utilisées pour étudier l'apoptosome (36,37), repose sur le fait que l'inflammasome est spontanément activé au sein d'un concentré cytosolique (*cell-free*), en conditions hypotoniques et pauvres en potassium (38). Néanmoins, l'obtention de tels concentrés cytosoliques nécessite plusieurs étapes de lyse, éliminant les compartiments nucléaires et membranaires et donc un certain nombre de protéines candidates potentielles pour leur interaction avec la caspase-1.

L'activation de la caspase-1 est très largement corrélée au clivage de sa proforme, la procaspase-1. Cette activation est essentiellement le fait de la caspase-1 elle-même, l'enzyme étant son propre substrat. L'activation de la caspase-1 au sein du complexe inflammasome est supposée se produire par effet stérique suite à son oligomérisation sur les filaments de ASC oligomérisé (39). Dans notre étude, nous avons généré un mutant inclivable de la caspase-1 (Q281H) pour favoriser son accumulation en évitant sa dégradation lors de l'activation de l'inflammasome. Malgré cet avantage, ce choix pourrait également avoir empêché l'identification de certains substrats de la caspase-1.

Enfin, une autre limite de notre méthodologie repose dans la sélection finale des candidats via l'utilisation du *Contaminant Repository for Affinity Purification* qui pourrait avoir éliminé d'authentiques substrats de la caspase-1. Néanmoins, l'identification de ASC, de la caspase-1 et de 25 autres protéines précédemment rapportées comme interagissant avec la caspase-1, semble indiquer la fiabilité de notre méthodologie.

De nouvelles techniques de biotinylation proximité-dépendante, plus performantes et permettant d'étudier les protéines interagissant avec l'inflammasome en conditions plus physiologiques, permettront certainement une meilleure définition de l'*interactome* de la caspase-1.

3. Régulation de l'inflammasome : le rôle complexe de p62/sqstm-1

Les résultats de notre crible nous ont permis d'identifier p62/sqstm1 (p62) comme un des substrats biotinylés par la ligase BirA fusionnée à la caspase-1. Par la suite, nous avons démontré qu'il existait une interaction réelle et que p62 était un substrat de la caspase-1. Le clivage générerait deux fragments qui avaient des conséquences fonctionnelles antagonistes. Le fragment Nter, porteur du domaine d'oligomérisation de p62, lorsqu'il était surexprimé induisait une inhibition forte de la sécrétion d'interleukine-1 β (IL-1 β) alors que le fragment Cter surexprimé induisait une augmentation de cette sécrétion. Notre modèle connaissait des limites importantes puisque l'expression ectopique des fragments de p62 était réalisée dans des macrophages immortalisés de souris sauvages, possédant par ailleurs une version de p62 murin sauvage (possiblement inclivable du fait d'une différence de séquence). Malgré de nombreuses tentatives, utilisant diverses cellules (murines ou humaines), nous n'avons pas réussi à obtenir une lignée cellulaire invalidée pour p62 reproduisant le phénotype rapporté dans la littérature. Les études précédentes rapportent, pour la plupart, une augmentation de la sécrétion d'IL-1 β en réponse à divers activateurs des inflammasomes dans les cellules invalidées (ou atténuées) pour p62 (40,41). Néanmoins, dans ces études le phénotype reste assez faible (40) ou nécessite l'utilisation de stimuli forts et/ou de durées d'exposition prolongées (41). Par ailleurs, certaines études contredisent ce phénotype (42–45). Ces différences semblent pouvoir être expliquées par le pléiotropisme de p62, un véritable *hub* de différentes voies de signalisation et de l'autophagie (46,47). p62 est ainsi un adaptateur majeur de l'autophagie sélective, avec une action de clairance de la pro-IL1 β en amont de l'activation de l'inflammasome (48), mais aussi un potentiel inhibiteur de l'autophagie via la régulation de mTORC1 (47), une protéine nécessaire au maintien des oligomères de caspase-8 via cullin-3 (49) ou encore une protéine impliquée dans la signalisation de NF- κ B. A l'inverse, un rétrocontrôle anti-inflammatoire a été décrit récemment : NF- κ B induit l'accumulation retardée de p62 qui délivre ensuite les mitochondries endommagées à l'autophagosome (50). La multiplicité et la complexité des mécanismes de régulation et de rétrocontrôle pourraient expliquer les difficultés pour obtenir un phénotype expérimental robuste.

Un clivage de p62 au cours de l'infection par le coxsackievirus B3 a été précédemment rapporté (51). Ce clivage était médié par une protéase de l'enterovirus au niveau du résidu glycine 241 et résultait dans la perte de fonction de p62, notamment dans la voie d'activation de NF κ B. Le fragment Cter perdait ainsi sa capacité de liaison à l'ubiquitine, sans perdre son interaction avec LC3B. Une étude ultérieure a démontré que le fragment Cter exerçait un effet dominant négatif sur la protéine p62 non clivée, par compétition sur LC3B (52).

Compte-tenu de ces données et des résultats de notre étude, nous avons émis l'hypothèse que l'augmentation de la sécrétion d'IL-1 β observée lors de l'expression ectopique du fragment Cter (après clivage par la caspase-1) résultait d'un effet dominant négatif. En inhibant l'autophagie, la caspase-1 induirait alors une véritable boucle d'auto-amplification conduisant à l'exacerbation du phénotype inflammatoire. Néanmoins, nos résultats indiquent que l'expression ectopique du fragment Nter conduit à une diminution de la sécrétion de l'IL-1 β . Nous avons émis l'hypothèse que cet effet résulterait d'une augmentation de l'oligomérisation de p62, conduisant à un renforcement du mécanisme inhibiteur autophagique. Le niveau d'« intensité » du stimulus activateur pourrait rendre compte de l'orientation fonctionnelle de p62. Une telle hypothèse nécessite d'être confirmée par des expériences ultérieures mais pourrait expliquer les résultats contradictoires de la littérature et implique une optimisation maximale des conditions expérimentales.

4. Les mutations de *MEFV*, la pyrine et la FMF

Dans la 2^e partie de cette thèse, nous avons utilisé la plate-forme de phénotypage fonctionnel des inflammasomes monocytaires mise au point dans notre laboratoire pour étudier plus particulièrement les inflammasomes des patients atteints de fièvre méditerranéenne familiale (FMF). Cette maladie a été décrite dans la littérature médicale au milieu du vingtième siècle (53) constitue le prototype des maladies auto-inflammatoires. Le bénéfice de la colchicine sur la prévention des crises et de l'amylose secondaire a été démontré dès les années 1970-1980 (54,55), les mécanismes physiopathologiques conduisant au développement de la maladie ne sont pas encore totalement élucidés. L'identification du gène *MEFV*, en 1997, par un consortium français et un consortium international, a permis la mise au point du premier diagnostic de certitude en révélant des variants pathogéniques bialléliques chez 70% des patients présentant une FMF typique (4,5). La FMF est considérée comme une maladie de transmission récessive autosomique (56). Le gène *MEFV*, localisé sur le bras court du chromosome 16, comprend 10 exons. 317 variations de séquence sont, à l'heure actuelle, répertoriées dans le registre Infevers (<https://fmf.igh.cnrs.fr/ISSAID/infevers>). L'effet de toutes ces variations de séquence est très variable : si certains variants sont connus pour leur pathogénie (*p.M694V*), d'autres ne sont que des mutations à faible pénétrance (variants de signification inconnue) ou des polymorphismes fonctionnels (*p.E148Q*), plus ou moins associés à une FMF clinique et ayant une prévalence élevée dans la population générale.

La découverte du gène *MEFV* a été accompagnée de la description de la protéine mutée, dénommée alors pyrine (ou marénostrine en France) (4,5). Par la suite le rôle de la pyrine a longtemps été débattu (voir chapitre 3), certaines études démontrant un effet régulateur inhibiteur de la protéine sur l'inflammasome NLRP3. Plus récemment, il a été démontré que la pyrine pouvait induire la formation d'un inflammasome spécifique en réponse à diverses toxines bactériennes (dont la TcdB du *Clostridium Difficile*) (57,58). Ces toxines inactivent les RhoGTPases, conduisant à une dé-phosphorylation de la pyrine, levant ainsi le mécanisme inhibiteur de l'inflammasome pyrine. L'identification de stimuli spécifiques de l'inflammasome pyrine a offert la possibilité d'étudier l'activation de ce dernier, *in vitro*.

Nous avons ainsi utilisé le stimulus TcdB afin de comparer la sécrétion d'IL-1 β , d'IL-18 et la mort cellulaire (des conséquences connues de l'activation de l'inflammasome) entre des sujets sains et des patients atteints de FMF. Dans un premier temps, nous avons démontré que l'inflammasome pyrine des patients atteints de FMF était activé en réponse à TcdB. Les mutations de *MEFV* n'entraînaient donc pas de perte de fonction de la protéine. Par ailleurs, les monocytes des patients atteints de FMF sécrétaient significativement plus d'IL-1 β et d'IL-

18 que les sujets sains, en réponse à TcdB. Cette différence était d'autant plus évidente pour des doses minimales de TcdB. Ces résultats indiquaient que les mutations à l'origine de la FMF étaient des mutations hypermorphiques, sans qu'il n'y ait d'activation constitutive de l'inflammasome pyrine. En outre, la réponse exacerbée à des doses faibles de TcdB indiquait qu'il existait un abaissement du seuil d'activation de l'inflammasome pyrine chez les patients FMF. Les données de mort cellulaire en temps réel indiquaient une survenue plus précoce de la pyroptose dans les monocytes des patients FMF, par rapports aux donneurs sains et confirmaient le gain de fonction de l'inflammasome pyrine chez les patients FMF. L'étude simultanée des inflammasomes NLRP3 et NLRC4 ne révélait pas de différence entre donneurs sains et patients FMF, éliminant la participation d'un autre inflammasome dans la réponse fonctionnelle.

Nous avons comparé la réponse IL-1 β entre les patients FMF en fonction du nombre de variants pathogènes (variants à forte pénétrance) et montré que la réponse était exacerbée en présence de 2 variants pathogènes. Ces résultats indiquaient un effet de dosage génique, semblable à celui rapporté au niveau du phénotype clinique (59) ou lors d'études fonctionnelles précédentes (60).

Les résultats que nous avons obtenus soulèvent diverses questions. Tout d'abord d'ordre technique : l'utilisation de monocytes primaires est critiquable du fait qu'il a été précédemment rapporté une activation de l'inflammasome NLRP3 monocyttaire en présence de signal 1 seul (61). Cette activation est secondaire à l'activation du récepteur purinergique de l'ATP (P2X7) membranaire par l'ATP relargué par la cellule elle-même ou par les cellules de voisinage (61,62). Les étapes de mise au point ont permis de déterminer la concentration optimale de cellules par puits permettant d'éviter cette activation ou d'obtenir des niveaux infra-déTECTABLES d'IL-1 β . Nous avons ensuite confirmé que ces faibles concentrations cellulaires n'empêchaient pas de détecter une activation spécifique de l'inflammasome en utilisant des monocytes de patients atteints de cryopyrinopathie (CAPS). Aux faibles concentrations cellulaires utilisées, l'addition du seul signal 1 induisait une sécrétion d'IL-1 β nettement quantifiable chez les patients CAPS (dont l'inflammasome NLRP3 est activé constitutivement) et comparable à l'activation de l'inflammasome par l'addition d'un signal 1 et d'un signal 2 (IL-1 β >1000 pg/ml). Ces résultats indiquaient donc que notre système permettait de détecter des gains-de-fonction des protéines impliquées dans l'activation de l'inflammasome. Par ailleurs, l'utilisation de faibles concentrations cellulaires était rendue nécessaire par le faible volume de sang prélevé chez les patients pédiatriques.

L'utilisation de monocytes 24 heures après le prélèvement, ainsi que la méthode de sélection positive (CD14+) pourraient être à l'origine de variations dans l'état d'activation monocyttaire

(63). Nous testons actuellement cette possibilité en comparant les réponses monocytaires à divers temps post-ponction et en utilisant une méthode de sélection négative. Quoiqu'il en soit, nous avons minimisé le risque de variations en comparant les monocytes des sujets sains et des patients FMF prélevés et sélectionnés dans les mêmes conditions expérimentales.

Omenetti et collègues ont précédemment rapporté des différences de sécrétion d'IL-1 β en réponse à l'activation de l'inflammasome NLRP3 par le LPS seul (60). Ces données pourraient donc sembler contradictoires avec nos résultats. Néanmoins, dans l'étude d'Omenetti, les monocytes étaient stimulés pendant une durée prolongée (18h versus 3h dans notre étude). Nous avons confirmé leurs données et montré que la concentration de LPS utilisée ne semblait pas modifier le profil de la réponse. Cependant, dans les conditions d'activation utilisées par Omenetti et collègues, il est vraisemblable que les résultats obtenus soient en lien avec l'activation de l'inflammasome NLRP3 non-canonique (caspases-8/4/5) (64). Ces données indiquent un possible rôle de la pyrine dans la régulation de l'inflammasome non-canonique, mais ce rôle reste à définir. La modification des RhoGTPases par le LPS seul pourrait rendre compte de ces différences (65). Pour notre étude, nous avons choisi d'utiliser une étape de pré-activation (*priming*) courte, suffisante pour induire la transcription de pro-IL-1 β et permettant d'éviter l'activation de l'inflammasome non-canonique.

Enfin, une des limites importantes de notre étude est l'inclusion d'un nombre restreint de patients FMF aux génotypes multiples, certains étant porteurs de mutations hétérozygotes ou de mutations dont le pouvoir pathogène n'est pas démontré. Il existe en effet, de grandes variabilités dans la corrélation génotype/phénotype, comme en témoignent les présentations cliniques différentes entre des malades de même génotype mais d'origines ethniques différentes, voire même au sein d'une même famille. Ces différences seraient en partie expliquées par l'hétérogénéité génétique, les gènes modificateurs, et les facteurs environnementaux. L'outil que nous avons développé devrait permettre d'appréhender sur le plan fonctionnel les différences de génotypes.

De manière plus pragmatique, le développement d'une plate-forme standardisée de phénotypage fonctionnel, rendu possible par la découverte des stimuli activateurs spécifiques de l'inflammasome pyrine, pourrait constituer un outil intéressant dans la démarche diagnostique, en complément des analyses génétiques.

5. Perspectives

Les résultats concernant l'effet régulateur du clivage de p62 par la caspase-1 interrogent sur les fonctions alternatives de cette enzyme. En effet, l'activation de l'inflammasome, et donc de la caspase-1, n'entraîne pas systématiquement la mort cellulaire. Dans certaines cellules, comme les kératinocytes, l'activation de la caspase-1 conduit à la sécrétion d'IL-1 β sans entraîner la pyroptose (66). Des voies de mort cellulaire pourraient alors être engendrées par d'autres substrats de la caspase-1, comme la caspase-7 (29). Par ailleurs, la diversité des substrats identifiés précédemment suggère l'existence de fonctions en conditions sub-lytiques ou non-lytiques. Ces fonctions annexes rendraient alors compte des interactions entre les différentes voies de signalisation de l'immunité innée. Par exemple, au cours des infections par des virus à ADN la caspase-1 clive cGAS et diminue ainsi la production d'IFN de type 1 (67). L'inhibition par l'autophagie et les rétrocontrôles par la caspase-1 méritent également d'être mieux définis (41, 68).

Comme nous l'avons dit dans la Discussion, l'étude des fonctions régulatrices de p62 est rendue difficile par la multiplicité de ses fonctions « au centre » de diverses voies de signalisation. L'étude des fragments Nter et Cter de p62 générés après le clivage par la caspase-1 est elle aussi difficile, du fait de rôles semblant antagonistes. Nous projetons de poursuivre ces analyses en utilisant des conditions d'activation de l'inflammasome sublytiques (inflammasome alternatif (64) ou des modèles cellulaires résistants à la pyroptose (kératinocytes, neutrophiles, ou macrophages invalidés pour GSDMD).

Concernant l'axe 2, nous poursuivons l'analyse des maladies auto-inflammatoires, sur le versant fonctionnel, via l'utilisation de notre plate-forme de phénotypage. Les perspectives envisagées pour le développement de cet outil sont : (i) l'utilisation de nouveaux stimuli plus spécifiques ; (ii) le recrutement d'un plus grand nombre de patients atteints de FMF (avec des génotypes différents) permettant de sensibiliser notre test; (iii) le recrutement de patients atteints d'autres pathologies auto-inflammatoires identifiées ou de pathologies cliniquement semblables, permettant d'améliorer la spécificité de notre test ; (iv) l'analyse des corrélations génotype/phénotype en utilisant des cellules invalidées pour la pyrine et reconstituées avec différents variants ; et (v) le développement futur d'un test de diagnostic fonctionnel utile aux médecins aux patients.

REFERENCES

1. Holzinger D, Kessel C, Omenetti A, Gattorno M. From bench to bedside and back again: translational research in autoinflammation. *Nat Rev Rheumatol*. 2015 Oct;11(10):573–85.
2. Livneh A, Langevitz P, Zemer D, Zaks N, Kees S, Lidar T, et al. Criteria for the diagnosis of familial Mediterranean fever. *Arthritis Rheum*. 1997 Oct;40(10):1879–85.
3. Federici S, Sormani MP, Ozen S, Lachmann HJ, Amaryan G, Woo P, et al. Evidence-based provisional clinical classification criteria for autoinflammatory periodic fevers. *Ann Rheum Dis*. 2015 May;74(5):799–805.
4. French FMF Consortium. A candidate gene for familial Mediterranean fever. *Nat Genet*. 1997 Sep;17(1):25–31.
5. Ancient missense mutations in a new member of the RoRet gene family are likely to cause familial Mediterranean fever. The International FMF Consortium. *Cell*. 1997 Aug 22;90(4):797–807.
6. McDermott MF, Aksentijevich I, Galon J, McDermott EM, Ogunkolade BW, Centola M, et al. Germline mutations in the extracellular domains of the 55 kDa TNF receptor, TNFR1, define a family of dominantly inherited autoinflammatory syndromes. *Cell*. 1999 Apr 2;97(1):133–44.
7. McGonagle D, McDermott MF. A proposed classification of the immunological diseases. *PLoS Med*. 2006 Aug;3(8):e297.
8. Pascual V, Allantaz F, Arce E, Punaro M, Banchereau J. Role of interleukin-1 (IL-1) in the pathogenesis of systemic onset juvenile idiopathic arthritis and clinical response to IL-1 blockade. *J Exp Med*. 2005 May 2;201(9):1479–86.
9. Park J-H, Bae JH, Choi Y-S, Lee H-S, Jun J-B, Jung S, et al. Adult-onset Still's disease with disseminated intravascular coagulation and multiple organ dysfunctions dramatically treated with cyclosporine A. *J Korean Med Sci*. 2004 Feb;19(1):137–41.
10. Sacré K, Brihaye B, Lidove O, Papo T, Pocard M-A, Cuisset L, et al. Dramatic improvement following interleukin 1beta blockade in tumor necrosis factor receptor-1-associated syndrome (TRAPS) resistant to anti-TNF-alpha therapy. *J Rheumatol*. 2008 Feb;35(2):357–8.
11. de Koning HD, Schalkwijk J, van der Meer JWM, Simon A. Successful canakinumab treatment identifies IL-1 β as a pivotal mediator in Schnitzler syndrome. *J Allergy Clin Immunol*. 2011 Dec;128(6):1352–4.
12. de Koning HD, Schalkwijk J, van der Ven-Jongekrijg J, Stoffels M, van der Meer JWM, Simon A. Sustained efficacy of the monoclonal anti-interleukin-1 beta antibody canakinumab in a 9-month trial in Schnitzler's syndrome. *Ann Rheum Dis*. 2013 Oct;72(10):1634–8.
13. Jamilloux Y, Sève P, Henry T. [Inflammasomes in human diseases]. *Rev Médecine Interne Fondée Par Société Natl Française Médecine Interne*. 2014 Nov;35(11):730–41.
14. Canna SW, de Jesus AA, Gouni S, Brooks SR, Marrero B, Liu Y, et al. An activating NLRC4 inflammasome mutation causes autoinflammation with recurrent macrophage activation syndrome. *Nat Genet*. 2014 Oct;46(10):1140–6.
15. Jéru I, Duquesnoy P, Fernandes-Alnemri T, Cochet E, Yu JW, Lackmy-Port-Lis M, et al. Mutations in NALP12 cause hereditary periodic fever syndromes. *Proc Natl Acad Sci U S A*. 2008 Feb 5;105(5):1614–9.
16. Jéru I, Le Borgne G, Cochet E, Hayrapetyan H, Duquesnoy P, Grateau G, et al. Identification and functional consequences of a recurrent NLRP12 missense mutation in periodic fever syndromes. *Arthritis Rheum*. 2011 May;63(5):1459–64.
17. Jéru I, Cochet E, Duquesnoy P, Hentgen V, Copin B, Mitjavila-Garcia MT, et al. Brief Report: Involvement of TNFRSF11A molecular defects in autoinflammatory disorders. *Arthritis Rheumatol Hoboken NJ*. 2014 Sep;66(9):2621–7.
18. Reddy S, Jia S, Geoffrey R, Lorier R, Suchi M, Broeckel U, et al. An autoinflammatory disease due to homozygous deletion of the IL1RN locus. *N Engl J Med*. 2009 Jun 4;360(23):2438–44.
19. Wakil SM, Monies DM, Abouelhoda M, Al-Tassan N, Al-Dusery H, Naim EA, et al. Association of a mutation in LACC1 with a monogenic form of systemic juvenile idiopathic arthritis. *Arthritis Rheumatol Hoboken NJ*. 2015 Jan;67(1):288–95.
20. Kallinich T, Thorwarth A, von Stuckrad S-L, Rösen-Wolff A, Luksch H, Hundsdorfer P, et al. Juvenile arthritis caused by a novel FAMIN (LACC1) mutation in two children with systemic and extended oligoarticular course. *Pediatr Rheumatol Online J*. 2016 Nov 24;14(1):63.
21. Nakagawa K, Gonzalez-Roca E, Souto A, Kawai T, Umebayashi H, Campistol JM, et al. Somatic NLRP3 mosaicism in Muckle-Wells syndrome. A genetic mechanism shared by different phenotypes of cryopyrin-associated periodic syndromes. *Ann Rheum Dis*. 2015 Mar;74(3):603–10.
22. de Koning HD, van Gijn ME, Stoffels M, Jongekrijg J, Zeeuwen PLJM, Elferink MG, et al. Myeloid lineage-restricted somatic mosaicism of NLRP3 mutations in patients with variant Schnitzler syndrome. *J Allergy Clin Immunol*. 2015 Feb;135(2):561–4.
23. Hoffman HM, Broderick L. Editorial: It Just Takes One: Somatic Mosaicism in Autoinflammatory Disease. *Arthritis Rheumatol Hoboken NJ*. 2017 Feb;69(2):253–6.
24. Rowczenio DM, Trojer H, Omoyinmi E, Aróstegui JI, Arakelov G, Mensa-Vilaro A, et al. Brief Report: Association of Tumor Necrosis Factor Receptor-Associated Periodic Syndrome With Gonosomal Mosaicism of a Novel 24-Nucleotide TNFRSF1A Deletion. *Arthritis Rheumatol Hoboken NJ*. 2016 Aug;68(8):2044–9.

25. Touitou I, Perez C, Dumont B, Federici L, Jorgensen C. Refractory auto-inflammatory syndrome associated with digenic transmission of low-penetrance tumour necrosis factor receptor-associated periodic syndrome and cryopyrin-associated periodic syndrome mutations. *Ann Rheum Dis*. 2006 Nov;65(11):1530–1.
26. Brehm A, Liu Y, Sheikh A, Marrero B, Omoyinmi E, Zhou Q, et al. Additive loss-of-function proteasome subunit mutations in CANDLE/PRAAS patients promote type I IFN production. *J Clin Invest*. 2015 Nov 2;125(11):4196–211.
27. Stoffels M, Kastner DL. Old Dogs, New Tricks: Monogenic Autoinflammatory Disease Unleashed. *Annu Rev Genomics Hum Genet*. 2016 Aug 31;17:245–72.
28. Shao W, Yeretssian G, Doiron K, Hussain SN, Saleh M. The caspase-1 digestome identifies the glycolysis pathway as a target during infection and septic shock. *J Biol Chem*. 2007 Dec 14;282(50):36321–9.
29. Agard NJ, Maltby D, Wells JA. Inflammatory stimuli regulate caspase substrate profiles. *Mol Cell Proteomics MCP*. 2010 May;9(5):880–93.
30. Wang L-J, Hsu C-W, Chen C-C, Liang Y, Chen L-C, Ojcius DM, et al. Interactome-wide analysis identifies end-binding protein 1 as a crucial component for the speck-like particle formation of activated absence in melanoma 2 (AIM2) inflammasomes. *Mol Cell Proteomics MCP*. 2012 Nov;11(11):1230–44.
31. Roux KJ, Kim DI, Raida M, Burke B. A promiscuous biotin ligase fusion protein identifies proximal and interacting proteins in mammalian cells. *J Cell Biol*. 2012 Mar 19;196(6):801–10.
32. Kwon K, Beckett D. Function of a conserved sequence motif in biotin holoenzyme synthetases. *Protein Sci Publ Protein Sci*. 2000 Aug;9(8):1530–9.
33. Martell JD, Deerinck TJ, Sancak Y, Poulos TL, Mootha VK, Sosinsky GE, et al. Engineered ascorbate peroxidase as a genetically encoded reporter for electron microscopy. *Nat Biotechnol*. 2012 Nov;30(11):1143–8.
34. Rhee H-W, Zou P, Udeshi ND, Martell JD, Mootha VK, Carr SA, et al. Proteomic mapping of mitochondria in living cells via spatially restricted enzymatic tagging. *Science*. 2013 Mar 15;339(6125):1328–31.
35. Martinon F, Burns K, Tschopp J. The inflammasome: a molecular platform triggering activation of inflammatory caspases and processing of proIL- β . *Mol Cell*. 2002 Aug;10(2):417–26.
36. Li P, Nijhawan D, Budihardjo I, Srinivasula SM, Ahmad M, Alnemri ES, et al. Cytochrome c and dATP-dependent formation of Apaf-1/caspase-9 complex initiates an apoptotic protease cascade. *Cell*. 1997 Nov 14;91(4):479–89.
37. Zou H, Henzel WJ, Liu X, Lutschg A, Wang X. Apaf-1, a human protein homologous to *C. elegans* CED-4, participates in cytochrome c-dependent activation of caspase-3. *Cell*. 1997 Aug 8;90(3):405–13.
38. Jamilloux Y, Martinon F. Cell-Free Assay for Inflammasome Activation. *Methods Mol Biol Clifton NJ*. 2016;1417:207–15.
39. Fernandes-Alnemri T, Wu J, Yu J-W, Datta P, Miller B, Jankowski W, et al. The pyroptosome: a supramolecular assembly of ASC dimers mediating inflammatory cell death via caspase-1 activation. *Cell Death Differ*. 2007 Sep;14(9):1590–604.
40. Ohtsuka S, Ishii Y, Matsuyama M, Ano S, Morishima Y, Yanagawa T, et al. SQSTM1/p62/A170 regulates the severity of *Legionella pneumophila* pneumonia by modulating inflammasome activity. *Eur J Immunol*. 2014 Apr;44(4):1084–92.
41. Shi C-S, Shenderov K, Huang N-N, Kabat J, Abu-Asab M, Fitzgerald KA, et al. Activation of autophagy by inflammatory signals limits IL-1 β production by targeting ubiquitinated inflammasomes for destruction. *Nat Immunol*. 2012 Mar;13(3):255–63.
42. Lee H-M, Yuk J-M, Kim K-H, Jang J, Kang G, Park JB, et al. Mycobacterium abscessus activates the NLRP3 inflammasome via Dectin-1-Syk and p62/SQSTM1. *Immunol Cell Biol*. 2012 Jul;90(6):601–10.
43. Park S, Ha S-D, Coleman M, Meshkibaf S, Kim SO. p62/SQSTM1 enhances NOD2-mediated signaling and cytokine production through stabilizing NOD2 oligomerization. *PLoS One*. 2013;8(2):e57138.
44. Choe J-Y, Jung H-Y, Park K-Y, Kim S-K. Enhanced p62 expression through impaired proteasomal degradation is involved in caspase-1 activation in monosodium urate crystal-induced interleukin-1 β expression. *Rheumatol Oxf Engl*. 2014 Jun;53(6):1043–53.
45. Kim S-K, Choe J-Y, Park K-Y. Enhanced p62 Is Responsible for Mitochondrial Pathway-Dependent Apoptosis and Interleukin-1 β Production at the Early Phase by Monosodium Urate Crystals in Murine Macrophage. *Inflammation*. 2016 Oct;39(5):1603–16.
46. Komatsu M, Kageyama S, Ichimura Y. p62/SQSTM1/A170: physiology and pathology. *Pharmacol Res*. 2012 Dec;66(6):457–62.
47. Katsuragi Y, Ichimura Y, Komatsu M. p62/SQSTM1 functions as a signaling hub and an autophagy adaptor. *FEBS J*. 2015 Dec;282(24):4672–8.
48. Harris J, Hartman M, Roche C, Zeng SG, O’Shea A, Sharp FA, et al. Autophagy controls IL-1 β secretion by targeting pro-IL-1 β for degradation. *J Biol Chem*. 2011 Mar 18;286(11):9587–97.
49. Jin Z, Li Y, Pitti R, Lawrence D, Pham VC, Lill JR, et al. Cullin3-based polyubiquitination and p62-dependent aggregation of caspase-8 mediate extrinsic apoptosis signaling. *Cell*. 2009 May 15;137(4):721–35.
50. Zhong Z, Umemura A, Sanchez-Lopez E, Liang S, Shalpour S, Wong J, et al. NF- κ B Restricts Inflammasome Activation via Elimination of Damaged Mitochondria. *Cell*. 2016 Feb 25;164(5):896–910.
51. Shi J, Wong J, Piesik P, Fung G, Zhang J, Jagdeo J, et al. Cleavage of sequestosome 1/p62 by an enteroviral protease results in disrupted selective autophagy and impaired NF κ B signaling. *Autophagy*. 2013 Oct;9(10):1591–603.

52. Shi J, Fung G, Piesik P, Zhang J, Luo H. Dominant-negative function of the C-terminal fragments of NBR1 and SQSTM1 generated during enteroviral infection. *Cell Death Differ.* 2014 Sep;21(9):1432–41.
53. Siegal S. BENIGN PAROXYSMAL PERITONITIS. *Ann Intern Med.* 1945;23(1):1–21.
54. Goldfinger SE. Colchicine for familial Mediterranean fever. *N Engl J Med.* 1972 Dec 21;287(25):1302.
55. Zemer D, Pras M, Sohar E, Modan M, Cabili S, Gafni J. Colchicine in the prevention and treatment of the amyloidosis of familial Mediterranean fever. *N Engl J Med.* 1986 Apr 17;314(16):1001–5.
56. Shohat M, Danon YL, Rotter JI. Familial Mediterranean fever: analysis of inheritance and current linkage data. *Am J Med Genet.* 1992 Sep 15;44(2):183–8.
57. Xu H, Yang J, Gao W, Li L, Li P, Zhang L, et al. Innate immune sensing of bacterial modifications of Rho GTPases by the Pyrin inflammasome. *Nature.* 2014 Sep 11;513(7517):237–41.
58. Park Y, Kastner D, Chae J. Activation of the pyrin inflammasome through the RhoA signaling pathway in FMF and HIDS. *Pediatr Rheumatol Online J.* 2015 Sep 28;13(Suppl 1):O11.
59. Federici S, Calcagno G, Finetti M, Gallizzi R, Meini A, Vitale A, et al. Clinical impact of MEFV mutations in children with periodic fever in a prevalent western European Caucasian population. *Ann Rheum Dis.* 2012 Dec;71(12):1961–5.
60. Omenetti A, Carta S, Delfino L, Martini A, Gattorno M, Rubartelli A. Increased NLRP3-dependent interleukin 1 β secretion in patients with familial Mediterranean fever: correlation with MEFV genotype. *Ann Rheum Dis.* 2014 Feb 1;73(2):462–9.
61. Netea MG, Nold-Petry CA, Nold MF, Joosten LAB, Opitz B, van der Meer JHM, et al. Differential requirement for the activation of the inflammasome for processing and release of IL-1 β in monocytes and macrophages. *Blood.* 2009 Mar 5;113(10):2324–35.
62. Liao Y-H, Lin Y-C, Tsao S-T, Lin Y-C, Yang A-J, Huang C-T, et al. HMG-CoA reductase inhibitors activate caspase-1 in human monocytes depending on ATP release and P2X7 activation. *J Leukoc Biol.* 2013 Feb;93(2):289–99.
63. Piccini A, Carta S, Tassi S, Lasiglié D, Fossati G, Rubartelli A. ATP is released by monocytes stimulated with pathogen-sensing receptor ligands and induces IL-1 β and IL-18 secretion in an autocrine way. *Proc Natl Acad Sci U S A.* 2008 Jun 10;105(23):8067–72.
64. Gaidt MM, Ebert TS, Chauhan D, Schmidt T, Schmid-Burgk JL, Rapino F, et al. Human Monocytes Engage an Alternative Inflammasome Pathway. *Immunity.* 2016 Apr 19;44(4):833–46.
65. Chen L-Y, Zuraw BL, Liu F-T, Huang S, Pan ZK. IL-1 receptor-associated kinase and low molecular weight GTPase RhoA signal molecules are required for bacterial lipopolysaccharide-induced cytokine gene transcription. *J Immunol Baltim Md 1950.* 2002 Oct 1;169(7):3934–9.
66. Feldmeyer L, Keller M, Niklaus G, Hohl D, Werner S, Beer H-D. The inflammasome mediates UVB-induced activation and secretion of interleukin-1 β by keratinocytes. *Curr Biol CB.* 2007 Jul 3;17(13):1140–5.
67. Wang D, Höing S, Patterson HC, Ahmad UM, Rathinam VAK, Rajewsky K, et al. Inflammation in mice ectopically expressing human Pyogenic Arthritis, Pyoderma Gangrenosum, and Acne (PAPA) Syndrome-associated PSTPIP1 A230T mutant proteins. *J Biol Chem.* 2013 Feb 15;288(7):4594–601.
68. Jabir MS, Ritchie ND, Li D, Bayes HK, Turlomousis P, Puleston D, et al. Caspase-1 cleavage of the TLR adaptor TRIF inhibits autophagy and β -interferon production during *Pseudomonas aeruginosa* infection. *Cell Host Microbe.* 2014 Feb 12;15(2):214–27.