



HAL
open science

An adaptive multi-agent system for the distribution of intelligence in electrical distribution networks: state estimation

Alexandre Perles

► **To cite this version:**

Alexandre Perles. An adaptive multi-agent system for the distribution of intelligence in electrical distribution networks: state estimation. Artificial Intelligence [cs.AI]. Université Paul Sabatier - Toulouse III, 2017. English. NNT : 2017TOU30017 . tel-01743586

HAL Id: tel-01743586

<https://theses.hal.science/tel-01743586v1>

Submitted on 26 Mar 2018

HAL is a multi-disciplinary open access archive for the deposit and dissemination of scientific research documents, whether they are published or not. The documents may come from teaching and research institutions in France or abroad, or from public or private research centers.

L'archive ouverte pluridisciplinaire **HAL**, est destinée au dépôt et à la diffusion de documents scientifiques de niveau recherche, publiés ou non, émanant des établissements d'enseignement et de recherche français ou étrangers, des laboratoires publics ou privés.



Université
de Toulouse

THESIS

to obtain the title of

DOCTEUR DE L'UNIVERSITÉ DE TOULOUSE

Delivered by : *Université Toulouse 3 Paul Sabatier (UT3 Paul Sabatier)*

Presented and defended on *February 9, 2017* by :

Alexandre Perles

**An Adaptive Multi-Agent System
for the Distribution of Intelligence in Electrical Distribution Networks:
State Estimation**

JURY

SALIMA HASSAS	Professor, Université Claude Bernard Lyon 1	Reviewer
VINCENT CHEVRIER	Professor, Université de Lorraine	Reviewer
GIOVANNA DI MARZO SERUGENDO	Professor, Université de Genève	Examiner
RAPHAËL CAIRE	Associate Professor, INP Grenoble	Examiner
MARIE-PIERRE GLEIZES	Professor, Université de Toulouse	Supervisor
GUY CAMILLERI	Associate professor, Université de Toulouse	Co-Supervisor
OLIVIER CHILARD	Research Engineer, EDF Lab Paris-Saclay	Co-Supervisor
DOMINIQUE CROTEAU	Research Engineer, EDF Lab Paris-Saclay	Invited

Doctoral school :

MITT : Domaine STIC : Intelligence Artificielle

Research unit :

Institut de Recherche en Informatique de Toulouse

Thesis directors :

Marie-Pierre Gleizes and Guy Camilleri

Referees :

Salima Hassas and Vincent Chevrier

THESIS

presented at

Université Paul Sabatier - Toulouse III

U.F.R. MATHÉMATIQUES, INFORMATIQUE ET GESTION

to obtain the title of

DOCTEUR DE L'UNIVERSITÉ DE TOULOUSE

delivered by

UNIVERSITÉ PAUL SABATIER - TOULOUSE III

Mention INFORMATIQUE

by

ALEXANDRE PERLES

Doctoral school: Informatique et Télécommunication

Laboratory: Institut de Recherche en Informatique de Toulouse

Team: Systèmes Multi-Agents Coopératifs

An Adaptive Multi-Agent System for the Distribution of Intelligence in Electrical Distribution Networks: State Estimation

JURY

Salima HASSAS	<i>Professor, Université Claude Bernard Lyon 1</i>	(Reviewer)
Vincent CHEVRIER	<i>Professor, Université de Lorraine</i>	(Reviewer)
Giovanna DI MARZO SERUGENDO	<i>Professor, Université de Genève</i>	(Examiner)
Raphaël CAIRE	<i>Associate Professor, INP Grenoble</i>	(Examiner)
Marie-Pierre GLEIZES	<i>Professor, Université de Toulouse</i>	(Supervisor)
Guy CAMILLERI	<i>Associate professor, Université de Toulouse</i>	(Co-Supervisor)
Olivier CHILARD	<i>Research engineer, EDF Lab Paris-Saclay</i>	(Co-Supervisor)
Dominique CROTEAU	<i>Research engineer, EDF Lab Paris-Saclay</i>	(Invited)

Alexandre Perles

**AN ADAPTIVE MULTI-AGENT SYSTEM FOR THE DISTRIBUTION
OF INTELLIGENCE IN ELECTRICAL DISTRIBUTION NETWORKS:
STATE ESTIMATION**

Supervisors: Marie-Pierre GLEIZES, Guy CAMILLERI, Olivier CHILARD
Université de Toulouse III

Abstract

Electricity plays an increasingly important role in our society. Indeed, we are moving toward the era of “everything electric”. The needs evolving, it is mandatory to rethink the way electricity is produced and distributed. This then introduces the concept of an autonomous and intelligent power system called the Smart Grid.

The Smart Grid is a concept of electrical network able to support autonomously any changes and faults that may occur. Obviously, the geographical distribution of electrical networks and the environment (weather conditions, ...) make it impossible to predict events that will occur.

To do this, this study proposes an innovative agent-based framework as well as the design and implementation of cooperative agents behaviors aiming at solving common power systems related problems: the Load Flow analysis and the State Estimation.

These issues have been addressed by the mean of Adaptive Multi-Agent Systems. These systems are known to be efficient to solve complex problems and have the ability to adapt their functioning to the evolutions of their environment.

The results obtained show the relevance of using such self-adaptive systems to solve the issues inherent to the Smart Grid.

Alexandre Perles

**UN SYSTÈME MULTI-AGENT AUTO-ADAPTATIF
POUR LA DISTRIBUTION DE L'INTELLIGENCE DANS LES RÉSEAUX
ÉLECTRIQUES DE DISTRIBUTION : ESTIMATION D'ÉTAT**

Encadrants: Marie-Pierre GLEIZES, Guy CAMILLERI, Olivier CHILARD
Université de Toulouse III

Abstract

L'électricité joue un rôle de plus en plus important dans notre société. En effet, nous nous dirigeons vers l'ère du "tout électrique". Les besoins évoluant, il est indispensable de repenser la manière dont l'électricité est produite et distribuée. Cela introduit le concept de Smart Grid.

Le Smart Grid est un concept de réseau électrique capable de supporter de manière autonome et intelligente les changements et pannes qui pourraient survenir dans un réseau. Cela répond directement au fait que de part la nature fortement distribuée et l'imprédictibilité de l'environnement (météo, ...), ces événements sont imprévisibles.

Pour cela, cette thèse propose un cadre applicatif (framework) innovant basé sur les multi-agents ainsi que la conception et l'implémentation de comportements coopératifs pour résoudre deux problèmes courants dans les réseaux électriques: l'analyse des flux de puissance et l'estimation d'état.

Ces problèmes ont été abordés avec l'approche des Systèmes Multi-Agent Adaptatifs. Ces systèmes sont efficaces pour résoudre des problèmes complexes et ont la capacité d'adapter leur fonctionnement aux évolutions de leur environnement.

Les résultats obtenus indiquent la pertinence d'utiliser de tels systèmes adaptatifs pour résoudre les problèmes inhérents au concept de Smart Grid.

*"Give me a place to stand, and a lever long enough, and I will move the world."
Archimedes*

Remerciements

Je ne peux que confirmer les propos de certains avant moi : c'est bien ce dernier texte le plus dur à rédiger. Toutefois, il paraît que c'est aussi la seule partie dans laquelle on peut s'exprimer à notre manière. Les mots qui suivent seront donc brefs mais sincères.

Tout d'abord, je tiens à remercier Marie-Pierre. En plus d'avoir dirigé ma thèse, tu es celle qui m'a montré que l'informatique était un univers encore plus étendu et passionnant que ce que je pensais. Depuis les premiers cours jusqu'à ce jour, tu m'as toujours donné envie d'avancer plus et m'a fait confiance en me permettant d'effectuer ces stages et cette thèse au sein de l'équipe SMAC. C'est également toi qui m'a fait découvrir les AMAS grâce à tes cours passionnants et pour ça, je te remercie énormément. Aussi, je souhaite te remercier pour ta patience et ton investissement dans tous mes travaux.

Je tiens également à remercier Guy, d'une part pour avoir co-dirigé ma thèse mais également pour nos longues discussions. Ce fut réellement un plaisir de travailler avec toi. Merci d'avoir été tant pédagogue, de m'avoir aidé et soutenu pendant toute cette thèse et m'avoir débloqué de nombreuses fois.

Merci aussi évidemment à toi, Pierre. Merci pour ta patience, ton écoute et tes "NON". Quand on croit connaître un domaine, c'est toujours un plaisir de s'apercevoir qu'il y a quelqu'un comme toi avec une telle passion qui en sait toujours plus et qui a tant à m'enseigner et ce, même après des années de pratique. C'est toujours un plaisir de discuter avec toi.

Tous les trois vous êtes des personnes que je respecte et que j'admire tant sur le plan professionnel que sur le plan personnel.

Merci également à mes encadrants EDF Olivier et Dominique. Même s'il a parfois été difficile de communiquer et d'échanger à cause de la distance et du fait que nous ne parlions pas toujours le même langage, nos discussions étaient souvent enrichissantes et m'ont un peu réconcilié avec les Mathématiques.

Merci évidemment à tous les membres de l'équipe SMAC : les permanents, les post-docs, les ATER, les doctorants et les stagiaires, passés, présents et futurs. Cette expérience de vie n'aurait pas été la même sans vous. Merci pour toutes ces pauses café, ces repas, ces séminaires, ces jeux de société, ces sorties et ces grandes discussions (Oui, je sais, je parle trop).

Merci aussi au conducteur de cette caravane ainsi qu'à tous ses passagers. Merci également d'avoir écouté la musique de la pub Royal Canin avec moi. Merci pour ce FrEEStYIE iN YoUR BAigNoiRE. Merci de n'avoir bu qu'une seule V-bière avec moi. Merci d'avoir toujours répondu à mes appels à Laine. Merci pour ces déboires et débauches, vous êtes vraiment la crème de la crème. Merci aussi à tous ceux d'Escalquens et alentours pour tous ces bons moments. Enfin, merci à tous mes autres amis, il serait trop long de vous remercier un par un mais sachez que je ne vous oublie pas.

Je souhaite aussi remercier toute ma grande famille : les tantes, les oncles, les cousins, les cousines, les petits cousins, les petites cousines et tous ceux qui se sont rajoutés au fur et à mesure et qui n'ont fait qu'agrandir la famille et lui rajouter encore plus de valeur. J'ai réellement de la chance de faire partie d'une famille unie comme peu d'autres. Que vous soyez proches ou non, vous comptez tous autant pour moi et avez joué un rôle très important

dans différentes parties de ma vie. Je suis très heureux et chanceux de vous avoir. Et plus particulièrement, merci à mes frères Romain et Bruno pour ces bagarres, cette tente un peu humide, cette guitare, ces sauts dans la neige, ces cabanes... Ah oui, et désolé pour le lion qui est mort ce soir. Merci également à ma belle soeur Aurélie (tu peux continuer à me traiter d'Einstein si tu veux), à Maurice (tu pousses le bouchon un peu loin mais t'en fais pas pour les Chocosui's, j'en rachèterai), à ma nièce Zya et mon neveu Noah (j'ai adoré vos chorégraphies). Et enfin, merci à mon père.

Je tiens bien sûr à remercier ma mère, Évelyne. Tu as toujours été là pour moi. Sans toi, je sais que je ne serais pas là. Tu m'as toujours poussé à me dépasser et à donner le meilleur de moi-même. Tu t'es également toujours assurée que je dispose de tout ce dont j'avais besoin et même plus. Tu es une mère formidable. Merci pour toute ma joyeuse enfance. Merci pour ce burger au poisson pané le mercredi, merci pour ces vacances, merci de m'avoir toujours montré le bon exemple, merci pour cette affection dont tu m'as toujours inondé et merci de t'être tant sacrifiée pour moi.

Enfin, merci à toi Ma Constance. Je n'aurai jamais espéré rencontrer quelqu'un qui me correspondait tant. Tu es arrivée dans ma vie au début de cette aventure et depuis tu as été un soutien sans faille pour moi. Tu es une personne exceptionnelle avec qui j'ai beaucoup de chance de passer ma vie. Je ne te remercierai jamais assez d'être la personne que tu es avec moi et ce n'est certainement pas ces quelques mots qui suffiront. Toutefois, je tenais à te dire merci. Merci pour ce palier, merci pour ce réveil sur les galets, merci d'être trop cute, merci pour Mein et merci pour tous ces moments passés et ceux qui suivront.

Enfin, je ne pouvais que terminer ces remerciements par ce mot : Mah !

Summary

I	Introduction	1
1	Introduction (version française)	5
2	Introduction	15
II	Context of the Study and State of the Art	27
3	Concepts and Definitions on Electrical Networks	29
4	The Multi-Agent Approaches for Smart Grids - An Overview	41
5	ATENA (Adaptive Transmission of Energy and Network Analysis)	49
III	Design and Implementation of Atena	63
6	ATENA for Load Flow Analysis	65
7	ATENA for Distribution System State Estimation	87
IV	Conclusion	117
8	Conclusion and Perspectives	119
9	Conclusion et Perspectives (version française)	123
V	Appendix	127
A	Notations	129
B	Power Systems Test Cases	131
	Bibliography	177

Contents

I	Introduction	1
1	Introduction (version française)	5
1.1	Vers une Production Décentralisée	5
1.2	Impact de l'Intégration Massive de Générateurs Distribués dans les Réseaux de Distribution	6
1.3	Smart Grid	9
1.4	Détection des Sous-Tensions et Sur-Tensions	12
1.5	Intervalles de Tensions Acceptables dans Différents Pays	12
1.6	Role de l'Analyse des Flux de Puissance et de l'Estimation d'État dans le Smart Grid	13
1.7	Les Systèmes Multi-Agents Adaptatifs pour la Résolution de Problèmes Complexes	13
1.8	Plan	14
2	Introduction	15
2.1	Toward Decentralized Production	15
2.2	Impact of the Massive Integration of Distributed Generator in Distribution Network	16
2.3	Smart Grid	19
2.4	Over and undervoltage awareness	22
2.5	Acceptable Voltage Range across Different Countries	22
2.6	Roles of the Load Flow Analysis and the State Estimation in the Smart Grid	23
2.7	Adaptive Multi-Agent Systems for Complex Problem Solving	24
2.8	Manuscript Organization	24
II	Context of the Study and State of the Art	27
3	Concepts and Definitions on Electrical Networks	29
3.1	Components of an Electrical Network	30
3.2	Types of Network	31
3.3	Definition of the State of a Network	34
3.4	Measures in an Electrical Network	35
3.5	Line Flows Computation	36
3.6	Conventions	37
3.7	Kirchhoff's Current Law	38
3.8	Conclusion	39

4	The Multi-Agent Approaches for Smart Grids - An Overview	41
4.1	Multi-Agent System	41
4.2	The Multi-Agent Systems for the Smart Grids	44
4.3	Conclusion	48
5	ATENA (Adaptive Transmission of Energy and Network Analysis)	49
5.1	The Functional Adequacy	50
5.2	Cooperative System	51
5.3	Criticality	51
5.4	The Non Cooperative Situations	51
5.5	Emergence and Self-Adaptation	52
5.6	The ADELFE Methodology	53
5.7	Modeling the Framework ATENA	55
III	Design and Implementation of Atena	63
6	ATENA for Load Flow Analysis	65
6.1	Introduction	65
6.2	Problem Description	66
6.3	Some Existing Works Solving the Load Flow Problem	68
6.4	ATENA for the Load Flow Analysis	76
6.5	Evaluation of the ATENA for Load Flow Analysis Multi-Agent System	82
6.6	Conclusion	86
7	ATENA for Distribution System State Estimation	87
7.1	Introduction	88
7.2	Problem Description	89
7.3	Existing Works to Solve the State Estimation Problem	92
7.4	ATENA for State Estimation	96
7.5	Evaluations of the ATENA framework for State Estimation Multi-Agent System	105
7.6	Conclusion	112
IV	Conclusion	117
8	Conclusion and Perspectives	119
8.1	Contributions to the Computer Sciences	119
8.2	Contributions to the Electrotechnical Field	120
8.3	Perspectives	120
9	Conclusion et Perspectives (version française)	123
9.1	Contributions au Domaine de l'Informatique	123
9.2	Contributions au Domaine de l'Electrotechnique	124
9.3	Perspectives	124

V Appendix	127
A Notations	129
B Power Systems Test Cases	131
B.1 41-bus Test System	132
B.2 64-bus Test System	135
B.3 80-bus Test System	139
B.4 111-bus Test System	144
B.5 133-bus Test System	150
B.6 153-bus Test System	157
B.7 207-bus Test System	165
Bibliography	177

*An Adaptive Multi-Agent System for the
Distribution
of Intelligence in Electrical Distribution Networks:
State Estimation*

Introduction

N.B. - Cette thèse a été rédigée en anglais afin qu'elle puisse être lue par une majorité de personnes. Toutefois, le lecteur trouvera une traduction de l'introduction et de la conclusion en français. ainsi qu'un bref résumé en début de chaque chapitre. Le lecteur anglophone pourra commencer la lecture à la page 15.

N.B. - This thesis has been written in english in order to be read by the majority of people. However, the reader will find a translation of the introduction and conclusion in french as well as short summaries at the beginning of each chapter. English-speaking readers are invited to start reading from the page 15.

1 Introduction (version française)

Quelles que soient les technologies mises en place, les réseaux électriques sont guidés par les lois physiques et sont par conséquent exposés à certains événements qui ne peuvent ni être prévus ni empêchés.

Découpé en deux parties, ce manuscrit propose une approche innovante pour la mise en place du concept de Smart Grid en commençant par la résolution de deux problèmes courants dans les systèmes électriques : l'analyse des flux de puissances et l'estimation d'état.

Cette introduction présente les raisons qui ont motivé ce travail ainsi que le rôle qu'ont ces deux points dans la mise en place du Smart Grid. De plus, la pertinence d'utiliser un système adaptatif est présentée. Enfin, la structure du manuscrit est donnée.

1.1 Vers une Production Décentralisée

De nos jours, la plupart des réseaux électriques nationaux s'appuient sur des centrales électriques qui fournissent de l'électricité pour l'ensemble du réseau auquel elles appartiennent. Cette approche a été utilisée pendant des décennies, en particulier car :

- ▷ leur production d'énergie est souvent indépendante des conditions météorologiques,
- ▷ leur capacité de production est très élevée,
- ▷ et elles permettent de faire de la cogénération (recyclage de l'énergie sous une forme lors de la génération d'énergie sous une autre forme, par exemple pour chauffer un bâtiment).

Malgré cela, il est important d'examiner divers aspects limitants.

Le premier est que la production centralisée nécessite de transporter l'électricité sur de longues distances. Cela conduit à des pertes d'énergie dues à l'effet Joule (la transformation d'une énergie électrique en énergie thermique). Dans le cas de réseau électrique, il y a des pertes sur les lignes. Comme une partie de l'énergie électrique est transformée en énergie thermique tout en circulant dans les lignes, cette énergie est perdue par un échange thermique avec l'air ambiant et ne peut donc servir au point de consommation. Plus le courant électrique est élevé, plus les pertes d'énergie sont importantes. Pour compenser, les réseaux de grande envergure utilisent de la haute tension. Ainsi, il est possible de transporter la même puissance avec un courant plus faible et donc moins de pertes.

Pour ouvrir le marché de l'électricité à la concurrence et réduire les émissions de gaz à effet de serre, un groupe d'entités (notamment le Parlement Européen) a décidé la mise en place de changements stratégiques. Ceci a amené à ajouter des producteurs décentralisés ayant pour but de fournir l'électricité générée localement au réseau de distribution.

De plus, les méthodes de production traditionnelles s'appuient généralement sur des énergies non renouvelables et actuellement les gouvernements encouragent l'utilisation d'énergies renouvelables dans le cadre d'une politique de développement durable.

Afin de maximiser les avantages des énergies renouvelables, il est inévitable de placer ce genre de générateurs là où leur production est à son maximum (régions venteuses pour les parcs éoliens, régions ensoleillées pour les panneaux photovoltaïques,...). Évidemment, cela implique la nécessité de passer d'une production centralisée d'énergie à une décentralisée. La figure 1.1 présente la topologie d'un réseau composé de cinq bus¹ et de deux producteurs décentralisés ainsi que les directions d'écoulement de puissance.

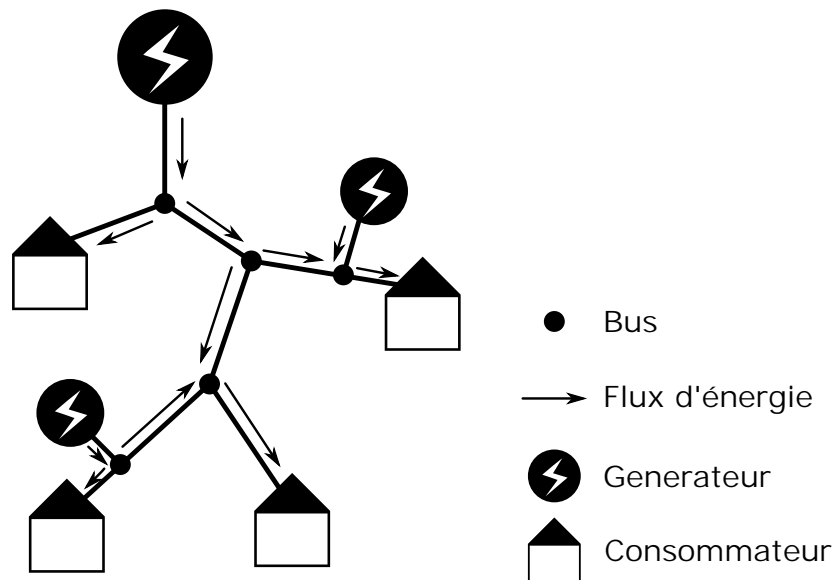

Figure 1.1: Topologie d'un réseau du futur

1.2 Impact de l'Intégration Massive de Générateurs Distribués dans les Réseaux de Distribution

L'intégration massive de producteurs décentralisés implique la nécessité de changer la manière dont les réseaux sont contrôlés. Les réseaux de distribution doivent être capables de bénéficier de ces nouvelles opportunités de contrôle.

Un réseau électrique peut être fait avec une structure radiale ou maillée. Ces réseaux peuvent contenir des interrupteurs qui ont pour effet de changer la topologie du réseau. Bien que cela n'affecte pas l'objectif d'un réseau électrique qui est le transport de l'électricité, ces deux configurations ont des avantages et des inconvénients différents. La principale

¹Point de connexion entre divers éléments d'un réseau

différence entre ces deux structures est que la structure radiale ne contient pas de boucles en fonctionnement. Dans les réseaux de configuration radiale, les interrupteurs sont ouverts pour éviter les boucles et donc il y a un seul et unique chemin d'un point à un autre.

Un réseau de distribution a habituellement une configuration radiale dans laquelle le poste source fournit toute l'électricité nécessaire aux consommateurs.

L'avantage d'une structure maillée est de rendre le réseau plus robuste pour continuer à fournir de l'énergie. En effet, dans le cas où une ligne est coupée, l'électricité peut être fournie via une autre. Cependant, cela nécessite d'installer physiquement plusieurs lignes et donc cela a un coût d'installation plus élevé. Cette structure est généralement utilisée dans les réseaux de transport. Pour un même nombre de nœuds, la configuration radiale a l'avantage de nécessiter moins de lignes. Cette structure est généralement utilisée pour les réseaux de distribution.

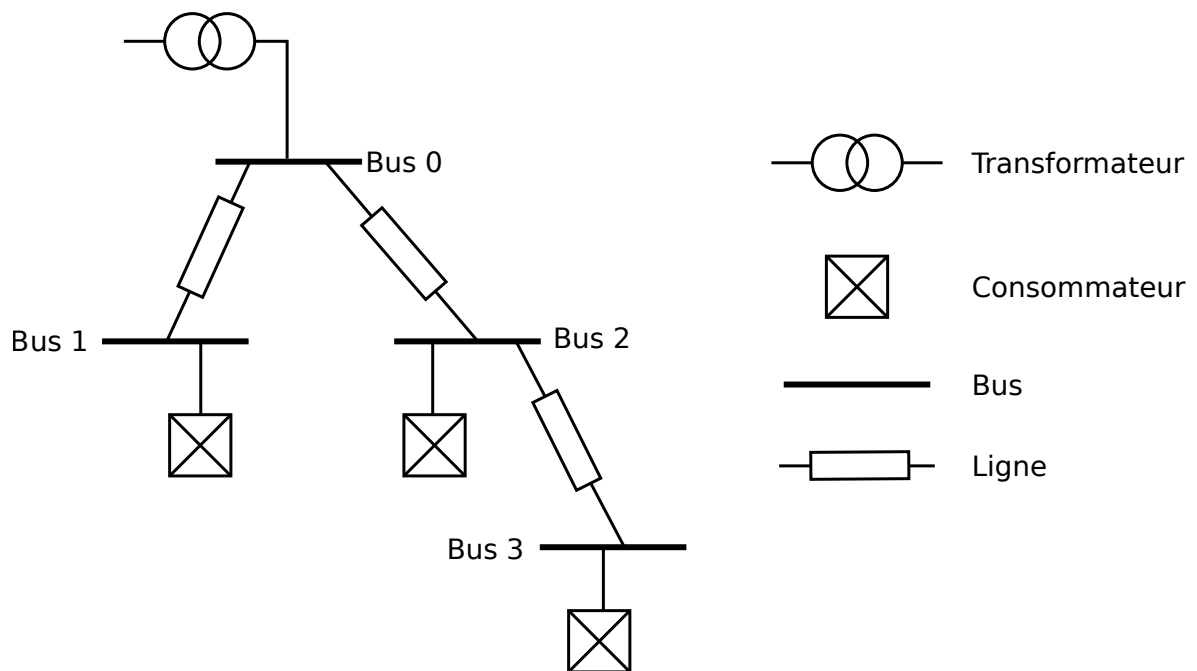

Figure 1.2: Réseau de distribution à configuration radiale

La figure 1.2 présente un exemple d'un réseau de distribution à configuration radiale. Le transformateur Haute Tension/Moyenne Tension est connecté au réseau haute tension en tant que consommateur et distribue de l'électricité à une tension plus faible au réseau moyenne tension. Comme nous pouvons le voir dans cette figure, il y a un seul fournisseur d'énergie. Par conséquent, le transit dans les lignes est unidirectionnel. L'absence de générateur décentralisé dans le réseau garantit que pour deux bus i et j (sur un même départ) si i est plus proche du poste source que j , alors l'amplitude de la tension au bus i sera supérieure ou égale à celui du bus j . Un exemple d'un profil de tension qui peut être associé au réseau de la figure 1.2 est présenté dans la figure 1.3.

Comme on peut le voir dans la figure 1.3, les consommateurs raccordés au réseau peuvent avoir un contrat avec le gestionnaire de réseau qui oblige ce dernier à maintenir la tension à un certain bus dans un intervalle prédéfini. Dans un réseau avec une structure radiale et un fournisseur d'énergie unique, il est relativement facile de garder ces valeurs de tension

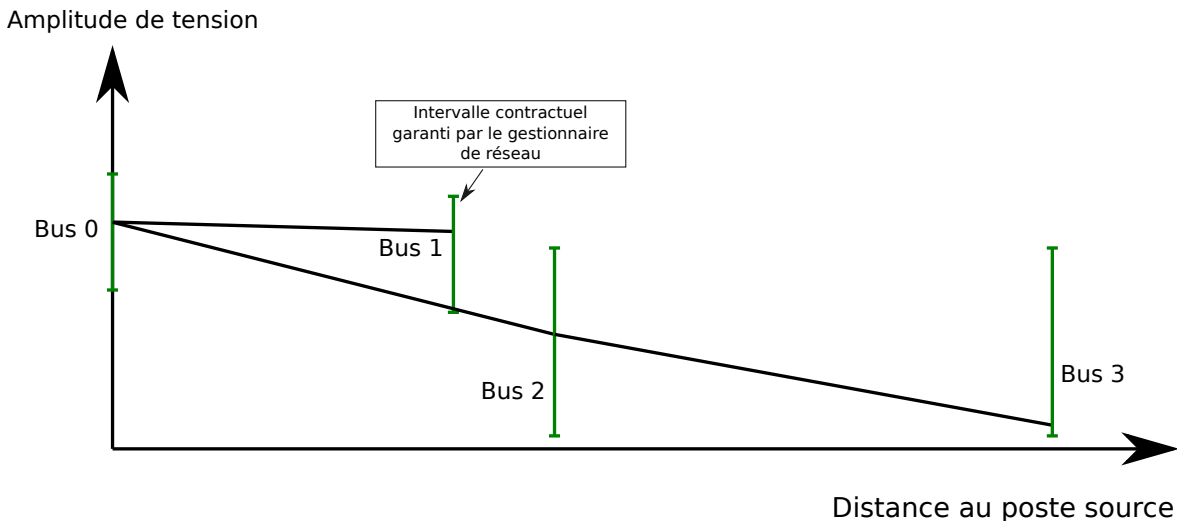

Figure 1.3: Exemple d'un profil de tension

dans un certain intervalle. Supposons la présence d'une valeur de tension inférieure à la valeur minimale de l'intervalle contractuel, la valeur de la tension au point de production doit être augmentée. À l'inverse, une tension trop élevée pourrait entraîner la réduction de la consigne au poste source. La figure 1.4 présente un problème qui peut se produire lors

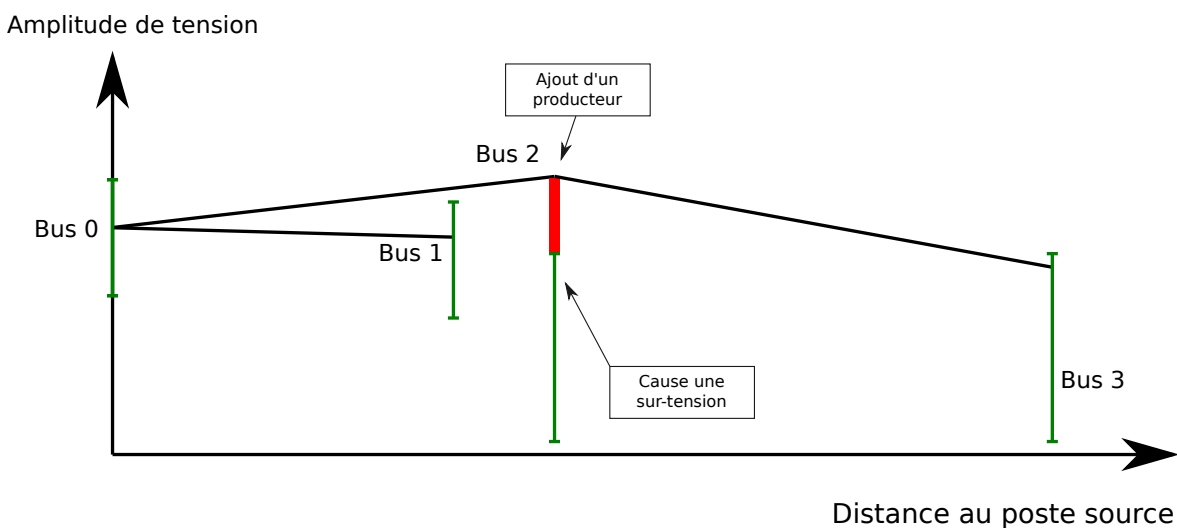

Figure 1.4: Surtension causée par l'ajout d'un producteur

de l'utilisation d'un générateur distribué. L'exploitation d'un générateur distribué dans le réseau peut remonter le profil de tension. Il est nécessaire de trouver les paramètres corrects pour éviter une surtension. Dans cette figure, le bus 2 a une surtension causée par l'ajout d'un producteur entraînant une magnitude de tension trop élevée.

Par conséquent, le réseau de distribution doit être capable de prendre en compte un nombre croissant de générateurs décentralisés tout en conservant une bonne qualité de service. Ceci peut être accompli avec des réseaux flexibles et contrôlables. Il est donc nécessaire d'automatiser les réseaux de distribution pour pouvoir les contrôler. Cela introduit

la notion de Smart Grid dans lequel le réseau sera contrôlé par le biais de fonctions avancées d'automatisation. Pour que les réseaux fonctionnent efficacement, il est nécessaire d'avoir une observation suffisante pour faire une bonne estimation de l'état du réseau.

1.3 Smart Grid

Cette partie présente le concept de Smart Grid comme une solution aux problèmes précédemment exprimés. Comme cette idée d'un réseau électrique intelligent est assez nouvelle, aucun consensus n'a été trouvé sur la définition du Smart Grid. Dans cette partie, nous donnerons les principales définitions proposées. Ensuite, nous présenterons les caractéristiques des réseaux intelligents. Et enfin, nous énumérerons les questions importantes à considérer telles que le contrôle, la sécurité et le stockage dans les Smart Grids.

1.3.1 Définitions

En 2010, trois communautés de chercheurs ont donné leur propre définition de la notion de "Smart Grid".

L'Ontario Smart Grid Forum a proposé la définition suivante :

Definition 1.

Smart Grid - "Un Smart Grid est un système moderne d'électricité. Il utilise des capteurs, des moyens de contrôle, de communications et d'automatisation et l'informatique pour améliorer la souplesse, sécurité, fiabilité, efficacité et sécurité des systèmes électriques." [Singer 2010]

Le "Department Of Energy" des États-Unis d'Amérique (D.O.E.) définit le Smart Grid de la manière suivante :

Definition 2.

Smart Grid - "Un réseau de livraison d'énergie automatisé largement distribué. Le Smart Grid se caractérise par une circulation bidirectionnelle de l'électricité et est capable de surveiller tout, des centrales électriques aux préférences des consommateurs pour les appareils individuels. Cela comprend les avantages de l'informatique distribuée et de la communication pour diffuser l'information en temps réel et permettre l'équilibre quasi instantané de l'offre et la demande au niveau matériel." [Department of Energy 2010]

Basé sur les définitions précédentes, la "Canadian Electricity Association" a proposé cette définition :

Definition 3.

Smart Grid - "Le réseau intelligent est une suite d'applications rendues possibles par une automatisation accrue du réseau d'électricité. Ces technologies intègrent le comportement et les actions des éléments et des charges connectés à travers des communications pour distribuer de l'énergie de manière sûre, économique et durable." [Canadian Electricity Association 2010]

D'après ces définitions, nous proposons la définition suivante qui reprend quelques concepts mentionnés précédemment :

Definition 4.

Smart Grid - Le Smart Grid est un concept de réseau électrique autonome capable de s'adapter aux besoins du client de manière sécurisée, économique et écologique. Il permet l'échange bidirectionnel d'électricité et d'informations via les lignes.

1.3.2 Caractéristiques du Smart Grid

Dans la littérature, le Smart Grid est défini par cinq caractéristiques: équilibrage de l'offre et la demande, auto-cicatrisation, réduction des pertes, minimisation des sollicitations matérielles et le réglage de la tension. Cette partie vise à définir ces caractéristiques.

1.3.2.0.1 Équilibrage de l'Offre et la Demande

Afin de satisfaire les clients et de garantir la sûreté du système électrique, il faut être capable de produire l'énergie nécessaire au moment où elle doit être utilisée ou en tout cas être capable d'en stocker suffisamment pour la fournir au moment voulu.

1.3.2.0.2 Auto-Cicatrisation

Nous parlons d'auto-cicatrisation lorsqu'un réseau Smart Grid est capable de détecter et résoudre des problèmes. Quel que soit le réseau, les pannes de courant sont inévitables [Solanki et al. 2007]. Au mieux, il est possible de les détecter avant qu'elles ne se produisent. Lors la détection de pannes dans un réseau, l'opération habituelle consiste à isoler le défaut, ce qui peut conduire (avec l'architecture actuelle) à des coupures dans certains secteurs initialement non concernés par la panne.

1.3.2.0.3 Réduction des Pertes

En raison de l'effet Joule, plus les lignes sont longues, plus les pertes d'énergie sont élevées. Une des caractéristiques du Smart Grid est de pouvoir contribuer à minimiser ces pertes.

1.3.2.0.4 Minimisation des Sollicitations Matérielles

Le but de cette caractéristique est de limiter la quantité de sollicitations faites sur le matériel afin de minimiser le coût résultant de l'usure des équipements.

1.3.2.0.5 Régulation de Tension

La régulation de tension est le processus qui consiste à choisir un ensemble de valeurs de tension afin de s'assurer que les tensions à des points spécifiques sont dans l'intervalle garanti par le gestionnaire de réseau. On considère également que la régulation de tension inclut la coordination des réseaux basse tension et moyenne tension.

1.3.3 Motivations pour passer des Réseaux Électriques Classiques au Smart Grid

Comme évoqué dans le livre de Roche [Roche 2012], les motivations pour passer des réseaux électriques classiques au concept de Smart Grids, en plus des raisons politiques, sont les suivantes :

- ▷ **Augmentation de la demande énergétique.** La demande en énergie augmente rapidement. La demande énergétique mondiale devrait augmenter de 150% de 2010 à 2050 selon le scénario de base de "Energy Technology Perspectives" 2010 (ETP 2010) et de 115% entre 2007 et 2050 dans le scénario de "Blue Map" [International Energy Agency 2011].
- ▷ **Le réchauffement climatique.** Depuis les années 1960, les températures de l'air et l'eau sont de plus en plus lointaines des conditions normales. Cela est dû au réchauffement climatique. Face à cette situation, certains gouvernements ont décidé de promouvoir l'utilisation des énergies renouvelables.
- ▷ **L'augmentation des générations distribuées et renouvelables.** Pour les raisons mentionnées précédemment (qui sont les besoins énergétiques en constante augmentation et la nécessité d'une production d'énergie plus écologique), le nombre de générateurs distribués et renouvelables va augmenter rapidement. Cela implique de nombreux nouveaux points de contrôle supplémentaires et donc l'augmentation de la complexité du problème visant à assurer l'intervalle de tension contractuel et, plus généralement, une bonne qualité de service.
- ▷ **L'appauvrissement des ressources actuellement utilisées pour la production d'énergie.** En plus des problèmes liés au réchauffement climatique, les ressources actuellement utilisées sont limitées et risquent de manquer.

1.3.4 Problématiques

L'intégration massive de producteurs d'énergie géographiquement très éloignés les uns des autres et la volonté de fournir de l'énergie de façon plus efficace pose des problèmes qui doivent être abordés lors du passage du réseau électrique classique au concept de Smart Grid et notamment la régulation de tension.

1.3.4.0.6 Contrôle

Afin de contrôler le réseau électrique de manière efficace, il est d'abord nécessaire d'identifier les points qui sont contrôlables. Le contrôle de la tension se fait essentiellement aux postes sources et aux producteurs décentralisés. En effet, même s'il est possible de faire une partie de la régulation au niveau des transformateurs Moyenne Tension/Basse Tension, dans l'état actuel de la technologie utilisée, celle-ci se fait rarement car cela requiert la déconnexion totale du réseau basse tension concerné. De plus, on sait que la consommation des clients a un impact important sur la chute de tension dans le réseau. Une option couramment utilisée est de proposer aux clients de changer la façon dont ils consomment comme cela est fait lors des heures creuses.

1.3.4.0.7 Sécurité Informatique

Comme dit dans la définition, le concept de Smart Grid comprend un système de communication. Par définition, ces systèmes sont vulnérables aux attaques informatiques. Pour éviter les pannes de courant dues à des attaques malveillantes ou simplement par un capteur défectueux, il est nécessaire de prendre en compte la sécurité dans le Smart Grid. Outre la protection contre les attaques informatiques, le Smart Grid doit également protéger les données du consommateur.

1.3.4.0.8 Stockage Dynamique d'Énergie

En dehors de la prise en compte des producteurs décentralisés, il faut prévoir l'intégration de stockage dynamique d'énergie tel que les véhicules électriques. Ils ont un impact significatif sur la stabilité du réseau. Il est nécessaire de contrôler quand ils doivent être chargés ou quand ils peuvent libérer de l'énergie pour alimenter une partie du réseau.

1.3.5 Conclusion

Outre la définition du concept de Smart Grid, cette partie présente ce qui le caractérise, pourquoi il est nécessaire de le mettre en place et quels aspects doivent être pris en compte.

1.4 Détection des Sous-Tensions et Sur-Tensions

Dans la section précédente, nous avons vu les motivations pour passer d'un réseau électrique classique au Smart Grid. L'une d'elles est le contrôle autonome de la tension. Afin de pouvoir détecter les sur-tensions et sous-tensions, il est nécessaire d'avoir une idée assez précise de l'état actuel du réseau. Une solution consiste à estimer la tension en un point par zone. Ces zones sont des groupes d'éléments pour lesquels les grandeurs tension évoluent de la même façon. Pour chaque zone, un bus particulièrement représentatif est choisi. Ces bus, appelés "Points Pilotes", sont ensuite surveillés afin de détecter les sous-tensions et sur-tensions. Cette approche a été utilisée par Rami [Rami 2006]. Dans le cadre de ce travail, nous avons décidé de mettre l'accent sur une autre approche qui consiste à estimer les tensions de chaque bus du réseau. Cette méthode est appelée "Estimation d'état" et a été expérimentée par Chilard et al. dans l'article [Chilard et al. 2009].

1.5 Intervalles de Tensions Acceptables dans Différents Pays

Afin d'assurer une qualité de service, le gestionnaire d'énergie doit spécifier les intervalles de tension (qui peuvent varier selon les différents types de clients). En effet, les dispositifs électriques des particuliers sont conçus pour fonctionner avec une certaine tension (avec une faible marge de tolérance). Si le gestionnaire d'énergie ne respecte pas l'intervalle de tension qu'il a garanti, cela peut causer d'importants dégâts sur les équipements des consommateurs. L'intervalle de tension garanti par le gestionnaire d'énergie diffère d'un pays à l'autre. Bien que la plupart des pays utilisent 110 ou 220 volts avec une fréquence de 50 Hz, certains

pays (comme les États-Unis) utilisent 120 V avec une fréquence de 60 Hz. Il est impossible de garantir une valeur de tension précise sur l'ensemble du réseau, mais il est possible de fournir un intervalle dans lequel la tension peut être garantie (généralement $\pm 10\%$).

Sur les réseaux français, pour les clients connectés en moyenne tension (entreprises nécessitant plus de puissance qu'un client individuel), l'intervalle de tension est généralement à environ 20 000 V $\pm 5\%$ [Bonhomme and Cortinas 2001].

1.6 Role de l'Analyse des Flux de Puissance et de l'Estimation d'État dans le Smart Grid

Le Smart Grid est un concept de réseau électrique capable de s'observer et de se contrôler de manière automatique.

Les réseaux électriques sont largement distribués à travers le monde. De plus, le nombre d'éléments composants ces réseaux est très élevé. Les méthodes classiques des mathématiques et d'Intelligence Artificielle sont généralement assez efficaces sur des problèmes statiques et de taille raisonnable mais ont souvent des difficultés pour les problèmes de tailles importantes et/ou dynamiques.

Ce manuscrit présente un cadre applicatif (framework) à base d'agents et propose des comportements pour ces derniers permettant de résoudre des problèmes courants dans l'analyse des réseaux électriques : l'analyse des flux de puissance et l'estimation d'état.

L'analyse des flux de puissance permet par exemple le dimensionnement des réseaux. Cette analyse est utilisée lors de la conception de nouveaux réseaux ou lors du changement de la topologie de réseaux existants pour s'assurer qu'ils seront en mesure de supporter la charge.

L'estimation de l'état d'un réseau électrique permet d'effectuer des fonctions avancées telles que la régulation de tension. Il permet, à partir d'un ensemble de mesures, de déterminer (avec plus ou moins de précision) la tension à chaque point d'un réseau.

L'étude de ces problèmes est particulièrement intéressante et pertinente dans la mise en place du Smart Grid.

1.7 Les Systèmes Multi-Agents Adaptatifs pour la Résolution de Problèmes Complexes

Un système complexe est un système qui, de part sa composition, a un comportement imprévisible. Alors que les problèmes sont généralement étudiés en utilisant une approche réductionniste (diviser le problème en sous-problèmes plus faciles à résoudre), cela ne peut être fait pour les problèmes complexes. La conception et l'utilisation d'un système visant à résoudre un problème complexe requiert généralement une expertise sur le domaine pour déterminer et paramétrer le système afin d'adapter son fonctionnement au problème étudié. Cette contrainte provient du manque de flexibilité des méthodes couramment utilisées qui par conséquent nécessitent que des réglages soient faits par un expert et dont la solution dépend fortement.

Les Systèmes Multi-Agents Adaptatifs suivent un processus de conception de type “bottom-up”. En effet, la théorie des Systèmes Multi-Agents Adaptatifs indique qu’un système composé d’entités coopératives a un comportement coopératif avec son environnement. Ces points et ces concepts sont détaillés plus loin.

Dans cette étude, nous avons fait le choix d’aborder le Smart Grid par la réalisation d’un Système Multi-Agent Adaptatif.

1.8 Plan

Le manuscrit est organisé en 5 chapitres auxquels sont ajoutées une introduction et une conclusion. Cette organisation a été choisie afin de guider le lecteur de la présentation de la problématique générale à la mise en œuvre de l’approche d’analyse des flux de puissances et de celle de l’estimation d’état en passant par la présentation de l’approche choisie.

Pour commencer, les généralités sur les réseaux électriques sont présentées (voir chapitre 3 page 29). Ce chapitre présente les concepts qui sont utilisés dans le manuscrit. Cela inclut notamment les formules et conventions utilisées dans les deux systèmes développés.

Deuxièmement, un état de l’art (voir chapitre 4 page 41) sur l’utilisation de systèmes multi-agents pour le Smart Grid est présenté. Ce chapitre définit tout d’abord le concept de systèmes multi-agents ainsi que les termes connexes; puis liste les précédentes études sur la réalisation de systèmes multi-agents pour le Smart Grid publiées au moment de la rédaction de ce document.

Troisièmement, la notion de système multi-agent adaptatif (voir chapitre 5 page 49) est présentée. Les lecteurs trouveront notamment des détails concernant l’adéquation fonctionnelle, la coopération et le concept d’émergence, ainsi que des explications sur la méthodologie utilisée pour développer de tels systèmes : la méthodologie Adelfe. Ainsi qu’une proposition de cadre applicatif utilisable pour certaines fonctions avancées du Smart Grid.

Ensuite, le problème d’analyse des flux de puissance (voir chapitre 6 page 65) est présenté. Le lecteur trouvera dans ce chapitre : la description et formalisation du problème, un état de l’art des solutions existantes, le système mis au point dans le cadre de cette thèse et ses évaluations.

Le chapitre suivant sur l’estimation d’état (voir chapitre 7 page 87) possède la même structure que le précédent. Le problème est d’abord présenté. Ensuite, un état de l’art est présenté et enfin les détails sur la conception et la mise en œuvre du système développé et les résultats des évaluations sont donnés.

Pour conclure, le chapitre “Conclusion” (voir chapitre 8 page 119) synthétise les solutions proposées et développe les perspectives d’amélioration des travaux en cours ainsi que les évolutions possibles pour continuer la mise en place du Smart Grid.

Ce manuscrit est à la frontière entre les deux champs: électrotechnique et informatique. Afin de lever toute ambiguïté et permettre à tous de le lire, le lecteur trouvera, dans l’annexe à la page 129, une liste des notations utilisées dans ce manuscrit.

2 Introduction

Whatever the technologies that are put in place, electrical networks are driven by physical laws and are therefore exposed to events that cannot be predicted nor avoided.

Cut in two main parts, this manuscript proposes an innovative approach to move toward the concept of Smart Grid through the resolution of two common problems in power systems: the Load Flow analysis and the State Estimation.

This introduction presents the motivations of this thesis as well as the roles that have these two points in the move toward the concept of Smart Grid and the relevance of using an Adaptive Multi-Agent System to solve complex problem. Finally, the structure of the manuscript is presented.

2.1 Toward Decentralized Production

Nowadays, most national electrical networks rely on power plants which provide electricity for the whole network it belongs to. This approach has been used for decades especially for the reasons that :

- ▷ their production of energy is often independent of the meteorological conditions,
- ▷ their capacity of production is very high,
- ▷ and they allow to co-generate (recycle lost energy, for example to warm up a building).

Despite this, it is important to consider various negative aspects.

The first one is that centralized production requires the transmission of electricity on long distance. This leads to energy losses due to the Joule Heating Effect (the transformation of an electrical energy to a thermal one). In the case of electrical networks, these losses are particularly visible with the lines. As a part of the electrical energy is transformed in a thermal one while flowing in the lines, this energy is lost through a thermal exchange with the surrounding air and cannot therefore be used at the consumption point. The more the electrical current is high, the more the energy losses are important. To counterbalance that, large scale networks use high voltage. Thus, it is possible to transport the same quantity of powers with a lowest current and therefore less losses.

In order to open up the electricity market to the competition and to reduce greenhouse gas emissions, a group of entities (notably the European Parliament) has decided the implementation of strategic changes. This has generated a progressive privatization of the electricity

production and distribution and therefore the integration of decentralized generators aiming at providing a local electricity to distribution networks. Moreover, traditional production methods generally rely on non renewable energy and currently governments encourage the use of renewable energy in a sustained development policy.

One solution to these problems can be to encourage the use of renewable energy. In order to maximize the benefit of renewable energy, it is inevitable to place this kind of generators where their production is at its maximum (windy region for wind farms, sunny regions for photovoltaic panels, ...). This obviously implies the need to move from a centralized production of energy to a decentralized one. The figure 2.1 presents the topology of a network with five buses¹ and two decentralized generators as well as power flow directions through it.

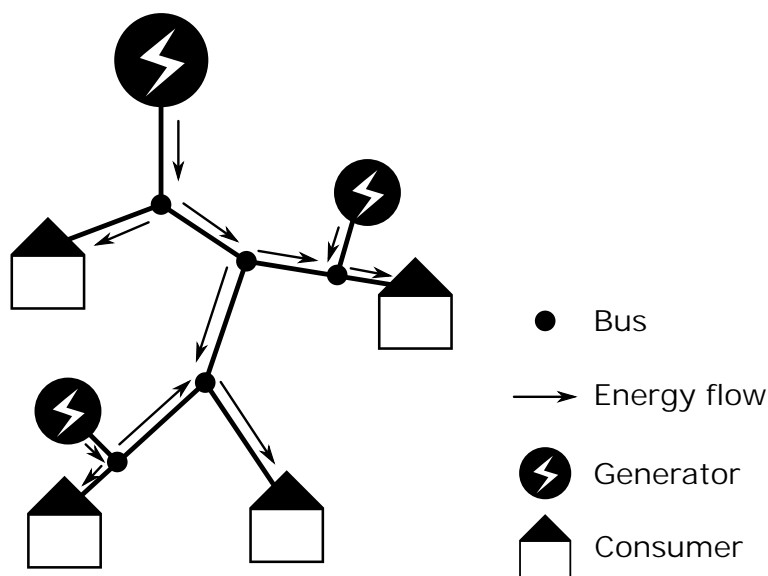

Figure 2.1: Future Network Topology

2.2 Impact of the Massive Integration of Distributed Generator in Distribution Network

This massive integration of decentralized generators implies the need to change the way networks are operated. The distribution networks must be able to handle the perturbations induced by this integration.

An electrical network can be made with a radial or a meshed structure. These networks may contain switches which can change the configuration of the network. Although this doesn't affect the aim of an electrical network which is the transmission of electricity, these two structures have different advantages and drawbacks. The main difference between these two structures is that loops can only be present in the meshed structure. In the radial

¹Connection point between various elements of an electrical network

structure networks, switches are opened to avoid loops. Therefore, there is one and only one path from a point to another.

A distribution network is usually made of a network in a radial configuration in which one point provides all the necessary electricity to the consumers.

The advantage of a meshed structure is that it is more robust. Indeed, in the case where a line is cut, the electricity can be provided through another line. However, it requires to physically install multiple lines and therefore it has an higher installation and maintenance cost. This structure is generally used in transmission networks. The radial structure, meanwhile, has the advantage of requiring less cable. However, it is less robust. A fault on a line is susceptible to cause a black-out in all the part of the network energized from this line. This structure is preferred for distribution networks.

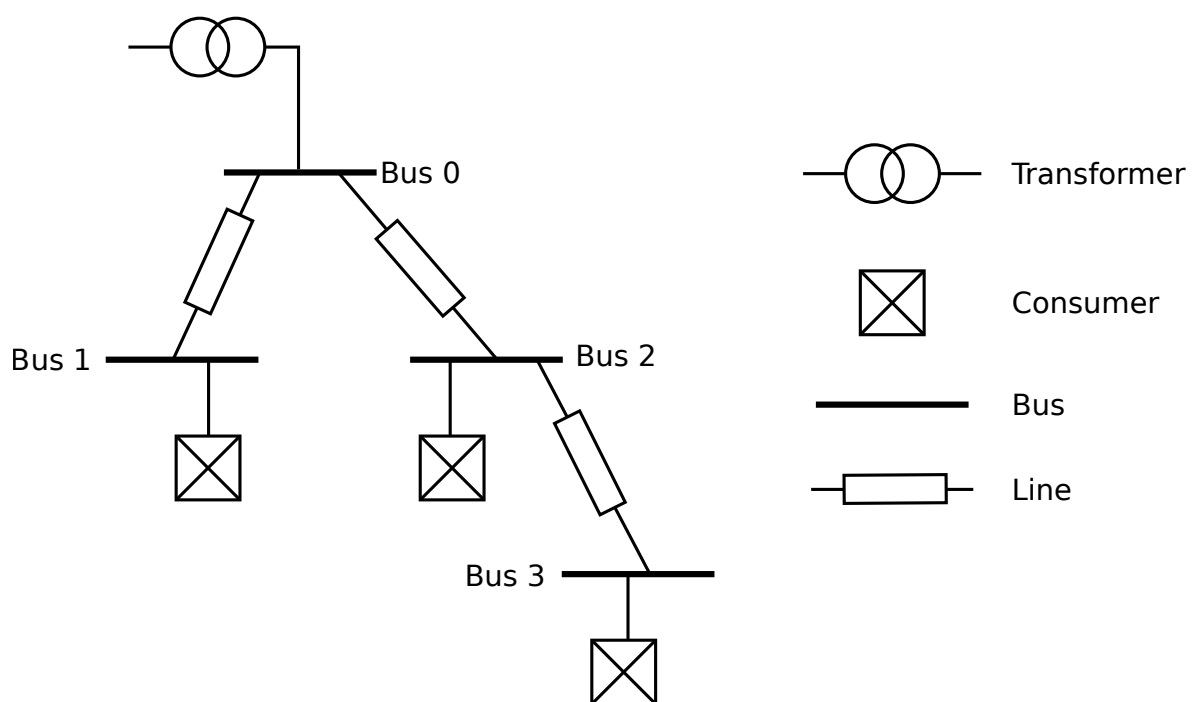

Figure 2.2: Radial Distribution Network

The figure 2.2 presents an example of a radial distribution network. The transformer HV/MV (High Voltage/Medium Voltage) is connected to the high voltage network and provides electricity at a lower voltage magnitude to the medium voltage network. As we can see in this figure, there is one energy provider. Therefore, the transit in the lines is unidirectional. The lack of decentralized generator in the network guarantees that for two buses i and j (from a same feeder), if i is closer to the source substation than j , then the voltage magnitude at bus i will be greater than or equal to the one at bus j . An example of a voltage profile that can be associated to the network in the figure 2.2 is presented in the figure 2.3. As it can be seen in the figure 2.3, consumers connected to the network can have a contract with the network manager which obliges this latter to maintain the voltage at a certain bus in a predefined range. In a network with a radial structure and a unique energy provider, it is relatively easy to keep these voltage values in a certain range, assuming that this is possible. Supposing the presence of a voltage value lower than the minimal value of the

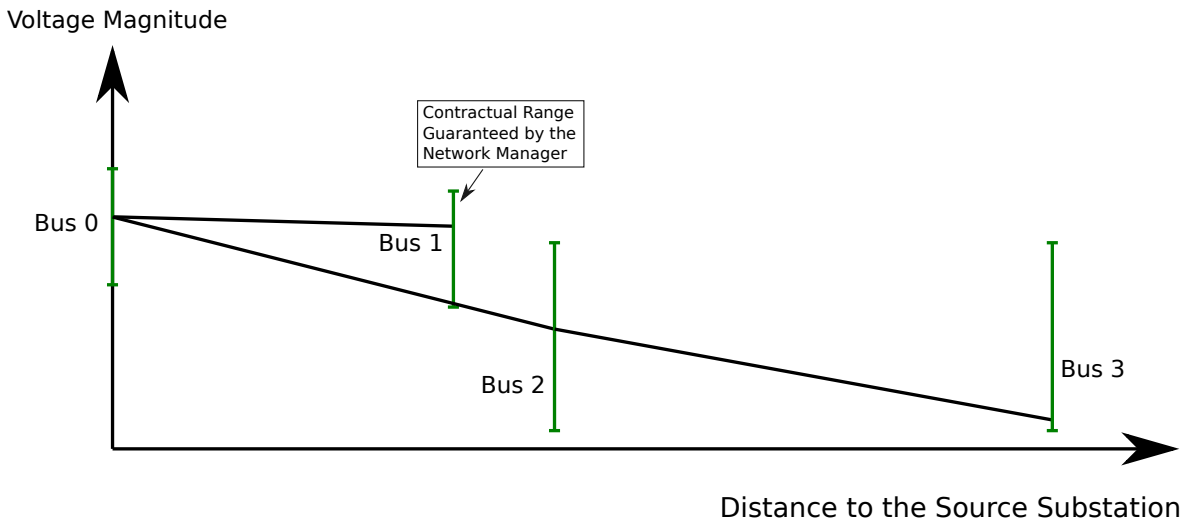

Figure 2.3: Example of a Voltage Magnitude Profile

contractual range, the voltage value at the production point should be increased. Conversely, the presence of a too high voltage value implies that the voltage setpoint of the production point should be reduced.

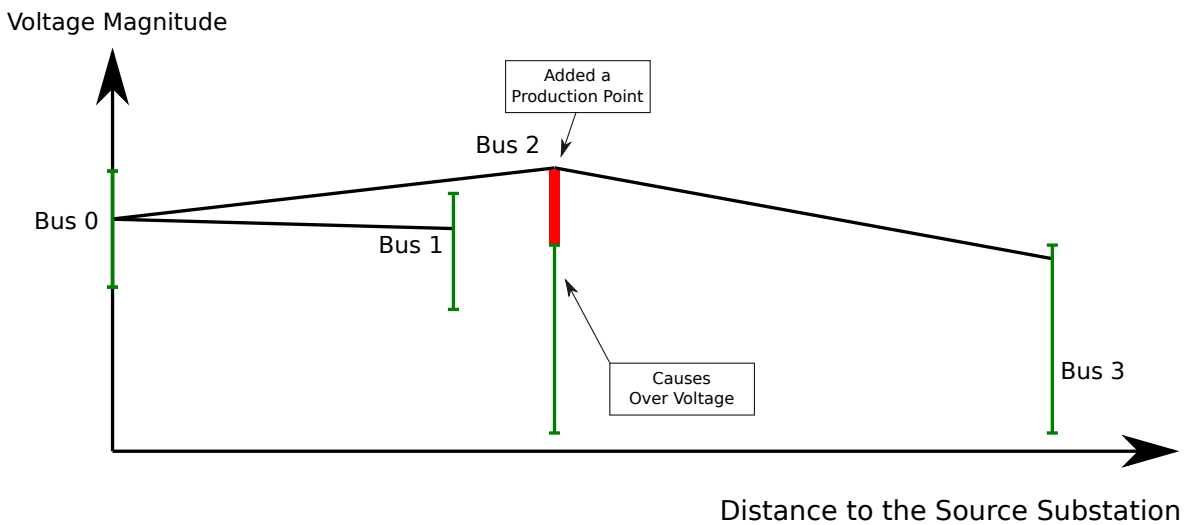

Figure 2.4: Overvoltage caused by the addition of a generator

The figure 2.4 presents a problem occurring when adding a distributed generator: the voltage magnitude profile may increase. It is necessary to find the correct settings to avoid an overvoltage. In this figure, the bus 2 has an over-voltage caused by the addition of a generator which imposes a too high voltage magnitude.

The distribution network must be able to take into account an increasing number of decentralized generators while maintaining a good quality of service. This transition can be accomplished with flexible and controllable networks. It is therefore necessary to automatize distribution networks to control them. To achieve that, it has been introduced the concept of "Smart Grid" (Self-Managing And Reliable Transmission Grid) in 1997 by Vu et al. [Vu et al. 1997], presented by the authors as *"an automated system of monitoring, control, and protection*

devices that improves the reliability of the transmission grid by preventing wide-spread break-ups". For the networks to be efficiently operated, it is necessary to have a good observability of the network. This observability can be obtained thanks to a state estimator.

2.3 Smart Grid

This part presents the concept of Smart Grid as a solution to the previously expressed problems. As this idea of an intelligent electrical network is pretty new, no consensus has been made to provide a worldwide definition of Smart Grid. We will see in this part the main proposed definitions. Then, we will present Smart Grids characteristics. And finally, we will see important issues to consider such as the control, the security and the storage in the Smart Grid.

2.3.1 Definitions

In 2010, three groups of researchers have proposed their own definition of the concept of "Smart Grid". The Ontario Smart Grid Forum has proposed the following definition:

Definition 5.

Smart Grid - *"A Smart Grid is a modern electricity system. It uses sensors, monitoring, communications, automation and computers to improve the flexibility, security, reliability, efficiency, and safety of the electricity system."*[Singer 2010]

The Department Of Energy of the United States of America (D.O.E.) has proposed the following:

Definition 6.

Smart Grid - *"An automated, widely distributed energy delivery network, the Smart Grid will be characterized by a two-way flow of electricity and information and will be capable of monitoring everything from power plants to customer preferences to individual appliances. It incorporates into the grid the benefits of distributed computing and communications to deliver real-time information and enable the near-instantaneous balance of supply and demand at the device level."* [Department of Energy 2010]

Based on previous definitions, the "Canadian Electricity Association" has proposed this definition:

Definition 7.

Smart Grid - *"The Smart Grid is a suite of information-based applications made possible by increased automation of the electricity grid, as well as the underlying automation itself; this suite of technologies integrates the behavior and actions of all connected supplies and loads through dispersed communication capabilities to deliver sustainable, economic and secure power supplies."* [Canadian Electricity Association 2010]

Based on these definitions, we would like to propose the following one which goes back over some concepts previously mentioned:

Definition 8.

***Smart Grid** - The Smart Grid is a concept of an autonomous electrical network able to adapt itself to client's needs in a secured, ecological and economical way. It enables bidirectional exchanges of electricity and information through lines.*

2.3.2 Characteristics of the Smart Grids

The study of the domain and the state of the art made on the Smart Grid led to the definition of five characteristics for the Smart Grid: Supply/Demand Balancing, Self-Healing, Losses Reduction, Hardware Stress Minimization and Voltage Regulation. This part aims at defining these characteristics.

2.3.2.0.9 Supply/Demand Balancing (SDB)

In order to satisfy the customers and to guarantee the safety of the electrical system, the network should be able to produce the necessary energy at the moment needed or at least be able to store enough energy to release it when necessary.

2.3.2.0.10 Self-Healing (SH)

We talk about Self-Healing when a Smart Grid network is able to detect and fix problems. Whatever the distribution system, fault and power cuts are unavoidable [Solanki et al. 2007]. At best, it is possible to detect them before they happen. During fault detection in a network, the usual operation consists in isolating the fault which may conduce (with the present architecture) to a power cut in some areas initially not concerned by the fault.

2.3.2.0.11 Losses Reduction (LR)

Due to the Joule effect, the more lines are long the more their will be energy losses. One characteristic of the Smart Grid is to contribute to the minimization of these losses.

2.3.2.0.12 Minimization of Hardware Stress (MHS)

The aim of this characteristic is to limit the amount of requests made on the hardware in order to minimize the cost resulting from the equipment wear especially on On-Line Tap Changer.

2.3.2.0.13 Voltage Regulation (VR)

Voltage regulation is the act of choosing a set of voltage values in order to ensure that voltages at specific points are in the admissible range ensured by the distribution network manager. We also consider that voltage regulation includes the coordination of Low Voltage and Medium Voltage networks.

2.3.3 Motivations to Move from Classical Electrical Network to Smart Grid

As said in the paper of Roche [Roche 2012], the motivations to move from classical electrical networks to the concept of the Smart Grids, in addition to the political ones, are the following:

- ▷ **The increase of energy demand.** The demand in energy is growing fast. The world-wide energy demand is expected to rise by over 150% from 2010 to 2050 under the Energy Technology Perspectives 2010 (ETP 2010) Baseline Scenario and over 115% between 2007 and 2050 under the Blue Map Scenario [International Energy Agency 2011].
- ▷ **The global warming.** Since the 1960's, the temperatures of air and water are more and more away from normal conditions. This is called the global warming. Given this situation, some governments have decided to promote new technologies and the usage of renewable energy.
- ▷ **The increase of distributed and renewable generation.** For the previously mentioned reasons (which are the constantly increasing energy demands and the need for a more ecological energy production), the number of distributed and renewable generators is going to increase quickly resulting in as many additional control points which will obviously result in the increase of complexity for ensuring voltage range and more generally a good quality of service.
- ▷ **The depletion of resources currently used for energy generation.** Besides the global warming, we are going to run out of currently used resources.

2.3.4 Issues

The integration of massive energy generators geographically far apart from each other and the willingness to provide energy in a more efficient way bring some issues that must be addressed in the process of moving from classical electrical network to the concept of Smart Grid.

2.3.4.0.14 Control

In order to control the electrical network in an efficient way, it is first necessary to identify which points are probably controllable. The voltage control is essentially made at source substations and decentralized generators. Indeed, even if it is possible to make a part of the regulation at MV/LV transformers, this one is rarely done because, with the present technology, it requires the complete disconnection of the concerned low-voltage network. We also know that clients consumption has a huge impact on voltage drop in the network. A commonly used option is to propose to clients to change the way they consume as it is done by proposing energy at a lower price during off-peak period.

2.3.4.0.15 Security

As said in the definition, the concept of Smart Grid includes a communication system. By definition, those systems are vulnerable to cyber attacks. In order not to cause a blackout due to a malicious attack or simply by a defective sensor, it is necessary to take into account the security in the Smart Grid. In addition to protecting from cyber attacks, the Smart Grid has to protect consumer's data.

2.3.4.0.16 Dynamic Energy Storage

Aside from taking into account the fact that there can be decentralized generators, we need to foresee the integration of dynamic energy storage like electrical vehicles. They have a significant impact on the stability of the network. It is necessary to control when they are charging or when they can release some energy to feed a part of the network.

2.3.5 Conclusion

In addition to the definition of the concept of Smart Grid, this part presents what characterizes it, why it is necessary to move toward it and what issues must be taken into account.

2.4 Over and undervoltage awareness

We have seen in the previous section the reasons to move from classical electrical network to the Smart Grid. One of them is the autonomous voltage control. In order to be able to detect over and undervoltage, it is necessary to have an enough accurate idea of the current state of the network. One solution is to estimate voltage per area. These areas are groups of buses for which voltage magnitudes evolve similarly. On this area, a particularly representative bus is chosen. These buses, called "Pilot Point", are then monitored to detect over- and undervoltage. This approach has been used by Rami in [Rami 2006]. As part of this work, we have decided to focus on another approach consisting in finding voltage magnitudes of every buses of the network. This method is called "State Estimation" and has been experimented by Chilard et al. in the paper [Chilard et al. 2009].

2.5 Acceptable Voltage Range across Different Countries

In order to ensure a quality of service, the energy manager needs to specify voltage ranges (which may vary for different types of customers). Indeed, our machines are made to work with a certain voltage (with a low margin of tolerance). If the energy manager doesn't respect the voltage range it has guaranteed, it can cause a lot of damages on consumer electrical goods.

The voltage range guaranteed by the energy manager differs from country to country. Although most countries use 110 or 220 V with a frequency of 50 Hz, some countries (like the United States) use 120 V with a frequency of 60 Hz. It is impossible to guarantee a precise

voltage value on the whole network but it is possible to provide a range in which the voltage can be guaranteed (generally $\pm 10\%$).

In France, for the clients connected to the medium voltage levels (companies requiring more energy than an individual customer), the voltage range tolerance is generally around 20,000 V $\pm 5\%$. [Bonhomme and Cortinas 2001]

2.6 Roles of the Load Flow Analysis and the State Estimation in the Smart Grid

The Smart Grid is a concept of electrical network able to automatically observe and control itself.

Electrical networks are geographically distributed around the world. Moreover, the amount of elements composing these networks is very high. Classical mathematical methods and Artificial Intelligence approaches usually suit well on reasonably-sized and static problems but are generally inefficient or inadequate to big-sized and dynamic ones.

The voltage regulation appears to be one major function of the Smart Grid given the fact that decentralized generators often implies over-voltages on some distribution networks. To do so, the network operator has to improve its capacity of observation of the network in order to have more control on it. Currently observed through a SCADA (Supervisory Control And Data Acquisition) system [Bornard 2000], the state of the system is not enough known to perform an accurate control on it.

To have an accurate knowledge about the state of a network, it exists two possibilities:

- ▷ setting up a lot of sensors (such as in the transmission network). This solution has an high cost given the important amount of buses to observe.
- ▷ determining the state of the network from the network model, load patterns and data given by already present sensors.

The initial aim of this thesis was to define and design an Adaptive Multi-Agent System to perform voltage regulation in distribution networks and determine its relevance. Given the low amount of time and the complexity of the problem, it has been decided that the work will be focused on Load Flow analysis and State Estimation as a first step toward an agent-based voltage regulation.

This thesis presents an agent-based framework named ATENA (Adaptive Transmission of Energy and Network Analysis) and proposes agent behaviors to solve common power systems problems: the Load Flow analysis and the State Estimation.

The Load Flow analysis allows on one hand the sizing of networks and, on the other hand, load provisional management and off-line decision making. This analysis is used by network managers when designing new networks or when changing the topology of existing ones to ensure that it will be able to support the load.

The State Estimation of an electrical network is an analysis aiming at making networks observable. One important objective of the State Estimation is to determine (with more or less accuracy) the voltage at each point of a network.

The study of the resolutions of these problems are particularly interesting and relevant in the transition from classical electrical networks to the Smart Grid because they help the system operator to solve problems that can occur in the network.

2.7 Adaptive Multi-Agent Systems for Complex Problem Solving

A complex system is a system which, from its composition, has an unpredictable behavior. While problems are generally studied using a reductionist approach (i.e. divide the problem into smaller ones), this cannot be done on complex system.

The design and the use of a system aiming at solving a complex problem generally requires an expert of the domain able to determine and tune the parameters of the system in order to adapt it to the studied problem. This constraint comes from the lack of flexibility of commonly used methods which therefore require a parametrization that can only be made by an expert and on which the solution highly depends.

The Adaptive Multi-Agent Systems are designed to adapt themselves to the problems they are facing and their potential evolutions. The design of Adaptive Multi-Agent Systems follows a bottom-up process and is based on the fact that a system composed of cooperative entities has a cooperative behavior with its environment. These points and concepts are detailed further.

In this study, we have made the choice to address the Smart Grid using an Adaptive Multi-Agent System.

2.8 Manuscript Organization

The manuscript is organized in 5 chapters, an introduction and a conclusion. This organization has been chosen in order to guide readers from the presentation of the general problem to the design and implementation of two solutions and passing through the presentation of the chosen approach.

To begin with, generalities about electrical networks (see chapter 3 page 29) are presented. This chapter presents the concepts that are used in the manuscript. This notably includes formulas and conventions used in the two developed systems.

Secondly, a state of the art (see chapter 4 page 41) about the use of Multi-Agent Systems for the Smart Grid is presented. This chapter firstly defines the concept of Multi-Agent System as well as the related terms; and then lists the previous studies published until the redaction of these pages.

Thirdly, the concept of Adaptive Multi-Agent System (see chapter 5 page 49) is presented. Readers will notably find details about functional adequacy, cooperation and emergence as well as explanations about the methodology used to develop such systems: the ADELFE methodology. As well as a modeling of the Smart Grid as an Adaptive Multi-Agent System.

Then, the Load Flow problem (see chapter 6 page 65) is addressed. The reader will find in this chapter: the description and formalization of the problem, a state of the art of existing solutions, the system developed as part of this thesis and the evaluations made on it.

Next, the chapter about State Estimation (see chapter 7 page 87) has the same structure than the previous one. The problem is firstly presented. Then, a state of the art is presented and finally the details about design and implementation of the developed system and the results of evaluations are given.

To conclude, the chapter “Conclusion” (see chapter 8 page 119) looks back on the proposed solutions and develops the perspectives to improve the current work and to do another step toward the Smart Grid.

This work is at the border between two fields: electrotechnical and computer science. In order to remove any ambiguity and allow everyone to read it, readers will find a list of notations used in this manuscript (see appendix A page 129).

*An Adaptive Multi-Agent System for the
Distribution
of Intelligence in Electrical Distribution Networks:
State Estimation*

**Context of the Study and State of the
Art**

3 Concepts and Definitions on Electrical Networks

The current policy of voltage's regulation consists in the usage of the most part of the contractual voltage's range. The voltage setpoint of the High Voltage/Medium Voltage source substation is such as the voltage profiles of the various branches remain in regulatory ranges.

In order to assure the respect of voltage ranges, it is necessary to change the way the voltage is regulated. Until nowadays, the control was made essentially through one point. Now, it is necessary to perform an active control on each energy source linked to the network to maintain the voltage stability.

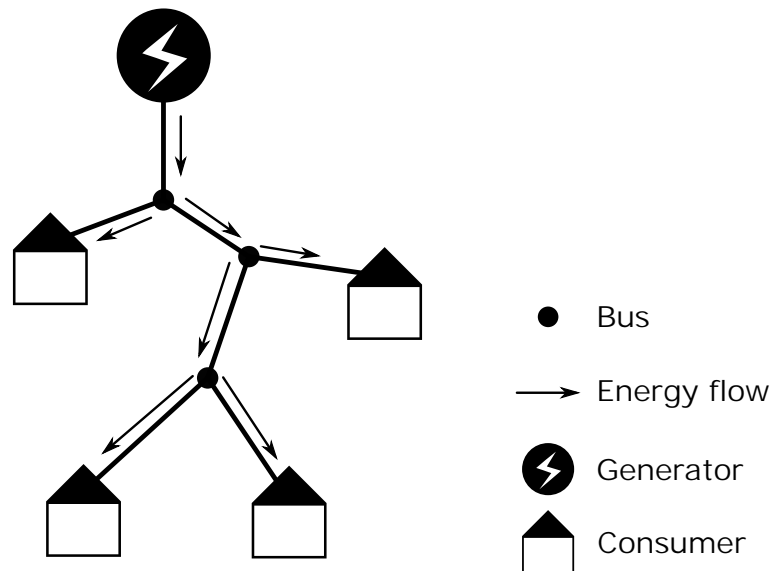

Figure 3.1: Classic network topology

The figure 3.1 page 29 represents the structure of a classic electrical network. On this figure, we can see that there is one generator that provides energy to multiple consumers.

Résumé

Les réseaux électriques sont constitués d'un ensemble d'éléments interconnectés dans le but de transmettre de l'électricité des producteurs jusqu'aux consommateurs. Pour traiter les réseaux électriques, il est possible de simplifier leur représentation en considérant uniquement les lignes et les bus. Les injections de puissance sont modélisées dans les bus, on parle alors d'"injection de puissance" aux bus. Si on se place dans cette formulation, on peut considérer que l'état d'un réseau est caractérisé uniquement par l'état des bus le composant, à savoir leur tension et leur injection de puissance. Enfin, les flux de puissance circulant dans un réseau dépendent des caractéristiques des lignes ainsi que des écarts de tensions entre les différents bus.

Ce chapitre décrit tous ces éléments en détail.

3.1 Components of an Electrical Network

An electrical network is a set of electrical elements (buses, loads, distributed energy resources, energy storage devices and transformers) interconnected through lines.

3.1.1 Bus/Node

A bus (also called a node) is an element of a network to which components in charge of consumption, generation or transformation are connected. The voltage magnitude and phase angle of a bus is the same for every connected element. Generally materialized as a metallic bar, buses are designed to allow energy transits from a set of elements to others (for example, a generator and a consumer).

3.1.2 Consumer/Load

A consumer is connected to an injection bus and can be an industrial, commercial or residential load. A Load is an electrical equipment (appliances, electronics, light fixtures, etc.) that uses electrical energy. This element absorbs power. Given the convention followed in this study, we will rather consider that consumers inject negative power. More informations about used conventions can be found in the section 3.6 page 37.

3.1.3 Distributed Energy Resources

Distributed Energy Sources (DER) are electricity sources, based on renewable or conventional energy sources, that are typically decentralized and located in close proximity to energy consumers in the distribution grid.

3.1.4 Energy Storage Device

An energy storage device is an element of a network connected to a bus. Depending on if it is charging or discharging, an energy storage device can be seen as a generator or a

consumer. As electric energy cannot be stored directly in high quantities, it must be converted to mechanical or electrochemical energy. Different existing technologies can be used in the power grid to provide load leveling, replace spinning reserves (conventional power plants on standby) or provide ancillary services such as reactive power for voltage regulation.

3.1.5 Line

A line is a system of structures, wires, insulators and associated hardware that carry electric energy from one bus to another bus in an electric power system. They have 4 characteristics: the resistance (R), the conductance (G), the capacitance (B) and the reactance (X). A line is represented by a two-port π -model defined by a series admittance $(R + i \cdot X)^{-1}$ and a transversal admittance $G + i \cdot B$. More information can be found in sections 3.5 page 36 and 3.7 page 38.

3.1.6 Transformer

An electrical power transformer is a static device which transforms electrical energy from one circuit to another without any direct electrical connection and with the help of mutual induction between two windings. It doesn't change its frequency but may impose a different voltage magnitude level. The transformer is a main component of High Voltage/Medium Voltage and Medium Voltage/Low Voltage substations.

3.1.7 Source Substation

A source substation is a part of an electrical network which provides electricity to the Medium Voltage network. It contains various elements aiming at transforming the voltage and generally have control equipments.

3.2 Types of Network

When we talk about national scale electrical networks, we make the distinction between three types of network: the "distribution grid", the "sub-transmission grid" and the "transmission grid". These three types of network are presented in figure 3.2.

The *Transmission Grid* is the part of the network to which main generators are connected. This kind of network is responsible of the energy transmission on long distances. The voltage in this kind of network must be high (several hundred kV) to minimize energy losses during the transmission. This grid has a meshed structure and is an interconnection of high-voltage generators, lines and sub-transmission networks. Moreover, it allows the exchange of electricity with neighbor countries. While meshed structure has an higher creation and maintenance cost, it allows an important robustness which is mandatory at this level of electricity transmission.

The *Sub-Transmission Grid*, regionally scaled, ensures the transmission of electricity between various generation points and the distribution grid.

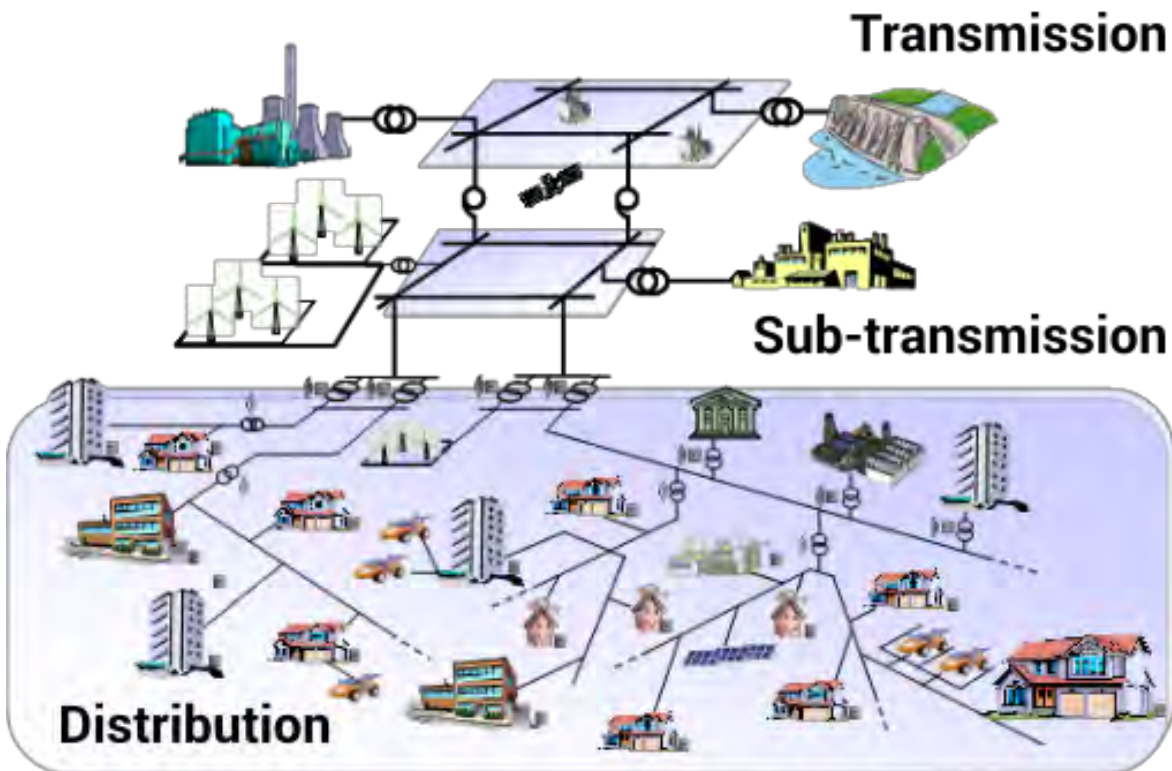

Figure 3.2: Hierarchy in an electrical network [Biserica 2011]

The *Distribution Grid* generally has a radial structure and is intended to distribute electricity from sub-transmission grid to low or medium voltage consumers. Distances traveled by electricity in this kind of network are low. Therefore, it is not necessary to have an high voltage as in transmission grid. Given their radial structure, this kind of network has a lower cost but is known to be less robust.

The needs in term of the observability of a network as presented in the introduction is related to distribution networks. Although there are similarities between these different types of network, it exists differences which have an high impact on the processes of Load Flow analysis and State Estimation. Thus, the term “*network*” widely used in this thesis refers to the distribution grid with a radial structure and more precisely the medium voltage part.

The figure 3.3 presents an example of the Medium Voltage distribution network. The low voltage networks are replaced by equivalent loads.

To improve the observability of these networks, sensors are installed. Mainly for cost reasons, active power, reactive power and voltage magnitude sensors are installed at the source substation. At each decentralized generator bus, a power sensor is installed and a voltage magnitude sensor is added too. Finally, voltage magnitude sensors are installed at some representative locations. Moreover, in order to have a complete observability of the network, we consider pseudo-measurements (rough estimations of power consumption) on each load and virtual measurement (null active and reactive power injection) at zero-injection buses.

The figure 3.4 presents an example of sensors placement in the distribution network

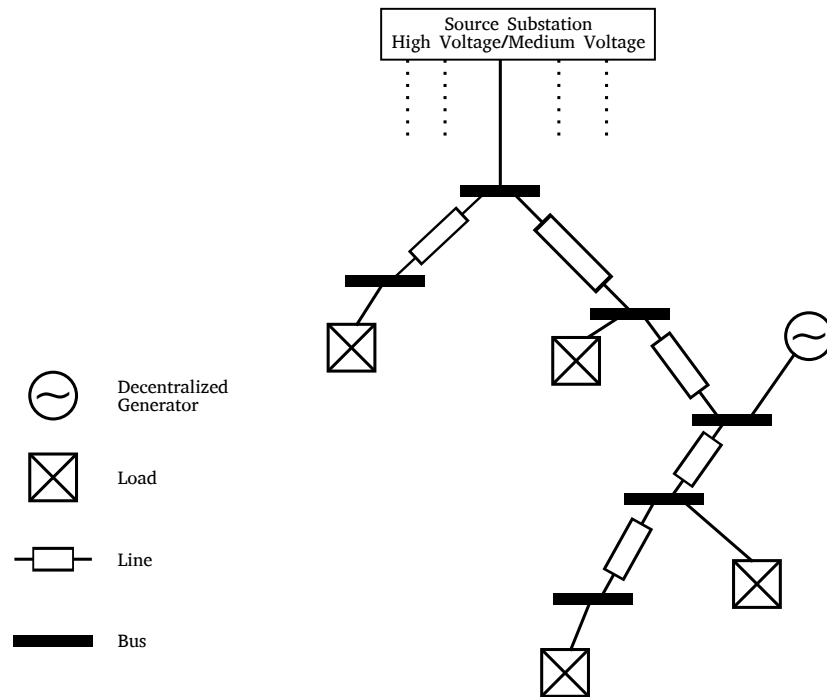

Figure 3.3: Medium voltage part of a distribution network

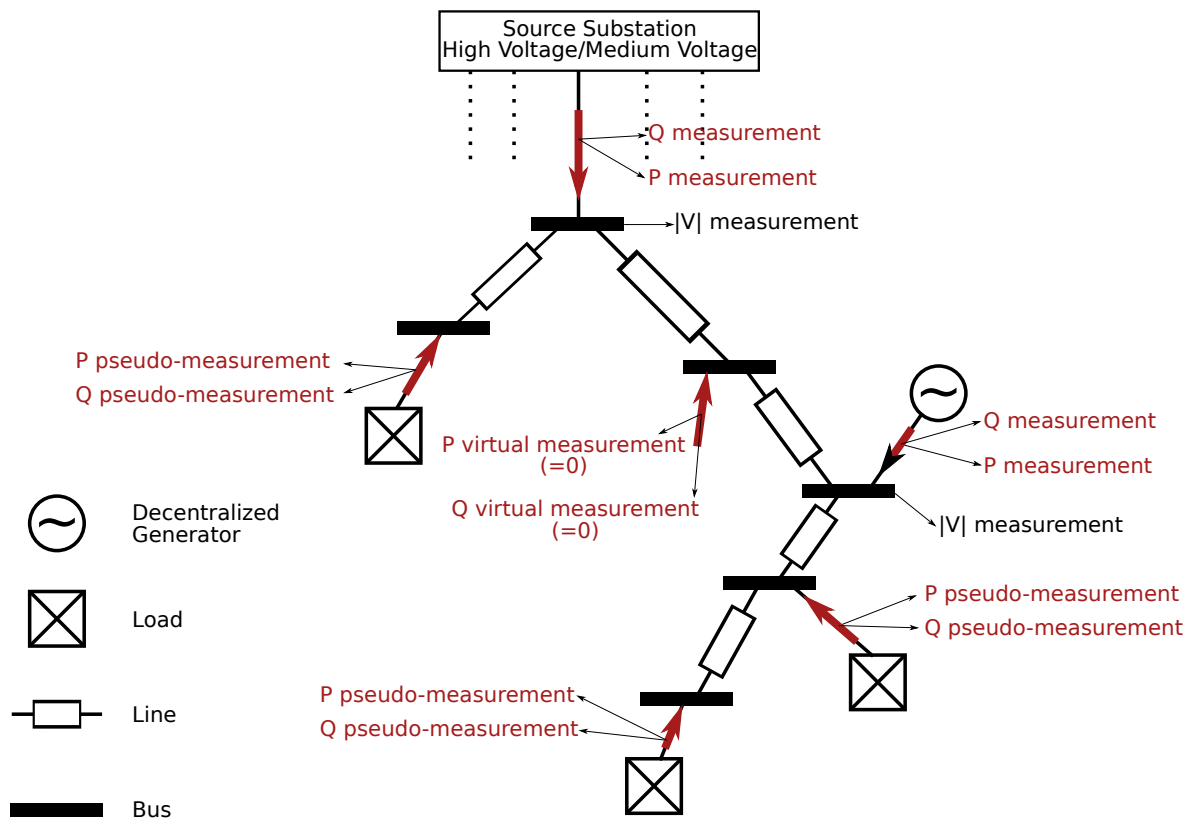

Figure 3.4: Distribution network equipped with sensors

presented in the figure 3.3.

3.3 Definition of the State of a Network

The state of a network is a vector of information qualifying it at a given moment. In the case of this thesis, a network exists only by the presence of the buses belonging to it. We then consider that the state vector of a network is the concatenation of the state vectors of each bus.

A network (such as presented in 3.1) can be abstracted as a bus connected to other buses through lines. For this study, we consider consumers and generators connected to the bus as an abstract and unique entity connected to the bus. We then talk of the “*injected power*” which corresponds to the sum of power generated and consumed at this bus.

We can distinguish three kinds of bus:

- ▷ A bus, to which a consumer and no generator are connected, is referred to as a “Load Bus”,
- ▷ A bus, to which at least one generator is connected, is referred to as a “Generator Bus”,
- ▷ A bus, to which no consumer nor generator are connected, is referred to as a “Virtual Bus”,
- ▷ A “Slack Bus” is chosen arbitrarily in the set of generator buses as the reference.

The state of a bus is a vector containing all state variables characterizing a bus at a given time. The state variables of a bus b are:

- ▷ $|V_b|$: the voltage magnitude of the bus;
- ▷ $\arg(V_b)$: the phase angle of the bus;
- ▷ P_b : the active power injected at the bus b (see the paragraph about bus injection the section 3.6.3 page 37);
- ▷ Q_b : the reactive power injected at the bus b (see the paragraph about bus injection the section 3.6.3 page 37).

The state of a bus can be expressed as the following vector:

$$\begin{bmatrix} |V_b| \\ \arg(V_b) \\ P_b \\ Q_b \end{bmatrix} \quad (3.1)$$

and, therefore, the state of a network with n buses is:

$$\begin{bmatrix} |V_1| \\ \arg(V_1) \\ P_1 \\ Q_1 \\ |V_2| \\ \arg(V_2) \\ P_2 \\ Q_2 \\ \dots \\ |V_n| \\ \arg(V_n) \\ P_n \\ Q_n \end{bmatrix} \quad (3.2)$$

3.4 Measures in an Electrical Network

Electrical networks can be equipped with various types of sensor. Notably, there are sensors for active and reactive power values and for voltage magnitude. These sensors are not completely accurate. To represent their errors, we use a Gaussian distribution, such as the one presented in the figure 3.5, with a mean value μ equals to the real voltage magnitude and a standard deviation σ computed with the error percentage of the sensor.

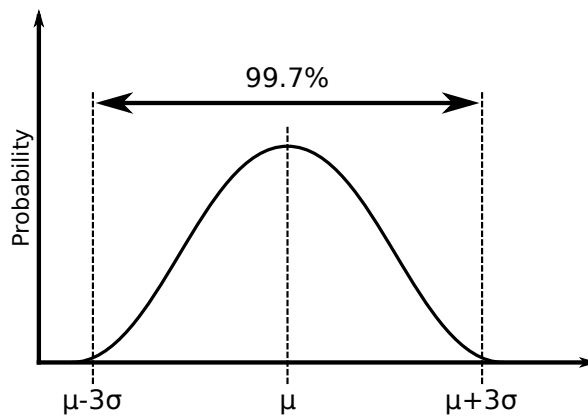

Figure 3.5: Density of a Gaussian Distribution

The standard deviation is equal to:

$$\sigma = \frac{\%error \cdot \mu}{3 \cdot 100} \quad (3.3)$$

A Gaussian variable with a mean value μ and a standard deviation σ has a 99.7% probability of being in the interval $[\mu - 3\sigma, \mu + 3\sigma]$.

Installing sensors on every bus of a network has a non-negligible cost. Therefore, it is necessary to consider pseudo-measurements on consumption point. These pseudo-

measurements are rough estimations based on load patterns. To consider the uncertainty of such values, we will consider these values as Gaussian variables with a percentage error equals to 50%.

Although a power measurement doesn't give any information on another one (the consumption of a client is independent to the one of an other), the voltage magnitude are redundant data that can be exploited to determine the state of a network. Due to the imprecision of the measurements, it is necessary to have enough sensors to benefit from redundancy. Supposing the errors are equitably distributed among the sensors, the addition of a sensor may allow to filter these errors.

3.5 Line Flows Computation

The active and reactive power flows of a line depend on its admittance and the voltage (magnitude and phase angle) of the two buses the line is connected to. To calculate power flowing through lines, it is a common practice to define an admittance matrix.

3.5.1 Admittance Matrix

These matrices are particularly useful to write power flow equations. Each item of this matrix indicates the admittance that must be considered while calculating the power flow between two buses. For a given line l , the admittance matrix is:

$$\begin{array}{|c|c|} \hline y_l + y_t & -y_l \\ \hline -y_l & y_l + y_t \\ \hline \end{array}$$

With:

$$\begin{aligned} \triangleright y_l &= \frac{1}{r+i \cdot x}, \\ \triangleright y_t &= \frac{g+i \cdot b}{2}. \end{aligned}$$

Where r , g , b and x are the characteristics of the line (respectively the resistance, the conductance, the capacitance and the reactance).

3.5.2 Line Power Flows Computation

Given the previously defined admittance matrix, it is possible to compute the flow between a line and a bus. Let:

- $\triangleright M$ be a line with the admittance matrix Y ;
- $\triangleright 1$ and 2 respectively be two buses linked through the line M ;
- $\triangleright V_i$ be the voltage at the bus i ;
- $\triangleright Y_{i,j}$ the admittance matrix of the line between the bus i to the bus j ;

- ▷ S_{ij} be the complex number (active and reactive) of the power flowing from the bus i to the bus j .

Knowing the voltage V_1 and V_2 and the admittance matrix of the line M , it is possible to compute the current flowing from a bus to the line.

$$I_{1M} = Y(1,1)_{1,2} \cdot V_1 + Y(1,2)_{1,2} \cdot V_2 \quad (3.4)$$

Knowing the current, it is now possible to compute the power flowing from a bus to a line.

$$S_{im}^* = V_i^* \cdot I_{im} \quad (3.5)$$

As a reminder, a power entering a bus is expressed as a positive value and a power leaving it as a negative one.

3.6 Conventions

While working on electrical networks concerns, it is common to simplify the problem by making some abstractions and by defining some conventions.

3.6.1 Per-Unit System

The per-unit system allows to normalize all the quantities of an electrical network, such as voltages, currents and powers. For each quantity, we define a ratio of a predefined base value. Generally, a “unit” is equal to the maximal value of the quantity. The various ratios of the unit quantity are calculated according to other quantities in order to maintain the consistency of the system.

3.6.2 Power Flows

By convention, the currents are assumed to flow from the buses to the lines and from other components to the buses. The sign of the value indicates the real direction of the flow. A positive value stands for an incoming flow and a negative value for an outgoing one.

3.6.3 Bus Injection

As seen in section 3.1 page 30, in addition to the lines, a bus can be connected to various components such as consumers, generators and power banks. In order to simplify the understanding of the problem and the proposed approaches, we consider in this thesis that the set of components connected to a bus will be abstracted as a unique abstract entity which sums up the consumption and generation at this bus. This is referred to as “bus power injection”.

3.6.4 One-Line Diagram

In the case of this thesis, we consider a perfectly balanced electrical network. Therefore, we can consider the three-phases network as a single phase equivalent system. This simplification is particularly convenient as it allows to use simple formulation of line flows equations.

3.7 Kirchhoff's Current Law

The power is defined according to the consumption, generation and lines power transit at the considered bus.

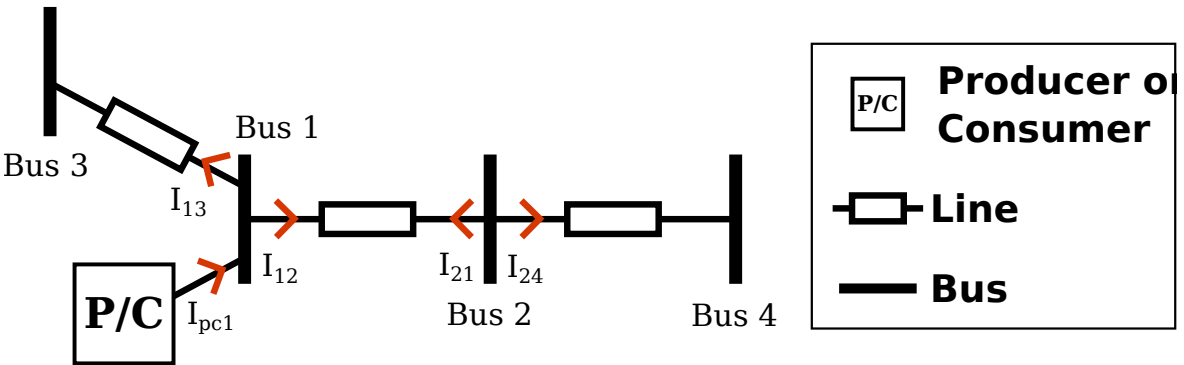

Figure 3.6: Current Flows

The figure 3.6 represents the current flows between four buses. For the bus 2, the Kirchhoff's Current Law is verified if $I_{24} + I_{21} = 0$. For the bus 1, the current of the generator (or consumer) has to be taken into account, the Kirchhoff's Current Law is then verified if $-I_{pc1} + I_{12} + I_{13} = 0$.

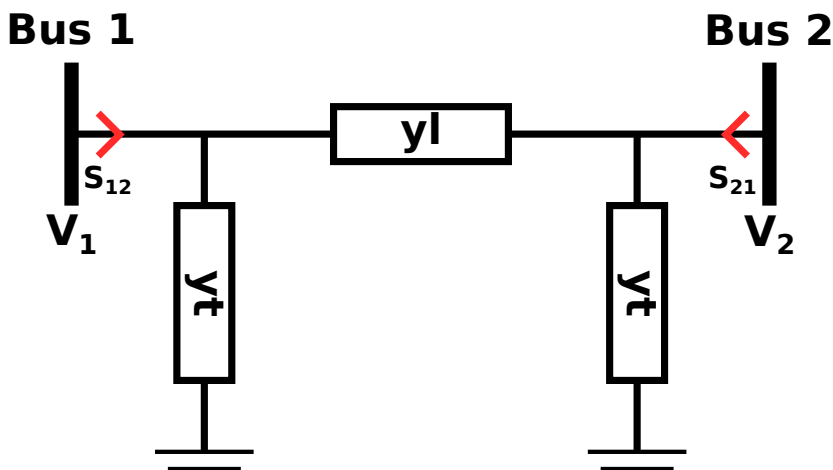

Figure 3.7: Example of π -Line Model

The model retained for each underground or overhead line is provided by the figure 3.7. Thus, the current at each bus of a line is entirely determined by its node equation (3.7). The value of these currents (I_1, I_2) depend both on the line matrix and the voltage value at each

bus.

The chosen convention implies that currents leave the buses. A negative current corresponds to a current entering a bus.

Let:

- ▷ 1 and 2 be two buses connected through a line,
- ▷ $Y_{1,2}$ be the admittance matrix of the line linking them,
- ▷ V_j be the voltage (complex number) of the bus j ,
- ▷ I_j be the current flowing into the bus j from the line,
- ▷ $Variable^*$ be the conjugate of the *Variable*.

We consider known the admittance matrix Y of the line as defined in section 3.5.1 page 36.

The complex apparent power value is calculated with :

$$S_{12} = P_{12} + i \cdot Q_{12} = V_1 \cdot I_{12}^* \quad (3.6)$$

$$\begin{bmatrix} I_{12} \\ I_{21} \end{bmatrix} = \begin{bmatrix} Y(1,1)_{1,2} & Y(1,2)_{1,2} \\ Y(2,1)_{1,2} & Y(2,2)_{1,2} \end{bmatrix} \cdot \begin{bmatrix} V_1 \\ V_2 \end{bmatrix} \quad (3.7)$$

Given the formulas (3.7) and (3.6), we can deduce the formula (3.8).

$$S_{12} = V_1 \cdot (V_1^* \cdot Y(1,1)_{1,2}^* + V_2^* \cdot Y(1,2)_{1,2}^*) \quad (3.8)$$

For a bus connected to one line, the Kirchhoff's Current Law is verified when the power calculated with the formula (3.8) (the power coming from the connected line) is equal to the power injected to the bus.

3.8 Conclusion

This chapter has shown basic concepts and definition on electrical networks. Moreover, some abstractions have been made on the components of the network and more specifically on buses. Conventions on power flows have been chosen and power flow equations have been given.

The following chapter introduces and develop the concept of Multi-Agent System in the context of Smart Grid.

4 The Multi-Agent Approaches for Smart Grids - An Overview

This chapter introduces the concept of Multi-Agent System for the Smart Grid and, notably, presents a non-exhaustive overview of recent works using a Multi-Agent System to give intelligence to power grids. In the first part, the concept of Multi-Agent System is detailed as well as terms and concepts required to understand the following chapters. In the second part, different types of multi-agent system architectures and their applications are presented. Coarse- and medium-grained systems are firstly presented, then fine-grained are developed.

Résumé

Un système multi-agent est un système dans lequel des agents interagissent entre eux et avec l'environnement pour accomplir une tâche commune. Ce chapitre introduit le concept de système multi-agent, certains termes nécessaires à la compréhension de la suite du manuscrit et dresse un état de l'art des travaux utilisant les systèmes multi-agents pour la mise en œuvre des Smart Grids.

Les systèmes multi-agents sont généralement utilisés pour la simulation, la programmation et la résolution de problèmes. De nombreux systèmes multi-agents ont été proposés pour aborder une ou plusieurs problématiques des Smart Grid. Ces approches peuvent être classées sous trois granularités différentes.

Cet état de l'art en accord avec les principes énoncés dans [Farid 2014] montre que l'utilisation de systèmes multi-agents est une approche tout à fait adaptée à la mise en place d'un réseau électrique intelligent et autonome.

4.1 Multi-Agent System

Multi-Agent Systems are essentially used in three fields of application: Simulation, Programming and Problem Solving.

In simulation, Multi-Agent Systems are generally used to represent a physically distributed system or to reduce the complexity of the simulation. Concept from Multi-Agent System are also used in programming essentially to distribute the computation and group functionality by agent. Finally, Multi-Agent Systems can be used to solve complex problems.

In this thesis, only this latter use is considered and will be defined.

A Multi-Agent System (in the sense of Multi-Agent System for problem solving) is a system in which agents interact with each other and with the environment in order to accomplish a common task. In this part, we will present multi-agent system, firstly by presenting the origin of multi-agent systems, then, by explaining what they are made of and finally, by pointing out why multi-agent systems are effective to solve the inherent problems of the Smart Grid.

4.1.1 Multi-Agent System Origins

We can consider that philosophers were the originators of Artificial Intelligence. Indeed, at the time, they were trying to determine the way we think. Later, during the 1940's, a group of scientists started to study the possibility to create an artificial brain. Nevertheless, it is in the 1950's that real works started, especially due to the admission of this discipline as an academical one and to the realization of the first neuronal network machine [Russell and Norvig 1995]. Then, by the observation of the fact that, most of time, one system is not enough in many applications, it has been introduced the concept of distributed Artificial Intelligence then followed by multi-agent systems which has been greatly inspired by social behaviors of some kind of insects.

4.1.2 Agent

A commonly agreed definition explains that an *agent* is an entity that can be seen as perceiving its environment through sensors and acting on it with effectors [Russell and Norvig 1995].

This definition can be completed by the fact that an agent has a partial representation of its environment, the ability to communicate with others and is autonomous in its decision making [Ferber 1995].

An agent is a software or hardware entity which:

- ▷ is autonomous,
- ▷ exists in an environment that it can perceive and on which it can act,
- ▷ owns a partial representation of this environment and of other agents,
- ▷ can communicate with other agents,
- ▷ owns resources,
- ▷ has skills and can offer services.

4.1.3 Life Cycle

An agent life cycle is made of 3 steps:

- ▷ **Perception**, during this phase, the agent updates the representation it has of its environment,

- ▷ **Decision**, the decision phase is the one in which the agent decides what action(s) it will do based on its new representation of the environment and on its knowledge,
- ▷ **Action**, in this phase, the agent executes the action(s) previously decided.

Figure 4.1 illustrates this life cycle.

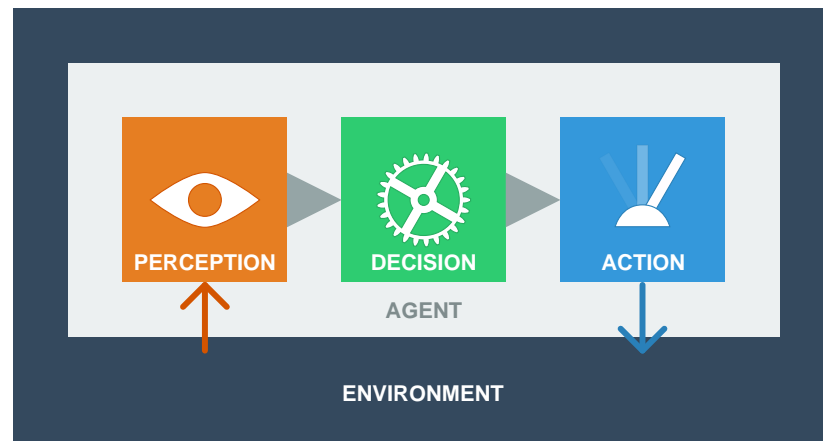

Figure 4.1: Life cycle of an agent in its environment

4.1.4 Intelligence

Despite the presence of common characteristics (like the autonomy), agents may be situated into a scale starting with reactive agents and ending with cognitive [Di Marzo Serugendo et al. 2011]. An agent is considered as *reactive* when it is able to react to modifications of its environment and has no memory. According to the problem to solve, agent may have some memory and highest computation capability. An agent is considered as *cognitive* when it is able to modify its goals. It owns a memory and can use complex learning algorithms.

4.1.5 Communication

As seen above, agents can communicate. There are two kinds of communication in multi-agent systems.

- ▷ The **Direct Communication** which allows agents to directly communicate with each others by sending messages.
- ▷ The **Indirect Communication** which is the act of communicating through the modification of the environment.

4.1.6 Environment

We consider two points of view about the environment:

1. **The multi-agent system environment** which consists of everything that is not part of the system itself. An adaptive system is able to adapt itself to the perturbations coming from its environment.
2. **The agent environment** which consists of the multi-agent system environment and agents of the system. Agents have a limited perception enabling them to perceive only a part of its environment.



4.2 The Multi-Agent Systems for the Smart Grids

This section presents existing works that have been made around the use of a Multi-Agent System to solve Smart Grid issues. As seen previously, the Multi-Agent System concept seems to be a pretty suitable candidate to make the power grid smart. Many researches have been made around the idea of using a Multi-Agent System for the Smart Grid. These works focus on a special functionality of the Smart Grid.

Although a lot of studies have been made on every functionality of the Smart Grid, the main preoccupation remains the distributed control. As electrical networks are evolving both on their size, the amount of connected elements and the amount of links with other networks, it is necessary to give them the ability to work in a decentralized way.

Existing systems can be divided in three granularity levels: coarse-grained, medium-grained and fine-grained.

4.2.1 Coarse-Grained and Medium-Grained Systems

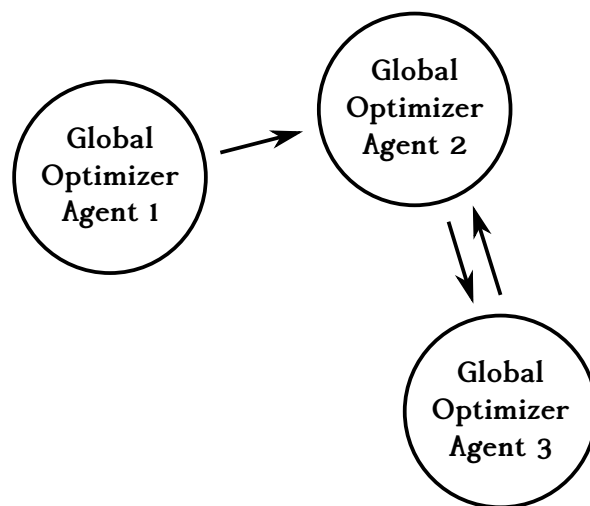

Figure 4.2: Coarse-Grained Multi-Agent System

The approach proposed in [Pandey 2011] consists in attributing an agent to each task the system has to realize. To make power grid smart, some tasks should be automated (State Estimation, Load Flow, ...). In this work, the authors propose to attribute an agent responsible of the Power Flow analysis and another responsible of the state estimation. In addition to

this, they also propose an “Alarm Management Agent” in charge of detecting errors and activating the system alarms.

The figure 4.2 represents an example of agentification of such system in which each agent is responsible of a specified task. For example, the Global Optimizer Agent 1 can be in charge of computing load flow while the Global Optimizer Agent 2 contains mechanisms to estimate the state of the network and the Global Optimizer Agent 3 acts as the Alarm Management Agent.

Although it is a simplistic agentification of system such complex as an electrical network, it has the advantage of giving the possibility to improve each part separately and add more functionalities later. However, this approach doesn't allow the decentralization of Smart Grid and have the same complexity issue as classical approaches.

To handle the previously expressed problems, works have been realized in order to reduce the complexity of agents computation. Indeed, in works such as [Lukovic and Kovac 2013; Yan et al. 2014; Zoka et al. 2014; Eriksson et al. 2015; de Oliveira Saraiva and Asada 2014], problems are distributed between multiple agents and then aggregated to a “Control Agent” (or and “Aggregator Agent”) able to interact with these smaller entities. We notably can find, in the paper [Ghazvini et al. 2014], a division of an electrical network into multiple zones considered to be small enough to minimize the complexity of computations made on it while maintaining their efficiencies. Each agent responsible of a zone is able to perceive it.

The Multi-Agent System designed in this way, are the ones the closest to current optimization methods used for electrical networks. However, they lack flexibility, the division into small zones is not obvious and each change in the network requires a reconfiguration of these zones.

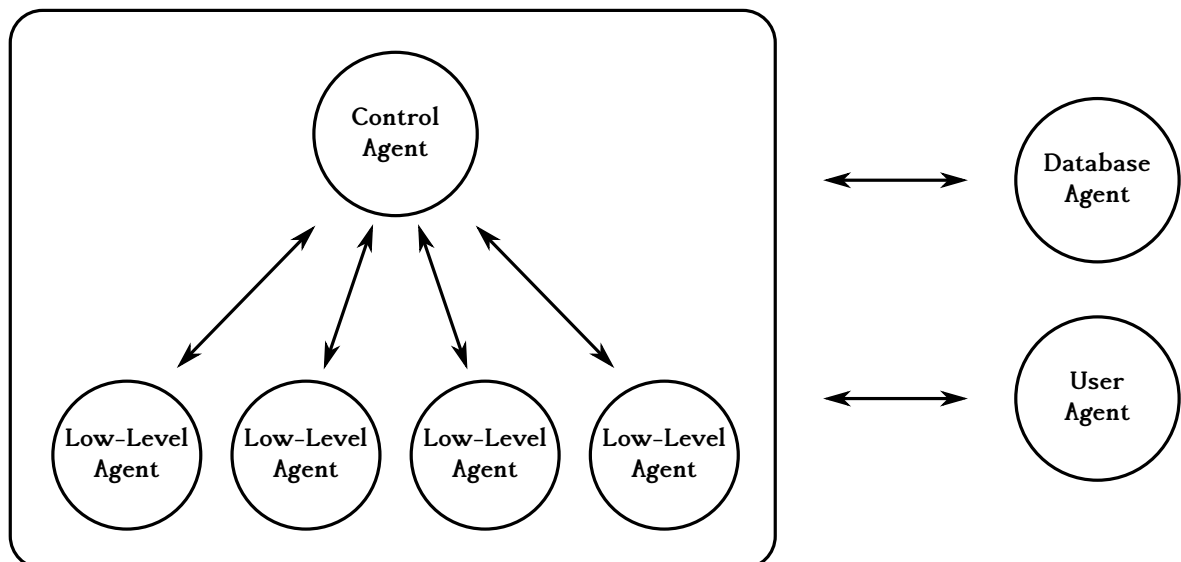

Figure 4.3: Medium-Grained Multi-Agent System

In 2009, the authors of [Pipattanasomporn et al. 2009] present their work in implementing a Multi-Agent System in an IDAPS (Intelligent Distributed Autonomous Power System) environment as introduced in [Rahman et al. 2007]. Similar Multi-Agent System architectures are also presented in [Kulasekera et al. 2011; Manickavasagam et al. 2011; Pandey 2011;

Pandey 2013; Logenthiran et al. 2010; Ghosn et al. 2010] and in [Roscia et al. 2013] in a larger concept of Smart City. In such architecture, can generally be found four types of agent (which names and behaviors may vary between systems but still remains very similar):

- ▷ **Low-Level Agents:** Generally based on the addressed problem, a certain number of “Low-Level Agents” can be present in such systems. A “Low-Level Agent” is an agent designed to control a small part of an electrical network. It is generally associated with an indivisible element such as a generator, a consumer, or a busbar. As these approaches generally focus on energy management, there are essentially agents associated to distributed energy resources and loads;
- ▷ **Control Agent:** This kind of agent is in charge of aggregating data from the other agents and takes decision for the whole system it is associated to. Examples of algorithms for this kind of agent are presented in [Nagata et al. 2012; Gupta et al. 2013];
- ▷ **Database Agents:** In order to maintain a consistent and accessible knowledge about the power system, Database Agents are created and associated with the whole group of agents. They are in charge of storing relevant information about the system and are generally used as routers to allow communication between agents;
- ▷ **User Agents:** The “User Agents” are the link between the Multi-Agent System and various actors who need to interact with this latter. They allow, on one hand, to observe relevant information about the state of the system and, on the other hand, to act on it and notably to control the priority of the various loads.

The interactions between these agents are represented in the figure 4.3.

4.2.2 Fine-Grained Systems

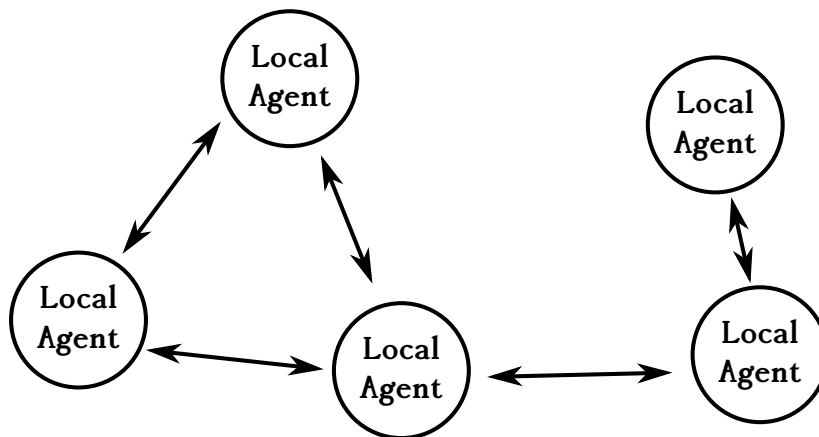

Figure 4.4: A Fine-Grained Multi-Agent System

Studies have been made at an even lower level than the previous one associating an agent to small parts such as buses and lines.

In 2011, a Multi-Agent System architecture for the Smart Grid control has been proposed in [Belkacemi et al. 2011]. This work has been developed as part of the West Virginia Super

Circuit (WVSC) Smart Grid Demonstration project in order to show the relevance to use a Multi-Agent System approach for a Smart Grid monitoring and control. The two main interesting points of this work reside in the absence of global control and in the fact that this approach comes from a biological system namely the Human Immune System. In this work, agents are instantiated at buses and are able to communicate and negotiate with their physical neighbors (ie. other buses connected through one and only one line to it). In addition to bringing a flexibility to Smart Grid control, such an agentification allows a geographical decentralization of the system and limits by nature the complexity of agents algorithm. Although the parallel with the biological system is well presented, but the agents algorithm has not been developed.

The authors of [Matei et al. 2012] propose a similar approach agentifying buses and giving them the ability to communicate with their direct neighbors. The addressed problem is the one of Decentralized State Estimation. To do this, the authors have introduced a notion of trustworthiness between agents in order to guide their State Estimation at a local level to allow a consistent global State Estimation.

The paper [Prostejovsky et al. 2012], in addition to agentifying the buses, also considers lines, loads, generators and substation as agents. Similarly to the work in [Matei et al. 2012], the presented approach is based on the fact that agents act locally and communicate with direct neighbors. This kind of approach forces the designer to determine new computation algorithms as it cannot benefit from the global knowledge exploited by global optimization methods. However, depending on the algorithms, the problems can be solved with a linear complexity.

The architectures presented in these papers seems to be adapted to the Smart Grid. However, viewing the results, the approach proposed in [Matei et al. 2012] seems to be unstable and the one in [Prostejovsky et al. 2012] is not yet enough developed.

The figure 4.4 shows the absence of hierarchy in this kind of systems.

4.2.3 Methodologies and standards

In the previously presented works, we can observe that the most commonly used communication standard is the FIPA's Agent Communication Language. This standard is based on Searle's speech act theory (see [Searle 1979]) and allows agents to communicate using predefined protocols and communication acts.

The compositional development method DESIRE (framework for DEsign and Specification of Interacting REasoning components) has been adapted to Multi-Agent System design in [Brazier et al. 1995] and has been applied in [Brazier et al. 1998].

From all frameworks, the most used to design and develop the presented systems are Jade and Zeus. Both of them are based on the standard FIPA ACL. A comparison between these two frameworks has been made in [Pipattanasomporn et al. 2009]. Some authors have preferred to design their own systems from scratch in order not to be limited or constrained by any platform. Finally, the Contract Net Protocol [Smith 1980] is widely used for negotiation between agents and notably in medium-grained systems such as the one in [Pandey 2011]. This protocol allows task-sharing in a Multi-Agent System and the establishment of a trust relationship among agents.

4.3 Conclusion

The works previously presented show that the use of a Multi-Agent System to monitor and control the Smart Grid is an interesting way of proceeding. In addition to this, a series of principles, presented in [Farid 2014], should be considered in the process of giving autonomy and intelligence to power grids. Among these principles, the 4th, the 6th and the 8th claim our attention.

- ▷ **Principle 4 (Physical Aggregation):** This principle indicates that the composition of an agent must represent the set of physical objects it is connected to and it represents. In a coarse-grained system, an agent associated to a whole micro-grid should have a representation of all of the elements it is made of. At a lower level, we can imagine a bus agent considering each consumer/generator and line connected to it;
- ▷ **Principle 6 (Interaction):** This principle indicates that agent interactions should be consistent with the structure of the network. In other words, it means that agents must interact with their nearest neighbors;
- ▷ **Principle 8 (Scope of Physical Agents):** This principle indicates that the agents' scope and boundaries should be accorded to the physical elements they represent.

These principles seem to be important to consider. From this state of the art and these principles, the use of the Adaptive Multi-Agent System theory (cf. 5 page 49) appears to be an interesting and suitable approach to consider in the Smart Grid design process. The following part presents this theory and its adequacy to the Smart Grids.

5 ATENA (Adaptive Transmission of Energy and Network Analysis)

This chapter introduces the concept of Adaptive Multi-Agent System (AMAS). As a first step, we will present different concepts specific to Adaptive Multi-Agent System. Secondly, we will describe a method developed to create such Adaptive Multi-Agent System. Then, we will see why Adaptive Multi-Agent Systems are adapted to this kind of problems and how they can contribute more than classical Multi-Agent Systems. And finally, the first part of the proposed methodology is applied to the Smart Grid to propose a framework named ATENA (Adaptive Transmission of Energy and Network Analysis) that will be reused in the following chapters.

The IRIT¹'s SMAC² team works on the resolution of complex problems using the AMAS theory. This theory, developed by the team, proposes a solution allowing multi-agent systems to adapt themselves to problems regardless of their complexity in order to provide a time and memory efficient solution. The theory, greatly inspired by social behaviors, has been presented in [Camps et al. 1998; Glize 2001; Di Marzo Serugendo et al. 2011].

A cooperative system is a system composed by entities which have a cooperative behavior with their neighbors. The concept of cooperation is explained more in details in this chapter. The functional adequacy theorem shows the relevance of cooperative systems to solve complex problems.

As seen in the previous part, multi-agent systems seems efficient to handle many characteristics of the Smart Grid. Moreover, the AMAS theory relies on the same principles than multi-agent systems and therefore benefits of the same advantages. Furthermore, works, such as the one presented in the paper [Djebali et al. 2015], have shown the relevance of using an Adaptive Multi-Agent System to solve a complex problem. Anyway, we often see multi-agent systems composed of generally one agent controlling others (acting as a coordinator). Despite the fact that classical multi-agent systems will work most of the time, they generally relies on one component: the agent coordinator (for example in the paper [Nagata et al. 2012]). If this one fails, the whole system may fail too. With the adaptive approach, agents don't rely on one pre-specified chief. Agents cooperate with each other providing a more robust and flexible system which perfectly fits with the Smart Grid requirements such as the coordination of multi-level networks and the dynamic inherent to the decentralized generators (see 2.3 page 19).

¹Institut de Recherche en Informatique de Toulouse

²Systemes Multi-Agents Coopératifs

Résumé

Cette partie introduit les Systèmes Multi-Agents Adaptatifs (AMAS). Premièrement, les différents concepts spécifiques à ces systèmes sont explicités. Deuxièmement, la méthodologie de développement de ces systèmes est présenté. Enfin, la pertinence d'utiliser de tels systèmes pour la mise en place du Smart Grid est présentée.

L'équipe de recherche SMAC (Systèmes Multi-Agents Coopératifs) de l'IRIT (Institut de Recherche en Informatique de Toulouse) travaille sur la résolution de problèmes complexes à l'aide de la théorie des AMAS. Cette théorie, développée par l'équipe, propose une approche pour permettre une auto-adaptation des systèmes multi-agents aux problèmes qu'ils traitent et ce, quelque soit leur complexité afin d'obtenir une solution en un temps raisonnable.

Un système multi-agent adaptatif est un système coopératif, c'est-à-dire un système dans lequel l'ensemble des agents agissent de manière coopérative entre eux. Leur but est d'améliorer la satisfaction de leur entourage. Pour ce faire, la notion de criticité est introduite. La criticité peut être vue comme une indication sur l'état de non-satisfaction d'un agent. La méthodologie ADELFE a été développée afin d'assister à la conception et à l'implémentation de tels systèmes.

5.1 The Functional Adequacy

The functional adequacy of a system is a judgment made by an observer on the relevance of its activity in its environment. Therefore, a system whose activity seems relevant in its environment is referred to as a "Functionally Adequate System".

Theorem 1.

Functional Adequacy - For every functionally adequate system, there exists at least one cooperative system which realizes an equivalent function in the same environment.

This theorem has been demonstrated by Valérie Camps, Marie-Pierre Gleizes and Pierre Glize in [Camps et al. 1998; Glize 2001] by applying operations on the following axioms and lemmas:

- ▷ A functionally adequate system doesn't do antinomic actions on its environment,
- ▷ Each cooperative system is functionally adequate,
- ▷ For each functionally adequate system S , there exists at least one cooperative system S^* which is functionally adequate in the same environment,
- ▷ Each system composed of cooperative elements is cooperative with its environment (performs action which have a beneficial effect on it),
- ▷ For each cooperative system, there exist at least one system composed of cooperative elements with a similar function in the same environment.

The following part presents the concept of cooperative systems.

5.2 Cooperative System

The cooperation is a social attitude. The interaction of some entities in order to solve a problem may require a kind of coordination and mutual assistance. In the context of multi-agent system, this is referred to as cooperation, or cooperative agents, when their behavior results in helping the ones which are struggling the most. Agents act in the wider interest. In order for this kind of system to work, it is necessary that agents trust each other and that there is no ambiguity during inter-agents communications [Camps et al. 1998]. In order to identify which neighbor is struggling the most, agents have the ability to compute a criticality value.

5.3 Criticality

The AMAS approach requires that each agent has a local goal that it tries to reach by executing local actions. It also requires that each agent has a cooperative attitude, in other words, the agent has to help its neighbor if this one is more struggling. It is then necessary to be able to evaluate and compare agent's state. That is why the notion of "Criticality" has been introduced (See [Lemouzy 2011]) and can be defined as follow:

Definition 9.

***Criticality** - The criticality of an agent represents the state of dissatisfaction of it regarding its local goal.*

This value is normalized between each entities of the system and can be defined from many criteria. During the decision phase, a cooperative agent evaluates its criticality and the one of its neighbors. Once it is done, this agent selects the action that minimizes the highest criticality at the next cycle.

In order to reduce the criticality, agents must be able to identify critical situations. These states are called Non Cooperative Situations.

5.4 The Non Cooperative Situations

In an Adaptive Multi-Agent System, agents are cooperative. A non cooperative situation is a situation in which a cooperative agent shouldn't be. A non cooperative situation can be defined as follow:

$$NCS(S) = \neg C_1(S) \vee \neg C_2(S) \vee \neg C_3(S) \vee \neg C_4(S) \vee \neg C_5(S) \vee \neg C_6(S) \vee \neg C_7(S)$$

with

S : a situation

$NCS(S)$: true if S is a non cooperative situation

$C_i(S)$: true if S is cooperative for the criteria i

It exists seven kinds of Non Cooperative Situations:

- ▷ **Ambiguity.** There exists a potential ambiguity in the perceived message. There isn't enough information to discriminate the signal.

- ▷ **Misunderstanding.** The agent cannot extract information from the perceived signal.
- ▷ **Conflict.** The action that an agent may do will be conflicting with the one of another.
- ▷ **Competition.** The action that an agent may do has the same consequences than the one of another.
- ▷ **Unproductivity.** Agent's decisions don't lead to action.
- ▷ **Uselessness.** The action of an agent has no effect on its environment.
- ▷ **Incompetence.** The agent cannot reach a decision from its current knowledge.

[Di Marzo Serugendo et al. 2011; Meftteh et al. 2013]

From the resolution of these non-cooperative situations is supposed to emerge a global function aiming at solving a global problem. This then introduces the concept of emergence.

5.5 Emergence and Self-Adaptation

In a multi-agent system, a global function is expected from a set of local specifications. This global level property shouldn't be programmed into agents. Due to the openness characteristic, disruptive elements (environment, users or other agents) force the system to adapt itself and to constantly restructure itself to keep acceptable performances. This self-organizing characteristic can be seen in many domains. It corresponds to spontaneous emergence [Kim and Slors 1997] of a global coherence from local interactions of micro level initially independent components.

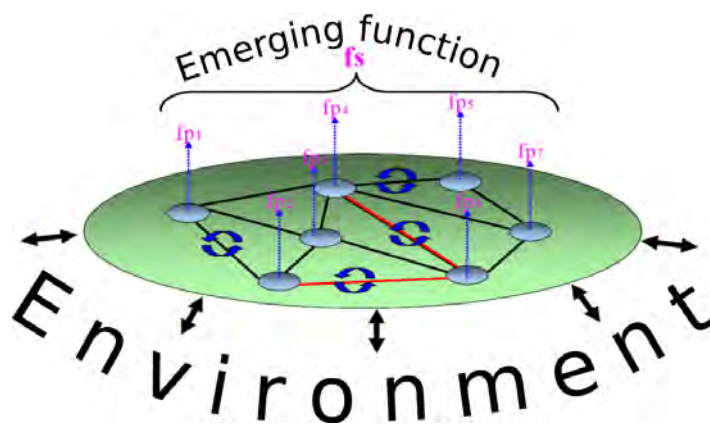

Figure 5.1: Emergence

The emergence appears from a self-adaptation between agents. Their cooperative behavior allows the appearance of a global function deemed as emerging, that is to say the appearance of a function which is not predictable by simply observing the local behaviors of entities in the system.

“[...] On the one hand, the emergence presupposes that there is the appearance of something new - properties, structures, shapes or functions -, and on the other hand, it

implies that it is impossible to describe, explain or predict these new phenomena in physical terms from the basic conditions set out below levels.” [Van de Vijver 1997]

With a dynamic environment, the system must be able to change the way it acts in order to adapt itself. [Georgé 2003]

To develop self-adaptive systems able to produce an expected result by emergence, this involves a bottom-up process. To assist this development, the ADELFE methodology has been proposed.

5.6 The ADELFE Methodology

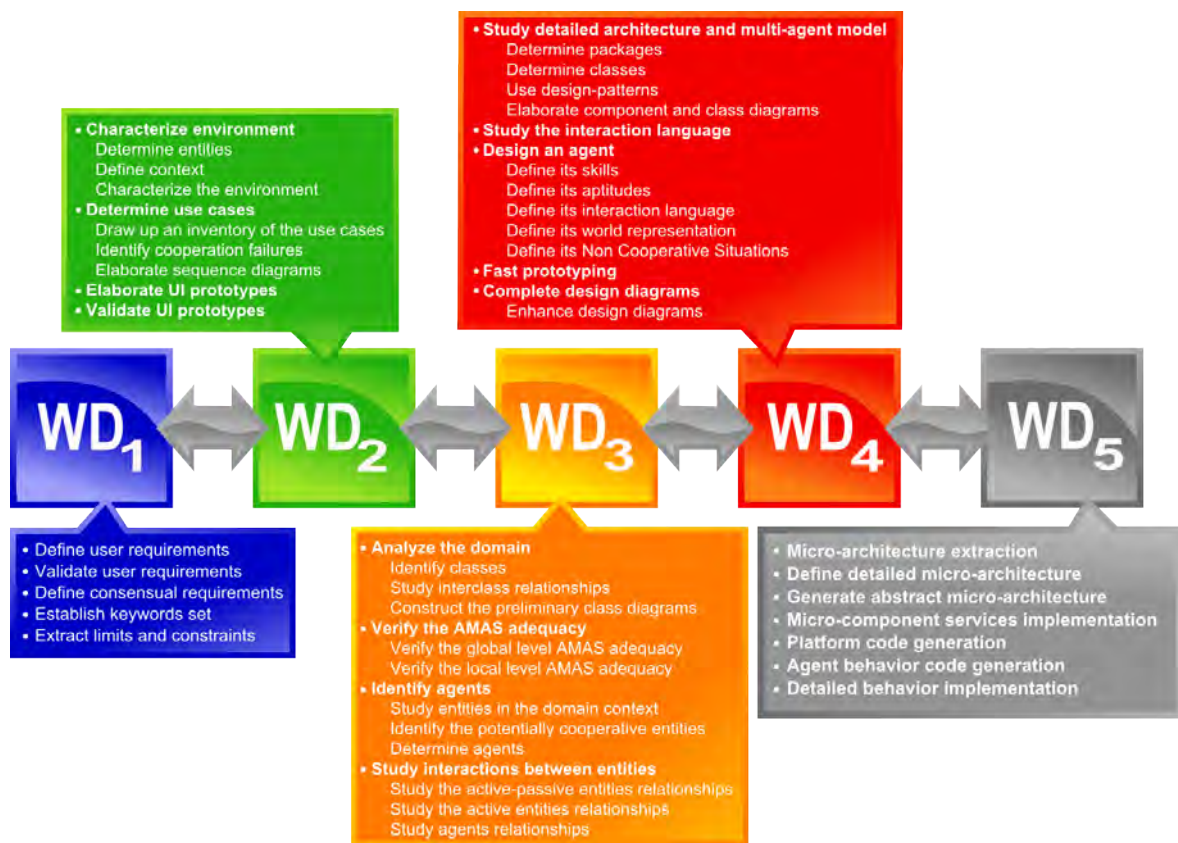

Figure 5.2: ADELFE Methodology Steps

The ADELFE (“Atelier de Développement de Logiciels à Fonctionnalité Émergente”: Toolkit to develop software with emergent functionality) methodology assists developers during the conception of Adaptive Multi-Agent Systems [Bernon et al. 2001; Picard 2004]. This methodology is based on the Rational Unified Process (initially called “Rational Objectory Process”) [Kruchten 2004] to which are added AMAS specific activities [Bonjean et al. 2012; Mefteh et al. 2015]. The methodology is separated in 5 phases and each one is split in a certain amount of steps.

5.6.1 Initial Requirements Specification

This phase consists in the specification of what the system has to do. The objective is to reach a consensus between the different actors of the process in order to determine, on the one hand what the system has to do, and on the other hand, its boundaries and constraints. This phase includes the following activities:

- ▷ Definition of users requirements,
- ▷ Definition of consensual requirements,
- ▷ Determination of business model,
- ▷ Establishment of keywords list,
- ▷ Extraction of limits and constraints.

5.6.2 Final Requirements Specification

This phase consists in the specification of use cases and final requirements from the initial requirements and the previously reached consensus. It also includes the multi-agent system adequacy verification (Is a multi-agent system needed to solve the problem with gains?). More precisely, this phase includes the following activities:

- ▷ Characterization of the system environment,
- ▷ Determination of use cases,
- ▷ Verification of multi-agent system adequacy,
- ▷ Elaboration of User Interface prototypes.

5.6.3 Analysis

During the analysis phase, we analyze the domain characteristics. The analysis phase consists in the analyze of domain characteristics, the determination of the agents and the validation of an AMAS approach. This phase includes the following activities:

- ▷ Analysis of the domain characteristics,
- ▷ Verification of the global level AMAS adequacy,
- ▷ Identification of the agents,
- ▷ Verification of the local level AMAS adequacy.

5.6.4 Design

The design phase aims at providing a detailed architecture of the system. In this phase, we define a communication protocol and the different behaviors of agents. Also, this phase includes the mapping of key elements to modules. This phase includes the following activities:

- ▷ Definition of module view,
- ▷ Study of communication acts,
- ▷ Definition of entity behavior,
- ▷ Definition of nominal behavior,
- ▷ Definition of cooperative behavior,
- ▷ Validation of the design phase.

5.6.5 Implementation

This phase consists in the realization of what have been specified in the previous phases. This phase includes the following activities:

- ▷ Implementation of the framework,
- ▷ Implementation of the agents behavior.

The five phases previously presented allow the development of emerging functionality software.

5.7 Modeling the Framework ATENA

We have seen previously that the AMAS theory seems to be a suitable approach to handle the Smart Grid. The ADELFE methodology (see 5.6 page 53) has been created to assist the design and implementation of Adaptive Multi-Agent Systems. This section details the ADELFE process as used during the conception of ATENA (Adaptive Transmission of Energy and Network Analysis). For the sake of brevity, only some important parts of the ADELFE methodology are developed in this manuscript: The characterization of the system environment, the analysis of the domain characteristics, the verification of the AMAS adequacy and the identification of agents. These parts are highlighted in the figure 5.3. The design phase depends on the implementation of the developed framework. This phase will then be detailed in the implementation for the Load Flow analysis and in the implementation for the State Estimation.



Figure 5.3: Parts of ADELFE developed in the manuscript

5.7.1 Characterization of the System Environment

The characterization of the system environment is the process aiming at determining the entities of this environment and some points that characterize it.

The system environment corresponds to the set of entities the developed system can potentially interact with. In the case of the proposed system ATENA, it is developed in order to progress toward the Smart Grid as a whole. Its environment is the electrical network (simulated or not).

A second entity present in the environment can also be the user, which is here represented as the network manager. This one has the capacity to interact with the system, notably to perceive the state of the system and be able to react if necessary. The electrical network is made of several entities. Those which are particularly interesting are buses, lines and measurements. Indeed, as mentioned previously, these entities are the minimal set required to describe a network.

To determine the characteristics of the environment, it is before necessary to define some terms. The following definitions come from the book "Artificial Intelligence : A Modern Approach" written by Stuart Russell and Peter Norvig [Russell and Norvig 1995].

Definition 10.

Observability of an Environment - An environment might be partially observable because of noisy and inaccurate sensors or because parts of the state are simply missing from sensors data [...]

Definition 11.

Deterministic or Stochastic - If the next state of the environment is completely determined by the current state and the action executed by the agent, then we say the environment is deterministic; otherwise, it is stochastic.

Definition 12.

Discrete or Continuous - The discrete/continuous distinction applies to the state of the environment, to the way time is handled, and to the percepts and actions of the agent. An ordered set is considered continuous if for two elements of this set, it always exists an other element between them. In a continuous environment, the amount of possible actions and perceptions is not limited.

Definition 13.

Static or Dynamic - If the environment can change while an agent is deliberating, then we say the environment is dynamic for that agent; otherwise, it is static.

Knowing the entities composing an electrical network as considered in this study (buses, lines and measurements), it is possible to determine the environment of the system with the following characteristics:

- ▷ **Partially Observable:** Sensors are not perfect and are limited in number. Furthermore, load patterns are used instead of real measurements in order to reduce the costs of deployment. It is impossible to have an exact knowledge about the state of a network at a given time. The environment is therefore partially observable;
- ▷ **Continuous:** Electrical networks are discontinuous as the retained model neglects transitory states caused by variations of various system variables. However, the various measurements provided to the Multi-Agent System are averaged in a sliding window of 10 minutes. Consequently, the electrical system is considered as continuous;
- ▷ **Deterministic:** The Multi-Agent System has an averaged vision of the operating point of the network. From these measurements, the Multi-Agent System estimates this operating point without acting on the electrical system. Moreover, the environment of the system is static as it represents a snapshot of the electrical network at a given moment. Therefore, for agents, the environment is considered as deterministic;
- ▷ **Dynamic:** As mentioned before, the state of the environment is influenced by various external factors. Thus, even if agents never modify the environment it cannot be guaranteed that this latter will remain the same between two perceptions. The environment is then considered as dynamic.

5.7.2 Analysis of the Domain Characteristics

The analysis of the domain characteristics allows to study the entities previously determined.

As mentioned previously, the system environment can be expressed as a set of buses, lines and measurements. We will then focus on these three entities. Moreover, the principles of the paper [Farid 2014] (notably the 4, 6 and 8), partly presented in the section 4.3 page 48, confirm the relevance of considering these entities as potential agents.

5.7.2.1 Bus

In the field of State Estimation and Load Flow analysis, a bus is an entity on which we have to determine the value of the four variables representing it. A bus is a connection point between the various components of the network. It can be materialized by a busbar. In the case of the State Estimation and Load Flow analysis they represent major actors. The choice has been made to consider buses as autonomous entities. Given these characteristics and the definition given in section 4.1.2 page 42, buses are considered *active entities* and can be agentified.

5.7.2.2 Line

Lines have characteristics (reactance, conductance, capacitance and resistance) which are static. Therefore, they are considered as not autonomous and not having an active role in the Smart Grid. Thus, they are considered *passive entities*.

5.7.2.3 Measurement

Measurements have an important role in the State Estimation and therefore in multiple other Smart Grids expected functions. A measurement is an information more or less accurate about a value in the network. We consider that they must be able to evaluate the quality of the measured value and to reconsider it if necessary. They are considered as autonomous in their decisions. Measurements are therefore *active entities* and can be agentified.

5.7.3 Verification of the AMAS Adequacy

In order to determine the relevance of using an AMAS to solve this problem, the ADELFE methodology proposes to answer a list of questions:

- ▷ **Is the algorithm for the task a priori unknown ?** The algorithms for these tasks are known. The context of this thesis imposes to evaluate the relevance of a new approach.
- ▷ **Is the correlated activity of several entities needed to solve this problem ?** As mentioned previously, our implementation choice implies that buses need to act in coordination with others to find their state variables values.
- ▷ **Is the solution usually obtained by repeating tests ?** Although, usual methods don't work by trials and errors, it generally requires multiple iterations. We then consider it as repeated tests.
- ▷ **Is the environment of the studied system dynamic ?** Although, current electrical networks topologies are generally considered as static. This study takes place in a context of dynamic networks able to handle distributed generators connection and disconnection at runtime. Moreover, unexpected events (such as faults) can occur in the system and must be taken into consideration.
- ▷ **Is the system process functionally or physically distributed ?** Although, the processes of State Estimation and Load Flow analysis are generally centralized. The focus of

this work is put on the physical distribution of such a system notably to allow the interactions between autonomous networks.

- ▷ **Are a great number of entities involved in the system ?** Electrical networks are made of an important number of entities.
- ▷ **Is the system potentially non-linear (the output of the system is not proportional to the input) ?** A small change made at a bus level may lead to an important disturbance in the rest of the network. The system is considered as non-linear.
- ▷ **Is the system open or evolutionary (elements can be introduced or removed at runtime) ?** As mentioned previously, the system needs to be able to handle connection and disconnection at runtime. It is then considered as open.
- ▷ **Have the systems entities a limited rationality ?** The entities of the system have a partial knowledge of the environment in which they are acting. Their behavior may be ineffective.

The answers given to these questions indicate that the AMAS theory is a relevant approach for the Smart Grid.

The system analysis enabled us to determine which entities are good candidates to be considered as agents.

5.7.4 Identification of the Agents

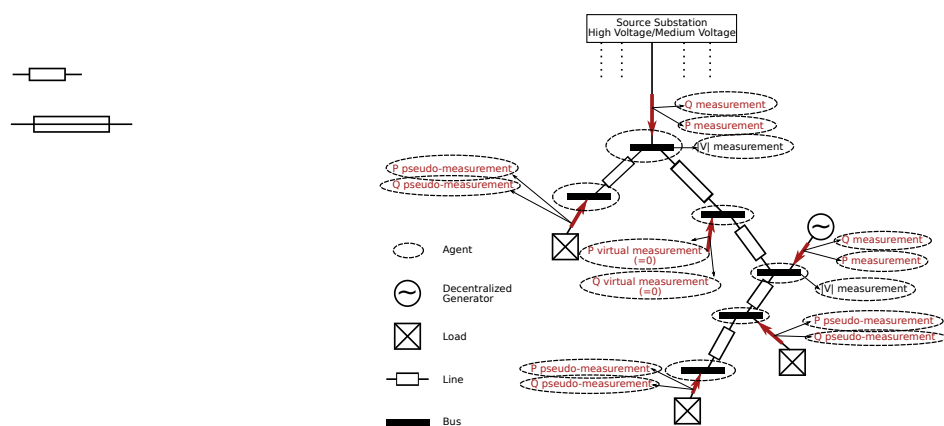

Figure 5.4: Example of a distribution network agentification

The analysis of the domain characteristics have shown that buses and measurements are active entities. We have made the decision to agentify the buses (as they are major actors in the State Estimation process and Load Flow analysis) as well as measurements (as they are major actors in the network observability). The agents are autonomous in their decision-making and act locally. Moreover, this fine granularity allows to reduce the impact a change can have in the controlling system.

In ATENA, we have defined two types of agents: Bus Agents and Measurement Agents. Whatever the behaviors of these agents are, the initialization of the framework requires the

instantiation of agents. For each bus, it's possible to have up to four associated agents: a Bus Agent, a voltage magnitude Measurement Agent, an active power Measurement Agent and a reactive power Measurement Agent. Depending on the application of the ATENA framework, there can be Measurement Agents but not necessarily. The presence of the voltage magnitude Measurement Agent depends on the presence of a voltage magnitude sensor on the bus. We consider measurements (pseudo, real or virtual) on every bus. Therefore, active and reactive power Measurement Agents are present on every bus.

The figure 5.4 presents the agentification of an example of distribution networks. On this figure, it can be seen that for each measurement (voltage magnitude, active power and reactive power) a Measurement Agent is placed. Also, to each bus, a Bus Agent is associated. These agents are instantiated during the initialization and are responsible of the bus or the measurement they are associated to.

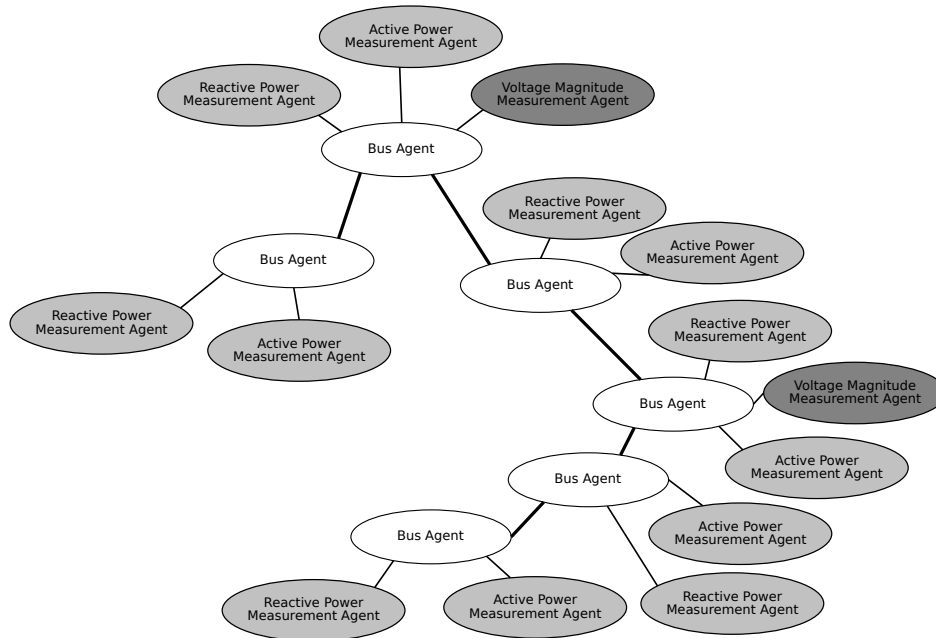

Figure 5.5: ATENA-based Multi-Agent System instantiation of the network in the figure 5.4

The figure 5.5 presents the agents and their connections without the distribution network. It can notably be seen that the connections between agents follow the topology of the distribution network and are strictly local. Therefore, during the instantiation of the framework, it will be possible to give the ability to agents to interact through these connections.

In order to maintain a certain flexibility during the development process and allow future evolutions, the object-oriented approach has been chosen to develop the system. The class diagram presented in the figure 5.6 presents the connections between agents and elements of electrical networks as well as the connections between these agents. In this diagram, rectangles represent the class and the links between them represent the associations. For example, the link between Bus and Line indicates that a bus is associated to 0 to n lines and a line is associated to two buses. The link between Network and Bus indicates that a network is composed of buses.

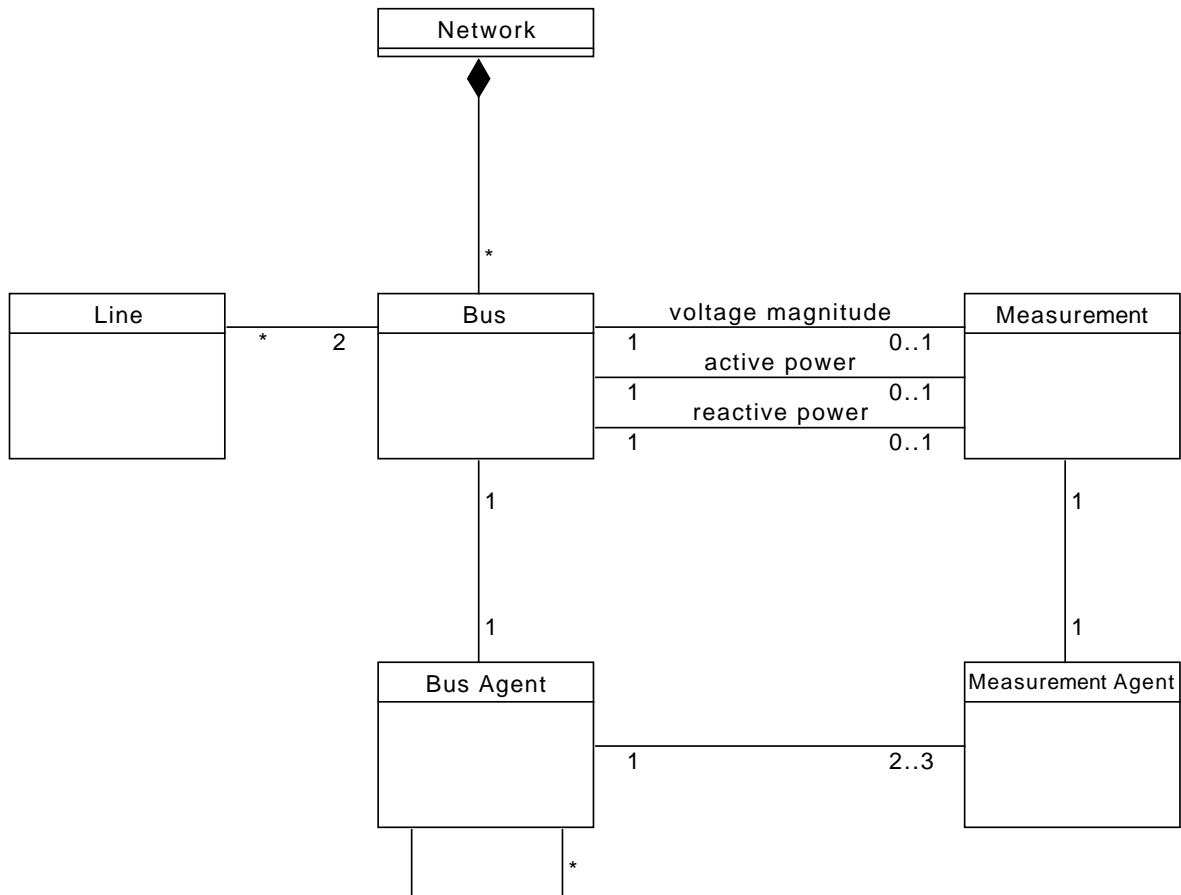

Figure 5.6: Class diagram showing the relation between the agents and the network

5.7.5 Conclusion

This chapter has presented the AMAS theory as well as concepts related to it and the ADELFE methodology. This methodology has then been applied to some ADA (Advanced Distribution Automation) functions of the Smart Grid.

The characterization of the system environment and the analysis of the domain characteristics have notably allowed to identify entities and more particularly agents.

This has led to the creation of the framework ATENA. The developed framework constitutes a basis for the design and the implementation of Adaptive Multi-Agent Systems for the Smart Grid. From this basis, the behaviors of agents can be developed to solve a specific problem.

The design phase of the ADELFE methodology depends on the problem that must be handled. The framework ATENA must be instantiated with this phase for the two problems: the Load Flow analysis (see chapter 6 page 65) and the State Estimation (see chapter 7 page 87).

*An Adaptive Multi-Agent System for the
Distribution
of Intelligence in Electrical Distribution Networks:
State Estimation*

Design and Implementation of Atena

6 ATENA for Load Flow Analysis

This chapter presents the design and implementation of a Multi-Agent System based on the framework ATENA which aims to solve Load Flow problems. This approach is based on the decentralization of the Newton-Raphson method applied to the Load Flow problem.

The formalization of the problem is developed in detail in the first section. Secondly, an overview of existing works around the Load Flow problem is presented. The third section details the Multi-Agent System structure and the behavior of agents which were designed in this thesis. Then, the results of evaluations are presented. And finally, a conclusion about the relevance of using a Multi-Agent System to solve the Load Flow problem is exposed.

Résumé

Ce chapitre présente le problème d'analyse des flux de puissance ainsi que le développement d'une approche innovante pour traiter ce problème. L'approche proposée est basée sur une décentralisation de la méthode de Newton-Raphson au travers un système multi-agent.

Généralement traitée de manière globale, cette résolution d'équations passe souvent par des traitements appliqués à des matrices de taille importantes. Dans l'approche présentée dans ce chapitre, les tailles de matrices sont de tailles 2×2 . Cela limite de manière évidente la complexité computationnelle de cette approche.

Le calcul des flux de puissance dans un réseau électrique permet de déterminer les flux de puissances actives et réactives, l'amplitude et phase de la tension en tout nœud pour une configuration données des productions et des consommations (contraintes imposées par l'ingénieur). Cette étude est généralement effectuée pour par exemple dimensionner un nouveau réseau. De nombreuses méthodes ont été proposées pour résoudre ce problème. Le système proposé dans ce chapitre est un système multi-agent dans lequel les bus sont des agents cherchant à trouver des valeurs de tension tout en respectant les contraintes de production et de consommation imposées par l'utilisateur.

6.1 Introduction

This chapter is aiming at giving details about the conception of a Multi-Agent System, based on ATENA, able to solve the Load Flow problem.

This work is a transposition of the Newton-Raphson method (generally applied at a

macro level) to a micro level.

Although, there is a lot of methods aiming at solving the Load Flow problem, the original proposition of this thesis is to design and implement a decentralized approach to distribute the intelligence, physically and conceptually, in electrical networks in order to be applied to the Smart Grids.

The Load Flow study is a computation of the power flows in an electrical network at one time. Generally, the problem is expressed as a simplified representation of a network. It involves notably the use of one-line diagrams and the per-unit system. Requiring accurate information about the network, the Load Flow study can be used to size the network and cannot directly be used to estimate the state of a running network.

The objective of the ATENA for Load Flow analysis system is to propose a decentralized approach to solve the load flow problem.

In the first section of this chapter, the problem is detailed and formalized. Secondly, a state of the art of existing methods is presented. Then, the design and implementation of the developed system is detailed. And finally evaluations are made on the complexity of the system.

6.2 Problem Description

In order to facilitate the understanding of the problem and the developed system, we define some abstractions made about the problem, such as about buses and lines. As mentioned in the section 3.1 page 30, the description of the Load Flow problem takes place in the context in which an abstraction is made about elements others than buses and lines (generators, consumers, transformers, ...). We then talk about *bus voltage* which is the voltage common to every elements connected to that bus and *bus injection* which is the sum of power injected to the bus (i.e. the sum of the powers produced by the generators and the powers consumed by consumers). We must have in mind the fact that consuming powers can be represented as an injection of negative power.

The state of a bus can be represented by four state variables:

- ▷ the voltage magnitude $|V|$,
- ▷ the voltage phase angle $\arg(V)$,
- ▷ the injected active power P_{inj} ,
- ▷ the injected reactive power Q_{inj} .

In a Load Flow, constraints imposed by the user are:

- ▷ PQ node: imposed active and reactive power (represents the operating point of a generator or a consumer);
- ▷ $V\Theta$ node: imposed voltage magnitude and phase angle (represents the operating point of a generator);

- ▷ *PV* node: imposed active power and voltage magnitude (represents the operating point of a generator).

More generally, the operating point of injections of each node is determined by four values P , Q , V and Θ . In a Load Flow, the user can impose two out of these four values. The Load Flow calculates the two others in order to respect operating constraints. Generally, types of usual constraints are *PQ*, *PV* and *V Θ* .

More generally, it is considered that for each bus, two out of the four state variables are known. Knowing these hypothesis, we can consider the load flow problem as a problem of calculating the missing state variables of an electrical network.

Let's consider a network N composed of n buses Bs which have the previously defined representation. The process of load flow is to find the missing values from the model and constants imposed by the engineer.

In the Load Flow analysis, the constraints are initialized at the beginning of the process and remain constants during the resolution. The unconstrained variables are evaluated iteratively until the value of each constrained variables reaches the expected value. We can consider the load flow solved when the Kirchhoff's Current Law is respected at every bus. In other words, the Load Flow problem is solved when the current injected at a bus is equal to the sum of the currents coming from neighbor buses.

The Load Flow problem can be expressed as a set of equations to solve. We are looking to validate the following equations for each bus n :

$$S_n = P_n + i \cdot Q_n = V_n \cdot I_n^* \quad (6.1)$$

The equation (6.1) corresponds to the relation between the injected power (expressed as S_n which is equal to $P_n + i \cdot Q_n$), the voltage V_b and the injected current I_n at a bus.

For a given bus b , the injected current I_b is equal to the sum of current flowing out to other buses:

$$I_b = I_{b,1} + I_{b,2} + \dots + I_{b,n} \quad (6.2)$$

Knowing the admittance of a link between two buses as given in section 3.5.1 page 36, the current flowing from a bus i to a bus j is:

$$I_{i,j} = Y(1,1)_{i,j} \cdot V_i + Y(1,2)_{i,j} \cdot V_j \quad (6.3)$$

As said previously, for each bus, at least two out of four state variables are known from (1) voltage magnitude, (2) phase angle, (3) injected active power and (4) injected reactive power. These values can be set in the previously defined equations system. The other variables are unknown and will be determined by the resolution of the equations (6.1) and (6.2), for example using the Newton-Raphson method (see 6.3 page 68).

The figure 6.1 represents a simple load flow problem. On each of these buses, two out of four state variables are known. The bus 1 is the slack bus¹. The bus 2 doesn't have a connected load or generator. Therefore, the active and reactive injected power is equal to

¹During a Load Flow, *V Θ* constraints are imposed to the slack bus. As a result of a Load Flow analysis, the active and reactive power of the slack bus will be equal to the sum of each injected power plus the losses.

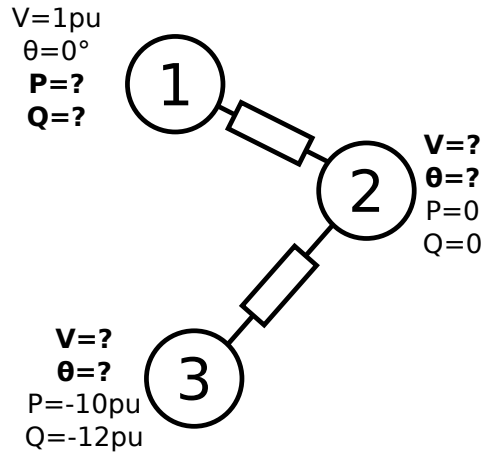

Figure 6.1: Example of Load Flow Problem



zero. Contrarily, the bus 3 is linked to a consumer which consumes 10pu of active power and 12pu of reactive power. Therefore, the injected active and reactive powers are respectively -10pu and -12pu. Based on these informations and on the network model (structure of the network and characteristics of the lines), the load flow problem of this example is to find the injected active power P and the injected reactive power Q of the bus 1, the voltage magnitude V and θ of the bus 2 and the voltage magnitude V and the phase angle θ of the bus 3.

Mixing the equations 6.1 and ??, we obtain the following one:

$$S = Y \cdot V \cdot V^* \tag{6.4}$$

$$0 = Y \cdot V \cdot V^* - S \tag{6.5}$$

$$0 = F(V) \tag{6.6}$$

Solving the Load Flow problem somehow is solving this equation. For conveniences, the right part of this equation will be referred to as the function F which takes in parameter a vector of voltages. The aim is to find the root of this equation:

$$F(V) = 0 \tag{6.7}$$

6.3 Some Existing Works Solving the Load Flow Problem

The Load Flow problem is not a new one. Sizing a network before its construction is an highly important process that shouldn't be neglected. Since the democratization of the use of electricity, works have been made to size electrical networks and determine optimal operating point. This section presents the main existing studies achieved for solving the Load Flow problem classified in ten categories: Newton-Raphson, Fast Decoupled Newton-Raphson, Jacobi, Gauss-Seidel, Backward/Forward Sweep, Neural Network, Probabilistic, Agent-based, Particle Swarm Optimization and Others.

6.3.1 Newton-Raphson

Initially proposed by Isaac Newton in 1685 as an algebraic method to solve polynomial equations, this work has been described from a different point of view by Joseph Raphson five years later who has described it as a successive variables approximations. In 1740, Thomas Simpson puts forward the fact that the method can be used to solve optimization problems [Emmer 2015].

The Newton-Raphson method is based on the approximation of a function with the first terms of a Taylor series. A complete Taylor series contains an infinite amount of values calculated from a derivative of a function.

A function f has the following corresponding Taylor series:

$$f(x) = f(x_0) + \frac{f'(x_0)}{1!}(x - x_0) + \frac{f''(x_0)}{2!}(x - x_0)^2 + \dots + \frac{f^{(\infty)}(x_0)}{\infty!}(x - x_0)^\infty \quad (6.8)$$

This can be simplified by eliminating all terms with an order higher than 1:

$$f(x) = f(x_0) + \frac{f'(x_0)}{1!}(x - x_0) \quad (6.9)$$

The goal is to find the input parameter x close to x_0 which solve the equation $f(x) = 0$.

This parameter is calculated by a first order Taylor development of the function f as expressed in the equation (6.11).

$$f(x) = 0 \quad (6.10)$$

$$\Leftrightarrow f(x_0) + \frac{f'(x_0)}{1!}(x - x_0) = 0 \quad (6.11)$$

$$\Leftrightarrow x = x_0 - \frac{f(x_0)}{f'(x_0)} \quad (6.12)$$

This allows to determine iteratively the different values of the parameter x to reach the solution. Given a parameter x^t at a time t , the x^{t+1} parameter at a time $t + 1$ which tends to solve the equation $f(x) = 0$ can be calculated as follow:

$$x^{t+1} = x^t - \frac{f(x^t)}{f'(x^t)} \quad (6.13)$$

The application of this method to solve the Load Flow problem has been realized and is presented in the book [Powell 2004] and in the paper [Meliopoulos and Zhang 1996].

As presented in the previous section, the Load Flow problem can be presented as a function F calculating from the set of voltages of a network, the distance to the satisfaction of

the Kirchhoff's Current Law for each bus.

$$\begin{bmatrix} \Delta P_1 \\ \Delta P_2 \\ \dots \\ \Delta P_n \\ \Delta Q_1 \\ \Delta Q_2 \\ \dots \\ \Delta Q_n \end{bmatrix} = 0 - F \left(\begin{bmatrix} Re(V_1) \\ Re(V_2) \\ \dots \\ Re(V_n) \\ Im(V_1) \\ Im(V_2) \\ \dots \\ Im(V_n) \end{bmatrix} \right) \quad (6.14)$$

$$\Leftrightarrow \Delta PQ = 0 - F(V) \quad (6.15)$$

For the Load Flow problem to be solved, it is necessary that the Kirchhoff's Current Law is respected at every bus. In other words, the aim is to determine the vector V such as the values of the vector ΔPQ are zero. This can be expressed by the equation $0 = F(V)$.

To apply the Newton-Raphson method to this problem, we can choose initial values for V .

$$V^{t_0} = \begin{bmatrix} 1 \\ \dots \\ 1 \\ 0 \\ \dots \\ 0 \end{bmatrix} \quad (6.16)$$

And calculate ΔV at each iteration as follow:

$$\Delta V^t = J^{-1}(V^t) \cdot \Delta PQ \quad (6.17)$$

With J , the Jacobian of the function F :

$$J = \begin{bmatrix} \frac{\delta P_1}{\delta Re(V_1)} & \frac{\delta P_1}{\delta Re(V_2)} & \cdots & \frac{\delta P_1}{\delta Re(V_n)} & \frac{\delta P_1}{\delta Im(V_1)} & \frac{\delta P_1}{\delta Im(V_2)} & \cdots & \frac{\delta P_1}{\delta Im(V_n)} \\ \frac{\delta P_2}{\delta Re(V_1)} & \frac{\delta P_2}{\delta Re(V_2)} & \cdots & \frac{\delta P_2}{\delta Re(V_n)} & \frac{\delta P_2}{\delta Im(V_1)} & \frac{\delta P_2}{\delta Im(V_2)} & \cdots & \frac{\delta P_2}{\delta Im(V_n)} \\ \vdots & \vdots & \vdots & \vdots & \vdots & \vdots & \vdots & \vdots \\ \frac{\delta P_n}{\delta Re(V_1)} & \frac{\delta P_n}{\delta Re(V_2)} & \cdots & \frac{\delta P_n}{\delta Re(V_n)} & \frac{\delta P_n}{\delta Im(V_1)} & \frac{\delta P_n}{\delta Im(V_2)} & \cdots & \frac{\delta P_n}{\delta Im(V_n)} \\ \hline \frac{\delta Q_1}{\delta Re(V_1)} & \frac{\delta Q_1}{\delta Re(V_2)} & \cdots & \frac{\delta Q_1}{\delta Re(V_n)} & \frac{\delta Q_1}{\delta Im(V_1)} & \frac{\delta Q_1}{\delta Im(V_2)} & \cdots & \frac{\delta Q_1}{\delta Im(V_n)} \\ \frac{\delta Q_2}{\delta Re(V_1)} & \frac{\delta Q_2}{\delta Re(V_2)} & \cdots & \frac{\delta Q_2}{\delta Re(V_n)} & \frac{\delta Q_2}{\delta Im(V_1)} & \frac{\delta Q_2}{\delta Im(V_2)} & \cdots & \frac{\delta Q_2}{\delta Im(V_n)} \\ \vdots & \vdots & \vdots & \vdots & \vdots & \vdots & \vdots & \vdots \\ \frac{\delta Q_n}{\delta Re(V_1)} & \frac{\delta Q_n}{\delta Re(V_2)} & \cdots & \frac{\delta Q_n}{\delta Re(V_n)} & \frac{\delta Q_n}{\delta Im(V_1)} & \frac{\delta Q_n}{\delta Im(V_2)} & \cdots & \frac{\delta Q_n}{\delta Im(V_n)} \end{bmatrix} \quad (6.18)$$

$$= \begin{bmatrix} J_1 & J_2 \\ J_3 & J_4 \end{bmatrix} \quad (6.19)$$

This formulation is referred to as Newton-Raphson method using Cartesian coordinates. The same approach can be applied using polar coordinates by replacing real part of voltages by voltage magnitudes and imaginary part by phase angles.

6.3.2 Fast Decoupled Newton-Raphson

In the previous method, we have seen that we can consider the derivative of active and reactive power with respect to voltage magnitude and angle. However, in current transmission networks, voltage angle has a low impact on active power and voltage magnitude on reactive [Stott and Alsac 1974; Powell 2004].

Considering this, the Jacobian matrix can be simplified as follow:

$$J = \begin{bmatrix} J_1 & 0 \\ 0 & J_4 \end{bmatrix} \quad (6.20)$$

This allows to reformulate the previous equation (6.17) page 70:

$$\Delta V^t = - \begin{bmatrix} J_1 & 0 \\ 0 & J_4 \end{bmatrix}^{-1} (V^t) \cdot \Delta PQ \quad (6.21)$$

$$\begin{bmatrix} \Delta |V^t| \\ \Delta arg(V^t) \end{bmatrix} = - \begin{bmatrix} J_1 & 0 \\ 0 & J_4 \end{bmatrix}^{-1} \cdot \begin{bmatrix} \Delta P \\ \Delta Q \end{bmatrix} \quad (6.22)$$

Which can be split in two equations:

$$\Delta|V^t| = J_1^{-1} \cdot \Delta P \quad (6.23)$$

$$\Delta \arg(V^t) = J_4^{-1} \cdot \Delta Q \quad (6.24)$$

In term of computation, it is known that inverting a matrix has an important cost. The process of splitting the matrix equation results in inverting matrices that are one quarter the size of the Jacobian.

The authors of the paper [Stott and Alsac 1974] have implemented this method. The solving process of these equations are made in four steps:

1. Computation of ΔP ,
2. Solving of the equation (6.23),
3. Computation of ΔQ ,
4. Solving of the equation (6.24).

This process is repeated indefinitely until $\Delta|V|$ and $\Delta \arg(V)$ are small enough. The paper [Chiang 1991] presents some evolutions of this method.

More recently, an approach to improve the robustness of such method has been proposed in the paper [Aravindhbabu and Ashokkumar 2011].

Finally, a generalization of this approach has been presented in [Tortelli et al. 2015] by using the “per-unit” normalization to improve the performance of fast decoupled power flow methods.

Although, this approach is efficient for transmission system, the line characteristics in distribution networks implies that Fast Decoupled Newton-Raphson cannot be applied.

6.3.3 Jacobi

The Jacobi method is based on an iterative process in which voltage values of each bus is calculated at each iteration.

The voltages (magnitude and phase angle) are initialized at a given value. Then, to calculate the new values, the equation based on the Kirchoff’s Current Law is formulated as follow [Powell 2004]:

$$V_k^{(t+1)} = \frac{1}{Y_{kk}} \left[\frac{S_k^*}{V_k^{(t)*}} - \sum_{j=1, j \neq k}^n Y_{kj} V_j^{(t)} \right] \quad (6.25)$$

At each iteration, the new bus voltages are calculated. Once it is done, voltage values are updated with the new ones and the process is repeated until it is stable ($\forall k \in buses, V_k^{t+1} = V_k^t$).

The Jacobi method is the easiest to implement however, it requires an important amount of cycles to reach the solution.

6.3.4 Gauss-Seidel

The Gauss-Seidel method is similar to the Jacobi one except that voltage values are updated after each voltage computation. In the Jacobi method values are updated at the end of the voltage computation of every bus.

At each iteration, for each bus, the voltage is updated with the previous formula.

Also, a method have been proposed to accelerate the convergence process. The idea is to extrapolate the delta at each iteration based on neighbors trends (i.e. if every neighbors of the bus k have a delta with the same sign, the delta of the bus k can be increased).

The accelerated value is calculated as follow:

$$V_{accelerated}^{t+1} = V^t + \alpha \cdot (V^{t+1} - V^t) \quad (6.26)$$

In the literature, the acceleration value is observed as efficient when equals to 1.6. This method is also easy to implement and require less iterations than the Jacobi method.

6.3.5 Backward/Forward Sweep

The Backward/Forward Sweep method takes place in two stages. Firstly, currents are calculated at source substation bus and propagated to other buses until load buses. And secondly, voltages are calculated at load buses and propagated to other buses until the source substation [Selvan and Swarup 2004].

In 2008, the authors of the paper [Augugliaro et al. 2008] have presented a similar approach except that they avoid the forward phase by considering it during the backward phase. Compared to the Newton-Raphson method, the computation time is reduced, however the number of iteration is higher and increases with the amount of buses.

The Backward/Forward Sweep method is pretty efficient in non-meshed networks. However, it is not able to handle loops. To solve this, a study, that is presented in [Wu and Zhang 2008], considers a loop-analysis method to perform Load Flow analysis on meshed network.

Singh has also proposed an implementation of this method in the paper [Singh and Ghosh 2011] and has, then, published the paper [Singh and Ghose 2013] in which they propose a novel matrix transformation technique to accelerate the Backward/Forward Sweep method.

Ghatak has proposed in [Ghatak and Mukherjee 2017] a similar approach except that the numbering of buses is not required. His approach uses a single load current to bus voltage matrix. This allow to avoid using the time consuming operations generally required by Backward/Forward Sweep techniques.

The paper [Eminoglu and Hocaoglu 2005] presents an approach derived from this method.

Finally, to handle distributed generators, a solution has been proposed in [Mishra et al. 2014] to consider them as constant negative loads. However, there have been no studies made on the adaptability of such system.

These methods are efficient. However, the more there is PV buses (buses to which the active power and the voltage magnitude are imposed), the more the convergence will be slow. The paper [Ju et al. 2014] proposes an interesting approach, based on loop-analysis, to handle PV buses and limit its impact on the convergence and maintain the same performance.

6.3.6 Neural Network

Artificial Neural Networks have also been proposed as an alternative Load Flow technique.

Two different approaches have been presented in the papers [Karami and Mohammadi 2008] and [Müller et al. 2010]. The first one is implemented as a Radio Basis Function Neural Network and the latter as a Multi Layer Perceptron. Although the Radio Basis Function seems to have better performance than the Multi Layer Perceptron. These systems must be trained before being able to compute Load Flow problem. In a dynamic context, it is impossible to predict all possible events. Therefore, the neural network cannot be able to handle the dynamics of future networks.

6.3.7 Probabilistic

Probabilistic approaches have also been experimented.

Generally less accurate than the other methods, the probabilistic methods have the advantage of being able to solve the Load Flow under uncertainties where classical methods require that the two out of four state variables must be accurately known.

An approach based on the point estimation method is presented in [Su 2005]. This method seems to be pretty efficient however, it may require a lot of estimation point to improve the accuracy.

The Load Flow solving with Monte Carlo simulations have been presented in [Caramia et al. 2007] and [Conti and Raiti 2007].

More recently, [Briceno Vicente et al. 2012] present a novel approach based on the linearization of Load Flow equations and which have results close to the ones obtained by the previously cited approaches using Monte Carlo Simulation.

These approaches are interesting and can be good starting points to solve problems with lack of precision such as the State Estimation problem. However, in the case of the Load Flow problem, we consider that known value are precise and should not be changed.

6.3.8 Agent-Based

One major problem of the classical methods such as the Newton-Raphson one, is that the Jacobian matrix may have an important size and its inversion has therefore a non-negligible cost in term of computation.

With this in mind, researchers have proposed, in [Wolter et al. 2010], an agent-based approach to considerably reduce the size of the matrix that must be inverted. In their study, the network is first split in various parts as independent as possible. Then, an agent is associated to each part and is responsible of computing load flows of it. Once the agents have solve their local Load Flow problem they communicate the values obtained at part connection buses and reiterate as long as they are not stable.

This approach has the advantage of considerably reducing the size of Jacobian matrices. However, the initial cutting in parts isn't obvious and moreover, the addition or removal of a physical element in the network may force the network manager to recompute the cutting in

parts.

6.3.9 Particle Swarm Optimization

The Particle Swarm Optimization is a method used in computer science to solve optimization problems. A random set of values is initially proposed and is improved step by step to reach the solution. The Load Flow problem has been solved using an hybrid Particle Swarm Optimization in the paper [El-dib et al. 2004]. The results obtained with this approach are as accurate as the ones calculated using the Newton-Raphson method. Moreover, this method is able to succeed where classical methods fail due to Jacobian singularity.

However, these methods highly rely on various parameters and initialization points and are likely to get stuck in local areas [Aote et al. 2013].

6.3.10 Other Works

In the paper [Abul'Wafa 2012], the authors propose an innovative approach based on the graph theory. This method allows to work with small-sized matrices and therefore the computation time is very low. However, this requires the graph to be directed. Therefore, it cannot solve the Load Flow problem in presence of distributed generators.

A parallel Load Flow algorithm has been proposed and implemented in the paper [El-Keib 1994]. The principle of this method is to split the matrices into block diagonal form and solve these parts simultaneously.

The application of the Ladder Network Theory has been proposed in the paper [Mendive 1975]. Although it appears to be fast, its application is complicated and the convergence is not guaranteed.

In order to improve the efficiency of methods such as the Backward Forward Sweep, various methods have been proposed to number the buses [Shirmohammadi et al. 1988; Goswami and Basu 1991; Ghosh and Sherpa 2008]. However, this lacks flexibility, when adding or removing a bus, it is necessary to repeat the numbering process.

Other methods based on a succession of formulas applications have also been proposed. These approaches have great performances as they don't rely on matrices inversion such as in the Newton-Raphson method. These methods are presented in the papers [Mekhamer et al. 2002; Mallick et al. 2011].

Homotopy methods [Chiang et al. 2014], successive linear programmings [Zehar and Sayah 2008], LU decomposition and GMR algorithms [Sun et al. 2011] have also been experienced to solve the Load Flow problem.

6.3.11 Conclusion

Most of the previously presented approaches are based on commonly used methods generally suited for small-sized problems. The operations on matrices on which most of these approaches rely have a polynomial complexity (of degree greater than 2).

Approach	Convergence speed	Flexibility
Newton-Raphson	+	-
Fast Decoupled Newton-Raphson (only for transmission system)	++	-
Jacobi	-	+
Gauss-Seidel	-	+
Backward/Forward Sweep	+	-
Neural network	+	-
Probabilistic	-	-
Agent-based	+	+
Particle Swarm Optimization	+	-
Other methods	-	-

This table summarizes some characteristics of the presented existing works. It can be seen that a lot of works have been to accelerate the convergence process. However, few have taken into account the flexibility of the system.

In the following section, the system ATENA for Load Flow analysis designed in this thesis is presented.

6.4 ATENA for the Load Flow Analysis

The ATENA for the Load Flow analysis system is based on the application of the Newton-Raphson method at a micro level. Methods to solve equations system are generally applied globally. In this system, the choice has been made to solve it locally at each bus. This allows, in one hand, to distribute the computation and, in other hand, to work on small-sized matrices. Moreover, distribution networks are often ill-conditioned. Therefore, traditional methods such as the one of Newton-Raphson and the decoupled ones are often inefficient [Das et al. 1995].

The proposed system is an implementation of the proposed Adaptive Multi-Agent System framework in section 5.7 page 55 in which only bus agents are considered. The figure 6.2 presents the relations between the distribution network and the corresponding ATENA for Load Flow analysis multi-agent system.

6.4.1 The Bus Agents

A bus is an entity of an electrical network which has an amount of injected power (active and reactive), a voltage magnitude and a phase angle. Bus Agents represent buses of the network. They are associated to one and only one bus and each bus is associated to one bus agent.

The figure 6.3 represents the structure of a bus agent. As it can be seen in the figure, the bus agents are able to perceive external informations but don't have effect on it. They are only able to modify their internal state variables. The variables surrounded by dashes are the one that can be perceived by other agents.

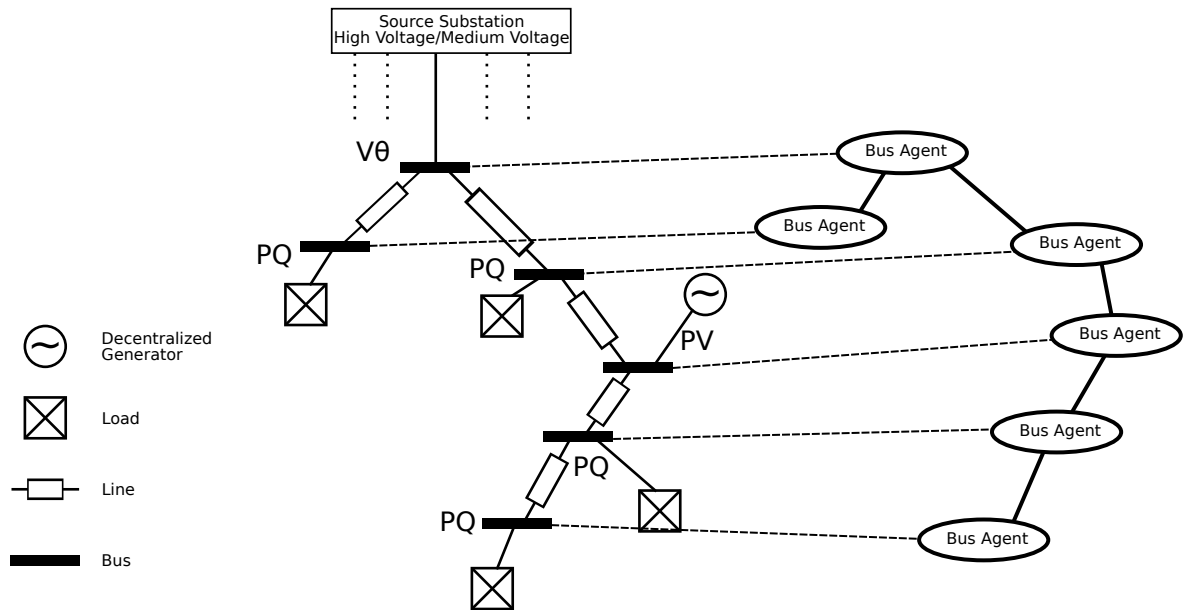

Figure 6.2: Relations between the Load Flow Multi-Agent System and the distribution network

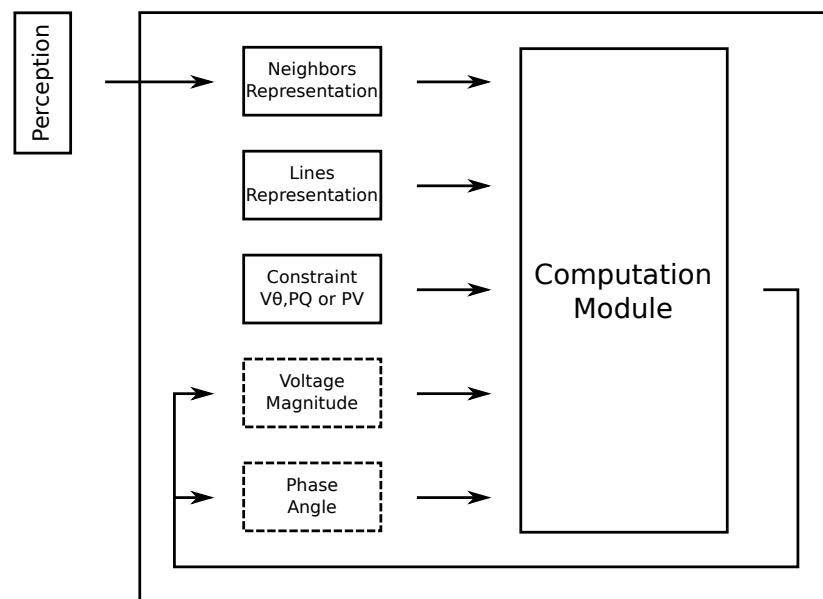

Figure 6.3: Internal Structure of a Bus Agent

6.4.1.1 Representation

The internal state of a Bus Agent is a representation of the world as seen by itself at a given moment. It is made of:

- ▷ its four state variables (voltage magnitude, phase angle, injected active power and injected reactive power),
- ▷ the voltage magnitude and phase angle of each of its neighbors,
- ▷ the characteristics (reactance, conductance, capacitance and resistance) of lines con-

nected to its bus.

At each cycle, this representation is susceptible to change. Before taking any decisions, the agent has to update this information by perceiving its environment. Also, this information may be changed by the agent during the action phase.

6.4.1.2 Computation Module

This module is a part of each bus agent dedicated to the decision making and allows them to locally use the Newton-Raphson method to determine which voltage (magnitude and phase angle) they should use as state variables. The main computation is made in this module. Although, agents manipulate voltage in polar form. The calculation made in this module is realized in cartesian form.

In our case, a bus agent has an individual goal which is to satisfy the Kirchoff's Current Law.

Let's call F the function which computes the sum of injected power and powers coming from connected lines.

Let:

- ▷ V_i^t be the vector containing the real and imaginary parts of the voltage at the bus i ,
- ▷ $Y(i, j)_{b,n}$ the mutual admittance between buses i and j of the matrix of the line connected between buses b and n ,
- ▷ $Y(i, i)_{b,n}$ the self admittance of the bus i of the line connected between buses b and n ,
- ▷ S_{inj_b} the power (active and reactive) injected to the bus b ,
- ▷ X^t the vector of complex voltage values at a given moment t ,
- ▷ $Re(X)$ and $Im(X)$ the real and imaginary parts of the complex X .

The function F can be expressed as follow for a bus b :

$$F(X^t) = S_{inj_b} - \sum_{n \in Neighbors_b} V_b^t \cdot (Y(1,1)_{b,n}^* \cdot V_b^* + Y(1,2)_{b,n}^* \cdot V_n^*) \quad (6.27)$$

This function comes directly from the formulation of the Load Flow analysis problem (see section 6.2 page 66).

Let:

$$\Delta X = X^{t+1} - X^t$$

As mentioned in the presentation of the Newton-Raphson method (see section 6.3.1 page 69), the function F can be represented as a simplified Taylor series:

$$F(X^{t+1}) = F(X^t) + J_F(X^t) \cdot \Delta X \quad (6.28)$$

Therefore, the equation that we want to solve is:

$$0 = F(X^t) + J_F(X^t) \cdot \Delta X \quad (6.29)$$

Which can be transformed in:

$$\Delta X = -J_F(X^t)^{-1} \cdot F(X^t) \quad (6.30)$$

The Jacobian J of the function F is:

$$J = \begin{bmatrix} \frac{\delta Re(F(X))}{\delta Re(V_b)} & \frac{\delta Re(F(X))}{\delta Im(V_b)} \\ \frac{\delta Im(F(X))}{\delta Re(V_b)} & \frac{\delta Im(F(X))}{\delta Im(V_b)} \end{bmatrix} \quad (6.31)$$

With:

$$\frac{\delta Re(F(X))}{\delta Re(V_b)} = -Re\left(\sum_{n \in Neighbors_b} Y(1,2)_{b,n}^* \cdot Im(V_n) \cdot i + Y(1,1)_{b,n}^* \cdot -2 \cdot Re(V_b) + Y(1,2)_{b,n}^* \cdot -Re(V_n)\right) \quad (6.32)$$

$$\frac{\delta Im(F(X))}{\delta Re(V_b)} = -Im\left(\sum_{n \in Neighbors_b} Y(1,2)_{b,n}^* \cdot Im(V_n) \cdot i + Y(1,1)_{b,n}^* \cdot -2 \cdot Re(V_b) + Y(1,2)_{b,n}^* \cdot -Re(V_n)\right) \quad (6.33)$$

$$\frac{\delta Re(F(X))}{\delta Im(V_b)} = -Re\left(\sum_{n \in Neighbors_b} Y(1,2)_{b,n}^* \cdot Re(V_n) \cdot -i + Y(1,1)_{b,n}^* \cdot -2 \cdot Im(V_b) + Y(1,2)_{b,n}^* \cdot -Im(V_n)\right) \quad (6.34)$$

$$\frac{\delta Im(F(X))}{\delta Im(V_b)} = -Im\left(\sum_{n \in Neighbors_b} Y(1,2)_{b,n}^* \cdot Re(V_n) \cdot -i + Y(1,1)_{b,n}^* \cdot -2 \cdot Im(V_b) + Y(1,2)_{b,n}^* \cdot -Im(V_n)\right) \quad (6.35)$$

Knowing the Jacobian and the function F , the computation module can determine the delta that must be applied to the voltage magnitude and phase angle with the formula 6.30 page 79.

Moreover, contrary to global Newton-Raphson based methods, the Jacobian is a 2x2 matrix. Therefore, the inversion of this matrix doesn't have an high impact on the complexity. It exists multiple methods to inverse a matrix (QR decomposition, LU decomposition ...). The choice between these methods doesn't impact the performance or the quality of the results.

This computation is abstracted in the rest of the manuscript by the function *NewtonRaphson.Compute* which takes in parameter the voltage of the agent and the one of its neighbors as well as the power injected at this bus. The algorithm 6.1 describes the behavior of this function.

6.4.1.3 Agent Life Cycle

The life cycle of an agent belonging to the ATENA for Load Flow analysis Multi-Agent System is divided in three steps: Perception, Decision and Action. Once these three steps are done, the agent starts over with the perception.

The algorithm 6.2 presents the behavior of a bus agent. *self* represents the considered agent and *currentEstimatedVoltage(b)* represents the voltage calculated by the agent b during the previous cycle.

Algorithm 6.1: Function `NewtonRaphson.compute` computing an iteration of the Newton-Raphson method for the bus agent a

Data: V_a the voltage of the agent calling the function, V_{ns} the voltage of its neighbors, S_{inj} the injected power

Result: The new voltage

begin

```

/* Initialization of the voltage matrix of the bus agent a
*/
MatrixVa = Matrix[1,2]
MatrixVa[0] = Re(Va)
MatrixVa[1] = Im(Va)
/* Compute the sum of powers */
totalPowerSum = Sinja
powerSum = 0
for n ∈ Neighbors(a) do
    powerSum =
        powerSum + Va · (Y11(line(a,n))* · Va* + Y12(line(a,n))* · Vns[n]*)
end
totalPowerSum = totalPowerSum – powerSum
/* Initialize the matrix containing the result of the
function F */
MatrixDPQ = Matrix[1,2]
MatrixDPQ[0] = Re(totalPowerSum)
MatrixDPQ[1] = Im(totalPowerSum)
MatrixJ =Jacobian of the sum of powers
/* Computation of the ΔX with the formula (6.30) */
MatrixDX = –MatrixJ–1 · MatrixDPQ
/* Application of the ΔX to the current voltage Va */
MatrixRes = MatrixVa + MatrixDX
return MatrixRes[0] + i · MatrixRes[1]

```

end

6.4.1.3.1 Perception

During the perception phase, the agent observes its neighbors and memorizes their current estimated voltage magnitude $|V|$ and phase angle $\arg(V)$. The perception can be expressed as a function returning a set of values:

$$\text{Perception} = \begin{bmatrix} |V_1| \\ \arg(V_1) \\ |V_2| \\ \arg(V_2) \\ \dots \\ |V_i| \\ \arg(V_i) \\ \dots \\ |V_n| \\ \arg(V_n) \end{bmatrix} \quad (6.36)$$

Algorithm 6.2: Behavior of a bus agent for the Load Flow problem solving

```

begin
  /* Perception */
  /* Get the estimated voltage of each neighbor */
  for  $n \in \text{Neighbors}(b)$  do
    |  $\text{estimatedVoltages}[n] \leftarrow \text{currentEstimatedVoltage}(n)$ 
  end
   $\text{selfEstimatedVoltage} \leftarrow \text{currentEstimatedVoltage}(\text{self})$ 
  /* Decision */
  /* Compute one step of the Newton-Raphson method */
   $\text{newVoltage} \leftarrow$ 
   $\text{NewtonRaphson.Compute}(\text{selfEstimatedVoltage}, \text{estimatedVoltages}, \text{injectedPower})$ 
   $\text{deltaVoltage} \leftarrow \text{newVoltage} - \text{selfEstimatedVoltage}$ 
  /* If the delta is too low, compute a weighted average with
  previous delta */
  if  $|\text{deltaVoltage}| < 1E - 6$  then
    |  $\text{deltaVoltage} = 0.95 \cdot \text{lastDeltaVoltage} + 0.05 \cdot \text{deltaVoltage}$ 
    |  $\text{newVoltage} = \text{selfEstimatedVoltage} + \text{deltaVoltage}$ 
  end
  /* Action */
   $\text{setNewVoltage}(\text{newVoltage})$ 
end

```

With $i \in [1; n]$ and n the amount of neighbors.

6.4.1.3.2 Decision

The local goal of an agent is to determine its voltage magnitude $|V|$ and phase angle $\arg(V)$ such as, for the current representation, the Kirchhoff's Current Law is respected. To do so, it can use its computation module presented in the previous section. During this phase, the agent provides its *Perceptions* and its internal state to the computation module (see 6.3 page 77). As said previously, agents are autonomous. Therefore, they are asynchronous which means that an agent can do two life cycles while its neighbors only made one. Given the fact that the behavior of an agent highly depends on the state of its neighbors, one solution to avoid the uselessness of a cycle is to detect if the current delta provided by the computation module is too low. In this case, the delta applied is a combination of the delta provided by the computation module and delta obtained in the previous cycle. This is directly inspired from the acceleration proposed in the Gauss-Seidel method (see section 6.3.4 page 73).

6.4.1.3.3 Action

Finally, in the action phase, the agent updates its state variables: voltage magnitude and phase angle, with the values returned by the computation module.

6.4.2 Implementation

This system is based on the ATENA framework. The main classes used in this system are:

- ▷ the *Bus Agent* class which corresponds to the internal state and behavior of an agent associated to a bus;
- ▷ the *Bus* class which corresponds to a bus and notably allows the associated bus agent to determine the connections with other buses (and therefore bus agents);
- ▷ the *Line* class which corresponds to a real line. It contains the lines' characteristics (such as admittance), contains calculation methods for the flowing power and put two buses (and their bus agents) in relation.

In order to experiment the developed system, this latter has been coupled to simulated electrical networks. These simulated networks are generated from information extracted from autonomous packages called Functional Mock-up Units (FMU). FMUs are made from a model described by a set of equations and an interface to interact with it.

6.5 Evaluation of the ATENA for Load Flow Analysis Multi-Agent System

This chapter presents the results of evaluations made on the two developed systems.

Firstly, the quality criterion of a solution is presented as well as the formula to calculate it. Secondly, the test cases used in these evaluations are listed. Then, the results made on the Load Flow resolutions are presented.

6.5.1 Quality of Solutions

In order to determine the quality of a solution, it is, first and foremost, necessary to define a criteria of quality. Ideally, the Load Flow analysis is valid if the distance between calculated values and real values. Generally, the real values are not known as they are the solution of the problem.

This distance is calculated as a relative error with the following formula:

$$\frac{\text{Real Value} - \text{Calculated Value}}{\text{Real Value}} \cdot 100 \quad (6.37)$$

6.5.2 Power System Variants

This part details the topology and characteristics of the seven networks variants used to evaluate the developed system. These networks have been taken or generated in order to be as representative as possible and to have a radial structure.

The network test cases are made of several buses: 41, 64, 80, 111, 133, 153 and 207. In this section, networks will be named by the amount of buses (41-bus network, 64-bus network, ...).

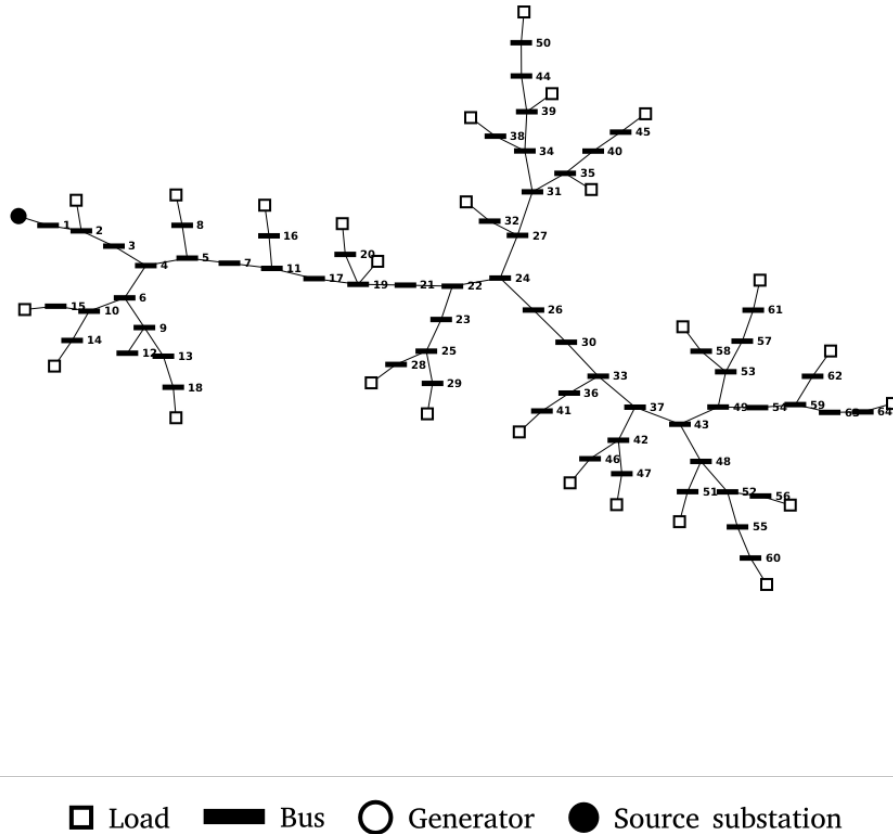

Figure 6.4: 64-bus test case

In this thesis, we have used two types of network. The 64-bus network (represented in the figure 6.4 page 83) is a network particularly representative of real cases medium voltage distribution network. The others have been generated but they are similar to real networks in term of topology. An example of such network is presented in the figure 6.5. Such networks with such amount of generators are not representative of commonly structured distribution networks. However, they are used to demonstrate the adaptation capability and robustness of the ATENA based systems. They enable to show that the cooperative behavior of agents doesn't rely on the structure of the network.

These configurations have been chosen manually.

These networks are described in the appendix.

6.5.3 Results of ATENA for Load Flow Analysis

The Load Flow problem can be expressed as an equation systems. Therefore, it exists numerous methods to solve it. However, it generally relies on big-sized matrices operations which have an important impact on the computation time and complexity. Moreover, the

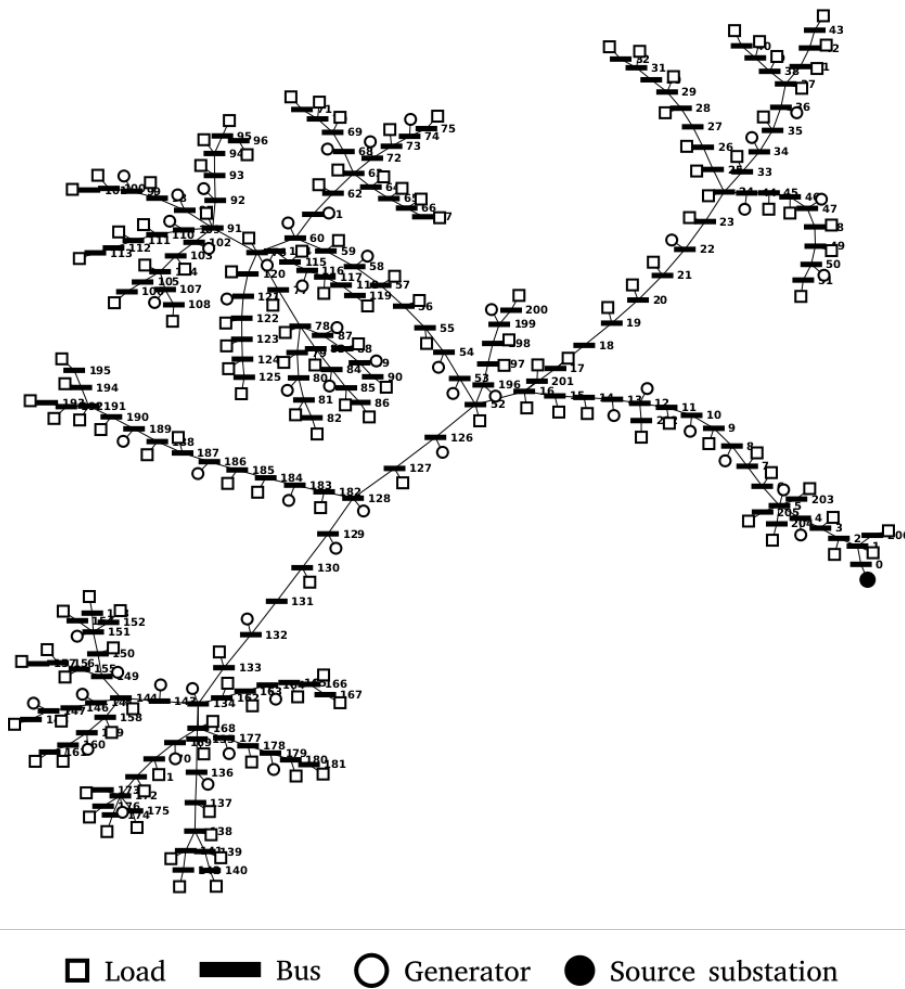

Figure 6.5: 207-bus test case

complexity in time and memory is polynomial with the number of buses. We consider a solution as viable when the relative voltage magnitude estimation error is lower than 10^{-4} .

6.5.3.1 Complexity

In order to evaluate the performance of the ATENA for Load Flow system, this part presents average values of the time and number of cycles required to reach a viable solution on a succession of 1,000 resolutions. These resolutions have been made on every power system variant.

Usual methods are based on matrices inversions. These operations are known to have a polynomial complexity (of degree greater than 2).

In our approach, the size of the matrices that need to be inverted is constant.

The figures 6.6 and 6.7 present these results. The required cycles to reach a viable solution (solution with a sum of relative errors close to zero) appears to evolve logarithmically. And the complexity in time appears to evolve linearly. This shows the relevance of such an approach to perform efficiently the solving of the Load Flow problem. This is confirmed by

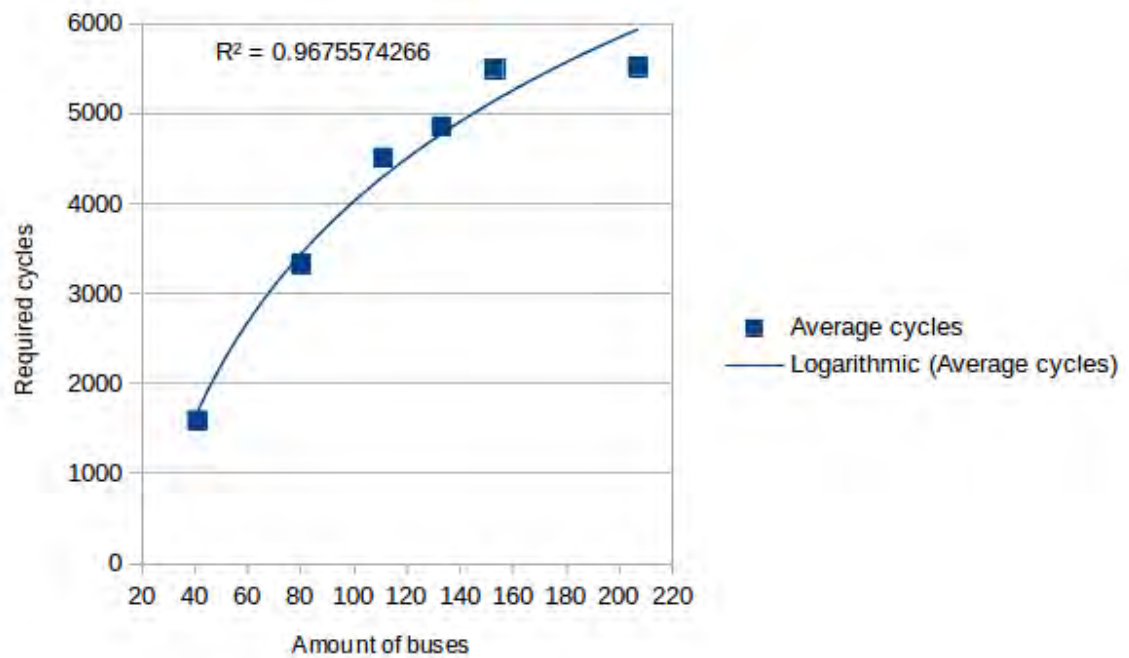

Figure 6.6: Required Number of Cycles Evolution over Networks Sizes for the Load Flow

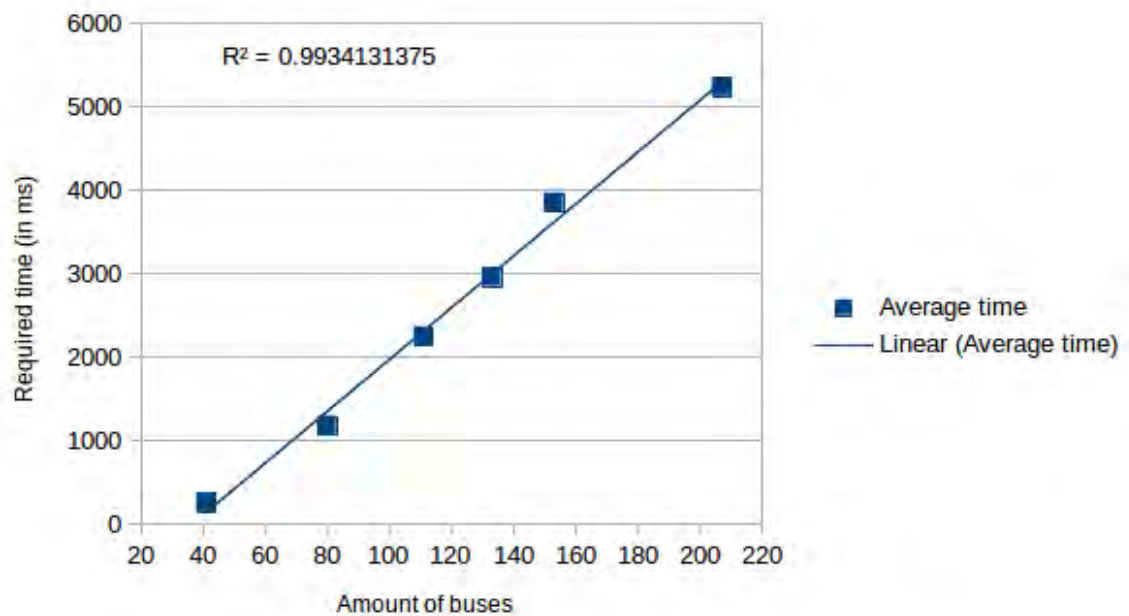

Figure 6.7: Required Time Evolution over Networks Sizes for the Load Flow

the values of the coefficients of determination (value, noted R^2 , indicating the quality of the trending line) close to 1.

The figure 6.8 shows the evolution of a polynomial complexity of degree 2 in comparison with a linear complexity.

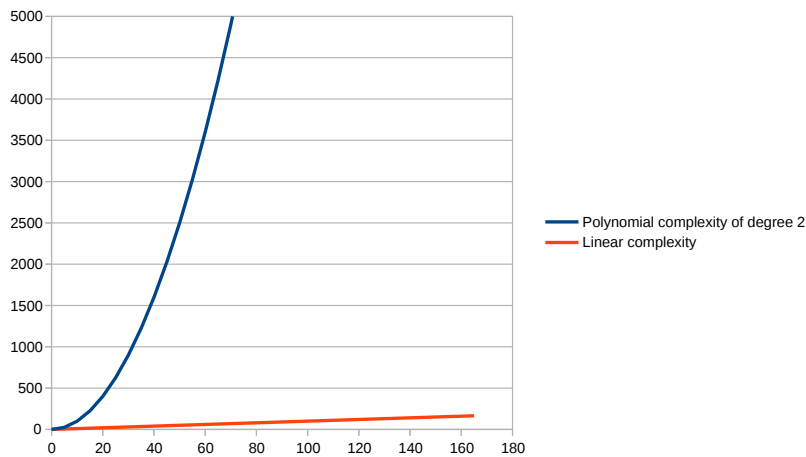

Figure 6.8: Polynomial of degree 2 complexity compared to linear complexity

III

6.6 Conclusion

We have presented in this chapter an innovative and decentralized to handle the Load Flow problem.

Firstly, the Load Flow problem is presented in details and formulated as a system of matrix equations to solve.

Secondly, a state of the art of the various studies is exposed. This state of the art notably describes in details the Newton-Raphson method as the developed system is based on it. Moreover, the following chapter presents a system also based on the Newton-Raphson method.

Then, the evaluations results are presented. It can notably be seen that the complexity of this algorithm in time seems to evolve linearly with the size of the networks and the complexity in term of required cycles to reach a valid solution appears to evolve logarithmically.

And finally, the ATENA framework instantiated for Load Flow Analysis is detailed with all necessary information to implement it. This includes notably the behavior of the agents.

In this approach, the matrices that need to be inverted are small-sized what reduces considerably the computation time as well as the impact of an ill-conditioned matrix. Moreover, the complexity evolves linearly with the size of the network. Indeed, the number of neighbors of a bus agent doesn't increase with the size of the network. Given the operations made, the complexity of this algorithm is $O(N)$.

The Load Flow Analysis problem is a static one (see section 6.2 page 66). However, the behavior of agents and their limited perceptions lead us to believe that the system should be able to adapt to changes. Consequently, a similar solution is expected to work well on a dynamic problem. Although this has no particular interest for classical Load Flow problems, this is a good basis to solve the State Estimation problem.

The following chapter proposes an extension of this system to solve the State Estimation problem.

7

ATENA for Distribution System State Estimation

One solution to control an electrical network is to firstly determine its operating point. This is referred to as System State Estimation. Indeed, the State Estimation makes the network observable and therefore makes it possible to perform advanced functions such as voltage regulation. Although efficient methods are known to solve the State Estimation problem on transmission networks, the Distribution System State Estimation is not trivial. This is mainly due to the radial structure of such systems, the low amount of sensors, the important amount of buses and various characteristics differences often leading to ill-conditioned matrices.

A state estimator aims to determine the most likely state estimation given a model of a network and inaccurate and limited sensors data provided by the acquisition system.

Currently, the only measurements available installed at the HV/MV (High Voltage/Medium Voltage) substation are:

- ▷ active and reactive powers sensors on each feeder,
- ▷ voltage magnitude sensor at the bus of the substation.

These measurements are the active and reactive power on each feeder of the source substation and the voltage magnitude. To fill the obvious lack of observability, some physical sensors are installed in the networks. In addition to this, load models are used at consumer sites. They are named “Pseudo-measurements”. These values give information about consumed active and reactive power with a high inaccuracy. This load estimation can be improved but this has not been taken into account in this thesis. Finally, active and reactive power at zero-injection buses are also considered as measurements. They are always equal to zero and are named “Virtual Measurements”.

The real and pseudo sensors are not 100% accurate. Moreover, networks cannot be fully equipped because it is too much expensive.

The goal of the State Estimation is to filter the errors of measurements thanks to the redundancy of sensors and find for each bus the voltage that matches as much as possible to the network model.

A state estimator estimates the operating point of a network using the following functions: raw data filtering, topology determination, observability analysis and bad data processing. The topology determination is the process of acquiring switches and circuit breakers to determine the configuration of the system. The observability analysis consists in determining

if a solution can be obtained from the available measurements. The State Estimation allows to determine the most likely state given the model of the network and measurements. The bad data processing consists in identifying and removing gross errors.

In this part, the focus is made on the state estimation.

In the first part, a description of the State Estimation problem is presented as well as a formalization of it. Then, the main studies made to solve the State Estimation problem are presented. And finally, the design and implementation of the ATENA for State Estimation system are detailed.

Résumé

Pour contrôler un réseau électrique, une solution est de passer par l'estimation de son point de fonctionnement. En effet, on peut supposer que plus l'état d'un réseau est connu de manière précise, plus il sera facile de déterminer les actions à lui appliquer. Ce chapitre présente d'une part le problème d'estimation d'état sous forme de problème d'optimisation et d'autre part une approche visant à résoudre ce problème de manière efficace.

Estimer l'état d'un réseau est un problème qui consiste à la fois à filtrer les erreurs des capteurs et déterminer les valeurs de tensions les plus vraisemblables pour tous les bus du réseau. Pour se faire, un certain nombre de capteurs de tensions et de puissance sont installés dans les réseaux. En recoupant les données fournies par les capteurs ainsi que le modèle du réseau, il est possible de corriger en partie les erreurs des capteurs et de fournir une approximation de l'état dans lequel se trouvait le réseau au moment de la perception des capteurs.

L'état du réseau évoluant de manière continue, il est indispensable que l'estimation d'état soit faite dans un temps faible pour éviter que celui-ci n'ait trop évolué entre le début et la fin de l'estimation.

Le système proposé est un système multi-agent adaptatif dans lequel les bus et les mesures sont des agents. Ces agents coopèrent pour déterminer l'état le plus vraisemblable du réseau. La capacité d'adaptation du système fait qu'il peut fonctionner en continu et réagir aux changements de valeurs retournées par les capteurs sans requérir une réinitialisation du système.

7.1 Introduction

Before the 1990's, the state estimation of electrical networks has never been a major concern. Indeed, the way they have been designed and dimensioned suits perfectly with the use which has been made of it. However, the needs in electricity have grown up quickly and it leads us to find a smarter way for producing, distributing and consuming energy. This can only be achieved with better knowledge about the operating point of the networks. An accurate knowledge of the state of the system is mandatory to perform an efficient control on it.

In the first place, we will explain why the State Estimation of Distribution Systems is an important and complex problem and we will formalize it. Secondly, some existing works

around state estimation are presented. Then, through the application of the theory, we will describe the proposed approach and the extension of the system aiming at solving this problem. The evaluations section shows the performances of the system. And finally, we will conclude and discuss perspectives.

7.2 Problem Description

The state estimation problem can be defined as follow:

Definition 14.

***State Estimation Problem** - Finding the most likely state of the system based on quantities that are measured and the model of this system and filtering the errors of the sensors thanks to their redundancy.*

More generally, the objective of state estimation is to determine the most likely state of the system based on quantities that are measured which are assumed to have a Gaussian (normal) distribution. One way to accomplish this state estimation is by using the statistic method of maximum likelihood.

By assuming the independence of measurements and their Gaussian distribution, determining the most likely state of a network is equivalent to solving an optimization problem where the objective function can be expressed as a sum of Weighted Least Squares (see 7.2.3 page 90). The most likely state is obtained by finding the state with few or ideally no error. Knowing that measurements are not 100% accurate, the objective of the State Estimation is to determine a set of values which satisfy the model and minimize the distance to measurements (weighted by the sensors accuracies).

In the case there is no power sensor associated to a consumer (or a generator), the load-patterns (or pseudo-measurements) generated from load forecasts or historical data are used. The generators are always instrumented with power and voltage magnitude sensors.

It is therefore a question of finding the voltage of buses that satisfies the model of the network while minimizing the distance between found values and measured ones.

In this work, the problem has been separated in two parts: solving the Kirchhoff's Current Law (see section 3.7 page 38) and filtering the measurements errors. The first part of the problem (solving the Kirchhoff's Current Law) has already been solved in the previously presented ATENA for Load Flow analysis system (see chapter 6 page 65).

This section presents the problem of data filtering in 7.2.1 to then formulate the problem as a Weighted Least Square in 7.2.3.

7.2.1 Data to be filtered by state estimator

Sensors are not perfect, their native inaccuracy can have a non-negligible impact on the voltage estimation. The number of physical sensors has to be limited in order to reduce the management cost of the network. However, it is necessary to have enough measurements for the observability of the network. Consequently, active and reactive power pseudo-measurements have to be used at each consumption point (load models).

In this study, we consider a limited number of voltage magnitude sensors.

For the observability of the network, three kinds of power measurements are considered. (1) *Real measurements* are the one provided by physical sensors. These sensors generally have an accuracy of 99%. (2) *Pseudo-Measurements* are rough estimations of the power injected at consumer sites. They are generally used to estimate a power on parts of a network that cannot be instrumented with physical sensors. (3) *Virtual Measurements* are the power injected at zero-injection buses (buses without generators nor consumers). We then consider these virtual measurements as measuring null active and reactive power injection with a 100% accuracy. This allows to have a full observation (with more or less accuracy) of the network.

Phase angles can be measured. However, it requires specific sensors synchronized by GPS. In this study, they are not considered.

The State Estimation problem can be solved by finding the maximum likelihood. By assuming the independence of measurements and their Gaussian distribution, determining the most likely state of a network can be expressed as solving an optimization problem where the objective function is formulated as a sum of Weighted Least Squares in which the weight of each square corresponds to the precision of the corresponding measurement type.

7.2.2 Maximum Likelihood

The likelihood corresponds to the relation between an observed distribution over a set of samples and the law of probability describing the values from which these samples are extracted. Given a sample of observations and a law of probability, the likelihood determines the probability that these observations belong to a sample from the law of probability.

The maximum likelihood is obtained by finding the parameters of a law of probability that most closely match an observed set of values. Generally, the density function of the observed population is assumed known. Given that, it can be written the following likelihood function:

$$L(x_1, x_2, \dots, x_n; \Theta) \quad (7.1)$$

With:

- ▷ x_i the observed samples,
- ▷ Θ the parameter of the density function that must be found.

As mentioned previously, the law of probability of the measurements are Gaussian-shaped. The probability density is therefore the one of the normal distribution. Determining the maximum likelihood of the state of a network is finding the parameters that maximize the likelihood weighted by the accuracy of the measurements. This formulation is referred to as Weighted Least Square.

7.2.3 Weighted Least Square

The Weighted Least Square is a formulation of an optimization problem in which the function to minimize is a sum of squared distances weighted by various factors.

Let z be the vector of measurements (voltage magnitude, active and reactive power) of the network, e the vector of measurement errors and $h(x)$ the vector of values calculated with the network model from the vector of parameters x .

The following equation presents the relation between the measurements and the model. It can notably be seen that the measurements are equal to the model values with an error.

$$z = \begin{bmatrix} z_1 \\ z_2 \\ \dots \\ z_n \end{bmatrix} = h(x) + e \quad (7.2)$$

To determine the most likely state, it is necessary to minimize these errors. It has been presented previously that measurements are more or less accurate (see 7.2.1 page 89). Therefore, based on the type of measurements, errors don't have the same importance. It is necessary to minimize the weighted sum of errors.

The function we want to minimize can be expressed as:

$$\sum_{i \in 1;n} \left(\frac{h_i(x) - z_i}{\sigma_i} \right)^2 \quad (7.3)$$

With:

- ▷ σ_i the standard deviation of the sensor associated to the measurement i ,
- ▷ $h_i(x)$ the model function giving the measurement i from a known state vector x ,
- ▷ z_i the measurement i .

This formulation is named "Weighted Least Square" and is the one commonly used in works related to maximum likelihood.

In the case of State Estimation, measurements correspond to values observed on the network and can be of three types: voltage magnitude, active power and reactive power.

Let $ht_b(x)$ the model function giving the measurement of type t for the bus b .

For a bus b , the weighted distance for the voltage magnitude in presence of a voltage magnitude sensor is:

$$\left(\frac{hv_b(x) - zv_b}{\sigma v_b} \right)^2 \quad (7.4)$$

The weighted distance for the active power is:

$$\left(\frac{hp_b(x) - zp_b}{\sigma p_b} \right)^2 \quad (7.5)$$

The weighted distance for the reactive power is:

$$\left(\frac{hq_b(x) - zq_b}{\sigma q_b} \right)^2 \quad (7.6)$$

The global function that must be minimized can be expressed in a compact form as:

$$\left[\sum_{b \in \text{Buses with voltage sensor}} \left(\frac{hv_b(x) - zv_b}{\sigma v_b} \right)^2 \right] + \sum_{b \in \text{Buses}} \left[\left(\frac{hp_b(x) - zp_b}{\sigma p_b} \right)^2 + \left(\frac{hq_b(x) - zq_b}{\sigma q_b} \right)^2 \right] \quad (7.7)$$

With:

- ▷ $hv_b(x)$ the model function giving the voltage magnitude at the bus b for a given state x ,
- ▷ $hp_b(x)$ and $hq_b(x)$ the model functions calculating, from the model, respectively the active and reactive power injected at the bus b for a given state x ,
- ▷ zv_b, zp_b and zq_b respectively the voltage magnitude, active and reactive measurements (real, pseudo or virtual) of the bus b ,
- ▷ $\sigma v_b, \sigma p_b$ and σq_b standard deviations corresponding to the inverse of the accuracy of the measurements.

7.2.4 Constrained Weighted Least Square

Ideally, the accuracy of virtual measurements is equal to 100%. This implies a standard deviation σ equals to zero. The previous formulation contains division by these standard deviations. Given the fact that a number can not be divided by zero, a workaround is to replace this zero by a value very close to zero (see section ?? page ??). However, this can lead to ill-conditioned matrices and therefore cause computation problems. The solution implemented in the paper [Chilard et al. 2009] is to extract the virtual measurements from the objective function and consider it as constraints ($c(x) = 0$). The problem is then expressed as minimizing the function (7.7) for real and pseudo measurements (values given by physical sensors or load estimations) while satisfying the equation (7.8) for virtual measurements (buses with zero injection).

$$\forall b \in \text{Buses}, S_{inj,b} = \sum_{n \in \text{Neighbors}_b} S_{n \Rightarrow b} \quad (7.8)$$

With:

- ▷ $S_{inj,b}$ the power injected to the bus b ,
- ▷ $S_{n \Rightarrow b}$ the power coming in the bus b from the bus n .

The work that is afterwards presented considers virtual measurements as constraints.

7.3 Existing Works to Solve the State Estimation Problem

This section presents the various studies made to solve the State Estimation problem as expressed in the previous part.

Although the concept of state estimation has appeared in 1969, notably thanks to the works of Schweppe [Schweppe and Wildes 1969], this one has been considered only for

transmission systems for 20 years. It was only from the year 1990 that state estimation applied to the distribution system has been considered. With the evolution of consumption, network managers are more and more expected to provide a more reliable supply of energy and reduce energy losses. This leads to the concept of Active Management and notably to the active voltage regulation which requires an important knowledge of the network. Over equip a network with sensors is not economically feasible. It is therefore necessary to find alternative way to determine the state of a network. This introduces the concept of "Distribution State Estimation" [Chilard et al. 2009]. The first ones who have published about this are Roytelman and Shahidehpour in their publication called "State estimation for electric power distribution system in quasi real-time conditions" [Roytelman and Shahidehpour 1993].

A lot of works have been done on transmission system state estimation. However, classic optimization approaches have a high computational complexity [Likith Kumar et al. 2015]. Also, few studies have been made to propose a multi-agent approach to solve the state estimation problem by applying a decomposition of the problem in smaller problems easier to solve, followed by an aggregation of these solutions. These approaches allow to reduce the size of the matrices. However, the decomposition in sub-problems is not trivial as well as the aggregation and needs a good expertise [Voropai et al. 2014; Nguyen and Kling 2010; Lu et al. 2014].

The most parts of these studies have formulated the problem as a Weighted Least Square Minimization problem and solved it with global optimization methods. It consists in minimizing the weighted square of errors between the model and measured values.

Examples of the application of such method can be found in the literature [Roytelman and Shahidehpour 1993; Lu et al. 1995; Chilard et al. 2009]. The main drawback of this kind of approach is that it requires to work with the whole set of equations with large matrices resulting in a resolution with a non-negligible complexity. In addition to state estimation, some works have been done to improve the estimation made for pseudo-measurements.

These works are classified in four categories: the Weighted Least Square based methods, the Particle Swarm Optimization Methods, the agent based methods and the others.

7.3.1 Weighted Least Square based Methods

The most part of methods uses the Weighted Least Square formulation to which the Newton's iterative technique is applied. This technique consists in finding iteratively the parameters of the function which minimize this latter.

[Cobelo et al. 2007] present an adaptation of the method conventionally used for Transmission Systems State Estimation. This method consists in the formulation of a matrices equation considering the model of the network, the values to minimize (Differences between model values and measurements) and the precision of the sensors. More details about this method are also given in the book [Abur and Exposito 2004].

This approach has also been experimented in [Chilard et al. 2009] with virtual measurements considered as constraint instead of being added to the measurement vector. The results obtained with this approach are particularly accurate and are obtained in a small time.

In order to improve the performance of Distribution System State Estimation, studies have

been made to pre-process the problem and convert it from a voltage-based State Estimation problem to a current-based one. This is notably the case of the studies presented in [Lin and Teng 1996a; Lin and Teng 1996b; Baran and Kelley 1995; Wang and Schulz 2004; Baran and McDermott 2009b; Lu et al. 1995]. These resolutions have been showed to be more computationally efficient than conventional voltage-based ones [Baran and Kelley 1995]. Furthermore, [Baran and McDermott 2009b] present another evolution of this method taking benefit of data provided by the Advanced Metering Infrastructure, namely voltage magnitudes and power demands at consumption sites.

Still in order to minimize the computation performance issues caused by big-sized matrices. [Deng et al. 2002] have proposed an approach in which the Weighted Least Square problem is decomposed in smaller problem. With this approach, the computational complexity is significantly reduced. However, the decomposition in smaller problems is not trivial. And it is notably difficult to determine a compromise between small-sized subsets for performance in term of computation complexity and big-sized subsets for performance in term of estimation quality. Moreover, in this study the decomposition is handmade and based on the meters location however no study has been made on this placement.

In order to reduce the computational complexity of solving the State Estimation problem, one solution can be to minimize the size of the problem. To do that, the study presented in [Dzafic et al. 2014] is based on the Interior Point Method [Quintana et al. 2000] and allows the reduction of the size of the problem by grouping the loads with the same weighting factors. As before, this decomposition is not trivial.

More recently, a study has been published [Khorshidi et al. 2016] and proposes a new technique taking benefits of Weighted Least Square method and an algorithm called "Firefly". The Firefly algorithm is based on the behavior of fireflies. In the application to an optimization problem, each firefly represents a solution. A firefly with a good solution produces a bright flash which has the effect of attracting other fireflies [Fister et al. 2013].

These methods are widely used as they are reliable and efficient. However, they are not adaptive. Therefore, if the problem changes (even a little), it requires to repeat the whole initialization and estimation process. Moreover, the matrices are oversized and calculations are costly in term of complexity. It is particularly true with these approaches as they require operation on matrices whose size depends on the size of the network. These operations are known to have a polynomial complexity (of degree greater than 2).

7.3.2 Particle Swarm Optimization Methods

[Naka et al. 2002; Naka et al. 2003] present an approach based on the Particle Swarm Optimization method. A short explanation of this method is presented in the section 6.3.9 page 75. However, this approach uses Constriction Factor which allows to generate more accurate estimation conditions and which ensures the convergence of the search procedures.

An Hybrid Particle Swarm Optimization method has also been presented in [Niknam and Firouzi 2009]. This one is a combination of a classical Particle Swarm Method and the Nelder-Mead method. The Nelder-Mead method is a non-linear optimization method aiming at minimizing a continuous function in a multi-dimensional space. The proposed algorithm estimates the production and the consumption by the Weighted Least Square approach. The

work presented has been compared with various other methods and seems to be effective and efficient to solve State Estimation problems.

As said in the Load Flow chapter, these methods are too dependent from parameters and initialization points and are likely to get stuck in local areas [Aote et al. 2013].

7.3.3 Agent Based Methods

As presented in the general state of the art (see chapter 4 page 41), [Matei et al. 2012] propose an architecture and agent behaviors to solve State Estimation problems. In this paper, the authors have made the choice to assign agents to measurements and to use a trust-based mechanism in which agents have a dynamic trustiness value for each neighbor giving them the ability to question the values estimated by them. The presented results show the efficiency of such system. However, it highly relies on Phasor Measurement Units which are measurements which use GPS for time synchronization and are therefore able to measurement phase angles.

Unlike in the previous paper, the authors of [Lu et al. 2014] have made the choice to agentify bigger parts of networks. In this approach, agents are responsible of estimating the state of a part of a network what reduces the computational complexity similarly to the approach presented in [Dzafic et al. 2014] cited previously. However, it still remains the problem of the decomposition in smaller parts.

7.3.4 Other Works

To handle the State Estimation problem, [Ghosh et al. 1997] have decided to design a radial standard power flow algorithm (see chapter 6 page 65) extended with probabilistic approaches. This takes benefits from the robustness of such algorithm while taking into account the uncertainties caused by the sensors.

A State Estimation algorithm based on Forward-Backward propagation is presented in [Thukaram et al. 2000]. Regarding at the evaluations made on this approach, it seems that it is able to provide a viable solution in most cases, whatever the feeder r/x (line reactance over line resistance) ratio is, contrarily to the conventional Weighted Least Square method. This is particularly interesting in radial distribution systems because they usually have an higher r/x ratio than transmission ones.

Although, distribution and transmission systems state estimations are designed and implemented separately, [Sun and Zhang 2005] propose an approach in which these two state estimations are made simultaneously as a Global State Estimation. This method consists in the solving of a global Weighted Least Square problem coupled with a novel “master-slave-splitting” iterative method.

Finally, [Choi et al. 2011] present an innovative concept to automatize the State Estimation process. Based on robotic concepts and advanced State Estimation methods, the proposed approach may make feasible the integration of a State Estimation solving process in an autonomous network control system which refers to the idea of Smart Grid presented in section 2.3 page 19.

Although their performances and reliability have not been stress-tested, these approaches

are interesting as they address the problem in unconventional ways.

7.3.5 Conclusion

This section has highlighted the advantages and drawbacks of existing methods. Although some of them seems to be suitable for static State Estimation on reasonably-sized distribution systems. Networks are expected to evolve in term of sizes and elements composing them. To improve the robustness of the State Estimation, the use of an Adaptive Multi-Agent System suits well with the dynamic of the Smart Grid. Many approaches have made the focus on splitting the networks in smaller parts and have shown the benefit in term of computational complexity (for example [Deng et al. 2002]). Moreover, the Weighted Least Square formulation is often used and is particularly relevant for this problem [Cobelo et al. 2007]. Finally, the computational complexity of proposed methods are generally polynomial of degree greater than 2.

We therefore propose to use the AMAS theory, by taking benefit from all the positive points expressed in this state of the art, to design ATENA for State Estimation, an Adaptive Multi-Agent System aiming at solving the State Estimation problem.

Approach	Convergence speed	Flexibility
Weighted Least Square based	++	-
Particle Swarm Optimization	+	-
Agent-based	+	+
Other methods	-	-

This table summarizes some characteristics of the presented existing works. As for the Load Flow analysis, it can be seen that flexibility of the system has not been enough taken into account.

7.4 ATENA for State Estimation

The system presented in this section is also based on the framework proposed in the section 5.7 page 55. Such as the ATENA for Load Flow Analysis system, this is an implementation of the ATENA framework. In this case, Bus agents have a similar behavior and Measurement Agents are also considered.

The aim of Bus Agents is to find the voltage magnitude and phase angle which satisfy the constraints given by the Measurement Agents. It is a cooperative system in which one set of agents try to solve a Load Flow problem while others help them by changing the constraints. The individual aim of a Measurement Agent is to help the associated Bus Agent while minimizing the weighted square of its measurement. As a Measurement Agent is cooperative, it acts to help the associated Bus Agent solving its local Kirchhoff's Current Law and to help the Measurement Agent from its neighborhood (including itself) which as the highest weighted distance to its measurement. Such a behavior implies that agents will constantly try to reduce the highest local weighted squares. This therefore implies that the emerging behavior will be to reduce the global objective function.

In this section, firstly, the interactions between agents are presented. Then, the behaviors

of the two kinds of agents are detailed.

7.4.1 Interactions between agents

To give the ability to the agents to cooperate and reach their goal, they need to be able to interact with other agents. A main difference is that global optimization methods rely on the complete knowledge of the problem. In an Adaptive Multi-Agent System, agents have only a limited perception.

The different interaction types are the following:

7.4.1.1 Interactions between the Bus Agents

The goal of Bus Agents is to determine the voltage magnitude and phase angle (relatively to the reference at the source substation) at the bus they are associated to to respect the constraints (more or less accurate) of the measurements. To do that, at each step and for each agent in its neighborhood, they need to be aware of the current estimation of voltage (magnitude and phase angle). The only interaction between the Bus Agents concerns the exchange of the current value of their respective voltage estimations. Bus agents perceive the voltage estimations of their neighbors.

7.4.1.2 Interactions between the Measurement Agents and the Bus Agents

The Bus Agents need to know the value estimated by the Measurement Agents associated to the bus if any. Moreover, the Measurement Agents need to know the difference between their estimated value and the one estimated by the Bus Agent associated to the same bus. These information are important for both agent in order to help them taking relevant decisions.

7.4.1.3 Interactions between the Measurement Agents

Measurement Agents are cooperative. Therefore, they distribute these errors among them. They need to communicate in order to cooperate. Given the complexity of the computation and the need to coordinate their actions, a communication protocol is required. Indeed, the needs of agents may evolve. A communication protocol allows to prevent an agent to perform an action too late and notably at a time where the action is not required anymore.

7.4.2 Cooperative Behavior of Bus Agents

The aim of a Bus Agent is to find the voltage (magnitude and phase angle) of its bus which satisfy the constraints imposed by the measurements (active power, reactive power and optionally voltage magnitude).

First of all, the bus agent perceives the constraints imposed by the Measurement Agents associated to its bus.

The rest of the behavior of a Bus Agent depends on the presence of a voltage magnitude constraint on the bus.

- ▷ In the presence of a voltage magnitude constraint, the bus agent considers it for its voltage magnitude estimation. Then, the bus agent locally applies the Newton-Raphson method to estimate the phase angle value.
- ▷ In the absence of a voltage magnitude constraint, the bus agent applies the Newton-Raphson method to estimate both the voltage magnitude and the phase angle. If the voltage magnitude delta is too low (lower than $1E - 6$), the delta applied to voltage magnitude is a weighted average between the delta provided by the Newton-Raphson method at this cycle and the delta calculated at the previous cycle. Experimentations results have shown great performances using 95% of the delta of the last cycle and 5% of the delta of the current cycle.

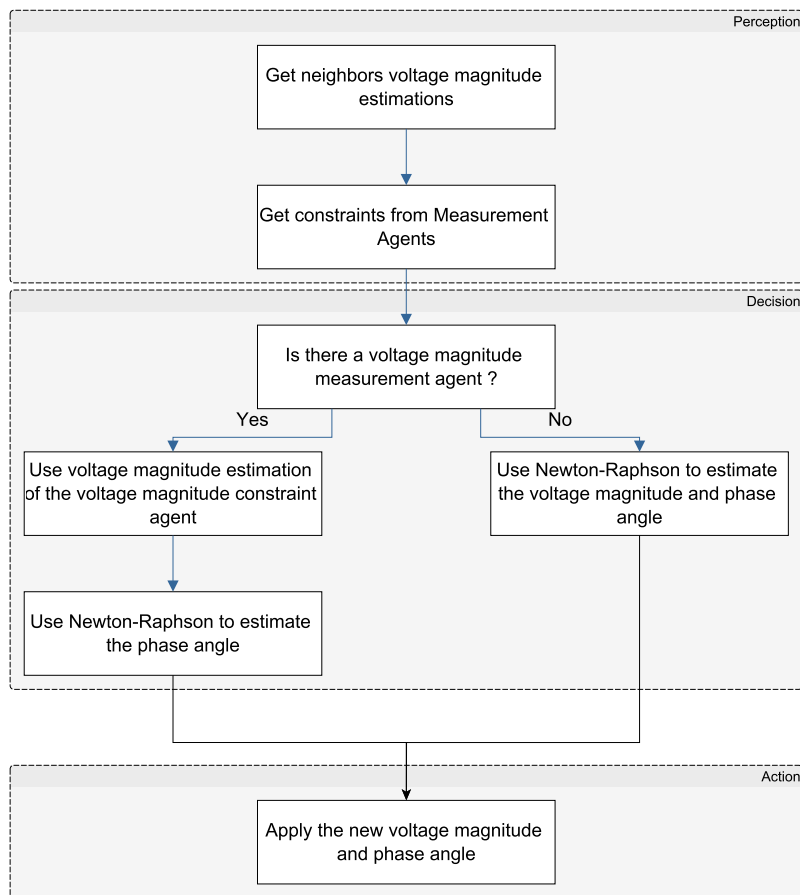

Figure 7.1: Behavior of a Bus Agent for the State Estimation problem solving

The diagram 7.1 and the algorithm 7.1 presents the behavior of a Bus Agent. This algorithm is mainly based on the function *NewtonRaphson.Compute* which is detailed in the algorithm 6.1 page 80. This function takes in parameters the current estimated voltage (magnitude and phase) of the agent as well as the current estimated voltage of its neighbors and the constraints of power injected at this bus as returned by the corresponding Measurement Agents. From this information, the function computes an iteration by applying the Newton-Raphson method and returns a new voltage value.

Algorithm 7.1: Behavior of a bus agent for the State Estimation problem solving

```

begin
  /* Perception */
  /* Get the estimated voltage of each neighbor */
  for  $n \in \text{Neighbors}(b)$  do
    |  $\text{neighborsEstimatedVoltage}[n] \leftarrow \text{estimatedVoltage}(n)$ 
  end
   $\text{selfEstimatedVoltage} \leftarrow \text{estimatedVoltage}(\text{self})$ 
  if bus is attached to a Measurement Agent then
    | /* Get the estimated voltage magnitude of the Measurement Agent */
    |  $\text{voltageMagnitudeConstraint} \leftarrow$ 
    |  $\text{voltageMagnitude}(\text{attachedVoltageMagnitudeMeasurementAgent}(\text{bus}))$ 
  end
  /* Get the power constraints of the Measurement Agents */
   $\text{activePowerConstraint} \leftarrow$ 
   $\text{activePower}(\text{attachedActivePowerMeasurementAgent}(\text{bus}))$ 
   $\text{reactivePowerConstraint} \leftarrow$ 
   $\text{reactivePower}(\text{attachedReactivePowerMeasurementAgent}(\text{bus}))$ 
  /* Decision */
  /* Compute one step of the Newton-Raphson method */
   $NV \leftarrow$ 
   $\text{NewtonRaphson.Compute}(\text{selfEstimatedVoltage}, \text{neighborsEstimatedVoltage},$ 
   $\text{activePowerConstraint}, \text{reactivePowerConstraint})$ 
  if bus is attached to a Voltage Magnitude Measurement Agent then
    | /* Use the voltage magnitude constraint of the Measurement Agent and the phase angle calculated with Newton-Raphson */
    |  $\text{newVoltage} \leftarrow \text{voltageMagnitudeOfVSAgent} \cdot e^{i \cdot \text{arg}(NV)}$ 
  else
    | /* Use the voltage magnitude and phase angle calculated with Newton-Raphson */
    |  $\text{deltaVoltage} \leftarrow NV - \text{selfEstimatedVoltage}$ 
    | /* If the delta is too low, compute a weighted average with previous delta */
    | if  $|\text{deltaVoltage}| < 1E - 6$  then
    | |  $\text{deltaVoltage} = 0.95 \cdot \text{lastDeltaVoltage} + 0.05 \cdot \text{deltaVoltage}$ 
    | |  $\text{newVoltage} = \text{selfEstimatedVoltage} + \text{deltaVoltage}$ 
    | end
  end
  /* Action */
   $\text{setNewVoltage}(\text{newVoltage})$ 
end

```

7.4.3 Cooperative Behavior of Measurement Agents

Roughly, Bus Agents are expected to find the voltage which locally satisfies the Kirchhoff's Current Law. Measurement Agents are here to correct the constraints of the measurements

by cooperating with others Measurement Agents to help Bus Agents reach their goal (which is satisfying the Kirchhoff's Current Law on their bus).

The individual goal of a Measurement Agent is to help the associated Bus Agent while minimizing its weighted square.

Measurement Agents should be able to interact with each other. In order to limit the complexity of the computation and therefore have a scalable system, the principle of local perception of the AMAS theory must be respected. The neighborhood of a Measurement Agents will be limited to two agents (not counting the Bus Agent) of the same type (i.e. associated to a similar measurement). Therefore, a Measurement Agent associated to an active power measurement (respectively reactive power or voltage magnitude) measurement will be linked to at least one other Measurement Agent associated to an active power measurement (respectively reactive power or voltage magnitude). No assumption is made about the impact of the choice of the neighbors. Neighborhoods will be initialized randomly with the only constraint that the neighborhood graph must be connected (i.e. it exists at least one path for every pair of Measurement Agents).

A Measurement Agent knows at least one other Measurement Agent. It allows each Measurement Agent to cooperate with the others. Moreover, contrarily to Bus Agents, Measurement Agents can exchange messages. Although, bus agents do not need to exchange message to act, Measurement Agents need to coordinate their actions. To do that, a communication protocol (presented in the section 7.4.3.3 page 102) has been set up.

Each Measurement Agent negotiates with its neighbors to determine its correct value.

In order to understand the cooperative behavior of a Measurement Agent, it is necessary to define some terms that will be used in the following parts:

Definition 15.

Estimated Value - The Estimated Value is the value of the measurement corrected by the Measurement Agent.

Definition 16.

Offset - The Offset of a Measurement Agent is the signed difference between its Estimated Value and the original value of the measurement.

In order to minimize the local objective function (the weighted square of the measurement they are associated to), Measurement Agents use the original measurement as their estimated value. This obviously corresponds to the smallest squared distance.

However, the constraints from the Kirchhoff's Current Law may not be satisfied. The agent will then change its value to satisfy the constraints.

We have made the assumption that the error of sensors in the network are equitably distributed. Therefore, if a Measurement Agent has to increment its estimated value to solve a constraint, it must be sure that another agent will decrease its own by the same factor and vice-versa. The communication protocol allows agents to change their estimated value to satisfy the constraint and to benefit from the redundancy of measurements to limit the distance between the estimated value and the one of the original measurement. This process allows to satisfy the constraints while increasing as little as possible the squared distance. The cooperation between agents ensures that an agent will try to help an other by compensating its required offset as long as this latter is more critical.

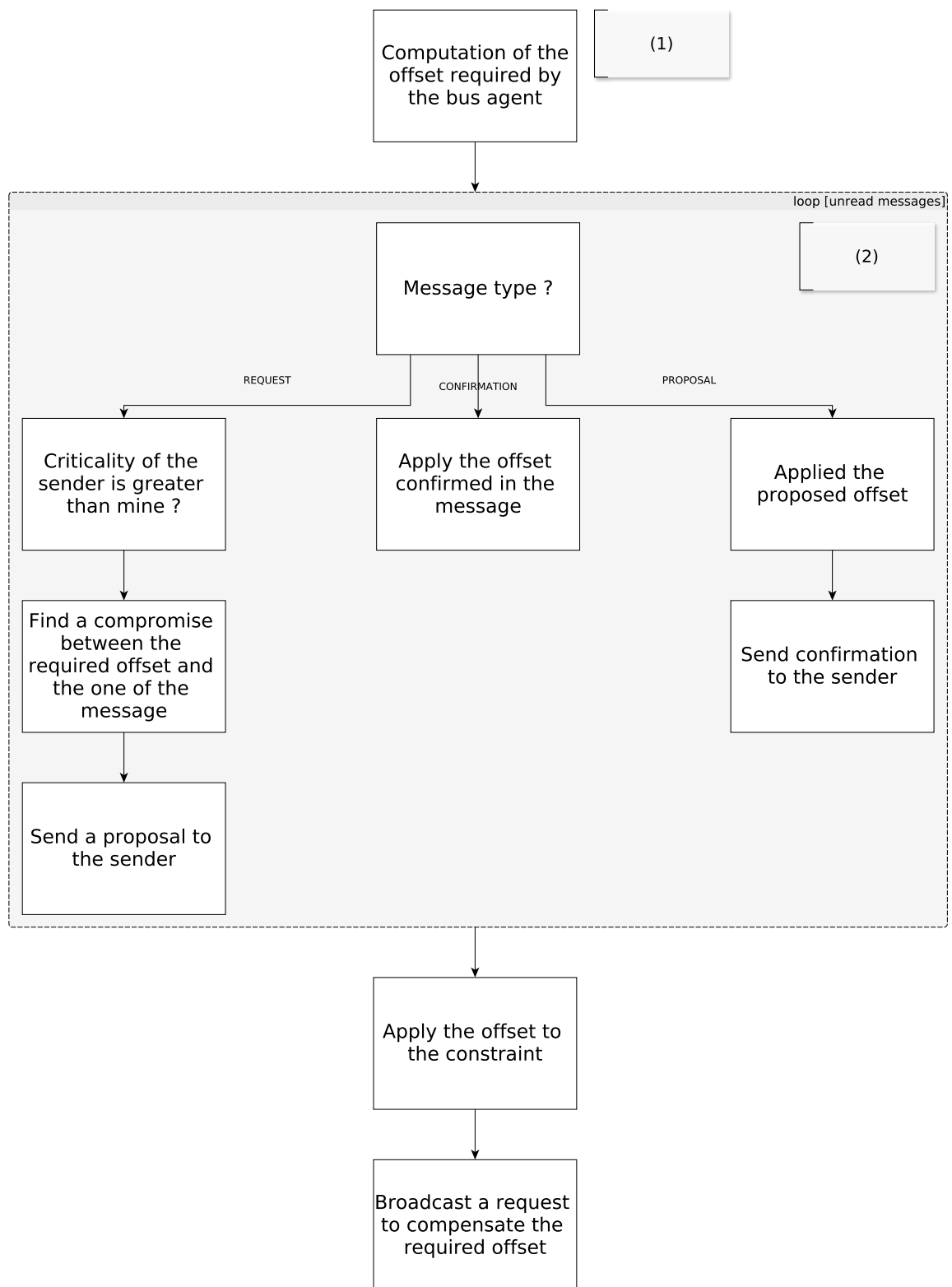

Figure 7.2: Decision process of a Measurement Agent for the State Estimation problem solving

7.4.3.1 Criticality of a Measurement Agent

The criticality of a Measurement Agent is the difference between its Estimated Value and the one calculated by the associated bus agent with the Newton-Raphson method weighted by the standard deviation of the measurement and expresses its degree of dissatisfaction. In other words, a Measurement Agent is satisfied when the value it has found is equal to the one found by the associated bus agent. This criticality is directly extracted from the Weighted Least Square formulation (see equation (7.3) page 91).

$$\left(\frac{\text{estimatedValue}(\text{self}) - \text{estimatedValue}(\text{busAgent})}{\text{standardDeviation}(\text{self})} \right)^2 \quad (7.9)$$

The standard deviation used in this formula is the standard deviation of the corresponding measurement. In the case of a Measurement Agents associated to virtual measurements, the standard deviation is null. To avoid division by zero, the chosen standard deviation is equal to the smallest standard deviation of the whole network divided by 10,000.

7.4.3.2 Perception of a Measurement Agent

The perception phase consists in acquiring all informations the agent needs to take a cooperative decision. During the perception phase, a Measurement Agent perceives:

- ▷ the criticality of each of its neighbors,
- ▷ the messages previously sent by its neighbors,
- ▷ the last measurement of the sensors it is associated to (where applicable),
- ▷ the value calculated by the bus agent of the bus it belongs to.

7.4.3.3 Decision of a Measurement Agent

The decision process is presented in the diagram 7.2. The first part of the decision process (1) is to get the value estimated by the bus agent, thanks to the Newton-Raphson method, and compare it to the value currently estimated by the Measurement Agent. This gives the required offset. Then, the agent has to consider messages received from its neighbors (2).

As mentioned previously, only Measurement Agents can exchange messages. It exists three types of message: an offset request (REQUEST), a proposal (PROPOSAL) and an offset confirmation (CONFIRM).

Offset Request. This type of message is intended to ask a neighbor to modify its Estimated Value in order to compensate the modification the sender wants to do on its own Estimated Value.

Proposal. Once an agent receives an offset request, it can answer with a Proposal message to propose to increase (or decrease) its own Estimated Value to compensate the one of the original request sender.

Offset Confirmation. The agent which has sent the first message (Offset Request) may have received a proposal. If it agrees with the proposal made by the second agent, it can confirm this proposal with an Offset Confirmation message.

When an agent receives an Offset Request, it has to decide if it helps the sender. To do that, it observes the criticality of the sender. If this latter is greater than its own, it answers with a proposal to inform it that it can compensate the requested offset or at least a part of it.

When an agent receives a proposal, it has to confirm the offset it wants to be compensated.

Finally, when an agent receives an Offset Confirmation, it has to fulfill its commitment and change its value.

The following table summarizes these rules:

Condition	Action
Receive an Offset Request and the emitter is more critical	Send a Proposal
Receive a Proposal	Send a confirmation for absorbing the offset and absorb it
Receive an Offset Confirmation	Absorb the offset

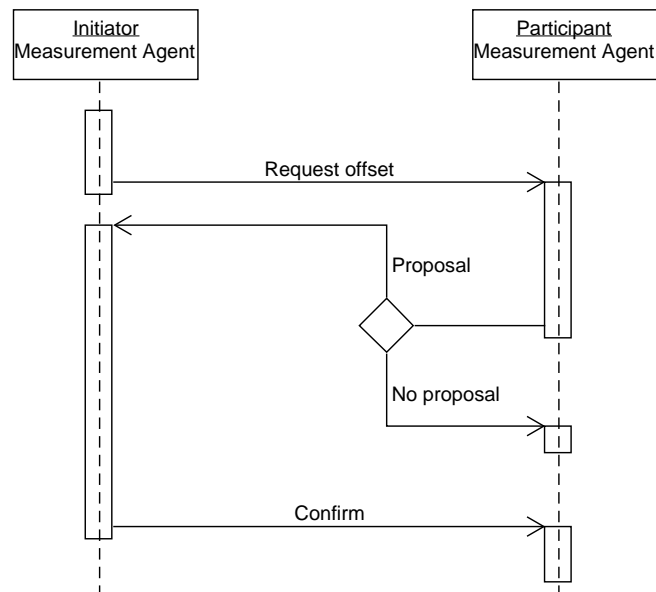

Figure 7.3: Communication Protocol

The protocol is a simplified version of the FIPA Contract Net Integration Protocol. The figure 7.3 presents the used protocol. And the figure 7.4 presents an example of the use of this protocol for a given situation.

This cooperative behavior guarantees that if an agent increases (respectively decreases) its estimated value from the one of its sensor, another agent will decrease (respectively increase) its own. This behavior has as consequence to distribute the measurement errors among them.

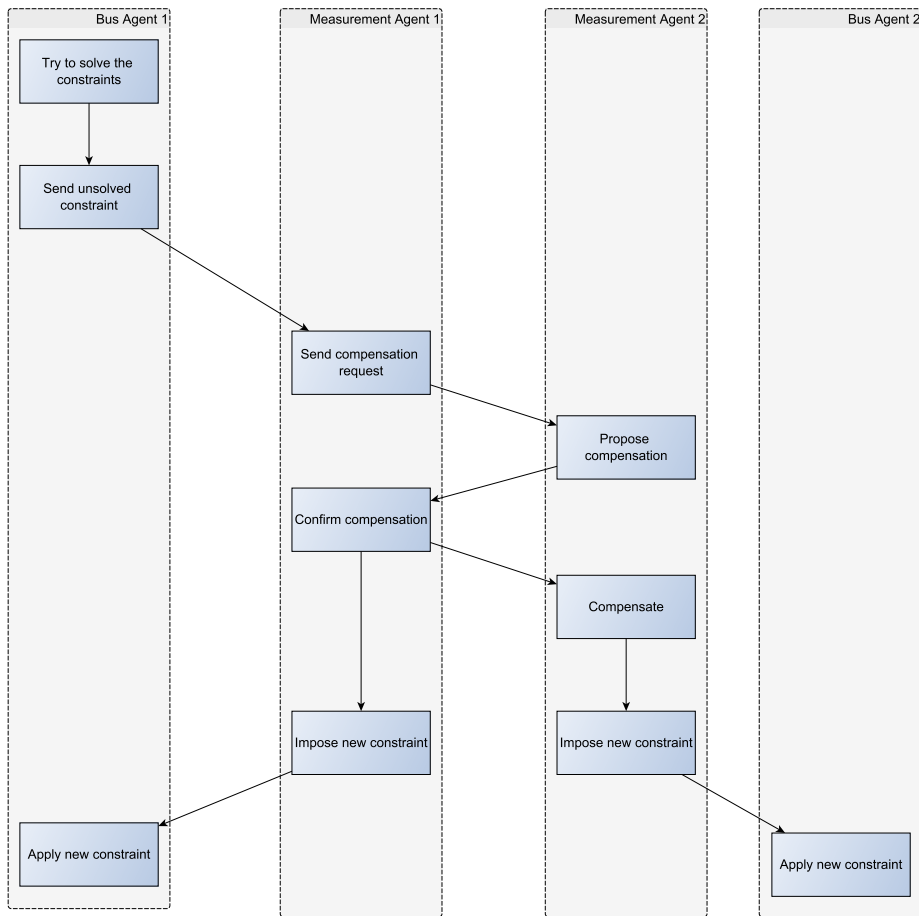

Figure 7.4: Example of use of the communication protocol for a given situation

7.4.3.4 Action

In the case where its Estimated Value is different than the value calculated by the bus agent, it means that the Measurement Agent is not yet satisfied. Therefore, the agent has to broadcast an Offset Request to its neighborhood. Finally, the agent updates its criticality value with the formula (7.9) page 102.

This cooperative behavior is aimed at distributing the sensors errors among these latter.

7.4.4 Adaptation

The behaviors of the agents are strictly local as well as their perceptions. Moreover, they perceives the state of their environment at each cycle. Therefore, if a part of a network changes, it is only necessary to inform agents directly connected to this part. Thus, at the next cycle, the agents will be able to perceive the new information without that much disturbance for the rest of the system.

7.4.5 Implementation

The system is based on the framework ATENA.

The Measurement Agent class implements the behavior of a Measurement Agent. Measurements classes give access to measurements data. An instance of the class Measurement Agent is created during the initialization for each voltage magnitude measurement, active power measurement and reactive power measurement. Given their behavior, the system is able to handle the adding and removal of voltage sensor, in this case where a corresponding Measurement Agent is created or respectively removed.

7.5 Evaluations of the ATENA framework for State Estimation Multi-Agent System

Although the State Estimation problem has already been solved, we have decided in this thesis to find an innovative manner to solve it in order to fill the gap that exists in classical methods. In this part, for each network, the voltage magnitude sensors are placed as indicated before (see 7.5.3 page 106). The source substation and decentralized generators are equipped with power sensors and voltage magnitude sensors. As usual, we consider pseudo-measurements at consumer sites.

The evaluations realized in this section are:

- ▷ the complexity of the system,
- ▷ the data filtering quality,
- ▷ the evolution of the global objective function,
- ▷ the maximal relative voltage magnitude error over the amount of voltage magnitude sensors,
- ▷ the self-adaptation capacity.

7.5.1 Relative Voltage Magnitude Estimation Error

A solution to the State Estimation problem is considered as acceptable, by the experts of the domain: Électricité De France, if the maximal relative voltage magnitude estimation error is lower than 1%.

The relative voltage magnitude estimation error of a bus is expressed as a percent of error and is calculated with the following formula:

$$\frac{\text{Real Value} - \text{Estimated Value}}{\text{Real Value}} \cdot 100 \quad (7.10)$$

7.5.2 Sensors Noise Simulations

In order to be as close as possible as real situations, noise errors should be simulated. In these evaluations, we consider that voltage and power sensors have a precision equals to 99%. Values returned by the sensors are given with the following formula which is detailed

in section 3.4 page 35:

$$\text{Sensor Value} = \text{Real Value} + \left(\frac{\%_{\text{error}} \cdot \text{Real Value}}{3 \cdot 100} \right) \cdot N(0,1) \quad (7.11)$$

With:

- ▷ Real Value: The real value of the variable observed by the sensors (for a voltage magnitude sensor associated to a bus b . The real value is the voltage magnitude of the bus b),
- ▷ $\%_{\text{error}}$: The percentage of imprecision (100-precision),
- ▷ $N(0,1)$: a function which generates a random number from the normal distribution with mean parameter 0 and standard deviation parameter 1.

III

7.5.3 Power System Variants

This part details the topology and characteristics of the seven networks variants used to evaluate the developed system. These networks have been taken or generated in order to be as representative as possible and to have a radial structure.

The network test cases are made of several buses: 41, 64, 80, 111, 133, 153 and 207. In this section, networks will be named by the amount of buses (41-bus network, 64-bus network, ...).

In this thesis, we have used two types of network. The 64-bus network (represented in the figure 7.5 page 107) is a network particularly representative of real cases medium voltage distribution network. The others have been generated but they are similar to real networks in term of topology. An example of such network is presented in the figure 7.6. Such networks with such amount of generators are not representative of commonly structured distribution networks. However, they are used to demonstrate the adaptation capability and robustness of the ATENA based systems. They enable to show that the cooperative behavior of agents doesn't rely on the structure of the network.

Except for the 64-bus network, we have considered one configuration by network:

- ▷ The 41-bus network (represented in the figure B.1 page 132) is equipped with 3 voltage magnitude sensors located at the buses 0, 10 and 30;
- ▷ The 80-bus network (represented in the figure B.3 page 139) is equipped with 5 voltage magnitude sensors located at the buses 0, 10, 30, 50 and 70;
- ▷ The 111-bus network (represented in the figure B.4 page 144) is equipped with 6 voltage magnitude sensors located at the buses 0, 10, 30, 50, 70 and 100;
- ▷ The 133-bus network (represented in the figure B.5 page 150) is equipped with 7 voltage magnitude sensors located at the buses 0, 10, 30, 50, 70, 100 and 110;
- ▷ The 153-bus network (represented in the figure B.6 page 157) is equipped with 8 voltage magnitude sensors located at the buses 0, 10, 30, 50, 70, 100, 110 and 150;

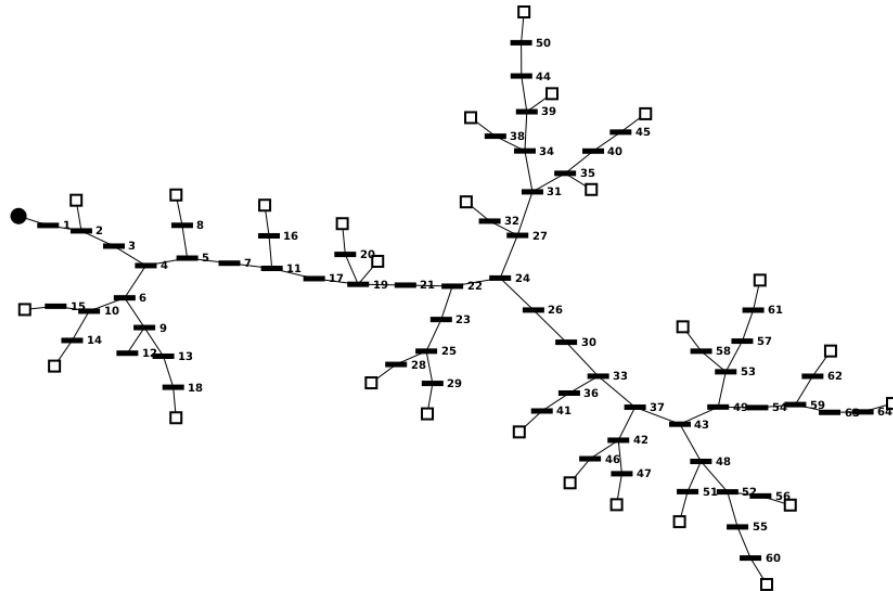

□ Load — Bus ○ Generator ● Source substation

Figure 7.5: 64-bus test case

- ▷ The 207-bus network (represented in the figure B.7 page 165) is equipped with 9 voltage magnitude sensors located at the buses 0, 10, 30, 50, 70, 100, 110, 150 and 200;

These configurations have been chosen manually and the number of installed sensors is based on the size of the networks. In addition to this, power sensors are installed at source substation and at each generation bus. And pseudo-measurements are considered at consumption buses.

These networks are described in the appendix.

7.5.4 Complexity

Similarly to the evaluation of the system on the Load Flow problem, the evaluations have been made on the State Estimation problem to observe the evolution of the time complexity over the size of the network. These evaluations have been made on a succession of 10,000 resolutions on every power system variant. The figure 7.7 presents these results. These results are similar to the ones for the Load Flow solving. It can be observed small variations on the 133-bus and the 153-bus networks cases. This is due to the topology of these networks. Despite this, We can observe that the complexity evolves also linearly with the size of the

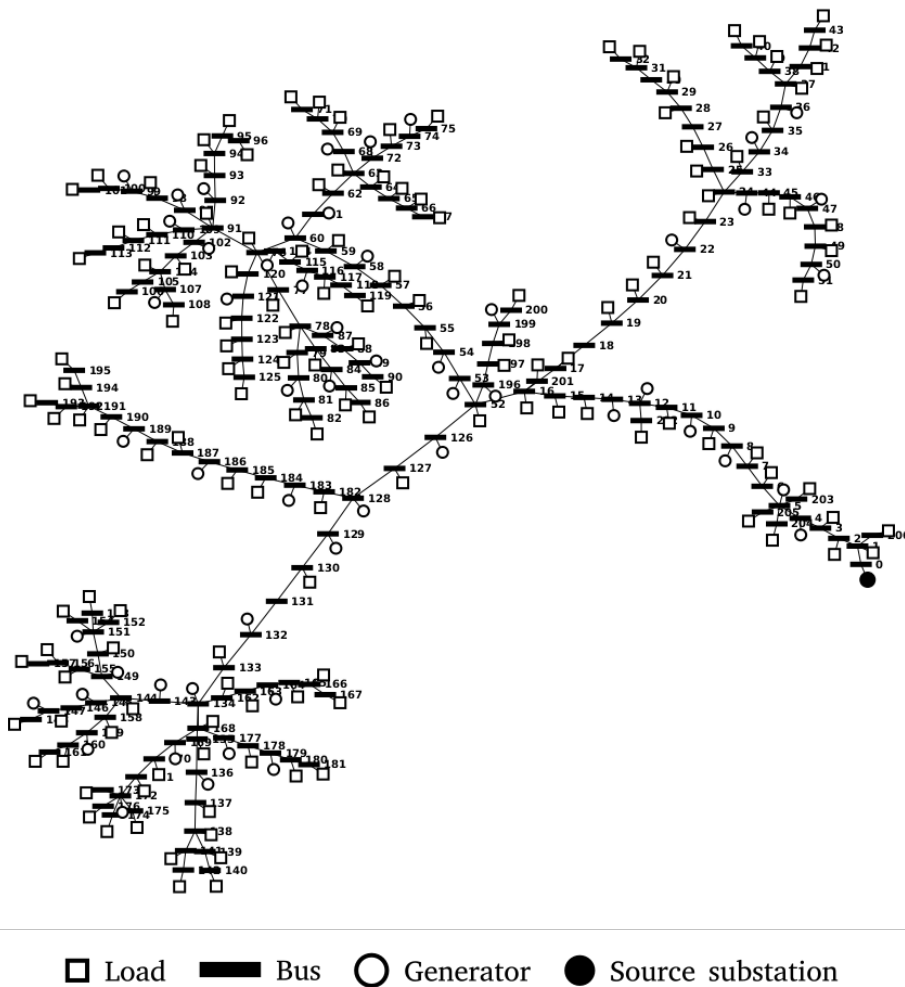

Figure 7.6: 207-bus test case

network contrarily to usual global methods.

7.5.5 Data Filtering Quality

Sensors are not 100% accurate. The measured values have an high probability of being close to the real values. The distribution of a sensor can be observed by querying this sensor multiple time and by tracing the corresponding histogram. For each resolution of the ATENA for State Estimation system, it is also possible to observe the distribution of obtained voltage magnitude.

By superposing these two histograms, the data filtering quality can be observed.

The figure 7.8 represents the number of occurrence of voltage magnitudes obtained for 1,000 resolutions on the 111-bus network for a given bus as well as the distribution of the voltage magnitude sensor at this same bus. The filtering is similar to this one on every tested networks and for every buses with a voltage magnitude sensor.

μ represents the real voltage magnitude for this bus. σ is the standard deviation of the voltage sensor present at this bus. τ is the standard deviation of the results obtained thanks

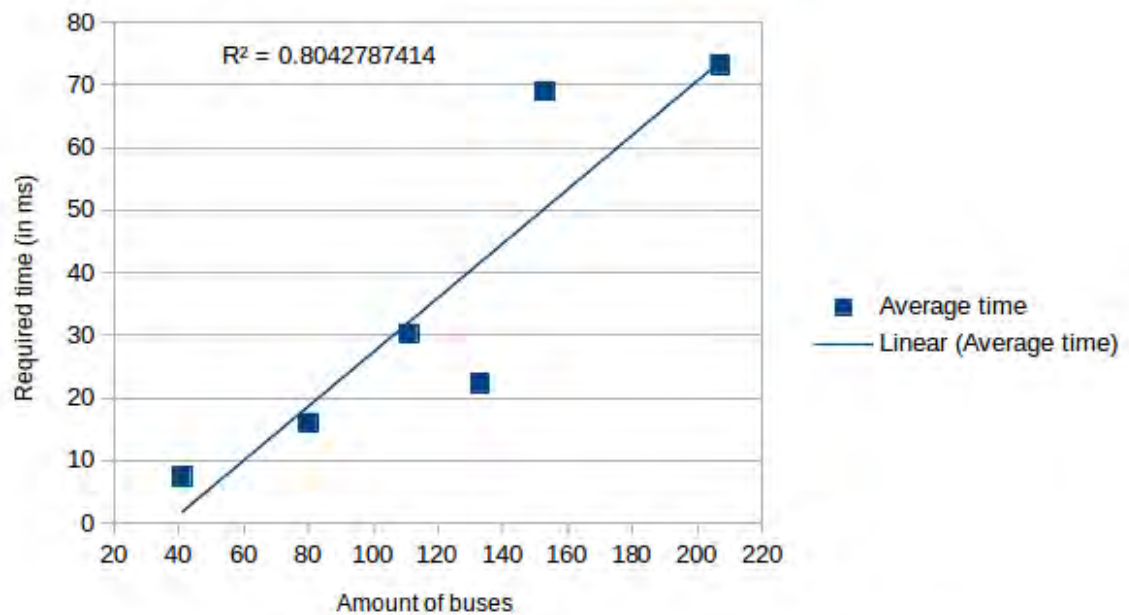

Figure 7.7: Required Time Evolution over Network Sizes for the State Estimation

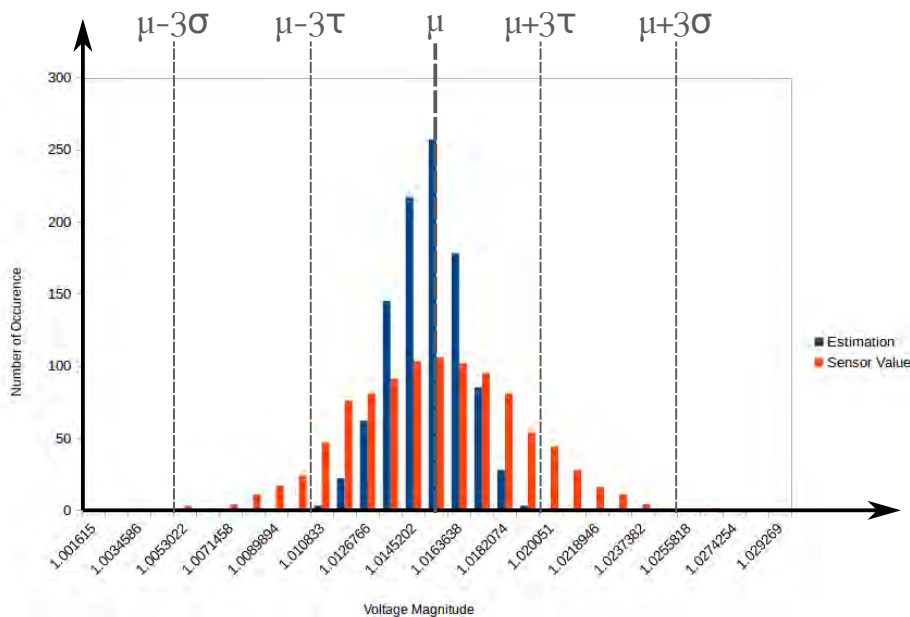

Figure 7.8: Gaussian Distribution of a Voltage Sensor and the State Estimation for the Bus 30 of the Configuration 6 of the 111-bus system

to the system.

Information about these distributions shown in the figure 7.8 are grouped in the table 7.9.

We can see on this figure that the system effectively filters errors of the voltage sensor. The filtering of errors provided by the various sensors is a prerequisite of the state estimation. We can see on this figure that the system effectively reduces the error of the sensors. However,

Figure 7.9: Standard deviations and mean value of the bus observed

Real value (μ)	1.014676
Estimation Standard Deviation (τ)	0.0014324118
Estimation Mean Value	1.014665402
Sensor Standard Deviation (σ)	0.0033071471
Sensor Mean Value	1.014882942

this study should be continued in this direction to filter even more the sensors data.

7.5.6 Relevance of the ATENA for State Estimation System

In order to show the relevance of the developed system, the 64-bus network (represented in the figure B.2 page 135) has been used in this evaluation. The 64-bus network is particularly representative of real distribution networks.

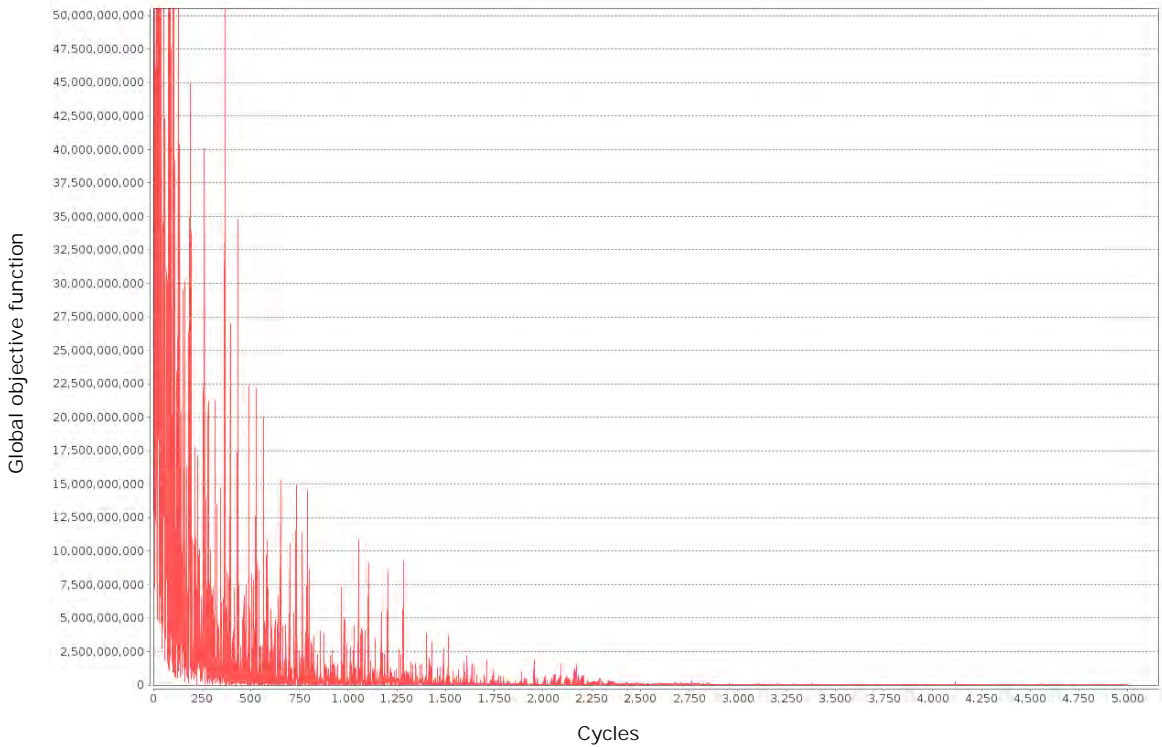

Figure 7.10: Evolution of the global objective function over the cycles of resolution of the developed system

Although the filtering is not as efficient as usual global methods, the figure 7.10 shows that the system tends to reduce the global objective function expressed as follow:

$$\left[\sum_{b \in \text{Buses with voltage sensor}} \left(\frac{hv_b(x) - zv_b}{\sigma v_b} \right)^2 \right] + \sum_{b \in \text{Buses}} \left[\left(\frac{hp_b(x) - zp_b}{\sigma p_b} \right)^2 + \left(\frac{hq_b(x) - zq_b}{\sigma q_b} \right)^2 \right] \quad (7.12)$$

With:

- ▷ $h v_b(x)$ the model function giving the voltage magnitude at the bus b for a given state x ,
- ▷ $h p_b(x)$ and $h q_b(x)$ the model functions calculating, from the model, respectively the active and reactive power injected at the bus b for a given state x ,
- ▷ $z v_b, z p_b$ and $z q_b$ respectively the voltage magnitude, active and reactive measurements (real, pseudo or virtual) of the bus b ,
- ▷ $\sigma v_b, \sigma p_b$ and σq_b standard deviations corresponding to the inverse of the accuracy of the measurements.

This evaluation has been made on the 64-bus network as it is particularly representative of real distribution networks.

7.5.7 Relative Voltage Magnitude Estimation Error over the Number of Voltage Sensors

Four configurations are considered for the 64-bus network:

- ▷ **Configuration 1:** A voltage magnitude sensor is installed at the bus 1 (source substation);
- ▷ **Configuration 2:** Voltage magnitude sensors are installed at the buses 1 and 30;
- ▷ **Configuration 3:** Voltage magnitude sensors are installed at the buses 1, 30 and 60;
- ▷ **Configuration 4:** Voltage magnitude sensors are installed at the buses 1, 30, 60 and 64.

In each configuration, active and reactive powers sensors are installed at the source substation. Also, on consumption buses, pseudo measurements are considered. In this part, we observe the impact of the amount of sensors on the voltage magnitude estimation. This evaluation has been made on the four configurations of the 64-bus network. For each configuration, we have launched 1,000 resolutions and observed the maximal relative voltage magnitude estimation error for each of these resolutions. At the end of these 1,000 resolutions, we have observed the minimal, maximal and average values of these 1,000 maximal relative voltage magnitude estimation error. The obtained results are presented in the figure 7.11 and show an estimation with an error lower than 1% for resolutions with at least two voltage magnitude sensors. Moreover, this shows that the system is able to take benefit of the number of voltage magnitude sensors.

7.5.8 Self-Adaptation

An experimentation have been realized to determine the robustness¹ of the developed system. In this experiment, we are looking forward to determine if the system is able to resist

¹“A robust system is a system which is able to maintain a stable behavior even under perturbations” [Kaddoum 2011]

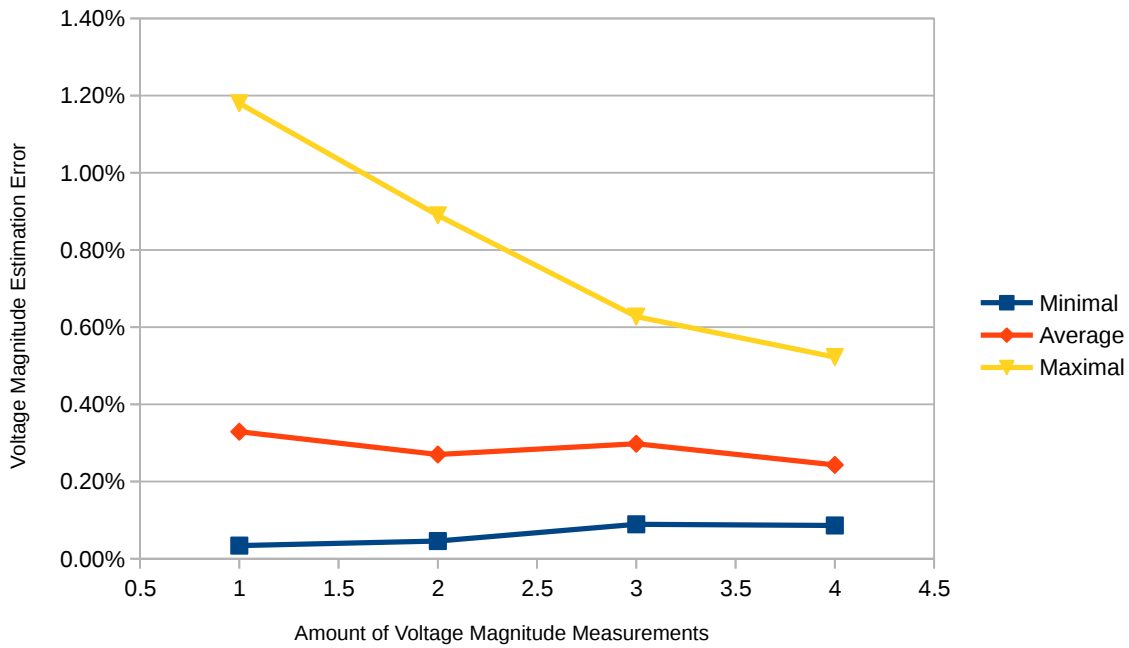

Figure 7.11: Relative Voltage Magnitude Estimation Error over the Number of Voltage Sensors for the 64-bus network

to perturbations. We have launched a State Estimation solving on the configuration 6 of the 111-bus network. Then, at the cycle 1,000, we have introduced a supplementary random noise to each voltage sensor values to observe the reaction of the system. These noises have then been removed at the cycle 2,000.

As expected, the figure 7.12 shows that the system is able to adapt itself to perturbations and that it tries to find the most likely solution despite the noise added to sensors values.

7.6 Conclusion

This chapter presents the State Estimation problem in details and formulates it as an optimization problem of distributing the global errors of the voltage sensors over them in order to minimize the Weighted Least Squares sum to approach the maximum likelihood. When the agents stop changing their values, the system is considered as stable and the state of the network can be extracted to be used in another process (such as the voltage regulation).

Furthermore, the design and implementation of the ATENA for State Estimation is detailed. Its application shows the relevance of using this kind of approach to solve this problem.

The design of the system ATENA has been done following a bottom-up approach. In other words, the work has been made at the agents level by considering their neighbors and which actions should they make to cooperate with others.

The evaluations presented in the previous section show the relevance of this approach as it effectively tends to reduce the global objective function. Also, it can be seen that there

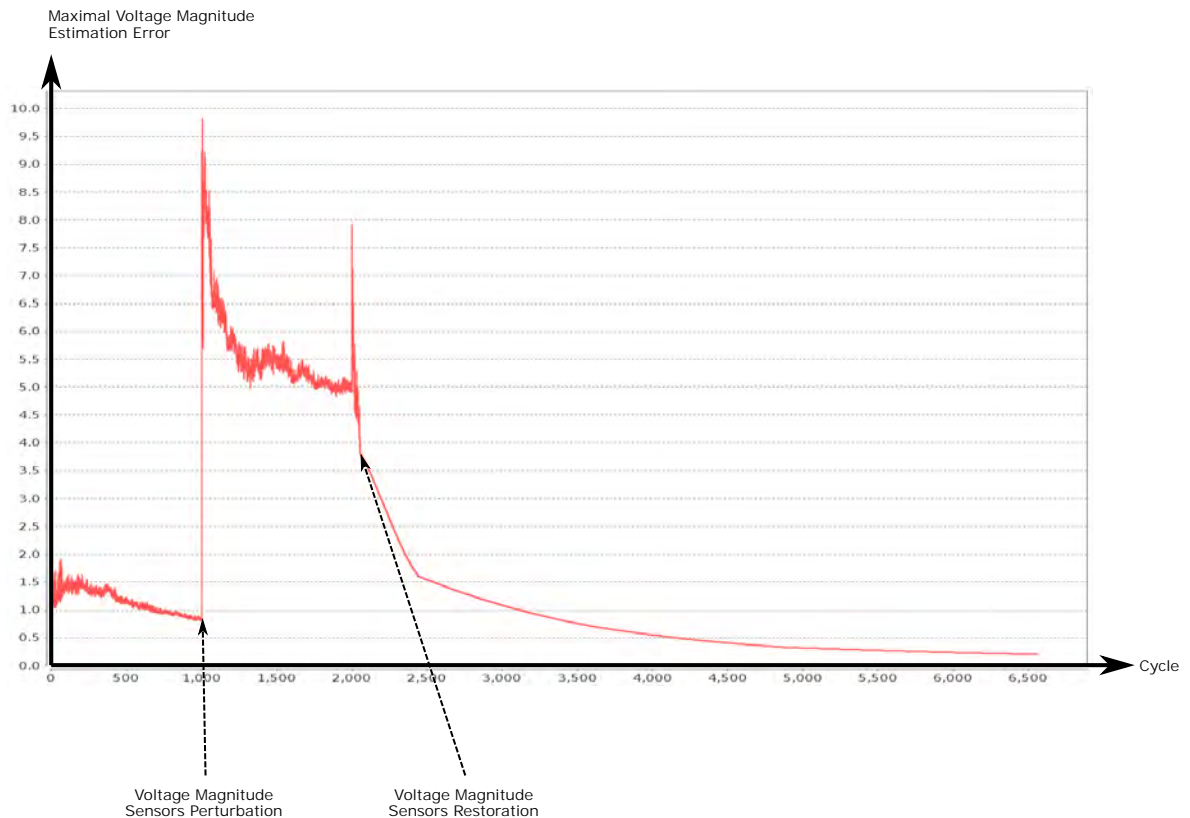

Figure 7.12: Impact of the addition of a perturbation during the resolution process

is an error filtering. However, the quality of the estimation is not sufficient for the system ATENA to be used in production. Moreover, it cannot be said that the system is able to find the maximum likelihood. Therefore, it is necessary to continue the development of the agents behaviors by determining other cooperation mechanisms to reach the maximum likelihood. Moreover, no evaluations have been made regarding the robustness (in the general sense of the term) against sensors failures and outliers.

In addition to solving the problem in a reasonable time, the bottom-up design of the system and the way agents are designed allows an openness of the system whether about the addition or removal of electrical elements at runtime or about the additions of new computer modules implementing new features.

The local behavior of agents implies that they are not aware of the whole system. Given the openness of the system (see 5 page 49), if this latter evolves (for example with the addition of a new Smart Grid feature), the behavior of agents will not necessarily be changed.

It can be observed that the complexity of the proposed system evolves linearly with the size of the networks and that the system is able to filter sensors errors in the presence of as few as two voltage magnitude sensors. Indeed, similarly to the Load Flow analysis system, the complexity of an agent cycle rely on the number of neighbors. As this one is not expected to increase with the size of the network, the complexity of this system should be linear.

The work presented in this chapter has led to the publication of the paper [Perles et al. 2016b] at the World Congress on Sustainable Technology (WCST 2016) as well as the paper [Perles et al. 2016a] at the EUMAS (European Conference on Multi-Agent Systems) 2016

conference.

Algorithm 7.2: Behavior of a Measurement Agent for the State Estimation problem solving

```

begin
  /* Perception */
  /* Get the criticality of each neighbor */
  for  $n \in \text{Neighbors}(\text{self})$  do
    |  $\text{criticality}[n] \leftarrow \text{criticality}(n)$ 
  end
   $\text{criticality}[\text{self}] \leftarrow \text{self.criticality}$ 
   $\text{receivedMessages} \leftarrow \text{receiveMessages}()$ 
   $\text{measurementValue} \leftarrow \text{measurementValue}$ 
  /* Get the value calculated by the bus agent */
   $\text{busAgentCalculatedValue} \leftarrow \text{calculatedValue}(\text{busAgent})$ 
  /* Decision */
   $\text{offset} \leftarrow \text{self.currentOffset}$ 
  /* Calculate the offset required by the bus agent */
   $\text{requiredOffset} \leftarrow (\text{busAgentCalculatedValue} - \text{measurementValue}) - \text{offset}$ 
  for  $m \in \text{ReceivedMessages}$  do
    if  $m.\text{type} == \text{REQUEST}$  then
      if  $\text{criticality}[m.\text{sender}] > \text{criticality}[\text{self}]$  then
        if  $\text{sign}(m.\text{requested}) == \text{sign}(\text{requiredOffset})$  then
          /* Use the smallest absolute value if the signs
          match */
           $\text{compromise} \leftarrow$ 
           $\text{sign}(m.\text{requested}) * \min(\text{abs}(m.\text{requested}), \text{abs}(\text{requiredOffset}))$ 
        else
          |  $\text{compromise} \leftarrow m.\text{requested} / 1000$ 
        end
        /* And I inform my neighbor */
         $\text{send}(m.\text{sender}, \text{PROPOSAL}, -\text{compromise})$ 
      end
      else if  $m.\text{type} == \text{PROPOSAL}$  then
        /* If a neighbor proposes a compensation, the action is
        done and a confirmation is sent */
         $\text{offset} += m.\text{proposed}$ 
         $\text{requiredOffset} -= m.\text{proposed}$ 
         $\text{send}(m.\text{sender}, \text{CONFIRM}, -m.\text{proposed})$ 
      else if  $m.\text{type} == \text{CONFIRM}$  then
        /* If a neighbor confirms its help, it compensates */
         $\text{offset} += m.\text{confirmed}$ 
         $\text{requiredOffset} -= m.\text{confirmed}$ 
      end
    end
    /* Action */
    if  $\text{requiredOffset} \neq 0$  then
      /* Broadcast remaining offset request */
       $\text{send}(\text{Neighbors}(\text{self}), \text{REQUEST}, -\text{requiredOffset} / \text{Neighbors}(\text{self}).\text{size}())$ 
    end
    end
     $\text{self.currentOffset} \leftarrow \text{offset}$ 
     $\text{self.estimatedValue} \leftarrow \text{measurementValue} + \text{offset}$ 
     $\text{self.criticality} \leftarrow \text{evalCriticality}()$ 
  end

```

*An Adaptive Multi-Agent System for the
Distribution
of Intelligence in Electrical Distribution Networks:
State Estimation*

Conclusion

8

Conclusion and Perspectives

This chapter returns to the essential notions addressed in this PhD and presents interesting perspectives associated to this work.

Although numerous methods and concepts have already been developed in both the field of Artificial Intelligence and Electricity, the works presented in this document constitute a new step towards the connection of these two domains.

This thesis is therefore an analyze of these two domains and presents a state of the art of the Multi-Agent System for the Smart Grid as well as specific states of the art for the Load Flow analysis and State Estimation. These parts have made it possible to identify the advantages and drawbacks of existing methods to guide the study.

This preliminary study and the presentation of the AMAS theory have confirmed the interest of determining the relevance of such approach for the Smart Grid.

The ATENA based systems presented in this thesis rely on the emergence of a global function from local interactions.

This study has led to the implementation of the system able to handle both the Load Flow analysis and the State Estimation and validated through experiments on both generated and realistic networks.

From the issues inherent to the massive introduction of distributed generators and more generally to the necessity to make electrical networks more autonomous, this thesis proposes an innovative framework and concepts directly taken from the Artificial Intelligence domain.

8.1 Contributions to the Computer Sciences

On the border between the computer sciences and the electrotechnical fields, this work contributes to the computer sciences by proposing the use of computers to solve in an innovative and efficient way equations systems and a category of optimization problems. The computer computation capabilities are limited. Therefore, the dynamic and the constantly increasing size of electrical networks require to change the way they are operated. The computation time of the ATENA based systems proposed in this thesis evolves almost linearly with the number of components of the network. Also, the framework ATENA is a basis that can be reused to implement new systems aiming at solving other Smart Grid characteristics. Moreover, the proposed system shows the relevance of using Multi-Agent Systems for solving complex problems. The adaptation capacities made possible by the

cooperation between agents are interesting characteristics that should be taken into account in dynamic problem solving.

Although experimentations haven't been made on real electrical networks, the multi-agent framework proposed clearly shows the way such systems can be coupled to real networks.

Finally, this work introduces a communication protocol coupled to cooperation mechanisms as well as a cooperation between two types of agents which have different goals, abilities and perceptions.

8.2 Contributions to the Electrotechnical Field

In the electrotechnical field, the contributions are more obvious.

Initially, the problem addressed was to find a way to "distribute intelligence in medium voltage and low voltage networks". This is part of the Smart Grid concept. The complexity of the problem and the amount of characteristics that should be considered make it impossible to be treated as one unique three-years study. The general project aims at providing an automatic system able to take into account the complexity and a lot of requirements of the Smart Grid such as: scalability, self-adaptation, ... My thesis of 3 years is a contribution to this general project. It focuses on the creation of a framework adapted to some advanced functions of the Smart Grid and allowing to develop the characteristics of the Smart Grid (see 2.3 page 19). Moreover, it has been showed that this fits with the resolution of two major problems in electricity: the Load Flow and the State Estimation.

The developed systems are stable, robust (see footnote in section 7.5.8 page 111) and able to support the addition of new features to move towards the concept of an autonomous electrical network.

Moreover, the evaluations have shown great improvements in term of computational complexity. Usual methods highly rely on matrices inversions and multiplications. Given the fact that the sizes of the matrices are proportional to the sizes of the networks and that these operations are known to be time consuming, these global methods shouldn't be used in dynamic and scalable networks. Although the number of required iterations is generally lower in global methods. The iterations of the ATENA systems have a low cost in term of computation time. The approach presented in this thesis has been designed and implemented in order not to suffer for such scalability problem. The presented results show that the required time evolves, at worst, linearly.

8.3 Perspectives

As mentioned previously, the framework ATENA presented in this manuscript constitutes a solid basis to solve the general problem of the Smart Grid. The first perspectives is therefore to continue this study and add additional features to this existing basis. This notably includes, but is not limited to: other functions of a State Estimator, the Automatic Voltage Regulation, Self-Healing, Supply/Demand Balancing, Losses Reduction, Minimization of Hardware Stress and the Maximization of the Use of Renewable Energies. Alongside this study, works

have been realized to co-initialize a set of independent units to simulate an electrical network and has been presented in the paper [Chilard et al. 2015]. Another perspective could then be to couple the developed systems with this simulator. Furthermore, the load profiles used in the State Estimation to give an approximation of power consumed at consumer sites could be slightly improved by considering the behavior of buildings occupants (See [Bonte et al. 2013]). Finally, the data filtering provided by the State Estimation resolution could certainly be improved. An interesting perspective can be to improve the agents behaviors to increase the quality of the solutions. For example by using trust-based mechanisms (see section 7.3.3 page 95) or adding power sensor agents able to correct the values returned by power sensors such as voltage magnitude sensor agents.

In addition to this, interesting perspectives are:

- ▷ defining a design pattern to solve optimization problems formulated as Weighted Least Squares,
- ▷ design and develop a generic optimizer using the AMAS4Opt model [Kaddoum 2011].

9

Conclusion et Perspectives (version française)

Ce chapitre revient sur les notions essentielles abordées dans ce travail de thèse et présente des perspectives intéressantes liées à ce travail.

Bien que de nombreux concepts et méthodes aient déjà été développés dans les domaines de l'Intelligence Artificielle et de l'Électrotechnique, les travaux présentés dans ce document constituent une étape de plus vers la connexion de ces deux domaines.

Cette thèse est donc une analyse de ces deux domaines et présente un état de l'art de l'approche multi-agents pour le Smart Grid, mais aussi l'état de l'art de l'analyse du flux de puissance et de l'estimation d'état. Ces parties ont permis d'identifier les avantages et les inconvénients des méthodes existantes pour orienter l'étude.

Cette étude préliminaire et la présentation de la théorie des AMAS ont confirmé l'intérêt d'évaluer la pertinence de cette approche pour le Smart Grid.

Les solutions présentées dans cette thèse s'appuient sur l'émergence d'une fonction globale à partir d'interactions locales.

Cette étude a conduit à la conception d'un système capable de prendre en compte autant l'analyse des flux de puissances que l'estimation d'état. Les validations que j'ai effectuées par des expériences sur des réseaux générés et réalistes sont très encourageantes.

Pour prendre en compte l'introduction massive de producteurs distribués et, plus généralement, la nécessité de rendre les réseaux électriques plus autonomes, ce document présente un cadre applicatif innovant et des concepts tirés directement du domaine de l'Intelligence Artificielle.

9.1 Contributions au Domaine de l'Informatique

À la frontière entre l'informatique et l'électrotechnique, ce travail contribue à l'informatique en proposant l'utilisation de technologies informatiques pour résoudre de façon innovante et efficace des systèmes d'équations et une catégorie de problèmes d'optimisation. Les capacités de calcul informatiques étant limitées, la dynamique et la taille sans cesse croissante des réseaux électriques nécessitent de changer la façon dont ils sont exploités. Le temps de calcul des systèmes proposés dans cette thèse évolue de manière quasiment linéaire par rapport au nombre d'éléments du réseau. Également, le cadre applicatif ATENA est une base qui peut

être réutilisée pour implémenter de nouveaux systèmes pour d'autres caractéristiques du Smart Grid. En outre, le système proposé montre la pertinence de l'utilisation de systèmes multi-agents pour résoudre des problèmes complexes. Les capacités d'adaptation rendues possibles par la coopération entre agents sont des caractéristiques intéressantes qui devraient être prises en compte dans la résolution de problème dynamique.

Bien que les expérimentations n'aient pas été réalisées sur des réseaux électriques réels en fonctionnement, le cadre applicatif proposé montre clairement la façon dont ces systèmes peuvent être couplés à des réseaux réels.

Enfin, cet ouvrage présente un protocole de communication couplé à des mécanismes de coopération, mais aussi une coopération entre deux types d'agents qui ont des perceptions, des capacités et des objectifs différents.

9.2 Contributions au Domaine de l'Electrotechnique

Dans le domaine de l'électrotechnique, les contributions sont plus évidentes.

Au départ, le problème était de trouver un moyen de "distribuer l'intelligence dans les réseaux moyenne tension et basse tension". Cela fait partie de la notion de Smart Grid. Le projet général est de fournir un système automatique capable de prendre en compte la complexité du problème et les caractéristiques du Smart Grid.

La contribution de ma thèse est une proposition d'un cadre applicatif adapté pour certaines fonctions avancées du Smart Grid et permettant l'ajout de fonctionnalités multiples dans lequel les bus et les mesures sont agentifiés. En outre, il a été montré que cela était possible pour la résolution de deux problèmes importants en électricité : l'analyse des flux de puissance et l'estimation d'état.

Le système développé est stable, robuste (voir note de bas de page partie 7.5.8 page 111) et capable de supporter l'ajout de nouvelles fonctionnalités pour faire avancer l'idée d'un réseau électrique autonome.

En outre, les évaluations ont montré des améliorations très importantes en terme de complexité algorithmique. Les approches existantes reposent fortement sur les multiplications et les inversions de matrices. Compte tenu du fait que les tailles des matrices sont proportionnelles à la taille des réseaux et que ces opérations sont connues pour avoir un temps de calcul important, ces méthodes globales ne devraient pas être utilisées dans les réseaux dynamiques et évolutifs. Bien que le nombre d'itérations requises soit généralement moins important pour les méthodes globales, les itérations des systèmes développés ont un coût en temps de calcul bien moins important. L'approche présentée dans cette thèse a été conçue et mise en œuvre pour ne pas avoir ce problème d'évolutivité. Les résultats présentés montrent qu'ils ont un temps de calcul qui évolue, au pire, linéairement par rapport au nombre de bus.

9.3 Perspectives

Les premières perspectives sont donc de poursuivre cette étude et d'ajouter des fonctionnalités supplémentaires à cette base existante. Ceci inclut notamment, mais n'est pas limité

à : l'ajout d'autres fonctions d'estimateur d'état, la régulation automatique de tension, l'auto-cicatrisation, l'équilibrage de l'offre et la demande, la réduction des pertes, la minimisation des sollicitations matérielles et la maximisation de l'utilisation des énergies renouvelables. Parallèlement à cette étude, des travaux ont été réalisés pour initialiser conjointement un ensemble de modules pour simuler un réseau électrique et ont été présentés dans le document [Chilard et al. 2015]. Une autre perspective intéressante serait de coupler ce simulateur avec le système ATENA. En outre, les profils de charge utilisés dans l'estimation d'état pour donner une approximation de l'énergie consommée dans les sites de consommation pourraient être sensiblement améliorés en prenant en considération le comportement des occupants (voir [Bonte et al. 2013]). Enfin, le filtrage de données fourni par l'estimation d'état pourrait certainement être amélioré. Une perspective intéressante serait d'améliorer les comportements des agents pour améliorer la qualité des solutions obtenues par exemple en utilisant les mécanismes axés sur la confiance (voir partie 7.3.3 page 95).

En plus de cela, des perspectives intéressantes sont :

- ▷ la définition d'un patron de conception pour résoudre les problèmes d'optimisation formulés en moindre carrés pondérés,
- ▷ la conception et l'implémentation d'un optimiseur générique en utilisant le modèle AMAS4Opt [Kaddoum 2011].

*An Adaptive Multi-Agent System for the
Distribution
of Intelligence in Electrical Distribution Networks:
State Estimation*

Appendix

A

Notations

C^*	Conjugate of the complex C . $(a + i \cdot b)^* = a - i \cdot b$
C	Magnitude (modulus or absolute value) of the complex C
$\arg(C)$	Angle of the complex C
$\text{Re}(C)$	Real part of the complex C
$\text{Im}(C)$	Imaginary part of the complex C
V	Volts
Hz	Hertz

B Power Systems Test Cases

The networks used in this thesis are detailed in this appendix. For each network, the topology is given, the list of buses with the corresponding voltage magnitude (expressed as “per-unit” with the base value equals to 20,000 V) and phase angle (in radians) and the list of lines with their characteristics (the resistance R , the conductance G , the capacitance B and the reactance X).

The networks that have been used are:

- ▷ the 41-bus network page 132,
- ▷ the 64-bus network page 135,
- ▷ the 80-bus network page 139,
- ▷ the 111-bus network page 144,
- ▷ the 133-bus network page 150,
- ▷ the 153-bus network page 157,
- ▷ the 207-bus network page 165.

B.1 41-bus Test System

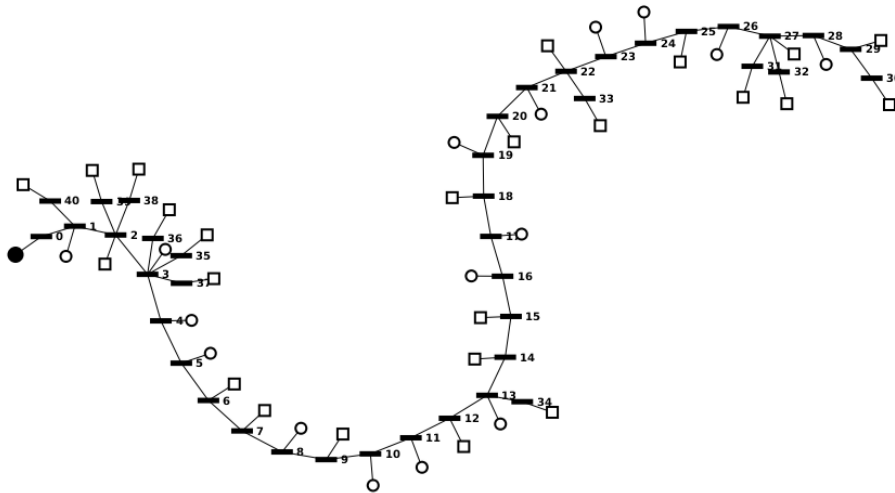

□ Load ■ Bus ○ Generator ● Source substation

Figure B.1: 41-bus test case

The figure B.1 represents the 41-bus test case. It is composed of multiple generators and loads. This network has been generated randomly.

B.1.1 Buses

Bus	Voltage Magnitude	Phase Angle
24	1.018748	0.002476
23	1.018782	0.002407
26	1.018689	0.002585
25	1.018720	0.002532
28	1.018641	0.002656
27	1.018651	0.002632
29	1.018631	0.002670

31	1.018639	0.002654
30	1.018620	0.002686
11	1.019318	0.001371
33	1.018810	0.002354
10	1.019357	0.001300
32	1.018641	0.002650
13	1.019193	0.001597
35	1.019688	0.000571
9	1.019410	0.001169
12	1.019256	0.001478
34	1.019185	0.001614
8	1.019472	0.001040
15	1.019115	0.001750
37	1.019689	0.000569
7	1.019520	0.000967
14	1.019156	0.001667
36	1.019695	0.000559
17	1.019020	0.001925
39	1.019790	0.000468
16	1.019066	0.001835
38	1.019788	0.000465
19	1.018940	0.002075
18	1.018983	0.001981
2	1.019800	0.000445
1	1.019891	0.000295
0	1.020000	0.000000
6	1.019561	0.000872
5	1.019613	0.000747
4	1.019661	0.000646
3	1.019702	0.000546
40	1.019878	0.000320
20	1.018902	0.002172
22	1.018820	0.002338
21	1.018863	0.002263

B.1.2 Lines

Bus 1	Bus 2	R	G	B	X
0	1	0.027628	0.000000	0.000001	0.005585
1	2	0.015909	0.000000	0.000001	0.006504
2	3	0.014089	0.000000	0.000001	0.010002
3	4	0.020798	0.000000	0.000001	0.005210
4	5	0.021364	0.000000	0.000001	0.006542
5	6	0.026090	0.000000	0.000001	0.006571

6	7	0.020014	0.000000	0.000001	0.005421
7	8	0.015634	0.000000	0.000001	0.007363
8	9	0.027187	0.000000	0.000001	0.008414
9	10	0.027355	0.000000	0.000000	0.006718
10	11	0.015114	0.000000	0.000001	0.005628
11	12	0.022818	0.000000	0.000001	0.009075
12	13	0.025091	0.000000	0.000001	0.009073
13	14	0.018513	0.000000	0.000001	0.006482
14	15	0.021810	0.000000	0.000001	0.007191
15	16	0.022323	0.000000	0.000001	0.009013
16	17	0.023861	0.000000	0.000001	0.008024
17	18	0.014898	0.000000	0.000001	0.006851
18	19	0.024470	0.000000	0.000001	0.007327
19	20	0.025121	0.000000	0.000001	0.005875
20	21	0.023571	0.000000	0.000001	0.006460
21	22	0.019804	0.000000	0.000001	0.007717
22	23	0.024696	0.000000	0.000001	0.009596
23	24	0.023976	0.000000	0.000001	0.008086
24	25	0.019914	0.000000	0.000001	0.006642
25	26	0.018708	0.000000	0.000001	0.007785
26	27	0.017206	0.000000	0.000001	0.010021
27	28	0.025902	0.000000	0.000001	0.006915
28	29	0.015721	0.000000	0.000000	0.008059
29	30	0.017058	0.000000	0.000001	0.009460
27	31	0.023811	0.000000	0.000001	0.008654
27	32	0.018914	0.000000	0.000001	0.007945
22	33	0.017093	0.000000	0.000001	0.007424
13	34	0.017959	0.000000	0.000001	0.005471
3	35	0.025155	0.000000	0.000000	0.008448
3	36	0.014111	0.000000	0.000001	0.005184
3	37	0.023365	0.000000	0.000001	0.008598
2	38	0.020925	0.000000	0.000001	0.008246
2	39	0.025425	0.000000	0.000000	0.005540
1	40	0.026361	0.000000	0.000001	0.009081



B.2 64-bus Test System

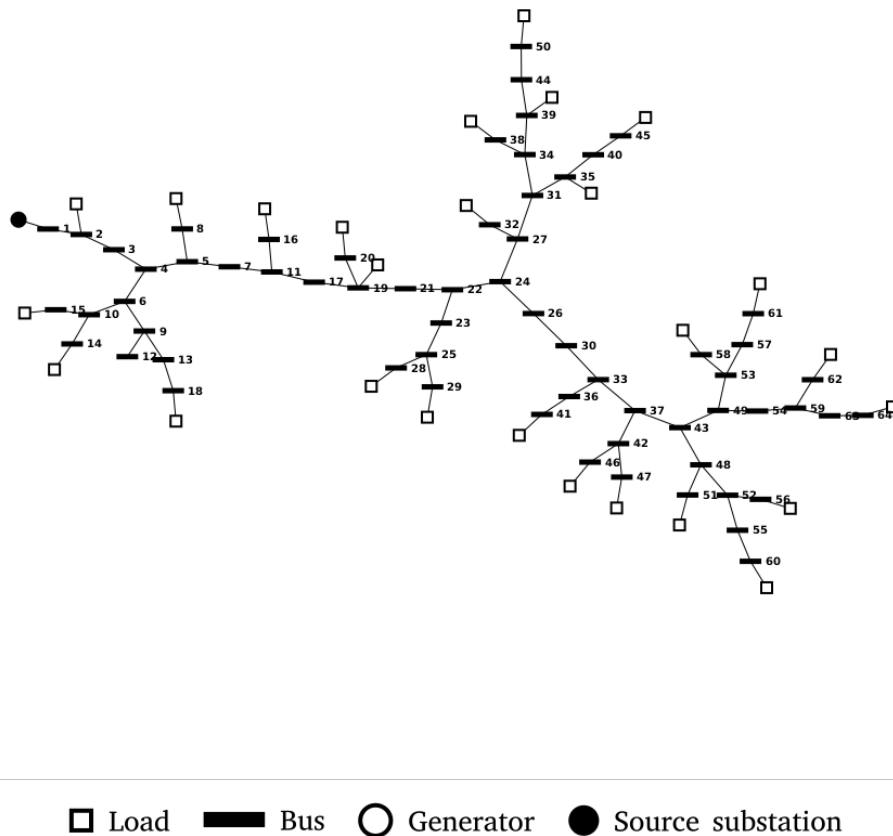

Figure B.2: 64-bus test case

The figure B.2 represents the 64-bus test case. It is composed of one source of energy (the source substation) and multiple loads. This network is particularly representative of real distribution networks.

B.2.1 Buses

Bus	Voltage Magnitude	Phase Angle
37	1.008799	-0.437886
3	1.011813	-0.436218
52	1.007994	-0.438057
14	1.011320	-0.436473
26	1.009843	-0.437564
49	1.007857	-0.438080

41	1.008985	-0.437848
64	1.007769	-0.438089
59	1.007788	-0.438086
36	1.008987	-0.437848
4	1.011575	-0.436357
51	1.008001	-0.438055
13	1.011494	-0.436404
48	1.008001	-0.438055
25	1.010338	-0.437057
63	1.007778	-0.438089
40	1.009762	-0.437616
58	1.007837	-0.438083
35	1.009763	-0.437615
5	1.011392	-0.436450
12	1.011494	-0.436403
50	1.009754	-0.437614
47	1.008795	-0.437887
24	1.009860	-0.437550
62	1.007732	-0.438085
19	1.010550	-0.436843
34	1.009764	-0.437612
57	1.007835	-0.438084
11	1.010819	-0.436746
6	1.011494	-0.436402
46	1.008777	-0.437890
23	1.010338	-0.437057
61	1.007834	-0.438084
18	1.011490	-0.436404
33	1.008998	-0.437844
56	1.007988	-0.438056
10	1.011325	-0.436474
7	1.011106	-0.436596
45	1.009746	-0.437617
22	1.010341	-0.437055
60	1.007993	-0.438057
17	1.010766	-0.436773
8	1.011389	-0.436450
55	1.007993	-0.438057
32	1.009817	-0.437578
29	1.010338	-0.437057
21	1.010542	-0.436846
44	1.009754	-0.437614
9	1.011494	-0.436403
16	1.010816	-0.436746

39	1.009755	-0.437614
1	1.012106	-0.436109
54	1.007822	-0.438086
31	1.009773	-0.437609
28	1.010334	-0.437058
20	1.010547	-0.436843
43	1.008028	-0.438048
15	1.011303	-0.436482
38	1.009763	-0.437613
2	1.011821	-0.436215
30	1.009705	-0.437682
53	1.007839	-0.438083
27	1.009817	-0.437578
42	1.008795	-0.437887

B.2.2 Lines

Bus 1	Bus 2	R	G	B	X
23	25	0.019855	0.000000	0.000001	0.007222
25	29	0.025091	0.000000	0.000001	0.009127
25	28	0.225168	0.000000	0.000007	0.081905
24	26	0.005524	0.000000	0.000001	0.008651
22	24	0.128221	0.000000	0.000018	0.200794
30	33	0.288529	0.000000	0.000015	0.166587
26	30	0.045105	0.000000	0.000006	0.070635
36	41	0.009317	0.000000	0.000041	0.003657
33	36	0.049898	0.000000	0.000003	0.028810
37	42	0.018007	0.000000	0.000001	0.010397
33	37	0.089212	0.000000	0.000004	0.051508
42	46	0.134161	0.000000	0.000007	0.077460
37	43	0.382002	0.000000	0.000019	0.220556
42	47	0.000412	0.000000	0.000000	0.000238
48	51	0.001310	0.000000	0.000006	0.000514
43	48	0.081377	0.000000	0.000004	0.046984
52	55	0.006048	0.000000	0.000000	0.003492
48	52	0.055637	0.000000	0.000002	0.020238
52	56	0.052146	0.000000	0.000002	0.018968
55	60	0.006624	0.000000	0.000029	0.002600
43	49	0.100346	0.000000	0.000005	0.057937
2	3	0.001517	0.000000	0.000012	0.000856
1	2	0.039430	0.000000	0.000310	0.022262
4	5	0.037397	0.000000	0.000002	0.027778
3	4	0.042832	0.000000	0.000003	0.032540
5	7	0.058980	0.000000	0.000004	0.043810

11	16	0.013091	0.000000	0.000000	0.004762
7	11	0.058919	0.000000	0.000004	0.044762
17	19	0.046552	0.000000	0.000368	0.026410
11	17	0.011433	0.000000	0.000001	0.008492
19	21	0.002641	0.000000	0.000021	0.001498
19	20	0.011792	0.000000	0.000021	0.002590
22	23	0.114230	0.000000	0.000006	0.065952
21	22	0.053518	0.000000	0.000007	0.083810
4	6	0.114548	0.000000	0.000004	0.041667
5	8	0.061747	0.000000	0.000002	0.022460
9	12	0.006982	0.000000	0.000000	0.002540
6	9	0.008073	0.000000	0.000000	0.002937
13	18	0.207059	0.000000	0.000007	0.075317
9	13	0.010047	0.000000	0.000079	0.005673
10	14	0.017869	0.000000	0.000001	0.006500
6	10	0.235226	0.000000	0.000007	0.085563
10	15	0.038350	0.000000	0.000325	0.020429
53	57	0.040413	0.000000	0.000002	0.023333
49	53	0.112030	0.000000	0.000006	0.064683
53	58	0.016770	0.000000	0.000001	0.009683
57	61	0.013964	0.000000	0.000000	0.005079
54	59	0.023346	0.000000	0.000001	0.008492
49	54	0.022681	0.000000	0.000001	0.013095
59	63	0.014296	0.000000	0.000001	0.008254
59	62	0.073092	0.000000	0.000002	0.026587
24	27	0.057871	0.000000	0.000003	0.033413
63	64	0.012340	0.000000	0.000054	0.004829
27	31	0.066256	0.000000	0.000003	0.038254
34	38	0.171825	0.000000	0.000009	0.099206
31	34	0.095947	0.000000	0.000005	0.055397
39	44	0.016083	0.000000	0.000001	0.009286
34	39	0.085638	0.000000	0.000004	0.049444
31	35	0.017583	0.000000	0.000138	0.009927
44	50	0.000437	0.000000	0.000002	0.000171
40	45	0.056484	0.000000	0.000149	0.011438
35	40	0.004313	0.000000	0.000034	0.002435
27	32	0.003299	0.000000	0.000000	0.001905



B.3 80-bus Test System

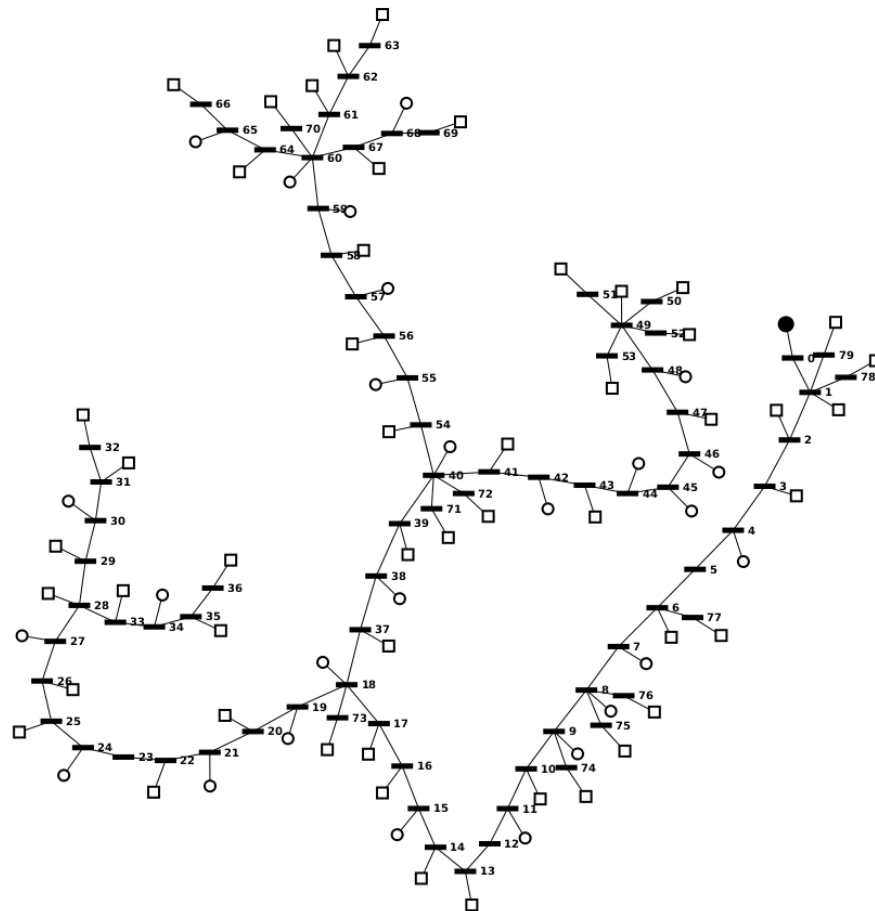

□ Load — Bus ○ Generator ● Source substation

Figure B.3: 80-bus test case

The figure B.3 represents the 80-bus test case. It is composed of multiple generators and loads. This network has been generated randomly.

B.3.1 Buses

Bus	Voltage Magnitude	Phase Angle
24	1.016902	0.005658
68	1.016268	0.006917
23	1.016922	0.005626
67	1.016275	0.006900
26	1.016865	0.005732
25	1.016885	0.005696
69	1.016258	0.006934

28	1.016824	0.005815
27	1.016846	0.005782
29	1.016812	0.005831
71	1.016578	0.006286
70	1.016276	0.006899
73	1.017012	0.005445
72	1.016579	0.006285
31	1.016790	0.005870
75	1.018466	0.002810
30	1.016802	0.005849
74	1.018281	0.003151
33	1.016813	0.005841
77	1.018885	0.002079
32	1.016780	0.005888
76	1.018466	0.002812
13	1.017737	0.004197
57	1.016426	0.006621
9	1.018294	0.003132
12	1.017896	0.004011
56	1.016466	0.006519
8	1.018479	0.002791
15	1.017461	0.004791
59	1.016335	0.006791
7	1.018707	0.002366
14	1.017625	0.004475
58	1.016383	0.006712
17	1.017129	0.005230
16	1.017294	0.005016
19	1.017003	0.005475
18	1.017023	0.005429
2	1.019588	0.000778
1	1.019777	0.000404
0	1.020000	0.000000
6	1.018894	0.002063
5	1.019089	0.001704
4	1.019247	0.001288
3	1.019429	0.001062
60	1.016285	0.006883
62	1.016262	0.006914
61	1.016275	0.006900
20	1.016983	0.005520
64	1.016273	0.006905
63	1.016250	0.006931
22	1.016940	0.005578



66	1.016245	0.006954
21	1.016962	0.005553
65	1.016260	0.006929
46	1.016305	0.006838
45	1.016352	0.006733
48	1.016202	0.006989
47	1.016252	0.006924
49	1.016149	0.007068
51	1.016136	0.007089
50	1.016136	0.007095
53	1.016139	0.007083
52	1.016141	0.007089
11	1.018023	0.003687
55	1.016504	0.006416
10	1.018137	0.003366
54	1.016542	0.006317
35	1.016791	0.005886
79	1.019763	0.000422
34	1.016804	0.005860
78	1.019768	0.000424
37	1.016884	0.005694
36	1.016783	0.005909
39	1.016696	0.006000
38	1.016805	0.005835
40	1.016588	0.006260
42	1.016484	0.006471
41	1.016540	0.006367
44	1.016402	0.006661
43	1.016436	0.006574

B.3.2 Lines

Bus 1	Bus 2	R	G	B	X
0	1	0.022310	0.000000	0.000001	0.008244
1	2	0.022914	0.000000	0.000001	0.007589
2	3	0.017545	0.000000	0.000000	0.006650
3	4	0.014355	0.000000	0.000001	0.008400
4	5	0.025069	0.000000	0.000001	0.005511
5	6	0.022060	0.000000	0.000001	0.008053
6	7	0.019984	0.000000	0.000001	0.008651
7	8	0.027693	0.000000	0.000001	0.010050
8	9	0.025394	0.000000	0.000001	0.009284
9	10	0.019122	0.000000	0.000000	0.009087
10	11	0.025109	0.000000	0.000001	0.005078

11	12	0.025519	0.000000	0.000001	0.005982
12	13	0.015520	0.000000	0.000001	0.009764
13	14	0.021920	0.000000	0.000001	0.005376
14	15	0.025229	0.000000	0.000001	0.008857
15	16	0.018488	0.000000	0.000001	0.009921
16	17	0.017643	0.000000	0.000001	0.009924
17	18	0.015877	0.000000	0.000001	0.005789
18	19	0.024685	0.000000	0.000000	0.006443
19	20	0.024185	0.000000	0.000001	0.006123
20	21	0.018093	0.000000	0.000001	0.008212
21	22	0.013922	0.000000	0.000001	0.008680
22	23	0.025799	0.000000	0.000001	0.005249
23	24	0.017264	0.000000	0.000001	0.007364
24	25	0.020645	0.000000	0.000001	0.005509
25	26	0.019427	0.000000	0.000001	0.007123
26	27	0.026571	0.000000	0.000001	0.005821
27	28	0.017748	0.000000	0.000000	0.008054
28	29	0.018040	0.000000	0.000001	0.008653
29	30	0.019935	0.000000	0.000001	0.006453
30	31	0.023184	0.000000	0.000001	0.007093
31	32	0.019629	0.000000	0.000001	0.006364
28	33	0.027206	0.000000	0.000001	0.007987
33	34	0.020472	0.000000	0.000001	0.007440
34	35	0.027406	0.000000	0.000001	0.009951
35	36	0.023681	0.000000	0.000000	0.005580
18	37	0.027223	0.000000	0.000001	0.009666
37	38	0.014518	0.000000	0.000001	0.005640
38	39	0.017272	0.000000	0.000001	0.008169
39	40	0.026307	0.000000	0.000001	0.006897
40	41	0.027537	0.000000	0.000001	0.007450
41	42	0.027142	0.000000	0.000001	0.009516
42	43	0.026484	0.000000	0.000001	0.007530
43	44	0.022123	0.000000	0.000001	0.005042
44	45	0.018976	0.000000	0.000001	0.009301
45	46	0.027019	0.000000	0.000001	0.007405
46	47	0.022441	0.000000	0.000000	0.009437
47	48	0.017528	0.000000	0.000001	0.009566
48	49	0.020836	0.000000	0.000001	0.009600
49	50	0.027388	0.000000	0.000001	0.007777
49	51	0.020884	0.000000	0.000001	0.009908
49	52	0.022174	0.000000	0.000001	0.005685
49	53	0.015976	0.000000	0.000001	0.007225
40	54	0.015270	0.000000	0.000001	0.008874
54	55	0.024847	0.000000	0.000001	0.005770



55	56	0.025735	0.000000	0.000001	0.005570
56	57	0.025701	0.000000	0.000000	0.006168
57	58	0.023161	0.000000	0.000001	0.007142
58	59	0.020351	0.000000	0.000001	0.008847
59	60	0.023744	0.000000	0.000000	0.008878
60	61	0.018010	0.000000	0.000001	0.007095
61	62	0.014731	0.000000	0.000001	0.010071
62	63	0.018246	0.000000	0.000001	0.009485
60	64	0.021412	0.000000	0.000001	0.007086
64	65	0.024037	0.000000	0.000001	0.008385
65	66	0.025315	0.000000	0.000001	0.008979
60	67	0.017014	0.000000	0.000001	0.006821
67	68	0.016535	0.000000	0.000000	0.005140
68	69	0.016827	0.000000	0.000001	0.007513
60	70	0.017204	0.000000	0.000001	0.006414
40	71	0.025943	0.000000	0.000001	0.006485
40	72	0.024962	0.000000	0.000001	0.005659
18	73	0.017964	0.000000	0.000001	0.009261
9	74	0.019957	0.000000	0.000000	0.009524
8	75	0.019893	0.000000	0.000001	0.008981
8	76	0.022671	0.000000	0.000000	0.009735
6	77	0.017230	0.000000	0.000001	0.005790
1	78	0.020729	0.000000	0.000001	0.007323
1	79	0.021195	0.000000	0.000000	0.010036

B.4 111-bus Test System



Figure B.4: 111-bus test case

The figure B.4 represents the 111-bus test case. It is composed of multiple generators and loads. This network has been generated randomly.

B.4.1 Buses

Bus	Voltage Magnitude	Phase Angle
68	1.014967	0.008935
67	1.014977	0.008913
69	1.014954	0.008959
71	1.014934	0.009008
70	1.014945	0.008981
73	1.014912	0.009051
72	1.014922	0.009034

75	1.014964	0.008934
74	1.014902	0.009072
77	1.014944	0.008971
76	1.014953	0.008952
57	1.014518	0.009788
56	1.014529	0.009773
59	1.014517	0.009797
58	1.014520	0.009800
60	1.014517	0.009789
62	1.015277	0.008326
61	1.015358	0.008155
64	1.015133	0.008632
63	1.015201	0.008518
66	1.015030	0.008813
65	1.015088	0.008732
46	1.014588	0.009612
45	1.014601	0.009586
48	1.014599	0.009581
47	1.014576	0.009629
49	1.014587	0.009599
51	1.014738	0.009399
50	1.014577	0.009625
53	1.014665	0.009520
52	1.014700	0.009454
55	1.014582	0.009691
54	1.014627	0.009578
35	1.014685	0.009464
34	1.014695	0.009448
37	1.014660	0.009502
36	1.014673	0.009480
39	1.014684	0.009452
38	1.014650	0.009527
40	1.014651	0.009507
42	1.014598	0.009579
41	1.014612	0.009559
44	1.014577	0.009616
43	1.014586	0.009602
24	1.014864	0.009215
23	1.014981	0.009030
26	1.014721	0.009406
25	1.014783	0.009334
28	1.014699	0.009446
27	1.014710	0.009431
29	1.014688	0.009459

110	1.019673	0.000616
31	1.014665	0.009503
30	1.014676	0.009484
33	1.014707	0.009425
32	1.014658	0.009520
13	1.016659	0.005978
9	1.017619	0.004305
12	1.016890	0.005489
8	1.017901	0.003769
15	1.016111	0.006936
7	1.018135	0.003396
14	1.016387	0.006411
17	1.015692	0.007664
16	1.015874	0.007212
19	1.015364	0.008200
18	1.015453	0.008038
2	1.019408	0.001147
1	1.019681	0.000591
0	1.020000	0.000000
6	1.018343	0.002855
5	1.018603	0.002461
4	1.018854	0.002069
3	1.019115	0.001501
20	1.015280	0.008421
22	1.015093	0.008840
21	1.015180	0.008656
89	1.014955	0.008956
91	1.014906	0.009027
90	1.014932	0.008996
93	1.014861	0.009095
92	1.014881	0.009054
95	1.014838	0.009136
94	1.014851	0.009115
97	1.014837	0.009137
96	1.014848	0.009116
11	1.017160	0.004920
99	1.015102	0.008682
10	1.017371	0.004589
98	1.015112	0.008670
79	1.014923	0.009014
78	1.014936	0.008989
108	1.018331	0.002880
109	1.019671	0.000605
106	1.016099	0.006952

107	1.018334	0.002875
80	1.014913	0.009035
82	1.014965	0.008936
100	1.015093	0.008696
81	1.014902	0.009052
101	1.015099	0.008697
84	1.014940	0.008981
83	1.014951	0.008956
86	1.014920	0.009008
104	1.016097	0.006958
85	1.014929	0.008995
105	1.016098	0.006950
88	1.014893	0.009053
102	1.015345	0.008181
87	1.014906	0.009027
103	1.015444	0.008055

B.4.2 Lines

Bus 1	Bus 2	R	G	B	X
0	1	0.024483	0.000000	0.000001	0.008450
1	2	0.024899	0.000000	0.000001	0.007519
2	3	0.016622	0.000000	0.000001	0.009647
3	4	0.025312	0.000000	0.000001	0.006952
4	5	0.017904	0.000000	0.000001	0.007702
5	6	0.018037	0.000000	0.000001	0.008098
6	7	0.025986	0.000000	0.000001	0.005397
7	8	0.018545	0.000000	0.000000	0.007761
8	9	0.026244	0.000000	0.000001	0.008739
9	10	0.014609	0.000000	0.000001	0.009024
10	11	0.016483	0.000000	0.000001	0.007091
11	12	0.027634	0.000000	0.000001	0.007988
12	13	0.023718	0.000000	0.000001	0.006863
13	14	0.021486	0.000000	0.000001	0.009098
14	15	0.025639	0.000000	0.000001	0.008690
15	16	0.016491	0.000000	0.000001	0.010053
16	17	0.025321	0.000000	0.000001	0.005772
17	18	0.021606	0.000000	0.000001	0.009357
18	19	0.018591	0.000000	0.000001	0.006684
19	20	0.024667	0.000000	0.000001	0.005224
20	21	0.026436	0.000000	0.000001	0.006623
21	22	0.020850	0.000000	0.000001	0.006147
22	23	0.021901	0.000000	0.000000	0.008687
23	24	0.021388	0.000000	0.000001	0.009225

24	25	0.013926	0.000000	0.000001	0.006542
25	26	0.015751	0.000000	0.000001	0.009417
26	27	0.027518	0.000000	0.000000	0.007396
27	28	0.016371	0.000000	0.000001	0.008405
28	29	0.014086	0.000000	0.000001	0.009147
29	30	0.027493	0.000000	0.000001	0.008115
30	31	0.020190	0.000000	0.000001	0.008127
31	32	0.018742	0.000000	0.000001	0.005467
26	33	0.021205	0.000000	0.000000	0.009866
33	34	0.025148	0.000000	0.000001	0.008007
34	35	0.018225	0.000000	0.000001	0.006330
35	36	0.018300	0.000000	0.000001	0.009184
36	37	0.024163	0.000000	0.000001	0.008586
37	38	0.025825	0.000000	0.000001	0.005681
26	39	0.016140	0.000000	0.000000	0.008777
39	40	0.019000	0.000000	0.000001	0.007334
40	41	0.018292	0.000000	0.000001	0.009393
41	42	0.020727	0.000000	0.000001	0.009460
42	43	0.023668	0.000000	0.000001	0.007502
43	44	0.014442	0.000000	0.000001	0.006254
41	45	0.025649	0.000000	0.000000	0.005368
45	46	0.026063	0.000000	0.000001	0.007320
46	47	0.016949	0.000000	0.000001	0.008246
41	48	0.022480	0.000000	0.000001	0.009493
48	49	0.018354	0.000000	0.000001	0.009426
49	50	0.026863	0.000000	0.000001	0.006443
25	51	0.016507	0.000000	0.000001	0.008599
51	52	0.014037	0.000000	0.000001	0.007169
52	53	0.016557	0.000000	0.000001	0.006213
53	54	0.014735	0.000000	0.000001	0.007156
54	55	0.027666	0.000000	0.000001	0.007235
55	56	0.020770	0.000000	0.000000	0.009956
56	57	0.014705	0.000000	0.000000	0.008206
56	58	0.026007	0.000000	0.000000	0.005515
56	59	0.024807	0.000000	0.000001	0.008900
56	60	0.016337	0.000000	0.000001	0.009595
18	61	0.015541	0.000000	0.000000	0.008983
61	62	0.024990	0.000000	0.000001	0.007309
62	63	0.027533	0.000000	0.000001	0.006236
63	64	0.016827	0.000000	0.000001	0.006774
64	65	0.020323	0.000000	0.000001	0.005413
65	66	0.016959	0.000000	0.000001	0.008519
66	67	0.020554	0.000000	0.000001	0.006994
67	68	0.021050	0.000000	0.000001	0.006252

68	69	0.023996	0.000000	0.000001	0.009956
69	70	0.021370	0.000000	0.000000	0.006101
70	71	0.026579	0.000000	0.000000	0.006840
71	72	0.024723	0.000000	0.000001	0.008742
72	73	0.017534	0.000000	0.000001	0.007879
73	74	0.019948	0.000000	0.000001	0.007154
67	75	0.021620	0.000000	0.000001	0.008760
75	76	0.018065	0.000000	0.000000	0.008061
76	77	0.019486	0.000000	0.000000	0.006420
77	78	0.018165	0.000000	0.000001	0.005218
78	79	0.025567	0.000000	0.000000	0.009464
79	80	0.020745	0.000000	0.000000	0.006130
80	81	0.017535	0.000000	0.000001	0.008492
67	82	0.023215	0.000000	0.000001	0.006544
82	83	0.020739	0.000000	0.000000	0.009783
83	84	0.025105	0.000000	0.000001	0.005693
84	85	0.014809	0.000000	0.000001	0.007374
85	86	0.014173	0.000000	0.000001	0.006679
86	87	0.019810	0.000000	0.000000	0.009713
87	88	0.026975	0.000000	0.000001	0.008083
67	89	0.022068	0.000000	0.000000	0.007071
89	90	0.020887	0.000000	0.000001	0.007763
90	91	0.016357	0.000000	0.000001	0.009655
91	92	0.014841	0.000000	0.000001	0.009712
92	93	0.021287	0.000000	0.000001	0.006375
93	94	0.020778	0.000000	0.000001	0.007379
94	95	0.022448	0.000000	0.000001	0.008846
93	96	0.020929	0.000000	0.000001	0.008982
96	97	0.020749	0.000000	0.000001	0.006553
64	98	0.019563	0.000000	0.000001	0.007724
98	99	0.014038	0.000000	0.000001	0.007965
99	100	0.014313	0.000000	0.000001	0.006073
98	101	0.027368	0.000000	0.000001	0.009170
61	102	0.027323	0.000000	0.000001	0.008631
18	103	0.016715	0.000000	0.000001	0.006274
15	104	0.022514	0.000000	0.000001	0.009721
15	105	0.014756	0.000000	0.000001	0.009695
15	106	0.018590	0.000000	0.000001	0.008571
6	107	0.020705	0.000000	0.000001	0.006420
6	108	0.026077	0.000000	0.000001	0.009062
1	109	0.014657	0.000000	0.000001	0.007093
1	110	0.024014	0.000000	0.000001	0.005374

B.5 133-bus Test System

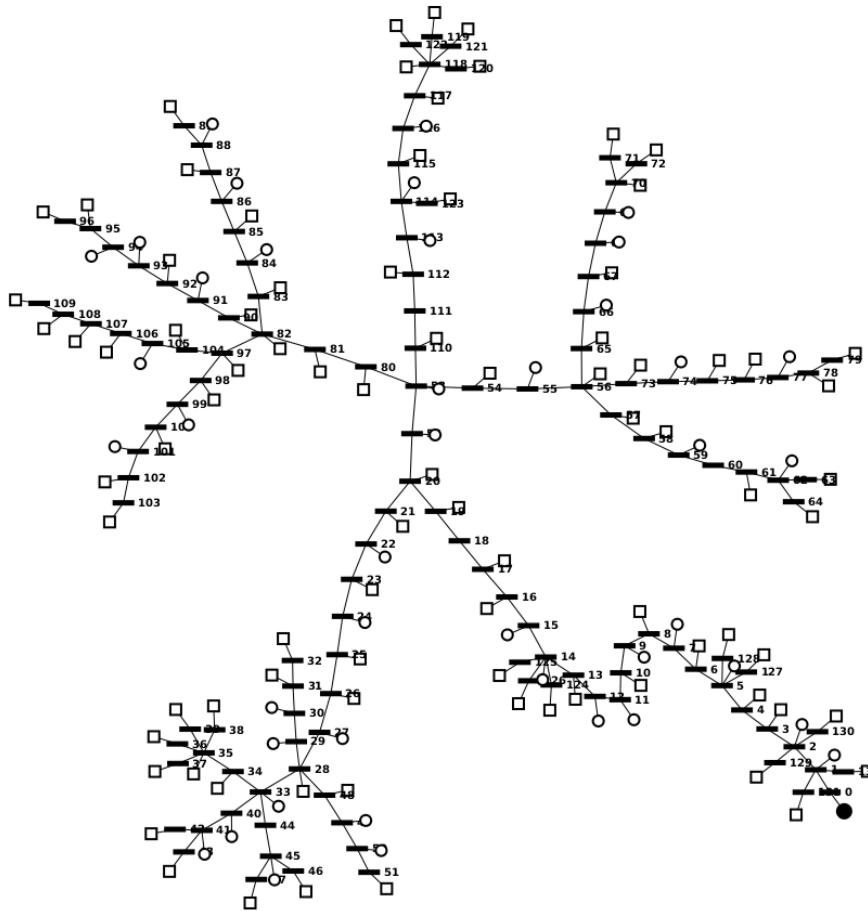

□ Load ■ Bus ○ Generator ● Source substation

Figure B.5: 133-bus test case

The figure B.5 represents the 133-bus test case. It is composed of multiple generators and loads. This network has been generated randomly.

B.5.1 Buses

Bus	Voltage Magnitude	Phase Angle
68	1.012910	0.011454
67	1.012935	0.011409
69	1.012889	0.011492
71	1.012853	0.011543
70	1.012864	0.011528
73	1.012988	0.011322
72	1.012854	0.011542

75	1.012965	0.011365
74	1.012975	0.011345
77	1.012948	0.011396
76	1.012956	0.011379
57	1.012975	0.011328
56	1.012999	0.011294
59	1.012933	0.011394
58	1.012957	0.011359
60	1.012906	0.011437
62	1.012853	0.011523
61	1.012879	0.011473
64	1.012839	0.011549
63	1.012838	0.011547
66	1.012959	0.011366
65	1.012979	0.011328
46	1.012457	0.012010
45	1.012467	0.011997
48	1.012587	0.011769
47	1.012456	0.012021
49	1.012577	0.011784
130	1.019250	0.001216
51	1.012559	0.011834
131	1.019547	0.000760
50	1.012568	0.011811
132	1.019546	0.000762
53	1.013152	0.011044
52	1.013316	0.010682
55	1.013045	0.011207
54	1.013089	0.011123
35	1.012416	0.012078
34	1.012469	0.011968
37	1.012408	0.012093
36	1.012402	0.012098
39	1.012404	0.012102
38	1.012402	0.012101
40	1.012492	0.011954
42	1.012459	0.012018
41	1.012472	0.011998
44	1.012493	0.011963
43	1.012461	0.012022
24	1.013051	0.011008
23	1.013156	0.010864
26	1.012804	0.011371
25	1.012926	0.011205

28	1.012599	0.011746
27	1.012699	0.011526
29	1.012588	0.011767
119	1.012689	0.011947
117	1.012735	0.011857
118	1.012697	0.011930
111	1.013037	0.011259
112	1.012976	0.011389
110	1.013086	0.011172
31	1.012564	0.011811
115	1.012816	0.011650
30	1.012578	0.011789
116	1.012774	0.011751
33	1.012518	0.011913
113	1.012926	0.011460
32	1.012552	0.011829
114	1.012860	0.011567
13	1.015563	0.007118
9	1.016788	0.005508
12	1.015894	0.006775
8	1.017095	0.005143
15	1.014909	0.008082
7	1.017430	0.004636
14	1.015190	0.007781
17	1.014326	0.008845
16	1.014640	0.008490
19	1.013707	0.009849
18	1.014035	0.009238
2	1.019262	0.001193
1	1.019557	0.000737
0	1.020000	0.000000
6	1.017813	0.003926
5	1.018185	0.003267
4	1.018575	0.002522
3	1.018951	0.001962
128	1.018173	0.003286
129	1.019251	0.001218
122	1.012685	0.011949
123	1.012849	0.011587
120	1.012688	0.011947
121	1.012684	0.011944
20	1.013466	0.010369
126	1.015180	0.007795
127	1.018176	0.003283

22	1.013288	0.010721
124	1.015179	0.007797
21	1.013370	0.010586
125	1.015180	0.007801
89	1.012941	0.011353
91	1.012993	0.011273
90	1.013003	0.011257
93	1.012969	0.011308
92	1.012981	0.011290
95	1.012951	0.011339
94	1.012960	0.011324
97	1.012994	0.011276
96	1.012938	0.011362
11	1.016261	0.006322
99	1.012969	0.011314
10	1.016480	0.005959
98	1.012979	0.011301
79	1.012920	0.011446
78	1.012935	0.011419
108	1.012942	0.011372
109	1.012931	0.011396
106	1.012961	0.011340
107	1.012953	0.011353
80	1.013095	0.011125
82	1.013018	0.011235
100	1.012955	0.011338
81	1.013057	0.011184
101	1.012945	0.011353
84	1.012995	0.011268
83	1.013006	0.011252
86	1.012975	0.011303
104	1.012983	0.011300
85	1.012984	0.011285
105	1.012973	0.011319
88	1.012953	0.011333
102	1.012934	0.011373
87	1.012962	0.011320
103	1.012921	0.011395

B.5.2 Lines

Bus 1	Bus 2	R	G	B	X
0	1	0.023831	0.000000	0.000000	0.008806
1	2	0.015821	0.000000	0.000001	0.006375

2	3	0.027345	0.000000	0.000001	0.005384
3	4	0.020797	0.000000	0.000001	0.008799
4	5	0.027022	0.000000	0.000001	0.008152
5	6	0.025783	0.000000	0.000001	0.008642
6	7	0.027670	0.000000	0.000001	0.008719
7	8	0.020147	0.000000	0.000001	0.008381
8	9	0.014910	0.000000	0.000001	0.008342
9	10	0.017950	0.000000	0.000001	0.007815
10	11	0.014274	0.000000	0.000001	0.005310
11	12	0.018379	0.000000	0.000001	0.009896
12	13	0.014250	0.000000	0.000001	0.009344
13	14	0.025855	0.000000	0.000001	0.008794
14	15	0.013979	0.000000	0.000001	0.008873
15	16	0.018166	0.000000	0.000000	0.007615
16	17	0.016399	0.000000	0.000001	0.009794
17	18	0.017683	0.000000	0.000001	0.008631
18	19	0.026652	0.000000	0.000001	0.008556
19	20	0.022382	0.000000	0.000001	0.005799
20	21	0.022030	0.000000	0.000001	0.005580
21	22	0.014074	0.000000	0.000001	0.005589
22	23	0.015609	0.000000	0.000001	0.010063
23	24	0.015329	0.000000	0.000001	0.007611
24	25	0.020528	0.000000	0.000001	0.008609
25	26	0.017624	0.000000	0.000001	0.008863
26	27	0.016277	0.000000	0.000001	0.007496
27	28	0.022370	0.000000	0.000001	0.005940
28	29	0.021827	0.000000	0.000001	0.007631
29	30	0.024280	0.000000	0.000001	0.006097
30	31	0.023668	0.000000	0.000001	0.009392
31	32	0.019393	0.000000	0.000001	0.008898
28	33	0.021259	0.000000	0.000001	0.006336
33	34	0.014510	0.000000	0.000001	0.009116
34	35	0.027700	0.000000	0.000001	0.008092
35	36	0.020795	0.000000	0.000001	0.009427
35	37	0.015541	0.000000	0.000000	0.005430
35	38	0.023161	0.000000	0.000001	0.010040
35	39	0.023923	0.000000	0.000001	0.009133
33	40	0.021771	0.000000	0.000001	0.009191
40	41	0.022164	0.000000	0.000001	0.005897
41	42	0.021719	0.000000	0.000001	0.008857
41	43	0.024575	0.000000	0.000001	0.006872
33	44	0.025557	0.000000	0.000001	0.008121
44	45	0.018181	0.000000	0.000001	0.009802
45	46	0.014045	0.000000	0.000001	0.007466



45	47	0.025593	0.000000	0.000001	0.005920
28	48	0.022584	0.000000	0.000001	0.008750
48	49	0.014406	0.000000	0.000001	0.007835
49	50	0.025665	0.000000	0.000001	0.005765
50	51	0.022540	0.000000	0.000001	0.006156
20	52	0.023355	0.000000	0.000001	0.006243
52	53	0.026889	0.000000	0.000001	0.006556
53	54	0.017421	0.000000	0.000001	0.009126
54	55	0.017601	0.000000	0.000001	0.005423
55	56	0.018431	0.000000	0.000001	0.005670
56	57	0.018067	0.000000	0.000001	0.008128
57	58	0.016753	0.000000	0.000000	0.005708
58	59	0.018429	0.000000	0.000000	0.008657
59	60	0.023196	0.000000	0.000001	0.009199
60	61	0.019003	0.000000	0.000001	0.009577
61	62	0.026255	0.000000	0.000001	0.008529
62	63	0.024700	0.000000	0.000001	0.009364
62	64	0.026275	0.000000	0.000000	0.008988
56	65	0.018074	0.000000	0.000001	0.006860
65	66	0.020486	0.000000	0.000001	0.006941
66	67	0.023625	0.000000	0.000001	0.007956
67	68	0.024017	0.000000	0.000001	0.009043
68	69	0.020615	0.000000	0.000001	0.007395
69	70	0.019134	0.000000	0.000001	0.009203
70	71	0.016417	0.000000	0.000001	0.008927
70	72	0.016276	0.000000	0.000001	0.008677
56	73	0.027054	0.000000	0.000001	0.005195
73	74	0.023195	0.000000	0.000001	0.008113
74	75	0.020592	0.000000	0.000001	0.005285
75	76	0.014064	0.000000	0.000001	0.005676
76	77	0.016665	0.000000	0.000001	0.005428
77	78	0.022429	0.000000	0.000001	0.008053
78	79	0.027098	0.000000	0.000000	0.010072
53	80	0.022409	0.000000	0.000001	0.009609
80	81	0.016099	0.000000	0.000001	0.006173
81	82	0.014412	0.000000	0.000001	0.006861
82	83	0.017816	0.000000	0.000001	0.008005
83	84	0.018055	0.000000	0.000001	0.007910
84	85	0.017925	0.000000	0.000001	0.007099
85	86	0.018548	0.000000	0.000001	0.005805
86	87	0.018031	0.000000	0.000001	0.009402
87	88	0.014053	0.000000	0.000001	0.006998
88	89	0.021175	0.000000	0.000001	0.008089
82	90	0.024552	0.000000	0.000001	0.008965

90	91	0.017176	0.000000	0.000001	0.007101
91	92	0.019062	0.000000	0.000000	0.007113
92	93	0.019284	0.000000	0.000001	0.008468
93	94	0.016998	0.000000	0.000001	0.005572
94	95	0.016175	0.000000	0.000001	0.005047
95	96	0.024158	0.000000	0.000001	0.008389
82	97	0.022153	0.000000	0.000000	0.007935
97	98	0.026924	0.000000	0.000001	0.008847
98	99	0.014076	0.000000	0.000000	0.006835
99	100	0.025921	0.000000	0.000001	0.008340
100	101	0.016011	0.000000	0.000001	0.007071
101	102	0.021136	0.000000	0.000001	0.006249
102	103	0.022690	0.000000	0.000000	0.008545
97	104	0.026016	0.000000	0.000001	0.007853
104	105	0.020712	0.000000	0.000000	0.007744
105	106	0.022932	0.000000	0.000001	0.008657
106	107	0.014208	0.000000	0.000001	0.006573
107	108	0.020477	0.000000	0.000001	0.009241
108	109	0.024793	0.000000	0.000001	0.008635
53	110	0.026417	0.000000	0.000001	0.008314
110	111	0.017950	0.000000	0.000001	0.006535
111	112	0.026564	0.000000	0.000001	0.007499
112	113	0.015000	0.000000	0.000001	0.007311
113	114	0.022228	0.000000	0.000001	0.009228
114	115	0.021227	0.000000	0.000001	0.007064
115	116	0.025267	0.000000	0.000001	0.006267
116	117	0.026361	0.000000	0.000000	0.005352
117	118	0.018605	0.000000	0.000001	0.006370
118	119	0.017206	0.000000	0.000001	0.005905
118	120	0.016941	0.000000	0.000001	0.006434
118	121	0.015023	0.000000	0.000001	0.009471
118	122	0.020666	0.000000	0.000001	0.009407
114	123	0.021382	0.000000	0.000001	0.006757
14	124	0.017301	0.000000	0.000000	0.007566
14	125	0.020502	0.000000	0.000001	0.005973
14	126	0.014620	0.000000	0.000001	0.006972
5	127	0.016167	0.000000	0.000001	0.006052
5	128	0.020562	0.000000	0.000001	0.008308
2	129	0.025733	0.000000	0.000001	0.006723
2	130	0.023807	0.000000	0.000001	0.007276
1	131	0.024494	0.000000	0.000001	0.007374
1	132	0.025446	0.000000	0.000001	0.006821



B.6 153-bus Test System

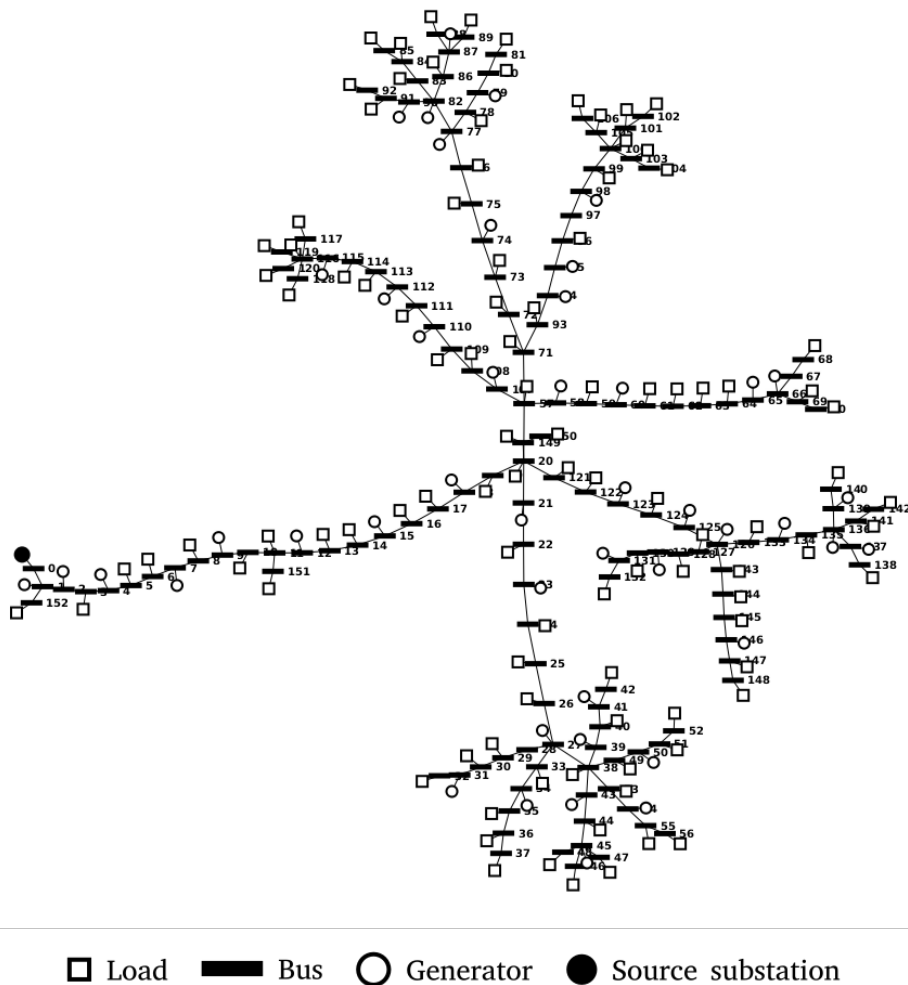

Figure B.6: 153-bus test case

The figure B.6 represents the 153-bus test case. It is composed of multiple generators and loads. This network has been generated randomly.

B.6.1 Buses

Bus	Voltage Magnitude	Phase Angle
68	1.012509	0.012400
67	1.012523	0.012380
69	1.012525	0.012377
151	1.016218	0.006389
152	1.019581	0.000452
150	1.012905	0.011659
71	1.012696	0.012110

70	1.012512	0.012402
73	1.012591	0.012279
72	1.012643	0.012205
75	1.012460	0.012475
74	1.012520	0.012383
77	1.012339	0.012635
76	1.012401	0.012574
57	1.012771	0.011964
56	1.012175	0.012776
59	1.012718	0.012059
58	1.012748	0.012012
60	1.012690	0.012113
62	1.012637	0.012194
61	1.012664	0.012143
64	1.012584	0.012281
63	1.012614	0.012233
66	1.012536	0.012363
65	1.012565	0.012319
46	1.012121	0.012908
45	1.012132	0.012884
48	1.012121	0.012909
47	1.012121	0.012908
49	1.012210	0.012729
130	1.012484	0.012381
139	1.012372	0.012542
133	1.012491	0.012353
134	1.012453	0.012429
51	1.012193	0.012763
131	1.012474	0.012405
50	1.012201	0.012749
132	1.012462	0.012419
53	1.012208	0.012717
137	1.012373	0.012544
52	1.012182	0.012791
138	1.012361	0.012562
55	1.012185	0.012753
135	1.012413	0.012477
54	1.012198	0.012739
136	1.012384	0.012521
35	1.012246	0.012648
34	1.012258	0.012624
37	1.012222	0.012687
36	1.012234	0.012667
39	1.012207	0.012720



140	1.012364	0.012556
38	1.012220	0.012702
141	1.012371	0.012544
144	1.012512	0.012324
145	1.012500	0.012343
40	1.012196	0.012745
142	1.012362	0.012568
143	1.012523	0.012309
42	1.012175	0.012774
148	1.012467	0.012405
41	1.012187	0.012759
149	1.012918	0.011637
44	1.012169	0.012811
146	1.012491	0.012360
43	1.012194	0.012762
147	1.012478	0.012385
24	1.012533	0.012244
23	1.012642	0.012077
26	1.012352	0.012476
25	1.012453	0.012349
28	1.012266	0.012599
27	1.012279	0.012585
29	1.012253	0.012614
119	1.012305	0.012772
117	1.012302	0.012772
118	1.012305	0.012776
111	1.012543	0.012334
112	1.012510	0.012406
110	1.012588	0.012268
31	1.012231	0.012658
115	1.012366	0.012676
30	1.012240	0.012638
116	1.012315	0.012752
33	1.012269	0.012607
113	1.012467	0.012516
32	1.012219	0.012685
114	1.012415	0.012621
13	1.015435	0.007638
9	1.016862	0.005097
12	1.015846	0.006945
8	1.017178	0.004559
15	1.014720	0.008949
7	1.017596	0.003903
14	1.015129	0.008338

17	1.014059	0.010045
16	1.014466	0.009385
19	1.013290	0.011260
18	1.013648	0.010642
2	1.019280	0.000995
1	1.019595	0.000432
0	1.020000	0.000000
6	1.017959	0.003315
5	1.018218	0.002816
4	1.018489	0.002391
3	1.018855	0.001741
128	1.012505	0.012345
129	1.012495	0.012367
122	1.012786	0.011874
123	1.012717	0.011981
120	1.012306	0.012774
121	1.012863	0.011751
20	1.012929	0.011620
126	1.012532	0.012296
127	1.012520	0.012321
22	1.012721	0.011921
124	1.012648	0.012059
21	1.012828	0.011771
125	1.012592	0.012172
89	1.012230	0.012779
91	1.012265	0.012726
90	1.012278	0.012712
93	1.012670	0.012153
92	1.012251	0.012750
95	1.012597	0.012283
94	1.012631	0.012227
97	1.012531	0.012368
96	1.012564	0.012324
11	1.016229	0.006374
99	1.012474	0.012484
10	1.016503	0.005830
98	1.012505	0.012416
79	1.012318	0.012663
78	1.012328	0.012648
108	1.012684	0.012101
109	1.012643	0.012172
106	1.012418	0.012591
107	1.012722	0.012031
80	1.012306	0.012684

82	1.012293	0.012688
100	1.012439	0.012546
81	1.012295	0.012703
101	1.012426	0.012573
84	1.012267	0.012728
83	1.012279	0.012706
86	1.012268	0.012723
104	1.012416	0.012579
85	1.012260	0.012744
105	1.012427	0.012570
88	1.012230	0.012783
102	1.012416	0.012592
87	1.012242	0.012765
103	1.012427	0.012563

B.6.2 Lines

Bus 1	Bus 2	R	G	B	X
0	1	0.016424	0.000000	0.000001	0.009899
1	2	0.020724	0.000000	0.000001	0.006394
2	3	0.027451	0.000000	0.000001	0.008733
3	4	0.023909	0.000000	0.000001	0.007528
4	5	0.015817	0.000000	0.000001	0.005928
5	6	0.018208	0.000000	0.000001	0.005065
6	7	0.021810	0.000000	0.000001	0.007887
7	8	0.024364	0.000000	0.000001	0.009191
8	9	0.019803	0.000000	0.000001	0.006711
9	10	0.026542	0.000000	0.000001	0.006826
10	11	0.019697	0.000000	0.000001	0.005341
11	12	0.022126	0.000000	0.000001	0.008970
12	13	0.026454	0.000000	0.000001	0.009078
13	14	0.025971	0.000000	0.000000	0.005532
14	15	0.023583	0.000000	0.000001	0.009629
15	16	0.016591	0.000000	0.000001	0.005607
16	17	0.025251	0.000000	0.000001	0.009263
17	18	0.023075	0.000000	0.000001	0.009854
18	19	0.023432	0.000000	0.000001	0.007943
19	20	0.014644	0.000000	0.000001	0.009774
20	21	0.020229	0.000000	0.000001	0.008548
21	22	0.020232	0.000000	0.000001	0.009205
22	23	0.020304	0.000000	0.000001	0.005894
23	24	0.022234	0.000000	0.000000	0.009143
24	25	0.014197	0.000000	0.000001	0.007126
25	26	0.017183	0.000000	0.000001	0.009140

26	27	0.014508	0.000000	0.000001	0.006334
27	28	0.016087	0.000000	0.000001	0.009235
28	29	0.016409	0.000000	0.000001	0.008845
29	30	0.023900	0.000000	0.000001	0.007719
30	31	0.020649	0.000000	0.000000	0.005373
31	32	0.027173	0.000000	0.000001	0.006400
27	33	0.023883	0.000000	0.000001	0.005860
33	34	0.019431	0.000000	0.000001	0.008663
34	35	0.026022	0.000000	0.000001	0.007897
35	36	0.020228	0.000000	0.000001	0.009239
36	37	0.021743	0.000000	0.000001	0.009751
27	38	0.020012	0.000000	0.000001	0.006044
38	39	0.019742	0.000000	0.000000	0.010048
39	40	0.025718	0.000000	0.000001	0.006452
40	41	0.014565	0.000000	0.000001	0.007056
41	42	0.016328	0.000000	0.000000	0.009642
38	43	0.019929	0.000000	0.000001	0.005342
43	44	0.016498	0.000000	0.000001	0.005530
44	45	0.024102	0.000000	0.000001	0.008154
45	46	0.024603	0.000000	0.000001	0.006180
45	47	0.023463	0.000000	0.000001	0.007711
45	48	0.025644	0.000000	0.000001	0.005955
38	49	0.027616	0.000000	0.000001	0.005225
49	50	0.019279	0.000000	0.000001	0.006161
50	51	0.014879	0.000000	0.000001	0.005072
51	52	0.026947	0.000000	0.000001	0.007296
38	53	0.017524	0.000000	0.000000	0.008018
53	54	0.023256	0.000000	0.000001	0.005617
54	55	0.016210	0.000000	0.000001	0.009382
55	56	0.024287	0.000000	0.000001	0.005677
20	57	0.025650	0.000000	0.000000	0.006172
57	58	0.024318	0.000000	0.000001	0.005788
58	59	0.024942	0.000000	0.000001	0.008899
59	60	0.027375	0.000000	0.000001	0.007923
60	61	0.016566	0.000000	0.000001	0.009010
61	62	0.026101	0.000000	0.000001	0.007460
62	63	0.020203	0.000000	0.000001	0.007136
63	64	0.024779	0.000000	0.000001	0.009625
64	65	0.019356	0.000000	0.000001	0.005606
65	66	0.022701	0.000000	0.000001	0.009550
66	67	0.018630	0.000000	0.000001	0.008711
67	68	0.020187	0.000000	0.000001	0.008736
66	69	0.014761	0.000000	0.000001	0.007903
69	70	0.024585	0.000000	0.000001	0.009396



57	71	0.019503	0.000000	0.000001	0.005446
71	72	0.020637	0.000000	0.000001	0.006421
72	73	0.016410	0.000000	0.000001	0.007156
73	74	0.022820	0.000000	0.000001	0.009807
74	75	0.020200	0.000000	0.000001	0.008004
75	76	0.021580	0.000000	0.000001	0.007734
76	77	0.014028	0.000000	0.000001	0.009802
77	78	0.014548	0.000000	0.000001	0.008064
78	79	0.016692	0.000000	0.000001	0.008006
79	80	0.022319	0.000000	0.000001	0.008118
80	81	0.019965	0.000000	0.000000	0.008575
77	82	0.015127	0.000000	0.000001	0.008622
82	83	0.020142	0.000000	0.000001	0.009972
83	84	0.024314	0.000000	0.000001	0.007938
84	85	0.016945	0.000000	0.000001	0.005221
82	86	0.018903	0.000000	0.000001	0.008589
86	87	0.022849	0.000000	0.000001	0.009324
87	88	0.020205	0.000000	0.000001	0.008148
87	89	0.015689	0.000000	0.000001	0.008030
82	90	0.024794	0.000000	0.000001	0.009677
90	91	0.015498	0.000000	0.000001	0.009603
91	92	0.023991	0.000000	0.000001	0.009309
71	93	0.015617	0.000000	0.000001	0.005640
93	94	0.026368	0.000000	0.000001	0.007996
94	95	0.020085	0.000000	0.000001	0.007392
95	96	0.015303	0.000000	0.000001	0.007982
96	97	0.016024	0.000000	0.000001	0.008098
97	98	0.016864	0.000000	0.000001	0.005633
98	99	0.023673	0.000000	0.000001	0.006107
99	100	0.022136	0.000000	0.000001	0.007788
100	101	0.026705	0.000000	0.000000	0.008969
101	102	0.019418	0.000000	0.000001	0.007290
100	103	0.018783	0.000000	0.000001	0.007653
103	104	0.018317	0.000000	0.000001	0.008138
100	105	0.025265	0.000000	0.000001	0.008338
105	106	0.021022	0.000000	0.000001	0.006196
57	107	0.017544	0.000000	0.000001	0.009002
107	108	0.017778	0.000000	0.000001	0.006212
108	109	0.018366	0.000000	0.000001	0.007063
109	110	0.024530	0.000000	0.000001	0.009469
110	111	0.017082	0.000000	0.000001	0.008136
111	112	0.018080	0.000000	0.000001	0.005420
112	113	0.027495	0.000000	0.000001	0.006378
113	114	0.026269	0.000000	0.000001	0.008638

114	115	0.014682	0.000000	0.000001	0.009794
115	116	0.019495	0.000000	0.000001	0.009334
116	117	0.020201	0.000000	0.000000	0.009617
116	118	0.023149	0.000000	0.000000	0.007254
116	119	0.020364	0.000000	0.000001	0.006932
116	120	0.021374	0.000000	0.000001	0.006248
20	121	0.027393	0.000000	0.000001	0.007044
121	122	0.026328	0.000000	0.000001	0.009457
122	123	0.023019	0.000000	0.000001	0.008710
123	124	0.017366	0.000000	0.000000	0.009803
124	125	0.023519	0.000000	0.000001	0.006151
125	126	0.025672	0.000000	0.000001	0.006393
126	127	0.026269	0.000000	0.000001	0.005767
127	128	0.025472	0.000000	0.000001	0.009110
128	129	0.022256	0.000000	0.000000	0.005447
129	130	0.015829	0.000000	0.000001	0.007932
130	131	0.023761	0.000000	0.000001	0.005641
131	132	0.015437	0.000000	0.000001	0.008809
126	133	0.020516	0.000000	0.000001	0.009334
133	134	0.026032	0.000000	0.000000	0.007690
134	135	0.017385	0.000000	0.000001	0.009619
135	136	0.015391	0.000000	0.000000	0.006870
136	137	0.022959	0.000000	0.000001	0.006439
137	138	0.017887	0.000000	0.000001	0.007800
136	139	0.021029	0.000000	0.000001	0.007680
139	140	0.014685	0.000000	0.000001	0.005118
136	141	0.023730	0.000000	0.000000	0.008846
141	142	0.024803	0.000000	0.000001	0.006006
126	143	0.014454	0.000000	0.000001	0.005485
143	144	0.017130	0.000000	0.000001	0.007438
144	145	0.019972	0.000000	0.000001	0.007817
145	146	0.018113	0.000000	0.000001	0.005568
146	147	0.026201	0.000000	0.000001	0.007398
147	148	0.021006	0.000000	0.000001	0.007420
20	149	0.018786	0.000000	0.000001	0.008532
149	150	0.022724	0.000000	0.000000	0.009785
11	151	0.015135	0.000000	0.000001	0.009190
1	152	0.022299	0.000000	0.000001	0.009442



B.7 207-bus Test System

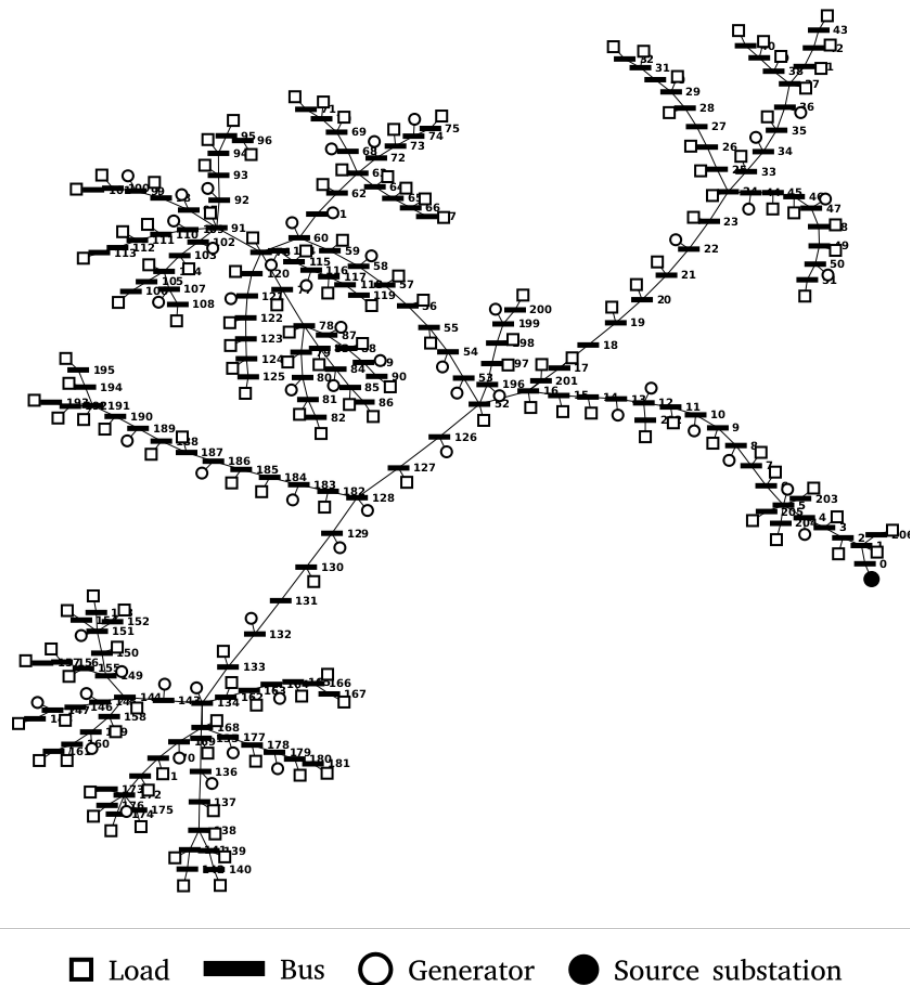

Figure B.7: 207-bus test case

The figure B.7 represents the 207-bus test case. It is composed of multiple generators and loads. This network has been generated randomly.

B.7.1 Buses

Bus	Voltage Magnitude	Phase Angle
151	1.010322	0.013968
152	1.010308	0.013992
150	1.010354	0.013926
155	1.010376	0.013877
156	1.010367	0.013895
153	1.010311	0.013994
154	1.010313	0.013985

159	1.010400	0.013807
157	1.010356	0.013912
158	1.010413	0.013794
162	1.010554	0.013616
163	1.010543	0.013637
160	1.010389	0.013830
161	1.010377	0.013848
166	1.010511	0.013683
167	1.010500	0.013707
164	1.010530	0.013651
165	1.010520	0.013667
168	1.010511	0.013688
169	1.010476	0.013750
130	1.011217	0.012545
139	1.010461	0.013788
133	1.010734	0.013277
134	1.010566	0.013594
131	1.011065	0.012800
132	1.010900	0.013045
137	1.010500	0.013718
138	1.010473	0.013762
135	1.010546	0.013628
136	1.010519	0.013679
140	1.010449	0.013804
141	1.010465	0.013784
144	1.010422	0.013781
145	1.010410	0.013800
142	1.010454	0.013803
143	1.010497	0.013673
148	1.010375	0.013854
149	1.010385	0.013863
146	1.010397	0.013817
147	1.010388	0.013831
191	1.011240	0.012457
192	1.011224	0.012482
190	1.011269	0.012415
195	1.011224	0.012490
196	1.012062	0.011174
193	1.011212	0.012503
194	1.011232	0.012471
199	1.012034	0.011227
197	1.012052	0.011196
198	1.012043	0.011210
89	1.010506	0.013719

170	1.010436	0.013816
173	1.010313	0.014008
174	1.010312	0.014005
171	1.010380	0.013914
172	1.010327	0.013981
91	1.010562	0.013640
90	1.010496	0.013741
93	1.010540	0.013680
177	1.010496	0.013709
92	1.010551	0.013657
178	1.010485	0.013727
95	1.010515	0.013713
175	1.010316	0.013996
94	1.010528	0.013692
176	1.010316	0.014006
97	1.010553	0.013654
96	1.010506	0.013736
99	1.010527	0.013697
179	1.010474	0.013754
98	1.010539	0.013678
79	1.010524	0.013688
180	1.010464	0.013773
78	1.010538	0.013662
181	1.010452	0.013792
184	1.011423	0.012185
185	1.011394	0.012238
182	1.011483	0.012100
183	1.011453	0.012137
80	1.010510	0.013715
82	1.010488	0.013759
188	1.011317	0.012350
81	1.010497	0.013741
189	1.011297	0.012381
84	1.010515	0.013702
186	1.011371	0.012271
83	1.010527	0.013686
187	1.011348	0.012300
86	1.010495	0.013748
85	1.010506	0.013722
88	1.010515	0.013699
87	1.010528	0.013681
68	1.010610	0.013530
67	1.010578	0.013587
69	1.010599	0.013544

71	1.010575	0.013583
70	1.010589	0.013563
73	1.010603	0.013540
72	1.010613	0.013524
75	1.010576	0.013573
74	1.010590	0.013556
77	1.010570	0.013609
76	1.010614	0.013540
57	1.011245	0.012478
56	1.011405	0.012170
59	1.010855	0.013125
58	1.011038	0.012803
205	1.017392	0.003525
206	1.019503	0.000531
60	1.010730	0.013326
200	1.012022	0.011243
62	1.010652	0.013464
61	1.010690	0.013403
64	1.010611	0.013529
203	1.017393	0.003524
63	1.010624	0.013511
204	1.017390	0.003518
66	1.010588	0.013565
201	1.012492	0.010602
65	1.010598	0.013546
202	1.014026	0.008462
46	1.012100	0.011185
45	1.012112	0.011163
48	1.012076	0.011218
47	1.012087	0.011198
49	1.012061	0.011240
51	1.012041	0.011275
50	1.012051	0.011256
53	1.011924	0.011350
52	1.012072	0.011161
55	1.011593	0.011864
54	1.011722	0.011632
35	1.012064	0.011262
34	1.012094	0.011209
37	1.012016	0.011353
36	1.012040	0.011308
39	1.011991	0.011390
38	1.012003	0.011368
40	1.011980	0.011415

42	1.011995	0.011397
41	1.012004	0.011377
44	1.012127	0.011148
43	1.011987	0.011417
24	1.012137	0.011134
23	1.012180	0.011068
26	1.012114	0.011174
25	1.012128	0.011150
28	1.012094	0.011208
27	1.012103	0.011190
29	1.012086	0.011223
119	1.010552	0.013647
117	1.010573	0.013601
118	1.010560	0.013627
111	1.010527	0.013693
112	1.010517	0.013719
110	1.010540	0.013675
31	1.012064	0.011266
115	1.010591	0.013570
30	1.012077	0.011244
116	1.010583	0.013586
33	1.012117	0.011181
113	1.010505	0.013739
32	1.012056	0.011289
114	1.010601	0.013557
13	1.013618	0.008982
9	1.015375	0.006409
12	1.014040	0.008434
8	1.015910	0.005584
15	1.012943	0.009923
7	1.016364	0.005131
14	1.013283	0.009475
17	1.012459	0.010636
16	1.012505	0.010578
19	1.012354	0.010755
18	1.012404	0.010693
2	1.018992	0.001168
1	1.019514	0.000505
0	1.020000	0.000000
6	1.016909	0.004371
5	1.017404	0.003501
4	1.017916	0.002930
3	1.018491	0.002145
128	1.011508	0.012061

129	1.011382	0.012301
122	1.010569	0.013594
123	1.010560	0.013611
120	1.010596	0.013565
121	1.010583	0.013579
20	1.012309	0.010855
126	1.011891	0.011475
127	1.011650	0.011831
22	1.012228	0.010986
124	1.010546	0.013634
21	1.012275	0.010905
125	1.010535	0.013655
11	1.014514	0.007641
10	1.014976	0.007074
108	1.010473	0.013827
109	1.010552	0.013653
106	1.010469	0.013837
107	1.010484	0.013808
100	1.010517	0.013716
101	1.010505	0.013733
104	1.010495	0.013789
105	1.010482	0.013813
102	1.010542	0.013694
103	1.010523	0.013742

B.7.2 Lines

Bus 1	Bus 2	R	G	B	X
0	1	0.014863	0.000000	0.000001	0.008835
1	2	0.019387	0.000000	0.000001	0.009028
2	3	0.027117	0.000000	0.000001	0.006778
3	4	0.022684	0.000000	0.000001	0.009683
4	5	0.017018	0.000000	0.000001	0.009343
5	6	0.026446	0.000000	0.000001	0.007764
6	7	0.023773	0.000000	0.000001	0.009805
7	8	0.014918	0.000000	0.000001	0.009278
8	9	0.025429	0.000000	0.000001	0.009154
9	10	0.020267	0.000000	0.000001	0.006586
10	11	0.017992	0.000000	0.000001	0.008840
11	12	0.024138	0.000000	0.000001	0.007827
12	13	0.017763	0.000000	0.000001	0.008133
13	14	0.015709	0.000000	0.000001	0.006106
14	15	0.014448	0.000000	0.000001	0.006528
15	16	0.020783	0.000000	0.000001	0.007959

16	17	0.016877	0.000000	0.000001	0.007804
17	18	0.016894	0.000000	0.000001	0.009976
18	19	0.018000	0.000000	0.000001	0.008536
19	20	0.026951	0.000000	0.000001	0.005277
20	21	0.014077	0.000000	0.000001	0.005471
21	22	0.022361	0.000000	0.000001	0.007023
22	23	0.022467	0.000000	0.000001	0.007084
23	24	0.018222	0.000000	0.000001	0.006843
24	25	0.018216	0.000000	0.000001	0.005602
25	26	0.026169	0.000000	0.000000	0.009080
26	27	0.017857	0.000000	0.000000	0.008213
27	28	0.018845	0.000000	0.000001	0.005823
28	29	0.015865	0.000000	0.000001	0.005640
29	30	0.021870	0.000000	0.000001	0.005908
30	31	0.022981	0.000000	0.000000	0.009532
31	32	0.023147	0.000000	0.000001	0.005526
24	33	0.023952	0.000000	0.000001	0.005372
33	34	0.015339	0.000000	0.000001	0.008486
34	35	0.027472	0.000000	0.000001	0.009529
35	36	0.023428	0.000000	0.000001	0.007943
36	37	0.022739	0.000000	0.000001	0.007738
37	38	0.016404	0.000000	0.000001	0.009805
38	39	0.021842	0.000000	0.000001	0.007701
39	40	0.024787	0.000000	0.000001	0.006507
37	41	0.024155	0.000000	0.000001	0.008475
41	42	0.020424	0.000000	0.000001	0.006394
42	43	0.019154	0.000000	0.000001	0.005619
24	44	0.017013	0.000000	0.000001	0.006432
44	45	0.019699	0.000000	0.000001	0.009886
45	46	0.025097	0.000000	0.000001	0.006329
46	47	0.015888	0.000000	0.000001	0.009990
47	48	0.022717	0.000000	0.000001	0.006325
48	49	0.024960	0.000000	0.000001	0.010012
49	50	0.017908	0.000000	0.000001	0.007351
50	51	0.020160	0.000000	0.000001	0.006584
16	52	0.021865	0.000000	0.000001	0.009645
52	53	0.016549	0.000000	0.000000	0.007697
53	54	0.024389	0.000000	0.000000	0.010069
54	55	0.019426	0.000000	0.000001	0.005529
55	56	0.025869	0.000000	0.000001	0.008672
56	57	0.025615	0.000000	0.000001	0.006612
57	58	0.027576	0.000000	0.000001	0.009877
58	59	0.026911	0.000000	0.000001	0.008117
59	60	0.016995	0.000000	0.000001	0.005936

60	61	0.026997	0.000000	0.000001	0.006700
61	62	0.022026	0.000000	0.000001	0.006973
62	63	0.016802	0.000000	0.000001	0.005335
63	64	0.019591	0.000000	0.000001	0.008971
64	65	0.017639	0.000000	0.000001	0.009482
65	66	0.018873	0.000000	0.000001	0.006562
66	67	0.022233	0.000000	0.000001	0.006687
63	68	0.019820	0.000000	0.000001	0.008972
68	69	0.015458	0.000000	0.000001	0.007329
69	70	0.018860	0.000000	0.000001	0.005744
70	71	0.020650	0.000000	0.000001	0.009693
63	72	0.015496	0.000000	0.000001	0.007796
72	73	0.017429	0.000000	0.000001	0.005511
73	74	0.018768	0.000000	0.000001	0.009380
74	75	0.018523	0.000000	0.000001	0.009452
60	76	0.023198	0.000000	0.000000	0.006706
76	77	0.025082	0.000000	0.000001	0.009143
77	78	0.019104	0.000000	0.000001	0.006706
78	79	0.026546	0.000000	0.000001	0.007280
79	80	0.027585	0.000000	0.000001	0.008317
80	81	0.025263	0.000000	0.000000	0.006725
81	82	0.018314	0.000000	0.000001	0.005316
78	83	0.024535	0.000000	0.000001	0.007195
83	84	0.017929	0.000000	0.000001	0.009704
84	85	0.020674	0.000000	0.000001	0.005826
85	86	0.026323	0.000000	0.000001	0.008460
78	87	0.020392	0.000000	0.000001	0.006371
87	88	0.019739	0.000000	0.000001	0.008763
88	89	0.020665	0.000000	0.000001	0.005193
89	90	0.022630	0.000000	0.000001	0.005591
76	91	0.021593	0.000000	0.000001	0.006049
91	92	0.019411	0.000000	0.000001	0.007394
92	93	0.024901	0.000000	0.000001	0.005155
93	94	0.014951	0.000000	0.000001	0.009304
94	95	0.022840	0.000000	0.000001	0.008880
95	96	0.024905	0.000000	0.000001	0.005126
91	97	0.015525	0.000000	0.000001	0.006106
97	98	0.025749	0.000000	0.000000	0.008315
98	99	0.020432	0.000000	0.000001	0.008503
99	100	0.019385	0.000000	0.000001	0.005521
100	101	0.018198	0.000000	0.000001	0.009693
91	102	0.027305	0.000000	0.000001	0.005804
102	103	0.024126	0.000000	0.000001	0.005490
103	104	0.024759	0.000000	0.000001	0.010079

104	105	0.024867	0.000000	0.000001	0.009366
105	106	0.025720	0.000000	0.000001	0.009537
104	107	0.018657	0.000000	0.000001	0.008521
107	108	0.019140	0.000000	0.000001	0.007803
91	109	0.014302	0.000000	0.000001	0.008275
109	110	0.023496	0.000000	0.000000	0.007329
110	111	0.020244	0.000000	0.000001	0.009696
111	112	0.026288	0.000000	0.000001	0.006780
112	113	0.020467	0.000000	0.000001	0.009281
76	114	0.019180	0.000000	0.000001	0.009970
114	115	0.015124	0.000000	0.000001	0.007192
115	116	0.017032	0.000000	0.000001	0.005973
116	117	0.017516	0.000000	0.000001	0.007956
117	118	0.026836	0.000000	0.000001	0.009686
118	119	0.020918	0.000000	0.000001	0.005594
76	120	0.027147	0.000000	0.000000	0.010062
120	121	0.015499	0.000000	0.000001	0.009131
121	122	0.016988	0.000000	0.000001	0.009414
122	123	0.017532	0.000000	0.000001	0.005323
123	124	0.023128	0.000000	0.000000	0.008780
124	125	0.020885	0.000000	0.000001	0.006717
52	126	0.021184	0.000000	0.000001	0.006787
126	127	0.024544	0.000000	0.000001	0.009796
127	128	0.015634	0.000000	0.000001	0.005536
128	129	0.018309	0.000000	0.000001	0.005215
129	130	0.019125	0.000000	0.000001	0.007807
130	131	0.019710	0.000000	0.000001	0.006872
131	132	0.019107	0.000000	0.000001	0.007887
132	133	0.018276	0.000000	0.000001	0.008117
133	134	0.024088	0.000000	0.000001	0.007202
134	135	0.017815	0.000000	0.000001	0.006772
135	136	0.026655	0.000000	0.000001	0.009574
136	137	0.020110	0.000000	0.000001	0.006026
137	138	0.022735	0.000000	0.000001	0.009982
138	139	0.027533	0.000000	0.000000	0.008106
139	140	0.016789	0.000000	0.000001	0.009698
138	141	0.021730	0.000000	0.000000	0.005534
141	142	0.019056	0.000000	0.000001	0.008741
134	143	0.014970	0.000000	0.000001	0.008587
143	144	0.019950	0.000000	0.000001	0.008499
144	145	0.021152	0.000000	0.000001	0.008609
145	146	0.018801	0.000000	0.000001	0.009159
146	147	0.014943	0.000000	0.000000	0.006834
147	148	0.023925	0.000000	0.000001	0.008720

144	149	0.021336	0.000000	0.000001	0.005752
149	150	0.021973	0.000000	0.000001	0.006775
150	151	0.015246	0.000000	0.000001	0.008265
151	152	0.025308	0.000000	0.000001	0.008499
151	153	0.026037	0.000000	0.000001	0.007744
151	154	0.017977	0.000000	0.000001	0.006398
149	155	0.015349	0.000000	0.000001	0.005321
155	156	0.019459	0.000000	0.000001	0.005463
156	157	0.018160	0.000000	0.000001	0.008131
144	158	0.014883	0.000000	0.000001	0.005962
158	159	0.014393	0.000000	0.000001	0.009491
159	160	0.024205	0.000000	0.000001	0.005759
160	161	0.019465	0.000000	0.000001	0.008203
134	162	0.024161	0.000000	0.000001	0.005466
162	163	0.022928	0.000000	0.000001	0.005697
163	164	0.016187	0.000000	0.000001	0.009617
164	165	0.017287	0.000000	0.000001	0.005984
165	166	0.016475	0.000000	0.000001	0.005349
166	167	0.025173	0.000000	0.000001	0.006774
134	168	0.020081	0.000000	0.000001	0.006800
168	169	0.016067	0.000000	0.000001	0.005579
169	170	0.017475	0.000000	0.000001	0.006377
170	171	0.025513	0.000000	0.000001	0.009083
171	172	0.018111	0.000000	0.000001	0.009926
172	173	0.027274	0.000000	0.000000	0.009065
172	174	0.024186	0.000000	0.000000	0.008930
172	175	0.016004	0.000000	0.000000	0.008193
172	176	0.025017	0.000000	0.000000	0.005324
168	177	0.022760	0.000000	0.000001	0.009768
177	178	0.019370	0.000000	0.000001	0.006435
178	179	0.026993	0.000000	0.000001	0.006468
179	180	0.019443	0.000000	0.000001	0.005545
180	181	0.020591	0.000000	0.000001	0.008895
128	182	0.021380	0.000000	0.000001	0.006611
182	183	0.020584	0.000000	0.000001	0.009935
183	184	0.026186	0.000000	0.000001	0.008755
184	185	0.027699	0.000000	0.000000	0.007796
185	186	0.017989	0.000000	0.000001	0.007347
186	187	0.015871	0.000000	0.000001	0.007678
187	188	0.026275	0.000000	0.000001	0.009364
188	189	0.016462	0.000000	0.000001	0.006519
189	190	0.018670	0.000000	0.000001	0.009718
190	191	0.022169	0.000000	0.000000	0.009593
191	192	0.025880	0.000000	0.000001	0.009834



192	193	0.020317	0.000000	0.000001	0.008092
191	194	0.014340	0.000000	0.000001	0.005346
194	195	0.019247	0.000000	0.000001	0.005171
52	196	0.015253	0.000000	0.000001	0.007676
196	197	0.022929	0.000000	0.000001	0.005663
197	198	0.015428	0.000000	0.000001	0.006746
198	199	0.018849	0.000000	0.000001	0.006974
199	200	0.017264	0.000000	0.000001	0.009276
16	201	0.023985	0.000000	0.000001	0.009310
12	202	0.027625	0.000000	0.000001	0.008587
5	203	0.024110	0.000000	0.000001	0.007091
5	204	0.019165	0.000000	0.000001	0.009884
5	205	0.024187	0.000000	0.000001	0.008033
1	206	0.025600	0.000000	0.000001	0.008069

Bibliography

- Aravindhababu and Ashokkumar. "A robust decoupled power flow for distribution systems". In: *Energy Conversion and Management* 52.4 (2011), pp. 1930–1933. ISSN: 01968904.
- Abul'Wafa. "A network-topology-based load flow for radial distribution networks with composite and exponential load". In: *Electric Power Systems Research* 91 (2012), pp. 37–43. ISSN: 03787796.
- Abur and Exposito. *Power System State Estimation Theory and Implementation*. 2004. ISBN: 0824755707.
- Aote, Raghuwanshi Principal, and Latesh Malik HOD. "PSO..A Brief Review on Particle Swarm Optimization: Limitations & Future Directions". In: *International Journal of Computer Science Engineering* 2.05 (2013), pp. 2319–7323.
- Augugliaro, Dusonchet, Favuzza, Ippolito, and Riva Sanseverino. "A new backward /forward method for solving radial distribution networks with PV nodes". In: *Electric Power Systems Research* 78.3 (2008), pp. 330–336. ISSN: 03787796.
- Bonhomme and Cortinas. "Une nouvelle fonction de regulation de tension pour faciliter le raccordement de producteurs decentralises sur le reseau de distribution". In: *Electricity Distribution, ...* (2001).
- Briceno Vicente, Caire, and Hadjsaid. "Probabilistic load flow for voltage assessment in radial systems with wind power". In: *International Journal of Electrical Power and Energy Systems* 41.1 (2012), pp. 27–33. ISSN: 01420615.
- Belkacemi, Feliachi, Choudhry, and Saymansky. "Multi-Agent systems hardware development and deployment for smart grid control applications". In: *IEEE Power and Energy Society General Meeting*. 2011. ISBN: 9781457710018.
- Bernon, Camps, Gleizes, and Glize. "La conception de systèmes multi-agents adaptatifs: contraintes et spécificités". In: *Atelier de Méthodologie et ... SMA* (2001).
- Biserica. "Observabilité et reconstruction d'état des réseaux de distribution du futur". PhD thesis. 2011.
- Baran and Kelley. "A branch-current-based state estimation method for distribution systems". In: *IEEE Transactions on Power Systems* 10.1 (1995), pp. 483–491. ISSN: 08858950.
- Baran and McDermott. "Distribution system state estimation using AMI data". In: *2009 IEEE/PES Power Systems Conference and Exposition, PSCE 2009*. 2009. ISBN: 9781424438112.
- Bonjean, Mefteh, Gleizes, Maurel, and Migeon. "Adelfe 2.0". In: (2012), pp. 1–45.

- Bonte, Perles, Lartigue, and Thellier. "An occupant behavior model based on artificial intelligence for energy building simulation". In: *IBPSA* (2013).
- Bornard. "Conduite d'un système de production-transport". In: (2000).
- Brazier, Keplicz, Jennings, and Treur. "Formal Specification of Multi-Agent Systems: a Real-World Case". In: (1995).
- Brazier. "Agents negotiating for load balancing of electricity use". In: *Proceedings. 18th International Conference on Distributed Computing Systems (Cat. No.98CB36183)*. 1998, pp. 622–629. ISBN: 0-8186-8292-2.
- Canadian Electricity Association. "The smart grid : a pragmatic approach". In: (2010).
- Caramia, Carpinelli, Pagano, and Varilone. "Probabilistic three-phase load flow for unbalanced electrical distribution systems with wind farms". In: *IET Renewable Power Generation* 1.2 (2007), p. 115. ISSN: 17521416.
- Camps, Gleizes, and Glize. "Une théorie des phénomènes globaux fondée sur des interactions locales". In: *Actes des Sixième journées francophones ...* (1998).
- Chilard, Grenard, Devaux, and Garcia. "Distribution state estimation based on voltage state variables : Assessment of results and limitations". In: *Electricity Distribution - Part 1, 2009. CIRED 2009. 20th International Conference and Exhibition on 0524* (2009), pp. 1–4. ISSN: 0537-9989.
- Chiang, Zhao, Deng, and Koyanagi. "Homotopy-Enhanced Power Flow Methods for General Distribution Networks With Distributed Generators". In: *IEEE Transactions on Power Systems* 29.1 (Jan. 2014), pp. 93–100. ISSN: 0885-8950.
- Chilard, Boes, Perles, Camilleri, and ... *The Modelica Language and the FMI Standard for Modeling and Simulation of Smart Grids*. Sept. 2015.
- Chiang. "A decoupled load flow method for distribution power networks: algorithms, analysis and convergence study". In: *International Journal of Electrical Power and Energy Systems* 13.3 (1991), pp. 130–138. ISSN: 01420615.
- Choi, Kim, Cokkinides, and Meliopoulos. "Feasibility study: Autonomous state estimation in distribution systems". In: *IEEE Transactions on Power Systems* 26.4 (2011), pp. 2109–2117. ISSN: 08858950.
- Cobelo, Shafiu, Jenkins, and Strbac. "State estimation of networks with distributed generation". In: *European Transactions on Electrical Power* 17.1 (2007), pp. 21–36. ISSN: 1430144X.
- Conti and Raiti. "Probabilistic load flow using Monte Carlo techniques for distribution networks with photovoltaic generators". In: *Solar Energy* 81.12 (2007), pp. 1473–1481. ISSN: 0038092X.
- de Oliveira Saraiva and Asada. "Multi-agent systems applied to topological reconfiguration of smart power distribution systems". In: *2014 International Joint Conference on Neural Networks (IJCNN)* (July 2014), pp. 2812–2819.
- Department of Energy. "Communications requirements of smart grid technologies". In: (2010).
- Di Marzo Serugendo, Gleizes, and Karageorgos. *Self-organising Software. From Natural to Artificial Adaptation*. 2011. ISBN: 978-3-642-17347-9.

- Dzafic, Huseinagic, and Henselmeyer. "Real Time Distribution System State Estimation Based On Interior Point Method". In: 5.12 (2014), pp. 996–1000.
- Deng, He, and Zhang. "A branch-estimation-based state estimation method for radial distribution systems". In: *Power Delivery, IEEE Transactions on* 17.4 (2002), pp. 1057–1062. ISSN: 0885-8977.
- Djebali. "Milling plan optimization with an emergent problem solving approach". In: *Computers & Industrial Engineering* 87 (2015), pp. 506–517. ISSN: 03608352.
- Das, Kothari, and Kalam. "Simple and efficient method for load flow solution of radial distribution networks". In: *International Journal of Electrical Power & Energy Systems* 17.5 (1995), pp. 335–346. ISSN: 01420615.
- Eminoglu and Hocaoglu. "A new power flow method for radial distribution systems including voltage dependent load models". In: *Electric Power Systems Research* 76.1-3 (2005), pp. 106–114. ISSN: 03787796.
- El-Keib. "A parallel load flow algorithm". In: *Electric Power Systems Research* 30.3 (1994), pp. 203–208. ISSN: 03787796.
- Emmer. *Imagine math 3: Between culture and mathematics*. 2015, pp. 1–330. ISBN: 9783319012315.
- Eriksson, Armendariz, Vasilenko, Saleem, and Nordstrom. "Multi-Agent Based Distribution Automation Solution for Self-Healing Grids". In: *IEEE Transactions on Industrial Electronics* 0046.c (2015), pp. 1–1. ISSN: 0278-0046.
- El-dib, Youssef, and Osran. "Load Flow Solution Using Hybrid Particle Swarm Optimization". In: *International Conference on Electrical, Electronic and Computer Engineering, 2004. ICEEC '04*. 742.9 (2004), pp. 742–746.
- Farid. "Multi-agent system design principles for resilient operation of future power systems". In: *Intelligent Energy Systems (IWIES), 2014 IEEE ...* (2014).
- Ferber. *Les systèmes multi-agents : vers une intelligence collective*. 1995.
- Fister, Yang, and Brest. "A comprehensive review of firefly algorithms". In: *Swarm and Evolutionary Computation* 13 (2013), pp. 34–46. ISSN: 22106502. arXiv: arXiv:1312.6609v1.
- Goswami and Basu. "Direct solution of distribution systems". In: *IEE Proceedings C Generation, Transmission and Distribution* 138.1 (1991), pp. 78–88. ISSN: 01437046.
- Georgé. *L'émergence*. Tech. rep. Institut de Recherche en Informatique de Toulouse, 2003.
- Ghazvini, Abedini, Pinto, and Vale. "Multiagent System Architecture for Short-term Operation of Integrated Microgrids". In: (2014), pp. 6355–6360.
- Ghosn. "Agent-Oriented Designs for a Self Healing Smart Grid". In: *2010 First IEEE International Conference on Smart Grid Communications* (Oct. 2010), pp. 461–466.
- Ghosh, Lubkeman, Downey, and Jones. "Distribution circuit state estimation using a probabilistic approach". In: *IEEE Transactions on Power Systems* 12.1 (1997), pp. 45–51. ISSN: 08858950.
- Glize. "L'adaptation des systèmes à fonctionnalité émergente par auto-organisation coopérative". In: *Hdr, Université Paul Sabatier, Toulouse III* (2001).

- Ghatak and Mukherjee. "An improved load flow technique based on load current injection for modern distribution system". In: *International Journal of Electrical Power & Energy Systems* 84 (2017), pp. 168–181. ISSN: 01420615.
- Ghosh and Sherpa. "An Efficient Method for Load Flow Solution of Radial Distribution Networks". In: *International Journal of Electrical, Computer, Electronics and Communication Engineering* 2.9 (2008), pp. 195–202.
- Gupta, Jha, Yadav, and Kumar. "A Multi-Agent Framework for Operation of a Smart Grid". In: *Energy and Power Engineering* 05.04 (2013), pp. 1330–1336. ISSN: 1949-243X.
- International Energy Agency. *Technology Roadmap, Smart Grid*. 2011.
- Ju, Wu, Zhang, and Sun. "An extension of FBS three-phase power flow for handling PV Nodes in active distribution networks". In: *IEEE Transactions on Smart Grid* 5.4 (July 2014), pp. 1547–1555. ISSN: 19493053.
- Kaddoum. "Optimization under constraints of distributed complex problems using cooperative self-organisation". In: (2011).
- Karami and Mohammadi. "Radial basis function neural network for power system load-flow". In: *International Journal of Electrical Power & Energy Systems* 30.1 (2008), pp. 60–66. ISSN: 01420615.
- Kruchten. *The rational unified process: an introduction*. Addison-Wesley Professional, 2004.
- Kim and Slors. "Explanation, prediction, and reduction in emergentism. Commentary : Emergence et explication." eng. In: *Intellectica* 25 (1997), pp. 45–65. ISSN: 0769-4113.
- Khorshidi, Shabaninia, and Niknam. "A new smart approach for state estimation of distribution grids considering renewable energy sources". In: *Energy* 94 (Jan. 2016), pp. 29–37. ISSN: 03605442.
- Kulasekera, Gopura, Hemapala, and Perera. "A review on multi-agent systems in micro-grid applications". In: *2011 IEEE PES International Conference on Innovative Smart Grid Technologies-India, ISGT India 2011*. 2011, pp. 173–177. ISBN: 9781467303163.
- Lemouzy. "Systèmes interactifs auto-adaptatifs par systèmes multi-agents auto-organiseurs: application à la personnalisation de l'accès à l'information". In: (2011).
- Lukovic and Kovac. "Adapting Multi-Agent Systems Approach for Integration of Prosumers in Smart Grids". In: July (2013), pp. 1485–1491.
- Likith Kumar, Maruthi Prasanna, and Ananthapadmanabha. "A Literature Review on Distribution System State Estimation". In: *Procedia Technology* 21 (2015), pp. 423–429. ISSN: 22120173.
- Logenthiran, Srinivasan, Khambadkone, and Aung. "Scalable Multi-Agent System (MAS) for operation of a microgrid in islanded mode". In: *2010 Joint International Conference on Power Electronics, Drives and Energy Systems, PEDES 2010 and 2010 Power India*. 2010. ISBN: 9781424477821.
- Lin and Teng. "State estimation for distribution systems with zero-injection constraints". In: *Power Systems, IEEE Transactions on* 11.1 (1996), pp. 518–524. ISSN: 0885-8950.
- Lin and Teng. "Distribution fast decoupled state estimation by measurement pairing". In: *IEE Proceedings - Generation, Transmission and Distribution* 143.1 (1996), p. 43. ISSN: 13502360.

- Lu, Teng, and Liu. "Distribution system state estimation". In: *IEEE Transactions on Power Systems* 10.1 (1995), pp. 229–240. ISSN: 15580679.
- Lu, Zhang, Feng, and Cheng. "Distributed agent-based state estimation considering controlled coordination layer". In: *International Journal of Electrical Power and Energy Systems* 54 (2014), pp. 569–575. ISSN: 01420615.
- Mallick, Rajan, Thakur, Acharjee, and Ghoshal. "Development of a new algorithm for power flow analysis". In: *International Journal of Electrical Power and Energy Systems* 33.8 (2011), pp. 1479–1488. ISSN: 0142-0615.
- Manickavasagam. "Control of distributed generator and smart grid using multi-agent system". In: *2011 1st International Conference on Electrical Energy Systems, ICEES 2011*. 2011, pp. 212–217. ISBN: 9781424497324.
- Matei, Baras, and Srinivasan. "Trust-based multi-agent filtering for increased Smart Grid security". In: *2012 20th Mediterranean Conference on Control and Automation, MED 2012 - Conference Proceedings*. Ieee, July 2012, pp. 716–721. ISBN: 9781467325318.
- Mishra, Das, and Paul. "A simple algorithm for distribution system load flow with distributed generation". In: *International Conference on Recent Advances and Innovations in Engineering, ICRAIE 2014*. 2014. ISBN: 9781479940400.
- Mefteh, Migeon, Gleizes, and Gargouri. "S-DLCAM: A self-design and learning cooperative agent model for adaptive multi-agent systems". In: *Proceedings of the Workshop on Enabling Technologies: Infrastructure for Collaborative Enterprises, WETICE 2013*. June (2013), pp. 39–41. ISSN: 15244547.
- Mefteh, Migeon, Gleizes, and Gargouri. "Simulation Based Design for Adaptive Multi-Agent Systems with the ADELFE Methodology". In: *Int. J. Agent Technol. Syst.* 7.1 (2015), pp. 1–16. ISSN: 1943-0744.
- Mekhamer, Soliman, Moustafa, and El-Hawary. "Load flow solution of radial distribution feeders: A new contribution". In: *International Journal of Electrical Power and Energy Systems* 24.9 (2002), pp. 701–707. ISSN: 01420615.
- Mendive. *An Application of Ladder Network Theory to the Solution of Three-phase Radial Load-flow Problems*. New Mexico State University, 1975.
- Müller, Rider, and Castro. "Artificial neural networks for load flow and external equivalents studies". In: *Electric Power Systems Research* 80.9 (2010), pp. 1033–1041. ISSN: 03787796.
- Meliopoulos and Zhang. "Multiphase power flow and state estimation for power distribution systems". In: *Ieee Transactions on Power Systems* 11.2 (1996), pp. 939–946.
- Naka, Genji, Yura, and Fukuyama. "Hybrid Particle Swarm Optimization based Distribution State Estimation using Constriction Factor Approach". In: *Proceedings of International Conference of SCIS & ISIS*, (2002), pp. 1–16.
- Naka, Genji, Yura, and Fukuyama. "A Hybrid Particle Swarm Optimization for Distribution State Estimation". In: *IEEE Transactions on Power Systems* 18.1 (2003), pp. 60–68. ISSN: 0885-8950.
- Niknam and Firouzi. *A practical algorithm for distribution state estimation including renewable energy sources*. 2009.

- Nguyen and Kling. *Distributed state estimation for multi-agent based active distribution networks*. 2010.
- Nagata, Ueda, and Utatani. "A multi-agent approach to Smart Grid operations". In: *2012 IEEE International Conference on Power System Technology, POWERCON 2012*. 2012. ISBN: 9781467328685.
- Pandey. "Intelligent agent based micro grid control". In: *2011 2nd International Conference on Intelligent Agent & Multi-Agent Systems* (Sept. 2011), pp. 62–66.
- Pandey. "Multi-agent control coordination of Microgrid". In: *2013 Students Conference on Engineering and Systems (SCES)* (Apr. 2013), pp. 1–5.
- Perles, Camilleri, and Gleizes. "Self-Adaptive Distribution System State Estimation". In: *EUMAS* (2016).
- Perles, Camilleri, Chilard, Croteau, and Gleizes. "Principle and Evaluation of a Self-Adaptive Multi-Agent System for State Estimation of Electrical Distribution Networks". In: *World Congress on Sustainable Technologies* (2016).
- Pipattanasomporn, Feroze, and Rahman. "Multi-agent systems in a distributed smart grid: Design and implementation". In: *2009 IEEE/PES Power Systems Conference and Exposition* (2009).
- Picard. "Méthodologie de développement de systèmes multi-agents adaptatifs et conception de logiciels à fonctionnalité émergente". PhD thesis. UPS Toulouse 3, 2004.
- Powell. *Power System Load Flow Analysis (Professional Engineering)*. McGraw-Hill, 2004, p. 181. ISBN: 0071447792.
- Prostejovsky, Lepuschitz, Strasser, and Merdan. "Autonomous service-restoration in smart distribution grids using Multi-Agent Systems". In: *Electrical & Computer Engineering (CCECE), 2012 25th IEEE Canadian Conference on* (Apr. 2012), pp. 1–5.
- Quintana, Torres, and Medina-Palomo. "Interior-point methods and their applications to power systems: a classification of publications and software codes". In: *IEEE Transactions on Power Systems* 15.1 (2000), pp. 170–176. ISSN: 08858950.
- Rami. "Contrôle de tension auto adaptatif pour des productions décentralisées d'énergies connectées au réseau électrique de distribution". In: (2006).
- Roscia, Longo, and Lazaroiu. "Smart City By Multi-Agent Systems". In: October (2013), pp. 20–23.
- Russell and Norvig. *Artificial Intelligence: A Modern Approach*. Vol. 9. 2. 1995, pp. 215–218. ISBN: 9780131038059.
- Roche. "Algorithmes et architectures multi-agents pour la gestion de l'énergie dans les réseaux électriques intelligents". In: (2012).
- Rahman, Pipattanasomporn, and Teklu. "Intelligent Distributed Autonomous Power Systems (IDAPS)". In: *2007 IEEE Power Engineering Society General Meeting, PES*. 2007. ISBN: 1424412986.
- Roytelman and Shahidehpour. "State Estimation for Electric Power Distribution Systems in Quasi real-Time Conditions". In: *IEEE Transactions on Power Delivery* 8.4 (1993), pp. 2009–2015. ISSN: 19374208.

- Stott and Alsac. "Fast Decoupled Load Flow". In: *Power Apparatus and Systems, IEEE Transactions on PAS-93.3* (May 1974), pp. 859–869. ISSN: 0018-9510.
- Searle. *Expression and Meaning: Studies in the Theory of Speech Acts*. Vol. 49. 3. 1979, p. 187. ISBN: 0521313937.
- Singh and Ghosh. "A New Efficient Method for Load-Flow Solution for Radial Distribution Networks". In: 12 (2011), pp. 66–73.
- Singh and Ghose. "Improved radial load flow method". In: *International Journal of Electrical Power and Energy Systems* 44.1 (2013), pp. 721–727. ISSN: 01420615.
- Shirmohammadi, Hong, Semlyen, and Luo. "A compensation-based power flow method for weakly meshed distribution and transmission networks". In: *IEEE Transactions on Power Systems* 3.2 (1988), pp. 753–762. ISSN: 15580679.
- Singer. "Enabling Tomorrow's Electricity System : Report of the ontario smart grid forum". In: (2010).
- Solanki, Khushalani, and Schulz. "A Multi-Agent Solution to Distribution Systems Restoration". In: *IEEE Transactions on Power Systems* 22.3 (Aug. 2007), pp. 1026–1034. ISSN: 0885-8950.
- Smith. "Communication and Control in Problem Solver". In: *IEEE Transactions on computers* 29.12 (1980), p. 12. ISSN: 0018-9340.
- Selvan and Swarup. "Distribution System Load Flow using Object-Oriented Methodology". In: *2004 International Conference on Power System Technology, 2004. PowerCon 2004*. 2 (2004), pp. 1168–1173.
- Su. "Probabilistic load-flow computation using point estimate method". In: *IEEE Transactions on Power Systems* 20.4 (Nov. 2005), pp. 1843–1851. ISSN: 08858950.
- Sun, Nikovski, Ohno, Takano, and Kojima. "A fast and robust load flow method for distribution systems with distributed generations". In: *Energy Procedia*. Vol. 12. 2011, pp. 236–244.
- Schweppe and Wildes. "Power system static state estimation. I - exact model". In: *1969 power industry computer applications conference, 18-21 May 1969*. 1969, pp. 85–91.
- Sun and Zhang. "Global state estimation for whole transmission and distribution networks". In: *Electric Power Systems Research* 74.2 (2005), pp. 187–195. ISSN: 03787796.
- Thukaram, Jerome, and Surapong. "Robust three-phase state estimation algorithm for distribution networks". In: *Electric Power Systems Research* 55.3 (2000), pp. 191–200. ISSN: 03787796.
- Tortelli, Lourenco, Garcia, and Pal. "Fast decoupled power flow to emerging distribution systems via complex PU normalization". In: *IEEE Transactions on Power Systems* 30.3 (May 2015), pp. 1351–1358. ISSN: 08858950.
- Van de Vijver. "Emergence et explication". In: *Intellectica* (1997), pp. 7–23.
- Vu, Begouic, and Novosel. "Grids get smart protection and control". In: *Computer Applications in ...* (1997), pp. 40–44.
- Voropai. *A Multi-Agent Approach to Electric Power Systems*. 2014.

- Wolter, Guercke, Isermann, and Hofmann. "Multi-agent based distributed power flow calculation". In: *Power and Energy Society General Meeting, 2010 IEEE (2010)*, pp. 1–6. ISSN: 1944-9925.
- Wang and Schulz. "A Revised Branch Current-Based Distribution System State Estimation Algorithm and Meter Placement Impact". In: *IEEE Transactions on Power Systems* 19.1 (2004), pp. 207–213. ISSN: 08858950.
- Wu and Zhang. "A three-phase power flow algorithm for distribution system power flow based on loop-analysis method". In: *International Journal of Electrical Power & Energy Systems* 30.1 (2008), pp. 8–15. ISSN: 01420615.
- Yan, Shi, Yao, Ni, and Bazargan. "A multi-agent based autonomous decentralized framework for power system restoration". In: *2014 International Conference on Power System Technology Powercon (Oct. 2014)*, pp. 871–876.
- Zoka, Yorino, Watanabe, and Kurushima. "An Optimal Decentralized Control for Voltage Control Devices by means of a Multi-agent System". In: 1 (2014).
- Zehar and Sayah. "Optimal power flow with environmental constraint using a fast successive linear programming algorithm: Application to the algerian power system". In: *Energy Conversion and Management* 49.11 (2008), pp. 3362–3366. ISSN: 01968904.

List of Figures

1.1	Topologie d'un réseau du futur	6
1.2	Réseau de distribution à configuration radiale	7
1.3	Exemple d'un profil de tension	8
1.4	Surtension causée par l'ajout d'un producteur	8
2.1	Future Network Topology	16
2.2	Radial Distribution Network	17
2.3	Example of a Voltage Magnitude Profile	18
2.4	Overvoltage caused by the addition of a generator	18
3.1	Classic network topology	29
3.2	Hierarchy in an electrical network [Biserica 2011]	32
3.3	Medium voltage part of a distribution network	33
3.4	Distribution network equipped with sensors	33
3.5	Density of a Gaussian Distribution	35
3.6	Current Flows	38
3.7	Example of π -Line Model	38
4.1	Life cycle of an agent in its environment	43
4.2	Coarse-Grained Multi-Agent System	44
4.3	Medium-Grained Multi-Agent System	45
4.4	A Fine-Grained Multi-Agent System	46
5.1	Emergence	52
5.2	ADELFE Methodology Steps	53
5.3	Parts of ADELFE developed in the manuscript	56
5.4	Example of a distribution network agentification	59
5.5	ATENA-based Multi-Agent System instantiation of the network in the figure 5.4	60
5.6	Class diagram showing the relation between the agents and the network	61
6.1	Example of Load Flow Problem	68
6.2	Relations between the Load Flow Multi-Agent System and the distribution network	77
6.3	Internal Structure of a Bus Agent	77
6.4	64-bus test case	83
6.5	207-bus test case	84
6.6	Required Number of Cycles Evolution over Networks Sizes for the Load Flow	85
6.7	Required Time Evolution over Networks Sizes for the Load Flow	85
6.8	Polynomial of degree 2 complexity compared to linear complexity	86

7.1	Behavior of a Bus Agent for the State Estimation problem solving	98
7.2	Decision process of a Measurement Agent for the State Estimation problem solving	101
7.3	Communication Protocol	103
7.4	Example of use of the communication protocol for a given situation	104
7.5	64-bus test case	107
7.6	207-bus test case	108
7.7	Required Time Evolution over Network Sizes for the State Estimation	109
7.8	Gaussian Distribution of a Voltage Sensor and the State Estimation for the Bus 30 of the Configuration 6 of the 111-bus system	109
7.9	Standard deviations and mean value of the bus observed	110
7.10	Evolution of the global objective function over the cycles of resolution of the developed system	110
7.11	Relative Voltage Magnitude Estimation Error over the Number of Voltage Sensors for the 64-bus network	112
7.12	Impact of the addition of a perturbation during the resolution process	113
B.1	41-bus test case	132
B.2	64-bus test case	135
B.3	80-bus test case	139
B.4	111-bus test case	144
B.5	133-bus test case	150
B.6	153-bus test case	157
B.7	207-bus test case	165