



HAL
open science

Une approche innovante basée sur un cadre de fonction-tâche-comportement pour intégrer les facteurs humains et l'ergonomie dès la première phase de conception

Xiaoguang Sun

► **To cite this version:**

Xiaoguang Sun. Une approche innovante basée sur un cadre de fonction-tâche-comportement pour intégrer les facteurs humains et l'ergonomie dès la première phase de conception. Ingénierie assistée par ordinateur. Université de Strasbourg, 2017. Français. NNT : 2017STRAD044 . tel-01743827

HAL Id: tel-01743827

<https://theses.hal.science/tel-01743827>

Submitted on 26 Mar 2018

HAL is a multi-disciplinary open access archive for the deposit and dissemination of scientific research documents, whether they are published or not. The documents may come from teaching and research institutions in France or abroad, or from public or private research centers.

L'archive ouverte pluridisciplinaire **HAL**, est destinée au dépôt et à la diffusion de documents scientifiques de niveau recherche, publiés ou non, émanant des établissements d'enseignement et de recherche français ou étrangers, des laboratoires publics ou privés.



UNIVERSITÉ DE STRASBOURG

ÉCOLE DOCTORALE MSII (ED n°269)

INSA DE STRASBOURG

Laboratoire de Génie de la Conception (LGéCo)-EA n°3938

THÈSE présentée par :

Xiaoguang SUN

soutenue le : 21 Décembre 2017

pour obtenir le grade de : **Docteur de l'Université de Strasbourg**

Discipline/ Spécialité : **Génie industriel - Conception**

**Une approche innovante basée sur un cadre
de fonction-tâche-comportement pour
intégrer les facteurs humains et l'ergonomie
dès la première phase de conception**

THÈSE dirigée par :

M. Mickaël GARDONI

Professeur des Universités, détaché de l'INSA de Strasbourg à l'ETS à Montréal, Directeur de Thèse

M. Jean RENAUD

Professeur des Universités et Directeur du laboratoire LGéCo, INSA de Strasbourg, Co-Directeur de Thèse

M. Rémy HOUSSIN

Maître de Conférences, HDR, CSIP-Icube, Université de Strasbourg, Encadrant

RAPPORTEURS :

M. Bernard Grabot

Professeur des Universités, LGP-ENIT Tarbes

M. Davy Monticolo

Maître de Conférence, HDR, ENSGSI, Nancy

AUTRES MEMBRES DU JURY :

M. Patrick Martin

Professeur émérite, ARTS et METIERS Metz

Une approche innovante basée sur un cadre de fonction-tâche-comportement pour intégrer les facteurs humains et l'ergonomie dès la première phase de conception

Résumé

Les facteurs humains et l'ergonomie (HF/E) sont devenus une discipline scientifique fournissant des contraintes pour la conception d'interaction entre l'homme et le système (le produit). La plupart des études sur HF/E couvrent non seulement les aspects d'ergonomie physique, mais aussi les sciences cognitives et organisationnelle. De nombreux travaux attestent que l'intégration insuffisante d'informations HF/E mène à une conception « pauvre ». Intégrer que ces informations de la phase de conception peuvent améliorer la performance du produit ou du système et de l'expérience utilisateur.

Les méthodes existantes pour l'intégration de l'information HF/E (HF/EII) sont catégorisées par deux types de conception : la conception Centrée sur la Technologie (TCD) et la conception Centrée sur l'Utilisateur (UCD). Les méthodes TCD intègrent des informations HF/E dans la phase de conception détaillée ou plus tard, ce qui peut causer des modifications et des itérations de conception. Par contre, les approches UCD prennent en considération les informations HF/E dès la première phase de conception et sont consommatrices de temps à cause de l'intégration des exigences HF/E. L'objectif de cette thèse est de développer une nouvelle méthodologie de conception et un outil pour l'intégration de HF/E dès la première phase de conception dans le but de réduire le temps de conception, notamment en ayant moins de boucles itératives.

Au cours de ce travail de recherche, un cadre « fonction-tâche-comportement » (FTB) a été développé, fournissant un guide systématique et détaillé pour l'intégration de HF/E dès la première phase de conception. Une étude de cas est présentée pour valider la faisabilité de la méthode et permettre une assistance pour la mise en œuvre. Ainsi, un module de Centre de Conception d'Interaction (IDC) a été développé et intégré dans un logiciel de CAO pour aider le travail de conception, en fournissant une procédure pratique de mise en œuvre du cadre FTB. Il permet aux concepteurs (1) d'intégrer les exigences fonctionnelles et non fonctionnelles dès la première phase de conception, et (2) de les convertir en des paramètres de conception pour effectuer au mieux le travail de conception. En utilisant le module d'IDC, les modifications et les boucles d'itération de conception peuvent être significativement réduits, fournissant ainsi une expérience utilisateur plus satisfaisante lors du respects les exigences fonctionnelles.

De plus, les méthodologies actuelles de génération de solutions de conception s'appuient trop sur l'expérience des concepteurs, c'est pourquoi un « modèle de d'aide à la génération de solution » a commencé à être développé pour produire les solutions de conception recherchées. Différentes approches de résolution de problèmes existent, ce modèle proposé est plus facile à appréhender et à utiliser par les concepteurs. Ce modèle offre une pensée divergente pour la génération de solution de conception basée sur la tâche de conception individuelle. En résumé, dans les conclusions, les contributions majeures et les limitations de notre étude sont présentées et les perspectives de recherche future sont proposées.

Mots-clés: facteurs humains et ergonomie, conception technique, conception interactif, méthodes de conception, fonction-tâche-comportement.

An innovative approach based on a function-task-behaviour framework for integrating human factors and ergonomics from the early design phase

Abstract

Human factors and ergonomics (HF/E) as a scientific discipline provide constraints for the engineering design of human and system (product) interactions. Most existing studies on HF/E cover the specialization of physical, cognitive, and organizational ergonomics. Numerous evidences show that insufficient consideration of HF/E information leads to poor design, and fully considering this information in the design phase can improve both the user experience and system performance.

Existing methods for HF/E information integration (HF/EII) can be categorized into two types: Technology-Centred Design (TCD) and User-Centred Design (UCD). TCD methods integrate HF/E information from the detailed design phase or later, which may cause design modifications and iterations. UCD approaches address HF/E information from the early design phase, which are time-consuming for HF/E requirements collection. The objective of this thesis is dedicated to a new design methodology and tool for HF/EII from the early design phase in a systematic, time-saving, less expensive, and less iteration way.

In this thesis, a function-task-behaviour framework has been developed, which provides a systematic and detailed guide for HF/EII from the early design phase. A case study has been presented to validate its feasibility, which offers the theoretical support for method implementation. Thus, an Interaction Design Centre (IDC) module was developed and integrated in CAD software to aid the design work, which provides a practical way for the implementation of FTB framework. It enables designers to (1) catch both functional requirements and non-functional requirements from the early design phase, and (2) convert them into design parameters to carry out the design work. By using IDC module, design modifications and iterations due to belated effort for HF/E consideration can be significantly reduced, thereby providing a satisfactory user experience in the case of meeting the functional requirements.

Regarding current method of design solution generation overly relies on designers' experience, a design solution generation model is developed for producing design solution. Different from current problem solving approaches, this model is easy for designers to cognize and operate. It offers a divergent thinking for design solution generation based on the individual design task. Finally, the major contributions and limitations of our study are presented and the future studies are previewed.

Key words: human factors and ergonomics, engineering design, interaction design, design methods, function-task-behaviour.

Acknowledgements

This dissertation has been kept on track and been seen through to completion with the support and encouragement of many individuals. I would like to express my deepest appreciation to all those who contributed in many ways to the success of this study and made it an unforgettable experience for me.

I would like to express my sincere gratitude to my supervisor, **Prof. Mickaël GARDONI**, for his valuable advice, constructive criticism and his extensive discussions around my work. I warmly thank my co-supervisor, **Prof. Jean RENAUD** for providing necessary infrastructure and resources to accomplish my research work, and guidance throughout my Ph.D. studies. My sincere thanks also to my co-supervisor, **Prof. Rémy HOUSSIN** for his guidance, assistance, understanding, and patience for every detail during my Ph.D. studies.

I would like to thank **China Scholarship Council (CSC)** for the financial support during my Ph.D. studies in the Design Engineering Laboratory (LGéCo) at the National Institute of Applied Science (INSA) Strasbourg and University of Strasbourg.

I am deeply grateful to the wonderful faculty **members and staff of the LGéCo** at INSA of Strasbourg, for their support, understanding, and kindness during my Ph.D. studies.

Specials thanks to **Dr. Lei LIN, Dr. Julien ROHMER, Dr. Achille SOULI**, Ph.D. students **Chenchen LIU, Pei ZHANG**, my interns **Rabih SLIM, Quentin STRINATI** and **Weimin SHI**, for the time that we have spent together.

Last but not least, I would like to pay high regards to **my parents, my brother, my sister, and my wife** for their endless love, unconditional support, sincere encouragement and inspiration throughout my life and lifting me uphill this phase of life.

Contents

Chapter 1. Introduction	1
1.1 General background	1
1.2 Research problems	3
1.3 Research scope	4
1.4 Thesis structure	5
Chapter 2. Literature review	9
2.1 HF/EII from conceptual design phase	9
2.2 HF/EII from embodiment design phase	14
2.3 HF/EII from detailed phase	20
2.4 Discussion	25
Conclusion of this chapter	27
Chapter 3. Function-Task-Behaviour framework	30
3.1 Function definition and decomposition	32
3.2 Task definition, assignment, and planning	37
3.3 Detailed design in behaviour level	47
3.4 Case study	49
Conclusion of this chapter	53
Chapter 4. Integration of FTB framework in CAD software	55
4.1 General Introduction to IDC module	55
4.2 IDC module modelling	61
4.3 IDC module implementation	66
Conclusion of this chapter	74
Chapter 5. Solution generation based on machine learning	77
5.1 Background	77
5.2 General description of solution generation model	82
5.3 Case study	86
5.4 Discussion	91
Conclusion of this chapter	92
Chapter 6. Conclusions and perspectives	93
6.1 Contributions	93
6.2 Limitations	95

6.3 Perspectives.....	96
References.....	99

List of figures

Figure 1.1. Framework of this thesis.....	5
Figure 2.1. TRIZ systematic approach to problem solving.....	14
Figure 2.2. Function-Behaviour-Structure (FBS) framework.....	21
Figure 3.1. Framework of the proposed methodology.....	31
Figure 3.2. The communication paths of requirements collection.....	33
Figure 3.3. Description and outcome of the function analysis.....	37
Figure 3.4. The notation of the improved SADT.....	38
Figure 3.5. Task model based on SADT methodology.....	39
Figure 3.6. Duration representation by triangular and trapezoidal fuzzy numbers.....	44
Figure 3.7. Representation of task planning in PERT diagram.....	45
Figure 3.8. Interaction between socio-technical task and technical task in time.....	46
Figure 3.9. Interaction zones in the process of drill working.....	49
Figure 3.10. Description of use case and function decomposition of drilling a hole..	50
Figure 3.11. SADT representation for drill operation.....	51
Figure 3.12. PERT diagram for drill operation.....	51
Figure 3.13. Interaction between user and product in the time distribution.....	52
Figure 3.14. Conceptual solution for the existing electric drill.....	53
Figure 4.1. Use case diagram of IDC module.....	58
Figure 4.2. General introduction to IDC.....	60
Figure 4.3. Framework of distributed IDC module for engineering design.....	61
Figure 4.4. IDC module context class diagram.....	62
Figure 4.5. Object structuring class diagram of IDC module.....	63
Figure 4.6. Class diagram of IDC module.....	66
Figure 4.7. Communication diagram of IDC module.....	66
Figure 4.8. Statechart diagram of IDC module.....	69
Figure 4.9. Menu interface of IDC module.....	69
Figure 4.10. User manual interface.....	70
Figure 4.11. Function level interface.....	71

Figure 4.12. Task level interface	72
Figure 4.13. Interaction interface	73
Figure 4.14. Behaviour level interface	74
Figure 5.1. Framework of CBR.....	78
Figure 5.2. Process of design solution generation	81
Figure 5.3. General description of AI model	82
Figure 5.4. General model of recommender system	85
Figure 5.5. Types of existing water tap	87
Figure 5.6. SADT illustration of using tap.....	87
Figure 5.7. Model development	89
Figure 5.8. An available solution of the tap for Alzheimer patients	90

List of tables

Table 2.1. Approaches of KE for involving users in the design process.....	13
Table 2.2. Comparison of reviewed DTM and DTT for HF/EII	28
Table 3.1. Comparison of our proposition with the existing methods.....	30
Table 3.2. Comparison of the performance between human and automation	41
Table 3.3. Difference between designer's model and user's model	50
Table 4.1. Functional requirements of IDC module with system interfaces.....	59
Table 4.2. Composition of IDC module	67
Table 5.1. Category of the task's input and output.....	83
Table 5.2. Relationship between the input and output of task (flow).....	83
Table 5.3. Partial training sample	88
Table 5.4. Predicting sample	89

Chapter 1. Introduction

In this chapter, we give a general introduction of this thesis that is realized at Laboratoire de Génie de la Conception (LGéCo). First, the general background of this thesis is presented. Then, the overall research problems, the research scope, and the objectives of this thesis are discussed. Finally, the structure of this thesis is given.

1.1 General background

Over the years, there is a continuous need for cost-effective and high-quality system in engineering fields. Automation systems serve as an effective mean to replace the human labour and introduce great benefits, such as increasing the reliability and productivity, decreasing errors, etc. (Bye, Hollnagel, and Brendeford 1999; Groover 2016). Whereas humans only play a supervisory role in automation systems, less information is acquired by human (Parasuraman, Sheridan, and Wickens 2000). Normally, automation systems perform a task repeatedly in normal situations, they are inadequate to address abnormal situations (Bindewald, Miller, and Peterson 2014). Consequently, human intervention is required to address these unforeseen circumstances to improve the robustness of the whole system (Bainbridge 1983). An ergonomically sound system provides optimum performance because it takes the advantage of the strengths and avoids the weaknesses of both human and machine components. To deal with this issue, the interaction design tries to solve the problems between human operator and machine in Man-Machine Systems (MMS) (Rouse and Cody 1988).

MMS indicates that the human operator and machine have a reciprocal relationship with each other. Interaction design in MMS is described as the question of how designers design the system that matches the requirements of usability, safety, reliability, and operability in the workplace and work environment (McRuer 1980; Rouse and Cody 1988; Hasan et al. 2003; Redström 2006). Specifically, on the base of engineering design process (Pahl and Beitz 1996; Courage and Baxter 2005;

Rogers, Sharp, and Preece 2007), it consists of (1) identifying the requirements, (2) translating and restating these requirements, (3) defining the design problems and the function of system, (4) conceptual design, (5) embodiment, (6) detailed design, and (7) prototype test. It should be emphasized that it is an iterative process and iteration may occur in every phase. The importance of user requirements collection is no longer controversial in the early design phase, but the considerations regarding how to gather the user requirements and how to employ these requirements to the design attracts extensive attention (Redström 2006). User requirements involve both functional and non-functional aspect. Functional requirements refer to the technical details of system's characteristics, properties, and parameters (Tsai 2000; Kandjani et al. 2015; Suh 2001), while non-functional requirements indicate sociotechnical aspect, which cover all constraints on how the system should run to assist users to fulfil their aims (Glinz 2007). System should be designed to fulfil the functional requirements as well as the non-functional requirements. Traditional engineering design approaches first solve the technical problems regarding the functional requirements, and then try to optimize these solutions under the constraints of the non-functional requirements (Pahl et al. 2007).

In most studies on engineering design, non-functional requirements reflect the needs of Human Factors and Ergonomics (HF/E). HF/E as a scientific discipline provides constraints for the design of human and system (product) interactions. It contributes to introduce numerous advantages in MMS, such as reducing errors, increasing the system flexibility and performance, increasing human safety, improving productivity, etc. (Salvendy 2012). Most existing studies on HF/E cover the specialization of physical, cognitive, and organizational ergonomics. Physical ergonomics primarily involves anthropometric, physiological, and biomechanical characteristics associated with physical activity (Karwowski 2012; Pheasant and Haslegrave 2016). Cognitive ergonomics mainly refers to mental process of situation awareness, including perception, memory, information processing, analysing, reasoning, and decision in the process of interaction between human and system (Vicente 1999; Hollnagel 2003;

Karwowski 2012). Organizational ergonomics mainly focuses on sociotechnical systems optimization, including their organizational structures, policies, and processes (Reason 1997; Nemeth 2004; Karwowski 2012).

As an increasing interest of the user experience in product performance, empirical marketing emphasizes that a system (or product) should no longer be treated as purely providing a set of functional features and benefits - it delivers experiences (Hassenzahl 2003). HF/E as a crucial perspective of user experience is concerned with design issues that supply methods and tools to human in interactive workplace. To date, HF/E has been received much attention and numerous evidences (Redström 2006) show that insufficient consideration of HF/E information leads to poor design, and fully considering this information in the design phase can improve both the user experience and system performance (Sun et al. 2016; Rieuf and Bouchard 2017).

1.2 Research problems

Literature review on HF/E information integration (HF/EII) in the design phase show that the current existing studies on this topic can be categorized into two types: one is Technology-Centred Design (TCD), and the other is User-Centred Design (UCD).

TCD methods first concern functional requirements to carry out the design work, and then HF/E information is regarded as the constraints to optimise the design solutions. In general, these methods integrate HF/E from the detailed design phase. HF/EII is more useful for the evaluation and verification of solutions that have been developed, rather than the methods of solution generation. In this case, design modifications are often required due to the HF/E requirements and thereby arising design iteration. Eppinger et al. (1994) argued that reducing the number of design iteration is beneficial to the entire engineering design process. On one hand, design modifications are easy and less expensive to repair in the early design phase, and the complexity and the cost of modifications will increase over time. From the tacit view, some studies claimed that it is not too late to integrate HF/E from the detailed design phase compared with addressing HF/E issues in prototype phase. However, it is too late

when it faces to the costly and time-consuming design modifications. On the other hand, supplementary procedures and apparatus may be introduced into designed system with the purpose of addressing the HF/E requirements (Houssin and Coulibaly 2011). These modifications may reduce the system performance and users may be compelled to change their habits (behaviour, operation, cognition, etc.) to cooperate with the system.

While UCD approaches first consider the HF/E requirements, which conduct design activity around how users can, want, or need to use the product, rather than compelling user to change their behaviour to accommodate the product. They can effectively avoid the late design modifications due to inadequate considerations and analysis of the HF/E (non-functional) requirements. These approaches carry out the design work around the user, thereby introduce user experience. However, UCD methods are time-consuming for the HF/E information collection and processing from the early design phase. Some non-functional needs may be easy to define but hard to meet from the technical aspect, and some non-functional requirements may be incompatible with functional requirements. In addition, many constraints will be introduced when HF/EII from the early design phase, which will limit the solution space and some promising solutions may be missed.

To sum up, both TCD and UCD approaches have pros and cons. These limitations point out the research direction for us and the research scope of this thesis is presented in the following section.

1.3 Research scope

As discussed above, it is shown that new design methodology and tool are required for HF/EII. The scope of this thesis is listed in the following:

(1) The method of requirements collection, interpretation, and integration: During the process of literature review, we are inclined to think that the definition between functional and non-functional requirements is rather vague. User requirements are collected from diverse group, including user, customer, marketing, distributor, etc.

Information loss and overlapped may occur in the process of information transmission.

(2) The method of HF/EII from the early design phase: It covers (1) how to convert the functional requirements into design parameters, (2) how to use the constraints regarding the non-functional requirements into the design phase, and (3) how to combine the design parameters and constraints to conduct the design.

(3) The method of design solution generation: According to the literature review, most current engineering design methods cannot offer solution directly, and it overly relies on designers' experience. Therefore, an artificial intelligence model for design solution generation is necessary to be established to reduce designers' workload.

1.4 Thesis structure

Figure 1.1 shows the overall organization of this thesis, including introduction, literature review, contributions, and conclusions and perspectives.

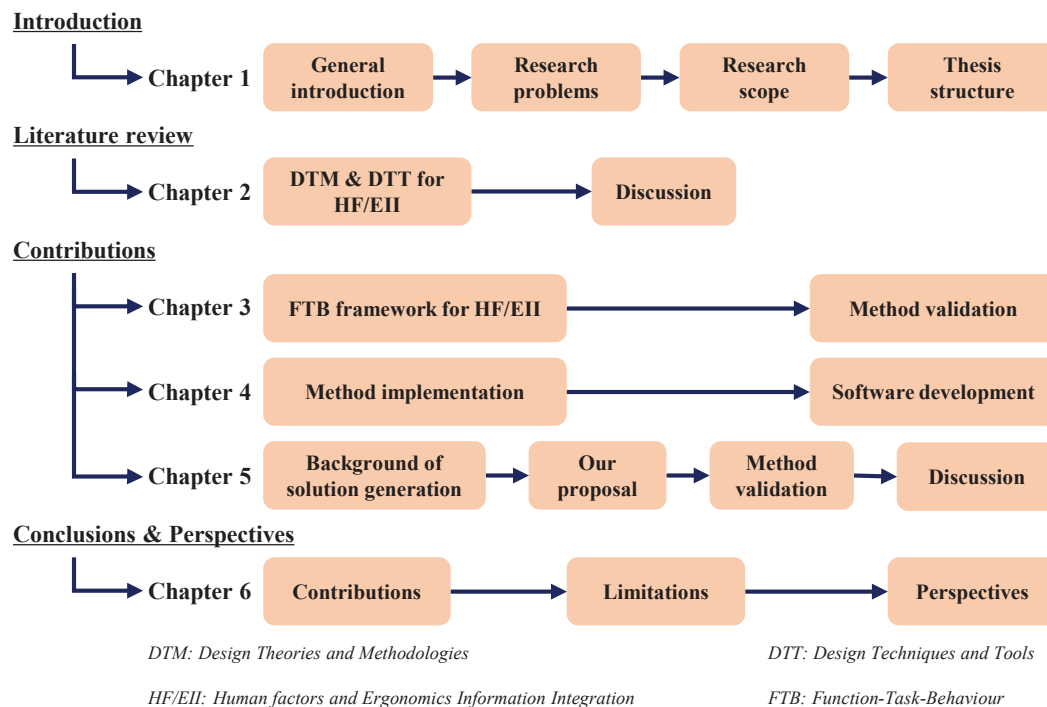

Figure 1.1. Framework of this thesis

In this chapter, we have illustrated the general introduction to our research, which

includes the general background, research problems, and research scope. The rest of this thesis is organized as follows.

In chapter 2, an overview of the Design Theories and Methodologies (DTM) and Design Techniques and Tools (DTT) for HF/EII in engineering design is presented. The focus is dedicated to the interaction design between product (system or machine) and its user (human), and not to the interaction design between human and computer. The merits and drawbacks of each DTM and DTT are discussed. The main findings indicate the research direction of this thesis.

In chapter 3, a Function-Task-Behaviour (FTB) framework is developed for HF/EII from the early design phase, which is applicable to the design of complex machine, equipment, system, or simple product. We mainly concern the HF/E information regarding use requirements and embody them as a user manual, which will be continuously improved with the refinement of design.

The framework of the proposed methodology involves three steps: (1) Functional specification involves function definition and decomposition according to initial user manual and other requirements; (2) Embodiment refers to conduct task identification, assignment, and planning to achieve the intended function. An improved SADT method is developed for task identification, a mathematical model is developed to solve the task assignment problem, and the PERT method is applied for user and product tasks planning; (3) Detailed design refers to analyse the interactions between user's behaviour and product's behaviour in the work area. A case study is shown at the end of this chapter to demonstrate the feasibility of the proposed method.

In chapter 4, the specific implementation methods, procedures, and instructions for putting FTB framework in practice is illustrated. To facilitate the design work, an Interaction Design Centre (IDC) system was developed as a module of CAD software in computer operation system. IDC module enables designer team to (1) catch both functional and non-functional requirements from the early design phase, and (2) convert them into design parameters to carry out the design work. Through IDC

module, the design modification and iteration due to belated effort for HF/EII will be reduced.

Considering the solution generation of existing engineering design excessively relies on designers' experience (empiricism), in chapter 5, a method to produce the design solutions is proposed based on machine learning with the purpose of reducing designer's workload or even replacing empiricism. The first results of carrying this work were also presented. Due to current situation, we adopted K-Nearest-Neighbours (k-NN) classification algorithm to develop this model with a small sample to verify our proposition. A case study shows that the proposed model enables designer to obtain solution for individual task directly once the data is imported. This method provides a new perspective for design solution generation based on FTB framework. However, the limitations of this approach also call for the future research, which will be illustrated in chapter 6.

In chapter 6, the overall conclusions of this thesis are made, which contains the contributions and limitations. Recommendations and future researches are also given according to the limitations.

Chapter 2. Literature review

In this chapter, publications regarding DTM and DTT for integrating human factors and ergonomics (HF/E) information between 1980 and 2017 were reviewed from two aspects: (1) the stage of HF/E information integration (HF/EII) in the design phase, and (2) the category of the HF/E, including physical ergonomics, cognitive ergonomics, and organizational ergonomics. The advantages and disadvantages of each DTM and DTT are discussed, thereby giving us the research directions.

In order to clarify the specific stage in which DTM and DTT are applied, three design phases proposed by Pahl et al. (2007) are adopted in this study:

(1) *Conceptual design aims at identifying the essential design problems and elaborating the solution principles, which includes abstraction, establishment of function structure, and development of working structure.*

(2) *Embodiment design focuses on determining the overall layout design (general arrangement and spatial compatibility) according to technical and economic criteria.*

(3) *Detailed design concentrates on completing the system (product) with final technical instructions (shapes, forms, dimensions and surface properties of all individual parts).*

2.1 HF/EII from conceptual design phase

Experience has shown that it is ineffective to address HF/E as an afterthought. The problems associated with poor user experience can best be avoided by starting human factors activities as early as possible in the design process and continuing them throughout. It is increasingly perceived that HF/E information must be considered as a central part of development consideration. Thus far, several DTM and DTT have been theorized for HF/EII from the conceptual design phase and also can be applied in later design phase, which are illustrated in this section.

2.1.1 User-Centered Design

The term ‘User-Centered Design’ (UCD) came originally in Donald Norman’s research laboratory at the University of California San Diego (UCSD) (Norman and Draper 1986). User-Centered Design (Kraft 2012) approaches claim that user information should be paid extensive attention in each phase of the design process. They improve the product performance around how users can, want, or need to use the product, rather than compelling user to change their behaviour to accommodate the product. It is accomplished by employing techniques, processes, and methods throughout the product lifecycle that focus on the end-user. Three crucial principles of UCD are proposed as follows (Gould and Lewis 1985).

An early focus on users and tasks: the first is to understand users’ cognitive, behavioural, anthropometric, and attitudinal characteristics. Additionally, the willingness of user intervenes in which part of work is also required to recognize. From the user perspective, the product will comply the users’ willingness to assist user to achieve their goals. It will provide a pleasant user experience. From the designer perspective, the earlier the user requirements are considered, the less mend works are required in later design stage.

Empirical measurement: the second principle is to provide a prototype for user testing and make the simulation to identify the usability issues.

Iterative design: considering some requirements are ambiguous and difficult to define, and requirements alteration are frequent, the final principle recommends that the product development process should go through design, modify, and test stage repeatedly.

2.1.1.1 Literature review of UCD in HF/EII

Norman (1986, 1988) suggested placing the user at the centre of design and several principles were provided. These principles stressed full exploration of user’s needs and desires and intended usage of the product. A similar set of principles in the form

of eight golden rules were proposed by Shneiderman (1998). Subsequently, some other researches optimized and popularized these basic concepts to produce heuristics for usability engineering (Vredenburg 1999; Nielsen 1994, 2005).

Successful design must consider the wide range of stakeholders of the product. In order to purposeful consider the requirements of diverse group, Courage and Baxter (2005) categorized the users into three types: primary, secondary, and tertiary. Not all stakeholder needs should be represented in design, but the effect of the product on design team must be considered (Abrams, Maloney-Krichmar, and Preece 2004; Rogers, Sharp, and Preece 2007). To recognize and measure the user experience related to the subjective satisfaction of effectiveness, efficiency, safety, utility, and learnability, some techniques that cope these issues from early design phase are summarized (Preece, Rogers, and Sharp 2002) with its benefits and drawbacks, such as Ethnography (Hammersley and Atkinson 1983), Coherence (Viller and Sommerville 1999), Contextual Design (Beyer and Holtzblatt 1997) and Participatory Design (Schuler and Namioka 1993).

UCD methods allow designers to integrate HF/E information from the conceptual design phase and continuous in the embodiment and detailed design phase. By means of UCD, HF/E problems can be successful avoided in terms of physical, cognitive, and organizational ergonomics perspectives. However, some requirements between functional and non-functional may be difficult to coordinate, and some of them are hard to meet from the technical perspective. Additionally, too many constraints will be introduced in the early design phase and it will limit the solution space. Some promising solutions may be missed. Surveys conducted by Vredenburg et al. (2002) showed that most widely used UCD methods referred to informal usability testing, user analysis/profiling, evaluating existing systems, low-fidelity prototyping, heuristic evaluation, task identification, navigation design, scenario-based design. And the cost-benefit trade-offs is a key consideration in the adoption of UCD methods. For example, it was time-consuming and costly for designers to collect and cognize how users use the product in the specific environment. In addition, UCD approaches

cannot be extensively applied as a unified standard by general designers because of these methods are customized.

2.1.2 Kansei Engineering

Kansei Engineering (KE) emerged initially in Japan in 1970s as a customer-oriented technology for new product development (Nagamachi 1995, 2016). In 1997, KE was introduced into Korea and Korea Kansei Engineering Society was established. Afterwards, KE spread all over the world and it is known as Affective Engineering in the west (Nagamachi 2016). KE considers customer's feelings and emotions from the early design phase with the purpose of bringing satisfaction to customer by converting customer's emotions to measurable and physical design parameters on the basis of ergonomics and computer science (Nagamachi 1995; Nagamachi and Lokman 2011). Over the past decades, enterprises cover a range of field in Japan, such as Mazda, Toyota, Honda, Ford, Komatsu, LG, etc. have produced great market achievements by employing KE (Nagamachi 2002).

The general procedures of KE are deemed as four steps. Originally, the first step is to grasp the consumer's Kansei in the specific product domain in terms of ergonomics and psychological measurements. The following step concerns analysing the Kansei data by statistical, medical, or engineering methods in order to clarify the Kansei structure, and then, interpreting and transferring the analysed data to the new product domain. Finally, design a Kansei product.

2.1.2.1 Literature review of KE in HF/EII

KE covers a wide spectrum of disciplines ranging from ergonomics to psychology. This approach was developed in order to maximize customers' satisfaction with their purchases (Vieira et al. 2017) . To date, five available approaches for performing KE were presented in table 2.1 (Nagamachi and Lokman 2011).

Type-II based method is most commonly used after Schütte (2002) introduced it into product development. This study has less assessments with users, but was

demonstrated through several applications and industrial case-studies (Vieira et al. 2017), like rocker switches (Schütte and Eklund 2005), refrigerator design (Nagamachi 2008), aesthetic design of smartphone (Nanda et al. 2008). However, KE also has some limitations regarding the indefinite definition of customer’s emotions, the comprehension of Kansei words, and the difficulty in translating user’s emotion verbalizations into design parameters (Steinberg, Tursch, and Woll 2015).

Table 2.1. Approaches of KE for involving users in the design process

<i>Type I</i>	<i>Conceptualizing and decomposing designed product into a more detailed concept, and then interpreting it in terms of the physical characteristics</i>
<i>Type II</i>	<i>Translating consumer’s feelings and image into design parameters, then identifying physical characteristics of product.</i>
<i>Type III</i>	<i>Bridging the relationship consumers’ emotions and physical design elements by employing a mathematical model.</i>
<i>Hybrid KE</i>	<i>Consisting of forward KE and backward KE</i>
<i>Virtual KE</i>	<i>Employing Virtual Reality (VR) and KE to satisfy customer’s need in purchasing.</i>

2.1.3 Theory of inventive problem solving (TRIZ)

TRIZ was developed by Altshuller in 1946 (1984) as a knowledge-based systematic methodology for determining and categorizing all regular features and aspects of technical systems and processes that need to be invented or improved (Savransky 2000; Rossi, Germani, and Zamagni 2016). About 400,000 technology patents were studied to create new ideas and innovations. TRIZ offers a systematic method for understanding and solving problems, which has been applied in various fields (Ilevbare, Probert, and Phaal 2013) (Figure 2.1).

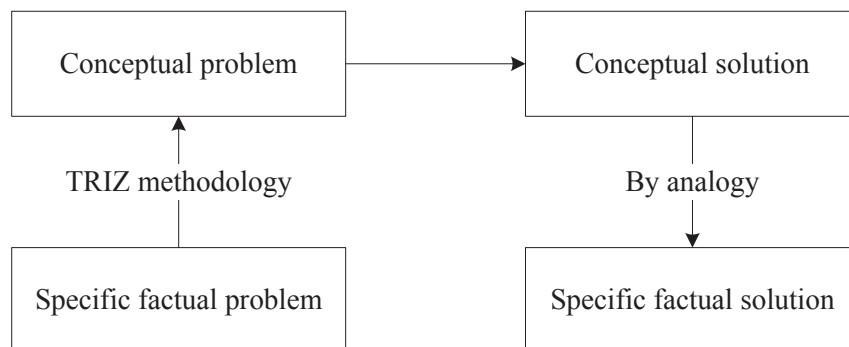

Figure 2.1. TRIZ systematic approach to problem solving

TRIZ provides several manners for finding the solutions by employing some methods and techniques like contradictions matrix, separation principles, standard solutions, and the Su-Field Analysis, etc. (Savransky 2000).

2.1.3.1 Literature review of TRIZ in HF/EII

Some of the TRIZ studies regarding HF/EII are listed as follows.

In order to integrate ergonomics in the design phase, Marsot and Claudon (2004) employed three multidisciplinary tools, including functional analysis (FA), quality function deployment (QFD), and TRIZ. In their study, TRIZ Separation Principle was used to solve the contradiction between certain functional parameters and ergonomic criteria. Houssin and Coulibaly (2011) used TRIZ as a capable tool to eliminate the contradiction between productivity and user's safety. This study aimed at improving both performance of product and user by integrating user's safety and maintainability in the design stage. Zhang, Yang, and Liu (2014) proposed a multidisciplinary approach for ergonomic product innovative design and evaluation in the early design phase. TRIZ was adopted as main tools for generating innovative alternatives by merging suitable inventive principles, the critical ergonomic design areas, and the ergonomic design principles.

TRIZ as an inspiring methods for problems solving still faces some challenges, which summarized by Ilevbare, Probert, and Phaal (2013). These global challenges limit the application of TRIZ methods in HF/EII in the design phase, and future studies in this field are also required for these issues.

2.2 HF/EII from embodiment design phase

Due to the time-consuming, costly, and too many constraints will be introduced when HF/EII in the early design phase, some DTM and DTT were theorized and established for HF/EII from embodiment phase. Comparing with DTM and DTT of HF/EII from conceptual design phase, the studies in this field first consider user requirements and

convert them to design parameters. Literature on this category covers Axiomatic Design (AD), Cognitive engineering, and Sociotechnical Systems Approach, which will be presented in the following.

2.2.1 Axiomatic Design (AD)

AD theory was developed as a general design framework that was applicable to various design activities, including machines, complicated systems, software, etc. (Suh 1998; 2001). AD theory is on the basis of the Independence Axiom and the Information Axiom that can eliminate the possibility of making mistakes in the product development process. It contributes to overcome the drawbacks of design modifications that occur after testing (Suh 2001; 2007).

AD theory divides the engineering design process into four domains: customer domain, functional domain, physical domain, and process domain (Suh 2001). The design process is represented as the following steps: (1) Customer requirements specification is collected in the customer domain. (2) These needs are converted to a set of characteristic vector in the functional domain, which presents the functional requirements. (3) Functional requirements are met by defining and choosing Design Parameters (DPs) in the physical domain. (4) Production Variables (PVs) are determined according to DPs in the similar way.

2.2.1.1 Literature review of AD in HF/EII

Over the years, numerous studies attempt to apply AD theory within HF/EII. Some of them are listed in the following.

Considering multiple functional system-human compatibility needs must be met simultaneously, Karwowski (2005) introduced AD theory to address this issue. Four domains of AD are conceptualized as 1) HFE requirements in terms of human needs and system performance; 2) functional requirements and constraints restated according to human capabilities and limitations; 3) physical domain expressed through the human-system interactions and specific work environment design

solutions; and 4) process domain expressed as management of compatibility. Ergonomic design is considered as mapping from system–human compatibility requirements to relevant compatibility needs.

Helander and Lin (2002) demonstrated time-consuming iterative optimizations of design solution can be avoided by using independence axiom, and the number of design iterations would be reduced if the work situation can be considered in the design phase. A novel manner is recommended to calculate the anthropometric information based on information axiom. This study showed the promising of the application of AD in ergonomics. Subsequently, Lo and Helander (2007) proposed a methodology based on AD principles to identify and recommend manners for eliminating the coupling between user goal and user actions. A human-machine system model is developed by employing the following domain: goal; functional; physical; and action. This method show the principles for usable design and then only consider user action to satisfy a specific goal (Sadeghi et al. 2016).

Requirements in AD are identified by mapping the customer needs to functional requirements and constraints (Thompson 2013). It seems to address both functional and non-functional requirements in this way, the category of requirements in AD are vague. Previous studies in this field primarily concern requirements of physical and organizational ergonomics, however cognitive ergonomics requirements are rare. Few studies (Mabrok, Efatmaneshnik, and Ryan 2015) attempt to extend AD that can be capability of integrating non-functional requirements. However, it meets the same problem of KE. In addition, when suitable design parameters are available for functional requirements, AD shows the insufficiency in supporting the designer to understand the interactions among the design parameters (geometry, spatial layout, and interfaces) (Cebi and Kahraman 2010).

2.2.2 Cognitive engineering

Cognitive engineering, as well known as cognitive ergonomics in later studies, concentrates on the analysis of cognitive process regarding diagnosis, workload,

situation awareness, decision making, and planning (Hollnagel and Woods 1983; Jones 1995; Parasuraman, Sheridan, and Wickens 2008; Lawler, Hedge, and Pavlovic-Veselinovic 2011). The objective of cognitive engineering is to improve the performance of cognitive tasks in dynamic, technology-intensive environments through designing effective support, including understand the fundamental principles behind human action and performance associated with engineering design development principles, and develop user-friendly systems (Norman and Draper 1986).

2.2.2.1 Literature of cognitive engineering in HF/EII

There are numerous studies on cognitive engineering to address the balance between the human cognitive abilities and limitations, and machine, task and environment.

Human's Situation Awareness (SA) largely decide the following action that human will take (Endsley, Bolté, and Jones 2003). Stanton et al. (2006) held that each agent holds their own SA, which may vary considerably from other agents. A distributed SA was developed to share different agent's awareness makes SA as a dynamic and collaborative process to bind agents together on tasks. However, the majority of models present SA from individual perspective. Team SA received less attention (Salmon et al. 2008). Subsequently, Salmon et al. (2009) reviewed the methods of SA measurement in complex industrial systems and provided recommendations on the types of methods for future SA assessments. These studies contribute to the data collection of cognitive ergonomics for the precondition of successful design.

Artificial Intelligence (AI) as a popular tool shows the superiority in Cognitive Engineering, especially in perception-related fields. A report on the latest research related to this field were made by Lee, Bressler, and Kozma (2017). These studies cover the fields of human cognitive behaviour, the brain-computer interface, and personal space protection, which concentrates on the issues of saliency detection (Zhang, Yang, and Zhang 2017), intrusion detection (Raman et al. 2017), speech emotion recognition (Fayek, Lech, and Cavedon 2017), human pose estimation

(Witoonchart and Chongstitvatana 2017), use of electroencephalograms (EEGs) for brain–computer interface classification (Alimardani, Boostani, and Blankertz 2017), wearable sensors (Lee et al. 2017), predictive models in robotics (Ahmadi and Tani 2017), use of EEGs for advertising preference prediction (Gauba et al. 2017), and human intention understanding (Kim, Yu, and Lee 2017).

A sound and complete data of cognitive ergonomics can ensure the design specification. Data from cognitive ergonomics usually in textual format use for AI systems, and it faces the challenge of how to ensure data's correctness, soundness, and completeness in the process of data collection and interpretation. Additionally, AI systems are normally supported by database and updating knowledge into AI systems is difficult when new information need to be added (Naderpour, Lu, and Zhang 2015).

2.2.3 Sociotechnical Systems Approach

Sociotechnical systems theory was developed and refined by a number of researchers, and a simply description of sociotechnical system was summarized by Pasmore et al. (1982), which intends to combine humans, machines, environments, work activities and organizational structures and processes with the purpose of improving the overall quality of working life (Carayon et al. 2015). Sociotechnical Systems Approach is a complete design process for the analysis, design, and implementation of systems, which focused on the merge between social and technical systems and the environment (Salvendy 2012). Some sociotechnical principles are provided for guiding system design, such as meta-principles, content principles, and process principles are presented in detail in Clegg (2000).

2.2.3.1 Literature review of Sociotechnical Systems Approach in HF/EII

Studies on this issue cover a wide range of topics. Some of them may overlap the DTM and DTT mentioned above. Three categories with nine properties contributed to the complex sociotechnical systems were summarized in Norman and Stappers (2015), which cover the consideration of physical, cognitive, and organizational ergonomics.

To better understand the requirements of complex sociotechnical systems, Jones and Maiden (2005) developed a method (Requirements Engineering with Scenarios for a User-centered Environment, RESCUE) for integrating human activity models, creative design workshops, system goal models. The RESCUE processes consist of four streams that run concurrently and are mutually supportive, which cover human activity modelling, system goal modelling, use case modelling and specification, and requirements management. This method has been applied in specifying requirements of air traffic control (CORA-2 system).

Kyriakidis et al. (2017) introduced a generic framework to consider human performance in sociotechnical systems. The authors claimed human performance, actions, and decisions as Performance Shaping Factors (PSFs) contributed either positively or negatively to sociotechnical system performance, which consists of personal factors, dynamic personal factors, organizational factors, task factors, team factors, system factors, and environmental factors. Based on the existing Railway-Performance Shaping Factors taxonomy (R-PSFs) and the basic concepts of Cognitive and Behavioural Science, a new Cross-Sectoral Performance Shaping Factors (C-PSFs) taxonomy was developed to provide new perceptiveness regarding any latent interactions between the humans and their working environment.

Hasan et al. (2003) and Houssin et al. (2006) also proposed to develop working situation model to solve the sociotechnical problems. These studies main focussed on safety requirements integration in the design phase, and their later researches are introduced in section 2.3.1.1.

Although Sociotechnical Systems Approach has introduced positive changes from social aspect. However, the social systems are often overemphasized and technical systems are received less attention in the design process (Czaja and Nair 2012). Poor designs are still commonplace around the world when it comes to creating an organizational system (including both social and technical system) that can well perform complex tasks together. Sociotechnical Systems Approach remains to be

improved and several future fields are given by Eason (2014).

2.3 HF/EII from detailed phase

User intervention in detailed design phase provides an intuitive understanding of how users will interact with the system or product. HF/E needs are more explicit in detailed design phase than at before stages. In this step, users play a role to allow HF/E evaluation and validation to ensure that the design will be safety, usability, and operability. Some studies of HF/EII from detailed phase are illustrated in the following.

2.3.1 Function-Behaviour-Structure (FBS) framework

FBS framework was developed by Gero (1990) to represent the design process as transformations between function, behaviour, and structure. It claimed that the function and the structure must be linked through behaviour explain “how does structure fulfils the function”. Afterward, situated FBS framework was developed by Gero and Kannengiesser (2004) based on previous study, which provided the capability of addressing agent’s interaction processes with the external world and within itself. Eight fundamental processes with 20 steps involved in designing was presented in (Gero and Kannengiesser 2004) (Figure 2.2).

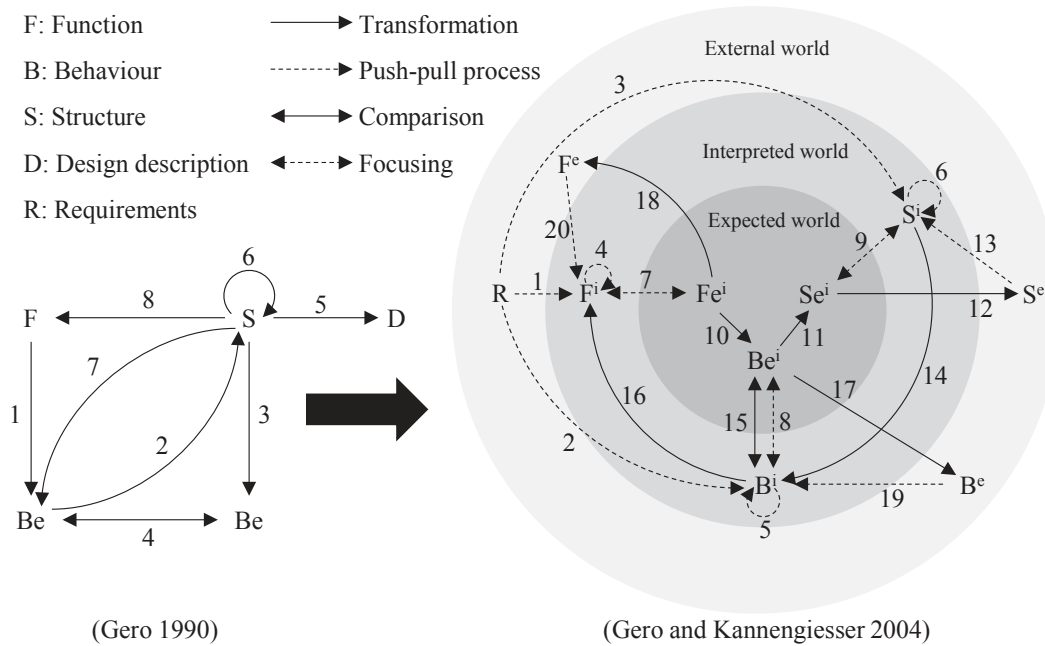

Figure 2.2. Function-Behaviour-Structure (FBS) framework

2.3.1.1 Literature review of FBS in HF/EI

FBS framework was originally proposed as a technology-centered design method. In 2002, Stalker claimed that user should be integrated in FBS framework primarily to identify how a user interacts with an artefact once it exists. And a FBS artefact lifecycle schema was developed based on FBS framework, which provides the chance for user intervention in the design process. This study advocates verifying the compatibility between user and structure according to the user’s feedback after design decisions have been made.

In order to consider the user factors in the design phase, a behaviour design approach (BDA) (Houssin, Sun, and Gardoni 2010; Sun et al. 2013) was proposed to integrate user behaviour in product design process. In their study, function is classified into two categories, automatic function and manual function. Specifically, automatic function is achieved by structure as well as manual function is fulfilled by user. Structure behaviour and user behaviour are driven by structure and user respectively. The interaction between structure behaviour and user behaviour are analysed to verify whether the structure behaviour meets performance criteria (functionality, productivity,

safety, cost, quality, etc.) or not. Finally, this approach was developed as computer-aid software to support the design work.

Literature on this category is relatively rare. These studies aim at integrating user behaviour to evaluate the design. However, it is imprecise to classify the function into two categories. Sometimes, it is difficult to define a function can be fulfilled by structure or user. Some functions may be required the cooperation of the user and structure.

2.3.2 Computer Aided Design

Computer Aided Design were initially used to serve as the creation, modification, analysis, or optimization of a design based on computer systems (Sarcar, Rao, and Narayan 2008). Currently, the CAD systems have been expanded to other potential uses, such as Digital human models (DHMs), Virtual Reality (VR), simulation, etc. To integrate HF/E information into design phase, CAD tools are required to enable the ergonomics data are available when performing ergonomics analysis and workplace design. Computer-Aided ergonomics as a branch of CAD was proposed to solve complex ergonomic problems involving interaction between the human body and its environment (Feyen et al. 2000).

2.3.2.1 Literature review of CAD in HF/EII

Literature on this issue mainly focuses on ergonomics analysis and workplace design. DHMs were developed for CAD tools to represent the capability, requirements, and performance of target population under consideration of workplace design in virtual environment (Chaffin et al. 2001). Many CAD tools allow designers to develop DHMs based on anthropometric and biomechanical database in order to estimate workstation ergonomics (reach area, physical performance, and procedure analysis) (Magistris et al. 2015). Indeed, DHMs contribute to safety principles in the design stage (before physical prototype) according to European standards (European Union 2006). To overcome most CAD DHMs tools only consider static posture, inspired by human motor control and based on robotics and physics simulation, Magistris et al.

(2015) proposed a dynamic DHMs that can be automatically controlled in force and acceleration. DHMs provide a chance to exam the multiple design scenarios before building physical prototype phase, however, it costs more than the others.

VR emerges as a promising technique that provides efficient and effective support for product design. It presents a virtual scene to represent the workplace for users to perform tasks in virtual environment. In 1998, Buck combined VR technique and DHMs tool to enable people to participant in design. Some other studies (Whitman et al. 2004; Jayaram et al. 2006) also showed the feasibility of VR in ergonomic applications regarding various operations of human movement estimation. To extract and re-use engineering knowledge, Mahdjoub et al. (2010) proposed collaborative workstation design approach based on Multi-Agent System (MAS) on a Virtual Reality (VR) platform. The MAS allows to annotate knowledge in accordance with the actions of the designers inside a PLM environment. Subsequently, this knowledge is employed by VR tools to analyze various perspectives of the virtual prototype such as manufacturing, maintenance, reliability or ergonomics. It contributes to improve ergonomics and collaborative design. Aromaa and Väänänen (2016) introduced augmented reality (AR) and virtual environment (VE) prototypes to evaluate the suitability of virtual prototyping to consider HF/E during the design phase. The results showed that VE system was more suitable to support the estimation of visibility, reach, and the use of tools than the AR system. The findings of these studies provide guidance for the virtual prototypes implementation during the design phase.

These studies primarily apply HF/E information to evaluate and validate the design after design decisions have been made. It may arise some design modifications due to requirements modification (is not discussed in this work) and the incomplete analysis of non-functional requirements, and the user behaviour must yield to the system or product. Some design modifications may be required due to HF/E problems and it will be costly and time-consuming.

2.3.3 Ecological Interface Design (EID)

EID was introduced by Vicente and Rasmussen (1992) as a theoretical framework for designing interfaces of complex sociotechnical systems in order to improve its safety and productivity. EID is developed based on two concepts from cognitive engineering, including the Abstraction Hierarchy (AH) (Rasmussen 1985) and the Skills-Rules-Knowledge (SRK) taxonomy (Rasmussen 1983). The AH is a multilevel knowledge representation framework that can be applied to develop models of particular work domains (Salvendy 2012). The SRK taxonomy is used to distinguish three modes of user behaviour (Rasmussen 1986). By realizing the behavioural mode and constraints of the end user, EID gives a promising manner to show the organizational and structural information to user. Comparing with other design approaches, EID improves performance and has been applied in a variety of domains for industry-scale problems solving (Vicente 2002).

2.3.3.1 Literature review of EID in HF/EII

Interface Design presented here is a multidisciplinary topic regarding the user interface for systems and products with the purpose for maximizing usability and user experience. Some studies of EID in HF/EII are presented in the following.

Young and Birrell (2012) applied EID approach to develop an in-vehicle human-machine interface with focus on encouraging more environment friendly or “green” driving. The Foot-LIFT project was presented by an in-vehicle interface that facilitates the desired behaviours while avoiding adverse impacts. A rapid prototyping demonstrated the feasibility of proposed in-vehicle human-machine interface for Foot-LIFT. Kim et al. (2012) validated the capability of EID in terms of improving operator’s SA in an advanced control room of a nuclear power plant. However, the findings of Burns et al. (2008) suggested that EID approach requires further development, especially in integrating EID with procedural support. Some limitations are also discussed in (Pawlak and Vicente 1996; Vicente 2002; Upton and Doherty 2008).

2.4 Discussion

In the previous sections, each DTM and DTT associated with HF/EII in the design phase has been discussed. Based on literature review, we categorized these DTM and DTT from two aspects (1) the stage of HF/EII in the design phase, including conceptual, embodiment, and detailed design phase, and (2) the category of HF/EII, including physical, cognitive, and organizational ergonomics. The perceived benefits and limitations of each stage's DTM and DTT were summarized in table 2.2.

HF/EII in different design phase will have different impact on the whole engineering design process, which is discussed in detail from three phases:

(1) HF/EII from conceptual design phase: On one hand, it can effectively avoid the late design modifications due to inadequate considerations and analysis of the HF/E requirements. On the other hand, integrating HF/E information from the early design phase can make the system (product) designed meet the user needs of behaviour habits, operation habits, cognitive habits, preferences, etc. By this mean, the functional requirements and the non-functional requirements can be satisfied simultaneously, which will improve product performance and introduce great user experience. However, it is time-consuming for gathering the HF/E information from the early design phase and applying these requirements into design process. There may be some conflicts between functional and non-functional requirements, and it is hard to coordinate them. Some non-functional requirements are easy to define but difficult to satisfy from the technical aspect. Furthermore, too many constraints will be brought in when integrating HF/E from the early design phase. It will limit the solution space and some promising solutions may be missed.

(2) HF/EII from the embodiment phase: In this step, DTM and DTT originally consider the design as the resolution of technical problems and address the problems from technical perspective. HF/E as the constraints to formulate and design the structure to fulfil the established function structure of system. These DTM and DTT allow designer to carry out embodiment design and HF/EII concurrently. HF/E

information is integrated to meet the functional requirements maximization by evaluating and verifying some potential solutions. Iteration design facilitates to refine design schemes that match the technical solutions and HF/E requirements. However, iterations are time-consuming, which increase designer's workload. Additionally, users may be compelled to change their habits (behaviour, operation, cognitive, etc.) to cooperate with the system (product) due to the consideration of safety.

(3) HF/EII from the detailed design phase: In this step, HF/E integration can be regarded as the evaluation and verification of solutions that have been developed, rather than the methods of solution generation. Visible assessment gives designers more intuitive cognition of user's abilities and limitations in the process of interaction, which will provide useful feedbacks for designers to improve design schemes. HF/EII in this phase is a belated action or advice. Since HF/EII is too late, design modifications are often required in this phase. Modifications are easy and less expensive to implement in the early development phase, and the complexity and cost of the modification will increase over time. Comparing with HF/EII in prototype testing phase, it is better to address these issues from detailed design phase. From the tacit view, some studies claimed that it is not too late to integrate HF/E from detailed design. However, it is too late when it faces to the costly and time-consuming design modifications. Additionally, supplementary procedures and apparatus may be introduced into designed system with the purpose of addressing the HF/E requirements (Houssin and Coulibaly 2011). These modifications may reduce the system performance and users may be compelled to change their habits (behaviour, operative, cognition, etc.) to cooperate with the system.

Overall, HF/EII in the early design phase can make a pleasant system (product) but too much time is required to address the requirements collection and analysis. While HF/EII in the late design phase will introduce design modification and iteration. The later consideration of HF/E, the more iteration, and the complexity of design modifications will increase over the time. Based on the above literature review, it is indicated that the application of DTM and DTT depends on (1) the trade-off between

the early time-consuming of HF/E requirements collection and analysis and the late complexity of design modification, and (2) the category of HF/E.

Conclusion of this chapter

In this chapter, this review outlines the DTM and DTT for HF/EII in engineering design in terms of the stage of HF/EII and the HF/E data category. After discussing the research topics from three design phases, the main findings are summarized to understand the merits and drawbacks of each DTM and DTT.

According to the above discussion, it is shown that new design methodology and tool are required for HF/EII from the early design phase in a systematic, time-saving, less expensive, and less iteration way. Therefore, in the following chapters, we mainly concentrate on (1) the method of HF/EII from the early design phase (Chapter 3 and Chapter 4), (2) the method of design solution generation (Chapter 5).

Table 2.2. Comparison of reviewed DTM and DTT for HF/EII

DTM & DTT	Stage of HF/EII in the design phase			Category of HF/E			Benefits	Limitations
	Conceptual design	Embodiment design	Detailed design	Physical ergonomics	Cognitive ergonomics	Organizational ergonomics		
UCD	✓	✓	✓	✓	✓	✓	Reduce design modifications.	Costly and time-consuming.
KE	✓	✓	✓		✓			
TRIZ	✓	✓	✓	✓		✓		
AD		✓	✓	✓		✓	Design and evaluation at the same time.	Heavy workload of design.
CE		✓	✓		✓			
STSA		✓	✓	✓	✓	✓		
FBS			✓	✓		✓	Intuitive estimate design according to HF/E needs.	Introduce design modifications.
CAD			✓	✓	✓	✓		
EID			✓	✓	✓	✓		

DTM : Design theories and methodologies

DTT: Design techniques and tools

UCD : User-Centered Design

KE : Kansei Engineering

TRIZ : Theory of inventive problem solving

AD : Axiomatic Design

CE : Cognitive Engineering

STSA : Sociotechnical Systems Approach

FBS : Function-Behaviour-Structure

CAD: Computer-Aided Design

EID: Ecological Interface Design

Chapter 3. Function-Task-Behaviour framework

For the purpose of integrating the HF/E information into design phase, avoiding limitations of TCD approaches and UCD methods, we aim at developing a systematic method which provides an opportunity of more HF/E information will be noticed in a cost-benefit way. We propose to first consider the performance to carry out the design work, which refers to both product performance and user performance. Considering user usually uses a product by following the user manual, we propose to develop a user manual for concerning HF/E information in the early design phase to direct design. In our work, HF/E information involves how users use the designed product (or system). Our proposition is shown in table 3.1.

Table 3.1. Comparison of our proposition with the existing methods

Conventional approaches	Our proposition	UCD & Kansei theory
Systematic approach	Systematic approach	Customized approach
Design for X	X refers to HF/E	X involves ergonomics
Functionalism: function first	Performance first	Humanization: user first
V model and others	Function-Task-Behaviour	
Use requirements integration in the last design stage	Use requirements integration in the early design step	User intervention in every design phase

The proposed method is a top-down process based on Function-Task-Behaviour (FTB) framework and the user manual will be constantly improved and refined in three steps (initial-conceptual-detailed). This method starts with three main questions:

What does user want to achieve and what’s the function of the product (system)?

How does the task assignment between multi-agents (users and product structure) to realize the prescribed functions?

What is the composition (structure or/and parameter) of the apparatus and what is the detailed operation (time schedule and behaviour) of user?

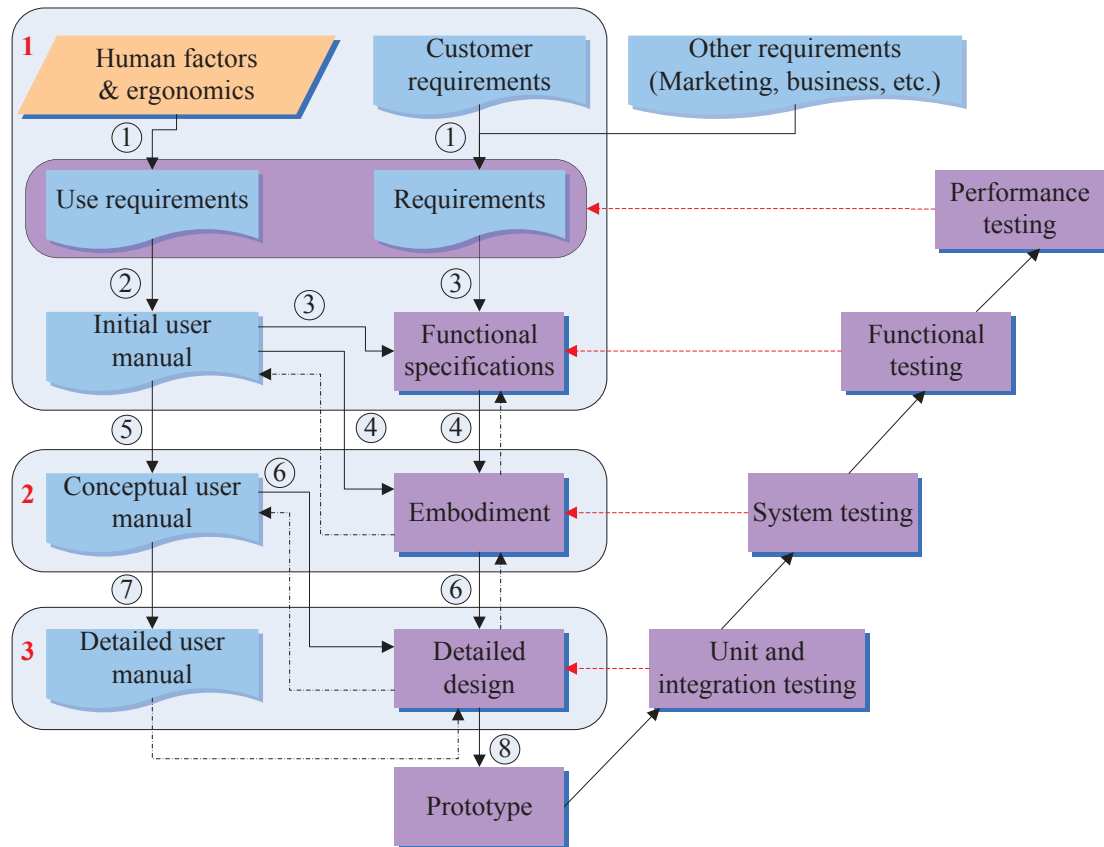

Figure 3.1. Framework of the proposed methodology

These questions are proposed to identify and describe the model of the global method. Figure 3.1 shows the overall framework of the proposed method. It contains three parts: functional specifications, embodiment, and detailed design, which are illustrated in the following:

Function specifications: Conducting the function definition and decomposition according to the requirements and initial user manual based on use-case analysis and Function Analysis (FA). The question of “What does user want to achieve and what’s the function of the product (system)?” can be answered. Data from HF/E conceives the “initial user manual”. Initial manual, not a real user manual, is just probable model that the potential users tend to the function, exterior and shape, interaction experience, operating habits, mode of thinking, etc. Meanwhile, Initial user manual will be a constraint of embodiment. Here, the result of function specifications can be represented as a function tree.

Embodiment: To fulfil the function, performing task identification, assignment, and planning in accordance with the initial user manual and function tree based on an improved Structured Analysis and Design Technique (SADT) method, a mathematic model, and Program Evaluation and Review Technique (PERT) method, respectively. In this work, the task performed by apparatus is defined as the technical task, and the task performed by users is defined as the sociotechnical task. Then, ensuring the time sequence and hierarchical of the tasks to meet the overall task interaction. Finally, updating the initial manual to conceptual user manual by turning to feedback from the results of embodiment. Here, the conceptual manual can be understood as when, how long, how often user will interact with the product.

Detailed design: Carrying out the detailed design by following the conceptual user manual. Herein, detailed design covers three steps, first of all, designing certain structures or/and parameters of the component (part) for the technical tasks. Next, ascertaining the users' behaviour for the sociotechnical tasks. Then, evaluating the interactions of the overall behaviour via employing behavioural design approach (Sun et al. 2013). Finally, updating the conceptual manual to detailed user manual. Here, detailed manual indicates how users will operate the designed product to achieve their goal in detail.

3.1 Function definition and decomposition

3.1.1 The correct and efficient way of collecting the requirements

Before product development, the most crucial work is to understand the requirements from all aspects. In this work, the collection of HF/E involves use requirements. If use requirements are ignored or kept a thoughtless attitude in design phase, it does not matter how usable the product is and it is bound to failure. The reality is that many product development teams are great pressured for time and they take less time for collecting information regarding product/system use that we name it as “use information” in the following. However, the consequences are that they spend more time and energy on iterative activities in later design phase.

It is necessary to discuss the requirements again before gathering the data. Requirements mean the features/attributes of product or system should have or how it should perform, which come from various aspects, such as business, marketing and sales, users, customers, etc. In fact, there is much overlapped and ambiguous information when product development team gathering the requirements. In many cases, customer (purchasing decision-makers) is different from user (the end-user who use the product). Managers, marketing and sales may receive information from the end-users, and then they combine their needs with the end-user's requirements (Figure 3.2) (Courage and Baxter 2005). In the process of transferring and interpreting these information to the product development team, some information may overlap as well as get lost. Indeed, this inaccurate information will mislead the product development team, furthermore, the overlapped and ambiguous information will significantly increase the work intensity of product development team.

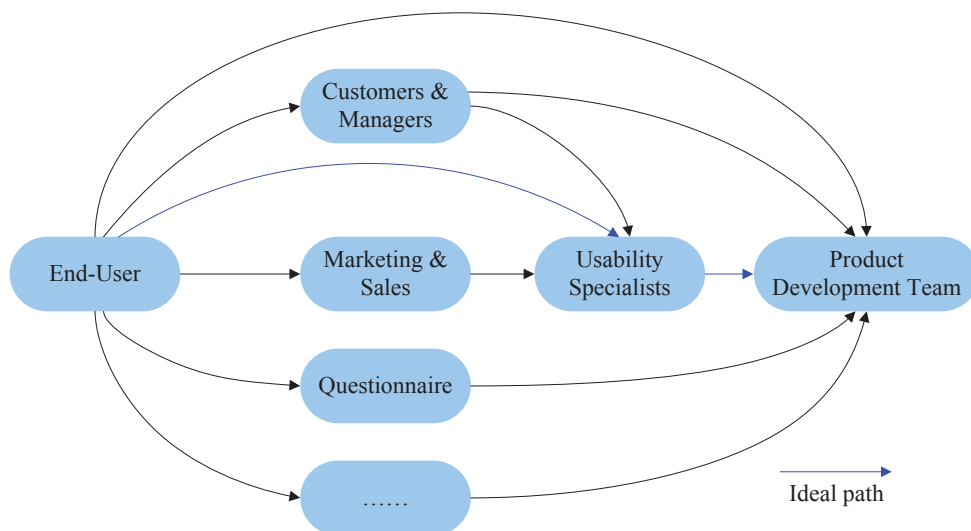

Figure 3.2. The communication paths of requirements collection

People only focus on their own problems, no matter end-users, customers, marketing and sales, or someone else do not care how product development team's solution is achieved. In order to complete a high quality needs collection in an efficient way, we suggest setting some indicators to gather the requirements purposefully on the basis of their interests. For example, customers and managers (purchasing decision-makers)

pay attention to the functionality, cost and efficiency. Therefore, customer (manager) requirements could be collected from these aspects. Similarly, user requirements can be collected from the reliability, security, usability, and operability perspective. This research mainly concentrates on concerning the use information in the early design phase. Next, the way of gathering the use information is introduced in the following section.

3.1.2 Several ways to gather the use information

One product character is created according to the requirements by the subjective decision of the designers. There is no guarantee that whether users will really accept and appreciate the style of the product or not. In fact, most of designers in such a situation: users should know what designers are familiar with, and users should accept what designers approve. It is very difficult for designers to think of the problems from user's perspective: how do users look on this problem? What is the judgment and evaluation of this problem? How do users understand the description of the problem from designers? What kind of solution users will think of? The knowledge storage between designers and users vary considerably, designers are in an expert level while users are in a novice level (Norman 1988). As a result, extensively employ expert-level mode of thinking and knowledge in design work, users may get some problems in the interaction process.

Usually, a conceptual model will be fabricated in designer's mind when they embark on design activities. It is the model that designers think how users operate the product. Actually, when users first get access to the product, a mental model will be created in their mind that they think how they operate the product. Obviously, there are differences between these model due to they are in the different knowledge level (Norman 1988). The target beneficiary of product is user, who aims to achieve their desired purpose by interacting with the product. Consequently, the best way is that designers carry out design work based on user's mental model.

There is no product initially, to obtain users' mental model requires designers to learn

the users before design. It may be difficult to develop a library of users' mental model that covers every conceivable task or situation that users might encounter. However, users' mental model can be documented by an initial user manual with some specific aspects. In this work, the initial user manual involves in technical and sociotechnical perspectives. Technical aspect covers technical details of system's characteristics, properties, and parameters, appearance and aesthetic, material, and the configuration of the product's function and modules. Sociotechnical aspect contains all constraints on how the system should run to assist users to fulfil their aims, such as initial task assignment that users' willingness of which part of function completed by themselves and which part of function accomplished by equipment, and user-friendly such as easy to understand and use, maintainable, environment-friendly, etc.

As mentioned in section 3.1.1, many problems, such as information loss, low efficiency, information overlapped, etc., will be generated in multi-layer information transmission. Therefore, good communication between designers and users is the key to gather the use information. Here, survey, interview, and wants and needs analysis method are applied in this study.

Building a survey is to create a series of questions and ask respondents to complete. Survey is a high-efficiency method to collect information from users, which can solve different problems in a new product (never appeared) and new version product (already existing) (Courage and Baxter 2005).

In the case of a new product, survey can help designers to (1) identify the potential user population; (2) find out what they really want and need; (3) ascertain how they are presently solving the problems or achieving their goals.

In the case of a new version product, survey can help designers to (1) discover what users dislike about the current existing product and what they want; (2) learn how users currently interact with the product.

Composing the questions is the key part of the survey. Well-composed questions enable designers to obtain a large quantity of information that can contribute to a

successful product. Here are some suggestions for building a good survey, (1) keep the survey short, no one like to take much time to complete your survey; (2) brain-storm the initial questions, try to write every potential questions and do not mind about the exact words and format of questions at this moment, then make the choice. The rest questions may be beneficial to the further issue later; (3) avoid similar repetitive questions, the respondents may think it is a bungling survey and it wastes their time; (4) friendly questions format and words, avoid the aggressive words and manner and respect individual privacy.

After survey, designers clearly understand users' mental model by one-on-one interviews. Interview provides the opportunity to gain the in-depth communication with the end-users. The contents of the interview involve both aspect of technical and sociotechnical that discussed above. When conducting interviews, it is necessary for designers clear that listening and recording the end-users' needs, do not impose designers' ideas to the end-users. Last, wants and needs analysis is an extremely efficient method to deal with the data from multiple users simultaneously. It provides an organized methodology to get a priority of initial use requirements and summary the practical information to develop the initial user manual.

3.1.3 The method of function definition and decomposition.

A function is an abstract concept model of the product, without any physical characters such as size, shape and material parts. At the beginning, function hierarchy can be built up from a limited number of high-level general functions. And then specify each high-level function until elementary function that can be achieved by simple task. The function analysis can be conducted as follows:

- Define the principal function of the product.
- Decompose the principal function into elementary functions according to the system running procedures. These procedures can be carried out by product or/and user to realize functions. Each elementary function can be performed by a smaller number (one or two) of procedures.

- Develop the hierarchy of the functions.
- Evaluate the function structure. Analyse the interaction among the relative functions, verify whether it exist the function conflicts.

In this study, use-case analysis and FA are employed to conduct the function definition and decomposition in light of requirements documents and the initial user manual. These steps above are described as the use case diagram by UML. The outcome of the function definition and decomposition is in a function tree (Figure 3.3).

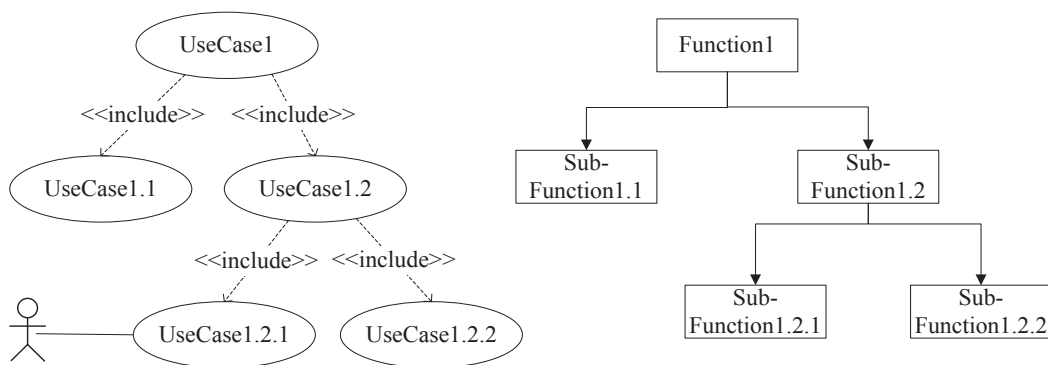

Figure 3.3. Description and outcome of the function analysis

3.2 Task definition, assignment, and planning

3.2.1 Task definition

In this section, by defining the task, the question of “how system will implement all the elementary functions” can be answered. A task can be considered as an activity that requires to be completed within a certain period of time to realize the specific function. To conduct a task, the activity resources such as inputs, constraints, outputs, and support resources should be defined. SADT was developed by Ross (1977) as a graphical language, which has been applied successfully in numerous projects involving activity descriptions. For the sake of facilitating the follow-up study, we describe tasks based on SADT with little improvements. Besides the input, output, control, supporting resources, we add the duration information in SADT. The improved SADT method (Figure 3.4) is represented as a box-arrow diagram, which

contains one activity block with four arrows end on each side named as: input, output, control, supporting resources, and we add the duration. The explanations as follows:

- Activity: serves to realize the intended function.
- Input: some consumables (the activity, data/information, etc.) that are needed by an activity.
- Output: the intended function (the activity, data/information, etc.) that are produced by the activity.
- Control: the commands or conditions that influence the execution of an activity but are not consumed.
- Supporting resources: the means, persons, components or tools that are required to accomplish the activity. It indicates task assignment that the activity will be performed by apparatus or human, the method of task assignment will be presented in next section.
- Duration: the length of time from the beginning to the end of the activity. The method of duration definition will be introduced in section 3.2.3.

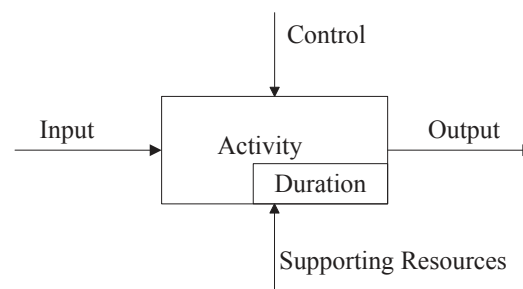

Figure 3.4. The notation of the improved SADT

This illustration means: under control, carry out the activity by certain supporting resources, after a period of time, input is transformed into output that signifies intended function.

In general, implementing a specified function requires a series of tasks are carried out according to a given pre-defined chronological sequence. All tasks linked in a relationship of input and output, or control and controlled. Task model based on

improved SADT methodology can be represented in Figure 3.5.

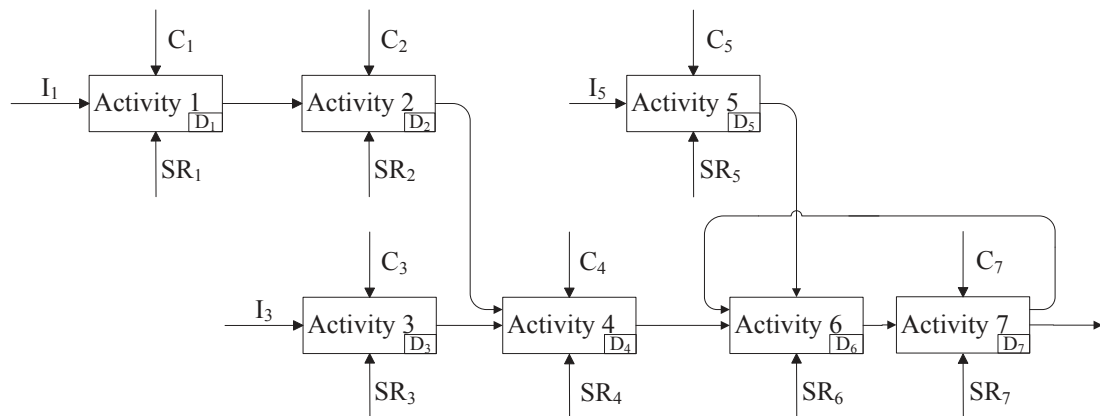

Figure 3.5. Task model based on SADT methodology

At the first stage, by conducting activity 1 with supporting resources SR_1 under the constraints of C_1 , input I_1 is transformed to the output of activity 1, which as the input of activity 2, and so on. Here, four task modes are used in this research. Serial task mode can be described as the combination of activity 1 and activity 2. Concurrent task mode can be depicted as the combination of activity 2, activity 3, and activity 4. Control task mode can be showed as the combination of activity 5 and activity 6. Feedback task mode can be presented as the combination of activity 6 and activity 7.

3.2.2 Task assignment

Each elementary function can be realized by technical or/and sociotechnical task. Task assignment is a key factor that will influence the cost of design and manufacture and the final performance of the product. There are many existing works about the task assignment (some researches named it as function allocation (Pritchett, Kim, and Feigh 2014)). Normally, in the process of the interaction between users and product, user not only play the role of the operation and control, but also as a supervisor to provide feedback to product. Automation brings a number of benefits, such as safety, reliability, and high efficiency of production (Parasuraman, Sheridan, and Wickens 2000). The problem, however, is that the higher the level of automation, the more

expensive of design and manufacture, and the less information user accesses to. Moreover, automation system has limitations to deal with some unforeseen circumstances. Accordingly, human intervention is necessary in the system to handle these unforeseen circumstances to improve the system flexibility. To assist in these problems, we propose to set several constraint conditions and objectives to assign the task to human or automation. In this study, safety and health of user and budget must be satisfied as the constraint conditions, and the needs of user's work intensity, reliability, productivity should be met in full measure as the objectives.

- Safety and health needs: in sociotechnical task, the user's safety issue is obviously a significant concern in the process of handling the activities. Design must prevent the injury and illness to users in the workplace. Potential hazards, such as product behaviour (vibration, cutting, rotation, etc.), workplace (aloft work, down-hole operation, etc.), and environment (chemical, electrical, fire, noise, etc.) must be instead of automation or provide some protections. Overall, all designs that damage user's safety and health must return to revise.
- Budget: it is a quantitative expression of financial plan for design and manufacturing before the deadline. The budget consists of the total costs of design and manufacturing.
- Users' work intensity: it refers to working hour and workload. Empiricism holds that long working hours and heavy workload will raise users' failure rate. Consequently, avoid long hours of work and reduce work intensity, if not, try to reduce the single working time and increase the operating frequency. In technical task, user plays a role of supervisor, user should also conduct the system maintenance when malfunction occurs. In this situation, the work intensity is represented as the supervisory and maintenance work intensity. In sociotechnical task, users' work intensity associates with the intensity of workload and working hours.
- Reliability: reliability can be expressed as the ability of a system to perform a

specific function under the contribution of user or/and product in a stated situation (time, environment, resources, etc.). Usually, product reliability involves in system malfunction due to design and manufacturing deficiency, use, installation and maintenance factors, material fatigue and failure, broken parts, etc. System reliability will gradually decrease over time, in other words, no one can guarantee that any product can be 100% probability of normal operation. The users' ability of cognitive failure usually decreases with the increase of users' work intensity, and users' reliability will decrease with the decline of their cognitive failure ability. While task is allocated to a part of product, the reliability of technical task is equal to the multiplication of the automatic parts' reliability and user's reliability. On the contrary, task is allocated to human, the reliability of sociotechnical is equal to the user's reliability. System reliability is equal to multiply all the reliability of technical parts and user.

- Efficiency: the efficiency of production is inversely proportional to the time of completing task. Obviously, automation can largely improve the efficiency. However, the cost of design and manufacture will increase with the improvement of the level of automation. Therefore, in the case of satisfying both needs of user work intensity and budget, as much as possible to improve the level of automation.

Table 3.2. Comparison of the performance between human and automation in system

	Safety & Health	Budget	Work Intensity	Reliability	Efficiency
Human	Low	Low	High	Low	Low
Automation	High	High	Low	High	High

To sum up above, task assignment problem can be described as: Task assignment is limited by 5 metrics (Table 3.2) (Parasuraman, Sheridan, and Wickens 2000; Bindewald, Miller, and Peterson 2014). How to allocate N tasks to user and product to achieve the following goals:

- (1) Make sure the user in a safety and health environment.
- (2) The efficiency is not less than E_T , improve the efficiency as much as possible.

- (3) The system's reliability is not less than reliability rating R_T .
- (4) The user's work intensity is less than WI_T , reduce it as much as possible.
- (5) The overall costs are less than budget B .

This question is a multiple objective decision-making problem. We use the multiple-objective optimization methods (Lai and Hwang 1994) to solve it. Assuming there are n technical tasks and $(N-n)$ sociotechnical tasks. The solution model as follows:

Condition (1) is rigid constraint, condition (5) is flexible constraint, and the others are goals. Firstly, the most important is the system's productivity, therefore the efficiency is in the first priority level (P_1). Secondly, we put the reliability in the second priority level (P_2). Finally, we consider the user's work intensity in the third priority level (P_3). Therefore, the priority level: $P_1 \gg P_2 \gg P_3$. The objective function is:

$$\min Q = P_1 d_1^- + P_2 d_2^- + P_3 d_3^+ \quad (1)$$

Where d^- and d^+ represent negative and positive deviational variables. $d^+ = \max\{d - d_0, 0\}$ denotes the part where the decision value exceeds the target value, as well as $d^- = -\min\{d - d_0, 0\}$ indicates the part where the decision value does not reach the target value, where d_0 is the target value of d . Condition (4) shows that the decision value should exceed the target value and there is no upper limit on the decision value. That is to say, d^+ is unlimited and d^- is as small as possible, accordingly, $\min E = f(d^-)$. Similarly, $\min R = f(d^-)$, $\min WI = f(d^+)$.

The objective function $\min Q$ subjects to:

$$SH_{ai} = 1, SH_{uj} = 1 \quad (2)$$

Where SH_a and SH_u are the user's safety and health factors of the technical task and sociotechnical task. The value 0 represents unsafety, while the value 1 indicates

safety.

$$\sum_{i=1}^n \sum_{j=1}^{N-n} (C_{ai} + C_{uj}) \leq B \quad (3)$$

Where C_a and C_u are the design and manufacturing costs of when tasks are allocated to product and user.

$$\begin{cases} E_{ai} \propto \frac{1}{t_{ai}}, E_{uj} \propto \frac{1}{t_{uj}} \\ \sum_{i=1}^n \sum_{j=1}^{N-n} (E_{ai} + E_{uj}) + d_1^- - d_1^+ = E_T \end{cases} \quad (4)$$

Where E_a and E_u represent the efficiency of technical task and sociotechnical task. t_a and t_u are the duration of technical task and sociotechnical task. And E is inversely proportional to t .

$$\begin{cases} R_{ai} \propto \frac{1}{WI_{ai}}, R_{uj} \propto \frac{1}{WI_{uj}} \\ \prod_{i=1}^n \prod_{j=1}^{N-n} (R_{ai} \cdot R_{uj}) + d_2^- - d_2^+ = R_T \end{cases} \quad (5)$$

Where R_a and R_u are the user's reliability of technical task and sociotechnical task. WI_a and WI_u are the user's work intensity in the technical and sociotechnical task. R is inversely proportional to WI .

$$\begin{cases} WI_{ai} = SWI_i + MWI_i, WI_{ai} \propto (t_{ai} + wl_{ai}) \\ WI_{uj} = DWI_j + SWI_j + MWI_j, WI_{uj} \propto (t_{uj} + wl_{uj}) \\ \sum_{i=1}^n \sum_{j=1}^{N-n} (WI_{ai} + WI_{uj}) + d_3^- - d_3^+ = WI_T \\ i = 1, \dots, n, \quad j = 1, \dots, N - n, \quad n \leq N \end{cases} \quad (6)$$

Where wl_a and wl_u denote user's workload in the technical task and sociotechnical task. SWI , MWI , and DWI respectively denote supervisory work intensity,

maintenance work intensity, and directly work intensity.

In this work, the solution of the mathematical model is computed by using Lingo software (Díaz-Madroño, Mula, and Peidro 2014). The result shows all tasks' nature (technical task or sociotechnical task). In this step, this mathematical method can help designers to allocate all tasks to user and product.

3.2.3 Task planning

Regarding the initial duration of each task is only an estimated value, for the purpose of increasing the system's flexibility, planning a reasonable time schedule of the correlative sub-functions, and reducing the conflicts among sub-functions within the system, the Program Evaluation and Review Technique (PERT) was applied to analyse and represent the tasks involved in completing a given project. Classical PERT uses the three-point estimation and assumes beta distribution for the duration of the task. Then it was questioned and criticized by many researches, and several new methods have been brought in, which produce an estimated value that is more closely to the real value of duration and easier to calculate from mathematical viewpoint (Hajdu and Bokor 2016; Shipley, de Korvin, and Omer 1997; Lootsma 1989).

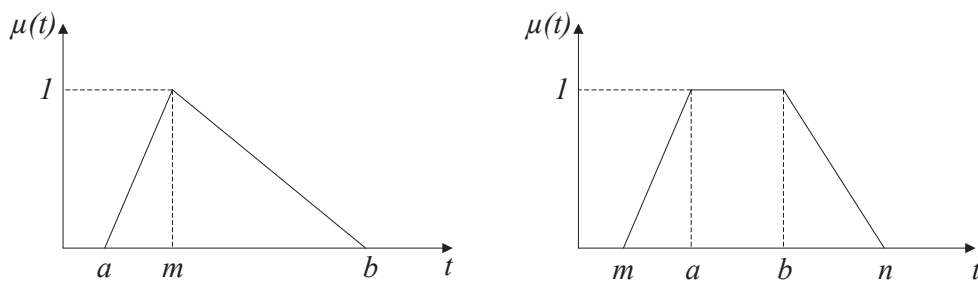

Figure 3.6. Duration representation by triangular and trapezoidal fuzzy numbers

Here, we only ensure task can be completed in estimated duration and do not concern the success rate of task due to the detailed design is unknown. In this study, the fuzzy sets theoretic method is employed to represent the estimated value of duration. The initial duration can be regarded as a fuzzy number of the time interval, and the

sequence of task is a fuzzy time series. Fuzzy numbers, which can be believed as representative values that denote sets of possible values rather than single values, allow us to treat a given planning problem as a fuzzy mathematical model. Generally, the triangular fuzzy numbers and the trapezoidal fuzzy numbers are often used to describe the task duration and the project duration (figure 3.6). Zimmermann (2001) holds that the trapezoidal fuzzy distribution is more appropriate to estimate duration, and the triangular fuzzy distribution is the special circumstance of the trapezoidal fuzzy distribution (Barajas and Agard 2010).

In this study, the classic graded mean integration representation (Khadar et al. 2013; Maniadakis, Hourdakakis, and Trahanias 2017) was adopted for the trapezoidal fuzzy number representation and defuzzification. Here, the fuzzy numbers was denoted as quadruplet (m, a, b, n) , where a and b , which were produced by the task planner, signify the approximation minimum and maximum time to complete the task, $m = 0.9 \times a$, and $n = 1.1 \times b$. The crisp value was represented as:

$$D = (m + 2a + 2b + n) / 6 \tag{7}$$

Suppose that a system contains nine tasks (T_0 to T_8), including four sociotechnical tasks (User, U) and five technical tasks (Product, P). The task planning is represented in PERT diagram as follows (Figure 3.7):

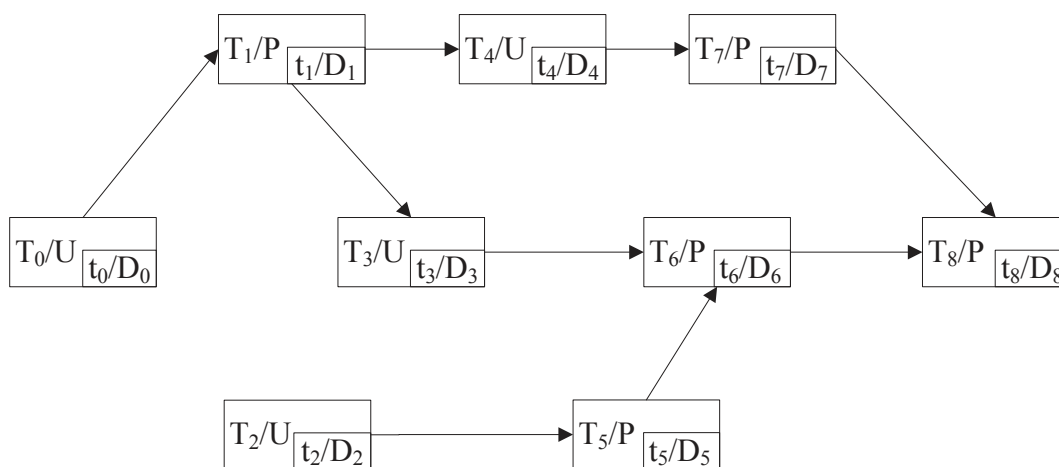

Figure 3.7. Representation of task planning in PERT diagram

Where D denotes the duration of each task and t indicates the starting time of task. There are three task paths. The overall duration of completing all tasks can be signified as $\max\{T_0 + T_1 + T_4 + T_7 + T_8, T_0 + T_1 + T_3 + T_6 + T_8, T_2 + T_5 + T_6 + T_8\}$. Assuming the time distribution of each task as Figure 3.8, and the Critical Path Method (CPM) is $T_0 + T_1 + T_4 + T_7 + T_8$.

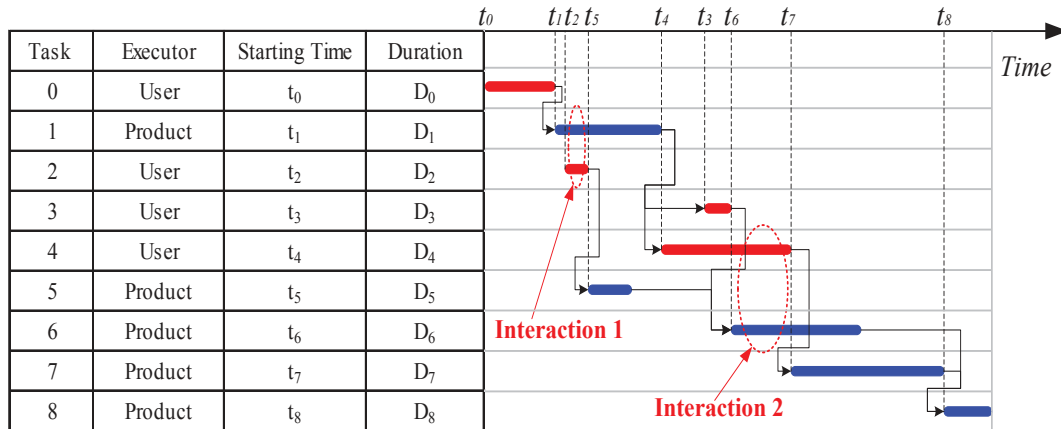

Figure 3.8. Interaction between sociotechnical task and technical task in the time distribution

There are two interactions in the time distribution, T_1 and T_2 , T_4 and T_6 . These interactive tasks should be designed thoughtful and avoided in the same operation area as much as possible in regard of user's safety and health. To the end, the time series model of system operation is represented as:

$$T = (t_0 \sim T_0, t_1 \sim T_1, t_2 \sim T_2, \dots, t_N \sim T_N) \quad (8)$$

In order to maximize the protection of the user's safety and ensure the production efficiency, some abnormal system failure must be prevented, consequently, it is imperative to conduct the regular system maintenance. The maintenance frequency of system can be predicted according to the system failure rate, and the data can be obtained from later prototype testing phase. The Auto-Regressive Moving Average (ARMA) model, as a description of stationary time series, has become a mature method in the system failure prediction. Here, we do not introduce this method in detail, see literature (Li and Kang 2008). Similarly, the time series model of system

maintenance is represented as:

$$T' = (t'_0 \sim T'_0, t'_1 \sim T'_1, t'_2 \sim T'_2, \dots, t'_N \sim T'_N) \quad (9)$$

3.2.4 Update the initial manual to the conceptual user manual

At this stage, the needs of initial task assignment can give helpful guideline for task planning. These needs show the users' willingness of when and how long they want to intervene in operation, control, or supervision process. Herein, when, how long, and how often the user in which workplace and under what environment will interact with product, are clear. At this step, adding the time schedule, workplace, and work environment into the initial user manual and updating it to the conceptual user manual.

3.3 Detailed design in behaviour level

Detailed design is carried out at this stage. For technical task, the detailed strategy of the solution indicates an elaborate object, which can be composed with structural components, mechanisms, or control components. For sociotechnical task, the detailed strategy of solution denotes user's intervention in the process of system operating, which can be described as identifying what kind of behaviour that user will generate at what time, in which workplace and work environment.

3.3.1 Behaviour identification

In existing studies, many prevalent approaches and tools have been developed for guiding detailed design. For example, Design for X (Sadeghi et al. 2016), X represents a specific feature (e.g. quality, safety, cost, etc.) or a lifecycle phase of the product (e.g. manufacturing, assembly, maintenance, etc.). To discuss all these guidelines in detail is beyond the scope of this thesis. In this study, X represents the use information. In this chapter, FTB framework provides some principles to constrain the detailed design. The question of "how designers propose detailed solution and how to design it in detail" will be answered in chapter 5. In this step, detailed design must comply the conceptual manual and we shall focus on those tasks

will interact with user.

Currently, this research work primarily deals with behaviour information. The concept of behaviour, which is represented as a sequence of states and transitions among tasks, can be explained as physical actions. For technical task, the behaviour produced by the structural component, mechanism, and control component is named as product's behaviour (e.g. translation, rolling, vibration, rotation, etc.), as well as the behaviour generated by user is named as user's behaviour (e.g. press, push, pull, lift, move, etc.). Since behaviour has multiple parameters, and the parameters vary enormously in different behaviour, for example, translation behaviour's parameters refer to the speed and distance, while rotation behaviour's parameters indicate the speed and radius. It is then reasonable to denote behaviour as a quintuplet (N, T, D, Z, P) . Here, N is the behaviour's name, T denotes time information when the behaviour starts, D is the duration of the behaviour, Z is the specific zone where the behaviour takes places, and P represents the parameters of the behaviour.

3.3.2 Interaction definition and estimation

As mentioned above, the interactions between technical task and sociotechnical task in time are known. For these interactive tasks, the guideline is that (1) avoid these interactions in the same zone, otherwise, (2) the parameters of components' behaviour should meet user's safety and health, and the things additional generated in these process (e.g. noise, irritating gas and liquid, light pollution, radiation, etc.) should please user's five senses in full measure (Krishna 2013). In this study, to estimate quality of the interactions in the detailed design, these interactions are rated in two categories unsafe and safe. If there are any latent dangerous phenomenon in the interaction zone that will be harmful to user's health and safety, we define the interaction as unsafe. Otherwise, we define it as safe. For example, when we need to drill a hole with an electric drill, the interactions between user and the electric drill will happen (Figure 3.9).

There are two interaction zones, (1) the handle and button zone; (2) the drill working

zone. Consequently, in the handle and button zone, the interactions are safe cause there are not any latent dangerous phenomenon. In the drill working zone, the drill can impel debris around with high speed. Small particles like sawdust can fly into user's eyes and cause irritation. Other debris and suddenly broken drill may puncture the skin or other body tissues. The drill working zone is unsafe.

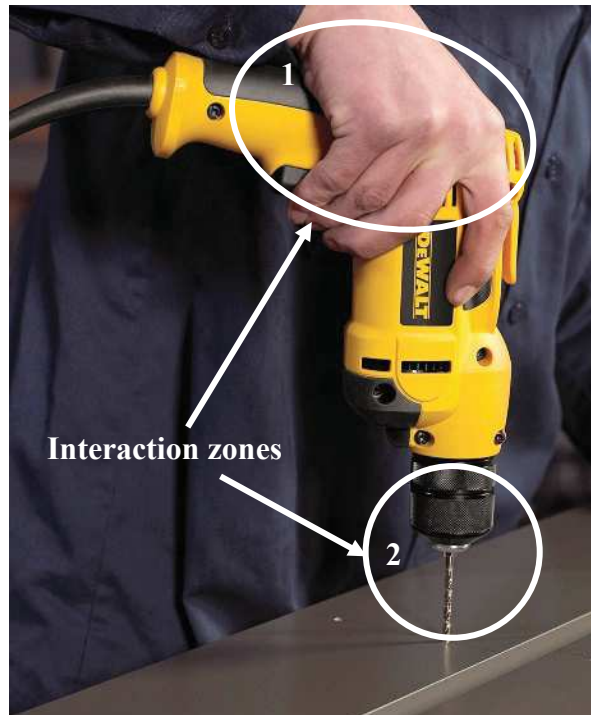

Figure 3.9. Interaction zones in the process of drill working

In this step, unsafe interactions must be redesigned until there are not any dangerous phenomena in the interaction zone. Particularly, the proposed design method is still an iterative process, these iterations can occur in every design phase. To the end, the conceptual manual can be updated into detailed user manual. The content of detailed user manual involves how user operates the product step by step in detail.

3.4 Case study

Based on the framework we presented, we optimize the existing corded electric drill as an example. First of all, we collect the information from seven users by survey, interview, and wants and needs analysis method. Six users claimed that the dusts and

debris, which are produced with high speed rotation of the drill, will block their view and may fly into the eyes and cause irritation, and one user's hand was injured by the suddenly broken bit. The existing manual has stated that the eye and hearing protection and safety clothes must be wore before operation. However, few users follow it. According to the investigation, the difference between the designer's conceptual model and user's mental model are shown in Table 3.3.

Table 3.3. Difference between designer's conceptual model and user's mental model

Designer's conceptual model	User's mental model
1. Ware protection (safe clothing, glasses, hearing protection, etc.)	1. Assembly the electric drill
2. Assembly the electric drill	2. Power on
3. Power on	3. Drill the hole
4. Drill the hole	

As mentioned in section 3.1.2, the best way is that the redesign should be carried out based on user's mental model. According to the user's mental model, the initial user manual involves safety and health requirements of the operation based on the existing manual. In order to fulfil these requirements, we propose to add some protective devices in the electric drill to prevent this interaction in the same zone. The use-case analysis and function structure is shown in Figure 3.10. There are five sub-functions, and the protective devices is the main designed object.

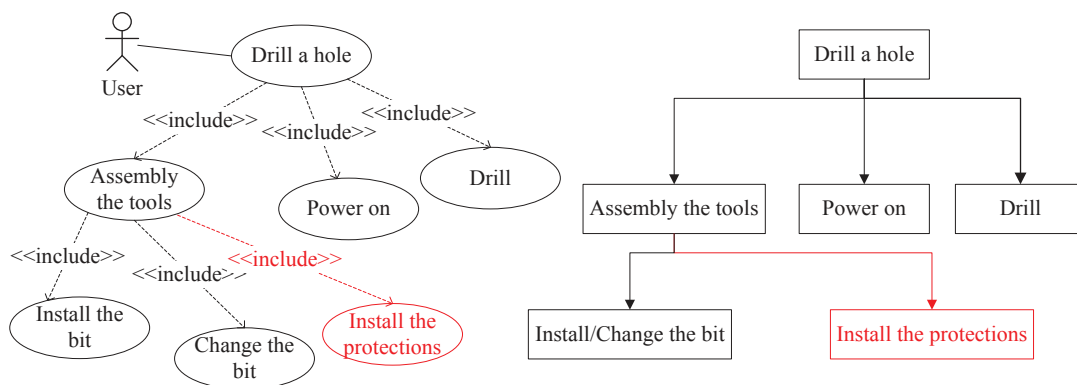

Figure 3.10. Description of use case and function decomposition of drilling a hole

Next, according to the initial user manual and function tree, the tasks were defined as SADT representation to achieve each of sub-functions (Figure 3.11). In the case of a new version product, we only focus on the user's problems and wants to improve both user and product performance. We did not change the main function and structure of the existing drill. Therefore, the task assignment keeps its original form. The method of task assignment proposed in this thesis can be used in the new product development. The fuzzy sets theoretic method was used to estimate the duration based on the data from the seven users cited above. For the task of drilling, the duration is to be determined (TBD), because it depends on the target material, the depth of the hole, etc. Specifically, in order to drill a hole, on one hand, it demands users to press the button and push the drill. On the other hand, the bit rotates with a high speed under the thrust to complete the drilling. Therefore, two tasks are defined to fulfil the function of drilling.

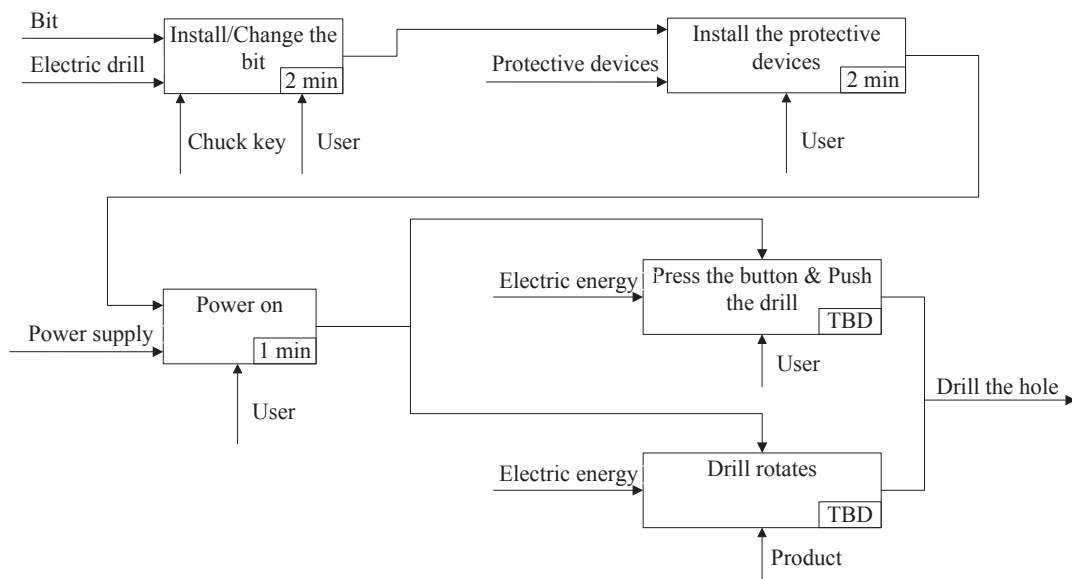

Figure 3.11. SADT representation for drill operation

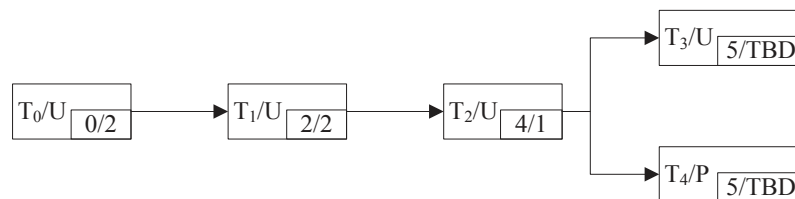

Figure 3.12. PERT diagram for drill operation

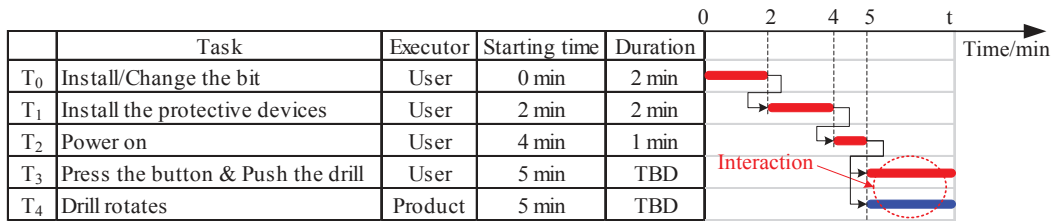

Figure 3.13. Interaction between user and product in the time distribution

Consequently, according to initial user manual, the task planning in PERT is shown in Figure 3.12. The interaction between T₃ and T₄ happen at the same time (Figure 3.13). In this step, the tasks have been defined, assigned, and planned to fulfil the intentional functions. The conceptual user manual can be described as: (1) user installs/modifications the bit, it will take almost 2 minutes; (2) then, user installs the protective devices, it will take almost 2 minutes; (3) after that, user power on the electric drill, it will take almost 1 minute; (4) user holds in the handle zone and presses the button, next drill a shallow “pilot hole”, then pushes the handle to drill the hole.

Here, the behaviour of drill in T₄ is unchanged, as mentioned in section 3.2.3, we propose to avoid product’s behaviour and user’s behaviour in the same zone. Figure 3.14 shows potential solutions, the graduated scale is also designed in the protective devices for knowing the depth of hole in the process of drilling.

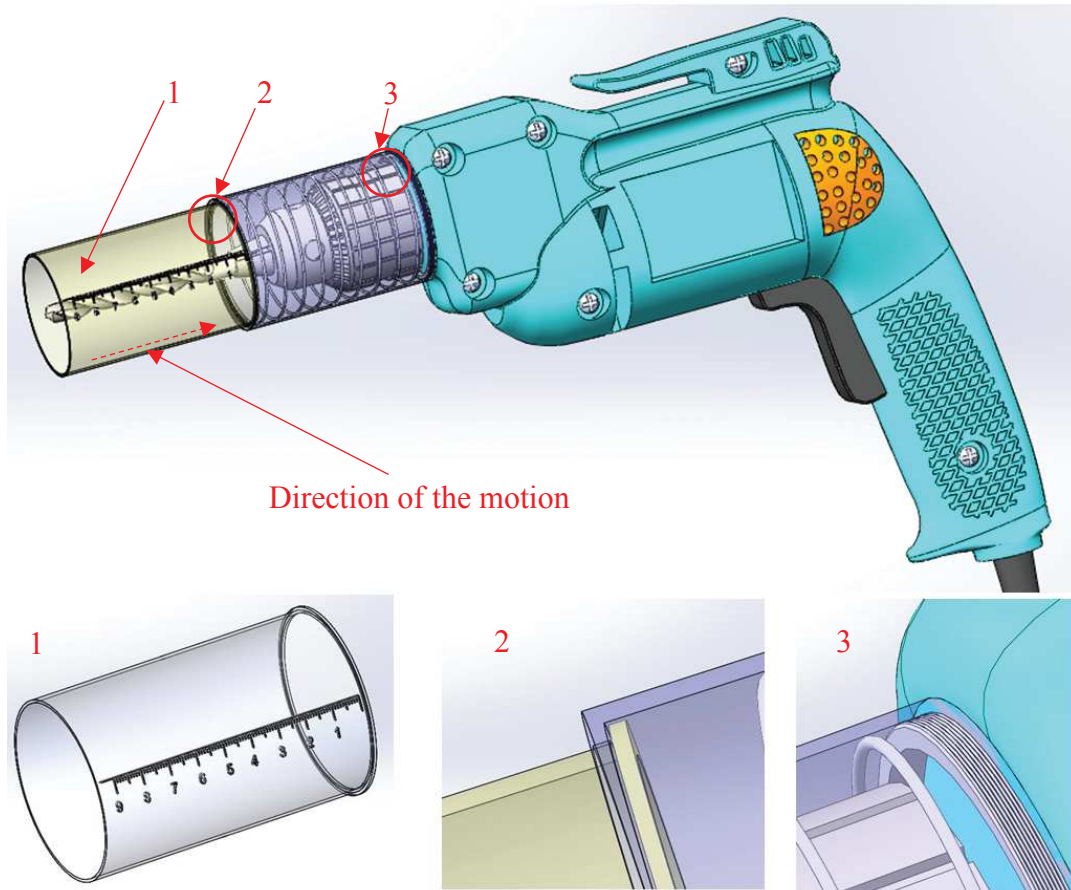

Figure 3.14. Conceptual solution for the existing electric drill

This is only a conceptual solution, it will be improved after detailed design (the protection's structure, dimension, material, machining parameters, installation introduction, etc.), and the detailed user manual involves how user conducts each task in detail. This case shows that conducting design work in accordance with user's mental model can improve the user performance. On the contrary, obstinately pursuing functionalism will lead some iteration in the design phase and decrease the user performance.

Conclusion of this chapter

In this chapter, a function-task-behaviour framework is developed for conducting design work. This framework is applicable to the design of a complex machine, equipment, system, or simple product. It contributes to a time-saving, less expensive and standardized methodology for designers to concern HF/E information from the

early design process. The proposed method claims that first considering the performance to carry out design work. It decreases the number of the iteration that caused by HF/E requirements in the design phase, thereby improves product and user performance. Through a case study, the effectiveness and feasibility of the approach are verified.

The proposed method cannot eliminate the iteration, but aims at maximally reducing the number of the iteration in the late design phase. The approach tends to help designers to discover the interactive problems between user and product in the early design phase. Yet, it shows limitation regarding how the detailed solution is created for these interactive problems in detailed design phase. Regarding this limitation, the method of design solution generation will be presented in chapter 5. In the following chapter, we will introduce the implementation of FTB framework.

Chapter 4. Integration of FTB framework in CAD software

In last chapter, we have introduced the overall FTB framework for integrating HF/E information from the early design phase, and a case study was presented to verify the feasibility of proposed method. This method is dedicated to the design process with the purpose of improving both product performance and user performance. As discussed in chapter 2, current CAD methods concern HF/E information as the evaluation and validation of the design solutions that have been made. Such as Digital Human Models (DHMs) and Virtual Reality (VR) are more useful for making comparison rather for creating designs, which can be considered as a belated action and advice. It is imperative and significant to represent FTB framework in a practical way to support design work. For this reason, this chapter illustrates a computer application supporting our method for designers.

The implementation of software development for FTB framework consists of the system modelling and the software specifications. Due to most design work is carried out with the aid of Computer-Aided-Design (CAD) software, hence, for the convenience of designers, we propose to integrate our method as a module into CAD software, and we named it as Interaction Design Centre (IDC). Most CAD software has Application Programming Interface (API) for designers to extend their own application, which provides feasibility for this work. The system model was built through UML, and software development was based on UGS NX 7.5 and C# language. IDC allows designers to integrate HF/E information from the early design phase and thus improving both product performance and user performance.

4.1 General Introduction to IDC module

This section gives the functional requirements of system modelling based on the analysis of the use case diagram of IDC module. A general IDC framework is also designed to support subsequent work.

4.1.1 Functional requirements of IDC module

Capturing the functional requirements of the designed system is the first phase in software development, which defines what this system should do or provide for the user. In chapter 3, we have presented the HF/E information can be integrated from the early design phase, which can be documented through user manual in three steps (initial, conceptual, and detailed user manual). It also restates the design process from the requirements to the designed product (system). In our work, we adopt a use case model in terms of use cases and actors (Figure 4.1) to catch the functional requirements of IDC module. The actor is a normal user of IDC module, who can be normally a member of design team. According to FTB framework, IDC module should contain the following primarily function components: knowledge collection, knowledge reuse, function definition and decomposition, task identification and planning, interactive task identification and evaluation, and design creation, which is discussed in the following.

Different from the existing design approaches, our approach allows design team to gather and reuse both functional and non-functional requirements from the early design phase. In order to appropriately collect these requirements, we suggest considering functional requirements and non-functional requirements from technical aspect and sociotechnical perspective. Technical aspect refers to technical details of designed system's characteristics, properties, and parameters, while non-functional requirements cover all constraints on how the designed system should run to assist users to fulfil their aims. These requirements are used as design knowledge to conceptualize the function tree.

After knowledge collection, function definition and decomposition are carried out by means of analysing use case diagram. Each case can be represented as a sub-function of the overall system. As well as the hierarchy and the sequence of the case map the function tree of the system. Next, tasks for these sub-functions are assigned. Each sub-function can be fulfilled by one or two tasks, which can be categorized to

technical task, sociotechnical task, or interactive task. To identify and define the task more clearly,

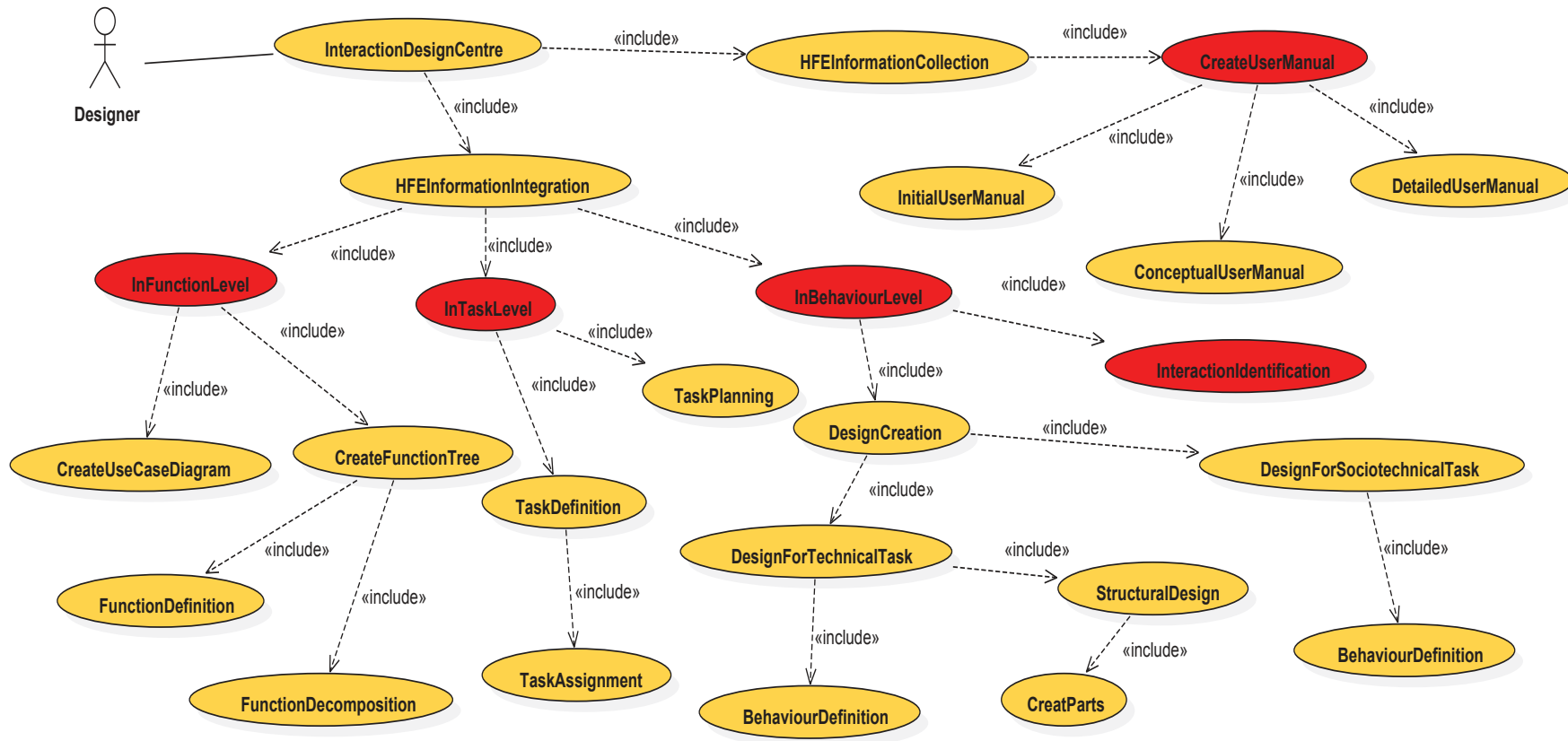

Figure 4.1. Use case diagram of IDC module

the task is considered as a black box with input, output, supporting resources, duration, and control information. And then, task planning is conducted under the guidelines of the task's duration and control information. In this step, interactive tasks in chronologically are found, which provides the crucial advices for detailed solution generation of interaction design. Finally, creating the design for each task.

As discussed above, all these functions are incorporated into the system framework and are implemented by different modules as shown in table 4.1.

Table 4.1. Functional requirements of IDC module with designed system interfaces

Interaction Design Centre	Functional requirements	Implemented interfaces
User Centre	Knowledge collection	User manual interface (initial, conceptual, detailed)
Design Centre	Knowledge reuse Function definition Function decomposition	Function level interface
	Task identification	Task level interface
	Task planning	
	Design creation	Behaviour level interface
Interaction Centre	Interactive task identification	Interaction Centre interface

The macro-architecture of IDC module consists of three parts, including *User Centre*, *Design Centre*, and *Interaction Centre* (Figure 4.2).

In *User Centre*, *User manual* enables designers to gather functional requirements and non-functional requirements from technical perspective and sociotechnical perspective respectively, which will be refined in three steps (initial, conceptual, and

detailed user manual).

Design Centre covers *Function level*, *Task level*, and *Behaviour level*. Function definition and decomposition, task identification and planning, and detailed design are performed in these three levels respectively.

In *Interaction Centre*, all the interactions between technical task and sociotechnical task will be recognized, which provides useful guidelines for detailed design.

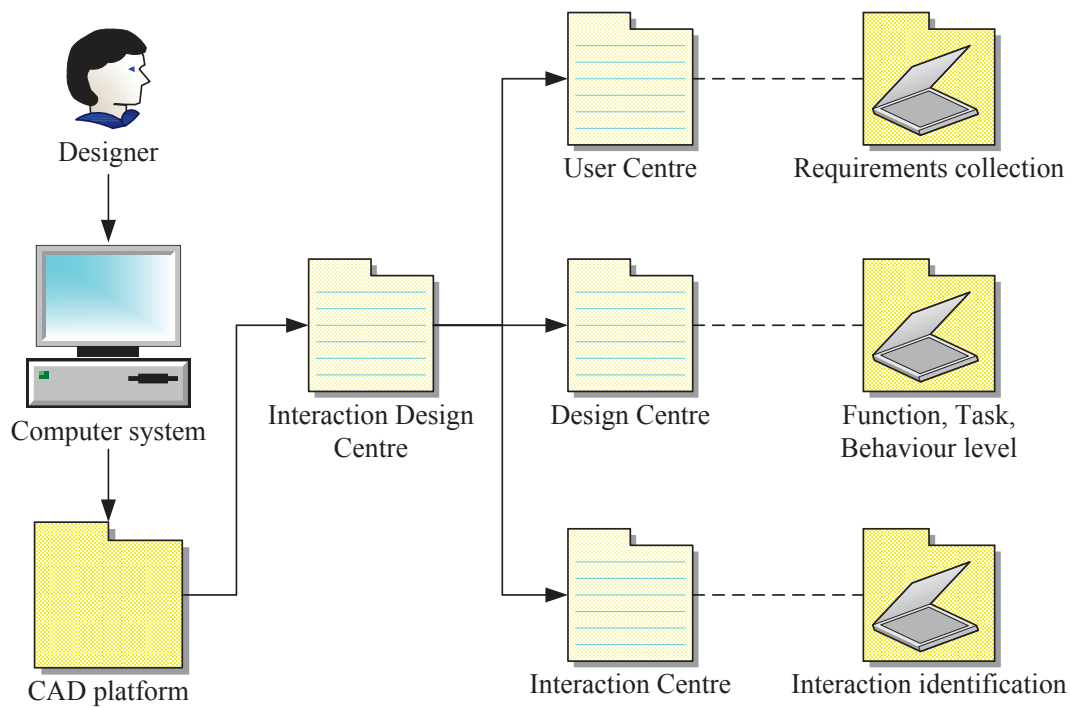

Figure 4.2. General introduction to IDC

4.1.2 IDC framework design

In the above section, we presented our method from the point view of individual designer. Since design is a multidisciplinary and complex work, huge amount of data needs to be processed, design work is always carried out by design team. Team is composed of a number of groups. And each group assigns the specific design work to members to ensure that the design work is carried out in an orderly manner. As a result, the distributed IDC framework for engineering design is shown in figure 4.3.

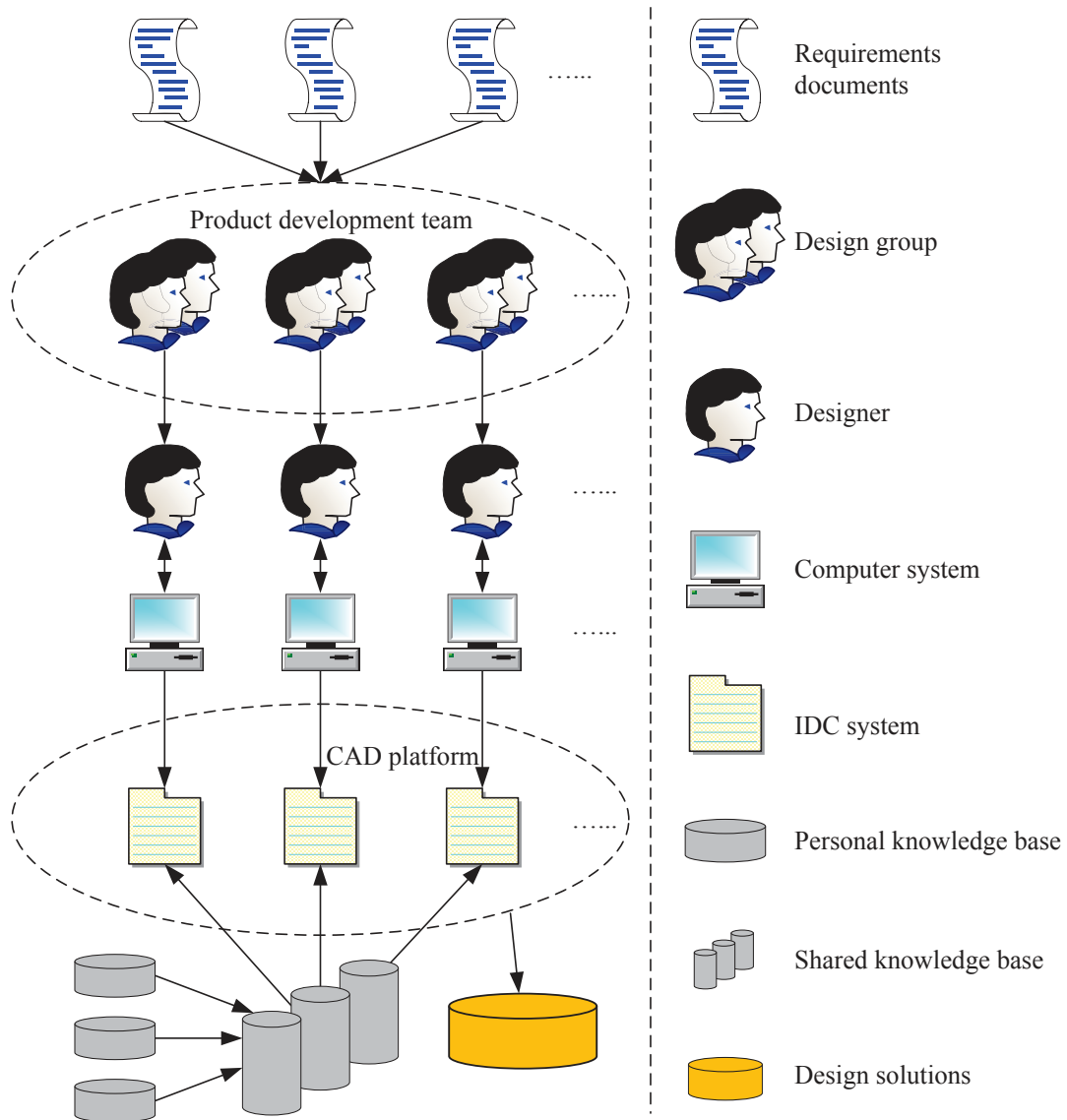

Figure 4.3. Framework of distributed IDC module for engineering design

4.2 IDC module modelling

In this section, IDC module model is analysed from static and dynamic perspectives. Static model was developed by class diagram and dynamic model is established by communication diagram and state chart diagram.

4.2.1 Static modelling

In order to better understand the interface between the IDC module and external environment, static model is established to describe the static structure of system. This

section introduces the process of static modelling, which covers the determination of the system’s external environment and internal objects, and the establishment of static model.

4.2.1.1 Determination of system’s external environment

External environment of system is depicted as external classes to which the system has to interface. According to functional requirements of IDC, the external classes of the system are identified by means of developing a system context class diagram.

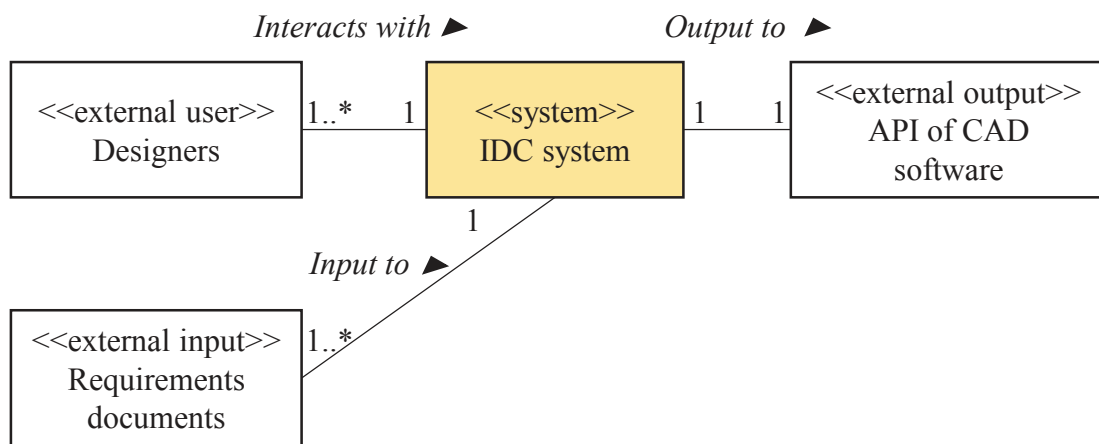

Figure 4.4. IDC module context class diagram

The system context class diagram of the IDC module is shown in Figure 4.4. In IDC module, a designer enters as an external user to import the functional requirements and non-functional requirements. It produces the design creation based on CAD software by the contributions of interaction between external user and IDC module. Therefore, the external classes correspond to the users (i.e., a member of design team who interacts with the system), knowledge documents (i.e., requirements documents), and API of CAD software (i.e., UGS NX 7.5).

4.2.1.2 Determination of system’s internal objects

After clarifying the external environments of IDC module, we structured the IDC module into objects, which can be considered as the precondition of dynamic modelling. The first step of the object structuring is to convert the problem into

objects within the system. We identified the internal objects according to the object structuring criteria in IDC module (see Figure 4.5). There are five interface objects identified in IDC module, including the interfaces that presented in table 4.1. Interface objects are identified by identifying the external classes that associated with system, for example, *User manual interface* is identified according to the classes of *external user* and *knowledge documents*, *Function level interface*, *Task level interface*, and *Interaction centre interface* are identified according to the class of *external user*, *Behaviour level interface* is identified according to the classes of *external user* and *API of CAD software*.

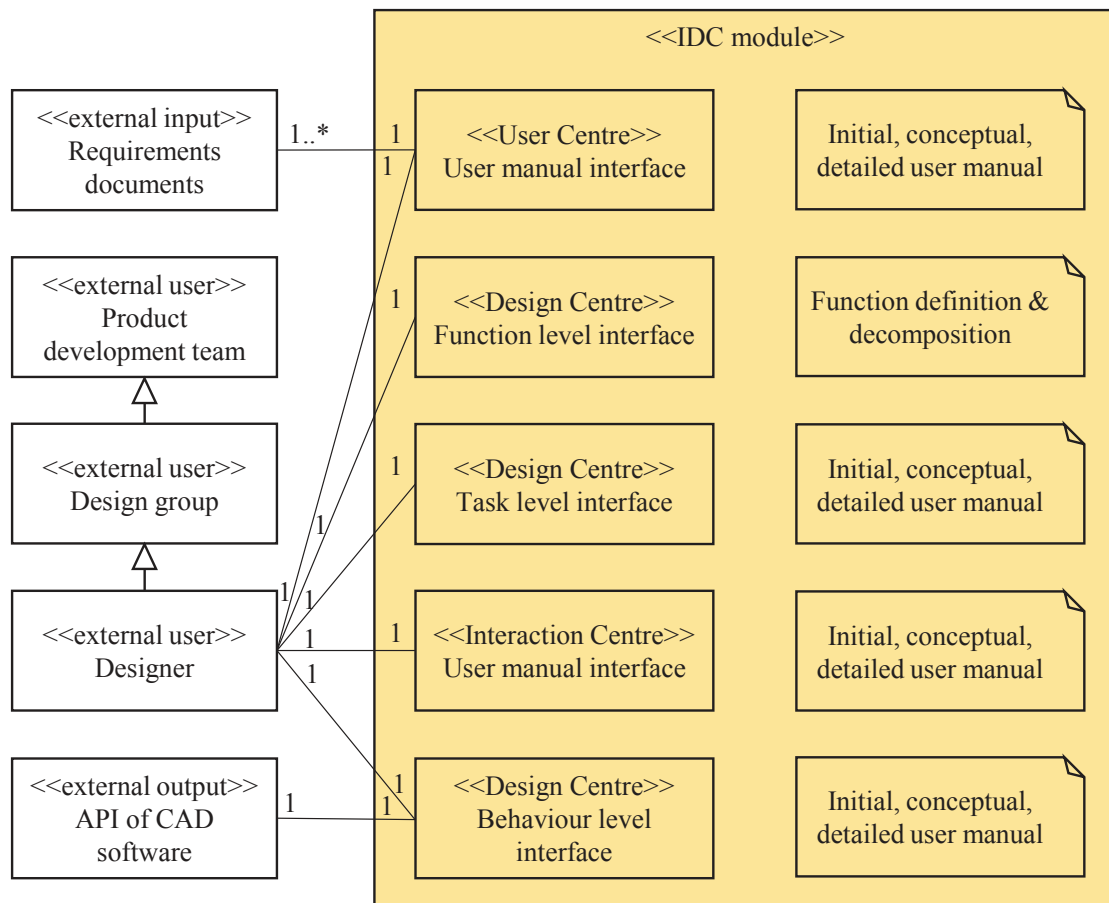

Figure 4.5. Object structuring class diagram of IDC module

4.2.1.3 Development of static model

To specify the internal structure of IDC module, the class diagram was drawn to develop the static model by UML. The class diagrams enable us to ascertain the

classes, their attributes, operations (or methods), and the relationships among objects of IDC module and thereby give a conceptual cognition for system implementation.

The classes of IDC module are identified from three aspects according to the object structuring class diagram. The first is user organization that refers to the task assignment of internal members of design team. Normally, system function can be represented by several high-level functions, and these high-level functions can be decomposed into many sub-functions. Design team allocates these high-level functions to the group, and each group assign specific task to the designer. The second is internal system organization aspect, which involves the internal objects and structure of IDC module. It describes the internal logic and the relationships among internal objects. The third is external organization aspect, which represents the techniques and tools used in the interaction with the IDC module. It includes the interfaces that IDC module provides and requires. As a result, the static model is represented as the connection of three aspects in a class diagram. The overall class diagram is illustrated in figure 4.6, and the detailed information of each class can be found in chapter 3.

4.2.2 Dynamic modelling

Dynamic modelling is an effective way to track the dynamic behaviours of the classes. A dynamic model displays the various states of elements and the messages that cause such state changes. It also defines the object interactions that correspond to each use case.

4.2.2.1 Selection of method

The main point of dynamic modelling is to make it clear to understand the sketch of model. Sequence diagram and collaboration diagram (renamed as communication diagram, communication diagram is used in the following) are the most used to support dynamic modelling by UML. Although communication diagram shows a lot of the same information as sequence diagram, it makes information easier to obtain by means of the way of information representation. Communication diagram

concentrates on the manner and the information of interaction among elements, but sequence diagram focuses on the expression of the order in which the interactions take place more clearly.

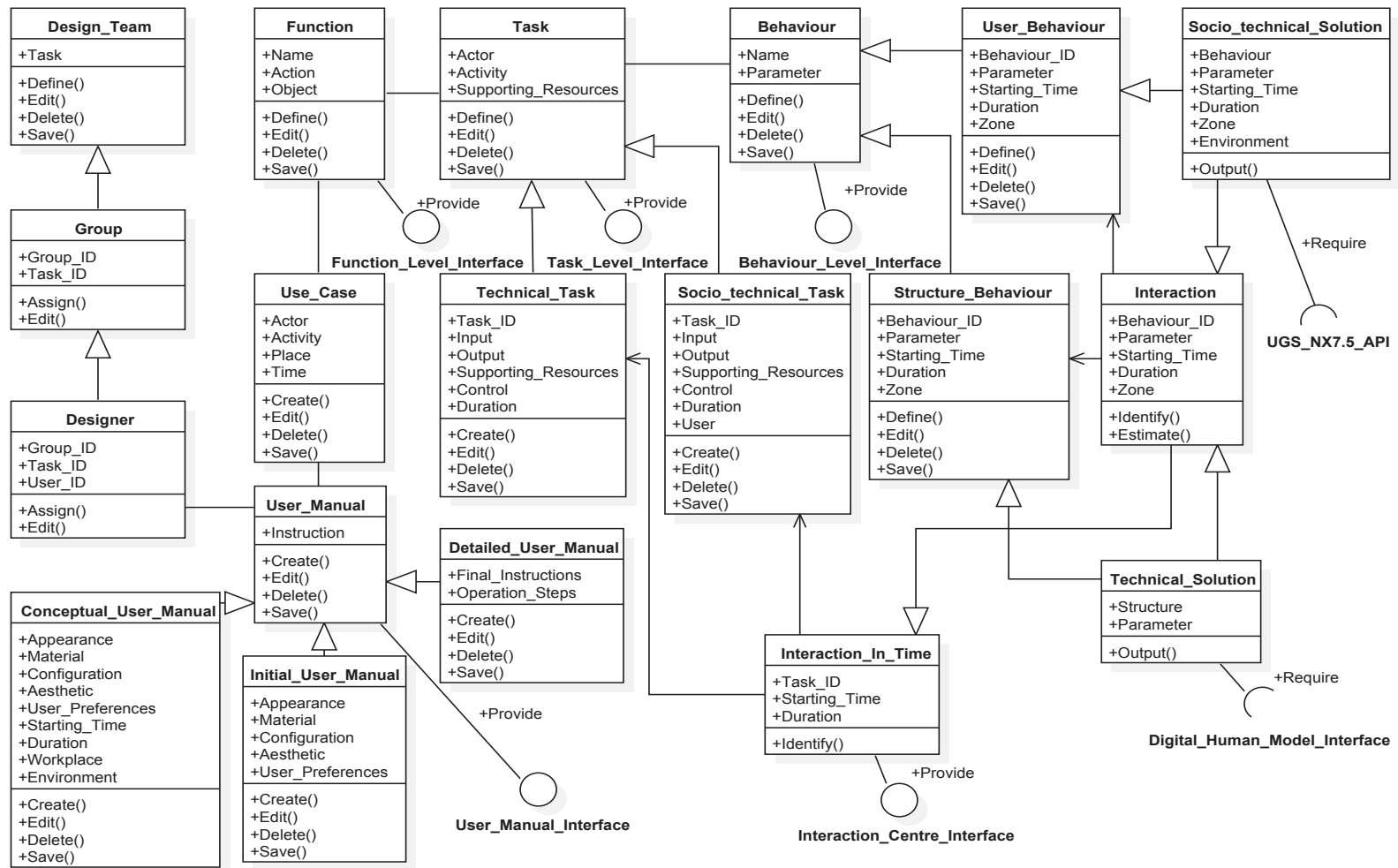

Figure 4.6. Class diagram of IDC module

In our work, communication diagrams are adopted due to the following reasons: communication diagrams aim at showing the communications that happen between objects, by defining messages that flow between each other, which illustrate the implied relationships between classes. While showing nearly all of the same information as a sequence diagram, the communication diagram can, at a glance, place a strong emphasize on which objects are interacting with one another. In order to describe the dynamic behaviour of a specific object, statechart diagram is employed to (1) model the dynamic aspect of a system, (2) model the life time of a reactive system, (3) describe different states of an object during its life time, and (4) define a state machine to model the states of an object.

4.2.2.2 Communication diagram and statechart diagram modelling

For a clear understanding of the behaviour of IDC module, the communications that happen between objects are listed in the following sequence according to the class diagram:

1. Interacts with: After task assignment, designer first interacts with IDC interface.
2. Clicks: Designer clicks User Centre button and enters User Centre.
3. Shows: User Manual interface is shown.
4. Creates: Designer creates Initial User Manual and then saves and exits.
5. Clicks: Designer clicks Design Centre button.
6. Clicks: Designer clicks Function Level button and enters the Function Level interface.
7. Shows: Function Level interface is shown.
8. Inputs operation: Designer inputs the data to create function tree according to initial user manual.
9. Clicks: Designer clicks Design Centre button, and then clicks Task Level button and enters the Task Level interface.

10. Shows: Task Level interface is shown.
11. Inputs operation: Designer inputs the data to carry out the task definition and planning according to the function tree.
12. Creates: Iterative operation to create the Conceptual User Manual in User Manual Interface according to the task planning.
13. Clicks: Clicks Design Centre button, and then clicks Behaviour Level button and enters Behaviour Level interface.
14. Shows: Behaviour Level interface is shown.
15. Inputs operation: Designer defines the behaviour of technical task and sociotechnical task.
16. Clicks: Designer clicks Interaction Centre button and enters the Interaction Centre interface.
17. Shows: Interaction Centre interface is shown.
18. Inputs operation: Designer identifies the interaction between structure behaviour and user behaviour.
19. Inputs operation: Designer estimates the interaction between structure behaviour and user behaviour.
20. Creates: Designer creates the parts and components in CAD software (UGS NX7.5) for each technical task.
21. Creates: Designer creates the Detailed User Manual.

To sum up above steps of the communications of IDC module with external environments, the communication diagram of IDC module is shown in figure 4.7, and the statechart diagram is shown in figure 4.8.

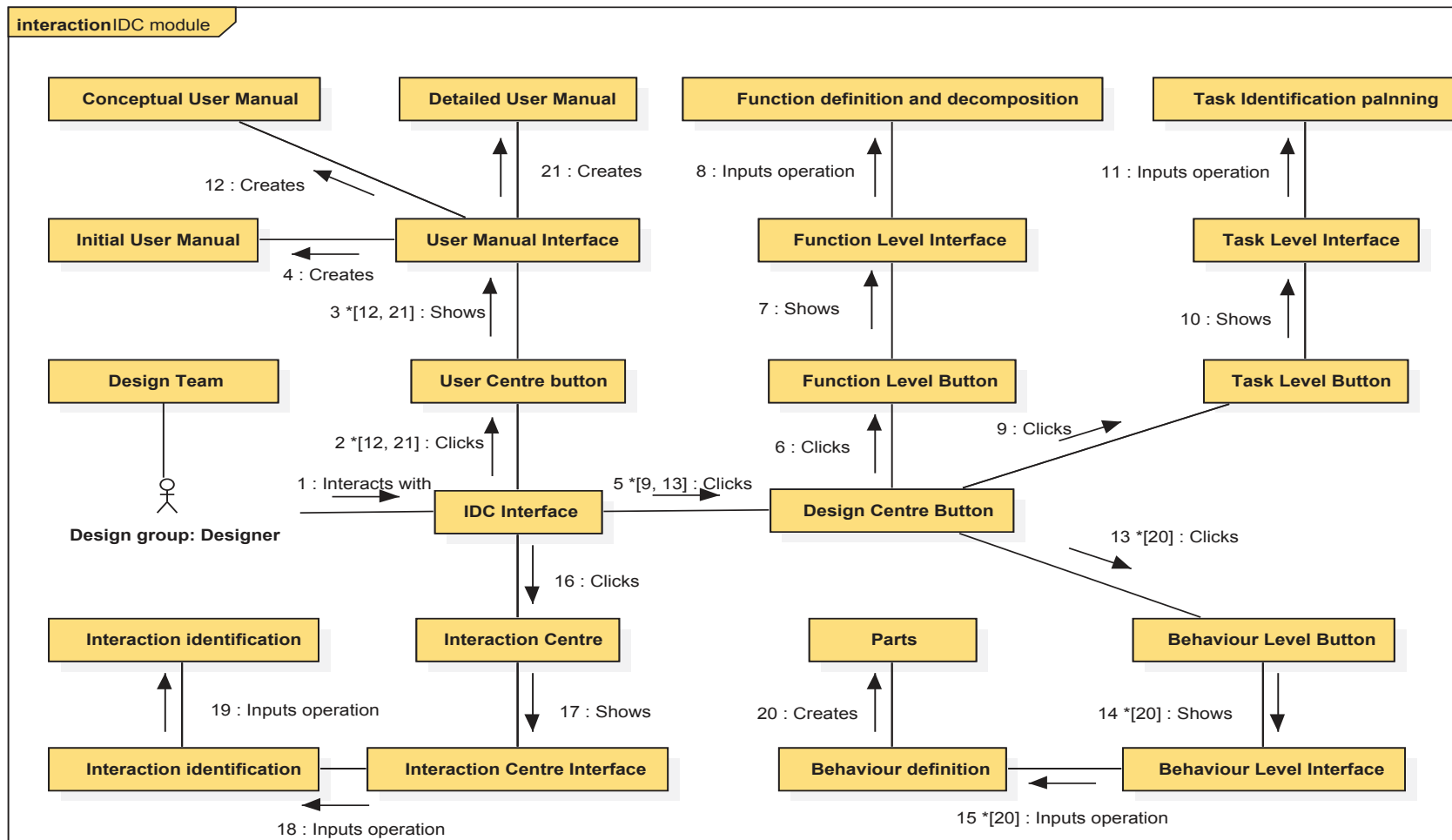

Figure 4.7. Communication diagram of IDC module

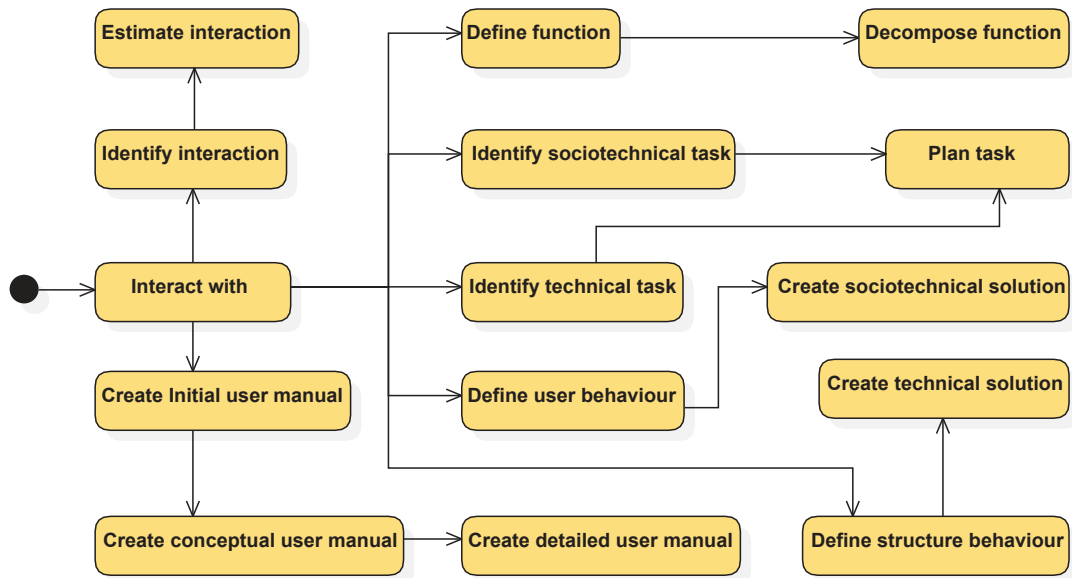

Figure 4.8. Statechart diagram of IDC module

4.3 IDC module implementation

After having a general understanding of IDC module, the static model and the dynamic model have been built in last section. As mentioned above, for the convenience of designer work, IDC module will be installed as a module of CAD software to support FTB framework. Due to the time constraints, user organization module is not yet considered in IDC module. In other words, now, IDC module that we developed does not provide the function of design work distribution within the design team in the early design process. This section introduces the implementation of IDC module development in computer platform, which is illustrated in detail in the following sections.

4.3.1 Development environment, tools, and methods

This section introduces the supportive conditions of the IDC module implementation, including hardware system, software system, and the method.

- Hardware system:
 - Intel Core i5-4200M 2.5 GHz.
 - 4 GB DDR3.

- 500 GB 7200 rpm Hard Drive.
- Software system:
 - Windows 8 Professional (64-bit) operation system.
 - Microsoft Visual Studio 2015, C# Language, SQLite database management system.
 - UGS NX7.5.
- Method:

UGS NX7.5 provides UG/Open API (also named as User Function, UF) which consists of graphics interactive programming (GRIP), API, User Interface (UI) Styler, and Menu Script. API provides 2,000 functions to support user for developing their own program. It gives the feasibility for this work. Thus, the API program and IDC module program were developed by C# Language, which was carried out in Visio Studio 2015.

Comparing with other database management systems, SQLite is not a client-server database engine. Rather, it is embedded into the end program. It is widely used as embedded database software for local/client storage in application software. Therefore, we adopted SQLite to manage the data in IDC module.

4.3.2 Structure of IDC module

According to static model, the composition of IDC module is shown in table 4.2.

Table 4.2. Composition of IDC module

IDC module	Interface	Object	Operation
User Centre	User Manual interface	Initial, conceptual, detailed user manual	Create, edit, delete, and save
Design Centre	Function Level interface	Function, function tree	Create, edit, delete, and save
	Task Level interface	Task	Create, edit, delete, and save
	Behaviour Level interface	Behaviour	Create, edit, delete, and save

IDC module consists of three modules with five interfaces. The attribute of each object is presented in class diagram. These interfaces will be presented in window form. Data transmission among each window also needs to be implemented.

4.3.3 Implementation of IDC module

In this section, the UML models are converted to the CAD modules through programming. With the reference to the API of UGS NX7.5, the interface of IDC module was implemented in UGS NX7.5. And then, user manual interface, function level interface, task level interface, behaviour level interface, and interaction interface were developed in Microsoft Visual Studio 2015.

4.3.3.1 Implementation of the interface between IDC and CAD software

To bridge the IDC module and CAD software, the first thing is to set the environment variables and path of system. The system environment variable name is UGII_USER_DIR, and the corresponding path is E:\Plug-in.

1. Deploying the application directory structure

Creating a folder named as *Plug-in* under the E drive, and then creating two folders named *application* and *startup* under it. Menu file (*.men) is stored in *startup* folder, and dynamic library file (*.dll) is stored in *application* folder.

2. Creating menu file

Creating a menu file named *InteractionDesignCenter.men* under *startup* folder, and then opening and editing it. The code is shown in the following.

```
VERSION 120
EDIT UG_GATEWAY_MAIN_MENUBAR
BEFORE UG_HELP
CASCADE_BUTTON InteractionDesignCenter
LABEL InteractionDesignCenter
END_OF_BEFORE

MENU InteractionDesignCenter
CASCADE_BUTTON UserCenter
LABEL User Center
SEPARATOR
CASCADE_BUTTON DesignCenter
LABEL Design Center
SEPARATOR
BUTTON InteractionCenter
```

```
LABEL Interaction Center
ACTIONS InteractionDesignCenter.dll
END_OF_MENU
```

```
MENU DesignCenter
CASCADE_BUTTON FunctionLevel
LABEL Function Level
SEPARATOR
BUTTON TaskLevel
LABEL Task Level
ACTIONS InteractionDesignCenter.dll
SEPARATOR
BUTTON BehaviourLevel
LABEL Behaviour Level
ACTIONS InteractionDesignCenter.dll
END_OF_MENU
```

```
MENU FunctionLevel
BUTTON UseCase
LABEL Use Case Diagram
ACTIONS InteractionDesignCenter.dll
SEPARATOR
BUTTON FunctionTree
LABEL Function Tree
ACTIONS InteractionDesignCenter.dll
END_OF_MENU
```

```
MENU UserCenter
BUTTON UserManual
LABEL User Manual
ACTIONS InteractionDesignCenter.dll
END_OF_MENU
```

Saving the above code in menu file. Launching UGS NX7.5, the menu interface of IDC module is shown in figure 4.9.

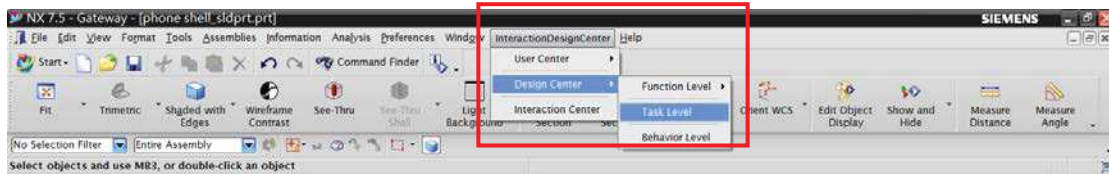

Figure 4.7. Menu interface of IDC module

3. Creating dynamic library link

Creating a project (Class library) named *InteractionDesignCentre*, located at E:\Plug-in by Visual C# in Microsoft Visual Studio 2015. And then, adding the following reference, NXOpen.dll, NXOpen.UF.dll, NXOpen.Utilities.dll, NXOpenUI.dll, which can be found in the installation directory of UGS NX7.5. The path is “\UGS NX7.5\UGII\managed”.

After this step, the link between CAD software (UGS NX7.5) and programming tool (Microsoft Visual Studio 2015) has been established. In next section, the main program of IDC module will be introduced.

4.3.3.2 Implementation of IDC interface

There are five main windows in IDC module. All these windows were introduced according to the structure of IDC module (section 4.3.2).

1. User manual interface

User manual interface is shown in figure 4.10. The initial user manual, conceptual user manual, and detailed user manual are combine in one window. At first, designer creates the initial user manual. After task identification and planning, designer edits conceptual user manual. Finally, after all the design solutions are made, designer produces the detailed user manual.

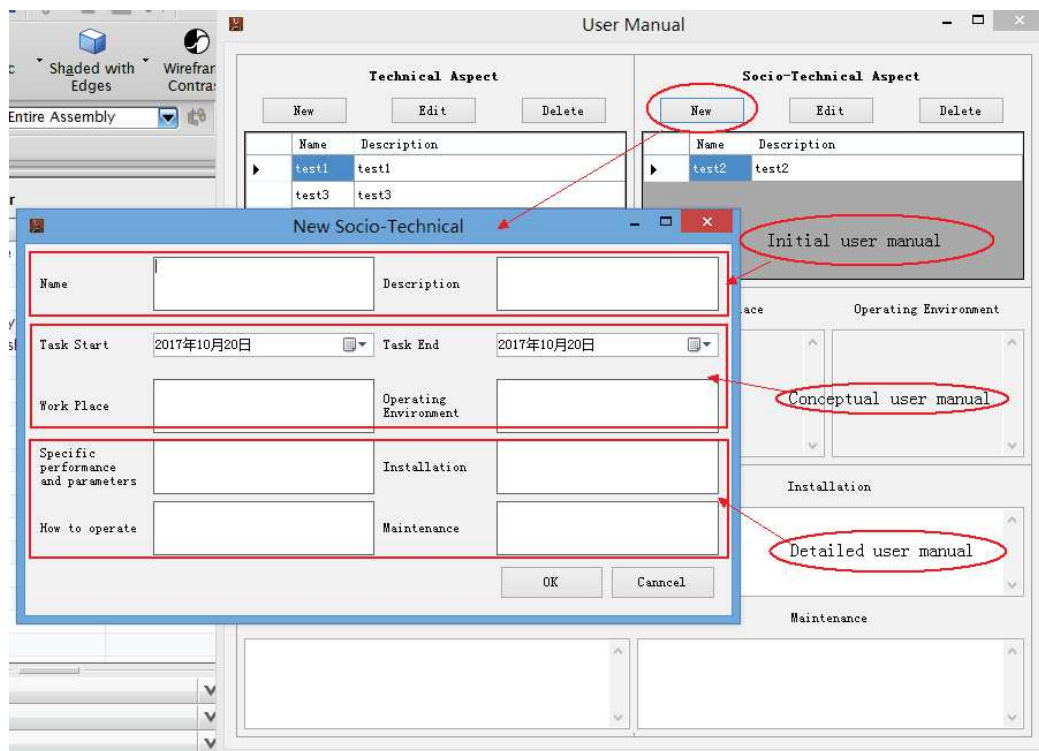

Figure 4.8.User manual interface

User manual can be created from technical aspect and sociotechnical aspect, which have been discussed in chapter 3. SQLite database management system was adopted to manage the data storage and transmission. The data will be saved and transmitted automatically. The same method was adopted for data management in the following interface windows.

2. Function level interface

After initial user manual creation, requirements are gathered by analysing the use case diagram created by UML. And then according to these requirements, defining and decomposing the function of the target system and building the function tree.

To facilitate the task identification in follow-up design activity. In this step, all functions should be decomposed into sub-functions that can be realized by one or two task. The process of function tree creation is shown in figure 4.11.

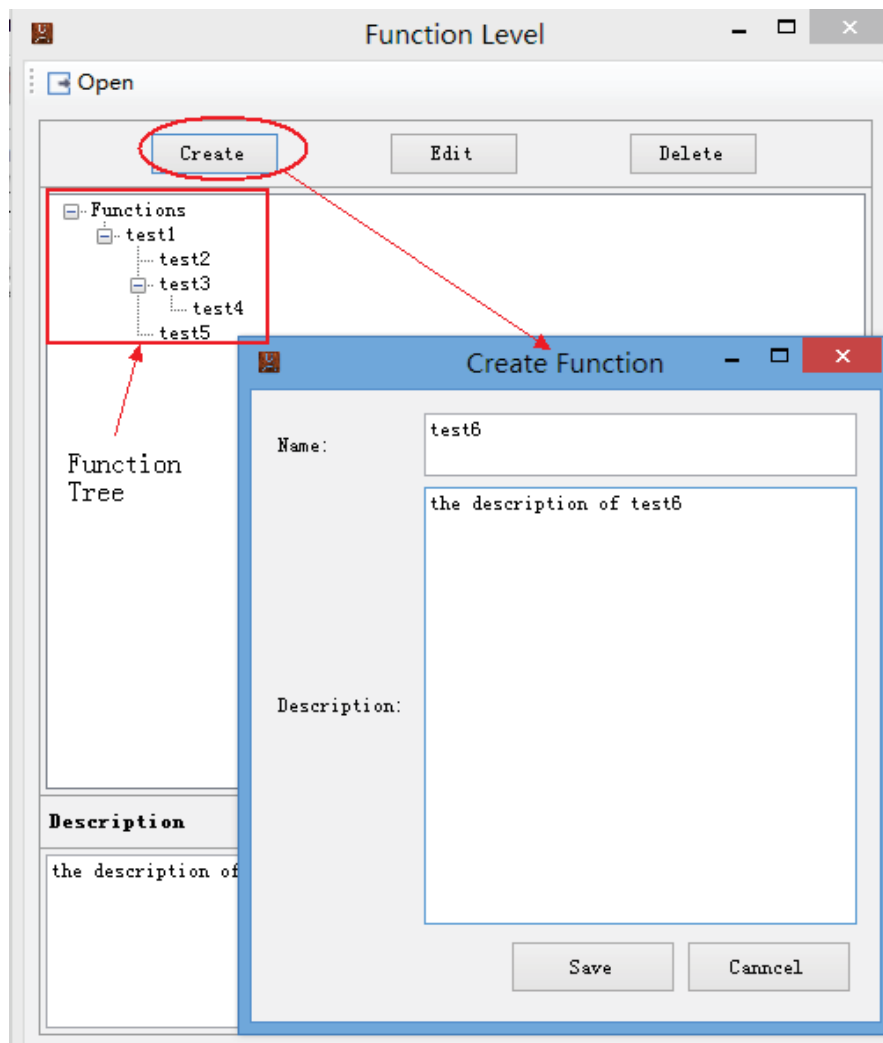

Figure 4.9. Function level interface

3. Task level interface

After function definition and decomposition, designer identifies tasks for all sub-functions in task level interface (see figure 4.12). It should be pointed out that only root node sub-function need to be realized by task. The attribute of task is defined by the improved SADT method, including the information of input, output, control, supporting resources, duration, and user intervention.

The task nature is associated with the user intervention in the task. Task with user intervention is defined as sociotechnical task. As well as task without user intervention is defined as technical task. According to the control and the duration information of all tasks to plan the sequence and hierarchy. Starting time and duration information is also determined to provide the guideline for identifying the interaction between technical task and sociotechnical task in time sequence. After task planning, designer updates the initial user manual to conceptual user manual in user manual interface.

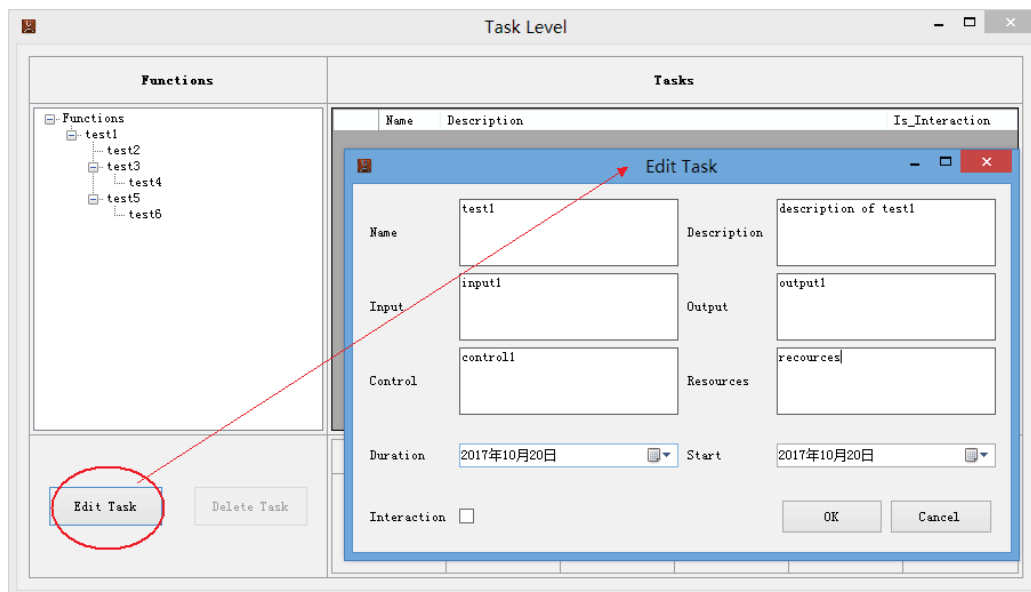

Figure 4.10. Task level interface

4. Interaction interface

Task planning shows the overall task hierarchy in time sequence. Interaction centre allows designer to see those technical tasks and sociotechnical tasks that interact in time sequence. After task planning, designer clicks interaction centre

button, those interactive tasks will be shown automatically (figure 4.13).

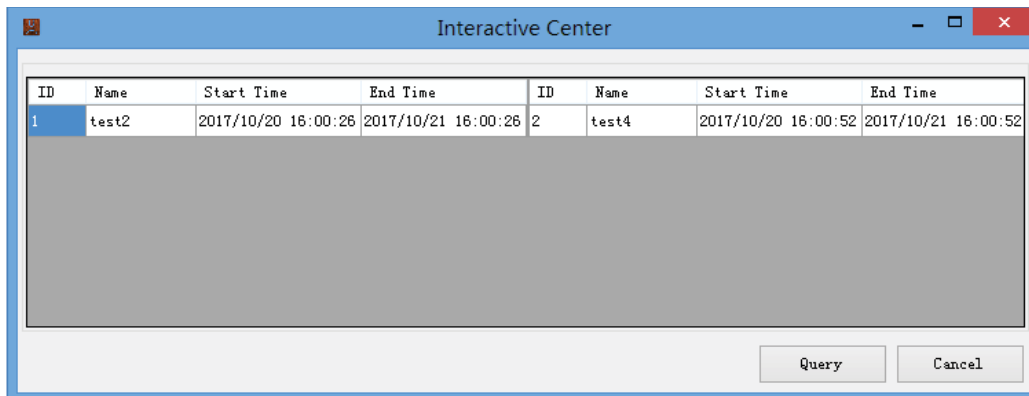

Figure 4.11. Interaction interface

In this step, these interactions indicate that the user will interact with the designed structure. It is significant to consider the users' factors in terms of the cognition habit, behaviour habits, and operation habits when creating the detailed solutions for these interactive technical tasks. The design solutions for these interactive technical tasks should satisfy the HF/E standards. Otherwise, we first suggest designers separating the structure behaviour and user behaviour in the different working zone. The second advice is to re-plan the tasks with the purpose of avoiding technical task and sociotechnical task overlap in time. In other words, it eliminates the interactions. Meanwhile, it will cause the design iteration, designer must go back to task level to redo the task planning.

5. Behaviour level interface

In behaviour level, designer creates the detailed solutions for sociotechnical tasks and technical tasks. Solution for sociotechnical task refers to ascertain (or define) the user behaviour in this task. That means as much as possible to satisfy the operation habits of user rather than compelling user to change their behaviour to interact with product. Solution for technical task indicates the designed object's structure, parameters, and so on.

The solution created in this step is only a general solution (figure 4.14). Technical solutions will be detailed by the component drawings in UG NX7.5. As well as

sociotechnical solution will be represented in digital human models. That will be applied in a virtual environment in CAD software for dynamic simulation to verify and evaluate the design. Others have achieved this work, such as mankind module of Pro/E software.

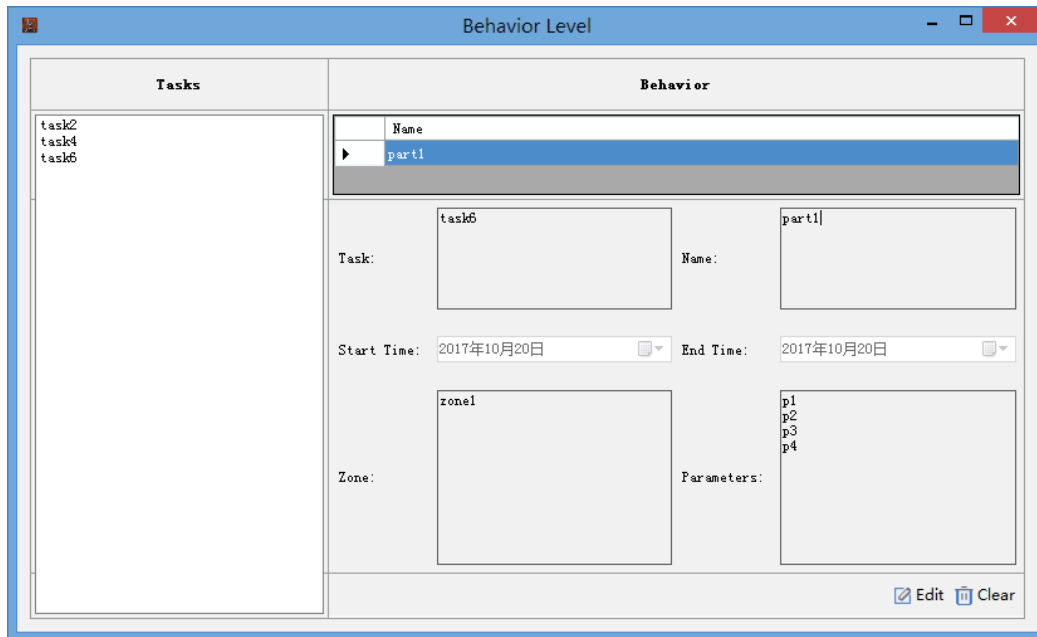

Figure 4.12. Behaviour level interface

Conclusion of this chapter

To put FTB framework in practice, this chapter illustrates the specific implementation methods, procedures, and instructions of the IDC module. To facilitate the design work, IDC module was developed as a module of CAD software in computer operation system.

In section 4.1, according to FTB framework presented in chapter 3, the use case diagram of IDC module was drawn by UML, and consequently the functional requirements of IDC module were given by analysing the use case diagram. And then, the framework of IDC module was designed.

In section 4.2, the static model and the dynamic model of IDC were built. (1) For static modelling: under the IDC module framework, firstly, the external environments and internal objects of IDC module was determined by context class diagram and

object structuring class diagram respectively. And then, the static model of IDC module was built as a class diagram in accordance with functional requirements. (2) For dynamic modelling, we first discussed and compared the sequence diagram and the communication diagram for dynamic modelling. The advantage of communication diagram was presented. And the dynamic model of IDC module was developed by communication diagram and statechart diagram.

In section 4.3, before software implementation, preparatory work (i.e. the environment, tools, and methods) was introduced. Next, we presented the general structure of IDC module and the implementation methods. The instruction of IDC module was presented step by step with all the interfaces.

According to the state of the art, the stage of HF/E information integration significant impacts on the whole design process. In fact, it is better to consider HF/E information as earlier as possible. IDC module enables design team to (1) catch both functional and non-functional requirements from the early design phase, and (2) convert them into design parameters to carry out the design work. By means of IDC module, the design modifications and iteration due to belated effort for HF/E information integration will be drastically reduced.

Chapter 5. Solution generation based on machine learning

In the previous chapters, according to the function-task-behaviour (FTB) framework, each sub-function can be fulfilled by technical task, sociotechnical task, or the interactive task (interaction between technical task and sociotechnical task). In this chapter, the method of creating the solution for each task is developed. Before introducing our method, the current existing approaches of solution generation are discussed.

5.1 Background

Based on current knowledge, the design has to solve the technical and sociotechnical problems. In chapter 2, we have argued that it is not advisable to first solve technical problems or first address sociotechnical problems. Several problems will appear based on existing methods in both cases (table 2.2). The best way is to deal with both technical and sociotechnical problems at the same time. Although the FTB framework and the IDC module have been developed for providing the method and tool to address this issue. How to concern functional and non-functional requirements to produce the solution in detailed design phase is still a problem. The functional and non-functional requirements map the technical and sociotechnical problems respectively. Case-Based Reasoning and TRIZ as the most popular methods for solution generation in engineering design are discussed in the following.

5.1.1 Introduction to current approaches of design solution generation

In detailed design phase, the final instructions of the shapes, forms, dimensions, surface properties of all individual components, the definitive selection of materials, and the assembly procedure of all components will be decided through the elaboration of production documents, including detailed component drawings, assembly drawings, and all parts lists. Before undertaking these works in CAD software, a general concept should be formulated by designer. In general, the previous experience of designers is used directly to produce design solutions, and for this purpose an approach known as

Case-Based Reasoning (CBR) was proposed to make more efficient use of this. Pioneered by Abelson and Schank (1977), CBR has been extensively used in product design (Purvis and Pu 1998; Haque et al. 2000; Belecheanu et al. 2003; Wu et al. 2006) and creative design (Gero 1990; Goel 1997; Gomes et al. 2006). By using priori knowledge about the similar cases for reference to explain, interpret, and solve a current problem, the CBR method imitates human behaviour of problem solving. When a new problem appears, designers normally search their early experiences and then match up the similar experience to solve it. The CBR method offers a database to store previous knowledge to help users to solve problems. Figure 5.1 illustrates the CBR framework (Aamodt and Plaza, 1994), which is illustrated in the following steps.

(1) Index assignment: Indices are allocated to cases based on its characteristics, which can be expressed as numerical values, words, or diagrams. Proper case categorization helps the system to trace similar cases.

(2) Case retrieval: After users describe a new problem, the index system searches for similar cases in the database on the basis of the predefined matching algorithms. A scenario in which the case with the highest value is retrieved and its solution is directly proposed to users.

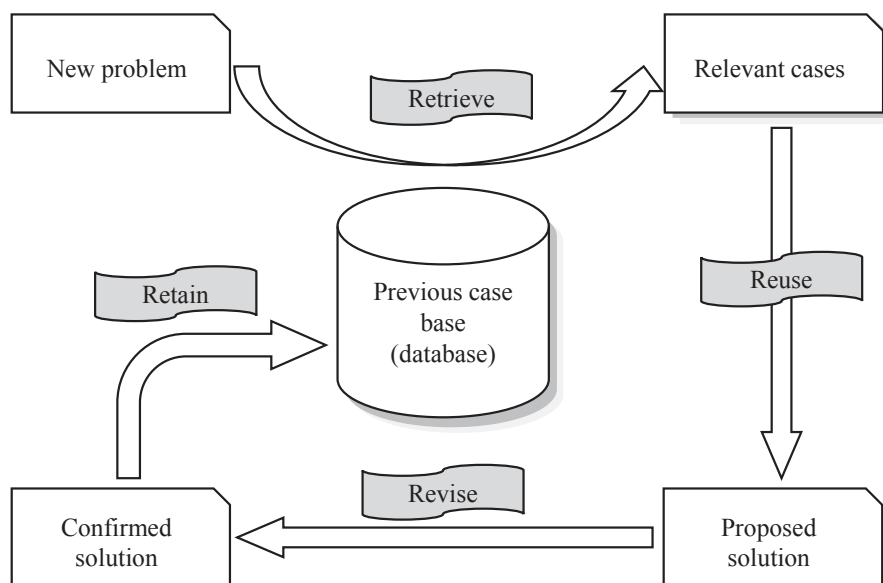

Figure 5.1. Framework of CBR

(3) Case reuse: When a case is retrieved, users can estimate whether the proposed solution is feasible. If the solution matches up the target problem completely, the cycle ends and the case solution is the answer to the problem. Nevertheless, the case solution only occasionally matches its characteristics directly to a certain extent. In addition, the gap arises between a problem and the solution that should be revised.

(4) Case revision: In this step, the proposed solution is modified. Among the numerous manners to revise the retrieval case contains using heuristics, human intervention and domain-specific knowledge.

(5) Case retention: After a satisfactory solution is obtained, the latest solved problem and all information, including approaches for revising, implementation procedures and other characteristics, are stored in the database as a new case. To this end, significantly increasing the system ability to solve future similar problems.

CBR is on the basis of the similarity between two problems: one to solve and the other has been solved. When there is a tiny difference between them, it is supposed that the solution of the solved problem can be applied to the target problem. According to the typology proposed by Gero (1990), most of the CBR systems are dedicated to design correspond to routine design. Indeed, it is considered that a new design is closed to a past one, consequently creativity is not directly stimulated. CBR is more applicable for repetitive design, while its use for inventive design is more limited. In addition, CBR is dedicated to address problems in technical domains, its use for sociotechnical problems is rare. In inventive design, problems are completely new and the required solutions are far from those already known.

Some drawbacks of the CBR approach like the problems of the psychological inertia, low level of innovation, absence of prediction, or no retrieved case, can be avoided by a method that changes the level of abstraction of the problem resolution - the TRIZ theory. It allows the passage from routine design to inventive design. As presented in chapter 2, TRIZ provides several types for inventive design, nevertheless, it is difficult to establish and use for a novice user. Another drawback is that TRIZ does

not offer an applicable solution directly, designers also need to spend time and energy to find the optimal solution.

Some other researches (Houssin et al. 2015) combine CBR and TRIZ for problem resolution. This approach shows both merit of CBR and TRIZ, which offers a promising direction for producing design solution. While there is a similar case or not, the system can offer a solution or a way to find a solution. However, the synergy of CBR and TRIZ does not get rid of their own shortcomings.

5.1.2 Problem statement

As discussed above, several drawbacks of current methods of design solution are listed in the following.

Lack of standard: CBR methods do not provide a detailed and standard steps for case revision from similar solution to the new solution, which are also confined to the lack of similar cases in case base memory. Similarly, TRIZ provides a large number of methods and multiple possible approaches for specifying the conceptual solution to the factual solution, however, which also makes it difficult to identify how best apply the TRIZ tools. In addition, the absence of a standardized best practice guide makes TRIZ hard to use.

Belated consideration of HF/E: CBR and TRIZ approaches mainly concentrate on technical problem resolution, HF/E normally as a belated consideration and advice for later solution refinement and optimization. As mentioned above, it is not advisable.

Dependence of designers' experience: Relying on previous similar cases, CBR can offer a proposed solution for new problem. Likewise, conceptual solution can be obtained by TRIZ methods. However, case revision in CBR and solution specification in TRIZ excessively relies on designers' personal experience. On one hand, the individual knowledge storage of designers varies considerable. Different solutions may be produced according to different designers, and these solutions differ in their respective superiority. Indeed, it is difficult to measure the quality of the solution

before another better solution emergence. On the other hand, it increases the workload of designers.

5.1.3 Objectives

In order to overcome the limitations discussed above, we aim at developing a standard, systematic model based on machine learning to address technical and sociotechnical problem at the same time.

For the problem of lack standard of CBR and TRIZ, we propose to produce solutions based on design task. General problem is converted to an overall function, which can be decomposed into sub-functions. Each sub-function can be achieved by task definition. The FTB framework offers the feasibility, the proposed model can provide several available solutions for each task, and then all optimal solutions are selected to

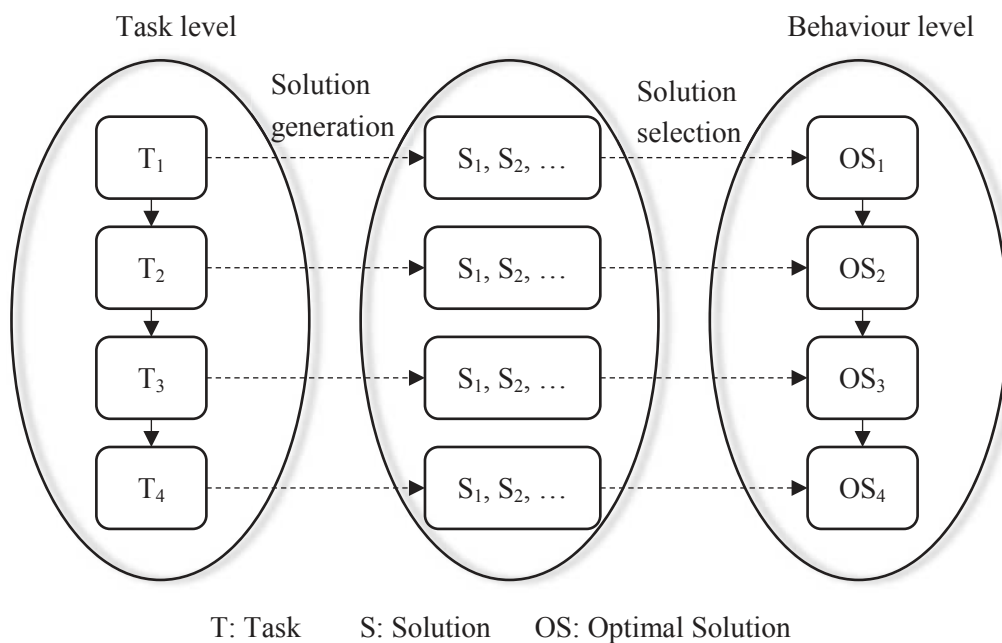

Three kinds of task: technical task, sociotechnical task, interactive task

produce the final solution, which is represented in figure 5.2.

Figure 5.2. Process of design solution generation

For the problem of belated consideration of HF/E, the proposed model enable designers to input both technical and sociotechnical data simultaneously into the

model, and then the model produce several available solutions.

To eliminate the disparity among designers' experience, we proposed to develop an "Solution-Generation Model" to produce design solution. This model can reduce designers' workload, which will be illustrated in the following section.

5.2 General description of Solution Generation Model (SGM)

In chapter 3, an improved SADT method is used for defining the input, control, supporting resources, output, and duration of task. To produce the solution for each task, it can be converted to the question of "how to obtain the solution from these task information". As presented above, we aim at developing a Solution Generation model (SGM) to produce the solution. This task's information will be represented as the input of the SGM. And the design solution is the output of the model, which shows a general description of the component's structure, parameter, etc. (Figure 5.3). Once the input information is imported, this model can produce several available solutions for one task, which are provided for designers to make more options.

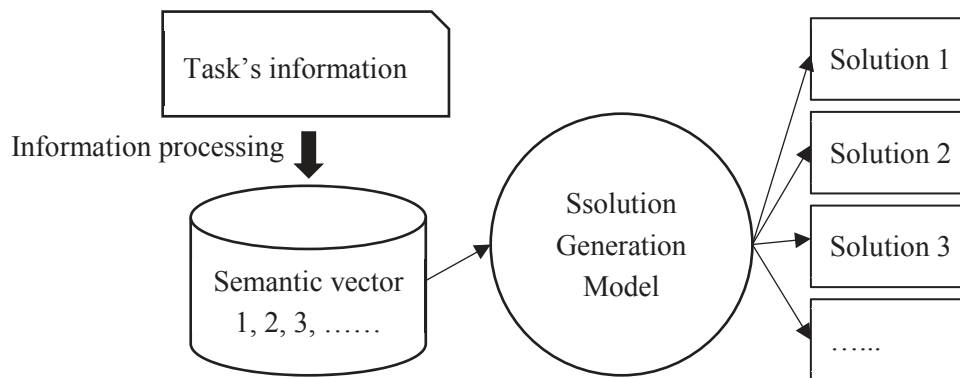

Figure 5.3. General description of AI model

5.2.1 Input and output of the model

As discussed above, the input of this model consists of the information of task's input, output, supporting resources, control, and duration. Normally, this information cannot be used directly as the input for a model. It is necessary to eliminate the redundant information and extract the useful features. The input of this model is discussed in the

following.

5.2.1.1 Input of the model

(1) Material, signal, and energy are considered basic concepts in any design problem. In other words, all kinds of input and output of a task are contained in these three categories (Table 5.1)

Table 5.1. Category of the task’s input and output

Material	Gas, Liquid, Solid
Signal	Auditory, Olfactory, Tactile, Taste, Visual
Energy	Acoustics, Biological, Chemical, Electrical, Electromagnetic, Mechanical, Radioactive, Thermal, Human force (only input)

It should be pointed out that the motive power could not be the model’s output in engineering design fields. For example, human force only can be as the model’s input, cannot be the model’s output. In order to accurately define the information of task’s input and output, it is better to ascertain the relationship between them. This work is summarized by (Stone and Wood 2000) (Table 5.2), and these connections are named as flows.

Table 5.2. Relationship between the input and output of task (flows)

Branch	Channel	Connect	Control	Convert	Provision
Separate	Import	Couple	Actuate	Transform	Store
Refine	Export	Mix	Regulate	Liquefy	Supply
Distribute	Guide		Change Stop	Solidify Evaporation	Extract

(2) The supporting resources refer to the means, persons, components or tools that are required to accomplish the activity. It indicates the task assignment that the activity will be performed by automation or human, which shows users’ willingness of whether they want to intervene this task or not, as well as indicates that this task’s

nature (technical task or sociotechnical task). The supporting resources normally contain the designed component or parts and the user intervention. The component or parts indicate the final instructions of the design, which is the objective of detailed design, thereby only the information of user intervention is considered in supporting resources.

(3) The control information can be considered as commands or conditions that influence the execution of this task.

(4) The duration indicates the length of time from the beginning to the end of the task.

(5) To integrate non-functional requirements, user preferences are also considered in this step. We take account of them from two perspectives. For technical task, user preferences denote the aesthetics requirements of designed component or parts. For sociotechnical task and interactive task, user preferences involve all the ergonomics requirements, including the behaviour habits, cognition habits, operation habits, aesthetic, etc.

In general, on one hand, control and duration information have little impact on the solution generation. On the other hand, it will introduce constraints when this information is imported in the model, thereby limit the solution space. Therefore, this information is not considered as the input of the model. However, control and duration information will be considered in the phase of the decision of overall layout solution planning. To sum up, the input of the model consists of task's input and output, flow, user intervention, and user preferences.

5.2.1.2 Output of the model

The output of the model is several available solutions, we expected it could be expressed as a detailed description in terms of the shapes, forms, dimensions, surface properties of individual components. Owing to the diversity and complexity of the product (system), currently, it will make a great deal of workload if the output as we expect. Therefore, the output of model is expressed as a general description of the

structure. In our study, semantics interpretation is adopted to represent the input and output of the model.

5.2.2 Method of machine learning

Machine learning (Webb, Pazzani, and Billsus 2001) is a promising method based on computational statistics to simulate human beings' thinking, which focuses on prediction-making based on computer program. It has been applied in many fields and made remarkable achievements. There are many machine learning methods, including decision tree learning, artificial neural networks, deep learning, support vector machines, similarity and metric learning, genetic algorithms, etc. (Michie, Spiegelhalter, and Taylor 1994; Kotsiantis 2007).

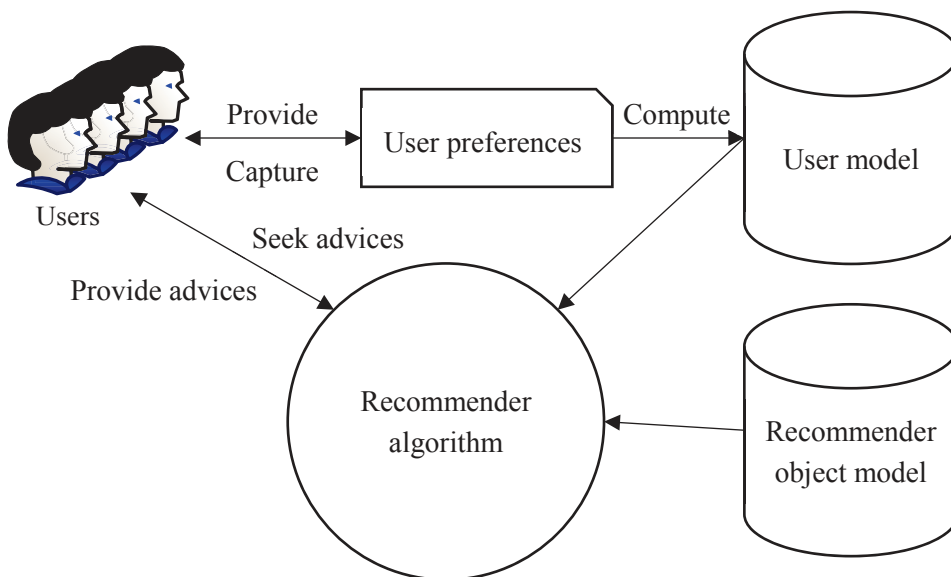

Figure 5.4. General model of recommender system

Recommender system (Webb, Pazzani, and Billsus 2001; Zhang, Yao, and Sun 2017) shows a great advantage of bridging the relationship between user preferences and the product. According to the user preferences (such as likes and dislikes in a ranking system), recommender system produces a list of similar options. The general model of recommender system is shown in figure 5.4. Deep learning (Schmidhuber 2015) is considered as a promising model to address the diversity and complexity data. It is able to effectively capture the non-linear and non-trivial user-item relationships, and

enable the codification of more complex abstractions as data representations in the higher layers. Furthermore, it catches the intricate relationships within the data itself, from abundant accessible data sources such as contextual, textual and visual information (Zhang, Yao, and Sun 2017). However, these methods primarily deal with big data sample.

Considering the current situation, it will take a large amount of time for us to collect data from all aspect. We use K-Nearest-Neighbors (k-NN) (Wang 2009) classification algorithm to develop this model and we take the case study of a tap case to verify our idea. The k-NN classification algorithm is a non-parametric method. This algorithm uses the majority vote in similarity to decide a classification result. The general principle of k-NN is to find the k data points in the training sample to determine the k-nearest neighbours based on a distance measure. This model is also on the basis of the database, we will develop and validate our model with a case in the following section.

5.3 Case study

To verify the feasibility of our idea, we choose the water tap in bathroom as an example to develop this model. This case comes from the cooperation between LGéCo laboratory of INSA de Strasbourg and an Alzheimer patient's reception home.

Alzheimer is a chronic neurodegenerative disease, which is the single most common cause of dementia. Dementia is the term used to describe a general decline in all areas of mental ability. The symptoms involve deterioration in cognitive processes-memory, language, thinking and so on-with important repercussions on behaviour.

Alzheimer patients only know to turn on the tap with the handle and often forget to turn off the tap after using the bathroom, they do not know how to use the taps without handles (see figure 5.5). Even the guidelines have been put in front of them because they lose the ability to learn. They still need some helps from the staff and it increases the workload of staff. The problem is that there is no tap in the marketing can satisfy the requirements of Alzheimer patients. For the spiral type, Alzheimer

patients forgot to turn off the water. Lift, press, and induction types provide the handle or valves that they cannot recognize, thereby they do not know how turn on the water. In order to find some available solutions, we attempted to develop this model based on k-NN classification algorithm.

5.3.1 Model development

The existing water tap in marketing broadly contains spiral type, lift type, press type, and induction type according to on-off mode (Figure 5.5).

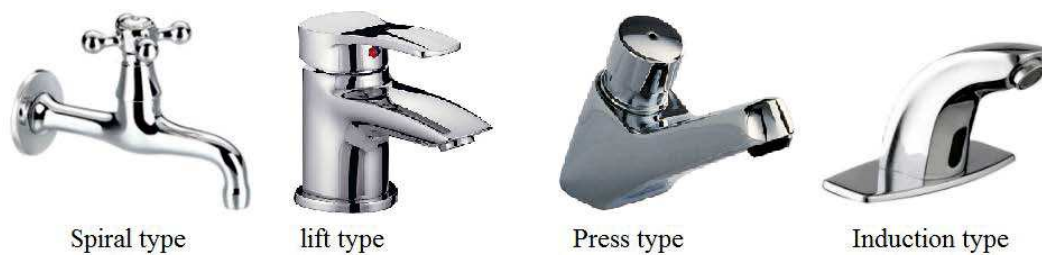

Figure 5.5. Types of existing water tap

There are three main tasks for using the tap in bathroom: discharge water, get water, and shut off water. The SADT illustration of these tasks is shown in figure 5.6.

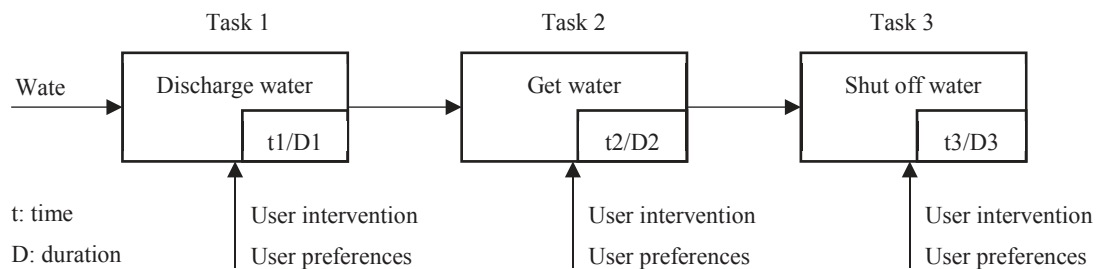

Figure 5.6. SADT illustration of using tap

As discussed above, this model provides solutions for each task and data collection from the aspects of task's input and output, flow, user intervention, user preferences, and general description of the structure. In this case, the problems of Alzheimer patients are that (1) in the first task, user has the problem of turning on the tap, it refers to the type of handle, and (2) in the third task, user often forgets to turn off the

tap, it refers to the type of water tap off mode.

We collected the data from 33 persons through questionnaire by mobile APP (WeChat). Partial training sample is shown in table 5.3. The input and output of these tasks are same, therefore we did not consider this redundant information in this case. User intervention indicates the users' willingness of touching the tap, which is a yes-no question. User preference involves user's behaviour habits, cognition habits, and operation habits. The flow can be defined according to the table 5.2.

Table 5.3. Partial training sample

Task	Input			Output
	Flow	User intervention	User preferences	
Task 1	Actuate	Yes	With left-right-motions handle	Spiral type
Task 2	Guide	No	Control the flow time by themselves	Spiral type
Task 3	Stop	Yes	Turn off the water by themselves	Spiral type
Task 1	Actuate	Yes	With up-down-motions handle	Lift type
Task 2	Guide	No	Control the flow time by themselves	Lift type
Task 3	Stop	Yes	Turn off the water by themselves	Lift type
Task 1	Actuate	Yes	With button	Press type
Task 2	Guide	No	Control the flow time automatically	Press type
Task 3	Stop	No	Turn off the water automatically	Press type
Task 1	Actuate	No	Without handle	Induction type
Task 2	Guide	No	Control the flow time by themselves	Induction type
Task 3	Stop	No	Turn off the water automatically	Induction type

According to the requirements of Alzheimer patients, they only know to turn on the

tap with a handle like spiral type, and often forget to turn off the tap. Therefore, the input of predicting sample of Alzheimer patients can be described as follows (Table 5.4).

Table 5.4. Predicting sample

Task	Input		
	Flow	User intervention	User preferences
Task 1	Actuate	Yes	With left-right-motions handle
Task 2	Guide	No	Control the flow time by themselves
Task 3	Stop	No	Turn off the water automatically

We used k-NN classification algorithm to develop this model, which is performed in Spyder (python 2.7) software platform (Figure 5.7).

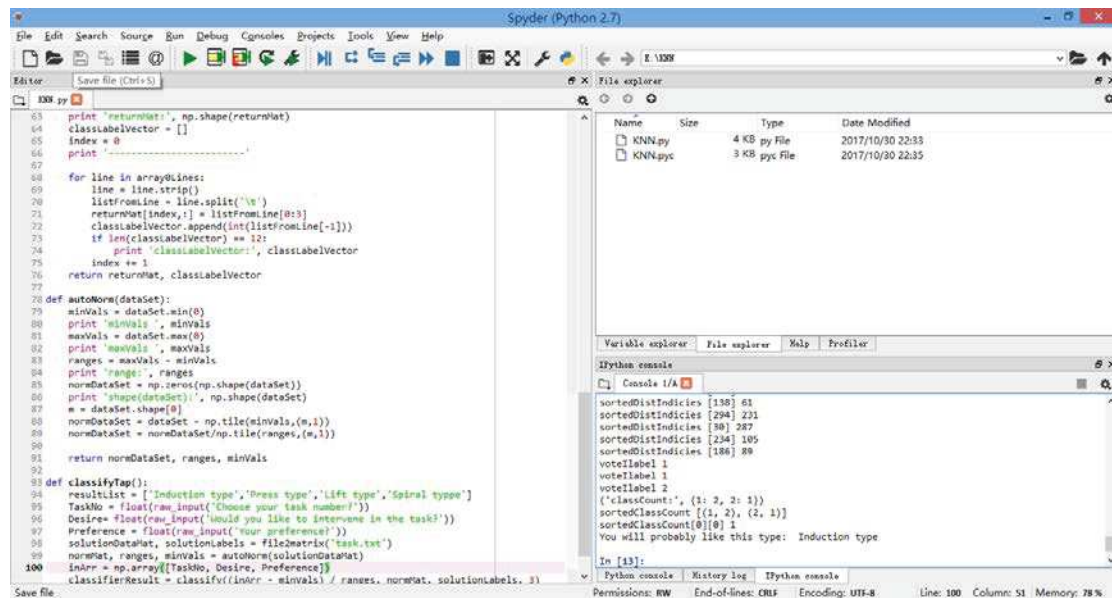

Figure 5.7. Model development

5.3.2 Predicting results

The predicting result of task 1 is spiral type, task 2 is lift type, and task 3 is induction type. Certainly, there is no existing tap like this. However, it shows that the user

requirements of each task and provides some inspirations to solve this problem. For example, an available solution is presented as follows (Figure 5.8).

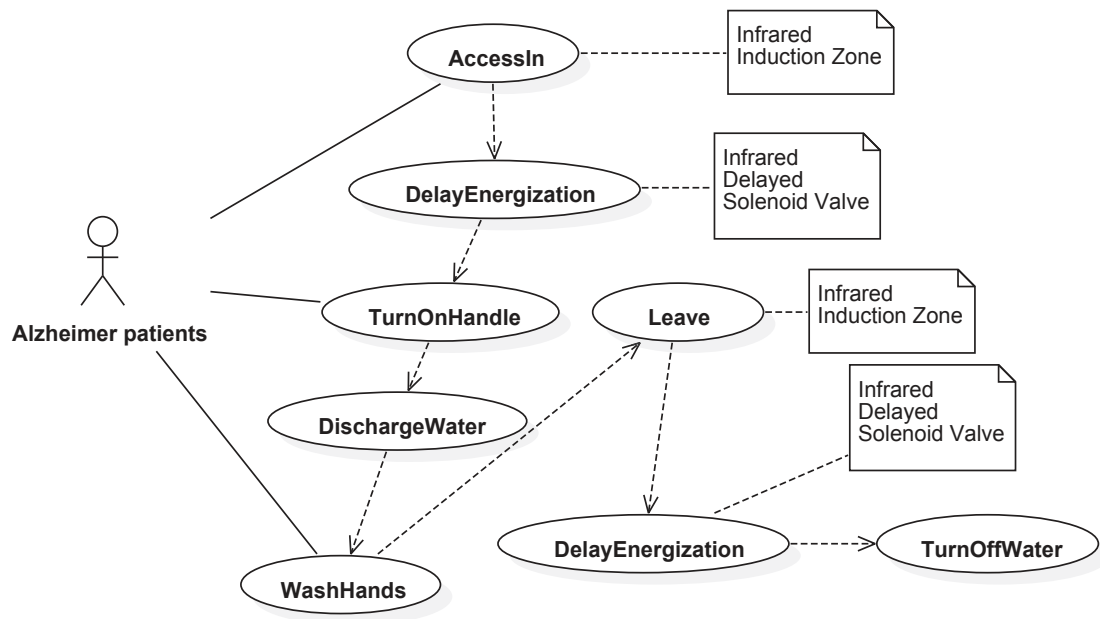

Figure 5.8. An available solution of the tap for Alzheimer patients

The solution for this tap could contain a delayed solenoid valve and machinery handle. The delayed solenoid valve works as to switch the solenoid in several seconds, and the delay time is equal to the time from Alzheimer patients get access in the induction zone to turn on the handle. The machinery handle only works as to meet the patients’ needs of “turn the handle” and has the feature of handle reset, it has not the function of switching the valve.

The scene of the interaction between user and product is described as: (1) when patients get access in the infrared sensor induction zone, the solenoid valve turns on in several seconds. (2) Then, Alzheimer patients turn the machinery valve and wash their hands. (3) After that, they leave the induction zone. Meanwhile, the infrared delayed solenoid valve switch in several seconds and turn off the water. Due to the pressure of time and funds, currently, we only have this general solution. In the future, we will develop this solution in detail.

5.4 Discussion

Differing from conventional design approaches, we proposed an idea to produce the design solutions based on machine learning by using all available technical and sociotechnical data. The tentative plan of carrying this work was also presented, which made a progressive attempt. Recommender system and deep learning show the superiority in addressing user preferences and complexity data. Due to lack of enough data, we adopted k-NN classification algorithm with a small sample to verify our idea. The discussion covers two parts about the model, including the results and the limitations of the case study.

5.4.1 Results of the case study

Existing engineering design approaches solve new problems based on the solutions of similar past problems, which overly depend on empiricism and technical data. Although many methods (such as case-based reasoning, expert system, TRIZ) have been established and successfully applied to assist designers to produce the design solutions. These methods cannot provide design solutions directly. These methods are also general that do not offer a detailed, systematic, and standard steps or procedures for specifying the general solution to the final solution, which are also confined to the absence of standard expert knowledge base. Thus, we proposed to develop an Solution Generation Model with the purpose of reducing designer's workload or even replacing empiricism. This model enables designers to produce design solutions for each task, afterward selects and combines the optimal solutions to formulate the overall layout solution according to the task planning. It provides a new perspective for design solution generation based on design task. For example, current methods may not be able to find the solution from the global perspective. However, the solution for individual design task can be found normally, thereby combining all optimal solutions of individual design task to formulate the final overall solution. The FTB framework offers the theoretical support for this method.

5.4.2 Limitations of case study

This case shows that the proposed Solution Generation Model enable designers to obtain solution for each task directly once the data is imported. The k-NN classification is the most basic algorithm of machine learning, which can effectively deal with the prediction problems of small sample. However, the limitations of this approach are obvious. One limitation is that this algorithm can only provide one solution for one task, some available and prospective solutions may be missed. As we envisioned, it is better to produce as many design solutions as possible for each task. Ranking formulation of recommender system effectively solves this problem, which can give several solutions in ranking of user preferences. Different from current problem solving approaches, this GSM is easy for designers to cognize and operate. For example, once available data is imported, several solutions will produce. However, this model is also confined to the expert knowledge base.

The above drawbacks also call for future work. In the future, we will develop this model by employing recommender system and deep learning. We will mainly concentrate on the method of selecting optimal solution for each task, and the method of organizing these solutions to a final overall solution.

Conclusion of this chapter

In this chapter, we have first presented and analysed the current design solution generation methods and then discussed the drawbacks of these methods. After that, a new idea is proposed to produce the design solution based on machine learning, which provides a standard and systematic guide for concerning both technical and sociotechnical data simultaneously in detailed design phase. Due to our current conditions, a tentative work of carrying this work was presented, which demonstrates our idea. The main findings and limitations of case study are presented in discussion. The future research on this topic is also proposed in order to overcome the limitations.

Chapter 6. Conclusions and perspectives

At present, design methodologies and theories for integrating human factors and ergonomics (HF/E) include Technology-Centered Design (TCD) and User-Centered Design (UCD). TCD methods consider HF/E in the detailed design phase or later, which will cause design modifications and iterations. Whereas UCD approaches integrate HF/E from the early design phase, which is time-consuming and will introduce many constraints.

The purpose of this thesis is to develop a systematic, time-saving, less expensive, and less iterative design approach for designers to integrate HF/E information from the early design phase. As a consequence, the function-task-behaviour (FTB) framework has been developed for assisting design work. To put our method in practice, the method is implemented as a module of CAD software to support HF/E information integration from the early design phase.

Regarding FTB framework does not provide the method of design solution generation, a new idea is proposed to produce the design solution based on machine learning, which provides a standard and systematic guide for concerning both functional and non-functional data simultaneously in detailed design phase. Due to current conditions, a model was presented to demonstrate our idea. In the following, the major contributions and limitations of this thesis are presented, and future studies are also previewed.

6.1 Contributions

By solving the research problems presented in section 1.2, (1) the FTB framework has been proposed for HF/E information integration (HF/EII) from the early design phase, (2) the IDC module has been developed to assist designers in design work, and (3) an Solution Generation Model based on k-NN classification algorithm has been built to produce design solution. The contributions of this thesis are presented in two parts as follows.

6.1.1 Contributions of FTB framework and IDC module

Information loss and Information overlapped often appear in the process of requirements collection, interpretation, and reuse, which will have a significant impact on early design. To solve these problems, FTB framework enables design team to purposefully gather the requirements from diverse group on the basis of their interests. In specific, it offers designers a clear category of functional and non-functional requirements, which can be collected from technical and sociotechnical aspect respectively.

The FTB framework also provides a detailed guideline to integrate the functional requirements and the non-functional requirements simultaneously. First, requirements are collected initially by creating a user manual from technical and sociotechnical perspectives. Then, the use case diagram of designed system is drawn according to the initial user manual, which can assist design team to construct the function tree of designed system. Next, tasks are defined for all sub-functions. After task definition and assignment, task planning enables designers to identify and characterise the interaction between technical task and sociotechnical task in time, which gives two recommendations for detailed design. In behaviour level, design for technical task indicates the specific instruction of components. Design for sociotechnical task denotes the identification of user behaviour. One suggestion is to prevent the structure behaviour and user behaviour in the same zone. The other is to make sure that the structure behaviour meets the HF/E requirements.

FTB framework offers a systematic and detailed approach for HF/EII from the early design phase, a case study has been presented to validate its feasibility. Interaction Design Centre (IDC) was developed as a module of UGS NX7.5 (CAD software) to aid the design work, which provides a practical way for the implementation of FTB framework. IDC module enables designer team to (1) catch both functional and non-functional requirements from the early design phase, and (2) convert them into design parameters to carry out the design work. By using IDC module, design

modifications and iterations due to belated effort for HF/E consideration can be significantly reduced, thereby providing a satisfactory user experience in the case of meeting the functional requirements.

6.1.2 Contributions of Solution Generation Model

To implement the third method mentioned in section 1.3, a solution generation model is presented for producing design solution based on machine learning. To validate the applicability of this method, we developed and verified this model based on k-NN classification algorithm with a small sample. This model enables designers to produce design solutions for individual task directly, afterward selecting and combining the optimal solutions to formulate the overall layout solution. It offers a divergent thinking for design solution generation based on the individual design task. The solution of a new problem may not be found through traditional methods from the global perspective. However, the solution for individual design task can be found generally, thereby combining all optimal solutions of individual design task to formulate the final overall solution.

Different from current problem solving approaches, this AI model is easy for designers to cognize and operate. For example, once available data is imported, the solution will be produced. Although this model is confined to the expert knowledge database, it offers an easy method for knowledge database updating. Simply changing the data file can complete the whole database updating. The FTB framework provides the theoretical support for this method.

6.2 Limitations

FTB framework aims at maximally reducing the design modifications and iterations in the late design phase, however it cannot totally eliminate them. In order to deal with the legacy problems of FTB framework, the Solution Generation Model developed based on k-NN classification algorithm shows the feasibility of producing solution for individual task directly. Yet, this approach has limitations, which is discussed as follows.

The first limitation is that the developed model can only provide one solution for one task, some available and promising solutions may be missed, which does not conform to our original idea. For the purpose of obtaining the optimal solution, it is imperative to produce enough design solutions for individual task.

The second limitation is that this model only is capable for producing solution for individual task, which does not offer a guide for the optimal solution selection, and combining and optimising all individual solutions to the final overall solution. That is to say, these works still need to be completed by designers.

The third limitation is that this model still relies on prior knowledge (sample), the larger the knowledge database, the more available solutions for individual task. More available solutions will provide more options for formulating the final solution.

6.3 Perspectives

In this thesis, a new perspective for engineering design method is presented, which will substantively improve the design and thereby improve our quality of life. To this end, regarding the limitations stated above, future research might be carried out in the following fields.

In order to enable Solution Generation Model to produce more solutions for individual task, it is significant to optimise the algorithm of proposed model. The k-NN classification is the most basic algorithm of machine learning, which cannot meet this need. Future research could adopt recommender system and deep learning model. The ranking formulation of recommender system shows its advantage to deal with the ranking problem, which can give several solutions in ranking according to the user preferences. Considering the data of design is diversity and complexity, deep learning could be used as a promising model to address this issue.

As presented in *section 5.2.1.1*, the duration and control information of task can be used for the final solution formulation. Therefore, to answer the question of how to select the optimal solution for each task, and how to combine and optimise all optimal

solutions to the final solution, we recommend finding a breakthrough from task's duration and control information. This work can also be a part of the algorithm of Solution Generation Model.

The absence of available data is a ubiquitous problem of machine learning, we suggest collecting as much priori knowledge as possible in specific design fields to produce a better solution.

References

- Aamodt, A. and Plaza, E. 1994. "Case-based reasoning: Foundational issues, methodological variations, and system approaches." *AI communications*, 7(1), 39-59.
- Abelson, R. and Schank, R. C. 1977. "Scripts, plans, goals and understanding." *An inquiry into human knowledge structures New Jersey*, 10.
- Abras, Chadia, Diane Maloney-Krichmar, and Jenny Preece. 2004. "User-Centered Design." *Bainbridge, W. Encyclopedia of Human-Computer Interaction. Thousand Oaks: Sage Publications* 37 (4): 445–56. doi:10.1.1.94.381.
- Ahmadi, Ahmadreza, and Jun Tani. 2017. "How Can a Recurrent Neurodynamic Predictive Coding Model Cope with Fluctuation in Temporal Patterns? Robotic Experiments on Imitative Interaction." *Neural Networks* 92. Elsevier Ltd: 3–16. doi:10.1016/j.neunet.2017.02.015.
- Alimardani, Fatemeh, Reza Boostani, and Benjamin Blankertz. 2017. "Weighted Spatial Based Geometric Scheme as an Efficient Algorithm for Analyzing Single-Trial EEGs to Improve Cue-Based BCI Classification." *Neural Networks* 92. Elsevier Ltd: 69–76. doi:10.1016/j.neunet.2017.02.014.
- Altshuller, Genrikh. 1984. "Creativity as an Exact Science: The Theory of the Solution of Inventive Problems." *Journal of Development Economics*. <http://scholar.google.com/scholar?hl=en&btnG=Search&q=intitle:Creativity+as+an+Exact+Science:+The+Theory+of+the+Solution+Inventive+Problems#0#2%5Cnhttp://www.sciencedirect.com/science/article/pii/S0304387809000108%5Cnhttp://scholar.google.com/scholar?hl=e>.
- Aromaa, Susanna, and Kaisa Väänänen. 2016. "Suitability of Virtual Prototypes to Support Human Factors/ergonomics Evaluation during the Design." *Applied*

- Ergonomics* 56: 11–18. doi:10.1016/j.apergo.2016.02.015.
- Bainbridge, Lisanne. 1983. “Ironies of Automation.” *Automatica* 19 (6): 775–79. doi:10.1016/0005-1098(83)90046-8.
- Barajas, M. A., and Agard, B. 2010. “Improved fuzzy ranking procedure for decision making in product design.” *International Journal of Production Research* 48(18): 5433-5453.
- Belecheanu, R., Pawar, K.S., Barson, R.J., Bredehorst, B. and Weber, F., 2003. “The application of case based reasoning to decision support in new product development.” *Integrated Manufacturing Systems*, 14(1), pp.36-45.
- Beyer, Hugh, and Karen Holtzblatt. 1997. *Contextual Design: Defining Customer-Centered Systems*. Morgan Kaufmann Publishers In. Vol. 32. doi:10.1145/291224.291229.
- Bindewald, Jason M., Michael E. Miller, and Gilbert L. Peterson. 2014. “A Function-to-Task Process Model for Adaptive Automation System Design.” *International Journal of Human Computer Studies* 72 (12). Elsevier: 822–834. doi:10.1016/j.ijhcs.2014.07.004.
- Burns, Catherine M, Gyrd Skraaning, Greg A. Jamieson, Nathan Lau, Jordanna Kwok, Robin Welch, and Gisle Andresen. 2008. “Evaluation of Ecological Interface Design for Nuclear Process Control: Situation Awareness Effects.” *Human Factors* 50 (4): 663–679. doi:10.1518/001872008X312305.
- Bye, Andreas, Erik Hollnagel, and Tor Steinar Brendeford. 1999. “Human–machine Function Allocation: A Functional Modelling Approach.” *Reliability Engineering & System Safety* 64 (2): 291–300. doi:10.1016/S0951-8320(98)00069-6.

- Carayon, Pascale, Sarah Kianfar, Yaqiong Li, Anping Xie, Bashar Alyousef, and Abigail Wooldridge. 2015. "A Systematic Review of Mixed Methods Research on Human Factors and Ergonomics in Health Care." *Applied Ergonomics* 51 (November): 291–321. doi:10.1016/j.apergo.2015.06.001.
- Catherine Courage & Kathy Baxter. 2005. *Understanding Your Users: A Practical Guide to User Requirements Methods, Tools, and Techniques*. World.
- Cebi, Selcuk, and Cengiz Kahraman. 2010. "Extension of Axiomatic Design Principles under Fuzzy Environment." *Expert Systems with Applications* 37 (3). Elsevier Ltd: 2682–2689. doi:10.1016/j.eswa.2009.08.010.
- Chaffin, Don B, John D Ianni, Darrell Bowman, Brian Peacock, Heather Reed, Robert Fox, and D Glenn Jimmerson. 2001. "Digital Human Modeling for Vehicle and Workplace Design." *Society of Automotive Engineers, Inc*.
- Clegg, C W. 2000. "Sociotechnical Principles for Systems Design." *Applied Ergonomics* 31 (February): 464–477. doi:http://dx.doi.org/10.1016/S0003-6870(00)00009-0.
- Czaja, Sara J, and Sankaran N Nair. 2012. "Human Factors Engineering and Systems Design." In *Handbook of Human Factors and Ergonomics*, 38–56. doi:10.1002/9781118131350.ch2.
- Díaz-Madroño, M., Mula, J., and Peidro, D. 2014. "A review of discrete-time optimization models for tactical production planning." *International Journal of Production Research* 52(17): 5171-5205.
- Eason, Ken. 2014. "Afterword: The Past, Present and Future of Sociotechnical Systems Theory." *Applied Ergonomics* 45 (2 Part A): 213–220. doi:10.1016/j.apergo.2013.09.017.

- Endsley, Mica R, Betty Bolté, and Debra G Jones. 2003. *Designing for Situation Awareness. Design*. doi:10.1201/9780203485088.
- Eppinger, Steven D., Daniel E. Whitney, Robert P. Smith, and David A. Gebala. 1994. "A Model-Based Method for Organizing Tasks in Product Development." *Research in Engineering Design* 6 (1): 1–13. doi:10.1007/BF01588087.
- European Union. 2006. "Directive on machinery-Directive 2006/42/EC of the European parliament and of the council of 17 may 2006 on machinery." *Official Journal of the European Union*.
- Fayek, Haytham M., Margaret Lech, and Lawrence Cavedon. 2017. "Evaluating Deep Learning Architectures for Speech Emotion Recognition." *Neural Networks* 92. Elsevier Ltd: 60–68. doi:10.1016/j.neunet.2017.02.013.
- Feyen, Robert, Yili Liu, Don Chaffin, Glenn Jimmerson, and Brad Joseph. 2000. "Computer-Aided Ergonomics: A Case Study of Incorporating Ergonomics Analyses into Workplace Design." *Applied Ergonomics* 31 (3): 291–300. doi:10.1016/S0003-6870(99)00053-8.
- Gaubha, Himaanshu, Pradeep Kumar, Partha Pratim Roy, Priyanka Singh, Debi Prosad Dogra, and Balasubramanian Raman. 2017. "Prediction of Advertisement Preference by Fusing EEG Response and Sentiment Analysis." *Neural Networks* 92. Elsevier Ltd: 77–88. doi:10.1016/j.neunet.2017.01.013.
- Gero, J.S. 1990. "Design Prototypes: A Knowledge Representation Schema for Design." *AI Magazine* 11 (4): 26. doi:10.1609/aimag.v11i4.854.
- Gero, John S., and Udo Kannengiesser. 2004. "The Situated Function-Behaviour-Structure Framework." *Design Studies* 25 (4): 373–391. doi:10.1016/j.destud.2003.10.010.
- Glinz, Martin. 2007. "On Non-Functional Requirements." *15th IEEE International*

- Requirements Engineering Conference (RE 2007)*, 21–26. doi:10.1109/RE.2007.45.
- Goel, A. K. 1997. “Design, analogy, and creativity.” *IEEE expert*, 12(3), 62-70.
- Gomes, P., Seco, N., Pereira, F. C., Paiva, P., Carreiro, P., Ferreira, J. L., and Bento, C. 2006. “The importance of retrieval in creative design analogies.” *Knowledge-Based Systems*, 19(7), 480-488.
- Gould, John D, and Clayton Lewis. 1985. “Designing for Usability---Key Principles and What Designers Think.” *CHI 83 Proceedings of the SIGCHI Conference on Human Factors in Computing Systems* 28 (3): 50–53. doi:10.1145/800045.801579.
- Groover, Mikell P. 2016. “Automation, Production Systems, and Computer Integrated Manufacturing.” *Pearson Education India*.
- Hajdu, M., and Bokor, O. 2016. “Sensitivity analysis in PERT networks: Does activity duration distribution matter?” *Automation in Construction* 65: 1-8.
- Hammersley, M. and Atkinson, P., 1983. *Ethnology: Principles in practice*. New York: Tavistock.
- Haque, B. U., R. A. Belecheanu, R. J. Barson, and K. S. Pawar. 2000. “Towards the Application of Case Based Reasoning to Decision-Making in Concurrent Product Development (Concurrent Engineering).” *Knowledge-Based Systems* 13 (2): 101–112. doi:10.1016/S0950-7051(00)00051-4.
- Hasan, Raïd, Alain Bernard, Joseph Ciccotelli, and Patrick Martin. 2003. “Integrating Safety into the Design Process: Elements and Concepts Relative to the Working Situation.” *Safety Science* 41 (2–3): 155–179. doi:10.1016/S0925-7535(02)00002-4.
- Hassenzahl, Marc. 2003. “Marc Hassenzahl Chapter 3.” *Funology* 3: 31–42.

doi:10.1007/1-4020-2967-5_4.

Helander, Martin G, and Li Lin. 2002. "Axiomatic Design in Ergonomics and an Extension of the Information Axiom." *Journal of Engineering Design* 13 (4): 321–339. doi:10.1080/0954482021000050794.

Hollnagel, E, and D D Woods. 1983. "Cognitive Systems Engineering: New Wine in New Bottles." *International Journal of Man-Machine Studies* 18: 583–600. doi:10.1006/ijhc.1982.0313.

Hollnagel, E. 2003. *Handbook of Cognitive Task Design. The Handbook of Cognitive Task Design*. doi:10.1201/9781410607775.

Houssin, R., A. Bernard, P. Martin, G. Ris, and F. Cherrier. 2006. "Information System Based on a Working Situation Model for a New Design Approach in Concurrent Engineering." *Journal of Engineering Design* 17 (1): 35–54. doi:10.1080/09544820500276048.

Houssin, R., and A. Coulibaly. 2011. "An Approach to Solve Contradiction Problems for the Safety Integration in Innovative Design Process." *Computers in Industry* 62 (4). Elsevier B.V.: 398–406. doi:10.1016/j.compind.2010.12.009.

Houssin, R., H Sun, and M Gardoni. 2010. "A Behavioural Design Approach to Improving Mechanical System Design with Integration of Use Conditions." *International Journal of Design and Innovation Research* 5 (3): 1–24.

Houssin, R., Renaud, J., Coulibaly, A., Cavallucci, D., and Rousselot, F. 2015. "TRIZ theory and case based reasoning: synergies and oppositions." *International Journal on Interactive Design and Manufacturing (IJIDeM)*, 9(3), 177-183.

Ilevbare, Imoh M., David Probert, and Robert Phaal. 2013. "A Review of TRIZ, and Its Benefits and Challenges in Practice." *Technovation* 33 (2–3). Elsevier: 30–37. doi:10.1016/j.technovation.2012.11.003.

- Jayaram, Uma, Sankar Jayaram, Imtiyaz Shaikh, Youngjun Kim, and Craig Palmer. 2006. "Introducing Quantitative Analysis Methods into Virtual Environments for Real-Time and Continuous Ergonomic Evaluations." *Computers in Industry* 57 (3): 283–296. doi:10.1016/j.compind.2005.12.005.
- Jones, Patricia M. 1995. "Designing for Operations: Towards a Sociotechnical Systems and Cognitive Engineering Approach to Concurrent Engineering." *International Journal of Industrial Ergonomics* 16 (4–6): 283–292. doi:10.1016/0169-8141(95)00013-7.
- Jones, S. and Maiden, N., 2005. "Rescue: An integrated method for specifying requirements for complex sociotechnical systems." In *Requirements engineering for sociotechnical systems* (pp. 245-265). IGI Global.
- Kandjani, Hadi, Madjid Tavana, Peter Bernus, Lian Wen, and Amir Mohtarami. 2015. "Using Extended Axiomatic Design Theory to Reduce Complexities in Global Software Development Projects." *Computers in Industry* 67. Elsevier B.V.: 86–96. doi:10.1016/j.compind.2014.10.008.
- Karwowski, W. 2005. "Ergonomics and Human Factors: The Paradigms for Science, Engineering, Design, Technology and Management of Human-Compatible Systems." *Ergonomics* 48 (5): 436–463. doi:10.1080/00140130400029167.
- Karwowski, Waldemar. 2012. "The Discipline of Human Factors and Ergonomics." In *Handbook of Human Factors and Ergonomics*, 1–37. doi:10.1002/9781118131350.ch1.
- Khadar, B. A. R., Madhusudhan, R., Ramanaiah, M., and Karthikeyan, K. 2013. "Statistical optimization for generalised fuzzy number." *International Journal of Modern Engineering Research* 3: 647–651.
- Kim, Sa Kil, Sang Moon Suh, Gwi Sook Jang, Seung Kweon Hong, and Jung Chul

- Park. 2012. "Empirical Research on an Ecological Interface Design for Improving Situation Awareness of Operators in an Advanced Control Room." *Nuclear Engineering and Design* 253. Elsevier B.V.: 226–237. doi:10.1016/j.nucengdes.2012.08.026.
- Kim, Sangwook, Zhibin Yu, and Minho Lee. 2017. "Understanding Human Intention by Connecting Perception and Action Learning in Artificial Agents." *Neural Networks* 92. Elsevier Ltd: 29–38. doi:10.1016/j.neunet.2017.01.009.
- Kotsiantis, Sotiris B. 2007. "Supervised Machine Learning: A Review of Classification Techniques." *Informatica* 31: 249–68. doi:10.1115/1.1559160.
- Kraft, Christian. 2012. "User Experience Innovation: User Centered Design That Works." *User Experience Innovation: User Centered Design That Works* 9781430241: 1–207. doi:10.1007/978-1-4302-4150-8.
- Krishna, A. 2013. *Customer sense: How the 5 senses influence buying behavior*. Springer.
- Kyriakidis, Miltos, Vivek Kant, Sulfikar Amir, and Vinh N. Dang. 2017. "Understanding Human Performance in Sociotechnical Systems - Steps towards a Generic Framework." *Safety Science*. Elsevier Ltd. doi:10.1016/j.ssci.2017.07.008.
- Lai, Y. J., and Hwang, C. L. 1994. "Fuzzy multiple objective decision making." *Fuzzy Multiple Objective Decision Making*: 139-262.
- Lawler, Erin K., Alan Hedge, and Sonja Pavlovic-Veselinovic. 2011. "Cognitive Ergonomics, Socio-Technical Systems, and the Impact of Healthcare Information Technologies." *International Journal of Industrial Ergonomics* 41 (4). Elsevier Ltd: 336–344. doi:10.1016/j.ergon.2011.02.006.

- Lee, Minho, Steven Bressler, and Robert Kozma. 2017. "Advances in Cognitive Engineering Using Neural Networks." *Neural Networks* 92. Elsevier Ltd: 1–2. doi:10.1016/j.neunet.2017.05.012.
- Lee, Sang Woo, Chung Yeon Lee, Dong Hyun Kwak, Jung Woo Ha, Jeonghee Kim, and Byoung Tak Zhang. 2017. "Dual-Memory Neural Networks for Modeling Cognitive Activities of Humans via Wearable Sensors." *Neural Networks* 92. Elsevier Ltd: 17–28. doi:10.1016/j.neunet.2017.02.008.
- Li, R. Y., and KANG, R. 2008. "Research on failure rate forecasting method based on ARMA model." *Systems engineering and electronics* 8: 049.
- Lo, Shuan, and Martin G. Helander. 2007. "Use of Axiomatic Design Principles for Analysing the Complexity of Human–machine Systems." *Theoretical Issues in Ergonomics Science* 8 (2): 147–169. doi:10.1080/14639220601092475.
- Lootsma, F. A. 1989. "Stochastic and fuzzy PERT." *European Journal of Operational Research* 43(2): 174-183.
- Mabrok, Mohamed A., Mahmoud Efatmaneshnik, and Michael Ryan. 2015. "Including Non-Functional Requirements in the Axiomatic Design Process," 54–60. doi:10.1109/SYSCON.2015.7116729.
- Magistris, G. De, A. Micaelli, J Savin, C Gaudez, and J Marsot. 2015. "Dynamic Digital Human Models for Ergonomic Analysis Based on Humanoid Robotics Techniques." *International Journal of the Digital Human* 1 (1): 81–109. doi:10.1504/IJDH.2015.067135.
- Mahdjoub, M., Monticolo D, Gomes, S., and Sagot, J.C. 2010. "A Collaborative Design for Usability Approach Supported by Virtual Reality and a Multi-Agent System Embedded in a PLM Environment." *CAD Computer Aided Design* 42 (5). Elsevier Ltd: 402–413. doi:10.1016/j.cad.2009.02.009.

- Maniadakis, M., Hourdakakis, E., and Trahanias, P. 2016. "Time-informed task planning in multi-agent collaboration." *Cognitive Systems Research* 43: 291-300.
- Marsot, J., and Claudon, L. 2004. "Design and Ergonomics. Methods for Integrating Ergonomics at Hand Tool Design Stage." *International Journal of Occupational Safety and Ergonomics* 10 (1): 13–23. doi:10.1080/10803548.2004.11076591.
- McRuer. 1980. "Human Dynamics in Man-Machine Systems." *Automatica*, 16(3): 237–253.
- Michie, E.D, D J Spiegelhalter, and C C Taylor. 1994. "Machine Learning , Neural and Statistical Classification." *Technometrics* 37 (4): 459. doi:10.2307/1269742.
- Naderpour, M., Lu, J., and Zhang, G. 2015. "An Abnormal Situation Modeling Method to Assist Operators in Safety-Critical Systems." *Reliability Engineering and System Safety* 133. Elsevier: 33–47. doi:10.1016/j.ress.2014.08.003.
- Nagamachi, M. 1995. "Kansei Engineering: A New Ergonomic Consumer-Oriented Technology for Product Development." *International Journal of Industrial Ergonomics* 15 (1): 3–11. doi:10.1016/0169-8141(94)00052-5.
- Nagamachi, M. 2002. "Kansei Engineering as a Powerful Consumer-Oriented Technology for Product Development." *Applied Ergonomics* 33 (3): 289–294. doi:10.1016/S0003-6870(02)00019-4.
- Nagamachi, M. 2008. "Perspectives and the New Trend of Kansei /affective Engineering." *The TQM Journal* 20 (4): 290–298. doi:10.1108/17542730810881285.
- Nagamachi, M (E.D). 2016. *Kansei/Affective Engineering*. <https://books.google.com.co/books?id=StcwNSMe0VQC>.

- Nagamachi, M., and Lokman, A.M. 2011. *Innovations of Kansei Engineering*. CRC Press. doi:10.1017/CBO9781107415324.004.
- Nanda, P., Bos, J., Kramer, K.L., Hay, C., and Ignacz, J. 2008. "Effect of Smartphone Aesthetic Design on Users' Emotional Reaction." *The TQM Journal* 20 (4): 348–355. doi:10.1108/17542730810881339.
- Nemeth, C.P. 2004. *Human Factors Methods for Design*. *Human Factors in Systems Engineering*. doi:10.1201/9780203643662.
- Nielsen, J. 1994. "Guerrilla HCI: Using Discount Usability Engineering to Penetrate the Intimidation Barrier." *Cost-Justifying Usability*, 245–272.
- Nielsen, J. 2005. "Ten Usability Heuristics." *Communications of the ACM* 3 (1990): 1–2. doi:10.1145/259963.260531.
- Norman, D. 1988. "The Design of Everyday Things (Originally Published: The Psychology of Everyday Things)." In *The Psychology of Everyday Things*, 1–104. doi:10.2307/1423268.
- Norman, D. 1986. "Cognitive Engineering." *User Centered System Design*, 31–61.
- Norman, D., and Draper, S.W. 1986. *Cognitive Engineering, in User Centered System Design: New Perspectives on Human-Computer Interaction*. *User Centered System Design: New Perspectives on Human-Computer Interaction*.
- Norman, D.A., and Stappers, P.J. 2015. "DesignX: Complex Sociotechnical Systems." *She Ji: The Journal of Design, Economics, and Innovation* 1 (2): 83–106. doi:10.1016/j.sheji.2016.01.002.
- Pahl, G, and W Beitz. 1996. *Engineering Design: A Systematic Approach*. Springer.
- Pahl, G., Beitz, B., Feldhusen, J., and Grote, K.H. 2007. *Engineering Design: A Systematic Approach*. A NASA STI/Recon Technical Report.

doi:10.1007/978-1-84628-319-2.

Parasuraman, R., T.B. Sheridan, and C.D. Wickens. 2000. "A Model for Types and Levels of Human Interaction with Automation." *IEEE Transactions on Systems, Man, and Cybernetics - Part A: Systems and Humans* 30 (3): 286–297. doi:10.1109/3468.844354.

Parasuraman, R., Thomas B.S., and Christopher D.W. 2008. "Situation Awareness, Mental Workload, and Trust in Automation: Viable, Empirically Supported Cognitive Engineering Constructs." *Journal of Cognitive Engineering and Decision Making* 2 (2): 140–160. doi:10.1518/155534308X284417.

Pasmore, W., Francis, C., Haldeman, J., and Shani, A. 1982. "Sociotechnical Systems: A North American Reflection on Empirical Studies of the Seventies." *Human Relations* 35 (12): 1179–1204. doi:10.1177/001872678203501207.

Pawlak, W.S., and Kim J.V. 1996. "Inducing Effective Operator Control through Ecological Interface Design." *International Journal of Human-Computer Studies* 44 (5): 653–688. doi:10.1006/ijhc.1996.0028.

Pheasant, S. and Haslegrave, C.M., 2016. *Bodyspace: Anthropometry, ergonomics and the design of work*. CRC Press.

Preece, J., Rogers, Y, and Sharp, H. 2002. "Interaction Design: Beyond Human-Computer Interaction." *Design* 18 (1): 68–68. doi:10.1016/S0010-4485(86)80021-5.

Pritchett, A. R., Kim, S. Y., and Feigh, K. M. 2014. "Modeling human–automation function allocation." *Journal of Cognitive Engineering and Decision Making* 8(1): 33-51.

- Purvis, L. and Pu, P., 1998. "Composer: A case-based reasoning system for engineering design." *Robotica*, 16(3), pp.285-295.
- Rogers, Y., Sharp, H. and Preece, J. 2007. "Interaction Design: Beyond Human-Computer Interaction." *Design* 18 (1): 68–68. doi:10.1016/S0010-4485(86)80021-5.
- Raman, M.R. Gauthama, N.S, Kannan Kirthivasan, and V.S. Shankar Sriram. 2017. "A Hypergraph and Arithmetic Residue-Based Probabilistic Neural Network for Classification in Intrusion Detection Systems." *Neural Networks* 92. Elsevier Ltd: 89–97. doi:10.1016/j.neunet.2017.01.012.
- Rasmussen, J. 1983. "Skills, Rules, and Knowledge; Signals, Signs, and Symbols, and Other Distinctions in Human Performance Models." *IEEE Transactions on Systems, Man and Cybernetics* SMC-13 (3): 257–266. doi:10.1109/TSMC.1983.6313160.
- Rasmussen, J. 1985. "The Role of Hierarchical Knowledge Representation in Decisionmaking and System Management." *IEEE Transactions on Systems, Man, and Cybernetics* SMC-15 (2): 234–43. doi:10.1109/TSMC.1985.6313353.
- Rasmussen, J. 1986. *Information Processing and Human-Machine Interaction. An Approach to Cognitive Engineering*. Vol. 12.
- Reason, J.T. 1997. "Managing the Risks of Organizational accidentsAshgate Publishing." *Aldershot, UK*.
- Redström, J. 2006. "Towards User Design? On the Shift from Object to User as the Subject of Design." *Design Studies* 27 (2): 123–139. doi:10.1016/j.destud.2005.06.001.
- Rieuf, V., and Bouchard, C. 2017. "Emotional Activity in Early Immersive Design:

- Sketches and Moodboards in Virtual Reality.” *Design Studies* 48. Elsevier Ltd: 43–75. doi:10.1016/j.destud.2016.11.001.
- Ross, D. T. 1977. “Structured analysis (SA): A language for communicating ideas.” *IEEE Transactions on software engineering* (1): 16-34.
- Rossi, M., Germani, M., and Zamagni, A. 2016. “Review of Ecodesign Methods and Tools. Barriers and Strategies for an Effective Implementation in Industrial Companies.” *Journal of Cleaner Production* 129. Elsevier Ltd: 361–373. doi:10.1016/j.jclepro.2016.04.051.
- Rouse, William B, and William J Cody. 1988. “On the Design of Man-Machine Systems : Principles , Practices and Prospects *” 24 (2).
- Sadeghi, L, Dantan, J.Y, Siadat, A, and Marsot, J. 2016. “Design for Human Safety in Manufacturing Systems: Applications of Design Theories, Methodologies, Tools and Techniques.” *Journal of Engineering Design* 27 (12). Taylor & Francis: 844–877. doi:10.1080/09544828.2016.1235262.
- Salmon, Paul M., Neville A. Stanton, Guy H. Walker, Chris Baber, Daniel P. Jenkins, Richard McMaster, and Mark S. Young. 2008. “What Really Is Going on? Review of Situation Awareness Models for Individuals and Teams.” *Theoretical Issues in Ergonomics Science* 9 (4): 297–323. doi:10.1080/14639220701561775.
- Salmon, P.M., Neville A. Stanton, Guy H. Walker, Daniel Jenkins, Darshna Ladva, Laura Rafferty, and Mark Young. 2009. “Measuring Situation Awareness in Complex Systems: Comparison of Measures Study.” *International Journal of Industrial Ergonomics* 39 (3): 490–500. doi:10.1016/j.ergon.2008.10.010.
- Salvendy, G. (Ed.). 2012. *Handbook of Human Factors and Ergonomics*.
- Sarcar, M. M. M., Rao, K. M., & Narayan, K. L. 2008. *Computer Aided Design and Manufacturing. PHI Learning Pvt. Ltd..*

- Savransky, S.D. 2000. *Engineering of Creativity*. CRC Press. Vol. 53. doi:10.1017/CBO9781107415324.004.
- Schmidhuber, J. 2015. "Deep Learning in Neural Networks: An Overview." *Neural Networks* 61. Elsevier Ltd: 85–117. doi:10.1016/j.neunet.2014.09.003.
- Schuler, D, and Namioka, A. 1993. "Participatory Design: Principles and Practices." *System*, 319. doi:10.1016/j.anclin.2007.12.004.
- Schütte, S. 2002. *Designing Feelings into Products: Integrating Kansei Engineering Methodology in Product Development [Tesis]*. Linköpings Universitet Printings. doi:10.1016/j.sbspro.2013.10.291.
- Schütte, S., and Eklund, J. 2005. "Design of Rocker Switches for Work-Vehicles - An Application of Kansei Engineering." *Applied Ergonomics* 36 (5): 557–567. doi:10.1016/j.apergo.2005.02.002.
- Shipley, M. F., de Korvin, A., and Omer, K. 1997. "BIFPET methodology versus PERT in project management: fuzzy probability instead of the beta distribution." *Journal of Engineering and Technology management* 14(1): 49-65.
- Shneiderman, B. 1998. "Designing the User Interface: Strategies for Effective Human-Computer Interaction." *Chapter*. doi:10.1016/0166-3615(93)90066-A.
- Stalker, R. 2002. "A Function-Behaviour-Structure Framework for the Lifecycle of an Artefact." *Creativity and Cognition* 4, 6. <http://www.ruthstalkerfirth.com/pdf/CC02.pdf>.
- Stanton, N. A., R. Stewart, D. Harris, R. J. Houghton, C. Baber, R. McMaster, P. Salmon, et al. 2006. "Distributed Situation Awareness in Dynamic Systems: Theoretical Development and Application of an Ergonomics Methodology."

- Ergonomics* 49 (12–13): 1288–1311. doi:10.1080/00140130600612762.
- Steinberg, F., Tursch, P., and Woll, R. 2015. “The Improvement of Kansei Engineering by Using the Repertory Grid Technique.” *Management and Production Engineering Review* 6 (3): 77–82. doi:10.1515/mper-2015-0029.
- Stone, Robert B., and Kristin L. Wood. 2000. “Development of Functional.” *Journal of Mechanical Design* 122(4) (December 2000): 359–370.
- Suh, N. P. 1998. “Axiomatic Design Theory for Systems.” *Research in Engineering Design* 10 (4): 189–209. doi:10.1007/s001639870001.
- Suh, N.P. 2001. *Axiomatic Design--Advances and Applications. Axiomatic Design Advances and Applications.*
- Suh, N.P. 2007. “Ergonomics, Axiomatic Design and Complexity Theory.” *Theoretical Issues in Ergonomics Science* 8 (2): 101–121. doi:10.1080/14639220601092509.
- Sun, H., Houssin, R., Gardoni, M. and de Bauvront, F. 2013. “Integration of User Behaviour and Product Behaviour during the Design Phase: Software for Behavioural Design Approach.” *International Journal of Industrial Ergonomics* 43 (1): 100–114. doi:10.1016/j.ergon.2012.11.009.
- Sun, X., Houssin, R., Renaud, R, and Gardoni, M. 2016. “Integrating User Information into Design Process to Solve Contradictions in Product Usage.” *Procedia CIRP* 39. Elsevier B.V.: 166–172. doi:10.1016/j.procir.2016.01.183.
- Thompson, M.K. 2013. “A Classification of Procedural Errors in the Definition of Functional Requirements in Axiomatic Design Theory.” *Proceedings of ICAD2013, The Seventh International Conference on Axiomatic Design.* <http://www.mkthompson.net/wp-content/uploads/2013/06/ICAD2013-16-Thompson-FR-Error-Classification.pdf>.

- Tsai. 2000. *Enumeration of Kinematic Structures Fundamentals of Environmental Discharge Modeling*. CRC Press LLC.
- Upton, C., and Gavin D. 2008. "Extending Ecological Interface Design Principles: A Manufacturing Case Study." *International Journal of Human Computer Studies* 66 (4): 271–286. doi:10.1016/j.ijhcs.2007.10.007.
- Vicente, K. J., and J. Rasmussen. 1992. "Ecological Interface Design : Theoretical Foundations." *IEEE Transactions on Systems, Man, and Cybernetics* 22 (4): 589–606. doi:10.1109/21.156574.
- Vicente, K. J. 2002. "Ecological Interface Design: Progress and Challenges." *Human Factors* 44 (1): 62–78. doi:10.1518/0018720024494829.
- Vicente, K. J. 1999. "Cognitive Work Analysis." *Analysis* 17 (3): 313–321. doi:10.1136/jamia.2009.000422.
- Vieira, J., Osório, J.M.A., Mouta, S., Delgado, P., Portinha, A., Meireles, J.F. and Santos, J.A. 2017. "Kansei Engineering as a Tool for the Design of in-Vehicle Rubber Keypads." *Applied Ergonomics* 61: 1–11. doi:10.1016/j.apergo.2016.12.019.
- Viller, S, and I Sommerville. 1999. "Coherence: An Approach to Representing Ethnographic Analyses in Systems Design." *Human-Computer Interaction* 14 (1): 9–41. doi:10.1207/s15327051hci1401&2_2.
- Vredenburg, Karel. 1999. "Increasing Ease of Use." *Communications of the ACM* 42 (5): 67–71. doi:10.1145/301353.301419.
- Vredenburg, K., Mao J.Y, Paul W. Smith, and Tom Carey. 2002. "A Survey of User-Centered Design Practice." *Proceedings of the SIGCHI Conference on Human Factors in Computing Systems Changing Our World, Changing Ourselves - CHI '02*, no. 1: 471. doi:10.1145/503457.503460.

- Wang, Y. 2009. *Statistical Techniques for Network Security: Modern Statistically-Based Intrusion Detection and Protection*. doi:10.4018/978-1-59904-708-9.
- Webb, G.I., M.J. Pazzani, and D. Billsus. 2001. "Machine Learning for User Modeling." *User Modeling and User-Adapted Interaction* 11 (1): 19–29. <http://www.springerlink.com/index/RL172M3L46614737.pdf>.
- Whitman, L, D Malzahn, V Madhavan, G Weheba, and K Krishnan. 2004. "Virtual Reality Case Study throughout the Curriculum to Address Competency Gaps." *International Journal of Engineering Education* 20 (5): 690–702. <https://www.scopus.com/inward/record.url?eid=2-s2.0-4644354578&partnerID=40&md5=c5b10cb60c23829852416a74f1a7f319>.
- Witoonchart, P, and P Chongstitvatana. 2017. "Application of Structured Support Vector Machine Backpropagation to a Convolutional Neural Network for Human Pose Estimation." *Neural Networks* 92. Elsevier Ltd: 39–46. doi:10.1016/j.neunet.2017.02.005.
- Wu, M. C., Lo, Y. F., & Hsu, S. H. 2006. "A case-based reasoning approach to generating new product ideas." *The International Journal of Advanced Manufacturing Technology*, 30(1), 166-173.
- Young, Mark S., and Stewart A. Birrell. 2012. "Ecological IVIS Design: Using EID to Develop a Novel in-Vehicle Information System." *Theoretical Issues in Ergonomics Science* 13 (2): 225–239. doi:10.1080/1463922X.2010.505270.
- Zhang, F.L, Yang, M.L, and Liu, W.D. 2014. "Using Integrated Quality Function Deployment and Theory of Innovation Problem Solving Approach for Ergonomic Product Design." *Computers and Industrial Engineering* 76 (1). Elsevier Ltd: 60–74. doi:10.1016/j.cie.2014.07.019.
- Zhang, S., Yao L.N, and Sun A.X. 2017. "Deep Learning Based Recommender

System: A Survey and New Perspectives.” <http://arxiv.org/abs/1707.07435>.

Zhang, Y.Y., Yang, C., and Zhang, P. 2017. “Reprint of ‘Two-Stage Sparse Coding of Region Covariance via Log-Euclidean Kernels to Detect Saliency.’” *Neural Networks* 92. Elsevier Ltd: 47–59. doi:10.1016/j.neunet.2017.06.001.

Zimmermann, H. J. 2001. *Fuzzy Set Theory—and Its Applications*. Springer Science & Business Media.

Annex

Journals:

1. **Sun, X.**, Houssin, R., Renaud, J., and Gardoni, M. 2016. “Integrating User Information into Design Process to Solve Contradictions in Product Usage.” *Procedia CIRP* 39. Elsevier B.V.: 166–72. doi:10.1016/j.procir.2016.01.183.
2. **Sun, X.**, Houssin, R., Renaud, J., and Gardoni, M. “Towards a use information integration framework in the early product design phase function-task-behaviour.” *International Journal of Production Research*. **Accepted with revision**.
3. **Sun, X.**, Houssin, R., Renaud, J., and Gardoni, M. “A review of human factors and ergonomics information integration in engineering design theories, methodologies, techniques, and tools.” *International Journal of Production Research*. **Accepted with revision**.

Book chapters:

1. **Sun, X.**, Houssin, R., Renaud, J., and Gardoni, M. 2015. “Product usage in engineering design.” In *IFIP International Conference on Product Lifecycle Management* (pp. 790-799). Springer, Cham.
2. **Sun, X.**, Houssin, R., Renaud, J., and Gardoni, M. 2017. “Generating a user manual in the early design phase to guide the design activities.” In *Advances on Mechanics, Design Engineering and Manufacturing* (pp. 1167-1176). Springer International Publishing.

International conferences:

1. **Sun, X.**, Houssin, R., Renaud, J., and Gardoni, M. 2015. Human factors and ergonomics in Man-Machine systems. *21^e journées STP du GDR MACS*. **Nantes, France**.
2. **Sun, X.**, Houssin, R., Renaud, J., and Gardoni, M. 2015. User in engineering innovative design and contradiction identification. *The 15th International TRIZ Future Conference*. **Berlin, Germany**.
3. **Sun, X.**, Houssin, R., Renaud, J., and Gardoni, M. 2017. Une méthodologie pour intégrer les informations d'utilisation dès la première phase de conception. *15^{ème} Colloque National AIP-Primeca*. **La Plagne, France**.
4. **Sun, X.**, Houssin, R., Renaud, J., and Gardoni, M. 2017. Innovative interaction design approach based on TRIZ separation principles and inventive principles. *The 17th International TRIZ Future Conference*. **Lappeenranta, Finland**.

**Une approche innovante basée sur un cadre de
fonction-tâche-comportement pour intégrer les facteurs
humains et l'ergonomie dès la première phase de conception**

Doctorant : **SUN Xiaoguang**

Directeur de thèse : **GARDONI Mickaël, Professeur des Universités**

Co-directeur de thèse : **RENAUD Jean, Professeur des Universités,
Directeur du LGECO**

Encadrant de thèse : **HOUSSIN Rémy, Maître de Conférences, HDR**

Laboratoire : **LGéCo – INSA Strasbourg, FRANCE**

Résumé

1. Contexte général

La prise en compte de « l'expérience utilisateur » dans la performance de produit, devient un intérêt croissant dans la conception des produits. Le marketing souligne qu'un système (ou un produit) ne devrait plus être considéré comme une solution d'un ensemble de caractéristiques fonctionnelles et technologiques, il est doté d'expériences (Hassenzahl 2003). Les facteurs humains et l'ergonomie (HF/E) sont devenus une discipline scientifique fournissant des contraintes au niveau de l'interaction entre l'homme et le système (le produit) lors de la conception.

La plupart des études sur HF/E couvrent, non seulement les aspects d'ergonomie, mais aussi les sciences cognitives et organisationnelles. Jusqu'à présent, HF/E a reçu beaucoup d'attention, mais de nombreux travaux (Redström 2006) démontrent que la prise en compte du couple d'informations HF/E est insuffisante et cela mène à une conception « pauvre » ou non complète. Ces informations nécessaires, dès la phase de conception, pourraient améliorer la performance du système et de l'expérience utilisateur.

De plus, l'étape d'intégration HF/E dans la phase de conception impacte aussi tout le processus de conception. Par exemple, un certain nombre de contraintes sont présentes et l'espace de solutions est limité ou réduit quand on considère HF/E dès la première phase de conception. Au contraire, si on considère les informations HF/E lors de la dernière phase de conception quand les décisions ou le modèle de CAO de système (ou le produit) ont été réalisés, cela peut causer des modifications de conception compliquées à prendre en considération. Ces modifications exigent des procédures supplémentaires pour assurer une facilité d'utilisation et de la sécurité de l'utilisateur (Houssin and Coulibaly 2011). Eppinger et al. 1994 ont démontré que la réduction du nombre d'itérations de conception est un avantage pour le processus de

conception complet d'ingénierie.

2. Objectifs de la thèse

Les objectifs de ces travaux de recherche sont de développer une méthode systématique, permettant de gagner du temps et donc de l'argent en intégrant les informations HF/E dès les premières phases de conception.

3. Travaux de la thèse

3.1 Revue de la littérature

Les publications entre 1980 et 2017 concernant les Théories de Conception et des Méthodologies (DTM) et les Techniques de Conception et des Outils (DTT) visant à intégrer les informations HF/E ont permis de dégager deux orientations :

- (1) L'étape d'intégration de l'information HF/E (HF/EII) dans la phase de conception ;
- (2) L'étape d'intégration de l'information HF/E, comprenant l'ergonomie physique, l'ergonomie cognitive et l'ergonomie organisationnelle sur les site d'utilisation.

Les avantages et les limites de DTM et DTT ont été récapitulés dans la table 1.

D'une part, l'intégration des HF/E dès la première phase de conception permet de concevoir un système plus ergonomique mais nécessite souvent trop de temps pour collecter et analyser les exigences des utilisateurs. D'autre part, l'intégration des HF/E dans les dernières phases de conception cause des modifications et des itérations dans le processus de conception ce qui augmentent le temps de conception et donc son coût.

Table 1. Comparaison de DTM et DTT passé en revue pour HF/EII

DTM & DTT	Stage of HF/EII in the design phase			Category of HF/E			Benefits	Limitations
	Conceptual design	Embodiment design	Detailed design	Physical ergonomics	Cognitive ergonomics	Organizational ergonomics		
UCD	✓	✓	✓	✓	✓	✓	Reduce design modifications.	Costly and time-consuming.
KE	✓	✓	✓		✓			
TRIZ	✓	✓	✓	✓		✓	Design and evaluation at the same time.	Heavy workload of design.
AD		✓	✓	✓		✓		
CE		✓	✓		✓		Intuitive estimate design according to HF/E needs.	User behaviour may yield
STSA		✓	✓	✓	✓	✓		
FBS			✓	✓		✓	Intuitive estimate design according to HF/E needs.	Introduce design modifications.
CAD			✓	✓	✓	✓		
EID			✓	✓	✓	✓		

DTM : Design theories and methodologies

DTT: Design techniques and tools

UCD : User-Centered Design

KE : Kansei Engineering

TRIZ : Theory of inventive problem solving

AD : Axiomatic Design

CE : Cognitive Engineering

STSA : Sociotechnical Systems Approach

FBS : Function-Behaviour-Structure

CAD: Computer-Aided Design

EID: Ecological Interface Design

3.2 Cadre de « fonction-tâche-comportement »

Afin d'intégrer les informations HF/E dans la phase de conception et d'éviter les limitations d'approches, Technical Centred Design (TCD) et User Centered-Design (UCD), un cadre de « fonction-tâche-comportement » (FTB) et un modèle ont été élaborés.

La figure 1 montre le cadre global de la méthode proposée. Il contient trois parties : La phase des spécifications fonctionnelles, la phase de dimensionnement et la phase de conception détaillée, illustrées dans la figure 1.

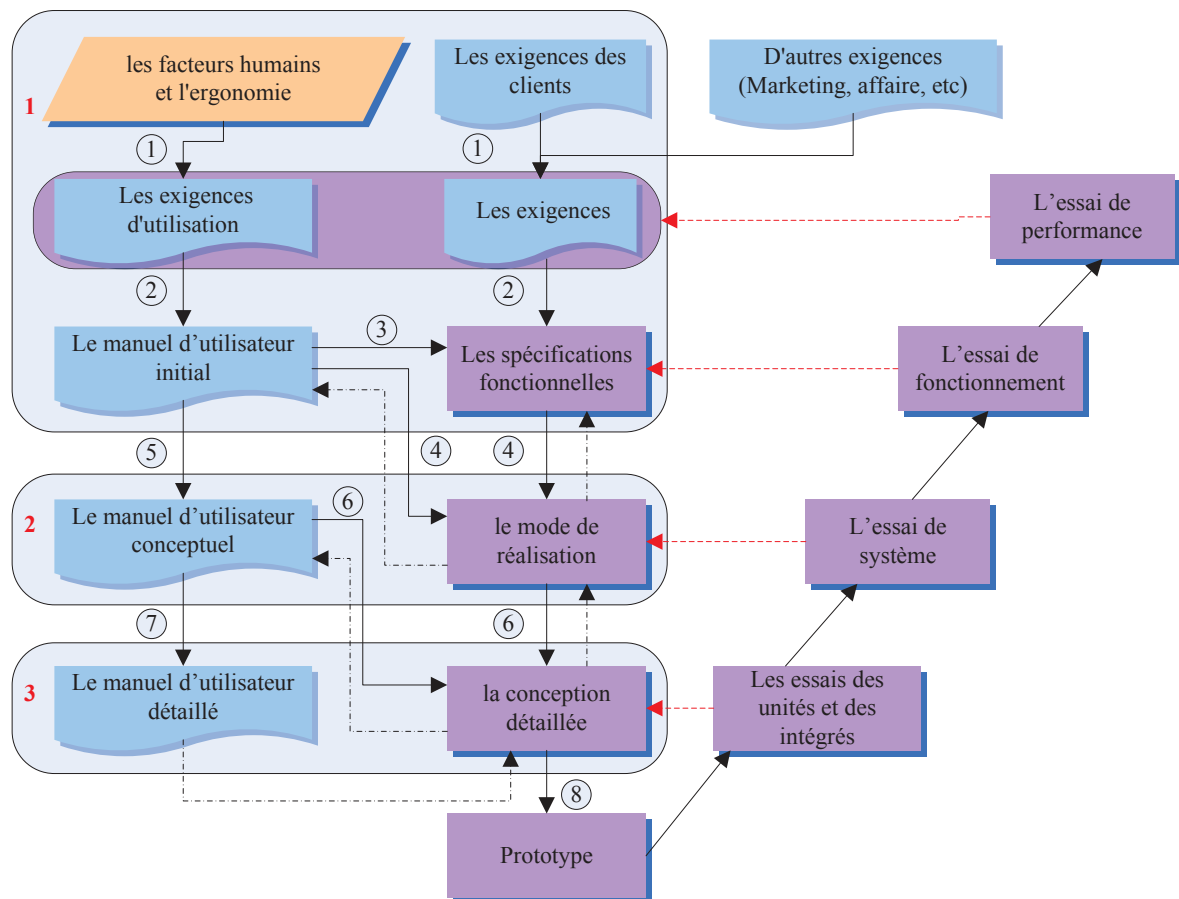

Figure 15. Cadre de la méthode proposée

1- La phase des spécifications fonctionnelles :

La phase des spécifications fonctionnelles consiste à exécuter la définition et la décomposition des fonctions selon les exigences. Le manuel d'utilisateur initial est

basé sur les exigences du client exprimées en cas d'utilisation lors des Analyses Fonctionnelles (FA). Les données de HF/E permettent de concevoir « le manuel d'utilisateur initial ». Le manuel initial n'est pas le manuel d'utilisateur final, c'est un modèle fonctionnel probable pour les utilisateurs potentiels prenant en compte les fonctions, la forme, l'expérience d'interaction, les habitudes d'exploitation, le mode de pensée, etc. Ce manuel initial présentera un cadre ou un guide pour la phase de dimensionnement dans le processus de conception. Le résultat de l'analyse fonctionnelle des spécifications fonctionnelles peut être représenté par un arbre des fonctions ou une hiérarchie des fonctions.

2- La phase de dimensionnement :

Pour accomplir les fonctions identifiées dans la phase précédente, il faut identifier les tâches nécessaires pour la réalisation des fonctions. Basée sur les méthodes SADT et PERT et un modèle mathématique, la distribution et la planification de ces tâches conformément au manuel d'utilisateur initial sont identifiées. Dans cette étude, la tâche exécutée par le produit (système) est définie par la tâche technique. La tâche exécutée par les utilisateurs est définie par la tâche sociotechnique. Ensuite, il faut assurer l'ordre de réalisation des tâches dans temps et la hiérarchie de ces tâches pour respecter la tâche d'interaction globale entre le produit et le système. Les résultats de cette phase d'allocation des tâches, leurs répartitions et leurs hiérarchisations permettent de développer le manuel d'utilisateur initial pour fournir le manuel d'utilisateur conceptuel. Le manuel d'utilisateur conceptuel peut supposer : comment, quand, combien de temps, combien de fois l'utilisateur interagira avec le système.

3- La phase de la conception détaillée :

Effectuer la conception détaillée permet de respecter le manuel d'utilisateur conceptuel. La conception détaillée comprend trois étapes, tout d'abord,

(1) concevoir certaines structures ou/et les paramètres du composant pour les tâches techniques ;

- (2) vérifier le comportement d'utilisateur pour les tâches sociotechniques ;
 - (3) Evaluer les interactions du comportement global entre le produit et son utilisateur.
- Finalement, il s'agit de détailler le manuel conceptuel pour le transformer en manuel détaillé. Le manuel détaillé indique comment les utilisateurs opéreront le produit conçu pour atteindre la performance attendue du produit lors de son utilisation.

Pour mettre en œuvre le cadre FTB, un module Centre de Conception d'Interaction (IDC) a été développé dans un logiciel de CAO pour faciliter le travail de concepteur. Le module IDC permet à l'équipe de conception (1) de prendre en compte dès la première phase de conception les exigences tant fonctionnelles que non fonctionnelles ; (2) de les transformer dans des paramètres de conception pour effectuer le travail de conception. Au moyen de module IDC, les modifications de conception et l'itération en raison de l'intégration tardive des HF/E seront considérablement réduites, fournissant ainsi une expérience utilisateur recherchée pour satisfaire les exigences fonctionnelles.

3.3 La génération de solution basée sur l'apprentissage automatique

Le démarche FTB (Fonction-tâche- comportement) fournit un cadre pour l'intégration des HF/E dès la première phase de conception afin de proposer des pistes de solutions possibles. Cependant, d'utilisateur du cadre ne fournit pas une méthode permettant de proposer des solutions techniques de conception. Les méthodologies actuelles de génération de solutions de conception s'appuient souvent sur l'expérience des concepteurs, c'est pourquoi un « modèle d'intelligence artificielle » a commencé à être développé pour produire les solutions de conception recherchées. Différentes approches de résolution de problèmes existent, ces modèles offrent une pensée divergente pour la génération de solution de conception basée sur la tâche de conception individuelle et toutes les données fonctionnelles et non fonctionnelles. Ensuite, toutes les solutions optimales sont choisies pour la proposition de la solution finale (Figure 2).

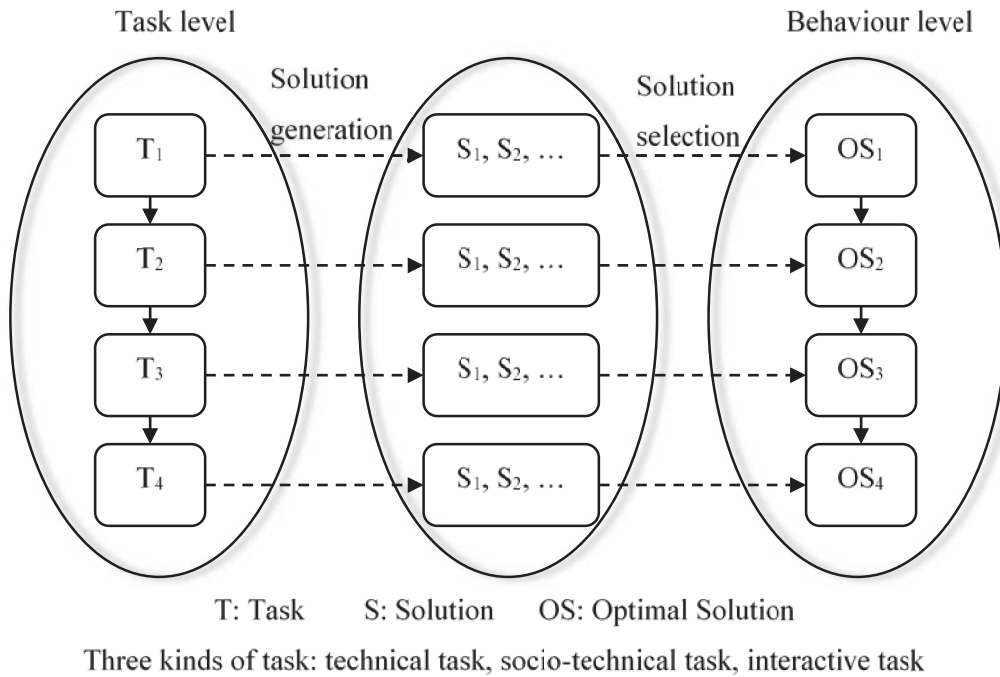

Figure 9. Processus de génération de solution de conception

La description générale du modèle d'AI est illustrée dans la figure 3. Les informations de tâche sont représentées comme entrée du modèle AI et les solutions de conception sont la production du modèle.

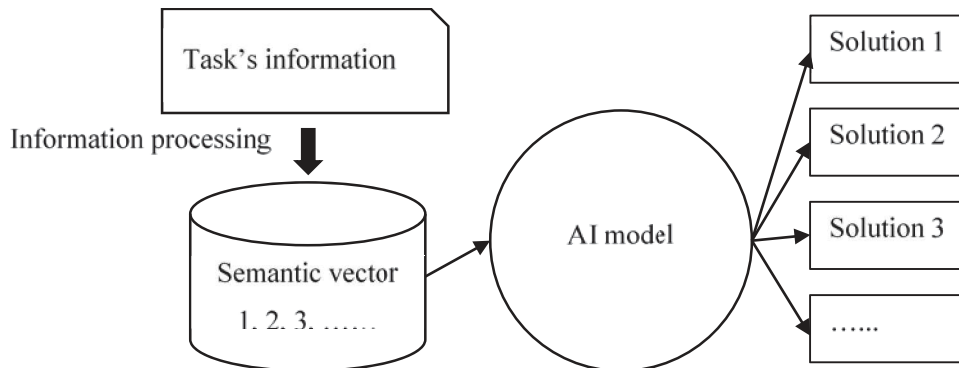

Figure 3. Description générale de modèle AI

Pour considérer les exigences fonctionnelles et non fonctionnelles, l'entrée du modèle correspond aux informations nécessaires pour la réalisation de la tâche, (les conditions de l'intervention d'utilisateur et les préférences d'utilisateur). Les premiers résultats de notre travail sur de modèle sont présentés pour produire la solution de conception basée sur l'apprentissage automatique. Pour valider l'applicabilité de cette méthode,

nous avons développé et avons vérifié ce modèle AI basé sur l'algorithme de classification k-NN avec un petit échantillon. Ce modèle permet aux concepteurs de produire les solutions de conception pour la tâche individuelle directement, en choisissant et combinant les solutions optimales pour formuler la solution globale.

4. Conclusion et perspectives

Au cours de ce travail de recherche, un cadre « fonction-tâche-comportement » (FTB) a été développé, fournissant un guide systématique et détaillé pour l'intégration des HF/E dès les premières phases de conception. Une étude de cas est présentée pour valider la faisabilité de la méthode et permettre d'offrir une assistance pour la mise en œuvre de modèle et méthode proposés. Ainsi, un module de Centre de Conception d'Interaction (IDC) a été développé et intégré dans un logiciel de CAO pour aider le travail de conception, qui va fournir une manière pratique de mise en œuvre du cadre FTB. De plus, un « modèle d'intelligence artificielle » a commencé à être développé pour produire les solutions de conception recherchées.

Comparé à différentes approches de résolution de problèmes existants, ce modèle proposé est plus facile à appréhender et à utiliser par les concepteurs. Par exemple, une fois que les données disponibles sont importées, une solution sera produite. Le cadre FTB fournit le support théorique pour cette méthode.

Le cadre FTB vise à réduire au maximum les modifications dans le processus de conception et limiter les itérations dans la dernière phase de conception, cependant il ne peut pas les éliminer complètement. Le modèle AI proposé a aussi quelques limitations. Ce modèle peut seulement fournir une solution pour une tâche, d'autres solutions disponibles et prometteuses peuvent être manquées. De plus, ce modèle n'offre pas un guide garantissant la sélection de la solution optimale ni l'optimisation de toutes les solutions individuelles pour avoir la solution globale finale pour l'ensemble des tâches identifiées pour la satisfaction des fonctions définies.

En résumé, une nouvelle perspective pour la méthode de conception d'ingénierie est présentée. Elle peut améliorer considérablement la conception et améliorer ainsi notre

qualité de vie. À cette fin, en considérant les limitations exposées ci-dessus, la recherche future pourrait être effectuée dans (1) l'optimisation d'algorithme du modèle AI; (2) la méthode de la sélection de solution optimale.

Bibliographie

- Eppinger, S. D., Whitney, D. E., Smith, R. P., and Gebala, D. A. 1994. "A Model-Based Method for Organizing Tasks in Product Development." *Research in Engineering Design* 6 (1): 1–13. doi:10.1007/BF01588087.
- Hassenzahl, M. 2003. "The thing and I: understanding the relationship between user and product." In *Funology*: 31–42. doi:10.1007/1-4020-2967-5_4.
- Houssin, R. and Coulibaly, A. 2011. "An Approach to Solve Contradiction Problems for the Safety Integration in Innovative Design Process." *Computers in Industry* 62 (4). Elsevier B.V.: 398–406. doi:10.1016/j.compind.2010.12.009.
- Redström, J. 2006. "Towards User Design? On the Shift from Object to User as the Subject of Design." *Design Studies* 27 (2): 123–139. doi:10.1016/j.destud.2005.06.001.